

DENSO

Catalogue 2006/2007

Glow Plugs



Driven by
Quality





DENSO Glow Plug Technology

WE'RE RAISING THE TEMPERATURE FOR DIESEL.

DENSO's all-makes range of Glow Plugs combines our expertise in diesel technology with all the strengths of our Aftermarket Spark Plug Programme to give you unrivalled choice and quality.

DENSO GLOW PLUGS provide excellent cold start performance, rapid heating time and extended post-heat temperatures that significantly reduce vehicle emissions. And now that we've raised the part numbers in our range by 30 – including 5 ceramic plugs – we offer 110 part numbers and over 500 new applications that give 98% parc coverage. In fact, DENSO are sure to have the Glow Plug for you!

DENSO GLOW PLUGS – raising the temperature for diesel.

Driven by
Quality



DENSO EUROPE B.V.

Hogeweyselaan 165, 1382 JL Weesp, The Netherlands.

Tel: +31 (0)294-493 493, Fax: +31 (0)294-417 122, E-mail: info.amsales@denso.nl, Internet: www.denso-europe.com

2 DENSO EUROPE BV

DENSO

GB

Table of Contents

- 4 Glow Plug Range
- 10 Characteristics
- 16 Fault Diagnosis
- 30 New Applications
New Glow Plug Types
- 31 Application Tables
- 83 Buyers Guide
- 89 Cross Reference Chart
- 97 Technical Overview
- 102 Abbreviations

DE

Inhaltsangabe

- 5 Produktgruppe - Glühkerzen
- 11 Eigenschaften
- 18 Fehlerdiagnose
- 30 Neue Anwendungen
Neue Glühkerzen-Typen
- 31 DENSO Glühkerzen,
Empfehlung je Fahrzeugtyp
- 83 Kundenführer
- 89 Querverweistabelle
- 97 Technische Übersicht
- 102 Abkürzungsverzeichnis

FR

Table des matières

- 5 Gamme de bougies de
préchauffage
- 11 Spécifications
- 20 Dépistage des pannes
- 30 Nouvelles applications
Nouveaux types de bougies
de préchauffage
- 31 Liste des applications
- 83 Guide de l'acheteur
- 89 Tableau de références
croisée
- 97 Aperçu technique
- 102 Abréviations

ES

Sumario

- 7 Gama de bujías de
calentadores
- 13 Características
- 22 Diagnóstico de fallos
- 30 Nuevas aplicaciones
Nuevos tipos de bujías
incandescentes
- 31 Recomendaciones para el tipo
de bujía DENSO por marca de
automóvil
- 83 Guía para compradores
- 89 Gráfico de equivalencias
- 97 Sinopsis técnica
- 102 Abreviaturas

IT

Indice

- 7 Gamma di candele di
preriscaldamento
- 13 Caratteristiche
- 24 Diagnosi dei guasti
- 30 Nuove applicazioni
Nuovi modelli di candele
di preriscaldamento
- 31 Tipi di candele DENSO
consigliate per le varie
marche di automobili
- 83 Guida all'acquisto
- 89 Tabella di riferimento
- 97 Panoramica sulle
caratteristiche tecniche
- 102 Abbreviazioni

SE

Innehållsförteckning

- 9 Glödstiftssortiment
- 15 Egenskaper
- 26 Feldiagnos
- 30 Nya tillämpningar
Nya stifttyper
- 31 Användningstabeller
- 83 Köpguide
- 89 Krosstabell
- 97 Teknisk översikt
- 102 Förkortningar

RU

Содержание

- 9 Ассортимент свечей накаливания
- 15 Характеристики
- 28 Диагностика неисправностей
- 30 Новые применения
Новые типы свечей накаливания
- 31 Таблицы применения
- 83 Руководство для покупателей
- 89 Таблица соответствий
- 97 Технический обзор
- 102 Принятые сокращения

Glow Plug Range

Comparison of DENSO Glow Plug Types

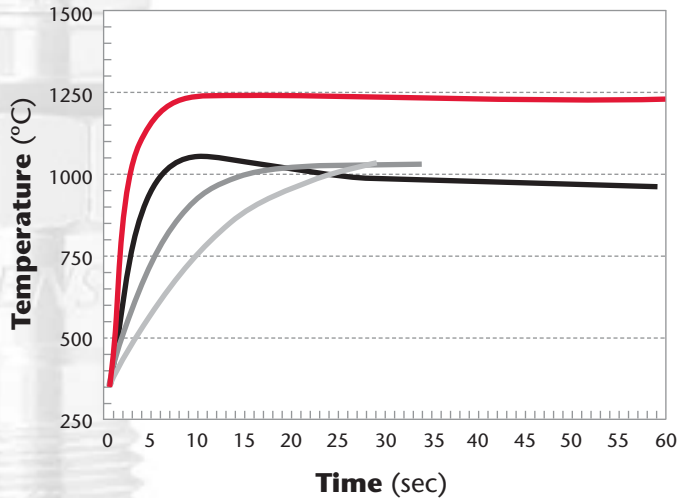

- **Ceramic**
- **Extended Post-Heating**
- **Double Coil**
- **Single Coil**

GB

Glow Plug Range

DENSO's Glow Plug programme is a major new OE quality, all-makes introduction; launched to provide Aftermarket customers with an alternative, advanced branded choice for their growing Diesel needs.

The cutting edge programme benefits from DENSO Corporation's pedigree as a world leading OE manufacturer of glow plugs for leading automotive suppliers around the world. Engineered to OE standards, our Aftermarket Glow Plug programme comprises 110 part numbers covering more than 2,400 applications; equivalent to 98% of the European, Japanese and US car parc. Ongoing extensions are planned to continually enhance and update the range.

The DENSO Glow Plug programme encompasses all current glow plug technologies including single coil, double coil, extended post-heating and ceramic glow plugs.

DENSO Glow Plugs feature:

- Excellent cold start performance
- A rapid heating up time from less than 3 seconds
- Extended post-heat temperatures that significantly reduce vehicle exhaust emissions.
- Increased durability
- Smoother cold engine running

The DENSO Glow Plug programme conforms to ISO TS16949, ISO14001 and OHSAS 18001 as well as DENSO's own demanding manufacturing and quality specifications.



DE

Produktgruppe - Glühkerzen

Das DENSO Glühkerzen-Programm verfügt über eine ausgezeichnete neue OE-Qualität. Mit der Markteinführung, ausgerichtet für alle Fahrzeughersteller, bietet DENSO eine echte Alternative mit dem neuen Produktprogramm und wird somit mit der fortschrittlichen Markenauswahl den gestiegenen Ansprüchen der modernen Dieselsechnologie gerecht.

Das Produktprogramm, welches sich auf dem neuesten technischen Stand befindet, profitiert vom Know-how der DENSO Corporation als einem der weltweit führenden OE-Hersteller von Glühkerzen für die führenden Fahrzeugzulieferer der Welt. Unser nach OE-Standards entwickeltes Glühkerzen-Programm für den Aftermarket umfasst 110 Teilenummern, die mehr als 2.400 Anwendungen abdecken. Dies entspricht 98% des europäischen, japanischen und US-amerikanischen Fahrzeugparks. Außerdem sind künftige Programmweiterungen geplant, um die DENSO Produktpalette stetig zu verbessern und auf dem aktuellen Stand zu halten.

Das Glühkerzen-Programm von DENSO umfasst alle aktuellen Glühkerzentechnologien, einschließlich Stabglühkerzen, 2-Phasen-Glühkerzen, Schnellstartglühkerzen und Keramikglühkerzen.

Eigenschaften der DENSO-Glühkerzen:

- Exzellente Kaltstart-Leistung
- Sehr kurze Vorglühzeit (3 Sekunden)
- Hohe Nachglühfähigkeit, welche den Schadstoffausstoß erheblich reduziert
- Erhöhte Lebensdauer
- Schonender Motorstart

Das Glühkerzen-Programm von DENSO entspricht den ISO-Normen TS16949, ISO14001 und OHSAS 18001, sowie den eigenen hohen Herstellungs- und Produktionsanforderungen von DENSO.

FR

Gamme de bougies de préchauffage

Le programme de bougies de préchauffage DENSO est une innovation universelle conforme aux produits première- monte. Ce programme a été lancé pour fournir à nos clients un choix alternatif en raison des besoins croissants dans le domaine du Diesel

Ce produit de pointe bénéficie de la renommée DENSO Corporation en tant que principal fabricant de bougies de préchauffage d'origine pour les plus grands constructeurs automobiles du monde. Conçu en conformité avec les normes OE, notre programme de bougies de préchauffage pour le marché des pièces de rechange comprend 110 numéros de pièces, couvrant plus de 2.400 applications, équivalent à 98% des parc automobiles européen, japonais et américain. Des extensions permanentes sont prévues de façon à améliorer et à mettre la gamme à jour.

Le programme de bougies de préchauffage DENSO englobe toutes les technologies actuelles, y compris le simple et double bobinages, le postchauffage ainsi que les bougies céramiques.

Les bougies de préchauffage DENSO présentent :

- Excellente performance de démarrage à froid
- Durée rapide de chauffage de moins de 3 secondes
- Excellentes températures de postchauffage qui réduisent sensiblement les gaz d'émission du véhicule.
- Durabilité étendue
- Fonctionnement plus souple du moteur à froid

Le programme de bougies de préchauffage DENSO est conforme aux normes ISO TS16949, ISO14001 et OHSAS 18001 ainsi qu'aux spécifications sévères propres à DENSO en matière de fabrication et de qualité.

Glow Plug Range



Comparison of DENSO Glow Plug Types

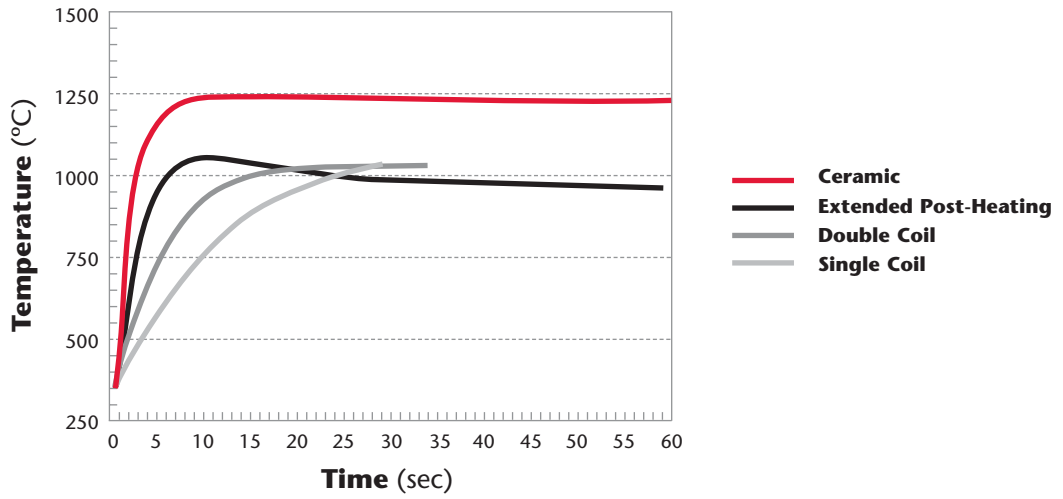

ES

Gama de bujías de calentadores

El programa de bujías de calentadores de DENSO es un importante lanzamiento de productos para equipos originales de todas las marcas, y tiene como objetivo proporcionar a los clientes de recambios una avanzada selección alternativa de marcas con las que hacer frente a las crecientes necesidades de sus vehículos diesel.

Este programa de última generación se beneficia del renombre de DENSO Corporation como uno de los mayores productores en todo el mundo de bujías de calentadores para Equipos Originales para destacados fabricantes de vehículos a nivel global. Desarrollado conforme a las normas de equipo original (OE), nuestro programa de Bujías Incandescentes para el Mercado del Recambio comprende 110 componentes, abarcando más de 2,400 aplicaciones. Esto equivale al 98% del parque automovilístico de Europa, Japón y de los EE UU. Se prevé la realización de extensiones continuas con el fin de ir mejorando nuestra gama de productos en todo momento.

El programa de bujías de calentadores DENSO abarca todas las tecnologías actuales en materia de bujías de calentadores, incluyendo bujías de una espiral, bujías de dos espirales, bujías con post-calentamiento de larga duración y bujías cerámicas.

Características de las bujías de calentadores DENSO:

- Excelente funcionamiento con arranque en frío
- Un rápido tiempo de calentamiento inferior a 3 segundos
- Temperaturas post-calentamiento de larga duración que reducen considerablemente las emisiones de gases del vehículo.
- Mayor durabilidad
- Facilita el funcionamiento del motor en frío

El programa de bujías de calentadores DENSO cumple con las normas ISO TS16949, ISO14001 y OHSAS 18001, así como con las estrictas especificaciones de fabricación y calidad de DENSO.

IT

Gamma di candele di preriscaldamento

Le candele di preriscaldamento DENSO sono un'importante novità in termini di ricambi di qualità originale con una gamma multimarche; creata per offrire ai clienti Aftermarket una scelta alternativa con un marchio all'avanguardia in grado di soddisfare le esigenze dettate dalla crescente presenza di autoveicoli diesel sul mercato.

Si tratta di prodotti innovativi che traggono vantaggio dall'esperienza di DENSO Corporation, uno dei maggiori produttori mondiali di candele di preriscaldamento originali per i più importanti fornitori del mercato automobilistico in tutto il mondo. Progettato secondo gli standard OE, il nostro programma per l'aftermarket delle candele di preriscaldamento comprende ben 110 codici articolo che coprono oltre 2.400 applicazioni, ovvero l'equivalente del 98% del parco macchine europeo, giapponese ed americano. Le aggiunte attualmente in fase di sviluppo hanno il compito di migliorare ed aggiornare continuamente l'offerta.

Le candele di preriscaldamento DENSO riuniscono tutte le più recenti tecnologie nel campo, come quelle a spirale singola, spirale doppia, esteso post-riscaldamento e in ceramica.

Le candele di preriscaldamento DENSO hanno le seguenti caratteristiche:

- Offrono delle eccellenti prestazioni di avviamento a freddo
- Garantiscono un tempo di riscaldamento molto rapido, inferiore ai 3 secondi
- Dispongono di temperature di post-riscaldamento lunghe per ridurre in modo significativo le emissioni di scarico del veicolo.
- Godono di una maggiore longevità
- Consentono al motore ancora freddo, di girare in modo più armonioso

La gamma di candele di preriscaldamento DENSO soddisfa le norme ISO TS16949, ISO14001 e OHSAS 18001, oltre alle esigenti specifiche di produzione e di qualità richieste dalla DENSO stessa.

Glow Plug Range

Glow Plug Range



Comparison of DENSO Glow Plug Types

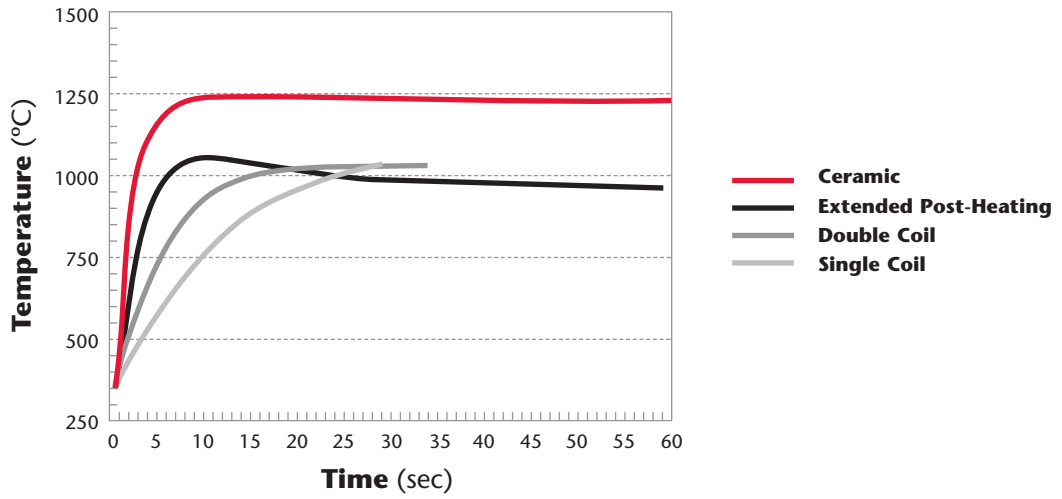

SE

Glödstiftssortiment

DENSO:s glödstiftsprogram är ett framstående nytt initiativ av OE-kvalitet för alla märken, framtaget för att erbjuda eftermarknadens kunder ett alternativ av märkeskvalitet för deras växande dieselbehov.

Det avancerade programmet drar fördel av DENSO:s bakgrund som världsledande OE-tillverkare av glödstift för framstående fordonsfabrikanter över hela världen. Vårt Aftermarket glödpluggsprogram är konstruerat efter OE-standard och omfattar 110 artiklar som täcker mer än 2.400 tillämpningar; tillräckligt för 98% av Europas, Japans och Förenata Staternas fordonspark. Fortgående kompletteringar är planerade för att ständigt bredda och uppdatera programmet.

DENSO:s glödstiftsprogram omfattar alla nuvarande glödstiftstekniker inklusive enkelspole, dubbelspole, höjd eftervärme och keramiska glödstift.

DENSO glödstift bjuder:

- Utmärkta egenskaper för kallstart
- Snabb uppvärmningstid från mindre än 3 sekunder
- Eftervärme med högre temperatur som avsevärt reducerar fordonets avgasutsläpp.
- Förbättrad hållbarhet
- Jämnare gång med kall motor

DENSO glödstiftsprogram uppfyller ISO TS16949, ISO14001 och OHSAS 18001 utöver DENSO:s egna stränga tillverknings- och kvalitetskrav.

RU

Ассортимент свечей накаливания

Программа свечей накаливания DENSO, имеющих качество оригинального оборудования и пригодных для использования во всех марках автомобилей, является важным нововведением.

Авангардность продукции обусловлена богатым опытом корпорации DENSO, являющейся одним из ведущих мировых поставщиков оригинальных свечей накаливания для самых крупных производителей автомобилей во всем мире. Разработанная согласно стандартам, применяемым к оригинальному оборудованию, наша программа для рынка запчастей по свечам накаливания включает в себя 110 моделей, обеспечивающих более 2400 вариантов применения, что соответствует 98% автопарка Европы, Японии и США. Продолжающиеся доработки призваны постоянно улучшать и обновлять ассортимент.

Программа свечей накаливания DENSO объединяет все новейшие технологии их производства и включает свечи накаливания с одной спиралью, с двумя спиральями, с продолжительным послепусковым нагревом и керамические свечи накаливания.

Преимущества свечей накаливания DENSO:

- Превосходные показатели при холодном пуске
- Быстрота нагрева свечи менее 3 секунд
- Продолжительный послепусковой подогрев, что значительно снижает выброс выхлопных газов автомобиля.
- Увеличенный срок службы
- Более мягкая работа холодного двигателя

Вся гамма свечей накаливания DENSO соответствует международным стандартам ISO TS16949, ISO14001 и OHSAS 18001, а также отвечает строгим требованиям к качеству, предъявляемых DENSO при производстве.

Glow Plug Range



Characteristics of DENSO Glow Plugs

Terminal & Shell

The outer casing and terminal are zinc coated to resist corrosion.

Insulator

The Glow Plug insulating disc has exceptional strength, insulation and thermal conductivity to ensure that a short circuit cannot occur.

Casing

An alloy casing surrounds and protects the Glow Plug to provide heat resistance.

Seal

A rubber seal is in place to prevent air from seeping through and corroding the coil

Insulation

Electrical insulation of the coil is provided by firmly packed magnesium oxide powder, which is also an efficient heat conductor

Regulating Coil

The main coil acts as a regulator within the Glow Plug to control and sustain temperature rise, and ensure a rapid warm-up.

Coil Connection

Laser welding connects the Heating and Regulating coils to maintain their position at all times and ensure consistent resistance characteristics.

Heating Coil

A shorter, tapered coil inside the end of the Glow Plug delivers a quick start (from as little as 3 seconds) even in cold conditions. It can then hold its post-heating temperature for up to six minutes after cold start. This contributes to lower engine emissions.

Tip

The narrowed plug tip ensures improved heating efficiency and excellent performance.

DE

Eigenschaften der DENSO-Glühkerzen

Rundmutter & Ummantelung

Die äußere Ummantelung und die Rundmutter sind verzinkt, um Korrosion entgegen zu wirken.

Isolator

Die isolierende Scheibe der Glühkerze hat eine außergewöhnlich starke isolierende und thermische Leitfähigkeit, um sicherzustellen, dass kein Kurzschluss auftreten kann.

Ummantelung

Die Glühkerze ist mit einer Metallummantelung geschützt, um einen Allwetter-Wärmewiderstand zu bieten.

Dichtung

Eine Gummidichtung verhindert das Eindringen von Luft und somit die Korrosion der Wendel.

Isolierung

Die elektrische Isolierung der Wendel wird durch gepresstes Magnesiumoxidpulver gewährleistet, welches gleichzeitig auch ein effizienter Wärmeleiter ist.

Regelwendel

Der Regelwendel arbeitet als Regulator innerhalb der Glühkerze, um den Temperaturanstieg zu kontrollieren und aufrecht zu erhalten und eine schnelle Erwärmung sicherzustellen.

Verbindung der Wendel

Der Heizwendel und der Regelwendel sind mit Laser verschweißt, um ihre Position und ihre Widerstandseigenschaften zu allen Zeiten sicherzustellen.

Heizwendel

Ein kürzerer, spitz zulaufender Heizwendel am Ende der Glühkerze sorgt für einen schnellen Start (weniger als 3 Sekunden), selbst bei kalten Witterungsbedingungen. Dieser kann seine Vorglühtemperatur bis zu sechs Minuten nach einem Kaltstart aufrecht erhalten. Dies führt zu einer Verringerung des Schadstoffausstoßes.

Spitze

Die verengte Spitze stellt eine verbesserte Wärmeeffizienz und exzellente Leistung sicher.

FR

Spécifications des bougies de préchauffage DENSO

Plot & Boîtier

Le boîtier extérieur et le plot sont en zinc plaqué pour résister à la corrosion.

Isolant

Le disque d'isolation de la bougie de préchauffage possède une résistance, un pouvoir d'isolation et une conductivité thermique exceptionnels pour éviter tout risque de court-circuit.

Culot

Le culot en aluminium entoure et protège la bougie de préchauffage pour fournir une résistance à la chaleur par tout temps.

Joint

Un joint en caoutchouc est en place pour empêcher l'air de pénétrer et de corroder le serpentin.

Isolation

L'isolation électrique de la spirale est assurée par une poudre d'oxyde de magnésium fortement compactée qui constitue également un conducteur de chaleur efficace.

Serpentin de régulation

Le serpentin principal fait office de régulateur dans la bougie de préchauffage pour contrôler et supporter l'augmentation de température et assurer un échauffement rapide.

Connexion de la spirale

La soudure au laser relie la spirale de chauffage et de régulation pour maintenir leur position à tout moment et assurer des caractéristiques de résistance constantes.

Spirale de chauffage et de régulation

Un serpentin plus court, conique à l'intérieur de l'extrémité de la bougie de préchauffage, assure un démarrage rapide (à partir de 3 petites secondes) même par temps froid. Il peut alors maintenir sa température de postchauffage jusqu'à six minutes après le démarrage à froid. Ceci contribue à diminuer les émissions de gaz du moteur.

Pointe

La pointe plus étroite de la bougie assure une plus grande efficacité de chauffage et une excellente performance.

Characteristics

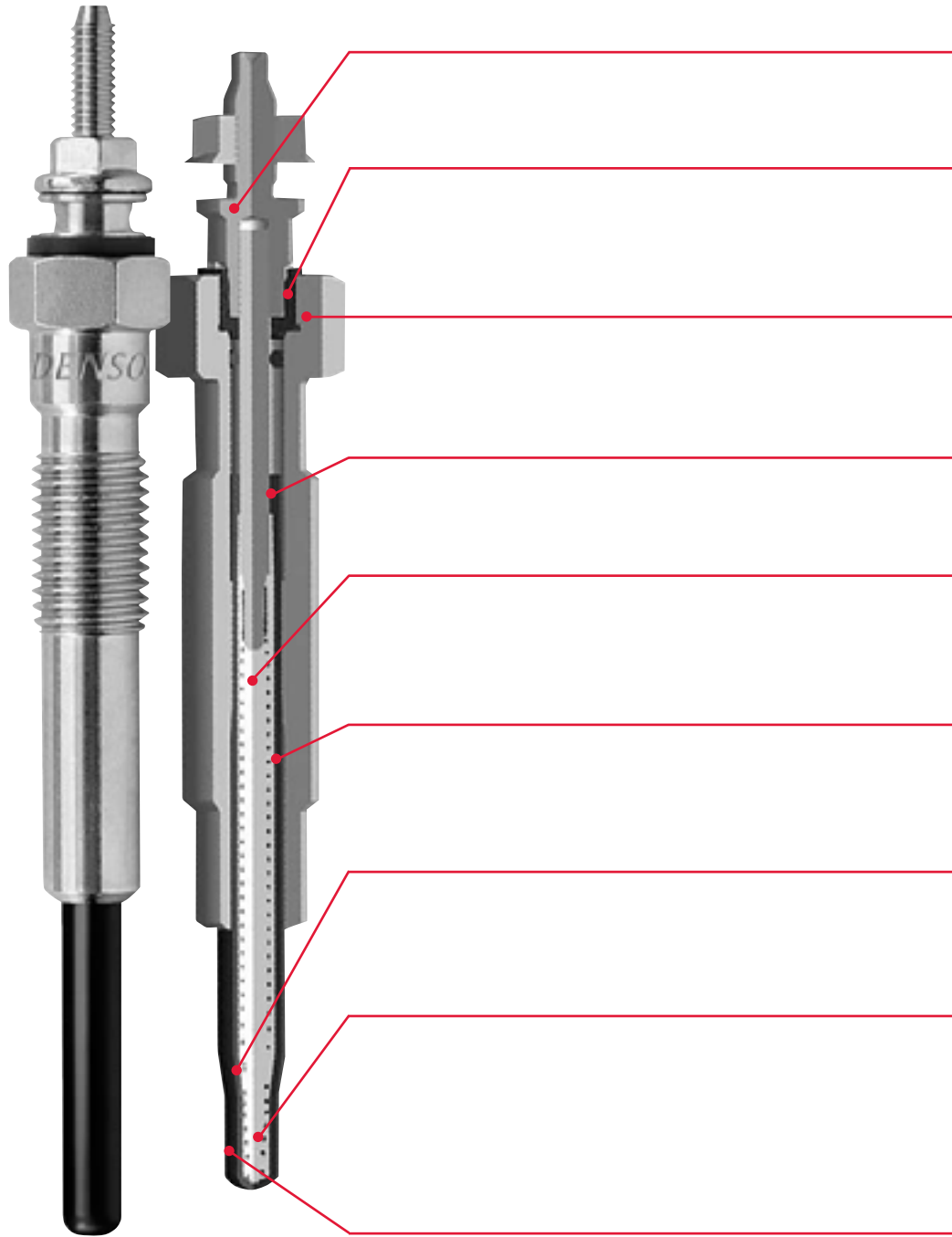

ES

Características de las bujías incandescentes DENSO

Terminal & Revestimiento

El revestimiento exterior y el terminal están recubiertos de cinc para resistir la corrosión.

Aislante

El disco aislante de la bujía de calentador posee un excepcional nivel de resistencia, aislamiento y conductibilidad térmica con el fin de evitar cualquier cortocircuito.

Revestimiento

Un revestimiento de aleación rodea y protege la bujía de calentador, garantizando una resistencia al calor en cualquier condición climática.

Junta

Una junta de goma evita que el aire se filtre y corroa la bobina.

Aislamiento

El aislamiento eléctrico de la bujía se consigue mediante el óxido de magnesio en polvo muy compactado, que es asimismo un eficaz conductor del calor.

Bobina reguladora

La bobina principal actúa como mecanismo regulador dentro de la bujía de calentador, controlando y manteniendo el aumento de la temperatura, y garantizando un rápido calentamiento.

Conexión de la bobina

Unas soldaduras láser conectan las bobinas de calentamiento y reguladoras y las mantienen en su sitio en todo momento, asegurando unas características de resistencia consecuentes.

Bobina de calentamiento

Una bobina más corta, de punta cónica, ubicada en la parte interior del extremo de la bujía de calentador, ofrece un arranque rápido (tan sólo unos 3 segundos) incluso en condiciones de mucho frío. Puede mantener su temperatura de postcalentamiento hasta un máximo de seis minutos tras su arranque en frío. De esta forma se reducen las emisiones del motor.

Punta

La punta estrecha de la bujía garantiza una mayor eficacia de calentamiento y un excelente rendimiento.

IT

Caratteristiche delle candele ad incandescenza DENSO

Terminale & Rivestimento

Il bulbo esterno e il terminale sono rivestiti di zinco per resistere alla corrosione.

Isolante

Il disco isolante della candele ad incandescenza ha un'eccezionale resistenza, isolamento e conduttività termica per evitare un eventuale corto circuito.

Bulbo esterno

Un bulbo esterno in metallo avvolge e protegge la candele ad incandescenza per garantire una resistenza al calore in qualsiasi condizione atmosferica.

Guarnizione

Una guarnizione in gomma impedisce che dell'aria possa filtrare e corrodere la spirale

Isolamento

L'isolamento elettrico e l'alta conducibilità termica della spirale sono garantite da una polvere di ossido di magnesio compattata.

Spirale di regolazione

La spirale principale funge da regolatore all'interno della candele ad incandescenza per controllare e far fronte all'aumento di temperatura, e garantire un riscaldamento rapido.

Connessione della spirale

Una saldatura laser collega le spirali di Riscaldamento e di Regolazione, gli consente di mantenere la loro posizione in qualsiasi situazione e garantisce delle caratteristiche di resistenza consistenti.

Spirale di riscaldamento

Una spirale più corta, affusolata all'interno della parte terminale della candele ad incandescenza, garantisce una partenza rapida (in poco più di 3 secondi) anche in condizioni di temperature rigide. Quindi è in grado di mantenere la sua temperatura post-riscaldata fino a sei minuti dopo una partenza a freddo. Questo contribuisce ad avere meno emissioni del motore.

Punta

La punta ravvicinata della candela garantisce una migliore efficienza di riscaldamento e delle prestazioni eccellenti.

Characteristics

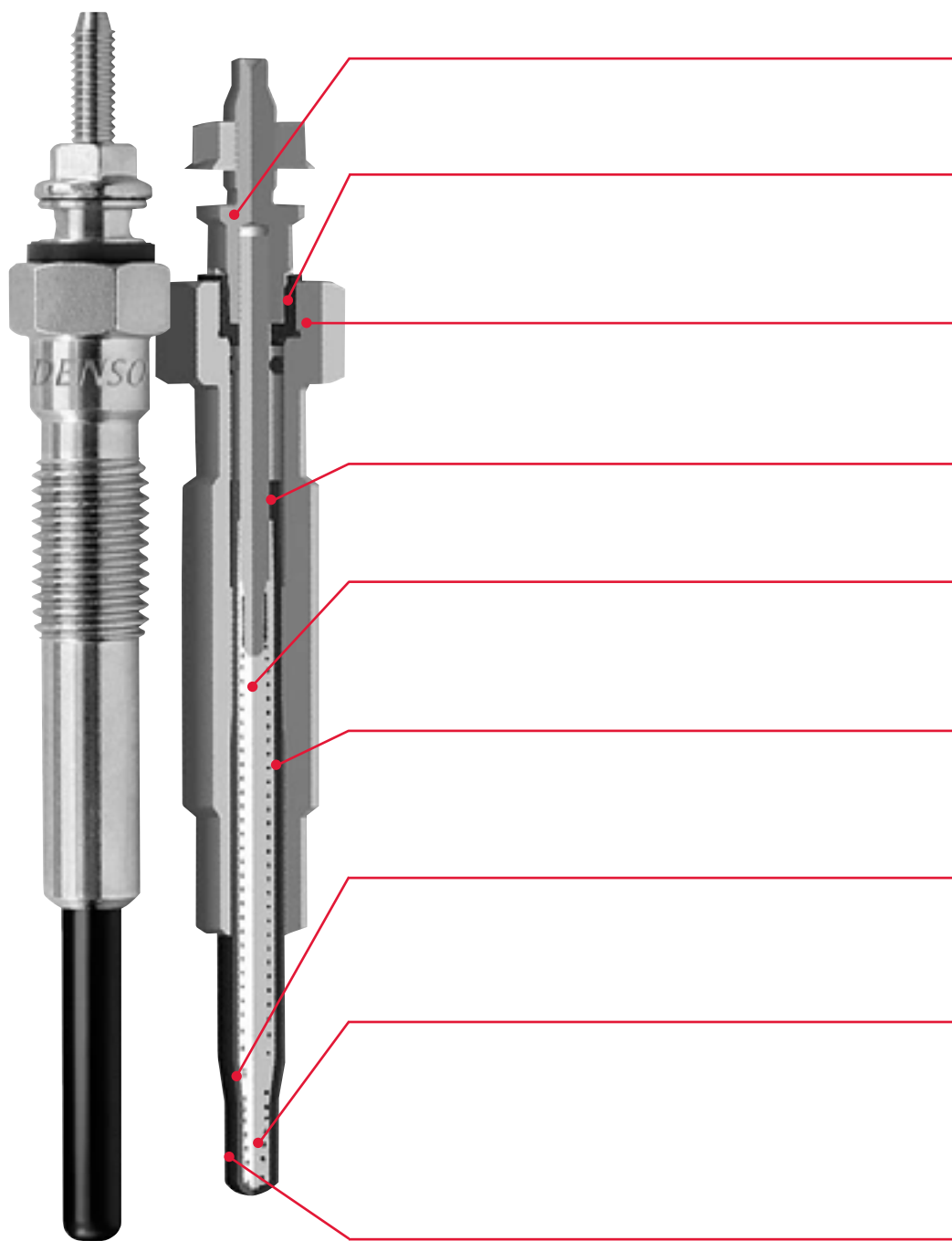

SE

DENSO glödstift, egenskaper**Kontakt & hölje**

Ytterhöljet och kontaktpunkten är förzinkade som skydd mot korrosion.

Isolator

Glödstiftets isoleringsplatta har suveräna egenskaper vad gäller styrka, isolering och värmeledning för att garantera att ingen kortslutning kan uppstå.

Hölje

Glödstiftet omges och skyddas med ett värmebeständigt hölje av lättmetall.

Tätning

En gummitätning förebygger att luft tränger in till spolen och orsakar korrosion.

Isolering

Spolens elektriska isolering består av tätpackat pulver av magnesiumoxid, som även är en effektiv värmeledare.

Reglerande spole

Huvudspolen fungerar som regulator inom glödstiftet för att styra och bibehålla temperaturstigningen samt garantera en snabb uppvärmning.

Spolkoppling

Spolarna för uppvärmning och reglering är sammankopplade med lasersvetsning för att ständigt bibehålla deras position och garantera oförändrade motståndsegenskaper.

Värmespole

En kortare, konisk spole i glödstiftets nedre del ger en snabb start (från så kort som 3 sekunder) även vid kall väderlek. Sedan kan den bibehålla sin eftervärmtemperatur i upp till sex minuter efter kallstart. Detta bidrar till lägre fordonsutsläpp.

Spets

Stiftets avsmalnande spets ger bättre värmeeffektivitet och suveräna prestanda.

RU

Характеристики свечей накаливания DENSO**Контактный стержень & Корпус**

Корпус и контактный стержень снаружи имеют покрытие из цинка для коррозионной стойкости.

Изолятор

Изолятор свечи накаливания обладает исключительной прочностью, изоляцией и теплопроводностью, что полностью исключает возможность возникновения короткого замыкания.

Оболочка

Оболочка из сплава металлов защищает свечу накаливания, обеспечивая ее жаропрочность при любых погодных условиях.

Уплотнение

Резиновое уплотнение защищает от проникновения воздуха и предохраняет спираль от коррозии.

Изоляция

Электрическая изоляция спирали обеспечивается благодаря плотно запрессованному порошку из окиси магния, который также является эффективным теплопроводником.

Регулировочная спираль

Главная спираль является регулятором внутри свечи накаливания, который контролирует и поддерживает рост температуры, и гарантирует быстрое нагревание.

Соединение спиралей

Лазерная сварка соединяет нагревательную и регулировочную спирали, что придает стабильность их положению в любой момент и обеспечивает устойчивые характеристики сопротивления.

Нагревательная спираль

Более короткая, витая спираль, расположенная в самом конце свечи накаливания, обеспечивает быстрый запуск двигателя (всего лишь за 3 секунды) даже в холодных условиях. Она может сохранять остаточный накал до шести минут после холодного запуска. Это способствует снижению выбросов в выхлопных газах двигателя.

Наконечник

Зауженный наконечник свечи гарантирует повышенный тепловой КПД и превосходные эксплуатационные характеристики.

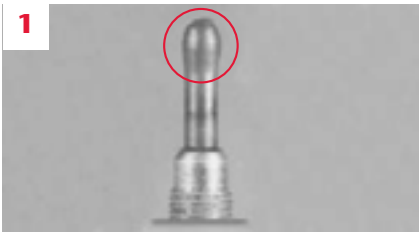

Enlarged probe tip

Cause

- Excessive voltage (e.g. 12-V Glow Plug in a 24-V system or vice versa)
- Failure of alternator and regulator
- Dampness during storage

Solution

- Check on-board and Glow Plug voltage
- Check charging system
- Check quality of storage conditions

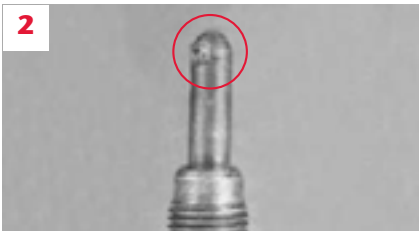

Broken probe tip

Cause

- Excessive glowing / voltage (e.g. 24-V Glow Plug in a 12-V system or vice versa)
- Failure of alternator and regulator

Solution

- Check contacts on Glow Plug regulator
- Check on-board and Glow Plug voltage
- Check charging system voltage

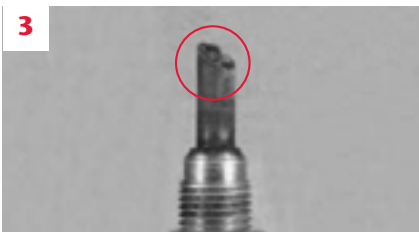

Damaged or missing probe tip

Cause

- Failure of ignition unit
- Direction or regularity of fuel jet incorrect
- Sealing fault causing spraying position error

Solution

- Check the ignition unit is correctly installed
- Check you are using the correct ignition unit for the vehicle model
- Check the Glow Plug installation point for carbon deposits

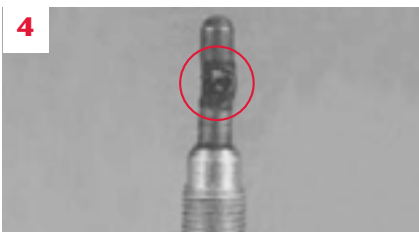

Deformed probe (overheating)

Cause

- Failure of ignition unit
- Direction or regularity of fuel jet incorrect
- Wrong spraying position caused by faulty sealing
- Excessive glowing / voltage (e.g. 24-V Glow Plug in a 12-V system or vice versa)
- Failure of alternator and regulator
- Function or timing fault in injection unit

Solution

- Check the ignition unit is correctly installed
- Check you are using the correct ignition unit for the vehicle model
- Check the Glow Plug installation point for carbon deposits
- Check contacts on Glow Plug regulator
- Check on-board and Glow Plug voltage
- Check charging system voltage
- Check fuel injection timing



Swollen ring on the probe tip

Cause

- Oil in the combustion chamber, probably caused by engine wear

Solution

- Check piston clearance in engine cylinders
- Check oil consumption

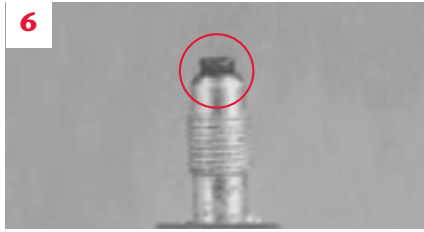

Missing probe

- Cause**
- Ignition unit failure
 - Direction or regularity of fuel jet incorrect
 - Wrong spraying position caused by faulty sealing
 - Function or timing fault in injection unit
 - Thread damage to opening of cylinder head where Glow Plug is installed
 - Glow Plug insufficiently tightened causing plug to sit incorrectly

- Solution**
- Check you are using the correct ignition unit for the vehicle model
 - Check the ignition unit is correctly installed
 - Check the Glow Plug installation point for carbon deposits
 - Check timing of injection pump
 - Check the opening of cylinder head for thread damage / carbon fouling

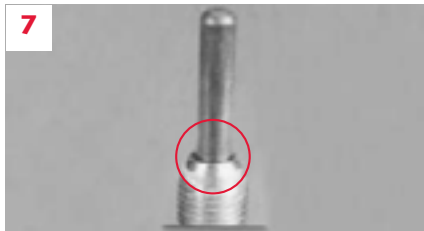

Probe touching body of Glow Plug

- Cause**
- Over-tightened torque
 - Wrong tool used
 - Thread damage to opening of cylinder head

- Solution**
- Check the opening of cylinder head for thread damage / carbon fouling
 - Check Glow Plug torque

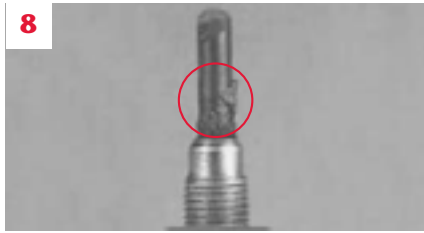

Holes in probe / cracks / melting next to body of Glow Plug

- Cause**
- Failure of ignition unit
 - Direction or regularity of fuel jet incorrect
 - Wrong spraying position caused by faulty sealing
 - Function or timing fault in injection unit
 - Thread damage to opening of cylinder head where Glow Plug is installed
 - Glow Plug insufficiently tightened causing plug to sit incorrectly

- Solution**
- Check you are using the correct ignition unit for the vehicle model
 - Check the ignition unit is correctly installed
 - Check the Glow Plug installation point for carbon deposits
 - Check the opening of cylinder head for thread damage / carbon fouling
 - Check timing of injection pump

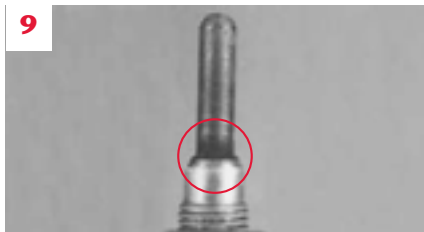

Carbon deposits between probe and body of Glow Plug

- Cause**
- Failure of ignition unit
 - Direction or regularity of fuel jet incorrect
 - Wrong spraying position caused by faulty sealing
 - Injection pump operation / timing failure

- Solution**
- Check you are using the correct ignition unit for the vehicle model
 - Check the ignition unit is correctly installed
 - Check the Glow Plug installation point for carbon deposits
 - Check the opening of cylinder head for thread damage / carbon fouling
 - Check timing of injection pump



Broken / Bent power terminal

- Cause**
- Over-tightened torque
 - Wrong tool used
 - Thread damage to opening of cylinder head

- Solution**
- Check the opening of cylinder head for thread damage / carbon fouling
 - Check Glow Plug torque

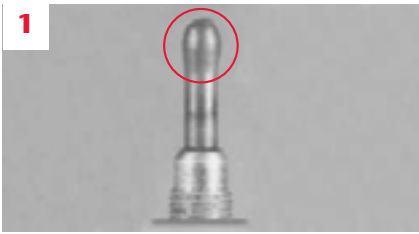

Aufgequollener Glühstab

Situation

- Überhöhte Spannung (z.B. 12 V Glühkerze in einem 24 V-System oder umgekehrt)
- Ausfall der Lichtmaschine und / oder des Reglers
- Feuchtigkeit während der Glühkerzenlagerung

Lösung

- Überprüfung der Fahrzeug- sowie der Glühkerzenspannung
- Ladeaggregat prüfen
- Qualität der Lagerbedingung der Glühkerzen prüfen

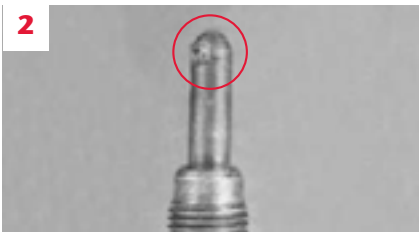

Gebrochener Glühstab

Situation

- Zu langes Glühen / überhöhte Spannung (z.B. 12 V Glühkerze in einem 24 V-System oder umgekehrt)
- Ausfall der Lichtmaschine und / oder des Reglers

Lösung

- Fahrzeugkontakte am Glühkerzenregler prüfen
- Überprüfung der Fahrzeug- sowie der Glühkerzenspannung
- Spannung des Ladesystems prüfen

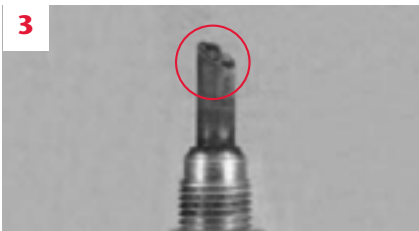

Beschädigter oder fehlender Glühstab

Situation

- Ausfall der Vorglühanlage
- Richtung oder Regularität der Treibstoffdüse ist inkorrekt
- Abdichtungsfehler verursacht Fehler in Einspritzung

Lösung

- Prüfen, ob die Vorglühanlage korrekt installiert ist
- Prüfen, ob die richtige Vorglühanlage für das Fahrzeugmodell benutzt wird
- Den Glühkerzeinbaupunkt auf Verkokung prüfen

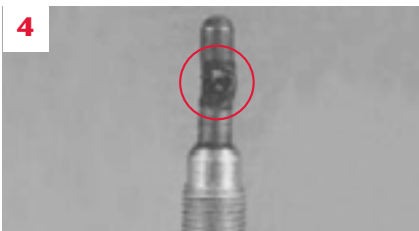

Deformierter Glühstab (überhitzt)

Situation

- Ausfall der Vorglühanlage
- Richtung oder Regularität der Treibstoffdüse ist inkorrekt
- Falsche Einspritzposition wegen fehlerhaft montierter Dichtung
- Zu langes Glühen / überhöhte Spannung (z.B. 12 V Glühkerze in einem 24 V-System oder umgekehrt)
- Ausfall der Lichtmaschine und / oder des Reglers
- Funktions- oder Zeitfehler in der Vorglühanlage

Lösung

- Prüfen, ob die Vorglühanlage korrekt installiert ist
- Prüfen, ob die richtige Vorglühanlage für das Fahrzeugmodell benutzt wird
- Den Glühkerzeinbaupunkt auf Verkokung prüfen
- Fahrzeugkontakte am Glühkerzenregler prüfen
- Überprüfung der Fahrzeug- sowie der Glühkerzenspannung
- Spannung des Ladesystems prüfen
- Einspritzzeitpunkt prüfen



Ringförmige Schwellung am Glühstab

Situation

- Öl in der Brennkammer, wahrscheinlich wegen Motorverschleiß

Lösung

- Verschleiß der Kolben in den Zylindern prüfen
- Ölverbrauch prüfen

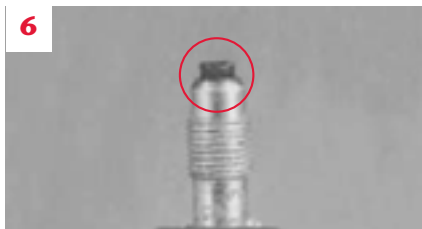

6

Fehlender Glühstab

Situation

- Vorglühanlage ausgefallen
- Richtung oder Regularität der Treibstoffdüse ist inkorrekt
- Falsche Einspritzposition wegen fehlerhafter Abdichtung
- Funktions- oder Zeitfehler in der Vorglühanlage
- Gewindebeschädigung an der Glühkerzenbohrung
- Ungenügendes Drehmoment der Glühkerze führt zu fehlerhafter Position der Glühkerze

Lösung

- Prüfen, ob die richtige Vorglühanlage für das Fahrzeugmodell benutzt wird
- Prüfen, ob die Vorglühanlage korrekt installiert ist
- Den Glühkerzeinbaupunkt auf Verkokung prüfen
- Einspritzzeitpunkt prüfen
- Glühkerzenbohrung auf Gewindefschäden / Verkokungen prüfen

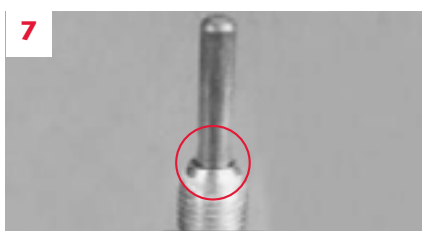

7

Glühstab berührt Körper der Glühkerze

Situation

- Anzugsdrehmoment überschritten
- Falsches Werkzeug benutzt
- Gewindefschaden an Glühkerzenbohrung

Lösung

- Glühkerzenbohrung auf Gewindefschäden / Verkokungen prüfen
- Drehmoment der Glühkerzen prüfen



8

Löcher in Glühstab / Risse / Verschmelzung am Glühkerzenkörper

Situation

- Ausfall der Vorglühanlage
- Richtung oder Regularität der Treibstoffdüse ist inkorrekt
- Falsche Einspritzposition wegen fehlerhafter Abdichtung
- Funktions- oder Zeitfehler in der Vorglühanlage
- Gewindefschaden an Glühkerzenbohrung
- Ungenügendes Drehmoment der Glühkerze führt zu fehlerhafter Position der Glühkerze

Lösung

- Prüfen, ob die richtige Vorglühanlage für das Fahrzeugmodell benutzt wird
- Prüfen, ob die Vorglühanlage korrekt installiert ist
- Glühkerzenbohrung auf Gewindefschäden / Verkokungen prüfen
- Einspritzzeitpunkt prüfen

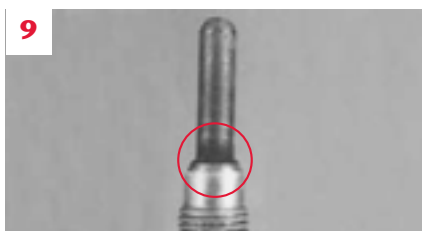

9

Karbonablagerung zwischen Glühstab und Glühkerzenkörper

Situation

- Ausfall der Vorglühanlage
- Richtung oder Regularität der Treibstoffdüse ist inkorrekt
- Falsche Einspritzposition wegen fehlerhafter Abdichtung
- Einspritzung- / Einspritzzeitpunktfehler

Lösung

- Prüfen, ob die richtige Vorglühanlage für das Fahrzeugmodell benutzt wird
- Prüfen, ob die Vorglühanlage korrekt installiert ist
- Glühkerzenbohrung auf Gewindefschäden / Verkokungen prüfen
- Einspritzzeitpunkt prüfen



10

Gebrochene / verbogene Rundmutter

Situation

- Drehmoment zu groß
- Falsches Werkzeug benutzt
- Gewindefschaden an Glühkerzenbohrung

Lösung

- Glühkerzenbohrung auf Gewindefschäden / Verkokungen prüfen
- Drehmoment der Glühkerzen prüfen

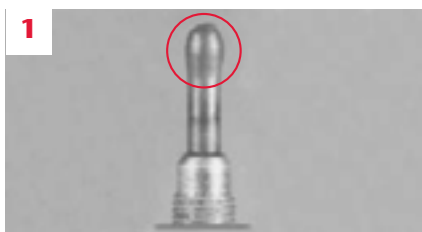

Tube à incandescence élargie

Cause

- Tension excessive (par ex. Bougie d'allumage 12 V dans un système 24 V ou inversement)
- Défaillance d'alternateur et régulateur
- Humidité pendant le stockage

Solution

- Vérifiez sur place ainsi que la tension de la bougie de préchauffage
- Vérifiez le système de chargement
- Vérifiez la qualité des conditions de stockage

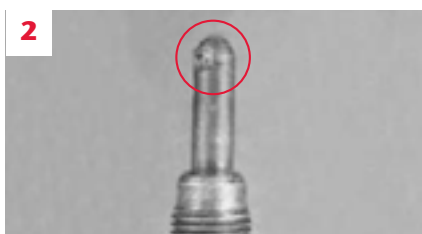

Tube à incandescence cassé

Cause

- Incandescence/tension excessive (par ex. Bougie d'allumage 24 V dans un système 12 V ou inversement)
- Défaillance d'alternateur et régulateur

Solution

- Vérifiez les contacts du régulateur de bougie de préchauffage
- Vérifiez sur place ainsi que la tension de la bougie de préchauffage
- Vérifiez la tension du système de chargement

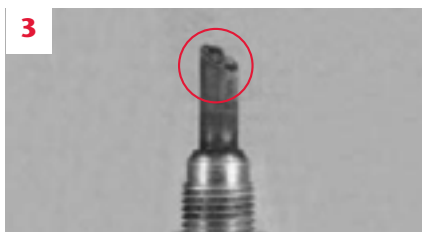

Tube à incandescence endommagée ou manquant

Cause

- Défaillance d'unité d'allumage
- Direction ou régularité de jet de carburant incorrecte
- Problème d'étanchéité provoquant une erreur de position d'aspersion

Solution

- Vérifiez si l'unité d'allumage est correctement installée
- Vérifiez si vous utilisez la bonne unité d'allumage pour le modèle de véhicule
- Vérifiez si la pointe d'installation de bougie de préchauffage ne présente pas un dépôt de carbone

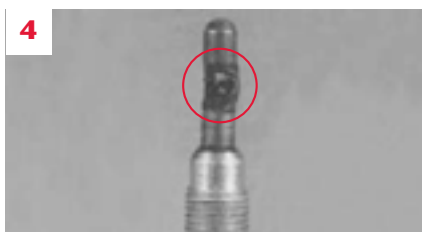

Tube à incandescence déformée (surchauffe)

Cause

- Défaillance d'unité d'allumage
- Direction ou régularité de jet de carburant incorrecte
- Mauvaise position d'aspersion provoquée par une mauvaise étanchéité
- Incandescence/tension excessive (par ex. Bougie d'allumage 24 V dans un système 12 V ou inversement)
- Défaillance d'alternateur et régulateur
- Erreur de fonctionnement ou de distribution dans l'unité d'injection

Solution

- Vérifiez si l'unité d'allumage est correctement installée
- Vérifiez si vous utilisez la bonne unité d'allumage pour le modèle de véhicule
- Vérifiez si la pointe d'installation de bougie de préchauffage ne présente pas un dépôt de carbone
- Vérifiez les contacts du régulateur de bougie de préchauffage
- Vérifiez sur place ainsi que la tension de la bougie de préchauffage
- Vérifiez la tension du système de chargement
- Vérifiez la distribution de l'injection de carburant



Bague enflée dans le tube à incandescence

Cause

- Huile dans la chambre de combustion, probablement suite à une usure du moteur

Solution

- Vérifiez le jeu du piston dans les cylindres du moteur
- Vérifiez la consommation d'huile

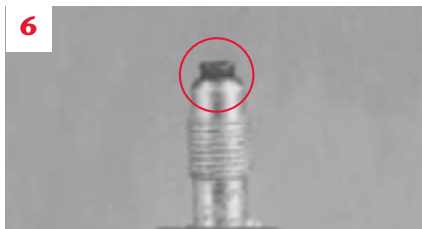

6

Tube a incandescence manquant

Cause

- Défaillance d'unité d'allumage
- Direction ou régularité de jet de carburant incorrecte
- Mauvaise position d'aspersion provoquée par une mauvaise étanchéité
- Erreur de fonctionnement ou de distribution dans l'unité d'injection
- Filet endommagé à l'ouverture de la culasse où la bougie de préchauffage est installée
- Bougie de préchauffage pas suffisamment serrée si bien que mal installée

Solution

- Vérifiez si vous utilisez la bonne unité d'allumage pour le modèle de véhicule
- Vérifiez si l'unité d'allumage est correctement installée
- Vérifiez si la pointe d'installation de bougie de préchauffage ne présente pas un dépôt de carbone
- Vérifiez la distribution de la pompe d' injection
- Vérifiez si l'ouverture de la culasse ne présente pas de dommages au niveau du filetage / encrassement de carbone

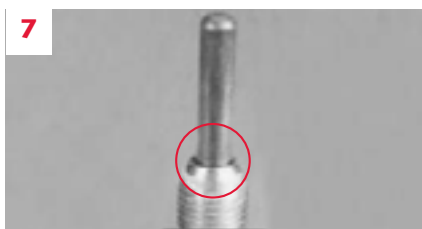

7

Tube touchant le corps de la bougie de préchauffage

Cause

- Serrage excessif
- Mauvais outil utilisé
- Endommagement de filetage à l'ouverture de la culasse

Solution

- Vérifiez si l'ouverture de la culasse ne présente pas de dommages au niveau du filetage / encrassement de carbone
- Vérifiez le serrage de la bougie de préchauffage



8

Trous dans le tube / fissures / fusion près du corps de bougie de prechauffage

Cause

- Défaillance d'unité d'allumage
- Direction ou régularité de jet de carburant incorrecte
- Mauvaise position d'aspersion provoquée par une mauvaise étanchéité
- Erreur de fonctionnement ou de distribution dans l'unité d'injection
- Filet endommagé à l'ouverture de la culasse où la bougie de préchauffage est installée
- Bougie de préchauffage pas suffisamment serrée si bien que mal installée

Solution

- Vérifiez si vous utilisez la bonne unité d'allumage pour le modèle de véhicule
- Vérifiez si l'unité d'allumage est correctement installée
- Vérifiez si la pointe d'installation de bougie de préchauffage ne présente pas un dépôt de carbone
- Vérifiez si l'ouverture de la culasse ne présente pas de dommages au niveau du filetage / encrassement de carbone
- Vérifiez la distribution de la pompe d' injection

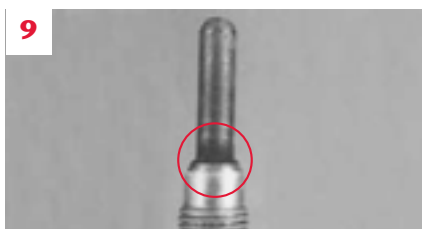

9

Dépôts de carbone entre la sonde et le corps de la bougie de préchauffage

Cause

- Défaillance d'unité d'allumage
- Direction ou régularité de jet de carburant incorrecte
- Mauvaise position d'aspersion provoquée par une mauvaise étanchéité
- Fonctionnement de pompe d' injection / erreur de distribution

Solution

- Vérifiez si vous utilisez la bonne unité d'allumage pour le modèle de véhicule
- Vérifiez si l'unité d'allumage est correctement installée
- Vérifiez si la pointe d'installation de bougie de préchauffage ne présente pas un dépôt de carbone
- Vérifiez si l'ouverture de la culasse ne présente pas de dommages au niveau du filetage / encrassement de carbone
- Vérifiez la distribution de la pompe d' injection



10

Plot cassé / plié

Cause

- Serrage excessif
- Mauvais outil utilisé
- Endommagement de filetage à l'ouverture de la culasse

Solution

- Vérifiez si l'ouverture de la culasse ne présente pas de dommages au niveau du filetage / encrassement de carbone
- Vérifiez le serrage de la bougie de préchauffage

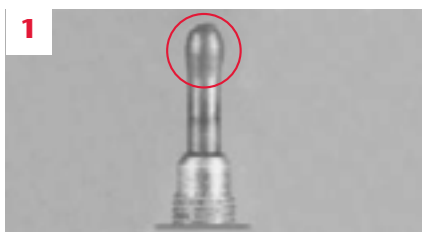

Punta del sensor agrandada

Causa

- Tensión excesiva (por ejemplo, una bujía de calentador de 12V en un sistema de 24V o viceversa)
- Fallo del alternador y del regulador
- Humedad durante el almacenamiento

Solución

- Comprobar la tensión de a bordo y de la bujía de calentador
- Comprobar el sistema de carga
- Comprobar la calidad de las condiciones de almacenamiento

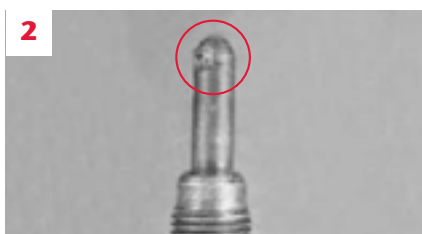

Punta del sensor rota

Causa

- Excesiva incandescencia / tensión (por ejemplo, una bujía de calentador de 12V en un sistema de 24V o viceversa)
- Fallo del alternador y del regulador

Solución

- Comprobar los contactos en el regulador de la bujía de calentador
- Comprobar la tensión de a bordo y de la bujía de calentador
- Comprobar la tensión del sistema de carga

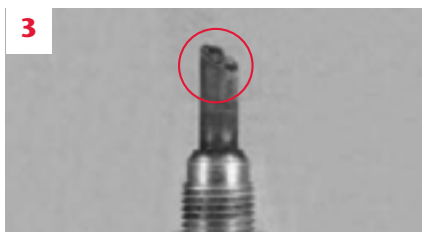

Punta del sensor dañada o inexistente

Causa

- Fallo de la unidad de encendido
- Incorrecta dirección o regularidad del chorro de combustible
- Fallo en la junta causante de error en la posición del chorro

Solución

- Comprobar la correcta instalación de la unidad de encendido
- Comprobar que se está utilizando la unidad de encendido correcta para el modelo de vehículo
- Comprobar si hay depósitos de carbón en el punto de instalación de la bujía de calentador

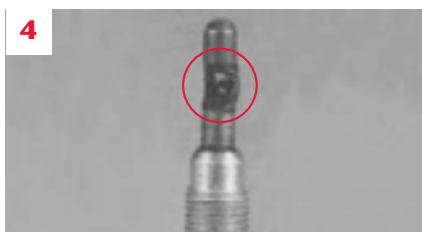

Sensor deformado (sobrecalentamiento)

Causa

- Fallo en la unidad de encendido
- Incorrecta dirección o regularidad del chorro de combustible
- Posición incorrecta del chorro causada por un fallo en la junta
- Excesiva incandescencia / tensión (por ejemplo, una bujía de calentador de 24V en un sistema de 12V o viceversa)
- Fallo del alternador y del regulador
- Fallo de función o tiempo en unidad de inyección

Solución

- Comprobar la correcta instalación de la unidad de encendido
- Comprobar que se está utilizando la unidad de encendido correcta para el modelo de vehículo
- Comprobar si hay depósitos de carbón en el punto de instalación de la bujía de calentador
- Comprobar los contactos en el regulador de la bujía de calentador
- Comprobar la tensión de a bordo y de la bujía incandescente
- Comprobar la tensión del sistema de carga
- Comprobar tiempo de inyección del carburante

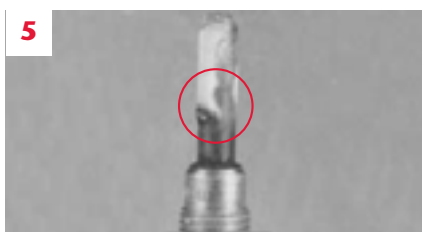

Anillo dilatado en la punta del sensor

Causa

- Aceite en la cámara de combustión, causado probablemente por el desgaste del motor

Solución

- Comprobar el espacio de los pistones en los cilindros del motor
- Comprobar consumo de aceite

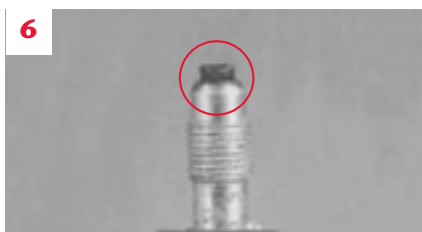

Sensor inexistente

Causa

- Fallo en la unidad de encendido
- Incorrecta dirección o regularidad del chorro de combustible
- Posición incorrecta del chorro causada por un fallo en la junta
- Fallo de función o tiempo en unidad de inyección
- Daño en la rosca en la apertura del cabezal del cilindro donde va instalada la bujía de calentador
- La bujía de calentador no está suficientemente enroscada, por lo que la bujía está en una posición incorrecta

Solución

- Comprobar que se está utilizando la unidad de encendido correcta para el modelo de vehículo
- Comprobar que la unidad de encendido está correctamente instalada
- Comprobar si hay depósitos de carbón en el punto de instalación de la bujía de calentador
- Comprobar el tiempo de la bomba de inyección.
- Comprobar si hay daño en la rosca / suciedad de carbón en la apertura del cabezal del cilindro

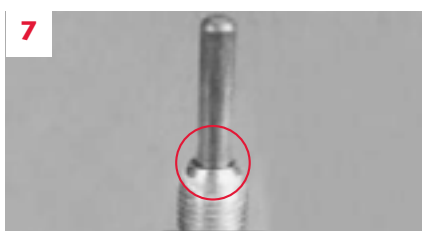

El sensor toca el cuerpo de la bujía incandescente

Causa

- Torque excesivo
- Se ha utilizado la herramienta incorrecta
- Daño en la rosca en la apertura del cabezal del cilindro

Solución

- Comprobar si hay daño en la rosca / suciedad de carbón en la apertura del cabezal del cilindro
- Comprobar el torque de la bujía de calentador



Agujeros en el sensor / grietas / derretimiento junto al cuerpo de la bujía de calentador

Causa

- Fallo en la unidad de encendido
- Incorrecta dirección o regularidad del chorro de combustible
- Posición incorrecta del chorro causada por un fallo en la junta
- Fallo de función o tiempo en unidad de inyección
- Daño en la rosca en la apertura del cabezal del cilindro donde va instalada la bujía de calentador
- La bujía de calentador no está suficientemente enroscada, por lo que la bujía está en una posición incorrecta

Solución

- Comprobar que se está utilizando la unidad de encendido correcta para el modelo de vehículo
- Comprobar que la unidad de encendido está correctamente instalada
- Comprobar si hay depósitos de carbón en el punto de instalación de la bujía de calentador
- Comprobar si hay daño en la rosca / suciedad de carbón en la apertura del cabezal del cilindro
- Comprobar el tiempo de la bomba de inyección.

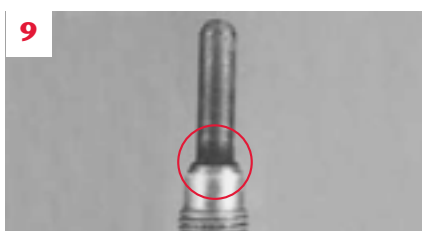

Depósitos de carbón entre el sensor y el cuerpo de la bujía de calentador

Causa

- Fallo de la unidad de encendido
- Incorrecta dirección o regularidad del chorro de combustible
- Posición incorrecta del chorro causada por un fallo en la junta
- Fallo en el funcionamiento / tiempo de la bomba de inyección

Solución

- Comprobar que se está utilizando la unidad de encendido correcta para el modelo de vehículo
- Comprobar que la unidad de encendido está correctamente instalada
- Comprobar si hay depósitos de carbón en el punto de instalación de la bujía de calentador
- Comprobar si hay daño en la rosca / suciedad de carbón en la apertura del cabezal del cilindro
- Comprobar el tiempo de la bomba de inyección



Terminal de alimentación roto / doblado

Causa

- Torque excesivo
- Se ha utilizado la herramienta incorrecta
- Daño en la rosca en la apertura del cabezal del cilindro

Solución

- Comprobar si hay daño en la rosca / suciedad de carbón en la apertura del cabezal del cilindro
- Comprobar el torque de la bujía de calentador

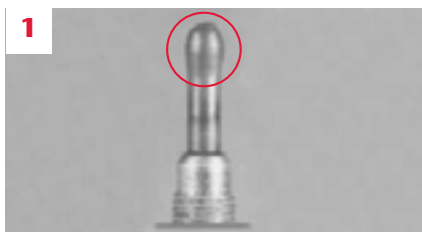

1

Punta della sonda allargata

Causa

- Voltaggio eccessivo (p.es. Candelella ad incandescenza da 12-V in un sistema a 24-V o viceversa)
- Difetto dell'alternatore e del regolatore
- Umidità durante lo stoccaggio

Soluzione

- Controllare il voltaggio a bordo e della candelella ad incandescenza
- Controllare il sistema di carica
- Controllare la qualità delle condizioni di stoccaggio

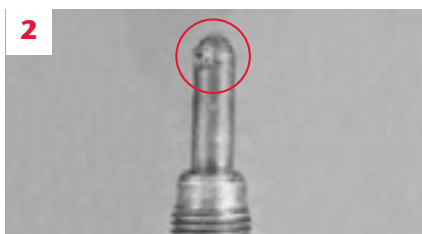

2

Punta della sonda rotta

Causa

- Voltaggio / incandescenza eccessivi (p.es. Candelella ad incandescenza da 24-V in un sistema a 12-V o viceversa)
- Difetto dell'alternatore e del regolatore

Soluzione

- Controllare i contatti sul regolatore della candelella ad incandescenza
- Controllare il voltaggio a bordo e della candelella ad incandescenza
- Controllare il voltaggio del sistema di carica

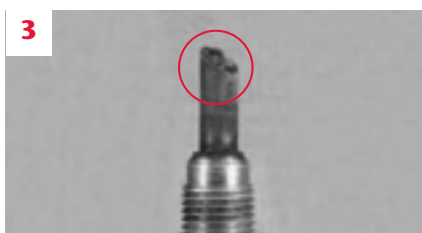

3

Punta della sonda danneggiata o mancante

Causa

- Difetto dell'unità di accensione
- Direzione o regolarità del getto del carburante scorrette
- Difetto di tenuta causa un errore di posizione dello spruzzo

Soluzione

- Controllare che l'unità di accensione sia installata correttamente
- Controllare che l'unità di accensione che si sta usando è corretta per il modello del veicolo
- Controllare il punto d'installazione della candelella ad incandescenza perché non vi siano depositi di carbonio

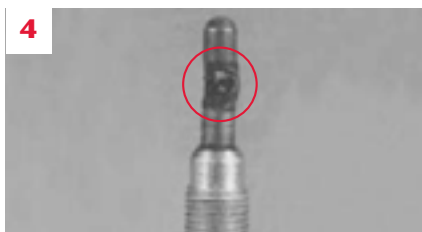

4

Sonda deformata (surriscaldamento)

Causa

- Difetto dell'unità di accensione
- Direzione o regolarità del getto del carburante scorrette
- Posizione di spruzzo sbagliata causata da una tenuta difettosa
- Voltaggio / incandescenza eccessivi (p.es. Candelella ad incandescenza da 24-V in un sistema a 12-V o viceversa)
- Difetto dell'alternatore e del regolatore
- Difetto di funzione o regolazione nell'unità di iniezione

Soluzione

- Controllare che l'unità di accensione sia installata correttamente
- Controllare che l'unità di accensione che si sta usando è corretta per il modello del veicolo
- Controllare il punto d'installazione della candelella ad incandescenza perché non vi siano depositi di carbonio
- Controllare i contatti sul regolatore della candelella ad incandescenza
- Controllare il voltaggio a bordo e della candelella ad incandescenza
- Controllare il voltaggio del sistema di carica
- Controllare la regolazione dell'iniezione del carburante



5

Anello gonfio sulla punta della sonda

Causa

- Olio nella camera di combustione, probabilmente causato da un'usura del motore

Soluzione

- Controllare la coppia di serraggio del pistone nei cilindri del motore
- Controllare il consumo dell'olio

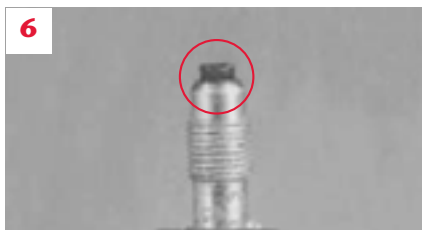

6

Sonda mancante

Causa

- Difetto dell'unità di accensione
- Direzione o regolarità del getto del carburante scorrette
- Posizione di spruzzo sbagliata causata da una tenuta difettosa
- Difetto di funzione o regolazione nell'unità di iniezione
- Filetto danneggiato nell'apertura della testa del cilindro dove è installata la candele ad incandescenza
- La candele ad incandescenza non sufficientemente serrata causa un posizionamento scorretto della candele stessa

Soluzione

- Controllare che l'unità di accensione che si sta usando è corretta per il modello del veicolo
- Controllare che l'unità di accensione sia installata correttamente
- Controllare il punto d'installazione della candele ad incandescenza perché non vi siano depositi di carbonio
- Controllare la regolazione della pompa di iniezione
- Controllare l'apertura della testa del cilindro perché non vi siano danni al filetto / incrostazione di carbonio

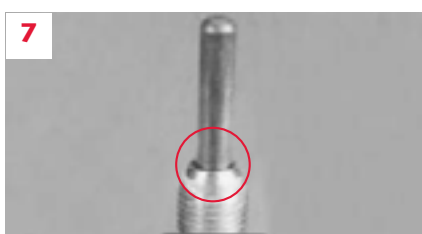

7

La sonda tocca il corpo della candele ad incandescenza

Causa

- Coppia di serraggio troppo elevata
- E' stato utilizzato l'utensile sbagliato
- Danno al filetto nell'apertura della testa del cilindro

Soluzione

- Controllare l'apertura della testa del cilindro perché non vi siano danni al filetto / incrostazione di carbonio
- Controllare la coppia di serraggio della candele ad incandescenza



8

Fori nella sonda / crepe / fusione in prossimità del corpo della candele ad incandescenza

Causa

- Difetto dell'unità di accensione
- Direzione o regolarità del getto del carburante scorrette
- Posizione di spruzzo sbagliata causata da una tenuta difettosa
- Difetto di funzione o regolazione nell'unità di iniezione
- Filetto danneggiato nell'apertura della testa del cilindro dove è installata la candele ad incandescenza
- La candele ad incandescenza non sufficientemente serrata causa un posizionamento scorretto della candele stessa

Soluzione

- Controllare che l'unità di accensione che si sta usando è corretta per il modello del veicolo
- Controllare che l'unità di accensione sia installata correttamente
- Controllare il punto d'installazione della candele ad incandescenza perché non vi siano depositi di carbonio
- Controllare l'apertura della testa del cilindro perché non vi siano danni al filetto / incrostazione di carbonio
- Controllare la regolazione della pompa di iniezione

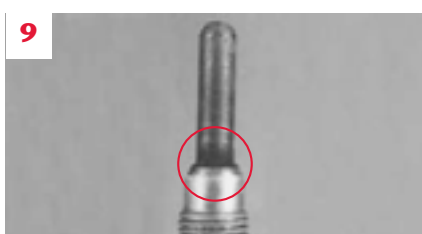

9

Depositi di carbonio fra la sonda e il corpo della candele ad incandescenza

Causa

- Difetto dell'unità di accensione
- Direzione o regolarità del getto del carburante scorrette
- Posizione di spruzzo sbagliata causata da una tenuta difettosa
- Difetto di funzionamento / regolazione della pompa di iniezione

Soluzione

- Controllare che l'unità di accensione che si sta usando è corretta per il modello del veicolo
- Controllare che l'unità di accensione sia installata correttamente
- Controllare il punto d'installazione della candele ad incandescenza perché non vi siano depositi di carbonio
- Controllare l'apertura della testa del cilindro perché non vi siano danni al filetto / incrostazione di carbonio
- Controllare la regolazione della pompa di iniezione



10

Terminale di alimentazione rotto / curvato

Causa

- Coppia di serraggio troppo elevata
- E' stato utilizzato l'utensile sbagliato
- Danno al filetto nell'apertura della testa del cilindro

Soluzione

- Controllare l'apertura della testa del cilindro perché non vi siano danni al filetto / incrostazione di carbonio
- Controllare la coppia di serraggio della candele ad incandescenza

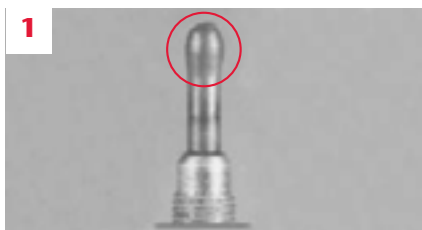

1

Förstorad sondspets

Orsak

- För hög spänning (t.ex. ett 12-V glödstift i ett 24-V system eller vice versa)
- Fel i generator eller regulator
- Fukt under förvaring

Åtgärd

- Kontrollera fordonets och glödstiftets spänning
- Syna laddningssystemet
- Kontrollera förvaringsplatsens kvalitet

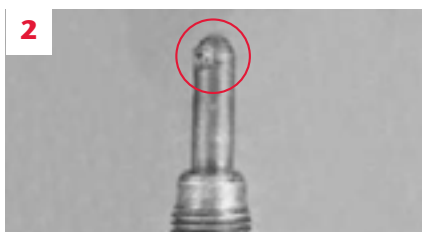

2

Brusten sondspets

Orsak

- För hög glödning / spänning (t.ex. ett 24-V glödstift i ett 12-V system eller vice versa)
- Fel i generator eller regulator

Åtgärd

- Syna glödstiftregulatorns kontakter
- Kontrollera fordonets och glödstiftets spänning
- Kontrollera laddningssystemets spänning

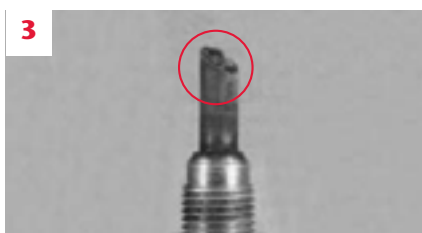

3

Sonspetsen skadad eller saknas

Orsak

- Fel i tändningsmodulen
- Bränsleinsprutningen felriktad eller oregelbunden
- Packningsfel som orsakar fel insprutningsposition

Åtgärd

- Kontrollera att tändningsmodulen är installerad korrekt
- Kontrollera att du använder rätt tändningsmodul för fordonets modell
- Syna glödstiftets monteringspunkt efter kolavsättning

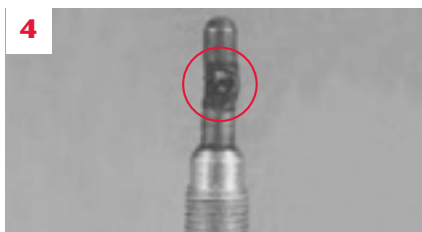

4

Deformerad sond (överhettning)

Orsak

- Fel i tändningsmodulen
- Bränsleinsprutningen felriktad eller oregelbunden
- Fel insprutningsposition till följd av dålig packning
- För hög glödning / spänning (t.ex. ett 24-V glödstift i ett 12-V system eller vice versa)
- Fel i generator eller regulator
- Funktions- eller synkroniseringsfel i insprutningsmodulen

Åtgärd

- Kontrollera att tändningsmodulen är korrekt installerad
- Kontrollera att du använder rätt tändningsmodul för fordonets modell
- Syna glödstiftets monteringspunkt efter kolavsättning
- Syna glödstiftregulatorns kontakter
- Kontrollera fordonets och glödstiftets spänning
- Kontrollera laddningssystemets spänning
- Kontrollera bränsleinsprutningens synkronisering



5

Svullen ring på sondspetsen

Orsak

- Olja i förbränningskammaren, troligen till följd av motorslitage

Åtgärd

- Kontrollera kolvspelet i motorns cylindrar
- Kontrollera oljeförbrukningen

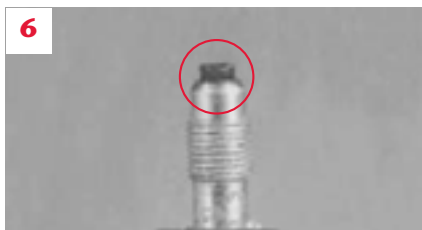

6

Sonden saknas

Orsak

- Fel i tändningsmodulen
- Bränsleinsprutningen felriktad eller oregelbunden
- Fel insprutningsposition till följd av fel insättning
- Funktions- eller synkroniseringsfel i insprutningsmodulen
- Skadad gänga i cylinderlockets öppning där glödstiftet är monterat
- Glödstiftet otillräckligt åtdraget och därför i fel läge

Åtgärd

- Kontrollera att du använder rätt tändningsmodul för fordonets modell
- Kontrollera att tändningsmodulen är rätt installerad
- Syna glödstiftets monteringspunkt efter kolavsättning
- Kontrollera insprutningspumpens synkronisering
- Syna cylinderlockets öppning efter skadad gänga / kolavsättning

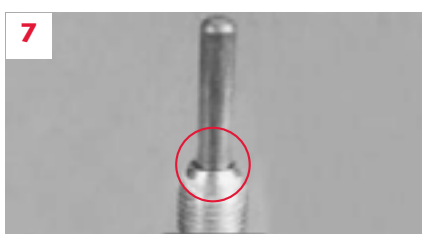

7

Sonden vidrör glödstiftets kropp

Orsak

- För högt åtdragningsmoment
- Fel redskap har använts
- Skadad gänga i cylinderlockets öppning

Åtgärd

- Syna cylinderlockets öppning efter skadad gänga / kolavsättning
- Kontrollera glödstiftets vridmoment



8

Hål i sonden / sprickor / smältning bredvid glödstiftets kropp

Orsak

- Fel i tändningsmodulen
- Bränsleinsprutningen felriktad eller oregelbunden
- Fel insprutningsposition till följd av fel insättning
- Funktions- eller synkroniseringsfel i insprutningsmodulen
- Skadad gänga i cylinderlockets öppning där glödstiftet är monterat
- Glödstiftet otillräckligt åtdraget och därför i fel läge

Åtgärd

- Kontrollera att du använder rätt tändningsmodul för fordonets modell
- Kontrollera att tändningsmodulen är rätt installerad
- Syna glödstiftets monteringspunkt efter kolavsättning
- Syna cylinderlockets öppning på skadad gänga / kolavsättning
- Kontrollera insprutningspumpens synkronisering

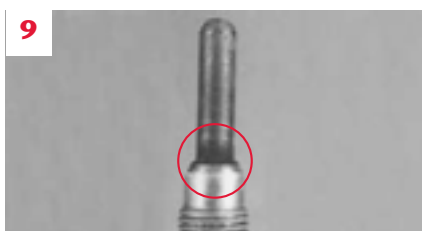

9

Kolavsättning mellan sonden och glödstiftets kropp

Orsak

- Fel i tändningsmodulen
- Bränsleinsprutningen felriktad eller oregelbunden
- Fel insprutningsposition till följd av fel insättning
- Funktions- / synkroniseringsfel i insprutningspumpen

Åtgärd

- Kontrollera att du använder rätt tändningsmodul för fordonets modell
- Kontrollera att tändningsmodulen är rätt installerad
- Syna glödstiftets monteringspunkt efter kolavsättning
- Syna cylinderlockets öppning efter skadad gänga / kolavsättning
- Kontrollera insprutningspumpens synkronisering



10

Brusten / böjd strömkontakt

Orsak

- För högt åtdragningsmoment
- Fel redskap har använts
- Skadad gänga i cylinderlockets öppning

Åtgärd

- Syna cylinderlockets öppning efter skadad gänga / kolavsättning
- Kontrollera glödstiftets vridmoment

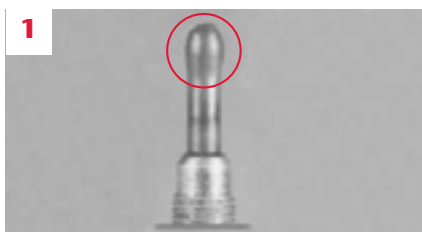

Расширен наконечник свечи

Причина

- Избыточное напряжение (напр. свеча накаливания на 12 В в системе на 24 В)
- Неисправность генератора и регулятора
- Избыточная влажность при хранении

Решение

- Проверить соответствие напряжения бортовой сети и напряжения свечи накаливания
- Проверить бортовую сеть
- Проверить качество условий хранения

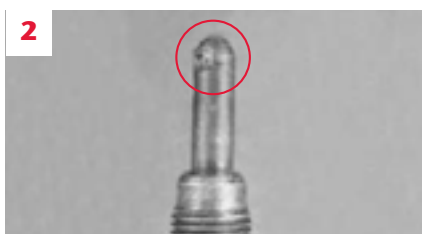

Сломан наконечник свечи

Причина

- Избыточный накал / избыточное напряжение (напр. свеча накаливания на 12 В в системе на 24 В)
- Неисправность генератора и регулятора

Решение

- Проверить контакты блока управления свечами накаливания
- Проверить соответствие напряжения бортовой сети и напряжения свечи накаливания
- Проверить напряжение в бортовой сети

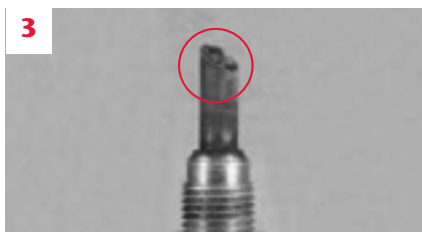

Поврежденный или отсутствующий наконечник свечи

Причина

- Неисправность блока управления пуском
- Неправильное направление или перебой в работе форсунки
- Неправильная точка распыления топлива из-за нарушения герметичности

Решение

- Проверить правильность установки блока управления
- Проверить правильность выбора блока управления для данной модели автомобиля
- Проверить посадочное место свечи зажигания на наличие слоя нагара

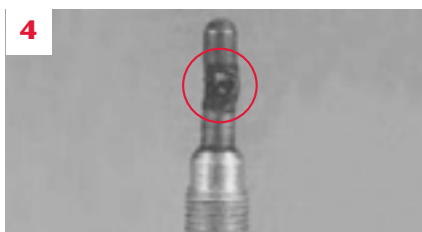

Наконечник деформирован (перегрев)

Причина

- Неисправность блока управления
- Неправильное направление или перебой в работе форсунки
- Неправильная точка распыления топлива из-за нарушения герметичности
- Избыточный накал / избыточное напряжение (напр. свеча накаливания на 12 В в системе на 24 В)
- Неисправность генератора и регулятора
- Функциональный сбой или нарушение синхронизации в блоке управления впрыском

Решение

- Проверить правильность установки блока управления
- Проверить правильность выбора блока управления для данной модели автомобиля
- Проверить посадочное место свечи зажигания на наличие слоя нагара
- Проверить контакты блока управления свечами накаливания
- Проверить соответствие напряжения бортовой сети и напряжения свечи накаливания
- Проверить напряжение в бортовой сети
- Проверить регулировку впрыска топлива



Вздутое кольцо на наконечнике свечи

Причина

- Масло в камере сгорания, возможно, по причине износа двигателя

Решение

- Проверить компрессию в цилиндрах
- Проверить расход масла

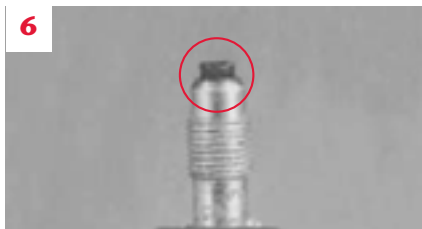

6

Отсутствует наконечник свечи

Причина

- Неисправность блока управления
- Неправильное направление или перебои в работе форсунки
- Неправильная точка распыления топлива из-за нарушения герметичности
- Функциональный сбой или нарушение синхронизации в блоке управления впрыском
- Повреждение резьбы в отверстии головки блока цилиндров, где установлена свеча накаливания
- Неправильная посадка свечи по причине недостаточной ее затяжки

Решение

- Проверить правильность выбора блока управления для данной модели автомобиля
- Проверить правильность установки блока управления
- Проверить посадочное место свечи накаливания на наличие слоя нагара
- Проверить регулировку ТНВД
- Проверить отверстие в головке блока цилиндров на наличие повреждений резьбы / образований нагара

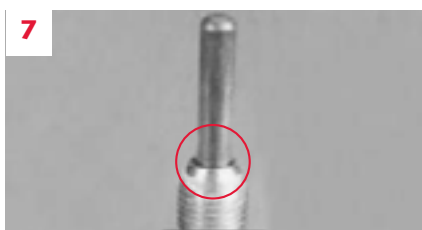

7

Наконечник касается корпуса свечи накаливания

Causa

- Черезмерная затяжка свечи
- Использование неподходящего инструмента
- Повреждение резьбы в отверстии головки блока цилиндров

Причина

- Проверить отверстие в головке блока цилиндров на наличие повреждений резьбы / образований нагара
- Проверить момент затяжки свечи накаливания



8

Дыры на наконечнике / трещины / оплавления вблизи корпуса свечи накаливания

Причина

- Неисправность блока управления
- Неправильное направление или перебои в работе форсунки
- Неправильная точка распыления топлива из-за нарушения герметичности
- Функциональный сбой или нарушение синхронизации в блоке управления впрыском
- Повреждение резьбы в отверстии головки блока цилиндров, где установлена свеча накаливания
- Неправильная посадка свечи по причине недостаточной ее затяжки

Решение

- Проверить правильность выбора блока управления для данной модели автомобиля
- Проверить правильность установки блока управления
- Проверить посадочное место свечи зажигания на наличие слоя нагара
- Проверить отверстие в головке блока цилиндров на наличие повреждений резьбы / образований нагара
- Проверить регулировку ТНВД

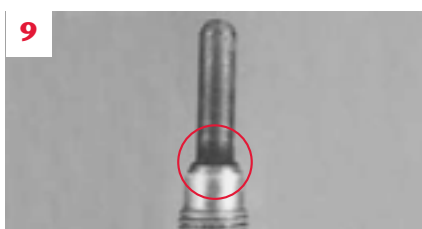

9

Слой нагара между наконечником и корпусом свечи накаливания

Причина

- Неисправность блока управления
- Неправильное направление или перебои в работе форсунки
- Неправильная точка распыления топлива из-за нарушения герметичности
- Сбой в работе / регулировке ТНВД

Решение

- Проверить правильность выбора блока управления для данной модели автомобиля
- Проверить правильность установки блока управления
- Проверить посадочное место свечи зажигания на наличие слоя нагара
- Проверить отверстие в головке блока цилиндров на наличие повреждений резьбы / образований нагара
- Проверить регулировку ТНВД

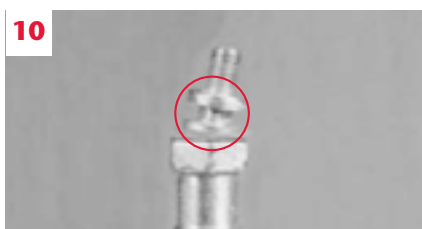

10

Сломанный / изогнутый контактный стержень

Причина

- Черезмерная затяжка
- Использование неподходящего инструмента
- Повреждение резьбы в отверстии головки блока цилиндров

Решение

- Проверить отверстие головки блока цилиндров на наличие повреждений резьбы / образований нагара
- Проверить момент затяжки свечи накаливания

New Applications

AUTOMOTIVE		Page
ALFA ROMEO	147, 156, 159, 166, GT	32
ALPINA	D10 (E39)	33
ASIA MOTORS	Rocsta	33
AUDI	A2, A3, A4	33
BMW	1, 3, 5, 7, X3, X5	34
CHEVROLET	Blazer, V8, C10, C20, C30, C3500, Express 2500, Express 3500, K10, K20, K30, K2500, K3500, P20, P30	35
CHRYSLER	PT Cruiser, Voyager III	36
CITROEN	C1, C4, C6, Jumper, Jumpy, Xsara Picasso	36
DAEWOO	Musso, Rexton	39
DAIHATSU	Charade, Delta, Delta Wide, Hijet, Rugger/Rocky, Taft	39
FIAT	Croma, Doblo, Ducato, Grande Punto, Idea, Panda, Punto, Multipla, Stilo, Strada	40
FORD	Econovan, Fiesta, Focus II, Focus C-Max, Fusion, Mondeo, Ranger, Tourneo Connect, Transit, Transit Connect	43
GMC	C15, C25, C35, C2500, C3500, Chassis, Full Size, Jimmy, K15, K25, K35, K2500, MD Bus Chassis, K3500, P25, P35, Savana 2500, Savana 3500, Truck, Van	45
HINO	Rainbow, Ranger, Truck	46
HUMMER	H1	46
HYUNDAI	Accent, Elantra, Excel, Galloper I, Galloper II, Getz, H-1, H100, H150, H200, Matrix, Santa Fe, Starex, Trajet, Tucson	46
INTERNATIONAL	44, 2424, 2444, 3414, 3444, 364, 384, BD144, BD154, BD250, B27, B414, B424, TD 5, 500 series, 7000 D	47
ISUZU	300, KB250, KB280, Trooper	47
JAGUAR	S-type	48
JEEP	Cherokee	48
KIA	Carens II	49
LANCIA	Musa, Phedra, Thesis, Ypsilon	49
LAND ROVER	88, 109, Defender, Discovery II, Range Rover III	50
LEXUS	IS 220 / 250, GS 300 / 430	50
MAZDA	2, 626, B2200, E2500, Light bus parkway	51

AUTOMOTIVE		Page
MERCEDES	170, CLK270, E290, G270, Viano, Vito	51
MINI	One D	54
MITSUBISHI	Canter 35, Colt, Galant V, Galant VI, L200, L300, L400, Lancer, Montero, Pajero, Shogun, Space Gear, Space Runner, Space Wagon	54
NISSAN	Almera, Bluebird, Cherry, Interstar, Nomad, Patrol, Pick-Up, Pulsar, Serena, Sentra, Stanza, Sunny I, Sunny II, Vanette	56
OPEL	Agila, Astra (C), Astra (H), Campo, Corsa (C), Meriva, Movano, Signum, Tigra Twin Top, Vectra (C), Vivaro	58
PEUGEOT	107, 1007, 206, 307, 406, 407, 607, Boxer	61
PUCH	250GD, G290	63
RENAULT	Avantime, Master II, Scenic II, Traffic, Vel Satis	63
ROVER	75	66
SEAT	Alhambra, Altea, Ibiza, Leon, Toledo	67
SKODA	Fabia, Octavia, Roomster, Superb	68
SSANG YOUNG	Korando, Musso, Rexton	69
SUZUKI	Ignis II, Jimny (FJ), Liana, Swift, Wagon R+	69
TOYOTA	Avensis, Avensis Verso, Aygo, Blizzard, Bus, Caldina, Camry Vista, Carina E, Chaser, Coaster, Corolla, Corolla Sprinter, Corolla Wagon, Corona, Corsa, Cresta, Crown, Deliboy, Dyna, Estima, Gaia, Granvia, Hiace, Hiace Van, Hilux, Ipsum, Landcruiser, Liteace, Liteace Noah, Lucida, Mark II, Masterace, Picnic, Premio, Previa, RAV4 II, Regius, Starlet, Tercel, Townace, Toyoace, Truck, Yaris	70
VAUXHALL	Astra Mk IV, Astra Mk V, Corsa, Corsa Mk II, Corsa Van Mk II, Meriva, Movano, Signum, Tigra Twin Top, Vectra Mk II, Vivaro	75
VOLKSWAGEN	Beetle, Caddy, Fox, Golf (5), Jetta, LT28, LT46, Passat, Polo, Touran, Sharan, Taro	77
VOLVO	S40, V50	81

New Glow Plug Types

NEW TYPES		Page
DG-108	Isuzu, Opel	47, 58
DG-114	Asia Motors, Ford, Mazda	33, 43, 51
DG-131	Land Rover	50
DG-135	International, Mercedes-Benz	47, 51
DG-139	Volkswagen	77
DG-157	Nissan	56
DG-170	Alfa Romeo, Lancia, Opel, Vauxhall	32, 49, 58, 75
DG-171	Fiat, Lancia, Opel, Suzuki, Vauxhall	40, 49, 58, 69, 75
DG-172	Hyundai	46
DG-173	Hyundai, Kia	46, 49
DG-174	Mitsubishi	54
DG-175	Chevrolet, GMC, Hummer	35, 45, 46
DG-176	Chrysler, Jeep	36, 48
DG-177	Seat, Skoda, Volkswagen	67, 68, 77

NEW GLOW PLUG TYPES		Page
DG-178	BMW	34
DG-236	Hino	46
DG-238	Toyota	70
DG-239	Toyota	70
DG-241	Toyota	70
DG-242	Toyota	70
DG-243	Toyota	70
DG-245	Toyota	70
DG-246	Toyota	70
DG-306	Mitsubishi	54
DG-307	Nissan	56
DG-308	Toyota	70
DG-309	Toyota	70
DG-310	Toyota	70
DG-400	Toyota	70
DG-401	Lexus	50

Application Tables





KW



ALFA ROMEO										
6										
2.5	D	77		VM-HR588HT	06/83 -> 02/87	5	DG-202	11V		
33										
1.8	TD	54,62		VM82A, VM96A	09/86 -> 03/94	3	DG-202	11V		
1.8	TD	62		VMHR-392	09/86 -> 03/94	3	DG-202	11V		
75										
2.0	TD	70		VM80A	05/85 -> 02/92	4	DG-202	11V		
2.4	TD	81		VM81A	10/88 -> 02/92	4	DG-202	11V		
90										
2.4	TDi	81		VM81A	10/84 -> 01/87	4	DG-202	11V		
145										
1.9	TD	66		AR67501 (AR67.502NO)	04/94 -> 09/96	4	DG-001	11V		
1.9	TD	66		AR33601	10/96 -> 09/97	4	DG-001	11V		
1.9	JTD	77		AR32302	01/98 -> 01/01	4	DG-127	11V		
146										
1.9	TD	66		AR67501 (AR67502NO)	02/95 -> 09/96	4	DG-001	11V		
1.9	TD	66		AR33601	10/96 -> 09/97	4	DG-001	11V		
1.9	JTD	77		AR32302	01/98 -> 01/01	4	DG-127	11V		
147										
1.9	JTD	81		937A2.000	03/01 ->	4	DG-122	11V		
1.9	JTD	103		192A5.000	11/02 ->	4	DG-170	11V		
1.9	JTD	74		182B9.000	06/03 ->	4	DG-122	11V		
1.9	JTDm	88		AR37101	07/05 ->	4	DG-122	11V		
1.9	JTDm	110		937A5.000	07/05 ->	4	DG-170	11V		
155										
1.9	TD	66		AR67502	04/93 -> 04/96	4	DG-001	11V		
2.5	TD	92		VM07, VM31B, VM425CLIEA	04/93 -> 04/95	4	DG-001	11V		
2.5	TD	92		VM07, VM31B, VM425CLIEA	05/95 -> 01/98	4	DG-109	11V		
156										
1.9	JTD	76		AR32302	01/98 ->	4	DG-127	11V		
1.9	JTD	81		AR37101	10/00 -> 05/01	4	DG-122	11V		
1.9	JTD	85		937A2.000	05/01 ->	4	DG-122	11V		
1.9	JTD	103		192A5.000	11/02 ->	4	DG-170	11V		
2.4	JTD	100		AR32501	01/98 -> 09/00	5	DG-122	11V		
2.4	JTD	100		AR32501	02/98 -> 11/99	5	DG-127	11V		
2.4	JTD	103		839A6.000	10/00 ->	5	DG-122	11V		
2.4	JTD	110		841C.000	03/02 ->	5	DG-122	11V		
2.4	JTD	129		841G.000	11/03 ->	5	DG-122	11V		
159										
1.9	JTDm	88	8V		09/05 ->	4	DG-122	11V		
1.9	JTDm	110	16V	939A2.000	09/05 ->	4	DG-170	11V		
2.4	JTDm	147		939A3.000	09/05 ->	5	DG-170	11V		
164										
2.5	TD	85		VM84A	06/87 -> 08/92	4	DG-202	11V		
2.5	TD	92	Super	VM08B.0000001, VM425-SLIRA	09/92 -> 04/95	4	DG-001	11V		
2.5	TD	92	Super	VM08B, VM32B (VM425-SLIRA)	05/95 -> 09/98	4	DG-109	11V		
166										
2.4	JTD	100		AR34202	10/98 -> 09/00	5	DG-127	11V		
2.4	JTD	103		AR36202	10/00 ->	5	DG-122	11V		
2.4	JTD	110		841C.000	04/02 ->	5	DG-122	11V		
2.4	JTD	129		841G.000, 841H.000	10/03 ->	5	DG-170	11V		
Alfetta										
2.0	TD	60,62		VM 4 HT/2	10/79 -> 03/83	4	DG-202	11V		
2.4	TD	69,70		VM 4 HT 2.4	04/83 -> 12/84	4	DG-202	11V		
AR6										
2.5	D	53	10,13,14	8144.62 (8144.61.200, 8144.67.220-814467220)	04/85 -> 02/86	4	DG-001	11V		
AR8										
2.5	D	53		8140.61.200	02/80 -> 06/82	4	DG-001	11V		
2.5	D	53		8140.61.200	07/82 -> 09/83	4	DG-001	11V		
2.5	D	53		8140.61.200	10/83 -> 12/89	4	DG-001	11V		
Giulietta										
2.0	TD	61		VM 4 HT	04/83 -> 04/85	4	DG-120	11V		
GT										
1.9	JTD	110		937A5.000	11/03 ->	4	DG-170	11V		



KW



ALPINA							
D10 (E39)							
3.0	D	180	Biturbo		09/99 ->	6	DG-145 11V
ARO							
240							
2.5	Di	55		XUD	03/77 -> 09/86	4	DG-001 11V
240-244,246							
2.5	D	55		Peugeot XD 3P	10/83 -> 12/93	6	DG-001 11V
2.5	D	70		Peugeot XD 3TP	10/83 -> 12/93	6	DG-001 11V
241							
2.5	Di	55		XUD	03/77 -> 09/86	4	DG-001 11V
242							
2.5	Di	55		XUD	03/77 -> 09/86	4	DG-001 11V
244							
2.5	Di	44		XUD	03/77 -> 09/86	4	DG-001 11V
ASIA MOTORS							
Rocsta							
2.2	D	45		R2	06/93 -> 09/99	4	DG-114 7V
AUDI							
80							
1.6	D	40		CR,JK	08/80 -> 07/89	4	DG-002 11V
1.6	TD	51		CY	02/82 -> 03/87	4	DG-002 11V
1.6	TD	59		RA	04/88 -> 07/90	4	DG-002 11V
1.6	TD	59		SB	04/88 -> 12/91	4	DG-002 11V
1.9	D	47		1Y	08/89 -> 12/91	4	DG-002 11V
1.9	TD	55		AAZ	09/91 -> 07/95	4	DG-002 11V
1.9	TDi	66	Avant,Cabrio	1Z	09/91 -> 07/95	4	DG-005 11V
1.9	TDi	66	Avant,Cabrio	1Z	09/91 -> 07/95	4	DG-005 11V
90							
1.6	TD	51		CY	10/84 -> 03/87	4	DG-002 11V
1.6	TD	59		RA	04/88 -> 07/90	4	DG-002 11V
1.6	TD	59		SB	04/89 -> 12/91	4	DG-002 11V
100							
2.0	D	51	Avant	CN	08/82 -> 11/90	5	DG-002 11V
2.0	TD	51		CN	08/78 -> 07/89	5	DG-002 11V
2.0	TD	66	Avant	DE	11/81 -> 12/87	5	DG-002 11V
2.0	TD	75	Avant	NC	03/88 -> 12/90	5	DG-002 11V
2.4	D	60	Avant	3D,AAS	08/89 -> 07/94	5	DG-002 11V
2.5	TDi	85,88	Avant	AAT, ABP, 1T	04/91 -> 07/94	5	DG-005 11V
A2							
1.2	TDi	45		ANY	02/00 ->	3	DG-005 11V
1.4	TDi	55		AMF	02/00 -> 08/03	3	DG-109 11V
1.4	TDI	55		AMF, BHC	09/03 ->	3	DG-177 * 5V
1.4	TDI	66		ATL	11/03 ->	3	DG-177 * 5V
A3							
1.9	TDi	66,81,85		AGR, AHF, AJM, ALH	09/96 -> 05/03	4	DG-005 11V
1.9	TDi	81		ASV	01/97 -> 07/98	4	DG-005 11V
1.9	TDi	66		ANU	08/98 ->	4	DG-005 11V
1.9	TDi	96		ASZ	10/00 -> 05/03	4	DG-005 11V
1.9	TDi	74		ATD	10/00 ->	4	DG-005 11V
1.9	TDi	74		AXR	10/00 -> 09/01	4	DG-005 11V
1.9	TDi	74,77		AZV, BKD	03/03 ->	4	DG-109 11V
1.9	TDI	77	Chassis No. 70251->	BKC	05/03 ->	4	DG-177 * 5V
A4							
1.9	D	55,66		AFF, AHH	03/96 -> 07/97	4	DG-005 11V
1.9	TDi	66		1Z	01/95 -> 07/96	4	DG-005 11V
1.9	TDi	81		AFN	02/96 -> 06/00	4	DG-005 11V
1.9	TDi	66		AFF	03/96 -> 06/00	4	DG-005 11V
1.9	TDi	66		AHU	08/96 -> 06/00	4	DG-005 11V
1.9	TDi	85		AJM	01/98 -> 12/98	4	DG-005 11V
1.9	TDi	81		AVG	08/99 -> 06/00	4	DG-005 11V
1.9	TDi	85		ATJ	03/00 -> 09/01	4	DG-005 11V
1.9	TDi	74		ATD	09/01 ->	4	DG-005 11V

* Available from Jan. 2007



KW



AUDI (continued)								
1.9	TDi	74	(8E2, B6)	AVB	09/01 -> 04/04	4	DG-005	11V
1.9	TDi	96	Avant	AVF, AWX	01/01 ->	4	DG-005	11V
1.9	TDi	85	Chassis No. 70251->	BKE	11/04 ->	4	DG-177 *	5V
2.5	TDi	110	Avant	AFB, AKN	09/97 -> 09/01	6	DG-144	11V
2.5	TDi	110	Avant	AKE, AVL	11/00 ->	6	DG-144	11V
2.5	TDi	120		BFC, BDG, BCZ	07/02 ->	6	DG-144	11V
A4 Quattro								
2.5	TDi	110		AFB, AKN	08/97 ->	6	DG-144	11V
2.5	TDi	132		AKE, AVL	11/00 ->	6	DG-144	11V
2.5	TDi	114		AYM	08/01 -> 07/02	6	DG-144	11V
2.5	TDi	120		BFC	05/02 ->	6	DG-144	11V
A6								
1.9	TDi	66		1Z, AHU	07/94 -> 10/97	4	DG-005	11V
1.9	TDi	66		AFN	04/97 -> 04/01	4	DG-005	11V
1.9	TDi	85	Avant	AJM	01/98 -> 04/01	4	DG-005	11V
1.9	TDi	96		AVF, AWX	07/01 ->	4	DG-005	11V
2.5	TDi	85,103		AAT, AEL	06/94 -> 10/97	5	DG-005	11V
2.5	TDi	110		AFB	04/97 -> 07/98	6	DG-144	11V
2.5	TDi	110		AKN	07/98 -> 05/01	6	DG-144	11V
2.5	TDi	132		AKE	02/00 ->	6	DG-144	11V
2.5	TDi	114		AYM	08/01 -> 06/02	6	DG-144	11V
2.5	TDi	114		BFC	05/02 ->	6	DG-144	11V
2.5	TDi	120		BFC, BDG, BCZ	07/02 ->	6	DG-144	11V
A8								
2.5	TDi	110		AFB	06/97 -> 09/98	6	DG-144	11V
2.5	TDi	110		AKN	07/98 -> 09/98	6	DG-144	11V
A8 Quattro								
2.5	TDi	110		AFB, AKN	11/97 -> 09/98	6	DG-144	11V
2.5	TDi	132		AKE	09/00 ->	6	DG-144	11V
3.3	TDi	165		AKF	09/99 -> 09/02	8	DG-144	11V
Allroad								
2.5	TDi	132		AKE	05/01 ->	8	DG-144	11V
Cabrio								
1.9	TDi	66		1Z	07/95 -> 06/96	4	DG-005	11V
1.9	TDi	66		AHU	07/96 -> 11/00	4	DG-005	11V
AUVERLAND								
A3								
1.9	D	47		XUD9	04/87 ->	4	DG-001	11V
2.1	TD	60		XUD11A	10/91 ->	4	DG-001	11V
AVIA								
A21.1								
All	D				10/90 ->	4	DG-001	11V
Avia								
3.6	D	65		D407	-> 01/93	4	DG-001	11V
BMW								
1-SERIES								
118 (E87)	D	90		M47 N204 D4	09/04 ->	4	DG-178 *	5V
120 (E87)	D	120		M47 N204 D5	09/04 ->	4	DG-178 *	5V
3-SERIES								
318 (E36)	TDS	66		M41	09/94 -> 01/98	4	DG-001	11V
318 (E46)	D	85		M47 204 D1	09/01 -> 03/03	4	DG-178 *	5V
318 (E46)	D	85		M47 N204 D4	03/03 -> 02/05	4	DG-178 *	5V
318 (E90)	D	90			09/05 ->	4	DG-178 *	5V
318 Compact (E36)	TDS	66		M41 D18U	03/94 -> 07/01	4	DG-001	11V
318 Compact (E46)	TD	85		M47 N204 D4	03/03 ->	4	DG-178 *	5V
320 (E46)	D	100		M47 D20	04/98 -> 09/01	4	DG-145	11V
320 (E46)	D	110		M47 N204 D4	09/01 -> 02/05	4	DG-178 *	5V
320 (E90)	D	120		M47 N204 D5	01/05 ->	4	DG-178 *	5V
320 Compact (E46)	TD	110		M47 N204 D4	09/01 ->	4	DG-145	11V
324 (E30)	D	63		M21 D24	09/85 -> 08/91	6	DG-001	11V
324 (E30)	TD	85	Touring	M21 D24	09/86 -> 08/93	6	DG-001	11V
325 (E36)	TD	85		M51	09/91 -> 01/98	6	DG-001	11V

* Available from Jan. 2007



KW



BMW (continued)									
325 (E36)	TDS	105		M51	08/93 -> 03/98	6	DG-001	11V	
330 (E46)	Di	135	Touring	DDE306, M57 D30	08/99 -> 02/05	6	DG-145	11V	
330 (E46)	D	135		M57306D1	08/00 -> 02/05	6	DG-145	11V	
330 (E46)	D	150		M57 N306 D2	03/03 -> 02/05	6	DG-178 *	5V	
330 (E90)	D	170			09/05 ->	6	DG-178 *	5V	
330 (E46)	Di	135	Touring	M57 D30	06/00 -> 02/05	6	DG-145	11V	
5-SERIES									
520 (E39)	Di	110		M47 D20	06/02 ->	4	DG-145	11V	
520 (E39)	D	100		M47 D20	02/00 -> 05/02	4	DG-145	11V	
520 (E60/61)	D	120		M47 N204 D5	07/05 ->	4	DG-178 *	5V	
524 (E28)	D	63		M21 D24	05/86 -> 12/87	6	DG-001	11V	
524 (E34)	TD	85		M21	03/88 -> 09/91	6	DG-001	11V	
524 (E28)	TD	85		M21 D24T/U	09/83 -> 12/87	6	DG-001	11V	
525 (E39)	D	120	Touring	M57 D25	02/00 -> 06/03	6	DG-145	11V	
525 (E60/61)	D	130		M57 N256 D4	06/04 ->	6	DG-178 *	5V	
525 (E34)	TD	85		M51 D25	09/91 -> 12/96	6	DG-001	11V	
525 (E34)	TDS	105	Touring	M51 D25	08/93 -> 01/96	6	DG-001	11V	
525 (E39)	TDS	105		M51 D25	01/96 -> 06/03	6	DG-001	11V	
525 (E39)	TDS	85		M51 D25	01/97 -> 06/98	6	DG-001	11V	
525 (E39)	TDS	120		M57 D25	02/00 -> 06/03	6	DG-145	11V	
525 (E39)	TDS	120	Touring	M57 D25	02/00 -> 05/04	6	DG-145	11V	
530 (E39)	D	135	Touring	M57 D30	05/98 -> 09/00	6	DG-145	11V	
530 (E60/61)	D	160-170		M57 N306 D2	07/03 ->	6	DG-178 *	5V	
535 (E60/61)	D	200		M57 N306 D4	09/04 ->	6	DG-178 *	5V	
7-SERIES									
725 (E38)	TDS	105		M51 D25	02/96 -> 09/98	6	DG-001	11V	
730 (E38)	D	135		M52 D30H	05/98 -> 04/00	6	DG-145	11V	
730 (E38)	D	142		M52 D30H	04/00 ->	6	DG-145	11V	
730 (E65/66)	D / LD	170		M57 N306 D2	10/02 ->	6	DG-178 *	5V	
740 (E38)	TD	180		M 67 D40	01/99 ->		DG-118	11V	
X3									
2.0 (E83)	D	110		M47 N204 D4	10/04 ->	4	DG-178 *	5V	
3.0 (E83)	D	160		M54 N306 D2	01/04 ->	6	DG-178 *	5V	
X5									
2.9 (E53)	Di	135		M57 D30	05/01 -> 06/03	6	DG-145	11V	
3.0 (E53)	D	160		M57 N306D4	12/03 ->	6	DG-178 *	5V	
CARBODIES									
Fairway									
2.7	D			(Nissan)	06/89 -> 12/98		DG-137	11V	
2.7	D	64		27TD	06/89 -> 12/98	4	DG-001	11V	
FX Taxi									
2.3	D	46		HL23R	01/61 -> 04/85	4	DG-001	11V	
FX4									
2.5	D	59			08/83 -> 12/92	4	DG-001	11V	
CHEVROLET									
Blazer									
6.2	D	105		16V	1982 -> 1984	8	DG-175	10.5V	
6.2	D	105		16V	1983 -> 1992	8	DG-175	10.5V	
V8									
6.2	D, TD					8	DG-175	10.5V	
6.5	D, TD					8	DG-175	10.5V	
C10									
All	D				1983 ->		DG-175	10.5V	
C20									
All	D				1983 ->		DG-175	10.5V	
C30									
All	D				1983 ->		DG-175	10.5V	
C3500									
6.5	D		Pickup		2000 -> 2003	8	DG-175	10.5V	
Express 2500									
6.5	D				2000 -> 2002	8	DG-175	10.5V	
Express 3500									
6.5	D				2000 -> 2002	8	DG-175	10.5V	

* Available from Jan. 2007



KW



CHEVROLET (continued)										
K10										
All	D							1983 ->	DG-175	10.5V
K20										
All	D							1983 ->	DG-175	10.5V
K30										
All	D							1983 ->	DG-175	10.5V
K2500										
6.5	D		Pickup					2000 ->	8	DG-175 10.5V
K3500										
6.5	D		Pickup					2000 ->	8	DG-175 10.5V
P20										
All	D							1983 ->	DG-175	10.5V
P30										
All	D							1983 ->	DG-175	10.5V
CHEVROLET (DAEWOO)										
Daewoo										
1.9	D	40		F8Q-290				02/99 -> 01/05	4	DG-112 11V
1.9	D	40		F8Q-292				06/99 -> 01/05	4	DG-112 11V
Korando										
2.9	D	73		MB-OM662				01/99 -> 01/05	5	DG-010 11.5V
2.9	TD	88		MB-OM601				01/99 -> 01/05	5	DG-010 11.5V
Musso										
2.2	TD	74		MB OM 601				09/99 ->	4	DG-010 11.5V
2.3	TDi	88		OM661LA				01/99 -> 01/05	4	DG-010 11.5V
2.9	D	73		OM622LA				01/99 -> 01/05	5	DG-010 11.5V
2.9	TD	73		MB-OM60129TD				01/99 -> 09/99	5	DG-010 11.5V
Rexton										
2.9	TD	88						04/02 ->	5	DG-010 11.5V
CHRYSLER										
Grand Voyager										
2.5	TD	85,87		HR425 CLI				04/92 -> 04/95	4	DG-001 11V
2.5	TD	85,88		VM HR425 CLIEE				05/95 -> 04/01	4	DG-109 11V
Jeep Cherokee										
2.1	TD	59,65		Renault J8S, J8S 814				01/87 -> 08/95	4	DG-001 11V
2.1	TD	65		Renault J8S 890				01/88 -> 01/91	4	DG-001 11V
2.1	TD	65		Renault J8S 890				02/91 -> 08/94	4	DG-006 11V
2.5	TD	85,87		VM HR425 CLIRX				10/94 ->	4	DG-001 11V
Jeep Grand Cherokee										
2.5	TD	88		VM HR492/VM 425CLIRE				01/93 ->	4	DG-001 11V
2.5	TD	110		ENC				04/99 ->	5	DG-109 11V
3.1	TD	103		EXA				04/99 ->	5	DG-109 11V
Laredo										
2.1	TD	64		MOT.Renault				07/88 ->	6	DG-001 11V
PT Cruiser										
2.2	CRD	89		EDJ				03/02 ->	4	DG-117 11V
Voyager										
2.2	TD	89		VM HR 492 /VM 425 CLIRE				06/92 -> 01/96	4	DG-001 11V
2.5	TD	85,88		VM HR 425 CLIEE				04/92 -> 04/95	4	DG-001 11V
2.5	TD	88		VM				05/95 -> 04/01	4	DG-109 11V
2.5	CRD	105		ENC, ENJ				02/00 ->	4	DG-176 * 11.5V
2.8	CRD	110		ENR				06/04 ->	4	DG-176 * 11.5V
Wrangler										
2.1	TD	64	(Laredo,Sahara,Texan)	MOT.Renault				07/88 ->	6	DG-001 11V
CITROËN										
AX										
1.4	D	37,39	14	TUD3, TUD3Y, TUD3L				09/88 -> 09/94	4	DG-004 11.5V
1.5	D	40,43		TUD5				10/94 -> 04/97	4	DG-003 11V
Berlingo										
1.8	D	43		XUD7				08/96 ->	4	DG-001 11V
1.8	D	43		XUD7				08/96 -> 08/98	4	DG-001 11V
1.8	TD			DW8TD				09/98 ->	4	DG-003 11V
1.9	D	51		XUD9A				07/96 -> 08/98	4	DG-001 11V

* Available from Jan. 2007



KW



CITROËN (continued)							
1.9	D	52		DW8B	07/98 ->	4	DG-003 11V
1.9	Di	51		XUD9A	09/98 ->	4	DG-001 11V
2.0	HDi	66		DW10	10/99 ->	4	DG-116 11V
BX							
1.8	D,TD	44,66	17	XUD 7T	03/88 -> 07/93	4	DG-001 11V
1.9	D	47,51	19	XUD9,A,L,T	09/83 -> 12/94	4	DG-001 11V
C1							
1.4	HDi	40		DV4D	06/05 ->	4	DG-113 11V
C2							
1.4	HDi	50		DV4TD (8HX)	2003 ->	4	DG-113 11V
C3							
1.4	HDi	50		DV4	02/02 ->	4	DG-113 11V
1.4	HDi	66		DV4TED4	02/02 ->	4	DG-113 11V
C4							
1.6	HDi	80	110 FAP	DV6TED4	11/04 ->	4	DG-113 11V
C5							
2.0	HDi	66,80		DW10TD, DW10TED	01/01 ->	4	DG-116 11V
2.2	HDi	98		DW12TED4	01/01 ->	4	DG-116 11V
C6							
2.7	HDi	150	208 FAP	DT17TED4 (UHZ)	09/05 ->	6	DG-140 11V
C8							
2.0	HDi	66,80		DW10TD, DW10TED	07/02 ->	4	DG-116 11V
2.2	HDi	98		DW12TED4	2002 ->	4	DG-116 11V
C15							
1.8	D	44		XUD7	06/85 -> 05/95	4	DG-001 11V
1.8	D	44		XUD7	06/95 ->	4	DG-001 11V
1.9	D	51		DW8B	07/98 ->	4	DG-003 11V
C25							
1.9	D	51		XU9DA	07/87 -> 01/94	4	DG-001 11V
2.5	D	54		CRD 93	07/81 -> 12/86	4	DG-001 11V
2.5	TD	70		CRD 93 LS	04/87 -> 01/94	4	DG-001 11V
C32							
2.2	D	45		CRD90	04/79 -> 12/79	4	DG-001 11V
C35							
2.2	D	45		CRD90	04/79 -> 12/79	4	DG-001 11V
2.5	D	50		CRD 93 B	01/80 -> 01/94	4	DG-001 11V
C45							
2.5	D	50		CRD 93 B	06/82 ->	4	DG-001 11V
CX							
2.5	D	55		M25-629	04/78 -> 06/82	4	DG-001 11V
2.5	D	54		M25-629	07/82 -> 06/88	4	DG-001 11V
2.5	D	54	25 Pallas	M25-660	07/82 -> 12/92	4	DG-001 11V
2.5	TD	78,106		M25-669,671	01/87 -> 12/92	4	DG-001 11V
Dispatch							
1.9	D	51		XUD9AU	03/94 -> 08/98	4	DG-001 11V
1.9	D	51		XUD9AU	09/98 ->	4	DG-001 11V
1.9	TD	68		XUD9TF	03/94 -> 08/98	4	DG-001 11V
1.9	TD	68		XUD9TF	09/98 ->	4	DG-001 11V
2.0	HDi	80		DW10	09/98 ->	4	DG-116 11V
2.4	D	63		DJ5	03/94 -> 08/98	4	DG-001 11V
2.4	D	63		DJ5	09/98 ->	4	DG-001 11V
2.4	TD	76		DJ5T	03/94 -> 08/96	4	DG-001 11V
2.5	TDi	79		DJ5TED	09/96 ->	4	DG-161 11V
Evasion							
1.9	TD	68		XUD9TF, XUD9BTF	07/94 -> 08/98	4	DG-001 11V
1.9	TD	68		XUD9TF, XUD9BTF	09/98 -> 10/02	4	DG-001 11V
2.0	HDi	80		DW10ATED	07/99 -> 10/02	4	DG-116 11V
2.0	TD	68		DHX	05/97 -> 10/02	4	DG-001 11V
2.1	TD	80		XUD11BTE	05/96 -> 04/97	4	DG-001 11V
2.1	TD	80		XUD11BTE	05/97 -> 10/02	4	DG-001 11V
Jumper							
1.9	D	51		XUD9AU	03/94 -> 05/95	4	DG-001 11V
1.9	D	51		XUD9, XUD9AU	06/95 ->	4	DG-001 11V
1.9	TD	68		XUD9TF	03/94 ->	4	DG-001 11V
1.9	TD	68		XUD9TF	09/98 ->	4	DG-001 11V



KW



CITROËN (continued)								
2.0	HDi	66,80		DW10, DW10TD	09/98 ->	4	DG-116	11V
2.2	HDi	74		DW12TED	04/02 ->	4	DG-116	11V
2.5	D	63		DJ5	03/94 ->	4	DG-001	11V
2.5	D	63		DJ5TE	03/94 -> 08/96	4	DG-001	11V
2.5	D	63	1400,1800 (Minibus)	DJ5	03/94 ->	4	DG-001	11V
2.5	TD	63	1400,1800 (Minibus)	DJ5TE	03/94 -> 12/96	4	DG-001	11V
2.5	TDi	76	1400,1800 (Minibus)	DJ5TED	09/96 ->	4	DG-161	11V
2.5	TDi	76		DJ5TED	09/96 ->	4	DG-161	11V
2.8	TDi	94			09/00 ->	4	DG-111	11V
Jumpy								
1.9	D	55		XUD9A	09/95 ->	4	DG-001	11V
1.9	D	51		DW8	07/98 ->	4	DG-003	11V
1.9	TD	66,68		XUD9TF	09/95 ->	4	DG-001	11V
2.0	HDi	69		RHX	10/99 ->	4	DG-116	11V
2.0	HDi	80		DW10ATED, BTED, TED4	2000 ->	4	DG-116	11V
Relay								
1.8	D	51		DW8	09/98 ->	4	DG-003	11V
1.8	TD			DW8TD	09/98 ->	4	DG-003	11V
1.9	D	51		XUD9A	09/95 ->	4	DG-001	11V
1.9	TD	68		XUD9TF	09/95 -> 08/98	4	DG-001	11V
1.9	TD	68		XUD9TF	09/98 ->	4	DG-001	11V
2.0	HDi	80		DW10	2000 ->	4	DG-116	11V
Saxo								
1.5	D	37,40,42		TUD5,5B	02/96 -> 10/03	4	DG-003	11V
Synergie								
1.9	TD	68		XUD9TF, XUD9BTF	01/94 -> 08/98	4	DG-001	11V
1.9	TD	51		DW8	09/98 ->	4	DG-003	11V
1.9	TD	68		XUD9TF, XUD9BTF	09/98 ->	4	DG-001	11V
2.0	HDi	80		DW10ATED	07/99 ->	4	DG-116	11V
2.1	TD	80		XUD11BTE	05/96 -> 08/98	4	DG-001	11V
2.1	TD	80		XUD11BTE	09/98 -> 2002	4	DG-001	11V
Visa								
1.8	D	44		XUD7	01/87 -> 03/91	4	DG-001	11V
Xantia								
1.9	D	51		XUD9 AL	03/93 -> 01/96	4	DG-001	11V
1.9	D			XUD9SD	06/94 ->	4	DG-001	11V
1.9	D	55		XUD9A	02/96 -> 08/98	4	DG-001	11V
1.9	TD	66,68		XUD9BTF	03/93 -> 08/98	4	DG-001	11V
1.9	TD	66,68		XUD9BTF	09/98 ->	4	DG-001	11V
2.0	HDi	66,80		DW10TD, DW10ATED	07/98 ->	4	DG-116	11V
2.1	TD	80		XUD11BTE	05/95 -> 08/98	4	DG-001	11V
2.1	TD	80		XUD11BTE	09/98 ->	4	DG-001	11V
XM								
2.1	D	60		XUD 11A,L	05/89 -> 06/95	4	DG-001	11V
2.1	TD	80		XUD 11ATE,L,BTE	05/89 -> 05/01	4	DG-001	11V
2.1	TD	80		XUD11ATE,BTE	07/94 -> 08/98	4	DG-001	11V
2.1	TD	80		XUD11ATE,BTE	09/98 -> 12/00	4	DG-001	11V
2.5	TD	96		DKSATE	07/94 -> 05/01	4	DG-001	11V
Xsara								
1.4	HDi	50		DV4	2003 ->	4	DG-113	11V
1.5	D	42		TUD5	09/97 ->	4	DG-003	11V
1.8	D	45		XUD7	09/97 ->	4	DG-001	11V
1.9	D	50		XUD9A	09/97 ->	4	DG-001	11V
1.9	D	51		DW8,8B	04/98 ->	4	DG-003	11V
1.9	D	55		XUD9BSD	09/98 ->	4	DG-001	11V
1.9	TD	66		XUD9TE, XUD9TE/Y	09/97 -> 08/98	4	DG-001	11V
1.9	TD	68		XUD9TE, XUD9BSD	09/98 ->	4	DG-001	11V
2.0	HDi	66,68		DW10TD	04/99 ->	4	DG-116	11V
Xsara Picasso								
1.6	HDi	80	110 FAP	DV6TED4	05/04 ->	4	DG-113	11V
2.0	HDi	66,80		DW10TD, DW10ATED	12/99 ->	4	DG-116	11V
ZX								
1.4	D	37,39		TUD3Y	06/94 -> 10/97	4	DG-004	11.5V
1.5	D	42		TUD5	10/94 -> 06/98	4	DG-003	11V
1.8	D	44		XUD7	03/91 -> 04/94	4	DG-001	11V



KW



CITROËN (continued)							
1.8	D	44		XUD7	05/94 -> 06/98	4	DG-001 11V
1.9	D	47,52		XUD 9A,L	03/91 -> 04/94	4	DG-001 11V
1.9	D	47,52		XUD 9A,L	05/94 -> 06/98	4	DG-001 11V
1.9	TD	66,68		XUD9T,L	09/92 -> 04/94	4	DG-001 11V
1.9	TD	66,68		XUD9T,L	05/94 -> 06/98	4	DG-001 11V
DACIA							
Duster							
All	D				11/89 ->	4	DG-001 11V
Logan							
1.5	dCi	48		KqK790	09/05 ->	4	DG-107 11V
DAEWOO = CHEVROLET (DAEWOO)							
DAF							
400							
2.5	D	53	Peugeot	EN25LD	10/88 -> 12/94	4	DG-001 11V
2.5	TD	71	Peugeot	ET25LDT	10/88 -> 12/94	4	DG-001 11V
DAIHATSU							
Charade							
1.0	D	27		CL	->	3	DG-234 8.5V
1.0	D	27		CL10	01/83 ->	3	DG-223 7V
1.0	D	27		CL11/CL61/CL30	01/87 -> 01/93	3	DG-216 11V
1.0	D	27	M/T only	CL70/CL70 T	01/87 ->	3	DG-216 11V
1.0	TD	27	M/T only	CL50 TURBO	09/84 ->	3	DG-223 7V
Delta							
2.0	TD	63	12 Volt only	2C-T	08/88 ->	4	DG-223 7V
2.5	D	55	12 Volt only	DG	08/77 -> 04/81	4	DG-234 8.5V
2.8	D	51	12 Volt only	DL	02/83 -> 04/95	4	DG-223 7V
3.0	D	59	24 Volt only	B	09/80 -> 07/88	4	DG-222 14V
3.0	D	59	24 Volt only	B	08/88 -> 04/95	4	DG-219 23V
3.4	D	68	24 Volt only	3B	05/95 ->	4	DG-219 23V
3.4	D	68	12 Volt only	3B	02/83 -> 07/84	4	DG-232 10.5V
			24 Volt only	13B	09/84 -> 08/88	4	DG-222 14V
			24 Volt only	14B	08/88 -> 04/95	4	DG-219 23V
3.0	D	59	24 Volt only	B	01/72 -> 07/77	4	DG-226 19V
Delta Wide							
1.8	D		12 Volt only	1C	05/83 -> 08/87	4	DG-223 7V
1.8	D		12 Volt only	1C	08/87 -> 08/88	4	DG-216 11V
2.0	D	54	12 Volt only	2C	05/83 -> 08/85	4	DG-223 7V
2.0	D	54	12 Volt only	2C	08/88 -> 08/95	4	DG-216 11V
2.0	D	54	12 Volt only	2C	08/95 -> 11/96	4	DG-214 11V
2.0	TD	63	12 Volt only	2C-T	08/85 -> 08/87	4	DG-223 7V
2.0	TD	63	12 Volt only	2C-T	08/87 -> 08/95	4	DG-216 11V
2.2	TD	67	12 Volt only	3C-T	09/93 -> 11/96	4	DG-305 11V
Hijet							
1.2	D	27		LDW	05/95 -> 02/98	4	DG-125 12.5V
Rugger/Rocky							
2.8	D			DL / DL50	05/84 ->	4	DG-223 7V
Taft							
2.5	D	46		DG	08/78 -> 11/82	4	DG-234 8.5V
2.8	D	51		DL	12/82 -> 04/84	4	DG-223 7V
DALLAS							
Fun							
1.8	D	44		XUD7	02/93 ->	4	DG-001 11V
Torpedo							
1.8	D	44		XUD7	05/97 ->	4	DG-001 11V
Vescovato							
1.8	D	44		XUD7	02/93 ->	4	DG-001 11V
DANGEL							
504							
2.3	D	51		XD2	10/79 -> 12/94	4	DG-001 11V



KW



FIAT							
10							
1.9	TD	60		280.A1000....	01/90 ->	4	DG-001 11V
2.5	D	53		8.144.61	07/82 -> 12/85	4	DG-001 11V
14							
1.9	TD	60		280.A1000....	01/90 ->	4	DG-001 11V
2.5	Di	85			03/94 ->	4	DG-004 11.5V
2.5	TD	68		8.144.21	01/86 -> 06/90	4	DG-001 11V
2.5	TDi	81			03/94 ->	4	DG-004 11.5V
18							
2.5	TD	65,68		8.144.67	01/86 -> 06/90	4	DG-001 11V
127							
1.3	D	33			04/81 -> 05/83	4	DG-001 11V
1.3	D	33		127A5.000	06/83 -> 12/86	4	DG-001 11V
131							
2.0	D	44		8144.65	03/78 -> 01/84	4	DG-001 11V
131 Mirafiori							
2.0	D	44		8144.65	03/78 -> 01/84	4	DG-001 11V
2.5	D	53		8144.61	08/78 -> 12/84	4	DG-001 11V
132							
2.0	D	44		8144.65	03/78 -> 05/81	4	DG-001 11V
2.5	D	52		8144.61	03/78 -> 05/81	4	DG-001 11V
242							
2.5	D	50			09/79 -> 05/83	4	DG-001 11V
Argenta							
2.4	TD	66		8144.81	06/83 -> 11/85	4	DG-001 11V
2.5	D	53		8144.61	06/81 -> 11/85	4	DG-001 11V
Brava							
1.9	D	48		160A7.000	09/95 -> 03/96	4	DG-001 11V
1.9	JTD	76		182B4000	10/98 -> 2002	4	DG-127 11V
1.9	JTD	74		182B9000	09/00 -> 2002	4	DG-122 11V
1.9	TDi	55,74		182A7,A8.000	06/96 -> 2002	4	DG-102 11V
1.9	D	48		160A7.000	09/95 -> 03/96	4	DG-001 11V
1.9	JTD	76		182B4000	10/98 -> 2002	4	DG-127 11V
1.9	JTD	74		182B9000	09/00 -> 2002	4	DG-122 11V
1.9	TDi	55,74		182A7,A8.000	06/96 -> 2002	4	DG-102 11V
Campagnola							
2.4	D	52			06/79 -> 1983	4	DG-001 11V
2.5	D	53			1984 -> 10/86	4	DG-001 11V
CityVan							
1.3	D	33			04/86 -> 12/88	4	DG-001 11V
1.7	D	44			02/88 -> 12/90	4	DG-001 11V
Croma							
1.9	D	88	Multijet 8V	939A1.000	06/05 ->	4	DG-122 11V
1.9	TD	68		154C6000	03/88 -> 1997	4	DG-132 11V
1.9	TD	66		154D1000	09/89 -> 1995	4	DG-132 11V
2.5	D	55		8144.67	12/85 -> 12/89	4	DG-001 11V
2.5	D	55		8144.67	1990 -> 1997	4	DG-001 11V
2.5	TD	74,86		8144.91.200	12/85 -> 12/89	4	DG-001 11V
2.5	TD	74,86		8144.91.200,8144.97	01/93 -> 12/93	4	DG-001 11V
Daily							
All	D		(28F8,30F8,32F8,35F8,40F8)		04/78 -> 12/82	4	DG-001 11V
2.5	D	53		XD2D	02/80 -> 04/87	4	DG-001 11V
Doblo							
1.3	JTD	51		188A9.000	02/04 ->	4	DG-171 11V
1.9	D	46		223A6.000	01/01 ->	4	DG-129 11V
1.9	JTD	77		182B9.000	01/01 ->	4	DG-122 11V
Ducato							
1.9	D	51	10	230.A2.000	03/94 -> 04/02	4	DG-001 11V
1.9	D	50	10	DJY	04/98 ->	4	DG-003 11V
1.9	TD	60	14	280A1.000	01/90 -> 02/94	4	DG-001 11V
1.9	TD	59	10	230A4.000	03/94 -> 04/02	4	DG-001 11V
1.9	TD	60	14	230A3.001	03/94 -> 04/02	4	DG-001 11V
1.9	TD	60	10	230A3.000	03/94 ->	4	DG-001 11V
1.9	TD	66	10	DHX	04/98 ->	4	DG-001 11V
2.0	JTD	62		RHV (DW10)	10/01 -> 04/02	4	DG-116 11V



KW



FIAT (continued)								
2.0	JTD	62	244,Z	RHV(DW10)	04/02 ->	4	DG-116	11V
2.5	D	53	10	8140.61	04/78 -> 06/82	4	DG-001	11V
2.5	D	53	13	8144.61	07/82 -> 12/85	4	DG-001	11V
2.5	D	55	14	8144.67.220	01/86 -> 02/94	4	DG-001	11V
2.5	D	53	13	8140.62	04/87 -> 06/82	4	DG-001	11V
2.5	D	55	14, 4x4	8144.67.220	01/89 -> 02/94	4	DG-001	11V
2.5	D	64	18	8140.63	06/98 ->	4	DG-111	11V
2.5	TD	68	Maxi	8144.21.220	01/86 -> 02/94	4	DG-001	11V
2.5	TD	68	14	8144.21.220	01/86 -> 08/90	4	DG-001	11V
2.5	TD	68	18	8144.21.220	01/86 -> 08/90	4	DG-001	11V
2.5	TD	68	14, 4x4	8144.21.220	01/89 -> 02/94	4	DG-001	11V
2.5	TD	80	14		03/94 ->		DG-001	11V
2.5	TDi	70	14	8140.27	08/90 -> 03/94	4	DG-001	11V
2.8	JTD	94	18	8140.63	11/00 ->	4	DG-111	11V
2.8	JTD	94	244,Z	8140.43S	04/02 ->	4	DG-111	11V
Duna								
1.7	D	44			10/86 -> 12/90	4	DG-001	11V
1.7	D	44		149B3.000	01/87 -> 12/91	4	DG-001	11V
Fiorino								
1.3	D	33			03/82 -> 10/82	4	DG-001	11V
1.3	D	33	Pick-up	127A5.000	05/84 -> 12/88	4	DG-001	11V
1.3	D	33		146B.1000	06/90 -> 08/93	4	DG-001	11V
1.7	D	43		146.B.3000	12/87 -> 12/91	4	DG-001	11V
1.7	D	42		149B4.046	01/88 ->	4	DG-001	11V
1.7	D	42		146.B2.000	1992 ->	4	DG-001	11V
1.7	TD	46		146D7.000	1997 ->	4	DG-001	11V
Freeclimber								
2.4	TD	85		HR-492	10/88 -> 10/90	6	DG-001	11V
Grande Punto								
1.3	D	55	Multijet 75		10/05 ->	4	DG-171	11V
1.3	D	66	Multijet 90		10/05 ->	4	DG-171	11V
1.9	D	88	Multijet 120		10/05 ->	4	DG-122	11V
1.9	D	96	Multijet 130		10/05 ->	4	DG-122	11V
Idea								
1.3	JTD	51		188A9.000	01/04 ->	4	DG-171	11V
1.9	JTD	74		188B2.000	01/04 ->	4	DG-122	11V
Marea								
1.9	TD	55,74		182A7.000, 182A8.000	06/96 -> 04/99	4	DG-102	11V
1.9	JTD	76		182B4.000	10/98 -> 08/00	4	DG-122	11V
1.9	JTD	81		186A6.000	09/00 ->	4	DG-122	11V
2.4	TD	91		185A2.000	09/96 -> 04/99	5	DG-102	11V
2.4	JTD	100		185A6.000	10/98 -> 04/99	5	DG-127	11V
2.4	JTD	96		839A5.000	04/99 ->	5	DG-122	11V
2.4	JTD	100		185A6.000	04/99 ->	5	DG-122	11V
Marengo								
1.9	D	48		160A7.000	01/92 ->	4	DG-001	11V
1.9	TD	66		160.A6.000	01/92 -> 12/96	4	DG-001	11V
1.9	TD	66		160.A6.000	02/97 ->	4	DG-102	11V
2.0	D	48		149.A1..	01/86 -> 07/89	4	DG-001	11V
2.5	D	53		8144.61	05/80 -> 09/83	4	DG-001	11V
2.5	D			8144.61	10/83 -> 07/89	4	DG-001	11V
Multipla								
1.9	JTD	77		182B4.000	03/99 ->	4	DG-122	11V
1.9	JTD	81		186A6.000	09/00 -> 07/02	4	DG-122	11V
1.9	JTD	85		186A8.000	07/02 ->	4	DG-122	11V
Palio								
1.7	D	52		176A3.000	04/96 ->	4	DG-001	11V
1.7	TD	51		176A3.000	04/96 ->	4	DG-001	11V
1.9	D	46		223A6.000	10/00 ->	4	DG-129	11V
1.9	JTD	74		188A2.000	01/01 ->	4	DG-122	11V
Palio Weekend								
1.7	TD	51		176A3.000	07/97 ->	4	DG-001	11V
1.9	D	46		223A6.000	10/00 ->	4	DG-129	11V
Panda								
1.3	D	28		156A5.000	03/86 -> 08/92	4	DG-001	11V



KW



FIAT (continued)							
1,3	JTD	51		188A9.000	09/03 ->	4	DG-171 11V
Penny							
1.7	D	44			1988 -> 12/90	4	DG-001 11V
Punto							
1.3	JTD	51		188A9.000	06/03 ->	4	DG-171 11V
1.7	D	42		176A3.000	06/93 -> 1999	4	DG-001 11V
1.7	D	42		176A3000, 176B3000	04/94 -> 11/96	4	DG-001 11V
1.7	TD	53		176TD 1697 TT	06/93 -> 09/96	4	DG-001 11V
1.7	TD	46		176B7.000	09/96 -> 09/99	4	DG-001 11V
1.7	TD	53		176A5.000	10/96 -> 09/99	4	DG-001 11V
1.7	JTD	52		188A7.000	02/00 ->	4	DG-122 11V
1.7	TDS	52		176A5000	04/96 -> 02/00	4	DG-001 11V
1.9	Di	44		188A3000	02/00 ->	4	DG-129 11V
1.9	D	44		188A3.000	08/99 ->	4	DG-129 11V
1.9	JTD	59		188A2.000	08/99 ->	4	DG-122 11V
1.9	JTD	63		188A7.000	07/01 ->	4	DG-122 11V
Regata							
1.7	D	43		138 B., 149 B3	09/83 -> 07/89	4	DG-001 11V
1.9	D	48		149 A1.	04/84 -> 07/89	4	DG-001 11V
1.9	TD	59		831 D 1	06/87 -> 07/89	4	DG-001 11V
Ritmo							
1.7	D	43		138 B., 149 B3	10/79 -> 09/82	4	DG-001 11V
1.7	D	43		831 D 1	10/82 -> 08/88	4	DG-001 11V
1.7	D	44		138C.000	05/85 -> 12/87	4	DG-001 11V
1.9	TD	59		831 D 1	1986 -> 12/87	4	DG-001 11V
Scudo							
1.8	D	51		DW8,B	09/98 ->	4	DG-003 11V
1.8	TD	68		DW8TD	09/98 ->	4	DG-003 11V
1.9	D	51		D9B	1995 -> 07/98	4	DG-001 11V
1.9	TD	68		D8B	1995 -> 07/98	4	DG-001 11V
2.0	JTD	66,80		DW10ATED4, DWBTED, RHW	2000 ->	4	DG-116 11V
Stilo							
1.9	D	74			09/05 ->	4	DG-122 11V
1.9	D	88	Multijet 120		09/05 ->	4	DG-122 11V
1.9	JTD	59		192A3.000	10/01 ->	4	DG-122 11V
1.9	JTD	85			10/01 ->	4	DG-122 11V
1.9	JTD	81		192A1.000	10/01 -> 12/02	4	DG-122 11V
2.4	JTD	100		839A6.000	10/01 ->	4	DG-122 11V
Strada							
1.7	D	43		138 B., 149 B3	10/79 -> 09/82	4	DG-001 11V
1.7	D	43		831 D 1	10/82 -> 08/88	4	DG-001 11V
1.9	D	46		223A6.000	01/01 ->	4	DG-129 11V
1.9	TD	59			1986 -> 12/87	4	DG-001 11V
1.9	JTD	59		188A2.000	04/03 ->	4	DG-122 11V
Talento							
1.9	D	51			03/88 -> 12/93	4	DG-001 11V
Tempra							
1.9	D	48		160 A.000	02/90 -> 09/96	4	DG-001 11V
1.9	D	66	Station Wagon	160A6.000	02/90 -> 09/96	4	DG-001 11V
1.9	TD	59		160B6.046	07/90 -> 12/96	4	DG-001 11V
1.9	TD	66		160 D.1000	04/93 -> 09/96	4	DG-001 11V
Tipo							
1.7	D	42		149B4.000	06/88 -> 09/95	4	DG-001 11V
1.9	D	48		149A1.000	07/87 -> 03/93	4	DG-001 11V
1.9	TD	68		149A1.000	07/87 -> 03/93	4	DG-001 11V
1.9	TD	66		160A0.046	09/90 -> 04/95	4	DG-001 11V
1.9	TD	66		160D.1000	04/93 -> 09/95	4	DG-001 11V
1.9	TD	68		160A7.000	06/93 -> 10/95	4	DG-001 11V
Ulysse							
1.9	JTD	66		XUD9TU	09/94 -> 03/99	4	DG-001 11V
2.0	TD	80		XUD11 ATE	05/96 ->	4	DG-001 11V
2.0	TD	80		RHZ	10/99 ->	4	DG-116 11V
2.0	JTD	80		DW10ATED, RHW	12/99 ->	4	DG-116 11V
2.1	TD	80		P8C	08/96 -> 10/99	4	DG-001 11V
2.2	JTD	94		DW12ATED,4HW	04/03 ->	4	DG-116 11V



KW



FIAT (continued)									
Uno									
1.3	D	33,38		146B1000,146B1100	04/84 -> 12/91	4	DG-001	11V	
1.3	D,TD	33,52			06/83 -> 12/91	4	DG-001	11V	
1.4	D	52		160B300	04/84 -> 12/91	4	DG-001	11V	
1.4	D	52		146B300	01/92 -> 12/94	4	DG-001	11V	
1.4	D,TD	33,52			06/83 -> 12/94	4	DG-001	11V	
1.7	D				06/87 -> 12/94	4	DG-001	11V	
1.9	D	58		160B6000	01/89 -> 12/91	4	DG-001	11V	
1.9	TD	66		834D1000	01/89 -> 12/91	4	DG-001	11V	
FISSORE									
Magnum									
2.4	TD	77		Sofim 8144.81..	07/84 -> 04/86	6	DG-001	11V	
Rayton									
2.4	TD	82		HR 492 Him	03/88 ->	6	DG-202	11V	
FORD									
A Series									
2.4	D	46			01/78 -> 06/83	4	DG-130	11.5V	
2.4	D	46			01/78 -> 06/83	4	DG-002	11V	
Autobus									
2.3	D	46	V (VAS,VBL,VUL,VZS)	4AA	12/77 -> 10/86	4	DG-001	11V	
Courier									
1.8	D	44		RTC,RTD	04/91 ->	4	DG-004	11.5V	
1.8	D	66		RTJ,RTK	02/96 -> 07/98	4	DG-007	11.5V	
1.8	Di	55		RTP	01/00 -> 12/01	4	DG-007	11.5V	
Econovan									
2.0	D	41		RF, RF2	09/85 -> 04/92	4	DG-114	7V	
Escort									
1.6	D (3)	40		LTC	1983 -> 1986	4	DG-123	11V	
1.6	D (3)	40		LTA	04/84 -> 07/90	4	DG-123	11V	
1.6	D (4)	40		LTC	04/84 -> 07/90	4	DG-123	11V	
1.8	D (4)	44		RTA, RTB	01/89 -> 07/90	4	DG-004	11.5V	
1.8	D (5)	44		RTE,RTF,RTH	09/90 -> 02/96	4	DG-004	11.5V	
1.8	TD (5)	66		RFD, RFS	1990 -> 02/96	4	DG-004	11.5V	
1.8	TD (5)	66		RFD,RFK	08/90 -> 07/98	4	DG-004	11.5V	
1.8	TD (5)	51		RVA	08/90 -> 07/98	4	DG-007	11.5V	
1.8	TD (5)	66		RFS	01/95 -> 02/99	4	DG-007	11.5V	
1.8	TD (5)	66		RFD,RFK	10/98 -> 07/00	4	DG-004	11.5V	
Escort Van									
1.6	D	40			1983 -> 1989	4	DG-123	11V	
1.8	D	44			1988 -> 02/96	4	DG-004	11.5V	
Fiesta									
1.6	D (2)	40		LTB	04/84 -> 03/89	4	DG-123	11V	
1.8	D (3)	44		RTC, RTD, RTG	03/89 -> 11/95	4	DG-004	11.5V	
1.8	D (3)	44		RTK,RTJ	11/95 ->	4	DG-007	11.5V	
1.8	TD (3)	57			03/89 -> 12/95	4	DG-004	11.5V	
1.8	D (4)	44	Euro 2	D18NA,RTK,RTJ	11/95 -> 04/00	4	DG-007	11.5V	
1.8	Di (4)	55		RTQ Endura	01/00 -> 12/01	4	DG-007	11.5V	
1.8	Di (4)	55		RTN, RTP, RTQ Endura	04/00 ->	4	DG-007	11.5V	
1.8	TD (4)	57			11/95 ->	4	DG-007	11.5V	
1.4	TDCi (5)	50		DV4	2001 ->	4	DG-113	11V	
1.6	TDCi (5)	66		HHJA / HHJB	11/04 ->	4	DG-113	11V	
Fiesta Van									
1.6	D			D16	09/83 -> 05/89	4	DG-006	11V	
1.8	D			D18	06/89 -> 08/95	4	DG-007	11.5V	
1.8	D	44		RTC,RTD,RTG	09/91 -> 02/96	4	DG-004	11.5V	
1.8	D	44		RTK	02/96 ->	4	DG-007	11.5V	
1.8	D	44		RTJ,RTK	05/98 ->	4	DG-007	11.5V	
Focus									
1.6	TDCi	66		HHDA, HHDB	01/05 ->	4	DG-113	11V	
1.6	TDCi	80		G8BA / G8DA	11/04 ->	4	DG-113	11V	
1.8	Di	66		C9DC, C9DA, C9DB Endura	08/98 ->	4	DG-121	10V	
1.8	Di	55		BHDA,BHDB	08/98 ->	4	DG-121	10V	
1.8	Di	85		FFDA	12/01 ->	4	DG-121	10V	



KW



FORD (continued)							
1.8	Di	74		FFDA	07/02 ->	4	DG-121 10V
Focus C-Max							
1.6	TDCi	66			02/05 ->	4	DG-113 11V
1.6	TDCi	80		G8BA / G8DA	10/03 ->	4	DG-113 11V
Fusion							
1.4	TDCi	50		DV4	2001 ->	4	DG-113 11V
1.4	TDCi	50			06/03 ->	4	DG-113 11V
1.6	TDCi	66		HHJA / HHJB	11/04 ->	4	DG-113 11V
Galaxy							
1.9	TD	66		1Z,AHU,ANU	10/95 -> 10/01	4	DG-005 11V
1.9	TDi	81		AFN	02/95 -> 04/00	4	DG-005 11V
1.9	TDi	81		AVG	06/99 ->	4	DG-005 11V
1.9	TDi	85		AUY	04/00 -> 09/01	4	DG-005 11V
1.9	TDi	66		AHU, 1Z, ANU	10/01 ->	4	DG-109 11V
1.9	TDi	85		AUY	10/01 ->	4	DG-109 11V
Granada							
1.9	D	40			08/77 -> 08/82	4	DG-001 11V
2.1	D	44		WTA (GD)	09/78 -> 08/82	4	DG-001 11V
2.5	D	51		STP (PD)	08/82 -> 08/85	4	DG-001 11V
Maverick							
2.7	TD	74		TD27T	02/93 -> 07/96	4	DG-137 11V
2.7	TD	92		TD27E	08/96 -> 05/01	4	DG-137 11V
Mondeo							
1.8	TD	65		RFN,RFM	07/93 -> 08/96	4	DG-004 11.5V
1.8	TDi	66		D18TDi	09/96 -> 09/00	4	DG-007 11.5V
1.8	TD Di	66,85		R5BA	10/00 ->	4	DG-130 11.5V
2.0	TDi	66,85		D5BA,D6BA	10/00 ->	4	DG-130 11.5V
2.0	TDCi	96			2002 ->	4	DG-130 11.5V
2.2	TDCi	114		QJBA, QJBB	09/04 ->	4	DG-130 11.5V
Orion							
1.6	D	40		LTA	05/83 -> 11/85	4	DG-123 11V
1.6	D	40		LTC	12/85 -> 01/89	4	DG-123 11V
1.6	D	44		RTA, RTB	02/89 -> 07/90	4	DG-004 11.5V
1.8	D	44		RTA,RTH, RTB, RTF	02/89 -> 08/93	4	DG-004 11.5V
1.8	TD	66		RFD, RFK	02/89 -> 08/93	4	DG-004 11.5V
P100							
1.8	TD	55		RFA	03/87 -> 12/92	4	DG-004 11.5V
2.3	D	49		YTR,YTT	01/90 -> 12/92	4	DG-001 11V
Ranger							
2,5	D	57		WL (MD25NA)	10/99 -> 04/02	4	DG-146 11V
2,5	TD	80		WL-T (MD25TI)	10/99 ->	4	DG-146 11V
Scorpio							
2.5	D	51		STR	05/85 -> 10/92	4	DG-001 11V
2.5	TD	85		SCB	05/85 -> 10/94	4	DG-001 11V
2.5	TD	68		SFA,SFB	06/88 -> 08/93	4	DG-001 11V
2.5	TD	68		SFA,SFB	09/93 -> 10/94	4	DG-001 11V
2.5	TD	85		SCB,SCC (E2D36)	11/94 -> 06/96	4	DG-109 11V
2.5	TD	92		SCD	09/96 -> 08/98	4	DG-109 11V
Sierra							
1.8	TD	55		RFA,RFB,RFL	01/90 -> 04/93	4	DG-004 11.5V
2.3	D	49		YTR (PD23),YTT (PD)	09/82 -> 12/89	4	DG-001 11V
Sierra Sapphire							
1.8	TD	55		D18T	10/91 -> 03/93	4	DG-004 11.5V
2.3	D	49		PD23	03/87 -> 01/90	4	DG-001 11V
Tourneo							
2.0	Di	74			06/01 ->	4	DG-130 11.5V
Tourneo Connect							
1.8	Di	55			09/02 ->	4	DG-121 10V
1.8	TDi	66			09/02 ->	4	DG-121 10V
Transit							
2.0	Di	63			08/00 ->	4	DG-130 11.5V
2.0	TDi	55,74		D3FA,ABFA	03/99 ->	4	DG-130 11.5V
2.4	D			York/Standard	01/78 -> 06/83	4	DG-004 11.5V
2.4	D	46	FT 100/120/130	York	01/78 -> 06/83	4	DG-004 11.5V
2.4	Di	66		D2FE,D2FA	01/00 ->	4	DG-130 11.5V



KW



FORD (continued)							
2.4	Di	88		D4FA	01/00 ->	4	DG-130 11.5V
2.4	TDi	55		F4FA	01/00 ->	4	DG-130 11.5V
Transit Connect							
1.8	TDdi	55		BHPA, BHPB	09/02 ->	4	DG-121 10V
1.8	TDCi	66		HCPA, HCPC	09/02 ->	4	DG-121 10V
FSO							
Polonez							
1.9	D	51		XUD9A	1991 ->	4	DG-001 11V
G.M.E.							
Midi							
2.0	TD	51	Bedford	20DT	09/90 -> 08/94	4	DG-159 5V
2.2	D	45	Bedford	22DIE	06/88 -> 08/94	4	DG-159 5V
GAZ							
3302, Gaselle							
2.2	D	70		M-14 Steyer Engine (GAZ-560)	1995 ->	4	DG-005 11V
Volga 3110							
2.2	D	70		M-14 Steyer Engine (GAZ-560)	1995 ->	4	DG-005 11V
GMC							
Savana 2500							
6.5	D				2000 -> 2002	8	DG-175 10.5V
Savana 3500							
6.5	D				2000 -> 2002	8	DG-175 10.5V
C15							
All	D				1983 ->		DG-175 10.5V
C25							
All	D				1983 ->		DG-175 10.5V
C35							
All	D				1983 ->		DG-175 10.5V
C2500							
6.5	D		Pickup		2000 ->	8	DG-175 10.5V
C3500							
6.5	D		Pickup		2000 -> 2002	8	DG-175 10.5V
Chassis							
6.5	TD		0.5T		01/82 ->	8	DG-175 10.5V
6.5	TD		0.7T		01/82 -> 12/89	8	DG-175 10.5V
6.5	TD		1.0T		01/82 -> 12/98	8	DG-175 10.5V
6.5	TD		1.0T		01/99 ->	8	DG-175 10.5V
6.5	TD		1.0T Motor Home		01/95 -> 12/96	8	DG-175 10.5V
Full Size							
ALL	TD				01/97 -> 12/98	8	DG-175 10.5V
Jimmy							
All	D				1983 ->		DG-175 10.5V
6.2	D				1982 -> 1991	8	DG-175 10.5V
K15							
All	D				1983 ->		DG-175 10.5V
K25							
All	D				1983 ->		DG-175 10.5V
K35							
All	D				1983 ->		DG-175 10.5V
K2500							
6.5	D		Pickup		2000 ->	8	DG-175 10.5V
MD Bus Chassis							
6.5	TD				01/97 -> 12/98	8	DG-175 10.5V
K3500							
6.5	D		Pickup		2000 ->	8	DG-175 10.5V
P25							
All	D				1983 ->		DG-175 10.5V
All	D				1983 ->		DG-175 10.5V
Truck							
6.2	TD					8	DG-175 10.5V
6.5	TD					8	DG-175 10.5V



KW



GMC (continued)									
Van									
6.5	TD					01/82 ->	8	DG-175	10.5V
HINO									
Ranger									
				DM100		1969 ->	6	DG-236	19V
				EC100		1969 ->	6	DG-236	19V
				DQ100		1971 ->	6	DG-236	19V
				EH100		1972 ->	6	DG-236	19V
				EH300		1974 ->	6	DG-236	19V
Truck									
				EB300		1971 ->	6	DG-236	19V
				EC100		1970 -> 1976	6	DG-236	19V
				EH100		1973 -> 1976	6	DG-236	19V
				EH300		1974	6	DG-236	19V
Rainbow									
				DM100		1970 -> 1976	6	DG-236	19V
				EC100		1970 -> 1979	6	DG-236	19V
				EB200		1970 ->	6	DG-236	19V
				EH300		1975 ->	6	DG-236	19V
				EB400		1977 ->	6	DG-236	19V
				EH100		1988 ->	6	DG-236	19V
HONDA									
Accord									
2.0	TDi	77		L Series 20TN2		05/95 -> 10/98	4	DG-101	11V
2.0	TDi	77				02/99 ->	4	DG-101	11V
Civic									
2.0	D			L Series		03/96 -> 2001	4	DG-101	11V
2.0	TDi	63,77		20TN2-20T2R		10/97 ->	4	DG-101	11V
Civic Aerodeck									
2.0	TDi	77	Rover T	20T2N		05/98 -> 2001	4	DG-101	11V
Civic Fastback									
2.0	TDi	63		20T2N		10/97 -> 02/01	4	DG-101	11V
Concerto									
1.8	TD	58		XUD7T		08/94 -> 10/96	4	DG-001	11V
HUMMER									
H1									
6.5	D / TD	125,143				01/92 ->	8	DG-175	10.5V
HYUNDAI									
Accent									
1.5	CRDi	60		D3-EA		04/02 ->	3	DG-173	11V
Elantra									
2.0	CRDi	83		D4EA		04/01 ->	4	DG-173	11V
Excel									
1.5	CRDi	60		D3-EA		04/02 ->	3	DG-173	11V
Galloper									
2.5	TD	62				08/91 -> 07/98	4	DG-120	11V
2.5	TD	73		D4BH		08/98 ->	4	DG-120	11V
2.5	TCl	77				08/98 ->	4	DG-172	11V
2.7	TD	76				01/99 ->	4	DG-301	11V
Getz									
1.5	CRDi	60		D3-EA		03/03 ->	3	DG-173	11V
H100									
2.5	TD	59		D4BF		07/93 -> 03/00	4	DG-172	11V
2.5	D	55		D4BA / D4BX		07/93 -> 12/94	4	DG-172	11V
2.5	D	57		D4BB		12/94 -> 03/00	4	DG-172	11V
H150									
2.5	D	55		D4BA / D4BX		07/93 -> 12/94	4	DG-172	11V
2.5	D	57		D4BB		12/94 -> 03/00	4	DG-172	11V
H200									
2.5	D	57		D4BB		10/97 ->	4	DG-172	11V



KW



HYUNDAI (continued)									
H-1									
2.5	TD	59		D4BF	03/00 -> 09/00	4	DG-172	11V	
2.5	TD	73		D4BH	03/00 ->	4	DG-120	11V	
Matrix									
1.5	CRDi	60		D3-EA	10/01 ->	3	DG-173	11V	
1.5	CRDi	75		D4FA	12/04 ->	3	DG-173	11V	
Porter (H100)									
2.5	D	53		4D56	07/93 -> 06/94	4	DG-105	12V	
Santa Fé									
2.0	CRDi	83		D4EA	04/01 ->	4	DG-173	11V	
Starex									
2.5	TD	59			06/97 ->	4	DG-120	11V	
Trajjet									
2.0	CRDi	83		D4EA	04/01 ->	4	DG-173	11V	
Tucson									
2.0	CRDi	83		D4EA	08/04 ->	4	DG-173	11V	
IBC (GM)									
Midi									
2.2	D	45		22DIE	06/88 -> 08/92	4	DG-159	5V	
INNOCENTI									
Elba									
1.7	D	42	(12 Volt)	146.B2.000	1993 -> 10/97	4	DG-001	11V	
Mille									
1.7	DS	42	Clip	146.B2.000	1994 ->	4	DG-001	11V	
INTERNATIONAL									
44, 2424, 2444, 3414, 3444, 364, 384									
ALL	D				1983 ->		DG-135	0.9V	
BD144, BD154, BD250, B27, B414, B424									
ALL	D				1983 ->		DG-135	0.9V	
TD 5, 500 series, 7000 D									
ALL	D				1983 ->		DG-135	0.9V	
ISUZU									
300									
	TDi			4JH1	2002 ->	4	DG-108	11V	
Bighorn									
2.2	D	39	(12 Volt)	C223 (T)	1981 -> 08/87	4	DG-143	5V	
2.2	D	39		C223	08/87 -> 10/88	4	DG-124	11V	
2.2	TD	53	(12 Volt)	C223 (T)	1981 -> 08/87	4	DG-143	5V	
2.3	TD	53		C223T	08/87 -> 10/88	4	DG-124	11V	
3.1	TD	84			08/91 ->	4	DG-104	11V	
Campo									
2.2	D	39		C223	04/88 -> 08/89	4	DG-143	5V	
2.2	D	45		22D	09/90 -> 08/92	4	DG-159	5V	
Gemini									
1.5	D	37	(12 Volt)	4EC1 (No 804794)	10/85 -> 11/88	4	DG-143	5V	
1.5	D	40		4EC1	10/85 -> 11/88	4	DG-143	5V	
1.5	D	37	(12 Volt)	4EC1 (No 804795)	12/88 -> 09/90	4	DG-124	11V	
1.5	D	40		4EC1	12/88 -> 12/90	4	DG-124	11V	
1.5	D	37		4EC1 (No 804795)	12/88 -> 12/90	4	DG-104	11V	
1.5	D	40		4EC1	12/88 -> 12/90	4	DG-104	11V	
1.5	TD	54		4EC1 T	02/88 -> 11/88	4	DG-159	5V	
1.5	TD	49		4EC1 T	12/88 -> 09/90	4	DG-104	11V	
1.5	TD	49		FF 4EC1 Isuzu	12/88 -> 09/90	4	DG-010	11.5V	
1.5	TD	49		FF 4EC1 Isuzu	12/88 -> 09/90	4	DG-010	11.5V	
KB									
All	D		40 (Van, Bus)	C190, C223	10/79 -> 03/88	4	DG-143	5V	
KB27									
2.2	D	39		C223	01/83 -> 03/88	4	DG-143	5V	



KW



ISUZU (continued)									
KB42									
2.2	D	39		C223		01/83 -> 03/88	4	DG-143	5V
KB47									
2.2	D	39		C223		01/83 -> 03/88	4	DG-143	5V
KB250									
2.5	D			4JA1		1989 -> 1996	4	DG-108	11V
KB280									
2.8	TD			4JB1		1993 ->	4	DG-108	11V
Midi									
2.0	D	51				01/86 -> 08/92	4	DG-159	5V
2.0	TD	51		Isuzu		01/86 -> 08/92	4	DG-104	11V
2.2	D	45		Isuzu		01/86 -> 08/92	4	DG-104	11V
Pick-up									
2.0	D	34		C190		01/83 ->	4	DG-143	5V
2.2	D	39		C223		04/86 -> 08/87	4	DG-143	5V
2.2	D	39		C223		08/87 -> 10/88	4	DG-124	11V
Rodeo									
2.2	D	39	(12 Volt)	C223 (T)		1981 -> 08/87	4	DG-143	5V
2.2	D	39		C223		08/87 -> 10/88	4	DG-124	11V
2.2	TD	53	(12 Volt)	C223 (T)		1981 -> 08/87	4	DG-143	5V
2.3	TD	53		C223T		08/87 -> 10/88	4	DG-124	11V
3.1	TD					08/91 ->	4	DG-104	11V
Trooper									
2.0	D	34		C 190		11/77 -> 08/83	4	DG-143	5V
2.2	D	39	(12 Volt)	C223 (T)		1981 -> 08/87	4	DG-143	5V
2.2	D	39		C223		08/87 -> 10/88	4	DG-124	11V
2.2	TD	53	(12 Volt)	C223 (T)		1981 -> 08/87	4	DG-143	5V
2.3	D	39		C223		02/81 -> 07/87	4	DG-143	5V
2.3	D	39		C223		08/87 -> 10/88	4	DG-124	11V
2.3	TD	53		C223T		02/81 -> 07/87	4	DG-143	5V
2.3	TD	53		C223T		08/87 -> 10/88	4	DG-124	11V
2.8	TD	78		4JB1		10/87 -> 07/92	4	DG-108	11V
3.1	TD					08/91 ->	4	DG-104	11V
IVECO									
Daily									
2.4	D					01/83 -> 09/83	4	DG-001	11V
2.4	D	53,72				10/83 -> 10/89	4	DG-001	11V
2.5	D			CH Only		1993 ->	4	DG-001	11V
2.8	D	90		8140.63		06/98 ->	6	DG-111	11V
2.8	TDi	90		8140.43		06/96 ->	4	DG-111	11V
Grinta									
2.4	D					01/83 -> 09/83	4	DG-001	11V
2.4	D	53,72				10/83 -> 10/89	4	DG-001	11V
2.5	D			CH Only		1993 ->	4	DG-001	11V
XJ									
2.0	TD	64	Cherokee	J8S-814		04/84 -> 12/87	4	DG-001	11V
JAGUAR									
S-Type									
2.7	D	152				06/04 ->	6	DG-140	11V
JEEP									
Cherokee									
2.0	TD	64		Renault J8S-814		04/84 -> 12/87	4	DG-001	11V
2.1	TD	65		Renault J8S-890		01/88 -> 01/91	4	DG-001	11V
2.1	TD	65		Renault J8S-890		02/91 -> 08/94	4	DG-006	11V
2.5	TD	85,89		VM		10/94 ->	4	DG-001	11V
2.5	CRD	105				09/01 ->	4	DG-176 *	11.5V
2.8	CRD	110				11/02 ->	4	DG-176 *	11.5V
3.1	TD	103				09/01 ->	6	DG-109	11V
Grand Cherokee									
2.5	TD	85,88		VM		01/93 -> 02/99	4	DG-109	11V
2.5	TD	85,88				03/99 ->	5	DG-109	11V
2.7	CRD	120				11/01 ->	5	DG-109	11V

* Available from Jan. 2007



KW



JEEP (continued)							
3.1	TD	103			03/99 ->	6	DG-109 11V
Wrangler							
2.1	D		Laredo,Sahara,Texan		07/88 ->	6	DG-001 11V
2.5	TD	88		VM	07/88 ->	4	DG-001 11V
KIA							
Carens II							
2.0	CRDi	83			07/02 ->	4	DG-173 11V
Pregio							
2.7	D	60		J2	10/97 ->	4	DG-146 11V
3.0	D	66		JT-MotorW3,NB9	01/98 ->	4	DG-146 11V
Prontier							
3.0	D	66		JT-MotorW3,NB9	01/98 ->	4	DG-146 11V
Sportage							
2.0	TD	61		RF	10/97 -> 09/98	4	DG-146 11V
2.0	TD			4WD	1997 ->		DG-146 11V
LADA							
Cossack							
1.9	D	47	2121	Peugeot XUD 9L	01/94 ->	4	DG-001 11V
Hussar							
1.9	D	47	2121	Peugeot XUD 9L	01/94 ->	4	DG-001 11V
Niva							
1.9	D	47	2121	Peugeot XUD 9L	01/94 ->	4	DG-001 11V
Sagona							
1.5	D	42		TUDSL	11/96 ->	4	DG-003 11V
1.5	D	42		TUDSL	11/96 ->	4	DG-003 11V
LANCIA							
Dedra							
1.9	TD	66		835A4.000	1989 -> 10/94	4	DG-001 11V
1.9	TD	66	Eco LE TD	160.D1.000	1994 -> 07/99	4	DG-001 11V
1.9	TD	48,59			1984 -> 1991	4	DG-001 11V
1.9	TD	66	HPE		10/96 -> 08/99	4	DG-102 11V
Kappa							
2.4	TD	91		838A3.000, 838A7.000	1994 -> 04/98	5	DG-102 11V
2.4	JTD	100		838A8.000	05/98 -> 10/01	5	DG-122 11V
Lybra							
1.9	JTD	77		AR32302	07/99 ->	4	DG-122 11V
1.9	JTD	81		AR3701	09/00 -> 05/01	4	DG-122 11V
1.9	JTD	85		AR32302	05/01 ->	4	DG-122 11V
2.0	JTD	103		839A5000	09/00 ->	5	DG-122 11V
2.2	JTD	110		839A5000	05/02 ->	5	DG-122 11V
2.4	JTD	100		839A5000	07/99 ->	5	DG-122 11V
Musa							
1.3	MultiJet	51		188A9.000	10/04 ->	4	DG-171 11V
1.9	MultiJet	74		188B2.000	10/04 ->	4	DG-122 11V
Phedra							
2.0	JTD	79		RHM	07/03 ->	4	DG-116 11V
2.0	JTD	80	RHW	DW10TD,DW10TED	09/02 ->	4	DG-116 11V
2.2	JTD	94	4HW	DW12TED4	09/02 ->	4	DG-116 11V
Prisma							
1.9	TD	48,59			1984 -> 1991	4	DG-001 11V
Thema							
2.4	TD	74		8144.91	11/84 -> 12/92	4	DG-001 11V
2.4	TD	74			01/93 -> 09/94	4	DG-001 11V
2.5	TD	85		8144.97	06/88 -> 09/94	4	DG-001 11V
2.5	TD	74		8144.	01/93 -> 12/93	4	DG-001 11V
Thesis							
1.9	JTD	59			10/01 ->	4	DG-122 11V
1.9	JTD	81			10/01 ->	4	DG-122 11V
2.4	JTD	110		841C.000	04/02 ->	5	DG-122 11V
2.4	JTD	129		841G.000	05/03 ->	5	DG-170 11V
Ypsilon							
1.3	JTD	51		188A9.000	10/04 ->	4	DG-171 11V



KW



LANCIA (continued)							
Zeta							
1.9	TD	68		XUD 9T	04/95 -> 09/02	4	DG-001 11V
2.0	D	80		DW10ATED4	2000 -> 09/02	4	DG-116 11V
2.1	TD	80		P8C	07/96 -> 1999	4	DG-001 11V
LAND ROVER							
88 / 109							
2.3	D	44		(Eng No ->10J01175)	10/67 -> 06/83	4	DG-131 1.7V
Defender							
2.3	D (90)	44		(Eng No 10J01176->)	1983 ->	4	DG-001 11V
2.5	D (90)				1983 -> 08/90	4	DG-001 11V
2.3	D (110)	44		(Eng No 10J01176->)	1983 -> 10/86	4	DG-001 11V
2.3	TD (110)		County		1983 -> 10/86	4	DG-202 11V
2.5	D (110)			12J	1985 -> 12/90	4	DG-001 11V
2.5	TD (110)		County		1989 -> 08/90	4	DG-202 11V
2.5	TDi (130)	78		11LL	09/90 -> 12/94	4	DG-115 11.5V
2.5	Td5	90			06/98 ->	5	DG-115 11.5V
Discovery							
2.5	TDi	83		12L 21L	10/89 -> 06/94	4	DG-115 11.5V
2.5	TDi	83		12L 21L	08/96 ->	4	DG-115 11.5V
2.5	TDi	90		19L	10/95 ->	4	DG-115 11.5V
Freelander							
2.0	Di	72		20TCIE	07/97 -> 11/00	4	DG-101 11V
2.0	Td4	82		M47 D20 (BMW)	11/00 ->	4	DG-145 11V
Range Rover							
2.4	D	68,78		VM-81A	04/86 -> 10/89	4	DG-202 11V
2.5	D	89		VM-HR-492	09/89 -> 10/95	4	DG-115 11.5V
2.5	TD	89		VM	10/89 -> 09/94	4	DG-001 11V
2.5	TDi			ETC 9091 N	1986 -> 1994		DG-115 11.5V
2.5	TDi	83		14L	08/94 -> 03/02	6	DG-115 11.5V
2.5	TDS	100,105		M51 D25 (BMW)	11/94 -> 03/02	6	DG-001 11V
3.0	Td6	130		M57 D30 (BMW)	03/02 ->	6	DG-145 11V
LDV							
200							
1.9	D	47		XUD9	10/94 -> 03/96	4	DG-001 11V
2.0	D	46			05/86 -> 03/89	4	DG-001 11V
2.0	D	46			03/89 ->	4	DG-125 12.5V
2.0	D			'O' Series	1989 -> 03/96	4	DG-001 11V
400							
2.5	D			Perkins	1983 -> 03/96	4	DG-001 11V
2.5	D			Peugeot	1989 -> 03/96	4	DG-001 11V
2.5	TD	71			01/87 -> 10/98	4	DG-001 11V
2.5	TD			Peugeot	1989 -> 08/96	4	DG-001 11V
Cub							
2.3	D	55		LD23	07/98 ->	4	DG-120 11V
Pilot							
1.9	D	52		XUD9A	04/96 ->	4	DG-001 11V
Sherpa							
1.8	D	48		KD18	03/74 -> 12/82	4	DG-202 11V
2.0	D				05/85 -> 03/91	4	DG-001 11V
2.0	D	46			05/86 -> 03/89		DG-001 11V
2.5	D				01/87 -> 03/89	6	DG-001 11V
LEXUS							
IS 220 / 250							
All	GSE20		Cooling heater		08/05 ->		DG-401 * 11V
GS 300 / 430							
All	GRS190		Cooling heater		01/05 ->		DG-401 * 11V
MAHINDRA							
CJ3							
2.1	D	44		XDP2	10/87 ->	4	DG-001 11V
CJ5							
2.1	D	48		XD490	1993 ->	4	DG-001 11V

* Cooling heater plug only



KW



MAHINDRA (continued)							
Indian Baja							
2.1	D			XDP2	10/87 -> 10/97	4	DG-001 11V
MAZDA							
2							
1.4	CD	50		F6JA	04/03 ->	4	DG-113 11V
1.21							
1.8	D	44		RTJ	03/96 ->	4	DG-007 11.5V
626							
2.0	D	46		RF 46 (GC)	01/83 -> 08/85	4	DG-114 7V
2.0	D	46	Hatchback	RF 46 (GC)	08/85 -> 06/87	4	DG-146 11V
2.0	D	44	Hatchback	RF-N (GD)	07/87 -> 07/91	4	DG-146 11V
2.0	D	55	Hatchback GLX Complex	RF (GE)	10/92 -> 04/97	4	DG-146 11V
2.0	D	55	Wagon	RF-CX	05/93 -> 11/96	4	DG-146 11V
2.0	D	55	Wagon		11/94 -> 02/98	4	DG-146 11V
B2200							
2.2	D	47	(12 Volt)	R2	1983 -> 1993	4	DG-114 7V
B2500							
2.5	TD	80	4WD	MD25 TI	06/99 ->	4	DG-146 11V
E2200							
2.2	D / R207, R003	46	(12 Volt)	R207, R003	01/84 -> 02/88	4	DG-114 7V
2.2	D / R203, R207	46,47		R203, R207	05/85 ->	4	DG-114 7V
2.2	D / R2	52		R2	02/97 ->	4	DG-114 7V
E2500							
2.5	D / XA			XA	03/77 ->	4	DG-114 7V
Light bus parkway							
All			(12 Volt)	HA	10/80 ->		DG-114 7V
T2500							
2.5	D	52	(12 Volt)	XA	05/82 ->	6	DG-146 11V
T3000							
3.0	D	68	(12 Volt)	HA	10/80 ->	6	DG-146 11V
T4100							
4.1	D		(12 Volt)	ZB	10/80 ->	6	DG-146 11V
MEGA							
Tjaffer							
1.4	D	39		TUD3	04/93 ->	4	DG-004 11.5V
MERCEDES BENZ							
1-CLASS							
170	1.7 D	29		OM636.915	01/51 -> 10/56	4	DG-135 0.9V
170	1.8 S-D	29		OM636.931	07/53 -> 02/58	4	DG-135 0.9V
190	2.0 D	55	Type 201	OM601.	09/83 -> 01/89	4	DG-001 11V
190	2.0 D	55	Type 201	OM601.	02/89 -> 05/93	4	DG-010 11.5V
190	2.4 D		Type 201	OM616.912	08/80 -> 11/84	5	DG-001 11V
190	2.5 D	69	Type 201	OM602.	04/85 -> 01/89	5	DG-001 11V
190	2.5 D	69	Type 201	OM602.	02/89 -> 05/93	5	DG-010 11.5V
190	2.5 TD	93	Type 201	OM602.961	02/88 -> 05/93	5	DG-010 11.5V
2-CLASS							
200	2.0 D	44	Type 123	OM615	02/76 -> 11/85	4	DG-001 11V
200	2.0 TD	53,55	Type 124	OM601.912	12/84 -> 01/89	4	DG-001 11V
200	2.0 TD	53,55	Type 124	OM601.912	02/89 -> 06/93	4	DG-010 11.5V
207	2.4 D	53		OM616.937, 939	09/82 -> 01/89	4	DG-001 11V
208	2.3 D	60		OM601.940	10/88 -> 06/95	4	DG-010 11.5V
209	3.0 D	65		OM617.913	04/82 -> 09/88	5	DG-001 11V
210	2.9 D	70,72		OM602.940	10/88 -> 04/95	5	DG-010 11.5V
240	2.4 D	48	Type 123	OM616.912	08/80 -> 11/84	4	DG-001 11V
240	2.4 D	53	Type 460	OM616.936	08/80 -> 1989	4	DG-001 11V
240	2.4 D,TD	48,53	Type 123	OM616.912	08/80 -> 11/85	4	DG-001 11V
250	2.5 D	62,69	Type 460	OM602930	02/89 -> 07/93	5	DG-001 11V
250	2.5 D	69	Type 463	OM602.931	09/89 -> 06/93	5	DG-010 11.5V
250	2.5 D	68	Type 460	OM602930	10/87 -> 10/91	5	DG-010 11.5V
250	2.5 D,TD	93	Type 124	OM602.962	09/88 -> 01/89	5	DG-001 11V
250	2.5 TD	66	Type 124	OM602.912	01/88 -> 09/92	5	DG-010 11.5V
250	2.5 TD	66	Type 124	OM602.912	04/85 -> 12/87	5	DG-001 11V



KW



MERCEDÉS BENZ (continued)								
250	2.5 TD	93	Type 124	OM602.962	05/88 -> 09/92	5	DG-010	11.5V
290	2.9 TD	70	Type 461	OM602.942	04/92 ->	5	DG-010	11.5V
290	2.9 TDi	88	Type 461	OM602.983	07/97 ->	5	DG-010	11.5V
3-CLASS								
300	3.0 CD,D	57	Type 123	OM617 A	08/80 -> 08/81	5	DG-001	11V
300	3.0 D	65	Type 460	617931	02/79 -> 08/89	5	DG-001	11V
300	3.0 D	57,59	Type 123	OM617 A	08/80 -> 11/85	5	DG-001	11V
300	3.0 D	83	Type 460	603912	08/80 -> 01/89	6	DG-001	11V
300	3.0 D	80,83	Type 124	OM603.912	12/84 -> 01/89	6	DG-001	11V
300	3.0 D	80,83	Type 124	OM603.913	03/86 -> 01/89	6	DG-001	11V
300	3.0 D	80,83	Type 124	OM603.912	02/89 -> 09/92	6	DG-010	11.5V
300	3.0 D	80,83	Type 124	OM603.913	02/89 -> 05/93	6	DG-010	11.5V
300	3.0 D	83	Type 463	OM603.931	02/89 -> 06/93	6	DG-010	11.5V
300	3.0 D,TD	59,65	Type 123	OM617.912	08/80 -> 11/85	6	DG-001	11V
300	3.0 TD	92	Type 123	OM617.952	10/80 -> 11/85	5	DG-001	11V
300	3.0 TD	105	Type 126	OM603.961	11/85 -> 12/87	6	DG-001	11V
300	3.0 TD	108	Type 124	OM603.960	09/86 -> 01/89	6	DG-001	11V
300	3.0 TD	105,108	Type 124	OM603.963	09/86 -> 01/89	6	DG-001	11V
300	3.0 TD	105,108	Type 124	OM603.960	01/88 -> 01/89	6	DG-010	11.5V
300	3.0 TD	105,108	Type 124	OM603.960	02/89 -> 06/93	6	DG-010	11.5V
300	3.0 TD	105,108	Type 124	OM603.963	02/89 -> 06/93	6	DG-010	11.5V
300	3.0 TD	108	Type 124	OM603.960	02/89 -> 09/92	6	DG-010	11.5V
300	3.0 TD	110	Type 126	OM617.951	08/80 -> 10/85	6	DG-001	11V
300	3.0 TD	110	Type 140	OM603.971	02/92 -> 09/92	6	DG-010	11.5V
300	3.5 TD	110	Type 140	OM603.971	10/92 -> 04/93	6	DG-010	11.5V
307	2.4 D	53		OM616.937, 939	09/82 -> 09/88	4	DG-001	11V
308	2.3 D	58		OM601.940	10/88 ->	4	DG-010	11.5V
309	3.0 D	65		617.913	08/81 -> 01/89	5	DG-001	11V
310	2.9 D	70,72		OM602.940	10/88 -> 04/95	5	DG-010	11.5V
350	3.5 D	100	Type 463	OM603.972	09/91 -> 09/96	6	DG-010	11.5V
350	3.5 TD	115	Type 126 SD, SDL, USA	OM603	02/89 -> 06/91	6	DG-010	11.5V
350	3.5 TD	100	Type 461	603970	03/90 -> 06/91	6	DG-010	11.5V
350	3.5 TD	100	Type 461	603.972	09/93 -> 08/96	6	DG-010	11.5V
4-CLASS								
407	2.4 D	53		OM616.910	07/81 -> 09/88	4	DG-001	11V
408	2.3 D	58		OM601	09/88 -> 10/94	4	DG-010	11.5V
409	3.0 D	65		OM617.913	04/82 -> 01/89	5	DG-001	11V
410	2.9 D	72		OM602	11/88 ->	5	DG-010	11.5V
5-CLASS								
507	2.4 D	53		OM616.914	04/82 -> 04/89	4	DG-001	11V
508	2.3 D	58			03/89 -> 07/96	4	DG-010	11.5V
511	4.0 D	77		OM364 LA	04/95 ->	4	DG-110	11.5V
6-CLASS								
611	4.0 D	77		OM364 LA	04/95 -> 07/96	4	DG-110	11.5V
612	2.9 TD	90		602980	08/96 ->	5	DG-001	11V
7-CLASS								
711	4.0 D	77		OM364 LA	04/95 -> 07/96	4	DG-110	11.5V
714	4.3 D	103		OM364 LA	04/95 -> 07/96	4	DG-110	11.5V
8-CLASS								
811	4.0 D	77		OM364 LA	04/95 -> 07/96	4	DG-110	11.5V
814	4.0 D	100		OM364 LA	04/95 ->	4	DG-110	11.5V
A-CLASS								
A160	1.7 CDi	44		OM688.941	07/98 -> 02/01	4	DG-155	11.5V
A160	1.7 CDi	55	Type 168	OM688.	02/01 ->	4	DG-155	11.5V
A170	1.7 CDi	66,70		OM668.940	07/98 -> 01/01	4	DG-155	11.5V
C-CLASS								
C180	1.8 D	65	Type 202	OM604	10/98 -> 05/00	4	DG-010	11.5V
C200	2.0 D	55		(202) OM601.913	06/93 -> 05/00	4	DG-010	11.5V
C200	2.0 D	65		(202) OM604.915	10/96 -> 05/00	4	DG-106	11.5V
C200	2.1 CDi	85	T Estate	(203) OM611.962	09/00 ->	4	DG-117	11.5V
C200	2.1 CDi	90		(203) OM	04/03 ->	4	DG-117	11.5V
C200	2.2 CDi	75		(202) OM611.960	03/98 -> 05/00	4	DG-117	11.5V
C200	2.2 CDi	75	Kombi	OM	03/98 -> 05/00	4	DG-117	11.5V
C220	2.2 D	70		(202) OM604.910 (Eng No ->021.055)	07/93 -> 05/98	4	DG-119	11.5V
C220	2.2 D	70		(202) OM604.910 (Eng No 021.056->)	07/93 -> 05/98	4	DG-010	11.5V



KW



MERCEDES BENZ (continued)								
C220	2.2 D	55		(202) OM611.913/915	07/96 -> 05/00	4	DG-106	11.5V
C220	2.2 CDi	92	T Estate	(202) OM611.960	09/97 -> 05/00	4	DG-117	11.5V
C220	2.2 CDi	105	T Estate	(203) OM611.962	05/00 -> 02/04	4	DG-117	11.5V
C220	2.2 CDi	105	Sportcoupe	(203) OM611.962	05/00 -> 02/04	4	DG-117	11.5V
C220	2.2 CDi	110		(203) OM646.963	02/04 ->	4	DG-117	11.5V
C250	2.5 D	83		(202) OM605.910	06/93 -> 08/95	5	DG-119	11.5V
C250	2.5 TD	110	Estate	(202) OM605.960	05/96 -> 05/00	5	DG-106	11.5V
C270	2.7 CDi	125		(203) OM612.962	06/00 ->	5	DG-117	11.5V
CLK-CLASS								
CLK270	2.7 CDi	125		(209) OM612.962/967	10/02 ->	5	DG-117	11.5V
E-CLASS								
E200	2.0 D	55		(124) OM601.913	10/92 -> 05/95	4	DG-010	11.5V
E200	2.0 D	55		(124) OM601.912	07/93 -> 06/95	4	DG-106	11.5V
E200	2.0 D	55,65		(210) OM604.917	06/95 -> 07/99	4	DG-106	11.5V
E200	2.1 CDi	75		(210) OM611.960	06/98 -> 07/99	4	DG-117	11.5V
E200	2.1 CDi	85		(210) OM611.962	07/99 -> 03/02	4	DG-117	11.5V
E200	2.1 TD	75,90		(211) OM	06/02 ->	4	DG-117	11.5V
E220	2.2 D	70		(210) OM604.912	03/95 -> 06/98	4	DG-106	11.5V
E220	2.2 D	55		(210) OM604.913	05/96 -> 07/99	4	DG-106	11.5V
E220	2.2 CDi	92	T Estate	(210) OM611.961	07/98 -> 06/00	4	DG-117	11.5V
E220	2.2 CDi	105	T Estate	(210) OM611.962	07/99 -> 03/02	4	DG-117	11.5V
E220	2.2 CDi	110		(210) OM611.961	03/02 ->	4	DG-117	11.5V
E250	2.5 D	69		(124) OM602	04/85 -> 01/89	5	DG-001	11V
E250	2.5 D	69		(124) OM602	02/89 -> 05/93	5	DG-010	11.5V
E250	2.5 D	83	TE Estate	(124) OM605.911	07/93 -> 05/95	5	DG-119	11.5V
E250	2.5 D	83	(Immobiliser)	(124) OM605.911	07/93 -> 05/96	5	DG-106	11.5V
E250	2.5 TD	93		(124) OM602.962	07/93 -> 06/95	5	DG-010	11.5V
E250	2.5 TD	83		(210) OM605.912	03/95 -> 05/95	5	DG-106	11.5V
E250	2.5 TD	110		(210) OM605.962	07/97 -> 07/99	4	DG-106	11.5V
E270	2.7 CDi	125		(210) OM612.961	07/99 -> 03/02	5	DG-117	11.5V
E270	2.7 CDi	130		(211) OM647.961	04/02 ->	5	DG-117	11.5V
E290	2.9 TD	95		(210) OM602.982	01/95 -> 12/99	4	DG-110	11.5V
E300	3.0 D	100	TE Estate	(124) OM606.910	07/93 -> 05/95	6	DG-119	11.5V
E300	3.0 TD	100		(124) OM606.910	06/93 -> 05/95	6	DG-119	11.5V
E300	3.0 TD	108		(124) OM603.960 / 963	07/93 -> 05/95	6	DG-010	11.5V
E300	3.0 TD	100		(124) OM606.910	06/95 -> 06/96	6	DG-106	11.5V
E300	3.0 TD	130		(210) OM606.962	06/96 -> 08/99	6	DG-106	11.5V
E300	3.0 TD	130		(210) OM606.962	06/96 -> 08/99	6	DG-119	11.5V
E320	3.2 DCi	145	T Estate	(210) OM613.961	07/99 -> 03/02	6	DG-117	11.5V
E320	3.2 DCi	150		9211) OM648.961	11/02 ->	6	DG-117	11.5V
G-CLASS								
G240	2.4 D	53		(460) OM616.936	08/80 -> 08/87	4	DG-001	11V
G240	2.5 D	68		(460) OM602.930	10/87 -> 01/89	5	DG-001	11V
G240	2.5 D	68		(460) OM602.930	02/89 -> 12/92	5	DG-010	11.5V
G270	2.7 CDi	115		(463) OM612.966	10/01 ->	8	DG-117	11.5V
G290	2.9 D	70,72		(461) OM602.942/947	08/93 -> 10/94	5	DG-010	11.5V
G290	2.9 TD	88		(461) OM602.983	07/97 -> 09/00	5	DG-110	11.5V
G300	3.0 D	83		(463) OM603.931	09/93 -> 09/95	6	DG-010	11.5V
G300	3.0 TD	130		(463) OM606.964	09/96 -> 09/00	6	DG-106	11.5V
G350	3.5 TD	100		(463) OM603.972	08/93 -> 09/96	6	DG-010	11.5V
G400	4.0 CDi	184		(463) OM628.962	09/00 ->	8	DG-117	11.5V
MB-CLASS								
MB80	2.4 D	53		616963	09/93 -> 10/95	4	DG-010	11.5V
MB100	2.4 D	56		OM616.963	09/87 -> 01/89	4	DG-001	11V
MB100	2.4 D	56		OM616.963	02/89 ->	4	DG-010	11.5V
MB180	2.4 D	56		OM616.963-01	01/87 -> 01/89	4	DG-001	11V
MB180	2.4 D	56		OM616.963-01	02/89 ->	4	DG-010	11.5V
ML270	2.7 CDi	120		(163) OM612.963	02/98 ->	5	DG-117	11.5V
ML400	4.0 CDi	184		(163) OM628.963	09/01 ->	8	DG-117	11.5V
O309								
2.4	D	53		OM616.937, 939	09/82 -> 02/89	4	DG-001	11V
S-CLASS								
S300	3.0 TD	130		(140) OM606.961	06/96 -> 10/98	6	DG-106	11.5V
S320	3.2 CDi	145		(220) M613.960	01/00 ->	6	DG-117	11.5V
S350	3.5 TD	110		(140) OM603.971	06/93 -> 09/95	6	DG-010	11.5V



KW



MERCEDES BENZ (continued)							
S350	3.5 TD	110		(140) OM603.971	10/95 -> 08/96	6	DG-106 11.5V
S400	4.0 CDi	184,191		(220) M628.960	01/00 ->	8	DG-117 11.5V
SPRINTER							
2.2	CDi	95	213, 313	OM611.960	04/00 ->	4	DG-117 11.5V
2.2	CDi	80	211, 411		04/00 ->	4	DG-117 11.5V
2.2	CDi	60	208	OM611A	04/00 ->	4	DG-117 11.5V
2.3	D	58	208,308,408	OM601.943	12/94 -> 03/00	4	DG-010 11.5V
2.7	CDi	115	216, 316, 416	OM612	04/00 ->	5	DG-117 11.5V
2.9	D	75	210	OM602.986	03/97 -> 03/00	5	DG-110 11.5V
2.9	D	75	310	OM602.986	05/97 ->	5	DG-110 11.5V
2.9	D	75	410	OM602.986	05/97 ->	5	DG-110 11.5V
2.9	D	90	212	OM602.980.10 (Dela ->9849)	02/95 ->	5	DG-001 11V
2.9	D	90	212	OM602.980.10 (Dela 9850->)	02/95 ->	5	DG-110 11.5V
2.9	D	90	212	OM602.980.12 (Dela 137->)	02/95 ->	5	DG-110 11.5V
2.9	D	90	212	OM602.980.12 (Dela->136)	02/95 ->	5	DG-001 11V
2.9	D	90	312	OM602.980.10 (Dela ->9849)	04/95 ->	5	DG-001 11V
2.9	D	90	312	OM602.980.10 (Dela 9850->)	04/95 ->	5	DG-110 11.5V
2.9	D	90	312	OM602.980.12 (Dela ->136)	04/95 ->	5	DG-110 11.5V
2.9	D	90	312	OM602.980.12 (Dela ->136)	04/95 ->	5	DG-001 11V
2.9	D	90	412	OM602.980.10 (Dela ->9849)	04/95 ->	5	DG-001 11V
2.9	D	90	412	OM602.980.10 (Dela 9850->)	04/95 ->	5	DG-110 11.5V
2.9	D	90	412	OM602.980.12 (Dela ->136)	04/95 ->	5	DG-001 11V
2.9	D	90	412	OM602.980.12 (Dela 137->)	04/95 ->	5	DG-110 11.5V
V-CLASS							
V200	2.0 CDi	75		OM611.960	03/99 -> 09/03	4	DG-117 11.5V
V220	2.2 CDi	90		OM611.980	03/99 -> 09/03	4	DG-117 11.5V
V230	2.3 TD	72		OM601.970	09/96 -> 02/99	4	DG-010 11.5V
Vaneo							
1.7	CDi	55,67		OM668.914	01/02 ->	4	DG-155 11.5V
Vario							
2.9	TD	90	512,612,812	OM602.984/5	09/96 ->	5	DG-110 11.5V
Viano							
2.2	Cdi	80	111	OM646.982	09/03 ->	4	DG-117 11.5V
2.2	Cdi	110	111	OM646.982	09/03 ->	4	DG-117 11.5V
Vito							
2.2	CDi	60	108	OM611A	03/99 -> 09/03	4	DG-117 11.5V
2.2	Cdi	65	109	OM646.983	09/03 ->	4	DG-117 11.5V
2.2	CDi	75	110	OM611.960	03/98 -> 09/03	4	DG-117 11.5V
2.2	Cdi	80	111	OM646.982	09/03 ->	4	DG-117 11.5V
2.2	CDi	92	112	OM611.980	03/99 -> 09/03	4	DG-117 11.5V
2.2	Cdi	110	115	OM646.983	09/03 ->	4	DG-117 11.5V
2.3	D	58	108	OM601.942	02/96 -> 09/03	4	DG-010 11.5V
2.3	TD	72	110	OM601.970	03/96 -> 02/98	4	DG-010 11.5V
MERCEDES-UNIMOG							
2.9	D	71		OM602.948	11/92 ->	5	DG-010 11.5V
2.4	D	38,44		OM616	01/88 ->	4	DG-001 11V
3.0	D	65		OM602.941	11/92 ->	5	DG-010 11.5V
2.5	D	66,69		OM602.911	04/85 -> 01/89	5	DG-001 11V
2.5	TD	90,93		OM602.961	02/88 -> 01/89	5	DG-001 11V
MINI							
One D							
1.4	D	55		W12 (1ND-TV)	06/03 ->	4	DG-240 11V
MITSUBISHI							
Canter 35							
2.8	TD	69		4M40-A	08/96 -> 12/99	4	DG-306 11V
2.8	TD	85		4M40T-2AT	07/98 ->	4	DG-306 11V
Carisma							
1.9	TD	66		F8QT	10/96 ->	4	DG-103 11V
Challenger							
2.5	D	73		4D56T	11/98 ->	4	DG-105 12V
Colt							
1.8	D	44		4D65 (C10)	11/83 -> 04/88	4	DG-105 12V



KW



MITSUBISHI (continued)										
1.8	D GLX	44			4 D 65		04/88 -> 05/92	4	DG-105	12V
Galant										
1.8	TD	44			4D65T		06/84 -> 12/87	4	DG-105	12V
2.0	TD	66			4D68(T)		11/92 -> 08/96	4	DG-174	11V
2.0	TDi	66			4D68		09/96 ->	4	DG-174	11V
2.3	D	62		Station Wagon (12 Volt)	4D 55 QGS		05/80 -> 10/82	4	DG-105	12V
2.3	TD	70			4D 55T		05/80 -> 1986	4	DG-105	12V
2.3	TD	62		Kombi	4D 55T		09/81 -> 05/84	4	DG-105	12V
L200										
2.3	D	49		(12 Volt)	4D55		03/83 -> 10/86	4	DG-105	12V
2.5	D	51			4D56		11/86 -> 08/96	4	DG-174	11V
2.5	D	55			Metal plug		06/96 ->	4	DG-174 *	11V
					Ceramic plug	4D56T	06/96 ->	4	DG-301	11V
2.5	TD	64	4X4		Metal plug	4D56T	04/92 -> 08/96	4	DG-174 *	11V
					Ceramic plug	4D56T	04/92 -> 08/96	4	DG-301	11V
2.5	TD	73					06/96 -> 10/01	4	DG-174	11V
2.5	TD	74					11/01 ->	4	DG-174	11V
L300										
2.3	D	49			4D55		04/83 -> 10/86	4	DG-105	12V
2.4	D	51			4D55		03/83 -> 10/86	4	DG-105	12V
2.5	D	51			4 D 56		11/86 -> 12/92	4	DG-105	12V
2.5	D	51			4 D 56		01/93 -> 04/94	4	DG-120	11V
2.5	D	51			Metal plug	4D56	11/86 -> 04/94	4	DG-174 *	11V
					Ceramic plug	4D56	11/86 -> 04/94	4	DG-301	11V
2.5	D	64			Metal plug		11/94 ->	4	DG-174 *	11V
					Ceramic plug		11/94 ->	4	DG-301	11V
2.5	TD	64			Metal plug	4D56T	11/88 ->	4	DG-174 *	11V
					Ceramic plug	4D56T	11/88 ->	4	DG-301	11V
L400										
2.5	TD	64			Metal plug	4D56T	06/96 ->	4	DG-174 *	11V
					Ceramic plug	4D56T	06/96 ->	4	DG-301	11V
Lancer										
1.8	D	44			4 D 65		09/86 -> 04/88	4	DG-105	12V
2.0	D	50			Metal plug	4D68	05/88 -> 08/97	4	DG-174 *	11V
					Ceramic plug	4D68	05/88 -> 08/97	4	DG-301	11V
Montero										
2.3	TD	62,64		TD (AGSAUT)	4D55		12/82 -> 08/84		DG-105	12V
2.5	TD	73	4X4		Metal plug	4D56 TD	12/90 -> 04/00	4	DG-174 *	11V
					Ceramic plug	4D56 TD	12/90 -> 04/00	4	DG-301	11V
2.5	TD	73			4D56 TD		12/90 -> 10/93	4	DG-105	12V
2.5	TD	73			Metal plug	4D56 TD	11/93 -> 01/98	4	DG-174 *	11V
					Ceramic plug	4D56 TD	11/93 -> 01/98	4	DG-301	11V
Pajero										
2.3	TD	62			4D55		12/82 -> 08/84	4	DG-105	12V
2.5	TD	62,70			4D56		05/86 -> 11/90	4	DG-105	12V
2.5	TD	73			4D56 TD		12/90 -> 10/93	4	DG-105	12V
2.5	TD	73			Metal plug	4D56 TD	12/90 -> 04/00	4	DG-174 *	11V
					Ceramic plug	4D56 TD	12/90 -> 04/00	4	DG-301	11V
2.8	TD	92			4M40T		06/94 -> 04/00	4	DG-306	11V
Shogun										
2.5	TD	73			4D56 TD		12/90 -> 10/93	4	DG-105	12V
2.5	TD	73	4X4		Metal plug	4D56 TD	12/90 -> 04/00	4	DG-174 *	11V
					Ceramic plug	4D56 TD	12/90 -> 04/00	4	DG-301	11V
2.5	TD	73			Metal plug	4D56 TD	11/93 -> 01/98	4	DG-174 *	11V
					Ceramic plug	4D56 TD	11/93 -> 01/98	4	DG-301	11V
Space Gear										
2.5	TD	73			Metal plug	4D56T	05/95 ->	4	DG-174 *	11V
					Ceramic plug	4D56T	05/95 ->	4	DG-301	11V
2.5	TD	64			Metal plug	4D56 TD	05/95 ->	4	DG-174 *	11V
					Ceramic plug	4D56 TD	05/95 ->	4	DG-301	11V
Space Runner										
2.5	TD	60			Metal plug	4D68T	06/93 ->	4	DG-174 *	11V
					Ceramic plug	4D68T	06/93 ->	4	DG-301	11V
Space Wagon										
2.5	TD	60			Metal plug	4D68T	10/93 -> 10/98	4	DG-174 *	11V
					Ceramic plug	4D68T	10/93 -> 10/98	4	DG-301	11V

* DG-174 is the metal variant of DG-301, the ceramic glow plug



KW



MOSKVICH							
Aleko							
1.8	D	44		Ford RTE,RTS		4	DG-004 11.5V
MULTICAR							
M25/1							
1.9	D	40		1Y (VW 028 B)		01/91 -> 12/92	4 DG-002 11V
M26							
All	D	40		1Y (VW 028 B)		01/91 -> 12/92	4 DG-002 11V
NISSAN							
280C							
2.8	D	62		LD28		03/81 -> 04/83	6 DG-002 11V
Almera							
1.5	dCi	60				01/03 ->	4 DG-107 11V
2.0	D	55		CD20		11/95 -> 03/00	4 DG-304 11V
Bluebird							
2.0	D	48		LD20		01/80 -> 05/84	4 DG-002 11V
2.0	D	49		LD20		03/86 -> 12/90	4 DG-307 11V
Brougham							
2.3	D	59	(12 Volt)	TD23		01/93 ->	4 DG-120 11V
2.3	TD	51		TD23		01/93 ->	4 DG-120 11V
Cabstar							
2.3	D			TD23		01/82 -> 06/92	4 DG-120 11V
2.3	D	54		LD23		02/99 -> 12/01	4 DG-137 11V
2.3	TD	56		TD23		10/86 ->	4 DG-120 11V
2.5	TD					01/82 -> 07/97	4 DG-120 11V
2.7	TD					01/82 ->	4 DG-120 11V
Cargo							
2.3	D	55		LD23		09/94 ->	4 DG-137 11V
Cedric							
2.3	TD			TD23		01/82 ->	4 DG-120 11V
2.8	D	67		LD28		11/79 -> 06/82	6 DG-002 11V
Cherry							
1.7	D	45		CD17		1987 ->	4 DG-307 11V
D21							
2.5	D	59,61		TD25		01/93 ->	4 DG-120 11V
2.7	D	73		TD27		01/93 ->	4 DG-120 11V
2.7	D	73,74		TD27T		01/93 ->	4 DG-120 11V
E24							
2.5	D	59,61		TD25		02/87 ->	4 DG-120 11V
F22							
2.3	D	51		TD23		11/86 -> 12/93	4 DG-120 11V
2.5	D	59,61		TD25		11/85 -> 12/93	4 DG-120 11V
2.7	TD	73		TD27		11/86 -> 12/93	4 DG-120 11V
F23							
2.5	D	59,61		TD25		11/85 -> 12/93	4 DG-120 11V
2.7	TD	73		TD27		11/86 -> 12/93	4 DG-120 11V
Gloria							
2.8	D	67		LD28		11/79 -> 06/82	6 DG-002 11V
H 41							
2.5	D	61,69		TD25			4 DG-120 11V
2.7	D	73		TD27		12/86 -> 12/93	4 DG-120 11V
Interstar							
1.9	dCi 80	60		F9Q 772		07/02 ->	4 DG-107 11V
1.9	dCi 90	66		F9T 772		07/02 ->	4 DG-126 11V
2.2	dCi 90	66		G9T 722		07/02 ->	4 DG-126 11V
King Cab							
2.5	D			TD25		1993 ->	4 DG-120 11V
2.5	TD	61		TD25		02/98 ->	4 DG-120 11V
2.5	TDi	76		TD25TI		05/98 ->	4 DG-120 11V
Laurel							
2.0	D	48		(C31) LD20		10/81 -> 10/85	DG-002 11V
2.8	D	62		LD28		11/80 -> 12/84	6 DG-002 11V
March							
1.5	D	42		TUD5		10/96 ->	4 DG-003 11V



KW



NISSAN (continued)							
Micra							
1.5	D	42		TUD5,TUD15	05/98 -> 12/02	4	DG-003 11V
1.5	TD	48		K9K	2002 ->	4	DG-107 11V
Nomad							
2.0	D	47,49		LD20	10/86 -> 12/95	4	DG-307 11V
Pathfinder							
2.7	D	59,73		TD25,TD27	02/93 ->	4	DG-120 11V
2.7	D	73,74		TD27T	02/93 ->	4	DG-137 11V
2.7	TD	59,61		TD27ET	1993 ->	4	DG-120 11V
Patrol							
2.7	TD	73		TD27	02/93 ->	4	DG-120 11V
2.8	D	62	(Ebro)	A428II	01/84 -> 02/89	6	DG-001 11V
2.8	D	56		A 428	10/84 -> 03/89	6	DG-001 11V
2.8	D	56	(12 Volt-Not 24 V)	A 428	10/84 -> 03/89	6	DG-001 11V
2.8	D	88	(Ebro)	L28D	11/84 -> 02/89	6	DG-001 11V
2.8	TD	88	(Ebro)	A428T	10/84 -> 02/89	6	DG-001 11V
3.2	TD	110		SD33T	07/85 -> 06/90	6	DG-157 11V
3.3	D	70	(Ebro)	SD33	07/85 -> 02/89	6	DG-157 11V
3.3	D	70	(12 Volt)	SD33	07/85 -> 08/88	6	DG-157 11V
3.3	TD	81	(Ebro)	SD33T	07/85 -> 02/89	6	DG-157 11V
3.3	TD	89	(12 Volt)	SD33T	07/85 -> 08/88	6	DG-157 11V
4.2	D			TD42	01/92 -> 12/98	6	DG-120 11V
Pick-Up							
2.3	D	54		SD23	09/85 -> 09/87	4	DG-157 11V
2.3	D	51		SD23	01/87 ->	4	DG-157 11V
2.5	D	53		SD24	09/85 -> 08/87	4	DG-157 11V
2.5	D	53		SD25	09/85 -> 08/87	4	DG-157 11V
2.5	D	61		TD25	02/98 ->	4	DG-120 11V
2.5	TD	59	D21	TD25	10/87 -> 01/98	4	DG-120 11V
2.7	TD		720	TD27		4	DG-120 11V
Primera							
2.0	D	55	P10/W10	CD20	12/90 -> 09/96	4	DG-304 11V
Pulsar							
1.7	D	41		CD17	05/86 -> 08/90	4	DG-307 11V
Santana							
1.6	TD	53		CY	01/84 -> 01/87	4	DG-002 11V
Sentra							
1.7	D			CD17	1987 ->	4	DG-307 11V
2.0	D	49		LD20	11/92 ->	4	DG-307 11V
2.3	D	55		LD23	10/94 -> 02/98	4	DG-137 11V
2.3	D	55		LD23	03/98 ->	4	DG-137 11V
Stanza							
2.0	D	49		LD20	1987 ->	4	DG-307 11V
Sunny							
1.7	D	40		CD17	01/86 -> 06/91	4	DG-307 11V
1.7	D	40		CD17	11/90 ->	4	DG-307 11V
2.0	D	55	MkIII Hatchback, Liftback 14	CD20	10/90 -> 05/95	4	DG-304 11V
2.0	D	55	Fam.10	CD20	06/91 ->	4	DG-304 11V
Terrano							
2.7	D	62		TD27	08/87 ->	4	DG-120 11V
2.7	TD	73		TD27T	02/89 -> 10/93	4	DG-137 11V
2.7	D	74		TD27, TD27T	02/93 -> 06/96	4	DG-137 11V
2.7	TD	74		TD27T	1993 -> 06/96	4	DG-137 11V
Trade							
2.0	D	46		LD2011	03/87 -> 11/89	4	DG-002 11V
2.3	D	55		LD23	05/97 ->	4	DG-137 11V
2.8	D	57		A42811	03/87 -> 11/89	4	DG-001 11V
Urvan							
2.3	TD	50		TD23(E24)	02/87 -> 02/88	4	DG-120 11V
2.5	D	59		TD25	1993 -> 10/96	4	DG-120 11V
2.7	TD			TD27	01/82 ->	4	DG-120 11V
Vanette							
2.0	D	67	(12 Volt)	LD20	06/81 -> 09/82	4	DG-002 11V
2.0	D	47,49	+ Cargo	LD20	10/86 -> 12/95	4	DG-307 11V
2.3	D	55		LD23	09/94 -> 02/98	4	DG-137 11V



KW



NISSAN/MOTOR IBERICA									
L35									
2.9	D	56		L35	05/85 ->	4	DG-001	11V	
Mot.AA.28									
2.8	D	62		A4.28	03/98 ->	4	DG-001	11V	
Patrol									
2.8	D	55		A4.28	09/87 ->	4	DG-001	11V	
Serena									
	D			GX3	12/94 ->	4	DG-137	11V	
Terrano TD II									
2.7	TD	74		TD27/TD27T	02/93 ->	4	DG-137	11V	
Trade									
2.0	D	43			09/83 -> 02/87	4	DG-002	11V	
Trade EW									
2.7	TD	55		TD27	03/98 ->	4	DG-137	11V	
OM									
Grinta									
2.4	D	53	30.8-40.8	814461	08/86 -> 08/89	4	DG-001	11V	
2.5	D	55	30.8-40.8	814467	09/89 -> 12/95	4	DG-001	11V	
2.5	TD	76	35.10-40.35	814491	09/89 -> 12/95	4	DG-001	11V	
OPEL									
Agila									
1.3	CDTi	51		Z13DT	08/03 ->	4	DG-171	11V	
Arena									
1.9	D	44		F8Q.606	06/98 ->	4	DG-008	11V	
2.5	TD	55		S8U.758,782	06/98 ->	4	DG-001	11V	
Ascona (B)									
2.0	D	43		B20D (Eng No ->90310)	11/79 -> 08/81	4	DG-001	11V	
Ascona (C)									
1.6	D	40		16D	03/82 -> 01/89	4	DG-001	11V	
Astra (F)									
1.7	D	42,44		17YD, 17DR	08/91 -> 08/97	4	DG-001	11V	
1.7	D	42		17D OHC II	10/91 -> 08/94	4	DG-001	11V	
1.7	TD	50		X17DTL	1994 -> 1998	4	DG-001	11V	
1.7	TD	60		17TD/TC4EE1 (Eng No ->956632)	10/91 -> 02/93	4	DG-104	11V	
1.7	TD	60		17TD/TC4EE1 (Eng No 956633->)	03/93 -> 01/98	4	DG-300	11V	
1.7	TD	60		17DT,TC4EE1 (Ch No ->52999999)	12/91 -> 05/98	4	DG-104	11V	
Astra (G)									
1.7	TD	50		X17DTL	02/98 -> 08/00	4	DG-001	11V	
1.7	DTi 16V	55		Y17DT	02/00 ->	4	DG-302	11V	
1.7	CDTi	59		Z17DTL	04/03 ->	4	DG-170	11V	
2.0	DTi	60		X20DTL, Y20DTL	03/98 -> 03/04	4	DG-118	11V	
2.0	DTi	74		X20DTH,Y20DTH	08/99 -> 03/04	4	DG-118	11V	
2.2	DTi	92		Y22DTR	08/00 ->	4	DG-142	11V	
Astra (H)									
1.3	CDTi	66		Z13DTH	08/05 ->	4	DG-171	11V	
1.7	CDTi	59		Z17DTL	03/04 ->	4	DG-170	11V	
1.7	CDTi	74		Z17DTH	03/04 ->	4	DG-170	11V	
1.9	CDTi	66		Z19DTL	09/05 ->	4	DG-122	11V	
1.9	CDTi	74		Z19DT	09/05 ->	4	DG-122	11V	
1.9	CDTi	88		Z19DTH	04/04 ->	4	DG-170	11V	
1.9	CDTi	110		Z19DTJ	09/04 ->	4	DG-170	11V	
Astra Delvan									
2.0	TD	60		X20DTL	04/98 ->	4	DG-118	11V	
Astra Delvan ECO									
1.7	TD	50		17DTL	04/98 ->	4	DG-001	11V	
Astra Van									
1.7	D	42		17D	09/91 -> 08/94	4	DG-001	11V	
1.7	D	44		17DR	09/91 -> 08/94	4	DG-001	11V	
1.7	TD	60		17TD	09/92 -> 08/98	4	DG-159	5V	
1.7	TD	50		X17DTL	09/94 -> 03/04	4	DG-001	11V	
2.0	D	60		X20DTL	09/98 -> 03/04	4	DG-118	11V	
2.0	Di	74		Y20DTH,Y20DTL	08/99 -> 03/04	4	DG-118	11V	
2.0	TDi			X20DTL	09/98 -> 03/04	4	DG-118	11V	



KW



OPEL (continued)							
Bedford Blitz							
2.0	D	44		Serie 97000	10/78 -> 12/80	4	DG-001 11V
2.3	D	46		Opel 23D	09/80 -> 07/87	4	DG-001 11V
Campo							
2.2	D	44	Pick-up	4 FD1 (C223 IN TD)	06/89 -> 09/96	4	DG-124 11V
2.5	D/TD	56		4JA1 / 4JA1T	02/89 -> 07/01	4	DG-108 11V
2.5	D	56		25D	06/90 -> 09/94	4	DG-001 11V
3.1	TDi	80		31DT	09/92 -> 09/96	4	DG-104 11V
3.1	TDi	80		4 JG2 T	03/95 -> 12/96	4	DG-104 11V
3.1	TDi	80		31TD	10/96 ->	4	DG-104 11V
3.1	TDi	80		4 JG2 T	03/97 -> 08/02	4	DG-104 11V
1.3	CDTi	51		Z13DT	10/04 ->	4	DG-171 11V
1.7	D	44		17D 4EE1; X17 D 4EE1	09/94 -> 10/01	4	DG-300 11V
1.7	Di	48		Y17DTL	10/01 ->	4	DG-001 11V
1.7	DTi	55		17D 4EE1; X17 D 4EE1	09/94 -> 10/01	4	DG-302 11V
Corsa (A)							
1.5	D	37		15D 4EC1 (Eng No ->804794)	10/85 -> 11/88	4	DG-143 5V
1.5	D	37		15D 4EC1 (Eng No 804795->)	12/88 -> 03/93	4	DG-124 11V
1.5	TD	49		15DT,T4EC1 AADT (Eng No ->804794)	09/86 -> 04/93	4	DG-159 5V
1.5	TD	49		T4EC1 (Eng No 804795->)	09/87 -> 03/93	4	DG-104 11V
Corsa (B)							
1.5	D	37		15D (4EC1)	03/93 -> 09/00	4	DG-300 11V
1.5	TD	49		15TD / X15DT (4EC1)	03/93 -> 09/00	4	DG-300 11V
1.7	TD	60		17D / X17D (4EE1)	03/93 -> 09/00	4	DG-300 11V
Corsa (C)							
1.3	CDTi	51		Z13DT	06/03 ->	4	DG-171 11V
1.7	TD	48		1.7 TD	09/00 ->	4	DG-001 11V
1.7	Di	48		Y17DTL	09/01 ->	4	DG-302 11V
1.7	DTi	55		Y17DT	09/01 ->	4	DG-302 11V
1.7	CDTi	74		Z17DTH	04/03 ->	4	DG-170 11V
Corsa Van							
1.5	D	37		15D	09/94 -> 05/97	4	DG-124 11V
Frontera							
2.2	DTi	85		X22DTH	09/98 -> 07/00	4	DG-118 11V
2.2	DTi	92		Y22DTH	08/00 ->	4	DG-142 11V
2.3	TD	74	Intercooler	23DTR	08/91 -> 09/98	4	DG-001 11V
2.5	TDS	85		25TDS	09/96 -> 09/98	4	DG-109 11V
Frontera (B)							
2.0	TDi	92		X22DTH	10/97 -> 08/00	4	DG-118 11V
2.2	TDi	85		X22DTH	10/97 ->	4	DG-118 11V
2.2	TDi	92		X22DTH	08/00 ->	4	DG-142 11V
2.2	TDi	92		Y22DTH	08/00 ->	4	DG-142 11V
Kadett (D)							
1.6	D	40		16D	03/82 -> 08/84	4	DG-001 11V
Kadett (E)							
1.5	D	37		15D74EC1	09/84 -> 08/91	4	DG-143 5V
1.5	D	37		4EC1 (Eng No 804795->)	09/84 -> 08/91	4	DG-124 11V
1.5	TD	53		TC4EC1 (Eng No 817253->)	09/88 -> 08/91	4	DG-104 11V
1.5	TD	53		15TD,TC4EC1	09/88 -> 08/91	4	DG-159 5V
1.6	D	40		16D	09/84 -> 01/89	4	DG-001 11V
1.7	D	42		17D	1989 -> 07/91	4	DG-001 11V
1.7	TD	60		TC 4EE1 OHC Isuzu (Eng No 817253->)	02/90 -> 08/91	4	DG-010 11.5V
1.7	TD	60		17TD,TC4EE1 (Eng No ->817252)	02/90 -> 08/91	4	DG-159 5V
1.7	TD	60		TC 4EE1 OHC Isuzu (Eng No 817253->)	02/90 -> 08/91	4	DG-010 11.5V
Meriva							
1.7	DTi	55		Y17DT	09/02 ->		DG-302 11V
1.7	CDTi	74		Z17DTH	08/03 ->	4	DG-170 11V
Midi							
2.0	TD	51		20D	02/86 -> 08/94	4	DG-159 5V
2.2	D	45		22D	02/86 -> 08/94	4	DG-159 5V
Monterey							
3.0	DTi	117		30TD	09/97 -> 08/99	4	DG-104 11V
3.1	TD	84		Isuzu 4JG2T	09/91 -> 12/97	4	DG-104 11V
Movano							
1.9	DTi	59,60		F9Q.770	12/99 ->	4	DG-107 11V



KW



OPEL (continued)							
2.2	DTi	66	G9T720	09/00 ->	4	DG-126	11V
2.5	D	59	S8U.770	07/98 -> 09/00	4	DG-004	11.5V
2.5	DTi	59	S8U.770	12/99 ->	4	DG-001	11V
2.5	DTi	84	G9U720	10/01 ->	4	DG-126	11V
Omega (A)							
2.3	D	53	23YD	09/86 -> 01/94	4	DG-001	11V
2.3	TD	66	23YDT	09/86 -> 01/94	4	DG-001	11V
2.3	TD	74	23DTR	09/89 -> 01/94	4	DG-001	11V
Omega (B)							
2.0	Di	60	X20DILC	09/96 -> 08/97	4	DG-133	11V
2.0	DTi	74	X20DILC	09/97 -> 09/99	4	DG-118	11V
2.0	DTi	74	Y20DTH	09/99 -> 08/03	4	DG-142	11V
2.2	DTi	92	Y22DTH	08/00 ->	4	DG-142	11V
2.2	DTi	88	Y22DTH	10/00 ->	4	DG-142	11V
2.5	TD	96	BMW - X25DT OHC-R6	02/94 -> 02/01	6	DG-001	11V
Omega (C)							
2.2	DTi	92	Y22DTR	08/00 ->	4	DG-142	11V
2.2	DTi	74	Y20DTH	09/00 ->	4	DG-142	11V
Rekord (E)							
2.0	D	43	20D	11/79 -> 08/81	4	DG-001	11V
2.1	D	45	21D	1980 -> 1981	4	DG-001	11V
2.3	D	48,52	23D	11/79 -> 08/86	4	DG-001	11V
2.3	TD	63	23TD	08/82 -> 05/84	4	DG-001	11V
2.3	TD	63	23TD	06/84 -> 08/86	4	DG-001	11V
Rekord Van							
2.1	D	44	21D	09/80 -> 08/86	4	DG-001	11V
2.3	D	48	23D	09/80 -> 08/86	4	DG-001	11V
2.3	TD	63	23TD	09/83 -> 08/86	4	DG-001	11V
Senator (A)							
2.0	D	45	(Eng No 90310->)	09/84 -> 08/87	4	DG-001	11V
2.3	D	70	(Eng No 40019->)	11/84 -> 08/87	4	DG-001	11V
2.3	TD	64	23TD	03/83 -> 08/87	4	DG-001	11V
Senator (B)							
2.0	D		(Eng No 90310	09/87 ->		DG-001	11V
Signum							
1.9	CDTi	88	Z19DT	04/04 ->	4	DG-122	11V
1.9	CDTi	110	Z19DTH	04/04 ->	4	DG-122	11V
2.0	DTi	74	Y20DTH	05/03 ->	4	DG-142	11V
2.2	DTi	92	Y20DTR	05/03 ->	4	DG-142	11V
Sintra							
2.2	DTi	85	X22DTH	07/97 -> 04/99	4	DG-118	11V
Tigra TwinTop							
1.3	CDTi	51	Z13DT	06/04 ->	4	DG-171	11V
Vectra (A)							
1.7	D	42	17D	09/88 -> 05/93	4	DG-001	11V
1.7	TD	60	TC4 EC1 Isuzu (Eng No ->817252)	03/90 -> 09/95	4	DG-300	11V
1.7	TD	60	TC4 EC1 Isuzu (Eng No 817253->)	03/90 -> 09/95	4	DG-300	11V
Vectra (B)							
1.7	TD	60	X17TD,TC4EC1	09/95 -> 12/96	4	DG-159	5V
2.0	Di	60	X20DTL	08/99 -> 03/02	4	DG-118	11V
2.0	DTi	74	X20DTH	07/97 -> 07/99	4	DG-118	11V
2.0	DTi	74	X20DTH	09/97 -> 02/98	4	DG-133	11V
2.0	DTi	74	X20DTH	03/98 -> 06/00	4	DG-118	11V
2.0	DTi	74	Y20DTH	07/00 -> 03/02	4	DG-142	11V
2.2	DTi	92	Y22DTR	07/00 -> 03/02	4	DG-142	11V
Vectra (C)							
1.9	CDTi		Z19DTL	04/04 ->	4	DG-122	11V
1.9	CDTi	88	Z19DT	04/04 ->	4	DG-122	11V
1.9	CDTi	110	Z19DTH	04/04 ->	4	DG-170	11V
2.0	DTi	74	Y20DTH	06/02 ->	4	DG-142	11V
2.2	DTi	92	Y20DTR	04/02 ->	4	DG-142	11V
Vivaro							
1.9	Di	59	F9Q.770	12/99 ->	4	DG-107	11V
1.9	DTi	74	F9Q.760	08/01 ->	4	DG-107	11V
2,5	CDTi	99	G9U-730	05/03 ->	4	DG-126	11V



KW



OPEL (continued)							
Zafira							
2.0	DTi	60		X20DTL	02/99 ->	4	DG-118 11V
2.0	DTi	74		Y20DTH	07/00 ->	4	DG-118 11V
2.2	DTi	92		X22DTL	09/99 ->	4	DG-118 11V
2.2	DTi	92		Y22DTR	01/02 ->	4	DG-142 11V
OTOSAN							
600 Pick Up							
1.9	D			ERK		4	DG-001 11V
PERKINS							
4.165							
2.7	D						DG-001 11V
PEUGEOT							
106							
1.4	D	37		TUD3	08/92 -> 03/96	4	DG-004 11.5V
1.5	D	40,55		TUD5,TUD5B	03/94 ->	4	DG-003 11V
107							
1.4	HDi	40		DV4D	06/05 ->	4	DG-113 11V
1007							
1.4	HDi	50		DV4TD (8HX, 8HZ)	04/05 ->	4	DG-113 11V
205							
1.8	D	44		XUD7	10/83 -> 05/97	4	DG-001 11V
1.8	TD	57		XU7,DT,XUD7	07/85 -> 05/97	4	DG-001 11V
1.9	D	47		XUD9	10/87 -> 06/94	4	DG-001 11V
206							
1.4	HDi	50		DV4	2001 ->	4	DG-113 11V
1.6	HDi	80	FAP 110	9HY (DV6 TED4)	05/04 ->	4	DG-113 11V
1.9	D	51		DW8,DW8B	07/98 ->	4	DG-003 11V
2.0	HDi	66,80		DW10,DW10TD	10/99 ->	4	DG-116 11V
305							
1.5	D	32,36		XID	11/77 -> 12/86	4	DG-001 11V
1.6	D	32,36		XD	11/77 -> 10/83	4	DG-001 11V
1.6	D	32,44		XID	07/81 -> 10/83	4	DG-001 11V
1.7	D	44		XUD7	11/77 -> 10/83	4	DG-001 11V
1.8	D	32		XID	1983 -> 1987	4	DG-001 11V
1.9	D	48	Furgonette	XUD9	10/82 -> 07/90	4	DG-001 11V
306							
1.8	D	44		XUD7(CEE19,5)	04/92 -> 06/95	4	DG-001 11V
1.8	D	44		XUD7(CEE95L3)	1994 -> 08/98	4	DG-001 11V
1.8	D	44		XUD7	06/95 -> 08/98	4	DG-001 11V
1.8	D	44		XUD7(CEE95L3)	09/98 -> 03/01	4	DG-001 11V
1.8	D	44		XUD7	09/98 -> 03/01	4	DG-001 11V
1.9	D	50,52		XUD9	04/92 -> 08/98	4	DG-001 11V
1.9	D	50,52		XUD9A,L	03/93 -> 03/01	4	DG-001 11V
1.9	D	51		DW8,DW8B	04/98 -> 03/01	4	DG-003 11V
1.9	D	50,52		XUD9	09/98 -> 03/01	4	DG-001 11V
1.9	TD	68		XUD9TE	03/93 -> 08/98	4	DG-001 11V
1.9	TD	68		XUD9TE	09/98 -> 03/01	4	DG-001 11V
2.0	HDi	66,80		DW10,DW10TD	08/98 -> 03/01	4	DG-116 11V
307							
1.4	HDi	50		DV4TD	04/01 ->	4	DG-113 11V
1.6	HDi	80	FAP 110	9HY (DV6 TED4)	02/04 ->	4	DG-113 11V
2.0	HDi	66	90	DW10TD	04/01 ->	4	DG-116 11V
2.0	HDi	80	FAP 110	DW10ATED	04/01 ->	4	DG-116 11V
2.0	HDi	100	FAP 135	RHR (DW10 BTED4)	10/03 ->	4	DG-116 11V
309							
1.6	D	40		TUD5	03/94 -> 12/95	4	DG-003 11V
1.8	D,TD	58		XUD7,DT	06/86 -> 05/93	4	DG-001 11V
1.9	D	48		XUD9 (Y)	06/86 -> 05/93	4	DG-001 11V
405							
1.8	D,TD	66		XUD7TE	03/88 -> 06/95	4	DG-001 11V
1.9	D	52		XUD9	03/88 -> 01/97	4	DG-001 11V
1.9	D	52		XUD9A	02/97 ->	4	DG-001 11V



KW



PEUGEOT (continued)							
1.9	TD	68		XUD9TE,XUD9TF	09/92 -> 01/97	4	DG-001 11V
406							
1.9	TD	68		XUD9BTF,SD,TE	10/95 -> 08/98	4	DG-001 11V
1.9	TD	68		XUD9BTF,SD,TE	09/98 -> 03/99	4	DG-001 11V
2.0	HDi	66		DW10TD	04/99 ->	4	DG-116 11V
2.0	HDi	79	110 FAP	DW10ATED4 (RHS)	08/01 ->	4	DG-116 11V
2.1	TD	80		XUD11BTE	10/95 -> 08/98	4	DG-001 11V
2.1	TD	80		XUD11BTE	09/98 -> 03/99	4	DG-001 11V
2.2	HDi	98		DW12TED4	02/00 ->	4	DG-116 11V
2.2	HDi	100		DW12TED	09/00 ->	4	DG-116 11V
407							
1,6	HDi	80	FAP 110	9HY (DV6 TED4)	05/04 ->	4	DG-113 11V
2.0	HDi	100	FAP 135	RHR (DW10 BTED4)	05/04 ->	4	DG-116 11V
504							
1.9	D	36,49		XD4-88	06/78 -> 06/87	4	DG-001 11V
1.9	D	39		XD88	02/79 -> 10/86	4	DG-001 11V
1.9	D	36,49		XD88	07/79 -> 10/86	4	DG-001 11V
1.9	D	43	Pick-Up	XD88	09/79 -> 10/86	4	DG-001 11V
2.1	D	43,58		XD4-90	06/78 -> 04/81	4	DG-001 11V
2.1	D	43,58		XD4-90	05/81 -> 09/81	4	DG-001 11V
2.3	D	47,64		XD2	06/78 -> 04/81	4	DG-001 11V
2.3	D	51		XD2	05/81 -> 06/83	4	DG-001 11V
2.3	D	51	Pick-Up	XD2	09/82 -> 10/86	4	DG-001 11V
2.5	D	55	Pick-Up	XD3	08/90 -> 10/93	4	DG-001 11V
505							
2.3	D	44		XD2	09/79 -> 09/81	4	DG-001 11V
2.3	TD	59		XD2S	09/80 -> 06/81	4	DG-001 11V
2.5	TD	56,70		XD3,XD3T	06/81 -> 12/93	4	DG-001 11V
604							
2.3	TD	59		XD2S	02/79 -> 06/83	6	DG-001 11V
2.5	TD	70		XD3T	07/82 -> 06/86	6	DG-001 11V
605							
2.1	D	60		XUD11,A	06/89 -> 06/94	4	DG-001 11V
2.1	TD	81		XUD11BTE(CEE95L3)	06/89 -> 08/98	4	DG-001 11V
2.1	TD	81		XUD11BTE(CEE19.5)	06/89 -> 02/00	4	DG-001 11V
2.1	TD	81		XUD11 ATE	06/89 -> 05/94	4	DG-001 11V
2.1	TD	81		XUD11BTE(CEE95L3)	09/98 -> 02/00	4	DG-001 11V
2.5	TD	96		DKSATE	07/94 -> 08/98	4	DG-001 11V
607							
2.0	HDi	80		DW10ATED	02/00 ->	4	DG-116 11V
2.2	HDi	98		DW12TED4	02/00 ->	4	DG-116 11V
2.7	HDi	150		DT17TED4	12/04 ->	6	DG-140 11V
806							
1.9	TD	68,92		XUD9TE	07/94 -> 08/98	4	DG-001 11V
1.9	TD	68,92		XUD9TE	09/98 -> 2002	4	DG-001 11V
2.0	HDi	80		DW10TED,4	09/98 -> 2002	4	DG-116 11V
2.1	TD	80		XUD11ATE,BTE	05/95 -> 08/98	4	DG-001 11V
2.1	TD	80		XUD11ATE,BTE	09/98 -> 09/99	4	DG-001 11V
807							
2.0	HDi	66,80		DW10TD,DW10TED	2002 ->	4	DG-116 11V
2.2	HDi	98		DW12TED4	2002 ->	4	DG-116 11V
Boxer							
1.8	D	44		XUD7	09/98 ->	4	DG-001 11V
1.9	D	51		XUD9	02/94 -> 06/95	4	DG-001 11V
1.9	D	51		XUD9	07/95 -> 08/98	4	DG-001 11V
1.9	D	51		XUD9,XUD9AU	09/98 ->	4	DG-001 11V
1.9	TD	60,68		XUD9TE	03/94 -> 08/98	4	DG-001 11V
1.9	TD	60,68		XUD9TE,XUD9UTF	09/98 ->	4	DG-001 11V
2.0	HDi	80		DW10TD	09/98 ->	4	DG-116 11V
2.0	HDi	62		DW10UTD (RHV)	04/02 ->	4	DG-116 11V
2.2	HDi	74		DW12UTED (4HY)	04/02 ->	4	DG-116 11V
2.5	D	63		DJ5	03/94 ->	4	DG-001 11V
2.5	DTi	76		DJ5T	03/94 ->	4	DG-001 11V
2.5	DTi	79		DJ5TED	09/96 ->	4	DG-161 11V
2.8	JTD	93			10/97 ->	4	DG-001 11V



KW



PEUGEOT (continued)								
Expert								
1.9	D	51	220 C	XUD9A,L	09/95 ->	4	DG-001	11V
1.9	D	51		DW8	07/98 ->	4	DG-003	11V
1.9	D	51	220 C	XUD9A,L	09/98 ->	4	DG-001	11V
1.9	TD	68	220 C	XUD9TE	09/95 ->	4	DG-001	11V
2.0	HDi	66		DW10TD	12/99 ->	4	DG-116	11V
2.0	HDi	80		DW10ATED	07/00 ->	4	DG-116	11V
Express								
1.9	D	47		XUD9	09/87 -> 01/94	4	DG-001	11V
2.5	D	54		CRD93	09/81 -> 08/90	4	DG-001	11V
2.5	TD	70		CRD93LS	09/81 -> 06/91	4	DG-001	11V
J5								
1.9	D	51		XUD9A (BOSCH,CAV)	11/87 -> 01/94	4	DG-001	11V
2.5	D	55		CRD93	09/81 -> 06/91	4	DG-001	11V
2.5	D	55		CRD93	07/91 -> 01/94	4	DG-001	11V
2.5	D			DJ5	02/94 ->	4	DG-001	11V
2.5	TD	70		CRD93LS	07/87 -> 01/94	4	DG-001	11V
2.5	TD			DJ5T	02/94 ->	4	DG-001	11V
J7								
All	D				07/79 ->	4	DG-001	11V
J9								
2.1	D	41		XDP 4.90	10/80 -> 07/82	4	DG-001	11V
2.1	D	59		XDP 4.90	08/82 -> 08/86	4	DG-001	11V
2.3	D	49		XD2P	05/81 -> 08/86	4	DG-001	11V
2.5	D	53		XD3P	01/83 -> 05/91	4	DG-001	11V
Partner								
1.8	D	44		XUD7	08/96 -> 08/98	4	DG-001	11V
1.8	D	44		XUD7	09/98 ->	4	DG-001	11V
1.9	D	50		XUD9A	08/96 -> 08/98	4	DG-001	11V
1.9	D	51		DW8	07/98 ->	4	DG-003	11V
1.9	D	50		XUD9A	09/98 ->	4	DG-001	11V
2.0	HDi	66		DW10TD	12/99 ->	4	DG-116	11V
Ranch								
1.9	D	51		XUD9A	05/96 -> 08/98	4	DG-001	11V
1.9	D	51		XUD9A	09/98 ->	4	DG-001	11V
PIAGGIO								
Ape								
0.5	D	11			01/83 ->		DG-002	11V
Porter								
1.2	D	27		LDW1204P	1995 ->	4	DG-125	12.5V
PUCH								
250GD								
2.5	D	62		OM 602.930	10/87 -> 12/92	5	DG-010	11.5V
290GD								
2.9	D	70		602946	09/92 -> 08/97	5	DG-010	11.5V
2.9	TDi	90		602980	09/97 ->	5	DG-001	11V
G290								
2.9	TD	88			07/97 ->	4	DG-010	11.5V
G350								
3.4	TD	100		603972	06/92 -> 08/96	6	DG-010	11.5V
RENAULT								
5								
1.6	D	40		F8M.	09/85 -> 12/96	4	DG-006	11V
5 Super								
1.6	D	40		F8M-720,730	10/87 -> 03/95	4	DG-006	11V
9								
1.6	D	40		F8M-700,720,730	01/83 -> 03/91	4	DG-006	11V
11								
1.6	D	40		F8M-700,720,730	01/83 -> 03/91	4	DG-006	11V
18								
2.1	D	49		J8S-711	08/80 -> 02/86	4	DG-001	11V
2.1	TD	50		J8S	05/81 -> 02/86	4	DG-001	11V



KW



RENAULT (continued)							
2.1	TD	65		J8S-712	04/84 -> 02/86	4	DG-001 11V
19							
1.9	D	48		F8Q-706,742	03/91 -> 05/96	4	DG-006 11V
1.9	TD	68		F8Q-740,744	09/90 -> 03/96	4	DG-103 11V
20							
2.1	D	47			12/79 -> 04/81	4	DG-001 11V
2.1	D	47		J8S	05/81 -> 12/83	4	DG-001 11V
2.1	TD	64		J8S	09/82 -> 12/83	4	DG-001 11V
21							
1.9	D	48	Fastback	F8Q-	09/89 -> 02/91	4	DG-006 11V
1.9	D	48		F8Q-	09/89 -> 02/91	4	DG-001 11V
1.9	D	48		F8Q-710	03/91 -> 05/93	4	DG-006 11V
2.1	D	48,51		J8S-704	03/86 -> 1993	4	DG-001 11V
2.1	TD	65	Nevada	J8S-714,768,788	03/86 -> 1993	4	DG-001 11V
25							
2.1	D,TD	47,65		J8S-706,708,736,738	01/84 -> 12/92	4	DG-001 11V
30							
2.1	TD	63		J8S-852	10/81 -> 12/83	4	DG-001 11V
Avantime							
2.2	dCi	99		F9Q	09/01 ->	4	DG-107 11V
2.2	dCi	99	90	G9T 720	09/01 ->	4	DG-126 11V
B60							
2.2	D	68		J7T	10/87 -> 12/92	4	DG-101 11V
B70							
2.4	D	53		C7J	10/87 -> 12/92	4	DG-001 11V
B90							
2.4	D	53		C7J	10/87 -> 12/92	4	DG-001 11V
Clio							
1.5	DCi	48,59		K9K65,K9K80,K9K700	06/01 ->	4	DG-107 11V
1.9	D	48		F8Q-714,730,732	03/90 -> 02/91	4	DG-006 11V
1.9	D	48		F8Q-676,678,692,696	03/91 -> 08/98	4	DG-009 11V
1.9	D	47		F8Q.630,662	03/98 ->	4	DG-008 11V
1.9	D	48	D55/60, Connexion par clips	F8Q.632	01/99 ->	4	DG-112 11V
1.9	D	47	D65	F8Q.632	01/99 ->	4	DG-112 11V
1.9	D	59		F9Q.780	03/99 ->	4	DG-107 11V
1.9	DTi	72		F9Q.716	02/99 ->	4	DG-107 11V
1.9	DTi	59		F9Q.716	03/99 ->	4	DG-107 11V
Espace							
1.9	DTi	72		F9Q-722	02/99 ->	4	DG-107 11V
1.9	DCi	88		F9Q-820	11/02 ->	4	DG-107 11V
2.1	TD	65		J8S	10/84 -> 03/91	4	DG-001 11V
2.1	TD	65		J8S-610,772,776,778	04/91 -> 09/96	4	DG-001 11V
2.2	DCi	85,95	Grand	G9T-710	09/00 ->	4	DG-126 11V
2.2	TD	84		G8T- 714,716	10/96 -> 08/00	4	DG-101 11V
2.2	DCi	110		G9T-742, 743	11/02 ->	4	DG-126 11V
Express							
1.6	D	40		F8M-720,730,736,760	02/86 -> 09/93	4	DG-006 11V
1.6	D	40		F8M	03/86 -> 01/88	4	DG-006 11V
1.9	D	47		F8Q-684,722,724,774,776	09/91 ->	4	DG-006 11V
1.9	D	47,48		F8Q 640,644,646,648,682	09/94 ->	4	DG-009 11V
Extra							
1.6	D	40		F8M	06/86 -> 10/94	4	DG-006 11V
1.9	D	40		F8Q-640,644,646,678	09/91 -> 12/95	4	DG-001 11V
1.9	D	47,48		F8Q 640	09/94 -> 12/95	4	DG-009 11V
1.9	D	47		F8Q-722,724,774,776	01/96 -> 11/98	4	DG-006 11V
1.9	D	47,48		F8Q 640	01/96 ->	4	DG-009 11V
Fuego							
2.1	TD	65		J8S 712	09/82 -> 07/84	4	DG-001 11V
Kangoo							
1.5	DCi	40		K9K-710	09/02 ->	4	DG-107 11V
1.5	DCi	48		K9K-700, 704	12/01 ->	4	DG-107 11V
1.5	DCi	60		K9K-702	07/02 ->	4	DG-107 11V
1.9	D	47	D55 (KCOD)	F8Q-630	03/98 ->	4	DG-008 11V
1.9	D	40	D65 (KCOE)	F8Q-662	03/98 ->	4	DG-008 11V
1.9	D	40	D55	F8Q-632	03/99 ->	4	DG-112 11V



KW



RENAULT (continued)								
1.9	D	47	D65	F8Q-632	03/99 ->	4	DG-112	11V
1.9	DTi	59		F9Q-780	02/00 ->	4	DG-107	11V
1.9	DTi	58	4x4	F9Q-790	10/01 ->	4	DG-107	11V
Laguna								
1.9	DTi	72	Grandtour	F9Q-716	05/98 -> 01/99	4	DG-101	11V
1.9	DTi	72	Grandtour,Nevada	F9Q710,717,718	01/99 -> 12/00	4	DG-107	11V
1.9	DCi	77,88	Grandtour	F9QT-750,751,752	01/01 ->	4	DG-107	11V
2.2	D	61		G8T-706,752,790,792,794	02/96 -> 06/98	4	DG-101	11V
2.2	TD	83,85		G8T	01/94 -> 03/01	4	DG-101	11V
2.2	TD	83		G8T-760	02/96 -> 06/98	4	DG-101	11V
2.2	DCi	99		F9Q	03/01 ->	4	DG-107	11V
2.2	DCi	110		G9T-702	01/02 ->	4	DG-126	11V
Master								
1.9	DTi	59		F9Q-770	09/99 ->	4	DG-107	11V
2.1	TD	45		J8S	01/86 ->	4	DG-001	11V
2.2	D	85		G9T-720 (722 INTD)	10/00 ->	4	DG-126	11V
2.2	DCi	85		F9Q	06/00 ->	4	DG-107	11V
2.4	D	52,72	T 35D	S8V-748	05/85 -> 02/98	4	DG-004	11.5V
2.4	TD	52-55	T 30D	Sofim 8140.61	09/80 ->	4	DG-004	11.5V
2.5	D	52		S8U-748	09/80 -> 05/82	4	DG-004	11.5V
2.5	D	52-55	T 35D	S8U-730,731,742	06/82 -> 07/98	4	DG-001	11V
2.5	D	59		S8U-770	07/98 -> 01/01	4	DG-111	11V
2.5	TD	52	T 35D	Sofim 8140.61.2300	09/80 -> 05/82	4	DG-001	11V
2.5	TD	57	T 35D	Sofim 8140.27.2500/2510	01/81 -> 12/85	4	DG-001	11V
2.5	TD	57		28D Sofim	01/81 -> 12/85	4	DG-001	11V
2.5	TD	52	T 35D	Sofim 8140.61.2300	06/82 -> 01/89	4	DG-001	11V
2.5	TD	69	T 35D	S8V-748	05/85 ->	4	DG-004	11.5V
2.5	TD	72	T 35D	Sofim 8140.27.2580	08/89 -> 07/98	4	DG-001	11V
2.5	dCi	73	100	G9T 722	10/03 ->	4	DG-126	11V
2.5	dCi	84	120	G9T 720	10/01 ->	4	DG-126	11V
2.8	DTi	84		S9W-700,702,714,740	10/97 ->	4	DG-111	11V
Megane II								
1.5	DCi	60			09/02 ->	4	DG-107	11V
1.9	D	47		F8Q-620,624	11/95 ->	4	DG-009	11V
1.9	D	47,48	Classic	F8Q-620	01/96 ->	4	DG-009	11V
1.9	D	47	Classic	F8Q-788	03/98 ->	4	DG-008	11V
1.9	D	47		F8Q-788	03/99 ->	4	DG-008	11V
1.9	D	47	Connexion par clips	F8Q-622,790	03/99 ->	4	DG-112	11V
1.9	D	47	Classic	F8Q-622,790	03/99 ->	4	DG-112	11V
1.9	TD	69	Classic	F8Q-784	01/96 ->	4	DG-103	11V
1.9	DCi	72	Coach	F9Q-731,736	01/99 -> 08/02	4	DG-107	11V
1.9	DCi	75		F9Q-732,733	03/99 -> 08/02	4	DG-107	11V
1.9	DCi	88	Sport Touring	F9Q	11/03 ->	4	DG-107	11V
1.9	DTi	72	Classic,Coach	F9Q-730,734	03/97 -> 12/98	4	DG-101	11V
1.9	DTi	72		F9Q-730,734	04/97 -> 02/99	4	DG-101	11V
1.9	DTi	72		F9Q-731,732,736,740	01/99 -> 08/02	4	DG-107	11V
1.9	DTi	72	Classic	F9Q-731,736	01/99 -> 08/02	4	DG-107	11V
1.9	DTi	59	Classic	F9Q-744	02/01 -> 08/02	4	DG-107	11V
1.9	DTi	59	Grandtour	F9Q-744	02/01 -> 08/02	4	DG-107	11V
Megane Scenic								
1.9	D	47		F8Q-620,624	11/95 -> 02/99	4	DG-009	11V
1.9	D	47		F8Q-788	03/98 -> 09/99	4	DG-008	11V
1.9	D	40	Connexion par clips	F8Q-622,790	01/99 -> 09/99	4	DG-112	11V
1.9	Di	59		F9QT-770	06/00 ->	4	DG-107	11V
1.9	TD	66		F8Q-784	01/96 -> 09/99	4	DG-103	11V
1.9	TD	66,69	Grandtour	F9Q-730, 734	01/96 -> 09/99	4	DG-101	11V
1.9	dCi	72		F9Q-730,734	01/96 -> 09/99	4	DG-107	11V
1.9	dCi	72		F9Q-732,733	03/99 ->	4	DG-107	11V
1.9	dCi	72		F9Q-731,736	03/99 -> 09/99	4	DG-107	11V
1.9	dCi	79		F9Q-716, 718	06/00 ->	4	DG-107	11V
1.9	DTi	72		F9Q-731,732,736,740	01/99 ->	4	DG-107	11V
1.9	DTi	72		F9Q-716, -718	03/99 ->	4	DG-107	11V
1.9	DTi	59	Grandtour	F9Q-744	02/01 ->	4	DG-107	11V
Rapid								
1.6	D	40		F8M-720,730,736,760	02/88 -> 09/93	4	DG-006	11V



KW



RENAULT (continued)								
1.9	D	47		F8Q-640,644,646,678	09/91 -> 12/95	4	DG-001	11V
1.9	D	47,48		F8Q-640	09/94 -> 03/98	4	DG-009	11V
1.9	D	47		F8Q-722,724,774,776	01/96 -> 03/98	4	DG-006	11V
Safrane								
2.1	TD	64		J8S-760	04/92 -> 10/96	4	DG-001	11V
2.2	TD	83		G8T-740	10/96 -> 11/01	4	DG-101	11V
2.5	TD	83		S8U-762,763	05/93 -> 10/96	4	DG-001	11V
Scenic								
1.5	dCi	60		K9K-722	06/03 ->	4	DG-107	11V
1.5	dCi	74		K9K-728	12/03 ->	4	DG-107	11V
1.9	dCi	72		F9Q-730, 734	01/96 -> 09/99	4	DG-101	11V
1.9	dCi	72		F9Q-731, 736	03/99 -> 09/99	4	DG-107	11V
1.9	dCi	75		F9Q-716, 733	11/00 ->	4	DG-107	11V
1.9	dCi	81			06/03 ->	4	DG-107	11V
1.9	dCi	88		F9Q-812	06/03 ->	4	DG-107	11V
1.9	dCi	96			05/05 ->	4	DG-107	11V
Trafic								
1.9	D	44		F8Q-600,606	05/98 -> 03/01	4	DG-008	11V
1.9	dCi	60,74	80, 100	F9Q-760, 762	03/01 ->	4	DG-107	11V
2.1	D	43,47	T800,T1000,T1200	J8S-620,622,758	09/80 -> 10/97	4	DG-001	11V
2.1	D	43	P800, P1000,	852-750	09/80 -> 10/97	4	DG-001	11V
2.5	D	50		S8U-720,750,752	09/80 -> 10/97	4	DG-004	11.5V
2.5	D	52		Sofim S8U	10/82 -> 10/97	4	DG-001	11V
2.5	D	55		S8U-758	05/89 -> 01/99	4	DG-004	11.5V
2.5	D	55		8140.67.2500	03/90 -> 10/97	4	DG-001	11V
2.5	dCi	99	140	G9U-730	05/03 ->	4	DG-126	11V
Vel Satis								
2.2	dCi	85102110		G9T 600, 702, 703	04/02 ->	4	DG-126	11V
Winnebago								
2.1	D	43-57		J8S-232-234	04/82 -> 06/87	4	DG-001	11V
ROVER								
25								
2.0	TD	74		20T	10/99 ->	4	DG-101	11V
45								
2.0	TD	74		20T	02/00 ->	4	DG-101	11V
75								
2.0	CDT	85	Tourer	M47R (BMW)	04/99 ->	4	DG-145	11V
2.0	CDTi	96		204 D2	02/03 ->	4	DG-145	11V
114								
1.4	D	37		TUD 3	01/92 -> 12/98	4	DG-004	11.5V
115								
1.5	D	57		TUD5	03/95 ->	4	DG-003	11V
218								
1.8	TD	65		XUD 7TE	03/91 -> 12/95	4	DG-001	11V
1.9	D	51		XUD 9A	03/91 -> 03/00	4	DG-001	11V
1.9	D	49	SD	XUD9	09/91 -> 03/00	4	DG-001	11V
220								
2.0	D	66,77		20T2N, 20T2R	01/96 -> 03/00	4	DG-101	11V
418								
1.8	TD	65		XUD 7TE	03/91 -> 03/00	4	DG-001	11V
1.9	D	51		XUD 9A	03/91 -> 03/00	4	DG-001	11V
420								
2.0	SD	63		20T2R	03/96 ->	4	DG-101	11V
2.0	SDI	77		20T2N	03/96 ->	4	DG-101	11V
620								
2.0	TD	77		20T2N	02/95 -> 06/99	4	DG-101	11V
825								
2.5	D	87		LBB 102 49/C-2500	01/88 -> 07/91	4	DG-202	11V
2.5	TD	88			04/90 -> 11/91	4	DG-202	11V
2.5	TD	87		VM425 Slira	12/91 -> 04/95	4	DG-001	11V
2.5	TD	87	SD, TD	VM HR-492/VM 425 SLIRR	01/93 -> 04/95	4	DG-001	11V
2.5	TD	87		VM425 Slira	05/95 -> 02/99	4	DG-109	11V
2400								
2.4	TD			VM-HR 492 HT	04/82 -> 04/86	4	DG-202	11V



KW



ROVER (continued)									
FL / R (Hire Car)									
2.2	D					08/83 ->	4	DG-101	11V
FX 4R Taxi									
2.2	D					08/83 ->	4	DG-101	11V
Maestro									
2.0	D	45			Perkins	1986 -> 1992	4	DG-001	11V
2.0	D	45	500D		Perkins-Prima 80	01/86 -> 12/89	4	DG-001	11V
2.0	D	45	700 D		Perkins-Prima 80	01/86 -> 12/89	4	DG-001	11V
2.0	TD	60			Perkins	01/86 -> 12/95	4	DG-001	11V
Metro									
1.4	D	37			TUD 3	01/92 -> 12/95	4	DG-004	11.5V
Montego									
2.0	D	45			Perkins	1986 -> 1992	4	DG-001	11V
2.0	TD	60			Perkins	1986 -> 1992	4	DG-001	11V
SAAB									
9-3									
2.2	TDi	85	TID		D223L/X22DTH	09/98 -> 11/00	4	DG-118	11V
2.2	TDi	92	TID			11/00 ->	4	DG-142	11V
SANTANA									
Santana									
2.5,3.5	D					1987 ->	4	DG-001	11V
SEAT									
131									
2.5	D	52				06/83 -> 12/84	4	DG-001	11V
Alhambra									
1.9	TDi	66,81			1Z,AFN	01/96 ->	4	DG-005	11V
1.9	TDi	66			AHU	07/96 ->	4	DG-005	11V
1.9	TDi	66			ANU	03/99 -> 09/01	4	DG-005	11V
1.9	TDi	81			AVG	06/99 ->	4	DG-005	11V
1.9	TDi	85			AJM	04/00 ->	4	DG-005	11V
1.9	TDi	85			AUY	06/00 ->	4	DG-005	11V
1.9	TDi	96			ASZ	11/02 ->	4	DG-109	11V
1.9	TDI	110				05/05 ->	4	DG-177 *	5V
Altea									
1.9	TDI	77			BJB, BKC	04/04 ->	4	DG-177 *	5V
2.0	TDI	100			AZV	03/04 ->	4	DG-177 *	5V
Arosa									
1.4	TDi	55			AMF	08/99 -> 10/01	3	DG-005	11V
1.4	TDi	55			AMF	11/01 ->	3	DG-109	11V
1.7	SDi	44			AKU	10/97 ->	4	DG-005	11V
Cordoba									
1.7	SDi	44				07/97 -> 06/99	4	DG-005	11V
1.9	D	47,50			1Y	05/93 -> 08/99	4	DG-002	11V
1.9	SDi	47			AEF	03/93 -> 08/99	4	DG-002	11V
1.9	SDi	47			AEY	01/96 -> 09/02	4	DG-005	11V
1.9	SDi	55			AQM,AGP	06/99 ->	4	DG-005	11V
1.9	SDi	47			ASY	10/02 ->	4	DG-109	11V
1.9	TD	55			AAZ	05/94 -> 08/99	4	DG-002	11V
1.9	TDi	66			1Z,AHU,ALH,AGR	08/96 ->	4	DG-005	11V
1.9	TDi	81			AFN,ASK,ASV	06/97 ->	4	DG-005	11V
1.9	TDi	96			ASZ	10/02 ->	4	DG-109	11V
1.9	TDi	74			ATD	10/02 ->	4	DG-109	11V
Ibiza									
1.7	D	40			Fiat- 138 A.5	06/84 -> 09/93	4	DG-001	11V
1.7	SDi	44				07/97 -> 08/99	4	DG-005	11V
1.9	D	47			EAF	03/93 ->	4	DG-002	11V
1.9	D	47,50			1Y	05/93 -> 08/96	4	DG-002	11V
1.9	SDi	47			AEF	03/93 -> 08/99	4	DG-002	11V
1.9	SDi	47			AEY	03/93 -> 08/99	4	DG-005	11V
1.9	SDi	50			AQM,AGP	08/99 ->	4	DG-005	11V
1.9	TD	55			AAZ	05/93 ->	4	DG-002	11V
1.9	TDi	66,81			1Z,AHU,AFN	08/96 -> 08/99	4	DG-005	11V

* Available from Jan. 2007



KW



SEAT (continued)								
1.9	TDi	66,81		ALK,ALH,AGR,ASK,ASV	08/99 ->	4	DG-005	11V
1.9	TDI Cupra R	118	Chassis No. 70251->	BPX	03/04 ->	4	DG-177 *	5V
Inca								
1.9	D	47		1Y,1EY	11/95 ->	4	DG-002	11V
1.9	SDi	47		AEY,AYQ	11/95 ->	4	DG-005	11V
Leon								
1.9	SDi	50		AQM	11/99 ->	4	DG-005	11V
1.9	TDi	66		ALG,AGR	09/99 ->	4	DG-005	11V
1.9	TDi	81		ASV,AHF	09/99 ->	4	DG-005	11V
1.9	TDi	110		ARL	01/01 ->	4	DG-005	11V
1.9	TDI	77		BJB, BKC	09/05 ->	4	DG-177 *	5V
1.9	TDI	81-110			09/05 ->	4	DG-177 *	5V
Malaga								
1.7	D	40		Fiat-138 A.5	05/85 -> 05/93	4	DG-001	11V
Ritmo								
1.7	D	40		138 A.5	09/80 -> 12/86	4	DG-001	11V
Ronda								
1.7	D	40		138 A.5	09/80 -> 12/86	4	DG-001	11V
1.7	D	40		022A.5000	09/85 -> 12/93	4	DG-001	11V
Terra								
1.3	D	33		MN	01/90 -> 12/94	4	DG-002	11V
1.3,1.4	D	35			01/90 -> 10/95	4	DG-002	11V
1.4	D	35		1400D	10/89 -> 10/95	4	DG-002	11V
1.4	D	35		1W	10/90 -> 12/95	4	DG-002	11V
1.4	D	35	Kombi	1W	10/91 -> 12/95	4	DG-002	11V
Toledo								
1.9	D	48		1Y	03/91 -> 10/98	4	DG-002	11V
1.9	SDi	48,50		AEY	12/95 -> 03/99	4	DG-005	11V
1.9	TD	55		AAZ	03/91 -> 04/97	4	DG-002	11V
1.9	TDi	66,81		1Z,AFN	08/96 -> 10/98	4	DG-005	11V
1.9	TDi	66		AGR,AHU,ALH	01/97 ->	4	DG-005	11V
1.9	TDi	81		AHF,ASV	11/98 ->	4	DG-005	11V
1.9	TDi	110		ARL	01/01 ->	4	DG-005	11V
1.9	TDI	77		BJB, BKC	10/04 ->	4	DG-177 *	5V
SKODA								
Fabia								
1.4	TDI	55		AMF	04/03 ->	4	DG-109	11V
1.9	SDi	47		ASY	1999 ->	4	DG-005	11V
1.9	SDI	47		AGP	12/99 ->	4	DG-005	11V
1.9	TDi	74		ATD	1999 ->	4	DG-005	11V
1.9	TDi	85		AJM	12/99 ->	4	DG-005	11V
1.9	TDi	81		AHF	10/00 ->	4	DG-005	11V
Felicia								
1.9	D	47		1Y	09/96 ->	4	DG-002	11V
1.9	D	47		AEF	1996 -> 06/01	4	DG-002	11V
Octavia								
1.9	D	50		AGP	07/96 ->	4	DG-005	11V
1.9	SDI	47		AEY	09/96 ->	4	DG-005	11V
1.9	SDi	50	LX,SLX	AGP,AQM	05/97 ->	4	DG-005	11V
1.9	TDi	66,81	4x4	1Z	1996 -> 07/00	4	DG-005	11V
1.9	TDi	66		AGR	01/96 ->	4	DG-005	11V
1.9	TDi	66		ALH	07/96 ->	4	DG-005	11V
1.9	TDi	81		AHF	01/97 ->	4	DG-005	11V
1.9	TDi	66,74,81		AGR,AHF,ALH,ASV,ATD	08/00 ->	4	DG-005	11V
1.9	TDi	85		AJM, AUY	10/00 ->	4	DG-005	11V
1.9	TDi	74		ATD	10/00 ->	4	DG-005	11V
1.9	TDi	96		ASZ	02/03 ->	4	DG-109	11V
1.9	TDI	77	Chassis No. 70251->	BJB, BKC	06/04 ->	4	DG-177 *	5V
Pick Up								
1.9	D	47		AEF	01/96 ->	4	DG-002	11V
Roomster								
1.9	TDI	77			09/06 ->	4	DG-177 *	5V
Superb								
1.9	TDI	74		AVB	08/02 ->	4	DG-109	11V

* Available from Jan. 2007



KW



SKODA (continued)							
1.9	TDI	96		AVF, AWX	02/02 ->	4	DG-109 11V
2.5	TDI	114		AYM	02/02 ->	6	DG-144 11V
2.5	TDI	120		BDG	06/03 ->	6	DG-144 11V
SSANG YOUNG							
Istana							
2.3	D	58		661, 911	07/95 ->	4	DG-010 11.5V
2.9	D	70		662, 911	07/95 ->	5	DG-010 11.5V
Korando							
2.2	D	51		DC23	01/93 -> 12/96	4	DG-124 11V
2.3	D	58		OM601	01/97 ->	4	DG-010 11.5V
2.5	D	58		XD3P	06/93 -> 07/97	4	DG-001 11V
2.9	D	73		OM602	09/96 ->	5	DG-010 11.5V
2.9	D	73		OM662	02/99 ->	5	DG-010 11.5V
2.9	TD	88			04/98 ->	5	DG-010 11.5V
Musso							
2.3	D	57,58		MB OM 601	07/93 ->	4	DG-010 11.5V
2.9	D	70		MB OM 602	07/93 ->	5	DG-010 11.5V
2.9	D	73		MB OM 602	03/96 -> 01/99	5	DG-010 11.5V
2.9	TD	88			04/98 ->	5	DG-010 11.5V
Rexton							
2.9	TD	88			04/02 ->	5	DG-010 11.5V
STEYR-DAIMLER-PUCH							
290 GD							
2.9	D	72		OM617, 603	08/93 ->	5	DG-010 11.5V
300							
3.0	D	83		OM617, 603	09/89 ->	6	DG-010 11.5V
3.5	TD	100		OM617, 603	09/91 ->	6	DG-010 11.5V
350 GD							
3.5	TD	100		OM617, 603	09/91 ->	6	DG-010 11.5V
SUZUKI							
Baleno							
1.9	TD	55		XUD9	02/99 ->	4	DG-001 11V
Grand Vitara							
2.0	TDi	64	Intercooler	RF	03/98 ->	4	DG-146 11V
2.0	TDi	80		DW10, RHW	2000 ->	4	DG-116 11V
Ignis (II)							
1.3	DDiS	51		Z 13DT	09/03 ->	4	DG-171 11V
Jimny (F)							
1.5	DDiS	48		K9K 700	12/03 ->	4	DG-107 11V
Liana							
1.4	TD	66		8HY (DV4TED4)	03/05 ->	4	DG-113 11V
Samurai							
1.9	TD	47		RFP	09/98 ->	4	DG-001 11V
Swift							
1.3	DDiS	51		Z 13DT	08/05 ->	4	DG-171 11V
Vitara							
1.9	D	50		XUD9	04/96 -> 03/98	4	DG-001 11V
1.9	TD	52		RF	12/94 -> 03/98	4	DG-146 11V
1.9	TD	50		XUD9	11/95 -> 08/98	4	DG-001 11V
1.9	TD	64		RF	12/95 -> 03/98	4	DG-146 11V
1.9	TD	50,55		XUD9	09/98 ->	4	DG-001 11V
2.0	TD	52,64	(ET, FT, GT, TA)	RF	08/95 ->	4	DG-146 11V
Wagon R+							
1.3	DDiS	51		Z 13DT	09/03 ->	4	DG-171 11V
TALBOT							
Express							
1.9	D	51		XUD9A	11/87 ->	4	DG-001 11V
2.5	D	55		CRD93 (LS)	09/81 ->	4	DG-001 11V
2.5	TD	70		CRD93 (LS)	09/81 ->	4	DG-001 11V
Horizon							
1.9	D	47	D		07/82 -> 06/86	4	DG-001 11V



KW



TALBOT (continued)									
Simca									
1.9	D	47		XUD9		04/84 -> 12/85	4	DG-001	11V
Solara									
1.9	D	48		XUD9		11/84 -> 07/86	4	DG-001	11V
Tagora									
2.3	TD	59				06/80 -> 12/83	4	DG-001	11V
TATA									
206									
1.9	D	44		4DL		07/88 ->	4	DG-001	11V
207									
1.9	D	50		4DL		07/88 ->	4	DG-001	11V
Gurkha									
1.9	D	50	Peugeot	483PLII		08/95 ->	4	DG-001	11V
Loadbeta									
1.9	D	50	Peugeot	483DLII		10/94 ->	4	DG-001	11V
1.9	TD	66	Peugeot	483DII		11/95 ->	4	DG-001	11V
Sumo									
1.9	TD	64	Peugeot	483DLT		10/97 ->	4	DG-001	11V
Telcoline									
1.9	D	50	Peugeot	483DLII		06/95 ->	4	DG-001	11V
1.9	TD	66	Peugeot	483DTII		02/96 ->	4	DG-001	11V
Telcosport									
1.9	D	50	Peugeot	483DLII		06/95 ->	4	DG-001	11V
TOYOTA									
Avensis									
All	CDT220		Cooling heater			08/99 -> 01/03		DG-400 *	11V
2.0	TD	66		2C-TE		10/97 -> 07/00	4	DG-214	11V
2.0	D-4D	81	CDT220	1CD-FTV		08/99 -> 01/03	4	DG-245	11V
2.0	D-4D	85	CDT250	1CD-FTV		03/03 ->	4	DG-245	11V
Avensis Verso									
2.0	D-4D	85	CLM20	1CD-FTV		05/01 ->	4	DG-245	11V
Aygo									
1.4	D	40		2WZ-TV		05/05 ->	4	DG-113	11V
Blizzard									
2.2	D			L		03/80 -> 10/81	4	DG-221	11V
2.2	D			L		01/82 -> 04/84	4	DG-215	7V
2.4	D			2L		08/83 -> 02/90	4	DG-215	7V
2.4	TD			2L-T		08/83 -> 02/90	4	DG-213	6V
2.4	TD			2L-TE		04/90 ->	4	DG-211	11V
Bus (DR10/11/15)									
	D		(24 Volt only)	2D		02/73 -> 04/77	6	DG-228	19V
	D		(24 Volt only)	2D		02/73 -> 03/77	6	DG-229	21V
	D		(24 Volt only)	2D		01/79 ->	6	DG-231	21.5V
Caldina									
2.0	D			2C		11/92 -> 01/96	4	DG-216	11V
2.0	TD			2C-T		01/96 -> 09/97	4	DG-214	11V
2.2	D			3C-E		05/98 ->	4	DG-214	11V
2.2	TD			3C-TE		09/97 ->	4	DG-305	11V
Camry									
1.8	TD	54		1C-TL		08/83 -> 10/86	4	DG-223	7V
2.0	TD	62		2C-TL		08/83 -> 10/86	4	DG-223	7V
2.0	TD	62		2C-T		10/86 -> 08/88	4	DG-223	7V
2.0	TD	63		2C-T		08/88 -> 06/91	4	DG-216	11V
Camry Vista									
2.2	TD			3C-T		07/94 ->	4	DG-305	11V
Carina									
1.8	D	48		1C		04/82 -> 09/83	4	DG-223	7V
Carina 2									
2.0	D	51		2C-L		10/83 -> 11/87	4	DG-223	7V
2.0	D	50		2C-L		10/83 -> 12/86	4	DG-232	10.5V
2.0	D	54		2C		12/87 -> 11/92	4	DG-216	11V
Carina E									
2.0	D	54		2C		02/92 -> 01/96	4	DG-216	11V

* Cooling heater plug only



KW



TOYOTA (continued)									
2.0	TD	61		2C-T	01/96 -> 10/97	4	DG-214	11V	
2.2	TD			3C-TE	07/94 ->	4	DG-305	11V	
Coaster									
3.0	D		24 Volt only	B	02/72 -> 10/74	4	DG-226	19V	
3.2	D			2B	08/80 -> 04/82	4	DG-234	8.5V	
3.2	D		(24 Volt)	2B	08/80 -> 04/82	4	DG-235	20.5V	
3.4	D		24 Volt only	3B	05/82 -> 07/89	4	DG-222	14V	
3.4	D			3B	05/82 -> 01/93	4	DG-232	10.5V	
3.4	D		(24 Volt)	3B	05/82 -> 01/93	4	DG-233	23V	
3.4	D		(24 Volt)	3B	08/88 -> 07/99	4	DG-219	23V	
4.0	D			2H	10/86 -> 08/88	6	DG-220	6V	
4.0	D			2H	10/86 -> 08/88	6	DG-232	10.5V	
4.0	D		(24 Volt)	2H	10/86 -> 08/88	6	DG-222	14V	
4.0	D		(24 Volt)	2H	10/86 -> 08/88	6	DG-233	23V	
4.0	D		(24 Volt)	2H	08/88 -> 01/90	6	DG-219	23V	
4.2	D		(24 Volt)	1HZ	01/90 -> 07/99	6	DG-219	23V	
4.2	TD		(24 Volt)	1H-DT	01/90 -> 01/93	6	DG-219	23V	
Corolla									
All	CDE110		Cooling heater		08/00 -> 11/01		DG-400 *	11V	
1.4	TD	55		1ND-TV	08/04 ->	4	DG-240	11V	
1.8	D	43		1C	10/82 -> 07/87	4	DG-223	7V	
1.8	D	47		1C-L	05/83 -> 04/87	4	DG-223	7V	
1.8	D	47		1C-L	05/83 -> 12/86	4	DG-232	10.5V	
1.8	D	47-49		1C	05/87 -> 06/92	4	DG-216	11V	
2.0	D	53		2C	05/92 -> 04/97	4	DG-216	11V	
2.0	D	53		2C	05/96 -> 04/97	4	DG-214	11V	
2.0	D	53		2C-E	04/97 -> 10/99	4	DG-214	11V	
2.0	D-4D	66,81,85	CDE120	1CD-FTV	09/00 ->	4	DG-245	11V	
Corolla Verso									
2.0	D-4D	66,85	CDE120	1CD-FTV	10/01 ->	4	DG-245	11V	
Corolla Sprinter									
1.5	TD			1N-T	05/86 -> 08/90	4	DG-215	7V	
1.5	TD			1N-T	09/90 -> 08/94	4	DG-211	11V	
1.5	TD			1N-T	09/94 ->	4	DG-212	11V	
1.8	D			1C-II / 1C-III	05/87 ->	4	DG-216	11V	
2.0	D			2C-III	06/91 -> 04/98	4	DG-216	11V	
Corolla Wagon									
2.2	D			3C-E	04/98 ->	4	DG-214	11V	
Corona									
1.8	D	43		1C	01/82 -> 12/83	4	DG-232	10.5V	
2.0	D	55		2C-L	10/83 -> 11/87	4	DG-223	7V	
2.0	D	55		2C-L	10/83 -> 12/86	4	DG-232	10.5V	
2.0	D	53		2C	01/86 -> 12/86	4	DG-223	7V	
2.0	D			2C / 2C-III	12/87 -> 01/96	4	DG-216	11V	
Cressida									
2.2	D	49		L	09/80 -> 07/84	4	DG-221	11V	
2.2	D	49		L	08/82 -> 07/84	4	DG-215	7V	
2.4	D	62		2L	08/84 -> 08/88	4	DG-221	11V	
2.4	D	62		2L	08/88 -> 02/93	4	DG-211	11V	
2.4	TD	63		2LT	08/84 -> 08/86	4	DG-213	6V	
Crown									
2.2	D			L	10/77 -> 08/79	4	DG-211	11V	
2.2	D	53		L	09/79 -> 07/83	4	DG-221	11V	
2.2	D	53		L	08/80 -> 07/83	4	DG-215	7V	
2.4	D	53		2L	08/83 -> 08/87	4	DG-221	11V	
2.4	D			2L	08/83 -> 07/89	4	DG-215	7V	
2.4	D			2L II	08/89 ->	4	DG-211	11V	
2.4	TD			2L - TE	08/82 -> 08/84	4	DG-211	11V	
2.4	TD			2L - T II	08/89 -> 08/89	4	DG-211	11V	
2.4	TD			2L-THE	12/84 -> 07/89	4	DG-213	6V	
2.4	TD			2L - THE II	08/89 ->	4	DG-211	11V	
2.4	TD			2L-T	07/89 -> 08/92	4	DG-213	6V	
2.4	TD		LS130, 131	2L-TE	08/93 -> 04/99	4	DG-310	11V	
Deliboy									
2.0	D			2C	05/91 ->	4	DG-216	11V	

* Cooling heater plug only



KW



TOYOTA (continued)							
Dyna							
2.4	D	55		2L	08/85 -> 08/88	4	DG-215 7V
2.4	D	55		2L	08/85 -> 09/91	4	DG-221 11V
2.4	D	55		2L	08/88 -> 01/99	4	DG-211 11V
2.4	D	55		2L	05/98 -> 08/01	4	DG-212 11V
2.4	D		LY100	2L	01/99 -> 08/01	4	DG-243 11V
2.4	D		LY100	2L	01/99 -> 08/01	4	DG-242 11V
2.5	D		12 Volt only	2J	01/73 -> 10/74	4	DG-234 8.5V
2.5	D		24 Volt only	2J	01/73 -> 10/74	4	DG-235 20.5V
2.5	TD			2KD-FTV	08/01 ->	4	DG-217 11V
2.8	D		12 Volt only	3L	02/69 -> 01/73	4	DG-224 8V
2.8	D	58		3L	08/88 -> 09/91	4	DG-221 11V
2.8	D	58		3L	08/88 -> 01/99	4	DG-211 11V
2.8	D	58		3L	05/96 -> 10/01	4	DG-212 11V
2.8	D		LY211	3L	01/99 -> 10/01	4	DG-243 11V
2.8	D		LY211	3L	01/99 -> 10/01	4	DG-242 11V
3.0	D		24 Volt only	B	02/72 -> 10/74	4	DG-226 19V
3.0	D		12 Volt only	B	02/72 -> 10/74	4	DG-227 8V
3.0	D		12 Volt only	B	10/74 -> 08/80	4	DG-234 8.5V
3.0	D		24 Volt only	B	10/74 -> 08/80	4	DG-235 20.5V
3.0	D	60		B	08/80 -> 11/84	4	DG-234 8.5V
3.0	D	60	(24 Volt)	B	08/80 -> 08/84	4	DG-235 20.5V
3.0	D		24 Volt only	B	04/82 -> 07/89	4	DG-222 14V
3.0	D	60		B	09/84 -> 08/87	4	DG-232 10.5V
3.0	D	60	(24 Volt)	B	09/84 -> 08/88	4	DG-233 23V
3.0	D		24 Volt only	B	08/90 -> 05/95	4	DG-219 23V
3.0	D			5L	10/96 -> 12/04	4	DG-212 11V
3.0	D		LY211	5L	01/99 -> 10/01	4	DG-243 11V
3.0	D		LY225, 235	5L	07/01 ->	4	DG-242 11V
3.2	D		12 Volt only	2B	08/77 -> 08/80	4	DG-234 8.5V
3.2	D		24 Volt only	2B	08/77 -> 08/80	4	DG-235 20.5V
3.2	D		12 Volt only	2B	08/80 ->	4	DG-232 10.5V
3.2	D		24 Volt only	2B	08/80 ->	4	DG-233 23V
3.2	D			2B	08/80 -> 11/84	4	DG-234 8.5V
3.4	D		24 Volt only	3B	08/80 -> 04/82	4	DG-235 20.5V
3.4	D		24 Volt only	3B	04/82 ->	4	DG-222 14V
3.4	D			3B	08/80 -> 11/84	4	DG-234 8.5V
3.4	D		(24 Volt)	3B	02/83 -> 08/84	4	DG-235 20.5V
3.4	D			3B	10/92 -> 08/99	4	DG-232 10.5V
3.4	D		(24 Volt)	3B	10/92 -> 05/95	4	DG-219 23V
3.4	D		(24 Volt)	3B	05/95 -> 05/99	4	DG-233 23V
3.4	D		24 Volt only	3B	05/95 ->	4	DG-219 23V
3.6	D		24 Volt only	H	05/72 -> 10/74	6	DG-226 19V
3.6	D	67	24 Volt only	H	08/77 -> 08/84	6	DG-225 19V
3.6	D			H	08/80 -> 11/84	6	DG-234 8.5V
4.0	D		24 Volt only	2H	05/72 -> 10/74	6	DG-226 19V
4.0	D		24 Volt only	2H	10/74 -> 04/82	6	DG-235 20.5V
4.0	D	77	24 Volt only	2H	08/77 -> 08/84	6	DG-225 19V
4.0	D			2H	08/80 -> 11/84	6	DG-234 8.5V
4.0	D		24 Volt only	2H	04/82 -> 04/83	4	DG-222 14V
4.0	D			2H	08/80 -> 11/84	6	DG-234 8.5V
4.0	D		WU90	1W	09/84 -> 08/87	4	DG-241 6V
Estima Emina							
2.2	TD			3C-T	01/92 ->	4	DG-305 11V
2.2	TD		CRX1#, 2#	3C-T	01/92 -> 05/93	4	DG-308 11V
2.2	TD		CRX1#, 2#	3C-TE	05/93 -> 08/99	4	DG-309 11V
Gaia							
2.2	TD			3C-TE	05/98 ->	4	DG-305 11V
Granvia							
3.0	TD			1KZ-TE	08/93 ->	4	DG-305 11V
Hiace							
2.2	D	46		L	09/79 -> 07/85	4	DG-221 11V
2.2	D	49		L	05/81 -> 08/87	4	DG-215 7V
2.4	D	55		2L	12/82 -> 08/89	4	DG-215 7V
2.4	D	55		2L	12/82 -> 08/87	4	DG-221 11V



KW



TOYOTA (continued)							
2.4	D	55		2L	08/89 -> 01/99	4	DG-211 11V
2.4	D	58		2L	08/96 -> 10/02	4	DG-212 11V
2.4	D			2L	01/99 -> 07/99	4	DG-243 11V
2.4	TD			2L-T	08/87 -> 07/89	4	DG-213 6V
2.4	TD	66		2LT	04/98 -> 08/01	4	DG-218 11V
2.5	TD	65-75		2KD-FTV	08/01 ->	4	DG-217 11V
2.8	D			3L	08/89 -> 01/99	4	DG-211 11V
2.8	D			3L	08/96 -> 08/00	4	DG-212 11V
3.0	D			5L	08/98 ->	4	DG-212 11V
3.0	D			5LE	08/01 -> 01/05	4	DG-212 11V
3.0	TD			1KZ-TE	08/93 ->	4	DG-305 11V
Hiace Van, Comuter							
2.4	D		LH1#	2L	01/99 -> 08/00	4	DG-243 11V
2.4	D		LH1#	2L	07/99 ->	4	DG-242 11V
2.8	D		LH1#	3L	01/99 -> 08/00	4	DG-243 11V
3.0	D		LH1#	5L	01/99 -> 08/02	4	DG-243 11V
3.0	D		LH1#	5L	07/99 -> 01/05	4	DG-243 11V
Hilux							
2.2	D	53		L	09/79 -> 09/84	4	DG-221 11V
2.2	D		LN40, 50	L (Cold spec)	12/79 -> 10/81	4	DG-238 23V
2.2	D	49		L	08/81 -> 08/85	4	DG-215 7V
2.4	D	55-61		2L	08/83 -> 08/91	4	DG-215 7V
2.4	D	55-61		2L	08/83 -> 08/95	4	DG-221 11V
2.4	D	59-61		2L	08/88 -> 07/98	4	DG-211 11V
2.4	D	58		2L	08/97 -> 08/01	4	DG-212 11V
2.4	D			2L	01/99 -> 08/01	4	DG-243 11V
2.4	D			2L	03/01 -> 08/01	4	DG-242 11V
2.4	TD		12 Volt only	2L-T	11/84 ->	4	DG-213 6V
2.4	TD		12 Volt only	2L-II T/2L-TE	08/90 -> 09/97	4	DG-211 11V
2.4	TD	66		2L-T	08/97 -> 05/98	4	DG-212 11V
2.4	TD	66		2L-T	05/98 -> 08/01	4	DG-218 11V
2.5	TD	65-75		2KD-FTV	08/01 -> 08/05	4	DG-217 11V
2,5	TD	75	D-4D	2KD-FTV	07/05 ->	4	DG-246 11V
2.8	D			3L	08/95 -> 07/98	4	DG-211 11V
3.0	D	92		1KZ-T	08/93 -> 11/95	4	DG-305 11V
3.0	D		12 Volt only	5L	09/97 ->	4	DG-212 11V
3.0	TD		12 Volt only	1KD-FTV	10/00 ->	4	DG-217 11V
Ipsum							
2.2	TD			3C-TE	08/97 ->	4	DG-305 11V
Land Cruiser							
2.4	D	53		2L	11/84 -> 10/85	4	DG-215 7V
2.4	TD	63		2L-T	10/85 -> 01/90	4	DG-213 6V
2.4	TD	66		2L-T	01/90 -> 01/95	4	DG-211 11V
3.0	D	59	(24 Volt)	B	02/74 -> 10/74	4	DG-226 19V
3.0	D		12 Volt only	B	02/74 -> 01/75	4	DG-227 8V
3.0	D		12 Volt only	B	01/75 -> 02/79	4	DG-234 8.5V
3.0	D	59		B	08/80 -> 10/84	4	DG-234 8.5V
3.0	D	59	(24 Volt)	B	08/80 -> 10/84	4	DG-235 20.5V
3.0	D	92		1KZ-T	05/93 -> 04/96	4	DG-305 11V
3.0	TD	92		1KZ-TE	04/96 -> 09/02	4	DG-305 11V
3.0	TD	120		1KD-FTV	08/00 ->	4	DG-217 11V
3.2	D		24 Volt only	2B	02/79 -> 10/81	4	DG-235 20.5V
3.2	D		24 Volt only	2B	10/81 -> 09/82	4	DG-222 14V
3.4	D	66-70		3B	08/80 -> 08/87	4	DG-232 10.5V
3.4	D	66-70	(24 Volt)	3B	08/80 -> 10/85	4	DG-233 23V
3.4	D	66		3B	08/80 -> 10/84	4	DG-234 8.5V
3.4	D	66	(24 Volt)	3B	08/80 -> 10/84	4	DG-235 20.5V
3.4	D	66-70	(24 Volt)	3B	10/81 -> 08/88	4	DG-222 14V
3.4	D	66-70		3B	10/82 -> 08/88	4	DG-220 6V
3.4	D	70	(24 Volt)	3B	08/88 -> 01/90	4	DG-219 23V
3.5	D	85	(24 Volt)	1PZ	01/90 -> 08/92	5	DG-219 23V
3.6	D	66		H	04/72 -> 06/73	6	DG-224 8V
3.6	D	66		H	06/73 -> 10/74	6	DG-227 8V
4.0	D	74-77		2H	08/80 -> 08/87	6	DG-232 10.5V
4.0	D	76	(24 Volt)	2H	08/80 -> 10/82	6	DG-233 23V



KW



TOYOTA (continued)							
4.0	D	76		2H	08/80 -> 06/85	6	DG-234 8.5V
4.0	D	74-77	(24 Volt)	2H	10/82 -> 08/88	6	DG-222 14V
4.0	D	74-77		2H	10/82 -> 08/87	6	DG-220 6V
4.0	D	76-79	(24 Volt)	2H	08/88 -> 01/90	6	DG-219 23V
4.2	D	96	(24 Volt)	1H-Z	01/90 -> 05/98	6	DG-219 23V
Liteace							
1.8	D	41		1C	10/82 -> 08/85	4	DG-232 10.5V
1.8	D	41		1C	10/82 -> 08/88	4	DG-223 7V
1.8	D			1C-II	08/88 ->	4	DG-216 11V
2.0	D			2C-II	08/85 ->	4	DG-223 7V
2.0	D			2C-III	08/88 ->	4	DG-216 11V
2.0	D	53		2C	08/88 -> 01/95	4	DG-216 11V
2.0	D			2C-III / 2C	10/96 ->	4	DG-214 11V
2.0	TD			2C-III-T/2C-T	08/88 ->	4	DG-216 11V
2.2	TD			3C-T	08/94 ->	4	DG-305 11V
Liteace Noah							
2.0	D			2C-III	10/96 ->	4	DG-214 11V
Lucida							
2.2	TD		CRX1#, 2#	3C-T	01/92 -> 05/93	4	DG-308 11V
2.2	TD		CRX1#, 2#	3C-TE	05/93 -> 08/99	4	DG-309 11V
Mark II/Chaser/Cresta							
2.2	D			L	08/82 -> 07/84	4	DG-215 7V
2.4	D			2L	08/84 -> 08/88	4	DG-215 7V
2.4	D			2L/2L II	08/88 -> 08/92	4	DG-211 11V
2.4	TD			2L-T/2L II-T	08/88 -> 08/92	4	DG-211 11V
2.4	TD		LX90, 100	2L-TE	10/92 -> 08/99	4	DG-310 11V
Masterace							
2.0	TD			2C-III T	08/88 ->	4	DG-216 11V
2.0	D			2C / 2C-II	04/83 ->	4	DG-223 7V
Model-F							
2.0	D			2C	05/83 -> 08/85	4	DG-232 10.5V
2.0	D			2C	05/83 -> 02/87	4	DG-223 7V
Picnic							
2.0	D-4D	85	CLM20	1CD-FTV	05/01 ->	4	DG-245 11V
2.2	TD	66		3C-TE	09/97 -> 05/01	4	DG-305 11V
Premio							
2.0	TD			2C-T	01/96 -> 01/98	4	DG-214 11V
2.2	TD			3C-TE	01/98 ->	4	DG-305 11V
Previa							
2.0	D-4D	85	CLR30	1CD-FTV	02/01 ->	4	DG-245 11V
Rav 4 II							
2.0	D-4D	85	CLR30	1CD-FTV	05/01 ->	4	DG-245 11V
Regius							
3.0	D			5L	08/97 ->	4	DG-212 11V
3.0	TD			1KZ-TE	07/97 ->	4	DG-305 11V
Starlet							
1,5	D	40		1N	12/86 -> 12/89	4	DG-215 7V
1,5	D	40		1N	12/89 -> 01/96	4	DG-211 11V
1.5	D			1N	01/96 -> 07/99	4	DG-212 11V
Tercel/Corsa/Corolla II							
1.5	TD			1N-T	05/86 -> 08/90	4	DG-215 7V
1.5	TD			1N-T	09/90 -> 08/94	4	DG-211 11V
1.5	TD			1N-T	09/94 -> 07/99	4	DG-212 11V
Townace							
1.8	D			1C/1C-II	11/82 -> 07/87	4	DG-223 7V
1.8	D			1C-II	08/87 -> 10/89	4	DG-216 11V
2.0	D			2C-II	08/85 -> 07/87	4	DG-223 7V
2.0	TD			2C-T II	08/85 -> 07/87	4	DG-223 7V
2.0	D			2C-II / 2C	08/87 -> 10/96	4	DG-216 11V
2.0	TD			2C-T II	08/87 -> 09/93	4	DG-216 11V
2.0	TD			2C-III T	08/88 -> 09/93	4	DG-216 11V
2.0	D			2C III	08/88 ->	4	DG-216 11V
2.0	D			2C	10/96 ->	4	DG-214 11V
2.0	TD			3C-T	08/94 ->	4	DG-305 11V
2.2	D		12 Volt only	L	03/79 -> 04/80	4	DG-211 11V



KW



TOYOTA (continued)							
2.2	D		LY20, 30	L (Cold spec)	03/79 -> 01/82	4	DG-238 23V
2.2	D			L	04/80 -> 09/84	4	DG-221 11V
2.2	D		12 Volt only	L	01/82 ->	4	DG-215 7V
2.2	D		LY2#, 3#	L (Cold spec)	01/82 -> 07/85	4	DG-239 16V
2.4	D			2L	04/80 -> 07/85	4	DG-221 11V
2.4	D		LY2#, 3#	2L (Cold spec)	01/82 -> 07/85	4	DG-239 16V
2.4	D		12 Volt only	2L	08/83 -> 08/88	4	DG-215 7V
2.4	D		12 Volt only	2L - II	08/88 -> 05/95	4	DG-211 11V
2.5	D			2J	07/72 -> 10/74	4	DG-227 8V
2.5	D		24 Volt only	2J	07/72 -> 04/74	4	DG-226 19V
2.5	D		12 Volt only	2J	04/74 -> 08/80	4	DG-234 8.5V
2.5	D		24 Volt only	2J	04/74 -> 08/80	4	DG-235 20.5V
2.5	D	53		2J	09/79 -> 04/80	4	DG-221 11V
2.5	D	53		2J	08/80 -> 08/83	4	DG-232 10.5V
2.5	D		24 Volt only	2J	02/82 -> 07/87	4	DG-233 23V
2.5	D		24 Volt only	2J	02/82 -> 07/87	4	DG-222 14V
2.8	D		12 Volt only	3L	08/88 ->	4	DG-211 11V
3.0	D		12 Volt only	B	08/80 ->	4	DG-232 10.5V
3.0	D		24 Volt only	B	08/80 -> 01/82	4	DG-233 23V
3.0	D		24 Volt only	B	02/82 -> 08/88	4	DG-222 14V
3.0	D		24 Volt only	B	08/88 -> 05/95	4	DG-219 23V
3.4	D		24 Volt only	3B	10/89 -> 05/95	4	DG-219 23V
Truck (DA110/120)							
	D		24 Volt only	D	02/73 -> 04/77	6	DG-228 19V
	D		24 Volt only	D/2D	04/77 -> 12/78	6	DG-229 21V
	D		24 Volt only	D/2D	01/79 ->	6	DG-231 21.5V
Truck 4-Runner							
2.4	D			2L	08/83 -> 08/87	4	DG-215 7V
2.4	TD	69		2LT	08/84 -> 08/87	4	DG-213 6V
Yaris / Echo Verso							
1.4	TD	55		1ND-TV	10/01 ->	4	DG-240 11V
1.4	TD	66		1ND-TV	11/05 ->	4	DG-240 11V
UAZ							
425PP							
All	D				08/81 ->	4	DG-001 11V
469B							
2.4	TD				-> 04/86	4	DG-202 11V
2.5	D				-> 11/85	4	DG-001 11V
VAUXHALL							
Arena							
1.9	D	44		F8Q	06/98 -> 11/99	4	DG-009 11V
2.5	TD	55		S8U	09/98 -> 11/99	4	DG-001 11V
Astra							
1.3	CDTi	66		Z13DTH	08/05 ->	4	DG-171 11V
1.5	D	37		15D 4EC1 (Eng No ->804794)	09/84 -> 08/91	4	DG-143 5V
1.5	D	37		15D 4EC1 (Eng No 804795->)	09/84 -> 08/91	4	DG-124 11V
1.5	TD	49		TC4EC1	09/88 -> 08/91	4	DG-104 11V
1.6	D	40		16D	03/82 -> 07/91	4	DG-001 11V
1.6	D	40		16D OHC	03/82 -> 08/84	4	DG-001 11V
1.7	D	42		17D	1989 -> 07/91	4	DG-001 11V
1.7	D	42		17YD	08/91 -> 03/04	4	DG-001 11V
1.7	TD	60		17DT,TC4EE1 (Isuzu) (Eng No 817253->)	02/90 -> 02/98	4	DG-104 11V
1.7	TD	60		17DT,TC4EE1 (Isuzu) (Eng No ->817252)	02/90 -> 08/91	4	DG-159 5V
1.7	TD	50		X17DTL	02/98 -> 08/00	4	DG-001 11V
1.7	DTi 16V	55		Y17DT	02/00 ->	4	DG-302 11V
1.7	CDTi	59		Z17DTL	04/03 ->	4	DG-170 11V
1.7	CDTi	59		Z17DTL	03/04 ->	4	DG-170 11V
1.7	CDTi	74		Z17DTH	03/04 ->	4	DG-170 11V
1.9	CDTi	66		Z19DTL	09/05 ->	4	DG-122 11V
1.9	CDTi	74		Z19DT	09/05 ->	4	DG-122 11V
1.9	CDTi	88		Z19DTH	04/04 ->	4	DG-170 11V
1.9	CDTi	110		Z19DTJ	09/04 ->	4	DG-170 11V
2.0	DTi	60		X20DTL, Y20DTL	03/98 -> 03/04	4	DG-118 11V



KW



VAUXHALL (continued)							
2.0	DTi	74		X20DTH,Y20DTH	08/99 -> 03/04	4	DG-118 11V
Astra Van							
1.6	D	40		16D OHC	03/82 -> 08/88	4	DG-001 11V
1.7	D				08/83 -> 03/04	4	DG-001 11V
1.7	D	42		17D	09/88 -> 08/94	4	DG-001 11V
1.7	D	44		17DR	09/93 -> 08/94	4	DG-001 11V
1.7	TD	50		X17DTL	09/94 -> 03/04	4	DG-001 11V
2.0	Di	60		X20DTL	09/98 -> 03/04	4	DG-118 11V
Astramax							
1.6	D	40		16D OHC	09/84 -> 08/91	4	DG-001 11V
1.6	D	40		16D	02/85 -> 06/89	4	DG-001 11V
1.7	D	42,44		17D	09/85 -> 08/91	4	DG-001 11V
Belmont							
1.6	D	40		16D	03/82 -> 1991	4	DG-001 11V
1.7	D	42		17D	1989 -> 1991	4	DG-001 11V
Brava							
2.2	D			Isuzu (Eng No 804794)	1986 -> 05/88	4	DG-143 5V
2.2	D	52	Pick-Up 4X4		12/88 ->	4	DG-143 5V
2.2	D	45			1990 -> 09/96	4	DG-143 5V
2.3	D	45			1988 -> 09/96	4	DG-143 5V
2.5	D	56			03/92 ->	4	DG-001 11V
Campo							
2.5	D	56		25D	06/90 -> 09/94	4	DG-001 11V
Carlton							
1.6	D				09/77 ->	4	DG-001 11V
2.3	D	53		23YD	1981 -> 01/94	4	DG-001 11V
2.3	TD	66		23YDT	09/86 -> 09/92	4	DG-001 11V
2.3	TD	74		23DTR	09/89 -> 05/94	4	DG-001 11V
Cavalier							
1.6	D	40			1982 -> 1988	4	DG-001 11V
1.7	D	42			1988 -> 06/94	4	DG-001 11V
1.7	TD	60		17DT,TC4EE1 (Isuzu) (Eng No 817253->)	03/90 -> 08/95	4	DG-104 11V
CF							
2.0	D				11/79 -> 04/84	4	DG-001 11V
2.1	D	44	220,250,280,340,350,97000	21D	10/69 -> 08/84	4	DG-001 11V
2.3	D	52		Opel23D OHC	09/80 -> 08/86	4	DG-001 11V
2.3	D	52		Opel23D OHC	01/81 ->	4	DG-001 11V
Combo							
1.7	DTi	55	Tour	17D 4EE;1 X17 D 4EE1	09/94 -> 10/01	4	DG-302 11V
Corsa							
1.3	CDTi	51		Z13DT	04/04 ->	4	DG-171 11V
1.5	D	37		15D 4EC1 (Eng No ->804794)	09/87 -> 02/93	4	DG-143 5V
1.5	D	37		15D 4EC1 (Eng No 804795->)	09/87 -> 02/93	4	DG-124 11V
1.5	D	37		15D (4EC1)	03/93 -> 09/00	4	DG-300 11V
1.5	TD	37		T4EC1 (Eng No 804795->)	03/88 -> 02/93	4	DG-104 11V
1.5	TD	37		15DT, T4EC1 AADT (Eng No ->804794)	03/88 -> 02/93	4	DG-159 5V
1.5	TD	49		15TD / X15DT (4EC1)	03/93 -> 09/00	4	DG-300 11V
1.7	DI	48		Y17DTL	09/01 ->	4	DG-302 11V
1.7	CDTi	74		Z17DTH	04/03 ->	4	DG-170 11V
1.7	DTi	55		Y17DTL	09/01 ->	4	DG-302 11V
1.7	TD	60		17D / X17D (4EE1)	03/93 -> 09/00	4	DG-300 11V
Corsa Van							
1.3	CDTi	51		Z13DT	04/04 ->	4	DG-171 11V
1.7	D	42,44		17D, X17D	09/93 ->	4	DG-001 11V
Frontera							
2.2	DTi	85		X22DTH	09/98 ->	4	DG-118 11V
2.2	DTi	92		Y22DTH	08/00 ->	4	DG-142 11V
2.3	TD	74		23DTR	08/91 -> 03/95	4	DG-001 11V
2.5	TD	85		25TD	09/96 -> 08/98	4	DG-109 11V
KB							
1.9	D	58	41	KB19	09/79 -> 08/89	4	DG-143 5V
2.0	D	41		KB19	1980 -> 1988	4	DG-143 5V
Meriva							
1.7	DTi	55		Y17DT	09/02 ->	4	DG-302 11V
1.7	CDTi	74		Z17DTH	04/04 ->	4	DG-170 11V



KW



VAUXHALL (continued)							
Midi							
2.0	TD	88			09/84 -> 08/94	4	DG-159 5V
2.2	D	45	22D1E		03/88 -> 08/92	4	DG-159 5V
Monterey							
3.1	TD	84	4JG2TC		05/94 ->	4	DG-104 11V
Movano							
1.9	DTi	59	F9Q770		12/99 ->	4	DG-107 11V
2.2	DTi	66	G9T 720		09/00 ->	4	DG-126 11V
2.5	DTi	59	S8U		12/99 ->	4	DG-001 11V
2.5	DTi	84			10/01 ->	4	DG-126 11V
2.8	DTi	84	S9W		11/98 ->	4	DG-001 11V
Nova							
1.5	D	37	4EC1 (Eng No ->804794)		10/85 -> 11/88	4	DG-143 5V
1.5	D	37	4EC1 (Eng No 804795->)		12/88 -> 03/93	4	DG-124 11V
1.5	TD	49	15DT,14EC1 AADT (Eng No ->804794)		09/86 -> 04/93	4	DG-159 5V
1.5	TD	49	4EC1		12/88 -> 03/93	4	DG-104 11V
Omega							
2.0	TDi	74	X20DTH		02/98 ->	4	DG-118 11V
2.2	DTi	92	Y22DTH		08/00 ->	4	DG-142 11V
2.5	TD	96	BMW - X25DT OHC-R6		04/94 ->	6	DG-001 11V
Signum							
1.9	CDTi	88	Z19DT		04/04 ->	4	DG-122 11V
1.9	CDTi	110	Z19DTH		04/04 ->	4	DG-122 11V
2.0	DTi	74	Y20DTH		05/03 ->	4	DG-142 11V
2.2	DTi	92	Y20DTR		05/03 ->	4	DG-142 11V
Sintra							
2.2	DTi	85	X22DTH		09/98 -> 04/99	4	DG-118 11V
Tigra TwinTop							
1.3	CDTi	51	Z13DT		06/04 ->	4	DG-171 11V
Vectra							
1.7	TD	60	X17TD,TC4EC1		09/95 -> 12/96	4	DG-159 5V
1.7	TD	60	X17DT		09/95 -> 12/96	4	DG-118 11V
1.9	CDTi		Z19DTL		04/04 ->	4	DG-122 11V
1.9	CDTi	88	Z19DT		04/04 ->	4	DG-122 11V
1.9	CDTi	110	Z19DTH		04/04 ->	4	DG-170 11V
2.0	Di	60	X20DTL		08/99 -> 03/02	4	DG-118 11V
2.0	DTi	74	X20DTH		06/96 -> 02/98	4	DG-133 11V
2.0	DTi	74	X20DTH		03/98 ->	4	DG-118 11V
2.0	DTi	74	Y20DTH		08/99 ->	4	DG-142 11V
2.0	DTi	74	Y20DTH		06/02 ->	4	DG-142 11V
2.2	DTi	92	Y22DTR		07/00 ->	4	DG-118 11V
2.2	DTi	92	Y20DTR		04/02 ->	4	DG-142 11V
Vivaro							
1.9	Di	59	F9Q770		12/99 ->	4	DG-107 11V
1.9	DTi	74	F9Q.760		08/01 ->	4	DG-107 11V
2.5	DTi	990	G9U 730		04/04 ->	4	DG-126 11V
Zafira							
2.0	DTi	60	X20DTL		05/99 ->	4	DG-118 11V
2.2	DTi		X22DTL		09/99 ->	4	DG-118 11V
VM							
HR488HT,2,HR488HT,HR492HT							
All	D						DG-202 11V
VOLKSWAGEN							
Beetle							
1.9	TDi	66	ALH, AGR		11/98 -> 09/00	4	DG-005 11V
1.9	TDi	74	ATD		10/00 -> 10/01	4	DG-005 11V
1.9	TDi	74	ATD		11/01 ->	4	DG-109 11V
1.9	TDi	74	AXR		03/03 ->	4	DG-109 11V
1.9	TDi	77	BSW		07/05 ->	4	DG-177 * 5V
Bora							
1.9	SDi	50	AGP, AQM		09/98 ->	4	DG-005 11V
1.9	TDi	66,81,85	AHF, ALH, AGR, ASV, AJM, AUY, ANU		10/98 -> 06/01	4	DG-005 11V
1.9	TDi	110	ARL		05/00 -> 10/01	4	DG-005 11V

* Available from Jan. 2007



KW



VOLKSWAGEN (continued)							
1.9	TDi	110		ARL	11/01 ->	4	DG-109 11V
1.9	TDi	96	4motion	ASZ (Ch No ->172.600000)	11/01 ->	4	DG-005 11V
1.9	TDi	96	4motion	ASZ (Ch No 172.600001->)	11/01 ->	4	DG-109 11V
1.9	TDi	74	4motion	ATD	11/01 ->	4	DG-109 11V
1.9	TDi	74		AXR	11/01 ->	4	DG-109 11V
Caddy							
1.6	D	40		JK	08/82 -> 07/91	4	DG-002 11V
1.6	D	40		ME	08/90 -> 07/91	4	DG-002 11V
1.7	SDi	42		AHB	10/96 ->	4	DG-005 11V
1.9	D	44		1Y, AEF	01/96 -> 02/04	4	DG-002 11V
1.9	SDi	47		AEY	11/95 -> 02/04	4	DG-005 11V
1.9	TDi	66		AHU, ALE	08/96 -> 02/04	4	DG-005 11V
1.9	TDI	77	Chassis No. 70251->	BJB	04/04 ->	4	DG-177 * 5V
California							
1.9	D	44		1X	09/90 -> 07/95	4	DG-002 11V
1.9	TD	50		ABL	08/92 -> 03/98	4	DG-002 11V
2.4	D	57		AAB	09/90 -> 04/98	5	DG-002 11V
2.4	D	57		AJA	05/97 -> 03/98	5	DG-002 11V
2.5	TDi	75		ACV	08/95 ->	5	DG-005 11V
2.5	TDi	65		AJT	05/98 ->	5	DG-005 11V
Caravelle							
1.6	D	37		CS	01/81 -> 07/87	4	DG-002 11V
1.6	TD	51		JX	01/81 -> 12/91	4	DG-002 11V
1.7	D	42		KY	08/85 -> 08/90	4	DG-002 11V
1.9	D				09/90 -> 04/96	4	DG-002 11V
2.4	D	57		AAB	09/90 -> 07/95	5	DG-002 11V
2.5	TDi	75			08/95 ->	5	DG-005 11V
Eurovan							
2.4	SDi	57	USA		10/92 ->	5	DG-002 11V
2.5	SDi	75	USA		01/95 ->	5	DG-005 11V
Fox							
1.4	TDi	51		BNM	04/05 ->	3	DG-109 11V
Golf							
1.5	D	37		CK	08/76 -> 09/80	4	DG-002 11V
1.6	D	40		JK	08/82 -> 07/84	4	DG-002 11V
1.6	D	40		JP	08/83 -> 08/91	4	DG-002 11V
1.6	D	44		1V,ME	08/89 -> 07/92	4	DG-002 11V
1.6	TD	51,59		CY, JR, MF, RA, SB	08/83 -> 08/91	4	DG-002 11V
1.9	D	47		1Y	09/91 -> 08/98	4	DG-002 11V
1.9	TD	55		AAZ	09/91 -> 08/98	4	DG-002 11V
1.9	SDi	47		AEY	09/93 -> 02/99	4	DG-005 11V
1.9	TDi	66		1Z, AHU, ALE	09/91 -> 07/96	4	DG-005 11V
1.9	TDi	81		AFN	09/93 -> 02/99	4	DG-005 11V
1.9	D	47		1Y	10/97 -> 02/99	4	DG-002 11V
1.9	Di	66		ANU	01/99 -> 03/04	4	DG-005 11V
1.9	TD	55		AAZ	10/97 -> 02/99	4	DG-002 11V
1.9	SDi	47		AEY	10/97 -> 02/99	4	DG-005 11V
1.9	SDi	50		AGP, AQM	07/97 -> 03/04	4	DG-005 11V
1.9	TDi	81		AFN, AHF, ASV	10/97 -> 06/01	4	DG-005 11V
1.9	TDi	66		AGR, ALH, AHU	09/97 -> 06/01	4	DG-005 11V
1.9	TDi	96		ASZ	01/98 -> 10/01	4	DG-005 11V
1.9	TDi	85		AJM, AUY	04/98 -> 06/01	4	DG-005 11V
1.9	TDi	110		ARL	05/00 -> 10/01	4	DG-005 11V
1.9	TDi	74		ATD	10/00 -> 03/03	4	DG-005 11V
1.9	TDi	96		AVF	07/01 -> 03/03	4	DG-005 11V
1.9	TDi	110	4motion	ARL	11/01 -> 03/03	4	DG-109 11V
1.9	TDi	96	4motion, Estate, 4motion Estate	ASZ	11/01 -> 03/03	4	DG-109 11V
1.9	TDi	74	4motion, Estate, 4motion Estate	ATD	11/01 -> 03/03	4	DG-109 11V
1.9	TDi	74	4motion, Estate	AXR	11/01 -> 03/03	4	DG-109 11V
1.9	TDI	66	Chassis No. 70251->	BRU	05/04 ->	4	DG-177 * 5V
1.9	TDI	77	Chassis No. 70251->	BKC	10/03 ->	4	DG-177 * 5V
Golf Van							
1.6	D				10/80 -> 05/92	4	DG-002 11V
1.9	D				08/92 ->	4	DG-002 11V

* Available from Jan. 2007



KW



VOLKSWAGEN (continued)							
Iltis							
1.6	D	51		1C	07/87 -> 12/88	4	DG-002 11V
Jetta							
1.5	D	37		CK	08/79 -> 07/80	4	DG-002 11V
1.6	D	40		CR	08/80 -> 02/84	4	DG-002 11V
1.6	D	40,44		1V,JK,JP	08/82 -> 07/92	4	DG-002 11V
1.6	D	40		ME	08/88 -> 07/92	4	DG-002 11V
1.6	TD	51		CY	08/82 -> 02/84	4	DG-002 11V
1.6	TD	51,59		JR,RA,SB	08/83 -> 08/91	4	DG-002 11V
1.6	TD	51		MF	05/88 -> 10/91	4	DG-002 11V
1.9	TDI	77		BKC, BLS	09/05 ->	4	DG-177 * 5V
Joker							
1.6	D	37		CS	07/79 -> 07/85	4	DG-002 11V
LT28							
2.4	D	51		1S, ACT	09/80 -> 07/91	6	DG-002 11V
2.4	TD	70		ACL	09/92 -> 08/96	6	DG-002 11V
2.5	SDi	55		AGX	05/96 ->	5	DG-005 11V
2.5	TDi	75		AHD, ACV	05/96 -> 08/99	5	DG-005 11V
2.5	TDi	80		ANJ, AVR	01/99 ->	5	DG-005 11V
2.5	TDi	66		APA	05/99 ->	5	DG-005 11V
2.8	TDi	92		AGK, ATA	06/97 -> 12/98	4	DG-139 11V
LT31							
2.4	D	55,57		DW, CP	09/80 -> 01/93	6	DG-002 11V
LT35							
2.4	D	57		DW	09/80 -> 07/94	6	DG-002 11V
2.4	TD	70		ACL	09/92 -> 08/96	6	DG-002 11V
2.5	SDi	55		AGX	05/96 -> 04/01	5	DG-005 11V
2.5	TDi	75		AHD	05/96 -> 08/99	5	DG-005 11V
2.5	TDi	80		ANJ, AVR	01/99 ->	5	DG-005 11V
2.5	TDi	66		APA	05/99 ->	5	DG-005 11V
LT40							
2.4	D	51		1S, ACT	08/89 -> 04/96	6	DG-002 11V
2.4	TD	68		1G	02/83 -> 04/96	6	DG-002 11V
LT45							
2.4	TD	70		ACL	09/92 -> 08/96	6	DG-002 11V
LT46							
2.5	TDi	80		ANJ	01/99 ->	5	DG-005 11V
2.5	TDi	66		APA	05/99 ->	5	DG-005 11V
2.8	TDi	92, 96		AGK, ATA	06/97 ->	4	DG-139 11V
LT50							
2.4	TD	68		1G	02/83 -> 07/91	6	DG-002 11V
Lupo							
1.2	TDi	44		ANY	06/99 -> 11/00	3	DG-005 11V
1.2	TDi	45		AYZ	11/00 -> 10/01	3	DG-005 11V
1.2	TDi	45		ANY, AYZ	11/01 ->	3	DG-109 11V
1.4	TDi	55		AMF	01/99 -> 10/01	3	DG-005 11V
1.4	TDi	55		AMF	11/01 ->	3	DG-109 11V
1.7	SDi	42,44		AKU	10/98 ->	4	DG-005 11V
Multivan							
1.6	D	37		CS	08/85 -> 07/87	4	DG-002 11V
1.6	TD	51		JX	08/85 -> 02/92	4	DG-002 11V
1.7	D	42		KY	08/85 -> 08/90	4	DG-002 11V
1.9	D	44		1X	09/90 -> 07/95	4	DG-002 11V
1.9	TD	50		ABL	09/92 -> 04/98	4	DG-002 11V
1.9	TDi	77	T5	AXB	04/03 ->	4	DG-109 11V
2.4	D	57		AAB	09/90 -> 04/98	5	DG-002 11V
2.4	D	55		AJA	05/98 ->	5	DG-002 11V
2.5	TDi	75		ACV	08/95 ->	5	DG-005 11V
2.5	TDi	65		AJT	05/98 ->	5	DG-005 11V
2.5	TDi	128	T5	AXE	04/03 ->	4	DG-109 11V
2.5	TDi	96	T5	AXD	04/03 ->	4	DG-109 11V
Passat							
1.5	D	37		CK	09/79 -> 07/81	4	DG-002 11V
1.6	D	40		CR	08/79 -> 07/82	4	DG-002 11V
1.6	D	40		JK (->32.D.300.000)	08/82 -> 07/83	4	DG-002 11V

* Available from Jan. 2007



KW



VOLKSWAGEN (continued)							
1.6	D	40		JK (32.E.000.001->)	08/83 -> 04/88	4	DG-002 11V
1.6	TD	51,59		CY, RA, SB	08/81 -> 12/93	4	DG-002 11V
1.9	D	47,50		1Y	05/89 -> 12/92	4	DG-002 11V
1.9	TD	55		AAZ	03/90 -> 10/96	4	DG-002 11V
1.9	TDi	66		1Z, AHU, AHH	10/93 -> 12/00	4	DG-005 11V
1.9	TDi	91		AFN, AVG	10/96 -> 12/00	4	DG-005 11V
1.9	TDi	85,96		AJM, AWX, ATJ	10/98 ->	4	DG-005 11V
1.9	TDi	74		AVB, ATD	11/00 -> 10/01	4	DG-005 11V
1.9	TDi	96		AVF	01/01 -> 10/01	4	DG-005 11V
1.9	TDi	96	4motion, Estate, 4motion Estate	AVF,AWX	11/01 ->	4	DG-109 11V
1.9	TDi	74	Estate	AVB	11/01 ->	4	DG-109 11V
1.9	TDI	77		BKC	03/05 ->	4	DG-177 * 5V
2.5	TDi	110		AFB, AKN	08/98 ->	6	DG-144 11V
Phaeton							
5.0	TDi	230		AJS	11/02 ->	10	DG-109 11V
Polo							
1.3	D	33		MN	09/86 -> 07/90	4	DG-002 11V
1.3	D	35		1W	08/90 -> 07/94	4	DG-002 11V
1.4	D	35		1W	10/90 -> 09/94	4	DG-002 11V
1.4	TDi	55		AMF	04/99 -> 09/01	3	DG-005 11V
1.4	TDi	55		AMF, BAY	10/01 ->	3	DG-109 11V
1.4	TDi	74		ATD, AXR	10/01 ->	4	DG-109 11V
1.7	SDi	42		AHB	01/96 -> 12/99	4	DG-005 11V
1.7	SDi	42		AHG, AKU, AKW	05/97 -> 09/01	4	DG-005 11V
1.7	SDi	42		AKW	11/97 ->	4	DG-005 11V
1.7	SDi	44		AKU	10/99 -> 04/00	4	DG-005 11V
1.9	D	47	Classic,Variant	1Y, AEF	12/95 -> 09/01	4	DG-002 11V
1.9	SDi	47	Classic	AEY, AGD	07/96 -> 09/01	4	DG-005 11V
1.9	SDi	50		AQM	09/99 -> 09/01	4	DG-005 11V
1.9	TDi	66	Classic,Variant	AHU, ALE	08/96 -> 08/99	4	DG-005 11V
1.9	TDi	81		AFN, ATD	06/98 -> 08/01	4	DG-005 11V
1.9	TDi	66		ALH, AGR	09/99 -> 08/01	4	DG-005 11V
1.9	TDI	96	Chassis No. 70251->	ASZ, BLT	11/03 ->	4	DG-177 * 5V
Polo Van							
1.4	D	35		1W	08/92 -> 08/94	4	DG-002 11V
1.9	D	47		AEF	09/94 -> 12/95	4	DG-005 11V
Quantum							
1.6	TD	51			07/82 -> 07/91	4	DG-002 11V
Rabbit							
1.6	TD				01/83 -> 07/91	4	DG-002 11V
All	D		Pick Up		08/81 -> 07/91	4	DG-002 11V
Santana							
1.6	D	40		JK	08/82 -> 07/85	4	DG-002 11V
1.6	TD	51		CY	08/81 -> 04/88	4	DG-002 11V
Sharan							
1.9	TDi	66		1Z,AHU, ANU	09/95 -> 10/01	4	DG-005 11V
1.9	TDi	81		AFN,AVG	09/95 -> 04/00	4	DG-005 11V
1.9	TDi	85		AUY	03/00 -> 10/01	4	DG-005 11V
1.9	TDi	85	4motion	AUY	11/01 ->	4	DG-109 11V
1.9	TDi	66		AHU, ANU	11/01 ->	4	DG-109 11V
1.9	TDi	96		ASZ	11/02 ->	4	DG-109 11V
1.9	TDI	110		BTB	06/05 ->	4	DG-177 * 5V
Taro							
2.4	D	61		2L	02/89 -> 03/97	4	DG-211 11V
Touareg							
5.0	TDi	230			10/02 ->	4	DG-109 11V
Touran							
1.9	TDI	74	Chassis No. 70251->	AVQ	02/03 ->	4	DG-177 * 5V
1.9	TDI	66		BRU	11/04 ->	4	DG-177 * 5V
1.9	TDI	77		BKC	08/03 ->	4	DG-177 * 5V
Transporter							
1.6	D	37			07/80 -> 07/91	4	DG-002 11V
1.6	D	37		CS	01/81 -> 07/87	4	DG-002 11V
1.6	TD	51		JX	08/84 -> 08/90	4	DG-002 11V
1.7	D	42		KY	01/85 -> 08/90	4	DG-002 11V

* Available from Jan. 2007



KW



VOLKSWAGEN (continued)							
1.9	D	45	1X	08/90 -> 07/95	4	DG-002	11V
1.9	TD	50	ABL	09/92 -> 04/98	4	DG-002	11V
2.4	D	55	CP	01/79 -> 09/83	5	DG-002	11V
2.4	D	55	DW	12/82 -> 08/90	5	DG-002	11V
2.4	D	51	1S	08/89 -> 07/92	5	DG-002	11V
2.4	D	57	AAB	09/90 ->	5	DG-002	11V
2.4	D	51	ACT	02/92 ->	5	DG-002	11V
2.4	D	55	AJA	04/97 -> 04/98	5	DG-002	11V
2.4	TD	75	DV	12/82 -> 08/90	5	DG-002	11V
2.4	TD	68	1G	08/88 -> 04/96	5	DG-002	11V
2.5	TDi	75	ACV	08/95 -> 04/98	5	DG-005	11V
2.5	TDi	65,110	AHY, AJT	05/98 ->	5	DG-005	11V
2.5	TDi	75	AUF	11/99 ->	5	DG-005	11V
2.5	TDi	75	AYC	09/00 ->	5	DG-005	11V
2.5	TDi	65	AYY	10/01 ->	5	DG-109	11V
2.7	D	48	CG	01/76 -> 03/80	4	DG-002	11V
Vento							
1.9	D	47	1Y	09/91 -> 10/98	4	DG-002	11V
1.9	TD	55	AAZ	09/91 -> 10/98	4	DG-002	11V
1.9	SDi	47	AEY	01/95 -> 07/97	4	DG-005	11V
1.9	TDi	66	1Z	10/93 -> 07/96	4	DG-005	11V
1.9	TDi	66,81	AHU, AFN, ALE	08/96 -> 10/98	4	DG-005	11V
VOLVO							
240							
2.0	D	50	D20	08/79 -> 09/81	4	DG-002	11V
2.4	D	58	D24	1979 -> 07/81	6	DG-002	11V
2.4	D	60	D24	08/81 -> 12/93	6	DG-002	11V
244							
2.4	D	60	D24	09/78 -> 09/82	6	DG-002	11V
245							
2.4	D	60	D24	09/78 -> 09/82	6	DG-002	11V
264							
2.4	D	60	D24	09/78 -> 07/82	6	DG-002	11V
340							
1.6	D	40	D16	1985 -> 12/93	4	DG-006	11V
360							
1.6	D	40	D16	1985 -> 12/93	4	DG-006	11V
1.8	D	44	XUD7	09/98 ->	4	DG-001	11V
440							
1.9	TD	66	F8Q, D19T	01/93 -> 12/96	4	DG-103	11V
460							
1.9	TD	66	F8Q, D19T	01/93 -> 08/97	4	DG-103	11V
740							
2.4	D	60	D24	04/84 -> 08/91	6	DG-002	11V
2.4	TD	80,85	D24T, D24TIC	08/82 -> 09/90	6	DG-002	11V
760							
2.4	D	60	D24	04/84 -> 08/91	6	DG-002	11V
2.4	TD	80,85	D24T, D24TIC	08/82 -> 09/87	6	DG-002	11V
780							
2.4	TD	80,85	D24T, D24TIC	08/82 -> 08/91	6	DG-002	11V
850							
2.5	TDi	103	D5252T	08/95 -> 12/98	5	DG-005	11V
940							
2.4	TD	80	D24	09/90 -> 08/91	6	DG-002	11V
2.4	TDi	90	D24TIC	01/94 -> 05/97	6	DG-002	11V
960							
2.4	TDi	85	D24TIC	09/91 -> 09/93	4	DG-002	11V
FL408-100							
3.6	TD	91	B360B	03/86 -> 08/88	6	DG-202	11V
S40							
1.6	D	81		01-05 ->	4	DG-113	11V
1.9	TD	66	F8Q	05/96 -> 08/99	4	DG-103	11V
1.9	TDi	66	D4192T (F8QT)	09/96 -> 08/99	4	DG-103	11V



KW



VOLVO (continued)									
S60									
2.4	D	120	D5	D5244T2	07/01 ->	5	DG-140	11V	
2.5	TDi	103		D5252T	10/01 ->	5	DG-005	11V	
S70									
2.5	TDi	103		D5252T	12/96 -> 11/00	5	DG-005	11V	
S80									
2.4	D	120	D5	D5244T2	08/01 ->	5	DG-140	11V	
2.5	TDi	103		D5252T	07/98 ->	5	DG-005	11V	
V40									
1.9	TD	66		F8Q Kombi	01/96 -> 08/99	4	DG-103	11V	
1.9	TD	66		D4192T (F8QT)	09/96 -> 08/99	4	DG-103	11V	
1.9	TD	70		D4192T2	03/99 -> 08/99	4	DG-103	11V	
V50									
1.6	D	81			01-05 ->	4	DG-113	11V	
V70									
2.4	D	120	D5	D5244T2	08/01 ->	5	DG-140	11V	
2.5	TDi	103		D5252T	12/96 -> 11/00	5	DG-005	11V	
XC90									
2.4	D	120	D5	D5244T2	10/02 ->	5	DG-140	11V	

Buyers Guide



PLUG	MAKE	MODEL
DG-001	ALFA ROMEO	Alfa 145, Alfa 146, Alfa 155, Alfa 164, AR6, AR8
	ARO	240, 240-244, 246, 241, 242, 244
	AUVERLAND	A3
	AVIA	A21.1, Avia
	BMW	318, 318 Compact, 324, 325, 524, 525, 725
	CARBODIES	Fairway, FX Taxi, FX4
	CHRYSLER	Grand Voyager, Jeep Cherokee, Jeep Grand Cherokee, Laredo, Voyager, Wrangler
	CITROEN	Berlingo, BX, C15, C25, C32, C35, C45, CX Dispatch, Evasion, Jumper, Jumpy, Relay, Synergie, Visa, Xantia, XM, Xsara, ZX
	DACIA	Duster
	DAF	400
	DALLAS	Fun, Torpedo, Vescovato
	DANGEL	504
	FIAT	10, 127, 131, 131 Mirafiori, 132, 14, 18, 242 Argenta, Brava, Bravo, Campagnola, CityVan, Cromia, Daily, Ducato, Duna, Fiorino, Freeclimber, Marengo, Palio, Palio Weekend, Panda, Penny, Punto, Regata, Ritmo, Scudo, Strada, Talento, Tempra, Tipo, Ulysse, Uno
	FISSORE	Magnum
	FORD	Autobus, Granada, P100, Scorpio, Sierra, Sierra Sapphire
	FSO	Polonez
	HONDA	Concerto
	INNOCENTI	Elba, Mille
	IVECO	Daily, Grinta, XJ
	JEEP	Cherokee, Wrangler
	LADA	Cossack, Hussar, Niva
	LANCIA	Dedra, Delta, Prisma, Thema, Zeta
	LAND ROVER	Defender 110, Defender 90, Range Rover
	LDV	200, 400, Pilot, Sherpa
	MAHINDRA	CJ3, CJ5, Indian Baja
	MERCEDES	190, 200, 207, 209, 240, 250, 300, 307, 309, 407, 409, 507, 612, E250, G240, MB100, MB180, O309, Sprinter
	MERCEDES-UNIMOG	600/650
	MERCEDES-USA	190
	NISSAN	Patrol, Trade
	NISSAN/MOTOR IBERICA	L35, Mot.AA.28, Patrol
	OM	Grinta
	OPEL	Arena, Ascona (B), Ascona (C), Astra (F), Astra (G), Astra Delvan ECO, Astra Van, Bedford Blitz, Campo, Combo, Corsa (C) Frontera, Kadett (D), Kadett (E), Movano Omega (A), Omega (B), Rekord (E), Rekord Van, Senator (A), Senator (B), Vectra (A)
	OTOSAN	600 Pick Up
	PERKINS	4.165
	PEUGEOT	205, 305, 306, 309, 405, 406, 504, 505 604, 605, 806, Boxer, Expert, Express, J5, J7, J9, Partner, Ranch
	PUCH	290GD
	RENAULT	18, 20, 21, 25, 30, B70, B90, Espace I Espace II, Extra, Fuego, Master, Rapid, Safrane, Trafic, Winnebago
	ROVER	218, 418, 825, Maestro, Montego
	SANTANA	Santana
	SEAT	131, Ibiza, Malaga, Ritmo, Ronda
	SSANGYONG	Korando
	SUZUKI	Baleno, Samurai, Vitara

PLUG	MAKE	MODEL	
DG-001 (continued)	TALBOT	Express, Horizon, Simca, Solara, Tagora	
	TATA	206, 207, Gurkha, Loadbeta, Sumo, Telcoline, Telcosport	
	UAZ	425PP, 469B	
	VAUXHALL	Arena, Astra, Astra Van, Astramax, Belmont Brava, Campo, Carlton, Cavalier, CF, Corsa Van, Frontera, Movano, Omega	
	VOLVO	360	
DG-002	AUDI	100, 80, 90	
	FORD	A Series	
	MULTICAR	M25/1, M26	
	NISSAN	280C, Bluebird, Cedric, Gloria, Laurel Santana, Trade, Vanette	
	NISSAN/MOTOR IBERICA	Trade	
	PIAGGIO	Ape	
	SEAT	Cordoba, Ibiza, Inca, Terra, Toledo	
	SKODA	Felicia, Pick Up	
	VOLKSWAGEN	Caddy, California, Caravelle, Eurovan, Golf (1), Golf (2), Golf (3), Golf (4), Golf Van Iltis, Jetta, Joker, LT28, LT31, LT35, LT40, LT45, LT50, Multivan, Passat, Polo, Polo Van, Quantum, Rabbit, Santana, Transporter, Vento	
	VOLVO	240, 244, 245, 264, 740, 760, 780, 940, 960	
DG-003	CITROEN	AX, Berlingo, C15, Jumpy, Relay, Saxo, Synergie, Xsara, ZX	
	FIAT	Ducato, Scudo	
	LADA	Sagona, Samara	
	NISSAN	March, Micra	
	PEUGEOT	106, 206, 306, 309, Expert, Partner	
	ROVER	115	
DG-004	CITROEN	AX, ZX	
	FIAT	14	
	FORD	Courier, Escort (4), Escort (5), Escort Van Fiesta (3), Fiesta Van, Mondeo, Orion, P100 Sierra, Sierra Sapphire, Transit	
	MEGA	Tjaffer	
	MOSKVICHI	Aleko	
	OPEL	Movano	
	PEUGEOT	106	
	RENAULT	Master, Trafic	
	ROVER	114, Metro	
	DG-005	AUDI	100, 80, A2, A3, A4, A6, Cabrio
FORD		Galaxy	
GAZ		3302, Gaselle, Volga 3110	
SEAT		Alhambra, Arosa, Cordoba, Ibiza, Inca, Leon, Toledo	
SKODA		Fabia, Octavia	
VOLKSWAGEN		Beetle, Bora, Caddy, California, Caravelle, Eurovan, Golf (3), Golf (4), LT28, LT35, LT46 Lupo, Multivan, Passat, Polo, Polo Van, Sharan, Transporter, Vento	
VOLVO		850, S60, S70, S80, V70	
DG-006		CHRYSLER	Jeep Cherokee
		FORD	Fiesta Van
		JEEP	Cherokee
	RENAULT	11, 19, 21, 5, 5 Super, 9, Clio, Express, Extra, Rapid	
DG-007	VOLVO	340, 360	
	FORD	Courier, Escort (5), Fiesta (3), Fiesta (4), Fiesta Van, Mondeo	
DG-008	MAZDA	121	
	OPEL	Arena	
RENAULT	Clio II, Kangoo, Megane, Megane Scenic Traffic		

PLUG	MAKE	MODEL
DG-009	RENAULT	Clio, Express, Extra, Megane, Megane Scenic, Rapid
	VAUXHALL	Arena
DG-010	DAEWOO	Korando, Musso, Rexton
	ISUZU	Gemini
	MERCEDES	190, 200, 208, 210, 250, 290, 300, 308, 310, 350, 408, 410, 508, C180, C200, C220, E200, E250, E300, G240, G290, G300, G350, MB100, MB180, MB80, S350 Sprinter, V230, Vito
	MERCEDES-UNIMOG	100L, U90
	OPEL	Kadett (E)
	PUCH	250GD, 290GD, G290, G350
	SSANGYONG	Istana, Korando, Musso, Rexton
	STEYR-DAIMLER-PUCH	290 GD, 300, 350 GD
DG-101	HONDA	Accord, Civic, Civic Aerodeck, Civic Fastback
	LAND ROVER	Freelander
	RENAULT	B60, Espace III, Laguna I, Megane, Megane Scenic, Safrane, Scenic
	ROVER	220, 25, 420, 45, 620, FL / R (Hire Car), FX 4R Taxi
DG-102	FIAT	Brava, Bravo, Marea, Marengo
	LANCIA	Delta, Kappa
DG-103	MITSUBISHI	Carisma
	RENAULT	19, Megane, Megane Scenic
	VOLVO	440, 460, S40, V40
DG-104	ISUZU	Bighorn, Gemini, Midi, Rodeo, Trooper
	OPEL	Astra (F), Astra (G), Campo, Corsa (A), Kadett (E), Monterey
DG-105	VAUXHALL	Astra, Cavalier, Corsa, Monterey, Nova
	HYUNDAI	Porter (H100)
DG-106	MITSUBISHI	Challenger, Colt, Galant, L200, L300, Lancer, Montero, Pajero, Shogun
	MERCEDES	C200, C220, C250, E200, E220, E250, E300, G300, S300, S350
DG-107	NISSAN	Almera, Interstar, Micra
	OPEL	Movano, Vivaro
	RENAULT	Avantime, Clio II, Espace III, Espace IIII, Kangoo, Laguna I, Laguna II, Master, Megane, Megane II, Megane Scenic, Scenic, Trafic
	SUZUKI	Jimny
	VAUXHALL	Movano, Vivaro
DG-108	ISUZU	300, KB250, KB280, Trooper
	OPEL	Campo
DG-109	ALFA ROMEO	Alfa 155, Alfa 164
	AUDI	A2, A3
	CHRYSLER	Grand Voyager, Jeep Grand Cherokee, Voyager
	FORD	Galaxy, Scorpio
	JEEP	Cherokee, Grand Cherokee
	OPEL	Frontera
	ROVER	825
	SEAT	Alhambra, Arosa, Cordoba
	SKODA	Octavia, Fabia, Superb
	VAUXHALL	Frontera
	VOLKSWAGEN	Beetle, Bora, Fox, Golf (4), Lupo, Multivan, Passat, Phaeton, Polo, Sharan, Touareg, Touran, Transporter
DG-110	MERCEDES	511, 611, 711, 714, 811, 814, E290, G290, Sprinter, Vario
DG-111	CITROEN	Jumper
	FIAT	Ducato
	IVECO	Daily
	RENAULT	Master

PLUG	MAKE	MODEL
DG-112	DAEWOO	Daewoo
	RENAULT	Clio II, Kangoo, Megane, Megane Scenic
DG-113	CITROEN	C1, C2, C3, C4, Xsara, Xsara Picasso
	FORD	Fiesta (4), Fiesta (5), Focus, Focus C-Max, Fusion, Fusion Plus
	MAZDA	2
	PEUGEOT	107, 206, 307, 407, 1007
	SUZUKI	Liana
	TOYOTA	Aygo
	VOLVO	S40, V50
DG-114	ASIA MOTORS	Rocsta
	FORD	Econovan
	MAZDA	626, B2200, E2200, E2500, Light bus parkway
DG-115	LAND ROVER	Defender, Defender 130, Discovery, Range Rover
DG-116	CITROEN	Berlingo, C5, C8, Dispatch, Evasion, Jumper Jumpy, Relay, Synergie, Xantia, Xsara, Xsara Picasso
	FIAT	Ducato, Scudo, Ulysse
	LANCIA	Phedra, Zeta
	PEUGEOT	206, 306, 307, 406, 407, 607, 806, 807, Boxer, Expert, Partner
	SUZUKI	Grand Vitara
DG-117	CHRYSLER	PT Cruiser
	MERCEDES	C200, C220, C270, CLK270, E200, E220, E270, E320, G270, G400, ML270, ML400, S320, S400, Sprinter, V200, V220, Viano, Vito
	BMW	740
DG-118	OPEL	Astra (G), Astra Delvan, Astra Van, Frontera Frontera (B), Omega (B), Sintra, Vectra (B), Zafira
	SAAB	9-3
	VAUXHALL	Astra, Astra Vanm, Frontera, Omega, Sintra, Vectra, Zafira
	MERCEDES	C220, C250, E250, E300
DG-119	ALFA ROMEO	Giulietta
	HYUNDAI	Galloper, H-1, Starex
	LDV	Cub
	MITSUBISHI	L300
DG-120	NISSAN	Brougham, Brougham, Cabstar, Cedric, D21 E24, F22, F23, H 41, King Cab, Pathfinder Patrol, Pick-up, Terrano, Urvan
	FORD	Focus, Tourneo Connect, Transit Connect
	ALFA ROMEO	147, 156, 159, 166
	FIAT	Brava, Bravo, Croma, Doblo, Grande Punto Idea, Marea, Multipla, Palio, Punto, Punto II Stilo, Strada
DG-121	LANCIA	Kappa, Lybra, Musa, Thesis
	OPEL	Astra (H), Signum, Vectra (C)
	VAUXHALL	Astra Mk V, Signum, Vectra MK II
	FORD	Escort (3), Escort (4), Escort Van, Fiesta (2) Orion
DG-122	ISUZU	Bighorn, Gemini, Pick-up, Rodeo, Trooper
	OPEL	Campo, Corsa (A), Corsa Van, Kadett (E)
	SSANGYONG	Korando
	VAUXHALL	Astra, Corsa, Nova
DG-123	DAIHATSU	Hijet
	LDV	200
	PIAGGIO	Porter
DG-124	NISSAN	Interstar
	OPEL	Movano, Vivaro
	RENAULT	Avantime, Espace III, Espace IIII, Laguna II Master, Traffic, Vel Satis

PLUG	MAKE	MODEL
DG-126 (continued)	VAUXHALL	Movano, Vivaro
DG-127	ALFA ROMEO	Alfa 145, Alfa 146, Alfa 156, Alfa 166
	FIAT	Brava, Bravo, Marea
DG-129	FIAT	Doblo, Palio, Palio Weekend, Punto, Punto II Strada
	FORD	A Series, Mondeo, Tourneo, Transit
DG-130	FORD	A Series, Mondeo, Tourneo, Transit
DG-131	LAND ROVER	88/109
DG-132	FIAT	Croma
DG-133	OPEL	Omega (B), Vectra (B)
	VAUXHALL	Vectra
DG-135	INTERNATIONAL	44,2424, 2444, 3414, 3444. 364. 384 BD144, BD154, BD250, B27, B414, B424 TD5, 500 series, 7000
	MERCEDES	170
	CARBODIES	Fairway
DG-137	FORD	Maverick
	NISSAN	Cabstar, Cargo, Pathfinder, Serena, Terrano Terrano II, Trade, Vanette
	NISSAN/MOTOR IBERICA	Serena, Terrano TD II, Trade EW
	VAUXHALL	Fairway
DG-139	VOLKSWAGEN	LT28, LT46
DG-140	CITROEN	C6
	JAGUAR	S-Type
	PEUGEOT	607
	VOLVO	S60, S80, V70, XC90
DG-142	OPEL	Astra (G), Frontera, Frontera (B), Omega (B) Omega (C), Signum, Vectra (B), Vectra (C), Zafira
	SAAB	9-3
	VAUXHALL	Frontera, Omega, Signum, Vectra
DG-143	ISUZU	Bighorn, Campo, Gemini, KB, KB27, KB42 KB47, Pick-up, Rodeo, Trooper
	OPEL	Corsa (A), Kadett (E)
	VAUXHALL	Astra, Brava, Corsa, KB, Nova
	VAUXHALL	Astra, Brava, Corsa, KB, Nova
DG-144	AUDI	A4, A4 Quattro, A6, A8, A8 Quattro, Allroad
	SKODA	Superb
	VOLKSWAGEN	Passat
DG-145	ALPINA	D10 (E39)
	BMW	320, 330, 520, 525, 530, 730, X5
	LAND ROVER	Freelander, Range Rover
	ROVER	75
DG-146	FORD	Ranger
	KIA	Pregio, Prontier, Sportage
	MAZDA	626, B2500, T2500, T3000, T4100
	SUZUKI	Grand Vitara, Vitara
DG-155	MERCEDES	A160, A170, Vaneo
DG-157	NISSAN	Patrol, Pick-up
DG-159	G.M.E.	Midi
	IBC (GM)	Midi
	ISUZU	Campo, Gemini, Midi
	OPEL	Astra Van, Corsa (A), Kadett (E), Midi, Vectra (B)
	VAUXHALL	Astra, Corsa, Midi, Nova, Vectra
DG-161	CITROEN	Dispatch, Jumper
	PEUGEOT	Boxer
DG-170	ALFA ROMEO	147, 156, 159, 166, GT
	LANCIA	Thesis
	OPEL	Astra (G), Astra (H), Corsa (C), Meriva, Vectra (C)
	VAUXHALL	Astra Mk IV, Astra Mk V, Corsa Mk II, Meriva Vectra Mk II
DG-171	FIAT	Doblo, Grande Punto, Idea, Panda, Punto
	LANCIA	Musa, Ypsilon
	OPEL	Agila, Astra (H), Combo, Corsa (C), Tigra Twin Top
	SUZUKI	Ignis, Wagon R+

PLUG	MAKE	MODEL
DG-171 (continued)	VAUXHALL	Astra Mk V, Corsa Mk II, Tigra Twin Top
DG-172	HYUNDAI	Galloper, H-1, H100, H150, H200
DG-173	HYUNDAI	Accent, Elantra, Getz, Matrix, Santa Fé Trajet, Tucson
	KIA	Carens
DG-174	NISSAN	Galant, L200, L300, L400, Lancer, Montero, Pajero, Shogun, Space Gear, Space Runner, Space Wagon
	NISSAN	Galant, L200, L300, L400, Lancer, Montero, Pajero, Shogun, Space Gear, Space Runner, Space Wagon
DG-175	CHEVROLET	Blazer, C10, C20, C30, C3500, Express 2500, 3500, K10, K20, K30, K2500, K3500, P20, P30, V8
	GMC	C15, C25, C35, C2500, C3500, Chassis, Full Size, Jimmy, K15, K25, K35, K2500, K3500, MD bus chassis, P25, P35, Savana 2500, 3500, Truck, Van
	HUMMER	H1
DG-176	CHRYSLER	Voyager
	JEEP	Cherokee
DG-177	AUDI	A2, A3, A4
	SEAT	Alhambra, Altea, Ibiza, Leon, Toledo
	SKODA	Octavia, Roomster
	VOLKSWAGEN	Beetle, Caddy, Golf (5), Jetta, Passat, Polo Sharan, Touran
DG-178	BMW	118, 120, 318, 320, 330, 520, 525, 530, 730, X3, X5
DG-202	ALFA ROMEO	Alfa 164, Alfa 33, Alfa 6, Alfa 75, Alfa 90, Alfetta
	FISSORE	Rayton
	LAND ROVER	Defender 110, Range Rover
	LDV	Sherpa
	ROVER	2400, 825
	UAZ	469B
DG-211	VM	HR488HT,2,HR488HT,HR492HT
	VOLVO	FL408-100
	TOYOTA	Blizzard, Corolla Sprinter, Cressida, Crown, Dyna, Hiace, Hilux, Land Cruiser, Mark II/Chaser/Cresta, Starlet, Tercel/Corsa/Corolla II, Toyoace
	VOLKSWAGEN	Taro
DG-212	TOYOTA	Corolla Sprinter, Dyna, Hiace, Hilux, Regius Starlet, Tercel/Corsa/Corolla II
DG-213	TOYOTA	Blizzard, Cressida, Crown, Hiace, Hilux, Land Cruiser, Truck 4-Runner
DG-214	DAIHATSU	Delta Wide
	TOYOTA	Avensis, Blizzard, Caldina, Carina E, Corolla Liteace / Noah, Premio, Townace
DG-215	TOYOTA	Blizzard, Corolla Sprinter, Cressida, Crown, Dyna, Hiace, Hilux, Land Cruiser, Mark II/Chaser/Cresta, Starlet, Tercel/Corsa/Corolla II, Toyoace, Truck 4-Runner
	DAIHATSU	Charade, Delta Wide
DG-216	TOYOTA	Caldina, Camry, Carina 2, Carina E, Corolla / Sprinter, Corona, Deliboy, Liteace, Masterace, Townace
	DAIHATSU	Charade, Delta Wide
DG-217	TOYOTA	Dyna, Hiace, Hilux, Land Cruiser
DG-218	TOYOTA	Hiace, Hilux
DG-219	TOYOTA	Coaster, Delta, Dyna, Land Cruiser, Toyoace
DG-220	TOYOTA	Coaster, Land Cruiser
DG-221	TOYOTA	Blizzard, Cressida, Crown, Dyna, Hiace, Hilux, Toyoace
DG-222	DAIHATSU	Delta
	TOYOTA	Coaster, Dyna, Land Cruiser, Toyoace
DG-223	DAIHATSU	Charade, Delta, Delta Wide, Rugged/Rocky, Taft



PLUG	MAKE	MODEL
DG-223 (continued)	TOYOTA	Camry, Carina, Carina 2, Corolla, Corona, Liteace, Masterace, Model-F, Townace
DG-224	TOYOTA	Dyna, Land Cruiser
DG-225	TOYOTA	Dyna
DG-226	DAIHATSU	Delta
	TOYOTA	Coaster, Dyna, Land Cruiser, Toyoace
DG-227	TOYOTA	Dyna, Land Cruiser, Toyoace
DG-228	TOYOTA	Bus, Truck
DG-229	TOYOTA	Bus, Truck
DG-231	TOYOTA	Bus, Truck
DG-232	DAIHATSU	Delta
	TOYOTA	Carina 2, Coaster, Corolla, Corona, Dyna, Land Cruiser, Liteace, Model-F, Toyoace
DG-233	TOYOTA	Coaster, Dyna, Land Cruiser, Toyoace
DG-234	DAIHATSU	Charade, Delta, Taft
	TOYOTA	Coaster, Dyna, Land Cruiser, Toyoace
DG-235	TOYOTA	Coaster, Dyna, Land Cruiser, Toyoace
DG-236	HINO	Rainbow, Ranger, Truck
DG-238	TOYOTA	Hilux, Toyoace
	TOYOTA	Toyoace
DG-240	MINI	One
	TOYOTA	Corolla, Yaris, Yaris / Echo Verso
DG-241	TOYOTA	Dyna
DG-242	TOYOTA	Dyna, Hiace Van, Comuter, Hilux
DG-243	TOYOTA	Dyna, Hiace, Hiace Van, Comuter, Hilux
DG-245	TOYOTA	Avensis, Avensis Verso, Corolla, Corolla Verso Picnic, Previa, Rav 4
DG-246	TOYOTA	Hilux
DG-300	OPEL	Astra (G), Combo, Corsa (B), Vectra (A)
DG-301	HYUNDAI	Galoper
	MITSUBISHI	Galant, L200, L300, L400, Lancer, Montero, Pajero, Shogun, Space Gear, Space Runner, Space Wagon
DG-302	OPEL	Astra (G), Combo, Corsa (C), Meriva
	VAUXHALL	Astra Mk IV, Combo, Corsa, Meriva
DG-304	NISSAN	Almera, Primera, Sunny
DG-305	DAIHATSU	Delta Wide
	TOYOTA	Caldina, Camry Vista, Carina E, Emina Lucida Gaia, Granvia, Hiace, Hilux, Ipsum, Land Cruiser, Liteace, Picnic, Premio, Regius Townace
DG-306	MITSUBISHI	Canter 35, Pajero
DG-307	NISSAN	Bluebird, Cherry, Nomad, Pulsar, Sentra, Serena, Stanza, Sunny, Vanette
DG-308	TOYOTA	Estima Emina, Lucida
DG-309	TOYOTA	Estima Emina, Lucida
DG-310	TOYOTA	Crown, Mark II/Chaser/Cresta
DG-400	TOYOTA	Cooling heater, Avensis, Corolla
DG-401	LEXUS	Cooling heater, GS300/430, IS220/250

Memo

Cross Reference Chart



GB

Caution

This Chart should only be used when your vehicle is NOT listed in the Application Table pages of this Catalogue.

DE

Achtung

Diese Tabelle sollte nur verwendet werden, wenn Ihr Fahrzeug NICHT in den Anwendungstabellen dieses Kataloges aufgelistet sein sollte.

FR

Attention

Ce tableau ne peut être utilisé que lorsque votre véhicule ne figure PAS dans la liste du tableau d'application de ce catalogue.

ES

Advertencia

Este gráfico sólo debe utilizarse si su vehículo NO aparece en las páginas con listas de aplicaciones de este Catálogo.

IT

Attenzione

Questa tabella dovrebbe essere utilizzata solamente se il vostro veicolo NON è elencato nella Tabella di Applicazione di questo Catalogo.

SE

Observera

Denna tabell ska endast användas om ditt fordon INTE står med i tillämpningstabellen i denna katalog.

RU

Предупреждение

Данная таблица должна использоваться только в случае, если Ваш автомобиль НЕ указан на страницах Таблицы применения данного каталога.

AC	DENSO
28G	DG-002
30G	DG-001
ALFA ROMEO	DENSO
116610535800/00	DG-202
116760535801/00	DG-202
46451951	DG-127
60507123	DG-202
60596245	DG-001
60617002	DG-109
60816139	DG-127
AUDI	DENSO
059963319A	DG-144
AUTO DELTA	DENSO
GP2003/1	DG-001
GP4162	DG-104
BERU	DENSO
0100100203	DG-131
0100100302	DG-135
0100220118	DG-157
0100220176	DG-010
0100221102	DG-001
0100221103	DG-001
0100221106	DG-001
0100221107	DG-001
0100221108	DG-001
0100221108	DG-002
0100221114	DG-001
0100221132	DG-123
0100221133	DG-001
0100221135	DG-001
0100221141	DG-202
0100221144	DG-004
0100221145	DG-001
0100221146	DG-004
0100221147	DG-105
0100221153	DG-001
0100221154	DG-114
0100221162	DG-010
0100221163	DG-001
0100221164	DG-001
0100221167	DG-001
0100221170	DG-132
0100221186	DG-143
0100222102	DG-159
0100226128	DG-125
0100226129	DG-115
0100226138	DG-121
0100226163	DG-006
0100226164	DG-103
0100226170	DG-137
0100226171	DG-137
0100226173	DG-002
0100226175	DG-119
0100226176	DG-010
0100226184	DG-101
0100226185	DG-001
0100226186	DG-001
0100226188	DG-003
0100226189	DG-001
0100226194	DG-120
0100226198	DG-004

BERU	DENSO
0100226203	DG-130
0100226206	DG-133
0100226207	DG-124
0100226208	DG-104
0100226209	DG-104
0100226209	DG-159
0100226227	DG-005
0100226229	DG-001
0100226233	DG-172
0100226234	DG-010
0100226235	DG-106
0100226237	DG-103
0100226238	DG-101
0100226246	DG-161
0100226248	DG-007
0100226249	DG-102
0100226250	DG-110
0100226251	DG-010
0100226258	DG-119
0100226260	DG-117
0100226284	DG-139
0100226299	DG-009
0100226300	DG-118
0100226301	DG-121
0100226338	DG-144
0100226343	DG-109
0100226351	DG-126
0100226352	DG-137
0100226353	DG-155
0100226354	DG-111
0100226362	DG-145
0100226365	DG-155
0100226366	DG-001
0100226373	DG-107
0100226375	DG-112
0100226379	DG-117
0100226381	DG-007
0100226383	DG-172
0100226384	DG-121
0100226385	DG-130
0100226391	DG-129
0100226395	DG-117
0100226417	DG-142
0100226418	DG-010
0100226419	DG-117
0100226422	DG-173
0100226449	DG-010
0100226459	DG-109
0100226458	DG-117
0100226473	DG-117
0100226474	DG-109
0100226479	DG-302
0100226482	DG-109
0100226510	DG-126
0100226511	DG-174
0100226514	DG-307
0100271106	DG-175
0100276002	DG-140
0100276004	DG-113
0100276005	DG-140
0100276006	DG-140
0100276007	DG-171
0100276008	DG-171
0100276010	DG-170
0100276015	DG-170

BERU	DENSO
105MN	DG-001
141M	DG-002
141MJ	DG-002
151MJ	DG-001
161MJ	DG-001
162MJ	DG-002
220G	DG-131
214GK	DG-135
601MJ	DG-002
603MJ	DG-001
604MJ	DG-001
605MJ	DG-002
607MJ	DG-001
609MJ	DG-001
613MJ	DG-001
631MJ	DG-123
633MJ	DG-001
636MJ	DG-001
642MJ	DG-001
651MJ	DG-001
657MJ	DG-202
661MJ	DG-004
663MJ	DG-001
666MJ	DG-004
673MJ	DG-105
687MJ	DG-002
689MJ	DG-002
691MJ	DG-001
705MJ	DG-114
719MJ	DG-001
724MJ	DG-001
727MJ	DG-001
730MJ	DG-132
749MJ	DG-143
783MJ	DG-115
798MJ	DG-125
844MJ	DG-103
852MJ	DG-006
853MJ	DG-137
854MJ	DG-137
855MJ	DG-005
857MJ	DG-002
858MJ	DG-010
896MJ	DG-159
905MJ	DG-101
908MJ	DG-001
909MJ	DG-001
912MJ	DG-003
917MJ	DG-001
920MJ	DG-157
921MJ	DG-120
944MJ	DG-133
946MJ	DG-124
947MJ	DG-104
948MJ	DG-106
950MJ	DG-005
955MJ	DG-172
964MJ	DG-161
970MJ	DG-102
999MJ	DG-101
GD214	DG-135
GD220	DG-131
GE100	DG-177
GE101	DG-178
GN003	DG-117

BERU	DENSO
GN005	DG-146
GN007	DG-109
GN008	DG-144
GN010	DG-155
GN012	DG-111
GN013	DG-001
GN016	DG-003
GN017	DG-127
GN018	DG-107
GN019	DG-112
GN022	DG-007
GN024	DG-145
GN025	DG-118
GN026	DG-126
GN027	DG-116
GN030	DG-129
GN033	DG-142
GN035	DG-173
GN039	DG-137
GN041	DG-122
GN042	DG-240
GN043	DG-216
GN045	DG-140
GN046	DG-109
GN047	DG-113
GN053	DG-171
GN055	DG-176
GN059	DG-170
GN101	DG-307
GN103	DG-300
GN104	DG-302
GN107	DG-174
GN217	DG-008
GN853	DG-137
GN854	DG-137
GN855	DG-005
GN857	DG-002
GN858	DG-010
GN860	DG-119
GN905	DG-101
GN908	DG-001
GN909	DG-001
GN912	DG-003
GN917	DG-001
GN927	DG-004
GN939	DG-130
GN944	DG-133
GN948	DG-106
GN954	DG-001
GN955	DG-172
GN959	DG-103
GN961	DG-110
GN963	DG-008
GN964	DG-161
GN966	DG-007
GN970	DG-102
GN989	DG-139
GN991	DG-009
GN992	DG-118
GN993	DG-121
GN999	DG-101
GV001	DG-213
GV004	DG-175
GV105	DG-001
GV151	DG-001

BERU	DENSO
GV362	DG-145
GV602	DG-001
GV603	DG-001
GV604	DG-002
GV631	DG-123
GV636	DG-001
GV642	DG-001
GV657	DG-202
GV662	DG-004
GV663	DG-001
GV666	DG-004
GV673	DG-105
GV678	DG-234
GV688	DG-221
GV691	DG-001
GV705	DG-114
GV719	DG-001
GV724	DG-001
GV727	DG-001
GV730	DG-132
GV749	DG-143
GV783	DG-115
GV798	DG-125
GV844	DG-103
GV852	DG-006
GV853	DG-137
GV886	DG-223
GV894	DG-215
GV896	DG-159
GV897	DG-232
GV920	DG-157
GV921	DG-120
GV945	DG-159
GV946	DG-124
GV947	DG-104
GV967	DG-216
GV968	DG-211
GV969	DG-233
GV985	DG-222
BMW	DENSO
12231286058	DG-001
12231288245	DG-001
12232240255	DG-001
12232241387	DG-001
12232241388	DG-001
12232241389	DG-001
12232248059	DG-145
12232248422	DG-118
12237786869	DG-178
12239061353	DG-001
12239061354	DG-001
BOSCH	DENSO
0250002009	DG-131
0250200049	DG-202
0250200053	DG-202
0250200054	DG-001
0250200056	DG-001
0250200057	DG-001
0250200058	DG-001
0250200059	DG-001
0250200060	DG-001
0250200063	DG-002
0250200064	DG-001

BOSCH	DENSO
0250200065	DG-001
0250200066	DG-001
0250200068	DG-001
0250200069	DG-001
0250200469	DG-001
0250201001	DG-001
0250201004	DG-002
0250201005	DG-001
0250201006	DG-001
0250201008	DG-001
0250201009	DG-001
0250201010	DG-003
0250201011	DG-002
0250201012	DG-202
0250201013	DG-001
0250201015	DG-002
0250201017	DG-123
0250201019	DG-001
0250201021	DG-002
0250201026	DG-010
0250201027	DG-001
0250201029	DG-006
0250201030	DG-001
0250201031	DG-002
0250201031	DG-103
0250201032	DG-002
0250201033	DG-001
0250201034	DG-202
0250201035	DG-119
0250201037	DG-001
0250201038	DG-106
0250201039	DG-001
0250201041	DG-010
0250201045	DG-001
0250201047	DG-010
0250201049	DG-007
0250201050	DG-103
0250201405	DG-001
0250201415	DG-002
0250201469	DG-001
0250201932	DG-002
0250201945	DG-001
0250201946	DG-010
0250201947	DG-202
0250202001	DG-004
0250202002	DG-132
0250202003	DG-105
0250202004	DG-234
0250202007	DG-114
0250202008	DG-143
0250202009	DG-005
0250202018	DG-004
0250202019	DG-001
0250202020	DG-003
0250202022	DG-005
0250202023	DG-109
0250202024	DG-009
0250202025	DG-101
0250202025	DG-101
0250202026	DG-101
0250202026	DG-110
0250202027	DG-133
0250202029	DG-117
0250202032	DG-116
0250202033	DG-127
0250202034	DG-102

BOSCH	DENSO
0250202035	DG-008
0250202035	DG-009
0250202036	DG-122
0250202039	DG-117
0250202040	DG-115
0250202042	DG-118
0250202043	DG-142
0250202045	DG-117
0250202046	DG-109
0250202048	DG-116
0250202051	DG-223
0250202054	DG-215
0250202056	DG-114
0250202058	DG-232
0250202060	DG-105
0250202064	DG-157
0250202065	DG-108
0250202073	DG-213
0250202076	DG-222
0250202077	DG-157
0250202085	DG-124
0250202086	DG-159
0250202087	DG-104
0250202089	DG-146
0250202093	DG-137
0250202094	DG-105
0250202095	DG-214
0250202095	DG-216
0250202096	DG-211
0250202096	DG-221
0250202097	DG-219
0250202097	DG-233
0250202102	DG-144
0250202103	DG-145
0250202119	DG-235
0250202121	DG-306
0250202125	DG-245
0250202128	DG-126
0250202130	DG-130
0250202131	DG-121
0250202910	DG-004
0250202911	DG-005
0250203001	DG-170
0250203002	DG-171
0250204001	DG-113
0250312001	DG-307
0250312002	DG-304
0250312003	DG-300
0250312007	DG-301
0250402001	DG-177
CHAMPION	DENSO
CH28	DG-135
CH45	DG-131
CH60	DG-002
CH62	DG-202
CH63	DG-001
CH68	DG-001
CH69	DG-001
CH70	DG-202
CH79	DG-123
CH87	DG-001
CH90	DG-132
CH94	DG-105
CH95	DG-223

CHAMPION	DENSO
CH103	DG-221
CH104	DG-222
CH110	DG-143
CH121	DG-234
CH132	DG-215
CH137	DG-001
CH147	DG-004
CH154	DG-211
CH156	DG-010
CH157	DG-124
CH158	DG-104
CH159	DG-001
CH160	DG-002
CH161	DG-157
CH162	DG-120
CH163	DG-001
CH164	DG-125
CH166	DG-127
CH167	DG-102
CH168	DG-003
CH169	DG-101
CH170	DG-116
CH171	DG-005
CH172	DG-101
CH173	DG-006
CH174	DG-001
CH175	DG-119
CH176	DG-010
CH177	DG-106
CH178	DG-115
CH179	DG-103
CH180	DG-176
CH181	DG-109
CH184	DG-107
CH185	DG-003
CH186	DG-137
CH187	DG-137
CH188	DG-159
CH189	DG-001
CH190	DG-133
CH196	DG-121
CH200	DG-113
CH203	DG-145
CH204	DG-110
CH205	DG-007
CH206	DG-009
CH207	DG-118
CH208	DG-161
CH209	DG-129
CH215	DG-144
CH216	DG-111
CH217	DG-008
CH218	DG-117
CH219	DG-155
CH222	DG-122
CH223	DG-171
CH224	DG-170
CH225	DG-172
CH226	DG-173
CH229	DG-130
CH231	DG-142
CH232	DG-126
CH233	DG-112
CH238	DG-175
CH239	DG-139

CHAMPION	DENSO
CH240	DG-140
CH242	DG-146
CH252	DG-240
CH256	DG-174
CH258	DG-245
CH271	DG-005
CH302	DG-214
CH600	DG-304
CH601	DG-300
CH602	DG-301
CH603	DG-302
CH607	DG-306
CH613	DG-307
CH700	DG-177
CH701	DG-178
CITROËN	DENSO
5960.19	DG-113
5960.77	DG-140
5962.1P	DG-161
5962.1Q	DG-161
5962.1R	DG-001
5962.1S	DG-123
5962.1T	DG-001
5962.1V	DG-001
5962.1W	DG-004
5962.1X	DG-103
5962.1Y	DG-006
5962.1Z	DG-002
5962.2Z	DG-003
5962.3E	DG-116
5962.3J	DG-001
5962.S8	DG-001
5962.T1	DG-006
5962.T2	DG-103
5962.W2	DG-003
5962.W8	DG-001
5962.008	DG-001
9153.6646	DG-001
9614.1678	DG-001
9631.658980	DG-003
MKP00071	DG-002
DELPHI	DENSO
HDS216	DG-001
HDS217	DG-002
HDS218	DG-001
HDS221	DG-001
HDS232	DG-105
HDS233	DG-223
HDS234	DG-221
HDS235	DG-215
HDS238	DG-235
HDS241	DG-114
HDS242	DG-222
HDS247	DG-143
HDS255	DG-001
HDS258	DG-002
HDS262	DG-211
HDS266	DG-202
HDS267	DG-202
HDS271	DG-123
HDS273	DG-004
HDS274	DG-001
HDS275	DG-216

DELPHI	DENSO
HDS276	DG-120
HDS283	DG-157
HDS295	DG-001
HDS296	DG-001
HDS303	DG-115
HDS317	DG-131
HDS337	DG-001
HDS338	DG-159
HDS339	DG-004
HDS341	DG-103
HDS342	DG-001
HDS343	DG-002
HDS345	DG-124
HDS346	DG-104
HDS347	DG-006
HDS348	DG-001
HDS349	DG-001
HDS350	DG-003
HDS351	DG-001
HDS352	DG-010
HDS353	DG-001
HDS354	DG-106
HDS355	DG-101
HDS356	DG-102
HDS357	DG-132
HDS358	DG-137
HDS359	DG-137
HDS360	DG-118
HDS361	DG-109
HDS362	DG-007
HDS363	DG-119
HDS364	DG-127
HDS365	DG-161
HDS366	DG-009
HDS367	DG-116
HDS368	DG-107
HDS369	DG-003
HDS370	DG-101
HDS371	DG-001
HDS372	DG-145
HDS373	DG-110
HDS374	DG-144
HDS375	DG-111
HDS376	DG-008
HDS377	DG-117
HDS378	DG-155
HDS379	DG-121
HDS380	DG-129
HDS382	DG-122
HDS383	DG-130
HDS384	DG-142
HDS385	DG-112
HDS386	DG-133
HDS391	DG-174
HDS393	DG-245
HDS394	DG-146
HDS396	DG-126
HDS398	DG-131
HDS399	DG-113
HDS400	DG-108
HDS401	DG-304
HDS402	DG-300
HDS403	DG-301
HDS404	DG-140

DELPHI	DENSO
HDS405	DG-302
DENSO	DENSO
067100-1042	DG-224
067100-1053	DG-225
067100-1071	DG-236
067100-1120	DG-226
067100-1130	DG-227
067100-1140	DG-228
067100-1190	DG-229
067100-1210	DG-211
067100-1220	DG-238
067100-1250	DG-231
067100-1330	DG-232
067100-1340	DG-233
067100-1350	DG-234
067100-1360	DG-235
067100-1370	DG-215
067100-1380	DG-239
067100-1430	DG-223
067100-1460	DG-222
067100-1500	DG-213
067100-1621	DG-241
067100-1630	DG-221
067100-1680	DG-220
067100-1690	DG-216
067100-1700	DG-219
067100-1710	DG-211
067100-1840	DG-212
067100-1841	DG-212
067100-1860	DG-214
067100-1861	DG-214
067100-1910	DG-218
067100-1920	DG-217
067100-1940	DG-400
067100-1950	DG-243
067100-1960	DG-242
067100-2020	DG-401
14200-0200	DG-305
14200-0031	DG-308
14200-0060	DG-310
14200-0210	DG-309
14200-0300	DG-310
TG067100-1980	DG-246
EYQUEM	DENSO
G10	DG-132
G11	DG-105
G12	DG-146
G13	DG-115
G14	DG-223
G14	DG-232
G15	DG-120
G16	DG-215
G17	DG-002
G18	DG-202
G18	DG-211
G18	DG-212
G18	DG-213
G18	DG-218
G19	DG-117
G20	DG-144
G21	DG-155
G23	DG-145
G24	DG-010

EYQUEM	DENSO
G27	DG-006
G28	DG-107
G29	DG-112
G34	DG-003
G35	DG-004
G36	DG-101
G37	DG-005
G39	DG-102
G41	DG-001
G42	DG-007
G43	DG-119
G45	DG-143
G46	DG-159
G47	DG-124
G48	DG-104
G49	DG-103
G50	DG-009
G52	DG-133
G53	DG-110
G54	DG-008
G55	DG-161
G56	DG-118
G57	DG-116
G58	DG-127
G59	DG-129
G60	DG-122
G61	DG-106
G62	DG-111
G63	DG-126
G64	DG-137
G65	DG-130
G66	DG-121
G67	DG-300
G68	DG-302
ACL588S	DG-105
CD566R	DG-004
CD659R	DG-002
CD660R	DG-002
CD661R	DG-103
CD666R	DG-123
CD670T	DG-001
CD674V	DG-202
CLS64P	DG-157
CLS80P	DG-104
CLS81S	DG-114
CLS86T	DG-124
CLS88S	DG-120
CTS80T	DG-132
DD6120V	DG-106
DD659R	DG-002
DD665T	DG-006
DD668S	DG-010
DD670T	DG-001
DD671T	DG-001
DD678S	DG-125
DT584T	DG-101
DT589V	DG-003
DT592T	DG-005
FAI	DENSO
FG100	DG-002
FG101	DG-002
FG103	DG-001
FG104	DG-001
FG105	DG-143

FAI	DENSO
FG106	DG-001
FG107	DG-001
FG108	DG-001
FG109	DG-001
FG110	DG-001
FG111	DG-001
FG113	DG-123
FG114	DG-004
FG116	DG-202
FG120	DG-202
FG121	DG-004
FG122	DG-114
FG124	DG-105
FG125	DG-105
FG128	DG-120
FG129	DG-120
FG132	DG-001
FG133	DG-001
FG134	DG-143
FG135	DG-001
FG137	DG-001
FG146	DG-104
FG147	DG-006
FG150	DG-001
FG153	DG-004
FG154	DG-001
FG155	DG-003
GGP01	DG-002
GGP02	DG-002
GGP04	DG-001
GGP05	DG-001
GGP06	DG-124
GGP09	DG-001
GGP11	DG-004
GGP15	DG-001
GGP16	DG-002
GGP17	DG-202
GGP18	DG-004
GGP26	DG-120
GGP29	DG-001
GGP30	DG-115
GGP31	DG-143
GGP32	DG-001
GGP33	DG-005
GGP34	DG-001
GGP36	DG-137
GGP38	DG-137
GGP40	DG-104
GGP41	DG-010
GGP42	DG-006
GGP44	DG-103
GGP46	DG-001
GGP47	DG-003
GGP49	DG-101
GGP50	DG-159
GGP51	DG-300
GGP52	DG-211
GGP53	DG-007
GGP54	DG-109
GGP55	DG-133
GGP56	DG-102
GGP57	DG-132
GGP58	DG-110
GGP59	DG-119
GGP60	DG-106

FAI	DENSO
GGP61	DG-009
GGP62	DG-101
GGP64	DG-127
GGP65	DG-008
GGP66	DG-161
GGP67	DG-116
GGP68	DG-001
GGP69	DG-001
GGP71	DG-122
GGP72	DG-144
GGP74	DG-145
GGP75	DG-111
GGP77	DG-155
GGP78	DG-117
GGP79	DG-118
GGP84	DG-107
FIAT	DENSO
07029585	DG-001
4393814	DG-001
4474413	DG-001
46447610	DG-102
46451951	DG-127
46754154	DG-122
46779614	DG-171
46796050	DG-171
4714294	DG-001
4729585	DG-001
4754011	DG-001
4774412	DG-001
4774413	DG-001
4781356	DG-001
4849406	DG-001
500303569	DG-111
500316493	DG-111
5493206	DG-001
5950464	DG-001
5951861	DG-001
5951861(FU2B)	DG-001
5951879	DG-001
5951881	DG-001
5951881(FU2A)	DG-001
5951882	DG-001
5973752	DG-001
5973753	DG-001
60507123	DG-202
60596245	DG-001
60617002	DG-109
60812292	DG-001
762266740	DG-001
7632587	DG-132
7702960	DG-001
7735920	DG-001
7777837	DG-004
9616472480	DG-001
9623638380	DG-116
9631658980	DG-003
9633214380	DG-001
98462490	DG-001
98498630	DG-004
F2VB	DG-001
FU2A	DG-001
FU4A	DG-001

FORD	DENSO
1008792	DG-007
1056857	DG-007
1079401	DG-121
1148105	DG-113
1690048	DG-109
1952464	DG-137
4025139	DG-146
6075812	DG-002
6132244	DG-123
6132246	DG-123
6154593	DG-001
7072673	DG-001
7088988	DG-004
795F6M090AA	DG-002
795F6M090CA	DG-002
83BB6M090A1A	DG-001
83BB6M090A2A	DG-001
84BB6M090AA	DG-001
84FF6M090B1A	DG-123
84FF6M090B2A	DG-123
89FF6M090AA	DG-004
910X6M090AA	DG-006
910X6M090BA	DG-001
93FF6M090AA	DG-004
96FF6M090AA	DG-007
96FF6M090AB	DG-007
96FF6M090BA	DG-007
96FF6M090BB	DG-007
99FF6M090AA	DG-007
V94DX6M090AA	DG-001
XS4U6M090AB	DG-121
XS7U6M090AB	DG-130
XS7U6M090BB	DG-130
EZD37	DG-121
EZD38	DG-130
EZD40	DG-113
GM	DENSO
09118201	DG-118
93178047	DG-171
HINO	DENSO
19110-1040	DG-236
63013-30011	DG-236
HKT	DENSO
B001	DG-135
B040	DG-001
CP01	DG-307
CP02	DG-304
CP05	DG-306
CP07	DG-301
CP50	DG-300
CP51	DG-302
P151	DG-104
PI46	DG-143
PI49	DG-108
PI51	DG-159
PI57	DG-104
PI58	DG-124
PM164	DG-174
PM165	DG-306
PM75	DG-105
PN86	DG-001
PN89	DG-002

HKT	DENSO
PN132	DG-157
PN135	DG-120
PZ33	DG-114
PZ39	DG-146
HYUNDAI	DENSO
36710-27000	DG-173
36710-27010	DG-173
36710-42010	DG-172
36710-42510	DG-172
ISUZU	DENSO
894133759-6	DG-108
894140115-6	DG-108
8942217193	DG-143
8942414490	DG-143
89424144901	DG-143
894241490	DG-143
8942496921	DG-143
8942555880	DG-143
8943197001	DG-124
8943197002	DG-124
8944023031	DG-159
8944392180	DG-143
8944819720	DG-104
IVECO	DENSO
4841294	DG-001
4849406	DG-001
98459883	DG-004
98462490	DG-001
98498630	DG-004
LUCAS	DENSO
DS001	DG-001
DS002	DG-002
DS003	DG-001
DS004	DG-002
DS006	DG-001
DS014	DG-001
DS017	DG-105
DS026	DG-114
DS051	DG-202
DS052	DG-202
MAGNETI MARELLI	DENSO
TIX1A	DG-002
TIX2A	DG-001
TIX7A	DG-202
UC2A	DG-132
UC3A	DG-005
UC4A	DG-102
UC7A	DG-003
UC8A	DG-101
UC9A	DG-104
UC10A	DG-124
UC11A	DG-127
UC12A	DG-116
UC13A	DG-101
UC14A	DG-109
UC15A	DG-003
UC16A	DG-118
UC17A	DG-117
UC18A	DG-155
UC19A	DG-122

MAGNETI MARELLI	DENSO
UC20A	DG-107
UC21A	DG-008
UC22A	DG-009
UC22A	DG-121
UC29A	DG-126
UX2A	DG-001
UX4A	DG-001
UX7A	DG-202
UX8A	DG-002
UX9A	DG-001
UX11A	DG-004
UX12A	DG-123
UX14A	DG-006
UX15A	DG-001
UX16A	DG-119
UX17A	DG-106
UX18A	DG-103
UX19A	DG-007
UX20A	DG-001
UX21A	DG-129
MAZDA	DENSO
S20118140	DG-114
S501181140A	DG-114
MERCEDES BENZ	DENSO
000.159.75.01	DG-001
000.159.77.01	DG-001
000.159.81.01	DG-001
000.159.83.01	DG-001
000.159.96.01	DG-001
000.159.99.01	DG-001
001.159.02.01	DG-001
001.159.15.01	DG-119
001.159.16.01	DG-119
001.159.20.01	DG-106
001.159.21.01	DG-106
001.159.27.01	DG-155
MITSUBISHI	DENSO
MD050212	DG-105
MD197511	DG-174
MD301950	DG-174
MD344460	DG-174
ME200970	DG-306
ME201638	DG-306
ME202785	DG-306
ME203583	DG-306
ME203754	DG-306
MR577131	DG-174
MOTORCRAFT	DENSO
EZD.2	DG-001
EZD.4	DG-001
EZD.5	DG-001
EZD.6	DG-123
EZD.7	DG-114
EZD.8	DG-004
EZD.10	DG-002
EZD.11	DG-001
EZD.12	DG-001
EZD.13	DG-202
EZD.14	DG-001
EZD.15	DG-001
EZD.16	DG-001

MOTORCRAFT	DENSO
EZD.18	DG-105
EZD.22	DG-114
EZD.23	DG-143
EZD.A	DG-002
EZD.B	DG-001
EZD.C	DG-001
EZD.D	DG-202
EZD.E	DG-001
EZD.F	DG-001
EZD.G	DG-001
EZD.U	DG-105
EZD.Y	DG-114
EZD.Z	DG-143
NGK	DENSO
A14T	DG-124
CY 07	DG-301
CY 51	DG-307
CY 52	DG-304
CY 53	DG-300
CY 55	DG-306
CY 57	DG-301
CZ 22	DG-302
Y-103-2	DG-001
Y-104R	DG-143
Y-107R	DG-114
Y-115T	DG-105
Y-115T1	DG-105
Y-118R	DG-215
Y-118T1	DG-221
Y-128T	DG-234
Y-146R	DG-223
Y-147T	DG-232
Y-168R	DG-210
Y-176	DG-236
Y-178T	DG-235
Y-197R	DG-222
Y-197T	DG-233
Y-204TS	DG-002
Y-204TS1	DG-002
Y-207T	DG-002
Y-208T	DG-001
Y-307R	DG-159
Y-502R	DG-111
Y-503R	DG-003
Y-504R	DG-116
Y-506R	DG-008
Y-507R	DG-145
Y-515J	DG-107
Y-516J	DG-112
Y-517J	DG-126
Y-523J	DG-142
Y-524J	DG-121
Y-525J	DG-130
Y-531J	DG-245
Y-532J	DG-214
Y-534J	DG-122
Y-701J	DG-146
Y-701R	DG-114
Y-703R	DG-216
Y-705RS	DG-157
Y-707RS	DG-120
Y-710R	DG-124
Y-711RS	DG-104
Y-712RS	DG-137

NGK	DENSO
Y-715R	DG-211
Y-729U	DG-115
Y-730U	DG-101
Y-731U	DG-003
Y-732U	DG-005
Y-732U	DG-144
Y-733J	DG-174
Y-738U	DG-161
Y-739R	DG-132
Y-740U	DG-101
Y-741U	DG-109
Y-745U	DG-117
Y-746R	DG-155
Y-747U	DG-127
Y-748U	DG-118
Y-749J	DG-173
Y-901R	DG-002
Y-902R	DG-001
Y-904M	DG-108
Y-907R	DG-123
Y-908R	DG-001
Y-909R	DG-202
Y-910R	DG-004
Y-911R	DG-004
Y-913M	DG-006
Y-914U	DG-001
Y-916R	DG-010
Y-917U	DG-001
Y-918R	DG-002
Y-922R	DG-001
Y-923U	DG-001
Y-924J	DG-001
Y-924U	DG-001
Y-925J	DG-106
Y-925R	DG-106
Y-925U	DG-117
Y-927R	DG-009
Y-928U	DG-102
Y-929U	DG-110
Y-930U	DG-119
Y-930Y-	DG-119
Y-932R	DG-103
Y-933R	DG-103
Y-937R	DG-007
Y-938R	DG-001
YE04	DG-113
NISSAN	DENSO
11065-31N00	DG-137
11065-43G01	DG-120
11065-63G00	DG-120
11065-7C000	DG-137
11065-9C600	DG-137
10065-10G00	DG-157
11065-G2400	DG-137
11065-G5501	DG-307
11065-V0700	DG-002
11065-V0710	DG-002
OPEL	DENSO
1214032	DG-171
1214034	DG-170
1214035	DG-302
1214040	DG-122
1214062	DG-302

OPEL	DENSO
1214304	DG-001
1214305	DG-001
1214306	DG-001
1214307	DG-001
1214308	DG-143
1214309	DG-159
1214310	DG-104
1214311	DG-124
1214312	DG-124
1214316	DG-300
1214317	DG-001
1214319	DG-001
1214322	DG-133
1214427	DG-109
1214457	DG-118
4403145	DG-004
5614216	DG-002
5614218	DG-001
5614219	DG-002
5614221	DG-143
88900715	DG-117
88900716	DG-109
88900717	DG-144
88900718	DG-155
88900720	DG-007
88900721	DG-145
88900722	DG-005
88900723	DG-002
88900724	DG-119
88900725	DG-001
88900726	DG-003
88900727	DG-106
88900728	DG-001
88900729	DG-102
88900731	DG-001
88900732	DG-123
88900733	DG-001
88900734	DG-001
88900736	DG-001
88900737	DG-004
88900738	DG-001
88900739	DG-143
88900740	DG-006
88900743	DG-124
90040991	DG-123
90051950	DG-001
90093867	DG-001
90093897	DG-001
90166155	DG-001
90210824	DG-001
90464737	DG-133
90487858	DG-001
90569338	DG-118
91153919	DG-109
9118201	DG-118
93178047	DG-171
94402303	DG-159
94439218	DG-143
94481972	DG-104
PEUGEOT	DENSO
5960.12	DG-113
5960.76	DG-140
5961.39	DG-001
5961.40	DG-001

PEUGEOT	DENSO
5961.53	DG-001
5961.57	DG-001
5962.1P	DG-161
5962.1Q	DG-161
5962.2Y	DG-003
5962.35	DG-001
5962.3C	DG-116
5962.3H	DG-001
5962.74	DG-001
5962.J2	DG-006
5962.J4	DG-001
5962.J5	DG-001
5962.J6	DG-001
5962.J7	DG-002
5962.K5	DG-001
5962.R8	DG-001
5962.S8	DG-001
5962.T1	DG-006
5962.T2	DG-103
5962.T7	DG-004
5962.W3	DG-003
7932.567718	DG-001
9150.860280	DG-002
9150.861080	DG-002
9152.184 980	DG-001
9153.664 680	DG-001
9553.4788	DG-001
9616.572480	DG-001
9631.658980	DG-003
9633.214380	DG-001
QUINTON HAZELL	DENSO
QGP105	DG-002
QGP106	DG-202
QGP107	DG-001
QGP110	DG-001
QGP111	DG-001
QGP111	DG-002
QGP111	DG-006
QGP112	DG-002
QGP113	DG-202
QGP114	DG-123
QGP115	DG-001
QGP117	DG-105
QGP120	DG-114
QGP131	DG-002
QGP139	DG-143
QGP139	DG-159
QGP147	DG-004
QGP148	DG-010
QGP151	DG-001
QGP154	DG-001
QGP154	DG-006
QGP154	DG-102
QGP155	DG-005
QGP163	DG-124
QGP168	DG-120
QGP169	DG-104
QGP170	DG-157
QGP174	DG-115
QGP175	DG-003
QGP178	DG-007
QGP179	DG-101
QGP180	DG-133
QGP181	DG-103

RENAULT	DENSO
5001001587	DG-001
7700100558	DG-008
7700100586	DG-101
7700100635	DG-112
7700103674	DG-126
7700105290	DG-009
7700111323	DG-107
7700111940	DG-112
7700701130	DG-001
7700704185	DG-001
7700715768	DG-001
7700741144	DG-001
7700854538	DG-103
7700855865	DG-006
7700856238	DG-006
7700856292	DG-103
7700860796	DG-101
7700861906	DG-101
7700867002	DG-009
7700867617	DG-103
7700874336	DG-009
7701033403	DG-001
7701035956	DG-001
7701039387	DG-001
7701040208	DG-004
7701349475	DG-001
7701349943	DG-006
7701349949	DG-103
7701414072	DG-001
7701414076	DG-001
7701414077	DG-002
7701414078	DG-123
7701414080	DG-001
7701414081	DG-004
7701414084	DG-202
7701414086	DG-001
7701414088	DG-002
7701414107	DG-010
7701414108	DG-001
7701414123	DG-001
7701414157	DG-010
82000012099	DG-126
8200517313	DG-126
ROVER	DENSO
568335	DG-131
ETC 8847	DG-115
NCC 100050	DG-101
SEAT	DENSO
SE1 38919000A	DG-001
X 0396 55 20	DG-001
SUZUKI	DENSO
18550-84E50	DG-171
TOYOTA	DENSO
19850-0L010	DG-246
19850-0W010	DG-240
19850-05010	DG-243
19850-27010	DG-245
19850-30010	DG-217
19850-46021	DG-224
19850-46031	DG-225
19850-54010	DG-211

TOYOTA	DENSO
19850-54020	DG-238
19850-54031	DG-221
19850-54050	DG-215
19850-54060	DG-239
19850-54071	DG-213
19850-54090	DG-211
19850-54110	DG-310
19850-54120	DG-212
19850-54130	DG-310
19850-54140	DG-242
19850-54150	DG-218
19850-56010	DG-226
19850-56020	DG-227
19850-58010	DG-219
19850-64010	DG-223
19850-64020	DG-216
19850-64040	DG-308
19850-64050	DG-214
19850-64060	DG-309
19850-67030	DG-305
19850-68010	DG-232
19850-68020	DG-233
19850-68030	DG-234
19850-68040	DG-235
19850-68051	DG-220
19850-68060	DG-222
19850-76020	DG-228
19850-77010	DG-229
19850-77011	DG-231
19850-78020	DG-241
87343-20010	DG-400
87343-30010	DG-401
UNIPART	DENSO
GGP1	DG-001
GGP2	DG-001
GGP4	DG-002
GGP5	DG-123
GGP7	DG-001
GGP8	DG-004
GGP13	DG-143
GGP15	DG-124
GGP16	DG-104
GGP17	DG-002
GGP18	DG-001
GGP20	DG-105
GGP22	DG-001
GGP23	DG-003
GGP24	DG-101
GGP25	DG-005
GGP26	DG-102
GGP27	DG-119
GGP28	DG-006
GGP29	DG-001
GGP30	DG-106
GGP31	DG-115
GGP32	DG-103
VOLKSWAGEN	DENSO
059963319	DG-144
059963319A	DG-144
061905061	DG-002
062905061	DG-131
068905061	DG-002
068905061	DG-002

VOLKSWAGEN	DENSO
10140105	DG-005
J1985054090	DG-211
N0190811	DG-002
N0190812	DG-002
N0190814	DG-002
N0190971	DG-002
N0191001	DG-002
N0191001	DG-002
N0191002	DG-002
N0191002	DG-002
N0191005	DG-002
N0191006	DG-002
N101401.01	DG-005
N101401.02	DG-005
N101401.03	DG-005
N101401.04	DG-005
N101401.05	DG-005
N102130.01	DG-002
N102130.02	DG-002
VOLVO	DENSO
1257141	DG-002
1257889	DG-002
1542319	DG-202
8631607	DG-140



	V	mm	mm	mm	mm	mm	Nm	mm	Nm
DG-001	11	M12x1.25	72	25	6,1	12	15-20	M5x0.8	3-4
DG-002	11	M12x1.25	62	21	6,1	12	15-20	M5x0.8	3-4
DG-003	11	M10x1	89	30	5	10	10-12	M4x0.7	1-1.5
DG-004	11,5	M12x1.25	70	21	5	12	15-20	M4x0.7	1-1.5
DG-005	11	M10x1	92	25	5	10	10-12	Pin	
DG-006	11	M12x1.25	67	25	6,1	12	15-20	M5x0.8	3-4
DG-007	11,5	M12x1.25	63	18	6,1	12	15-20	M5x0.8	3-4
DG-008	11	M10x1	93	25	5	10	10-12	M4x0.7	1-1.5
DG-009	11	M12x1.25	70	26	5	12	15-20	M4x0.7	1-1.5
DG-010	11,5	M12x1.25	70	23	6,1	12	15-20	M5x0.8	3-4
DG-101	11	M10x1	84	25	5	10	10-12	M4x0.7	1-1.5
DG-102	11	M12x1.25	71,5	25	5	12	15-20	M4x0.7	1-1.5
DG-103	11	M12x1.25	63	21	6,1	12	15-20	M5x0.8	1-1.5
DG-104	11	M10x1.25	80	17	5	12	10-12	M4x0.7	1-1.5
DG-105	12	M10x1.25	95	22	5	12	10-12	M4x0.7	1-1.5
DG-106	11,5	M12x1.25	114	28	6,1	12	15-20	Pin	
DG-107	11	M10x1	90	24,5	5	10	10-12	Pin	
NEW DG-108	11	M12x1.25	135	23,85	5	12	15-20	M4x0.7	1-1.5
DG-109	11	M10x1	97	30	5	10	10-12	Pin	
DG-110	11,5	M12x1.25	87	28	5	12	15-20	Pin	
DG-111	11	M10x1	76	25	5	10	10-12	M4x0.7	1-1.5
DG-112	11	M10x1	99	25	5	10	10-12	Pin	
DG-113	11	M8x1	118,5	28	4	8	8-10	M4x0.7	1-1.5
NEW DG-114	7	M10x1.25	86	22	5	12	10-12	M4x0.7	1-1.5
DG-115	11,5	M10x1	125	26,5	5	10	10-12	M4x0.7	1-1.5
DG-116	11	M10x1	107,5	28	5	10	10-12	M4x0.7	1-1.5
DG-117	11,5	M10x1	130	27	5	10	10-12	Pin	
DG-118	11	M10x1	133	29	5	10	10-12	Pin	
DG-119	11,5	M12x1.25	120	28	6,1	12	15-20	Pin	
DG-120	11	M10x1.25	88	22	5	12	10-12	M4x0.7	1-1.5
DG-121	10	M10x1	95	25	5	10	10-12	M4x0.7	1-1.5
DG-122	11	M10x1	102,4	24,5	5	10	10-12	Pin	
DG-123	11	M12x1.25	67	20	6,1	12	15-20	M5x0.8	3-4
DG-124	11	M10x1.25	87	24	5	12	10-12	M4x0.7	1-1.5
DG-125	12,5	M12x1.25	73	26	6,1	12	15-20	M5x0.8	3-4
DG-126	11	M10x1	150,5	24,5	5	10	10-12	Pin	
DG-127	11	M10x1	95	25	5	10	10-12	M4x0.7	1-1.5
DG-129	11	M12x1.25	75,2	21	6,1	12	15-20	Pin	
DG-130	11,5	M10x1	147	35,5	5	10	10-12	M4x0.7	1-1.5
NEW DG-131	1,7	M14x1.25	106,5	19,5	8,3	18	20-25	M5x0.8	3-4
DG-132	11	M10x1	82	25	5	10	10-12	M4x0.7	1-1.5
DG-133	11	M10x1	126	29	5	10	10-12	M4x0.7	1-1.5
NEW DG-135	0,7	M18x1.5	91	27,5	9,8	21	30-40	M5x0.8	3-4
DG-137	11	M10x1.25	85	19,25	5	12	10-12	M4x0.7	1-1.5
NEW DG-139	11	M10x1	149,5	26	5	8	10-12	Pin	
DG-140	11	M8x1	126	24,5	4	8	8-10	Pin	
DG-142	11	M10x1	135	31	5	10	10-12	Pin	
DG-143	5	M10x1.25	89	24	5	12	10-12	M4x0.7	1-1.5
DG-144	11	M10x1	125	34	5	10	10-12	Pin	
DG-145	11	M10x1	105	32	5	10	10-12	Pin	
DG-146	11	M10x1.25	83	22	5	12	10-12	M4x0.7	1-1.5
DG-155	11,5	M10x1	128	30	5	10	10-12	M4x0.7	1-1.5
NEW DG-157	11	M10x1.25	68	17	5	12	10-12	M4x0.7	1-1.5
DG-159	5	M10x1.25	83	18	5	12	10-12	M4x0.7	1-1.5
DG-161	11	M10x1	117	34	5	10	10-12	M4x0.7	1-1.5
NEW DG-170	11	M9x1	151	29,6	4	9	8-10	Pin	
NEW DG-171	11	M8x1	119	27,6	4	9	8-10	Pin	
NEW DG-172	11	M10x1.25	97	21,85	5	12	10-12	M4x0.7	1-1.5
NEW DG-173	11	M10x1	111,5	29,6	5	10	10-12	M4x0.7	1-1.5
NEW DG-174	11	M10x1.25	82	19	5	12	10-12	M4x0.7	1-1.5
NEW DG-175	10,5	M10x1	78,4	28,3	5	3/8"	10-12	Faston	
NEW DG-176	11,5	M10x1	127	26	5	10	10-12	Pin	
NEW DG-177	5	M10x1	96	29,5	5	10	10-12	Pin	
NEW DG-178	5	M10x1	105	32	5	10	10-12	Pin	
DG-202	11	M12x1.25	77	30	6,1	12	15-20	M5x0.8	3-4

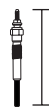













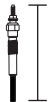
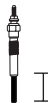

	V	mm	mm	mm	mm	mm	Nm	mm	Nm
DG-211	11	M10x1.25	95,5	32	4,3	12	10-12	M4x0.7	1-1.5
DG-212	11	M10x1.25	95,5	32	4,3	12	10-12	M4x0.7	1-1.5
DG-213	6	M10x1.25	95,5	32	3,6	12	10-12	M4x0.7	1-1.5
DG-214	11	M10x1.25	102,5	28	4,3	12	10-12	M4x0.7	1-1.5
DG-215	7	M10x1.25	95,5	32	4,3	12	10-12	M4x0.7	1-1.5
DG-216	11	M10x1.25	101,5	28	5	12	10-12	M4x0.7	1-1.5
DG-217	11	M10x1.25	170	36	3,5	12	10-12	M4x0.7	1-1.5
DG-218	11	M10x1.25	94	30,5	4,3	12	10-12	M4x0.7	1-1.5
DG-219	23	M10x1.25	101,5	28	5	12	10-12	M4x0.7	1-1.5
DG-220	6	M10x1.25	100,5	28	5	12	10-12	M4x0.7	1-1.5
DG-221	11	M10x1.25	95,5	32	5,2	12	10-12	M4x0.7	1-1.5
DG-222	14	M10x1.25	100,5	28	5	12	10-12	M4x0.7	1-1.5
DG-223	7	M10x1.25	101,5	28	5	12	10-12	M4x0.7	1-1.5
DG-224	8	M14x1.25	89	28	5	17	20-25	M5x0.8	3-4
DG-225	19	M14x1.25	89	28	5	17	20-25	M5x0.8	3-4
DG-226	19	M10x1.25	100,5	28	5	12	10-12	M5x0.8	3-4
DG-227	8	M10x1.25	100,5	28	5	12	10-12	M5x0.8	3-4
DG-228	19	M18x1.5	78	21	5	26	25-30	M5x0.8	3-4
DG-229	21	M10x1.25	94,5	22	5	12	10-12	M5x0.8	3-4
DG-231	21,5	M10x1.25	94,5	22	5	12	10-12	M5x0.8	3-4
DG-232	10,5	M10x1.25	101,5	28	5	12	10-12	M4x0.7	1-1.5
DG-233	23	M10x1.25	101,5	28	5	12	10-12	M4x0.7	1-1.5
DG-234	8,5	M10x1.25	101,5	28	5	12	10-12	M4x0.7	1-1.5
DG-235	20,5	M10x1.25	100,5	28	5	12	10-12	M4x0.7	1-1.5
NEW DG-236	19	M10x1.25	84,5	25	5,2	12	10-12	M5x0.8	3-4
NEW DG-238	23	M10x1.25	91,5	32	5	12	10-12	M5x0.8	3-4
NEW DG-239	16	M10x1.25	95,5	32	4,3	12	10-12	M4x0.7	1-1.5
DG-240	11	M10x1.25	121	36,4	5	10	10-12	M4x0.7	1-1.5
NEW DG-241	6	M12x1.25	141	24	5	12	15-20	M4x0.7	1-1.5
NEW DG-242	11	M10x1.25	95,5	32	5	12	10-12	M4x0.7	1-1.5
NEW DG-243	11	M10x1.25	95,5	32	4,3	12	10-12	M4x0.7	1-1.5
NEW DG-245	11	M10x1.25	170	36,6	5	12	10-12	M4x0.7	1-1.5
NEW DG-246	11	M10x1.25	170	36	3,5	12	10-12	M4x0.7	1-1.5
DG-300	11	M10x1.25	87,5	18	4,5	12	10-12	M4x0.7	1-1.5
DG-301	11	M10x1.25	81,5	18	4,5	12	10-12	M4x0.7	1-1.5
DG-302	11	M10x1.25	144,4	24	4,5	12	10-12	Pin	
DG-304	11	M10x1.25	96,5	19	4,5	12	10-12	M4x0.7	1-1.5
DG-305	11	M10x1.25	103,8	25	3,5	12	10-12	M4x0.7	1-1.5
NEW DG-306	11	M10x1.25	84	21,4	4,5	12	10-12	M4x0.7	1-1.5
NEW DG-307	11	M10x1.25	82	18,7	4,5	12	10-12	M4x0.7	1-1.5
NEW DG-308	11	M10x1.25	100,8	25	3,5	12	10-12	M4x0.7	1-1.5
NEW DG-309	11	M10x1.25	103,8	25	3,5	12	10-12	M4x0.7	1-1.5
NEW DG-310	11	M10x1.25	103,8	28	3,5	12	10-12	M4x0.7	1-1.5
NEW DG-400	11	M10x1.25	96,5	33	5	12	10-12	M4x0.7	1-1.5
NEW DG-401	11	M10x1.25	90,5	33	5	12	10-12	M4x0.7	1-1.5

Memo

Memo



	GB	DE	FR	ES	IT	SE	RU
Ch No	Chassis number	Fahrgestellnummer	Numéro de châssis	Número de chasis	Numero (di serie) del telaio	Chassinummer	Номер шасси
Eng No	Engine number	Motornummer	Numéro de moteur	Número de motor	Numero (di serie) del motore	Motornummer	Номер двигателя
	Vehicle: Make, Model, Engine capacity	Fahrzeug: Fabrikat, Modell, Motorkapazität	Véhicule: Marque, modèle, capacité de moteur	Vehículo: marca, modelo, capacidad del motor	Veicolo: Marca, Modello, capacità del motore	Fordon: märke, modell, motorkapacitet	Автомобиль: марка, модель, объем двигателя
KW	Engine power	Motorleistung	Puissance du moteur	Potencia del motor	Potenza del motore	Motoreffekt	Мощность двигателя
	Additional information	Zusätzliche Information	Informations complémentaires	Información adicional	Informazioni aggiuntive	Kompletterande information	Дополнительная информация
	Engine code	Motorkenn- buchstaben	Code du moteur	Código del motor	Codice del motore	Motorkod	Код двигателя
	Year (from - to)	Jahr (von - bis)	Année (de - à)	Año (de - a)	Anno (da - a)	År (från - till)	Год (с – по)
	Number of cylinders	Zylinderanzahl	Nombre de cylindres	Número de cilindros	Numero di cilindri	Antal cylindrar	Количество цилиндров
	Glow plug part number (short code)	Teilenummer - Glühkerze (Kurzschlüssel)	Numéro de pièce de bougie de préchauf- fage (code abrégé)	Número referencia de la bujía de calentador (código corto)	Codice articolo candeletta ad incandescenza (codice abbreviato)	Glödstift - delnummer (kortnummer)	Каталожный номер свечи накаливания (сокращенный код)
	Voltage	Volt	Tension	Tensión	Voltaggio	Spänning	Напряжение
	Thread size	Gewindegröße	Dimension de filetage	Tamaño de la rosca	Dimensione del filetto	Gängstorlek	Диаметр резьбы
	Overall length	Gesamtlänge	Longueur totale	Longitud total	Lunghezza totale	Total längd	Общая длина
	Probe length	Fühlerlänge	Longueur de sonde	Longitud del sensor	Lunghezza della sonda	Sondens längd	Длина наконечника
	Probe diameter	Fühlerdurchmesser	Diamètre de sonde	Diámetro del sensor	Diametro della sonda	Sondens diameter	Диаметр наконечника
	Hexagon size	Sechskantgröße	Taille hexagonale	Tamaño del hexágono	Dimensione dell'esagono	Hexagonstorlek	Размер под ключ

	GB	DE	FR	ES	IT	SE	RU
	Glow plug installation torque	Drehmoment: Glühkerzenmontage	Couple d'installation de bougie de préchauffage	Torcion para la instalación de la bujía de calentador	Coppia di serraggio per l'installazione della candeletta ad incandescenza	Glödstiftets installationsmoment	Момент затяжки свечи накаливания
	Terminal type	Rundmutter-Typ	Type de plot	Tipo de terminal	Tipo di terminale	Kontakttyp	Тип клеммы контактного стержня
	Terminal installation torque	Drehmoment: Rundmuttermontage	Couple d'installation de plot	Torcion para la instalación del terminal	Coppia di serraggio per l'installazione del terminale	Kontaktens installationsmoment	Момент затяжки клеммы



DENSO EUROPE B.V.

Hogeweyselaan 165
1382 JL WEESP
The Netherlands

Mailing address:
P.O. Box 89
1380 AB WEESP
The Netherlands

Tel. +31 (0)294 - 493 493
Fax +31 (0)294 - 417 122

info.amsales@denso.nl
www.denso-europe.com

Printed in The Netherlands DEGP06-0001

