



RUS 2005/2006



Содержание

Bic	3
(RUS) V-Line	4 – 9
(RUS) Схема условных обозначений	10 – 11
(RUS) Определение типа двигателя	12
Серии свечей зажигания	1 – 11
Серии свечей накаливания	12 – 24
Свечи зажигания для легковых автомобилей/Свечи накаливания для легковых/грузовых автомобилей	25 – 189
Свечи зажигания для мотоциклов	190 – 281
Свечи зажигания для мотороллеров	282 – 304
Свечные штекеры для мотоциклов/мотороллеров	305 – 342
Свечи зажигания для катеров со стационарным двигателем	343 – 377
Свечи зажигания для катеров с подвесным двигателем	378 – 434
Свечи зажигания для катеров с воздушно-реактивным двигателем	435 – 443
Свечи зажигания для бензопил ..	444 – 461
Свечи зажигания для газонокосилок	462 – 491
Свечи зажигания для ручных косилок	492 – 508
Свечи зажигания для генераторов	509 – 518
Свечи зажигания для различных двигателей и орудий труда	519 – 544
Свечи зажигания для снегоходов	545 – 561
Свечные штекеры для мотоциклов/мотороллеров	562 – 569
Таблица сопоставлений с другими производителями	
V-Line – Beru – Bosch – Champion .	570
V-Line No. – 	571
Свеча –    /    – свеча	572 – 635
Таблица сопоставлений с другими производителями	636 – 710
Таблица пересчета момента затяжки .	711
ЛС ↔ кВт	712
Info	713
Гоночные свечи зажигания	714 – 716
Последняя информация	717 – 718

⌚ = 2005 –

Примечания:

Данный перечень спецификаций предназначен только для выбора типа свечей.

С опубликованием данного издания все предшествующие перечни спецификаций теряют силу. Содержание списка не может послужить основой для возникновения правопритязания.

Рекомендации для авиационных двигателей согласно директивам FAA в данное издание не включены.

Свечи зажигания, свечи накаливания и наконечники, приведенные в каталоге, могут быть установлены на конкретные двигатели в соответствии с рекомендациями в каталоге.

Видимые ошибки и очевидные описки подлежат проверки со стороны пользователей.

Отсутствие брака и правильность параметров продукции компания NGK гарантирует в соответствии с развитием техники. Гарантия действует только при надлежащей эксплуатации продукции компании NGK. Гарантия на отсутствие заводского брака и на качество используемых материалов действует 24 месяца с момента покупки товара, если иное не предписано производителем автомобиля.

Исключение составляет нормальный износ а также использования продукции в гоночных двигателях.

Автомобили производителей АвтоВАЗ обозначены VAZ, ГАЗ обозначены GAZ, УАЗ UAZ и Москвич MOSKWICZ. Не используйте для подбора свечей зажигания/накаливания обозначения LADA, VOLGA. Эти обозначения действуют для немецкого рынка.



Bic^{**} Chance

NEW

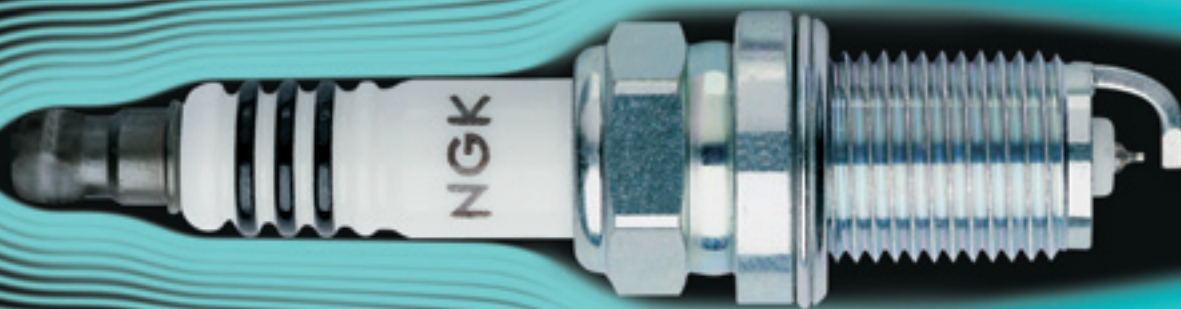

Свечи зажигания Bic^{**} (Best in class) – высококачественные свечи, которые многими производителями автомобилей применяются как оригинальное оборудование. То, что эти свечи подходят и имеют значительные преимущества для неновых двигателей, подтверждается использованием их такими именитыми компаниями-производителями как BMW, DaimlerChrysler, VW. Однако и для новых двигателей, которые еще не оснащены современной технологией свечей зажигания, в разделе Bic^{**} этого каталога непременно найдут для себя альтернативу те водители, которые всегда стремятся к лучшему.

Торговля и сервис откроют для себя в Bic^{**} следующие преимущества:

- Больше прибыли,
- Лучшее функционирование Бортовой Диагностической Системы (OBD),
- Разрешение автопроизводителей для применения в неновых двигателях,
- Минимизация проблем зажигания и холодного старта,
- Приток новых клиентов, которые стремятся к лучшему,
- Удовлетворение высоких запросов оригинального оборудования.

Автовладельца Bic^{**} привлечет следующим:

- Разрешение автопроизводителей для использования на неновых двигателях,
- Более эффективное сгорание, которое не имеет вредного воздействия на катализатор,
- Лучшая защита окружающей среды,
- Экономный расход топлива,
- Минимизация проблем зажигания и холодного старта,
- Длительный эксплуатационный период,
- Улучшенная динамика разгона за счет улучшенной чувствительности двигателя к открытию дроссельной заслонки,
- Более плавный ход.

Cyl.	Valve	Order No.	Bic ^{**}	Order No.
4	0.5	BK9E0UP	3199	
6	0.7	BK9E6EK	2288 20	BK9E0UP 3199

Вы найдете шедевр в технологии свечей зажигания практически для всех двигателей в колонке "BIC^{**}" данного каталога.



****Best in class.**

... сбытовая концепция со множеством преимуществ

- 1. Система числовой кодировки:**
Числа от 1 до 32 позволяют быстро найти нужную свечу зажигания.
- 2. Компактность:**
Небольшая занимаемая площадь благодаря компактным размерам. Тем самым остается больше места для размещения других товаров.
- 3. Привлекательная упаковка:**
Яркая упаковка привлекает покупателей и способствует более быстрой продаже.
- 4. Большая скорость оборота товаров:**
32 типов свечей подходят для 97 % всех легковых автомобилей. Это повысит Вашу рентабельность.
- 5. Сбыт через специализированные магазины:**
Отсутствие конкуренции с универсальными магазинами и супермаркетами.
- 6. Снижение расходов:**
Низкие складские расходы увеличивают Вашу прибыль.
- 7. Экологический фактор:**
Большая надежность зажигания. Тем самым уменьшение расхода топлива, выделения выхлопных газов и более длительный период эксплуатации катализатора, в результате лучшее отношение покупателей. Экологически чистая картонная упаковка без блистера.
- 8. Реклама для конечных потребителей:**
Фирма NGK заботится о росте спроса у Ваших покупателей.



Весь сортимент из 32 наименований Вы можете представительно и обозримо разместить в напольном контейнере. Благодаря интегрированному классификационному списку поиск нужной свечи зажигания становится просто детской забавой!



Вы можете разместить свечи, упакованные по четыре, на имеющемся стенде с перфорацией вместе с откидным классификационным списком. Простая номерная система (номера от 1 до 32) позволяет безошибочно и быстро найти нужную свечу зажигания.



Ассортимент состоит из 32 различных типов свечей зажигания – всего 700 свечей, отсортированных по их спросу.

V-Line No.**Car-Manufacturer**

1	BUR6ET	Audi, Fiat, Lancia, Seat, Skoda, VW
2	BPR6E	Alfa Romeo, Austin, Autobianchi, BMW, Chrysler, Daewoo, Daihatsu, Fiat, Ford, FSO, Honda, Hyundai, Innocenti, Isuzu, Lada, Lancia, Lotus, Mazda, MG, Mitsubishi, Nissan, Opel, Porsche, Renault, Rover, Seat, Subaru, Suzuki, TVR, Vauxhall, Volvo, Zastava
3	BPR6H	Daewoo, Opel, Vauxhall
4	BP6E	Alfa Romeo, Aston Martin, Audi, Austin, BMW, Citroen, Fiat, FSO, Innocenti, Lada, Lotus, Maserati, Mercedes, Mitsubishi, Morgan, Moskwicz, Nissan, Peugeot, Renault, Rover, Saab, Seat, Subaru, Talbot, Tofas, Volvo, VW, Wartburg, Yugo, Zastava
5	BP6EF	Citroen, Mercedes, Peugeot, Renault, Rover, Talbot
6	BPR5E	Asia, Daihatsu, Fiat, Honda, Innocenti, Mazda, Mitsubishi, Nissan, Opel, Renault, Rolls Royce, Rover, Seat, Suzuki, Toyota, TVR, Vauxhall
7	BPR6EF	Chevrolet, Ford, Lancia, Renault, TVR, Volvo
8	BP5E	BMW, Citroen, Daimler, Isuzu, Jaguar, Mitsubishi, Nissan, Renault, Rover, VW
9	BPR5EY	Daihatsu, Innocenti, Suzuki, Toyota
10	BPR6EY-11	Daihatsu, Honda, Toyota
11	BCPR6E-11	Ford, Honda, Mazda, Nissan, Renault, Rover, Saab, Subaru
12	BCPR6E	Aston Martin, Autobianchi, Chrysler, Citroen, Daimler, Fiat, Ford, FSO, Jaguar, Lada, Lancia, Mazda, Morgan, Nissan, Opel, Peugeot, Porsche, Rover, Skoda, TVR, Volvo
13	BPR6ES-11	Honda, Hyundai, Isuzu, Kia, Mazda, Mitsubishi, Nissan, Opel, Rover, Subaru, Suzuki, Vauxhall
14	BKR6E-11	Daewoo, Daihatsu, Honda, Hyundai, Isuzu, Kia, Lotus, Mazda, Mitsubishi, Nissan, Proton, Rover, Subaru, Suzuki
15	ZGR5A	BMW, Daihatsu
16	BCP5E	Citroen, Mercedes, Nissan, Peugeot, Renault, Ssangyong
17	BCP6E	Alfa Romeo, Citroen, Lada, Mercedes, Nissan, Peugeot, Renault, Rover, Skoda, Ssangyong, Tatra
18	BP6H	Citroen, Dacia, Renault, Seat, Skoda, Z.A.Z., Zastava
19	BPR7E	Alfa Romeo, Austin, Autobianchi, Caterham, Fiat, Ford, Lancia, Lotus, Mitsubishi, Porsche, Renault, Rover, Subaru, Volvo
20	BKR6EK	BMW, Citroen, Fiat, Lancia, Mercedes, Opel, Peugeot, Porsche, Renault, Vauxhall, VW, Wiesmann
21	BUR5ET-10	Audi, Seat, VW
22	BUR5ET	Audi, Seat, VW
23	BKR5EK	Citroen, Daewoo, Fiat, Lancia, Opel, Peugeot, Saab, Vauxhall
24	BKUR6ET-10	Audi, Mercedes, Seat, Skoda, VW
25	PTR5A-13	Ford, Mazda, Morgan
26	BKR6EKC	Fiat, Lancia, Lotus
27	BKUR6ET	Audi, Fiat, Lancia, Seat, Skoda, VW
28	BKR6E	Caterham, Chrysler, Daihatsu, Kia, Lotus, Mazda, Nissan, Opel, Rover, Suzuki
29	BKUR5ET	Mercedes, Seat, VW
30	BKR6EQUP	Alpina, Audi, BMW, Bentley, Land Rover, Mini, Morgan, Porsche, Rolls Royce
31	PTR5D-10	Aston Martin, Ford, Mazda
32	BCPR5ES	Citroen, Nissan, Peugeot, Reliant, Renault, Skoda

Полный Ассортимент V-Line – одним взглядом

Номер V-Line Для заказа	Наименование свечи зажигания	Тип с аналогичным калильным числом:
V-Line № 01	BUR6ET	
V-Line № 02	BPR6E	BPR6ES
V-Line № 04	BP6E	BP6ES
V-Line № 05	BP6EF	BP6EFS
V-Line № 06	BPR5E	BPR5ES
V-Line № 07	BPR6EF	BPR6EFS
V-Line № 11	BCPR6E-11	BCPR6ES-11
V-Line № 12	BCPR6E	BCPR6ES
V-Line № 13	BPR6ES-11	
V-Line № 14	BKR6E-11	
V-Line № 15	ZGR5A	
V-Line № 16	BCP5E	BCP5ES
V-Line № 17	BCP6E	BCP6ES
V-Line № 19	BPR7E	BPR7ES
V-Line № 20	BKR6EK	
V-Line № 21	BUR5ET-10	
V-Line № 22	BUR5ET	
V-Line № 23	BKR5EK	
V-Line № 24	BKUR6ET-10	
V-Line № 25	PTR5A-13	
V-Line № 26	BKR6EKC	
V-Line № 27	BKUR6ET	
V-Line № 28	BKR6E	BKR6ES
V-Line № 29	BKUR5ET	
V-Line № 30	BKR6EQUP	
V-Line № 31	PTR5D-10	
V-Line № 32	PCPR5E	PCPR5ES

СВЕЧИ ЗАЖИГАНИЯ V-LINE – преимущества на протяжении всей линии

1. Надежное зажигание:

больше защиты для окружающей среды

Благодаря конструкции V-Line сокращается до минимума опасность возникновения перебоев в процессе искрообразования. За счет этого предупреждаются отрицательные последствия перебоев искрообразования, например, повышенный расход топлива и повышенные выбросы вредных веществ, оказывающих нагрузку на окружающую среду.

2. Надежное зажигание: больше защиты для каталитического нейтрализатора ОГ

Насколько важна надежная работа свечи зажигания, особенно наглядно проявляется на примере каталитического нейтрализатора ОГ: его срок службы и эффективность зачастую ограничиваются в результате незаметных перебоев искрообразования, которых вполне можно избежать. Свечи зажигания V-Line обеспечивают эффективную защиту для каталитического нейтрализатора ОГ.

3. Надежность для водителя: качество на уровне предприятия-изготовителя

Свечи зажигания фирмы NGK являются высококачественными изделиями.

Доказательство: они применяются во всем мире крупными изготовителями двигателей и автомобилей в рамках серийного производства: Alfa Romeo, Audi, BMW, Fiat, Honda, Mazda, Mitsubishi, Renault, Rover, Saab, Seat, Toyota, VW и т. д.

V-Line № 1, 21, 22, 24, 27, 29

свеча зажигания с 3 боковыми электродами



V-Line № 2-12, 14-19, 28, 32

свечи зажигания с V-образной насечкой на центральном электроде; патент № DE 2922 305 C2

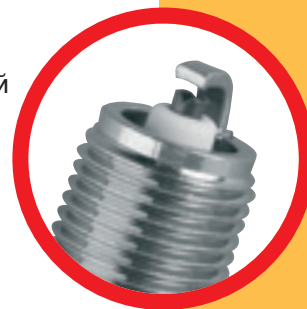

V-Line № 20, 23

свеча зажигания с 2 боковыми электродами



V-Line № 30

свеча зажигания с 4 боковыми электродами



V-Line № 31

свеча зажигания с 1 боковыми электродами



СВЕЧИ ЗАЖИГАНИЯ V-LINE – преимущества на протяжении всей ЛИНИИ



**V-Line № 1, 21,
22, 24, 27, 29**
свеча зажигания
с 3 боковыми
электродами



**V-Line № 2-12,
14-19, 28, 32**
свечи зажигания
с V-образной
засечкой на
центральной
электроде;
патент № DE
2922 305 C2



V-Line № 20, 23
свеча зажигания
с 2 боковыми
электродами



V-Line № 30
свеча зажигания
с 4 боковыми
электродами

V-Line № 1, 21, 22, 24, 27, 29

Свеча зажигания с 3-мя боковыми электродами для концерна VW

Фирма NGK выпускает этот тип свечей зажигания специально для автомобилей производства концерна VW. Ими могут оснащаться почти все новые модели (смотри перечень соответствия). Интервалы замены свечей согласованы с интервалами техосмотров предписанными изготовителем автомобилей.

Технические преимущества:

использование специального материала изоляторов дает возможность удлинить вершину теплового конуса изолятора. Кроме того, был оптимизирован медный сердечник внутри центрального электрода. Обе меры способствуют еще лучшему отводу тепла. Увеличенный таким образом температурный диапазон нормальной работы обеспечивает надежный пуск и еще более стабильную характеристику зажигания даже в экстремальных условиях эксплуатации двигателя и автомашины.

V-Line № 2 – 12, 14 – 19, 28, 32

С точки зрения технологии принцип действия отличается гениальной простотой, но еще и хорошей эффективностью: в центральном электроде свечи зажигания V-Line находится V-образная засечка. Вследствие этого воспламеняющая искра перескакивает на наружную сторону центрального электрода. В этом месте скапливается способная воспламениться топливовоздушная смесь в большем количестве, чем непосредственно между электродами. Дополнительный плюс: требуется меньше вторичного напряжения системы зажигания. Тем самым повышается надежность зажигания! ОСОБЕННО В СОВРЕМЕННЫХ ДВИГАТЕЛЯХ, ТОПЛИВОВОЗДУШНАЯ СМЕСЬ КОТОРЫХ ДОВОДИТСЯ ДО ОЧЕНЬ БЕДНОЙ СТЕПЕНИ НАСЫЩЕНИЯ В ИНТЕРЕСАХ СОКРАЩЕНИЯ ВЫБРОСОВ ВРЕДНЫХ ВЕЩЕСТВ, КОНСТРУКЦИЯ NGK В ЛЮБЫХ УСЛОВИЯХ ОБЕСПЕЧИВАЕТ АБСОЛЮТНО НАДЕЖНОЕ ВОСПЛАМЕНЕНИЕ СМЕСИ, В ТОМ ЧИСЛЕ И В ЭКСТРЕМАЛЬНЫХ УСЛОВИЯХ ЭКСПЛУАТАЦИИ!

V-Line № 20, 23

Принцип действия свечи зажигания для BMW: если на вершине теплового конуса изолятора имеются токопроводящие отложения, то утекающее вторичное напряжение системы зажигания "перехватывается", а между изолятором и боковым электродом возникает воспламеняющая искра. При этом отложения сажи удаляются и топливовоздушная смесь надежно воспламеняется.

V-Line № 30

Результатом тесного сотрудничества между BMW и NGK явилась разработка свечи зажигания VKR6EQUF с большим сроком службы, оснащенной центральным электродом из платины и 4-мя боковыми электродами с современной технологии полуповерхностного разряда. Применение техники полуповерхностного разряда возможно только благодаря специальному дизайну внутреннего окончания изолятора. С помощью этой техники обеспечивается образование искры только между теми электродами, которые в данный момент времени обеспечивает надежное зажигания воздушно-топливной смеси. Так как каждая искра перед тем, как перескочить от изолятора на боковой электрод, сначала «скользит» через окончание внутренней части изолятора, возможно возникший нагар мгновенно удаляется, и таким образом предотвращаются пропуски в зажигании. Оптимальные параметры холодного запуска при очень низких температурах и высочайшая надежность зажигания даже при экстремальных условиях эксплуатации таким образом гарантируются.

Этот новый тип свечей NGK применяется серийно на автомобилях BMW, начиная с 1997 года выпуска. Допуск к установке этого типа свечи на определенные более поздние автомобили BMW, начиная с 1987 года выпуска, был одобрен задним числом.

V-LINE № 25

Для моделей FORD, оборудованных двигателями ZETEC, фирма NGK разработала двойную платиновую свечу зажигания PTR5A-13. Преимущества платиновых электродов заключаются в том, что требуется меньше вторичного напряжения системы зажигания. Таким образом появилась возможность увеличить зазор между электродами с тем, чтобы добиться стабильного сгорания и плавного холостого хода. Благодаря улучшенным характеристикам воспламенения удалось оптимизировать как эмиссию неочищенных выбросов, так и крутящий момент.



V-Line № 25

V-LINE № 26

В сотрудничестве с FIAT фирма NGK разработала свечу зажигания ВКР6ЕКС. Буква "С" обозначает специальную свечу зажигания для двигателей производства концерна FIAT. Свеча ВКР6ЕКС безупречно работает даже в труднейших условиях эксплуатации — от движения по принципу "тронулся-остановился" при низкой температуре сгорания до максимальной температурной нагрузки двигателя при его полной нагрузке. Результаты испытаний показывают, что особая конструкция двух боковых электродов гарантирует высочайшую воспламеняемость, а также требуемый срок службы свечей зажигания в пределах рекомендованного фирмой Fiat интервала замены свечей зажигания.



V-Line № 26

V-LINE № 31

Для моделей FORD, оборудованных двигателями ENDURA, фирма NGK разработала двойную платиновую свечу зажигания PTR5D-10. Преимущества платиновых электродов заключаются в том, что требуется меньше вторичного напряжения системы зажигания. Таким образом появилась возможность увеличить зазор между электродами с тем, чтобы добиться стабильного сгорания и плавного холостого хода. Благодаря улучшенным характеристикам воспламенения удалось оптимизировать как эмиссию неочищенных выбросов, так и крутящий момент.



V-Line № 31

V-Line №
2-12, 14-19, 28, 32

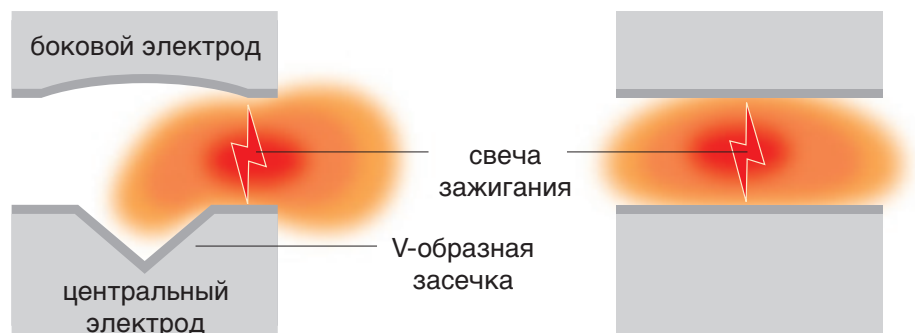

МАРКИРОВАЧНЫЕ МЕТКИ НА СВЕЧАХ ЗАЖИГАНИЯ ФИРМЫ NGK

* Здесь указаны стандартные обозначения. Также имеются несколько нестандартных обозначений.

	диаметр резьбы	Размер 6-гранного ключа	Особенности конструкции		Калильное число	Длина резьбы	
A	18 мм	25,4 мм	L	Компактный тип (Shorty)	2		
B	14 мм	20,8 мм	M	Компактный тип (Bantam)	4		
C	10 мм	16,0 мм	P	Смещенный вперед наконечник изолятора	5		
D	12 мм	18,0 мм	R	Тип с резистором	6		
E	8 мм	13,0 мм	U	Тип поверхностного или полуповерхностного разряда	7		
G	PF 1/2	23,8 мм	Z	Тип индукционного резистора	8		
J	12 мм	18,0 мм			(85)		
AB	18 мм	20,8 мм			9		
BC	14 мм	16,0 мм			(95)		
BK	14 мм	16,0 мм			10		
DC	12 мм	16,0 мм	BCP, тип ISO				11
							12
							13
						Холоднее	

BC P R 6 E S - 11

Зазор свечи (мм)

Нет: Стандартный зазор

Зазор свечи (мм)

Нет: Стандартный зазор

P F R 6 A - 11 A

Конструкция искрообразующего наконечника и т. п.

C	Заземленный электрод с низким углом
F	Конусное седло
G	Средний электрод из тонкого никелевого сплава
GV	Средний электрод особой конструкции из золота - палладия
J	Удлиненные 2-заземленные электроды
K	2-заземленные электроды
M	2-заземленные электроды для роторного двигателя Mazda или длины изолятора: 18,5 мм
T	3-заземленные электроды
Q	4-заземленные электроды
P	Платиновый электрод
S	Стандарт электрод из меди
U	Тип полуповерхностного разряда
V	Средний электрод из золота - палладия
VX	Средний электрод из платины и особый заземленный электрод
W	Вольфрамовый электрод
X	Зазор для увеличения производительности
Y	Средний электрод с V-образной выемкой
A, B, D, E, Z	Особый дизайн
-L	Половина калильного числа, напр.: DR8ESL=DR7,5ES диапазон
-LM	Компактный тип (длина изолятора: 14,5 мм)
-N	Особый заземленный электрод
IX	Иридий

Типы свечей зажигания

I	С иридиевым электродом
P	С платиновым электродом
Z	С увеличенным зазором
PZ	С платиновым электродом и увеличенным зазором
IZ	С иридиевым электродом и увеличенным зазором

Конструкция

R Резистор

Особенность

A	Беспрокладочный тип
B	Особая
C	Особая
D	Особая

Конструкция

A	Особая конструкция
B	Особая конструкция
C	Особая конструкция
D	Особая конструкция

Размеры металлического корпуса

F	14 Ш X 19 мм 16,0 мм., 6-гранник
G	14 Ш X 19 мм 20,8 мм., 6-гранник
J	12 Ш X 19 мм 18,0 мм., 6-гранник
K	12 Ш X 19 мм 16,0 мм., 6-гранник
M	10 Ш X 19 мм 16,0 мм., 6-гранник
T	Тип конусного седла 14 Ш X 17,5 мм 16,0 мм., 6-гранник (PTRSA: 14 Ш X 25 мм 16,0 мм., 6-гранник)

МАРКИРОВОЧНЫЕ МЕТКИ НА СВЕЧАХ НАКАЛИВАНИЯ ФИРМЫ NGK

СТЕРЖНЕВЫЕ СВЕЧИ НАКАЛИВАНИЯ

Y-204T S 1

Y:
однополюсная
YD:
двухполюсная с
изолированным
массовым
проводом

диаметр резьбы и
число
нагревательных
спиралей
1.3: Ø 10 мм
одиночная
2: Ø 12 мм
одиночная
4: Ø 14 мм
одиночная
7: Ø 10 мм
двоинная
8: Ø 18 мм
одиночная
9: Ø 12 мм
двоинная

рабочее
напряжение
0---4: 12 В
5---9: 24 В

Тип

исполнение:
стержневая свеча
-: накаливания
T: свеча
накаливания
быстрого пуска
R: свеча
накаливания
„Ультра“-
Быстрого пуска

материал в
корпусе
без: нормальный
S: специальный
материал,
предотвращающий
перегрев

номер
модификаций

Y E 0 1

Y:
однополюсная

Тип

DG 237

C Y 0 1

керамика

Тип

Примечания к таблице

△ = Только для автомобилей с противоугонным устройством!

◆ = Только для автомобилей без противоугонного устройства!

* = Поставка только через договорные торговые организации!

i.V.: на подготовительной стадии

Abbildungen siehe ab Seite 12
Pictures look at page 12



Определение типа двигателя:

Alfa:	типовая табличка, блок двигателя
Audi:	в сервисном паспорте, блок двигателя, а также: A2, A3, A4, A6, A8: SPARE WHEEL PAN RIGHT 100/200: замыкающая пластина сзади, на внутренней стороне слева Avant: днище сзади в центре 80/90, Audi V8: внутренняя сторона полки багажника Audi Coupé: багажник справа, под вкладышем углубления для груза
BMW:	блок двигателя
Citroën:	на блоке двигателя
Daihatsu:	инструкция по эксплуатации, блок двигателя
Fiat:	типовая табличка, блок двигателя
Ford:	блок двигателя, типовая табличка
Honda:	блок двигателя в месте перехода к коробке передач
Hyundai:	блок двигателя в месте перехода к коробке передач
Jaguar:	блок двигателя, типовая табличка
Kia:	блок двигателя со стороны коробки передач
Lada:	блок двигателя слева
Lancia:	блок двигателя, типовая табличка
Mazda:	блок двигателя (положение см. инструкцию по эксплуатации)
Mercedes:	блок двигателя
Mitsubishi:	блок двигателя, типовая табличка на капоте двигателя сервисный паспорт
Nissan:	блок двигателя
Opel:	блок двигателя на уровне коробки передач
Peugeot:	блок двигателя (алюминиевая табличка)
Renault:	блок двигателя (в центре) или алюминиевая табличка
Rover:	блок двигателя впереди справа, на уровне головки блока цилиндров
Saab:	блок двигателя внизу
Seat:	блок двигателя, начиная с моделей 1993 г. - как у VW
Skoda:	блок двигателя рядом с распределителем
Subaru:	блок двигателя рядом с кожухом зубчатого ремня
Suzuki:	блок двигателя в месте перехода к коробке передач F = литейный блок; G = алюминиевый блок
Toyota:	наклейка на кожухе зубчатого ремня или на крышке клапана
VW:	в сервисном паспорте, блок двигателя, а также Käfer: замыкающая пластина впереди слева Lupo, Polo, Derby, Golf, Scirocco, Jetta, Passat Limousine, Corrado, Vento, Bora: замыкающая пластина сзади, на внутренней стороне слева Golf Cabrio: поперечина под скамьей заднего сиденья, слева Passat Variant: ниша для запасного колеса, сзади слева Transporter: поперечина блока управления слева LT: колонка, слева внизу Ittis: днище слева, рядом с „аптечкой“ Taro: задняя стенка кабины, с внутренней стороны слева
Volvo:	серии 300, 700, 900, C, S и V: наклейка на лобовой крышке все прочие модели: наклейка на крышке клапана

Эти сведения касаются исключительно первичного оснащения со стороны производителей автомобилей

SERIES OF NGK SPARK PLUGS

NGK ZÜNDKERZENSERIEN

SÉRIES DES BOUGIES NGK

SERIES DE BUJÍAS DE ENCENDIDO NGK TYPBETECKNINGAR FÖR NGK TÄNDSTIFT

STANDARD TYPES

STANDARD AUSFÜHRUNGEN
TIPOS ESTANDARES

TYPES STANDARDS
STANDARDTYPER

	NON-RESISTOR NON-RÉSISTANCE ICKERESISTOR	OHNE WIDERSTAND NO-RESISTOR	RESISTOR RÉSISTANCE RESISTOR	MIT WIDERSTAND RESISTOR	
14mm ϕ \times 9.5mm 20.8 Hex Fig. ①a	B-2 B-4,-10 B6S B7S B8S		BR6S		
	Fig. ①c	BP-4 BP5S BP6S			
14mm ϕ \times 19.0mm 20.8 Hex Fig. ②a	B4ES B5ES B6ES,-11 B7ES,-11 B8ES B9ES B10ES		BR4ES BR5ES BR6ES,-11 BR7ES BR8ES,-11 BR9ES BR10ES		
	Fig. ②b		BR6EB-L-11		
	Fig. ②h		BR8EYA BR9EYA BR10EYA		
	Fig. ②c	BP2ES, BP-2E BP4ES,-11 BP4ES-L-11 BP5ES,-11,-13 BP6ES,-11,-13 BP7ES,-11 BP8ES BP9ES	BP5ESZ BP6ESZ	BPR2ES, BPR-2E BPR4ES,-11,-13 BPR5ES,-11,-13 BPR6ES,-11,-13 BPR7ES,-11 BPR8ES BPR9ES	
	Fig. ②d	BP5EA,-11 BP5EA-L,-11 BP6EA		BPR5EA BPR5EA-L,-11	
	Fig. ③e	BP6EK		BPR6EKN BPR7EKN	
	Fig. ②f	BP4EY,-11 BP5EY,-11 BP6EY,-11 BP7EY		BPR4EY,-11 BPR5EY,-11 BPR6EY,-11 BPR7EY,-11	
	Fig. ②i	BP5E BP6E BP7E		BPR4E,-11 BPR5E,-11 BPR6E,-11 BPR7E	
	Fig. ④g	BP5ET,-10 BP6ET BP7ET			
	Fig. ⑤i	BP5EJ BP6EJ		BPR5EJ	
14mm ϕ \times 19.0mm 16.0 Hex Fig. ⑥c	BCP4ES,-11 BCP5ES,-11 BCP6ES,-11 BCP7ES,-11		BCPR4ES-11 BCPR5ES,-11 BCPR6ES,-11 BCPR7ES,-11 BCPR9ES-11		
	Fig. ⑧g ISO	BCP5ET BCP6ET BCP7ET	BCPR5ET BCPR6ET BCPR7ET		
	Fig. ⑥a	BC6ES	BCR8ES		
	Fig. ⑦c ISO	BK5ES	BK5ESZ	BKR4ES-11 BKR5ES,-11 BKR6ES,-11 BKR7ES-11 BKR8ES	

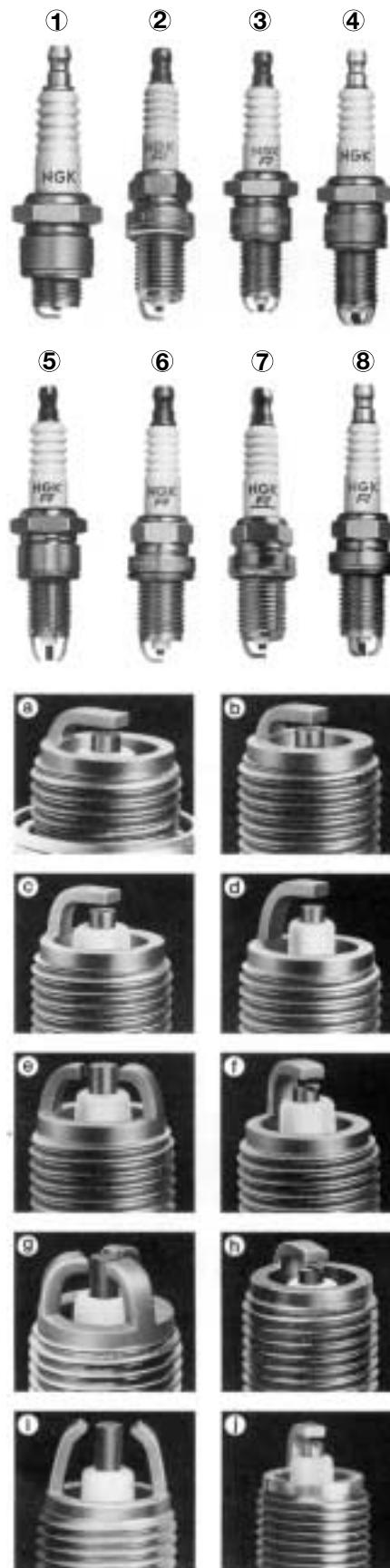



	NON-RESISTOR NON-RÉSISTANCE ICKERESISTOR	OHNE WIDERSTAND NO-RESISTOR	RESISTOR RÉSISTANCE RESISTOR	MIT WIDERSTAND RESISTOR
14mm ϕ × 19.0mm 16.0 Hex Fig. ① ③	BCP5EY-11		BCPR4EY-11 BCPR5EY,-11,-N-11 BCPR6EY,-11,-N-11 BCPR7EY,-11,-N-11	
Fig. ② ③ ISO			BKR4EY,-11 BKR5EY,-11 BKR5EYA,-11 BKR6EY,-11 BKR6EYA,-11 BKR7EY	
Fig. ① ④	BCP5E,-11 BCP6E,-11 BCP7E,-11		BCPR5E,-11 BCPR6E,-11 BCPR7E,-11	
Fig. ② ④ ISO	BK5E,-11 BK6E,-11 BK7E-11		BKR4E,-11 BKR5E,-11,-N,-N-11 BKR5EZ BKR6E,-11,-N,-N-11 BKR6EZ BKR7E,-11,-N,-N-11 BKR8E-11	
Fig. ⑥ ⑦ ISO			BKR5EK BKR6EK	
Fig. ⑥ ⑧ ISO			BKR5EKB-11 BKR6EKB-11 BKR5EKC BKR6EKC,-N-11 BKR6EKE BKR7EKC,-N,-N-11	
14mm ϕ × 26.5mm 16.0 Hex Fig. ⑧ ④			LFR4A,-11 LFR5A,-11 LFR6A,-11	
14mm ϕ × 11.2mm Conical seat 16.0 Hex Fig. ③ ③	B6FS B7FS B10FS		BR5FS BR6FS,-15	
Fig. ③ ③	BP4FS BP5FS BP6FS BP7FS		BPR4FS,-11,-15 BPR5FS,-11,-15 BPR6FS	
Fig. ③ ④	BP5F BP6F			
14mm ϕ × 17.5mm Conical seat 16.0 Hex Fig. ④ ④	B6EFS B8EFS B9EFS		BR7EFS	
Fig. ④ ⑤			BR6EF BR7EF	
Fig. ④ ③	BP4EFS BP5EFS,-13 BP6EFS,-13 BP7EFS		BPR5EFS,-13 BPR6EFS,-13,-15 BPR7EFS-15	
Fig. ④ ④	BP6EF,-13		BPR6EF,-11,-13	
14mm ϕ × 25.0mm Conical seat 16.0 Hex Fig. ⑦ ③			TR5A-13 TR5B-13 TR6B-10,-13	
14mm ϕ × 11.2mm 20.8 Hex Fig. ⑤ ④	B-4L B-6L B6LY(Fig. ⑤ ⑤)			



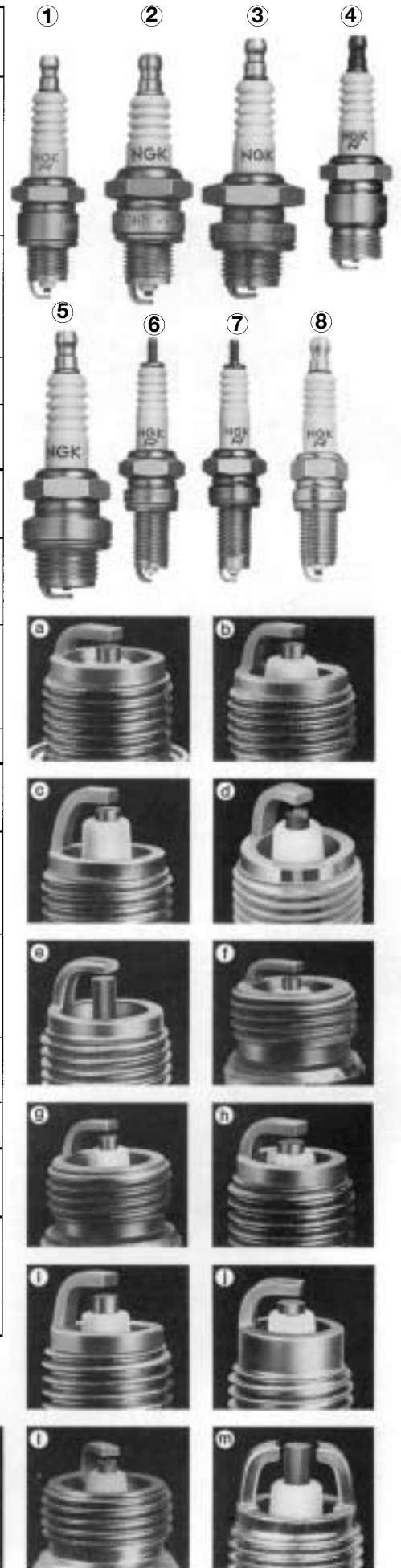



	NON-RESISTOR NON-RÉSISTANCE ICKERESISTOR	OHNE WIDERSTAND NO-RESISTOR	RESISTOR RÉSISTANCE RESISTOR	MIT WIDERSTAND RESISTOR
14mm ϕ \times 12.7mm 20.8 Hex Fig. ①a		B-2H B-4H,-10 B5HS B6HS,-10 B7HS,-10 B8HS,-10 B9HS,-10 B10HS	BR4HS BR5HS BR6HS,-10 BR7HS,-10 BZ7HS-10 BR8HS,-10 BR9HS,-10	
	Fig. ①b	BP2HS,-10 BP-2H BP4HS,-10 BP4HSA BP-4H BP5HS,-10 BP6HS,-10 BP6HSA BP7HS,-10 BP8HS,-10,-15 BP8HSA	BPR2HS BPR4HS,-10 BPR4HSA BPR-4H BPR5HS BPR6HS,-10 BPR6HSA BPR7HS,-10 BPR8HS,-10 BPR8HSA BPZ8HS-10,-15	
	Fig. ①c	BP4HA BP5HA		
	Fig. ①e	B6HSA B8HSA	BR4HSA,-9 BR6HSA,-9 BR8HSA,-9	
18mm ϕ \times 12.0mm 25.4 Hex Fig. ③f	A-6 A-7 A-8			
18mm ϕ \times 10.9mm Conical seat 20.8 Hex Fig. ④f		A6FS A7FS A8FS A9FS	AR6FS	
	Fig. ④g	AP4FS AP5FS AP6FS AP7FS AP8FS AP9FS	APR5FS APR6FS	
	Fig. ④i	AP6F	APR6F	
18mm ϕ \times 12.0mm 20.8 Hex Fig. ⑤f	AB-2 AB-6 AB-7			
12mm ϕ \times 19.0mm 18.0 Hex Fig. ⑥h		D6EA D7EA D8EA D9EA D10EA	DR7ES DR7EA DR8ES-L DR8EA DR8EB DR8ES DR9EA	
	Fig. ⑥i	DP5EA-9 DP6EA-9 DP7EA-9 DP8EA-9 DP9EA-9	DPR5EA-9 DPR6EA-9 DPR7EA-9 DPR8EA-9 DPR9EA-9	
	Fig. ⑥h	J9A J10A	JR8B JR9B JR10B	
	Fig. ⑥k		JR8C JR9C	
12mm ϕ \times 21.0mm 18.0 Hex Fig. ⑦i	DP7Z DP8Z DP9Z		DPR7Z DPR8Z DPR9Z	
12mm ϕ \times 19.0mm 16.0 Hex Fig. ⑧i		DCP6E DCP7E DCP8E	DCPR6E DCPR7E DCPR7E-N DCPR8E DCPR8E-N DCPR9E	
	Fig. ⑧m		DCPR8EKC	

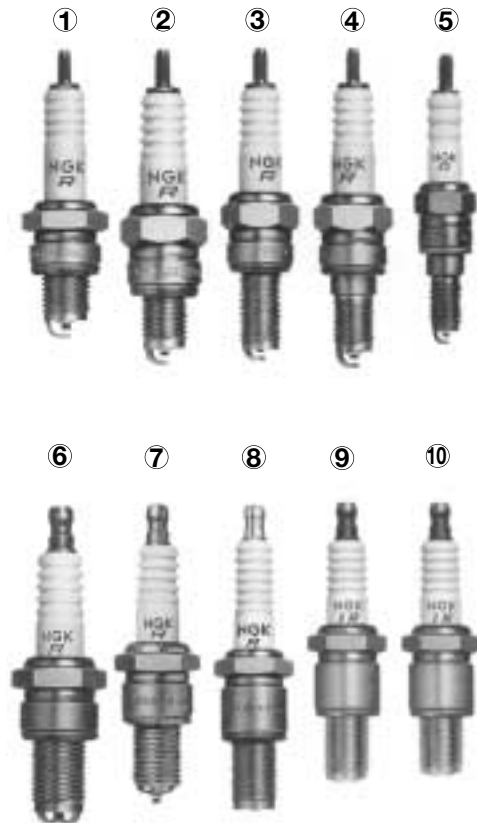

	NON-RESISTOR NON-RÉSISTANCE ICKERESISTOR	OHNE WIDERSTAND NO-RESISTOR	RESISTOR RÉSISTANCE RESISTOR	MIT WIDERSTAND RESISTOR	
12mm ϕ \times 12.7mm 18.0 Hex Fig. ①(a)	D-4H D5HS D6HS,D6HA D8HS,D8HA		DR2HS DR4HS DR5HS DR6HS DR8HS		
10mm ϕ \times 12.7mm 16.0 Hex Fig. ②(a)	C2H C5HSA C6HSA C7HSA C8HSA	C4HA C5HA C6HA C7HA C8HA	C4HSB C5HSB	CR4HSA CR5HSA CR6HSA CR7HSA CR8HSA	CR4HSB CR5HSB LR8A
10mm ϕ \times 19.0mm 16.0 Hex Fig. ③(j)	C7E C8E C9E		CR6E CR7E CR8E CR9E CR10E		
			CPR8E		
10mm ϕ \times 19.0mm 16.0 Hex Fig. ④(a)	C7EH-9 C8EH-9 C9EH-9		CR7EH-9 CR8EH-9 CR9EH-9 CR10EH-9		
10mm ϕ \times 19.0mm 16.0 Hex Fig. ③(b)			CR7EK CR8EK CR9EK CR10EK		
			CR9EKB CR7EKC		
8mm ϕ \times 19.0mm 13.0 Hex Fig. ⑤(a)			ER8EH ER9EH ER10EH		



FOR ROTARY ENGINE
FÜR WANKELMOTOR **POUR MOTEUR ROTATIF**
PARA MOTOR ROTATIVO **TÄNDSTIFT FÜR WANKELMOTORER**

	NON-RESISTOR NON-RÉSISTANCE ICKERESISTOR	OHNE WIDERSTAND NO-RESISTOR	RESISTOR RÉSISTANCE RESISTOR	MIT WIDERSTAND RESISTOR
14mm ϕ \times 19.5mm 20.8 Hex Fig. ⑥(c)	B6EM B7EM		BR6EM BR7EM BR8EM	
			BR7ET BR8ET BR9ET BR10ET	
			BR7EQ,-14 BR8EQ,-14 BR9EQ,-14	
14mm ϕ \times 18.5mm 20.8 Hex Fig. ⑦(f)			BRE813L	
14mm ϕ \times 21.5mm 20.8 Hex Fig. ⑧(g)			SD9A SD10A SD11A	
			BUR5EQ BUR6EQ BUR7EQ BUR8EQ BUR9EQ	BUR6EQP BUR7EQP BUR8EQP BUR9EQP
14mm ϕ \times 21.0mm 20.8 Hex Fig. ⑨(i)			RE7A-L RE8A-L	
14mm ϕ \times 19.0mm 20.8 Hex Fig. ⑩(l)			RE9B-T	

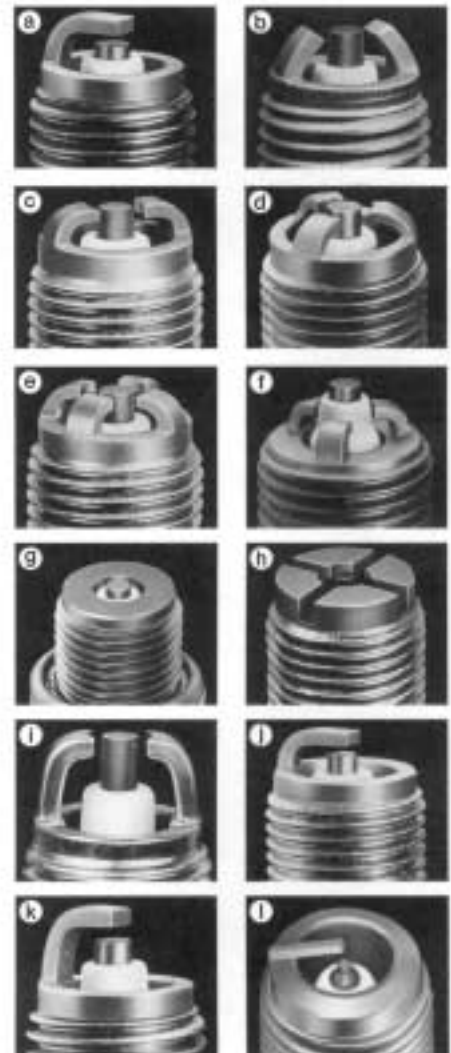

SEMI SURFACE DISCHARGE TYPES
HALBLEITFUNKENTYP TYPE À DÉCHARGE
TIPO DE DESCARGA DE MEDIA SUPERFICIE
STIFT MED YTGNISTGAP

	NON-RESISTOR NON-RÉSISTANCE ICKERESISTOR	OHNE WIDERSTAND NO-RESISTOR	RESISTOR RÉSISTANCE RESISTOR	MIT WIDERSTAND RESISTOR
14mm ϕ × 12.7mm 20.8 Hex Fig. ①a	BU8H		BUZ8H	
14mm ϕ × 19.0mm 20.8 Hex Fig. ②b	BU6EA-11 BU7EA-11		BUR5EA-11 BUR6EA-11 BUR7EA-11	
14mm ϕ × 19.0mm 20.8 Hex Fig. ②c			BUR4EB-11 BUR5EB-11 BUR6EB-11 BUR7EB-11	
	Fig. ②d		BUR5ET,-10 BUR6ET	
14mm ϕ × 19.0mm 20.8 Hex Fig. ③e	BP5EK-A BP6EK-A		BPR5EK-A BPR6EK-A	
	Fig. ③f		BPR5EKU	
14mm ϕ × 17.5mm Conical seat 16.0 Hex Fig. ④g	BU6EFSZ		BUR6EFSZ	
14mm ϕ × 19.0mm 16.0 Hex Fig. ⑥e ISO			BKUR6EK,-9 BKUR7EK	
	Fig. ⑤d ISO		BKUR5ET,-10 BKUR5ETZ-10 BKUR6ET,-10 BKUR6ETB BKUR7ET	
	Fig. ⑥f ISO		BK7EKU	
			BKR5EKU	
	Fig. ⑥h ISO		BKR6EKUE	
			BKR6EKUB	
14mm ϕ × 22.0mm 16.0 Hex Fig. ⑦i			BKR5EKUC BKR6EKUC	
14mm ϕ × 19.0mm 16.0 Hex Fig. ⑥j			BKR6EQUA	

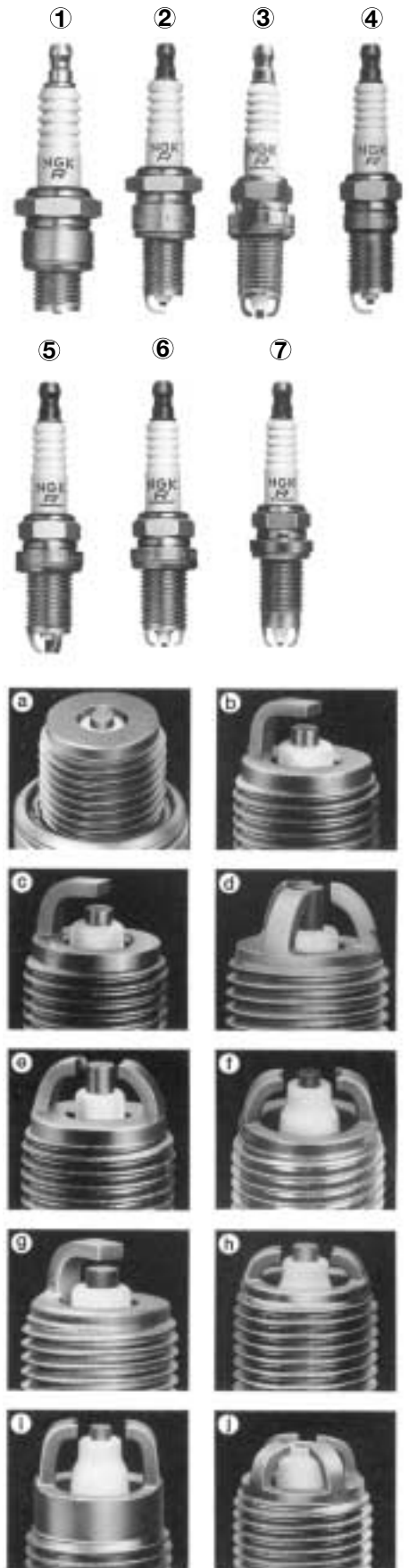

PLATINUM, IRIIDIUM TIPPED TYPES
 TYPEN MIT PLATINELEKTRODENSPIITZE, IRIIDIUMSPITZE
 TYPE[S] À EXTREMITÉ EN PLATINE, IRIIDIUM
 TIPOS CON PUNTA DE PLATINO, IRIIDIO
 STIFT MED MITTELEKTRODÄNDA AV PLATINA OCH IRIIDIUM

	RESISTOR MIT WIDERSTAND RÉSISTANCE RESISTOR RESISTOR
14mm ϕ \times 19.0mm 20.8 Hex Fig. ①①	PGR5A,-11 PGR5C-11 BPR5EP-11,-13 PGR6A,-11 PGR6C-11 BPR6EP-8 PGR7A,-11
	IGR7A
14mm ϕ \times 19.0mm 20.8 Hex Fig. ①①h	IGR5C13
14mm ϕ \times 19.0mm 16.0 Hex Fig. ②②a	PFR5A-11 PFR5K-11 BCPR5EP-8,-11,-13 PFR6A-11 PFR6H-10 PFR6K-11 BCPR6EP-8,-N-8,-11,-N-11,-13 PFR7A-11 PFR7H-10
Fig. ③③h ISO	FR4AP-10,-11 FR4BP-11 FR5AP-10,-11 FR5BP-11 FR5AP-11E FR6AP-10,-11 FR6BP-11 FR7AP-11
	FR5EI-13
	PFR4B-11 PFR4C-11 PFR5B,-9,-11,-11B,-11C PFR5C-11 PFR6B,-9,-11,-11B,-11C PFR6C-11 PFR6E-10 PFR7B,-9,-11,-11C PFR8B,-9
	PFR4G-11 PFR5J-11 PFR5G-9,-11,-13E PFR6J,-11 PFR6G,-9,-11,-13,-13E PFK6H-10 PFR6J,-11 PFR7G,-9,-11
	PFR5L-11 PFR5N-11 PFR4P,-11 PFR6L-11,-13 PFR6N-11 PFR5P,-11 PFR7N-D PFR6P,-11 PFR6Q PFR7Q
	PFR5R-11
	BKR5EP-8,-11 BKR6EP-8,-11,-13,-N-8
Fig. ④④c ISO	BKR6EKPA
Fig. ④④d ISO	BKR5EKUP
Fig. ④④e ISO	BKR5EKPB-11,-13 BKR6EKPB-11
Fig. ④④j ISO	BKR5EQUPA BKR6EQUP BKR6EQUPA
Fig. ③③f ISO	PFR6M PFR7M
Fig. ③③g ISO	PZFR5B PZFR5F,-11,-13 PZFR6B PZFR6F,-11 PZFR7F
Fig. ③③h ISO	IFR5A11,-8N IFR5D10 IFR5E11 IFR6A11 IFR6C IFR6D10 IFR6E11 IFR7F-D
	IFR5G11 IFR5J11 IFR5T-8N,11 IFR6J11 IFR6S IFR6T11
Fig. ②②g	IZFR5B IZFR5F11 IZFR6B IZFR6F11
	ZFR5LP-13G
14mm ϕ \times 22.0mm 16.0 Hex Fig. ⑩⑩k ISO	PZFR5C PZFR5D-11
Fig. ⑩⑩k ISO	IZFR5C IZFR7E-D
14mm ϕ \times 25.0mm conical seat 16.0 Hex Fig. ⑥⑥h	PTR5A-13



	RESISTOR MIT WIDERSTAND RÉSISTANCE RESISTOR RESISTOR
14mm ϕ \times 17.5mm conical seat 16.0 Hex Fig. ⑨①	PTR4B-15 PTR5C-13,-15 ITR4A15 ITR5F13 ITR6F13
14mm ϕ \times 17.5mm conical seat 16.0 Hex Fig. ③④	PTR5D-10,-13 PTR6D-13,-13G
Fig. ⑨⑨	PZTR5A-15
14mm ϕ \times 20.5mm 16.0 Hex Fig. ③②	IZFR6K11,13
14mm ϕ \times 21.5mm 16.0 Hex Fig. ①③	PZFR5N-11TG
14mm ϕ \times 22.0mm 16.0 Hex Fig.	PZFR6J-11
14mm ϕ \times 26.5mm 16.0 Hex Fig. ①④	PLFR4A-11 PLFR5A-9,-11 PLFR6A-9,-11 PLFR7A-9
Fig. ①⑨	ILZFR6A11
14mm ϕ \times 29.5mm 16.0 Hex Fig. ①⑤	LZFR5AQP
12mm ϕ \times 19.0mm 18.0 Hex Fig. ⑤④	PJR6A PJR7A PJR8A
	IJR7A9
12mm ϕ \times 19.0mm 16.0 Hex Fig. ⑦①	PKR7A PKR9B
12mm ϕ \times 19.0mm 16.0 Hex Fig. ⑦③	DCPR8EKP
12mm ϕ \times 22.0mm 16.0 Hex Fig.	IZKR7A
10mm ϕ \times 19.0mm 16.0 Hex Fig. ⑧①	PMR7A PMR8B PMR8A
10mm ϕ \times 19.0mm 16.0 Hex Fig. ⑫	IMR9C-9H

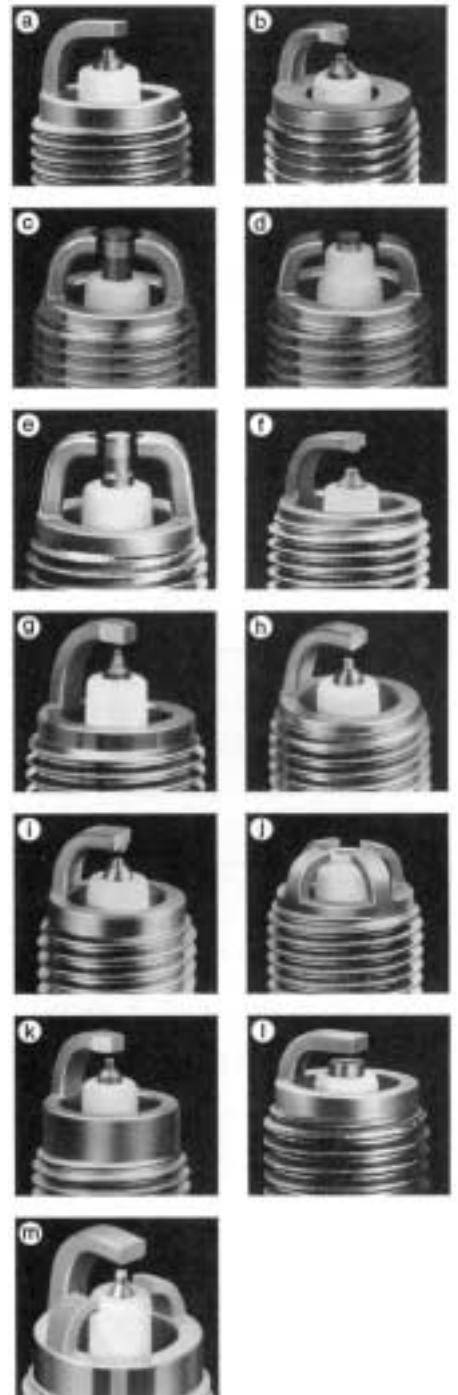

PROJECTED GAP TYPES
ZUNDKERZEN MIT VORSRINGENDER FUNKENSTRECK
TYPE À ÉCARTEMENT EN SAILLIE
TIPOS DE ABERTURA DE CHISPA PROYECTADA
STIFT MED FÖRLÅNGDA ELEKTRODER

	NON-RESISTOR NON-RESISTANCE ICKERESISTOR	OHNE WIDERSTAND NO-RESISTOR	RESISTOR RÉSISTANCE RESISTOR	MIT WIDERSTAND RESISTOR
14mm ϕ × 19.0mm 20.8 Hex Fig. ①(a)	BE527Y-11 BE529Y-11		BRE527Y-11 BRE529Y,-11	
Fig. ②(b)			ZGR4A ZGR5A ZGR6A	
14mm ϕ × 21.0mm 20.8 Hex Fig. ②(c)	ZG5E		ZGR5E	
14mm ϕ × 26.0mm 20.8 Hex Fig. ②(d)	ZG5D-11			
14mm ϕ × 20.5mm 20.8 Hex Fig. ②(b)			ZGR5B,-11 ZGR6B-11	
14mm ϕ × 22.0mm 20.8 Hex Fig. ②(c)			ZGR5C	
14mm ϕ × 19.0mm 16.0 Hex Fig. ③(b)	ZF6A-11		ZFR5A-11 ZFR6A-11	
Fig. ④(b) ISO			ZFR4F-11 ZFR5F,-11 ZFR6F,-11 ZFR7F,-11	
Fig. ④(b) ISO			ZFR5J-11 ZFR6J-11 ZFR7J-11	
Fig. ③(a)			BCRE527Y	
14mm ϕ × 20.5mm 16.0 Hex Fig. ③(e)			ZFR5G ZFR6G	
14mm ϕ × 22.5mm 16.0 Hex Fig. ③(c)			ZFR4E-11 ZFR5E-11 ZFR6E-11	
Fig. ③(d)			ZFR4D-11 ZFR5D-11 ZFR6D-11	
14mm ϕ × 25.0mm Conical seat 16.0 Hex Fig. ⑤(b)			LZTR4A-11 LZTR5A-13	

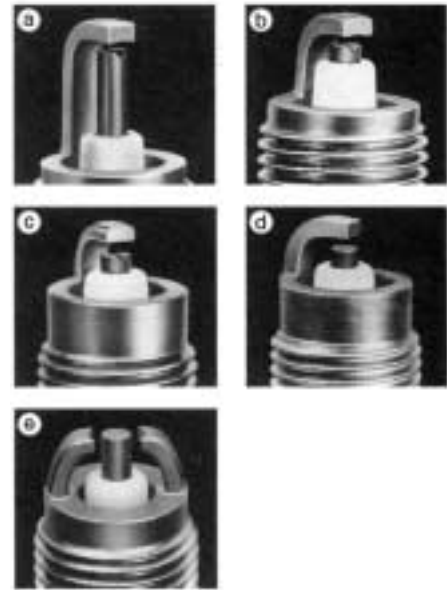
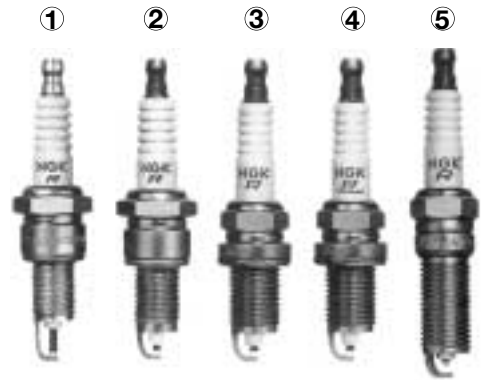

COMPACT TYPES
KOMPAKT STIFT **TYPES CMPACTES**
TIPOS COMPACTOS **KOMPAKTE TYPEN**

	NON-RESISTOR NON-RÉSISTANCE ICKERESISTOR	OHNE WIDERSTAND NO-RESISTOR	RESISTOR RÉSISTANCE RESISTOR	MIT WIDERSTAND RESISTOR
14mm ϕ \times 9.5mm 19.0 Hex Fig. ①(a)	BM4A BM6A BM7A	B2-LM * B4-LM * BM6 * BM7 * *Hex.20.8mm	BMR2A,-10 BMR4A BMR6A BMR7A	BR2-LM * BR4-LM * *Hex.20.8mm
Fig. ①(b)	BPM4A,-10 BPM6A,-10 BPM7A		BPMR4A,-10 BPMR6A,-10 BPMR7A,-9	
14mm ϕ \times 12.7mm 20.8 Hex Fig. ②(a)	BL-6H			
14mm ϕ \times 7.8mm Conical seat 16.0 Hex Fig. ③(a)	BM6F BM7F	BM6FY	BMR6F	
Fig. ③(b)	BPM6F BPM7F		BPMR6F	
10mm ϕ \times 8.6mm 14.0 Hex Fig. ④(a)	CM-6			
10mm ϕ \times 9.5mm 16.0 Hex Fig. ⑧(a)			CMR6A CMR7A	
10mm ϕ \times 12.7mm 16.0 Hex Fig. ⑧(e)			CMR6H CMR7H	
14mm ϕ \times 9.5mm 19.0 Hex Fig. ①(c)	BPM6Y BPM7Y BPM8Y		BPMR6Y BPMR8Y	



FARM EQUIPMENT TYPES
LANDMASCHINEN TYPEN **TYPES MACHINES AGRICOLES**
TIPOS MÁQUINAS AGRICOLAS **FÖR JORDBRUKS-MASKINER**

PF1/2" \times 22.5mm 23.8 Hex Fig. ⑤(d)	G-27 G-2Z
---	----------------------------

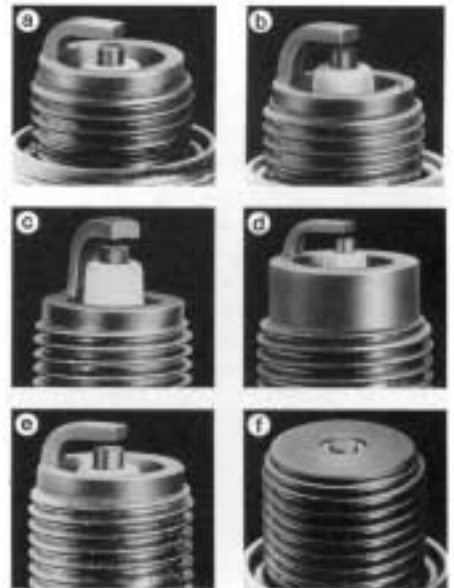

SURFACE DISCHARGE TYPES
GLEITFUNKENTYPEN **TYPE À DÉCHARGE SUPERFICIELLE**
TIPO DESCARGA EN SUPERFICIE **TÄNDSTIFT MED YTGNISTGAP**

14mm ϕ \times 12.7mm 20.8 Hex Fig. ⑥(f)	BUHX(Series gap) BUHXW-1(Series gap)	
	BUH	
	BUHW BUHW-2	BUZHW BUZHW-2
14mm ϕ \times 19.0mm 20.8 Hex Fig. ⑦(f)	BUE	

VX TYPES

VX TYPEN TYPES VX
TIPOS VX VX-STIFT

	NON-RESISTOR NON-RÉSISTANCE ICKERESISTOR	OHNE WIDERSTAND NO-RESISTOR	RESISTOR RÉSISTANCE RESISTOR	MIT WIDERSTAND RESISTOR
14mm ϕ \times 19.0mm 20.8 Hex Fig. ①a	B6EVX B7EVX B8EVX B9EVX B10EVX		BR7EVX BR8EVX BR9EVX BR10EVX	
	Fig. ①b	BP5EVX BP6EVX BP7EVX BP8EVX	BPR4EVX BPR5EVX,-11 BPR6EVX,-11 BPR7EVX BPR8EVX BPR9EVX BPR10EVX	
	Fig. ②c		BR9ECMVX BR10ECMVX	
	Fig. ①d		BUR5EBVX-11 BUR6EBVX-11	
14mm ϕ \times 19.0mm 16.0 Hex Fig. ③b	BCP5EVX BCP6EVX BCP7EVX		BCPR5EVX-11 BCPR6EVX-11 BCPR7EVX-11 BCPR8EVX-11	
	Fig. ④b ISO		BKR4EVX BKR5EVX,-11 BKR6EVX,-11 BKR7EVX,-11	
	Fig. ④b ISO		BKR5EVXA-11,-13 BKR6EVXA-11,-13	
	Fig. ④b ISO		ZFR5FVX-11 ZFR6FVX-11	
14mm ϕ \times 11.2mm Conical seat 16.0 Hex Fig. ⑩a			BR6FVX	
14mm ϕ \times 17.5mm Conical seat 16.0 Hex Fig. ⑪b	BP7EFVX		BPR5EFVX	
14mm ϕ \times 12.7mm 20.8 Hex Fig. ⑤a	B6HVX B7HVX B8HVX B9HVX B10HVX		BR8HVX	
	Fig. ⑤b	BP6HVX BP7HVX BP8HVX BP9HVX	BPR6HVX BPR7HVX	
12mm ϕ \times 19.0mm 18.0 Hex Fig. ⑫b	D7EVX D8EVX D9EVX		DR8EVX DR9EVX	
	Fig. ⑫b		CPR7EVX-9 CPR8EVX-9 CPR9EVX-9	
12mm ϕ \times 19.0mm 16.0 Hex Fig. ⑥b	DCP7EVX DCP8EVX		DCPR7EVX DCPR8EVX DCPR9EVX	
10mm ϕ \times 19.0mm 16.0 Hex Fig. ⑦e			CR8EVX CR9EVX	
10mm ϕ \times 19.0mm 16.0 Hex Fig. ⑧e	C8EHVX-9 C9EHVX-9		CR8EHVX-9 CR9EHVX-9	
10mm ϕ \times 12.7mm 16.0 Hex Fig. ⑨e	C7HVX C8HVX		CR8HVX	

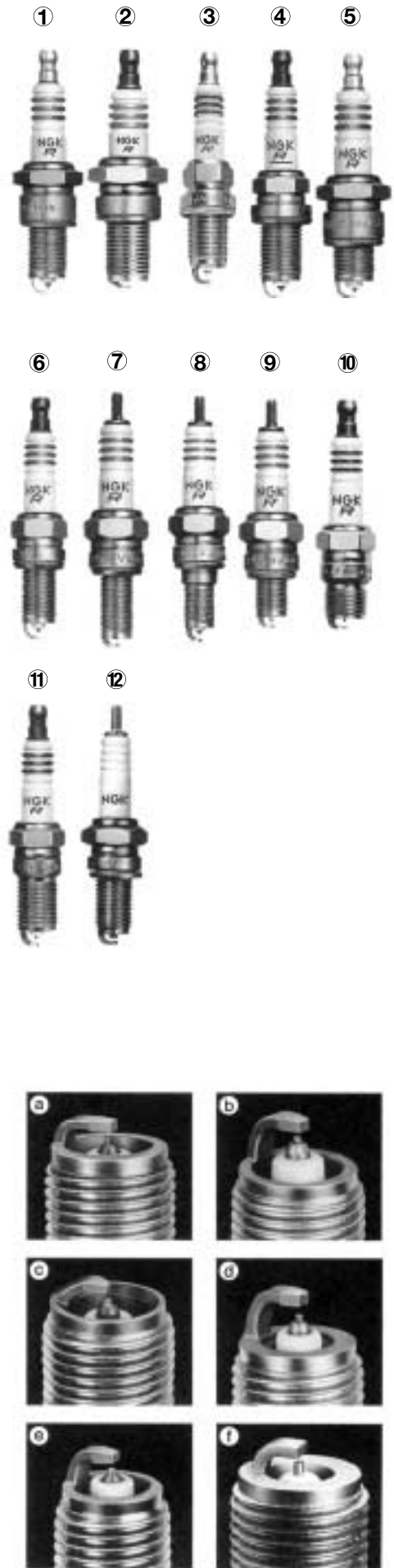

COMPETITION TYPES

WETTBEWERBS-TYPEN TYPES COMPÉTITION
TIPOS DE COMPETICIÓN RACERSTIFT

14mm ϕ × 12.7mm 20.8 Hex Fig. ⑤④	B7HCS B8HCS B9HCS	BR8HCS-10
14mm ϕ × 19.0mm 20.8 Hex Fig. ⑥④	B7ECS B8ECS B9ECS B10ECS	BR8ECS BR9ECS BR10ECS
Fig. ⑦④		BR8ECM BR9ECM BR10ECM

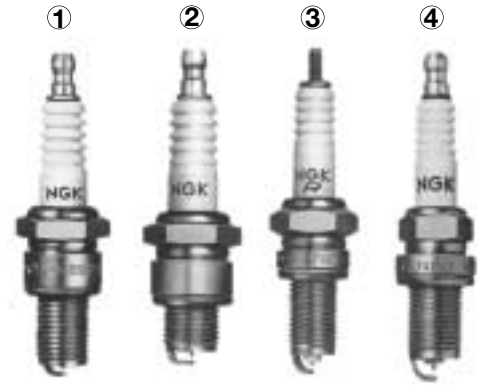

V TYPES

V TYPEN TYPES V
TIPOS V V-STIFT

	NON-RESISTOR OHNE WIDERSTAND NON-RÉSISTANCE NO-RESISTOR ICKERESISTOR	RESISTOR MIT WIDERSTAND RÉSISTANCE RESISTOR RESISTOR
14mm ϕ × 19.0mm 20.8 Hex Fig. ①②	B8EV B9EV	



RACING TYPES

RENN-TYPEN TYPES COURS
TIPOS DE CARRERAS RACERSTIFT

	Nickel electrode Nickel Elektrode Electrodo de nickel Electrodo de niquel Nickel elektrod	Precious metal electrode Elektrode mit sönde-redel metall Electrode en metal precieux Electrodo de metal precioso Ädelmetall elektrod	Platinum electrode Platinel Elektrode Electrode de platine Electrodo de platino Platina elektrod
14mm ϕ × 19.0mm 20.8 Hex	B8EG Fig. ①③ BR8EG*	B8EGV Fig. ①③ B85EGV B9EGV B95EGV B10EGV B105EGV B11EGV	B8EGP Fig. ①④ B85EGP B9EGP B95EGP B10EGP B105EGP B11EGP
*Resistor Type	B11EG		



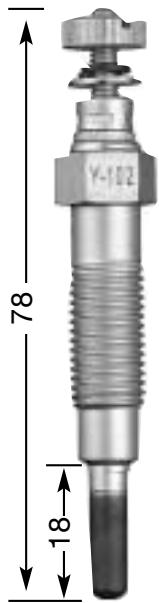

Y-102
M 10 x 1.25
12 Hex
10,5 V

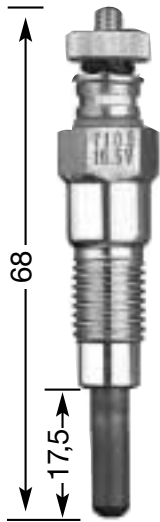

Y-103
M 10 x 1.25
12 Hex
10,5 V

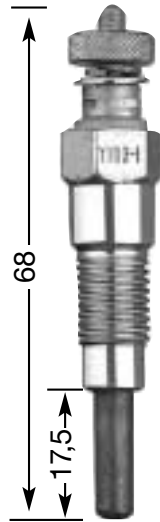

Y-103-1
M 10 x 1.25
12 Hex

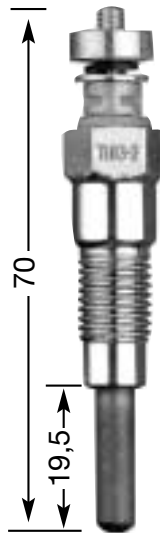

Y-103-2
M 10 x 1.25
12 Hex

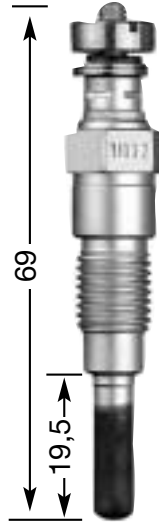

Y-103-2A
M 10 x 1.25
12 Hex



Y-103 K
M 10 x 1.25
12 Hex
10,5 V

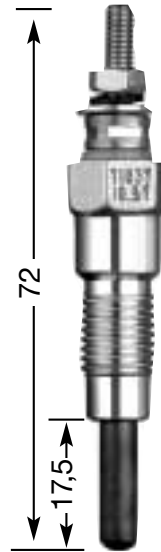

Y-103 V
M 10 x 1.25
12 Hex
10,5 V

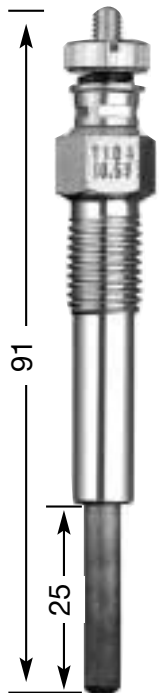

Y-104
M 10 x 1.25
12 Hex
10,5 V

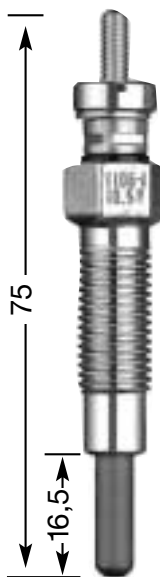

Y-106-1
M 10 x 1.25
12 Hex
10,5 V

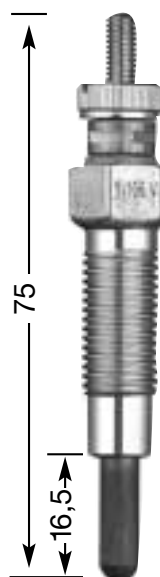

Y-106 V
M 10 x 1.25
12 Hex
10,5 V

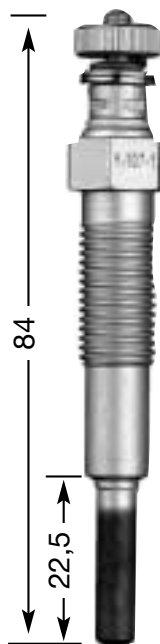

Y-107-1
M 10 x 1.25
12 Hex
10,5 V

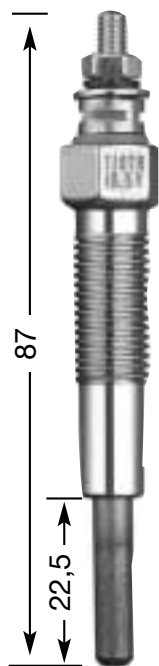

Y-107 R
M 10 x 1.25
12 Hex
10,5 V

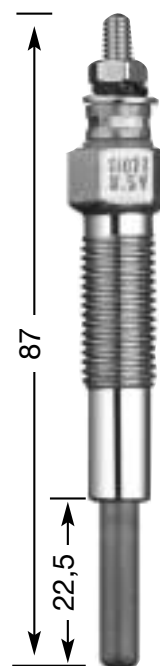

Y-107 T
M 10 x 1.25
12 Hex
8,5 V

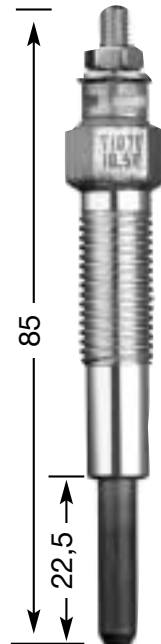

Y-107 V
M 10 x 1.25
12 Hex
10,5 V

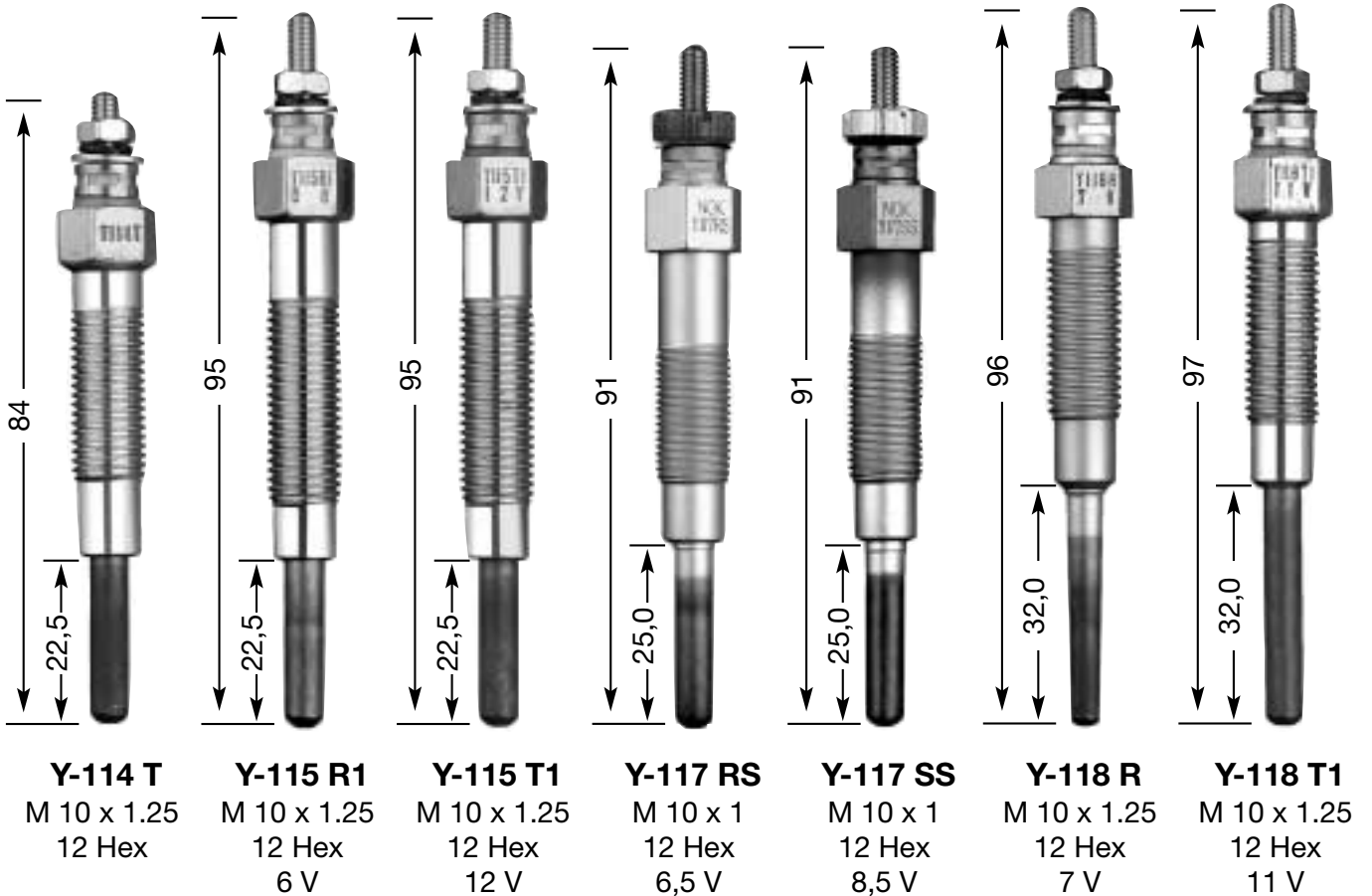
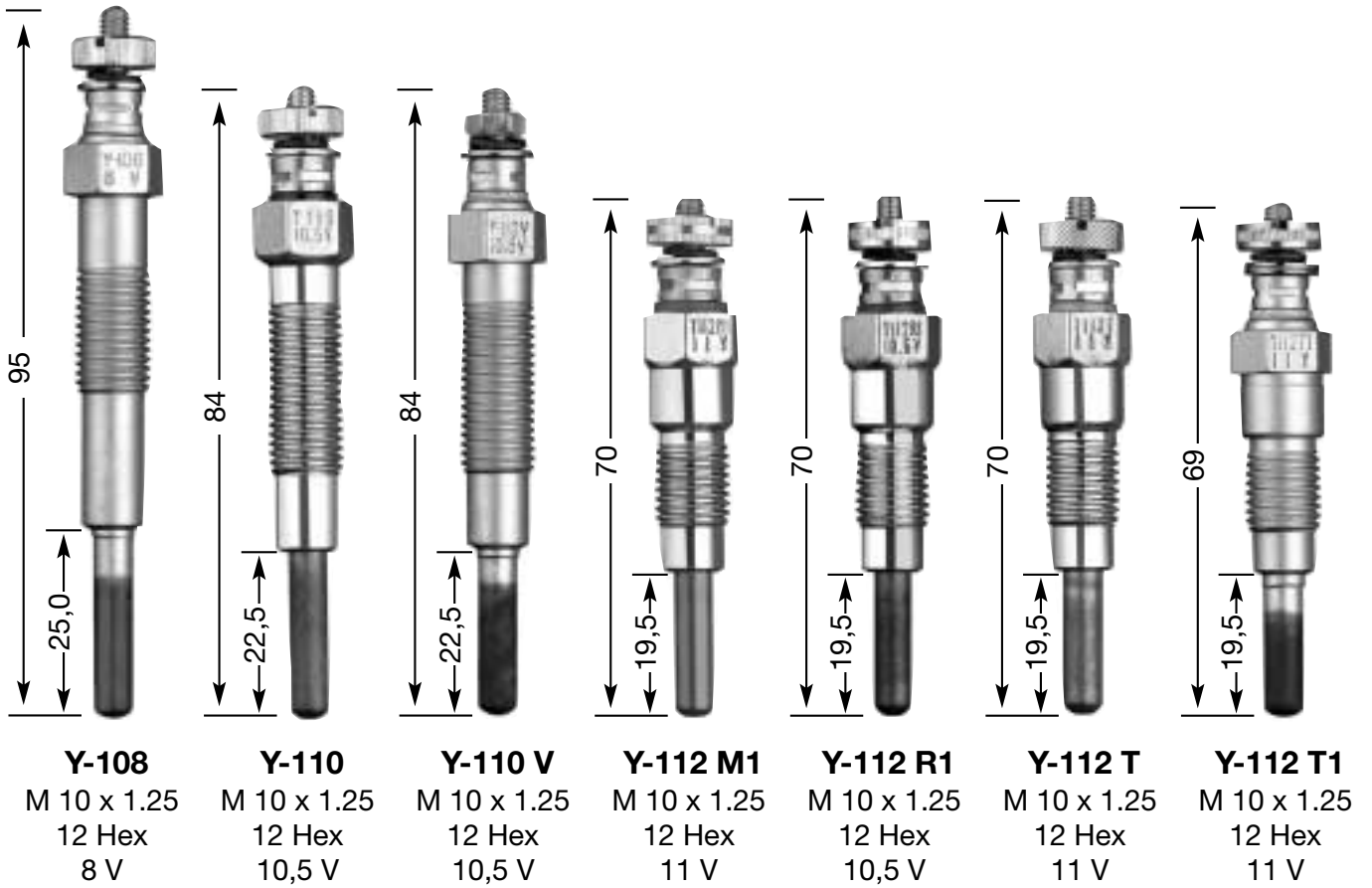

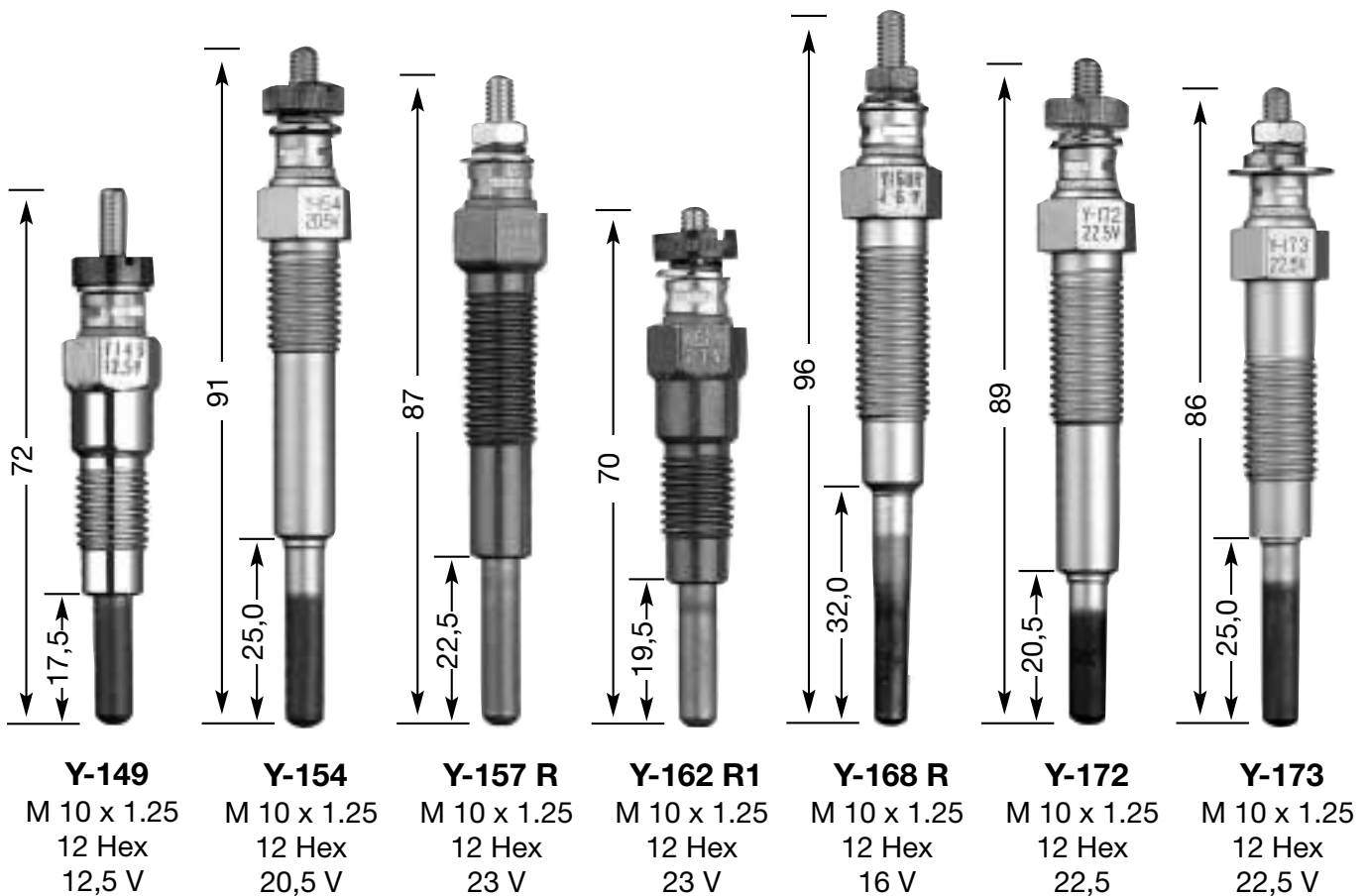
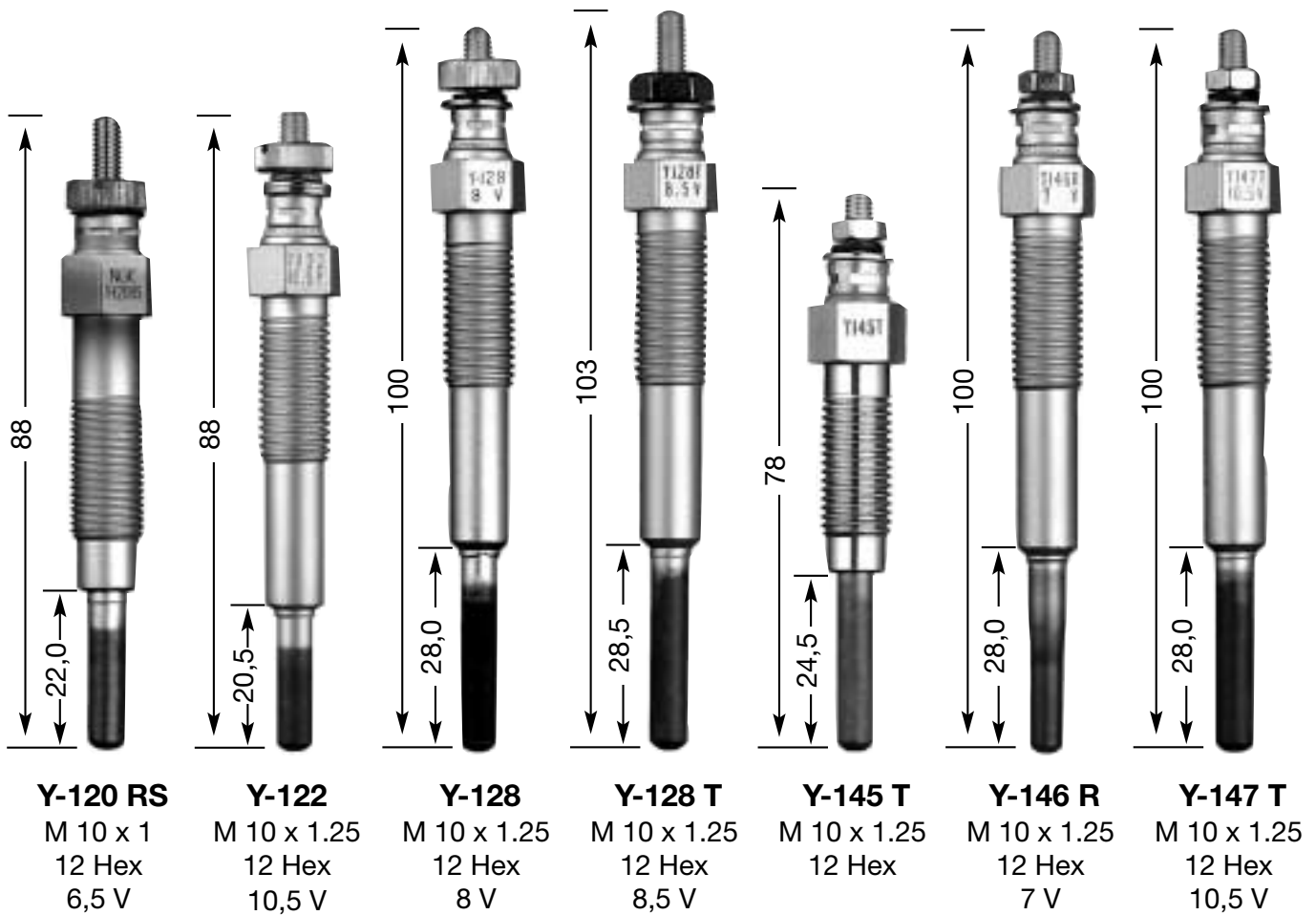

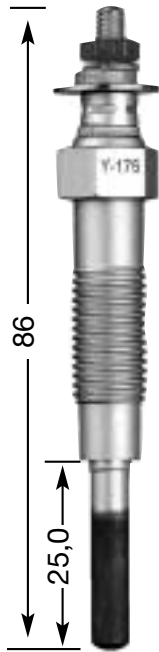
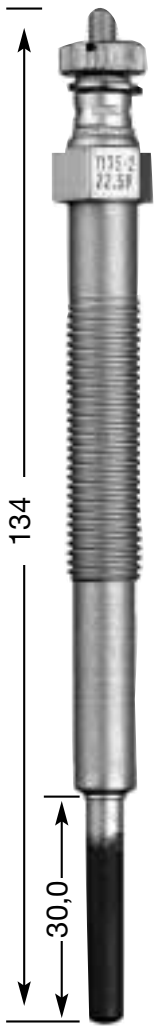

Y-176
M 10 x 1.25
12 Hex
19 V

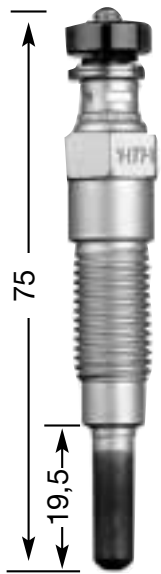

Y-177-1
M 10 x 1.25
12 Hex

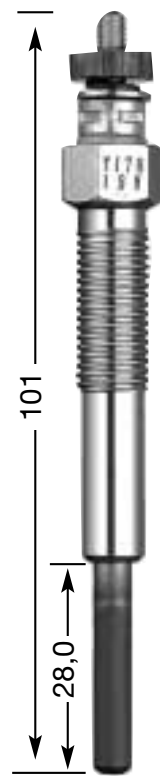

Y-178
M 10 x 1.25
12 Hex
19 V

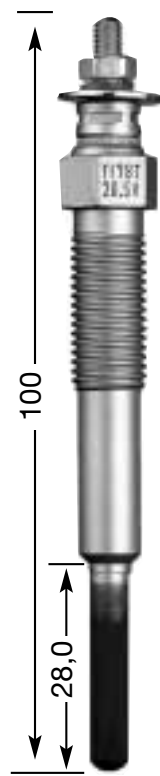

Y-178 T
M 10 x 1.25
12 Hex
20,5 V

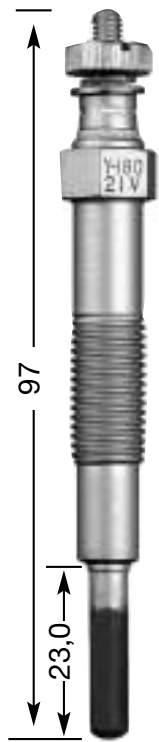

Y-180
M 10 x 1.25
12 Hex
21 V

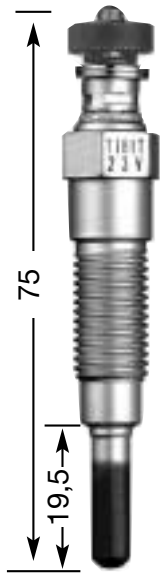

Y-181 T
M 10 x 1.25
12 Hex
23 V

Y-175-2
M 10 x 1.25
12 Hex
22,5 V

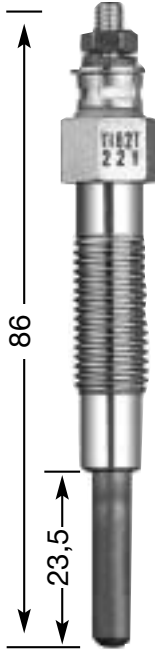

Y-182 T
M 10 x 1.25
12 Hex
22 V

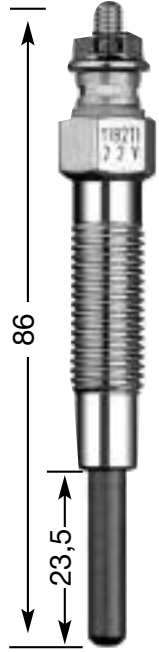

Y-182 T1
M 10 x 1.25
12 Hex
22 V

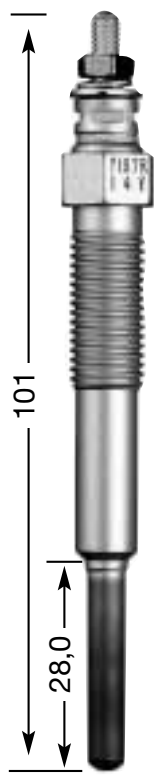

Y-197 R
M 10 x 1.25
12 Hex
14 V

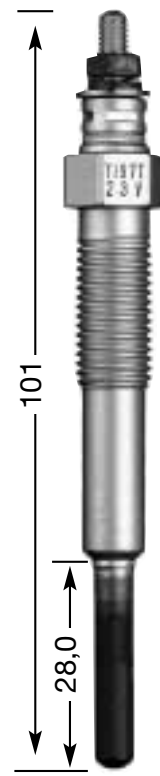

Y-197 T
M 10 x 1.25
12 Hex
23 V

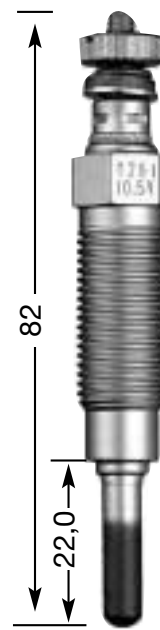

Y-201
M 10 x 1.25
12 Hex
10,5 V

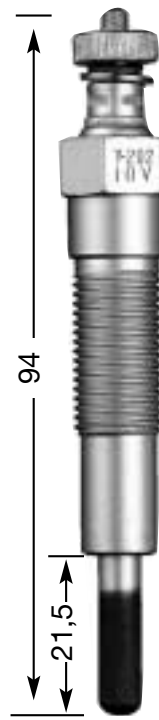

Y-202
M 12 x 1.25
14 Hex
10 V

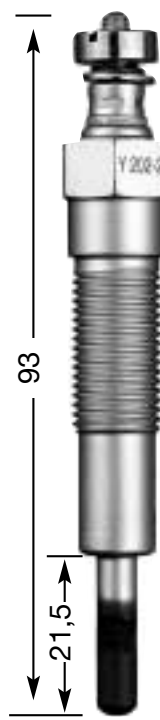

Y-202-2
M 12 x 1.25
14 Hex

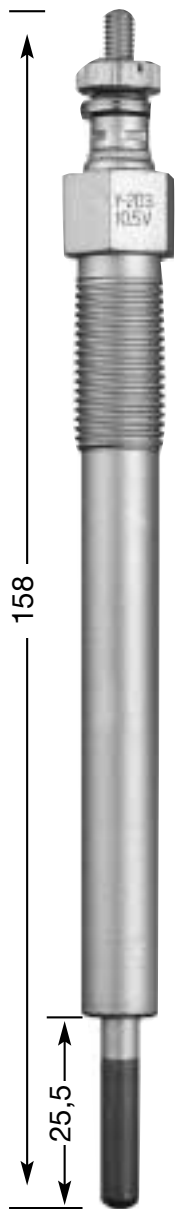

Y-203
M 12 x 1.25
14 Hex
10,5 V

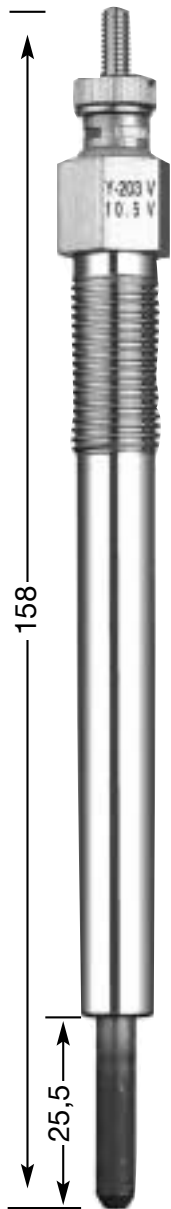

Y-203 V
M 12 x 1.25
14 Hex
10,5 V

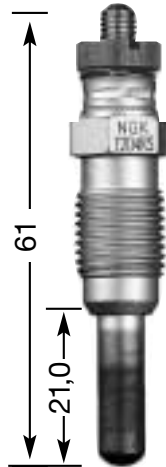

Y-204 RS
M 12 x 1.25
12 Hex
6,5 V

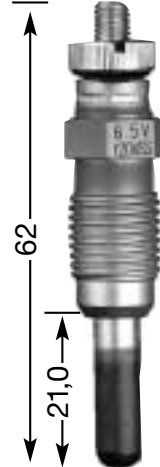

Y-204 SS
M 12 x 1.25
12 Hex
8,5 V

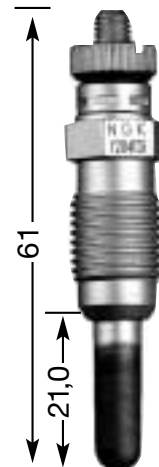

Y-204 TS1
M 12 x 1.25
12 Hex
11 V

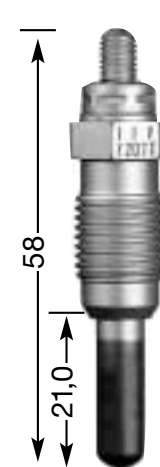

Y-207 T
M 12 x 1.25
12 Hex
11 V

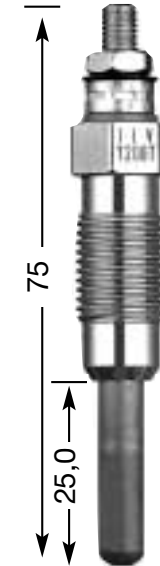

Y-208 T
M 12 x 1.25
12 Hex
11 V

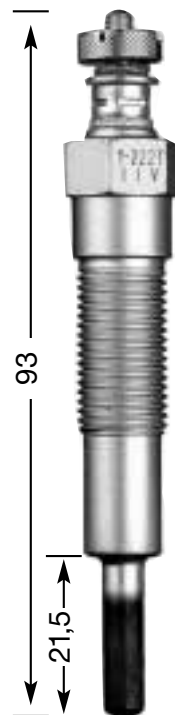

Y-222 T
M 12 x 1.25
14 Hex
11 V

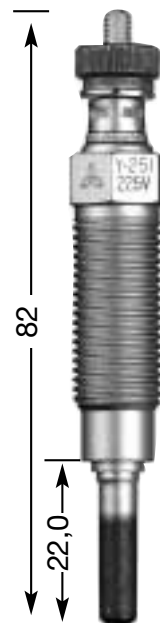

Y-251
M 12 x 1.25
12 Hex
22,5 V

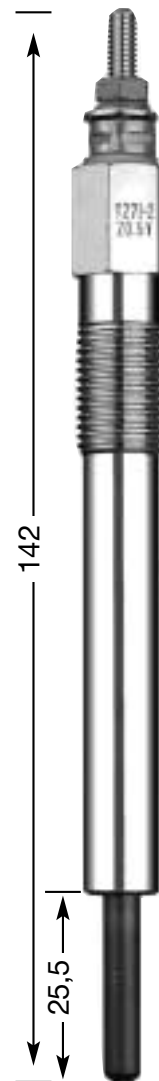

Y-271-2
M 12 x 1.25
12 Hex
20,5 V

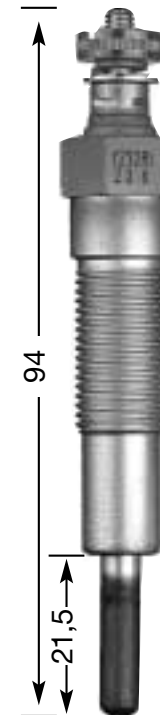

Y-272 R1
M 12 x 1.25
14 Hex
23 V



Y-274
M 12 x 1.25
12 Hex
20,5 V

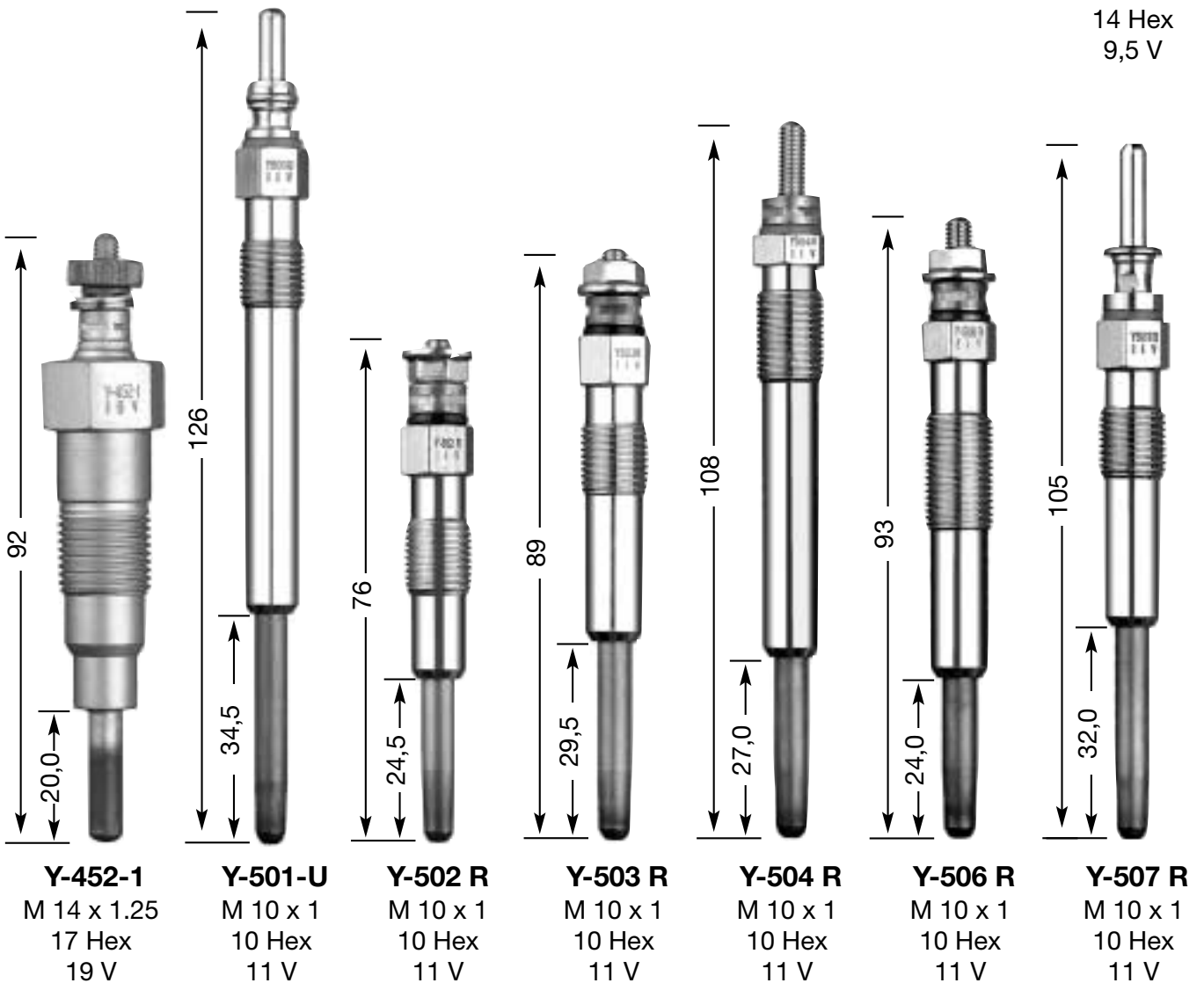
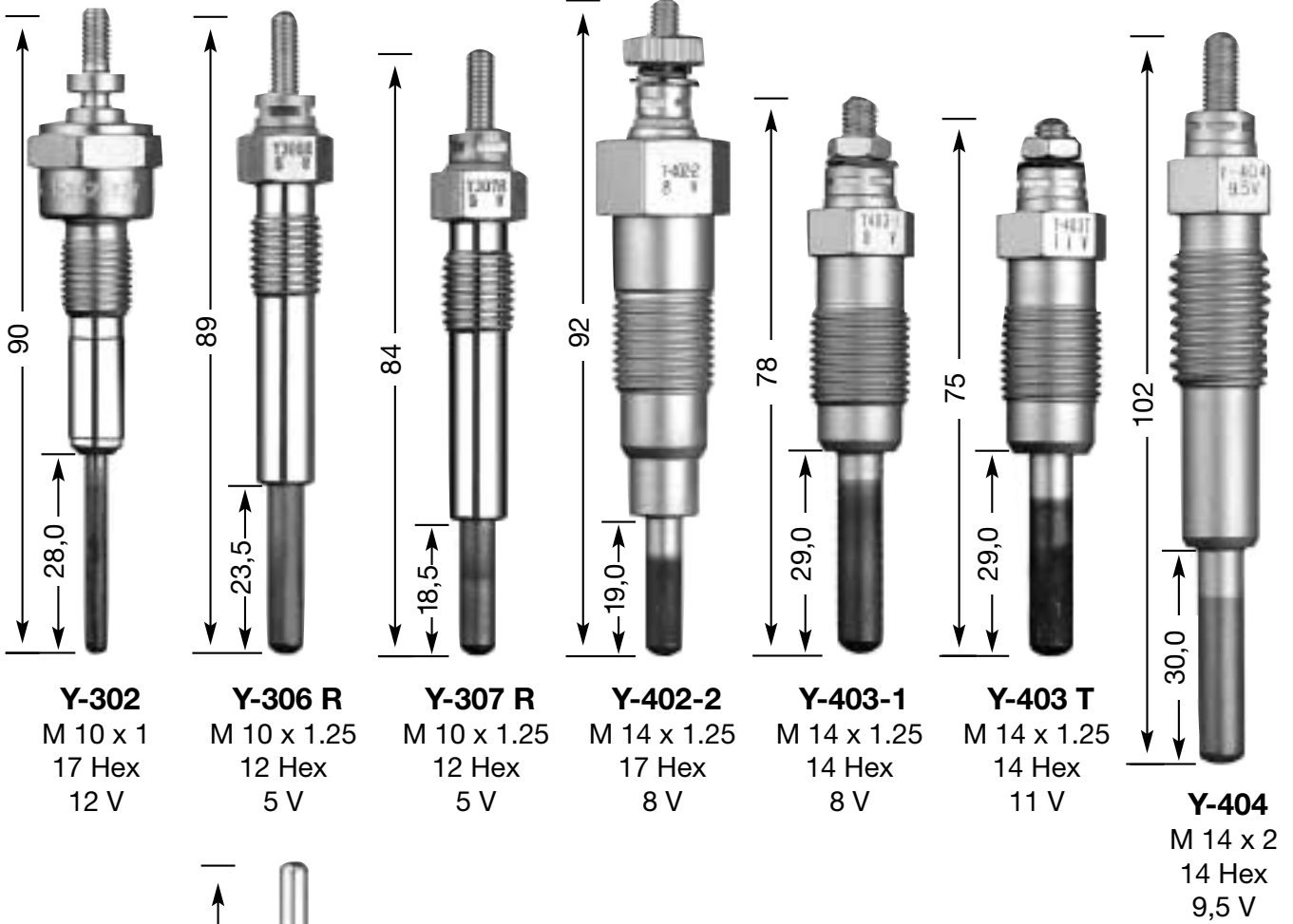

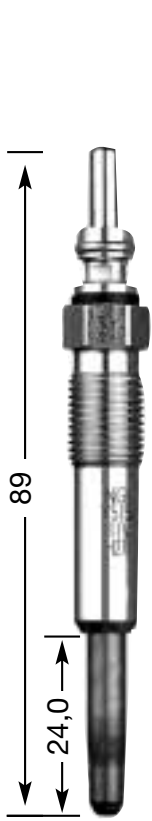

Y-515 J
M 10 x 1
10 Hex
11 V

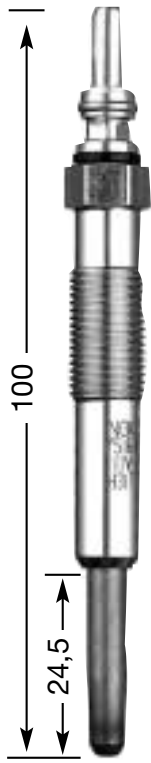

Y-516 J
M 10 x 1
10 Hex
11 V

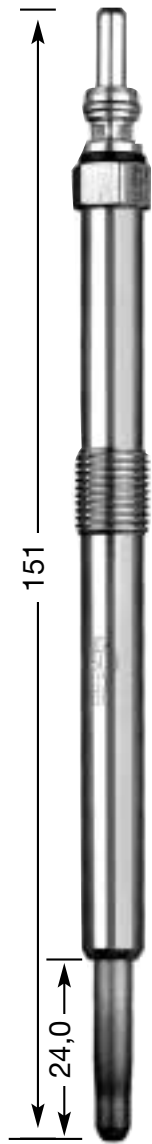

Y-517 J
M 10 x 1
10 Hex
11 V

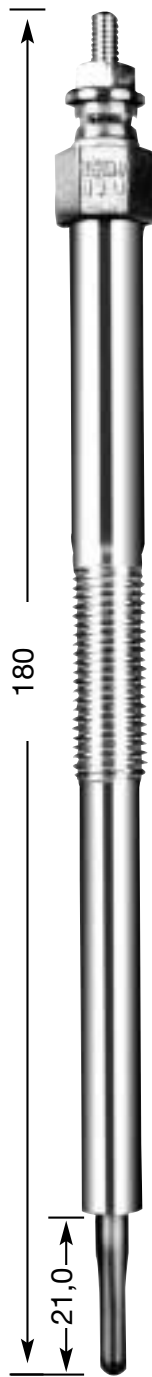

Y-519 J
M 10 x 1
10 Hex
11 V

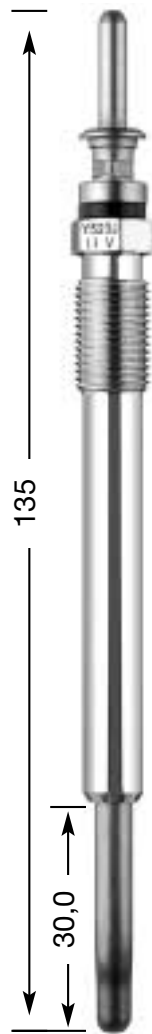

Y-523 J
M 10 x 1,25
10 Hex
11 V



Y-524 J
M 10 x 1,25
10 Hex
10 V

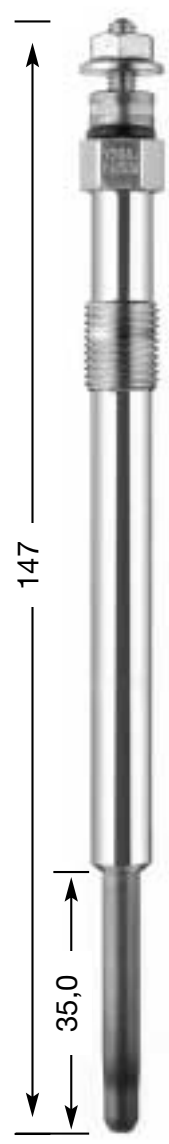

Y-525 J
M 10 x 1,25
10 Hex
11,5 V

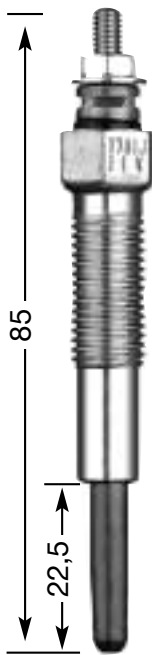

Y-701 J
M 10 x 1,25
12 Hex
11 V

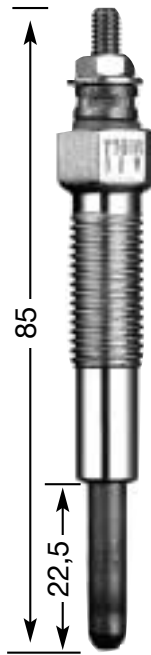

Y-701 R
M 10 x 1,25
12 Hex
11 V

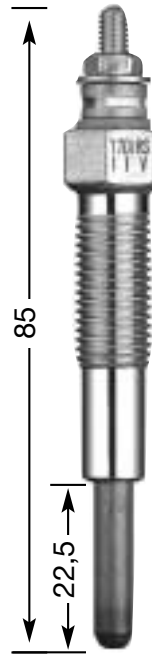

Y-701 RS
M 10 x 1,25
12 Hex
11 V

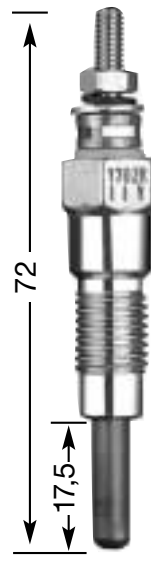

Y-702 R
M 10 x 1,25
12 Hex
11 V

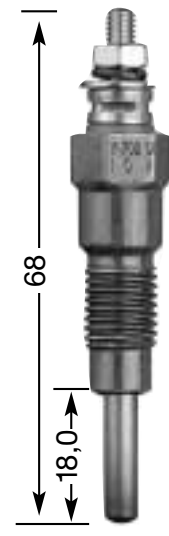

Y-702 U
M 10 x 1,25
12 Hex
10 V

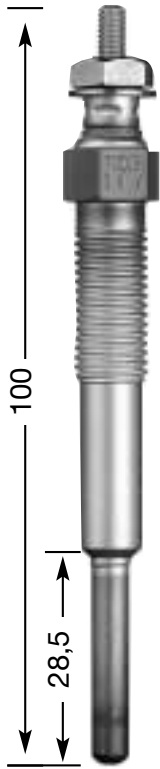

Y-703 R
M 10 x 1.25
12 Hex
11 V

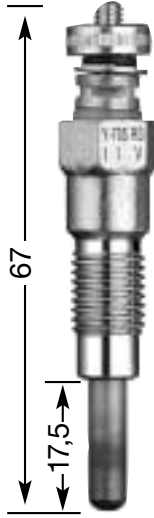

Y-705 RS
M 10 x 1.25
12 Hex
11 V

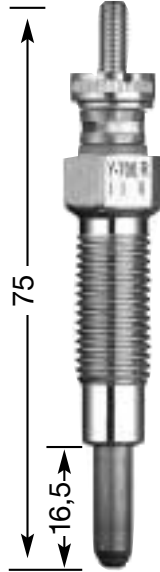

Y-706 R
M 10 x 1.25
12 Hex
11 V

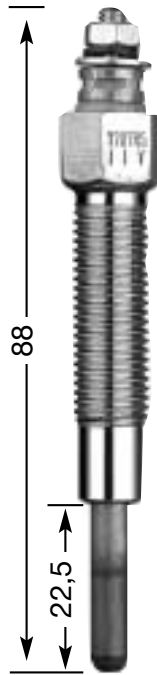

Y-707 RS
M 10 x 1.25
12 Hex
11 V

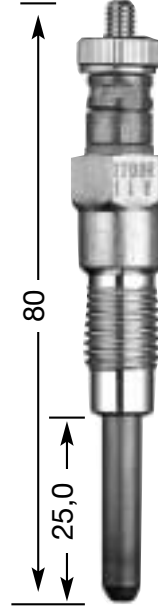

Y-709 R
M 10 x 1.25
12 Hex
11 V

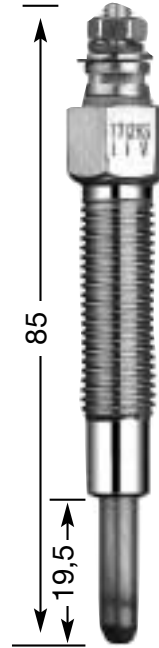

Y-712 RS
M 10 x 1.25
12 Hex
11 V

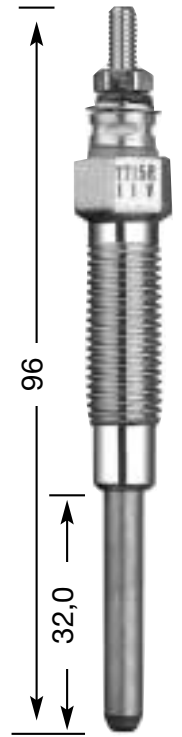

Y-715 R
M 10 x 1.25
12 Hex
11 V

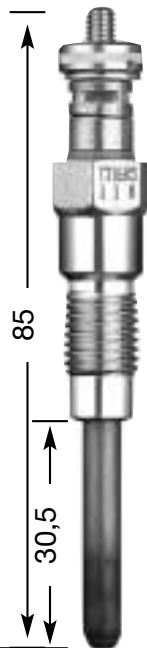

Y-716 RS
M 10 x 1.25
12 Hex
11 V

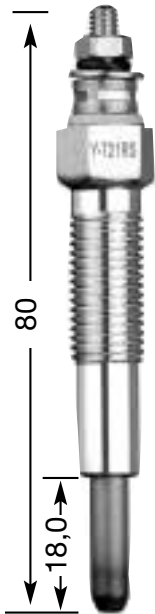

Y-721 RS
M 10 x 1.25
12 Hex
11 V

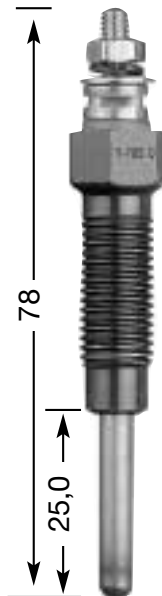

Y-723 U
M 10 x 1.25
12 Hex
8 V

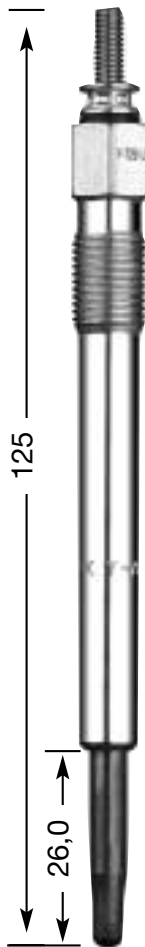

Y-729 U
M 10 x 1
10 Hex
11,5 V

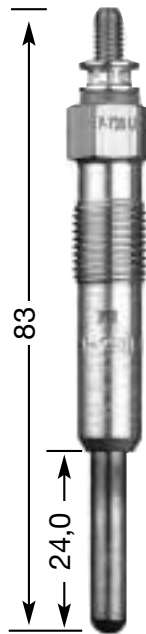

Y-730 U
M 10 x 1
10 Hex
11 V

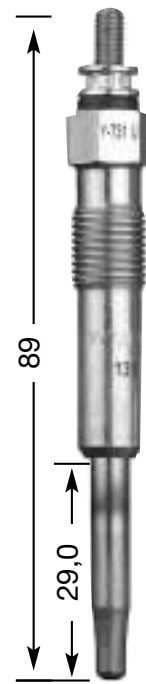

Y-731 U
M 10 x 1
10 Hex
11 V

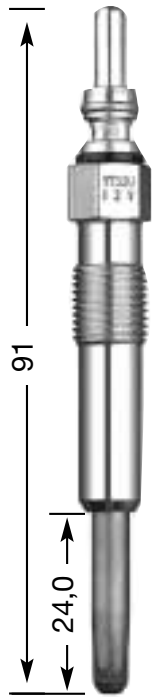

Y-732 U
M 10 x 1
10 Hex
12 V

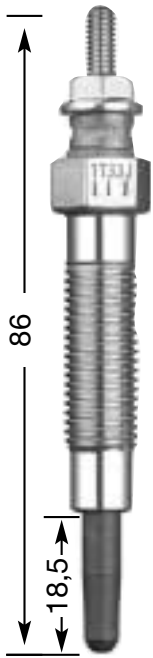

Y-733 J
M 10 x 1.25
12 Hex
11 V

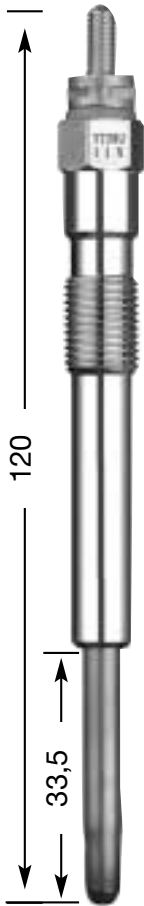

Y-738 U
M 10 x 1
10 Hex
11 V

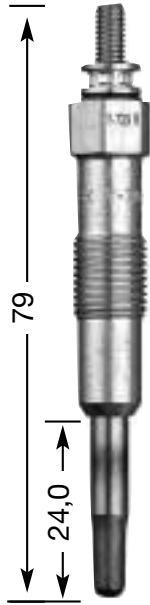

Y-739 R
M 10 x 1
10 Hex
11 V

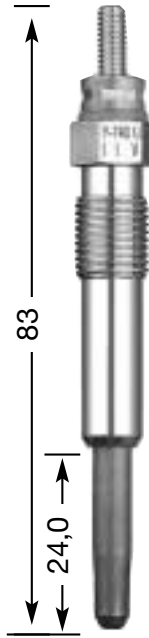

Y-740 U
M 10 x 1
10 Hex
11 V

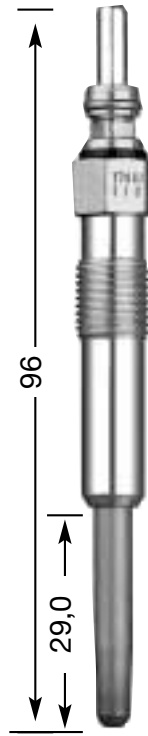

Y-741 U
M 10 x 1
10 Hex
11 V

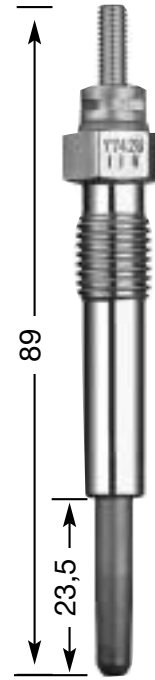

Y-742 U
M 10 x 1.25
12 Hex
11 V

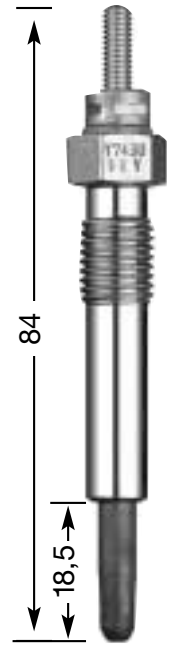

Y-743 U
M 10 x 1.25
12 Hex
11 V

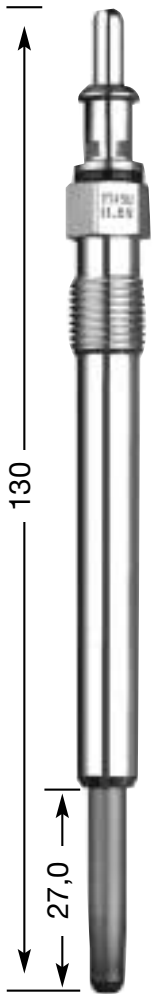

Y-745 U
M 10 x 1
10 Hex
11,5 V

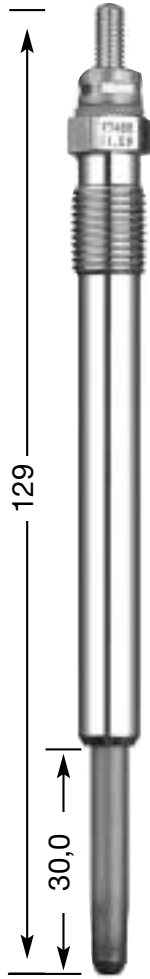

Y-746 R
M 10 x 1
10 Hex
11,5 V

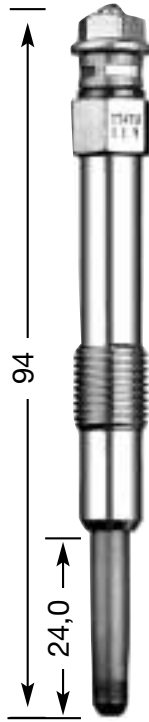

Y-747 U
M 10 x 1
10 Hex
11 V

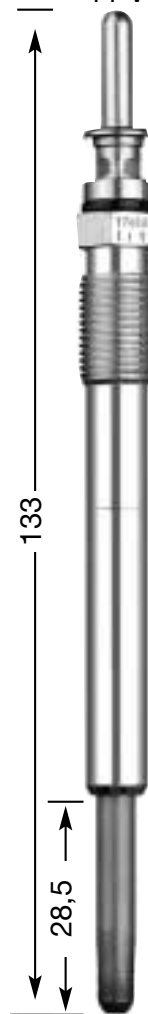

Y-748 U
M 10 x 1
10 Hex
11 V

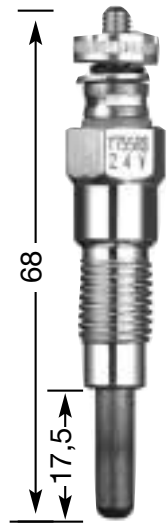

Y-755 RS
M 10 x 1.25
12 Hex
24 V

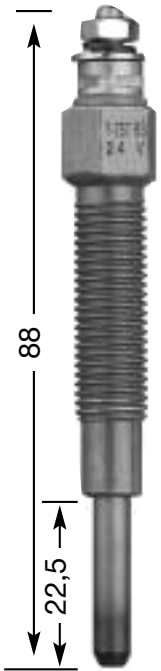

Y-757 RS
M 10 x 1.25
12 Hex
24 V

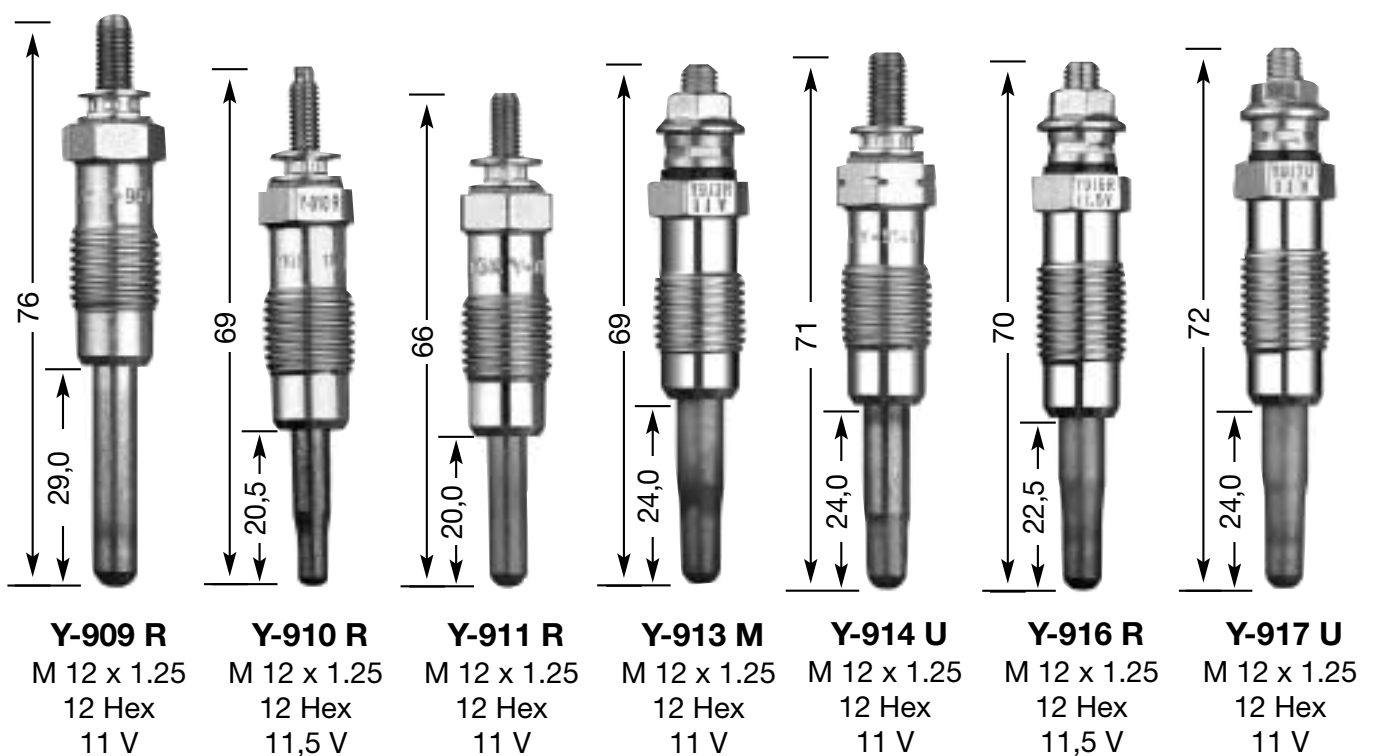
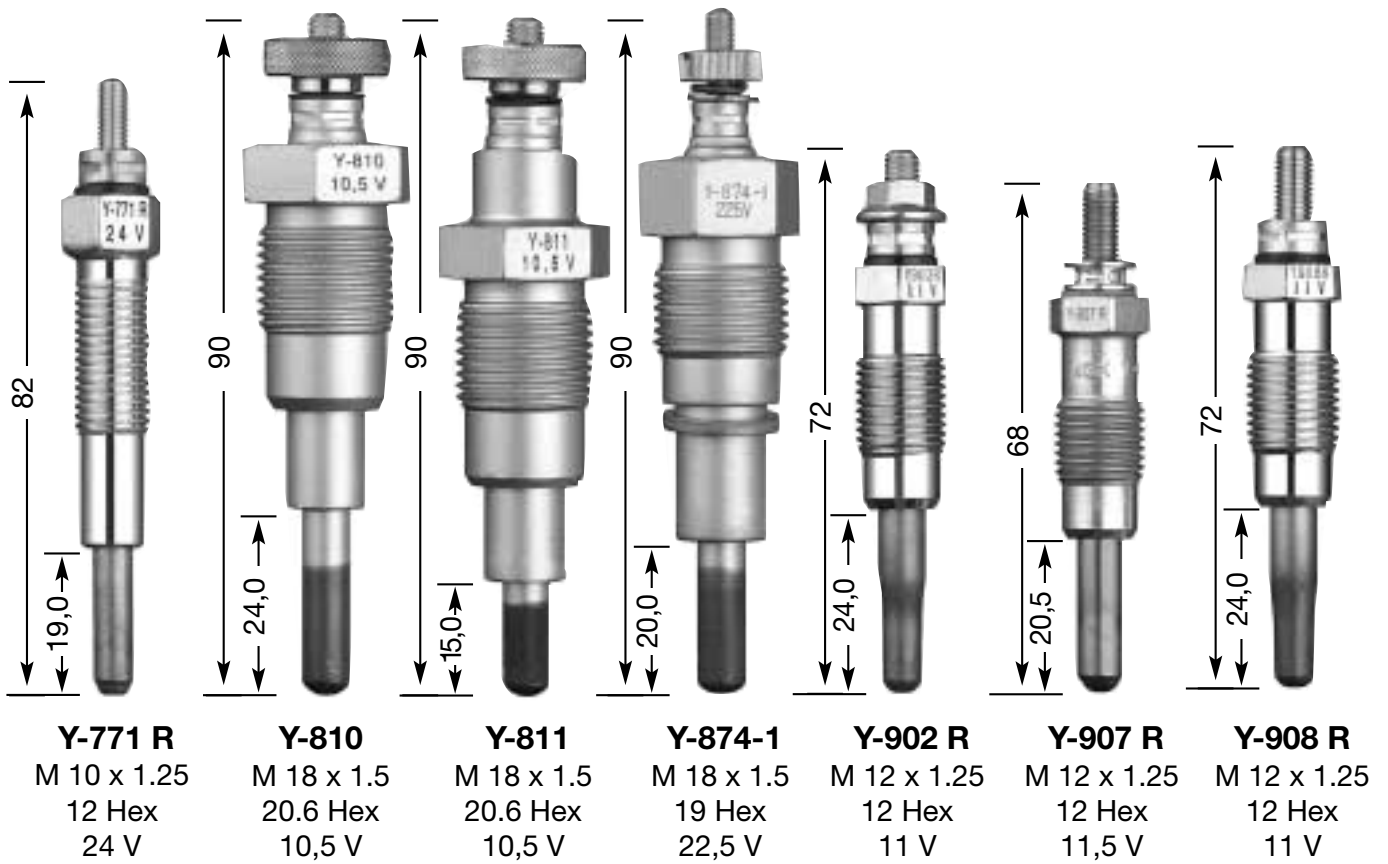

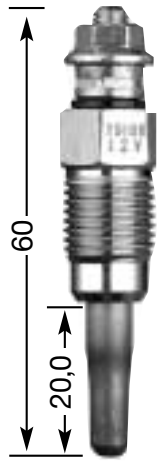

Y-918 R
M 12 x 1.25
12 Hex
12 V

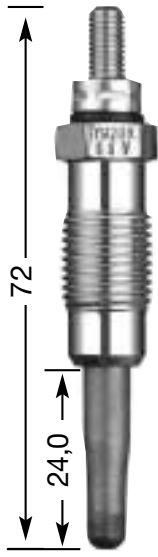

Y-920 R
M 12 x 1.25
12 Hex
11 V

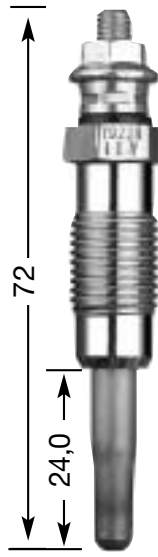

Y-922 R
M 12 x 1.25
12 Hex
11 V

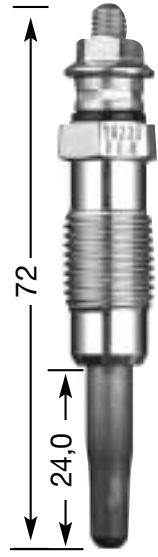

Y-923 U
M 12 x 1.25
12 Hex
11 V

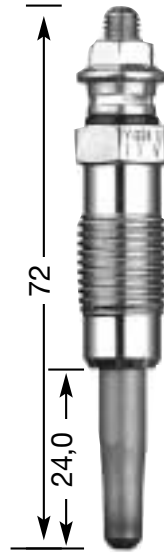

Y-924 U
M 12 x 1.25
12 Hex
11 V

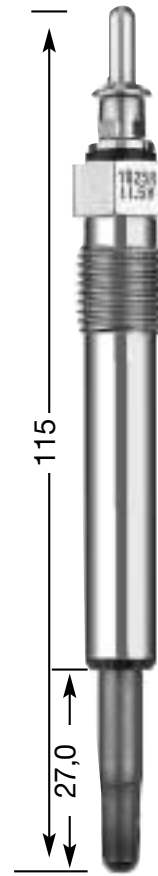

Y-925 R
M 12 x 1.25
12 Hex
11,5 V

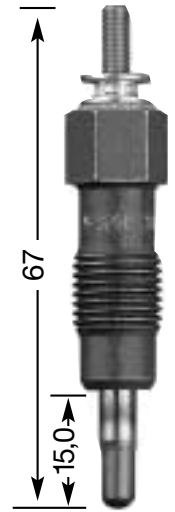

Y-926 U
M 12 x 1.25
12 Hex
11 V

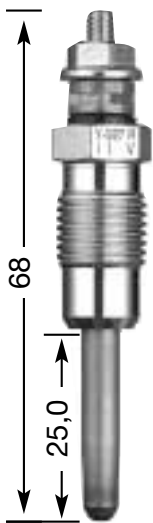

Y-927 R
M 12 x 1.25
12 Hex
11 V

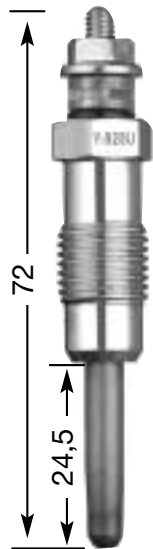

Y-928 U
M 12 x 1.25
12 Hex
11 V

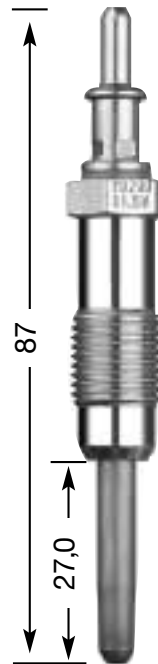

Y-929 U
M 12 x 1.25
12 Hex
11,5 V

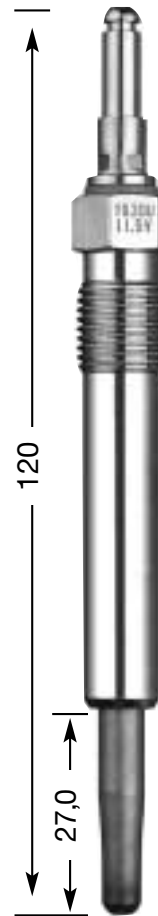

Y-930 U
M 12 x 1.25
12 Hex
11,5 V

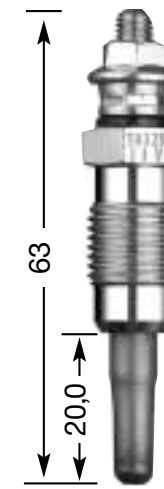

Y-932 R
M 12 x 1.25
12 Hex
11 V

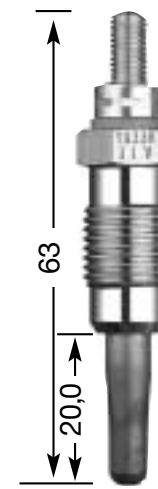

Y-933 R
M 12 x 1.25
12 Hex
11 V

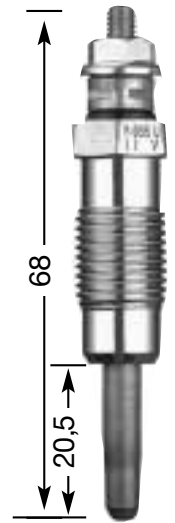

Y-935 U
M 12 x 1.25
12 Hex
11 V

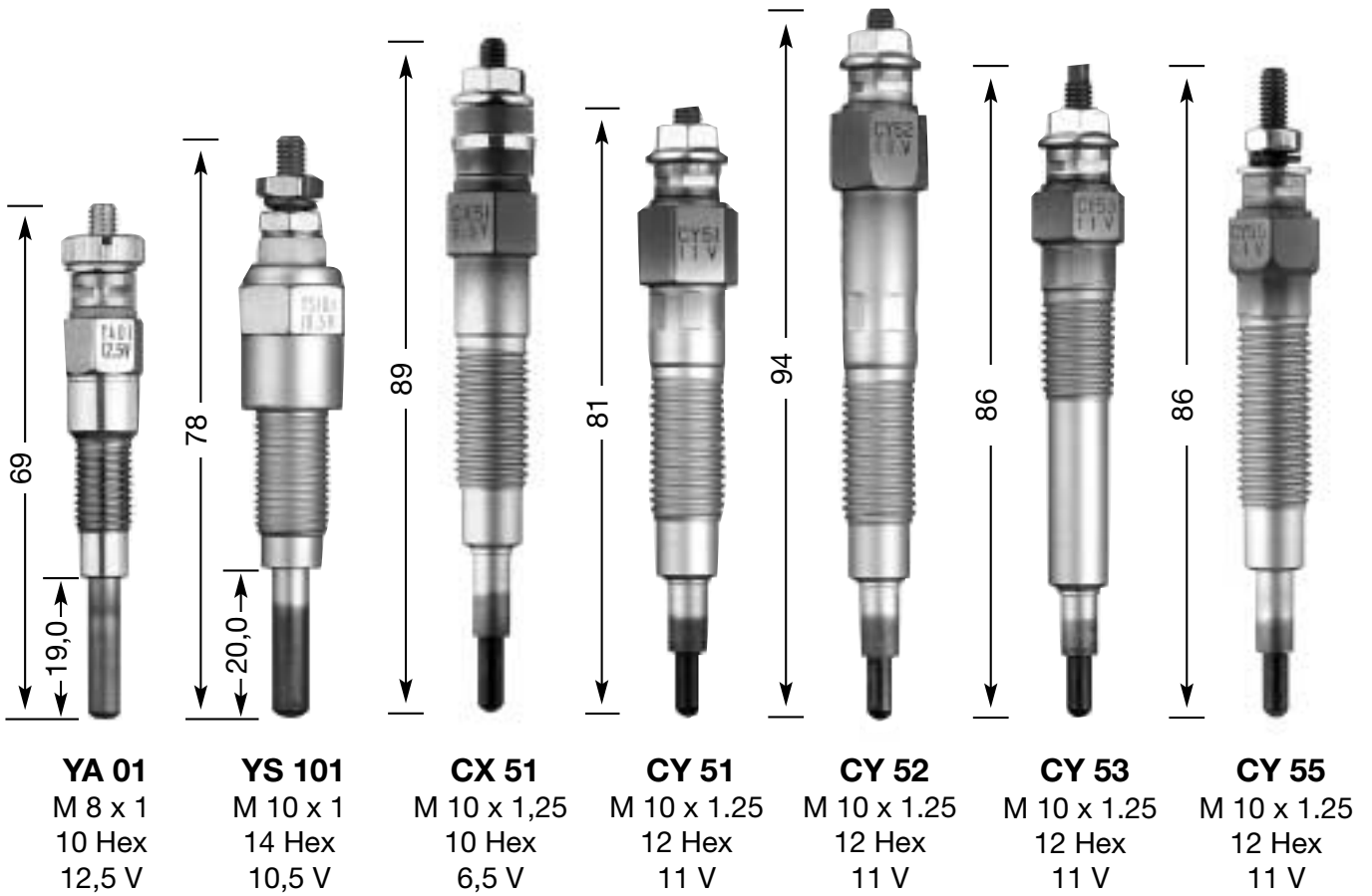
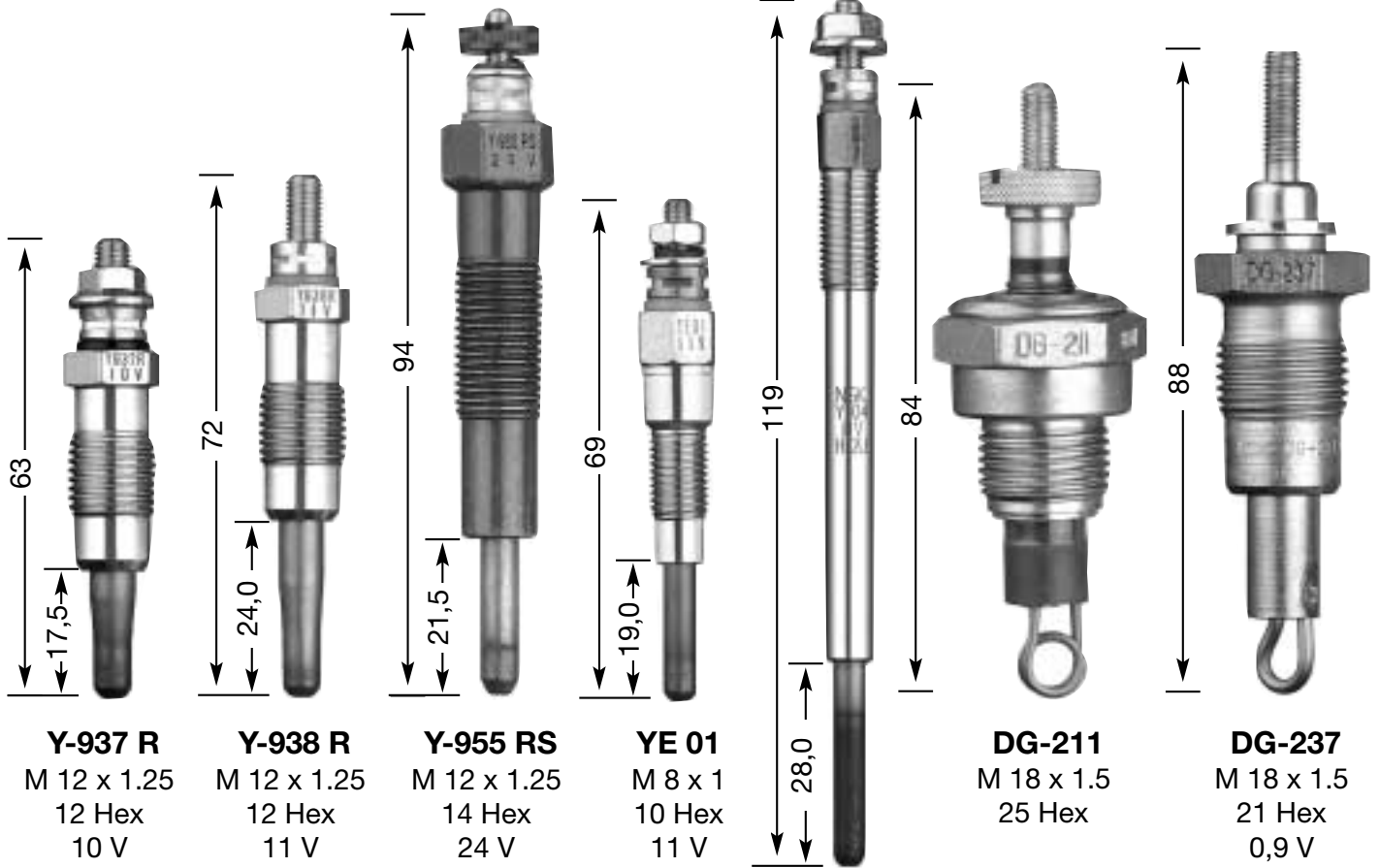

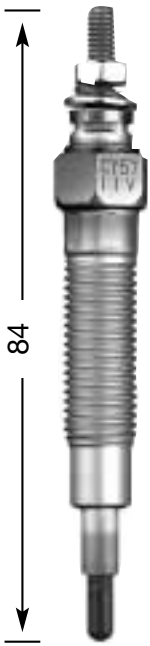

CY 57
M 10 x 1.25
12 Hex
11 V

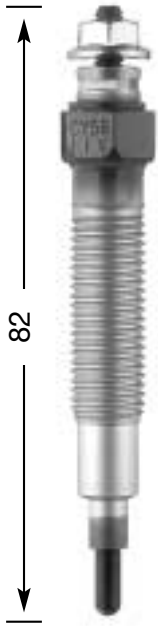

CY 58
M 10 x 1.25
12 Hex
11 V

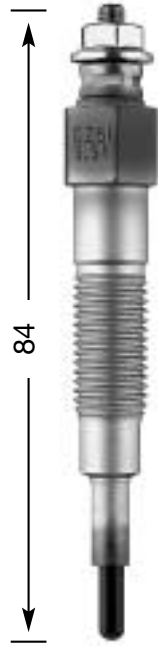

CZ 51
M 10 x 1,25
12 Hex
6,5 V



l kW

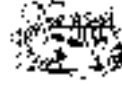

Cyl.

Order-
No. No.Bic¹⁾ Order-
No. No.

											AC
Cobra Mk4 SVO					8	0,8	BP7ES	2412		BPR7EIX	4055
Cobra Mk4					8	0,8	BKR5EK	7956	23	BKR5EIX	6341
Cobra 212 SC	3.5				8	0,9	BKR6EKC	2848	26	BKR6EIX	6418
Cobra Mk4 CRS	5.0				8	1,1	BPR5FS-11	2924			
Cobra Super Blower	5.0				8	1,1	BPR4FS-11	2527			
Cobra Mk3 427	7.0				8	0,6	AP6FS	2710			

											ACURA
Legend LX	2.5	122	01.86-12.87	C25A1	6	1,1	BCPR6E-11	3132	11	BCPR6EIX-11	4919
RSX	2.0		02- 03	K20A2	4	1,1	IFR7G-11K	4965			
RSX	2.0		(02)	K20A3	4	1,1	IZFR6K-11				
SLX	3.2		96- 97	6VD1	6	1,1	PFR5G-11	2647			
SLX	3.5		98-	6VE1	6	1,1	PFR5G-11	2647			

											ALFA ROMEO
6	2.0	100	09.83-12.86	AR019.32	4	0,7	BP7ES	2412		BPR7EIX	4055
6 TD	2.5	77	06.83-02.87	VM HR 588HT	6	█	Y-909R	4602			
6 / I.Q.O.	2.5	117	09.83-12.86	AR019.28	6	0,7	BP7ES	2412		BPR7EIX	4055
10 AR 6, 13 AR 6 D	2.5	53	04.85-02.86		4	█	Y-208T	1250			
30 AR 8, 35 AR 8, 40 AR 8 D	2.5	53	10.83-12.89	Sofim 8140.61.200	4	█	Y-908R	4585			
33 - 1.3 L	1.3		87-01.94	AR305.02-86-87	4	0,7	BP6ES	7811	4	BPR6EIX	6637
33 i.e Sport Wagon	1.3	65	02.94-10.94	AR307.32-301.68	4	0,7	BP6ES	7811	4	BPR6EIX	6637
33 i.e	1.3	65	02.94-10.94	AR307.32	4	0,7	BP6ES	7811	4	BPR6EIX	6637
33 i.e.	1.4	66	01.92-12.93	AR307.53	4	0,7	BP6ES	7811	4	BPR6EIX	6637
33 i.e.; Cat.	1.5	74	12.90- 93	AR307.51	4	0,7	BP6ES	7811	4	BPR6EIX	6637
33 - 1.5 L	1.5	77	84- 93	AR307.34-305.88	4	0,7	BP6ES	7811	4	BPR6EIX	6637
33 i.e. all 1.7 Ltr.cat.	1.7	77	90- 93	AR307.46-47	4	0,7	PFR6B	3500			
33 i.e. - 1.7 L	1.7	85	88- 93	AR305.50	4	0,7	BP6ES	7811	4	BPR6EIX	6637
33 i.e.- 1.7 Ltr.16V	1.7	95	01.88-12.93	AR307.36-37	4	0,7	PFR6B	3500			
33 TD	1.8	55	09.86-03.94		4	█	Y-909R	4602			
33 TD	1.8	62	09.86-03.94	VM HR-392	3	█	Y-909R	4602			
33 TD	1.8	62	02.90-03.94	VM 82 A	4	█	Y-909R	4602			
33 TD Sport Wagon	1.8	62	01.90-03.94	VM 96 A	4	█	Y-909R	4602			
75	1.6	81	05.85-09.89	AR061.00	4	0,7	BP6ES	7811	4	BPR6EIX	6637
75	1.8	89	05.85-09.89	AR062.02	4	0,7	BP6ES	7811	4	BPR6EIX	6637
75 i. Turbo	1.8	121	12.86-12.87	AR061.58	4	0,7	BP6ES	7811	4	BPR6EIX	6637
75 TD	2.0	70	05.85-02.92	VM 80 A	4	█	Y-909R	4602			
75	2.0	94	05.85-10.88	AR062.12	4	0,7	BP6ES	7811	4	BPR6EIX	6637
75 i.Twin Spark	2.0	106	01.87-02.92	AR061.66 Cat.-062.24	4	0,7	BGP6ES	4930	17	BCPR6EIX-1	4919
75 TD	2.4	81	10.88-02.92	VM 81 A	4	█	Y-909R	4602			
75 i. V6	2.5	110	09.85-02.92	AR016.46-019.11 Cat.	6	0,7	BP7ES	2412		BPR7EIX	4055
75 i. V6	3.0	133	01.87-02.92	AR061.20-061.24 Cat.	6	0,7	BP6ES	7811	4	BPR6EIX	6637
75 i. V6	3.0	139	02.90-02.92	AR061.503	6	0,7	PGR6A	4984			
Alfa 90 Super	1.8	89	10.84-01.87	AR062.02	4	0,7	BP6ES	7811	4	BPR6EIX	6637
Alfa 90 / i. Super	2.0	94	10.84-01.87	AR017.13	4	0,7	BP6ES	7811	4	BPR6EIX	6637
Alfa 90 i. V6 Super	2.0	97	05.85-01.87	AR062.10	6	0,7	BP7ES	2412		BPR7EIX	4055
90 TD	2.4	81	10.84-01.87	VM 81 A	4	█	Y-909R	4602			
Alfa 90 i. Super	2.5	110	10.84-12.90	AR016.46-019.11 cat	6	0,7	B7ES	1111			
145 i.e L	1.4	66	08.94-11.96	AR33.501	4	0,7	BP6ES	7811	4	BPR6EIX	6637
145 i. 16V Twin Spark;L; Junior	1.4	76	04.97-12.01	AR33.503	4	0,9+	BKR6EK	2513+			
						0,7		4259			
145 i.e L	1.6	76	08.94-11.96	AR33.201	4	0,7	BP6ES	7811	4	BPR6EIX	6637

¹⁾ Bic = Best in class (siehe Seite 3) / (see page 3)



ℓ kW

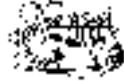

Cyl.

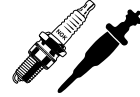
Order-
No. No.Bic¹⁾ Order-
No.**ALFA ROMEO**

145 i. 16V Twin Spark L	1.6	88	04.96-12.01	AR67.601	4	0,9+ 0,7	BKR6EK	2513+ 4259				
145 i.e 16V	1.7	95	08.94-11.96	AR33.401	4	0,7	PFR6B	3500				
145 i. Twin Spark 16V- L	1.8	103	12.96-03.98	AR67.106	4	0,9+ 0,7	BKR6EK	2513+ 4259				
145 i. 16V Twin Spark	1.8	106	03.98-12.01	AR32.201	4	0,9+ 0,7	BKR6EK	2513+ 4259				
145 TD	1.9	66	04.94-09.96	AR67.501	4	█	Y-922R	4356				
145 TD	1.9	66	10.96-09.97	AR33.601	4	█	Y-922R	4356				
145 JTD	1.9	77	05.98-11.99	AR32.302	4	█	Y-747U	4951				
145 16V T.S. (Brazil)	2.0	110	12.96-04.01		4	0,9+ 0,7	BKR6EK	2513+ 4259				
145 i. 16V T.S. Quadrifoglio	2.0	110	10.95-04.01	AR67.204	4	0,9+ 0,7	BKR6EK	2513+ 4259				
145 i 2.0 16V T.S.	2.0	114	03.98-04.01	AR32.301	4	0,9+ 0,7	BKR6EK	2513+ 4259				
146 i.e.	1.3	66	07.95-11.97	AR33.201	4	0,7	BP6ES	7811	4	BPR6EIX	6637	
146 i.e- L	1.4	66	08.94-02.97	AR33.501	4	0,7	BP6ES	7811	4	BPR6EIX	6637	
146 i Twin Spark 16V; L	1.4	76	02.97-03.98	AR33.503	4	0,9+ 0,7	BKR6EK	2513+ 4259				
146 T.S.	1.4	76	11.96-12.01	AR33.503	4	0,9+ 0,7	BKR6EK	2513+ 4259				
146 1.4i 16V Twin Spark; L; Junior	1.4	76	04.98-12.01	AR33.503	4	0,9+ 0,7	BKR6EK	2513+ 4259				
146 i.e L	1.6	76	07.94-12.97	AR33.201	4	0,7	BP6ES	7811	4	BPR6EIX	6637	
146 i 16V Twin Spark L	1.6	88	04.96-12.01	AR67.601	4	0,9+ 0,7	BKR6EK	2513+ 4259				
146	1.7	78	08.98-04.99	AR32.201	4	0,9+ 0,7	BKR6EK	2513+ 4259				
146 i.e 16V	1.7	95	08.94-02.97	AR33.401	4	0,7	PFR6B	3500				
146 i 16V Twin Spark L	1.8	103	02.97-12.01	AR67.106	4	0,9+ 0,7	BKR6EK	2513+ 4259				
146 i. 16V Twin Spark	1.8	106	12.96-04.01	AR32.201	4	0,9+ 0,7	BKR6EK	2513+ 4259				
146 TD	1.9	66	10.96-09.97	AR33.601	4	█	Y-922R	4356				
146 TD	1.9	66	02.95-09.96	AR67.501	4	█	Y-922R	4356				
146 JTD	1.9	77	05.98-11.99	AR32.302	4	█	Y-747U	4951				
146 i. Twin Spark 16V- ti	2.0	110	02.96-04.01	AR67.204	4	0,9+ 0,7	BKR6EK	2513+ 4259				
146 i 2.0 16V T.S.	2.0	114	03.98-12.01	AR32.301	4	0,9+ 0,7	BKR6EK	2513+ 4259				
147 1.6 T.S. 16 V	1.6	77	10.00-	AR37.203	4	0,8+ 0,7	BKUR6ETB+ CR7EKC	6992+ 7004				
147 1.6 T.S. 16V	1.6	88	10.00-	AR32.104	4	0,9+ 0,7	BKR6EK	2513+ 4259				
147 2.0 T.S. 16V	2.0	110	10.00-	AR 32310	4	0,9+ 0,7	BKR6EK	2513+ 4259				
147 GTA	3.2	184	11.02-	932A.000	6	0,7	PFR6B	3500				
155 i.16 V T.S.	1.6	88	07.96-01.98	AR67.601	4	0,9+ 0,7	BKR6EK	2513+ 4259				
155 i T.S.	1.7	86	02.92-04.93	AR67.103	4	0,7	BCP6ES	4930	17	BCPR6EIX-1	4919	
155 i T.S.	1.7	95	05.93-07.96	AR67.105	4	0,7	BCP6ES	4930	17	BCPR6EIX-1	4919	

¹⁾ Bic = Best in class (siehe Seite 3) / (see page 3)



l kW

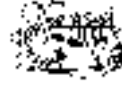

Cyl.

Order-
No. No.Bic¹⁾ Order-
No.**ALFA ROMEO**

155 i.T.S.	1.8	93	04.94-07.96	AR67.101-67.102	4	0,7	BKP6ES	4930	17	BCPR6EIX-1	4919
155 i.Twin Spark	1.8	93	02.92-07.96	AR67.102	4	0,7	BKP6ES	4930	17	BCPR6EIX-1	4919
155 i.16 V T.S.	1.8	103	05.96-01.98	AR67.106	4	0,9+	BKR6EK	2513+			
						0,7		4259			
155 TD	1.9	68	04.93-04.96	AR67.501	4	█	Y-902R	2237			
155 TD	2.0	66	08.93-04.96	AR67.502	4	█	Y-922R	4356			
155 i.T.S.L	2.0	104	06.94-		4	0,7	BKP6ES	4930	17	BCPR6EIX-1	4919
155 i.T.S.L	2.0	104	02.92-02.95	AR67.201-67.202	4	0,7	BKP6ES	4930	17	BCPR6EIX-1	4919
155 i.Twin Spark	2.0	106	02.92-02.95	AR67.202	4	0,7	BKP6ES	4930	17	BCPR6EIX-1	4919
155 i.16V T.S.	2.0	110	06.94-01.98	AR67.204	4	0,9+	BKR6EK	2513+			
						0,7		4259			
155 i - Turbo- Turbo 4x4	2.0	137	08.92-04.98	AR67.203	4	0,8	BP6ET	1263			
155 TD	2.5	92	05.95-10.97	VM 425 CLIEA	4	█	Y-741U	5065			
155 TD	2.5	92	04.93-04.95	VM 425 CLIEA	4	█	Y-922R	4356			
155 i.	2.5	120	02.92-	AR67.301	6	0,8	BPR7ES	2023	19	BPR7EIX	4055
155 i. V6	2.5	120	05.95-02.97	AR67.301	6	0,7	BP6ES	7811	4	BPR6EIX	6637
155 i. V6	2.5	120	02.92-04.95	AR67.301	6	0,8	BPR7ES	2023	19	BPR7EIX	4055
156 16V T.S.	1.6	88	12.97-	AR32.101	4	0,9+	BKR6EK	2513+			
						0,7		4259			
156 16V T.S.	1.8	106	12.97-	AR32.201	4	0,9+	BKR6EK	2513+			
						0,7		4259			
156 JTD	1.9	81	01.98-09.00	AR32.302	4	█	Y-747U	4951			
156 JTD	1.9	85	10.97-09.00	AR32.302	4	█	Y-747U	4951			
156 16V T.S	2.0	114	12.97-12.02	AR32.301	4	0,9+	BKR6EK	2513+			
						0,7		4259			
156 16V T.S. Selespeed	2.0	114	05.99-12.02	AR32.301	4	0,9+	BKR6EK	2513+			
						0,7		4259			
156 JTS	2.0	121	11.01-	937A.1000	4	0,9	BKR6EK	2513			
156 JTD	2.4	100	10.97-09.00	AR32.501	5	█	Y-747U	4951			
156 24V	2.5	140	10.97-	AR32.401	6	0,7	PFR6B	3500			
156 GTA	3.2	184	11.02-	932A.000	6	0,7	PFR6B	3500			
164 i.	2.0		03.91-			0,7	BP7ES	2412		BPR7EIX	4055
164 i.T.S.	2.0	102	06.87-09.92	AR064.16Cat-064.20	4	0,7	BKP6ES	4930	17	BCPR6EIX-1	4919
164 i.T.S Super / Super L	2.0	106	07.94-10.98	AR67.201-67202	4	0,7	BKP6ES	4930	17	BCPR6EIX-1	4919
164 i.e. Turbo	2.0	126	01.88-09.92	AR064.76	4	0,8	BPR7ES	2023	19	BPR7EIX	4055
164 i. V6 turbo Super	2.0	148	03.91-10.98	AR64.102	6	0,7	BP7ES	2412		BPR7EIX	4055
164 TD	2.5	85	06.87-08.92	VM 84 A	4	█	Y-909R	4602			
164 TD Super	2.5	92	09.92-04.95	VM 425-SLIRA	4	█	Y-922R	4356			
164 TD	2.5	92	05.95-10.98	VM 425 SLIRA	4	█	Y-741U	5065			
164 12V	3.0		06.87-09.93	06410, 06412		0,8	B7ES	1111			
164 i. V6 Super	3.0	132	01.96-		6	0,7	PGR6A	4984			
164 i. V6 12V	3.0	138	01.90-10.98	AR64.305	6	0,7	BP6ES	7811	4	BPR6EIX	6637
164 i. V6 12V	3.0	155	92-10.98	AR66.301	6	0,7	PFR6B	3500			
164 i. V6 24V Super	3.0	155	07.94-10.98	AR64.304-64.308	6	0,7	PFR6B	3500			
164 i. V6 24V CF2	3.0	155	01.87- 92	AR64.301	6	0,7	PGR6A	4984	6		
164 i. V6 QV	3.0	169	-10.98	AR16.102	6	0,7	PGR6A	4984			
164 i. Q.4	3.0	171	01.90-10.98	AR64.304	6	0,7	PFR6B	3500			
166 2.0 T.S. 16V	2.0	114	11.98-	AR34.103	4	0,9+	BKR6EK	2513+			
						0,7		4259			
166 2.0 V6 Turbo Super;Prog.Distint.	2.0	151	11.98-	AR34.102	6	0,8	BP6ES	7811	4	BPR6EIX	6637
166 24V V6 (Brazil)	2.0	151	10.98-			0,7	PFR6B	3500			
166 JTD	2.4	103	10.98-11.99	AR34.202	5	█	Y-747U	4951			

¹⁾ Bic = Best in class (siehe Seite 3) / (see page 3)



ℓ kW

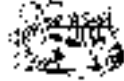

Cyl.

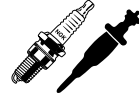
Order-
No. No.Bic¹⁾ Order-
No.**ALFA ROMEO**

166 2.5 I V6 24V	2.5	140	11.98-	AR34.201	6	0,7	PFR6B	3500				
166 3.0 I V6 24V	3.0	162	11.98-	AR34.301	6	0,7	PFR6B	3500				
Arna L / SL	1.2	44	09.83-12.86	AR305.00-310.00	4	0,7	BP6ES	7811	4	BPR6EIX	6637	
Arna TI	1.3	63	09.83-12.86	AR310.10	4	0,7	BP6ES	7811	4	BPR6EIX	6637	
Giulietta TD	2.0	61	03.83-04.85	VM 4 HT	4	█	Y-909R	4602				
GT 2.0 JTS	2.0	121	12.03-	937A1000	4	0,9	BKR6EK	2513				
GTV i 16V Twin Spark	1.8	106	06.98-06.02	AR32.201	4	0,9+	BKR6EK	2513+				
						0,7		4259				
GTV T.S. 16V	2.0	110	04.95-05.98	AR16.201	4	0,9+	BKR6EK	2513+				
						0,7		4259				
GTV 2.0 L Twin Spark -16V	2.0	110	06.98-	AR32.301	4	0,9+	BKR6EK	2513+				
						0,7		4259				
GTV 2.0 JTS 16V	2.0	121	06.03-	937A.1000	4	0,9	BKR6EK	2513				
GTV V6 Turbo	2.0	147	04.95-05.98	AR16.202	6	0,7	BP7ES	2412		BPR7EIX	4055	
GTV 2.0 L V6 turbo L	2.0	148	06.98-12.99	AR16.202	6	0,9	BPR6E	6464	2			
GTV V6 12V	2.0	151	09.97-		6	0,8	BPR7ES	2023	19	BPR7EIX	4055	
GTV V6 24V- L	3.0	160	11.96-	AR16.102	6	0,7	PFR6B	3500				
GTV V6 24V	3.0	162	02.97-05.98	AR67.601	6	0,7	PFR6B	3500				
Spider	1.6	76	12.79-12.94	AR005.26-015.63	4	0,7	BP6ES	7811	4	BPR6EIX	6637	
Spider 16V T.S.	1.8	106	05.98-03.01	AR32.201	4	0,9+	BKR6EK	2513+				
						0,7		4259				
Spider i.	2.0	86	01.90-12.94	AR015.44-88-90	Cat.	4	0,7	BP6ES	7811	4	BPR6EIX	6637
Spider / I / Q.V.	2.0	94	04.71-12.89	AR005.15		4	0,8	B7ES	1111			
Spider 16V T.S.	2.0	110	04.95-05.98	AR16.201		4	0,9+	BKR6EK	2513+			
						0,7		4259				
Spider 16V T.S.	2.0	114	06.98-	AR32.301		4	0,9+	BKR6EK	2513+			
						0,7		4259				
Spider 2.0 JTS 16V	2.0	121	06.03-	937A.1000		4	0,9	BKR6EK	2513			
Spider i V6 turbo	2.0	147	06.98-	AR16.202		6	0,9	BPR6E	6464	2		
Spider i V6 12V	3.0	140	04.95-05.98	AR16.101-16.199		6	0,8	BPR6ES	7822	2	BPR6EIX	6637
Spider 3.0 V6 24V	3.0	165	06.98- 04	AR16.102		6	0,7	PFR6B	3500			
Sprint	1.3	64	07.79-12.89	AR301.68		4	0,7	BP6ES	7811	4	BPR6EIX	6637
Sprint Veloce	1.3	64	01.90-	AR301.68		4	0,7	BP6ES	7811	4	BPR6EIX	6637
Sprint Q.V.	1.5	70	01.83-12.89	AR301.28-46-98		4	0,7	BP6ES	7811	4	BPR6EIX	6637
Sprint Q.V.	1.7	87	10.87-12.89	AR305.50		4	0,7	BP6ES	7811	4	BPR6EIX	6637
SZ V6 / RZ V6	3.0	152	03.90-05.96	AR64.304		6	0,7	PGR6A	4984			

ALPINA

B 3	E36	3.2	191		S52B32	6	0,8	BKR6EK	2288	20**	BKR6EQUIP	3199
B 3 3.2	Cabrio	3.2	195	04.96-03.99	S52B32	6	0,8	BKR6EK	2288	20**	BKR6EQUIP	3199
B 3 3.3	E46	3.3	206	03.99-	S52B33	6		BKR6EQUIP	3199	30		
B 8	E36	4.6	245	-09.98	M62B46	8	0,8	BKR6EK	2288	20**	BKR6EQUIP	3199
B 10 3.2	E39	3.2	191	08.97-12.98	S52B32	6	0,8	BKR6EK	2288	20**	BKR6EQUIP	3199
B 10 3.3	E39	3.3	206	02.99-	S52B33	6		BKR6EQUIP	3199	30		
B 10 V8	E39	4.6	250	12.96-09.98	M62B46	8	0,8	BKR6EK	2288	20**	BKR6EQUIP	3199
B 10 V8	E39	4.6	255	10.98-	M62B46	8		BKR6EQUIP	3199	30		
B 12	E38	5.7	285	-04.99	M73B57	12	0,8	BKR6EK	2288	20**	BKR6EQUIP	3199
B 12	E38 6.0 E-Kat	6.0	316	06.99-	M73B60	12		BKR6EQUIP	3199	30		

AMG

C 32		3.2	260	02.00-		6	1,1	PFR5G-11	2647			
C 36	(202)	3.6	206	01.94-05.97	M 104.E36	6	0,8	BKR5EKU	3964			

¹⁾ Bic = Best in class (siehe Seite 3) / (see page 3)

** alternative/wahlweise V-Line 30



l kW

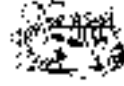

Cyl.

Order-
No. No.Bic¹⁾ Order-
No. No.**AMG**

C 43	(202)	4.3	225	09.97-	M 113.	8	1,0	IFR5D10	4696				
CL 55		5.5	265	04.00-		8	1,1	PFR5G-11	2647				
CLK 55	(208)	5.5	255	99- 03	M 113.980	8	1,0	IFR5D10	4696				
E 50	(210)	5.0	255	02.96-	M 119.E50	8	0,8	BKR5EKU	3964				
E 55	(210)	5.5	260	09.97-	M 113.980	8	1,0	IFR5D10	4696				
ML 55	(163)	5.5	255	99-	M 113.E55	8	1,0	IFR5D10	4696				
S 55	(220)	5.5	265	99-	M 113.980	8	1,0	IFR5D10	4696				
SL 60	(129)	6.0	280	95-	M 119.E60	12	0,8	BKR5EKU	3964				
SLK 32 AMG	(170)	3.2	260	01-	M 112.960 Twin Spark	6	1,0	IFR6D10	5344				

ARO

10						4	0,6	BP6HS	4511	18	BPR6HIX	4085	
10.1, 10.2, 10.3, 10.4 D		1.9	47		Renault F8Q248	4	█	Y-908R	4585				
240, 241, 242, 243, 244, 246 D		2.5	55		Peugeot XD 3P	6	█	Y-902R	2237				
240, 241, 242, 243, 244, 246 D		2.5	70		Peugeot XD 3TP	6	█	Y-902R	2237				
Spartana		1.2	39	97-	C3GD7	4	0,8	BP5ESZ	4691		BPR5EIX	6597	
Turbo 10		1.9	68		F8Q Turbo	4	█	Y-932R	4956				

ASIA

Rocsta		1.8	57	02.94-12.97		4	0,9	BPR5ES	7422	6	BPR5EIX	6597	
Rocsta		2.2		03.94-12.97	R2	4	█	Y-107R	1229				

ASTON MARTIN

DB7		3.2	250	09.94-06.99	DOHC	6	0,7	BCPR7ES	3330				
DB7		5.9		07.99-11.00	DOHC	12	1,3	PTR6D-13	5598				
DB7		5.9		11.00-	DOHC	12	1,3	PTR5D-13	6644				
Turbo 24V Coupé, Cabriolet		3.2	246	95-		6	0,7	BCPR7ES	3330				
48V V12		6.0	420	04.00-		12	1,0	PTR5D-10	3784	31			
V8 Carb				-03.86		8	0,7	BPR5EIX	6597				
DBS / VOLANTE		4.0				6	0,6	BP6ES	7811	4	BPR6EIX	6637	
DBS V8		5.3		73-03.86		8	0,7	BPR5EV	4728				
Lagonda		5.3		01.86-06.90		8	0,9	BPR6EY	6427		BPR6EIX	6637	
V8 & V8 DBS		5.3		-03.86		8	0,7	BPR5EV	4728				
V8 / Volante		5.3		01.87-12.89	V5805743x 9,25	8	0,9	BPR8ES	3923				
V8 / Vantage		5.3		01.87-12.89	V5805743X 9,25	8	0,9	BPR8ES	3923				
V8		5.3		06.75-03.86		8	0,7	BPR5EV	4728				
Vanquish		5.9		06.01-	AM 702	12	1,3	PTR6D-13	5598				
Vantage		5.3		03.86-12.89	9.3:1 Comp	8	0,9	BPR7EY	1144				
Vantage		5.3	410	08.93-	10.2:1Comp(Zagato)	8	0,8	BCR8ES	5430				
Virage / Volante		5.3		02.90-01.98	V8 32V	8	0,8	BCPR6ES	2330	12	BCPR6EIX-11	4919	

AUDI

A 2 TDI		1.2	45	03.01-	ANY	3	█	Y-741U	5065				
A 2		1.4	55	05.02-	BBY	4	1,0	BKUR6ET-10	2397	24	PFR6Q	6458	
A 2 TDI		1.4	55	05.03-	BAY	4	█	Y-732U	2408				
A 2		1.4	55	06.00-04.02	AUA	4	1,0	BKUR6ET-10	2397	24	PFR6Q	6458	
A 2		1.4	55	06.00-08.03	AMF	3	█	Y-741U	5065				
A 2		1.4	55	09.03-	BHC	3	█	Y-741U	5065				
A 2 FSI		1.6	81	05.02-	BAD	4		ZFR6S-Q	6449				
A 3		1.6	74	06.99-08.00	APF	4	1,0	BKUR6ET-10	2397	24	PFR6Q	6458	
A 3		1.6	74	09.96-06.01	AEH	4	1,0	BKUR6ET-10	2397	24	PFR6Q	6458	
A 3		1.6	74	08.97-06.03	AKL	4	1,0	BKUR6ET-10	2397	24	PFR6Q	6458	

¹⁾ Bic = Best in class (siehe Seite 3) / (see page 3)



ℓ kW

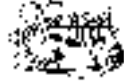

Cyl.

Order-
No. No.Bic¹⁾ Order-
No.**AUDI**

A 3	1.6	74	05.00-04.02	AVU	4	1,0	BKUR6ET-10	2397	24	PFR6Q	6458
A 3	1.6	75	05.03-	BGU	4	1,0	BKUR6ET-10	2397	24	PFR6Q	6458
A 3	1.6	75	05.02-06.03	BFQ	4	1,0	BKUR6ET-10	2397	24	PFR6Q	6458
A 3 FSI	1.6	85	08.03-05.04	BAG	4		ZFR6S-Q	6449			
A 3 FSI	1.6	85	06.04-	BLP	4		ZFR6S-Q	6449			
A 3	1.8	92	11.99-06.03	APG	4	1,0	BKUR6ET-10	2397	24	PFR6Q	6458
A 3	1.8	92	09.96-08.00	AGN	4	1,0	BKUR6ET-10	2397	24	PFR6Q	6458
A 3	1.8	110	09.00-06.03	ARX	4	0,8	PFR6Q	6458			
A 3	1.8	110	05.00-06.03	AUM	4	0,8	PFR6Q	6458			
A 3	1.8	110	07.99-04.00	ARZ	4	0,8	PFR6Q	6458			
A 3	1.8	110	08.98-04.01	AQA	4	0,8	PFR6Q	6458			
A 3	1.8	110	12.96-06.03	AGU	4	0,8	PFR6Q	6458			
A 3	1.8	132	11.98-08.00	AJQ	4	0,8	PFR6Q	6458			
A 3	1.8	132	07.99-05.00	APP	4	0,8	PFR6Q	6458			
A 3	1.8	132	05.00-06.03	AUQ	4	0,8	PFR6Q	6458			
A 3	1.8	132	09.00-06.03	ARY	4	0,8	PFR6Q	6458			
A 3	1.9	66	08.98-	ANU	4	█	Y-732U	2408			
A 3	1.9	66	08.97-06.01	ALH	4	█	Y-732U	2408			
A 3	1.9	66	09.96-08.00	AGR	4	█	Y-732U	2408			
A 3 TDI Fgst 8L-2-037-878 --->	1.9	74	11.01-06.03	AXR	4	█	Y-741U	5065			
A 3 TDI Fgst ---> 8L-2-037-877	1.9	74	01.01-06.03	ATD	4	█	Y-732U	2408			
A 3 TDI Fgst 8L-2-037-878 --->	1.9	74	01.01-06.03	ATD	4	█	Y-741U	5065			
A 3 TDI Fgst ---> 8L-2-037-877	1.9	74	11.01-06.03	AXR	4	█	Y-732U	2408			
A 3 TDI	1.9	81	01.97-04.02	AHF	4	█	Y-732U	2408			
A 3 TDI	1.9	81	09.99-06.01	ASV	4	█	Y-732U	2408			
A 3	1.9	85	08.98-	AJM	4	█	Y-732U	2408			
A 3 TDI Fgst ---> 8L-2-037-877	1.9	96	05.00-06.03	ASZ	4	█	Y-732U	2408			
A 3 TDI Fgst 8L-2-037-878 --->	1.9	96	05.00-06.03	ASZ	4	█	Y-741U	5065			
A 3 FSI	2.0	110	06.04-	BLX	4	1,1	PZFR5N-11TG				
A 3 FSI	2.0	110	03.04-05.04	BMB	4	1,1	PZFR5N-11TG				
A 3 FSI	2.0	110	05.03-	AXW	4	1,1	PZFR5N-11TG				
A 3	3.2	184	09.04-	BMJ	6	0,9	IZKR7B				
A 3	3.2	184	07.03-08.04	BDB	6	0,9	IZKR7B				
A 4	1.6	74	11.94-10.96	ADP	4	1,0	BKUR6ET-10	2397	24	PFR6Q	6458
A 4	1.6	74	08.98-09.01	ARM	4	1,0	BKUR6ET-10	2397	24	PFR6Q	6458
A 4	1.6	74	08.98-06.00	ANA	4	1,0	BKUR6ET-10	2397	24	PFR6Q	6458
A 4	1.6	74	10.96-07.99	AHL	4	1,0	BKUR6ET-10	2397	24	PFR6Q	6458
A 4	1.6	75	06.00-	ALZ	4	1,0	BKUR6ET-10	2397	24	PFR6Q	6458
A 4	1.8	85	07.95-12.98	AFY	4	1,0	BKUR6ET-10	2397	24	PFR6Q	6458
A 4	1.8	92	06.00-09.01	AVV	4	1,0	BKUR6ET-10	2397	24	PFR6Q	6458
A 4	1.8	92	07.98-09.01	ARG	4	1,0	BKUR6ET-10	2397	24	PFR6Q	6458
A 4	1.8	92	02.99-09.01	APT	4	1,0	BKUR6ET-10	2397	24	PFR6Q	6458
A 4	1.8	92	11.94-04.99	ADR	4	1,0	BKUR6ET-10	2397	24	PFR6Q	6458
A 4	1.8	110	08.98-09.01	APU	4	0,8	PFR6Q	6458			
A 4	1.8	110	05.99-06.00	ANB	4	0,8	PFR6Q	6458			
A 4	1.8	110	12.00-06.02	AVJ	4	0,8	PFR6Q	6458			
A 4	1.8	110	01.96-12.98	AEB	4	0,8	PFR6Q	6458			
A 4	1.8	110	06.00-09.01	AWT	4	0,8	PFR6Q	6458			
A 4	1.8	110	08.98-09.01	*APU*	4	0,8	PFR6Q	6458			
A 4	1.8	110	07.98-07.99	ARK	4	0,8	PFR6Q	6458			
A 4 (B6) USA	1.8	110	08.99-05.00	ATW	4	0,8	PFR6Q	6458			
A 4	1.8	120	07.02-	BFB	4	0,8	PFR6Q	6458			

¹⁾ Bic = Best in class (siehe Seite 3) / (see page 3)

Fgst = Chassis No.



l kW

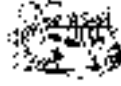

Cyl.

Order-
No. No.Bic¹⁾ Order-
No. No.**AUDI**

A 4	1.8	132	08.97-09.01	AJL	4	0,8	PFR6Q	6458				
A 4	1.8	140	11.02-	BEX	4	0,8	PFR6Q	6458				
A 4	1.9	55	03.96-06.00	AFF	4	█	Y-732U	2408				
A 4	1.9	66	11.94-07.96	1Z	4	█	Y-732U	2408				
A 4 TDI	1.9	66	04.97-09.01	AHH	4	█	Y-732U	2408				
A 4 TDI	1.9	66	08.96-06.00	AHU	4	█	Y-732U	2408				
A 4 TDI Fgst 8E-2-148-698 --->	1.9	74	04.01-	AVB	4	█	Y-741U	5065				
A 4 TDI Fgst ---> 8E-2-148-697	1.9	74	04.01-	AVB	4	█	Y-732U	2408				
A 4	1.9	81	02.96-07.99	AFN	4	█	Y-732U	2408				
A 4 TDI	1.9	81	08.99-06.00	AVG	4	█	Y-732U	2408				
A 4	1.9	85	08.98-09.01	AJM	4	█	Y-732U	2408				
A 4 TDI	1.9	85	01.00-09.01	ATJ	4	█	Y-732U	2408				
A 4 TDI Fgst 8E-2-148-698 --->	1.9	96	12.00-05.03	AWX	4	█	Y-741U	5065				
A 4 TDI Fgst 8E-2-148-698 --->	1.9	96	04.01-	AVF	4	█	Y-741U	5065				
A 4 TDI Fgst ---> 8E-2-148-697	1.9	96	12.00-06.03	AWX	4	█	Y-732U	2408				
A 4 TDI Fgst ---> 8E-2-148-697	1.9	96	04.01-	AVF	4	█	Y-732U	2408				
A 4	2.0	95	12.00-	ALT	4	1,0	BKUR5ET-10	7553				
A 4 FSI	2.0	110	07.02-	AWA	4	1,1	PZFR5N-11TG					
A 4	2.4	110	07.95-07.97	AFM	6	1,0	BKUR6ET-10	2397	24	PFR6Q	6458	
A 4	2.4	120	06.00-09.01	AMM	6	0,8	BKR6EKUB	3584	30	BKR6EQUP	3199	
A 4	2.4	120	08.97-07.98	AJG	6	0,8	BKR6EKUB	3584	30	BKR6EQUP	3199	
A 4	2.4	120	08.98-06.00	APZ	6	0,8	BKR6EKUB	3584	30	BKR6EQUP	3199	
A 4	2.4	121	08.98-09.01	AML	6	0,8	BKR6EKUB	3584	30	BKR6EQUP	3199	
A 4	2.4	121	08.97-07.98	AGA	6	0,8	BKR6EKUB	3584	30	BKR6EQUP	3199	
A 4	2.4	121	08.97-07.98	ALF	6	0,8	BKR6EKUB	3584	30	BKR6EQUP	3199	
A 4	2.4	121	08.98-09.01	APS	6	0,8	BKR6EKUB	3584	30	BKR6EQUP	3199	
A 4	2.4	121	08.98-06.00	ARJ	6	0,8	BKR6EKUB	3584	30	BKR6EQUP	3199	
A 4	2.4	125	09.01-	BDV	6	0,8	BKR6EKUB	3584	30	BKR6EQUP	3199	
A 4	2.5	110	07.98-09.01	AKN	6	█	Y-501U	3786				
A 4 TDI	2.5	110	11.97-06.00	AFB	6	█	Y-501U	3786				
A 4 TDI	2.5	114	04.01-06.02	AYM	6	█	Y-501U	3786				
A 4 TDI	2.5	120	06.03-	BCZ	6	█	Y-501U	3786				
A 4	2.5	120	07.02-05.03	BFC	6	█	Y-501U	3786				
A 4 TDI	2.5	120	06.03-	BDG	6	█	Y-501U	3786				
A 4 TDI	2.5	132	12.00-05.03	AKE	6	█	Y-501U	3786				
A 4 TDI	2.5	132	06.03-	BDH	6	█	Y-501U	3786				
A 4	2.5	132	06.03-	BAU	6	█	Y-501U	3786				
A 4 (China / GUS)	2.6	102	06.94-10.97	ACZ	6	1,0	BKUR6ET-10	2397	24	PFR6Q	6458	
A 4	2.6	110	11.94-07.97	ABC	6	1,0	BKUR6ET-10	2397	24	PFR6Q	6458	
A 4	2.8	128	11.94-04.97	AFC	6	1,0	BKUR6ET-10	2397	24	PFR6Q	6458	
A 4	2.8	128	11.94-07.97	AAH	6	1,0	BKUR6ET-10	2397	24	PFR6Q	6458	
A 4 (China,SA)	2.8	140	03.99-09.01	ATX	6	0,8	BKR6EKUB	3584	30	BKR6EQUP	3199	
A 4	2.8	142	08.98-06.00	AQD	6	0,8	BKR6EKUB	3584	30	BKR6EQUP	3199	
A 4	2.8	142	08.98-06.00	APR	6	0,8	BKR6EKUB	3584	30	BKR6EQUP	3199	
A 4	2.8	142	07.98-09.01	AMX	6	0,8	BKR6EKUB	3584	30	BKR6EQUP	3199	
A 4	2.8	142	05.97-07.98	ALG	6	0,8	BKR6EKUB	3584	30	BKR6EQUP	3199	
A 4 30V	2.8	142	03.96-07.98	ACK	6	0,8	BKR6EKUB	3584	30	BKR6EQUP	3199	
A 4 RS4	2.8	280	11.00-09.01	AZR	6		PFR7Q	7963				
A 4	3.0	160	04.01-	BBJ	6	0,8	BKR6EKUB	3584	30	BKR6EQUP	3199	
A 4	3.0	162	12.00-	ASN	6	0,8	BKR6EKUB	3584	30	BKR6EQUP	3199	
A 4	3.0	162	09.01-06.02	AVK	6	1,1	PFR6U-11G					
A 4	4.2	253	02.04-	BBK	8		BKR6EQUA					

¹⁾ Bic = Best in class (siehe Seite 3) / (see page 3)

Fgst = Chassis No.



ℓ kW

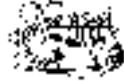

Cyl.

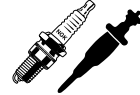
Order-
No. No.Bic¹⁾ Order-
No.**AUDI**

A 6	1.6	75	11.93-10.98	ABB	4	0,8	BUR6ET	3172	1	PGR6D	6248
A 6 (GUS)	1.8	85	05.97-05.00	AFY	4	1,0	BKUR6ET-10	2397	24	PFR6Q	6458
A 6	1.8	92		ANQ	4	1,0	BKUR6ET-10	2397	24	PFR6Q	6458
A 6	1.8	92	01.99-04.01	AQE	4	1,0	BKUR6ET-10	2397	24	PFR6Q	6458
A 6	1.8	92	01.99-04.01	ARH	4	1,0	BKUR6ET-10	2397	24	PFR6Q	6458
A 6	1.8	92	12.97-07.99	AJP	4	1,0	BKUR6ET-10	2397	24	PFR6Q	6458
A 6	1.8	92	10.95-10.97	ADR	4	1,0	BKUR6ET-10	2397	24	PFR6Q	6458
A 6	1.8	110		AWL	4	0,8	PFR6Q	6458			
A 6	1.8	110	01.99-05.01	ANB	4	0,8	PFR6Q	6458			
A 6	1.8	110	01.99-05.99	ARK	4	0,8	PFR6Q	6458			
A 6	1.8	110	04.97-01.99	AEB	4	0,8	PFR6Q	6458			
A 6	1.8	110	11.98-05.01	APU	4	0,8	PFR6Q	6458			
A 6	1.8	110	05.00-	AWT	4	0,8	PFR6Q	6458			
A 6	1.8	132	11.97-10.00	AJL	4	0,8	PFR6Q	6458			
A 6 TDI	1.9	66	07.96-10.97	AHU	4	█	Y-732U	2408			
A 6	1.9	66	07.94-06.96	IZ	4	█	Y-732U	2408			
A 6 TDI	1.9	74		AVB	4	█	Y-741U	5065			
A 6 TDI	1.9	81	08.99-10.00	AVG	4	█	Y-732U	2408			
A 6	1.9	81	04.97-04.01	AFN	4	█	Y-732U	2408			
A 6	1.9	85	11.00-04.01	AJM	4	█	Y-741U	5065			
A 6 TDI	1.9	96	06.01-	AVF	4	█	Y-732U	2408			
A 6 TDI	1.9	96	06.01-	AWX	4	█	Y-741U	5065			
A 6	2.0	74	06.94-06.96	AAE	4	0,8	BUR6ET	3172	1	PGR6D	6248
A 6	2.0	79	06.96-10.97	ADW	4	0,8	BUR6ET	3172	1	PGR6D	6248
A 6	2.0	85	06.94-06.96	ABK	4	0,8	BUR6ET	3172	1	PGR6D	6248
A 6	2.0	95	06.01-	ALT	4	1,0	BKUR5ET-10	7553			
A 6	2.0	103	06.94-10.97	ACE	4	0,8	BKUR7ET	7873		PFR7Q	7963
A 6	2.2	169	07.96-07.97	AAN	5	0,6	PFR7B	4853			
A 6	2.3	98	06.94-06.96	AAR	5	0,8	BPR5EKU	5685		PGR6D	6248
A 6	2.4	99	08.97-01.99	ALW	6	0,8	BKR6EKUB	3584		PFR6Q	6458
A 6	2.4	100	02.99-05.00	ARN	6	0,8	BKR6EKUB	3584	30	BKR6EQU	3199
A 6	2.4	100	06.00-	ASM	6	0,8	BKR6EKUB	3584	30	BKR6EQU	3199
A 6	2.4	110	07.95-10.97	AFM	6	1,0	BKUR6ET-10	2397	24	PFR6Q	6458
A 6	2.4	120	06.00-04.01	AMM	6	0,8	BKR6EKUB	3584	30	BKR6EQU	3199
A 6	2.4	120	11.98-05.01	APZ	6	0,8	BKR6EKUB	3584	30	BKR6EQU	3199
A 6	2.4	120	04.97-01.99	AJG	6	0,8	BKR6EKUB	3584	30	BKR6EQU	3199
A 6	2.4	121	04.98-05.01	APC	6	0,8	BKR6EKUB	3584	30	BKR6EQU	3199
A 6	2.4	121	04.97-01.99	AGA	6	0,8	BKR6EKUB	3584	30	BKR6EQU	3199
A 6	2.4	121	11.98-05.01	ARJ	6	0,8	BKR6EKUB	3584	30	BKR6EQU	3199
A 6	2.4	121	11.98-05.01	APS	6	0,8	BKR6EKUB	3584	30	BKR6EQU	3199
A 6	2.4	121	06.97-01.99	ALF	6	0,8	BKR6EKUB	3584	30	BKR6EQU	3199
A 6	2.4	121	06.00-05.01	AML	6	0,8	BKR6EKUB	3584	30	BKR6EQU	3199
A 6	2.4	125	06.01-	BDV	6	0,8	BKR6EKUB	3584	30	BKR6EQU	3199
A 6	2.5	85	06.94-10.97	AAT	5	█	Y-732U	2408			
A 6 TDI	2.5	103	10.94-10.97	AEL	5	█	Y-732U	2408			
A 6 TDI	2.5	110	04.97-05.00	AFB	6	█	Y-501U	3786			
A 6	2.5	110	10.98-05.01	AKN	6	█	Y-501U	3786			
A 6 TDI	2.5	114	06.01-06.02	AYM	6	█	Y-501U	3786			
A 6 TDI	2.5	120	02.03-	BCZ	6	█	Y-501U	3786			
A 6	2.5	120	07.02-08.03	BFC	6	█	Y-501U	3786			
A 6	2.5	120	02.03-	BDG	6	█	Y-501U	3786			
A 6	2.5	132	02.03-	BAU	6	█	Y-501U	3786			

¹⁾ Bic = Best in class (siehe Seite 3) / (see page 3)



l kW

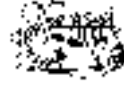

Cyl.

Order-
No. No.Bic¹⁾ Order-
No.**AUDI**

A 6 TDI	2.5	132	02.03-	BDH	6	Y-501U	3786				
A 6 TDI	2.5	132	11.99-	AKE	6	Y-501U	3786				
A 6 (China / GUS)	2.6	102	06.94-10.97	ACZ	6	1,0 BKUR6ET-10	2397	24	PFR6Q	6458	
A 6	2.6	110	06.94-10.97	ABC	6	1,0 BKUR6ET-10	2397	24	PFR6Q	6458	
A 6	2.7	169	09.00-05.01	AZA	6	0,8 PFR6Q	6458				
A 6 biturbo	2.7	169	02.99-08.00	AJK	6	0,8 PFR6Q	6458				
A 6 biturbo	2.7	184	05.00-06.02	ARE	6	0,8 PFR6Q	6458				
A 6	2.7	184	07.02-	BES	6	0,8 PFR6Q	6458				
A 6 biturbo	2.7	184	07.98-	APB	6	0,8 PFR6Q	6458				
A 6 (GUS)	2.8	120	07.96-10.97	AEJ	6	0,8 PFR5B	5341				
A 6	2.8	128	06.94-10.97	AAH	6	1,0 BKUR6ET-10	2397	24	PFR6Q	6458	
A 6	2.8	128	08.94-06.95	AFC	6	1,0 BKUR6ET-10	2397	24	PFR6Q	6458	
A 6	2.8	132	02.98-05.01	AGE	6	0,8 BKR6EKUB	3584	30	BKR6EQUP	3199	
A 6	2.8	140		BBG	6	0,8 BKR6EKUB	3584	30	BKR6EQUP	3199	
A 6	2.8	140	07.99-05.01	ATX	6	0,8 BKR6EKUB	3584	30	BKR6EQUP	3199	
A 6	2.8	142	06.00-05.01	AMX	6	0,8 BKR6EKUB	3584	30	BKR6EQUP	3199	
A 6	2.8	142	06.97-01.99	ALG	6	0,8 BKR6EKUB	3584	30	BKR6EQUP	3199	
A 6	2.8	142	11.98-05.01	APR	6	0,8 BKR6EKUB	3584	30	BKR6EQUP	3199	
A 6	2.8	142	11.98-05.01	AQD	6	0,8 BKR6EKUB	3584	30	BKR6EQUP	3199	
A 6	2.8	142	05.97-07.98	AHA	6	0,8 BKR6EKUB	3584	30	BKR6EQUP	3199	
A 6	2.8	142	10.95-07.98	ACK	6	0,8 BKR6EKUB	3584	30	BKR6EQUP	3199	
A 6	3.0	160	06.01-	BBJ	6	0,8 BKR6EKUB	3584	30	BKR6EQUP	3199	
A 6	3.0	162	06.01-	ASN	6	0,8 BKR6EKUB	3584	30	BKR6EQUP	3199	
A 6	3.7	191	10.98-02.01	AQG	8	BKR6EQUP	3199	30			
A 6	4.2	220	04.03-	BAS	8	BKR6EQUA					
A 6	4.2	220	06.00-	ASG	8	BKR6EQUP	3199	30	BKR6EQUP	3199	
A 6	4.2	220	04.99-05.00	ART	8	BKR6EQUP	3199	30	BKR6EQUP	3199	
A 6 4.2	4.2	221	04.99-05.01	ARS	8	BKR6EQUP	3199	30	BKR6EQUP	3199	
A 6	4.2	246	04.04-	BAT	8	BKR6EQUA					
A 8	2.5	110	11.97-09.02	AKN	6	Y-501U	3786				
A 8 TDI	2.5	110	06.97-04.00	AFB	6	Y-501U	3786				
A 8 TDI	2.5	132	11.99-09.02	AKE	6	Y-501U	3786				
A 8	2.8	120	07.95-03.96	AEJ	6	0,8 PFR5B	5341				
A 8	2.8	128	06.94-03.96	AAH	6	1,0 BKUR6ET-10	2397	24	PFR6Q	6458	
A 8	2.8	142	05.00-09.02	AMX	6	0,8 BKR6EKUB	3584	30	BKR6EQUP	3199	
A 8 V6	2.8	142	10.97-12.98	ALG	6	0,8 BKR6EKUB	3584	30	BKR6EQUP	3199	
A 8	2.8	142	01.99-02.01	APR	6	0,8 BKR6EKUB	3584	30	BKR6EQUP	3199	
A 8	2.8	142	01.99-02.01	AQD	6	0,8 BKR6EKUB	3584	30	BKR6EQUP	3199	
A 8	2.8	142	04.96-09.98	ACK	6	0,8 BKR6EKUB	3584	30	BKR6EQUP	3199	
A 8	3.0	160	07.03-	BBJ	6	0,8 BKR6EKUB	3584	30	BKR6EQUP	3199	
A 8	3.0	162	07.03-	ASN	6	0,8 BKR6EKUB	3584	30	BKR6EQUP	3199	
A 8 TDI	3.3	165	12.99-09.02	AKF	8	Y-501U	3786				
A 8	3.7	169	05.97-12.98	AKJ	8	0,8 BUR6EFSZ	6837				
A 8	3.7	169	07.95-12.98	AEW	8	0,8 BUR6EFSZ	6837				
A 8	3.7	191	05.00-09.02	AKC	8	0,8 BKR6EKUB	3584	30	BKR6EQUP	3199	
A 8	3.7	191	10.98-02.01	AQG	8	BKR6EQUP	3199	30			
A 8	3.7	206	11.02-	BFL	8	BKR6EQUP	3199	30			
A 8	4.2	175	02.99-04.00	ARU	8	BKR6EQUP	3199	30			
A 8 4.2	4.2	180	06.94-07.96	AEM	8	0,8 BUR6EFSZ	6837				
A 8	4.2	210	06.94-12.98	AGH	8	0,8 BUR6EFSZ	6837				
A 8	4.2	220	06.97-12.98	AKG	8	0,8 BUR6EFSZ	6837				
A 8 4.2	4.2	220	06.94-05.99	ABZ	8	0,8 BUR6EFSZ	6837				

¹⁾ Bic = Best in class (siehe Seite 3) / (see page 3)



ℓ kW

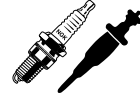

Cyl.

Order-
No. No.Bic¹⁾ Order-
No.**AUDI**

A 8	4.2	228	10.98-02.01	AQF	8		BKR6EQUP	3199	30		
A 8	4.2	228	05.00-09.02	AUW	8		BKR6EQUP	3199	30		
A 8	4.2	228	08.98-	AKB	8		BKR6EQUP	3199	30		
A 8	4.2	246	11.02-	BFM	8		BKR6EQUP	3199	30		
A 8	4.2	257	08.98-	AKD	8		BKR6EQUP	3199	30		
A 8	6.0	309	03.01-09.02	AZC	12	1,1	PZFR6J-11				
A 8	6.0	331	02.04-	BHT	12	1,1	PZFR6J-11				
80 D,TD	1.6	37	08.81-08.91		4	☑	Y-918R	4182			
80	1.6	40	08.82-07.89	JK	4	☑	Y-918R	4182			
80 TD	1.6	51	02.82-03.87	CY	4	☑	Y-918R	4182			
80	1.6	51	08.89-12.91	PP	4	1,0	BUR5ET-10	7264	21	PGR6D	6248
80	1.6	51	08.83-07.86	DTA	4	1,0	BP5ET-10	5156			
80	1.6	51	02.86-07.86	RNA	4	1,0	BP5ET-10	5156			
80	1.6	52	01.92-06.94	ABM	4	0,8	BUR5ET	3377	22	PGR6D	6248
80	1.6	53	02.86-03.87	SA	4	1,0	BP5ET-10	5156			
80	1.6	55	08.83-03.87	JU	4	1,0	BP5ET-10	5156			
80	1.6	55	08.83-03.87	DT	4	1,0	BP5ET-10	5156			
80	1.6	55	08.83-12.91	RN	4	1,0	BP5ET-10	5156			
80 TD	1.6	59	04.89-12.91	SB	4	☑	Y-918R	4182			
80	1.6	74	06.93-07.95	ADA	4	0,8	BUR6ET	3172	1	PGR6D	6248
80	1.6	75	08.90-05.93	ABB	4	0,8	BUR6ET	3172	1	PGR6D	6248
80	1.8	55	10.86-10.91	RU	4	1,0	BUR5ET-10	7264	21	PGR6D	6248
80	1.8	64	02.86-07.90	SF	4	0,8	BUR6ET	3172	1	PGR6D	6248
80	1.8	66	03.88-12.91	PM	4	0,8	BUR6ET	3172	1	PGR6D	6248
80	1.8	66	08.84-12.91	NE	4	0,8	BUR6ET	3172	1	PGR6D	6248
80	1.8	66	08.83-12.91	JN	4	0,8	BUR6ET	3172	1	PGR6D	6248
80	1.8	66	01.83-03.87	DS	4	0,8	BUR6ET	3172	1	PGR6D	6248
80	1.8	66	08.83-07.88	JV	4	0,8	BUR6ET	3172	1	PGR6D	6248
80	1.8	81	03.85-03.87	PV	4	0,8	BUR6ET	3172	1	PGR6D	6248
80	1.8	82	06.84-03.87	MU	4	0,8	BUR6ET	3172	1	PGR6D	6248
80	1.8	82	01.83-12.91	DZ	4	0,8	BUR6ET	3172	1	PGR6D	6248
80	1.9	47	08.89-12.91	1Y	4	☑	Y-918R	4182			
80 TD	1.9	55	09.91-07.95	AAZ	4	☑	Y-918R	4182			
80 TDi	1.9	66	09.91-07.95	1Z	4	☑	Y-732U	2408			
80	1.9	83	09.86-07.88	SD	4	0,8	BUR6ET	3172	1	PGR6D	6248
80	2.0	66	09.91-06.95	ABT	4	0,8	BUR6ET	3172	1	PGR6D	6248
80	2.0	74	12.90-10.94	AAE	4	0,8	BUR6ET	3172	1	PGR6D	6248
80	2.0	79	11.93-07.95	ADW	4	0,8	BUR6ET	3172	1	PGR6D	6248
80	2.0	83	08.88-10.90	3A	4	0,8	BUR6ET	3172	1	PGR6D	6248
80	2.0	83	08.83-03.87	SK	4	0,8	BUR6ET	3172	1	PGR6D	6248
80	2.0	85	08.90-12.91	AAD	4	0,8	BUR6ET	3172	1	PGR6D	6248
80	2.0	85	04.87-12.91	PS	4	0,8	BUR6ET	3172	1	PGR6D	6248
80	2.0	85	09.91-07.95	ABK	4	0,8	BUR6ET	3172	1	PGR6D	6248
80	2.0	101	03.90-07.92	6A	4	0,8	BKUR7ET	7873		PFR7Q	7963
80	2.0	103	08.92-07.95	ACE	4	0,8	BKUR7ET	7873		PFR7Q	7963
80 S2	2.2	169	02.93-07.95	ABY	5	0,6	PFR7B	4853			
80 Avant RS2	2.2	232	03.94-07.95	ADU	5	0,6	PFR7B	4853			
80	2.3	98	09.91-11.94	NG	5	0,8	BPR5EKU	5685		PGR6D	6248
80 (China / GUS)	2.6	102	05.93-07.95	ACZ	6	1,0	BKUR6ET-10	2397	24	PFR6Q	6458
80	2.6	110	07.92-07.95	ABC	6	1,0	BKUR6ET-10	2397	24	PFR6Q	6458
80	2.8	128	09.91-07.95	AAH	6	1,0	BKUR6ET-10	2397	24	PFR6Q	6458
90 TD	1.6	59	07.87-12.91	SB	4	☑	Y-918R	4182			

¹⁾ Bic = Best in class (siehe Seite 3) / (see page 3)



l kW

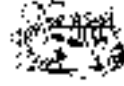

Cyl.

Order-
No. No.Bic¹⁾ Order-
No. No.**AUDI**

90	1.8	66	06.84-03.87	JN	4	0,8	BUR6ET	3172	1	PGR6D	6248
90	1.8	82	08.89-12.91	DZ	4	0,8	BUR6ET	3172	1	PGR6D	6248
90	2.0	81	10.84-03.87	JL	4	0,8	BUR6ET	3172	1	PGR6D	6248
90	2.0	85	10.84-03.87	JS	4	0,8	BUR6ET	3172	1	PGR6D	6248
90	2.0	85	10.84-03.87	HP	4	0,8	BUR6ET	3172	1	PGR6D	6248
90	2.0	118	08.88-10.91	NM	4	0,8	BCP7ET	2078		BCPR7EIX	5690
90	2.2	85	01.85-03.87	KX	5	0,8	BUR6ET	3172	1	PGR6D	6248
90	2.2	88	08.85-03.87	JT	5	0,8	BUR6ET	3172	1	PGR6D	6248
90	2.2	100	06.84-12.91	KV	5	0,8	BUR6ET	3172	1	PGR6D	6248
90	2.2	100	06.84-03.87	HY	5	0,8	BUR6ET	3172	1	PGR6D	6248
90	2.3	98	04.87-12.91	NG	5	0,8	BPR5EKU	5685		PGR6D	6248
90	2.3	125	06.88-12.91	7A	5	0,8	BKUR7ET	7873		PFR7Q	7963
90	2.8	128	07.93-05.95	AFC	6	1,0	BKUR6ET-10	2397	24	PFR6Q	6458
100	1.6	75	03.92-07.93	ABB	4	0,8	BUR6ET	3172	1	PGR6D	6248
100	1.8	55	10.86-12.87	RS	4	1,0	BUR5ET-10	7264	21	PGR6D	6248
100	1.8	55	05.82-10.86	DR	4	0,8	BP6ESZ	7639		PGR6D	6248
100	1.8	65	02.86-07.90	SH	4	0,8	BUR6ET	3172	1	PGR6D	6248
100	1.8	66	10.84-12.90	NP	4	0,8	BUR6ET	3172	1	PGR6D	6248
100	1.8	66	03.83-12.90	JW	4	0,8	BUR6ET	3172	1	PGR6D	6248
100	1.8	66	05.83-07.89	DS	4	0,8	BUR6ET	3172	1	PGR6D	6248
100	1.8	66	10.84-12.90	4B	4	0,8	BUR6ET	3172	1	PGR6D	6248
100	1.8	66	04.85-12.90	PH	4	0,8	BUR6ET	3172	1	PGR6D	6248
100 D,TD	2.0	51	08.82-11.90		4	█	Y-918R	4182			
100	2.0	74	12.90-07.94	AAE	4	0,8	BUR6ET	3172	1	PGR6D	6248
100	2.0	79	12.93-07.94	ADW	4	0,8	BUR6ET	3172	1	PGR6D	6248
100	2.0	83	02.86-12.87	SL	4	0,8	BUR6ET	3172	1	PGR6D	6248
100	2.0	85	01.88-12.92	RT	4	0,8	BUR6ET	3172	1	PGR6D	6248
100	2.0	85	01.93-07.94	ABK	4	0,8	BUR6ET	3172	1	PGR6D	6248
100	2.0	85	08.84-12.87	KP	5	0,8	BUR6ET	3172	1	PGR6D	6248
100	2.0	85	12.90-12.92	AAD	4	0,8	BUR6ET	3172	1	PGR6D	6248
100	2.0	103	01.92-07.94	ACE	4	0,8	BKUR7ET	7873		PFR7Q	7963
100	2.2	85	08.84-09.86	KZ	5	0,8	BUR6ET	3172	1	PGR6D	6248
100	2.2	88	08.85-07.88	PX	5	0,8	BUR6ET	3172	1	PGR6D	6248
100 China	2.2	100	08.89-12.90	PR	5	0,7	BP6ES	7811	4	BPR6EIX	6637
100	2.2	101	08.84-07.86	HX	5	0,8	BUR6ET	3172	1	PGR6D	6248
100	2.2	101	08.84-12.90	KU	5	0,8	BUR6ET	3172	1	PGR6D	6248
100	2.2	121	03.86-12.90	MC	5	0,8	BUR6ET	3172	1	PGR6D	6248
100	2.3	98	12.90-07.94	AAR	5	0,8	BPR5EKU	5685		PGR6D	6248
100	2.3	100	08.86-12.90	NF	5	0,8	BPR5EKU	5685		PGR6D	6248
100	2.4	60	05.91-07.94	AAS	5	█	Y-918R	4182			
100 D	2.4	60	08.89-12.90	3D	5	█	Y-918R	4182			
100 TDI	2.5	85	08.91-07.94	AAT	5	█	Y-732U	2408			
100 TDI	2.5	85	04.91-07.92	ABP	5	█	Y-732U	2408			
100 TDI	2.5	88	01.90-12.90	1T	5	█	Y-732U	2408			
100 (China / GUS)	2.6	102	01.93-07.94	ACZ	6	1,0	BKUR6ET-10	2397	24	PFR6Q	6458
100	2.6	110	03.92-07.94	ABC	5	1,0	BKUR6ET-10	2397	24	PFR6Q	6458
100	2.8	128	12.90-07.94	AAH	6	1,0	BKUR6ET-10	2397	24	PFR6Q	6458
200	2.2	100	08.79-07.85	KH	5	0,8	BUR6ET	3172	1	PGR6D	6248
200	2.2	101	08.84-07.85	KU	5	0,8	BUR6ET	3172	1	PGR6D	6248
200	2.2	121	01.85-11.90	MC	5	0,8	BUR6ET	3172	1	PGR6D	6248
200	2.2	134	08.83-01.87	JY	5	0,8	BUR6ET	3172	1	PGR6D	6248
200	2.2	134	08.83-12.87	KG	5	0,8	BUR6ET	3172	1	PGR6D	6248

¹⁾ Bic = Best in class (siehe Seite 3) / (see page 3)



ℓ kW

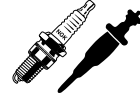

Cyl.

Order-
No. No.Bic¹⁾ Order-
No.**AUDI**

200	2.2	147	02.88-11.90	1B	5	0,8	BUR6ET	3172	1	PGR6D	6248
200	2.2	162	03.89-11.90	3B	5	0,6	PFR7B	4853			
200	2.3	140	02.88-11.90	2B	5	0,8	BUR6ET	3172	1	PGR6D	6248
Coupe	1.8	64	02.86-07.87	SF	4	0,8	BUR6ET	3172	1	PGR6D	6248
Coupe	1.8	66	01.85-07.88	JN	4	0,8	BUR6ET	3172	1	PGR6D	6248
Coupe	1.8	66	08.82-07.88	DS	4	0,8	BUR6ET	3172	1	PGR6D	6248
Coupe	1.8	66	01.85-07.87	JV	4	0,8	BUR6ET	3172	1	PGR6D	6248
Coupe	1.8	81	08.86-07.88	PV	4	0,8	BUR6ET	3172	1	PGR6D	6248
Coupe	1.8	82	08.86-07.91	DZ	4	0,8	BUR6ET	3172	1	PGR6D	6248
Coupe	2.0	81	08.83-07.88	JL	4	0,8	BUR6ET	3172	1	PGR6D	6248
Coupe	2.0	83	05.89-07.90	3A	4	0,8	BUR6ET	3172	1	PGR6D	6248
Coupe	2.0	83	02.86-07.86	SK	4	0,8	BUR6ET	3172	1	PGR6D	6248
Coupe	2.0	85	08.90-07.91	AAD	4	0,8	BUR6ET	3172	1	PGR6D	6248
Coupe	2.0	85	08.91-12.95	ABK	4	0,8	BUR6ET	3172	1	PGR6D	6248
Coupe	2.0	85	08.83-07.86	JS	4	0,8	BUR6ET	3172	1	PGR6D	6248
Coupe	2.0	85	08.83-07.86	HP	4	0,8	BUR6ET	3172	1	PGR6D	6248
Coupe	2.0	101	03.90-07.92	6A	4	0,8	BKUR7ET	7873		PFR7Q	7963
Coupe	2.0	103	08.92-12.95	ACE	4	0,8	BKUR7ET	7873		PFR7Q	7963
Coupe	2.0	118	11.88-07.91	NM	4	0,8	BCP7ET	2078		BCPR7EIX	5690
Coupe	2.2	85	01.85-07.88	KX	5	0,8	BUR6ET	3172	1	PGR6D	6248
Coupe	2.2	100	08.84-07.88	HY	5	0,8	BUR6ET	3172	1	PGR6D	6248
Coupe	2.2	100	08.84-07.91	KV	5	0,8	BUR6ET	3172	1	PGR6D	6248
Coupe S2	2.2	162	09.90-09.92	3B	5	0,6	PFR7B	4853			
Coupe S2	2.2	169	10.92-12.95	ABY	5	0,6	PFR7B	4853			
Coupe	2.3	98	08.86-07.94	NG	5	0,8	BPR5EKU	5685		PGR6D	6248
Coupe	2.3	125	11.88-07.91	7A	5	0,8	BKUR7ET	7873		PFR7Q	7963
Coupe	2.6	110	08.92-12.95	ABC	6	1,0	BKUR6ET-10	2397	24	PFR6Q	6458
Coupe	2.8	128	08.91-12.95	AAH	6	1,0	BKUR6ET-10	2397	24	PFR6Q	6458
Quattro	2.2	147	08.87-07.89	MB	5	0,8	BUR6ET	3172	1	PGR6D	6248
V 8 3.6	3.6	184	10.88-11.93	PT	8	0,8	BUR6EFSZ	6837			
V 8 4.2	4.2	206	08.91-11.93	ABH	8	0,8	BUR6EFSZ	6837			
Cabrio	1.8	92	04.97-08.00	ADR	4	1,0	BKUR6ET-10	2397	24	PFR6Q	6458
Cabrio	1.9	66	07.95-07.96	1Z	4		Y-732U	2408			
Cabrio	1.9	66	07.96-08.00	AHU	4		Y-732U	2408			
Cabrio	2.0	85	01.93-09.98	ABK	4	0,8	BUR6ET	3172	1	PGR6D	6248
Cabrio	2.0	103	05.95-07.96	ACE	4	0,8	BKUR7ET	7873		PFR7Q	7963
Cabrio	2.3	98	06.91-07.94	NG	5	0,8	BPR5EKU	5685		PGR6D	6248
Cabrio (China / GUS)	2.6	102	05.95-12.99	ACZ	6	1,0	BKUR6ET-10	2397	24	PFR6Q	6458
Cabrio	2.6	110	01.94-08.00	ABC	6	1,0	BKUR6ET-10	2397	24	PFR6Q	6458
Cabrio	2.8	128	11.94-07.98	AFC	6	1,0	BKUR6ET-10	2397	24	PFR6Q	6458
Cabrio	2.8	128	11.92-08.00	AAH	6	1,0	BKUR6ET-10	2397	24	PFR6Q	6458
RS 4 biturbo	2.7	280	03.00-10.00	ASJ	6		PFR7Q	7963			
RS 6	4.2	331	07.02-04.04	BCY	8		PFR7Q	7963			
RS 6	4.2	353	04.04-09.04	BRV	8		PFR7Q	7963			
S 3	1.8	154	09.99-04.01	AUL	4	0,8	PFR6Q	6458			
S 3	1.8	154	11.98-08.00	APY	4	0,8	PFR6Q	6458			
S 3	1.8	154	09.00-04.02	AMK	4	0,8	PFR6Q	6458			
S 3	1.8	165	08.01-06.03	BAM	4	0,8	PFR6Q	6458			
S 4	2.2	169	08.91-07.94	AAN	5	0,6	PFR7B	4853			
S 4 biturbo	2.7	169	07.98-	AJK	6	0,8	PFR6Q	6458			
S 4 biturbo	2.7	184	07.98-12.98	APB	6	0,8	PFR6Q	6458			
S 4	2.7	195	11.00-09.01	AZB	6	0,8	PFR6Q	6458			

¹⁾ Bic = Best in class (siehe Seite 3) / (see page 3)



l kW

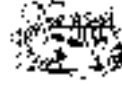

Cyl.

Order-
No. No.Bic¹⁾ Order-
No. No.**AUDI**

S 4 biturbo	2.7	195	10.97-09.01	AGB	6	0,8	PFR6Q	6458			
S 4	4.2	206	10.92-07.94	ABH	8	0,8	BUR6EFSZ	6837			
S 4	4.2	253	03.03-	BBK	8		BKR6EQUA				
S 6	2.2	169	06.94-07.97	AAN	5	0,6	PFR7B	4853			
S 6 4.2	4.2	213	09.94-10.97	AEC	8	0,8	BUR6EFSZ	6837			
S 6 Plus	4.2	235	06.96-10.97	AHK	8	0,8	BUR6EFSZ	6837			
S 6	4.2	250	09.99-05.01	AQJ	8		BKR6EQUA	3199	30		
S 6	4.2	250	09.00-	ANK	8		BKR6EQUA	3199	30		
S 8	4.2	250	08.97-12.98	AKH	8		BUR6EFSZ	6837			
S 8	4.2	250	09.96-12.98	AHC	8	0,8	BUR6EFSZ	6837			
S 8	4.2	265	02.01-09.02	AYS	8		BKR6EQUA	3199	30		
S 8	4.2	265	09.00-02.01	BCS	8		BKR6EQUA	3199	30		
S 8	4.2	265	09.00-09.02	AVP	8		BKR6EQUA	3199	30		
S 8	4.2	265	05.99-02.01	AQH	8		BKR6EQUA	3199	30		
TT / TTS	1.8	110	01.01-	AUM	4	0,8	PFR6Q	6458			
TT / TTS	1.8	132	09.00-	AUQ	4	0,8	PFR6Q	6458			
TT / TTS	1.8	132	09.99-09.00	APP	4	0,8	PFR6Q	6458			
TT / TTS USA	1.8	132	09.00-	AWP	4	0,8	PFR6Q	6458			
TT / TTS	1.8	132	10.98-08.00	AJQ	4	0,8	PFR6Q	6458			
TT / TTS	1.8	132	09.00- 05	ARY	4	0,8	PFR6Q	6458			
TT / TTS USA	1.8	165	03.00-	AMU	4	0,8	PFR6Q	6458			
TT / TTS	1.8	165	10.98-08.01	APX	4	0,8	PFR6Q	6458			
TT / TTS	1.8	165	09.00-	BAM	4	0,8	PFR6Q	6458			
TT / TTS	3.2	184	07.03-	BHE	6	0,9	IZKR7B				

AUSTIN

1100	1.1				4	0,6	BP6ES	7811	4	BPR6EIX	6637
1300	1.3				4	0,6	BP6ES	7811	4	BPR6EIX	6637
1500	1.5				4	0,6	BP6ES	7811	4	BPR6EIX	6637
1700	1.7			O SERIES	4	0,6	BP6EF	4666			
1800	1.8				4	0,6	BP6ES	7811	4	BPR6EIX	6637
2000	2.0			O SERIES	4	0,6	BP6EF	4666			
2200	2.2				6	0,6	BP6ES	7811	4	BPR6EIX	6637
Maestro 1,3HLE	1.3		-08.88		4	0,6	BP6ES	7811	4	BPR6EIX	6637
Maestro	1.3		03.83-07.89	A-PLUS	4	0,8	BPR6ES	7822	2	BPR6EIX	6637
Maestro 1,6HLE	1.6		-08.88		4	0,6	BP6ES	7811	4	BPR6EIX	6637
Maestro	1.6		05.84-07.89	S-Serie	4	0,6	BCPR6ES	2330	12	BCPR6EIX-11	4919
Maestro (D)	1.6		05.84-07.89	S-Serie	4	0,6	BCP7ES	5030		BCP7EVX	7681
Metro			10.84-04.90		4	0,6	BP6ES	7811	4	BPR6EIX	6637
Metro	1.0		01.87-01.90		4	0,6	BP5ES	6511	8	BPR5EIX	6597
Metro 310	1.0		09.89-04.92		4	0,6	BP6ES	7811	4	BPR6EIX	6637
Metro	1.0		01.90-09.90		4	0,6	BPR5ES	7422	6	BPR5EIX	6597
Metro	1.0		10.80-12.86		4	0,6	BP6ES	7811	4	BPR6EIX	6637
Metro	1.3		10.80-04.92		4	0,6	BPR6ES	7822	2	BPR6EIX	6637
Metro 310	1.3		09.89-04.92		4	0,8	BPR6ES	7822	2	BPR6EIX	6637
Mini			07.89-10.89	ERA Turbo	4	0,6	BPR7ES	2023	19	BPR7EIX	4055
Mini			01.87-10.89	not Turbo	4	0,6	BP5ES	6511	8	BPR5EIX	6597
Mini			08.59-12.86	not Turbo	4	0,8	BP6ES	7811	4	BPR6EIX	6637
Mini	1.0	31	09.86-08.88		4	0,6	BP6ES	7811	4	BPR6EIX	6637
Minor	1.0				4	0,6	BP6ES	7811	4	BPR6EIX	6637

¹⁾ Bic = Best in class (siehe Seite 3) / (see page 3)



ℓ kW

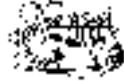

Cyl.

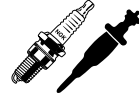
Order-
No. No.Bic¹⁾ Order-
No.**AUTOBIANCHI**

Y10 Fire	1.0	32	10.87-09.92	156A2.100	Cat.	4	0,8	BCPR6ES	2330	12	BCPR6EIX-1	4919
Y10 Fire/Fire LX/Fire 4WD	1.0	37	09.86-12.88	156A3..		4	0,8	BCPR6ES	2330	12	BCPR6EIX-1	4919
Y10 Touring	1.05	38	03.85-02.89	156A0..		4	0,8	BPR6ES	7822	2	BPR6EIX	6637
Y10 Turbo	1.05	63	03.85-02.89	156A1..		4	0,6	BR8ES	5422			
Y10 i.e Junior	1.1	37	03.94-10.96	156C046		4	0,8	BCPR6ES	2330	12	BCPR6EIX-1	4919
Y10 i.e Mia	1.1	37	01.94-10.96	156C046		4	0,8	BCPR6ES	2330	12	BCPR6EIX-1	4919
Y10 i.e Selectronic Ville	1.1	37	03.94-01.95	156C046		4	0,8	BCPR6ES	2330	12	BCPR6EIX-1	4919
Y10 i.e Igloo	1.1	37	03.94-10.96	156C046		4	0,8	BCPR6ES	2330	12	BCPR6EIX-1	4919
Y10 i.e 4WD Sestrieres	1.1	37	03.94-10.96	156C046		4	0,8	BCPR6ES	2330	12	BCPR6EIX-1	4919
Y10 i.e.	1.1	40	03.95-			4	0,8	BCPR6ES	2330	12	BCPR6EIX-1	4919
Y10 Fire IE alle Modelle	1.1	41	01.89-10.96	156C000		4	0,8	BCPR6ES	2330	12	BCPR6EIX-1	4919
Y10 i.e GT/i.e GT Kat./Elite	1.3	53	11.87-09.92	156C5.046		4	0,8	BPR6ES	7822	2	BPR6EIX	6637

AUVERLAND

A3 D	1.9	51		PSA engine		4	█	Y-902R	2237			
A3 TD	1.9	67		PSA engine		4	█	Y-923U	3380			
A4 D	1.9	51		PSA engine		4	█	Y-902R	2237			
A4 TD	1.9	67		PSA engine		4	█	Y-923U	3380			

AVIA

A21.1 D			10.90-			4	█	Y-208T	1250			
Avia D	3.6	65	-01.93	D407		4	█	Y-208T	1250			

AVTOVAZ

Lada 2101/ 21011/ 21012/ 21013/ 21014						4	0,7	BP6ES	7811	4	BPR6EIX	6637
Lada 2102/ 21021/ 21022/ 21023/ 21024/ 21026						4	0,7	BP6ES	7811	4	BPR6EIX	6637
Lada 2103/ 21033/ 21035						4	0,7	BP6ES	7811	4	BPR6EIX	6637
Lada 2104/ 21043/ 21046/ 21047						4	0,7	BP6ES	7811	4	BPR6EIX	6637
Lada 2105/ 21051/ 21053/ 21056/ 21057						4	0,7	BP6ES	7811	4	BPR6EIX	6637
Lada 2106/ 21061/ 21064/ 21065-01/ 21066						4	0,7	BP6ES	7811	4	BPR6EIX	6637
Lada 2107/ 21072/ 21073/ 21074/ 21076/ 21077/ 21078/ 210736-40						4	0,7	BP6ES	7811	4	BPR6EIX	6637
Lada 2108/ 21081/ 21083/ 21087/ 21088						4	0,8	BPR6ES	7822	2	BPR6EIX	6637
Lada 21083i/ 21093i/ 21099i/ 21102/ 211026/ 21110/ 2131i						4	1,1	BPR6ES-11	4824	13	BPR6EIX-11	3903
Lada 2109/ 21091/ 21093						4	0,8	BPR6ES	7822	2	BPR6EIX	6637
Lada 21099						4	0,8	BPR6ES	7822	2	BPR6EIX	6637
Lada 2110/ 2111						4	0,8	BPR6ES	7822	2	BPR6EIX	6637
Lada 21103/ 211036/ 21113/ 21109/ 21108/ 21083-37/ 2112/ 2113/ 21103						4	1,1	BCPR6ES-11	7121	11	BCPR6EIX-11	4919
Lada 2115-01/ 2115-03/ 21153-01						4	0,8	BPR6ES	7822	2	BPR6EIX	6637
Lada 2115-20/ 2115-21/ 2115-23/ 21153-21						4	1,1	BPR6ES-11	4824	13	BPR6EIX-11	3903
Lada NIVA 4x4 2121						4	0,7	BP6ES	7811	4	BPR6EIX	6637
Lada NIVA 4x4 21211/ 21212						4	0,8	BPR6ES	7822	2	BPR6EIX	6637
Lada NIVA 4x4 2131/ 2130/ 2129/ 21217/ 21214/ 21213						4	0,8	BPR6ES	7822	2	BPR6EIX	6637

¹⁾ Bic = Best in class (siehe Seite 3) / (see page 3)



l kW

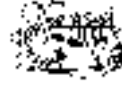

Cyl.

Order-
No. No.Bic¹⁾ Order-
No.**AVTOVAZ**

Lada OKA 1111/ 1113					4	0,7	BGP6ES	4930	17	BCPR6EIX-11	4919
---------------------	--	--	--	--	---	-----	--------	------	----	-------------	------

AZLK

Moskwitch 214101		56		VAZ 2106-70	4	0,7	BP6ES	7811	4	BPR6EIX	6637
Moskwitch 21412/ 2140/ 2137/ 2734/ 407/ 408/ 410/ 412/ 427/ 434		53		UZAM-331.10,412	4	0,8	BP7ES	2412		BPR7EIX	4055

BARKAS

B 1000 Serie	0.9	34	01.75-12.90		4	0,6	B6HS	4510		BR6HIX	3419
B 1000 Serie	1.3	34	01.75-12.90	BM 880	4	0,6	B6HS	4510		BR6HIX	3419

BEDFORD

Astra Max D	1.6		02.85-	16D OHC	4	█	Y-902R	2237			
Astra Van D	1.6		03.82-	16D OHC	4	█	Y-902R	2237			
Brava	2.3				4	0,7	BPR6ES	7822	2	BPR6EIX	6637
Brava Pickup 4x4	2.2		12.98-			█	Y-306R	6244			
CF2 Van	2.0	57	08.84-07.87		4	0,7	BPR6HS	7022	3	BPR6HIX	4085
Chevanne	1.3				4	0,8	BP6ES	7811	4	BPR6EIX	6637
HA	1.2				4	0,8	BP6ES	7811	4	BPR6EIX	6637
KB26/41	1.6		01.84-01.88		4	0,8	BPR6ES	7822	2	BPR6EIX	6637
Midi	1.8	55	02.85-05.90	4ZB1	4	0,8	BPR6ES	7822	2	BPR6EIX	6637
Midi 2.0TD	2.0		03.88-05.90		4	█	Y-711RS	4444			
Midi 2.0TD	2.0	50	03.88-05.90		4	█	Y-307R	5837			
Midi	2.0	60	03.88-05.90		4	0,8	BPR6ES	7822	2	BPR6EIX	6637
Midi 2.2D	2.2		03.88-05.90		4	█	Y-711RS	4444			
Midi 2.2D	2.2	44	03.88-05.90		4	█	Y-307R	5837			
Rascal	1.0	32	02.86-05.90		4	0,8	BPR5ES	7422	6	BPR5EIX	6597
TK						0,8	B6S	3510			

BENTLEY

Arnage	4.4		09.99- 01	BMW	8		BKR6EQUP	3199	30		
Arnage	4.4	210	04.98-08.98	BMW M62B44	8	0,8	BKR6EK	2288	20**	BKR6EQUP	3199
Arnage	4.4	210	08.98-	BMW M62B44	8		BKR6EQUP	3199	30		
Arnage Le Mans	6.8		03.01-	RR	8	0,9	BKR4EVX	4870			
Arnage Red Label V8 6.8 turbo	6.8		09.99-	RR	8	0,9	BKR5EVX	2546		BKR5EIX	6341
Azure	6.7					0,9	BKR4EVX	4870			
Azure	6.8		03.95-		8	0,9	BKR5EVX	2546		BKR5EIX	6341
Azure Mulliner	6.8		03.99-		8	0,9	BKR5EVX	2546		BKR5EIX	6341
Continental / Mulliner	6.8		02.97-		8	0,9	BKR5EVX	2546		BKR5EIX	6341
Continental R Mulliner	6.8		03.99-		8	0,9	BKR5EVX	2546		BKR5EIX	6341
Continental R	6.8		12.91-		8	0,9	BKR5EVX	2546		BKR5EIX	6341
Continental SC / Mulliner	6.8		03.99-09.00		8	0,9	BKR5EVX	2546		BKR5EIX	6341
Continental R Le Mans	6.8		03.01-		8	0,9	BKR5EVX	2546		BKR5EIX	6341
Continental	6.8		89-	L4101	Cat.	1,0	BPR4EVX	3436			
Continental R	6.8		03.92-	L4101T	Cat.	1,0	BPR4EVX	3436			
Corniche 71--->02	6.8		07.93-08.95		8	0,9	BKR4EVX	4870			
Corniche 71--->02	6.8		09.95-		8	0,9	BKR5EVX	2546		BKR5EIX	6341
Corniche 71--->02	6.8		01.89-06.93		8	0,9	BPR4EVX	3436			
Corniche 71--->02	6.8		03.87-12.88		8	1,0	BPR5EV	4728			
Eight	6.8		89-	L4101	Cat.	1,0	BPR4EVX	3436			
Mulsanne / S / Eight	6.8		01.89-06.93		8	0,9	BPR4EVX	3436			
Mulsanne / S / Eight	6.8		07.93-		8	0,9	BKR4EVX	4870			

¹⁾ Bic = Best in class (siehe Seite 3) / (see page 3)

** alternative/wahlweise V-Line 30



ℓ kW

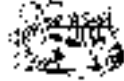

Cyl.

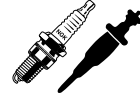
Order-
No. No.

V-LINE

Bic¹⁾ Order-
No. No.**BENTLEY**

Mulsanne / S / Eight	6.8		10.80-11.86			8	0.8	BPR5ES	7422	6	BPR5EIX	6597
Mulsanne TURBO --->85	6.8		01.82-09.85			8	0.8	BPR5ES	7422	6	BPR5EIX	6597
Mulsanne / S / Eight	6.8		12.86-12.88			8	1.0	BPR5EV	4728			
Mulsanne S	6.8		89-	L4101	Cat.		1.0	BPR4EVX	3436			
S TYPE	4.6					6	0.6	B6ES	7310			
S TYPE	6.2					8	0.6	BP5E	4669			
Turbo R 85--->96	6.8		01.89-09.96			8	0.9	BKR5EVX	2546		BKR5EIX	6341
Turbo R 85--->96	6.8		01.87-12.88			8	1.0	BPR5EV	4728			
Turbo R	6.8		89-	L4101T	Cat.	8	1.0	BPR4EVX	3436			

BERTONE

Freeclimber 1.6i	1.6	74	02.92-	M40B16		4	0.8	BKR6EK	2288	20**	BKR6EQU	3199
Freeclimber 2.0i 4x4	2.0	95	01.91-	M20B20		6	0.8	ZGR5A	5839	15		
Freeclimber 2.7i 4x4	2.7	95	01.91-	M20B27		6	0.8	ZGR5A	5839	15		

BMW

116i	E87	1.6	85	09.05-	N45 B16	4		BKR6EQU				
120 i	E87	2.0	105	09.05-	N42 B20	4		BKR6EQU	3199	30		
316	E21	1.8	66	09.80-08.87	M10 B18	4	0.8	BP5ES	6511	8	BPR5EIX	6597
316 g Compact	E36/5	1.6	65	02.96-07.00	M43 B16	4	0.8	BKR6EK	2288	20**	BKR6EQU	3199
316 i	E30	1.6	73	09.88-09.94	M40 B16	4	0.8	BKR6EK	2288	20**	BKR6EQU	3199
316 i	E30	1.8	75	09.87-08.88	M10 B18	4	0.8	BP5ES	6511	8	BPR5EIX	6597
316 i	E36	1.6	73	05.91-08.93	M40 B16	4	0.8	BKR6EK	2288	20**	BKR6EQU	3199
316 i	E36	1.6	75	08.93-05.99	M43 B16	4	0.8	BKR6EK	2288	20**	BKR6EQU	3199
316 i Compact	E36/5	1.6	75	04.94-12.98	M43 B16	4	0.8	BKR6EK	2288	20**	BKR6EQU	3199
316 i Compact	E36/5	1.9	77	01.99-	M43 B19	4	0.8	BKR6EK	2288	20**	BKR6EQU	3199
316 i Touring	E46/3	1.8	85	10.01-	N42 B18	4		BKR6EQU	3199	30		
316 i	E46/4	1.8	85	10.01-	N42 B18	4		BKR6EQU	3199	30		
316 i	E46/4	1.9	77	01.99-	M43 B19	4		BKR6EQU	3199	30		
316 ti Compact	E46/5	1.8	85	05.01-	N42 B18	4		BKR6EQU	3199	30		
318 Ci	E46/2	1.9	87	09.99-	M43 B19	4		BKR6EQU	3199	30		
318 Ci	E46/2	2.0	105	09.01-	N42 B20	4		BKR6EQU	3199	30		
318 Ci Cabrio	E46/C	2.0	105	09.01-	N42 B20	4		BKR6EQU	3199	30		
318 d Touring	E46/3	2.0	85	09.01-	M47 D20	4	█	Y-507R	4600			
318 d	E46/4	2.0	85	09.01-	M47 D20	4	█	Y-507R	4600			
318 i	E30	1.8	75	12.84-08.87	M10 B18	4	0.8	BP5ES	6511	8	BPR5EIX	6597
318 i	E30	1.8	77	09.82-08.87	M10 B18	4	0.8	BP5ES	6511	8	BPR5EIX	6597
318 i Touring	E30	1.8	82	04.89-09.94	M40 B18	4	0.8	BKR6EK	2288	20**	BKR6EQU	3199
318 i	E30	1.8	83	09.87-04.91	M40 B18	4	0.8	BKR6EK	2288	20**	BKR6EQU	3199
318 i	E36	1.8	83	10.90-09.93	M40 B18	4	0.8	BKR6EK	2288	20**	BKR6EQU	3199
318 i	E36	1.8	85	08.93-09.99	M43 B18	4	0.8	BKR6EK	2288	20**	BKR6EQU	3199
318 i Touring	E36/3	1.8	85	09.94-09.99	M43 B18	4	0.8	BKR6EK	2288	20**	BKR6EQU	3199
318 i Touring	E46/3	1.9	87	09.00-	M43 B19	4		BKR6EQU	3199	30		
318 i Touring	E46/3	2.0	105	09.01-	N42 B20	4		BKR6EQU	3199	30		
318 i	E46/4	1.9	87	04.98-	M43 B19	4		BKR6EQU	3199	30		
318 i	E46/4	2.0	105	09.01-	N42 B20	4		BKR6EQU	3199	30		
318 iS	E30	1.8	103	09.89-10.90	M42 B18	4	0.8	BKR6EK	2288	20**	BKR6EQU	3199
318 iS	E36	1.8	103	10.91-03.96	M42 B18	4	0.8	BKR6EK	2288	20**	BKR6EQU	3199
318 iS Coupe	E36	1.9	103	01.96-09.99	M44 B19	4	0.8	BKR6EK	2288	20**	BKR6EQU	3199
318 Tds	E36	1.8	66	11.94-02.98	M41 D18	4	█	Y-917U	3219			
318 ti Compact	E36/5	1.8	103	11.94-02.96	M42 B18	4	0.8	BKR6EK	2288	20**	BKR6EQU	3199
318 ti Compact	E36/5	1.9	103	01.96-	M44 B19	4	0.8	BKR6EK	2288	20**	BKR6EQU	3199

¹⁾ Bic = Best in class (siehe Seite 3) / (see page 3)

** alternative/wahlweise V-Line 30



l kW

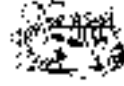

Cyl.

Order-
No. No.Bic¹⁾ Order-
No. No.**BMW**

318 ti Compact	E46/5	2.0	105	09.01-	N42 B20	4		BKR6EQP	3199	30			
320 Ci	E46/2	2.0	110	06.99-	M52 B20	6		BKR6EQP	3199	30			
320 Ci	E46/2	2.2	125	08.00-	M54 B22	6		BKR6EQP	3199	30			
320 Ci Cabrio	E46/C	2.2	125	08.00-	M54 B22	6		BKR6EQP	3199	30			
320 d Touring	E46/3	2.0	100	09.00-08.01	M47 D20	4	■	Y-507R	4600				
320 d	E46/4	2.0	100	04.98-08.01	M47 D20	4	■	Y-507R	4600				
320 i	E30	2.0	90	12.86-12.90	M20 B20	Cat. 6	0,8	ZGR5A	5839	15			
320 i Touring	E30	2.0	90	01.88-08.91	M20 B20	6	0,8	ZGR5A	5839	15			
320 i	E30	2.0	92	01.88-08.88	M20 B20	6	0,8	ZGR5A	5839	15			
320 i	E30	2.0	92	09.82-12.87	M20 B20	6	0,8	BP5ES	6511	8	BPR5EIX	6597	
320 i	E36	2.0	110	09.94-09.99	M52 B20	6	0,8	BKR6EK	2288	20**	BKR6EQP	3199	
320 i	E36	2.0	110	01.90-07.95	M50 B20	6	0,8	BKR6EK	2288	20**	BKR6EQP	3199	
320 i Touring	E36/3	2.0	110	04.94-05.99	M52 B20	6	0,8	BKR6EK	2288	20**	BKR6EQP	3199	
320 i Touring	E46/3	2.0	110	10.99-09.00	M52 B20	6		BKR6EQP	3199	30			
320 i Touring	E46/3	2.2	125	08.00-	M54 B22	6		BKR6EQP	3199	30			
320 i	E46/4	2.0	110	04.98-	M52 B20	6		BKR6EQP	3199	30			
320 i	E46/4	2.2	125	08.00-	M54 B22	6		BKR6EQP	3199	30			
323 Ci	E46/2	2.5	125	04.99-	M52 B25	6		BKR6EQP	3199	30			
323 i	E30	2.3	105	09.82-08.86	M20 B23	6	0,8	BP5ES	6511	8	BPR5EIX	6597	
323 i	E36	2.5	125	06.95-04.99	M52 B25	6	0,8	BKR6EK	2288	20**	BKR6EQP	3199	
323 i Touring	E36/3	2.5	125	12.95-05.99	M52 B25	6	0,8	BKR6EK	2288	20**	BKR6EQP	3199	
323 i	E46/4	2.5	125	04.98-	M52 B25	6		BKR6EQP	3199	30			
323 ti Compact	E36/5	2.5	125	10.97-12.98	M52 B25	6	0,8	BKR6EK	2288	20**	BKR6EQP	3199	
323Ci Cabrio	E46/C	2.5	125	04.00-09.00	M52 B25	6		BKR6EQP	3199	30			
324 d	E30	2.4	63	09.85-08.91	M21 D24	6	■	Y-902R	2237				
324 Td	E30	2.4	85	09.87-12.93	M21 D24	6	■	Y-917U	3219				
325 Ci	E46/2	2.5	141	08.00-	M54 B25	6		BKR6EQP	3199	30			
325 Ci Cabrio	E46/C	2.5	141	08.00-	M54 B25	6		BKR6EQP	3199	30			
325 e	E30	2.7	90	01.85-08.87	M20 B27	6	0,8	ZGR5A	5839	15			
325 i Touring	E30	2.5	125	07.87- 91	M20 B25	6	0,8	ZGR5A	5839	15			
325 i	E30	2.5	125	12.86-12.90	M20 B25	6	0,8	ZGR5A	5839	15			
325 i	E30	2.5	126	09.85-12.86	M20 B25	6	0,8	BPR6ES	7822	2	BPR6EIX	6637	
325 i	E36	2.5	141	12.89-12.94	M50 B25	6	0,8	BKR6EK	2288	20**	BKR6EQP	3199	
325 i Touring	E46/3	2.5	141	09.00-	M54 B25	6		BKR6EQP	3199	30			
325 i	E46/4	2.5	141	08.00-	M54 B25	6		BKR6EQP	3199	30			
325 iX	E30	2.5	125	12.86-01.91	M20 B25	6	0,8	ZGR5A	5839	15			
325 iX Touring	E30	2.5	125	06.88- 91	M20 B25	6	0,8	ZGR5A	5839	15			
325 iX	E30	2.5	126	03.86-12.86	M20 B25	6	0,8	BPR6ES	7822	2	BPR6EIX	6637	
325 Td	E36	2.5	85	01.91-02.98	M51 D25	6	■	Y-917U	3219				
325 Tds	E36	2.5	105	06.93-05.99	M51 D25	6	■	Y-917U	3219				
325 ti Compact	E46/5	2.5	141	05.01-	M54 B25	6		BKR6EQP	3199	30			
325 Xi Touring	E46/3	2.5	141	09.00-	M54 B25	6		BKR6EQP	3199	30			
325 Xi	E46/4	2.5	141	09.00-	M54 B25	6		BKR6EQP	3199	30			
328 Ci	E46/2	2.8	142	04.99-	M52 B28	6		BKR6EQP	3199	30			
328 i	E36	2.8	142	01.95-09.99	M52 B28	6	0,8	BKR6EK	2288	20**	BKR6EQP	3199	
328 i Touring	E36/3	2.8	142	05.95-05.99	M52 B28	6	0,8	BKR6EK	2288	20**	BKR6EQP	3199	
328 i Touring	E46/3	2.8	142	10.99-	M52 B28	6		BKR6EQP	3199	30			
328 i	E46/4	2.8	142	04.98-	M52 B28	6		BKR6EQP	3199	30			
330 Ci	E46/2	3.0	170	06.00-	M54 B30	6		BKR6EQP	3199	30			
330 Ci Cabrio	E46/C	3.0	170	08.00-	M54 B30	6		BKR6EQP	3199	30			
330 d Touring	E46/3	3.0	135	02.00-	M57 D30	6	■	Y-507R	4600				
330 d	E46/4	3.0	135	09.00-	M57 D30	6	■	Y-507R	4600				

¹⁾ Bic = Best in class (siehe Seite 3) / (see page 3)

** alternative/wahlweise V-Line 30



ℓ kW

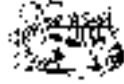

Cyl.

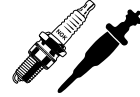
Order-
No. No.

V-LINE

Bic¹⁾ Order-
No.**BMW**

330 i Touring	E46/3	3.0	170	06.00-	M54 B30	6		BKR6EQU	3199	30		
330 i	E46/4	3.0	170	08.00-	M54 B30	6		BKR6EQU	3199	30		
330 Xd Touring	E46/3	3.0	135	09.00-	M57 D30	6	■	Y-507R	4600			
330 Xd	E46/4	3.0	135	09.00-	M57 D30	6	■	Y-507R	4600			
330 Xi Touring	E46/3	3.0	170	09.99-	M54 B30	6		BKR6EQU	3199	30		
330 Xi	E46/4	3.0	170	09.99-	M54 B30	6		BKR6EQU	3199	30		
518 g Touring	E34	1.8	75	11.95-06.96	M43 B18	4	0,8	BKR6EK	2288	20**	BKR6EQU	3199
518 i	E28	1.8	77	09.84-12.87	M10 B18	4	0,8	BP5ES	6511	8	BPR5EIX	6597
518 i	E34	1.8	83	09.89-04.94	M40 B18	4	0,8	BKR6EK	2288	20**	BKR6EQU	3199
518 i	E34	1.8	85	05.94-06.96	M43 B18	4	0,8	BKR6EK	2288	20**	BKR6EQU	3199
520 d	E39	2.0	100	09.99-08.03	M47 D20	4	■	Y-507R	4600			
520 d Touring	E39	2.0	100	09.99-08.03	M47 D20	4	■	Y-507R	4600			
520 i	E28	2.0	90	12.86-12.87	M20 B20	Cat. 6	0,8	ZGR5A	5839	15		
520 i	E28	2.0	92	09.82-12.87	M20 B20	6	0,8	BP5ES	6511	8	BPR5EIX	6597
520 i	E34	2.0	95	01.88-08.91	M20 B20	6	0,8	ZGR5A	5839	15		
520 i	E34	2.0	110	03.89-06.96	M50 B20	6	0,8	BKR6EK	2288	20**	BKR6EQU	3199
520 i	E39	2.0	110	01.96-08.98	M52 B20	6	0,8	BKR6EK	2288	20**	BKR6EQU	3199
520 i	E39	2.0	110	03.96-06.03	M52 B20	6		BKR6EQU	3199	30		
520 i	E39	2.0	125	08.00-	M54 B20	6		BKR6EQU	3199	30		
520 i	E39	2.2	125	08.00-09.03	M54 B22	6		BKR6EQU	3199	30		
520 i Touring	E39/2	2.0	110	03.97-08.98	M52 B20	6	0,8	BKR6EK	2288	20**	BKR6EQU	3199
520 i Touring	E39/2	2.0	110	03.97-08.98	M52 B20	6		BKR6EQU	3199	30		
520 i Touring	E39/2	2.0	125	08.00-	M54 B20	6		BKR6EQU	3199	30		
520 i Touring	E39/2	2.2	125	08.00-	M54 B22	6		BKR6EQU	3199	30		
520 i	E60	2.2	125	07.03-	M54 B22	6		BKR6EQU	3199	30		
523 i	E39	2.5	125	12.95-08.98	M52 B25	6	0,8	BKR6EK	2288	20**	BKR6EQU	3199
523 i	E39	2.5	125	09.98-12.00	M52 B25	6		BKR6EQU	3199	30		
523 i Touring	E39/2	2.5	125	03.97-08.98	M52 B25	6		BKR6EQU	3199	30		
523 i Touring	E39/2	2.5	125	03.97-08.98	M52 B25	6	0,8	BKR6EK	2288	20**	BKR6EQU	3199
524 d	E28	2.4	63	09.83-12.87	M21 D24	6	■	Y-902R	2237			
524 Td	E28	2.4	85	09.83-12.87	M21 D24	6	■	Y-902R	2237			
524 Td	E34	2.4	85	03.88-08.91	M21 D24	6	■	Y-917U	3219			
525 d Touring	E39/2	2.5	120	03.00-12.03	M57 D25	6	■	Y-507R	4600			
525 d	E39	2.5	120	03.00-12.03	M57 D25	6	■	Y-507R	4600			
525 e	E28	2.7	90	05.83-12.87	M20 B27	6	0,8	ZGR5A	5839	15		
525 e	E28	2.7	92	05.83-12.87	M20 B27	6	0,8	BP5ES	6511	8	BPR5EIX	6597
525 i	E28	2.5	110	06.81-12.87	M20 B25	6	0,8	BP5ES	6511	8	BPR5EIX	6597
525 i	E34	2.5	125	01.88-08.91	M20 B25	6	0,8	ZGR5A	5839	15		
525 i	E34	2.5	141	01.89-06.96	M50 B25	6	0,8	BKR6EK	2288	20**	BKR6EQU	3199
525 i	E39	2.5	141	08.00-11.03	M54 B25	6		BKR6EQU	3199	30		
525 i Touring	E39/2	2.5	141	08.00-	M54 B25	6		BKR6EQU	3199	30		
525 i	E60	2.5	141	09.03-	M54 B25	6		BKR6EQU	3199	30		
525 i Touring	E61	2.5	141	05.04-	M54 B25	6		BKR6EQU	3199	30		
525 iX	E34	2.5	141	01.92-09.95	M50 B25	6	0,8	BKR6EK	2288	20**	BKR6EQU	3199
525 iX Touring	E34/2	2.5	141	01.92-09.96	M50 B25	6	0,8	BKR6EK	2288	20**	BKR6EQU	3199
525 Td	E34	2.5	85	06.92-06.96	M51 D25	6	■	Y-917U	3219			
525 Tds	E34	2.5	105	01.90-06.96	M51 D25	6	■	Y-917U	3219			
525 Tds	E39	2.5	105	03.96-	M51 D25	6	■	Y-917U	3219			
528 i	E28	2.8	135	06.81-12.87	M30 B28	6	0,8	BP5ES	6511	8	BPR5EIX	6597
528 i	E39	2.8	142	09.98-11.00	M52 B28	6		BKR6EQU	3199	30		
528 i	E39	2.8	142	12.95-08.98	M52 B28	6	0,8	BKR6EK	2288	20**	BKR6EQU	3199
528 i Touring	E39/2	2.8	142	03.97-08.98	M52 B28	6	0,8	BKR6EK	2288	20**	BKR6EQU	3199

¹⁾ Bic = Best in class (siehe Seite 3) / (see page 3)

** alternative/wahlweise V-Line 30



l kW

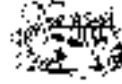

Cyl.

Order-
No. No.Bic¹⁾ Order-
No.**BMW**

528 i Touring	E39/2	2.8	142	09.98-12.00	M52 B28	6		BKR6EQUP	3199	30			
530 d Touring	E39/2	3.0	142	02.99-03.04	M57 D30	6	■	Y-507R	4600				
530 d	E39	3.0	142	09.98-12.03	M57 D30	6	■	Y-507R	4600				
530 i	E34	3.0	138	01.88-08.91	M30 B30	6	0,8	ZGR5A	5839	15			
530 i	E34	3.0	155	04.92-06.96	M60 B30	8	0,8	BKR6EK	2288	20**	BKR6EQUP	3199	
530 i	E39	3.0	170	08.00-	M54 B30	6		BKR6EQUP	3199	30			
530 i Touring	E39/2	3.0	170	08.00-	M54 B30	6		BKR6EQUP	3199	30			
530 i	E60	3.0	170	07.03-	M54 B30	6		BKR6EQUP	3199	30			
535 i	E28	3.4	136	01.85-12.87	M30 B35	6	0,8	ZGR5A	5839	15			
535 i	E28	3.4	155	09.84-12.87	M30 B35	6	0,8	BP5ES	6511	8	BPR5EIX	6597	
535 i	E34	3.5	155	01.88-08.92	M30 B35	6	0,8	ZGR5A	5839	15			
535 i	E39	3.5	180	09.98-09.03	M62 B35	8		BKR6EQUP	3199	30			
535 i	E39	3.5	180	06.96-08.98	M62 B35	8	0,8	BKR6EK	2288	20**	BKR6EQUP	3199	
540 i	E34	4.0	210	03.92-06.96	M60 B40	8	0,8	BKR6EK	2288	20**	BKR6EQUP	3199	
540 i	E39	4.4	210	09.98-11.03	M62 B44	8		BKR6EQUP	3199	30			
540 i	E39	4.4	210	04.96-08.98	M62 B44	8	0,8	BKR6EK	2288	20**	BKR6EQUP	3199	
540 i Touring	E39/2	4.4	210	09.98-	M62 B44	8		BKR6EQUP	3199	30			
540 i Touring	E39/2	4.4	210	03.97-08.98	M62 B44	8	0,8	BKR6EK	2288	20**	BKR6EQUP	3199	
545 i	E60	4.4	245	09.03-	N62 B44	8		BKR6EQUP	3199	30			
545 i Touring	E61	4.4	245	05.04-	N62 B44	8		BKR6EQUP	3199	30			
628 CSi	E24	2.8	135	09.79-08.87	M30 B28	6	0,8	BP5ES	6511	8	BPR5EIX	6597	
635 CSi	E24	3.4	136	01.85-05.89	M30 B35	6	0,8	ZGR5A	5839	15			
635 CSi	E24	3.4	150	06.87-08.88	M30 B35	6	0,8	ZGR5A	5839	15			
635 CSi	E24	3.4	150	05.82-05.87	M30 B35	6	0,8	BP5ES	6511	8	BPR5EIX	6597	
645 Ci	E 63	4.4	245	10.03-	N62 B44	8		BKR6EQUP	3199	30			
645 Ci Cabrio	E 64	4.4	245	02.04-	N62 B44	8		BKR6EQUP	3199	30			
725 Tds	E38	2.5	105	01.96-	M51 D25	6	■	Y-917U	3219				
728 i	E23	2.8	135	07.78-08.86	M30 B28	6	0,8	BP5ES	6511	8	BPR5EIX	6597	
728 i	E38	2.8	142	09.95-08.98	M52 B28	6	0,8	BKR6EK	2288	20**	BKR6EQUP	3199	
728 i	E38	2.8	142	09.98-11.01	M52 B28	6		BKR6EQUP	3199	30			
730 d	E38	3.0	142	09.98-	M57 D30	6	■	Y-507R	4600				
730 d	E65	3.0	160	09.02-	M57 D30	6	■	Y-507R	4600				
730 i	E32	3.0	136	09.86-08.92	M30 B30	6	0,8	ZGR5A	5839	15			
730 i	E32	3.0	160	04.92-09.94	M60 B30	8	0,8	BKR6EK	2288	20**	BKR6EQUP	3199	
730 i	E38	3.0	160	09.94-09.95	M60 B30	8	0,8	BKR6EK	2288	20**	BKR6EQUP	3199	
732 i	E23	3.2	145	09.79-08.86	M30 B32	6	0,8	BP5ES	6511	8	BPR5EIX	6597	
735 i	E32	3.4	136	01.85-08.86	M30 B35	6	0,8	ZGR5A	5839	15			
735 i	E32	3.4	155	09.86-07.92	M30 B35	6	0,8	ZGR5A	5839	15			
735 i	E32	3.4	160	09.82-08.86	M30 B35	6	0,8	BP5ES	6511	8	BPR5EIX	6597	
735 i	E38	3.5	175	09.98-	M62 B35	8		BKR6EQUP	3199	30			
735 i	E38	3.5	175	03.96-08.98	M62 B35	8	0,8	BKR6EK	2288	20**	BKR6EQUP	3199	
735 i	E65	3.6	200	07.01-	N62 B36	8		BKR6EQUP	3199	30			
740 i	E32	4.0	210	04.92-09.94	M60 B40	8	0,8	BKR6EK	2288	20**	BKR6EQUP	3199	
740 i	E38	4.0	210	09.94-05.95	M60 B40	8	0,8	BKR6EK	2288	20**	BKR6EQUP	3199	
740 i	E38	4.4	210	09.96-11.01	M62 B44	8		BKR6EQUP	3199	30			
740 i	E38	4.4	210	05.95-08.98	M62 B44	8	0,8	BKR6EK	2288	20**	BKR6EQUP	3199	
745 i	E32	3.4	185	05.83-08.86	M30 B34	6	0,8	BP5ES	6511	8	BPR5EIX	6597	
745 i	E65	4.4	245	07.01-	N62 B44	8		BKR6EQUP	3199	30			
750 i	E32	5.0	220	09.87-09.94	M70 B50	12	0,7	ZFR5F	5165		ZFR5FIX-11	2477	
750 i	E38	5.4	240	11.94-	M73 B54	12		BKR6EQUP	3199	30			
840 Ci	E31	4.0	210	12.93-02.96	M60 B40	8	0,8	BKR6EK	2288	20**	BKR6EQUP	3199	
840 Ci	E31	4.4	210	03.96-05.99	M62 B44	8	0,8	BKR6EK	2288	20**	BKR6EQUP	3199	

¹⁾ Bic = Best in class (siehe Seite 3) / (see page 3)

** alternative/wahlweise V-Line 30



ℓ kW

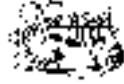

Cyl.

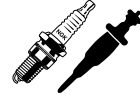
Order-
No. No.Bic¹⁾ Order-
No. No.**BMW**

850 Ci	E31	5.0	220	05.89-10.94	M70 B50	12	0,7	ZFR5F	5165		ZFR5FIX-11	2477
850 Ci	E31	5.4	240	10.94-05.99	M73 B54	12		BKR6EQUP	3199	30		
850 CSI	E31	5.6	280	02.93-11.96	S70 B56	12	0,7	ZFR5F	5165		ZFR5FIX-11	2477
M3	E30	2.3	143	07.86-12.90	S14 B23	4		---				
M3	E36	3.0	210	11.92-07.95	S50 B30	6		---				
M3	E36	3.2	236	11.95-10.99	S50 B32	6	0,7	PKR7A	3641			
M3	E46	3.2	252	11.00-	S54 B32	6		DCPR8EKP	7415			
M3 CSL	E46	3.2	265	06.03-	S54 B32	6		DCPR8EKP	7415			
M3 Sport Evolution	E30	2.5	175	11.89-08.91	S14 B25	6		---				
M5	E28	3.5	191	01.85-12.87	S38 B35	6		---				
M5	E34	3.5	232	10.88-12.92	S38 B35	6		---				
M5	E34	3.8	250	01.92-07.95	S38 B38	6		---				
M5	E39	5.0	294	09.98-07.03	S62 B50	8		BKR6EQUP	3199	30		
M535 i	E28	3.4	136	01.85-12.87	M30 B35	6	0,8	ZGR5A	5839	15		
M535 i	E28	3.4	155	09.84-09.87	M30 B35	6	0,8	BP5ES	6511	8	BPR5EIX	6597
M635 Csi	E24	3.5	191	01.85-05.89	S38 B35	6	0,7	---				
X 5 4x4	E53	3.0	142	08.01-12.03	M57 D30	6	█	Y-507R	4600			
X 5 4x4	E53	3.0	170	10.99-	M54 B30	6		BKR6EQUP	3199	30		
X 5 4x4	E53	4.4	210	09.99-09.03	M62 B44	8		BKR6EQUP	3199	30		
X 5 4x4	E53	4.4	235	10.03-	N62 B44	8		BKR6EQUP	3199	30		
X 5 4.6iS 4x4	E53	4.6	255	10.01-09.03	M62 B46	8		BKR6EQUP	3199	30		
X 5 4.8iS 4x4	E53	4.8	265	04.04-	N62 B48	8					BKR7EIX-11	6988
Z 1		2.5	125	11.88-06.91	M20 B25	6	0,8	ZGR5A	5839	15		
Z 3	E36/7	1.8	85	02.96-09.98	M43 B18	4	0,8	BKR6EK	2288	20**	BKR6EQUP	3199
Z 3	E36/7	1.8	85	09.98-	M43 B18	4		BKR6EQUP	3199	30		
Z 3	E36/7	1.9	87	03.99-	M43 B19	4		BKR6EQUP	3199	30		
Z 3	E36/7	1.9	103	11.95-03.99	M44 B19	4	0,8	BKR6EK	2288	20**	BKR6EQUP	3199
Z 3	E36/7	2.0	110	09.98-12.00	M52 B20	6		BKR6EQUP	3199	30		
Z 3	E36/7	2.2	125	09.00-	M54 B22	6		BKR6EQUP	3199	30		
Z 3	E36/7	2.8	142	03.97-08.98	M52 B28	6	0,8	BKR6EK	2288	20**	BKR6EQUP	3199
Z 3	E36/7	2.8	142	09.98-12.00	M52 B28	6		BKR6EQUP	3199	30		
Z 3	E36/7	3.0	170	09.00-	M54 B30	6		BKR6EQUP	3199	30		
Z 3 M	E36/7	3.2	239	01.97-	S50 B32	6	0,7	PKR7A	3641			
Z 3 Coupè	E36/7C	2.8	142	09.98-12.00	M52 B28	6		BKR6EQUP	3199	30		
Z 3 Coupè	E36/7C	3.0	170	09.00-	M54 B30	6		BKR6EQUP	3199	30		
Z 3 M Coupè	E36/7C	3.2	239	09.98-	S50 B32	6	0,7	PKR7A	3641			
Z 4	E85	2.5	141	04.03-	M54 B25	6		BKR6EQUP	3199	30		
Z 4	E85	3.0	170	04.03-	M54 B30	6		BKR6EQUP	3199	30		
Z 8	E52	5.0	294	06.00-07.03	S62 B50	8		BKR6EQUP	3199	30		

BRISTOL

Beaufighter V8 Turbo		5.9		01.80-12.89		8	0,9	BPR5ES	7422	6	BPR5EIX	6597
Beaufighter		5.9		01.80-12.89		8	0,9	BPR5ES	7422	6	BPR5EIX	6597
Blenheim		5.9	170	03.94-	360 V8 Chrysler	8	0,9	BPR5ES	7422	6	BPR5EIX	6597
Brigand Turbo		5.9				8	0,9	BPR5ES	7422	6	BPR5EIX	6597
Britannia Turbo		5.9		10.82-12.89		8	0,9	BPR5ES	7422	6	BPR5EIX	6597

BUICK

Century		2.2		95- 96	4	4	1,5	TR55-1	6674		TR55-11X	7316
Century		2.2		93- 94	4	4	1,1	TR4	4392		TR4IX	7300
Century		2.5		84- 92	R	4	1,5	UR55	6950		UR55IX	7272
Century		2.8		83- 86	X V6	6	1,1	UR5	2139		UR5IX	7177

¹⁾ Bic = Best in class (siehe Seite 3) / (see page 3)

** alternative/wahlweise V-Line 30



l kW

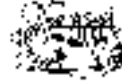

Cyl.

Order-
No. No.Bic¹⁾ Order-
No. No.**BUICK**

Century	2.8		87- 89	W V6	6	1,1	TR4	4392		TR4IX	7300
Century	3.0		82-	E V6	6	2,0	UR40	4386			
Century	3.0		83- 85	E V6	6	1,5	UR45	2451		UR45IX	7559
Century	3.1		94- 99	M OHV V6	6	1,5				TR55IX	7164
Century	3.1		00-	J OHV V6	6	1,5				TR55IX	7164
Century	3.3		89- 93	N V6	6	1,5	TR55	1048		TR55IX	7164
Century	3.8		86-	B V6	6	1,1	TR5	7837		TR5IX	7397
Century	3.8		86- 88	3 V6	6	1,1	TR5	7837		TR5IX	7397
Century	3.8		84- 85	3 V6	6	2,0	UR40	4386			
LeSabre	3.0		86-	L V6	6	1,1	TR5	7837		TR5IX	7397
LeSabre	3.8		88- 91	C V6	6	1,5	PTR4B-15	5146		TR55IX	7164
LeSabre	3.8		92- 95	L V6	6	1,5	PTR4B-15	5146		TR55IX	7164
LeSabre	3.8		77- 85	A V6	6	1,5	UR45	2451		UR45IX	7559
LeSabre	3.8		86- 88	3 V6	6	1,1	TR5	7837		TR5IX	7397
LeSabre	3.8		02-	K V6	6	1,5	PTR4B-15	5146		TR55IX	7164
LeSabre	3.8		96- 01	K V6	6	1,5	PTR4B-15	5146		TR55IX	7164
LeSabre	5.0		85- 90	Y V8	8	1,5	FR45	4636			
Park Avenue	3.8		92-	1 V6 Super Charged	6	1,5	PTR4B-15	5146		TR55IX	7164
Park Avenue	3.8		91-	K V6	6	1,5	PTR4B-15	5146		TR55IX	7164
Regal	3.8		96-	K V6 MFI	6	1,5	PTR4B-15	5146		TR55IX	7164
Regal	3.8		96-	SC V6 MFI 1	6	1,5	PTR4B-15	5146		TR55IX	7164
Rivera	3.8		96-	SC V6 MFI 1	6	1,5	PTR4B-15	5146		TR55IX	7164
Rivera	3.8		96- 97	K V6 MFI	6	1,5	PTR4B-15	5146		TR55IX	7164

CADILLAC

Allante	4.6		91- 94	8 / 9 MFI	8	1,5	TR55	1048		TR55IX	7164
Allante	4.6		87- 90	7 DFI / 8 MFI	8	1,5	TR55	1048		TR55IX	7164
Brougham	5.0		91- 92	E TBI	8	0,7	UR4	4762		UR4IX	7401
Brougham	5.7		93-	7 TBI	8	0,7				UR4IX	7401
Brougham	5.7		91- 92	7 TBI	8	0,7	UR5	2139		UR5IX	7177
Catera	3.0		97- 01	R DOHC MFI	6	0,7	BKR5EK	7956	23	BKR5EIX	6341
Concours	4.6		96- 98	9 MFI	8	1,5	TR55	1048		TR55IX	7164
Concours	4.6		(95)	Y MFI	8	1,5	TR55	1048		TR55IX	7164
Concours	4.6		(94)	Y SFI	8	1,5	TR55	1048		TR55IX	7164
De Ville	4.5		(90)	3 MFI	8	1,5	TR55	1048		TR55IX	7164
De Ville	4.6		01-	9 MFI	8	1,5	TR55	1048		TR55IX	7164
De Ville	4.6		96- 98	Y MFI	8	1,5	TR55	1048		TR55IX	7164
De Ville	4.6		99-	Y MFI	8	1,5	TR55	1048		TR55IX	7164
De Ville	4.9		(91)	B MFI	8	1,5	TR55	1048		TR55IX	7164
De Ville	4.9		92- 95	B MFI	8	1,5	TR55	1048		TR55IX	7164
Eldorado	4.6		99-	V8 MFI Y	8	1,3	TR55	1048		TR55IX	7164
Eldorado	4.6		94- 98	9 MFI / SFI	8	1,5	TR55	1048		TR55IX	7164
Eldorado	4.6		(93)	9 / Y MFI	8	1,5	TR55	1048		TR55IX	7164
Eldorado	4.6		94- 98	Y MFI / SFI	8	1,5	TR55	1048		TR55IX	7164
Eldorado	4.6		99-	V8 MFI 9	8	1,3	TR55	1048		TR55IX	7164
Eldorado	4.9		92- 93	B MFI	8	1,5	TR55	1048		TR55IX	7164
Seville	4.6		99-	V8 MFI 9	8	1,3	TR55	1048		TR55IX	7164
Seville	4.6		99-	V8 MFI Y	8	1,3	TR55	1048		TR55IX	7164

CATERHAM

7	1.6	85		K SERIES	4	0,7	BKR6E	6962	28	BKR6EIX	6418
7 Superlight/Sport	1.6	101		K SERIES	4	0,7	BCPR7ES	3330			

¹⁾ Bic = Best in class (siehe Seite 3) / (see page 3)



ℓ kW



Cyl.

Order-
No. No.Bic¹⁾ Order-
No. No.**CATERHAM**

21	1.6	85		K SERIES	4	0,7	BKR6E	6962	28	BKR6EIX	6418
21 Superlight/Sport	1.6	100		K SERIES	4	0,7	BCPR7ES	3330			
Seven	1.1			Honda	4	0,9	CR9EHVX-9	3872			
Seven	1.4			K Series	4	0,7	BKR6ES	3783	28	BKR6EIX	6418
Seven Super Sprint	1.7	99			4	0,6	B8ECS	2821			
Seven	1.7	125		BDR	4	0,6	B8ECS	2821			
Seven R500	1.8				4	0,7	BKR7E	6097		BKR7EVX	3544
Super Seven			85-		4	0,6	B8ECS	2841			
Super Seven GT	1.6			FORD Kent S	4	0,6	BPR7ES	2023	19	BPR7EIX	4055
Super Seven Sprint	1.6			Ford Kent T	4	0,6	BP7ES	2412		BPR7EIX	4055
Super Seven HPC	2.0	110	07.91-	Opel 16V	4	0,7	BCPR7ES	3330			

CHEVROLET

Blazer	5.7		94-	TBI K	8	0,8	UR6	4079		UR6IX	7348
Blazer	5.7		87- 93	TBI K	8	0,8	UR5	2139		UR5IX	7177
Blazer	5.7		84- 86	4Bbl L	8	0,8	UR5	2139		UR5IX	7177
Camaro	2.5		84- 86	2 L4 EFI	4	1,5				UR55IX	7272
Camaro	2.8		85- 89	S V6 EFI	6	1,1				UR5IX	7177
Camaro	3.1		90- 92	T V6 EFI	6	1,1				UR5IX	7177
Camaro	3.4		93- 95	S V6 EFI	6	1,3				UR5IX	7177
Camaro	3.8		01-		6	1,5	PTR4B-15	5146			
Camaro	3.8		96-	V6 MFI K	6	1,5	TR55	1048		TR55IX	7164
Camaro	5.0		79- 85	G V8 4BBL/ Carburator	8	1,1	UR4	4762		UR4IX	7401
Camaro	5.0		84- 87	H V8 4BBL/ Carburator	8	0,9	UR4	4762		UR4IX	7401
Camaro	5.0		88- 92	E V8 EFI	8	0,9	UR4	4762		UR4IX	7401
Camaro	5.0		(86)	G V8 4BBL/ Carburator	8	1,1				UR5IX	7177
Camaro	5.0		85- 92	F V8 EFI	8	0,9	UR4	4762		UR4IX	7401
Camaro	5.7		87- 92	V8 EFI Alu Heads	8	0,9	FR4	5188			
Camaro	5.7		93- 97	P V8 EFI	8	1,5	TR55	1048		TR55IX	7164
Camaro	5.7		98- 02	G V8 EFI	8	1,5	TR55	1048		TR55IX	7164
Camaro	5.7		87- 92	V8 EFI Cast Iron Heads	8	0,9	UR4	4762		UR4IX	7401
Cavalier	2.4		99-	L4 MFI T	4	1,5	TR55	1048		TR55IX	7164
Corvette	5.7		86- 91	8 V8 EFI Alu Heads	8	0,9	FR4	5188			
Corvette	5.7		01-	G V8 EFI	8	1,3	TR55	1048		TR55IX	7164
Corvette	5.7		(96)	5 V8 EFI	8	1,2	TR55	1048		TR55IX	7164
Corvette	5.7		92- 96	P V8 EFI	8	1,3	TR55	1048		TR55IX	7164
Corvette	5.7		(85)	8 V8 EFI	8	0,9				UR5IX	7177
Corvette	5.7		93- 95	J V8 EFI	8	1,2	TR55	1048		TR55IX	7164
Corvette	5.7		86- 87	8 V8 EFI Cast Iron Heads	8	0,9				UR5IX	7177
Corvette	5.7		88- 91	8 V8 EFI Cast Iron Heads	8	1,1	UR4	4762		UR4IX	7401
Corvette	5.7		90- 92	J V8 EFI ZR1	8	1,2	TR55	1048		TR55IX	7164
Corvette	5.7		(01)	S V8 EFI	8	1,3	TR55	1048		TR55IX	7164
Corvette	5.7	294	97- 00	G V8 EFI	8	1,3	TR55	1048		TR55IX	7164
Lumina	3.8		98-	V6 MFI K	6	1,5	PTR4B-15	5146			
Malibu	2.4		97- 99	T MFI DOHC	4	1,5	TR55	1048		TR55IX	7164
Malibu	3.1		00-	J V6 SFI	6	1,5	TR55	1048		TR55IX	7164
Malibu	3.1		97- 99	M V6 MFI	6	1,5	TR55	1048		TR55IX	7164
Malibu	3.8		83-	9 V6 2Verg./Cab.	6	1,1	UR4	4762		UR4IX	7401
Metro	1.0		98-	L3 TBI 6	3	1,1	BPR6ES-11	4824	13	BPR6EIX-11	3903
Metro	1.3		98-	L4 TBI 9	4	1,1	BKR6E-11	2756	14	BKR6EIX-11	3764
Monte Carlo	3.8		96-	V6 MFI K	6	1,5	PTR4B-15	5146			
Prizum	1.8		00-	L4 MPI 8 DOHC	4	1,1	IFR5T-11	4996			

¹⁾ Bic = Best in class (siehe Seite 3) / (see page 3)



l kW

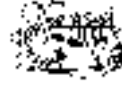

Cyl.

Order-
No. No.Bic¹⁾ Order-
No. No.**CHEVROLET**

Prizum	1.8		98- 99	L4 MPI 8 DOHC	4	1,1	BKR5EKB-11	3967				
Suburban	5.7	140	04.95-	L05 V8-EFI	8	0,8	BPR6FS	2623				
Tahoe	5.3	201	00-		8	1,5					TR55IX	7164
Tahoe	5.7	147	04.96-	R V8	8	1,5	TR55	1048			TR55IX	7164
Tracker	1.6		98-	L4 MFI 6	4	1,1	BKR6E-11	2756	14		BKR6EIX-11	3764
Trail Blazer 4.2 LTZ	4.2	201	02- 03	S EFI	6	1,3	PTR5A-13 *	2467	25			
Trail Blazer 5.3	5.3		03-	V8 P EFI	8	1,5	TR55	1048			TR55IX	7164

CHRYSLER

300M	2.7	149	12.98-	V6	6		only car dealer					
300M	3.5	189	09.99-	V6	6		ZFR5LP-13G					
Cherokee	2.5		05.95-07.99	VM	4	☑	Y-741U	5065				
Cherokee	2.5		04.92-04.95	VM	4	☑	Y-923U	3380				
Cirrus	2.4		99-	X DOHC	4	1,3	FR45	4636				
Cirrus	2.5		95-	V6 MPI H DOHC	6	1,1	PFR5G-11	2647				
Concorde	2.7		98-	V6 MPI R DOHC	6	1,3	PTR5A-13	2467	25			
Concorde	3.3		(94)	V6 FF U	6	1,2	GR45	2822				
Concorde	3.3		93- 96	V6 MPI T	6	1,2	GR45	2822				
Concorde	3.5		93- 97	V6 MPI F	6	0,9	FR5-1	7252				
Crossfire	3.2	160	03-	engine Mercedes SLK	6	1,0	IFR6D10	5344				
Daytona	2.5	114	92-	EDT L4 Turbo	4	0,8	BPR6ES	7822	2		BPR6EIX	6637
Dodge Viper	8.0		96-	E MPI V10	10	1,1	FR5-1	7252				
ES	2.2	105	(88)	EDR 2,2 Turbo	4	0,8	BPR6ES	7822	2		BPR6EIX	6637
ES	2.5		(89)	EDT 2,5	4	0,8	BPR6ES	7822	2		BPR6EIX	6637
ES	2.5	72	88- 89	EDM 2,5	4	0,8	BPR6ES	7822	2		BPR6EIX	6637
Grand Cherokee	2.5		02.97-07.99	VM	4	☑	Y-741U	5065				
Grand Cherokee	3.1		11.98-	EXA	5	☑	Y-741U	5065				
Grand Cherokee	3.3		03.97-01.01	EGA	6	1,1	BPR5EP-11	3971				
Grand Cherokee	4.0	128	01.96-03.99		6	1,0	FR5-1	7252				
Grand Cherokee	4.0	138	03.99-		6	1,0	FR5-1	7252				
Grand Cherokee	4.7		03.99-		8	1,1	BKR5E-11	6953			BKR5EIX-11	5464
Grand Cherokee	5.2		03.94-07.99		8	1,1	ZFR5F-11	2262				
Grand Cherokee	5.9		10.97-07.99		8	1,1	ZFR5F-11	2262				
GS Turbo 2	2.2	130	88- 89	EDS Turbo2	4	0,8	BPR6ES	7822	2		BPR6EIX	6637
GTS	2.2	109	(88)	EDR	4	0,8	BPR6ES	7822	2		BPR6EIX	6637
GTS	2.5	72	88- 89	EDM	4	0,8	BPR6ES	7822	2		BPR6EIX	6637
GTS	2.5	108	(89)	EDT	4	0,8	BPR6ES	7822	2		BPR6EIX	6637
GTS Shelby	2.2	130	(89)	EDS	4	0,8	BPR6ES	7822	2		BPR6EIX	6637
Imperial	3.3		90- 91	V6 MPI 3	6	1,2	GR45	2822				
Imperial	3.8		91- 93	V6 MPI L	6	1,2	GR45	2822				
Le Baron GTC	2.2		(89)	EDS	4	0,8	BPR6ES	7822	2		BPR6EIX	6637
Le Baron	2.2	105	(88)	EDR	4	0,8	BPR6ES	7822	2		BPR6EIX	6637
Le Baron	2.5	72	88- 89	EDM	4	0,8	BPR6ES	7822	2		BPR6EIX	6637
Le Baron	2.5	108	89-	EDT	4	0,8	BPR6ES	7822	2		BPR6EIX	6637
Le Baron	3.0	100	90- 95	EFA V6	6	1,1	BPR5ES-11	4424			BPR5EIX-11	2115
Neon	1.8		03.98-10.99		4	0,7	BKR6E	6962	28		BKR6EIX	6418
Neon LE	2.0	98	01.95-	ECB 16V	4	0,8	BCPR6ES	2330	12		BCPR6EIX-11	4919
New Yorker	3.3		90- 93	V6 MPI R	6	1,3	GR45	2822				
New Yorker	3.5		94- 96	V6 MPI F	6	0,9	FR5-1	7252				
New Yorker	3.8		91-93.93	V6 MPI U	6	1,3	GR45	2822				
PT Cruiser	1.6	85	06.01-		4		---					
PT Cruiser	2.0	104	06.00-		4	1,1	LZTR4A-11	5444				

¹⁾ Bic = Best in class (siehe Seite 3) / (see page 3)

* Standardtype TR5A-10 / standard type TR5A-10



ℓ kW

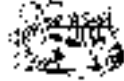

Cyl.

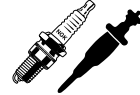
Order-
No. No.Bic¹⁾ Order-
No.**CHRYSLER**

PT Cruiser CRD	2.2	89	03.02-		4	█	Y-745U	4705				
Saratoga	2.5	72	90- 94	EDM	4	0,8	BPR6ES	7822	2	BPR6EIX	6637	
Saratoga	3.0	104	90- 94	EFA V6	6	1,1	BPR5ES-11	4424		BPR5EIX-11	2115	
Sebring	2.0		95- 99	L4 MPI Y DOHC	4	1,1	BKR6EVX-11	3540				
Sebring	2.0	104	06.01-	EC4	4	1,1	LZTR4A-11	5444				
Sebring	2.4		96- 98	L4 MPI X DOHC	4	1,1	FR45	4636				
Sebring	2.4		01-	4G64 SOHC	4	1,1	BKR5E-11	6953		BKR5EIX-11	5464	
Sebring	2.5		95- 99	V6 MPI N DOHC	6	1,1	PFR5G-11	2647				
Sebring	2.7	149	04.01-	V6 R DOHC	6		only car dealer					
Stratus	2.0	96	00-		4	0,9	BKR6E	6962	28	BKR6EIX	6418	
Stratus	2.0	98	95- 00	ECB 16V	4	0,8	BCPR6ES	2330	12	BCPR6EIX-11	4919	
Stratus	2.5	120	04.95-	EEB V6 MPI	6	1,1	PFR6B-11	4014				
Vision	3.5	155	94-	EGE V6 MPI	6	0,9	FR5-1	7252				
Voyager 1	2.5	72	88- 90	EDM	6	0,8	BPR6ES	7822	2	BPR6EIX	6637	
Voyager 1	3.0	100	88- 91	EFA	6	1,1	BPR5ES-11	4424		BPR5EIX-11	2115	
Voyager 2	2.5	72	91- 95	EDM	6	0,8	BPR6ES	7822	2	BPR6EIX	6637	
Voyager 2	2.5	88	04.92-04.95	VM HR-492	4	█	Y-923U	3380				
Voyager 2	2.5	88	04.92-04.95	VM 425 CLIRE	4	█	Y-923U	3380				
Voyager 2	3.3	120	91- 95	EGA V6 MPI R	6	1,3	GR4	7038		GR4IX	7149	
Voyager 3	2.0	98	97-01.01	ECB COO	4	0,8	BKR6E	6962	28	BKR6EIX	6418	
Voyager 3	2.4	110	96-01.01	EDZ BOO	4	1,1	BKR5ES-11	2382		BKR5EIX-11	5464	
Voyager 3	2.5	88	05.95-01.01	VM HR425 CLIEE	4	█	Y-741U	5065				
Voyager 3	3.8	122	96-01.01	EGH V6 MPI	6	1,3	GR4	7038		GR4IX	7149	
Voyager 4	2.4	108	03.01-	EDZ	4	1,1	LZTR4A-11	5444				
Voyager 4	2.4	112	00-		4		FR45	4636				
Voyager 4	3.3	134	00-		6		GR4VX	2757		GR4IX	7149	
Wrangler Jeep	2.5		01.93-01.01		4	1,0	FR5-1	7252				
Wrangler Jeep	4.0		93- 99		6	1,0	FR5-1	7252				

CITROEN

2CV 4/6	0.6	18	07.79-07.90	A06/...	2	0,6	BP6HS	4511	18	BPR6HIX	4085	
AX 1.0i	1.0		07.92-02.95	TU9M CDZ	4	0,8	BCPR5ES	6130		BCPR5EIX-1	3306	
AX 1.0i	1.0		09.86-06.92	TU9 C1A	4	0,8	BCP5ES	7496	16	BCPR5EIX-11	3306	
AX 1.0i	1.0	30	10.86-	TU9..	4	0,7	BCP6ES	4930	17	BCPR6EIX-11	4919	
AX 1.0i	1.0	37	03.95-	TU9M CDZ	4	0,8	BKR5EK	7956	23	BKR5EIX	6341	
AX 1.0i	1.0	37	07.92-	TU9.M	Cat.	4	0,8	BKR5EK	7956	23	BKR5EIX	6341
AX 1.1i	1.1		09.86-06.92	TU1 H1A	4	0,8	BCP5ES	7496	16	BCPR5EIX-1	3306	
AX 1.1i	1.1		07.95-	TU1M HDZ	4	0,8	BKR5EK	7956	23	BKR5EIX	6341	
AX 1.1	1.1	44	07.92-06.95	TU1M HDZ	Cat.	4	0,8	BCPR5ES	6130		BCPR5EIX-11	3306
AX 1.3i Sport	1.3	69	02.87-12.92	TU24 M4A	4	0,9	BKUR7ET	7873		PFR7Q	7963	
AX 1.4 GTi	1.4		09.91-12.92	TU3J2 K6B	4	0,8	BKR6EK	2288	20**	BKR6EQUIP	3199	
AX 1.4i	1.4		07.92-06.95	TU3MC KDX	4	0,8	BCPR5ES	6130		BCPR5EIX-1	3306	
AX 1.4i	1.4		07.95-	TU3MC KDX	4	0,8	BKR6EK	2288	20**	BKR6EQUIP	3199	
AX 1.4i GT	1.4		07.92-06.95	TU3MC KDX	4	0,8	BCPR5ES	6130		BCPR5EIX-1	3306	
AX 1.4	1.4		09.86-12.92	TU3 K1A, TU3A K1G	4	0,8	BCP5ES	7496	16	BCPR5EIX-1	3306	
AX 1.4 GTi	1.4		07.92-	TU3J2 KFZ	4	0,8	BKR6EK	2288	20**	BKR6EQUIP	3199	
AX 1.4i Gti	1.4		09.91-12.92	TU3FJ2Z	4	0,8	BKR6EK	2288	20**	BKR6EQUIP	3199	
AX 1.4	1.4		07.92-	TU3M ...	Cat.	4	0,8	BCPR5ES	6130		BCPR5EIX-11	3306
AX 1.4 GT	1.4		10.87-12.92	TU3S K2A	4	0,7	BCP6ES	4930	17	BCPR6EIX-11	4919	
AX D	1.4	39	09.88-09.94	TUD 3 L	4	█	Y-911R	4544				
AX 1.4i	1.4	55	07.92-	TU3MC	Cat.	4	0,8	BKR6EK	2288	20**	BKR6EQUIP	3199
AX 1.4i	1.4	55	07.94-	TU3FM	4	0,8	BKR6EK	2288	20**	BKR6EQUIP	3199	

¹⁾ Bic = Best in class (siehe Seite 3) / (see page 3)

** alternative/wahlweise V-Line 30



l kW

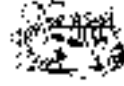

Cyl.

Order-
No. No.Bic¹⁾ Order-
No. No.**CITROEN**

AX 1.4i GT	1.4	55	07.92-	TU3FM	Cat.	4	0,8	BKR6EK	2288	20**	BKR6EQU	3199
AX D	1.5	40	10.94-12.99	TUD 5 VJZ		4	█	Y-731U	5274			
Berlingo 1.1i	1.1	44	07.96-	TU1M HDZ		4	0,8	BKR6EK	2288	20**	BKR6EQU	3199
Berlingo 1.4i	1.4	55	01.00-	TU3JP KFX		4	0,9	BKR6EZ	4619		BKR6EIX	6418
Berlingo 1.6i 16V	1.6	81	02.01-	TU5JP4 NFU		4	0,9	LF6B	6677			
Berlingo	1.8	43	09.98-03.99	XUD7 A9A		4	█	Y-938R	5267			
Berlingo	1.8	43	07.96-08.98	XUD7 A9A		4	█	Y-923U	3380			
Berlingo	1.8	50	09.98-03.99	DW8 WJZ		4	█	Y-503R	4279			
Berlingo 1.8i	1.8	66	07.96-	XU7JB LFX		4	0,8	BKR6EK	2288	20**	BKR6EQU	3199
Berlingo	1.8	66	09.98-03.99	DW8TD		4	█	Y-503R	4279			
Berlingo	1.9	50	07.96-09.98	XUD9A D9B / DJY		4	█	Y-923U	3380			
Berlingo	1.9	52	09.98-12.02	XUD9A		4	█	Y-938R	5267			
Berlingo HDI	2.0	66	10.99-	DW10TD		4	█	Y-504R	4359			
Berlingo Multispace 1.4i	1.4	55	01.00-	TU3JP KFX, KFW		4	0,9	BKR6EZ	4619		BKR6EIX	6418
Berlingo Multispace 1.4i	1.4	55	01.97-12.99	TU3JP KFX, KFW		4	0,8	BKR6EK	2288	20**	BKR6EQU	3199
Berlingo Multispace 1.6i	1.6	81	02.01-	TU5JP4 NFU		4	0,9	LF6B	6677			
Berlingo Multispace 1.8i	1.8	66	07.97-	XU7JB LFX		4	0,8	BKR6EK	2288	20**	BKR6EQU	3199
Berlingo Multispace	1.9	50	01.97-09.98	XUD9A D9B / DJY		4	█	Y-923U	3380			
Berlingo Multispace	1.9	50	09.98-12.02	DW8 WJZ		4	█	Y-503R	4279			
Berlingo Multispace HDI	2.0	66	10.99-	DW10TD		4	█	Y-504R	4359			
BX 17 D	1.8	44	07.85-01.93	XUD 7		4	█	Y-902R	2237			
BX 17 TD, TRD	1.8	66	03.88-01.93	XUD 7 TE		4	█	Y-902R	2237			
BX 19 D RD, TD, TRD	1.9	47	09.83-12.87	XUD 9		4	█	Y-902R	2237			
BX 19 D TD, TRD	1.9	51	03.87-	XUD 9 A/L		4	█	Y-902R	2237			
BX 4TC				N9TE		4	0,9	BP6ET	1263		PGR6D	6248
BX 14	1.4	47	09.82-06.88	XY6D		4	0,8	BP6EFS	3812	5		
BX 14	1.4	47	09.82-06.88	XY6C		4	0,8	BP6EFS	3812	5		
BX 14	1.4	47	07.88-	TU3.A		4	0,8	BCP5ES	7496	16	BCPR5EIX-11	3306
BX 14	1.4	55		TU3M ...		4	0,8	BCPR5ES	6130		BCPR5EIX-11	3306
BX 15	1.5	59	07.87-06.92	XU5.1C		4	0,8	BCP5ES	7496	16	BCPR5EIX-1	3306
BX 15	1.5	59	01.87-06.87	XU5.1C		4	0,8	BP6EFS	3812	5		
BX 16 S, 16RS, 16TRS			07.84-03.88	XU5S 171C		4	0,8	BP6EFS	3812	5		
BX 16i Image, Millésime			07.92-	XU5M BDY	cat.	4	0,8	BCPR5ES	6130		BCPR5EIX-1	3306
BX 16 16V	1.6		07.87-06.92	XU9.J4		4	0,9	BCP6ET	4563		BCPR6EIX-11	4919
BX 16 16V	1.6		07.92-	XU9.J4	Cat.	4	0,9	BCPR6ET	2197			
BX 16	1.6		07.92-	XU5MZ BDZ	Cat.	4	0,8	BCPR5ES	6130		BCPR5EIX-11	3306
BX 16	1.6	68	04.88-06.92	XU5.2C		4	0,7	BCP6ES	4930	17	BCPR6EIX-11	4919
BX 19i GTi, TRi, TZi / 4x4			07.86-06.92	XU9J2 D6A		4	0,7	BCP6ES	4930	17	BCPR6EIX-1	4919
BX 19i GTi 16s			07.92-	XU9J4 DFW	cat.	4	0,9	BCPR6ET	2197			
BX 19i GTi 16s			07.87-06.92	XU9J4 D6C		4	0,8	BCP6ET	4563		BCPR6EIX-1	4919
BX 19 GT	1.9		07.84-07.86	XU9.S 159A		4	0,8	BP6EFS	3812	5		
BX 19i GTI	1.9		07.88-06.92	XU9.J2		4	0,7	BCP6ES	4930	17	BCPR6EIX-11	4919
BX 19i	1.9		07.92-	XU9.JA DKZ	Cat.	4	0,8	BCPR5ES	6130		BCPR5EIX-11	3306
BX 19	1.9	77	07.87-06.89	XU92C D2A		4	0,8	BCP5ES	7496	16	BCPR5EIX-11	3306
BX 19	1.9	77	07.89-06.92	XU92C D2E		4	0,7	BCP6ES	4930	17	BCPR6EIX-11	4919
BX 19	1.9	77	07.87-06.89	XU92C		4	0,8	BCP5ES	7496	16	BCPR5EIX-11	3306
BX 19	1.9	77	09.86-06.87	XU92C D2A		4	0,8	BP6EFS	3812	5		
BX 19	1.9	77	07.89-06.92	XU92C		4	0,7	BCP6ES	4930	17	BCPR6EIX-11	4919
BX Sport			05.85-06.86	XU9.4 159B		4	0,9	BU6EFSZ	3488			
C 3	1.1	44	04.02-	TU1JP-HFZ;HFY		4	0,9	BKR6EZ	4619		BKR6EIX	6418
C 3 HDI	1.4	52	04.02-	DV4TD		4	█	YE-04	1101			
C 3 / Pluriel	1.4	55	04.02-	TU3JP-KFX		4	0,9	BKR6EZ	4619		BKR6EIX	6418

¹⁾ Bic = Best in class (siehe Seite 3) / (see page 3)

** alternative/wahlweise V-Line 30



ℓ kW



Cyl.

Order-
No. No.Bic¹⁾ Order-
No.**CITROEN**

C 3 HDI 16V	1.4	68	07.02-	DV4TED4	4	█	YE-04	1101				
C 3 / Pluriel	1.6	81	04.02-	TU5JP4-NFU	4	0,9	LFR6B	6677				
C 5	1.8	86	06.02-	EW7J4 6FZ	4	0,8	LFR5B	7113				
C 5 HDI	2.0	66	06.02-	DW10ATD	4	█	Y-504R	4359				
C 5 HDI	2.0	81	02.01-	DW10ATED	4	█	Y-504R	4359				
C 5	2.0	100	10.00-	EW10J4-RFN	4	0,9	LFR5B	7113				
C 5 HDI 16V	2.2	100	02.01-	DW12TED4	4	█	Y-504R	4359				
C 5	3.0	154	10.00-	ES9J4S XFX	6	1,1	PLFR5A-11	6240				
C 8 Hdi 16V	2.0	80	07.02-	DW10TED4/RHT	4	█	Y-504R	4359				
C 8	2.0	102	06.02-	EW10J4-RFN	4	0,9	LFR5B	7113				
C 8 Hdi 16V	2.2	94	07.02-	DW12TED4/4HW	4	█	Y-504R	4359				
C 8	2.2	118	06.02-	EW12J4-3FZ	4	0,9	LFR5B	7113				
C 15 D	1.8	44	10.84-05.95	XUD7	4	█	Y-902R	2237				
C 15 D	1.8	44	06.95-	XUD7	4	█	Y-938R	5267				
C 15 E 1.0	1.0		11.86-09.88	XV8 108C	4	0,8	BP6EFS	3812	5			
C 15 E	1.0		10.84-09.88	108C-109K	4	0,8	BP6EFS	3812	5			
C 15 E	1.0	33	09.88-	TU9 C1A	4	0,8	BCP5ES	7496	16	BCPR5EIX-11	3306	
C 15 E	1.1		10.84-08.87	XW7B 109K	4	0,8	BP6EFS	3812	5			
C 15 E	1.1		10.87-09.88	E1A	4	0,7	BCP6ES	4930	17	BCPR6EIX-11	4919	
C 15 E	1.1		10.88-	TU1 H1A	4	0,8	BCP5ES	7496	16	BCPR5EIX-11	3306	
C 15 E	1.1	44	09.92-06.95	TU1.M HDZ	Cat. 4	0,8	BCPR5ES	6130		BCPR5EIX-1	3306	
C 15 E	1.3	47	10.87-09.88	G1A	4	0,8	BCP5ES	7496	16	BCPR5EIX-1	3306	
C 15 E	1.4		10.87-	TU3A K1G	4	0,8	BCP5ES	7496	16	BCPR5EIX-11	3306	
C 15 E	1.4		11.86-09.87	XY7 150D	4	0,8	BP6EFS	3812	5			
C 25 D	1.9	51	07.87-01.94	D9B	4	█	Y-902R	2237				
C 25	2.0	58	09.81-03.94	XM7T/XN1T/XN1TA	4	0,7	BP6ES	7811	4	BPR6EIX	6637	
C 25 D	2.5	54	07.81-01.94	CRD93	4	█	Y-208T	1250				
C 25 TD	2.5	70	08.87-01.94	CRD93LS	4	█	Y-208T	1250				
C 35 D	2.5	50	01.80-01.91	CRD93B	4	█	Y-208T	1250				
C 45 D	2.5	50	06.82-01.91	CRD93B	4	█	Y-208T	1250				
C3 X-TR 16V	1.4		04-	DV4ETD4	4	█	YE04	1101				
CX Athena	2.0			J6RA / J6TA	4	0,8	BP6EFS	3812	5			
CX Reflex Break	2.0			J6RA / J6TA	4	0,8	BP6EFS	3812	5			
CX 2000 Break / Pallas	2.0			M20	4	0,6	BP6HS	4511	18	BPR6HIX	4085	
CX 2200 / 2400	2.2			M22 / M23	4	0,6	BP6HS	4511	18	BPR6HIX	4085	
CX 25 Turbo	2.5			M25/66	4	0,6	BP6HS	4511	18	BPR6HIX	4085	
CX 25 Turbo	2.5		04.83-12.86	M25 648	4	█	Y-208T	1250				
CX 25	2.5	54	07.82-12.92	M25 660	4	█	Y-902R	2237				
CX 25 TD Turbo 2	2.5	78	01.87-12.92	M25 669/671	4	█	Y-208T	1250				
Dispatch	1.9		09.96-07.98	XUD9A, XUD9TF	4	█	Y-923U	3380				
Dispatch	1.9		09.98-	XUD9A, XUD9TF	4	█	Y-938R	5267				
Dispatch	1.9		09.98-	DW8, DW8TD	4	█	Y-503R	4279				
Dispatch	2.0		03.00-	DW10	4	█	Y-504R	4359				
Evasion	1.8	72	09.96-06.00	XU7JP LFW	4	0,8	BKR5EK	7956	23	BKR5EIX	6341	
Evasion TD	1.9	66	03.94-08.98	XUD9TF	4	█	Y-923U	3380				
Evasion	1.9	67	09.98-09.02	XUD9TF, XUD9BTF	4	█	Y-938R	5267				
Evasion Hdi	2.0	81	09.98-09.02	DW10ATED	4	█	Y-504R	4359				
Evasion	2.0	89	07.94-03.95	XU10J2 RFU	4	0,8	BCPR5ES	6130		BCPR5EIX-11	3306	
Evasion	2.0	90	04.95-05.00	XU10J2 RFU	4	0,8	BKR5EK	7956	23	BKR5EIX	6341	
Evasion	2.0	101	06.00-	EW10J4-RFR	4	0,9	LFR5B	7113				
Evasion	2.0	110		XU10J2 CTE	4	0,8	BKR6EK	2288	20**	BKR6EQUIP	3199	
Evasion Turbo	2.0	110	09.94-05.00	XU10J2TE RGX	4	0,8	BKR6EK	2288	20**	BKR6EQUIP	3199	

¹⁾ Bic = Best in class (siehe Seite 3) / (see page 3)

** alternative/wahlweise V-Line 30



l kW

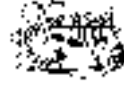

Cyl.

Order-
No. No.Bic¹⁾ Order-
No. No.**CITROEN**

Evasion TD	2.1	80	05.97-12.98	XUD11BTE	4	Y-938R	5267				
Evasion TD	2.1	80	05.96-04.97	XUD11BTE	4	Y-923U	3380				
GS 1015 / 1130 / 1220					4	0,7 BP6ES	7811	4	BPR6EIX	6637	
GS X2 / X3					4	0,7 BP6ES	7811	4	BPR6EIX	6637	
GSA			-07.86		4	0,7 BP6ES	7811	4	BPR6EIX	6637	
GSA A/D/DK			-07.86		4	0,8 BP6EFS	3812	5			
Jumper D	1.9	51	03.94-05.95	XUD9AU	4	Y-923U	3380				
Jumper	1.9	52	06.95-	XUD9AU	4	Y-938R	5267				
Jumper	1.9	67	09.98-	XUD9TF	4	Y-938R	5267				
Jumper TD	1.9	68	03.94-08.98	XUD9TF	4	Y-923U	3380				
Jumper HDI	2.0	66	09.98-	DW10TD	4	Y-504R	4359				
Jumper	2.0	81	-03.95	XU10.J2U RFW	4	0,8 BCP6RES	2330	12	BCPR6EIX-1	4919	
Jumper	2.0	81	04.95-	XU10.J2U RFW	4	0,8 BKR6EK	2288	20**	BKR6EQU	3199	
Jumper Hdi	2.2	76	09.98-	DW10TED4	4	Y-504R	4359				
Jumper HDI	2.2	100	09.98-	DW12TED4	4	Y-504R	4359				
Jumper D	2.5	63	03.94-	DJ5	4	Y-923U	3380				
Jumper TD	2.5	76	03.94-08.96	DJ5T	4	Y-923U	3380				
Jumper Tdi	2.5	78	09.96-	DJ5TED	4	Y-738U	5390				
Jumper HDI	2.8	93	09.00-04.02	4HY	4	Y-502R	3852				
Jumpy	1.6	59	10.95-	1580 SPI 220.A2.000	4	0,8 BCP6RES	3330				
Jumpy	1.8	50	09.98-	DW8	4	Y-503R	4279				
Jumpy	1.9	51	09.98-	XUD9A	4	Y-938R	5267				
Jumpy D	1.9	51	01.96-08.98	XUD9A	4	Y-923U	3380				
Jumpy	1.9	68	09.96-	XUD9TF/BTF	4	Y-938R	5267				
Jumpy HDI	2.0	70	02.00-	DW10TED	4	Y-504R	4359				
Jumpy HDI	2.0	81	02.00-	DW10ATED	4	Y-504R	4359				
Jumpy	2.0	102	06.01-	EW10J4-RFN	4	0,9 LFR5B	7113				
LNA / 11E / 11RE / 14TRS	0.6		-06.86		2	0,8 BP6EFS	3812	5			
Relay	1.9		09.98-	XUD9TF	4	Y-938R	5267				
Relay	1.9		03.94-08.98	XUD9TF, 9AU	4	Y-923U	3380				
Relay	2.0		09.98-	DW10TED/DU	4	Y-504R	4359				
Relay	2.5		03.94-	DJ5, DJ5T	4	Y-923U	3380				
Relay	2.5		09.96-	DJ5TED 12V	4	Y-738U	5390				
Saxo	1.0	37	02.96-09.99	TU9M CDZ	4	0,8 BKR5EK	7956	23	BKR5EIX	6341	
Saxo	1.1	44	02.96-08.99	TU1M+ HDZ	4	0,8 BKR6EK	2288	20**	BKR6EQU	3199	
Saxo	1.5	43	05.96-08.99	TUD 5	4	Y-731U	5274				
Saxo	1.6	66	07.98-08.99	TU5JP+ NFZ	4	0,8 BKR6EK	2288	20**	BKR6EQU	3199	
Saxo	1.0	37	09.99-12.00	TU9M CDZ	4	0,8 BKR5EK	7956	23	BKR5EIX	6341	
Saxo	1.1	44	09.99-	TU1M+ HDZ	4	0,8 BKR6EK	2288	20**	BKR6EQU	3199	
Saxo	1.4	55	09.99-	TU3JP+ KFX	4	0,9 BKR6EZ	4619		BKR6EIX	6418	
Saxo	1.5	43	09.99-05.03	TUD 5	4	Y-731U	5274				
Saxo	1.6	66	09.99-12.00	TU5JP+ NFZ	4	0,9 BKR6EZ	4619		BKR6EIX	6418	
Saxo	1.6	88	03.01-04.02	TU5JP NFX	4	0,8 BKR6EK	2288	20**	BKR6EQU	3199	
SM 3L / i					6	0,8 BP5ES	6511	8	BPR5EIX	6597	
Synergie	1.9		09.98-10.00	XUD9TF, XUD9BTF	4	Y-938R	5267				
Synergie	1.9		10.95-08.98	XUD9BTF/L3	4	Y-923U	3380				
Synergie	2.0		08.99-	DW10TED	4	Y-504R	4359				
Visa Special / Super			-03.91		4	0,8 BP6EFS	3812	5			
Visa GT / GTi			-06.87	XU5.J/JA	4	0,6 BP7EFS	3526				
Visa 10			-03.91		4	0,8 BP6EFS	3812	5			
Visa Chrono				XYR	4	0,6 BR7EF	3346				
Visa GTi		85	07.87-	XU5.JA	4	0,7 BCP6ES	4930	17	BCPR6EIX-1	4919	

¹⁾ Bic = Best in class (siehe Seite 3) / (see page 3)

** alternative/wahlweise V-Line 30



ℓ kW



Cyl.

Order-
No. No.Bic¹⁾ Order-
No. No.**CITROEN**

Visa	0.6		-03.91	V06/...	4	0,8	BP6EFS	3812	5		
Visa Club	0.6		-03.91		4	0,6	BP7EFS	3526			
Visa 14TRS	1.4		-03.91	150D	Cat.	4	0,8	BP6EFS	3812	5	
Visa 17 D	1.8	44	04.84-03.91	161A		4	Y-902R	2237			
Xantia	1.6	66	06.93-05.95	XU5JP BFZ		4	0,8	BCPR5ES	6130		BCPR5EIX-11 3306
Xantia	1.6	66	06.95-	XU5JP BFZ		4	0,8	BKR5EK	7956	23	BKR5EIX 6341
Xantia	1.8	66	01.98-	XU7JB LFX		4	0,8	BKR6EK	2288	20**	BKR6EQUIP 3199
Xantia	1.8	76	07.93-03.95	XU7JP LFZ		4	0,8	BCPR5ES	6130		BCPR5EIX-1 3306
Xantia	1.8	76	04.95-	XU7JP LFZ		4	0,8	BKR5EK	7956	23	BKR5EIX 6341
Xantia 16V	1.8	83	07.95-	XU7JP4 LFY		4	0,8	BKR5EK	7956	23	BKR5EIX 6341
Xantia D	1.9	51	03.93-01.96	XUD 9 A/L		4	Y-902R	2237			
Xantia	1.9	55	05.94-	XUD9A		4	Y-938R	5267			
Xantia	1.9	55	09.98-	XUD9A/L		4	Y-938R	5267			
Xantia TDX	1.9	55	02.96-04.94	XUD9SD		4	Y-923U	3380			
Xantia	1.9	67	09.98-12.00	XUD9BTF, XUD9BSD		4	Y-938R	5267			
Xantia TD	1.9	68	06.93-08.98	XUD9TF		4	Y-923U	3380			
Xantia HDI	2.0	66	10.98-	DW10TD		4	Y-504R	4359			
Xantia HDI	2.0	81	10.98-12.01	DW10ATED		4	Y-504R	4359			
Xantia	2.0	90	06.95-	XU10J2 RFX		4	0,8	BKR5EK	7956	23	BKR5EIX 6341
Xantia	2.0	90	03.93-05.95	XU10J2 RFX		4	0,8	BCPR5ES	6130		BCPR5EIX-1 3306
Xantia 16V	2.0	99	06.95-	XU10J4R RFV		4	0,8	BKR5EK	7956	23	BKR5EIX 6341
Xantia turbo	2.0	110	07.96-	XU10J2TE RGX		4	0,8	BKR6EK	2288	20**	BKR6EQUIP 3199
Xantia 16V	2.0	112	93-	XU10J4D		4	0,8	BKR6ES	3783	28	BKR6EIX 6418
Xantia TD	2.1	80	06.95-08.98	XUD11BTE		4	Y-923U	3380			
Xantia	2.1	80	09.98-	XUD11BTF		4	Y-938R	5267			
Xantia	3.0	142	03.97-	ES9J4 XFZ		6	0,8	BKR6EK	2288	20**	BKR6EQUIP 3199
XM	2.0		05.89-12.92	XU10J2 R6A		4	0,8	BCPR6ES	2330	12	BCPR6EIX-1 4919
XM	2.0		05.92-12.00	XU10J2 RFZ	Cat.	4	0,8	BCPR5ES	6130		BCPR5EIX-1 3306
XM 16V	2.0		07.94-			4	0,8	BCPR6ES	2330	12	BCPR6EIX-1 4919
XM	2.0		05.89-12.92	XU102C-R2A		4	0,7	BCP6ES	4930	17	BCPR6EIX-1 4919
XM	2.0	99	07.94-12.00	XU10J4R RFV		4	0,8	BKR5EK	7956	23	BKR5EIX 6341
XM Turbo	2.0	110	11.92-12.00	XU10J2TE RGX		4	0,8	BKR6EK	2288	20**	BKR6EQUIP 3199
XM	2.0	110	96-	XU10J2CTE		4	0,8	BKR6EK	2288	20**	BKR6EQUIP 3199
XM	2.1	80	09.98-12.00	XUD11ATE/L/BTE		4	Y-938R	5267			
XM	3.0		05.89-06.94	ZPJ-SFZ		6	0,9	BCPR6ET	2197		
XM	3.0		07.94-06.97	ZPJ-UFZ		6	0,9	BCPR6ET	2197		
XM V6 24V	3.0		07.94-07.97	ZPJ4-UKZ		6	0,8	BCPR7ET	2164		
XM V6 24V	3.0	140	01.97-12.00	ES9J4-XFZ		6	0,8	BKR6EK	2288	20**	BKR6EQUIP 3199
XM D 12 D	2.1	60	05.89-06.94	XUD11A/L		4	Y-902R	2237			
XM D 12 TD	2.1	80	05.89-08.98	XUD11ATE/L/BTE		4	Y-923U	3380			
XM TD	2.5	96	07.94-12.00	DK5ATE		4	Y-923U	3380			
Xsara	1.4	55	09.97-08.00	TU3JP KFX		4	0,8	BKR6EK	2288	20**	BKR6EQUIP 3199
Xsara	1.5	43	09.97-08.00	TUD5		4	Y-731U	5274			
Xsara	1.6	66	09.97-08.00	TU5JP NFZ		4	0,8	BKR6EK	2288	20**	BKR6EQUIP 3199
Xsara	1.8	43	10.97-09.00	XUD7		4	Y-938R	5267			
Xsara	1.8	66	09.97-08.00	XU7JB LFX		4	0,8	BKR6EK	2288	20**	BKR6EQUIP 3199
Xsara 16V	1.8	75	09.97-08.00	XU7JP LFZ		4	0,8	BKR5EK	7956	23	BKR5EIX 6341
Xsara 16V	1.8	82	09.97-08.00	XU7JP4 LFY		4	0,8	BKR5EK	7956	23	BKR5EIX 6341
Xsara	1.9	51	06.99-08.00	DW8		4	Y-503R	4279			
Xsara TD	1.9	66	10.97-09.00	XUD9TE DHY		4	Y-938R	5267			
Xsara	1.9	92	09.97-09.00	XUD9A DJY		4	Y-938R	5267			
Xsara HDI	2.0	66	04.99-08.00	DW10TD		4	Y-504R	4359			

¹⁾ Bic = Best in class (siehe Seite 3) / (see page 3)

** alternative/wahlweise V-Line 30



l kW

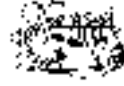

Cyl.

Order-
No. No.Bic¹⁾ Order-
No.**CITROEN**

Xsara 16V	2.0	120	09.97-08.00	XU10J4RS RFS	4	0,8	BKR6EK	2288	20**	BKR6EQU	3199	
Xsara 2	1.4	55	09.00-	TU3JP KFW	4	0,9	BKR6EZ	4619		BKR6EIX	6418	
Xsara 2	1.5	43	09.00-	TUD5	4	█	Y-731U	5274				
Xsara 2 16V	1.6	80	09.00-	TU5JP4-NFU	4	0,9	LFR6B	6677				
Xsara 2 1.8 16V [117ch]	1.8	86	09.00-	EW7J4 6FZ	4	0,9	LFR5B	7113				
Xsara 2	1.9	52	09.00-	DW8 WJZ	4	█	Y-503R	4279				
Xsara 2 HDI	2.0	66	09.00-12.02	DW10TD RHY	4	█	Y-504R	4359				
Xsara 2 HDI	2.0	81	05.01-	DW10ATED RHZ	4	█	Y-504R	4359				
Xsara 2 16V	2.0	100	09.00-	EW10J4-RFN	4	0,9	LFR5B	7113				
Xsara 2 2.0i 16V VTS [167ch]	2.0	123	09.00-	XU10J4RS RFS	4	0,9	BKR5EZ	7642		BKR5EIX	6341	
Xsara Picasso	1.6	65	12.99-	TU5JP NFZ, NFV	4	0,9	BKR6EZ	4619		BKR6EIX	6418	
Xsara Picasso 1.8i 16V	1.8	85	12.99-	EW7J4-6FZ	4	0,9	LFR5B	7113				
Xsara Picasso HDI	2.0	66	01.00-	DW10TD	4	█	Y-504R	4359				
Xsara Picasso	2.0	101	09.00-	EW10J4-RFM	4	0,9	LFR5B	7113				
ZX 1.0	1.0	44		TU1M	4	0,8	BKR5EK	7956	23	BKR5EIX	6341	
ZX 1.1	1.1	40	03.91-06.92	TU1	4	0,8	BCP5ES	7496	16	BCPR5EIX-11	3306	
ZX 1.1	1.1	44	07.92-03.96	TU1M HDZ	4	0,8	BCPR5ES	6130		BCPR5EIX-11	3306	
ZX 1.1	1.1	44	04.96-	TU1M	4	0,8	BKR5EK	7956	23	BKR5EIX	6341	
ZX 1.1i	1.1	44	04.96-	TU1M HDZ	4	0,8	BKR5EK	7956	23	BKR5EIX	6341	
ZX 1.4	1.4	55	03.91-06.97	TU3MC KDX	4	0,8	BCPR6ES	2330	12	BCPR6EIX-1	4919	
ZX 1.4	1.4	55	03.91-12.92	TU32 K2C	4	0,8	BCP5ES	7496	16	BCPR5EIX-11	3306	
ZX 1.4	1.4	55	07.97-	TU3JP-KFX	4	0,8	BKR6EK	2288	20**	BKR6EQU	3199	
ZX 1.4	1.4	55	07.92-06.97	TU3MC KDY	Cat.	4	0,8	BKR6EK	2288	20**	BKR6EQU	3199
ZX 1.6	1.6	65	03.91-06.93	XU5M BDY	Cat.	4	0,8	BCPR5ES	6130		BCPR5EIX-11	3306
ZX 1.6	1.6	66	07.93-06.95	XU5JP	Cat.	4	0,8	BCPR5ES	6130		BCPR5EIX-11	3306
ZX 1.6i	1.6	66	07.93-06.95	XU5JP BFZ	4	0,8	BCPR5ES	6130		BCPR5EIX-11	3306	
ZX 1.6	1.6	66	07.95-07.98	TU5JP	4	0,8	BKR5EK	7956	23	BKR5EIX	6341	
ZX 1.6i	1.6	66	07.95-07.98	XU5JP BFZ	4	0,8	BKR5EK	7956	23	BKR5EIX	6341	
ZX 1.8i	1.8	76	07.95-	XU7JP LFZ	4	0,8	BKR5EK	7956	23	BKR5EIX	6341	
ZX 1.8	1.8	76	07.92-06.95	XU7JP LFZ	4	0,8	BCPR5ES	6130		BCPR5EIX-11	3306	
ZX 1.8	1.8	76	07.95-	XU7JP	Cat.	4	0,8	BKR5EK	7956	23	BKR5EIX	6341
ZX 1.8	1.8	83	07.97-	XU7JP4 LFY	4	0,8	BKR5EK	7956	23	BKR5EIX	6341	
ZX 1.9	1.9	88	07.92-	XU9JA DKZ	Cat.	4	0,8	BCPR5ES	6130		BCPR5EIX-11	3306
ZX 1.9	1.9	96	03.91-06.92	XU9JA D6A	4	0,7	BCP6ES	4930	17	BCPR6EIX-11	4919	
ZX 2.0i	2.0	90	07.92-03.96	XU10J2 RFX	4	0,8	BCPR5ES	6130		BCPR5EIX-11	3306	
ZX 2.0i	2.0	90	04.96-	XU10J2 RFX	4	0,8	BKR5EK	7956	23	BKR5EIX	6341	
ZX 2.0	2.0	90	07.92-03.96	XU10J2C	4	0,8	BCPR5ES	6130		BCPR5EIX-11	3306	
ZX 2.0	2.0	90	04.96-	XU10J2C	Cat.	4	0,8	BKR5EK	7956	23	BKR5EIX	6341
ZX 2.0	2.0	110	11.92-06.96	XU10J4D RFT	Cat.	4	0,8	BKR6EK	2288	20**	BKR6EQU	3199
ZX 2.0	2.0	110	07.94-06.96	XU10J4D	4	0,8	BCPR6ES	2330	12	BCPR6EIX-1	4919	
ZX 2.0	2.0	110	07.96-	XU10J4RS-RFS	4	0,9	BKR5EZ	7642		BKR5EIX	6341	
ZX D	1.8	44	03.91-04.94	XUD 7 A9A	4	█	Y-902R	2237				
ZX D	1.9	47	03.91-04.94	XUD 9 A/L D9B	4	█	Y-902R	2237				
ZX TD	1.9	68	09.92-04.94	XUD 9 T/L D8A	4	█	Y-923U	3380				
ZX Reflex D	1.8	44	03.91-	XUD 7 A9A	4	█	Y-902R	2237				

DACIA

All models	1.2	40	01.77-		4	0,6	BP6HS	4511	18	BPR6HIX	4085
All models	1.3	40	01.77-		4	0,6	BP6HS	4511	18	BPR6HIX	4085
All models	1.4	47	01.77-		4	0,6	BP6HS	4511	18	BPR6HIX	4085
Duster	1.6		92- 99			█	Y-908R	4585			

¹⁾ Bic = Best in class (siehe Seite 3) / (see page 3)

** alternative/wahlweise V-Line 30



ℓ kW

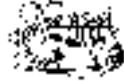

Cyl.

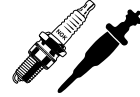
Order-
No. No.Bic¹⁾ Order-
No.**DAEWOO**

Aranos	1.8	70	11.94-	SOHC	4	0,9	BPR5ES	7422	6	BPR5EIX	6597
Aranos	2.0	81	11.94-	SOHC	4	1,1	BPR5ES-11	4424		BPR5EIX-11	2115
Arcadia	3.2	158	09.93-	V6	6	1,1	PFR6J-11	2743			
Brougham	2.0	85	09.91-12.95	C20LE Holden	4	1,1	BPR5ES-11	4424		BPR5EIX-11	2115
Cielo	1.5				4	0,8	BPR6ES	7822	2	BPR6EIX	6637
Cielo	1.5			DOHC	4	1,1	BKR6E-11	2756	14	BKR6EIX-11	3764
Damas	0.8	28	10.91-04.93	F8CB Suzuki	3	0,9	BPR5ES	7422	6	BPR5EIX	6597
Espero	1.5	66	95-	A15MF DOHC 16V	4	1,1	BKR6E-11	2756	14	BKR6EIX-11	3764
Espero	1.8	66	02.95-	C18LE	4	0,8	BPR6ES	7822	2	BPR6EIX	6637
Espero	2.0	77	02.95-	C20LE	4	0,8	BPR6ES	7822	2	BPR6EIX	6637
Evanda	1.9	96	03-	T20SED	4	0,8	BKR5EK	7956	23	BKR5EIX	6341
Imperial	3.0	135	02.89-08.93	C30NE Opel	6	0,7	BPR6HS	7022	3	BPR6HIX	4085
Kalos 1.2 SE	1.2	53	04.03-	B12S1	4	1,1	BPR5EY-11	3028		BPR5EIX-11	2115
Kalos 1.4 SE S100	1.4	61	09.02-	F14S3	4	0,8	BPR6ES	7822	2	BPR6EIX	6637
Kalos 1.4 SE	1.4	61	04.03-	F14S3 SOHC	4	0,8	BPR6ES	7822	2	BPR6EIX	6637
Kalos 1.4 SX	1.4	69	04.03-	F14D3 DOHC	4	1,1	BKR6E-11	2756	14	BKR6EIX-11	3764
Korando TD	2.3		04.00-		4	█	Y-916R	2785			
Korando	2.9		04.00-		4	█	Y-916R	2785			
Korando TD, Cabriolet	2.9	88	04.00-		5	█	Y-916R	2785			
Labo	0,8		97-	SOHC	4	0,8	BPR6ES	7822	2	BPR6EIX	6637
Lacetti	1.4	68	09.03-	F14D3	4	1,1	BKR6E-11	2756	14	BKR6EIX-11	3764
Lacetti	1.6	80	09.03-	F16D3	4	1,1	BKR6E-11	2756	14	BKR6EIX-11	3764
Lacetti	1.8	90	09.03-	T18SED	4	0,8	BKR5EK	7956	23	BKR5EIX	6341
Lanos	1.4	55	05.97-	A14SMS SOHC	4	0,8	BPR6ES	7822	2	BPR6EIX	6637
Lanos	1.5	63	05.97-	A15SMS SOHC	4	0,8	BPR6ES	7822	2	BPR6EIX	6637
Lanos	1.6	78	05.97-	A16DMS DOHC	4	1,1	BKR6E-11	2756	14	BKR6EIX-11	3764
Leganza	2.0	100	07.97-	X20SED DOHC	4		BKR5EK	7956	23	BKR5EIX	6341
Leganza	2.2		07.97-	DOHC	4	0,8	BKR6EK	2288	20**	BKR6EQUIP	3199
LeMans	1.5				4	0,8	BPR6ES	7822	2	BPR6EIX	6637
LeMans	1.5			DOHC	4	1,1	BKR6E-11	2756	14	BKR6EIX-11	3764
Matiz	0.8	38	06.98-	F8CV	3	1,1	BPR5EY-11	3028		BPR5EIX-11	2115
Matiz	1.0	47	03.03-	B10S	4	1,1	BPR5EY-11	3028		BPR5EIX-11	2115
Musso	2.0	100	09.96-	M 161.940	4	0,8	BCP5ES	7496	16	BCPR5EIX-11	3306
Musso SLTD	2.3	74	04.00-		4	█	Y-916R	2785			
Musso 16V	2.3	110	11.96-	M 161.970	4	0,8	BCP5ES	7496	16	BCPR5EIX-11	3306
Musso	2.9		04.00-		4	█	Y-916R	2785			
Musso SELTD	2.9	88	04.00-		5	█	Y-916R	2785			
Musso E32	3.2	162	05.96-	Mercedes M162990	6	0,8	BCP5ES	7496	16	BCPR5EIX-11	3306
New Brougham	2.0	85	01.96-02.97	SOHC	4	1,1	BPR5ES-11	4424		BPR5EIX-11	2115
New Brougham	2.0	106	01.96-02.97	DOHC 16V	4		BKR5EK	7956	23	BKR5EIX	6341
New Brougham	2.2	110	01.96-02.97	DOHC 16V	4		BKR5EK	7956	23	BKR5EIX	6341
New Prince	1.8	81	04.96-02.97	SOHC	4	1,1	BPR5ES-11	4424		BPR5EIX-11	2115
New Prince	1.8	101	04.96-02.97	DOHC 16V	4		BKR5EK	7956	23	BKR5EIX	6341
New Prince	2.0	85	04.96-02.97	SOHC	4	1,1	BPR5ES-11	4424		BPR5EIX-11	2115
New Prince	2.0	106	04.96-02.97	DOHC 16V	4		BKR5EK	7956	23	BKR5EIX	6341
Nexia	1.5	55	02.95-	OHC	4	0,8	BPR6ES	7822	2	BPR6EIX	6637
Nexia	1.5	66	02.95-	DOHC 16V	4	1,1	BKR6E-11	2756	14	BKR6EIX-11	3764
Nexia	1.8	74	12.95-10.96	C18LE SOHC	4	0,8	BPR6ES	7822	2	BPR6EIX	6637
Nubira	1.6	80	07.97-	A16DMS DOHC	4	1,1	BKR6E-11	2756	14	BKR6EIX-11	3764
Nubira	2.0	99	07.97-	X20SED DOHC	4		BKR5EK	7956	23	BKR5EIX	6341
Nubria 1.8 CDX	1.8	90	03-	T18SED	4	0,8	BKR5EK	7956	23	BKR5EIX	6341
Racer	1.5		01.88-02.93		4	0,9	BPR5ES	7422	6	BPR5EIX	6597

¹⁾ Bic = Best in class (siehe Seite 3) / (see page 3)

** alternative/wahlweise V-Line 30



l kW

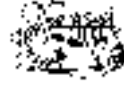

Cyl.

Order-
No. No.Bic¹⁾ Order-
No.**DAEWOO**

Rexton 290 RX Td	2.9	87	05.02-	Mercedes	5	█	Y-929U	6003			
Rezzo / Tacuma U100	1.6	77	01-	A16DMS	4	1,1	BKR5E-11	6953		BKR5EIX-11	5464
Rezzo / Tacuma U100	2.0	89	01-	T20SED	4		BKR5EK	7956	23	BKR5EIX	6341
Royal Duke	1.5	65	05.87-12.89		4	0,8	BPR6EY	6427		BPR6EIX	6637
Royal Prince i.	1.5	55	01.90-12.90		4	0,8	BPR6EY	6427		BPR6EIX	6637
Royal Prince	1.5	65	01.88-12.89		4	0,8	BPR6EY	6427		BPR6EIX	6637
Royal Prince	1.9	78	09.80-12.87		4	0,7	BPR6HS	7022	3	BPR6HIX	4085
Royal Prince i.	1.9	78	01.88-12.90		4	0,7	BPR6HS	7022	3	BPR6HIX	4085
Royal Prince	2.0	87	09.80-12.87		4	0,7	BPR6HS	7022	3	BPR6HIX	4085
Royal Prince i.	2.0	94	01.88-12.90		4	0,7	BPR6HS	7022	3	BPR6HIX	4085
Royal Salon i.	2.0	94	01.88-12.90		4	0,7	BPR6HS	7022	3	BPR6HIX	4085
Royal XQ	1.5	62	08.82-05.86		4	0,7	BPR6HS	7022	3	BPR6HIX	4085
Super Salon	2.0	81	09.91-12.95	C20LE Holden	4	1,1	BPR5ES-11	4424		BPR5EIX-11	2115
Tico	0.8			SOHC unleaded	3	0,9	BPR5ES	7422	6	BPR5EIX	6597
Tico	0.8	30		SOHC leaded	3	1,1	BPR5EY-11	3028		BPR5EIX-11	2115

DAIHATSU

850 Cab	0.85				4	0,8	BPR5EY	2828	9	BPR5EIX	6597
55 WIDE	0.85				3	0,8	BPR6ES	7822	2	BPR6EIX	6637
550	0.55				3	0,8	BPR6ES	7822	2	BPR6EIX	6637
850	0.85				3	0,8	BPR5EY	2828	9	BPR5EIX	6597
Applause A101	1.6	66		HD-E	4	0,8	BKR6E	6962	28	BKR6EIX	6418
Applause A101	1.6	73		HD-E EG	4		BKUR6EK	2213			
Applause A101	1.6	77		HD-E	4	0,8	BKR6E	6962	28	BKR6EIX	6418
Applause A111	1.6	77		HD-E	4	0,8	BKR6E	6962	28	BKR6EIX	6418
Bertone 184BEO	2.7	95		276KB	6	0,8	ZGR5A	5839	15		
Charade G100	1.0	38		CB23	4	1,1	BPR5EY-11	3028		BPR5EIX-11	2115
Charade G10	1.0	38	81-	CB20	4	0,8	BPR5EAL	5823			
Charade G11	1.0	38	83-	CB22	4	0,8	BPR5EAL	5823			
Charade G100	1.0	40		CB90	4	1,1	BPR5EY-11	3028		BPR5EIX-11	2115
Charade Turbo G11	1.0	50		CB60	4	0,8	BPR5EAL	5823			
Charade Turbo G100	1.0	50		CB61	Cat 4	0,8	BPR5EA	5623			
Charade GTti G100	1.0	74	03.87-	CB80	4	0,8	BPR6EKN	1128			
Charade G200	1.3	44		HC	4	1,1	BKR6E-11	2756	14	BKR6EIX-11	3764
Charade G200	1.3	55		HC	4	1,1	BKR6E-11	2756	14	BKR6EIX-11	3764
Charade G200	1.3	62		HC	4	1,1	BKR6E-11	2756	14	BKR6EIX-11	3764
Charade G102	1.3	66	07.91-	HC-E	4	1,1	BKR6E-11	2756	14	BKR6EIX-11	3764
Charade G112 4WD	1.3	66	02.97-	HC-E	4	1,1	BKR6E-11	2756	14	BKR6EIX-11	3764
Charade G203	1.5	55		HE	4	1,1	BKR6E-11	2756	14	BKR6EIX-11	3764
Charade G203	1.5	66		HE	4	1,1	BKR6E-11	2756	14	BKR6EIX-11	3764
Charade G201	1.6	77		HD-E	4	1,1	BKR6E-11	2756	14	BKR6EIX-11	3764
Charade CL10,60	1.0	27	86-	CL	4	█	Y-703R	3782			
Charade CL10,60 / G30	1.0	27	10.83-02.87	CL	4	█	Y-146R	7492			
Charade CL50	1.0		86-	CL	4	█	Y-703R	3782			
Charade CL50	1.0		- 85	CL	4	█	Y-146R	7492			
Charmant A35	1.3	48		4K OHV	4	0,8	BPR5EY	2828	9	BPR5EIX	6597
Charmant A45	1.6	55		2T OHV	4	0,9	BPR5ES	7422	6	BPR5EIX	6597
Charmant A60	1.6	60		4A-C Cat OHV	4	0,8	BPR5EY	2828	9	BPR5EIX	6597
Charmant A60	1.6	61		4A	4	0,8	BPR5EY	2828	9	BPR5EIX	6597
Copen L880K	0.66	50	04-	JB-DET	4	1,1	IFR6J-11	7658			
Cuore L55	0.54	21		AB30	3	0,8	BPR6ES	7822	2	BPR6EIX	6637
Cuore L60	0.61	22		AD10	3	0,8	BPR6ES	7822	2	BPR6EIX	6637

¹⁾ Bic = Best in class (siehe Seite 3) / (see page 3)



ℓ kW

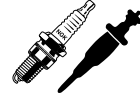

Cyl.

Order-
No. No.Bic¹⁾ Order-
No. No.**DAIHATSU**

Cuore L201	0.85	30		ED10	3	0,8	BPR6EY	6427		BPR6EIX	6637
Cuore L80	0.85	32		ED10	3	0,8	BPR6EY	6427		BPR6EIX	6637
Cuore L501	0.85	32	05.95-	ED20	3	0,8	BPR6EY	6427		BPR6EIX	6637
Cuore L701	1.0	40	06.98- 01	EJ-DE	3	1,1	BKR5E-11	6953		BKR5EIX-11	5464
Cuore L251	1.0	43	05.03-	EJ-VE	3	0,8	BKR5EKC	5216			
Cuore L701	1.0	43	09.01-	EJ-VE	3	0,8	BKR5EKC	5216			
Delta				4Y	4	0,8	BP5EY	7327		BPR5EIX	6597
Delta Truck D			02.83-	DL40	4	█	Y-128T	7227			
Delta Truck D			08.77-	DG	4	█	Y-128T	7227			
Delta Truck D			02.83-	3 B	4	█	Y-147T	7493			
Delta Truck D			02.83-	B	4	█	Y-147T	7493			
Domino					3	0,8	BPR6ES	7822	2	BPR6EIX	6637
Feroza F300	1.6	63	10.88-	HD-E	4	1,1	BKR6E-11	2756	14	BKR6EIX-11	3764
Feroza F300	1.6	70		HD-E	4	1,1	BKR6E-11	2756	14	BKR6EIX-11	3764
Fourtrak	2.0		86-		4	0,9	BPR5EY	2828	9	BPR5EIX	6597
Fourtrak	2.2		86-	DL52	4	0,9	BPR5EY	2828	9	BPR5EIX	6597
Fourtrak	2.8		- 84	DL40	4	█	Y-128T	7227			
Fourtrak	2.8		84- 93	DL50	4	█	Y-146R	7492			
Fourtrak	2.8		10.89- 93	DL-T	4	█	Y-146R	7492			
Gran Move L901	1.0	40	10.99-	EJ-DE	3		BKUR6EK	2213			
Gran Move G303	1.5	66	04.97-	HE-EG	4	1,1	BKR6E-11	2756	14	BKR6EIX-11	3764
Gran Move G301	1.6	67	07.99-	HD-EP	4	1,1	BKR6E-11	2756	14	BKR6EIX-11	3764
Hijet S77/N				CL20	4	█	Y-146R	7492			
Hijet S76	0.9	33		CB41	3	0,8	BPR5EY	2828	9	BPR5EIX	6597
Hijet S75	0.9	33		CB41	3	0,8	BPR5EY	2828	9	BPR5EIX	6597
Hijet S85	0.9	33		CB41	3	0,8	BPR5EY	2828	9	BPR5EIX	6597
Hijet S86	0.9	33		CB41	3	0,8	BPR5EY	2828	9	BPR5EIX	6597
Hijet S77	0.9	33		CB41	3	0,8	BPR5EY	2828	9	BPR5EIX	6597
Hijet	1.0		86-	CB42	3	0,9	BPR5EY	2828	9	BPR5EIX	6597
Hijet	1.3	48	08.98-	HC-ES	4		BKUR6EK	2213			
Mira	0.85		93-		3	0,9	BPR6EY	6427		BPR6EIX	6637
Move L601	0.85	31	97-10.00	ED20	3	1,1	BPR6EY-11	4228	10	BPR6EIX-11	3903
Move L901	1.0	40	10.99-	EJ-DE	3		BKUR6EK	2213			
Piaggio-Hijet S85	0.9	33		CB41	3	0,8	BPR6EY	6427		BPR6EIX	6637
Rocky 4WD			85-	DL40	4	█	Y-128T	7227			
Rocky 4WD TD				DL42	4	█	Y-146R	7492			
Rocky F85	2.0	65		3Y	4	0,8	BP5EY	7327		BPR5EIX	6597
Rocky F80	2.0	65		3Y	4	0,8	BP5EY	7327		BPR5EIX	6597
Rocky 4WD D	2.8	54	85-	DL50	4	█	Y-146R	7492			
Rocky	2.8	67	12.87-04.93	DL51	4	█	Y-146R	7492			
Sirion	1.0	43	06.98-	EJ-VE	3	0,8	BKR5EKC	5216			
Sirion	1.0	43	06.98-	EJ-DE	3		BKUR6EK	2213			
Sirion	1.3	75	09.01-	K3-VE2	3	1,0	BKUR6ETB-10				
Sparcar S65	0.55	20		AB20	2	0,8	BPR5EY	2828	9	BPR5EIX	6597
Sparcar S70	0.8	29	09.83-05.86	CD20	2	0,8	BPR6EY	6427		BPR6EIX	6637
Sportrak	1.6				4	1,1	BKR6E-11	2756	14	BKR6EIX-11	3764
Taft 4WD D			10.82-	DL40	4	█	Y-128T	7227			
Taft	1.6		82-		4	0,8	BPR5EA-L	5823			
Terios J102	1.3	63	05.00-	K3VE	4	1,0	BKUR6ETB-10				
Terios J100	1.3	61	09.97-	HC-EJ	4		BKUR6EK	2213			
Valéra	1.5	66	95-	HE-EG	4	1,1	BKR6E-11	2756	14	BKR6EIX-11	3764
Wildcat F10	0.95	30		FE	4	0,7	B6ES	7310			

¹⁾ Bic = Best in class (siehe Seite 3) / (see page 3)



l kW

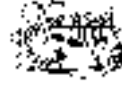

Cyl.

Order-
No. No.Bic¹⁾ Order-
No.**DAIHATSU**

Wildcat F25	1.6	48		12R	4	0,9	BPR5ES	7422	6	BPR5EIX	6597
Wildcat F20	1.6	48		12R	4	0,9	BPR5ES	7422	6	BPR5EIX	6597
Wildcat F85	2.0	65		3Y	4	0,8	BP5EY	7327		BPR5EIX	6597
Wildcat F80	2.0	65		3Y	4	0,8	BP5EY	7327		BPR5EIX	6597
YRV (M201)	1.0	43	08.00-	EJ-VE	4	0,8	BKR5EKC	5216			
YRV (M201)	1.3	64	01.01-	K3-VE	4	1,0	BKUR6ETB-10				
YRV Turbo	1.3	95	02-	K3-VET	4	0,8	BKR6EP-8	2215			

DAIMLER

3.6 Litre	3.6	163	10.86-09.89	AJ6	6	0,9	BCPR6ES	2330	12	BCPR6EIX-11	4919
4.0 Litre	4.0	164	09.89-09.94	AJ6	6	0,9	BCPR6ES	2330	12	BCPR6EIX-11	4919
4.0 Super V8	4.0		03.02-		8	1,0	IFR5N10	7866			
4.0 Super V8	4.0		03.00-03.02		8	1,1	PFR5G-11E	3000			
4.0 Super V8	4.0		09.97-03.00		8	1,3	PFR6G-13E	2341			
4.0 V8	4.0		09.98-03.00		8	1,3	PFR5G-13E	2761			
4.0 V8	4.0		09.97-09.98		8	1,3	BKR5EVXA-13	1188			
4.0 V8	4.0		03.02-		8	1,0	IFR5N10	7866			
4.0 V8	4.0		03.00-03.02		8	1,1	PFR5G-11E	3000			
Century 4.0	4.0	180	10.95-09.96	AJ6	6	0,9	BCPR6ES	2330	12	BCPR6EIX-11	4919
Century 6.0	6.0		10.95-09.96	HE	12	0,6	BR6EF	3177			
Double Six			10.91- 93	HE	12	0,6	BR7EF	3346			
Double Six			86-09.91	HE	12	0,6	BR7EFS	1094			
Double Six			82- 85	HE	12	0,6	B6EFS	2042			
Double Six	5.3		90-	V12 HE	12	0,6	BR7EFS	1094			
Double Six	6.0		02.93-09.94	HE	12	0,6	BR7EFS	1094			
Double Six	6.0				12	0,6	BR7EF	3346			
Double Six 6.0	6.0		93-	HE	12	0,6	BR7EF	3346			
Double six	6.0		09.94-09.97	HE	12	0,6	BR6EF	3177			
Limousine 4.2	4.2		-09.92	XK	6	0,6	BP5ES	6511	8	BPR5EIX	6597
Six 4.0	4.0		09.94-09.97	AJ6	6	0,9	BCPR6ES	2330	12	BCPR6EIX-11	4919
Sovereign 3.4	3.4		75- 86	XK	6	0,6	BP5ES	6511	8	BPR5EIX	6597
Sovereign 3.6	3.6		86- 89			0,9	BCPR6ES	2330	12	BCPR6EIX-11	4919
Sovereign 4.0	4.0		89-			0,9	BCPR6ES	2330	12	BCPR6EIX-11	4919
Sovereign 4.2	4.2		73- 86	XK	6	0,6	BP5E	4669			
Sovereign 4.2	4.2		79- 86	Einspritzer/Injection		0,6	BP5ES	6511	8	BPR5EIX	6597
4.0 V8	4.0		09.97-09.98	AJ26	8	1,3	BKR5EVXA-13	1188			
4.0 V8	4.0		09.98-03.00	AJ26	8	1,3	PFR5G-13E	2761			
4.0 V8	4.0		03.00-03.02	AJ26	8	1,1	PFR5G-11E	3000			
4.0 Super V8	4.0		03.00-03.02	AJ26	8	1,1	PFR5G-11E	3000			
4.0 Super V8	4.0	267	09.97-03.00	V8	8	1,3	PFR6G-13E	2341			
4.2 V8	4.2		03.02-	AJ26	8	1,0	IFR5N10	7866			
4.2 Super V8	4.2		03.02-	AJ26	8	1,0	IFR5N10	7866			

DODGE

Avenger	2.0		95- 99	L4 MPI Y DOHC	4	1,1	BKR6EVX-11	3540			
Avenger	2.5		95-	V6 MPI N DOHC	6	1,1	PFR5G-11	2647			
Colt	1.5		93- 94	L4 MPI A	4	1,1	BPR5EVX-11	2738			
Colt	1.8		92- 94	L4 MPI C	4	1,1	BKR5EVX-11	5182		BKR5EIX-11	5464
Colt	2.4		(92)	L4 MPI W	4	1,1	BPR5EVX-11	2738			
Colt	2.4		93- 94	L4 MPI G	4	1,1	BKR6EVX-11	3540			
Intrepid	2.7		98-	V6 MPI R DOHC	6	1,3	PTR5A-13	2467	25		
Intrepid	3.3		93- 97	V6 MPI T	6	1,3	GR45	2822			

¹⁾ Bic = Best in class (siehe Seite 3) / (see page 3)



ℓ kW

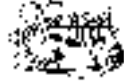

Cyl.

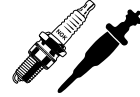
Order-
No. No.Bic¹⁾ Order-
No.**DODGE**

Intrepid	3.3		94- 95	V6 FF U	6	1,3	GR45	2822			
Intrepid	3.5		93- 97	V6 MPI F	6	0,9	FR5-1	7252			
Neon	2.0		95-	L4 MPI C SOHC	4	0,9	FR5	4876			
Neon	2.0		95- 99	L4 MPI Y DOHC	4	0,9	FR5	4876			
R1500-3500	3.9		94- 96	MPI X	6	0,9	FR4	5188			
R1500-3500	3.9		97- 99	MPI X	6	1,1	FR5-1	7252			
R1500-3500	5.2		97- 99	CNG T	8	1,1	FR5-1	7252			
R1500-3500	5.2		97- 99	MPI Y	8	1,1	FR5-1	7252			
R1500-3500	5.2		95- 96	CNG T	8	0,9	FR4	5188			
R1500-3500	5.2		94- 96	MPI Y	8	0,9	FR4	5188			
R1500-3500	5.9		98- 99	MPI Z	8	1,1	FR5-1	7252			
R1500-3500	5.9		(97)	MPI 5	8	0,9	FR4	5188			
R1500-3500	5.9		98- 99	MPI 5	8	1,1	FR5-1	7252			
R1500-3500	5.9		94- 95	TBI 5	8	0,9	WR5	1071	WR5IX		7510
R1500-3500	5.9		94- 97	MPI Z	8	0,9	FR4	5188			
R1500-3500	8.0		97- 99	MPI W	10	1,1	PZFR5F-11	4363			
R1500-3500	8.0		94- 96	MPI W	10	1,1	PZFR5F-11	4363			
Stealth	3.0		91- 92	V6 MPI B DOHC	6	1,1	PFR6J-11	2743			
Stealth Turbo	3.0		91- 92	V6 MPI C DOHC	6	1,1	PFR6J-11	2743			
Stealth	3.0		93- 96	V6 MPI J DOHC	6	1,1	PFR6J-11	2743			
Stealth	3.0		93- 96	V6 MPI H SOHC	6	1,1	BPR5EVX-11	2738			
Stealth Turbo	3.0		93- 96	V6 MPI K DOHC	6	1,1	PFR6J-11	2743			
Stratus	2.0		95-	L4 MPI C SOHC	4	0,9	FR5	4876			
Stratus	2.4		95-	L4 MPI X DOHC	4	1,1	FR45	4636			
Stratus	2.5		95-	V6 MPI H DOHC	6	1,1	PFR5G-11	2647			
Viper	8.0		92-	V10 MPI E	10	0,9	FR5-1	7252			

DONKERVOORT

D8 1.8 Turbo 20V	1.8	110		Audi	4	0,8	PFR6Q	6458			
------------------	-----	-----	--	------	---	-----	-------	------	--	--	--

EAGLE

Talon	2.0		95- 99	L4 MPI Y	4	1,1	BKR6EVX-11	3540			
Talon Turbo	2.0		95- 99	L4 MPI F	4	0,9	BPR6EVX	6764	BPR6EIX		6637

FERRARI

575 M Maranello / F1	5.7	379	02.02-	F133E	12	0,7	DCPR9EVX	6436			
612 Scaglietti /F1	5.7	397	09.04-	F133E	12	0,7	DCPR9EVX	6436			
F208 GTB; GTS	2.0	187	04.86-10.90	F106N..		0,5	B95EGV	2145			
F308 GTB; GTS	3.0	157	07.81-06.85	F106B		0,6	BP8EVX	2671			
F328 GTB; GTS	3.2	199	01.88-09.89	F105CB..		0,6	D8EVX	2850			
348 GTB; GTS	3.4	221	01.89-03.90	F119D		0,7	DCPR9EVX	6436			
348 GTB; GTS	3.4	221	04.90-03.93	F119F		0,7	DCPR9EVX	6436			
F348 TB; TS	3.4	221	09.89-04.94	F119D040	Cat.	0,6	D8EVX	2850			
348 GTB; GTS	3.4	236	03.93-06.94	F119H		0,7	DCPR9EVX	6436			
F348 GTB; GTS / Spider	3.9	221	07.94-07.95	F119		0,7	DCPR9EVX	6436			
F355	3.5	280	05.94-01.96	F129C		0,7	PMR8A	5851			
F355 Berlinetta	3.5	280	07.94-			0,6	CR8EVX	6487			
F355GTS	3.5	280	02.96-	F129C		0,7	PMR7A	4259			
F355GTS	3.5	280	05.94-01.96	F129B		0,7	PMR8A	5851			
F355 Spider	3.5	280	07.95-		8	0,7	PMR7A	4259			
F355 F1 berlinetta; GTS; Spider	3.5	280	11.97-	F129C		0,7	PMR7A	4259			
Modena 360 - 360 F1	3.6	294	05.99-11.03	F131B		0,7	PMR8A	5851			

¹⁾ Bic = Best in class (siehe Seite 3) / (see page 3)



l kW

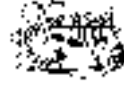

Cyl.

Order-
No. No.Bic¹⁾ Order-
No.**FERRARI**

360 Spider / F1	3.6	294	09.00-11.03	F131B	8	0,7	PMR8A	5851			
F40	2.9	353	01.88-05.92	F120A		0,5	C8E	7471			
F400 i/Automatic	4.8	232	05.79-03.85	F101..		0,6	BP7ES	2412		BPR7EIX	4055
F412	4.9	250	06.85-12.88	F101C.. - E..	12	0,6	BP8EVX	2671			
F456 GT	5.5	324	02.96-04.98	F116C	12	0,7	DCPR9EVX	6436			
F456 GT	5.5	324	04.93-01.96	F116B	12	0,7	DCPR9EVX	6436			
F456 GTA	5.5	324	07.96-04.98	F116C.010	12	0,7	DCPR9EVX	6436			
465 M GT	5.5	325	05.98-	F116C	12	0,7	DCPR9EVX	6436			
456 M GTA	5.5	325	05.98-	F116C.010	12	0,7	DCPR9EVX	6436			
F50	4.7	361	05.95-	F130B	12	0,7	PMR7A	4259			
512 TR	5.0	316	02.91-10.96	F113D	12	0,7	DCPR9EVX	6436			
F550 Maranello	5.5	357	08.96-	F133A	12	0,7	DCPR9EVX	6436			
Mondial - Cabriolet	3.0	177	06.82-06.85	F105A		0,6	BP8EVX	2671			
Mondial / Cabriolet	3.2	191	09.85-12.87	F105C..	Cat	0,6	D8EVX	2850			
Mondial T/ T Cabriolet	3.4	221	11.88-02.94	F119DL	Cat	0,6	D8EVX	2850			
Testarossa	4.9	272	10.84-10.91	F113B000	Cat.	12	0,6	D8EVX	2850		

FIAT

126 650 (D)	0.65	17	07.77-09.87	126A..	2	0,8	BPR7ES	2023	19	BPR7EIX	4055
126 650 / Personal 4	0.65	17	07.77-09.87	126A1.000	2	0,6	BPR7HS	6422			
126 (650)	0.65	22	01.83-06.96	141A.000		0,8	BPR6ES	7822	2	BPR6EIX	6637
126 BIS	0.7	19	09.87-06.91	126 A2.000	2	0,8	BPR6ES	7822	2	BPR6EIX	6637
127- 1050	1.05	37	04.77-12.86	127A1	4	0,8	BPR6ES	7822	2	BPR6EIX	6637
127 D	1.3	33	06.83-12.86		4	█	Y-902R	2237			
127 D	1.3	33	04.83-02.87	127 A., 127 A 5.	4	█	Y-208T	1250			
176 TD	1.7		06.93-		4	█	Y-922R	4356			
Argenta 100	1.6	72	06.83-11.85	132D	4	0,8	BPR6ES	7822	2	BPR6EIX	6637
Argenta 120 IE	2.0	90	06.83-11.85	132C3..	4	0,8	BPR7ES	2023	19	BPR7EIX	4055
Argenta D	2.5	53	06.81-11.85	B 144.61	4	█	Y-908R	4585			
Argenta TD	2.4	66	06.81-11.85	B 144.81	4	█	Y-908R	4585			
Barchetta	1.8	96	04.95-07.00	183A1.000	4	0,9	BKR6EKC	2848	26	BKR6EIX	6418
Barchetta	1.8	96	08.00-	183A1.000	4	0,9	BKR6EZ	4619		BKR6EIX	6418
Brava ;80 16V; Trofeo,Steel Sx,Hsx	1.2	59	06.99-05.01	182B2.000	4	0,9	DCPR8E-N	5692			
Brava i.,80 16V Sx,Hsx	1.2	59	03.98-05.99	182B2.000	4	0,9	DCPR8EKC	7168			
Brava i. 12V	1.4	55	10.95-02.98	182A5.000	4	0,9	BKR6EKC	2848	26	BKR6EIX	6418
Brava - 12V- S,SX	1.4	59	10.95-05.01	182A3.000	4	0,9	BKR6EKC	2848	26	BKR6EIX	6418
Brava 16V	1.6	66	10.95-05.01	182A6.000	4	0,9	BKR6EKC	2848	26	BKR6EIX	6418
Brava i.,100 16V;Aut. Sx,Hsx,Elx	1.6	76	05.98-06.99	182A4.000	4	0,9	BKR6EKC	2848	26	BKR6EIX	6418
Brava 100 16V Sx,Hsx,Elx;Aut.	1.6	76	07.99-05.01	182A4.000	4	0,9	BKR5EZ	7642		BKR5EIX	6341
Brava i. 16V EL; aut. EL; ELX	1.6	76	10.95-06.96	182A4.000	4	0,9	BKR6EKC	2848	26	BKR6EIX	6418
Brava 16V	1.8	83	10.95-05.01	182A2.000	4	0,9	BKR6EKC	2848	26	BKR6EIX	6418
Brava 1,9 JTD	1.9	77	12.98-11.99	182B4.000	4	█	Y-747U	4951			
Brava / Bravo D	2.0	74	09.95-07.96		4	█	Y-923U	3380			
Brava / Bravo D; TD	1.9	55	04.96-11.99		4	█	Y-928U	5700			
Brava / Bravo D	1.9	55	09.95-10.96	160A7.000	4	█	Y-920R	3645			
Bravo 80 16V Sx Trofeo; Steel	1.2	59	06.99-05.01	182B2.000	4	0,9	DCPR8E-N	5692			
Bravo i.,80 16V Sx;Trofeo;Steel	1.2	59	03.98-05.99	182B2.000	4	0,9	DCPR8EKC	7168			
Bravo i. 12V	1.4	55	10.95-02.98	182A5.000	4	0,9	BKR6EKC	2848	26	BKR6EIX	6418
Bravo 1.4i 12V S	1.4	59	03.98-05.01	182A3.000	4	0,9	BKR6EK	2848	26	BKR6EIX	6418
Bravo i. 16V	1.6	66	10.95-05.01	182A6.000	4	0,9	BKR6EK	2848	26	BKR6EIX	6418
Bravo i., 100 16V EL;Aut.	1.6	76	10.95-06.01	182A4.000	4	0,9	BKR6EKC	2848	26	BKR6EIX	6418
Bravo i.100 16V El,Sx,GT,Steel; Aut.	1.6	76	07.99-05.01	182A4.000	4	0,9	BKR5EZ	7642		BKR5EIX	6341

¹⁾ Bic = Best in class (siehe Seite 3) / (see page 3)



ℓ kW

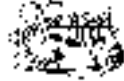

Cyl.

Order-
No. No.Bic¹⁾ Order-
No.

FIAT												
Bravo 1.8L - 16V GT	1.8	83	03.95-05.01	182A2.000	4	0,9	BKR6EKC	2848	26	BKR6EIX	6418	
Bravo 1,9 JTD	1.9	77	12.98-11.99	182B4.000	4	█	Y-747U	4951				
Bravo i. 20V, 155 HGT	2.0	108	10.95-05.01	182A1.000	5	0,9	BKR6EKC	2848	26	BKR6EIX	6418	
Bravo 155 20V	2.0	113	12.99-05.01	182A1.000	4	0,9	BKR6EK	2848	26	BKR6EIX	6418	
Campagnola D	2.5	53	06.79-10.86	B 142.61	4	█	Y-208T	1250				
Cinquecento 700 ED	0.7	23	07.91-02.97	170A.000	2	0,8	BPR6ES	7822	2	BPR6EIX	6637	
Cinquecento i S,SX,SUITE	0.9	29	07.95-12.99		4	0,8	BPR6ES	7822	2	BPR6EIX	6637	
Cinquecento 900 -Van	0.9	29	04.96-05.98	1170.1046	4	0,8	BPR6ES	7822	2	BPR6EIX	6637	
Cinquecento 900	0.9	29	02.95-05.98	1170 A1.046	4	0,8	BPR6ES	7822	2	BPR6EIX	6637	
Cinquecento	0.9	30	92-05.98	170A1.000	4	0,8	BPR6ES	7822	2	BPR6EIX	6637	
Cinquecento 900	0.9	30	92-05.98	170A1.046	Cat.	4	0,8	BPR6ES	7822	2	BPR6EIX	6637
Cinquecento	1.1	40	10.94-05.98	176B2.000	4	0,8	BCPR6ES	2330	12	BCPR6EIX-1	4919	
Cinquecento Sporting Fire	1.1	40	94-05.98	176A6.000	4	0,8	BCPR6ES	2330	12	BCPR6EIX-1	4919	
Cinquecento Sport	1.2	55	04.96-05.98	176B2.000	4	0,8	BCPR6ES	2330	12	BCPR6EIX-1	4919	
Coupè 1.8L 16V	1.8	96	02.96-02.01	183A1.000	4	0,9	BKR6EK	2848	26	BKR6EIX	6418	
Coupè 2.0L 16V	2.0	103	02.94-09.96	836A3.000	4	0,8	BPR7ES	2023	19	BPR7EIX	4055	
Coupè 2.0L 20 V	2.0	108	10.96-02.01	182A1.000	5	0,9	BKR6EK	2848	26	BKR6EIX	6418	
Coupè 2.0L 16V Turbo	2.0	140	02.94-09.96	175A1.000	4	0,8	BUR6ET	3172	1	PGR6D	6248	
Coupè 2.0L 20V Turbo	2.0	162	10.96-02.01	175A3.000	5	0,8	BKUR6ET	6437	27	PFR6Q	6458	
Coupè 2.0L 20V Turbo	2.0	162	-12.96	175A3.000	5	0,9	BKR6EK	2848	26	BKR6EIX	6418	
Croma CHT- 1.6L	1.6	61	12.85-06.90	154A0..48	4	0,8	BPR7ES	2023	19	BPR7EIX	4055	
Croma Turbo D	1.9	66	03.88-06.90	154 B	4	█	Y-739R	6639				
Croma TD (TDId)	1.9	69	07.90- 98	154 C6.000; 154 D 1.000	4	█	Y-739R	6639				
Croma 2.0L	2.0	66	86- 91	154.C2.000	4	0,8	BPR7ES	2023	19	BPR7EIX	4055	
Croma CHT- 2.0L	2.0	72	91-02.97	154.C5.000	4	0,8	BPR7ES	2023	19	BPR7EIX	4055	
Croma 2.0L	2.0	84	86-02.97	834.B.146	4	0,8	BPR7ES	2023	19	BPR7EIX	4055	
Croma 2.0L -.S	2.0	85	04.95- 99		4	0,8	BPR7ES	2023	19	BPR7EIX	4055	
Croma 2.0L	2.0	85	07.91-02.97	154C3.046	Cat.	4	0,8	BPR7ES	2023	19	BPR7EIX	4055
Croma I 2.0L	2.0	86	91-02.97	154.C3.000	4	0,8	BPR7ES	2023	19	BPR7EIX	4055	
Croma 2.0L	2.0	89	86- 91	154C.000	4	0,8	BPR7ES	2023	19	BPR7EIX	4055	
Croma 16V- 2.0L	2.0	101	91-02.97	154E1.000	4	0,8	BPR7ES	2023	19	BPR7EIX	4055	
Croma 2.0L - 16V	2.0	101	04.95-06.00		4	0,8	BPR7ES	2023	19	BPR7EIX	4055	
Croma Ti Turbo	2.0	110	86-02.97	154.C4.000	4	0,8	BP6ET	1263				
Croma Turbo	2.0	110	91-02.97	154C4.046 /Cat.	4	0,8	BP6ET	1263				
Croma Ti Turbo	2.0	110	86-02.97	834.C.146	4	0,8	BP6ET	1263				
Croma Turbo 2.0L	2.0	110	04.95-06.00		4	0,8	BUR6ET	3172	1	PGR6D	6248	
Croma Turbo	2.0	114	86-02.97	154.A2.000	4	0,8	BP6ET	1263				
Croma D	2.5	55	12.85-12.89	8144.67	4	█	Y-902R	2237				
Croma TD	2.5	74	12.85-02.89	8144.91.200	4	█	Y-908R	4585				
Croma TD	2.5	85	01.94- 99			█	Y-926U	7119				
Croma Td	2.5	85	02.89-12.92	8144.97.200/.2200	4	█	Y-908R	4585				
Croma	2.5	90	01.93-12.93		4	█	Y-914U	2643				
Croma 2.5L	2.5	90	01.94- 98		4	█	Y-914U	2643				
Croma V6- 2.5L	2.5	117	93-02.97	834G.000	6	0,8	BPR7ES	2023	19	BPR7EIX	4055	
Croma V6- 2.5L	2.5	117	04.95- 99		6	0,8	BPR7ES	2023	19	BPR7EIX	4055	
Doblò 1.2	1.2	48	11.00-	223 A5.000	4	0,9	BKR5EZ	7642		BKR5EIX	6341	
Doblò Bipower	1.6	76	11.00-	182B6.000	4	0,9	BKR6EKC	2848	26	BKR6EIX	6418	
Doblò 1.6	1.6	76	11.00-	182B6.000	4	0,9	BKR5EZ	7642		BKR5EIX	6341	
Ducato 10	1.8	49	09.81-12.90	XM7T/ 169B XM	4	0,7	BP6ES	7811	4	BPR6EIX	6637	
Ducato 10	2.0	55	09.81-12.85	XN1T/ 170B XN	4	0,7	BP6ES	7811	4	BPR6EIX	6637	
Ducato 13	2.0	55	09.81-12.85	XN1T / 170BXN	4	0,7	BP6ES	7811	4	BPR6EIX	6637	
Ducato 14	2.0	55	01.86-01.94	170BXN1T/170DXN 1TA	4	0,7	BP6ES	7811	4	BPR6EIX	6637	

¹⁾ Bic = Best in class (siehe Seite 3) / (see page 3)



l kW

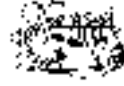

Cyl.

Order-
No. No.Bic¹⁾ Order-
No. No.**FIAT**

Ducato 10	2.0	62	06.88-	170D XN 1TA	4	0,7	BP6ES	7811	4	BPR6EIX	6637	
Ducato 18 Maxi	2.0	62	06.86-06.90	170C XN 1TA	4	0,7	BP6ES	7811	4	BPR6EIX	6637	
Ducato 10-14 Maxi	2.0	80	01.94-	RFW	4	0,7	BP6ES	7811	4	BPR6EIX	6637	
Ducato TD	2.5	68	01.86-02.94		4	█	Y-908R	4585				
Ducato (230) 2,8D	2.8	64	02.98-			█	Y-502R	3852				
Ducato 10D D	1.9	51	03.94-		4	█	Y-914U	2643				
Ducato 10TD	1.9	59	03.94-	Kat.	4	█	Y-922R	4356				
Ducato 10TD	1.9	60	03.94-		4	█	Y-914U	2643				
Ducato 10 D	2.0	52	02.87-	149 B1.000	4	█	Y-902R	2237				
Ducato 10 TD	2.0	60	01.90-02.94	280 A1.000	4	█	Y-914U	2643				
Ducato 10 D	2.5	53	01.86-02.94	8144.67	4	█	Y-908R	4585				
Ducato 10, 13 D	2.5	53	07.82-12.85		4	█	Y-208T	1250				
Ducato 14 TD	1.9	60	01.90-02.94	280 A 1.000	4	█	Y-914U	2643				
Ducato 14 D	2.4		01.86-02.94		4	█	Y-908R	4585				
Ducato 14 TD	2.4	68	01.86-02.94	8144.21.220	4	█	Y-908R	4585				
Ducato 14 D 4x4	2.5	55	01.89-02.94	8144.67.220	4	█	Y-908R	4585				
Ducato 14 D	2.5	55	01.86-02.94	8144.67.220	4	█	Y-908R	4585				
Ducato 14 TD	2.5	62	03.94-	8140.67.2200	4	█	Y-922R	4356				
Ducato 14 TD 4x4	2.5	68	01.89-02.94	8144.21.220	4	█	Y-914U	2643				
Ducato 14 TDi	2.5	81	03.94-	8140.47.2280 Kat.		█	Y-935U	5915				
Ducato 14 Di	2.5	85	03.94-	8140.47.2200		█	Y-935U	5915				
Ducato 18 Maxi D	2.5	55	01.86-02.94			█	Y-935U	5915				
Ducato 18 Maxi TD	2.5	68	01.86-02.94	8144.21.220	4	█	Y-908R	4585				
Duna 60 / 60 Weekend	1.1	43	10.86-12.90	146A6	4	0,8	BPR6ES	7822	2	BPR6EIX	6637	
Duna 70 / 70 Weekend	1.3	48	10.86-12.90	146A5	4	0,8	BPR6ES	7822	2	BPR6EIX	6637	
Duna DS D	1.7	44	10.86-12.90		4	█	Y-902R	2237				
Fiorino D	1.3	33	06.90-08.93	146 B1.000	4	█	Y-902R	2237				
Fiorino D	1.3	33	11.82-12.87		4	█	Y-902R	2237				
Fiorino	1.4	51	01.93-	160.A1.046	4	0,9	BPR5ES	7422	6	BPR5EIX	6597	
Fiorino	1.5	55	01.90-08.93	149C1.000	Cat.	4	0,8	BPR6ES	7822	2	BPR6EIX	6637
Fiorino D	1.7	42	01.88-	149 B4.046	4	█	Y-902R	2237				
Fiorino D	1.7	43	12.87-	149 B3.000	4	█	Y-902R	2237				
Marea i.;80 16V ,Weekend	1.2	59	03.98-05.99	182B2.000	4	0,9	DCPR8EKC	7168				
Marea 80 16V Sx,Hsx; Weekend	1.2	60	12.98-12.00	182B2.000	4	0,9	DCPR8E-N	5692				
Marea i. 12 V; Weekend	1.4	55	10.96-02.98	182A3.000	4	0,9	BKR6EKC	2848	26	BKR6EIX	6418	
Marea 16V Sx,Elx,Aut., Weekend	1.6	76	05.98-11.98	182A4.000	4	0,9	BKR5EZ	7642		BKR5EIX	6341	
Marea 100 16V,Sx,Elx,Aut., Weekend	1.6	76	12.98-12.03	182A4.000	4	0,9	BKR5EZ	7642		BKR5EIX	6341	
Marea i. 16V Sx Bipower	1.6	76	11.97-12.03	182A4.000	4	0,9	BKR6EKC	2848	26	BKR6EIX	6418	
Marea i. 16V; Weekend	1.6	76	09.96-04.98	182A4.000	4	0,9	BKR6EKC	2848	26	BKR6EIX	6418	
Marea i. 16 V, Weekend	1.8	83	09.96-11.98	182A2.000	4	0,9	BKR6EKC	2848	26	BKR6EIX	6418	
Marea 115 16V; Weekend	1.8	83	12.99-01.01	182A2.000	4	0,9	BKR6EKC	2848	26	BKR6EIX	6418	
Marea	1.9	55	09.96-12.00	182 A8.000	4	█	Y-928U	5700				
Marea	1.9	74	09.96-12.00	182 A7.000	4	█	Y-928U	5700				
Marea JTD	1.9	77	12.98-11.99	186A6.000	4	█	Y-747U	4951				
Marea i. 155 20 V Weekend	2.0	108	10.96-12.03	182 A1.000	5	0,9	BKR6EKC	2848	26	BKR6EIX	6418	
Marea 20V	2.0	108	09.96-11.98	182 A1.000	5	0,9	BKR6EKC	2848	26	BKR6EIX	6418	
Marea	2.4	91	09.96-12.00	185 A2.000	5	█	Y-928U	5700				
Marea JTD	2.4	96	03.99-11.99	185 A6.000	5	█	Y-747U	4951				
Marengo D	1.9	48	01.92-	160 A 7.000	4	█	Y-902R	2237				
Marengo TD	1.9	66	01.92-	160 A 6.000	4	█	Y-902R	2237				
Marengo D	1.9	66	01.92-	160 A 6.000	4	█	Y-902R	2237				
Marengo D	2.0	48	01.86-07.89		4	█	Y-902R	2237				

¹⁾ Bic = Best in class (siehe Seite 3) / (see page 3)



ℓ kW

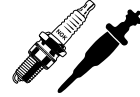

Cyl.

Order-
No. No.Bic¹⁾ Order-
No.

FIAT												
Marengo D	2.5	53	05.80-07.89	8144.61	4	█	Y-208T	1250				
Multipla 100 16V Bluepower	1.6	70	01.99-12.04	186A3.000	4	0,9	BKR6EKC	2848	26	BKR6EIX	6418	
Nuova Multipla Nat Power	1.6	76	09.04-	182B4.000	4	0,9	BKR6EKC	2848	26	BKR6EIX	6418	
Nuova Multipla	1.6	76	09.04-	182B6.000	4	0,9	BKR5EZ	7642		BKR5EIX	6341	
Multipla 100 16V Bipower	1.6	76	01.99-12.04	186A4.000	4	0,9	BKR6EKC	2848	26	BKR6EIX	6418	
Multipla 100 16V Sx	1.6	76	07.99-12.04	186A4.000	4	0,9	BKR5EZ	7642		BKR5EIX	6341	
Multipla 100 16V Sx	1.6	76	01.99-06.99	186A4.000	4	0,9	BKR6EKC	2848	26	BKR6EIX	6418	
Multipla JTD	1.9	77	11.98-11.99	182B4.000	4	█	Y-747U	4951				
Multipla JTD	1.9	81	11.98-11.99	182B4.000	4	█	Y-747U	4951				
Multipla JTD	1.9	85	11.99-11.00	182B4.000	4	█	Y-747U	4951				
Palio 65 1.2L	1.2	50	01.00-12.00	178E2.000	4	0,9	BKR6EKC	2848	26	BKR6EIX	6418	
Palio 75 Weekend	1.2	54	11.97-12.00	178B5.000	4	0,9	BKR6EKC	2848	26	BKR6EIX	6418	
Palio 16V	1.2	59	09.01-11.02	188A5.000	4	0,9	DCPR8E-N	5692				
Palio 16V	1.2	59	12.02-	188A5.000	4	0,9	DCPR7E-N	4795		DCPR7EIX	6046	
Palio 1.4L	1.4	51	09.97-	178B2.000	4	0,9	BKR5EZ	7642		BKR5EIX	6341	
Palio 1.6L 16V	1.6	74	96-06.99		4	0,9	BKR6EKC	2848	26	BKR6EIX	6418	
Palio 100 16V Weekend	1.6	76	11.97-06.99	178B3.000	4	0,9	BKR6EKC	2848	26	BKR6EIX	6418	
Palio 100 16V Weekend	1.6	76	07.99-	178B3.000	4	0,9	BKR5EZ	7642		BKR5EIX	6341	
Palio TD	1.7	51	97-		4	█	Y-922R	4356				
Panda 30 L/ 30 CL / 30 S	0.65	22	03.80-12.85	141AE...	2	0,6	BPR7HS	6422				
Panda 750 CLX -CL-L- Fire	0.75	24	01.86-12.96	156A...	4	0,8	BCPR6ES	2330	12	BCPR6EIX-1	4919	
Panda 750 Young	0.75	25	01.86-12.96	141B000	4	0,8	BPR6ES	7822	2	BPR6EIX	6637	
Panda 34	0.85	25	02.81-12.85	M 020 BS	4	0,8	BPR6ES	7822	2	BPR6EIX	6637	
Panda i.	0.9	29	01.96-01.01		4	0,8	BPR6ES	7822	2	BPR6EIX	6637	
Panda 900- Jolly-Van	0.9	29	01.97-01.01	1170A1.046	4	0,9	BKR5EZ	7642		BKR5EIX	6341	
Panda 900	0.9	29	-12.96	1170A1.046	4	0,8	BPR6ES	7822	2	BPR6EIX	6637	
Panda 45 / 45 S / 4x4	0.9	33	-12.96	146A..	4	0,8	BPR6ES	7822	2	BPR6EIX	6637	
Panda 4x4	0.95	35	09.83-12.85	A112 B1	4	0,8	BPR6ES	7822	2	BPR6EIX	6637	
Panda 1000	1.0	32	01.86-04.96	156A2.048-156A2.146/246	4	0,8	BCPR6ES	2330	12	BCPR6EIX-1	4919	
Panda Van	1.0	33	01.97-	141C2.000	4	0,9	BKR6EKC	2848	26	BKR6EIX	6418	
Panda - 1.0 L- young-L- CLX	1.0	33	06.94-12.97	141C2.000	4	0,8	BPR6ES	7822	2	BPR6EIX	6637	
Panda 1100 Selecta	1.1	37	07.90-12.96	156C.046	Cat.	4	0,8	BCPR6ES	2330	12	BCPR6EIX-1	4919
Panda 4X4	1.1	40	01.96-08.00	156C046	4	0,8	BCPR6ES	2330	12	BCPR6EIX-1	4919	
Panda 1100	1.1	40	02.95-12.96	176B2.000	4	0,8	BCPR6ES	2330	12	BCPR6EIX-1	4919	
Panda 4x4	1.1	40	02.95-12.96	176B2.000	4	0,8	BCPR6ES	2330	12	BCPR6EIX-1	4919	
Panda D	1.3	27	03.86-12.89	156A 5.000	4	█	Y-902R	2237				
Punto 55	1.1	40	11.93-05.97	176A6.000	4	0,8	BCPR6ES	2330	12	BCPR6EIX-1	4919	
Punto Van	1.1	40	06.97-06.00	176B2.000	4	0,8	BCPR6ES	2330	12	BCPR6EIX-1	4919	
Punto 55 S	1.1	40	06.94-05.97	176A6.000	4	0,8	BCPR6ES	2330	12	BCPR6EIX-1	4919	
Punto 55 S; Sx; 6 Speed	1.1	40	06.97-09.99	176B2.000	4	0,8	BCPR6ES	2330	12	BCPR6EIX-1	4919	
Punto 60 Cabrio S	1.2	40	06.97-06.98	176 B2.000	4	0,8	BCPR6ES	2330	12	BCPR6EIX-1	4919	
Punto 60 - SPI- Cabrio-Selecta	1.2	43	06.94-05.98	176A7.000	4	0,8	BCPR6ES	2330	12	BCPR6EIX-1	4919	
Punto 60 S; Sx; Selecta	1.2	44	06.97-09.99	176 B4.000	4	0,8	BCPR6ES	2330	12	BCPR6EIX-1	4919	
Punto 1.2L 8V	1.2	44	09.00-	188 A4.000	4	0,9	BKR5EZ	7642		BKR5EIX	6341	
Punto SPI	1.2	44	11.93-05.97	176B1.000	4	0,8	BCPR6ES	2330	12	BCPR6EIX-1	4919	
Punto Cabrio 1.2L	1.2	44	06.98-02.01	176 B4.000	4	0,8	BCPR6ES	2330	12	BCPR6EIX-1	4919	
Punto 75	1.2	54	11.93-05.98	176A8.000	4	0,8	BCPR6ES	2330	12	BCPR6EIX-1	4919	
Punto 1.2L 16V	1.2	59	12.02-	188 A5.000	4	0,9	DCPR7E-N	4795		DCPR7EIX	6046	
Punto 1.2L 16V	1.2	59	09.00-11.02	188 A5.000	4	0,9	DCPR8E-N	5692				
Punto 16V 1.2L Cabrio	1.2	63	06.97-06.01	176 B9.000	4	0,9	DCPR8E	4339		DCPR8EVX	2265	
Punto Cabrio 1.2L 16V	1.2	63	06.98-02.01	176 B9.000	4	0,9	DCPR8E	4339		DCPR8EVX	2265	
Punto 85 16V 1.2L	1.2	63	05.97-09.01	176B9.000	4	0,9	DCPR8E	4339		DCPR8EVX	2265	

¹⁾ Bic = Best in class (siehe Seite 3) / (see page 3)



l kW

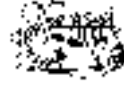

Cyl.

Order-
No. No.Bic¹⁾ Order-
No.**FIAT**

Punto 1.4L 16V	1.4	70	06.03-	843 A1.000	4	0,9	DCPR7E-N	4795		DCPR7EIX	6046
Punto Turbo GT	1.4	96	06.93-09.99	176 B6.000/ 176A4.000	4	0,9	BCPR6ET	2197			
Punto Sporting	1.6	65	07.95-05.97	176A9.000	4	0,9	BCPR7ES	3330			
Punto 90 Cabrio ELX	1.6	65	06.94-05.98	176A9.000	4	0,9	BCPR7ES	3330			
Punto 90	1.6	65	01.94-05.97	176A9.000	4	0,9	BCPR7ES	3330			
Punto D	1.7	42	11.94-	176 A 3.000	4	█	Y-902R	2237			
Punto S, SX,ELX TD	1.7	53	10.96-12.99		4	█	Y-928U	5700			
Punto 70 TD	1.7	53	10.96-12.99		4	█	Y-928U	5700			
Punto S, SX, ELX TD	1.7	53	06.93-09.96	176 TD, 1697 TT	4	█	Y-922R	4356			
Punto 1,8 HGT	1.8	96	09.02-	188 A1.000	4	0,9	BKR6EZ	4619		BKR6EIX	6418
Punto 1,8 HGT	1.8	96	09.00-08.02	188 A1.000	4	0,9	BKR6EKC	2848	26	BKR6EIX	6418
Regata 70	1.3	48	09.83-07.89	149A7.000	4	0,8	BPR6ES	7822	2	BPR6EIX	6637
Regata 75 IE	1.5	55	02.87-06.90	149C1.000	4	0,8	BPR7ES	2023	19	BPR7EIX	4055
Regata 85 S	1.5	62	01.84-12.87	149A.000	4	0,8	BPR7ES	2023	19	BPR7EIX	4055
Regata 90 IE	1.6	66	01.87-03.89	149C2.000	Cat. 4	0,8	BPR6ES	7822	2	BPR6EIX	6637
Regata 100 IE S / IE Riv.	1.6	74	06.86-07.89	149C3.000	4	0,8	BPR6ES	7822	2	BPR6EIX	6637
Regata 100 IE Week./Riv./S	1.6	74	06.86-06.90	149A4..	4	0,8	BPR6ES	7822	2	BPR6EIX	6637
Regata 100 S / Weekend	1.6	74	06.86-06.90	149A4..	4	0,8	BPR7ES	2023	19	BPR7EIX	4055
Regata D	1.7	43	09.83-05.87	138 B., 149 B 3.	4	█	Y-902R	2237			
Regata D	1.7	43	06.87-		4	█	Y-902R	2237			
Regata D	1.9	48	06.87-		4	█	Y-902R	2237			
Regata D	1.9	48	04.84-05.87	149 A 1.	4	█	Y-902R	2237			
Regata TD	1.9	59	06.86-07.89		4	█	Y-902R	2237			
Ritmo 60	1.1	41	07.78-12.87	138B., 146A4..	4	0,8	BPR6ES	7822	2	BPR6EIX	6637
tutti modelli/alle Modelle/all models											
Ritmo 70 S / S Team	1.3	48	05.85-12.87	138B2., 149A7..	4	0,8	BPR6ES	7822	2	BPR6EIX	6637
Ritmo 85 S	1.5	61	01.81-12.87	138AE, 138B3, 149A..	4	0,8	BPR7ES	2023	19	BPR7EIX	4055
Ritmo 100 S / S Team	1.6	74	05.85-12.87	149A4..	4	0,8	BPR6ES	7822	2	BPR6EIX	6637
Ritmo 105 TC	1.6	77	10.82-04.85	138AR..	4	0,8	BPR6ES	7822	2	BPR6EIX	6637
Ritmo D	1.7	43	10.82-		4	█	Y-902R	2237			
Ritmo TD	1.9	59	12.85-12.87	831 D 1.	4	█	Y-902R	2237			
Ritmo 130 TC Abarth	2.0	96	04.83-12.87	138AR2..	4	0,8	BPR7ES	2023	19	BPR7EIX	4055
Scudo	1.6	58	02.96-	220A2.000	4	0,8	BCPR7ES	3330			
Scudo D	1.9	51	03.96-		4	█	Y-923U	3380			
Scudo TD	1.9	68	03.96-		4	█	Y-923U	3380			
Seicento 900 i.e. S; SX; Citymatic	0.9	29	05.98-12.00	1170A1.046	4	0,8	BPR6ES	7822	2	BPR6EIX	6637
Seicento Sporting	1.1	40	03.98-09.00	176B2.000	4	0,8	BCPR6ES	2330	12	BCPR6EIX-1	4919
Seicento 1100	1.1	40	05.98-09.00	176B2.000	4	0,8	BCPR6ES	2330	12	BCPR6EIX-1	4919
Seicento 1100	1.1	40	10.00-	187A1000	4	0,9	BKR5EZ	7642		BKR5EIX	6341
Siena 1.4	1.4	51	11.97-	178 B2.000	4	0,9	BKR5EZ	7642		BKR5EIX	6341
Stilo 1.2 16V	1.2	59	12.02-06.04	188.A5000	4	0,9	DCPR7E-N	4795		DCPR7EIX	6046
Stilo 1.2 16V	1.2	59	09.01-11.02	188.A5000	4	0,9	DCPR8E-N	5692			
Stilo 1.6	1.6	76	09.01-	182.B6000	4	0,9	BKR5EZ	7642		BKR5EIX	6341
Stilo 1.6 SW	1.6	76	09.02-	182.B6000	4	0,9	BKR5EZ	7642		BKR5EIX	6341
Stilo 1.8 16V	1.8	96	09.01-	192.A4000	4	0,9	BKR6EZ	4619		BKR6EIX	6418
Stilo 1.8 SW	1.8	98	09.02-	192.A4000	4	0,9	BKR6EZ	4619		BKR6EIX	6418
Stilo 2.4 20V	2.4	125	09.01-	192.A2000	5	0,9	BKR6EZ	4619		BKR6EIX	6418
Strada 75	1.2	54	05.99-	178B5.000	4	0,9	BKR6EKC	2848	26	BKR6EIX	6418
Strada D	1.7	43	10.82-		4	█	Y-902R	2237			
Talento D	1.9	51	03.88-		4	█	Y-902R	2237			
Tempra 1.4- S.W- .S	1.4	51	10.94-10.96	836A4.000	4	0,8	BPR6ES	7822	2	BPR6EIX	6637
Tempra / SX / Sta. Wagon	1.4	56	03.90-10.96	159A2.000	4	0,8	BPR6ES	7822	2	BPR6EIX	6637

¹⁾ Bic = Best in class (siehe Seite 3) / (see page 3)



ℓ kW

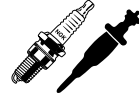

Cyl.

Order-
No. No.Bic¹⁾ Order-
No.

FIAT												
Tempra 1.6	1.6	55	02.90-12.94	159 A3.048		4	0,8	BPR7ES	2023	19	BPR7EIX	4055
Tempra 1.6	1.6	55	09.94-10.96	835C1.000		4	0,9	BCPR7ES	3330			
Tempra 1.6 90CV-Liberty S.W.	1.6	66	03.95-			4	0,9	BCPR7ES	3330			
Tempra ie SX, S.W.	1.8	74	05.95-			4	0,8	BPR7ES	2023	19	BPR7EIX	4055
Tempra 1800 i.e/a.Modelle	1.8	77	02.90-10.96	159A4.046		4	0,8	BPR7ES	2023	19	BPR7EIX	4055
Tempra D - SW	1.9	48	02.90-06.96	160 A7.000		4	█	Y-902R	2237			
Tempra TD	1.9	59	07.90-	160 B6.046		4	█	Y-902R	2237			
Tempra TD /SW	1.9	66	02.90-	160 A6.000		4	█	Y-902R	2237			
Tempra TD	1.9	68	06.93-09.96	160 D1.000		4	█	Y-922R	4356			
Tempra 2.0L	2.0	83	02.90-10.96	159A6.046		4	0,8	BPR7ES	2023	19	BPR7EIX	4055
Tipo 1.1L	1.1	41	07.87-03.93	160A3.000		4	0,8	BCPR6ES	2330	12	BCPR6EIX-1	4919
Tipo	1.4	51	07.87-11.90	160 A1.046		4	0,8	BPR6ES	7822	2	BPR6EIX	6637
Tipo1.4L	1.4	51	02.88-11.90	160A1.000		4	0,8	BPR7ES	2023	19	BPR7EIX	4055
Tipo Selecta	1.4	53	02.88-	160A1.000		4	0,8	BPR7ES	2023	19	BPR7EIX	4055
Tipo	1.4	57	01.90-05.95	159A2.000		4	0,8	BPR6ES	7822	2	BPR6EIX	6637
Tipo i.e.	1.6	55	03.94-			4	0,9	BCPR7ES	3330			
Tipo i.e.	1.6	55	03.93-10.95	835C1.000		4	0,8	BPR7ES	2023	19	BPR7EIX	4055
Tipo 1.6L	1.6	55	03.93-10.94	835C1.000		4	0,9	BCPR7ES	3330			
Tipo Selecta	1.6	57	01.92-03.93	159A3.046		4	0,8	BPR7ES	2023	19	BPR7EIX	4055
Tipo	1.6	60	02.88-06.90	160A2.000		4	0,8	BPR7ES	2023	19	BPR7EIX	4055
Tipo	1.6	63	04.90-12.92	159A3.000 DOHC		4	0,8	BPR7ES	2023	19	BPR7EIX	4055
Tipo	1.6	63	07.87-03.90	160A2.000		4	0,8	BPR7ES	2023	19	BPR7EIX	4055
Tipo i.e.	1.6	66	03.93-10.95	159 A3.048		4	0,8	BPR7ES	2023	19	BPR7EIX	4055
Tipo i.e	1.6	66	02.88-06.90	160A1.000		4	0,8	BPR7ES	2023	19	BPR7EIX	4055
Tipo D	1.7	42	07.87-03.93	149 B 4.000		4	█	Y-902R	2237			
Tipo IE SX / GT / SLX	1.8	76	11.91-10.95	835C2.000		4	0,8	BPR7ES	2023	19	BPR7EIX	4055
Tipo i.e. GT	1.8	80	03.92-03.93	139A4.000		4	0,8	BPR7ES	2023	19	BPR7EIX	4055
Tipo IE 16V	1.8	80	06.89-05.90	159A4.000		4	0,8	BPR7ES	2023	19	BPR7EIX	4055
Tipo IE 16V	1.8	102	06.89-09.91	160A5.000		4	0,8	BP6ET	1263			
Tipo D	1.9	48	07.89-03.93	149 A1.000		4	█	Y-902R	2237			
Tipo TD	1.9	66	07.87-	160 D1.000		4	█	Y-902R	2237			
Tipo TD	1.9	68	07.87-03.93	149 A 1.000		4	█	Y-902R	2237			
Tipo TD	1.9	68	06.93-12.94			4	█	Y-922R	4356			
Tipo 2.0 L	2.0	83	03.90-03.92	159A6.046		4	0,8	BPR7ES	2023	19	BPR7EIX	4055
Tipo 2.0 L- GT / SLX	2.0	83	11.91-10.95	159A6.046	Cat.	4	0,8	BPR7ES	2023	19	BPR7EIX	4055
Tipo IE 16V	2.0	102	05.91-10.95	836A3.000	Cat.	4	0,8	BPR7ES	2023	19	BPR7EIX	4055
Tipo i.e. 16V	2.0	109	05.91-10.95	160A8.046		4	0,8	BPR7ES	2023	19	BPR7EIX	4055
Ulysse TD	1.9	68	09.94-	XUD 9 TU		4	█	Y-923U	3380			
Ulysse i.S	2.0	89	07.94-	RFU		4	0,9	BKR5EK	7956	23	BKR5EIX	6341
Ulysse i.turbo	2.0	108	07.94-12.98	RGX		4	0,8	BKR6EK	2288	20**	BKR6EQUIP	3199
Ulysse TD	2.1	80	07.96-	XUD11ATE		4	█	Y-923U	3380			
Uno 45 ES/S/Sting/Trend	0.9	33	01.83-10.95	146A...		4	0,8	BPR6ES	7822	2	BPR6EIX	6637
Uno 45	1.0	32	06.85-10.95	156A2...		4	0,8	BCPR6ES	2330	12	BCPR6EIX-1	4919
Uno 1.0L- Start	1.0	33	08.94-10.95	156A2.000-2.048		4	0,9	BPR5ES	7422	6	BPR5EIX	6597
Uno 1.0 L	1.0	35	08.94-			4	0,8	BPR6ES	7822	2	BPR6EIX	6637
Uno 60 IE / S	1.1	37	07.91-10.95	156C.046	Cat.	4	0,8	BCPR6ES	2330	12	BCPR6EIX-1	4919
Uno 55 / 55 S	1.1	41	01.83-04.85	138B..		4	0,8	BPR6ES	7822	2	BPR6EIX	6637
Uno 60 SL / Trend	1.1	41	09.89-09.92	146A6.000		4	0,8	BPR6ES	7822	2	BPR6EIX	6637
Uno 60 S / SX / Fire	1.1	41	05.85-10.95	146A6.000		4	0,8	BCPR6ES	2330	12	BCPR6EIX-1	4919
Uno 60 /60 CS / 60 S	1.1	43	05.85-08.89	146A4...		4	0,8	BPR6ES	7822	2	BPR6EIX	6637
Uno Selecta / Selecta S	1.1	43	04.87-08.89	146A4.048		4	0,8	BPR6ES	7822	2	BPR6EIX	6637
Uno 45 D	1.3	33	06.83-08.89	127 A 5.		4	█	Y-902R	2237			

¹⁾ Bic = Best in class (siehe Seite 3) / (see page 3)

** alternative/wahlweise V-Line 30



l kW

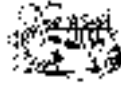

Cyl.

Order-
No. No.Bic¹⁾ Order-
No.**FIAT**

Uno 60 D	1.3	33	06.83-08.89	127 A 5.	4	Y-902R	2237				
Uno 70 S / SL / SX	1.3	48	05.85-09.89	149A7...	4	0,8 BPR6ES	7822	2	BPR6EIX	6637	
Uno Turbo i.e.	1.3	73	04.85-08.89	146A2...	Cat. 4	0,7 BCPR7ET	2164				
Uno 70 all models	1.4	51	83-10.95	160A1.046	4	0,8 BPR6ES	7822	2	BPR6EIX	6637	
Uno i.e.	1.4	51	08.94-		4	0,8 BPR6ES	7822	2	BPR6EIX	6637	
Uno 60 TD	1.4	51	03.86-09.92	146 B	4	Y-902R	2237				
Uno 70 TD	1.4	51	03.86-08.89	146 A 653, 146 B.	4	Y-902R	2237				
Uno TD	1.4	52	09.89-12.95	146 B3.000	4	Y-902R	2237				
Uno Turbo IE/ Racing	1.4	82	09.89-12.93	146A8.046	Cat. 4	0,7 BCPR7ET	2164				
Uno 75 IE SX / Selecta	1.5	55	10.85-08.87	138C2...	Cat. 4	0,8 BPR7ES	2023	19	BPR7EIX	4055	
Uno 75 I.E. SPi	1.5	55	12.87-10.95	149C1.000	4	0,8 BPR6ES	7822	2	BPR6EIX	6637	
Uno D	1.7		10.89-		4	Y-902R	2237				
Uno D	1.7		01.91-		4	Y-902R	2237				
Uno 60 D	1.7	40	09.89-09.92	146 B 2.000	4	Y-902R	2237				
Uno D Van	1.7	42	09.89-03.96	146 B2.000	4	Y-902R	2237				
Uno 60 D	1.7	44	07.86-08.89	149 B 3.	4	Y-902R	2237				

FISSORE

Magnum Volumex	2.0	102	01.86-03.88	132E.000 Fiat	4	0,8 BPR6ES	7822	2	BPR6EIX	6637	
Magnum 4x4 TD	2.4	77	07.84-04.86		6	Y-908R	4585				
Rayton	3.5	155	03.88-		6	BP6ES	7811	4	BPR6EIX	6637	
Rayton 4x4 TD	2.4	82	03.88-	HR 492 HIM	6	Y-909R	4602				
Vip V6 i.e.	2.5	118	03.86-03.88	019.11 Alfa	6	BP6ES	7811	4	BPR6EIX	6637	

FORD

Aerostar	3.0				6	0,9 BPR6EFS	3623	7			
A-Series	2.4			4AA YORK-D		Y-208T	1250				
A-Series	3.6			8AA YORK-D		Y-208T	1250				
Capri	2.0	74	01.78-04.87	2VHC OHC	4	0,7 APR6FS	2922				
Capri	2.3	84	06.79-04.87	2VHC V6	6	0,8 BPR7ES	2023	19	BPR7EIX	4055	
Capri	2.8	118	01.81-04.87	FIHC V6	6	0,8 BPR7ES	2023	19	BPR7EIX	4055	
Cougar	2.0	96	08.98-01.01	EDBC ZETEC-E SEFI	4	1,3 PTR5A-13 *	2467	25			
Cougar	2.0	96	08.98-01.01	EDBD ZETEC-E SEFI	4	1,3 PTR5A-13 *	2467	25			
Cougar	2.0	96	08.98-01.01	EDBA ZETEC-E SEFI	4	1,3 PTR5A-13 *	2467	25			
Cougar	2.0	96	08.98-01.01	EDBB ZETEC-E SEFI	4	1,3 PTR5A-13 *	2467	25			
Cougar	2.5	125	08.98-01.01	LCBB Duratec-VE SEFI	6	1,3 TR55	1048		TR55IX	7164	
Cougar	2.5	125	08.98-01.01	LCBE Duratec-VE SEFI	6	1,3 TR55	1048		TR55IX	7164	
Cougar	2.5	125	08.98-01.01	LCBA Duratec VE SEFI	6	1,3 TR55	1048		TR55IX	7164	
Cougar	2.5	125	08.98-01.01	LCBC Duratec VE SEFI	6	1,3 TR55	1048		TR55IX	7164	
Cougar	2.5	151	08.98-01.01	MABB Duratec VE SEFI	6	1,3 TR55	1048		TR55IX	7164	
Courier D	1.8	66	03.93-		4	Y-910R	4751				
Econovan	1.4	48	09.85-	UC OHC/E 2V	4	0,8 BPR6ES	7822	2	BPR6EIX	6637	
Econovan	2.0	41	09.85-	RF	4	Y-107R	1229				
Escort '81	1.1	37	08.80-12.85	GSE VAL VV	4	1,0 BPR6EFS	3623	7			
Escort '81	1.1	40	08.80-12.85	GMA CVH VV	4	0,8 BCPR6ES	2330	12	BCPR6EIX-11	4919	
Escort '81	1.1	40	08.80-12.85	GLB VAL VV	4	1,0 BPR6EFS	3623	7			
Escort '81	1.1	43	08.80-12.85	GPA CVH VV	4	0,8 BCPR7ES	3330				
Escort '81	1.3	43	08.80-12.85	JGA CHT 2V	4	0,8 BCPR6ES	2330	12	BCPR6EIX-11	4919	
Escort '81	1.3	51	08.80-12.85	JPA CVH VV	4	0,8 BCPR6ES	2330	12	BCPR6EIX-11	4919	
Escort '81 Express Van 55	1.6	40	04.84-07.90	LTA	4	Y-907R	4479				
Escort '81	1.6	40	08.80-12.85	LTA	4	Y-907R	4479				
Escort '81	1.6	48	08.80-12.85	LGA CHT 2V	4	0,8 BCPR6ES	2330	12	BCPR6EIX-11	4919	

¹⁾ Bic = Best in class (siehe Seite 3) / (see page 3)

* Standardtype TR5A-10 / standard type TR5A-10



ℓ kW

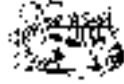

Cyl.

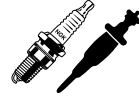
Order-
No. No.Bic¹⁾ Order-
No.**FORD**

Escort '81	1.6	58	08.80-12.85	LPA CVH VV	4	0,8	BCPR7ES	3330			
Escort '81	1.6	58	08.80-12.85	LPI CVH VV	4	0,8	BCPR7ES	3330			
Escort '81	1.6	66	08.80-12.85	L4B CVH FI	4	0,8	BCPR6ES	2330	12	BCPR6EIX-11	4919
Escort '81	1.6	71	08.80-12.85	LUA CVH 2V	4	0,8	BCPR7ES	3330			
Escort '81	1.6	77	08.80-12.85	LRA CVH FI	4	0,8	BCPR7ES	3330			
Escort '81	1.6	77	08.80-12.85	LRI CVH FI	4	0,8	BCPR7ES	3330			
Escort '81	1.6	85	08.80-12.85	LUAE CVH FI	4	0,8	BCPR9ES-11	1152			
Escort '81	1.6	97	08.80-12.85	LNA CVH FI	4	0,8	BCR8ES	5430			
Escort '86	1.1	37	01.86-07.90	GSG VAL VV	4	1,0	BPR6EFS	3623	7		
Escort '86	1.1	40	01.86-07.90	GUC HCS 2V	4	1,0	BPR6EFS	3623	7		
Escort '86	1.3	44	01.86-07.90	JLB VAL VV	4	1,0	BPR6EFS	3623	7		
Escort '86	1.3	44	01.86-07.90	JLA VAL VV	4	1,0	BPR6EFS	3623	7		
Escort '86	1.3	44	01.86-07.90	JLA VAL VV	Cat. 4	1,0	BPR6EFS	3623	7		
Escort '86	1.3	44	01.86-07.90	JBB HCS 2V	4	1,0	BPR6EFS	3623	7		
Escort '86	1.3	46	01.86-07.90	JBA HCS 2V	4	1,0	BPR6EFS	3623	7		
Escort '86	1.4	51	01.86-07.90	FUAA CVH 2V	4	0,8	BCPR6ES	2330	12	BCPR6EIX-11	4919
Escort '86	1.4	54	01.86-07.90	F6B CVH CFI	4	1,1	BCPR6ES-11	7121	11	BCPR6EIX-11	4919
Escort '86	1.4	54	01.86-07.90	FUC CVH 2V	4	1,1	BCPR7ES-11	1095		BCPR7EIX-11	5691
Escort '86	1.4	54	01.86-07.90	F6D CVH CFI	4	1,1	BCPR6ES-11	7121	11	BCPR6EIX-11	4919
Escort '86	1.4	55	01.86-07.90	FUA CVH 2V	Cat. 4	0,8	BCPR6ES	2330	12	BCPR6EIX-11	4919
Escort '86	1.4	55	01.86-07.90	FUA CVH 2V	4	0,8	BCPR6ES	2330	12	BCPR6EIX-11	4919
Escort '86	1.6	40	01.86-07.90	LTC	4	█	Y-907R	4479			
Escort '86	1.6	58	01.86-07.90	LP2 CVH VV	4	0,8	BCPR6ES	2330	12	BCPR6EIX-11	4919
Escort '86	1.6	65	01.86-07.90	LUG CVH 2V	4	0,8	BCPR6ES	2330	12	BCPR6EIX-11	4919
Escort '86	1.6	66	01.86-07.90	L4B CVH FI	4	0,8	BCPR6ES	2330	12	BCPR6EIX-11	4919
Escort '86	1.6	66	01.86-07.90	LUC CVH 2V	4	0,8	BCPR6ES	2330	12	BCPR6EIX-11	4919
Escort '86	1.6	66	01.86-07.90	LUC CVH 2V	Cat. 4	0,8	BCPR6ES	2330	12	BCPR6EIX-11	4919
Escort '86	1.6	75	01.86-07.90	LJB CVH EFI	4	1,1	BCPR6ES-11	7121	11	BCPR6EIX-11	4919
Escort '86	1.6	77	01.86-07.90	LR2 CVH FI	4	0,8	BCPR7ES	3330			
Escort '86	1.6	77	01.86-07.90	LRB CVH FI	4	0,8	BCPR7ES	3330			
Escort '86	1.6	77	01.86-07.90	LRB CVH FI	Cat. 4	0,8	BCPR7ES	3330			
Escort '86	1.6	79	01.86-07.90	LJA CVH EFI	4	1,1	BCPR6ES-11	7121	11	BCPR6EIX-11	4919
Escort '86	1.6	97	01.86-07.90	LNB CVH FI	4	0,8	BCR8ES	5430			
Escort '86	1.8	44	01.86-07.90	RTA	4	█	Y-910R	4751			
Escort '86	1.8	44	01.86-07.90	RTB	4	█	Y-910R	4751			
Escort '91	1.1	40	08.90-09.01	GUF HCS 2V	4	1,0	PTR5D-10	3784	31		
Escort '91	1.3	44	08.90-09.01	JBE HCS 2V	4	1,0	PTR5D-10	3784	31		
Escort '91	1.3	44	08.90-09.01	J4B Endura-E SEFI	4	1,0	PTR5D-10	3784	31		
Escort '91	1.3	44	08.90-09.01	J6A HCS CFI	4	1,0	PTR5D-10	3784	31		
Escort '91	1.3	46	08.90-09.01	JBD HCS 2V	4	1,0	PTR5D-10	3784	31		
Escort '91	1.4	52	08.90-09.01	F6F CVH CFI	4	1,1	BCPR6ES-11	7121	11	BCPR6EIX-11	4919
Escort '91	1.4	52	08.90-09.01	F6G CVH CFI	4	1,1	BCPR6ES-11	7121	11	BCPR6EIX-11	4919
Escort '91	1.4	54	08.90-09.01	F4B PTE SEFI	4	1,1	BCPR6ES-11	7121	11	BCPR6EIX-11	4919
Escort '91	1.4	54	08.90-09.01	FUH CVH 2V	4	0,8	BCPR6ES	2330	12	BCPR6EIX-11	4919
Escort '91	1.6	65	08.90-09.01	L1H ZETEC-E SEFI	4	1,3	PTR5A-13 *	2467	25		
Escort '91	1.6	66	08.90-09.01	LUJ CVH 2V	4	0,8	BCPR6ES	2330	12	BCPR6EIX-11	4919
Escort '91	1.6	66	08.90-09.01	LUK CVH 2V	4	0,8	BCPR6ES	2330	12	BCPR6EIX-11	4919
Escort '91	1.6	66	08.90-09.01	L1E ZETEC SEFI	4	1,3	PTR5A-13 *	2467	25		
Escort '91	1.6	66	08.90-09.01	L1K ZETEC-E SEFI	4	1,3	PTR5A-13 *	2467	25		
Escort '91	1.6	77	08.90-09.01	LJF CVH EFI	4	1,1	BCPR6ES-11	7121	11	BCPR6EIX-11	4919
Escort '91	1.6	79	08.90-09.01	LJE CVH EFI	4	1,1	BCPR6ES-11	7121	11	BCPR6EIX-11	4919
Escort '91	1.8	44	08.90-09.01	RTE	4	█	Y-910R	4751			

¹⁾ Bic = Best in class (siehe Seite 3) / (see page 3)

* Standardtype TR5A-10 / standard type TR5A-10



l kW

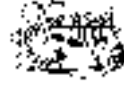

Cyl.

Order-
No. No.Bic¹⁾ Order-
No. No.**FORD**

Escort '91	1.8	44	08.90-09.01	RTF	4	☑	Y-910R	4751					
Escort '91	1.8	44	08.90-09.01	RTH	4	☑	Y-910R	4751					
Escort '91 TD	1.8	51	08.90-09.01	RVA Endura-DE (TC)	4	☑	Y-937R	5148					
Escort '91	1.8	66	08.90-09.01	RFK	4	☑	Y-910R	4751					
Escort '91	1.8	66	08.90-09.01	RFS Endura-DE (TC)	4	☑	Y-937R	5148					
Escort '91	1.8	66	08.90-09.01	RFD	4	☑	Y-910R	4751					
Escort '91	1.8	77	08.90-09.01	RDA ZETEC SEFI	4	1,3	PTR5A-13 *	2467	25				
Escort '91	1.8	85	08.90-09.01	RKC ZETEC-E SEFI	4	1,3	PTR5A-13 *	2467	25				
Escort '91	1.8	96	08.90-09.01	RQB ZETEC SEFI	4	1,3	PTR5A-13 *	2467	25				
Escort '91	2.0	110	08.90-09.01	N7A DOHC 16V EFI	4	1,1	BCPR6ES-11	7121	11	BCPR6EIX-11	4919		
Escort '91 Cosworth	2.0	162	08.90-09.01	N5E DOHC COSWORTH	4	1,1	PFR7B-11	5667					
Escort '91	2.0	162	08.90-09.01	N5F DOHC COSWORTH	4	0,6	PFR7B	4853					
Escort '91 Cosworth	2.0	184	92-	NC8 1711 COSWORTH 16V	4	0,8	R7234-10	5558					
Explorer	4.0	115	01.93-	V6 SEFI	6	1,3	TR55	1048		TR55IX	7164		
Explorer	4.0	121	01.93-	V6 EFI	6	1,3	TR55	1048		TR55IX	7164		
Explorer	4.0	152	01.93-	V6 SOHC SEFI	6	1,3	TR55	1048		TR55IX	7164		
Fiesta '01	1.25	51	11.01-	M7JA Duratec 16V SFI	4	1,3	PTR5A-13 *	2467	25				
Fiesta '01	1.25	51	11.01-	M7JB Duratec 16V SFI	4	1,3	PTR5A-13 *	2467	25				
Fiesta '01	1.25	55	11.01-	FUJB Duratec 16V SFI	4	1,3	PTR5A-13 *	2467	25				
Fiesta '01	1.25	55	11.01-	FUJA Duratec 16V SFI	4	1,3	PTR5A-13 *	2467	25				
Fiesta '01	1.3	44	11.01-	BAJA Duratec 8V SFI	4	1,3	PTR5A-13 *	2467	25				
Fiesta '01	1.3	51	11.01-	A9JA Duratec 8V SFI	4	1,3	PTR5A-13 *	2467	25				
Fiesta '01	1.3	51	11.01-	A9JB Duratec 8V SFI	4	1,3	PTR5A-13 *	2467	25				
Fiesta '01 TDCI	1.4	50	11.01-	F6JB DuraTorq-TDCi	4	☑	YE04	1101					
Fiesta '01 TDCI	1.4	50	11.01-	F6JA DuraTorq-TDCi	4	☑	YE04	1101					
Fiesta '01	1.4	59	11.01-	FXJB Duratec 16V SFI	4	1,3	PTR5A-13 *	2467	25				
Fiesta '01 16V	1.4	59	11.01-	FXJA Duratec 16V SFI	4	1,3	PTR5A-13 *	2467	25				
Fiesta '01	1.6	74	11.01-	FYJB Duratec 16V SFI	4	1,3	PTR5A-13 *	2467	25				
Fiesta '01 16V	1.6	74	11.01-	FYJA Duratec 16V SFI	4	1,3	PTR5A-13 *	2467	25				
Fiesta '83	1.3	51	08.83-01.87	JPC CVH VV	4	0,8	BCPR6ES	2330	12	BCPR6EIX-11	4919		
Fiesta '83	1.6	40	08.83-01.87	LTB D	4	☑	Y-907R	4479					
Fiesta '84	1.0	33	08.83-01.87	TKB VAL 1V	Cat.	4	1,0	BPR6EFS	3623	7			
Fiesta '84	1.0	33	08.83-01.87	TKB VAL 1V		4	1,0	BPR6EFS	3623	7			
Fiesta '84	1.1	37	08.83-01.87	GSF VAL VV	Cat.	4	1,0	BPR6EFS	3623	7			
Fiesta '84	1.1	37	08.83-01.87	GSF VAL VV		4	1,0	BPR6EFS	3623	7			
Fiesta '84	1.1	37	08.83-01.87	GLC VAL 1V		4	1,0	BPR6EFS	3623	7			
Fiesta '84	1.1	39	08.83-01.87	GSI VAL VV		4	1,0	BPR6EFS	3623	7			
Fiesta '84	1.1	39	08.83-01.87	GLI VAL VV		4	1,0	BPR6EFS	3623	7			
Fiesta '84	1.1	41	08.83-01.87	GL VAL 1V		4	1,0	BPR6EFS	3623	7			
Fiesta '84	1.4	51	08.83-01.87	FUBA CVH 2V		4	0,8	BCPR6ES	2330	12	BCPR6EIX-11	4919	
Fiesta '84	1.4	55	08.83-01.87	FUB CVH 2V	Cat.	4	0,8	BCPR6ES	2330	12	BCPR6EIX-11	4919	
Fiesta '84	1.4	55	08.83-01.87	FUB CVH 2V		4	0,8	BCPR6ES	2330	12	BCPR6EIX-11	4919	
Fiesta '84	1.6	58	08.83-01.87	LP3 CVH VV		4	0,8	BCPR7ES	3330				
Fiesta '84	1.6	71	08.83-01.87	LUB CVH 2V	Cat.	4	0,8	BCPR6ES	2330	12	BCPR6EIX-11	4919	
Fiesta '84	1.6	71	08.83-01.87	LUB CVH 2V		4	0,8	BCPR7ES	3330				
Fiesta '87	1.0	33	02.87-02.89	TKB VAL 1V		4	1,0	BPR6EFS	3623	7			
Fiesta '87	1.0	33	02.87-02.89	TKB VAL 1V	Cat.	4	1,0	BPR6EFS	3623	7			
Fiesta '87	1.1	35	02.87-02.89	GUB VAL 2V		4	1,0	BPR6EFS	3623	7			
Fiesta '87	1.1	36	02.87-02.89	GSH VAL VV		4	1,0	BPR6EFS	3623	7			
Fiesta '87	1.1	37	02.87-02.89	GSF VAL VV	Cat.	4	1,0	BPR6EFS	3623	7			
Fiesta '87	1.1	37	02.87-02.89	GSF VAL VV		4	1,0	BPR6EFS	3623	7			
Fiesta '87	1.1	39	02.87-02.89	GS1 VAL VV		4	1,0	BPR6EFS	3623	7			

¹⁾ Bic = Best in class (siehe Seite 3) / (see page 3)

* Standardtype TR5A-10 / standard type TR5A-10



ℓ kW



Cyl.

Order-
No. No.Bic¹⁾ Order-
No.**FORD**

Fiesta '87	1.4	52	02.87-02.89	F6C CVH CFI	4	1,1	BCPR6ES-11	7121	11	BCPR6EIX-11	4919
Fiesta '87	1.4	52	02.87-02.89	F6A CVH CFI	4	1,1	BCPR6ES-11	7121	11	BCPR6EIX-11	4919
Fiesta '87	1.4	54	02.87-02.89	FUD CVH 2V	4	1,1	BCPR6ES-11	7121	11	BCPR6EIX-11	4919
Fiesta '87	1.4	55	02.87-02.89	FUB CVH 2V	4	0,8	BCPR6ES	2330	12	BCPR6EIX-11	4919
Fiesta '87	1.6	40	02.87-02.89	LTB D	4	█	Y-907R	4479			
Fiesta '87	1.6	58	02.87-02.89	LP3 CVH W	4	0,8	BCPR7ES	3330			
Fiesta '87	1.6	70	02.87-02.89	LUD CVH 2V	4	0,8	BCPR6ES	2330	12	BCPR6EIX-11	4919
Fiesta '87	1.6	70	02.87-02.89	LUD CVH 2V	Cat. 4	0,8	BCPR6ES	2330	12	BCPR6EIX-11	4919
Fiesta '89	1.0	33	03.89-06.96	TLB HCS 1V	4	1,0	BPR6EFS	3623	7		
Fiesta '89	1.1	37	03.89-06.96	G6A HCS CFI	4	1,0	BPR6EFS	3623	7		
Fiesta '89	1.1	40	03.89-06.96	GUE HCS 2V	4	1,0	BPR6EFS	3623	7		
Fiesta '89	1.1	40	03.89-06.96	GUD HCS 2V	4	1,0	BPR6EFS	3623	7		
Fiesta '89	1.3	44	03.89-06.96	JBC HCS 2V	4	1,0	BPR6EFS	3623	7		
Fiesta '89	1.3	44	03.89-06.96	J6B HCS CFI	4	1,0	BPR6EFS	3623	7		
Fiesta '89	1.4	52	03.89-06.96	F6E CVH CFI	4	1,1	BCPR6ES-11	7121	11	BCPR6EIX-11	4919
Fiesta '89	1.4	54	03.89-06.96	F4A PTE SEFI	4	1,1	BCPR6ES-11	7121	11	BCPR6EIX-11	4919
Fiesta '89	1.4	54	03.89-06.96	FUJ CVH 2V	4	0,8	BCPR6ES	2330	12	BCPR6EIX-11	4919
Fiesta '89	1.4	54	03.89-06.96	FUG CVH 2V	4	1,1	BCPR6ES-11	7121	11	BCPR6EIX-11	4919
Fiesta '89	1.4	55	03.89-06.96	FUF CVH 2V	4	0,8	BCPR6ES	2330	12	BCPR6EIX-11	4919
Fiesta '89	1.6	66	03.89-06.96	L1G ZETEC SEFI	4	1,3	PTR5A-13 *	2467	25		
Fiesta '89	1.6	66	03.89-06.96	LUH CVH 2V	4	0,8	BCPR6ES	2330	12	BCPR6EIX-11	4919
Fiesta '89	1.6	76	03.89-06.96	LJD CVH EFI	4	1,1	BCPR6ES-11	7121	11	BCPR6EIX-11	4919
Fiesta '89	1.6	81	03.89-06.96	LJC CVH EFI	4	1,1	BCPR6ES-11	7121	11	BCPR6EIX-11	4919
Fiesta '89	1.6	96	03.89-06.96	LHA CVH Turbo	4	0,8	BCR8ES	5430			
Fiesta '89	1.8	44	03.89-06.96	RTG D	4	█	Y-910R	4751			
Fiesta '89	1.8	44	03.89-06.96	RTC D	4	█	Y-910R	4751			
Fiesta '89	1.8	44	03.89-06.96	RTD D	4	█	Y-910R	4751			
Fiesta '89	1.8	77	03.89-06.96	RDB ZETEC SEFI	4	1,3	PTR5A-13 *	2467	25		
Fiesta '89	1.8	96	03.89-06.96	RQC ZETEC SEFI	4	1,3	PTR5A-13 *	2467	25		
Fiesta '96	1.25	55	11.95-02.02	DHE ZETEC-SE SEFI	4	1,3	PTR5A-13 *	2467	25		
Fiesta '96	1.25	55	11.95-02.02	DHC ZETEC-SE SEFI	4	1,3	PTR5A-13 *	2467	25		
Fiesta '96	1.25	55	11.95-02.02	DHF ZETEC-SE SEFI	4	1,3	PTR5A-13 *	2467	25		
Fiesta '96	1.25	55	11.95-02.02	DHA ZETEC-SE SEFI	4	1,3	PTR5A-13 *	2467	25		
Fiesta '96	1.25	55	11.95-02.02	DHD ZETEC-SE SEFI	4	1,3	PTR5A-13 *	2467	25		
Fiesta '96	1.25	55	11.95-02.02	DHG ZETEC-SE SEFI	4	1,3	PTR5A-13 *	2467	25		
Fiesta '96	1.25	55	11.95-02.02	DHB ZETEC-SE SEFI	4	1,3	PTR5A-13 *	2467	25		
Fiesta '96	1.3	37	11.95-02.02	JJE Endura-E SEFI	4	1,0	PTR5D-10	3784	31		
Fiesta '96	1.3	37	11.95-02.02	JJM Endura-E SEFI	4	1,0	PTR5D-10	3784	31		
Fiesta '96	1.3	37	11.95-02.02	JJK Endura-E SEFI	4	1,0	PTR5D-10	3784	31		
Fiesta '96	1.3	37	11.95-02.02	JJJ Endura-E SEFI	4	1,0	PTR5D-10	3784	31		
Fiesta '96	1.3	37	11.95-02.02	JJC Endura-E SEFI	4	1,0	PTR5D-10	3784	31		
Fiesta '96	1.3	37	11.95-02.02	JJA Endura-E SEFI	4	1,0	PTR5D-10	3784	31		
Fiesta '96	1.3	44	11.95-02.02	J4T Endura-E SEFI	4	1,0	PTR5D-10	3784	31		
Fiesta '96	1.3	44	11.95-02.02	J4R Endura-E SEFI	4	1,0	PTR5D-10	3784	31		
Fiesta '96	1.3	44	11.95-02.02	J4Q Endura-E SEFI	4	1,0	PTR5D-10	3784	31		
Fiesta '96	1.3	44	11.95-02.02	J4L Endura-E SEFI	4	1,0	PTR5D-10	3784	31		
Fiesta '96	1.3	44	11.95-02.02	J4C Endura-E SEFI	4	1,0	PTR5D-10	3784	31		
Fiesta '96	1.3	44	11.95-02.02	J4J Endura-E SEFI	4	1,0	PTR5D-10	3784	31		
Fiesta '96	1.4	66	11.95-02.02	FHE ZETEC-SE SEFI	4	1,3	PTR5A-13 *	2467	25		
Fiesta '96	1.4	66	11.95-02.02	FHA ZETEC-SE SEFI	4	1,3	PTR5A-13 *	2467	25		
Fiesta '96	1.6		96-		4	█	Y-910R	4751			
Fiesta '96	1.6	76	11.95-02.02	L1T ZETEC-SE SEFI	4	1,3	PTR5A-13 *	2467	25		

¹⁾ Bic = Best in class (siehe Seite 3) / (see page 3)

* Standardtype TR5A-10 / standard type TR5A-10



l kW

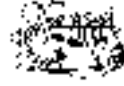

Cyl.

Order-
No. No.Bic¹⁾ Order-
No. No.**FORD**

Fiesta '96	1.6	76	11.95-02.02	L1V ZETEC-SE SEFI	4	1,3	PTR5A-13 *	2467	25		
Fiesta '96	1.8	44	11.95-02.02	RTK	4	☑	Y-937R	5148			
Fiesta '96	1.8	44	11.95-02.02	RTJ	4	☑	Y-937R	5148			
Focus / C-Max	1.6	74	06.03-	HWDA Duratec-16V SFI	4	1,3	PTR5A-13 *	2467	25		
Focus / C-Max TDCi	1.6	80	06.03-	G8DA DuraTorq-TDCi	4	☑	YE04	1101			
Focus / C-Max	1.8	88	06.03-	CSDA Duratec-HE SFI	4		ITR6F-13	4477			
Focus / C-Max	1.8	88	06.03-	CSDB Duratec-HE SFI	4		ITR6F-13	4477			
Focus '98	1.4	55	08.98-	FXDD ZETEC-SE SFI	4	1,3	PTR5A-13 *	2467	25		
Focus '98	1.4	55	08.98-	FXDC ZETEC-SE SEFI	4	1,3	PTR5A-13 *	2467	25		
Focus '98	1.4	55	08.98-	FXDB ZETEC-SE SFI	4	1,3	PTR5A-13 *	2467	25		
Focus '98	1.4	55	08.98-	FXDA ZETEC-SE SFI	4	1,3	PTR5A-13 *	2467	25		
Focus '98	1.6	72	08.98-	CDDA Duratec SFI	4	1,3	PTR5A-13	2467	25		
Focus '98	1.6	74	08.98-	FYDB ZETEC-SE SFI	4	1,3	PTR5A-13 *	2467	25		
Focus '98	1.6	74	08.98-	FYDH Zetec-SE SFI	4	1,3	PTR5A-13 *	2467	25		
Focus '98	1.6	74	08.98-	FYDA ZETEC-SE SFI	4	1,3	PTR5A-13 *	2467	25		
Focus '98	1.6	74	08.98-	FYDC ZETEC-SE SFI	4	1,3	PTR5A-13 *	2467	25		
Focus '98	1.6	74	08.98-	FYDD ZETEC-SE SFI	4	1,3	PTR5A-13 *	2467	25		
Focus '98	1.8	55	08.98-	BHDA Endura-DI	4	☑	Y-524J	5986			
Focus '98	1.8	55	08.98-	BHDB Endura-DI	4	☑	Y-524J	5986			
Focus '98	1.8	66	08.98-	C9DB Endura-DI	4	☑	Y-524J	5986			
Focus '98	1.8	66	08.98-	C9DA Endura-DI	4	☑	Y-524J	5986			
Focus '98 Turbo Di	1.8	66	08.98-	C9DC Endura-DI	4	☑	Y-524J	5986			
Focus '98	1.8	74	08.98-	FFDA DuraTorq-TDCi	4	☑	Y-524J	5986			
Focus '98	1.8	85	08.98-	F9DB DuraTorq-TDCi	4	☑	Y-524J	5986			
Focus '98	1.8	85	08.98-	EYDF ZETEC-E SFI	4	1,3	PTR5A-13 *	2467	25		
Focus '98	1.8	85	08.98-	EYDE ZETEC-E SFI	4	1,3	PTR5A-13 *	2467	25		
Focus '98	1.8	85	08.98-	EYDC ZETEC-E SFI	4	1,3	PTR5A-13 *	2467	25		
Focus '98 TDCi	1.8	85	08.98-	F9DA DuraTorq-TDCi	4	☑	Y-524J	5986			
Focus '98	1.8	85	08.98-	EYDB ZETEC-E SFI	4	1,3	PTR5A-13 *	2467	25		
Focus '98	2.0	96	08.98-	EDDD ZETEC-E SFI	4	1,3	PTR5A-13 *	2467	25		
Focus '98	2.0	96	08.98-	EDDC ZETEC-E SFI	4	1,3	PTR5A-13 *	2467	25		
Focus '98	2.0	96	08.98-	EDDF ZETEC-E SFI	4	1,3	PTR5A-13 *	2467	25		
Focus '98	2.0	96	08.98-	EDDB ZETEC-E SFI	4	1,3	PTR5A-13 *	2467	25		
Focus '98 RS Turbo	2.0	158	10.02-	HMDA Duratec RS SFI	4	1,0	PLTR6A-10G				
Fusion TDCi	1.4	50	06.02-	F6JB DuraTorq-TDCi	4	☑	YE04	1101			
Fusion TDCi	1.4	50	06.02-	F6JA DuraTorq-TDCi	4	☑	YE04	1101			
Fusion	1.4	59	06.02-	FXJB Duratec 16V SFI	4	1,3	PTR5A-13 *	2467	25		
Fusion	1.4	59	06.02-	FXJA Duratec 16V SFI	4	1,3	PTR5A-13 *	2467	25		
Fusion	1.6	74	06.02-	FYJA Duratec 16V SFI	4	1,3	PTR5A-13 *	2467	25		
Galaxy TDI	1.9		06.95-	AJM	4	☑	Y-732U	2408			
Galaxy TDI	1.9	66	03.96-03.00	1Z	4	☑	Y-732U	2408			
Galaxy TDI	1.9	66	09.96-03.00	AHU	4	☑	Y-732U	2408			
Galaxy TDI	1.9	66	02.95-02.96	1Z	4	☑	Y-732U	2408			
Galaxy TDI	1.9	66	02.95-03.00	ANU	4	☑	Y-732U	2408			
Galaxy TDI	1.9	81	09.99-03.00	AVG	4	☑	Y-732U	2408			
Galaxy TDI	1.9	81	02.95-08.99	AFN	4	☑	Y-732U	2408			
Galaxy	2.0	85	02.95-03.00	NSE DOHC SEFI	4	1,1	BKR7EVX-11	4685		BKR7EIX-11	6988
Galaxy 16V	2.3	107	02.95-03.00	Y5B DOHC 16V SEFI	4	1,1	BKR6EVX-11	3540			
Galaxy VR6 4x4	2.8	128	02.95-03.98	AAA CD V6 SEFI	6	0,8	BKR5EKUP	2890			
Galaxy VR6 4x4	2.8	128	04.98-03.00	AMY CD V6 SEFI	6	0,8	BKR5EKUP	2890			
Galaxy /2 TDI	1.9	66	04.00-	ANU	4	☑	Y-732U	2408			
Galaxy /2 TDI	1.9	85	04.00-	AUY	4	☑	Y-732U	2408			

¹⁾ Bic = Best in class (siehe Seite 3) / (see page 3)

* Standardtype TR5A-10 / standard type TR5A-10



ℓ kW

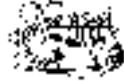

Cyl.

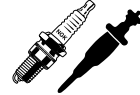
Order-
No. No.Bic¹⁾ Order-
No.**FORD**

Galaxy /2 TDI	1.9	96	04.00-	ASZ	4	█	Y-732U	2408			
Galaxy /2	2.0	85	04.00-	ZVSA DOHC SEFI	4	1,1	BKR7EVX-11	4685		BKR7EIX-11	6988
Galaxy /2 16V	2.3	103	04.00-	E5SB DOHC 16V SEFI	4	1,1	BKR6EVX-11	3540			
Galaxy /2 16V	2.3	107	04.00-	E5SA DOHC 16V SEFI	4	1,1	BKR6EVX-11	3540			
Galaxy /2 24V	2.8	150	04.00-	AYL CD V6 24V SEFI	6	1,1	PZFR5D-11	7968			
Granada '82	1.6	55	08.81-04.85	LCK OHC VV	4	0,8	AP6FS	2710			
Granada '82	2.0	64	08.81-04.85	NYU V6 2V	4	0,8	BPR6ES	7822	2	BPR6EIX	6637
Granada '82	2.0	66	08.81-04.85	NYP V6 2V	4	0,8	BPR6ES	7822	2	BPR6EIX	6637
Granada '82	2.0	72	08.81-04.85	NE2 OHC 2V	4	0,8	APR6FS	2922			
Granada '82	2.0	74	08.81-04.85	NEP OHC 2V	4	0,8	AP6FS	2710			
Granada '82	2.0	77	08.81-04.85	NEK OHC 2V	4	0,8	AP6FS	2710			
Granada '82	2.3	82	08.81-04.85	YYU V6 2V	6	0,8	BPR6ES	7822	2	BPR6EIX	6637
Granada '82	2.3	84	08.81-04.85	YYP V6 2V	6	0,8	BPR6ES	7822	2	BPR6EIX	6637
Granada '82	2.5		08.81-04.85	STP D	4	█	Y-902R	2237			
Granada '82	2.8	97	08.81-04.85	PYU V6 2V	6	0,8	BPR6ES	7822	2	BPR6EIX	6637
Granada '82	2.8	99	08.81-04.85	PYA V6 2V	6	0,8	BPR6ES	7822	2	BPR6EIX	6637
Granada '82	2.8	108	08.81-04.85	PRD V6 FI	6	0,8	BPR6ES	7822	2	BPR6EIX	6637
Granada '82	2.8	109	08.81-04.85	PR2 V6 FI	6	0,8	BPR6ES	7822	2	BPR6EIX	6637
Granada '82	2.8	110	08.81-04.85	PRC V6 FI	6	0,8	BPR6ES	7822	2	BPR6EIX	6637
Granada '85	1.8	66	05.85-10.94	REC OHC 2V	4	0,8	APR6FS	2922			
Granada '85	2.0	74	05.85-10.94	NRC OHC EFI	4	0,8	APR6FS	2922			
Granada '85	2.0	74	05.85-10.94	NER OHC 2V	4	0,8	APR6FS	2922			
Granada '85	2.0	74	05.85-10.94	NE4 OHC 2V	4	0,8	APR6FS	2922			
Granada '85	2.0	77	05.85-10.94	NEL OHC 2V	4	0,8	APR6FS	2922			
Granada '85	2.0	77	05.85-10.94	N8D DOHC 2V	4	0,8	BCPR6ES	2330	12	BCPR6EIX-11	4919
Granada '85	2.0	77	05.85-10.94	NEL OHC 2V	Cat. 4	0,8	APR6FS	2922			
Granada '85	2.0	80	05.85-10.94	N8B DOHC 2V	4	0,8	BCPR6ES	2330	12	BCPR6EIX-11	4919
Granada '85	2.0	85	05.85-10.94	N9F DOHC EFI	4	0,8	BCPR6ES	2330	12	BCPR6EIX-11	4919
Granada '85	2.0	85	05.85-10.94	NRI OHC EFI	4	0,8	APR6FS	2922			
Granada '85	2.0	85	05.85-10.94	NRA OHC EFI	Cat. 4	0,8	APR6FS	2922			
Granada '85	2.0	85	05.85-10.94	NRA OHC EFI	4	0,8	APR6FS	2922			
Granada '85	2.0	88	05.85-10.94	N9D DOHC EFI	4	0,8	BCPR6ES	2330	12	BCPR6EIX-11	4919
Granada '85	2.0	90	05.85-10.94	N9B DOHC EFI	4	0,8	BCPR6ES	2330	12	BCPR6EIX-11	4919
Granada '85	2.4	92	05.85-10.94	ARD V6 EFI	6	1,0	BPR6EFS	3623	7		
Granada '85	2.4	96	05.85-10.94	ARC V6 EFI	6	0,8	BCPR6ES	2330	12	BCPR6EIX-11	4919
Granada '85	2.5	51	05.85-10.94	STR D	4	█	Y-902R	2237			
Granada '85	2.5	68	05.85-10.94	SFB D TURBO	4	█	Y-902R	2237			
Granada '85	2.5	68	05.85-10.94	SFA D TURBO	4	█	Y-902R	2237			
Granada '85	2.8	105	05.85-10.94	PR4 V6 EFI	6	0,8	BPR6ES	7822	2	BPR6EIX	6637
Granada '85	2.8	107	05.85-10.94	PR3 V6 EFI	6	0,8	BPR6ES	7822	2	BPR6EIX	6637
Granada '85	2.8	110	05.85-10.94	PRE V6 EFI	6	0,8	BPR6ES	7822	2	BPR6EIX	6637
Granada '85	2.9	107	05.85-10.94	BRE V6 EFI	6	1,0	BPR6EFS	3623	7		
Granada '85	2.9	107	05.85-10.94	BRD V6 EFI	6	1,0	BPR6EFS	3623	7		
Granada '85	2.9	107	05.85-10.94	BRF V6 EFI	6	1,0	BPR6EFS	3623	7		
Granada '85	2.9	110	05.85-10.94	BRC V6 EFI	6	0,8	BCPR6ES	2330	12	BCPR6EIX-11	4919
Granada '85	2.9	143	05.85-10.94	BOA V6 24V EFI	6	1,1	BKR6EVX-11	3540			
Ka '96	1.3	36	09.96-	JJL Endura-E SEFI	4	1,0	PTR5D-10	3784	31		
Ka '96	1.3	36	09.96-	JJH Endura-E SEFI	4	1,0	PTR5D-10	3784	31		
Ka '96	1.3	36	09.96-	JJF Endura-E SEFI	4	1,0	PTR5D-10	3784	31		
Ka '96	1.3	36	09.96-	JJD Endura-E SEFI	4	1,0	PTR5D-10	3784	31		
Ka '96	1.3	36	09.96-	JJG Endura-E SEFI	4	1,0	PTR5D-10	3784	31		
Ka '96	1.3	37	09.96-	JJB Endura-E SEFI	4	1,0	PTR5D-10	3784	31		

¹⁾ Bic = Best in class (siehe Seite 3) / (see page 3)



l kW

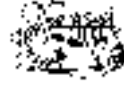

Cyl.

Order-
No. No.Bic¹⁾ Order-
No. No.**FORD**

Ka '96	1.3	44	09.96-	J4M Endura-E SEFI	4	1,0	PTR5D-10	3784	31		
Ka '96	1.3	44	09.96-	J4N Endura-E SEFI	4	1,0	PTR5D-10	3784	31		
Ka '96	1.3	44	09.96-	J4P Endura-E SEFI	4	1,0	PTR5D-10	3784	31		
Ka '96	1.3	44	09.96-	BAA Duratec 8V SFI	4	1,3	PTR5A-13	2467	25		
Ka '96	1.3	44	09.96-	J4K Endura-E SEFI	4	1,0	PTR5D-10	3784	31		
Ka '96	1.3	44	09.96-	J4D Endura-E SEFI	4	1,0	PTR5D-10	3784	31		
Ka '96	1.3	44	09.96-	J4S Endura-E SEFI	4	1,0	PTR5D-10	3784	31		
Ka '96	1.3	51	09.96-	A9B Duratec 8V SFI	4	1,3	PTR5A-13	2467	25		
Ka '96	1.3	51	09.96-	A9A Duratec 8V SFI	4	1,3	PTR5A-13	2467	25		
Ka '96	1.6	70	09.96-	CDB Duratec 8V SFI	4	1,3	PTR5A-13 *	2467	25		
Ka '96	1.6	70	09.96-	CDC Duratec 8V SFI	4	1,3	PTR5A-13 *	2467	25		
Maverick '01 16V	2.0	91	12.00-	YF ZETEC-E SFI	4	1,3	PTR5A-13	2467	25		
Maverick '01	3.0	145	12.00-	AJ Duratec-VE SFI	6	1,1				TR5IX	7397
Maverick '93	2.4	85	06.93-04.98	KA24 OHC 12V SEFI	4	1,1	ZFR5E-11	4435			
Maverick '93	2.4	87	06.93-04.98	KA24 OHC 12V SEFI	4	1,1	ZFR5E-11	4435			
Maverick '93	2.4	91	06.93-04.98	KA24 OHC 12V SEFI	4	1,1	ZFR5E-11	4435			
Maverick '93	2.7	74	04.93-04.98	TD27	4	█	Y-712RS	6140			
Maverick '93	2.7	92	05.96-04.98	TD27E	4	█	CY58	5486			
Mondeo '01	1.8	81	10.00-	CGBB Duratec-HE SFI	4	1,3	PTR6F-13	7569			
Mondeo '01	1.8	81	10.00-	CGBA Duratec-HE SFI	4	1,3	PTR6F-13	7569			
Mondeo '01	1.8	92	10.00-	CHBA Duratec-HE SFI	4	1,3	PTR6F-13	7569			
Mondeo '01	1.8	92	10.00-	CHBB Duratec-HE SFI	4	1,3	PTR6F-13	7569			
Mondeo '01	2.0	66	10.00-	D5BA DuraTorq-DI	4	█	Y-525J	7925			
Mondeo '01	2.0	85	10.00-	HJBC DuraTorq-TDCi	4	█	Y-525J	7925			
Mondeo '01	2.0	85	10.00-	D6BA DuraTorq-DI	4	█	Y-525J	7925			
Mondeo '01	2.0	85	10.00-	HJBA DuraTorq-TDCi	4	█	Y-525J	7925			
Mondeo '01	2.0	85	10.00-	HJBB DuraTorq-TDCi	4	█	Y-525J	7925			
Mondeo '01	2.0	96	10.00-	N7BA DuraTorq-TDCi	4	█	Y-525J	7925			
Mondeo '01	2.0	96	10.00-	FMBA DuraTorq-TDCi	4	█	Y-525J	7925			
Mondeo '01	2.0	107	10.00-	CJBB Duratec-HE SFI	4	1,3	PTR6F-13	7569			
Mondeo '01	2.0	107	10.00-	CJBA Duratec-HE SFI	4	1,3	PTR6F-13	7569			
Mondeo '01	2.5	125	10.00-	LCBD Duratec-VE SFI	6	1,3				TR55IX	7164
Mondeo '93	1.6	65	01.93-07.96	L1J ZETEC-E SEFI	4	1,3	PTR5A-13 *	2467	25		
Mondeo '93	1.6	66	01.93-07.96	L1F ZETEC SEFI	4	1,3	PTR5A-13 *	2467	25		
Mondeo '93	1.8	65	01.93-07.96	RFN D TCI	4	█	Y-910R	4751			
Mondeo '93	1.8	65	01.93-07.96	RFM D TCI	4	█	Y-910R	4751			
Mondeo '93	1.8	82	01.93-07.96	RKB ZETEC-E SEFI	4	1,3	PTR5A-13 *	2467	25		
Mondeo '93	1.8	85	01.93-07.96	RKA ZETEC SEFI	4	1,3	PTR5A-13 *	2467	25		
Mondeo '93	2.0	100	01.93-07.96	NGA ZETEC SEFI	4	1,3	PTR5A-13 *	2467	25		
Mondeo '93	2.5	125	01.93-07.96	SEA Duratec-VE SEFI	6	1,3	TR55	1048		TR55IX	7164
Mondeo '97	1.6	65	08.96-09.00	L1J ZETEC-E SEFI	4	1,3	PTR5A-13 *	2467	25		
Mondeo '97	1.6	70	08.96-09.00	L1L ZETEC-E SEFI	4	1,3	PTR5A-13 *	2467	25		
Mondeo '97	1.6	70	08.96-09.00	L1N ZETEC-E SEFI	4	1,3	PTR5A-13 *	2467	25		
Mondeo '97	1.6	70	08.96-09.00	L1Q ZETEC-E SEFI	4	1,3	PTR5A-13 *	2467	25		
Mondeo '97	1.8	66	08.96-09.00	RFN Endura-De TCI	4	█	Y-937R	5148			
Mondeo '97	1.8	85	08.96-09.00	RKB ZETEC-E SEFI	4	1,3	PTR5A-13 *	2467	25		
Mondeo '97	1.8	85	08.96-09.00	RKJ ZETEC-E SEFI	4	1,3	PTR5A-13 *	2467	25		
Mondeo '97	1.8	85	08.96-09.00	RKH ZETEC-E SEFI	4	1,3	PTR5A-13 *	2467	25		
Mondeo '97	1.8	85	08.96-09.00	RKK ZETEC-E SEFI	4	1,3	PTR5A-13 *	2467	25		
Mondeo '97	1.8	85	08.96-09.00	RKF ZETEC-E SEFI	4	1,3	PTR5A-13 *	2467	25		
Mondeo '97	2.0	96	08.96-09.00	NGD ZETEC-E SEFI	4	1,3	PTR5A-13 *	2467	25		
Mondeo '97	2.0	96	08.96-09.00	NGC ZETEC-E SEFI	4	1,3	PTR5A-13 *	2467	25		

¹⁾ Bic = Best in class (siehe Seite 3) / (see page 3)

* Standardtype TR5A-10 / standard type TR5A-10



ℓ kW

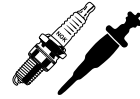

Cyl.

Order-
No. No.Bic¹⁾ Order-
No.**FORD**

Mondeo '97	2.0	96	08.96-09.00	NGB ZETEC-E SEFI	4	1,3	PTR5A-13 *	2467	25		
Mondeo '97	2.0	96	08.96-09.00	NGA ZETEC-E SEFI	4	1,3	PTR5A-13 *	2467	25		
Mondeo '97	2.5	125	08.96-09.00	SEB Duratec-VE SEFI	6	1,3	TR55	1048		TR55IX	7164
Mondeo '97	2.5	125	08.96-09.00	SEC Duratec-VE SEFI	6	1,3	TR55	1048		TR55IX	7164
Mondeo '97	2.5	125	08.96-09.00	SEA Duratec-VE SEFI	6	1,3	TR55	1048		TR55IX	7164
Orion '83	1.3	51	05.83-12.85	JPA CVH VV	4	0,8	BCPR6ES	2330	12	BCPR6EIX-11	4919
Orion '83	1.6	58	05.83-12.85	LPI CVH VV	4	0,8	BCPR7ES	3330			
Orion '83	1.6	58	05.83-12.85	LPA CVH VV	4	0,8	BCPR7ES	3330			
Orion '83	1.6	66	05.83-12.85	L4B CVH FI	4	0,8	BCPR6ES	2330	12	BCPR6EIX-11	4919
Orion '83	1.6	77	05.83-12.85	LRI CVH FI	4	0,8	BCPR7ES	3330			
Orion '83	1.6	77	05.83-12.85	LRA CVH FI	4	0,8	BCPR7ES	3330			
Orion '86	1.3	44	01.86-07.90	JLA VAL VV	4	1,0	BPR6EFS	3623	7		
Orion '86	1.3	44	01.86-07.90	JLA VAL VV	Cat. 4	1,0	BPR6EFS	3623	7		
Orion '86	1.3	44	01.86-07.90	JLB VAL VV	4	1,0	BPR6EFS	3623	7		
Orion '86	1.3	44	01.86-07.90	JBB HCS 2V	4	1,0	BPR6EFS	3623	7		
Orion '86	1.4	54	01.86-07.90	F6D CVH CFI	4	1,1	BCPR6ES-11	7121	11	BCPR6EIX-11	4919
Orion '86	1.4	54	01.86-07.90	FUC CVH 2V	4	1,1	BCPR7ES-11	1095		BCPR7EIX-11	5691
Orion '86	1.4	54	01.86-07.90	F6B CVH CFI	4	1,1	BCPR6ES-11	7121	11	BCPR6EIX-11	4919
Orion '86	1.4	55	01.86-07.90	FUA CVH 2V	Cat. 4	0,8	BCPR6ES	2330	12	BCPR6EIX-11	4919
Orion '86	1.4	55	01.86-07.90	FUA CVH 2V	4	0,8	BCPR6ES	2330	12	BCPR6EIX-11	4919
Orion '86	1.6	40	01.86-07.90	LTC	4	█	Y-907R	4479			
Orion '86	1.6	65	01.86-07.90	LUG CVH 2V	4	0,8	BCPR6ES	2330	12	BCPR6EIX-11	4919
Orion '86	1.6	66	01.86-07.90	L4B CVH FI	4	0,8	BCPR6ES	2330	12	BCPR6EIX-11	4919
Orion '86	1.6	66	01.86-07.90	LUC CVH 2V	Cat. 4	0,8	BCPR6ES	2330	12	BCPR6EIX-11	4919
Orion '86	1.6	66	01.86-07.90	LUC CVH 2V	4	0,8	BCPR6ES	2330	12	BCPR6EIX-11	4919
Orion '86	1.6	75	01.86-07.90	LJB CVH EFI	4	1,1	BCPR6ES-11	7121	11	BCPR6EIX-11	4919
Orion '86	1.6	77	01.86-07.90	LRB CVH FI	Cat. 4	0,8	BCPR7ES	3330			
Orion '86	1.6	77	01.86-07.90	LRB CVH FI	4	0,8	BCPR7ES	3330			
Orion '86	1.6	79	01.86-07.90	LJA CVH EFI	4	1,1	BCPR6ES-11	7121	11	BCPR6EIX-11	4919
Orion '86	1.8	44	01.86-07.90	RTB	4	█	Y-910R	4751			
Orion '86	1.8	44	01.86-07.90	RTA	4	█	Y-910R	4751			
Orion '91	1.3	44	08.90-07.93	JBE HCS 2V	4	1,0	PTR5D-10	3784	31		
Orion '91	1.3	44	08.90-07.93	J6A HCS CFI	4	1,0	PTR5D-10	3784	31		
Orion '91	1.3	46	08.90-07.93	JBD HCS 2V	4	1,0	PTR5D-10	3784	31		
Orion '91	1.4	52	08.90-07.93	F6G CVH CFI	4	1,1	BCPR6ES-11	7121	11	BCPR6EIX-11	4919
Orion '91	1.4	52	08.90-07.93	F6F CVH CFI	4	1,1	BCPR6ES-11	7121	11	BCPR6EIX-11	4919
Orion '91	1.4	54	08.90-07.93	FUH CVH 2V	4	0,8	BCPR6ES	2330	12	BCPR6EIX-11	4919
Orion '91	1.6	66	08.90-07.93	LUJ CVH 2V	4	0,8	BCPR6ES	2330	12	BCPR6EIX-11	4919
Orion '91	1.6	66	08.90-07.93	LUK CVH 2V	4	0,8	BCPR6ES	2330	12	BCPR6EIX-11	4919
Orion '91	1.6	66	08.90-07.93	L1E ZETEC SEFI	4	1,3	PTR5A-13 *	2467	25		
Orion '91	1.6	77	08.90-07.93	LJF CVH EFI	4	1,1	BCPR6ES-11	7121	11	BCPR6EIX-11	4919
Orion '91	1.6	79	08.90-07.93	LJE CVH EFI	4	1,1	BCPR6ES-11	7121	11	BCPR6EIX-11	4919
Orion '91	1.8	44	08.90-07.93	RTH	4	█	Y-910R	4751			
Orion '91	1.8	44	08.90-07.93	RTE	4	█	Y-910R	4751			
Orion '91	1.8	44	08.90-07.93	RTF	4	█	Y-910R	4751			
Orion '91	1.8	66	08.90-07.93	RFK	4	█	Y-910R	4751			
Orion '91	1.8	66	08.90-07.93	RFD	4	█	Y-910R	4751			
Orion '91	1.8	77	08.90-07.93	RDA ZETEC SEFI	4	1,3	PTR5A-13 *	2467	25		
Orion '91	1.8	96	08.90-07.93	RQB ZETEC SEFI	4	1,3	PTR5A-13 *	2467	25		
P 100	1.6	54	04.82-08.87	LCR OHC VV	4	0,8	AP6FS	2710			
P 100	2.3		82-			█	Y-902R	2237			
P 100 Turbo	1.8		89-		4	█	Y-910R	4751			

¹⁾ Bic = Best in class (siehe Seite 3) / (see page 3)

* Standardtype TR5A-10 / standard type TR5A-10



l kW

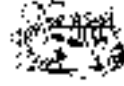

Cyl.

Order-
No. No.Bic¹⁾ Order-
No. No.**FORD**

P 100 Pick-Up	1.8	55	10.87-12.92	RFA DT	4	█	Y-910R	4751				
P 100 Pick-Up	2.0	57	10.87-12.92	NAE OHC VV	4	0,8	APR6FS	2922				
Probe	2.0	85	01.93-07.97	FS DOHC 16V SEFI	4	1,1	BCPR6ES-11	7121	11	BCPR6EIX-11	4919	
Probe GT	2.2	108	03.91-12.92	OHC EFI	4	1,1	ZFR6F-11	4291		ZFR6FIX-11	6441	
Probe	2.5	120	01.93-07.97	KL V6 24V EFI	6	1,1	ZFR6F-11	4291		ZFR6FIX-11	6441	
Puma '97	1.4	66	06.97-12.01	FHD ZETEC-SE SEFI	4	1,3	PTR5A-13 *	2467	25			
Puma '97	1.4	66	06.97-12.01	FHF ZETEC-SE SEFI	4	1,3	PTR5A-13 *	2467	25			
Puma '97	1.6	76	06.97-12.01	L1W ZETEC-SE SFI	4	1,3	PTR5A-13 *	2467	25			
Puma '97	1.7	92	06.97-12.01	MHA ZETEC-S VCT SFI	4	1,3	PTR5A-13 *	2467	25			
Puma '97	1.7	92	06.97-12.01	MHB ZETEC-S VCT SFI	4	1,3	PTR5A-13 *	2467	25			
Ranger Pick Up	2.5	57	05.99-	WL	4	█	Y-701J	5116				
Ranger Pick Up	2.5	80	05.99-	WL-T	4	█	Y-701J	5116				
Scorpio '85	1.8	66	05.85-10.94	REC OHC 2V	4	0,8	APR6FS	2922				
Scorpio '85	2.0	74	05.85-10.94	NER OHC 2V	4	0,8	APR6FS	2922				
Scorpio '85	2.0	74	05.85-10.94	NE4 OHC 2V	4	0,8	APR6FS	2922				
Scorpio '85	2.0	74	05.85-10.94	NRC OHC EFI	4	0,8	APR6FS	2922				
Scorpio '85	2.0	77	05.85-10.94	N8D DOHC 2V	4	0,8	BCPR6ES	2330	12	BCPR6EIX-11	4919	
Scorpio '85	2.0	77	05.85-10.94	NEL OHC 2V	Cat. 4	0,8	APR6FS	2922				
Scorpio '85	2.0	77	05.85-10.94	NEL OHC 2V	4	0,8	APR6FS	2922				
Scorpio '85	2.0	80	05.85-10.94	N8B DOHC 2V	4	0,8	BCPR6ES	2330	12	BCPR6EIX-11	4919	
Scorpio '85	2.0	85	05.85-10.94	NRI OHC EFI	4	0,8	APR6FS	2922				
Scorpio '85	2.0	85	05.85-10.94	NRA OHC EFI	4	0,8	APR6FS	2922				
Scorpio '85	2.0	85	05.85-10.94	N9F DOHC EFI	4	0,8	BCPR6ES	2330	12	BCPR6EIX-11	4919	
Scorpio '85	2.0	85	05.85-10.94	NRA OHC EFI	Cat. 4	0,8	APR6FS	2922				
Scorpio '85	2.0	88	05.85-10.94	N9D DOHC EFI	4	0,8	BCPR6ES	2330	12	BCPR6EIX-11	4919	
Scorpio '85	2.0	90	05.85-10.94	N9B DOHC EFI	4	0,8	BCPR6ES	2330	12	BCPR6EIX-11	4919	
Scorpio '85	2.4	92	05.85-10.94	ARD V6 EFI	6	1,0	BPR6EFS	3623	7			
Scorpio '85	2.4	96	05.85-10.94	ARC V6 EFI	6	0,8	BCPR6ES	2330	12	BCPR6EIX-11	4919	
Scorpio '85	2.5		11.94-07.98	SCB	4	█	Y-741U	5065				
Scorpio '85	2.5	51	05.85-10.94	STR D	4	█	Y-902R	2237				
Scorpio '85	2.5	68	05.85-10.94	SFB D TURBO	4	█	Y-902R	2237				
Scorpio '85	2.5	68	05.85-10.94	SFA D TURBO	4	█	Y-902R	2237				
Scorpio '85	2.8	105	05.85-10.94	PR4 V6 EFI	6	0,8	BPR6ES	7822	2	BPR6EIX	6637	
Scorpio '85	2.8	107	05.85-10.94	PR3 V6 EFI	6	0,8	BPR6ES	7822	2	BPR6EIX	6637	
Scorpio '85	2.8	110	05.85-10.94	PRE V6 EFI	6	0,8	BPR6ES	7822	2	BPR6EIX	6637	
Scorpio '85	2.9	107	05.85-10.94	BRE V6 EFI	6	1,0	BPR6EFS	3623	7			
Scorpio '85	2.9	107	05.85-10.94	BRF V6 EFI	6	1,0	BPR6EFS	3623	7			
Scorpio '85	2.9	107	05.85-10.94	BRD V6 EFI	6	1,0	BPR6EFS	3623	7			
Scorpio '85	2.9	110	05.85-10.94	BRC V6 EFI	6	0,8	BCPR6ES	2330	12	BCPR6EIX-11	4919	
Scorpio '85	2.9	143	05.85-10.94	BOA V6 24V EFI	6	1,1	BKR6EVX-11	3540				
Scorpio '95	2.0	85	10.94-06.98	NSD DOHC 8V SEFI	4	1,1	PFR6B-11	4014				
Scorpio '95	2.0	100	10.94-06.98	N3A DOHC 16V SEFI	4	1,1	PFR6B-11	4014				
Scorpio '95	2.3	108	10.94-06.98	Y5A 16V SEFI	4	1,1	BKR6EVX-11	3540				
Scorpio '95	2.5	85	10.94-06.98	SCC TCI	4	█	Y-741U	5065				
Scorpio '95	2.5	92	10.94-06.98	SCD TCI	4	█	Y-741U	5065				
Scorpio '95	2.9	110	10.94-06.98	BRG V6 12V SEFI	6	1,0	BPR6EFS	3623	7			
Scorpio '95	2.9	152	10.94-06.98	BOB V6 24V SEFI	6	1,1	PFR6B-11	4014				
Sierra '83	1.3	44	08.82-01.87	JCT OHV VV	4	0,8	APR6FS	2922				
Sierra '83	1.6	51	08.82-01.87	LSDA OHC 2V	4	0,8	APR6FS	2922				
Sierra '83	1.6	55	08.82-01.87	LSD OHV 2V	Cat. 4	0,8	APR6FS	2922				
Sierra '83	1.6	55	08.82-01.87	LCS OHV VV	4	0,8	APR6FS	2922				
Sierra '83	1.6	55	08.82-01.87	LCT OHV VV	4	0,8	APR6FS	2922				

¹⁾ Bic = Best in class (siehe Seite 3) / (see page 3)

* Standardtype TR5A-10 / standard type TR5A-10



ℓ kW

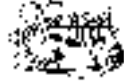

Cyl.

Order-
No. No.Bic¹⁾ Order-
No.**FORD**

Sierra '83	1.6	55	08.82-01.87	LSD OHV 2V	4	0,8	APR6FS	2922				
Sierra '83	1.8	59	08.82-01.87	REB OHC 2V	4	0,8	APR6FS	2922				
Sierra '83	1.8	66	08.82-01.87	REB OHC 2V	4	0,8	APR6FS	2922				
Sierra '83	2.0	66	08.82-01.87	NYT V6 2V	6	0,8	BPR6ES	7822	2	BPR6EIX	6637	
Sierra '83	2.0	67	08.82-01.87	NAI OHC 2V	4	0,8	APR6FS	2922				
Sierra '83	2.0	69	08.82-01.87	NA OHC 2V	4	0,8	APR6FS	2922				
Sierra '83	2.0	74	08.82-01.87	NRD OHC EFI	4	0,8	APR6FS	2922				
Sierra '83	2.0	74	08.82-01.87	NE OHC 2V	4	0,8	APR6FS	2922				
Sierra '83	2.0	74	08.82-01.87	NEI OHC 2V	4	0,8	APR6FS	2922				
Sierra '83	2.0	77	10.84-01.87	NET OHC 2V	4	0,8	APR6FS	2922				
Sierra '83	2.0	77	10.84-01.87	NET OHC 2V	Cat. 4	0,8	APR6FS	2922				
Sierra '83	2.0	85	08.82-01.87	NRB OHC EFI	4	0,8	APR6FS	2922				
Sierra '83	2.0	85	08.82-01.87	NRB OHC EFI	Cat. 4	0,8	APR6FS	2922				
Sierra '83	2.0	85	08.82-01.87	NR2 OHC EFI	4	0,8	APR6FS	2922				
Sierra '83	2.0	150	08.82-01.87	N5A DOHC COSWORTH	4	0,8	BCR8ES	5430				
Sierra '83	2.3	49	08.82-01.87	YTT	4	█	Y-902R	2237				
Sierra '83	2.3	84	08.82-01.87	YYT V6 2V	6	0,8	BPR6ES	7822	2	BPR6EIX	6637	
Sierra '83	2.8	105	08.82-01.87	PR6 V6 EFI	6	0,8	BPR6ES	7822	2	BPR6EIX	6637	
Sierra '83	2.8	107	08.82-01.87	PR5 V6 EFI	6	0,8	BPR6ES	7822	2	BPR6EIX	6637	
Sierra '83	2.8	109	08.82-01.87	PRI V6 EFI	6	0,8	BPR6ES	7822	2	BPR6EIX	6637	
Sierra '83	2.8	110	08.82-01.87	PRT V6 FL	6	0,8	BPR6ES	7822	2	BPR6EIX	6637	
Sierra '83	2.8	111	08.82-01.87	PR V6 EFI	6	0,8	BPR6ES	7822	2	BPR6EIX	6637	
Sierra '87	1.6	53	01.87-12.92	LSF OHC 2V	4	0,8	APR6FS	2922				
Sierra '87	1.6	55	01.87-12.92	LSE OHC 2V	4	0,8	APR6FS	2922				
Sierra '87	1.6	55	01.87-12.92	LSE OHC 2V	Cat. 4	0,8	APR6FS	2922				
Sierra '87	1.6	59	01.87-12.92	L6B CVH CFI	4	1,1	BCPR6ES-11	7121	11	BCPR6EIX-11	4919	
Sierra '87	1.8	55	01.87-12.92	RFA	4	█	Y-910R	4751				
Sierra '87	1.8	55	01.87-12.92	RFB	4	█	Y-910R	4751				
Sierra '87	1.8	55	01.87-12.92	RFL	4	█	Y-910R	4751				
Sierra '87	1.8	59	01.87-12.92	REF OHC 2V	4	0,8	APR6FS	2922				
Sierra '87	1.8	59	01.87-12.92	RED OHC 2V	Cat. 4	0,8	APR6FS	2922				
Sierra '87	1.8	63	01.87-12.92	R6A CVH CFI	4	1,1	BCPR6ES-11	7121	11	BCPR6EIX-11	4919	
Sierra '87	1.8	64	01.87-12.92	R2C CVH 2V	4	1,1	BCPR6ES-11	7121	11	BCPR6EIX-11	4919	
Sierra '87	1.8	66	01.87-12.92	R2A CVH 2V	4	1,1	BCPR6ES-11	7121	11	BCPR6EIX-11	4919	
Sierra '87	1.8	66	01.87-12.92	RED OHC 2V	4	0,8	APR6FS	2922				
Sierra '87	2.0	74	01.87-12.92	NE5 OHC 2V	4	0,8	APR6FS	2922				
Sierra '87	2.0	74	01.87-12.92	N4B OHC EFI	4	0,8	APR6FS	2922				
Sierra '87	2.0	74	01.87-12.92	NEJ OHC 2V	4	0,8	APR6FS	2922				
Sierra '87	2.0	77	01.87-12.92	NES OHC 2V	Cat. 4	0,8	APR6FS	2922				
Sierra '87	2.0	77	01.87-12.92	NES OHC 2V	4	0,8	APR6FS	2922				
Sierra '87	2.0	77	01.87-12.92	N8C DOHC 2V	4	0,8	BCPR6ES	2330	12	BCPR6EIX-11	4919	
Sierra '87	2.0	80	01.87-12.92	N8A DOHC 2V	4	0,8	BCPR6ES	2330	12	BCPR6EIX-11	4919	
Sierra '87	2.0	85	01.87-12.92	N9E DOHC EFI	4	0,8	BCPR6ES	2330	12	BCPR6EIX-11	4919	
Sierra '87	2.0	85	01.87-12.92	N4A OHC EFI	Cat. 4	0,8	APR6FS	2922				
Sierra '87	2.0	85	01.87-12.92	N4I OHC EFI	4	0,8	APR6FS	2922				
Sierra '87	2.0	85	01.87-12.92	N4A OHC EFI	4	0,8	APR6FS	2922				
Sierra '87	2.0	88	01.87-12.92	N9C DOHC EFI	4	0,8	BCPR6ES	2330	12	BCPR6EIX-11	4919	
Sierra '87	2.0	90	01.87-12.92	N9A DOHC EFI	4	0,8	BCPR6ES	2330	12	BCPR6EIX-11	4919	
Sierra '87	2.0	150	01.87-12.92	N5B DOHC COSWORTH	4	0,9	R7234-9	5487				
Sierra '87	2.0	162	01.87-12.92	N5D DOHC COSWORTH	4	1,1	PFR7B-11	5667				
Sierra '87	2.0	162	01.87-12.92	N5C DOHC COSWORTH	4	1,1	PFR7B-11	5667				
Sierra '87	2.3	49	01.87-12.92	YTR	4	█	Y-902R	2237				

¹⁾ Bic = Best in class (siehe Seite 3) / (see page 3)



l kW

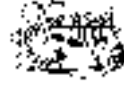

Cyl.

Order-
No. No.Bic¹⁾ Order-
No. No.**FORD**

Sierra '87	2.8	105	01.87-12.92	PR8 V6 EFI	6	0,8	BPR6ES	7822	2	BPR6EIX	6637
Sierra '87	2.8	107	01.87-12.92	PR7 V6 EFI	6	0,8	BPR6ES	7822	2	BPR6EIX	6637
Sierra '87	2.8	110	01.87-12.92	PRG V6 FI	6	0,8	BPR6ES	7822	2	BPR6EIX	6637
Sierra '87	2.9	107	01.87-12.92	B4C V6 EFI	6	1,0	BPR6EFS	3623	7		
Sierra '87	2.9	107	01.87-12.92	B4B V6 EFI	6	1,0	BPR6EFS	3623	7		
Sierra '87	2.9	110	01.87-12.92	B4A V6 EFI	6	0,8	BCPR6ES	2330	12	BCPR6EIX-11	4919
Streetka	1.6	70	01.03-	CDRB Duratec 8V	4	1,3	PTR5A-13 *	2467	25		
Streetka	1.6	70	01.03-	CDRA Duratec 8V	4	1,3	PTR5A-13	2467	25		
Tourneo	2.0	84	08.94-	DOHC 8V	4		---				
Tourneo Connect	1.8	55	06.02-	BHPA Endura-DI	4	█	Y-524J	5986			
Tourneo Connect	1.8	66	06.02-	HCPB Duratorq-TDCi	4	█	Y-524J	5986			
Tourneo Connect	1.8	66	06.02-	HCPA Duratorq-TDCi	4	█	Y-524J	5986			
Tourneo Connect	1.8	85	06.02-	EYPA ZETEC-E SFI	4	1,3	PTR5A-13	2467	25		
Transit Connect	1.8	55	06.02-	BHPA Endura-DI	4	█	Y-524J	5986			
Transit Connect	1.8	66	06.02-	HCPB Duratorq-TDCi	4	█	Y-524J	5986			
Transit Connect	1.8	66	06.02-	HCPA Duratorq-TDCi	4	█	Y-524J	5986			
Transit Connect	1.8	85	06.02-	EYPA ZETEC-E SFI	4	1,3	PTR5A-13	2467	25		
Transit '85	1.6	48	08.83-12.85	B OHC VV	4	0,8	AP6FS	2710			
Transit '85	2.0	55	08.83-12.85	C OHC VV	4	0,8	AP6FS	2710			
Transit '85	2.0	57	08.83-12.85	C OHC VV	4	0,8	AP6FS	2710			
Transit '85	2.4	46	08.83-12.85	4AA YORK-D	4	█	Y-208T	1250			
Transit '85	3.0	74	08.83-12.85	HX ESX 1V	6	0,8	BPR6ES	7822	2	BPR6EIX	6637
Transit '86	1.6	46	01.86-07.91	LAC OHC VV	4	0,8	APR6FS	2922			
Transit '86	1.6	46	01.86-07.91	LAT OHC VV	4	0,8	APR6FS	2922			
Transit '86	2.0	55	01.86-07.91	NAV OHC VV	4	0,8	APR6FS	2922			
Transit '86	2.0	56	01.86-07.91	NAX OHC	4	0,8	APR6FS	2922			
Transit '86	2.0	56	01.86-07.91	NAW OHC	4	0,8	APR6FS	2922			
Transit '86	2.0	57	01.86-07.91	NAT OHC VV	4	0,8	APR6FS	2922			
Transit '86	2.0	57	01.86-07.91	N6T OHC CFI	4	0,8	APR6FS	2922			
Transit '86	2.0	60	01.86-07.91	N6TS OHC CFI	4	0,8	APR6FS	2922			
Transit '86	2.9	110	01.86-07.91	B4T V6 EFI	6	0,8	BCPR6ES	2330	12	BCPR6EIX-11	4919
Transit '86	3.0	78	01.86-07.91	HXC V6 ESX 1V	6	0,8	BPR6ES	7822	2	BPR6EIX	6637
Transit '92	2.0	66	08.91-07.94	NBA OHC 2V	4	0,8	APR6FS	2922			
Transit '92	2.0	72	08.91-07.94	NCA OHC EFI	4	0,8	APR6FS	2922			
Transit '92	2.9	107	08.91-07.94	BRT V6 EFI	6	1,1	BCPR6ES-11	7121	11	BCPR6EIX-11	4919
Transit '95	2.0	84	08.94-07.00	NSG DOHC 8V SEFI	4	1,1	BKR7EVX-11	4685		BKR7EIX-11	6988
Transit '95	2.0	84	08.94-07.00	NSF DOHC 8V SEFI	4	1,1	BKR7EVX-11	4685		BKR7EIX-11	6988
Transit '95	2.0	84	08.94-07.00	NSH DOHC-8V SEFI	4	1,1	BKR7EVX-11	4685		BKR7EIX-11	6988
Transit 2000.5 (Vorderradantrieb)	2.0	55	08.00-	D3FA	4	█	Y-525J	7925			
Transit 2000.5 (Vorderradantrieb)	2.0	63	08.00-	F3FA	4	█	Y-525J	7925			
Transit 2000.5 (Vorderradantrieb)	2.0	74	08.00-	ABFA	4	█	Y-525J	7925			
Transit 2000.5 (Vorderradantrieb)	2.0	92	08.00-	F1FA	4	█	Y-525J	7925			
Transit 2000.5 (Hinterradantrieb)	2.3	107	01.00-	E5FC	4		PFR6B-11	4014			
Transit 2000.5 (Hinterradantrieb)	2.3	107	01.00-	E5FA	4		PFR6B-11	4014			
Transit 2000.5 (Hinterradantrieb)	2.4	55	01.00-	F4FA	4	█	Y-525J	7925			
Transit 2000.5 (Hinterradantrieb)	2.4	66	01.00-	D2FA	4	█	Y-525J	7925			
Transit 2000.5 (Hinterradantrieb)	2.4	88	01.00-	D4FA	4	█	Y-525J	7925			
Transit 2000.5 (Hinterradantrieb)	2.4	92	01.00-	DOFA	4	█	Y-525J	7925			
Windstar	3.0	109	10.94-	V6 SEFI	6	1,3	TR5	7837		TR5IX	7397
FORD (USA)											
Bronco	4.9		83- 86	Y	6	1,1	WR5	1071		WR5IX	7510

¹⁾ Bic = Best in class (siehe Seite 3) / (see page 3)

* Standardtype TR5A-10 / standard type TR5A-10



ℓ kW

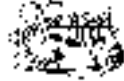

Cyl.

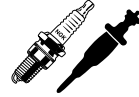
Order-
No. No.Bic¹⁾ Order-
No. No.**FORD (USA)**

Bronco	4.9		87- 95	Y EFI	6	1,1	WR4-1	4258			
Bronco	5.0		80- 85	F	8	1,1	UR4	4762		UR4IX	7401
Bronco	5.0		85- 96	N EFI	8	1,1	UR4	4762		UR4IX	7401
Bronco	5.8		85- 86	H Vergaser/Carb.	8	1,1	UR5	2139		UR5IX	7177
Bronco	5.8		88- 95	H EFI	8	1,1	UR5	2139		UR5IX	7177
Bronco	5.8		(87)	H Vergaser/Carb.	8	1,1	UR4	4762		UR4IX	7401
Bronco	5.8		80- 85	G	8	1,1	UR4	4762		UR4IX	7401
Bronco II	2.3		84- 85	A Vergaser/Carb.	4	1,1	TR5-1	2321		TR5-1IX	7243
Bronco II	2.3		(88)	A EFI	4	1,1	TR5-1	2321		TR5-1IX	7243
Bronco II	2.8		83- 85	S	6	1,1	TR5	7837		TR5IX	7397
Bronco II	2.9		86- 90	T EFI	6	1,1	TR5	7837		TR5IX	7397
Bronco II	4.0		90-	X EFI	6	1,1	TR55	1048		TR55IX	7164
Taurus	3.0		96- 99	S DOHC V6 SFI	6	1,3	TR55	1048		TR55IX	7164
Taurus	3.0		92- 99	U OHV V6 SFI	6	1,3	TR5	7837		TR5IX	7397
Taurus	3.0		89- 95	Y DOHC V6 SFI	6	1,1	PFR5G-11	2647			
Taurus	3.0		96- 99	N SHO V8 SFI	8	1,3	TR5	7837		TR5IX	7397
Taurus	3.2		93- 95	P SHO V6 SFI	6	1,1	PFR5G-11	2647			
Thunderbird	3.8		88- 97	4 EFI V6 EFI	6	1,5	TR55-1	6674		TR55-1IX	7316
Thunderbird	3.8		89- 95	R EFI V6 EFISupercharged	6	1,5	TR55-1	6674		TR55-1IX	7316
Thunderbird	3.9		- 02	A EFI V8 DOHC	8	1,1	BKR5ES-11	2382		BKR5EIX-11	5464
Thunderbird	3.9		03-	A EFI V8 DOHC	8	1,0	FR5AP-10				
Thunderbird	4.6		94- 97	W EFI V8 SOHC	8	1,5	TR55	1048		TR55IX	7164
Thunderbird	5.0		86- 88	F EFI V8	8	1,5	TR55-1	6674		TR55-1IX	7316
Thunderbird	5.0		91- 93	T EFI V8 H O	8	1,5	UR45	2451		UR45IX	7559

FREIGHTROVER

Sherpa D	2.0		05.86-03.91	Perkins - Prima 65	4	█	Y-902R	2237			
Sherpa Van DI D	2.5		01.87-		4	█	Y-902R	2237			

FSO

125 P	1.3	48	09.68-12.90	116C.076	4	0,7	BP6ES	7811	4	BPR6EIX	6637
125P , Montana, Arizona	1.5	60	09.68-12.90		4	0,7	BP6ES	7811	4	BPR6EIX	6637
126 BIS	0.7	19	87-		4	0,8	BPR6ES	7822	2	BPR6EIX	6637
Pick-Up	1.5		86- 89		4	0,7	BP6ES	7811	4	BPR6EIX	6637
Polonez	1.3	48	01.78-		4	0,7	BP6ES	7811	4	BPR6EIX	6637
Polonez	1.4	75	09.93-	16DOHC Rover	4	0,8	BKR6ES	3783	28	BKR6EIX	6418
Polonez 1500	1.5	55	78-		4	0,7	BP6ES	7811	4	BPR6EIX	6637
Polonez	1.5	60	01.78-		4	0,7	BP6ES	7811	4	BPR6EIX	6637
Polonez	1.5	60	07.95-	Cat.	4	0,8	BP6ET	1263		PGR6D	6248
Polonez D	1.6	37	01.86-	VW - Motor	4	█	Y-918R	4182			
Polonez	1.6	64	05.87-		4	0,7	BP6ES	7811	4	BPR6EIX	6637
Polonez 1600	1.6	64	87-		4	0,6	BP7ES	2412		BPR7EIX	4055
Polonez	1.6	64	07.95-	Cat.	4	0,8	BP6ET	1263		PGR6D	6248
Polonez Caro D	1.9	51	10.92-	XUD Kat.	4	█	Y-902R	2237			

GAZ

Chaika		161		GAZ-14	8	0,9	BPR5ES	7422	6	BPR5EIX	6597
Gazel 3302/ 2752 16V		107		ZMZ-4061.10 / 4063.10	4	0,9	BPR5ES	7422	6	BPR5EIX	6597
Gazel 3302/ 33027/ 33021/ 2705/ 3221 8V		71		ZMZ-4025.10 / 4026.10	4	0,6	BP6HS	4511	18	BPR6HIX	4085
Sobol 2217 16V		107		ZMZ-4061.10	4	0,9	BPR5ES	7422	6	BPR5EIX	6597
Volga 24		75		ZMZ-24D	4	0,6	BP6HS	4511	18	BPR6HIX	4085

¹⁾ Bic = Best in class (siehe Seite 3) / (see page 3)



l kW

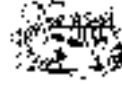

Cyl.

Order-
No. No.Bic¹⁾ Order-
No.**GAZ**

Volga 2410		66		ZMZ-402	4	0,6	BP6HS	4511	18	BPR6HIX	4085
Volga 3102/ 31021/ 31022/ 31024/ 31029/ 3110/ 8V		66		ZMZ-402	4	0,6	BP6HS	4511	18	BPR6HIX	4085
Volga 3110/ 16V		107		ZMZ-406	4	0,9	BPR5ES	7422	6	BPR5EIX	6597

GME

Rascal, MIDI					4	0,7	BPR5ES	7422	6	BPR5EIX	6597
--------------	--	--	--	--	---	-----	--------	------	---	---------	------

HINO

Ranger			78-	DG	4	☑	Y-128T	7227			
Ranger (B) D	3.0	60	01.83-07.88	B	4	☑	Y-197R	2188			
Ranger (3B) D	3.4	70	01.83-07.88	3 B	4	☑	Y-197R	2188			

HOMMEL

Berlinette RS 16V	2.0	123	98-	XU10.J4RS	4	0,9	BKR6EK	2288	20**	BKR6EQU	3199
-------------------	-----	-----	-----	-----------	---	-----	--------	------	------	---------	------

HONDA

Accord 1,6 L CA-45200C..(MT)	1.6	65	86-	A16A1	4	1,1	BPR6EY-11	4228	10	BPR6EIX-11	3903	
Accord 1,6 L CA-46200C..(AT)	1.6	65	86-	A16A1	4	1,1	BPR6EY-11	4228	10	BPR6EIX-11	3903	
Accord 1,6 2D AC-5320C..(MT)	1.6	65	84-	EZ	4	1,1	BPR6ES-11	4824	13	BPR6EIX-11	3903	
Accord 1,6 2D AC-5330C..(MT)	1.6	65	84-	EZ	4	1,1	BPR6ES-11	4824	13	BPR6EIX-11	3903	
Accord 1,6 4D AC-5430C..(MT)	1.6	65	84-	EZ	4	0,8	BPR6ES	7822	2	BPR6EIX	6637	
Accord 1,6 4D AC-7430C..(AT)	1.6	65	84-	EZ	4	0,8	BPR6ES	7822	2	BPR6EIX	6637	
Accord 1,6 2D AC-7330C..(AT)	1.6	65	84-	EZ	4	1,1	BPR6ES-11	4824	13	BPR6EIX-11	3903	
Accord 1,8 4D AD-5430C..(MT)	1.8	74	84-	ET1	4	1,1	BPR6EY-11	4228	10	BPR6EIX-11	3903	
Accord 1,8 2D AD-5330C..(MT)	1.8	74	84-	ET1	4	1,1	BPR6EY-11	4228	10	BPR6EIX-11	3903	
Accord 1,8 2D AD-7330C..(AT)	1.8	74	84-	ET1	4	1,1	BPR6EY-11	4228	10	BPR6EIX-11	3903	
Accord 1,8 4D AD-7430C..(AT)	1.8	74	84-	ET1	4	1,1	BPR6EY-11	4228	10	BPR6EIX-11	3903	
Accord 1,8 i/iLS CE7	1.8	85	96-	F18A3	4	1,1	ZFR6F-11	4291		ZFR6FIX-11	6441	
Accord 1,8 iS CG8	1.8	100	99-	F18B2	4	1,1	ZFR6F-11	4291		ZFR6FIX-11	6441	
Accord 2,0 CB3..(MT/AT)	2.0	66	90-	F20A2	Cat.	4	1,1	ZFR6F-11	4291		ZFR6FIX-11	6441
Accord 2,0 CB3..(MT/AT)	2.0	66	90-	F20A6		4	1,1	ZFR6F-11	4291		ZFR6FIX-11	6441
Accord 2,0 EX CA-55300C..(5MT)	2.0	75	86-	A20A1	Cat.	4	1,1	BPR6EY-11	4228	10	BPR6EIX-11	3903
Accord 2,0 EX CA-56300C..(4AT)	2.0	76	86-	A20A1	Cat.	4	1,1	BPR6EY-11	4228	10	BPR6EIX-11	3903
Accord TDi CF1	2.0	77	09.99-	20TN2		4	☑	Y-730U	2273			
Accord iTD LS	2.0	77	09.95-08.99	20TN2		4	☑	Y-740U	5104			
Accord TDi	2.0	77	05.95-08.99	Rover (L-Serie)		4	☑	Y-730U	2273			
Accord 2,0 EX CA-55300C..(MT)	2.0	78	86-	A20A2		4	1,1	BPR6EY-11	4228	10	BPR6EIX-11	3903
Accord 2,0 EX CA-56300C..(AT)	2.0	78	86-	A20A2		4	1,1	BPR6EY-11	4228	10	BPR6EIX-11	3903
Accord 2,0i CC7..(MT)	2.0	85	93-	F30Z2		4	1,1	ZFR6F-11	4291		ZFR6FIX-11	6441
Accord 2,0i EX CA-56800C..(AT)	2.0	85	87-	A20A3	Cat.	4	1,1	BPR6EY-11	4228	10	BPR6EIX-11	3903
Accord 2,0i EX CA-55800C..(MT)	2.0	85	87-	A20A3	Cat.	4	1,1	BPR6EY-11	4228	10	BPR6EIX-11	3903
Accord 2,0 EXi CA-56400C..(AT)	2.0	90	86-	A20A4		4	1,1	BPR6EY-11	4228	10	BPR6EIX-11	3903
Accord 2,0 EXi CA-55400C..(MT)	2.0	90	86-	A20A4		4	1,1	BPR6EY-11	4228	10	BPR6EIX-11	3903
Accord 2,0i LS/ES CE8	2.0	96	96-	F20Z1		4	1,1	ZFR6F-11	4291		ZFR6FIX-11	6441
Accord 2,0i LS CE8..	2.0	96	95-			4	1,1	ZFR6F-11	4291		ZFR6FIX-11	6441
Accord 2,0 S,LS,ES CC7..(MT/AT)	2.0	96	93-	F20Z1		4	1,1	ZFR6F-11	4291		ZFR6FIX-11	6441
Accord 2,0i CB3..(MT/AT)	2.0	98	90-	F20A8		4	1,1	ZFR6F-11	4291		ZFR6FIX-11	6441
Accord 2,0i 16V CA5	2.0	98	88-	B20A8	Cat.	4	1,1	BCPR6E-11	3132	11	BCPR6EIX-11	4919
Accord 2,0i CB3..(MT/AT)	2.0	98	90-	F20A4		4	1,1	ZFR6F-11	4291		ZFR6FIX-11	6441
Accord 2,0i 16V EX CA-55500C..(MT)	2.0	101	87-	B20A2		4	1,1	BCPR6EYN-11	6262			
Accord 2,0iLS / iES CG9	2.0	108	99-	F20B6		4	1,1	ZFR6F-11	4291		ZFR6FIX-11	6441

¹⁾ Bic = Best in class (siehe Seite 3) / (see page 3)

** alternative/wahlweise V-Line 30



ℓ kW

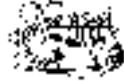

Cyl.

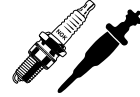
Order-
No. No.Bic¹⁾ Order-
No.**HONDA**

Accord 2,0i	CL7	2.0	114	03-	K20A6	4	1,1	ZFR6K-11	6711				
Accord 2.0 Sport	CL7	2.0	114	03-	K20A6	4	1,1	ZFR6K-11	6711				
Accord 2,2i 16V	CE9..	2.2	110	95-		4	1,1	ZFR6F-11	4291		ZFR6FIX-11	6441	
Accord 2,2i (4WS)	CB7..(MT/AT)	2.2	110	90-	F22A3	4	1,1	ZFR6F-11	4291		ZFR6FIX-11	6441	
Accord 2,2i VTEC	CE9	2.2	110	95-	F22Z2	4	1,1	ZFR6F-11	4291		ZFR6FIX-11	6441	
Accord 2,2iR	CH1	2.2	156	99-	H22A7	4	1,1	PZFR6F-11	3271				
Accord 2,3 ES	CL3	2.3	113	01-	F23Z5	4	1,1	ZFR6F-11	4291		ZFR6FIX-11	6441	
Accord 2,3 SR	CC7.. (MT)	2.3	116	93-	H23A3	4	1,1	ZFR6F-11	4291		ZFR6FIX-11	6441	
Accord 2.4 Sport	CL9	2.4	140	03-	K24A3	4	1,1	IZFR6K-11	6994				
Accord 2,4i	CL9	2.4	140	03-	K24A3	4	1,1	IZFR6K-11	6994				
Accord Aero 2,0 EX CA-53700C..(MT)		2.0	75	87-	A20A1 Cat. 5MT	4	1,1	BPR6EY-11	4228	10	BPR6EIX-11	3903	
Accord Aero 2,0 EX CA-54700C..(AT)		2.0	76	87-	A20A1 Cat. 4AT	4	1,1	BPR6EY-11	4228	10	BPR6EIX-11	3903	
Accord Aero 2,0 EXCA-54300C..(AT)		2.0	78	86-	A20A2	4	1,1	BPR6EY-11	4228	10	BPR6EIX-11	3903	
Accord Aero 2,0 EXCA-53300C..(MT)		2.0	78	86-	A20A2	4	1,1	BPR6EY-11	4228	10	BPR6EIX-11	3903	
Accord Aero 2,0i EXCA-54800C..(AT)		2.0	85	87-	A20A3	Cat.	4	1,1	BPR6EY-11	4228	10	BPR6EIX-11	3903
Accord Aero 2,0i EXCA-53800C..(MT)		2.0	85	87-	A20A3	Cat.	4	1,1	BPR6EY-11	4228	10	BPR6EIX-11	3903
Accord Aero 2,0 EXiCA-54400C..(AT)		2.0	90	86-	A20A4	4	1,1	BPR6EY-11	4228	10	BPR6EIX-11	3903	
Accord Aero 2,0 EXiCA-53400C..(MT)		2.0	90	86-	A20A4	4	1,1	BPR6EY-11	4228	10	BPR6EIX-11	3903	
Accord Aero 2,0i	CC9	2.0	98	93-	F20Z3	4	1,1	ZFR6F-11	4291		ZFR6FIX-11	6441	
Accord Aero 2,0i LS,ES	CE2 (MT/AT)	2.0	100	94-	F20B3	4	1,1	ZFR6F-11	4291		ZFR6FIX-11	6441	
Accord Aero 2,2i LS,ES	CE1 (MT/AT)	2.2	110	94-	F22B5	4	1,1	ZFR6F-11	4291		ZFR6FIX-11	6441	
Accord Aero 2,2i	CB8	2.2	110	(91)	F22A7-F22A8	4	1,1	ZFR6F-11	4291		ZFR6FIX-11	6441	
Accord Coupe 2,0	CC1..(MT/AT)	2.0	98	92-	F20A7	4	1,1	ZFR6F-11	4291		ZFR6FIX-11	6441	
Accord Coupe 2,0i ES / iLS	(CG4)	2.0	108	01.98-	F20B5	4	1,1	ZFR6F-11	4291		ZFR6FIX-11	6441	
Accord Coupe 2,2i	CD7 (MT/AT)	2.2	110	94-	F22B5	4	1,1	ZFR6F-11	4291		ZFR6FIX-11	6441	
Accord Coupe 3,0i V6	CG2	3.0	147	98-	J30A1	6	1,1	ZFR5F-11	2262		ZFR5FIX-11	2477	
Accord Tourer	CM1	2.0	114	04.03-	K20A6	4	1,1	ZFR6K-11	6711				
Accord Tourer	CM2	2.4	140	04.03-	K24A3	4	1,1	IZFR6K-11	6994				
Civic 1,2	AL-4310S..(MT)	1.2	40	84-	ZA2	4	1,1	BPR6EY-11	4228	10	BPR6EIX-11	3903	
Civic 1300	AG-5320S..(MT)	1.3	52	84-	EV2	4	1,1	BPR6EY-11	4228	10	BPR6EIX-11	3903	
Civic 1300	AG-3320S..(AT)	1.3	52	02.84-	EV2	4	1,1	BPR6EY-11	4228	10	BPR6EIX-11	3903	
Civic 1,3	EG3	1.3	55	92-	D13B2	4	1,1	BKR6E-11	2756	14	BKR6EIX-11	3764	
Civic 1,3	EC8..(MT/AT)	1.3	55	88-	D13B1	4	1,1	BCPR6E-11	3132	11	BCPR6EIX-11	4919	
Civic 1,3	EC8..(MT/AT)	1.3	55	90-	D16B2	Cat.	4	1,1	BCPR6E-11	3132	11	BCPR6EIX-11	4919
Civic		1.4		01.97-	PIJ (SOHC)	4	1,1	ZFR5F-11	2262		ZFR5FIX-11	2477	
Civic 1,4i	EJ9	1.4	55	99-	D14Z1	4	1,1	ZFR5J-11	5584				
Civic 1,4i	EJ9	1.4	55	96-	D14A3	4	1,1	BKR6E-11	2756	14	BKR6EIX-11	3764	
Civic	EU7	1.4	66	03.01-	D14Z6	4	1,1	ZFR6J-11	5585				
Civic 1,4iS	EJ9	1.4	66	99-	D14Z2	4	1,1	ZFR5J-11	5584				
Civic 1,4	EC9/ED2..(AT/MT)	1.4	66	88-	D14A1	4	1,1	BCPR6E-11	3132	11	BCPR6EIX-11	4919	
Civic 1,4iS	EJ9	1.4	66	96-	D14A4	4	1,1	BKR6E-11	2756	14	BKR6EIX-11	3764	
Civic		1.5		01.97-	P9L(VTEC)	4	1,1	ZFR5F-11	2262		ZFR5FIX-11	2477	
Civic		1.5		97-	VTi	4	1,1	BKR6EN-11	5724				
Civic GL	AH-5320S..(MT)	1.5	63	85-	EW2	4	1,1	BPR6EY-11	4228	10	BPR6EIX-11	3903	
Civic GL	AH-3320S..(AT)	1.5	63	85-	EW2	4	1,1	BPR6EY-11	4228	10	BPR6EIX-11	3903	
Civic 1,5S	AH-5330S..(MT)	1.5	63	84-	EW2	4	1,1	BPR6EY-11	4228	10	BPR6EIX-11	3903	
Civic 1,5DXi/LSi	EG4/EG8	1.5	66	92-	D15B2	4	1,1	BKR6E-11	2756	14	BKR6EIX-11	3764	
Civic 1,5VEI	EG4	1.5	66	92-	D15Z1	4	1,1	ZFR6F-11	4291		ZFR6FIX-11	6441	
Civic 1,5iGT	AH-5330S..(MT)	1.5	66	86-	EW4	Cat.	4	1,1	BPR6EY-11	4228	10	BPR6EIX-11	3903
Civic 1,5i	ED6/ED3	1.5	66	89-	D15B2	Cat.	4	1,1	BCPR6E-11	3132	11	BCPR6EIX-11	4919
Civic 1,5iGT	AH-5330S..(MT)	1.5	74	85-	EW3	4	1,1	BPR6EY-11	4228	10	BPR6EIX-11	3903	
Civic 1,5iLS	EK3	1.5	84	96-	D15Z6	4	1,1	ZFR6J-11	5585				

¹⁾ Bic = Best in class (siehe Seite 3) / (see page 3)



l kW

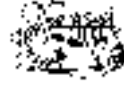

Cyl.

Order-
No. No.Bic¹⁾ Order-
No. No.**HONDA**

Civic		1.6		01.97-	PIK(SOHC)		4	1,1	ZFR5F-11	2262		ZFR5FIX-11	2477
Civic 1,6	ED4/ED7	1.6	80	88-	D16A6	Cat.	4	1,1	BCPR6E-11	3132	11	BCPR6EIX-11	4919
Civic 1,6	ED4/ED7	1.6	81	90- 01	D16Z2	Cat.	4	1,1	BCPR6E-11	3132	11	BCPR6EIX-11	4919
Civic	EU8	1.6	81	03.01-	D16V1		4	1,1	ZFR6J-11	5585			
Civic 1,6i ES	EK1	1.6	84	96-	D16Y5		4	1,1	ZFR6J-11	5585			
Civic 1,6ESI	EG5/EG9	1.6	92	92-	D16Z6		4	1,1	BKR6E-11	2756	14	BKR6EIX-11	3764
Civic VTEC	EE9	1.6	110	90-	B16A1		4	1,1	BKR6EN-11	5724			
Civic 1,6VTi	EK4	1.6	118	96-	B16A2		4	1,1	BKR7EN-11	6256			
Civic 1,6VTI	EG6/EG9	1.6	118	92- 95	B16A2		4	1,1	BKR6E-11	2756	14	BKR6EIX-11	3764
Civic iTD LS		2.0	63	96- 97			4	█	Y-730U	2273			
Civic iTD LS		2.0	63	05.97- 01	20T2R		4	█	Y-740U	5104			
Civic Type-R	EP3	2.0	147	08.01-	K20A2		4	1,1	IFR7G-11K	4965			
Civic 5 Door		1.4			PIH		4	1,1	BKR6E-11	2756	14	BKR6EIX-11	3764
Civic 1,4 i 5Door	MB2	1.4	55	97-	D14A7		4	1,1	ZFR5F-11	2262		ZFR5FIX-11	2477
Civic 1,4i 5Door	MA8	1.4	55	96-	D14A5		4	1,1	BKR6E-11	2756	14	BKR6EIX-11	3764
Civic 1,4i 5Door	MB2	1.4	55	99-	D14Z3		4	1,1	ZFR5F-11	2262		ZFR5FIX-11	2477
Civic 1,4i 5Doorr	MA8 (MT/AT)	1.4	66	95-	D14A2		4	1,1	BKR6E-11	2756	14	BKR6EIX-11	3764
Civic 1,4 5Door	EU7	1.4	66	01-	D14Z6 SOHC		4	1,1	ZFR6J-11	5585			
Civic 1,4iS 5Door	MB2	1.4	66	99-	D14Z4		4	1,1	ZFR5F-11	2262		ZFR5FIX-11	2477
Civic 1,4 iS 5Door	MB2	1.4	66	97-	D14A8		4	1,1	ZFR5F-11	2262		ZFR5FIX-11	2477
Civic 1,5 VTEC-E 5Door	MA9	1.5	66	95-	D15Z3		4	1,1	ZFR6F-11	4291		ZFR6FIX-11	6441
Civic 1,5 Vtec 5Door	MB3	1.5	85	97-	D15Z8		4	1,1	ZFR5F-11	2262		ZFR5FIX-11	2477
Civic 5 Door		1.6			PIJ DOHC		4	1,1	BKR6E-11	2756	14	BKR6EIX-11	3764
Civic 5 Door		1.6			PIK DOHC		4	1,1	BKR6E-11	2756	14	BKR6EIX-11	3764
Civic 1,6 Vtec 5Door	EU8	1.6	81	01-	D16V1 SOHC		4	1,1	ZFR6J-11	5585			
Civic 1,6LS 5Door	MB1 (MT/AT)	1.6	83	95-	D16Y3		4	1,1	BKR6E-11	2756	14	BKR6EIX-11	3764
Civic 1,6 LS 5Door	MB4	1.6	85	97-	D16B2		4	1,1	ZFR5F-11	2262		ZFR5FIX-11	2477
Civic 1,6i/LS 5Door	MB4	1.6	85	99-	D16W3		4	1,1	ZFR5F-11	2262		ZFR5FIX-11	2477
Civic 1,6SR VTEC 5Door	MB1 (MT/AT)	1.6	93	95-	D16Y2		4	1,1	BKR6E-11	2756	14	BKR6EIX-11	3764
Civic 1.4i Aerodeck	MB8	1.4	55	98-	D14A7		4	1,1	ZFR6F-11	4291		ZFR6FIX-11	6441
Civic 1.4iS Aerodeck	MB8	1.4	66	98-	D14A8		4	1,1	ZFR6F-11	4291		ZFR6FIX-11	6441
Civic 1.5iVTEC Aerodeck	MB9	1.5	85	98-	D15Z8		4	1,1	ZFR6F-11	4291		ZFR6FIX-11	6441
Civic 1.6iSR Aerodeck	MC1	1.6	85	98-	D16B2		4	1,1	ZFR6F-11	4291		ZFR6FIX-11	6441
Civic 1.8iVTi Aerodeck	M18C4	1.8	124	98-	B18C4		4	1,1	BKR7EN-11	6256			
Civic Coupe 1,5i/LSi	EJ2	1.5	74	94-	D15B7		4	1,1	ZFR6F-11	4291		ZFR6FIX-11	6441
Civic Coupe 1,6 LS	EJ6	1.6	77	96- 98	D16Y7		4	1,1	BKR6E-11	2756	14	BKR6EIX-11	3764
Civic Coupe 1,6iLS	EJ6	1.6	77	99-	D16Y7		4	1,1	ZFR5F-11	2262		ZFR5FIX-11	2477
Civic Coupe 1,6 LS	EJ6	1.6	77	96- 98	D16Y7		4	1,1	BKR6E-11	2756	14	BKR6EIX-11	3764
Civic Coupe 1,6 SR	EJ8	1.6	92	99-	D16Y8		4	1,1	ZFR5F-11	2262		ZFR5FIX-11	2477
Civic Coupe 1,6i SREJ8		1.6	92	96- 98	D16Y8		4	1,1	BKR6E-11	2756	14	BKR6EIX-11	3764
Civic Coupe 1,6i SREJ8		1.6	92	96-	D16Y8		4	1,1	BKR6E-11	2756	14	BKR6EIX-11	3764
Civic Coupe 1,6 ESi	EJ1	1.6	92	94-	D16Z9		4	1,1	BKR6E-11	2756	14	BKR6EIX-11	3764
Civic Coupe 1,7 LS	EM2	1.7	88	01-	D17A8		4	1,1	ZFR6J-11	5585			
Civic Coupe 1,7 ES	EM2	1.7	92	01-	D17A9		4	1,1	ZFR6J-11	5585			
Civic Shuttle 1,6i	EE	1.6	80	88-	D16A6	Cat.	4	1,1	BCPR6E-11	3132	11	BCPR6EIX-11	4919
Civic Shuttle 1,6i	EE	1.6	81	88-	D16Z2	Cat.	4	1,1	BCPR6E-11	3132	11	BCPR6EIX-11	4919
Civic 1,8 VTI 5Door	MB6	1.8	124	97-	B18C4		4	1,1	BKR6EN-11	5724			
Concerto 1,5i	HW..(MT/AT)	1.5	66	90-	D15B2	Cat.	4	1,1	BCPR6E-11	3132	11	BCPR6EIX-11	4919
Concerto 1,6i	HW..(MT/AT)	1.6	82	90-	D16Z2 SOHC	Cat.	4	1,1	BCPR6E-11	3132	11	BCPR6EIX-11	4919
Concerto 1,6-16V	HW	1.6	90	90-	D16A8 DOHC		4	1,1	BCPR6E-11	3132	11	BCPR6EIX-11	4919
Concerto TD		1.8	64	10.94-12.95	XUD 7 TE		4	█	Y-902R	2237			
CR-V	RD1	2.0	94	05.97-	B20B3		4	1,1	ZFR5F-11	2262		ZFR5FIX-11	2477

¹⁾ Bic = Best in class (siehe Seite 3) / (see page 3)



ℓ kW



Cyl.

Order-
No. No.Bic¹⁾ Order-
No.**HONDA**

CR-V	RD1	2.0	108	03.99-	B20Z1	4	1,1	ZFR6F-11	4291		ZFR6FIX-11	6441	
CR-V	RD8	2.0	110	02-	K20A4	4	1,1	ZFR6K-11	6711				
CRX	AF-5320S..(MT)	1.5	74	84-	EW3	4	1,1	BPR6EY-11	4228	10	BPR6EIX-11	3903	
CRX 1,6i-16	ED9	1.6	91	89-	D16Z5	Cat.	4	1,1	BCPR6E-11	3132	11	BCPR6EIX-11	4919
CRX 1,6	EH6..(MT/AT)	1.6	92	92-	D16Z6		4	1,1	BKR6E-11	2756	14	BKR6EIX-11	3764
CRX 16V	AS-5330S..(MT)	1.6	92	01.86-	ZC1		4	1,1	BCPR6EY-11	3720			
CRX 1,6i-16	ED9	1.6	96	88-	D16A9		4	1,1	BCPR6E-11	3132	11	BCPR6EIX-11	4919
CRX VTEC	EE8	1.6	110	90-	B16A1		4	1,1	BKR6EN-11	5724			
CRX 1,6	EG2	1.6	118	92-	B16A2		4	1,1	BKR6EN-11	5724			
HR-V	GH2	1.6	77	02.99-	D16W1		4	1,1	ZFR5J-11	5584			
HR-V 1.6 VTEC	GH2	1.6	91	10.99-	VTEC		4	1,1	ZFR5J-11	5584			
Insight 6CDS3Y00A	ZE1	1.0	56	00-	ECA1		3	1,1	ILZFR6A-11				
Integra Type-R 16V		2.0	162	02.02-	K20A		4	1,1	IFR7G-11K	4965			
Integra R	DC2	1.8	140	99-	B18C6		4	1,1	PFR7G-11	2380			
Integra R	DC2	1.8	140	10.97-	B18C6		4	1,1	PFR7G-11	2380			
Integra		1.6		88-			4	1,1	BCPR6E-11	3132	11	BCPR6EIX-11	4919
Jazz 45	AA-4310S.. (4MT)	1.2	33	84-	ER2		4	1,1	BPR5EY-11	3028		BPR5EIX-11	2115
Jazz 55	AA-3320S.. (3HMT)	1.2	40	85-	ER4		4	1,1	BPR5EY-11	3028		BPR5EIX-11	2115
Jazz 56	AA-5320S.. (5MT)	1.2	41	84-	ER1		4	1,1	BPR5EY-11	3028		BPR5EIX-11	2115
Jazz i-DSI		1.2	57	02-			4	1,1	BKR6E-11	2756	14	BKR6EIX-11	3764
Jazz 1.2 GD5		1.3	57	03-	L12A1		4	1,1	BKR6E-11	2756	14	BKR6EIX-11	3764
Jazz TwinSpark	(GD1)	1.4	61	02-	L13A1		4	1,1	BKR6E-11	2756	14	BKR6EIX-11	3764
Legend V6 2,5i	HS..N..(MT)	2.5	110	87-	C25A1	Cat.	6	1,1	BCPR6E-11	3132	11	BCPR6EIX-11	4919
Legend V6 2,5i	HS..Y..(AT)	2.5	110	87-	C25A1	Cat.	6	1,1	BCPR6E-11	3132	11	BCPR6EIX-11	4919
Legend V6 2,5i	HS..Y..(AT)	2.5	127	87-	C25A1		6	1,1	BCPR6E-11	3132	11	BCPR6EIX-11	4919
Legend V6 2,5i	HS..N..(MT)	2.5	127	87-	C25A1		6	1,1	BCPR6E-11	3132	11	BCPR6EIX-11	4919
Legend 2,7i	HS/KA4	2.7	124	88-	C27A1	Cat.	6	1,1	BCPR6E-11	3132	11	BCPR6EIX-11	4919
Legend 3,2	KA7/KA8	3.2	151	91-	C32A2		6	1,1	PFR6G-11	5555			
Legend 3,2	KA7/KA8	3.2	151	93-	C32A2		6	1,1	PFR6G-11	5555			
Legend 3,5 V6	KA9	3.5	151	96-			6	1,1	PFR6G-11	5555			
Legend V6		3.5	151	95-			6	1,1	PFR6G-11	5555			
Legend Coupe 2,7i	KA3	2.7	124	88-	C27A1	Cat.	6	1,1	BCPR6EYN-11	6262			
Logo 1,3 i		1.3	48	99- 01	D13B7		4	1,1	ZFR5J-11	5584			
NSX	NA1	3.0	188	91-	C30A3/C30A4		6	1,1	PFR6G-11	5555			
NSX	NA2	3.2	206	01.97-	C32B2		6	1,1	PFR6G-11	5555			
Prelude 1,8	AB-7230C..(AT)	1.8	74	83-	ET		4	0,8	BPR6EY	6427		BPR6EIX	6637
Prelude 1,8	AB-5240C..(MT)	1.8	74	85-	ET2		4	1,1	BPR6EY-11	4228	10	BPR6EIX-11	3903
Prelude 1,8	AB-5220C..(MT)	1.8	77	83-	ET		4	0,8	BPR6EY	6427		BPR6EIX	6637
Prelude 1,8	AB-5230C..(MT)	1.8	77	83-	ET		4	0,8	BPR6EY	6427		BPR6EIX	6637
Prelude 2,0	BA4..(MT/AT)	2.0	80	90-	B20A3	Cat.	4	1,1	BCPR6EYN-11	6262			
Prelude 2,0	BA4..(MT/AT)	2.0	80	88-	B20A3	Cat.	4	1,1	BCPR6EYN-11	6262			
Prelude 2,0	BA4..	2.0	84	88-	B20A4		4	1,1	BCPR6EYN-11	6262			
Prelude 2,0	BB3..(MT/AT)	2.0	98	92-	F20A4		4	1,1	ZFR6F-11	4291		ZFR6FIX-11	6441
Prelude 2,0		2.0	98	97-			4	1,1	ZFR6F-11	4291		ZFR6FIX-11	6441
Prelude 2,0 i	(BB9)	2.0	98	99-	F20A4		4	1,1	ZFR6F-11	4291		ZFR6FIX-11	6441
Prelude 2,0 16V	4WS)BA4	2.0	101	88-	B20A5	Cat.	4	1,1	BCPR6EYN-11	6262			
Prelude 2,0i 16V	BA2-1300C..(MT)	2.0	101	86-	BA20A1 DOHC		4	1,1	BCPR6E-11	3132	11	BCPR6EIX-11	4919
Prelude 2,0 16V	4WS)BA4	2.0	103	90-	B20A9	Cat.	4	1,1	BCPR6EYN-11	6262			
Prelude 2,2i		2.2	136	97-	H22A5		4	1,1	PZFR6F-11	3271			
Prelude 2,2 Vti	(BB6/BB8)	2.2	136	99-	H22A5		4	1,1	PZFR6F-11	3271			
Prelude 2,2 VTEC	BB1..(MT)	2.2	136	93-	H22A2		4	1,1	PZFR6F-11	3271			
Prelude 2,3	BB2..(MT/AT)	2.3	118	92-	H23A2		4	1,1	ZFR6F-11	4291		ZFR6FIX-11	6441

¹⁾ Bic = Best in class (siehe Seite 3) / (see page 3)



l kW

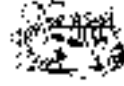

Cyl.

Order-
No. No.Bic¹⁾ Order-
No. No.**HONDA**

S 2000 (AP1)	2.0	177	06.00-	F20C2	4	1,1	PFR7G-11S				
Shuttle AN-5520S..(MT)	1.5	63	84-	EW2	4	1,1	BPR6EY-11	4228	10	BPR6EIX-11	3903
Shuttle 4WD AR-6520C..(MT)	1.5	63	85-	EW2	4	1,1	BPR6EY-11	4228	10	BPR6EIX-11	3903
Shuttle AN-3520S..(AT)	1.5	63	84-	EW2	4	1,1	BPR6EY-11	4228	10	BPR6EIX-11	3903
Shuttle 2,2i ES	2.2	110	95-	RA1 (AT)	4	1,1	ZFR6F-11	4291		ZFR6FIX-11	6441
Shuttle 2,3 RA3	2.3	110	98-	F23A7	4	1,1	ZFR6F-11	4291		ZFR6FIX-11	6441
Stream (RN1)	1.7	92	04.01-	D17A2	4	1,1	ZFR6J-11	5585			
Stream (RN3)	2.0	115	04.01-	K20A1	4	1,1	ZFR6K-11	6711			

HYUNDAI

Accent	1.3	44	10.94-	G4EH	4	1,1	BKR5ES-11	2382		BKR5EIX-11	5464
Accent	1.3	55	10.94-	G4EH	4	1,1	BKR5ES-11	2382		BKR5EIX-11	5464
Accent/LC	1.3	55	99-	G4EA	4	1,1	BKR5ES-11	2382		BKR5EIX-11	5464
Accent/LC	1.3	64	99-	G4EA	4	1,1	BKR5ES-11	2382		BKR5EIX-11	5464
Accent GT 16V	1.5		95-	G4EK	4	1,1	BKR5ES-11	2382		BKR5EIX-11	5464
Accent	1.5	65	10.94-	G4EK	4	1,1	BKR5ES-11	2382		BKR5EIX-11	5464
Accent/LC	1.5	66	01.00-	G4EB	4	1,1	BKR5ES-11	2382		BKR5EIX-11	5464
Accent/LC 16V	1.5	75	99-	G4EA	4	1,1	BKR5ES-11	2382		BKR5EIX-11	5464
Amica	1.0		00-		4	1,1	BKR5E-11	6953		BKR5EIX-11	5464
Atos	0.8		- 02	LPG	4	0,8	BKR6ES	3783	28	BKR6EIX	6418
Atos Prime	1.0	40	99- 02	G4HC	4	1,1	BKR5ES-11	2382		BKR5EIX-11	5464
Atos / MX	1.0	40	99- 02	G4HC	4	1,1	BKR5ES-11	2382		BKR5EIX-11	5464
Atos	1.1	46	03.04-		4	1,1	BKR5ES-11	2382		BKR5EIX-11	5464
Avante	1.5			DOHC	4	1,1	BKR5ES-11	2382		BKR5EIX-11	5464
Avante	1.6			DOHC	4	1,1	BKR5ES-11	2382		BKR5EIX-11	5464
Avante	1.8			DOHC	4	1,1	BKR5ES-11	2382		BKR5EIX-11	5464
Avante	2.0			DOHC	4	1,1	BKR5ES-11	2382		BKR5EIX-11	5464
Coupe	2.0		03.02-		4	1,1	BKR5ES-11	2382		BKR5EIX-11	5464
Coupe 2.0	2.0	99	01-	G4GF-EG	4	1,1	BKR5ES-11	2382		BKR5EIX-11	5464
Coupe	2.0	102	03.96-	G4GF DOHC	4	1,1	BKR5ES-11	2382		BKR5EIX-11	5464
Coupe 2.0	2.0	102	99-		4	1,1	BPR5ES-11	4424		BPR5EIX-11	2115
Coupe	2.7	128	03.02-	G6BA-G V6	6	1,1	BKR5ES-11	2382		BKR5EIX-11	5464
Dynasty 2.5 V6	2.5				6	1,1	PFR6N-11	3546			
Dynasty 3.0 V6	3.0				6	1,1	PFR6N-11	3546			
Dynasty 3.5 V6	3.5				6	1,1	PFR6N-11	3546			
Elantra	1.5			DOHC	4	1,1	BPR6ES-11	4824	13	BPR6EIX-11	3903
Elantra	1.6		- 99	DOHC	4	1,1	BPR6ES-11	4824	13	BPR6EIX-11	3903
Elantra / XD	1.6	79	00-	G4ED-G DOHC	4	1,1	BKR5ES-11	2382		BKR5EIX-11	5464
Elantra	1.8			DOHC	4	1,1	BPR6ES-11	4824	13	BPR6EIX-11	3903
Elantra CRDI	2.0	83	01-	D4EA	4	█	Y-749J	5013			
Elantra / XD	2.0	102	00-	G4GC-G DOHC	4	1,1	BKR5ES-11	2382		BKR5EIX-11	5464
Elantra	2.0	105	03-		4	1,1	BKR5E-11	6953		BKR5EIX-11	5464
Exel	1.3	62	96-	G4EK	4	1,1	BKR6E-11	2756	14	BKR6EIX-11	3764
FC	1.6	76	07.01-		4	1,1	BKR5ES-11	2382		BKR5EIX-11	5464
Galopper	2.5	57	-01.94	4D55	4	█	Y-115T1	2189			
Galopper TC,TCI	2.5	65	11.95-	4D56	4	█	CY57	5287			
Galopper TD 3/5p GLS, Inovation	2.5	74	01.99-		4	█	CY57	5287			
Galopper	3.0		98-	SOHC V6	6	1,1	BKR5ES-11	2382		BKR5EIX-11	5464
Galopper	3.0	104	08.98-	G6AT Unleaded	6	1,1	BPR5ES-11	4424		BPR5EIX-11	2115
Galopper	3.0	104	08.98-	Leaded+LPG	6	0,9	BPR5ES	7422	6	BPR5EIX	6597
Getz TB	1.1	46	09.02-		4	1,1	BKR5ES-11	2382		BKR5EIX-11	5464
Getz TB	1.3	60	09.02-		4	1,1	BKR5ES-11	2382		BKR5EIX-11	5464

¹⁾ Bic = Best in class (siehe Seite 3) / (see page 3)



ℓ kW

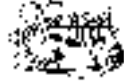

Cyl.

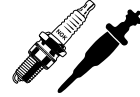
Order-
No. No.Bic¹⁾ Order-
No.**HYUNDAI**

Getz D	1.5	60	07.03-	D3EA	3	█	Y-749J	5013				
Getz TB	1.6	77	09.02-		4	1,1	BKR5ES-11	2382		BKR5EIX-11	5464	
Grace 2.4	2.4	82		SOHC	4	1,1	BPR6ES-11	4824	13	BPR6EIX-11	3903	
Grace H100	2.5			4D55	4	█	Y-115T1	2189				
H-1 Starex	2.4	82	98-	G4CS	4	1,1	BPR6ES-11	4824	13	BPR6EIX-11	3903	
H 100 D	2.5	57	- 96	D4BA 4D55	4	█	Y-115T1	2189				
H 100 D	2.5	57	- 96	4D56	4	█	CY57	5287				
H 100 D intercooler	2.5	63	07.94-	D4BF	4	█	Y-722J	2686				
H 100 i	2.4	84	01.97-		4	1,1	BP6EY-11	4128				
H-1	2.4	85	09.97-	H100	4	1,1	BPR6ES-11	4824	13	BPR6EIX-11	3903	
Lantra 1(J-1)	1.5	63	92-	G4DJ	4	1,1	BPR6ES-11	4824	13	BPR6EIX-11	3903	
Lantra 2(J-2)	1.6	66	09.95-	G4GR	4	1,1	BKR5ES-11	2382		BKR5EIX-11	5464	
Lantra 1(J-1)	1.6	78	92-	G4CR	4	1,1	BPR6ES-11	4824	13	BPR6EIX-11	3903	
Lantra 3	1.6	79	09.00-	G4ED-G DOHC	4	1,1	BKR5ES-11	2382		BKR5EIX-11	5464	
Lantra 2(J-2)	1.6	84	09.95-	G4GR	4	1,1	BKR5ES-11	2382		BKR5EIX-11	5464	
Lantra 1(J-1)	1.8	93	92-	G4CN	4	1,1	BPR6ES-11	4824	13	BPR6EIX-11	3903	
Lantra 2(J-2)	1.8	94	09.95-	G4GM	4	1,1	BKR5ES-11	2382		BKR5EIX-11	5464	
Lantra D	1.9	50	98-	XUD9A	4	█	Y-938R	5267				
Lantra 3	2.0	101	09.00-	G4GC-G DOHC	4	1,1	BKR5ES-11	2382		BKR5EIX-11	5464	
Lantra 2(J-2)	2.0	102	02.97-		4	1,1	BKR5ES-11	2382		BKR5EIX-11	5464	
LC 1.3i	1.3	55	01-	G4EA-G	4	1,1	BKR5ES-11	2382		BKR5EIX-11	5464	
LC 1.5i	1.5	75	01-	G4EC-G DOHC	4	1,1	BKR5ES-11	2382		BKR5EIX-11	5464	
M.X.	1.0	43	05.98-		4	1,1	BKR6ES-11	5553	14	BKR6EIX-11	3764	
Matrix CRDI	1.5	60	09.01-	D3EA	3	█	Y-749J	5013				
Matrix	1.8	90	08.01-		4	1,1	BKR5ES-11	2382		BKR5EIX-11	5464	
Matrix FC	1.6	76	08.01-	G4ED-G	4	1,1	BKR5ES-11	2382		BKR5EIX-11	5464	
Matrix FC	1.8	98	07.01-		4	1,1	BKR5ES-11	2382		BKR5EIX-11	5464	
Pony	1.2				4	0,8	BP5ES	6511	8	BPR5EIX	6597	
Pony	1.4				4	0,8	BP5ES	6511	8	BPR5EIX	6597	
Pony/Exel	1.3		85-	G13B/G4DG	4	1,1	BPR6ES-11	4824	13	BPR6EIX-11	3903	
Pony/Exel	1.5		85-	G15B/G4DJ	Cat. 4	1,1	BPR6ES-11	4824	13	BPR6EIX-11	3903	
Pony/Exel	1.5		85- 94	G15B/G4DJ	4	1,1	BPR6ES-11	4824	13	BPR6EIX-11	3903	
Porter	2.4			SOHC	4	1,1	BP6ES-11	1212				
Porter H100	2.5			4D55	4	█	Y-115T1	2189				
Presto	1.3				4	0,8	BPR6ES	7822	2	BPR6EIX	6637	
Presto	1.5				4	0,8	BPR6ES	7822	2	BPR6EIX	6637	
S Coupe	1.5		92-	G15B	4	1,1	BKR5ES-11	2382		BKR5EIX-11	5464	
S Coupe Turbo	1.5		92-		4	0,8	BKR6ES	3783	28	BKR6EIX	6418	
S Coupe N/A	1.5	65	04.92-05.96	G4EK	4	1,1	BKR5ES-11	2382		BKR5EIX-11	5464	
S Coupe Turbo Charge	1.5	85	04.91-05.98	G4EK-TC	4	0,8	BKR6ES	3783	28	BKR6EIX	6418	
Santa Fe CRDI	2.0	83	04.01-	4DEA	4	█	Y-749J	5013				
Santa Fe / SM	2.4	107	02.01-	G4JS-G	4	1,1	PFR5C-11	2271				
Santa Fe / SM	2.7	127	02.01-	G6BA-G	6	1,1	PFR5N-11	5838				
Santamo	2.0	101	99-	DOHC / SOHC	4	1,1	BP6ES-11	1212				
Sonata 1.8i	1.8	70	89-	G62B	4	1,1	BPR6ES-11	4824	13	BPR6EIX-11	3903	
Sonata 2.0i	2.0		93-	G4CP-D DOHC	4	1,1	BPR6ES-11	4824	13	BPR6EIX-11	3903	
Sonata 2.0i	2.0	74	89-	4G63 DOHC	4	1,1	BPR6ES-11	4824	13	BPR6EIX-11	3903	
Sonata 2.0i	2.0	77	06.94-	G4CP-D SOHC	4	1,1	BUR6EA-11	5428				
Sonata 2.0 EF	2.0	100	09.98-	G4JP-G DOHC	4	1,1	BPR6ES-11	4824	13	BPR6EIX-11	3903	
Sonata 2.4i	2.4	83	89-	4G64	4	1,1	BPR6ES-11	4824	13	BPR6EIX-11	3903	
Sonata 2.5 EF V6	2.5	118	09.98-	G6BV-EG DOHC	6	1,1	PFR5J-11	4642				
Sonata 2.7 V 6	2.7	127	10.01-	G6BA-G	6	1,1	PFR5B-11	2300				

¹⁾ Bic = Best in class (siehe Seite 3) / (see page 3)



l kW

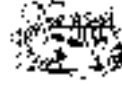

Cyl.

Order-
No. No.Bic¹⁾ Order-
No.**HYUNDAI**

Sonata V 6	3.0		91-	G6AT	6	1,1	PGR5A-11	3573			
Starex	2.4	82	02.98-	SOHC	4	1,1	BP6ES-11	1212			
Stellar 1.6	1.6	56	10.83-12.91		4	0,8	BP5ES	6511	8	BPR5EIX	6597
Stellar 2.0	2.0				4	0,8	BP5ES	6511	8	BPR5EIX	6597
Terracan CRDI	2.9	110	10.01-		4	█	CY57	5287			
Tiburon	1.6			DOHC	4	1,1	BKR5ES-11	2382		BKR5EIX-11	5464
Tiburon	1.8			DOHC	4	1,1	BKR5ES-11	2382		BKR5EIX-11	5464
Tiburon	2.0			DOHC	4	1,1	BKR5ES-11	2382		BKR5EIX-11	5464
Trajjet CRDI	2.0	83	04.01-	4DEA	4	█	Y-749J	5013			
Trajjet / FO	2.0	100	05.00-	G4JP-G DOHC	4	1,1	PFR6N-11	3546			
Trajjet / FO	2.7	127	07.00-	G6BA DOHC	6	1,1	PFR5N-11	5838			
X2	1.3				4	1,1	BPR6ES-11	4824	13	BPR6EIX-11	3903
X2	1.5				4	1,1	BPR6ES-11	4824	13	BPR6EIX-11	3903
XG 300 V6	3.0	138	99-	G6CT-EG DOHC	6	1,1	PFR5J-11	4642			
XG 350 V6	3.5	145	03-		6	1,1	PFR5J-11	4642			

INFINITI

G20	2.0		91- 94	SR20DE	4	1,1	PFR5B-11	2300			
G20	2.0		99-	SR20DE	4	1,1	PFR5G-11	2647			
G20	2.0		95- 96	SR20DE	4	1,1	PFR5B-11	2300			
I30	3.0		96- 99	VQ30DE V6	6	1,1	PFR5G-11	2647			
J30	3.0		93- 97	VG30DE V6	6	1,1	PFR5G-11	2647			
M30	3.0		90- 92	VG30E	6	1,1	PFR6B-11	4014			
Q45	4.1		97- 98	VH41DE	8	1,1	PFR5G-11	2647			
Q45	4.5		90- 93	VH45D	8	1,1	PFR5B-11	2300			
Q45	4.5		94- 96	VH45DE	8	1,1	PFR5G-11	2647			
QX4	3.3		97- 98	VG33E	6	1,1	BKR5ES-11	2382		BKR5EIX-11	5464
QX4	3.5		01-	VQ35DE	6	1,1	PLFR5A-11	6240			

INNOCENTI

3-Cylinder D CL-001				CL-001	3	█	Y-146R	7492			
500 L / SL	0.5	23	87-07.90	Daihatsu EB	3	0,9	BPR6EY	6427		BPR6EIX	6637
650 / SE / (AD 10)	0.6	23	11.84-04.86	AD.. Daihatsu	2	0,8	BPR6ES	7822	2	BPR6EIX	6637
990 Matic / SE / SL / (CB22)	1.0	38	05.86-12.90	Z 670 Daihatsu	4	0,8	BPR5EY	2828	9	BPR5EIX	6597
Clip ie	1.0	35	09.95-06.97	146C7.000	4	0,9	BPR5ES	7422	6	BPR5EIX	6597
Clip ie Super	1.4	51	09.95-06.97	160A1.046	4	0,8	BPR6ES	7822	2	BPR6EIX	6637
De Tomaso Turbo	1.0	50	10.83-04.86	Daihatsu CB 60	4	0,9	BPR6EY	6427		BPR6EIX	6637
Elba	1.3	49	07.91-08.93	146A5.000	4	0,8	BPR6ES	7822	2	BPR6EIX	6637
Elba D	1.7	42	09.92-	146 B 2.000	4	█	Y-902R	2237			
Elba ie	1.4	49	11.95-06.97	146C5.000	4	0,8	BPR6ES	7822	2	BPR6EIX	6637
Elba ie	1.6	55	11.95-06.97	146C6.000	4	0,8	BPR6ES	7822	2	BPR6EIX	6637
Elba ie Happy	1.6	55	06.95-06.96	146C6.000	4	0,8	BPR6ES	7822	2	BPR6EIX	6637
Koral 45	0.9	33	10.90-06.97	100GL 064	4	0,8	BPR6ES	7822	2	BPR6EIX	6637
Koral 55	1.1	41	10.90-06.97	128A 064	4	0,8	BPR6ES	7822	2	BPR6EIX	6637
Mille	1.0	35	07.94-06.97	146C7.000	4	0,7	BP6ES	7811	4	BPR6EIX	6637
Mille i.	1.0	35	07.94-06.97	146C7.000	4	0,9	BPR5ES	7422	6	BPR5EIX	6597
Mini 990 D	1.0	27	01.82-12.90	Daihatsu	4	█	Y-146R	7492			
Minitre/SE/SE Special/SL	1.0	40	06.84-04.86	Daihatsu Z 670	4	0,8	BPR5EY	2828	9	BPR5EIX	6597
Small 500 L / LS	0.6	23	01.91-06.97	Daihatsu E	3	0,9	BPR6EY	6427		BPR6EIX	6637
Small 990 SE	1.0	38	01.91-06.97	Daihatsu CB	3	0,8	BPR5EY	2828	9	BPR5EIX	6597

¹⁾ Bic = Best in class (siehe Seite 3) / (see page 3)



ℓ kW



Cyl.

Order-
No. No.Bic¹⁾ Order-
No.**ISCHMASCHAVTO**

Isch 2126/ 2715/ 27151/ 21171		53		412		4	0,8	BP7ES	2412		BPR7EIX	4055
-------------------------------	--	----	--	-----	--	---	-----	-------	------	--	---------	------

ISUZU

117 Coupe						4	0,7	BP6ES	7811	4	BPR6EIX	6637
Aska	1.8	77	-12.93	4ZB1		4	1,1	BPR5ES-11	4424		BPR5EIX-11	2115
Aska Turbo	2.0	110	-12.93	4ZC1		4	1,1	BPR5ES-11	4424		BPR5EIX-11	2115
Bellele						4	0,7	BP6ES	7811	4	BPR6EIX	6637
Fargo	2.0			4ZC1	Cat.	4	0,8	BPR6ES	7822	2	BPR6EIX	6637
Faster	2.3			4ZD1	Cat.	4	1,1	BPR6ES-11	4824	13	BPR6EIX-11	3903
Faster	2.3			4ZD1		4	0,8	BPR6ES	7822	2	BPR6EIX	6637
Gemini FR				4FB1				Y-306R	6244			
Gemini D	1.5		10.85-11.88	4EC1				Y-306R	6244			
Gemini FF Turbo	1.5		12.88-	4EC1		4		Y-711J	5264			
Gemini FF D	1.5		12.88-	4EC1		4		Y-710J	7880			
Gemini TD	1.5		12.88-	4EC1T		4		Y-711J	5264			
Gemini D	1.5	40	12.88-	4EC1		4		Y-710J	7880			
Gemini TD	1.5	49	02.88-12.88	4EC1T		4		Y-307R	5837			
Gemini	1.5	54	05.87-	4XC1, 4XB1		4	0,8	BP5ES	6511	8	BPR5EIX	6597
Gemini 1.5 Turbo	1.5	88	02.88-	4XC1UT		4	1,1	BPR6ES-11	4824	13	BPR6EIX-11	3903
Gemini 16V	1.6	92	01.89-	4XE1-W		4	1,1	BKR6E-11	2756	14	BKR6EIX-11	3764
Gemini 16V	1.6	92	01.89-	4XE1-V		4	1,1	BPR6ES-11	4824	13	BPR6EIX-11	3903
I-Mark				G180Z		4	1,1	BPR6ES-11	4824	13	BPR6EIX-11	3903
Impulse Turbo				4ZCI		4	0,8	BPR6ES	7822	2	BPR6EIX	6637
Impulse				G200Z		4	1,1	BP5ES-11	7311			
Impulse				4ZCI		4	0,8	BPR6ES	7822	2	BPR6EIX	6637
Light Bus BE			76-	6BB1				Y-271-2	7467			
Light Bus BE			80-	4BD1				Y-271-2	7467			
Light Bus BE			76-	6BD1				Y-271-2	7467			
Light Bus BL			07.81-	4BC2				Y-271-2	7467			
Light Bus BL			07.81-	4BC1				Y-271-2	7467			
Light Bus CCM			07.78-	6BF1				Y-271-2	7467			
Light Bus CCM			07.79-	6BD1				Y-271-2	7467			
Midi TD 11V	2.0	51	01.86-			4		Y-711J	5264			
Midi TD 5V	2.0	51	01.86-			4		Y-307R	5837			
Midi D 11V	2.2	45	01.86-			4		Y-711J	5264			
Midi D 5V	2.2	45	01.86-			4		Y-307R	5837			
Piazza	2.0	100	06.81-	G200Z		4	1,1	BP5ES-11	7311			
Piazza Turbo	2.0	132	-12.90	4ZCI		4	0,8	BPR6ES	7822	2	BPR6EIX	6637
Pickup D	2.0		01.83-	C190		4		Y-306R	6244			
Pickup D	2.2		08.86-08.87	C223		4		Y-306R	6244			
Pickup D	2.2	53	08.87-10.88	C223		4		Y-710J	7880			
Rodeo	2.3			4ZD1		4	0,8	BPR6ES	7822	2	BPR6EIX	6637
Rodeo	2.3			4ZD1	Cat.	4	1,1	BPR6ES-11	4824	13	BPR6EIX-11	3903
Rodeo	3.2	151	98-	V DOHC		6	1,1	PFR5G-11	2647			
Trooper 2.2	2.2	66	-10.88	4ZD1		4	0,7	BPR6ES	7822	2	BPR6EIX	6637
Trooper	2.3		88-	4ZD1		4	0,8	BPR6ES	7822	2	BPR6EIX	6637
Trooper	2.3		87-			4	0,8	BPR6ES	7822	2	BPR6EIX	6637
Trooper TD	2.3		02.81-07.87	C223T		4		Y-306R	6244			
Trooper D	2.3		02.81-07.87	C223		4		Y-306R	6244			
Trooper D	2.3	39	08.87-10.88	C223		4		Y-710J	7880			
Trooper TD	2.3	53	08.87-10.88	C223T		4		Y-710J	7880			
Trooper	2.3	66	01.87-	4ZD1	Cat.	4	1,1	BPR6ES-11	4824	13	BPR6EIX-11	3903

¹⁾ Bic = Best in class (siehe Seite 3) / (see page 3)



l kW

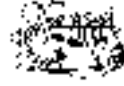

Cyl.

Order-
No. No.Bic¹⁾ Order-
No. No.**ISUZU**

Trooper	2.6			4ZE1		4	0,8	BPR6ES	7822	2	BPR6EIX	6637
Trooper	2.6	85	10.87-	4ZE1	Cat.	4	1,1	BPR6ES-11	4824	13	BPR6EIX-11	3903
Trooper TD	2.8	71	10.87-12.91	4JB1T		4	█	Y-904M	4334			
Trooper TD	2.8	78	10.88-12.91	4JB1TC		4	█	Y-904M	4334			
Trooper DTI	3.0	117	07.98-	4JX1		4	█	Y-711J	5264			
Trooper TD	3.1	83	06.92-	4JG2T		4	█	Y-711J	5264			
Trooper 3.2 24V	3.2	142	03.92-	6VDI		6	1,1	BKR6E-11	2756	14	BKR6EIX-11	3764
Trooper	3.5	158	04.00-	6VE1 V6		6	1,1	PFR6B-11	4014			
Vehicross 3.2 24V	3.2	158	03.97-	6VDI		6	1,1	BKR6E-11	2756	14	BKR6EIX-11	3764

IVECO

242/15 18 D	2.5	50	09.79-				█	Y-208T	1250			
Daily	2.0					4	0.7	BPR7ES	2023	19	BPR7EIX	4055
Daily D30/35/40-8	2.4	53	10.83-06.89	Sofim 8140.61.200		4	█	Y-908R	4585			
Daily	2.5					4	█	Y-907R	4479			
Daily TDi	2.8	90	09.97-			6	█	Y-502R	3852			

JAGUAR

Double Six	5.3		90-	V 12 HE		12	0,6	BR7EF	3346			
Sovereign 2.9	2.9		08.86-08.90	AJ6 SOHC		6	0,9	B8ES	2411		BR8EIX	5044
Sovereign 3.2	3.2		07.90-07.97	AJ6		6	0,9	BCPR6ES	2330	12	BCPR6EIX-11	4919
Sovereign 3.6	3.6		08.86-08.89	AJ6		6	0,6	BCPR6ES	2330	12	BCPR6EIX-11	4919
Sovereign 4.0	4.0		09.89-09.97	AJ6		6	0,9	BCPR6ES	2330	12	BCPR6EIX-11	4919
Sovereign V12	5.3		81- 90	V12 HE		12	0,6	BR7EFS	1094			
S-Type V6	2.5	143	02.01-	AJV6		6	1,3	PTR6D-13	5598			
S-Type V6	3.0	175	10.98-	FC AJ-V6		6	1,3	PTR6D-13	5598			
S-Type V8	4.0	203	03.00-03.02	GC AJ-V8		8	1,1	PFR5G-11E	3000			
S-Type V8	4.0	203	10.98-03.00	GC AJ-V8		8	1,3	PFR5G-13E	2761			
S-Type R	4.2		03.02-	AJ-V8		8	1,0	IFR5N10	7866			
S-Type 4.2 V8	4.2		03.02-	AJ-V8		8	1,0	IFR5N10	7866			
S-Type R	4.2		03.02-	AJ28		8	1,0	IFR5N10	7866			
XJ12	5.3		91- 93	HE(V12)		12	0,6	BR7EF	3346			
XJ12	5.3		82- 85	HE(V12)		12	0,6	B6EFS	2042			
XJ12	5.3		86- 90	HE(V12)		12	0,6	BR7EF	3346			
XJ12	6.0		11.94-09.96	V12		12	0,6	BR6EF	3177			
XJ12	6.0		92-11.94	V12		12	0,6	BR7EF	3346			
XJ6 2.9	2.9		08.86-08.90	AJ6 SOHC		6	0,9	B8ES	2411		BR8EIX	5044
XJ6	3.2		07.90-07.97	AJ6	Cat.	6	0,9	BCPR6ES	2330	12	BCPR6EIX-11	4919
XJ6	3.6	136	08.86-05.92	AJ6		6	0,9	BCPR6ES	2330	12	BCPR6EIX-11	4919
XJ6	4.0		09.89-09.97	AJ6	Cat.	6	0,9	BCPR6ES	2330	12	BCPR6EIX-11	4919
XJ6 4.2 inj.	4.2		79- 86	XK		6	0,6	BP5ES	6511	8	BPR5EIX	6597
XJ6 V12	5.3		01.91-	V12		12	0,6	BR7EFS	1094			
XJ8	3.2		09.98-03.00	AJ26		8	1,3	PFR5G-13E	2761			
XJ8	3.2		03.02-	AJ26		8	1,0	IFR5N10	7866			
XJ8	3.2		03.00-03.02	AJ26		8	1,1	PFR5G-11E	3000			
XJ8	3.2	174	09.97-09.98	V8		8	1,3	BKR6EVXA-13	2563			
XJ8	3.2	176	09.97-			8	1,3	BKR6EVXA-13	2563			
XJ8	3.5		03.02-	AJ26		8	1,0	IFR5N10	7866			
XJ8	4.0		03.02-	AJ26		8	1,0	IFR5N10	7866			
XJ8	4.0		09.98-03.00	AJ26		8	1,3	PFR5G-13E	2761			
XJ8	4.0		03.00-03.02	AJ26		8	1,1	PFR5G-11E	3000			
XJ8	4.0	209	09.97-	V8		8	1,3	BKR6EVXA-13	2563			

¹⁾ Bic = Best in class (siehe Seite 3) / (see page 3)



ℓ kW

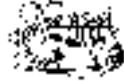

Cyl.

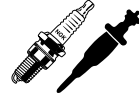
Order-
No. No.Bic¹⁾ Order-
No. No.**JAGUAR**

XJ8	4.2		03.02-	AJ26	8	1.0	IFR5N10	7866			
XJ8R	4.0		03.02-	AJ26	8	1,0	IFR5N10	7866			
XJ8R Supercharged	4.0		09.97-02.00	AJ26	8	1,3	PFR6G-13E	2341			
XJ8R 4.0	4.0		03.00-03.02	AJ26	8	1,1	PFR5G-11E	3000			
XJ8R	4.0	272	09.97-03.00		8	1,3	PFR6G-13E	2341			
XJ8R 4.2	4.2		03.02-		8	1,0	IFR5N10	7866			
XJR	3.6		11.88-09.89	AJ6	6	0,9	BCPR6E	1269	12	BCPR6EIX-11	4919
XJR 4.0	4.0		09.89-09.94	AJ6	6	0,9	BCPR6ES	2330	12	BCPR6EIX-11	4919
XJR Supercharged X300	4.0	235	08.94-08.97	AJ16 Kompressor	6	0,9	BKR7E	6097		BKR7EVX	3544
XJR8 V8 (X308)	4.0	267	09.97-	V8	8	1,3	PFR6G-13E	2341			
XJS 3.6	3.6		08.86-05.91	AJ6	6	0,9	BCPR6ES	2330	12	BCPR6EIX-11	4919
XJS Coupe	4.0		04.91-09.96	AJ6	6	0,9	BCPR6ES	2330	12	BCPR6EIX-11	4919
XJS	5.3		86- 90	HE(V12)	12	0,6	BR7EF	3346			
XJS	5.3		91- 93	V12 HE	12	0,6	BR7EF	3346			
XJS	5.3		81- 90	V12 HE	12	0,6	BR7EFS	1094			
XJS V12	6.0		05.93-11.94	V12	12	0,6	BR7EF	3346			
XJS V12	6.0		11.94-05.95	V12	12	0,6	BR6EF	3177			
XK8	4.0		09.98-03.00	AJ27	8	1,3	PFR5G-13E	2761			
XK8	4.0		03.02-	AJ27	8	1,0	IFR5N10	7866			
XK8	4.0		03.00-02.02	AJ27	8	1,1	PFR5G-11E	3000			
XK8	4.0		09.98-03.00	AJ26	8	1,3	PFR5G-13E	2761			
XK8	4.0		03.00-	AJ26	8	1,1	PFR5G-11E	3000			
XK8	4.0	213	09.97-09.98	AJ26	8	1,3	BKR5EVXA-13	1188			
XK8	4.0	213	10.96-	AJ / V8	8	1,1	BKR6EVXA-11	6838			
XK8	4.0	389	10.96-09.97	AJ26	8	1,1	BKR6EVXA-11	6838			
XK8	4.2		09.02-	AJ34	8	1,0	IFR5N10	7866			
XKR	4.0		03.02-	AJ27	8	1,0	IFR5N10	7866			
XKR	4.0	267	03.00-02.02	AJ27	8	1,1	PFR5G-11E	3000			
XKR	4.0	267	05.98-03.00	AJ27	8	1,3	PFR6G-13E	2341			
XKR	4.2		09.02-	AJ34	8	1,0	IFR5N10	7866			
X-Type 2.0	2.0	117	12.01-	AJ-V6	6	1,3	PTR6D-13	5598			
X-Type 2.5	2.5	140	02.01-	AJ-V6	6	1,3	PTR6D-13	5598			
X-Type 3.0	3.0	173	02.01-	AJ-V6	6	1,3	PTR6D-13	5598			

JEEP

Cherokee Td			04.84-12.87	Renault		☑	Y-908R	4585			
Cherokee TD	2.1	59	01.88-		6	☑	Y-908R	4585			
Cherokee TD	2.1	65	01.87-01.91	Renault J8S 814, J8S 890	4	☑	Y-908R	4585			
Cherokee	2.4	108	08.01-		4	1,1	LZTR4A-11	5444			
Cherokee	2.5		86- 88	L4 TBI H	4	0,9	FR5-1	7252			
Cherokee	2.5		90- 98	L4 MPI P	4	0,9	FR5-1	7252			
Cherokee	2.5		84- 85	L4 1Bbl U	4	1,1	ZFR5A-11	5084			
Cherokee	2.5		89- 90	L4 TBI E	4	0,9	FR5-1	7252			
Cherokee TD	2.5	85	10.94-	VM HR 425	4	☑	Y-923U	3380			
Cherokee	2.8		84- 86	L6 2Bbl W	6	1,1	UR4	4762		UR4IX	7401
Cherokee 3.7 V6	3.7	154	10.01-		6	1,0	ZFR5F-11	2262		ZFR5FIX-11	2477
Cherokee	4.0		89- 90	L6 MPI L	6	0,9	FR5	4876			
Cherokee	4.0		91- 98	L6 MPI S	6	0,9	FR5-1	7252			
Cherokee	4.0		87- 88	L6 MPI M	6	0,9	FR5	4876			
CJ	2.5	78	84- 86	L4 1Bbl U	4	1,1	ZFR5A-11	5084			
CJ	4.2	76	81- 86	L6 2Bbl C	6	1,1	ZFR5A-11	5084			
Comanche	2.5		91- 92	L4 MPI P	4	0,9	FR5-1	7252			

¹⁾ Bic = Best in class (siehe Seite 3) / (see page 3)



l kW

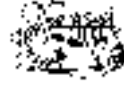

Cyl.

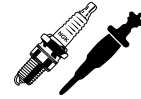

Order-
No. No.



Bic¹⁾ Order-
No.

JEEP

Commanche	2.5		86- 88	L4 TBI H	4	0,9	FR5-1	7252			
Commanche	2.5		90- 89	L4 TBI E	4	0,9	FR5-1	7252			
Commanche	2.8		(86)	V6 2Bbl W	6	1,1	UR4	4762		UR4IX	7401
Commanche	4.0		89- 90	L6 MPI L	6	0,9	FR5-1	7252			
Commanche	4.0		91- 92	L6 MPI S	6	0,9	FR5-1	7252			
Commanche	4.0		87- 88	L6 MPI M	6	0,9	FR5-1	7252			
Grand Cherokee TD	2.5	88	01.93-	VM HR 425 CLIRE	4	█	Y-923U	3380			
Grand Cherokee TD	2.5	88	01.93-	VM HR-492	4	█	Y-923U	3380			
Grand Cherokee TD	2.5	110	04.99-	ENC	4	█	Y-741U	5065			
Grand Cherokee CRD	2.7	120	01.02-	CDI Mercedes	5	█	Y-745U	4705			
Grand Cherokee TD / Limited	3.1	103	04.98-	EXA	5	█	Y-741U	5065			
Grand Cherokee	4.0		91- 98	L6 MPI S	6	0,9	FR5-1	7252			
Grand Cherokee	4.0	130	02.99-				---				
Grand Cherokee	4.7	173	02.99- 99	MPI N V8	8	1,1	PZFR6F-11	3271		ZFR6FIX-11	6441
Grand Cherokee	5.2		93- 96	V8 MPI Y	8	0,9	FR4	5188			
Grand Cherokee	5.2		97-	V8 MPI Y	8		---				
Grand Cherokee	5.9		98-	V8 MPI Z	8	1,0	FR5-1	7252			
Grand Voyager 2.5 Td Le	2.5	88	05.95-	VM HR425 CLIEE	4	█	Y-741U	5065			
Grand Wagoneer	5.2		(93)	V8 MPI Y	8	0,9	FR4	5188			
Grand Wagoneer	5.9		89- 91	V8 2Bbl 7	8	1,3	GR4	7038		GR4IX	7149
Grand Wagoneer	5.9		97-	V8 MPI Z	8	0,9	FR4	5188			
J Serie	4.2		81- 88	L6 2Bbl C	6	1,1	ZFR5A-11	5084			
J Serie	5.9		75- 88	V8 2Bbl N	8	1,3	GR4	7038		GR4IX	7149
Wagoneer	2.5		91- 92	L4 MPI P	4	0,9	FR5-1	7252			
Wagoneer	2.5		86- 88	L4 TPI H	4	0,9	FR5-1	7252			
Wagoneer	2.5		89- 90	L4 TPI E	4	0,9	FR5-1	7252			
Wagoneer	2.5		84- 85	L4 1Bbl U	4	1,1	ZFR5A-11	5084			
Wagoneer	2.8		84- 86	V6 W	6	1,1	UR4	4762		UR4IX	7401
Wagoneer	4.0		87- 88	L6 M	6	0,9	FR5-1	7252			
Wagoneer	4.0		89- 90	L6 L	6	0,9	FR5-1	7252			
Wagoneer	4.0		91- 92	L6 MPI S	6	0,9	FR5-1	7252			
Wagoneer	4.2		80- 85	L6 2Bbl C	6	1,1	ZFR5A-11	5084			
Wagoneer	5.9		80- 85	V8 N	8	1,3	GR4	7038		GR4IX	7149
Wrangler Laredo, Sahara, Texan TD	2.1	65	07.88-		4	█	Y-908R	4585			
Wrangler	2.5		07.88-		6	█	Y-908R	4585			
Wrangler, Texan D	2.5		07.88-		6	█	Y-908R	4585			
Wrangler, Laredo, Sahara	2.5		07.88-		6	█	Y-908R	4585			
Wrangler	2.5		91-01.01	L4 MPI P	4	0,9	FR5-1	7252			
Wrangler	2.5		87- 88	L4 H	4	0,9	FR5-1	7252			
Wrangler	2.5		89- 90	L4 TBI H	4	0,9	FR5-1	7252			
Wrangler	4.0		98-	L6 MPI S	6	0,9	FR5-1	7252			
Wrangler	4.0		91- 95	L6 MPI S	6	0,9	FR5-1	7252			
Wrangler	4.0		96- 97	L6 MPI V	6	0,9	FR5-1	7252			
Wrangler	4.0	135	91-	L6 MPI	6	1,1	ZFR5A-11	5084			
Wrangler	4.2		(90)	L6 T	6	1,1	ZFR5A-11	5084			
Wrangler	4.2		88- 89	L6 M	6	1,1	ZFR5A-11	5084			
Wrangler	4.2		87- 88	L6 C	6	1,1	ZFR5A-11	5084			
XJ Cherokee TD	2.0	64	04.84-12.87	Renault J8S-814	4	█	Y-908R	4585			
XJ Cherokee TD	2.4	64	04.84-12.87		4	█	Y-908R	4585			

KIA

Avella	1.3				4	1,1	BPR5EY-11	3028		BPR5EIX-11	2115
--------	-----	--	--	--	---	-----	-----------	------	--	------------	------

¹⁾ Bic = Best in class (siehe Seite 3) / (see page 3)



ℓ kW

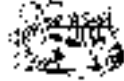

Cyl.

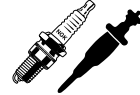
Order-
No. No.Bic¹⁾ Order-
No.**KIA**

Avella	1.5				4	1,1	BPR5ES-11	4424		BPR5EIX-11	2115
Besta 2.2	2.2				4	0,7	BP6ES	7811	4	BPR6EIX	6637
Besta	2.2	52	03.90-07.99	HW	4	█	Y-701R	7464			
Besta	2.7	60	03.90-07.99	VN	4	█	Y-701R	7464			
Bongo	2.4			E-2400	4	█	Y-107T	1253			
Carens	1.6	77	06.02-	S6D	4	1,1	BKR6ES-11	5553	14	BKR6EIX-11	3764
Carens	1.8	81	01-		4	0,8	BKR6E	6962	28	BKR6EIX	6418
Carens	1.8	93	06.02-	TB	4	0,8	BKR6ES	3783	28	BKR6EIX	6418
Carens 2.0 CRDI EX	2.0	83	02-		4	█	Y-749J	5013			
Carnival	2.5	121	12.98-	K5	6	1,1	PFR6N-11	3546			
Carnival	2.5	129	12.98-	KV5 DOHC	6	1,1	PFR6N-11	3546			
Cerato	1.6	77	05.04-	G4ED	4	1,1	BKR5ES-11	2382		BKR5EIX-11	5464
Cerato	2.0	106	05.04-	G4GC	4	1,1	BKR5ES-11	2382		BKR5EIX-11	5464
Clarus	1.8	85	06.96-	T8 DOHC	4	0,8	BKR5E	7938		BKR5EIX	6341
Clarus	2.0	98	09.96-	FE DOHC	4	1,1	BK6E-11	7340			
Joice	2.0	103	09.01-	G4CP	4	1,1	BPR6ES-11	4824	13	BPR6EIX-11	3903
Magentis	2.0	100	01-		6	0,8	BPR6ES	7822	2	BPR6EIX	6637
Magentis V6	2.5	118	01-		6	0,8	BKR5ES	2460		BKR5EIX	6341
Magentis V6	2.5	124	03-		6	0,8	BKR5ES	2460		BKR5EIX	6341
Mentor	1.5			B5	4	1,1	BPR5ES-11	4424		BPR5EIX-11	2115
Mentor	1.6		06.94-12.00		4	1,1	BPR5ES-11	4424		BPR5EIX-11	2115
Mentor	1.6		01-	A6	4	0,8	BKR6E	6962	28	BKR6EIX	6418
Opirus GH	3.5	149	03-		6	1,1	PFR5N-11	5838			
Picanto	1.1	48	10.03-	G4HG	4	1,1	BKR5ES-11	2382		BKR5EIX-11	5464
Power Bango	2.4			E-2400	4	█	Y-107R	1229			
Pregio	2.7	60	06.96-	J2	4	█	Y-701R	7464			
Pregio	3.0	66	06.97-	W3 / NB9	4	█	Y-701J	5116			
Pride	1.3	44	05.95-		4	1,1	BPR5ES-11	4424		BPR5EIX-11	2115
Pride	1.3	53	05.95-		4	1,1	BPR5ES-11	4424		BPR5EIX-11	2115
Retona	2.0	61	04.00-		4	█	Y-721J	6919			
Retona 16V	2.0	94	00-	FED	4	1,1	BKR6E-11	2756	14	BKR6EIX-11	3764
Rio	1.3	55	00- 02		4	1,1	BPR5EY-11	3028		BPR5EIX-11	2115
Rio	1.3	60	03-		4	1,1	BPR5ES-11	4424		BPR5EIX-11	2115
Rio	1.5	71	03-		4	1,1	BKR6ES-11	5553	14	BKR6EIX-11	3764
Rio	1.5	72	00- 02		4	0,8	BKR6E	6962	28	BKR6EIX	6418
Roadster	1.8	103	98-	T8 DOHC	4	0,8	BK6E	3536			
Rockstar	1.8			SOHC	4	0,7	BP6ES	7811	4	BPR6EIX	6637
Sedona	2.5		09.99-	KV6	6	1,1	PFR6N-11	3546			
Sephia	1.5	59	96-	B5E MMO	4	1,1	BPR5ES-11	4424		BPR5EIX-11	2115
Sephia	1.8		06.96-		4	0,8	BKR5E	7938		BKR5EIX	6341
Sephia 2 FB522	1.6	75	04.01-	OKAB5	4	0,8	BKR6E	6962	28	BKR6EIX	6418
Sephia GTX	1.6	59	09.93-	B6 SOHC	4	1,1	BPR6ES-11	4824	13	BPR6EIX-11	3903
Shuma 1	1.5	65	05.98-	BFD	4	1,1	BKR6E-11	2756	14	BKR6EIX-11	3764
Shuma 1	1.8	82	05.98-	TED	4	0,8	BKR6E	6962	28	BKR6EIX	6418
Shuma 2 FB522,FB624	1.6	75	04.01-	OKAB5	4	0,8	BKR6E	6962	28	BKR6EIX	6418
Shuma 2	1.8	82	01-	TED	4	0,8	BKR6E	6962	28	BKR6EIX	6418
Sorento	2.4	75	02-	G4JF	4	1,1	PGR5C-11	5760			
Sorento CRDi	2.5	103	02-		4	█	Y-508J				
Sorento	3.5	143	02-	G6CU	6	1,1	PFR5N-11	5838			
Sportage TD	2.0	61	07.96-	Mazda engine	4	█	Y-701R	7464			
Sportage	2.0	70	94-	SOHC	4	0,8	BKR5E	7938		BKR5EIX	6341
Sportage 16V	2.0	94	94-	DOHC 16V	4	1,1	BKR6E-11	2756	14	BKR6EIX-11	3764

¹⁾ Bic = Best in class (siehe Seite 3) / (see page 3)



l kW

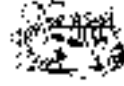

Cyl.

Order-
No. No.Bic¹⁾ Order-
No.**KIA**

Super Titan	3.0			E-3000	6	Y-107T	1253			
Titan	2.5			E-2500	4	Y-107T	1253			
Wide Bongo	2.2			LPG engine	4	0,7 BP6ES	7811	4	BPR6EIX	6637

LADA

100 2110	1.5	54	01.95-	VAZ-2111	4	0,8 BPR6ES	7822	2	BPR6EIX	6637
100 2111	1.5	67	01.95-	VAZ-2112	4	0,8 BPR6ES	7822	2	BPR6EIX	6637
100 2110 GTi 16V	2.0	110	01.96-	C20XE Opel	4	0,8 BKR6EK	2288	20**	BKR6EQU	3199
108 2110 16V	1.5	68	06.99-	VAZ-2112	4	0,8 BPR6ES	7822	2	BPR6EIX	6637
110 21103 16V	1.5	56	01.96-	VAZ-2111,2112	4	0,8 BPR6ES	7822	2	BPR6EIX	6637
110 21103 8V	1.5	56	01.96-	VAZ-2111,2112	4	0,8 BPR6ES	7822	2	BPR6EIX	6637
110 Li	1.5	56	03-	8V (OBD)	4	0,8 BPR6ES	7822	2	BPR6EIX	6637
110 Gli	1.5	67	03-	16V (OBD)	4	1,1 BCPR6ES-11	7121	11	BCPR6EIX-11	4919
110 2.0 GTI	2.0	110	01.00-	C20XE	4	0,8 BKR6EK	2288	20**	BKR6EQU	3199
110 2110 GTi 16V	2.0	110	01.96-12.00	C20XE Opel	4	0,8 BKR6EK	2288	20**	BKR6EQU	3199
110 / 111/112 GLI 16 Valve	1.5		01.95-		4	1,1 BCPR6ES-11	7121	11	BCPR6EIX-11	4919
111 Li	1.5	56	03-	8V	4	0,8 BPR6ES	7822	2	BPR6EIX	6637
110/111/112 LI 8 Valve	1.5	57	01.00-		4	0,8 BPR6ES	7822	2	BPR6EIX	6637
111 21113 16V	1.5	67	01.96-	VAZ-2112	4	0,8 BPR6ES	7822	2	BPR6EIX	6637
111 Gli	1.5	67	03-	16V	4	1,1 BCPR6ES-11	7121	11	BCPR6EIX-11	4919
111 2111 16V	1.5	70	01.96-	VAZ-2112	4	0,8 BPR6ES	7822	2	BPR6EIX	6637
112 2112 16V	1.5	54	01.96-	VAZ-2111	4	0,8 BPR6ES	7822	2	BPR6EIX	6637
112 Li	1.5	56	03-	8V	4	0,8 BPR6ES	7822	2	BPR6EIX	6637
112 Gli	1.5	67	03-	16V	4	1,1 BCPR6ES-11	7121	11	BCPR6EIX-11	4919
115 2115	1.5	53	01.00-		4	0,8 BPR6ES	7822	2	BPR6EIX	6637
2101 Lada 1200/1300					4	0,7 BP6ES	7811	4	BPR6EIX	6637
2102 Lada Kombi 1200/1500					4	0,7 BP6ES	7811	4	BPR6EIX	6637
2103 1500	1.5				4	0,7 BP6ES	7811	4	BPR6EIX	6637
2104 Nova Kombi 1300/1500					4	0,7 BP6ES	7811	4	BPR6EIX	6637
2105 Nova Junior	1.2				4	0,7 BP6ES	7811	4	BPR6EIX	6637
2105 Nova 1300	1.3				4	0,7 BP6ES	7811	4	BPR6EIX	6637
2105 Nova Spezial	1.5				4	0,7 BP6ES	7811	4	BPR6EIX	6637
2107 Lada 1300 L	1.3				4	0,7 BP6ES	7811	4	BPR6EIX	6637
2107 Lada 1500 L	1.5				4	0,7 BP6ES	7811	4	BPR6EIX	6637
2107 Toscana	1.5	55	07.88-		4	0,7 BP6ES	7811	4	BPR6EIX	6637
2108 Samara / Fun 1100	1.1				4	0,7 BP6ES	7811	4	BPR6EIX	6637
2108 Samara / Fun 1300	1.3				4	0,7 BP6ES	7811	4	BPR6EIX	6637
2108 Samara / Fun 1500	1.5				4	0,7 BP6ES	7811	4	BPR6EIX	6637
2110	1.5	56	96-		4	0,8 BPR6ES	7822	2	BPR6EIX	6637
2110	1.5	58	97-		4	0,8 BPR6ES	7822	2	BPR6EIX	6637
2111	1.5	58	96-		4	0,8 BPR6ES	7822	2	BPR6EIX	6637
2111	1.5	58	97-		4	0,8 BPR6ES	7822	2	BPR6EIX	6637
2112	1.5	58	97-		4	0,8 BCPR6ES	2330	12	BCPR6EIX-11	4919
2112	1.5	69	96-		4	0,8 BCPR6ES	2330	12	BCPR6EIX-11	4919
2121 Niva	1.6	51	12.76-		4	0,7 BP6ES	7811	4	BPR6EIX	6637
Aleko D	1.8	44		Ford RTE, RTS	4	Y-910R	4751			
Forma	1.3		09.91-		4	0,8 BPR6ES	7822	2	BPR6EIX	6637
Forma	1.5	50	09.91-		4	0,8 BPR6ES	7822	2	BPR6EIX	6637
Forma 21099	1.5	56			4	0,8 BPR6ES	7822	2	BPR6EIX	6637
Niva 4x4 / Vaz 2121	1.6	58	07.88-		4	0,8 BPR6ES	7822	2	BPR6EIX	6637
Niva	1.7	59	95-		4	0,8 BPR6ES	7822	2	BPR6EIX	6637
Niva 21214	1.7	60			4	0,8 BPR6ES	7822	2	BPR6EIX	6637

¹⁾ Bic = Best in class (siehe Seite 3) / (see page 3)

** alternative/wahlweise V-Line 30



ℓ kW

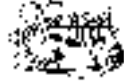

Cyl.

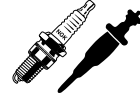
Order-
No. No.Bic¹⁾ Order-
No. No.**LADA**

Niva D	1.9	47	10.93-	Peugeot XUD 9L	4	█	Y-902R	2237			
Nova / Vaz 2104, 2105		55	07.88-		4	0,8	BPR6ES	7822	2	BPR6EIX	6637
Nova / Vaz 2104, 2105		55	09.86-06.88		4	0,7	BP6ES	7811	4	BPR6EIX	6637
Nova / Vaz 2107		57	07.88-		4	0,8	BPR6ES	7822	2	BPR6EIX	6637
Nova / Vaz 2107		57	05.81-06.88		4	0,7	BP6ES	7811	4	BPR6EIX	6637
Nova / Vaz 21051	1.2	44	07.88-		4	0,8	BPR6ES	7822	2	BPR6EIX	6637
Nova / Vaz 21051	1.2	44	09.81-06.88		4	0,7	BP6ES	7811	4	BPR6EIX	6637
Nova / Vaz 2102, 2105	1.3	48	07.88-		4	0,8	BPR6ES	7822	2	BPR6EIX	6637
Nova / Vaz 2102, 2105	1.3	48	05.81-06.88		4	0,7	BP6ES	7811	4	BPR6EIX	6637
Nova / Vaz 21043	1.5	55	07.88-		4	0,8	BPR6ES	7822	2	BPR6EIX	6637
Nova / Vaz 21043	1.5	55	01.88-06.88		4	0,7	BP6ES	7811	4	BPR6EIX	6637
Nova i	1.7	59	11.94-		4	0,8	BPR6ES	7822	2	BPR6EIX	6637
Nova i	1.7	62	11.94-		4	0,8	BPR6ES	7822	2	BPR6EIX	6637
Oka /640	0.65	22	09.89-	Vaz 1111	2	0,7	BCP6ES	4930	17	BCPR6EIX-11	4919
Oka 1.3 VAZ-1111	1.3	46	01.98-	A-Plus ROV	4	0,8	BPR6ES	7822	2	BPR6EIX	6637
Riva 1200	1.2	47	11.85-	OHC 21012	4	0,7	BP6ES	7811	4	BPR6EIX	6637
Riva 1300	1.3	49	11.85-	OHC 21056	4	0,7	BP6ES	7811	4	BPR6EIX	6637
Riva 1500	1.5	55	11.85-	OHC 21026	4	0,7	BP6ES	7811	4	BPR6EIX	6637
Riva 1600	1.6	63	01.86-	OHC 21062	4	0,7	BP6ES	7811	4	BPR6EIX	6637
Sagona GLX	1.5		07.95-		4	0,8	BPR6ES	7822	2	BPR6EIX	6637
Sagona i	1.5		07.94-		4	0,9	BPR5ES	7422	6	BPR5EIX	6597
Sagona D	1.5	40	01.95-	TUD5	4	█	Y-731U	5274			
Samara Fun	1.1	39	09.91-		4	0,8	BPR6ES	7822	2	BPR6EIX	6637
Samara / Vaz 2108	1.1	41	08.86-06.88		4	0,7	BP6ES	7811	4	BPR6EIX	6637
Samara / Vaz 2108	1.1	41	07.88-		4	0,8	BPR6ES	7822	2	BPR6EIX	6637
Samara Fun	1.3	45	09.91-		4	0,8	BPR6ES	7822	2	BPR6EIX	6637
Samara / Vaz 2108	1.3	46	07.88-		4	0,8	BPR6ES	7822	2	BPR6EIX	6637
Samara / Vaz 2108	1.3	46	01.88-06.88		4	0,7	BP6ES	7811	4	BPR6EIX	6637
Samara D	1.5	40	01.95-	TUD 5	4	█	Y-731U	5274			
Samara Fun	1.5	50	09.91-		4	0,8	BPR6ES	7822	2	BPR6EIX	6637
Samara i	1.5	51	11.94-		4	0,7	BP6ES	7811	4	BPR6EIX	6637
Samara / Vaz 2108	1.5	53	07.88-		4	0,8	BPR6ES	7822	2	BPR6EIX	6637
Samara / Vaz 2108	1.5	53	01.88-06.88		4	0,7	BP6ES	7811	4	BPR6EIX	6637
Samara 21093	1.5	56			4	0,8	BPR6ES	7822	2	BPR6EIX	6637
Samara Sport	1.5	65	96-		4	0,8	BPR6ES	7822	2	BPR6EIX	6637
Toscana / Vaz 2107		55	07.88-		4	0,8	BPR6ES	7822	2	BPR6EIX	6637
Toscana / Vaz 2107		55	01.86-06.88		4	0,7	BP6ES	7811	4	BPR6EIX	6637
Toscana / Vaz 2107	1.5	55	01.86-		4	0,7	BP6ES	7811	4	BPR6EIX	6637

LANCIA

A112	0.9	30	03.84-12.86	A112B...	4	0,8	BPR6ES	7822	2	BPR6EIX	6637	
Dedra 1.6L i.e.	1.6	57	08.89-09.94	835A1.046	Cat.	4	0,8	BPR6ES	7822	2	BPR6EIX	6637
Dedra 1.6L - LE/S.W. LE	1.6	66	10.94-02.98	159B9.000		4	0,9	BCPR7ES	3330			
Dedra 1.6	1.6	66	03.97-02.98	159B9.000		4	0,9	BCPR7ES	3330			
Dedra 1.6i.e. S.W. 16V	1.6	76	03.98-01.00	182A4.000		4	0,9	BKR5EZ	7642	BKR5EIX	6341	
Dedra 1.6i.e. 16V	1.6	76	03.98-01.00	182A4.000		4	0,9	BKR5EZ	7642	BKR5EIX	6341	
Dedra 1.8L - LE-LS-SW	1.8	74	10.94-02.98	835A2.046		4	0,9	BCPR7ES	3330			
Dedra i.e./ LE	1.8	77	01.89-09.94	835A2.046	Cat.	4	0,8	BPR7ES	2023	19	BPR7EIX	4055
Dedra 1.8- 16V	1.8	83	07.97-01.00	182A2.000		4	0,9	BKR6EKC	2848	26	BKR6EIX	6418
Dedra TD	1.9	66	03.89-09.94	835 A 4.000		4	█	Y-902R	2237			
Dedra TD ds	1.9	66	10.94-	160 D 1.000		4	█	Y-922R	4356			
Dedra Eco LE TD	1.9	68	06.93-	160 D 1.000		4	█	Y-922R	4356			

¹⁾ Bic = Best in class (siehe Seite 3) / (see page 3)



ℓ kW

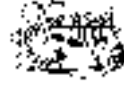

Cyl.

Order-
No. No.Bic¹⁾ Order-
No.**LANCIA**

Dedra i.e. / LS	2.0	83	01.89-09.94	835A5.046	Cat.	4	0,8	BPR7ES	2023	19	BPR7EIX	4055
Dedra i.e. automatica LS	2.0	83	10.94-04.97	835A5.046		4	0,8	BPR7ES	2023	19	BPR7EIX	4055
Dedra 2.0L-16V- S.W.LX / integrale	2.0	102	10.94-02.98	836A3.000		4	0,8	BPR7ES	2023	19	BPR7EIX	4055
Dedra 2000 Turbo	2.0	119	08.91-02.98	835A8.046		4	0,8	BP6ET	1263			
Dedra i.e. Turbo/Integr.	2.0	124	01.91-09.94	835A7.046	Cat.	4	0,8	BP6ET	1263			
Delta / LX	1.3	57	- 93	831A...- 831B.000		4	0,8	BPR7ES	2023	19	BPR7EIX	4055
Delta / LX / Automatic	1.5	59	- 93	831A...- 831B.000		4	0,8	BPR7ES	2023	19	BPR7EIX	4055
Delta	1.6	55	09.93-11.97	851C1.000		4	0,9	BCPR7ES	3330			
Delta (836)	1.6	66	03.96-02.98	182A6.000		4	0,9	BCPR7ES	3330			
Delta	1.6	76	03.98-01.00	182A4.000		4	0,9	BKR5EZ	7642		BKR5EIX	6341
Delta 1.6i.e. 16V HPE; LS	1.6	76	12.97-02.98	182A4.000		4	0,9	BKR6EK	2848	26	BKR6EIX	6418
Delta 16V - HPE	1.6	76	06.96-11.97	182A4.000		4	0,8	BKR6EK	2848	26	BKR6EIX	6418
Delta i.e. GT	1.6	77	- 93	182A4.000	Cat.	4	0,8	BPR6ES	7822	2	BPR6EIX	6637
Delta GT	1.6	77	- 93	831A4.000		4	0,8	BPR7ES	2023	19	BPR7EIX	4055
Delta i.e. / Turbo HF	1.6	95	- 93	831A7.000	Cat.	4	0,8	BPR7ES	2023	19	BPR7EIX	4055
Delta i.e. / LE	1.8	66	09.93-11.97	835C4.000		4	0,8	BPR7ES	2023	19	BPR7EIX	4055
Delta 1.8- 16V- HPE/LS	1.8	96	12.97-01.00	183A1.000		4	0,9	BKR6EKC	2848	26	BKR6EIX	6418
Delta 16V/ HPE	1.8	96	06.96-11.97	183A1.000		4	0,8	BKR6EKC	2848	26	BKR6EIX	6418
Delta TD	1.9	59	06.86-06.91	831 D 1.000		4	█	Y-902R	2237			
Delta TD LS	1.9	66	10.94-	160 D 1.000		4	█	Y-922R	4356			
Delta TD- ds LE	1.9	66	10.94-	160 D 1.000		4	█	Y-922R	4356			
Delta HPE TD	1.9	66	10.94-	160 D 1.000		4	█	Y-922R	4356			
Delta HPE Td	1.9	66	10.96-			4	█	Y-928U	5700			
Delta TD ds	1.9	66	10.94-	160 D 1.000		4	█	Y-922R	4356			
Delta i.e. Turbo HF 4WD	2.0		05.86-09.87			4	0,8	BPR7ES	2023	19	BPR7EIX	4055
Delta i.e. 16V GT	2.0	102	10.94-11.97	836A3.000		4	0,8	BPR7ES	2023	19	BPR7EIX	4055
Delta HPE ie	2.0	102	06.95-			4	0,8	BPR7ES	2023	19	BPR7EIX	4055
Delta i.e. 16V / LS	2.0	102	09.93-11.97	836A3.000		4	0,8	BPR7ES	2023	19	BPR7EIX	4055
Delta i.e. Turbo HF 16V Inte	2.0	122	05.86-09.87	831B5.000		4	0,8	BPR7ES	2023	19	BPR7EIX	4055
Delta HF Integrale Evo 3	2.0	130	07.92-11.97	831C5.046		4	0,8	BP6ET	1263			
Delta i.e. Turbo HF Integr.	2.0	130	07.92-11.97	831C5.046		4	0,8	BPR7ES	2023	19	BPR7EIX	4055
Delta i.e. Turbo HF 16V Inte	2.0	133	10.87-11.97	831 C5.000		4	0,8	BPR7ES	2023	19	BPR7EIX	4055
Delta Turbo	2.0	137	09.93-11.97	836 A2.000		4	0,8	BP6ET	1263			
Delta HPE Turbo 16V HF	2.0	137	06.95-			4	0,8	BUR6ET	3172	1	PGR6D	6248
Delta i.e. HPE Turbo 16V	2.0	137	01.93-09.96	836 A2.000		4	0,8	BPR7ES	2023	19	BPR7EIX	4055
Delta i.e. HPE Turbo 16V HF	2.0	142	12.97-01.00	175A4.000		4	0,8	BCPR6ET	2197			
Delta HF integrale Spec.ed.	2.0	155	02.94-11.97	831E5.046		4	0,8	BUR6ET	3172	1	PGR6D	6248
HPE	1.6					4	0,8	BPR7ES	2023	19	BPR7EIX	4055
HPE i.e.	2.0					4	0,8	BPR7ES	2023	19	BPR7EIX	4055
K 20V LE	2.0	107	01.95-	838A1.000		5	0,9	BKR6EKC	2848	26	BKR6EIX	6418
K- 20V	2.0	107	01.95-02.01	838A1.000		5	0,9	BKR6EKC	2848	26	BKR6EIX	6418
K 20V LS; S.W.	2.0	114	07.98-02.01	838 A6.000		5	0,9	BKR6EKC	2848	26	BKR6EIX	6418
K	2.0	114	07.98-02.01	838A6.000		4	0,6	BCPR6ET	2197			
K	2.0	114	11.94-02.01	838 A6.000		4	0,9	BKR6EKC	2848	26	BKR6EIX	6418
K Turbo 16V Coupé	2.0	151	07.97-06.98	838A4.000		4	0,9	BP6ET	1263			
K turbo	2.0	151	02.95-06.98	838A4.000		4	0,6	BP6ET	1263			
K Turbo 20V; S.W.; Coupè	2.0	162	07.98-02.01	175 A3.000		5		BKUR6ET	6437	27	PFR6Q	6458
K i. 20V LS/LE/LX/SW	2.4	129	01.95-02.01	838A2.000		5	0,9	BKR6EKC	2848	26	BKR6EIX	6418
K i 20V Coupé	2.5	129	07.97-02.01	838A2.000		5	0,9	BKR6EKC	2848	26	BKR6EIX	6418
K i V6 24V aut. Coupé	3.0	150	07.97-02.01	838B.000		6	0,9	PFR6B	3500			
K V6 - 24V-LX/LS/SW/coupè	3.0	150	01.95-02.01	838B.000		6	0,7	PFR6B	3500			
Kappa i. 20V	2.0	107	01.95-02.01	838A1.000		4	0,9	BKR6EKC	2848	26	BKR6EIX	6418

¹⁾ Bic = Best in class (siehe Seite 3) / (see page 3)



ℓ kW

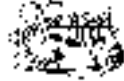

Cyl.

Order-
No. No.Bic¹⁾ Order-
No.**LANCIA**

Kappa turbo	2.0	151	02.95-02.01	838A4.000		4	0,6	BP6ET	1263				
Kappa TD	2.4		10.94-12.98	838 A3.000				Y-935U	5915				
Kappa	2.4	91	11.94-06.96	838.A3.000				Y-928U	5700				
Kappa / SW (838A) 2,4 JTD	2.4	100	06.98-11.99	838 A8.000		5		Y-747U	4951				
Kappa i. 20V	2.4	129	01.95-02.01	838A2.000		4	0,9	BKR6EKC	2848	26	BKR6EIX	6418	
Kappa i. V6 24V	3.0	150	01.95-02.01	838B.000		4	0,7	PFR6B	3500				
Lybra 16V;Lx;S.W.	1.6	76	09.99-	182 A4.000		4	0,9	BKR5EZ	7642		BKR5EIX	6341	
Lybra 16V;Lx;S.W.	1.8	96	09.99-08.02	839 A4.000		4	0,9	BKR6EKC	2848	26	BKR6EIX	6418	
Lybra 16V;Lx;S.W.	1.8	96	09.02-	839 A4.000		4	0,9	BKR6EZ	4619		BKR6EIX	6418	
Lybra 1.9 JTD	1.9	77	09.99-11.99	AR 32302		4		Y-747U	4951				
Lybra 20V;Lx;S.W.;Aut.	2.0	110	09.02-	182 B7.000		5	0,9	BKR6EZ	4619		BKR6EIX	6418	
Lybra 20V;Lx;S.W.;Aut.	2.0	110	09.99-08.02	182 B7.000		5	0,9	BKR6EKC	2848	26	BKR6EIX	6418	
Lybra 2.4 JTD	2.4	99	09.99-11.99	AR 32501		5		Y-747U	4951				
Prisma	1.3	57	12.82-12.89	831A2..- 831B000		4	0,8	BPR7ES	2023	19	BPR7EIX	4055	
Prisma / LX	1.5	59	- 89	838C..		4	0,8	BPR7ES	2023	19	BPR7EIX	4055	
Prisma / IE	1.6	66	05.86-12.89	831B7..		4	0,8	BPR7ES	2023	19	BPR7EIX	4055	
Prisma TD	1.9	48	06.84-12.89	831 D. 000		4		Y-902R	2237				
Prisma TD ds	1.9	59	05.85-12.89	831 D.		4		Y-902R	2237				
Prisma TD	1.9	59	07.85-			4		Y-908R	4585				
Prisma i.e.Integrale / 4WD	2.0	82	07.87-12.89	831B4.046		4	0,8	BPR7ES	2023	19	BPR7EIX	4055	
Thema i.e. / Wagon	2.0	85	-01.95	834B.146	Cat.	4	0,8	BPR7ES	2023	19	BPR7EIX	4055	
Thema i.e. 16V Tur. SW/LS/LX	2.0	108	-01.95	834B2.000		4	0,8	BP6ET	1263				
Thema i.e. Turbo SW	2.0	110	-01.95	834C146	Cat.	4	0,8	BPR7ES	2023	19	BPR7EIX	4055	
Thema 16V / LE / LS	2.0	112	-01.95	834F1.000	Cat.	4	0,8	BPR7ES	2023	19	BPR7EIX	4055	
Thema i.e.16V S.W. Fairway	2.0	112	04.94-01.95	834F1.000		4	0,8	BPR7ES	2023	19	BPR7EIX	4055	
Thema i.e. Turbo	2.0	122	-01.95	834C146		4	0,8	BPR7ES	2023	19	BPR7EIX	4055	
Thema Turbo 16V LS/LX	2.0	132	-01.95	834C1.000		4	0,8	BP6ET	1263				
Thema i.e. Turbo 16V	2.0	148	04.94-			4	0,9	BP6ET	1263				
Thema i.e. Turbo 16V S.W.Fairway	2.0	148	04.94-01.95	834C1.246		4	0,8	BUR6ET	3172	1	PGR6D	6248	
Thema i.e. Turbo 16V LX	2.0	148	10.91-01.95	834F2.000	Cat.	4	0,8	BP6ET	1263				
Thema TD	2.4	74	01.93-			4		Y-914U	2643				
Thema TD	2.5	85	01.94-12.94					Y-926U	7119				
Thema i.e. V6	2.8	110	-01.95	PRV834AB	Cat.	6	1,0	BPR6EFS	3623	7			
Thema i.e. V6 LS / LX / SW	3.0	126	92-01.95	834F.000		6	0,8	BPR7ES	2023	19	BPR7EIX	4055	
Thema 8.32	3.0	150	90- 92	F105L	Cat.	8	0,7	DCPR9E	2641				
Thema 8.32	3.0	158	- 89	F105L		8	0,7	D8EA	2120				
Thesis 2.0 TB cambio 6 marce	2.0	136	11.02-	841E.000		5	0,9	BKUR6ETB	6992				
Thesis 2.0 20 V TB	2.0	136	11.02-	841E.000		5	0,9	BKUR6ETB	6992				
Thesis 2.4 20V	2.4	125	11.02-	841D.000		5	0,9	BKR6EZ	4619		BKR6EIX	6418	
Thesis 3.0 24V V6	3.0	158	11.02-	841A.000		6	0,7	PFR6B	3500				
Trevi	1.6	74	- 85	828B.000		4	0,8	BPR7ES	2023	19	BPR7EIX	4055	
Trevi i.e. / Volumex	2.0	90	- 85	828B4.000-B7.000		4	0,8	BPR7ES	2023	19	BPR7EIX	4055	
Y 1.2 8V: Vanity- LS-Unica	1,2	44	10.00-12.03	188A4.000		4	0,9	BKR5EZ	7642		BKR5EIX	6341	
Y 1.2 16V- LS-LX-Unica	1,2	59	10.00-11.02	188A5.000		4	0,9	DCPR8E-N	5692				
Y 1.2 16V- LS-LX-Unica	1,2	59	12.02-12.03	188A5.000		4	0,9	DCPR7E-N	4795		DCPR7EIX	6046	
Y 10 4WD	1.0	33	85-10.96	156A2.246		4	0,8	BCPR6ES	2330	12	BCPR6EIX-1	4919	
Y 10 Fire	1.0	33	85-10.96	156A2.000		4	0,8	BCPR6ES	2330	12	BCPR6EIX-1	4919	
Y 10 /4x4	1.1	37	09.86-10.96	156C.046		4	0,6	BCPR7ES	3330				
Y 10 Selectronic i.e.	1.1	37	-10.96	156C.046	Cat.	4	0,8	BCPR6ES	2330	12	BCPR6EIX-1	4919	
Y Elefantino Blu	1.1	40	05.97-04.00	176B2.000		4	0,9	BKR6E	6962	28	BKR6EIX	6418	
Y Elefantino Blu	1.1	40	05.97-09.00	176B2.000		4	0,8	BCPR6ES	2330	12	BCPR6EIX-1	4919	
Y 8V LS,LE;ECVT	1.2	44	01.96-10.99	840 A3.000		4	0,8	BCPR6ES	2330	12	BCPR6EIX-1	4919	

¹⁾ Bic = Best in class (siehe Seite 3) / (see page 3)



l kW

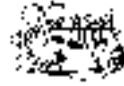

Cyl.

Order-
No. No.Bic¹⁾ Order-
No. No.**LANCIA**

Y 8 V	1.2	44	01.96-03.97	840.A3.000	4	0,8	BCPR6ES	2330	12	BCPR6EIX-1	4919
Y 8 V Elefantino Blu -unica	1.2	44	10.99-09.03	188A4.000	4	0,9	BKR5EZ	7642		BKR5EIX	6341
Y 16V elefantino Blu /Rosso	1.2	59	10.00-11.02	188A5.000	4	0,9	DCPR8E-N	5692			
Y 16V	1.2	63	04.97-03.00	176B9.000	4	0,9	DCPR8E	4339		DCPR8EVX	2265
Y 16V LE	1.2	63	02.98-09.00	176B9.000	4	0,9	DCPR8E	4339		DCPR8EVX	2265
Y 16V,LE,LS,LX, Elefantino Rosso	1.2	63	04.97-04.00	176B9.000	4	0,9	DCPR8E	4339		DCPR8EVX	2265
Y 10 1300; G.T.	1.3	53	11.87-10.96	146A5.046	4	0,8	BPR6ES	7822	2	BPR6EIX	6637
Y i. 12V	1.4	55	01.96-01.98	840 A2.000 - 4.000	4	0,9	BKR6EKC	2848	26	BKR6EIX	6418
Y	1.4	55	01.96-12.97		4	0,9	BCPR6ET	2197			
Y i.e. 12V	1.4	59	01.96-01.98	840A4.000	4	0,9	BKR6EKC	2848	26	BKR6EIX	6418
Z TD	1.9	68	04.95-	XUD 9TE	4	█	Y-923U	3380			
Z i.e.	2.0	89	04.99-12.01	RFV	4	0,9	BKR5EK	7956	23	BKR5EIX	6341
Z i.e. Turbo,LS	2.0	108	10.94-03.99	RGX	4	0,8	BKR6EK	2288	20**	BKR6EQUP	3199
Z TD	2.1	80	07.96-	XUD11ATE	4	█	Y-923U	3380			

LAND ROVER

90			83-		4	█	Y-907R	4479			
110			83-		4	█	Y-907R	4479			
88/109 2.3 L rap vol 7/1	2.3		- 85		4	0,7	B6ES	7310			
88/109 2.3 L rap vol 8/1	2.3		- 85		4	0,7	BP5ES	6511	8	BPR5EIX	6597
90/110 V8			83-		8	0,7	BP6ES	7811	4	BPR6EIX	6637
90/110 2.3 L rap vol 7/1	2.3		- 85		4	0,7	B6ES	7310			
90/110 2.3 L rap vol. 8/1	2.3		- 85		4	0,7	BP5ES	6511	8	BPR5EIX	6597
90/110 2.5 L	2.5		- 85		4	0,7	BP6ES	7811	4	BPR6EIX	6637
Country TD	2.5	83	01.89-		4	█	Y-909R	4602			
Defender 2.5	2.5		90-		6	0,8	BP6ES	7811	4	BPR6EIX	6637
Defender TDI	2.5	83	11.89-10.98	200/300 Gemini 1	4	█	Y-729U	2203			
Defender TDI 90 & 110	2.5	102	01.99-		4	█	Y-917U	3219			
Defender 3.5 V8	3.5		90-		8	0,9	BPR5ES	7422	6	BPR5EIX	6597
Discovery 2.0	2.0	99	06.93-01.99	Mpi	4	0,9	BKR6E	6962	28	BKR6EIX	6418
Discovery TDi ES	2.5	83	09.89-		4	█	Y-729U	2203			
Discovery TDI	2.5	83	09.89-01.99	200/300 Gemini 1	4	█	Y-729U	2203			
Discovery TDi Vogue ES	2.5	90	10.93-		4	█	Y-729U	2203			
Discovery & Restylé TD5	2.5	102	01.99-		5	█	Y-917U	3219			
Discovery V8	3.5	107	09.89-01.99	V8 3.5	8	0,8	BPR6ES	7822	2	BPR6EIX	6637
Discovery V8	3.9	136	02.99-	V8	8	0,8	BPR6ES	7822	2	BPR6EIX	6637
Discovery	4.0		94- 99		8	0,9	BPR6ES	7822	2	BPR6EIX	6637
Discovery	4.0		10.98-		8	1,1	PFR6N-11	3546			
Freelander	1.8	87	97-	K SERIES	4	1,1	PFR6N-11	3546			
Freelander	2.0		01-	KV6	6	1,1	PFR6N-11	3546			
Freelander TDI	2.0	71	10.97-08.98	20 T2R	4	█	Y-730U	2273			
Freelander TD4	2.0	80	08.98-	M47D20 (BMW)	4	█	Y-507R	4600			
Freelander TDi	2.5	102	05.98-		5	█	Y-917U	3219			
Freelander V6	2.5	130	09.00-	KV6	6	1,1	PFR6N-11	3546			
Land Rover County D			01.89-			█	Y-909R	4602			
Land Rover (90,110)	2.25		83-			█	Y-208T	1250			
Land Rover	2.3		09.83-		4	0,6	BP6EFS	3812	5		
Land Rover (90,110)	2.5		83-			█	Y-208T	1250			
Land Rover	2.5	62	09.83-		4	0,8	BP6ES	7811	4	BPR6EIX	6637
Land Rover	3.5	103	09.83-07.90	V8	8	0,8	BP6ES	7811	4	BPR6EIX	6637
Range Rover	2.5		09.89-	200/300 Gemini 1	4	█	Y-729U	2203			
Range Rover	2.5	66	04.86-10.92	VM UNIT (NOT GEMINI ENG.)	4	█	Y-909R	4602			

¹⁾ Bic = Best in class (siehe Seite 3) / (see page 3)

** alternative/wahlweise V-Line 30



ℓ kW

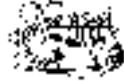

Cyl.

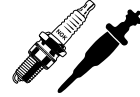
Order-
No. No.Bic¹⁾ Order-
No.**LAND ROVER**

Range Rover TDI	2.5	83	01.86-12.94	ETC 9091 N	4	█	Y-729U	2203			
Range Rover Vogue TD	2.5	87	01.90-09.94	VM 425 SLIRR	4	█	Y-923U	3380			
Range Rover Vogue TD	2.5	87	01.90-09.94	VM HR-492	4	█	Y-923U	3380			
Range Rover	2.5	100	09.94-	M51 D25 (BMW)	6	█	Y-917U	3219			
Range Rover	3.5		08.81-10.89	V8EFi	8	0,8	BPR6ES	7822	2	BPR6EIX	6637
Range Rover	3.9	127	11.88-10.95	V8	8	0,8	BPR6ES	7822	2	BPR6EIX	6637
Range Rover	4.0		09.94-12.98		8	0,9	BPR6ES	7822	2	BPR6EIX	6637
Range Rover	4.0	131	01.99- 02		8	1,1	PFR6N-11	3546			
Range Rover	4.2		10.92-12.94	V8	8	0,9	BPR6ES	7822	2	BPR6EIX	6637
Range Rover	4.4	210	09.99-	BMW M62 B44	8		BKR6EQUP	3199	30		
Range Rover	4.6		01.99-		8	1.1	PFR6N-11	3546			
Range Rover	4.6	165	09.94-10.98	V8	8	0,8	BPR6ES	7822	2	BPR6EIX	6637
Range Rover III	3.0	130	03.02-	M57 D30 BMW	6	█	Y-507R	4600			

LEXUS

Lexus IS 300 (GXE10)(JCE10/ 15)	2.0		09.01-	1G-FE	4	1,1	IFR6T-11	4589			
Lexus IS 200 (GXE10)	2.0	114	01.00-	1G-FE	6	1,1	IFR6T-11	4589			
Lexus RX 300 (MCU35,38)	3.0		01.04-	1MZ-FE	6	1,1	IFR6T-11	4589			
Lexus RX 330 (MCU35,38)	3.0		01.04-	1MZ-FE	6	1,1	IFR6T-11	4589			
Lexus ES 300 (MCV20)	3.0		01.00- 03	2JZ-GE	6	1,1	BKR6EKP-11	3452			
Lexus IS 300 (GXE10)(JCE10/ 15)	3.0		01.02-	2JZ-GE	6	1,1	BKR6EP-11	2978			
Lexus GS 300 (JZS160)	3.0		01.00-	1MZ-FE	6	1,1	BKR6EKP-11	3452			
Lexus RX 300 (MCU15)	3.0	150	07.00-	1MZ-FE	6	1,1	IFR6T-11	4589			
Lexus GS 300 (JZS147)	3.0	156	93- 99	2JZ-GE	6	1,1	BKR5EP-11	3440			
Lexus GS 300 (JZS160, UZS161)	3.0	161	01.02-	2JZ-GE	6	1,1	BKR6EP-11	2978			
Lexus GS 300	3.0	163	97-	2TZ-GE	6	1,1	BKR6EKP-11	3452			
Lexus RX 330 (MCU35,38)	3.3		01.04-	3MZ-FE	6	1,1	IFR6T-11	4589			
Lexus RX 300 (MCU35,38)	3.3		01.04-	3MZ-FE	6	1,1	IFR6T-11	4589			
Lexus LS 400 (UCF20)	4.0		01.00-	1UZ-FE	8	1,1	IFR6T-11	4589			
Lexus LS400	4.0		06.90-06.97	1UAZ-FE	8	1,1	BKR5EP-11	3440			
Lexus LS 400	4.0	180	90- 94	1UZ-FE	8	1,1	BKR6EP-11	2978			
Lexus LS 400	4.0	194	10.94-12.99	1UZ-FE	8	0,8	BKR6EP-8	2215			
Lexus LS 430 (UCF30)	4.3	207	08.00-	3UZ-FE with TWC	8	1,1	IFR6T-11	4589			
Lexus GS 430 (JZS160, UZS161)	4.3	208	01.02-	3UZ-FE	6	1,1	IFR6T-11	4589			
Lexus SC 430 (UZZ40)	4.3	210	05.01-	3UZ-FE	8	1,1	IFR6T-11	4589			
Lexus LX 470 (UZJ100)	4.7		01.00-	2UZ-FE with TWC	8	1,1	IFR6T-11	4589			
Lexus LX 470 (UZJ100)	4.7		01.00-	2UZ-FE without TWC	8	0,8	BKR6EYA	2249			

LEYLAND

200-Serie D			03.89-		6		---				
400-Serie LTD DI	2.5		01.87-		5	█	Y-902R	2237			
EA Range	1.8				4	█	Y-302	2100			
Readline					4	█	Y-302	2100			

LEYLAND DAF

Pilot	1.9		96-	PEUGEOT	4	█	Y-923U	3380			
Sherpa	1.8		74- 86		4	█	Y-909R	4602			
Sherpa	2.0		86- 88	PERKINS PRIMA	4	█	Y-902R	2237			
Sherpa	2.5		04.86- 89		4	█	Y-208T	1250			
Sherpa	2.5		89-	PEUGEOT ENGINE	4	█	Y-923U	3380			

¹⁾ Bic = Best in class (siehe Seite 3) / (see page 3)



l kW

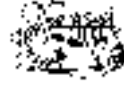

Cyl.

Order-
No. No.Bic¹⁾ Order-
No. No.**LOTUS**

Elan 1.6 16V	1.6		10.89-		4	1,1	BKR6E-11	2756	14	BKR6EIX-11	3764
Elan SE 16V Turbo	1.6		10.89-		4	0,8	BKR6E	6962	28	BKR6EIX	6418
Elise	1.8	88	96-	K- SERIES (Including) VVC	4	1,1	PFR6N-11	3546			
Elite				Carbu. Zenith	4	0,6	BP6ES	7811	4	BPR6EIX	6637
Elite GR, Super 95					4	0,6	B8ES	2411		BR8EIX	5044
Elite			76-	Carbu. Dellorto	4	0,6	BP6ES	7811	4	BPR6EIX	6637
Esprit Sport 300	2.2		93-		4	0,6	BPR6EKN	1128			
Esprit S4	2.2		93-07.96		4	0,6	BPR6EKN	1128			
Esprit SE 2.2	2.2		11.94-07.96		Cat.	4	0,8	BPR6EKN	1128		
Esprit Turbo	2.2		87-		4	0,6	BPR6ES	7822	2	BPR6EIX	6637
Esprit HC	2.2		85-	DOHC	4	0,8	BPR7ES	2023	19	BPR7EIX	4055
Esprit Turbo SE	2.2	197	89-	910S	4	0,6	BPR6EKN	1128			
Esprit	3.5	260	96-	918	8	0,9	BKR6EKC	2848	26	BKR6EIX	6418
Europa Special, Twin-Cam, S2, S1			85-		4	0,6	BP7ES	2412		BPR7EIX	4055
Excel SA / SE	2.2	135	85- 91	912S	4	0,8	BPR7ES	2023	19	BPR7EIX	4055
Exige 1.8 16V [177ch]	1.8	132	07.00-		4	0,8	BKR7E	6097		BKR7EVX	3544
Seven	1.3			1300cc (Ford)	4	0,6	BP6ES	7811	4	BPR6EIX	6637
Seven	1.6			1600cc (Ford)	4	0,6	BP6ES	7811	4	BPR6EIX	6637
Seven	1.6			1558cc (Lotus)	4	0,6	BP7ES	2412		BPR7EIX	4055

LUBLIN (Daewoo)

Lublin 1.8	1.8	70	02.96-		4	0,8	BPR5EY	2828	9	BPR5EIX	6597
Lublin 2.0	2.0	77	02.96-		4	0,8	BPR5EY	2828	9	BPR5EIX	6597

MAHINDRA

CJ 340 Classic D	2.1	48	93-	XD 4.90	4	Y-208T	1250				
CJ 540 D	2.1	48	93-	XD 4.90	4	Y-208T	1250				
CJ3			04.86-	Peugeot	4	Y-902R	2237				
CJ5			04.86-	Peugeot	4	Y-902R	2237				

MARUTI

800	0,8	26	01.91-		3	0,7	BPR5ES	7422	6	BPR5EIX	6597
-----	-----	----	--------	--	---	-----	--------	------	---	---------	------

MASERATI

2.24 V	2.0	180	88-	AM 475	4	0,7	DCPR8E	4339		DCPR8EVX	2265
222	2.0	162	01.89-10.89	471	4	0,7	BP8ES	2912			
228 I	2.8	184	12.87-	Bi Turbo	Cat.	6	0,7	BP8ES	2912		
3200 GT	3.2	271	12.98-09.01	585	8	0,7	PMR8A	5851			
4.18 V	2.0		02.91-		6	0,7	BP8ES	2912			
4.24 V / Spider 24V	2.0	180	90-	475	6	0,7	DCPR8E	4339		DCPR8EVX	2265
420 / I / S / SI /	2.0	138	01.87-	470	6	0,7	BP8ES	2912			
422	2.0	164	88-	AM 471	6	0,7	BP8ES	2912			
430	2.8	182	02.88-	473	Cat.	6	0,7	BP8ES	2912		
Biturbo	2.0	136	12.81-02.87	452	4	0,7	BP8ES	2912			
Coupè GT / Cambiocorsa	4.2	287	06.02-11.03	F136R	8	0,7	PMR8A	5851			
Ghibli	2.0	209	09.96-	496	6	0,7	DCPR9E	2641			
Ghibli V6	2.8	209	11.95-		6	0,8	DCPR9E	2641			
Karif	2.8	165	04.88-	437	Cat.	6	0,7	BP8ES	2912		
Quattroporte i. V6 24V	2.0	211	11.94-	475	6	0,6	DCPR9E	2641			
Quattroporte i. V6 24V	2.8	209	11.95-01.99		6	0,8	DCPR9E	2641			
Quattroporte V6 Evoluzione	2.8	260	02.99-12.01	588	6	0,9	DCPR8E	4339		DCPR8EVX	2265
Quattroporte V8 Evoluzione	3.2	270	02.99- 02	578	8	0,7	PMR8A	5851			

¹⁾ Bic = Best in class (siehe Seite 3) / (see page 3)



ℓ kW



Cyl.

Order-
No. No.Bic¹⁾ Order-
No.**MASERATI**

Racing	2.0	194	02.91-	475		6	0,7	DCPR9E	2641			
Shamal I Turbo 32V	3.2	240	02.91-02.96	AM 479	Cat.	8	0,7	DCPR8E	4339		DCPR8EVX	2265
Spyder 16V	2.0	136	07.85-04.87	452		4	0,7	BP8ES	2912			
Spyder	2.8	165	01.90-	473	Cat.	6	0,7	BP8ES	2912			
Spyder GT/Cambiocorsa	4.2	287	10.01-11.03	F136R		8	0,7	PMR8A	5851			

MAZDA

121 DA Fgst---> 200000	1.1	40	-03.91	B1	u.Cat.	4	0,9	BPR5ES	7422	6	BPR5EIX	6597
121 16V	1.25	55	00-	DHB / DHC / DHD / DHF		4	1,3	PTR5A-13 *	2467	25		
121 ZQ	1.3	37	03.96-	JJA / JJC / JJE / J4C		4	1,0	PTR5D-10	3784	31		
121 DB Fgst---> 400000	1.3	39		B3 16V	Cat.	4	1,1	BKR6E-11	2756	14	BKR6EIX-11	3764
121 DA Fgst 200001--->	1.3	40		B3	Cat.	4	1,1	BPR6ES-11	4824	13	BPR6EIX-11	3903
121 DA Fgst---> 200000	1.3	44	03.96-	B3		4	0,9	BPR5ES	7422	6	BPR5EIX	6597
121 DB Fgst 400000--->	1.3	53		B3 16V	Cat.	4	1,1	BKR6E-11	2756	14	BKR6EIX-11	3764
121 ZQ	1.3	55	03.96-	DHA Zetec (FORD)		4	1,3	PTR5A-13 *	2467	25		
121	1.8	44	03.96-	RTJ		4	█	Y-910R	4751			
2 DY Fgst 3*00001--->	1.25	55	03-	MZI FUJA / F8JB		4	1,3	PTR5A-13 *	2467	25		
2 DY Fgst 3*00001--->	1.4	59	03-	MZI DOHC FXJA / FXJB		4	1,3	PTR5A-13 *	2467	25		
2 DY Fgst 3*00001--->	1.6	74	03-	MZI DOHC FYJA		4	1,3	PTR5A-13 *	2467	25		
3	1.4	59	04-	ZJ		4	1,1	IFR5E-11	7994			
3	1.6	77	10.03-	Z6		4	1,1	IFR5E-11	7994			
3	2.0	110	10.03-	LF		4	1,3	ITR6F-13	4477			
323 BD1 Fgst 800000 --->	1.1	40		E1		4	0,8	BPR6ES	7822	2	BPR6EIX	6637
323 BF Fgst---> 400000	1.1	40		E1		4	0,8	BPR6ES	7822	2	BPR6EIX	6637
323 BG ...	1.3		90-	B3 Vergaser		4	0,8	BKR5E	7938		BKR5EIX	6341
323 BD1 Fgst 800000 --->	1.3	44		E3		4	0,8	BPR6ES	7822	2	BPR6EIX	6637
323 BF Fgst 400001 --->	1.4	44		B3	u.Cat.	4	0,8	BPR6ES	7822	2	BPR6EIX	6637
323 BG Fgst---> 500000	1.4	49		B3E	Cat.	4	1,1	BPR6ES-11	4824	13	BPR6EIX-11	3903
323 BJ Fgst 400001--->	1.4	53	02-	B3 SOHC		4	1,1	BKR5E-11	6953		BKR5EIX-11	5464
323 BJ Fgst 100001--->	1.4	54	09.98-	B3		4	1,1	BKR5E-11	6953		BKR5EIX-11	5464
323 BA Fgst 300001 --->	1.4	54	09.94-	B3		4	1,1	BKR6E-11	2756	14	BKR6EIX-11	3764
323 BA Fgst 500001 --->	1.4	54		B3 16V	Cat.	4	1,1	BKR6E-11	2756	14	BKR6EIX-11	3764
323 BG Fgst 500001 --->	1.4	54		B3 16V	Cat.	4	1,1	BKR6E-11	2756	14	BKR6EIX-11	3764
323 BF Fgst 400001 --->	1.5	54		B5	u.Cat.	4	0,8	BPR6ES	7822	2	BPR6EIX	6637
323 BW Fgst400001---500000	1.5	54		B5	u.Cat.	4	0,8	BPR6ES	7822	2	BPR6EIX	6637
323 BW Fgst---> 400000	1.5	55		E5		4	0,8	BPR6ES	7822	2	BPR6EIX	6637
323 BF Fgst---> 400000	1.5	55		E5		4	0,8	BPR6ES	7822	2	BPR6EIX	6637
323 BD1 Fgst 800000 --->	1.5	55		E5		4	0,8	BPR6ES	7822	2	BPR6EIX	6637
323 BA Fgst 100001--->	1.5	65	09.94-	Z5		4	1,1	BKR5E-11	6953		BKR5EIX-11	5464
323 BA Fgst 500001 --->	1.5	65		Z5 16V	Cat.	4	1,1	BKR6E-11	2756	14	BKR6EIX-11	3764
323 BJ Fgst 100001 --->	1.5	65	09.98-	ZL		4	1,1	BKR5E-11	6953		BKR5EIX-11	5464
323 BG Fgst---> 500000	1.6	62		B6E	Cat.	4	1,1	BPR6ES-11	4824	13	BPR6EIX-11	3903
323 BW Fgst 400001-500000	1.6	63		B6	Cat.	4	1,1	BPR5ES-11	4424		BPR5EIX-11	2115
323 BW Fgst 500001 --->	1.6	63		B6	Cat.	4	1,1	BPR6ES-11	4824	13	BPR6EIX-11	3903
323 BF1 Fgst 400001 --->	1.6	63		B6	Cat.	4	0,8	BPR6ES	7822	2	BPR6EIX	6637
323 BF1 Fgst---> 400000	1.6	63		B6	Cat.	4	1,1	BPR5ES-11	4424		BPR5EIX-11	2115
323 BG Fgst 500001 --->	1.6	65		B6 16V	Cat.	4	1,1	BKR6E-11	2756	14	BKR6EIX-11	3764
323 BF1 Fgst---> 400000	1.6	77		B6		4	0,8	BPR6ES	7822	2	BPR6EIX	6637
323 Turbo BF2 400001 --->	1.6	103		B6 DOHC	Cat.	4	1,1	BCPR6E-11	3132	11	BCPR6EIX-11	4919
323 BF1 Fgst 400001 --->	1.6	103	85- 91	B6 DOHC	Cat.	4	1,1	BCPR6E-11	3132	11	BCPR6EIX-11	4919
323 BF2 Fgst---> 400000	1.6	110		B6 DOHC		4	0,8	BCPR6E	1269	12	BCPR6EIX-11	4919
323	1.7					4	█	CY53	4315			

¹⁾ Bic = Best in class (siehe Seite 3) / (see page 3)

Fgst = Chassis No.

* Standardtype TR5A-10 / standard type TR5A-10



l kW

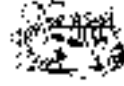

Cyl.

Order-
No. No.Bic¹⁾ Order-
No. No.**MAZDA**

323		1.8		89-	BP DOHC		4	0,8	BKR6E	6962	28	BKR6EIX	6418
323		1.8		89-	BP DOHC	Cat.	4	1,1	BKR6E-11	2756	14	BKR6EIX-11	3764
323		1.8		89-	BP EGI		4	1,1	BKR5E-11	6953		BKR5EIX-11	5464
323		1.8		89-	BP EGI	Cat.	4	0,8	BKR5E	7938		BKR5EIX	6341
323 Turbo		1.8		89-	BP		4	1,1	BKR6E-11	2756	14	BKR6EIX-11	3764
323		1.8	84	02.97-	B6D		4	1,1	BKR5E-11	6953		BKR5EIX-11	5464
323 GTR Turbo		1.8	136	95-			4	1,1	BKR6EVX-11	3540			
323 BG	Fgst---> 500000	1.9	76		BP SOHC 16V	Cat.	4	1,1	BKR6E-11	2756	14	BKR6EIX-11	3764
323 BG	Fgst 500001 --->	1.9	76		BP SOHC 16V	Cat.	4	1,1	BKR6E-11	2756	14	BKR6EIX-11	3764
323 BJ	Fgst 100001 --->	1.9	84	09.98-	FP		4	1,1	BKR5E-11	6953		BKR5EIX-11	5464
323 BA	Fgst 300001 --->	1.9	84	09.94-	BP 16V	Cat.	4	1,1	BKR5E-11	6953		BKR5EIX-11	5464
323 BA	Fgst 500001 --->	1.9	84		BP 16V	Cat.	4	1,1	BKR6E-11	2756	14	BKR6EIX-11	3764
323 BG	Fgst---> 500000	1.9	94		BP DOHC 16V	Cat.	4	1,1	BKR6E-11	2756	14	BKR6EIX-11	3764
323 BG	Fgst 500001 --->	1.9	94		BP DOHC 16V	Cat.	4	1,1	BKR6E-11	2756	14	BKR6EIX-11	3764
323 BG Turbo 16V		1.9	120		BP DOHC 16V	Cat.	4	1,1	BKR6E-11	2756	14	BKR6EIX-11	3764
323 BJ	Fgst 400001--->	2.0	96	02-	FS DOHC (High Power)		4	1,1	ZFR5F-11	2262		ZFR5FIX-11	2477
323 BA	Fgst 500001 --->	2.0	106	08.94-10.98	KF DOHC V6		6	1,1	BKR6E-11	2756	14	BKR6EIX-11	3764
323 BA	Fgst 100001 --->	2.0	106	09.94-10.98	KF DOHC V6		6	1,1	BKR6E-11	2756	14	BKR6EIX-11	3764
6 Sport-Kombi	GY Fgst 100001--->	1.8	88	06.02-	MZR-L8 DOHC		4	1,3	ITR6F-13	4477			
6 GG	Fgst 100001--->	1.8	88	06.02-	MZR-L8 DOHC		4	1,3	ITR6F-13	4477			
6 Sport-Kombi	GY Fgst 100001--->	2.0	104	06.02-	MZR-LF DOHC		4	1,3	ITR6F-13	4477			
6 GG	Fgst 100001--->	2.0	104	06.02-	MZR-LF DOHC		4	1,3	ITR6F-13	4477			
6 Sport-Kombi	4WD	2.3	119	06.02-	MZR-L3 DOHC		4	1,3	ITR6F-13	4477			
	GY Fgst 100001--->												
6 Sport-Kombi	GY Fgst 100001--->	2.3	122	06.02-	MZR-L3 DOHC		4	1,3	ITR6F-13	4477			
6 GG	Fgst 100001--->	2.3	122	06.02-	MZR-L3 DOHC		4	1,3	ITR6F-13	4477			
616 GC	Fgst 700001--->	2.0	74		FE		4	0,8	BPR6ES	7822	2	BPR6EIX	6637
626 GC	Fgst 650001 --->	1.6	59		F6		4	0,8	BPR6ES	7822	2	BPR6EIX	6637
626 GC	Fgst---> 650000	1.6	59		F6		4	0,8	BPR6ES	7822	2	BPR6EIX	6637
626 GF	Fgst 100001--->	1.8	66	07.97-	FP DOHC		4	0,8	PZFR6F	7550			
626		1.8	66	90-	F8		4	0,8	BKR6E	6962	28	BKR6EIX	6418
626		1.8	66	- 89	F8		4	0,9	BPR5ES	7422	6	BPR5EIX	6597
626		1.8	66	90-	F8	Cat.	4	1,1	BKR6E-11	2756	14	BKR6EIX-11	3764
626 GW	Fgst 100001 --->	1.9	66		FP DOHC 16V		4	0,8	PZFR6F	7550			
626 GE	Fgst 434202 --->	1.9	66	09.94-	FP DOHC		4	1,1	BKR6E-11	2756	14	BKR6EIX-11	3764
626 GF..		1.9	66	07.97-	FP		4	0,8	PZFR6F	7550			
626 GF	Fgst.100001 --->	1.9	66		FP DOHC		4	0,8	PZFR6F	7550			
626 GF	Fgst 400001--->	1.9	74	00-	FP DOHC		4	0,8	PZFR6F	7550			
626 GW	Fgst 208843--->	1.9	74	00-	FP DOHC		4	0,8	PZFR6F	7550			
626 GE	Fgst 100001 --->	1.9	77	92-	FP DOHC	Cat.	4	1,1	BKR6E-11	2756	14	BKR6EIX-11	3764
626		2.0	53	11.82-08.85	RF46		4		Y-107R	1229			
626 GD	Fgst---> 500000	2.0	66		FE	Cat.	4	1,1	BPR6ES-11	4824	13	BPR6EIX-11	3903
626 GD	Fgst---> 500000	2.0	66		FE	Cat.	4	0,8	BPR6ES	7822	2	BPR6EIX	6637
626 GV	Fgst 200001 --->	2.0	66		FE	Cat.	4	0,8	BPR6ES	7822	2	BPR6EIX	6637
626 GV	Fgst---> 200000	2.0	66		FE	Cat.	4	0,8	BPR6ES	7822	2	BPR6EIX	6637
626 GD	Fgst 500001--->	2.0	66		FE	Cat.	4	0,8	BPR6ES	7822	2	BPR6EIX	6637
626 GC	Fgst 700001--->	2.0	68		FE	Cat.	4	0,8	BPR6ES	7822	2	BPR6EIX	6637
626 GC	Fgst---> 700000	2.0	74		FE		4	0,8	BPR6ES	7822	2	BPR6EIX	6637
626 GD	Fgst---> 500000	2.0	79		FE 12 Valve		4	0,8	BCPR6E	1269	12	BCPR6EIX-11	4919
626 GF	Fgst 400001--->	2.0	85	00-	FS DOHC		4	0,8	PZFR6F	7550			
626(USA)GE	Fgst 803719--->	2.0	85		FS DOHC		4	1,1	BKR5E-11	6953		BKR5EIX-11	5464
626 GE	Fgst 4343202--->	2.0	85	94-	FS DOHC	Cat.	4	1,1	BKR6E-11	2756	14	BKR6EIX-11	3764

¹⁾ Bic = Best in class (siehe Seite 3) / (see page 3)

Fgst = Chassis No.



ℓ kW

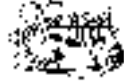

Cyl.

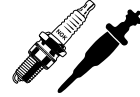
Order-
No. No.Bic¹⁾ Order-
No.**MAZDA**

626 GF..	Fgst 100001--->	2.0	85			FS DOHC	4	0,8	PZFR6F	7550			
626(USA)GE	Fgst 802219--->	2.0	85	92-	98	FS DOHC	4	1,1	BKR5E-11	6953		BKR5EIX-11	5464
626 GW	Fgst 200001--->	2.0	85	00-		FS DOHC	4	0,8	PZFR6F	7550			
626 GW	Fgst 100001 --->	2.0	85			FS DOHC 16V	4	0,8	PZFR6F	7550			
626 GC	Fgst 700001--->	2.0	88			FE	4	0,8	BPR6ES	7822	2	BPR6EIX	6637
626 GF..		2.0	100	07.97-		FS	4	0,8	PZFR6F	7550			
626 GW	Fgst 100001 --->	2.0	100			FS DOHC 16V	4	0,8	PZFR6F	7550			
626 GF	Fgst.100001 --->	2.0	100			FS DOHC	4	0,8	PZFR6F	7550			
626 GF	Fgst 400001--->	2.0	100	00-		FS DOHC High Power	4	0,8	PZFR6F	7550			
626 GW	Fgst 208843--->	2.0	100	00-		FS DOHC High Power	4	0,8	PZFR6F	7550			
626 GD	Fgst---> 500000	2.0	103			FE 16V	Cat. 4	1,1	BCPR6E-11	3132	11	BCPR6EIX-11	4919
626 GD	Fgst 500001--->	2.0	103			FE 16V	Cat. 4	1,1	BKR6E-11	2756	14	BKR6EIX-11	3764
626 GD	Fgst 500001--->	2.2	85			F2 12 Valve	Cat. 4	1,1	ZFR6F-11	4291		ZFR6FIX-11	6441
626 GV	Fgst---> 200000	2.2	85			F2	4	1,1	ZFR6A-11	1041			
626 GV	Fgst 200001--->	2.2	85			F2 12 Valve	Cat. 4	1,1	ZFR6F-11	4291		ZFR6FIX-11	6441
626 GD	Fgst---> 500000	2.2	85			F2 12 Valve	Cat. 4	1,1	ZFR6A-11	1041			
626 GE	Fgst 434202 --->	2.5	120	09.94-		KL DOHC V6	6	1,1	ZFR5F-11	2262		ZFR5FIX-11	2477
626 GE	Fgst 100001--->	2.5	121	92-	94	KL DOHC V6	Cat. 6	1,1	ZFR6F-11	4291		ZFR6FIX-11	6441
929		2.0				S 2	4	█	Y-107T	1253			
929 HV	Fgst 800001--->	2.0	66			MA	4	0,8	BPR6ES	7822	2	BPR6EIX	6637
929 HB	Fgst 500001--->	2.0	74			FE	4	0,8	BPR6ES	7822	2	BPR6EIX	6637
929 HC	Fgst---> 200000	2.0	85			FE	without Cat. 4	0,8	BPR6ES	7822	2	BPR6EIX	6637
929 HB	Fgst 500001--->	2.0	88			FE	4	0,8	BPR6ES	7822	2	BPR6EIX	6637
929 HC	Fgst---> 200000	2.2	85			F2 12Valve	Cat. 4	1,1	ZFR6A-11	1041			
929 HC	Fgst 200001--->	2.2	94			F2 12Valve	Cat. 4	1,1	ZFR6F-11	4291		ZFR6FIX-11	6441
929 HC	Fgst---> 200000	2.2	100			F2 12Val.	o.Cat. 4	0,8	BCPR6E	1269	12	BCPR6EIX-11	4919
929		2.5		92-		JS-DE	6	1,1	BKR5EVX-11	5182		BKR5EIX-11	5464
929 HC	Fgst 200001--->	3.0	123			JE	Cat. 6	1,1	ZFR6F-11	4291		ZFR6FIX-11	6441
929 HC	Fgst---> 200000	3.0	125			JE	Cat. 6	1,1	ZFR6A-11	1041			
929 HC	Fgst---> 200000	3.0	140			JE	ohne Cat. 6	0,8	BCPR6E	1269	12	BCPR6EIX-11	4919
B 1600		1.6					4	0,9	BPR5ES	7422	6	BPR5EIX	6597
B 1800		1.8					4	0,9	BPR5ES	7422	6	BPR5EIX	6597
B 2000		2.0					4	0,9	BPR5ES	7422	6	BPR5EIX	6597
B 2200		2.0		08.84-		F 2	4	█	Y-107R	1229			
B 2200		2.2		90-		F2	4	0,9	BPR5ES	7422	6	BPR5EIX	6597
B 2200		2.2		-10.96		R 2	4	█	Y-107R	1229			
B 2200		2.2				S 2	4	█	Y-107T	1253			
B 2200		2.2		90-		F2 EGI	4	1,1	BPR5ES-11	4424		BPR5EIX-11	2115
B 2200		2.2		-	89		4	0,9	BPR5ES	7422	6	BPR5EIX	6597
B 2500 UF	Fgst 702487--->	2.5	57	99-		WL		█	Y-701J	5116			
B 2600		2.6		-	89		6	0,9	BPR5ES	7422	6	BPR5EIX	6597
B 2600		2.6		90-		G6	6	1,1	ZFR5F-11	2262		ZFR5FIX-11	2477
B Serie				97-11.02		WLT		█	Y-701J	5116			
Boxer 3700 / 5500				11.74-		XC / ZC		█	Y-172	7325			
Demio DW	Fgst 100.001 --->	1.4	46	98-	03	B3 SOHC	4	1,1	BKR6E-11	2756	14	BKR6EIX-11	3764
Demio DW	Fgst 300001--->	1.4	46	00-	03	B3 SOHC	4	1,1	BKR5E-11	6953		BKR5EIX-11	5464
Demio DW	Fgst 100.001 --->	1.4	53	98-	03	B3 (High Power)	4	1,1	BKR6E-11	2756	14	BKR6EIX-11	3764
Demio DW	Fgst 300001--->	1.5	55	05.00-	03	B5 SOHC	4	1,1	BKR6E-11	2756	14	BKR6EIX-11	3764
E 2000 SR	Fgst 600001--->	2.0	60			FE	4	0,9	BPR5ES	7422	6	BPR5EIX	6597
E 2000 SR	Fgst---> 600000	2.0	63	84-	95	FE	4	0,8	BPR6ES	7822	2	BPR6EIX	6637
E 2000 SR	Fgst 800001--->	2.0	70			FE 8V	4	1,1	BKR5E-11	6953		BKR5EIX-11	5464
E 2000 SR	Fgst 700001--->	2.0	70	95-		FE	4	1,1	BKR6E-11	2756	14	BKR6EIX-11	3764

¹⁾ Bic = Best in class (siehe Seite 3) / (see page 3)

Fgst = Chassis No.



l kW

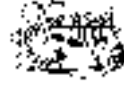

Cyl.

Order-
No. No.Bic¹⁾ Order-
No. No.**MAZDA**

E Serie				RF / RF Turbo / R2		Y-701R	7464			
E Serie			97-	R2		Y-721RS	3687			
E 2000	2.0		93-	RF	4	Y-107R	1229			
E 2000 SR Fgst X100001--->	2.0	70	99-	FE	4	1,1 BKR5E-11	6953		BKR5EIX-11	5464
E 2200	2.2		93-	R2	4	Y-107R	1229			
E 2200	2.2		02.83-	F2	4	Y-107R	1229			
E 3000	3.0		93-	L4DE		Y-721RS	3687			
E 3000	3.0		93-	VS		Y-721RS	3687			
Light Bus Parkway			10.80-	HA 12V		Y-107R	1229			
Light Bus Parkway			10.80-	HA 24V		Y-157R	2029			
MPV LW Fgst Y100001--->	2.0	90	06.99-04.02	FS DOHC	4	1,1 ZFR5F-11	2262		ZFR5FIX-11	2477
MPV	2.0	100	97-06.02	WLT	4	Y-701J	5116			
MPV LW Fgst 200001--->	2.3	104	05.02-	MZR-L3 DOHC	4	1,3 ITR6F-13	4477			
MPV LV Fgst 100001--->	3.0	109	05.96-	JE 12V	6	1,1 BKR6E-11	2756	14	BKR6EIX-11	3764
MPV LV 52 Fgst 631983--->	3.0	113	09.94-	JEE	6	1,1 ZFR6F-11	4291		ZFR6FIX-11	6441
MX-3 EC	1.6	65	08.91-	B6 SOHC	Cat. 4	1,1 BKR5E-11	6953		BKR5EIX-11	5464
MX-3 EC Fgst 208015--->	1.6	79	94-	B6 DOHC	4	1,1 BKR6E-11	2756	14	BKR6EIX-11	3764
MX-3 EC Fgst 208015--->	1.8	95	95-	K8 DOHC	6	1,1 BKR5E-11	6953		BKR5EIX-11	5464
MX-3 EC	1.8	98	08.91-	K8 DOHC	Cat. 6	1,1 BKR5E-11	6953		BKR5EIX-11	5464
MX-5 NA Fgst 308212--->	1.6	66		B6 DOHC	4	1,1 BKR6E-11	2756	14	BKR6EIX-11	3764
MX-5 NA Fgst 200001--->	1.6	66	95-	B6 DOHC	4	1,1 BKR6E-11	2756	14	BKR6EIX-11	3764
MX-5 NB Fgst 100001 --->	1.6	81	98-	B6 DOHC	4	1,1 BKR5E-11	6953		BKR5EIX-11	5464
MX-5 NA Fgst 100001--->	1.6	85	90-	B6 DOHC	Cat. 4	1,1 BKR6E-11	2756	14	BKR6EIX-11	3764
MX-5 NA Fgst 100000--->	1.9	96	94-	BP DOHC	Cat. 4	1,1 BKR6E-11	2756	14	BKR6EIX-11	3764
MX-5 NA Fgst 308212--->	1.9	96		BP DOHC	4	1,1 BKR6E-11	2756	14	BKR6EIX-11	3764
MX 5 NB Fgst 300001---> Automatic	1.9	102	01-	BP DOHC	4	1,1 BKR5E-11	6953		BKR5EIX-11	5464
MX 5 NB Fgst 121912--->	1.9	103	00-	BP DOHC	4	1,1 BKR5E-11	6953		BKR5EIX-11	5464
(Anniversary)										
MX-5 NB Fgst 100001--->	1.9	103	98-	BP DOHC	4	1,1 BKR5E-11	6953		BKR5EIX-11	5464
MX 5 NB Fgst 200001--->	1.9	107	01-	BP DOHC	4	1,1 BKR5E-11	6953		BKR5EIX-11	5464
MX-6 GE Fgst 400001--->	2.0	85	09.94-	FS DOHC	4	1,1 BKR5E-11	6953		BKR5EIX-11	5464
MX-6 GE Fgst 100001--->	2.0	85	92-	FS DOHC	Cat. 4	1,1 BKR6E-11	2756	14	BKR6EIX-11	3764
MX-6	2.2		92-	F2	4	1,1 ZFR6F-11	4291		ZFR6FIX-11	6441
MX-6 GE Fgst 400001--->	2.5	120	09.94-	KL DOHC V6	6	1,1 ZFR5F-11	2262		ZFR5FIX-11	2477
MX-6 GE Fgst 100001--->	2.5	121	92-	KL DOHC V6	Cat. 6	1,1 ZFR5F-11	2262		ZFR5FIX-11	2477
Premacy CP Fgst 300001--->	1.9	74		FP DOHC	4	1,1 BKR5E-11	6953		BKR5EIX-11	5464
Premacy CP Fgst 151177--->	1.9	74	06.99-	FP DOHC	4	1,1 ZFR5F-11	2262		ZFR5FIX-11	2477
Premacy CP Fgst 151177--->	1.9	85	06.99-	FP DOHC with VICS	4	1,1 ZFR5F-11	2262		ZFR5FIX-11	2477
Premacy CP Fgst 300001--->	2.0	96		FS DOHC	4	1,1 BKR5E-11	6953		BKR5EIX-11	5464
Ranger				S 2		Y-107T	1253			
RX-7 FB Fgst 700001--->		83		12 A		1,1 BR8ET	4221			
RX-7 FC Fgst---> 200000		110		13 B		1,1 BR10ET	7480			
RX-7 Turbo FC Fgst--->200000		133		RE 13 B		1,0 SD11A	1199			
RX-7 Turbo FC Fgst 200001--->		147	90-	RE 13 B		1,4 BUR9EQ	5483			
RX-7 Turbo FD Fgst--->100000		176		13B-REV		1,2 BUR9EQP	5255			
RX-8	2.6	141	09.03-	13B-MSP		RE8A-L+	4964+			
						RE9B-T	2809			
RX-8 Sport	2.6	177	09.03-	13B-MSP(high power)		RE8A-L+	4964+			
						RE9B-T	2809			
T 2500	2.5		10.80-	XA 12V		Y-107R	1229			
T 2500	2.5		10.80-	XA 24V		Y-157R	2029			
T 3000	3.0		93-	HA		Y-771R	4262			

¹⁾ Bic = Best in class (siehe Seite 3) / (see page 3)

Fgst = Chassis No.



ℓ kW

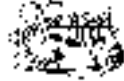

Cyl.

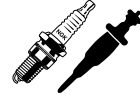
Order-
No. No.Bic¹⁾ Order-
No.**MAZDA**

T 3000	3.0		10.80-	92	HA 12V		Y-107R	1229			
T 3000	3.0		10.80-	92	HA 24V		Y-157R	2029			
T 3000	3.0		93-		L4DE		Y-771R	4262			
T 3700			04.76-		XC		Y-172	7325			
T 4100	4.1		10.80-		ZB 12V		Y-107R	1229			
T 4100	4.1		10.80-		ZB 24V		Y-157R	2029			
T 5500			75-		ZC		Y-172	7325			
T Serie			97-		VS		Y-771R	4262			
Tribute	2.0		03-		Ford	4 1,3	PTR5A-13 *	2467	25		
Tribute EP Fgst M00001--->	2.0	91	04.00-		Zetec 16V	4 1,3	PTR5A-13	2467	25		
Tribute EP2 Fgst M00001--->	2.0	91	04.00-		Zetec 16V	4 1,3	PTR5A-13	2467	25		
Tribute	2.0	110	03-		L3	4 1,3	ITR6F-13	4477			
Tribute V6 EP Fgst M00001--->	3.0	145	04.00-		Duratec 24V	6 1,1				TR5IX	7397
Tribute V6 EP2 Fgst M00001--->	3.0	145	04.00-		Duratec 24V	6 1,1				TR5IX	7397
Xedos 6 CA Fgst 210758--->	1.6	79	09.94-		B6 DOHC	4 1,1	BKR5E-11	6953		BKR5EIX-11	5464
Xedos 6 CA Fgst 210758--->	2.0	103	09.94-		KF DOHC V6	6 1,1	BKR6E-11	2756	14	BKR6EIX-11	3764
Xedos 6 CA Fgst 100001--->	2.0	106	06.92-			4 1,1	BKR6E-11	2756	14	BKR6EIX-11	3764
Xedos 9 TA Fgst 200001--->	2.0	105	10.93-		KF V6 DOHC	6 1,1	BKR6E-11	2756	14	BKR6EIX-11	3764
Xedos 9 TA Fgst 200001--->	2.3	155	02.95-		KJ V6 DOHC Miller Mot	6 0,8	PZFR5F	3741			
Xedos 9 TA Fgst 400001--->	2.5	120			KL-V6 DOHC	6 1,1	ZFR5F-11	2262		ZFR5FIX-11	2477
Xedos 9 TA V6	2.5	120	01-		KJD	6 1,1	BKR5E-11	6953		BKR5EIX-11	5464
Xedos 9 TA Fgst 200001--->	2.5	128	10.93-		KL-ZE V6	6 1,1	ZFR5F-11	2262		ZFR5FIX-11	2477

MERCEDES

190 (201)	2.0	63	10.82-05.90		M 102.921/924	4 0,8	BP6EFS	3812	5		
190 D (201)	2.0	53	02.89-05.93		OM 601.911	4	Y-916R	2785			
190 D (201)	2.0	53	02.83-01.89		OM 601.911	4	Y-902R	2237			
190 D (201)	2.5	66	04.85-01.89		OM 602.911	5	Y-902R	2237			
190 D (201)	2.5	66	02.89-05.93		OM 602.911	5	Y-916R	2785			
190 D (201)	2.5	90	02.88-01.89		OM 602.961	5	Y-902R	2237			
190 D (201)	2.5	90	02.89-05.93		OM 602.961	5	Y-916R	2785			
190 DT (201)	2.5	90	02.89-05.93		OM 602.961	5	Y-918R	4182			
190 E (201)	2.0	87	09.85-08.93		M 102.962	4 0,8	BP6EFS	3812	5		
190 E (201)	2.0	90	10.82-08.86		M 102.961/962	4 0,8	BP6EFS	3812	5		
190 E (201)	2.3	97	09.86-05.93		M 102.985	4 0,8	BP6EFS	3812	5		
190 E (201)	2.6	118	09.86-05.93		M 103.942	6 0,8	BP6EFS	3812	5		
190 E 1.8 (201)	1.8	80	05.90-05.93		M 102.910	4 0,8	BP6EFS	3812	5		
190 E 16V (201)	2.3	125	04.84-08.88		M 102.983	4 0,8	BP7EFVX	3344			
190 E 16V (201)	2.5	143	09.88-05.93		M 102.990	4 0,8	BP6EFS	3812	5		
190 E 16V Evo.1 (201)	2.5	143	03.89-04.90		M 102.991	4 0,8	BP6EFS	3812	5		
190 E 16V Evo.2 (201)	2.5	173	05.90-05.93		M 102.992	4 0,8	BP6EFS	3812	5		
200 (123)	2.0	74	06.80-11.85		M 102.920/939	4 0,8	BP6EFS	3812	5		
200 (124)	2.0	77	12.84-05.90		M 102.922	4 0,8	BP6EFS	3812	5		
200 D (123)	2.0	44	08.80-11.85		OM 615.940	4	Y-902R	2237			
200 D,TD (124)	2.0	53	12.84-01.89		OM 601.912	4	Y-902R	2237			
200 D,TD (124)	2.0	53	02.89-06.93		OM 601.912	4	Y-916R	2785			
200 E (124)	2.0	87	12.88-09.92		M 102.963	4 0,8	BP6EFS	3812	5		
200 E (124)	2.0	100	10.92-06.93		M 111.940	4 0,7	BKP6ES	4930	17	BCPR6EIX-11	4919
207 D	2.4	53	09.82-09.88		OM 616.	4	Y-902R	2237			
208 D	2.3	58	10.88-03.95		OM 601.	4	Y-916R	2785			
209 D	3.0	65	04.82-09.88		OM 617.	4	Y-902R	2237			
210	2.3	70	08.82-08.91		M 102.942/945	4 0,8	BP6EFS	3812	5		

¹⁾ Bic = Best in class (siehe Seite 3) / (see page 3)

Fgst = Chassis No.

* Standardtype TR5A-10 / standard type TR5A-10



l kW

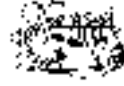

Cyl.

Order-
No. No.Bic¹⁾ Order-
No. No.**MERCEDES**

210		2.3	77	08.91-	M 102. ...	4	0,8	BP6EFS	3812	5			
210 D		2.9	70	10.88-	OM 602.	5	█	Y-916R	2785				
220	(187)	2.2				4	0,6	BP6HS	4511	18	BPR6HIX	4085	
220 E	(124)	2.2	110	10.92-06.93	M 111.960	4	0,7	BCP6ES	4930	17	BCPR6EIX-11	4919	
230 E	(123)	2.3	100	04.80-12.85	M 102.982	4	0,8	BP6EFS	3812	5			
230 E	(124)	2.3	90	12.84-09.92	M 102.982	4	0,8	BP6EFS	3812	5			
230 GE	(460)	2.3	90	03.86-03.90	M 102.987	Cat. 4	0,8	BP6EFS	3812	5			
230 GE	(460)	2.3	92	04.82-08.85	M 102.981	4	0,8	BP6EFS	3812	5			
230 GE	(463)	2.3	93	09.89-07.93	M 102.989	4	0,8	BP6EFS	3812	5			
240 GD	(460)	2.4	53	08.80-08.87	OM 616.936	4	█	Y-902R	2237				
250	(123)	2.5	95	02.76-07.85	M 123.920/921	4	0,7	BP6ES	7811	4	BPR6EIX	6637	
250 D,TD	(124)	2.5	66	02.89-06.93	OM 602.912	5	█	Y-916R	2785				
250 D,TD	(124)	2.5	66	04.85-01.89	OM 602.912	5	█	Y-902R	2237				
250 DT	(124)	2.5	93	02.89-06.93	OM 602.962	5	█	Y-916R	2785				
250 DT	(124)	2.5	93	09.88-01.89	OM 602.962	5	█	Y-902R	2237				
250 GD	(460)	2.5	69	09.89-06.93	OM 602.931	5	█	Y-916R	2785				
250 GD	(460)	2.5	62	02.89-07.93	OM 602.930	5	█	Y-916R	2785				
250 GD	(460)	2.5	62	09.87-01.89	OM 602.930	5	█	Y-902R	2237				
260 E	(124)	2.6	118	09.85-09.92	M 103.940/943	6	0,8	BP6EFS	3812	5			
260 SE	(126)	2.6	118	09.85-06.91	M 103.941	6	0,8	BP6EFS	3812	5			
280 E	(123)	2.8	130	02.76-11.85	M 110.984/988	6	0,7	BP6ES	7811	4	BPR6EIX	6637	
280 E	(124)	2.8	142	-06.95	M 104.942	6	0,7	BCP6ES	4930	17	BCPR6EIX-11	4919	
280 GE	(460)	2.8	110	11.79-08.89	M 110.994	6	0,7	BP6ES	7811	4	BPR6EIX	6637	
280 S	(126)	2.8	115	12.79-07.85	M 110.924/926	6	0,7	BP6ES	7811	4	BPR6EIX	6637	
280 SE/SEL	(126)	2.8	136	10.79-07.85	M 110.987/989	6	0,7	BP6ES	7811	4	BPR6EIX	6637	
280 SL	(107)	2.8	130	06.76-07.85	M 110.982/86/90	6	0,7	BP6ES	7811	4	BPR6EIX	6637	
300 D	(124)	3.0	80	02.89-06.93	OM 603.912	6	█	Y-916R	2785				
300 D	(124)	3.0	80	12.84-01.89	OM 603.912	6	█	Y-902R	2237				
300 D 4-Mat.	(124)	3.0	80	09.86-01.89	OM 603.913	6	█	Y-902R	2237				
300 D 4-Mat.	(124)	3.0	80	02.89-06.93	OM 603.913	6	█	Y-916R	2785				
300 D,TD	(123)	3.0	59	08.80-11.85	OM 617.912	6	█	Y-902R	2237				
300 E	(124)	3.0	132	09.85-09.92	M 103.983	6	0,8	BP6EFS	3812	5			
300 E	(124)	3.0	138	01.85-08.85	M 103.980	6	0,8	BP6EFS	3812	5			
300 E 4-Matic	(124)	3.0	132	09.86-06.93	M 103.985	6	0,8	BP6EFS	3812	5			
300 E-24V	(124)	3.0	162	09.89-06.93	M 104.980	6	0,7	BCP6ES	4930	17	BCPR6EIX-11	4919	
300 GD	(460)	3.0	65	08.80-01.89	OM 617/931	6	█	Y-902R	2237				
300 GD	(460)	3.0	83	08.80-01.89	OM 603.912	6	█	Y-902R	2237				
300 GD	(463)	3.0	83	02.89-06.93	OM 603.931	6	█	Y-916R	2785				
300 GE	(463)	3.0	125	09.89-07.93	M 103.987	6	0,8	BP6EFS	3812	5			
300 SD	(140)	3.0	110	02.92-04.93	OM 603.971	6	█	Y-916R	2785				
300 SE 2.8	(140)	2.8	142	02.93-10.98	M 104.944	6	0,7	BCP6ES	4930	17	BCPR6EIX-11	4919	
300 SE/SEL	(126)	3.0	132	09.85-06.91	M 103.981	6	0,8	BP6EFS	3812	5			
300 SE/SEL 3,2	(140)	3.2	170	03.91-06.93	M 104.990	6	0,7	BCP6ES	4930	17	BCPR6EIX-11	4919	
300 SED	(140)	3.0		02.91-		6	█	Y-916R	2785				
300 SL	(107)	3.0	132	09.85-08.89	M 103.982	6	0,8	BP6EFS	3812	5			
300 SL	(129)	3.0	140	03.89-06.93	M 103.984	6	0,8	BP6EFS	3812	5			
300 SL-24V	(129)	3.0	170	07.89-06.93	M 104.981	6	0,7	BCP6ES	4930	17	BCPR6EIX-11	4919	
300 TD	(123)	3.0	92	10.80-11.85	OM 617.952	5	█	Y-902R	2237				
300 TD	(124)	3.0	92	02.89-06.93	OM 603.960	6	█	Y-916R	2785				
300 TD	(124)	3.0	92	12.84-01.89	OM 603.960	6	█	Y-902R	2237				
300 TD	(124)	3.0	108	01.88-01.89	OM 603.960	6	█	Y-902R	2237				
300 TD	(124)	3.0	108	02.89-06.93	OM 603.960	6	█	Y-916R	2785				

¹⁾ Bic = Best in class (siehe Seite 3) / (see page 3)



ℓ kW

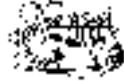

Cyl.

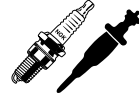
Order-
No. No.Bic¹⁾ Order-
No.**MERCEDES**

300 TD (126)	3.0	107	11.85-12.87	OM 603.961	6	Y-902R	2237			
300 TD 4Mat. (124)	3.0	105	09.86-01.89	OM 603.963	6	Y-902R	2237			
300 TD 4Mat. (124)	3.0	105	02.89-06.93	OM 603.963	6	Y-916R	2785			
300 TD SD (126)	3.0	110	08.80-10.85	OM 617.951	5	Y-902R	2237			
307 D	2.4	53	09.82-09.88	OM 616.	4	Y-902R	2237			
308 D	2.3	58	10.88-03.95	OM 601.	4	Y-916R	2785			
309	2.3	77	08.82-	M 102. ...	4	0,8 BP6EFS	3812	5		
309 D	3.0	65	04.82-09.88	OM 617.	4	Y-902R	2237			
310	2.3	70	08.82-08.91	M 102.942/945	4	0,8 BP6EFS	3812	5		
310	2.3	77	08.91-	M 102. ...	4	0,8 BP6EFS	3812	5		
310 D	2.9	70	10.88-	OM 602.	5	Y-916R	2785			
320 E (124)	3.2	162	10.92-06.93		6	0,7 BCP6ES	4930	17	BCPR6EIX-11	4919
350 D (126)	3.5	115	02.89-06.91	OM 603.		Y-916R	2785			
350 D,TD (126)	3.5	100	03.90-06.91	OM 603.970	6	Y-916R	2785			
350 GD (463)	3.5	100	09.91-06.93	OM 603.972	6	Y-916R	2785			
380 (126)	3.8	150	12.79-08.85	M 116.961/963	8	0,7 BP6ES	7811	4	BPR6EIX	6637
380 SL/SLC (107)	3.8	160	07.80-08.85	M 116.960/962	8	0,7 BP6ES	7811	4	BPR6EIX	6637
400 E (124)	4.2	205	10.92-06.93	M 119.975	8	0,7 BCP6ES	4930	17	BCPR6EIX-11	4919
400 SE/SEL (140)	4.2	210	02.91-06.93	M 119.971	8	0,7 BCP6ES	4930	17	BCPR6EIX-11	4919
407 D	2.4	53	07.81-09.88	OM 616.	4	Y-902R	2237			
408 D	2.3	58	10.88-	OM 601.	4	Y-916R	2785			
409 D	3.0	65	04.82-08.88	OM 617.	4	Y-902R	2237			
410	2.3	70	08.82-08.91	M 102.942/943/945	4	0,8 BP6EFS	3812	5		
410	2.3	77	08.91-	M 102. ...	4	0,8 BP6EFS	3812	5		
410 D	2.9	70	10.88-	OM 602.	5	Y-916R	2785			
420 (126)	4.2	150	09.85-06.91	M 116.965	8	0,7 BP6ES	7811	4	BPR6EIX	6637
420 SL (107)	4.2	150	01.86-08.89	M 116.964	8	0,7 BP6ES	7811	4	BPR6EIX	6637
500 (126)	5.0	170	12.79-06.91	M 117.961/63/65	8	0,7 BP6ES	7811	4	BPR6EIX	6637
500 E (124)	5.0	235	06.91-06.93	M 119.974	8	0,7 BCP6ES	4930	17	BCPR6EIX-11	4919
500 SE/SEL (140)	5.0	240	02.91-06.93	M 119.970	8	0,7 BCP6ES	4930	17	BCPR6EIX-11	4919
500 SEC (140)	5.0	240	10.92-06.93	M 119.970	8	0,7 BCP6ES	4930	17	BCPR6EIX-11	4919
500 SL (107)	5.0	164	03.80-08.89	M 117.964	8	0,7 BP6ES	7811	4	BPR6EIX	6637
500 SL (129)	5.0	235	09.92-06.93	M 119.972	8	0,7 BCP6ES	4930	17	BCPR6EIX-11	4919
500 SL (129)	5.0	240	03.89-06.93	M 119.960	8	0,7 BCP6ES	4930	17	BCPR6EIX-11	4919
507 D	2.4	53	04.82-09.88	OM 616.	4	Y-902R	2237			
508 D	2.3	58	03.89-	OM 601.	4	Y-916R	2785			
510	2.3	70	08.82-08.91	M 102.946	4	0,8 BP6EFS	3812	5		
510	2.3	77	08.91-	M 102. ...	4	0,8 BP6EFS	3812	5		
560 (126)	5.6	178	09.87-06.91	M 117.968	8	0,7 BP6ES	7811	4	BPR6EIX	6637
600 SE/SEL (140)	6.0	290	04.91-06.93	M 120.980	12	0,7 BCP6ES	4930	17	BCPR6EIX-11	4919
600 SEC (140)	6.0	290	10.92-06.93	M 120.980	12	0,7 BCP6ES	4930	17	BCPR6EIX-11	4919
600 SL (129)	6.0	290	07.92-06.93	M 120.981	12	0,7 BCP6ES	4930	17	BCPR6EIX-11	4919
A 140 (168)	1.4	60	10.97-	M 166.940	4	0,9 BKUR5ET	2789	29	PFR6Q	6458
A 160 (168)	1.6	75	10.97-	M 166.960	4	0,9 BKUR5ET	2789	29	PFR6Q	6458
A 160 CDi (168)	1.7	44	10.97-	OM 668.941	4	Y-746R	4842			
A 170 CDi (168)	1.7	70	08.98-	OM 668.940	4	Y-746R	4842			
A 190 (168)	1.9	92	98-	M 166.990	4	0,9 BKUR5ET	2789	29	PFR6Q	6458
C 180 D (202)	1.8	65	10.98-05.00	OM 604.	4	Y-925R	5045			
C 180 (202)	1.8	90	07.97-	M 111.921	4	0,9 BKUR5ET	2789	29	PFR6Q	6458
C 180 (202)	1.8	90	06.93-06.97	M 111.920	4	0,7 BCP6ES	4930	17	BCPR6EIX-11	4919
C 180 (203)	1.8		03-	M 271.946	4	ILFR6A				
C 180 Kompressor (203)	1.8	105	02.03-	M 271.940	4	ILFR6A				

¹⁾ Bic = Best in class (siehe Seite 3) / (see page 3)



l kW

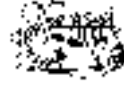

Cyl.

Order-
No. No.Bic¹⁾ Order-
No. No.**MERCEDES**

C 180 (203)	2.0	95	05.00-	M 111.951	4	1,0	IFR6D10	5344				
C 200 D (202)	2.0	55	07.93-05.00	OM 601.913	4	■	Y-916R	2785				
C 200 D (202)	2.0	65	10.96-05.00	OM 604.915	4	■	△ Y-925R	5045				
C 200 (202)	2.0	100	07.97-	M 111.945	4	0,9	BKUR5ET	2789	29	PFR6Q		6458
C 200 (202)	2.0	100	03.94-06.97	M 111.941	4	0,7	BCP6ES	4930	17	BCPR6EIX-11		4919
C 200 CDI (202)	2.2	75	03.98-05.00	OM 611.960	4	■	Y-745U	4705				
C 200 Kompressor (203)	1.8	105	02.03-	M 271.940	4		ILFR6A					
C 200 Kompressor (203)	1.8	105	02.03-	M 271.942	4		ILFR6A					
C 200 CGI Kompressor (203)	1.8	125	03-	M 271.942	4		ILFR6A					
C 200 CDI (203)	2.2	85	05.00-	OM 611.962	4	■	Y-745U	4705				
C 200 Kompressor (202)	2.0	132	09.95-10.96	M 111.944	4	0,8	BKR6ES	3783	28	BKR6EIX		6418
C 200 Kompressor (202)	2.0	141	11.96-	M 111.944	4	1,0	BKUR6ET-10	2397	24	PFR6Q		6458
C 200 Kompressor (203)	2.0	120	05.00-	M 111.955	4	1,0	IFR6D10	5344				
C 220 D (202)	2.2	70	07.93-05.95	OM 604.910	4	■	◆ Y-930U	5568				
C 220 D (202)	2.2	70	06.95-05.00	OM 604.910	4	■	△ Y-925R	5045				
C 220 CDI (202)	2.2	75	06.98-	OM 611.961	4	■	Y-745U	4705				
C 220 CDI (202)	2.2	92	09.97-05.00	OM 611.960	4	■	Y-745U	4705				
C 220 (202)	2.2	110	06.93-09.96	M 111.961	4	0,7	BCP6ES	4930	17	BCPR6EIX-11		4919
C 220 CDI (203)	2.2	105	05.00-	OM 611.962	4	■	Y-745U	4705				
C 230 (202)	2.3	110	09.96-05.97	M 111.974	4	0,7	BCP6ES	4930	17	BCPR6EIX-11		4919
C 230 Kompressor (202)	2.3	142	10.95-	M 111.975	4	1,0	BKUR6ET-10	2397	24	PFR6Q		6458
C 240 (203)	2.6	125	05.00-	M 112.912 Twin Spark	6	1,0	IFR5D10	4696				
C 240 V6 (202)	2.4	125	04.97-	M 112.910 Twin Spark	6	1,0	IFR5D10	4696				
C 250 D (202)	2.5	83	02.95-08.95	OM 605.910	5	■	△ Y-925R	5045				
C 250 D (202)	2.5	83	07.93-01.95	OM 605.910	5	■	◆ Y-930U	5568				
C 250 Td (202)	2.5	110	05.96-05.00	OM 605.960	5	■	△ Y-925R	5045				
C 270 CDI (203)	2.7	125	12.00-	OM 612.962	5	■	Y-745U	4705				
C 280 (202)	2.8	141	06.93-05.97	M 104.941	6	0,7	BCP6ES	4930	17	BCPR6EIX-11		4919
C 280 V6 (202)	2.8	145	06.97-	M 112.920 Twin Spark	6	1,0	IFR5D10	4696				
C 32 AMG Kompressor (203)	3.2	260	00-	M 112.961 Twin Spark	6	1,0	IFR6D10	5344				
C 320 (203)	3.2	160	05.00-	M 112.946 Twin Spark	6	1,0	IFR5D10	4696				
C 36 AMG (202)	3.6	206	01.94-05.97	M 104.941	6	0,8	BKR5EKU	3964				
C 43 AMG (202)	4.3	225	09.97-	M 113.944 Twin Spark	8	1,0	IFR5D10	4696				
CL 420 (140)	4.2	205	07.97-	M 119.981	8	1,0	IFR5D10	4696				
CL 420 (140)	4.2	205	06.96-06.97	M 119.981	8	0,7	BCP6ES	4930	17	BCPR6EIX-11		4919
CL 500 (140)	5.0	235	07.97-	M 119.980	8	1,0	IFR5D10	4696				
CL 500 (140)	5.0	235	09.96-06.97	M 119.980	8	1,0	IFR5D10	4696				
CL 500 (215)	5.0	225	09.00-	M 113.960 Twin Spark	8	1,0	IFR5D10	4696				
CL 55 AMG (215)	5.5	265	10.99-	M 113.986 Twin Spark	8	1,0	IFR5D10	4696				
CL 55 AMG Kompressor (215)	5.5	386	00-	M 113.991 Twin Spark	8	1,0	IFR5D10	4696				
CL 600 (215)	5.8	270	03.99-	M 137.970 Twin Spark	12		IFR6D10	5344				
CL 600 (140)	6.0	290	06.96-05.97	M 120.982	12	0,7	BCP6ES	4930	17	BCPR6EIX-11		4919
CL 600 (140)	6.0	290	06.97-	M 120.982	12	1,0	IFR5D10	4696				
CLK 200 (208)	2.0	100	06.97- 02	M 111.945	4	0,9	BKUR5ET	2789	29	PFR6Q		6458
CLK 200 Kompressor (208)	2.0	120	06.00- 02	M 111.956	4	1,0	IFR6D10	5344				
CLK 200 Kompressor (208)	2.0	135	07.97- 02	M 111.944	4	1,0	BKUR6ET-10	2397	24	PFR6Q		6458
CLK 200 Kompressor (209)	1.8	105	02.03-	M 271.940	4		ILFR6A					
CLK 200 CGI (209)	1.8	125	02.03-	M 271.942	4		ILFR6A					
CLK 230 Kompressor (208)	2.3	142	06.97-02.00	M 111.973	4	1,0	BKUR6ET-10	2397	24	PFR6Q		6458
CLK 230 Kompressor (208)	2.3	145	03.00- 02	M 111.982	4	1,0	IFR6D10	5344				
CLK 240 (209)	2.6	125	02.03-	M 112.912 Twin Spark	6	1,0	IFR5D10	4696				
CLK 320 V6 (208)	3.2	160	06.97- 02	M 112.940 Twin Spark	6	1,0	IFR5D10	4696				

¹⁾ Bic = Best in class (siehe Seite 3) / (see page 3)

△ ◆ siehe Seite 11 / see page 11



ℓ kW

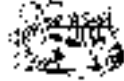

Cyl.

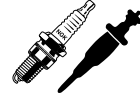
Order-
No. No.Bic¹⁾ Order-
No.**MERCEDES**

CLK 320 (209)	3.2	160	03.03-	M 112.955 Twin Spark	6	1,0	IFR5D10	4696				
CLK 430 (208)	4.3	205	06.98- 02	M 113.943 Twin Spark	8	1,0	IFR5D10	4696				
CLK 500 (209)	5.0	225	03.03-	M 113.968 Twin Spark	8		IFR5D10	4696				
CLK 55 AMG (208)	5.5	255	08.99- 02	M 113.980 Twin Spark	8	1,0	IFR5D10	4696				
CLK 55 AMG (209)	5.4	270	02-	M 113.987 Twin Spark	8		IFR6D10	5344				
CLS 500 (219)	5.0	225	04-	M 113.967 Twin Spark	8	1,0	IFR5D10	4696				
E 180 Kompressor (211)	2.0		02-	M 271.941	4		ILFR6A					
E 200 (124)	2.0		07.93-06.95	M 111.921	4	0,7	BCP6ES	4930	17	BCPR6EIX-11	4919	
E 200 D (124)	2.0	53	07.93-05.95	OM 601.912	4	▣	Y-916R	2785				
E 200 (124)	2.0	100	06.93-06.97	M 111.942	4	0,7	BCP6ES	4930	17	BCPR6EIX-11	4919	
E 200 D (210)	2.0	65	01.96-03.02	OM 604.917	4	▣	△ Y-925R	5045				
E 200 (210)	2.0	100	07.97-	M 111.942	4	0,9	BKUR5ET	2789	29	PFR6Q	6458	
E 200 (210)	2.0	100	06.95-06.97	M 111.942	4	0,8	BCP5ES	7496	16	BCPR5EIX-11	3306	
E 200 CDI (210)	2.2	75	06.98-06.99	OM 611.961	4	▣	Y-745U	4705				
E 200 CDI (210)	2.2	85	07.99-	OM 611.961	4	▣	Y-745U	4705				
E 200 Kompressor (211)	2.0	120	02-	M 271.941	4		ILFR6A					
E 200 Kompressor (210)	2.0	120	06.00-	M 111.957	4	1,0	IFR6D10	5344				
E 200 Kompressor (210)	2.0	137	09.96-	M 111.947	4	1,0	BKUR6ET-10	2397	24	PFR6Q	6458	
E 220 (124)	2.2	110	06.93-06.95	M 111.960	4	0,7	BCP6ES	4930	17	BCPR6EIX-11	4919	
E 220 D (210)	2.2	55	05.96-	OM 611.913	4	▣	△ Y-925R	5045				
E 220 D (210)	2.2	70	03.95-	OM 604.912	4	▣	△ Y-925R	5045				
E 220 CDI (210)	2.2	92	06.98-06.99	OM 611.961	4	▣	Y-745U	4705				
E 220 CDI (210)	2.2	105	07.99-	OM 611.961	4	▣	Y-745U	4705				
E 220 D (210)	2.2	105	07.99-	OM 611.962	4	▣	Y-745U	4705				
E 230 (210)	2.3	110	06.95-06.97	M 111.970	4	0,8	BCP5ES	7496	16	BCPR5EIX-11	3306	
E 240 V6 (210)	2.4	125	04.97-06.99	M 112.911 Twin Spark	6	1,0	IFR5D10	4696				
E 240 (210)	2.6	125	06.00-	M 112.914 Twin Spark	6	1,0	IFR5D10	4696				
E 240 (211)	2.6	130	02-	M 112.913 Twin Spark	6	1,0	IFR5D10	4696				
E 250 T,TD (124)	2.5	66	07.93-	OM 602.962	5	▣	Y-916R	2785				
E 250 D (124)	2.5	66	07.93-	OM 602.912/962	5	▣	Y-916R	2785				
E 250 D (124)	2.5	83	07.93-04.96	OM 605.911/912	5	▣	△ Y-925R	5045				
E 250 D (124)	2.5	83	07.93-05.95	OM 605.911	5	▣	◆ Y-930U	5568				
E 250 TD (124)	2.5	93	07.93-05.95	OM 602.962	5	▣	Y-916R	2785				
E 250 D (210)	2.5	83	03.95-	OM 605.912	5	▣	Y-925R	5045				
E 250 TD (210)	2.5	150	06.97-07.99	OM 605.962	5	▣	Y-925R	5045				
E 270 CDI (210)	2.7	105	07.99-	OM 612.961	5	▣	Y-745U	4705				
E 280 (124)	2.8	142	07.93-02.97	M 104.942	6	0,7	BCP6ES	4930	17	BCPR6EIX-11	4919	
E 280 (124)	2.8	142	06.93-06.95	M 104.945	6	0,7	BCP6ES	4930	17	BCPR6EIX-11	4919	
E 280 (210)	2.8	142	01.96-06.99	M 104.945	6	0,8	BCP5ES	7496	16	BCPR5EIX-11	3306	
E 280 V6 (210)	2.8	150	03.97-	M 112.921 Twin Spark	6	1,0	IFR5D10	4696				
E 290 TD (210)	2.9	95	06.95-	OM 602.982	5	▣	Y-929U	6003				
E 300 TD (124)	3.0	100	07.93-05.95	OM 606.910	6	▣	◆ Y-930U	5568				
E 300 D (124)	3.0	100	07.93-05.95	OM 606.910	6	▣	Y-930U	5568				
E 300 TD (124)	3.0	100	06.95-06.96	OM 606.910	6	▣	△ Y-925R	5045				
E 300 TD (124)	3.0	108	07.93-	OM 603.960	6	▣	Y-916R	2785				
E 300 4 MATIC (124)	3.0	132	09.86-06.93	M 103.985	6	0,8	BP6EFS	3812	5			
E 300 24V (124)	3.0	162	06.93-06.97	M 104.980	6	0,7	BCP6ES	4930	17	BCPR6EIX-11	4919	
E 300 D (210)	3.0	100	03.95-	OM 606.912	6	▣	Y-925R	5045				
E 300 Td T (210)	3.0	130	03.97-	OM 606.962	6	▣	◆ Y-930U	5568				
E 300 Td T (210)	3.0	130	03.97-	OM 606.962	6	▣	△ Y-925R	5045				
E 320 (124)	3.2	162	06.93-06.95	M 104.992	6	0,7	BCP6ES	4930	17	BCPR6EIX-11	4919	
E 320 CDI (210)	3.2	145	07.99-	OM 613.961	6	▣	Y-745U	4705				

¹⁾ Bic = Best in class (siehe Seite 3) / (see page 3)

△ ◆ siehe Seite 11 / see page 11



l kW

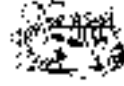

Cyl.

Order-
No. No.Bic¹⁾ Order-
No. No.**MERCEDES**

E 320 V6 (210)	3.2	165	03.97-	M 112.941 Twin Spark	6	1,0	IFR5D10	4696				
E 320 (210)	3.2	170	06.95-06.99	M 104.995	6	0,8	BCP6ES	7496	16	BCPR6EIX-11	3306	
E 320 (211)	3.2	165	02-	M 112.949 Twin Spark	6	1,0	IFR5D10	4696				
E 420 (124)	4.2	205	06.93-06.95	M 119.975	8	0,7	BCP6ES	4930	17	BCPR6EIX-11	4919	
E 420 V8 (210)	4.2	205	01.96-06.97	M 119.985	8	0,7	BCP6ES	4930	17	BCPR6EIX-11	4919	
E 420 V8 (210)	4.2	205	07.97-	M 119.985	8	0,9	BKUR5ET	2789	29	PFR6Q	6458	
E 430 V8 (210)	4.3	205	04.97-	M 113.940 Twin Spark	8	1,0	IFR5D10	4696				
E 50 AMG (210)	4.2	235	02.96-05.99	M 119.980	8	0,8	BCP6ES	3964				
E 500 (124)	5.0	235	06.93-06.95	M 119.974	8	0,7	BCP6ES	4930	17	BCPR6EIX-11	4919	
E 500 (211)	5.0	225	02-	M 113.967 Twin Spark	8	1,0	IFR5D10	4696				
E 55 AMG (210)	5.5	260	05.97-	M 113.980 Twin Spark	8	1,0	IFR5D10	4696				
E 55 AMG (211)	5.4	350	02-	M 113.990 Twin Spark	8		ILFR6A					
G 200 (463)	2.0		09.93-	M 102.965	4	0,8	BP6EFS	3812	5			
G 230 (463)	2.3	93	08.93-10.94	M 102.989	4	0,8	BP6EFS	3812	5			
290 GD (461)	2.9	72	08.93-10.94	OM 602.942/947	6		Y-916R	2785				
290 GD (461)	2.9	90	07.97-	OM 602.983	5		Y-916R	2785				
G 300 D (463)	3.0	83	08.93-	OM 603.931	6		Y-916R	2785				
G 300 (463)	3.0	126	08.93-10.94	M 103.987	6	0,8	BP6EFS	3812	5			
G 320 (463)	3.2	155	09.93-11.97	M 104.996	6	0,7	BCP6ES	4930	17	BCPR6EIX-11	4919	
G 320 (463)	3.2	158	12.97-	M 112.945	6	1,0	IFR5D10	4696				
G 500 (463)	5.0	195	08.93-10.94	M 117.965	8	0,7	BP6ES	7811	4	BPR6EIX	6637	
G 500 (463)	5.0	218	00-	M 113.962	8	1,0	IFR5D10	4696				
G 55 AMG (463)	5.5	260	00-	M 113.E55	8	1,0	IFR5D10	4696				
L 410	2.3	70	08.82-	M 102.943	4	0,8	BP6EFS	3812	5			
LM 409	2.3	60	01.75-	M 115. ...	4	0,7	BP6ES	7811	4	BPR6EIX	6637	
MB 100	2.4	43	02.89-	OM 615.970	4		Y-902R	2237				
MB 100 D	2.4	56	09.87-01.89	OM 616.963	4		Y-902R	2237				
MB 100 D	2.4	56	02.89-	OM 616.963	4		Y-916R	2785				
ML 230 (163)	2.3	110	11.98-	M 111.977	4	0,9	BKUR5ET	2789	29	PFR6Q	6458	
ML 270 CDI (163)	2.7	120	12.99-	OM 612.963	5		Y-745U	4705				
ML 320 (163)	3.2	160	11.98-	M 112.942 Twin Spark	6	1,0	IFR5D10	4696				
ML 350 (163)	3.7	173	09.00-	M 112.970 Twin Spark	6	1,0	IFR5D10	4696				
ML 430 (163)	4.3	200	11.98-	M 113.942 Twin Spark	8	1,0	IFR5D10	4696				
ML 500 (163)	5.0	215	09.00-	M 113.965 Twin Spark	8	1,0	IFR5D10	4696				
ML 55 AMG (163)	5.5	255	11.99-	M 113.981 Twin Spark	8	1,0	IFR5D10	4696				
O 309 B	2.3	70	08.82-	M 102.943	4	0,8	BP6EFS	3812	5			
S 280 (140)	2.8	142	07.93-06.97	M 104.944	6	0,7	BCP6ES	4930	17	BCPR6EIX-11	4919	
S 280 (220)	2.8	142	10.99-	M 112.922 Twin Spark	6	1,0	IFR5D10	4696				
S 320 (140)	3.2	170	07.93-06.97	M 119.944	6	0,7	BCP6ES	4930	17	BCPR6EIX-11	4919	
S 320 CDI (220)	3.2	145	11.99-	OM 648.960	6		Y-745U	4705				
S 320 (220)	3.2	165	10.98-	M 112.944 Twin Spark	6	1,0	IFR5D10	4696				
S 350 TD (140)	3.5	110	93-		6		Y-916R	2785				
S 350 (220)	3.5	180	09.02-	M 112.972 Twin Spark	6	1,0	IFR5D10	4696				
S 400 CDI (220)	4.0	184	00-	OM 628.960	8		Y-745U	4705				
S 420 (140)	4.2	205	07.93-06.97	M 119.971	8	0,7	BCP6ES	4930	17	BCPR6EIX-11	4919	
S 420 (140)	4.2	205	06.93-06.97	M 119.981	8	0,7	BCP6ES	4930	17	BCPR6EIX-11	4919	
S 430 (220)	4.3	205	10.98-	M 113.941 Twin Spark	8	1,0	IFR5D10	4696				
S 500 (140)	5.0	235	07.93-06.97	M 119.970	8	0,7	BCP6ES	4930	17	BCPR6EIX-11	4919	
S 500 (220)	5.0	225	10.98-	M 113.960 Twin Spark	8	1,0	IFR5D10	4696				
S 55 AMG (220)	5.5	265	99-	M 113.986 Twin Spark	8	1,0	IFR5D10	4696				
S 55 AMG Kompressor (220)	5.5	386	02-	M 113.991 Twin Spark	8		ILFR6A					
S 600 (140)	6.0	290	06.93-06.97	M 120.982	12	0,7	BCP6ES	4930	17	BCPR6EIX-11	4919	

¹⁾ Bic = Best in class (siehe Seite 3) / (see page 3)



ℓ kW

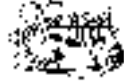

Cyl.

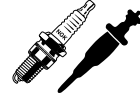
Order-
No. No.Bic¹⁾ Order-
No. No.**MERCEDES**

S 600 (140)	6.0	290	07.93-06.97	M 120.980	12	0,7	BCP6ES	4930	17	BCPR6EIX-11	4919
S 600 (220)	6.0	294	10.99-	M 137.970 Twin Spark	12	1,0	IFR6D10	5344			
SL 280 (129)	2.8	141	07.93-06.97	M 104.943	6	0,7	BCP6ES	4930	17	BCPR6EIX-11	4919
SL 280 (129)	2.8	142	07.97-05.98	M 104.943	6	0,9	BKUR5ET	2789	29	PFR6Q	6458
SL 280 (129)	2.8	150	06.98-	M 112.923 Twin Spark	6	1,0	IFR5D10	4696			
SL 320 (129)	3.2	165	06.98-	M 112.943 Twin Spark	6	1,0	IFR5D10	4696			
SL 320 (129)	3.2	170	07.97-05.98	M 104.991	6	0,9	BKUR5ET	2789	29	PFR6Q	6458
SL 320 (129)	3.2	170	07.93-06.97	M 104.991	6	0,7	BCP6ES	4930	17	BCPR6EIX-11	4919
SL 350 (230)	3.7	180	03.03-	M 112.973 Twin Spark	6	1,0	IFR5D10	4696			
SL 500 (129)	5.0	225	98-	M 113.961 Twin Spark	8	1,0	IFR5D10	4696			
SL 500 (129)	5.0	235	07.93-06.97	M 119.982	8	0,7	BCP6ES	4930	17	BCPR6EIX-11	4919
SL 500 (129)	5.0	235	07.93-06.97	M 119.972	8	0,7	BCP6ES	4930	17	BCPR6EIX-11	4919
SL 500 (230)	5.0	225	10.01-	M 113.963 Twin Spark	8	1,0	IFR5D10	4696			
SL 55 AMG (230)	5.5	260	00-	M 113.992 Twin Spark	8	1,0	IFR5D10	4696			
SL 60 AMG (129)	6.0	280	95-	M 119.E60	12	0,8	BKR5EKU	3964			
SL 600 (129)	6.0	290	98-	M 120.983	12	1,0	IFR5D10	4696			
SL 600 (129)	6.0	290	07.93-06.97	M 120.983	12	0,8	BCP5ES	7496	16	BCPR5EIX-11	3306
SL 600 (129)	6.0	290	07.93-06.97	M 120.981	12	0,7	BCP6ES	4930	17	BCPR6EIX-11	4919
SL 73 AMG (129)	7.3	386	99-	M 120.E73	12	1,0	IFR5D10	4696			
SLK 200 (170)	2.0	100	09.96-	M 111.946	4	0,9	BKUR5ET	2789	29	PFR6Q	6458
SLK 200 Kompressor (171)	1.8	120	04.04-	M 271.944	4		ILFR6A				
SLK 200 Kompressor (170)	2.0	120	03.00-	M 111.958	4	1,0	IFR6D10	5344			
SLK 200 Kompressor (170)	2.0	141	09.96-02.00	M 111.943	4	1,0	BKUR6ET-10	2397	24	PFR6Q	6458
SLK 230 Kompressor (170)	2.3	142	09.96-02.00	M 111.973	4	1,0	BKUR6ET-10	2397	24	PFR6Q	6458
SLK 230 Kompressor (170)	2.3	145	03.00-	M 111.983	4	1,0	IFR6D10	5344			
SLK 32 AMG Kompressor (170)	3.2	260	11.00-	M 112.960 Twin Spark	6	1,0	IFR6D10	5344			
SLK 320 (170)	3.2	160	03.00-	M 112.947 Twin Spark	6	1,0	IFR5D10	4696			
Sprinter 208 CDI	2.1	60	04.00-				Y-745U	4705			
Sprinter 208 D	2.3	58	04.95-	OM 601.	4		Y-916R	2785			
Sprinter 211 CDI	2.1	80	04.00-				Y-745U	4705			
Sprinter 212 D	2.9	90	04.95-	OM 602.980.12 DELA ->136	5		Y-923U	3380			
Sprinter 212 D	2.9	90	04.95-	OM 602.980.10 DELA 9850->	5		Y-929U	6003			
Sprinter 212 D	2.9	90	04.95-	OM 602.980.10 DELA ->9849	5		Y-923U	3380			
Sprinter 212 D	2.9	90	04.95-	OM 602.980.12 DELA 137 ->	5		Y-929U	6003			
Sprinter 213 CDI	2.1	95	04.00-				Y-745U	4705			
Sprinter 214	2.3	105	04.95-	M 111.979	4	0,9	BKUR5ET	2789	29	PFR6Q	6458
Sprinter 216 CDI	2.7	115	04.00-				Y-745U	4705			
Sprinter 308 CDI	2.1	60	04.00-				Y-745U	4705			
Sprinter 308 D	2.3	58	04.95-	OM 601.	4		Y-916R	2785			
Sprinter 311 CDI	2.1	80	04.00-				Y-745U	4705			
Sprinter 312 D	2.9	90	04.95-	OM 602.980.12 DELA 137 ->	5		Y-929U	6003			
Sprinter 312 D	2.9	90	04.95-	OM 602.980.12 DELA ->136	5		Y-923U	3380			
Sprinter 312 D	2.9	90	04.95-	OM 602.980.10 DELA9850->	5		Y-929U	6003			
Sprinter 312 D	2.9	90	04.95-	OM 602.980.10 DELA ->9849	5		Y-923U	3380			
Sprinter 313 CDI	2.1	95	04.00-				Y-745U	4705			
Sprinter 314	2.3	105	04.95-	M 111.979	4	0,9	BKUR5ET	2789	29	PFR6Q	6458
Sprinter 316 CDI	2.7	115	04.00-				Y-745U	4705			
Sprinter 412 D	2.9	90	04.95-	OM 602.980.10 DELA ->9849	5		Y-923U	3380			
Sprinter 412 D	2.9	90	04.95-	OM 602.980.10 DELA 9850 ->	5		Y-929U	6003			
Sprinter 412 D	2.9	90	04.95-	OM 602.980.12 DELA ->136	5		Y-923U	3380			
Sprinter 412 D	2.9	90	04.95-	OM 602.980.12 DELA 137 ->	5		Y-929U	6003			
Unimog 100 L	2.9	71	11.92-	OM 602.948	5		Y-916R	2785			

¹⁾ Bic = Best in class (siehe Seite 3) / (see page 3)



l kW

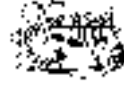

Cyl.

Order-
No. No.Bic¹⁾ Order-
No. No.**MERCEDES**

Unimog 421	2.0	34	01.66-	OM 621.	4	☑	DG237	4826			
Unimog 600/650	2.4	38	01.88-	OM 616.	4	☑	Y-902R	2237			
Unimog U 90	3.0	65	11.92-	OM 602.941	5	☑	Y-916R	2785			
V 220 CDI	2.2	90	03.99-	OM 611.980	4	☑	Y-745U	4705			
V 230 TD	2.3	72	09.96-	OM 601.970	4	☑	Y-916R	2785			
V 230	2.3	105	09.96-	M 111.978	4	0,8	BKR6EK	2288	20**	BKR6EQU	3199
V 280 VR6	2.8	125	98-	M 104.900(AFS)	6	0,8	BKR5EKUP	2890			
Vito 113	2.0	95	03.96-	M 111.948	4	1,0	BKUR5ET-10	7553			
Vito 114	2.3	105	03.96-	M 111.978	4	1,0	BKUR5ET-10	7553			
Vito 108 D	2.3	60	02.96-	OM 601.942	4	☑	Y-916R	2785			
Vito 110 CDI	2.1	72	02.96-	OM 601.970	4	☑	Y-916R	2785			

MG

MGF 1.6	1.6	81	02.00-	K	4	1,1	PFR6N-11	3546			
MGF Roadster	1.8	88	11.95-	NPI	4	1,1	PFR6N-11	3546			
MGF Roadster	1.8	106	11.95-	VV10	4	1,1	PFR6N-11	3546			
MGF Trophy 160 SE	1.8	116	02.95-	K Series VVC	4	1,0	PFR6N-11	3546			
MGTF 1.6	1.6	85	03.02-	K Series	4	1,0	PFR6N-11	3546			
MGTF 1.8	1.8	88	03.02-	K Series	4	1,0	PRF6N-11	3546			
MGTF 1.8	1.8	99	03.02-	K Series	4	1,0	PFR6N-11	3546			
MGTF 1.8	1.8	118	03.02-	K Series	4	1,0	PFR6N-11	3546			
RV 8	3.9		10.92-10.95	V8	8	0,8	BPR6ES	7822	2	BPR6EIX	6637
ZR 105	1.4	74	06.01-	K	4	1,1	PFR6N-11	3546			
ZR 105	1.4	74	06.01-	K	4	1,1	PFR6N-11	3546			
ZR 120	1.8	85	06.01-	K	4	1,1	PFR6N-11	3546			
ZR 120	1.8	85	06.01-	K	4	1,1	PFR6N-11	3546			
ZR 160	1.8	116	06.01-	K WVC	4	1,1	PFR6N-11	3546			
ZS 120	1.8	85	06.01-	K	4	1,1	PFR6N-11	3546			
ZS 120	1.8	88	06.01-	K	4	1,1	PFR6N-11	3546			
ZS 180	2.5	132	06.01-	KV6	6	1,1	PFR6N-11	3546			
ZT-T 160	2.5	116	06.01-	KV6	6	1,1	PFR6N-11	3546			
ZT 160	2.5	116	06.01-	KV6	6	1,1	PFR6N-11	3546			
ZT 160	2.5	116	06.01-	KV6	6	1,1	PFR6N-11	3546			
ZT-T 160	2.5	116	06.01-	KV6	6	1,1	PFR6N-11	3546			
ZT 190	2.5	138	06.01-	KV6	6	1,1	PFR6N-11	3546			
ZT-T 190	2.5	138	06.01-	KV6	6	1,1	PFR6N-11	3546			
ZT-T 190	2.5	138	06.01-	KV6	6	1,1	PFR6N-11	3546			
ZT 190	2.5	138	06.01-	KV6	6	1,1	PFR6N-11	3546			

MINI

Mini One	1.6	66	04.01-	W10 B16	4		BKR6EQU	3199	30		
Mini Cooper	1.6	85	04.01-	W10 B16	4		BKR6EQU	3199	30		
Mini Cooper S 16V	1.6	120	12.01-	W11 B16	4		BKR6EQU	3199	30		

MITSUBISHI

1300 Mini Bus / Van				4D56S-QGS Type	4		only OE				
1300 Mini Bus / Van				4D56	4	☑	Y-115T1	2189			
2000 GTX	2.0		94-	4G63	4	1,1	BKR5E-11	6953		BKR5EIX-11	5464
3000 GT	3.0		95-	6G72 MPI TC	6	1,1	PFR6J-11	2743			
3000 GT	3.0		97-	6G7	6	1,1	PFR6J-11	2743			
3000 GT	3.0	210	09.92-	6G72/T DOHC	6	1,1	PFR6J-11	2743			
Airtrek	2.0		06.02-	4G63	4	0,7	PGR6A	4984			

¹⁾ Bic = Best in class (siehe Seite 3) / (see page 3)

** alternative/wahlweise V-Line 30



ℓ kW

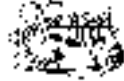

Cyl.

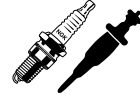
Order-
No. No.Bic¹⁾ Order-
No.**MITSUBISHI**

Airtrek	2.0	93	02-	4G63 MPI	4	1,1	BKR6E-11	2756	14	BKR6EIX-11	3764	
Airtrek	2.4		01.03-	4G64	4	1,1	BKR5E-11	6953		BKR5EIX-11	5464	
Canter				4DR51	4	█	Y-251	2026				
Canter			78-	4D30	4	█	Y-274	2165				
Canter				4D56	4	█	Y-115T1	2189				
Carisma	1.6		97-	4G92 SOHC	4	1,1	BKR6E-11	2756	14	BKR6EIX-11	3764	
Carisma 1600 DAO	1.6	66	09.95-	4G92	4	1,1	BKR6E-11	2756	14	BKR6EIX-11	3764	
Carisma	1.8		97-	4G93 SOHC	4	1,1	BKR6E-11	2756	14	BKR6EIX-11	3764	
Carisma 1800 DAO	1.8	85	09.95-	4G93	4	1,1	BKR6E-11	2756	14	BKR6EIX-11	3764	
Carisma GDI	1.8	92	09.97-	4G93 GDI	4	0,8	IZFR6B	3116				
Carisma Elegance GDI	1.8	92	99-	4G93 GDI	4	0,6	IZFR6B	3116				
Carisma 1800 DAO	1.8	103	09.95-	4G93	4	1,1	BKR6E-11	2756	14	BKR6EIX-11	3764	
Carisma TD	1.9	66	10.96-	F8Q	4	█	Y-932R	4956				
Challenger	2.5		11.98-		4	█	Y-733J	8944				
Champ 1300	1.3		94-	4G13	4	0,8	BP5ES	6511	8	BPR5EIX	6597	
Champ 1500	1.5		94-	4G15	4	1,1	BPR5ES-11	4424		BPR5EIX-11	2115	
Colt 1200 C10	1.2	40	85- 88	4G16	4	0,8	BPR6ES	7822	2	BPR6EIX	6637	
Colt 1300	1.3		89- 92	4G13	4	0,8	BPR6ES	7822	2	BPR6EIX	6637	
Colt 1300	1.3		95-	4G13	4	1,1	BPR5ES-11	4424		BPR5EIX-11	2115	
Colt 1300	1.3		97-	4G1	4	1,1	BPR5ES-11	4424		BPR5EIX-11	2115	
Colt 1300	1.3		92-	4G13 / MPI	4	1,1	BPR5ES-11	4424		BPR5EIX-11	2115	
Colt 1300	1.3	55	93- 94	4G13 / MPI	Cat.	4	1,1	BPR6ES-11	4824	13	BPR6EIX-11	3903
Colt 1300	1.3	55	03.96-	4G13	4	1,1	BUR6EA-11	5428				
Colt 1300	1.3	60	09.00-		4	1,1	BKR6E-11	2756	14	BKR6EIX-11	3764	
Colt 1400	1.4		- 87		4	0,8	BPR6ES	7822	2	BPR6EIX	6637	
Colt 1500	1.5			4G15	Cat.	4	1,1	BPR6ES-11	4824	13	BPR6EIX-11	3903
Colt 1500	1.5		-12.93	4G15	4	0,8	BPR6ES	7822	2	BPR6EIX	6637	
Colt 1500	1.5	69	94-	4G15	4	0,8	BP5ES	6511	8	BPR5EIX	6597	
Colt 1600	1.6		97-	4G9 MVV	4	1,1	BKR5E-11	6953		BKR5EIX-11	5464	
Colt 1600 Turbo	1.6		01.86- 88		4	0,8	BPR6ES	7822	2	BPR6EIX	6637	
Colt 1600 Turbo	1.6		(85)		4	0,8	BPR7ES	2023	19	BPR7EIX	4055	
Colt 1600	1.6		95- 96	4G92 MPI MVV	4	1,1	BKR5E-11	6953		BKR5EIX-11	5464	
Colt 1600	1.6		92- 93	4G92	4	1,1	BKR6E-11	2756	14	BKR6EIX-11	3764	
Colt 1600	1.6				4	0,8	BPR6ES	7822	2	BPR6EIX	6637	
Colt 1600	1.6		97-	4G9(not MVV Magermix)	4	1,1	BKR6E-11	2756	14	BKR6EIX-11	3764	
Colt	1.6	66	03.96-	4G92	4	1,1	BKR6E-11	2756	14	BKR6EIX-11	3764	
Colt 1600	1.6	66	03.96-	4G92	4	1,1	BKR6E-11	2756	14	BKR6EIX-11	3764	
Colt 1600 16V	1.6	83	12.91-	4G92	4	0,8	BPR6ES	7822	2	BPR6EIX	6637	
Colt 1600	1.6	83	94- 95	4G92 MPI	4	1,1	BKR6E-11	2756	14	BKR6EIX-11	3764	
Colt 1800	1.8			4G67	Cat.	4	0,8	BPR7ES	2023	19	BPR7EIX	4055
Colt 1800	1.8			4G67	Cat.	4	0,8	BPR7ES	2023	19	BPR7EIX	4055
Colt 1800 GTI 16V	1.8	103	94-	4G93 MPI	4	1,1	BKR6E-11	2756	14	BKR6EIX-11	3764	
Cordia	1.6		82-	4G32	4	0,9	BPR5ES	7422	6	BPR5EIX	6597	
Cordia Turbo	1.6	84	- 84	4G32	4	0,8	BPR6ES	7822	2	BPR6EIX	6637	
Cordia Turbo	1.8	100	85- 88	4G62 / G62B Turbo	4	0,8	BR7ES	5122				
Debonair 3000			91-	6G72	4	0,8	BP5ES	6511	8	BPR5EIX	6597	
Debonair 3000			- 88	6G72	4	0,8	BP5ES	6511	8	BPR5EIX	6597	
Debonair 3000			89- 90	6G72	4	0,8	PGR6A-11	3738				
Diamante 3000	3.0		94-	6G72 MPI SOHC	6	1,1	BPR6ES-11	4824	13	BPR6EIX-11	3903	
Diamante 3000	3.0		94-	6G72 MPI DOHC	6	0,8	BK6E	3536				
Eclipse	2.0		97-	4G6	4	1,1	BPR6ES-11	4824	13	BPR6EIX-11	3903	
Eclipse 2000 D30	2.0	107	11.95-	4G63	4	1,1	BUR7EA-11	7031				

¹⁾ Bic = Best in class (siehe Seite 3) / (see page 3)



l kW

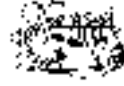

Cyl.

Order-
No. No.Bic¹⁾ Order-
No.**MITSUBISHI**

Eclipse 2000	2.0	110	91-10.95	4G63 MPI DOHC	4	0,8	BPR7ES	2023	19	BPR7EIX	4055
Expo 1800 LRV	1.8		94-	4G93 MPI	4	1,1	BKR5E-11	6953		BKR5EIX-11	5464
Expo 2400 / LRV	2.4	113	94-	4G64 MPI SOHC	4	1,1	BKR5E-11	6953		BKR5EIX-11	5464
Express	2.0			4G63	4	0,7	BP6ES	7811	4	BPR6EIX	6637
Express	2.4			4G64	4	0,7	BP6ES	7811	4	BPR6EIX	6637
FTO	1.8			4G93	4	1,1	BKR5E-11	6953		BKR5EIX-11	5464
FTO with MIVEC Front Bank	2.0			6A12 MIVEC	4		BKR7EKC-N	2095			
FTO without MIVEC Rear Bank	2.0			6A12	4	1,1	PFR6G-11	5555			
FTO without MIVEC Front Bank	2.0			6A12	4	1,1	BKR6E-11	2756	14	BKR6EIX-11	3764
FTO with MIVEC Rear Bank	2.0			6A12 MIVEC	4		PFR7M	4877			
Galant 1200	1.2		- 84		4	0,8	BPR6ES	7822	2	BPR6EIX	6637
Galant 1400	1.4		- 84		4	0,9	BPR5ES	7422	6	BPR5EIX	6597
Galant 1600	1.6		85- 87	4G32	4	0,8	BPR6ES	7822	2	BPR6EIX	6637
Galant 1800	1.8		92-	4G37	Cat. 4	1,1	BPR7ES-11	7226			
Galant 1800	1.8		94-	4G93	4	0,8	BK6E	3536			
Galant 1800	1.8		88- 93	4G37	Cat. 4	0,8	BPR6ES	7822	2	BPR6EIX	6637
Galant 1800	1.8		- 91	4G37	Cat. 4	1,1	BPR6ES-11	4824	13	BPR6EIX-11	3903
Galant 1800	1.8	85	93- 94	4G93 MPI	4	1,1	BKR6E-11	2756	14	BKR6EIX-11	3764
Galant	2.0		82- 87	4G63 TURBO	4	0,8	BR7ES	5122			
Galant	2.0		88- 93	4G63 GTi16	4	0,8	BPR7ES	2023	19	BPR7EIX	4055
Galant	2.0		85- 87	4G63	4	0,8	BPR7ES	2023	19	BPR7EIX	4055
Galant Dynamic	2.0		91-	4G63	4	0,8	BPR6ES	7822	2	BPR6EIX	6637
Galant 2000	2.0		92-		Cat. 4	1,1	BPR7ES-11	7226			
Galant 2000	2.0		92-	4G63D	4	0,8	BPR6ES	7822	2	BPR6EIX	6637
Galant 2000	2.0			4G63	Cat. 4	0,8	BPR6ES	7822	2	BPR6EIX	6637
Galant 2000	2.0		(92)	4G63	4	1,1	BPR7ES-11	7226			
Galant	2.0		97-	4G63	4	1,1	BKR6E-11	2756	14	BKR6EIX-11	3764
Galant 2000	2.0		93-	4G63	4	0,8	BK6E	3536			
Galant 2000	2.0			4G63	Cat. 4	1,1	BPR6ES-11	4824	13	BPR6EIX-11	3903
Galant TD (E5..8)	2.0	66	12.93-10.96	4D68 SOHC	4		CY57	5287			
Galant TD (EA)	2.0	66	10.96-02.00	4D68	4		CY57	5287			
Galant 2000	2.0	100	96-	4G63	4	1,1	BKR6E-11	2756	14	BKR6EIX-11	3764
Galant 2000	2.0	101	94-	4G63 MPI	4	1,1	BKR6E-11	2756	14	BKR6EIX-11	3764
Galant 2000 V6	2.0	110	93-	6A12 MPI 24V	4	1,1	PFR6J-11	2743			
Galant 2400	2.4		94-	4G64 MPI DOHC	6	1,1	BPR6ES-11	4824	13	BPR6EIX-11	3903
Galant 2400	2.4		94-	4G64 MPI SOHC	6	1,1	BKR6E-11	2756	14	BKR6EIX-11	3764
Galant GDI	2.4	110	10.98-	4G64 GDI	6	0,6	IZFR5B	4080			
Galant V6	2.5		03.97-	6A13	6	1,1	PFR6G-11	5555			
Galant V6 24V	2.5		95-	6G73 MPI	6	1,1	PFR6J-11	2743			
Galant 2500 V6	2.5	125	93-03.97	6G12 24V	6	1,1	PFR6J-11	2743			
Galant / Sigma			80-	4D55	4		Y-115T1	2189			
Galant / Sigma QGS Typ			80-	4D55 / T	4		Y-115R1	2161			
Galant Station Wagon QGS Typ			83-	4D55	4		Y-115R1	2161			
Galant Wagon TD (EA)	2.0	66	10.96-02.00	4D68	4		CY57	5287			
Galopper Td	2.5	73	98-	D4BH	4		CY57	5287			
Galopper	3.0	104	98-	G6-AT	6	1,1	BPR5ES-11	4424		BPR5EIX-11	2115
L200	1.6			4G32	Cat. 4	0,8	BPR6ES	7822	2	BPR6EIX	6637
L200	1.6		92-	4G32	4	0,9	BPR5ES	7422	6	BPR5EIX	6597
L200	2.0		92-	4G63	4	0,8	BPR6ES	7822	2	BPR6EIX	6637
L200	2.0		- 92	4G63	4	0,8	BPR7ES	2023	19	BPR7EIX	4055
L200	2.4	82	94-	4G64 MPI	4	1,1	BPR6ES-11	4824	13	BPR6EIX-11	3903
L200	2.4	97	99-		4	1,1	BPR6ES-11	4824	13	BPR6EIX-11	3903

¹⁾ Bic = Best in class (siehe Seite 3) / (see page 3)



ℓ kW

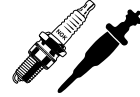

Cyl.

Order-
No. No.Bic¹⁾ Order-
No. No.**MITSUBISHI**

L200	2.5		- 93	4D5	4	█	Y-115T1	2189				
L200	2.5		99-	4D56	4	█	Y-733J	8944				
L200 (KOT-K3T) ohne Schnellstartanlage	2.5	51	11.93-05.94	4D56 without QGS	4	█	Y-733J	8944				
L200 (KOT-K3T)	2.5	51	06.94-08.96	4D56 SOHC	4	█	CY57	5287				
L200	2.6		- 92	4G54	4	1,1	BPR6ES-11	4824	13	BPR6EIX-11	3903	
L200	2.6		95-	G54B	4	1,1	BUR6EA-11	5428				
L200	2.6	76	93-	4G54/B	4	1,1	BPR6ES-11	4824	13	BPR6EIX-11	3903	
L200 / 4WD	2.3		04.83-10.86	4D55	4	█	Y-115T1	2189				
L300	1.4		94-	4G33	4	0,7	BP6ES	7811	4	BPR6EIX	6637	
L300	1.6	51	80- 94	4G32	4	0,9	BPR5ES	7422	6	BPR5EIX	6597	
L300	2.0		10.94-	4G63 MPI	4	1,1	BKR5E-11	6953		BKR5EIX-11	5464	
L300	2.0		95-	4G63 FBC	4	1,1	BKR5E-11	6953		BKR5EIX-11	5464	
L300	2.0		- 92	4G63	4	0,8	BPR6ES	7822	2	BPR6EIX	6637	
L300	2.0	66	92-	4G63	Cat.	4	0,8	BPR6ES	7822	2	BPR6EIX	6637
L300	2.0	85	07.94-	4G63	4	0,9	BPR5ES	7422	6	BPR5EIX	6597	
L300	2.4	82	92-	4G64	Cat.	4	1,1	PGR6A-11	3738			
L300	2.5		97-	4D56	4	█	Y-733J	8944				
L300	2.5		- 92	4D5	4	█	Y-115T1	2189				
L300 TD (P)	2.5	64	06.93- 96	4D56 SOHC	4	█	CY57	5287				
L300 / 4WD	2.3		04.83-	4D55	4	█	Y-115T1	2189				
L300 / 4WD QGS Type	2.3			4D55	4	█	Y-115R1	2161				
L400			95- 97	4D56	4	█	CY57	5287				
L400	2.0		95-	4G63 MPI	4	1,1	BKR5E-11	6953		BKR5EIX-11	5464	
L400	2.4		95-	4G64 MPI	4	1,1	BKR5E-11	6953		BKR5EIX-11	5464	
L400	2.5		98-	4D56	4	█	Y-733J	8944				
L400 TD	2.5	73	12.94-	4D56	4	█	CY57	5287				
Lancer 1200	1.2		08.84- 89	4G16	4	0,8	BPR6ES	7822	2	BPR6EIX	6637	
Lancer 1300	1.3		97-	4G1	4	1,1	BPR5ES-11	4424		BPR5EIX-11	2115	
Lancer 1300	1.3		10.92-	4G13	4	0,8	BP5ES	6511	8	BPR5EIX	6597	
Lancer 1300	1.3		89- 92	4G13	4	0,8	BPR6ES	7822	2	BPR6EIX	6637	
Lancer 1300	1.3		-09.92	4G13	Cat.	4	0,8	BPR6ES	7822	2	BPR6EIX	6637
Lancer	1.3	55	03.96-	4G13	4	1,1	BUR6EA-11	5428				
Lancer 1300	1.3	55	10.92-	4G13 MPI	4	1,1	BPR5ES-11	4424		BPR5EIX-11	2115	
Lancer	1.5		01.84-07.84	4G15	4	0,8	BPR5ES	7422	6	BPR5EIX	6597	
Lancer 1500	1.5		94-	4G91 MPI	4	1,1	BK6E-11	7340				
Lancer 1500	1.5		86- 92	4G15	Cat.	4	1,1	BPR6ES-11	4824	13	BPR6EIX-11	3903
Lancer 1500	1.5		08.84- 92	4G15	4	0,8	BPR6ES	7822	2	BPR6EIX	6637	
Lancer 1500	1.5	69	93-	4G15	4	0,8	BP5ES	6511	8	BPR5EIX	6597	
Lancer 1600	1.6		94-	4G92 MVV	4	1,1	BKR5E-11	6953		BKR5EIX-11	5464	
Lancer 1600 Twin Carb.	1.6				4	0,8	BPR6ES	7822	2	BPR6EIX	6637	
Lancer 1600 Turbo	1.6		(85)	4G32T	4	0,8	BPR7ES	2023	19	BPR7EIX	4055	
Lancer 1600	1.6		90-09.92	4G61 DOHC	4	0,8	BPR6ES	7822	2	BPR6EIX	6637	
Lancer 1600	1.6		97-	4G9 MVV	4	1,1	BKR5E-11	6953		BKR5EIX-11	5464	
Lancer 1600	1.6		97-	4G9 (not MVV Magermix)	4	1,1	BKR6E-11	2756	14	BKR6EIX-11	3764	
Lancer 1600 Turbo	1.6		86- 88	4G32T	4	0,8	BPR6ES	7822	2	BPR6EIX	6637	
Lancer 1600	1.6	83	10.92-	4G92 MPI	4	1,1	BKR6E-11	2756	14	BKR6EIX-11	3764	
Lancer	1.8		90- 92	4G37 GTi16	4	0,8	BPR6ES	7822	2	BPR6EIX	6637	
Lancer	1.8		93-	4G93 GTi16	4	1,1	BKR6E-11	2756	14	BKR6EIX-11	3764	
Lancer	1.8		90- 92	4G37 GLXi	4	1,1	BPR6ES-11	4824	13	BPR6EIX-11	3903	
Lancer 1800	1.8			4G37	Cat.	4	1,1	BPR6ES-11	4824	13	BPR6EIX-11	3903
Lancer 1800 16V	1.8		93-	4G93 MPI	4	0,8	BK6E	3536				
Lancer 1800	1.8			4G67	4	0,8	BPR7ES	2023	19	BPR7EIX	4055	

¹⁾ Bic = Best in class (siehe Seite 3) / (see page 3)



l kW

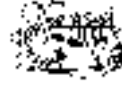

Cyl.

Order-
No. No.Bic¹⁾ Order-
No.**MITSUBISHI**

Lancer (CB/CD)	2.0	50	12.93-06.96	4D68	4	☑	CY57	5287				
Lancer Evolution-V	2.0				4	0,8	PGR7A	3200				
Lancer Evolution-VI Tommi Makinen Edit.	2.0		01.99-		4	0,8	IGR7A	7509				
Lancer Evolution-VI (CP9A)	2.0	206	02.98-05.99	4G63 TURBO	4	0,8	PGR7A	3200				
Lancer Evolution-VII	2.0	206	01-		4	0,8	IGR7A-G	3106				
Laser 1800	1.8			4G37	4	1,1	BPR6ES-11	4824	13	BPR6EIX-11	3903	
Laser 2000	2.0			4G63	4	1,1	BPR6ES-11	4824	13	BPR6EIX-11	3903	
Laser 2000 Turbo	2.0			4G63	4	0,8	BPR6ES	7822	2	BPR6EIX	6637	
Mirage	1.5		94-	4G15 MPI	4	1,1	BPR5ES-11	4424		BPR5EIX-11	2115	
Mirage	1.8		94-	4G93 MPI	4	1,1	BKR5E-11	6953		BKR5EIX-11	5464	
Montero			92- 93	4D56	4	☑	Y-115T1	2189				
Montero			85-	4D55T			only OE					
Montero			94- 95	4D56	4	☑	CY57	5287				
Montero			83-	4D55 QGS Type	4	☑	Y-115R1	2161				
Montero			83-	4D55	4	☑	Y-115T1	2189				
Montero			96-	4D56	4	☑	Y-733J	8944				
Montero V6 3000	3.0		91-	6G72	6	1,1	BPR5ES-11	4424		BPR5EIX-11	2115	
Multicar M25		40	01.91-	VW028B-1Y	4	☑	Y-918R	4182				
Multicar M26		40	01.91-	VW028B-1Y	4	☑	Y-918R	4182				
Outlander	2.0	100	05.03-	4G63	4	1,1	IGR6A-11					
Pajero			85-	4D55T	4		only OE					
Pajero			92- 93	4D56	4	☑	Y-115T1	2189				
Pajero				4D56 S-QGS Type	4		only OE					
Pajero Sport			97-	4D56-QGS	4		only OE					
Pajero	2.4		97-	4G64	4	1,1	BPR6ES-11	4824	13	BPR6EIX-11	3903	
Pajero 2400	2.4		03.91-	4G64	4	1,1	BPR6ES-11	4824	13	BPR6EIX-11	3903	
Pajero TD Intercooler (IV)	2.5	62	08.93-05.99	4D56 T	4	☑	Y-733J	8944				
Pajero TD not QGS Type	2.5	62	06.86-	4D56 Turbo not QGS Type		☑	Y-115T1	2189				
Pajero TD Intercooler (V)	2.5	73	11.93-01.98	4D56 T	4	☑	CY57	5287				
Pajero 2600	2.6			4G54	4	0,9	BPR5ES	7422	6	BPR5EIX	6597	
Pajero 2600	2.6		92-		4	1,1	BP6ES-11	1212				
Pajero 2600	2.6			4G54	Cat. 4	1,1	BPR5ES-11	4424		BPR5EIX-11	2115	
Pajero (V4..)	2.8	92	06.94-04.00	4M40	4	☑	CY55	3861				
Pajero Sport	3.0		99-	6G72 24Ventiler	6	1,1	PFR6J-11	2743				
Pajero 3000 V6	3.0		89-	6G72	6	1,1	BPR5ES-11	4424		BPR5EIX-11	2115	
Pajero	3.0		97-	6G72 12Ventiler	6	1,1	BPR5ES-11	4424		BPR5EIX-11	2115	
Pajero	3.0	130	97-	6G72 24Ventiler	6	1,1	PFR6J-11	2743				
Pajero	3.5	143	97-	6G74	6	1,1	PFR5J-11	4642				
Pajero GDI V60	3.5	149	00-		6	0,6	IZFR5B	4080				
Pajero 3500 V6	3.5	153	04.94- 97	6G74 DOHC	6	1,1	PFR6J-11	2743				
Pajero Pinin (H66W,H67W)	1.8	88	00-	4G93 GDI	4	0,6	IZFR6B	3116				
Pajero Pinin (H76W,H77W)	2.0	95	09.00-	4G94 GDI	4	0,6	IZFR5B	4080				
Sapporo 1200	1.2				4	0,8	BPR6ES	7822	2	BPR6EIX	6637	
Sapporo 1400	1.4				4	0,9	BPR5ES	7422	6	BPR5EIX	6597	
Sapporo 1600 Twin Carb.	1.6				4	0,8	BPR6ES	7822	2	BPR6EIX	6637	
Sapporo 1600	1.6				4	0,9	BPR5ES	7422	6	BPR5EIX	6597	
Sapporo 2000	2.0		81- 84	4G63	4	0,8	BPR6ES	7822	2	BPR6EIX	6637	
Sapporo 2400	2.4			4G64	4	1,1	BPR7ES-11	7226				
Shogun	2.3		01.84-09.86	4D55	4	☑	Y-115R1	2161				
Shogun	2.3		01.84-09.86	4D55	4	☑	Y-115T1	2189				
Shogun	2.5		94- 95	4D56	4	☑	CY57	5287				
Shogun	2.5		85-12.90	4D56	4	☑	Y-115T1	2189				

¹⁾ Bic = Best in class (siehe Seite 3) / (see page 3)



ℓ kW

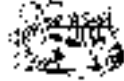

Cyl.

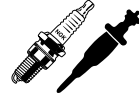
Order-
No. No.Bic¹⁾ Order-
No. No.**MITSUBISHI**

Shogun	2.5		01.96-03.00	4D56	4	█	Y-733J	8944				
Shogun	2.6		83- 90	4G54	4	0.8	BPR5ES	7422	6	BPR5EIX	6597	
Shogun	2.6		83- 90	4G54	4	0.8	BPR5ES	7422	6	BPR5EIX	6597	
Shogun	3.0		94-	6G72	6	1,1	PFR6J-11	2743				
Shogun	3.0		91- 94	6G72	6	1,1	BPR5ES-11	4424		BPR5EIX-11	2115	
Shogun	3.0		91- 94	6G72	6	1,1	BPR5ES-11	4424		BPR5EIX-11	2115	
Shogun	3.0		83- 90	6G72	6	1,1	BPR5ES-11	4424		BPR5EIX-11	2115	
Shogun	3.5		00-		6	0.8	IZFR5B	4080				
Shogun	3.5		91-	6G74	6	1,1	PFR5J-11	4642				
Shogun PININ	1.8		00-	4G93 GDI	4	0.8	IZFR6B	3116				
Shogun PININ	2.0		00-	4G94 GDI	4	0.8	IZFR5B	4080				
Sigma			80-	4D55		█	Y-115T1	2189				
Sigma			80-	4D55 / T QGS Type		█	Y-115R1	2161				
Sigma V6	3.0		91- 93	6G72 DOHC 24V	6	1,1	PFR6J-11	2743				
Sigma V6	3.0		91- 93	6G72 SOHC	6	1,1	BPR6ES-11	4824	13	BPR6EIX-11	3903	
Sigma 3000	3.0		94-	6G72 MPI V6-24V	6	1,1	PFR6J-11	2743				
Sigma 3000	3.0		93-	6G72 MPI V6	6	1,1	BPR6ES-11	4824	13	BPR6EIX-11	3903	
Space Gear	2.0		97-	4G69	4	1,1	BKR5E-11	6953		BKR5EIX-11	5464	
Space Gear	2.0	83	04.95-	4G63 MPI	4	1,1	BKR5E-11	6953		BKR5EIX-11	5464	
Space Gear	2.4	97	04.95-	4G64 MPI	4	1,1	BKR5E-11	6953		BKR5EIX-11	5464	
Space Gear	2.5		98-	4D56 Turbo	4	█	Y-733J	8944				
Space Gear	2.5	73	06.94-05.95	4D56 Turbo	4	█	Y-733J	8944				
Space Gear	2.5	73	12.94-	4D56	4	█	CY57	5287				
Space Runner 1800	1.8		94-	4G93	4	0.8	BK6E	3536				
Space Runner	1.8		97-	4G93	4	1,1	BKR6E-11	2756	14	BKR6EIX-11	3764	
Space Runner 1800	1.8	90	09.91- 92	4G93	4	1,1	BKR6E-11	2756	14	BKR6EIX-11	3764	
Space Runner 1800	1.8	90	94-	4G93 MPI	4	1,1	BKR6E-11	2756	14	BKR6EIX-11	3764	
Space Star GDI	1.8	92	99-	4G93 GDI	4	0,6	IZFR6B	3116				
Space Runner	2.0	60	06.93-	4D68	4	█	CY57	5287				
Space Runner	2.0	100	99-	4G63 MPI	4	1,1	BKR6E-11	2756	14	BKR6EIX-11	3764	
Space Runner GDI	2.4	110	99-	4G64 GDI	4	0,6	IZFR5B	4080				
Space Star 1300	1.3	63	12.98-	4G13	4	1,1	BKR5E-11	6953		BKR5EIX-11	5464	
Space Star	1.6		99-	4G92	4	1,1	BKR5E-11	6953		BKR5EIX-11	5464	
Space Star 1600	1.6	72	12.98-	4G16	4	1,1	BKR5E-11	6953		BKR5EIX-11	5464	
Space Star 1800 GDI	1.8	90	03.99-	4G93	4	0,8	IZFR6B	3116				
Space Star 1.9 DI-D	1.9	75	00-	DCI Renault	4	█	Y-515J	1019				
Space Wagon			86- 88		4	0,8	BPR6ES	7822	2	BPR6EIX	6637	
Space Wagon			(85)		4	0,8	BPR7ES	2023	19	BPR7EIX	4055	
Space Wagon 1800	1.8		84- 91	4G37	4	0,8	BPR6ES	7822	2	BPR6EIX	6637	
Space Wagon 1800	1.8		09.91- 93	4G93	4	1,1	BKR6E-11	2756	14	BKR6EIX-11	3764	
Space Wagon 1800	1.8		94-	4G93 MPI	4	1,1	BKR6E-11	2756	14	BKR6EIX-11	3764	
Space Wagon 1800	1.8		94-	4G93	4	0,8	BK6E	3536				
Space Wagon 2000 4WD	2.0		89-		4	0,8	BPR7ES	2023	19	BPR7EIX	4055	
Space Wagon	2.0		97-	4G63	4	1,1	BKR5E-11	6953		BKR5EIX-11	5464	
Space Wagon 2000	2.0		89-	4G63	Cat.	4	1,1	BPR7ES-11	7226			
Space Wagon (N)	2.0	60	06.93-	4D68	4	█	CY57	5287				
Space Wagon 2000	2.0	98	92-	4G63 MPI	Cat.	4	1,1	BKR6E-11	2756	14	BKR6EIX-11	3764
Space Wagon GDI (N84W,N94W)	2.4	110	10.98-07.00	4G64 GDI	4	0,6	IZFR5B	4080				
Starion 2000	2.0				4	0,8	BPR7ES	2023	19	BPR7EIX	4055	
Starion Turbo	2.0		82- 88	4G63	4	0,8	BR7ES	5122				
Starion 2600 Turbo	2.6		89-	4G54	Cat.	1,1	BPR6ES-11	4824	13	BPR6EIX-11	3903	
Tredia	1.6		86-		4	0,9	BPR5ES	7422	6	BPR5EIX	6597	

¹⁾ Bic = Best in class (siehe Seite 3) / (see page 3)



l kW

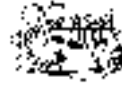

Cyl.

Order-
No. No.Bic¹⁾ Order-
No. No.**MITSUBISHI**

Tredia	1.6		(85)		4	0,8	BPR6ES	7822	2	BPR6EIX	6637
Tredia Turbo	1.6		82- 84	4G32 TURBO	4	0,8	BPR6ES	7822	2	BPR6EIX	6637
Tredia Turbo	1.8	100	01.85-07.86	4G37T	4	0,8	BR7ES	5122			
Truck / 4WD			83-	4D55T			Y-115R1	2161			

MORGAN

4/4	1.6	71	01.82- 93	CVH Ford	4	0,8	BCPR6ES	2330	12	BCPR6EIX-11	4919	
4/4	1.6	72	01.82-	132D.000	4	0,6	BP6ES	7811	4	BPR6EIX	6637	
4/4	1.8	89	02.93-	Zetec 16V	4	1,3	PTR5A-13 *	2467	25			
Aero 8.	4.4	210	00-	BMW M62B44	8		BKR6EQUIP	3199	30			
Plus 4	2.0	90	01.85- 86	132C3.000	4	0,6	BP6ES	7811	4	BPR6EIX	6637	
Plus 4	2.0	98	09.87- 92	M16i	4	0,8	BCPR6ES	2330	12	BCPR6EIX-11	4919	
Plus 4	2.0	99	09.92- 96	T16	4	0,8	BCPR6ES	2330	12	BCPR6EIX-11	4919	
Plus 8	3.5	116	08.77-01.90	V8 Rover	8	0,8	BP6ES	7811	4	BPR6EIX	6637	
Plus 8	3.5	136	01.90- 01	V8 Rover	Cat.	8	0,8	BP6ES	7811	4	BPR6EIX	6637
Plus 8	3.5	142	01.90- 01	V8 Rover	8	0,8	BP6ES	7811	4	BPR6EIX	6637	
Plus 8	4.0		01-	ROVER V8	8	1,1	PFR6N-11	3546				
Plus 8	4.6		97- 99	ROVER V8	8	1,1	PFR6N-11	3546				

MOSKWICZ

2136,2138	1.4				4	0,8	BP5HS	4111			
2140,2141			74-		4	0,7	BP7ES	2412		BPR7EIX	4055
Aleko	1.5		-12.00		4	0,8	BP7ES	2412		BPR7EIX	4055
Aleko S / SL	1.6		-12.00		4	0,8	BP5ES	6511	8	BPR5EIX	6597
Aleko	1.6		-12.00		4	0,7	BP6ES	7811	4	BPR6EIX	6637
Aleko	1.8	70	12.86-12.00		4	0,8	BPR6ES	7822	2	BPR6EIX	6637
Aleko	2.0	83	01.86-12.00	REN-F3R	4	0,9	BPR5ES	7422	6	BPR5EIX	6597
Ish 2126	1.5		09.87-		4	0,7	BP6ES	7811	4	BPR6EIX	6637

NISSAN

100 NX	B13	1.6	66	10.90- 95	GA16DE	Cat.	4	0,9	BKR6E	6962	28	BKR6EIX	6418
100 NX	B13	1.6	66	10.90- 93	GA16DS	Cat.	4	0,9	BKR6E	6962	28	BKR6EIX	6418
100 NX	B13	1.6	75	94-	GA16DE		4	0,9	BKR5E	7938		BKR5EIX	6341
100 NX	B13	2.0	105	10.90- 95	SR20DE	Cat.	4	0,9	BKR6EY	3696		BKR6EIX	6418
200 SX Turbo	S13	1.8	124	89- 93	CA18DET		4	1,1	PFR6A-11	4045			
200 SX Turbo	S14	2.0	147	08.94-	SR20DET		4	0,9	PFR6B-9	3100			
200 SX Turbo	S30	1.8	124	09.88-	CA18DET	Cat.	4	1,1	PFR6A-11	4045			
200 SX Turbo	S30	1.8	129	09.88-	CA18DET		4	1,1	BCPR6ES-11	7121	11	BCPR6EIX-11	4919
300 ZX	Z31	3.0	122	01.84- 89	VG30		6	1,1	BCPR6ES-11	7121	11	BCPR6EIX-11	4919
300 ZX	Z32	3.0		90-	VG30DE		6	1,1	PFR6B-11	4014			
300 ZXTT Biturbo	Z32	3.0	197	90- 95	VG30DETT		6	1,1	PFR6B-11	4014			
300 ZX Biturbo	Z32	3.0	206	01.90- 95	VG30DETT	Cat.	6	1,1	PFR6B-11	4014			
300 ZXT Turbo	Z31	3.0	149	02.87- 90	VG30ET	Cat.	6	1,1	BCPR6E-11	3132	11	BCPR6EIX-11	4919
300 ZX Turbo	Z31	3.0	169	01.84- 87	VG30T		6	1,1	BCPR6E-11	3132	11	BCPR6EIX-11	4919
350 Z		3.5	206	09.03-	VQ35DE		6	1,1	PLFR5A-11	6240			
Almera	N15	1.4	55	09.95-	GA14DE		4	0,8	BKR5E	7938		BKR5EIX	6341
Almera	N15	1.6	66	09.95-	GA16DE		4	0,8	BKR5E	7938		BKR5EIX	6341
Almera	N15	1.6	66	95- 00	QG15DE		4	1,1	BKR5E-11	6953		BKR5EIX-11	5464
Almera	N15 / Hatchback	2.0	55	07.95- 00	CD20E		4		CY52	3017			
Almera dCi	N16	1.5	60	01.03-	K9K		4		Y-515J	1019			
Almera	N16	1.5	66	02.00-09.02	QG15DE		4	1,1	BKR5E-11	6953		BKR5EIX-11	5464
Almera	N16	1.5	72	10.02-	QG15DE		4	1,1	LFR5A-11	6376			

¹⁾ Bic = Best in class (siehe Seite 3) / (see page 3)

* Standardtype TR5A-10 / standard type TR5A-10



ℓ kW

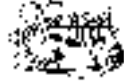

Cyl.

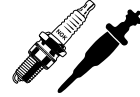
Order-
No. No.Bic¹⁾ Order-
No.**NISSAN**

Almera	N16	1.8	84	02.00-09.02	QG18DE	4	1,1	BKR5E-11	6953		BKR5EIX-11	5464	
Almera	N16	1.8	85	10.02-	QG18DE	4	1,1	LFR5A-11	6376				
Almera	N16	2.2	82	02.00- 03	YD22DDT	4	█	Y-519J	2500				
Almera Gti	N15	2.0	105	95-	SR20DE	4	1,1	BKR5EY-11	2355		BKR5EIX-11	5464	
Almera Tino	ATV10	1.8	84	00- 02	QG18DE	4	1,1	BKR5E-11	6953		BKR5EIX-11	5464	
Almera Tino	ATV10	1.8	85	03-	QG18DE	4	1,1	LFR5A-11	6376				
Almera Tino	ATV10	2.0	100	00- 02	SR20DE	4	1,1	PFR6G-11	5555				
Almera Tino	2.2 VDI	2.2	84	04.02-	YD22ET	4	█	Y-519J	2500				
Axxess	M11	2.4		93-	KA24E	6	1,1	ZFR5E-11	4435				
Bluebird		1.8		90-	CA18S	4	0,8	BCP5ES	7496	16	BCPR5EIX-11	3306	
Bluebird		1.8		- 89	CA18S	4	0,8	BPR6ES	7822	2	BPR6EIX	6637	
Bluebird		1.8		90-	CA18NS	4	0,8	BCP5ES	7496	16	BCPR5EIX-11	3306	
Bluebird	T12	1.6	66	12.85- 88	CA16S	4	0,8	BCPR6ES	2330	12	BCPR6EIX-11	4919	
Bluebird	T12	2.0	77	12.85-	CA20S	4	0,8	BCPR6ES	2330	12	BCPR6EIX-11	4919	
Bluebird	T72	1.6		- 88	CA16	4	0,8	BCPR5ES	6130	32	BCPR5EIX-11	3306	
Bluebird	T72	1.6	62	09.88-	CA16S	4	0,8	BCPR6ES	2330	12	BCPR6EIX-11	4919	
Bluebird	T72	2.0	77	09.88- 92	CA20S	4	0,8	BCPR6ES	2330	12	BCPR6EIX-11	4919	
Bluebird	T72	2.0	85	09.88-	CA20E	4	1,1	BCPR6ES-11	7121	11	BCPR6EIX-11	4919	
Bluebird	U11	1.8	66	11.83-01.86	CA18S	4	0,8	BPR6ES	7822	2	BPR6EIX	6637	
Bluebird	U11	2.0	75	11.83-01.86	CA20S	4	0,8	BCPR6ES	2330	12	BCPR6EIX-11	4919	
Bluebird	U13	1.6		94-	CA16NS	4	0,8	BCP5ES	7496	16	BCPR5EIX-11	3306	
Bluebird	U13	2.0		93-	CA20E	4	1,1	BCPR6ES-11	7121	11	BCPR6EIX-11	4919	
Bluebird	U13	2.0		93-	CA20S	4	0,7	BCP6ES	4930	17	BCPR6EIX-11	4919	
Bluebird 16V	T12	1.8	99	11.88- 90	CA18DE	Cat.	4	1,1	PFR6A-11	4045			
Bluebird 16V	T72	1.8	95	02.89- 90	CA18DE	Cat.	4	1,1	PFR6A-11	4045			
Bluebird 4X EX + 4X IN	T12	2.0	77	03.86- 92	CA20E Twin Spark	Cat.	4	1,1	BCPR5ES-11+ BCPR6ES-11	3524+ 7121		BCPR5EIX-11+ BCPR6EIX-11	3306+ 4619
Bluebird 4X EX + 4X IN	T72	2.0	77	09.88- 90	CA20E Twin Spark	Cat.	4	1,1	BCPR5ES-11+ BCPR6ES-11	3524+ 7121		BCPR5EIX-11+ BCPR6EIX-11	3306+ 4619
Bluebird 4X EX + 4X IN	U11	2.0	77	04.86- 90	CA20E Twin Spark	Cat.	4	1,1	BCPR5ES-11+ BCPR6ES-11	3524+ 7121		BCPR5EIX-11+ BCPR6EIX-11	3306+ 4619
Bluebird Turbo	T12	1.8	88	12.85-	CA18T	4	1,1	BCPR6ES-11	7121	11	BCPR6EIX-11	4919	
Bluebird Turbo	T72	1.8	99	09.88-	CA18T	4	1,1	BCPR6ES-11	7121	11	BCPR6EIX-11	4919	
Bluebird Turbo	U11	1.8	100	11.83-01.86	CA18ET	4	1,1	BCPR6ES-11	7121	11	BCPR6EIX-11	4919	
Bluebird/819/910		2.0		01.82- 87	LD20, LD20T	4	█	Y-204RS	4573				
Bluebird/819/910	T12	2.0	47	12.85-02.90	LD20	4	█	CY51	2696				
Bluebird/819/910	T72	2.0	49	09.88-04.90	LD20	4	█	CY51	2696				
Bluebird/819/910	QGS Type 1	2.0		01.81-	LD20, LD20T	4	█	Y-204RS	4573				
Bluebird/819/910	QGS Type 1	2.8		08.81-	LD28		█	Y-204RS	4573				
Bluebird/819/910	QGS Type 2	2.0		01.81-	LD20, LD20T	4	█	Y-204SS	7629				
Bluebird/819/910	QGS Type 2	2.8		08.81-	LD28		█	Y-204SS	7629				
Bluebird/Hatchback	T12	2.0	47	12.85-02.90	LD20	4	█	CY51	2696				
Bluebird/Hatchback	T72	2.0	49	09.88-04.90	LD20	4	█	CY51	2696				
Brougham		2.3		93-	TD23		█	Y-707RS	4937				
Brougham		3.0			VG30E	6	1,1	BCP6ES-11	7210		BCPR6EIX-11	4919	
C120 / Vanette		2.0		87-	LD20		█	CY51	2696				
C120 / Vanette	QGS Type 1	2.0		09.82-	LD20		█	Y-204RS	4573				
Caball		2.2		82-	SD22		█	Y-112R1	1032				
Caball		3.0		12.81-	ED30		█	Y-272R-1	2731				
Cabstar		2.2		01.82-	SD22		█	Y-112R1	1032				
Cabstar		2.3			TD23		█	Y-707RS	4937				
Cabstar		2.3			SD23		█	Y-112M1	2531				

¹⁾ Bic = Best in class (siehe Seite 3) / (see page 3)



l kW

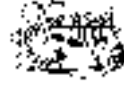

Cyl.

Order-
No. No.Bic¹⁾ Order-
No.**NISSAN**

Cabstar		2.5						SD25			Y-112M1	2531					
Cabstar		2.5						TD25			Y-707RS	4937					
Cabstar		2.7						TD27			Y-707RS	4937					
Cabstar		3.3						ED33			Y-272R-1	2731					
Cabstar		3.3						ED33			Y-955RS	4995					
Cabster		2.3						TD23			Y-707RS	4937					
Cabster		3.3						ED33			Y-955RS	4995					
Cabster	F23/H41	1.6		93-				Z16	4	0,8	BP5ES	6511	8	BPR5EIX		6597	
Cabster	F23/H41	2.0						Z20S,NA20S	4	0,9	BPR5ES	7422	6	BPR5EIX		6597	
Cabster	F23/H41	2.0		93-				Z20	4	0,8	BP5ES	6511	8	BPR5EIX		6597	
Cabster	F23/H41	2.4		93-				Z24	6	0,7	BP6ES	7811	4	BPR6EIX		6637	
Cabster	F23 & H41	2.5						TD25			Y-707RS	4937					
Cabster	F23 & H41	2.7						TD27			Y-707RS	4937					
Cedric		2.0	92	07.87-				VG20E	4	1,1	BCPR6ES-11	7121	11	BCPR6EIX-11		4919	
Cedric		3.0	118	07.87-				VG30E	6	1,1	BCPR6ES-11	7121	11	BCPR6EIX-11		4919	
Cedric	430	2.4	81	07.79-06.87				L24	6	0,8	BPR6ES	7822	2	BPR6EIX		6637	
Cedric	430	2.8	92	07.79-06.87				L28	6	0,8	BPR6ES	7822	2	BPR6EIX		6637	
Cedric Turbo		3.0	144	07.87-				VG30ET	6	1,1	BCPR6ES-11	7121	11	BCPR6EIX-11		4919	
Cedric Turbo 24V		2.0	136	07.87-				VG20DET	6	1,1	BCPR6ES-11	7121	11	BCPR6EIX-11		4919	
Cedric/220C/280C		2.0		06.79-				SD20			Y-112T	6327					
Cedric/220C/280C		2.2		06.79-				SD22			Y-112T	6327					
Cedric/220C/280C		2.3		84-				SD23			Y-112R1	1032					
Cedric/220C/280C		2.3						TD23			Y-707RS	4937					
Cedric/220C/280C QGS Type 1		2.8		06.82-				LD28			Y-204RS	4573					
Cedric/220C/280C QGS Type 1		2.8		06.82-				LD28			Y-204RS	4573					
Cedric/220C/280C QGS Type 2		2.8		06.82-				LD28			Y-204SS	7629					
Cherry	N12	1.0	37	05.82-05.86				E10	4	0,9	BPR5ES	7422	6	BPR5EIX		6597	
Cherry	N12	1.3	44	05.82-05.86				E13	4	0,9	BPR5ES	7422	6	BPR5EIX		6597	
Cherry	N12	1.5	51	05.82-05.86				E15	4	0,9	BPR5ES	7422	6	BPR5EIX		6597	
Cherry Turbo	N12	1.5	77	07.83-05.86				E15T	4	0,8	BPR6ES	7822	2	BPR6EIX		6637	
Cherry	N12	1.6	51	06.85-05.86				E16	4	1,1	BPR5ES-11	4424		BPR5EIX-11		2115	
Cherry	N12	1.7	45	87-				CD17	4		CY51	2696					
Chery	N12 QGS Type 1	1.7		10.82-				CD17			Y-117RS	2930					
Chery	N12 QGS Type 2	1.7		10.82-				CD17			Y-117SS	2231					
Civilian		2.2		82-				SD22			Y-112R1	1032					
Civilian		3.0		12.81-				ED30			Y-272R-1	2731					
Civilian		3.3		04.88-				ED33			Y-955RS	4995					
Civilian		3.3		(87)				ED33			Y-272R-1	2731					
Clipper		2.2		82-				SD22			Y-112R1	1032					
Clipper		3.0		12.81-				ED30			Y-272R-1	2731					
D21		1.6						Z 16S	4	0,7	BP6ES	7811	4	BPR6EIX		6637	
D21		2.0						Z 20S	4	0,8	BPR6ES	7822	2	BPR6EIX		6637	
D21		2.4						Z 24S	4	0,9	BPR5ES	7422	6	BPR5EIX		6597	
D21		2.5		93-				TD25			Y-707RS	4937					
D21		2.7		93-				TD27			Y-707RS	4937					
D21		2.7		93-				TD27T			Y-712RS	6140					
D21		3.0						VG30E	6	0,9	BKR6EY	3696		BKR6EIX		6418	
EXA		1.8						CA18DE	4	1,1	PFR6A-11	4045					
F22		2.3						TD23			Y-707RS	4937					
F22		2.3						SD23			Y-162R1	2431					
F22		2.5						TD25			Y-707RS	4937					
F22		2.5						SD25			Y-162R1	2431					

¹⁾ Bic = Best in class (siehe Seite 3) / (see page 3)



ℓ kW

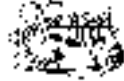

Cyl.

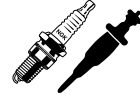
Order-
No. No.Bic¹⁾ Order-
No.**NISSAN**

F22		2.5		12.81-	SD25			Y-112M1	2531				
F22		2.7			TD27			Y-707RS	4937				
F22		3.3			ED33			Y-955RS	4995				
F22	QGS Type 1	2.3		02.82-	SD23			Y-112RS1	1132				
Hommer		2.2		01.82-	SD22			Y-112R1	1032				
Infiniti	G20	2.0		94-	SR20DE	4	0,9	BKR6E	6962	28	BKR6EIX	6418	
Junior		2.5			SD25			Y-112M1	2531				
Kubistar	X76	1.1	43	03-	D7F	4	0,8	BKR5EK	7956	23	BKR5EIX	6341	
Laurel		2.4	83	- 85	L24	6	0,8	BPR6ES	7822	2	BPR6EIX	6637	
Laurel	C32 (1,2,3 CYL)	2.8		02.87-	RD28T	6		CZ51	3209				
Laurel	C32 (4,5,6 CYL)	2.8		02.87-	RD28T	6		CX51	2896				
Laurel	QGS Type 1	2.8		10.81-	LD28			Y-204RS	4573				
Laurel	QGS Type 2	2.8		10.81-	LD28			Y-204SS	7629				
Laurel	A31	2.0		94-	RB20E	4	1,1	BCPR5ES-11	3524		BCPR5EIX-11	3306	
Laurel	A31	2.0		93-	CA20S	4	0,7	BCP6ES	4930	17	BCPR6EIX-11	4919	
Laurel	A31	2.4		94-	RB24S	6	0,9	BKR6E	6962	28	BKR6EIX	6418	
Laurel	C32	2.0	77	01.85-	CA20S	4	0,8	BCPR6ES	2330	12	BCPR6EIX-11	4919	
Laurel	C32	2.4	81	01.85-	L24S	6	0,8	BPR6ES	7822	2	BPR6EIX	6637	
Laurel	C32	2.4	93	01.85-	L24E	6	1,1	BCPR6ES-11	7121	11	BCPR6EIX-11	4919	
Laurel	C32	3.0	112	03.86-	VG30E	Cat.	6	0,9	BCPR6EY	1146			
Laurel	C32	3.0	122	01.85-	VG30S		6	1,1	BCP6ES-11	7210		BCPR6EIX-11	4919
Maxima QX	A32	2.0	103	95- 00	VQ20DE	6	1,1	PFR6G-11	5555				
Maxima QX	A32	3.0	141	95- 00	VQ30DE	6	1,1	PFR6G-11	5555				
Maxima	A33	2.0	103	00-	VQ20DE	6	1,1	PFR6G-11	5555				
Maxima	A33	3.0	147	00-	VQ30DE	6	1,1	PFR6G-11	5555				
Maxima	J30	3.0			VG30DE	6	1,1	PFR5C-11	2271				
Maxima	J30	3.0	125	10.88- 95	VG30E	6	1,1	BKR6ES-11	5553	14	BKR6EIX-11	3764	
Micra	K9	1.5		04.84-	TUD5	4		Y-731U	5274				
Micra	K10	1.0	37	12.82- 92	MA10S	4	0,9	BPR5ES	7422	6	BPR5EIX	6597	
Micra	K10	1.0	40	93-	MA10	4	0,9	BPR5ES	7422	6	BPR5EIX	6597	
Micra	K10	1.2	40	01.86- 93	MA12	4	1,1	BPR5ES-11	4424		BPR5EIX-11	2115	
Micra	K10	1.2	42	07.86-11.88	MA12S	Cat.	4	1,1	BPR5ES-11	4424		BPR5EIX-11	2115
Micra	K10	1.2	44	07.86-11.88	MA12S		4	1,1	BPR5ES-11	4424		BPR5EIX-11	2115
Micra Super S	K10	1.3	55	93-	CG13DE	4	1,1	BKR5E-11	6953		BKR5EIX-11	5464	
Micra 16V	K11	1.0	40	93- 00	CG10DE	Cat.	4	1,1	BKR5E-11	6953		BKR5EIX-11	5464
Micra	K11	1.0	44	00- 02	CG10DE		4	1,1	BKR5E-11	6953		BKR5EIX-11	5464
Micra 16V	K11	1.3	55	93- 00	CG13DE	Cat.	4	1,1	BKR5E-11	6953		BKR5EIX-11	5464
Micra 16 V Sport	K11	1.3	60	00- 02	CGA3DE		4	1,1	BKR5E-11	6953		BKR5EIX-11	5464
Micra	K12	1.2	48	02.03-	CR12DE	4	1,1	LFR5AP-11	4775				
Micra	K12	1.2	59	02.03-	CR12DE	4	1,1	LFR5AP-11	4775				
Micra	K12	1.4	65	02.03-	CR14DE	4	1,1	LFR5AP-11	4775				
Micra dCi	K12	1.5	48	04.03-	K9K	4		Y-515J	1019				
Micra dCi	K12	1.5	60	09.03-	K9K	4		Y-515J	1019				
Murano 3.5	E51 /NE51	3.5	183	12.02-	VQ35DE	6	1,1	PLFR5A-11	6240				
Nomad		2.0			LD20			CY51	2696				
Pathfinder	D21	2.0			Z20S	4	0,8	BPR6ES	7822	2	BPR6EIX	6637	
Pathfinder	D21	2.4			Z24i	6	0,9	BPR5ES	7422	6	BPR5EIX	6597	
Pathfinder	D21	2.4			KA24	6	1,1	ZFR5E-11	4435				
Pathfinder	D21	2.4			Z24S	6	0,8	BPR6ES	7822	2	BPR6EIX	6637	
Pathfinder	D21	2.5		93-	TD25			Y-707RS	4937				
Pathfinder	D21	2.7		93-	TD27			Y-707RS	4937				
Pathfinder	D21	2.7		93-	TD27T			Y-712RS	6140				

¹⁾ Bic = Best in class (siehe Seite 3) / (see page 3)



l kW

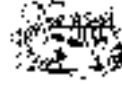

Cyl.

Order-
No. No.Bic¹⁾ Order-
No. No.**NISSAN**

Pathfinder	D21	3.0			VG30i	6	1,1	BCPR5ES-11	3524		BCPR5EIX-11	3306	
Pathfinder	D21	3.0		92-	VG30E	6	0,9	BKR6EY	3696		BKR6EIX	6418	
Pathfinder	R50	3.3	110	97- 00	VG33E V6	6	1,1	BKR5ES-11	2382		BKR5EIX-11	5464	
Pathfinder	R50	3.3	110	92-12.00	VG33E V6	6	1,1	BKR5E-11	6953		BKR5EIX-11	5464	
Pathfinder	R50	3.5	162	01.00-	VQ35E V6	6	1,1	PLFR5A-11	6240				
Patrol		2.7		02.93-	TD27			Y-707RS	4937				
Patrol / 160/Y60 (4,5,6 Cyl CX51.) (1,2,3 Cyl.CZ51)		2.8			RD28T			CX51+	2896+				
								CZ51	3209				
Patrol Y61		2.8	95	04.98-	RD28	6		CX51+	2896+				
								CZ51	3209				
Patrol		3.3		-11.84	SD33T	24V	6	Y-162R1	2431				
Patrol		3.3		-11.84	SD33T	12V	6	Y-112M1	2531				
Patrol		3.3		11.84-	SD33	12V	6	Y-705RS	1249				
Patrol		3.3		11.84-	SD33T	12V	6	Y-705RS	1249				
Patrol		3.3		11.84-	SD33T	24V	6	Y-755RS	7771				
Patrol		3.3		11.84-	SD33	24V	6	Y-755RS	7771				
Patrol		4.2		- 92	TB42S		6	0,8	BP5ES	6511	8	BPR5EIX	6597
Patrol		4.2			TD42	24V	6	Y-757RS	4018				
Patrol		4.2			TD42	12V	6	Y-707RS	4937				
Patrol		4.5		98-	TB45E		6	1,1	BPR5E-11	5638		BPR5EIX-11	2115
Patrol	160	2.8	88	07.80-08.88	L28		6	0,8	BPR6ES	7822	2	BPR6EIX	6637
Patrol	160	4.0	101	11.79-06.85	P40		6	0,9	BPR5ES	7422	6	BPR5EIX	6597
Patrol	260	2.8	88	02.87-03.89	L28		6	0,8	BPR6ES	7822	2	BPR6EIX	6637
Patrol	Y60	4.2		93-	TB42E		6	0,9	BPR5E	7281	6	BPR5EIX	6597
Patrol	Y60	4.2		95-	TB42S		6	0,7	BP6ES	7811	4	BPR6EIX	6637
Patrol	Y60	4.2		93- 94	RB42S		6	0,9	BPR5E	7281	6	BPR5EIX	6597
Patrol	Y60 & 260	2.0		04.89-	RB30S		4	0,9	BKR6E	6962	28	BKR6EIX	6418
Patrol 160		4.2		-12.98	TD42		6	Y-757RS	4018				
Patrol 160		4.2		-12.98	TD42		6	Y-707RS	4937				
Pick Up		3.0		93-	VG30E		6	0,9	BKR6EY	3696		BKR6EIX	6418
Pick Up		3.0		90-	VG30I		6	1,1	BCPR5ES-11	3524		BCPR5EIX-11	3306
Pick Up	720	1.6		08.79-09.85	J16		4	0,9	BPR5ES	7422	6	BPR5EIX	6597
Pick Up	720	1.8	59	08.79-09.85	L18		4	0,9	BPR5ES	7422	6	BPR5EIX	6597
Pick Up	720	2.2	71	03.86-04.93	Z22		4	0,7	BP6ES	7811	4	BPR6EIX	6637
Pick Up	B120	1.2		93-	A12		4	0,8	BP5ES	6511	8	BPR5EIX	6597
Pick Up	B120	1.2			A12S		4	0,9	BPR5ES	7422	6	BPR5EIX	6597
Pick Up	B120	1.5			A15S		4	0,9	BPR5ES	7422	6	BPR5EIX	6597
Pick Up	D21	1.6		09.85-	Z16		4	0,8	BPR6ES	7822	2	BPR6EIX	6637
Pick Up	D21	2.0		09.85-04.92	Z20		4	0,8	BPR6ES	7822	2	BPR6EIX	6637
Pick Up	D21	2.0		04.92-	Z20S		4	0,8	BPR6ES	7822	2	BPR6EIX	6637
Pick Up	D21	2.4	74	09.85-04.92	Z24		4	0,8	BPR6ES	7822	2	BPR6EIX	6637
Pick Up	D21	2.4	76	10.88-04.92	Z24i		4	0,8	BPR6ES	7822	2	BPR6EIX	6637
Pick Up	D22	2.4	88	98- 01	KA24E		4	1,1	ZFR5E-11	4435			
Pick Up	D22	2.4	98	02-	KA24E		4	1,1	BKR6E-11	2756	14	BKR6EIX-11	3764
Pick Up	MD21	2.4	93	94- 98	KA24E		4	1,1	ZFR5E-11	4435			
Pick-up		2.7			TD27T			Y-712RS	6140				
Pick-up	QGS Type 2	2.3		84- 86	SD23			Y-112M1	2531				
Pick-up	QGS Type 2	2.5		84- 86	SD25			Y-112M1	2531				
Pick-up / 720		2.3		87-	SD23			Y-705RS	1249				
Pick-up / 720		2.5			TD25			Y-707RS	4937				
Pick-up / 720		2.5		87-	SD25			Y-705RS	1249				
Pick-up / 720		2.7			TD27			Y-707RS	4937				

¹⁾ Bic = Best in class (siehe Seite 3) / (see page 3)



ℓ kW

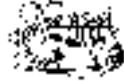

Cyl.

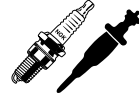
Order-
No. No.Bic¹⁾ Order-
No.**NISSAN**

Pick-up / 720	QGS Type 1	2.3		84- 86	SD23		█	Y-112R1	1032				
Pick-up / 720	QGS Type 1	2.5		83- 86	SD25		█	Y-112R1	1032				
Prairie	M10	1.5	51	01.83-09.88	E15S	4	0,9	BPR5ES	7422	6	BPR5EIX	6597	
Prairie	M10	1.8	66	07.83-09.88	CA18S	4	0,8	BPR6ES	7822	2	BPR6EIX	6637	
Prairie	M10	2.0	67	01.86-09.88	CA20S	4	0,8	BPR6ES	7822	2	BPR6EIX	6637	
Prairie	M11	2.0		90- 92	CA20S	4	0,8	BCPR6ES	2330	12	BCPR6EIX-11	4919	
Prairie	M11	2.0	67	10.88- 89	CA20S	4	0,8	BPR6ES	7822	2	BPR6EIX	6637	
Prairie	M11	2.0	98	93- 95	CA20S	4	0,7	BCP6ES	4930	17	BCPR6EIX-11	4919	
Prairie	M11	2.4	98	94- 95	KA24E		1,1	ZFR5E-11	4435				
Prairie	M11	3.0	98	92- 95	KA24E	4	1,1	ZFR5E-11	4435				
Prairie 4 x EX + 4 x IN	M10	2.0	72	01.86-09.88	CA20E Twin Spark	Cat.	4	1,1	BCPR5ES-11+	3524+	BCPR5EIX-11+	3306+	
									BCPR6ES-11	7121	BCPR6EIX-11	4619	
Prairie 4 x EX + 4 x IN	M11	2.0	72	10.88- 92	CA20E Twin Spark	Cat.	4	1,1	BCPR5ES-11+	3524+	BCPR5EIX-11+	3306+	
									BCPR6ES-11	7121	BCPR6EIX-11	4619	
Prairie 4 x EX + 4 x IN	M11	2.0	73	10.88- 92	CA20E Twin Spark		4	1,1	BCPR5ES-11+	3524+	BCPR5EIX-11+	3306+	
									BCPR6ES-11	7121	BCPR6EIX-11	4619	
Prairie 4 x EX + 4 x IN	M11	2.0	98	93- 95	CA20E Twin Spark		4	1,1	BCPR5ES-11+	3524+	BCPR5EIX-11+	3306+	
									BCPR6ES-11	7121	BCPR6EIX-11	4619	
President	H250	4.4		93-	Y44S	6	0,9	BP4ES	6928				
Primastar J4		2.0	88	03-	F4R	4	0,8	BKR6EZ	4619		BKR6EIX	6418	
Primera 1.9 dCi		1.9	88	09.03-	F9Q...	4	█	Y-515J	1019				
Primera P10E		2.0	55	01.91-06.96	CD20	4	█	CY52	3017				
Primera 16V		2.0	96	09.96-	SR20DE	4	1,1	BKR5EY-11	2355		BKR5EIX-11	5464	
Primera Di		2.2	93	03.02-	YD22ET	4	█	Y-519J	2500				
Primera	P10	1.6	66	93- 96	GA16DE	4	0,9	BKR5E	7938		BKR5EIX	6341	
Primera	P10	1.6	66	93-	GA16DS	4	0,9	BKR6EY	3696		BKR6EIX	6418	
Primera	P10	2.0	85	93- 96	SR20DE	4	0,9	BKR5EY	7390		BKR5EIX	6341	
Primera	P10E	1.6	66	06.90- 93	GA16DS	Cat.	4	0,9	BKR6E	6962	28	BKR6EIX	6418
Primera	P10E	1.6	70	06.90- 92	GA16DS		4	0,9	BKR6E	6962	28	BKR6EIX	6418
Primera	P10E	2.0	85	06.90- 96	SR20Di		4	0,9	BKR5EY	7390		BKR5EIX	6341
Primera	P10E	2.0	89	06.90- 96	SR20Di SPI		4	0,9	BKR5EY	7390		BKR5EIX	6341
Primera	P10E	2.0	110	06.90- 96	SR20DE EGI	Cat.	4	0,9	BKR6EY	3696		BKR6EIX	6418
Primera 16V	P11	1.6	66	09.96- 00	GA16DE		4	0,8	BKR5E	7938		BKR5EIX	6341
Primera	P11	1.6	74	96-	GA16DE		4	0,8	BKR6E	6962	28	BKR6EIX	6418
Primera	P11	1.6	78	02.00-07.02	QG16DE		4	1,1	BKR5E-11	6953		BKR5EIX-11	5464
Primera	P11	1.8	83	02.00- 02	QG18DE		4	1,1	BKR5E-11	6953		BKR5EIX-11	5464
Primera 16V	P11	2.0	85	09.96- 99	SR20DE		4	1,1	BKR5EY-11	2355		BKR5EIX-11	5464
Primera	P11	2.0	91	96- 99	SR20DE		4	0,9	BKR5EY	7390		BKR5EIX	6341
Primera 16V	P11	2.0	96	09.96- 99	SR20DE		4	1,1	BKR5EY-11	2355		BKR5EIX-11	5464
Primera	P11	2.0	103	00- 02	SR20DE		4	1,1	PFR6G-11	5555			
Primera	P11	2.0	109	96- 99	SR20DE		4	0,9	BKR5EY	7390		BKR5EIX	6341
Primera	P11	2.0	110	06.97- 99	SR20DE		4	0,9	BKR6EY	3696		BKR6EIX	6418
Primera	P12	1.8	85	03.02-	QG18DE		4	1,1	LFR5A-11	6376			
Primera Traveller	P12	1.8	85	03.02-	QG18DE		4	1,1	LFR5A-11	6376			
Primera	P12	2.0	103	03.02-	QR20DE		4	1,1	LFR5A-11	6376			
Primera	W10	1.6	66	07.90- 93	GA16DS	Cat.	4	0,9	BKR6E	6962	28	BKR6EIX	6418
Primera	W10	1.6	66	93- 97	GA16DE		4	0,9	BKR5EY	7390		BKR5EIX	6341
Primera	W10	1.6	66	93-	GA16DS		4	0,9	BKR6E	6962	28	BKR6EIX	6418
Primera	W10	1.6	70	07.90- 93	GA16DS		4	0,9	BKR6E	6962	28	BKR6EIX	6418
Primera / Wagon	W10	2.0	55	07.90-04.96	CD20		4	█	CY52	3017			
Primera	W10	2.0	85	07.90- 96	SR20Di		4	0,9	BKR5EY	7390		BKR5EIX	6341
Primera	W10	2.0	89	07.90- 96	SR20Di SPI		4	0,9	BKR5EY	7390		BKR5EIX	6341

¹⁾ Bic = Best in class (siehe Seite 3) / (see page 3)



l kW

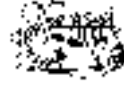

Cyl.

Order-
No. No.Bic¹⁾ Order-
No. No.**NISSAN**

Primera GT	(made in UK)	2.0	110	04.97-	SR20DE	4	1,1	BKR5EY-11	2355		BKR5EIX-11	5464	
Pulsar	N12	1.3	55	04.82-05.86	E13	4	0,8	BP5ES	6511	8	BPR5EIX	6597	
Pulsar	N12	1.5	63	04.82-05.86	E15	4	0,8	BP5ES	6511	8	BPR5EIX	6597	
Pulsar	N13	1.0	37	06.86-	E10S	4	0,8	BP5ES	6511	8	BPR5EIX	6597	
Pulsar	N13	1.3	50	06.86-	E13S	4	0,8	BP5ES	6511	8	BPR5EIX	6597	
Pulsar	N13	1.4		10.88-	GA14S	4	0,7	BCP6ES	4930	17	BCPR6EIX-11	4919	
Pulsar	N13	1.6		10.88-	GA16S	4	0,7	BCP6ES	4930	17	BCPR6EIX-11	4919	
Pulsar	N13	1.6	54	06.86-	E16i	Cat.	4	1,1	BPR6ES-11	4824	13	BPR6EIX-11	3903
Pulsar	N13	1.6	62	06.86-	E16i		4	1,1	BPR6ES-11	4824	13	BPR6EIX-11	3903
Pulsar	N13	1.6	62	06.86-	E16S		4	0,8	BPR6ES	7822	2	BPR6EIX	6637
Pulsar	N13	1.6	81	02.87-10.88	CA16D DOHC	Cat.	4	1,1	PFR6A-11	4045			
Pulsar	N13	1.6	88	02.87-10.88	CA16D DOHC		4	1,1	BCPR6ES-11	7121	11	BCPR6EIX-11	4919
Pulsar	N13	1.8	92	10.88-	CA18D DOHC		4	1,1	PFR6A-11	4045			
Pulsar / Cherry / N12 QGS Type 1		1.7		10.82-	87 CD17	4		Y-117RS	2930				
Pulsar / Cherry / N12 QGS Type 2		1.7		10.82-	87 CD17	4		Y-117SS	2231				
Pulsar / Cherry / N13		1.7	41	05.86-08.90	CD17	4		CY51	2696				
Pulsar NX		1.6		90-	GA16i	4	1,1	BCPR5ES-11	3524		BCPR5EIX-11	3306	
Santana Turbo		1.6	53	01.84-01.87	CY	4		Y-918R	4182				
Sentra	QGS Type 1	1.7		10.82-	86 CD17	4		Y-117RS	2930				
Sentra		1.7		87-	CD17	4		CY51	2696				
Sentra	QGS Type 2	1.7		10.82-	86 CD17	4		Y-117SS	2231				
Serena	C23	1.6	71	07.93-	GA16DE	Cat.	4	0,9	BKR5E	7938	BKR5EIX	6341	
Serena	C23	2.0	93	01.92-	SR20DE	Cat.	4	0,9	BKR5EY	7390	BKR5EIX	6341	
Serena	C23	2.3	55	01.95-02.98	LD23	4		Y-712RS	6140				
Serena	C23M	2.0	49	07.92-01.96	LD20	4		CY51	2696				
Silvia	S12	2.0	107	10.83-	CA20E	4	0,7	BCP6ES	4930	17	BCPR6EIX-11	4919	
Silvia	S12	2.0	107	10.83-	FJ20E	4	1,1	BPR6ES-11	4824	13	BPR6EIX-11	3903	
Silvia	S12	2.0	111	10.83-	FJ20E	4	1,1	BPR6ES-11	4824	13	BPR6EIX-11	3903	
Silvia RS12 4x EX + 4 x IN		1.8	90	89- 95	CA18E	4	1,1	BCPR5ES-11+	3524+		BCPR5EIX-11+	3306+	
								BCPR6ES-11	7121		BCPR6EIX-11	4619	
Silvia Turbo	S12	1.8	90	10.83-	CA18ET	Cat.	4	1,1	BCPR6ES-11	7121	11	BCPR6EIX-11	4919
Silvia Turbo	S12	1.8	101	10.83-	CA18ET		4	1,1	BCPR6ES-11	7121	11	BCPR6EIX-11	4919
Silvia Turbo 4x EX + 4 x IN S12(CH)		1.8	90	10.83-	95 CA18ET	Cat.	4	1,1	BCPR5ES-11+	3524+		BCPR5EIX-11+	3306+
								BCPR6ES-11	7121		BCPR6EIX-11	4619	
Skyline		1.8		10.77-08.85	L18	4	0,8	BP5ES	6511	8	BPR5EIX	6597	
Skyline		2.0	72	09.85-	CA20S	4	0,7	BCP6ES	4930	17	BCPR6EIX-11	4919	
Skyline		2.8			L28S	6	0,8	BPR6ES	7822	2	BPR6EIX	6637	
Skyline / 180K	QGS Type 1	2.0		10.81-	LD20	4		Y-204RS	4573				
Skyline / 180K	QGS Type 1	2.8		10.81-	LD28			Y-204RS	4573				
Skyline / 180K	QGS Type 2	2.0		10.81-	LD20	4		Y-204SS	7629				
Skyline / 180K	QGS Type 2	2.8		08.81-	LD28			Y-204SS	7629				
Stanza		2.0			CA20S	4	1,1	BCPR6ES-11	7121	11	BCPR6EIX-11	4919	
Stanza	T11	1.6	60	08.81-12.85	CA16S	4	0,8	BPR6ES	7822	2	BPR6EIX	6637	
Stanza	T11	1.8	65	08.81-12.85	CA18S	4	0,8	BPR6ES	7822	2	BPR6EIX	6637	
Stanza / T11		1.7			CD17T	4		Y-120RS	7463				
Stanza / T11		2.0		87-	LD20	4		CY51	2696				
Stanza 4 x EX + 4 x IN		2.0			CA20 Twin Spark	4	1,1	BPR5ES-11+	4424+		BPR5EIX-11+	2115+	
								BPR6ES-11	4824		BPR6EIX-11	3903	
Stanza 4 x EX + 4 x IN HT11		2.0	77	85- 86	CA20E Twin Spark	4	1,1	BCPR5ES-11+	3524+		BCPR5EIX-11+	3306+	
								BCPR6ES-11	7121		BCPR6EIX-11	4619	
Stanza Turbo		1.8			CA18ET	4	1,1	BCPR6ES-11	7121	11	BCPR6EIX-11	4919	
Sunny	B11	1.3	44	03.82-12.85	E13S	4	0,8	BPR6ES	7822	2	BPR6EIX	6637	

¹⁾ Bic = Best in class (siehe Seite 3) / (see page 3)



ℓ kW

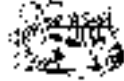

Cyl.

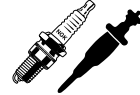
Order-
No. No.Bic¹⁾ Order-
No.**NISSAN**

Sunny	B11	1.5	51	03.82-05.88	E15S		4	0,8	BPR6ES	7822	2	BPR6EIX	6637
Sunny	B11	1.6	51	03.85-05.88	E16	Cat.	4	1,1	BPR6ES-11	4824	13	BPR6EIX-11	3903
Sunny	B12	1.0	37	01.86-09.88	E10S		4	0,9	BPR5ES	7422	6	BPR5EIX	6597
Sunny	B12	1.3	44	01.86-	E13S		4	0,9	BPR5ES	7422	6	BPR5EIX	6597
Sunny	B12	1.4		10.88-	GA14S		4	0,8	BCPR6ES	2330	12	BCPR6EIX-11	4919
Sunny	B12	1.5	52	01.86-10.88	E15S		4	0,7	BP6ES	7811	4	BPR6EIX	6637
Sunny	B12	1.6		06.86-10.88	E16i		4	1,1	BPR6ES-11	4824	13	BPR6EIX-11	3903
Sunny	B12	1.6		01.86-10.88	E16i	Cat.	4	1,1	BPR6ES-11	4824	13	BPR6EIX-11	3903
Sunny	B12	1.6		10.88-	GA16S		4	0,8	BCPR6ES	2330	12	BCPR6EIX-11	4919
Sunny	B12	1.6	62	10.88-	CA16S		4	0,8	BCPR6ES	2330	12	BCPR6EIX-11	4919
Sunny	B12	1.6	62	10.88-	CA16S		4	1,1	BPR6ES-11	4824	13	BPR6EIX-11	3903
Sunny	B12	1.6	62	06.86-10.88	E16S		4	0,8	BPR6ES	7822	2	BPR6EIX	6637
Sunny	B12	1.6	66	10.88-	GA16i	Cat.	4	1,1	BCPR6ES-11	7121	11	BCPR6EIX-11	4919
Sunny	B13	1.0		93-	E10S	Cat.	4	0,8	BP5ES	6511	8	BPR5EIX	6597
Sunny	B13	1.3		93-	GA13DS		4	0,9	BKR6E	6962	28	BKR6EIX	6418
Sunny	B13	1.4	55	93-	GA14DS		4	0,8	BKR6E	6962	28	BKR6EIX	6418
Sunny	B13	1.6			GA16DS		4	0,9	BKR6E	6962	28	BKR6EIX	6418
Sunny	B13	1.6			GA16DE		4	0,9	BKR6E	6962	28	BKR6EIX	6418
Sunny	B13	2.0		91-	SR20DE		4	0,9	BKR6EY	3696		BKR6EIX	6418
Sunny	Y10 /B13	1.7	40	93- 96	CD17		4	█	CY51	2696			
Sunny	B14	1.3		95-	GA13DS		4	0,8	BKR6E	6962	28	BKR6EIX	6418
Sunny	B14	1.3		95-	GA13DE		4	1,1	BKR6E-11	2756	14	BKR6EIX-11	3764
Sunny	B14	1.4		95-	GA14DE		4	0,8	BKR6E	6962	28	BKR6EIX	6418
Sunny	B14	1.6		95-	GA16DE		4	1,1	BKR6E-11	2756	14	BKR6EIX-11	3764
Sunny	B14	1.8		95-	GA18DE(B)		4	0,8	BKR6E	6962	28	BKR6EIX	6418
Sunny	B14	1.8		95-	GA18DE(A)		4	1,1	BKR6E-11	2756	14	BKR6EIX-11	3764
Sunny	B14	2.0		95-	SR20DE		4	0,8	BKR6EY	3696		BKR6EIX	6418
Sunny	B14	2.0			CD20		4	█	CY51	2696			
Sunny	N13	1.0		10.88-	E10S		4	0,9	BPR5ES	7422	6	BPR5EIX	6597
Sunny	N13	1.0	37	06.86-10.88	E10S		4	0,8	BPR6ES	7822	2	BPR6EIX	6637
Sunny	N13	1.3	49	06.86-10.88	E13S		4	0,8	BPR6ES	7822	2	BPR6EIX	6637
Sunny	N13	1.4	55	10.88-	GA14S		4	0,7	BCP6ES	4930	17	BCPR6EIX-11	4919
Sunny	N13	1.5	52	06.86-10.88	E15S		4	0,8	BPR6ES	7822	2	BPR6EIX	6637
Sunny	N13	1.6		10.88-	GA16S		4	0,8	BCPR6ES	2330	12	BCPR6EIX-11	4919
Sunny	N13	1.6	54	06.86-	E16i	Cat.	4	1,1	BPR5ES-11	4424		BPR5EIX-11	2115
Sunny	N13	1.6	62	06.86-10.88	E16S		4	0,8	BPR6ES	7822	2	BPR6EIX	6637
Sunny	N13	1.6	62	06.86- 91	E16i		4	1,1	BPR5ES-11	4424		BPR5EIX-11	2115
Sunny	N13	1.6	66	10.88-	GA16i	Cat.	4	1,1	BCP6ES-11	7210		BCPR6EIX-11	4919
Sunny	N13	1.6	88	02.87-10.88	CA16D DOHC		4	1,1	BCPR6ES-11	7121	11	BCPR6EIX-11	4919
Sunny	N13/ B12	1.7		06.86-08.90	CD17		4	█	CY51	2696			
Sunny	N14	1.4	55	10.92- 95	GA14DE		4	0,9	BKR5E	7938		BKR5EIX	6341
Sunny	N14	1.4	55	10.90- 93	GA14DS		4	0,8	BKR5E	7938		BKR5EIX	6341
Sunny	N14	1.6	66	10.90- 93	GA16DS		4	0,9	BKR6E	6962	28	BKR6EIX	6418
Sunny	N14	1.6	66	10.92- 95	GA16DE		4	0,9	BKR5E	7938		BKR5EIX	6341
Sunny	N14	1.6	75	10.92-	GA16DE		4	0,9	BKR5E	7938		BKR5EIX	6341
Sunny	N14	1.7		(91)	CD17		4	█	CY52	3017			
Sunny	N14	2.0		95-	SR20DET		4	0,6	PFR7B	4853			
Sunny	Y10	1.6	66	94-	GA16DS		4	0,9	BKR6E	6962	28	BKR6EIX	6418
Sunny	Y10	1.6	67	94-	SR16DE		4	0,9	BKR5E	7938		BKR5EIX	6341
Sunny	Y10	2.0	105	93-	GA20DE		4	0,9	BKR6EY	3696		BKR6EIX	6418
Sunny	Y10L	1.6	66	10.92- 00	GA16DE		4	0,9	BKR5E	7938		BKR5EIX	6341
Sunny	Y10L	1.6	66	10.90- 93	GA16DS		4	0,9	BKR6E	6962	28	BKR6EIX	6418

¹⁾ Bic = Best in class (siehe Seite 3) / (see page 3)



l kW

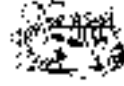

Cyl.

Order-
No. No.Bic¹⁾ Order-
No. No.**NISSAN**

Sunny	Y11	1.7	40	05.92-04.98	CD17	4	█	CY51	2696				
Sunny 16V	B12	1.6	88	01.86-09.88	CA16DE	4	1,1	BCPR6ES-11	7121	11	BCPR6EIX-11	4919	
Sunny GTI	B12	1.6	81	01.86-09.89	CA16DE	4	1,1	PFR6A-11	4045				
Sunny GTI	B12	1.8	92	10.89- 91	CA18DE	4	1,1	PFR6A-11	4045				
Sunny GTI	N13	1.6	81	02.87-10.89	CA16DE.	4	1,1	PFR6A-11	4045				
Sunny GTI	N13	1.8	92	10.89- 91	CA18DE	4	1,1	PFR6A-11	4045				
Sunny GTI	N14	2.0	105	10.90-05.95	SR20DE	Cat. 4	0,9	BKR6EY	3696		BKR6EIX	6418	
Sunny GTI-R	N14	2.0	162	10.93- 95	SR20DET	Cat. 4	0,9	PFR7B-9	4180				
Sunny N14 / Y10 / N15 / B14		2.0	55	10.90-	CD20	4	█	CY52	3017				
Terrano 1		2.0			Z20S	4	0,8	BPR6ES	7822	2	BPR6EIX	6637	
Terrano 1	WD21	2.4	76	08.87-07.92	Z24i	Cat. 6	0,9	BPR5ES	7422	6	BPR5EIX	6597	
Terrano 1	4 x EX + 4 x IN	2.4	76	08.86-	Z24i Twin Spark	4	0,9	BPR5ES	7422	6	BPR5EIX	6597	
Terrano 1		2.5			TD25		█	Y-707RS	4937				
Terrano 1		2.7			TD27		█	Y-707RS	4937				
Terrano 1	WYD21	3.0	95	08.88- 90	VG30i	6	1,1	BCPR5ES-11	3524		BCPR5EIX-11	3306	
Terrano 1	WD/WHYD21	3.0	109	01.90-07.96	VG30E	Cat. 6	0,9	BKR6EY	3696		BKR6EIX	6418	
Terrano 2	R20	2.4	86	05.96- 01	KA24E	6	1,1	ZFR5E-11	4435				
Terrano 2	R20	2.4	87	05.96- 01	KA24E	6	1,1	ZFR5E-11	4435				
Terrano 2	R20	2.4	91	07.93- 96	KA24E	6	1,1	ZFR5E-11	4435				
Terrano 2	not Europe	2.7		07.93-	TD27T		█	Y-712RS	6140				
Terrano 2	only Europa	2.7	92	05.96-	TD27T For EU		█	CY58	5486				
Tino 1.8 16V		1.8	88	99-	NEOQG18DE	4	1,1	BKR5E-11	6953		BKR5EIX-11	5464	
Tino 2.0 16V		2.0	99	99-	SR20DE	4	1,1	PFR6G-11	5555				
Tino 2.0 16V	V10	2.2	84	07.00-	YD22DT	4	█	Y-519J	2500				
Trade JX1100		2.0		03.85-	LD20		█	Y-204RS	4573				
Trade PF1104		2.0	46	10.87-	LD20IIE	4	█	Y-918R	4182				
Urvan	E23	1.8		04.82-02.87	Z18	4	0,9	BPR5ES	7422	6	BPR5EIX	6597	
Urvan	E23	2.0	64	04.82-02.87	Z20	4	0,8	BPR6ES	7822	2	BPR6EIX	6637	
Urvan	E24	2.0		95-	NA20S	4	1,1	BPR6ES-11	4824	13	BPR6EIX-11	3903	
Urvan	E24	2.0	64	11.86-	Z20 OHC	4	0,9	BPR5ES	7422	6	BPR5EIX	6597	
Urvan	E24	2.4		95-	Z24	6	0,7	BP6ES	7811	4	BPR6EIX	6637	
Urvan	E24	2.4	74	05.89- 96	Z24i	6	0,9	BPR5ES	7422	6	BPR5EIX	6597	
Urvan	E24	2.4	74	02.87-	Z24S OHC	6	0,9	BPR5ES	7422	6	BPR5EIX	6597	
Urvan	E24L	2.5		93-	TD25	4	█	Y-707RS	4937				
Urvan	QGS Type 2	2.0		05.82-	LD20T	4	█	Y-204SS	7629				
Urvan	QGS Type 2	2.3		05.82-	SD23	4	█	Y-112M1	2531				
Urvan / E20 / E23 / E24		2.2		09.80-	SD22	4	█	Y-112T	6327				
Urvan / E20 / E23 / E24		2.2		09.80-	SD22	4	█	Y-181T	2728				
Urvan / E20 / E23 / E24		2.3			TD23	4	█	Y-707RS	4937				
Urvan / E20 / E23 / E24		2.3		05.82-	SD23	4	█	Y-162R1	2431				
Urvan / E20 / E23 / E24		2.7		87-	TD27	4	█	Y-707RS	4937				
Urvan / E20 / E23 / E24 QGS Type 1		2.0		05.82-	LD20T	4	█	Y-204RS	4573				
Urvan / E20 / E23 / E24 QGS Type 1		2.3		05.82-	SD23	4	█	Y-112R1	1032				
Vanette		2.0			CD20		█	CY52	3017				
Vanette		2.0		93-	SR20E	4	0,9	BKR5EY	7390		BKR5EIX	6341	
Vanette	C120	1.5	51	06.81-09.86	A15	4	0,9	BPR5ES	7422	6	BPR5EIX	6597	
Vanette	C22	2.4	74	09.86- 93	Z24i	4	0,9	BPR5ES	7422	6	BPR5EIX	6597	
Vanette	GC22	1.5	51	09.86-	A15S	4	0,9	BPR5ES	7422	6	BPR5EIX	6597	
Vanette	GC22	2.0	64	09.86-	Z20S	4	0,8	BPR6ES	7822	2	BPR6EIX	6637	
Vanette	C220	2.0	44	04.87-11.94	LD20 II OHV		█	CY51	2696				
Vanette	C220	2.0	47	01.91-11.94	LD20 IIL	4	█	CY51	2696				
Vanette	GC22	2.0	47	09.86-03.93	LD20 OHV	4	█	CY51	2696				

¹) Bic = Best in class (siehe Seite 3) / (see page 3)



ℓ kW



Cyl.

Order-
No. No.Bic¹⁾ Order-
No.**NISSAN**

Vanette	QGS Type 1	2.0		09.82-	86	LD20		Y-204RS	4573			
Vanette	QGS Type 2	2.0		09.82-	86	LD20		Y-204SS	7629			
Vanette	Cargo	2.0	49	07.92-	09.94	LD20 OHV	4	CY51	2696			
Vanette	Cargo (NL)	1.6	71	03.95-			4	0,8 BKR5E	7938		BKR5EIX	6341
Vanette E	(NL)	1.6	71	03.95-			4	0,8 BKR5E	7938		BKR5EIX	6341
X-Trail	T30	2.0	103	06.01-		QR20DE	4	1,1 LFR5A-11	6376			
X-Trail	T30	2.5	121	03-		QR25DE	4	1,1 LFR5A-11	6376			

NISSAN (Spain)

L 35 D		2.9	56	05.85-			6	Y-902R	2237			
Mot. A 4.28 D		2.8	62	09.87-	05.93	A 4.28	4	Y-902R	2237			
Patrol				-03.88				Y-902R	2237			
Patrol D		2.8	62	09.87-		A 4.28	4	Y-902R	2237			
Trade D		2.8	62	09.87-		A 4.28	4	Y-902R	2237			

NSU

1200C							4	0,6 B7ES	1111			
-------	--	--	--	--	--	--	---	----------	------	--	--	--

OLDSMOBILE

Delta 88		3.8		(95)		V6 MFI K	6	1,5 TR55	1048		TR55IX	7164
Delta 88		3.8		(94)		V6 SFI L	6	1,5 TR55	1048		TR55IX	7164
Delta 88		3.8		(95)		V6 MFI 1 SC	6	1,5 TR55	1048		TR55IX	7164
Delta 88		3.8		96-	99	V6 MFI K	6	1,5 PTR4B-15	5146			
Intrigue		3.5		99-		V6 MFI H	6	1,3 TR55	1048		TR55IX	7164
Intrigue		3.8		98-	99	V6 MFI K	6	1,5 PTR4B-15	5146			
LSS		3.8		96-	99	V6 MFI 1 SC	6	1,5 PTR4B-15	5146			
LSS		3.8		96-	99	V6 MFI K	6	1,5 PTR4B-15	5146			

OPEL

Agila 12V		1.0	43	07.00-		Z10XE	3	0,8 BKR5EK	7956	23	BKR5EIX	6341
Agila 16V		1.2	55	07.00-		Z12XE	4	0,8 BKR5EK	7956	23	BKR5EIX	6341
Arena 1.9D		1.9	44	01.98-		F8Q M6	4	Y-506R	4409			
Arena 2.5D		2.5	55	07.98-		S8U V7	4	Y-908R	4585			
Ascona B		1.3	44	03.79-	08.86	13N OHC	4	0,8 BPR6ES	7822	2	BPR6EIX	6637
Ascona B		1.3	55	08.79-	08.88	13S OHC	4	0,8 BPR6ES	7822	2	BPR6EIX	6637
Ascona B		1.6	51	09.81-	08.88	16N OHC II	4	0,8 BPR6ES	7822	2	BPR6EIX	6637
Ascona C		1.6	40	03.82-	09.88	16 D, DA OHC	4	Y-924U	4950			
Ascona C		1.6	55	09.86-	09.87	C16LZ OHC I	4	1,1 BPR6ES-11	4824	13	BPR6EIX-11	3903
Ascona C		1.6	55	09.87-	09.88	E16NZ OHC	4	0,8 BPR6ES	7822	2	BPR6EIX	6637
Ascona C		1.6	55	09.87-	08.88	C16NZ	4	0,9 BPR5ES	7422	6	BPR5EIX	6597
Ascona C		1.6	60	09.81-	09.88	16SV OHC	4	0,8 BPR6ES	7822	2	BPR6EIX	6637
Ascona C		1.6	60	09.81-	08.88	16SH OHC	4	0,8 BPR6ES	7822	2	BPR6EIX	6637
Ascona C		1.8	62	09.87-	09.88	E18NV OHC II	4	0,8 BPR6ES	7822	2	BPR6EIX	6637
Ascona C		1.8	74	09.82-	09.86	C18NE OHC II	4	0,8 BPR6ES	7822	2	BPR6EIX	6637
Ascona C		1.8	74	01.85-	08.86	C18NE OHC II	4	0,8 BPR6ES	7822	2	BPR6EIX	6637
Ascona C		1.8	74	09.82-	09.86	18E OHC II	4	0,8 BPR6ES	7822	2	BPR6EIX	6637
Ascona C		1.8	82	09.86-	09.88	18SE OHC II	4	0,8 BPR6ES	7822	2	BPR6EIX	6637
Ascona C		1.8	85	09.82-	08.86	18E OHC II	4	0,8 BPR6ES	7822	2	BPR6EIX	6637
Ascona C		2.0	85	09.86-	09.88	20NE	4	0,9 BPR5ES	7422	6	BPR5EIX	6597
Ascona C		2.0	85	09.86-	09.88	C20NE OHC	4	0,9 BPR5ES	7422	6	BPR5EIX	6597
Ascona C		2.0	95	03.87-	09.88	20SEH OHC II	4	0,8 BPR6ES	7822	2	BPR6EIX	6637
Astra F		1.4	44	08.95-	02.98	C14NZ OHC I	4	0,8 BKR5EK	7956	23	BKR5EIX	6341

¹⁾ Bic = Best in class (siehe Seite 3) / (see page 3)



l kW

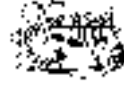

Cyl.

Order-
No. No.Bic¹⁾ Order-
No. No.**OPEL**

Astra F	1.4	44	09.91-07.95	C14NZ	OHC 1	4	0,9	BPR5ES	7422	6	BPR5EIX	6597
Astra F	1.4	44	08.96-02.98	X14NZ	OHC I	4	0,8	BKR5EK	7956	23	BKR5EIX	6341
Astra F	1.4	55	09.91-03.93	14NV	OHC 1	4	0,8	BKR5EK	7956	23	BKR5EIX	6341
Astra F	1.4	60	03.93-07.95	14SE	OHC	4	0,9	BPR5ES	7422	6	BPR5EIX	6597
Astra F	1.4	60	09.91-07.95	C14SE	OHC	4	0,9	BPR5ES	7422	6	BPR5EIX	6597
Astra F	1.4	60	08.95-02.98	14SE	OHC	4	0,8	BKR5EK	7956	23	BKR5EIX	6341
Astra F	1.4	60	08.95-02.98	C14SE	OHC	4	0,8	BKR5EK	7956	23	BKR5EIX	6341
Astra F	1.4	66	02.96-02.98	X14XE	DOHC	4	0,8	BKR5EK	7956	23	BKR5EIX	6341
Astra F	1.6	52	03.93-03.94	X16SZ	OHC	4	0,9	BPR5ES	7422	6	BPR5EIX	6597
Astra F	1.6	52	01.95-02.96	X16SZ	OHC	4	0,8	BKR5EK	7956	23	BKR5EIX	6341
Astra F	1.6	52	04.94-12.94	X16SZ	OHC	4	0,9	BPR5ES	7422	6	BPR5EIX	6597
Astra F	1.6	55	08.95-02.96	C16NZ	OHC	4	0,8	BKR5EK	7956	23	BKR5EIX	6341
Astra F	1.6	55	09.91-07.95	C16NZ	OHC	4	0,9	BPR5ES	7422	6	BPR5EIX	6597
Astra F	1.6	55	09.97-	16NZR	OHC	4	0,8	BKR5EK	7956	23	BKR5EIX	6341
Astra F	1.6	55	08.94-02.98	16LZ2	OHC	4	0,8	BKR5EK	7956	23	BKR5EIX	6341
Astra F	1.6	55	02.96-08.00	X16SZR	OHC	4	0,8	BKR5EK	7956	23	BKR5EIX	6341
Astra F	1.6	74	08.95-02.98	C16SE	OHC I	4	0,8	BKR5EK	7956	23	BKR5EIX	6341
Astra F	1.6	74	02.92-07.95	C16SE	OHC I	4	0,9	BPR5ES	7422	6	BPR5EIX	6597
Astra F	1.6	74	08.94-02.98	X16XEL	DOHC	4	0,8	BKR5EK	7956	23	BKR5EIX	6341
Astra F	1.7	42	09.91-09.92	17 D	OHC II	4	█	Y-924U	4950			
Astra F	1.7	44	09.92-08.94	17 DR		4	█	Y-924U	4950			
Astra F Eco D	1.7	50	08.94-02.98	X17 DTL		4	█	Y-924U	4950			
Astra F TD	1.7	60	12.91-02.98	17DT TC4 EE1 OHC		4	█	CY53	4315			
				Isuzu Mot.956633--->								
Astra F TD	1.7	60	04.96-02.98	X17DT TC4 EE1		4	█	CY53	4315			
				OHC Isuzu Mot.956633--->								
Astra F	1.8	66	08.95-02.98	C18NZ	OHC II	4	0,8	BKR5EK	7956	23	BKR5EIX	6341
Astra F	1.8	66	09.91-07.95	C18NZ	OHC II	4	0,9	BPR5ES	7422	6	BPR5EIX	6597
Astra F 16V	1.8	85	02.96-02.98	X18XE	DOHC	4	0,8	BKR5EK	7956	23	BKR5EIX	6341
Astra F 16V	1.8	85	02.94-03.96	C18XEL	DOHC	4	0,8	BKR5EK	7956	23	BKR5EIX	6341
Astra F 16V	1.8	92	05.93-04.94	C18XE	DOHC II	4	0,8	BKR5EK	7956	23	BKR5EIX	6341
Astra F	2.0	85	09.91-07.95	C20NE	OHC II	4	0,9	BPR5ES	7422	6	BPR5EIX	6597
Astra F	2.0	85	08.95-02.98	C20NE	OHC II	4	0,8	BKR5EK	7956	23	BKR5EIX	6341
Astra F 16V	2.0	100	02.95-02.98	X20XE	DOHC	4	0,8	BKR5EK	7956	23	BKR5EIX	6341
Astra F 16V	2.0	110	09.91-08.92	C20XE	DOHC	4	0,8	BKR6EK	2288	20**	BKR6EQUP	3199
Astra F 16V	2.0	110	09.92-02.98	C20XE-LN	DOHC I	4	0,8	BKR5EK	7956	23	BKR5EIX	6341
Astra F 16V	2.0	110	09.91-08.92	C20XE-LN	DOHC I	4	0,8	BKR6EK	2288	20**	BKR6EQUP	3199
Astra F 16V	2.0	110	09.92-02.98	C20XE	DOHC	4	0,8	BKR5EK	7956	23	BKR5EIX	6341
Astra G 16V	1.2	48	03.98- 00	X12XE	DOHC	4	0,8	BKR5EK	7956	23	BKR5EIX	6341
Astra G	1.2	55	08.00-	Z12XE		4	0,8	BKR5EK	7956	23	BKR5EIX	6341
Astra G 16V	1.4	66	03.98-	X14XE	DOHC	4	0,8	BKR5EK	7956	23	BKR5EIX	6341
Astra G	1.4	66	08.00-	Z14XE	DOHC	4	0,8	BKR5EK	7956	23	BKR5EIX	6341
Astra G 16V	1.6	55	03.98-08.00	X16SZR		4	0,8	BKR5EK	7956	23	BKR5EIX	6341
Astra G	1.6	62	08.00-	Z16SE		4	0,8	BKR5EK	7956	23	BKR5EIX	6341
Astra G 16V	1.6	74	08.00-	Z16XE		4	0,8	BKR5EK	7956	23	BKR5EIX	6341
Astra G 16V	1.6	74	03.98-	X16XEL		4	0,8	BKR5EK	7956	23	BKR5EIX	6341
Astra G D	1.7	50	02.98-	X17 DTL		4	█	Y-924U	4950			
Astra G DTI 16V	1.7	55	09.99-	Y17DT		4	█	only OE				
Astra G 16V	1.8	85	03.98-	X18XE1		4	0,8	BKR5EK	7956	23	BKR5EIX	6341
Astra G 16V	1.8	92	08.00-	Z18XE		4	0,8	BKR5EK	7956	23	BKR5EIX	6341
Astra G DTI 16V	2.0	60	02.98-	X20DTL	SOHC	4	█	Y-748U	5000			
Astra G DTI II	2.0	60	08.00-	Y20DTL		4	█	Y-748U	5000			

¹⁾ Bic = Best in class (siehe Seite 3) / (see page 3)

** alternative/wahlweise V-Line 30



ℓ kW

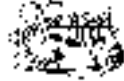

Cyl.

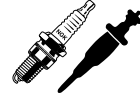
Order-
No. No.Bic¹⁾ Order-
No.**OPEL**

Astra G DTI II 16V	2.0	74	08.00-	Y20DTH	4	█	Y-523J	3703				
Astra G 16V	2.0	100	03.98-	X20XE	4	0,8	BKR5EK	7956	23	BKR5EIX	6341	
Astra G 16V	2.0	118	10.99-	X20XER DOHC	4	0,8	BKR5EK	7956	23	BKR5EIX	6341	
Astra G 16V Turbo	2.0	140	09.00-	Z20LET	4	0,8	BKR5EK	7956	23	BKR5EIX	6341	
Bedford Blitz D		46	09.80-		4	█	Y-208T	1250				
Calibra	2.0	85	08.95-08.97	C20NE OHC II	4	0,8	BKR5EK	7956	23	BKR5EIX	6341	
Calibra	2.0	85	06.90-07.95	C20NE OHC II	4	0,9	BPR5ES	7422	6	BPR5EIX	6597	
Calibra 16V	2.0	100	11.93-08.97	X20XE DOHC	4	0,8	BKR5EK	7956	23	BKR5EIX	6341	
Calibra 16V	2.0	110	09.92-02.94	C20XE	4	0,8	BKR5EK	7956	23	BKR5EIX	6341	
Calibra 16V	2.0	110	02.90-08.92	C20XE	4	0,8	BKR6EK	2288	20**	BKR6EQUIP	3199	
Calibra 16V	2.0	110	06.90-04.97	C20XE-LN DOHC	4	0,8	BKR6EK	2288	20**	BKR6EQUIP	3199	
Calibra Turbo	2.0	150	03.92-08.97	C20LET DOHC	4	1,1	ZFR6F-11	4291		ZFR6FIX-11	6441	
Calibra	2.5	125	09.93-08.97	C25XE DOHC	6	0,8	BKR5EK	7956	23	BKR5EIX	6341	
Campo	2.3	66	11.88-09.91	4ZD1	4	0,8	BPR6ES	7822	2	BPR6EIX	6637	
Campo	2.3	72	08.94-08.95	4ZD1	4	0,8	BPR6ES	7822	2	BPR6EIX	6637	
Combo	1.4	44	02.96-	X14SZ OHC	4	0,8	BKR5EK	7956	23	BKR5EIX	6341	
Combo	1.4	44	03.93-	C14NZ OHC	4	0,8	BKR5EK	7956	23	BKR5EIX	6341	
Combo	1.4	60	03.93-	C14SE OHC	4	0,8	BKR5EK	7956	23	BKR5EIX	6341	
Combo	1.7	44	04.96-	X17D (4EE1)/OHC	4	█	CY53	4315				
Combo	1.7	44	07.94-	17D 4EE1 OHC	4	█	CY53	4315				
Corsa A	1.0	33	09.82-09.92	10S OHV	4	0,7	BPR6HS	7022	3	BPR6HIX	4085	
Corsa A	1.2	33	03.87-06.90	E12GV OHV	4	0,7	BPR6HS	7022	3	BPR6HIX	4085	
Corsa A	1.2	33	02.90-03.93	12NV OHC I	4	0,8	BPR6ES	7822	2	BPR6EIX	6637	
Corsa A	1.2	33	09.90-03.93	C12NZ OHC I	4	0,9	BPR5ES	7422	6	BPR5EIX	6597	
Corsa A	1.2	33	03.85-03.87	12NC OHV	4	0,7	BPR6HS	7022	3	BPR6HIX	4085	
Corsa A	1.2	37	09.86-03.93	A12ST OHC	4	0,8	BPR6ES	7822	2	BPR6EIX	6637	
Corsa A	1.2	37	09.82-03.93	12S OHC	4	0,8	BPR6ES	7822	2	BPR6EIX	6637	
Corsa A	1.2	40	09.82-02.90	12ST OHC	4	0,8	BPR6ES	7822	2	BPR6EIX	6637	
Corsa A	1.2	40	09.84-03.93	S12ST OHC	4	0,8	BPR6ES	7822	2	BPR6EIX	6637	
Corsa A	1.3	44	09.85-10.89	C13N OHC	4	0,8	BPR6ES	7822	2	BPR6EIX	6637	
Corsa A	1.3	44	03.86-10.89	13NB OHC	4	0,8	BPR6ES	7822	2	BPR6EIX	6637	
Corsa A	1.3	51	09.82-03.93	13S OHC	4	0,8	BPR6ES	7822	2	BPR6EIX	6637	
Corsa A	1.3	52	09.82-10.89	13SB OHC	4	0,8	BPR6ES	7822	2	BPR6EIX	6637	
Corsa A Sprint	1.3	61	04.85-03.93	13E irmscher	4	0,8	BPR6ES	7822	2	BPR6EIX	6637	
Corsa A	1.4	44	10.89-03.93	C14NZ OHC I	4	0,9	BPR5ES	7422	6	BPR5EIX	6597	
Corsa A	1.4	53	10.89-09.92	14NV OHC I	4	0,8	BPR6ES	7822	2	BPR6EIX	6637	
Corsa A	1.4	60	09.91-03.93	C14SE OHC I	4	0,9	BPR5ES	7422	6	BPR5EIX	6597	
Corsa A D (Isuzu-Mot.)	1.5	37	09.87-03.93	15 D/4 EC1 AAD ---> Motor 804 794	4	█	Y-306R	6244				
Corsa A	1.6	55	03.88-09.91	C16NZ	4	0,9	BPR5ES	7422	6	BPR5EIX	6597	
Corsa A irmscher	1.6	72	06.90-03.92	C16SE irmscher	4	0,8	BPR6ES	7822	2	BPR6EIX	6637	
Corsa A	1.6	74	02.92-03.93	C16SE DOHC	4	0,9	BPR5ES	7422	6	BPR5EIX	6597	
Corsa A	1.6	74	03.88-03.92	E16SE OHC I	4	0,8	BPR6ES	7822	2	BPR6EIX	6637	
Corsa B 12V	1.0	40	03.97-08.00	X10XE DOHC	3	0,8	BKR5EK	7956	23	BKR5EIX	6341	
Corsa B	1.2	33	08.95-12.97	C12NZ OHC I	4	0,8	BKR5EK	7956	23	BKR5EIX	6341	
Corsa B	1.2	33	03.93-07.95	C12NZ OHC I	4	0,9	BPR5ES	7422	6	BPR5EIX	6597	
Corsa B	1.2	33	08.95-03.98	X12SZ OHC	4	0,8	BKR5EK	7956	23	BKR5EIX	6341	
Corsa B	1.2	33	08.95-12.97	12NZ	4	0,8	BKR5EK	7956	23	BKR5EIX	6341	
Corsa B	1.2	33	03.93-07.95	X12SZ OHC	4	0,9	BPR5ES	7422	6	BPR5EIX	6597	
Corsa B	1.2	33	03.93-07.95	12NZ	4	0,9	BPR5ES	7422	6	BPR5EIX	6597	
Corsa B 16V	1.2	48	09.97-08.01	X12XE	4	0,8	BKR5EK	7956	23	BKR5EIX	6341	
Corsa B	1.4	44	08.95-08.98	C14NZ OHC I	4	0,8	BKR5EK	7956	23	BKR5EIX	6341	

¹⁾ Bic = Best in class (siehe Seite 3) / (see page 3)

** alternative/wahlweise V-Line 30



l kW

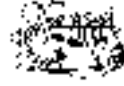

Cyl.

Order-
No. No.Bic¹⁾ Order-
No. No.**OPEL**

Corsa B	1.4	44	03.96-07.00	X14SZ		4	0,8	BKR5EK	7956	23	BKR5EIX	6341
Corsa B	1.4	44	03.93-07.95	C14NZ	OHC I	4	0,9	BPR5ES	7422	6	BPR5EIX	6597
Corsa B	1.4	60	03.93-07.95	C14SE	OHC I	4	0,9	BPR5ES	7422	6	BPR5EIX	6597
Corsa B	1.4	60	08.95-07.97	C14SE	OHC I	4	0,8	BKR5EK	7956	23	BKR5EIX	6341
Corsa B	1.4	63	06.98-10.00	C14SEL	OHC	4	0,8	BKR5EK	7956	23	BKR5EIX	6341
Corsa B 16V	1.4	66	11.94-08.00	X14XE	DOHC	4	0,8	BKR5EK	7956	23	BKR5EIX	6341
Corsa B D	1.5	37	03.93-08.00	15D (4EC1)	OHC Isuzu	4	█	CY53	4315			
Corsa B	1.5	49	04.96-08.01	X15DT 4EE1	OHC	4	█	CY53	4315			
Corsa B TD	1.5	49	03.93-08.00	X/15DT (T4EC1)	OHC Isuzu	4	█	CY53	4315			
Corsa B	1.6	74	06.98-10.00	C16SEL	DOHC	4	0,8	BKR5EK	7956	23	BKR5EIX	6341
Corsa B 16V	1.6	78	08.94-08.01	X16XE	DOHC	4	0,8	BKR5EK	7956	23	BKR5EIX	6341
Corsa B	1.6	80	03.93-08.94	C16XE	DOHC I	4	0,8	BKR5EK	7956	23	BKR5EIX	6341
Corsa B D	1.7	44	04.96-08.01	X17D (4EE1)/OHC		4	█	CY53	4315			
Corsa B TD	1.7	44	03.93-08.00	17D (4EE1)/OHC		4	█	CY53	4315			
Corsa C 12V	1.0	44	08.00-	Z10XE		3	0,8	BKR5EK	7956	23	BKR5EIX	6341
Corsa C	1.2	55	08.00-	Z12XE		4	0,8	BKR5EK	7956	23	BKR5EIX	6341
Corsa C	1.4	66	08.00-	Z14XE		4	0,8	BKR5EK	7956	23	BKR5EIX	6341
Corsa C	1.6	62	08.00-	Z16SE		4	0,8	BKR5EK	7956	23	BKR5EIX	6341
Corsa C	1.8	92	08.00-	Z18XE		4	0,8	BKR5EK	7956	23	BKR5EIX	6341
Frontera	2.0	85	09.91-02.92	C20NE	OHC II	4	0,9	BPR5ES	7422	6	BPR5EIX	6597
Frontera	2.0	85	02.95-06.98	X20SE	OHC II	4	0,8	BKR5EK	7956	23	BKR5EIX	6341
Frontera	2.0	85	02.95-	X20XE	OHC	4	0,8	BKR5EK	7956	23	BKR5EIX	6341
Frontera 16V	2.2	100	02.95-06.98	X22XE	DOHC	4	0,8	BKR5EK	7956	23	BKR5EIX	6341
Frontera A TD Intercool	2.3	74	03.92-09.95	DTR	OHC	4	█	Y-924U	4950			
Frontera A 2,3 TD Intercooler	2.3	74	09.91-02.95	23 DTR	OHC	4	█	Y-924U	4950			
Frontera	2.4	92	09.91-02.95	C24NE	CIH	6	0,7	BPR6HS	7022	3	BPR6HIX	4085
Frontera A TDI	2.5	85	09.96-10.98	25TD/TDS/OHC		4	█	Y-741U	5065			
Frontera B DTI 16V	2.2	85	08.00-	Y22DTH		4	█	Y-523J	3703			
Frontera B DTI 16V	2.2	85	06.98-08.00	X22DTH		4	█	Y-748U	5000			
Frontera 16V	2.2	100	10.98-	X22XE	DOHC	4	0,8	BKR5EK	7956	23	BKR5EIX	6341
Frontera B	2.2	100	10.98-12.00	X22SE		4	0,8	BKR5EK	7956	23	BKR5EIX	6341
Frontera V6	3.2	151	08.00-	6VD1		6	1,1	PFR5G-11	2647			
Kadett E	1.2	40	09.84-09.91	12S,SC	OHV	4	0,7	BPR6HS	7022	3	BPR6HIX	4085
Kadett E	1.2	40	09.84-08.88	12S,ST	OHC	4	0,8	BPR6ES	7822	2	BPR6EIX	6637
Kadett E	1.3	44	03.86-10.89	13N,NB	OHC	4	0,8	BPR6ES	7822	2	BPR6EIX	6637
Kadett E	1.3	44	09.85-10.89	C13N	OHC	4	0,8	BPR6ES	7822	2	BPR6EIX	6637
Kadett E	1.3	55	09.84-10.89	13S,SC	OHC	4	0,8	BPR6ES	7822	2	BPR6EIX	6637
Kadett E	1.4	44	10.89-09.93	14NV	OHC I	4	0,8	BPR6ES	7822	2	BPR6EIX	6637
Kadett E	1.4	44	10.89-09.91	C14NZ	OHC I	4	0,9	BPR5ES	7422	6	BPR5EIX	6597
Kadett E	1.4	44	01.90-08.91	E14LV	OHC I	4	0,8	BPR6ES	7822	2	BPR6EIX	6637
Kadett E D(Isuzu-Mot.)	1.5	37	09.84-08.91	4 EC1 Isuzu ---> Mot. 804794		4	█	Y-306R	6244			
Kadett E D	1.6	40	09.84-02.89	16 D, DA	OHC	4	█	Y-924U	4950			
Kadett E	1.6	55	09.87-08.91	E16SE	OHC	4	0,8	BPR6ES	7822	2	BPR6EIX	6637
Kadett E	1.6	55	09.87-09.91	E16NZ	OHC	4	0,8	BPR6ES	7822	2	BPR6EIX	6637
Kadett E	1.6	55	09.87-09.93	C16NZ	OHC	4	0,9	BPR5ES	7422	6	BPR5EIX	6597
Kadett E	1.6	55	09.86-10.87	C16LZ	OHC I	4	1,1	BPR6ES-11	4824	13	BPR6EIX-11	3903
Kadett E	1.6	60	09.86-09.91	16SV	OHC I	4	0,8	BPR6ES	7822	2	BPR6EIX	6637
Kadett E D	1.7	42	02.89-09.92	17 D	OHC II	4	█	Y-924U	4950			
Kadett E D	1.7	44	09.92-09.93	17 DR		4	█	Y-924U	4950			
Kadett E	1.8	62	09.86-08.91	S18NV	OHC II	4	0,8	BPR6ES	7822	2	BPR6EIX	6637
Kadett E	1.8	62	03.87-07.89	E18NV	OHC II	4	0,8	BPR6ES	7822	2	BPR6EIX	6637

¹⁾ Bic = Best in class (siehe Seite 3) / (see page 3)



ℓ kW

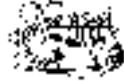

Cyl.

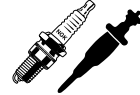
Order-
No. No.Bic¹⁾ Order-
No.**OPEL**

Kadett E	1.8	66	01.84-09.85	C18NT	OHC II	4	0,8	BPR6ES	7822	2	BPR6EIX	6637
Kadett E	1.8	66	09.90-09.91	C18NZ	OHC II	4	0,9	BPR5ES	7422	6	BPR5EIX	6597
Kadett E	1.8	74	09.85-09.86	C18NE	OHC II	4	0,9	BPR5ES	7422	6	BPR5EIX	6597
Kadett E	1.8	82	09.86-09.91	18SE	OHC II	4	0,8	BPR6ES	7822	2	BPR6EIX	6637
Kadett E	1.8	85	09.84-09.86	18E	OHC II	4	0,8	BPR6ES	7822	2	BPR6EIX	6637
Kadett E	2.0	85	09.86-03.93	C20NE	OHC	4	0,9	BPR5ES	7422	6	BPR5EIX	6597
Kadett E	2.0	85	09.86-09.91	20NE	OHC	4	0,9	BPR5ES	7422	6	BPR5EIX	6597
Kadett E	2.0	91	03.87-09.91	20SER	OHC II	4	0,8	BPR6ES	7822	2	BPR6EIX	6637
Kadett E	2.0	95	09.86-09.91	20SEH	OHC II	4	0,8	BPR6ES	7822	2	BPR6EIX	6637
Kadett E	2.0	110	03.88-09.91	C20XE	DOHC	4	0,8	BKR6EK	2288	20**	BKR6EQUIP	3199
Kadett E	2.0	110	04.89-09.91	20XEJ	DOHC	4	0,8	BKR6EK	2288	20**	BKR6EQUIP	3199
Manta	1.3	51	08.79-08.86	13S	OHC	4	0,8	BPR6ES	7822	2	BPR6EIX	6637
Manta	1.8	66	07.82-08.87	18S	OHC	4	0,8	BPR6ES	7822	2	BPR6EIX	6637
Manta	2.0	74	08.77-08.85	20S	CIH	4	0,7	BPR6HS	7022	3	BPR6HIX	4085
Manta	2.0	77	08.77-08.88	20E	CIH Cat.	4	0,7	BPR6HS	7022	3	BPR6HIX	4085
Manta	2.0	81	08.77-08.88	20E	CIH	4	0,7	BPR6HS	7022	3	BPR6HIX	4085
Meriva	1.6	64	05.03-	Z16SE		4	0,8	BKR5EK	7956	23	BKR5EIX	6341
Meriva	1.6	74	05.03-	Z16XE		4	0,8	BKR5EK	7956	23	BKR5EIX	6341
Meriva	1.8	92	05.03-	Z18XE		4	0,8	BKR5EK	7956	23	BKR5EIX	6341
Monterey 24V	3.2	130	04.92-07.99	6VDI	SOHC	6	0,7	BKR6E	6962	28	BKR6EIX	6418
Monterey	3.5	158	02.98-07.99	6VE1		6	1,1	BKR5EVX-11	5182		BKR5EIX-11	5464
Monza	2.2	85	11.84-08.86	22E	CIH	4	0,7	BPR6HS	7022	3	BPR6HIX	4085
Monza	2.5	100	09.84-08.86	S25E	CIH	6	0,7	BPR6HS	7022	3	BPR6HIX	4085
Monza	2.5	100	05.81-08.86	25E	CIH	6	0,7	BPR6HS	7022	3	BPR6HIX	4085
Monza	3.0	115	01.83-08.86	C30NE		6	0,7	BPR6HS	7022	3	BPR6HIX	4085
Monza	3.0	115	01.83-08.86	30E	CIH	6	0,7	BPR6HS	7022	3	BPR6HIX	4085
Monza	3.0	132	01.83-08.86	S30E	CIH	6	0,7	BPR6HS	7022	3	BPR6HIX	4085
Movano 2.5 D	2.5	59	10.98-10.00	S8U W7		4	█	Y-935U	5915			
Omega A	1.8	60	09.86-03.94	18NV	OHC II	4	0,8	BPR6ES	7822	2	BPR6EIX	6637
Omega A	1.8	60	09.87-03.90	E18NVR	OHC II	4	0,8	BPR6ES	7822	2	BPR6EIX	6637
Omega A	1.8	62	09.86-03.94	S18NV	OHC II	4	0,8	BPR6ES	7822	2	BPR6EIX	6637
Omega A	1.8	66	09.86-09.90	18SV	OHC II	4	0,8	BPR6ES	7822	2	BPR6EIX	6637
Omega A	1.8	85	09.86-09.92	18SEH	OHC II	4	0,8	BPR6ES	7822	2	BPR6EIX	6637
Omega A	2.0	74	04.90-02.92	C20NEJ	OHC	4	0,8	BKR6EK	2288	20**	BKR6EQUIP	3199
Omega A	2.0	74	09.86-03.94	C20NE	OHC	4	0,9	BPR5ES	7422	6	BPR5EIX	6597
Omega A	2.0	74	09.86-03.94	20NE		4	0,9	BPR5ES	7422	6	BPR5EIX	6597
Omega A	2.0	74	09.86-03.94	20NEJ		4	0,8	BKR6EK	2288	20**	BKR6EQUIP	3199
Omega A	2.0	90	09.89-03.94	20SE	OHC II	4	0,8	BKR6EK	2288	20**	BKR6EQUIP	3199
Omega A D	2.3	54	09.86-02.94	23 YD	OHC	4	█	Y-924U	4950			
Omega A D	2.3	66	09.86-09.88	23 YDT	OHC	4	█	Y-924U	4950			
Omega A TD	2.3	74	09.88-02.94	23 DTR	OHC	4	█	Y-924U	4950			
Omega A	2.4	92	09.88-03.94	C24NE	CIH	6	0,7	BPR6HS	7022	3	BPR6HIX	4085
Omega A	2.6	110	09.90-03.94	C26NE	CIH	6	0,7	BPR6HS	7022	3	BPR6HIX	4085
Omega A 3000	3.0	115	03.87-03.94	C30NE	CIH	6	0,7	BPR6HS	7022	3	BPR6HIX	4085
Omega A 3000	3.0	115	03.87-09.90	30NE	CIH	6	0,7	BPR6HS	7022	3	BPR6HIX	4085
Omega A 3000	3.0	115	03.87-03.88	C30LE	CIH	6	0,7	BPR6HS	7022	3	BPR6HIX	4085
Omega A	3.0	130	03.87-03.94	C30NE	CIH	6	0,7	BPR6HS	7022	3	BPR6HIX	4085
Omega A	3.0	130	03.87-09.90	30NE	CIH	6	0,7	BPR6HS	7022	3	BPR6HIX	4085
Omega A 3000 24V	3.0	147	09.90-03.94	C30SEJ	DOHC	6	0,8	BKR6EK	2288	20**	BKR6EQUIP	3199
Omega A 3000 24V	3.0	147	09.89-03.94	C30SE		6	0,8	BKR6EK	2288	20**	BKR6EQUIP	3199
Omega A 3000 24V Evo	3.0	170	03.91-09.92	C30XEI	DOHC	6	0,8	BKR6EK	2288	20**	BKR6EQUIP	3199
Omega-Lotus A	3.6	265	09.90-09.92	C36GET	DOHC	6	---					

¹⁾ Bic = Best in class (siehe Seite 3) / (see page 3)

** alternative/wahlweise V-Line 30



l kW

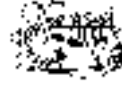

Cyl.

Order-
No. No.Bic¹⁾ Order-
No. No.**OPEL**

Omega B DTI	2.0	74	09.99-	Y20DTH		4	█	Y-523J	3703				
Omega B D	2.0	74	10.98-09.00	X20DTH OHC		4	█	Y-748U	5000				
Omega B DI 16V	2.0	74	09.97-	X20DILC		4	█	Y-748U	5000				
Omega B	2.0	85	01.94-09.99	20SE OHC		4	0,8	BKR5EK	7956	23	BKR5EIX	6341	
Omega B	2.0	85	01.94-09.00	X20SE OHC		4	0,8	BKR5EK	7956	23	BKR5EIX	6341	
Omega B 16V	2.0	100	01.94-09.00	X20XEV DOHC		4	0,8	BKR5EK	7956	23	BKR5EIX	6341	
Omega B DTI 16V	2.2	88	05.01-	Y22DTR		4	█	Y-523J	3703				
Omega B DTI 16V	2.2	88	08.01-	Y22DTH		4	█	Y-523J	3703				
Omega B 2.2	2.2	106	09.99-09.00	Y22XE		4	0,8	BKR5EK	7956	23	BKR5EIX	6341	
Omega B	2.2	108	08.00-	Z22XE		4	0,8	BKR5EK	7956	23	BKR5EIX	6341	
Omega B TD	2.5	96	02.94-02.96	U25TD (Mot. BMW)		6	█	Y-917U	3219				
Omega B V6	2.5	125	01.94-09.00	X25XE DOHC		6	0,8	BKR5EK	7956	23	BKR5EIX	6341	
Omega B 24V	3.0	155	09.94-10.01	X30XE DOHC		6	0,8	BKR5EK	7956	23	BKR5EIX	6341	
Rekord	1.8	55	11.82-08.86	18N OHC		4	0,8	BPR6ES	7822	2	BPR6EIX	6637	
Rekord	1.8	59	03.84-08.86	S18S OHC		4	0,8	BPR6ES	7822	2	BPR6EIX	6637	
Rekord	1.8	66	11.82-08.86	18S OHC		4	0,8	BPR6ES	7822	2	BPR6EIX	6637	
Rekord	1.8	74	05.85-08.86	C18NV OHC		4	0,8	BPR6ES	7822	2	BPR6EIX	6637	
Rekord	2.0	74	09.77-08.86	20S CIH		6	0,7	BPR6HS	7022	3	BPR6HIX	4085	
Rekord	2.2	85	11.84-08.86	22E CIH		4	0,7	BPR6HS	7022	3	BPR6HIX	4085	
Rekord E D	2.3	48	11.79-09.86	23 D		4	█	Y-208T	1250				
Rekord E D	2.3	48	11.82-08.86	Mot.-Nr. 40019 --->		4	█	Y-208T	1250				
Rekord E TD	2.3	63	05.84-09.86	23 DT		4	█	Y-924U	4950				
Senator A D	2.0			Mot.-Nr. 90310 --->		4	█	Y-208T	1250				
Senator A D	2.0			---> Mot.-Nr. 90309		4	█	Y-403T	7494				
Senator A	2.2	85	11.84-07.86	22E		6	0,7	BPR6HS	7022	3	BPR6HIX	4085	
Senator A TD	2.3	64	11.84-08.87	Mot.-Nr. 121527 --->		4	█	Y-924U	4950				
Senator A D	2.3	64	11.84-08.87	---> Mot.-Nr. 40018		4	█	Y-403T	7494				
Senator A D	2.3	70	03.85-07.86	23 TDC		4	█	Y-924U	4950				
Senator A	2.5	100	09.84-08.87	S25E CIH		6	0,7	BPR6HS	7022	3	BPR6HIX	4085	
Senator A	2.5	100	05.81-07.86	25E CIH		6	0,7	BPR6HS	7022	3	BPR6HIX	4085	
Senator A	3.0	115	08.78-09.86	30E CIH		6	0,7	BPR6HS	7022	3	BPR6HIX	4085	
Senator A	3.0	115	08.79-09.86	C30NE CIH		6	0,7	BPR6HS	7022	3	BPR6HIX	4085	
Senator A	3.0	132	01.83-08.87	S30E CIH		6	0,7	BPR6HS	7022	3	BPR6HIX	4085	
Senator B	2.5	103	03.88-09.90	25NE CIH		6	0,7	BPR6HS	7022	3	BPR6HIX	4085	
Senator B	2.6	110	09.90-09.93	C26NE CIH		6	0,7	BPR6HS	7022	3	BPR6HIX	4085	
Senator B	3.0	115	08.87-09.90	C30LE CIH		6	0,7	BPR6HS	7022	3	BPR6HIX	4085	
Senator B	3.0	130	08.87-09.90	30NE CIH		6	0,7	BPR6HS	7022	3	BPR6HIX	4085	
Senator B	3.0	150	09.89-06.93	C30SE DOHC		6	0,8	BKR6EK	2288	20**	BKR6EQU	3199	
Senator B	3.6	145	08.89-09.93	C3,6NE irmscher		6	0,8	BKR6EK	2288	20**	BKR6EQU	3199	
Senator B	3.6	145	08.89-09.93	C3,6NE irmscher		6	0,8	BKR6EK	2288	20**	BKR6EQU	3199	
Senator B	4.0	200	01.91-09.93	C40SE irmscher		6	0,8	BKR6EK	2288	20**	BKR6EQU	3199	
Sintra TDI	2.2	85	01.98-	X22DTH		4	█	Y-748U	5000				
Sintra 16V	2.2	104	09.96-09.99	X22XE DOHC		4	0,9	BKR5EK	7956	23	BKR5EIX	6341	
Sintra 24V	3.0	155	09.96-09.99	X30XE DOHC		6	0,9	BKR5EK	7956	23	BKR5EIX	6341	
Speedster Turbo	2.0	147	03-	Z20LET		4	0,8	BKR5EK	7956	23	BKR5EIX	6341	
Tigra	1.4	63	06.98-	C14SEL OHC		4		BKR5EK	7956	23	BKR5EIX	6341	
Tigra 16V	1.4	66	08.94- 00	X14XE DOHC		4	0,8	BKR5EK	7956	23	BKR5EIX	6341	
Tigra	1.6	74	06.98-	C16SEL DOHC		4	0,8	BKR5EK	7956	23	BKR5EIX	6341	
Tigra 16V	1.6	78	08.94-	X16XE DOHC		4	0,8	BKR5EK	7956	23	BKR5EIX	6341	
Vectra A	1.4	55	09.88-09.92	14NV OHC I		4	0,8	BPR6ES	7822	2	BPR6EIX	6637	
Vectra A	1.6	52	09.93-08.95	X16SZ OHC		4	0,8	BKR5EK	7956	23	BKR5EIX	6341	
Vectra A	1.6	55	09.88-08.94	C16NZ		4	0,9	BPR5ES	7422	6	BPR5EIX	6597	

¹⁾ Bic = Best in class (siehe Seite 3) / (see page 3)

** alternative/wahlweise V-Line 30



ℓ kW

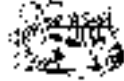

Cyl.

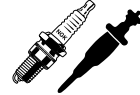
Order-
No. No.Bic¹⁾ Order-
No.**OPEL**

Vectra A	1.6	55	09.88-09.89	E16NZ	OHC	4	0,8	BKR5EK	7956	23	BKR5EIX	6341
Vectra A	1.6	60	09.88-09.92	16SV	OHC I	4	0,8	BPR6ES	7822	2	BPR6EIX	6637
Vectra A D	1.7	42	02.88-09.92	17D	OHC II	4	█	Y-924U	4950			
Vectra A TD	1.7	60	10.92-08.95	17DT Isuzu TC4EE1		4	█	CY53	4315			
Vectra A TD	1.7	60	03.90-	Isuzu TC4EC1 817253--->		4	█	Y-743U	5642			
Vectra A TD	1.7	60	10.92-08.95	X17DT Isuzu TC4EE1		4	█	CY53	4315			
Vectra A	1.8	65	09.88-08.95	E18NVR	OHC II	4	0,8	BPR6ES	7822	2	BPR6EIX	6637
Vectra A 4x4	1.8	65	01.89-08.95	E18NVR	OHC II	4	0,8	BPR6ES	7822	2	BPR6EIX	6637
Vectra A 4x4	1.8	66	09.89-08.95	C18SV	OHC	4	0,8	BPR6ES	7822	2	BPR6EIX	6637
Vectra A	1.8	66	09.89-08.95	18SV		4	0,8	BPR6ES	7822	2	BPR6EIX	6637
Vectra A	1.8	66	03.90-08.95	C18NZ	OHC II	4	0,8	BKR5EK	7956	23	BKR5EIX	6341
Vectra A 4x4	1.8	66	09.89-08.95	18SV		4	0,8	BPR6ES	7822	2	BPR6EIX	6637
Vectra A	1.8	66	09.89-08.95	C18SV	OHC	4	0,8	BPR6ES	7822	2	BPR6EIX	6637
Vectra A 4x4	2.0	85	01.89-08.95	20NE		4	0,8	BKR5EK	7956	23	BKR5EIX	6341
Vectra A	2.0	85	09.89-08.95	20NE		4	0,8	BKR5EK	7956	23	BKR5EIX	6341
Vectra A	2.0	85	09.89-08.95	C20NE	OHC	4	0,8	BKR5EK	7956	23	BKR5EIX	6341
Vectra A 4x4	2.0	85	01.89-08.95	C20NE	OHC	4	0,8	BKR5EK	7956	23	BKR5EIX	6341
Vectra A 4x4	2.0	95	01.89-09.92	20SEH	OHC II	4	0,8	BPR6ES	7822	2	BPR6EIX	6637
Vectra A	2.0	95	09.88-09.92	20SEH	OHC II	4	0,8	BPR6ES	7822	2	BPR6EIX	6637
Vectra A 16V	2.0	100	08.92-08.95	C20XE		4	0,8	BKR5EK	7956	23	BKR5EIX	6341
Vectra A 16V	2.0	100	08.92-08.95	20XE		4	0,8	BKR5EK	7956	23	BKR5EIX	6341
Vectra A 16V	2.0	100	12.94-08.95	X20XE	DOHC	4	0,8	BKR5EK	7956	23	BKR5EIX	6341
Vectra A 16V	2.0	100	08.92-08.95	C20XE-LN		4	0,8	BKR5EK	7956	23	BKR5EIX	6341
Vectra A 2000 16V 4x4	2.0	110	09.89-08.92	C20XE	DOHC	4	0,8	BKR6EK	2288	20**	BKR6EQUIP	3199
Vectra A 2000 16V 4x4	2.0	110	09.89-08.92	20XE		4	0,8	BKR6EK	2288	20**	BKR6EQUIP	3199
Vectra A 2000 16V	2.0	110	09.89-08.92	C20XE	DOHC	4	0,8	BKR6EK	2288	20**	BKR6EQUIP	3199
Vectra A 2000 16V	2.0	110	09.89-08.92	20XE		4	0,8	BKR6EK	2288	20**	BKR6EQUIP	3199
Vectra A	2.0	150	09.92-08.95	C20LET	DOHC	4	1,1	ZFR6F-11	4291		ZFR6FIX-11	6441
Vectra A	2.5	125	02.93-08.95	25XE		6	0,8	BKR5EK	7956	23	BKR5EIX	6341
Vectra A	2.5	125	03.93-08.95	C25XE	DOHC	6	0,8	BKR5EK	7956	23	BKR5EIX	6341
Vectra B	1.6	55	08.95-	16LZ2	OHC	4	0,8	BKR5EK	7956	23	BKR5EIX	6341
Vectra B	1.6	55	08.95-02.00	X16SZR	OHC	4	0,8	BKR5EK	7956	23	BKR5EIX	6341
Vectra B	1.6	74	08.95-	X16XEL	DOHC	4	0,8	BKR5EK	7956	23	BKR5EIX	6341
Vectra B	1.6	74	08.00-	Z16XE	DOHC	4	0,8	BKR5EK	7956	23	BKR5EIX	6341
Vectra B TD	1.7	60	08.95-	X17TD/TC4 EE1 Isuzu		4	█	CY53	4315			
Vectra B	1.8	85	03.99-	X18XE1		4	0,8	BKR5EK	7956	23	BKR5EIX	6341
Vectra B	1.8	85	08.95-	X18XE		4	0,8	BKR5EK	7956	23	BKR5EIX	6341
Vectra B	1.8	92	08.00-	Z18XE		4	0,8	BKR5EK	7956	23	BKR5EIX	6341
Vectra B DTI	2.0	74	08.97-	X20DTH	OHC	4	█	Y-748U	5000			
Vectra B DTI 16V	2.0	74	09.97-07.99	X20DILC		4	█	Y-748U	5000			
Vectra B DTI 16V	2.0	74	08.00-	Y20DTH		4	█	Y-523J	3703			
Vectra B	2.0	80	08.95-	20NEJ	OHC	4	0,8	BKR5EK	7956	23	BKR5EIX	6341
Vectra B	2.0	100	08.95-	X20XE		4	0,8	BKR5EK	7956	23	BKR5EIX	6341
Vectra B DTI 16V	2.2	92	08.00-	Y22DTR		4	█	Y-523J	3703			
Vectra B	2.2	106	10.99-	C22SEL	DOHC	4	0,8	BKR5EK	7956	23	BKR5EIX	6341
Vectra B V6	2.5	125	08.95-	X25XE	DOHC	6	0,8	BKR5EK	7956	23	BKR5EIX	6341
Vectra B i500	2.5	143	01.98-	X25XE	DOHC	6	0,8	BKR5EK	7956	23	BKR5EIX	6341
Vectra C DTI	2.0	74	04.02-	Y20DTH		4	█	Y-523J	3703			
Vectra C DTI	2.2	92	04.02-	Y22DTR		4	█	Y-523J	3703			
Zafira 16V	1.6	74	03.99-	X16XE	DOHC	4	0,8	BKR5EK	7956	23	BKR5EIX	6341
Zafira 16V	1.8	85	03.99-	X18XE	DOHC	4	0,8	BKR5EK	7956	23	BKR5EIX	6341
Zafira DI 16V	2.0	60	09.99-11.00	X20DTL		4	█	Y-748U	5000			

¹⁾ Bic = Best in class (siehe Seite 3) / (see page 3)

** alternative/wahlweise V-Line 30



l kW

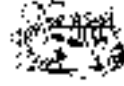

Cyl.

Order-
No. No.Bic¹⁾ Order-
No. No.**OPEL**

Zafira DTI 16V	2.0	74	08.99-	Y20DTL	4	Y-748U	5000			
Zafira DTI 16V	2.0	74	08.00-	Y20DTH	4	Y-523J	3703			
Zafira DTI 16V	2.0	74	04.99-	X20DILC	4	Y-748U	5000			
Zafira Turbo 16V	2.0	141	01-	Z20LET	4	BKR5EK	7956	23	BKR5EIX	6341

OTOSAN

600 Pickup D	1.9			ERK 1.9	4	Y-902R	2237			
--------------	-----	--	--	---------	---	--------	------	--	--	--

PANTHER

Deville	4.2				0,8	BP5ES	6511	8	BPR5EIX	6597
Deville V12	4.2				0,8	BP5ES	6511	8	BPR5EIX	6597
J72 V12	4.2				0,8	BP5ES	6511	8	BPR5EIX	6597
J72SE	4.2				0,8	BP5ES	6511	8	BPR5EIX	6597
Kalistra	1.6	71	01.82-12.92	Ford	4	BKR6E	6962	28	BKR6EIX	6418
Kalistra V6	2.8	99	01.82-12.89	Ford	6	BPR6ES	7822	2	BPR6EIX	6637
R10 Spezial					4	BP6EFS	3812	5		

PERODUA

Kenari	0.85		00-	EJ-VE	3	BKR5EKC	5216			
Kenari	1.0		11.00-	EJ-VE	3	BKR5EKC	5216			
Nippa	0.85		08.97-01.00		3	BPR5ES	7422	6	BPR5EIX	6597

PEUGEOT

104 GL,ZA,ZL	0.9	32	10.72-06.88	XV...	4	BP6EFS	3812	5		
104 GL,GR,SL,Z,ZA,ZR,S,ZS	1.1	36	07.76-06.88	XW3/XW5/XW7	4	BP6EFS	3812	5		
104 ZS	1.4	59	07.82-06.86	XY8	4	BP7EFS	3526			
106 D	1.4	37	08.91-06.94	TUD3/L	4	Y-911R	4544			
106 D	1.5	42	07.94-03.96	TUD5	4	Y-731U	5274			
106 D	1.5	42	04.96-10.03	TUD5	4	Y-731U	5274			
106i XN, XA, Kid	0.9	37	07.95-03.96	TU9M-CDZ	4	BKR5EK	7956	23	BKR5EIX	6341
106i XN, XA, Kid	0.9	37	07.92-06.95	TU9M-CDZ	4	BCPR5ES	6130		BCPR5EIX-1	3306
106 XN	0.9	37	08.91-12.92	TU9-C1A	4	BKP5ES	7496	16	BCPR5EIX-1	3306
106 XN, XR	1.1	38	08.91-12.92	TU1-H1A	4	BKP5ES	7496	16	BCPR5EIX-1	3306
106i XN, XR, XT, Green	1.1	44	07.92-06.95	TU1M-HDZ	4	BCPR5ES	6130		BCPR5EIX-1	3306
106i XN, XR, XT, Green	1.1	44	07.95-03.96	TU1M-HDZ	4	BKR6EK	2288	20**	BKR6EQUIP	3199
106 Rallye	1.3	74	11.93-03.96	TU2J2-MFZ	4	BKR6EK	2288	20**	BKR6EQUIP	3199
106 XR, XT	1.4	51	08.91-12.92	TU3.2-K2D	4	BKP6ES	4930	17	BCPR6EIX-1	4919
106 Xsi	1.4	55	08.91-12.92	TU3JP~KFX	4	BKR6EK	2288	20**	BKR6EQUIP	3199
106i XR, XS, XT	1.4	55	07.95-03.96	TU3MC~KDX	4	BKR6EK	2288	20**	BKR6EQUIP	3199
106i XR, XS, XT	1.4	55	07.92-06.95	TU3MC~KDX	4	BCPR5ES	6130		BCPR5EIX-1	3306
106 Xsi	1.4	55	07.92-03.96	TU3JP cat.~KFX	4	BKR6EK	2288	20**	BKR6EQUIP	3199
106i XS, XT, Griffe	1.6	66	07.94-03.96	TU5JP~NFZ	4	BKR6EK	2288	20**	BKR6EQUIP	3199
106 Xsi	1.6	74	12.93-06.95	TU5J2~NFW	4	BKR6ES	3783	28	BKR6EIX	6418
106 Xsi	1.6	74	07.95-05.96	TU5J2~NFW	4	BKR6EK	2288	20**	BKR6EQUIP	3199
106i, Kid	1.0	37	04.96-	TU9M~CDZ	4	BKR5EK	7956	23	BKR5EIX	6341
106i	1.1	44	04.96-	TU1M+ ~HDZ	4	BKR6EK	2288	20**	BKR6EQUIP	3199
106 Pop Art	1.1	44	03-	TU1JP	4	BKR6EZ	4619		BKR6EIX	6418
106i	1.4	55	01.00-	TU3JP~KFX	4	BKR6EZ	4619		BKR6EIX	6418
106i	1.4	55	04.96-12.99	TU3JP~KFX	4	BKR6EK	2288	20**	BKR6EQUIP	3199
106i	1.6	66	04.96-12.99	TU5JP~NFZ	4	BKR6EK	2288	20**	BKR6EQUIP	3199
106i	1.6	66	01.00-	TU5JP~NFZ	4	BKR6EZ	4619		BKR6EIX	6418
106 Rallye	1.6	74	06.96-	TU5J2~NFW	4	BKR6EK	2288	20**	BKR6EQUIP	3199

¹⁾ Bic = Best in class (siehe Seite 3) / (see page 3)

** alternative/wahlweise V-Line 30



ℓ kW

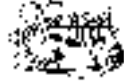

Cyl.

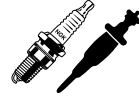
Order-
No. No.Bic¹⁾ Order-
No. No.**PEUGEOT**

106 16V S16, Gti	1.6	88	06.96-12.99	TU5J4~NFX		4	0,8	BKR6EK	2288	20**	BKR6EQUIP	3199
106 16V S16, Gti	1.6	88	01.00-	TU5J4~NFX		4	0,9	BKR6EZ	4619		BKR6EIX	6418
205 GL, XL, XE	0.9		-06.87	XV8		4	0,6	BP6EFS	3812	5		
205 GL,XL,XE	0.9	31	-06.87	XV..		4	0,8	BP6EFS	3812	5		
205 XE,GL,Junior	0.9	33	07.92-	TU9M	Cat.	4	0,8	BCPR5ES	6130		BCPR5EIX-1	3306
205 XE,GL,Junior	0.9	33	07.87-12.92	TU9		4	0,8	BCP5ES	7496	16	BCPR5EIX-1	3306
205 Entreprise XA, XRA	1.1		88-	E1		4	0,8	BCP6ES	4930	17	BCPR6EIX-11	4919
205 XR,XL,GL,GR	1.1	34	07.87-12.92	TU1		4	0,8	BCP5ES	7496	16	BCPR5EIX-1	3306
205 XA,XL,XR,GL,GR	1.1	36	-06.87	XW7		4	0,8	BP6EFS	3812	5		
205 GR,Color Line	1.1	44	07.92-06.95	TU1M	Cat.	4	0,8	BCPR5ES	6130		BCPR5EIX-1	3306
205	1.1	44	-06.92			4	0,8	BCPR6ES	2330		BCPR6EIX-1	4919
205 GR,Color,Sacre`Num	1.1	44	03.95-	TU1.M	Cat.	4	0,8	BKR6EK	2288	20**	BKR6EQUIP	3199
205	1.1	44		TU1M		4	0,8	BKR5EK	7956	23	BKR5EIX	6341
205 Enterprise,XA,XRA	1.3		88-	G1		4	0,7	BCP6ES	4930	17	BCPR6EIX-1	4919
205 Rallye	1.3	75	03.88-06.92	TU2.4		4	0,9	BKUR7ET	7873		PFR7Q	7963
205 Rallye	1.4		03.88-06.92	TU2.4		4	0,9	BKUR7ET	7873		PFR7Q	7963
205 XR,GR,SR,CJ	1.4	43	07.87-12.92	TU3 , TU3A		4	0,8	BCP5ES	7496	16	BCPR5EIX-1	3306
205 XR,GR,SR	1.4	44	-06.87	XY7		4	0,8	BP6EFS	3812	5		
205 CT	1.4	52	02.83-10.87	XY6.B		4	0,8	BP6EFS	3812	5		
205	1.4	55		TU3M		4	0,8	BKR6EK	2288	20**	BKR6EQUIP	3199
205 XR,GR,SR,SJ,Sacre`N	1.4	55	07.95-	TU3.MC	Cat.	4	0,8	BKR6EK	2288	20**	BKR6EQUIP	3199
205 XR,XS	1.4	55	07.92-06.95	TU3MC	Cat.	4	0,8	BCPR6ES	2330		BCPR6EIX-1	4919
205 XR,GR,SR,CJ	1.4	55	07.92-	TU3FM	Cat.	4	0,8	BCPR5ES	6130		BCPR5EIX-1	3306
205 XT,GT	1.4	58	-06.87	XY8		4	0,8	BP7EFS	3526			
205 XT,XS,GT,CT	1.4	62	07.87-12.92	TU3S		4	0,7	BCP6ES	4930	17	BCPR6EIX-1	4919
205 GR,XS,XT,Auto	1.6		07.90-12.92	XU5.1C		4	0,7	BCP6ES	4930	17	BCPR6EIX-1	4919
205 Enterprise XA,XRA	1.6		88-	E1E / G1E		4	0,7	BCP6ES	4930	17	BCPR6EIX-1	4919
205 GR,XS,XT,Auto	1.6	53	-06.87	XU5.1C		4	0,8	BP6EFS	3812	5		
205 GR,XS,XT,Auto	1.6	58	07.87-06.90	XU5.1C		4	0,8	BCP5ES	7496	16	BCPR5EIX-1	3306
205 XS,GT,Auto	1.6	65	07.92-	XU5.M	Cat.	4	0,8	BCPR5ES	6130		BCPR5EIX-1	3306
205 GTi / CTi	1.6	76	-06.87	XU5.J / XU5JA		4	0,8	BP6EFS	3812	5		
205 GTi / CTi	1.6	83	07.87-06.92	XU5JA		4	0,7	BCP6ES	4930	17	BCPR6EIX-1	4919
205 Turbo 16 Stan.	1.8		84-			4	0,8	R5724-9	6434			
205 D	1.8	44	10.83-08.98	XUD7		4	█	Y-902R	2237			
205 D	1.8	44	09.98-12.99	XUD7		4	█	Y-938R	5267			
205 TD	1.8	58	07.85-08.98	XUD7T		4	█	Y-902R	2237			
205	1.8	58	09.98-12.99	XUD7T		4	█	Y-938R	5267			
205 D	1.9	47	10.87-08.98	XUD9		4	█	Y-902R	2237			
205	1.9	51	09.98-12.99	XUD9A		4	█	Y-938R	5267			
205 Gentry	1.9	75	07.92-	XU9.J1	Cat.	4	0,8	BCPR5ES	6130		BCPR5EIX-1	3306
205 GTi	1.9	88	07.92-	XU9.JA	Cat.	4	0,8	BCPR5ES	6130		BCPR5EIX-1	3306
205 GTi / Gentry	1.9	93	-12.92	XU9.JA		4	0,7	BCP6ES	4930	17	BCPR6EIX-1	4919
206	1.1	44	09.98-12.99	TU1.JP-HFZ,HFY		4	0,8	BKR6EK	2288	20**	BKR6EQUIP	3199
206	1.1	44	01.00-	TU1.JP-HFZ,HFY		4	0,9	BKR6EZ	4619		BKR6EIX	6418
206 & SW HDI	1.4	51	11.01-	DV4TD		4	█	YE04	1101			
206	1.4	55	09.98-12.99	TU3JP-KFX		4	0,8	BKR6EK	2288	20**	BKR6EQUIP	3199
206	1.4	55	01.00-	TU3JP-KFX		4	0,9	BKR6EZ	4619		BKR6EIX	6418
206	1.6	66	09.98-08.00	TU5JP-NFZ		4	0,8	BKR6EK	2288	20**	BKR6EQUIP	3199
206	1.6	66	01.00-	TU5JP-NFZ		4	0,9	BKR6EZ	4619		BKR6EIX	6418
206 D	1.9	51	09.98-	DW8/ DW8B		4	█	Y-503R	4279			
206 & SW HDI	2.0	66	10.99-	DW10TD		4	█	Y-504R	4359			
206 S16,GT,CC	2.0	101	04.99-	EW10J4		4	0,9	LFR5B	7113			

¹⁾ Bic = Best in class (siehe Seite 3) / (see page 3)

** alternative/wahlweise V-Line 30



l kW

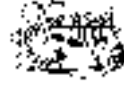

Cyl.

Order-
No. No.Bic¹⁾ Order-
No.**PEUGEOT**

206 & SW	1.1	44	01.00-	TU1JP~HFZ, HFY	4	0,9	BKR6EZ	4619		BKR6EIX	6418
206 & SW	1.1	44	09.98-12.99	TU1JP~HFZ, HFY	4	0,9	BKR6EK	2288	20**	BKR6EQU	3199
206 & SW	1.4	55	01.00-	TU3JP~KFX	4	0,9	BKR6EZ	4619		BKR6EIX	6418
206 & SW	1.4	55	09.98-12.99	TU3JP~KFX	4	0,9	BKR6EK	2288	20**	BKR6EQU	3199
206 & SW HDI	1.6		04-	DV6TED4	4		YE04	1101			
206 & SW	1.6	66	09.98-12.99	TU5JP~NFZ	4	0,9	BKR6EK	2288	20**	BKR6EQU	3199
206 & SW	1.6	66	01.00-	TU5JP~NFZ	4	0,9	BKR6EZ	4619		BKR6EIX	6418
206 & SW 16V, CC	1.6	81	03.01-	TU5JP4~NFU	4	0,9	LFR6B	6677			
206 & SW S16, GT, CC	2.0	101	04.99-	EW10J4~RFR, RFN	4	0,9	LFR5B	7113			
206 COUPE 16V XS, XT	1.6	81	03.01-	TU5JP4	4	0,9	LFR6B	6677			
206 COUPE 16V	2.0	102	04.99-	EW10J4	4	0,9	LFR5B	7113			
305 GL,GR	1.3	44	-06.87	XL5	4	0,8	BP6EFS	3812	5		
305 S	1.5	50	-06.87	XR5S	4	0,8	BP6EFS	3812	5		
305 GL,SR	1.5	54	-06.87	XR5	4	0,8	BP6EFS	3812	5		
305 GT	1.6	50	-06.87	XU5S	4	0,8	BP6EFS	3812	5		
305 GR,SR	1.6	58	07.87-07.90	XU5.1C	4	0,8	BCP5ES	7496	16	BCPR5EIX-1	3306
305 GR,SR	1.6	58	-06.87	XU5.1C	4	0,8	BP6EFS	3812	5		
305 D	1.8	44	10.82-06.88	XUD7	4		Y-902R	2237			
305 D	1.9	47	10.82-06.88	XUD 9	4		Y-902R	2237			
305 GTX	1.9	75	07.84-07.86	XU9S	4	0,8	BP6EFS	3812	5		
305 GTX	1.9	75	07.87-07.90	XU9.2C	4	0,8	BCP5ES	7496	16	BCPR5EIX-1	3306
305 GTX	1.9	75	07.86-06.87	XU9.2C	4	0,8	BP6EFS	3812	5		
306	1.1		96-	TU1.M+	4	0,8	BKR6EK	2288	20**	BKR6EQU	3199
306	1.1	44	07.95-	TU1.M-HDZ	4	0,8	BKR5EK	7956	23	BKR5EIX	6341
306	1.1	44	02.93-06.95	TU1.M-HDZ	4	0,8	BCPR5ES	6130		BCPR5EIX-1	3306
306	1.4	55	01.00-	TU3JP-KFX	4	0,9	BKR6EZ	4619		BKR6EIX	6418
306	1.4	55	02.93-06.95	TU3.MC-KDX	4	0,8	BCPR5ES	6130	32	BCPR5EIX-11	3306
306	1.4	55	07.95-12.99	TU3JP-KFX	4	0,8	BKR6EK	2288	20**	BKR6EQU	3199
306	1.6	66	02.93-12.99	TU5JP-NFZ	4	0,8	BKR6EK	2288	20**	BKR6EQU	3199
306	1.6	66	01.00-	TU5JP-NFZ	4	0,9	BKR6EZ	4619		BKR6EIX	6418
306	1.8	43	10.93-08.98	XUD7	4		Y-902R	2237			
306 D	1.8	44	09.98-07.02	DW8	4		Y-503R	4279			
306	1.8	44	09.98-	XUD7	4		Y-938R	5267			
306 TD	1.8	59	09.98-07.02	DW8TD	4		Y-503R	4279			
306	1.8	74	04.95-	XU7JP-LFZ	4	0,8	BKR5EK	7956	23	BKR5EIX	6341
306 / Cabrio	1.8	74	02.93-03.95	XU7JP-LFZ	4	0,8	BCPR5ES	6130		BCPR5EIX-1	3306
306 16V	1.8	81	04.97-	XU7JP4-LFY	4	0,8	BKR5EK	7956	23	BKR5EIX	6341
306	1.9	51	09.98-07.02	DW8	4		Y-503R	4279			
306	1.9	51	09.98-12.99	XUD9A/XUD9BSD	4		Y-938R	5267			
306 D	1.9	51	02.93-08.98	XUD9A	4		Y-902R	2237			
306 D	1.9	68	03.93-08.98	XUD9TE	4		Y-923U	3380			
306 D	1.9	68	09.98-12.99	XUD9TE	4		Y-938R	5267			
306 HDI	2.0	66	04.99-07.02	DW10TD	4		Y-504R	4359			
306 D	2.0	80	09.98-	DW10TD	4		Y-504R	4359			
306	2.0	89	02.93-03.95	XU10.J2-RFX	4	0,8	BCPR5ES	6130	32	BCPR5EIX-11	3306
306	2.0	89	-03.97	XU10.J4-RFY	4	0,8	BKR6ES	3783	28	BKR6EIX	6418
306	2.0	89	04.95-04.97	XU10.J2-RFX	4	0,8	BKR5EK	7956	23	BKR5EIX	6341
306	2.0	98	04.97-	XU10.J4R-RFV	4	0,8	BKR5EK	7956	23	BKR5EIX	6341
306	2.0	120	07.96-	XU10.J4RS-RFS	4	0,9	BKR5EZ	7642		BKR5EIX	6341
307 HDI	1.4	51	01.02-	DV4TD	4		YE04	1101			
307	1.4	55	04.01-	TU3JP-KFX	4	0,9	BKR6EZ	4619		BKR6EIX	6418
307	1.6	81	04.01-	TU5JP4-NFU	4	0,9	LFR6B	6677			

¹⁾ Bic = Best in class (siehe Seite 3) / (see page 3)

** alternative/wahlweise V-Line 30



ℓ kW

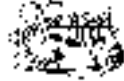

Cyl.

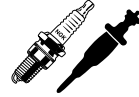
Order-
No. No.Bic¹⁾ Order-
No.**PEUGEOT**

307 & SW HDI	2.0	66	04.01-	DW10TD	4	█	Y-504R	4359			
307 & SW HDI	2.0	81	09.01-	DW10ATED	4	█	Y-504R	4359			
307	2.0	101	04.01-	EW10J4-RFN	4	0,9	LFR5B	7113			
307 & SW XR	1.4	55	04.01- 99	TU3JP~KFX	4	0,9	BKR6EZ	4619		BKR6EIX	6418
307 & SW HDI	1.6		03.04-	DV6TED4	4	█	YE04	1101			
307 & SW 16V	1.6	81	04.01-	TU5JP4~NFU	4	0,9	LFR6B	6677			
307 & SW HDI	2.0		03.04-	DW10TED	4	█	Y-504R	4359			
307 & SW 16V	2.0	101	04.01-	EW10J4~RFN	4	0,9	LFR5B	7113			
307 COUPE 16V	2.0	102	03-	EW10J4	4	0,9	LFR5B	7113			
309 XE,GE	1.1	40	-12.92	TU1	4	0,8	BCP5ES	7496	16	BCPR5EIX-1	3306
309 GE,GL,GR	1.1	40	-12.92	E1A	4	0,8	BCP5ES	7496	16	BCPR5EIX-1	3306
309 XA,XR,XL	1.1	40	-12.92	E1A	4	0,8	BCP5ES	7496	16	BCPR5EIX-1	3306
309 Vital	1.1	40	07.92-	TU1M	Cat.	4	0,8	BCPR5ES	6130		BCPR5EIX-1 3306
309 GE,GL,GR,XE,XL,XR,XA	1.3	47	-12.92	G1A	4	0,8	BCP5ES	7496	16	BCPR5EIX-1	3306
309 XL,GL	1.4	44	-12.92	TU3	4	0,8	BCP5ES	7496	16	BCPR5EIX-1	3306
309 GXR	1.4	55	09.92-	TU3M	Cat.	4	0,8	BCPR5ES	6130		BCPR5EIX-1 3306
309	1.5	42	03.94-12.95	TUD5	4	█	Y-731U	5274			
309 GR,SR	1.6	53	-06.87	XU5.1C	4	0,8	BP6EFS	3812	5		
309 GR,SR	1.6	53	07.87-06.89	XU5.1C	4	0,8	BCP5ES	7496	16	BCPR5EIX-1	3306
309 SR,GRX	1.6	65	07.92-	XU5M	Cat.	4	0,8	BCPR5ES	6130		BCPR5EIX-1 3306
309 GR,GRX,SR,SX,XS,XR	1.6	68	07.89-12.92	XU5.2C	4	0,7	BCP6ES	4930	17	BCPR6EIX-1	4919
309 D	1.8	44	06.86-12.93	XUD7	4	█	Y-902R	2237			
309 TD	1.8	58	11.89-12.93	XUD7T	4	█	Y-902R	2237			
309 D	1.9	47	06.86-12.93	XUD9 / XUD9Y	4	█	Y-902R	2237			
309 GT	1.9	75	-06.87	XU9.2C	4	0,8	BP6EFS	3812	5		
309 GT	1.9	75	07.87-06.89	XU9.2C	4	0,8	BCP5ES	7496	16	BCPR5EIX-1	3306
309	1.9	75	03.86-07.89	XU9.J1	Cat.	4	0,8	BCPR5ES	6130	32	BCPR5EIX-1 3306
309 XS,SX	1.9	80	07.89-06.92	XU9.2C	4	0,7	BCP6ES	4930	17	BCPR6EIX-1	4919
309 XS,SX	1.9	80	07.92-	XU9M	Cat.	4	0,8	BCPR5ES	6130		BCPR5EIX-1 3306
309 GTi	1.9	88	07.92-	XU9.JA	Cat.	4	0,8	BCPR5ES	6130		BCPR5EIX-1 3306
309 GTi	1.9	94	-12.92	XU9.JA	4	0,7	BCP6ES	4930	17	BCPR6EIX-1	4919
309 GTi 16V	1.9	110	07.92-	XU9.J4	Cat.	4	0,9	BCPR6ET	2197		
309 GTi 16V	1.9	118	-06.92	XU9.J4	4	0,9	BCP6ET	4563		BCPR6EIX-11	4919
405	1.4		07.95-	TUM-KDX	Cat.	4	0,8	BKR6EK	2288	20**	BKR6EQUIP 3199
405 GL	1.4	47	07.87-06.92	TU3	4	0,8	BCP5ES	7496	16	BCPR5EIX-1	3306
405 GL	1.4	55	07.92-06.95	TU3M-KDX	Cat.	4	0,8	BCPR5ES	6130		BCPR5EIX-1 3306
405 Sillage,Style	1.6		07.94-03.95	XU5JP-BFZ	Cat.	4	0,8	BCPR5ES	6130		BCPR5EIX-1 3306
405 GL,GR,SR	1.6	55	07.87-06.92	XU51C	4	0,8	BCP5ES	7496	16	BCPR5EIX-1	3306
405 GL,GR,SR	1.6	65	07.92-06.94	XU5M-BDY	Cat.	4	0,8	BCPR5ES	6130		BCPR5EIX-1 3306
405	1.6	66	04.95-	XU5JP-BFZ	4	0,8	BKR5EK	7956	23	BKR5EIX	6341
405	1.8		04.95-	XU7JP-LFZ	4	0,8	BKR5EK	7956	23	BKR5EIX	6341
405 TD	1.8	68	03.88-12.92	XUD7TE	4	█	Y-902R	2237			
405 Signa,Style	1.8	74	07.92-03.95	XU7JP-LFZ	Cat.	4	0,8	BCPR5ES	6130		BCPR5EIX-1 3306
405 GR,SR	1.9		07.87-06.92	XU92C	4	0,7	BCP6ES	4930	17	BCPR6EIX-1	4919
405 GRi,SRi,Si,X4	1.9		07.87-06.92	XU9J2-D6A	4	0,7	BCP6ES	4930	17	BCPR6EIX-1	4919
405 MI16,X4	1.9		07.90-06.92	XU9J4-D6C	4	0,9	BCPR6ET	2197			
405 GLD	1.9	47	07.88-12.92	XUD9Y	4	█	Y-902R	2237			
405	1.9	51	09.98-12.99	XUD9A	4	█	Y-938R	5267			
405 D	1.9	51	03.88-	XUD9A	4	█	Y-902R	2237			
405	1.9	55	10.95-	XUD9SD	4	█	Y-923U	3380			
405 TD	1.9	68	09.92-12.97	XUD9TE / XUD9TF	4	█	Y-923U	3380			
405 Mi16,X4	1.9	116	07.87-06.90	XU9J4-D6C	4	0,8	BCP6ET	4563		BCPR6EIX-11	4919

¹⁾ Bic = Best in class (siehe Seite 3) / (see page 3)

** alternative/wahlweise V-Line 30



l kW

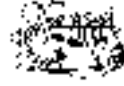

Cyl.

Order-
No. No.Bic¹⁾ Order-
No.**PEUGEOT**

405 Signature,STI	2.0		07.92-03.95	XU10J2-RFX	Cat.	4	0,8	BCPR5ES	6130		BCPR5EIX-1	3306
405 Signature,STI	2.0	90	04.95-	XU10J2-RFX	Cat.	4	0,8	BKR5EK	7956	23	BKR5EIX	6341
405 T16	2.0	104		XU10J4TE-RGZ	Cat.	4	0,8	BKR6EK	2288	20**	BKR6EQU	3199
405 Mi16	2.0	110	07.92-	XU10J4-RFY	Cat.	4	0,8	BKR6ES	3783	28	BKR6EIX	6418
406	1.6	66	10.95-	XU5JP-BFZ		4	0,8	BKR5EK	7956	23	BKR5EIX	6341
406	1.8	66	10.95-	XU7JP-L6A		4	0,8	BKR5EK	7956	23	BKR5EIX	6341
406	1.8	81	10.95-	XU7JP4-LFY		4	0,8	BKR5EK	7956	23	BKR5EIX	6341
406	1.9	68	09.98-12.99	XUD9TE /TF/BTF		4	█	Y-938R	5267			
406 TD	1.9	68	10.95-08.98	XUD9TE/TF/BTF		4	█	Y-923U	3380			
406 HDI	2.0	81	12.98-04.04	DW10ATED		4	█	Y-504R	4359			
406	2.0	97	10.95-	XU10J4R-RFV		4	0,8	BKR5EK	7956	23	BKR5EIX	6341
406	2.0	107	07.96-	XU10J2TE-RGX		4	0,8	BKR6EK	2288	20**	BKR6EQU	3199
406 TD	2.1	80	10.95-08.98	XUD11BTE		4	█	Y-923U	3380			
406	2.1	80	09.98-12.99	XUD11BTE		4	█	Y-938R	5267			
406 24V V6	3.0	139	10.96-	ES9J4-XFZ		6	0,8	BKR6EK	2288	20**	BKR6EQU	3199
406 Coupé 16V	2.0	97	06.97-03.99	XU10J4R-RFV		4	0,8	BKR5EK	7956	23	BKR5EIX	6341
406 Coupé 16V	2.0	101	04.99-	EW10J4-RFR		4	0,9	LFR5B	7113			
406 Coupé	2.2	100	03.01-	DW12TED4		4	█	Y-504R	4359			
406 Coupé 16V	2.2	118	05.00-	EW12J4-3FZ		4	0,9	LFR5B	7113			
406 Coupé V6	3.0	143	06.97-05.00	ES9J4-XFZ		6	0,8	BKR6EK	2288	20**	BKR6EQU	3199
406 Coupé V6	3.0	154	06.00-	ES9J4S-XFX		6	1,1	PLFR5A-11	6240			
406 Phase 2	1.8	66	04.99-	XU7JB-LFX		4	0,8	BKR6EK	2288	20**	BKR6EQU	3199
406 Phase 2	1.8	81	04.99-08.00	XU7JP4-LFY		4	0,8	BKR5EK	7956	23	BKR5EIX	6341
406 Phase 2	1.8	86	09.00-	EW7J4-6FZ		4	0,9	LFR5B	7113			
406 TD Phase 2	2.0	66	04.99-04.04	DW10TD		4	█	Y-504R	4359			
406 TD Phase 2	2.0	81	04.99-04.04	DW10ATED		4	█	Y-504R	4359			
406 Phase 2	2.0	101	04.99-	EW10J4-RFR		4	0,9	LFR5B	7113			
406 HDI Phase 2	2.2	100	09.00-05.03	DW12TED4		4	█	Y-504R	4359			
406 Phase 2	2.2	117	05.00-	EW12J4-3FZ		4	0,9	LFR5B	7113			
406 Phase 2	3.0	139	04.99-09.00	ES9J4-XFZ		6	0,8	BKR6EK	2288	20**	BKR6EQU	3199
406 Phase 2	3.0	154	10.00-	ES9J4S-XFX		6	1,1	PLFR5A-11	6240			
407 HDI	1.6		04.04-	DV6TED		4	█	YE04	1101			
407 HDI	2.0		04.04-	DW10TED		4	█	Y-504R	4359			
504			11.77-	Injection/Einspritzer		4	0,8	BP5ES	6511		BPR5EIX	6597
504				Carburettor/Vergaser		4	0,8	BP5ES	6511		BPR5EIX	6597
504	1.9		05.81-06.87	XD4.88		4	█	Y-902R	2237			
504 D Pick Up	2.3	47	07.84-12.90	XD 2		4	█	Y-902R	2237			
505 GL,SR,ST,SX	1.8	55	05.79-	XN.. / XM..		4	0,7	BP6ES	7811	4	BPR6EIX	6637
505 Ti,STi	2.0	81	08.79-	ZEJ..		4	0,8	BP6EFS	3812	5		
505 GTi	2.2		05.81-12.93	ZAJ..		4	0,8	BP6EFS	3812	5		
505 Turbo	2.2	105	-10.88	N9T		4	0,6	BR7ES	5122			
505 Turbo	2.2	110	03.84-10.88	N9TE		4	0,8	BP6ET	1263		PGR6D	6248
505 D	2.3	44	09.79-09.86	XD 2		4	█	Y-208T	1250			
505 TD	2.3	54	09.80-06.86	XD 2 S		4	█	Y-208T	1250			
505 D	2.5	51	06.87-12.93	XD 3		4	█	Y-902R	2237			
505 TD	2.5	66	10.83-12.93	XD 3 T		4	█	Y-902R	2237			
505 TD	2.5	77	10.86-12.93	XD 3 TE		4	█	Y-902R	2237			
505 V6	2.8	105	08.86-12.93	ZN3J		6	0,6	BR7EF	3346			
604 TD	2.5	66	07.83-06.86	XD 3 T		4	█	Y-902R	2237			
604 V6	2.8	106	-06.86	ZNJ/K..		6	0,8	BP6EFS	3812	5		
605 SL	2.0	79	07.89-06.92	XU102C-R2A		4	0,7	BCP6ES	4930	17	BCPR6EIX-1	4919
605 SLI	2.0	89	07.92-07.94	XU10J2-RFZ	Cat.	4	0,8	BCPR5ES	6130		BCPR5EIX-1	3306

¹⁾ Bic = Best in class (siehe Seite 3) / (see page 3)

** alternative/wahlweise V-Line 30



ℓ kW



Cyl.

Order-
No. No.Bic¹⁾ Order-
No.**PEUGEOT**

605 SRI	2.0	89	09.89-12.92	XU10J2-R6A	4	0,8	BCPR6ES	2330		BCPR6EIX-1	4919
605	2.0	99	08.94-05.99	XU10J4R-RFV	4	0,8	BKR5EK	7956	23	BKR5EIX	6341
605 SRTi Turbo	2.0	104	12.92-05.99	XU10J2TE-RGX	4	0,8	BKR6EK	2288	20**	BKR6EQUIP	3199
605 D	2.1	60	09.89-06.94	XUD11A/L	4	█	Y-902R	2237			
605 TD	2.1	80	09.98-07.00	XUD11ATE/BTE	4	█	Y-938R	5267			
605 TD	2.1	80	09.89-06.94	XUD11ATE/L, BTE	4	█	Y-923U	3380			
605 TD	2.5	96	07.94-05.99	DK5ATE	4	█	Y-923U	3380			
605 SR,SV	3.0	125	07.89-06.97	ZPJ-SFZ	Cat. 6	0,9	BCPR6ET	2197			
605 3.0	3.0	140	07.97-05.99	ES9J4-XFZ	6	0,8	BKR6EK	2288	20**	BKR6EQUIP	3199
605 SV 24V	3.0	147	07.89-06.97	ZPJ4-SKZ	Cat. 6	0,9	BCPR6ET	2197			
607 HDI	2.0			DW10TED	4	█	Y-504R	4359			
607	2.0	101	05.00-	EW10J4-RFN	4	0,9	LFR5B	7113			
607 HDI 16V	2.2	100	05.00-	DW12TED4	4	█	Y-504R	4359			
607	2.2	118	05.00-	EW12J4-3FZ	4	0,9	LFR5B	7113			
607 3.0 V6	3.0	152	05.00-	ES9J4S-XFX	6	1,1	PLFR5A-11	6240			
806	1.8	74	10.96-06.00	XU7JP-LFW	4	0,8	BKR5EK	7956	23	BKR5EIX	6341
806 D	1.9	68	09.98-01.01	XUD9TF	4	█	Y-938R	5267			
806 D	1.9	68	09.98-	XUD9BTF	4	█	Y-938R	5267			
806 TD	1.9	68	06.94-08.98	XUD9TF	4	█	Y-923U	3380			
806 D	2.0	80	09.98-	DW10TED	4	█	Y-504R	4359			
806 D HDI	2.0	81	09.99-	DW10ATED	4	█	Y-504R	4359			
806 16V	2.0	88	06.94-03.95	XU10J2-RFU	4	0,8	BCPR5ES	6130		BCPR5EIX-1	3306
806	2.0	90	04.95-05.00	XU10J2-RFU	4	0,8	BKR5EK	7956	23	BKR5EIX	6341
806	2.0	101	06.00-	EW10J4-RFR	4	0,9	LFR5B	7113			
806 Turbo	2.0	110	06.94-05.00	XU10J2TE-RGX	4	0,8	BKR6EK	2288	20**	BKR6EQUIP	3199
806 D	2.1	80	09.98-01.01	XUD11BTE	4	█	Y-938R	5267			
806 D	2.1	80	06.96-08.98	XUD11BTE	4	█	Y-923U	3380			
806 TD	2.1	80	07.96-	XUD11ATE	4	█	Y-923U	3380			
807 Hdi	2.0	80	06.02-	DW10ATED4/RHT	4	█	Y-504R	4359			
807	2.0	102	06.02-	EW10J4-RFR	4	0,9	LFR5B	7113			
807 Hdi	2.2	94	06.02-	DW12TED4/4HW	4	█	Y-504R	4359			
807	2.2	118	06.02-	EW12J4-3FZ	4	0,9	LFR5B	7113			
807	3.0	154	06.02-	ES9J4S-XFX	6	1,1	PLFR5A-11	6240			
Boxer D	1.8	44	09.98-	XUD7	4	█	Y-938R	5267			
Boxer D	1.9	51	03.94-08.98	XUD9A	4	█	Y-923U	3380			
Boxer D	1.9	51	09.98-	XUD9AU	4	█	Y-938R	5267			
Boxer TD	1.9	67	03.94-08.98	XUD9TF	4	█	Y-923U	3380			
Boxer	1.9	68	09.98-	XUD9TF	4	█	Y-938R	5267			
Boxer	2.0	81	-03.95	XU10J2U-RFW	4	0,8	BCPR6ES	2330		BCPR6EIX-11	4919
Boxer	2.0	81	04.95-	XU10J2U-RFW	4	0,8	BKR6EK	2288	20**	BKR6EQUIP	3199
Boxer	2.5	63	03.94-08.98	DJ5	4	█	Y-923U	3380			
Boxer Tdi	2.5	76	09.96-	DJ5TED	4	█	Y-738U	5390			
Boxer TD	2.5	76	03.94-08.96	DJ5T	4	█	Y-923U	3380			
Boxer HDI	2.8	93	10.97-	Sofim	4	█	Y-924U	4950			
Boxer 2 HDI	2.0	80	09.98-	DW10TD	4	█	Y-504R	4359			
Boxer 2 HDI	2.2	100	03.01-	DW10TED4	4	█	Y-504R	4359			
Expert	1.6	59	95-	1580 SPI 222A2.000	4	0,8	BCPR7ES	3330			
Expert	1.8	44	09.98-	DW8	4	█	Y-503R	4279			
Expert TD	1.8	59	09.98-	DW8TD	4	█	Y-503R	4279			
Expert	1.8	74	96-	XU7JP	4	0,8	BKR5EK	7956	23	BKR5EIX	6341
Expert	1.9	51	09.98-	XUD9A	4	█	Y-938R	5267			
Expert	1.9	51	01.96-08.98	XUD9A	4	█	Y-923U	3380			

¹⁾ Bic = Best in class (siehe Seite 3) / (see page 3)

** alternative/wahlweise V-Line 30



l kW

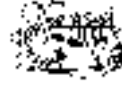

Cyl.

Order-
No. No.Bic¹⁾ Order-
No. No.**PEUGEOT**

Expert TD	1.9	66	09.95-	XUD 9TE	4	☑	Y-923U	3380			
Expert TD	1.9	66	09.98-	XUD9TF	4	☑	Y-938R	5267			
Expert TD	1.9	66	09.98-	XUD9BTF	4	☑	Y-938R	5267			
Expert	1.9	68	01.96-08.98	XUD9TF	4	☑	Y-923U	3380			
Expert	1.9	68	01.96-08.98	XUD9BTF	4	☑	Y-923U	3380			
Expert HDI	2.0	70	02.00-	DW10TED	4	☑	Y-504R	4359			
Expert HDI	2.0	81	02.00-	DW10ATED	4	☑	Y-504R	4359			
Expert	2.0	101	06.00-	EW10J4-RFN	4	0,9	LFR5B	7113			
Expert	2.1	80	07.96-	XUD11ATE	4	☑	Y-923U	3380			
J5, J7, J9					4	0,8	BP5ES	6511		BPR5EIX	6597
J 5 D	1.9	51	11.87-	XUD9A	4	☑	Y-902R	2237			
J 5 D	2.5	54	09.81-06.91	CRD93	4	☑	Y-208T	1250			
J 5 TD	2.5	70	07.87-06.91	CRD93LS	4	☑	Y-208T	1250			
J 9 Transporter D		59	05.81-		4	☑	Y-902R	2237			
J 9 Transporter D	2.1	41	05.81-	XDP 4.90	4	☑	Y-902R	2237			
J 9 Transporter D	2.5	53	10.82-	XD3P	4	☑	Y-902R	2237			
Partner	1.1	44	07.96-	TU1M+HDZ	4	0,8	BKR6EK	2288	20**	BKR6EQU	3199
Partner	1.4	55	07.96-	TU3JP-KFX;KFW	4	0,8	BKR6EK	2288	20**	BKR6EQU	3199
Partner	1.8	66	07.97-	XU7JB-LFX	4	0,8	BKR6EK	2288	20**	BKR6EQU	3199
Partner Combi	1.8	43	07.96-08.98	XUD7	4	☑	Y-923U	3380			
Partner Combi	1.8	44	09.98-03.02	DW8	4	☑	Y-503R	4279			
Partner Combi	1.8	44	09.98-03.02	XUD7	4	☑	Y-938R	5267			
Partner Combi	1.8	59	09.98-03.02	DW8TD	4	☑	Y-503R	4279			
Partner Combi	1.9	51	09.98-03.02	DW8 / DW8B	4	☑	Y-503R	4279			
Partner Combi	1.9	51	07.96-08.98	XUD9A	4	☑	Y-923U	3380			
Partner Combi	1.9	51	09.98-03.02	XUD9A	4	☑	Y-938R	5267			
Partner Combi HDI	2.0	66	10.99-03.02	DW10TD	4	☑	Y-504R	4359			
Partner Multispace	1.4	55	01.00-	TU3JP-KFX;KFW	4	0,9	BKR6EZ	4619		BKR6EIX	6418
Partner Multispace	1.4	55	01.97-12.99	TU3JP-KFX;KFW	4	0,8	BKR6EK	2288	20**	BKR6EQU	3199
Partner Multispace	1.6	81	02.01-	TU5JP4-NFU	4	0,9	LFR6B	6677			
Partner Multispace	1.8	66	07.97-	XU7JB-LFX	4	0,8	BKR6EK	2288	20**	BKR6EQU	3199
Partner Multispace	1.9	51	01.97-09.98	XUD9A	4	☑	Y-923U	3380			
Partner Multispace	1.9	51	09.98-	DW8 / DW8B	4	☑	Y-503R	4279			
Partner Multispace HDI	2.0	66	10.99-	DW10TD	4	☑	Y-504R	4359			

PIAGGIO

Ape Car D	0.5	11	01.83-			☑	Y-918R	4182			
-----------	-----	----	--------	--	--	---	--------	------	--	--	--

PLYMOUTH

Breeze	2.0		96-	L4 MPI C SOHC		0,9	FR5	4876			
Breeze	2.0		96- 99	L4 MPI X DOHC		1,2	FR45	4636			
Neon	2.0		95-	L4 MPI C SOHC		0,9	FR5	4876			
Neon	2.0		95-	L4 MPI Y DOHC		0,9	FR5	4876			

PONTIAC

Bonneville	3.8		98- 99	V6 MFI 1 SC	6	1,5	PTR4B-15	5146			
Bonneville	3.8		96- 99	V6 MFI K	6	1,5	PTR4B-15	5146			
Bonneville	3.8		96- 97	V6 SFI 1 SC	6	1,5	PTR4B-15	5146			
Firebird	3.8		96- 99	V6 MFI K	6	1,5	PTR4B-15	5146			
Grand Prix	3.1		94- 95	V6 MFI M	6	1,5	TR55	1048		TR55IX	7164
Grand Prix	3.4		91- 95	V6 MFI X	6	1,1	TR5	7837		TR5IX	7397
Grand Prix	3.8		98-	V6 MFI 1 SC	6	1,5	PTR4B-15	5146			

¹⁾ Bic = Best in class (siehe Seite 3) / (see page 3)

** alternative/wahlweise V-Line 30



ℓ kW

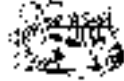

Cyl.

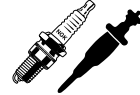
Order-
No. No.Bic¹⁾ Order-
No. No.**PONTIAC**

Grand Prix	3.8		97-	V6 MFI K	6	1,5	PTR4B-15	5146			
Grand Prix	3.8		97-	V6 MFI 1 SC	6	1,5	PTR4B-15	5146			
Trans Sport	2.3	101	01.93-	L4 16V G	4	0,8	BCPR6ES	2330	12	BCPR6EIX-11	4919
Trans Sport V6	3.1		90- 95	V6 SFI D	6	1,3	UR5	2139		UR5IX	7177
Trans Sport V6	3.4		96-	V6 MFI E	6	1,3	TR55	1048		TR55IX	7164
Trans Sport V6	3.8		94- 95	V6 SFI L	6	1,3	TR55	1048		TR55IX	7164
Trans Sport V6	3.8		01.92- 93	V6 MFI L	6	1,3	TR55	1048		TR55IX	7164

PORSCHE

911 Carrera	3.2	152	08.86-08.89	930.21 / 930.25	6	0,8	BPR6ES	7822	2	BPR6EIX	6637
911 Carrera 3.2	3.2	170	08.83-08.89	930.20 / 930.26	6	0,7	BR8EVX	1262			
911 Turbo	3.3	221	08.82-08.89	930.66/60	6	0,6	BP8EVX	2671			
911 Turbo	3.3	235	12.90-08.92	30.69	6	0,6	B8EGV	5627			
911 Carrera 4	3.4	221	08.98-	M 96.02	6		BKR6EQU	3199	30		
911 (996)	3.4	221	09.97-	M 96.02	6		BKR6EQU	3199	30		
911 (996)	3.4	221	09.97-	M 96.01 / 04	6		BKR6EQU	3199	30		
911 Carrera 2/4/RS	3.6	184	08.89-08.93	64.01/02/03	6	0,8	BCPR7ET	2164			
911 Carrera Speedster	3.6	184	03.93-		6	0,8	BCPR7ET	2164			
911 Carrera	3.6	200	09.93-08.97	64.07/08/23/24	6	0,8	BCPR7ET	2164			
911 (993)	3.6	200	09.93-08.97	64.05/06	6	0,8	BCPR7ET	2164			
911	3.6	220	08.93-08.97	64.21/22	6	0,8	BKR6EK	2288	20**	BKR6EQU	3199
911 Turbo	3.6	265	03.93-08.94	M 64.50	6	0,8	BKR6EK	2288	20**	BKR6EQU	3199
911 GT 3	3.6	265	03.99-	M 96.76	6	0,8	BKR6EK	2288	20**	BKR6EQU	3199
911 Turbo	3.6	300	03.95-08.97	M 64.60	6	0,8	BKR6EK	2288	20**	BKR6EQU	3199
911 Turbo (996)	3.6	309	06.00-	M 96.70	6		BKR7EKC	7354			
911 Turbo GT 2 Carrera	3.6	316	01.95-05.97		6	0,8	BKR6EK	2288	20**	BKR6EQU	3199
911 Carrera RS	3.8	221	09.94-08.97	64.20	6	0,8	BCPR7ET	2164			
914 1,7 / 2,0 Ltr					4	0,7	B6ES	7310			
924	2.0	85	01.76-08.85	XK,XJ	4	0,7	BP7ES	2412		BPR7EIX	4055
924 S	2.5	110	09.85-07.88	M44.07/08/09/10	4	0,8	BPR6ES	7822	2	BPR6EIX	6637
928 S	4.7	200	12.84-07.86	M28.43/44/45/46	8	0,8	BPR6ES	7822	2	BPR6EIX	6637
928 S	4.7	221	09.79-07.86	M28.11/12/21/22	8	0,8	BPR6ES	7822	2	BPR6EIX	6637
928 S4/CS	5.0	235	08.86-07.91	M28.41/42	8	0,8	BPR6ES	7822	2	BPR6EIX	6637
928 GT	5.0	243	01.89-07.91	M28.47	8	0,8	BPR6ES	7822	2	BPR6EIX	6637
928 GTS	5.4	250	08.91-11.95	M28.49/50	8	0,8	BP6ET	1263		PGR6D	6248
944 2.5	2.5	118	01.85-07.88	M44.05/06/09/10	4	0,8	BPR6ES	7822	2	BPR6EIX	6637
944	2.5	135	08.86-07.88	M44.40	4	0,8	BPR6ES	7822	2	BPR6EIX	6637
944 2.5 Turbo	2.5	162	08.85-07.88	M44.50/51	4	0,8	BPR6ES	7822	2	BPR6EIX	6637
944 Turbo	2.5	162	08.85-07.88	M44.50/51	4	0,8	BPR6ES	7822	2	BPR6EIX	6637
944 Turbo	2.5	184	09.87-07.91	M44.52	4	0,8	BPR6ES	7822	2	BPR6EIX	6637
944 2.5 Turbo	2.5	184	09.87-07.91	M44.52	4	0,8	BPR6ES	7822	2	BPR6EIX	6637
944	2.7	121	11.88-08.89	M44.11/12	4	0,8	BPR6ES	7822	2	BPR6EIX	6637
944 S2	3.0	155	12.88-07.91	M44.41	6	0,8	BPR7ES	2023	19	BPR7EIX	4055
959	2.8	330	05.86-07.88	959.50	6	0,7				DR9EIX	4772
968	3.0	176	08.91-11.95	M44.43/44	6	0,8	BP6ET	1263		PGR6D	6248
968 Turbo S	3.0	224	01.93-11.95		6	0,8	BKR6ES	3783	28	BKR6EIX	6418
Boxster / 1	2.5	150	09.96-05.02	M 96.20	6	0,8	BKR6EK	2288	20**	BKR6EQU	3199
Boxster / 1	2.7	168	09.99-05.02	M 96.22	6		BKR6EQU	3199	30		
Boxster S / 1	3.2	185	09.99-05.02	M 96.21	6		BKR6EQU	3199	30		
Cayenne	3.2	184	10.03-	BFD	6	0,9	IZKR7B				

¹⁾ Bic = Best in class (siehe Seite 3) / (see page 3)

** alternative/wahlweise V-Line 30



l kW

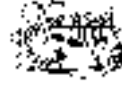

Cyl.

Order-
No. No.Bic¹⁾ Order-
No. No.**PRAGA**

14mm					4	0,7	B6HS	4510		BR6HIX	3419
18mm					4	0,7	A7	1110			

PROTON

313	1.3	55	96-	(Mitsubishi)	4	1,1	BPR5ES-11	4424		BPR5EIX-11	2115
315	1.5	64	96-	(Mitsubishi)	4	1,1	BKR6E-11	2756	14	BKR6EIX-11	3764
318 GTI	1.9	100	09.99-		4	1,1	BKR6E-11	2756	14	BKR6EIX-11	3764
413	1.3	55	05.96-	C96	4	1,1	BPR5ES-11	4424		BPR5EIX-11	2115
415	1.5	66	03.95-	C97	4	1,1	BPR5ES-11	4424		BPR5EIX-11	2115
416	1.6	85	03.95-	C98	4	1,1	BKR6E-11	2756	14	BKR6EIX-11	3764
418	1.8	85	05.96-	C99	4	1,1	BKR6E-11	2756	14	BKR6EIX-11	3764
418 LRS	1.8	99	98-		4	1,1	BKR6E-11	2756	14	BKR6EIX-11	3764
Persona	1.3			4G13	4	0,7	BPR6ES	7822	2	BPR6EIX	6637
Persona	1.5		11.93-	4G15	4	0,7	BPR5ES	7422	6	BPR5EIX	6597
Persona	1.6		11.93-	4G92	4	1,1	BKR6E-11	2756	14	BKR6EIX-11	3764
Persona	1.8		09.96-	4G92	4	1,1	BKR6E-11	2756	14	BKR6EIX-11	3764
Satria	1.3		03.00-		4	0,7	BPR5ES	7422	6	BPR5EIX	6597
Wira	1.5		03.00-	4G15	4	1,1	BPR5ES-11	4424		BPR5EIX-11	2115
Wira	1.6		05.00-	4G92	4	1,1	BKR6E-11	2756	14	BKR6EIX-11	3764
Wira	1.8		05.00-		4	1,1	BKR6E-11	2756	14	BKR6EIX-11	3764

RELIANT

Kitten					4	0,6	BPR5ES	7422	6	BPR5EIX	6597
Rebel			74-		4	0,6	BPR6ES	7822	2	BPR6EIX	6637
Regal			74-		4	0,6	BPR6ES	7822	2	BPR6EIX	6637
Rialto					4	0,6	BPR5ES	7422	6	BPR5EIX	6597
Robin			-09.96		4	0,6	BPR5ES	7422	6	BPR5EIX	6597
Robin			09.96-		4	0,6	BCPR5ES	6130	32	BCPR5EIX-11	3306
Scimitar	2.8				6	0,7	BPR6ES	7822	2	BPR6EIX	6637
Scimitar	3.0				6	0,7	BPR6ES	7822	2	BPR6EIX	6637
SS1	1.3				4	0,7	BCPR6E	1269	12	BCPR6EIX-11	4919
SS1	1.6				4	0,7	BCPR7ES	3330			
SS1	1.8				4	1,1	BCPR6E-11	3132	11	BCPR6EIX-11	4919

RENAULT

Alpine A 310	2.6	110			6	0,8	BP6EFS	3812	5		
Alpine A 610	3.0			Z7X-744	6	0,9	BKUR7ET	7873		PFR7Q	7963
Alpine V 6 Turbo, Le Mans	2.5			Z7U-730/734 Z6W	6	0,6	BP7EFVX	3344			
Alpine V 6	2.9		03.85-12.92		6	0,8	BP6EFS	3812	5		
Avantime 16V Turbo	2.0	121	04.02-	F4R-760 / 761	4	0,8				BKR6EIX	6418
Avantime	2.2	110	06.02-	03	4	█	Y-517J	3319			
Avantime 24V V6	3.0	154	02.02-		6	1,1	PLFR5A-11	6240			
Cavalier D					4	█	Y-902R	2237			
Cherokee D	2.1	59			4	█	Y-908R	4585			
Clio	1.1	35	06.90-03.96	C1E-700	4	0,8	BP5ES	6511	8	BPR5EIX	6597
Clio	1.2	40	06.90-02.98	E5F-710/716	4	0,8	BCP5ES	7496	16	BCPR5EIX-1	3306
Clio	1.2	40	06.90-02.98	E7F-706/700	4	0,8	BCP5ES	7496	16	BCPR5EIX-1	3306
Clio	1.2	40	11.94-03.96	C3G-720	4	0,8	BP5ESZ	4691		BPR5EIX	6597
Clio	1.2	44	01.96-06.97	D7F-730	4	0,9	BK5ESZ	5675			
Clio	1.2	44	07.97-02.98	D7F-730	4	0,8	BKR5EK	7956	23	BKR5EIX	6341
Clio	1.4	55	06.90-	E7J-718 / 719	4	0,8	BCP5ES	7496	16	BCPR5EIX-1	3306
Clio	1.4	55	06.90-02.98	E6J-712 / 713	4	0,8	BCP5ES	7496	16	BCPR5EIX-1	3306

¹⁾ Bic = Best in class (siehe Seite 3) / (see page 3)



ℓ kW

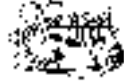

Cyl.

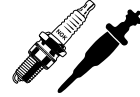
Order-
No. No.

V-LINE

Bic¹⁾ Order-
No.**RENAULT**

Clio	1.4	55	04.96-	E7J-754	4	0,8	BCP5ES	7496	16	BCPR5EIX-1	3306	
Clio	1.4	58	06.90-02.98	E7J-710 / 711	4	0,8	BCP5ES	7496	16	BCPR5EIX-1	3306	
Clio	1.7	66	06.90-03.96	F2N 770	4	0,8	BP7ES	2412		BPR7EIX	4055	
Clio	1.8	65	06.96-02.98	F3P-755	4	0,9	BP6ESZ	7639	4	PGR6D	6248	
Clio	1.8	65	06.90-04.96	F3P-710/714	4	0,9	BP6ESZ	7639	4	PGR6D	6248	
Clio	1.8	66	06.90-02.98	F3P	4	0,7	BP6ESZ	7639	4	PGR6D	6248	
Clio RSi	1.8	79	08.94-	F3P 758	Cat.	4	0,8	BP7ES	2412		BPR7EIX	4055
Clio	1.8	79	08.95-	F3P-R758		4	0,7	BP6ES	7811	4	BPR6EIX	6637
Clio	1.8	81	02.91-04.96	F3P 712		4	0,7	BP6ESZ	7639	4	PGR6D	6248
Clio 16V	1.8	100	03.91-03.96	F7P 720, F7P 722		4	0,8	BKR6EK	2288	20**	BKR6EQUIP	3199
Clio	1.9	47	05.90-02.91			4	█	Y-908R	4585			
Clio	1.9	48	03.91-08.98	F8Q676/678/692/696		4	█	Y-927R	5171			
Clio	1.9	48	05.90-02.91	F8Q-714/730/732		4	█	Y-913M	3965			
Clio Williams 2.0 16S	2.0	110	12.93-01.96	F7R-700		4	0,8	BKR6EK	2288	20**	BKR6EQUIP	3199
Clio 2	1.2	44	03.98-	D7F 720, 722		4	0,8	BKR5EK	7956	23	BKR5EIX	6341
Clio 2	1.2	44	10.99-	D7F-726		4	0,9	BKR6EZ	4619		BKR6EIX	6418
Clio 2 16V	1.2	55	03.00-	D4F-712		4	0,8	LZKAR7A	6799			
Clio 2	1.4	55	03.98-03.01	E7J-780		4	0,9	BKR5EZ	7642		BKR5EIX	6341
Clio 2 16V	1.4	73	01.00-	K4J 712, 713		4	0,9	BKR6EZ	4619		BKR6EIX	6418
Clio 2 16V	1.6	66	03.98-09.99	K7M-744		4	0,8	BKR5EK	7956	23	BKR5EIX	6341
Clio 2	1.6	66	03.98-09.99	K7M-745		4	0,8	BKR5EK	7956	23	BKR5EIX	6341
Clio 2	1.6	81	02.99-	K4M 748		4	0,9	BKR6EZ	4619		BKR6EIX	6418
Clio 2	1.9	48	03.99-12.03	F8Q632		4	█	Y-516J	1436			
Clio 2	1.9	48	03.98-12.03	F8Q630/662 BBOEOF		4	█	Y-506R	4409			
Clio 2 dTi	1.9	59	01.99-06.01	F9Q782		4	█	Y-740U	5104			
Clio 2 dTi	1.9	59	03.99-12.03	F9Q780		4	█	Y-515J	1019			
Clio 2 16V RS	2.0	126	01.00-	F4R 730		4	1,0	PFR6E-10	3688			
Clio 2 Phase 2 8S	1.2	44	06.01-	D7F 726		4	0,9	BKR5EZ	7642		BKR5EIX	6341
Clio 2 Phase 2 16S	1.2	55	01.02-	D4F-712		4	0,8	LZKAR7A	6799			
Clio 2 Phase 2 16S	1.4	72	06.01-	K4J 710, 711		4	0,9	BKR6EZ	4619		BKR6EIX	6418
Clio 2 Phase 2 dCi	1.5	48	06.01-	K9K704, 710		4	█	Y-515J	1019			
Clio 2 Phase 2 dCi	1.5	59	11.01-	K9K702		4	█	Y-515J	1019			
Clio 2 Phase 2 16S	1.6	81	06.01-	K4M 744, 745		4	0,9	BKR6EZ	4619		BKR6EIX	6418
Clio 2 Phase 2 16V RS	2.0	126	06.01-	F4R 730		4	1,0	PFR6E-10	3688			
Espace 1	2.0	74	07.84-03.91	J6R		4	0,8	BP6EFS	3812	5		
Espace 1	2.0	77	06.87-03.91	J7R		4	0,7	BP7EFS	3526			
Espace 1	2.1	65	10.84-10.90	J8S240/774		4	█	Y-908R	4585			
Espace 2	2.0		04.91-10.96	J7R-768	Cat	4	0,8	BP6EFS	3812	5		
Espace 2	2.2	81	04.91-10.96	J7T-772 CAT		4	0,7	BP7EFS	3526			
Espace 2	2.2	85	91-10.96	G8T-714/716/760		4	█	Y-730U	2273			
Espace 2	2.8	113	04.91-10.96	Z7W-712/ 717	Cat	6	0,7	BP7EFS	3526			
Espace 3 dCi	1.9	74	02.99-12.02	F9Q-722		4	█	Y-515J	1019			
Espace 3 dTi	1.9	74	02.99-12.02	F9Q716/730/734		4	█	Y-740U	5104			
Espace 3	2.0		10.98-	F4R-700		4	0,8	BKR6EK	2288	20**	BKR6EQUIP	3199
Espace 3	2.0	85	11.96-09.00	F3R-...		4	0,9	BPR5ES	7422	6	BPR5EIX	6597
Espace 3 dT	2.2	81	01.97-08.00	G8T-714/716		4	█	Y-730U	2273			
Espace 3 dCi	2.2	85	06.00-12.02	G9T-710		4	█	Y-517J	3319			
Espace 3 dCi	2.2	96	06.00-12.02			4	█	Y-517J	3319			
Espace 3	3.0	121	11.96-09.98	Z7X-775 V6		6	0,9	BCPR6ET	2197			
Espace 3	3.0	143	10.98-	L7X-727 V6 24V		6	1,0	PFR6E-10	3688			
Espace 4	2.0	121	10.02-	F4R-760		4	0,9	PFR6G-9	4377			
Espace 4 dci	2.2	110	03-	G9T		4	█	Y-517J	3319			

¹⁾ Bic = Best in class (siehe Seite 3) / (see page 3)

** alternative/wahlweise V-Line 30



l kW

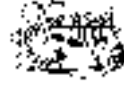

Cyl.

Order-
No. No.Bic¹⁾ Order-
No.**RENAULT**

Espace 4 dCi	3.0	132	10.02-	P9X701	6	█	CZ24 only OE					
Espace 4	3.5	180	10.02-	V4Y-711	6	1,1	PLFR5A-11	6240				
Express	1.6	40	07.86-03.97	F8M-720/730/736/760	4	█	Y-913M	3965				
Express	1.9	48	09.94-12.95	F8Q-640/644/646/648	4	█	Y-927R	5171				
Express	1.9	48	01.96-	F8Q-640/680/682	4	█	Y-927R	5171				
Express	1.9	48	09.91-08.94	F8Q-684/722/724/774/776	4	█	Y-913M	3965				
Express	1.0		03.86-08.91	C1C706/700	4	0,8	BP5ES	6511	8	BPR5EIX	6597	
Express	1.1	35	06.87-10.97	C1E-...	4	0,8	BP5ES	6511	8	BPR5EIX	6597	
Express	1.4	44	03.86-09.91	C1J-... / C2J-...	4	0,8	BP5ES	6511	8	BPR5EIX	6597	
Express	1.0		10.91-	C1C-...	4	0,8	BP5ES	6511	8	BPR5EIX	6597	
Express	1.2		10.91-10.97	C1G-...	4	0,8	BP5ES	6511	8	BPR5EIX	6597	
Express	1.2	40	10.91-	C3G-710	Cat.	4	0,9	BP5ESZ	4691	8	BPR5EIX	6597
Express	1.4		08.92-	C3J-760	Cat.	4	0,9	BPR5ES	7422	6	BPR5EIX	6597
Express	1.4		10.91-	E6J-...		4	0,8	BGP5ES	7496	16	BCPR5EIX-1	3306
Express	1.4	59	10.91-	E7J...	Cat.	4	0,8	BGP5ES	7496	16	BCPR5EIX-1	3306
Fuego GTX / TX	2.0	81	10.80-10.85	829.../J6R-..		4	0,8	BP6EFS	3812	5		
Kangoo (XCOA)	1.2	44	10.97-	D7F-710		4	0,8	BKR5EK	7956	23	BKR5EIX	6341
Kangoo	1.2	44	05.00-	D7F-726 Euro2000		4	0,9	BKR6EZ	4619		BKR6EIX	6418
Kangoo 16V	1.2	55	07.00-	D4F-712		4	0,8	LZKAR7A	6799			
Kangoo (XCOC)	1.4	55	10.97-	E7J-780		4	0,8	BKR5EZ	7642		BKR5EIX	6341
Kangoo dCi	1.5	48	06.01-	K9K		4	█	Y-515J	1019			
Kangoo	1.6	70	07.01-	K7M-746		4	0,8	BKR5EK	7956	23	BKR5EIX	6341
Kangoo Express D	1.9	40	03.98-	F8Q-662		4	█	Y-506R	4409			
Kangoo Express D	1.9	48	03.98-	F8Q-630		4	█	Y-506R	4409			
Kangoo Express D	1.9	48	03.99-	F8Q-632		4	█	Y-516J	1436			
Kangoo dTi	1.9	59	03.98-	F9Q780		4	█	Y-515J	1019			
Kangoo dCi 4X4	1.9	59	11.01-			4	█	Y-515J	1019			
Kangoo 2 4X4	1.6	70	03-	K4M		4	0,9	BKR6EZ	4619		BKR6EIX	6418
Laguna / Nevada	1.8	66	01.94-	F3P-720/724/678		4	0,9	BP6ESZ	7639	4	PGR6D	6248
Laguna / Nevada	1.8	70	01.94-	F3P-720		4	0,9	BP6ESZ	7639	4	PGR6D	6248
Laguna / Nevada	1.9	103	03.94-	N7Q-700		4	0,8	BKR5EK	7956	23	BKR5EIX	6341
Laguna / Nevada	2.0	83	01.94-	F3R-722/723		4	0,9	BP6ESZ	7639	4	PGR6D	6248
Laguna / Nevada	2.0	85	01.94-	F3R-722/723		4	0,9	BP6ESZ	7639	4	PGR6D	6248
Laguna / Nevada D	2.2	62	09.94-	G8T...		4	█	Y-730U	2273			
Laguna / Nevada dT	2.2	85	03.96-	G8T.Turbo		4	█	Y-730U	2273			
Laguna / Nevada	3.0	123	04.94-05.96	Z7X-760/765		6	0,8	BKR6EK	2288	20**	BKR6EQUIP	3199
Laguna / Nevada	3.0	143	06.96-04.98	L7X 700/701		6	1,0	PFR6E-10	3688			
Laguna 2	1.6	81	01.01-	K4M-720		4	0,8	BKR6ES	3783	28	BKR6EIX	6418
Laguna 2 / Estate dCi	1.9	74	03.99-	F9Q710/717/718		4	█	Y-515J	1019			
Laguna 2 / Estate dCi	1.9	81	03.01-			4	█	Y-515J	1019			
Laguna 2 / Estate dCi	1.9	88	01.01-	F9QC750		4	█	Y-515J	1019			
Laguna 2 / Estate dCi	2.2	110	01.02-	G9T710		4	█	Y-517J	3319			
Laguna 2	3.0	152	01.01-	L7X-731		6	1,0	PFR6E-10	3688			
Laguna 2 / Estate	1.6	81	01.01-	K4M 720		4	0,9	BKR6EZ	4619		BKR6EIX	6418
Laguna 2 / Estate	1.8	87	01.01-	F4P 760		4	0,8	BKR6ES	3783	28	BKR6EIX	6418
Laguna 2 / Estate	3.0	154	01.01-	L7X		6	1,0	PFR6E-10	3688			
Laguna / Nevada Phase 2	1.6	81	04.98-	K4M-720/724		4	0,8	BKR5EK	7956	23	BKR5EIX	6341
Laguna / Nevada Phase 2	1.8	88	09.98-	F4P-760		4	0,8	BKR6ES	3783	28	BKR6EIX	6418
Laguna / Nevada Phase2 dTi	1.9	74	10.97-	F9Q-716/730/734		4	█	Y-740U	5104			
Laguna / Nevada Phase2 dCi	1.9	81	01.00-	F9Q718		4	█	Y-515J	1019			
Laguna / Nevada Phase 2	2.0	85	04.98-08.98	F3R-...		4	0,8	BPR6ES	7822	2	BPR6EIX	6637
Laguna / Nevada Phase 2	2.0	103	02.99-	F4R-780		4	0,8	BKR6ES	3783	28	BKR6EIX	6418

¹⁾ Bic = Best in class (siehe Seite 3) / (see page 3)

** alternative/wahlweise V-Line 30



ℓ kW

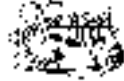

Cyl.

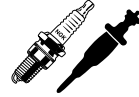
Order-
No. No.Bic¹⁾ Order-
No.**RENAULT**

Laguna / Nevada Phase2 dT	2.2	80	04.98-	G8T-Turbo	4	█	Y-730U	2273				
Laguna / Nevada Phase 2	3.0	142	05.98-12.00	L7X-700/701	6	1,0	PFR6E-10	3688				
Master T28 , T33 , T35			07.98-		4	█	Y-502R	3852				
Master dCi	1.9	59	06.00-	F9Q-770	4	█	Y-515J	1019				
Master	2.0	58		829../J5R..	4	0,7	BP6ES	7811	4	BPR6EIX	6637	
Master D T30	2.1	45	11.81- 96	852	4	█	Y-908R	4585				
Master	2.2			J7T-782	4	0,8	BP6EFS	3812	5			
Master dCi 16S	2.2	66	05.01-		4	█	Y-517J	3319				
Master dCi	2.2	85	00-	G9T-710	4	█	Y-517J	3319				
Master D T 30	2.4	52	06.82- 96	8140 / S8U	4	█	Y-908R	4585				
Master Turbo D T 35	2.5	55	06.82- 96	S9U	4	█	Y-908R	4585				
Master D T28	2.5	57	01.81-12.85	Sofim	4	█	Y-914U	2643				
Master D	2.5	59	07.98-	S8U-770/772	4	█	Y-502R	3852				
Master D	2.5	69	09.97-	S8V-748	4	█	Y-935U	5915				
Master dCi 16S	2.5	88	10.00-		4	█	Y-517J	3319				
Master dTi	2.8	85	09.97-	S9W-700/702	4	█	Y-502R	3852				
Mégane / Classic	1.4	51	10.95-03.99	E7J 624	4	0,8	BCP5ES	7496	16	BCPR5EIX-1	3306	
Mégane / Classic	1.4	55	10.95-03.99	E7J 764	4	0,8	BCP5ES	7496	16	BCPR5EIX-1	3306	
Mégane / Classic	1.6	66	10.98-04.99	K7M 702, 703, 720	4	0,9	BKR5EZ	7642				
Mégane / Classic	1.6	66	10.95-10.98	K7M 702, 703, 720	4	0,8	BCPR5ES	6130	32	BCPR5EIX-1	3306	
Mégane / Classic GPL	1.6	66	07.97-04.99	K7M 702	4	0,8	BKR5EK	7956	23	BKR5EIX	6341	
Mégane / Classic D	1.9	48	03.99-02.01	F8Q622	4	█	Y-516J	1436				
Mégane / Classic D	1.9	48	01.96-	F8Q620/624	4	█	Y-927R	5171				
Mégane / Classic D	1.9	48	03.98-	F8Q788	4	█	Y-506R	4409				
Mégane / Classic dT	1.9	66	01.96-	F8Q784/786	4	█	Y-932R	4956				
Mégane / Classic di	1.9	66	01.96-08.99	F9Q730/734	4	█	Y-740U	5104				
Mégane / Classic dTi	1.9	74	01.96-	F9Q716/730/734	4	█	Y-740U	5104				
Mégane / Classic dCi	1.9	77	03.99-	F9Q731/732/736/740	4	█	Y-515J	1019				
Mégane / Classic	2.0	85	10.95-03.99	F3R 750, 751, 791, 796, 797, 798	4	0,9	BPR5ES	7422	6	BPR5EIX	6597	
Mégane / Classic	2.0	110	10.95-03.99	F7R 710, 714	4	0,8	BKR6EK	2288	20**	BKR6EQUIP	3199	
Mégane / Classic Phase 2	1.4	55	04.99-	E7J 626	4	0,8	BKR6ES	3783	28	BKR6EIX	6418	
Mégane / Classic Phase 2	1.4	68	09.99-	K4J 750	4	0,9	BKR6EZ	4619		BKR6EIX	6418	
Mégane / Classic Phase 2	1.6	66	04.99-	K7M 704	4	0,8	BKR5EK	7956	23	BKR5EIX	6341	
Mégane / Classic Phase 2	1.6	81	04.99-	K4M 700, 701, 704, 706	4	0,9	BKR6EZ	4619		BKR6EIX	6418	
Mégane 2	1.4	70	03-	K4J 730	4	0,9	BKR6EZ	4619		BKR6EIX	6418	
Mégane 2	1.6	85	03-	K4M 760	4	0,9	BKR6EZ	4619		BKR6EIX	6418	
Mégane 2	2.0	100	03-	F4R	4	0,9	BKR6EZ	4619		BKR6EIX	6418	
Mégane 2 1.5 dCi	1.5	60	09.03-	K9K722	4	█	Y-515J	1019				
Mégane 2 1.5 dCi	1.5	60	09.03-	K9K722	4	█	Y-515J	1019				
Mégane 2 Coupe dci	1.9	88	09.02-	F9Q800	4	█	Y-515J	1019				
Mégane 2 1.5 dCi	1.5	60	09.02-	K9K722	4	█	Y-515J	1019				
Mégane 2 Coupé / cab	2.0	100	03-	F4R	4	0,9	BKR6EZ	4619		BKR6EIX	6418	
Mégane Coupé / cabrio	1.6	66	10.98-03.99	K7M 702, 703	4	0,9	BKR5EZ	7642				
Mégane Coupé / cabrio	1.6	66	10.95-10.98	K7M 702, 703	4	0,8	BCPR5ES	6130	32	BCPR5EIX-1	3306	
Mégane Coupé / cabrio	2.0	85	10.95-03.99	F3R 750, 751, 791, 796, 797, 798	4	0,9	BPR5ES	7422	6	BPR5EIX	6597	
Mégane Coupé / cabrio	2.0	110	10.95-03.99	F7R 710, 714	4	0,8	BKR6EK	2288	20**	BKR6EQUIP	3199	
Mégane Coupé / cab. phase 2	1.4	70	09.99-	K4J 750	4	0,9	BKR6EZ	4619		BKR6EIX	6418	
Mégane Coupé / cab. phase 2	1.6	81	04.99-	K4M 700, 701	4	0,9	BKR6EZ	4619		BKR6EIX	6418	
Mégane Coupé / cab. phase 2	1.8	87	05.01-	F4P 760	4	0,8	BKR6ES	3783	28	BKR6EIX	6418	
Mégane Phase 2 D	1.9	48	03.99-	F8Q622/790	4	█	Y-516J	1436				

¹⁾ Bic = Best in class (siehe Seite 3) / (see page 3)

** alternative/wahlweise V-Line 30



l kW

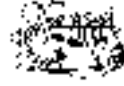

Cyl.

Order-
No. No.Bic¹⁾ Order-
No.**RENAULT**

Mégane Phase 2 D	1.9	48	09.99-	F8Q620/624	4	☑	Y-927R	5171				
Mégane Phase 2 dTi	1.9	59	04.01-	F9QT770	4	☑	Y-515J	1019				
Mégane Phase 2 dTi	1.9	74	01.96-	F9Q716/730/734	4	☑	Y-740U	5104				
Mégane Phase 2 dCi	1.9	77	03.99-	F9Q718/722/731/736/780	4	☑	Y-515J	1019				
Mégane Scenic	1.9	48	03.98-	F8Q788	4	☑	Y-506R	4409				
Mégane Scenic	1.9	48	10.96-08.99	F8Q620/624	4	☑	Y-927R	5171				
Mégane Scenic	1.9	48	03.99-	F8Q622/790	4	☑	Y-516J	1436				
Mégane Scenic	1.9	66	01.96-	F8Q784/786	4	☑	Y-932R	4956				
Mégane Scenic di	1.9	66	10.96-08.99	F9Q716/730/734	4	☑	Y-740U	5104				
Mégane Scenic dTi	1.9	74	01.96-	F9Q716/730/734	4	☑	Y-740U	5104				
R 4 alle Modelle			- 90		4	0,6	BP6HS	4511	18	BPR6HIX		4085
R 5 Rodéo			82- 86		4	0,6	BP6HS	4511	18	BPR6HIX		4085
R 5	1.0	30	10.84-12.96	C1C-700	4	0,7	BP6ES	7811	4	BPR6EIX		6637
R 5	1.0	32	10.79-03.85	689-710	4	0,6	BP6HS	4511	18	BPR6HIX		4085
R 5	1.1	33	10.79-12.96	688 ..., C1E	4	0,6	BP6HS	4511	18	BPR6HIX		4085
R 5	1.2	40	10.86-12.96	C1G-720/722	4	0,7	BP6ES	7811	4	BPR6EIX		6637
R 5	1.4	43	10.84-12.96	C1J-768	4	0,7	BP6ES	7811	4	BPR6EIX		6637
R 5	1.4	44	06.87-12.96	C2J-784	4	0,7	BP6ES	7811	4	BPR6EIX		6637
R 5	1.4	44	10.84-12.96	C3J-700/702/760	4	0,9	BPR5ES	7422	6	BPR5EIX		6597
R 5	1.4	46	06.82-03.85	C2J-713	4	0,7	BP6ES	7811	4	BPR6EIX		6637
R 5	1.4	49	10.84-12.96	C2J-780/781/782	4	0,7	BP6ES	7811	4	BPR6EIX		6637
R 5	1.4	49	10.84-12.96	C2J-788/789/798	4	0,7	BP6ES	7811	4	BPR6EIX		6637
R 5	1.4	50	06.87-12.96	C2J-700	4	0,7	BP6ES	7811	4	BPR6EIX		6637
R 5 Turbo	1.4	77	10.84-12.96	C1J-782/784	4	0,7	B8EVX	7051				
R 5 Turbo	1.4	81	10.81-12.85	840-726	4	0,6	B8EFS	1049				
Super 5	1.6	40	09.85-12.90	F8M720/730	4	☑	Y-913M	3965				
R 5	1.7	55	10.86-12.96	F3N-716/717	4	0,8	BPR6ES	7822	2	BPR6EIX		6637
R 5	1.7	66	06.87-12.96	F2N-740/742	4	0,7	BP6ES	7811	4	BPR6EIX		6637
R 5	1.7	69	10.86-12.96	F3N-702	4	0,8	BP7ES	2412		BPR7EIX		4055
R 9	1.1	36	09.81-10.87	C1E-715/720	4	0,7	BP6ES	7811	4	BPR6EIX		6637
R 9	1.2	40	09.85-03.91	C1G-700/710	4	0,7	BP6ES	7811	4	BPR6EIX		6637
R 9	1.4	45	09.81-		4	0,7	BP6ES	7811	4	BPR6EIX		6637
R 9 Turbo	1.4	77	09.84-03.91	C1J-760,764,770	4	0,7	B8EVX	7051				
R 9 D	1.6	40	01.83-03.91	F8M700/730	4	☑	Y-913M	3965				
R 9	1.7			F3N-718	4	0,8	BPR6ES	7822	2	BPR6EIX		6637
R 9	1.7		09.84-	F2N-.../F3N-708	4	0,8	BP7ES	2412		BPR7EIX		4055
R 11	1.1	35	03.83-06.86	C1E-715	4	0,7	BP6ES	7811	4	BPR6EIX		6637
R 11	1.4	44	03.83-12.88	C1J 715/C2J73	4	0,7	BP6ES	7811	4	BPR6EIX		6637
R 11 Turbo	1.4	77	09.83-03.91	C1J-760,764,770	4	0,6	B8EVX	7051				
R 11 D	1.6	40	01.83-08.89	F8M700/730	4	☑	Y-913M	3965				
R 11	1.7		10.83-03.91	F2N-..., F3N-708	4	0,8	BP7ES	2412		BPR7EIX		4055
R 11	1.7			F3N-718	4	0,8	BPR6ES	7822	2	BPR6EIX		6637
R 18	1.4	46	04.78-02.86	841..847-../A2M../A6M..	4	0,7	BP6ES	7811	4	BPR6EIX		6637
R 18 Turbo	1.6	92	10.82-09.85	A5L717/ 807-...	4	0,7	B8EG	3430				
R 18 GTX	2.0		-02.86	J6R-...	4	0,8	BP6EFS	3812	5			
R 18 D	2.1	48	08.80-02.86	J8S	4	☑	Y-908R	4585				
R 18 D	2.1	50	04.84-02.86	J8S	4	☑	Y-908R	4585				
R 18 TD	2.1	65	04.84-02.86	J8S	4	☑	Y-908R	4585				
R 19	1.2	40	09.88-30.92	C1G 730	4	0,9	BP5ESZ	4691		BPR5EIX		6597
R 19	1.4	43	09.88-03.92	C1J 742, C2J 772	4	0,9	BP5ESZ	4691		BPR5EIX		6597
R 19	1.4	50	09.88-03.96	C2J-776	4	0,8	BP5ES	6511	8	BPR5EIX		6597
R 19	1.4	59	09.88-03.92	E6J...,E7J....	Cat. 4	0,8	BCP5ES	7496	16	BCPR5EIX-1		3306

¹⁾ Bic = Best in class (siehe Seite 3) / (see page 3)



ℓ kW

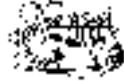

Cyl.

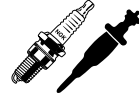
Order-
No. No.Bic¹⁾ Order-
No.**RENAULT**

R 19	1.7	54	03.86-	F3N-740/741		4	0,8	BPR6ES	7822	2	BPR6EIX	6637
R 19	1.7	55	09.88-03.96	F2N-724		4	0,8	BP7ES	2412		BPR7EIX	4055
R 19	1.7	66	09.88-03.92	F3N 746		4	0,8	BPR6ES	7822	2	BPR6EIX	6637
R 19	1.7	68	09.88-03.96	F2N-720/721		4	0,8	BP7ES	2412		BPR7EIX	4055
R 19	1.7	70	09.88-03.92	F3N-742/743	Cat	4	0,8	BP7ES	2412		BPR7EIX	4055
R 19 16V	1.8		06.89-03.96	F7P-704	Cat.	4	0,7	BCP6ES	4930	17	BCPR6EIX-1	4919
R 19	1.8	81	06.89-03.92	F7P-700	Cat.	4	0,8	BKR6EK	2288	20**	BKR6EQUIP	3199
R 19 D	1.9	48	03.91-12.95	F8Q706/742/764		4	█	Y-913M	3965			
R 19 D	1.9	48	06.88-02.91	F8Q		4	█	Y-908R	4585			
R 19 tD	1.9	66	09.90-06.96	F8Q610/740/744/768		4	█	Y-933R	6136			
R 19 Phase 2	1.2	40	04.92-12.95	C1G-730		4	0,8	BP5ESZ	4691		BPR5EIX	6597
R 19 Phase 2	1.2	45	04.92-12.95	E7F730	Cat	4	0,8	BCP5ES	7496	16	BCPR5EIX-1	3306
R 19 Phase 2	1.4		04.92-12.95	E6J...,E7J....	Cat.	4	0,8	BCP5ES	7496	16	BCPR5EIX-1	3306
R 19 Phase 2	1.4		04.92-12.95	C1J-...		4	0,8	BP5ESZ	4691		BPR5EIX	6597
R 19 Phase 2	1.4	44	04.92-12.95	C3J-710	Cat.	4	0,9	BPR5ES	7422	6	BPR5EIX	6597
R 19 Phase 2	1.4	55	04.92-12.95	E7J-706		4	0,8	BCP5ES	7496	16	BCPR5EIX-1	3306
R 19 Phase 2	1.4	55	04.92-12.95	E7J-745		4	0,8	BCP5ES	7496	16	BCPR5EIX-1	3306
R 19 Phase 2	1.8		04.92-12.95	F3P-707		4	0,7	BP6ES	7811	4	BPR6EIX	6637
R 19 Phase 2	1.8		04.92-12.95	F7P-700	Cat.	4	0,9	BP6ESZ	7639	4	PGR6D	6248
R 19 Phase 2	1.8		04.92-12.95	F3P-705		4	0,7	BP6ES	7811	4	BPR6EIX	6637
R 19 Phase 2	1.8	70	04.92-12.95	F3P-704/706	Cat.	4	0,7	BP6ES	7811	4	BPR6EIX	6637
R 19 Phase 2	1.8	99	04.92-12.95	F7P-704	Cat.	4	0,8	BKR6EK	2288	20**	BKR6EQUIP	3199
R 21	1.4	51	09.89-10.93	C2J-...		4	0,7	BP6ES	7811	4	BPR6EIX	6637
R 21	1.7		09.89-12.95	F3N-726		4	0,8	BPR6ES	7822	2	BPR6EIX	6637
R 21 Nevada	1.7		09.89-12.95	F3N-722/723		4	0,8	BP7ES	2412		BPR7EIX	4055
R 21 Nevada	1.7	65	03.86-12.95	F2N-711		4	0,8	BP7ES	2412		BPR7EIX	4055
R 21 Nevada	1.7	65	02.88-12.95	F2N-754		4	0,8	BP7ES	2412		BPR7EIX	4055
R 21 D / Nevada	1.9	48	09.89-02.91	F8Q		4	█	Y-908R	4585			
R 21 D / Nevada	1.9	48	03.91- 95	F8Q710		4	█	Y-908R	4585			
R 21	2.0	66	08.86-12.95	F2R-702		4	0,8	BP7ES	2412		BPR7EIX	4055
R 21	2.0	76	03.86-12.95	J6R-...		4	0,8	BP6EFS	3812	5		
R 21 Nevada	2.0	85	-12.92	J7R-750/751		4	0,8	BP7EFS	3526			
R 21 Nevada	2.0	98	05.89-12.95	J7R-754		4	0,8	BCP6ET	4563		BCPR6EIX-11	4919
R 21	2.0	99	06.90-12.93	J7R-746/747		4	0,8	BP6EFS	3812	5		
R 21 Nevada	2.0	110	09.89-12.95	J7R-740		4	0,9	BCP6ET	4563		BCPR6EIX-11	4919
R 21 Nevada Turbo	2.0	119	01.93-	J7R-756		4	0,8	BP7EFVX	3344			
R 21 Nevada Turbo	2.0	119	08.89-10.93	J7R-752		4	0,8	BP7EFVX	3344			
R 21 D / Nevada	2.1	53	09.89-12.93	J8S...		4	█	Y-908R	4585			
R 21 TD / Nevada	2.1	65	03.86-12.93	J8S...		4	█	Y-908R	4585			
R 21 Nevada	2.2	79	01.93-	J7T-754/755		4	0,9	BP7EFS	3526			
R 25	2.0	74	01.84-12.92	J6R-762/763		4	0,8	BP6EFS	3812	5		
R 25	2.0	74	01.84-12.92	J6R-706/707		4	0,8	BP6EFS	3812	5		
R 25	2.0	88	06.87-12.92	J7R-722/723		4	0,9	BP7EFS	3526			
R 25	2.0	103	10.88-12.92	J7R-720/721/726		4	0,8	BCP6ET	4563		BCPR6EIX-11	4919
R 25 D	2.1	47	01.84-12.92	J8S-736		4	█	Y-908R	4585			
R 25 TD	2.1	63	01.84-12.92	J8S-708-/-738		4	█	Y-908R	4585			
R 25	2.2	79	10.86-12.92	J7T-706/707/730/731/ 732/733		4	0,9	BP7EFS	3526			
R 25 V6 Turbo	2.6	147	05.89-12.92	Z7U-700	Cat.	6	0,8	BP7EFVX	3344			
R 25	2.7	106	83-09.87	Z7V-		6	1,0	BPR6EFS	3623	7		
R 25 V6	2.8	110	06.87-12.92	Z7W-706/707	Cat.	6	0,9	BP7EFS	3526			
R 25 V6	2.8	110	06.87-12.92	Z7W-700/701		6	0,9	BP7EFS	3526			

¹⁾ Bic = Best in class (siehe Seite 3) / (see page 3)

** alternative/wahlweise V-Line 30



l kW

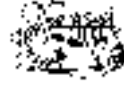

Cyl.

Order-
No. No.Bic¹⁾ Order-
No.**RENAULT**

Rapid 1,4	1.4		91-		4	0,8	BCP5ES	7496	16	BCPR5EIX-1	3306
Rapid	1.9		03.86-		4	█	Y-913M	3965			
Rapid Express	1.9	64	09.94-	F8Q640	4	█	Y-927R	5171			
Safrane	1.9			N7Q 710, 711	4	0,8	BKR5EK	7956	23	BKR5EIX	6341
Safrane	2.0	79	06.92-09.96	J7R-732/733	4	0,8	BP6EFS	3812	5		
Safrane	2.0	97	04.92-09.96	J7R 734/735/738/739	4	0,9	BCP6ET	4563		BCPR6EIX-11	4919
Safrane dT	2.1	65	06.92-09.96	J8S760	4	█	Y-908R	4585			
Safrane	2.2		06.92-09.96	J7T-762	4	0,8	BP6EFS	3812	5		
Safrane	2.2	103	06.92-09.96	J7T-760/761	4	0,9	BCP6ET	4563		BCPR6EIX-11	4919
Safrane dT	2.5	83	03.93-09.96	S8U762/763	4	█	Y-914U	2643			
Safrane V6	3.0	123	10.96-	Z7X-W755	6	0,8	BKR6EK	2288	20**	BKR6EQUIP	3199
Safrane V6	3.0	125	06.92-09.96	Z7X-721/722/723/753/755	6	0,9	BCPR6ET	2197			
Safrane Biturbo	3.0	194	94-	Z7X-726	6	0,9	BKUR7ET	7873		PFR7Q	7963
Safrane Phase 2	1.9	100	10.96-	N7Q-710/711	4	0,8	BKR5EK	7956	23	BKR5EIX	6341
Safrane Phase 2 dT	2.2	85	10.96-11.00	G8T740	4	█	Y-730U	2273			
Safrane Phase 2	2.5	121	10.96-	N7U-700/701	6	0,8	BCPR6ES	2330	12	BCPR6EIX-1	4919
Safrane Phase 2 V6	3.0	125	10.96-03.99	Z7X-721/722/723/753/755	6	0,9	BCPR6ET	2197			
Safrane Phase 2 V6	3.0	142	04.99-	L7X-713	6	1,0	PFR6E-10	3688			
Scenic	1.4	55	10.95-03.99	E7J-764	4	0,8	BCP5ES	7496	16	BCPR5EIX-1	3306
Scenic	1.6	66	10.95-09.98	K7M-702,703,720	4	0,8	BCPR5ES	6130	32	BCPR5EIX-1	3306
Scenic	1.6	66	10.98-03.99	K7M-702,703,720	4	0,9	BKR5EZ	7642		BKR5EIX	6341
Scenic GPL	1.6	66	07.97-03.99	K7M-702	4	0,8	BKR5EK	7956	23	BKR5EIX	6341
Scenic D	1.9	48	03.98-	F8Q-788	4	█	Y-506R	4409			
Scenic D	1.9	48	10.96-08.99	F8Q-620/624	4	█	Y-927R	5171			
Scenic D	1.9	48	03.99-	F8Q-622/790	4	█	Y-516J	1436			
Scenic di	1.9	66	10.96-08.99	F9Q-716730/734	4	█	Y-740U	5104			
Scenic dTi	1.9	74	01.96-	F9Q-716/730/734	4	█	Y-740U	5104			
Scenic	2.0	85	10.95-03.99	F3R-750,751,791,796, 797,798	4	0,9	BPR5ES	7422	6	BPR5EIX	6597
Scenic dT	1.9	66	01.96-	F8Q-784/786	4	█	Y-932R	4956			
Scenic dci RX4	1.9	75	99-		4	█	Y-515J	1019			
Scenic 2 & Break	1.4	72	03-	K4J	4	0,9	BKR6EZ	4619		BKR6EIX	6418
Scenic 2 & Break	1.6	85	03-	K4M	4	0,9	BKR6EZ	4619		BKR6EIX	6418
Scenic 2 & Break	2.0	100	03-	F4R	4	0,9	BKR6EZ	4619		BKR6EIX	6418
Scénic 2 dci	1.5	59	03-	K9K	4	█	Y-515J	1019			
Scénic 2 dci	1.9	88	03-	F9Q	4	█	Y-515J	1019			
Scenic Phase 2	1.4	70	09.99-	K4J- 750	4	0,9	BKR6EZ	4619		BKR6EIX	6418
Scenic Phase 2	1.6	81	09.99-	K4M-708,709	4	0,9	BKR6EZ	4619		BKR6EIX	6418
Scenic Phase 2	1.8	87	07.00-	F4P-760	4	0,8	BKR6ES	3783	28	BKR6EIX	6418
Scenic Phase 2 D	1.9	48	09.99-		4	█	Y-927R	5171			
Scenic Phase 2 dTi	1.9	59	06.01-	F9Q-T770	4	█	Y-515J	1019			
Scenic Phase 2 dTi	1.9	74	09.99-	F9Q-730/734	4	█	Y-740U	5104			
Scenic Phase 2 dCi RX4	1.9	77	09.00-	F9Q....	4	█	Y-515J	1019			
Scenic Phase 2 dCi	1.9	77	03.99-	F9Q718/731/736	4	█	Y-515J	1019			
Scenic Phase 2	2.0	103	03.00-	F4R-744	4	0,8	BKR6ES	3783	28	BKR6EIX	6418
Scenic Phase 2	2.0	103	08.99-	F4R-740,741	4	0,8	BKR6ES	3783	28	BKR6EIX	6418
Sport Spider	2.0	110	03.95-	F7R-710/712/720	4	0,8	BKR6EK	2288	20**	BKR6EQUIP	3199
Super 5	1.0			C1C.	4	0,8	BP5ES	6511	8	BPR5EIX	6597
Super 5	1.1			C1E	4	0,8	BP5ES	6511	8	BPR5EIX	6597
Super 5	1.2			C1G	4	0,8	BP5ES	6511	8	BPR5EIX	6597
Super 5 GT Turbo	1.4			C1J-782/784/788	4	0,7	B8EVX	7051			
Super 5	1.4			C2J	4	0,8	BP5ES	6511	8	BPR5EIX	6597

¹⁾ Bic = Best in class (siehe Seite 3) / (see page 3)

** alternative/wahlweise V-Line 30



ℓ kW

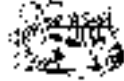

Cyl.

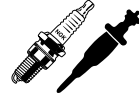
Order-
No. No.Bic¹⁾ Order-
No. No.**RENAULT**

Super 5	1.4	44	08.92-	C3J-760	4	0,9	BPR5ES	7422	6	BPR5EIX	6597
Super 5 D	1.6	40	09.85-12.90	F8M-720/730	4	█	Y-913M	3965			
Super 5	1.7			F2N...	4	0,8	BP7ES	2412		BPR7EIX	4055
Supercinc D	1.6	40	09.85-		4	█	Y-913M	3965			
Trafic T800 / P800	1.4	35	03.80-04.89	C1J-.../847-...	4	0,7	BP6ES	7811	4	BPR6EIX	6637
Trafic P1200 / T1200	1.6			A1M-.../ 841	4	0,7	BP6ES	7811	4	BPR6EIX	6637
Trafic V1000 / T1000 / 4X4	1.6			A1M-.../ 841	4	0,7	BP6ES	7811	4	BPR6EIX	6637
Trafic T1100 / P1000	1.7	50	06.86-04.89	F1N-...	4	0,8	BP7ES	2412		BPR7EIX	4055
Trafic D T 1000	1.9	45	11.97-	F8Q-600/606	4	█	Y-506R	4409			
Trafic dCi	1.9	60	05.01-	F9Q762	4	█	Y-515J	1019			
Trafic dCi	1.9	74	05.01-	F9Q760	4	█	Y-515J	1019			
Trafic T1100 / P1400 / T1400 / V1000	2.0	59	09.89-12.97	J5R- 829	4	0,7	BP6ES	7811	4	BPR6EIX	6637
Trafic D T800, T1000, T1200	2.1	43	09.80-10.97	J8S-620/758	4	█	Y-908R	4585			
Trafic D P1000, P1200, 4x4	2.1	43	11.81-10.97	852/720/750	4	█	Y-908R	4585			
Trafic D T 1000	2.1	56	11.97-	S8U-758/780/782	4	█	Y-935U	5915			
Trafic T1400	2.2			J7T 780	4	0,8	BP6EFS	3812	5		
Trafic D	2.5	52	10.82-10.97	S8U	4	█	Y-208T	1250			
Trafic D	2.5	55	03.90-10.97	Sofim 8140	4	█	Y-908R	4585			
Twingo	1.2	40	03.93-06.97	C3G-700	4	0,9	BP5ESZ	4691		BPR5EIX	6597
Twingo easy	1.2	40	09.94- 96	C3G-702	4	0,9	BP5ESZ	4691		BPR5EIX	6597
Twingo	1.2	44	07.97-07.98	D7F-...	4	0,8	BKR5EK	7956	23	BKR5EIX	6341
Twingo	1.2	44	04.94-06.97	D7F-...	4	0,8	BK5ESZ	5675			
Twingo 2	1.2	43	08.98-	D7F-702, 703	4	0,8	BKR5EK	7956	23	BKR5EIX	6341
Twingo 2 Euro2000	1.2	43	04.00-	D7F-726	4	0,9	BKR6EZ	4619		BKR6EIX	6418
Twingo 2 16V	1.2	55	11.00-	D4F-702	4	0,8	LZKAR7A	6799			
Vel Satis 16V Turbo	2.0	121	03.02-	F4R-762	4	0,9	PFR6G-9	4377			
Vel Satis dCi	2.2	85	03.02-		4	█	Y-517J	3319			
Vel Satis dCi	2.2	110	03.02-12.03	G9T702	4	█	Y-517J	3319			
Vel Satis dCi V6	3.0	132	03.02-12.03	P9X (Isuzu)	6	█	CZ24 only OE				
Vel Satis 24V V6	3.5	180	02.02-	V4Y-701	6	1,1	PLFR5A-11	6240			
Winnebago	2.1	43	04.82-06.87	J8S 232, J8S 234	4	█	Y-908R	4585			

ROLLS ROYCE

Carmague	6.75		12.75-06.85		8	0,8	BPR5ES	7422	6	BPR5EIX	6597
Corniche 71--->02	6.75		01.89-06.93		8	0,9	BPR4EVX	3436			
Corniche 71--->02	6.75		03.87-12.88		8	1,0	BPR5EV	4728			
Corniche 71--->02	6.75		03.71-02.87		8	0,6	BPR5ES	7422	6	BPR5EIX	6597
Corniche 71--->02	6.75		09.95-		8	0,9	BKR5EVX	2546		BKR5EIX	6341
Corniche 71--->02	6.75		07.93-08.95		8	0,9	BKR4EVX	4870			
Flying Spur	6.75		08.94-07.95		8	0,9	BKR5EVX	2546		BKR5EIX	6341
Park Ward	5.4		10.00-	V12 BMW	12		BKR6EQU	3199	30		
Park Ward	6.8		02.97-09.00		8	0,9	BKR4EVX	4870			
Phantom	6.75		68- 91		8	0,6	BP5ES	6511	8	BPR5EIX	6597
Silver Cloud	4.56				6	0,6	B6ES	7310			
Silver Cloud	6.25				8	0,6	BP5ES	6511	8	BPR5EIX	6597
Silver Seraph	5.4	240	08.99-	BMW M73B54	12		BKR6EQU	3199	30		
Silver Seraph	5.4	240	98-07.99	BMW M73B54	12	0,9	BKR6EK	2288	20**	BKR6EQU	3199
Silver Spirit/ Spur	6.75		01.89-06.93		8	0,9	BPR4EVX	3436			
Silver Spirit/ Spur	6.75		10.80-11.86		8	0,8	BPR5ES	7422	6	BPR5EIX	6597
Silver Spirit/ Spur	6.75		12.86-12.88		8	1,0	BPR5EV	4728			
Silver Spirit/ Spur	6.75		07.93-		8	0,9	BKR4EVX	4870			

¹⁾ Bic = Best in class (siehe Seite 3) / (see page 3)

** alternative/wahlweise V-Line 30



l kW

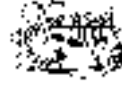

Cyl.

Order-
No. No.Bic¹⁾ Order-
No. No.**ROVER**

25	1.1	43	11.99-	K Series	4	1,0	PFR6N-11	3546				
25	1.4	62	11.99-	K Series	4	1,1	PFR6N-11	3546				
25	1.6	79	11.99-	K Series	4	1,0	PFR6N-11	3546				
25	1.8	85	99-	K Series with VVC	4	1,1	PFR6N-11	3546				
25 Steptronic	1.8	86	05.01-		4	1,1	PFR6N-11	3546				
25	1.8	107	02.00-	K Series	4	1,1	PFR6N-11	3546				
45	1.4	76	11.99-	K Series	4	1,1	PFR6N-11	3546				
45	1.6	80	11.99-	K Series	4	1,1	PFR6N-11	3546				
45	1.8	86	99-	K Series	4	1,1	PFR6N-11	3546				
45	2.0	110	99-	KV6	6	1,1	PFR6N-11	3546				
25 TD	2.0	74	11.99-		4	Y-730U	2273					
45 TD	2.0	73	11.99-		4	Y-730U	2273					
90, 110 D			01.83-		4	Y-208T	1250					
111	1.1	44	91-	K8 8 VALVE	4	0,8	BKR6E	6962	28	BKR6EIX	6418	
114	1.4		91-	K16	4	0,8	BKR6E	6962	28	BKR6EIX	6418	
114 D	1.4	39		Peugeot TUD 3	4	Y-911R	4544					
114	1.4	55	91-	K8	4	0,8	BKR6E	6962	28	BKR6EIX	6418	
115 SD/CSD	1.5	57	01.95- 98	TUD 5	4	Y-731U	5274					
211	1.1	43	01.98-04.99	K Series 8 V	4	0,8	BKR6ES	3783	28	BKR6EIX	6418	
213 Mk.1	1.3		06.84-09.90	Honda	4	1,1	BPR6EY-11	4228	10	BPR6EIX-11	3903	
214 Mk.3	1.4		11.95-		4	0,8	BKR6E	6962	28	BKR6EIX	6418	
214 Mk.2	1.4		10.89-	K Series	4	0,8	BKR6E	6962	28	BKR6EIX	6418	
216 Mk.3	1.6		11.95-		4	0,8	BKR6E	6962	28	BKR6EIX	6418	
216 Mk.1	1.6		03.85-09.90	Vergaser/Carb.	4	0,8	BCP6ES	4930	17	BCPR6EIX-11	4919	
216 Mk.1	1.6		03.85-09.90	Injection	4	0,8	BCPR6ES	2330	12	BCPR6EIX-11	4919	
216 Mk.2	1.6		10.89-	SOHC	4	1,0	BCPR6E-11	3132	11	BCPR6EIX-11	4919	
216 Mk.2	1.6		09.90-	DOHC	4	1,0	BCPR6E-11	3132	11	BCPR6EIX-11	4919	
217 SD, 218 SD/SLD	1.9	49	09.91-	XUD 9	4	Y-902R	2237					
218 Mk.3	1.8		01.96-	K Series with VVC	4	1,1	PFR6N-11	3546				
218 TD	1.8	65	09.91-	XUD 7 TE	4	Y-902R	2237					
218 D	1.9	49	09.91-	XUD 9	4	Y-902R	2237					
220 Mk.2	2.0		06.91-	T16 TURBO	4	0,8	BKR6E	6962	28	BKR6EIX	6418	
220 SDi	2.0	63	10.95-	20 T2R	4	Y-730U	2273					
220 SDi	2.0	77	10.95-	20T2N (Intercooled)	4	Y-730U	2273					
400 D			01.87-			Y-902R	2237					
414 Mk.1	1.4		03.90-07.95		4	0,8	BKR6E	6962	28	BKR6EIX	6418	
414 Mk.2	1.4		05.95-		4	0,8	BKR6E	6962	28	BKR6EIX	6418	
416 Mk.1	1.6		03.90-	SOHC	4	1,0	BCPR6E-11	3132	11	BCPR6EIX-11	4919	
416 Mk.1	1.6		03.90-12.91	DOHC	4	1,0	BCPR6E-11	3132	11	BCPR6EIX-11	4919	
416 Mk.2	1.6		05.95-	Automatik	4	1,0	BKR6E-11	2756	14	BKR6EIX-11	3764	
416 Mk.2	1.6		05.95-	Schaltgetriebe	4	0,8	BKR6E	6962	28	BKR6EIX	6418	
Tourer 1.6	1.6	80	03.96-04.99	K Series	4	0,8	BKR6ES	3783	28	BKR6EIX	6418	
418 SLD/GSD TD	1.8	65	09.91-03.96	XUD 7 T	4	Y-902R	2237					
418	1.8	105	03.96-10.97	K Series	4	1,0	PFR6N-11	3546				
420 Mk.1	2.0		10.91-11.94		4	0,8	BKR6E	6962	28	BKR6EIX	6418	
420 Turbo	2.0		92-	T16 TURBO	4	0,8	BKR6E	6962	28	BKR6EIX	6418	
420 Mk.2	2.0		12.95-		4	0,9	BCP6ES	4930	17	BCPR6EIX-11	4919	
420 D / SD	2.0	63	07.95-		4	Y-730U	2273					
420 Di / Sdi	2.0	77	07.95-		4	Y-730U	2273					
618	1.8		02.96-	Honda	4	1,1	ZFR6F-11	4291		ZFR6FIX-11	6441	
620 Turbo	2.0		94-	T Series	4	0,9	BKR6E	6962	28	BKR6EIX	6418	
620	2.0	85	04.93-	HONDA	4	1,1	ZFR6F-11	4291		ZFR6FIX-11	6441	

¹⁾ Bic = Best in class (siehe Seite 3) / (see page 3)



ℓ kW

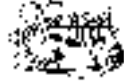

Cyl.

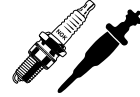
Order-
No. No.Bic¹⁾ Order-
No.**ROVER**

623	2.3	116	04.94-	HONDA	4	1,1	ZFR6F-11	4291		ZFR6FIX-11	6441
820 i	2.0		91-	20T4 MPI	4	0,8	BKR6E	6962	28	BKR6EIX	6418
820	2.0		05.88-09.90	Vergaser/Carb.	4	0,9	BPR6ES	7822	2	BPR6EIX	6637
820	2.0		11.91-	T16 / Turbo/ Inj.	4	0,8	BKR6E	6962	28	BKR6EIX	6418
820	2.0		03.91-10.91	M16 Turbo Inj.	4	0,8	BKR6E	6962	28	BKR6EIX	6418
820	2.0		07.86-10.91	M16 Inj.	4	0,8	BKR6E	6962	28	BKR6EIX	6418
820 E,SE	2.0	88	10.86- 90	M16E	4	0,8	BCPR6ES	2330	12	BCPR6EIX-11	4919
820 i,Si	2.0	98	10.86- 90	M16i	4	0,8	BCPR6ES	2330	12	BCPR6EIX-11	4919
820 Turbo	2.0	132	10.92-	20T4 TURBO MPI	4	0,8	BKR6E	6962	28	BKR6EIX	6418
825 i	2.5		01.96-	KV6	6	0,8	BKR6E	6962	28	BKR6EIX	6418
825	2.5		07.86-02.88		6	1,0	BCPR6E-11	3132	11	BCPR6EIX-11	4919
825 D/SD/SLD	2.5		90-03.96	VM	4	█	Y-902R	2237			
825 SD TD	2.5	87	01.93-	VM HR-492/VM 425 SLIRR	4	█	Y-923U	3380			
827	2.7		02.88-01.96	C27A V6	6	0,8	BCPR6E-11	3132	11	BCPR6EIX-11	4919
2000 SD1	2.0		01.82-10.86		4	0,8	BP6EFS	3812	5		
2300	2.3		10.77-01.87		6	0,6	BP5EFS	3712			
2400 TD			82-		4	█	Y-902R	2237			
2400 TD SDI	2.4		82- 86		4	█	Y-909R	4602			
2600	2.6		10.77-01.87		6	0,6	BP5EFS	3712			
420 SDi, SLDi TD	2.0		10.95- 99	20 T2R, 20T2N (Intercooled)	4	█	Y-730U	2273			
620 SDi, SLDi TD	2.0		10.95- 99	20 T2R, 20T2N (Intercooled)	4	█	Y-730U	2273			
75	1.8	87	02.99-	K Series	4	1,0	PFR6N-11	3546			
75	2.0		02.99-	M47R (BMW)	4	█	Y-507R	4600			
75 2.0 CDT	2.0	85	99-	M47R	4	█	Y-507R	4600			
75	2.0	109	02.99-	K V6	6	1,0	PFR6N-11	3546			
75	2.5	128	02.99-	K V6	6	1,0	PFR6N-11	3546			
825	2.5		03.96-10.99	VM	4	█	Y-741U	5065			
FL 2 / R (Hire Car) D			08.83-			█	Y-208T	1250			
FX 4R Taxi D			08.83-			█	Y-208T	1250			
Maestro 500/700 D			86- 89		4	█	Y-902R	2237			
Maestro	1.3	51	03.89-12.94		4	0,8	BPR6ES	7822	2	BPR6EIX	6637
Maestro	1.6	63	07.89-04.92	S Series	4	0,8	BCPR6ES	2330	12	BCPR6EIX-11	4919
Maestro Van TD	2.0	60	01.86-		4	█	Y-902R	2237			
Maestro TD	2.0	60	07.89-	Perkins-Prima 80 T	4	█	Y-902R	2237			
Metro	1.1		05.90-12.94	K8	4	0,8	BKR6E	6962	28	BKR6EIX	6418
Metro /16V/16V GTI	1.4		05.90-01.95	K8/K16/K16	4	0,8	BKR6E	6962	28	BKR6EIX	6418
Metro D	1.4	39	01.92-01.95	Peugeot TUD 3	4	█	Y-911R	4544			
MG RV8	3.9	140	94-	V8i	8	0,9	BPR6ES	7822	2	BPR6EIX	6637
Mini	1.0		10.89-04.92		4	0,8	BPR6ES	7822	2	BPR6EIX	6637
Mini	1.3		10.89-	not Turbo	4	0,8	BPR6ES	7822	2	BPR6EIX	6637
Mini	1.3		10.89-01.90	Turbo	4	0,8	BPR7ES	2023	19	BPR7EIX	4055
Mini Cooper i	1.3	46	91-	12A2EF77/SPI	4	0,8	BPR6ES	7822	2	BPR6EIX	6637
Montego	1.4		12.94-		4	0,8	BCP6ES	4930	17	BCPR6EIX-11	4919
Montego	1.6		04.89-01.93		4	0,8	BCPR6ES	2330	12	BCPR6EIX-11	4919
Montego	2.0		04.89-12.94		4	0,8	BPR6ES	7822	2	BPR6EIX	6637
Montego TD	2.0	60	09.88-	Perkins-Prima 80 T	4	█	Y-902R	2237			
Sterling	2.5		10.87-	C25A V6	6	0,8	BCPR6ES	2330	12	BCPR6EIX-11	4919
Sterling	2.7		02.88-	C27A V6	6	1,1	BCPR6E-11	3132	11	BCPR6EIX-11	4919
Vanden Plas EFi	1.6	75	03.85-09.89	S-Series	4	0,8	BCPR6E-11	3132	11	BCPR6EIX-11	4919
Vitesse	1.6	75	03.85-09.89	S-Series	4	0,8	BCPR6ES	2330	12	BCPR6EIX-11	4919
Vitesse i	3.5	139	10.82-10.86	V8	8	0,8	BPR6ES	7822	2	BPR6EIX	6637

¹⁾ Bic = Best in class (siehe Seite 3) / (see page 3)



l kW

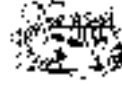

Cyl.

Order-
No. No.Bic¹⁾ Order-
No.**SAAB**

90	2.0	74	08.84-08.87	B201C / XC	4	0,7	BP6ES	7811	4	BPR6EIX	6637
L 850			09.02-		4	1,0	PFR6T-10G				
900 S/Cabrio.	2.0		- 93	B202S	4	0,6	BCP7EVX	7681		BCPR7EIX	5690
900	2.0		- 93	B202	4	0,7	BCP5EVX	5664			
900	2.0		- 93	B212	4	0,7	BCP5EVX	5664			
900 Turbo	2.0		83- 93	B201 mit / with APC	4	0,6	BP7EVX	7270			
900 Turbo 16V/S/SE/Cabrio.	2.0			B202L	4	0,6	BCP7EVX	7681		BCPR7EIX	5690
900 Turbo 16V	2.0		- 93	B202	4	0,6	BCP7EV	3733		BCPR7EIX	5690
900	2.0	74	- 93	B201C	4	0,7	BP6ES	7811	4	BPR6EIX	6637
900	2.0	96	94-	B204i	4	0,7	BCP5EVX	5664			
900	2.0	136	10.93-	B204L	4	1,1	BCPR7ES-11	1095		BCPR7EIX-11	5691
900	2.3	110	10.93-	B234I	4	0,7	BCP6EVX	6323			
900	2.5		10.93-	B258i, B308i	6	0,9	BKR6EK	2288	20**	BKR6EQUP	3199
900	2.5	125	94-	B258 Motronic	6	0,8	BKR5EK	7956	23	BKR5EIX	6341
9000 CDI-16	2.0			B202i	4	0,7	BCP6EVX	6323			
9000	2.0		94- 96	B202S mit Di	4	1,0	BCPR7ES	3330			
9000	2.0		94- 96	B202 mit Di	4	1,0	BCPR7ES	3330			
9000	2.0		- 93	B202i ohne Di	4	0,7	BCP5EVX	5664			
9000	2.0	87	09.84-12.98	B202L	4	1,0	BCPR7ES-11	1095		BCPR7EIX-11	5691
9000	2.0	96	94- 98	B204i	4	0,7	BCP5EVX	5664			
9000	2.0	110	94- 98	B204 E	4	1,1	BCPR7ES-11	1095		BCPR7EIX-11	5691
9000	2.3	96	94- 96	B234I	4	0,7	BCP6EVX	6323			
9000 CS 2.3-16	2.3	107	09.91-	B234I	Cat. 4	1,1	BCPR7ES-11	1095		BCPR7EIX-11	5691
9000	2.3	125	94- 98	B234 E	4	1,1	BCPR7ES-11	1095		BCPR7EIX-11	5691
9000	2.3	147	92- 98	B234L	4	1,1	BCPR7ES-11	1095		BCPR7EIX-11	5691
9000 Aero	2.3	165	93- 98	B234R	4	1,1	BCPR7ES-11	1095		BCPR7EIX-11	5691
9000 V6	3.0	155	11.94-	B308 V6	6	0,8	BKR5EK	7956	23	BKR5EIX	6341
9-3 t	1.8	110	09.02-	B207L	4	1,0	PFR6T-10G				
9-3 16V Pack	2.0	96	04.98-	B204i	4	0,7	BCP5EVX	5664			
9-3	2.0	96	02.98-	B204Ei	4	0,7	BCP5EVX	5664			
9-3	2.0	110	10.98-	B204E	4	1,1	BCPR7ES-11	1095		BCPR7EIX-11	5691
9-3 2.0t	2.0	129	09.02-	B207E	4	1,0	PFR6T-10G				
9-3	2.0	136	00-	B205L	4	1,0	PFR6H-10	6290			
9-3	2.0	136	98- 99	B204L	4	1,1	BCPR7ES-11	1095		BCPR7EIX-11	5691
9-3	2.0	147	08.98- 99	B204R	4	1,1	BCPR7ES-11	1095		BCPR7EIX-11	5691
9-3	2.0	150	00-	B205R	4	1,0	PFR6H-10	6290			
9-3 t	2.0	154	09.02-	B207R	4	1,0	PFR6T-10G				
9-3 TiD	2.2	85	09.98-	X22DTH Opel			Y-748U	5000			
9-3	2.3	110	02.98-12.98	B234I	4	0,7	BCP6EVX	6323			
9-3	2.3	169		B235R	4	1,0	PFR6H-10	6290			
9-3	2.5	125	98-	B258 Motronic	6	0,8	BKR5EK	7956	23	BKR5EIX	6341
9-5	2.0	110	09.97-	B205E	4	1,1	BCPR6ES-11	7121	11	BCPR6EIX-11	4919
9-5	2.0	140	09.97-	B205E Trim Kit	4	1,0	PFR6H-10	6290			
9-5 TiD	2.2	88	01.02-		4		Y-748U	5000			
9-5	2.3	125	09.97-	B235E	4	1,1	BCPR6ES-11	7121	11	BCPR6EIX-11	4919
9-5	2.3	165	07.98-	B235R	4	1,0	PFR6H-10	6290			
9-5	2.3	169	10.99-09.01	B235R	4	1,0	PFR6H-10	6290			
9-5 V6	3.0	147	09.97-	B308E	6	1,1	BKR7ES-11	2387		BKR7EIX-11	6988

SAM SUNG

SM518	1.8			DOHC	4	1,1	PFR5G-11	2647			
SM520	2.0			DOHC	4	1,1	PFR5G-11	2647			

¹⁾ Bic = Best in class (siehe Seite 3) / (see page 3)

** alternative/wahlweise V-Line 30



ℓ kW

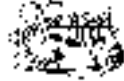

Cyl.

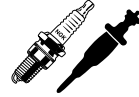
Order-
No. No.Bic¹⁾ Order-
No.**SAM SUNG**

SM520	2.0			DOHC LPG	4	0,8	BKR6ES	3783	28	BKR6EIX	6418
SM520 V6	2.0			DOHC	6	1,1	PFR5G-11	2647			
SM525 V6	2.5			DOHC	6	1,1	PFR5G-11	2647			

SAO

PENZA	1.3				4	0.8	BPR5ES	7422	6	BPR5EIX	6597
-------	-----	--	--	--	---	-----	--------	------	---	---------	------

SEAT

1.430 Especial 1.600	1.6	70			4	0,6	BP7ES	2412		BPR7EIX	4055
1.430 Especial 1.800	1.8	79			4	0,6	BP7ES	2412		BPR7EIX	4055
124 D	1.2	48			4	0,7	BP6ES	7811	4	BPR6EIX	6637
124 D	1.6	70			4	0,6	BP7ES	2412		BPR7EIX	4055
124 D	1.8	79			4	0,6	BP7ES	2412		BPR7EIX	4055
124 Especial	1.4	55			4	0,7	BP6ES	7811	4	BPR6EIX	6637
124 Sport 1.600	1.6	81			4	0,6	BP7ES	2412		BPR7EIX	4055
124 Sport 1.800	1.8	87			4	0,6	BP7ES	2412		BPR7EIX	4055
124-2.000	1.9				4	0,6	BP7ES	2412		BPR7EIX	4055
127	0.9	33			4	0,7	BP6ES	7811	4	BPR6EIX	6637
127	0.9	37			4	0,7	BP6ES	7811	4	BPR6EIX	6637
127	1.0	38			4	0,7	BP6ES	7811	4	BPR6EIX	6637
128-1.200 3p	1.2	48			4	0,7	BP6ES	7811	4	BPR6EIX	6637
128-1.430 3p	1.4	57			4	0,7	BP6ES	7811	4	BPR6EIX	6637
131/Supermirafiori 1.430	1.4	55			4	0,7	BP6ES	7811	4	BPR6EIX	6637
131/Supermirafiori 1.600	1.6	70			4	0,6	BP7ES	2412		BPR7EIX	4055
131/Supermirafiori 1.800	1.8	79			4	0,6	BP7ES	2412		BPR7EIX	4055
131/Supermirafiori 2.000	1.9				4	0,6	BP7ES	2412		BPR7EIX	4055
132-1.600	1.6	70			4	0,6	BP7ES	2412		BPR7EIX	4055
132-1.800	1.8	79			4	0,6	BP7ES	2412		BPR7EIX	4055
132-2.000	1.9				4	0,6	BP7ES	2412		BPR7EIX	4055
133	0.8	25			4	0,7	BP6ES	7811	4	BPR6EIX	6637
133	0.8	27			4	0,7	BP6ES	7811	4	BPR6EIX	6637
1430	1.4	42			4	0,7	BP6ES	7811	4	BPR6EIX	6637
1500	1.5	55			4	0,7	BP6ES	7811	4	BPR6EIX	6637
600 D, E	0.8				4	0,6	BP6HS	4511	18	BPR6HIX	4085
850 Coupé	0.8				4	0,7	BP6ES	7811	4	BPR6EIX	6637
850 D	0.8	27			4	0,7	BP6ES	7811	4	BPR6EIX	6637
850 Especial	0.8	35			4	0,7	BP6ES	7811	4	BPR6EIX	6637
850 Spider	0.9				4	0,7	BP6ES	7811	4	BPR6EIX	6637
Alhambra	1.8	110	06.00-	AWC	4	0,8	PFR6Q	6458			
Alhambra	1.8	110	05.98-02.00	AJH	4	0,8	BKR6ETA-10	7998			
Alhambra TDI	1.9	66	07.96-02.00	AHU	4		Y-732U	2408			
Alhambra	1.9	66	06.00-	ANU	4		Y-732U	2408			
Alhambra TDI	1.9	66	04.95-	1Z	4		Y-732U	2408			
Alhambra TDI	1.9	81	97-	AFN	4		Y-732U	2408			
Alhambra TDI	1.9	85	06.00-	AUY	4		Y-732U	2408			
Alhambra	2.0	85	06.00-	ATM	4	1,0	BKUR6ET-10	2397	24	PFR6Q	6458
Alhambra	2.0	85	03.96-02.00	ADY	4	0,8	BKUR6ET	6437	27	PFR6Q	6458
Alhambra	2.8	128	06.96-	AAA	6	0,8	BKR5EKUP	2890			
Alhambra	2.8	150	06.00-	AYL	6	1,1	PZFR5D-11	7968			
Alhambra	2.8	150	06.00-	AUE	6	1,1	PZFR5D-11	7968			
Arosa	1.0	37	07.00-	AUC	4	1,1	PZFR5D-11	7968			
Arosa	1.0	37	08.99-	ALD	4	1,1	PZFR5D-11	7968			

¹⁾ Bic = Best in class (siehe Seite 3) / (see page 3)



l kW

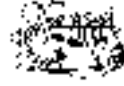

Cyl.

Order-
No. No.Bic¹⁾ Order-
No. No.**SEAT**

Arosa	1.0	37	11.98-02.00	AHT	4	1,0	BKR6ETA-10	7998				
Arosa	1.0	37	07.99-	ANV	4	1,1	PZFR5D-11	7968				
Arosa	1.0	37	02.97-09.99	AER	4	0,8	BUR6ET	3172	1	PGR6D		6248
Arosa	1.0	37	08.97-06.99	ALL	4	0,8	BUR6ET	3172	1	PGR6D		6248
Arosa	1.4	44	12.97-08.99	APQ	4	0,8	BUR6ET	3172	1	PGR6D		6248
Arosa	1.4	44	07.99-	AKK	4	1,1	PZFR5D-11	7968				
Arosa	1.4	44	05.97-01.99	AKV	4	0,8	BUR6ET	3172	1	PGR6D		6248
Arosa	1.4	44	02.97-11.97	AEX	4	0,8	BUR6ET	3172	1	PGR6D		6248
Arosa	1.4	44	07.00-	AUD	4	1,1	PZFR5D-11	7968				
Arosa	1.4	44	07.99-	ANW	4	1,1	PZFR5D-11	7968				
Arosa TDI	1.4	55	09.99-	AMF	3	█	Y-732U	2408				
Arosa 16V	1.4	55	01.98-	AHW	4	1,0	BKUR6ET-10	2397	24	PFR6Q		6458
Arosa 16V	1.4	74	01.99-	ANM	4	1,0	BKUR6ET-10	2397	24	PFR6Q		6458
Arosa 16V	1.4	74	01.99-	AFK	4	1,0	BKUR6ET-10	2397	24	PFR6Q		6458
Arosa 16V	1.4	74	09.00-	AUB	4	1,0	BKUR6ET-10	2397	24	PFR6Q		6458
Arosa 16V	1.4	74	08.99-	AQQ	4	1,0	BKUR6ET-10	2397	24	PFR6Q		6458
Arosa SDI	1.7	44	08.97-04.98	AKU	4	█	Y-732U	2408				
Cordoba	1.0	37	07.00-	AUC	4	1,1	PZFR5D-11	7968				
Cordoba / Vario	1.0	37	08.99-	ALD	4	1,1	PZFR5D-11	7968				
Cordoba / Vario	1.0	37	09.96-	AER	4	0,8	BUR6ET	3172	1	PGR6D		6248
Cordoba / Vario	1.0	37	08.99-07.00	ANV	4	1,1	PZFR5D-11	7968				
Cordoba	1.0	51	05.00-	AVZ	4	1,0	BKUR6ETB-10					
Cordoba	1.3	40	02.93-08.94	AAV	4	0,8	BP5ET	2287				
Cordoba	1.3	40	02.93-08.94	2G	4	0,8	BUR6ET	3172	1	PGR6D		6248
Cordoba	1.4	40	01.98-	ANX	4	0,8	BUR6ET	3172	1	PGR6D		6248
Cordoba / Vario	1.4	44	08.99-	AKK	4	1,1	PZFR5D-11	7968				
Cordoba / Vario	1.4	44	09.95-12.97	AEX	4	0,8	BUR6ET	3172	1	PGR6D		6248
Cordoba / Vario	1.4	44	12.97-05.98	APQ	4	0,8	BUR6ET	3172	1	PGR6D		6248
Cordoba / Vario	1.4	44	09.97-	AKV	4	0,8	BUR6ET	3172	1	PGR6D		6248
Cordoba	1.4	44	09.93-12.95	ABD	4	0,8	BP5ET	2287				
Cordoba / Vario	1.4	44	06.00-	AUD	4	1,1	PZFR5D-11	7968				
Cordoba / Vario	1.4	44	05.99-08.00	ANW	4	1,1	PZFR5D-11	7968				
Cordoba 16V	1.4	55	06.00-	AUA	4	1,0	BKUR6ET-10	2397	24	PFR6Q		6458
Cordoba 16V	1.4	55	05.99-	APE	4	1,0	BKUR6ET-10	2397	24	PFR6Q		6458
Cordoba / Vario 16V	1.4	74	07.00-	AUB	4	1,0	BKUR6ET-10	2397	24	PFR6Q		6458
Cordoba / Vario 16V	1.4	74	09.99-07.00	AQQ	4	1,0	BKUR6ET-10	2397	24	PFR6Q		6458
Cordoba / Vario 16V	1.4	74	06.97-	AFH	4	0,8	BKUR6ET	6437	27	PFR6Q		6458
Cordoba	1.6	52	11.93-	ABM	4	0,8	BUR5ET	3377	22	PGR6D		6248
Cordoba / Vario	1.6	55	09.94-09.97	1F	4	0,8	BUR5ET	3377	22	PGR6D		6248
Cordoba	1.6	55	02.93-07.94	ABU	4	0,8	BUR6ET	3172	1	PGR6D		6248
Cordoba / Vario	1.6	55	05.97-12.98	AEE	4	0,8	BUR6ET	3172	1	PGR6D		6248
Cordoba / Vario	1.6	55	09.97-	ALM	4	0,8	BUR6ET	3172	1	PGR6D		6248
Cordoba	1.6	74	01.96-	AEK	4	0,9	BKUR5ET	2789	29	PFR6Q		6458
Cordoba / Vario	1.6	74	05.00-	AUR	4	1,0	BKUR6ET-10	2397	24	PFR6Q		6458
Cordoba	1.6	74	05.99-	AKL	4	1,0	BKUR6ET-10	2397	24	PFR6Q		6458
Cordoba / Vario	1.6	74	03.00-	APF	4	1,0	BKUR6ET-10	2397	24	PFR6Q		6458
Cordoba / Vario	1.6	74	05.99-	AEH	4	1,0	BKUR6ET-10	2397	24	PFR6Q		6458
Cordoba	1.6	74			4	0,8	BUR5ET	3377	22	PGR6D		6248
Cordoba / Vario	1.6	74	09.95-05.98	AFT	4	1,0	BKUR6ET-10	2397	24	PFR6Q		6458
Cordoba	1.8	55	08.91-	AAM	4	0,8	BUR5ET	3377	22	PGR6D		6248
Cordoba / Vario	1.8	66	07.94-	ADZ	4	0,8	BUR6ET	3172	1	PGR6D		6248
Cordoba	1.8	66	02.93-08.94	ABS	4	0,8	BUR6ET	3172	1	PGR6D		6248

¹⁾ Bic = Best in class (siehe Seite 3) / (see page 3)



ℓ kW

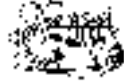

Cyl.

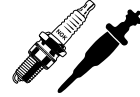
Order-
No. No.Bic¹⁾ Order-
No.**SEAT**

Cordoba	1.8	66	07.96-	ACC	4	0,8	BUR6ET	3172	1	PGR6D	6248
Cordoba	1.8	95	02.94-06.96	ADL	4	0,8	BKUR7ET	7873		PFR7Q	7963
Cordoba 16V	1.8	100			4	0,8	BUR6ET	3172	1	PGR6D	6248
Cordoba 20V	1.8	115	12.99-	AQX	4	1,0	BKUR6ET-10	2397	24	PFR6Q	6458
Cordoba	1.8	115	09.00-	AYP	4	1,0	BKUR6ET-10	2397	24	PFR6Q	6458
Cordoba / Vario SDI	1.9	47	07.96-	AEY	4	█	Y-732U	2408			
Cordoba / Vario D	1.9	47	02.93-	1Y	4	█	Y-918R	4182			
Cordoba SDI	1.9	50	04.99-	AGP	4	█	Y-732U	2408			
Cordoba SDI	1.9	50	06.99-	AQM	4	█	Y-732U	2408			
Cordoba / Vario TD	1.9	55	02.93-08.97	AAZ	4	█	Y-918R	4182			
Cordoba / Vario TDI	1.9	66	07.95-12.96	1Z	4	█	Y-732U	2408			
Cordoba TDI	1.9	66	10.99-	ALH	4	█	Y-732U	2408			
Cordoba / Vario TDI	1.9	66	12.96-	AHU	4	█	Y-732U	2408			
Cordoba TDI	1.9	66	04.99-	AGR	4	█	Y-732U	2408			
Cordoba / Vario TDI	1.9	81	03.97-	AFN	4	█	Y-732U	2408			
Cordoba TDI	1.9	81	03.99-	ASV	4	█	Y-732U	2408			
Cordoba	2.0	85	02.93-06.96	2E	4	0,8	BUR6ET	3172	1	PGR6D	6248
Cordoba / Vario	2.0	85	04.96-	AGG	4	0,8	BUR6ET	3172	1	PGR6D	6248
Cordoba 16V	2.0	110	07.96-	ABF	4	1,0	BKUR6ET-10	2397	24	PFR6Q	6458
Fura Crono	1.4	55			4	0,7	BP6ES	7811	4	BPR6EIX	6637
Ibiza	0.9	29	06.84-09.93	100GL	4	0,8	BPR6ES	7822	2	BPR6EIX	6637
Ibiza	1.0	33	03.93-	AAU	4	0,8	BP5ET	2287			
Ibiza	1.0	37	08.99-07.00	ANV	4	1,1	PZFR5D-11	7968			
Ibiza	1.0	37	08.99-	ALD	4	1,1	PZFR5D-11	7968			
Ibiza	1.0	37	09.96-	AER	4	0,8	BUR6ET	3172	1	PGR6D	6248
Ibiza	1.0	37	07.00-	AUC	4	1,1	PZFR5D-11	7968			
Ibiza 16V	1.0	51	05.00-	AVZ	4	1,0	BKUR5ET-10	7553			
Ibiza 16V	1.0	51	06.00-	AST	4	1,0	BKUR5ET-10	7553			
Ibiza	1.2	47	07.01-		3	1,1	PZFR5J-11				
Ibiza	1.3	40	02.93-08.94	AAV	4	0,8	BP5ET	2287			
Ibiza	1.3	40	02.93-08.94	2G	4	0,8	BUR6ET	3172	1	PGR6D	6248
Ibiza	1.4	44	09.95-12.97	AEX	4	0,8	BUR6ET	3172	1	PGR6D	6248
Ibiza	1.4	44	05.99-08.00	ANW	4	1,1	PZFR5D-11	7968			
Ibiza	1.4	44	06.00-	AUD	4	1,1	PZFR5D-11	7968			
Ibiza	1.4	44	08.99-	AKK	4	1,1	PZFR5D-11	7968			
Ibiza	1.4	44	09.93-12.95	ABD	4	0,8	BP5ET	2287			
Ibiza	1.4	44	09.97-	AKV	4	0,8	BUR6ET	3172	1	PGR6D	6248
Ibiza	1.4	44	12.97-05.98	APQ	4	0,8	BUR6ET	3172	1	PGR6D	6248
Ibiza 16V	1.4	55	09.99-	APE	4	1,0	BKUR6ET-10	2397	24	PFR6Q	6458
Ibiza 16V	1.4	55	06.00-	AUA	4	1,0	BKUR6ET-10	2397	24	PFR6Q	6458
Ibiza	1.4	55	05.98-	AHW	4	1,0	BKUR6ET-10	2397	24	PFR6Q	6458
Ibiza 16V	1.4	74	06.97-	AFH	4	0,8	BKUR6ET	6437	27	PFR6Q	6458
Ibiza 16V	1.4	74	07.00-	AUB	4	1,0	BKUR6ET-10	2397	24	PFR6Q	6458
Ibiza 16V	1.4	74	09.99-07.00	AQQ	4	1,0	BKUR6ET-10	2397	24	PFR6Q	6458
Ibiza	1.6	55	02.93-07.94	ABU	4	0,8	BUR6ET	3172	1	PGR6D	6248
Ibiza	1.6	55	09.94-09.97	1F	4	0,8	BUR5ET	3377	22	PGR6D	6248
Ibiza	1.6	55	05.97-12.98	AEE	4	0,8	BUR6ET	3172	1	PGR6D	6248
Ibiza	1.6	55	09.97-	ALM	4	0,8	BUR6ET	3172	1	PGR6D	6248
Ibiza	1.6	74	03.00-	APF	4	1,0	BKUR6ET-10	2397	24	PFR6Q	6458
Ibiza	1.6	74	01.96-	AEK	4	0,9	BKUR5ET	2789	29	PFR6Q	6458
Ibiza	1.6	74	09.95-05.98	AFT	4	1,0	BKUR6ET-10	2397	24	PFR6Q	6458
Ibiza	1.6	74	06.99-	AKL	4	1,0	BKUR6ET-10	2397	24	PFR6Q	6458

¹⁾ Bic = Best in class (siehe Seite 3) / (see page 3)



l kW

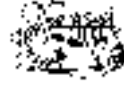

Cyl.

Order-
No. No.Bic¹⁾ Order-
No. No.**SEAT**

Ibiza	1.6	74	05.00-	AUR	4	1,0	BKUR6ET-10	2397	24	PFR6Q	6458
Ibiza	1.6	74	05.99-	AEH	4	1,0	BKUR6ET-10	2397	24	PFR6Q	6458
Ibiza D	1.7		09.87-		4	█	Y-902R	2237			
Ibiza D	1.7	40	06.84-08.87		4	█	Y-208T	1250			
Ibiza	1.7	72	02.92-09.93	021C3000	Cat.	4	0,9	BCP7ES	5030	BCPR7EIX	5690
Ibiza	1.8	55	08.91-	AAM	4	0,8	BUR5ET	3377	22	PGR6D	6248
Ibiza	1.8	66	02.93-08.94	ABS	4	0,8	BUR6ET	3172	1	PGR6D	6248
Ibiza	1.8	66	07.94-	ADZ	4	0,8	BUR6ET	3172	1	PGR6D	6248
Ibiza	1.8	95	02.94-06.96	ADL	4	0,8	BKUR7ET	7873		PFR7Q	7963
Ibiza 16V	1.8	100			4	0,8	BUR6ET	3172	1	PGR6D	6248
Ibiza 20V Turbo	1.8	115	05.00-	AYP	5	1,0	BKUR6ET-10	2397	24	PFR6Q	6458
Ibiza 20V Turbo	1.8	115	12.99-	AQX	5	1,0	BKUR6ET-10	2397	24	PFR6Q	6458
Ibiza SDI	1.9	47	07.96-	AEY	4	█	Y-732U	2408			
Ibiza D	1.9	47	02.93-	1Y	4	█	Y-918R	4182			
Ibiza SDI	1.9	50	05.99-	AQM	4	█	Y-732U	2408			
Ibiza SDI	1.9	50	04.99-	AGP	4	█	Y-732U	2408			
Ibiza TD	1.9	55	02.93-08.97	AAZ	4	█	Y-918R	4182			
Ibiza TDI	1.9	66	04.99-	AGR	4	█	Y-732U	2408			
Ibiza TDI	1.9	66	07.96-12.96	1Z	4	█	Y-732U	2408			
Ibiza TDI	1.9	66	05.99-	ALH	4	█	Y-732U	2408			
Ibiza TDI	1.9	66	12.96-	AHU	4	█	Y-732U	2408			
Ibiza TDI	1.9	81	03.99-	ASV	4	█	Y-732U	2408			
Ibiza TDI	1.9	81	03.97-	AFN	4	█	Y-732U	2408			
Ibiza	2.0	85	02.93-06.96	2E	4	0,8	BUR6ET	3172	1	PGR6D	6248
Ibiza	2.0	85	04.96-	AGG	4	0,8	BUR6ET	3172	1	PGR6D	6248
Ibiza Cupra	2.0	110	07.96-	ABF	4	1,0	BKUR6ET-10	2397	24	PFR6Q	6458
Ibiza/Malaga 1,2	1.2	46	06.84-08.89	021-A-1000	4	0,9	BCP7ES	5030		BCPR7EIX	5690
Ibiza/Malaga 1,2i	1.2	52	08.89-03.93	021-C-1000	Cat.	4	0,9	BCP7ES	5030	BCPR7EIX	5690
Ibiza/Malaga 1,5	1.5	65	04.89-08.91	021-D-2000	4	0,9	BCP7ES	5030		BCPR7EIX	5690
Ibiza/Malaga 1,5i	1.5	66	09.87-09.93	021-C-2000	Cat.	4	0,9	BCP7ES	5030	BCPR7EIX	5690
Ibiza/Malaga 1,5i SXi	1.5	74	06.88-08.91	021-B-2000	4	0,9	BCP7ES	5030		BCPR7EIX	5690
Inca	1.4	44	12.97-	APQ	4	0,8	BUR6ET	3172	1	PGR6D	6248
Inca	1.4	44	12.97-09.00	AKV	4	0,8	BUR6ET	3172	1	PGR6D	6248
Inca	1.4	44	11.95-12.97	AEX	4	0,8	BUR6ET	3172	1	PGR6D	6248
Inca	1.4	44	09.00-	AUD	4	1,1	PZFR5D-11	7968			
Inca 16V	1.4	55	09.00-	AUA	4	1,0	BKUR6ET-10	2397	24	PFR6Q	6458
Inca	1.6	55	11.95-05.97	1F	4	0,8	BUR5ET	3377	22	PGR6D	6248
Inca	1.6	55	06.97-09.00	AEE	4	0,8	BUR6ET	3172	1	PGR6D	6248
Inca D	1.7	42	07.96-09.00	AHB	4	█	Y-918R	4182			
Inca SDI	1.9	47	09.00-	AYQ	4	█	Y-732U	2408			
Inca SDI	1.9	47	11.95-09.00	AEY	4	█	Y-732U	2408			
Inca D	1.9	47	11.95-	1Y	4	█	Y-918R	4182			
León 16V	1.4	55	06.00-	AXP	4	1,0	BKUR6ET-10	2397	24	PFR6Q	6458
León	1.4	55	11.99-05.00	APE	4	1,0	BKUR6ET-10	2397	24	PFR6Q	6458
León	1.4	55	00-	AKQ	4	1,0	BKUR6ET-10	2397	24	PFR6Q	6458
León	1.4	55	01.00-	AHW	4	1,0	BKUR6ET-10	2397	24	PFR6Q	6458
León	1.6	74	11.98-	AEH	4	1,0	BKUR6ET-10	2397	24	PFR6Q	6458
León	1.6	74	10.98-	AKL	4	1,0	BKUR6ET-10	2397	24	PFR6Q	6458
León	1.6	77	11.99-	ATN	4	1,0	BKUR6ET-10	2397	24	PFR6Q	6458
León 20V	1.8	92	10.98-	AGN	4	1,0	BKUR6ET-10	2397	24	PFR6Q	6458
León 20V	1.8	132	04.00-	AJQ	4	0,8	PFR6Q	6458			
León turbo	1.8	132	11.99-	APP	4	0,8	PFR6Q	6458			

¹⁾ Bic = Best in class (siehe Seite 3) / (see page 3)



ℓ kW

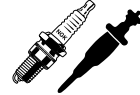

Cyl.

Order-
No. No.Bic¹⁾ Order-
No. No.**SEAT**

León	1.8	132	09.00-	ARY		4	0,8	PFR6Q	6458				
León 20V	1.8	132	06.00-	APG		4	1,0	BKUR6ET-10	2397	24	PFR6Q	6458	
León 20V	1.8	132	09.00-	AUQ		4	0,8	PFR6Q	6458				
León SDI	1.9	50	03.00-	AQM		4	█	Y-732U	2408				
León TD	1.9	66	04.99-	AGR		4	█	Y-732U	2408				
León TDI	1.9	66	03.99-	ALH		4	█	Y-732U	2408				
León TDI	1.9	81	10.98-	AHF		4	█	Y-732U	2408				
León TDI	1.9	81	11.99-	ASV		4	█	Y-732U	2408				
León TDI	1.9	110	09.00-	ARL		4	█	Y-732U	2408				
León Cupra	2.8	150	10.00-	AUE		6	1,1	PZFR5D-11	7968				
Malaga D	1.7		09.87-08.91			4	█	Y-902R	2237				
Malaga D	1.7	40	05.85-08.87			4	█	Y-208T	1250				
Marbella 0,8	0.9	25	01.87-12.91	903 08NCA		4	0,8	BPR6ES	7822	2	BPR6EIX	6637	
Marbella 0,9	0.9	29	86-12.92	09NCA Verg.		4	0,8	BPR6ES	7822	2	BPR6EIX	6637	
Marbella 0,9	0.9	30	92-05.98	09NCB	Cat.	4	0,9	BPR5ES	7422	6	BPR5EIX	6597	
Panda 35	0.8	26				4	0,7	BP6ES	7811	4	BPR6EIX	6637	
Panda 45	0.9	33				4	0,7	BP6ES	7811	4	BPR6EIX	6637	
Ritmo D	1.7	40	09.80-08.88			4	█	Y-208T	1250				
Ritmo 65 / Ronda 1,2	1.2	47				4	0,7	BP6ES	7811	4	BPR6EIX	6637	
Ritmo 75 / Ronda 1,4	1.4	57				4	0,7	BP6ES	7811	4	BPR6EIX	6637	
Ritmo Crono 100 / Ronda CLX	1.6	74				4	0,7	BP6ES	7811	4	BPR6EIX	6637	
Ronda 1,2	1.2	44	05.84-08.91	021.1000		4	0,7	BCP7ES	5030		BCPR7EIX	5690	
Ronda 1,2	1.2	47	05.84-08.91	124B.6000		4	0,8	BPR6ES	7822	2	BPR6EIX	6637	
Ronda 1,5	1.5	63	05.84-08.91	021A.2000		4	0,7	BCP7ES	5030		BCPR7EIX	5690	
Ronda 1,6	1.6	68	05.84-08.91	022A.000		4	0,7	BP7ES	2412		BPR7EIX	4055	
Ronda D	1.7		09.87-08.88			4	█	Y-902R	2237				
Ronda D	1.7	40	06.82-12.86	138 A5		4	█	Y-208T	1250				
Sport 1.200	1.2	49				4	0,7	BP6ES	7811	4	BPR6EIX	6637	
Sport 1.430	1.4	57				4	0,7	BP6ES	7811	4	BPR6EIX	6637	
Terra 0,9	0.9	29	08.91-05.98	09NCB	Cat.	4	0,9	BPR5ES	7422	6	BPR5EIX	6597	
Terra 0,9	0.9	29	09.87-08.91	09NCA		4	0,8	BPR6ES	7822	2	BPR6EIX	6637	
Terra Kombi D	1.4		10.91-	1W		4	█	Y-918R	4182				
Terra D	1.4	35	01.90-			4	█	Y-918R	4182				
Terra D	1.4	35	10.90-			4	█	Y-918R	4182				
Toledo	1.4	55	00-	AKQ		4	1,0	BKUR6ET-10	2397	24	PFR6Q	6458	
Toledo 16V	1.4	55	11.99-	APE		4	1,0	BKUR6ET-10	2397	24	PFR6Q	6458	
Toledo	1.4	55	01.00-	AHW		4	1,0	BKUR6ET-10	2397	24	PFR6Q	6458	
Toledo 16V	1.4	55	06.00-	AXP		4	1,0	BKUR6ET-10	2397	24	PFR6Q	6458	
Toledo	1.6	52	11.93-10.99	ABM		4	0,8	BUR5ET	3377	22	PGR6D	6248	
Toledo	1.6	54	08.91-10.99	EZ		4	1,0	BUR5ET-10	7264	21	PGR6D	6248	
Toledo	1.6	55	11.93-	1F		4	0,8	BUR5ET	3377	22	PGR6D	6248	
Toledo	1.6	55	03.93-	ABU		4	0,8	BUR6ET	3172	1	PGR6D	6248	
Toledo	1.6	74	04.96-	AFT		4	1,0	BKUR6ET-10	2397	24	PFR6Q	6458	
Toledo	1.6	74	11.98-	AEH		4	1,0	BKUR6ET-10	2397	24	PFR6Q	6458	
Toledo	1.6	74	02.99-	AKL		4	1,0	BKUR6ET-10	2397	24	PFR6Q	6458	
Toledo	1.6	74	09.99-	APF		4	1,0	BKUR6ET-10	2397	24	PFR6Q	6458	
Toledo	1.6	74	01.96-	AEK		4	0,9	BKUR5ET	2789	29	PFR6Q	6458	
Toledo	1.6	77	11.99-	ATN		4	1,0	BKUR6ET-10	2397	24	PFR6Q	6458	
Toledo 16V	1.6	77	06.00-	AUS		4	1,0	BKUR6ET-10	2397	24	PFR6Q	6458	
Toledo	1.8	66	05.91-07.94	ABS		4	0,8	BUR6ET	3172	1	PGR6D	6248	
Toledo	1.8	66	01.95-	ACC		4	0,8	BUR6ET	3172	1	PGR6D	6248	
Toledo	1.8	66	11.94-05.99	ADZ		4	0,8	BUR6ET	3172	1	PGR6D	6248	

¹⁾ Bic = Best in class (siehe Seite 3) / (see page 3)



l kW

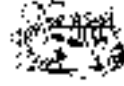

Cyl.

Order-
No. No.Bic¹⁾ Order-
No.**SEAT**

Toledo	1.8	66	08.91-12.92	RP	4	0,8	BUR6ET	3172	1	PGR6D	6248
Toledo 16V	1.8	92	08.91-05.94	PL	4	0,8	BKUR7ET	7873		PFR7Q	7963
Toledo 20V	1.8	92	10.98-	AGN	4	1,0	BKUR6ET-10	2397	24	PFR6Q	6458
Toledo	1.8	92	09.00-	APG	4	1,0	BKUR6ET-10	2397	24	PFR6Q	6458
Toledo 16V	1.8	98	08.91-	KR	4	0,8	BCP7ET	2078		BCPR7EIX	5690
Toledo	1.8	132	05.01-	ARY	4	0,8	PFR6Q	6458			
Toledo	1.8	132	03.00-	AJQ	4	0,8	PFR6Q	6458			
Toledo	1.8	132	05.01-	AUQ	4	0,8	PFR6Q	6458			
Toledo turbo	1.8	132	11.99-	APP	4	0,8	PFR6Q	6458			
Toledo D	1.9	47	03.91-	1Y	4	█	Y-918R	4182			
Toledo SDI	1.9	50	05.01-	AQM	4	█	Y-732U	2408			
Toledo TD	1.9	55	03.91-	AAZ	4	█	Y-918R	4182			
Toledo Tdi	1.9	66	08.93-	1Z	4	█	Y-732U	2408			
Toledo TDI	1.9	66	03.99-	ALH	4	█	Y-732U	2408			
Toledo TDI	1.9	66	05.99-	AGR	4	█	Y-732U	2408			
Toledo TDI	1.9	81	97-	AFN	4	█	Y-732U	2408			
Toledo TDI	1.9	81	05.99-	AHF	4	█	Y-732U	2408			
Toledo TDI	1.9	81	10.99-	ASV	4	█	Y-732U	2408			
Toledo TDI	1.9	110	10.00-	ARL	4	█	Y-732U	2408			
Toledo	2.0	85	06.99-	AQY	4	1,0	BKUR6ET-10	2397	24	PFR6Q	6458
Toledo	2.0	85	05.91-	2E	4	0,8	BUR6ET	3172	1	PGR6D	6248
Toledo 2,0i	2.0	85	07.95-	AGG	4	0,8	BUR6ET	3172	1	PGR6D	6248
Toledo	2.0	100		9A	4	0,8	BKUR7ET	7873		PFR7Q	7963
Toledo	2.0	110	05.94-	ABF	4	1,0	BKUR6ET-10	2397	24	PFR6Q	6458
Toledo VR5	2.3	110	10.98-	AGZ	5	0,8	BKR5EKUP	2890			
Toledo	2.3	125	09.00-	AQN	5	1,1	PZFR5D-11	7968			
Toledo	2.8	150	05.01-	BDE	6	1,1	PZFR5D-11	7968			
Toledo	2.8	150	05.01-	AUE	6	1,1	PZFR5D-11	7968			
VAN	1.0	33	-09.96		4	0,8	BUR6ET	3172	1	PGR6D	6248
VAN	1.0	37	09.96-	AER	4	0,8	BUR6ET	3172	1	PGR6D	6248
VAN	1.4	44			4	0,8	BUR6ET	3172	1	PGR6D	6248
VAN	1.6	55			4	0,8	BUR5ET	3377	22	PGR6D	6248

SKODA

105 L / S	1.0	34	76-12.90		4	0,6	BP6HS	4511	18	BPR6HIX	4085	
120 A	1.2	37	76-12.90		4	0,6	BP6HS	4511	18	BPR6HIX	4085	
120 GLS / LS / LSE / Garde	1.2	39	76-12.90		4	0,6	BP6HS	4511	18	BPR6HIX	4085	
125 L / GL / GLE	1.2	37	76-12.90		4	0,6	BP6HS	4511	18	BPR6HIX	4085	
130 L / GL / Garde	1.3	46	76-12.90		4	0,6	BP6HS	4511	18	BPR6HIX	4085	
135 LX / GLX	1.3		01.93- 96		4	0,8	BKR6ES	3783	28	BKR6EIX	6418	
135 LE / LSE	1.3		08.89-08.92		4	0,8	BKR6ES	3783	28	BKR6EIX	6418	
135 L / GL / Rapid	1.3	43	08.87-08.90		u.Cat.	4	0,8	BCPR5ES	6130	32	BCPR5EIX-11	3306
135 Favorit L / LS	1.3		04.88- 95		4	0,8	BCPR5ES	6130	32	BCPR5EIX-11	3306	
135 Favorit LE / LSE	1.3		08.89- 95		4	0,8	BKR6ES	3783	28	BKR6EIX	6418	
135 Favorit LX / GLX	1.3		01.93- 95		4	0,8	BKR6ES	3783	28	BKR6EIX	6418	
135 Forman L / LS	1.3		08.90- 95		4	0,8	BCPR5ES	6130	32	BCPR5EIX-11	3306	
135 Forman LE / LSE	1.3		02.91- 95		4	0,8	BKR6ES	3783	28	BKR6EIX	6418	
135 Forman LX / GLX	1.3		01.93- 95		4	0,8	BKR6ES	3783	28	BKR6EIX	6418	
135 / 136	1.3	46	-12.90		4	0,6	BP6HS	4511	18	BPR6HIX	4085	
136 L / GL / Rapid	1.3	46	87-12.90		4	0,7	BCP6ES	4930	17	BCPR6EIX-11	4919	
136 Favorit			93- 95		4	0,8	BKR6E	6962	28	BKR6EIX	6418	
136 Favorit					4	0,7	BP7EFS	3526				

¹⁾ Bic = Best in class (siehe Seite 3) / (see page 3)



ℓ kW

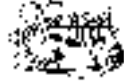

Cyl.

Order-
No. No.Bic¹⁾ Order-
No.**SKODA**

136 Favorit					4	0,7	BCPR6E	1269	12	BCPR6EIX-11	4919
136 Favorit			93- 95		4		BCPR6ET	2197			
Coupe	1.2	43	-12.90		4	0,6	BP6HS	4511	18	BPR6HIX	4085
Fabia	1.0	37	02.00-	ARV	4	1,0	BKR6ETA-10	7998			
Fabia	1.0	37	01.00-	AQV	4	1,0	BKR6ETA-10	7998			
Fabia	1.0	37	02.00-	ATY	4	1,0	BKR6ETA-10	7998			
Fabia	1.2	40	12.02-	AWY	3		ZFR5P-G				
Fabia	1.2	40	04.02-12.02	AWY	3	1,1	PZFR5J-11				
Fabia	1.2	47	02.03-	AZQ	3		ZFR5P-G				
Fabia	1.4	44	12.99-	AZE	4	0,8	PFR6Q	6458			
Fabia	1.4	44	12.99-	AZF	4	0,8	PFR6Q	6458			
Fabia	1.4	50	02.00-	AME	4	1,0	BKUR5ET-10	7553			
Fabia	1.4	50	02.00-	ATZ	4	1,0	BKUR5ET-10	7553			
Fabia	1.4	50	08.00-	AQW	4	1,0	BKUR5ET-10	7553			
Fabia 16V AUTOMATIC	1.4	55		BBY	4	1,1	PZFR5D-11	7968			
Fabia	1.4	55	01.00-	AUA	4	1,0	BKUR6ET-10	2397	24	PFR6Q	6458
Fabia	1.4	55		BBY	4	1,0	BKUR6ET-10	2397	24	PFR6Q	6458
Fabia	1.4	74		BBZ	4	1,0	BKUR6ET-10	2397	24	PFR6Q	6458
Fabia	1.4	74	10.99-	AUB	4	1,0	BKUR6ET-10	2397	24	PFR6Q	6458
Fabia SDI	1.9	47	02.00-	ASY	4	█	Y-732U	2408			
Fabia TDI PD	1.9	74	00-	ATD	4	█	Y-732U	2408			
Fabia	2.0	85	00-	AZL	4	1,0	BKUR6ET-10	2397	24	PFR6Q	6458
Felicia	1.0	37	08.99-	AHT	4	1,0	BKR6ETA-10	7998			
Felicia 135i	1.3	40	95-	MPI	4	1,0	BKUR5ET-10	7553			
Felicia	1.3	40	08.96-	AMG	4	1,0	BKUR5ET-10	7553			
Felicia 135i	1.3	43	08.96-	AMJ	4	0,8	BCPR5ES	6130	32	BCPR5EIX-11	3306
Felicia	1.3	43	-12.90		4	0,8	BCPR5ES	6130	32	BCPR5EIX-11	3306
Felicia 136i	1.3	50	10.94-08.96		4	0,8	BKR6ES	3783	28	BKR6EIX	6418
Felicia	1.3	50	08.96-	AMH	4	1,0	BKUR5ET-10	7553			
Felicia 136i	1.3	50	95-	136B	4	0,8	BCPR6ES	2330	12	BCPR6EIX-11	4919
Felicia	1.4	74	99-		4	1,0	BKUR6ET-10	2397	24	PFR6Q	6458
Felicia	1.6	55	01.96-	AEE	4	0,8	BUR6ET	3172	1	PGR6D	6248
Felicia D	1.9	47	06.97-		4	█	Y-918R	4182			
Felicia D	1.9	47	97-	AEY	4	█	Y-732U	2408			
Octavia	1.4	44	02.99-	AMD	4	1,0	BKUR6ET-10	2397	24	PFR6Q	6458
Octavia	1.4	55	00-	AKQ	4	1,0	BKUR6ET-10	2397	24	PFR6Q	6458
Octavia	1.4	55	00-	APE	4	1,0	BKUR6ET-10	2397	24	PFR6Q	6458
Octavia	1.4	55	08.00-	AXP	4	1,0	BKUR6ET-10	2397	24	PFR6Q	6458
Octavia	1.4	55	05.99-	AHW	4	1,0	BKUR6ET-10	2397	24	PFR6Q	6458
Octavia	1.6	55	09.96-09.00	AEE	4	0,8	BUR6ET	3172	1	PGR6D	6248
Octavia	1.6	74	02.97-	AKL	4	1,0	BKUR6ET-10	2397	24	PFR6Q	6458
Octavia	1.6	74	02.97-12.97	AEH	4	1,0	BKUR6ET-10	2397	24	PFR6Q	6458
Octavia	1.6	75	06.02-	BFQ	4	1,0	BKUR6ET-10	2397	24	PFR6Q	6458
Octavia	1.6	75	08.00-	AVU	4	1,0	BKUR6ET-10	2397	24	PFR6Q	6458
Octavia 20V	1.8	92	11.96-03.00	AGN	4	1,0	BKUR6ET-10	2397	24	PFR6Q	6458
Octavia Turbo	1.8	110	08.00-	ARX	4	0,8	PFR6Q	6458			
Octavia	1.8	110	98-	AEB	4	0,8	BKR6ETA-10	7998			
Octavia	1.8	110	05.98-	AGU	4	1,0	BKR6ETA-10	7998			
Octavia Turbo	1.8	110	08.00-	AUM	4	0,8	PFR6Q	6458			
Octavia Turbo	1.8	110	08.00-	ARZ	4	0,8	PFR6Q	6458			
Octavia RS Turbo	1.8	132	12.00-	AUQ	4	0,8	PFR6Q	6458			
Octavia SDI	1.9	47	09.96-	AEY	4	█	Y-732U	2408			

¹⁾ Bic = Best in class (siehe Seite 3) / (see page 3)



l kW

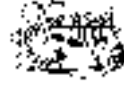

Cyl.

Order-
No. No.Bic¹⁾ Order-
No. No.**SKODA**

Octavia SDI	1.9	50	08.00-	AQM	4	█	Y-732U	2408				
Octavia TD (SK)	1.9	50	97-		4	█	Y-918R	4182				
Octavia SDI	1.9	50	05.97-	AGP	4	█	Y-732U	2408				
Octavia TDI	1.9	66	97-	1Z	4	█	Y-732U	2408				
Octavia TDI	1.9	66	08.00-	ALH	4	█	Y-732U	2408				
Octavia TD	1.9	66	09.96-	AGR	4	█	Y-732U	2408				
Octavia TDI	1.9	74	00-	ATD	4	█	Y-732U	2408				
Octavia TDI	1.9	81	97-	AFN	4	█	Y-732U	2408				
Octavia TDI	1.9	81	10.00-	ASV	4	█	Y-732U	2408				
Octavia TDI	1.9	81	08.97-	AHF	4	█	Y-732U	2408				
Octavia TDI	1.9	96	01.03-	ASZ	4	█	Y-741U	5065				
Octavia	2.0	85	-01.02	AZJ	4	1,1	PZFR5D-11	7968				
Octavia	2.0	85	05.99-12.01	AQY	4	1,0	BKUR6ET-10	2397	24	PFR6Q		6458
Octavia	2.0	85	04.99-01.02	AEG	4	1,0	BKUR6ET-10	2397	24	PFR6Q		6458
Octavia	2.0	85	04.99-12.01	AZH	4	1,0	BKUR6ET-10	2397	24	PFR6Q		6458
Octavia	2.0	85	05.99-12.01	APK	4	1,0	BKUR6ET-10	2397	24	PFR6Q		6458
Octavia Combi GLX / SLX	2.0	88	11.99-	ATF	4	1,1	PZFR5D-11	7968				
Pickup 135 L	1.3		06.90- 96		4	0,8	BCPR5ES	6130	32	BCPR5EIX-11		3306
Pickup 135 LE	1.3		10.91- 96		4	0,8	BKR6ES	3783	28	BKR6EIX		6418
Pickup 135 LX	1.3		01.93- 96		4	0,8	BKR6ES	3783	28	BKR6EIX		6418
Pickup	1.9	47	97-	AEY	4	█	Y-732U	2408				
Pick-up 135i	1.3	40	96-	135M	4	1,0	BKUR5ET-10	7553				
Pick-up 136i	1.3	50	96-	136M	4	1,0	BKUR5ET-10	7553				
Superb Turbo	1.8	110	10.01-	AWT	4	0,8	PFR6Q	6458				
Superb	2.0	85	10.01-	AZM	4	1,0	BKUR6ET-10	2397	24	PFR6Q		6458
Superb	2.8	142	10.01-	AMX	6	0,8	BKR6EKUB	3584	30	BKR6EQUP		3199

SMART

Smart	0.6	33	10.98-	M 160 ... Twin Spark	3	0,65	BKR6EKE	5649				
Smart	0.6	40	10.98-	M 160 ... Twin Spark	3	0,65	BKR6EKE	5649				
Smart	0.7	37	10.02-	M 160/1 Twin Spark	3		LKR8A					
Smart	0.7	45	10.02-	M 160/1 Twin Spark	3		LKR8A					
Smart	0.7	60	10.02-	M 160/1 Twin Spark	3		LKR8A					
Smart Roadster	0.7	60	06.03-	M 160/1 Twin Spark	3		LKR8A					

SSANGYONG

Korando	2.0	100	07.96-	M161E20 M111.940	4	0,8	BCP5ES	7496	16	BCPR5EIX-11		3306
Korando D	2.2	51	01.93-	DC 23	4	█	Y-710J	7880				
Korando D	2.3	55	03.97-	OM 601 DM	4	█	Y-916R	2785				
Korando TD	2.3	73	03.99-03.00		4	█	Y-916R	2785				
Korando	2.3	110	09.96-02.99	M161E23 M111.970	4	0,8	BCP5ES	7496	16	BCPR5EIX-11		3306
Korando D	2.9	73	12.96-	MB-OM 602	5	█	Y-916R	2785				
Korando TD	2.9	88	03.99-03.00		5	█	Y-916R	2785				
Korando GPL	3.2	162	07.97-03.00		6	0,7				BKR5EIX		6341
Korando	3.2	162	09.96-03.00	M162E32 M104...	6	0,8	BCP5ES	7496	16	BCPR5EIX-11		3306
Musso	2.0	100	05.96-	M161E20 M111.940	4	0,8	BCP5ES	7496	16	BCPR5EIX-11		3306
Musso 601 D	2.3	58	07.93-01.00	MB-OM 601	4	█	Y-916R	2785				
Musso TD	2.3	73	03.99-03.00		4	█	Y-916R	2785				
Musso	2.3	110	05.96-02.99	M161E23 M111.970	4	0,8	BCP5ES	7496	16	BCPR5EIX-11		3306
Musso 602 D	2.9	73	07.93-01.00	MB-OM 602	5	█	Y-916R	2785				
Musso TD	2.9	88	03.99-		5	█	Y-916R	2785				
Musso E32	3.2	162	01.96-	M162E32 M104...	6	0,8	BCP5ES	7496	16	BCPR5EIX-11		3306

¹⁾ Bic = Best in class (siehe Seite 3) / (see page 3)



ℓ kW

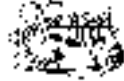

Cyl.

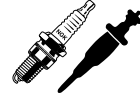
Order-
No. No.Bic¹⁾ Order-
No.**SSANGYONG**

Musso Sports 290S TD	2.9	88	03.04-		5	█	Y-916R	2785			
Rexton RX 270XDI	2.7	115	07.04-		5	█	Y-745U	4705			
Rexton RX 290s	2.9	88			5	█	Y-916R	2785			
Rexton RX 320s	3.2	162			6	0,7	BCP6ES	4930	17	BCPR6EIX-11	4919

STEYR

Puch 290 GD	2.9	72	08.93-	OM602	5	█	Y-916R	2785			
Puch 300 GD	3.0	83	09.89-	OM617/603	6	█	Y-916R	2785			
Puch 350 GTD	3.5	100	09.91-	OM617/603	6	█	Y-916R	2785			

SUBARU

1600					4	0,8	BPR6ES	7822	2	BPR6EIX	6637	
1800 Turbo					4	0,8	BPR7ES	2023	19	BPR7EIX	4055	
1800 Injection	1.8	59	81- 85	EA81	4	0,7	BP6ES	7811	4	BPR6EIX	6637	
Forester	2.0	90	09.97-	EJ20J	4	1,1	BCPR6ES-11	7121	11	BCPR6EIX-11	4919	
Forester S-Turbo	2.0	125	03.99-	EJ20	4	0,8	PFR6B	3500				
Impreza 1,6	1.6	66	93-	EJ16	4	1,1	BKR6E-11	2756	14	BKR6EIX-11	3764	
Impreza	1.6	70	12.00-	EJ16	4	1,1	BKR6E-11	2756	14	BKR6EIX-11	3764	
Impreza 1,8	1.8	76	93-	EJ18	4	1,1	BKR6E-11	2756	14	BKR6EIX-11	3764	
Impreza	2.0	92	12.00-	EJ20	4	1,1	BKR6E-11	2756	14	BKR6EIX-11	3764	
Impreza Turbo	2.0	155	05.94-07.96	EJ20	4	0,8	PFR6G	4793				
Impreza Turbo	2.0	160	03.94-	EJ20	4	0,8	PFR6B	3500				
Impreza WRX Turbo	2.0	160	12.00-	EJ20	4	0,8	PFR6B	3500				
Impreza WRX Turbo	2.0	165	11.02-	EJ20	4	0,8	PFR6B	3500				
Impreza WRX STI	2.0	206	02-		4	0,8	PFR6G	4793				
Justy 1000	1.0		85- 03	EF10	Cat.	4	1,1	BPR6ES-11	4824	13	BPR6EIX-11	3903
Justy 1200	1.2	55	87- 03	EF12/EF12	Cat.	4	1,1	BPR6ES-11	4824	13	BPR6EIX-11	3903
Justy 1300	1.3	50	10.95- 03	G13BA		4	0,8	BPR6ES	7822	2	BPR6EIX	6637
Justy G3X	1.3	69	09.03-	M13 DOHC		4	1,1	IFR6J-11	7658			
Justy G3X	1.5	73	09.03-	M15 DOHC		4	1,1	IFR6J-11	7658			
L-1800	1.8	66	85- 89			4	0,8	BPR6ES	7822	2	BPR6EIX	6637
L-1800 MPFJ	1.8	72	87-	EA82		4	1,1	BPR6ES-11	4824	13	BPR6EIX-11	3903
L-1800 Turbo	1.8	97	87- 89	EA82	u.Cat.	4	0,8	BPR7ES	2023	19	BPR7EIX	4055
L-1800 Turbo	1.8	100	85- 89	EA82		4	0,8	BPR7ES	2023	19	BPR7EIX	4055
Legacy 1,8 Station	1.8	76	90-	EJ18/4		4	1,1	BKR6E-11	2756	14	BKR6EIX-11	3764
Legacy 1,8 Super Station	1.8	76	90- 91	EJ18/4		4	1,1	BKR6E-11	2756	14	BKR6EIX-11	3764
Legacy 1,8 Sedan	1.8	76	90- 91	EJ18/4		4	1,1	BKR6E-11	2756	14	BKR6EIX-11	3764
Legacy 2.0	2.0		05.04-	only CNG DOHC		4	0,8	ILFR7F-D				
Legacy 2,0 Sedan	2.0	84	92-	EJ20/4		4	1,1	BKR6E-11	2756	14	BKR6EIX-11	3764
Legacy 2,0 Super Station	2.0	84	92-	EJ20		4	1,1	BKR6E-11	2756	14	BKR6EIX-11	3764
Legacy	2.0	85	05.94-	EJ20		4	1,1	BKR6E-11	2756	14	BKR6EIX-11	3764
Legacy 2,0	2.0	92	12.98-	EJ20		4	1,1	BKR6E-11	2756	14	BKR6EIX-11	3764
Legacy	2.0	101	09.03-	EJ20		4	1,1	BKR5ES-11	2382		BKR5EIX-11	5464
Legacy 2,0 Turbo Sup.Stat.	2.0	147	92- 93	EJ20		4	0,8	BKR6EVX	3539			
Legacy 2,0 Turbo	2.0	147	93- 96	EJ20		4	0,8	PFR6G	4793			
Legacy 2,0 Turbo Sedan	2.0	147	92- 93	EJ20		4	0,8	BKR6EVX	3539			
Legacy	2.2	94	05.94-	EJ22		4	1,1	BKR6E-11	2756	14	BKR6EIX-11	3764
Legacy 2,2 Station	2.2	96	94-	EJ22		4	1,1	BKR6E-11	2756	14	BKR6EIX-11	3764
Legacy 2,2 Super Station	2.2	100	90-	EJ22/4		4	1,1	BKR6E-11	2756	14	BKR6EIX-11	3764
Legacy 2,2 Sedan	2.2	100	90- 93	EJ22		4	1,1	BKR6E-11	2756	14	BKR6EIX-11	3764
Legacy Outback	2.5	110	96-	EJ25		4	1,1	PFR6B-11	4014			
Legacy 2,5 Outback	2.5	115	12.98-	EJ25		4	1,1	BKR6E-11	2756	14	BKR6EIX-11	3764

¹⁾ Bic = Best in class (siehe Seite 3) / (see page 3)



l kW

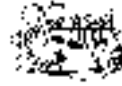

Cyl.

Order-
No. No.Bic¹⁾ Order-
No. No.**SUBARU**

Legacy Outback 2.5	2.5	121	09.03-	EJ25	4	1,1	PFR5B-11	2300				
Legacy	2.5	121	09.03-	EJ25	4	1,1	PFR5B-11	2300				
Legacy H6-3.0	3.0	154	01-		6	1,1	PLFR6A-11	7654				
Legacy Outback H6-3.0	3.0	154	01-		6	1,1	PLFR6A-11	7654				
Legacy Outback 3.0 R	3.0	180	11.03-	EZ30	6		ILFR6B					
Legacy 3.0 R	3.0	180	11.03-	EZ30	6		ILFR6B					
Libero 1000	1.0	37	-	86 EF10	4	1,1	BPR6ES-11	4824	13	BPR6EIX-11	3903	
Libero 1200	1.2	38	87-	EF12	4	1,1	BPR6ES-11	4824	13	BPR6EIX-11	3903	
M80 Mini Jumbo	0.8			M80	4	0,8	BKR6E	6962	28	BKR6EIX	6418	
MV Pickup	1.8		80-	94	4	0,7	BPR6ES	7822	2	BPR6EIX	6637	
Sumo	1.0				3	1,1	BPR6ES-11	4824	13	BPR6EIX-11	3903	
Sumo	1.2				3	1,1	BPR6ES-11	4824	13	BPR6EIX-11	3903	
SVX	3.3	162	92-	EG33	6	1,1	PFR6G-11	5555				
Vivio	0.7		03.92-	Vergaser/Carb	4	1,1	BKR5E-11	6953		BKR5EIX-11	5464	
Vivio	0.7		03.92-	MFI	4	1,1	BKR6E-11	2756	14	BKR6EIX-11	3764	
XT Turbo	1.8	88	(90)		Cat.	4	1,1	BPR6ES-11	4824	13	BPR6EIX-11	3903
XT Turbo	1.8	97	87-	89	u.Cat.	4	0,8	BPR7ES	2023	19	BPR7EIX	4055
XT-Turbo	1.8	100	85-	89		4	0,8	BPR7ES	2023	19	BPR7EIX	4055

SUZUKI

Alto 600 / Turbo (SS80)	0.6	22	06.82-12.85	F5A	4	0,9	BPR5ES	7422	6	BPR5EIX	6597	
Alto (SB308)	0.8	29	86- 92	F8B	4	0,9	BPR5ES	7422	6	BPR5EIX	6597	
Alto (SS80)	0.8	29	81- 85	F8B	4	0,9	BPR5ES	7422	6	BPR5EIX	6597	
Alto	1.0		01.01-	G10B	4	0,8	BKR6E	6962	28	BKR6EIX	6418	
Alto (SH410)	1.0	39	94- 00	G10B	4	0,8	BPR5EY	2828	9	BPR5EIX	6597	
Alto (SH410)	1.0	53	94-12.00	G10B	4	0,8	BPR5EY	2828	9	BPR5EIX	6597	
Alto (FF)	1.1	46	06.02-	K10A DOHC 16V	4	0,8	DCPR7EVX	1179		DCPR7EIX	6046	
Alto Lapin HE21S	1.6		01.02-	K6A...	4	0,8	DCPR7E	3932		DCPR7EIX	6046	
Baleno (SY413)	1.3	63	04.95-	G13BB	4	0,8	BKR6E	6962	28	BKR6EIX	6418	
Baleno	1.6		95-	G16A (16V)	4	0,7	BKR6E	6962	28	BKR6EIX	6418	
Baleno (SY416)	1.6	72	04.95-	G16B	4	0,8	BKR6E	6962	28	BKR6EIX	6418	
Baleno	1.8		11.00-	16V	4	1,1	IFR6J-11	7658				
Baleno	1.8	89	03.96-12.00	J18A	4	1,1	BKR6E-11	2756	14	BKR6EIX-11	3764	
Baleno D	1.9	46	98-		4		Y-923U	3380				
Baleno TD	1.9	55	98-		4		Y-923U	3380				
Cappuccino 660 12V Turbo	0.66	47	05.95-	K6A DOHC	Cat.	3	0,8	DCPR7EVX	1179		DCPR7EIX	6046
Cappuccino 660 12V Turbo	0.66	47	09.91-	F6A DOHC	Cat.	3	0,8	DCPR7EVX	1179		DCPR7EIX	6046
Carry (ST90)	0.8	27	81- 86	F8A	4	0,9	BPR5ES	7422	6	BPR5EIX	6597	
Carry Super (SK410)	1.0	31	92-	F10A	Cat.	4	0,9	BPR5ES	7422	6	BPR5EIX	6597
Carry Super (SK410)	1.0	33	87-	F10A	u.Cat.	4	0,9	BPR5ES	7422	6	BPR5EIX	6597
Carry Super (SK410)	1.0	33	85- 87	F10A		4	0,9	BPR5ES	7422	6	BPR5EIX	6597
Carry Van	1.3		99-	G13BB	4	0,7	BKR6E	6962	28	BKR6EIX	6418	
Cervo	0.55				3	0,9	BPR5ES	7422	6	BPR5EIX	6597	
Escudo	1.6	71	05.00-	G16A	4	1,1	IFR6E-11	6741				
Escudo	1.6	71	08.90-11.97	G16A	4	0,8	BKR6E	6962	28	BKR6EIX	6418	
Escudo	1.6	71	12.97-04.00	G16A	4	1,1	BKR6E-11	2756	14	BKR6EIX-11	3764	
Escudo	2.0		12.94-10.96	H20A	4	0,8	BKR6E	6962	28	BKR6EIX	6418	
Escudo	2.0		04.00-	H25A	6	1,1	IFR5J-11	7418				
Escudo	2.0		04.00-	J20A	4	1,1	IFR5J-11	7418				
Escudo	2.0		10.96-11.97	J20A	4	0,8	BKR6E	6962	28	BKR6EIX	6418	
Escudo	2.0		11.97-04.00	J20A	4	1,1	BKR6E-11	2756	14	BKR6EIX-11	3764	
Escudo	2.5		03.98-04.00	H25A	6	1,1	BKR6E-11	2756	14	BKR6EIX-11	3764	

¹⁾ Bic = Best in class (siehe Seite 3) / (see page 3)



ℓ kW

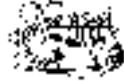

Cyl.

Order-
No. No.Bic¹⁾ Order-
No.**SUZUKI**

Escudo	2.5		10.96-11.97	H25A	6	0,9	BKR6E	6962	28	BKR6EIX	6418	
Grand Vitara	1.6	69	03.98-	J16A	4	1,1	BKR6E-11	2756	14	BKR6EIX-11	3764	
Grand Vitara	2.0		10.00-	J20	4	1,1	IFR5J11	7418				
Grand Vitara D	2.0	81	04.01-	HDi PSA	4	█	Y-504R	4359				
Grand Vitara	2.0	94	01.98-09.00	J20A	4	1,1	BKR6E-11	2756	14	BKR6EIX-11	3764	
Grand Vitara	2.5		10.00-	H25	6	1,1	IFR5J11	7418				
Grand Vitara V6 (SV620)	2.5	106	04.98-09.00	H25	6	1,1	BKR6E-11	2756	14	BKR6EIX-11	3764	
Grand Vitara V6 (SV620)	2.5	125	01.98-	H25A	6	1,1	BKR6E-11	2756	14	BKR6EIX-11	3764	
Grand Vitara XL-7	2.7	127	07.01-	H27A	6	1,1	IFR5J-11	7418				
Ignis	1.3	61	10.00-	M13A	4	1,1	IFR5E-11	7994				
Ignis	1.3	69	09.03-	M13A mit V V T	4	1,1	IFR6J-11	7658				
Ignis	1.5	73	09.03-	M15A mit V V T	4	1,1	IFR6J-11	7658				
Jimmy Cabrio	1.3	59	10.98-	G13BB	4	0,8	BKR6E	6962	28	BKR6EIX	6418	
Jimmy	1.3	60	10.00-	M13A	4	1,1	IFR5E-11	7994				
Liana	1.3	66	02.04-	M13A	4	1,1	IFR6J-11	7658				
Liana	1.3	66	03.01-01.04		4	1,1	BKR6E-11	2756	14	BKR6EIX-11	3764	
Liana	1.6	78	02.04-	M16A	4	1,1	IFR6J-11	7658				
Liana	1.6	78	03.01-01.04		4	1,1	BKR6E-11	2756	14	BKR6EIX-11	3764	
SA 310	1.0	37	84- 85	G10	4	0,8	BPR6ES	7822	2	BPR6EIX	6637	
SA 413/ SA 413GS	1.3	54		G13A	4	0,8	BPR6ES	7822	2	BPR6EIX	6637	
Samurai	1.0	33	90-	F10A	4	0,9	BPR5ES	7422	6	BPR5EIX	6597	
Samurai	1.3	44	88- 90	G13A	u.Cat.	4	0,9	BPR5ES	7422	6	BPR5EIX	6597
Samurai	1.3	47	88- 89	G13A		4	0,9	BPR5ES	7422	6	BPR5EIX	6597
Samurai	1.3	51	92-	G13BA		4	0,9	BPR5ES	7422	6	BPR5EIX	6597
Samurai (SJ413)	1.3	51	90-	G13BA	Cat.	4	0,9	BPR5ES	7422	6	BPR5EIX	6597
Samurai Pick-up	1.3	51	10.99-10.00	G13BA		4	0,9	BPR5ES	7422	6	BPR5EIX	6597
Samurai TD	1.9	46	09.98-			4	█	Y-923U	3380			
SB 308	0.8	29		F8B	4	0,9	BPR5ES	7422	6	BPR5EIX	6597	
SC 80					4	0,9	BPR5ES	7422	6	BPR5EIX	6597	
SC 100					4	0,9	BPR5ES	7422	6	BPR5EIX	6597	
SJ 410	1.0	33	82- 85	F10A	4	0,9	BPR5ES	7422	6	BPR5EIX	6597	
SJ 413	1.3	44	87- 88	G13A	u.Cat.	4	0,9	BPR5ES	7422	6	BPR5EIX	6597
SJ 413	1.3	47	85- 88	G13A		4	0,8	BPR6ES	7822	2	BPR6EIX	6637
SK 408					4	0,9	BPR5ES	7422	6	BPR5EIX	6597	
SK 410 Super Carry	1.0	31	85-	F10A	4	0,9	BPR5ES	7422	6	BPR5EIX	6597	
ST 90 Carry	0.8	27	81- 86	F8A	4	0,9	BPR5ES	7422	6	BPR5EIX	6597	
Swift (SA310)	1.0	37	84- 85	G10	4	0,8	BPR6ES	7822	2	BPR6EIX	6637	
Swift (SF310)	1.0	37	89- 90	G10A	u.Cat.	3	0,8	BPR6ES	7822	2	BPR6EIX	6637
Swift (SF310)Typ1+2	1.0	39	92-	G10A SOHC	Cat.	3	0,8	BPR6ES	7822	2	BPR6EIX	6637
Swift (SF310)	1.0	40	89- 92	G10A	Cat.	3	0,8	BPR6ES	7822	2	BPR6EIX	6637
Swift (SF413)	1.3			G13	4	0,8	BPR6ES	7822	2	BPR6EIX	6637	
Swift (SA413)	1.3	47	86- 89	G13A	u.Cat.	4	0,8	BPR6ES	7822	2	BPR6EIX	6637
Swift (SF310)	1.3	50	89- 92	G13BA	u.Cat.	4	0,8	BPR6ES	7822	2	BPR6EIX	6637
Swift (SA413)	1.3	50	84- 89	G13A		4	0,8	BPR6ES	7822	2	BPR6EIX	6637
Swift (SF413)	1.3	50	92-	G13BA	Cat.	4	0,8	BPR6ES	7822	2	BPR6EIX	6637
Swift (SF413)	1.3	52	89- 92	G13BA	Cat.	4	0,8	BPR6ES	7822	2	BPR6EIX	6637
Swift (SA413)	1.3	54	84- 86	G13A		4	0,8	BPR6ES	7822	2	BPR6EIX	6637
Swift (SA413)	1.3	74	86-	G13B		4	0,8	BPR6ES	7822	2	BPR6EIX	6637
Swift (SF413)Typ1+2	1.3	74	89-	G13B OHC	Cat.	4	0,8	BPR6ES	7822	2	BPR6EIX	6637
Swift	1.6		95-		4	1,1	BPR6ES-11	4824	13	BPR6EIX-11	3903	
Swift (SF416)Typ1+2	1.6	68	92-	G16B OHC	Cat.	4	0,8	BKR6E	6962	28	BKR6EIX	6418
Swift (SF416)	1.6	70	89- 92	G16B	Cat.	4	0,8	BKR6E	6962	28	BKR6EIX	6418

¹⁾ Bic = Best in class (siehe Seite 3) / (see page 3)



l kW

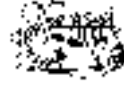

Cyl.

Order-
No. No.Bic¹⁾ Order-
No.**SUZUKI**

SX 306 Cappuccino	0.65	47	94-	F6A		0,8	DCPR7EVX	1179		DCPR7EIX	6046
Vitara	1.6		10.00-	G16A	4	1,1	IFR6E-11	6741			
Vitara	1.6	59	91-	G16B	Cat. 4	0,8	BPR6ES	7822	2	BPR6EIX	6637
Vitara (SE416) Typ 2	1.6	59		G16A SOHC	4	0,9	BPR5ES	7422	6	BPR5EIX	6597
Vitara	1.6	60	91-	G16A	4	0,9	BPR5ES	7422	6	BPR5EIX	6597
Vitara (SE416) Typ 1	1.6	60	88-	G16A SOHC	Cat. 4	0,9	BPR5ES	7422	6	BPR5EIX	6597
Vitara	1.6	70	09.93-	G16B	4	0,8	BKR6E	6962	28	BKR6EIX	6418
Vitara 16V	1.6	71	04.95-	G16A	4	0,8	BKR6E	6962	28	BKR6EIX	6418
Vitara Long	1.6	71	91-	G16B SOHC	Cat. 4	0,8	BKR6E	6962	28	BKR6EIX	6418
Vitara TD	1.9	50	04.96-03.98		4	█	Y-938R	5267			
Vitara TD	1.9	55	97- 98		4	█	Y-923U	3380			
Vitara TD	1.9	66	05.00-	XUD... PSA Group	4	█	Y-923U	3380			
Vitara	2.0			J20A	6	0,8	BKR6E	6962	28	BKR6EIX	6418
Vitara D	2.0	52	95-	RFL-4	4	█	Y-701R	7464			
Vitara (SV620)	2.0	100	06.95-	H20A	6	0,8	BKR6E	6962	28	BKR6EIX	6418
Vitara V6 (SV620)	2.5	125	05.98-	H25A	6	1,1	BKR6E-11	2756	14	BKR6EIX-11	3764
Wagon R+ (SR410)	1.0	48	97-	K10A	4	0,8	DCPR7E	3932		DCPR7EIX	6046
Wagon R+	1.0	55	02.04-	G10	4	1,1	BPR6ES-11	4824	13	BPR6EIX-11	3903
Wagon R+	1.2	51	98-	K12A	4	0,8	DCPR7E	3932		DCPR7EIX	6046
Wagon R GL	1.3	56	04.00-	G13BB	4	1,1	BKR6E-11	2756	14	BKR6EIX-11	3764
Wagon R+	1.3	68	02.04-	M13A mit VVT	4	1,1	IFR6J-11	7658			
Wagon R+	1.3	69		G13BB	4	1,1	BKR6E-11	2756	14	BKR6EIX-11	3764
X-90	1.6	71	10.95-	G16A	4	0,8	BKR6E	6962	28	BKR6EIX	6418
X-90	1.6	71	03.96-	G16B/G16W	4	0,8	BKR6E	6962	28	BKR6EIX	6418

TALBOT

1100	1.1		-06.85	5CV	4	0,7	BP6ES	7811	4	BPR6EIX	6637
1500/1501 S/1508 GT/GTS	1.5				4	0,7	BP6ES	7811	4	BPR6EIX	6637
Express D	1.9	51	11.87-	XUD 9 A	4	█	Y-902R	2237			
Express D	2.5	55	09.81-10.93	CRD 93	4	█	Y-208T	1250			
Express TD	2.5	70	09.81-10.93	CRD 93 LS	4	█	Y-208T	1250			
Horizon alle Modelle / Tous types			-06.86		4	0,7	BP6ES	7811	4	BPR6EIX	6637
Horizon D	1.9	47	07.82-06.86	XUD9	4	█	Y-902R	2237			
Horizon D	1.9	51	11.87-	XUD9A	4	█	Y-902R	2237			
Samba alle Modelle / Tous types			-06.86		4	0,8	BP6EFS	3812	5		

TATRA

613-3	3.5	123	01.84-03.94		6	0,7	BCP6ES	4930	17	BCPR6EIX-11	4919
613-4	3.5	124	93-		8	0,8	BKR6E	6962	28	BKR6EIX	6418

TAXI

Austin			08.83-		4	█	Y-208T	1250			
Fairway	2.7			NISSAN	4	█	Y-707RS	4937			

TOFAS

124 Serce	1.3	48	09.83-		4	0,7	BP6ES	7811	4	BPR6EIX	6637
131 Dogan S/SX/SLX	1.6	55	06.92-		4	0,8	BPR6ES	7822	2	BPR6EIX	6637
131 Dogan	1.6	55	03.81-		4	0,7	BP6ES	7811	4	BPR6EIX	6637
131 Kartal SL / SLX	1.6	55	06.92-		4	0,8	BPR6ES	7822	2	BPR6EIX	6637
131 Kartal L	1.6	55	03.81-06.92		4	0,7	BP6ES	7811	4	BPR6EIX	6637
Sahin	1.6	55	02.82-		4	0,7	BP6ES	7811	4	BPR6EIX	6637
Tempra	1.6	63	11.90-		4	0,8	BPR6ES	7822	2	BPR6EIX	6637

¹⁾ Bic = Best in class (siehe Seite 3) / (see page 3)



ℓ kW

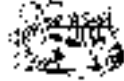

Cyl.

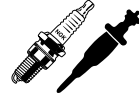
Order-
No. No.Bic¹⁾ Order-
No.**TOFAS**

Tempra i.e.	2.0	88	07.92-			4	0,8	BPR6ES	7822	2	BPR6EIX	6637
-------------	-----	----	--------	--	--	---	-----	--------	------	---	---------	------

TOYOTA

4 Runner TD	2.4		01.90-12.96	2L-T	12V	4	█	Y-715R	5376			
4 Runner D	2.4			2L	12V	4	█	Y-118R	2187			
4 Runner	2.4	82	89-	22R/22RE	Cat.	4	0,8	BPR5EY	2828	9	BPR5EIX	6597
4 Runner D	2.5		01.93-	2L-T	12V	4	█	Y-715R	5376			
4 Runner (RZN180,185,VZN180 185)	2.7		01.00-	3RZ-FE		6	0,8	BKR5EYA	2087			
4 Runner (RZN185)	2.7	112	98-12.99	3RZ-FE		6	0,8	BKR5EYA	2087			
4 Runner (VZN185)	2.7	112	98-12.99	3RZ-FE		6	0,8	BKR5EYA	2087			
4 Runner D	2.8		01.93-	3L	12V	4	█	Y-715R	5376			
4 Runner	2.8			2L	24V	4	█	Y-168R	2162			
4 Runner	2.8		93-	3L	12V	4	█	Y-715R	5376			
4 Runner (.../KZN185)	3.0	92	10.93-	1KZ-T	12V	4	█	Y-715R	5376			
4 Runner	3.0	105	89-	3VZ-E	Cat.	6	0,8	BKR5EYA	2087			
4 Runner (RZN180,185,VZN180,185)	3.4		01.00-	5VZ-FE		6	1,1	BKR5EKB-11	3967			
4 Runner (RZN185)	3.4	136	98-12.99	5VZ-FE		6	1,1	BKR5EKB-11	3967			
4 Runner (VZN185)	3.4	136	98-12.99	5VZ-FE		6	1,1	BKR5EKB-11	3967			
4 Runner (GRN210,215)	4.0		01.04-	1GR-FE		6	1,1	LFR6C-11				
Avalon (MCX20)	3.0		01.02-	1MZ-FE		6	1,1	BKR6EKP-11	3452			
Avalon (MCX20)	3.0		01.01-12.01	1MZ-FE		6	1,1	BKR6EKB-11	3583			
Avensis (ZZT250,251)(AZT250)	1.6		09.03-	3ZZ-FE		4	1,1	BKR5EYA-11	2526			
Avensis (ST220)	1.6		01.02-	3ZZ-FE		4	1,1	BKR5EYA-11	2526			
Avensis (AZT220)	1.6		01.02-	3ZZ-FE		4	1,1	BKR5EYA-11	2526			
Avensis (ZZT220, 221)	1.6		01.02-	3ZZ-FE		4	1,1	BKR5EYA-11	2526			
Avensis (AT220,221,ST220)	1.6	81	04.98-	4A-FE		4	1,1	BKR6EYA-11	4073			
Avensis (ZZT250,251)(AZT250)	1.8		09.03-	1ZZ-FE		4	1,1	BKR5EYA-11	2526			
Avensis (AZT220)	1.8		01.02-	1ZZ-FE		4	1,1	BKR5EYA-11	2526			
Avensis (AT220,221,ST220)	1.8	81	01.98-	7A-FE		4	1,3	BKR6EP-13	2550			
Avensis (ST220)	1.8	95	01.02-	1ZZ-FE		4	1,1	BKR5EYA-11	2526			
Avensis (ZZT220, 221)	1.8	95	01.02-	1ZZ-FE		4	1,1	BKR5EYA-11	2526			
Avensis (ZZT250,251)(AZT250)	2.0		09.03-	1AZ-FSE without TWC		4	1,1	BKR6EYA-11	4073			
Avensis (ZZT250,251)(AZT250)	2.0		09.03-	1AZ-FSE with TWC		4	1,1	IFR6T-11	4589			
Avensis (1AZ-FE)	2.0		01.03-	1AZ-FE without TWC		4	1,1	BKR6EYA-11	4073			
Avensis (1AZ-FE)	2.0		01.03-	1AZ-FE with TWC		4	1,1	IFR6T-11	4589			
Avensis (ZZT220, 221)	2.0		01.02-	3S-FE		4	1,1	BKR6EKB-11	3583			
Avensis (AZT220)	2.0		01.02-	3S-FE		4	1,1	BKR6EKB-11	3583			
Avensis (ST220)	2.0		01.02-	3S-FE		4	1,1	BKR6EKB-11	3583			
Avensis (CT220)	2.0	66	01.98-	2C-TE	12V	4	█	Y-928U	5700			
Avensis D4-D	2.0	85	04.01-		12V	4	█	Y-928U	5700			
Avensis (AT220,221,ST220)	2.0	94	01.98-	3S-FE		4	1,1	BKR6EKP-11	3452			
Avensis (AZT220)	2.0	108	01.02-	1AZ-FSE		4	1,1	IFR6A-11T				
Avensis (ST220)	2.0	108	01.02-	1AZ-FSE		4	1,1	IFR6A-11T				
Avensis (ZZT220, 221)	2.0	108	01.02-	1AZ-FSE		4	1,1	IFR6A-11T				
Avensis Verso (ACM20)	2.0	110	05.01-	1AZ-FE		4	1,1	IFR6T-11	4589			
Avensis Verso (ACM20)	2.4		01.04-	2AZ-FE		4	1,1	BKR6EYA-11	4073			
Avensis (ZZT250,251)(AZT250)	2.4		09.03-	2AZ-FSE		4	1,1	IFR6A-11T				
Camry (SV20,21,25)	1.8	66	- 87	1S-L		4	0,8	BPR5EY	2828	9	BPR5EIX	6597
Camry (SV20,21,25)	1.8	66	(87)	1S-I		4	1,1	BRE527Y-11	6029			
Camry	1.8	66	- 85	1S		4	0,8	BPR5EY	2828	9	BPR5EIX	6597
Camry (MVC30)	2.0		08.01-	1AZ-FE		4	1,1	IFR6T-11	4589			
Camry (ACV30,31)	2.0		08.01-	1AZ-FE		4	1,1	IFR6T-11	4589			

¹⁾ Bic = Best in class (siehe Seite 3) / (see page 3)



l kW

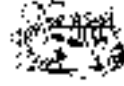

Cyl.

Order-
No. No.Bic¹⁾ Order-
No. No.**TOYOTA**

Camry	2.0		- 92	1-CT	12V	4	█	Y-146R	7492				
Camry	2.0	62	90- 91	2C-T	12V	4	█	Y-703R	3782				
Camry	2.0	73	- 85	2S-EC		4	0,8	BPR5EY	2828	9	BPR5EIX	6597	
Camry	2.0	73	(86)	2S-E		4	1,1	BPR5EY-11	3028		BPR5EIX-11	2115	
Camry (SV20,21,25,VZV21)	2.0	89	86-	3S-FE	Cat.	4	1,1	BCPR6EY-11	3720				
Camry (SV20,21,25,VZV21)	2.0	94	87-	3S-FE		4	1,1	BCPR6EY-11	3720				
Camry (SVX20, MCV20)	2.2		01.00-	5S-FE		4	1,1	BKR6EKB-11	3583				
Camry (MCV20)	2.2		98-12.99	5S-FE		4	1,1	BKR6EKP-11	3452				
Camry (SVX20)	2.2		98-12.99	5S-FE		4	1,1	BKR6EKP-11	3452				
Camry MCV20	2.2	100	08.96-12.99	5S-FE without 3way cat		4	1,1	BKR6EKB-11	3583				
Camry SXV20	2.2	100	08.96-12.99	5S-FE with 3way cat		4	1,1	BKR6EKP-11	3452				
Camry SXV20	2.2	100	08.96-12.99	5S-FE without 3way cat		4	1,1	BKR6EKB-11	3583				
Camry MCV20	2.2	100	08.96-12.99	5S-FE with 3way cat		4	1,1	BKR6EKP-11	3452				
Camry (SXV10,VCV10)	2.2	100	92-	5S-FE		4	1,1	BKR6EYA-11	4073				
Camry (MCV30)	2.4		08.01-	2AZ-FE		6	1,1	IFR6T-11	4589				
Camry (ACV30,31)	2.4		08.01-	2AZ-FE		6	1,1	IFR6T-11	4589				
Camry (SV21,25,VZV21)	2.5	118	88- 92	2VZ-FE	Cat.	6	1,1	BCPR6EP-11	3350				
Camry (ACV30,31)	3.0		08.01-	1MZ-FE		6	1,1	IFR6T-11	4589				
Camry (MCV30)	3.0		08.01-	1MZ-FE		6	1,1	IFR6T-11	4589				
Camry (SVX20, MCV20)	3.0	137	01.00-	1MZ-FE V6		6	1,1	BKR6EKP-11	3452				
Camry MCV20	3.0	138	08.96-12.99	1MZ-FE with 3way cat		6	1,1	BKR6EKP-11	3452				
Camry (SXV10,VCV10)	3.0	138	92-	3VZ-FE		6	1,1	BCPR6EP-11	3350				
Camry SXV20	3.0	138	08.96-12.99	1MZ-FE with 3way cat		6	1,1	BKR6EKP-11	3452				
Camry SXV20	3.0	138	08.96-12.99	1MZ-FE without 3way cat		6	1,1	BKR6EKB-11	3583				
Camry MCV20	3.0	138	08.96-12.99	1MZ-FE without 3way cat		6	1,1	BKR6EKB-11	3583				
Carina E (AT190,191,ST191)	1.6		93-	4A-FE Standard engine		4	0,8	BKR6EYA	2249				
Carina E (AT190,191,ST191)	1.6	77	93-	4A-FE Lean Burn engine		4	1,3	BKR6EP-13	2550				
Carina E (AT190,191,ST191)	1.8	79	95-	7A-FE		4	1,3	BKR6EP-13	2550				
Carina E	2.0		02.92-	2C	12V	4	█	Y-703R	3782				
Carina E (AT190,191,ST191)	2.0	98	93-	3S-FE	Cat.	4	1,1	BKR6EYA-11	4073				
Carina E (AT190,191,ST191)	2.0	116	93-	3S-GE	Cat.	4	0,8	BKR6EP-8	2215				
Carina E (DK)	1.6		92-	4A-FE	Cat.	4	0,8	BKR6EYA	2249				
Carina E (DK)	1.6		92-	4A-FE Cat. Lean Burn		4	1,3	BKR6EP-13	2550				
Carina E (DK)	1.8		92-	7A-FE Cat. Lean Burn		4	1,3	BKR6EP-13	2550				
Carina E (DK)	2.0		92-	3S-FE	Cat.	4	1,1	BKR6EYA-11	4073				
Carina E (DK)	2.0		92-	3S-FE Cat. Lean Burn		4	1,1	BKR6EP-11	2978				
Carina II (AT151,ST150)	1.6	52	- 87	4A-C	Cat.	4	1,1	BPR5EY-11	3028		BPR5EIX-11	2115	
Carina II (AT151,ST150)	1.6	55	- 87	4A-C		4	1,1	BPR5EY-11	3028		BPR5EIX-11	2115	
Carina II (AT151,ST150)	1.6	55	- 87	4A		4	0,8	BPR5EY	2828	9	BPR5EIX	6597	
Carina II (AT171,177,ST171)	1.6	66	87- 92	4A-F	Cat.	4	0,8	BCRE527Y	2074				
Carina II (AT171,177,ST171)	1.6	66	- 90	4A-F		4	0,8	BCRE527Y	2074				
Carina II (AT171,177,ST171)	1.6	72	90- 92	4A-FE with EGR		4	0,8	BCPR5EY	1266		BCPR5EIX-11	3306	
Carina II (AT171,177,ST171)	1.6	72	90- 92	4A-FE		4	0,8	BCPR5EY	1266		BCPR5EIX-11	3306	
Carina II (AT171,177,ST171)	1.6	72	90- 92	4A-FE	Cat.	4	1,3	BCPR6EP-13	3837				
Carina II (AT171,177,ST171)	1.6	72	90- 92	4A-FE without EGR		4	1,3	BCPR6EP-13	3837				
Carina II (AT171,177,ST171)	1.6	75	88- 90	4A-FE	u.Cat.	4	1,3	BCPR6EP-13	3837				
Carina II (AT151,ST150)	1.8	66	- 87	1S		4	0,8	BPR5EY	2828	9	BPR5EIX	6597	
Carina II (AT151,ST150)	1.8	74	85- 87	1S-E		4	0,8	BPR5EY	2828	9	BPR5EIX	6597	
Carina II	2.0		93-	2C	12V	4	█	Y-703R	3782				
Carina II	2.0		- 92	2C	12V	4	█	Y-146R	7492				
Carina II (AT171,177,ST171)	2.0	89	88- 92	3S-F		4	1,1	BCPR6EY-11	3720				
Carina II	2.0	89	- 88	3S-F		4	0,8	BCPR6EY	1146				

¹⁾ Bic = Best in class (siehe Seite 3) / (see page 3)



ℓ kW

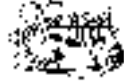

Cyl.

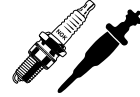
Order-
No. No.Bic¹⁾ Order-
No.**TOYOTA**

Carina II (AT171,177,ST171)	2.0	98	88- 92	3S-FE	Cat.	4	1,1	BCPR6EY-11	3720			
Celica (AT160,ST162,165)	1.6	62	- 88	4A		4	0,8	BPR5EY	2828	9	BPR5EIX	6597
Celica (AT180,ST182,184,185)	1.6	77	90- 94	4A-FE		4	0,8	BCPR5EY	1266		BCPR5EIX-11	3306
Celica (AT160,ST162,165)	1.6	91	- 89	4A-GE	Cat.	4	1,1	BCPR5EP-11	2097			
Celica (AT160,ST162,165)	1.6	91	- 89	4A-GE		4	1,1	BCPR6EY-11	3720			
Celica (ZZT230,231)	1.8		08.99-	1ZZ-FE		4	1,1	BKR5EYA-11	2526			
Celica (ZZT230,231)	1.8		08.99-	2ZZ-GE		4	1,1	IFR6T-11	4589			
Celica (AT200,ST202,204,205)	1.8	85	03.94-	7A-FE		4	0,6	BKR6EYA	2249			
Celica	2.0		90- 99	3S-GTE		4	0,8	BKR6EP-8	2215			
Celica (AT200)	2.0		98-	3S-GE		4	0,8	BKR6EP-8	2215			
Celica (AT160,162,165)	2.0		- 88	3S-FE		4	1,1	BCPR6EY-11	3720			
Celica (ST202,204,205)	2.0		98-	3S-GE		4	0,8	BKR6EP-8	2215			
Celica (AT200,ST202,204,205)	2.0	95	94-	3S-FE		4	1,1	BKR6EYA-11	4073			
Celica (AT160,162,165)	2.0	103	- 89	3S-GE	Cat.	4	1,1	BCPR6EP-11	3350			
Celica (AT160,162,165)	2.0	110	86- 89	3S-GE		4	1,1	BCPR6EY-11	3720			
Celica (AT180,200,ST182,184,185, 202,204,205)	2.0	115	90-	3S-GE	Cat.	4	0,8	BKR6EP-8	2215			
Celica (AT180,200,ST182,184,185, 202,204,205)	2.0	129	03.94-	3S-GE		4	0,8	BKR6EP-8	2215			
Celica (AT200)	2.2		98-	5S-FE		4	1,1	BKR6EP-11	2978			
Celica (ST202,204,205)	2.2		98-	5S-FE		4	1,1	BKR6EP-11	2978			
Celica (AT180,ST182,184,185)	2.2	100	- 90	5S-FE	Cat.	4	1,1	BKR5EYA-11	2526			
Celica (AT180,ST182,184,185)	2.2	100	91-	5S-FE	Cat.	4	1,1	BKR6EP-11	2978			
Celica Supra	2.8	103	82- 85	5M-E		6	0,8	BPR5EY	2828	9	BPR5EIX	6597
Celica Supra	2.8	125	12.81-12.85	5M-GE		6	0,8	BPR6EY	6427		BPR6EIX	6637
Celica Supra	3.0			7M-GE		6	0,8	BCPR6EY	1146			
Celica Turbo	2.0	136	- 89	3S-GTE		4	0,8	BCPR5EP-8	2950			
Celica Turbo (AT200,ST202,204,205)	2.0	150	90-	3S-GTE		4	0,8	BKR6EP-8	2215			
Coaster			- 93	13B	24V		█	Y-197T	2190			
Coaster			05.82-	B, 2B, 3B	24V	4	█	Y-197R	2188			
Coaster			- 93	13B	12V		█	Y-147T	7493			
Coaster	4.0		05.82-	2H	24V	6	█	Y-197R	2188			
Corolla	1.2			3K		4	0,9	BPR5ES	7422	6	BPR5EIX	6597
Corolla (EE110,111)	1.3		98-12.99	2E		4	0,8	BPR6EY	6427		BPR6EIX	6637
Corolla (ZZE120,121,122,123)	1.3		10.01-	2NZ-FE		4	1,1	BKR5EYA-11	2526			
Corolla (AE110,111,112,115)	1.3		98-12.99	4E-FE		4	1,1	BKR5EKB-11	3967			
Corolla (EE100,101,105,AE101,102)	1.3		92- 97	4E-FE		4	0,8	BKR5EYA	2087			
Corolla	1.3		- 00	2A (8V SOHC)		4	0,8	BPR5EY	2828	9	BPR5EIX	6597
Corolla (NZE120,121)	1.3		10.01-	2NZ-FE		4	1,1	BKR5EYA-11	2526			
Corolla	1.3		07.97-12.99	4E-FE		4	1,1	BKR5EYA-11	2526			
Corolla (EE110,111,AE110-112,115, ZZE111,112)	1.3		01.00-	4E-FE		4	1,1	BKR5EKB-11	3967			
Corolla (EE110,111)	1.3		98-12.99	4E-FE (16V DOHC)		4	1,1	BKR5EKB-11	3967			
Corolla (EE110,111,AE110-112,115, ZZE111,112)	1.3		01.00-	2E		4	0,8	BPR6EY	6427		BPR6EIX	6637
Corolla (EE100,101,105,AE101,102)	1.3		94-	2E		4	0,8	BPR6EY	6427		BPR6EIX	6637
Corolla (AE110,111,112,115)	1.3		98-12.99	2E		4	0,8	BPR6EY	6427		BPR6EIX	6637
Corolla (EE100,101,105,AE101,102)	1.3		93- 97	2E		4	0,8	BPR6EY	6427		BPR6EIX	6637
Corolla (EE100,101,105,AE101,102)	1.3		95-12.99	2E	o.Cat.	4	1,1	BPR5EY-11	3028		BPR5EIX-11	2115
Corolla (KE70,AE71,86)	1.3	48	82- 87	4K		4	0,8	BPR5EY	2828	9	BPR5EIX	6597
Corolla (KE70,AE71,86)	1.3	48	- 86	4K-C		4	0,8	BPR4EY	2128			
Corolla (EE90,97,AE92,95)	1.3	55	90- 92	2E-E		4	0,8	BPR5EY	2828	9	BPR5EIX	6597

¹⁾ Bic = Best in class (siehe Seite 3) / (see page 3)



l kW

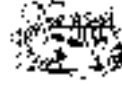

Cyl.

Order-
No. No.Bic¹⁾ Order-
No. No.**TOYOTA**

Corolla (EE80,90,97,100,105,AE82, 92,95,101)	1.3	55	86- 92	2E		4	1,1	BPR6EY-11	4228	10	BPR6EIX-11	3903
Corolla (EE80,AE82)	1.3	55	86- 87	2E-C	u.Cat.	4	1,1	BPR6EY-11	4228	10	BPR6EIX-11	3903
Corolla (EE105)	1.3	63	07.97-	2E		4	0,8	BPR6EY	6427		BPR6EIX	6637
Corolla EE110,111,AE110,111, 112,115	1.4		01.98-	4E-FE		4	1,1	BKR5EKB-11	3967			
Corolla	1.4		- 91			4	0,9	BPR5ES	7422	6	BPR5EIX	6597
Corolla (ZZE120,121,122,123)	1.4		10.01-	4ZZ-FE		4	1,1	BKR5EYA-11	2526			
Corolla (NZE120,121)	1.4		10.01-	4ZZ-FE		4	1,1	BKR5EYA-11	2526			
Corolla (EE100,101,105,AE101,102)	1.4	65	92- 94	4E-FE		4	0,8	BKR6EYA	2249			
Corolla (EE110,111,AE110-112,115, ZZE111,112)	1.4	71	01.00-	4ZZ-FE		4	1,1	BKR5EYA-11	2526			
Corolla (NZE120,121 ZZE120,121, 122,123)	1.4	71	01.02-	4ZZ-FE		4	1,1	BKR5EYA-11	2526			
Corolla	1.5			1N,1NT	12V	4	█	Y-118R	2187			
Corolla (EE110,111,AE110-112,115, ZZE111,112)	1.5		01.00-	5A-FE		4	1,1	BKR5EYA-11	2526			
Corolla (AE110,111,112,115)	1.5		98-12.99	5A-FE		4	1,1	BKR5EYA-11	2526			
Corolla (ZZE120,121,122,123)	1.5		10.01-	1NZ-FE		4	1,1	BKR5EYA-11	2526			
Corolla (NZE120,121)	1.5		10.01-	1NZ-FE		4	1,1	BKR5EYA-11	2526			
Corolla (EE110,111)	1.5		98-12.99	5A-FE		4	1,1	BKR5EYA-11	2526			
Corolla (EE110,111)	1.6		98-12.99	4A-FE		4	0,8	BKR6EYA	2249			
Corolla (EE80,AE82)	1.6		86- 87	4A-GE	Cat.	4	1,1	BPR5EY-11	3028		BPR5EIX-11	2115
Corolla (EE110,111)	1.6		98-12.99	4A-F		4	0,8	BCRE527Y	2074			
Corolla (EE80,AE82)	1.6		86- 87	4A-GE	o.Cat.	4	1,1	BCPR6EY-11	3720			
Corolla (AE110,111,112,115)	1.6		98-12.99	4A-F		4	0,8	BCRE527Y	2074			
Corolla (EE110,111,AE110-112,115, ZZE111,112)	1.6		01.00-	4A-F		4	0,8	BCRE527Y	2074			
Corolla (EE110,111,AE110-112,115, ZZE111,112)	1.6		01.00-	4A-FE		4	0,8	BKR6EYA	2249			
Corolla (AE110,111,112,115)	1.6		98-12.99	4A-FE		4	0,8	BKR6EYA	2249			
Corolla (EE100,101,105,AE101,102)	1.6		95-12.99	4A-FE		4	0,8	BKR6EYA	2249			
Corolla Spacio (AE111)	1.6		01.00-	4A-FE		4	0,8	BKR6EYA	2249			
Corolla (EE80,AE82)	1.6	52	85- 87	4A-C		4	0,8	BPR5EY	2828	9	BPR5EIX	6597
Corolla (EE80,AE82)	1.6	52	- 87	4A-C	Cat.	4	1,1	BPR5EY-11	3028		BPR5EIX-11	2115
Corolla	1.6	55		2T		4	0,8	BPR5EAL	5823			
Corolla (EE80,AE82)	1.6	58	- 87	4A	Cat.	4	1,1	BPR5EY-11	3028		BPR5EIX-11	2115
Corolla (KE70,AE71,86,EE80,AE82)	1.6	62	- 87	4A		4	0,8	BPR5EY	2828	9	BPR5EIX	6597
Corolla (EE90,97,100,101,105,AE92, 95,101,102)	1.6	66	87-12.99	4A-F		4	0,8	BCRE527Y	2074			
Corolla (EE90,97,AE92,95)	1.6	77	89- 91	4A-FE	Cat.	4	0,8	BCPR5EY	1266		BCPR5EIX-11	3306
Corolla (NZE120,121)	1.6	81	10.01-	3ZZ-FE		4	1,1	BKR5EYA-11	2526			
Corolla (EE110,111,AE110-112,115, ZZE111,112)	1.6	81	01.00-	3ZZ-FE		4	1,1	BKR5EYA-11	2526			
Corolla (ZZE120,121,122,123)	1.6	81	10.01-	3ZZ-FE		4	1,1	BKR5EYA-11	2526			
Corolla	1.6	81	07.97-	4A-FE		4	1,1	BKR5EYA-11	2526			
Corolla (EE100,101,105,AE101,102)	1.6	84	92- 94	4A-FE		4	0,8	BKR6EYA	2249			
Corolla	1.6	85	93-	4A-GE	Cat.	4	0,8	BKR6EYA	2249			
Corolla (EE90,AE92)	1.6	85	- 89	4A-GE	Cat.	4	1,1	BCPR5EP-11	2097			
Corolla (EE90,97,AE92,95)	1.6	85	90-	4A-GE	Cat.	4	0,8	BKR6EP-8	2215			
Corolla	1.8		- 92	1C	12V	4	█	Y-146R	7492			
Corolla (EE110,111)	1.8		98-12.99	7A-FE		4	0,8	BKR6EYA	2249			

¹⁾ Bic = Best in class (siehe Seite 3) / (see page 3)



ℓ kW

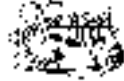

Cyl.

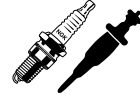
Order-
No. No.Bic¹⁾ Order-
No.**TOYOTA**

Corolla (EE110,111,AE110-112,115, ZZE111,112)	1.8		01.00-	7A-FE		4	0,8	BKR6EYA	2249				
Corolla	1.8		12.92-	1C	12V	4	█	Y-703R	3782				
Corolla (AE110,111,112,115)	1.8		98-12.99	7A-FE		4	0,8	BKR6EYA	2249				
Corolla (EE100,101,105,AE101,102)	1.8		93-12.99	7A-FE		4	0,8	BKR6EYA	2249				
Corolla (ZZE120,121,122,123)	1.8	99	10.01-	1ZZ-FE		4	1,1	BKR5EYA-11	2526				
Corolla (NZE120,121)	1.8	99	10.01-	1ZZ-FE		4	1,1	BKR5EYA-11	2526				
Corolla (ZZE120,121,122,123)	1.8	141	10.01-	2ZZ-GE		4	1,1	IFR6T-11	4589				
Corolla (NZE120,121)	1.8	141	10.01-	2ZZ-GE		4	1,1	IFR6T-11	4589				
Corolla 4WD	1.6		95-	4A-FE		4	0,8	BCPR5EY	1266		BCPR5EIX-11	3306	
Corolla 4WD	1.6	84	93-	4A-FE		4	0,8	BCPR5EY	1266		BCPR5EIX-11	3306	
Corolla Spacio (AE111)	1.6		01.01-	4A-FE		4	0,8	BKR6EYA	2249				
Corolla Verso (ZZE121, 122)	1.6		09.01-	3ZZ-FE		4	1,1	BKR5EYA-11	2526				
Corolla Verso (ZZE121, 122)	2.0		09.01-	1ZZ-FE		4	1,1	BKR5EYA-11	2526				
Corona (ST210, AT210)	1.6		01.00-	4A-FE		4	0,8	BKR6EYA	2249				
Corona (AZT220)	1.6		01.02-	3ZZ-FE		4	1,1	BKR5EYA-11	2526				
Corona (ZZT220, 221)	1.6		01.02-	3ZZ-FE		4	1,1	BKR5EYA-11	2526				
Corona (AT151,ST150)	1.6		- 87	4A		4	0,8	BPR5EY	2828	9	BPR5EIX	6597	
Corona (ST220)	1.6		01.02-	3ZZ-FE		4	1,1	BKR5EYA-11	2526				
Corona (AT171,177,ST171)	1.6		- 89	4A-FE	Cat.	4	1,3	BCPR5EP-13	2529				
Corona (AT190,ST191)	1.6		93-	4A-FE		4	1,1	BKR5EYA-11	2526				
Corona (AT151,ST150)	1.6		- 87	4A-C		4	0,8	BPR5EY	2828	9	BPR5EIX	6597	
Corona (AT151,ST150)	1.6	55	- 87	4A-C	Cat.	4	1,1	BPR5EY-11	3028		BPR5EIX-11	2115	
Corona (AT171,177,ST171)	1.6	66	88- 92	4A-F	Cat.	4	0,8	BCRE527Y	2074				
Corona	1.6	70		4A-F	Cat. not Europe	4	1,1	BCPR5EY-11	4120		BCPR5EIX-11	3306	
Corona (AT171,177,ST171)	1.6	70		4A-F		4	0,8	BCRE527Y	2074				
Corona (AT171,177,ST171)	1.6	72	90- 92	4A-FE		4	1,3	BCPR6EP-13	3837				
Corona (AT171,177,ST171)	1.6	75	90- 92	4A-FE		4	0,8	BCPR5EY	1266		BCPR5EIX-11	3306	
Corona (AT220,221,ST220)	1.6	81	04.98-	4A-FE		4	1,3	BKR6EP-13	2550				
Corona (AZT220)	1.8		01.02-	1ZZ-FE		4	1,1	BKR5EYA-11	2526				
Corona (ST220)	1.8		01.02-	1ZZ-FE		4	1,1	BKR5EYA-11	2526				
Corona	1.8			1S-I		4	1,1	BRE527Y-11	6029				
Corona (ZZT220, 221)	1.8		01.02-	1ZZ-FE		4	1,1	BKR5EYA-11	2526				
Corona	1.8	57	86-	2Y		4	0,8	BPR5EY	2828	9	BPR5EIX	6597	
Corona (AT151,ST150)	1.8	64	- 87	1S		4	0,8	BPR5EY	2828	9	BPR5EIX	6597	
Corona (AT151,ST150)	1.8	74	- 87	1S-E		4	0,8	BPR5EY	2828	9	BPR5EIX	6597	
Corona (AT220,221,ST220)	1.8	81	01.98-	7A-FE		4	1,3	BKR6EP-13	2550				
Corona	2.0		- 92	2C	12V	4	█	Y-146R	7492				
Corona	2.0		93-	2C	12V	4	█	Y-703R	3782				
Corona (ST210, AT210)	2.0		01.00-	3S-FE		4	1,1	BKR6EKB-11	3583				
Corona (AT171,177,ST171)	2.0		- 92	3S-F		4	1,1	BCPR6EY-11	3720				
Corona (ZZT220, 221)	2.0		01.02-	3S-FE		4	1,1	BKR6EKB-11	3583				
Corona (ST220)	2.0		01.02-	1AZ-FSE		4	1,1	IFR6A-11T					
Corona (AZT220)	2.0		01.02-	3S-FE		4	1,1	BKR6EKB-11	3583				
Corona (AZT220)	2.0		01.02-	1AZ-FSE		4	1,1	IFR6A-11T					
Corona (ZZT220, 221)	2.0		01.02-	1AZ-FSE		4	1,1	IFR6A-11T					
Corona (ST220)	2.0		01.02-	3S-FE		4	1,1	BKR6EKB-11	3583				
Corona (AT171,177,ST171)	2.0	89	- 92	3S-FE	Cat.	4	1,1	BCPR6EY-11	3720				
Corona (AT220,221,ST220)	2.0	94	01.98-	3S-FE		4	1,1	BKR6EBPB-11	3452				
Corona (AT190,191,ST191)	2.0	98	93-	3S-FE		4	1,1	BKR6EYA-11	4073				
Corona (AT171,177,ST171)	2.0	116	92-	3S-GE		4	0,8	BKR6EP-8	2215				
Corona Super Glow System	2.2		08.82-	L	12V	4	█	Y-118R	2187				

¹⁾ Bic = Best in class (siehe Seite 3) / (see page 3)



l kW

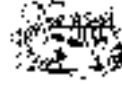

Cyl.

Order-
No. No.Bic¹⁾ Order-
No.**TOYOTA**

Corona	2.2		08.82-	L	12V	4	☑	Y-118T1	2951				
Corona	2.4			2L / 2L-T	12V	4	☑	Y-118R	2187				
Cressida	2.0	73	85-	21R		4	0,8	BPR5EY	2828	9	BPR5EIX	6597	
Cressida	2.0	80	- 88	1G-E		4	0,8	BPR6EY	6427		BPR6EIX	6637	
Cressida	2.0	80		1G-GE		4	1,1	BCPR6EY-11	3720				
Cressida	2.0	99	90-	1G-FE		4	0,8	BKR6EYA	2249				
Cressida	2.2		08.82-	L	12V	4	☑	Y-118T1	2951				
Cressida Super Glow System	2.2		08.82-	L	12V	4	☑	Y-118R	2187				
Cressida	2.4	77		22R		4	0,8	BPR5EY	2828	9	BPR5EIX	6597	
Cressida	2.5		93-	2L	12V	4	☑	Y-715R	5376				
Cressida	2.8	92	84-	5M-E		6	0,8	BPR5EY	2828	9	BPR5EIX	6597	
Cressida	2.8	125	85-	5M-GE		6	0,8	BPR6EY	6427		BPR6EIX	6637	
Cressida	3.0	142	88-	7M-GE	Cat.	6	1,1	BCPR5EP-11	2097				
Crown			09.83-	91 2L	12V	4	☑	Y-118T1	2951				
Crown (GS151)	2.0		98-	1G-FE		4	1,1	BKR5EYA-11	2526				
Crown	2.0		93-	1G-FE		4	0,8	BKR6EYA	2249				
Crown (JZS155)	2.0		98-	1G-FE		4	1,1	BKR5EYA-11	2526				
Crown Super Glow System	2.2		08.80-	L	12V	4	☑	Y-118R	2187				
Crown	2.2		08.80-	L	12V	4	☑	Y-118T1	2951				
Crown	2.5		93-	2L	12V	4	☑	Y-715R	5376				
Crown	2.8			5M		6	0,8	BPR5EY	2828	9	BPR5EIX	6597	
Crown	2.8		86-	5M-GE		6	0,8	BPR5EY	2828	9	BPR5EIX	6597	
Crown	2.8		- 85	5M-GE		6	0,8	BPR6EY	6427		BPR6EIX	6637	
Crown (JZS155)	2.9		98-12.99	2JZ-GE with 3way cat.		6	1,1	BKR5EKB-11	3967				
Crown (GS151)	2.9		98-	2JZ-GE without 3way cat.		6	0,8	BKR6EYA	2249				
Crown (JZS155)	2.9		98-	2JZ-GE without 3way cat.		6	0,8	BKR6EYA	2249				
Crown (GS151)	2.9		98-	2JZ-GE with 3way cat.		6	1,1	BKR5EKB-11	3967				
Crown (JZS175)	3.0		01.01-	2JZ-GE		6	1,1	IFR5A-11N					
Crown	3.0		93-12.99	2JZ-GE		6	0,8	BKR6EYA	2249				
Crown (JZS155)	3.0		01.00-	2JZ-GE		6	1,1	BKR5EKP-11	4302				
Crown	3.0	140		7M-GE		6	0,8	BCPR6EY	1146				
Crown	3.0	140		6M-GE		6	0,8	BPR6EY	6427		BPR6EIX	6637	
Dyna 2500				2L	12V		☑	Y-168R	2162				
Dyna 2500				2L	12V		☑	Y-118R	2187				
Dyna 2500			93-	2L	12V		☑	Y-715R	5376				
Dyna 2800	2.8		93-	3L	12V	4	☑	Y-715R	5376				
Dyna 3000			04.82-	3B	24V	4	☑	Y-197T	2190				
Dyna 3000			08.80-	2B	24V		☑	Y-197T	2190				
Dyna 3000	3.0		90- 91	B	24V	4	☑	Y-178T	3030				
Dyna 3000	3.0		93-	B / 11B	12V	4	☑	Y-147T	7493				
Dyna 3000	3.0		93-	B / 11B	24V	4	☑	Y-197T	2190				
Dyna 3000	3.0		05.82-	89 B	24V	4	☑	Y-197R	2188				
Dyna 3000	3.0		04.82-	B	12V	4	☑	Y-147T	7493				
Dyna 3700			93-	14B	12V		☑	Y-147T	7493				
Dyna 3700			93-	14B	24V		☑	Y-197T	2190				
Dyna 3700			04.82-	H, 2H	24V	6	☑	Y-197R	2188				
Dyna All E/G				A11		4	0,8	BPR5EY	2828	9	BPR5EIX	6597	
Echo (SCP10,NCP10,11,12,13)	1.0		01.99-	1SZ-FE		4	0,8	BKR5EYA	2087				
Echo (NCP10,11,12,13, SCP10)	1.3		01.01-	2NZ-FE		4	1,1	BKR5EYA-11	2526				
Echo Verso (NCP20,21 ,22)	1.3	63	08.99-	2NZ-FE		4	1,1	BKR5EYA-11	2526				
Echo (NCP20, 21, 22)	1.5	78	01.02-	1NZ-FE		4	0,8	BKR5EYA	2087				
Echo (NCP10,11,12,13, SCP10)	1.5	78	01.02-	1NZ-FE		4	0,8	BKR5EYA	2087				

¹⁾ Bic = Best in class (siehe Seite 3) / (see page 3)



ℓ kW

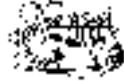

Cyl.

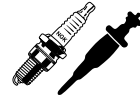
Order-
No. No.Bic¹⁾ Order-
No.**TOYOTA**

Echo (NCP10,11,12,13, SCP10)	1.5	78	01.01-12.01	1NZ-FE		4	1,1	BKR5EYA-11	2526			
Hi-Ace 3700			93-	14B	12V			Y-147T	7493			
Hi-Ace 3700			93-	14B	24V			Y-197T	2190			
Hi-Ace	1.8		95-	2Y	o.Cat.	4	0,8	BPR5EY	2828	9	BPR5EIX	6597
Hi-Ace	1.8	58	82- 85	2Y,2Y-C		4	0,8	BPR5EY	2828	9	BPR5EIX	6597
Hi-Ace (RZH102-105,112-115,125, 135,153,155)	2.0		98-	1RZ		4	0,8	BP5EY	7327		BPR5EIX	6597
Hi-Ace (YH51,53,56,60,61,63,66,73)	2.0	65	85- 89	3Y		4	0,8	BPR5EY	2828	9	BPR5EIX	6597
Hi-Ace (RZH102,103,104,109, 112-115,119,125)	2.0	74	90- 98	1R-Z		4	0,8	BPR5EY	2828	9	BPR5EIX	6597
Hi-Ace Super Glow System	2.2		07.79-	L	12V	4		Y-118R	2187			
Hi-Ace	2.2		07.79-	L	12V	4		Y-118T1	2951			
Hi-Ace (YH51,53,56,60,61,63,66,73)	2.2	69	- 89	4Y, 4YZ		4	0,8	BPR5EY	2828	9	BPR5EIX	6597
Hi-Ace 2500 (LH102-104,112-115, 125)	2.4		93-	2L	12V	4		Y-715R	5376			
Hi-Ace	2.4		- 92	2L	12V	4		Y-118R	2187			
Hi-Ace	2.4		- 92	2L	24V	4		Y-168R	2162			
Hi-Ace Super Glow System	2.4		09.83-	92	12V	4		Y-118R	2187			
Hi-Ace Super Glow System	2.4		09.83-	92	12V	4		Y-118R	2187			
Hi-Ace (RZH102,103,104,109, 112-115,119,125)	2.4		90-	2R-Z		4	0,8	BP5EY	7327		BPR5EIX	6597
Hi-Ace (RCH12, 13, 19, 22, 23, 29)	2.4		01.00-	2RZ-E		4	1,1	BPR5EP-11	3971			
Hi-Ace (RZH102-105,112-115,125, 135,153,155)	2.4		98-	2RZ-E		4	1,1	BPR5EP-11	3971			
Hi-Ace (RZH102-105,112-115,125, 135,153, 155)	2.4		98-	2RZ		4	0,8	BP5EY	7327		BPR5EIX	6597
Hi-Ace	2.4		09.83-	92	12V	4		Y-118T1	2951			
Hi-Ace (RZH102,103,104,109, 112-115,119,125)	2.4	88	90-	2R-ZE		4	1,1	BPR5EP-11	3971			
Hi-Ace (LH102-104,112-115,125)	2.5		98-	2L	12V	4		Y-715R	5376			
Hi-Ace (RCH 13,19,23,29)	2.7		01.04-	3RZ-FE		4	1,1	IFR5A-11				
Hi-Ace (RCH12,13,19,22,23,29)	2.7	105	01.00- 03	3RZ-FE		6	0,8	IFR5T-8N	3508			
Hi-Ace 2800	2.8		93-	3L	12V	4		Y-715R	5376			
Hi-Ace (LH102-104,112-115,125)	2.8		98-	3L	12V	4		Y-715R	5376			
Hi-Ace 3000	3.0		93-	B / 11B	12V	4		Y-147T	7493			
Hi-Ace 3000	3.0		93-	B / 11B	24V	4		Y-197T	2190			
Hi-Lux 2500			- 90	2C	12V	4		Y-703R	3782			
Hi-Lux			09.83-	92	12V			Y-118T1	2951			
Hi-Lux Super Glow System			09.83-	92	12V			Y-118R	2187			
Hi-Lux	1.6		(90)	1Y,1Y-C		4	0,8	BPR5EY	2828	9	BPR5EIX	6597
Hi-Lux	1.8			2Y-C		4	0,8	BPR5EY	2828	9	BPR5EIX	6597
Hi-Lux	1.8		95-	2Y		4	0,8	BP5EY	7327		BPR5EIX	6597
Hi-Lux	1.8	61	88- 94	2Y		4	0,8	BPR5EY	2828	9	BPR5EIX	6597
Hi-Lux	2.0		88- 94	3Y,3Y-C		4	0,8	BPR5EY	2828	9	BPR5EIX	6597
Hi-Lux	2.0		95-	3Y		4	0,8	BP5EY	7327		BPR5EIX	6597
Hi-Lux(RZN142,144,147-149,154, 168,169,173,174,193)	2.0		01.01-	1RZ		4	0,8	BP5EY	7327		BPR5EIX	6597
Hi-Lux(VZN 167, 172)	2.0		01.01-	1RZ		4	0,8	BP5EY	7327		BPR5EIX	6597
Hi-Lux(RZN142,144,147-149,154, 168,169,173,174,193)	2.0		01.01-	1RZ-E		4	0,8	BPR5EY	2828	9	BPR5EIX	6597
Hi-Lux	2.2		07.79-	L	12V	4		Y-118T1	2951			
Hi-Lux Super Glow System	2.2		07.79-	L	12V	4		Y-118R	2187			

¹⁾ Bic = Best in class (siehe Seite 3) / (see page 3)



l kW

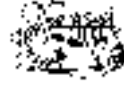

Cyl.

Order-
No. No.Bic¹⁾ Order-
No. No.**TOYOTA**

Hi-Lux	2.2		88- 94	4Y,4Y-C	4	0,8	BPR5EY	2828	9	BPR5EIX	6597
Hi-Lux	2.2		95-	4Y	4	0,8	BP5EY	7327		BPR5EIX	6597
Hi-Lux	2.2		(90)	4Y-E	4	1,1	BPR5EP-11	3971			
Hi-Lux	2.2		- 89	4Y-E	4	1,1	BPR5EY-11	3028		BPR5EIX-11	2115
Hi-Lux	2.4		- 92	2L	24V	4	Y-168R	2162			
Hi-Lux 2500	2.4		93-	2L	12V	4	Y-715R	5376			
Hi-Lux	2.4		- 92	2L	12V	4	Y-118R	2187			
Hi-Lux(RZN142,144,147-149,154, 168,169,173,174,193)	2.4		01.01-	2RZ-FE	6	0,8	BKR5EYA	2087			
Hi-Lux	2.4		88-	22R	4	0,8	BPR5EY	2828	9	BPR5EIX	6597
Hi-Lux(VZN 167, 172)	2.4		01.01-	2RZ-FE	6	0,8	BKR5EYA	2087			
Hi-Lux Super Glow System	2.4		09.83-	2L	12V	4	Y-118R	2187			
Hi-Lux	2.4	84	88-	22R-E	Cat.	4	0,8	BPR5EY	2828	9	BPR5EIX 6597
Hi-Lux	2.7		96-	3RZ-FE	6	0,8	BKR5EYA	2087			
Hi-Lux(RZN142,144,147-149,154, 168,169,173,174,193)	2.7		01.01-	3RZ-FE	6	0,8	BKR5EYA	2087			
Hi-Lux(RZN142,144,147-149,154, 168,169,173,174,193)	2.7		01.01-	3RZ-F	6	0,8	BKR5EYA	2087			
Hi-Lux 2800	2.8		93-	3L	12V	4	Y-715R	5376			
Hi-Lux	3.0	105	89-	3VZ-E	6	0,8	BKR5EYA	2087			
Hi-Lux	3.4		96-	5VZ-FE	6	1,1	BKR5EKB-11	3967			
Land Cruiser	2.4	77	-12.96	22R-E	4	0,8	BPR5EY	2828	9	BPR5EIX	6597
Land Cruiser (FJ62,70,73,75,RJ70)	2.4	77		22R	4	0,8	BPR5EY	2828	9	BPR5EIX	6597
Land Cruiser (HZJ70,73,75)	2.5			2L-T	12V	4	Y-715R	5376			
Land Cruiser (RZJ90,95, VZJ90,95)	2.7		05.96-	3RZ-FE	6	0,8	BKR5EYA	2087			
Land Cruiser (RZJ90,95, VZJ90,95)	2.7		05.96-	3RZ-F	6	0,8	BKR5EYA	2087			
Land Cruiser (RZJ120,125)	2.7		01.03-	3RZ-FE with 3way cat.	4	1,1	BKR5EYA-11	2526			
Land Cruiser (RZJ120,125)	2.7		01.03-	3RZ-FE without 3way cat.	4	0,8	BKR5EYA	2087			
Land Cruiser (KZJ90,95)	2.8		98-	3L	12V	4	Y-715R	5376			
Land Cruiser (LJ90,95)	2.8		98-	3L	12V	4	Y-715R	5376			
Land Cruiser (RZJ90,95, VZJ90,95)	3.4	131	05.96-	5VZ-FE	6	1,1	BKR5EKB-11	3967			
Land Cruiser (FJ62,70,73,75,RJ70)	4.0		08.87-12.89	3F-E	6	0,8	BPR5EY	2828	9	BPR5EIX	6597
Land Cruiser (FJ62,70,73,75,RJ70)	4.0	107	88-	3F	6	0,8	BPR4EY	2128			
Land Cruiser (FJ62,70,73,75,RJ70)	4.0	115	01.90-08.92	3F-E	Cat.	6	1,1	BPR5EY-11	3028	BPR5EIX-11	2115
Land Cruiser (RZJ120,125)	4.0	183	02-	1GR-FE	6	1,1	IFR6T-11				
Land Cruiser	4.2	88	81-	2F	6	0,8	BPR4EY	2128			
Land Cruiser	4.5		93-	1FZ-FE	6	0,8	BKR5EYA	2087			
Land Cruiser (FZJ100,105)	4.5		98-12.99	1FZ-FE	6	1,1	BKR5EKB-11	3967			
Land Cruiser (UZJ100,FZJ100,105)	4.5		01.01-	1FZ-FE	6	1,1	BKR5EKB-11	3967			
Land Cruiser (FZJ71,74,78,79)	4.5		01.00-	1FZ-FE	6	1,1	BKR5EKB-11	3967			
Land Cruiser (UZJ100)	4.5		98-12.99	1FZ-FE	6	1,1	BKR5EKB-11	3967			
Land Cruiser (FZJ70,73,75)	4.5		98-12.99	1FZ-FE	6	0,8	BKR5EYA	2087			
Land Cruiser (FZJ80)	4.5		96-	1FZ-F	6	0,8	BKR5EYA	2087			
Land Cruiser (UZJ100)	4.5		01.02-	1FZ-FE	6	1,1	BKR5EKB-11	3967			
Land Cruiser (FZJ100,105)	4.5		01.02-	1FZ-FE	6	1,1	BKR5EKB-11	3967			
Land Cruiser (FZJ70,73,75)	4.5		98-12.99	1FZ-F	6	0,8	BKR5EYA	2087			
Land Cruiser (UZJ100,FZJ100,105)	4.7		01.01-	2UZ-FE with 3way cat.	6	1,1	IFR6T-11	4589			
Land Cruiser (UZJ100)	4.7	173	01.98-	2UZ-FE	6	1,1	IFR6T-11	4589			
Land Cruiser (FZJ100,105)	4.7	173	01.98-	2UZ-FE	6	1,1	IFR6T-11	4589			

¹⁾ Bic = Best in class (siehe Seite 3) / (see page 3)



ℓ kW

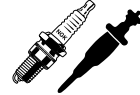

Cyl.

Order-
No. No.Bic¹⁾ Order-
No.**TOYOTA**

Land-Cruiser			10.81-	2B	24V		Y-197R	2188			
Land-Cruiser			05.82-	H / 2H	24V	6	Y-197R	2188			
Land-Cruiser				3B 4 Zyl., 2H 6Zyl.	12V		Y-147T	7493			
Land-Cruiser	2.4			2L 2.4L	12V	4	Y-118R	2187			
Land-Cruiser	2.5		90-	2L 2.5L	12V	4	Y-715R	5376			
Land-Cruiser	2.5		93-	2L-T	12V	4	Y-715R	5376			
Land-Cruiser	2.8		93-	3L	12V	4	Y-715R	5376			
Lite-Ace	1.3	42		4K,4K-C		4	0,8 BPR5EAL	5823			
Lite-Ace (KR41,42)	1.5		98-	5K		4	0,8 BPR5EY	2828	9	BPR5EIX	6597
Lite-Ace (SR40)	1.5		98-	5K		4	0,8 BPR5EY	2828	9	BPR5EIX	6597
Lite-Ace (KM30,36,37, YM30,35))	1.5	52	86- 90	5K,5K-C		4	0,8 BPR5EY	2828	9	BPR5EIX	6597
Lite-Ace	1.6		84- 85	1Y		4	0,8 BPR5EY	2828	9	BPR5EIX	6597
Lite-Ace (KM30,36,37, YM30,35,40,41)	1.8		- 89	2Y-CU	Cat.	4	1,1 BPR5EP-11	3971			
Lite-Ace (KM30,36,37, YM30,35,40,41)	1.8		86- 89	2Y	Cat.	4	1,1 BPR5EP-11	3971			
Lite-Ace (SR40)	1.8		98-	7K		4	0,8 BPR5EY	2828	9	BPR5EIX	6597
Lite-Ace (KM30,36,37, YM30,35,40,41)	1.8		89-	2Y-C		4	0,8 BP5EY	7327		BPR5EIX	6597
Lite-Ace (KM30,36,37, YM30,35)	1.8		90-	2Y-C	Cat.	4	1,1 BPR5EP-11	3971			
Lite-Ace (KM30,36,37, YM30,35)	1.8		90-	2Y-CU	Cat.	4	0,8 BP5EY	7327		BPR5EIX	6597
Lite-Ace (KM30,36,37, YM30,35)	1.8		90-	2Y	Cat.	4	0,8 BP5EY	7327		BPR5EIX	6597
Lite-Ace (KR41,42)	1.8		98-	7K		4	0,8 BPR5EY	2828	9	BPR5EIX	6597
Lite-Ace (KR42,SR40)	1.8		01.00-	7K-E		4	1,1 BPR5EY-11	3028		BPR5EIX-11	2115
Lite-Ace (KM30,36,37, YM30,35,40,41)	1.8	57	86- 88	2Y		4	0,8 BP5EY	7327		BPR5EIX	6597
Lite-Ace (KM30,36,37, YM30,35,40,41)	1.8	58	86- 89	2Y-C	Cat.	4	1,1 BPR5EP-11	3971			
Lite-Ace (KR41,42)	2.0		98-	3S-FE		4	1,1 BKR6EKB-11	3583			
Lite-Ace (KM30,36,37, YM30,35,40,41)	2.0		93-	3Y		4	0,8 BP5EY	7327		BPR5EIX	6597
Lite-Ace (KM30,36,37, YM30,35,40,41)	2.0			3Y-CU		4	1,1 BPR5EP-11	3971			
Lite-Ace (SR40)	2.0		98-	3S-FE		4	1,1 BKR6EKB-11	3583			
Lite-Ace	2.2		93-	4Y-E		4	1,1 BPR5EP-11	3971			
Lite-Ace 2000	1.8			1C	12V	4	Y-146R	7492			
Lite-Ace 2000	2.0			2C	12V	4	Y-703R	3782			
Model F	2.0			3Y-EC		4	0,8 BPR5EY	2828	9	BPR5EIX	6597
Model F (YR21,22,31)	2.0	65	08.84- 90	3Y		4	0,8 BPR5EY	2828	9	BPR5EIX	6597
Model F (YR21,22,31)	2.0	65		3Y-C		4	0,8 BPR5EY	2828	9	BPR5EIX	6597
Model F (YR21,22,31)	2.0	65	08.84- 88	3Y-C	Cat.	4	1,1 BPR5EP-11	3971			
Model F	2.2		08.85-	4Y-E	Cat.	4	1,1 BPR5EP-11	3971			
Model F	2.2		08.85-	4Y-EC		4	0,8 BPR5EY	2828	9	BPR5EIX	6597
Model F	2.2		90-	4Y-E		4	0,8 BPR5EY	2828	9	BPR5EIX	6597
Model F (YR21,22,31)	2.2	73	08.85-	4Y-EC	Cat.	4	1,1 BPR5EP-11	3971			
Model F / Tarago	2.0			2C	12V	4	Y-146R	7492			
MR 2	1.6			4A-GZE		4	1,1 BCPR6EP-11	3350			
MR 2 (AW11)	1.6	85	86- 90	4A-GE	Cat.	4	1,1 BCPR5EP-11	2097			
MR 2 (AW11)	1.6	91	86- 88	4A-GE		4	1,1 BCPR6EY-11	3720			
MR 2 (ZZW30)	1.8	103	12.99-	1ZZ-FE		4	1,1 BKR5EYA-11	2526			
MR 2 (SW20)	2.0		93-	3S-GTE		4	0,8 BKR6EP-8	2215			
MR 2 (SW20)	2.0	115	90- 93	3S-GE	Cat.	4	0,8 BKR6EP-8	2215			
MR 2 (SW20)	2.0	118	89- 92	3S-GE		4	0,8 BKR6EYA	2249			
MR 2 (SW20)	2.0	129	94-	3S-GE		4	0,8 BKR6EP-8	2215			
MR 2	2.2		93-	5S-FE		4	1,1 BKR6EP-11	2978			
MR 2 (SW20)	2.2	89	90-	3S-FE	Cat.	4	1,1 BKR6EYA-11	4073			
Paseo (EL54)	1.5		03.96-03.98	5E-FE (only Europe)		4	1,1 BKR5EP-11	3440			
Paseo (EL54)	1.5	66	07.95-12.97	5E-FE (only Europe)		4	0,8 BKR5EYA	2087			
Pick-up Super Glow System	2.2		08.82-	L	12V	4	Y-118R	2187			

¹⁾ Bic = Best in class (siehe Seite 3) / (see page 3)



l kW

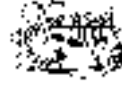

Cyl.

Order-
No. No.Bic¹⁾ Order-
No. No.**TOYOTA**

Pick-up	2.2		08.82-	L	12V	4	Y-118T1	2951				
Picnic (SXM10)	2.0	94	09.96-09.01	3S-FE		4	1,1 BKR6EBPB-11	3452				
Picnic (ACM20)	2.0	110	05.01-	1AZ-FE		4	1,1 IFR6T-11	4589				
Pirus (Hybrid) (NHW20)	1.5	57	03-	1NZ-FXE		4	1,1 IFR5A-11					
Previa (TCR10,11,20,21)	2.4		96-	2TZ-FE	without Cat.	4	0,8 BKR5EYA	2087				
Previa (TCR10,11,20,21)	2.4	97	05.90-	2TZ-FE	3way Cat.	4	0,8 BKR5EYA	2087				
Previa (TCR10,11,20,21)	2.4	97	05.90- 00	2TZ-FE	Cat.	4	1,1 BKR5EP-11	3440				
Previa (ACR30)	2.4	115	03.00-	2AZ-FE		4	1,1 IFR6T-11	4589				
Prius (Hybrid)(NHW11)	1.5	53	05.00- 03	1NZ-FXE		4	1,1 IFR5A-11					
RAV 4 (ZCA25,26, ACA20,21,22,23)	1.8	92	05.00-	1ZZ-FE		4	1,1 BKR5EYA-11	2526				
RAV 4 (SXA10,11)	2.0		98- 00	3S-FE		4	1,1 BKR6EBPB-11	3452				
RAV 4 (ZCA25,26, ACA20,21,22,23)	2.0		05.00-	1AZ-FE		4	1,1 IFR6T-11	4589				
RAV 4 (SXA10)	2.0	95	94- 97	3S-FE		4	1,1 BKR6EYA-11	4073				
RAV 4 (ZCA25,26, ACA20,21,22,23)	2.4		01.04-	2AZ-FE		4	1,1 IFR6T-11	4589				
Spacecruiser	1.8			2Y		4	0,8 BPR5EY	2828	9	BPR5EIX	6597	
Spacecruiser	2.0			3Y		4	0,8 BPR5EY	2828	9	BPR5EIX	6597	
Starlet (EP70,EP71,EP76,EP80,EP81)	1.0	40	85- 92	1E		4	0,8 BPR6EY	6427		BPR6EIX	6637	
Starlet	1.3		95-	2E-E		4	0,8 BPR4EY	2128				
Starlet (EP90,91)	1.3		98-	2E		4	0,8 BPR6EY	6427		BPR6EIX	6637	
Starlet (EP90,91)	1.3		98-	4E-FE		4	0,8 BKR5EYA	2087				
Starlet	1.3	36	- 84	4K		4	0,8 BPR5EAL	5823				
Starlet (EP80,81)	1.3	53	88- 92	2E		4	1,1 BPR5EY-11	3028		BPR5EIX-11	2115	
Starlet (EP80,81)	1.3	53	93-	2E		4	0,8 BPR6EY	6427		BPR6EIX	6637	
Starlet (EP70,71,76)	1.3	53	- 87	2E		4	1,1 BPR6EY-11	4228	10	BPR6EIX-11	3903	
Starlet	1.3	55	- 87	2E-C		4	1,1 BPR6EY-11	4228	10	BPR6EIX-11	3903	
Starlet (EP70,71,76)	1.3	55	88-	2E-C		4	1,1 BPR6EY-11	4228	10	BPR6EIX-11	3903	
Starlet	1.3	55	93-	4A-FE		4	1,1 BKR5EYA-11	2526				
Starlet (EP80,81)	1.3	55	90-12.95	2E-E	Cat.	4	0,8 BPR5EY	2828	9	BPR5EIX	6597	
Starlet (EP80,81)	1.3	55	02.96-	4E-FE		4	0,8 BKR5EYA	2087				
Starlet	1.5		93-	1N	12V	4	Y-715R	5376				
Starlet	1.5		90- 92	1N	12V	4	Y-715R	5376				
Supra	2.8			5M-GE		6	0,8 BPR6EY	6427		BPR6EIX	6637	
Supra (JZA80)	3.0		(95)	2JZ-GE		6	1,1 BKR6EP-11	2978				
Supra (MA70)	3.0		90- 92	7M-GE		6	0,8 BCPR6EY	1146				
Supra (JZA80)	3.0		96-	2JZ-GE		6	0,8 BKR6EYA	2249				
Supra (JZA80)	3.0		95-	2JZ-GTE		6	1,1 BKR6EP-11	2978				
Supra (MA70)	3.0	150	87- 89	7M-GE	Cat.	6	1,1 BCPR5EP-11	2097				
Supra (MA70)	3.0	150	86- 88	7M-GE		6	0,8 BCPR6EY	1146				
Supra (JZA80)	3.0	165	93- 94	2JZ-GE		6	1,1 BKR5EP-11	3440				
Supra Turbo (MA70)	3.0	175	87- 92	7M-GTE		6	0,8 BCPR6EPN-8	5275				
Supra V6 Biturbo (JZA80)	3.0	243	93- 94	2JZ-GTE		6	1,1 BKR6EP-11	2978				
Tarago	2.0			2C	12V	4	Y-146R	7492				
Targo (ACR30)	2.4		03.00-	2AZ-FE		4	1,1 IFR6T-11	4589				
Tarago	2.4	97	90-	2TZ-FE		4	1,1 BKR5EP-11	3440				
Tercel	1.3			2E		4	0,8 BPR6EY	6427		BPR6EIX	6637	
Tercel (EL50,53)	1.3		98-	2E		4	0,8 BPR6EY	6427		BPR6EIX	6637	
Tercel	1.5		93-	3E-E		4	1,1 BPR5EY-11	3028		BPR5EIX-11	2115	
Tercel (EL50,53)	1.5		98-	5E-FE		4	1,1 BKR5EKB-11	3967				
Tercel (AL25)	1.5	50	88-	3A-C	Cat.	4	1,1 BPR5EY-11	3028		BPR5EIX-11	2115	
Tercel	1.5	50	86- 88	3A-C		4	0,8 BPR5EY	2828	9	BPR5EIX	6597	
Tercel	1.5	52	81- 91	3A		4	0,8 BPR5EAL	5823				
Tercel (AL25)	1.5	52	82- 87	3A		4	0,8 BPR5EY	2828	9	BPR5EIX	6597	

¹⁾ Bic = Best in class (siehe Seite 3) / (see page 3)



ℓ kW

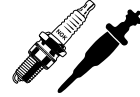

Cyl.

Order-
No. No.Bic¹⁾ Order-
No.**TOYOTA**

Townace (KR41,42)	1.5		98-	5K	4	0,8	BPR5EY	2828	9	BPR5EIX	6597
Townace (SR40)	1.5		98-	5K	4	0,8	BPR5EY	2828	9	BPR5EIX	6597
Townace (SR40)	1.8		98-	7K	4	0,8	BPR5EY	2828	9	BPR5EIX	6597
Townace (KR42,SR40)	1.8		01.00-	7K-E	4	1,1	BPR5EY-11	3028		BPR5EIX-11	2115
Townace (KR41,42)	1.8		98-	7K	4	0,8	BPR5EY	2828	9	BPR5EIX	6597
Townace (SR40)	2.0		98-	3S-FE	4	1,1	BKR6EKB-11	3583			
Townace (KR41,42)	2.0		98-	3S-FE	4	1,1	BKR6EKB-11	3583			
Toyo-Ace Super Glow System			09.83-	2L			Y-118R	2187			
Toyo-Ace			01.82-	2L			Y-197R	2188			
Toyo-Ace			09.83-	2L			Y-118R	2187			
Toyo-Ace			09.83-	2L			Y-168R	2162			
Toyo-Ace Super Glow System	2.2		03.79-	L	4		Y-118R	2187			
Toyo-Ace Super Glow System	2.2		03.79-	L	4		Y-118R	2187			
Toyo-Ace	2.2		03.79-	L	4		Y-118T1	2951			
Toyo-Ace	3.0		01.82-	B	4		Y-197R	2188			
Yaris (SCP10,NCP10,11,12,13)	1.0	48	01.99-	1SZ-FE	4	0,8	BKR5EYA	2087			
Yaris (NCP10,11,12,13)(SCP10,12)	1.3		01.03-	2SZ-FE	4	0,8	BKR5EYA	2087			
Yaris (NCP10,11,12,13, SCP10)	1.3		01.01-	2NZ-FE	4	1,1	BKR5EYA-11	2526			
Yaris Verso	1.3		01.00-	1NZ-FE	4	1,1	BKR5EYA-11	2526			
Yaris Verso (NCP20,21,22)	1.3	63	08.99-	2NZ-FE	4	1,1	BKR5EYA-11	2526			
Yaris (NCP20, 21, 22)	1.5	78	01.02-	1NZ-FE	4	0,8	BKR5EYA	2087			
Yaris (NCP10,11,12,13, SCP10)	1.5	78	01.02-	1NZ-FE	4	0,8	BKR5EYA	2087			
Yaris (NCP10,11,12,13, SCP10)	1.5	78	01.01-12.01	1NZ-FE	4	1,1	BKR5EYA-11	2526			
Yaris Verso (NCP20,21,22)	1.5	78	01-12.00	1NZ-FE	4	1,1	BKR5EYA-11	2526			

TRABANT

600	0.6		74-		2	0,7	A7	1110			
601 14mm					2	0,7	B6HS	4510		BR6HIX	3419

TVR

280 i	2.8				6	0,7	BPR6ES	7822	2	BPR6EIX	6637	
280 s	2.8				6	0,7	BPR6ES	7822	2	BPR6EIX	6637	
290 i	2.9				6	0,7	BPR6ES	7822	2	BPR6EIX	6637	
350 i	3.5				8	0,7	BPR6ES	7822	2	BPR6EIX	6637	
400	4.0				8	0,8	B7ECS	2528				
450	4.5				8	0,8	B7ECS	2528				
Cerbera	4.0		09.98-	IL6 4.0L	6	0,7	DCPR8E	4179		DCPR8EVX	2265	
Cerbera	4.2	306	95-	AJP (TVR engine)	8	0,7	BKR5EYU	3964				
Chimaera	4.0			V8 Rover	8	0,8	B7ECS	2528				
Chimaera	4.3			V8 Rover	8	0,8	B7ECS	2528				
Chimaera	5.0			V8 Rover	8	0,8	B7ECS	2528				
Griffith	3.9				8	0,8	B7ECS	2528				
Griffith	4.3				8	0,8	B7ECS	2528				
Griffith	4.5				8	0,8	B7ECS	2528				
Griffith 500	5.0		95-	V8 Rover	8	0,8	B7ECS	2528				
S2					6	0,7	BCPR6ES	2330	12	BCPR6EIX-11	4919	
S3				non	Cat.	6	0,7	BCPR6ES	2330	12	BCPR6EIX-11	4919
S3				With	Cat.	6	1,0	BPR6EFS	3623	7		
S3C	2.9				6	0,7	BPR6EFS	3623	7			
Speed	3.9			39	8	0,8	B7ECS	2528				
Speed	4.3			43	8	0,8	B7ECS	2528				
Tamora	3.6			IL6	6	0,7	DCPR8E	4179		DCPR8EVX	2265	

¹⁾ Bic = Best in class (siehe Seite 3) / (see page 3)



l kW

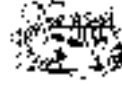

Cyl.

Order-
No. No.Bic¹⁾ Order-
No. No.**TVR**

Tasmin	2.0				4	0,6	APR6FS	2922				
Tasmin	2.8				6	0,6	BCPR6ES	2330	12		BCPR6EIX-11	4919
Tuscan	3.5				8	0,8	BPR5ES	7422	6		BPR5EIX	6597
Tuscan Speed Six	4.0		09.98-		6	0,7	DCPR8E	4339			DCPR8EVX	2265

UAZ

31 59 Bars						0,9	BPR5ES	7422	6		BPR5EIX	6597
31512, 31514, 31516, 31519						0,6	B5HS	4210				
31512				3M3-4021. 10		0,8	BP5HS	4111				
3303, 3714, 3153, 3741, 3909, 3962, 3221						0,6	B5HS	4210				
425 PP Promiscuo D			08.81-	Peugeot	4	☑	Y-902R	2237				
469 B TD	2.4		-04.86	VM	4	☑	Y-909R	4602				
469 B D	2.5		-11.85	Peugeot	4	☑	Y-902R	2237				

VAUXHALL

Astra D	1.6	40	09.84-01.89	16 D, DA OHC	4	☑	Y-924U	4950				
Astra D	1.7	42	10.91-		4	☑	Y-924U	4950				
Astra D	1.7	42	01.89-08.91	17 D OHC II	4	☑	Y-924U	4950				
Astra D	1.7	60	10.91-		4	☑	Y-924U	4950				
Astra E D	1.5	37	09.84-08.91	4 EC1 Isuzu ---> Mot. 804794	4	☑	Y-306R	6244				
Belmont 1.6D	1.6		01.86-01.89		4	☑	Y-924U	4950				
Brava Pick-up DI D	2.5	56	03.92-		6	☑	Y-924U	4950				
Carlton D	2.3	51	05.83-08.86	23 D	6	☑	Y-924U	4950				
Carlton TD	2.3	74	03.92-	23 DTR	6	☑	Y-924U	4950				
Cavalier D	1.6	40	03.82-08.88	16 D,DA OHC	4	☑	Y-924U	4950				
Cavalier D	1.7	42	09.88-	17 D	4	☑	Y-924U	4950				
Corsa D	1.5	37	09.87-02.93	15 D/4 EC1 AAD ---> Mot. 804 794	4	☑	Y-306R	6244				
Frontera Estate TD	2.3	74	01.92-	23 DTR	6	☑	Y-924U	4950				
Nova D, TD	1.5	37	07.87-	15D	4	☑	Y-902R	2237				
Omega TD	2.5	96	02.94-	Mot. BMW	6	☑	Y-917U	3219				

VAZ

1111	0.6	21		BA3 1111		0,8	BPR6ES	7822	2		BPR6EIX	6637
1113	0.7	24		BA3 1113		0,8	BPR6ES	7822	2		BPR6EIX	6637
2101, 2102	1.2	43		BA3 2101	4	0,7	BP6ES	7811	4		BPR6EIX	6637
2101, 2102	1.3	47		BA3 21011	4	0,7	BP6ES	7811	4		BPR6EIX	6637
2103, 2104	1.3	47		BA3 21011	4	0,7	BP6ES	7811	4		BPR6EIX	6637
2103, 2104	1.5	52		BA3 2103	4	0,7	BP6ES	7811	4		BPR6EIX	6637
21044-40	1.7	59		BA3 21073	4	0,8	BPR6ES	7822	2		BPR6EIX	6637
2105, 2106, 2107	1.5	52		BA3 2103	4	0,7	BP6ES	7811	4		BPR6EIX	6637
2106, 2107	1.6	55		BA3 2106	4	0,7	BP6ES	7811	4		BPR6EIX	6637
21073-40	1.7	59		BA3 21073	4	0,8	BPR6ES	7822	2		BPR6EIX	6637
2108, 2109	1.3	47		BA3 2108	4	0,7	BP6ES	7811	4		BPR6EIX	6637
2108, 2109	1.5	52		BA3 2111	4	0,8	BPR6ES	7822	2		BPR6EIX	6637
2108, 2109	1.5	52		BA3 21083	4	0,8	BPR6ES	7822	2		BPR6EIX	6637
21099	1.5	52		BA3 21083	4	0,8	BPR6ES	7822	2		BPR6EIX	6637
21099	1.5	52		BA3 2111	4	0,8	BPR6ES	7822	2		BPR6EIX	6637
2110, 2111, 2112	1.5	52		BA3 2111	4	0,8	BPR6ES	7822	2		BPR6EIX	6637
2110, 2111	1.5	54		BA3 2110	4	0,8	BPR6ES	7822	2		BPR6EIX	6637

¹⁾ Bic = Best in class (siehe Seite 3) / (see page 3)



ℓ kW

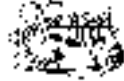

Cyl.

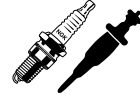
Order-
No. No.Bic¹⁾ Order-
No.**VAZ**

21108, 21109	1.5	68		BA3 2112	4	1,1	BCPR6ES-11	7121	11	BCPR6EIX-11	4919
2111, 2111, 2112	1.5	68		BA3 2112	4	1,1	BCPR6ES-11	7121	11	BCPR6EIX-11	4919
2115	1.5	49		BA3 21083	4	0,8	BPR6ES	7822	2	BPR6EIX	6637
2115	1.5	52		BA3 2111	4	0,8	BPR6ES	7822	2	BPR6EIX	6637
2121	1.6	54		BA3 2121	4	0,7	BP6ES	7811	4	BPR6EIX	6637
2121, 2346	1.7	59		BA3 21213	4	0,8	BPR6ES	7822	2	BPR6EIX	6637
2131	1.7	61		BA3 2130	4	0,8	BPR6ES	7822	2	BPR6EIX	6637

VOLGA

3102	2.0	100	01.86-	20T4	4	0,8	BKR6E	6962	28	BKR6EIX	6418
3110	2.0	100	01.96-	20T4	4	0,8	BKR6E	6962	28	BKR6EIX	6418

VOLVO

240	1.8	66	11.78-07.88	B17A	4	0,7	BP6ES	7811	4	BPR6EIX	6637	
240	2.0	72	08.84-07.89	B200K	4	0,7	BP6ES	7811	4	BPR6EIX	6637	
240i	2.0	77	08.88-08.92		4	0,8	BPR6ES	7822	2	BPR6EIX	6637	
240i	2.0	86	08.87-07.92	B200E	4	0,8	BPR6ES	7822	2	BPR6EIX	6637	
240i	2.0	86	08.84-07.87	B200E	4	0,7	BP6ES	7811	4	BPR6EIX	6637	
240 / 240i Turbo	2.1	74	08.74-07.86	B21A/B21ET	4	0,7	BP6ES	7811	4	BPR6EIX	6637	
240i	2.3		08.92-	B230FD	4	0,8	BPR6ES	7822	2	BPR6EIX	6637	
240	2.3	78	08.84-07.86	B230K	4	0,7	BP6ES	7811	4	BPR6EIX	6637	
240	2.3	78	08.86-07.90	B230K	4	0,8	BPR6ES	7822	2	BPR6EIX	6637	
240 / 240i	2.3	78	03.79-07.88	B23A/B23E/B230A	4	0,7	BP6ES	7811	4	BPR6EIX	6637	
240i	2.3	85	08.84-08.93	B230F	Cat.	4	0,8	BPR6ES	7822	2	BPR6EIX	6637
240i	2.3	91	03.79-07.87	B230E	4	0,7	BP6ES	7811	4	BPR6EIX	6637	
240i	2.3	96	08.87-07.92	B230E	4	0,8	BPR6ES	7822	2	BPR6EIX	6637	
240 D	2.4	60	08.79-08.93	D 24	4	■	Y-918R	4182				
340	1.4	47	08.84-	B14	4	0,8	BPR6ES	7822	2	BPR6EIX	6637	
340 D	1.6	40	09.84-07.91	D 16	4	■	Y-913M	3965				
340	1.7	61	07.85-07.91	B172K	4	0,8	BPR6ES	7822	2	BPR6EIX	6637	
340 / 340i	2.0		08.82-07.88	B200E/B200K	4	0,8	BPR6ES	7822	2	BPR6EIX	6637	
340 / 360	2.0	65	-07.84	B19A	4	0,7	BP6ES	7811	4	BPR6EIX	6637	
360 D	1.6		07.84-	D 16	4	■	Y-913M	3965				
360 / 360i	2.0	72	08.82-07.89	B19E/B200E	4	0,8	BPR6ES	7822	2	BPR6EIX	6637	
360 / 360i	2.0	72	08.82-07.90	B200K/B200F	Cat.	4	0,8	BPR6ES	7822	2	BPR6EIX	6637
440i	1.6	62	02.92-12.95	B16F	Cat.	4	0,7	ZGR5B	7345			
440	1.7	58	09.89-12.91	B18KD	Cat.	4	0,7	ZGR5B	7345			
440	1.7	58	09.88-08.94	B18K/B/	Cat.	4	0,8	BPR6ES	7822	2	BPR6EIX	6637
440	1.7	64	09.88-02.92	B18KPD	Cat.	4	0,7	ZGR5B	7345			
440i	1.7	70	09.88-03.92	B18F	Cat.	4	0,7	ZGR5B	7345			
440i	1.7	75	09.89-08.91	B18FP	Cat.	4	0,7	ZGR5B	7345			
440i	1.7	78	09.88-12.89	B18ED	Cat.	4	0,8	BPR7ES	2023	19	BPR7EIX	4055
440i	1.7	88	09.88-12.95	B18FTM/FT	Cat.	4	0,8	BPR7ES	2023	19	BPR7EIX	4055
440i	1.8	66	09.91-12.95	B18U	Cat.	4	0,7	ZGR5B	7345			
440i	1.8	69	09.91-12.95	B18 u.	Cat.	4	0,8	BPR6ES	7822	2	BPR6EIX	6637
440 TD	1.9	66	01.93-	Renault F8Q Turbo	4	■	Y-933R	6136				
440i	2.0	81	09.92-	B20U	Cat.	4	0,8	BPR7ES	2023	19	BPR7EIX	4055
440i	2.0	81	09.92-	B20F	Cat.	4	0,8	BPR7ES	2023	19	BPR7EIX	4055
460	1.7	64	01.90-09.91	B18KPD	Cat.	4	0,7	ZGR5B	7345			
460 / 460i	1.7	66	03.90-12.95	B18KP/EP/	Cat.	4	0,8	BPR6ES	7822	2	BPR6EIX	6637
460i	1.7	75	01.90-09.92	B18FP	Cat.	4	0,7	ZGR5B	7345			
460i	1.7	88	01.90-12.95	B18FT	Cat.	4	0,8	BPR7ES	2023	19	BPR7EIX	4055

¹⁾ Bic = Best in class (siehe Seite 3) / (see page 3)



l kW

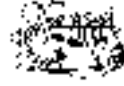

Cyl.

Order-
No. No.Bic¹⁾ Order-
No.**VOLVO**

460i	1.8	66	09.91-12.95	B18U	Cat.	4	0,7	ZGR5B	7345				
460i	1.8	69	09.91-12.95	B18 u.	Cat.	4	0,8	BPR6ES	7822	2	BPR6EIX	6637	
460 TD	1.9	66	06.94-	D 19 T		4	█	Y-933R	6136				
460i	2.0	81	09.92-12.95	B20F	Cat.	4	0,8	BPR7ES	2023	19	BPR7EIX	4055	
480i	1.7	70	09.88-03.90	B18F	Cat.	4	0,7	ZGR5B	7345				
480i	1.7	75	10.89-09.92	B18FP	Cat.	4	0,7	ZGR5B	7345				
480	1.7	78	04.86-07.89	B18E		4	0,8	BPR7ES	2023	19	BPR7EIX	4055	
480i	1.7	78	10.87-08.88	B18ED	Cat.	4	0,8	BPR7ES	2023	19	BPR7EIX	4055	
480i	1.7	88	03.88-	B18FT	Cat.	4	0,8	BPR7ES	2023	19	BPR7EIX	4055	
480i	2.0	81	09.92-12.95	B20F	Cat.	4	0,8	BPR7ES	2023	19	BPR7EIX	4055	
740	2.0	76	08.84-07.89	B200K		4	0,8	BPR6ES	7822	2	BPR6EIX	6637	
740i	2.0	76	08.83-07.91	B19E/B200E		4	0,8	BPR6ES	7822	2	BPR6EIX	6637	
740i	2.0	82	08.89-07.91	B200F	Cat.	4	0,8	BPR6ES	7822	2	BPR6EIX	6637	
740i Turbo	2.0	105	08.86-07.92	B200ET/FT	Cat.	4	0,8	BPR6ES	7822	2	BPR6EIX	6637	
740i Turbo	2.0	110	04.84-08.86	B19ET/B200ET		4	0,7	BP6ES	7811	4	BPR6EIX	6637	
740i	2.3	80	08.86-07.90	B230K		4	0,8	BPR6ES	7822	2	BPR6EIX	6637	
740 / 740i	2.3	80	08.83-07.87	B23E/B230K/A		4	0,7	BP6ES	7811	4	BPR6EIX	6637	
740i	2.3	85	08.88-07.95	B230F	Cat.	4	0,8	BPR6ES	7822	2	BPR6EIX	6637	
740i	2.3	96	08.84-07.92	B230E/B230F	Cat.	4	0,8	BPR6ES	7822	2	BPR6EIX	6637	
740i 16V	2.3	111	04.88-07.91	B234F	Cat.	4	0,8	BPR6ES	7822	2	BPR6EIX	6637	
740i Turbo	2.3	114	08.89-07.91	B230FT	Cat.	4	0,8	BPR6ES	7822	2	BPR6EIX	6637	
740i Turbo	2.3	130	08.84-08.86	B230ET		4	0,7	BP6ES	7811	4	BPR6EIX	6637	
740i Turbo	2.3	130	08.86-07.89	B230ET		4	0,8	BPR6ES	7822	2	BPR6EIX	6637	
740 D	2.4	60	04.84-07.92	D 24		6	█	Y-918R	4182				
740 TD	2.4	80	04.87-07.92	D 24 T		6	█	Y-918R	4182				
740 TD (air condition)	2.4	85	08.87-07.92	D 24 TIC		6	█	Y-918R	4182				
740i 16V (I)	2.0	76	08.88-07.91	B204E		4	0,8	BPR6ES	7822	2	BPR6EIX	6637	
760i Turbo	2.0	120	08.84-07.87	B200ET		4	0,7	BP6ES	7811	4	BPR6EIX	6637	
760i Turbo	2.0	120	08.87-07.89	B200ET		4	0,8	BPR6ES	7822	2	BPR6EIX	6637	
760i Turbo	2.3	114	08.84-07.92	B230ET/FT	Cat.	4	0,8	BPR6ES	7822	2	BPR6EIX	6637	
760 TD	2.4	80	08.82-07.87	D 24 T		6	█	Y-918R	4182				
760 TD	2.4	85	08.87-07.92	D 24 TIC		6	█	Y-918R	4182				
760	2.8	96	08.82-07.86	B28A		6	1,0	BPR6EFS	3623	7			
760i	2.8	100	08.82-08.91	B28F/B280F	Cat.	6	1,0	BPR6EFS	3623	7			
760i / 780i	2.8	108	05.86-07.91	B280E		6	0,6	BP7EFS	3526				
760i	2.8	115	02.82-04.86	B28E		6	1,0	BPR6EFS	3623	7			
780i Turbo / 16V /Interco.	2.0	120	08.87-07.90	B200ET/B204GT		4	0,8	BPR6ES	7822	2	BPR6EIX	6637	
780i Turbo	2.0	120	01.86-07.87	B200ET		4	0,7	BP6ES	7811	4	BPR6EIX	6637	
780 TD	2.4	85	08.85-	D 24 TIC		6	█	Y-918R	4182				
780i	2.8	108	05.86-07.91	B280F	Cat.	6	1,0	BPR6EFS	3623	7			
850	2.0	93	94-	B5202S		5	0,8	BCPR6ES	2330	12	BCPR6EIX-11	4919	
850i	2.0	96	09.91-	B5204F		5	0,8	BCPR6ES	2330	12	BCPR6EIX-11	4919	
850 T	2.0	154	08.93-	B5204T		5	0,8	BCPR6ES	2330	12	BCPR6EIX-11	4919	
850i T5	2.3	166	04.94-	B5234FT		5	0,7	BCP7EVX	7681		BCPR7EIX	5690	
850 T5 R	2.3	177	94-	B5234T5		5	0,8	BKR7EVX	3544		BKR7EIX	2667	
850 R	2.3	184	95-	B5234T		5	0,8	BKR7EVX	3544		BKR7EIX	2667	
850 TDi	2.5	103		D5252 (Audi)		5	█	Y-732U	2408				
850i	2.5	103	10.92-	B5252S		5	0,8	BCPR6ES	2330	12	BCPR6EIX-11	4919	
850i	2.5	125	09.91-	B5254F		5	0,8	BCPR6ES	2330	12	BCPR6EIX-11	4919	
940i	2.0	82	09.90-	B200E/B200F		4	0,8	BPR6ES	7822	2	BPR6EIX	6637	
940i Turbo	2.0	105	01.91-	B200FT		4	0,8	BPR6ES	7822	2	BPR6EIX	6637	
940i	2.3		92-	B230FB		5	0,8	BPR6ES	7822	2	BPR6EIX	6637	

¹⁾ Bic = Best in class (siehe Seite 3) / (see page 3)



ℓ kW

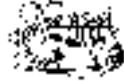

Cyl.

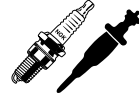
Order-
No. No.Bic¹⁾ Order-
No.**VOLVO**

940i	2.3	96	09.90-	B230F	5	0,8	BPR6ES	7822	2	BPR6EIX	6637
940	2.3	99	12.94-	B230GK	5	0,8	BPR6ES	7822	2	BPR6EIX	6637
940i 16V	2.3	114	09.90-07.91	B234F	5	0,8	BPR6ES	7822	2	BPR6EIX	6637
940i Turbo Intercooler	2.3	121	09.90-	B230FT	5	0,8	BPR6ES	7822	2	BPR6EIX	6637
940 TD	2.4	80	09.90-08.93	D 24 T	6	█	Y-918R	4182			
940 GL, GLE TD	2.4	85	09.90-	D 24 TIC	6	█	Y-918R	4182			
940 TD Interc., Kombi	2.4	90	01.94-	D 24 T	6	█	Y-918R	4182			
940i	2.3	121	09.90-	B230FT / FK	5	0,8	BPR6ES	7822	2	BPR6EIX	6637
960i 16V Turbo Intercooler	2.0	140	09.90-	B204FT	4	0,8	BPR6ES	7822	2	BPR6EIX	6637
960i Turbo Intercooler	2.3	121	09.90-	B230FT / FK	5	0,8	BPR6ES	7822	2	BPR6EIX	6637
960 TD Interc.	2.4	85	09.91-	D 24 TIC	6	█	Y-918R	4182			
960	2.5	125	09.94-	B6254F/G	6	0,8	BCPR6ES	2330	12	BCPR6EIX-11	4919
960i	2.8	110	09.90-08.91	B280F	6	1,0	BPR6EFS	3623	7		
960i	2.8	125	09.90-	B280E	6	0,6	BP7EFS	3526			
960i	2.9	150	09.90-	B6304F	6	0,8	BCPR6ES	2330	12	BCPR6EIX-11	4919
960	3.0	135	09.94-	B6304F	6	0,8	BCPR6ES	2330	12	BCPR6EIX-11	4919
960	3.0	150	09.94-	B6304F/G	6	0,8	BCPR6ES	2330	12	BCPR6EIX-11	4919
C 70	2.0	106	98-	B5204S	5	0,8	BKR6ES	3783	28	BKR6EIX	6418
C 70 2.0 T	2.0	120	99-	B5204T4	5	0,8	BKR6EVX	3539			
C 70	2.0	132	03.98-	B5204T2	5	0,8	BCPR7ES	3330			
C 70	2.0	166	01.97-	B5204T3	5	0,8	BCPR7ES	3330			
C 70 T5	2.3	176	97-	B5234T	5	0,8	BKR7EVX	3544		BKR7EIX	2667
C 70 T5	2.3	176	09.99-09.02	B5234T3	5	0,8	BKR6EVX	3539			
C 70	2.4	125	99-	B5244S	5	0,8	BKR6ES	3783	28	BKR6EIX	6418
C 70 2.4 T	2.4	142	99-	B5244T	5	0,8	BKR6EVX	3539			
C 70	2.4	176	00-	B5224T	5	0,8	BKR6EVX	3539			
C 70	2.5	121	03.99-	B5254S	5	0,8	BKR6ES	3783	28	BKR6EIX	6418
C 70	2.5	142	01.98-	B5254T	5	0,8	BKR7EVX	3544		BKR7EIX	2667
F 407/408	3.6	80	04.78-02.86	TD 40A	6	█	Y-909R	4602			
S 40 1.6	1.6	80	97-	B4164S2	4	0,8	BCPR6ET	2197			
S 40 1.8	1.8	90	96-	B4184S2	4	0,8	BCPR6ET	2197			
S 40 1.8 GDI	1.8	92		B4184SJ	4		IZFR6B	3116			
S 40 1.9D	1.9	66	05.96-	D4192T	4	█	Y-932R	4956			
S 40 1.9D	1.9	75	09.00-	D4192T4/Di	4	█	Y-515J	1019			
S 40 1.9D	1.9	85	07.00-	D4192T3/Di	4	█	Y-515J	1019			
S 40 T4	1.9	147	09.97-	B4194T / T2	4	0,8	PFR6G	4793			
S 40 2.0	2.0	100	96-	B4204S2	4	0,8	BCPR6ET	2197			
S 40 2.0 T	2.0	120	00-	B4204T3	4	0,8	BKR6EVX	3539			
S 40 T4	2.0	147	00-	B4204T5	4	0,8	BKR6EVX	3539			
S 60 2.0 T	2.0	132	09.01-	B5204T5	5	0,8	BKR6EVX	3539			
S 60 2.3 T	2.3	147	00-	B5234T7	5	0,8	BKR6EVX	3539			
S 60 T5	2.3	184	11.00-	B5234T3	5	0,8	BKR6EVX	3539			
S 60	2.4		10.00-	B5244T	5	0,8	PFR6B	3500			
S 60 2.4	2.4	103	11.00-	B5244S2	5	0,8	BKR6ES	3783	28	BKR6EIX	6418
S 60 2.4	2.4	125	11.00-	B5244S	5	0,8	BKR6ES	3783	28	BKR6EIX	6418
S 60 2.4 T	2.4	147	11.00-	B5244T3	5	0,8	BKR6EVX	3539			
S 60 R 2.5T	2.5	220	03.03-	B5254T4	5	1,1	PLFR6A-11	7654			
S 70	2.0	93	01.97-	B5202S	5	0,8	BKR6ES	3783	28	BKR6EIX	6418
S 70	2.0	105	01.97-	B5204S	5	0,8	BKR6ES	3783	28	BKR6EIX	6418
S 70	2.0	120	99-	B5204T4	5	0,8	BCPR7ES	3330			
S 70	2.0	132	01.97-	B5204T2	5	0,8	BCPR7ES	3330			
S 70	2.0	154	01.97-	B5204T	5	0,8	BCPR7ES	3330			

¹⁾ Bic = Best in class (siehe Seite 3) / (see page 3)



ℓ kW

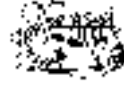

Cyl.

Order-
No. No.Bic¹⁾ Order-
No. No.**VOLVO**

S 70	2.0	166	01.97-	B5204T3	5	0,8	BCPR7ES	3330				
S 70	2.3	120	99-	B5234S	5	0,8	BKR6ES	3783	28	BKR6EIX	6418	
S 70	2.3	166	09.97-	B5234T	5	0,8	BCPR7ES	3330				
S 70	2.3	177	99-	B5234T6	5	0,8	BCPR7ES	3330				
S 70	2.3	177	99-	B5234T5	5	0,8	BCPR7ES	3330				
S 70	2.3	184	99-	B5234T4	5	0,8	BCPR7ES	3330				
S 70	2.3	184	99-	B5234T8	5	0,8	BCPR7ES	3330				
S 70	2.3	184	01.97-11.00	B5234T3	5	0,8	BKR7EVX	3544		BKR7EIX	2667	
S 70	2.4	103	99-	B5244S2	5	0,8	BKR6ES	3783	28	BKR6EIX	6418	
S 70	2.4	125	99-	B5244S	5	0,8	BKR6ES	3783	28	BKR6EIX	6418	
S 70 2.4 T	2.4	142	01.97-	B5244T		1,1	BKR7EVX-11	4685		BKR7EIX-11	6988	
S 70	2.4	142	99-	B5244T	5	0,8	BCPR7ES	3330				
S 70	2.4	195	99-	B5244T2	5	0,8	BCPR7ES	3330				
S 70	2.5	103	01.97-	D5252T	5	■	Y-732U	2408				
S 70 TDi	2.5	103	01.97-	D5252 (Audi)	5	■	Y-732U	2408				
S 70 2.5 10V	2.5	106	01.97-	B5252S	5	0,8	BKR6ES	3783	28	BKR6EIX	6418	
S 70 2.5 20V	2.5	125	01.97-	B5254S	5	0,8	BKR6ES	3783	28	BKR6EIX	6418	
S 70 2.5 T	2.5	142	01.97-	B5254T	5	0,8	BKR7EVX	3544		BKR7EIX	2667	
S 80 2.0 T	2.0	132	12.99-	B5204T5	5	0,8	BKR6EVX	3539				
S 80	2.0	166	06.98-	B5204T3	5	0,8	BCPR7ES	3330				
S 80 2.3 T	2.3	147	99-	B5234T7	5	0,8	BKR6EVX	3539				
S 80 2.4	2.4	125	99-	B5244S2	5	0,8	BKR6ES	3783	28	BKR6EIX	6418	
S 80 2.4	2.4	125	01.99-	B5244S	5	0,8	BKR6ES	3783	28	BKR6EIX	6418	
S 80 2.4 T	2.4	147	06.00-	B5244T3	5	0,8	BKR6EVX	3539				
S 80 2.4	2.4	162		B5244T3	5	0,8	BKR6EVX	3539				
S 80 2.5D	2.5	103	01.99-	D5252T	5	■	Y-732U	2408				
S 80 2.5 T AWD	2.5	154	07.03-	B5254T2	5	0,8	BKR6EVX	3539				
S 80 T6	2.8	200	06.98-	B6284T2	6	0,8	BKR6EVX	3539				
S 80 2.8 T	2.8	200	06.99-	B6284T	6	0,8	BKR6EVX	3539				
S 80 T6	2.9	200	06.00-	B6294T	6	0,8	BKR6EVX	3539				
S 80	3.0	150	06.99-	B6304S	6	0,8	BKR6ES	3783	28	BKR6EIX	6418	
S 90	2.4	120	97-	B6244F	6	0,8	BCPR6ES	2330	12	BCPR6EIX-11	4919	
S 90	2.5	125	97-	B6254G	6	0,8	BCPR6ES	2330	12	BCPR6EIX-11	4919	
S 90	2.5	125	97-	B6254F	6	0,8	BCPR6ES	2330	12	BCPR6EIX-11	4919	
S 90 3.0	3.0	132	01.97-	B6304S	6	0,8	BKR6ES	3783	28	BKR6EIX	6418	
S 90 3.0	3.0	150	01.97-	B6304S	6	0,8	BKR6ES	3783	28	BKR6EIX	6418	
S 90	3.0	150	97-	B6304F	6	0,8	BCPR6ES	2330	12	BCPR6EIX-11	4919	
S 90	3.0	150	97-	B6304G	6	0,8	BCPR6ES	2330	12	BCPR6EIX-11	4919	
V 40 1.6	1.6	80	97-	B4164S2	4	0,8	BCPR6ET	2197				
V 40 1.8	1.8	90	96-	B4184S2	4	0,8	BCPR6ET	2197				
V 40 1.9DCI	1.9		07.00-	dCi Renault	4	■	Y-515J	1019				
V 40 1.9D	1.9	66	02.96-	D4192T	4	■	Y-932R	4956				
V 40 T4	1.9	147	09.97-	B4194T / T2	4	0,8	PFR6G	4793				
V 40 2.0	2.0	100	96-	B4204S2	4	0,8	BCPR6ET	2197				
V 40 2.0 T	2.0	120	00-	B4204T3	4	0,8	BKR6EVX	3539				
V 40 2.0 T	2.0	147	00-	B4204T5	4	0,8	BKR6EVX	3539				
V 70 2.0	2.0	93	01.97-03.00	B5202S	5	0,8	BKR6ES	3783	28	BKR6EIX	6418	
V 70	2.0	105	01.97-03.00	B5204S	5	0,8	BKR6ES	3783	28	BKR6EIX	6418	
V 70 2.0 T	2.0	120	99-	B5204T4	5	0,8	BKR6EVX	3539				
V 70 2.0 T	2.0	132	01.97-03.00	B5204T2	5	0,8	BKR6EVX	3539				
V 70	2.0	154	01.97-03.00	B5204T	5	0,8	BCPR7ES	3330				
V 70	2.0	166	01.97-03.00	B5204T3	5	0,8	BCPR7ES	3330				

¹⁾ Bic = Best in class (siehe Seite 3) / (see page 3)



ℓ kW

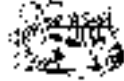

Cyl.

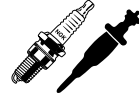
Order-
No. No.Bic¹⁾ Order-
No.**VOLVO**

V 70	2.3	120	99-	B5234S	5	0,8	BKR6ES	3783	28	BKR6EIX	6418
V 70 2.3 T	2.3	147	00-	B5234T7	5	0,8	BKR6EVX	3539			
V 70	2.3	166	09.97-03.00	B5234T	5	0,8	BCPR7ES	3330			
V 70	2.3	177	99-	B5234T5	5	0,8	BCPR7ES	3330			
V 70	2.3	177	99-	B5234T6	5	0,8	BCPR7ES	3330			
V 70 T-5	2.3	184	01.97-03.00	B5234T3	5	0,8	BKR7EVX	3544		BKR7EIX	2667
V 70	2.3	184	00-	B5234T3	5	0,8	BKR6EVX	3539			
V 70	2.3	184	99-	B5234T8	5	0,8	BKR6EVX	3539			
V 70	2.3	184	04.97-03.00	B5234T4	5	0,8	BKR6EVX	3539			
V 70 2.4	2.4	103	08.99-03.00	B5244S2	5	0,8	BKR6ES	3783	28	BKR6EIX	6418
V 70 2.4	2.4	125	99-	B5244S	5	0,8	BKR6ES	3783	28	BKR6EIX	6418
V 70	2.4	142	99-	B5244T	5	0,8	BKR7EVX	3544		BKR7EIX	2667
V 70 2.4 T	2.4	147	00-	B5244T3	5	0,8	BKR6EVX	3539			
V 70 T5	2.4	191	00-	B5244T5	5	0,8	BKR6EVX	3539			
V 70	2.4	195	03.99-03.00	B5244T2	5	0,8	BCPR7ES	3330			
V 70 2.5D	2.5	103	01.97-03.00	D5252T	5	█	Y-732U	2408			
V 70 2.5 10V	2.5	106	01.97-03.00	B5252S	5	0,8	BKR6ES	3783	28	BKR6EIX	6418
V 70 2.5 20V	2.5	125	01.97-03.00	B5254S	5	0,8	BKR6ES	3783	28	BKR6EIX	6418
V 70	2.5	142	01.97-03.00	B5254T	5	0,8	BKR7EVX	3544		BKR7EIX	2667
V 70 R	2.5	220	07.03-	B5254T4	5	1,1	PLFR6A-11	7654			
V 90	2.4	120	97-	B6244F	6	0,8	BCPR6ES	2330	12	BCPR6EIX-11	4919
V 90	2.5	125	97-	B6254F	6	0,8	BCPR6ES	2330	12	BCPR6EIX-11	4919
V 90	2.5	125	97-	B6254G	6	0,8	BCPR6ES	2330	12	BCPR6EIX-11	4919
V 90	2.9	150	97-	B6304G	6	0,8	BCPR6ES	2330	12	BCPR6EIX-11	4919
V 90	2.9	150	97-	B6304F	6	0,8	BCPR6ES	2330	12	BCPR6EIX-11	4919
V 90 3.0	3.0	132	01.97-	B6304S2	6	0,8	BKR6ES	3783	28	BKR6EIX	6418
V 90 3.0	3.0	150	01.97-	B6304S	6	0,8	BKR6ES	3783	28	BKR6EIX	6418
XC70 2.4T	2.4	147	09.00-09.02	B5244T3	5	0,8	BKR6EVX	3539			
XC70 2.5T	2.5	154	09.02-	B5254T2	5	0,8	BKR6EVX	3539			
XC90 2.5T	2.5	154	02.03-	B5254T2	5	0,8	BKR6EVX	3539			
XC90 T6 Biturbo	2.9	200	02.03-	B6294T	6	0,8	BKR6EVX	3539			

VW

Beetle	1.4	55	08.01-	BCA	4	1,1	PZFR5D-11	7968			
Beetle	1.6	74	11.99-10.00	AWH	4	1,0	BKUR6ET-10	2397	24	PFR6Q	6458
Beetle	1.6	74	06.00-	AYD	4	1,0	BKUR6ET-10	2397	24	PFR6Q	6458
Beetle	1.6	75	06.02-	BFS	4	1,0	BKUR6ET-10	2397	24	PFR6Q	6458
Beetle	1.8	110	06.00-05.01	AWV	4	0,8	PFR6Q	6458			
Beetle	1.8	110	07.99-10.00	AVC	4	0,8	PFR6Q	6458			
Beetle	1.8	110	10.00-	AWU	4	0,8	PFR6Q	6458			
Beetle	1.8	110	01.99-06.00	APH	4	0,8	PFR6Q	6458			
Beetle	1.8	132	06.02-06.04	AWP	4	0,8	PFR6Q	6458			
Beetle TDI	1.9	66	11.98-	ALH	4	█	Y-732U	2408			
Beetle TDI	1.9	74	10.00-	ATD	4	█	Y-732U	2408			
Beetle	2.0	85	06.02-	AZG	4	1,1	PZFR5D-11	7968			
Beetle	2.0	85	01.03-	BER	4	1,1	PZFR5D-11	7968			
Beetle	2.0	85	03.00-	APK	4	1,0	BKUR6ET-10	2397	24	PFR6Q	6458
Beetle	2.0	85	06.00-05.01	AEG	4	1,0	BKUR6ET-10	2397	24	PFR6Q	6458
Beetle	2.0	85	06.01-	AZJ	4	1,1	PZFR5D-11	7968			
Beetle	2.0	85	11.98-	AQY	4	1,0	BKUR6ET-10	2397	24	PFR6Q	6458
Beetle	2.3	125	10.00-	AQN	5	1,1	PZFR5D-11	7968			
Beetle RSI	3.2	165	10.00-05.01	AXJ	6	1,1	PZFR5D-11	7968			

¹⁾ Bic = Best in class (siehe Seite 3) / (see page 3)



ℓ kW

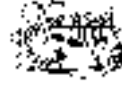

Cyl.

Order-
No. No.Bic¹⁾ Order-
No.**VW**

Bora AUTOMATIC	1.4	55	05.00-10.01	AXP	4	1,1	PZFR5D-11	7968				
Bora	1.4	55	10.01-	BCA	4	1,1	PZFR5D-11	7968				
Bora	1.4	55	05.00-10.01	AXP	4	1,0	BKUR6ET-10	2397	24	PFR6Q		6458
Bora 16V	1.4	55	05.99-05.00	APE	4	1,0	BKUR6ET-10	2397	24	PFR6Q		6458
Bora 16V	1.4	55	09.98-05.00	AKQ	4	1,0	BKUR6ET-10	2397	24	PFR6Q		6458
Bora	1.4	55	10.98-	AHW	4	1,0	BKUR6ET-10	2397	24	PFR6Q		6458
Bora	1.6	74	09.98-05.03	AKL	4	1,0	BKUR6ET-10	2397	24	PFR6Q		6458
Bora	1.6	74	09.00-04.02	AVU	4	1,0	BKUR6ET-10	2397	24	PFR6Q		6458
Bora	1.6	74	09.98-06.02	AEH	4	1,0	BKUR6ET-10	2397	24	PFR6Q		6458
Bora	1.6	74	05.99-09.00	APF	4	1,0	BKUR6ET-10	2397	24	PFR6Q		6458
Bora	1.6	75	05.02-	BFQ	4	1,0	BKUR6ET-10	2397	24	PFR6Q		6458
Bora	1.6	77	11.99-05.00	ATN	4	1,0	BKUR6ET-10	2397	24	PFR6Q		6458
Bora	1.6	77	11.01-	BCB	4	1,0	BKUR6ET-10	2397	24	PFR6Q		6458
Bora	1.6	77	05.00-10.00	AUS	4	1,0	BKUR6ET-10	2397	24	PFR6Q		6458
Bora 16V	1.6	77	09.00-11.01	AZD	4	1,0	BKUR6ET-10	2397	24	PFR6Q		6458
Bora	1.6	78		AWB	4	1,0	BKUR6ET-10	2397	24	PFR6Q		6458
Bora FSI	1.6	81	08.01-	BAD	4		ZFR6S-Q	6449				
Bora	1.8	92	09.98-10.00	AGN	4	1,0	BKUR6ET-10	2397	24	PFR6Q		6458
Bora	1.8	92		BAF	4	1,0	BKUR6ET-10	2397	24	PFR6Q		6458
Bora	1.8	110	09.00-	AUM	4	0,8	PFR6Q	6458				
Bora	1.8	110	09.00-04.01	ARX	4	0,8	PFR6Q	6458				
Bora	1.8	110	09.00-05.03	AGU	4	0,8	PFR6Q	6458				
Bora Turbo	1.8	110		BAE	4	0,8	PFR6Q	6458				
Bora	1.8	132	05.02-	AUQ	4	0,8	PFR6Q	6458				
Bora SDI	1.9	50	11.98-	AQM	4		Y-732U	2408				
Bora	1.9	50	05.00-04.01	AGP	4		Y-732U	2408				
Bora TDI	1.9	66	01.99-05.00	ANU	4		Y-732U	2408				
Bora TDI	1.9	66	09.98-05.03	ALH	4		Y-732U	2408				
Bora	1.9	66	10.98-09.02	AGR	4		Y-732U	2408				
Bora TDI Fgst ---> 1J-2-600000	1.9	74	05.01-05.03	AXR	4		Y-732U	2408				
Bora TDI Fgst 1J-2-600001 --->	1.9	74	05.01-05.03	AXR	4		Y-741U	5065				
Bora TDI Fgst 1J-2-600001 --->	1.9	74	05.00-05.03	ATD	4		Y-741U	5065				
Bora TDI Fgst ---> 1J-2-600000	1.9	74	05.00-05.03	ATD	4		Y-732U	2408				
Bora TDI	1.9	81	05.00-	ASV	4		Y-732U	2408				
Bora TDI	1.9	81	09.98-05.03	AHF	4		Y-732U	2408				
Bora	1.9	85	11.98-07.01	AJM	4		Y-732U	2408				
Bora TDI	1.9	85	05.00-07.01	AUY	4		Y-732U	2408				
Bora TDI Fgst ---> 1J-2-600000	1.9	96	04.01-	ASZ	4		Y-732U	2408				
Bora TDI Fgst 1J-2-600001 --->	1.9	96	04.01-	ASZ	4		Y-741U	5065				
Bora TDI Fgst 1J-2-600001 --->	1.9	110	09.00-	ARL	4		Y-741U	5065				
Bora TDI Fgst ---> 1J-2-600000	1.9	110	09.00-	ARL	4		Y-732U	2408				
Bora	2.0	85	04.00-06.01	AZH	4	1,0	BKUR6ET-10	2397	24	PFR6Q		6458
Bora	2.0	85	11.98-	APK	4	1,0	BKUR6ET-10	2397	24	PFR6Q		6458
Bora	2.0	85	09.98-	AQY	4	1,0	BKUR6ET-10	2397	24	PFR6Q		6458
Bora	2.0	85	05.01-	AZJ	4	1,1	PZFR5D-11	7968				
Bora	2.3	110	09.98-02.01	AGZ	5	0,8	BKR5EKUP	2890				
Bora	2.3	125	09.00-05.03	AQN	5	1,1	PZFR5D-11	7968				
Bora VR6	2.8	150	05.99-05.00	AQP	6	1,1	PZFR5D-11	7968				
Bora	2.8	150	05.01-05.03	BDE	6	1,1	PZFR5D-11	7968				
Bora VR6	2.8	150	05.00-04.01	AUE	6	1,1	PZFR5D-11	7968				
Caddy	1.4	44	11.97-09.00	AKV	4	0,8	BUR6ET	3172	1	PGR6D		6248
Caddy	1.4	44	11.95-12.97	AEX	4	0,8	BUR6ET	3172	1	PGR6D		6248

¹⁾ Bic = Best in class (siehe Seite 3) / (see page 3)

Fgst = Chassis No.



ℓ kW



Cyl.

Order-
No. No.Bic¹⁾ Order-
No.**VW**

Caddy	1.4	44	12.97-06.03	APQ	4	0,8	BUR6ET	3172	1	PGR6D	6248
Caddy	1.4	44	09.00-06.03	AUD	4	1,1	PZFR5D-11	7968			
Caddy	1.4	44	08.98-	ANX	4	0,8	BUR6ET	3172	1	PGR6D	6248
Caddy	1.4	55	09.00-06.03	AUA	4	1,0	BKUR6ET-10	2397	24	PFR6Q	6458
Caddy	1.6	40	08.90-07.92	ME	4	█	Y-918R	4182			
Caddy	1.6	40	10.82-07.90	JK	4	█	Y-918R	4182			
Caddy	1.6	55	11.83-07.91	EW	4	0,7	BP6ES	7811	4	BPR6EIX	6637
Caddy	1.6	55	11.95-05.97	1F	4	0,8	BUR5ET	3377	22	PGR6D	6248
Caddy Pickup	1.6	55	06.96-12.00	AEE	4	0,8	BUR6ET	3172	1	PGR6D	6248
Caddy	1.6	55	08.83-07.89	HN	4	0,7	BP6ES	7811	4	BPR6EIX	6637
Caddy	1.7	42	07.96-09.00	AHB	4	█	Y-918R	4182			
Caddy	1.8	70	08.85-07.92	JH	4	0,8	BUR6ET	3172	1	PGR6D	6248
Caddy	1.9	47	06.96-12.00	AEF	4	█	Y-918R	4182			
Caddy SDI	1.9	47	07.96-09.01	AGD	4	█	Y-732U	2408			
Caddy	1.9	47	11.95-09.00	AEY	4	█	Y-732U	2408			
Caddy SDI	1.9	47	09.00-06.03	AYQ	4	█	Y-732U	2408			
Caddy	1.9	47	11.95-	1Y	4	█	Y-918R	4182			
Caddy TDI	1.9	66	09.97-09.00	ALE	4	█	Y-732U	2408			
Caddy TDI	1.9	66	09.00-	ALH	4	█	Y-732U	2408			
Caddy TDI	1.9	66	10.96-09.00	AHU	4	█	Y-732U	2408			
Corrado 16V	1.8	98	04.89-07.92	KR	4	0,8	BCP7ET	2078		BCPR7EIX	5690
Corrado G60	1.8	118	10.88-09.93	PG	4		---				
Corrado G60	1.8	118	09.88-07.93	PG	4		---				
Corrado	2.0	85	04.93-09.94	2E	4	0,8	BUR6ET	3172	1	PGR6D	6248
Corrado	2.0	85	07.94-07.95	ADY	4	0,8	BUR6ET	3172	1	PGR6D	6248
Corrado	2.0	100	08.91-07.95	9A	4	0,8	BKUR7ET	7873		PFR7Q	7963
Corrado VR6	2.8	128	08.91-01.96	AAA	6	0,8	BKR5EKUP	2890			
Corrado VR6	2.8	132	08.91-06.95	AAA	6	0,7	BKR5EKU	3964			
Corrado VR6	2.8	132	07.95-01.96	AAA	6	0,8	BKR5EKUP	2890			
Corrado VR6	2.9	140	08.91-07.95	ABV	6	0,7	BKR5EKU	3964			
Golf 1 D,TD	1.6	40	08.80-10.91		4	█	Y-918R	4182			
Golf 2/ Jetta	1.0	37	08.88-07.89	HZ	4	0,7	BP6ESZ	7639		PGR6D	6248
Golf 2/ Jetta	1.0	37	05.85-08.88	HZ	4	0,8	BUR6ET	3172	1	PGR6D	6248
Golf 2/ Jetta	1.0	37	08.89-10.91	HZ	4	0,8	BUR6ET	3172	1	PGR6D	6248
Golf 2/ Jetta	1.3	37	08.85-12.87	NU	4	0,8	BUR6ET	3172	1	PGR6D	6248
Golf 2/ Jetta	1.3	40	08.85-08.88	NZ	4	0,8	BUR6ET	3172	1	PGR6D	6248
Golf 2/ Jetta	1.3	40	08.89-08.91	MH	4	0,8	BUR6ET	3172	1	PGR6D	6248
Golf 2/ Jetta	1.3	40	08.89-07.92	NZ	4	0,8	BUR6ET	3172	1	PGR6D	6248
Golf 2/ Jetta	1.3	40	08.88-07.89	NZ	4	0,7	BP6ESZ	7639		PGR6D	6248
Golf 2/ Jetta	1.3	40	01.89-07.92	2G	4	0,8	BUR6ET	3172	1	PGR6D	6248
Golf 2/ Jetta	1.3	40	08.88-07.89	MH	4	0,7	BP6ESZ	7639		PGR6D	6248
Golf 2/ Jetta	1.3	40	08.85-08.88	MH	4	0,8	BUR6ET	3172	1	PGR6D	6248
Golf 2/ Jetta	1.3	40	08.83-07.86	HK	4	0,7	BP6ES	7811	4	BPR6EIX	6637
Golf 2/ Jetta	1.3	44	08.85-08.88	2C	4	0,8	BUR6ET	3172	1	PGR6D	6248
Golf 2 D,TD	1.6	40	01.84-10.91		4	█	Y-918R	4182			
Golf 2/ Jetta	1.6	44	08.98-07.92	1V	4	█	Y-918R	4182			
Golf 2/ Jetta	1.6	51	08.85-07.92	PN	4	1,0	BUR5ET-10	7264	21	PGR6D	6248
Golf 2/ Jetta	1.6	51	08.85-07.87	EZA	4	1,0	BP5ET-10	5156			
Golf 2/ Jetta	1.6	53	08.86-10.91	RF	4	1,0	BUR5ET-10	7264	21	PGR6D	6248
Golf 2 / Jetta	1.6	53		ACR	4	0,8	BP6ET	1263		PGR6D	6248
Golf 2 / Jetta	1.6	53		ANL	4	0,8	BP6ET	1263		PGR6D	6248
Golf 2	1.6	53	07.91-07.92	ABX	4	1,0	BP5ET-10	5156			

¹⁾ Bic = Best in class (siehe Seite 3) / (see page 3)



l kW

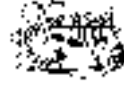

Cyl.

Order-
No. No.Bic¹⁾ Order-
No.**VW**

Golf 2/ Jetta	1.6	53	04.86-07.90	RE	4	1,0	BUR5ET-10	7264	21	PGR6D	6248
Golf 2/ Jetta	1.6	55	08.83-07.91	EZ	4	1,0	BP5ET-10	5156			
Golf 2/ Jetta	1.6	55	08.83-07.92	EW	4	1,0	BP5ET-10	5156			
Golf 2/ Jetta	1.6	55	08.86-07.92	ABN	4	1,0	BP5ET-10	5156			
Golf 2/ Jetta	1.6	55	08.83-07.88	HM	4	1,0	BP5ET-10	5156			
Golf 2/ Jetta	1.6	55	08.83-07.86	HN	4	1,0	BP5ET-10	5156			
Golf 2/ Jetta	1.6	59	08.89-10.91	SB	4	█	Y-918R	4182			
Golf 2 / Jetta	1.6	64		ATK	4	0,8	BKR5E	7938		BKR5EIX	6341
Golf 2 / Jetta	1.6	74		AHP	4	0,8	BKR5E	7938		BKR5EIX	6341
Golf 2/ Jetta	1.8	62	08.89-07.90	RH	4	0,8	BUR6ET	3172	1	PGR6D	6248
Golf 2/ Jetta	1.8	62	08.87-07.89	RH	4	0,7	BP6ESZ	7639		PGR6D	6248
Golf 2/ Jetta	1.8	62	08.86-07.87	RH	4	0,8	BUR6ET	3172	1	PGR6D	6248
Golf 2/ Jetta	1.8	66	08.83-07.93	EX	4	0,8	BUR6ET	3172	1	PGR6D	6248
Golf 2/ Jetta	1.8	66	01.84-10.91	RP	4	0,8	BUR6ET	3172	1	PGR6D	6248
Golf 2/ Jetta	1.8	66	08.84-07.85	GX	4	0,8	BUR6ET	3172	1	PGR6D	6248
Golf 2/ Jetta	1.8	66	08.84-07.85	HV	4	0,8	BUR6ET	3172	1	PGR6D	6248
Golf 2/ Jetta	1.8	66	08.83-10.91	GU	4	0,8	BUR6ET	3172	1	PGR6D	6248
Golf 2	1.8	70	08.83-07.93	JH	4	0,8	BUR6ET	3172	1	PGR6D	6248
Golf 2/ Jetta	1.8	72	08.88-07.91	1P	4	0,8	BUR6ET	3172	1	PGR6D	6248
Golf 2/ Jetta	1.8	72	08.89-07.93	2H	4	0,8	BUR6ET	3172	1	PGR6D	6248
Golf 2/ Jetta	1.8	77	08.87-10.91	RV	4	0,8	BUR6ET	3172	1	PGR6D	6248
Golf 2/ Jetta	1.8	77	08.85-07.87	RD	4	0,8	BUR6ET	3172	1	PGR6D	6248
Golf 2/ Jetta	1.8	77	01.85-07.85	HT	4	0,8	BUR6ET	3172	1	PGR6D	6248
Golf 2/ Jetta	1.8	79	08.85-07.88	RG	4	0,8	BUR6ET	3172	1	PGR6D	6248
Golf 2/ Jetta	1.8	79	01.87-10.91	PF	4	0,8	BUR6ET	3172	1	PGR6D	6248
Golf 2/ Jetta	1.8	82	01.87-10.91	PB	4	0,8	BUR6ET	3172	1	PGR6D	6248
Golf 2/ Jetta	1.8	82	08.83-07.89	KT	4	0,8	BUR6ET	3172	1	PGR6D	6248
Golf 2/ Jetta	1.8	82	01.84-07.85	EV	4	0,8	BUR6ET	3172	1	PGR6D	6248
Golf 2/ Jetta	1.8	82	01.84-07.88	GZ	4	0,8	BUR6ET	3172	1	PGR6D	6248
Golf 2/ Jetta	1.8	95	02.86-10.91	PL	4	0,8	BKUR7ET	7873		PFR7Q	7963
Golf 2/ Jetta	1.8	102	02.86-10.91	KR	4	0,8	BCP7ET	2078		BCPR7EIX	5690
Golf 2 /G60	1.8	118	04.90-07.91	PG	4		---				
Golf 2/ G60	1.8	118	08.88-07.91	PG	4		---				
Golf 2/ Jetta (USA)	2.0	100	07.89-07.92	9A	4	0,8	BKUR7ET	7873		PFR7Q	7963
Golf 3/ Vento	1.4	44	11.91-07.95	ABD	4	0,8	BP5ET	2287			
Golf 3/ Vento	1.4	44	07.95-12.97	AEX	4	0,8	BUR6ET	3172	1	PGR6D	6248
Golf 3/ Vento	1.6	55	07.95-12.97	AEE	4	0,8	BUR6ET	3172	1	PGR6D	6248
Golf 3/ Vento	1.6	55	10.94-07.95	AEA	4	0,8	BUR6ET	3172	1	PGR6D	6248
Golf 3/ Vento	1.6	55	08.92-09.94	ABU	4	0,8	BUR6ET	3172	1	PGR6D	6248
Golf 3/ Vento	1.6	74	10.94-12.95	AEK	4	0,9	BKUR5ET	2789	29	PFR6Q	6458
Golf 3/ Vento	1.6	74	04.97-10.00	AKS	4	0,9	BKUR5ET	2789	29	PFR6Q	6458
Golf 3/ Vento	1.6	74	01.96-10.00	AFT	4	1,0	BKUR6ET-10	2397	24	PFR6Q	6458
Golf 3/ Vento	1.8	55	07.91-10.00	AAM	4	0,8	BUR5ET	3377	22	PGR6D	6248
Golf 3/ Vento	1.8	55	12.97-10.00	ANN	4	0,8	BUR5ET	3377	22	PGR6D	6248
Golf 3 only Cab.&Vari.	1.8	66	12.97-10.00	ANP	4	0,8	BUR6ET	3172	1	PGR6D	6248
Golf 3/ Vento	1.8	66	08.91-12.97	ACC	4	0,8	BUR6ET	3172	1	PGR6D	6248
Golf 3/ Vento	1.8	66	01.98-	ADD	4	0,8	BUR6ET	3172	1	PGR6D	6248
Golf 3/ Vento	1.8	66	10.94-10.00	ADZ	4	0,8	BUR6ET	3172	1	PGR6D	6248
Golf 3/ Vento	1.8	66	11.91-07.95	ABS	4	0,8	BUR6ET	3172	1	PGR6D	6248
Golf 3 D,TD	1.9	47	11.91-		4	█	Y-918R	4182			
Golf 3	1.9	47	07.95-02.99	AEY	4	█	Y-732U	2408			
Golf 3 SDI	1.9	47	11.91-08.98	1Y	4	█	Y-918R	4182			

¹⁾ Bic = Best in class (siehe Seite 3) / (see page 3)



ℓ kW

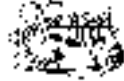

Cyl.

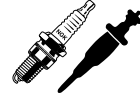
Order-
No. No.Bic¹⁾ Order-
No.**VW**

Golf 3 TD	1.9	55	11.91-08.98	AAZ	4	█	Y-918R	4182			
Golf 3 TDI	1.9	66	07.96-06.00	AHU	4	█	Y-732U	2408			
Golf 3/ Vento TDI	1.9	66	05.96-12.01	ALE	4	█	Y-732U	2408			
Golf 3 TDI	1.9	66	07.93-07.96	1Z	4	█	Y-732U	2408			
Golf 3 TDI	1.9	81	02.96-08.99	AFN	4	█	Y-732U	2408			
Golf 3/ Vento (GUS)	2.0	79	01.95-12.97	AEP	4	0,8	BUR6ET	3172	1	PGR6D	6248
Golf 3/ Vento	2.0	85	10.94-05.96	ADY	4	0,8	BUR6ET	3172	1	PGR6D	6248
Golf 3/ Vento	2.0	85	07.95-12.01	AGG	4	0,8	BUR6ET	3172	1	PGR6D	6248
Golf 3 (USA)	2.0	85	03.92-07.95	ABA	4		BKR5EVX	2546		BKR5EIX	6341
Golf 3/ Vento	2.0	85	11.91-09.94	2E	4	0,8	BUR6ET	3172	1	PGR6D	6248
Golf 3/ Vento (USA)	2.0	85	02.94-07.98	ADC	4		BKR5EVX	2546		BKR5EIX	6341
Golf 3/ Vento	2.0	85	04.97-04.00	AKR	4	0,8	BUR6ET	3172	1	PGR6D	6248
Golf 3/ Vento 16V	2.0	110	08.92-07.94	ABF	4	1,0	BKUR6ET-10	2397	24	PFR6Q	6458
Golf 3 Cabrio	2.3	125	04.00-		5	1,1	PZFR5D-11	7968			
Golf 3/ Vento / VR6	2.8	128	01.92-06.95	AAA	6	0,7	BKR5EKU	3964			
Golf 3/ Vento / VR6	2.8	128	07.95-12.97	AAA	6	0,8	BKR5EKUP	2890			
Golf 3 Syncro / VR6	2.9	140	10.94-12.97	ABV	6	0,7	BKR5EKU	3964			
Golf 4	1.4	44	12.97-05.98	APQ	4	0,8	BUR6ET	3172	1	PGR6D	6248
Golf 4	1.4	55	05.99-05.00	APE	4	1,0	BKUR6ET-10	2397	24	PFR6Q	6458
Golf 4	1.4	55	10.01-	BCA	4	1,1	PZFR5D-11	7968			
Golf 4	1.4	55	10.97-	AHW	4	1,0	BKUR6ET-10	2397	24	PFR6Q	6458
Golf 4 AUTOMATIC	1.4	55	05.00-10.01	AXP	4	1,1	PZFR5D-11	7968			
Golf 4	1.4	55	10.97-05.00	AKQ	4	1,0	BKUR6ET-10	2397	24	PFR6Q	6458
Golf 4	1.4	55	05.00-10.01	AXP	4	1,0	BKUR6ET-10	2397	24	PFR6Q	6458
Golf 4 FSI	1.4	66	10.03-	BKG	4		ZFR6S-Q	6449			
Golf 4	1.6	74	10.97-05.03	AKL	4	1,0	BKUR6ET-10	2397	24	PFR6Q	6458
Golf 4	1.6	74	01.98-06.02	AEH	4	1,0	BKUR6ET-10	2397	24	PFR6Q	6458
Golf 4	1.6	74	09.00-04.02	AVU	4	1,0	BKUR6ET-10	2397	24	PFR6Q	6458
Golf 4	1.6	74	05.99-08.00	APF	4	1,0	BKUR6ET-10	2397	24	PFR6Q	6458
Golf 4	1.6	75	05.02-	BFQ	4	1,0	BKUR6ET-10	2397	24	PFR6Q	6458
Golf 4	1.6	77	11.01-	BCB	4	1,0	BKUR6ET-10	2397	24	PFR6Q	6458
Golf 4	1.6	77	11.99-05.00	ATN	4	1,0	BKUR6ET-10	2397	24	PFR6Q	6458
Golf 4	1.6	77	09.00-11.01	AZD	4	1,0	BKUR6ET-10	2397	24	PFR6Q	6458
Golf 4	1.6	77	05.00-10.00	AUS	4	1,0	BKUR6ET-10	2397	24	PFR6Q	6458
Golf 4 FSI	1.6	81	08.01-	BAD	4		ZFR6S-Q	6449			
Golf 4 FSI	1.6	85	10.03-	BAG	4		ZFR6S-Q	6449			
Golf 4	1.8	92	07.98-10.00	AGN	4	1,0	BKUR6ET-10	2397	24	PFR6Q	6458
Golf 4	1.8	110	09.00-	AUM	4	0,8	PFR6Q	6458			
Golf 4 GTI	1.8	110	10.97-05.03	AGU	4	0,8	PFR6Q	6458			
Golf 4 USA	1.8	110	12.99-09.00	AWD	4	0,8	PFR6Q	6458			
Golf 4	1.8	110	05.99-09.00	ARZ	4	0,8	PFR6Q	6458			
Golf 4 USA	1.8	110	08.00-	AWW	4	0,8	PFR6Q	6458			
Golf 4 GTI	1.8	132	06.01-	AUQ	4	0,8	PFR6Q	6458			
Golf 4 SDI	1.9	50	10.97-04.01	AGP	4	█	Y-732U	2408			
Golf 4 SDI	1.9	50	11.98-	AQM	4	█	Y-732U	2408			
Golf 4	1.9	66	10.97-09.02	AGR	4	█	Y-732U	2408			
Golf 4 TDI	1.9	66	10.97-05.03	ALH	4	█	Y-732U	2408			
Golf 4 TDI	1.9	66	01.99-	ANU	4	█	Y-732U	2408			
Golf 4 TDI Fgst 1J-2-600001 --->	1.9	74	05.01-	AXR	4	█	Y-741U	5065			
Golf 4 TDI Fgst ---> 1J-2-600000	1.9	74	02.00-	ATD	4	█	Y-732U	2408			
Golf 4 TDI Fgst ---> 1J-2-600000	1.9	74	05.01-	AXR	4	█	Y-732U	2408			
Golf 4 TDI Fgst 1J-2-600001 --->	1.9	74	02.00-	ATD	4	█	Y-741U	5065			

¹⁾ Bic = Best in class (siehe Seite 3) / (see page 3)

Fgst = Chassis No.



l kW

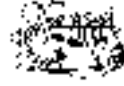

Cyl.

Order-
No. No.Bic¹⁾ Order-
No.

VW

Golf 4 TDI	1.9	81	05.00-	ASV	4	Y-732U	2408				
Golf 4 TDI	1.9	81	10.97-05.03	AHF	4	Y-732U	2408				
Golf 4 TDI	1.9	81	08.99-10.00	AVG	4	Y-732U	2408				
Golf 4	1.9	85	05.99-07.01	AJM	4	Y-732U	2408				
Golf 4 TDI	1.9	85	01.00-07.01	AUY	4	Y-732U	2408				
Golf 4 TDI Fgst 1J-2-600001 --->	1.9	96	04.01-	ASZ	4	Y-741U	5065				
Golf 4 TDI Fgst ---> 1J-2-600000	1.9	96	04.01-	ASZ	4	Y-732U	2408				
Golf 4 TDI Fgst ---> 1J-2-600000	1.9	110	09.00-	ARL	4	Y-732U	2408				
Golf 4 TDI Fgst 1J-2-600001 --->	1.9	110	09.00-	ARL	4	Y-741U	5065				
Golf 4	2.0	85	04.00-06.01	AZH	4	1,0 BKUR6ET-10	2397	24	PFR6Q		6458
Golf 4	2.0	85	08.98-05.03	AQY	4	1,0 BKUR6ET-10	2397	24	PFR6Q		6458
Golf 4	2.0	85	08.98-05.03	APK	4	1,0 BKUR6ET-10	2397	24	PFR6Q		6458
Golf 4	2.0	85	05.01-	AZJ	4	1,1 PZFR5D-11	7968				
Golf 4 Cabrio	2.0	85	06.00-06.02	AWG	4	0,8 PFR6Q	6458				
Golf 4	2.0	85	05.01-04.02	AZG	4	1,1 PZFR5D-11	7968				
Golf 4 Cabrio	2.0	85	06.00-06.02	AWF	4	0,8 PFR6Q	6458				
Golf 4	2.0	85	06.98-	AEG	4	1,0 BKUR6ET-10	2397	24	PFR6Q		6458
Golf 4	2.0	85	06.99-06.00	ATU	4	0,8 PFR6Q	6458				
Golf 4	2.0	85	05.02-	BEH	4	1,1 PZFR5D-11	7968				
Golf 4 V5	2.3	110	10.97-02.01	AGZ	5	0,8 BKR5EKUP	2890				
Golf 4	2.3	125	09.00-05.03	AQN	5	1,1 PZFR5D-11	7968				
Golf 4 USA	2.8	130	03.98-05.00	AFP	6	0,8 BKR5EKUP	2890				
Golf 4 VR6	2.8	150	01.00-04.01	AUE	6	1,1 PZFR5D-11	7968				
Golf 4 VR6	2.8	150	05.99-05.00	AQP	6	1,1 PZFR5D-11	7968				
Golf 4	2.8	150	05.01-	BDE	6	1,1 PZFR5D-11	7968				
Golf 4 R32	3.2	177	06.02-	BFH	6	0,9 IZKR7B					
Golf 4 R32	3.2	184	01.03-	BHR	6	0,9 IZKR7B					
Golf 5	1.4	55	10.03-	BCA	4	1,0 BKUR6ET-10	2397	24	PFR6Q		6458
Golf 5	1.6	75	01.04-	BGU	4	1,0 BKUR6ET-10	2397	24	PFR6Q		6458
Golf 5 FSI	1.6	85	10.03-	BAG	4	ZFR6S-Q	6449				
Golf 5 FSI	1.6	85	05.04-	BLP	4	ZFR6S-Q	6449				
Golf 5 FSI	2.0	110	10.03-05.04	AXW	4	1,1 PZFR5N-11TG					
Golf 5 FSI	2.0	110	05.04-	BLX	4	1,1 PZFR5N-11TG					
Ittis	1.7	55	01.79-12.88	WL	4	0,7 BP6ES	7811	4	BPR6EIX		6637
Ittis	1.7	55	01.79-12.88	YX	4	0,7 BP6ES	7811	4	BPR6EIX		6637
Jetta D,TD	1.6	40	01.84-10.91		4	Y-918R	4182				
Jetta	1.6	53		ABX	4	1,0 BP5ET-10	5156				
Jetta (USA)	2.0	85	08.92-01.94	ABA	4	BKR5EVX	2546		BKR5EIX		6341
Käfer (MEXICO IMPORT)	1.6	34	01.93-	ACD	4	0,8 BP5ESA	2285				
LT	2.3	105	05.96-11.01	AGL	4	0,9 BKUR5ET	2789	29	PFR6Q		6458
LT	2.4	51	08.89-03.96		5	Y-918R	4182				
LT	2.4	51	08.92-12.95	ACT	6	Y-918R	4182				
LT TD	2.4	55	08.78-03.96		5	Y-918R	4182				
LT	2.4	55	08.78-03.96		5	Y-918R	4182				
LT TD	2.4	55	12.82-07.92	DW	6	Y-918R	4182				
LT TD 4X4	2.4	55	09.85-03.96		5	Y-918R	4182				
LT	2.4	62	12.82-07.86	HS	4	0,7 BP6ES	7811	4	BPR6EIX		6637
LT	2.4	66	08.82-07.92	DL	6	0,7 BP6ESZ	7639		PGR6D		6248
LT Td	2.4	68	08.88-07.91	1G	6	Y-918R	4182				
LT TD	2.4	68	12.82-03.96		5	Y-918R	4182				
LT	2.4	70	08.88-12.95	1E	6	0,7 BP6ESZ	7639		PGR6D		6248
LT TD	2.4	70	08.91-12.95	ACL	6	Y-918R	4182				

¹⁾ Bic = Best in class (siehe Seite 3) / (see page 3)

Fgst = Chassis No.



ℓ kW

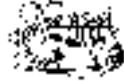

Cyl.

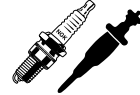
Order-
No. No.Bic¹⁾ Order-
No.**VW**

LT TD	2.4	75	12.82-07.92	DV	6	█	Y-918R	4182			
LT	2.5	66	05.99-04.01	APA	4	█	Y-732U	2408			
LT TDI	2.5	70	04.01-	BBF	5	█	Y-732U	2408			
LT TD	2.5	75	08.95-04.96	ACV	5	█	Y-732U	2408			
LT TDI	2.5	75	05.96-05.99	AHD	5	█	Y-732U	2408			
LT	2.5	80	05.99-	ANJ	5	█	Y-732U	2408			
LT 28 D	2.4	51	08.88-12.95	1S	6	█	Y-918R	4182			
LT 28 D	2.4	55	08.78-		6	█	Y-918R	4182			
LT 28 D TD	2.4	68	12.82-		6	█	Y-918R	4182			
LT 28 SDI	2.5	55	05.96-		5	█	Y-732U	2408			
LT 28 TDi	2.8	92	05.96-		6	█	Y-732U	2408			
LT 31 D	2.4	51	08.88-12.95	1S	6	█	Y-918R	4182			
LT 31 D	2.4	55	08.78-		6	█	Y-918R	4182			
LT 31 D TD	2.4	68	12.82-		6	█	Y-918R	4182			
LT 35 SDI	2.5	55	05.96-04.01	AGX	5	█	Y-732U	2408			
LT 35 TDi	2.8	92	05.96-		5	█	Y-732U	2408			
LT 40 D	2.4	51	08.88-12.95	1S	6	█	Y-918R	4182			
LT 40 D / TD 4X4	2.4	55	09.85-		4	█	Y-918R	4182			
LT 40 D	2.4	55	08.78-		6	█	Y-918R	4182			
LT 40 D TD	2.4	68	12.82-		4	█	Y-918R	4182			
LT 45 D / TD 4X4	2.4	55	08.78-		4	█	Y-918R	4182			
LT 45 D / TD	2.4	55	09.85-		4	█	Y-918R	4182			
LT 50 D / TD	2.4	55	08.78-		4	█	Y-918R	4182			
LT 55 D / TD	2.4	55	08.78-		4	█	Y-918R	4182			
Lupo	1.0	37	05.99-	ALD	4	1,1	PZFR5D-11	7968			
Lupo	1.0	37	10.98-05.00	AHT	4	1,0	BKR6ETA-10	7998			
Lupo	1.0	37	10.98-05.00	ALL	4	0,8	BUR6ET	3172	1	PGR6D	6248
Lupo	1.0	37	01.99-05.00	AER	4	0,8	BUR6ET	3172	1	PGR6D	6248
Lupo	1.0	37	05.99-05.00	ANV	4	1,1	PZFR5D-11	7968			
Lupo	1.0	37	05.00-	AUC	4	1,1	PZFR5D-11	7968			
Lupo TDI	1.2	45	06.99-11.00	ANY	3	█	Y-732U	2408			
Lupo TDI 6x-2-005 001>	1.2	45	11.00-	AYZ	3	█	Y-741U	5065			
Lupo TDI >6x-2-005 000	1.2	45	11.00-	AYZ	3	█	Y-732U	2408			
Lupo	1.4	44	09.00-	AUD	4	1,1	PZFR5D-11	7968			
Lupo	1.4	55	05.99-09.00	APE	4	1,0	BKUR6ET-10	2397	24	PFR6Q	6458
Lupo	1.4	55	04.02-	BBY	4	1,0	BKUR6ET-10	2397	24	PFR6Q	6458
Lupo	1.4	55	07.98-05.99	AKQ	4	1,0	BKUR6ET-10	2397	24	PFR6Q	6458
Lupo TDI 6x-2-005 001>	1.4	55	05.99-	AMF	4	█	Y-741U	5065			
Lupo	1.4	55	01.99-	AHW	4	1,0	BKUR6ET-10	2397	24	PFR6Q	6458
Lupo	1.4	55	05.00-04.02	AUA	4	1,0	BKUR6ET-10	2397	24	PFR6Q	6458
Lupo TDI >6x-2-005 000	1.4	55	05.99-	AMF	4	█	Y-732U	2408			
Lupo	1.4	74	05.99-10.00	AFK	4	1,0	BKUR6ET-10	2397	24	PFR6Q	6458
Lupo	1.4	74	05.00-	AUB	4	1,0	BKUR6ET-10	2397	24	PFR6Q	6458
Lupo	1.4	74	05.99-05.00	AQQ	4	1,0	BKUR6ET-10	2397	24	PFR6Q	6458
Lupo	1.4	74	05.99-05.00	ANM	4	1,0	BKUR6ET-10	2397	24	PFR6Q	6458
Lupo FSI	1.4	77	09.00-	ARR	4		ZFR6S-Q	6449			
Lupo GTI	1.6	92	06.00-	AVY	4	1,0	BKUR6ET-10	2397	24	PFR6Q	6458
Lupo SDI	1.7	42	10.98-	AKU	3	█	Y-732U	2408			
Passat 1 (Typ 32/33) D	1.6	40	08.80-07.91		4	█	Y-918R	4182			
Passat 1 (Typ 32/33)	1.6	40	08.81-03.88	JK	4	█	Y-918R	4182			
Passat 2 (Typ 32B)	1.6	51	08.83-03.88	PP	4	1,0	BUR5ET-10	7264	21	PGR6D	6248
Passat 2 (Typ 32B) TD	1.6	51	12.81-03.88	CY	4	█	Y-918R	4182			

¹⁾ Bic = Best in class (siehe Seite 3) / (see page 3)



ℓ kW

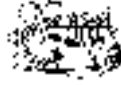

Cyl.

Order-
No. No.Bic¹⁾ Order-
No.

VW

Passat 2 (Typ 32B)	1.6	51	08.86-03.88	DTA	4	1,0	BP5ET-10	5156				
Passat 2 (Typ 32B)	1.6	53	08.83-03.88	RL	4	1,0	BP5ET-10	5156				
Passat 2 (Typ 32B)	1.6	55	08.83-03.88	DT	4	1,0	BP5ET-10	5156				
Passat 2 (Typ 32B)	1.6	55	08.83-07.86	JU	4	1,0	BP5ET-10	5156				
Passat 2 (Typ 32B)	1.8	64	09.82-03.88	RM	4	0,8	BUR6ET	3172	1	PGR6D		6248
Passat 2 (Typ 32B)	1.8	66	08.83-07.88	JN	4	0,8	BUR6ET	3172	1	PGR6D		6248
Passat 2 (Typ 32B)	1.8	66	09.82-04.88	JV	4	0,8	BUR6ET	3172	1	PGR6D		6248
Passat 2 (Typ 32B)	1.8	66	01.83-07.88	DS	4	0,8	BUR6ET	3172	1	PGR6D		6248
Passat 2 (Typ 32B)	1.8	79	01.83-07.90	PF	4	0,8	BUR6ET	3172	1	PGR6D		6248
Passat 2 (Typ 32B)	1.8	82	01.83-07.90	PB	4	0,8	BUR6ET	3172	1	PGR6D		6248
Passat 2 (Typ 32B) D	1.9	47	05.89-10.93	1Y	4	█	Y-918R	4182				
Passat 2 (Typ 32B)	2.0	85	08.83-03.88	JS	4	0,8	BUR6ET	3172	1	PGR6D		6248
Passat 2 (Typ 32B)	2.0	85	08.83-07.88	HP	4	0,8	BUR6ET	3172	1	PGR6D		6248
Passat 2 (Typ 32B)	2.2	85	08.85-03.88	KX	5	0,8	BUR6ET	3172	1	PGR6D		6248
Passat 2 (Typ 32B)	2.2	88	08.85-07.88	JT	5	0,8	BUR6ET	3172	1	PGR6D		6248
Passat 2 (Typ 32B)	2.2	100	01.85-03.88	KV	5	0,8	BUR6ET	3172	1	PGR6D		6248
Passat 2 (Typ 32B)	2.2	100	08.84-07.88	HY	5	0,8	BUR6ET	3172	1	PGR6D		6248
Passat 3 (Typ 35i)	1.6	53	04.88-07.91	RF	4	1,0	BUR5ET-10	7264	21	PGR6D		6248
Passat 3 (Typ 35i)	1.6	55	08.88-07.89	1F	4	0,8	BUR5ET	3377	22	PGR6D		6248
Passat 3 (Typ 35i)	1.6	55	04.88-07.89	EZ	4	0,8	BUR6ET	3172	1	PGR6D		6248
Passat 3 (Typ 35i)	1.6	55	08.89-09.91	EZ	4	1,0	BP5ET-10	5156				
Passat 3 (Typ 35i)	1.6	55	08.89-07.92	ABN	4	1,0	BP5ET-10	5156				
Passat 3 (Typ 35i) TD	1.6	59	08.89-10.93	SB	4	█	Y-918R	4182				
Passat 3 (Typ 35i)	1.6	65		AYE	4	0,8	BP5ES	6511	8	BPR5EIX		6597
Passat 3 (Typ 35i)	1.6	74	10.94-12.95	AEK	4	0,9	BKUR5ET	2789	29	PFR6Q		6458
Passat 3 (Typ 35i)	1.6	74	12.95-12.96	AFT	4	1,0	BKUR6ET-10	2397	24	PFR6Q		6458
Passat 3 (Typ 35i)	1.8	55	08.90-12.96	AAM	4	0,8	BUR5ET	3377	22	PGR6D		6248
Passat 3 (Typ 35i)	1.8	66	08.91-09.94	ABS	4	0,8	BUR6ET	3172	1	PGR6D		6248
Passat 3 (Typ 35i)	1.8	66	04.88-07.91	RP	4	0,8	BUR6ET	3172	1	PGR6D		6248
Passat 3 (Typ 35i)	1.8	66	08.94-12.96	ADZ	4	0,8	BUR6ET	3172	1	PGR6D		6248
Passat 3 (Typ 35i)	1.8	74		AYJ	4	0,8	BKR5E	7938		BKR5EIX		6341
Passat 3 (Typ 35i) (GUS)	1.8	85	01.97-04.00	AFY	4	1,0	BKUR6ET-10	2397	24	PFR6Q		6458
Passat 3 (Typ 35i)	1.8	100	04.88-07.92	KR	4	0,8	BCP7ET	2078		BCPR7EIX		5690
Passat 3 (Typ 35i) G60	1.8	118	10.88-04.93	PG	4		---					
Passat 3 (Typ 35i) D,TD	1.9	48	05.89-		4	█	Y-918R	4182				
Passat 3 (Typ 35i) TD	1.9	55	03.91-12.96	AAZ	4	█	Y-918R	4182				
Passat 3 (Typ 35i) TDI	1.9	66	08.89-12.96	1Z	4	█	Y-732U	2408				
Passat 3 (Typ 35i) TDI	1.9	66	08.96-08.00	AHU	4	█	Y-732U	2408				
Passat 3 (Typ 35i) TDI	1.9	81	03.96-08.99	AFN	4	█	Y-732U	2408				
Passat 3 (Typ 35i)	2.0	79	03.95-12.96	AEP	4	0,8	BUR6ET	3172	1	PGR6D		6248
Passat 3 (Typ 35i)	2.0	85	10.94-12.95	ADY	4	0,8	BUR6ET	3172	1	PGR6D		6248
Passat 3 (Typ 35i)	2.0	85	06.93-12.94	ACX	4	0,8	BUR6ET	3172	1	PGR6D		6248
Passat 3 (Typ 35i)	2.0	85	07.96-12.96	AGG	4	0,8	BUR6ET	3172	1	PGR6D		6248
Passat 3 (Typ 35i)	2.0	85	03.90-09.94	2E	4	0,8	BUR6ET	3172	1	PGR6D		6248
Passat 3 (Typ 35i)	2.0	100	04.88-10.93	9A	4	0,8	BKUR7ET	7873		PFR7Q		7963
Passat 3 (Typ 35i)	2.0	110	07.94-12.96	ABF	4	1,0	BKUR6ET-10	2397	24	PFR6Q		6458
Passat 3 (Typ 35i)	2.8	128	07.95-12.96	AAA	6	0,8	BKR5EKUP	2890				
Passat 3 (Typ 35i) (US)	2.8	142	10.94-12.95	AHA	6	0,8	BKR6EKUB	3584	30	BKR6EQU		3199
Passat 3 (Typ 35i)	2.9	135	07.95-12.96	ABV	6	0,8	BKR5EKUP	2890				
Passat 3 (Typ 35i)	2.9	135	07.94-06.95	ABV	6	0,7	BKR5EKU	3964				
Passat 4 (Typ 3B)	1.6	74	10.96-08.00	AHL	4	1,0	BKUR6ET-10	2397	24	PFR6Q		6458
Passat 4 (Typ 3B)	1.6	74	07.99-08.00	ANA	4	1,0	BKUR6ET-10	2397	24	PFR6Q		6458

¹⁾ Bic = Best in class (siehe Seite 3) / (see page 3)



ℓ kW

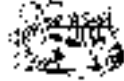

Cyl.

Order-
No. No.Bic¹⁾ Order-
No.**VW**

Passat 4 (Typ 3B)	1.6	74	01.99-08.00	ARM	4	1,0	BKUR6ET-10	2397	24	PFR6Q	6458
Passat 4 (Typ 3B)	1.6	74	01.97-10.97	ADP	4	1,0	BKUR6ET-10	2397	24	PFR6Q	6458
Passat 4 (Typ 3B)	1.6	75	10.00-	ALZ	4	1,0	BKUR6ET-10	2397	24	PFR6Q	6458
Passat 4 (Typ 3B)	1.8	84		AJR	4	0,8	BKR5E	7938		BKR5EIX	6341
Passat 4 (Typ 3B)	1.8	92	02.99-08.00	ARG	4	1,0	BKUR6ET-10	2397	24	PFR6Q	6458
Passat 4 (Typ 3B)	1.8	92	01.99-08.00	APT	4	1,0	BKUR6ET-10	2397	24	PFR6Q	6458
Passat 4 (Typ 3B)	1.8	92	12.96-01.99	ADR	4	1,0	BKUR6ET-10	2397	24	PFR6Q	6458
Passat	1.8	92		ANQ	4	1,0	BKUR6ET-10	2397	24	PFR6Q	6458
Passat 4 (Typ 3B)	1.8	110		AWL	4	0,8	PFR6Q	6458			
Passat 4 (Typ 3B)	1.8	110	10.96-12.98	AEB	4	0,8	PFR6Q	6458			
Passat 4 (Typ 3B)	1.8	110	01.99-08.00	APU	4	0,8	PFR6Q	6458			
Passat 4 (Typ 3B)	1.8	110	01.99-08.00	ANB	4	0,8	PFR6Q	6458			
Passat 4 (Typ 3B) USA	1.8	110	08.99-05.00	ATW	4	0,8	PFR6Q	6458			
Passat 4 (Typ 3B)	1.8	110	10.00-	AWT	4	0,8	PFR6Q	6458			
Passat 4 (Typ 3B) USA	1.8	110	05.00-08.00	AUG	4	0,8	PFR6Q	6458			
Passat 4 (Typ 3B) USA	1.8	125	02.01-	AWM	4	0,8	PFR6Q	6458			
Passat 4 (Typ 3B) TDI	1.9	66	05.98-08.00	AHH	4	█	Y-732U	2408			
Passat 4 (Typ 3B) TDI	1.9	74	10.00-	AVB	4	█	Y-741U	5065			
Fgst 3B-2-350-001 --->											
Passat 4 (Typ 3B) TDI	1.9	74	10.00-	AVB	4	█	Y-732U	2408			
Fgst ---> 3B-2-350-000											
Passat 4 (Typ 3B) TDI	1.9	81	08.99-08.00	AVG	4	█	Y-732U	2408			
Passat 4 (Typ 3B) TDI	1.9	85	01.00-08.00	ATJ	4	█	Y-732U	2408			
Passat 4 (Typ 3B) TDI	1.9	85	01.99-12.99	AJM	4	█	Y-732U	2408			
Passat 4 (Typ 3B) TDI	1.9	96	10.00-	AVF	4	█	Y-732U	2408			
Fgst ---> 3B-2-350-000											
Passat 4 (Typ 3B) TDI	1.9	96	10.00-	AWX	4	█	Y-741U	5065			
Fgst 3B-2-350-001 --->											
Passat 4 (Typ 3B) TDI	1.9	96	10.00-	AWX	4	█	Y-732U	2408			
Fgst ---> 3B-2-350-000											
Passat 4 (Typ 3B) TDI	1.9	96	10.00-	AVF	4	█	Y-741U	5065			
Fgst 3B-2-350-001 --->											
Passat 4 (Typ 3B)	2.0	85	10.00-	AZM	4	1,0	BKUR6ET-10	2397	24	PFR6Q	6458
Passat 4 (Typ 3B)	2.0	95	11.01-	ALT	4	1,0	BKUR5ET-10	7553			
Passat 4 (Typ 3B)	2.3	110	09.97-08.00	AGZ	5	0,8	BKR5EKUP	2890			
Passat 4 (Typ 3B)	2.3	125	01.01-	AZX	5	1,1	PZFR5D-11	7968			
Passat 4 (Typ 3B) TDI V6	2.5	110	08.98-08.00	AFB	6	█	Y-501U	3786			
Passat 4 (Typ 3B) TDI V6	2.5	110	05.99-05.03	AKN	6	█	Y-501U	3786			
Passat 4 (Typ 3B) TDI	2.5	120	05.03-	BDG	6	█	Y-501U	3786			
Passat 4 (Typ 3B) TDI	2.5	132	01.03-	BDH	6	█	Y-501U	3786			
Passat 4 (Typ 3B) TDI	2.5	132	01.03-	BAU	6	█	Y-501U	3786			
Passat 4 (Typ 3B)	2.8	128	06.91-06.95	AAA	6	0,7	BKR5EKU	3964			
Passat 4 (Typ 3B) (GUS, CHINA)	2.8	132	09.97-09.99	AGE	6	0,8	BKR6EKUB	3584	30	BKR6EQUP	3199
Passat 4 (Typ 3B)	2.8	140	09.99-08.00	ATX	6	0,8	BKR6EKUB	3584	30	BKR6EQUP	3199
Passat 4 (Typ 3B)	2.8	140	10.00-	BBG	6	0,8	BKR6EKUB	3584	30	BKR6EQUP	3199
Passat 4 (Typ 3B)	2.8	142	01.99-08.00	AQD	6	0,8	BKR6EKUB	3584	30	BKR6EQUP	3199
Passat 4 (Typ 3B)	2.8	142	08.97-12.98	ALG	6	0,8	BKR6EKUB	3584	30	BKR6EQUP	3199
Passat 4 (Typ 3B)	2.8	142	10.00-	ATQ	6	0,8	BKR6EKUB	3584	30	BKR6EQUP	3199
Passat 4 (Typ 3B)	2.8	142	06.97-12.98	ACK	6	0,8	BKR6EKUB	3584	30	BKR6EQUP	3199
Passat 4 (Typ 3B)	2.8	142	01.99-08.00	APR	6	0,8	BKR6EKUB	3584	30	BKR6EQUP	3199
Passat 4 (Typ 3B)	2.8	142	10.00-	AMX	6	0,8	BKR6EKUB	3584	30	BKR6EQUP	3199
Passat 4 W8	4.0	202	05.02-	BDP	8		BKR6EKUE				

¹⁾ Bic = Best in class (siehe Seite 3) / (see page 3)

Fgst = Chassis No.



ℓ kW

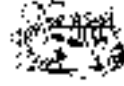

Cyl.

Order-
No. No.Bic¹⁾Order-
No.

VW

Passat 4 W8 4 MOTION	4.0	202	09.01-	BDN	8		BKR6EKUE					
Phaeton	3.2	177	05.02-	AYT	6	0,9	IZKR7B					
Phaeton	3.2	177	08.03-	BKL	6	0,9	IZKR7B					
Phaeton	4.2	246	05.03-07.03	BGJ	8		BKR6EQUA					
Phaeton	4.2	246	05.03-	BGH	8		BKR6EQUA					
Phaeton	6.0	309	10.03-	BAP	12	1,1	PZFR6J-11					
Phaeton	6.0	309	05.02-	BAN	12	1,1	PZFR6J-11					
Polo 2 (Typ 86C..)	1.0	29	08.81-10.86	GL	4	0,7	BP6ES	7811	4	BPR6EIX	6637	
Polo 2 (Typ 86C..)	1.0	33	08.89-12.92	ACM	4	0,8	BUR6ET	3172	1	PGR6D	6248	
Polo 2 (Typ 86C..)	1.0	33	08.88-07.89	HZ	4	0,7	BP6ESZ	7639		PGR6D	6248	
Polo 2 (Typ 86C..)	1.0	33	10.90-07.94	AAU	4	0,8	BP5ET	2287				
Polo 2 (Typ 86C..)	1.0	33	08.85-08.88	HZ	4	0,8	BUR6ET	3172	1	PGR6D	6248	
Polo 2 (Typ 86C..)	1.0	33	01.90-07.90	AAK	4	0,8	BUR6ET	3172	1	PGR6D	6248	
Polo 2 (Typ 86C..)	1.0	33	08.89-01.92	HZ	4	0,8	BUR6ET	3172	1	PGR6D	6248	
Polo 2 (Typ 86C..) D	1.3	33	08.85-07.90	MN	4		Y-918R	4182				
Polo 2 (Typ 86C..)	1.3	37	08.85-08.88	NU	4	0,8	BUR6ET	3172	1	PGR6D	6248	
Polo 2 (Typ 86C..)	1.3	37	08.88-07.89	NU	4	0,7	BP6ESZ	7639		PGR6D	6248	
Polo 2 (Typ 86C..)	1.3	40	08.88-07.89	MH	4	0,7	BP6ESZ	7639		PGR6D	6248	
Polo 2 (Typ 86C..)	1.3	40	01.89-07.94	2G	4	0,8	BUR6ET	3172	1	PGR6D	6248	
Polo 2 (Typ 86C..)	1.3	40	08.89-12.92	NZ	4	0,8	BUR6ET	3172	1	PGR6D	6248	
Polo 2 (Typ 86C..)	1.3	40	05.86-08.88	NZ	4	0,8	BUR6ET	3172	1	PGR6D	6248	
Polo 2 (Typ 86C..)	1.3	40	08.88-07.89	NZ	4	0,7	BP6ESZ	7639		PGR6D	6248	
Polo 2 (Typ 86C..)	1.3	40	08.85-08.88	MH	4	0,8	BUR6ET	3172	1	PGR6D	6248	
Polo 2 (Typ 86C..)	1.3	40	01.91-07.94	AAV	4	0,8	BP5ET	2287				
Polo 2 (Typ 86C..)	1.3	40	08.83-07.85	HK	4	0,7	BP6ES	7811	4	BPR6EIX	6637	
Polo 2 (Typ 86C..)	1.3	40	08.89-08.91	MH	4	0,8	BUR6ET	3172	1	PGR6D	6248	
Polo 2 (Typ 86C..)	1.3	55	07.82-08.88	GK	4	0,8	BUR6ET	3172	1	PGR6D	6248	
Polo 2 (Typ 86C..)	1.3	55	01.90-07.94	3F	4	0,8	BUR6ET	3172	1	PGR6D	6248	
Polo 2 (Typ 86C..)	1.3	55	08.89-07.90	GK	4	0,8	BUR6ET	3172	1	PGR6D	6248	
Polo 2 (Typ 86C..)	1.3	55	08.88-07.89	GK	4	0,7	BP7ES	2412		BPR7EIX	4055	
Polo 2 (Typ 86C..) G40	1.3	82	08.86-09.90	PY	4		---					
Polo 2 (Typ 86C..) G40	1.3	82	10.90-07.94	PY	4		---					
Polo 2 (Typ 86C..) D	1.4	35	10.90-07.94	1W	4		Y-918R	4182				
Polo 2 (Typ 86C..)	1.8	55	08.91-12.97	AAM	4	0,8	BUR5ET	3377	22	PGR6D	6248	
Polo 3 (Typ 6...)	1.0	33	10.94-06.96	AEV	4	0,8	BUR6ET	3172	1	PGR6D	6248	
Polo 3 (Typ 6...)	1.0	37	10.99-09.01	ALD	4	1,1	PZFR5D-11	7968				
Polo 3 (Typ 6...)	1.0	37	07.96-12.99	AER	4	0,8	BUR6ET	3172	1	PGR6D	6248	
Polo 3 (Typ 6...)	1.0	37	10.99-09.01	AUC	4	1,1	PZFR5D-11	7968				
Polo 3 (Typ 6...)	1.0	37	08.97-12.99	ALL	4	0,8	BUR6ET	3172	1	PGR6D	6248	
Polo 3 (Typ 6...)	1.3	40	10.94-04.97	ADX	4	0,8	BUR6ET	3172	1	PGR6D	6248	
Polo 3 (Typ 6...)	1.4	40	10.99-09.01	AKP	4	1,1	PZFR5D-11	7968				
Polo 3 (Typ 6...)	1.4	44	11.97-12.99	APQ	4	0,8	BUR6ET	3172	1	PGR6D	6248	
Polo 3 (Typ 6...)	1.4	44	01.98-12.99	ANX	4	0,8	BUR6ET	3172	1	PGR6D	6248	
Polo 3 (Typ 6...)	1.4	44	10.99-09.01	AKK	4	1,1	PZFR5D-11	7968				
Polo 3 (Typ 6...)	1.4	44	07.95-12.97	AEX	4	0,8	BUR6ET	3172	1	PGR6D	6248	
Polo 3 (Typ 6...)	1.4	44	10.99-09.01	AUD	4	1,1	PZFR5D-11	7968				
Polo 3 (Typ 6...)	1.4	44	10.99-08.00	ANW	4	1,1	PZFR5D-11	7968				
Polo 3 (Typ 6...)	1.4	44	05.97-12.99	AKV	4	0,8	BUR6ET	3172	1	PGR6D	6248	
Polo 3 (Typ 6...)	1.4	55	10.99-09.01	AHW	4	1,0	BKUR6ET-10	2397	24	PFR6Q	6458	
Polo 3 (Typ 6...)	1.4	55	10.99-06.00	APE	4	1,0	BKUR6ET-10	2397	24	PFR6Q	6458	
Polo 3 (Typ 6...)	1.4	55	10.99-01.02	AUA	4	1,0	BKUR6ET-10	2397	24	PFR6Q	6458	
Polo 3 (Typ 6...) TDI	1.4	55	10.99-	AMF	3		Y-741U	5065				

¹⁾ Bic = Best in class (siehe Seite 3) / (see page 3)



ℓ kW



Cyl.

Order-
No. No.Bic¹⁾ Order-
No.**VW**

Polo 3 (Typ 6...)	1.4	74	04.96-12.99	AFH	4	0,8	BKUR6ET	6437	27	PFR6Q	6458
Polo 3 (Typ 6...)	1.4	74	10.99-09.01	AFK	4	1,0	BKUR6ET-10	2397	24	PFR6Q	6458
Polo 3 (Typ 6...)	1.4	74	05.00-06.02	AUB	4	1,0	BKUR6ET-10	2397	24	PFR6Q	6458
Polo 3 (Typ 6...)	1.6	55	10.94-07.95	AEA	4	0,8	BUR6ET	3172	1	PGR6D	6248
Polo 3 (Typ 6...)	1.6	55	10.94-08.95	ABU	4	0,8	BUR6ET	3172	1	PGR6D	6248
Polo 3 (Typ 6...)	1.6	55	07.98-09.01	ALM	4	0,8	BUR6ET	3172	1	PGR6D	6248
Polo 3 (Typ 6...) (only Japan)	1.6	55	03.96-12.99	AHS	4	0,8	BPR5EKU	5685		PGR6D	6248
Polo 3 (Typ 6...)	1.6	55	07.95-12.99	AEE	4	0,8	BUR6ET	3172	1	PGR6D	6248
Polo 3 (Typ 6...)	1.6	55	10.94-09.97	1F	4	0,8	BUR5ET	3377	22	PGR6D	6248
Polo 3 (Typ 6...)	1.6	74	07.00-09.01	AUR	4	1,0	BKUR6ET-10	2397	24	PFR6Q	6458
Polo 3 (Typ 6...)	1.6	74	10.99-09.01	AKL	4	1,0	BKUR6ET-10	2397	24	PFR6Q	6458
Polo 3 (Typ 6...)	1.6	74	03.00-10.00	APF	4	1,0	BKUR6ET-10	2397	24	PFR6Q	6458
Polo 3 (Typ 6...)	1.6	74	10.99-09.01	AEH	4	1,0	BKUR6ET-10	2397	24	PFR6Q	6458
Polo 3 (Typ 6...) Variant	1.6	74	12.95-08.99	AFT	4	1,0	BKUR6ET-10	2397	24	PFR6Q	6458
Polo 3 (Typ 6...) Gti	1.6	88	08.98-12.99	AJV	4	1,0	BKUR6ET-10	2397	24	PFR6Q	6458
Polo 3 (Typ 6...)	1.6	92	05.00-09.01	AVY	4	1,0	BKUR6ET-10	2397	24	PFR6Q	6458
Polo 3 (Typ 6...)	1.6	92	11.99-09.01	ARC	4	1,0	BKUR6ET-10	2397	24	PFR6Q	6458
Polo 3 (Typ 6...) SDI	1.7	42	08.97-04.00	AKU	3	█	Y-732U	2408			
Polo 3 (Typ 6...) SDI	1.7	42	04.97-12.99	AHG	4	█	Y-732U	2408			
Polo 3 (Typ 6...) SDI	1.7	44	11.97-08.99	AKW	4	█	Y-732U	2408			
Polo 3 (Typ 6...) Classic	1.8	66	03.98-09.01	ADD	4	0,8	BUR6ET	3172	1	PGR6D	6248
Polo 3 (Typ 6...)	1.9	47	10.94-12.99	AEF	4	█	Y-918R	4182			
Polo 3 (Typ 6...)	1.9	47	01.96-10.96	1Y	4	█	Y-918R	4182			
Polo 3 (Typ 6...)	1.9	47	12.95-08.99	AEY	4	█	Y-732U	2408			
Polo 3 (Typ 6...) SDI	1.9	47	10.99-09.01	ASX	4	█	Y-732U	2408			
Polo 3 (Typ 6...) SDI	1.9	47	07.96-09.01	AGD	4	█	Y-732U	2408			
Polo 3 (Typ 6...) SDI	1.9	50	10.99-09.01	AQM	4	█	Y-732U	2408			
Polo 3 (Typ 6...) SDI	1.9	50	10.99-09.01	AGP	4	█	Y-732U	2408			
Polo 3 (Typ 6...) TDI	1.9	66	01.97-08.99	AHU	4	█	Y-732U	2408			
Polo 3 (Typ 6...) TDI	1.9	66	10.99-09.01	AGR	4	█	Y-732U	2408			
Polo 3 (Typ 6...) TDI	1.9	66	10.99-09.01	ALH	4	█	Y-732U	2408			
Polo 3 (Typ 6...) TDI	1.9	66	11.97-08.99	ALE	4	█	Y-732U	2408			
Polo 3 (Typ 6...) TDI	1.9	81	08.98-	AHF	4	█	Y-732U	2408			
Polo 3 (Typ 6...) TDI	1.9	81	06.98-08.99	AFN	4	█	Y-732U	2408			
Polo 3 (Typ 6...) TDI	1.9	81	10.99-09.01	ASV	4	█	Y-732U	2408			
Polo 3 (Typ 6...) (Mex)	2.0	85	08.99-09.01	ADC	4	0,8	BKR5EVX	2546		BKR5EIX	6341
Polo 4	1.2	40	01.02-07.04	AWY	3	1,1	PZFR5D-11	7968			
Polo 4 Manual	1.4			BCC	4	1,0	BKUR6ET-10	2397	24	PFR6Q	6458
Polo 4 Automatic	1.4	55		BCC	4	1,1	PZFR5D-11	7968			
Polo 4 TDI	1.4	55	11.01-	BAY	3	█	Y-732U	2408			
Polo 4 (Typ 9N) 16V	1.4	55	11.01-	BBY	4	1,0	BKUR6ET-10	2397	24	PFR6Q	6458
Polo 4 16V AUTOMATIC	1.4	55	11.01-	BBY	4	1,1	PZFR5D-11	7968			
Polo 4 FSI	1.4	63	02.02-	AXU	4		ZFR6S-Q	6449			
Polo 4 (Typ 9N) 16V	1.4	74	05.02-	BBZ	4	1,0	BKUR6ET-10	2397	24	PFR6Q	6458
Polo 4 SDI	1.9	47	11.01-	ASY	4	█	Y-732U	2408			
Polo 4 TDI	1.9	74	11.01-	ATD	4	█	Y-741U	5065			
Polo 4 TDI	1.9	74	11.01-	AXR	4	█	Y-741U	5065			
Scirocco	1.6	53	04.86-07.90	RE	4	1,0	BUR5ET-10	7264	21	PGR6D	6248
Scirocco	1.6	55	08.83-07.86	HN	4	1,0	BP5ET-10	5156			
Scirocco	1.6	55	01.83-07.91	EW	4	1,0	BP5ET-10	5156			
Scirocco	1.8	66	08.83-07.92	EX	4	0,8	BUR6ET	3172	1	PGR6D	6248
Scirocco	1.8	70	08.83-07.92	JH	4	0,8	BUR6ET	3172	1	PGR6D	6248

¹⁾ Bic = Best in class (siehe Seite 3) / (see page 3)



l kW

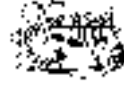

Cyl.

Order-
No. No.Bic¹⁾ Order-
No.**VW**

Scirocco	1.8	82	08.82-07.92	DX	4	0,8	BUR6ET	3172	1	PGR6D	6248
Scirocco	1.8	82	08.82-07.91	JJ	4	0,8	BUR6ET	3172	1	PGR6D	6248
Scirocco	1.8	82	08.83-07.91	KT	4	0,8	BUR6ET	3172	1	PGR6D	6248
Scirocco	1.8	95	02.86-07.92	PL	4	0,8	BKUR7ET	7873		PFR7Q	7963
Scirocco 16V	1.8	102	08.84-07.89	KR	4	0,8	BCP7ET	2078		BCPR7EIX	5690
Sharan turbo	1.8	110	11.97-02.00	AJH	4	1,0	BKR6ETA-10	7998			
Sharan TDI Fgst ---> 7M-2-030-004	1.9	66	03.99-	ANU	4	█	Y-732U	2408			
Sharan TDI	1.9	66	08.96-02.00	AHU	4	█	Y-732U	2408			
Sharan TDI	1.9	66	09.95-07.96	1Z	4	█	Y-732U	2408			
Sharan TDI Fgst 7M-2-030-005 --->	1.9	66	03.99-	ANU	4	█	Y-741U	5065			
Sharan TDI	1.9	81	02.96-07.99	AFN	4	█	Y-732U	2408			
Sharan TDI	1.9	81	08.99-02.00	AVG	4	█	Y-732U	2408			
Sharan TDI Fgst 7M-2-030-005 --->	1.9	85	04.00-	AUY	4	█	Y-741U	5065			
Sharan TDI Fgst ---> 7M-2-030-004	1.9	85	04.00-	AUY	4	█	Y-732U	2408			
Sharan TDI	1.9	96	11.02-	ASZ	4	█	Y-741U	5065			
Sharan	2.0	85	09.95-02.00	ADY	4	0,8	BKUR6ET	6437	27	PFR6Q	6458
Sharan VR6	2.8	128	04.98-02.00	AMY	6	0,8	BKR5EKUP	2890			
Sharan VR6	2.8	128	09.95-03.98	AAA	6	0,8	BKR5EKUP	2890			
Sharan / 2	1.8	110	04.00-	AWC	4	0,8	PFR6Q	6458			
Sharan / 2	2.0	85	04.00-	ATM	4	1,0	BKUR6ET-10	2397	24	PFR6Q	6458
Sharan VR6 / 2	2.8	150	04.00-	AYL	6	1,1	PZFR5D-11	7968			
T 2 D	1.6	37	01.81-08.90		4	█	Y-918R	4182			
T 2	1.7	42	10.86-08.90		4	█	Y-918R	4182			
T 4 D	1.9	44	09.90-12.95	1X	4	█	Y-918R	4182			
T 4 TD	1.9	50	10.92-04.02	ABL	4	█	Y-918R	4182			
T 4	2.0	62	09.90-07.93	AAC	4	0,8	BUR5ET	3377	22	PGR6D	6248
T 4	2.4	55	04.97-	AJA	5	█	Y-918R	4182			
T 4 D	2.4	57	09.90-04.98	AAB	5	█	Y-918R	4182			
T 4	2.5	65	05.98-09.03	AJT	5	█	Y-732U	2408			
T 4 TDI	2.5	75	04.01-09.03	AYC	5	█	Y-732U	2408			
T 4 TDI	2.5	75	05.97-11.99	ACV	5	█	Y-732U	2408			
T 4	2.5	75	11.99-09.03	AUF	5	█	Y-732U	2408			
T 4	2.5	81	08.93-10.96	ACU	5	0,8	BUR5ET	3377	22	PGR6D	6248
T 4	2.5	81	08.96-	AET	5	0,8	BUR5ET	3377	22	PGR6D	6248
T 4 (China / GUS)	2.5	81	08.96-	AEU	5	0,8	BUR5ET	3377	22	PGR6D	6248
T 4	2.5	81	09.90-12.93	AAF	5	0,8	BPR5EKU	5685		PGR6D	6248
T 4	2.5	81	05.95-12.95	AEN	5	0,8	BUR5ET	3377	22	PGR6D	6248
T 4	2.5	85	05.99-12.99	APL	5	0,9	BKUR5ET	2789	29	PFR6Q	6458
T 4	2.5	85	12.99-06.03	AVT	5	0,9	BKUR5ET	2789	29	PFR6Q	6458
T 4	2.5	111	07.99-09.00	AHY	5	█	Y-732U	2408			
T 4 VR6	2.8	103	01.96-05.00	AES	6	0,8	BKR5EKUP	2890			
T 4 VR6	2.8	150	09.00-	AXK	6	1,1	PZFR5D-11	7968			
T 4	3.2	170	02.04-	BDL	6	0,9	IZKR7B				
T 5	2.3	125	00-		5	1,1	PZFR5D-11	7968			
Taro	1.8	61	02.89-09.94	2Y	4	1,1	BPR5EY-11	3028		BPR5EIX-11	2115
Taro	2.2	69	06.89-07.94	4Y	4	1,1	BPR5EY-11	3028		BPR5EIX-11	2115
Touareg USA	3.2	162	08.03-05.04	BAA	6	0,9	IZKR7B				
Touareg	3.2	162	05.03-05.04	BKJ	6	0,9	IZKR7B				
Touareg	3.2	162	11.02-05.04	AZZ	6	0,9	IZKR7B				
Touareg	3.2	162	05.04-	BMV	6	0,9	IZKR7B				
Touareg	3.2	162	05.04-	BMX	6	0,9	IZKR7B				
Touareg	4.2	228	04.03-	BHX	8		BKR6EQUA				

¹⁾ Bic = Best in class (siehe Seite 3) / (see page 3)

Fgst = Chassis No.



ℓ kW

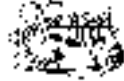

Cyl.

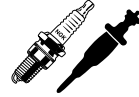
Order-
No. No.Bic¹⁾ Order-
No.**VW**

Touareg	4.2	228	12.02-	AXQ	8		BKR6EQUA					
Touareg TDI	5.0	230	11.02-	AYH	10	■	Y-741U	5065				
Touareg	6.0	309	11.02-	BAN	12	1,1	PZFR6J-11					
Touran	1.6	75	07.03-	BGU	4	1,0	BKUR6ET-10	2397	24	PFR6Q	6458	
Touran FSI	1.6	85	02.03-	BAG	4		ZFR6S-Q	6449				
Touran FSI	1.6	85	05.04-	BLP	4		ZFR6S-Q	6449				
Touran FSI	2.0	110	10.03-	AXW	4	1,1	PZFR5N-11TG					
Touran FSI	2.0	110	10.03-01.04	BHD	4	1,1	PZFR5N-11TG					
Touran FSI	2.0	110	05.04-	BLX	4	1,1	PZFR5N-11TG					
Transporter	1.8	49	09.90-07.92	PD	4	0,8	BUR6ET	3172	1	PGR6D	6248	
Transporter 2 (MEXICO)	1.8	63	01.93-	ACB	4	0,8	BP5ES	6511	8	BPR5EIX	6597	
Transporter	1.9	44	08.87-07.89	DF	4	0,7	BP6ESZ	7639		PGR6D	6248	
Transporter	1.9	44	08.82-08.87	DF	4	0,8	BUR6ET	3172	1	PGR6D	6248	
Transporter	1.9	44	08.89-07.92	DF	4	0,8	BUR6ET	3172	1	PGR6D	6248	
Transporter	1.9	54	08.87-07.89	SP	4	0,7	BP6ESZ	7639		PGR6D	6248	
Transporter	1.9	54	08.82-08.87	SP	4	0,8	BUR6ET	3172	1	PGR6D	6248	
Transporter	1.9	60	07.83-07.85		4	0,7	B6ES	7310				
Transporter TDI	1.9	63	04.03-	AXC	4	■	Y-741U	5065				
Transporter	1.9	66	08.83-07.85	GW	4	0,7	B6ES	7310				
Transporter TDI	1.9	77	04.03-	AXB	4	■	Y-741U	5065				
Transporter	2.0	85	11.03-	AXA	4	1,0	BKUR6ET-10	2397	24	PFR6Q	6458	
Transporter	2.1	64	08.86-07.92	SR	4	0,7	B6ES	7310				
Transporter	2.1	68	08.85-07.92	SS	4	0,7	B6ES	7310				
Transporter	2.1	70	08.85-07.92	MV	4	0,7	B6ES	7310				
Transporter	2.1	82	08.84-07.92	DJ	4	0,8	BUR6ET	3172	1	PGR6D	6248	
Transporter TDI	2.5	96	04.03-	AXD	5	■	Y-741U	5065				
Transporter TDI	2.5	128	04.03-	AXE	5	■	Y-741U	5065				
Transporter	2.8	150	05.00-09.03	AMV	6	1,1	PZFR5D-11	7968				
Transporter	3.2	173	02.04-	BKK	6	0,9	IZKR7B					
Vento D	1.9	47	01.92-12.97	1Y	4	■	Y-918R	4182				
Vento SDI	1.9	47	07.95-12.97	AEY	4	■	Y-732U	2408				
Vento TD	1.9	55	01.92-12.97	AAZ	4	■	Y-918R	4182				
Vento TDI	1.9	66	07.93-07.96	1Z	4	■	Y-732U	2408				
Vento TDI	1.9	66	08.96-12.97	AHU	4	■	Y-732U	2408				
Vento TDI	1.9	81	02.96-12.97	AFN	4	■	Y-732U	2408				

WARSZAWA

14mm					4	0,6	B6L	3212				
18mm					4	0,6	A7	1110				

WARTBURG AWE

1.3	1.3	43	09.88-05.91	VW	4	0,7	BP6ES	7811	4	BPR6EIX	6637	
353	1.0	37	01.78-12.90		4	0,6	B6HS	4510		BR6HIX	3419	
Alle Modelle 14mm	1.0		71-		4	0,6	B6HS	4510		BR6HIX	3419	
Alle Modelle 18mm	1.0	37	07.71-09.89		4	0,6	A7	1110				

WIESMANN

Roadster MF28	2.8	142	95-	M52 B28	6	0,8	BKR6EK	2288	20**	BKR6EQUA	3199	
Roadster MF3	3.2	236	95-	S50 B32	6	0,7	PKR7A	3641				

YALTA

3A3	1.0				4	0,6	B6HS	4510		BR6HIX	3419	
-----	-----	--	--	--	---	-----	------	------	--	--------	------	--

¹⁾ Bic = Best in class (siehe Seite 3) / (see page 3)

** alternative/wahlweise V-Line 30



l kW

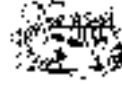

Cyl.

Order-
No. No.Bic¹⁾ Order-
No.**YALTA**

Saporodshe					4	0,6	B6L	3212				
------------	--	--	--	--	---	-----	-----	------	--	--	--	--

YUGO

101 1.1, 1.3					4	0,6	BP6ES	7811	4	BPR6EIX	6637
311 / 313					4	0,6	BP6ES	7811	4	BPR6EIX	6637
411 / 413					4	0,6	BP6ES	7811	4	BPR6EIX	6637
511 / 513					4	0,6	BP6ES	7811	4	BPR6EIX	6637
Florida 1.4, 1.5, 1.6			-12.93		4	0,6	BPR6ES	7822	2	BPR6EIX	6637
Sana					4	0,6	BPR6ES	7822	2	BPR6EIX	6637
Tempo					4	0,6	BPR6ES	7822	2	BPR6EIX	6637
Yugo 45,55,65,Florida			80-		4	0,7	BP6ES	7811	4	BPR6EIX	6637

Z.A.Z.

1102 Tawrija	1.1	37	06.90-		4	0,7	BP6ES	7811	4	BPR6EIX	6637
1102 Tawrija	1.3	44	06.90-		4	0,7	BP6ES	7811	4	BPR6EIX	6637
Megane kombi	1.1	37	06.90-		4	0,7	BP6ES	7811	4	BPR6EIX	6637

ZASTAVA

45			01.82-		4	0,7	BP6ES	7811	4	BPR6EIX	6637
55			82-		4	0,7	BP6ES	7811	4	BPR6EIX	6637
60			82-		4	0,7	BP6ES	7811	4	BPR6EIX	6637
65			82-		4	0,7	BP6ES	7811	4	BPR6EIX	6637
65 EFI	1.3		89-		4	0,8	BPR6ES	7822	2	BPR6EIX	6637
65 Skala			72-		4	0,7	BP6ES	7811	4	BPR6EIX	6637
311					4	0,7	BP6ES	7811	4	BPR6EIX	6637
313					4	0,7	BP6ES	7811	4	BPR6EIX	6637
411					4	0,7	BP6ES	7811	4	BPR6EIX	6637
413					4	0,7	BP6ES	7811	4	BPR6EIX	6637
511					4	0,7	BP6ES	7811	4	BPR6EIX	6637
513					4	0,7	BP6ES	7811	4	BPR6EIX	6637
750			78-		4	0,6	BP6HS	4511	18	BPR6HIX	4085
850			78-		4	0,6	BP6HS	4511	18	BPR6HIX	4085
Florida	1.4	48	07.89-12.93		4	0,8	BPR6ES	7822	2	BPR6EIX	6637
Florida	1.6	62	07.89-12.93		4	0,8	BPR6ES	7822	2	BPR6EIX	6637
Florida EFI	1.4	53	10.88-12.93		4	0,8	BPR6ES	7822	2	BPR6EIX	6637
Sana	1.4	53	89-		4	0,8	BPR6ES	7822	2	BPR6EIX	6637

ZUK

Transport	2.4	51		C90	4	☑	Y-403T	7494			
Transport	2.4	68		CT90	4	☑	Y-403T	7494			

¹⁾ Bic = Best in class (siehe Seite 3) / (see page 3)

Order
No.Platin
Gold-
Palla-
diumOrder Quick
No. No.

Iridium

Order
No.**ACCOSSATO**

Enduro Unitrac	50	03.74-	B6ES	7310	0,7	B6EVX	5136			
CR 80 Cross/Enduro	80				0,5	B9EGV	5827			

AEON

Cobra (ATV)	50	03-	BPR7HS	6422	0,8	BPR7HVX	2938	215	BPR7HIX	5944
Minicolt (ATV)	50	03-	BPR7HS	6422	0,8	BPR7HVX	2938	215	BPR7HIX	5944
Revo (ATV)	50	04-	BPR7HS	6422	0,8	BPR7HVX	2938	215	BPR7HIX	5944
Cobra (ATV)	100	02-	BPR7HS	6422	0,8	BPR7HVX	2938	215	BPR7HIX	5944
Revo (ATV)	100	04-	BPR7HS	6422	0,8	BPR7HVX	2938	215	BPR7HIX	5944
Cobra Sport (ATV)	125	02-	CR8HSA	2086	0,8	CR8HVX	7236		CR8HIX	7669
Cobra RS 1(ATV)	125		CR7HS	7223	0,8				CR7HIX	7544
Cobra RS 2(ATV)	125		CR7HS	7223	0,8				CR7HIX	7544
Overland (ATV)	125	04-	CR7HS	7223	0,8				CR7HIX	7544
Utility (ATV)	125	02-	CR7HS	7223	0,8				CR7HIX	7544
Cobra RS 2 (ATV)	180	04-	CR7HSA	4549	0,8				CR7HIX	7544
Cobra Sport (ATV)	180	02-	CR8HSA	2086	0,8	CR8HVX	7236		CR8HIX	7669
Cobra RS 1 (ATV)	180		CR7HS	7223	0,8				CR7HIX	7544
Cobra RS 2 (ATV)	180		CR7HS	7223	0,8				CR7HIX	7544
Overland (ATV)	180	04-	CR7HS	7223	0,8				CR7HIX	7544
Utility (ATV)	180	02-	CR7HS	7223	0,8				CR7HIX	7544

AJP

Enduro 125	125	03-	DR8ES	5423	0,8	DR8EVX	6354	217	DR8EIX	6681
Super-Moto 125	125	03-	DR8ES	5423	0,8	DR8EVX	6354	217	DR8EIX	6681
P 250 Cross	250	04-	CR8EB	7784	0,6	CR8EVX	6487		CR8EIX	4218

ALFER

GR 30, TX 30	50		BR8HS	4322	0,6	BR8HVX	6265	212	BR8HIX	7001
MC 80	80				0,5	B9EGV	5827			
GR125 ISDE	125				0,5	B8EGV	5627			
MC 125	125				0,5	B9EGV	5827			
VRE 125 (4T)	125		CR9E	6263	0,7	CR9EVX	5943	227	CR9EIX	3521
VRE 125 no limit (4T)	125		CR9E	6263	0,7	CR9EVX	5943	227	CR9EIX	3521
EGR 250 Agua / Air	250		B8ES	2411	0,5	B8EGV	5627	201	BR8EIX	5044
MC 250	250				0,5	B9EGV	5827			
VR 250 (2T)	250		BR8ES	5422	0,8	BR8EVX	1262	207	BR8EIX	5044
VR 250 no limit Supermoto (2T)	250		BR8ES	5422	0,8	BR8EVX	1262	207	BR8EIX	5044
AR-1	300		B8ES	2411	0,5	B8EVX	7051	201	BR8EIX	5044
GR 300 Agua	300		B8ES	2411	0,5	B8EGV	5627	201	BR8EIX	5044
TX-300	300		B8ES	2411	0,5	B8EGV	5627	201	BR8EIX	5044
MC 500	490				0,5	B9EGV	5827			

APRILIA

AF1 50	50	01.86-	B9ES	2611	0,5	B9EVX	7254	202	BR9EIX	3981
Classic 50 (GI)	50	99-	BR8ES	5422	0,8	BR8EVX	1262	207	BR8EIX	5044
ET 50 AE,-Fire	50	01.87-	B9ES	2611	0,5	B9EVX	7254	202	BR9EIX	3981
GL 50	50	02.93-	B9ES	2611	0,5	B9EVX	7254	202	BR9EIX	3981
LX 50	50	02.93-	B9ES	2611	0,5	B9EVX	7254	202	BR9EIX	3981
MX 50 (RX50)	50	03-	BR9ES	5722	0,6	BR9EVX	1265	208	BR9EIX	3981
RC 50	50	01.79-12.82	B6ES	7310	0,6	B6EVX	5136			
Red Rose 50	50	06.87-	B9ES	2611	0,5	B9EVX	7254	202	BR9EIX	3981
RS 50 (PG)	50	01.97-	BR8ES	5422	0,8	BR8EVX	1262	207	BR8EIX	5044

Order
No.Platin
Gold-
Palla-
diumOrder Quick
No.

No.

Iridium

Order
No.**APRILIA**

RS 50 Extrema/Replica	50	01.93-	B8ES	2411	0,5	B8EGV	5627	201	BR8EIX	5044
RX 50	50	09.90-	B9ES	2611	0,5	B9EVX	7254	202	BR9EIX	3981
Tuareg 50	50	01.87-	B9ES	2611	0,5	B9EVX	7254	202	BR9EIX	3981
AF 1 Futura	125	06.90-	B10EG	3630	0,5	B10EGV	5927			
AF 1 Sport	125	06.90-	B10EG	3630	0,5	B10EGV	5927			
AF1 125 Replica 89	125	03.87-	B10EG	3630	0,6	B10EGV	5927			
AF1 125, RR, Sintesi	125	06.88-	B10EG	3630	0,5	B10EGV	5927			
AS 125 R	125	01.91-	B9ES	2611	0,5	B9EVX	7254	202	BR9EIX	3981
Classic 125	125	97- 98			0,6	BR10EG	3830			
Classic 125 (MF)	125	99-	BR8ES	5422	0,8	BR8EVX	1262	207	BR8EIX	5044
ETX 125 (PH)	125	99-	BR8ES	5422	0,8	BR8EVX	1262	207	BR8EIX	5044
ETX 125	125	01.84- 98	B9ES	2611	0,5	B9EVX	7254	202	BR9EIX	3981
Europa 125	125	06.90-	B10EG	3630	0,5	B10EGV	5927			
MX 125 Supermotard	125	04-	BR8ES	5422	0,8	BR8EVX	1262	207	BR8EIX	5044
Pegaso 125	125	01.92-	B10EG	3630	0,5	B10EGV	5927			
Red Rose 125	125	01.88-	B10EG	3630	0,5	B10EGV	5927			
Red Rose 125	125	01.97-	BR8ES	5422	0,8	BR8EVX	1262	207	BR8EIX	5044
RS 125 (MP) (11kW) (80km/h)	125	96-	BR8ES	5422	0,8	BR8EVX	1262	207	BR8EIX	5044
RS 125 (MP) (18kW)	125	96-	BR10EG	3830	0,5					
RS 125 (MP) (22kW)	125	99-	BR10EG	3830	0,5					
RS 125 Extrema/Repli. 20kW	125	- 93	BR10EG	3830	0,5					
RS 125 Extrema/Repli. 23kW	125	- 93	BR10EG	3830	0,5					
RX 125	125	01.90-	B10EG	3630	0,5	B10EGV	5927			
ST 125	125	01.82-	B9EG	3530	0,5	B9EGV	5827		BR9EIX	3981
STX 125	125	01.82-	B9EG	3530	0,5	B9EGV	5827		BR9EIX	3981
Tuareg	125	01.86-	B9ES	2611	0,5	B9EVX	7254	202	BR9EIX	3981
Tuareg Rallye	125	06.89-	B10EG	3630	0,5	B10EGV	5927			
Tuareg Wind 125	125	07.88-	B9ES	2611	0,6	B9EVX	7254	202	BR9EIX	3981
250 GP (I)	250		B10EG	3630	0,5	B10EGV	5927			
RS 250 ((LD)	250	95-	BR9ECM	3252	0,5	BR9ECMVX	2434			
RX 250	250	01.85-04.86	B10EG	3630	0,5	B10EGV	5927			
Tuareg Rally	250	01.85-	B10EG	3630	0,5	B10EGV	5927			
Climber	276	01.89-	BP5ES	6511	0,7	BP5EVX	5470		BPR5EIX	6597
TX 300	276	- 84	BP5ES	6511	0,7	BP5EVX	5470		BPR5EIX	6597
TX 311 M	276	- 84	BP5ES	6511	0,7	BP5EVX	5470		BPR5EIX	6597
TXR 312 M	276	- 86	BP5ES	6511	0,5	BP5EVX	5470		BPR5EIX	6597
TL 320	320	- 86	BP5ES	6511	0,5	BP5EVX	5470		BPR5EIX	6597
EXT 350	349	01.85-	D8EA	2120	0,5	D8EVX	2850	216	DR8EIX	6681
Tuareg 350	349	01.87- 91	D8EA	2120	0,5	D8EVX	2850	216	DR8EIX	6681
Wind	349	01.87-	D8EA	2120	0,5	D8EVX	2850	216	DR8EIX	6681
Tuareg 600 Wind	562	01.88- 93	D8EA	2120	0,6	D8EVX	2850	216	DR8EIX	6681
Pegaso 600	600	03.90- 94	D8EA	2120	0,6	D8EVX	2850	216	DR8EIX	6681
Moto 6.5 (MH)	650	95-	D8EA	2120	0,6	D8EVX	2850	216	DR8EIX	6681
Pegaso 650 (ML) Kat.	650	97- 00	DR8EA	7162	0,7	DR8EVX	6354		DR8EIX	6681
Pegaso 650 (MX)	650	96- 00	DR8EA	7162	0,7	DR8EVX	6354		DR8EIX	6681
Pegaso 650 (ML)	650	97- 00	DR8EA	7162	0,7	DR8EVX	6354		DR8EIX	6681
Pegaso 650 (GA)	650	04.92- 95	DR8EA	7162	0,7	DR8EVX	6354		DR8EIX	6681
Pegaso Cube 650	650	97-	DR8EA	7162	0,7	DR8EVX	6354		DR8EIX	6681
Pegaso 650 i.e. (RW)	650	01- 03	DR8EB	4855	0,7				DR8EIX	6681
SL 1000 Falco	998	99-	DCPR9E	2641	0,7	DCPR9EVX	6436			
ETV Caponord (PS)	1000	01-	DCPR9E	2641	0,7	DCPR9EVX	6436			
RST Futura (PW)	1000	01-	DCPR9E	2641	0,7	DCPR9EVX	6436			

Order
No.Platin
Gold-
Palla-
diumOrder Quick
No. No.Iridium
Order
No.**APRILIA**

RSV 1000 R Factory	1000	03-	DCPR9E	2641	0,7	DCPR9EVX	6436			
RSV 1000 R	1000	04-	DCPR9E	2641	0,7	DCPR9EVX	6436			
RSV mille R	1000	98- 03	DCPR9E	2641	0,7	DCPR9EVX	6436			
RSV mille SP (MED)	1000	99-	R0045J-10	7400	1,1					
RSV mille 01 (RP)	1000	01-	DCPR9E	2641	0,7	DCPR9EVX	6436			
RSV mille (MEA;ME;ME0010)	1000	98-	DCPR9E	2641	0,7	DCPR9EVX	6436			
SL 1000 (PA)	1000	99-	DCPR9E	2641	0,7	DCPR9EVX	6436			
Tuono Fighter 1000	1000	03-	DCPR9E	2641	0,7	DCPR9EVX	6436			
Tuono Fighter R 1000	1000	03-	DCPR9E	2641	0,7	DCPR9EVX	6436			

ARCTIC CAT

90 (ATV)	90	02-	BPR7HS	6422	0,6	BPR7HVX	2938	215	BPR7HIX	5944
250 Quad 4x4 (ATV)	250	01-	DR7EA	7839	0,6					
300 Quad 2x4 / 4x4 (ATV)	300	99-	DR7EA	7839	0,6					
300 (ATV)	300	04-	DR7EA	7839	0,6					
375 (ATV)	375	02-	CR7E	4578	0,8			225	CR7EIX	7385
400 (ATV)	400	99- 01	CR6E	6965	0,7					
400 (ATV)	400	- 98	CR8E	1275	0,7	CR8EVX	6487	226	CR8EIX	4218
400 (ATV)	400	03-	CR7E	4578	0,8			225	CR7EIX	7385
400 (ATV)	400	04-	CR7E	4578	0,6			225	CR7EIX	7385
400 TBX (ATV)	400	04-	CR7E	4578	0,6			225	CR7EIX	7385
400i (ATV)	400	04-	CR7E	4578	0,6			225	CR7EIX	7385
454 (ATV)	454	98-	CR6E	6965	0,7					
454 (ATV)	454	96- 97	CR8E	1275	0,7	CR8EVX	6487	226	CR8EIX	4218
500 Auto (ATV)	493	01-	CR6E	6965	0,7					
500 (ATV)	493	99-	CR6E	6965	0,7					
500 TBX (ATV)	500	04-	CR6E	6965	0,7					
500 TRV (ATV)	500	04-	CR6E	6965	0,7					

ARM

125 Velocidad Enduro	125				0,5	B10EGV	5927			
125 Cross	125				0,5	B11EGV	5831			
250 Velocidad Enduro/Cross	250				0,5	B9EGV	5827			
365 Enduro	350				0,5	B9EGV	5827			

AT MOTO

S 3800 (Velo Solex)	50		B6HS	4510	0,6	B6HVX	7435	203	BR6HIX	3419
---------------------	----	--	------	------	-----	-------	------	-----	--------	------

ATK

50 Mini Quad (ATV)	50	01-	B7HS	5110	0,5	B7HVX	7836	204	BR7HIX	7067
90 Mini Quad (ATV)	90	01-	B7HS	5110	0,5	B7HVX	7836	204	BR7HIX	7067
350 Enduro 4 Ventil / 4 Stroke SOHC	350	91- 00	D8EA	2120	0,5	D8EVX	2850	216	DR8EIX	6681
350 Cross 4 Ventil / 4 Stroke SOHC	350	91-	D8EA	2120	0,5	D8EVX	2850	216	DR8EIX	6681
406	400	96- 99	B8ES	2411	0,5	B8EVX	7051	201	BR8EIX	5044
500 DT 4 Ventil / 4 Stroke SOHC	490	99-	D8EA	2120	0,5	D8EVX	2850	216	DR8EIX	6681
Supermot 4 Ventil / 4 Stroke SOHC	500	01-	D8EA	2120	0,5	D8EVX	2850	216	DR8EIX	6681
604 4 Ventil / 4 Stroke SOHC	560	93-	D8EA	2120	0,5	D8EVX	2850	216	DR8EIX	6681
605 Cross 4 Ventil / 4 Stroke SOHC	600	93-	D8EA	2120	0,5	D8EVX	2850	216	DR8EIX	6681
Supermot 4 Ventil / 4 Stroke SOHC	600	01-	D8EA	2120	0,5	D8EVX	2850	216	DR8EIX	6681
605 DT 4 Ventil / 4 Stroke SOHC	600	98-	D8EA	2120	0,5	D8EVX	2850	216	DR8EIX	6681
605 Enduro 4 Ventil / 4 Stroke SOHC	600	93- 00	D8EA	2120	0,5	D8EVX	2850	216	DR8EIX	6681

Order
No.Platin
Gold-
Palla-
diumOrder Quick
No. No.Order
No.**AVIAN**

RM 125 (Tau Motor)	125				0,5	B10EGV	5927			
RM 250 (Tau Motor)	250				0,5	B8EGV	5627			

AWO

425 T	425	56-	B7HS	5110	0,5	B7HVX	7836	204	BR7HIX	7067
-------	-----	-----	------	------	-----	-------	------	-----	--------	------

B.S.A

Tracker	125		B8ES	2411	0,5	B8EVX	7051	201	BR8EIX	5044
Bantam 175, Bushman	175		B7ES	1111	0,5	B7EVX	6934			
Bantam D10, 14, 14/4, 14/5	175		B7ES	1111	0,5	B7EVX	6934			
Tracker	175		B8ES	2411	0,5	B8EVX	7051	201	BR8EIX	5044
B25 R / SS Gold Star	250		B8ES	2411	0,5	B8EVX	7051	201	BR8EIX	5044
B25 Starfire, B25T Victor	250		B8ES	2411	0,5	B8EVX	7051	201	BR8EIX	5044
B40 SS90	350		B7ES	1111	0,5	B7EVX	6934			
A50W, B50MX, Victor MC	500		B8ES	2411	0,5	B8EVX	7051	201	BR8EIX	5044
B50SS, Gold Star, B50T Vict.	500		B7ES	1111	0,5	B7EVX	6934			
A75 Rocket 3	750		B8ES	2411	0,6	B8EVX	7051	201	BR8EIX	5044

BATAVUS

G50, Mosquito, M40, TS49	50		B6HS	4510	0,5	B6HVX	7435	203	BR6HIX	3419
Go-Go2, -V, -S	50		B6HS	4510	0,5	B6HVX	7435	203	BR6HIX	3419
TS 49 S	50		B8HS	5510	0,5	B8HVX	2634	205	BR8HIX	7001

BELGARDA

DT / TDR / TZR (Yamaha)	125		B9ES	2611	0,5	B9EVX	7254	202	BR9EIX	3981
TZR 125 R S/P (Yamaha)	125				0,5	B10EGV	5927			

BENELLI

G2, Elle, Pedali	50	01.83-06.89	B6HS	4510	0,5	B6HVX	7435	203	BR6HIX	3419
Gentleman, Magnum 5V	50		B5ES	6410	0,5					
Laser	50	01.84-06.89	B6HS	4510	0,5	B6HVX	7435	203	BR6HIX	3419
Magnum 3V	50		B7ES	1111	0,5	B7EVX	6934			
S50	50	04.81-06.89	B6HS	4510	0,5	B6HVX	7435	203	BR6HIX	3419
Spring 50	50		B8ES	2411	0,5	B8EVX	7051	201	BR8EIX	5044
125	125		B6HS	4510	0,5	B6HVX	7435	203	BR6HIX	3419
125-2C Twin	125		B7ES	1111	0,5	B7EVX	6934			
Jarno	125		B8ES	2411	0,5	B8EVX	7051	201	BR8EIX	5044
Scooter S-125	125		B7HS	5110	0,5	B7HVX	7836	204	BR7HIX	7067
304	230	09.82-	B7HS	5110	0,6	B7HVX	7836	204	BR7HIX	7067
250	250		B6ES	7310	0,5	B6EVX	5136			
250 Quattro	250	10.77-06.80	B7HS	5110	0,6	B7HVX	7836	204	BR7HIX	7067
254	250	01.80-07.82	B7HS	5110	0,6	B7HVX	7836	204	BR7HIX	7067
2C, 2CE, Sport Speciale	250		B7ES	1111	0,5	B7EVX	6934			
500 LS, Quattro, 504 / Sport	500		D8EA	2120	0,5	D8EVX	2850	216	DR8EIX	6681
654 / Sport / 4C	650		D8EA	2120	0,5	D8EVX	2850	216	DR8EIX	6681
Tornado 650/S/SV	650		B8ES	2411	0,5	B8EVX	7051	201	BR8EIX	5044
750 Sei	750		D8EA	2120	0,5	D8EVX	2850	216	DR8EIX	6681
900 Sei VT/NT	900		D8EA	2120	0,5	D8EVX	2850	216	DR8EIX	6681
Toronado 900	900	00-	CR9E	6263	0,7	CR9EVX	5943	227	CR9EIX	3521

Order
No.Platin
Gold-
Palla-
diumOrder Quick
No. No.Order
No.**BENETTI**

Stilo / AI	50		B6HS	4510	0,5	B6HVX	7435	203	BR6HIX	3419
------------	----	--	------	------	-----	-------	------	-----	--------	------

BETA

ALP 50	50	93-	B8ES	2411	0,5	B8EVX	7051	201	BR8EIX	5044
Bad	50		B9ES	2611	0,5	B9EVX	7254	202	BR9EIX	3981
KR-50	50		B6ES	7310	0,5	B6EVX	5136			
Minicross 12/15	50	00-	B7HS	5110	0,5	B7HVX	7836	204	BR7HIX	7067
Minicross 10/10	50	00-	B7HS	5110	0,5	B7HVX	7836	204	BR7HIX	7067
Minitrail	50	00-	B7HS	5110	0,5	B7HVX	7836	204	BR7HIX	7067
MX 50	50	93-	B9ES	2611	0,5	B9EVX	7254	202	BR9EIX	3981
RK 6-50	50		B8ES	2411	0,5	B8EVX	7051	201	BR8EIX	5044
RR Enduro	50		B10ES	7928	0,5	B10EVX	7335		BR10EIX	6801
Super Trail	50		B8ES	2411	0,5	B8EVX	7051	201	BR8EIX	5044
Supermotard 50	50		B10ES	7928	0,5	B10EVX	7335		BR10EIX	6801
Tempo / Crono	50		BR7HS	4122	0,5			211	BR7HIX	7067
Tempo 50	50		BR7HS	4122	0,5			211	BR7HIX	7067
Tempo Crono	50		BR7HS	4122	0,5			211	BR7HIX	7067
TR-50	50		B6ES	7310	0,5	B6EVX	5136			
Zero 50	50		B9ES	2611	0,5	B9EVX	7254	202	BR9EIX	3981
Dougie Lampkin Replica	124		B8ES	2411	0,5	B8EVX	7051	201	BR8EIX	5044
Alp 4T	125	00-	DR8EA	7162	0,7	DR8EVX	6354		DR8EIX	6681
REV 3	125	00-	B8ES	2411	0,5	B8EVX	7051	201	BR8EIX	5044
Techno 125	125		BP7ES	2412	0,6	BP7EVX	7270	206	BPR7EIX	4055
TR-34	125		B8ES	2411	0,5	B8EVX	7051	201	BR8EIX	5044
Zero 125	125		B8ES	2411	0,5	B8EVX	7051	201	BR8EIX	5044
Alp 4T	200	00-	DR8EA	7162	0,7	DR8EVX	6354		DR8EIX	6681
REV 3	200		BP7ES	2412	0,5	BP7EVX	7270	206	BPR7EIX	4055
TR-33	240		B6ES	7310	0,5	B6EVX	5136			
Dougie Lampkin Replica	247		BP7ES	2412	0,5	BP7EVX	7270	206	BPR7EIX	4055
Alp 250	250		B8ES	2411	0,5	B8EVX	7051	201	BR8EIX	5044
REV 3	250	00-	B8ES	2411	0,5	B8EVX	7051	201	BR8EIX	5044
Super Trail 250	250		B8ES	2411	0,5	B8EVX	7051	201	BR8EIX	5044
Techno	250		BGP7ES	5030	0,5	BGP7EV	3733			
Alp	260		B8ES	2411	0,5	B8EVX	7051	201	BR8EIX	5044
Super Trail	260		B8ES	2411	0,5	B8EVX	7051	201	BR8EIX	5044
Synt 260	260		B8ES	2411	0,5	B8EVX	7051	201	BR8EIX	5044
TR-34/Campionato	260		B8ES	2411	0,5	B8EVX	7051	201	BR8EIX	5044
Zero	260		B8ES	2411	0,5	B8EVX	7051	201	BR8EIX	5044
Alp 4.0 4 Stroke	350	03-	CR9EK	4548	0,7			230	CR9EIX	3521
Euro 350	350		CR9EK	4548	0,7			230	CR9EIX	3521
Jonathan 350	350		CR9EK	4548	0,7			230	CR9EIX	3521
Motard 4.0 4 Stroke	350	03-	CR9EK	4548	0,7			230	CR9EIX	3521

BIMOTA

YB-9 Bellaria	600		CR9E	6263	0,7	CR9EVX	5943	227	CR9EIX	3521
YB-9 SR	600	95-	CR9E	6263	0,7	CR9EVX	5943	227	CR9EIX	3521
BB 1 Supermono / Biposto	650	95-	D8EA	2120	0,7	D8EVX	2850	216	DR8EIX	6681
DB-1/S	750		BP7HS	5111	0,5	BP7HVX	7468		BPR7HIX	5944
SB 7	750		CR9EK	4548	0,7			230	CR9EIX	3521
YB-4	750		DR8EA	7162	0,7	DR8EVX	6354		DR8EIX	6681
Tesi 1	851	92-			0,6	D9EVX	2834		DR9EIX	4772
DB-2	900	92-	DPR8EA-9	4929	0,9	DPR8EVX-9	2872	221	DPR8EIX-9	2202



Order No.



Platin Gold-Palladium

Order Quick No.



Order No.

BIMOTA

DB-2 SR	900		DPR8EA-9	4929	0,9	DPR8EVX-9	2872	221	DPR8EIX-9	2202
DB-3 Mantra	904	95-	DPR8EA-9	4929	0,9	DPR8EVX-9	2872	221	DPR8EIX-9	2202
SB 8 R	1000	99-	CR9EK	4548	0,7			230	CR9EIX	3521
YB-6	1000		DR8ESL	2923	0,7	DR8EVX	6354	218	DR8EIX	6681
YB-8 EXUP	1000	95-	DR8ESL	2923	0,7	DR8EVX	6354	218	DR8EIX	6681
YB 11	1002	96-	DR8EA	7162	0,7	DR8EVX	6354		DR8EIX	6681
SB 6	1100		CR9E	6263	0,7	CR9EVX	5943	227	CR9EIX	3521
SB 6 R	1100	97-	CR9E	6263	0,7	CR9EVX	5943	227	CR9EIX	3521
SB-5/S	1150		DPR9EA-9	5329	0,9	DPR9EVX-9	3854	222	DPR9EIX-9	5545
YB-5	1200		DPR8EA-9	4929	0,9	DPR8EVX-9	2872	221	DPR8EIX-9	2202

BLATA

Elite 13	40		B9ES	2611	0,5	B9EVX	7254	202	BR9EIX	3981
Elite 13 / 13W	40		B9ES	2611	0,8	B9EVX	7254	202	BR9EIX	3981
Elite 13 W R S	40				0,5	B9EGV	5827			
Elite 13 W R	40				0,5	B9EGV	5827			
Elite 13 R	40				0,5	B9EGV	5827			
Elite 13 W	40		B9ES	2611	0,5	B9EVX	7254	202	BR9EIX	3981
Elite 13S	40				0,5	B9EGV	5827			

BMW

R 20 (220/1)	192	37- 38	B6HS	4510	0,7	B6HVX	7435	203	BR6HIX	3419
R 23 (223/1)	192	38- 40	B6HS	4510	0,7	B6HVX	7435	203	BR6HIX	3419
R 24	250	48- 50	B8HS	5510	0,6	B8HVX	2634	205	BR8HIX	7001
R 25	250	50- 51	B8HS	5510	0,6	B8HVX	2634	205	BR8HIX	7001
R 25/2	250	51- 53	B8HS	5510	0,6	B8HVX	2634	205	BR8HIX	7001
R 25/3	250	53- 56	B8HS	5510	0,6	B8HVX	2634	205	BR8HIX	7001
R 26	250	56- 60	B8HS	5510	0,6	B8HVX	2634	205	BR8HIX	7001
R 27	250	60- 67	B8HS	5510	0,6	B8HVX	2634	205	BR8HIX	7001
R 51/2	250	50- 51	B8HS	5510	0,6	B8HVX	2634	205	BR8HIX	7001
R 51/3	250	51- 54	B8HS	5510	0,6	B8HVX	2634	205	BR8HIX	7001
R 3 (203/1)	305	(36)	B6HS	4510	0,7	B6HVX	7435	203	BR6HIX	3419
R 45 26kW	475	06.78-06.83	BP7ES	2412	0,6	BP7EVX	7270	206	BPR7EIX	4055
R 45 20kW	475	06.78-07.85	BP6ES	7811	0,6	BP6EVX	5832		BPR6EIX	6637
R 5 (254)	494	36- 37	B7HS	5110	0,7	B7HVX	7836	204	BR7HIX	7067
R 50	500	55- 69	B8HS	5510	0,6	B8HVX	2634	205	BR8HIX	7001
R 50/5	500		BP7ES	2412	0,6	BP7EVX	7270	206	BPR7EIX	4055
R 50S	500	60- 62	B8HS	5510	0,6	B8HVX	2634	205	BR8HIX	7001
R 52	500	28- 29	B6HS	4510	0,6	B6HVX	7435	203	BR6HIX	3419
R 6 (261)	600	(37)	B6HS	4510	0,7	B6HVX	7435	203	BR6HIX	3419
R 60	600	56- 69	B8HS	5510	0,6	B8HVX	2634	205	BR8HIX	7001
R 60/5, /6, /7	600	-06.78	BP7ES	2412	0,6	BP7EVX	7270	206	BPR7EIX	4055
R 67	600	51-	B8HS	5510	0,6	B8HVX	2634	205	BR8HIX	7001
R 67/2	600	52- 54	B8HS	5510	0,6	B8HVX	2634	205	BR8HIX	7001
R 68	600	52- 54	B8HS	5510	0,6	B8HVX	2634	205	BR8HIX	7001
R 69	600	55- 60	B8HS	5510	0,6	B8HVX	2634	205	BR8HIX	7001
R 69S	600	60- 69	B8HS	5510	0,6	B8HVX	2634	205	BR8HIX	7001
F 650 TwinSpark (BMS-C II)	650	09.04-	DR8EB	4855	0,6				DR8EIX	6681
F 650 25kW	650	93- 99	D8EA	2120	0,7	D8EVX	2850	216	DR8EIX	6681
F 650 34kW	650	93- 99	D8EA	2120	0,7	D8EVX	2850	216	DR8EIX	6681
F 650 ST 34kW	650	97- 99	D8EA	2120	0,6	D8EVX	2850	216	DR8EIX	6681
F 650 GS 25kW	650	00-08.03	D8EA	2120	0,6	D8EVX	2850	216	DR8EIX	6681



Order No.

Platin
Gold-Palladium

Order Quick No. No.



Order No.

BMW

F 650 GS	34kW	650	00-08.03	D8EA	2120	0,6	D8EVX	2850	216	DR8EIX	6681
F 650 CS		650	02-08.03	DR8EB	4855	0,6				DR8EIX	6681
R 65		650	06.78-	BP7ES	2412	0,6	BP7EVX	7270	206	BPR7EIX	4055
R 16 Serie 1-5		736	29- 35	B6HS	4510	0,7	B6HVX	7435	203	BR6HIX	3419
R 17 (M60)		736	35- 37	A6	1010	0,7					
R 11 Serie 1-5		745	29- 34	B6HS	4510	0,7	B6HVX	7435	203	BR6HIX	3419
R 12 2-Vergaser (M56S6&212)		745	35- 42	B6HS	4510	0,7	B6HVX	7435	203	BR6HIX	3419
K 75 RT		750	- 96	D7EA	7912	0,6	D7EVX	2734			
K 75 S		750	- 96	D7EA	7912	0,6	D7EVX	2734			
K 75		750	06.85- 96	D7EA	7912	0,6	D7EVX	2734			
R 75/5, /6, /7		750		BP6ES	7811	0,6	BP6EVX	5832		BPR6EIX	6637
R 80		800	08.82- 95	BP6ES	7811	0,7	BP6EVX	5832		BPR6EIX	6637
R 80 R		800	80-	BP6ES	7811	0,7	BP6EVX	5832		BPR6EIX	6637
R 80 GS		800	08.82- 94	BP6ES	7811	0,7	BP6EVX	5832		BPR6EIX	6637
R 80 RT		800	08.82- 95	BP6ES	7811	0,7	BP6EVX	5832		BPR6EIX	6637
R 80 ST		800	08.82- 95	BP6ES	7811	0,7	BP6EVX	5832		BPR6EIX	6637
R 80/7N /7S		800	09.77-08.80	BP6ES	7811	0,7	BP6EVX	5832		BPR6EIX	6637
R 850 GS		850	98-	BKR7EKC	7354						
R 850 R	52kW	850	10.94-	BKR7EKC	7354						
R 850 RT		850	99-	BKR7EKC	7354						
R 90/6		900		BP6ES	7811	0,6	BP6EVX	5832		BPR6EIX	6637
R 90/S		900		BP7ES	2412	0,6	BP7EVX	7270	206	BPR7EIX	4055
K 100 LT / RT	65kW	1000	09.83-11.91	D7EA	7912	0,5	D7EVX	2734			
K 100 RS 4V		1000		DR7EA	7839	0,6					
K 100 RS	65kW	1000	09.83-12.89	D7EA	7912	0,6	D7EVX	2734			
K 100 RS	72-74kW	1000	01.90- 93	D7EA	7912	0,6	D7EVX	2734			
K 1	72-74kW	1000	05.89- 93	DR7EA	7839	0,6					
R 100 R		1000	94-	BP6ES	7811	0,6	BP6EVX	5832		BPR6EIX	6637
R 100		1000		BP7ES	2412	0,6	BP7EVX	7270	206	BPR7EIX	4055
R 100 RS		1000	09.86-	BP6ES	7811	0,6	BP6EVX	5832		BPR6EIX	6637
R 100/7		1000		BP6ES	7811	0,6	BP6EVX	5832		BPR6EIX	6637
R 100/CS /RT		1000		BP7ES	2412	0,6	BP7EVX	7270	206	BPR7EIX	4055
R 100/RS		1000	-08.86	BP7ES	2412	0,6	BP7EVX	7270	206	BPR7EIX	4055
R 100 GS		1000	09.86-	BP6ES	7811	0,6	BP6EVX	5832		BPR6EIX	6637
R 100/S /T		1000	09.76-08.80	BP7ES	2412	0,6	BP7EVX	7270	206	BPR7EIX	4055
K 1100 LT	72-74kW	1100	01.92- 98	DR7EA	7839	0,6					
K 1100 RS	72-74kW	1100	01.92- 96	DR7EA	7839	0,6					
R 1100 GS	59kW	1100	08.93- 99	BCP7ET	2078	0,8					
R 1100 R	59kW	1100	10.94-	BCP7ET	2078	0,8					
R 1100 RS	66kW	1100	11.92-	BCP7ET	2078	0,8					
R 1100 RT	66kW	1100	09.95-	BCP7ET	2078	0,8					
R 1100 S	72kW not twinspark	1100	98- 03	BKR7EKC	7354						
R 1100 S Boxer Cup	not twinspark	1100	02- 03	BKR7EKC	7354						
R 1150 GS	not twinspark	1150	99- 03	BKR7EKC	7354						
R 1150 GS Adventure	not twinspark	1150	02- 03	BKR7EKC	7354						
R 1150 R	not twinspark	1150	01- 03	BKR7EKC	7354						
R 1150 RT	not twinspark	1150	01- 03	BKR7EKC	7354						
K 1200 RS	96kW	1200	97-	DCPR7E	3932	0,8	DCPR7EVX	1179		DCPR7EIX	6046
K 1200 RS	72kW	1200	97-	DCPR7E	3932	0,8	DCPR7EVX	1179		DCPR7EIX	6046
K 1200 LT	72kW	1200	97-	DCPR7E	3932	0,8	DCPR7EVX	1179		DCPR7EIX	6046
K 1200 GT		1200	03-	DCPR7E	3932	0,8	DCPR7EVX	1179		DCPR7EIX	6046
K 1200 LT		1200	98-	DCPR7E	3932	0,8	DCPR7EVX	1179		DCPR7EIX	6046



Order No.



Platin Gold-Palladium

Order Quick No.

Iridium



Order No.

BMW

R 1200 C	1200			BKR7EKC	7354						
R 1200 CL	1200	03-		BKR7EKC	7354						

BOMBARDIER

50 DS (ATV)	50	02-		BPR7HS	6422	0,6	BPR7HVX	2938	215	BPR7HIX	5944
50 Quest (ATV)	50	(03)		BPR7HS	6422	0,6	BPR7HVX	2938	215	BPR7HIX	5944
DS 50 (ATV)	50	04-		BR9ECS	3570	0,5					
Quest 50 (ATV)	50	04-		BR9ECS	3570	0,5					
90 DS (ATV)	83	02-		BPR7HS	6422	0,6	BPR7HVX	2938	215	BPR7HIX	5944
90 Quest (ATV)	90	(03)		CR7HSA	4549	0,7				CR7HIX	7544
90 DS 4stroke (ATV)	90	02-		CR7HSA	4549	0,7				CR7HIX	7544
DS 90 (ATV)	90	04-		BR9ECS	3570	0,5					
Quest 90 (ATV)	90	04-		BR9ECS	3570	0,5					
175 (ATV)	175	03-		CR8E	1275	0,7	CR8EVX	6487	226	CR8EIX	4218
Rally 200 (ATV)	176	04-		BR9ECS	3570	0,5					
200 Rally (ATV)	200	03-		CR8E	1275	0,7	CR8EVX	6487	226	CR8EIX	4218
330 (ATV)	330	02-		DCPR8E	4339	0,9	DCPR8EVX	2265			
Outlander 330 (ATV)	330	04-		BR9ECS	3570	0,5					
400 Outlander (ATV)	400	03-		DCPR8E	4339	0,9	DCPR8EVX	2265			
Outlander 400 (ATV)	400	04-		BR9ECS	3570	0,5					
Quest 498 (ATV)	498	03-		BR9ECS	3570	0,5					
Traxter 498 (ATV)	498	03-		BR9ECS	3570	0,5					
500 (ATV)	500	02-		DCPR8E	4339	0,9	DCPR8EVX	2265			
500 Traxter 7401 (ATV)	500	99- 02		DR8EA	7162	0,7	DR8EVX	6354		DR8EIX	6681
500 Traxter 7414 (ATV)	500	98- 02		DR8EA	7162	0,7	DR8EVX	6354		DR8EIX	6681
Quest 644 (ATV)	644	03-		BR9ECS	3570	0,5					
650 Quest (ATV)	650	02- 03		DCPR8E	4339	0,9	DCPR8EVX	2265			
650 Traxter DS / DR (ATV)	650	00-		DR8EA	7162	0,7	DR8EVX	6354		DR8EIX	6681
650 DS 653 (ATV)	653	03-		BR9ECS	3570	0,5					

BOSS

HOSS	8226			BPR4ES	7222	0,7	BPR4EVX	3436			
------	------	--	--	--------	------	-----	---------	------	--	--	--

BSA

A 7	500	47- 62		B7HCS	2421	0,7					
-----	-----	--------	--	-------	------	-----	--	--	--	--	--

BSM

City	50	99- 01		BPR7HS	6422	0,6	BPR7HVX	2938	215	BPR7HIX	5944
Off Road	50	99- 01		BPR7HS	6422	0,6	BPR7HVX	2938	215	BPR7HIX	5944
Thunderbike	50	99-		BPR7HS	6422	0,6	BPR7HVX	2938	215	BPR7HIX	5944
Winner	50	99-		BPR7HS	6422	0,6	BPR7HVX	2938	215	BPR7HIX	5944
Thunderbike 2	100	99-		BPR7HS	6422	0,6	BPR7HVX	2938	215	BPR7HIX	5944
125	125	99-		DR8EA	7162	0,7	DR8EVX	6354		DR8EIX	6681
Thunderbike 4	125	99-		CR7HSA	4549	0,7				CR7HIX	7544

BUELL

RR 1000	1000	87- 88		DCPR7E	3932	1,0	DCPR7EVX	1179		DCPR7EIX	6046
XB9R	1000	01-		DCPR9E	2641	0,9	DCPR9EVX	6436			
XB9S	1000	03-		DCPR9E	2641	0,9	DCPR9EVX	6436			
M2 Cyclone	1200	97- 98		DCPR7E	3932	1,0	DCPR7EVX	1179		DCPR7EIX	6046
RSS 1200/ RS/ RR	1200	89- 94		DCPR7E	3932	1,0	DCPR7EVX	1179		DCPR7EIX	6046
S1 White Lightning	1200	98-		DCPR7E	3932	1,0	DCPR7EVX	1179		DCPR7EIX	6046



Order No.

Platin
Gold-Palladium

Order Quick No. No.

Iridium



Order No.

BUELL

S1 Lightning	1200	96- 97	DCPR7E	3932	1,0	DCPR7EVX	1179		DCPR7EIX	6046
S2 Thunderbolt	1200	95- 96	DCPR7E	3932	1,0	DCPR7EVX	1179		DCPR7EIX	6046
S3 Thunderbolt	1200	97-	DCPR7E	3932	1,0	DCPR7EVX	1179		DCPR7EIX	6046
X1 Lightning	1200	99-	DCPR7E	3932	1,0	DCPR7EVX	1179		DCPR7EIX	6046
XB 12 S	1200	04-	DCPR9E	2641	0,9	DCPR9EVX	6436			

BULTACO

49/GT	50		B5HS	4210	0,5					
Astro	50	98-	B9ES	2611	0,5	B9EVX	7254	202	BR9EIX	3981
Chispa	50		B5HS	4210	0,5					
Lobito	50	98-	B9ES	2611	0,5	B9EVX	7254	202	BR9EIX	3981
Tiron	50		B5HS	4210	0,5					
Brinco	75		B7HS	5110	0,5	B7HVX	7836	204	BR7HIX	7067
Frontera	75		B8HS	5510	0,5	B8HVX	2634	205	BR8HIX	7001
Junior GT2	75		B7HS	5110	0,5	B7HVX	7836	204	BR7HIX	7067
Lobito	75		B6HS	4510	0,5	B6HVX	7435	203	BR6HIX	3419
Sherpa T	75		B6HS	4510	0,5	B6HVX	7435	203	BR6HIX	3419
Streaker	75		B6HS	4510	0,5	B6HVX	7435	203	BR6HIX	3419
Junior	100		B6HS	4510	0,5	B6HVX	7435	203	BR6HIX	3419
Lobito	100		B6HS	4510	0,5	B6HVX	7435	203	BR6HIX	3419
Lobito K	100		B9HS	5810	0,5	B9HVX	2254			
Sherpa S	100		B9HS	5810	0,5	B9HVX	2254			
Tiron	100		B6HS	4510	0,5	B6HVX	7435	203	BR6HIX	3419
Alpina	125		BP5ES	6511	0,5	BP5EVX	5470		BPR5EIX	6597
Frontera	125		B6HS	4510	0,5	B6HVX	7435	203	BR6HIX	3419
Junior	125		B6HS	4510	0,5	B6HVX	7435	203	BR6HIX	3419
Lobito MK3/MK6	125		BP5ES	6511	0,5	BP5EVX	5470		BPR5EIX	6597
Lobito MK7	125		B6HS	4510	0,5	B6HVX	7435	203	BR6HIX	3419
Mercurio	125		B6HS	4510	0,5	B6HVX	7435	203	BR6HIX	3419
Pursang MK5	125		B10EG	3630	0,5	B10EGV	5927			
Pursang MK6	125		B9EG	3530	0,5	B9EGV	5827		BR9EIX	3981
Sherco	125	00-	BPR5ES	7422	0,6	BPR5EVX	4875		BPR5EIX	6597
Sherpa S	125		B9EG	3530	0,5	B9EGV	5827		BR9EIX	3981
Sherpa T	125		B6HS	4510	0,5	B6HVX	7435	203	BR6HIX	3419
Streaker	125		B6HS	4510	0,5	B6HVX	7435	203	BR6HIX	3419
Tralla	125		B6HS	4510	0,5	B6HVX	7435	203	BR6HIX	3419
Campera	150		B6HS	4510	0,5	B6HVX	7435	203	BR6HIX	3419
Mercurio/GT/150	150		B6HS	4510	0,5	B6HVX	7435	203	BR6HIX	3419
Tralla	150		B6HS	4510	0,5	B6HVX	7435	203	BR6HIX	3419
Alpina	175		BP5ES	6511	0,5	BP5EVX	5470		BPR5EIX	6597
Campera MK2	175		B5ES	6410	0,5					
Lobito MK6	175		BP5ES	6511	0,5	BP5EVX	5470		BPR5EIX	6597
Lobito MK7	175		B5ES	6410	0,5					
Mercurio	175		B6HS	4510	0,5	B6HVX	7435	203	BR6HIX	3419
Mercurio GT	175		BP5ES	6511	0,5	BP5EVX	5470		BPR5EIX	6597
Pursang MK5	175		B9EG	3530	0,5	B9EGV	5827		BR9EIX	3981
Sherpa MK3	175		B9EG	3530	0,5	B9EGV	5827		BR9EIX	3981
El Tigre	200		B8ES	2411	0,5	B8EVX	7051	201	BR8EIX	5044
Go Kart	200		B9EG	3530	0,5	B9EGV	5827		BR9EIX	3981
Mercurio	200		B8ES	2411	0,5	B8EVX	7051	201	BR8EIX	5044
Metise	200		B8ES	2411	0,5	B8EVX	7051	201	BR8EIX	5044
Pursang MK5	200		B9EG	3530	0,5	B9EGV	5827		BR9EIX	3981

Order
No.Platin
Gold-
Palla-
diumOrder Quick
No.

Iridium

Order
No.**BULTACO**

Senior	200		B8ES	2411	0,5	B8EVX	7051	201	BR8EIX	5044
Sherco	200	00-	BPR5ES	7422	0,6	BPR5EVX	4875		BPR5EIX	6597
Sherpa MK3	200		B9EG	3530	0,5	B9EGV	5827		BR9EIX	3981
Sherpa S	200		B7ES	1111	0,5	B7EVX	6934			
Alpina	250		BP5ES	6511	0,5	BP5EVX	5470		BPR5EIX	6597
Astro	250		B9EG	3530	0,5	B9EGV	5827		BR9EIX	3981
Frontera	250		B8ES	2411	0,5	B8EVX	7051	201	BR8EIX	5044
Matador 250/SD	250		BP5ES	6511	0,5	BP5EVX	5470		BPR5EIX	6597
Matador MK2/MK3	250		B8ES	2411	0,5	B8EVX	7051	201	BR8EIX	5044
Matador MK4	250		BP6ES	7811	0,5	BP6EVX	5832		BPR6EIX	6637
Metralla GT/MK2/MK250	250		B8ES	2411	0,5	B8EVX	7051	201	BR8EIX	5044
Metralla GTS	250		BP5ES	6511	0,5	BP5EVX	5470		BPR5EIX	6597
Pursang MK4/MK5 lado admis	250		B8ES	2411	0,5	B8EVX	7051	201	BR8EIX	5044
Pursang MK4/MK5 lado escap	250		B9EG	3530	0,5	B9EVX	7254		BR9EIX	3981
Pursang MK6/MK7 lado admis	250		B8ES	2411	0,5	B8EGV	5627	201	BR8EIX	5044
Pursang MK6/MK7 lado escap	250		B9EG	3530	0,5	B9EGV	5827		BR9EIX	3981
Sherco	250	99-	BPR5ES	7422	0,6	BPR5EVX	4875		BPR5EIX	6597
Sherpa S	250		B9EG	3530	0,5	B9EGV	5827		BR9EIX	3981
Sherpa T	250		BP5ES	6511	0,5	BP5EVX	5470		BPR5EIX	6597
Sherco	290	00-	BPR5ES	7422	0,6	BPR5EVX	4875		BPR5EIX	6597
Alpina	350		BP5ES	6511	0,5	BP5EVX	5470		BPR5EIX	6597
Matador MK9/MK10	350		BP5ES	6511	0,5	BP5EVX	5470		BPR5EIX	6597
Pursang MK5/MK6 lado admis	350		B8ES	2411	0,5	B8EVX	7051	201	BR8EIX	5044
Pursang MK5/MK6 lado escap	350		B9EG	3530	0,5	B9EGV	5827		BR9EIX	3981
Sherpa T	350		BP5ES	6511	0,5	BP5EVX	5470		BPR5EIX	6597
Astro lado admision	360		B8ES	2411	0,5	B8EVX	7051	201	BR8EIX	5044
Astro lado escape	360		B9EG	3530	0,5	B9EGV	5827		BR9EIX	3981
El Bandito MK2 lado admis.	360		B8ES	2411	0,5	B8EVX	7051	201	BR8EIX	5044
El Bandito MK2 lado escape	360		B9EG	3530	0,5	B9EGV	5827		BR9EIX	3981
Frontera	360		B8ES	2411	0,5	B8EVX	7051	201	BR8EIX	5044
Pursang lado admision	360		B8ES	2411	0,5	B8EVX	7051	201	BR8EIX	5044
Pursang lado escape	360		B9EG	3530	0,5	B9EGV	5827		BR9EIX	3981
Frontera MK11	370		B8ES	2411	0,5	B8EVX	7051	201	BR8EIX	5044
Pursang lado admision	370		B8ES	2411	0,5	B8EVX	7051	201	BR8EIX	5044
Pursang lado escape	370		B9EG	3530	0,5	B9EGV	5827		BR9EIX	3981
Pursang MK15	450		B8ES	2411	0,5	B8EVX	7051	201	BR8EIX	5044

CAGIVA

City	50	98-	BR8HSA	5539	0,5	BR8HVX	6265		BR8HIX	7001
Cocis	50		B8ES	2411	0,5	B8EVX	7051	201	BR8EIX	5044
K3	50		B8ES	2411	0,5	B8EVX	7051	201	BR8EIX	5044
Prima	50		B8ES	2411	0,5	B8EVX	7051	201	BR8EIX	5044
Supercity	50		B8ES	2411	0,5	B8EVX	7051	201	BR8EIX	5044
W4	50		B8ES	2411	0,5	B8EVX	7051	201	BR8EIX	5044
Cocis	75		B8ES	2411	0,5	B8EVX	7051	201	BR8EIX	5044
125 Elefant 2	125		B9EG	3530	0,5	B9EGV	5827		BR9EIX	3981
Aletta Electra, Oro	125	84-	B9ES	2611	0,5	B9EVX	7254	202	BR9EIX	3981
Aletta Oro 125/S1	125	07.85-12.85	B9EG	3530	0,5	B9EGV	5827		BR9EIX	3981
Aletta Oro 125/S2	125	01.86-	B9ES	2611	0,6	B9EVX	7254	202	BR9EIX	3981
Aletta,Low Rider	125	01.82-	B8ES	2411	0,5	B8EVX	7051	201	BR8EIX	5044
Blues,C10,Cruiser	125	10.87-	B9ES	2611	0,5	B9EVX	7254	202	BR9EIX	3981
Elefant 3	125	01.87-	B9ES	2611	0,5	B9EVX	7254	202	BR9EIX	3981

Order
No.Platin
Gold-
Palla-
diumOrder Quick
No. No.

Iridium

Order
No.**CAGIVA**

Freccia C 9 (D)	125	06.87-	B9ES	2611	0,6	B9EVX	7254	202	BR9EIX	3981
Freccia C10 (D)	125		B9ES	2611	0,6	B9EVX	7254	202	BR9EIX	3981
Freccia C12 (D)	125	06.87-	B9ES	2611	0,6	B9EVX	7254	202	BR9EIX	3981
K7	125				0,5	B95EGV	2145			
Mito	125	95- 98			0,5	B95EGV	2145			
Mito	125	99-	BR9EG	3230	0,5					
Mito 1 (D)	125				0,5	B95EGV	2145			
Mito 2 (D)	125				0,5	B95EGV	2145			
Mito EV 125	125		BR10EG	3830	0,6					
Mito Racing (D)	125				0,5	B95EGV	2145			
N 90	125	03.90-	B9ES	2611	0,5	B9EVX	7254	202	BR9EIX	3981
Passing (Roller)	125	94-	BP6HS	4511	0,6	BP6HVX	4635		BPR6HIX	4085
Planet	125	99- 03	BR9EG	3230	0,5					
RL, SS, SX	125		B8ES	2411	0,5	B8EVX	7051	201	BR8EIX	5044
Roadster	125	98-	BR9ES	5722	0,6	BR9EVX	1265	208	BR9EIX	3981
Aletta Rossa / Dakar	125		B9EG	3530	0,5	B9EGV	5827		BR9EIX	3981
RX 125 Rally	125	01.81-12.81	B9EG	3530	0,5	B9EGV	5827		BR9EIX	3981
RX,WRX,WSXT	125	01.82-12.83	B9EG	3530	0,5	B9EGV	5827		BR9EIX	3981
ST,SXT	125	01.82-12.82	B9ES	2611	0,5	B9EVX	7254	202	BR9EIX	3981
Supercity	125	99-	BR9EG	3230	0,5					
Supercity (D)	125				0,5	B95EGV	2145			
Tamanaco 125	125	01.88-	B9ES	2611	0,6	B9EVX	7254	202	BR9EIX	3981
W 8	125	98-	BR9ES	5722	0,6	BR9EVX	1265	208	BR9EIX	3981
W 8 (only D)	125	91-			0,5	B95EGV	2145			
W 8 11kW	125	96- 97	B9ES	2611	0,5	B9EVX	7254	202	BR9EIX	3981
WMX 125/84	125				0,5	B9EVX	7254		BR9EIX	3981
WMX 125/85	125				0,5	B10EGV	5927			
WMX 125/88	125				0,5	B10EGV	5927			
WR 125	125	02-	BR9EG	3230	0,5					
WRE 125	125	02-	BR9EG	3230	0,5					
All	175		B8ES	2411	0,5	B8EVX	7051	201	BR8EIX	5044
All	200		B9ES	2611	0,5	B9EVX	7254	202	BR9EIX	3981
MX,MXR,RR,RX,WMX	250		B9ES	2611	0,5	B9EVX	7254	202	BR9EIX	3981
NC,RL,SS,SST	250	01.83-	B8ES	2411	0,5	B8EVX	7051	201	BR8EIX	5044
RX 250 Rally	250	01.79-11.83	B9EG	3530	0,5	B9EGV	5827		BR9EIX	3981
SX, SXT	250	01.83-12.84	B8ES	2411	0,5	B8EVX	7051	201	BR8EIX	5044
Ala Blu 350	350		B8ES	2411	0,5	B8EVX	7051	201	BR8EIX	5044
Ala Rossa 350/4T	350	01.83-	B8ES	2411	0,5	B8EVX	7051	201	BR8EIX	5044
Ala Verde 350	350		B8ES	2411	0,5	B8EVX	7051	201	BR8EIX	5044
Alazzurra 350 (D)	350	01.84-	BP7HS	5111	0,5	BP7HVX	7468		BPR7HIX	5944
Elefant 350 (D)	350		BP7HS	5111	0,5	BP7HVX	7468		BPR7HIX	5944
Lucky 350	350		DP8EA-9	5829	0,9	DPR8EVX-9	2872		DPR8EIX-9	2202
SST 350	350		B8ES	2411	0,5	B8EVX	7051	201	BR8EIX	5044
SX 350	350	11.81-12.82	B8ES	2411	0,5	B8EVX	7051	201	BR8EIX	5044
T4 350 E, R (D)	350	10.86-	DP8EA-9	5829	0,9	DPR8EVX-9	2872		DPR8EIX-9	2202
Trial 350	350	01.82-	BP5ES	6511	0,6	BP5EVX	5470		BPR5EIX	6597
W12	350	94-	DP8EA-9	5829	0,9	DPR8EVX-9	2872		DPR8EIX-9	2202
T4 500 E, R (D)	450		DP8EA-9	5829	0,9	DPR8EVX-9	2872		DPR8EIX-9	2202
Canyon 500	500	98-	BPR8ES	3923	0,7	BPR8EVX	5573	213		
MXR 500	500				0,5	B95EGV	2145			
Canyon 600	600	96- 97			0,7	BKR7EVX	3544			
Canyon 600	600	98-	BCP7ES	5030	0,8	BCP7EV	3733			

Order
No.Platin
Gold-
Palla-
diumOrder Quick
No.

Iridium

Order
No.**CAGIVA**

River 600	600	95-			0,7	BKR7EVX	3544			
Super City	600	95-			0,7	BKR7EVX	3544			
W16	600	94-			0,7	BKR7EVX	3544			
Alazzurra 650 (D)	650	01.84-	BP7HS	5111	0,6	BP7HVX	7468		BPR7HIX	5944
Elefant 650 (D)	650	01.85-12.88	BP7HS	5111	0,6	BP7HVX	7468		BPR7HIX	5944
Raptor	650	00-	CR8E	1275	0,7	CR8EVX	6487	226	CR8EIX	4218
V-Raptor	650	00-	CR8E	1275	0,7	CR8EVX	6487	226	CR8EIX	4218
Elefant 750	750	94-	DPR8EA-9	4929	0,9	DPR8EVX-9	2872	221	DPR8EIX-9	2202
Elefant 750 Lucky (D)	750	02.87-	DPR8EA-9	4929	0,9	DPR8EVX-9	2872	221	DPR8EIX-9	2202
Elefant 900 AC (D)	900	93-	DPR9EA-9	5329	0,9	DPR9EVX-9	3854	222	DPR9EIX-9	5545
Elefant 900 ie/GT (D)	900	92-	DPR9EA-9	5329	0,9	DPR9EVX-9	3854	222	DPR9EIX-9	5545
Grand Canyon 900	900	98-	DPR8EA-9	4929	0,9	DPR8EVX-9	2872	221	DPR8EIX-9	2202
Navigator	1000	99-	CR8EK	3478	0,7					
Raptor	1000	99-	CR8EK	3478	0,7					
V-Raptor	1000	03.00-	CR8EK	3478	0,7					
X-tra Raptor 1000	1000	03-	CR8EK	3478	0,7					

CANNONDALE

EX 400	432	01-	CR9EK	4548	0,7			230	CR9EIX	3521
FX 400 (ATV)	432	00-	CR9EK	4548	0,7			230	CR9EIX	3521
MX 400	432	00-	CR9EK	4548	0,7			230	CR9EIX	3521
XC 400	432	01-	CR9EK	4548	0,7			230	CR9EIX	3521
440 Moto (ATV)	440	02-	CR9EK	4548	0,7			230	CR9EIX	3521
Blaze (ATV)	440	02-	CR9EK	4548	0,7			230	CR9EIX	3521
Cannibal (ATV)	440	02-	CR9EK	4548	0,7			230	CR9EIX	3521
Glamis (ATV)	440	03-	CR9EK	4548	0,7			230	CR9EIX	3521
Speed (ATV)	440	02-	CR9EK	4548	0,7			230	CR9EIX	3521

CARABELA

Carrera	50		BP5HS	4111	0,5					
Super SP / de Luxe	50		BP5HS	4111	0,5					
Ciclo Motor Ciao	60		B6HS	4510	0,5	B6HVX	7435	203	BR6HIX	3419
Merida, Mototic, Moto pony	60		B6HS	4510	0,5	B6HVX	7435	203	BR6HIX	3419
Coyote Enduro	100		B6ES	7310	0,5	B6EVX	5136			
Coyote MX	100		B7ES	1111	0,6	B7EVX	6934			
Enduro , MX	100		B6HS	4510	0,5	B6HVX	7435	203	BR6HIX	3419
Marquesa MX	100		B8ES	2411	0,6	B8EVX	7051	201	BR8EIX	5044
Marquesa Enduro	100		B7ES	1111	0,6	B7EVX	6934			
Marquesa Mini Enduro	100		B6ES	7310	0,5	B6EVX	5136			
Marquesa Mini MX	100		B7ES	1111	0,6	B7EVX	6934			
Mini Moto	100		B6ES	7310	0,5	B6EVX	5136			
Motorcarro 100	100		B6ES	7310	0,5	B6EVX	5136			
Panthera	100		B6HS	4510	0,5	B6HVX	7435	203	BR6HIX	3419
Panthera100,Sprint 100, TS-3 100	100		B6ES	7310	0,5	B6EVX	5136			
Rally Enduro	100		B6ES	7310	0,5	B6EVX	5136			
Torero Flat Track	100		B8ES	2411	0,6	B8EVX	7051	201	BR8EIX	5044
Coyote Enduro	125		B6ES	7310	0,5	B6EVX	5136			
Coyote MX	125		B7ES	1111	0,6	B7EVX	6934			
De Luxe	125		B6ES	7310	0,5	B6EVX	5136			
Marquesa MX 111	125		B8ES	2411	0,6	B8EVX	7051	201	BR8EIX	5044
Marquesa MXV	125		B8ES	2411	0,6	B8EVX	7051	201	BR8EIX	5044
Mini Enduro	125		B6ES	7310	0,5	B6EVX	5136			

Order
No.Platin
Gold-
Palla-
diumOrder Quick
No. No.

Iridium

Order
No.**CARABELA**

Rally Enduro	125		B6ES	7310	0,5	B6EVX	5136			
Torero Flat Track	125		B8ES	2411	0,6	B8EVX	7051	201	BR8EIX	5044
Marquesa Enduro	175		B8ES	2411	0,6	B8EVX	7051	201	BR8EIX	5044
Marquesa MK-II	175		B8ES	2411	0,6	B8EVX	7051	201	BR8EIX	5044
Rally Enduro	175		B6ES	7310	0,5	B6EVX	5136			
Strada	175		B6ES	7310	0,5	B6EVX	5136			
Torero Flat Track	175		B8ES	2411	0,6	B8EVX	7051	201	BR8EIX	5044
Enduro	200		B6ES	7310	0,5	B6EVX	5136			
Moto Cross	200		B8ES	2411	0,6	B8EVX	7051	201	BR8EIX	5044
Motocarro Ariete	200		B6ES	7310	0,5	B6EVX	5136			
Super Turismo	200		B6ES	7310	0,5	B6EVX	5136			
Centauro Enduro	250		B8ES	2411	0,6	B8EVX	7051	201	BR8EIX	5044
Centauro MX-II, MX-III, MX-IV	250		B8ES	2411	0,6	B8EVX	7051	201	BR8EIX	5044
Torero Flat Track	250		B8ES	2411	0,6	B8EVX	7051	201	BR8EIX	5044
Centauro MX-III	360		B8ES	2411	0,6	B8EVX	7051	201	BR8EIX	5044
Enduro	400		B6ES	7310	0,5	B6EVX	5136			
MX	400		B8ES	2411	0,6	B8EVX	7051	201	BR8EIX	5044
Centauro MX-II	450		B8ES	2411	0,6	B8EVX	7051	201	BR8EIX	5044
Enduro	450		B6ES	7310	0,5	B6EVX	5136			
Torero Flat Track	450		B7ES	1111	0,6	B7EVX	6934			

CARREFOUR

Web / Gap	50	00-	B7HS	5110	0,5	B7HVX	7836	204	BR7HIX	7067
PFM	125	00-	DR8EA	7162	0,7	DR8EVX	6354		DR8EIX	6681

CASAL

M 105 Six Speed (RZ, Mag.)	50	92-	B9HS	5810	0,6	B9HVX	2254			
M 109 Four Speed	50	91-	B8HS	5510	0,6	B8HVX	2634	205	BR8HIX	7001
M 140 Automatic	50	82-	B7HS	5110	0,6	B7HVX	7836	204	BR7HIX	7067
M 147 Two Speed	50	91-	B7HS	5110	0,6	B7HVX	7836	204	BR7HIX	7067
M 233 Six Speed	50	90-	B8ES	2411	0,6	B8EVX	7051	201	BR8EIX	5044
Super Boss K 168-8	50	91-	B8HS	5510	0,6	B8HVX	2634	205	BR8HIX	7001

CCM

CMX 125 L / C	125	83- 85	B9EG	3530	0,5	B9EGV	5827		BR9EIX	3981
Moto X Hiro	125	79- 80	B10EG	3630	0,5	B10EGV	5927			
240 CMT Trails	240		BP5ES	6511	0,7	BP5EVX	5470		BPR5EIX	6597
250 CMT Trails	250		BP5ES	6511	0,7	BP5EVX	5470		BPR5EIX	6597
250 CMX	250	82-	B8ES	2411	0,5	B8EVX	7051	201	BR8EIX	5044
250 CMX I / C	250	83- 85	B9EG	3530	0,5	B9EGV	5827		BR9EIX	3981
250 Moto Hiro	250	79- 81	B9EG	3530	0,5	B9EGV	5827		BR9EIX	3981
310 CMT Trails	310		BP5ES	6511	0,7	BP5EVX	5470		BPR5EIX	6597
320 CMT Trails	320		BP5ES	6511	0,7	BP5EVX	5470		BPR5EIX	6597
350 Trails	350	78-	B6ES	7310	0,7	B6EVX	5136			
350 CMT Trails	350		BP5ES	6511	0,7	BP5EVX	5470		BPR5EIX	6597
CM 36 Road Racer	350	78-			0,5	B9EVX	7254	202	BR9EIX	3981
CMX	450	82-			0,5	B8EVX	7051		BR8EIX	5044
490 CMX	490		B9EG	3530	0,5	B9EGV	5827		BR9EIX	3981
500 MTT	500		DR8EA	7162	0,7	DR8EVX	6354		DR8EIX	6681
CMX 500	500	82-	DR8EA	7162	0,7	DR8EVX	6354		DR8EIX	6681
Moto X 2Ventil	500	72- 79	B9EG	3530	0,5	B9EGV	5827		BR9EIX	3981
Moto X 4Ventil	500	79- 81	R017-8	3943	0,5				CR8EIX	4218

Order
No.Platin
Gold-
Palla-
diumOrder Quick
No. No.Order
No.**CCM**

560 CCM 2Takt	560		DR8EA	7162	0,7	DR8EVX	6354		DR8EIX	6681
560 CCM 4Takt	560		DR8EA	7162	0,7	DR8EVX	6354		DR8EIX	6681
604 R / RS / R30	600		DR8EA	7162	0,7	DR8EVX	6354		DR8EIX	6681
604 Supermoto dual Sport	600	01-	DR8EA	7162	0,7	DR8EVX	6354		DR8EIX	6681
604 Trail dual Sport	600	01-	DR8EA	7162	0,7	DR8EVX	6354		DR8EIX	6681
604 Roadster RS	600	01-	DR8EA	7162	0,7	DR8EVX	6354		DR8EIX	6681
640 RS	640		DR8EA	7162	0,7	DR8EVX	6354		DR8EIX	6681
644	650	02-	CR10EK	2360	0,7					
R30	650	02-	CR9EK	4548	0,7			230	CR9EIX	3521

CLIPIC

Trial	50	00-	B7HS	5110	0,5	B7HVX	7836	204	BR7HIX	7067
Trial E	50	00-	B10ES	7928	0,5	B10EVX	7335		BR10EIX	6801
Trial R	80	00-	B9ES	2611	0,5	B9EVX	7254	202	BR9EIX	3981

COSSACK

Jupiter 350	350		BR6HS	3922	0,5			209	BR6HIX	3419
Planeta 350	350		BR6HS	3922	0,5			209	BR6HIX	3419
Dnepr 650	650		BR6HS	3922	0,5			209	BR6HIX	3419
Ural 650, Ural MT10	650		B6HS	4510	0,5	B6HVX	7435	203	BR6HIX	3419

CPI

ATV 200	50	03-	BR7HS	4122	0,8			211	BR7HIX	7067
ATV 50	50	03-	BR7HS	4122	0,8			211	BR7HIX	7067
Supercross 50	50	03-	BR7HS	4122	0,8			211	BR7HIX	7067
Supermoto 50	50	03-	BR7HS	4122	0,8			211	BR7HIX	7067
ATV 100	100	03-	BR7HS	4122	0,8			211	BR7HIX	7067

CRAZY-VEHICLE

Crazy Buggy	125	03-	CR7HSA	4549	0,7				CR7HIX	7544
-------------	-----	-----	--------	------	-----	--	--	--	--------	------

CZ

488	125		B6HS	4510	0,6	B6HVX	7435	203	BR6HIX	3419
487	175		B6HS	4510	0,6	B6HVX	7435	203	BR6HIX	3419
485	250		B6HS	4510	0,6	B6HVX	7435	203	BR6HIX	3419
472	350		B6HS	4510	0,6	B6HVX	7435	203	BR6HIX	3419

DAELIM

125 Daystar	125	01.00-	C8EH-9	7473	0,9	C8EHVX-9	4450		CR8EHIX-9	3797
VC 125 Advance	125	95-	C8EH-9	7473	0,9	C8EHVX-9	4450		CR8EHIX-9	3797
VT 125 Evolution	125	03.98-	C8EH-9	7473	0,9	C8EHVX-9	4450		CR8EHIX-9	3797

DAREN

50 (ATV)	50	00-	BPR7HS	6422	0,8	BPR7HVX	2938	215	BPR7HIX	5944
100 (ATV)	100	00-	BPR7HS	6422	0,8	BPR7HVX	2938	215	BPR7HIX	5944
125 (ATV)	125	00-	DR8EA	7162	0,7	DR8EVX	6354		DR8EIX	6681
150 (ATV)	150	00-	DR8EA	7162	0,7	DR8EVX	6354		DR8EIX	6681

DERBI

Antorcha, Coppa, Diablo	50	- 91	B7HS	5110	0,6	B7HVX	7836	204	BR7HIX	7067
Aventura	50	95-	B8HS	5510	0,6	B8HVX	2634	205	BR8HIX	7001
Aventura	50	95-	B8HS	5510	0,6	B8HVX	2634	205	BR8HIX	7001

Order
No.Gold-
Palla-
dium

Platin

Order
No.Quick
No.

Iridium

Order
No.**DERBI**

Dirt Boy 10/10	50	03-	CR9E	6263	0,7	CR9EVX	5943	227	CR9EIX	3521
Dirt Kid 10/12	50	03-	CR9E	6263	0,7	CR9EVX	5943	227	CR9EIX	3521
FDS, GTS, RD-2	50	- 91	B7HS	5110	0,6	B7HVX	7836	204	BR7HIX	7067
Fenix, FDS Super, Start DS	50	92-	B8HS	5510	0,6	B8HVX	2634	205	BR8HIX	7001
Furax	50	95-	B8HS	5510	0,6	B8HVX	2634	205	BR8HIX	7001
GPR Replica	50	03-	B8ES	2411	0,5	B8EVX	7051	201	BR8EIX	5044
GPR Racing	50	02-	B8ES	2411	0,5	B8EVX	7051	201	BR8EIX	5044
GPR 50 R	50	02-	B8ES	2411	0,5	B8EVX	7051	201	BR8EIX	5044
Hunter (D+A)	50	95-	BP7HS	5111	0,6	BP7HVX	7468		BPR7HIX	5944
Hunter (Spain)	50	95-	B8HS	5510	0,6	B8HVX	2634	205	BR8HIX	7001
Naked	50	04-	B8ES	2411	0,5	B8EVX	7051	201	BR8EIX	5044
Olimpica, Savannah, Start	50	- 91	B7HS	5110	0,6	B7HVX	7836	204	BR7HIX	7067
R DRD	50	02-	B8ES	2411	0,5	B8EVX	7051	201	BR8EIX	5044
R Racer	50	02-	B8ES	2411	0,5	B8EVX	7051	201	BR8EIX	5044
R X-treme	50	02-	B8ES	2411	0,5	B8EVX	7051	201	BR8EIX	5044
RD-2 Country	50	92-	B8HS	5510	0,6	B8HVX	2634	205	BR8HIX	7001
Senda (Wasserkühlung)	50		B8ES	2411	0,5	B8EVX	7051	201	BR8EIX	5044
Sendra-R	50	95-	B9ES	2611	0,6	B9EVX	7254	202	BR9EIX	3981
SM Black Edition	50	02-	B8ES	2411	0,5	B8EVX	7051	201	BR8EIX	5044
SM DRD	50		B9ES	2611	0,6	B9EVX	7254	202	BR9EIX	3981
SM Racer	50	02-	B9ES	2611	0,6	B9EVX	7254	202	BR9EIX	3981
SM X-treme	50	02-	B9ES	2611	0,6	B9EVX	7254	202	BR9EIX	3981
Sport, Variant, Yumbo	50	- 91	B7HS	5110	0,6	B7HVX	7836	204	BR7HIX	7067
Urban	50	95-	B8HS	5510	0,6	B8HVX	2634	205	BR8HIX	7001
Vamos	50		BR8HS	4322	0,6	BR8HVX	6265	212	BR8HIX	7001
Variant Box/Sport R / Top	50	92-	B8HS	5510	0,6	B8HVX	2634	205	BR8HIX	7001
Variant AIR	50	05.03-	B8HS	5510	0,5	B8HVX	2634	205	BR8HIX	7001
1001,Extra Sport Coppa	75		B8ES	2411	0,5	B8EVX	7051	201	BR8EIX	5044
CR 74	75				0,5	B10EGV	5927			
Europa RD15, Scoot 74	75		B8ES	2411	0,5	B8EVX	7051	201	BR8EIX	5044
GPR-75, Sport-75	75		B10ES	7928	0,5	B10EGV	5927		BR10EIX	6801
Gran Prix 74	75		B6HS	4510	0,5	B6HVX	7435	203	BR6HIX	3419
Vivo-75	75		BP5HS	4111	0,6					
BI 3	80	95-	B8ES	2411	0,6	B8EVX	7051	201	BR8EIX	5044
CRS, RC	125				0,5	B10EGV	5927			
Enduro, RS125TT, Karmathan	125				0,5	B9EGV	5827			
Senda R 125	125	02-	DPR8EA-9	4929	0,9	DPR8EVX-9	2872	221	DPR8EIX-9	2202
Senda SM 125	125	02-	DPR8EA-9	4929	0,9	DPR8EVX-9	2872	221	DPR8EIX-9	2202
Sport Coppa, TTS9	125		B9ES	2611	0,5	B9EVX	7254	202	BR9EIX	3981
2002, Gran Prix, 6V	200		B9ES	2611	0,5	B9EVX	7254	202	BR9EIX	3981
CRX, RC, Enduro	250				0,5	B10EGV	5927			
Turismo 250	250		B9ES	2611	0,5	B9EVX	7254	202	BR9EIX	3981

DKW

RT 175	175	59-	B7HS	5110	0,5	B7HVX	7836	204	BR7HIX	7067
RT 250	175	59-	B7HS	5110	0,5	B7HVX	7836	204	BR7HIX	7067

DNEPR

11 J Gespann 28Kw	650		BP4HS	3611	0,6					
16 J Gespann 28Kw	650		BP4HS	3611	0,6					
KM3-8.157	650		BP6ES	7811	0,7	BP6EVX	5832		BPR6EIX	6637
KM3-8.157-022	650		BP6ES	7811	0,7	BP6EVX	5832		BPR6EIX	6637

Order
No.Platin
Gold-
Palla-
diumOrder Quick
No. No.Order
No.**DNEPR**

MT 11 20KW	650		BP4HS	3611	0,6					
MT 16 20KW	650		BP4HS	3611	0,6					

DRR

DRR 50 (ATV)	50	04-	BP7HS	5111	0,7	BP7HVX	7468		BPR7HIX	5944
DRR 90 (ATV)	90	04-	BP7HS	5111	0,7	BP7HVX	7468		BPR7HIX	5944
DRR 90 GT (ATV)	90	04-	C7HSA	4629	0,7	C7HVX	4533		CR7HIX	7544

DUCATI

100 Sport	100	58- 60	B7HS	5110	0,6	B7HVX	7836	204	BR7HIX	7067
125 Scrambler	125	71-	B8HS	5510	0,5	B8HVX	2634	205	BR8HIX	7001
125 Sport	125	58- 65	B7HS	5110	0,6	B7HVX	7836	204	BR7HIX	7067
125 TS	125	59- 65	B6HS	4510	0,5	B6HVX	7435	203	BR6HIX	3419
160 Monza	160		B7HS	5110	0,6	B7HVX	7836	204	BR7HIX	7067
175 Sport	175	58- 61	B7HS	5110	0,6	B7HVX	7836	204	BR7HIX	7067
175 TS	175	58- 60	B6HS	4510	0,5	B6HVX	7435	203	BR6HIX	3419
200 Elite	200	59- 65	B7HS	5110	0,6	B7HVX	7836	204	BR7HIX	7067
250 Mach 1	250	64- 66	B7HS	5110	0,6	B7HVX	7836	204	BR7HIX	7067
250 Monza	250	68-	B7HS	5110	0,6	B7HVX	7836	204	BR7HIX	7067
250 SCR	250	68- 74	B7HS	5110	0,6	B7HVX	7836	204	BR7HIX	7067
250 SCR-MC	250	62- 67	B7HS	5110	0,6	B7HVX	7836	204	BR7HIX	7067
350 Desmo	350	70- 76	B6HS	4510	0,5	B6HVX	7435	203	BR6HIX	3419
350 F3	350	86- 87	B6HS	4510	0,5	B6HVX	7435	203	BR6HIX	3419
350 F3 Desmo	350		BP7HS	5111	0,5	BP7HVX	7468		BPR7HIX	5944
350 Forza	350		B6HS	4510	0,5	B6HVX	7435	203	BR6HIX	3419
350 GTL	350	79-	B6HS	4510	0,5	B6HVX	7435	203	BR6HIX	3419
350 Indiana	350	86-	BR7HS	4122	0,5			211	BR7HIX	7067
350 Junior	350	92-	BP7HS	5111	0,6	BP7HVX	7468		BPR7HIX	5944
350 MK III	350	70- 76	B6HS	4510	0,5	B6HVX	7435	203	BR6HIX	3419
350 MK III D	350		B6HS	4510	0,5	B6HVX	7435	203	BR6HIX	3419
350 Sebring	350	65- 68	B7HS	5110	0,6	B7HVX	7836	204	BR7HIX	7067
350 Sport	350	92-	BP5ES	6511	0,7	BP5EVX	5470		BPR5EIX	6597
350 Sport Desmo	350		BR7HS	4122	0,5			211	BR7HIX	7067
350 Vento	350	80-	B6HS	4510	0,5	B6HVX	7435	203	BR6HIX	3419
XL 350	350		BPR7HS	6422	0,6	BPR7HVX	2938	215	BPR7HIX	5944
400 Supersport Junior (D)	400	91-	BPR7HS	6422	0,6	BPR7HVX	2938	215	BPR7HIX	5944
Monster 400	400	03-	DCPR8E	4339	0,9	DCPR8EVX	2265			
450 /Scrambler (D)	450	70- 76	B6HS	4510	0,5	B6HVX	7435	203	BR6HIX	3419
450 Desmo Sport	450	71- 74	BR7HS	4122	0,5			211	BR7HIX	7067
450 Mark 3D	450	69- 71	BR7HS	4122	0,5			211	BR7HIX	7067
450 R/T	450	71- 72	BR7HS	4122	0,5			211	BR7HIX	7067
450 SCR	450	69- 74	B7HS	5110	0,6	B7HVX	7836	204	BR7HIX	7067
450 T/S	450	71- 73	BR7HS	4122	0,5			211	BR7HIX	7067
500 GTL	500	74- 79	B7HS	5110	0,5	B7HVX	7836	204	BR7HIX	7067
500 Pantah (D)	500	80-	B7HS	5110	0,5	B7HVX	7836	204	BR7HIX	7067
500 SL Pantah (D)	500		BPR7HS	6422	0,6	BPR7HVX	2938	215	BPR7HIX	5944
500 Sport Desmo	500	79- 83	B6HS	4510	0,5	B6HVX	7435	203	BR6HIX	3419
500 Sport Twin	500	78-	B7HS	5110	0,5	B7HVX	7836	204	BR7HIX	7067
600 Monster	600	94- 96	DCPR8E	4339	0,9	DCPR8EVX	2265			
600 Pantah SL/TL (D)	600	81-	BPR7HS	6422	0,6	BPR7HVX	2938	215	BPR7HIX	5944
600 SS	600	94-	DCPR8E	4339	0,9	DCPR8EVX	2265			
M 600 Monster all models	600	97-	DCPR8E	4339	0,9	DCPR8EVX	2265			



Order No.



Gold-Palladium



Platin

Order Quick No.

Iridium



Order No.

DUCATI

620 i.e.	620	02-	DPR8EA-9	4929	0,9	DPR8EVX-9	2872	221	DPR8EIX-9	2202
620 i.e. Dark	620	02-	DPR8EA-9	4929	0,9	DPR8EVX-9	2872	221	DPR8EIX-9	2202
620 S i.e.	620	02-	DPR8EA-9	4929	0,9	DPR8EVX-9	2872	221	DPR8EIX-9	2202
620 Sport	620	03-	DCPR8E	4339	0,9	DCPR8EVX	2265			
M 620S i.e.	620	01-	DPR8EA-9	4929	0,9	DPR8EVX-9	2872	221	DPR8EIX-9	2202
M 620 i.e.	620	01-	DPR8EA-9	4929	0,9	DPR8EVX-9	2872	221	DPR8EIX-9	2202
650 Indiana	650	87-	BP7HS	5111	0,6	BP7HVX	7468		BPR7HIX	5944
748 / SP/ SPS	748	95-			0,6	DCPR9EVX	6436			
748 / Biposto	748	99-			0,6	DCPR9EVX	6436			
748 R	748		R2270-9	4319		---			---	
748 S	748				0,6	DCPR9EVX	6436			
749 S 76kW	748	03-	---			---			---	
750 SS i.e.	750	99-	DPR8EA-9	4929	0,9	DPR8EVX-9	2872	221	DPR8EIX-9	2202
750 F1 Desmo	750	88-	DCPR8E	4339	0,9	DCPR8EVX	2265			
750 F1/LS (D)	750	85-	DCPR8E	4339	0,9	DCPR8EVX	2265			
750 GT	750	74- 76	BPR7HS	6422	0,6	BPR7HVX	2938	215	BPR7HIX	5944
750 Indiana (D)	750	87-	BPR7HS	6422	0,6	BPR7HVX	2938	215	BPR7HIX	5944
750 Monster	750	96- 97	DCPR8E	4339	0,9	DCPR8EVX	2265			
750 Paso (D)	750	86-	DCPR8E	4339	0,9	DCPR8EVX	2265			
750 Sport (D)	750	88- 90	BPR7HS	6422	0,6	BPR7HVX	2938	215	BPR7HIX	5944
750 SS	750	91-			0,6	DCPR9EVX	6436			
750 SS Königswelle	750	72- 83	BPR7HS	6422	0,6	BPR7HVX	2938	215	BPR7HIX	5944
750 SS i.e.	750	99-	DPR8EA-9	4929	0,9	DPR8EVX-9	2872	221	DPR8EIX-9	2202
M 750 Monster all models	750	97-	DCPR8E	4339	0,6	DCPR8EVX	2265			
SS 750 HF I.E.	750				0,6	DCPR9EVX	6436			
SS 750 I.E.	750				0,6	DCPR9EVX	6436			
800 Sport	800	03-	DCPR8E	4339	0,9	DCPR8EVX	2265			
800 SuperSport	800	03-	DCPR8E	4339	0,9	DCPR8EVX	2265			
Monster 800 i.e.	800	03-	DCPR8E	4339	0,9	DCPR8EVX	2265			
851 S1 (D)	851	(88)			0,6	D9EVX	2834		DR9EIX	4772
851 S3 (D)	851	89- 92			0,6	D9EVX	2834		DR9EIX	4772
860 Desmo SS (D)	860		B6HS	4510	0,5	B6HVX	7435	203	BR6HIX	3419
860 GT,GTS,S (D)	860	75-	B6HS	4510	0,5	B6HVX	7435	203	BR6HIX	3419
851 S.P.,II,III,IV	888				0,6	D9EVX	2834		DR9EIX	4772
888 SP5	888	93-	R2270-9	4319	0,5					
888 Strada	888	93-			0,6	DCPR9EVX	6436			
900 S,SS,GTS,SD,S2,HR (D)	900	80-	BP7HS	5111	0,6	BP7HVX	7468		BPR7HIX	5944
900 Super Sport (D)	900	88- 90	DCPR8E	4339	0,9	DCPR8EVX	2265			
900 SS / SL	900	91- 98	DCPR8E	4339	0,9	DCPR8EVX	2265			
907 I.E.	900	91-	DCPR8E	4339	0,9	DCPR8EVX	2265			
Darmah 900 (D)	900		B6HS	4510	0,6	B6HVX	7435	203	BR6HIX	3419
M 900 I.E.	900	99-	DCPR8E	4339	0,9	DCPR8EVX	2265			
M 900 Monster all models	900	97-	DCPR8E	4339	0,9	DCPR8EVX	2265			
MH 900 EVOLUZIONE (75PS)	900	00-	DPR8EA-9	4929	0,9	DPR8EVX-9	2872	221	DPR8EIX-9	2202
Monster 900 Spezial (57kW)	900	00-	DPR8EA-9	4929	0,9	DPR8EVX-9	2872	221	DPR8EIX-9	2202
Paso 906	900	88- 90	DCPR8E	4339	0,9	DCPR8EVX	2265			
Super Sport 900	900	91- 92	DCPR8E	4339	0,9	DCPR8EVX	2265			
900 SS I.E.	904	91- 98	DCPR8E	4339	0,9	DCPR8EVX	2265			
916 (non SP model)	916	94-			0,6	DCPR9EVX	6436			
S 4	916	01-	---			---			---	
S T 4	916	98-			0,6	DCPR9EVX	6436			
S T 2	944	97-	DCPR8E	4339	0,9	DCPR8EVX	2265			

Order
No.Platin
Gold-
Palla-
diumOrder Quick
No. No.Order
No.**DUCATI**

Mille (D)	972		BP7HS	5111	0,6	BP7HVX	7468		BPR7HIX	5944
916 SP / SPS	996	98-	R2270-9	4319	0,5					
996 Biposto	996	99-			0,6	DCPR9EVX	6436			
996 SP / SPS	996	98-	R2270-9	4319	0,5					
S T 4 s	996				0,6	DCPR9EVX	6436			
998	997	01-	---			---			---	
996 R 99kW (H2)	998		---			---			---	
998 (H2)	998	02-	---			---			---	
998 R (H2)	998	02-	---			---			---	
998 S (H2)	998	02-	---			---			---	
999 S 100kW	998	03-	---			---			---	
999 / R	998	09.02-	---			---			---	
1000 DS	1000	03-	DCPR8E	4339	0,9	DCPR8EVX	2265			
1000 S2,HR	1000	85-	BPR7HS	6422	0,6	BPR7HVX	2938	215	BPR7HIX	5944
1000 SuperSport	1000	03-	DCPR8E	4339	0,9	DCPR8EVX	2265			
Monster 1000 i.e.	1000	03-	DCPR8E	4339	0,9	DCPR8EVX	2265			
Multistrada 1000	1000	02-	DPR8EA-9	4929	0,9	DPR8EVX-9	2872	221	DPR8EIX-9	2202
ST 3	1000	04-			0,6	CR9EVX	5943		CR9EIX	3521

DUCSON

Automatic 49	50		B6HS	4510	0,5	B6HVX	7435	203	BR6HIX	3419
S21TT,S30TT,XL50 Mercury	50		B6HS	4510	0,5	B6HVX	7435	203	BR6HIX	3419
S9,S15,S16,S20TT	50		B6HS	4510	0,5	B6HVX	7435	203	BR6HIX	3419

ENFIELD

Bonny	50		B6HS	4510	0,5	B6HVX	7435	203	BR6HIX	3419
Sunny	50		B6HS	4510	0,5	B6HVX	7435	203	BR6HIX	3419
KB 100	100		B8ES	2411	0,5	B8EVX	7051	201	BR8EIX	5044
Bullet Strada 12,7 mm	350		BR6HS	3922	0,6			209	BR6HIX	3419
Bullet Strada 19,0 mm	350		BR6ES	4922	0,6					
De Luxe,Super Star 12,7 mm	350		BR6HS	3922	0,6			209	BR6HIX	3419
De Luxe,Super Star 19,0 mm	350		BR6ES	4922	0,6					
India	350		B7HS	5110	0,5	B7HVX	7836	204	BR7HIX	7067
India	500		B8ES	2411	0,5	B8EVX	7051	201	BR8EIX	5044

ERING

AT 50 pt 2	50		B6HS	4510	0,6	B6HVX	7435	203	BR6HIX	3419
RT 50	50		B6HS	4510	0,6	B6HVX	7435	203	BR6HIX	3419
Tornado 50 ATV	50		BP7HS	5111	0,5	BP7HVX	7468		BPR7HIX	5944

E-TON

Viper Juior (ATV)	40	03-	BPM7A	7321	0,6			305		
Viper (ATV)	50	02-	BPR7HS	6422	0,8	BPR7HVX	2938	215	BPR7HIX	5944
Sierra Ranger (ATV)	90	03-	BPR7HS	6422	0,8	BPR7HVX	2938	215	BPR7HIX	5944
Viper (ATV)	90	02-	BPR7HS	6422	0,8	BPR7HVX	2938	215	BPR7HIX	5944
Yukon (ATV)	150	99-	C7HSA	4629	0,7	C7HVX	4533		CR7HIX	7544

FANTIC

Issimo Convert/Kick	50		B5HS	4210	0,5					
Junior,Tender To	50		B5HS	4210	0,5					
Trial 50	50		B7HS	5110	0,5	B7HVX	7836	204	BR7HIX	7067
Caballero 80	75		B9HS	5810	0,5	B9HVX	2254			

Order
No.Platin
Gold-
Palla-
diumOrder Quick
No. No.Iridium
Order
No.**FANTIC**

Trial 75	75		B8HS	5510	0,5	B8HVX	2634	205	BR8HIX	7001
Caballero	80		B8EG	3430	0,5	B8EGV	5627			
Enduro	80		B8EG	3430	0,5	B8EGV	5627			
RSX 80	80		B8EG	3430	0,5	B8EGV	5627			
Caballero	125		B9EG	3530	0,5	B9EGV	5827		BR9EIX	3981
Cross	125		B9EG	3530	0,5	B9EGV	5827		BR9EIX	3981
Professional	125		B6HS	4510	0,5	B6HVX	7435	203	BR6HIX	3419
RSX 125	125		B9EG	3530	0,5	B9EGV	5827		BR9EIX	3981
Trial 125	125		B6HS	4510	0,5	B6HVX	7435	203	BR6HIX	3419
Trial / Competicion	125		B7HS	5110	0,5	B7HVX	7836	204	BR7HIX	7067
Trial 200	160		BP7HS	5111	0,5	BP7HVX	7468		BPR7HIX	5944
TX 160	160		B8EG	3430	0,5	B8EGV	5627			
Enduro	175		B8EG	3430	0,5	B8EGV	5627			
Trial 200	200		B6HS	4510	0,5	B6HVX	7435	203	BR6HIX	3419
Trial 240	240		B6HS	4510	0,5	B6HVX	7435	203	BR6HIX	3419
Section	250	95- 97	BCP7ES	5030	0,5	BCP7EV	3733			
Trial 301 Competicion	250		BP5ES	6511	0,5	BP5EVX	5470		BPR5EIX	6597
Trial 301/305/307	250		B8ES	2411	0,5	B8EVX	7051	201	BR8EIX	5044
Trial Coach	250		B8ES	2411	0,5	B8EVX	7051	201	BR8EIX	5044
Trial K-Roo	250		B8ES	2411	0,5	B8EVX	7051	201	BR8EIX	5044
TX 250	250		B8EG	3430	0,5	B8EGV	5627			
TX 260	260		B8EG	3430	0,5	B8EGV	5627			
Professional	300		B8EG	3430	0,5	B8EGV	5627			
TX 330	330		B8EG	3430	0,5	B8EGV	5627			

FITE (LEM)

Champion H-Y, Sandy 4M	50		B8HS	5510	0,6	B8HVX	2634	205	BR8HIX	7001
Cross CR-2, Safari BX	50		B8HS	5510	0,6	B8HVX	2634	205	BR8HIX	7001
Cross CR-3,Small,Safari BX	50		B6HS	4510	0,6	B6HVX	7435	203	BR6HIX	3419

FOX

50 (ATV)	50	00-	BPR7HS	6422	0,8	BPR7HVX	2938	215	BPR7HIX	5944
50 VR Sport (ATV)	50	01-	BPR7HS	6422	0,8	BPR7HVX	2938	215	BPR7HIX	5944
90 MT (ATV)	90	99-	CR7HSA	4549	0,8				CR7HIX	7544
100 (ATV)	100	00-	BPR7HS	6422	0,8	BPR7HVX	2938	215	BPR7HIX	5944

G.A.C. MobyLe.

87//89/188/188E/188TC	50	- 87	B6HS	4510	0,5	B6HVX	7435	203	BR6HIX	3419
AV49R/51/69/70/70E/72/83R	50		B6HS	4510	0,5	B6HVX	7435	203	BR6HIX	3419
AV87,AV90,D55,	50	88-	B7HS	5110	0,5	B7HVX	7836	204	BR7HIX	7067
Cady/E14,Campera	50	- 87	B6HS	4510	0,5	B6HVX	7435	203	BR6HIX	3419
Canpera,Coma First	50	88-	B7HS	5110	0,5	B7HVX	7836	204	BR7HIX	7067
D55/E/77/Cross,SP50	50	- 87	B6HS	4510	0,5	B6HVX	7435	203	BR6HIX	3419
D55NTT,SP95R,Cady	50	88-	B7HS	5110	0,5	B7HVX	7836	204	BR7HIX	7067
Hawar,Chopper,Cross NTT,	50		B7HS	5110	0,5	B7HVX	7836	204	BR7HIX	7067
Kanowey,Onix,	50	88-	B7HS	5110	0,5	B7HVX	7836	204	BR7HIX	7067
Liberty,Moby Cross,	50		B6HS	4510	0,5	B6HVX	7435	203	BR6HIX	3419
MTR Top Racing,Winner	50		B8ES	2411	0,5	B8EVX	7051	201	BR8EIX	5044
Onix 2/City/Coma,Rural	50		B7HS	5110	0,5	B7HVX	7836	204	BR7HIX	7067
Onix ,Stylo GT,	50	- 87	B6HS	4510	0,5	B6HVX	7435	203	BR6HIX	3419
SP90/90R/94/95R /96	50	- 87	B6HS	4510	0,5	B6HVX	7435	203	BR6HIX	3419
Transport ,University	50	- 87	B6HS	4510	0,5	B6HVX	7435	203	BR6HIX	3419

Order
No.Platin
Gold-
Palla-
diumOrder Quick
No. No.Iridium
Order
No.**G.A.C. MobyLe.**

Transporter ,Zarpa NTT	50	88-	B7HS	5110	0,5	B7HVX	7836	204	BR7HIX	7067
------------------------	----	-----	------	------	-----	-------	------	-----	--------	------

G+G

QUAD not Twinspark (ATV)	1130	03-	BKR7EKC	7354						
Cruso	1200	03-	BKR7EKC	7354						
Cruso S	1200	03-	BKR7EKC	7354						

GARELLI

Bonanza	25		B6HS	4510	0,6	B6HVX	7435	203	BR6HIX	3419
Bimatic,ES,Gary Uno	50		B6HS	4510	0,5	B6HVX	7435	203	BR6HIX	3419
Formuno,Noi Matic,TL,2V	50		B6HS	4510	0,5	B6HVX	7435	203	BR6HIX	3419
Noi Bimatic,TL,ES,Team Mat	50		B6HS	4510	0,5	B6HVX	7435	203	BR6HIX	3419
Sahel 80	75		B9ES	2611	0,5	B9EVX	7254	202	BR9EIX	3981
GTA 125/ES	125		B10ES	7928	0,5	B10EGV	5927		BR10EIX	6801
Tiger 125 XLE	125		B10ES	7928	0,5	B10EGV	5927		BR10EIX	6801
323 Trail	320		BP5ES	6511	0,5	BP5EVX	5470		BPR5EIX	6597

GAS GAS

Contact, Enducross	50		B8HS	5510	0,6	B8HVX	2634	205	BR8HIX	7001
ec boy 50	50	00-	B8HS	5510	0,5	B8HVX	2634	205	BR8HIX	7001
Endurocross BOY	50		BPR5ES	7422	0,6	BPR5EVX	4875		BPR5EIX	6597
TXT BOY	50		BPR5ES	7422	0,6	BPR5EVX	4875		BPR5EIX	6597
Contact T 12	125	94-	BP5ES	6511	0,5	BP5EVX	5470		BPR5EIX	6597
Cross TT 125	125				0,5	B10EGV	5927			
ec 125	125	97-	B9EG	3530	0,6	B9EGV	5827		BR9EIX	3981
Enducross TT 125	125				0,5	B10EGV	5927			
125 Enduro	125	02-	BR8EG	3130	0,6					
Pampera 125	125		BPR6ES	7822	0,8	BPR6EVX	6764		BPR6EIX	6637
Trial 125	125		BP5ES	6511	0,5	BP5EVX	5470		BPR5EIX	6597
TT 125	125		BR8EG	3130	0,6					
TXT 125	125	99-	BPR5ES	7422	0,6	BPR5EVX	4875		BPR5EIX	6597
Contact T 16	143	94-	BP5ES	6511	0,5	BP5EVX	5470		BPR5EIX	6597
ec 200	200	99-	B10EGV	5927	0,6	B10EVX	7335			
200 Enduro	200	02-	BR8EG	3130	0,6					
Pampera 200	200		BPR6ES	7822	0,8	BPR6EVX	6764		BPR6EIX	6637
TT 200	200		BR8EG	3130	0,6					
TXT 200	200	99-	BPR5ES	7422	0,6	BPR5EVX	4875		BPR5EIX	6597
Contact JT 25	238	94-	BP5ES	6511	0,5	BP5EVX	5470		BPR5EIX	6597
TXT 249	249	99-	BPR5ES	7422	0,6	BPR5EVX	4875		BPR5EIX	6597
250 MC	250	04-	BR8EG	3130	0,6					
Cross 250	250		BR8EG	3130	0,6					
Delta 25 GT	250		BP5ES	6511	0,5	BP5EVX	5470		BPR5EIX	6597
ec 250	250	97-	B8EG	3430	0,5	B8EGV	5627			
Enducross 250	250				0,5	B10EGV	5927			
250 Enduro	250	02-	BR8EG	3130	0,6					
Pampera 250	250		BPR6ES	7822	0,8	BPR6EVX	6764		BPR6EIX	6637
Piri-A 6 Magnum	250		BP5ES	6511	0,5	BP5EVX	5470		BPR5EIX	6597
Trial 250 (water + air)	250		BP5ES	6511	0,5	BP5EVX	5470		BPR5EIX	6597
TT 250	250		BR8EG	3130	0,6					
TXT 250	250		BPR5ES	7422	0,6	BPR5EVX	4875		BPR5EIX	6597
TXT 280	272	00-	BP5ES	6511	0,5	BP5EVX	5470		BPR5EIX	6597
TXT 280	280		BPR5ES	7422	0,6	BPR5EVX	4875		BPR5EIX	6597

Order
No.Platin
Gold-
Palla-
diumOrder Quick
No. No.Order
No.**GAS GAS**

300 Wild (ATV)	300	02-	BR8EG	3130	0,5					
ec 300	300	99-	B10EGV	5927	0,6	B10EVX	7335			
300 Enduro	300	02-	BR8EG	3130	0,6					
TT 300	300		BR8EG	3130	0,6					
Pampera 320	320		BPR6ES	7822	0,8	BPR6EVX	6764		BPR6EIX	6637
TXT 321	321	99-	BPR5ES	7422	0,6	BPR5EVX	4875		BPR5EIX	6597
Delta 32 GT	330		BP5ES	6511	0,5	BP5EVX	5470		BPR5EIX	6597
Trial 327	330		BP5ES	6511	0,5	BP5EVX	5470		BPR5EIX	6597
Trial Halley PXC 325	330		B9ES	2611	0,5	B9EVX	7254	202	BR9EIX	3981
FSE 400	400	02-	CR8E	1275	0,7	CR8EVX	6487	226	CR8EIX	4218
450 Wild (ATV)	450	02-	CR8E	1275	0,7	CR8EVX	6487	226	CR8EIX	4218
Normada 500	500		D8EA	2120	0,5	D8EVX	2850	216	DR8EIX	6681

GILERA

50 TS	50	01.79-12.82	B7ES	1111	0,5	B7EVX	6934			
CB1 4V	50		B6ES	7310	0,5	B6EVX	5136			
CBA, SS, SSV	50		B6HS	4510	0,5	B6HVX	7435	203	BR6HIX	3419
DNA 50	50	01-	BR9ES	5722	0,6	BR9EVX	1265	208	BR9EIX	3981
Eaglet	50		B9ES	2611	0,5	B9EVX	7254	202	BR9EIX	3981
EC 1	50	92-	B5HS	4210	0,5					
ECO	50	01.79-	B6HS	4510	0,5	B6HVX	7435	203	BR6HIX	3419
GR 2	50	01.77-12.82	B6ES	7310	0,5	B6EVX	5136			
GR 2 (Export)	50		B7ES	1111	0,5	B7EVX	6934			
Grande	50		B6HS	4510	0,5	B6HVX	7435	203	BR6HIX	3419
GSA	50	03.82-	B6HS	4510	0,5	B6HVX	7435	203	BR6HIX	3419
GSM	50	01-	BR9ES	5722	0,6	BR9EVX	1265	208	BR9EIX	3981
RS	50	01.75-07.80	B6ES	7310	0,5	B6EVX	5136			
Storm	50	94-	B9ES	2611	0,5	B9EVX	7254	202	BR9EIX	3981
Super RE, RL	50		B6ES	7310	0,5	B6EVX	5136			
Touring	50	01.73-12.81	B7ES	1111	0,5	B7EVX	6934			
Trend 50	50		B5HS	4210	0,6					
Trial	50		B7ES	1111	0,5	B7EVX	6934			
TS	50	01.79-12.82	B6ES	7310	0,5	B6EVX	5136			
80 TG 2, 3	80	03.82-12.82	B9ES	2611	0,5	B9EVX	7254	202	BR9EIX	3981
Jubilee	90		B7ES	1111	0,5	B7EVX	6934			
Giubileo 4 T, SS	98		B8ES	2411	0,5	B8EVX	7051	201	BR8EIX	5044
125 5V Regolarità	125				0,5	B10EGV	5927			
125 Arcore, Export	125	01.72-06.80	B8ES	2411	0,5	B8EVX	7051	201	BR8EIX	5044
125 C1	125				0,5	B105EGV	2171			
125 C3	125				0,5	B10EGV	5927			
125 Cross Competition	125				0,5	B105EGV	2171			
125 E1	125				0,5	B105EGV	2171			
125 Endurance	125		B9ES	2611	0,5	B9EVX	7254	202	BR9EIX	3981
125 Enduro	125				0,5	B105EGV	2171			
125 ER	125	12.87-03.88	B9ES	2611	0,5	B9EVX	7254	202	BR9EIX	3981
125 GR1	125	01.76-03.81	B7ES	1111	0,5	B7EVX	6934			
125 Hawk	125	11.85-12.86	B9ES	2611	0,5	B9EVX	7254	202	BR9EIX	3981
125 RTT Nebraska	125	02.86-03.88	B9ES	2611	0,5	B9EVX	7254	202	BR9EIX	3981
125 SV Regolarità	125				0,5	B95EGV	2145			
125 TG1	125	01.76-12.81	B7ES	1111	0,5	B7EVX	6934			
125 TG2	125	12.81-12.83	B8ES	2411	0,5	B8EVX	7051	201	BR8EIX	5044
125 TG3	125	12.81-12.83	B8ES	2411	0,5	B8EVX	7051	201	BR8EIX	5044

Order
No.Platin
Gold-
Palla-
diumOrder Quick
No. No.Order
No.**GILERA**

Arizona	125		B9EG	3530	0,5	B9EGV	5827		BR9EIX	3981
Coguar	125		DPR8EA-9	4929	0,9	DPR8EVX-9	2872	221	DPR8EIX-9	2202
DNA 125	125	01-	CR9EB	6955	0,6				CR9EIX	3521
E1 Competition	125				0,5	B105EGV	2171			
Fast Bike 125	125	02.87-12.88	B9ES	2611	0,5	B9EVX	7254	202	BR9EIX	3981
HX 125	125				0,5	B105EGV	5927			
KK 125	125	09.86-12.87	B9ES	2611	0,5	B9EVX	7254	202	BR9EIX	3981
KZ 125	125	03.86-12.89	B9ES	2611	0,5	B9EVX	7254	202	BR9EIX	3981
R1 S	125	09.89-	B9EG	3530	0,5	B9EGV	5827		BR9EIX	3981
RC 125 Rally	125		B9ES	2611	0,5	B9EVX	7254	202	BR9EIX	3981
RTX	125	02.86-12.86	B9EG	3530	0,5	B9EGV	5827		BR9EIX	3981
RV 125	125	05.84-12.86	B9EG	3530	0,5	B9EGV	5827		BR9EIX	3981
RX 125	125	01.84-06.85	B9EG	3530	0,5	B9EGV	5827		BR9EIX	3981
Top Rally RC	125	09.90-	B10EG	3630	0,5	B105EGV	5927			
XR 2	125	01.89-	B9EG	3530	0,5	B9EGV	5827		BR9EIX	3981
XRI 125	125		B9EG	3530	0,5	B9EGV	5827		BR9EIX	3981
150 Arcore, Export	150	01.72-06.80	B8ES	2411	0,5	B8EVX	7051	201	BR8EIX	5044
DNA 180	180	01-	CR9EB	6955	0,6				CR9EIX	3521
200 T4	200	09.82-06.84	B8ES	2411	0,5	B8EVX	7051	201	BR8EIX	5044
Arizona	200	11.85-12.86	B9EG	3530	0,5	B9EGV	5827		BR9EIX	3981
RTX	200	02.86-12.86	B9EG	3530	0,5	B9EGV	5827		BR9EIX	3981
RV 200 LC	200	01.85-12.86	B9EG	3530	0,5	B9EGV	5827		BR9EIX	3981
RX 200 LC	200	01.85-12.86	B9EG	3530	0,5	B9EGV	5827		BR9EIX	3981
250 Arizona Rally	250	11.85-12.86	B9ES	2611	0,5	B9EVX	7254	202	BR9EIX	3981
250 C3	250				0,5	B105EGV	2171			
250 KK, KZ	250		B9ES	2611	0,5	B9EVX	7254	202	BR9EIX	3981
250 NGR	250	05.85-12.86	B9ES	2611	0,5	B9EVX	7254	202	BR9EIX	3981
HX 250	250				0,5	B105EGV	2171			
NX 250 LC	250				0,5	B105EGV	2171			
RV 250 NGR	250		B9ES	2611	0,5	B9EVX	7254	202	BR9EIX	3981
Dakota 350	350		DP9EA-9	6629	0,9	DRP9EVX-9	3331		DPR9EIX-9	5545
Dakota 350 ER	350		DP9EA-9	6629	0,9	DP9EVX-9	3331		DPR9EIX-9	5545
XRT 350	350	05.88-	DP9EA-9	6629	0,9	DP9EVX-9	3331		DPR9EIX-9	5545
Dakota 500	500	04.87-	DP9EA-9	6629	0,9	DP9EVX-9	3331		DPR9EIX-9	5545
Saturno 500	500	04.88- 92	DP9EA-9	6629	0,9	DP9EVX-9	3331		DPR9EIX-9	5545
XRT 600	550	05.88- 92	DP9EA-9	6629	0,9	DP9EVX-9	3331		DPR9EIX-9	5545
600 FB (Nordcape)	600	92-	D8EA	2120	0,5	D8EVX	2850	216	DR8EIX	6681
RC 600	600	- 92	D8EA	2120	0,5	D8EVX	2850	216	DR8EIX	6681
RC 600 C	600	92-	D8EA	2120	0,5	D8EVX	2850	216	DR8EIX	6681

GIMSON

Cantigo TT,Cross,Jumper	50		B5HS	4210	0,5					
Elite Sport/Super/E2/E87,	50		B5HS	4210	0,5					
Nevada/AL,Maxi Automatico	50		B5HS	4210	0,5					
Polaris,Shipper Trial,	50		B5HS	4210	0,5					
Variomatic,LSA,LSA-RA	50		B5HS	4210	0,5					

HARLEY-DAVIDSON

M50	50		B8ES	2411	0,5	B8EVX	7051	201	BR8EIX	5044
M50S	50		B8ES	2411	0,5	B8EVX	7051	201	BR8EIX	5044
M65	65		BP5ES	6511	0,6	BP5EVX	5470		BPR5EIX	6597
M65S	65		BP5ES	6511	0,6	BP5EVX	5470		BPR5EIX	6597

Order
No.Gold-
Palla-
dium

Platin

Order
No.Quick
No.

Iridium

Order
No.**HARLEY-DAVIDSON**

MC65	65		BP5ES	6511	0,6	BP5EVX	5470		BPR5EIX	6597
80DS	80		B7HS	5110	0,6	B7HVX	7836	204	BR7HIX	7067
X 90	90		BP5ES	6511	0,6	BP5EVX	5470		BPR5EIX	6597
XZ 90	90		BP5ES	6511	0,6	BP5EVX	5470		BPR5EIX	6597
Baja MSR	100		B8ES	2411	0,5	B8EVX	7051	201	BR8EIX	5044
SR 100	100		B8ES	2411	0,5	B8EVX	7051	201	BR8EIX	5044
M 125	125		BP5ES	6511	0,6	BP5EVX	5470		BPR5EIX	6597
ML 125	125		BP5ES	6511	0,6	BP5EVX	5470		BPR5EIX	6597
MLS 125	125		BP5ES	6511	0,6	BP5EVX	5470		BPR5EIX	6597
Rapido	125		BP5ES	6511	0,6	BP5EVX	5470		BPR5EIX	6597
SS 125	125		B9ES	2611	0,5	B9EVX	7254	202	BR9EIX	3981
SX 125	125		B7ES	1111	0,5	B7EVX	6934			
SXT 125	125		B9ES	2611	0,5	B9EVX	7254	202	BR9EIX	3981
SS 175	175		B9ES	2611	0,5	B9EVX	7254	202	BR9EIX	3981
SX 175	175		B9ES	2611	0,5	B9EVX	7254	202	BR9EIX	3981
MX 250	250				0,6	B10EVX	7335		BR10EIX	6801
SS 250	250		B9ES	2611	0,5	B9EVX	7254	202	BR9EIX	3981
SX 250	250		B9ES	2611	0,5	B9EVX	7254	202	BR9EIX	3981
all models / Alle Modelle	350	73- 74	B8ES	2411	0,5	B8EVX	7051	201	BR8EIX	5044
XL V2 Evolution	883	85-	DCPR7E	3932	1,0	DCPR7EVX	1179		DCPR7EIX	6046
KH	900	54- 71	B6L	3212	1,0					
XL	900	54- 71	B6L	3212	1,0					
XL	1000	71- 78	B6L	3212	1,0					
XL	1000	79- 85	BPR6HS-10	2633	1,0					
XR	1000	83- 85	BPR6ES-11	4824	1,1	BPR6EVX-11	4233		BPR6EIX-11	3903
XL	1100	86- 87	DCPR7E	3932	1,0	DCPR7EVX	1179		DCPR7EIX	6046
VRSC-V-Rod	1130	02-	DCPR8E	4339	0,7	DCPR8EVX	2265			
FL Panhead	1200	48- 65	XR5	5953	0,7				XR5IX	7355
FL Shovel Head	1200	66- 74	XR5	5953	0,7				XR5IX	7355
FL Shovel Head	1200	75- 81	BPR5ES-11	4424	1,1	BPR5EVX-11	2738		BPR5EIX-11	2115
FX Panhead	1200	48- 65	XR5	5953	0,7				XR5IX	7355
FX Shovel Head	1200	75- 81	BPR5ES-11	4424	1,1	BPR5EVX-11	2738		BPR5EIX-11	2115
FX Shovel Head	1200	66- 74	XR5	5953	0,7				XR5IX	7355
XL V-2 Evolution	1200	86-	DCPR7E	3932	1,0	DCPR7EVX	1179		DCPR7EIX	6046
FL Shovel Head	1340	78- 81	BPR5ES-11	4424	1,1	BPR5EVX-11	2738		BPR5EIX-11	2115
FL Shovel Head	1340	82- 84	BPR5ES-11	4424	1,1	BPR5EVX-11	2738		BPR5EIX-11	2115
FL V-2 Evolution	1340	84-	BPR5ES-11	4424	1,1	BPR5EVX-11	2738		BPR5EIX-11	2115
FL V-2 Evolution FI.	1340	95- 98	BPR5ES-11	4424	1,1	BPR5EVX-11	2738		BPR5EIX-11	2115
FX Shovel Head	1340	78- 81	BPR5ES-11	4424	1,1	BPR5EVX-11	2738		BPR5EIX-11	2115
FX Shovel Head	1340	82- 84	BPR5ES-11	4424	1,1	BPR5EVX-11	2738		BPR5EIX-11	2115
FX V-2 Evolution	1340	84-	BPR5ES-11	4424	1,1	BPR5EVX-11	2738		BPR5EIX-11	2115
FL TC 88 CV Carb	1450	98-	DCPR7E	3932	1,0	DCPR7EVX	1179		DCPR7EIX	6046
FL TC88 EFI	1450	98-	DCPR7E	3932	1,0	DCPR7EVX	1179		DCPR7EIX	6046
FX TC88 CV Carb	1450	98-	DCPR7E	3932	1,0	DCPR7EVX	1179		DCPR7EIX	6046

HERCULES

Saxonette	30	01.87-	BP4	2911	0,5					
City Bike C1	50	10.72-08.78	B6HS	4510	0,7	B6HVX	7435	203	BR6HIX	3419
City Bike C2	50	10.72-08.78	B6HS	4510	0,7	B6HVX	7435	203	BR6HIX	3419
City Bike C3	50	09.74-08.78	B6HS	4510	0,7	B6HVX	7435	203	BR6HIX	3419
Hobby Rider HR 1	50	10.72-12.87	B6HS	4510	0,7	B6HVX	7435	203	BR6HIX	3419
Hobby Rider HR 2	50	10.72-12.87	B6HS	4510	0,7	B6HVX	7435	203	BR6HIX	3419

Order
No.Platin
Gold-
Palla-
diumOrder Quick
No. No.Iridium
Order
No.**HERCULES**

Jogging	50		B6HS	4510	0,5	B6HVX	7435	203	BR6HIX	3419
K 50	50	-08.78	B8HS	5510	0,7	B8HVX	2634	205	BR8HIX	7001
K 50 Ultra	50	-08.78	B8HS	5510	0,7	B8HVX	2634	205	BR8HIX	7001
K 50 Ultra II	50	-08.78	B8HS	5510	0,5	B8HVX	2634	205	BR8HIX	7001
K 50 Ultra LC	50	-08.78	B9ES	2611	0,5	B9EVX	7254	202	BR9EIX	3981
K 50 Ultra LC II	50	-08.78	B9ES	2611	0,5	B9EVX	7254	202	BR9EIX	3981
K 50 Ultra LC III	50	-08.78	B9ES	2611	0,5	B9EVX	7254	202	BR9EIX	3981
KX 5	50	01.86-	BP7HS	5111	0,5	BP7HVX	7468		BPR7HIX	5944
Lastboy	50		B7HS	5110	0,5	B7HVX	7836	204	BR7HIX	7067
M1	50	10.72-12.77	B6HS	4510	0,5	B6HVX	7435	203	BR6HIX	3419
M2	50	10.72-12.77	B6HS	4510	0,5	B6HVX	7435	203	BR6HIX	3419
M4	50	09.74-12.78	B6HS	4510	0,5	B6HVX	7435	203	BR6HIX	3419
M5	50	09.74-12.78	B6HS	4510	0,5	B6HVX	7435	203	BR6HIX	3419
MK 1S	50	01.78-08.80	B6HS	4510	0,5	B6HVX	7435	203	BR6HIX	3419
MK 2S	50	01.78-08.80	B6HS	4510	0,5	B6HVX	7435	203	BR6HIX	3419
MP 2	50	10.72-12.77	B6HS	4510	0,5	B6HVX	7435	203	BR6HIX	3419
MP 4	50	10.72-12.77	B6HS	4510	0,5	B6HVX	7435	203	BR6HIX	3419
MX 1	50		B6HS	4510	0,5	B6HVX	7435	203	BR6HIX	3419
MX 1	50	01.89-	B5HS	4210	0,5					
Optima 3	50	01.78-	B6HS	4510	0,5	B6HVX	7435	203	BR6HIX	3419
Optima 50	50		BR8HS	4322	0,5	BR8HVX	6265	212	BR8HIX	7001
Prima 2	50		B6HS	4510	0,5	B6HVX	7435	203	BR6HIX	3419
Prima 2S	50	01.89-	B5HS	4210	0,5					
Prima 3	50		B6HS	4510	0,5	B6HVX	7435	203	BR6HIX	3419
Prima 3S	50	01.89-	B5HS	4210	0,5					
Prima 4	50		B6HS	4510	0,5	B6HVX	7435	203	BR6HIX	3419
Prima 4LN,5LN	50		B6HS	4510	0,5	B6HVX	7435	203	BR6HIX	3419
Prima 5	50		B6HS	4510	0,5	B6HVX	7435	203	BR6HIX	3419
Prima 5,5S,5SE	50	01.89-	B5HS	4210	0,5					
Prima 6	50		B6HS	4510	0,5	B6HVX	7435	203	BR6HIX	3419
Prima G3	50		B6HS	4510	0,5	B6HVX	7435	203	BR6HIX	3419
Prima GT	50	01.89-	B5HS	4210	0,5					
Prima GT,GX	50	-12.88	B6HS	4510	0,5	B6HVX	7435	203	BR6HIX	3419
Prima Presto	50		B6HS	4510	0,5	B6HVX	7435	203	BR6HIX	3419
Prima Pronto	50		B6HS	4510	0,5	B6HVX	7435	203	BR6HIX	3419
Prima S	50		B6HS	4510	0,5	B6HVX	7435	203	BR6HIX	3419
Prima SL	50		B6HS	4510	0,5	B6HVX	7435	203	BR6HIX	3419
Prima SX	50		B6HS	4510	0,5	B6HVX	7435	203	BR6HIX	3419
Sport Bike SB1	50	10.72-08.74	B8HS	5510	0,5	B8HVX	2634	205	BR8HIX	7001
Sport Bike SB2	50	10.72-08.79	B6HS	4510	0,5	B6HVX	7435	203	BR6HIX	3419
Sport Bike SB3	50	09.74-08.79	B6HS	4510	0,5	B6HVX	7435	203	BR6HIX	3419
Sport Bike SB5	50	09.74-08.76	B8HS	5510	0,5	B8HVX	2634	205	BR8HIX	7001
Supra 2D,3D	50	06.80-	B6HS	4510	0,5	B6HVX	7435	203	BR6HIX	3419
Supra 4	50	06.78-	B7HS	5110	0,5	B7HVX	7836	204	BR7HIX	7067
Supra 4GP	50	01.80-	B6HS	4510	0,5	B6HVX	7435	203	BR6HIX	3419
Supra Enduro	50	03.80-	B6HS	4510	0,5	B6HVX	7435	203	BR6HIX	3419
Ultra 50	50		B9ES	2611	0,5	B9EVX	7254	202	BR9EIX	3981
XE 5	50	01.86-	BP7HS	5111	0,5	BP7HVX	7468		BPR7HIX	5944
ZX 1	50		B7ES	1111	0,5	B7EVX	6934			
RX 9	80		B8HS	5510	0,5	B8HVX	2634	205	BR8HIX	7001
Ultra 80 LC	80		B8HS	5510	0,5	B8HVX	2634	205	BR8HIX	7001
Ultra 80 AC	80	01.82-	B7HS	5110	0,5	B7HVX	7836	204	BR7HIX	7067

Order
No.Gold-
Palla-
dium

Platin

Order Quick
No. No.

Iridium

Order
No.**HERCULES**

XE 9	80	01.82-	B8HS	5510	0,5	B8HVX	2634	205	BR8HIX	7001
K 100 X	100		B8HS	5510	0,5	B8HVX	2634	205	BR8HIX	7001
K 125 BW Military	125	09.74-	B8HS	5510	0,5	B8HVX	2634	205	BR8HIX	7001
K 125 GS	125		B9ES	2611	0,5	B9EVX	7254	202	BR9EIX	3981
K 125 MC	125		B9ES	2611	0,5	B9EVX	7254	202	BR9EIX	3981
K 125 S	125	10.72-08.79			0,5	B9EVX	7254		BR9EIX	3981
K 125 T	125	10.72-08.79			0,5	B9EVX	7254		BR9EIX	3981
K 125 X	125		B8HS	5510	0,5	B8HVX	2634	205	BR8HIX	7001
175 GS	175		B9ES	2611	0,5	B9EVX	7254	202	BR9EIX	3981
250 GS	250		B9ES	2611	0,5	B9EVX	7254	202	BR9EIX	3981
W 2000 (Wankel)	294		BR8ES	5422	0,5	BR8EVX	1262	207	BR8EIX	5044
350 GS	350				0,5	B9EVX	7254		BR9EIX	3981

HESKETH

V 1000	1000		DR8ES	5423	0,7	DR8EVX	6354	217	DR8EIX	6681
--------	------	--	-------	------	-----	--------	------	-----	--------	------

HM RACING

Baja SX	50	98-	B8ES	2411	0,5	B8EVX	7051	201	BR8EIX	5044
CRX Junior & Senior	50	01-	B8HS	5510	0,5	B8HVX	2634	205	BR8HIX	7001
CRX Racing Junior & Senior	50	01-	B8HS	5510	0,5	B8HVX	2634	205	BR8HIX	7001
Derapage	50	98-	B8ES	2411	0,5	B8EVX	7051	201	BR8EIX	5044
MX Junior & Senior	50	01-	B8HS	5510	0,5	B8HVX	2634	205	BR8HIX	7001
Six	50	98-	B8ES	2411	0,5	B8EVX	7051	201	BR8EIX	5044

HMZ

Cruise 125	125	96-	D8EA	2120	0,6	D8EVX	2850	216	DR8EIX	6681
------------	-----	-----	------	------	-----	-------	------	-----	--------	------

HONDA

Camino PA 50	50	01.75-12.87	BPR6HS	7022	0,7	BPR6HVX	2740	214	BPR6HIX	4085
CB 50	50		CR6HS	7023	0,7			223	CR6HIX	7274
CB 50 Y	50	01.73-01.83	CR6HS	7023	0,7			223	CR6HIX	7274
CY 50	50	01.81-	CR6HS	7023	0,7			223	CR6HIX	7274
Elite 50/S	50		BPR6HSA	4632	0,7				BPR6HIX	4085
MB 50 F (AC01)	50		BR8HS	4322	0,8	BR8HVX	6265	212	BR8HIX	7001
MB 50 S (AC01)	50		BR7HS	4122	0,8			211	BR7HIX	7067
MBX 50 M (AC05)	50		BR9ES	5722	0,8	BR9EVX	1265	208	BR9EIX	3981
MBX 50 S (AC05)	50		BR9ES	5722	0,7	BR9EVX	1265	208	BR9EIX	3981
MBX 50 SD (AC05)	50		BR6ES	4922	0,7					
MR 50	50		BR6HS	3922	0,7			209	BR6HIX	3419
MT 50 F (AD04)	50		BR8HS	4322	0,7	BR8HVX	6265	212	BR8HIX	7001
MT 50 S (AD04)	50		BR6ES	4922	0,7					
MTX 50 R	50		BR8ES	5422	0,7	BR8EVX	1262	207	BR8EIX	5044
MTX 50 S	50	86-	BR7HS	4122	0,7			211	BR7HIX	7067
NC 50	50		BPR4HS	7823	0,7					
NE 50	50		BPR6HSA	4632	0,7				BPR6HIX	4085
NE 50 Vision	50	90-	BR6HSA	4296	0,7			210	BR6HIX	3419
NSR 50	50	89-	BR5ES	4722	0,8					
NT 50	50		BPR6HSA	4632	0,7				BPR6HIX	4085
NX 50	50		BPR5HS	6222	0,7					
NX 50 M	50		BPR5HS	6222	0,7					
PA 50	50	84-	BP6HS	4511	0,7	BP6HVX	4635		BPR6HIX	4085
PF 50	50		BR6HS	3922	0,7			209	BR6HIX	3419

Order
No.Platin
Gold-
Palla-
diumOrder Quick
No. No.Order
No.**HONDA**

PK 50 DX (AB25)	50	95-	BR6HSA	4296	0,7			210	BR6HIX	3419
PK 50 Wallaroo	50	90-	BR6HSA	4296	0,7			210	BR6HIX	3419
PM 50	50		BR6HS	3922	0,7			209	BR6HIX	3419
PX 50	50	84-	BPR5HS	6222	0,7					
PX 50 E	50	80-	BPR5HS	6222	0,7					
PX 50 R	50	85-	BPR5HS	6222	0,7					
PZ 50	50		BR6HS	3922	0,7			209	BR6HIX	3419
SA 50 (AF29)	50		BR6HSA	4296	0,7			210	BR6HIX	3419
SE 50	50		BPR6HSA	4632	0,7				BPR6HIX	4085
SFX 50	50	96-	BR6HSA	4296	0,6			210	BR6HIX	3419
SH 50 T (AF40)	50	97-	BR6HSA	4296	0,7			210	BR6HIX	3419
SH 50	50	01.84-	BR8HS	4322	0,7	BR8HVX	6265	212	BR8HIX	7001
SJ 50 Bali	50		BR6HSA	4296	0,6			210	BR6HIX	3419
ST 50 C (AB23) Dax	50		CR6HSA	2983	0,7				CR6HIX	7274
TLM 50	50		BR8ES	5422	0,8	BR8EVX	1262	207	BR8EIX	5044
XL 50	50	01.80-	CR6HS	7023	0,7			223	CR6HIX	7274
XR 50	50	93- 02	CR6HSA	2983	0,7				CR6HIX	7274
XR 50 R	50	03-	CR6HSA	2983	0,7				CR6HIX	7274
Z 50 GZ	50	01.80-12.84	CR6HS	7023	0,7			223	CR6HIX	7274
Z 50 J	50		CR6HS	7023	0,7			223	CR6HIX	7274
Z 50 R	50	94-	CR6HSA	2983	0,7				CR6HIX	7274
ZB 50 P (AB22)	50	88-	CR6HSA	2983	0,7				CR6HIX	7274
Zoomer	50	05-	ER8EH-N							
CT 70	70	92-	CR6HSA	2983	0,7				CR6HIX	7274
ST 70	70	94-	CR6HSA	2983	0,7				CR6HIX	7274
TRX 70 (ATV)	70		CR7HS	7223	0,7				CR7HIX	7544
NS-1	75	96-	BR8ECS	3972	0,7					
CR 80 R	80	86-	BR10EG	3830	0,6					
CR 80 R	80	- 85	BR9ES	5722	0,8	BR9EVX	1265	208	BR9EIX	3981
CY 80	80		CR7HS	7223	0,7				CR7HIX	7544
MB 80 (HC01)	80	01.80-	BR8HS	4322	0,7	BR8HVX	6265	212	BR8HIX	7001
MBX 80 SWD/SW2D (HC04)	80	87-	BR9ES	5722	0,8	BR9EVX	1265	208	BR9EIX	3981
MCX 80 (HC05)	80	01.80-	BR9ES	5722	0,8	BR9EVX	1265	208	BR9EIX	3981
MT 80 F	80		BR9HS	4522	0,7					
MT 80 S (HD02)	80		BR8HS	4322	0,7	BR8HVX	6265	212	BR8HIX	7001
MTX 80 C	80	82-	BR9HS	4522	0,7					
MTX 80 R (D) (HD08)	80		BR9ES	5722	0,7	BR9EVX	1265	208	BR9EIX	3981
MTX 80 R (F) (HD08)	80		BR8ES	5422	0,7	BR8EVX	1262	207	BR8EIX	5044
MTX 80 R II (HD09)	80	87-	BR9ES	5722	0,8	BR9EVX	1265	208	BR9EIX	3981
MTX 80 RS (HD08)	80	83- 85	BR9ES	5722	0,8	BR9EVX	1265	208	BR9EIX	3981
NSR 80	80		BR8ES	5422	0,8	BR8EVX	1262	207	BR8EIX	5044
SH 80 E Scoopy	80	84-	BPR6HS	7022	0,7	BPR6HVX	2740	214	BPR6HIX	4085
XR 80R	80	92-	CR7HSA	4549	0,7				CR7HIX	7544
CR 85 R	85	03-	BR10EG	3830	0,6					
CR 85 R 2	85	03-	BR10EG	3830	0,6					
EZ 90	90	93-	BR7HS	4122	0,7			211	BR7HIX	7067
NH 90 M	90	93-	BPR6HSA	4632	0,7				BPR6HIX	4085
NH 90 Yupy	90	90-	BPR6HSA	4632	0,7				BPR6HIX	4085
TRX 90 (ATV)	90	93- 94	CR6HSA	2983	0,7				CR6HIX	7274
TRX 90 (ATV)	90	95-	CR7HSA	4549	0,7				CR7HIX	7544
XR 100R	100	92-	CR7HSA	4549	0,7				CR7HIX	7544
CG 110	110		DR8ESL	2923	0,7	DR8EVX	6354	218	DR8EIX	6681

Order
No.Platin
Gold-
Palla-
diumOrder
No.Quick
No.

Iridium

Order
No.**HONDA**

ATC 125 M (ATV)	125		DR8ESL	2923	0,6	DR8EVX	6354	218	DR8EIX	6681
CA 125 Rebel (JC24)	125	95-	CR6HSA	2983	0,7				CR6HIX	7274
CA 125 C Rebel (JC26)	125	97-	CR6HSA	2983	0,7				CR6HIX	7274
CB 125	125		DR8ES	5423	0,7	DR8EVX	6354	217	DR8EIX	6681
CB 125 K	125		D8HA	7012	0,7					
CB 125 T	125		CR8HS	7423	0,7	CR8HVX	7236		CR8HIX	7669
CB 125 Y	125		CR8HS	7423	0,7	CR8HVX	7236		CR8HIX	7669
CBR 125 R	125	04-	CR9E	6263	0,7	CR9EVX	5943	227	CR9EIX	3521
CG 125	125		DR8ESL	2923	0,6	DR8EVX	6354	218	DR8EIX	6681
CG 125 (JC27)	125	98-	DPR8EA-9	4929	0,9	DPR8EVX-9	2872	221	DPR8EIX-9	2202
CH 125	125		DPR7EA-9	5129	0,9	DPR7EVX-9	7682	220	DPR7EIX-9	7803
CLR 125 Cityfly (JD18A/B)	125	98-	DPR8EA-9	4929	0,9	DPR8EVX-9	2872	221	DPR8EIX-9	2202
CM 125 (JC05)	125		CR7HS	7223	0,7				CR7HIX	7544
CM 125 C Custum	125	94-	CR7HSA	4549	0,7				CR7HIX	7544
CR 125 R	125		BR9EG	3230	0,6	BR9EVX	1265		BR9EIX	3981
CR 125 R	125	03-	BR9EG	3230	0,6	BR9EVX	1265		BR9EIX	3981
Italia 125 (I)	125		DR8ESL	2923	0,6	DR8EVX	6354	218	DR8EIX	6681
Lead 125 (JF01)	125		BPR6HS	7022	0,7	BPR6HVX	2740	214	BPR6HIX	4085
MBX 125 F	125		BR9ES	5722	0,7	BR9EVX	1265	208	BR9EIX	3981
MTX 125	125		BR9ES	5722	0,7	BR9EVX	1265	208	BR9EIX	3981
MTX 125 R (I)	125		BR8ES	5422	0,7	BR8EVX	1262	207	BR8EIX	5044
MTX 125 R2 (I)	125		BR9ES	5722	0,7	BR9EVX	1265	208	BR9EIX	3981
NS 125 F (I)	125		BR9ES	5722	0,6	BR9EVX	1265	208	BR9EIX	3981
NS 125 R (I)	125		BR9ES	5722	0,6	BR9EVX	1265	208	BR9EIX	3981
NSR 125 F	125		BR9ECS	3570	0,8					
NSR 125 R (JC22)	125		BR9ECS	3570	0,8					
NX 125	125		DR8ESL	2923	0,7	DR8EVX	6354	218	DR8EIX	6681
TL 125	125		DR8ESL	2923	0,6	DR8EVX	6354	218	DR8EIX	6681
TRAX 125 (ATV)	125		DR8ESL	2923	0,7	DR8EVX	6354	218	DR8EIX	6681
TRX 125 (ATV)	125		DR8ESL	2923	0,7	DR8EVX	6354	218	DR8EIX	6681
Varadero 125	125	01-	CR8EH-9	5666	0,9	CR8EHVX-9	4546	228	CR8EHIX-9	3797
VT 125 C Shadow (G-Type)	125		CR8EH-9	5666	0,9	CR8EHVX-9	4546	228	CR8EHIX-9	3797
XL 125 (I)	125		DR8ESL	2923	0,6	DR8EVX	6354	218	DR8EIX	6681
XL 125 R	125		DR8ESL	2923	0,7	DR8EVX	6354	218	DR8EIX	6681
XL 125 S	125		DR8ESL	2923	0,7	DR8EVX	6354	218	DR8EIX	6681
XLR 125 R	125	98-	DPR8EA-9	4929	0,9	DPR8EVX-9	2872	221	DPR8EIX-9	2202
XR 125	125		DR8ESL	2923	0,7	DR8EVX	6354	218	DR8EIX	6681
XR 125 L	125	03-	DPR9EA-9	5329	0,9	DPR9EVX-9	3854	222	DPR9EIX-9	5545
XR 125 L (ED)	125	03-	DPR8EA-9	4929	0,9	DPR8EVX-9	2872	221	DPR8EIX-9	2202
ATC 185 (ATV)	185		D8EA	2120	0,7	D8EVX	2850	216	DR8EIX	6681
ATC 185 S (ATV)	185		DR8ESL	2923	0,6	DR8EVX	6354	218	DR8EIX	6681
CD 185 T	185		CR7HS	7223	0,7				CR7HIX	7544
CM 185 T	185	01.78-	CR7HS	7223	0,7				CR7HIX	7544
XL 185 S	185	01.79-	DR8ESL	2923	0,6	DR8EVX	6354	218	DR8EIX	6681
ATC 200 (ATV)	200		DR8ESL	2923	0,6	DR8EVX	6354	218	DR8EIX	6681
CD 200 T	200		CR7HS	7223	0,7				CR7HIX	7544
CM 200 T	200		CR7HS	7223	0,7				CR7HIX	7544
MTX 200 RW (MD07)	200	83- 85	BR9ES	5722	0,7	BR9EVX	1265	208	BR9EIX	3981
TR 200	200		DR8ESL	2923	0,6	DR8EVX	6354	218	DR8EIX	6681
TRX 200 D (ATV)	200	92-	DR8ESL	2923	0,6	DR8EVX	6354	218	DR8EIX	6681
TRX 200 SX (ATV)	200		DR8ESL	2923	0,7	DR8EVX	6354	218	DR8EIX	6681
XL 200 R	200	01.83-	DR8EA	7162	0,7	DR8EVX	6354		DR8EIX	6681

Order
No.Platin
Gold-
Palla-
diumOrder Quick
No. No.Order
No.**HONDA**

XR 200		200	87-	DR8ESL	2923	0,7	DR8EVX	6354	218	DR8EIX	6681
XR 200		200	84- 86	DPR9Z	4830	0,7					
XR 200		200	- 83	DR8ESL	2923	0,6	DR8EVX	6354	218	DR8EIX	6681
XR 200 R		200	- 83	DR8ESL	2923	0,7	DR8EVX	6354	218	DR8EIX	6681
XR 200 R		200	(84)	DPR9Z	4830	0,7					
XR 200 R		200	94-	DR8ESL	2923	0,6	DR8EVX	6354	218	DR8EIX	6681
250 Spacy (I)		250		DPR6EA-9	5531	0,9					
ATC 250 ES /SX	(ATV)	250	85-	DR8ESL	2923	0,7	DR8EVX	6354	218	DR8EIX	6681
ATC 250 R	(ATV)	250		BR9ES	5722	0,8	BR9EVX	1265	208	BR9EIX	3981
CB 250	(MC26)	250	96-	CR6HSA	2983	0,7				CR6HIX	7274
CB 250 N		250	01.80-	DR8ES	5423	0,7	DR8EVX	6354	217	DR8EIX	6681
CB 250 Nighthawk		250	92-	CR6HSA	2983	0,7				CR6HIX	7274
CB 250 RS	(MC02)	250	01.80-	DR8ES	5423	0,7	DR8EVX	6354	217	DR8EIX	6681
CB 250 T		250		DR8ESL	2923	0,7	DR8EVX	6354	218	DR8EIX	6681
CBF 250		250	04-	CR8EH-9	5666	0,9	CR8EHVX-9	4546	228	CR8EHIX-9	3797
CBX 250		250		DPR8EA-9	4929	0,9	DPR8EVX-9	2872	221	DPR8EIX-9	2202
CD 250 U		250		CR6HSA	2983	0,7				CR6HIX	7274
CH 250		250		DPR6EA-9	5531	0,9					
CM 250 C	(MC06)	250	01.82-	CR7HS	7223	0,7				CR7HIX	7544
CM 250 T		250		DR8ES	5423	0,7	DR8EVX	6354	217	DR8EIX	6681
CMX 250 CT	(MC13)	250	96-	CR6HSA	2983	0,7				CR6HIX	7274
CMX 250 C	(MC32B)	250	97-	CR6HSA	2983	0,7				CR6HIX	7274
CR 250		250	87-	BR9EG	3230	0,6	BR9EVX	1265		BR9EIX	3981
CR 250 R		250	82- 02	BR8EG	3130	0,6					
CR 250 R		250	- 81			0,6	BR9EVX	1265		BR9EIX	3981
CR 250 R		250	03-	BR8EG	3130	0,6					
CRF 250 R		250	04-			0,9				IMR9C-9H	6777
EX 250		250		CR7HS	7223	0,7				CR7HIX	7544
FL 250	(ATV)	250		BR9ES	5722	0,8	BR9EVX	1265	208	BR9EIX	3981
NSR 250		250	93- 96	BR9ECM	3252	0,6	BR9ECMVX	2434			
NX 250 J	(MD21)	250	88-	CR9EH-9	7502	0,9	CR9EHVX-9	3872	229	CR9EHIX-9	6216
NX 250 K	(MD21)	250	89-	CR9EH-9	7502	0,9	CR9EHVX-9	3872	229	CR9EHIX-9	6216
NX 250 L	(MD25)	250	91-	CR9EH-9	7502	0,9	CR9EHVX-9	3872	229	CR9EHIX-9	6216
TLR 250		250		DPR6EA-9	5531	0,9					
TRAX 250	(ATV)	250		DR8ESL	2923	0,6	DR8EVX	6354	218	DR8EIX	6681
TRX 250	(ATV)	250		DR8ESL	2923	0,6	DR8EVX	6354	218	DR8EIX	6681
TRX 250 R	(ATV)	250		BR9ES	5722	0,6	BR9EVX	1265	208	BR9EIX	3981
TRX 250 X	(ATV)	250		DR8ESL	2923	0,7	DR8EVX	6354	218	DR8EIX	6681
VT 250 F2		250		DPR8EA-9	4929	0,9	DPR8EVX-9	2872	221	DPR8EIX-9	2202
XL 250 R	(MD11)	250	- 83	DR8ESL	2923	0,7	DR8EVX	6354	218	DR8EIX	6681
XL 250 R	(MD11)	250	84- 85	DPR9Z	4830	0,8					
XL 250 R	(MD11)	250	86-	DPR9Z	4830	0,7					
XL 250 S	(MD11)	250	01.73-12.83	DR8ESL	2923	0,6	DR8EVX	6354	218	DR8EIX	6681
XR 250 L		250	92-	DPR8Z	4730	0,7					
XR 250 R		250	- 83	DR8ESL	2923	0,6	DR8EVX	6354	218	DR8EIX	6681
XR 250 R / RN		250	84-	DPR9Z	4830	0,7					
TRX 300	(ATV)	300	93-	DPR8EA-9	4929	0,9	DPR8EVX-9	2872	221	DPR8EIX-9	2202
TRX 300 EX	(ATV)	300	93-	DR8ESL	2923	0,6	DR8EVX	6354	218	DR8EIX	6681
TRX 300 FW	(ATV)	300	93-	DPR8EA-9	4929	0,9	DPR8EVX-9	2872	221	DPR8EIX-9	2202
TRX 300 N	(ATV)	300	92-	DPR8EA-9	4929	0,9	DPR8EVX-9	2872	221	DPR8EIX-9	2202
ATC 350 X	(ATV)	350		DR8ESL	2923	0,7	DR8EVX	6354	218	DR8EIX	6681
FL 350 R	(ATV)	350		BR9ES	5722	0,8	BR9EVX	1265	208	BR9EIX	3981



Order No.

Platin
Gold-Palladium

Order Quick No. No.

Iridium
Order No.**HONDA**

TRX 350		350		DR8ESL	2923	0,7	DR8EVX	6354	218	DR8EIX	6681
TRX 350 (ATV)		350	93-	DR8ESL	2923	0,6	DR8EVX	6354	218	DR8EIX	6681
XL 350 R (ND03)		350	85- 87	DPR8EA-9	4929	0,9	DPR8EVX-9	2872	221	DPR8EIX-9	2202
XR 350 R		350		DPR8EA-9	4929	0,9	DPR8EVX-9	2872	221	DPR8EIX-9	2202
400 Hawk (I)		400		DR8ES	5423	0,7	DR8EVX	6354	217	DR8EIX	6681
CB 400 A		400	01.79-	DR8ES	5423	0,7	DR8EVX	6354	217	DR8EIX	6681
CB 400 N		400	01.78-12.84	DR8ES	5423	0,7	DR8EVX	6354	217	DR8EIX	6681
CB 400 T		400		DR8ES	5423	0,7	DR8EVX	6354	217	DR8EIX	6681
CB-1 (NC27)		400	91-	CR8EH-9	5666	0,9	CR8EHVX-9	4546	228	CR8EHIX-9	3797
CBX 400 F		400		DPR9Z	4830	0,7					
CBX 400 F2		400		DPR9Z	4830	0,7					
CBX 400 SS (I)		400		DPR9Z	4830	0,7					
CM 400 T		400	01.80-12.84	DR8ES	5423	0,7	DR8EVX	6354	217	DR8EIX	6681
CX 400 C		400		DR8ESL	2923	0,7	DR8EVX	6354	218	DR8EIX	6681
CX 400 F2		400		DR8ESL	2923	0,7	DR8EVX	6354	218	DR8EIX	6681
NS 400		400		BR9ES	5722	0,8	BR9EVX	1265	208	BR9EIX	3981
NS 400 R (NC19)		400	85-	BR9ES	5722	0,8	BR9EVX	1265	208	BR9EIX	3981
TRX 400 FW (ATV)		400	95-	DPR7EA-9	5129	0,9	DPR7EVX-9	7682	220	DPR7EIX-9	7803
VF 400 F		400	01.85-	DPR8EA-9	4929	0,9	DPR8EVX-9	2872	221	DPR8EIX-9	2202
VFR 400 R (NC24)		400	87-	C8EH-9	7473	0,7	C8EHVX-9	4450		CR8EHIX-9	3797
VFR 400 R (NC30)		400	91-	ER9EH	5869	0,7					
XL 400		400	01.84-	DR8EA	7162	0,7	DR8EVX	6354		DR8EIX	6681
XR 400 R		400	96-	DPR8Z	4730	0,7					
CB 450 N (PC14)		450	85-	DR8ES	5423	0,7	DR8EVX	6354	217	DR8EIX	6681
CB 450 S (PC17)(D)		450	86- 88	DR8ESL	2923	0,7	DR8EVX	6354	218	DR8EIX	6681
CB 450 S (PC17)(I)		450		DR8ES	5423	0,7	DR8EVX	6354	217	DR8EIX	6681
CMX 450 C		450		DPR8EA-9	4929	0,9	DPR8EVX-9	2872	221	DPR8EIX-9	2202
CRF 450 R 4T		450	02-			1,1				IFR8H-11	5068
CRS R2 / R3		450	02-			1,1				IFR9H-11	6588
CR 480 R		480		BR8EG	3130	0,5					
CB 500 (PC26)		500	94-	CR9EH-9	7502	0,9	CR9EHVX-9	3872	229	CR9EHIX-9	6216
CB 500 (K1)		500	- 75			0,6	D7EVX	2734			
CB 500 (K3)		500	- 75	DR7ES	3123	0,6					
CB 500 (PC32)		500	96-	CR8EH-9	5666	0,9	CR8EHVX-9	4546	228	CR8EHIX-9	3797
CB 500 R		500		BR8EG	3130	0,5					
CB 500 / S (PC32)		500	98-	CR8EH-9	5666	0,9	CR8EHVX-9	4546	228	CR8EHIX-9	3797
CBF 500 (ED)		500	04-	CR8EH-9S		0,9					
CBR 500 F		500		DPR8EA-9	4929	0,9	DPR8EVX-9	2872	221	DPR8EIX-9	2202
CR 500		500		BR8EG	3130	0,5					
CX 500		500		DR8ESL	2923	0,7	DR8EVX	6354	218	DR8EIX	6681
CX 500 C (PC01)		500	01.79-12.84	DR8ESL	2923	0,7	DR8EVX	6354	218	DR8EIX	6681
CX 500 E (PC06)		500	01.79-12.84	DR8ESL	2923	0,6	DR8EVX	6354	218	DR8EIX	6681
CX 500 Turbo (PC03)		500	01.83-			0,9	DPR8EVX-9	2872		DPR8EIX-9	2202
FT 500 (PC07)		500	01.82-12.85	DR8EA	7162	0,7	DR8EVX	6354		DR8EIX	6681
GB 500 (PC16)		500	92-	DPR8EA-9	4929	0,9	DPR8EVX-9	2872	221	DPR8EIX-9	2202
GL 500 (PC02)		500	01.79-12.84	DR8ESL	2923	0,6	DR8EVX	6354	218	DR8EIX	6681
NX 500		500		DPR8EA-9	4929	0,9	DPR8EVX-9	2872	221	DPR8EIX-9	2202
TRX 500 FA (ATV)		500	02-							IJR7A-9	
VF 500 F (PC12)		500	84-	DPR8EA-9	4929	0,9	DPR8EVX-9	2872	221	DPR8EIX-9	2202
VF 500 F2 (PC12)		500	85-	DPR9EA-9	5329	0,9	DPR9EVX-9	3854	222	DPR9EIX-9	5545
VF 500 F2 (PC12)		500	- 84	DPR8EA-9	4929	0,9	DPR8EVX-9	2872	221	DPR8EIX-9	2202
VT 500 C (PC08)		500	83-	DPR8EA-9	4929	0,9	DPR8EVX-9	2872	221	DPR8EIX-9	2202

Order
No.Platin
Gold-
Palla-
diumOrder Quick
No. No.Order
No.**HONDA**

VT 500 E (PC11)	500	83- 85	DPR8EA-9	4929	0,9	DPR8EVX-9	2872	221	DPR8EIX-9	2202
XBR 500 (PC15)	500	85- 87	DPR8EA-9	4929	0,9	DPR8EVX-9	2872	221	DPR8EIX-9	2202
XBR 500 S (PC15)	500	88-	DPR8EA-9	4929	0,9	DPR8EVX-9	2872	221	DPR8EIX-9	2202
XL 500 (I)	500		DR8ESL	2923	0,7	DR8EVX	6354	218	DR8EIX	6681
XL 500 R (PD02)	500	- 85	DR8ESL	2923	0,7	DR8EVX	6354	218	DR8EIX	6681
XL 500 R (PD02)	500	86-	DR8ES	5423	0,7	DR8EVX	6354	217	DR8EIX	6681
XL 500 S (PD01)	500	01.79-12.81	DR8ESL	2923	0,7	DR8EVX	6354	218	DR8EIX	6681
XR 500	500		DR8ESL	2923	0,7	DR8EVX	6354	218	DR8EIX	6681
XR 500 R	500		DPR8EA-9	4929	0,9	DPR8EVX-9	2872	221	DPR8EIX-9	2202
CB 550	550	06.71-12.87	DR7ES	3123	0,7					
CB 550 (F1/F2)	550	76-			0,6	D7EVX	2734			
CB 550 (K3/4)	550	76-	DR7ES	3123	0,6					
CB 550 F	550	06.71-12.87	DR7ES	3123	0,7					
CBX 550 F (PC04)	550		DR8ES	5423	0,7	DR8EVX	6354	217	DR8EIX	6681
CBX 550 F2 (PC04)	550		DR8ES	5423	0,7	DR8EVX	6354	217	DR8EIX	6681
600 V Transalp (PD06)	600	87-	DPR8EA-9	4929	0,9	DPR8EVX-9	2872	221	DPR8EIX-9	2202
CB 600 F W (PC34A/B/D)	600	98-	CR9EH-9	7502	0,9	CR9EHVX-9	3872	229	CR9EHIX-9	6216
CB 600 F W (PC34A/B/D) Hornet	600	98-	CR9EH-9	7502	0,9	CR9EHVX-9	3872	229	CR9EHIX-9	6216
CBF 600 (ED)	600	04-	CR9EH-9	7502	0,9	CR9EHVX-9	3872	227	CR9EHIX-9	6216
CBR 600 F (PC19)	600	87- 88	DPR8EA-9	4929	0,9	DPR8EVX-9	2872	221	DPR8EIX-9	2202
CBR 600 F (PC23)	600	89- 90	DPR9EA-9	5329	0,9	DPR9EVX-9	3854	222	DPR9EIX-9	5545
CBR 600 F (PC25)	600	91- 94	CR9EH-9	7502	0,9	CR9EHVX-9	3872	229	CR9EHIX-9	6216
CBR 600 F X (PC35)	600	99- 00	CR9EH-9	7502	0,9	CR9EHVX-9	3872	229	CR9EHIX-9	6216
CBR 600 F / FS (PC35)	600	01- 03			0,9				IMR9C-9H	6777
CBR 600 F2	600	93- 94	CR9EH-9	7502	0,9	CR9EHVX-9	3872	229	CR9EHIX-9	6216
CBR 600 F3 (PC31)(PC35)	600	95- 00	CR9EH-9	7502	0,9	CR9EHVX-9	3872	229	CR9EHIX-9	6216
CBR 600 RR (G)	600	03-			0,9				IMR9C-9H	6777
CBX 600 E	600	01.83-12.87	DPR8EA-9	4929	0,9	DPR8EVX-9	2872	221	DPR8EIX-9	2202
NTV 600	600		DPR8EA-9	4929	0,9	DPR8EVX-9	2872	221	DPR8EIX-9	2202
NX 600	600		DPR8EA-9	4929	0,9	DPR8EVX-9	2872	221	DPR8EIX-9	2202
VT 600 / D	600	93- 00	DPR8EA-9	4929	0,9	DPR8EVX-9	2872	221	DPR8EIX-9	2202
VT 600 C (PC21)	600	88- 93	DPR8EA-9	4929	0,9	DPR8EVX-9	2872	221	DPR8EIX-9	2202
VT 600 C Shadow (I)	600	01.88- 93	DPR8EA-9	4929	0,9	DPR8EVX-9	2872	221	DPR8EIX-9	2202
XL 600 L	600		DPR8EA-9	4929	0,9	DPR8EVX-9	2872	221	DPR8EIX-9	2202
XL 600 LM (PD04)	600	85- 87	DPR8EA-9	4929	0,9	DPR8EVX-9	2872	221	DPR8EIX-9	2202
XL 600 R (PD03)	600	83- 87	DPR8EA-9	4929	0,9	DPR8EVX-9	2872	221	DPR8EIX-9	2202
XL 600 RM (I)	600		DPR8EA-9	4929	0,9	DPR8EVX-9	2872	221	DPR8EIX-9	2202
XL 600 RM (PD04)	600	86-	DPR8EA-9	4929	0,9	DPR8EVX-9	2872	221	DPR8EIX-9	2202
XL 600 V / VN	600	87-	DPR8EA-9	4929	0,9	DPR8EVX-9	2872	221	DPR8EIX-9	2202
XR 600 / V	600		DPR8EA-9	4929	0,9	DPR8EVX-9	2872	221	DPR8EIX-9	2202
XR 600 R / L	600	01.87-	DPR8EA-9	4929	0,9	DPR8EVX-9	2872	221	DPR8EIX-9	2202
FX 650 (RD09) Vigor	650	99-	DPR8EA-9	4929	0,9	DPR8EVX-9	2872	221	DPR8EIX-9	2202
CB 650 (RC03)	650	01.80-	DR8ESL	2923	0,7	DR8EVX	6354	218	DR8EIX	6681
CB 650 C (RC05)	650		DR8ESL	2923	0,7	DR8EVX	6354	218	DR8EIX	6681
CB 650 SC (RC08)	650	01.80-	DPR8EA-9	4929	0,9	DPR8EVX-9	2872	221	DPR8EIX-9	2202
CB 650 Z	650		DR8ESL	2923	0,7	DR8EVX	6354	218	DR8EIX	6681
CBX 650 E (RC13)	650	83-	DPR9EA-9	5329	0,9	DPR9EVX-9	3854	222	DPR9EIX-9	5545
CBX 650 Night Hawk(I)	650		DPR9EA-9	5329	0,9	DPR9EVX-9	3854	222	DPR9EIX-9	5545
CX 650 C (RC11)	650	01.83-	DPR8EA-9	4929	0,9	DPR8EVX-9	2872	221	DPR8EIX-9	2202
CX 650 E (RC13)	650	01.83-	DPR8EA-9	4929	0,9	DPR8EVX-9	2872	221	DPR8EIX-9	2202
CX 650 Turbo (RC16)	650	01.82-			0,9	DPR8EVX-9	2872		DPR8EIX-9	2202
GL 650 (RC10)	650	01.83-	DPR8EA-9	4929	0,9	DPR8EVX-9	2872	221	DPR8EIX-9	2202

Order
No.Platin
Gold-
Palla-
diumOrder Quick
No. No.

Iridium

Order
No.**HONDA**

NT 650 V (RC47) Deauville	650	98-	DPR8EA-9	4929	0,9	DPR8EVX-9	2872	221	DPR8EIX-9	2202
NTV 650 (RC33)	650	88-	DPR8EA-9	4929	0,9	DPR8EVX-9	2872	221	DPR8EIX-9	2202
NTV 650 Revere (I)	650	01.88-	DPR8EA-9	4929	0,9	DPR8EVX-9	2872	221	DPR8EIX-9	2202
NX 650 (RD02)/Dominator	650	88-	DPR8EA-9	4929	0,9	DPR8EVX-9	2872	221	DPR8EIX-9	2202
NX 650 Dominator (RD08)(I)	650	01.88-	DPR8EA-9	4929	0,9	DPR8EVX-9	2872	221	DPR8EIX-9	2202
SLR 650 (RD09)	650	97-	DPR8EA-9	4929	0,9	DPR8EVX-9	2872	221	DPR8EIX-9	2202
Rincon TRX 650 (ATV)	650	01.04-			1,1				IFR5L-11	
XL 650L	650	94-	DPR8EA-9	4929	0,9	DPR8EVX-9	2872	221	DPR8EIX-9	2202
Transalp XL 650	650	94-	DPR8EA-9	4929	0,9	DPR8EVX-9	2872	221	DPR8EIX-9	2202
XR 650 R (R1)	650	00-	BKR8E-11	6587	1,1					
XRV 650 (RD03)	650	88-	DPR8EA-9	4929	0,9	DPR8EVX-9	2872	221	DPR8EIX-9	2202
VT 700 C	700		DPR7EA-9	5129	0,9	DPR7EVX-9	7682	220	DPR7EIX-9	7803
CB 750 (RC42)	750	92-	DPR8EA-9	4929	0,9	DPR8EVX-9	2872	221	DPR8EIX-9	2202
CB 750 (RC04)	750	01.82-12.83	DR8EA	7162	0,7	DR8EVX	6354		DR8EIX	6681
CB 750 C (RC06)	750	01.80-	DR8ES	5423	0,7	DR8EVX	6354	217	DR8EIX	6681
CB 750 F	750	- 91	DR8ES	5423	0,7	DR8EVX	6354	217	DR8EIX	6681
CB 750 F2	750		DR8ES	5423	0,7	DR8EVX	6354	217	DR8EIX	6681
CB 750 F2N / FII	750	91-	DPR8EA-9	4929	0,9	DPR8EVX-9	2872	221	DPR8EIX-9	2202
CB 750 FA (I)	750		DR8ES	5423	0,7	DR8EVX	6354	217	DR8EIX	6681
CB 750 Four (I)	750		DR8ESL	2923	0,7	DR8EVX	6354	218	DR8EIX	6681
CB 750 FZ	750		DR8ESL	2923	0,7	DR8EVX	6354	218	DR8EIX	6681
CB 750 K	750	01.82-12.83	DR8ES	5423	0,7	DR8EVX	6354	217	DR8EIX	6681
CB 750 KZ	750		DR8ESL	2923	0,9	DR8EVX	6354	218	DR8EIX	6681
CB Seven Fifty	750		DPR8EA-9	4929	0,9	DPR8EVX-9	2872	221	DPR8EIX-9	2202
CBX 750 F (RC17)	750	84- 86	DPR8EA-9	4929	0,9	DPR8EVX-9	2872	221	DPR8EIX-9	2202
CBX 750 F2	750		DPR9EA-9	5329	0,9	DPR9EVX-9	3854	222	DPR9EIX-9	5545
NR 750 (RC40)	750	93-	CR9EH-9	7502	0,9	CR9EHVX-9	3872	229	CR9EHIX-9	6216
RVF (RC45)	750	94-			0,9	CR9EHVX-9	3872		CR9EHIX-9	6216
Shadow 750	750	04-	DPR8EA-9	4929	0,9	DPR8EVX-9	2872	221	DPR8EIX-9	2202
VF 750 C	750	95- 00	CR8EH-9	5666	0,9	CR8EHVX-9	4546	228	CR8EHIX-9	3797
VF 750 C Magna	750	94- 95	CR8EH-9	5666	0,9	CR8EHVX-9	4546	228	CR8EHIX-9	3797
VF 750 C (RC09)	750	86- 94	DPR9EA-9	5329	0,9	DPR9EVX-9	3854	222	DPR9EIX-9	5545
VF 750 C (RC44)	750	97- 00	DPR9EA-9	5329	0,9	DPR9EVX-9	3854	222	DPR9EIX-9	5545
VF 750 C (RC09)	750	82- 84	DPR8EA-9	4929	0,9	DPR8EVX-9	2872	221	DPR8EIX-9	2202
VF 750 F (RC15)	750	83- 84	DPR8EA-9	4929	0,9	DPR8EVX-9	2872	221	DPR8EIX-9	2202
VF 750 S (RC07)	750	82- 83	DPR8EA-9	4929	0,9	DPR8EVX-9	2872	221	DPR8EIX-9	2202
VFR 750 F	750	94-	CR8EH-9	5666	0,9	CR8EHVX-9	4546	228	CR8EHIX-9	3797
VFR 750 F (I)	750		DPR9EA-9	5329	0,9	DPR9EVX-9	3854	222	DPR9EIX-9	5545
VFR 750 F (RC24)	750	86- 87	DPR8EA-9	4929	0,9	DPR8EVX-9	2872	221	DPR8EIX-9	2202
VFR 750 F (RC24)	750	88- 89	DPR9EA-9	5329	0,9	DPR9EVX-9	3854	222	DPR9EIX-9	5545
VFR 750 F (RC36)	750	90- 94	CR8EH-9	5666	0,9	CR8EHVX-9	4546	228	CR8EHIX-9	3797
VFR 750 FJ (I)	750		DPR9EA-9	5329	0,9	DPR9EVX-9	3854	222	DPR9EIX-9	5545
VFR 750 R (RC30)	750	88-	CR9EH-9	7502	0,9	CR9EHVX-9	3872	229	CR9EHIX-9	6216
VT 750 Black Widow (RC48)	750	00-	DPR8EA-9	4929	0,9	DPR8EVX-9	2872	221	DPR8EIX-9	2202
VT 750 C (RC29)	750	87-	DPR8EA-9	4929	0,9	DPR8EVX-9	2872	221	DPR8EIX-9	2202
VT 750 C/C2V (RC44)	750	97-	DPR8EA-9	4929	0,9	DPR8EVX-9	2872	221	DPR8EIX-9	2202
XLV 750 R (RD01)	750	83-	DPR8EA-9	4929	0,9	DPR8EVX-9	2872	221	DPR8EIX-9	2202
XRV 750 (RD04)	750	90- 92	DPR8EA-9	4929	0,9	DPR8EVX-9	2872	221	DPR8EIX-9	2202
XRV 750 (RD07)	750	93-	DPR8EA-9	4929	0,9	DPR8EVX-9	2872	221	DPR8EIX-9	2202
PC 800 Pacific Coast	800	98-	DPR7EA-9	5129	0,9	DPR7EVX-9	7682	220	DPR7EIX-9	7803
VFR / VFR ABS	800	02-			0,9				IMR9B-9H	4888
VFR 800 FI W (RC46)	800	98-	CR9EH-9	7502	0,9	CR9EHVX-9	3872	229	CR9EHIX-9	6216



Order No.



Platin Gold-Palladium

Order Quick No.



Order No.

HONDA

CB 900 F	900	01.79-	DR8ES	5423	0,7	DR8EVX	6354	217	DR8EIX	6681
CB 900 F2	900	01.79-12.83	DR8ES	5423	0,7	DR8EVX	6354	217	DR8EIX	6681
CBR 900 RR (SC33)	900	96-	CR9EH-9	7502	0,9	CR9EHVX-9	3872	229	CR9EHIX-9	6216
CBR 900 RR (SC28)	900	91-	CR9EH-9	7502	0,9	CR9EHVX-9	3872	229	CR9EHIX-9	6216
CBR 900 RRY (Fireblade)(SC44)	900	00-			0,9				CR9EHI-9	6419
Hornet 900	900	02-	CR8EH-9	5666	0,9	CR8EHVX-9	4546	228	CR8EHIX-9	3797
CBR 900 RR Fireblade 2002 (SC50)	950	02-			0,9				IMR9C-9H	6777
CB 1000 F (SC30)	1000	93- 00	DPR9EA-9	5329	0,9	DPR9EVX-9	3854	222	DPR9EIX-9	5545
CBR 1000 RR Fireblade	1000	04-			0,9				IMR9C-9H	6777
CBR 1000 F (SC24)	1000	95- 00	DPR9EA-9	5329	0,9	DPR9EVX-9	3854	222	DPR9EIX-9	5545
CBR 1000 F (SC21)	1000	87- 88	DPR9EA-9	5329	0,9	DPR9EVX-9	3854	222	DPR9EIX-9	5545
CBR 1000 F (SC24)	1000	89- 92	DPR9EA-9	5329	0,9	DPR9EVX-9	3854	222	DPR9EIX-9	5545
CBR 1000 Fireblade (G)	1000	04-			0,9				IMR9C-9HES	
CBR 1000 K (I)	1000		DPR9EA-9	5329	0,9	DPR9EVX-9	3854	222	DPR9EIX-9	5545
GL 1000 (GL1)	1000		DR8ESL	2923	0,7	DR8EVX	6354	218	DR8EIX	6681
Varadero 1000	1000	03-			0,9				IJR8B-9	
VF 1000 Bol D'Dor(I)	1000		DPR9EA-9	5329	0,9	DPR9EVX-9	3854	222	DPR9EIX-9	5545
VF 1000 F	1000	- 86	DPR9EA-9	5329	0,9	DPR9EVX-9	3854	222	DPR9EIX-9	5545
VF 1000 F (SC15)	1000	87-	DPR8EA-9	4929	0,9	DPR8EVX-9	2872	221	DPR8EIX-9	2202
VF 1000 F2 (SC15)	1000	85-	DPR9EA-9	5329	0,9	DPR9EVX-9	3854	222	DPR9EIX-9	5545
VF 1000 R (SC16)	1000	84- 86	DPR8EA-9	4929	0,9	DPR8EVX-9	2872	221	DPR8EIX-9	2202
VTR 1000 F (SC36)	1000	97- 00			0,9	DPR9EVX-9	3854		DPR9EIX-9	5545
VTR1000 SP-1	1000	00- 01			1,1				FR9BI-11	4709
VTR1000 SP-2	1000	02-			1,1				IFR9H-11	6588
XL 1000 V X Varadero (SD01)	1000	99-			0,9	DPR8EVX-9	2872		DPR8EIX-9	2202
XL 1000 V Varadero (G) 69kW	1000	03-			0,9				IJR8B-9	
CBX 1000 (CB1)	1050		DR8ESL	2923	0,7	DR8EVX	6354	218	DR8EIX	6681
CB 1100 F (SC11)	1100		DR8ES	5423	0,7	DR8EVX	6354	217	DR8EIX	6681
CB 1100 R (SC08)	1100		DR8ES	5423	0,7	DR8EVX	6354	217	DR8EIX	6681
CBR 1100 XX Super Blackbird	1100	01-			0,9				IMR9C-9H	6777
CBR 1100 XX (SC35)	1100	97- 00			0,9	CR9EHVX-9	3872		CR9EHIX-9	6216
GL 1100 (SC02)	1100	82-	DPR8EA-9	4929	0,9	DPR8EVX-9	2872	221	DPR8EIX-9	2202
GL 1100 (SC02)	1100	- 81	DR8ESL	2923	0,7	DR8EVX	6354	218	DR8EIX	6681
GL 1100 DX (SC02)	1100	82-	DPR8EA-9	4929	0,9	DPR8EVX-9	2872	221	DPR8EIX-9	2202
GL 1100 DX (SC02)	1100	- 81	DR8ESL	2923	0,7	DR8EVX	6354	218	DR8EIX	6681
GL 1100 R	1100		DR8ES	5423	0,7	DR8EVX	6354	217	DR8EIX	6681
ST 1100 CBS	1100	96-	CR8EH-9	5666	0,8	CR8EHVX-9	4546	228	CR8EHIX-9	3797
ST 1100 (SC26)	1100	90-	CR8EH-9	5666	0,9	CR8EHVX-9	4546	228	CR8EHIX-9	3797
ST 1100 AN (SC26)	1100	92-	CR8EH-9	5666	0,9	CR8EHVX-9	4546	228	CR8EHIX-9	3797
VF 1100 C (SC12)	1100	83-	DPR8EA-9	4929	0,9	DPR8EVX-9	2872	221	DPR8EIX-9	2202
VT 1100 C3 W Shadow Aero(SC39A/E/C)	1100	98- 00	DPR7EA-9	5129	0,9	DPR7EVX-9	7682	220	DPR7EIX-9	7803
VT 1100 C	1100	95- 00	DPR7EA-9	5129	0,9	DPR7EVX-9	7682	220	DPR7EIX-9	7803
VT 1100 C (SC23)	1100	94- 95	DPR8EA-9	4929	0,9	DPR8EVX-9	2872	221	DPR8EIX-9	2202
VT 1100 C (SC23)	1100	88- 95	DPR7EA-9	5129	0,9	DPR7EVX-9	7682	220	DPR7EIX-9	7803
VT 1100 C2 (SC32)	1100	95-	DPR7EA-9	5129	0,9	DPR7EVX-9	7682	220	DPR7EIX-9	7803
X-Eleven	1100	00-			0,9	CR8EHVX-9	4546		CR8EHIX-9	3797
GL 1200 (SC14)	1200	84- 87	DPR8EA-9	4929	0,9	DPR8EVX-9	2872	221	DPR8EIX-9	2202
CB 1300	1300	03-	DPR9EA-9	5329	0,9	DPR9EVX-9	3854	222	DPR9EIX-9	5545
Pan European (SC51)	1300	02-	CR8EH-9	5666	0,9	CR8EHVX-9	4546	228	CR8EHIX-9	3797
VTX 1300	1300	03-	DCPR6E	3481	0,8					
VTX 1300S	1300	03-	DCPR6E	3481	0,8					
X 4	1300	97-	DPR9EA-9	5329	0,9	DPR9EVX-9	3854	222	DPR9EIX-9	5545

Order
No.Platin
Gold-
Palla-
diumOrder Quick
No. No.

Iridium

Order
No.**HONDA**

F 6 C	1500	11.96-	DPR7EA-9	5129	0,9	DPR7EVX-9	7682	220	DPR7EIX-9	7803
GL 1500 (SC22)	1500	91- 93	DPR7EA-9	5129	0,9	DPR7EVX-9	7682	220	DPR7EIX-9	7803
GL 1500 C (SC34)	1500	97-	DPR7EA-9	5129	0,9	DPR7EVX-9	7682	220	DPR7EIX-9	7803
GL 1500 C F6C (SC34)	1500	97-	DPR7EA-9	5129	0,9	DPR7EVX-9	7682	220	DPR7EIX-9	7803
GL 1500 SE.A	1500	95-	DPR7EA-9	5129	0,9	DPR7EVX-9	7682	220	DPR7EIX-9	7803
GL 1500A/SE	1500	(94)	DPR6EA-9	5531	0,9					
VTX 1500 (Twinspark)	1500	03-			1,1				IFR6L11	3687
GL 1800 Gold Wing	1800	01-	BKR6E-11	2756	1,1	BKR6EVX-11	3540		BKR6EIX-11	3764
Gold Wing (GL1800)	1800	01-	BKR6E-11	2756	1,1	BKR6EVX-11	3540		BKR6EIX-11	3764
VTX 1800	1800	01-			1,1				IFR6L-11	3678

HRD

GS Enduro	50	98- 99	BR8ES	5422	0,6	BR8EVX	1262	207	BR8EIX	5044
Slide Sonic Supermotorrad	50	98-	BR8ES	5422	0,6	BR8EVX	1262	207	BR8EIX	5044
Sonic 2 SM	50	99-	BR8ES	5422	0,6	BR8EVX	1262	207	BR8EIX	5044
Sonic 2 Trail	50	99-	BR8ES	5422	0,6	BR8EVX	1262	207	BR8EIX	5044
Super Mot. Cabr.	125	99-	CR9EB	6955	0,7				CR9EIX	3521
Trail Cabr.	125	99-	CR9EB	6955	0,7				CR9EIX	3521

HUSABERG

FE 350	350	91- 99	C8E	7471	0,7	CR8EVX	6487		CR8EIX	4218
MC 350	350	- 99	C8E	7471	0,7	CR8EVX	6487		CR8EIX	4218
400	400	03-			0,6	DCPR8EVX	2265			
FC 400	400	97- 99	C8E	7471	0,7	CR8EVX	6487		CR8EIX	4218
FE 400	400	97- 99	C8E	7471	0,7	CR8EVX	6487		CR8EIX	4218
FE 400 e	400	00- 02	DCPR8E	4179	0,6	DCPR8EVX	2265			
FS 400 c	400	00- 02	DCPR8E	4179	0,6	DCPR8EVX	2265			
FS 400 e	400	00- 02	DCPR8E	4179	0,6	DCPR8EVX	2265			
450	450	03-			0,6	DCPR8EVX	2265			
FC 470/6	470	00- 02	DCPR8E	4179	0,6	DCPR8EVX	2265			
FX 470 e	470	00- 02	DCPR8E	4179	0,6	DCPR8EVX	2265			
FC 499MX	499	95- 99	C8E	7471	0,7	CR8EVX	6487		CR8EIX	4218
FE 500	500	91- 94	C8E	7471	0,7	CR8EVX	6487		CR8EIX	4218
FE 500	500	91- 99	C8E	7471	0,7	CR8EVX	6487		CR8EIX	4218
FE 501 e	500	00-	DCPR8E	4179	0,6	DCPR8EVX	2265			
MC 501	500	- 99	C8E	7471	0,7	CR8EVX	6487		CR8EIX	4218
501	501	03-			0,6	DCPR8EVX	2265			
FC 501	501	95- 99	C8E	7471	0,7	CR8EVX	6487		CR8EIX	4218
FE 501 E	501	93- 99	C8E	7471	0,7	CR8EVX	6487		CR8EIX	4218
FE 501	501	93- 99	C8E	7471	0,7	CR8EVX	6487		CR8EIX	4218
FX 501	501	97- 99	C8E	7471	0,7	CR8EVX	6487		CR8EIX	4218
FX 501	501	97- 99	C8E	7471	0,7	CR8EVX	6487		CR8EIX	4218
550	550	03-			0,6	DCPR8EVX	2265			
FC 550/4	550	00-	DCPR8E	4179	0,6	DCPR8EVX	2265			
FC 550/6	550	00-	DCPR8E	4179	0,6	DCPR8EVX	2265			
FC 600	600	92- 99	C8E	7471	0,7	CR8EVX	6487		CR8EIX	4218
FE 600	600	92- 99	C8E	7471	0,7	CR8EVX	6487		CR8EIX	4218
FES 600 E	600	98- 99	C8E	7471	0,7	CR8EVX	6487		CR8EIX	4218
FX 600	600	97- 99	C8E	7471	0,7	CR8EVX	6487		CR8EIX	4218
FX 600	600	97- 99	C8E	7471	0,7	CR8EVX	6487		CR8EIX	4218
FX 600 E	600	97- 99	C8E	7471	0,7	CR8EVX	6487		CR8EIX	4218
MC 600	600	- 99	C8E	7471	0,7	CR8EVX	6487		CR8EIX	4218

Order
No.Platin
Gold-
Palla-
diumOrder Quick
No. No.

Iridium

Order
No.**HUSABERG**

650	650	03-			0,6	DCPR8EVX	2265			
FE 650 e	650	00-	DCPR8E	4179	0,6	DCPR8EVX	2265			
FS 650 c	650	00-	DCPR8E	4179	0,6	DCPR8EVX	2265			
FS 650 e	650	00-	DCPR8E	4179	0,6	DCPR8EVX	2265			
FX 650 e	650	00-	DCPR8E	4179	0,6	DCPR8EVX	2265			

HUSQVARNA

Husky boy junior	50	01-	B6HS	4510	0,5	B6HVX	7435	203	BR6HIX	3419
Husky boy senior	50	01-	B6HS	4510	0,5	B6HVX	7435	203	BR6HIX	3419
Husky boy basic	50	01-	B8HS	5510	0,5	B8HVX	2634	205	BR8HIX	7001
Husky boy racing	50	01-	B6HS	4510	0,5	B6HVX	7435	203	BR6HIX	3419
SM 50	50	02-	BR9ES	5722	0,6	BR9EVX	1265	208	BR9EIX	3981
WRE 50	50	02-	BR9ES	5722	0,6	BR9EVX	1265	208	BR9EIX	3981
125 CR	125	92- 94			0,5	B10EGV	5927			
125 CR	125	97-			0,5	B10EGV	5927			
125 CR	125	90- 91			0,6	B10EGV	5927			
125 CR	125	99- 00			0,5	BR9EG	3230			
CR 125	125	01-			0,5	BR9EG	3230			
125 NWR	125	99-			0,5	B95EGV	2145			
125 SM	125	99-	BR9EG	3230	0,5					
125 WER	125	99-	BR9EG	3230	0,5					
125 WR	125	95- 00			0,5	B10EGV	5927			
125 WR	125	90- 92			0,5	B95EGV	2145			
125 WR	125	93- 94			0,5	B9EGV	5827			
125 WRE	125	98- 01	B9EG	3530	0,7	B9EGV	5827		BR9EIX	3981
SM 125	125	02-			0,5	BR9EG	3230			
WER 125	125	02-	B9EG	3530	0,7	B9EGV	5827		BR9EIX	3981
WR 125	125	01-			0,5	BR9EG	3230			
250 CR	250	(92)			0,5	B9EGV	5827			
250 CR	250	95- 00			0,5	B9EGV	5827			
250 CR	250	90-			0,5	B9EGV	5827			
250 CR	250	93- 94			0,6	B10EGV	5927			
250 CR	250	01-	BR8EG	3130	0,8					
250 WR	250	92- 95			0,5	B9EGV	5827			
250 WR (5A00)	250	96- 99			0,6	B9EGV	5827			
250 WR	250	99-	B8EG	3430	0,5	B8EGV	5627			
260 WR	250	90-			0,5	B9EGV	5827			
CR 250	250	01-	BR8EG	3130	0,6					
TC 250	250	01-	CR8EB	7784	0,6	CR8EVX	6487		CR8EIX	4218
TE 250 / R	250	01-	CR8EB	7784	0,6	CR8EVX	6487		CR8EIX	4218
WR 250	250	01-	B8EG	3430	0,5	B8EGV	5627			
350 TE	350	95-	C7E	5096	0,7				CR7EIX	7385
350 TE	350	90-	C7E	5096	0,7				CR7EIX	7385
360 CR	360	91-			0,5	B8EGV	5627			
360 WR	360	91- 97			0,5	B8EGV	5627			
360 WR	360	98- 00	B8EG	3430	0,5	B8EGV	5627			
360 WXC	360	98-	B8EG	3430	0,5	B8EGV	5627			
WR 360	360	01-	B8EG	3430	0,5	B8EGV	5627			
390 MX	390		B9ES	2611	0,5	B9EVX	7254	202	BR9EIX	3981
400 MX	400		B9ES	2611	0,5	B9EVX	7254	202	BR9EIX	3981
410 TE (2AA)	400	96- 00	C7E	5096	0,6				CR7EIX	7385
SM / R 400 R	400	01-	CR8EB	7784	0,6	CR8EVX	6487		CR8EIX	4218

Order
No.Platin
Gold-
Palla-
diumOrder Quick
No. No.

Iridium

Order
No.**HUSQVARNA**

TE 400 R	400	01-	CR8EB	7784	0,6	CR8EVX	6487		CR8EIX	4218
TE 410	400	01-	C7E	5096	0,6				CR7EIX	7385
410 TE	410	95- 96	C7E	5096	0,7				CR7EIX	7385
430 CR	430		B9ES	2611	0,5	B9EVX	7254	202	BR9EIX	3981
450 SMR	450	04-	CR8EB	7784	0,6	CR8EVX	6487		CR8EIX	4218
SM 450 R	450	03-	CR8EB	7784	0,6	CR8EVX	6487		CR8EIX	4218
SMR 450	450	03-	CR7EB	4663	0,6					
TC 450	450	01-	CR8EB	7784	0,6	CR8EVX	6487		CR8EIX	4218
TE 450	450	03-	CR8EB	7784	0,6	CR8EVX	6487		CR8EIX	4218
TE 510	450	03-	CR8EB	7784	0,6	CR8EVX	6487		CR8EIX	4218
510 TE/AC	510		DP8EA-9	5829	0,9	DPR8EVX-9	2872		DPR8EIX-9	2202
510 TE/TC	510	87- 90	C7E	5096	0,7				CR7EIX	7385
SM 570 R	570	01-	C7E	5096	0,7				CR7EIX	7385
SMR 570	570	03-	CR7EB	4663	0,6					
SMR 570 NOX	570	02-	R0045J-10	7400						
SM / R 570	576	07.01-	CR7EB	4663	0,6					
TC 570	576	07.01-	CR7EB	4663	0,7					
TE 570	576	07.01-	CR7EB	4663	0,7					
610 e TE/TC	610	98-	C7E	5096	0,7				CR7EIX	7385
610 TE/TC	610	91-	C7E	5096	0,7				CR7EIX	7385
SM 610 e	610	98-	C7E	5096	0,7				CR7EIX	7385
SM 610 S	610	03-	C7E	5096	0,7				CR7EIX	7385
SMR 630	630	04-	R0045J-10	7400						

HYOSUNG

50 (ATV)	50	03-	BP6HS	4511	0,7	BP6HVX	4635		BPR6HIX	4085
90 (ATV)	50	03-	BPR7HS	6422	0,8	BPR7HVX	2938	215	BPR7HIX	5944
WOW 50 (ATV)	50	04-	BP7HS	5111	0,7	BP7HVX	7468		BPR7HIX	5944
WOW 90 (ATV)	90	04-	BP7HS	5111	0,7	BP7HVX	7468		BPR7HIX	5944
Aquila (GV125)	125	00-	CR8E	1275	0,6	CR8EVX	6487	226	CR8EIX	4218
Cruise 125 II (GA125F)	125	97-	CR8EH-9	5666	0,7	CR8EHVX-9	4546	228	CR8EHIX-9	3797
Cruise 125 I (GA125)	125	97-	DR8EA	7162	0,6	DR8EVX	6354		DR8EIX	6681
Cruise 125 I (GA125)	125	(96)	D8EA	2120	0,6	D8EVX	2850	216	DR8EIX	6681
Cruise 125 II Classic (GA125F-CLS)	125	99-	CR8EH-9	5666	0,7	CR8EHVX-9	4546	228	CR8EHIX-9	3797
GF 125 (GF125)	125	98-	CR8EH-9	5666	0,8	CR8EHVX-9	4546	228	CR8EHIX-9	3797
GS 125 (GS125)	125	97-	DR8EA	7162	0,6	DR8EVX	6354		DR8EIX	6681
Hyper 125 (GPS125)	125	98-	DR8EA	7162	0,6	DR8EVX	6354		DR8EIX	6681
Karion 125	125	02-	CR8EH-9	5666	0,8	CR8EHVX-9	4546	228	CR8EHIX-9	3797
Naked 125	125	01-	CR8E	1275	0,6	CR8EVX	6487	226	CR8EIX	4218
XRX 125 (RX125)	125	99-	CR8EH-9	5666	0,8	CR8EHVX-9	4546	228	CR8EHIX-9	3797
Aquila (GV250) 8V	250	00-	CR8E	1275	0,6	CR8EVX	6487	226	CR8EIX	4218
650 Naked	650	04-	CR8E	1275	0,6	CR8EVX	6487	226	CR8EIX	4218

INDIAN

all models / Alle Modelle V-Twin		36- 53	B7HS	5110	0,6	B7HVX	7836	204	BR7HIX	7067
Chief	1450	99- 01	BPR5ES-11	4424	1,1	BPR5EVX-11	2738		BPR5EIX-11	2115
Scout	1450	01-	BPR5ES-11	4424	1,1	BPR5EVX-11	2738		BPR5EIX-11	2115
Spirit	1450	01-	BPR5ES-11	4424	1,1	BPR5EVX-11	2738		BPR5EIX-11	2115
Chief	1650	02-	BPR5ES-11	4424	1,1	BPR5EVX-11	2738		BPR5EIX-11	2115

ISCH

Jupitter 20,6kW	346		BP6HS	4511	0,7	BP6HVX	4635		BPR6HIX	4085
-----------------	-----	--	-------	------	-----	--------	------	--	---------	------

Order
No.Platin
Gold-
Palla-
diumOrder Quick
No. No.Order
No.**ISCH**

Jupiter	13,2kW	346		BP6HS	4511	0,7	BP6HVX	4635		BPR6HIX	4085
6.113.6.114	17,7kW	347		BP6HS	4511	0,7	BP6HVX	4635		BPR6HIX	4085
6.113-01	17,7kW	347		BP6HS	4511	0,7	BP6HVX	4635		BPR6HIX	4085
7.107	16,2kW	347		BP7HS	5111	0,7	BP7HVX	7468		BPR7HIX	5944
Planeta	13,2kW	347		BP7HS	5111	0,7	BP7HVX	7468		BPR7HIX	5944
Planeta	14,7kW	347		BP7HS	5111	0,7	BP7HVX	7468		BPR7HIX	5944

ITALJET

Pirana, Pulce		50		B6HS	4510	0,5	B6HVX	7435	203	BR6HIX	3419
Tiffany, Winner		50		B5HS	4210	0,5					
Super Range		125		B7HS	5110	0,5	B7HVX	7836	204	BR7HIX	7067

JAWA

05		50		B6HS	4510	0,6	B6HVX	7435	203	BR6HIX	3419
20		50		B6HS	4510	0,6	B6HVX	7435	203	BR6HIX	3419
21 Sport		50		B6HS	4510	0,6	B6HVX	7435	203	BR6HIX	3419
23 Mustang		50		B6HS	4510	0,6	B6HVX	7435	203	BR6HIX	3419
207 Babetta		50		B4H	4110	0,6					
210		50	01.85-	B6HS	4510	0,5	B6HVX	7435	203	BR6HIX	3419
210 Babetta		50		B5HS	4210	0,6					
215		50	01.86-	B6HS	4510	0,5	B6HVX	7435	203	BR6HIX	3419
Moped		50		B8HS	5510	0,5	B8HVX	2634	205	BR8HIX	7001
CZ 125		125	84-	B8HS	5510	0,5	B8HVX	2634	205	BR8HIX	7001
CZ 125 De Luxe		125	- 84	B8HS	5510	0,5	B8HVX	2634	205	BR8HIX	7001
CZ 175		175	84-	B8HS	5510	0,5	B8HVX	2634	205	BR8HIX	7001
CZ 175 De Luxe		175	- 84	B8HS	5510	0,5	B8HVX	2634	205	BR8HIX	7001
CZ 250		250	84-	B8HS	5510	0,5	B8HVX	2634	205	BR8HIX	7001
CZ 250 Single/De Luxe		250	- 84	B8HS	5510	0,5	B8HVX	2634	205	BR8HIX	7001
350 Gespann		350	01.87-	B6HS	4510	0,5	B6HVX	7435	203	BR6HIX	3419
350/640 Black Style		350	93-	B8HS	5510	0,5	B8HVX	2634	205	BR8HIX	7001
634		350		B6HS	4510	0,6	B6HVX	7435	203	BR6HIX	3419
638		350		B6HS	4510	0,6	B6HVX	7435	203	BR6HIX	3419
638.5 Gespann		350	01.85-	B6HS	4510	0,5	B6HVX	7435	203	BR6HIX	3419
639		350		B6HS	4510	0,6	B6HVX	7435	203	BR6HIX	3419
640		350		B6HS	4510	0,6	B6HVX	7435	203	BR6HIX	3419
CZ 350		350	84-	B8HS	5510	0,5	B8HVX	2634	205	BR8HIX	7001
CZ 350 De Luxe		350	- 84	B8HS	5510	0,5	B8HVX	2634	205	BR8HIX	7001
TS 350		350	09.86-	B6HS	4510	0,5	B6HVX	7435	203	BR6HIX	3419
Twin Sport		350		B8HS	5510	0,5	B8HVX	2634	205	BR8HIX	7001
GS 360		360	01.74-12.85	B9HS	5810	0,7	B9HVX	2254			
500 DT Speedway		500				0,5	B9EVX	7254		BR9EIX	3981
500 R		500		D8EA	2120	0,5	D8EVX	2850	216	DR8EIX	6681
500 R Spezial		500				0,5	D8EVX	2850		DR8EIX	6681

JCM

125 Trail		125		BP6ES	7811	0,7	BP6EVX	5832		BPR6EIX	6637
240 Trail		240		BP7ES	2412	0,5	BP7EVX	7270	206	BPR7EIX	4055
333 Trail		333		BP7ES	2412	0,5	BP7EVX	7270	206	BPR7EIX	4055

JOHN DEERE

Gator 6x4 (ATV)				BMR2A-10	4452	1,0					
Gator 4x2 (ATV)				BPR6ES	7822	0,8	BPR6EVX	6764		BPR6EIX	6637

Order
No.Gold-
Palla-
dium

Platin

Order
No.Quick
No.

Iridium

Order
No.**KAWASAKI**

AE 50	50	- 82	B6ES	7310	0,8	B6EVX	5136			
AE 50	50	83-	B8ES	2411	0,8	B8EVX	7051	201	BR8EIX	5044
AR 50	50	- 82	B6ES	7310	0,8	B6EVX	5136			
AR 50	50	83- 92	B8ES	2411	0,8	B8EVX	7051	201	BR8EIX	5044
AR 50	50	93-	BR8ES	5422	0,8	BR8EVX	1262	207	BR8EIX	5044
AV 50	50	84-	C6HSA	3228	0,7				CR6HIX	7274
AV 50	50	- 83	D8EA	2120	0,7	D8EVX	2850	216	DR8EIX	6681
KFX 50 A (SQ)(ATV)	50	03-	BPR4HS	7823	0,7					
KH 50	50		B6ES	7310	0,8	B6EVX	5136			
KMX 50 (KSR-I)	50	93-	BR8ES	5422	0,8	BR8EVX	1262	207	BR8EIX	5044
KX 60	60	- 92	B9EG	3530	0,6	B9EGV	5827		BR9EIX	3981
KX 60	60	93-	BR9EG	3230	0,7	BR9EVX	1265		BR9EIX	3981
KX 65	65		BR10EG	3830	0,6					
AE 80	80	83-	BPR8ES	3923	0,8	BPR8EVX	5573	213		
AE 80	80	- 82	BP7ES	2412	0,8	BP7EVX	7270	206	BPR7EIX	4055
AN 80	80		C6HSA	3228	0,7				CR6HIX	7274
AR 80	80	- 82	BP7ES	2412	0,8	BP7EVX	7270	206	BPR7EIX	4055
AR 80	80	83-	BPR8ES	3923	0,8	BPR8EVX	5573	213		
DX 80	80		B8ES	2411	0,8	B8EVX	7051	201	BR8EIX	5044
KD 80	80		B7ES	1111	0,7	B7EVX	6934			
KDX 80	80		B8ES	2411	0,8	B8EVX	7051	201	BR8EIX	5044
KFX 80 (ATV)	80	04-	BPR4HS	7823	0,6					
KH 80	80		B7ES	1111	0,8	B7EVX	6934			
KMX 80 (KSR-2)	80	93-	BR8ES	5422	0,8	BR8EVX	1262	207	BR8EIX	5044
KX 80	80	- 80	B8ES	2411	0,8	B8EVX	7051	201	BR8EIX	5044
KX 80	80	81- 82	B9ES	2611	0,6	B9EVX	7254	202	BR9EIX	3981
KX 80	80	83- 91	B9EG	3530	0,6	B9EGV	5827		BR9EIX	3981
KX 80 (KX80S7)	80	97-	R6252K-105	2741	0,6					
KX 80 (KX80V7)	80	97-	R6252K-105	2741	0,6					
KX 80 /80-2	80	92-	R6252K-105	2741	0,6					
KX 85	85	01-	R6252K-105	2741	0,8					
KX 85-II	85	01-	R6252K-105	2741	0,8					
KC 90	90		B8ES	2411	0,8	B8EVX	7051	201	BR8EIX	5044
KC 90 A	90		B8ES	2411	0,8	B8EVX	7051	201	BR8EIX	5044
KC 90 C	90		B8HS	5510	0,7	B8HVX	2634	205	BR8HIX	7001
KC 90 D	90		B8HS	5510	0,7	B8HVX	2634	205	BR8HIX	7001
KE 90	90		B8ES	2411	0,8	B8EVX	7051	201	BR8EIX	5044
KH 90	90		B8ES	2411	0,8	B8EVX	7051	201	BR8EIX	5044
KM 90	90		B7HS	5110	0,7	B7HVX	7836	204	BR7HIX	7067
KC 100	100	80-	B8ES	2411	0,8	B8EVX	7051	201	BR8EIX	5044
KD 100	100		B7HS	5110	0,7	B7HVX	7836	204	BR7HIX	7067
KE 100	100	01.76-12.79	B8ES	2411	0,8	B8EVX	7051	201	BR8EIX	5044
KE 100	100	93-	BR8ES	5422	0,8	BR8EVX	1262	207	BR8EIX	5044
KH 100	100		B8ES	2411	0,8	B8EVX	7051	201	BR8EIX	5044
KM 100	100	01.79-12.81	B7HS	5110	0,7	B7HVX	7836	204	BR7HIX	7067
KV 100	100		B7HS	5110	0,7	B7HVX	7836	204	BR7HIX	7067
KX 100	100	92-	R6252K-105	2741	0,6					
KAZE 110	110	95-	C6HSA	3228	0,7				CR6HIX	7274
AR 125	125	01.82-	BR8ES	5422	0,8	BR8EVX	1262	207	BR8EIX	5044
BN125A Eliminator	125	97-	CR8E	1275	0,6	CR8EVX	6487	226	CR8EIX	4218
DX 125	125				0,6	B9EVX	7254		BR9EIX	3981
KC 125	125		B6HS	4510	0,7	B6HVX	7435	203	BR6HIX	3419

Order
No.Platin
Gold-
Palla-
diumOrder Quick
No. No.Order
No.**KAWASAKI**

KD 125	125		B8HS	5510	0,7	B8HVX	2634	205	BR8HIX	7001
KDX 125 SR	125		BR8ES	5422	0,8	BR8EVX	1262	207	BR8EIX	5044
KE 125	125	01.76-12.83	B8HS	5510	0,8	B8HVX	2634	205	BR8HIX	7001
KH 125	125	93-	BR8ES	5422	0,8	BR8EVX	1262	207	BR8EIX	5044
KH 125	125	01.77-12.81	BR8ES	5422	0,8	BR8EVX	1262	207	BR8EIX	5044
KMX 125	125	01.86-	BR8ES	5422	0,7	BR8EVX	1262	207	BR8EIX	5044
KS 125	125	01.73-12.76	B8HS	5510	0,7	B8HVX	2634	205	BR8HIX	7001
KX 125	125	85- 90			0,6	B10EVX	7335		BR10EIX	6801
KX 125	125	90- 91	R6254E-105	3949	0,6					
KX 125	125	91- 99	R6252K-105	2741	0,6					
KX 125	125	82- 84			0,6	B9EVX	7254		BR9EIX	3981
KX 125	125	00-			0,8	BR9EVX	1265		BR9EIX	3981
KX 125	125	03-							BR9EIX	3981
KX 125	125	04-	R6918B-9	2954	0,7					
KX 125 (KX125K4)	125	97-			0,6	BR9EVX	1265		BR9EIX	3981
KD 175	175		B9HS	5810	0,7	B9HVX	2254			
KDX 175	175	01.80-12.84			0,6	BR9EVX	1265		BR9EIX	3981
KE 175	175	81-	B7ES	1111	0,8	B7EVX	6934			
KE 175	175	- 80	B9HS	5810	0,7	B9HVX	2254			
KE 175 B	175		B9HS	5810	0,7	B9HVX	2254			
KE 175 D	175		B7ES	1111	0,8	B7EVX	6934			
KLF 185 (ATV)	185		DR8ES	5423	0,7	DR8EVX	6354	217	DR8EIX	6681
KDX 200	200	93- 94	BR9ES	5722	0,8	BR9EVX	1265	208	BR9EIX	3981
KDX 200 H	200	95-	BR8ES	5422	0,8	BR8EVX	1262	207	BR8EIX	5044
KMX 200	200	01.88- 92	BR8ES	5422	0,8	BR8EVX	1262	207	BR8EIX	5044
Z 200	200	01.77-12.79	B8ES	2411	0,8	B8EVX	7051	201	BR8EIX	5044
KLF 220 (ATV)	220	88- 02	DR8ES	5423	0,7	DR8EVX	6354	217	DR8EIX	6681
BJ 250A (Estrella)	250	93- 96	DR8ES	5423	0,7	DR8EVX	6354	217	DR8EIX	6681
BJ 250 C(Estrella)	250	97-	DR9EA	3437	0,7	DR9EVX	6361	219	DR9EIX	4772
EL 250/E/F/Eliminator LX/SE	250	89-	CR8HSA	2086	0,7	CR8HVX	7236		CR8HIX	7669
EX 250 F (GPX 250 R)	250	93-	C8HA	2168	0,7	C8HVX	2672		CR8HIX	7669
EX 250 H (ZZ-R 250)	250	93-	CR8HSA	2086	0,7	CR8HVX	7236		CR8HIX	7669
GPX 250 R	250		CR8HSA	2086	0,7	CR8HVX	7236		CR8HIX	7669
GPZ 250 Belt Drive	250		DPR8EA-9	4929	0,9	DPR8EVX-9	2872	221	DPR8EIX-9	2202
GPZ 250 R	250		CR8HS	7423	0,7	CR8HVX	7236		CR8HIX	7669
KDX 250 (ATV)	250		BR8ES	5422	0,8	BR8EVX	1262	207	BR8EIX	5044
KDX 250 (ATV)	250	91-	BR9ES	5722	0,8	BR9EVX	1265	208	BR9EIX	3981
KDX 250 SR (ATV)	250	92-	BR8ES	5422	0,8	BR8EVX	1262	207	BR8EIX	5044
KE 250	250		B8ES	2411	0,8	B8EVX	7051	201	BR8EIX	5044
KH 250	250	01.73-12.79	B9HS	5810	0,7	B9HVX	2254			
KL 250 (A)	250	01.79-12.83	BR7ES	5122	0,8					
KLF 250 A (ATV)	250	02-	DR8ES	5423	0,7	DR8EVX	6354	217	DR8EIX	6681
KL 250 (KLR 250)	250	01.83- 91	DPR9EA-9	5329	0,9	DPR9EVX-9	3854	222	DPR9EIX-9	5545
KLX 250	250	01.80-12.84	B7ES	1111	0,8	B7EVX	6934			
KLX 250 (KLX250E)	250	93-	CR8E	1275	0,8	CR8EVX	6487	226	CR8EIX	4218
KR-1R	250		BR10ES	4832	0,8	BR10EVX	3788		BR10EIX	6801
KR-1S	250		BR10ES	4832	0,8	BR10EVX	3788		BR10EIX	6801
KSF 250 A (SQ)	250	87-	DPR8EA-9	4929	0,9	DPR8EVX-9	2872	221	DPR8EIX-9	2202
KT 250	250		B7HS	5110	0,7	B7HVX	7836	204	BR7HIX	7067
KX 250	250	92-	R6252E-9	4741	0,9					
KX 250	250	- 91	B9EG	3530	0,6	B9EGV	5827		BR9EIX	3981
KX 250	250	03-							BR8EIX	5044

Order
No.Platin
Gold-
Palla-
diumOrder Quick
No. No.Iridium
Order
No.**KAWASAKI**

KX 250 (KX250K4)	250	97-				BR8EVX	1262		BR8EIX	5044
KX 250 F	250	04-	CR8EB	7784	0,6	CR8EVX	6487		CR8EIX	4218
LTD 250 Belt Drive	250		DR8ES	5423	0,7	DR8EVX	6354	217	DR8EIX	6681
LX 250	250		BR7ES	5122	0,8					
Z 250	250		BR7ES	5122	0,8					
Z 250 A	250	01.80-	DR8ES	5423	0,7	DR8EVX	6354	217	DR8EIX	6681
Z 250 B	250		DR8ES	5423	0,7	DR8EVX	6354	217	DR8EIX	6681
Z 250 Belt Drive	250		DPR8EA-9	4929	0,9	DPR8EVX-9	2872	221	DPR8EIX-9	2202
Z 250 C	250	01.80-	B7ES	1111	0,8	B7EVX	6934			
Z 250 D	250		B7ES	1111	0,8	B7EVX	6934			
Z 250 G	250		B7ES	1111	0,8	B7EVX	6934			
Z 250 J	250		DR8ES	5423	0,7	DR8EVX	6354	217	DR8EIX	6681
Z 250 LTD	250	01.81-	BR8ES	5422	0,8	BR8EVX	1262	207	BR8EIX	5044
Z 250 T	250		DPR9EA-9	5329	0,9	DPR9EVX-9	3854	222	DPR9EIX-9	5545
ZR 250 (Balius)	250	93-	CR9E	6263	0,8	CR9EVX	5943	227	CR9EIX	3521
ZX 250 (ZXR 250)	250	93-	CR9E	6263	0,8	CR9EVX	5943	227	CR9EIX	3521
KEF 300 A&B (SQ)	300	95-	DR7EA	7839	0,7					
KLF 300 (ATV)	300	88-	BR8ES	5422	0,8	BR8EVX	1262	207	BR8EIX	5044
KLX 300 R (LX300B5)	300	01-	CR9E	6263	0,6	CR9EVX	5943	227	CR9EIX	3521
KVF 300 A&B	300	99- 02	DR8EA	7162	0,7	DR8EVX	6354		DR8EIX	6681
MULE 500/ KAF 300 A&B (UV)	300	92- 96	BPR5ES	7422	0,8	BPR5EVX	4875		BPR5EIX	6597
GPZ 305 Belt Drive	305	01.83-	DPR9EA-9	5329	0,9	DPR9EVX-9	3854	222	DPR9EIX-9	5545
Z 305	305		D8EA	2120	0,7	D8EVX	2850	216	DR8EIX	6681
KVF 360 A & B (ATV)	360	02-	DPR8EA-9	4929	0,9	DPR8EVX-9	2872	221	DPR8EIX-9	2202
EN 400 A	400		DR8ES	5423	0,7	DR8EVX	6354	217	DR8EIX	6681
GPZ 400	400		DPR9EA-9	5329	0,9	DPR9EVX-9	3854	222	DPR9EIX-9	5545
GPZ 400 F	400		DPR9EA-9	5329	0,9	DPR9EVX-9	3854	222	DPR9EIX-9	5545
GPZ 400 F II	400		DPR9EA-9	5329	0,9	DPR9EVX-9	3854	222	DPR9EIX-9	5545
KFX 400 A (SQ) (ATV)	400	03-	CR8E	1275	0,7	CR8EVX	6487	226	CR8EIX	4218
KFX 400 (ATV)	400	03-	CR7E	4578	0,8			225	CR7EIX	7385
KH 400	400		B8HS	5510	0,7	B8HVX	2634	205	BR8HIX	7001
KLE 400	400	93-	DR8EA	7162	0,7	DR8EVX	6354		DR8EIX	6681
KLF 400 B (ATV)	400	93- 99	DPR8EA-9	4929	0,9	DPR8EVX-9	2872	221	DPR8EIX-9	2202
KVF 400 C&D (ATV)	400	99- 02	DPR8EA-9	4929	0,9	DPR8EVX-9	2872	221	DPR8EIX-9	2202
KX 400	400				0,6	B9EVX	7254		BR9EIX	3981
KXF 400 A	400	03-	CR8EA		0,6					
LTD 400	400		DR8ES	5423	0,7	DR8EVX	6354	217	DR8EIX	6681
Z 400	400	01.76-12.81	BR7ES	5122	0,8					
Z 400 A/B/C/D/G/H	400		B7ES	1111	0,8	B7EVX	6934			
Z 400 F	400	83-	DR8ES	5423	0,7	DR8EVX	6354	217	DR8EIX	6681
Z 400 F	400		DPR9EA-9	5329	0,9	DPR9EVX-9	3854	222	DPR9EIX-9	5545
Z 400 F-II	400		DPR9EA-9	5329	0,9	DPR9EVX-9	3854	222	DPR9EIX-9	5545
Z 400 J	400		DR8EA	7162	0,7	DR8EVX	6354		DR8EIX	6681
Z 400 J (I)	400		D8EA	2120	0,7	D8EVX	2850	216	DR8EIX	6681
Z 400 K	400		DR7ES	3123	0,7					
Z 400 LTD	400		BR7ES	5122	0,8					
Z 400 M	400		DR8EA	7162	0,7	DR8EVX	6354		DR8EIX	6681
ZL 400 (Eliminator 400SE)	400	93-	DR8ES	5423	0,7	DR8EVX	6354	217	DR8EIX	6681
ZR 400	400	84-	DR8ESL	2923	0,7	DR8EVX	6354	218	DR8EIX	6681
ZR 400	400	- 83	DR7ES	3123	0,7					
ZR 400-C (Zephyr 400)	400	93-	DPR9EA-9	5329	0,9	DPR9EVX-9	3854	222	DPR9EIX-9	5545
ZR 400-D (Xanthus)	400	93-	CR9EK	4548	0,8			230	CR9EIX	3521

Order
No.Platin
Gold-
Palla-
diumOrder Quick
No. No.Order
No.**KAWASAKI**

ZX 400 (Z 400-F2)	400	93-	DPR9EA-9	5329	0,9	DPR9EVX-9	3854	222	DPR9EIX-9	5545
ZX 400 (ZXR400R,ZZR400)	400	93-	CR9EK	4548	0,8			230	CR9EIX	3521
ZXR 400	400		CR9EK	4548	0,8			230	CR9EIX	3521
Z 440	440	01.80-12.85	BR7ES	5122	0,8					
Z 440 H (I)	440		BR7ES	5122	0,8					
EN 450 A (I)	450		DR8ES	5423	0,7	DR8EVX	6354	217	DR8EIX	6681
LTD 450	450	01.85-	DR8ES	5423	0,7	DR8EVX	6354	217	DR8EIX	6681
Mule 1000 / KAF 450B (UV)	450	90- 95	D6EA	7512	0,7					
EN 500	500	90-	DR9EA	3437	0,7	DR9EVX	6361	219	DR9EIX	4772
ER-5 (ER500A1)(ER500C1)	500	97-	DR9EA	3437	0,7	DR9EVX	6361	219	DR9EIX	4772
ER-5 (ER500B1)(ER500D1)	500	97-	DR9EA	3437	0,7	DR9EVX	6361	219	DR9EIX	4772
EX 500 (GPZ 500S EN 500)	500	93-	DR8ES	5423	0,7	DR8EVX	6354	217	DR8EIX	6681
GPX 500 R	500	01.89-	DR8ES	5423	0,7	DR8EVX	6354	217	DR8EIX	6681
GPZ 500 R	500		DR8ES	5423	0,7	DR8EVX	6354	217	DR8EIX	6681
GPZ 500 S	500		DR8ES	5423	0,7	DR8EVX	6354	217	DR8EIX	6681
GPZ 500 S (EX500D)	500	94-	DR9EA	3437	0,7	DR9EVX	6361	219	DR9EIX	4772
GPZ 500 S (EX500E4)	500	97-	DR9EA	3437	0,7	DR9EVX	6361	219	DR9EIX	4772
GPZ 500 S (I)	500		D9EA	2420	0,7	D9EVX	2834		DR9EIX	4772
GRZ 500 S (EX500E)	500		D9EA	2420	0,7	D9EVX	2834		DR9EIX	4772
KH 500	500		B9HS-10	3626	1,0					
KLE 500	500	90-	DR9EA	3437	0,7	DR9EVX	6361	219	DR9EIX	4772
KLR 500	500		DPR8EA-9	4929	0,9	DPR8EVX-9	2872	221	DPR8EIX-9	2202
KX 500	500	93-	BR8EG	3130	0,6					
LE 500 A	500		DR9EA	3437	0,8	DR9EVX	6361	219	DR9EIX	4772
Z 500	500		DR8EA	7162	0,7	DR8EVX	6354		DR8EIX	6681
ZL 500	500		DR8ES	5423	0,7	DR8EVX	6354	217	DR8EIX	6681
ZR 500	500		DR8ESL	2923	0,7	DR8EVX	6354	218	DR8EIX	6681
ZZ-R 500	500		CR9E	6263	0,8	CR9EVX	5943	227	CR9EIX	3521
Mule 2010 / KAF 540C (UV)	540	90- 93	BPR5ES	7422	0,6	BPR5EVX	4875		BPR5EIX	6597
GPZ 550	550		DPR9EA-9	5329	0,9	DPR9EVX-9	3854	222	DPR9EIX-9	5545
GPZ 550 Unitrack (I)	550		D8EA	2120	0,7	D8EVX	2850	216	DR8EIX	6681
GT 550	550	01.83-	DR8ES	5423	0,7	DR8EVX	6354	217	DR8EIX	6681
LTD 550	550	01.80-12.85	DR8ES	5423	0,7	DR8EVX	6354	217	DR8EIX	6681
Z 550	550		DR8ES	5423	0,7	DR8EVX	6354	217	DR8EIX	6681
Zephyr (ZR550B8)	550	97-	DR9EA	3437	0,7	DR9EVX	6361	219	DR9EIX	4772
ZR 550 B Zephyr	550	91-	DR9EA	3437	0,8	DR9EVX	6361	219	DR9EIX	4772
ZX 550 A1	550		DPR9EA-9	5329	0,9	DPR9EVX-9	3854	222	DPR9EIX-9	5545
Eliminator 600 (ZL600B)	600	95-	DR9EA	3437	0,7	DR9EVX	6361	219	DR9EIX	4772
GPX 600	600		DR8ES	5423	0,8	DR8EVX	6354	217	DR8EIX	6681
GPZ 600	600		DR8ES	5423	0,7	DR8EVX	6354	217	DR8EIX	6681
GPZ 600 R (I)	600		D9EA	2420	0,7	D9EVX	2834		DR9EIX	4772
KL 600	600		DPR8EA-9	4929	0,9	DPR8EVX-9	2872	221	DPR8EIX-9	2202
KL 600 R-AI (I)	600		D8EA	2120	0,7	D8EVX	2850	216	DR8EIX	6681
KLR 600	600	85-	DPR8EA-9	4929	0,9	DPR8EVX-9	2872	221	DPR8EIX-9	2202
KLR 600	600	- 84	DR8ES	5423	0,7	DR8EVX	6354	217	DR8EIX	6681
KLR 600 EL (I)	600		DP9EA-9	6629	0,9	DP9EVX-9	3331		DPR9EIX-9	5545
ZL 600	600	01.86-	DR8ES	5423	0,7	DR8EVX	6354	217	DR8EIX	6681
ZL 600 (ZL600B/B1)	600	95-	DR9EA	3437	0,7	DR9EVX	6361	219	DR9EIX	4772
ZX 600 A (I)	600		D9EA	2420	0,7	D9EVX	2834		DR9EIX	4772
ZX-6R Ninja (ZX 600 G)	600	98-	CR9E	6263	0,7	CR9EVX	5943	227	CR9EIX	3521
ZX-6R Ninja (ZX600F1/F3)	600	95-	CR9E	6263	0,8	CR9EVX	5943	227	CR9EIX	3521
ZX-6R Ninja (ZX 600 H Kat)	600	98-	CR9E	6263	0,7	CR9EVX	5943	227	CR9EIX	3521

Order
No.Gold-
Palla-
diumOrder Quick
No. No.

Iridium

Order
No.**KAWASAKI**

ZX-6R Ninja (Kat.) (Zx600J1H)	600	00-	CR9E	6263	0,8	CR9EVX	5943	227	CR9EIX	3521
ZX-6R Ninja (Kat.)	600	03-	CR9E	6263	0,8	CR9EVX	5943	227	CR9EIX	3521
ZX-6RR	600	04-	CR9E	6263	0,8	CR9EVX	5943	227	CR9EIX	3521
ZZ-R 600	600	90-	CR9E	6263	0,8	CR9EVX	5943	227	CR9EIX	3521
ZZ-R 600 (ZX600E9)	600	01-	CR9E	6263	0,7	CR9EVX	5943	227	CR9EIX	3521
ZZ-R 600 (ZX600E/E5)	600	93-	CR9E	6263	0,8	CR9EVX	5943	227	CR9EIX	3521
Mule 2510 / KAF 620A&C (UV)	620	93- 02	BMR2A	7677	0,6					
Mule 3010 / KAF 620E&G (UV)	620	01-	BPR2ES	2264	0,6					
Ninja ZX-6R (ZX636B)	636	03-	CR9E	6263	0,8	CR9EVX	5943	227	CR9EIX	3521
Ninja ZX-6RR (ZX600K)	636	03-	CR9E	6263	0,8	CR9EVX	5943	227	CR9EIX	3521
KL 650 (KLR 650/Tengai)	650	93-	DPR8EA-9	4929	0,9	DPR8EVX-9	2872	221	DPR8EIX-9	2202
KLR 650	650	09.86- 94	DPR8EA-9	4929	0,9	DPR8EVX-9	2872	221	DPR8EIX-9	2202
KLR 650 (KL650C1/C3)	650	95-	DPR8EA-9	4929	0,9	DPR8EVX-9	2872	221	DPR8EIX-9	2202
KLX 650 (KLX650C)	650	93-	DPR8EA-9	4929	0,9	DPR8EVX-9	2872	221	DPR8EIX-9	2202
KLX 650 R	650	98-	DPR8EA-9	4929	0,9	DPR8EVX-9	2872	221	DPR8EIX-9	2202
KLX 650 R (KLX650A)	650	93- 96	DPR8EA-9	4929	0,9	DPR8EVX-9	2872	221	DPR8EIX-9	2202
KVF 650 A (ATV)	650	00-	CR7E	4578	0,8			225	CR7EIX	7385
W 650 (EJ650A1)	650	99-	CR9E	6263	0,8	CR9EVX	5943	227	CR9EIX	3521
Z 650	650		BR7ES	5122	0,8					
Z 650 F-B	650		B8ES	2411	0,7	B8EVX	7051	201	BR8EIX	5044
KFV 700 (ATV)	700	04-	CR7E	4578	0,8			225	CR7EIX	7385
KFX 700 (ATV) Quad	700	04-	CR7E	4578	0,8			225	CR7EIX	7385
KSV 700 (ATV)	700	04-	CR7E	4578	0,8			225	CR7EIX	7385
LTD 700	700		BR8ES	5422	0,8	BR8EVX	1262	207	BR8EIX	5044
Z 700	700		BR8ES	5422	0,8	BR8EVX	1262	207	BR8EIX	5044
750 Turbo	750	01.73-12.86			0,6	BR9EVX	1265		BR9EIX	3981
GPX 750 R	750	01.87-	DR8ES	5423	0,7	DR8EVX	6354	217	DR8EIX	6681
GPX 750 R (I)	750		DR8ESL	2923	0,7	DR8EVX	6354	218	DR8EIX	6681
GPZ 750	750	01.82-	BR9ES	5722	0,8	BR9EVX	1265	208	BR9EIX	3981
GPZ 750 R	750	01.85-	DR8ES	5423	0,7	DR8EVX	6354	217	DR8EIX	6681
GT 750	750	01.82-12.87	BR8ES	5422	0,8	BR8EVX	1262	207	BR8EIX	5044
LTD 750 4 Cyl.	750	01.82-12.87	BR8ES	5422	0,8	BR8EVX	1262	207	BR8EIX	5044
VN 750 Twin	750		DPR7EA-9	5129	0,9	DPR7EVX-9	7682	220	DPR7EIX-9	7803
VN 750 Vulcan	750		DPR7EA-9	5129	0,9	DPR7EVX-9	7682	220	DPR7EIX-9	7803
Z 2	750		B8ES	2411	0,8	B8EVX	7051	201	BR8EIX	5044
Z 750	750		BR8ES	5422	0,8	BR8EVX	1262	207	BR8EIX	5044
Z 750	750	04-	CR9EK	4548	0,7			230	CR9EIX	3521
Z 750 (GT750)	750	93-	DR8ES	5423	0,7	DR8EVX	6354	217	DR8EIX	6681
Z 750 B	750		BR8ES	5422	0,8	BR8EVX	1262	207	BR8EIX	5044
Z 750 D	750		B8ES	2411	0,8	B8EVX	7051	201	BR8EIX	5044
Z 750 E	750		BR8ES	5422	0,8	BR8EVX	1262	207	BR8EIX	5044
Z 750 GP	750		BR8ES	5422	0,8	BR8EVX	1262	207	BR8EIX	5044
Z 750 H	750		BR8ES	5422	0,8	BR8EVX	1262	207	BR8EIX	5044
Z 750 L	750		BR8ES	5422	0,8	BR8EVX	1262	207	BR8EIX	5044
Z 750 LTD	750		BR8ES	5422	0,8	BR8EVX	1262	207	BR8EIX	5044
Z 750 LTD Belt Drive	750		BPR6ES	7822	0,8	BPR6EVX	6764		BPR6EIX	6637
Z 750 LTD Twin.	750		BPR6ES	7822	0,8	BPR6EVX	6764		BPR6EIX	6637
Z 750 M	750		BR6ES	4922	0,8					
Z 750 S	750		BR6ES	4922	0,8					
ZR-7 (ZR750F1)	750	99-	DR9EA	3437	0,7	DR9EVX	6361	219	DR9EIX	4772
ZR 750 C Zephyr	750	91- 00	DR8ES	5423	0,7	DR8EVX	6354	217	DR8EIX	6681
ZR 750 D1/2 Zephyr	750	96- 00	DR9EA	3437	0,7	DR9EVX	6361	219	DR9EIX	4772

Order
No.Platin
Gold-
Palla-
diumOrder Quick
No. No.Order
No.**KAWASAKI**

ZR-7S (ZR750F1)(ZR750-H1)	750	99-	DR9EA	3437	0,7	DR9EVX	6361	219	DR9EIX	4772
ZX 750 J	750		CR9E	6263	0,8	CR9EVX	5943	227	CR9EIX	3521
ZX 750 N1 Ninja ZX-7RR	750	96-	CR9E	6263	0,8	CR9EVX	5943	227	CR9EIX	3521
ZX 750 P1/P2 Ninja ZX-7R	750	96-	CR9E	6263	0,8	CR9EVX	5943	227	CR9EIX	3521
ZX-7R Ninja (ZX750P6)	750	00-	CR9E	6263	0,7	CR9EVX	5943	227	CR9EIX	3521
ZXR 750	750	09.88-	CR9E	6263	0,8	CR9EVX	5943	227	CR9EIX	3521
ZXR 750 R	750	90-	CR9E	6263	0,8	CR9EVX	5943	227	CR9EIX	3521
ZXR 750 R (ZX750L/M)	750	93-	CR9E	6263	0,8	CR9EVX	5943	227	CR9EIX	3521
VN 800 Drifter (VN800C1)	800	99- 00	CR8E	1275	0,8	CR8EVX	6487	226	CR8EIX	4218
VN 800 Drifter (VN800E1)	800	01-	CR7E	4578	0,8			225	CR7EIX	7385
VN 800 (VN800A)	800	95-	CR8E	1275	0,8	CR8EVX	6487	226	CR8EIX	4218
VN 800 (VN800A3)	800	97-	CR8E	1275	0,8	CR8EVX	6487	226	CR8EIX	4218
VN 800 B1/B2	800	96-	CR8E	1275	0,8	CR8EVX	6487	226	CR8EIX	4218
Vulcan 800	800	95-	CR8E	1275	0,8	CR8EVX	6487	226	CR8EIX	4218
GPZ 900 R	900		DR8ES	5423	0,7	DR8EVX	6354	217	DR8EIX	6681
GPZ 900 R (I)	900		D9EA	2420	0,6	D9EVX	2834		DR9EIX	4772
Ninja ZX-9R	900	98-	CR9EK	4548	0,7			230	CR9EIX	3521
Z 1	900		B8ES	2411	0,8	B8EVX	7051	201	BR8EIX	5044
Z 900	900	01.73-12.76	B8ES	2411	0,8	B8EVX	7051	201	BR8EIX	5044
ZX 900 B/B4 (Ninja ZX-9R)	900	94- 97	CR9EK	4548	0,7			230	CR9EIX	3521
ZX 900 C (Ninja ZX-9R)	900	98- 99	CR9EK	4548	0,7			230	CR9EIX	3521
ZX 900 D (Kat) (Ninja ZX-9R)	900	98- 99	CR9EK	4548	0,7			230	CR9EIX	3521
ZX-9R	900	03-	CR9EK	4548	0,7			230	CR9EIX	3521
ZX 900 E1H (Kat.) (Ninja ZX-9R)	900	00-	CR9EK	4548	0,7			230	CR9EIX	3521
1000 GTR	1000		DR8ES	5423	0,7	DR8EVX	6354	217	DR8EIX	6681
1000 GTR (ZG1000A12)	1000	97-	DR9EA	3437	0,7	DR9EVX	6361	219	DR9EIX	4772
1000 GTR (ZGT00A)	1000	94-	DR9EA	3437	0,7	DR9EVX	6361	219	DR9EIX	4772
1000 GTR (I)	1000		D9EA	2420	0,7	D9EVX	2834		DR9EIX	4772
A 1000 R1	1000		BR8ES	5422	0,8	BR8EVX	1262	207	BR8EIX	5044
GPZ 1000 AZ (I)	1000		B8ES	2411	0,7	B8EVX	7051	201	BR8EIX	5044
GPZ 1000 R (I)	1000		D9EA	2420	0,7	D9EVX	2834		DR9EIX	4772
GPZ 1000 RX	1000		DR8ES	5423	0,7	DR8EVX	6354	217	DR8EIX	6681
GPZ 1000 RX (I)	1000		D9EA	2420	0,7	D9EVX	2834		DR9EIX	4772
KLV 1000	1000	04-	CR8EK	3478	0,7					
KZ 1000 Police	1000	93-	BR8ES	5422	0,8	BR8EVX	1262	207	BR8EIX	5044
ST 1000 (I)	1000		B8ES	2411	0,7	B8EVX	7051	201	BR8EIX	5044
Z 1000	1000	- 80	B8ES	2411	0,8	B8EVX	7051	201	BR8EIX	5044
Z 1000	1000	81-	BR8ES	5422	0,8	BR8EVX	1262	207	BR8EIX	5044
Z 1000	1000	03-	CR9EK	4548	0,8			230	CR9EIX	3521
Z 1000 ES (I)	1000		B8ES	2411	0,8	B8EVX	7051	201	BR8EIX	5044
Z 1000 J (I)	1000		BR8ES	5422	0,8	BR8EVX	1262	207	BR8EIX	5044
Z1R 1000 (I)	1000		B8ES	2411	0,7	B8EVX	7051	201	BR8EIX	5044
ZL 1000	1000	09.86-	DR8ES	5423	0,7	DR8EVX	6354	217	DR8EIX	6681
ZX 10	1000	87- 90	CR9E	6263	0,8	CR9EVX	5943	227	CR9EIX	3521
Ninja ZX-10 R	1000	04-							CR9EIA-9	6289
ZZR 1100 Kat (ZX1100G)	1052	98-	CR9E	6263	0,7	CR9EVX	5943	227	CR9EIX	3521
GPZ 1100	1100		BR8ES	5422	0,8	BR8EVX	1262	207	BR8EIX	5044
GPZ 1100 (ZX1100E1E1H)	1100	95-	CR9EK	4548	0,8			230	CR9EIX	3521
GPZ 1100 ABS (ZX1100F1)	1100	97-	CR9EK	4548	0,8			230	CR9EIX	3521
LTD 1100	1100		BR8ES	5422	0,8	BR8EVX	1262	207	BR8EIX	5044
Z 1100	1100		BR8ES	5422	0,8	BR8EVX	1262	207	BR8EIX	5044
Zephyr 1100 (ZR1100A)	1100		CR9E	6263	0,8	CR9EVX	5943	227	CR9EIX	3521

Order
No.Platin
Gold-
Palla-
diumOrder Quick
No. No.

Iridium

Order
No.**KAWASAKI**

Zephyr 1100 (ZRT10A)	1100	92-	CR9E	6263	0,8	CR9EVX	5943	227	CR9EIX	3521
ZRX 1100 (ZR1100C1)(ZRT10C)	1100	97- 00	CR9EK	4548	0,8			230	CR9EIX	3521
Zephyr (ZR 1100 B1)	1100	96-	CR9E	6263	0,8	CR9EVX	5943	227	CR9EIX	3521
ZX 1100 F1	1100	96-	CR9EK	4548	0,8			230	CR9EIX	3521
ZZR 1100 (ZXT10C)	1100	90- 92	CR9E	6263	0,8	CR9EVX	5943	227	CR9EIX	3521
ZZR 1100 (ZX1100D5)	1100	97-	CR9E	6263	0,8	CR9EVX	5943	227	CR9EIX	3521
ZZR 1100 (ZXT10D)	1100	93- 96	CR9E	6263	0,8	CR9EVX	5943	227	CR9EIX	3521
ZG 1200 (Voyager XII)	1200	93-	DPR8EA-9	4929	0,9	DPR8EVX-9	2872	221	DPR8EIX-9	2202
ZRX 1200 (ZR1200C1P)	1200	01-	CR9EK	4548	0,6			230	CR9EIX	3521
ZRX 1200 R (ZR1200C1P)	1200	01-	CR9EK	4548	0,6			230	CR9EIX	3521
ZRX 1200 S (ZR1200C1P)	1200	01-	CR9EK	4548	0,6			230	CR9EIX	3521
Ninja ZX-12R (Kat.) (ZX1200A1H)	1200	00-	CR9EKPA	7785	0,7					
ZZ-R 1200 (ZX1200C1)	1200	02-	CR9E	6263	0,7	CR9EVX	5943	227	CR9EIX	3521
Z 1300	1300	80-	BPR6ES	7822	0,8	BPR6EVX	6764		BPR6EIX	6637
Z 1300	1300	79-	B8ES	2411	0,8	B8EVX	7051	201	BR8EIX	5044
VN 1500F Classic	1471	98- 00	DPR5EA-9	2887	0,9					
VN 1500 Drifter (VN1500J1)	1500	99- 00	DPR5EA-9	2887	0,9					
VN 1500 Mean Streak (P1)	1500	-	DPR6EA-9	5531	0,9					
VN 1500 Drifter (VN1500R1)	1500	01-	DPR6EA-9	5531	0,9					
VN-15 A/B (VN-1500/SE/C/D2)	1500		DPR7EA-9	5129	0,9	DPR7EVX-9	7682	220	DPR7EIX-9	7803
VN 1600 Mean Streak	1600	04-	DPR6EA-9	5531	0,9					
VN 1600 Classic	1600	03-	DPR6EA-9	5531	0,9					
VN 2000	2053	04-	IZFR6F-11							

KRAMER

250	250		B9ES	2611	0,6	B9EVX	7254	202	BR9EIX	3981
-----	-----	--	------	------	-----	-------	------	-----	--------	------

KREIDLER

Enduro	125	00-	DP7EA-9	5629	0,9	DPR7EVX-9	7682		DPR7EIX-9	7803
Mustang	125		DR8EA	7162	0,7	DR8EVX	6354		DR8EIX	6681

KTM

50 GP	50	10.81-	B7HS	5110	0,6	B7HVX	7836	204	BR7HIX	7067
50 GXE	50		B9EG	3530	0,6	B9EGV	5827		BR9EIX	3981
50 GXR	50				0,6	B9EVX	7254		BR9EIX	3981
50 SX Pro Junior LC Beta Engine	50	03-	BR8ECM	3035	0,6					
50 Junior Adventure	50	02-	BR8HS	4322	0,6	BR8HVX	6265	212	BR8HIX	7001
50 ME	50	10.81-	B7HS	5110	0,6	B7HVX	7836	204	BR7HIX	7067
50 Mini Adventure	50	02-	BR8HS	4322	0,6	BR8HVX	6265	212	BR8HIX	7001
50 Mini Adventure GS getrennte Schmierung	50	02-	BR8HS	4322	0,6	BR8HVX	6265	212	BR8HIX	7001
50 Mini Adventure	50	(01)	B8HS	5510	0,6	B8HVX	2634	205	BR8HIX	7001
50 MLS	50		B6HS	4510	0,6	B6HVX	7435	203	BR6HIX	3419
50 MMS	50		B7HS	5110	0,6	B7HVX	7836	204	BR7HIX	7067
50 MS	50	10.81-	B6HS	4510	0,6	B6HVX	7435	203	BR6HIX	3419
50 RSL	50		B7HS	5110	0,6	B7HVX	7836	204	BR7HIX	7067
50 Senior	50	03-	BR8ECM	3035	0,6					
50 SX Pro Senior LC	50	03-	BR8ECM	3035	0,6					
50 Senior Adventure	50	(02)	BR8HS	4322	0,6	BR8HVX	6265	212	BR8HIX	7001
50 SX Junior	50	(01)	B8HS	5510	0,6	B8HVX	2634	205	BR8HIX	7001
50 SX Senior	50	(01)	B8HS	5510	0,6	B8HVX	2634	205	BR8HIX	7001
50 SX Senior LC	50	(02)	BR10EG	3830	0,6					
50 SX Junior LC	50	(02)	BR10EG	3830	0,6					

Order
No.Platin
Gold-
Palla-
diumOrder Quick
No.

Order No.

Iridium

Order
No.**KTM**

50 SXR Adventure	50	98- 01	B8HS	5510	0,6	B8HVX	2634	205	BR8HIX	7001
50 SXR Pro Senior	50	98- 01	B8HS	5510	0,6	B8HVX	2634	205	BR8HIX	7001
50 XR Pro Junior	50	98- 01	B8HS	5510	0,6	B8HVX	2634	205	BR8HIX	7001
Bora 25	50	10.81-	BP6HS	4511	0,6	BP6HVX	4635		BPR6HIX	4085
Bora 50	50		B6HS	4510	0,6	B6HVX	7435	203	BR6HIX	3419
Comet	50	09.76-	B6HS	4510	0,6	B6HVX	7435	203	BR6HIX	3419
Crazy (CH)	50		BP5HS	4111	0,6					
Foxi	50		B5HS	4210	0,6					
Foxi (DK)	50		B7HS	5110	0,6	B7HVX	7836	204	BR7HIX	7067
Hobby	50	10.81-	BP6ES	7811	0,6	BP6EVX	5832		BPR6EIX	6637
Pony	50	10.81-	B5HS	4210	0,6					
Pony (CH)	50	10.81-	B7HS	5110	0,6	B7HVX	7836	204	BR7HIX	7067
Postmofa	50		BP6ES	7811	0,6	BP6EVX	5832		BPR6EIX	6637
S5-E	50	99-	B8HS	5510	0,6	B8HVX	2634	205	BR8HIX	7001
S5-GS Pro Junior	50	99-	B8HS	5510	0,6	B8HVX	2634	205	BR8HIX	7001
S5-GS Pro Senior	50	99-	B8HS	5510	0,6	B8HVX	2634	205	BR8HIX	7001
SM 25	50		BP6HS	4511	0,6	BP6HVX	4635		BPR6HIX	4085
Squadra	50		BP6ES	7811	0,6	BP6EVX	5832		BPR6EIX	6637
60 SX	60	98-	R7234-10	5558	0,6					
65 SX	65	98- 00	R7234-10	5558	0,6					
65 SX Beta Engine	65	03-	BR8ECM	3035	0,6					
65 SX	65	01- 02			0,6	BR10EG	4832			
80 Chopper	80		B9HS	5810	0,6	B9HVX	2254			
80 Enduro	80		B10EG	3630	0,6	B10EGV	5927			
80 IGS	80				0,6	B10EGV	5927			
80 IMX	80				0,6	B10EGV	5927			
80 PL	80	06.83-12.84	B8HS	5510	0,6	B8HVX	2634	205	BR8HIX	7001
80 RL	80	10.81-	B8HS	5510	0,6	B8HVX	2634	205	BR8HIX	7001
80 RLS	80	10.81-	B9HS	5810	0,6	B9HVX	2254			
80 RLW	80	10.81-	B9HS	5810	0,6	B9HVX	2254			
80 RS	80	10.81-	B8HS	5510	0,6	B8HVX	2634	205	BR8HIX	7001
Bora 80	80	10.81-	B8HS	5510	0,6	B8HVX	2634	205	BR8HIX	7001
85 IGS	85				0,6	B10EGV	5927			
85 IMX	85				0,6	B10EGV	5927			
85 SX	85	04-			0,6	BR10ECMVX	2457			
GS 100	100	08.73-08.76	B9HCS	2721	0,6					
MC 100	100	08.73-08.76	B9HCS	2721	0,6					
105 SX	105	04-			0,7	BR10ECMVX	2457			
125 EGS	125	93-			0,6	B10EGV	5927			
125 EGS	125	99-	R6918B-8	4492	0,6					
125 EGS	125	98-	R6918B-8	4492	0,6					
125 Enduro	125		B10EG	3630	0,6	B10EGV	5927			
125 EXC	125	96-08.97			0,6	B10EGV	5927			
125 EXC	125	08.97- 98	R6918B-8	4492	0,6					
125 EXC	125	93- 95			0,6	B10EGV	5927			
125 EXC	125	01-			0,6	BR9EVX	1265		BR9EIX	3981
125 EXC	125	98- 99	R6918B-8	4492	0,6					
125 EXC	125	99- 00	R6918B-8	4492	0,6					
125 EXE	125	99-	BR8HS	4322	0,6	BR8HVX	6265	212	BR8HIX	7001
125 LC 2 (Langgewinde)	125	96- 00	BR9ES	5722	0,6	BR9EVX	1265	208	BR9EIX	3981
125 LC2 (Kurzgewinde)	125	00-	BR8HS	4322	0,6	BR8HVX	6265	212	BR8HIX	7001
125 MX	125				0,6	B10EGV	5927			



Order No.



Gold-Palladium

Platin



Order No.

Quick No.

Iridium



Order No.

KTM										
125 Sting	125	98-	BR8ES	5422	0,7	BR8EVX	1262	207	BR8EIX	5044
125 Supermoto	125	99-	BR8HS	4322	0,6	BR8HVX	6265	212	BR8HIX	7001
125 SX (98er)	125	08.97- 98	R6918B-8	4492	0,6					
125 SX	125	93- 95			0,6	B10EGV	5927			
125 SX	125	96-08.97	BR10EG	3830	0,6					
125 SX	125	02-			0,6	BR9EVX	1265		BR9EIX	3981
125 SX	125	99- 00	R6918B-8	4492	0,6					
125 SX	125	(01)			0,7	BR8EVX	1262		BR8EIX	5044
125 TXC	125				0,6	B10EGV	5927			
GS 125 12,7 mm	125		B8HS	5510	0,6	B8HVX	2634	205	BR8HIX	7001
GS 125 19,0 mm	125				0,6	B10EGV	5927			
MC 125 12,7 mm	125		B8HS	5510	0,6	B8HVX	2634	205	BR8HIX	7001
MC 125 19,0 mm	125		B9EG	3530	0,6	B9EGV	5827		BR9EIX	3981
MC 125 GP	125		B10HS	2399	0,6	B10HVX	2940			
GS 175	175		B8HS	5510	0,6	B8HVX	2634	205	BR8HIX	7001
MC 175	175		B8HS	5510	0,6	B8HVX	2634	205	BR8HIX	7001
200 EGS	200	99-	BR8EG	3130	0,6					
200 EGS	200	98-	BR8EG	3130	0,6					
200 EXC	200	99- 01	BR9EG	3230	0,6					
200 EXC	200	02-	BR8EG	3130	0,6					
200 EXC	200	98- 99	BR8EG	3130	0,6					
200 MXC	200	99-	BR8EG	3130	0,6					
200 SX	200	03-			0,6	BR9EVX	1265		BR9EIX	3981
250 DXC	250				0,6	B9EGV	5827			
250 EGS	250	93- 95			0,6	B9EGV	5827			
250 EGS	250	97-	BR8ECM	3035	0,6					
250 EGS	250	99-	BR8ECM	3035	0,6					
250 EGS	250	98-	BR8ECM	3035	0,8					
250 Enduro	250		B10EG	3630	0,6	B10EGV	5927			
250 EXC	250	97- 98	BR8ECM	3035	0,6					
250 EXC	250	(96)			0,6	B8EGV	5627			
250 EXC	250	93- 95			0,6	B9EGV	5827			
250 EXC Racing	250	03-	DCPR8E	4179	0,6	DCPR8EVX	2265			
250 EXC / Sixt Days	250	98- 01	BR8ECM	3035	0,8					
250 EXC Racing GS	250	03-	DCPR8E	4179	0,6	DCPR8EVX	2265			
250 EXC Enduro Competition	250	03-	BR7ES	5122	0,6	BR7EVX	4556			
250 EXC Racing	250	(02)	CR8EK	3478	0,6					
250 EXC Racing / Sixt Days	250	(02)	CR8EK	3478	0,6					
250 MX	250				0,6	B9EGV	5827			
250 SX	250	93- 95			0,6	B9EGV	5827			
250 SX	250	96-	BR8EG	3130	0,6					
250 SX	250	97- 98	BR8ECM	3035	0,6					
250 SX	250	99-	BR8ECM	3035	0,6					
250 SX	250	98- 99	BR8ECM	3035	0,8					
250 SXC	250	99-	BR8ECM	3035	0,6					
250 TXC	250				0,6	B9EGV	5827			
GS 250 12,7 mm	250		B9HS	5810	0,6	B9HVX	2254			
GS 250 19,0 mm	250				0,6	B9EGV	5827			
MC 250 12,7 mm	250		B9HS	5810	0,6	B9HVX	2254			
MC 250 19,0 mm	250		B9EG	3530	0,6	B9EGV	5827		BR9EIX	3981
MC 250 GP 12,7 mm	250		B9HS	5810	0,6	B9HVX	2254			
MC 250 GP 19,0 mm	250		B9EG	3530	0,6	B9EGV	5827		BR9EIX	3981

Order
No.Gold-
Palla-
diumOrder Quick
No. No.Order
No.**KTM**

300 DXC	300	90- 95			0,6	B9EGV	5827			
300 EGS	300	97-	BR8ECM	3035	0,6					
300 EGS	300	93- 95			0,6	B9EGV	5827			
300 EGS	300	99-	BR8ECM	3035	0,6					
300 EXC	300	93- 95			0,6	B9EGV	5827			
300 EXC	300	(96)			0,6	B8EGV	5627			
300 EXC	300	97- 98	BR8ECM	3035	0,6					
300 EXC Enduro Competition	300	03-	BR7ES	5122	0,6	BR7EVX	4556			
300 EXC / Sixt Days	300	99-	BR8ECM	3035	0,6					
300 GS	300	90- 95			0,6	B9EGV	5827			
300 LC (I)	300		B10EG	3630	0,6	B10EGV	5927			
300 MX	300	- 95			0,6	B9EGV	5827			
300 MXC	300	97- 02	BR8ECM	3035	0,6					
300 MXC	300	03-	BR7ES	5122	0,6	BR7EVX	4556			
300 SX	300	93- 95			0,6	B9EGV	5827			
300 SX	300	99-	BR8ECM	3035	0,6					
300 TXC	300	- 95			0,6	B9EGV	5827			
350 GS	350				0,6	B9EVX	7254		BR9EIX	3981
350 MX	350				0,6	B9EVX	7254		BR9EIX	3981
LC4 18kW	350	- 93	D8EA	2120	0,6	D8EVX	2850	216	DR8EIX	6681
LC4 30kW	350	- 93	D8EA	2120	0,6	D8EVX	2850	216	DR8EIX	6681
LC4 350 EGS	350	93-	D8EA	2120	0,6	D8EVX	2850	216	DR8EIX	6681
LC4 350 EXC	350	93-	D8EA	2120	0,6	D8EVX	2850	216	DR8EIX	6681
360 EGS	360	97-	BR8ECM	3035	0,6					
360 EXC	360	97-	BR8ECM	3035	0,6					
360 MXC	360	97-	BR8ECM	3035	0,6					
360 SX	360	97-	BR8ECM	3035	0,6					
360 SX	360	96-	BR8EG	3130	0,6					
380 Enduro	380	98-	BR8ECM	3035	0,6					
380 EGS	380	98-	BR8ECM	3035	0,8					
380 EGS	380	99-	BR8ECM	3035	0,6					
380 EXC	380	98-	BR8ECM	3035	0,8					
380 SX	380	99-	BR8ECM	3035	0,6					
390	390		B9EG	3530	0,6	B9EGV	5827		BR9EIX	3981
400 Enduro-E	400	98-	D8EA	2120	0,6	D8EVX	2850	216	DR8EIX	6681
400 EGS	400	97-	D8EA	2120	0,6	D8EVX	2850	216	DR8EIX	6681
400 EGS-E	400	97-	DR8EA	7162	0,6	DR8EVX	6354		DR8EIX	6681
400 EXC Racing	400	99-04.02	CR8EK	3478	0,7					
400 EXC Racing	400	03-	DCPR8E	4179	0,6	DCPR8EVX	2265			
400 EXC Racing	400	05.02-	DCPR8E	4179	0,6	DCPR8EVX	2265			
400 LC4-E	400	99-04.02	DR8EA	7162	0,7	DR8EVX	6354		DR8EIX	6681
400 LC4	400	99-04.02	DR8EA	7162	0,7	DR8EVX	6354		DR8EIX	6681
400 LS-E	400	97-04.02	DR8EA	7162	0,6	DR8EVX	6354		DR8EIX	6681
400 SC	400	96-	D8EA	2120	0,6	D8EVX	2850	216	DR8EIX	6681
400 SC	400	98-	D8EA	2120	0,6	D8EVX	2850	216	DR8EIX	6681
400 Supercompetition	400	97-	D8EA	2120	0,6	D8EVX	2850	216	DR8EIX	6681
400 SX	400	98-04.02	D8EA	2120	0,6	D8EVX	2850	216	DR8EIX	6681
400 SX Racing / Six Days	400	99-04.02	CR8EK	3478	0,7					
400 SX Racing	400	05.02-	DCPR8E	4179	0,6	DCPR8EVX	2265			
400 SXC	400	99-04.02	D8EA	2120	0,6	D8EVX	2850	216	DR8EIX	6681
400 SXC	400	98-04.02	D8EA	2120	0,6	D8EVX	2850	216	DR8EIX	6681
400 SXC 20kW	400	99-04.02	D8EA	2120	0,6	D8EVX	2850	216	DR8EIX	6681



Order No.



Platin Gold-Palladium

Order Quick No. No.



Iridium Order No.

KTM										
GS 400	400		B9HS	5810	0,6	B9HVX	2254			
LC4- E 400 Enduro	400	01-	DR8EA	7162	0,7	DR8EVX	6354		DR8EIX	6681
LC4 400	400	98-	DR8EA	7162	0,7	DR8EVX	6354		DR8EIX	6681
LC4 400 EGS	400	93-	D8EA	2120	0,6	D8EVX	2850	216	DR8EIX	6681
LC4 400 EXC	400	93-	D8EA	2120	0,6	D8EVX	2850	216	DR8EIX	6681
LC4 Competition	400	98-	DR8EA	7162	0,7	DR8EVX	6354		DR8EIX	6681
LC4-E	400	05.02-	DCPR8E	4179	0,6	DCPR8EVX	2265			
MC 400	400		B9HS	5810	0,6	B9HVX	2254			
MC 400 GP	400		B9HS	5810	0,6	B9HVX	2254			
420	420		B9EG	3530	0,6	B9EGV	5827		BR9EIX	3981
440 EXC	440	94-			0,6	B85EGV	7498			
440 SX	440	94-			0,6	B85EGV	7498			
450 EXC Racing	450	03-	DCPR8E	4179	0,6	DCPR8EVX	2265			
450 EXC Racing GS	450	03-	DCPR8E	4179	0,6	DCPR8EVX	2265			
450 MXC Dessert	450	03-	DCPR8E	4179	0,6	DCPR8EVX	2265			
450 MXC GS	450	03-	DCPR8E	4179	0,6	DCPR8EVX	2265			
450 SX Racing	450	03-	DCPR8E	4179	0,6	DCPR8EVX	2265			
495	495		B9EG	3530	0,6	B9EGV	5827		BR9EIX	3981
500 4 TGS	500		DP9EA-9	6629	0,9	DP9EVX-9	3331		DPR9EIX-9	5545
500 4 TXC	500		DP9EA-9	6629	0,9	DP9EVX-9	3331		DPR9EIX-9	5545
500 DXC	500		B9ES	2611	0,6	B9EVX	7254	202	BR9EIX	3981
500 EXC	500		B9ES	2611	0,6	B9EVX	7254	202	BR9EIX	3981
500 MX	500				0,6	B9EVX	7254		BR9EIX	3981
500 SX	500	93-	B10ES	7928	0,6	B10EVX	7335		BR10EIX	6801
GS 500 2Stroke	500		B10EG	3630	0,6	B10EGV	5927			
GS 500 4Stroke	500		D8EA	2120	0,6	D8EVX	2850	216	DR8EIX	6681
MC 500 2Stroke	500		B10EG	3630	0,6	B10EGV	5927			
MC 500 4Stroke	500		D8EA	2120	0,6	D8EVX	2850	216	DR8EIX	6681
520 EXC Racing / Six Days	520	99-04.02	CR8EK	3478	0,7					
520 EXC Racing	520	05.02-	DCPR8E	4179	0,6	DCPR8EVX	2265			
520 SX Racing	520	99-04.02	CR8EK	3478	0,7					
520 SX Racing	520	05.02-	DCPR8E	4179	0,6	DCPR8EVX	2265			
525 EXC Racing	525	03-	DCPR8E	4179	0,6	DCPR8EVX	2265			
525 EXC Racing GS	525	03-	DCPR8E	4179	0,6	DCPR8EVX	2265			
525 MXC	525	03-	DCPR8E	4179	0,6	DCPR8EVX	2265			
525 SX Racing	525	03-	DCPR8E	4179	0,6	DCPR8EVX	2265			
540 DXC	540				0,6	B10EGV	5927			
540 MX	540		B9ES	2611	0,6	B9EVX	7254	202	BR9EIX	3981
540 SXC	540	99-	D8EA	2120	0,6	D8EVX	2850	216	DR8EIX	6681
540 SXC	540	98-	D8EA	2120	0,6	D8EVX	2850	216	DR8EIX	6681
540 SXC 20kW	540	99-	D8EA	2120	0,6	D8EVX	2850	216	DR8EIX	6681
540 SXS Racing	540	02-	CR8EK	3478	0,7					
600 4 TGS	600		DP9EA-9	6629	0,9	DP9EVX-9	3331		DPR9EIX-9	5545
600 4 TMX	600		DP9EA-9	6629	0,9	DP9EVX-9	3331		DPR9EIX-9	5545
600 4 TXC	600		DP9EA-9	6629	0,9	DP9EVX-9	3331		DPR9EIX-9	5545
600 Country	600		D8EA	2120	0,6	D8EVX	2850	216	DR8EIX	6681
600 Enduro	600		D8EA	2120	0,6	D8EVX	2850	216	DR8EIX	6681
600 MX	600		D8EA	2120	0,6	D8EVX	2850	216	DR8EIX	6681
LC4 Enduro 17kW	600	- 87	D8EA	2120	0,6	D8EVX	2850	216	DR8EIX	6681
LC4 Enduro 36kW	600	- 87	D8EA	2120	0,6	D8EVX	2850	216	DR8EIX	6681
LC4 600 EGS	600	93-	D8EA	2120	0,6	D8EVX	2850	216	DR8EIX	6681
LC4 600 EXC	600	93-	D8EA	2120	0,6	D8EVX	2850	216	DR8EIX	6681

Order
No.Platin
Gold-
Palla-
diumOrder Quick
No.

Iridium

Order
No.**KTM**

620 Duke	609	94-	D8EA	2120	0,6	D8EVX	2850	216	DR8EIX	6681
LC4 620 SC Supermoto	609	01-04.02	DR8EA	7162	0,7	DR8EVX	6354		DR8EIX	6681
LC4 620 Supercompetition	609	01-04.02	DR8EA	7162	0,7	DR8EVX	6354		DR8EIX	6681
LC4 612 EGS	612	93-	D8EA	2120	0,6	D8EVX	2850	216	DR8EIX	6681
LC4 612 EXC	612	93-	D8EA	2120	0,6	D8EVX	2850	216	DR8EIX	6681
620 Duke-E	620	97-	DR8EA	7162	0,6	DR8EVX	6354		DR8EIX	6681
620 EGS	620	97-	D8EA	2120	0,6	D8EVX	2850	216	DR8EIX	6681
620 EGS-E	620	97-	DR8EA	7162	0,6	DR8EVX	6354		DR8EIX	6681
620 LS4 Rally	620	97-	D8EA	2120	0,6	D8EVX	2850	216	DR8EIX	6681
620 LS-E	620	97-	DR8EA	7162	0,6	DR8EVX	6354		DR8EIX	6681
620 SC	620	96-	D8EA	2120	0,6	D8EVX	2850	216	DR8EIX	6681
620 SC	620	98-	D8EA	2120	0,6	D8EVX	2850	216	DR8EIX	6681
620 Supercompetition	620	97-04.02	D8EA	2120	0,6	D8EVX	2850	216	DR8EIX	6681
620 SX	620	96-	D8EA	2120	0,6	D8EVX	2850	216	DR8EIX	6681
620 SX	620	99-	D8EA	2120	0,6	D8EVX	2850	216	DR8EIX	6681
LC4 620 SX	620	94-	D8EA	2120	0,6	D8EVX	2850	216	DR8EIX	6681
LC4 620 EXC	620	94-	D8EA	2120	0,6	D8EVX	2850	216	DR8EIX	6681
LC4 620 EGS	620	94-	D8EA	2120	0,6	D8EVX	2850	216	DR8EIX	6681
LC 4 Supercopetition Supermoto	620	05.02-	DCPR8E	4179	0,6	DCPR8EVX	2265			
LC4 Super Competition	620	00-04.02	DPR8EA-9	4929	0,9	DPR8EVX-9	2872	221	DPR8EIX-9	2202
Supermoto Competition 620	620	98- 00	D8EA	2120	0,6	D8EVX	2850	216	DR8EIX	6681
625 SC	625	02-	DPR8EA-9	4929	0,9	DPR8EVX-9	2872	221	DPR8EIX-9	2202
625 SXC Hard Enduro	625	03-	DCPR8E	4179	0,6	DCPR8EVX	2265			
625 SXC Super Moto	625	02-	DCPR8E	4179	0,6	DCPR8EVX	2265			
640 Duke 2	625	02-04.02	DPR8EA-9	4929	0,9	DPR8EVX-9	2872	221	DPR8EIX-9	2202
640 Supermoto Spezial Edition	625	03-	DCPR8E	4179	0,6	DCPR8EVX	2265			
Adventure R 640	625	98- 01	DR8EA	7162	0,7	DR8EVX	6354		DR8EIX	6681
Duke 2	625	00-04.02	DPR8EA-9	4929	0,9	DPR8EVX-9	2872	221	DPR8EIX-9	2202
Duke 640	625	98- 01	DR8EA	7162	0,7	DR8EVX	6354		DR8EIX	6681
Duke II	625	99- 01	DR8EA	7162	0,7	DR8EVX	6354		DR8EIX	6681
Duke II	625	05.02-	DCPR8E	4179	0,6	DCPR8EVX	2265			
LC 4 E Supermoto	625	05.02- 02	DCPR8E	4179	0,6	DCPR8EVX	2265			
LC4- E	625	(00)	DPR8EA-9	4929	0,9	DPR8EVX-9	2872	221	DPR8EIX-9	2202
LC4- E Supermoto	625	(00)	DPR8EA-9	4929	0,9	DPR8EVX-9	2872	221	DPR8EIX-9	2202
LC4 640	625	98- 00	DR8EA	7162	0,7	DR8EVX	6354		DR8EIX	6681
LC4 Prestige Supermoto	625	03-	DCPR8E	4179	0,6	DCPR8EVX	2265			
LC4- E 640 Supermoto	625	(01)	DR8EA	7162	0,7	DR8EVX	6354		DR8EIX	6681
LC 4 E	625	05.02-	DCPR8E	4179	0,6	DCPR8EVX	2265			
LC 4 Adventure R	625	05.02-	DCPR8E	4179	0,6	DCPR8EVX	2265			
640 LC4	625	99- 01	DR8EA	7162	0,7	DR8EVX	6354		DR8EIX	6681
640 LC4-E Six Days	625	02-04.02	DPR8EA-9	4929	0,9	DPR8EVX-9	2872	221	DPR8EIX-9	2202
640 LC4-E SM Prestige	625	02-04.02	DPR8EA-9	4929	0,9	DPR8EVX-9	2872	221	DPR8EIX-9	2202
LC4- E 640 Enduro	625	(01)	DR8EA	7162	0,7	DR8EVX	6354		DR8EIX	6681
640 LC4 Super Moto	625	02-04.02	DPR8EA-9	4929	0,9	DPR8EVX-9	2872	221	DPR8EIX-9	2202
640 LC4	625	02-04.02	DPR8EA-9	4929	0,9	DPR8EVX-9	2872	221	DPR8EIX-9	2202
LC4-640 Hard Enduro	625	03-	DCPR8E	4179	0,6	DCPR8EVX	2265			
LC4- 640 Adverture	625	01-04.02	DR8EA	7162	0,7	DR8EVX	6354		DR8EIX	6681
LC4 640 Duke II	625	03-	DCPR8E	4179	0,6	DCPR8EVX	2265			
LC4 Adventure	625	(00)	DPR8EA-9	4929	0,9	DPR8EVX-9	2872	221	DPR8EIX-9	2202
640 LC4 Adventure	625	02-04.02	DPR8EA-9	4929	0,9	DPR8EVX-9	2872	221	DPR8EIX-9	2202
660 Rallye	650	02-04.02	DR9EA	3437	0,6	DR9EVX	6361	219	DR9EIX	4772
660 Super Moto Factory Replica	650	02-	DR9EA	3437	0,6	DR9EVX	6361	219	DR9EIX	4772

Order
No.Gold-
Palla-
dium

Platin

Order
No.Quick
No.

Iridium

Order
No.

KTM										
LC4 660	650	03-	DR9EA	3437	0,6	DR9EVX	6361	219	DR9EIX	4772
660 LC4 Rallye	650	99- 01	DR8EA	7162	0,6	DR8EVX	6354		DR8EIX	6681
Rallye	650	05.02- 02	DCPR8E	4179	0,6	DCPR8EVX	2265			
Rallye	650	00- 01	DPR8EA-9	4929	0,9	DPR8EVX-9	2872	221	DPR8EIX-9	2202
950 Adventure	950	03-	CR8EK	3478	0,7					
950 Adventure S	950	03-	CR8EK	3478	0,7					
LC8 950 Rally	950	03-	CR8EK	3478	0,7					
990 Duke	1000	09.04-	DCPR8E	4179	0,6	DCPR8EVX	2265			

KUANG YANG										
GS7E - Movie	50		BP6HSA	1046	0,6				BPR6HIX	4085
KA 50	50		BP6HSA	1046	0,6				BPR6HIX	4085
KA 50G	50		BP6HSA	1046	0,6				BPR6HIX	4085

KYMCO										
MX 50 (Quad) (ATV)	50	01-	BR8HSA	5539	0,5	BR8HVX	6265		BR8HIX	7001
Tomos TX 50	50	01-	B6HS	4510	0,6	B6HVX	7435	203	BR6HIX	3419
Hipster 125 2Ventil	125		DR8EA	7162	0,7	DR8EVX	6354		DR8EIX	6681
Hipster 125 4Takt/4Ventil	125	01-	CR8E	1275	0,6	CR8EVX	6487	226	CR8EIX	4218
Pulsar 125 4Takt	125	01-	DR8EA	7162	0,7	DR8EVX	6354		DR8EIX	6681
Stryker 125	125	99-	DR8EA	7162	0,7	DR8EVX	6354		DR8EIX	6681
Stryker 125 II	125	02-	DR8EA	7162	0,7	DR8EVX	6354		DR8EIX	6681
Zing 125	125	99-	DR8EA	7162	0,7	DR8EVX	6354		DR8EIX	6681
MX 150 (Quad) (ATV)	150	01-	DR8EA	7162	0,7	DR8EVX	6354		DR8EIX	6681
KXR 250 (Quad) (ATV)	250	01-	DPR7EA-9	5129	0,9	DPR7EVX-9	7682	220	DPR7EIX-9	7803
Venox 250 4Takt	250	01-	DPR7EA-9	5129	0,9	DPR7EVX-9	7682	220	DPR7EIX-9	7803

LAMBRETTA										
3V77/4V/5V	50		B6HS	4510	0,5	B6HVX	7435	203	BR6HIX	3419
Puma Cross,Trial	50		B6HS	4510	0,5	B6HVX	7435	203	BR6HIX	3419
125,Lince,Linea,SX	125		B7ES	1111	0,5	B7EVX	6934			
150 GP	150		B7ES	1111	0,5	B7EVX	6934			
Spezial 150	150		B7ES	1111	0,5	B7EVX	6934			
200 GP	200		B7ES	1111	0,5	B7EVX	6934			
200,Jet,Lince,Mensa-Expres	200		B7ES	1111	0,5	B7EVX	6934			
Pony,SX	200		B7ES	1111	0,5	B7EVX	6934			

LAVERDA										
CU125 Ride, GS125 Lesmo	125		B8ES	2411	0,5	B8EVX	7051	201	BR8EIX	5044
Custom, Strada	125		B9ES	2611	0,5	B9EVX	7254	202	BR9EIX	3981
LB125 Uno	125		B8ES	2411	0,5	B8EVX	7051	201	BR8EIX	5044
350 Alpino	350		D9EA	2420	0,5	D9EVX	2834		DR9EIX	4772
500 Alpino/Montjuich	500		D9EA	2420	0,5	D9EVX	2834		DR9EIX	4772
OR600 Atlas	600		D8EA	2120	0,6	D8EVX	2850	216	DR8EIX	6681
650 Ghost	650	96-	DPR8EA-9	4929	0,9	DPR8EVX-9	2872	221	DPR8EIX-9	2202
650 Ghost Strike	650	96-	DPR8EA-9	4929	0,9	DPR8EVX-9	2872	221	DPR8EIX-9	2202
650 Ghost Legend	650	96-	DPR8EA-9	4929	0,9	DPR8EVX-9	2872	221	DPR8EIX-9	2202
650 Sport	650	95-	DPR9EA-9	5329	0,9	DPR9EVX-9	3854	222	DPR9EIX-9	5545
650 Ghost	668	97-	DPR9EA-9	5329	0,9	DPR9EVX-9	3854	222	DPR9EIX-9	5545
668	668	96-	DPR9EA-9	5329	0,9	DPR9EVX-9	3854	222	DPR9EIX-9	5545
668	668		DPR8EA-9	4929	0,9	DPR8EVX-9	2872	221	DPR8EIX-9	2202
668	668	97-	DPR9EA-9	5329	0,9	DPR9EVX-9	3854	222	DPR9EIX-9	5545

Order
No.Platin
Gold-
Palla-
diumOrder Quick
No. No.Order
No.**LAVERDA**

750 S Formula	750	98-	DCPR9E	2641	0,6	DCPR9EVX	6436			
750/GS/GT/S/SFC/SF-2D	750		BP8ES	2912	0,5	BP8EVX	2671			
770 GTL	750		BP7ES	2412	0,5	BP7EVX	7270	206	BPR7EIX	4055
SF,SF Competizione/SS	750		B10EGV	5927	0,5	B10EVX	7335			
SF2-10, SF3	750		B8ES	2411	0,5	B8EVX	7051	201	BR8EIX	5044
1000 RGS	1000		B8ES	2411	0,6	B8EVX	7051	201	BR8EIX	5044
1000/Jarama/Jota/SC/CE/CL	1000		B8ES	2411	0,6	B8EVX	7051	201	BR8EIX	5044
1200/Mirage/TS	1200		B8ES	2411	0,6	B8EVX	7051	201	BR8EIX	5044

LEM

2001 Bay	50		BP6ES	7811	0,5	BP6EVX	5832		BPR6EIX	6637
2001 Matic	50		BP6ES	7811	0,5	BP6EVX	5832		BPR6EIX	6637
2001 Variant	50		BP6ES	7811	0,5	BP6EVX	5832		BPR6EIX	6637
Cayman	50		B7HS	5110	0,5	B7HVX	7836	204	BR7HIX	7067
Cayman LC	50		B7HS	5110	0,5	B7HVX	7836	204	BR7HIX	7067
Chembol Form	50		B6ES	7310	0,5	B6EVX	5136			
Chembol Raid	50		B6ES	7310	0,5	B6EVX	5136			
Cinno Corsa 8 / 10	50		B6HS	4510	0,5	B6HVX	7435	203	BR6HIX	3419
Condor	50		B7HS	5110	0,5	B7HVX	7836	204	BR7HIX	7067
Convert	50		B5HS	4210	0,5					
CR 3	50	97-	B7HS	5110	0,5	B7HVX	7836	204	BR7HIX	7067
L 2	50		B7HS	5110	0,5	B7HVX	7836	204	BR7HIX	7067
LX 1	50		B8HS	5510	0,6	B8HVX	2634	205	BR8HIX	7001
LX 2	50	97-	B7HS	5110	0,5	B7HVX	7836	204	BR7HIX	7067
LX 2-S Sport	50	97-	B7HS	5110	0,5	B7HVX	7836	204	BR7HIX	7067
LX 2-SR	50		B7HS	5110	0,5	B7HVX	7836	204	BR7HIX	7067
LX 4 New	50		B9ES	2611	0,6	B9EVX	7254	202	BR9EIX	3981
Piesse	50		B5HS	4210	0,5					
Pizeta	50		B5HS	4210	0,5					
Pratikal Kit SL	50		B5HS	4210	0,5					
R 2 Air	50					B10EGV	5927			
R 3 Air	50					B10EGV	5927			
R 3 Usa	50					B10EGV	5927			
SK 6	50		B7HS	5110	0,5	B7HVX	7836	204	BR7HIX	7067
SM 2	50		B7HS	5110	0,5	B7HVX	7836	204	BR7HIX	7067
SM 3	50					B10EGV	5927			
Stratos	50		B6ES	7310	0,5	B6EVX	5136			
Stratos Matic	50		B5HS	4210	0,5					

MAGNI

Sfida	1000		BP6ES	7811	0,6	BP6EVX	5832		BPR6EIX	6637
-------	------	--	-------	------	-----	--------	------	--	---------	------

MAICO

GS 125	125		B9ES	2611	0,5	B9EVX	7254	202	BR9EIX	3981
MC 125	125		B9ES	2611	0,5	B9EVX	7254	202	BR9EIX	3981
SG 125	125		B9ES	2611	0,5	B9EVX	7254	202	BR9EIX	3981
250	250	94-	B9ES	2611	0,5	B9EVX	7254	202	BR9EIX	3981
GM Star 250	250		B9ES	2611	0,5	B9EVX	7254	202	BR9EIX	3981
GM Star E 250	250		B9ES	2611	0,5	B9EVX	7254	202	BR9EIX	3981
GS 250	250		B9ES	2611	0,5	B9EVX	7254	202	BR9EIX	3981
GSE 250	250	-05.83	B9ES	2611	0,5	B9EVX	7254	202	BR9EIX	3981
MC 250	250		B9ES	2611	0,5	B9EVX	7254	202	BR9EIX	3981

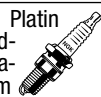
Order
No.Gold-
Palla-
diumOrder
No.Quick
No.

Iridium

Order
No.**MAICO**

320	320	94-	B9ES	2611	0,6	B9EVX	7254	202	BR9EIX	3981
GS 400	400	01.74-05.83	B9ES	2611	0,5	B9EVX	7254	202	BR9EIX	3981
MC 400	400		B9ES	2611	0,5	B9EVX	7254	202	BR9EIX	3981
440	440	94-	B9ES	2611	0,6	B9EVX	7254	202	BR9EIX	3981
GSE 490	490	-05.83	B9ES	2611	0,5	B9EVX	7254	202	BR9EIX	3981
MC 490	490	-05.83	B9ES	2611	0,5	B9EVX	7254	202	BR9EIX	3981
500	500	94-	B9ES	2611	0,5	B9EVX	7254	202	BR9EIX	3981
GS 500	500		B9ES	2611	0,5	B9EVX	7254	202	BR9EIX	3981
GS Star 500	500		B9ES	2611	0,5	B9EVX	7254	202	BR9EIX	3981
GS Star E 500	500		B9ES	2611	0,5	B9EVX	7254	202	BR9EIX	3981
MC 500	500		B9ES	2611	0,5	B9EVX	7254	202	BR9EIX	3981
685 Gespänn	685	94-			0,6	B10EVX	7335			

MALAGUTI

Custon Fox	50		B6HS	4510	0,5	B6HVX	7435	203	BR6HIX	3419
Fifty Top	50		B9ES	2611	0,5	B9EVX	7254	202	BR9EIX	3981
Grizzly RCW4/RCW50/RCX10	50		B6HS	4510	0,5	B6HVX	7435	203	BR6HIX	3419
Grizzly RCX50,Ranocchio	50		B6HS	4510	0,5	B6HVX	7435	203	BR6HIX	3419
RCX 4	50		B8HS	5510	0,5	B8HVX	2634	205	BR8HIX	7001
RCX 10 Automatic	50		B6HS	4510	0,5	B6HVX	7435	203	BR6HIX	3419
RCX 12 Automatic	50		B8HS	5510	0,5	B8HVX	2634	205	BR8HIX	7001
Dune Enduro 75	75		B7ES	1111	0,5	B7EVX	6934			
RST 75 Turismo	75		B7ES	1111	0,5	B7EVX	6934			
Runner 125 Rally	125		B9ES	2611	0,5	B9EVX	7254	202	BR9EIX	3981
Runner 125 YLC	125		B8ES	2411	0,5	B8EVX	7051	201	BR8EIX	5044

MARS

M 25	25		B5HS	4210	0,8					
Enduro Dakarino	50		B8HCS	2621	0,6					
M 25 Mini Califo	50		B5HS	4210	0,8					
M 50	50		B5HS	4210	0,8					
MK 50	50		BPR6HSA	4632	0,6				BPR6HIX	4085

MBK

41	49		B6HS	4510	0,5	B6HVX	7435	203	BR6HIX	3419
50 EV	49		B6HS	4510	0,5	B6HVX	7435	203	BR6HIX	3419
50 EW	49		B6HS	4510	0,5	B6HVX	7435	203	BR6HIX	3419
50 L	49		B6HS	4510	0,5	B6HVX	7435	203	BR6HIX	3419
50 S	49		B6HS	4510	0,5	B6HVX	7435	203	BR6HIX	3419
50 VL	49		B6HS	4510	0,5	B6HVX	7435	203	BR6HIX	3419
50 VS	49		B6HS	4510	0,5	B6HVX	7435	203	BR6HIX	3419
51 New West	49		B6HS	4510	0,5	B6HVX	7435	203	BR6HIX	3419
51 S	49		B6HS	4510	0,5	B6HVX	7435	203	BR6HIX	3419
51 SL	49		B6HS	4510	0,5	B6HVX	7435	203	BR6HIX	3419
51 Super	49		B6HS	4510	0,5	B6HVX	7435	203	BR6HIX	3419
51 Super Special	49		B6HS	4510	0,5	B6HVX	7435	203	BR6HIX	3419
51 V	49		B6HS	4510	0,5	B6HVX	7435	203	BR6HIX	3419
51 VL	49		B6HS	4510	0,5	B6HVX	7435	203	BR6HIX	3419
88	49		B6HS	4510	0,5	B6HVX	7435	203	BR6HIX	3419
88 IP	49		B6HS	4510	0,5	B6HVX	7435	203	BR6HIX	3419
88 IU	49		B6HS	4510	0,5	B6HVX	7435	203	BR6HIX	3419
89	49		B6HS	4510	0,5	B6HVX	7435	203	BR6HIX	3419

Order
No.Platin
Gold-
Palla-
diumOrder
No.Quick
No.

Iridium

Order
No.**MBK**

Active	49		BPR7HS	6422	0,7	BPR7HVX	2938	215	BPR7HIX	5944
AV 40	49		B6HS	4510	0,5	B6HVX	7435	203	BR6HIX	3419
AV 42	49		B6HS	4510	0,5	B6HVX	7435	203	BR6HIX	3419
AV 44	49		B6HS	4510	0,5	B6HVX	7435	203	BR6HIX	3419
AV 46	49		B6HS	4510	0,5	B6HVX	7435	203	BR6HIX	3419
AV 48	49		B6HS	4510	0,5	B6HVX	7435	203	BR6HIX	3419
AV 56	49		B6HS	4510	0,5	B6HVX	7435	203	BR6HIX	3419
AV 59	49		B6HS	4510	0,5	B6HVX	7435	203	BR6HIX	3419
AV 65	49		B6HS	4510	0,5	B6HVX	7435	203	BR6HIX	3419
AV 68	49		B6HS	4510	0,5	B6HVX	7435	203	BR6HIX	3419
AV 76	49		B6HS	4510	0,5	B6HVX	7435	203	BR6HIX	3419
AV 79	49		B6HS	4510	0,5	B6HVX	7435	203	BR6HIX	3419
AV 85	49		B6HS	4510	0,5	B6HVX	7435	203	BR6HIX	3419
AV 88	49		B6HS	4510	0,5	B6HVX	7435	203	BR6HIX	3419
AV 89	49		B6HS	4510	0,5	B6HVX	7435	203	BR6HIX	3419
AV 92	49		B6HS	4510	0,5	B6HVX	7435	203	BR6HIX	3419
AV 98	49		B6HS	4510	0,5	B6HVX	7435	203	BR6HIX	3419
Cady	49		B6HS	4510	0,5	B6HVX	7435	203	BR6HIX	3419
CF	49		B6HS	4510	0,5	B6HVX	7435	203	BR6HIX	3419
Champ	49		B6HS	4510	0,5	B6HVX	7435	203	BR6HIX	3419
Daytona Beach	49		B6HS	4510	0,5	B6HVX	7435	203	BR6HIX	3419
Daytona Cruiser	49		B6HS	4510	0,5	B6HVX	7435	203	BR6HIX	3419
FXK	49		B8ES	2411	0,5	B8EVX	7051	201	BR8EIX	5044
G 40	49		B6HS	4510	0,5	B6HVX	7435	203	BR6HIX	3419
G 50	49		B6HS	4510	0,5	B6HVX	7435	203	BR6HIX	3419
Hobby IV	49		BP6ES	7811	0,5	BP6EVX	5832		BPR6EIX	6637
KW Magnum	49		B6HS	4510	0,5	B6HVX	7435	203	BR6HIX	3419
M 1	49		B6HS	4510	0,5	B6HVX	7435	203	BR6HIX	3419
M 1L	49		B6HS	4510	0,5	B6HVX	7435	203	BR6HIX	3419
M 1P	49		B6HS	4510	0,5	B6HVX	7435	203	BR6HIX	3419
M 1PR	49		B6HS	4510	0,5	B6HVX	7435	203	BR6HIX	3419
M 1PRT	49		B6HS	4510	0,5	B6HVX	7435	203	BR6HIX	3419
M 1PRTS	49		B6HS	4510	0,5	B6HVX	7435	203	BR6HIX	3419
Mobylett	49		B6HS	4510	0,5	B6HVX	7435	203	BR6HIX	3419
N 40	49		B6HS	4510	0,5	B6HVX	7435	203	BR6HIX	3419
N 50	49		B6HS	4510	0,5	B6HVX	7435	203	BR6HIX	3419
Rock	49		B6HS	4510	0,5	B6HVX	7435	203	BR6HIX	3419
SP 50	49		B6HS	4510	0,5	B6HVX	7435	203	BR6HIX	3419
SP 92	49		B6HS	4510	0,5	B6HVX	7435	203	BR6HIX	3419
SP 93	49		B6HS	4510	0,5	B6HVX	7435	203	BR6HIX	3419
SP 94	49		B6HS	4510	0,5	B6HVX	7435	203	BR6HIX	3419
SP 98	49		B6HS	4510	0,5	B6HVX	7435	203	BR6HIX	3419
SP 99	49		B6HS	4510	0,5	B6HVX	7435	203	BR6HIX	3419
Weekly	49		B7HS	5110	0,5	B7HVX	7836	204	BR7HIX	7067
X 1	49		B6HS	4510	0,5	B6HVX	7435	203	BR6HIX	3419
X 1L	49		B6HS	4510	0,5	B6HVX	7435	203	BR6HIX	3419
X 7L	49		B6HS	4510	0,5	B6HVX	7435	203	BR6HIX	3419
X 7S	49		B6HS	4510	0,5	B6HVX	7435	203	BR6HIX	3419
X 7VL	49		B6HS	4510	0,5	B6HVX	7435	203	BR6HIX	3419
X 7VS	49		B6HS	4510	0,5	B6HVX	7435	203	BR6HIX	3419
ZX	49		BR7HS	4122	0,5			211	BR7HIX	7067
151 L	50	01.79-07.83	B6HS	4510	0,5	B6HVX	7435	203	BR6HIX	3419

Order
No.Platin
Gold-
Palla-
diumOrder Quick
No. No.

Iridium

Order
No.

MBK										
151 LB	50	01.79-07.83	B6HS	4510	0,5	B6HVX	7435	203	BR6HIX	3419
151 LC	50	01.79-07.83	B6HS	4510	0,5	B6HVX	7435	203	BR6HIX	3419
50 R	50		B7HS	5110	0,5	B7HVX	7836	204	BR7HIX	7067
50 VL	50	01.71-12.80	B6HS	4510	0,5	B6HVX	7435	203	BR6HIX	3419
50 VLC	50	01.71-12.80	B6HS	4510	0,5	B6HVX	7435	203	BR6HIX	3419
51 SU	50	01.81-07.83	B6HS	4510	0,5	B6HVX	7435	203	BR6HIX	3419
89	50	-07.83	B7HS	5110	0,5	B7HVX	7836	204	BR7HIX	7067
93	50		B7HS	5110	0,5	B7HVX	7836	204	BR7HIX	7067
98	50	-07.83	B7HS	5110	0,5	B7HVX	7836	204	BR7HIX	7067
99	50		B7HS	5110	0,5	B7HVX	7836	204	BR7HIX	7067
D50	50		B7HS	5110	0,5	B7HVX	7836	204	BR7HIX	7067
Monty MB3V	50	01.77-07.83	BP6ES	7811	0,5	BP6EVX	5832		BPR5EIX	6597
Monty SP3V	50	-11.81	BP6ES	7811	0,6	BP6EVX	5832		BPR6EIX	6637
Monty SP3V	50	12.81-	B6HS	4510	0,5	B6HVX	7435	203	BR6HIX	3419
SP 94 TT	50		B7HS	5110	0,5	B7HVX	7836	204	BR7HIX	7067
X power	50	03-	BR9ES	5722	0,8	BR9EVX	1265	208	BR9EIX	3981
D75	75		B8HS	5510	0,5	B8HVX	2634	205	BR8HIX	7001
125 12,7 mm	125		B8HS	5510	0,5	B8HVX	2634	205	BR8HIX	7001
125 19,0 mm	125		B8ES	2411	0,5	B8EVX	7051	201	BR8EIX	5044
250	250		B8ES	2411	0,5	B8EVX	7051	201	BR8EIX	5044
350	350	04.73-04.79	B8ES	2411	0,5	B8EVX	7051	201	BR8EIX	5044
350 E	350		B8ES	2411	0,5	B8EVX	7051	201	BR8EIX	5044
350 Injection	350		B8ES	2411	0,5	B8EVX	7051	201	BR8EIX	5044

MECATECNO										
Chic,Funny/2,Cuc	50		B6HS	4510	0,5	B6HVX	7435	203	BR6HIX	3419
Dragon Fly School Boy	50		B6HS	4510	0,5	B6HVX	7435	203	BR6HIX	3419
Grac,Hobby,Huracan	50		B6HS	4510	0,5	B6HVX	7435	203	BR6HIX	3419
Micro GP,Mini 4	50		B6HS	4510	0,5	B6HVX	7435	203	BR6HIX	3419
Racing CR-7	50		B9ES	2611	0,5	B9EVX	7254	202	BR9EIX	3981
Tanga	50		BP6ES	7811	0,5	BP6EVX	5832		BPR6EIX	6637
Dragon Fly,Sky Walker	330		BP5ES	6511	0,5	BP5EVX	5470		BPR5EIX	6597
MR 326 Trial	330		BP5ES	6511	0,5	BP5EVX	5470		BPR5EIX	6597

MERLIN										
DG1,DG2/T	50		B5HS	4210	0,5					
DG7	125		BP5ES	6511	0,5	BP5EVX	5470		BPR5EIX	6597
DG3 350/Cresta/Trial/GR	350		BP5ES	6511	0,5	BP5EVX	5470		BPR5EIX	6597
DG3 350/FIUS	350		BP5ES	6511	0,5	BP5EVX	5470		BPR5EIX	6597
Nomada 500	500		D8EA	2120	0,5	D8EVX	2850	216	DR8EIX	6681

METEORIT / A . T . U										
Cruiser 125	125		DR8EA	7162	0,7	DR8EVX	6354		DR8EIX	6681

MINARELLI										
50 Cross	50				0,5	B105EGV	2171			
50 Trial	50				0,5	B95EGV	2145			
C2,E2,G1,V2,C3PK 12,7mm	50		B6HS	4510	0,5	B6HVX	7435	203	BR6HIX	3419
C2,E2,G1,V2,C3PK 19,0mm	50		B6ES	7310	0,5	B6EVX	5136			
C3KS	50		B6ES	7310	0,5	B6EVX	5136			
H3,P4E	50		B6HS	4510	0,5	B6HVX	7435	203	BR6HIX	3419
P 6 Competizione	50				0,5	B95EGV	2145			

Order
No.Platin
Gold-
Palla-
diumOrder
No.Quick
No.

Iridium

Order
No.**MINARELLI**

P 6 Super	50		B8HS	5510	0,5	B8HVX	2634	205	BR8HIX	7001
P3N,P3A,P3S	50		B6HS	4510	0,5	B6HVX	7435	203	BR6HIX	3419
P4, A, P6, E	50		B6HS	4510	0,5	B6HVX	7435	203	BR6HIX	3419
P4CS, CSA, P4R	50		B7ES	1111	0,5	B7EVX	6934			
P6CS, CSA, P6R	50		B7ES	1111	0,5	B7EVX	6934			
RV4, A	50		B7ES	1111	0,5	B7EVX	6934			
V1,V1A,V1KS,VIP 12,7mm	50		B6HS	4510	0,5	B6HVX	7435	203	BR6HIX	3419
V1,V1A,V1KS,VIP 19,0mm	50		B6ES	7310	0,5	B6EVX	5136			
V1H,V1HLE,V1L	50		B6HS	4510	0,5	B6HVX	7435	203	BR6HIX	3419
W3 QM	60		B6HS	4510	0,5	B6HVX	7435	203	BR6HIX	3419
Trial	75		B9EG	3530	0,5	B9EGV	5827		BR9EIX	3981
MR 6/80	80				0,5	B11EGV	5831			
P 680	80		B6HS	4510	0,5	B6HVX	7435	203	BR6HIX	3419
125 Cross	125				0,5	B95EGV	2145			
125 Regolarità	125				0,5	B95EGV	2145			
125 YPVS (Yamaha)	125		B8ES	2411	0,5	B8EVX	7051	201	BR8EIX	5044
125/5	125		B8ES	2411	0,5	B8EVX	7051	201	BR8EIX	5044
125/5 Cross	125				0,5	B10EGV	5927			
125/5 Regolarità	125				0,5	B10EGV	5927			

MINSK

MMB3-3.112	7,3kW	125	BP7HS	5111	0,7	BP7HVX	7468		BPR7HIX	5944
MMB3-3.113	7,3kW	125	BP7HS	5111	0,7	BP7HVX	7468		BPR7HIX	5944
MMB3-3.1131	7,3kW	125	BP7HS	5111	0,7	BP7HVX	7468		BPR7HIX	5944
MMB3-3.11311	7,3kW	125	BP7HS	5111	0,7	BP7HVX	7468		BPR7HIX	5944
Mototeleschka C-3.901	7,3kW	125	BP7HS	5111	0,7	BP7HVX	7468		BPR7HIX	5944

MONDIAL

Cross Spezial	50		B7HS	5110	0,5	B7HVX	7836	204	BR7HIX	7067
Mondialino	50		B7HS	5110	0,5	B7HVX	7836	204	BR7HIX	7067
Radial	50		B8HS	5510	0,5	B8HVX	2634	205	BR8HIX	7001
Regolarita	50		B8HS	5510	0,5	B8HVX	2634	205	BR8HIX	7001
Spezial V4 Record	50		B7ES	1111	0,5	B7EVX	6934			
Touring	50		B8HS	5510	0,5	B8HVX	2634	205	BR8HIX	7001
Tourismo	50		B7HS	5110	0,5	B7HVX	7836	204	BR7HIX	7067
Cross Radial v6	125		B7HS	5110	0,5	B7HVX	7836	204	BR7HIX	7067
175 SS	175		B9HS	5810	0,5	B9HVX	2254			
Piega VTR 1000 SP	1000	03-							FR9BI-11	4709

MONTESA

Brio,Cirlo,Fura,Mini Cota	50		B7HS	5110	0,5	B7HVX	7836	204	BR7HIX	7067
Cota 25A/25C/49,Mini Mont.	50		B7HS	5110	0,5	B7HVX	7836	204	BR7HIX	7067
Scorpion 50R	50		B7HS	5110	0,5	B7HVX	7836	204	BR7HIX	7067
Cota 74 /74T /80	75		B7ES	1111	0,5	B7EVX	6934			
Crono 75	75		B7ES	1111	0,5	B7EVX	6934			
Enduro 75 H6 /H7/ L	75		B7ES	1111	0,5	B7EVX	6934			
Cota 123/C/T, Cota 125	123		B8ES	2411	0,5	B8EVX	7051	201	BR8EIX	5044
Cappra 125 MX	125		B8HS	5510	0,5	B8HVX	2634	205	BR8HIX	7001
Cappra 125 VA/VB/VE/VF	125		B10ES	7928	0,5	B10EVX	7335		BR10EIX	6801
Crono 125D	125		B8ES	2411	0,5	B8EVX	7051	201	BR8EIX	5044
Enduro 125 H6/H7/L	125		B8ES	2411	0,5	B8EVX	7051	201	BR8EIX	5044
Cota 172/200	175		B7ES	1111	0,5	B7EVX	6934			

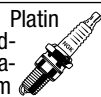
Order
No.Gold-
Palla-
diumOrder
No.Quick
No.

Iridium

Order
No.

MONTESA

Impala /2/Sport	175		B7HS	5110	0,5	B7HVX	7836	204	BR7HIX	7067
Impala 175 Comando/Turismo	175		B6HS	4510	0,5	B6HVX	7435	203	BR6HIX	3419
Kenya 175, Texas 175	175		B6HS	4510	0,5	B6HVX	7435	203	BR6HIX	3419
Cappra VA/B/E/F/G/R	250		B9ES	2611	0,5	B9EVX	7254	202	BR9EIX	3981
Cappra MX	250		B8HS	5510	0,6	B8HVX	2634	205	BR8HIX	7001
Cappra 250 /GP/MX	250		B8HS	5510	0,5	B8HVX	2634	205	BR8HIX	7001
Cappra 250 CA/VB/VE	250		B9ES	2611	0,5	B9EVX	7254	202	BR9EIX	3981
Cappra 250 VF/VG/VR	250		B9ES	2611	0,5	B9EVX	7254	202	BR9EIX	3981
Cota 242 /304 /307	250		BP7ES	2412	0,5	BP7EVX	7270	206	BPR7EIX	4055
Cota 247 /C/T	250		B8HS	5510	0,5	B8HVX	2634	205	BR8HIX	7001
Cota 248	250		BP5ES	6511	0,5	BP5EVX	5470		BPR5EIX	6597
Enduro 250 H6	250		B8ES	2411	0,5	B8EVX	7051	201	BR8EIX	5044
Enduro 250 H7	250		B10EG	3630	0,5	B10EGV	5927			
Impala	250		B8HS	5510	0,6	B8HVX	2634	205	BR8HIX	7001
Impala 250 King	250		B8HS	5510	0,5	B8HVX	2634	205	BR8HIX	7001
Impala 250 Scorpion/Sport	250		B8HS	5510	0,5	B8HVX	2634	205	BR8HIX	7001
K.Scorpion	250		B8HS	5510	0,6	B8HVX	2634	205	BR8HIX	7001
Enduro Rapita 250 Automix	250		B8ES	2411	0,5	B8EVX	7051	201	BR8EIX	5044
Cota 309	260		BPR7ES	2023	0,6	BPR7EVX	5565		BPR7EIX	4055
Cota 310/Evasion	260		BPR7ES	2023	0,6	BPR7EVX	5565		BPR7EIX	4055
Cota 311	260		BPR5ES	7422	0,6	BPR5EVX	4875		BPR5EIX	6597
Cota 348, Trial	310		BP5ES	6511	0,5	BP5EVX	5470		BPR5EIX	6597
315R	315	97-	BR6ES	4922	0,8					
Cota 330, Trial	330		BP5ES	6511	0,5	BP5EVX	5470		BPR5EIX	6597
Cota 335/335E/349/349T/350	350		BP5ES	6511	0,5	BP5EVX	5470		BPR5EIX	6597
Crono 350	350		B7ES	1111	0,5	B7EVX	6934			
Enduro 360 H6/H7/H7S/L	350		B7ES	1111	0,5	B7EVX	6934			
Cappra GP,Cappra 360VA/VB	360		B8ES	2411	0,5	B8EVX	7051	201	BR8EIX	5044
Cappra 414VE/VF/VG	410		B8ES	2411	0,5	B8EVX	7051	201	BR8EIX	5044

MOTO GUZZI

Cross 50	50		B5HS	4210	0,5					
Dingo 3M	50		B6HS	4510	0,5	B6HVX	7435	203	BR6HIX	3419
Dingo MM	50		B6HS	4510	0,5	B6HVX	7435	203	BR6HIX	3419
Furghino	50		B6HS	4510	0,5	B6HVX	7435	203	BR6HIX	3419
Magnum	50		B6ES	7310	0,5	B6EVX	5136			
Nibbio	50		B7ES	1111	0,5	B7EVX	6934			
Trotter	50	10.70-12.73	B6HS	4510	0,5	B6HVX	7435	203	BR6HIX	3419
125 2C4T	125	10.79-12.83	C8HSA	6821	0,5	C8HVX	2672		CR8HIX	7669
125 TT	125	07.85-12.87	B9ES	2611	0,5	B9EVX	7254	202	BR9EIX	3981
125 Custom	125	01.86-	B9ES	2611	0,5	B9EVX	7254	202	BR9EIX	3981
Turismo	125	01.74-12.79	B8ES	2411	0,5	B8EVX	7051	201	BR8EIX	5044
250 FD	250	74- 76	D8EA	2120	0,5	D8EVX	2850	216	DR8EIX	6681
250 TS	250	01.74-07.80	B8ES	2411	0,5	B8EVX	7051	201	BR8EIX	5044
254	250	78- 80	C8HSA	6821	0,5	C8HVX	2672		CR8HIX	7669
350 GTS	350	04.74-07.80	D8EA	2120	0,5	D8EVX	2850	216	DR8EIX	6681
350 NTX	350	10.86-	BP8ES	2912	0,6	BP8EVX	2671			
V 35	350	06.77-	BP7ES	2412	0,6	BP7EVX	7270	206	BPR7EIX	4055
V 35 Florida	350	05.86-	BP8ES	2912	0,6	BP8EVX	2671			
V 35 II	350	12.80-01.87	B7ES	1111	0,5	B7EVX	6934			
V 35 III	350	07.85-	BP8ES	2912	0,5	BP8EVX	2671			
V 35 Imola	350	11.79-01.87	B7ES	1111	0,5	B7EVX	6934			

Order
No.Platin
Gold-
Palla-
diumOrder Quick
No. No.

Iridium

Order
No.**MOTO GUZZI**

V 35 Imola II	350	79- 86	C8HSA	6821	0,5	C8HVX	2672		CR8HIX	7669
V 35 TT	350	06.84-12.87	BPR7ES	2023	0,5	BPR7EVX	5565		BPR7EIX	4055
V 350 Nevada	350	92-	B8ES	2411	0,6	B8EVX	7051	201	BR8EIX	5044
400 GTS	400	05.75-07.80	DP8EA-9	5829	0,9	DPR8EVX-9	2202		DPR8EIX-9	2202
V 40 Imola	400		BP8ES	2912	0,6	BP8EVX	2671			
Monza 500	500	01.81-01.87	BP8ES	2912	0,6	BP8EVX	2671			
V 50	500	06.77-	BP7ES	2412	0,6	BP7EVX	7270	206	BPR7EIX	4055
V 50 Custom	500	78- 80	BP7ES	2412	0,6	BP7EVX	7270	206	BPR7EIX	4055
V 50 II	500	11.79-12.81	BP7ES	2412	0,5	BP7EVX	7270	206	BPR7EIX	4055
V 50 III	500	01.81-01.87	BP8ES	2912	0,5	BP8EVX	2671			
V 50 Monza II	500	06.84-12.87	C8HSA	6821	0,5	C8HVX	2672		CR8HIX	7669
V 65	650	- 86	BP8ES	2912	0,6	BP8EVX	2671			
V 65	650	87-	BCPR6ES	2330	0,5					
V 65 Florida	650	- 86	BP8ES	2912	0,6	BP8EVX	2671			
V 65 Florida	650	92-	B8ES	2411	0,6	B8EVX	7051	201	BR8EIX	5044
V 65 Lario	650	- 86	C8HSA	6821	0,5	C8HVX	2672		CR8HIX	7669
V 65 NTX	650	90- 92	B8ES	2411	0,6	B8EVX	7051	201	BR8EIX	5044
V 65 NTX	650	- 89	BP8ES	2912	0,6	BP8EVX	2671			
V 65 Polizia NT	650		B8ES	2411	0,6	B8EVX	7051	201	BR8EIX	5044
V 65 SP	650	- 86	BP8ES	2912	0,6	BP8EVX	2671			
V 65 TT	650	- 86	BP8ES	2912	0,6	BP8EVX	2671			
V7 Sport / Spezial	700		BP6ES	7811	0,5	BP6EVX	5832		BPR6EIX	6637
750 S	750	- 74	BP6ES	7811	0,5	BP6EVX	5832		BPR6EIX	6637
750 SP	750	92-	B8ES	2411	0,6	B8EVX	7051	201	BR8EIX	5044
750 Targa	750	92-	B8ES	2411	0,6	B8EVX	7051	201	BR8EIX	5044
Breva Naked	750	03-	BR8ES	5422	0,6	BR8EVX	1262	207	BR8EIX	5044
Nevada Classic 750 ie	750	04-	BR8ES	5422	0,6	BR8EVX	1262	207	BR8EIX	5044
V 75 Nevada	750	92-	B8ES	2411	0,6	B8EVX	7051	201	BR8EIX	5044
V 75, Duna	750		C8HSA	6821	0,5	C8HVX	2672		CR8HIX	7669
V 750 NTX	750	92-	B8ES	2411	0,6	B8EVX	7051	201	BR8EIX	5044
V 750 Polizia NT	750	92-	B8ES	2411	0,6	B8EVX	7051	201	BR8EIX	5044
850 California	850	12.75-12.81	BP6ES	7811	0,6	BP6EVX	5832		BPR6EIX	6637
850 Le Mans II / III	850	01.78-12.81	BP6ES	7811	0,6	BP6EVX	5832		BPR6EIX	6637
850 T4	850	07.80-12.83	BP6ES	7811	0,6	BP6EVX	5832		BPR6EIX	6637
850 T5	850	06.83-12.87	BP6ES	7811	0,6	BP6EVX	5832		BPR6EIX	6637
850 TS 5	850	82- 84	BP6ES	7811	0,6	BP6EVX	5832		BPR6EIX	6637
1000	1000		BP6ES	7811	0,6	BP6EVX	5832		BPR6EIX	6637
1000 GT	1000	88-	BP6ES	7811	0,6	BP6EVX	5832		BPR6EIX	6637
1000 Le Mans	1000	90-	BP7ES	2412	0,6	BP7EVX	7270	206	BPR7EIX	4055
1000 Le Mans IV	1000	01.85- 89	BP8ES	2912	0,6	BP8EVX	2671			
1000 S	1000	89-	BP7ES	2412	0,6	BP7EVX	7270	206	BPR7EIX	4055
1000 SP III	1000	88- 92	BP6ES	7811	0,6	BP6EVX	5832		BPR6EIX	6637
California I.E.	1000	91-	BP7ES	2412	0,6	BP7EVX	7270	206	BPR7EIX	4055
California III	1000	88-	BP6ES	7811	0,6	BP6EVX	5832		BPR6EIX	6637
Daytona 1000	1000	92-	D9EA	2420	0,6	D9EVX	2834		DR9EIX	4772
Quota 1000	1000	92-	BP7ES	2412	0,6	BP7EVX	7270	206	BPR7EIX	4055
T 5 Polizia	1000	92-	BP6ES	7811	0,6	BP6EVX	5832		BPR6EIX	6637
V 10 Centauro	1000	96-	DR9EA	3437	0,7	DR9EVX	6361	219	DR9EIX	4772
California 1100 KC	1100	94-	BPR6ES	7822	0,6	BPR6EVX	6764		BPR6EIX	6637
California 1100 KD	1100	94-	BPR6ES	7822	0,6	BPR6EVX	6764		BPR6EIX	6637
California Aluminium	1100	03-	BPR6ES	7822	0,6	BPR6EVX	6764		BPR6EIX	6637
California EV (KD)	1100	97-	BPR6ES	7822	0,6	BPR6EVX	6764		BPR6EIX	6637

Order
No.Gold-
Palla-
dium

Platin

Order Quick
No. No.

Iridium

Order
No.**MOTO GUZZI**

California Jackal (KD)	1100	99-	BPR6ES	7822	0,6	BPR6EVX	6764		BPR6EIX	6637
California Special	1100	02-	BPR6ES	7822	0,6	BPR6EVX	6764		BPR6EIX	6637
California Special Sport (KD) 54kW	1100	02-	BPR6ES	7822	0,6	BPR6EVX	6764		BPR6EIX	6637
California Stone (KD) 54kW	1100		BPR6ES	7822	0,6	BPR6EVX	6764		BPR6EIX	6637
California Titanium	1100	03-	BPR6ES	7822	0,6	BPR6EVX	6764		BPR6EIX	6637
Daytona RS (KL)	1100	96-	DR8EA	7162	0,7	DR8EVX	6354		DR8EIX	6681
Quota 1100 (KM)	1100	06.98-	BPR6ES	7822	0,6	BPR6EVX	6764		BPR6EIX	6637
1100 Sport (KF) (Injec.) (Iniezione)	1100	96-	BPR6ES	7822	0,6	BPR6EVX	6764		BPR6EIX	6637
Sport 1100i	1100	96-	BPR6ES	7822	0,6	BPR6EVX	6764		BPR6EIX	6637
Sport	1100	95-	BPR6ES	7822	0,6	BPR6EVX	6764		BPR6EIX	6637
Stone Touring	1100	03-	BPR6ES	7822	0,6	BPR6EVX	6764		BPR6EIX	6637
V 11 Le Mans (KS)	1100		BPR6ES	7822	0,6	BPR6EVX	6764		BPR6EIX	6637
V 11 Sport (KS)	1100	99-	BPR6ES	7822	0,6	BPR6EVX	6764		BPR6EIX	6637
V 11 Rosso Mandello (KR)	1100	99-	BPR6ES	7822	0,6	BPR6EVX	6764		BPR6EIX	6637
V 11 Le Mans Nero Corsa (67kW)	1100	04-	BPR6ES	7822	0,6	BPR6EVX	6764		BPR6EIX	6637
V 11 Scura	1100	03-	BPR6ES	7822	0,6	BPR6EVX	6764		BPR6EIX	6637
V 11 Naked	1100	03-	BPR6ES	7822	0,6	BPR6EVX	6764		BPR6EIX	6637

MOTO MORINI

350 Excalibur	350	92-	BP7ES	2412	0,5	BP7EVX	7270	206	BPR7EIX	4055
400 Dart	400	91-	BP8ES	2912	0,5	BP8EVX	2671			
501 Excalibur	500	91-	BP8ES	2912	0,5	BP8EVX	2671			
501 Excalibur	501	92-	BP7ES	2412	0,5	BP7EVX	7270	206	BPR7EIX	4055

MOTOR HISPANIA

Cangurito Cross, MH	50		B6HS	4510	0,5	B6HVX	7435	203	BR6HIX	3419
Cross/MH/MH49,Sport 49	50		B6HS	4510	0,5	B6HVX	7435	203	BR6HIX	3419
Feria,Jabato,50SL	50		B6ES	7310	0,5	B6EVX	5136			
Furia 4v	50		BR9ES	5722	0,8	BR9EVX	1265	208	BR9EIX	3981
Furia 6v Cross / Super.	50		BR9ES	5722	0,8	BR9EVX	1265	208	BR9EIX	3981
GT 81, MH 80	50		B6HS	4510	0,5	B6HVX	7435	203	BR6HIX	3419
M 80 Automatico	50		B6ES	7310	0,5	B6EVX	5136			
Minicross	50		B7HS	5110	0,5	B7HVX	7836	204	BR7HIX	7067
Racing RX	50		BR9ES	5722	0,8	BR9EVX	1265	208	BR9EIX	3981
Style	50		B7HS	5110	0,5	B7HVX	7836	204	BR7HIX	7067

MOTORTEK

MT 125 R Quad	125	00-	C7HSA	4629	0,7	C7HVX	4533		CR7HIX	7544
MT 175 R Quad	175	00-	D8EA	2120	0,5	D8EVX	2850	216	DR8EIX	6681

MOTO-SPEZIAL

Bassa-Lunga	1100	99-	BP6ES	7811	0,8	BP6EVX	5832		BPR6EIX	6637
Sportiva 1100i	1100	99-	BP6ES	7811	0,8	BP6EVX	5832		BPR6EIX	6637

MOTOTECHNIKA

Karpati	50		BP6HS	4511	0,6	BP6HVX	4635		BPR6HIX	4085
Mokick	50		BP7HS	5111	0,7	BP7HVX	7468		BPR7HIX	5944
Riga	50		BP6HS	4511	0,6	BP6HVX	4635		BPR6HIX	4085
Turist	50		BP6HS	4511	0,6	BP6HVX	4635		BPR6HIX	4085
Veachowina	50		BP6HS	4511	0,6	BP6HVX	4635		BPR6HIX	4085
Veterok	50		BP6HS	4511	0,6	BP6HVX	4635		BPR6HIX	4085

Order
No.Platin
Gold-
Palla-
diumOrder Quick
No. No.Order
No.**MTV**

50 Cross/ Sport	50		BP5ES	6511	0,5	BP5EVX	5470		BPR5EIX	6597
-----------------	----	--	-------	------	-----	--------	------	--	---------	------

MÜNCH

Mammut 1000 TTS	1000	-12.82	BP8ES	2912	0,5	BP8EVX	2671			
4-1200 TS/TTS-E	1200	-12.82	BP8ES	2912	0,5	BP8EVX	2671			
Mammut 1200 TS	1200	-12.82	BP8ES	2912	0,5	BP8EVX	2671			

MV AGUSTA

350 B GT/S/Scrambler	350		B8ES	2411	0,5	B8EVX	7051	201	BR8EIX	5044
350 BE GT(216)	350		B8ES	2411	0,5	B8EVX	7051	201	BR8EIX	5044
350 BE GT/S/Scrambler	350		B8ES	2411	0,5	B8EVX	7051	201	BR8EIX	5044
350 BES (216)	350		B8ES	2411	0,5	B8EVX	7051	201	BR8EIX	5044
350 Sport	350	-12.80	B8ES	2411	0,5	B8EVX	7051	201	BR8EIX	5044
GT Electronique	350		B8ES	2411	0,5	B8EVX	7051	201	BR8EIX	5044
S Electronique	350		B8ES	2411	0,5	B8EVX	7051	201	BR8EIX	5044
Scrambler Electronique	350		B8ES	2411	0,5	B8EVX	7051	201	BR8EIX	5044
199,4C6	600		B8ES	2411	0,5	B8EVX	7051	201	BR8EIX	5044
4C75S/GT, 750GT/S/SS	750		B8ES	2411	0,5	B8EVX	7051	201	BR8EIX	5044
750 S American	750		B7ES	1111	0,5	B7EVX	6934			
F4 Brutale S	750	02-	CR9EKB		0,7					
F4 Oro --> Fgst.300	750	99-	CR9EKB		0,7					
F4 Senna 103KW	750	99-	CR9EKB		0,7					
F4 S SPR 103KW	750	99-	CR9EKB		0,7					
F4 Brutale (oro) 93kW	750	99-	CR9EKB		0,7					
800 S	800	-06.80	B8ES	2411	0,5	B8EVX	7051	201	BR8EIX	5044
900 S	900	-06.80	B8ES	2411	0,5	B8EVX	7051	201	BR8EIX	5044

MZ

ATV 50	50	03-	BP6HS	4511	0,6	BP6HVX	4635		BPR6HIX	4085
ATV 100	100	03-	BP6HS	4511	0,6	BP6HVX	4635		BPR6HIX	4085
125 Fun X	125	01-	CR8E	1275	0,7	CR8EVX	6487	226	CR8EIX	4218
125 Fun X	125	03-	CR8E	1275	0,6	CR8EVX	6487	226	CR8EIX	4218
125 SM	125	01-	CR8E	1275	0,7	CR8EVX	6487	226	CR8EIX	4218
125 SX	125	01-	CR8E	1275	0,7	CR8EVX	6487	226	CR8EIX	4218
125 Younster Cup	125	03-	CR8E	1275	0,6	CR8EVX	6487	226	CR8EIX	4218
RT 125	125	00-	CR8E	1275	0,6	CR8EVX	6487	226	CR8EIX	4218
RT 125 Classic	125	03-	CR8E	1275	0,6	CR8EVX	6487	226	CR8EIX	4218
RT 125 SM	125	00-	CR8E	1275	0,6	CR8EVX	6487	226	CR8EIX	4218
Saxon Roadstar 7kW	125		B8HS	5510	0,6	B8HVX	2634	205	BR8HIX	7001
Saxon Sportstar 7/11kW	125		B8HS	5510	0,6	B8HVX	2634	205	BR8HIX	7001
Saxon Roadstar 9kW	150		B8HS	5510	0,6	B8HVX	2634	205	BR8HIX	7001
Saxon Sportstar 9kW	150		B8HS	5510	0,6	B8HVX	2634	205	BR8HIX	7001
ETZ Classic 13/15kW	251		B8HS	5510	0,6	B8HVX	2634	205	BR8HIX	7001
Saxon 251 Fun 13/15kW	251		B8HS	5510	0,6	B8HVX	2634	205	BR8HIX	7001
Saxon 251 Tour 13/15kW	251		B8HS	5510	0,6	B8HVX	2634	205	BR8HIX	7001
ETZ 301 Classic 17kW	301		B8HS	5510	0,6	B8HVX	2634	205	BR8HIX	7001
Saxon 301 Fun 17kW	301		B8HS	5510	0,6	B8HVX	2634	205	BR8HIX	7001
Saxon 301 Tour 17kW	301		B8HS	5510	0,6	B8HVX	2634	205	BR8HIX	7001
Saxon 500 Country 25kW	500		D8EA	2120	0,7	D8EVX	2850	216	DR8EIX	6681
Saxon 500 Fun 20/25kW	500		D8EA	2120	0,7	D8EVX	2850	216	DR8EIX	6681
Saxon 500 Funkkrad 20/25kW	500		D8EA	2120	0,7	D8EVX	2850	216	DR8EIX	6681
Saxon 500 Tour 20/25kW	500		D8EA	2120	0,7	D8EVX	2850	216	DR8EIX	6681

Order
No.Gold-
Palla-
dium

Platin

Order Quick
No. No.

Iridium

Order
No.**MZ**

Saxon 500 Voyager 20/25kW	500		D8EA	2120	0,7	D8EVX	2850	216	DR8EIX	6681
Silver Star Classic 500 20kW	500		D8EA	2120	0,7	D8EVX	2850	216	DR8EIX	6681
Silver Star Classic 500 25kW	500		D8EA	2120	0,7	D8EVX	2850	216	DR8EIX	6681
Silver Star Gespann 500 25kW	500	95-	D8EA	2120	0,7	D8EVX	2850	216	DR8EIX	6681
Baghira	660	97-	DPR9EA-9	5329	0,9	DPR9EVX-9	3854	222	DPR9EIX-9	5545
Baghira Black Panther (4NN)	660	99-	DPR9EA-9	5329	0,9	DPR9EVX-9	3854	222	DPR9EIX-9	5545
Baghira Black Panther HR	660	00-	DPR9EA-9	5329	0,9	DPR9EVX-9	3854	222	DPR9EIX-9	5545
Baghira Forest	660	99-	DPR9EA-9	5329	0,9	DPR9EVX-9	3854	222	DPR9EIX-9	5545
Baghira HR	660	99-	DPR9EA-9	5329	0,9	DPR9EVX-9	3854	222	DPR9EIX-9	5545
Baghira Street Moto (4NN)	660	99-	DPR9EA-9	5329	0,9	DPR9EVX-9	3854	222	DPR9EIX-9	5545
Baghira Street Moto HR	660	00-	DPR9EA-9	5329	0,9	DPR9EVX-9	3854	222	DPR9EIX-9	5545
Mastiff	660	97-	DPR9EA-9	5329	0,9	DPR9EVX-9	3854	222	DPR9EIX-9	5545
Replica 660	660	02.95-	DPR9EA-9	5329	0,9	DPR9EVX-9	3854	222	DPR9EIX-9	5545
Skorpion Cup (4NN)	660	96-	DPR9EA-9	5329	0,9	DPR9EVX-9	3854	222	DPR9EIX-9	5545
Skorpion Replica	660	02.95-	DPR9EA-9	5329	0,9	DPR9EVX-9	3854	222	DPR9EIX-9	5545
Skorpion Sport	660	94-	DPR9EA-9	5329	0,9	DPR9EVX-9	3854	222	DPR9EIX-9	5545
Skorpion Tour	660	94-	DPR9EA-9	5329	0,9	DPR9EVX-9	3854	222	DPR9EIX-9	5545
Skorpion Traveller	660	96-	DPR9EA-9	5329	0,9	DPR9EVX-9	3854	222	DPR9EIX-9	5545
1000 S	1000	04-	BCPR6ET	2197	0,8					

MZ (TR)

ETZ Standard OR	125	01.91-	B8HS	5510	0,6	B8HVX	2634	205	BR8HIX	7001
ETZ Standard	125	01.91-	B8HS	5510	0,6	B8HVX	2634	205	BR8HIX	7001
Saxon Tour 251	125	01.91-	B8HS	5510	0,6	B8HVX	2634	205	BR8HIX	7001
TS 125	125	01.75-12.85	B8HS	5510	0,6	B8HVX	2634	205	BR8HIX	7001
ETZ 150	150	01.84-12.90	B8HS	5510	0,6	B8HVX	2634	205	BR8HIX	7001
TS 150	150	01.75-12.85	B8HS	5510	0,6	B8HVX	2634	205	BR8HIX	7001
TS 250	250	01.75-12.85	B8HS	5510	0,6	B8HVX	2634	205	BR8HIX	7001

NORTON

Atlas			BP8ES	2912	0,6	BP8EVX	2671			
Commander			C8E	7471	0,6	CR8EVX	6487		CR8EIX	4218
Commando			BP7ES	2412	0,6	BP7EVX	7270	206	BPR7EIX	4055
F 1			C8E	7471	0,6	CR8EVX	6487		CR8EIX	4218
C 652 SM engine F650	650	99-	D8EA	2120	0,6	D8EVX	2850	216	DR8EIX	6681

NSU

Supermax	250	56-	B8HS	5510	0,5	B8HVX	2634	205	BR8HIX	7001
----------	-----	-----	------	------	-----	-------	------	-----	--------	------

OMER

Cross Mini	50		B6HS	4510	0,6	B6HVX	7435	203	BR6HIX	3419
Daytona 8 Mini	50		B6HS	4510	0,6	B6HVX	7435	203	BR6HIX	3419
Maggiolino	50		B5HS	4210	0,5					
Maggiolione	50		B5HS	4210	0,5					
Tanga / Noleggiato	50		B6HS	4510	0,6	B6HVX	7435	203	BR6HIX	3419
Valllunga 10	50		B6HS	4510	0,6	B6HVX	7435	203	BR6HIX	3419
Vivo	50		BP6ES	7811	0,6	BP6EVX	5832		BPR6EIX	6637

OSSA

Ossita 50	50		B5HS	4210	0,5					
125 Enduro/Super Pioneer	125		B8ES	2411	0,5	B8EVX	7051	201	BR8EIX	5044
125 Moto Cross/Phantom	125		B9ES	2611	0,5	B9EVX	7254	202	BR9EIX	3981

Order
No.Platin
Gold-
Palla-
diumOrder Quick
No. No.Order
No.**OSSA**

150 Phantom	150		B8ES	2411	0,5	B8EVX	7051	201	BR8EIX	5044
160 GT-T2	160		B7ES	1111	0,5	B7EVX	6934			
175 American/Enduro/Sport	175		B8ES	2411	0,5	B8EVX	7051	201	BR8EIX	5044
175 Moto Cross/Phantom	175		B9ES	2611	0,5	B9EVX	7254	202	BR9EIX	3981
175 Super Pioneer/ 6 Dias	175		B8ES	2411	0,5	B8EVX	7051	201	BR8EIX	5044
230 Explorer/Trial	230		BP5ES	6511	0,5	BP5EVX	5470		BPR5EIX	6597
230 Super Pioneer	230		B8ES	2411	0,5	B8EVX	7051	201	BR8EIX	5044
250 American Enduro/Copa	250		B9ES	2611	0,5	B9EVX	7254	202	BR9EIX	3981
Copa F3	250				0,5	B9EVX	7254		BR9EIX	3981
Desert, Phantom, S.Pioneer	250		B9ES	2611	0,5	B9EVX	7254	202	BR9EIX	3981
Desert/Enduro/Moto Cross	250		B9ES	2611	0,5	B9EVX	7254	202	BR9EIX	3981
M.A.R. Explorer / Trial	250		BP5ES	6511	0,5	BP5EVX	5470		BPR5EIX	6597
Sport/Super Pioneer,TE 250	250		B9ES	2611	0,5	B9EVX	7254	202	BR9EIX	3981
T, Copa,F3	250		B9ES	2611	0,5	B9EVX	7254	202	BR9EIX	3981
TR 80,250 Exp./Trial/Tu-yo	250		BP5ES	6511	0,5	BP5EVX	5470		BPR5EIX	6597
Urbe Phanton,Trofeo 250 E7	250		B9ES	2611	0,5	B9EVX	7254	202	BR9EIX	3981
303 Trial,TR 80,	350		BP5ES	6511	0,5	BP5EVX	5470		BPR5EIX	6597
350 Desert/Super Pionner	350		B8ES	2411	0,5	B8EVX	7051	201	BR8EIX	5044
350 Explorer/Tu-yo , Trail	350		BP5ES	6511	0,5	BP5EVX	5470		BPR5EIX	6597
500 S, Yankee	500		B8ES	2411	0,5	B8EVX	7051	201	BR8EIX	5044

PANDA

KD 50 A (ATV)	50	00-	CR6HSA	2983	0,7				CR6HIX	7274
KD 80 A (ATV)	80	00-	CR6HSA	2983	0,7				CR6HIX	7274
KD 125 A (ATV)	125	00-	CR6HSA	2983	0,7				CR6HIX	7274

PEUGEOT

101	50	04.75-	B5HS	4210	0,5					
102	50	04.75-	B5HS	4210	0,5					
103	50	04.75-	B5HS	4210	0,5					
103 CRX	50		B8HS	5510	0,5	B8HVX	2634	205	BR8HIX	7001
103 LC	50		B8ES	2411	0,5	B8EVX	7051	201	BR8EIX	5044
103 LSM-D	50	06.82-	B6HS	4510	0,5	B6HVX	7435	203	BR6HIX	3419
103 MP/MR	50		B8HS	5510	0,5	B8HVX	2634	205	BR8HIX	7001
103 Racen	50		B8HS	5510	0,5	B8HVX	2634	205	BR8HIX	7001
103 SP	50	86-	B8HS	5510	0,5	B8HVX	2634	205	BR8HIX	7001
103 SPM-D	50	04.75-	B6HS	4510	0,5	B6HVX	7435	203	BR6HIX	3419
103 T16	50		B8HS	5510	0,5	B8HVX	2634	205	BR8HIX	7001
103 TXLC,TXR	50		B8ES	2411	0,5	B8EVX	7051	201	BR8EIX	5044
103 Vogue	50		B8HS	5510	0,5	B8HVX	2634	205	BR8HIX	7001
103 XP,XPLC	50	01.86-	B8ES	2411	0,5	B8EVX	7051	201	BR8EIX	5044
104	50		B5HS	4210	0,5					
105	50		B5HS	4210	0,5					
BB3K	50		B6HS	4510	0,5	B6HVX	7435	203	BR6HIX	3419
BB3L	50		B6HS	4510	0,5	B6HVX	7435	203	BR6HIX	3419
BB3SP	50		B6HS	4510	0,5	B6HVX	7435	203	BR6HIX	3419
C 50	50		B5HS	4210	0,5					
GL 10	50	01.79-	B6HS	4510	0,5	B6HVX	7435	203	BR6HIX	3419
GT 10	50		B6HS	4510	0,5	B6HVX	7435	203	BR6HIX	3419
P 80	50		B8HS	5510	0,5	B8HVX	2634	205	BR8HIX	7001
RS	50		B5HS	4210	0,5					
RT	50		B5HS	4210	0,5					



Order No.

Platin
Gold-Palladium

Order Quick No. No.



Order No.

PEUGEOT

S 157	50		B5HS	4210	0,5					
S 55	50		B5HS	4210	0,5					
SC 50	50		B6HS	4510	0,5	B6HVX	7435	203	BR6HIX	3419
SC 50 L (I)	50		BPR6HS	7022	0,6	BPR6HVX	2740	214	BPR6HIX	4085
SC 50L	50		B6HS	4510	0,5	B6HVX	7435	203	BR6HIX	3419
Scoper V50	50		B6HS	4510	0,5	B6HVX	7435	203	BR6HIX	3419
ST, STL 2, Rapido	50		BR6HSA	4296	0,6			210	BR6HIX	3419
SX5	50		B5HS	4210	0,5					
TLX 50	50		B6HS	4510	0,5	B6HVX	7435	203	BR6HIX	3419
TSA	50		B6HS	4510	0,5	B6HVX	7435	203	BR6HIX	3419
Velo a moteur Count.	50		B8HS	5510	0,5	B8HVX	2634	205	BR8HIX	7001
X 125 LC	50		B10ES	7928	0,5	B10EVX	7335		BR10EIX	6801
SC80L	80	06.82-	BPR6HS	7022	0,7	BPR6HVX	2740	214	BPR6HIX	4085
SX8T	80	02.78-12.82	B7HS	5110	0,5	B7HVX	7836	204	BR7HIX	7067
P51-53	100		B6S	3510	0,5					
55 C	125		B6HS	4510	0,5	B6HVX	7435	203	BR6HIX	3419
55 D	125		B6HS	4510	0,5	B6HVX	7435	203	BR6HIX	3419
550	125		B6HS	4510	0,5	B6HVX	7435	203	BR6HIX	3419
P 150	150		B6HS	4510	0,5	B6HVX	7435	203	BR6HIX	3419
P 155	155		B6HS	4510	0,5	B6HVX	7435	203	BR6HIX	3419
P 156	155		B6HS	4510	0,5	B6HVX	7435	203	BR6HIX	3419
176	175		B6HS	4510	0,5	B6HVX	7435	203	BR6HIX	3419
176 BB	175		B6HS	4510	0,5	B6HVX	7435	203	BR6HIX	3419
176 Grand Sport	175		B8ES	2411	0,5	B8EVX	7051	201	BR8EIX	5044
176 TC	175		B6HS	4510	0,5	B6HVX	7435	203	BR6HIX	3419
256	250		B7HS	5110	0,5	B7HVX	7836	204	BR7HIX	7067

PIAGGIO

--> Scooter/Roller

POLARIS

Big Boss (ATV)	244	89- 93	BR8ES	5422	0,6	BR8EVX	1262	207	BR8EIX	5044
Cyclone (ATV)	244	88- 89	BR8ES	5422	0,6	BR8EVX	1262	207	BR8EIX	5044
Scrambler (ATV)	244	89- 93	BR8ES	5422	0,6	BR8EVX	1262	207	BR8EIX	5044
Trail Blazer (ATV)	244	90-	BR8ES	5422	0,6	BR8EVX	1262	207	BR8EIX	5044
Trail Boss (ATV)	244	85-	BR8ES	5422	0,6	BR8EVX	1262	207	BR8EIX	5044
Xplorer 300 (ATV)	283	94-	BR8ES	5422	0,6	BR8EVX	1262	207	BR8EIX	5044
Xpress 300 (ATV)	283	94-	BR8ES	5422	0,6	BR8EVX	1262	207	BR8EIX	5044
Sportsman 335 (ATV)	334	99-	BKR7E	6097	0,6				BKR7EIX	2667
Big Boss (ATV)	350	93-	BR8ES	5422	0,6	BR8EVX	1262	207	BR8EIX	5044
Trail Boss (ATV)	350	90- 93	BR8ES	5422	0,6	BR8EVX	1262	207	BR8EIX	5044
Big Boss 400L (6X6) (ATV)	379	95- 97	BR8ES	5422	0,6	BR8EVX	1262	207	BR8EIX	5044
Scambler 400 (4X4) (ATV)	379	94-	BR8ES	5422	0,6	BR8EVX	1262	207	BR8EIX	5044
Sport 400 (ATV)	379	98-	BR8ES	5422	0,6	BR8EVX	1262	207	BR8EIX	5044
Sport ATV (ATV)	379	95- 97	BR8ES	5422	0,6	BR8EVX	1262	207	BR8EIX	5044
Sportsman 4x4 (ATV)	379	94- 97	BR8ES	5422	0,6	BR8EVX	1262	207	BR8EIX	5044
Xplorer 400/400L 4x4 (ATV)	379	94-	BR8ES	5422	0,6	BR8EVX	1262	207	BR8EIX	5044
Xpress 400 L 2x4 (ATV)	379	96- 97	BR8ES	5422	0,6	BR8EVX	1262	207	BR8EIX	5044
Magnum (2X4) (ATV)	425	95-	BKR5E	7938	0,6				BKR5EIX	6341
Magnum (4X4) (ATV)	425	95-	BKR5E	7938	0,6				BKR5EIX	6341
Magnum (6X6) (ATV)	425	96- 97	BKR5E	7938	0,6				BKR5EIX	6341
Big Boss 500 (6X6) (ATV)	500	98-	BKR5E	7938	0,6				BKR5EIX	6341

Order
No.Platin
Gold-
Palla-
diumOrder Quick
No. No.Order
No.**POLARIS**

Magnum 500 (ATV)	500	99-	BKR5E	7938	0,6				BKR5EIX	6341
Ranger (ATV)	500	99-	BKR5E	7938	0,6				BKR5EIX	6341
Scrambler 500 (ATV)	500	98-	BKR5E	7938	0,6				BKR5EIX	6341
Sportsman 500 (ATV)	500	96-	BKR5E	7938	0,6				BKR5EIX	6341
Xplorer 500 (ATV)	500	97-	BKR5E	7938	0,6				BKR5EIX	6341
Sportsmann 600 (ATV)	600	03-	BKR7E	6097	0,6				BKR7EIX	2667
Sportsmann 700 (ATV)	700	03-	BKR7E	6097	0,6				BKR7EIX	2667

POLINI

Steel 910	50		B6HS	4510	0,6	B6HVX	7435	203	BR6HIX	3419
Steel 910 LC	50		B6HS	4510	0,6	B6HVX	7435	203	BR6HIX	3419
Steel 910 LC Race	50				0,6	B7HVX	7836		BR7HIX	7067
Steel 910 Race	50				0,6	B7HVX	7836		BR7HIX	7067

PUCH

DS 50	50		B6HS	4510	0,5	B6HVX	7435	203	BR6HIX	3419
DS 50 K	50		B6HS	4510	0,5	B6HVX	7435	203	BR6HIX	3419
DS 50 KXN	50		B6HS	4510	0,5	B6HVX	7435	203	BR6HIX	3419
DS 50 RN	50		B6HS	4510	0,5	B6HVX	7435	203	BR6HIX	3419
DS 60 C	50		B6HS	4510	0,5	B6HVX	7435	203	BR6HIX	3419
DS 60 CN	50		B6HS	4510	0,5	B6HVX	7435	203	BR6HIX	3419
DS 60 R	50		B6HS	4510	0,5	B6HVX	7435	203	BR6HIX	3419
DS 60 RN	50		B6HS	4510	0,5	B6HVX	7435	203	BR6HIX	3419
GS 50	50		B9HCS	2721	0,5					
GT 50	50		B9HS	5810	0,5	B9HVX	2254			
GTL 50	50		B9HS	5810	0,5	B9HVX	2254			
M 50 Jet	50		B8HS	5510	0,5	B8HVX	2634	205	BR8HIX	7001
M 50 Racing	50		B6HS	4510	0,5	B6HVX	7435	203	BR6HIX	3419
M 50 SE	50		B6HS	4510	0,5	B6HVX	7435	203	BR6HIX	3419
Maxi	50		B4H	4110	0,5					
Maxi 2 Gang	50		B5HS	4210	0,5					
Maxi II	50		B5HS	4210	0,5					
Maxi II-25	50		B4H	4110	0,5					
Maxi N	50		B5HS	4210	0,5					
Maxi S	50		B4H	4110	0,5					
MC 60 Scrambler	50		B8HS	5510	0,5	B8HVX	2634	205	BR8HIX	7001
MS 25	50		B6HS	4510	0,5	B6HVX	7435	203	BR6HIX	3419
MS 50 De Luxe Sears	50		B6HS	4510	0,5	B6HVX	7435	203	BR6HIX	3419
MS 50 Standard Sears	50		B6HS	4510	0,5	B6HVX	7435	203	BR6HIX	3419
MS 50 STD.California	50		B6HS	4510	0,5	B6HVX	7435	203	BR6HIX	3419
MS 50 V	50		B6HS	4510	0,5	B6HVX	7435	203	BR6HIX	3419
MS 50 V-Autolec	50		B6HS	4510	0,5	B6HVX	7435	203	BR6HIX	3419
P 1 L	50		B4H	4110	0,5					
P 1 XL	50		B4H	4110	0,5					
R 50	50		B6HS	4510	0,5	B6HVX	7435	203	BR6HIX	3419
R 50 K	50		B6HS	4510	0,5	B6HVX	7435	203	BR6HIX	3419
R 50 M	50		B8HS	5510	0,5	B8HVX	2634	205	BR8HIX	7001
R 50 V	50		B6HS	4510	0,5	B6HVX	7435	203	BR6HIX	3419
R 60 R	50		B6HS	4510	0,5	B6HVX	7435	203	BR6HIX	3419
VS 50 D	50		B6HS	4510	0,5	B6HVX	7435	203	BR6HIX	3419
VS 50 DK	50		B6HS	4510	0,5	B6HVX	7435	203	BR6HIX	3419
VS 50 DS	50		B6HS	4510	0,5	B6HVX	7435	203	BR6HIX	3419

Order
No.Gold-
Palla-
dium

Platin

Order
No.Quick
No.

Iridium

Order
No.**PUCH**

VS 50 L	50		B6HS	4510	0,5	B6HVX	7435	203	BR6HIX	3419
VS 50 L-Autolec	50		B6HS	4510	0,5	B6HVX	7435	203	BR6HIX	3419
VS 60 R	50		B6HS	4510	0,5	B6HVX	7435	203	BR6HIX	3419
VZ 50 K	50		B6HS	4510	0,5	B6HVX	7435	203	BR6HIX	3419
VZ 50 M	50		B8HS	5510	0,5	B8HVX	2634	205	BR8HIX	7001
VZ 50 R	50		B6HS	4510	0,5	B6HVX	7435	203	BR6HIX	3419
VZ 50 V	50		B6HS	4510	0,5	B6HVX	7435	203	BR6HIX	3419
VZ 60 R	50		B6HS	4510	0,5	B6HVX	7435	203	BR6HIX	3419
X 30	50		B6HS	4510	0,5	B6HVX	7435	203	BR6HIX	3419
X 50-3	50		B7HS	5110	0,5	B7HVX	7836	204	BR7HIX	7067
Cobra 12,9 mm	80	81-	B9HS	5810	0,5	B9HVX	2254			
Cobra 19,0 mm	80	81-	B9ES	2611	0,5	B9EVX	7254	202	BR9EIX	3981
MC 125	125		B9ES	2611	0,5	B9EVX	7254	202	BR9EIX	3981
MC 175	175		B8ES	2411	0,5	B8EVX	7051	201	BR8EIX	5044
GS 250	250		B8ES	2411	0,5	B8EVX	7051	201	BR8EIX	5044
MC 250	250		B9ES	2611	0,5	B9EVX	7254	202	BR9EIX	3981
GS 350	350		B10EG	3630	0,6	B10EGV	5927			
GS 366	366		B8ES	2411	0,5	B8EVX	7051	201	BR8EIX	5044
GS 500	500		DP9EA-9	6629	0,9	DP9EVX-9	3331		DPR9EIX-9	5545
MC 500	500				0,6	B10EGV	5927			
GS 560	560		DP9EA-9	6629	0,9	DP9EVX-9	3331		DPR9EIX-9	5545

REGENT

Roadster,Tourer,RT 125	125		B7HS	5110	0,6	B7HVX	7836	204	BR7HIX	7067
Roadster,Tourer,RT 150	150		B7HS	5110	0,6	B7HVX	7836	204	BR7HIX	7067
Roadster,Tourer,RT 175	175		B7HS	5110	0,6	B7HVX	7836	204	BR7HIX	7067

REX

Chopper 125	125		DR8EA	7162	0,7	DR8EVX	6354		DR8EIX	6681
Cruiser 125	125		DR8EA	7162	0,7	DR8EVX	6354		DR8EIX	6681
Fun Bike	125	00-	DP7EA-9	5629	0,9	DPR7EVX-9	7682		DPR7EIX-9	7803

RIEJU

Confort 402/403,Pony 50	50		B5HS	4210	0,5					
Confort 501,Helios,Varimat	50		B5HS	4210	0,5					
Drac 50(Air),Marathon 50	50		B6ES	7310	0,5	B6EVX	5136			
Drac/Water),RS-1,RV 50	50		B7ES	1111	0,5	B7EVX	6934			
MRX 50	50	03-	BR8ES	5422	0,7	BR8EVX	1262	207	BR8EIX	5044
MX 50 (Child's)	50		B6HS	4510	0,5	B6HVX	7435	203	BR6HIX	3419
NKD 50 RS 2 Naked	50	03-	BR8ES	5422	0,7	BR8EVX	1262	207	BR8EIX	5044
RR 50 AM6	50		BR8ES	5422	0,7	BR8EVX	1262	207	BR8EIX	5044
RR 50 Spezial Edition	50	03-	BR8ES	5422	0,7	BR8EVX	1262	207	BR8EIX	5044
RS 2	50	03-	BR8ES	5422	0,7	BR8EVX	1262	207	BR8EIX	5044
RS 1	50		BR8ES	5422	0,7	BR8EVX	1262	207	BR8EIX	5044
SMX 50	50	03-	BR8ES	5422	0,7	BR8EVX	1262	207	BR8EIX	5044
Spike 50	50	03-	BR8ES	5422	0,7	BR8EVX	1262	207	BR8EIX	5044
Sprint,Autom.Kick Starter	50		B5HS	4210	0,5					
Strada GT 49/GT Sport	50		B6ES	7310	0,5	B6EVX	5136			
Super Marathon 50/FDN/MT	50		B6ES	7310	0,5	B6EVX	5136			
Marathon 74 TT/Enduro	75		B6ES	7310	0,5	B6EVX	5136			
Marathon 75 Cross(Competi)	75				0,5	B10EGV	5927			
Marathon 75 Enduro	75				0,5	B10EGV	5927			

Order
No.Platin
Gold-
Palla-
diumOrder Quick
No. No.Order
No.**RIEJU**

MR 74E,MR 75E,Strada GT75	75		B6ES	7310	0,5	B6EVX	5136			
TT 406	75		B6HS	4510	0,5	B6HVX	7435	203	BR6HIX	3419
MR 80 Enduro/Cross(Compet)	80				0,5	B10EGV	5927			
MR 80E, RST-80	80		B6ES	7310	0,5	B6EVX	5136			
MRX 125	125	03-	BR8ES	5422	0,8	BR8EVX	1262	207	BR8EIX	5044
SMX 125	125	03-	BR8ES	5422	0,8	BR8EVX	1262	207	BR8EIX	5044

RIERA

Windy	50		BR7HS	4122	0,5			211	BR7HIX	7067
-------	----	--	-------	------	-----	--	--	-----	--------	------

RIXE

Champion FT / FTH	50		B6HS	4510	0,6	B6HVX	7435	203	BR6HIX	3419
Derby B	50		B7HS	5110	0,5	B7HVX	7836	204	BR7HIX	7067
Derby D	50		B8HS	5510	0,5	B8HVX	2634	205	BR8HIX	7001
Geschäftsmoped	50		B7HS	5110	0,5	B7HVX	7836	204	BR7HIX	7067
Hight Sport	50		B6HS	4510	0,6	B6HVX	7435	203	BR6HIX	3419
Libelle E21	50		B4H	4110	0,5					
Libelle E23	50		B4H	4110	0,5					
Libelle FT/FTH/GTH	50		B6HS	4510	0,6	B6HVX	7435	203	BR6HIX	3419
Libelle Hight Sport Super	50		B4H	4110	0,5					
R503	50		B6HS	4510	0,6	B6HVX	7435	203	BR6HIX	3419
R504	50		B7HS	5110	0,5	B7HVX	7836	204	BR7HIX	7067
RS50 B3/ B4	50		B6HS	4510	0,6	B6HVX	7435	203	BR6HIX	3419
RS50S	50		B8HS	5510	0,5	B8HVX	2634	205	BR8HIX	7001
Standard 7 h	50		B7HS	5110	0,5	B7HVX	7836	204	BR7HIX	7067
Turismo 4	50		B7HS	5110	0,5	B7HVX	7836	204	BR7HIX	7067
Turismo E21	50		B6HS	4510	0,6	B6HVX	7435	203	BR6HIX	3419
Turismo ELS	50		B6HS	4510	0,6	B6HVX	7435	203	BR6HIX	3419
Turismo SL40	50		B6HS	4510	0,6	B6HVX	7435	203	BR6HIX	3419

RIZZATO

Califfo K	50		B5HS	4210	0,5					
Califfo 121 matic	50		B6HS	4510	0,6	B6HVX	7435	203	BR6HIX	3419
Califfo 80	50		B5HS	4210	0,5					
Califfo engine 119	50		B5HS	4210	0,5					
Califfo Mini	50		B5HS	4210	0,5					
Califfo Monomarcia Super	50		B6HS	4510	0,6	B6HVX	7435	203	BR6HIX	3419
Califfone 4 M	50		B5HS	4210	0,5					
Cross Satan 71	50		B6HS	4510	0,6	B6HVX	7435	203	BR6HIX	3419
Gio	50		B5HS	4210	0,5					
Mirage P4 Daytona	50		B6HS	4510	0,6	B6HVX	7435	203	BR6HIX	3419
Piu	50		B5HS	4210	0,5					
Ringo	50		B6HS	4510	0,6	B6HVX	7435	203	BR6HIX	3419
Satan	50		B6HS	4510	0,6	B6HVX	7435	203	BR6HIX	3419
Super Luxe 73	50		B6HS	4510	0,6	B6HVX	7435	203	BR6HIX	3419
Super Sprint Mirage	50		B6HS	4510	0,6	B6HVX	7435	203	BR6HIX	3419
Turismo Monomarcia	50		B6HS	4510	0,6	B6HVX	7435	203	BR6HIX	3419
Zum 3	50		B6HS	4510	0,6	B6HVX	7435	203	BR6HIX	3419
Cross Coguaro	125		B8ES	2411	0,5	B8EVX	7051	201	BR8EIX	5044
Tourismo	125		B8ES	2411	0,5	B8EVX	7051	201	BR8EIX	5044

Order
No.Platin
Gold-
Palla-
diumOrder
No.Quick
No.

Iridium

Order
No.**S.I.S.**

4 Cyclone	50		B8HS	5510	0,5	B8HVX	2634	205	BR8HIX	7001
Almirante 4/5	50		B8HS	5510	0,5	B8HVX	2634	205	BR8HIX	7001
Asa d'Ouro	50		B6HS	4510	0,6	B6HVX	7435	203	BR6HIX	3419
Brass	50		B6HS	4510	0,6	B6HVX	7435	203	BR6HIX	3419
EKO 70	50		B7HS	5110	0,5	B7HVX	7836	204	BR7HIX	7067
Felino	50		B7HS	5110	0,5	B7HVX	7836	204	BR7HIX	7067
Lebre / V4	50		B8HS	5510	0,5	B8HVX	2634	205	BR8HIX	7001
Mini Sport	50		B7HS	5110	0,5	B7HVX	7836	204	BR7HIX	7067
Mini Turismo	50		B7HS	5110	0,5	B7HVX	7836	204	BR7HIX	7067
Minor GT	50		B6HS	4510	0,6	B6HVX	7435	203	BR6HIX	3419
V5 Sport	50		B8HS	5510	0,5	B8HVX	2634	205	BR8HIX	7001
V5 Super Sport	50		B8HS	5510	0,5	B8HVX	2634	205	BR8HIX	7001
V5 Turismo	50		B8HS	5510	0,5	B8HVX	2634	205	BR8HIX	7001

SACHS

Saxonette Classic	30		BP4	2911	0,5					
Saxonette	30	01.87-	BPR4S	4427	0,5					
City Bike C1	50	10.72-08.78	B6HS	4510	0,7	B6HVX	7435	203	BR6HIX	3419
City Bike C2	50	10.72-08.78	B6HS	4510	0,7	B6HVX	7435	203	BR6HIX	3419
City Bike C3	50	09.74-08.78	B6HS	4510	0,7	B6HVX	7435	203	BR6HIX	3419
Dirty Devil 50	50		BP5HS	4111	0,5					
Enduro ZX 50	50		BR8ES	5422	0,5	BR8EVX	1262	207	BR8EIX	5044
Hobby Rider HR 1	50	10.72-12.87	B6HS	4510	0,7	B6HVX	7435	203	BR6HIX	3419
Hobby Rider HR 2	50	10.72-12.87	B6HS	4510	0,7	B6HVX	7435	203	BR6HIX	3419
Jogging	50		B6HS	4510	0,5	B6HVX	7435	203	BR6HIX	3419
K 50	50	-08.78	B8HS	5510	0,7	B8HVX	2634	205	BR8HIX	7001
K 50 Ultra	50	-08.78	B8HS	5510	0,7	B8HVX	2634	205	BR8HIX	7001
K 50 Ultra II	50	-08.78	B8HS	5510	0,5	B8HVX	2634	205	BR8HIX	7001
K 50 Ultra LC	50	-08.78	B9ES	2611	0,5	B9EVX	7254	202	BR9EIX	3981
K 50 Ultra LC II	50	-08.78	B9ES	2611	0,5	B9EVX	7254	202	BR9EIX	3981
K 50 Ultra LC III	50	-08.78	B9ES	2611	0,5	B9EVX	7254	202	BR9EIX	3981
KX 5	50	01.86-	BP7HS	5111	0,5	BP7HVX	7468		BPR7HIX	5944
KX 50	50		B6HS	4510	0,5	B6HVX	7435	203	BR6HIX	3419
Lastboy	50		B7HS	5110	0,5	B7HVX	7836	204	BR7HIX	7067
M1	50	10.72-12.77	B6HS	4510	0,5	B6HVX	7435	203	BR6HIX	3419
M2	50	10.72-12.77	B6HS	4510	0,5	B6HVX	7435	203	BR6HIX	3419
M4	50	09.74-12.78	B6HS	4510	0,5	B6HVX	7435	203	BR6HIX	3419
M5	50	09.74-12.78	B6HS	4510	0,5	B6HVX	7435	203	BR6HIX	3419
MK 1S	50	01.78-08.80	B6HS	4510	0,5	B6HVX	7435	203	BR6HIX	3419
MK 2S	50	01.78-08.80	B6HS	4510	0,5	B6HVX	7435	203	BR6HIX	3419
MP 2	50	10.72-12.77	B6HS	4510	0,5	B6HVX	7435	203	BR6HIX	3419
MP 4	50	10.72-12.77	B6HS	4510	0,5	B6HVX	7435	203	BR6HIX	3419
MX 1	50		B6HS	4510	0,5	B6HVX	7435	203	BR6HIX	3419
MX 1	50	01.89-	B5HS	4210	0,5					
Optima 3	50	01.78-	B6HS	4510	0,5	B6HVX	7435	203	BR6HIX	3419
Optima 50	50		BR8HS	4322	0,5	BR8HVX	6265	212	BR8HIX	7001
Prima 2	50		BR5HS	3722	0,5					
Prima 2S	50	01.89-	B5HS	4210	0,5					
Prima 3	50		B6HS	4510	0,5	B6HVX	7435	203	BR6HIX	3419
Prima 3S	50	01.89-	B5HS	4210	0,5					
Prima 4	50		B6HS	4510	0,5	B6HVX	7435	203	BR6HIX	3419
Prima 4LN,5LN	50		B6HS	4510	0,5	B6HVX	7435	203	BR6HIX	3419

Order
No.Platin
Gold-
Palla-
diumOrder Quick
No. No.Order
No.**SACHS**

Prima 5	50		B6HS	4510	0,5	B6HVX	7435	203	BR6HIX	3419
Prima 5,5S	50	01.89-	BR5HS	3722	0,5					
Prima 6	50		B6HS	4510	0,5	B6HVX	7435	203	BR6HIX	3419
Prima G3	50		B6HS	4510	0,5	B6HVX	7435	203	BR6HIX	3419
Prima GT	50	01.89-	B5HS	4210	0,5					
Prima GT,GX	50		B6HS	4510	0,5	B6HVX	7435	203	BR6HIX	3419
Prima Presto	50		B6HS	4510	0,5	B6HVX	7435	203	BR6HIX	3419
Prima Pronto	50		B6HS	4510	0,5	B6HVX	7435	203	BR6HIX	3419
Prima S	50		B6HS	4510	0,5	B6HVX	7435	203	BR6HIX	3419
Prima SL	50		B6HS	4510	0,5	B6HVX	7435	203	BR6HIX	3419
Prima SX	50		B6HS	4510	0,5	B6HVX	7435	203	BR6HIX	3419
Sport Bike SB1	50	10.72-08.74	B8HS	5510	0,5	B8HVX	2634	205	BR8HIX	7001
Sport Bike SB2	50	10.72-08.79	B6HS	4510	0,5	B6HVX	7435	203	BR6HIX	3419
Sport Bike SB3	50	09.74-08.79	B6HS	4510	0,5	B6HVX	7435	203	BR6HIX	3419
Sport Bike SB5	50	09.74-08.76	B8HS	5510	0,5	B8HVX	2634	205	BR8HIX	7001
Supra 2D,3D	50	06.80-	B6HS	4510	0,5	B6HVX	7435	203	BR6HIX	3419
Supra 4	50	06.78-	B7HS	5110	0,5	B7HVX	7836	204	BR7HIX	7067
Supra 4GP	50	01.80-	B6HS	4510	0,5	B6HVX	7435	203	BR6HIX	3419
Supra Enduro	50	03.80-	B6HS	4510	0,5	B6HVX	7435	203	BR6HIX	3419
Ultra 50	50		B9ES	2611	0,5	B9EVX	7254	202	BR9EIX	3981
XE 5	50	01.86-	BP7HS	5111	0,5	BP7HVX	7468		BPR7HIX	5944
ZX 1	50		B7ES	1111	0,5	B7EVX	6934			
RX 9	80		B8HS	5510	0,5	B8HVX	2634	205	BR8HIX	7001
Ultra 80 LC	80		B8HS	5510	0,5	B8HVX	2634	205	BR8HIX	7001
Ultra 80 AC	80	01.82-	B7HS	5110	0,5	B7HVX	7836	204	BR7HIX	7067
XE 9	80	01.82-	B8HS	5510	0,5	B8HVX	2634	205	BR8HIX	7001
K 100 X	100		B8HS	5510	0,5	B8HVX	2634	205	BR8HIX	7001
Dirty Devil 110	110		C7HSA	4629	0,6	C7HVX	4533		CR7HIX	7544
K 125 BW Military	125	09.74-	B8HS	5510	0,5	B8HVX	2634	205	BR8HIX	7001
K 125 GS	125		B9ES	2611	0,5	B9EVX	7254	202	BR9EIX	3981
K 125 MC	125		B9ES	2611	0,5	B9EVX	7254	202	BR9EIX	3981
K 125 S	125	10.72-08.79			0,5	B9EVX	7254		BR9EIX	3981
K 125 T	125	10.72-08.79			0,5	B9EVX	7254		BR9EIX	3981
K 125 X	125		B8HS	5510	0,5	B8HVX	2634	205	BR8HIX	7001
Roadster 125 V2	125	98-	CR6HSA	2983	0,8				CR6HIX	7274
RS 125	125	97-	BR8ES	5422	0,7	BR8EVX	1262	207	BR8EIX	5044
XTC 125 V2 11kW	125	98-	BR9ES	5722	0,8	BR9EVX	1265	208	BR9EIX	3981
XTC-N 125 V2 7,8kW	125	98-	BR8ES	5422	0,8	BR8EVX	1262	207	BR8EIX	5044
ZX 125	125	97-	BR8ES	5422	0,7	BR8EVX	1262	207	BR8EIX	5044
ZX 125 11PS	125	97-	BR8ES	5422	0,6	BR8EVX	1262	207	BR8EIX	5044
ZX 125 15PS	125	97-	BR9ES	5722	0,6	BR9EVX	1265	208	BR9EIX	3981
ZZ 125 Typ B	125	01-	BR8ES	5422	0,8	BR8EVX	1262	207	BR8EIX	5044
ZZ 125 Typ A >10kW	125	01-	BR9ES	5722	0,8	BR9EVX	1265	208	BR9EIX	3981
175 GS	175		B9ES	2611	0,5	B9EVX	7254	202	BR9EIX	3981
250 GS	250		B9ES	2611	0,5	B9EVX	7254	202	BR9EIX	3981
W 2000	294		BR7ES	5122	0,5					
350 GS	350				0,5	B9EVX	7254		BR9EIX	3981
Roadster 650	650	99-	CR9E	6263	0,8	CR9EVX	5943	227	CR9EIX	3521
Roadster 800	800	01-	DPR8EA-9	4929	0,9	DPR8EVX-9	2872	221	DPR8EIX-9	2202
SAN YANG										
Bullet 50 (G5A,B)	50		BR8HSA	5539	0,6	BR8HVX	6265		BR8HIX	7001

Order
No.Platin
Gold-
Palla-
diumOrder Quick
No. No.

Iridium

Order
No.**SAN YANG**

DIO (F5A,B,E)	50		BR8HSA	5539	0,6	BR8HVX	6265		BR8HIX	7001
---------------	----	--	--------	------	-----	--------	------	--	--------	------

SANGLAS

350	350		BP6ES	7811	0,5	BP6EVX	5832		BPR6EIX	6637
400 E	400		BP6ES	7811	0,5	BP6EVX	5832		BPR6EIX	6637
400 Y (Motor Yamaha)	400		BP7ES	2412	0,7	BP7EVX	7270	206	BPR7EIX	4055
500 S/ S2-V5	500		BP6ES	7811	0,5	BP6EVX	5832		BPR6EIX	6637

SCORPA

Easy Trail	250	94-	BP5ES	6511	0,7	BP5EVX	5470		BPR5EIX	6597
SY 2001 (engine YamahaTY250Z)	250	01-			0,6	BCP6EVX	6323			
Easy Trail	280	94-	BP5ES	6511	0,7	BP5EVX	5470		BPR5EIX	6597

SHERCO

Trial Kid	50	02-							BR9EIX	3981
Trail 1,2	125	00-	BP5ES	6511	0,5	BP5EVX	5470		BPR5EIX	6597
Scottish Six Days Winner	250	00-	BP5ES	6511	0,5	BP5EVX	5470		BPR5EIX	6597
Trail 2,5	250	00-	BP5ES	6511	0,5	BP5EVX	5470		BPR5EIX	6597
Trail 2,9	250	00-	BP5ES	6511	0,5	BP5EVX	5470		BPR5EIX	6597

SHERCO- HRD

Enduro	50	02-	BR8ES	5422	0,5	BR8EVX	1262	207	BR8EIX	5044
Super Motard	50	02-	BR8ES	5422	0,5	BR8EVX	1262	207	BR8EIX	5044

SIAMOTO

Birdie 25 Mofa	25	99-	BPR6HS	7022	0,6	BPR6HVX	2740	214	BPR6HIX	4085
Birdie 50 Mokick	50	99-	BPR6HS	7022	0,6	BPR6HVX	2740	214	BPR6HIX	4085

SIMONINI IMEA

Competizione Sachs	50		B10EGV	5927	0,5	B10EVX	7335			
Indian	50		B8HS	5510	0,5	B8HVX	2634	205	BR8HIX	7001
Indian	50		B6HS	4510	0,6	B6HVX	7435	203	BR6HIX	3419
Masetti Racing	50		B10EGV	5927	0,5	B10EVX	7335			
Masetti Strada	50		B10EGV	5927	0,5	B10EVX	7335			
Mustang Rino Baby	50		B8HS	5510	0,5	B8HVX	2634	205	BR8HIX	7001
SF 150	50		B10EGV	5927	0,5	B10EVX	7335			
Speedy 2 Morini	50		B7HS	5110	0,5	B7HVX	7836	204	BR7HIX	7067
Mustang Regolarita 125	125		B10EGV	5927	0,5	B10EVX	7335			
Diamond Sachs	250		B10EGV	5927	0,5	B10EVX	7335			
Hard Racer	250		B10EGV	5927	0,5	B10EVX	7335			
Mustang 250A	250		B10EGV	5927	0,5	B10EVX	7335			
Mustang 250H20	250		B10EGV	5927	0,5	B10EVX	7335			
Mustang Cross SA	250		B10EGV	5927	0,5	B10EVX	7335			
Mustang Cross SSH20	250		B10EGV	5927	0,5	B10EVX	7335			
Shadow 250	250		B10EGV	5927	0,5	B10EVX	7335			

SIMSON

Albatros	50		B8HS	5510	0,4	B8HVX	2634	205	BR8HIX	7001
AT 50	50	09.90-	B8HS	5510	0,6	B8HVX	2634	205	BR8HIX	7001
Bunny 50	50	01.87-12.90	B8HS	5510	0,6	B8HVX	2634	205	BR8HIX	7001
Habicht 25	50		B8HS	5510	0,4	B8HVX	2634	205	BR8HIX	7001
Habicht 50	50		B8HS	5510	0,4	B8HVX	2634	205	BR8HIX	7001

Order
No.Platin
Gold-
Palla-
diumOrder
No.Quick
No.

Iridium

Order
No.**SIMSON**

Habicht 50 Basic	50		B8HS	5510	0,4	B8HVX	2634	205	BR8HIX	7001
Habicht 50 s	50		B8HS	5510	0,4	B8HVX	2634	205	BR8HIX	7001
Kleinkraftrad	50		B8HS	5510	0,4	B8HVX	2634	205	BR8HIX	7001
S 50 B1	50	01.75-12.80	B8HS	5510	0,6	B8HVX	2634	205	BR8HIX	7001
S 51 Enduro	50	01.81-12.90	B8HS	5510	0,6	B8HVX	2634	205	BR8HIX	7001
S 51 B2-4	50	01.82-12.90	B8HS	5510	0,6	B8HVX	2634	205	BR8HIX	7001
S 53	50	09.90-	B8HS	5510	0,6	B8HVX	2634	205	BR8HIX	7001
Sperber 50 Basic	50		B8HS	5510	0,4	B8HVX	2634	205	BR8HIX	7001
SR 50 CC , CCE	50	01.93-	B8HS	5510	0,6	B8HVX	2634	205	BR8HIX	7001
SR 50 XC , XCE , XG	50	06.93-	B8HS	5510	0,6	B8HVX	2634	205	BR8HIX	7001
SR 50	50	01.85-12.90	B8HS	5510	0,6	B8HVX	2634	205	BR8HIX	7001
SR 50 , 1B ,C,CE	50	09.90-	B8HS	5510	0,6	B8HVX	2634	205	BR8HIX	7001
Star 25	50	96-	B8HS	5510	0,4	B8HVX	2634	205	BR8HIX	7001
Star 25 Base E	50	96-	B8HS	5510	0,4	B8HVX	2634	205	BR8HIX	7001
Star Classic 50	50	96-	B8HS	5510	0,4	B8HVX	2634	205	BR8HIX	7001
Star Classic 50 Hot Summer	50	96-	B8HS	5510	0,4	B8HVX	2634	205	BR8HIX	7001
Trucky SD 50 CT	50		B8HS	5510	0,4	B8HVX	2634	205	BR8HIX	7001
GS 75/1	70	01.75-12.90	B8HS	5510	0,6	B8HVX	2634	205	BR8HIX	7001
Leichtkraftrad	70		B8HS	5510	0,4	B8HVX	2634	205	BR8HIX	7001
S 70 C,C,E/2	70	01.80-12.90	B8HS	5510	0,6	B8HVX	2634	205	BR8HIX	7001
Habicht 80	80		B8HS	5510	0,4	B8HVX	2634	205	BR8HIX	7001
Habicht 80 Basic	80		B8HS	5510	0,4	B8HVX	2634	205	BR8HIX	7001
Habicht 80 s	80		B8HS	5510	0,4	B8HVX	2634	205	BR8HIX	7001
Hot Summer 80	80	96-	B8HS	5510	0,4	B8HVX	2634	205	BR8HIX	7001
Sperber 80 Basic	80		B8HS	5510	0,4	B8HVX	2634	205	BR8HIX	7001
Star Classic 80	80	96-	B8HS	5510	0,4	B8HVX	2634	205	BR8HIX	7001

SOLO

712 Mofa	48		BR6HS	3922	0,7			209	BR6HIX	3419
713 Moped	48		BR7HS	4122	0,7			211	BR7HIX	7067
722 Mofa	48		BR6HS	3922	0,7			209	BR6HIX	3419
723 Moped	48		BR7HS	4122	0,7			211	BR7HIX	7067

SPARTA

Buddy	50		B6HS	4510	0,6	B6HVX	7435	203	BR6HIX	3419
Happy	50		B6HS	4510	0,6	B6HVX	7435	203	BR6HIX	3419
Lucky	50		B6HS	4510	0,6	B6HVX	7435	203	BR6HIX	3419
Sport 2V	50		B6HS	4510	0,6	B6HVX	7435	203	BR6HIX	3419
Sport 3V	50		B6HS	4510	0,6	B6HVX	7435	203	BR6HIX	3419
Tour Automatica	50		B6HS	4510	0,6	B6HVX	7435	203	BR6HIX	3419

STARFLITE

25 (Laura M48-15B)	50		B6HS	4510	0,6	B6HVX	7435	203	BR6HIX	3419
40 (Laura M48-11B)	50		B6HS	4510	0,6	B6HVX	7435	203	BR6HIX	3419
Bronco	50		B6HS	4510	0,6	B6HVX	7435	203	BR6HIX	3419
City Laura M48-15B	50		B6HS	4510	0,6	B6HVX	7435	203	BR6HIX	3419
GTM (F&S 501 BKF)	50		B6HS	4510	0,6	B6HVX	7435	203	BR6HIX	3419
GTS (F&S 50SA)	50		B8HS	5510	0,5	B8HVX	2634	205	BR8HIX	7001
Tramp (Laura M48-15)	50		B6HS	4510	0,6	B6HVX	7435	203	BR6HIX	3419

SUNDIRO

Phönix XDZ 125 TN	125	96-	DR8EA	7162	0,6	DR8EVX	6354		DR8EIX	6681
-------------------	-----	-----	-------	------	-----	--------	------	--	--------	------

Order
No.Platin
Gold-
Palla-
diumOrder Quick
No. No.Order
No.**SUZUKI**

A 50 K	50		BR8HS	4322	0,7	BR8HVX	6265	212	BR8HIX	7001
A 50 P	50		BR7HS	4122	0,7			211	BR7HIX	7067
AE 50	50	93-	BPR6HS	7022	0,7	BPR6HVX	2740	214	BPR6HIX	4085
AJ 50	50	95-	BPR7HS	6422	0,6	BPR7HVX	2938	215	BPR7HIX	5944
AJ 50 ZZ	50	95-	BPR7HS	6422	0,6	BPR7HVX	2938	215	BPR7HIX	5944
AP 50 (CA1JA)	50	95-	BPR6HS	7022	0,7	BPR6HVX	2740	214	BPR6HIX	4085
CL 50 DO	50		BP4HS	3611	0,7					
CP 50 (CA14C/E)	50		BPR6HS	7022	0,7	BPR6HVX	2740	214	BPR6HIX	4085
CP 50 H-J,L/M/N	50		BPR6HS	7022	0,7	BPR6HVX	2740	214	BPR6HIX	4085
CS 50	50		BPR4HS	7823	0,7					
CX 50	50		BPR6HS	7022	0,7	BPR6HVX	2740	214	BPR6HIX	4085
CY 50	50		BPR6HS	7022	0,7	BPR6HVX	2740	214	BPR6HIX	4085
DM 50	50		BP6HS	4511	0,7	BP6HVX	4635		BPR6HIX	4085
DR Big 50	50	89-	BR7HS	4122	0,7			211	BR7HIX	7067
DV 50	50		BP6ES	7811	0,7	BP6EVX	5832		BPR6EIX	6637
FA 50	50		BPR4HS	7823	0,7					
FR 50	50		BPR4HS	7823	0,7					
FS 50	50		BP4HA	3511	0,7					
FZ 50	50		BPR4HS	7823	0,7					
GT 50	50		BP6HS	4511	0,7	BP6HVX	4635		BPR6HIX	4085
JR 50	50	93- 94	BP4H	3310	0,7					
JR 50	50	95-	BPR4HS	7823	0,6					
JR 50 (JA143)	50		BPR4HS	7823	0,7					
K 50	50		BP7HS	5111	0,7	BP7HVX	7468		BPR7HIX	5944
Katana AY50 aircooled	50	97-	BPR6HS	7022	0,7	BPR6HVX	2740	214	BPR6HIX	4085
Katana AY50 water (Spain)	50	97-	BPR7HS	6422	0,7	BPR7HVX	2938	215	BPR7HIX	5944
Katana AY50 watercooled	50	97-	BPR6HS	7022	0,7	BPR6HVX	2740	214	BPR6HIX	4085
LT 50 (ATV)	50		BPR4HS	7823	0,7					
Maxi 50	50		B7HS	5110	0,6	B7HVX	7836	204	BR7HIX	7067
OR 50	50		BP6HS	4511	0,7	BP6HVX	4635		BPR6HIX	4085
RB 50 GAG	50	(88)	CR6HS	7023	0,7			223	CR6HIX	7274
RG 50 KE	50		BP8ES	2912	0,7	BP8EVX	2671			
RG 50 W	50		BPR8ES	3923	0,8	BPR8EVX	5573	213		
RM 50	50	90-	BR7HS	4122	0,7			211	BR7HIX	7067
RM 50	50	- 89	B7HS	5110	0,7	B7HVX	7836	204	BR7HIX	7067
RV 50	50		BP6HS	4511	0,7	BP6HVX	4635		BPR6HIX	4085
Suzy	50	95-	BPR6HS	7022	0,7	BPR6HVX	2740	214	BPR6HIX	4085
TR 50	50		BP4H	3310	0,7					
TR 50 S Magic	50	98-	BPR6HS	7022	0,7	BPR6HVX	2740	214	BPR6HIX	4085
TS 50 12,7mm	50		BP6HS	4511	0,7	BP6HVX	4635		BPR6HIX	4085
TS 50 19,0mm	50		BP6ES	7811	0,8	BP6EVX	5832		BPR6EIX	6637
TS 50 ER	50		BP6HS	4511	0,7	BP6HVX	4635		BPR6HIX	4085
TS 50 XK (SA11C)	50		BP6ES	7811	0,7	BP6EVX	5832		BPR6EIX	6637
ZR 50	50		BP6ES	7811	0,8	BP6EVX	5832		BPR6EIX	6637
RM 65	65	04-	BR10EG	3830	0,6					
CS 80	80		BPR6HS	7022	0,7	BPR6HVX	2740	214	BPR6HIX	4085
DS 80	80	93- 94	B7ES	1111	0,7	B7EVX	6934			
DS 80	80	95-	BP7ES	2412	0,6	BP7EVX	7270	206	BPR7EIX	4055
FR 80	80		BPR6HS	7022	0,7	BPR6HVX	2740	214	BPR6HIX	4085
GT 80 EX/LX	80		B8ES	2411	0,7	B8EVX	7051	201	BR8EIX	5044
JR 80 (K2)	80	02-	BR7ES	5122	0,8					
LT 80 (ATV)	80		BPR7HS	6422	0,7	BPR7HVX	2938	215	BPR7HIX	5944

Order
No.Gold-
Palladium

Platin

Order Quick
No. No.Order
No.**SUZUKI**

RG 80 G (D) (NC11A)	80		BP7ES	2412	0,8	BP7EVX	7270	206	BPR7EIX	4055
RG 80 Gamma	80		BP7ES	2412	0,8	BP7EVX	7270	206	BPR7EIX	4055
RG 80 WF	80		BPR7ES	2023	0,8	BPR7EVX	5565		BPR7EIX	4055
RM 80	80	93-	B10ES	7928	0,8	B10EVX	7335		BR10EIX	6801
RM 80 H	80		BR9ES	5722	0,8	BR9EVX	1265	208	BR9EIX	3981
RM 80 X	80	91-	BR10ES	4832	0,7	BR10EVX	3788		BR10EIX	6801
RM 80 X	80	- 90	BR9ES	5722	0,8	BR9EVX	1265	208	BR9EIX	3981
TS 80 ERX	80		B7ES	1111	0,8	B7EVX	6934			
TS 80 X (SA11A)	80		BP7ES	2412	0,7	BP7EVX	7270	206	BPR7EIX	4055
TS 80 XE-H	80		BP8ES	2912	0,8	BP8EVX	2671			
RM 85 (K2)(K3)(K4)	85	02-	BR10ES	4832	0,8	BR10EVX	3788		BR10EIX	6801
FM 90	90		BPR6HS	7022	0,7	BPR6HVX	2740	214	BPR6HIX	4085
RV 90	90		BP6HS	4511	0,6	BP6HVX	4635		BPR6HIX	4085
A 100	100	95-	BP6HS	4511	0,6	BP6HVX	4635		BPR6HIX	4085
FB 100 / D	100	95-	D8EA	2120	0,6	D8EVX	2850	216	DR8EIX	6681
GP 100	100		B8HS	5510	0,7	B8HVX	2634	205	BR8HIX	7001
RM 100	100				0,6	B9EGV	5827			
RM 100 X	100				0,6	B9EGV	5827			
TS 100 X	100	78-	B8ES	2411	0,7	B8EVX	7051	201	BR8EIX	5044
TS 100 X	100	- 77	B8HS	5510	0,7	B8HVX	2634	205	BR8HIX	7001
DR-Z 110 (LX110A)	111	03-	CR6HSA	2983	0,7				CR6HIX	7274
125 Van Van	125	03-	CR8E	1275	0,6	CR8EVX	6487	226	CR8EIX	4218
CS 125	125		DR8ESL	2923	0,7	DR8EVX	6354	218	DR8EIX	6681
DR 125 S/L-N	125	91-	DR8ESL	2923	0,7	DR8EVX	6354	218	DR8EIX	6681
DR 125 SE (SF44A)	125	95-	DR8EA	7162	0,6	DR8EVX	6354		DR8EIX	6681
DR 125 SJ (SF43B)	125		DR8ESL	2923	0,7	DR8EVX	6354	218	DR8EIX	6681
GN 125	125	91-	DR8ESL	2923	0,7	DR8EVX	6354	218	DR8EIX	6681
GN 125 V (NF41A)	125	97-	DR8EA	7162	0,7	DR8EVX	6354		DR8EIX	6681
GP 125	125		B8HS	5510	0,7	B8HVX	2634	205	BR8HIX	7001
GS 125 S	125		DR8ESL	2923	0,9	DR8EVX	6354	218	DR8EIX	6681
GS 125 S	125	99-	DR8EA	7162	0,7	DR8EVX	6354		DR8EIX	6681
GT 125,-E	125		B8HS	5510	0,7	B8HVX	2634	205	BR8HIX	7001
GZ 125 / U (AP) Marauder	125	99-	DR8EA	7162	0,7	DR8EVX	6354		DR8EIX	6681
RG 125	125	01.85-	BR9ES	5722	0,7	BR9EVX	1265	208	BR9EIX	3981
RM 125	125	93- 95	R4118S-9	3245	0,6					
RM 125	125	87- 92			0,6	BR9EVX	1265		BR9EIX	3981
RM 125	125	96-	R6918B-8	4492	0,6					
RM 125	125	- 86			0,6	B9EGV	5827			
RV 125	125		B7HS	5110	0,6	B7HVX	7836	204	BR7HIX	7067
RC 125	125		B7HS	5110	0,6	B7HVX	7836	204	BR7HIX	7067
TS 125	125	01.75-12.85	BR8ES	5422	0,8	BR8EVX	1262	207	BR8EIX	5044
TS 125 R	125		BR9ES	5722	0,8	BR9EVX	1265	208	BR9EIX	3981
TS 125 RC,C2,ER	125	- 86	BR9ES	5722	0,7	BR9EVX	1265	208	BR9EIX	3981
TS 125 X	125		BR8ES	5422	0,8	BR8EVX	1262	207	BR8EIX	5044
TU 125 XT (AZ)	125	99-	DR8EA	7162	0,7	DR8EVX	6354		DR8EIX	6681
UE 125 C (WVBH)	125	01-	CR7E	4578	0,6			225	CR7EIX	7385
VL 125 LC Intruder	125	00-	CR8E	1275	0,6	CR8EVX	6487	226	CR8EIX	4218
LT 160 E (ATV)	160	- 92	D7EA	7912	0,7	D7EVX	2734			
LT 160 E (ATV)	160	93-	DPR7EA-9	5129	0,9	DPR7EVX-9	7682	220	DPR7EIX-9	7803
LT 160 F (ATV)	160	93-	DP7EA-9	5629	0,9	DPR7EVX-9	7682		DPR7EIX-9	7803
LT-F 160 (ATV)	160	95-	DP7EA-9	5629	0,9	DPR7EVX-9	7682		DPR7EIX-9	7803
PE 175	175	79-			0,6	B10EGV	5927			

Order
No.Platin
Gold-
Palla-
diumOrder Quick
No. No.

Iridium

Order
No.**SUZUKI**

PE 175	175	(78)			0,6	B8EGV	5627			
GT 185	185		B7HS	5110	0,7	B7HVX	7836	204	BR7HIX	7067
TS 185 ER	185	93-	BP7ES	2412	0,8	BP7EVX	7270	206	BPR7EIX	4055
DR 200 SZ	200	95-	DR8EA	7162	0,6	DR8EVX	6354		DR8EIX	6681
GT 200	200		B8ES	2411	0,8	B8EVX	7051	201	BR8EIX	5044
TS 200	200		BR9ES	5722	0,8	BR9EVX	1265	208	BR9EIX	3981
LT 230 E (ATV)	230	93-	D7EA	7912	0,7	D7EVX	2734			
LT 230 E/F (ATV)	230		DR7ES	3123	0,7					
LT 230 GE (ATV)	230		D7EA	7912	0,7	D7EVX	2734			
DR 250	250	91-	DPR9EA-9	5329	0,9	DPR9EVX-9	3854	222	DPR9EIX-9	5545
DR 250 S	250	90-	DPR9EA-9	5329	0,9	DPR9EVX-9	3854	222	DPR9EIX-9	5545
DR 250 S (SJ42A)	250		DR8ESL	2923	0,7	DR8EVX	6354	218	DR8EIX	6681
DR 250 SZ	250	95-	DPR9EA-9	5329	0,8	DPR9EVX-9	3854	222	DPR9EIX-9	5545
DR 250 SZ-H	250		DR8ESL	2923	0,7	DR8EVX	6354	218	DR8EIX	6681
GN 250 EZ-J	250		DR8ESL	2923	0,7	DR8EVX	6354	218	DR8EIX	6681
GN 250 L-N (NJ42A)	250	- 97	DR8ESL	2923	0,7	DR8EVX	6354	218	DR8EIX	6681
GN 250 (NJ42A)	250	98-	DR8EA	7162	0,7	DR8EVX	6354		DR8EIX	6681
GNX 250	250	01.82-12.84	DR8ESL	2923	0,7	DR8EVX	6354	218	DR8EIX	6681
GSX 250 EZ (GJ53B)	250		DR8ES	5423	0,7	DR8EVX	6354	217	DR8EIX	6681
GSX 250 L	250		DR8ES	5423	0,7	DR8EVX	6354	217	DR8EIX	6681
GSX 250 T/ET 1	250		DR8ES	5423	0,7	DR8EVX	6354	217	DR8EIX	6681
GZ 250 (JS1AR)	250	99-	DR8EA	7162	0,7	DR8EVX	6354		DR8EIX	6681
LT 250 4WD/F4WD (ATV)	250	- 94	DR7ES	3123	0,7					
LT 250 E/EF (ATV)	250	93-	D8EA	2120	0,7	D8EVX	2850	216	DR8EIX	6681
LT 250 EF (ATV)	250		DR8ESL	2923	0,7	DR8EVX	6354	218	DR8EIX	6681
LT 250 R (ATV)	250				0,6	BR8EVX	1262		BR8EIX	5044
LT 250 R (ATV)	250	93-			0,6	B9EGV	5827			
LT 250 S (ATV)	250		DPR7EA-9	5129	0,9	DPR7EVX-9	7682	220	DPR7EIX-9	7803
LTF 250 (ATV)	250	93-	DR7ES	3123	0,7					
LTF 250 (ATV)	250	- 94	DR7ES	3123	0,7					
LTF 250 (ATV)	250	95-	D7EA	7912	0,6	D7EVX	2734			
PE 250	250	80-			0,6	B10EGV	5927			
PE 250	250	- 78			0,6	B8EGV	5627			
PE 250	250	(79)			0,6	B9EGV	5827			
RG 250 CH/FCH (GJ21D)	250		BR9ES	5722	0,7	BR9EVX	1265	208	BR9EIX	3981
RG 250 G-CH	250		BR9ES	5722	0,8	BR9EVX	1265	208	BR9EIX	3981
RG 250 WE (GJ21A)	250		BR9ES	5722	0,8	BR9EVX	1265	208	BR9EIX	3981
RGV 250 L (VJ21A)	250	(90)	BR9ES	5722	0,8	BR9EVX	1265	208	BR9EIX	3981
RGV 250 M-N (VJ22B)	250	91-	BR9ECM	3252	0,8	BR9ECMVX	2434			
RM 250 (JS1RJ18A)(K2,K3,K4)	250	01- 03	BR8EG	3130	0,6					
RM 250	250	- 81			0,6	B9EGV	5827			
RM 250	250	82- 92			0,6	B8EGV	5627			
RM 250	250	93- 00	R4118S-8	3236	0,6					
RMX 250	250				0,6	B9EGV	5827			
RM-Z 250	250	04-	CR8EB	7784	0,6	CR8EVX	6487		CR8EIX	4218
TS 250 X G-K (SJ11D)	250		BR9ES	5722	0,8	BR9EVX	1265	208	BR9EIX	3981
LT-4 WDX (ATV)	280	95-	D7EA	7912	0,6	D7EVX	2734			
LT-4WD / F4WD (ATV)	280	95-	DR7EA	7839	0,6					
LT-F4WDX (ATV)	280	93- 94	DR7ES	3123	0,7					
LT-300 (ATV)	300	87- 89	D8EA	2120	0,6	D8EVX	2850	216	DR8EIX	6681
LT-F 300 (ATV)	300	99-	D7EA	7912	0,6	D7EVX	2734			
350 Goose	350	93-	CR9EK	4548	0,7			230	CR9EIX	3521

Order
No.Gold-
Palla-
diumOrder Quick
No. No.

Iridium

Order
No.**SUZUKI**

DR 350	350	95-	CR9EK	4548	0,6			230	CR9EIX	3521
DR 350 S/L-P (SK42B)	350	91-	DPR9EA-9	5329	0,9	DPR9EVX-9	3854	222	DPR9EIX-9	5545
DR 350 SH/N/S	350	90-	DPR9EA-9	5329	0,9	DPR9EVX-9	3854	222	DPR9EIX-9	5545
DR 350 SZ	350	95-	CR9EK	4548	0,6			230	CR9EIX	3521
DR 400 S	400	01.80-12.83	DR8ESL	2923	0,7	DR8EVX	6354	218	DR8EIX	6681
DR-Z 400 (WVBC)	400	00-	CR8E	1275	0,6	CR8EVX	6487	226	CR8EIX	4218
DR-Z 400 S (WVBC)	400	00-	CR8E	1275	0,6	CR8EVX	6487	226	CR8EIX	4218
GN 400 TD-X	400		DR8ESL	2923	0,7	DR8EVX	6354	218	DR8EIX	6681
GS 400 R/C/EC/N/EN	400		B8ES	2411	0,7	B8EVX	7051	201	BR8EIX	5044
GS 400 TX	400		B8ES	2411	0,7	B8EVX	7051	201	BR8EIX	5044
GSF 400 (BANDIT GK75B)	400	- 92	CR8EK	3478	0,7					
GSF 400 (BANDIT GK75B)	400	92-	CR9EK	4548	0,7			230	CR9EIX	3521
GSX 400 E (GS40X)	400	01.83-	DR8ESL	2923	0,7	DR8EVX	6354	218	DR8EIX	6681
GSX 400 FW	400		CR8HS	7423	0,7	CR8HVX	7236		CR8HIX	7669
GSX 400 FX	400		DR8ESL	2923	0,6	DR8EVX	6354	218	DR8EIX	6681
GSX 400 LX	400		DR8ESL	2923	0,7	DR8EVX	6354	218	DR8EIX	6681
GSX 400 S	400		DR8ESL	2923	0,6	DR8EVX	6354	218	DR8EIX	6681
GSX 400 SE/EF (GK53C)	400		DR8ESL	2923	0,7	DR8EVX	6354	218	DR8EIX	6681
GSX-R400	400	93-	CR9EK	4548	0,7			230	CR9EIX	3521
GSX-R400	400		CR8EK	3478	0,7					
LT-A 400 (ATV)	400	02-	CR7E	4578	0,6			225	CR7EIX	7385
LT-A 400F (ATV)	400	02-	CR7E	4578	0,6			225	CR7EIX	7385
LT-F 400F (ATV)	400	02-	CR7E	4578	0,6			225	CR7EIX	7385
LT-F 400 (ATV)	400	02-	CR7E	4578	0,6			225	CR7EIX	7385
LT-Z 400 (ATV)	400	02-	CR7E	4578	0,6			225	CR7EIX	7385
VS 400	400	95-	DPR8EA-9	4929	0,8	DPR8EVX-9	2872	221	DPR8EIX-9	2202
GS 450 E/ES (GS450)	450		B8ES	2411	0,7	B8EVX	7051	201	BR8EIX	5044
GS 450 L (GL51D)	450		B8ES	2411	0,7	B8EVX	7051	201	BR8EIX	5044
GS 450 LT/X (GS450)	450		B8ES	2411	0,7	B8EVX	7051	201	BR8EIX	5044
GS 450 SF	450		BR8ES	5422	0,7	BR8EVX	1262	207	BR8EIX	5044
GS 450 TX	450		B8ES	2411	0,7	B8EVX	7051	201	BR8EIX	5044
RM 495	495				0,5	B8EGV	5627			
DR 500 S (D)	500		DR8ESL	2923	0,7	DR8EVX	6354	218	DR8EIX	6681
DR 500 S (I)	500		D8EA	2120	0,7	D8EVX	2850	216	DR8EIX	6681
DR 500 SX-Z	500		DR8ESL	2923	0,7	DR8EVX	6354	218	DR8EIX	6681
GS 500 E	500	- 00	B8ES	2411	0,7	B8EVX	7051	201	BR8EIX	5044
GS 500 E (GM51B)	500	93- 00	DPR8EA-9	4929	0,9	DPR8EVX-9	2872	221	DPR8EIX-9	2202
GS 500 F	500	04-	DPR8EA-9	4929	0,9	DPR8EVX-9	2872	221	DPR8EIX-9	2202
LT-A 500F (ATV)	500	00-	CR6E	6965	0,6					
LT-F 500 (ATV)	500	98- 99	CR7E	4578	0,6			225	CR7EIX	7385
LT-F 500F (ATV)	500	00-	CR6E	6965	0,6					
RG 500	500	(87)	BR9ES	5722	0,8	BR9EVX	1265	208	BR9EIX	3981
RM 500	500				0,5	B8EGV	5627			
GS 550 MX/LN/T	550		B8ES	2411	0,7	B8EVX	7051	201	BR8EIX	5044
GSX 550 (GN71D)	550		DR8ES	5423	0,7	DR8EVX	6354	217	DR8EIX	6681
GSX 550 EF (I)	550		DP9EA-9	6629	0,9	DP9EVX-9	3331		DPR9EIX-9	5545
GT 550	550	01.73-12.77	B8ES	2411	0,7	B8EVX	7051	201	BR8EIX	5044
DR 600	600		DPR9EA-9	5329	0,9	DPR9EVX-9	3854	222	DPR9EIX-9	5545
DR 600 R Djebel (I)	600		DPR9EA-9	5329	0,9	DPR9EVX-9	3854	222	DPR9EIX-9	5545
DR 600 S (SN41A)	600		DPR9EA-9	5329	0,9	DPR9EVX-9	3854	222	DPR9EIX-9	5545
GSF 600 Y (WVA8)	600	00-	CR9EK	4548	0,6			230	CR9EIX	3521
GSF 600 (GN77B)	600	95-	CR9EK	4548	0,7			230	CR9EIX	3521

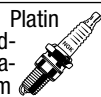
Order
No.Gold-
Palla-
diumOrder
No.Quick
No.

Iridium

Order
No.**SUZUKI**

GSF 600 (K2)	600	02-	CR9EK	4548	0,6			230	CR9EIX	3521
GSF 600 S (K2)	600	02-	CR9EK	4548	0,6			230	CR9EIX	3521
GSX 600 F (W)	600	98-	CR9EK	4548	0,7			230	CR9EIX	3521
GSX 600 F/FU/FU2 (GN72B)	600		DR8ES	5423	0,7	DR8EVX	6354	217	DR8EIX	6681
GSX-R 600 (JS1AD)	600	97- 00	CR9E	6263	0,7	CR9EVX	5943	227	CR9EIX	3521
GSX-R 600 (W) (JS1BG)(WVBG)	600	98-	CR9E	6263	0,7	CR9EVX	5943	227	CR9EIX	3521
RF 600 R / RU (GN76B)	600	93-	CR9E	6263	0,7	CR9EVX	5943	227	CR9EIX	3521
VS 600 (VN51B)	600	95-	DPR8EA-9	4929	0,9	DPR8EVX-9	2872	221	DPR8EIX-9	2202
DR 650 R/RU (SP41B)	650		DPR9EA-9	5329	0,9	DPR9EVX-9	3854	222	DPR9EIX-9	5545
DR 650 R/RU (SP44B)	650		DPR9EA-9	5329	0,9	DPR9EVX-9	3854	222	DPR9EIX-9	5545
DR 650 RE (SP45B)	650	94-	DPR9EA-9	5329	0,9	DPR9EVX-9	3854	222	DPR9EIX-9	5545
DR 650 RS/RSU (SP42B)	650	91-	DPR9EA-9	5329	0,9	DPR9EVX-9	3854	222	DPR9EIX-9	5545
DR 650 RSE/RSEU (SP43B)	650	90-	DPR9EA-9	5329	0,9	DPR9EVX-9	3854	222	DPR9EIX-9	5545
DR 650 SET	650	96- 00	CR9E	6263	0,6	CR9EVX	5943	227	CR9EIX	3521
GR 650 D/XD/XF (GP51A)	650		DR8ESL	2923	0,6	DR8EVX	6354	218	DR8EIX	6681
GS 650 G	650		DR8ESL	2923	0,6	DR8EVX	6354	218	DR8EIX	6681
LS 650 (NP41B)	650	- 00	DPR8EA-9	4929	0,9	DPR8EVX-9	2872	221	DPR8EIX-9	2202
SV 650 (K3)	650	03-	CR8E	1275	0,7	CR8EVX	6487	226	CR8EIX	4218
SV 650 S (AV)	650	99-	CR9E	6263	0,6	CR9EVX	5943	227	CR9EIX	3521
SV 650 S (K3)	650	03-	CR8E	1275	0,7	CR8EVX	6487	226	CR8EIX	4218
SV 650 SU (AV)	650	99-	CR9E	6263	0,6	CR9EVX	5943	227	CR9EIX	3521
XF 650 (JS1AC) Freewind	650	97-	CR9EK	4548	0,7			230	CR9EIX	3521
DR 750 S (DR BIG SR41B)	750		DPR9EA-9	5329	0,9	DPR9EVX-9	3854	222	DPR9EIX-9	5545
GS 750 D/E/L	750		B8ES	2411	0,7	B8EVX	7051	201	BR8EIX	5044
GSX 750 E	750		DR8ESL	2923	0,6	DR8EVX	6354	218	DR8EIX	6681
GSX 750 E (I)	750		D8EA	2120	0,7	D8EVX	2850	216	DR8EIX	6681
GSX 750 EF	750	- 85	DR8ESL	2923	0,7	DR8EVX	6354	218	DR8EIX	6681
GSX 750 ES (I)	750		D8EA	2120	0,7	D8EVX	2850	216	DR8EIX	6681
GSX 750 F (GR78A)	750	89-	JR9C	6193	0,7					
GSX 750 S	750		DR8ESL	2923	0,6	DR8EVX	6354	218	DR8EIX	6681
GSX 750 S Katana (I)	750		DR8EA	7162	0,7	DR8EVX	6354		DR8EIX	6681
GSX 750 T	750		DR8ESL	2923	0,6	DR8EVX	6354	218	DR8EIX	6681
GSX 750 (W)(AK)	750	98-	CR9EK	4548	0,7			230	CR9EIX	3521
GSX R 750 (GR75A)	750	- 87	DR8ES	5423	0,7	DR8EVX	6354	217	DR8EIX	6681
GSX R 750 (GR77B)	750	88-	JR9C	6193	0,7					
GSX-R 750 Y (WVBD)	750	00-	CR9E	6263	0,7	CR9EVX	5943	227	CR9EIX	3521
GSX-R 750 (GR7AB)	750	91-	CR10EK	2360	0,7					
GSX-R 750 J-K	750		JR9B	3188	0,7			224		
GSX-R 750 R	750	89-	CR10EK	2360	0,7					
GSX-R 750 RG (GR75A)(GR79B)	750		DR8ES	5423	0,7	DR8EVX	6354	217	DR8EIX	6681
GSX-R 750 T	750	96-	CR9E	6263	0,6	CR9EVX	5943	227	CR9EIX	3521
GSX-R 750 W	750	95-	CR9E	6263	0,6	CR9EVX	5943	227	CR9EIX	3521
GSX-R 750 (W)	750	98-	CR9E	6263	0,7	CR9EVX	5943	227	CR9EIX	3521
GSX-R 750 W (GR7BB)	750	- 93	CR9EK	4548	0,7			230	CR9EIX	3521
VS 750 GL/H/J-K	750		DPR9EA-9	5329	0,9	DPR9EVX-9	3854	222	DPR9EIX-9	5545
DR 800 S/SU L (SR42B)	773	90-	DPR9EA-9	5329	0,9	DPR9EVX-9	3854	222	DPR9EIX-9	5545
DR 800 S/SU M-N (SR43B)	800		DPR9EA-9	5329	0,9	DPR9EVX-9	3854	222	DPR9EIX-9	5545
VL 800 (K2) (WVBM) Intruder	800	01-	DPR7EA-9	5129	0,9	DPR7EVX-9	7682	220	DPR7EIX-9	7803
VS 800 N-P (VS52B)	800	92- 00	DPR8EA-9	4929	0,9	DPR8EVX-9	2872	221	DPR8EIX-9	2202
VX 800/U (VS51B)	800		DPR8EA-9	4929	0,9	DPR8EVX-9	2872	221	DPR8EIX-9	2202
VZ 800 (JS1AF)Marauder	800	97-	DPR8EA-9	4929	0,9	DPR8EVX-9	2872	221	DPR8EIX-9	2202
GS 850 G (GS72A)	850		B8ES	2411	0,7	B8EVX	7051	201	BR8EIX	5044

Order
No.Platin
Gold-
Palla-
diumOrder Quick
No. No.Order
No.**SUZUKI**

GS 850 GL	850		B8ES	2411	0,7	B8EVX	7051	201	BR8EIX	5044
GS 850 GT E-G (GS72A)	850		B9ES	2611	0,7	B9EVX	7254	202	BR9EIX	3981
RF 900 R (GT73B)	900	94-	CR9E	6263	0,7	CR9EVX	5943	227	CR9EIX	3521
GS 1000 D/E/H/S-1980/GL/GX	1000		B8ES	2411	0,7	B8EVX	7051	201	BR8EIX	5044
GSX 1000 E	1000	86-	DPR9EA-9	5329	0,9	DPR9EVX-9	3854	222	DPR9EIX-9	5545
GSX R 1000	1000	- 99	JR9B	3188	0,7			224		
GSX R 1000 (WVBL) Fuel Injection	1000	01-	CR9E	6263	0,7	CR9EVX	5943	227	CR9EIX	3521
GSX-R 1000 (K3) (WVBZ)	1000	03-	CR9E	6263	0,7	CR9EVX	5943	227	CR9EIX	3521
SV 1000 (WVBX)	1000	03-	CR8EK	3478	0,7					
SV 1000 S (WVBX)	1000	03-	CR8EK	3478	0,7					
TL 1000 R (W)	1000	98-	CR9EK	4548	0,7			230	CR9EIX	3521
TL 1000 S (JS1AG)	1000	97- 00	CR8EK	3478	0,7					
V-Strom 1000	1000	02-	CR8EK	3478	0,7					
GS 1100 E,GSX 1100 E	1100		DR8ESL	2923	0,6	DR8EVX	6354	218	DR8EIX	6681
GS 1100 G /GG (GU71A)	1100		B8ES	2411	0,8	B8EVX	7051	201	BR8EIX	5044
GS 1100 GT	1100		B8ES	2411	0,7	B8EVX	7051	201	BR8EIX	5044
GSX 1100 EFE (I)	1100		D8EA	2120	0,7	D8EVX	2850	216	DR8EIX	6681
GSX 1100 EFG/ESG/EG(GV71C)	1100		DR8ES	5423	0,7	DR8EVX	6354	217	DR8EIX	6681
GSX 1100 EZ/ESD (GU71B)	1100		DR8ESL	2923	0,6	DR8EVX	6354	218	DR8EIX	6681
GSX 1100 F (GV72C)72-100kW	1100		JR9B	3188	0,7			224		
GSX 1100 G L-N (GV74A)	1100		JR9B	3188	0,7			224		
GSX 1100 S/SZ Kata.(GS110XS)	1100		D8EA	2120	0,7	D8EVX	2850	216	DR8EIX	6681
GSX-K 1100 (I)	1100		JR9B	3188	0,7			224		
GSX R-1100 W (GU75C)	1100	93-	CR9E	6263	0,7	CR9EVX	5943	227	CR9EIX	3521
GSX-R 1100 (GU74C,GV73C)	1100		JR9B	3188	0,7			224		
GS 1150 EF (NL,I)	1150		D9EA	2420	0,7	D9EVX	2834		DR9EIX	4772
GS 1150 ES (NL,I)	1150		D9EA	2420	0,7	D9EVX	2834		DR9EIX	4772
GSX 1150 E	1150	86-	DPR9EA-9	5329	0,9	DPR9EVX-9	3854	222	DPR9EIX-9	5545
GSX 1150 E	1150	- 85	DR8ES	5423	0,7	DR8EVX	6354	217	DR8EIX	6681
GSX 1150 EF	1150		DR8ES	5423	0,7	DR8EVX	6354	217	DR8EIX	6681
GSX 1150 ES	1150		DR8ES	5423	0,7	DR8EVX	6354	217	DR8EIX	6681
GSF 1200 / S (JS1A9..)(WVA9)	1200	01-	JR9B	3188	0,7			224		
GSF 1200 /S/SA	1200	96-	JR9B	3188	0,7			224		
GSX 1200	1200		JR8B	7237	0,7					
GV 1200 GL	1200	86-	DR8ESL	2923	0,7	DR8EVX	6354	218	DR8EIX	6681
GSX 1300 R Hayabusa (WV A1)	1300	99-	CR9E	6263	0,7	CR9EVX	5943	227	CR9EIX	3521
GSX 1400	1400	01-	CR8EK	3478	0,7					
VS 1400 GLP H-J (VX51L)	1400		DPR8EA-9	4929	0,9	DPR8EVX-9	2872	221	DPR8EIX-9	2202
VL 1500 Intruder LC	1500	98-	DPR7EA-9	5129	0,9	DPR7EVX-9	7682	220	DPR7EIX-9	7803
VZ 1600 Marauder 1600	1600	04-	DPR6EA-9	5531	0,9					

SV

Dakar 2/3	35		BPM6A	7021	0,5					
Triciclo Mini-Dakar	35		BPM6A	7021	0,5					

SWM

TLM 125	125		BP5ES	6511	0,4	BP5EVX	5470		BPR5EIX	6597
TL 200	200		BP5ES	6511	0,4	BP5EVX	5470		BPR5EIX	6597
TL 240	240		BP5ES	6511	0,4	BP5EVX	5470		BPR5EIX	6597
TLM 320	320		BP5ES	6511	0,4	BP5EVX	5470		BPR5EIX	6597
TL 350	350		BP5ES	6511	0,4	BP5EVX	5470		BPR5EIX	6597

Order
No.Platin
Gold-
Palla-
diumOrder Quick
No. No.

Iridium

Order
No.**SYM**

Husky	125	97-	DR8EA	7162	0,7	DR8EVX	6354		DR8EIX	6681
-------	-----	-----	-------	------	-----	--------	------	--	--------	------

TESTI

Amico (Minarelli V1)	50		B5HS	4210	0,5					
Carabo CR (8.5PS)	50		B8HS	5510	0,5	B8HVX	2634	205	BR8HIX	7001
Carabo(Minarelli P4A)	50		B6HS	4510	0,6	B6HVX	7435	203	BR6HIX	3419
Carabo(Minarelli P6CS)	50		B6HS	4510	0,6	B6HVX	7435	203	BR6HIX	3419
Carabo(Minarelli P6RAD)	50		B6ES	7310	0,7	B6EVX	5136			
Champion Special(Minarelli P6CS)	50		B6HS	4510	0,6	B6HVX	7435	203	BR6HIX	3419
Champion Special(Minarelli P6RAD)	50		B6ES	7310	0,7	B6EVX	5136			
Champion(Minarelli P4/P6RAD)	50		B6ES	7310	0,7	B6EVX	5136			
Champion(Minarelli P4A/CS)	50		B6HS	4510	0,6	B6HVX	7435	203	BR6HIX	3419
Champion(Minarelli P6A/CS)	50		B6HS	4510	0,6	B6HVX	7435	203	BR6HIX	3419
Confort (Minarelli V1N)	50		B5HS	4210	0,5					
Confort(Minarelli P3NK)	50		B6HS	4510	0,6	B6HVX	7435	203	BR6HIX	3419
Corsa (8.5PS)	50		B8HS	5510	0,5	B8HVX	2634	205	BR8HIX	7001
Criket (Minarelli V1AK/NK)	50		B5HS	4210	0,5					
Criket(Minarelli P4A)	50		B6HS	4510	0,6	B6HVX	7435	203	BR6HIX	3419
Criket(Minarelli P4CS/RAD)	50		B6ES	7310	0,7	B6EVX	5136			
Gran Prix(Minarelli P4A)	50		B6HS	4510	0,6	B6HVX	7435	203	BR6HIX	3419
IO (Minarelli V1AKS)	50		B5HS	4210	0,5					
Jeans(Minarelli P4/P6 RAD)	50		B6ES	7310	0,7	B6EVX	5136			
Mini Criket (Minarelli V1N/AK)	50		B5HS	4210	0,5					
O.K.C. (Minarelli C2)	50		B5HS	4210	0,5					
O.K.S. (Minarelli V1N)	50		B5HS	4210	0,5					
Pull (Minarelli V1NK)	50		B5HS	4210	0,5					
Grand Touring (Minarelli)	80		B8HS	5510	0,5	B8HVX	2634	205	BR8HIX	7001
2000 Special	125		B8ES	2411	0,5	B8EVX	7051	201	BR8EIX	5044
Corsa	125		B8ES	2411	0,5	B8EVX	7051	201	BR8EIX	5044
Corsa Easy Rider	125		B8ES	2411	0,5	B8EVX	7051	201	BR8EIX	5044

TGB

202T big wvells	50	98-	BPR7HS	6422	0,8	BPR7HVX	2938	215	BPR7HIX	5944
Ergon	50	98-	BPR7HS	6422	0,8	BPR7HVX	2938	215	BPR7HIX	5944
202T Palio	125	98-	C7HSA	4629	0,7	C7HVX	4533		CR7HIX	7544

TITAN

Coyote	1573	97- 03	BPR5ES	7422	0,7	BPR5EVX	4875		BPR5EIX	6597
Gecko	1573	97- 03	BPR5ES	7422	0,7	BPR5EVX	4875		BPR5EIX	6597
Roadrunner	1573	97- 03	BPR5ES	7422	0,7	BPR5EVX	4875		BPR5EIX	6597
Scorpion	1573	97- 03	BPR5ES	7422	0,7	BPR5EVX	4875		BPR5EIX	6597
Sidewinder	1573	97- 03	BPR5ES	7422	0,7	BPR5EVX	4875		BPR5EIX	6597

TM

Cross, Enduro	80	94-	B9EG	3530	0,6	B9EGV	5827		BR9EIX	3981
125 EN	125	03-	BR9EG	3230	0,6	BR9EVX	1265		BR9EIX	3981
Cross, Enduro	125	94-	B10EG	3630	0,6	B10EGV	5927			
250 EN	250	03-	BR8EG	3130	0,5					
250 EN-F	250	04-	CR8E	1275	0,7	CR8EVX	6487	226	CR8EIX	4218
Cross, Enduro	250	94-	B9EG	3530	0,6	B9EGV	5827		BR9EIX	3981
300 EN	300	03-	BR8EG	3130	0,5					
Cross, Enduro	300		B9EG	3530	0,6	B9EGV	5827		BR9EIX	3981

Order
No.Platin
Gold-
Palla-
diumOrder Quick
No. No.Order
No.

										TM
450 EN-F	450	04-	CR8E	1275	0,7	CR8EVX	6487	226	CR8EIX	4218
										TOKAIDO
RC 25	25		B5HS	4210	0,8					
										TOMOS
Forza	49		BPR8HS	3725	0,6				BPR8HIX	6742
Quadro 25	49		B6HS	4510	0,6	B6HVX	7435	203	BR6HIX	3419
Tomos	50		B7HS	5110	0,5	B7HVX	7836	204	BR7HIX	7067
Tomos Cross	50		B8HS	5510	0,5	B8HVX	2634	205	BR8HIX	7001
Tomos	80		B7HS	5110	0,5	B7HVX	7836	204	BR7HIX	7067
										TORROT
Ciclomatic/ 2VL	50		B7HS	5110	0,5	B7HVX	7836	204	BR7HIX	7067
City CX/N/SL/X	50		B7HS	5110	0,5	B7HVX	7836	204	BR7HIX	7067
City/L/2V/2V-TT	50		B6HS	4510	0,5	B6HVX	7435	203	BR6HIX	3419
Cycloscooter S50/HL	50		B6HS	4510	0,5	B6HVX	7435	203	BR6HIX	3419
Gran Cross,Maxi,Mini	50		B5HS	4210	0,5					
Mustang,Panther,Tiburon	50		B5HS	4210	0,5					
Sport Sachs TX50, TT50	50		B7HS	5110	0,5	B7HVX	7836	204	BR7HIX	7067
Super Cross/Rally Sachs	50		B7HS	5110	0,5	B7HVX	7836	204	BR7HIX	7067
Trial,Turismo	50		B5HS	4210	0,5					
										TRAILBLAZER
170 (ATV)	170	04-	DR8EA	7162	0,7	DR8EVX	6354		DR8EIX	6681
										TRAILSPORT
TS-500 5.0hp (ATV)		04-	BR2LM	5798	0,6			310		
TSB-600 6.0hp (ATV)		04-	BR2LM	5798	0,6			310		
										TRIUMPH
Daytona 600	600	03-	CR9EK	4548	0,7			230	CR9EIX	3521
Speed Four	600	02-	CR9EK	4548	0,7			230	CR9EIX	3521
Speed Triple S	600	02-	CR9EK	4548	0,7			230	CR9EIX	3521
Supersport	600	01-	CR9EK	4548	0,7			230	CR9EIX	3521
TT 600 (806AD)	600	00-	CR9EK	4548	0,7			230	CR9EIX	3521
Bonneville T120, R, V	650		B8ES	2411	0,5	B8EVX	7051	201	BR8EIX	5044
Tiger, Trophy Sport TR6C	650		B8ES	2411	0,5	B8EVX	7051	201	BR8EIX	5044
Trophy TR6 --> Nr.029363	650		B7HS	5110	0,5	B7HVX	7836	204	BR7HIX	7067
Trophy TR6 Nr.029364 -->	650		B7ES	1111	0,5	B7EVX	6934			
Bonneville T140D/E	750		B6ES	7310	0,5	B6EVX	5136			
Bonneville T140V	750		B8ES	2411	0,5	B8EVX	7051	201	BR8EIX	5044
Daytona 750	750	91-	DPR8EA-9	4929	0,9	DPR8EVX-9	2872	221	DPR8EIX-9	2202
Hurricane TRX75	750		B8ES	2411	0,5	B8EVX	7051	201	BR8EIX	5044
Speed Triple 750	750	97-	DPR8EA-9	4929	0,9	DPR8EVX-9	2872	221	DPR8EIX-9	2202
Sprint RS	750	99-	DPR8EA-9	4929	0,9	DPR8EVX-9	2872	221	DPR8EIX-9	2202
Tiger TR7RV, TR7V	750		B8ES	2411	0,5	B8EVX	7051	201	BR8EIX	5044
Trident T150V, T160	750		B8ES	2411	0,5	B8EVX	7051	201	BR8EIX	5044
Trident 750	750	91-	DPR8EA-9	4929	0,9	DPR8EVX-9	2872	221	DPR8EIX-9	2202
Bonneville (908MD)	790	00-	DPR8EA-9	4929	0,9	DPR8EVX-9	2872	221	DPR8EIX-9	2202
Bonneville America(908M)	790	02-	DPR8EA-9	4929	0,9	DPR8EVX-9	2872	221	DPR8EIX-9	2202
Bonneville T100	790	02-	DPR8EA-9	4929	0,9	DPR8EVX-9	2872	221	DPR8EIX-9	2202



Order No.



Platin Gold-Palladium

Order Quick No. No.

Iridium



Order No.

TRIUMPH

Speedmaster	790	02-	DPR8EA-9	4929	0,9	DPR8EVX-9	2872	221	DPR8EIX-9	2202
Thruxton 900	865	04-	DPR8EA-9	4929	0,9	DPR8EVX-9	2872	221	DPR8EIX-9	2202
Adventurer	885	96-	DPR8EA-9	4929	0,9	DPR8EVX-9	2872	221	DPR8EIX-9	2202
Daytona 900	885	93- 96	DPR8EA-9	4929	0,9	DPR8EVX-9	2872	221	DPR8EIX-9	2202
Legend TT	885	98-	DPR9EA-9	5329	0,9	DPR9EVX-9	3854	222	DPR9EIX-9	5545
Daytona Super III	885	94-	DPR8EA-9	4929	0,9	DPR8EVX-9	2872	221	DPR8EIX-9	2202
Speed Triple	885	94- 96	DPR8EA-9	4929	0,9	DPR8EVX-9	2872	221	DPR8EIX-9	2202
Speed Triple T509	885	97-	DPR8EA-9	4929	0,9	DPR8EVX-9	2872	221	DPR8EIX-9	2202
Sport	885	98-	DPR8EA-9	4929	0,9	DPR8EVX-9	2872	221	DPR8EIX-9	2202
Sport Sprint 900	885	97-	DPR8EA-9	4929	0,9	DPR8EVX-9	2872	221	DPR8EIX-9	2202
Sprint	885	95-	DPR8EA-9	4929	0,9	DPR8EVX-9	2872	221	DPR8EIX-9	2202
Sprint 900	885	93-	DPR8EA-9	4929	0,9	DPR8EVX-9	2872	221	DPR8EIX-9	2202
Sprint Executive	885	98-	DPR8EA-9	4929	0,9	DPR8EVX-9	2872	221	DPR8EIX-9	2202
Sprint ST	885	99-	DPR8EA-9	4929	0,9	DPR8EVX-9	2872	221	DPR8EIX-9	2202
Thunderbird (T309RT)	885	95-	DPR8EA-9	4929	0,9	DPR8EVX-9	2872	221	DPR8EIX-9	2202
Thunderbird Sport	885	98- 00	DPR8EA-9	4929	0,9	DPR8EVX-9	2872	221	DPR8EIX-9	2202
Tiger 900 T400	885	93- 98	DPR8EA-9	4929	0,9	DPR8EVX-9	2872	221	DPR8EIX-9	2202
Tiger	885	99-	DPR8EA-9	4929	0,9	DPR8EVX-9	2872	221	DPR8EIX-9	2202
Trident 900	885	91-	DPR8EA-9	4929	0,9	DPR8EVX-9	2872	221	DPR8EIX-9	2202
Trophy 900	885	96-	DPR8EA-9	4929	0,9	DPR8EVX-9	2872	221	DPR8EIX-9	2202
Trophy 900	885	91- 95	DPR8EA-9	4929	0,9	DPR8EVX-9	2872	221	DPR8EIX-9	2202
Daytona 955i 72Kw	955	99- 00	DPR8EA-9	4929	0,9	DPR8EVX-9	2872	221	DPR8EIX-9	2202
Daytona 955i 94Kw	955	99- 01	DPR8EA-9	4929	0,9	DPR8EVX-9	2872	221	DPR8EIX-9	2202
Daytona 955i (595N)	955	02-	CR9EK	4548	0,6			230	CR9EIX	3521
Daytona Centennial Edition (595N)	955	02-	CR9EK	4548	0,6			230	CR9EIX	3521
Speed Triple (595N)	955	02-	CR9EK	4548	0,6			230	CR9EIX	3521
Sprint RS (695AC)	955	02-	CR9EK	4548	0,6			230	CR9EIX	3521
Sprint ST (695AB)	955	02-	CR9EK	4548	0,6			230	CR9EIX	3521
Tiger 955i 72Kw (709EN)	955	01-	DPR8EA-9	4929	0,9	DPR8EVX-9	2872	221	DPR8EIX-9	2202
Daytona T595	956	97-	DPR8EA-9	4929	0,9	DPR8EVX-9	2872	221	DPR8EIX-9	2202
Speed Triple	956	99- 01	DPR8EA-9	4929	0,9	DPR8EVX-9	2872	221	DPR8EIX-9	2202
Sprint ST	956	99- 01	DPR8EA-9	4929	0,9	DPR8EVX-9	2872	221	DPR8EIX-9	2202
Daytona 1000	1000	91- 92	DPR8EA-9	4929	0,9	DPR8EVX-9	2872	221	DPR8EIX-9	2202
Trophy 1200 (T300E)	1180	96-	DPR8EA-9	4929	0,9	DPR8EVX-9	2872	221	DPR8EIX-9	2202
Trophy 1200	1180	91- 95	DPR8EA-9	4929	0,9	DPR8EVX-9	2872	221	DPR8EIX-9	2202
Daytona 1200	1200	93-	DPR8EA-9	4929	0,9	DPR8EVX-9	2872	221	DPR8EIX-9	2202

UNISOM

Desert-Cat 50 (ATV)	50	04-	BR8HS	4322	0,6	BR8HVX	6265	212	BR8HIX	7001
Desert-Cat 90 (ATV)	90	04-	BR8HS	4322	0,6	BR8HVX	6265	212	BR8HIX	7001

URAL

Deco Cruiser	648	98-	BP4HS	3611	0,6					
Italia Cruiser	648	98-	BP4HS	3611	0,6					
Solo Cruiser	648	98-	BP4HS	3611	0,6					
Sportsman Classic	648	97-	BP4HS	3611	0,6					
Tourist Classic	648	97-	BP4HS	3611	0,6					
IMZ-10	650		BP4HS	3611	0,6					
IMZ-40	650		BP4HS	3611	0,6					
IMZ-50	650		BP4HS	3611	0,6					
Solo Single	650	94- 96	BP4HS	3611	0,6					
Sportsman	650	94- 96	BP4HS	3611	0,6					

Order
No.Platin
Gold-
Palla-
diumOrder Quick
No. No.Order
No.**URAL**

Tourist Sidecar	650	94- 96	BP4HS	3611	0,6					
Ural M3-8.103 23,6kW	650		BP5HS	4111	0,5					
Ural M3-8.123 26,5kW	650		BP6ES	7811	0,7	BP6EVX	5832		BPR6EIX	6637
Tourist	750		B7HS	5110	0,5	B7HVX	7836	204	BR7HIX	7067

URAL AMERICA

Bavarian Classic	650	99-			0,7	BP8HVX	2855			
Deco Classic	650	99-			0,7	BP8HVX	2855			
Deco Classic	650	97- 98	BP7HS	5111	0,7	BP7HVX	7468		BPR7HIX	5944
Deco Cruiser	650	98-	BP7HS	5111	0,7	BP7HVX	7468		BPR7HIX	5944
Italia Cruiser	650	94- 97	BP7HS	5111	0,7	BP7HVX	7468		BPR7HIX	5944
Italia Cruiser II	650	98-	BP7HS	5111	0,7	BP7HVX	7468		BPR7HIX	5944
Patrol Classic	650	99-			0,7	BP8HVX	2855			
Solo Classic	650	99-			0,7	BP8HVX	2855			
Solo Cruiser	650	98-	BP7HS	5111	0,7	BP7HVX	7468		BPR7HIX	5944
Solo Single	650	94- 97	BP7HS	5111	0,7	BP7HVX	7468		BPR7HIX	5944
Sportsman	650	94- 96	BP7HS	5111	0,7	BP7HVX	7468		BPR7HIX	5944
Sportsman Classic	650	97- 98	BP7HS	5111	0,7	BP7HVX	7468		BPR7HIX	5944
Tourist Classic	650	99-			0,7	BP8HVX	2855			
Tourist Classic	650	97- 98	BP7HS	5111	0,7	BP7HVX	7468		BPR7HIX	5944
Tourist Sidecar	650	94- 97	BP7HS	5111	0,7	BP7HVX	7468		BPR7HIX	5944

VALENTI

CR 80W Cross (Yamaha/Valent)	80				0,5	B10EGV	5927			
------------------------------	----	--	--	--	-----	--------	------	--	--	--

VELOSOLEX

2200	50		B4H	4110	0,5					
3300 /3800	50		B4H	4110	0,5					
5000	50		B4H	4110	0,5					
6000	50		B4H	4110	0,5					
8000 / 8000 GS Ténor	50		B6HS	4510	0,6	B6HVX	7435	203	BR6HIX	3419
GL Ténor	50		B6HS	4510	0,6	B6HVX	7435	203	BR6HIX	3419
GR Ténor	50		B6HS	4510	0,6	B6HVX	7435	203	BR6HIX	3419
L / R / S Ténor	50		B6ES	7310	0,7	B6EVX	5136			
Micron	50		B4H	4110	0,5					
Pli-solex	50		B4H	4110	0,5					

VERTEMATI

E 450 E	503		CR9EK	4548	0,7			230	CR9EIX	3521
E 450	503		CR9EK	4548	0,7			230	CR9EIX	3521
E 501 E	503		CR9EK	4548	0,7			230	CR9EIX	3521
E 501	503		CR9EK	4548	0,7			230	CR9EIX	3521
E 570	503		CR9EK	4548	0,7			230	CR9EIX	3521
E 570 E	503		CR9EK	4548	0,7			230	CR9EIX	3521

VOR

EN Enduro	400	00-	CR8EK	3478	0,6					
ENE	400	04-	CR8EK	3478	0,6					
EN-MAR	400	04-	CR8EK	3478	0,6					
MX Cross	400	00-	CR8EK	3478	0,6					
SM Super Moto	400	00-	CR8EK	3478	0,6					
SM Super Moto Competition	400	00-	CR8EK	3478	0,6					

Order
No.Gold-
Palla-
dium

Platin

Order Quick
No. No.

Iridium

Order
No.**VOR**

EN Enduro	503	99-	CR8EK	3478	0,6					
MX Cross	503	99-	CR8EK	3478	0,6					
SM Super Moto	503	99-	CR8EK	3478	0,6					
SM Super Moto Competition	503	99-	CR8EK	3478	0,6					
ENE	530	04-	CR8EK	3478	0,6					
EN-MAR	530	04-	CR8EK	3478	0,6					
Super Motard Com.	530	00-	CR8EK	3478	0,6					

VOXAN

Cafe Racer V 1000	1000	99-			0,8	BCPR8EVX-11	5186			
Roadster V 1000	1000	99-			0,8	BCPR8EVX-11	5186			

YAMAHA

Golf Car G2A/G9A		92-	B5ES	6410	0,7					
CA 50 (14T)	50	83- 87	BPR6HS	7022	0,7	BPR6HVX	2740	214	BPR6HIX	4085
CE 50 E	50		BP6HS-10	6326	1,0					
CH 50	50		BPR7HS	6422	0,7	BPR7HVX	2938	215	BPR7HIX	5944
CR 50 Z/SS	50	93-	BP7HS-10	7829	1,0					
CV 50	50		BPR6HS	7022	0,7	BPR6HVX	2740	214	BPR6HIX	4085
CW 50	50	91- 93	BR7HS	4122	0,8			211	BR7HIX	7067
CW 50 (4BX)	50	94-	BPR7HS	6422	0,7	BPR7HVX	2938	215	BPR7HIX	5944
CY 50	50	94-	BP7HS	5111	0,7	BP7HVX	7468		BPR7HIX	5944
CY 50 E	50	93-	BP7HS	5111	0,7	BP7HVX	7468		BPR7HIX	5944
CY 50 F	50	94-	BPR7HS	6422	0,7	BPR7HVX	2938	215	BPR7HIX	5944
DT 50	50		B7HS	5110	0,8	B7HVX	7836	204	BR7HIX	7067
DT 50 / supermotard	50	03-	BR9ES	5722	0,8	BR9EVX	1265	208	BR9EIX	3981
DT 50 A (F)	50		BR6HS	3922	0,7			209	BR6HIX	3419
DT 50 E	50	93-	BR8ES	5422	0,7	BR8EVX	1262	207	BR8EIX	5044
DT 50 F	50	94-	BR8ES	5422	0,8	BR8EVX	1262	207	BR8EIX	5044
DT 50 LC (3UN3/4/5/6/7)	50	93-	BR8ES	5422	0,7	BR8EVX	1262	207	BR8EIX	5044
DT 50 M (D)	50	86-	BR7HS	4122	0,7			211	BR7HIX	7067
DT 50 M (S)	50	86-	BR6HS	3922	0,7			209	BR6HIX	3419
DT 50 M (2M4)	50	78- 81	B6HS	4510	0,7	B6HVX	7435	203	BR6HIX	3419
DT 50 M (A) (B)	50	86-	B8HS	5510	0,7	B8HVX	2634	205	BR8HIX	7001
DT 50 M (NL)	50	86-	B6HS	4510	0,7	B6HVX	7435	203	BR6HIX	3419
DT 50 MX (1NN)	50	01.86-12.89	BR6HS	3922	0,7			209	BR6HIX	3419
DT 50 MX (4ET1)	50	92-	B6HS	4510	0,7	B6HVX	7435	203	BR6HIX	3419
DT 50 MX (3TG2)	50	92-	BR6HS	3922	0,7			209	BR6HIX	3419
DT 50 MX (4ER1)	50	92-	BR7HS	4122	0,7			211	BR7HIX	7067
DT 50 R (3MN2)(3MN3)(3HL3)(4CT2)(4CT4)(4CT6)	50	91-	BR7HS	4122	0,7			211	BR7HIX	7067
DT 50 R (5BK1)(5BL1)	50	97-	BR8ES	5422	0,8	BR8EVX	1262	207	BR8EIX	5044
DT 50 R (3MP2)(3MS2)(3MR2)(4AD2)(4JU1)	50	91-	BR6HS	3922	0,7			209	BR6HIX	3419
DT 50 R (5EC1)(5VB2)(5BK4)(5BK3)(5VB1)	50	97-	CR8E	1275	0,7	CR8EVX	6487	226	CR8EIX	4218
DX 50 R (5BK2)	50	97-	BR8ES	5422	0,8	BR8EVX	1262	207	BR8EIX	5044
DX 50 S (4CT3)(4CT5)(4CT7)	50	92-	BR7HS	4122	0,7			211	BR7HIX	7067
ES 50	50		B8HS	5510	0,7	B8HVX	2634	205	BR8HIX	7001
Fizz (4RC)	50	95-	BR8HS	4322	0,7	BR8HVX	6265	212	BR8HIX	7001
FS 1 DX (3F2)	50	79- 80	BR6HS	3922	0,7			209	BR6HIX	3419
FS 1 E	50		B7HS	5110	0,6	B7HVX	7836	204	BR7HIX	7067
FS 3 M	50		B8HS	5510	0,7	B8HVX	2634	205	BR8HIX	7001
GT 50 B	50		B7HS	5110	0,7	B7HVX	7836	204	BR7HIX	7067
GT 50 D (FT1)	50	73- 75	B7HS	5110	0,7	B7HVX	7836	204	BR7HIX	7067

Order
No.Platin
Gold-
Palla-
diumOrder Quick
No. No.

Iridium

Order
No.**YAMAHA**

Jog 50	50	90-	BPR6HS	7022	0,7	BPR6HVX	2740	214	BPR6HIX	4085
LB 2	50		B7HS	5110	0,7	B7HVX	7836	204	BR7HIX	7067
LB 2 80	50	81-	BP6HS	4511	0,7	BP6HVX	4635		BPR6HIX	4085
LB 2 80	50	- 80	B6HS	4510	0,7	B6HVX	7435	203	BR6HIX	3419
LB 2 M	50	81-	BP6HS	4511	0,7	BP6HVX	4635		BPR6HIX	4085
LB 2 M (551)	50	75- 80	B6HS	4510	0,7	B6HVX	7435	203	BR6HIX	3419
LB 3 80	50		B6HS	4510	0,7	B6HVX	7435	203	BR6HIX	3419
LB 3 M	50		BP6HS	4511	0,7	BP6HVX	4635		BPR6HIX	4085
LC 50	50		BP4HS	3611	0,7					
LC 50 H	50		BP4HS	3611	0,7					
LC 50 M	50		BP4HS	3611	0,7					
MA 50	50		BP4HS	3611	0,7					
MA 50 M	50		BP4HS	3611	0,7					
MBK Magnum	50	90-	B8ES	2411	0,6	B8EVX	7051	201	BR8EIX	5044
MR 50	50		B7HS	5110	0,7	B7HVX	7836	204	BR7HIX	7067
MR 50 H	50		B7HS	5110	0,7	B7HVX	7836	204	BR7HIX	7067
PW 50 (3PT)	50	01.87-	BP4HS	3611	0,6					
PW 50 E	50	93-	BPR4HS	7823	0,8					
PW 50 H / F	50		BP4HS	3611	0,7					
QT 50	50		BP4HS	3611	0,7					
QT 50 H	50		BP4HS	3611	0,7					
RD 50 DX (353)	50	73- 75	B8HS	5510	0,7	B8HVX	2634	205	BR8HIX	7001
RD 50 H	50		B7HS	5110	0,7	B7HVX	7836	204	BR7HIX	7067
RD 50 MX (2E0)	50	77- 81	B6HS	4510	0,7	B6HVX	7435	203	BR6HIX	3419
SA 50	50		BP4HS	3611	0,7					
SA 50 H	50		BP4HS	3611	0,7					
SA 50 M	50		BP4HS	3611	0,7					
SG 50 (34N)	50	84- 85	BPR6HS	7022	0,7	BPR6HVX	2740	214	BPR6HIX	4085
SH 50 / F	50		BPR6HS-10	2633	1,0					
SH 50 E / ED / MF	50	93-	BP6HS-10	6326	1,0					
T 50	50		C6HSA	3228	0,7				CR6HIX	7274
TY 50 M (1G3)	50	77- 80	B6HS	4510	0,7	B6HVX	7435	203	BR6HIX	3419
TZR 50	50	03-	BR9ES	5722	0,8	BR9EVX	1265	208	BR9EIX	3981
V 50	50		B6HS	4510	0,6	B6HVX	7435	203	BR6HIX	3419
V 50 D	50	93-	B7HS	5110	0,7	B7HVX	7836	204	BR7HIX	7067
V 50 E	50		B7HS	5110	0,7	B7HVX	7836	204	BR7HIX	7067
V 50 M	50	- 80	B6HS	4510	0,7	B6HVX	7435	203	BR6HIX	3419
V 50 M	50	81- 83	BP6HS	4511	0,7	BP6HVX	4635		BPR6HIX	4085
V 50 M	50	84-	BR6ES	4922	0,8					
YA 50 (5AK)	50	97-	BR7HS	4122	0,7			211	BR7HIX	7067
YB 50 S	50		B7HS	5110	0,7	B7HVX	7836	204	BR7HIX	7067
YE 50	50	93-	BR7HS	4122	0,7			211	BR7HIX	7067
YMF 50 S (ATV)	50	04-	CR7HS	7223	0,7				CR7HIX	7544
YZ 50	50		B9ES	2611	0,8	B9EVX	7254	202	BR9EIX	3981
YZ 50 H	50		B9ES	2611	0,8	B9EVX	7254	202	BR9EIX	3981
RD 60 B	60		B7HS	5110	0,7	B7HVX	7836	204	BR7HIX	7067
YB 60	60		B7HS	5110	0,7	B7HVX	7836	204	BR7HIX	7067
YF 60 (1HN) (MOTO4 ATV)	60	87- 88	BPR6HS	7022	0,7	BPR6HVX	2740	214	BPR6HIX	4085
YZ 60 H	60		B8ES	2411	0,8	B8EVX	7051	201	BR8EIX	5044
CW 65	65	94-	BR7HS	4122	0,7			211	BR7HIX	7067
Active 80	80	90-	BPR7HS	6422	0,7	BPR7HVX	2938	215	BPR7HIX	5944
CH 80	80		BR7HS	4122	0,7			211	BR7HIX	7067

Order
No.Platin
Gold-
Palla-
diumOrder
No.Quick
No.

Iridium

Order
No.**YAMAHA**

CV 80	80		BPR7HS	6422	0,7	BPR7HVX	2938	215	BPR7HIX	5944
DT 80 LC-I (37A)	80	83- 86	BR8ES	5422	0,8	BR8EVX	1262	207	BR8EIX	5044
DT 80 LC-II (53V)	80	84-	BR9ES	5722	0,8	BR9EVX	1265	208	BR9EIX	3981
DT 80 MX (5J1)	80	81- 84	B8HS	5510	0,7	B8HVX	2634	205	BR8HIX	7001
DT 80 MX-S (5T8)	80	83- 86	BR8HS	4322	0,7	BR8HVX	6265	212	BR8HIX	7001
FS 80	80		B7HS	5110	0,7	B7HVX	7836	204	BR7HIX	7067
FS 80 SE (5A7)	80	81- 82	B7HS	5110	0,7	B7HVX	7836	204	BR7HIX	7067
GT 80 (477)	80	74- 75	B7HS	5110	0,7	B7HVX	7836	204	BR7HIX	7067
GT 80 D	80		B7HS	5110	0,7	B7HVX	7836	204	BR7HIX	7067
GT 80 E	80		B7HS	5110	0,7	B7HVX	7836	204	BR7HIX	7067
LB 80	80		BP6HS	4511	0,7	BP6HVX	4635		BPR6HIX	4085
LB 80 2A	80		B6HS	4510	0,7	B6HVX	7435	203	BR6HIX	3419
LB 80 2AC	80		B6HS	4510	0,7	B6HVX	7435	203	BR6HIX	3419
LB 80 2AD	80		B6HS	4510	0,7	B6HVX	7435	203	BR6HIX	3419
LB 80 2H	80		B6HS	4510	0,7	B6HVX	7435	203	BR6HIX	3419
LB 80 2HD	80		B7HS	5110	0,7	B7HVX	7836	204	BR7HIX	7067
LB 80 3 (1M9)	80	78- 79	B6HS	4510	0,7	B6HVX	7435	203	BR6HIX	3419
LB 80 3D	80		B6HS	4510	0,7	B6HVX	7435	203	BR6HIX	3419
MX 80	80		B7HS	5110	0,7	B7HVX	7836	204	BR7HIX	7067
MX 80 H	80		B7HS	5110	0,7	B7HVX	7836	204	BR7HIX	7067
PW 80 (21W)	80	83- 90	BPR6HS	7022	0,7	BPR6HVX	2740	214	BPR6HIX	4085
PW 80 E / F (4BC)	80	93-	BP6HS	4511	0,7	BP6HVX	4635		BPR6HIX	4085
RD 80 LC-II (30W)	80	83- 87	BR8ES	5422	0,8	BR8EVX	1262	207	BR8EIX	5044
RD 80 MX (5G1)	80	81- 82	B8HS	5510	0,7	B8HVX	2634	205	BR8HIX	7001
RX 80 SE (12N)	80	82- 83	B8HS	5510	0,7	B8HVX	2634	205	BR8HIX	7001
T 80	80		CR7HS	7223	0,7				CR7HIX	7544
TY 80	80		B7HS	5110	0,7	B7HVX	7836	204	BR7HIX	7067
V 80	80		BP6HS	4511	0,7	BP6HVX	4635		BPR6HIX	4085
V 80 H / D	80		BP6HS	4511	0,7	BP6HVX	4635		BPR6HIX	4085
Y 80	80		BP6HS	4511	0,7	BP6HVX	4635		BPR6HIX	4085
Y 80 E	80		BP6HS	4511	0,7	BP6HVX	4635		BPR6HIX	4085
YB 80	80		B7HS	5110	0,7	B7HVX	7836	204	BR7HIX	7067
YE 80 (4MU)	80	94-	BR7HS	4122	0,7			211	BR7HIX	7067
YFM 80 (MOTO4 ATV)	80		CR7HS	7223	0,7				CR7HIX	7544
YFM 80 W Raptor (ATV)	80	02-	CR7HS	7223	0,7				CR7HIX	7544
YFM 80 W Badger (ATV)	80	02-	CR7HS	7223	0,7				CR7HIX	7544
YFM 80 E / F (MOTO4 ATV)	80	93-	C7HSA	4629	0,7	C7HVX	4533		CR7HIX	7544
YZ 80	80	84- 85	B9EG	3530	0,6	B9EGV	5827		BR9EIX	3981
YZ 80 (4GT)	80	95-	B10EG	3630	0,7	B10EGV	5927			
YZ 80 (1LR)	80	86-	BR9EG	3230	0,6	BR9EVX	1265		BR9EIX	3981
YZ 80 B	80		B8HS	5510	0,7	B8HVX	2634	205	BR8HIX	7001
YZ 80 C	80		B8ES	2411	0,8	B8EVX	7051	201	BR8EIX	5044
YZ 80 D	80		B8ES	2411	0,8	B8EVX	7051	201	BR8EIX	5044
YZ 80 E	80	- 92	B8ES	2411	0,8	B8EVX	7051	201	BR8EIX	5044
YZ 80 E / F/LW(4LB)/ LWF	80	93-	B10EG	3630	0,6	B10EGV	5927			
YZ 80 H	80	- 83	B8ES	2411	0,8	B8EVX	7051	201	BR8EIX	5044
YZ 80 H.R.	80		B7HS	5110	0,7	B7HVX	7836	204	BR7HIX	7067
YZ 80 L.R.	80		B8ES	2411	0,8	B8EVX	7051	201	BR8EIX	5044
YA 90 E / F	90	93-	BR7HS	4122	0,7			211	BR7HIX	7067
AG 100	100		B7HS	5110	0,7	B7HVX	7836	204	BR7HIX	7067
AG 100 H / E / F	100		B7ES	1111	0,8	B7EVX	6934			
DT 100	100		B7ES	1111	0,8	B7EVX	6934			

Order
No.Platin
Gold-
Palla-
diumOrder Quick
No. No.Order
No.**YAMAHA**

DT 100 B	100		B8HS	5510	0,7	B8HVX	2634	205	BR8HIX	7001
DT 100 C	100		B7ES	1111	0,8	B7EVX	6934			
DT 100 D	100		B8ES	2411	0,8	B8EVX	7051	201	BR8EIX	5044
DT 100 E	100		B8ES	2411	0,8	B8EVX	7051	201	BR8EIX	5044
DT 100 H	100		B8ES	2411	0,8	B8EVX	7051	201	BR8EIX	5044
DT 100 SD	100		B8ES	2411	0,8	B8EVX	7051	201	BR8EIX	5044
DT 100 X	100		B7ES	1111	0,8	B7EVX	6934			
DX 100	100		B7HS	5110	0,7	B7HVX	7836	204	BR7HIX	7067
DX 100 H	100		B7HS	5110	0,7	B7HVX	7836	204	BR7HIX	7067
MX 100	100	79-	B7ES	1111	0,8	B7EVX	6934			
MX 100 B	100				0,6	B8EVX	7051		BR8EIX	5044
MX 100 H	100		B7ES	1111	0,8	B7EVX	6934			
RS 100 B	100		B8HS	5510	0,7	B8HVX	2634	205	BR8HIX	7001
RS 100 DX (1Y8)	100	76- 81	B8HS	5510	0,7	B8HVX	2634	205	BR8HIX	7001
RS 100 P	100		BP6HS	4511	0,7	BP6HVX	4635		BPR6HIX	4085
RS 100 S	100		B8HS	5510	0,7	B8HVX	2634	205	BR8HIX	7001
RS 100 X	100		B8HS	5510	0,7	B8HVX	2634	205	BR8HIX	7001
RT 100 E / F	100	93-	B7ES	1111	0,8	B7EVX	6934			
RX 100 12,7mm	100		B8HS	5510	0,7	B8HVX	2634	205	BR8HIX	7001
RX 100 19,0mm	100		B8ES	2411	0,8	B8EVX	7051	201	BR8EIX	5044
RXS 100	100		BR8HS	4322	0,7	BR8HVX	6265	212	BR8HIX	7001
RX-ZD	100	93-	BP8ES	2912	0,8	BP8EVX	2671			
V 100/E/S/SH	100	93-	BP7HS-10	7829	1,0					
YB 100	100	94-	BP6HS	4511	0,7	BP6HVX	4635		BPR6HIX	4085
YB 100 M	100		B8HS	5510	0,7	B8HVX	2634	205	BR8HIX	7001
YB 100 P	100		B7HS	5110	0,7	B7HVX	7836	204	BR7HIX	7067
YZ 100	100	- 83	B10EG	3630	0,6	B10EGV	5927			
YZ 100 E	100		B10EG	3630	0,6	B10EGV	5927			
YZ 100 H	100		B10EG	3630	0,6	B10EGV	5927			
V 110 E	110	93-	BP7HS-10	7829	1,0					
RX 115	115	93-	BP8HS	2630	0,7				BPR8HIX	6742
V 120 JR / ZR	120	94-	BP8ES	2912	0,8	BP8EVX	2671			
BL 125 (50W)	125	85- 89	BPR8HS	3725	0,7				BPR8HIX	6742
DT 125	125	94-	B8ES	2411	0,8	B8EVX	7051	201	BR8EIX	5044
DT 125 RE	125	04-	BR8ES	5422	0,8	BR8EVX	1262	207	BR8EIX	5044
DT 125 E (1G0)	125	77- 79	BR9ES	5722	0,8	BR9EVX	1265	208	BR9EIX	3981
DT 125 E (AT2)	125	73- 76	B8ES	2411	0,8	B8EVX	7051	201	BR8EIX	5044
DT 125 ED	125		B8ES	2411	0,8	B8EVX	7051	201	BR8EIX	5044
DT 125 F	125		B8ES	2411	0,8	B8EVX	7051	201	BR8EIX	5044
DT 125 H	125		B8ES	2411	0,8	B8EVX	7051	201	BR8EIX	5044
DT 125 LC	125	86-	BR9ES	5722	0,8	BR9EVX	1265	208	BR9EIX	3981
DT 125 LC (10V)	125	82- 85	BR8ES	5422	0,8	BR8EVX	1262	207	BR8EIX	5044
DT 125 MX	125		B8ES	2411	0,8	B8EVX	7051	201	BR8EIX	5044
DT 125 R (4BL) / RE (3RM)	125	91-	BR9ES	5722	0,8	BR9EVX	1265	208	BR9EIX	3981
DT 125 Tenere (I)	125		B9ES	2611	0,8	B9EVX	7254	202	BR9EIX	3981
IT 125	125		B9EG	3530	0,6	B9EGV	5827		BR9EIX	3981
IT 125 H	125		B9EG	3530	0,6	B9EGV	5827		BR9EIX	3981
MX 125	125				0,6	B9EVX	7254		BR9EIX	3981
R 125 SE	125		BP7HS	5111	0,7	BP7HVX	7468		BPR7HIX	5944
RD 125 12,7mm	125		B8HS	5510	0,7	B8HVX	2634	205	BR8HIX	7001
RD 125 19,0mm	125		B8ES	2411	0,8	B8EVX	7051	201	BR8EIX	5044
RD 125 C	125		B8ES	2411	0,8	B8EVX	7051	201	BR8EIX	5044

Order
No.Gold-
Palla-
diumOrder
No.Quick
No.

Iridium

Order
No.**YAMAHA**

RD 125 C-DX	125		B8ES	2411	0,8	B8EVX	7051	201	BR8EIX	5044
RD 125 D	125		B8ES	2411	0,8	B8EVX	7051	201	BR8EIX	5044
RD 125 D-DX (AS3)	125	73- 75	B8HS	5510	0,7	B8HVX	2634	205	BR8HIX	7001
RD 125 LC	125	84-	BR8ES	5422	0,8	BR8EVX	1262	207	BR8EIX	5044
RD 125 LC (10W)	125	82- 83	BR9ES	5722	0,8	BR9EVX	1265	208	BR9EIX	3981
RS 125 DX	125		B8HS	5510	0,7	B8HVX	2634	205	BR8HIX	7001
RS 125 E	125		B7HS	5110	0,7	B7HVX	7836	204	BR7HIX	7067
RS 125 P	125		BP7HS	5111	0,7	BP7HVX	7468		BPR7HIX	5944
RS 125 Z	125		B8HS	5510	0,7	B8HVX	2634	205	BR8HIX	7001
RX 125 12,7mm	125		B8HS	5510	0,7	B8HVX	2634	205	BR8HIX	7001
RX 125 19,0mm	125		B8ES	2411	0,8	B8EVX	7051	201	BR8EIX	5044
RX 125 H	125		B7HS	5110	0,7	B7HVX	7836	204	BR7HIX	7067
SR 125	125		D8EA	2120	0,7	D8EVX	2850	216	DR8EIX	6681
SR 125 (10F)	125	97-	DR8EA	7162	0,7	DR8EVX	6354		DR8EIX	6681
SR 125 Z	125	93-	DR8EA	7162	0,7	DR8EVX	6354		DR8EIX	6681
TA 125 (400)	125	73- 75	B10EG	3630	0,6	B10EGV	5927			
TA 125 A	125		B10EG	3630	0,6	B10EGV	5927			
TDR 125 (4GW)	125	92-	BR9ES	5722	0,9	BR9EVX	1265	208	BR9EIX	3981
TDR 125 (5AN)	125	97-	BR8ES	5422	0,8	BR8EVX	1262	207	BR8EIX	5044
TW 125 (DE011/012)	125	99-	DR8EA	7162	0,6	DR8EVX	6354		DR8EIX	6681
TY 125 (1K6)	125	77- 81	B7ES	1111	0,7	B7EVX	6934			
TZ 125 (4JT)	125	95-	R7376-10	4457	0,6					
TZ 125 (3V3)	125	80-			0,6	B10EVX	7335		BR10EIX	6801
TZ 125 / F	125	94-	R7376-10	4457	0,6					
TZ 125 H	125				0,6	B10EVX	7335		BR10EIX	6801
TZR 125	125	- 92	BR9ES	5722	0,8	BR9EVX	1265	208	BR9EIX	3981
TZR 125	125	93-	BR9ECM	3252	0,8	BR9ECMVX	2434			
XT 125	125		D8EA	2120	0,7	D8EVX	2850	216	DR8EIX	6681
XV 125 (5AJ)	125	97-	CR6HSA	2983	0,6				CR6HIX	7274
XV 125 S Virago(5AJ)	125	99-	CR6HSA	2983	0,6				CR6HIX	7274
XVS 125 (VP05)	125	00-	CR7HSA	4549	0,6				CR7HIX	7544
YB 125	125		B7HS	5110	0,7	B7HVX	7836	204	BR7HIX	7067
YFA 1 Breeze (MOTO4 ATV)	125	89- 04	CR7HS	7223	0,7				CR7HIX	7544
YFA 1 F (MOTO4 ATV)	125	94-	C7HSA	4629	0,7	C7HVX	4533		CR7HIX	7544
YS 125	125				0,6	B9EVX	7254		BR9EIX	3981
YT 125 (MOTO4 ATV)	125		BP6ES	7811	0,8	BP6EVX	5832		BPR6EIX	6637
YT 125 CH (MOTO4 ATV)	125		BP6ES	7811	0,8	BP6EVX	5832		BPR6EIX	6637
YT 125 H (MOTO4 ATV)	125		BP6ES	7811	0,8	BP6EVX	5832		BPR6EIX	6637
YZ 125	125		B9EG	3530	0,6	B9EGV	5827		BR9EIX	3981
YZ 125 B	125		B9EG	3530	0,6	B9EGV	5827		BR9EIX	3981
YZ 125 C	125		B9EG	3530	0,6	B9EGV	5827		BR9EIX	3981
YZ 125 E	125		B9EG	3530	0,6	B9EGV	5827		BR9EIX	3981
YZ 125 E / E1 / F	125	93-	BR9EG	3230	0,6	BR9EVX	1265		BR9EIX	3981
YZ 125 H	125		B9EG	3530	0,6	B9EGV	5827		BR9EIX	3981
YZ 125 X	125		B9EG	3530	0,6	B9EGV	5827		BR9EIX	3981
FZ 150	150	94-	C7HSA	4629	0,7	C7HVX	4533		CR7HIX	7544
FZR 150	150	94-	C7HSA	4629	0,7	C7HVX	4533		CR7HIX	7544
RX 150	150	93-	BP8ES	2912	0,8	BP8EVX	2671			
SR 150	150	93-	D8EA	2120	0,7	D8EVX	2850	216	DR8EIX	6681
DT 165 R	165	91-	BR8ES	5422	0,8	BR8EVX	1262	207	BR8EIX	5044
AG 175	175		B8ES	2411	0,8	B8EVX	7051	201	BR8EIX	5044
AG 175 H	175		B7ES	1111	0,8	B7EVX	6934			

Order
No.Platin
Gold-
Palla-
diumOrder Quick
No. No.Order
No.**YAMAHA**

DT 175 (CT1)	175	74- 75	B8ES	2411	0,8	B8EVX	7051	201	BR8EIX	5044
DT 175 E / F	175		B8ES	2411	0,8	B8EVX	7051	201	BR8EIX	5044
DT 175 H	175		B9ES	2611	0,8	B9EVX	7254	202	BR9EIX	3981
DT 175 MX (2K4)	175	09.78-12.81	B8ES	2411	0,8	B8EVX	7051	201	BR8EIX	5044
IT 175 (5Y0)	175	83- 84	B9EG	3530	0,6	B9EGV	5827		BR9EIX	3981
IT 175 E	175				0,6	B10EVX	7335		BR10EIX	6801
IT 175 H	175		B9EG	3530	0,6	B9EGV	5827		BR9EIX	3981
MX 175	175		B8ES	2411	0,8	B8EVX	7051	201	BR8EIX	5044
MX 175 B	175				0,6	B8EVX	7051		BR8EIX	5044
MX 175 H	175		B8ES	2411	0,8	B8EVX	7051	201	BR8EIX	5044
TY 175	175		B7ES	1111	0,8	B7EVX	6934			
TY 175 E	175		B7ES	1111	0,8	B7EVX	6934			
TY 175 J	175		B7ES	1111	0,8	B7EVX	6934			
YT 175 (MOTO4 ATV)	175		BP7ES	2412	0,8	BP7EVX	7270	206	BPR7EIX	4055
YZ 175	175				0,6	B10EVX	7335		BR10EIX	6801
RT 180 E	180	93-	B8ES	2411	0,8	B8EVX	7051	201	BR8EIX	5044
XC 180 (32H)	180	83- 84	DPR8EA-9	4929	0,9	DPR8EVX-9	2872	221	DPR8EIX-9	2202
SH 185 H	185		D7EA	7912	0,7	D7EVX	2734			
RS 195	195		B7ES	1111	0,8	B7EVX	6934			
AG 200 E / F	200	93-	D8EA	2120	0,7	D8EVX	2850	216	DR8EIX	6681
BW 200	200		D8EA	2120	0,7	D8EVX	2850	216	DR8EIX	6681
DT 200 LC / RE / RF	200	93-	BR9ES	5722	0,8	BR9EVX	1265	208	BR9EIX	3981
DT 200 R	200		BR9ES	5722	0,8	BR9EVX	1265	208	BR9EIX	3981
IT 200 S	200		BR9EG	3230	0,6	BR9EVX	1265		BR9EIX	3981
YFM 200 (MOTO4 ATV)	200	92-	D7EA	7912	0,6	D7EVX	2734			
NR 200	200		B7ES	1111	0,8	B7EVX	6934			
RD 200 12,7mm	200		B7HS	5110	0,7	B7HVX	7836	204	BR7HIX	7067
RD 200 19,0mm (397)	200		B7ES	1111	0,7	B7EVX	6934			
RD 200 C	200		B8ES	2411	0,8	B8EVX	7051	201	BR8EIX	5044
RD 200 C-DX	200		B8ES	2411	0,8	B8EVX	7051	201	BR8EIX	5044
RD 200 D	200		B8ES	2411	0,8	B8EVX	7051	201	BR8EIX	5044
RD 200 D-DX (1E8)	200	77- 80	B8ES	2411	0,8	B8EVX	7051	201	BR8EIX	5044
RS 200	200		B8ES	2411	0,8	B8EVX	7051	201	BR8EIX	5044
TW 200	200	01.87-	DR8EA	7162	0,7	DR8EVX	6354		DR8EIX	6681
TW 200 E / EC / F	200	93-	DR8EA	7162	0,7	DR8EVX	6354		DR8EIX	6681
TW 200 FC	200	94-	D8EA	2120	0,7	D8EVX	2850	216	DR8EIX	6681
WR 200 R / RE / RF	200	93-	BR9ES	5722	0,8	BR9EVX	1265	208	BR9EIX	3981
YFM 200 (52H) (MOTO4 ATV)	200	85- 86	DR7ES	3123	0,7					
YFM 225 (2HT) (MOTO4 ATV)	200		DR7ES	3123	0,7					
YFM 225 (59V) (MOTO4 ATV)	200		DR7ES	3123	0,7					
YFS 200 Blaster (MOTO4 ATV)	200	90- 04	BR8ES	5422	0,8	BR8EVX	1262	207	BR8EIX	5044
YFS 200 E / F (MOTO4 ATV)	200	93-	B8ES	2411	0,8	B8EVX	7051	201	BR8EIX	5044
YFM 225 59V/2HT (MOTO4 ATV)	225	92-	DR7ES	3123	0,7					
TT 225 (MOTO4 ATV)	225		DR8ESL	2923	0,7	DR8EVX	6354	218	DR8EIX	6681
XT 225 E / EC / F / FC	225	93-	DR8EA	7162	0,7	DR8EVX	6354		DR8EIX	6681
TDR 240	240		BR9ES	5722	0,8	BR9EVX	1265	208	BR9EIX	3981
XV 240	240		CR6HS	7023	0,7			223	CR6HIX	7274
DT 250 (512)	250	75- 76	B8ES	2411	0,8	B8EVX	7051	201	BR8EIX	5044
DT 250 E	250		B8ES	2411	0,8	B8EVX	7051	201	BR8EIX	5044
DT 250 H	250		B8ES	2411	0,8	B8EVX	7051	201	BR8EIX	5044
DT 250 MX (1R7)	250	77- 81	B8ES	2411	0,8	B8EVX	7051	201	BR8EIX	5044
IT 250 (45J)	250	85-	B9EG	3530	0,6	B9EGV	5827		BR9EIX	3981

Order
No.Platin
Gold-
Palla-
diumOrder Quick
No. No.

Iridium

Order
No.**YAMAHA**

IT 250 (4V5)	250	81-	B8EG	3430	0,6	B8EGV	5627			
IT 250 J	250		B9EG	3530	0,6	B9EGV	5827		BR9EIX	3981
IT 250 K	250		B9EG	3530	0,6	B9EGV	5827		BR9EIX	3981
IT 250 N	250		BR9EG	3230	0,6	BR9EVX	1265		BR9EIX	3981
MX 250	250				0,6	B8EVX	7051		BR8EIX	5044
R1-Z	250	93-	BR9ES	5722	0,8	BR9EVX	1265	208	BR9EIX	3981
RD 250 (522)	250	75-	B8ES	2411	0,8	B8EVX	7051	201	BR8EIX	5044
RD 250 D	250		B8ES	2411	0,8	B8EVX	7051	201	BR8EIX	5044
RD 250 LC (4L1)	250	80- 83	B8ES	2411	0,8	B8EVX	7051	201	BR8EIX	5044
SE 250 (I)	250		BPR7ES	2023	0,8	BPR7EVX	5565		BPR7EIX	4055
SR 250 (I)	250		BPR7ES	2023	0,8	BPR7EVX	5565		BPR7EIX	4055
SR 250 H / F	250		BP7ES	2412	0,8	BP7EVX	7270	206	BPR7EIX	4055
SR 250 SE (3Y8)	250	80- 82	BP7ES	2412	0,8	BP7EVX	7270	206	BPR7EIX	4055
SR 250 TH	250		BP7ES	2412	0,8	BP7EVX	7270	206	BPR7EIX	4055
TDR 250 (3CK)	250	88- 89	BR9ES	5722	0,8	BR9EVX	1265	208	BR9EIX	3981
TRD 250 (I)	250		BR9ES	5722	0,7	BR9EVX	1265	208	BR9EIX	3981
TT 250	250		D8EA	2120	0,7	D8EVX	2850	216	DR8EIX	6681
TT 250 R / RF	250	94-	CR9E	6263	0,7	CR9EVX	5943	227	CR9EIX	3521
TY 250 (38V)	250	84- 87	BR6ES	4922	0,8					
TY 250 (3BA)	250	88- 90	B7ES	1111	0,8	B7EVX	6934			
TY 250 (S16)	250	75- 79	B7ES	1111	0,8	B7EVX	6934			
TY 250 Z (4GG)	250	94- 96			0,6	BP6EVX	5832		BPR6EIX	6637
TZ 250	250	- 83			0,6	B10EVX	7335		BR10EIX	6801
TZ 250	250	84-	B10EG	3630	0,5	B10EGV	5927			
TZ 250 (4DP)	250	95-	R6179A-105P	2697	0,6					
TZ 250 / F	250	94-	R6179A-105P	2697	0,6					
TZ 250 E	250	- 83			0,6	B10EVX	7335		BR10EIX	6801
TZ 250 E/E1	250	93-	R5184-105	3334	0,6					
TZ 250 H	250	- 83			0,6	B10EVX	7335		BR10EIX	6801
TZR 250 "V2"	250	91- 95	BR9ECM	3252	0,6	BR9ECMVX	2434			
TZR 250 (2MA)	250	87- 89	BR9ES	5722	0,8	BR9EVX	1265	208	BR9EIX	3981
TZR 250R/RS/RSP	250	93-	BR9ECM	3252	0,8	BR9ECMVX	2434			
WR 250 F	250	01-	CR8E	1275	0,7	CR8EVX	6487	226	CR8EIX	4218
WR 250 F	250	03-	CR8E	1275	0,7	CR8EVX	6487	226	CR8EIX	4218
WR 250 Z / ZE / ZF (4JW)	250	93-	B8EG	3430	0,6	B8EGV	5627			
XS 250 (1V5)	250	78- 79	BP7ES	2412	0,8	BP7EVX	7270	206	BPR7EIX	4055
XS 250 C	250		BP7ES	2412	0,8	BP7EVX	7270	206	BPR7EIX	4055
XS 250 H	250		BP7ES	2412	0,8	BP7EVX	7270	206	BPR7EIX	4055
XS 250 RH	250	- 83	BP7ES	2412	0,8	BP7EVX	7270	206	BPR7EIX	4055
XS 250 SE	250		BP7ES	2412	0,8	BP7EVX	7270	206	BPR7EIX	4055
XS 250 SH	250		BP7ES	2412	0,8	BP7EVX	7270	206	BPR7EIX	4055
XT 250 (3Y3)	250	80- 82	DR8ESL	2923	0,6	DR8EVX	6354	218	DR8EIX	6681
XT 250 H	250	- 84	BP7ES	2412	0,8	BP7EVX	7270	206	BPR7EIX	4055
XV 250	250	94-	CR6HSA	2983	0,7				CR6HIX	7274
XV 250 (3LS,3LW)	250	89-	CR6HS	7023	0,7			223	CR6HIX	7274
XV 250 F	250	94-	C6HSA	3228	0,7				CR6HIX	7274
XV 250 S (3LW)	250	95-	CR6HS	7023	0,8			223	CR6HIX	7274
XVS 250 (VG031)	250	01-	CR6HS	7023	0,7			223	CR6HIX	7274
YFB 250 / E / F / FWF (MOTO4 ATV)	250	93-	D7EA	7912	0,7	D7EVX	2734			
YFB 250 / FW (MOTO4 ATV)	250	94-	DR7EA	7839	0,7					
YFM 250 Timberwolf (MOTO4 ATV)	250		DR7EA	7839	0,7					
YFM 250 (3GH)	250	90-	DR7ES	3123	0,7					

Order
No.Gold-
PalladiumOrder Quick
No.

Iridium

Order
No.**YAMAHA**

YFM 250 X Bear Tracker (MOTO4 ATV)	250	99- 04	DR7EA	7839	0,7						
YZ 250 (4MX)	250	95-	B8EG	3430	0,7	B8EGV	5627				
YZ 250 (2VM,3JE,3SP,3XK)	250	88- 91	B8EG	3430	0,6	B8EGV	5627				
YZ 250 (39X,56A,1LU,2HH)	250	84- 87	B8EG	3430	0,6	B8EGV	5627				
YZ 250 (4DA,4EW)	250	92-	B8EG	3430	0,6	B8EGV	5627				
YZ 250 (5X5,24Y)	250	82- 83	B9EG	3530	0,6	B9EGV	5827		BR9EIX	3981	
YZ 250 F	250	94-	B8EG	3430	0,6	B8EGV	5627				
YZ 250 F (CG10C)	250	01-	CR8E	1275	0,7	CR8EVX	6487	226	CR8EIX	4218	
XVZ 13 (3JS)	300	89- 92	DPR8EA-9	4929	0,9	DPR8EVX-9	2872	221	DPR8EIX-9	2202	
BW 350	350		DR8ESL	2923	0,9	DR8EVX	6354	218	DR8EIX	6681	
RD 350	350	87-	BR9ES	5722	0,8	BR9EVX	1265	208	BR9EIX	3981	
RD 350 12,7mm	350		B8HS	5510	0,7	B8HVX	2634	205	BR8HIX	7001	
RD 350 19,0mm	350		B8ES	2411	0,8	B8EVX	7051	201	BR8EIX	5044	
RD 350 C	350		B8ES	2411	0,8	B8EVX	7051	201	BR8EIX	5044	
RD 350 H 12,7mm (351)	350	73- 74	B8HS	5510	0,7	B8HVX	2634	205	BR8HIX	7001	
RD 350 H 19,0mm (521)	350	75-	B8ES	2411	0,8	B8EVX	7051	201	BR8EIX	5044	
RD 350 J	350		B8ES	2411	0,8	B8EVX	7051	201	BR8EIX	5044	
RD 350 LC	350	- 85	BR8ES	5422	0,8	BR8EVX	1262	207	BR8EIX	5044	
RD 350 LC (1WX,1WW)	350	86- 89	BR9ES	5722	0,8	BR9EVX	1265	208	BR9EIX	3981	
RD 350 LCF	350	86-	BR9ES	5722	0,8	BR9EVX	1265	208	BR9EIX	3981	
TT 350 (1TJ)	350	86- 89	D8EA	2120	0,7	D8EVX	2850	216	DR8EIX	6681	
TT 350 E / F	350	93-	D8EA	2120	0,7	D8EVX	2850	216	DR8EIX	6681	
TZ 350 B	350		B10EG	3630	0,6	B10EGV	5927				
TZ 350 H	350		B10EG	3630	0,6	B10EGV	5927				
XT 350 (3YT)	350	91-	DR8ESL	2923	0,6	DR8EVX	6354	218	DR8EIX	6681	
XT 350 (55V)	350	85- 90	DR8ESL	2923	0,7	DR8EVX	6354	218	DR8EIX	6681	
XT 350 E / F	350	93-	D8EA	2120	0,7	D8EVX	2850	216	DR8EIX	6681	
YFM 350 (3HN) (MOTO4 ATV)	350	89-	DR8ESL	2923	0,6	DR8EVX	6354	218	DR8EIX	6681	
YFM 350 2HR/2HN (MOTO4 ATV)	350	92-	DR8ESL	2923	0,6	DR8EVX	6354	218	DR8EIX	6681	
YFM 350 4x4 (3HN) (MOTO4 ATV)	350		DR8ESL	2923	0,7	DR8EVX	6354	218	DR8EIX	6681	
YFM 350 4x4 (2HR) (MOTO4 ATV)	350		DR8ESL	2923	0,7	DR8EVX	6354	218	DR8EIX	6681	
YFM 350 ERF / FWF / XF (MOTO4 ATV)	350	94-	D8EA	2120	0,7	D8EVX	2850	216	DR8EIX	6681	
YFM 350 FW (MOTO4 ATV)	350	94-	DR8EA	7162	0,7	DR8EVX	6354		DR8EIX	6681	
YFM 350 X Warrior (MOTO4 ATV)	350	97- 04	DR8EA	7162	0,7	DR8EVX	6354		DR8EIX	6681	
YFZ 350 (MOTO4 ATV)	350	94-	BR8ES	5422	0,8	BR8EVX	1262	207	BR8EIX	5044	
YFZ 350 Banshee (MOTO4 ATV)	350	86- 04	BR8ES	5422	0,8	BR8EVX	1262	207	BR8EIX	5044	
YFZ 350 E / F (MOTO4 ATV)	350	93-	B8ES	2411	0,8	B8EVX	7051	201	BR8EIX	5044	
DT 360 (RT2)	360	01.73-12.75	B9ES	2611	0,8	B9EVX	7254	202	BR9EIX	3981	
MX 360	360				0,6	B8EVX	7051		BR8EIX	5044	
XS 360 (1V4)	360	01.77-12.78	BP6ES	7811	0,8	BP6EVX	5832		BPR6EIX	6637	
YZ 360	360				0,6	B8EVX	7051		BR8EIX	5044	
DT 400 (513)	400	11.75-12.76	B8ES	2411	0,8	B8EVX	7051	201	BR8EIX	5044	
DT 400 E	400		B9ES	2611	0,8	B9EVX	7254	202	BR9EIX	3981	
DT 400 H	400		B8ES	2411	0,8	B8EVX	7051	201	BR8EIX	5044	
DT 400 MX (1R6)	400	77- 80	B8ES	2411	0,8	B8EVX	7051	201	BR8EIX	5044	
FZR 400	400	04.87-	CR8E	1275	0,7	CR8EVX	6487	226	CR8EIX	4218	
IT 400	400		B8ES	2411	0,8	B8EVX	7051	201	BR8EIX	5044	
IT 400 E	400				0,6	B8EVX	7051		BR8EIX	5044	
MX 400	400				0,6	B8EVX	7051		BR8EIX	5044	
RD 400 (1A3)	400	76- 79	B8ES	2411	0,8	B8EVX	7051	201	BR8EIX	5044	
RD 400 E	400		B8ES	2411	0,8	B8EVX	7051	201	BR8EIX	5044	
SR 400	400		BP7ES	2412	0,8	BP7EVX	7270	206	BPR7EIX	4055	

Order
No.Gold-
Palla-
dium

Platin

Order
No.Quick
No.

Iridium

Order
No.**YAMAHA**

TT 400 C	400				0,6	B8EVX	7051		BR8EIX	5044
WR 400 F	400	98-	CR8E	1275	0,7	CR8EVX	6487	226	CR8EIX	4218
XJ 400	400		D8EA	2120	0,7	D8EVX	2850	216	DR8EIX	6681
XS 400 (12E)	400	82- 89	DR8ESL	2923	0,7	DR8EVX	6354	218	DR8EIX	6681
XS 400 (2A2)	400	78- 82	BP7ES	2412	0,8	BP7EVX	7270	206	BPR7EIX	4055
XS 400 SE (465)	400	80- 82	BP7ES	2412	0,8	BP7EVX	7270	206	BPR7EIX	4055
XT 400	400	84-	DR7ES	3123	0,7					
XT 400	400	- 83	BP7ES	2412	0,8	BP7EVX	7270	206	BPR7EIX	4055
XV 400 SE	400		BPR7ES	2023	0,8	BPR7EVX	5565		BPR7EIX	4055
YFM 400 (MOTO4 ATV)	400	93-	DR8ESL	2923	0,7	DR8EVX	6354	218	DR8EIX	6681
YFM 400 AN Kodiak (MOTO4 ATV)	400	03- 04	DR8EA	7162	0,7	DR8EVX	6354		DR8EIX	6681
YFM 400 FW (MOTO4 ATV)	400	94- 04	DR8EA	7162	0,7	DR8EVX	6354		DR8EIX	6681
YFM 400 FWF (MOTO4 ATV)	400	94-	D8EA	2120	0,7	D8EVX	2850	216	DR8EIX	6681
YFM 400 FWA Kodiak (MOTO4 ATV)	400	00- 04	DR8EA	7162	0,7	DR8EVX	6354		DR8EIX	6681
YFM 450 FWAN Kodiak (MOTO4 ATV)	400	03- 04	DR8EA	7162	0,7	DR8EVX	6354		DR8EIX	6681
YZ 400	400				0,6	B8EVX	7051		BR8EIX	5044
YZ 400 C	400				0,6	B8EVX	7051		BR8EIX	5044
YZ 400 E	400				0,6	B8EVX	7051		BR8EIX	5044
YZ 400 F	400	12.97-	CR8E	1275	0,7	CR8EVX	6487	226	CR8EIX	4218
IT 425	425		B8ES	2411	0,8	B8EVX	7051	201	BR8EIX	5044
WR 426 F (CJ02W)	426	01-	CR8E	1275	0,7	CR8EVX	6487	226	CR8EIX	4218
YZF 426 F	426	01-	CR8E	1275	0,6	CR8EVX	6487	226	CR8EIX	4218
WR 450 F	450	03-	CR8E	1275	0,7	CR8EVX	6487	226	CR8EIX	4218
YFZ 450 S (ATV)	450	04-	CR8E	1275	0,7	CR8EVX	6487	226	CR8EIX	4218
YZ 450 F	450	03-	CR8E	1275	0,7	CR8EVX	6487	226	CR8EIX	4218
IT 465 (4V6)	465	81-	B8ES	2411	0,8	B8EVX	7051	201	BR8EIX	5044
IT 465 H	465		B8ES	2411	0,8	B8EVX	7051	201	BR8EIX	5044
YZ 465	465		B8ES	2411	0,8	B8EVX	7051	201	BR8EIX	5044
YZ 465 H	465		B8ES	2411	0,8	B8EVX	7051	201	BR8EIX	5044
IT 490 (29W)	490	83- 85	BR8ES	5422	0,6	BR8EVX	1262	207	BR8EIX	5044
YZ 490	490		BR9EG	3230	0,6	BR9EVX	1265		BR9EIX	3981
IT 500	500		BP7ES	2412	0,7	BP7EVX	7270	206	BPR7EIX	4055
MX 500	500				0,6	B8EVX	7051		BR8EIX	5044
RD 500 LC (1GE)	500	85- 86	BR9HS	4522	0,7					
RD 500 LC (47X)	500	- 84	BR9HS	4522	0,7					
SR 500 (3EB)	500	95-	BPR7ES	2023	0,6	BPR7EVX	5565		BPR7EIX	4055
SR 500 (2J4,48T)	500	01.79- 96	BP7ES	2412	0,8	BP7EVX	7270	206	BPR7EIX	4055
SR 500 (48T)	500	97-	BPR7ES	2023	0,8	BPR7EVX	5565		BPR7EIX	4055
SR 500 E	500		BP7ES	2412	0,8	BP7EVX	7270	206	BPR7EIX	4055
SR 500 H	500		BP7ES	2412	0,8	BP7EVX	7270	206	BPR7EIX	4055
TT 500 (1T1)	500	78- 79	BP7ES	2412	0,8	BP7EVX	7270	206	BPR7EIX	4055
TT 500 C	500		BP7ES	2412	0,8	BP7EVX	7270	206	BPR7EIX	4055
TT 500 E	500		BP7ES	2412	0,8	BP7EVX	7270	206	BPR7EIX	4055
TT 500 H	500		BP7ES	2412	0,8	BP7EVX	7270	206	BPR7EIX	4055
TZ 500	500				0,6	B10EVX	7335		BR10EIX	6801
TZ 500 H	500				0,6	B10EVX	7335		BR10EIX	6801
XJ 500	500		D8EA	2120	0,7	D8EVX	2850	216	DR8EIX	6681
XS 500 (1H2)	500	77- 79	D8EA	2120	0,7	D8EVX	2850	216	DR8EIX	6681
XS 500 E	500		D8EA	2120	0,7	D8EVX	2850	216	DR8EIX	6681
XT 500 (1E6,1V6)	500	76- 89	BP7ES	2412	0,8	BP7EVX	7270	206	BPR7EIX	4055
XT 500 C	500		BP7ES	2412	0,8	BP7EVX	7270	206	BPR7EIX	4055
XT 500 E	500	- 92	BP7ES	2412	0,8	BP7EVX	7270	206	BPR7EIX	4055

Order
No.Platin
Gold-
Palla-
diumOrder Quick
No. No.

Iridium

Order
No.**YAMAHA**

XT 500 E	500	93-	DPR8EA-9	4929	0,9	DPR8EVX-9	2872	221	DPR8EIX-9	2202
XT 500 H	500		BP7ES	2412	0,8	BP7EVX	7270	206	BPR7EIX	4055
XT 500 T	500		DPR8EA-9	4929	0,9	DPR8EVX-9	2872	221	DPR8EIX-9	2202
XT 500 Z	500		DPR8EA-9	4929	0,9	DPR8EVX-9	2872	221	DPR8EIX-9	2202
XV 500 (I)	500		BPR7ES	2023	0,8	BPR7EVX	5565		BPR7EIX	4055
XV 500 SE (26R)	500	83- 87	BPR7ES	2023	0,8	BPR7EVX	5565		BPR7EIX	4055
XV 535 DX (H) VJ011 32kW	535	00-	BPR6ES	7822	0,8	BPR6EVX	6764		BPR6EIX	6637
XV 535 DX (N) VJ012 25kW	535	00-	BPR6ES	7822	0,8	BPR6EVX	6764		BPR6EIX	6637
XV 535 (2YL,3BR)	535	88- 96	BPR7ES	2023	0,8	BPR7EVX	5565		BPR7EIX	4055
XV 535 (4KU / 4MC)	535	95-	BPR7ES	2023	0,8	BPR7EVX	5565		BPR7EIX	4055
XV 535 S / SP (2YL,3BR)	535	93- 96	BPR7ES	2023	0,8	BPR7EVX	5565		BPR7EIX	4055
XV 535/S(h) (2YL)	535	97- 99	BPR6ES	7822	0,8	BPR6EVX	6764		BPR6EIX	6637
XV 535/S(n) (3BR)	535	97- 99	BPR6ES	7822	0,8	BPR6EVX	6764		BPR6EIX	6637
YV 535 FC	535	94-	BP7ES	2412	0,8	BP7EVX	7270	206	BPR7EIX	4055
XJ 550 (4V8)	550	81- 83	D8EA	2120	0,6	D8EVX	2850	216	DR8EIX	6681
XJ 550 H	550		D8EA	2120	0,6	D8EVX	2850	216	DR8EIX	6681
XJ 550 RH	550		D8EA	2120	0,6	D8EVX	2850	216	DR8EIX	6681
XT 550 (5Y3)	550	82- 83	DR7ES	3123	0,6					
XZ 550 (11V)	550	82- 84	DR8ESL	2923	0,6	DR8EVX	6354	218	DR8EIX	6681
XZ 550 S (11V)	550	83- 84	DR8ESL	2923	0,7	DR8EVX	6354	218	DR8EIX	6681
FZ 6 Fazer	600	04-	CR9EK	4548	0,7			230	CR9EIX	3521
FZ 600,-U	600		DR8ESL	2923	0,7	DR8EVX	6354	218	DR8EIX	6681
FZR 600 (3HE,3RG,3RH)	600	89- 93	CR9E	6263	0,7	CR9EVX	5943	227	CR9EIX	3521
FZR 600 F / R / RF / RFC	600	94-	CR9E	6263	0,7	CR9EVX	5943	227	CR9EIX	3521
FZR 600 R (4JH) 72kW	600	94-	CR9E	6263	0,7	CR9EVX	5943	227	CR9EIX	3521
FZR 600 R (4MH) 25kW	600	94-	CR9E	6263	0,7	CR9EVX	5943	227	CR9EIX	3521
FZS 600 Fazer (RJ021)(5DM)	600	98- 02	CR9E	6263	0,7	CR9EVX	5943	227	CR9EIX	3521
FZS 600 Fazer (RJ022)	600	98- 02	CR8E	1275	0,7	CR8EVX	6487	226	CR8EIX	4218
FZS 600 Fazer	600	03- 04	CR9EK	4548	0,7			230	CR9EIX	3521
SRX 600 (1XM,1XN)	600	86- 89	DPR7EA-9	5129	0,9	DPR7EVX-9	7682	220	DPR7EIX-9	7803
TT 600	600	86-	DPR7EA-9	5129	0,9	DPR7EVX-9	7682	220	DPR7EIX-9	7803
TT 600 RE (DJ012)	600	03-	DPR8EA-9	4929	0,9	DPR8EVX-9	2872	221	DPR8EIX-9	2202
TT 600 (36A)	600	83- 85	D7EA	7912	0,6	D7EVX	2734			
TT 600 E (4LW)	600	93-	DPR8EA-9	4929	0,9	DPR8EVX-9	2872	221	DPR8EIX-9	2202
TT 600 R (DJ011)	600	98-	DPR9EA-9	5329	0,9	DPR9EVX-9	3854	222	DPR9EIX-9	5545
TT 600 S (4LW)	600	93-	DPR8EA-9	4929	0,9	DPR8EVX-9	2872	221	DPR8EIX-9	2202
TT 600 S (59X) (I)	600	85- 89	DPR7EA-9	5129	0,9	DPR7EVX-9	7682	220	DPR7EIX-9	7803
XJ 600 (51J,3KM,3KN)	600	84- 90	DR8ESL	2923	0,7	DR8EVX	6354	218	DR8EIX	6681
XJ 600 N (4KA)	600	95-	CR8E	1275	0,6	CR8EVX	6487	226	CR8EIX	4218
XJ 600 N (4MB)	600	95-	CR8E	1275	0,6	CR8EVX	6487	226	CR8EIX	4218
XJ 600 N (h) (4BR)	600	97-	CR8E	1275	0,6	CR8EVX	6487	226	CR8EIX	4218
XJ 600 N (n) (4LX)	600	97-	CR7E	4578	0,6			225	CR7EIX	7385
XJ 600 S (4EB / 4LX)	600	95- 96	CR8E	1275	0,6	CR8EVX	6487	226	CR8EIX	4218
XJ 600 S (4BR,4BRA,4BRB)	600	91- 96	CR8E	1275	0,7	CR8EVX	6487	226	CR8EIX	4218
XJ 600 S (h) (4BR)(1R..)	600	97-	CR8E	1275	0,6	CR8EVX	6487	226	CR8EIX	4218
XJ 600 S (n) (4LX)	600	97-	CR7E	4578	0,7			225	CR7EIX	7385
XJ 600 S / N (4LX)	600	94- 96	CR9E	6263	0,7	CR9EVX	5943	227	CR9EIX	3521
XT 600 (2KF,2NF)	600	87- 90	DPR8EA-9	4929	0,9	DPR8EVX-9	2872	221	DPR8EIX-9	2202
XT 600 (43F)	600	84- 87	DR7ES	3123	0,6					
XT 600 E (4PT / 4SK)	600	95-	DPR8EA-9	4929	0,9	DPR8EVX-9	2872	221	DPR8EIX-9	2202
XT 600 E / EF / EFC	600	94-	DPR8EA-9	4929	0,9	DPR8EVX-9	2872	221	DPR8EIX-9	2202
XT 600 E(h) (3TB)	600	97-	DPR8EA-9	4929	0,9	DPR8EVX-9	2872	221	DPR8EIX-9	2202



Order No.



Gold-Palladium

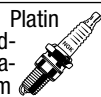

Order Quick No. No.

Iridium



Order No.

YAMAHA

XT 600 E(n) (3UW)	600	97-	DPR8EA-9	4929	0,9	DPR8EVX-9	2872	221	DPR8EIX-9	2202
XT 600 E/K (3TB/3UW)	600	90- 94	DPR8EA-9	4929	0,9	DPR8EVX-9	2872	221	DPR8EIX-9	2202
XT 600 S	600	(86)	DPR8EA-9	4929	0,9	DPR8EVX-9	2872	221	DPR8EIX-9	2202
XT 600 Z (34L,55W)	600	83- 85	DR7ES	3123	0,6					
XT 600 Z Tenere (1VJ,3AJ)	600	86-	DPR7EA-9	5129	0,9	DPR7EVX-9	7682	220	DPR7EIX-9	7803
YX 600	600		DR8ESL	2923	0,7	DR8EVX	6354	218	DR8EIX	6681
YZF 600 R (4TV)	600	96-	CR9E	6263	0,8	CR9EVX	5943	227	CR9EIX	3521
YZF 600 R (4WD)	600	96-	CR9E	6263	0,8	CR9EVX	5943	227	CR9EIX	3521
YZF-R6	600	03-	CR10EK	2360	0,6					
YZF-R6 (RJ031/032)	600	99-	CR10EK	2360	0,6					
Drag Star (4VR/4XR)	650	97-	DPR7EA-9	5129	0,9	DPR7EVX-9	7682	220	DPR7EIX-9	7803
TS 650	650		B8ES	2411	0,6	B8EVX	7051	201	BR8EIX	5044
XJ 650 (4K0)	650	80- 83	BP7ES	2412	0,7	BP7EVX	7270	206	BPR7EIX	4055
XJ 650 H	650		BP7ES	2412	0,7	BP7EVX	7270	206	BPR7EIX	4055
XJ 650 LH	650		BP7ES	2412	0,7	BP7EVX	7270	206	BPR7EIX	4055
XJ 650 SH	650		BP7ES	2412	0,7	BP7EVX	7270	206	BPR7EIX	4055
XJ 650 T (Turbo) (11T)	650	82-	BPR8ES	3923	0,7	BPR8EVX	5573	213		
XS 650 (447)	650	76- 83	BP8ES	2912	0,7	BP8EVX	2671			
XS 650 (I)	650		BP7ES	2412	0,7	BP7EVX	7270	206	BPR7EIX	4055
XS 650 E	650		BP7ES	2412	0,7	BP7EVX	7270	206	BPR7EIX	4055
XS 650 H	650		BP7ES	2412	0,7	BP7EVX	7270	206	BPR7EIX	4055
XS 650 II	650		BP7ES	2412	0,7	BP7EVX	7270	206	BPR7EIX	4055
XS 650 S	650		BP7ES	2412	0,7	BP7EVX	7270	206	BPR7EIX	4055
XS 650 SE (3L1)	650	79- 81	BP7ES	2412	0,7	BP7EVX	7270	206	BPR7EIX	4055
XS 650 SH	650		BP7ES	2412	0,7	BP7EVX	7270	206	BPR7EIX	4055
XVS 650 Drag Star Classic (VM022)	650	98-	DPR7EA-9	5129	0,9	DPR7EVX-9	7682	220	DPR7EIX-9	7803
XVS 650 (4VR)	650	97-	DPR7EA-9	5129	0,9	DPR7EVX-9	7682	220	DPR7EIX-9	7803
XVS 650 Drag Star Classic (VM025)	650	98-	DPR7EA-9	5129	0,9	DPR7EVX-9	7682	220	DPR7EIX-9	7803
XVS 650 (4XR)	650	97-	DPR7EA-9	5129	0,9	DPR7EVX-9	7682	220	DPR7EIX-9	7803
SZR 660 (4SU)	660	(96)	DPR9EA-9	5329	0,9	DPR9EVX-9	3854	222	DPR9EIX-9	5545
SZR 660 (4SU)	660	97-	DPR8EA-9	4929	0,9	DPR8EVX-9	2872	221	DPR8EIX-9	2202
XT 660 R	660	04-	CR7E	4578	0,6			225	CR7EIX	7385
XT 660 X	660	04-	CR7E	4578	0,6			225	CR7EIX	7385
XTZ 660 (4MD)	660	94-	DR8EA	7162	0,9	DR8EVX	6354		DR8EIX	6681
XTZ 660 (3YF)	660	97-	DPR8EA-9	4929	0,9	DPR8EVX-9	2872	221	DPR8EIX-9	2202
XTZ 660 (3YF)	660	91- 93	DPR9EA-9	5329	0,9	DPR9EVX-9	3854	222	DPR9EIX-9	5545
YFM 660 FWA Grizzly (ATV)	660	02- 04	DPR8EA-9	4929	0,9	DPR8EVX-9	2872	221	DPR8EIX-9	2202
YFM 660 R Raptor (ATV)	660	01- 04	DPR8EA-9	4929	0,9	DPR8EVX-9	2872	221	DPR8EIX-9	2202
YXR 660 FAS (ATV)	660	04-	DPR8EA-9	4929	0,9	DPR8EVX-9	2872	221	DPR8EIX-9	2202
750 Laguna Seca (11M)	750	82-	BP7ES	2412	0,7	BP7EVX	7270	206	BPR7EIX	4055
FZ 750 (1FN)	750	85- 86	DR8ESL	2923	0,7	DR8EVX	6354	218	DR8EIX	6681
FZ 750 (3KT)	750	91-	DR8ESL	2923	0,6	DR8EVX	6354	218	DR8EIX	6681
FZ 750 Genesis (2KK)	750	87- 90	DR8ESL	2923	0,6	DR8EVX	6354	218	DR8EIX	6681
FZR 750 R (3PJ,3CV)	750	88- 92	DR8EA	7162	0,7	DR8EVX	6354		DR8EIX	6681
FZX 750 (2JE)	750	87- 89	DR8ESL	2923	0,6	DR8EVX	6354	218	DR8EIX	6681
FZX 750 Phaser (I)	750		DR8ESL	2923	0,7	DR8EVX	6354	218	DR8EIX	6681
TZ 750	750		B10EG	3630	0,5	B10EGV	5927			
TZ 750 D	750				0,6	B10EVX	7335		BR10EIX	6801
XJ 750	750	- 83	B7ES	1111	0,7	B7EVX	6934			
XJ 750 (41Y)	750	84- 85	BPR8ES	3923	0,7	BPR8EVX	5573	213		
XJ 750 RH	750		B7ES	1111	0,7	B7EVX	6934			
XS 750 (1T5)	750	77- 79	B7ES	1111	0,7	B7EVX	6934			

Order
No.Platin
Gold-
Palla-
diumOrder Quick
No. No.Order
No.**YAMAHA**

XS 750 C	750		B7ES	1111	0,7	B7EVX	6934				
XS 750 D	750		B7ES	1111	0,7	B7EVX	6934				
XS 750 E	750		B7ES	1111	0,7	B7EVX	6934				
XS 750 S	750		B7ES	1111	0,7	B7EVX	6934				
XS 750 SE	750		B7ES	1111	0,7	B7EVX	6934				
XS 750 T	750		B7ES	1111	0,7	B7EVX	6934				
XTS 750 SE	750		B7ES	1111	0,7	B7EVX	6934				
XTZ 750 (3LD, 3WM)	750	89-	DPR8EA-9	4929	0,9	DPR8EVX-9	2872	221	DPR8EIX-9	2202	
XV 750	750	- 83	B7ES	1111	0,7	B7EVX	6934				
XV 750 (4PW)	750	95-	BPR7ES	2023	0,8	BPR7EVX	5565		BPR7EIX	4055	
XV 750 / F / FC	750	84-	BPR7ES	2023	0,7	BPR7EVX	5565		BPR7EIX	4055	
XV 750 SE (5G5)	750	81- 82	B7ES	1111	0,7	B7EVX	6934				
XV 750 SE (I)	750		BP7ES	2412	0,7	BP7EVX	7270	206	BPR7EIX	4055	
YZF 750 R / RF / RFC (4HN)	750	93-	CR9E	6263	0,9	CR9EVX	5943	227	CR9EIX	3521	
YZF 750 SP / SPF (4HT)	750	93-	CR9E	6263	0,8	CR9EVX	5943	227	CR9EIX	3521	
YZF-R7 (RM011)	750	01-	R-0256R-10	7641	1,0						
TDM 850 (4TX)	850	(96)	DPR9EA-9	5329	0,9	DPR9EVX-9	3854	222	DPR9EIX-9	5545	
TDM 850 (3VD)	850	97-	DPR8EA-9	4929	0,9	DPR8EVX-9	2872	221	DPR8EIX-9	2202	
TDM 850 (4TX)	850	97-	DPR8EA-9	4929	0,9	DPR8EVX-9	2872	221	DPR8EIX-9	2202	
TDM 850 / F (3VD)	850	91- 95	DPR8EA-9	4929	0,9	DPR8EVX-9	2872	221	DPR8EIX-9	2202	
TRX 850	850	(95)	DPR8EA-9	4929	0,9	DPR8EVX-9	2872	221	DPR8EIX-9	2202	
TRX 850 (4UN)	850	(96)	DPR9EA-9	5329	0,9	DPR9EVX-9	3854	222	DPR9EIX-9	5545	
TRX 850 (4UN)	850	97-	DPR8EA-9	4929	0,9	DPR8EVX-9	2872	221	DPR8EIX-9	2202	
XS 850 (4E2)	850	80- 81	BP7ES	2412	0,7	BP7EVX	7270	206	BPR7EIX	4055	
XS 850 H	850		BP7ES	2412	0,7	BP7EVX	7270	206	BPR7EIX	4055	
XS 850 LH	850		BP7ES	2412	0,7	BP7EVX	7270	206	BPR7EIX	4055	
XS 850 SH	850		BP7ES	2412	0,7	BP7EVX	7270	206	BPR7EIX	4055	
TDM 900	900	02-	DPR8EA-9	4929	0,9	DPR8EVX-9	2872	221	DPR8EIX-9	2202	
XJ 900 (31A)	900	83- 84	BPR8ES	3923	0,7	BPR8EVX	5573	213			
XJ 900 (4BB)	900	91-	BPR8ES	3923	0,7	BPR8EVX	5573	213			
XJ 900 (58L)	900	85- 90	BPR8ES	3923	0,7	BPR8EVX	5573	213			
XJ 900 S (4KM)	900	95-	DPR8EA-9	4929	0,9	DPR8EVX-9	2872	221	DPR8EIX-9	2202	
XV 920 RH	920		BP7ES	2412	0,7	BP7EVX	7270	206	BPR7EIX	4055	
FZR 1000 / FC (3LE)	1000	94-	DR8EA	7162	0,7	DR8EVX	6354		DR8EIX	6681	
FZR 1000 EXUP (I)	1000		DR8ESL	2923	0,7	DR8EVX	6354	218	DR8EIX	6681	
FZR 1000 F	1000	94-	DP8EA-9	5829	0,9	DPR8EVX-9	2872		DPR8EIX-9	2202	
FZR 1000 / U	1000		DR8ESL	2923	0,7	DR8EVX	6354	218	DR8EIX	6681	
FZS 1000 Fazer(RN064)	1000	01-	CR9E	6263	0,7	CR9EVX	5943	227	CR9EIX	3521	
GTS 1000 (4BH)	1000	92-	DPR8EA-9	4929	0,9	DPR8EVX-9	2872	221	DPR8EIX-9	2202	
GTS 1000 A / AF / AFC (4BH)	1000	92-	DPR8EA-9	4929	0,9	DPR8EVX-9	2872	221	DPR8EIX-9	2202	
TR1 (578)	1000	81- 82	BPR7ES	2023	0,7	BPR7EVX	5565		BPR7EIX	4055	
XV 1000 / F / FC	1000		BPR7ES	2023	0,7	BPR7EVX	5565		BPR7EIX	4055	
XV 1000 SE (23W,2AE)	1000	83- 88	BPR7ES	2023	0,7	BPR7EVX	5565		BPR7EIX	4055	
XV 1000 SH	1000		BPR7ES	2023	0,7	BPR7EVX	5565		BPR7EIX	4055	
YZF 1000 R (4VD)	1000	97-	DPR8EA-9	4929	0,9	DPR8EVX-9	2872	221	DPR8EIX-9	2202	
YZF R1 (RN012)(RN04)	1000	98- 01	CR9E	6263	0,7	CR9EVX	5943	227	CR9EIX	3521	
YZF R1	1000	02- 03							CR9EIA-9	6289	
YZF 1000 (4VD)	1000	96-	DR8EA	7162	0,7	DR8EVX	6354		DR8EIX	6681	
YZF-R1	1000	04-	CR9EK	4548	0,7			230	CR9EIX	3521	
BT 1100 Bulldog	1100	02-	BPR7ES	2023	0,6	BPR7EVX	5565		BPR7EIX	4055	
FJ 1100 (47E)	1100	84- 85	DPR8EA-9	4929	0,9	DPR8EVX-9	2872	221	DPR8EIX-9	2202	
XS 1100 (2H9)	1100	78- 82	BP6ES	7811	0,7	BP6EVX	5832		BPR6EIX	6637	

Order
No.Gold-
Palla-
dium

Platin

Order Quick
No. No.

Iridium

Order
No.**YAMAHA**

XS 1100 E	1100		BP6ES	7811	0,7	BP6EVX	5832		BPR6EIX	6637
XS 1100 H	1100		BP6ES	7811	0,7	BP6EVX	5832		BPR6EIX	6637
XS 1100 LH	1100		BP6ES	7811	0,7	BP6EVX	5832		BPR6EIX	6637
XS 1100 RH	1100		BP6ES	7811	0,7	BP6EVX	5832		BPR6EIX	6637
XS 1100 S (5K7)	1100	81- 82	BP6ES	7811	0,7	BP6EVX	5832		BPR6EIX	6637
XS 1100 SH	1100		BP6ES	7811	0,7	BP6EVX	5832		BPR6EIX	6637
XV 1100 (3LP)	1100	95-	BPR7ES	2023	0,8	BPR7EVX	5565		BPR7EIX	4055
XV 1100 SC	1100		BPR7ES	2023	0,8	BPR7EVX	5565		BPR7EIX	4055
XVS 1100 Drag Star (VP05)	1100	99-	BPR7ES	2023	0,7	BPR7EVX	5565		BPR7EIX	4055
FJ 1200 (1XJ)	1200	86- 87	DPR8EA-9	4929	0,9	DPR8EVX-9	2872	221	DPR8EIX-9	2202
FJ 1200 (3CW)	1200	88- 90	DPR8EA-9	4929	0,9	DPR8EVX-9	2872	221	DPR8EIX-9	2202
FJ 1200 (3YA)	1200	91-	DPR8EA-9	4929	0,9	DPR8EVX-9	2872	221	DPR8EIX-9	2202
FJ 1200 AE/ AEC / E / F	1200	93-	DP8EA-9	5829	0,9	DPR8EVX-9	2872		DPR8EIX-9	2202
VMAX 1200 (2EN)	1200	97-	DPR8EA-9	4929	0,9	DPR8EVX-9	2872	221	DPR8EIX-9	2202
VMAX 1200 (2EN) (I)	1200		DPR8EA-9	4929	0,9	DPR8EVX-9	2872	221	DPR8EIX-9	2202
VMX 1200 / F / FC	1200		DPR8EA-9	4929	0,9	DPR8EVX-9	2872	221	DPR8EIX-9	2202
XJR 1200 (4PU)	1200	95-	DPR8EA-9	4929	0,9	DPR8EVX-9	2872	221	DPR8EIX-9	2202
XJR 1200 (4PU)	1200	97-	DPR8EA-9	4929	0,9	DPR8EVX-9	2872	221	DPR8EIX-9	2202
XVZ 1200 TD	1200		DPR8EA-9	4929	0,9	DPR8EVX-9	2872	221	DPR8EIX-9	2202
XVZ 12T (47G)	1200	84- 87	DPR8EA-9	4929	0,9	DPR8EVX-9	2872	221	DPR8EIX-9	2202
FJR 1300	1300	01-	CR8E	1275	0,7	CR8EVX	6487	226	CR8EIX	4218
FJR 1300 A	1300	03-	CR8E	1275	0,7	CR8EVX	6487	226	CR8EIX	4218
Royal Star(4YP)	1300	97-	DPR7EA-9	5129	0,9	DPR7EVX-9	7682	220	DPR7EIX-9	7803
XJR 1300 (RP022)	1300	99-	DPR8EA-9	4929	0,9	DPR8EVX-9	2872	221	DPR8EIX-9	2202
XJR 1300	1300	98-	DPR8EA-9	4929	0,9	DPR8EVX-9	2872	221	DPR8EIX-9	2202
XJR 1300 SP (RP022)	1300	99-	DPR8EA-9	4929	0,9	DPR8EVX-9	2872	221	DPR8EIX-9	2202
XVZ 13 A (4NK)	1300	97-	DPR7EA-9	5129	0,9	DPR7EVX-9	7682	220	DPR7EIX-9	7803
XVZ 13 A (4YP)	1300	97-	DPR7EA-9	5129	0,9	DPR7EVX-9	7682	220	DPR7EIX-9	7803
XVZ 13DE	1300	93-	DPR8EA-9	4929	0,9	DPR8EVX-9	2872	221	DPR8EIX-9	2202
XV 1600 Wild Star (VP981)	1600	03.99-	DPR7EA-9	5129	0,9	DPR7EVX-9	7682	220	DPR7EIX-9	7803
XU 1700 Road Star Warrior	1670	03-	DPR7EA-9	5129	0,9	DPR7EVX-9	7682	220	DPR7EIX-9	7803

YERF-DOG

23000 (ATV)	90	04-	BP7HS	5111	0,7	BP7HVX	7468		BPR7HIX	5944
23100 (ATV)	150	04-	BR6ES	4922	0,6					

ZID

Woshod 144.000-01-900 9,9kW	175		BP7HS	5111	0,7	BP7HVX	7468		BPR7HIX	5944
Woshod 128.000-01-900 10,3kW	175		BP7HS	5111	0,7	BP7HVX	7468		BPR7HIX	5944
Woshod 124.000-01-900 7,7kW	175		BP7HS	5111	0,7	BP7HVX	7468		BPR7HIX	5944
Zid-200 3DK5.104 11,1kW	197		BP7HS	5111	0,7	BP7HVX	7468		BPR7HIX	5944
Fermer 3DK5.904 9,6kW	197		BP7HS	5111	0,7	BP7HVX	7468		BPR7HIX	5944
Sova 11kW	200		BP7HS	5111	0,7	BP7HVX	7468		BPR7HIX	5944

ZÜNDAPP

KS 50 12.7 mm Gewindelänge	50		B7HS	5110	0,5	B7HVX	7836	204	BR7HIX	7067
KS 50 19.0 mm Gewindelänge	50		B7ES	1111	0,5	B7EVX	6934			
KS 50 Cross/Sport 517	50		B8HS	5510	0,5	B8HVX	2634	205	BR8HIX	7001
KS 50 Sport/Super Sport	50		B8HS	5510	0,5	B8HVX	2634	205	BR8HIX	7001
KS 50 TT/WK	50		B9ES	2611	0,5	B9EVX	7254	202	BR9EIX	3981
K 80	80		B8ES	2411	0,5	B8EVX	7051	201	BR8EIX	5044
KS 80	80		B8ES	2411	0,5	B8EVX	7051	201	BR8EIX	5044



Order No.



Gold-Palladium

Platin



Order Quick No.



Order No.

ZÜNDAPP

Motorcycle Model	Capacity	Valves	Part No.	Gap	Part No.	Part No.	Part No.	Part No.	Part No.	
KS 80 Super	80		B8ES	2411	0,5	B8EVX	7051	201	BR8EIX	5044
KS 80 Touring	80		B8ES	2411	0,5	B8EVX	7051	201	BR8EIX	5044
KS 125	125		B8HS	5510	0,5	B8HVX	2634	205	BR8HIX	7001
KS 125 GS	125		B8HS	5510	0,5	B8HVX	2634	205	BR8HIX	7001
KS 125 MC	125		B8HS	5510	0,5	B8HVX	2634	205	BR8HIX	7001
KS 600	600	38-	BP6HS	4511	0,6	BP6HVX	4635		BPR6HIX	4085
KS 601	600		BP7HS	5111	0,5	BP7HVX	7468		BPR7HIX	5944



Order No.



Gold-Palladium



Order No.

Quick No.

Iridium



Order No.

APRILIA

Amico 25 (MK)	25	96-	BR7HS	4122	0,5	---		211	BR7HIX	7067
Amico GL (HV)	50		BR7HS	4122	0,5	---		211	BR7HIX	7067
Amico LX / LK /Sport	50		BR7HS	4122	0,5	---		211	BR7HIX	7067
Amico 50	50	01.90- 95	BR7HS	4122	0,6	---		211	BR7HIX	7067
Amico 50 Clubmann	50	97-	BR7HS	4122	0,5	---		211	BR7HIX	7067
Area 51 (MY)	50	99-	BR8HS	4322	0,7	BR8HVX	6265	212	BR8HIX	7001
Gulliver AC (LH)	50		BR7HS	4122	0,5	---		211	BR7HIX	7067
Gulliver 50 LC (LH)	50	96-	BR8HS	4322	0,7	BR8HVX	6265	212	BR8HIX	7001
Gulliver 50	50	01.95- 96	BR7HS	4122	0,6	---		211	BR7HIX	7067
Gulliver 50 H2O	50	01.96-	BR8HS	4322	0,6	BR8HVX	6265	212	BR8HIX	7001
Habana 50 / Custom (PK)	50	99-	BPR8HS	3725	0,6	---			BPR8HIX	6742
Mojito Custom 50	50	99-	BPR8HS	3725	0,6	---			BPR8HIX	6742
MX 50 (RX50)	50	03-	BR9ES	5722	0,6	BR9EVX	1265	208	BR9EIX	3981
Rally 50 AC (MD)	50		BR7HS	4122	0,5	---		211	BR7HIX	7067
Rally 50	50	01.95- 96	BR8HS	4322	0,6	BR8HVX	6265	212	BR8HIX	7001
Rally 50 LC / Fun (MZ)	50	96-	BR8HS	4322	0,5	BR8HVX	6265	212	BR8HIX	7001
Rally 50 H2O	50	01.96-	BR8HS	4322	0,6	BR8HVX	6265	212	BR8HIX	7001
Scarabeo 50	50	93- 03	BR7HS	4122	0,5	---		211	BR7HIX	7067
Scarabeo De Luxe	50	98- 03	BR7HS	4122	0,5	---		211	BR7HIX	7067
Scarabeo 50 (DiTech)	50	07.00-	CPR8E	7411	0,6	---			---	
Sonic 50 (PB)	50		BR8HS	4322	0,6	BR8HVX	6265	212	BR8HIX	7001
Sonic 50 G.P. / Spice	50	01.98-	BR8HS	4322	0,6	BR8HVX	6265	212	BR8HIX	7001
SR 50 AC (LY)	50	93-	BR7HS	4122	0,5	---		211	BR7HIX	7067
SR 50 i.e. (RLE) (DiTech)25km/h	50	01-	CPR8E	7411	0,6	---			---	
SR 50	50	01.92- 96	BR7HS	4122	0,6	---		211	BR7HIX	7067
SR 50 i.e. (RLB) (DiTech)	50	07.00-	CPR8E	7411	0,6	---			---	
SR 50 LC (MZA)	50	93-	BR8HS	4322	0,5	BR8HVX	6265	212	BR8HIX	7001
SR 50 WWV - Netscaper	50	01.97-	BR8HS	4322	0,6	BR8HVX	6265	212	BR8HIX	7001
SR 50 H20 (RLA)	50	00-	BPR8HS	3725	0,6	---			BPR8HIX	6742
SR 50 H20 (I)	50	01.96-	BR8HS	4322	0,6	BR8HVX	6265	212	BR8HIX	7001
Scarabeo 100 (RE) 2T	100	00-	BR8HS	4322	0,7	BR8HVX	6265	212	BR8HIX	7001
Scarabeo 100 (SA) 4T	100	00-	CR7E	4578	0,7	---		225	CR7EIX	7385
Atlantic 125	125	03-	CR8EB	7784	0,6	---			CR8EIX	4218
Habana 125 (PM)	125	99-	CR7E	4578	0,7	---		225	CR7EIX	7385
Leonardo 125 (MB)	125	01.95-	CR8E	1275	0,7	CR8EVX	6487	226	CR8EIX	4218
Scarabeo 125 (PC)	125	99-	CR8E	1275	0,6	CR8EVX	6487	226	CR8EIX	4218
Sportcity 125	125		CR8E	1275	0,6	CR8EVX	6487	226	CR8EIX	4218
SR 125 AC	125	99-	BR8ES	5422	0,6	BR8EVX	1262	207	BR8EIX	5044
Leonardo 150	150	02-	DR8EA	7162	0,6	DR8EVX	6354		DR8EIX	6681
Leonardo 150 (MBA)	150	01.97- 00	CR8E	1275	0,7	CR8EVX	6487	226	CR8EIX	4218
Leonardo 150 (MBA)	150	01.97- 00	CR8E	1275	0,7	CR8EVX	6487	226	CR8EIX	4218
Scarabeo 150 (PCA)	150	99-	CR8E	1275	0,6	CR8EVX	6487	226	CR8EIX	4218
SR 150	150		BR9ES	5722	0,6	BR9EVX	1265	208	BR9EIX	3981
Atlantic 200	200	03-	CR8EB	7784	0,6	---			CR8EIX	4218
Scarabeo	200	00-	---		0,6	CR8EVX	6487	226	CR8EIX	4218
Leonardo 250 (PD)	250	98- 00	DR8EA	7162	0,6	DR8EVX	6354		DR8EIX	6681
Leonardo 300	300	03-	DR8EA	7162	0,6	DR8EVX	6354		DR8EIX	6681
Atlantic 500	500	02-	CR7EKB	4455	0,6	---			---	
Scarabeo 500	500	02-	CR7EKB	4455	0,6	---			---	

ATALA

Byte	50		B7HS	5110	0,6	B7HVX	7836	204	BR7HIX	7067
------	----	--	------	------	-----	-------	------	-----	--------	------

Order
No.Gold-
Palla-
diumOrder Quick
No. No.

Iridium

Order
No.**ATALA**

Byte 25	50	96-	BPR6HS	7022	0,6	BPR6HVX	2740	214	BPR6HIX	4085
Byte 50	50	96-	BPR6HS	7022	0,6	BPR6HVX	2740	214	BPR6HIX	4085
Carosello	50		B7HS	5110	0,6	B7HVX	7836	204	BR7HIX	7067
Hacker - Hacker Racing	50		BPR6HS	7022	0,6	BPR6HVX	2740	214	BPR6HIX	4085
Hacker AT12 Racing	50	96-	BPR6HS	7022	0,5	BPR6HVX	2740	214	BPR6HIX	4085
Hacker AT12 Racing LC	50	96-	BPR6HS	7022	0,5	BPR6HVX	2740	214	BPR6HIX	4085
Hacker AT12	50	96-	BPR6HS	7022	0,5	BPR6HVX	2740	214	BPR6HIX	4085
Master LF	50	96-	B6HS	4510	0,5	B6HVX	7435	203	BR6HIX	3419
Racing	50	96-	BPR6HS	7022	0,5	BPR6HVX	2740	214	BPR6HIX	4085
Skeggia	50	01.98-	BPR6HS	7022	0,6	BPR6HVX	2740	214	BPR6HIX	4085

BAJAJ

Spirit	50	99-	B6HS	4510	0,5	B6HVX	7435	203	BR6HIX	3419
Sunny 50	50	97-	B6HS	4510	0,5	B6HVX	7435	203	BR6HIX	3419
Chetak	125		BP5HS	4111	0,6	---			---	
Chetak 125 Electr.	125		BP6HS	4511	0,6	BP6HVX	4635		BPR6HIX	4085
Chetak 125 electr.; D	125		BP6HS	4511	0,6	BP6HVX	4635		BPR6HIX	4085
Chetak 125 Electr.D	125		BP6HS	4511	0,6	BP6HVX	4635		BPR6HIX	4085
Chetak	150		BP5HS	4111	0,6	---			---	
Chetak 150 Classic	150		BPR5HS	6222	0,6	---				
Chetak 150 Classic Green	150		BPR5HS	6222	0,6	---				
Chetak 150 Classic Sidec	150		BPR5HS	6222	0,6	---				
Chetak 150 Electr.	150		BPR5HS	6222	0,6	---				
Chetak 150 electr.; D; Classic; Sidec; Green	150		BPR5HS	6222	0,6	---				
Chetak 150 Electr.D	150		BPR5HS	6222	0,6	---				

BENELLI

491 only Italien	50		BR8ES	5422	0,6	BR8EVX	1262	207	BR8EIX	5044
491 Sport watercooler	50	97-	BR7HS	4122	0,6	---		211	BR7HIX	7067
491 Racing watercooler	50	97-	BR7HS	4122	0,6	---		211	BR7HIX	7067
491 GT aircooler	50	97-	BR7HS	4122	0,6	---		211	BR7HIX	7067
491 Superbike watercooler	50	99-	BR7HS	4122	0,6	---		211	BR7HIX	7067
491 SBK	50	00-	BR8HS	4322	0,7	BR8HVX	6265	212	BR8HIX	7001
491 ST GP	50	00-	BR8HS	4322	0,7	BR8HVX	6265	212	BR8HIX	7001
491 Rage ST	50	00-	BR8HS	4322	0,7	BR8HVX	6265	212	BR8HIX	7001
K2 air cool	50		BR7HS	4122	0,6	---		211	BR7HIX	7067
K2 liquid cool/watercooler	50		BR8HS	4322	0,6	BR8HVX	6265	212	BR8HIX	7001
K2 Namur	50	00-	BR8HS	4322	0,7	BR8HVX	6265	212	BR8HIX	7001
Laser 50	50		B6HS	4510	0,5	B6HVX	7435	203	BR6HIX	3419
Naked 50	50		BR8HS	4322	0,6	BR8HVX	6265	212	BR8HIX	7001
Pepe Kat	50	99-	BR8HS	4322	0,6	BR8HVX	6265	212	BR8HIX	7001
Pepe	50	99-	BR7HS	4122	0,6	---		211	BR7HIX	7067
S 50	50		B6HS	4510	0,5	B6HVX	7435	203	BR6HIX	3419
Scoothy 50	50		B6HS	4510	0,6	B6HVX	7435	203	BR6HIX	3419
K2 100	100	99-	BR8HS	4322	0,7	BR8HVX	6265	212	BR8HIX	7001
Adiva 125	125		CR8EB	7784	0,6	---			CR8EIX	4218
Velvet Eco 125	125	99-	CR8E	1275	0,6	CR8EVX	6487	226	CR8EIX	4218
Adiva 150	150		CR8EB	7784	0,6	---			CR8EIX	4218
Velvet Eco 150	150	99-	CR8E	1275	0,6	CR8EVX	6487	226	CR8EIX	4218
Velvet Eco 250	250	00-	DR8EA	7162	0,7	DR8EVX	6354		DR8EIX	6681

Order
No.Platin
Gold-
Palla-
diumOrder Quick
No. No.

Iridium

Order
No.**BETA**

Ark watercooler	50	97-	BR8HS	4322	0,6	BR8HVX	6265	212	BR8HIX	7001
Ark aircooler	50	97-	BR7HS	4122	0,6	---		211	BR7HIX	7067
Chrono 50	50	95-	BR7HS	4122	0,5	---		211	BR7HIX	7067
Chrono 502	50	95-	BR7HS	4122	0,5	---		211	BR7HIX	7067
Eikon	50	98-	BR8HS	4322	0,6	BR8HVX	6265	212	BR8HIX	7001
Quadra 50	50	95-	BR7HS	4122	0,6	---		211	BR7HIX	7067
Tempo 50	50	94-	BR7HS	4122	0,5	---		211	BR7HIX	7067
Tempo 50 13"	50	96-	BR7HS	4122	0,5	---		211	BR7HIX	7067
Tempo 50 16"	50	96-	BR7HS	4122	0,5	---		211	BR7HIX	7067
Alp 125	125		DR8EA	7162	0,6	DR8EVX	6354		DR8EIX	6681
Alp 4T 200	125		DR8EA	7162	0,6	DR8EVX	6354		DR8EIX	6681
Eikon 125	125	99-	DR8EA	7162	0,6	DR8EVX	6354		DR8EIX	6681
Eikon 150	250	99-	DPR7EA-9	5129	0,9	DPR7EVX-9	7682	220	DPR7EIX-9	7803
REV-3	250		BP7ES	2412	0,6	BP7EVX	7270		BPR7EIX	4055

BMW

C1 125 4T	125	04.00-	03	CR8EB	7784	0,6	---		CR8EIX	4218
C1 200 4T	180	00-	03	CR8EB	7784	0,6	---		CR8EIX	4218

BS VILLA

Giorno	50			BR8HSA	5539	0,6	BR8HVX	6265	BR8HIX	7001	
GP Dio	50	90-		BPR8HS	3725	0,6	---		BPR8HIX	6742	
SP Dio	50			BPR7HS	6422	0,6	BPR7HVX	2938	215	BPR7HIX	5944
Z5	50	93-		BR8HSA	5539	0,6	BR8HVX	6265		BR8HIX	7001
ZX	50	93-		BR8HSA	5539	0,6	BR8HVX	6265		BR8HIX	7001

BUFFALO

CY 25	50	97-		BR7HS	4122	0,6	---		211	BR7HIX	7067
CY 50	50	97-		BR7HS	4122	0,6	---		211	BR7HIX	7067
CY 50 aircooled	50	96-		BR7HS	4122	0,6	---		211	BR7HIX	7067
MK 50	50	96-		BP7HS	5111	0,6	BP7HVX	7468		BPR7HIX	5944
MM 50	50	97-		BR7HS	4122	0,6	---		211	BR7HIX	7067
MY 50 aircooled	50	96-		BR7HS	4122	0,6	---		211	BR7HIX	7067
Silver watercooled	50	96-		BR8ES	5422	0,5	BR8EVX	1262	207	BR8EIX	5044

CAGIVA

City	50	93-		B7HS	5110	0,5	B7HVX	7836	204	BR7HIX	7067
City	50	94-	97	BPR8HS	3725	0,6	---			BPR8HIX	6742
City	50	98-		BR8HSA	5539	0,5	BR8HVX	6265		BR8HIX	7001
City L.E.	50	93-		B7HS	5110	0,5	B7HVX	7836	204	BR7HIX	7067
City, City LE	50	01.93-		B7HS	5110	0,6	B7HVX	7836	204	BR7HIX	7067
Cucciolo	50			B8HS	5510	0,6	B8HVX	2634	205	BR8HIX	7001
Mantis	50	99-		B9ES	2611	0,6	B9EVX	7254	202	BR9EIX	3981
Passing	50			BP6HS	4511	0,6	BP6HVX	4635		BPR6HIX	4085
Progress 50	50			B8HS	5510	0,6	B8HVX	2634	205	BR8HIX	7001
Progress Corsa	50			B9ES	2611	0,6	B9EVX	7254	202	BR9EIX	3981
Scooter	50	93-		BR8HSA	5539	0,7	BR8HVX	6265		BR8HIX	7001
Cucciolo	125	99-		CR7E	4578	0,7	---		225	CR7EIX	7385
Nuvola	125			CR7E	4578	0,7	---		225	CR7EIX	7385
Passing	125	95-		BP6HS	4511	0,6	BP6HVX	4635		BPR6HIX	4085

Order
No.Gold-
Palla-
diumOrder Quick
No.

No.

Iridium

Order
No.**CAPRI**

Roller 50	50		B7ES	1111	0,5	B7EVX	6934		---	
Roller 50S	50		B8ES	2411	0,5	B8EVX	7051	201	BR8EIX	5044
Roller 125	125		B8HS	5510	0,6	B8HVX	2634	205	BR8HIX	7001

CCF

Adly 50	50	96-	BP7HS	5111	0,6	BP7HVX	7468		BPR7HIX	5944
Cat 50	50	97-	BP7HS	5111	0,6	BP7HVX	7468		BPR7HIX	5944
Adly 100	100	96-	BP7HS	5111	0,6	BP7HVX	7468		BPR7HIX	5944
Cat 125	125	98-	CR7HSA	4549	0,6	---			CR7HIX	7544

CPI

GTR 50	50	03-	BR7HS	4122	0,8	---		211	BR7HIX	7067
GTS 50	50	03-	BR7HS	4122	0,8	---		211	BR7HIX	7067
Hussar 50	50	03-	BR7HS	4122	0,8	---		211	BR7HIX	7067
Oliver 50	50	03-	BR7HS	4122	0,8	---		211	BR7HIX	7067
Popcorn 50	50	03-	BR7HS	4122	0,8	---		211	BR7HIX	7067
GTS 125	125	03-	BR7HS	4122	0,8	---		211	BR7HIX	7067
X-Large 125	125	03-	BR7HS	4122	0,8	---		211	BR7HIX	7067
GTS 150	150	03-	BR7HS	4122	0,8	---		211	BR7HIX	7067
X-Large 150	150	03-	BR7HS	4122	0,8	---		211	BR7HIX	7067
GTS 200	200	03-	BR7HS	4122	0,8	---		211	BR7HIX	7067
X-Large 200	200	03-	BR7HS	4122	0,8	---		211	BR7HIX	7067

DAELIM

Message	50	98-	BR8HSA	5539	0,6	BR8HVX	6265		BR8HIX	7001
Tapo	50	98-	BR8HSA	5539	0,6	BR8HVX	6265		BR8HIX	7001
NS 125	125	98-	CR8EH-9	5666	0,9	CR8EHVX-9	4546	228	CR8EHIX-9	3797
Othello	125	98-	CR8EH-9	5666	0,9	CR8EHVX-9	4546	228	CR8EHIX-9	3797
VC 125	125	97-	CR8EH-9	5666	0,9	CR8EHVX-9	4546	228	CR8EHIX-9	3797
VS 125	125	97-	CR8EH-9	5666	0,9	CR8EHVX-9	4546	228	CR8EHIX-9	3797

DERBI

Atlantis LC	50		B9ES	2611	0,6	B9EVX	7254	202	BR9EIX	3981
Atlantis O2	50	99-	B8HS	5510	0,6	B8HVX	2634	205	BR8HIX	7001
Atlantis Air	50	03-	BR9ES	5722	0,6	BR9EVX	1265	208	BR9EIX	3981
Atlantis City	50	03-	BR9ES	5722	0,6	BR9EVX	1265	208	BR9EIX	3981
Aventura	50	95-	B8HS	5510	0,6	B8HVX	2634	205	BR8HIX	7001
Bullet	50	03-	BR9ES	5722	0,6	BR9EVX	1265	208	BR9EIX	3981
Furax 50	50	95-	B8HS	5510	0,5	B8HVX	2634	205	BR8HIX	7001
GP Serie Air Cool	50		BR10ES	4832	0,6	BR10EVX	3788		BR10EIX	6801
GP1 Replica water Cool	50	03-	BR10ES	4832	0,6	BR10EVX	3788		BR10EIX	6801
Hunter	50		B8HS	5510	0,6	B8HVX	2634	205	BR8HIX	7001
Manhattan	50		B8HS	5510	0,6	B8HVX	2634	205	BR8HIX	7001
Paddock 50 O2	50		B8HS	5510	0,6	B8HVX	2634	205	BR8HIX	7001
Paddock LC	50		B9ES	2611	0,6	B9EVX	7254	202	BR9EIX	3981
Predator O2 (ES)	50		B8HS	5510	0,6	B8HVX	2634	205	BR8HIX	7001
Predator O2	50	98-	B9ES	2611	0,6	B9EVX	7254	202	BR9EIX	3981
Predator LC	50	98-	B9ES	2611	0,6	B9EVX	7254	202	BR9EIX	3981
Racing Replica	50	02-	BR9ES	5722	0,6	BR9EVX	1265	208	BR9EIX	3981
Red Bullet	50	03-	BR9ES	5722	0,6	BR9EVX	1265	208	BR9EIX	3981
Vamos FL 50	50		BR8HS	4322	0,6	BR8HVX	6265	212	BR8HIX	7001
Vamos SE 50	50		BR8HS	4322	0,6	BR8HVX	6265	212	BR8HIX	7001

Order
No.Platin
Gold-
Palla-
diumOrder Quick
No. No.

Iridium

Order
No.**DERBI**

Vamos 50	50	93-	B8HS	5510	0,5	B8HVX	2634	205	BR8HIX	7001
Variant Revolution	50	03-	B8HS	5510	0,6	B8HVX	2634	205	BR8HIX	7001
Atlantis 100	100		B9ES	2611	0,6	B9EVX	7254	202	BR9EIX	3981
Boulevard 125 4T air cooler	125		CR9E	6263	0,7	CR9EVX	5943	227	CR9EIX	3521
Boulevard 150 4T	150		CR9E	6263	0,7	CR9EVX	5943	227	CR9EIX	3521

ENDRESS

EMR 50 DJ	50	97-	BR8HSA	5539	0,6	BR8HVX	6265		BR8HIX	7001
EMR 50 Ergon	50	97-	BP6HS	4511	0,6	BP6HVX	4635		BPR6HIX	4085

ENDRESS EMR

EMR 50	50		BR8HSA	5539	0,6	BR8HVX	6265		BR8HIX	7001
--------	----	--	--------	------	-----	--------	------	--	--------	------

ENFIELD

Scooter	125		B6HS	4510	0,5	B6HVX	7435	203	BR6HIX	3419
---------	-----	--	------	------	-----	-------	------	-----	--------	------

ERING

Cat 50	50		B6HS	4510	0,6	B6HVX	7435	203	BR6HIX	3419
Jet 50	50		B6HS	4510	0,6	B6HVX	7435	203	BR6HIX	3419
Rapido	50		B6HS	4510	0,6	B6HVX	7435	203	BR6HIX	3419
Silver Fox	50		B6HS	4510	0,6	B6HVX	7435	203	BR6HIX	3419
Thunderbike 50	50		B6HS	4510	0,6	B6HVX	7435	203	BR6HIX	3419
Cat 125	125		CR7HSA	4549	0,6	---			CR7HIX	7544
Shining 125	125		CR7HSA	4549	0,6	---			CR7HIX	7544
Thunderbike 125	125		CR7HSA	4549	0,6	---			CR7HIX	7544

FAMEL-ZÜNDAPP

Yuppie, XF	50		B8ES	2411	0,6	B8EVX	7051	201	BR8EIX	5044
------------	----	--	------	------	-----	-------	------	-----	--------	------

FANTIC

Grinta	50		BP7HS	5111	0,6	BP7HVX	7468		BPR7HIX	5944
Queenie	50		BP7HS	5111	0,6	BP7HVX	7468		BPR7HIX	5944
Koala,Oasis	75		B8ES	2411	0,5	B8EVX	7051	201	BR8EIX	5044
Caballero RC80	80		---		0,6	B10EG	3630			

GARELLI

GS-1			BR8HSA	5539	0,6	BR8HVX	6265		BR8HIX	7001
XM-1			BR8HSA	5539	0,6	BR8HVX	6265		BR8HIX	7001
303 50	50		BPR7HS	6422	0,6	BPR7HVX	2938	215	BPR7HIX	5944
Astro 50	50		BR9HS	4522	0,6	---			---	
Astro 50 2001	50	01-	BR9HS	4522	0,6	---			---	
Big Whell	50	93-	BPR7HS	6422	0,6	BPR7HVX	2938	215	BPR7HIX	5944
Flo 50	50		BPR7HS	6422	0,6	BPR7HVX	2938	215	BPR7HIX	5944
FX 50	50		BR9HS	4522	0,6	---			---	
Grinta 50	50	01.93-	BP7HS	5111	0,6	BP7HVX	7468		BPR7HIX	5944
Hussar 50	50		BR8HSA	5539	0,6	BR8HVX	6265		BR8HIX	7001
KRC 50	50		BR9HS	4522	0,6	---			---	
KRS 50	50		BR9HS	4522	0,6	---			---	
M 901 50	50		BR9HS	4522	0,6	---			---	
Mars 50	50		BR9HS	4522	0,6	---			---	
Match 50	50		BR8HSA	5539	0,6	BR8HVX	6265		BR8HIX	7001
PMX Rally 50	50		BPR7HS	6422	0,6	BPR7HVX	2938	215	BPR7HIX	5944

Order
No.Gold-
Palla-
diumOrder Quick
No. No.

Iridium

Order
No.**GARELLI**

PMX Sport 50	50		BPR7HS	6422	0,6	BPR7HVX	2938	215	BPR7HIX	5944
Pony 50	50		BP7HS	5111	0,6	BP7HVX	7468		BPR7HIX	5944
Queenie 50	50	01.92-	BP7HS	5111	0,6	BP7HVX	7468		BPR7HIX	5944
Racing SR / Racing	50	- 93	BP7HS	5111	0,6	BP7HVX	7468		BPR7HIX	5944
Raider 50	50		BR9HS	4522	0,6	---			---	
Roadshow 50	50		BR9HS	4522	0,6	---			---	
RZ1 50	50		BR9HS	4522	0,6	---			---	
Shark 50	50		BR9HS	4522	0,6	---			---	
SR	50		BP7HS	5111	0,6	BP7HVX	7468		BPR7HIX	5944
Starter 50	50		BR9HS	4522	0,6	---			---	
PMX Sport	106		BR8HS	4322	0,6	BR8HVX	6265	212	BR8HIX	7001
PMX Sport 110	110		BPR6HS	7022	0,6	BPR6HVX	2740	214	BPR6HIX	4085
303 R 125	125		CR7HSA	4549	0,5	---			CR7HIX	7544
Blast 125	125		CR7HSA	4549	0,5	---			CR7HIX	7544
GTA 125 / ES	125		B10ES	7928	0,5	B10EGV	5927		BR10EIX	6801
Hussar 125	125		CR7HSA	4549	0,6	---			CR7HIX	7544
Hussar 125 2001	125	01-	CR7HSA	4549	0,6	---			CR7HIX	7544
Joker 125	125	03-	CR7HSA	4549	0,7	---			CR7HIX	7544
Tiger 125 XLE	125		B10ES	7928	0,5	B10EGV	5927		BR10EIX	6801
T-Rex 125	125		CR7HSA	4549	0,6	---			CR7HIX	7544
T-Rex 150 2001	125		CR7HSA	4549	0,5	---			CR7HIX	7544
Freeland 150	150		CR7HSA	4549	0,7	---			CR7HIX	7544
Joker 150	150		CR7HSA	4549	0,7	---			CR7HIX	7544
T-Rex 150	150		CR7HSA	4549	0,5	---			CR7HIX	7544
T-Rex 150 2001	150	01-	CR7HSA	4549	0,6	---			CR7HIX	7544

GILERA

DNA 50	50	00-	BR9ES	5722	0,6	BR9EVX	1265	208	BR9EIX	3981
Eaglet 50	50	01.93-	B9ES	2611	0,6	B9EVX	7254	202	BR9EIX	3981
Easy Mooving	50	01.95-	B9ES	2611	0,6	B9EVX	7254	202	BR9EIX	3981
GSM 50	50	00-	BR9ES	5722	0,6	BR9EVX	1265	208	BR9EIX	3981
Ice	50	00-	BR9ES	5722	0,6	BR9EVX	1265	208	BR9EIX	3981
Runner	50	97-	B9EG	3530	0,6	B9EGV	5827		---	
Runner 2P 2D	50	01.97-	B9ES	2611	0,6	B9EVX	7254	202	BR9EIX	3981
Runner Racing Replica	50	04-	BR9ES	5722	0,6	BR9EVX	1265	208	BR9EIX	3981
Runner SP	50	00-	BR9ES	5722	0,6	BR9EVX	1265	208	BR9EIX	3981
Stalker	50	01.97-	B9ES	2611	0,6	B9EVX	7254	202	BR9EIX	3981
Storm 50	50	94-	B9ES	2611	0,5	B9EVX	7254	202	BR9EIX	3981
Typhoon 50	50	01.93-	B9ES	2611	0,6	B9EVX	7254	202	BR9EIX	3981
Typhoon 50 Martini Racing	50	01.95-	B9ES	2611	0,6	B9EVX	7254	202	BR9EIX	3981
Typhoon Benetton F1	50	01.96-	B9ES	2611	0,6	B9EVX	7254	202	BR9EIX	3981
Cougar 125	125	00-	DPR8EA-9	4929	0,9	DPR8EVX-9	2872	221	DPR8EIX-9	2202
DNA 125	125	00-	CR8EB	7784	0,7	---			CR8EIX	4218
Runner FX 125	125	97-	B9ES	2611	0,6	B9EVX	7254	202	BR9EIX	3981
Typhoon 125	125	01.95-	B9ES	2611	0,6	B9EVX	7254	202	BR9EIX	3981
Runner	150	98-	BR9ES	5722	0,6	BR9EVX	1265	208	BR9EIX	3981
DNA 180	180	00-	CR8EB	7784	0,7	---			CR8EIX	4218
Runner FRX 180	180	98-	B9ES	2611	0,6	B9EVX	7254	202	BR9EIX	3981
Runner VRX	180	01-	CR9EB	6955	0,6	---			CR9EIX	3521

HMZ

Cab SB50	50	96-	BP6HS	4511	0,6	BP6HVX	4635		BPR6HIX	4085
----------	----	-----	-------	------	-----	--------	------	--	---------	------



Order No.



Gold-Palladium



Order No.

Quick No.

Iridium



Order No.

HONDA

DIO 50	50	04-	ER8EH-N		0,7					
Joker SRX50T	50	97-	BR6HSA	4296	0,5	---		210	BR6HIX	3419
NB 50	50		BPR6HSA	4632	0,7	BPR6HVX	2740	214	BPR6HIX	4085
NB 50 M Melody (AB07)	50	84-	BPR6HS	7022	0,7	BPR6HVX	2740	214	BPR6HIX	4085
NH 50 Lead	50	01.87- 88	BPR6HS	7022	0,6	BPR6HVX	2740	214	BPR6HIX	4085
NH 50 M	50	93-	BPR6HS	7022	0,7	BPR6HVX	2740	214	BPR6HIX	4085
NH 50 MS Lead (AF01)	50	85- 87	BPR6HS	7022	0,7	BPR6HVX	2740	214	BPR6HIX	4085
PK 50 Wallaro	50	90-	BR6HSA	4296	0,6	---		210	BR6HIX	3419
PX 50	50	89- 90	BPR5HS	6222	0,6	---				
SA 50 Vision	50	91-	BPR6HSA	4632	0,6	BPR6HVX	2740	214	BPR6HIX	4085
SA 50 Vision	50	01.88- 90	BPR6HSA	4632	0,6	BPR6HVX	2740	214	BPR6HIX	4085
SFX 50	50	95-	BR6HSA	4296	0,6	---		210	BR6HIX	3419
SGX 50 Sky	50	97-	BR6HSA	4296	0,6	---		210	BR6HIX	3419
SH 50 T	50	96-	BR6HSA	4296	0,6	---		210	BR6HIX	3419
SH 50 (AF40)	50	97-	BR6HSA	4296	0,7	---		210	BR6HIX	3419
SH 50 (I)	50	01.87- 96	BPR6HS	7022	0,6	BPR6HVX	2740	214	BPR6HIX	4085
SH 50 P	50	01.93- 95	BPR6HSA	4632	0,6	BPR6HVX	2740	214	BPR6HIX	4085
SH 50 New	50	01.97-	BPR6HS	7022	0,6	BPR6HVX	2740	214	BPR6HIX	4085
Shadow 50	50	01.97-	BR6HSA	4296	0,6	---		210	BR6HIX	3419
SJ 50 Bali	50		BR6HSA	4296	0,6	---		210	BR6HIX	3419
Sky 50 DX	50	01.96-	BR6HSA	4296	0,6	---		210	BR6HIX	3419
SXR 50 W	50	98-	BR6HSA	4296	0,6	---		210	BR6HIX	3419
SZX 50 X8R-S/X	50	98-	BR6HSA	4296	0,6	---		210	BR6HIX	3419
X8R-S	50	01.98-	BR6HSA	4296	0,6	---		210	BR6HIX	3419
X8R-X	50	01.98-	BR6HSA	4296	0,6	---		210	BR6HIX	3419
Zoomer	50	04-	ER8EH-N							
NH 80 MS Lead (HD01)	80	83-	BPR6HS	7022	0,7	BPR6HVX	2740	214	BPR6HIX	4085
SRX 90 Shadow (JH2 HF09A)	90	98-	BR6HSA	4296	0,7	---		210	BR6HIX	3419
SCV 100 Lead	100	03-	CR6HSA	2983	0,7	---			CR6HIX	7274
SH 100 T	100	01.96-	BR6HSA	4296	0,6	---		210	BR6HIX	3419
SJ 100 Bali	100	01.96-	BR6HSA	4296	0,6	---		210	BR6HIX	3419
@ 125	125	00-	CR8EH-9	5666	0,9	CR8EHVX-9	4546	228	CR8EHIX-9	3797
CH 125	125	01.86- 95	DPR7EA-9	5129	0,9	DPR7EVX-9	7682	220	DPR7EIX-9	7803
CH 125 P	125	-01.93	DPR7EA-9	5129	0,9	DPR7EVX-9	7682	220	DPR7EIX-9	7803
Dylan 125	125	02-	CR8EH-9	5666	0,9	CR8EHVX-9	4546	228	CR8EHIX-9	3797
FES 125 Pantheon (JF05) 2Takt	125	98-	BR8ES	5422	0,7	BR8EVX	1262	207	BR8EIX	5044
FES 125 Pantheon 4Takt	125	03-	CR8EH-9	5666	0,9	CR8EHVX-9	4546	228	CR8EHIX-9	3797
NH 125 D Lead	125	83-	BPR6HS	7022	0,7	BPR6HVX	2740	214	BPR6HIX	4085
Pantheon 125	125	01.98-	BR8ES	5422	0,7	BR8EVX	1262	207	BR8EIX	5044
SH 125	125	01-	CR8EH-9	5666	0,9	CR8EHVX-9	4546	228	CR8EHIX-9	3797
Spacy CH 125 (JS03)	125	97-	DPR7EA-9	5129	0,9	DPR7EVX-9	7682	220	DPR7EIX-9	7803
CN 250	250	01.86-	DPR6EA-9	5531	0,9	---			---	
CN 250 Fusion	250		DPR8EA-9	4929	0,9	DPR8EVX-9	2872	221	DPR8EIX-9	2202
CN 250 Helix (MF02)	250	01.87- 99	DPR6EA-9	5531	0,9	---			---	
FES 250 Foresight (MF04)	250	97-	DPR7EA-9	5129	0,9	DPR7EVX-9	7682	220	DPR7EIX-9	7803
Foresight 250 (I)	250	01.98-	DPR7EA-9	5129	0,9	DPR7EVX-9	7682	220	DPR7EIX-9	7803
Silver Wing ABS (G2)	600	03-	CR8EH-9	5666	0,9	CR8EHVX-9	4546	228	CR8EHIX-9	3797
Silver Wing 600	600	01-	CR8EH-9	5666	0,9	CR8EHVX-9	4546	228	CR8EHIX-9	3797

HYOSUNG

Avanti 50 (SD50)	50	99-	BP6HS	4511	0,6	BP6HVX	4635		BPR6HIX	4085
Cab 50 (SB50G)	50	95-	BP6HS	4511	0,6	BP6HVX	4635		BPR6HIX	4085



Order No.



Gold-Palladium



Order Quick No.

Iridium



Order No.

HYOSUNG

Gamma 50 (SB50G)	50	97-	BP6HS	4511	0,6	BP6HVX	4635		BPR6HIX	4085
Prima	50		BR8HSA	5539	0,6	BR8HVX	6265		BR8HIX	7001
Sense	50		BP6HS	4511	0,6	BP6HVX	4635		BPR6HIX	4085
SF 50	50	99-	BR8HSA	5539	0,6	BR8HVX	6265		BR8HIX	7001
SF Rally 50	50	04-	BR8HSA	5539	0,6	BR8HVX	6265		BR8HIX	7001
Supercab (EZ100)	100	97-	BP7HS	5111	0,6	BP7HVX	7468		BPR7HIX	5944
Boomer 125	125	02-	DR8EA	7162	0,6	DR8EVX	6354		DR8EIX	6681
Grand Prix	125		DR8EA	7162	0,6	DR8EVX	6354		DR8EIX	6681
Plus 125	125		DR8EA	7162	0,6	DR8EVX	6354		DR8EIX	6681

ITALJET

Ascot 50	50		BP7HS	5111	0,6	BP7HVX	7468		BPR7HIX	5944
Bazooka - Bazooka II	50		BP7HS	5111	0,6	BP7HVX	7468		BPR7HIX	5944
Cruise	50		BP6HS	4511	0,6	BP6HVX	4635		BPR6HIX	4085
Dragster 50	50	96- 97	BPR8HS	3725	0,6	---			BPR8HIX	6742
Dragster 50	50	97- 98	BPR8HS	3725	0,6	---			BPR8HIX	6742
Dragster	50	98-	B7HS	5110	0,6	B7HVX	7836	204	BR7HIX	7067
Dragster 50	50	98-	BR8HS	4322	0,6	BR8HVX	6265	212	BR8HIX	7001
Fastboy	50	98-	BR7HS	4122	0,6	---		211	BR7HIX	7067
Formula 50 Mofa (aircool)	50	99-	BR8HS	4322	0,6	BR8HVX	6265	212	BR8HIX	7001
Formula 50 watercool	50	98-	BR8HS	4322	0,6	BR8HVX	6265	212	BR8HIX	7001
Formula 50 aircool	50	98-	BR7HS	4122	0,6	---		211	BR7HIX	7067
Formula 50	50	01.95-	BPR6HS	7022	0,6	BPR6HVX	2740	214	BPR6HIX	4085
Pista 50 ; Pista II	50		BP7HS	5111	0,6	BP7HVX	7468		BPR7HIX	5944
Reporter	50		BP7HS	5111	0,6	BP7HVX	7468		BPR7HIX	5944
Scoop 50	50		BP7HS	5111	0,6	BP7HVX	7468		BPR7HIX	5944
Sunny 50	50		BP6HS	4511	0,6	BP6HVX	4635		BPR6HIX	4085
Torpedo 2T	50		B7HS	5110	0,6	B7HVX	7836	204	BR7HIX	7067
Torpedo 50	50	98-	BR7HS	4122	0,6	---		211	BR7HIX	7067
Torpedo 25	50	97-	BPR8HS	3725	0,6	---			BPR8HIX	6742
Torpedo 4T	50		CR7E	4578	0,6	---		225	CR7EIX	7385
Velocifero	50	- 97	BPR6HS	7022	0,7	BPR6HVX	2740	214	BPR6HIX	4085
Velocifero "8", "10"	50	98-	BR8HS	4322	0,6	BR8HVX	6265	212	BR8HIX	7001
Yankee 50	50		BP7HS	5111	0,6	BP7HVX	7468		BPR7HIX	5944
Millenium 100	100		BR7HS	4122	0,6	---			BR7HIX	7067
Dragster 125	125	(97)	B7HS	5110	0,6	B7HVX	7836	204	BR7HIX	7067
Dragster 125	125	98-	BR9ES	5722	0,6	BR9EVX	1265	208	BR9EIX	3981
Formula 125 (I)	125		BR7HS	4122	0,6	---		211	BR7HIX	7067
Formula 125	125	97- 98	B7HS	5110	0,6	B7HVX	7836	204	BR7HIX	7067
Formula 125	125	98-	BR8HS	4322	0,6	BR8HVX	6265	212	BR8HIX	7001
Jet Set	125		CR7E	4578	0,6	---		225	CR7EIX	7385
Jupiter	125		CR8E	1275	0,7	CR8EVX	6487	226	CR8EIX	4218
Millenium	125	99-	CR8E	1275	0,7	CR8EVX	6487	226	CR8EIX	4218
Torpedo 125 4T	125	98-	CR7E	4578	0,7	---		225	CR7EIX	7385
Jet Set	150		CR7E	4578	0,6	---		225	CR7EIX	7385
Jupiter	150		CR8E	1275	0,7	CR8EVX	6487	226	CR8EIX	4218
Millenium	150		CR8E	1275	0,7	CR8EVX	6487	226	CR8EIX	4218
Dragster 180	180	98-	BR9ES	5722	0,6	BR9EVX	1265	208	BR9EIX	3981
Jupiter	250		DR8EA	7162	0,6	DR8EVX	6354		DR8EIX	6681
Millenium	250	99-	DR8EA	7162	0,6	DR8EVX	6354		DR8EIX	6681

Order
No.Gold-
Palla-
dium

Platin

Order
No.Quick
No.

Iridium

Order
No.**ITTECO**

Hornet	50		BP6HS	4511	0,6	BP6HVX	4635		BPR6HIX	4085
--------	----	--	-------	------	-----	--------	------	--	---------	------

KINETIC

Pride	50		BP7HS	5111	0,6	BP7HVX	7468		BPR7HIX	5944
Pride	80		BP7HS	5111	0,6	BP7HVX	7468		BPR7HIX	5944

KREIDLER

Flory 25	25	96-	BPR7HS	6422	0,6	BPR7HVX	2938	215	BPR7HIX	5944
Florett XL 25	50		BPR7HS	6422	0,6	BPR7HVX	2938	215	BPR7HIX	5944
Florett 25	50	01.96-	BPR7HS	6422	0,6	BPR7HVX	2938	215	BPR7HIX	5944
Florett XL 50	50		BPR7HS	6422	0,6	BPR7HVX	2938	215	BPR7HIX	5944
Florett 50	50	01.96-	BPR7HS	6422	0,6	BPR7HVX	2938	215	BPR7HIX	5944
Flory 50	50	96-	BPR7HS	6422	0,6	BPR7HVX	2938	215	BPR7HIX	5944
MK	50	96-	BPR7HS	6422	0,6	BPR7HVX	2938	215	BPR7HIX	5944
Flory 125	125		CR7HSA	4549	0,5	---			CR7HIX	7544
Mustang	125	97-	CR7HSA	4549	0,5	---			CR7HIX	7544

KTM

Chrono 50	50		BR7HS	4122	0,5	---		211	BR7HIX	7067
Go 50	50		BR7HS	4122	0,5	---		211	BR7HIX	7067
K 50 (I)	50		BR7HS	4122	0,5	---		211	BR7HIX	7067

KYMCO

Calypso 50	50	97-	BR8HS	4322	0,6	BR8HVX	6265	212	BR8HIX	7001
Cobra Cross	50	97-	BR8HSA	5539	0,6	BR8HVX	6265		BR8HIX	7001
Cobra Racer	50	97-	BR8HSA	5539	0,6	BR8HVX	6265		BR8HIX	7001
CSX 50	50		BR8HSA	5539	0,6	BR8HVX	6265		BR8HIX	7001
Curio	50		BR8HSA	5539	0,6	BR8HVX	6265		BR8HIX	7001
CX 50; CX Super	50		BR8HSA	5539	0,6	BR8HVX	6265		BR8HIX	7001
Dink 50 LC /Bet&Win 50LC	50		BR6HSA	4296	0,6			210	BR6HIX	3419
Dink 50 2Takt (Italy)	50	99-	CR7HSA	4549	0,5	---			CR7HIX	7544
DJ 50	50		BR8HSA	5539	0,6	BR8HVX	6265		BR8HIX	7001
DJW 50 ;W / X / Y	50	01.93-	BR8HSA	5539	0,6	BR8HVX	6265		BR8HIX	7001
Fever II ZX 50	50		BR8HSA	5539	0,6	BR8HVX	6265		BR8HIX	7001
Fever ZX 50	50		BR8HSA	5539	0,6	BR8HVX	6265		BR8HIX	7001
Filly 50	50	98-	C7HSA	4629	0,7	C7HVX	4533		CR7HIX	7544
Heroism 50	50		BR8HSA	5539	0,6	BR8HVX	6265		BR8HIX	7001
K 12 50	50		BR8HSA	5539	0,6	BR8HVX	6265		BR8HIX	7001
KB 50	50		BR8HSA	5539	0,6	BR8HVX	6265		BR8HIX	7001
People 50	50	99-	BR8HSA	5539	0,6	BR8HVX	6265		BR8HIX	7001
Scout	50	97-	BR8HSA	5539	0,6	BR8HVX	6265		BR8HIX	7001
Sniper 50	50	01.93-	BR8HSA	5539	0,6	BR8HVX	6265		BR8HIX	7001
Snuper 50 DD	50		BR8HSA	5539	0,6	BR8HVX	6265		BR8HIX	7001
Spacer 50	50	99-	BR8HSA	5539	0,6	BR8HVX	6265		BR8HIX	7001
Super 9 AC	50	01-	BR8HSA	5539	0,6	BR8HVX	6265		BR8HIX	7001
Super 9 LC	50	01-	BR8HSA	5539	0,6	BR8HVX	6265		BR8HIX	7001
Tomos Classic;Quadro;Flexer	50	01-	B6HS	4510	0,6	B6HVX	7435	203	BR6HIX	3419
Top Boy 50	50	01-	BR8HSA	5539	0,6	BR8HVX	6265		BR8HIX	7001
Yager 50 2Takt	50	01-	BR8HSA	5539	0,6	BR8HVX	6265		BR8HIX	7001
YUP 50	50	00-	BR8HSA	5539	0,6	BR8HVX	6265		BR8HIX	7001
Cobra Racer 100	100	99-	BR8HSA	5539	0,6	BR8HVX	6265		BR8HIX	7001
Calypso 125	125	97-	C7HSA	4629	0,6	C7HVX	4533		CR7HIX	7544

Order
No.Platin
Gold-
Palla-
diumOrder Quick
No. No.

Iridium

Order
No.**KYMCO**

Dink 125 4Takt	125	99-	DPR7EA-9	5129	0,9	DPR7EVX-9	7682	220	DPR7EIX-9	7803
Grand Dink 125 4Takt	125	99-	DPR7EA-9	5129	0,9	DPR7EVX-9	7682	220	DPR7EIX-9	7803
Heroism 125	125		C7HSA	4629	0,7	C7HVX	4533		CR7HIX	7544
Hipster 125 4 Ventiler	125		CR8E	1275	0,7	CR8EVX	6487	226	CR8EIX	4218
Hipster 125 2 Ventiler	125	01-	DR8EA	7162	0,7	DR8EVX	6354		DR8EIX	6681
Movie 125 4Takt	125		C7HSA	4629	0,6	C7HVX	4533		CR7HIX	7544
Pulsar 125	125	01-	DR8EA	7162	0,7	DR8EVX	6354		DR8EIX	6681
Spacer	125	97-	DPR7EA-9	5129	0,6	DPR7EVX-9	7682	220	DPR7EIX-9	7803
Spacer 125	125		DPR7EA-9	5129	0,9	DPR7EVX-9	7682	220	DPR7EIX-9	7803
Yager 125 4Takt	125	01-	DPR7EA-9	5129	0,9	DPR7EVX-9	7682	220	DPR7EIX-9	7803
Zing	125	97-	DR8EA	7162	0,6	DR8EVX	6354		DR8EIX	6681
Heroism	150		C7HSA	4629	0,7	C7HVX	4533		CR7HIX	7544
Dink 250 4Takt	250	99-	DPR7EA-9	5129	0,9	DPR7EVX-9	7682	220	DPR7EIX-9	7803
Grand Dink 250 4Takt	250	99-	DPR7EA-9	5129	0,9	DPR7EVX-9	7682	220	DPR7EIX-9	7803

K-ZWO

Cat 50	50	97-	BR7HS	4122	0,6	---		211	BR7HIX	7067
K-zwo VIVA 50/25	50		BR7HS	4122	0,5	---		211	BR7HIX	7067
Motron Sting	50		BR7HS	4122	0,5	---		211	BR7HIX	7067
Motron Thunder	50		BR7HS	4122	0,5	---		211	BR7HIX	7067
Siamoto Falkon	50		C7HSA	4629	0,6	C7HVX	4533		CR7HIX	7544
Siamoto Scross	50		C7HSA	4629	0,6	C7HVX	4533		CR7HIX	7544
K-Zwo Apache	125		D8EA	2120	0,6	D8EVX	2850	216	DR8EIX	6681
K-Zwo Royal 125	125	96-	C7HSA	4629	0,6	C7HVX	4533		CR7HIX	7544
Royal 125	125	96-	C7HSA	4629	0,6	C7HVX	4533		CR7HIX	7544

LECSON

LTS 50 BW	50		BP6HS	4511	0,6	BP6HVX	4635		BPR6HIX	4085
LTS 50 TR	50		BP6HS	4511	0,6	BP6HVX	4635		BPR6HIX	4085

LEM

Flash (I)	50		BR7HS	4122	0,6	---		211	BR7HIX	7067
Ghibli (I)	50		BR7HS	4122	0,6	---		211	BR7HIX	7067

LML- VESPA

NV 125 SPL	125		BP8ES	2912	0,6	BP8EVX	2671			
NV 150 SPL	150		BP8ES	2912	0,6	BP8EVX	2671			
NV 200 SPL	200		B5ES	6410	0,6	---				

MACAL

GTX	50	98-	BR7HS	4122	0,6	---		211	BR7HIX	7067
MY 50	50	99-	BR7HS	4122	0,6	---		211	BR7HIX	7067
New Star	50	98-	BR7HS	4122	0,6	---		211	BR7HIX	7067
Star Flight	50	98-	BR7HS	4122	0,6	---		211	BR7HIX	7067
Trophy	50	98-	BR8ES	5422	0,6	BR8EVX	1262	207	BR8EIX	5044

MALAGUTI

Centro SL 50	50		BR7HS	4122	0,6	---		211	BR7HIX	7067
Centro SL	50	93-	BR7HS	4122	0,5	---		211	BR7HIX	7067
Centro	50	00-	BR8HS	4322	0,5	BR8HVX	6265	212	BR8HIX	7001
Centro 50	50	01.92-	BR7HS	4122	0,6	---		211	BR7HIX	7067
Ciak	50		BR8HS	4322	0,5	BR8HVX	6265	212	BR8HIX	7001



Order No.



Gold-Palladium



Order No.

Quick No.

Iridium



Order No.

MALAGUTI

CR 1	50	10.95-	BPR6HS	7022	0,5	BPR6HVX	2740	214	BPR6HIX	4085
Crosser CR1 50	50		BPR6HS	7022	0,6	BPR6HVX	2740	214	BPR6HIX	4085
ET	50		B6HS	4510	0,6	B6HVX	7435	203	BR6HIX	3419
F-10 Jet Line Tigers 50	50		BR7HS	4122	0,6	---		211	BR7HIX	7067
F-10	50	93-	BR7HS	4122	0,5	---		211	BR7HIX	7067
F-10 Jetline	50	00-	BR8HS	4322	0,5	BR8HVX	6265	212	BR8HIX	7001
F-10 Jetline WAP	50	03-	BR7HS	4122	0,6	---		211	BR7HIX	7067
F-10 Jet Line 50	50	01.92-	BR7HS	4122	0,6	---		211	BR7HIX	7067
F-11	50		BR8HS	4322	0,5	BR8HVX	6265	212	BR8HIX	7001
F-12 LC	50		BR7HS	4122	0,5	---		211	BR7HIX	7067
F-12 Phantom	50		BR7HS	4122	0,6	---		211	BR7HIX	7067
F-12 Phantom	50		BR7HS	4122	0,5	---		211	BR7HIX	7067
F-12 Phantom AC	50	00-	BR8HS	4322	0,5	BR8HVX	6265	212	BR8HIX	7001
F-12 Phantom LC dd	50	00-	BR8HS	4322	0,5	BR8HVX	6265	212	BR8HIX	7001
F-12 Phantom 3 AC	50	03-	BR7HS	4122	0,6	---		211	BR7HIX	7067
F-15 Firefox	50	97-	BR8HS	4322	0,5	BR8HVX	6265	212	BR8HIX	7001
F-15 Firefox 50	50	01.96-	BR8HS	4322	0,6	BR8HVX	6265	212	BR8HIX	7001
Grizzly RXC 10	50		BR6HS	3922	0,5	---		209	BR6HIX	3419
Grizzly RXC 12	50		BR8HS	4322	0,5	BR8HVX	6265	212	BR8HIX	7001
Phantom LC Tiger 50	50	01.93-	BR7HS	4122	0,6	---		211	BR7HIX	7067
Yesterday	50	97-	BR8HS	4322	0,6	BR8HVX	6265	212	BR8HIX	7001
Ciak 125 4Takt	125		CR7HSA	4549	0,7	---			CR7HIX	7544
Madison	125		CR8E	1275	0,7	CR8EVX	6487	226	CR8EIX	4218
Ciak 150 4Takt	150		CR7HSA	4549	0,7	---			CR7HIX	7544
F-12 Phantom Max 200	200	04-	CR8EB	7784	0,6	---			CR8EIX	4218
Madison S 200	200	03-	CR8EB	7784	0,6	---			CR8EIX	4218
Madison S250	250		DR8EA	7162	0,7	DR8EVX	6354		DR8EIX	6681
Madison 400	400	03-	CR9E	6263	0,7	CR9EVX	5943	227	CR9EIX	3521
Spidermax 500 GT	500	04-	CR7EKB	4455	0,6	---			---	

MARS

MK 50/1	50		BP6HS	4511	0,6	BP6HVX	4635		BPR6HIX	4085
SM 50	50		BP7HS	5111	0,6	BP7HVX	7468		BPR7HIX	5944
SM 50/1	50		BP7HS	5111	0,6	BP7HVX	7468		BPR7HIX	5944

MBK

Active 50 (I)	50		BR7HS	4122	0,6	---		211	BR7HIX	7067
Booster R 50 (I)	50		BR7HS	4122	0,6	---		211	BR7HIX	7067
Booster (4FG) (CH)	50		BR8HS	4322	0,5	BR8HVX	6265	212	BR8HIX	7001
Booster (3TX) (GB)	50		BPR7HS	6422	0,5	BPR7HVX	2938	215	BPR7HIX	5944
Booster Spirit 50 (I)	50		BR8HS	4322	0,6	BR8HVX	6265	212	BR8HIX	7001
Booster N.G. 50 (I)	50		BR8HS	4322	0,6	BR8HVX	6265	212	BR8HIX	7001
Booster	50	93-	BR7HS	4122	0,5	---		211	BR7HIX	7067
Booster NG (CW50RS)	50	97-	BR8HS	4322	0,6	BR8HVX	6265	212	BR8HIX	7001
Booster Rocket (CW50RSP)	50	97-	BR8HS	4322	0,6	BR8HVX	6265	212	BR8HIX	7001
Booster Track (CW50RSX)	50	97-	BR8HS	4322	0,6	BR8HVX	6265	212	BR8HIX	7001
Booster (CW50)	50	97-	BR8HS	4322	0,6	BR8HVX	6265	212	BR8HIX	7001
Booster 50 (I)	50	01.90- 94	BPR7HS	6422	0,6	BPR7HVX	2938	215	BPR7HIX	5944
CT 50 S - CT 50 SS (I)	50		BP7HS-10	7829	0,6	---				
Evolis (4HU) (NL)	50		BR6HS	3922	0,5	---		209	BR6HIX	3419
Evolis (4FW)	50	93-	BR7HS	4122	0,5	---		211	BR7HIX	7067
Evolis 50 (YE50)	50	97-	BR8HS	4322	0,6	BR8HVX	6265	212	BR8HIX	7001

Order
No.Gold-
Palla-
diumOrder Quick
No. No.

Iridium

Order
No.**MBK**

Evolis 50 (I)	50	01.92-	BR7HS	4122	0,6	---		211	BR7HIX	7067
Fizz	50	- 96	BR8HS	4322	0,5	BR8HVX	6265	212	BR8HIX	7001
Fizz (YM50)	50	97-	BR8HS	4322	0,6	BR8HVX	6265	212	BR8HIX	7001
Fizz 50 (I)	50	01.94-	BR7HS	4122	0,6	---		211	BR7HIX	7067
Flipper	50		BR8HS	4322	0,6	BR8HVX	6265	212	BR8HIX	7001
Forte (3UG)	50	96-	BR8HS	4322	0,6	BR8HVX	6265	212	BR8HIX	7001
Forte (YA50R)	50	97-	BR7HS	4122	0,5	---		211	BR7HIX	7067
Forte 50 (I)	50	01.94-	BR7HS	4122	0,6	---		211	BR7HIX	7067
Mach G	50		BR8HS	4322	0,6	BR8HVX	6265	212	BR8HIX	7001
Mach G LC 50	50		BR8HS	4322	0,6	BR8HVX	6265	212	BR8HIX	7001
New Sorriso 50 (I)	50	01.95-	BP7HS	5111	0,6	BP7HVX	7468		BPR7HIX	5944
Nitro	50	97-	BR8HS	4322	0,6	BR8HVX	6265	212	BR8HIX	7001
Ovetto	50	01.97-	BR7HS	4122	0,6	---		211	BR7HIX	7067
Sorriso 50 (I)	50		BP7HS-10	7829	0,6	---				
Stunt 50	50	03-	BR8HS	4322	0,6	BR8HVX	6265	212	BR8HIX	7001
Target 50 (I)	50		BP7HS	5111	0,6	BP7HVX	7468		BPR7HIX	5944
Evolis (4MU)(YE80)	80	96-	BR7HS	4122	0,7	---		211	BR7HIX	7067
Zest (4MU)	80		BR7HS	4122	0,7	---		211	BR7HIX	7067
Nitro 100	100		BR8HS	4322	0,6	BR8HVX	6265	212	BR8HIX	7001
Ovetto 100	100		BR8HS	4322	0,6	BR8HVX	6265	212	BR8HIX	7001
Flame (4NB)	125		CR7E	4578	0,6	---		225	CR7EIX	7385
Flame (XC125T)	125		CR7E	4578	0,6	---		225	CR7EIX	7385
Flame (XC125R)	125		CR7E	4578	0,6	---		225	CR7EIX	7385
Doodo 4T	125		CR8E	1275	0,7	CR8EVX	6487	226	CR8EIX	4218
Skyliner	125	98-	CR8E	1275	0,7	CR8EVX	6487	226	CR8EIX	4218
Thunder 125 4T	125		CR8E	1275	0,7	CR8EVX	6487	226	CR8EIX	4218
XC 125 Flame (I)	125	- 94	CR6HSA	2983	0,7	---			CR6HIX	7274
XC 125 Flame (I)	125	01.95-	CR7E	4578	0,7	---		225	CR7EIX	7385
Vertex 150 (I)	150		CR7E	4578	0,7	---		225	CR7EIX	7385

MOTRON

Spike (I)	50		BR7HS	4122	0,6	---		211	BR7HIX	7067
Sting 50 (I)	50		BR7HS	4122	0,6	---		211	BR7HIX	7067
Sting 50	50	96-	BR7HS	4122	0,6	---		211	BR7HIX	7067
Syncro (I)	50		BR7HS	4122	0,6	---		211	BR7HIX	7067
Thunder S 50 (I)	50		BR7HS	4122	0,6	---		211	BR7HIX	7067
Thunder 50	50	96-	BR7HS	4122	0,6	---		211	BR7HIX	7067

MZ

Moskito FB 50	50	97-	BR7HS	4122	0,6	---		211	BR7HIX	7067
Moskito 50 SX (CPI50C)	50	99-	BR7HS	4122	0,6	---		211	BR7HIX	7067
Moskito 50RX (not EG Country)	50	02-	BPR6HS	7022	0,6	BPR6HVX	2740	214	BPR6HIX	4085
Moskito 50 RX (EG Country)	50	02-	BR8HSA	5539	0,6	BR8HVX	6265		BR8HIX	7001
Moskito 125	125	01-	CR7HSA	4549	0,6	---			CR7HIX	7544

OTTO

Fashion 50	50	96-	BR8HSA	5539	0,6	BR8HVX	6265		BR8HIX	7001
GTX 50	50	96-	BR7HS	4122	0,6	---		211	BR7HIX	7067

PEGASUS

Corona 25	50		BPR7HS	6422	0,5	BPR7HVX	2938	215	BPR7HIX	5944
Corona 50	50		BPR7HS	6422	0,5	BPR7HVX	2938	215	BPR7HIX	5944

Order
No.Gold-
Palla-
dium

Platin

Order
No.Quick
No.

Iridium

Order
No.**PEGASUS**

Skiper 25	50		BPR7HS	6422	0,5	BPR7HVX	2938	215	BPR7HIX	5944
Skiper 50	50		BPR7HS	6422	0,5	BPR7HVX	2938	215	BPR7HIX	5944
Sky 25	50		BPR7HS	6422	0,5	BPR7HVX	2938	215	BPR7HIX	5944
Sky 25 High Wheels	50		BPR7HS	6422	0,5	BPR7HVX	2938	215	BPR7HIX	5944
Sky 50	50		BPR7HS	6422	0,5	BPR7HVX	2938	215	BPR7HIX	5944
Sky 50 High Wheels	50		BPR7HS	6422	0,5	BPR7HVX	2938	215	BPR7HIX	5944
Solero 25	50		BPR7HS	6422	0,5	BPR7HVX	2938	215	BPR7HIX	5944
Solero 50	50		BPR7HS	6422	0,5	BPR7HVX	2938	215	BPR7HIX	5944
Corona 125 Comfort Edition	125		CR7HSA	4549	0,6	---			CR7HIX	7544
Corona 125 Sport Edition	125		CR7HSA	4549	0,6	---			CR7HIX	7544
Skiper 125	125		CR7HSA	4549	0,7	---			CR7HIX	7544
Sky 125	125		CR7HSA	4549	0,7	---			CR7HIX	7544

PEUGEOT

Buxi 50; Road (I)	50		B7HS	5110	0,6	B7HVX	7836	204	BR7HIX	7067
Buxy	50		B7HS	5110	0,6	B7HVX	7836	204	BR7HIX	7067
Eliséo 50	50	98-	BR7HS	4122	0,7	---		211	BR7HIX	7067
Elystar 50	50		CPR8E	7411	0,6	---			---	
Jet Force 50	50	03.03-	CPR8E	7411	0,6	---			---	
Looxor Vergaser	50	-	BR7HS	4122	0,6	---		211	BR7HIX	7067
Looxor 50 TSDI	50		CPR8E	7411	0,6	---			---	
Metal-X 50	50		BR7HS	4122	0,6	---		211	BR7HIX	7067
Rapido	50		BP6HS	4511	0,6	BP6HVX	4635		BPR6HIX	4085
Speedake	50		B7HS	5110	0,6	B7HVX	7836	204	BR7HIX	7067
Speedake 50	50		B7HS	5110	0,6	B7HVX	7836	204	BR7HIX	7067
Speedfight	50		BR8HS	4322	0,6	BR8HVX	6265	212	BR8HIX	7001
Speedfight 2 50 AC / LC	50		BR7HS	4122	0,7	---		211	BR7HIX	7067
Speedfight M	50	96-	BR7HS	4122	0,6	---		211	BR7HIX	7067
Speedfight LC	50	96-	BR7HS	4122	0,6	---		211	BR7HIX	7067
Speedfight LC " Prost X Team " Watercool	50	98-	BR7HS	4122	0,7	---		211	BR7HIX	7067
Speedfight AC Air	50	98-	BR7HS	4122	0,7	---		211	BR7HIX	7067
Squab	50	96-	BR8HS	4322	0,5	BR8HVX	6265	212	BR8HIX	7001
Squab 50 (I)	50		BR8HS	4322	0,6	BR8HVX	6265	212	BR8HIX	7001
ST 50 (I)	50		B7HS	5110	0,5	B7HVX	7836	204	BR7HIX	7067
ST 50; Metropolis (I)	50		B7HS	5110	0,6	B7HVX	7836	204	BR7HIX	7067
SV 50	50	- 95	B8HS	5510	0,6	B8HVX	2634	205	BR8HIX	7001
SV 50	50	96-	BR8HS	4322	0,6	BR8HVX	6265	212	BR8HIX	7001
SV 50 Geo (I)	50		B8HS	5510	0,6	B8HVX	2634	205	BR8HIX	7001
SV 50 Junior	50		B8HS	5510	0,6	B8HVX	2634	205	BR8HIX	7001
TKR Streetboard 50 / WRC	50	-	BR7HS	4122	0,6	---		211	BR7HIX	7067
Trekker Road	50		BR7HS	4122	0,6	---		211	BR7HIX	7067
Trekker (I)	50		BR8HS	4322	0,6	BR8HVX	6265	212	BR8HIX	7001
Trekker Off Road	50	98-	BR7HS	4122	0,6	---		211	BR7HIX	7067
Vivacity 50	50	99-	BR7HS	4122	0,7	---		211	BR7HIX	7067
Zenith 50 (I)	50		B7HS	5110	0,5	B7HVX	7836	204	BR7HIX	7067
Zenith 50; F.D. (I)	50		B7HS	5110	0,6	B7HVX	7836	204	BR7HIX	7067
Zenith F.D. 50 (I)	50		B7HS	5110	0,5	B7HVX	7836	204	BR7HIX	7067
Zenith LM2	50	96-	BR8HS	4322	0,5	BR8HVX	6265	212	BR8HIX	7001
SV 80	80		B8HS	5510	0,6	B8HVX	2634	205	BR8HIX	7001
Eliséo 100	100	98-	BR8ES	5422	0,7	BR8EVX	1262	207	BR8EIX	5044
Looxor 100	100	02.01-	BR8ES	5422	0,6	BR8EVX	1262	207	BR8EIX	5044
Speedfight 100	100	96- 03	BR8ES	5422	0,6	BR8EVX	1262	207	BR8EIX	5044

Order
No.Gold-
Palla-
diumOrder Quick
No. No.

Iridium

Order
No.**PEUGEOT**

Speedfight 2 100	100	03-	BR8ES	5422	0,6	BR8EVX	1262	207	BR8EIX	5044
SV 100	100	96-	BR8ES	5422	0,6	BR8EVX	1262	207	BR8EIX	5044
TKR 100	100	-	BR8ES	5422	0,6	BR8EVX	1262	207	BR8EIX	5044
Trekker 100	100	98-	BR8ES	5422	0,6	BR8EVX	1262	207	BR8EIX	5044
Vivacity 100	100	99-	BR8ES	5422	0,7	BR8EVX	1262	207	BR8EIX	5044
Eliséo 125	125	98-	CR8E	1275	0,7	CR8EVX	6487	226	CR8EIX	4218
Eliséo Advantage 125	125	04-	CR8E	1275	0,7	CR8EVX	6487	226	CR8EIX	4218
Elystar 125	125		CR8E	1275	0,7	CR8EVX	6487	226	CR8EIX	4218
Jet Force 125	125	03.03-	CR7EB	4663	0,6	---			---	
Looxor 125	125		CR7EB	4663	0,6	---			---	
Ludix 125	125	04-	CR7EB	4663	0,6	---			---	
Satelis 125	125	04-	CR7EB	4663	0,6	---			---	
SV 125	125		BP6HS	4511	0,6	BP6HVX	4635		BPR6HIX	4085
SV 125; Metropolis (I)	125		BP6HS	4511	0,6	BP6HVX	4635		BPR6HIX	4085
Elyseo 150	150	-	CR8E	1275	0,7	CR8EVX	6487	226	CR8EIX	4218
Elystar 150	150		CR7E	4578	0,7			225	CR7EIX	7385
Looxor 150	150		CR7EB	4663	0,6	---			---	
SV 250	250	01-	DPR7EA-9	5129	0,9	DPR7EVX-9	7682	220	DPR7EIX-9	7803

PGO

Big Max 25/50	50		BPR7HS	6422	0,5	BPR7HVX	2938	215	BPR7HIX	5944
Big Max 50	50		BPR7HS	6422	0,5	BPR7HVX	2938	215	BPR7HIX	5944
Big Max Sport 50	50	96-	BP7HS	5111	0,6	BP7HVX	7468		BPR7HIX	5944
Comet	50		BP7HS	5111	0,6	BP7HVX	7468		BPR7HIX	5944
Galaxy 50	50		BP7HS	5111	0,6	BP7HVX	7468		BPR7HIX	5944
Galaxy 25	50		BP7HS	5111	0,6	BP7HVX	7468		BPR7HIX	5944
Mega 50	50	96-	BPR7HS	6422	0,5	BPR7HVX	2938	215	BPR7HIX	5944
New Galaxy 50 (I)	50		BP6HS	4511	0,6	BP6HVX	4635		BPR6HIX	4085
PMS 50	50	99-	BP7HS	5111	0,6	BP7HVX	7468		BPR7HIX	5944
PMX 50	50	99-	BP7HS	5111	0,6	BP7HVX	7468		BPR7HIX	5944
Rodoshow	50	02.00-	BP7HS	5111	0,6	BP7HVX	7468		BPR7HIX	5944
Star 2	50		BP7HS	5111	0,6	BP7HVX	7468		BPR7HIX	5944
Star 50	50		BP6HS	4511	0,6	BP6HVX	4635		BPR6HIX	4085
Super Comet 50 (I)	50		BP7HS	5111	0,6	BP7HVX	7468		BPR7HIX	5944
Tornado 50	50	97-	BPR7HS	6422	0,5	BPR7HVX	2938	215	BPR7HIX	5944
T-REX 50	50	99-	BP7HS	5111	0,6	BP7HVX	7468		BPR7HIX	5944
Star 80	80		BP6HS	4511	0,6	BP6HVX	4635		BPR6HIX	4085
Big Max 90	82	96-	BPR7HS	6422	0,5	BPR7HVX	2938	215	BPR7HIX	5944
Galaxy 90	90		BPR7HS	6422	0,6	BPR7HVX	2938	215	BPR7HIX	5944
Tornado 1.25	125	97-	BPR7HS	6422	0,5	BPR7HVX	2938	215	BPR7HIX	5944
T-REX 125 2T	125	99-	BP7HS	5111	0,6	BP7HVX	7468		BPR7HIX	5944
T-REX 125 4T	125	99-	C7HSA	4629	0,6	C7HVX	4533		CR7HIX	7544
T-REX 150 4T	150	03-	C7HSA	4629	0,6	C7HVX	4533		CR7HIX	7544

PIAGGIO

Free 25 Mofa	25		BP8ES	2912	0,5	BP8EVX	2671			
Zip 25 Mofa	25		BPR8ES	3923	0,5	BPR8EVX	5573			
Zip Base 25 / Mofa	25		BPR8ES	3923	0,5	BPR8EVX	5573			
50 R, Special	50		B6HS	4510	0,5	B6HVX	7435	203	BR6HIX	3419
50 S	50		B6HS	4510	0,5	B6HVX	7435	203	BR6HIX	3419
Boss	50		B6HS	4510	0,6	B6HVX	7435	203	BR6HIX	3419
Boss	50		B6HS	4510	0,5	B6HVX	7435	203	BR6HIX	3419



Order No.



Gold-Palladium



Order No.

Quick No.

Iridium



Order No.

PIAGGIO

Bravo P	50		BR6HS	3922	0,7	---		209	BR6HIX	3419
Bravo - Si / Moped	50		B5HS	4210	0,5	---				
Bravo PV	50		BR6HS	3922	0,7	---		209	BR6HIX	3419
Ciao M Kat	50		BR6HS	3922	0,7	---		209	BR6HIX	3419
Ciao Mix / Mix	50		B5HS	4210	0,5	---				
Ciao V Kat	50		BR6HS	3922	0,7	---		209	BR6HIX	3419
Ciao-Bravo SI / Mofa	50		B5HS	4210	0,5	---				
Diesis 50	50		BR9ES	5722	0,7	BR9EVX	1265	208	BR9EIX	3981
Eaglet	50		B9ES	2611	0,5	B9EVX	7254	202	BR9EIX	3981
ET2 (iniezione / Einspritzer)	50	98-	---		0,6	DCPR9EVX	6436			
Free Kat	50		BR9ES	5722	0,7	BR9EVX	1265	208	BR9EIX	3981
Free 50	50	93-	B9ES	2611	0,5	B9EVX	7254	202	BR9EIX	3981
Free Business 50	50	01.96-	B9ES	2611	0,6	B9EVX	7254	202	BR9EIX	3981
Grillo / Mofa	50		B5HS	4210	0,5	---				
Liberty Kat	50		BR9ES	5722	0,7	BR9EVX	1265	208	BR9EIX	3981
Liberty 4T	50	02-	CR9EB	6955	0,8	---			CR9EIX	3521
Liberty	50	01.97-	B9ES	2611	0,6	B9EVX	7254	202	BR9EIX	3981
NRG Extreme	50		B9ES	2611	0,5	B9EVX	7254	202	BR9EIX	3981
NRG H ² O Kat	50		B9ES	2611	0,5	B9EVX	7254	202	BR9EIX	3981
NRG mc2 DT,DD	50		B9ES	2611	0,5	B9EVX	7254	202	BR9EIX	3981
NRG Extreme Kat	50		B9ES	2611	0,5	B9EVX	7254	202	BR9EIX	3981
NRG	50		B9ES	2611	0,5	B9EVX	7254	202	BR9EIX	3981
NRG mc3 Pure Jet	50	02-	CPR8E	7411	0,6	---			---	
NRG 50	50	01.94-	B9ES	2611	0,6	B9EVX	7254	202	BR9EIX	3981
NRG mc2 50	50	01.96-	B9EG	3530	0,6	B9EGV	5827		---	
NSP 4T (Aria)	50	02-	CR9EB	6955	0,8	---			CR9EIX	3521
NTT 50	50	01.95-	B9ES	2611	0,6	B9EVX	7254	202	BR9EIX	3981
PK 50 XL2 Auto	50		B8ES	2411	0,5	B8EVX	7051	201	BR8EIX	5044
PK 50 XL 2	50		BR7HS	4122	0,6	---		211	BR7HIX	7067
PK 50 SS	50		B7HS	5110	0,5	B7HVX	7836	204	BR7HIX	7067
PK 50 S Auto	50		BR7ES	5122	0,5	BR7EVX	4556			
PK 50 S	50	09.82-12.87	B6HS	4510	0,5	B6HVX	7435	203	BR6HIX	3419
PK 50	50	09.82-12.87	B6HS	4510	0,5	B6HVX	7435	203	BR6HIX	3419
Plurimatic	50		B6HS	4510	0,5	B6HVX	7435	203	BR6HIX	3419
PX 50	50		B6HS	4510	0,5	B6HVX	7435	203	BR6HIX	3419
Quarz 50	50	01.92-	B9ES	2611	0,6	B9EVX	7254	202	BR9EIX	3981
Quarz 50 Automatic	50	06.92-	B9ES	2611	0,5	B9EVX	7254	202	BR9EIX	3981
Rush	50		BR7HS	4122	0,6	---		211	BR7HIX	7067
Sfera 50 , FL, RL, RST	50		B9ES	2611	0,5	B9EVX	7254	202	BR9EIX	3981
Sfera 50	50	01.90-	B9ES	2611	0,6	B9EVX	7254	202	BR9EIX	3981
Sfera 50 Automatico	50	01.91-	B9ES	2611	0,5	B9EVX	7254	202	BR9EIX	3981
Sfera RL 50	50		B9ES	2611	0,6	B9EVX	7254	202	BR9EIX	3981
Skipper	50		BR9ES	5722	0,6	BR9EVX	1265	208	BR9EIX	3981
Storm Automatic	50	94-	B9ES	2611	0,5	B9EVX	7254	202	BR9EIX	3981
Super Bravo / Mofa	50		B5HS	4210	0,5	---				
Super Bravo 2 Gang / Mofa	50		B5HS	4210	0,5	---				
TPH	50	93-	B9ES	2611	0,5	B9EVX	7254	202	BR9EIX	3981
Typhoon air / X 50	50	01.96-	BR9ES	5722	0,7	BR9EVX	1265	208	BR9EIX	3981
Velofax / Mofa	50		BP8ES	2912	0,6	BP8EVX	2671			
Velofax 50	50	01.95-	B8ES	2411	0,5	B8EVX	7051	201	BR8EIX	5044
Velofax 50 AE	50	01.95-	B8ES	2411	0,5	B8EVX	7051	201	BR8EIX	5044
Vespa Vale Especial/Standard	50		B5HS	4210	0,5	---				

Order
No.Gold-
Palla-
diumOrder
No.Quick
No.

Iridium

Order
No.**PIAGGIO**

Vespa PK 50 XL 2 ,Automatic	50		B8ES	2411	0,5	B8EVX	7051	201	BR8EIX	5044
Vespa HP 4M	50		B6HS	4510	0,5	B6HVX	7435	203	BR6HIX	3419
Vespa ET2 IE	50		---			DCPR9EVX	6436		---	
Vespa ET3 Primavera	50		BR7HS	4122	0,6	---		211	BR7HIX	7067
Vespa Delta,Puch Condor	50		B7HS	5110	0,5	B7HVX	7836	204	BR7HIX	7067
Vespa Elestart	50		B6HS	4510	0,5	B6HVX	7435	203	BR6HIX	3419
Vespa ET 4	50	02-	CR9EB	6955	0,8	---			CR9EIX	3521
Vespa 50 HP 4M	50	01.93-	B7HS	5110	0,5	B7HVX	7836	204	BR7HIX	7067
Vespino TX/XE	50		BR7HS	4122	0,6	---		211	BR7HIX	7067
Vespino NX/SC/T/TL/TN/TS	50		BR7HS	4122	0,6	---		211	BR7HIX	7067
Vespino	50		BR7HS	4122	0,6	---		211	BR7HIX	7067
Zip 4 4T	50		CR7E	4578	0,6	---		225	CR7EIX	7385
Zip 50 RST	50		B9ES	2611	0,6	B9EVX	7254	202	BR9EIX	3981
Zip Kat	50		BPR8ES	3923	0,5	BPR8EVX	5573			
Zip 50 SP	50		---		0,5	B9EG	3530			
Zip Base 50	50		B9ES	2611	0,5	B9EVX	7254	202	BR9EIX	3981
Zip 50	50	01.92-	B9ES	2611	0,6	B9EVX	7254	202	BR9EIX	3981
Zip 50 Fast Rider	50	01.93-	B9ES	2611	0,6	B9EVX	7254	202	BR9EIX	3981
Zip water	50	01.96-	B10ES	7928	0,7	B10EVX	7335		BR10EIX	6801
Zip 50 SP	50	01.96-	B9ES	2611	0,6	B9EVX	7254	202	BR9EIX	3981
Zip air	50	01.96-	BR9ES	5722	0,7	BR9EVX	1265	208	BR9EIX	3981
Zip & Zip (Hybrid)	50	94-	B9ES	2611	0,5	B9EVX	7254	202	BR9EIX	3981
Zip & Zip 50 4 T Aria	50	02-	CR9EB	6955	0,8	---			CR9EIX	3521
Zip & Zip 50	50	01.94-	B9ES	2611	0,6	B9EVX	7254	202	BR9EIX	3981
SKR City	75		BR9ES	5722	0,6	BR9EVX	1265	208	BR9EIX	3981
Vespa PK 75S/Elestart/Junior	75		B7HS	5110	0,5	B7HVX	7836	204	BR7HIX	7067
Vespa PK 75XL/ Elestart	75		B9ES	2611	0,6	B9EVX	7254	202	BR9EIX	3981
Vespa PK 75S Primavera / T3 Prima.	75		B7HS	5110	0,5	B7HVX	7836	204	BR7HIX	7067
PK 80 S	80	09.82-12.85	BR7HS	4122	0,6	---		211	BR7HIX	7067
PX 80 E Lusso	80		B6ES	7310	0,5	B6EVX	5136			
PX 80 E,P 80 X	80		B6ES	7310	0,5	B6EVX	5136			
Sfera 80 Automatic	80		B9ES	2611	0,5	B9EVX	7254	202	BR9EIX	3981
Skipper	80		B9ES	2611	0,6	B9EVX	7254	202	BR9EIX	3981
TPH Automatic	80	94-	B9ES	2611	0,5	B9EVX	7254	202	BR9EIX	3981
Typhoon	80		BR9ES	5722	0,6	BR9EVX	1265	208	BR9EIX	3981
Diesis 100	100	01-	CR8EB	7784	0,6	---			CR8EIX	4218
Free 100	100	02-	CR8EB	7784	0,6	---			CR8EIX	4218
PK 100 S	100	06.82-	BR7HS	4122	0,6	---		211	BR7HIX	7067
125 T5	125	03.85-	B8ES	2411	0,6	B8EVX	7051	201	BR8EIX	5044
Ape	125		B7HS	5110	0,5	B7HVX	7836	204	BR7HIX	7067
Beverly 125	125	02-	CR8EB	7784	0,6	---			CR8EIX	4218
Cosa 200 FL EBC 12PS	125		B8ES	2411	0,5	B8EVX	7051	201	BR8EIX	5044
Cosa 125	125	- 91	B8ES	2411	0,5	B8EVX	7051	201	BR8EIX	5044
Cosa FL 125	125	91-	B9ES	2611	0,5	B9EVX	7254	202	BR9EIX	3981
Cosa 125 MA AE	125	01.88-	B9ES	2611	0,6	B9EVX	7254	202	BR9EIX	3981
ET 3	125		BR7HS	4122	0,6	---		211	BR7HIX	7067
ET 4 Automatic	125		CR7EB	4663	0,6	---			---	
Gandturismo	125	-04.04	CR9EB	6955	0,6	---			CR9EIX	3521
Hexagon LX 4Takt 2V Air	125		CR7EB	4663	0,6	---			---	
Hexagon LX 4T / 4V H2O watercoler	125		CR8EB	7784	0,6	---			CR8EIX	4218
Hexagon LX 125	125	94-	B9ES	2611	0,5	B9EVX	7254	202	BR9EIX	3981
Liberty 125	125		CR7E	4578	0,6	---		225	CR7EIX	7385

Order
No.Gold-
Palla-
diumOrder
No.Quick
No.

Iridium

Order
No.**PIAGGIO**

Liberty 4Takt	125		CR7EB	4663	0,6	---			---	
P 125 ETS	125	01.83-12.85	BR7HS	4122	0,6	---		211	BR7HIX	7067
PK 125, E, S	125		BR6HS	3922	0,5	---		209	BR6HIX	3419
PK 125 XL Automatic	125		BR7HS	4122	0,6	---		211	BR7HIX	7067
PK 125 XL 2	125		B8ES	2411	0,5	B8EVX	7051	201	BR8EIX	5044
PK Automatic	125		B7HS	5110	0,5	B7HVX	7836	204	BR7HIX	7067
Primavera	125	01.76-12.83	BR7HS	4122	0,6	---		211	BR7HIX	7067
PX 125 E Lusso	125	01.82-	B6HS	4510	0,5	B6HVX	7435	203	BR6HIX	3419
Sfera RL 125 - 4Takt	125		CR9E	6263	0,6	CR9EVX	5943	227	CR9EIX	3521
Sfera RST 4 Takt	125	95-	CR7E	4578	0,6	---		225	CR7EIX	7385
Sfera 125	125	01.95-	CR9E	6263	0,6	CR9EVX	5943	227	CR9EIX	3521
Skipper 125 LX	125	01.93-	B9ES	2611	0,6	B9EVX	7254	202	BR9EIX	3981
Skipper 125 4 Takt	125	00-	CR7EB	4663	0,6	---			---	
SKR 125	125	08.93-	B9ES	2611	0,5	B9EVX	7254	202	BR9EIX	3981
Super Hexagon GTX 125 4Takt	125	01-	CR8EB	7784	0,6	---			CR8EIX	4218
TPH	125	95-	B9ES	2611	0,5	B9EVX	7254	202	BR9EIX	3981
Vespa Special ET4 Carburatore	125		CR8EB	7784	0,6	---			CR8EIX	4218
Vespa Special ET3 Primavera	125		B7HS	5110	0,6	B7HVX	7836	204	BR7HIX	7067
Vespa T3Li/T3	125		B6HS	4510	0,5	B6HVX	7435	203	BR6HIX	3419
Vespa T5	125		B9ES	2611	0,5	B9EVX	7254	202	BR9EIX	3981
Vespa PX 125 Kat	125		B9ES	2611	0,5	B9EVX	7254	202	BR9EIX	3981
Vespa 125 T5 Sport/Elestart	125		B9ES	2611	0,6	B9EVX	7254	202	BR9EIX	3981
Vespa 125 CL/LS/NK Primavera	125		B6HS	4510	0,5	B6HVX	7435	203	BR6HIX	3419
Vespa XL 125 Plurimat/Elestart	125		B7HS	5110	0,6	B7HVX	7836	204	BR7HIX	7067
Vespa PK 125	125	85-	BR7HS	4122	0,6	---		211	BR7HIX	7067
Vespa PX 125 MA AE	125	86-	B6HS	4510	0,5	B6HVX	7435	203	BR6HIX	3419
Vespa ET4	125	99-	CR7EB	4663	0,6	---			---	
Vespa GT	125	03-	CR8EB	7784	0,6	---			CR8EIX	4218
Vespa 125 FL2	125	01.90-	B7HS	5110	0,6	B7HVX	7836	204	BR7HIX	7067
Vespa ET4 125	125	01.96-	CR8EB	7784	0,7	---			CR8EIX	4218
Vespa PX 125 MA AE	125	01.96-	B6HS	4510	0,6	B6HVX	7435	203	BR6HIX	3419
X 9 11kW	125	-04.02	CR9EB	6955	0,6	---			CR9EIX	3521
X 9 11kW	125	05.02-	CR8EB	7784	0,6	---			CR8EIX	4218
Zip 125	125		CR9EB	6955	0,6	---			CR9EIX	3521
Cosa	150		BR9ES	5722	0,6	BR9EVX	1265	208	BR9EIX	3981
EX 150 (Hexagon)	150	94-	B9ES	2611	0,5	B9EVX	7254	202	BR9EIX	3981
Hexagon 150	150	01.94-	B9ES	2611	0,6	B9EVX	7254	202	BR9EIX	3981
Liberty	150		CR7EB	4663	0,6	---			---	
PX 150 E Lusso	150	01.82-	B6HS	4510	0,5	B6HVX	7435	203	BR6HIX	3419
Skipper ST 150 4Takt	150	- 00	BR9ES	5722	0,7	BR9EVX	1265	208	BR9EIX	3981
Skipper 150	150	01.93-	B9ES	2611	0,6	B9EVX	7254	202	BR9EIX	3981
Skipper ST 4T	150	01-	CR7EB	4663	0,6	---			---	
SKR 150	150	98-	B9ES	2611	0,5	B9EVX	7254	202	BR9EIX	3981
Vespa 150 long 19,0 mm	150		B6ES	7310	0,5	B6EVX	5136			
Vespa PX 150 Kat	150		BR6HS	3922	0,7	---		209	BR6HIX	3419
Vespa 150 ET4	150	- 01	CR7E	4578	0,6	---		225	CR7EIX	7385
Vespa 150 long 12,7 mm	150		B6HS	4510	0,5	B6HVX	7435	203	BR6HIX	3419
Vespa PX 150 MA AE	150	86-	B6HS	4510	0,5	B6HVX	7435	203	BR6HIX	3419
Vespa 150 ET4	150	01- 02	CR8EB	7784	0,6	---			CR8EIX	4218
Vespa 150 ET 4	150	02-	CR7EB	4663	0,8	---			---	
Vespa PX 150 MA AE	150	01.96-	B6HS	4510	0,6	B6HVX	7435	203	BR6HIX	3419
Vespa 160/ GT	160		B6HS	4510	0,5	B6HVX	7435	203	BR6HIX	3419

Order
No.Platin
Gold-
Palla-
diumOrder Quick
No.

No.

Iridium

Order
No.**PIAGGIO**

Vespa 175	175		B6HS	4510	0,5	B6HVX	7435	203	BR6HIX	3419
Hexagon LXT 180	180	01.98-	B9ES	2611	0,6	B9EVX	7254	202	BR9EIX	3981
Super Hexagon LXT 180	180	01-	CR8EB	7784	0,6	---			CR8EIX	4218
Vespa SS	180		B6HS	4510	0,5	B6HVX	7435	203	BR6HIX	3419
X 9 4T Amalfi	180	01-	CR8EB	7784	0,6	---			CR8EIX	4218
Ape	190		B7HS	5110	0,5	B7HVX	7836	204	BR7HIX	7067
Cosa MA AE	200		BR8ES	5422	0,6	BR8EVX	1262	207	BR8EIX	5044
Cosa FL 200	200	91-	BR8ES	5422	0,6	BR8EVX	1262	207	BR8EIX	5044
Cosa 200 Aluzyl.12PS	200	93- 97	BR8ES	5422	0,6	BR8EVX	1262	207	BR8EIX	5044
Beverly 200	200	01-	CR8EB	7784	0,6	---			CR8EIX	4218
Cosa 2 200 MA AE	200	01.88-	BR8ES	5422	0,6	BR8EVX	1262	207	BR8EIX	5044
Cosa 2 200	200	01.88- 91	BR8ES	5422	0,6	BR8EVX	1262	207	BR8EIX	5044
Cosa 200 MA AE	200	01.88-	BR8ES	5422	0,6	BR8EVX	1262	207	BR8EIX	5044
DN	200		BR7ES	5122	0,5	BR7EVX	4556			
DS	200		BR7ES	5122	0,5	BR7EVX	4556			
PE	200		BR7ES	5122	0,5	BR7EVX	4556			
PX 200 E Lusso	200	01.84-	BR7ES	5122	0,5	BR7EVX	4556			
PX 200 E Grand-Sport	200	01.84-	BR7ES	5122	0,5	BR7EVX	4556			
Vespa 200 DN/ DS/ E	200		B5ES	6410	0,5	---				
Vespa PX 200E/Iris/Iris Elestart	200		B7ES	1111	0,6	B7EVX	6934		---	
Vespa 200 TX/Elestart	200		B7ES	1111	0,6	B7EVX	6934		---	
Vespa PX 200 MA AE	200	86-	B6ES	7310	0,5	B6EVX	5136			
Vespa PX 200 MA AE	200	01.96-	B6ES	7310	0,6	B6EVX	5136			
Vespa Rally	200		BR7ES	5122	0,5	BR7EVX	4556			
Ape	220		B7HS	5110	0,5	B7HVX	7836	204	BR7HIX	7067
Hexagon GT 250 4Takt	250	98-	DPR6EA-9	5531	0,9	---			---	
Super Hexagon GTX 250	250		CR9E	6263	0,7	CR9EVX	5943	227	CR9EIX	3521
X 9 (4T)	250	00- 03	DPR7EA-9	5129	0,9	DPR7EVX-9	7682	220	DPR7EIX-9	7803
Beverly 500	500	03-	CR7EKB	4455	0,6	---			---	
X 9 EVO (4T)	500	04-	CR7EKB	4455	0,6	---			---	
X 9 (4T)	500	11.03-	CR7EKB	4455	0,6	---			---	

PUCH

Lido	50		BPR6HS	7022	0,7	BPR6HVX	2740	214	BPR6HIX	4085
Lido 125	125		DR8ES	5423	0,7	DR8EVX	6354	217	DR8EIX	6681

REX

Rex 25	25		BPR7HS	6422	0,6	BPR7HVX	2938	215	BPR7HIX	5944
Rexy 25	25	96-	BPR7HS	6422	0,6	BPR7HVX	2938	215	BPR7HIX	5944
Rexy 50	25	96-	BPR7HS	6422	0,6	BPR7HVX	2938	215	BPR7HIX	5944
Rex 50	50	96-	BPR7HS	6422	0,6	BPR7HVX	2938	215	BPR7HIX	5944
Scooter	50	96-	BPR7HS	6422	0,6	BPR7HVX	2938	215	BPR7HIX	5944
Silver Star	50		BPR7HS	6422	0,6	BPR7HVX	2938	215	BPR7HIX	5944
Silver Street	50		BPR7HS	6422	0,6	BPR7HVX	2938	215	BPR7HIX	5944
Rex 125	125	97-	CR7HSA	4549	0,5	---			CR7HIX	7544
Rexy 125	125		CR7HSA	4549	0,5	---			CR7HIX	7544

RIEJU

Drac 50 (AM5)	50	96-	BR8ES	5422	0,6	BR8EVX	1262	207	BR8EIX	5044
MRX 50 EURO (AM6)	50	02-	BR9ES	5722	0,6	BR9EVX	1265	208	BR9EIX	3981
MRX 50 Top (AM6)	50	03-	BR9ES	5722	0,6	BR9EVX	1265	208	BR9EIX	3981
MX 50 Infantil (Morini S5)	50	(01)	B6HS	4510	0,5	B6HVX	7435	203	BR6HIX	3419



Order No.



Gold-Palladium



Order No.

Quick No.

Iridium



Order No.

RIEJU

MX 50 Infantil	(Morini S6)	50	02-	B9ES	2611	0,6	B9EVX	7254	202	BR9EIX	3981
NKD 50	(AM6)	50	03-	BR9ES	5722	0,6	BR9EVX	1265	208	BR9EIX	3981
RR 50	(AM5)	50	97-	BR8ES	5422	0,6	BR8EVX	1262	207	BR8EIX	5044
RR 50	(AM6)	50	01-	BR8ES	5422	0,6	BR8EVX	1262	207	BR8EIX	5044
RR 50 Castrol	(AM6)	50	02-	BR9ES	5722	0,6	BR9EVX	1265	208	BR9EIX	3981
RR 50 EURO	(AM6)	50	02-	BR9ES	5722	0,6	BR9EVX	1265	208	BR9EIX	3981
RS1	(AM5)	50	97-	BR8ES	5422	0,6	BR8EVX	1262	207	BR8EIX	5044
RS1 EVO	(AM6)	50	98-	BR8ES	5422	0,6	BR8EVX	1262	207	BR8EIX	5044
RS1 EVO EURO	(AM6)	50	02-	BR9ES	5722	0,6	BR9EVX	1265	208	BR9EIX	3981
RS2 Matrix	(AM6)	50	03-	BR9ES	5722	0,6	BR9EVX	1265	208	BR9EIX	3981
SMX 50 EURO	(AM6)	50	02-	BR9ES	5722	0,6	BR9EVX	1265	208	BR9EIX	3981
Windy (MY50)		50		BR7HS	4122	0,5	---		211	BR7HIX	7067
MRX 125	(Yamaha)	125	02-	CR7HSA	4549	0,6	---			CR7HIX	7544
SMX 125	(Yamaha)	125	02-	CR7HSA	4549	0,6	---			CR7HIX	7544

RIVERO

Linos 50		50		BPR7HS	6422	0,5	BPR7HVX	2938	215	BPR7HIX	5944
----------	--	----	--	--------	------	-----	---------	------	-----	---------	------

ROYAL

Royal 125		125	96-	C7HSA	4629	0,6	C7HVX	4533		CR7HIX	7544
-----------	--	-----	-----	-------	------	-----	-------	------	--	--------	------

SACHS

Buxy (RS)		50		B7HS	5110	0,6	B7HVX	7836	204	BR7HIX	7067
City Roller CV 50		50		BPR6HS	7022	0,7	BPR6HVX	2740	214	BPR6HIX	4085
Limbo		50		BP6HS	4511	0,6	BP6HVX	4635		BPR6HIX	4085
MadAss 50		50	04-	CR7HSA	4549	0,6	---			CR7HIX	7544
Reggae (RS)		50		B7HS	5110	0,6	B7HVX	7836	204	BR7HIX	7067
Samba SR		50		B8HS	5510	0,5	B8HVX	2634	205	BR8HIX	7001
Speedake		50		B7HS	5110	0,6	B7HVX	7836	204	BR7HIX	7067
Speedfight 50 AC		50	97-	BR7HS	4122	0,6	---		211	BR7HIX	7067
Speedfight 50 LC		50	97-	BR7HS	4122	0,6	---		211	BR7HIX	7067
Speedfight 50 LC ADT		50	97-	BR7HS	4122	0,6	---		211	BR7HIX	7067
Splinter		50		B7HS	5110	0,6	B7HVX	7836	204	BR7HIX	7067
Squab		50		BR8HS	4322	0,6	BR8HVX	6265	212	BR8HIX	7001
SR 50		50		B8HS	5510	0,6	B8HVX	2634	205	BR8HIX	7001
SV 50		50		B8HS	5510	0,6	B8HVX	2634	205	BR8HIX	7001
SV 50 Junior		50		B8HS	5510	0,6	B8HVX	2634	205	BR8HIX	7001
Zenith		50		BP6HS	4511	0,6	BP6HVX	4635		BPR6HIX	4085
City Roller CV 80		80		BPR6HS	7022	0,7	BPR6HVX	2740	214	BPR6HIX	4085
City Roller CV 80 E		80		BR8HS	4322	0,7	BR8HVX	6265	212	BR8HIX	7001
SR 80		80		B8HS	5510	0,6	B8HVX	2634	205	BR8HIX	7001
SV 80		80		B8HS	5510	0,6	B8HVX	2634	205	BR8HIX	7001
SR 125		125		BP6HS	4511	0,6	BP6HVX	4635		BPR6HIX	4085
SR 125 C		125		BP6HS	4511	0,6	BP6HVX	4635		BPR6HIX	4085
Superduke		125	97-	C7HSA	4629	0,6	C7HVX	4533		CR7HIX	7544
SV 125		125		BP6HS	4511	0,6	BP6HVX	4635		BPR6HIX	4085
SV 125 C		125		BP6HS	4511	0,6	BP6HVX	4635		BPR6HIX	4085

SAN YANG

Fancy 50		50	10.95-	BR8HSA	5539	0,6	BR8HVX	6265		BR8HIX	7001
Flash 50		50		BR8HSA	5539	0,6	BR8HVX	6265		BR8HIX	7001
Free 50		50		BR8HSA	5539	0,6	BR8HVX	6265		BR8HIX	7001

Order
No.Platin
Gold-
Palla-
diumOrder Quick
No. No.

Iridium

Order
No.**SAN YANG**

Jet 50	50		BR8HSA	5539	0,6	BR8HVX	6265		BR8HIX	7001
Mike 50	50		BR8HSA	5539	0,6	BR8HVX	6265		BR8HIX	7001
Pure 50	50		BR8HSA	5539	0,6	BR8HVX	6265		BR8HIX	7001
Red Devil 50	50		BR8HSA	5539	0,6	BR8HVX	6265		BR8HIX	7001
Super Fancy 50	50		BR8HSA	5539	0,6	BR8HVX	6265		BR8HIX	7001
Duke 125	125		C7HSA	4629	0,6	C7HVX	4533		CR7HIX	7544
Super Duke 125	125		C7HSA	4629	0,6	C7HVX	4533		CR7HIX	7544

SASY

Classic 200 E	50	96-	BPR6HS	7022	0,5	BPR6HVX	2740	214	BPR6HIX	4085
JC 50	50	96-	C7HSA	4629	0,6	C7HVX	4533		CR7HIX	7544
Jet 50	50	96-	BPR6HS	7022	0,5	BPR6HVX	2740	214	BPR6HIX	4085
Mulan B	50	96-	BPR6HS	7022	0,5	BPR6HVX	2740	214	BPR6HIX	4085
Mulan Super AG	50	96-	BPR6HS	7022	0,5	BPR6HVX	2740	214	BPR6HIX	4085
Standard 50	50	96-	BPR6HS	7022	0,5	BPR6HVX	2740	214	BPR6HIX	4085

SHE LUNG

Club (I)	50		BP7HS	5111	0,6	BP7HVX	7468		BPR7HIX	5944
Racer (I)	50		BP7HS	5111	0,6	BP7HVX	7468		BPR7HIX	5944

SIAM

Falkon 50	50	97-	BR7HS	4122	0,6	---		211	BR7HIX	7067
Scros (I)	50		BPR6HS	7022	0,6	BPR6HVX	2740	214	BPR6HIX	4085
Scross	50		BPR6HS	7022	0,7	BPR6HVX	2740	214	BPR6HIX	4085

SIAMOTO

Birdie 25 Mofa	25	99-	BPR6HS	7022	0,7	BPR6HVX	2740	214	BPR6HIX	4085
Sross 50	50	99-	BR7HS	4122	0,5	---		211	BR7HIX	7067
Capri 125 4-Takt	125	99-	C7HSA	4629	0,7	C7HVX	4533		CR7HIX	7544
Favourite 125 4-Takt	125	99-	C7HSA	4629	0,7	C7HVX	4533		CR7HIX	7544
KD 125 4-Takt	125	99-	C7HSA	4629	0,7	C7HVX	4533		CR7HIX	7544

SIMSON

City 2000	50	95-	B8HS	5510	0,6	B8HVX	2634	205	BR8HIX	7001
SR 50 (1B)	50		B8HS	5510	0,6	B8HVX	2634	205	BR8HIX	7001
SR 50 (1XCE) Gamma	50		B8HS	5510	0,6	B8HVX	2634	205	BR8HIX	7001
SR 50 (1XG) Gamma	50		B8HS	5510	0,6	B8HVX	2634	205	BR8HIX	7001
Star 50	50	96-	BPR6HS	7022	0,7	BPR6HVX	2740	214	BPR6HIX	4085
Hot Summer 80	70	97-	B9HS	5810	0,4	B9HVX	2254		---	
Star Classic 80	70	97-	B9HS	5810	0,4	B9HVX	2254		---	
SR 80 /1B	80		B8HS	5510	0,6	B8HVX	2634	205	BR8HIX	7001
SR 80 /1XCE	80		B8HS	5510	0,6	B8HVX	2634	205	BR8HIX	7001

STEFFEN

Steffi	50	98-	BP6HS	4511	0,6	BP6HVX	4635		BPR6HIX	4085
Steffi S	50	98-	BP6HS	4511	0,6	BP6HVX	4635		BPR6HIX	4085

SUNDIRO

Speedy 50	50	96-	---		0,6	B9EVX	7254			
Speedy 80	80		---		0,6	B9EVX	7254			
Phönix XDZ 125 T	125	96-	CR7HSA	4549	0,6	---			CR7HIX	7544
Phönix XDZ 125 TA	125	96-	CR7HSA	4549	0,6	---			CR7HIX	7544

Order
No.Gold-
Palla-
diumOrder Quick
No. No.

Iridium

Order
No.**SUZUKI**

Address (l)	50		BPR6HS	7022	0,6	BPR6HVX	2740	214	BPR6HIX	4085
AH 50 (l)	50	01.92-	BPR6HS	7022	0,6	BPR6HVX	2740	214	BPR6HIX	4085
AH 50 Adress (CA1GA)	50	92-	BPR6HS	7022	0,7	BPR6HVX	2740	214	BPR6HIX	4085
AH 50 GP	50	95-	BPR6HS	7022	0,6	BPR6HVX	2740	214	BPR6HIX	4085
AJ 50 ZZ (l)	50	95-	BPR7HS	6422	0,5	BPR7HVX	2938	215	BPR7HIX	5944
AP 50 S CA1JA)	50	95-	BPR6HS	7022	0,6	BPR6HVX	2740	214	BPR6HIX	4085
AP 50 T (l)	50	96-	BPR6HS	7022	0,7	BPR6HVX	2740	214	BPR6HIX	4085
AY Katana WRX/WR/W (AA)	50	97-	BPR6HS	7022	0,6	BPR6HVX	2740	214	BPR6HIX	4085
CP 50 (l)	50	89- 92	BPR6HS	7022	0,7	BPR6HVX	2740	214	BPR6HIX	4085
UF50 Estilete (WVBA)	50	00-	BPR7HS	6422	0,6	BPR7HVX	2938	215	BPR7HIX	5944
UX 50 W Zillion (AT)	50	99-	BPR6HS	7022	0,7	BPR6HVX	2740	214	BPR6HIX	4085
AH 100 (l)	100	- 93	BPR7HS	6422	0,5	BPR7HVX	2938	215	BPR7HIX	5944
AH 100 (l)	100	- 93	BPR7HS	6422	0,6	BPR7HVX	2938	215	BPR7HIX	5944
AH 100 (CE12A)	100	95-	BPR7HS	6422	0,7	BPR7HVX	2938	215	BPR7HIX	5944
AN 125 (CF42A)	125	(95)	CR8E	1275	0,7	CR8EVX	6487	226	CR8EIX	4218
AN 125 (CF42A)	125	96-	CR7E	4578	0,7	---		225	CR7EIX	7385
AN 125 S (l)	125	95-	CR8E	1275	0,7	CR8EVX	6487	226	CR8EIX	4218
AN 125 T (l)	125	01.96-	CR7E	4578	0,7	---		225	CR7EIX	7385
UC 125 / U Epicuro (AX)	125	99-	CR8E	1275	0,7	CR8EVX	6487	226	CR8EIX	4218
UE 125 (WVBH)	125	01-	CR7E	4578	0,7	---		225	CR7EIX	7385
UH 125 (WVBP)	125	02-	CR8E	1275	0,7	CR8EVX	6487	226	CR8EIX	4218
AN 150 T (l)	150	01.96-	CR7E	4578	0,7	---		225	CR7EIX	7385
AN 250 Burgman (AN/WVAN)	250	05.98-	CR8EK	3478	0,7	CR8EVX	6487		---	
AN 400 Burgman (AU/WVAU)(WVBW)	400	99-	CR7E	4578	0,7	---		225	CR7EIX	7385
AN 650 Burgmann 650 (K3)(K4)	650	03-	CR8E	1275	0,7	CR8EVX	6487	226	CR8EIX	4218

SYM

DD 50	50		BR8HSA	5539	0,6	BR8HVX	6265		BR8HIX	7001
Fancy	50	96-	BR8HSA	5539	0,6	BR8HVX	6265		BR8HIX	7001
Fiddle 50	50		BR8HSA	5539	0,6	BR8HVX	6265		BR8HIX	7001
Flash	50	96-	BR8HSA	5539	0,6	BR8HVX	6265		BR8HIX	7001
Free	50	96-	BR8HSA	5539	0,6	BR8HVX	6265		BR8HIX	7001
Jet	50	96-	BR8HSA	5539	0,6	BR8HVX	6265		BR8HIX	7001
Mask 50	50		BR8HSA	5539	0,6	BR8HVX	6265		BR8HIX	7001
Pure 50	50	96-	BR8HSA	5539	0,6	BR8HVX	6265		BR8HIX	7001
Red Devil	50		BR8HSA	5539	0,6	BR8HVX	6265		BR8HIX	7001
Shark 50	50		BR8HSA	5539	0,6	BR8HVX	6265		BR8HIX	7001
Super Fancy	50	96-	BR8HSA	5539	0,6	BR8HVX	6265		BR8HIX	7001
HD 125	125	04-	CR7HSA	4549	0,6	---			CR7HIX	7544
Joyride 125	125	03-	CR7HSA	4549	0,6	---			CR7HIX	7544
Megalo 125	125		C7HSA	4629	0,7	C7HVX	4533		CR7HIX	7544
Shark 125	125	99-	C7HSA	4629	0,7	C7HVX	4533		CR7HIX	7544
Super Duke 125	125	96-	C7HSA	4629	0,7	C7HVX	4533		CR7HIX	7544
500 GT	500	04-	CR7EKB	4455	0,6	---			---	
500 XP	500	04-	CR7EKB	4455	0,6	---			---	

T.G.M. Bimota

Akros 50	50		BP6HS	4511	0,7	BP6HVX	4635		BPR6HIX	4085
Ergon 50	50		BP6HS	4511	0,7	BP6HVX	4635		BPR6HIX	4085

TGB

Bunny AS 50 X	50		BP6HS	4511	0,6	BP6HVX	4635		BPR6HIX	4085
---------------	----	--	-------	------	-----	--------	------	--	---------	------

Order
No.Gold-
Palla-
diumOrder Quick
No. No.

Iridium

Order
No.

TGB										
KBX 50	50		BP6HS	4511	0,6	BP6HVX	4635		BPR6HIX	4085
TOKAIDO										
2000 K50	50	96-	BR7HS	4122	0,6	---		211	BR7HIX	7067
50 V	50		BP7HS	5111	0,6	BP7HVX	7468		BPR7HIX	5944
SM 50	50		BP7HS	5111	0,6	BP7HVX	7468		BPR7HIX	5944
SM 50/1	50		BP7HS	5111	0,6	BP7HVX	7468		BPR7HIX	5944
VELOCIFERO										
Velocifero 50 (I)	50		B8HS	5510	0,6	B8HVX	2634	205	BR8HIX	7001
VESPA										
-> PIAGGIO										
VILLA BS										
Giorno 50 (I)	50		BR8HSA	5539	0,6	BR8HVX	6265		BR8HIX	7001
GP 50 Dio (I)	50		BPR8HS	3725	0,6	---			BPR8HIX	6742
SP 50 Dio (I)	50		BPR7HS	6422	0,6	BPR7HVX	2938	215	BPR7HIX	5944
Z5 50 (I)	50		BR8HSA	5539	0,6	BR8HVX	6265		BR8HIX	7001
ZX 50 (I)	50		BR8HSA	5539	0,6	BR8HVX	6265		BR8HIX	7001
VIVA										
Viva 50	50	96-	BP7HS	5111	0,5	BP7HVX	7468		BPR7HIX	5944
WINKING										
Bunny AS / AT / AX	50		BP7HS	5111	0,7	BP7HVX	7468		BPR7HIX	5944
Bunny AS 50 X	50		BP6HS	4511	0,7	BP6HVX	4635		BPR6HIX	4085
Koala 2	50		B5HS	4210	0,6	---				
Koala LM	50		B6HS	4510	0,6	B6HVX	7435	203	BR6HIX	3419
Scooty Roller	50		B6HS	4510	0,6	B6HVX	7435	203	BR6HIX	3419
WP										
Wave 50	50	96-	BPR7HS	6422	0,5	BPR7HVX	2938	215	BPR7HIX	5944
YAMAHA										
Aerox	50	97-	BR8HS	4322	0,6	BR8HVX	6265	212	BR8HIX	7001
Aerox Racing	50	04-	BR8HS	4322	0,6	BR8HVX	6265	212	BR8HIX	7001
Aerox R Toyota Racing	50	03-	BR8HS	4322	0,6	BR8HVX	6265	212	BR8HIX	7001
Axis (YA50R) (3UG)	50	97-	BR8HS	4322	0,7	BR8HVX	6265	212	BR8HIX	7001
Axis 50 (I)	50	01.95-	BR7HS	4122	0,6	---		211	BR7HIX	7067
Axis Mofa (5AK)(YA50R)	50	97-	BR7HS	4122	0,7	---		211	BR7HIX	7067
Beluga (I)	50		BP7HS-10	7829	1,0	---				
Breeze (4RC)(YM50)	50	95-	BR8HS	4322	0,7	BR8HVX	6265	212	BR8HIX	7001
Breeze 50 (I)	50	01.94-	BR7HS	4122	0,6	---		211	BR7HIX	7067
BW'S NG 99 (SA056)	50	99-	BR8HS	4322	0,6	BR8HVX	6265	212	BR8HIX	7001
BW 50 Spy (CW50RSP;4VA)	50	96-	BR8HS	4322	0,7	BR8HVX	6265	212	BR8HIX	7001
BW 50 (4BX)	50	91- 95	BR7HS	4122	0,7	---		211	BR7HIX	7067
BW 50 (CW50)	50	96-	BR8HS	4322	0,7	BR8HVX	6265	212	BR8HIX	7001
BW 50 Bump (CW50RSX)	50	96-	BR8HS	4322	0,7	BR8HVX	6265	212	BR8HIX	7001
BW 50 NG (CW50RS;4VA)	50	96-	BR8HS	4322	0,7	BR8HVX	6265	212	BR8HIX	7001
BW 50 R (4BX)	50	96-	BR8HS	4322	0,7	BR8HVX	6265	212	BR8HIX	7001
CR 50 Z (I)	50		BR7HS	4122	0,5	---		211	BR7HIX	7067



Order No.



Gold-Palladium



Order No.

Quick No.

Iridium



Order No.

YAMAHA

CT 50 S (I)	50		BP7HS-10	7829	0,7	---				
CT 50 SS (I)	50		BP7HS	5111	0,7	BP7HVX	7468		BPR7HIX	5944
CW 50 R (4BX)	50		BR8HS	4322	0,7	BR8HVX	6265	212	BR8HIX	7001
Evolis (YE50)(4FW)	50		BR8HS	4322	0,7	BR8HVX	6265	212	BR8HIX	7001
Forte (YA50R) (3UG)	50		BR8HS	4322	0,7	BR8HVX	6265	212	BR8HIX	7001
JogR	50		BR8HS	4322	0,6	BR8HVX	6265	212	BR8HIX	7001
JogRR	50		BR8HS	4322	0,6	BR8HVX	6265	212	BR8HIX	7001
Jog-Z 50 (I)	50	01.95-	BP7HS	5111	0,7	BP7HVX	7468		BPR7HIX	5944
Neo's	50	97-	BR8HS	4322	0,6	BR8HVX	6265	212	BR8HIX	7001
Neo's	50	01.97-	BR7HS	4122	0,6	---		211	BR7HIX	7067
Slider (SA09)	50	00-	BR8HS	4322	0,6	BR8HVX	6265	212	BR8HIX	7001
Spy 50 (I)	50		BR8HS	4322	0,6	BR8HVX	6265	212	BR8HIX	7001
Why (SA03)	50	99-	BR8HS	4322	0,6	BR8HVX	6265	212	BR8HIX	7001
YA 50 (5AK)	50	97-	BR7HS	4122	0,7	---		211	BR7HIX	7067
Zest/ YE50 (4FW)	50		BR8HS	4322	0,7	BR8HVX	6265	212	BR8HIX	7001
Evolis (4MU)	80		BR7HS	4122	0,7	---		211	BR7HIX	7067
Zest (4MU)(YE80)	80		BR7HS	4122	0,7	---		211	BR7HIX	7067
Aerox 100	100	01-	BR8HS	4322	0,6	BR8HVX	6265	212	BR8HIX	7001
BW 100 (SB02)	100	99- 00	BR8HS	4322	0,6	BR8HVX	6265	212	BR8HIX	7001
BW 100 (SB02)	100	00-	BR7HS	4122	0,7	---		211	BR7HIX	7067
Neos 100 (SB04)	100	00-	BR8HS	4322	0,6	BR8HVX	6265	212	BR8HIX	7001
BL 125 (50W)	125	85- 89	BPR8HS	3725	0,6	---			BPR8HIX	6742
Doodo (SE041)	125	01-	CR8E	1275	0,7	CR8EVX	6487	226	CR8EIX	4218
Majesty 125 (I)	125		DR8EA	7162	0,6	DR8EVX	6354		DR8EIX	6681
Maxster 125	125	00-	CR8E	1275	0,7	CR8EVX	6487	226	CR8EIX	4218
Teo's (SE041)	125	01-	CR8E	1275	0,7	CR8EVX	6487	226	CR8EIX	4218
XC 125 (3TE)	125	90-	CR6HSA	2983	0,7	---			CR6HIX	7274
XC 125 Beluga	125		CR6HSA	2983	0,7	---			CR6HIX	7274
XC 125 Cygnus	125	- 94	CR6HSA	2983	0,7	---			CR6HIX	7274
XC 125 Cygnus	125	04-	CR7E	4578	0,7	---		225	CR7EIX	7385
XC 125 Cygnus	125	01.95-	CR7E	4578	0,7	---		225	CR7EIX	7385
XC 125 T (4KY)	125	95-	CR7E	4578	0,6	---		225	CR7EIX	7385
XC 125 T (4NB)	125	94-	CR7E	4578	0,7	---		225	CR7EIX	7385
XC 125 T Cygnus T (4NB)	125	96-	CR7E	4578	0,6	---		225	CR7EIX	7385
XC 125 TR Cygnus (4NB)	125	96-	CR7E	4578	0,7	---		225	CR7EIX	7385
YP 125 R Majesty	125	98-	CR8E	1275	0,7	CR8EVX	6487	226	CR8EIX	4218
XC 150 Fly one (I)	150	01.95-	CR7E	4578	0,7	---		225	CR7EIX	7385
YP 250 Majesty (4UC)	250		DR8EA	7162	0,6	DR8EVX	6354		DR8EIX	6681
YP 250 Majesty (I)	250		DR8EA	7162	0,6	DR8EVX	6354		DR8EIX	6681
YP 250 DX Majesty ABS (SG021)	250	99-	DR8EA	7162	0,6	DR8EVX	6354		DR8EIX	6681
YP 250 (SG041)	250	00-	DR8EA	7162	0,6	DR8EVX	6354		DR8EIX	6681
YP 250 Grand Majesty	250	04-	CPR7EA-9		0,9					
VP 300 Versity	300	03-	DR8EA	7162	0,6	DR8EVX	6354		DR8EIX	6681
T MAX 500	500	04-	CR7E	4578	0,7	---		225	CR7EIX	7385



ccm

Order-
No.

APRILIA					
AF1 50		01.86-	50	LB05F	8051
ET 50 AE,-Fire		01.87-	50	LB05F	8051
GL 50		02.93-	50	LB05F	8051
LX 50		02.93-	50	LB05F	8051
RC 50		01.79-12.82	50	LB05F	8051
Red Rose 50		06.87-	50	LB05F	8051
RS 50 Extrema/Replica		01.93-	50	LB05F	8051
RX 50		09.90-	50	LB05F	8051
Tuareg 50		01.87-	50	LB05F	8051
RX 125		01.90-	125	LB05F	8051
BMW					
R 45	26kW	06.78-06.83	475	LB05F	8051
R 45	20kW	06.78-07.85	475	LB05F	8051
R 50/5			500	LB05F	8051
R 60/5, /6, /7		-06.78	600	LB05F	8051
R 65		06.78-	650	LB05F	8051
R 75/5, /6, /7			750	LB05F	8051
R 80 R		80-	800	LB05F	8051
R 80 ST		08.82- 95	800	LB05F	8051
R 80 RT		08.82- 95	800	LB05F	8051
R 80 GS		08.82- 94	800	LB05F	8051
R 80		08.82- 95	800	LB05F	8051
R 80/7N /7S		09.77-08.80	800	LB05F	8051
R 850 GS		98-	850	LB05F	8051
R 850 R	52kW	10.94-	850	LB05F	8051
R 850 RT		99-	850	LB05F	8051
R 90/6			900	LB05F	8051
R 90/S			900	LB05F	8051
R 100			1000	LB05F	8051
R 100 R		94-	1000	LB05F	8051
R 100 RS		09.86-	1000	LB05F	8051
R 100/7			1000	LB05F	8051
R 100/CS /RT			1000	LB05F	8051
R 100/RS		-08.86	1000	LB05F	8051
R 100 GS		09.86-	1000	LB05F	8051
R 100/S /T		09.76-08.80	1000	LB05F	8051
R 1100 GS	59kW	08.93- 99	1100	LB05F	8051
R 1100 R	59kW	10.94-	1100	LB05F	8051
R 1100 RS	66kW	11.92-	1100	LB05F	8051
R 1100 RT	66kW	09.95-	1100	LB05F	8051
CAGIVA					
WMX 125/84			125	LB05F	8051
WMX 125/85			125	LB05F	8051
WMX 125/88			125	LB05F	8051
All			175	LB05F	8051
All			200	LB05F	8051
MX,MXR,RR,RX,WMX			250	LB05F	8051
NC,RL,SS,SST		01.83-	250	LB05F	8051
RX 250 Rally		01.79-11.83	250	LB05F	8051
SX, SXT		01.83-12.84	250	LB05F	8051



ccm

Order-
No.**CAGIVA**

Ala Blu 350		350	LB05F	8051
Ala Rossa 350/4T	01.83-	350	LB05F	8051
Ala Verde 350		350	LB05F	8051
Alazzurra 350 (D)	01.84-	350	LB05F	8051
Elefant 350 (D)		350	LB05F	8051
Lucky 350		350	LB05F	8051
SST 350		350	LB05F	8051
W12	94-	350	SD05FP	8325

DAELIM

125 Daystar	01.00-	125	XB01F	30275
VC 125 Advance	95-	125	XB01F	30275
VT 125 Evolution	03.98-	125	XB01F	30275

DUCATI

600 Pantah SL/TL (D)	81-	600	VB05F	8032
900 S,SS,GTS,SD,S2,HR (D)	80-	900	VB05F	8032

GAS GAS

TT 125		125	LB05F/CR2	8051/8048
TT 200		200	LB05F/CR2	8051/8048
Cross 250		250	LB05F/CR2	8051/8048
TT 250		250	LB05F/CR2	8051/8048
TT 300		300	LB05F/CR2	8051/8048

GILERA

50 TS	01.79-12.82	50	LB05F	8051
CB1 4V		50	LB05F	8051
Touring	01.73-12.81	50	LB05F	8051
Trial		50	LB05F	8051
Giubileo 4 T, SS		98	LB05F	8051
125 5V Regolarità		125	LB05F	8051
125 Arcore, Export	01.72-06.80	125	LB05F	8051
125 SV Regolarità		125	LB05F	8051
Saturno 500	04.88- 92	500	LB05F	8051

HERCULES

City Bike C1	10.72-08.78	50	LB05F	8051
City Bike C2	10.72-08.78	50	LB05F	8051
City Bike C3	09.74-08.78	50	LB05F	8051
Hobby Rider HR 1	10.72-12.87	50	LB05F	8051
Hobby Rider HR 2	10.72-12.87	50	LB05F	8051
Jogging		50	LB05F	8051
K 50	-08.78	50	LB05F	8051
K 50 Ultra	-08.78	50	LB05F	8051
K 50 Ultra II	-08.78	50	LB05F	8051
K 50 Ultra LC	-08.78	50	LB05F	8051
K 50 Ultra LC II	-08.78	50	LB05F	8051
K 50 Ultra LC III	-08.78	50	LB05F	8051
KX 5	01.86-	50	LB05F	8051
Lastboy		50	LB05F	8051
M1	10.72-12.77	50	LB05F	8051



ccm

Order-
No.**HERCULES**

M2	10.72-12.77	50	LB05F	8051
M4	09.74-12.78	50	LB05F	8051
M5	09.74-12.78	50	LB05F	8051
MK 1S	01.78-08.80	50	LB05F	8051
MK 2S	01.78-08.80	50	LB05F	8051
MP 2	10.72-12.77	50	LB05F	8051
MP 4	10.72-12.77	50	LB05F	8051
MX 1		50	LB05F	8051
MX 1	01.89-	50	LB05F	8051
Optima 3	01.78-	50	LB05F	8051
Optima 50		50	LB05F	8051
Prima 2		50	LB05F	8051
Prima 2S	01.89-	50	LB05F	8051
Prima 3		50	LB05F	8051
Prima 3S	01.89-	50	LB05F	8051
Prima 4		50	LB05F	8051
Prima 4LN,5LN		50	LB05F	8051
Prima 5		50	LB05F	8051
Prima 5,5S,5SE	01.89-	50	LB05F	8051
Prima 6		50	LB05F	8051
Prima G3		50	LB05F	8051
Prima GT	01.89-	50	LB05F	8051
Prima GT,GX		50	LB05F	8051
Prima Presto		50	LB05F	8051
Prima Pronto		50	LB05F	8051
Prima S		50	LB05F	8051
Prima SL		50	LB05F	8051
Prima SX		50	LB05F	8051
Sport Bike SB1	10.72-08.74	50	LB05F	8051
Sport Bike SB2	10.72-08.79	50	LB05F	8051
Sport Bike SB3	09.74-08.79	50	LB05F	8051
Sport Bike SB5	09.74-08.76	50	LB05F	8051
Supra 2D,3D	06.80-	50	LB05F	8051
Supra 4	06.78-	50	LB05F	8051
Supra 4GP	01.80-	50	LB05F	8051
Supra Enduro	03.80-	50	LB05F	8051
Ultra 50		50	LB05F	8051
XE 5	01.86-	50	LB05F	8051
ZX 1		50	LB05F	8051
RX 9		80	LB05F	8051
Ultra 80 LC		80	LB05F	8051
Ultra 80 AC	01.82-	80	LB05F	8051
XE 9	01.82-	80	LB05F	8051
K 100 X		100	LB05F	8051
K 125 BW Military	09.74-	125	LB05F	8051
K 125 GS		125	LB05F	8051
K 125 MC		125	LB05F	8051
K 125 S	10.72-08.79	125	LB05F	8051
K 125 T	10.72-08.79	125	LB05F	8051
K 125 X		125	LB05F	8051
175 GS		175	LB05F	8051
250 GS		250	LB05F	8051



ccm

Order-
No.**HERCULES**

350 GS		350	LB05F	8051
--------	--	-----	-------	------

HONDA

Camino PA 50	01.75-12.87	50	LB05F	8051
CB 50		50	LD05F	8060
CB 50 Y	01.73-01.83	50	LD05F	8060
CY 50	01.81-	50	LD05F	8060
Elite 50/S		50	LB05F	8051
MB 50 F (AC01)		50	LB05F	8051
MB 50 S (AC01)		50	LB05F	8051
MBX 50 M (AC05)		50	LB05EMH	8160
MBX 50 S (AC05)		50	LB05EMH	8160
MBX 50 SD (AC05)		50	LB05EMH	8160
MR 50		50	LB05F	8051
MT 50 F (AD04)		50	LB05F	8051
MT 50 S (AD04)		50	LB05F	8051
MTX 50 R		50	LB05EMH	8160
MTX 50 S	86-	50	LB05EMH	8160
NC 50		50	LB05F	8051
NE 50		50	LB05F	8051
NE 50 Vision	90-	50	LB05F	8051
NSR 50	89-	50	LB05F	8051
NT 50		50	LB05F	8051
NX 50		50	LB05F	8051
NX 50 M		50	LB05F	8051
PA 50	84-	50	LB05F	8051
PF 50		50	LB05F	8051
PK 50 DX (AB25)	95-	50	LB05F	8051
PK 50 Wallaroo	90-	50	LB05F	8051
PM 50		50	LB05F	8051
PX 50	84-	50	LB05F	8051
PX 50 E	80-	50	LB05F	8051
PX 50 R	85-	50	LB05F	8051
PZ 50		50	LB05F	8051
SA 50 (AF29)		50	LB05F	8051
SE 50		50	LB05F	8051
SFX 50	96-	50	LB05F	8051
SH 50	01.84-	50	LB05F	8051
SH 50 T (AF40)	97-	50	LB05F	8051
SJ 50 Bali		50	LB05F	8051
ST 50 C (AB23) Dax		50	LD05F	8060
TLM 50		50	LB05EMH	8160
XL 50	01.80-	50	LD05F	8060
XR 50	93- 02	50	LD05F	8060
Z 50 GZ	01.80-12.84	50	LD05F	8060
Z 50 J		50	LD05F	8060
Z 50 R	94-	50	LD05F	8060
ZB 50 P (AB22)	88-	50	VD05F	8052
CT 70	92-	70	LD05F	8060
ST 70	94-	70	LD05F	8060
TRX 70 (ATV)		70	LD05F	8060
NS-1	96-	75	LB05F	8051



ccm

Order-
No.

					HONDA
CR 80 R		86-	80	LB05EMH	8160
CR 80 R		- 85	80	LB05EMH	8160
CY 80			80	LD05F	8060
MB 80	(HC01)	01.80-	80	LB05F	8051
MBX 80 SWD/SW2D	(HC04)	87-	80	LB05F	8051
MCX 80	(HC05)	01.80-	80	LB05F	8051
MT 80 F			80	LB05F	8051
MT 80 S	(HD02)		80	LB05F	8051
MTX 80 C		82-	80	LB05EMH	8160
MTX 80 R (D)	(HD08)		80	LB05EMH	8160
MTX 80 R (F)	(HD08)		80	LB05EMH	8160
MTX 80 R II	(HD09)	87-	80	LB05EMH	8160
MTX 80 RS	(HD08)	83- 85	80	LB05EMH	8160
NSR 80			80	LB05F	8051
SH 80 E Scoopy		84-	80	LB05F	8051
XR 80R		92-	80	LB05F	8051
EZ 90		93-	90	LB05F	8051
NH 90 M		93-	90	LB05F	8051
NH 90 Yupy		90-	90	LB05F	8051
TRX 90	(ATV)	95-	90	LD05F	8060
TRX 90	(ATV)	93- 94	90	LD05F	8060
XR 100R		92-	100	VD05F	8052
CG 110			110	LD05F	8060
ATC 125 M	(ATV)		125	LD05F	8060
CA 125 Rebel	(JC24)	95-	125	LD05F	8060
CA 125 C Rebel	(JC26)	97-	125	LD05F	8060
CB 125			125	LD05F	8060
CB 125 K			125	LD05F	8060
CB 125 T			125	LD05F	8060
CB 125 Y			125	LD05F	8060
CG 125	(JC27)	98-	125	LD05FP	8070
CG 125			125	LD05F	8060
CH 125			125	LD05F	8060
CLR 125 Cityfly	(JD18A/B)	98-	125	VD05FMH	30570
CM 125	(JC05)		125	LD05FP	8070
CM 125 C Custum		94-	125	LD05F	8060
CR 125 R			125	LB05F/CR2	8051/8048
Italia 125 (I)			125	LD05F	8060
Lead 125	(JF01)		125	LB05F/CR2	8051/8048
MBX 125 F			125	SD05FM	30460
MTX 125			125	LB05EMH	8160
MTX 125 R (I)			125	LB05F	8051
MTX 125 R2 (I)			125	LB05F	8051
NS 125 F (I)			125	LB05EMH	8160
NS 125 R (I)			125	LB05F	8051
NSR 125 F			125	LB05F	8051
TL 125			125	VD05F	8052
TRAX 125	(ATV)		125	LD05F	8060
TRX 125	(ATV)		125	VD05F	8052
XL 125 (I)			125	LD05F	8060
XL 125 R			125	VD05FMH	30570
XL 125 S			125	LD05F	8060



ccm

Order-
No.**HONDA**

XLR 125 R		98-	125	VD05FMH	30570
XR 125			125	LD05F	8060
ATC 185	(ATV)		185	LD05F	8060
ATC 185 S	(ATV)		185	LD05F	8060
CD 185 T			185	LD05F	8060
CM 185 T		01.78-	185	LD05F	8060
XL 185 S		01.79-	185	VD05F	8052
ATC 200	(ATV)		200	VD05F	8052
CD 200 T			200	LD05F	8060
CM 200 T			200	LD05F	8060
MTX 200 RW	(MD07)	83- 85	200	LB05EMH	8160
TRX 200 D	(ATV)	92-	200	VD05F	8052
XL 200 R		01.83-	200	VD05F	8052
250 Spacy (I)			250	LD05F/CR2	8060/8048
ATC 250 ES /SX	(ATV)	85-	250	VD05F	8052
CB 250	(MC26)	96-	250	XD05F	8072
CB 250 N		01.80-	250	XD05F	8072
CB 250 RS	(MC02)	01.80-	250	XD05F	8072
CB 250 T			250	LD05F	8060
CBX 250			250	SD05FM	30460
CD 250 U			250	XD05F	8072
CH 250			250	VD05F	8052
CM 250 C	(MC06)	01.82-	250	LD05FP	8070
CMX 250 C	(MC32B)	97-	250	VD05F	8052
CMX 250 CT	(MC13)	96-	250	VD05F	8052
CR 250 R		- 81	250	LB05F/CR2	8051/8048
CR 250 R		82- 02	250	LB05F/CR2	8051/8048
NX 250 J	(MD21)	88-	250	VD05F	8052
NX 250 K	(MD21)	89-	250	VD05F	8052
NX 250 L	(MD25)	91-	250	VD05F	8052
TLR 250			250	VD05FMH	30570
TRX 250	(ATV)		250	VD05F	8052
TRX 250 R	(ATV)		250	VD05F	8052
TRX 250 X	(ATV)		250	VD05F	8052
VT 250 F2			250	SD05FMC	30465
XL 250 R	(MD11)	86-	250	SD05F/CR1	8022/8035
XL 250 R	(MD11)	84- 85	250	SD05F/CR1	8022/8035
XL 250 R	(MD11)	- 83	250	SD05F/CR1	8022/8035
XR 250 L		92-	250	SD05F	8022
XL 350 R	(ND03)	85- 87	350	VD05F	8052
XR 350 R			350	VD05F	8052
CB 400 A		01.79-	400	VD05F(IN)XD05F(OUT)	8052/8072
CB 400 N		01.78-12.84	400	XD05F	8072
CB 400 T			400	YB05F	8082
CB-1	(NC27)	91-	400	SD05F/CR1	8022/8035
CBX 400 F			400	SD05FMC	30465
CBX 400 F2			400	SD05FMC	30465
CM 400 T		01.80-12.84	400	XD05F	8072
CB 450 N	(PC14)	85-	450	LB05F	8051
CB 450 S	(PC17)(D)	86- 88	450	XD05F	8072
CB 450 S	(PC17)(I)		450	XD05F	8072
CMX 450 C			450	XD05F	8072



ccm

Order-
No.

					HONDA
FT 500	(PC07)	01.82-12.85	500	VD05F	8052
GB 500	(PC16)	92-	500	SD05F	8022
VF 500 F	(PC12)	84-	500	SD05FMC/CR1	30465/8035
VF 500 F2	(PC12)	- 84	500	SD05FMC/CR1	30465/8035
VF 500 F2	(PC12)	85-	500	SD05FMC/CR1	30465/8035
VT 500 C	(PC08)	83-	500	VD05F	8052
VT 500 E	(PC11)	83- 85	500	VD05F	8052
XL 500 R	(PD02)	86-	500	VD05F	8052
XL 500 R	(PD02)	- 85	500	VD05F	8052
XL 500 S	(PD01)	01.79-12.81	500	VD05F	8052
XR 500			500	VD05F	8052
XR 500 R			500	VD05F	8052
CB 550		06.71-12.87	550	SD05F(IN)XD05F(OUT)	8022/8072
CB 550	(F1/F2)	76-	550	SD05F(IN)XD05F(OUT)	8022/8072
CB 550	(K3/4)	76-	550	SD05F(IN)XD05F(OUT)	8022/8072
CB 550 F		06.71-12.87	550	SD05FMC	30465
CBX 550 F	(PC04)		550	SD05FMC	30465
CBX 550 F2	(PC04)		550	SD05FMC	30465
CBX 600 E		01.83-12.87	600	SD05FMC	30465
NTV 600			600	SD05F/VD05F	8022/8052
XL 600 L			600	SD05FM	30460
XL 600 LM	(PD04)	85- 87	600	SD05FM	30460
XL 600 R	(PD03)	83- 87	600	SD05FM	30460
XL 600 RM (I)			600	SD05FM	30460
XL 600 RM	(PD04)	86-	600	SD05FM	30460
XL 600 V / VN		87-	600	SD05F	8022
XR 600 / V			600	SD05FM	30460
XR 600 R / L		01.87-	600	SD05FM	30460
CB 650 C	(RC05)		650	XD05F	8072
CB 650 SC	(RC08)	01.80-	650	XD05F	8072
CB 650 Z			650	XD05F	8072
CBX 650 E	(RC13)	83-	650	SD05FMC	30465
NX 650	(RD02)/Dominator	88-	650	SD05F	8022
NX 650 Dominator	(RD08)(I)	01.88-	650	SD05F	8022
Transalp XL 650		94-	650	SD05F	8022
XL 650L		94-	650	SD05F	8022
CB 750	(RC42)	92-	750	SD05F	8022
CB 750	(RC04)	01.82-12.83	750	SD05F	8022
CB 750 C	(RC06)	01.80-	750	SD05F	8022
CB 750 F		- 91	750	SD05F	8022
CB 750 F2			750	SD05F	8022
CB 750 F2N / FII		91-	750	SD05F(IN)XD05F(OUT)	8022/8072
CB 750 FA (I)			750	SD05F	8022
CB 750 Four (I)			750	SD05F	8022
CB 750 FZ			750	SD05F	8022
CB 750 K		01.82-12.83	750	SD05F	8022
CB 750 KZ			750	SD05F	8022
NR 750	(RC40)	93-	750	SD05F	8022
RVF	(RC45)	94-	750	SD05F	8022
VF 750 C		95- 00	750	SD05F/CR1	8022/8035
VF 750 S	(RC07)	82- 83	750	SD05F	8022
VFR 750 F		94-	750	XD05F	8072



ccm

Order-
No.**HONDA**

VFR 750 F (I)			750	XD05F	8072
VFR 750 F	(RC24)	86- 87	750	XD05F	8072
VFR 750 F	(RC24)	88- 89	750	XD05F	8072
VFR 750 F	(RC36)	90- 94	750	XD05F	8072
VFR 750 FJ (I)			750	XD05F	8072
VT 750 C	(RC29)	87-	750	XD05F/VD05F	8072/8052
VT 750 C/C2V	(RC44)	97-	750	XD05F/VD05F	8072/8052
PC 800 Pacific Coast		98-	800	SD05F	8022
CB 900 F		01.79-	900	SD05F(IN)XD05F(OUT)	8022/8072
CB 900 F2		01.79-12.83	900	SD05F(IN)XD05F(OUT)	8022/8072
CBR 900 RR	(SC33)	96-	900	XD05F	8072
CBR 900 RR	(SC28)	91-	900	XD05F	8072
CB 1000 F	(SC30)	93- 00	1000	SD05F(IN)XD05F(OUT)	8022/8072
CBR 1000 F	(SC24)	95- 00	1000	SD05F(IN)XD05F(OUT)	8022/8072
CBR 1000 F	(SC21)	87- 88	1000	SD05F(IN)XD05F(OUT)	8022/8072
CBR 1000 F	(SC24)	89- 92	1000	SD05F(IN)XD05F(OUT)	8022/8072
GL 1000 (GL1)			1000	XD05F	8072
VF 1000 F		- 86	1000	SD05FMC	30465
VF 1000 F	(SC15)	87-	1000	SD05FMC	30465
VF 1000 F2	(SC15)	85-	1000	SD05FMC	30465
VF 1000 R	(SC16)	84- 86	1000	SD05FMC	30465
CBX 1000 (CB1)			1050	XD05F	8072
CB 1100 F	(SC11)		1100	XD05F	8072
CB 1100 R	(SC08)		1100	SD05F(IN)XD05F(OUT)	8022/8072
GL 1100	(SC02)	- 81	1100	XD05F	8072
GL 1100	(SC02)	82-	1100	XD05F	8072
GL 1100 DX	(SC02)	- 81	1100	XD05F	8072
GL 1100 DX	(SC02)	82-	1100	XD05F	8072
GL 1100 R			1100	XD05F	8072
VF 1100 C	(SC12)	83-	1100	SD05FMC/CR1	30465/8035
GL 1200	(SC14)	84- 87	1200	XD05F	8072

HUSQVARNA

CR 250		01-	250	LB05F/CR2	8051/8048
WR 250		01-	250	LB05F/CR2	8051/8048
410 TE (2AA)		96- 00	400	SD05FP	8325
TE 410		01-	400	SD05FP	8325
SM 570 R		01-	570	SD05FP	8325
TC 570		07.01-	576	SD05FP	8325
TE 570		07.01-	576	SD05FP	8325
610 e TE/TC		98-	610	SD05FP	8325
SM 610 e		98-	610	SD05FP	8325

KAWASAKI

AE 50		83-	50	LB05F	8051
AE 50		- 82	50	LB05F	8051
AR 50		93-	50	LB05F	8051
AR 50		83- 92	50	LB05F	8051
AR 50		- 82	50	LB05F	8051
AV 50		84-	50	LB05F	8051
AV 50		- 83	50	LB05F	8051
KH 50			50	LB05F	8051



ccm

Order-
No.**KAWASAKI**

KMX 50	(KSR-I)	93-	50	LB05F	8051
KX 60		- 92	60	LB05F	8051
KX 60		93-	60	LB05F	8051
AE 80		83-	80	LB05F	8051
AE 80		- 82	80	LB05F	8051
AN 80			80	LB05F	8051
AR 80		- 82	80	LB05F	8051
AR 80		83-	80	LB05F	8051
DX 80			80	LB05F	8051
KD 80			80	LB05F	8051
KDX 80			80	LB05F	8051
KH 80			80	LB05F	8051
KMX 80	(KSR-2)	93-	80	LB05F	8051
KX 80		- 80	80	LBER	30100
KX 80		81- 82	80	LBER	30100
KX 80		83- 91	80	LBER	30100
KX 80	(KX80S7)	97-	80	LBER	30100
KX 80	(KX80V7)	97-	80	LBER	30100
KX 80 /80-2		92-	80	LBER	30100
KC 90			90	LB05F	8051
KC 90 A			90	LB05F	8051
KC 90 C			90	LB05F	8051
KC 90 D			90	LB05F	8051
KE 90			90	LB05F	8051
KH 90			90	LB05F	8051
KM 90			90	LB05F	8051
KC 100		80-	100	LB05F	8051
KD 100			100	LB05E	8031
KE 100		01.76-12.79	100	LB05F	8051
KE 100		93-	100	LB05F	8051
KH 100			100	LB05F	8051
KM 100		01.79-12.81	100	LB05E	8031
KV 100			100	LB05E	8031
AR 125		01.82-	125	LB05F	8051
DX 125			125	LB05F	8051
KC 125			125	LB05F	8051
KD 125			125	LB05E	8031
KDX 125 SR			125	LB05F/CR2	8051/8048
KE 125		01.76-12.83	125	LB05E	8031
KH 125		01.77-12.81	125	LB05F	8051
KH 125		93-	125	LB05F	8051
KMX 125		01.86-	125	LB05F	8051
KS 125		01.73-12.76	125	LB05E	8031
KX 125		90- 91	125	LB05EMH	8160
KX 125		85- 90	125	LB05F	8051
KX 125		91- 99	125	LB05EMH	8160
KX 125		82- 84	125	LB05F	8051
KX 125	(KX125K4)	97-	125	LB05EMH	8160
KD 175			175	LB05F	8051
KDX 175		01.80-12.84	175	LBER	30100
KE 175		81-	175	LB05F	8051
KE 175		- 80	175	LB05F	8051



ccm

Order-
No.**KAWASAKI**

KE 175 B			175	LB05F	8051
KE 175 D			175	LB05F	8051
KLF 185 (ATV)			185	LD05F	8060
KDX 200	93-	94	200	LBER	30100
KDX 200 H	95-		200	LB05EMH	8160
KMX 200	01.88-	92	200	LB05F/CR2	8051/8048
Z 200	01.77-	12.79	200	LB05F	8051
KLF 220 (ATV)	88-	02	220	LD05F	8060
BJ 250A (Estrella)	93-	96	250	LD05F	8060
BJ 250 C(Estrella)	97-		250	LD05F	8060
GPZ 250 Belt Drive			250	LD05F	8060
GPZ 250 R			250	LD05F	8060
KDX 250 (ATV)	91-		250	LB05F	8051
KDX 250 (ATV)			250	LBER	30100
KDX 250 SR (ATV)	92-		250	LB05F	8051
KE 250			250	LB05E	8031
KH 250	01.73-	12.79	250	LB05E	8031
KL 250 (A)	01.79-	12.83	250	LB05F	8051
KL 250 (KLR 250)	01.83-	91	250	LD05F	8060
KLX 250	01.80-	12.84	250	LB05E	8031
KLX 250 (KLX250E)	93-		250	XD05F	8072
KR-1R			250	LB05F	8051
KR-1S			250	LB05F	8051
KT 250			250	LB05E	8031
KX 250	-	91	250	LB05F	8051
LTD 250 Belt Drive			250	LD05F	8060
LX 250			250	LB05F	8051
Z 250			250	LB05F	8051
Z 250 A	01.80-		250	LD05F	8060
Z 250 B			250	LD05F	8060
Z 250 Belt Drive			250	LD05F	8060
Z 250 C	01.80-		250	LB05F	8051
Z 250 D			250	LB05F	8051
Z 250 G			250	LB05F	8051
Z 250 J			250	LD05F	8060
Z 250 LTD	01.81-		250	LB05F	8051
Z 250 T			250	LD05F	8060
ZR 250 (Balius)	93-		250	SD05F/CR1	8022/8035
KEF 300 A&B (SQ)	95-		300	LD05F	8060
KLF 300 (ATV)	88-		300	LB05F	8051
MULE 500/ KAF 300 A&B (UV)	92-	96	300	LB05F	8051
GPZ 305 Belt Drive	01.83-		305	LD05F	8060
Z 305			305	LD05F	8060
EN 400 A			400	XD05F	8072
GPZ 400			400	XD05F	8072
GPZ 400 F			400	XD05F	8072
GPZ 400 F II			400	XD05F	8072
KH 400			400	LB05E	8031
KLE 400	93-		400	XD05F	8072
KX 400			400	LBER	30100
LTD 400			400	LD05F	8060
Z 400	01.76-	12.81	400	LB05F	8051



ccm

Order-
No.**KAWASAKI**

Z 400 A/B/C/D/G/H		400	LB05F	8051
Z 400 F		400	LD05F	8060
Z 400 F	83-	400	LD05F	8060
Z 400 F-II		400	LD05F	8060
Z 400 J		400	LD05F	8060
Z 400 J (I)		400	LD05F	8060
Z 400 K		400	LD05F	8060
Z 400 LTD		400	LB05F	8051
Z 400 M		400	LD05F	8060
ZL 400 (Eliminator 400SE)	93-	400	LD05F	8060
ZR 400	84-	400	LD05F	8060
ZR 400	- 83	400	LD05F	8060
ZR 400-C (Zephyr 400)	93-	400	LD05F/CR2	8060/8048
ZR 400-D (Xanthus)	93-	400	LD05F	8060
ZX 400 (Z 400-F2)	93-	400	LD05F	8060
Z 440	01.80-12.85	440	LB05F	8051
Z 440 H (I)		440	LB05F	8051
EN 450 A (I)		450	XD05F	8072
LTD 450	01.85-	450	LD05F	8060
EN 500	90-	500	XD05F	8072
EX 500 (GPZ 500S EN 500)	93-	500	XB05F	8062
KH 500		500	LB05E	8031
KX 500	93-	500	LBER	30100
Z 500		500	LD05F	8060
ZR 500		500	LD05F	8060
GPZ 550		550	LD05F	8060
GPZ 550 Unitrack (I)		550	LD05F	8060
LTD 550	01.80-12.85	550	LD05F	8060
Z 550		550	LD05F	8060
ZR 550 B Zephyr	91-	550	LD05F	8060
ZX 550 A1		550	LD05F	8060
ZL 600	01.86-	600	XD05F	8072
ZL 600 (ZL600B/B1)	95-	600	XD05F	8072
ZX 600 A (I)		600	LD05F	8060
ZX-6R Ninja (ZX600F1/F3)	95-	600	XD05F	8072
ZX-6R Ninja (ZX 600 H Kat)	98-	600	XD05F	8072
ZX-6R Ninja (ZX 600 G)	98-	600	XD05F	8072
KLR 650	09.86- 94	650	XD05F	8072
KLR 650 (KL650C1/C3)	95-	650	XD05F	8072
KLX 650 (KLX650C)	93-	650	SD05FM	30460
KLX 650 R	98-	650	SD05FM	30460
KLX 650 R (KLX650A)	93- 96	650	SD05FM	30460
Z 650		650	LB05F	8051
Z 650 F-B		650	LB05F	8051
LTD 700		700	LB05F	8051
750 Turbo	01.73-12.86	750	LB05F	8051
GPX 750 R	01.87-	750	SD05F/CR1	8022/8035
GPX 750 R (I)		750	SD05F/CR1	8022/8035
GPZ 750	01.82-	750	LB05F	8051
GPZ 750 R	01.85-	750	SD05F/CR1	8022/8035
LTD 750 4 Cyl.	01.82-12.87	750	LB05F	8051
VN 750 Twin		750	XD05F(IN)LD05F(OUT)	8072/8060



ccm

Order-
No.**KAWASAKI**

VN 750 Vulcan		750	XD05F(IN)LD05F(OUT)	8072/8060
Z 2		750	XD05F(IN)LD05F(OUT)	8072/8060
Z 750		750	LB05F	8051
ZR 750 C Zephyr	91- 00	750	LD05FP	8070
ZR 750 D1/2 Zephyr	96- 00	750	LD05FP	8070
ZX 750 J		750	LB05FP	8030
ZX 750 N1 Ninja ZX-7RR	96-	750	LB05FP	8030
ZX 750 P1/P2 Ninja ZX-7R	96-	750	LB05FP	8030
ZXR 750	09.88-	750	XD05F	8072
ZXR 750 R	90-	750	XD05F	8072
ZXR 750 R (ZX750L/M)	93-	750	XD05F	8072
GPZ 900 R		900	XD05F(IN)LD05F(OUT)	8072/8060
GPZ 900 R (I)		900	XD05F(IN)LD05F(OUT)	8072/8060
Z 1		900	SB05F(IN)YB05F(OUT)	8080/8082
Z 900	01.73-12.76	900	SB05F(IN)YB05F(OUT)	8080/8082
KZ 1000 Police	93-	1000	XB05F(IN)LB05FP(OUT)	8062/8030
Z 1000	- 80	1000	LB05F	8051
Z 1000	81-	1000	LB05F	8051
Z 1000 ES (I)		1000	LB05F	8051
Z 1000 J (I)		1000	LB05F	8051
ZL 1000	09.86-	1000	SD05FM	30460
ZX 10	87- 90	1000	SD05FM	30460
GPZ 1100		1100	XB05F(IN)YB05F(OUT)	8062/8082
GPZ 1100 (ZX1100E1E1H)	95-	1100	XB05F(IN)YB05F(OUT)	8062/8082
GPZ 1100 ABS (ZX1100F1)	97-	1100	XB05F(IN)YB05F(OUT)	8062/8082
Z 1100		1100	XB05F(IN)YB05F(OUT)	8062/8082
Zephyr 1100 (ZR1100A)		1100	SD05FM	30460
ZRX 1100 (ZR1100C1)(ZRT10C)	97- 00	1100	SD05FM	30460
Zephyr (ZR 1100 B1)	96-	1100	SD05FM	30460
VN-15 A/B (VN-1500/SE/C/D2)		1500	XD05F(IN)LD05FP(OUT)	8072/8070

KTM

50 GP	10.81-	50	LB05F	8051
50 GXE		50	LB05F	8051
50 SX Pro Junior LC Beta Engine	03-	50	LB05EMH	8160
50 ME	10.81-	50	LB05F	8051
50 MLS		50	LB05F	8051
50 MMS		50	LB05F	8051
50 MS	10.81-	50	LB05F	8051
50 RSL		50	LB05F	8051
50 SX Pro Senior LC	03-	50	LB05EMH	8160
50 Senior	03-	50	LB05EMH	8160
Bora 25	10.81-	50	LB05F	8051
Bora 50		50	LB05F	8051
Comet	09.76-	50	LB05F	8051
Crazy (CH)		50	LB05F	8051
Foxi		50	LB05F	8051
Foxi (DK)		50	LB05F	8051
Hobby	10.81-	50	LB05F	8051
Pony	10.81-	50	LB05F	8051
Pony (CH)	10.81-	50	LB05F	8051
Postmofa		50	LB05F	8051



ccm

Order-
No.**KTM**

SM 25		50	LB05F	8051
Squadra		50	LB05F	8051
60 SX	98-	60	LB05EMH	30315
65 SX Beta Engine	03-	65	LB05EMH	8160
65 SX	98- 00	65	LB05EMH	30315
80 Chopper		80	LB05F	8051
80 Enduro		80	LB05F	8051
80 PL	06.83-12.84	80	LB05F	8051
80 RL	10.81-	80	LB05F	8051
80 RLS	10.81-	80	LB05F	8051
80 RLW	10.81-	80	LB05F	8051
80 RS	10.81-	80	LB05F	8051
Bora 80	10.81-	80	LB05F	8051
85 SX	04-	85	TB05EMA	8636
GS 100	08.73-08.76	100	LB05F	8051
MC 100	08.73-08.76	100	LB05F	8051
105 SX	04-	105	TB05EMA	8636
125 EGS	98-	125	LB05EMH	8160
125 EGS	99-	125	LB05EMH	8160
125 Enduro		125	LB05F	8051
125 EXC	98- 99	125	LB05EMH	8160
125 EXC	96-08.97	125	LB05EMH	8160
125 EXC	93- 95	125	LB05EMH	8160
125 EXC	99- 00	125	LB05EMH	8160
125 EXC	08.97- 98	125	LB05EMH	8160
125 EXC	01-	125	LB05EMH	8160
125 EXE	99-	125	LB05EMH	8160
125 LC 2 (Langgewinde)	96- 00	125	LB05EMH	8160
125 Sting	98-	125	LB05EMH	8160
125 Supermoto	99-	125	LB05EMH	8160
125 SX	99- 00	125	LB05EMH	8160
125 SX (98er)	08.97- 98	125	LB05EMH	8160
125 SX	96-08.97	125	LB05EMH	8160
125 SX	02-	125	LB05EMH	8160
GS 125 12,7 mm		125	LB05F	8051
MC 125 12,7 mm		125	LB05F	8051
MC 125 19,0 mm		125	LB05F	8051
MC 125 GP		125	LB05F	8051
GS 175		175	LB05F	8051
MC 175		175	LB05F	8051
200 EGS	99-	200	LB05EMH	8160
200 EGS	98-	200	LB05EMH	8160
200 EXC	99- 01	200	LB05EMH	8160
200 EXC	98- 99	200	LB05EMH	8160
200 EXC	02-	200	LB05EMH	8160
200 MXC	99-	200	LB05EMH	8160
200 SX	03-	200	LB05EMH	8160
250 DXC		250	LB05EMH	8160
250 EGS	98-	250	LB05EMH	8160
250 EGS	93- 95	250	LB05EMH	8160
250 EGS	99-	250	LB05EMH	8160
250 EGS	97-	250	LB05EMH	8160



ccm

Order-
No.**KTM**

250 Enduro		250	LB05EMH	8160
250 EXC / Sixt Days	98- 01	250	LB05EMH	8160
250 EXC Racing	03-	250	VD05EG	
250 EXC	(96)	250	LB05EMH	8160
250 EXC Enduro Competition	03-	250	LB05EMH	8160
250 EXC	93- 95	250	LB05EMH	8160
250 EXC	97- 98	250	LB05EMH	8160
250 EXC Racing GS	03-	250	VD05EG	
250 MX		250	LB05EMH	8160
250 SX	98- 99	250	LB05EMH	8160
250 SX	97- 98	250	LB05EMH	8160
250 SX	93- 95	250	LB05EMH	8160
250 SX	96-	250	LB05EMH	8160
250 SX	99-	250	LB05EMH	8160
250 SXC	99-	250	LB05EMH	8160
GS 250 12,7 mm		250	LB05F	8051
MC 250 12,7 mm		250	LB05F	8051
MC 250 19,0 mm		250	LB05F	8051
MC 250 GP 12,7 mm		250	LB05F	8051
MC 250 GP 19,0 mm		250	LB05F	8051
300 EGS	99-	300	LB05EMH	8160
300 EXC	97- 98	300	LB05EMH	8160
300 EXC / Sixt Days	99-	300	LB05EMH	8160
300 EXC Enduro Competition	03-	300	LB05EMH	8160
300 MXC	03-	300	LB05EMH	8160
300 SX	99-	300	LB05EMH	8160
360 EXC	97-	360	LB05EMH	8160
360 MXC	97-	360	LB05EMH	8160
360 SX	96-	360	LB05EMH	8160
360 SX	97-	360	LB05EMH	8160
380 Enduro	98-	380	LB05EMH	8160
380 EGS	99-	380	LB05EMH	8160
380 EGS	98-	380	LB05EMH	8160
380 EXC	98-	380	LB05EMH	8160
380 SX	99-	380	LB05EMH	8160
400 Enduro-E	98-	400	SD05F	8022
400 EGS	97-	400	SD05F	8022
400 EGS-E	97-	400	SD05F	8022
400 EXC Racing	03-	400	VD05EG	
400 EXC Racing	99-04.02	400	VD05F	30725
400 LC4	99-04.02	400	SD05F	8022
400 LC4-E	99-04.02	400	SD05F	8022
400 LS-E	97-04.02	400	SD05F	8022
400 SC	98-	400	SD05F	8022
400 SC	96-	400	SD05F	8022
400 SX Racing / Six Days	99-04.02	400	VD05F	30725
400 SX	98-04.02	400	SD05F	8022
400 SXC	98-04.02	400	SD05F	8022
400 SXC	99-04.02	400	SD05F	8022
400 SXC 20KW	99-04.02	400	SD05F	8022
GS 400		400	LB05F	8051
LC4- E 400 Enduro	01-	400	SD05F	8022



ccm

Order-
No.**KTM**

LC4 400	98-	400	SD05F	8022
LC4 400 EGS	93-	400	SD05F	8022
LC4 400 EXC	93-	400	SD05F	8022
LC4 Competition	98-	400	SD05F	8022
MC 400		400	LB05F	8051
MC 400 GP		400	LB05F	8051
450 EXC Racing GS	03-	450	VD05EG	
450 EXC Racing	03-	450	VD05EG	
450 MXC Dessert	03-	450	VD05EG	
450 MXC GS	03-	450	VD05EG	
450 SX Racing	03-	450	VD05EG	
GS 500 2Stroke		500	LB05F	8051
GS 500 4Stroke		500	LD05F	8060
MC 500 2Stroke		500	LB05F	8051
MC 500 4Stroke		500	LD05F	8060
520 EXC Racing / Six Days	99-04.02	520	VD05F	30725
520 SX Racing	99-04.02	520	VD05F	30725
525 EXC Racing GS	03-	525	VD05EG	
525 EXC Racing	03-	525	VD05EG	
525 MXC	03-	525	VD05EG	
525 SX Racing	03-	525	VD05EG	
540 SXC	99-	540	SD05F	8022
540 SXC	98-	540	SD05F	8022
540 SXC 20kW	99-	540	SD05F	8022
540 SXS Racing	02-	540	VD05F	30725
600 Country		600	LD05F	8060
600 Enduro		600	LD05F	8060
600 MX		600	LD05F	8060
LC4 Enduro 17kW	- 87	600	LD05F	8060
LC4 Enduro 36kW	- 87	600	LD05F	8060
LC4 600 EGS	93-	600	LD05F	8060
LC4 600 EXC	93-	600	LD05F	8060
620 Duke	94-	609	LD05F	8060
LC4 620 SC Supermoto	01-04.02	609	SD05F	8022
LC4 620 Supercompetition	01-04.02	609	SD05F	8022
LC4 612 EXC	93-	612	LD05F	8060
LC4 612 EGS	93-	612	LD05F	8060
620 Duke-E	97-	620	SD05F	8022
620 EGS	97-	620	SD05F	8022
620 EGS-E	97-	620	SD05F	8022
620 LS4 Rally	97-	620	SD05F	8022
620 LS-E	97-	620	SD05F	8022
620 SC	98-	620	SD05F	8022
620 SC	96-	620	SD05F	8022
620 Supercompetition	97-04.02	620	SD05F	8022
620 SX	96-	620	SD05F	8022
620 SX	99-	620	SD05F	8022
LC4 620 EXC	94-	620	SD05F	8022
LC4 620 EGS	94-	620	SD05F	8022
LC4 620 SX	94-	620	SD05F	8022
LC4 Super Competition	00-04.02	620	SD05F	8022
Supermoto Competition 620	98- 00	620	SD05F	8022



ccm

Order-
No.**KTM**

625 SC	02-	625	SD05F	8022
625 SXC Hard Enduro	03-	625	SD05EG	
625 SXC Super Moto	02-	625	SD05F	8022
640 Duke 2	02-04.02	625	SD05F	8022
640 Supermoto Spezial Edition	03-	625	SD05EG	
Adventure R 640	98- 01	625	SD05F	8022
Duke 2	00-04.02	625	SD05F	8022
Duke 640	98- 01	625	SD05F	8022
Duke II	99- 01	625	SD05F	8022
LC4- E 640 Enduro	(01)	625	SD05F	8022
640 LC4 Super Moto	02-04.02	625	SD05F	8022
LC4 640 Duke II	03-	625	SD05EG	
640 LC4-E SM Prestige	02-04.02	625	SD05F	8022
640 LC4-E Six Days	02-04.02	625	SD05F	8022
LC4 Adventure	(00)	625	SD05F	8022
640 LC4 Adventure	02-04.02	625	SD05F	8022
LC4- E Supermoto	(00)	625	SD05F	8022
LC4-640 Hard Enduro	03-	625	SD05EG	
LC4- E	(00)	625	SD05F	8022
LC4- E 640 Supermoto	(01)	625	SD05F	8022
640 LC4	99- 01	625	SD05F	8022
LC4 640	98- 00	625	SD05F	8022
LC4- 640 Adverture	01-04.02	625	SD05F	8022
640 LC4	02-04.02	625	SD05F	8022
660 Rallye	02-04.02	650	SD05F	8022
660 Super Moto Factory Replica	02-	650	SD05F	8022
660 LC4 Rallye	99- 01	650	SD05F	8022
Rallye	00- 01	650	SD05F	8022

MAICO

GS 125		125	LBER	30100
MC 125		125	LBER	30100
SG 125		125	LBER	30100
250	94-	250	LBER	30100
GM Star 250		250	LBER	30100
GM Star E 250		250	LBER	30100
GS 250		250	LBER	30100
GSE 250	-05.83	250	LBER	30100
MC 250		250	LBER	30100
320	94-	320	LBER	30100
GS 400	01.74-05.83	400	LBER	30100
MC 400		400	LBER	30100
440	94-	440	LBER	30100
GSE 490	-05.83	490	LBER	30100
MC 490	-05.83	490	LBER	30100
500	94-	500	LBER	30100
GS 500		500	LBER	30100
GS Star 500		500	LBER	30100
GS Star E 500		500	LBER	30100
MC 500		500	LBER	30100
685 Gespann	94-	685	LBER	30100



ccm

Order-
No.**MBK**

41		49	LB05F	8051
50 EV		49	LB05F	8051
50 EW		49	LB05F	8051
50 L		49	LB05F	8051
50 S		49	LB05F	8051
50 VL		49	LB05F	8051
50 VS		49	LB05F	8051
51 New West		49	LB05F	8051
51 S		49	LB05F	8051
51 SL		49	LB05F	8051
51 Super		49	LB05F	8051
51 Super Special		49	LB05F	8051
51 V		49	LB05F	8051
51 VL		49	LB05F	8051
88		49	LB05F	8051
88 IP		49	LB05F	8051
88 IU		49	LB05F	8051
89		49	LB05F	8051
Active		49	LB05F	8051
AV 40		49	LB05F	8051
AV 42		49	LB05F	8051
AV 44		49	LB05F	8051
AV 46		49	LB05F	8051
AV 48		49	LB05F	8051
AV 56		49	LB05F	8051
AV 59		49	LB05F	8051
AV 65		49	LB05F	8051
AV 68		49	LB05F	8051
AV 76		49	LB05F	8051
AV 79		49	LB05F	8051
AV 85		49	LB05F	8051
AV 88		49	LB05F	8051
AV 89		49	LB05F	8051
AV 92		49	LB05F	8051
AV 98		49	LB05F	8051
Cady		49	LB05F	8051
CF		49	LB05F	8051
Champ		49	LB05F	8051
Daytona Beach		49	LB05F	8051
Daytona Cruiser		49	LB05F	8051
FXK		49	LB05F	8051
G 40		49	LB05F	8051
G 50		49	LB05F	8051
Hobby IV		49	LB05F	8051
KW Magnum		49	LB05F	8051
M 1		49	LB05F	8051
M 1L		49	LB05F	8051
M 1P		49	LB05F	8051
M 1PR		49	LB05F	8051
M 1PRT		49	LB05F	8051
M 1PRTS		49	LB05F	8051
Mobylett		49	LB05F	8051



ccm

Order-
No.**MBK**

N 40		49	LB05F	8051
N 50		49	LB05F	8051
Rock		49	LB05F	8051
SP 50		49	LB05F	8051
SP 92		49	LB05F	8051
SP 93		49	LB05F	8051
SP 94		49	LB05F	8051
SP 98		49	LB05F	8051
SP 99		49	LB05F	8051
Weeky		49	LB05F	8051
X 1		49	LB05F	8051
X 1L		49	LB05F	8051
X 7L		49	LB05F	8051
X 7S		49	LB05F	8051
X 7VL		49	LB05F	8051
X 7VS		49	LB05F	8051
ZX		49	LB05F	8051
151 L	01.79-07.83	50	LB05F	8051
151 LB	01.79-07.83	50	LB05F	8051
151 LC	01.79-07.83	50	LB05F	8051
50 R		50	LB05F	8051
50 VL	01.71-12.80	50	LB05F	8051
50 VLC	01.71-12.80	50	LB05F	8051
51 SU	01.81-07.83	50	LB05F	8051
89	-07.83	50	LB05F	8051
93		50	LB05F	8051
98	-07.83	50	LB05F	8051
99		50	LB05F	8051
D50		50	LB05F	8051
Monty MB3V	01.77-07.83	50	LB05F	8051
Monty SP3V	-11.81	50	LB05F	8051
Monty SP3V	12.81-	50	LB05F	8051
SP 94 TT		50	LB05F	8051
D75		75	LB05F	8051
125 12,7 mm		125	LB05F	8051
125 19,0 mm		125	LB05F	8051
250		250	LB05F	8051
350	04.73-04.79	350	LB05F	8051
350 E		350	LB05F	8051
350 Injection		350	LB05F	8051

MONTESA

Brio,Cirlo,Fura,Mini Cota		50	LB05F	8051
Cota 25A/25C/49,Mini Mont.		50	LB05F	8051
Scorpion 50R		50	LB05F	8051
Cota 74 /74T /80		75	LB05F	8051
Crono 75		75	LB05F	8051
Enduro 75 H6 /H7/ L		75	LB05F	8051
Cota 123/C/T, Cota 125		123	LB05F	8051
Cota 172/200		175	LB05F	8051
Cota 348,Trial		310	LB05F	8051
315R	97-	315	LB05F	8051



ccm

Order-
No.**MONTESA**

Cota 330, Trial		330	LB05F	8051
Cota 335/335E/349/349T/350		350	LB05F	8051
Crono 350		350	LB05F	8051
Enduro 360 H6/H7/H7S/L		350	LB05F	8051

MOTO GUZZI

250 FD	74- 76	250	LD05F	8060
250 TS	01.74-07.80	250	LB05F	8051
V 35 II	12.80-01.87	350	LB05F	8051
V 35 III	07.85-	350	LB05F	8051
V 35 Imola	11.79-01.87	350	LB05F	8051
V 35 Imola II	79- 86	350	LB05F	8051
V 65 NTX	90- 92	650	LB05F	8051
V 65 Polizia NT		650	LB05F	8051
V 65 SP	- 86	650	LB05F	8051
850 California	12.75-12.81	850	LB05F	8051
850 Le Mans II / III	01.78-12.81	850	LB05F	8051
850 T4	07.80-12.83	850	LB05F	8051
850 T5	06.83-12.87	850	LB05F	8051
850 TS 5	82- 84	850	LB05F	8051
1000 SP III	88- 92	1000	LB05F	8051

MOTOR HISPANIA

Minicross		50	LB05F	8051
Style		50	LB05F	8051

MZ

Saxon Roadstar	7kW	125	LB05F	8051
Saxon Sportstar	7/11kW	125	LB05F	8051
Saxon Roadstar	9kW	150	LB05F	8051
Saxon Sportstar	9kW	150	LB05F	8051
ETZ Classic	13/15kW	251	LB05F	8051
Saxon 251 Fun	13/15kW	251	LB05F	8051
Saxon 251 Tour	13/15kW	251	LB05F	8051
ETZ 301 Classic	17kW	301	LB05F	8051
Saxon 301 Fun	17kW	301	LB05F	8051
Saxon 301 Tour	17kW	301	LB05F	8051

PEUGEOT

101	04.75-	50	LB05F	8051
102	04.75-	50	LB05F	8051
103	04.75-	50	LB05F	8051
103 CRX		50	LB05F	8051
103 LC		50	LB05F	8051
103 LSM-D	06.82-	50	LB05F	8051
103 MP/MR		50	LB05F	8051
103 Racen		50	LB05F	8051
103 SP	86-	50	LB05F	8051
103 SPM-D	04.75-	50	LB05F	8051
103 T16		50	LB05F	8051
103 TXLC, TXR		50	LB05F	8051
103 Vogue		50	LB05F	8051



ccm

Order-
No.**PEUGEOT**

103 XP,XPLC	01.86-	50	LB05F	8051
104		50	LB05F	8051
105		50	LB05F	8051
SC80L	06.82-	80	LB05F	8051
SX8T	02.78-12.82	80	LB05F	8051

POLARIS

Big Boss (ATV)	89- 93	244	LB05EZ	8744
Cyclone (ATV)	88- 89	244	LB05EZ	8744
Scrambler (ATV)	89- 93	244	LB05EZ	8744
Trail Blazer (ATV)	90-	244	LB05EZ	8744
Trail Boss (ATV)	85-	244	LB05EZ	8744
Xplorer 300 (ATV)	94-	283	LB05EZ	8744
Xpress 300 (ATV)	94-	283	LB05EZ	8744
Sportsman 335 (ATV)	99-	334	LB05EZ	8744
Big Boss (ATV)	93-	350	LB05EZ	8744
Trail Boss (ATV)	90- 93	350	LB05EZ	8744
Big Boss 400L (6X6) (ATV)	95- 97	379	LB05EZ	8744
Scambler 400 (4X4) (ATV)	94-	379	LB05EZ	8744
Sport 400 (ATV)	98-	379	LB05EZ	8744
Sport ATV (ATV)	95- 97	379	LB05EZ	8744
Sportsman 4x4 (ATV)	94- 97	379	LB05EZ	8744
Xplorer 400/400L 4x4 (ATV)	94-	379	LB05EZ	8744
Xpress 400 L 2x4 (ATV)	96- 97	379	LB05EZ	8744
Magnum (2X4) (ATV)	95-	425	LB05EZ	8744
Magnum (4X4) (ATV)	95-	425	LB05EZ	8744
Magnum (6X6) (ATV)	96- 97	425	LB05EZ	8744
Big Boss 500 (6X6) (ATV)	98-	500	LB05EZ	8744
Magnum 500 (ATV)	99-	500	LB05EZ	8744
Ranger (ATV)	99-	500	LB05EZ	8744
Scrambler 500 (ATV)	98-	500	LB05EZ	8744
Sportsman 500 (ATV)	96-	500	LB05EZ	8744
Xplorer 500 (ATV)	97-	500	LB05EZ	8744

PUCH

Cobra 12,9 mm	81-	80	LB05F	8051
Cobra 19,0 mm	81-	80	LB05F	8051

RIEJU

RR 50 AM6		50	LB05F	8051
RS 1		50	LB05F	8051

SACHS

RS 125	97-	125	LB05F	8051
ZX 125	97-	125	LB05F	8051

SUZUKI

A 50 K		50	LB05F	8051
A 50 P		50	LB05F	8051
AE 50	93-	50	LB05F	8051
AJ 50	95-	50	LB05F	8051
AJ 50 ZZ	95-	50	LB05F	8051



ccm

Order-
No.**SUZUKI**

AP 50 (CA1JA)	95-	50	LB05F	8051
CL 50 DO		50	LB05F	8051
CP 50 (CA14C/E)		50	LB05F	8051
CP 50 H-J,L/M/N		50	LB05F	8051
CS 50		50	LB05F	8051
CX 50		50	LB05F	8051
CY 50		50	LB05F	8051
DM 50		50	LB05F	8051
DR Big 50	89-	50	LB05F	8051
DV 50		50	LB05F	8051
FA 50		50	LB05F	8051
FR 50		50	LB05F	8051
FS 50		50	LB05F	8051
FZ 50		50	LB05F	8051
GT 50		50	LB05F	8051
JR 50	93- 94	50	LB10EH	31110
JR 50	95-	50	LB10EH	31110
K 50		50	LB05F	8051
Katana AY50 aircooled	97-	50	LB05F	8051
Katana AY50 water (Spain)	97-	50	LB05F	8051
Katana AY50 watercooled	97-	50	LB05F	8051
LT 50 (ATV)		50	LB05F	8051
Maxi 50		50	LB05F	8051
OR 50		50	LB05F	8051
RB 50 GAG	(88)	50	LD05F	8060
RG 50 KE		50	LB05F	8051
RG 50 W		50	LB05F	8051
RM 50	90-	50	LB05F	8051
RM 50	- 89	50	LB05F	8051
RV 50		50	LB05F	8051
Suzy	95-	50	LB05F	8051
TR 50		50	LB05F	8051
TR 50 S Magic	98-	50	LB05F	8051
TS 50 12,7mm		50	LB05F	8051
TS 50 19,0mm		50	LB05F	8051
TS 50 ER		50	LB05F	8051
TS 50 XK (SA11C)		50	LB05F	8051
ZR 50		50	LB05F	8051
CS 80		80	LB05F	8051
DS 80	93- 94	80	LB05F	8051
DS 80	95-	80	LB05F	8051
FR 80		80	LB05F	8051
GT 80 EX/LX		80	LB05F	8051
LT 80 (ATV)		80	LB05F	8051
RG 80 G (D) (NC11A)		80	LB05F	8051
RG 80 Gamma		80	LB05F	8051
RG 80 WF		80	LB05F	8051
RM 80	93-	80	LB05F	8051
RM 80 H		80	LB05F	8051
RM 80 X	91-	80	LB05F	8051
RM 80 X	- 90	80	LB05F	8051
TS 80 ERX		80	LB05F	8051



ccm

Order-
No.**SUZUKI**

TS 80 X (SA11A)			80	LB05F	8051
TS 80 XE-H			80	LB05F	8051
FM 90			90	LB05F	8051
RV 90			90	LB05F	8051
A 100	95-		100	LB05F	8051
FB 100 / D	95-		100	LD05F	8060
GP 100			100	LB05F	8051
TS 100 X	-	77	100	LB05F	8051
TS 100 X	78-		100	LB05F	8051
CS 125			125	LD05F	8060
DR 125 S/L-N	91-		125	LD05F	8060
DR 125 SE (SF44A)	95-		125	LD05F	8060
DR 125 SJ (SF43B)			125	LD05F	8060
GN 125	91-		125	LD05F	8060
GN 125 V (NF41A)	97-		125	LD05F	8060
GP 125			125	LB05F	8051
GS 125 S	99-		125	LD05F	8060
GS 125 S			125	LD05F	8060
GT 125,-E			125	LB05F	8051
RG 125	01.85-		125	LB05F	8051
RM 125	93-	95	125	LB05F/CR2	8051/8048
RM 125	87-	92	125	LB05F/CR2	8051/8048
RM 125	-	86	125	LB05F/CR2	8051/8048
RM 125	96-		125	LB05F/CR2	8051/8048
RC 125			125	LB05F	8051
TS 125	01.75-	12.85	125	LB05F	8051
TS 125 R			125	LB05F/CR2	8051/8048
TS 125 RC,C2,ER	-	86	125	LB05F	8051
TS 125 X			125	LB05F	8051
LT 160 E (ATV)	93-		160	LD05F	8060
LT 160 E (ATV)	-	92	160	LD05F	8060
LT 160 F (ATV)	93-		160	LD05F	8060
LT-F 160 (ATV)	95-		160	LD05F	8060
GT 185			185	LB05F	8051
TS 185 ER	93-		185	LB05F	8051
DR 200 SZ	95-		200	LD05F	8060
GT 200			200	LB05F	8051
TS 200			200	LB05F/CR2	8051/8048
LT 230 E (ATV)	93-		230	LD05F	8060
LT 230 E/F (ATV)			230	LD05F	8060
LT 230 GE (ATV)			230	LD05F	8060
DR 250	91-		250	LD05F	8060
DR 250 S	90-		250	XD05F	8072
DR 250 S (SJ42A)			250	XD05F	8072
DR 250 SZ	95-		250	XD05F	8072
DR 250 SZ-H			250	XD05F	8072
GSX 250 L			250	SD05F	8022
DR 400 S	01.80-	12.83	400	LD05F	8060
GN 400 TD-X			400	LD05F	8060
GS 400 TX			400	VB05F	8032
GSF 400 (BANDIT GK75B)	-	92	400	SD05F/CR1	8022/8035
GSF 400 (BANDIT GK75B)	92-		400	SD05F/CR1	8022/8035



ccm

Order-
No.

SUZUKI				
GSX 400 E (GS40X)	01.83-	400	VB05F	8032
GSX 400 FW		400	SD05F/CR1	8022/8035
GSX 400 FX		400	SD05F	8022
GSX 400 LX		400	SD05F	8022
GSX 400 S		400	SD05F	8022
GSX 400 SE/EF (GK53C)		400	SD05F	8022
GSX-R400	93-	400	SD05F/CR1	8022/8035
GSX-R400		400	SD05F/CR1	8022/8035
GS 450 E/ES (GS450)		450	VB05F	8032
GS 450 L (GL51D)		450	VB05F	8032
GS 450 SF		450	VB05F	8032
GS 450 TX		450	VB05F	8032
GS 500 E	- 00	500	XB05F(IN)VB05F(OUT)	8062/8032
GS 500 E (GM51B)	93- 00	500	XD05F(IN)VD05F(OUT)	8072/8052
GSX 550 EF (I)		550	SD05F	8022
GT 550	01.73-12.77	550	LB05F	8051
DR 600		600	LD05F	8060
DR 600 R Djebel (I)		600	LD05F	8060
DR 600 S (SN41A)		600	LD05F	8060
GR 650 D/XD/XF (GP51A)		650	LD05F	8060
GS 750 D/E/L		750	XB05F(IN)VB05F(OUT)	8062/8032
GSX 750 E		750	SD05F	8022
GSX 750 E (I)		750	SD05F	8022
GSX 750 EF	- 85	750	SD05F	8022
GSX 750 ES (I)		750	SD05F	8022
GSX 750 S		750	SD05F/CR1	8022/8035
GSX 750 S Katana (I)		750	SD05F/CR1	8022/8035
GSX R 750 (GR75A)	- 87	750	XD05F	8072
GSX R 750 (GR77B)	88-	750	XD05F	8072
GSX-R 750 (GR7AB)	91-	750	XD05F	8072
VS 750 GL/H/J-K		750	SD05F	8022
GS 850 G (GS72A)		850	XB05F(IN)VB05F(OUT)	8062/8032
GS 850 GL		850	XB05F(IN)VB05F(OUT)	8062/8032
GS 1000 D/E/H/S-1980/GL/GX		1000	XB05F(IN)VB05F(OUT)	8062/8032
GSX 1100 EFE (I)		1100	SD05F	8022
GSX 1100 EFG/ESG/EG(GV71C)		1100	SD05F	8022
GSX 1100 EZ/ESD (GU71B)		1100	SD05F	8022
GSX 1100 S/SZ Kata.(GS110XS)		1100	SD05F	8022
GSX 1150 E	- 85	1150	SD05F	8022
GSX 1150 E	86-	1150	SD05F	8022
GSX 1150 EF		1150	SD05F	8022
GSX 1150 ES		1150	SD05F	8022
YAMAHA				
Golf Car G2A/G9A	92-		LB05F	8051
CA 50 (14T)	83- 87	50	LB05F	8051
CE 50 E		50	LB05F	8051
CH 50		50	LB05F	8051
CR 50 Z/SS	93-	50	LB05F	8051
CV 50		50	LB05F	8051
CW 50	91- 93	50	LB05F	8051
CW 50 (4BX)	94-	50	LB05F	8051



ccm

Order-
No.**YAMAHA**

CY 50	94-	50	LB05F	8051
CY 50 E	93-	50	LB05F	8051
CY 50 F	94-	50	LB05F	8051
DT 50		50	LB05F	8051
DT 50 A (F)		50	LB05F	8051
DT 50 E	93-	50	LB05F	8051
DT 50 F	94-	50	LB05F	8051
DT 50 M (S)	86-	50	LB05F	8051
DT 50 M (NL)	86-	50	LB05F	8051
DT 50 M (D)	86-	50	LB05F	8051
DT 50 M (A) (B)	86-	50	LB05F	8051
DT 50 M (2M4)	78- 81	50	LB05F	8051
DT 50 MX (1NN)	01.86-12.89	50	LB05F	8051
DT 50 R (3MN2)(3MN3)(3HL3)(4CT2)(4CT4)(4CT6)	91-	50	LB05F	8051
ES 50		50	LB05F	8051
Fizz (4RC)	95-	50	LB05F	8051
FS 1 DX (3F2)	79- 80	50	LB05F	8051
FS 1 E		50	LB05F	8051
FS 3 M		50	LB05F	8051
GT 50 B		50	LB05F	8051
GT 50 D (FT1)	73- 75	50	LB05F	8051
Jog 50	90-	50	LB05F	8051
LB 2		50	LB05F	8051
LB 2 80	81-	50	LB05F	8051
LB 2 80	- 80	50	LB05F	8051
LB 2 M	81-	50	LB05F	8051
LB 2 M (551)	75- 80	50	LB05F	8051
LB 3 80		50	LB05F	8051
LB 3 M		50	LB05F	8051
LC 50		50	LB05F	8051
LC 50 H		50	LB05F	8051
LC 50 M		50	LB05F	8051
MA 50		50	LB05F	8051
MA 50 M		50	LB05F	8051
MBK Magnum	90-	50	LB05F	8051
MR 50		50	LB05F	8051
MR 50 H		50	LB05F	8051
PW 50 (3PT)	01.87-	50	LB05F	8051
PW 50 E	93-	50	LB05F	8051
PW 50 H / F		50	LB05F	8051
QT 50		50	LB05F	8051
QT 50 H		50	LB05F	8051
RD 50 DX (353)	73- 75	50	LB05F	8051
RD 50 H		50	LB05F	8051
RD 50 MX (2E0)	77- 81	50	LB05F	8051
SA 50		50	LB05F	8051
SA 50 H		50	LB05F	8051
SA 50 M		50	LB05F	8051
SG 50 (34N)	84- 85	50	LB05F	8051
SH 50 / F		50	LB05F	8051
SH 50 E / ED / MF	93-	50	LB05F	8051
T 50		50	LD05F	8060



ccm

Order-
No.**YAMAHA**

TY 50 M (1G3)	77- 80	50	LB05F	8051
V 50		50	LB05F	8051
V 50 D	93-	50	LB05F	8051
V 50 E		50	LB05F	8051
V 50 M	- 80	50	LB05F	8051
V 50 M	81- 83	50	LB05F	8051
V 50 M	84-	50	LB05F	8051
YA 50 (5AK)	97-	50	LB05F	8051
YB 50 S		50	LB05F	8051
YE 50	93-	50	LB05F	8051
YZ 50		50	LB05F	8051
YZ 50 H		50	LB05F	8051
RD 60 B		60	LB05F	8051
YB 60		60	LB05F	8051
YF 60 (1HN) (MOTO4 ATV)	87- 88	60	LB05F	8051
YZ 60 H		60	LB05F	8051
CW 65	94-	65	LB05F	8051
Active 80	90-	80	LB05F	8051
CH 80		80	LB05F	8051
CV 80		80	LB05F	8051
DT 80 LC-I (37A)	83- 86	80	LB05F	8051
DT 80 LC-II (53V)	84-	80	LB05F	8051
DT 80 MX (5J1)	81- 84	80	LB05F	8051
DT 80 MX-S (5T8)	83- 86	80	LB05F	8051
FS 80		80	LB05F	8051
FS 80 SE (5A7)	81- 82	80	LB05F	8051
GT 80 (477)	74- 75	80	LB05F	8051
GT 80 D		80	LB05F	8051
GT 80 E		80	LB05F	8051
LB 80		80	LB05F	8051
LB 80 2A		80	LB05F	8051
LB 80 2AC		80	LB05F	8051
LB 80 2AD		80	LB05F	8051
LB 80 2H		80	LB05F	8051
LB 80 2HD		80	LB05F	8051
LB 80 3 (1M9)	78- 79	80	LB05F	8051
LB 80 3D		80	LB05F	8051
MX 80		80	LB05F	8051
MX 80 H		80	LB05F	8051
PW 80 (21W)	83- 90	80	LB05F	8051
PW 80 E / F (4BC)	93-	80	LB05F	8051
RD 80 LC-II (30W)	83- 87	80	LB05F	8051
RD 80 MX (5G1)	81- 82	80	LB05F	8051
RX 80 SE (12N)	82- 83	80	LB05F	8051
T 80		80	LD05F	8060
TY 80		80	LB05F	8051
V 80		80	LB05F	8051
V 80 H / D		80	LB05F	8051
Y 80		80	LB05F	8051
Y 80 E		80	LB05F	8051
YB 80		80	LB05F	8051
YE 80 (4MU)	94-	80	LB05F	8051



ccm

Order-
No.**YAMAHA**

YFM 80 W Badger (ATV)	02-	80	LD05F	8060
YFM 80 (MOTO4 ATV)		80	LD05F	8060
YFM 80 W Raptor (ATV)	02-	80	LD05F	8060
YFM 80 E / F (MOTO4 ATV)	93-	80	LD05F	8060
YZ 80	84- 85	80	LB05F	8051
YZ 80 (4GT)	95-	80	LB05F	8051
YZ 80 (1LR)	86-	80	LB05F	8051
YZ 80 B		80	LB05F	8051
YZ 80 C		80	LB05F	8051
YZ 80 D		80	LB05F	8051
YZ 80 E	- 92	80	LB05F	8051
YZ 80 E / F/LW(4LB)/ LWF	93-	80	LB05F	8051
YZ 80 H	- 83	80	LB05F	8051
YZ 80 H.R.		80	LB05F	8051
YZ 80 L.R.		80	LB05F	8051
YA 90 E / F	93-	90	LB05F	8051
AG 100		100	LB05F	8051
AG 100 H / E / F		100	LB05F	8051
DT 100		100	LB05F	8051
DT 100 B		100	LB05F	8051
DT 100 C		100	LB05F	8051
DT 100 D		100	LB05F	8051
DT 100 E		100	LB05F	8051
DT 100 H		100	LB05F	8051
DT 100 SD		100	LB05F	8051
DT 100 X		100	LB05F	8051
DX 100		100	LB05F	8051
DX 100 H		100	LB05F	8051
MX 100	79-	100	LB05F	8051
MX 100 B		100	LB05F	8051
MX 100 H		100	LB05F	8051
RS 100 B		100	LB05F	8051
RS 100 DX (1Y8)	76- 81	100	LB05F	8051
RS 100 P		100	LB05F	8051
RS 100 S		100	LB05F	8051
RS 100 X		100	LB05F	8051
RT 100 E / F	93-	100	LB05F	8051
RX 100 12,7mm		100	LB05F	8051
RX 100 19,0mm		100	LB05F	8051
RXS 100		100	LB05F	8051
RX-ZD	93-	100	LB05F	8051
V 100/E/S/SH	93-	100	LB05F	8051
YB 100	94-	100	LB05F	8051
YB 100 M		100	LB05F	8051
YB 100 P		100	LB05F	8051
YZ 100	- 83	100	LB05F	8051
YZ 100 E		100	LB05F	8051
YZ 100 H		100	LB05F	8051
V 110 E	93-	110	LB05F	8051
RX 115	93-	115	LB05F	8051
V 120 JR / ZR	94-	120	LB05F	8051
BL 125 (50W)	85- 89	125	LB05F	8051



ccm

Order-
No.**YAMAHA**

DT 125	94-	125	LB05F	8051
DT 125 E (1G0)	77- 79	125	LB05F	8051
DT 125 E (AT2)	73- 76	125	LB05F	8051
DT 125 ED		125	LB05F	8051
DT 125 F		125	LB05F	8051
DT 125 H		125	LB05F	8051
DT 125 LC	86-	125	LB05F	8051
DT 125 LC (10V)	82- 85	125	LB05F	8051
DT 125 MX		125	LB05F	8051
DT 125 R (4BL) / RE (3RM)	91-	125	LB05F/CR2	8051/8048
DT 125 Tenere (I)		125	LB05F	8051
IT 125		125	LB05F	8051
IT 125 H		125	LB05F	8051
MX 125		125	LB05F	8051
R 125 SE		125	LB05F	8051
RD 125 12,7mm		125	LB05F	8051
RD 125 19,0mm		125	LB05F	8051
RD 125 C		125	LB05F	8051
RD 125 C-DX		125	LB05F	8051
RD 125 D		125	LB05F	8051
RD 125 D-DX (AS3)	73- 75	125	LB05F	8051
RD 125 LC	84-	125	LB05F	8051
RD 125 LC (10W)	82- 83	125	LB05F	8051
RS 125 DX		125	LB05F	8051
RS 125 E		125	LB05F	8051
RS 125 P		125	LB05F	8051
RS 125 Z		125	LB05F	8051
RX 125 12,7mm		125	LB05F	8051
RX 125 19,0mm		125	LB05F	8051
RX 125 H		125	LB05F	8051
SR 125		125	LD05F	8060
SR 125 (10F)	97-	125	LD05F	8060
SR 125 Z	93-	125	LD05F	8060
TA 125 (400)	73- 75	125	LB05F	8051
TA 125 A		125	LB05F	8051
TDR 125 (4GW)	92-	125	LB05F	8051
TDR 125 (5AN)	97-	125	LB05F	8051
TY 125 (1K6)	77- 81	125	LB05F	8051
TZ 125 (4JT)	95-	125	LB05F	8051
TZ 125 (3V3)	80-	125	LB05F	8051
TZ 125 / F	94-	125	LB05F	8051
TZ 125 H		125	LB05F	8051
TZR 125	- 92	125	LB05F/CR2	8051/8048
TZR 125	93-	125	LB05E	8031
XT 125		125	LD05F	8060
XV 125 (5AJ)	97-	125	LD05F	8060
YB 125		125	LB05F/CR2	8051/8048
YFA 1 Breeze (MOTO4 ATV)	89- 04	125	LD05F	8060
YFA 1 F (MOTO4 ATV)	94-	125	LD05F	8060
YS 125		125	LB05F	8051
YT 125 (MOTO4 ATV)		125	LB05F	8051
YT 125 CH (MOTO4 ATV)		125	LB05F	8051



ccm

Order-
No.**YAMAHA**

YT 125 H	(MOTO4 ATV)		125	LB05F	8051
YZ 125			125	LB05F/CR2	8051/8048
YZ 125 B			125	LB05F	8051
YZ 125 C			125	LB05F	8051
YZ 125 E			125	LB05F	8051
YZ 125 E / E1 / F		93-	125	LB05F	8051
YZ 125 H			125	LB05F	8051
YZ 125 X			125	LB05F	8051
FZ 150		94-	150	LD05F	8060
FZR 150		94-	150	LD05F	8060
RX 150		93-	150	LB05F	8051
SR 150		93-	150	LD05F	8060
DT 165 R		91-	165	LB05F	8051
AG 175			175	LB05F	8051
AG 175 H			175	LB05F	8051
DT 175 (CT1)		74- 75	175	LB05F	8051
DT 175 E / F			175	LB05F	8051
DT 175 H			175	LB05F	8051
DT 175 MX (2K4)		09.78-12.81	175	LB05F	8051
IT 175 (5Y0)		83- 84	175	LB05F	8051
IT 175 E			175	LB05F	8051
IT 175 H			175	LB05F	8051
MX 175			175	LB05F	8051
MX 175 B			175	LB05F	8051
MX 175 H			175	LB05F	8051
TY 175			175	LB05F	8051
TY 175 E			175	LB05F	8051
TY 175 J			175	LB05F	8051
YT 175	(MOTO4 ATV)		175	LB05F	8051
YZ 175			175	LB05F	8051
RT 180 E		93-	180	LB05F	8051
XC 180 (32H)		83- 84	180	LD05F	8060
SH 185 H			185	LD05F	8060
RS 195			195	LB05F	8051
AG 200 E / F		93-	200	LD05F/CR2	8060/8048
BW 200			200	LD05F	8060
DT 200 LC / RE / RF		93-	200	LB05F	8051
DT 200 R			200	LB05F/CR2	8051/8048
IT 200 S			200	LB05F	8051
YFM 200	(MOTO4 ATV)	92-	200	LD05F	8060
NR 200			200	LB05F	8051
RD 200 12,7mm			200	LB05F	8051
RD 200 19,0mm (397)			200	LB05F	8051
RD 200 C			200	LB05F	8051
RD 200 C-DX			200	LB05F	8051
RD 200 D			200	LB05F	8051
RD 200 D-DX (1E8)		77- 80	200	LB05F	8051
RS 200			200	LB05F	8051
TW 200		01.87-	200	LD05F	8060
TW 200 E / EC / F		93-	200	LD05F	8060
TW 200 FC		94-	200	LD05F	8060
WR 200 R / RE / RF		93-	200	LB05F	8051



ccm

Order-
No.**YAMAHA**

YFM 200 (52H)	(MOTO4 ATV)	85- 86	200	LD05F	8060
YFM 225 (2HT)	(MOTO4 ATV)		200	LD05F	8060
YFM 225 (59V)	(MOTO4 ATV)		200	LD05F	8060
YFS 200 Blaster	(MOTO4 ATV)	90- 04	200	LB05F	8051
YFS 200 E / F	(MOTO4 ATV)	93-	200	LB05F	8051
YFM 225 59V/2HT	(MOTO4 ATV)	92-	225	LD05F	8060
TT 225	(MOTO4 ATV)		225	LD05F	8060
XT 225 E / EC / F / FC		93-	225	LD05F	8060
TDR 240			240	LB05F	8051
XV 240			240	LD05F	8060
DT 250 (512)		75- 76	250	LB05F	8051
DT 250 E			250	LB05F	8051
DT 250 H			250	LB05F	8051
DT 250 MX (1R7)		77- 81	250	LB05F	8051
IT 250 (45J)		85-	250	LB05F	8051
IT 250 (4V5)		81-	250	LB05F	8051
IT 250 J			250	LB05F	8051
IT 250 K			250	LB05F	8051
IT 250 N			250	LB05F	8051
MX 250			250	LB05F	8051
R1-Z		93-	250	L05F/CR2	.../8048
RD 250 (522)		75-	250	LB05F	8051
RD 250 D			250	LB05F	8051
RD 250 LC (4L1)		80- 83	250	LB05F	8051
SE 250 (I)			250	LB05F	8051
SR 250 (I)			250	LB05F	8051
SR 250 H / F			250	LB05F	8051
SR 250 SE (3Y8)		80- 82	250	LB05F	8051
SR 250 TH			250	LB05F	8051
TDR 250 (3CK)		88- 89	250	LB05F	8051
TRD 250 (I)			250	LB05F	8051
TT 250			250	LB05F	8051
TT 250 R / RF		94-	250	LB05F/CR2	8051/8048
TY 250 (38V)		84- 87	250	LB05F	8051
TY 250 (3BA)		88- 90	250	LB05F	8051
TY 250 (S16)		75- 79	250	LB05F	8051
TY 250 Z (4GG)		94- 96	250	LB05F	8051
TZ 250		84-	250	LB05F	8051
TZ 250		- 83	250	LB05F	8051
TZ 250 (4DP)		95-	250	LB05F	8051
TZ 250 / F		94-	250	LB05F	8051
TZ 250 E		- 83	250	LB05F	8051
TZ 250 E/E1		93-	250	LB05F	8051
TZ 250 H		- 83	250	LB05F	8051
TZR 250 " V2"		91- 95	250	LB05E	8051
TZR 250 (2MA)		87- 89	250	LB05F	8051
TZR 250R/RS/RSP		93-	250	LB05E	8051
WR 250 Z / ZE / ZF (4JW)		93-	250	LB05E	8031
XS 250 (1V5)		78- 79	250	LB05F	8051
XS 250 C			250	LB05F	8051
XS 250 H			250	LB05F	8051
XS 250 RH		- 83	250	LB05F	8051



ccm

Order-
No.**YAMAHA**

XS 250 SE			250	SD05F/CR1	8022/8035
XS 250 SH			250	SD05F/CRI	8022/8035
XT 250 (3Y3)	80-	82	250	SD05F	8022
XT 250 H	-	84	250	LB05F	8051
XV 250	94-		250	LD05F	8060
XV 250 (3LS,3LW)	89-		250	LD05F	8060
XV 250 F	94-		250	LD05F	8060
XV 250 S (3LW)	95-		250	LD05F	8060
YFB 250 / E / F / FWF (MOTO4 ATV)	93-		250	LD05F	8060
YFB 250 / FW (MOTO4 ATV)	94-		250	LD05F	8060
YFM 250 Timberwolf (MOTO4 ATV)			250	LD05F	8060
YFM 250 (3GH) (MOTO4 ATV)	90-		250	LD05F	8060
YZ 250 (4MX)	95-		250	LB05F	8051
YZ 250 (2VM,3JE,3SP,3XK)	88-	91	250	LB05F	8051
YZ 250 (39X,56A,1LU,2HH)	84-	87	250	LB05F	8051
YZ 250 (4DA,4EW)	92-		250	LB05F	8051
YZ 250 (5X5,24Y)	82-	83	250	LB05F	8051
YZ 250 F	94-		250	LB05F	8051
BW 350			350	LD05F	8060
TZ 350 B			350	LB05F	8051
TZ 350 H			350	LB05F	8051
XT 350 (3YT)	91-		350	LD05F	8060
XT 350 (55V)	85-	90	350	LD05F	8060
XT 350 E / F	93-		350	LD05F	8060
DT 360 (RT2)	01.73-	12.75	360	LB05F	8051
MX 360			360	LB05F	8051
YZ 360			360	LB05F	8051
DT 400 (513)	11.75-	12.76	400	LB05F	8051
DT 400 E			400	LB05F	8051
DT 400 H			400	LB05F	8051
DT 400 MX (1R6)	77-	80	400	LB05F	8051
FZR 400	04.87-		400	SD05F/CR1	8022/8035
IT 400			400	LB05F	8051
IT 400 E			400	LB05F	8051
MX 400			400	LB05F	8051
RD 400 (1A3)	76-	79	400	LB05F	8051
RD 400 E			400	LB05F	8051
SR 400			400	LB05F/CR2	8051/8048
TT 400 C			400	LB05F	8051
XJ 400			400	XD05F	8072
XT 400	84-		400	LD05F	8060
XV 400 SE			400	XB05F	8062
YZ 400			400	LB05F	8051
YZ 400 C			400	LB05F	8051
YZ 400 E			400	LB05F	8051
IT 425			425	LB05E	8031
IT 465 (4V6)	81-		465	LB05E	8031
IT 465 H			465	LB05E	8031
YZ 465			465	LB05E	8031
YZ 465 H			465	LB05E	8031
IT 490 (29W)	83-	85	490	LB05F	8051
YZ 490			490	LB05F	8051



ccm

Order-
No.**YAMAHA**

IT 500		500	LB05F	8051
RD 500 LC (1GE)	85- 86	500	LB05F	8051
RD 500 LC (47X)	- 84	500	LB05F	8051
SR 500 (3EB)	95-	500	LB05F/CR2	8051/8048
SR 500 (2J4,48T)	01.79- 96	500	LB05F/CR2	8051/8048
SR 500 (48T)	97-	500	LB05F/CR2	8051/8048
SR 500 E		500	LB05F/CR2	8051/8048
SR 500 H		500	LB05F/CR2	8051/8048
XJ 500		500	XD05F	8072
XT 500 (1E6,1V6)	76- 89	500	LB05F	8051
XT 500 C		500	LB05F	8051
XT 500 E	- 92	500	LB05F	8051
XT 500 H		500	LB05F	8051
XV 500 (I)		500	XB05F	8062
XV 500 SE (26R)	83- 87	500	XB05F	8062
XT 550 (5Y3)	82- 83	550	LD05F	8060
XZ 550 (11V)	82- 84	550	LD05F	8060
XZ 550 S (11V)	83- 84	550	LD05F	8060
SRX 600 (1XM,1XN)	86- 89	600	SD05F/CR1	8022/8035
XT 600 (2KF,2NF)	87- 90	600	XD05F	8072
XT 600 (43F)	84- 87	600	XD05F	8072
XT 600 E (4PT / 4SK)	95-	600	LD05F	8060
XT 600 E / EF / EFC	94-	600	LD05F	8060
XT 600 E(h) (3TB)	97-	600	LD05F	8060
XT 600 E(n) (3UW)	97-	600	LD05F	8060
XT 600 E/K (3TB/3UW)	90- 94	600	LD05F	8060
XJ 650 (4K0)	80- 83	650	XB05F	8062
XJ 650 H		650	XB05F	8062
XJ 650 LH		650	XB05F	8062
XJ 650 SH		650	XB05F	8062
XJ 650 T (Turbo) (11T)	82-	650	XB05F	8062
XS 650 (447)	76- 83	650	XB05F	8062
XS 650 (I)		650	XB05F	8062
XS 650 E		650	XB05F	8062
XS 650 H		650	XB05F	8062
XS 650 II		650	XB05F	8062
XS 650 S		650	XB05F	8062
XS 650 SE (3L1)	79- 81	650	XB05F	8062
XS 650 SH		650	XB05F	8062
FZ 750 (1FN)	85- 86	750	SD05F/CR1	8022/8035
FZ 750 (3KT)	91-	750	SD05F/CR1	8022/8035
FZ 750 Genesis (2KK)	87- 90	750	SD05F/CR1	8022/8035
TZ 750		750	LB05F	8051
TZ 750 D		750	LB05F	8051
XJ 750	- 83	750	LB05F/CR2	8051/8048
XJ 750 (41Y)	84- 85	750	LB05F/CR2	8051/8048
XJ 750 RH		750	LB05F/CR2	8051/8048
XS 750 (1T5)	77- 79	750	XB05F	8062
XS 750 C		750	XB05F	8062
XS 750 D		750	XB05F	8062
XS 750 E		750	XB05F	8062
XS 750 S		750	XB05F	8062



ccm

Order-
No.

APRILIA				
Scarabeo De Luxe	98- 03	50	LB05F	8051
Scarabeo 50	93- 03	50	LB05F	8051
CCF				
Cat 50	97-	50	LB05FP	8030
DAELIM				
VC 125	97-	125	XB01F	30275
VS 125	97-	125	XB01F	30275
HONDA				
Joker SRX50T	97-	50	LB05F	8051
NB 50		50	LB05F	8051
NB 50 M Melody (AB07)	84-	50	LB05F	8051
NH 50 M	93-	50	LB05F	8051
NH 50 MS Lead (AF01)	85- 87	50	LB05F	8051
PK 50 Wallaro	90-	50	LB05F	8051
PX 50	89- 90	50	LB05F	8051
SA 50 Vision	01.88- 90	50	LB05F	8051
SFX 50	95-	50	LB05F	8051
SGX 50 Sky	97-	50	LB05F	8051
SH 50 T	96-	50	LB05F	8051
SH 50 (AF40)	97-	50	LB05F	8051
SH 50 (I)	01.87- 96	50	LB05F	8051
SH 50 P	01.93- 95	50	LB05F	8051
SJ 50 Bali		50	LB05F	8051
NH 80 MS Lead (HD01)	83-	80	LB05F	8051
SH 100 T	01.96-	100	LB05F	8051
SJ 100 Bali	01.96-	100	LB05F	8051
CH 125	01.86- 95	125	LD05F	8060
CH 125 P	-01.93	125	LD05F	8060
NH 125 D Lead	83-	125	LB05F	8051
Spacy CH 125 (JS03)	97-	125	LD05F	8060
CN 250	01.86-	250	VD05F	8052
CN 250 Fusion		250	VD05F	8052
CN 250 Helix (MF02)	01.87- 99	250	VD05F	8052
ITALJET				
Dragster 50	97- 98	50	LB10F	31125
Dragster 50	96- 97	50	LB10F	31125
Dragster 50	98-	50	LB10F	31125
Fastboy	98-	50	LB05F	8051
Formula 50 aircool	98-	50	LB05F	8051
Formula 50 watercool	98-	50	LB05F	8051
Torpedo 25	97-	50	LB10F	31125
Dragster 125	(97)	125	LB05F	8051
Formula 125	97- 98	125	LB05F	8051
Formula 125	98-	125	LB05F	8051
KTM				
Chrono 50		50	LB05F	8051
Go 50		50	LB05F	8051



ccm

Order-
No.**KTM**

K 50 (I)		50	LB05F	8051
----------	--	----	-------	------

KYMCO

Calypso 50	97-	50	VD05F	8052
Calypso 125	97-	125	VD05F	8052

K-ZWO

Cat 50	97-	50	LB05FP	8030
--------	-----	----	--------	------

PEUGEOT

Speedfight LC	96-	50	LB05E	8031
Speedfight M	96-	50	LB05E	8031
SV 50	96-	50	LB05E	8031
Trekker Road		50	LB05E	8031
Trekker Off Road	98-	50	LB05E	8031
Speedfight 100	96- 03	100	LB05E	8031
SV 100	96-	100	LB05E	8031
Trekker 100	98-	100	LB05E	8031

PGO

Big Max 25/50		50	LB05F	8051
Big Max 50		50	LB05F	8051
Big Max Sport 50	96-	50	LB05F	8051
Comet		50	LB05F	8051
Galaxy 25		50	LB05F	8051
Galaxy 50		50	LB05F	8051
Mega 50	96-	50	LB05F	8051
PMS 50	99-	50	LB05F	8051
PMX 50	99-	50	LB05F	8051
Rodoshow	02.00-	50	LB05F	8051
Star 2		50	LB05F	8051
Star 50		50	LB05F	8051
Tornado 50	97-	50	LB05F	8051
T-REX 50	99-	50	LB05F	8051
Star 80		80	LB05F	8051
Big Max 90	96-	82	LB05F	8051
T-REX 125 2T	99-	125	LB05F	8051
T-REX 125 4T	99-	125	YB05F	8082

PIAGGIO

Free 25 Mofa		25	LB05F	8051
Zip 25 Mofa		25	LB05F	8051
Zip Base 25 / Mofa		25	LB05F	8051
50 R, Special		50	LB05F	8051
50 S		50	LB05F	8051
Boss		50	LB05F	8051
Bravo - Si / Moped		50	LB05F	8051
Bravo P		50	LB05F	8051
Bravo PV		50	LB05F	8051
Ciao M Kat		50	LB05F	8051
Ciao Mix / Mix		50	LB05F	8051
Ciao V Kat		50	LB05F	8051



ccm

Order-
No.**PIAGGIO**

Ciao-Bravo SI / Mofa		50	LB05F	8051
Eaglet		50	LB05F	8051
Free 50	93-	50	LB05F	8051
Grillo / Mofa		50	LB05F	8051
NRG Extreme Kat		50	LB05F	8051
NRG H_0 Kat		50	LB05F	8051
NRG mc2 DT,DD		50	LB05F	8051
NRG Extreme		50	LB05F	8051
NRG mc2 50	01.96-	50	LB05F	8051
NRG		50	LB05F	8051
PK 50 S	09.82-12.87	50	LB05F	8051
PK 50	09.82-12.87	50	LB05F	8051
PK 50 S Auto		50	LB05F	8051
PK 50 SS		50	LB05F	8051
PK 50 XL 2		50	LB05F	8051
PK 50 XL2 Auto		50	LB05F	8051
Plurimatic		50	LB05F	8051
PX 50		50	LB05F	8051
Quarz 50 Automatic	06.92-	50	LB05F	8051
Sfera 50 , FL, RL, RST		50	LB05F	8051
Sfera 50 Automatico	01.91-	50	LB05F	8051
Storm Automatic	94-	50	LB05F	8051
Super Bravo / Mofa		50	LB05F	8051
Super Bravo 2 Gang / Mofa		50	LB05F	8051
TPH	93-	50	LB05F	8051
Velofax / Mofa		50	LB05F	8051
Vespa HP 4M		50	LB05F	8051
Vespa Elestart		50	LB05F	8051
Vespa Vale Especial/Standard		50	LB05F	8051
Vespa Delta,Puch Condor		50	LB05F	8051
Vespa PK 50 XL 2 ,Automatic		50	LB05F	8051
Vespino		50	LB05F	8051
Vespino NX/SC/T/TL/TN/TS		50	LB05F	8051
Vespino TX/XE		50	LB05F	8051
Zip 50 SP		50	LB05F	8051
Zip 50 Fast Rider	01.93-	50	LB05F	8051
Zip Base 50		50	LB05F	8051
Zip 50	01.92-	50	LB05F	8051
Zip & Zip (Hybrid)	94-	50	LB05F	8051
Vespa PK 75S/Elestart/Junior		75	LB05F	8051
Vespa PK 75XL/ Elestart		75	LB05F	8051
Vespa PK 75S Primavera / T3 Prima.		75	LB05F	8051
PK 80 S	09.82-12.85	80	LB05F	8051
PX 80 E Lusso		80	LB05F	8051
PX 80 E,P 80 X		80	LB05F	8051
Sfera 80 Automatic		80	LB05F	8051
TPH Automatic	94-	80	LB05F	8051
PK 100 S	06.82-	100	LB05F	8051
125 T5	03.85-	125	LB05F	8051
Ape		125	LB05F	8051
Cosa FL 125	91-	125	LB05F	8051
Cosa 125	- 91	125	LB05F	8051



ccm

Order-
No.**PIAGGIO**

Cosa 200 FL EBC 12PS		125	LB05F	8051
Cosa 125 MA AE	01.88-	125	LB05F	8051
ET 3		125	LB05F	8051
ET 4 Automatic		125	LB05F	8051
Hexagon LX 125	94-	125	LB05F	8051
P 125 ETS	01.83-12.85	125	LB05F	8051
PK 125 XL Automatic		125	LB05F	8051
PK 125, E, S		125	LB05F	8051
PK Automatic		125	LB05F	8051
PK 125 XL 2		125	LB05F	8051
Primavera	01.76-12.83	125	LB05F	8051
PX 125 E Lusso	01.82-	125	LB05F	8051
Sfera 125	01.95-	125	LB05F	8051
Sfera RST 4 Takt	95-	125	LB05F	8051
Skipper 125 LX	01.93-	125	LB05F	8051
SKR 125	08.93-	125	LB05F	8051
TPH	95-	125	LB05F	8051
Vespa Special ET3 Primavera		125	LB05F	8051
Vespa 125 FL2	01.90-	125	LB05F	8051
Vespa T5		125	LB05F	8051
Vespa ET4 125	01.96-	125	LB05F	8051
Vespa PK 125	85-	125	LB05F	8051
Vespa PX 125 MA AE	86-	125	LB05F	8051
Vespa PX 125 Kat		125	LB05F	8051
Vespa XL 125 Plurimat/Elestart		125	LB05F	8051
Vespa 125 CL/LS/NK Primavera		125	LB05F	8051
Vespa T3Li/T3		125	LB05F	8051
Vespa 125 T5 Sport/Elestart		125	LB05F	8051
EX 150 (Hexagon)	94-	150	LB05F	8051
Hexagon 150	01.94-	150	LB05F	8051
PX 150 E Lusso	01.82-	150	LB05F	8051
Skipper 150	01.93-	150	LB05F	8051
SKR 150	98-	150	LB05F	8051
Vespa PX 150 Kat		150	LB05F	8051
Vespa 150 long 12,7 mm		150	LB05F	8051
Vespa PX 150 MA AE	86-	150	LB05F	8051
Vespa 150 long 19,0 mm		150	LB05F	8051
Vespa 160/ GT		160	LB05F	8051
Vespa 175		175	LB05F	8051
Vespa SS		180	LB05F	8051
Ape		190	LB05F	8051
Cosa 200 MA AE	01.88-	200	LB05F	8051
Cosa 200 Aluzyl.12PS	93- 97	200	LB05F	8051
Cosa FL 200	91-	200	LB05F	8051
Cosa 2 200	01.88- 91	200	LB05F	8051
PX 200 E Lusso	01.84-	200	LB05F	8051
PX 200 E Grand-Sport	01.84-	200	LB05F	8051
Vespa PX 200E/Iris/Iris Elestart		200	LB05F	8051
Vespa 200 TX/Elestart		200	LB05F	8051
Vespa 200 DN/ DS/ E		200	LB05F	8051
Vespa PX 200 MA AE	86-	200	LB05F	8051
Ape		220	LB05F	8051



ccm

Order-
No.

					PIAGGIO
Hexagon GT 250 4Takt	98-	250	VD05F		8052
					PUCH
Lido		50	LB05F		8051
Lido 125		125	LB05F		8051
					SACHS
Speedfight 50 AC	97-	50	LB05F		8051
Speedfight 50 LC	97-	50	LB05F		8051
Speedfight 50 LC ADT	97-	50	LB05F		8051
					SIAM
Falkon 50	97-	50	LB05FP		8030
					SUZUKI
AH 50 Adress (CA1GA)	92-	50	LB05F		8051
AH 50 GP	95-	50	LB05F		8051
AJ 50 ZZ (I)	95-	50	LB05F		8051
AP 50 S CA1JA)	95-	50	LB05F		8051
AP 50 T (I)	96-	50	LB05F		8051
CP 50 (I)	89- 92	50	LB05F		8051
AH 100 (I)	- 93	100	LB05F		8051
AH 100 (CE12A)	95-	100	LB05F		8051
AN 125 (CF42A)	(95)	125	LD05F		8060
AN 125 (CF42A)	96-	125	LD05F		8060
AN 150 T (I)	01.96-	150	LD05F		8060
					YAMAHA
Aerox	97-	50	LB05F		8051
Axis (YA50R) (3UG)	97-	50	LB05F		8051
Axis Mofa (5AK)(YA50R)	97-	50	LB05F		8051
Breeze (4RC)(YM50)	95-	50	LB05F		8051
BW 50 Spy (CW50RSP;4VA)	96-	50	LB05F		8051
BW 50 (4BX)	91- 95	50	LB05F		8051
BW 50 (CW50)	96-	50	LB05F		8051
BW 50 Bump (CW50RSX)	96-	50	LB05F		8051
BW 50 NG (CW50RS;4VA)	96-	50	LB05F		8051
BW 50 R (4BX)	96-	50	LB05F		8051
CR 50 Z (I)		50	LB05F		8051
CT 50 S (I)		50	LB05F		8051
CT 50 SS (I)		50	LB05F		8051
CW 50 R (4BX)		50	LB05F		8051
Evolis (YE50)(4FW)		50	LB05F		8051
Forte (YA50R) (3UG)		50	LB05F		8051
Jog-Z 50 (I)	01.95-	50	LB05F		8051
Neo's	97-	50	LB05F		8051
Spy 50 (I)		50	LB05F		8051
YA 50 (5AK)	97-	50	LB05F		8051
Zest/ YE50 (4FW)		50	LB05F		8051
Evolis (4MU)		80	LB05F		8051
Zest (4MU)(YE80)		80	LB05F		8051
BL 125 (50W)	85- 89	125	LB05F		8051



ccm



Order-
No.

YAMAHA

XC 125	(3TE)	90-	125	LD05F	8060
XC 125 Cygnus		- 94	125	LD05F	8060
XC 125 Cygnus		01.95-	125	LD05F	8060
XC 125 T	(4KY)	95-	125	LD05F	8060
XC 125 T	(4NB)	94-	125	LD05F	8060
XC 125 T Cygnus T	(4NB)	96-	125	LD05F	8060
XC 125 TR Cygnus	(4NB)	96-	125	LD05F	8060
XC 150 Fly one (I)		01.95-	150	LD05F	8060
YP 250 Majesty	(4UC)		250	LD05F	8060



Cyl.

Order
No.

Iridium

Order
No.**AERO MARINE**

165 CR Serie	1966 - 1970	0,8	BR6ES	4922		
240 Serie		0,6	XR5	5953	XR5IX	7355
265 Serie	1969 - 1970	0,9	XR5	5953	XR5IX	7355
265 Serie	1971 -	1,1	UR4	4762	UR4IX	7401
304		0,8	BPR6ES	7822	BPR6EIX	6637
320 Serie	1966 - 1970	0,8	BR6ES	4922		
320 Serie	1971 -	1,1	UR4	4762	UR4IX	7401
350 Serie	1966 - 1970	0,8	BR6ES	4922		
360 Jet		0,8	BPR6ES	7822	BPR6EIX	6637
375 Serie	1966 - 1970	0,8	BR6ES	4922		
375 Serie	1970 - 1971	1,1	UR4	4762	UR4IX	7401
427 Jet Serie	1971 -	1,1	UR4	4762	UR4IX	7401
454 Serie		1,1	UR4	4762	UR4IX	7401
455 Serie		0,9	XR5	5953	XR5IX	7355
482 Serie		0,8	BPR6ES	7822	BPR6EIX	6637

AIRMASTER

Airboot (V-Twin) 25h.p. Kohler engine		0,8	BKR5ES	2460		
---------------------------------------	--	-----	--------	------	--	--

ALBIN

0-1 No.18965>		0,8	A6	1010		
0-11		0,8	A6	1010		
0-1L No.1948>		0,6	B6HS	4510	BR6HIX	3419
0-2 No.15826>		0,8	A6	1010		
0-21		0,8	A6	1010		
0-21		0,6	B6HS	4510	BR6HIX	3419
0-41		0,8	A6	1010		
0-411		0,8	A6	1010		
0-4SP No. 19325>		0,8	A6	1010		
2000 V-1		0,6	B6HS	4510	BR6HIX	3419
2000 SP		0,7	BR7HS	4122	BR7HIX	7067
A4		0,6	B6HS	4510	BR6HIX	3419
A-6SP		0,7	BR7HS	4122	BR7HIX	7067
AL22		0,8	A6	1010		
AL23		0,8	A6	1010		
E4		0,8	A6	1010		
E5		0,8	A6	1010		
E6		0,8	A6	1010		
G-6		0,8	A6	1010		
G-6B		0,8	A6	1010		
S-4		0,6	B6HS	4510	BR6HIX	3419
T1500 Spezial		0,6	B6HS	4510	BR6HIX	3419
T-4		0,8	A6	1010		

AMECO

302 Ford engine		0,8	WR5	1071	WR5IX	7510
351 W cid Ford engine		0,8	WR5	1071	WR5IX	7510



Cyl.

Order
No.

Iridium

Order
No.**AMERICAN CHALLENGER**

Eagle 400			0,5	UR5	2139	UR5IX	7177
Eagle 400			0,5	UR5	2139	UR5IX	7177
Eagle 400			0,9	UR5	2139	UR5IX	7177
Eagle 600			0,9	UR5	2139	UR5IX	7177
Eagle 600			0,5	UR5	2139	UR5IX	7177
Eagle 600			0,5	UR5	2139	UR5IX	7177
Eagle 800			0,8	UR5	2139	UR5IX	7177
Eagle 800			0,5	UR5	2139	UR5IX	7177
Eagle 800			0,5	UR5	2139	UR5IX	7177

AUSTIN

18 mm			0,6	A6	1010		
Chief (14mm)			0,6	BR6ES	4922		
Healey 35			0,6	BR6ES	4922		
Healey 55			0,6	BR6ES	4922		
Healey 75			0,6	BR6ES	4922		
Healey 3300			0,6	BR6ES	4922		
Skipper (14mm)			0,6	BR6ES	4922		

B & W

BW30 , 35			0,6	B6ES	7310		
BW60 , 105 , 155 , 165			0,6	B6S	3510		
LH Master , LH (dual ign.)			0,6	B6S	3510		
LH Super , LH Super Special			0,6	B6S	3510		

B.L.M.C.

1100 Vedette			0,6	B6ES	7310		
1622 Navigator 1959			0,6	B6ES	7310		
850 Sea Prince 2912 cc			0,6	BP5ES	6511	BPR5EIX	6597
950 , 1678 , 3000 CC			0,6	B6ES	7310		

BARR (Conversions)*Buick*

Buick engines 400cid		1967 - 1969	1,1	UR4	4762	UR4IX	7401
Buick engines 430cid		1967 - 1969	1,1	UR4	4762	UR4IX	7401
Buick engines 455cid		1970 - 1970	1,1	UR4	4762	UR4IX	7401
Buick engines 455cid		1971 - 1974	0,7	BPR5FS	2423		

Chevrolet

Chevrolet engines 194cid	6	1962 - 1969	0,9	BPR5ES	7422	BPR5EIX	6597
Chevrolet engines 230cid	6	1962 - 1969	0,9	BPR5ES	7422	BPR5EIX	6597
Chevrolet engines 230cid	6	1970 -	1,1	UR4	4762	UR4IX	7401
Chevrolet engines 250cid	6	1962 - 1969	0,9	BPR5ES	7422	BPR5EIX	6597
Chevrolet engines 250cid	6	1970 - 1978	0,7	BPR5FS	2423		
Chevrolet engines 250cid	6	1979 - 1984	1,1	UR4	4762	UR4IX	7401
Chevrolet engines 283cid	8	1955 - 1967	1,0	XR4	2637	XR4IX	7189
Chevrolet engines 292cid	6	1963 - 1969	0,9	BR6ES	4922		



Cyl.

Order
No.

Iridium

Order
No.**BARR (Conversions)*****Chevrolet***

Chevrolet engines 292cid	6	1970 - 1992	1,1	UR4	4762	UR4IX	7401
Chevrolet engines 302cid	8	1967 - 1969	0,9	XR4	2637	XR4IX	7189
Chevrolet engines 307cid	8	1968 - 1970	1,0	XR4	2637	XR4IX	7189
Chevrolet engines 307cid	8	1971 - 1973	0,7	BPR5FS	2423		
Chevrolet engines 327cid	8	1961 - 1969	0,9	XR5	5953	XR5IX	7355
Chevrolet engines 350cid	8	1971 - 1990	1,1	UR4	4762	UR4IX	7401
Chevrolet engines 350cid 2-bbl	8	1967 - 1970	1,0	XR4	2637	XR4IX	7189
Chevrolet engines 350cid 4-bbl	8	1970 -	1,0	XR4	2637	XR4IX	7189
Chevrolet engines 400cid	8	1970 -	1,0	XR4	2637	XR4IX	7189
Chevrolet engines 400cid	8	1971 - 1990	1,1	UR4	4762	UR4IX	7401
Chevrolet engines 427cid	8	1971 - 1972	0,9	UR5	2139	UR5IX	7177
Chevrolet engines 427cid	8	1973 - 1990	1,1	UR4	4762	UR4IX	7401
Chevrolet engines 454cid	8	1979 - 1989	1,1	UR4	4762	UR4IX	7401

Chrysler

Chrysler engines 383cid 2-bbl		1960 - 1971	0,9	BP4	2911		
Chrysler engines 383cid 4-bbl		1968 - 1971	1,0	XR4	2637	XR4IX	7189
Chrysler engines 383cid Hi-Perf.		1966 - 1967	1,0	XR4	2637	XR4IX	7189
Chrysler engines 413cid		1963 - 1965	0,9	BP4	2911		
Chrysler engines 413cid Hi-Perf.		1963 - 1965	1,0	XR4	2637	XR4IX	7189
Chrysler engines 413cid two 4-bbl		1963 - 1964	1,0	XR4	2637	XR4IX	7189
Chrysler engines 440cid 350hp.		1966 - 1971	1,0	XR4	2637	XR4IX	7189
Chrysler engines 440cid 375hp.		1966 - 1971	0,9	XR4	2637	XR4IX	7189
Chrysler engines 440cid.		1972 - 1979	1,0	XR4	2637	XR4IX	7189

Oldsmobile

Oldsmobile engines 350cid		1971 - 1974	1,0	XR4	2637	XR4IX	7189
Oldsmobile engines 350cid 2-bbl		1968 - 1970	1,0	XR4	2637	XR4IX	7189
Oldsmobile engines 350cid 4-bbl		1968 - 1970	1,0	XR4	2637	XR4IX	7189
Oldsmobile engines 455cid		1976 - 1978	0,9	BP4	2911		
Oldsmobile engines 455cid 2-bbl		1971 -	0,9	BP4	2911		
Oldsmobile engines 455cid 4-bbl		1970 - 1971	1,0	XR4	2637	XR4IX	7189
Oldsmobile engines 455cid 4-bbl		1972 - 1974	0,9	BP4	2911		
Oldsmobile engines 455cid Hi-Perf.		1972 - 1974	1,0	XR4	2637	XR4IX	7189

Pontiac

Pontiac engines 389cid		1960 - 1967	1,0	XR4	2637	XR4IX	7189
Pontiac engines 400cid		1967 - 1971	1,0	XR4	2637	XR4IX	7189
Pontiac engines 400cid		1972 - 1974	0,7	BPR5FS	2423		
Pontiac engines 421cid		1963 - 1966	1,0	XR4	2637	XR4IX	7189
Pontiac engines 428cid		1967 - 1969	1,0	XR4	2637	XR4IX	7189
Pontiac engines 455cid		1972 - 1974	0,7	BPR5FS	2423		
Pontiac engines 455cid 2-bbl		1971 -	0,9	BP4	2911		
Pontiac engines 455cid 4-bbl		1970 - 1971	0,9	BP4	2911		

BAUDOIN

CR , H4 , LH , LK , LKL			0,6	B6L	3212		
LA , LO3 , LO3H , LOL			0,5	B4	3210		



Cyl.

Order
No.

Iridium

Order
No.**BAUDOIN**

VL3 , VL3F , VL3FT

0,5

B6S**3510****BERKELEY***Chevrolet*

350 cid Chevrolet

1976 - 1990

0,9

YR5**5334****YR5IX****7516***Ford*

460 cid Ford Big Block

1976 - 1990

0,9

UR5**2139****UR5IX****7177***GM*

454 cid GM Big Block

1976 - 1990

0,9

YR5**5334****YR5IX****7516***Oldsmobile*

302 cid Oldsmobile, 14mm Hds.

1974 - 1990

0,9

UR5**2139****UR5IX****7177**

302 cid Oldsmobile, 18mm Hds.

1974 - 1977

0,9

AR6FS**3323**

351 cid Oldsmobile, 14mm Hds.

1974 - 1990

0,9

UR5**2139****UR5IX****7177**

351 cid Oldsmobile, 18mm Hds.

1974 - 1977

0,9

AR6FS**3323**

455 cid Oldsmobile

1976 - 1968

0,9

XR4**2637****XR4IX****7189****BMW**

411

0,6

BP6ES**7811****BPR6EIX****6637**

412

0,6

BP8ES**2912**

611

0,6

BP6ES**7811****BPR6EIX****6637**

B130 , 130S

0,6

BP5ES**6511****BPR5EIX****6597**

B190, B220

0,6

BP5ES**6511****BPR5EIX****6597**

B1901, B190S

0,6

BP5ES**6511****BPR5EIX****6597**

B2201, B220S

0,6

BP5ES**6511****BPR5EIX****6597**

G130-1, G130-S

0,6

BP5ES**6511****BPR5EIX****6597**

G190-1, G190-S

0,6

BP5ES**6511****BPR5EIX****6597**

G220-1, G220-S

0,6

BP5ES**6511****BPR5EIX****6597**

G2400 , G3400 , G4700

0,5

BR4HS**3322**

G800

0,5

B6HS**4510****BR6HIX****3419****BOG MARIN**

16 (14 mm)

0,6

B6HS**4510****BR6HIX****3419**

16 (18mm)

0,6

A6**1010**

26

0,6

B6S**3510**

55 (14 mm)

0,6

B6S**3510**

55 (18 mm)

0,6

A6**1010****BOMBARDIER (Sea-Doo)***Rotax*

Challenger Rotax 787 cc

0,6

BR8ES**3961****BR8EIX****5044**

Explorer Rotax 717 cc

0,6

BR8ES**3961****BR8EIX****5044**

Speedster Rotax 717 cc

0,5

BR8ES**3961****BR8EIX****5044**

Sportser Rotax 717 cc

0,6

BR8ES**3961****BR8EIX****5044**



Cyl.

Order
No.

Iridium

Order
No.**BPM**

1800L / LR / M / MR ,3500LR/MR			0,6	B6S	3510		
Artic 181 / 157			0,6	BP6ES	7811	BPR6EIX	6637
Ionic 144 / 127			0,6	BP7ES	2412	BPR7EIX	4055
Oceanic 235 / 265, Vulcano 375			0,6	BP7ES	2412	BPR7EIX	4055
Vulcano 450			0,6	BP8ES	2912		

BRIDAN

500 cc , 700 cc			0,6	B6HS	4510	BR6HIX	3419
-----------------	--	--	-----	-------------	-------------	---------------	-------------

BRIT

18 mm			0,5	A6	1010		
Imp , Sprite			0,5	B6ES	7310		
Minor 1255 , Skippy			0,6	B6HS	4510	BR6HIX	3419

BRIT. LEYLAND

1622 Navigator			0,6	B6ES	7310		
850 Sea Prince 2912 cc			0,6	BP5ES	6511	BPR5EIX	6597
950 , 1678 , 3000 cc			0,6	B6ES	7310		

BRIT. SEAGULL

SD110 (102cc)			0,9	A6	1010		
SD160 (102cc)			0,9	B7ES	1111		
ST110		1979 - 1981	0,9	A6	1010		

BUEHLER

Jetstream,Chrysler273,428cu.in			0,9	BR6ES	4922		
--------------------------------	--	--	-----	--------------	-------------	--	--

CAILLE

all models 18 mm			0,5	A6	1010		
------------------	--	--	-----	-----------	-------------	--	--

CASTOLDI

1966cc 113hp		1974 -	0,9	WR5	1071	WR5IX	7510
2261E		1974 -	0,9	BR6ES	4922		
2264E		1974 -	0,9	BPR5ES	7422	BPR5EIX	6597
2614E		1974 -	0,9	GR5	7537	GR5IX	7214

CHEVROLET (Marine Conversions)

194cid	6	1962 - 1969	0,9	BPR5ES	7422	BPR5EIX	6597
230cid	6	1962 - 1969	0,9	BPR5ES	7422	BPR5EIX	6597
230cid	6	1970 -	1,1	UR4	4762	UR4IX	7401
250cid	6	1962 - 1969	0,9	BPR5ES	7422	BPR5EIX	6597
250cid	6	1979 - 1984	1,1	UR4	4762	UR4IX	7401
283cid	8	1955 - 1967	1,0	XR4	2637	XR4IX	7189



Cyl.

Order
No.

Iridium

Order
No.**CHEVROLET (Marine Conversions)**

292cid	6	1963 - 1969	1,1	UR4	4762	UR4IX	7401
292cid	6	1970 - 1978	0,7	BPR5FS	2423		
302cid	8	1967 - 1969	0,9	XR4	2637	XR4IX	7189
307cid	8	1968 - 1970	0,9	XR4	2637	XR4IX	7189
307cid	8	1971 - 1973	0,7	BPR5FS	2423		
327cid	8	1961 - 1969	0,9	XR5	5953	XR5IX	7355
350cid	8	1971 - 1990	1,1	UR4	4762	UR4IX	7401
350cid 2-bbl	8	1967 - 1970	1,0	XR4	2637	XR4IX	7189
350cid 4-bbl	8	1970 -	1,0	XR4	2637	XR4IX	7189
400cid	8	1970 -	1,0	XR4	2637	XR4IX	7189
400cid	8	1971 - 1990	1,1	UR4	4762	UR4IX	7401
427cid	8	1971 - 1972	0,7	UR6	4079	UR6IX	7348
427cid	8	1973 - 1990	1,1	UR4	4762	UR4IX	7401
454cid	8	1979 - 1990	0,8	UR5	2139	UR5IX	7177

CHRIS-CRAFT

153 ->No. 603191			0,9	BR6ES	4922		
181 ->No. 603191			0,9	BR6ES	4922		
181 No.603192->			0,7	UR6	4079	UR6IX	7348
225 Serie			1,0	XR4	2637	XR4IX	7189
283 Gasket Seat			0,6	XR5	5953	XR5IX	7355
3.0 Ltr. OMC Cobra			1,1	UR4	4762	UR4IX	7401
302, 307, 327 Gasket Seat			0,6	XR5	5953	XR5IX	7355
305, GLV, K-Serie		1986 - 1997	1,1	UR4	4762	UR4IX	7401
307, 350 Tapered Seat			0,7	UR6	4079	UR6IX	7348
307, GLV,K 215hp		1975 - 1976	0,7	BPR5FS	2423		
350 Hi-Perf.			0,9	UR5	2139	UR5IX	7177
350, FLV Hi-Perf. 300hp		1975 - 1986	1,1	UR4	4762	UR4IX	7401
350, GLV, K-Serie 250hp		1975 - 1986	1,1	UR4	4762	UR4IX	7401
350, Q-Serie		1979 - 1991	1,1	UR4	4762	UR4IX	7401
4.3 Ltr. OMC Cobra			1,1	UR4	4762	UR4IX	7401
427 Serie			0,8	WR5	1071	WR5IX	7510
430 Serie			0,8	WR5	1071	WR5IX	7510
431 Serie			0,8	WR5	1071	WR5IX	7510
454 Tapered Seat			0,7	UR6	4079	UR6IX	7348
5.0Ltr. EFi OMC Cobra			1,1	UR4	4762	UR4IX	7401
5.7 Ltr. TBI / Carburator			1,1	UR4	4762	UR4IX	7401
5.8 Ltr. Efi OMC Cobra			0,9	BPR6EFS	3623		
5.8 Ltr. Efi OMC King Cobra			0,9	BPR6EFS	3623		
5.8 Ltr. OMC Cobra			0,9	BPR6EFS	3623		
7.4Ltr. OMC Cobra			1,1	UR4	4762	UR4IX	7401
7.4Ltr. EFi OMC Cobra			1,1	UR4	4762	UR4IX	7401
8.2Ltr. Mpi / Carburator			1,1	UR4	4762	UR4IX	7401
A,B,BA,C,H,K,KB / Alu Heads			0,7	B6L	3212		
A,B,BA,C,H,K,KB / Regular Heads			0,7	BR6S	3522		
KBL,KC,KFL,KL,KLC / Alu Heads			0,7	B6L	3212		
KBL,KC,KFL,KL,KLC / Regular Heads			0,7	BR6S	3522		
LC,LD,M,MB,MBL / Alu Heads			0,7	B6L	3212		
LC,LD,M,MB,MBL / Regular Heads			0,7	BR6S	3522		
MC,MCL,ML,W,WB / Alu Heads			0,7	B6L	3212		



Cyl.



Order No.

Iridium



Order No.

CHRIS-CRAFT

MC,MCL,ML,W,WB / Regular Heads			0,7	BR6S	3522		
--------------------------------	--	--	-----	------	------	--	--

CHRYSLER

B46-4	6		0,9	BR6S	3522	---	---
B46S-3	6		0,9	BR6S	3522	---	---
LM318A	8		0,9	BPR6ES	7822	BPR6EIX	6637
LM318AC	8		0,9	BPR6ES	7822	BPR6EIX	6637
LM318B	8		0,9	BPR6ES	7822	BPR6EIX	6637
LM318BC	8		0,9	BPR6ES	7822	BPR6EIX	6637
LM318BJ	8		0,9	BPR6ES	7822	BPR6EIX	6637
LM318BT	8		0,9	BPR6ES	7822	BPR6EIX	6637
LM318BV	8		0,9	BPR6ES	7822	BPR6EIX	6637
LM318D	8		0,9	BPR6ES	7822	BPR6EIX	6637
LM340B	8		0,9	BPR6ES	7822	BPR6EIX	6637
LM340BJ	8		0,9	BPR6ES	7822	BPR6EIX	6637
LM340BT	8		0,9	BPR6ES	7822	BPR6EIX	6637
LM340BV	8		0,9	BPR6ES	7822	BPR6EIX	6637
M122A	4		0,9	B7HS	5110	---	---
M122B	4		0,9	B7HS	5110	---	---
M170	6		0,9	BR6ES	4922	---	---
M183B	6		0,9	B7HS	5110	---	---
M225A	6		0,9	BR6ES	4922	---	---
M225D	6	- 1974	0,9	BR6ES	4922	---	---
M225D	6	1975 - 1979	0,9	BPR6FS	2623	---	---
M225GD	6		0,9	BR6ES	4922	---	---
M265	6		0,9	BR6S	3522	---	---
M265A	6		0,9	BR6S	3522	---	---
M273A	8		0,9	BPR6ES	7822	BPR6EIX	6637
M273B	8		0,9	BPR6ES	7822	BPR6EIX	6637
M273BT	8		0,9	BPR6ES	7822	BPR6EIX	6637
M318A	8		0,9	XR5	5953	XR5IX	7355
M318B	8		0,9	XR5	5953	XR5IX	7355
M318C	8		0,9	XR5	5953	XR5IX	7355
M318GD	8		0,9	XR5	5953	XR5IX	7355
M360A	8		0,9	BPR6ES	7822	BPR6EIX	6637
M360B	8		0,9	BPR6ES	7822	BPR6EIX	6637
M360BC	8		0,9	BPR6ES	7822	BPR6EIX	6637
M360BJ	8		0,9	BPR6ES	7822	BPR6EIX	6637
M360BT	8		0,9	BPR6ES	7822	BPR6EIX	6637
M360BV	8		0,9	BPR6ES	7822	BPR6EIX	6637
M383B	8		0,9	XR5	5953	XR5IX	7355
M383BV	8		0,9	XR5	5953	XR5IX	7355
M400B	8		0,9	XR5	5953	XR5IX	7355
M400BV	8		0,9	XR5	5953	XR5IX	7355
M400S	8		0,9	XR5	5953	XR5IX	7355
M413B	8		0,9	XR5	5953	XR5IX	7355
M413D	8		0,9	XR5	5953	XR5IX	7355
M413E	8		0,9	BR6ES	4922	---	---
M426B	8		0,9	XR5	5953	XR5IX	7355
M426D	8		0,9	XR5	5953	XR5IX	7355
M426-Ski	8		0,9	XR5	5953	XR5IX	7355



Cyl.



Order No.

Iridium



Order No.

CHRYSLER

M44	8		0,9	BR6S	3522	---	---
M440B	8		0,9	XR5	5953	XR5IX	7355
M440BJ	8		0,9	XR5	5953	XR5IX	7355
M440BV	8		0,9	XR5	5953	XR5IX	7355
M440D	8		0,9	XR5	5953	XR5IX	7355
M440S	8		0,9	XR5	5953	XR5IX	7355
M440SV	8		0,9	XR5	5953	XR5IX	7355
M44-3	8		0,9	BR6S	3522	---	---
M45	8		0,9	BR6ES	4922	---	---
M45-3	8		0,9	BR6ES	4922	---	---
M45S	8		0,9	BR6ES	4922	---	---
M45-S3	8		0,9	BR6ES	4922	---	---
M45-SP3	8		0,9	BR6ES	4922	---	---
M460B	8		0,9	UR5	2139	UR5IX	7177
M46-3	6		0,9	BR6S	3522	---	---
M47-3	6		0,9	BR6S	3522	---	---
M47-4	6		0,9	BR6S	3522	---	---
M47S-3	6		0,9	BR6S	3522	---	---
M80	8		0,9	XR5	5953	XR5IX	7355
M81	8		0,9	BR6ES	4922	---	---
M91D	4		0,9	BP6ES	7811	BPR6EIX	6637
M91F	4		0,9	BP6ES	7811	BPR6EIX	6637

CHRYSLER-VOLVO

110			0,7	BR7HS	4122	BR7HIX	7067
115			0,7	BR7HS	4122	BR7HIX	7067
120			0,7	BR7HS	4122	BR7HIX	7067
130			0,7	BR7HS	4122	BR7HIX	7067
165			0,7	BR7HS	4122	BR7HIX	7067
170			0,7	BR7HS	4122	BR7HIX	7067

CLIMAX

98 cu in.			0,8	BPR6ES	7822	BPR6EIX	6637
302 , 351 cu in.			0,8	A6FS	2210		
460 cu in.			0,8	APR6FS	2922		

CLINTON

all models			0,6	B6S	3510		
------------	--	--	-----	-----	------	--	--

CON-O-LIFT

Marine Hydraulic Triler Honda engine 5,5hp			0,8	BPR5ES	7422	BPR5EIX	6597
--	--	--	-----	--------	------	---------	------

CORNELL

Marine Hoists			0,7	A6	1010		
---------------	--	--	-----	----	------	--	--



Cyl.



Order No.

Iridium



Order No.

CORNELL

<i>Chrysler</i>							
225cid Marine Hoists	Chrysler engine		0,7	BPR5FS	2423		
<i>Ford</i>							
300cid Marine Hoists	Ford engine		0,8	AR6FS	3323		

COVENTRY-VICTOR

all other models	18mm, 18 x 1		0,5	A6	1010		
AN3 , WN3			0,5	B6ES	7310		
Midget			0,5	B6HS	4510	BR6HIX	3419

CRESCENT

45			0,5	B8HS	5510	BR8HIX	7001
----	--	--	-----	------	------	--------	------

CROSLEY

all models			0,6	B6S	3510		
------------	--	--	-----	-----	------	--	--

CRUSADER

165	229 cid	1979 - 1980	0,9	BPR6FS	2623	---	---
185	292 cid	1971 - 1980	0,9	R5674-7	3535	---	---
210	307 cid	1971 - 1980	0,9	R5674-7	3535	---	---
229	cu	1979 - 1980	0,7	UR6	4079	UR6IX	7348
229	cu	1981 - 1984	0,8	UR5	2139	UR5IX	7177
255	351 cid	1974 - 1975	0,8	AR6FS	3323	---	---
270	350 cid	1971 - 1998	0,9	BPR6FS	2623	---	---
292	cu Modell 185	1971 - 1980	0,7	UR6	4079	UR6IX	7348
302	cid	1974 - 1975	0,8	AR6FS	3323	---	---
307	cu Modell 210	1971 - 1980	0,7	UR6	4079	UR6IX	7348
350	454 cid	1972 - 1980	0,9	BPR6FS	2623	---	---
350	460 cid	1974 - 1975	0,9	BPR6FS	2623	---	---
427	427 cid	1968 - 1980	0,9	R5674-7	3535	---	---
502	502 cid	1989 - 1998	0,9	BPR6FS	2623	---	---
CH185	229 cid	1981 - 1984	0,9	BPR6FS	2623	---	---
Mark 140			0,6	B6S	3510	---	---
Mark 170			0,6	B6S	3510	---	---
Mark 200			0,6	B6S	3510	---	---
Mark 225			0,6	B6S	3510	---	---
Mark 240			0,8	B6ES	7310	---	---
Mark 275			0,8	B8S	3810	---	---
Mark 280			0,8	B6ES	7310	---	---
Mark 300			0,8	B8S	3810	---	---
Mark 325			0,8	B8S	3810	---	---
<i>Boat Builder</i>							
170J			0,6	B6S	3510	---	---
185			0,6	XR5	5953	XR5IX	7355
190			0,6	XR5	5953	XR5IX	7355
200J			0,6	XR5	5953	XR5IX	7355



Cyl.

Order
No.

Iridium

Order
No.**CRUSADER**

<i>Boat Builder</i>							
210			0,6	XR5	5953	XR5IX	7355
220			0,6	XR5	5953	XR5IX	7355
230			0,6	XR5	5953	XR5IX	7355
230J			0,6	XR5	5953	XR5IX	7355
250			0,6	XR5	5953	XR5IX	7355
280			0,9	BR6ES	4922		
CM Cadillac			0,6	XR5	5953	XR5IX	7355
CS100			0,8	B6ES	7310	---	---
CS150			0,8	B6ES	7310	---	---
CS165			0,8	B6ES	7310	---	---
CS180			0,8	B6S	3510	---	---
CS220			0,8	B6S	3510	---	---
CS250			0,8	B6S	3510	---	---
CS280			0,8	B6ES	7310	---	---
CS320			0,8	B6ES	7310	---	---
<i>Champion</i>							
305 cid			0,9	BPR6FS	2623	---	---
350 cid			0,9	BPR6FS	2623	---	---
350 cu HT			0,8	UR5	2139	UR5IX	7177
454 cid			0,9	BPR6FS	2623	---	---
<i>Charger</i>							
CS185			0,6	B6S	3510	---	---
CS220			0,6	B6S	3510	---	---
CS250			0,6	B6S	3510	---	---
CS280			0,9	B6ES	7310	---	---
CS320			0,8	B6ES	7310	---	---
<i>Classic</i>							
5.7L Plus EFI			1,1	---	---	TR5IX	7397
5.7L Plus MPI			1,1	---	---	TR5IX	7397
7.4L HO MPI			1,1	BR6FS	4323	---	---
7.4L MPI			1,1	---	---	TR5IX	7397
8.2L MPI			1,1	BR6FS	4323	---	---
<i>Platinum</i>							
5.7L Plus MPI			1,1	---	---	TR5IX	7397
7.4L HO MPI			1,1	BR6FS	4323	---	---
7.4L MPI			1,1	---	---	TR5IX	7397
8.2L MPI			1,1	BR6FS	4323	---	---
<i>XL/Xii</i>							
262 cid		1985 - 1998	0,9	BPR6FS	2623	---	---
305 cid			0,9	BPR6FS	2623	---	---
350 cid			0,9	BPR6FS	2623	---	---
350 cid HT			0,9	BPR6FS	2623	---	---
454 cid		1981 - 1998	0,9	BPR6FS	2623	---	---
454 cid HO			0,9	BPR6FS	2623	---	---



Cyl.



Order No.

Iridium



Order No.

CRUSADER						
<i>XL/Xli</i>						
502 cid			0,9	BPR6FS	2623	---
CUYUNA						
430LC 40hp Jet Drive			0,8	BR8ES	5422	BR8EIX 5044
DAIMLER						
SP 250			0,7	BR6ES	4922	
DAYTONA						
100 , 150			0,9	B6ES	7310	
200 , 300			0,9	B6S	3510	
400 , 400 Turbo			0,9	B7ES	1111	
427 , 427 Turbo heavy Service			0,9	B8ES	2411	BR8EIX 5044
427 , 427 Turbo light Service			0,9	B7ES	1111	
DIESEL-TECHNIEK						
DTR 40			0,6	BP6HS	4511	BPR6HIX 4085
DTR 50			0,6	BP6HS	4511	BPR6HIX 4085
DYNAFOIL						
G440-BW (432cc) Xenoah engine			0,9	BR6ES	4922	
EVINRUDE						
CU , SU 153cid 110, 120hp			0,9	BR6ES	4922	
DU 89 cid 88, 90hp			0,8	B6S	3510	
HU 225 cid 150,155hp			0,9	BP5S	3011	
KU 283 cid 185hp			0,9	B6S	3510	
NU 1600cc 89,90hp			0,6	BP6ES	7811	BPR6EIX 6637
TU 14 , 15 , 16 300 cid 200hp			0,9	XR4	2637	XR4IX 7189
TU 17 ->283,307 cid 210hp			0,9	XR4	2637	XR4IX 7189
FAGEOL						
44 , 53			0,6	B6S	3510	
FM 200 , FM 225			0,5	B6S	3510	
FLAGSHIP						
155 292 cid			0,9	B6ES	7310	---
181FL 181 cid 125FMC	1975 - 1977		0,9	YR5	5334	YR5IX 7516
280E 280 cid	1975 - 1977		0,9	R5674-7	3535	---
300 427 cid	1971 - 1974		0,9	B7ES	1111	---



Cyl.

Order
No.

Iridium

Order
No.**FLAGSHIP***Heavy Service*

454 cid	1975 - 1993	1,1	R5674-7	3535	---	---
350 cid	1975 - 1993	1,1	R5674-7	3535	---	---
305 cid	1975 - 1993	1,1	R5674-7	3535	---	---
300 cid	1977 -	1,1	R5674-7	3535	---	---

Hi Performance

295FAS 350 cid	1975 - 1993	0,9	R5674-7	3535	---	---
335 350 cid	1975 - 1993	0,9	R5674-7	3535	---	---
380FAS 350 cid	1975 - 1993	0,9	R5674-7	3535	---	---
400FAJ 454 cid	1975 - 1977	0,9	R5674-7	3535	---	---
400FAS 454 cid	1975 - 1977	0,9	R5674-7	3535	---	---
450FAJ 454 cid	1975 - 1993	0,9	R5674-7	3535	---	---
450FAS 454 cid	1975 - 1993	0,9	R5674-7	3535	---	---
460FAJ 454 cid	1975 - 1977	0,9	R5674-7	3535	---	---
460FAS 454 cid	1975 - 1977	0,9	R5674-7	3535	---	---
500FAJ 454 cid	1975 - 1977	0,9	R5674-7	3535	---	---
500FAJ 490 cid	1975 - 1981	0,9	R5674-7	3535	---	---
500FAS 454 cid	1975 - 1977	0,9	R5674-7	3535	---	---
500FAS 490 cid	1975 - 1981	0,9	R5674-7	3535	---	---
675FAJ (Normal Use) 466 cid	1975 - 1981	0,9	R5674-7	3535	---	---
675FAJ (Racing) 466 cid	1975 - 1977	0,9	R5673-10	2482	---	---
675FAS (Normal Use) 466 cid	1975 - 1981	0,9	R5674-7	3535	---	---
675FAS (Racing) 466 cid	1975 - 1977	0,9	R5673-10	2482	---	---
TC400 350 cid	1975 - 1993	0,9	R5674-7	3535	---	---
TC450 350 cid	1975 - 1993	0,9	R5673-7	4367	---	---
TC500 454 cid	1975 - 1993	0,9	R5673-8	4140	---	---
TC500 350 cid	1975 - 1993	0,9	R5673-8	4140	---	---
TC550 454 cid	1975 - 1993	0,9	R5674-7	3535	---	---
TC600 454 cid	1975 - 1993	0,9	R5673-7	4367	---	---
TC650 454 cid	1975 - 1977	0,9	R5673-8	4140	---	---
TC700 466 cid	1975 - 1981	0,9	R5673-10	2482	---	---
TC800 460 cid	1975 - 1977	0,9	R5673-10	2482	---	---
TCX950 466 cid	1975 - 1981	0,9	R5673-10	2482	---	---

Light Service

454 cid	1975 - 1977	1,1	UR5	2139	UR5IX	7177
305 cid	1975 - 1977	1,1	UR5	2139	UR5IX	7177
300 cid	1977 -	1,1	UR5	2139	UR5IX	7177

Transdrive, Inboard, V-Drive

66		0,8	B4	3210		
85		0,8	BR6S	3522		
90		0,8	BR6S	3522		
96		0,8	B4	3210		
100		0,8	BR6S	3522		
118		0,8	BR6S	3522		
136		0,8	B4	3210		
145		0,8	BR6S	3522		
150		0,8	BR6S	3522		
181FL	1975 - 1977	1,1	UR4	4762	UR4IX	7401



Cyl.

Order
No.

Iridium

Order
No.**FLAGSHIP***Transdrive, Inboard, V-Drive*

185			0,8	BR6S	3522		
190			0,8	BR6S	3522		
220			0,8	BR6S	3522		
225			0,8	BR6S	3522		
240			0,8	BR6S	3522		
250			0,8	BR6S	3522		
280E		1975 - 1977	0,7	UR6	4079	UR6IX	7348
283			0,8	BR6S	3522		
292 cu in. 155			0,9	BR6ES	4922		
292 cu in.		1971 - 1974	0,7	UR5	2139	UR5IX	7177
305 cu in.		1977 - 1993	0,7	UR6	4079	UR6IX	7348
307 cu in.		1971 - 1974	0,7	UR6	4079	UR6IX	7348
310			0,8	BR6S	3522		
327			0,8	BR6S	3522		
350 cu in.		1971 - 1993	0,7	UR6	4079	UR6IX	7348
350M			0,8	BR6S	3522		
427 cu in. 300			0,9	BR6ES	4922		
427 cu in.		1971 - 1974	0,7	UR6	4079	UR6IX	7348
454 cu in.		1971 - 1993	0,9	UR6	4079	UR6IX	7348

FORD

67 cu in.			0,9	GR5	7537	GR5IX	7214
98 cu in.			0,9	GR5	7537	GR5IX	7214
104 cu in.			0,7	GR4	7038	GR4IX	7149
158 cu in.			0,9	BR6ES	4922		
172 cu in.			0,7	B6L	3212		
201 cu in.			0,9	BR6ES	4922		
250 cu in.			0,8	AR6FS	3323		
427 cu in.		1975 - 1989	0,7	UR5	2139	UR5IX	7177
427 cu in. 302,351W		- 1974	0,9	WR5	1071	WR5IX	7510
429 cu in.		1975 - 1989	0,7	UR5	2139	UR5IX	7177
460 cu in. 302,351W		1975 - 1989	0,8	UR5	2139	UR5IX	7177
477 cu in.		1976 -	0,8	AR6FS	3323		
534 cu in.		1976 -	0,8	AR6FS	3323		

GOFF

GMP 225		1969 - 1973	0,9	XR4	2637	XR4IX	7189
GMP 455		1961 - 1970	0,8	XR4	2637	XR4IX	7189
GMP 455		1971 - 1972	1,0	XR4	2637	XR4IX	7189
GMP 455		1973 -	1,0	XR4	2637	XR4IX	7189

GOTA

5-6 , 10-12 , 15-18			0,5	A6	1010		
SLF10 , SL3 , SL6 , SL12			0,5	A6	1010		



Cyl.

Order
No.

Iridium

Order
No.**GRAYMARINE**

<i>Express</i>						
Four 52			0,7	AB6	2910	
Four 112			0,7	AB6	2910	
Four 140			0,7	A6	1010	
Four 162			0,7	A6	1010	
Seascout 91			0,9	BR6S	3522	
Six 71			0,7	AB6	2910	
Six 77			0,7	AB6	2910	
Six 80			0,7	AB6	2910	
Six 91			0,7	A8	1210	
Six 111			0,7	AB6	2910	
Six 121			0,7	A6	1010	
Six 186			0,7	A6	1010	
Six 224			0,7	A8	1210	
Six 427			0,7	AB6	2910	
Super 117			0,7	A6	1010	
Super 427			0,7	A6	1010	
<i>Fireball</i>						
135			0,7	XR5	5953	XR5IX 7355
138			0,7	XR5	5953	XR5IX 7355
138A			0,7	XR5	5953	XR5IX 7355
170			0,7	XR5	5953	XR5IX 7355
175			0,7	XR5	5953	XR5IX 7355
178			0,7	XR5	5953	XR5IX 7355
178B			0,7	XR5	5953	XR5IX 7355
188			0,7	XR5	5953	XR5IX 7355
195			0,7	XR5	5953	XR5IX 7355
215			0,7	XR5	5953	XR5IX 7355
220			0,7	XR5	5953	XR5IX 7355
225			0,7	XR5	5953	XR5IX 7355
238			0,7	XR5	5953	XR5IX 7355
260			0,7	XR5	5953	XR5IX 7355
280			0,7	XR5	5953	XR5IX 7355
304			0,7	GR4	7038	GR4IX 7149
310			0,7	XR5	5953	XR5IX 7355
360			0,7	GR4	7038	GR4IX 7149
427			0,7	XR5	5953	XR5IX 7355
C, CF, CH			0,7	XR5	5953	XR5IX 7355
Four 50			0,9	BR6S	3522	
Four 90			0,7	AB6	2910	
Six 116			0,7	A6	1010	
Six 140			0,7	A6	1010	
Six 150			0,7	A6	1010	
Six 160			0,7	A6	1010	
Six 232 Stern Drive			0,9	GR5	7537	GR5IX 7214
Super 330			0,7	A6	1010	
<i>Lugger</i>						
Four 22			0,7	A7	1110	
Four 40			0,7	AB6	2910	
Four 52			0,7	A7	1110	
Four 69			0,9	BR6S	3522	



Cyl.



Order No.

Iridium



Order No.

GRAYMARINE*Lugger*

Four 75		0,7	AB6	2910
Four 80		0,7	AB6	2910
Four 85TD		0,7	AB6	2910
Four 112		0,7	A7	1110
Four 140		0,7	AB6	2910
Four 162		0,7	AB6	2910
Seascout 45		0,9	BR6S	3522
Seascout 91		0,9	BR6S	3522
Six 51		0,7	A7	1110
Six 71		0,7	A6	1010
Six 77		0,7	A6	1010
Six 91		0,7	AB6	2910
Six 121		0,7	A7	1110
Six 186		0,7	A7	1110
Six 226		0,7	A7	1110
Six 244		0,7	AB6	2910
Six 330		0,7	A7	1110

Phantom

Four 45		0,9	BR6S	3522
Four 62		0,7	A6	1010
Four 75		0,7	AB6	2910
Four 85		0,7	AB6	2910
Four 86		0,7	AB6	2910
Four 162		0,7	AB6	2910
Four 620		0,7	AB6	2910
Four 750		0,7	AB6	2910
Six 70		0,7	AB6	2910
Six 80		0,7	AB6	2910
Six 88		0,7	A6	1010
Six 90		0,7	A6	1010
Six 100		0,7	AB6	2910
Six 103		0,7	A6	1010
Six 104		0,7	A6	1010
Six 109		0,7	AB6	2910
Six 109TD		0,7	AB6	2910
Six 110		0,7	AB6	2910
Six 112		0,7	A6	1010
Six 115		0,7	A8	1210
Six 116		0,7	AB6	2910
Six 118		0,7	AB6	2910
Six 120		0,7	AB6	2910
Six 122		0,7	AB6	2910
Six 125		0,7	A6	1010
Six 135		0,7	A8	1210
Six 135		0,7	AB6	2910
Six 136		0,7	AB6	2910
Six 150		0,7	AB6	2910
Six 165		0,7	AB6	2910
Six 175		0,7	AB6	2910
Six 185		0,7	AB6	2910



Cyl.

Order
No.

Iridium

Order
No.**GRAYMARINE**

<i>Phantom</i>							
Six 200			0,7	A8	1210		

GUARDIAN MARINE

<i>Chevrolet</i>							
454 cid			1,1	UR4	4762	UR4IX	7401
<i>Ford</i>							
302 cid			0,9	UR5	2139	UR5IX	7177
351W cid			0,9	UR5	2139	UR5IX	7177
460 cid			0,9	UR5	2139	UR5IX	7177
<i>Oldsmobile</i>							
455 cid			0,9	XR4	2637	XR4IX	7189

HARDIN

H225IO		1980 - 1986	0,9	YR5	5334	YR5IX	7516
H225J		1980 - 1986	0,9	YR5	5334	YR5IX	7516
H225V		1980 - 1986	0,9	YR5	5334	YR5IX	7516
H240J (Taper Seat)		1969 - 1990	0,9	UR5	2139	UR5IX	7177
H240J (Gasket Seat)		1969 - 1990	0,9	XR5	5953	XR5IX	7355
H240V (Taper Seat)		1969 - 1990	0,9	UR5	2139	UR5IX	7177
H240V (Gasket Seat)		1969 - 1990	0,9	XR5	5953	XR5IX	7355
H260IO		1980 - 1986	0,9	YR5	5334	YR5IX	7516
H260J		1980 - 1986	0,9	YR5	5334	YR5IX	7516
H260V		1980 - 1986	0,9	YR5	5334	YR5IX	7516
H280		1980 - 1986	0,9	YR5	5334	YR5IX	7516
H280J		1980 - 1980	0,9	YR5	5334	YR5IX	7516
H280V		1980 - 1986	0,9	YR5	5334	YR5IX	7516
H295J		1960 - 1976	0,9	XR5	5953	XR5IX	7355
H295V		1960 - 1976	0,9	XR5	5953	XR5IX	7355
H300J		1977 - 1990	0,9	XR5	5953	XR5IX	7355
H300V		1977 - 1990	0,9	XR5	5953	XR5IX	7355
H305I		1979 - 1990	0,9	YR5	5334	YR5IX	7516
H320J		1979 - 1990	0,9	YR5	5334	YR5IX	7516
H320TC		1978 - 1990	0,7	R5673-7	4367	---	---
H320V		1979 - 1990	0,9	YR5	5334	YR5IX	7516
H324J		1975 - 1976	0,9	XR5	5953	XR5IX	7355
H324V		1975 - 1976	0,9	XR5	5953	XR5IX	7355
H325J		1969 - 1976	0,7	XR5	5953	XR5IX	7355
H325V		1969 - 1976	0,7	XR5	5953	XR5IX	7355
H333J		1976 - 1990	0,9	YR5	5334	YR5IX	7516
H333V		1976 - 1990	0,9	YR5	5334	YR5IX	7516
H345J		1969 - 1976	0,7	XR5	5953	XR5IX	7355
H345V		1969 - 1976	0,7	XR5	5953	XR5IX	7355
H350I		1979 - 1990	0,9	YR5	5334	YR5IX	7516
H405J		1974 - 1990	0,9	YR5	5334	YR5IX	7516
H405TC		1978 - 1990	0,7	B7HS	5110	---	---
H405V		1974 - 1990	0,9	YR5	5334	YR5IX	7516
H454I		1979 - 1990	0,9	YR5	5334	YR5IX	7516



Cyl.



Order No.

Iridium



Order No.

HARDIN

H455J (ET)		1976 -	0,9	XR5	5953	XR5IX	7355
H455V (ET)		1976 -	0,9	XR5	5953	XR5IX	7355
HM225		1983 - 1990	0,9	UR5	2139	UR5IX	7177
HM260		1983 - 1990	0,9	UR5	2139	UR5IX	7177
HM280		1983 - 1990	0,9	UR5	2139	UR5IX	7177
HM333		1983 - 1990	0,9	UR5	2139	UR5IX	7177
HM400		1983 - 1990	0,9	UR5	2139	UR5IX	7177
HM405		1983 - 1990	0,9	UR5	2139	UR5IX	7177
HM430		1983 - 1990	0,9	UR5	2139	UR5IX	7177

HARMAN HOUSE

<i>Chevrolet</i>							
350 cid			0,9	UR5	2139	UR5IX	7177
454 cid			1,1	UR4	4762	UR4IX	7401
<i>Ford</i>							
460 cid			0,9	UR5	2139	UR5IX	7177

HOVER AIR AMERICA

3 +1 (4,3Ltr)			1,1	UR4	4762	UR4IX	7401
---------------	--	--	-----	-----	------	-------	------

HUSTLER

350			0,7	UR6	4079	UR6IX	7348
375			0,7	UR6	4079	UR6IX	7348
450			0,7	UR6	4079	UR6IX	7348
525			0,7	UR6	4079	UR6IX	7348
585			0,7	UR6	4079	UR6IX	7348

IMC

850cc			0,8	BR9ES	5722	BR9EIX	3981
1300cc			0,8	BR9ES	5722	BR9EIX	3981

INDMAR

<i>Cadillac</i>							
4.6L MPI Northstar	279 cid Cadillac	6		1,2	---	---	TR55IX 7164
<i>Ford</i>							
5.0L V8 200	302 cid Ford	8	1991 - 1995	1,1	UR5	2139	UR5IX 7177
5.0L V8 225	302 cid Ford	8	1991 - 1997	0,9	UR5	2139	UR5IX 7177
5.8L V8	351 cid Ford	8	1983 - 1987	0,9	A6FS	2210	---
5.8L V8 250	351 cid Ford	8	1991 - 1997	0,9	UR5	2139	UR5IX 7177
5.8L V8 285 H.O.	351 cid Ford	8	1991 - 1997	1,1	BPR6EFS	3623	---
7.5L V8	460 cid Ford	8	1976 - 1984	0,9	UR5	2139	UR5IX 7177
<i>GM</i>							
3.0L	GM	4		0,9	BR6FS	4323	---
4.3L V6 EFI	GM	6		1,1	BR6FS	4323	---



Cyl.



Order No.

Iridium



Order No.

INDMAR

<i>GM</i>								
5.0L V8 230	GM Small Block	8		1,1	BR6FS	4323	---	---
5.0L V8 230SP	GM Small Block	8		1,1	BR6FS	4323	---	---
5.7L V8	GM Small Block	8	1976 - 1987	1,0	UR5	2139	UR5IX	7177
5.7L V8 Carb	GM Small Block	8		1,1	BR6FS	4323	---	---
5.7L V8 Carb H.O.	GM Small Block	8		1,1	BPR6EFS	3623	---	---
5.7L V8 EFI	GM Small Block	8		1,1	BR6FS	4323	---	---
5.7L V8 EFI H.O.	GM Small Block	8		1,1	BPR6EFS	3623	---	---
5.7L V8 Gen 1+ Carb	GM Small Block	8		1,1	BPR6EFS	3623	---	---
5.7L V8 Gen 1+ H.O. Carb	GM Small Block	8		1,1	BPR6EFS	3623	---	---
5.7L V8 Gen 1+ H.O. PFI	GM Small Block	8		1,1	BPR6EFS	3623	---	---
5.7L V8 Indmar TBI	GM Small Block	8		1,1	BR6FS	4323	---	---
5.7L V8 LT-1	GM Small Block	8		1,1	BPR6EFS	3623	---	---
6.6L V8	GM Small Block	8		1,1	BR6FS	4323	---	---
7.4L V8	GM Big Block	8	1998 - 1999	1,1	BPR6EFS	3623	---	---
7.4L V8 Carb	GM Big Block	8	- 1997	1,1	BR6FS	4323	---	---
7.4L V8 Carb H.O.	GM Big Block	8	- 1997	1,1	BR6FS	4323	---	---
7.4L V8 EFI	GM Big Block	8	- 1997	1,1	BR6FS	4323	---	---
7.4L V8 EFI H.O.	GM Big Block	8	- 1997	1,1	BR6FS	4323	---	---
7.4L V8 H.O.	GM Big Block	8	- 1997	1,1	BPR6EFS	3623	---	---
8.2L V8	GM Big Block	8	- 1997	1,1	BR6FS	4323	---	---
8.2L V8	GM Big Block	8	1998 - 1999	1,1	BPR6EFS	3623	---	---
8.2L V8 H.O.	GM Big Block	8	- 1997	1,1	BR6FS	4323	---	---

Oldsmobile

5.7L V8 350 cid	Oldsmobile	8	1976 - 1982	1,0	XR4	2637	XR4IX	7189
6.6L V8 403 cid	Oldsmobile	8	1976 - 1982	1,0	XR4	2637	XR4IX	7189
7.5L V8 455 cid	Oldsmobile	8	1975 - 1976	1,0	XR4	2637	XR4IX	7189

INTERCEPTOR

104 V4		4		0,8	BPR7HS	6422	BPR7HIX	5944
122 V6		6		0,8	BPR7HS	6422	BPR7HIX	5944
144 Side Draught				0,8	WR5	1071	WR5IX	7510
170 Down Draught				0,9	AR6FS	3323		
170 Side Draught				0,8	WR5	1071	WR5IX	7510
200				0,9	AR6FS	3323		
256				0,9	AR6FS	3323		
272				0,9	AR6FS	3323		
289				0,9	AR6FS	3323		
292				0,9	AR6FS	3323		
302				0,8	WR5	1071	WR5IX	7510
312				0,9	AR6FS	3323		
352				0,9	AR6FS	3323		
390				0,8	WR5	1071	WR5IX	7510
427 300hp				0,9	AR6FS	3323		
427 400hp				0,8	WR5	1071	WR5IX	7510

JOHNSON

CU , SU 153cid 110,120hp				0,9	B6ES	7310		
DU 89cid 88,90hp				0,8	B6S	3510		



Cyl.

Order
No.

Iridium

Order
No.**JOHNSON**

HU 225cid 150,155hp			0,9	XR4	2637	XR4IX	7189
KU 283cid 185hp			0,9	XR5	5953	XR5IX	7355
NU 1600cc 80,90hp			0,7	GR5	7537	GR5IX	7214
TU -14 ,-15 ,-16 300cid 200hp			0,9	XR4	2637	XR4IX	7189
TU -17 ->283,307 cid 210hp			1,0	XR4	2637	XR4IX	7189

KERMATH

Sea Pup , Sea Twin			0,9	XR5	5953	XR5IX	7355
--------------------	--	--	-----	------------	-------------	--------------	-------------

KING

350 cid 240hp	1971 - 1973	1,0	XR4	2637	XR4IX	7189
454 cid 450hp	1973 - 1986	1,1	UR4	4762	UR4IX	7401
455 cid 270hp	1971 - 1973	1,0	XR4	2637	XR4IX	7189
455 cid 325hp	1972 - 1973	1,0	XR4	2637	XR4IX	7189
455 cid 410hp	1972 - 1973	1,0	XR4	2637	XR4IX	7189

KODIAK

3.0L L4 140 hp 181 cid	4 1999 - 2000	1,1	UR4	4762	UR4IX	7401
4.3L V6 220 hp 262 cid	6 1999 - 2000	1,1	BR6FS	4323	---	---
5.7L V8 310 hp 350 cid	8 1999 - 2000	1,1	TR5	7837	TR5IX	7397
7.4L V8 350 hp 454 cid	8 1999 - 2000	1,1	BR6FS	4323	---	---

KOHLER

L-160			0,6	B6S	3510		
TU-17			0,9	B6S	3510		

MARINE DRIVE SYSTEMS

85 Stern Drive			0,6	BP7HS	5111	---	---
110 Stern Drive			0,6	BP7HS	5111	---	---

MARINE POWER

181	Gasket Seat	4	1975 - 1978	0,9	BR6ES	4922		
181 .460" Reach	Tapered Seat		1975 - 1991	1,1	UR4	4762	UR4IX	7401
181 .708" Reach	Tapered Seat		1992 - 1997	0,9	TR4	4392	TR4IX	7300
181 .708" Reach	Tapered Seat	4	1998 -	0,9	TR4	4392	TR4IX	7300
229 cid GM engine		6		1,1	UR4	4762	UR4IX	7401
250 cid GM engine		6		0,7	BPR5FS	2423		
262 200, 225 hp		6	- 2000	1,1	UR4	4762	UR4IX	7401
262 cid GM engine		6		1,1	UR4	4762	UR4IX	7401
292 cid GM engine	Gasket Seat			0,9	BR6ES	4922		
292 cid GM engine	Tapered Seat			1,1	UR4	4762	UR4IX	7401
302 cid Ford engine				0,9	UR5	2139	UR5IX	7177
305 GLV, K-Serie		8	1977 - 1986	1,1	UR4	4762	UR4IX	7401



Cyl.

Order
No.

Iridium

Order
No.**MARINE POWER**

305 cid GM engine			1,1	UR4	4762	UR4IX	7401
307 GLV, K-215 hp	8	1975 - 1976	0,9	UR4	4762	UR4IX	7401
318 cid Chrysler engine			0,9	BPR5ES	7422	BPR5EIX	6597
327 cid GM engine			0,9	XR5	5953	XR5IX	7355
350 GLV K-Serie 250hphp	8	1975 - 1986	1,1	UR4	4762	UR4IX	7401
350 FLV Hi-Perf. 300hp	8	1975 - 1986	1,1	UR4	4762	UR4IX	7401
350 Q-Serie	8	1979 - 1991	1,1	UR4	4762	UR4IX	7401
350 260,300,325 hp	8	1992 -	1,1	UR4	4762	UR4IX	7401
350 Premium 294hp	8	1996 - 1997	0,9	TR4	4392	TR4IX	7300
350 cid GM engine			1,1	UR4	4762	UR4IX	7401
351 W cid Ford engine			0,9	WR5	1071	WR5IX	7510
360 cid Chrysler engine			0,9	BPR5ES	7422	BPR5EIX	6597
440 cid Chrysler engine			1,0	XR4	2637	XR4IX	7189
454 B,BM 330hp	8	1975 - 1991	1,1	UR4	4762	UR4IX	7401
454 340,390,440hp	8	1992 -	1,1	UR4	4762	UR4IX	7401
454 cid GM engine			0,9	UR5	2139	UR5IX	7177
460 cid Ford engine			0,9	UR5	2139	UR5IX	7177
502 410,475hp	8	- 1997	1,1	UR4	4762	UR4IX	7401
502 410,475hp	8	1998 - 2000	1,1	UR4	4762	UR4IX	7401
502 502X	8	1999 -	1,1	UR4	4762	UR4IX	7401
502 700X 700hp	8	2000 -	1,1	UR4	4762	UR4IX	7401
540 550HP	8	- 1997	0,7	UR5	2139	UR5IX	7177
Vortec 4.3L 225hp	8	1998 -	0,7	UR5	2139	UR5IX	7177
Vortec 5.7L 325hp	8	1998 -	0,7	UR5	2139	UR5IX	7177
Vortec 7.4L Mpi 325,340hp	8	1998 -	1,1	UR4	4762	UR4IX	7401

MARINE REPOWER

<i>Chrysler</i>							
318 cid			0,9	BPR5ES	7422	BPR5EIX	6597
360 cid			0,9	BPR5ES	7422	BPR5EIX	6597
440 cid			1,0	XR4	2637	XR4IX	7189
<i>Ford</i>							
302 cid			0,9	UR5	2139	UR5IX	7177
351W cid			0,9	WR5	1071	WR5IX	7510
460 cid			0,9	UR5	2139	UR5IX	7177
<i>GM</i>							
229 cid V6	6		1,1	UR4	4762	UR4IX	7401
250 cid V6	6		0,7	BPR5FS	2423		
262 cid V6	6		1,1	UR4	4762	UR4IX	7401
292 cid Gasket Seat			0,7	BR6ES	4922		
292 cid Tapered Seat			1,1	UR4	4762	UR4IX	7401
305 cid			1,1	UR4	4762	UR4IX	7401
327 cid			0,9	XR5	5953	XR5IX	7355
350 cid			1,1	UR4	4762	UR4IX	7401
454 cid			0,9	UR5	2139	UR5IX	7177



Cyl.



Order No.

Iridium



Order No.

MARINETEK*Chrysler*

318 cid		1966 - 1974	1,0	XR4	2637	XR4IX	7189
318 cid		1975 - 1988	0,9	BPR5ES	7422	BPR5EIX	6597
360 cid		1975 - 1988	0,9	BPR5ES	7422	BPR5EIX	6597

Ford

302 cid		1968 - 1974	0,9	WR5	1071	WR5IX	7510
302 cid		1975 - 1980	0,9	UR5	2139	UR5IX	7177
302 cid		1981 - 1995	1,1	UR4	4762	UR4IX	7401
351 cid		1969 - 1974	0,9	WR5	1071	WR5IX	7510
351 cid		1975 - 1987	0,9	UR5	2139	UR5IX	7177
460 cid		1973 - 1974	0,9	WR5	1071	WR5IX	7510
460 cid		1975 - 1987	0,9	UR5	2139	UR5IX	7177

GM

181 cid 3.0I HO		1990 - 1997	1,1	TR4	4392	TR4IX	7300
229 cid		1980 - 1984	1,1	UR4	4762	UR4IX	7401
250 cid		1970 - 1980	1,1	UR4	4762	UR4IX	7401
262 cid		1985 - 1992	1,1	UR4	4762	UR4IX	7401
305 cid		1976 - 1995	1,1	UR4	4762	UR4IX	7401
350 cid		1967 - 1970	1,0	XR4	2637	XR4IX	7189
350 cid		1971 - 1995	1,1	UR4	4762	UR4IX	7401
350 cid HO		1987 - 1995	0,9	UR5	2139	UR5IX	7177
454 cid		1973 - 1987	1,1	UR4	4762	UR4IX	7401
454 cid Gen V		1992 - 1993	0,9	UR5	2139	UR5IX	7177
454 cid HO		1984 - 1991	0,9	UR5	2139	UR5IX	7177

MERCURISER*224Kw Petrol*

350MAG Mpi Horizon	8		0,9			TR55IX	7164
--------------------	---	--	-----	--	--	---------------	-------------

Ford 302 & 351cid

215	8		0,8	AR6FS	3323		
225	8		0,8	AR6FS	3323		
233 14mm Dia	8		1,1	UR4	4762	UR4IX	7401
233 18mm Dia	8		0,8	AR6FS	3323		
255	8		1,1	UR4	4762	UR4IX	7401

GM 305, 327&350

198	8		1,1	UR4	4762	UR4IX	7401
225	8		0,8	B7S	3710		
228	8		1,1	UR4	4762	UR4IX	7401
230	8		1,1	UR4	4762	UR4IX	7401
250 (from 2317201->2797056	8		0,8	B7S	3710		
255	8		1,1	UR4	4762	UR4IX	7401
260	8		1,1	UR4	4762	UR4IX	7401
270 Tapered Seat	8		1,1	UR4	4762	UR4IX	7401
270 Gasket Seat	8		0,8	B7S	3710		
350 Magnum OF800000-> /Gen+Efi,Mpi	8		0,8	TR4	4392	TR4IX	7300



Cyl.

Order
No.

Iridium

Order
No.**MERCURISER****GM 305,327&350**

350 MagnumSki Carb.	8		1,0	BR6FS	4323		
350 Magnum ->0F799999 / Efi,MP,Mpi	8		1,0	BR6FS	4323		
5.0 L	8		1,0	BR6FS	4323		
5.7 L	8		1,0	BR6FS	4323		
5.7 Ski	8		1,0	BR6FS	4323		

GM 427,454 &502

325 2762442->	8		0,9	R5673-7	4367		
330	8		1,1	UR4	4762	UR4IX	7401
340	8		1,1	UR4	4762	UR4IX	7401
350	8		0,9	R5673-7	4367		
400 Jet	8		1,1	UR4	4762	UR4IX	7401
454 EFi, MP,,Mpi SKI	8		1,1	UR4	4762	UR4IX	7401
7.4 L Efi,MP,Mpi	8		1,1	UR4	4762	UR4IX	7401
7.4 L Hurth	8		1,1	UR4	4762	UR4IX	7401
7.4 L B-W	8		1,1	UR4	4762	UR4IX	7401
8.2 L Carbu. ,Mpi	8		1,1	UR4	4762	UR4IX	7401

Jet Drive

Sportjet 90		1993 - 1995	0,8	BZ7HS-10	3579		
Sportjet 120		1995 -	0,8	BZ7HS-10	3579		
Sportjet 95XR		1996 - 1997	0,8	BZ7HS-10	3579		
Sportjet 120XR		1996 - 1997	0,8	BZ7HS-10	3579		
Sportjet 175XR2		1997 -		BU8H	6431		
Sportjet 175XR2		1997 -		BU8H	6431		

MCM Renault

60	4		0,6	BR7HS	4122	BR7HIX	7067
80	4		0,9	GR5	7537	GR5IX	7214
90	4		0,9	GR5	7537	GR5IX	7214

Mercury

165 224cid	4		0,8	UR5	2139	UR5IX	7177
170 224cid	4		0,8	UR5	2139	UR5IX	7177
180 224cid	4		0,8	UR5	2139	UR5IX	7177
190 224cid	4		0,8	UR5	2139	UR5IX	7177
3.7L 224cid	4		0,8	UR5	2139	UR5IX	7177
3.7LX 224cid	4		0,8	UR5	2139	UR5IX	7177
470 224cid	4		0,8	UR5	2139	UR5IX	7177
485 224cid	4		0,8	UR5	2139	UR5IX	7177
488 224cid	4		0,8	UR5	2139	UR5IX	7177

Mercury 224cid

470 224cid	4		0,9	UR6	4079	UR6IX	7348
------------	---	--	-----	-----	------	-------	------

Stern Drive-Ford 302 & 351

215	8		0,8	AR6FS	3323		
225	8		0,8	AR6FS	3323		



Cyl.



Order No.

Iridium



Order No.

MERCURISER**Stern Drive-Ford 302 & 351**

233 18mm Dia	8		0,8	AR6FS	3323		
255 ->4175498	8		0,8	AR6FS	3323		
255 14mm Dia 4175499->	8		1,1	UR4	4762	UR4IX	7401
255 18mm Dia 4175499->	8		0,8	AR6FS	3323		
888 ->4169596	8		0,8	AR6FS	3323		
888 18mm Dia 4169597->	8		0,8	AR6FS	3323		
888 14mm Dia 4169597->	8		1,1	UR4	4762	UR4IX	7401

Stern Drive-GM 153

110	4		0,9	BR6ES	4922		
120 ->3825578	4		0,9	BR6ES	4922		
120 3825579->	4		1,1	UR4	4762	UR4IX	7401
2.5L	4		1,1	UR4	4762	UR4IX	7401

Stern Drive-GM 194, 230 & 292

140	6		0,9	BR6ES	4922		
150	6		0,9	BR6ES	4922		
160	6		0,9	BR6ES	4922		
165 2771484->	6		1,1	UR4	4762	UR4IX	7401
165 ->2771483	6		0,9	BR6ES	4922		
200	6		0,9	BR6ES	4922		

Stern Drive-GM 229

185	6		1,1	UR4	4762	UR4IX	7401
-----	---	--	-----	-----	------	-------	------

Stern Drive-GM 262

175	6		1,1	UR4	4762	UR4IX	7401
185	6		1,1	UR4	4762	UR4IX	7401
262 Mag. OF80300-> Efi Gen+	6		1,1	TR4	4392	TR4IX	7300
4.3 LX Alpha ->OF80299	6		1,1	UR4	4762	UR4IX	7401
4.3 LX Alpha OF80300-> Gen+	6		1,1	TR4	4392	TR4IX	7300
4.3 LXH Alpha OF80300-> Gen+	6		1,1	TR4	4392	TR4IX	7300
4.3 L Alpha ->OF80299	6		1,1	UR4	4762	UR4IX	7401
4.3 Mpi	6	2002 -	1,1	UR4	4762	UR4IX	7401

Stern Drive-GM 283, 305, 327 & 350

190	8		0,9	XR5	5953	XR5IX	7355
200	8		1,0	BR6FS	4323		
225 2278647->	8		0,9	XR5	5953	XR5IX	7355
225 -> 2278646	8		0,8	B7S	3710		
228	8		1,0	BR6FS	4323		
230	8		1,0	BR6FS	4323		
250 4768000->	8		1,1	UR4	4762	UR4IX	7401
250 -> 2639854	8		0,8	B7S	3710		
255	8		1,1	UR4	4762	UR4IX	7401
260	8		1,0	BR6FS	4323		
270 Tapered Seat	8		0,9	R5673-7	4367		
270 Gasket Seat	8		0,8	B7S	3710		
280	8		1,1	UR4	4762	UR4IX	7401
300 Tempest	8		1,1	UR4	4762	UR4IX	7401



Cyl.

Order
No.

Iridium

Order
No.**MERCUISER*****Stern Drive-GM 283, 305, 327 & 350***

320 Efi	8		1,1	UR4	4762	UR4IX	7401
350 Mag. No.OF602000-> Mpi Gen+	8		1,1	TR4	4392	TR4IX	7300
350 Magnum No.->OF602199 Efi, Mpi	8		1,0	BR6FS	4323		
350 Mag. No.OF800500-> Efi Gen+	8		1,1	TR4	4392	TR4IX	7300
350 Magnum Carburator	8		1,0	BR6FS	4323		
377 Scorpion OL416146->	8		1,1	TR4	4392	TR4IX	7300
5.0L Alpha	8		1,0	BR6FS	4323		
5.0LX Alpha	8		1,0	BR6FS	4323		
5.0L Bravo	8		1,0	BR6FS	4323		
5.0L Mpi	8	2002 -	1,1	TR4	4392	TR4IX	7300
5.7L, LX Bravo, Efi	8		1,0	BR6FS	4323		
5.7LX Bravo Gen+	8		1,1	TR4	4392	TR4IX	7300
5.7L, LX Alpha , Efi	8		1,0	BR6FS	4323		
898	8		1,0	BR6FS	4323		

Stern Drive-GM 427, 454 & 482

325 3043030->	8		0,9	R5673-7	4367		
330 No.3043030->	8		1,1	UR4	4762	UR4IX	7401
330 B-W	8		1,1	UR4	4762	UR4IX	7401
370	8		1,1	UR4	4762	UR4IX	7401
400	8		1,1	UR4	4762	UR4IX	7401
400 Cyclone	8		1,1	UR4	4762	UR4IX	7401
420	8		1,1	UR4	4762	UR4IX	7401
440 Cyclone	8		1,1	UR4	4762	UR4IX	7401
454 Magnum Bravo	8		1,1	UR4	4762	UR4IX	7401
454 Magnum Efi, Mpi	8		1,1	UR4	4762	UR4IX	7401
454 Magnum Alpha	8		1,1	UR4	4762	UR4IX	7401
460 Cyclone	8		0,9	R5673-7	4367		
475 Turbo	8		0,9	R5673-7	4367		
7.4L Alpha	8		1,1	UR4	4762	UR4IX	7401
7.4LX Mpi Bravo	8		1,1	UR4	4762	UR4IX	7401
7.4LX Efi Bravo	8		1,1	UR4	4762	UR4IX	7401
7.4LTR No.OB771113->OC407646	8		1,1	UR4	4762	UR4IX	7401
7.4L Bravo 1,2&3	8		1,1	UR4	4762	UR4IX	7401
HP 425	8		0,9	R5673-7	4367		
HP 450	8		0,9	R5673-7	4367		
HP 525SC	8		0,9	R5673-7	4367		

Stern Drive-GM 502, 540 & 572

502 Magnum Carburator	8		0,9	R5673-7	4367		
502 Magnum Efi,Mp,Mpi	8		0,9	R5673-7	4367		
HP 465	8		0,9	R5673-7	4367		
HP 500 (502cid)	8		0,9	R5673-7	4367		
HP 500 Bulldog (540cid)	8		0,9	R5673-7	4367		
HP 525SC (454cid)	8		0,9	R5673-7	4367		
HP 575	8		0,9	R5673-7	4367		
HP 600SC Bobtail	8		0,9	R5673-7	4367		
HP 800SC (572cid)	8		0,9	R5673-7	4367		
HP 900SC	8		0,9	R5671A-9	7382		



Cyl.

Order
No.

Iridium

Order
No.**MERCUISER***Stern Drive-GMI 181*

140 No. 3826283->	4		1,1	UR4	4762	UR4IX	7401
140 -> No.3826282	4		0,9	BR6ES	4922		
3.0LX Alpha Delco Digital Ign.	4		1,1	TR4	4392	TR4IX	7300
3.0LX Alpha Delco EST Ign.	4		1,1	UR4	4762	UR4IX	7401
3.0L	4		1,1	UR4	4762	UR4IX	7401

MERCURY*273kW Racing Sterndrive*

Scorpion 377 6,2Ltr.	8		0,9	TR4	4392	TR4IX	7300
----------------------	---	--	-----	-----	------	-------	------

350kW Racing Sterndrive

HP500 Bulldog 8,9Ltr.	8		0,9	R5673-7	4367		
HP500 EFI 8,2Ltr.	8		1,1	UR4	4762	UR4IX	7401

410kW Racing Sterndrive

HP575 SCI 8,2Ltr.	8		0,9	R5673-7	4367		
-------------------	---	--	-----	---------	------	--	--

Jet Drive

90hp Sport Jet		1995 -	0,9	BZ7HS-10	3579		
95hp Sport Jet XR		1996 -	0,9	BZ7HS-10	3579		
120hp Sport Jet		1995 -	0,9	BZ7HS-10	3579		
120hp Sport Jet XR		1996 -	0,9	BZ7HS-10	3579		
175hp Sport Jet XR		1997 -		BUZ8H	7447		

NISSAN Marine

HA 120		1987 - 1989	0,9	BR6ES	4922		
--------	--	-------------	-----	-------	------	--	--

O.M.C.

AJ, 14mm Hds, 3/8" Rch. Inboard			0,9	XR5	5953	XR5IX	7355
AJ, 14mm Hds, Taper Seat Inboard			0,9	UR5	2139	UR5IX	7177
AT, 14mm Hds, 3/8" Rch. Inboard			0,9	XR5	5953	XR5IX	7355
AT, 14mm Hds, Taper Seat Inboard			0,9	UR5	2139	UR5IX	7177
TJ, 14mm Hds, 3/8" Rch. Inboard			0,9	XR5	5953	XR5IX	7355
TJ, 14mm Hds, Taper Seat Inboard			0,9	UR5	2139	UR5IX	7177
TT, 14mm Hds, 3/8" Rch. Inboard			0,9	XR5	5953	XR5IX	7355
TT, 14mm Hds, Taper Seat Inboard			0,9	UR5	2139	UR5IX	7177

Jet Drive

Turbojet 115			0,8	BZ7HS-10	3579	---	---
Turbojet 90			0,8	BZ7HS-10	3579	---	---

Sail Drive

15S10G		1977 - 1984	1,1	BPR6HS	7022	BPR6HIX	4085
15S10S		1977 - 1984	1,1	BPR6HS	7022	BPR6HIX	4085
15S11C		1977 - 1984	1,1	BPR6HS	7022	BPR6HIX	4085
15S13A		1977 - 1984	1,1	BPR6HS	7022	BPR6HIX	4085
15S14M		1977 - 1984	1,1	BPR6HS	7022	BPR6HIX	4085



Cyl.

Order
No.

Iridium

Order
No.**O.M.C.***Sea Drive*

1.6L 115-SD	1985 - 1991	0,8	BZ7HS-10	3579	---	---
1.8L 140-SD	1985 - 1991	0,8	BZ7HS-10	3579	---	---
2.0L 140-SD	1985 - 1991	0,8	BZ7HS-10	3579	---	---
2.7L 225-SD	1987 -	0,8	BZ7HS-10	3579	---	---
3.0L 225-SD	1985 - 1991	0,8	BZ7HS-10	3579	---	---
3.6L 275-SD	1987 - 1981	0,8	BZ7HS-10	3579	---	---
4.0L 300-SD	1985 - 1991	0,8	BZ7HS-10	3579	---	---

Stern Drive

14mm Hds, 3/4" Rch.	1973 - 1974	0,9	B6ES	7310	---	---
14mm Hds, Taper Seat	1973 - 1985	0,9	UR5	2139	UR5IX	7177
18mm Hds, Taper Seat	1974 -	0,7	AR6FS	3323	---	---
2.3L Cobra Stern Drive	1987 - 1990	0,9	TR5	7837	TR5IX	7397
3.0L Cobra Stern Drive	1987 - 1992	1,1	UR4	4762	UR4IX	7401
3.0L Cobra Stern Drive	1993 - 1994	1,1	TR5	7837	TR5IX	7397
3.0L Cobra HO	1990 - 1995	1,1	TR5	7837	TR5IX	7397
4.3L Cobra	1986 - 1995	0,9	UR4	4762	UR4IX	7401
4.3L Cobra HO	1990 - 1991	0,9	UR4	4762	UR4IX	7401
4.3L Cobra HO	1993 - 1994	1,1	UR4	4762	UR4IX	7401
4.3L Stinger	1978 - 1986	0,8	UR4	4762	UR4IX	7401
480		0,7	B8S	3810	---	---
5.0L Cobra	1986 - 1995	0,9	UR4	4762	UR4IX	7401
5.0L Cobra EFI	1993 - 1995	1,1	TR5	7837	TR5IX	7397
5.0L Cobra HO	1989 - 1995	0,9	UR4	4762	UR4IX	7401
5.7L Cobra	1986 - 1992	0,9	UR4	4762	UR4IX	7401
5.7L K	1993 - 1995	1,1	UR4	4762	UR4IX	7401
5.7L King Cobra	1986 - 1992	0,9	UR4	4762	UR4IX	7401
5.8L Cobra	1989 - 1995	0,9	UR4	4762	UR4IX	7401
5.8L Cobra EFI	1992 - 1995	1,1	TR5	7837	TR5IX	7397
5.8L King Cobra EFI HO	1993 - 1995	1,1	TR5	7837	TR5IX	7397
7.4L Cobra	1990 - 1994	1,1	UR4	4762	UR4IX	7401
7.4L Cobra HO	1991 - 1993	1,1	UR4	4762	UR4IX	7401
7.4L King Cobra	1995 -	1,1	UR4	4762	UR4IX	7401
7.4L King Cobra EFI	1995 -	1,1	UR4	4762	UR4IX	7401
7.5L Cobra	1986 - 1990	0,9	UR4	4762	UR4IX	7401
8.2L King Cobra	1992 - 1994	1,1	UR4	4762	UR4IX	7401
CU		0,9	B6ES	7310	---	---
DU		0,7	B8S	3810	---	---
GU		0,9	B6ES	7310	---	---
HU		0,9	XR5	5953	XR5IX	7355
JU		0,9	BR6FS	4323	---	---
KU		0,9	B6S	3510	---	---
LU		0,9	B6ES	7310	---	---
NU		0,6	BP6ES	7811	BPR6EIX	6637
Stinger	1978 - 1986	0,9	UR4	4762	UR4IX	7401
SU		0,9	B6ES	7310	---	---
TU-14		0,9	XR5	5953	XR5IX	7355
TU-15		0,9	XR5	5953	XR5IX	7355
TU-16		0,9	XR5	5953	XR5IX	7355
TU-17		0,9	B6S	3510	---	---
TU-20		0,9	BR6FS	4323	---	---



Cyl.



Order No.

Iridium



Order No.

O.M.C.**Stern Drive**

TU-21			0,9	BR6FS	4323	---	---
VU			0,9	B6ES	7310	---	---
WU			0,9	BR6FS	4323	---	---
XU-20C			0,9	BR6FS	4323	---	---
XU20S			0,9	B6S	3510	---	---

PALMER-GREENW.

M196 , M265 , M392			0,8	B6S	3510		
M304, M345, MKIV-115, MKVI-150			0,8	B6S	3510		
M549 , M345B , M392B			0,8	B6S	3510		
MKVIII: 200 , 225 , 275 , 300			0,8	B6S	3510		
P302 , P351			0,8	AP6FS	2710		
PA190 , PA220 , PA255			0,8	AR6FS	3323		
PA350			0,8	BPR5FS	2423		
PB-V-215 (V-8)	8		0,9	B6HS	4510	BR6HIX	3419
PW27 (14mm)			0,8	BP5S	3011		
PW27 (18mm)			0,8	A6	1010		
Y304 , Y345 , Y392			0,8	B6S	3510		

PANTER

400 Plus C		1976 - 1980	1,1	UR4	4762	UR4IX	7401
400 Plus-F		1976 - 1980	0,8	UR5	2139	UR5IX	7177
500 Plus		1976 - 1980	1,1	UR4	4762	UR4IX	7401
500 Plus-7		1978 - 1980	0,9	R5673-7	4367		
F 110		1978 - 1980	1,1	UR4	4762	UR4IX	7401
F 140		1978 - 1980	1,1	UR4	4762	UR4IX	7401
F 185		1976 - 1980	0,9	BPR5ES	7422	BPR5EIX	6597
F 235		1976 - 1980	0,9	BPR5ES	7422	BPR5EIX	6597
M 360		1976 - 1980	0,9	BPR5ES	7422	BPR5EIX	6597
M 405		1976 - 1980	1,1	UR4	4762	UR4IX	7401
M 454		1976 - 1980	1,1	UR4	4762	UR4IX	7401
M 460		1976 - 1980	0,8	UR5	2139	UR5IX	7177

PCM

150 cid			1,1	UR4	4762	UR4IX	7401
200 cid			1,1	UR4	4762	UR4IX	7401
220 cid			1,1	UR4	4762	UR4IX	7401
229 cid			1,1	UR4	4762	UR4IX	7401
230 cid			1,1	UR4	4762	UR4IX	7401
250 cid			1,1	UR4	4762	UR4IX	7401
280 cid			1,1	UR4	4762	UR4IX	7401
302 cid	14mm		1,1	UR4	4762	UR4IX	7401
302 cid	18mm		0,8	AR6FS	3323		
305 cid			1,1	UR4	4762	UR4IX	7401
350 cid			1,1	UR4	4762	UR4IX	7401
350 cid			1,1	UR4	4762	UR4IX	7401
351 cid	14mm		1,1	UR4	4762	UR4IX	7401
351 cid	18mm		0,8	AR6FS	3323		



Cyl.

Order
No.

Iridium

Order
No.**PCM**

454 cid			1,1	UR4	4762	UR4IX	7401
460 cid	14mm		1,1	UR4	4762	UR4IX	7401
460 cid	18mm		0,8	AR6FS	3323		
5.7L HO MPI			1,1	TR4	4392	TR4IX	7300
5.7L HO Ski TBI	275hp		1,1	UR4	4762	UR4IX	7401
5.8L Carburator	260hp		0,7	UR6	4079	UR6IX	7348
5.8L HO MPI	310hp		1,1	TR4	4392	TR4IX	7300
7.4L MPI			1,1	TR4	4392	TR4IX	7300
7.4L Carburator			1,1	UR4	4762	UR4IX	7401
7.4L HO TBI	350hp		1,1	UR4	4762	UR4IX	7401

PERFORMANCE JET SYSTEM

Viper 5000			0,8	BR8ES	5422	BR8EIX	5044
Viper 6000			0,8	BR8ES	5422	BR8EIX	5044
Viper 7000			0,8	BR8ES	5422	BR8EIX	5044
Viper 8000			0,8	BR8ES	5422	BR8EIX	5044
Viper 9000			0,8	BR8ES	5422	BR8EIX	5044

PIAGGIO

Idrogetto (2-cyl. + 3-cyl.)			0,5	B7ES	1111		
KS 150 , KS 200			0,6	B7ES	1111		

PMC

<i>Chrysler</i>							
225 cid	Gasket Seat		0,9	BR6ES	4922		
225 cid	Tapered Seat		0,7	UR6	4079	UR6IX	7348
318 cid			0,9	BPR5ES	7422	BPR5EIX	6597
340 cid			0,9	GR5	7537	GR5IX	7214
360 cid			0,9	BPR5ES	7422	BPR5EIX	6597
440 cid			0,9	XR4	2637	XR4IX	7189
<i>Ford</i>							
302 cid	14mm		1,1	UR4	4762	UR4IX	7401
302 cid	18mm		0,8	AR6FS	3323		
351 cid	14mm		1,1	UR4	4762	UR4IX	7401
351 cid	18mm		0,8	AR6FS	3323		
390 cid			0,8	WR5	1071	WR5IX	7510
460 cid	14mm		1,1	UR4	4762	UR4IX	7401
460 cid	18mm		0,8	AR6FS	3323		
5.8L HO EFI			0,9	BPR6EFS	3623		
<i>GM</i>							
229 cid		6	1,1	UR4	4762	UR4IX	7401
250 cid			0,7	BPR5FS	2423		
305 cid			1,1	UR4	4762	UR4IX	7401
307 cid	Gasket Seat		1,0	XR4	2637	XR4IX	7189
307 cid	Tapered Seat		1,1	UR4	4762	UR4IX	7401
350 cid			1,1	UR4	4762	UR4IX	7401



Cyl.



Order No.

Iridium



Order No.

PMC

<i>GM</i>							
350 cid	Efi			1,1	UR4	4762	UR4IX 7401
4.3L		6		1,1	UR4	4762	UR4IX 7401
454 cid				1,1	UR4	4762	UR4IX 7401

POLARIS

<i>Jet Drive</i>							
Optimax 3.0L 250 h p	EX2100/LE2100			1,1	PZFR5F-11	4363	

POWER PRODUCTS

626				0,6	B6S	3510	
1000				0,6	B4	3210	
3000				0,6	B6L	3212	

REDLINE

5.0L 302 cid				0,9	BPR6FS	2632	---
5.8L 351 cid				0,9	BPR6FS	2632	---
5.8L 351 cid HO				1,0	BPR6EFS	3623	---
7.5L 460 cid				0,9	BPR6FS	2632	---

RENAULT/COUACH

RC25 , RC30				0,6	BP6HS	4511	BPR6HIX 4085
RC6 , RC8 , RC15				0,6	A6	1010	

REVLEY

R225 , R300 , R401				0,9	BP5S	3011	
--------------------	--	--	--	-----	------	------	--

ROLLS ROYCE

LM 841				0,9	B6ES	7310	
V8 Marine	8			0,6	B6ES	7310	

SALSBURY

all models				0,6	B4	3210	
------------	--	--	--	-----	----	------	--

SCRIPPS

(14mm)				0,6	B6S	3510	
(18mm)				0,6	A6	1010	

SEADRIVE

1100				0,6	B6ES	7310	
------	--	--	--	-----	------	------	--



Cyl.

Order
No.

Iridium

Order
No.**SEAFARER**

Seafarer

0,5

B6ES**7310****SEAMASTER**

300 , 534

0,8

A6FS**2210****ST.LAWRENCE**

(14mm)

0,6

B6L**3212**

(18mm)

0,6

A6**1010****STARBUCK BOATS**

350 cid

1,1

UR4**4762****UR4IX****7401**

454 cid

0,9

UR5**2139****UR5IX****7177****STOKES**

Willys Tornado

0,6

B6HS**4510****BR6HIX****3419****STUART TURNER**

other models (14mm)

0,6

B6HS**4510****BR6HIX****3419**

other models (18mm)

0,5

A6**1010**

P6 , P66 , R3M , ST4M

0,5

B6HS**4510****BR6HIX****3419****TEMPEST**

Vedette Mk8

0,6

B6ES**7310****TOYOTA**

Epic VT300i 4,0Ltr.

8

1,1

PFR5G-11**2647**

Epic 21 4.0L 300 hp

1,1

IFR6T-11**4589**

Epic 22 4.0L 300 hp

1,1

IFR6T-11**4589**

S22 4.0L 300 hp

1,1

IFR6T-11**4589**

X22 4.0L 300 hp

1,1

IFR6T-11**4589****TURBO MARINE***Ford*

104 cid

1973 -

0,9

GR5**7537****GR5IX****7214**

302 cid Escort

8

1973 -

0,8

AR6FS**3323***Kohler*

K-399-2

1971 - 1973

0,8

A6**1010****UNIVERSAL**

Arrow

0,9

B6S**3510**

Atomic 1

0,9

B6S**3510**



Cyl.



Order No.

Iridium



Order No.

UNIVERSAL

Atomic 2			0,9	B6S	3510	---	---
Atomic 3			0,9	B6S	3510	---	---
Atomic 4			0,9	B6S	3510	---	---
Atomic Stevedore			0,9	B6S	3510	---	---
Big King			0,9	WR5	1071	WR5IX	7510
Bluefin			0,9	B6S	3510	---	---
Bullit			0,9	B6S	3510	---	---
Colt			0,9	B6S	3510	---	---
DX Super Sabre			0,9	XR5	5953	XR5IX	7355
Elf			0,7	B6S	3510	---	---
Knight			0,7	B6S	3510	---	---
LEV 188 hp			0,7	B6S	3510	---	---
LEVH 188 hp			0,7	B6S	3510	---	---
Little King			0,7	B6S	3510	---	---
Marlin			0,7	B6S	3510	---	---
NKEV 277 hp			0,9	WR5	1071	WR5IX	7510
Sabre 198 cid 140 hp			0,9	XR5	5953	XR5IX	7355
Strato King			0,7	B6S	3510	---	---
Super Sabre 225 cid 155 hp			0,9	XR5	5953	XR5IX	7355
Tarpon			0,7	B6S	3510	---	---
Z-Drive			0,9	B6S	3510	---	---

US MARINE

181 F 3.0L			0,9	BR6ES	4922		
305 cid 5.0L 225 hp			0,9	BR6FS	4323		
305 K 5.0L			0,8	UR5	2139	UR5IX	7177
350 K 5.7L			1,1	UR4	4762	UR4IX	7401
351 cid 5.8L 240 hp			1,0	UR5	2139	UR5IX	7177
454 cid 7.4L 330 hp			0,9	BR6FS	4323		
454 7.5L			1,1	UR4	4762	UR4IX	7401

VALMET

BVRE (6 PS) , BVR (6 PS)			0,5	B6HS	4510	BR6HIX	3419
Vire 70E (7 PS)			0,7	B6HS	4510	BR6HIX	3419

VOLVO PENTA

<i>AQ Series</i>							
80			0,8	BR6S	3522		
90			0,8	BR6HS	3922		
95 A			0,8	BPR6HS	7022	BPR6HIX	4085
95			0,8	BPR6HS	7022	BPR6HIX	4085
100			0,8	BPR6HS	7022	BPR6HIX	4085
105 A			0,8	BPR7HS	6422	BPR7HIX	5944
110			0,8	BPR7HS	6422	BPR7HIX	5944
115 A			0,8	BPR7HS	6422	BPR7HIX	5944
120 (B21)			0,9	GR5	7537	GR5IX	7214
120			0,8	BPR7HS	6422	BPR7HIX	5944
125 A / B			0,9	GR5	7537	GR5IX	7214
130 / A / B / C / D			0,8	BPR7HS	6422	BPR7HIX	5944



Cyl.

Order
No.

Iridium

Order
No.**VOLVO PENTA***AQ Series*

131 / A / B / C / D		0,9	GR5	7537	GR5IX	7214
140 / A		0,9	GR5	7537	GR5IX	7214
145 / A / B		0,9	GR5	7537	GR5IX	7214
145		0,9	GR5	7537	GR5IX	7214
150 A / B		0,9	XR4	2637	XR4IX	7189
151 / A / B / C		0,9	GR5	7537	GR5IX	7214
165 A		0,8	BPR7HS	6422	BPR7HIX	5944
170 / A / B / C		0,8	BPR7HS	6422	BPR7HIX	5944
171 / A / C		0,9	GR5	7537	GR5IX	7214
175 / A		1,1	UR4	4762	UR4IX	7401
180		0,9	XR5	5953	XR5IX	7355
190 Ford		1,1	UR4	4762	UR4IX	7401
190 A Ford		0,6	AR6FS	3323		
200 / A / B / C / D / F		0,7	UR6	4079	UR6IX	7348
205 A		1,1	UR4	4762	UR4IX	7401
210 A No. 177315->		0,7	UR6	4079	UR6IX	7348
210 A -> No.177314		0,9	XR5	5953	XR5IX	7355
211 / A / DP		1,1	UR4	4762	UR4IX	7401
225 D 305cid		1,0	BR6FS	4323		
225 E / F		1,1	UR4	4762	UR4IX	7401
225 / A / C		0,7	UR6	4079	UR6IX	7348
230 A		0,9	BPR6ES	7822	BPR6EIX	6637
231 / DP		1,1	UR4	4762	UR4IX	7401
231 A / B		1,1	UR4	4762	UR4IX	7401
240 A Ford		0,7	UR5	2139	UR5IX	7177
255 B		0,7	UR6	4079	UR6IX	7348
260 A / B		1,1	UR4	4762	UR4IX	7401
271 A / B / C / D		1,1	UR4	4762	UR4IX	7401
271 / DP		1,1	UR4	4762	UR4IX	7401
280 A		0,7	UR6	4079	UR6IX	7348
290 A / B		1,1	UR4	4762	UR4IX	7401
311 A / B		1,1	UR4	4762	UR4IX	7401
430		1,1	UR4	4762	UR4IX	7401
500 A		1,1	UR4	4762	UR4IX	7401
501 A		1,1	UR4	4762	UR4IX	7401
531		1,1	UR4	4762	UR4IX	7401
570 A		1,1	UR4	4762	UR4IX	7401
571 A		1,1	UR4	4762	UR4IX	7401
572		1,1	UR4	4762	UR4IX	7401
740 A		1,1	UR4	4762	UR4IX	7401

B / BB Series

16 A / C		0,9	BP4	2911		
18 A / C		0,7	BR7HS	4122	BR7HIX	7067
25		0,8	BR6S	3522		
30 B		0,7	BR7HS	4122	BR7HIX	7067
70 sustained full throttle		0,8	B6S	3510		
70		0,8	BR6S	3522		
100 / A		0,8	BR6HS	3922		
115 / A / B		0,8	BPR7HS	6422	BPR7HIX	5944
140		0,8	BPR7HS	6422	BPR7HIX	5944
145 / A		0,9	BPR6ES	7822	BPR6EIX	6637



Cyl.

Order
No.

Iridium

Order
No.**VOLVO PENTA***B / BB Series*

165 A		0,8	BPR7HS	6422	BPR7HIX	5944
170 A / B / C		0,8	BPR7HS	6422	BPR7HIX	5944
225 A / B / C		1,1	UR4	4762	UR4IX	7401
231 A		1,1	UR4	4762	UR4IX	7401
260 A / B / C		1,1	UR4	4762	UR4IX	7401
261		1,1	UR4	4762	UR4IX	7401

C Series

C5		0,7	A7	1110		
C10		0,7	A7	1110		
C23		0,7	A7	1110		

DP Series

4.3L GIPNCS. 708" Reach		0,9	TR4	4392	TR4IX	7300
4.3L GIPNCA. 460" Reach		1,1	UR4	4762	UR4IX	7401
5.0L FL		1,1	UR4	4762	UR4IX	7401
5.0L Fi		0,9	TR4	4392	TR4IX	7300
5.7L Gi / GL / GLi / GS		1,1	UR4	4762	UR4IX	7401
5.7L Gsi		0,9	TR4	4392	TR4IX	7300
5.8L FL		1,1	UR4	4762	UR4IX	7401
5.8L Fsi		0,9	BPR6EFS	3623		
7.4L Gi / GL		1,1	UR4	4762	UR4IX	7401
8.2L GSi		1,1	UR4	4762	UR4IX	7401

DPX Series

7.4L DPX 385		1,1	UR4	4762	UR4IX	7401
8.2L 525		0,9	R5673-7	4367		
8.2L 600		0,9	R5673-7	4367		
8.2L 500		0,9	R5673-7	4367		
8.2L DPX 415		1,1	UR4	4762	UR4IX	7401

Inboard Series

5.8L FSi / HS1		0,9	BPR6EFS	3623		
5.7L Gi	2002 -	1,1	UR4	4762	UR4IX	7401
5.7L Gsi / Gxi	2002 -	1,1	TR4	4392	TR4IX	7300
5.8L FL / HS1		1,1	UR4	4762	UR4IX	7401
7.4L GL / Gi / HS1		1,1	UR4	4762	UR4IX	7401
8.1L Gi / Gsi	2002 -	1,1	TR4	4392	TR4IX	7300
8.2L GL / HS1	2002 -	1,1	UR4	4762	UR4IX	7401

M Series

AQ 60 F Kerosine engine		0,9	B5HS	4210		
B 18 F Kerosine engine		0,9	B5HS	4210		
BB 30 F Kerosine engine		0,9	B5HS	4210		
MB 10 / A		0,6	BP5HS	4111		
MB 20 / A / B / C		0,8	BPR6HS	7022	BPR6HIX	4085
MB 36 / A / B		0,9	XR5	5953	XR5IX	7355
MB 250S Sail Drive		0,6	D6HA	6512		
PZ-200 I / O W / Chevrolet 305 cid		1,1	UR4	4762	UR4IX	7401



Cyl.

Order
No.

Iridium

Order
No.**VOLVO PENTA***Ocean Series*

4.3L OSi-XDP GM V-6	6	2002 -	0,9	TR4	4392	TR4IX	7300
5.0L OSi-XDP GM V-8	8	2002 -	0,9	TR4	4392	TR4IX	7300
5.7L OXSi-XDP GM V-8	8	2002 -	0,9	TR4	4392	TR4IX	7300
5.7L OSi-XDP GM V-8	8	2002 -	0,9	TR4	4392	TR4IX	7300

PJX Water Jet

4.3L Gi / GS			1,1	UR4	4762	UR4IX	7401
--------------	--	--	-----	-----	------	-------	------

SX Cobra Series

3.0L GS			1,1	TR4	4392	TR4IX	7300
4.3L GIPNCA. 460" Reach			1,1	UR4	4762	UR4IX	7401
4.3L GIPNCS. 708" Reach			1,1	TR4	4392	TR4IX	7300
5.0L Fi			1,1	TR4	4392	TR4IX	7300
5.0L FL			1,1	UR4	4762	UR4IX	7401
5.7L Gi / GL / GLi / GS			1,1	UR4	4762	UR4IX	7401
5.7L Gsi			1,1	TR4	4392	TR4IX	7300
5.8L Fi / Fsi			0,9	BPR6EFS	3623		
5.8L FL			1,1	UR4	4762	UR4IX	7401
7.4L Gi / GL / Gsi			1,1	UR4	4762	UR4IX	7401
8.2L Gsi			1,1	UR4	4762	UR4IX	7401

WAUKESHA

155 hp / WAR / WLA / 302/2B			0,8	AR6FS	3323		
165 hp / 302/2A			0,8	AR6FS	3323		
165 hp / WRE / WLE			0,8	AR6FS	3323		
185 hp / 302/ 2			0,8	AR6FS	3323		
185 hp / WRB / WLB			0,8	AR6FS	3323		
215 hp / WRC / WLC /302/4			0,8	AR6FS	3323		
255 hp / WRD / WLD /351/4			0,8	AR6FS	3323		
350 hp / 460/4			0,9	UR5	2139	UR5IX	7177
350 hp / WRF / WLF			0,9	UR5	2139	UR5IX	7177

WEST BEND

Shark-o-Matic			0,8	BR6S	3522		
---------------	--	--	-----	------	------	--	--

WICKSTROM

W 1 / 2 / 3			0,7	A6	1010		
-------------	--	--	-----	----	------	--	--

WORTHAM BLAKE

Dolphin Mk.2	4		0,9	BPR5ES	7422	BPR5EIX	6597
Dolphin V6	6		0,5	GR5	7537	GR5IX	7214
Fisherboy 4 OHV	4		0,5	GR5	7537	GR5IX	7214
Fisherboy 4 SV			0,6	B6HS	4510	BR6HIX	3419
Sprite	4		0,9	BPR5ES	7422	BPR5EIX	6597
Sprite 4	4		0,9	GR5	7537	GR5IX	7214



Cyl.



Order No.

Iridium



Order No.

YAMAHA

AR 210	1200cc	2003 -	0,8	BR8HS	4322	BR8HIX	7001
Exciter 135	1200cc	1998 - 1999	0,8	BR8HS	4322	BR8HIX	7001
Exciter 220	1100cc	1996 - 1998	0,8	BR8HS	4322	BR8HIX	7001
Exciter 227	1200cc	1998 - 1999	0,8	BR8HS	4322	BR8HIX	7001
LS 2000	1200cc	1999 -	0,8	BR8HS	4322	BR8HIX	7001
LS 210	1200cc	2003 -	0,8	BR8HS	4322	BR8HIX	7001
LX 2000	1200cc	2002 -	0,8	BR8HS	4322	BR8HIX	7001
SR 230	999cc	2003 -	0,8	CR9EB	6955		
XR 1800	1200cc	2000 - 2001	1,0	BR8HS-10	1134		

Stern Drive

L4 3.0L All		4	0,8	BR6FS	4323		
V6 All		6	0,8	BR6FS	4323		
V8 All		8	0,8	BR6FS	4323		



Cyl.

Order
No.

Iridium

Order
No.**AERO MARINE**

AM 4000	4 PS	1970 - 1973	0,9	BP5S	3011		
AM 5000 M, AM 5000 E	5 PS	1970 - 1972	0,9	B6L	3212		
AM 7500M, AM 7500E	7,5 PS	1970 - 1973	0,9	BM6A	5921		
AM 9000	9 PS	1971 - 1973	0,6	BM6A	5921		
Jet Pak		1971 - 1973	0,9	BP5S	3011		

AILSA CRAIG

AL-23			0,6	A6	1010		
0-11, 0-21, 0-22, 0-41, 0-411			0,6	A6	1010		

AIRBOY

120			0,8	B6L	3212		
20, 40, 90 (B S)			0,8	B6S	3510		
50			0,8	B6S	3510		
90 (OMC)			0,8	AP5FS	2610		

ALSPORT

14mm			0,8	BR6HS	3922	BR6HIX	3419
18mm			0,8	A7	1110		

APACHE

J 5			0,8	BR6S	3522		
J 9			0,8	BR6S	3522		

ARKOS

Aquascooter			0,5	B6HS	4510	BR6HIX	3419
-------------	--	--	-----	-------------	-------------	---------------	-------------

ARROW

4, 5.5, 7.5 PS			0,5	BP5S	3011		
----------------	--	--	-----	-------------	-------------	--	--

BEAVER

2.0 hp			0,8	BR6S	3522		
4.0 hp			0,7	BM4A	5628		
5.5 hp			0,7	XR4	2637	XR4IX	7189
7.5 hp			0,7	XR4	2637	XR4IX	7189
9.0 hp			0,7	XR4	2637	XR4IX	7189

BIANCHI

125 CC			0,5	B6S	3510		
--------	--	--	-----	------------	-------------	--	--



Cyl.



Order No.

Iridium



Order No.

BLUEJET

3.5 hp	1961 -	0,8	BR6S	3522		
5.0 hp	1963 -	0,7	BM4A	5628		

BOATIMPELLER

all models		0,5	A6	1010		
------------	--	-----	----	------	--	--

BOMBARDIER

Speedster 20	Mot. 1503	0,7	DCPR8E	4339		
Sportster 4-TEC	Mot. 1503	0,7	DCPR8E	4339		
Sportster LE-Di	Mot. 947Di	1,1	ZFR4F-11	4043		

BRIT. SEAGULL

125, 160, 170		0,8	B7ES	1111		
45, 55, 60, 75, 80, 90		0,5	A6	1010		
Century, /Plus, Featherweight		0,5	A6	1010		
Century, /Plus, Featherweight		0,5	A6	1010		
Forty Plus (CD ign. -'80)		0,5	A6	1010		
Forty Plus (Magneto ign. -'80)		0,5	A6	1010		
Minor BM		0,5	B6HS	4510	BR6HIX	3419
QB serie: Curlew, Osprey		0,8	B7ES	1111		
QB serie: Kingfisher		0,8	B7ES	1111		

BRITISH ANZANI

180	18 PS	0,7	B6L	3212		
65		0,7	B6S	3510		
Fleetwin, Unitwin, 400		0,6	B6HS	4510	BR6HIX	3419
Pilot 1, 2, 3, 4		0,6	B6HS	4510	BR6HIX	3419
Pilot 30 Minor Seamaid, Jet 3		0,6	B6HS	4510	BR6HIX	3419
Seasprite, Supertwin, Magnitwin		0,6	B6HS	4510	BR6HIX	3419
Super Single, Super Snipe		0,6	A6	1010		
Triton		0,6	B6ES	7310		

CAL-JET

Econojet, Ramjet		0,8	B6S	3510		
------------------	--	-----	-----	------	--	--

CARNITI

18, 280CN, 45, 55, 65, 80		0,5	B8HS	5510	BR8HIX	7001
25, 40, 50, 70, 85, 100 PS		0,5	B6HS	4510	BR6HIX	3419
3, 3.5, 5, 8, 9.5, 15, 20 PS		0,5	B6HS	4510	BR6HIX	3419
45S, 65S, 80S		0,8	B9HS	5810		
700Sport, 850Sport, 1000Sport		0,5	B8HS	5510	BR8HIX	7001



Cyl.

Order
No.

Iridium

Order
No.**CARNITS**

90.0 hp			0,8	BR6HS	3922	BR6HIX	3419
---------	--	--	-----	-------	------	--------	------

CHIEF

J-200/300/350/400/500/700			0,8	BM6A	5921		
J-5			0,8	BM6A	5921		
J-9			0,8	BP5S	3011		
K-150/200/300/400/990			0,8	BM6A	5921		
K-201	1976 - 1978		0,6	BP5S	3011		
K-350	1976 - 1978		0,6	BM6A	5921		
K-500, K-700, K-750	1973 -		0,8	BM6A	5921		
K-500, K-700, K-750	1974 - 1975		0,8	BP5S	3011		
K-505, K-550, K-751	1976 - 1978		0,6	BP5S	3011		
K-753, K-900	1976 - 1978		0,6	BP5S	3011		

CHRIS-CRAFT

Challenger, Commander			0,7	B6S	3510		
-----------------------	--	--	-----	-----	------	--	--

CHRYSLER

3.5PS Economate Std.Ign.	1980 - 1986		0,8	BR6HS	3922	BR6HIX	3419
4.0PS	1976 - 1986		0,8	BR6HS	3922	BR6HIX	3419
5.0PS	1974 - 1976		0,8	BR5HS	3722		
6.0PS	1971 - 1977		0,8	BR6HS	3922	BR6HIX	3419
6.0PS	1978 - 1986		0,8	BR6HS	3922	BR6HIX	3419
7.5PS	1978 - 1983		0,8	BR6HS	3922	BR6HIX	3419
8.0PS	1971 - 1977		0,8	B7HS	5110	BR7HIX	7067
8.0PS	1978 - 1981		0,8	BR6HS	3922	BR6HIX	3419
9.9PS	1968 - 1986		0,8	BR6HS	3922	BR6HIX	3419
4.4PS	1968 -		0,8	BR6HS	3922	BR6HIX	3419
4.5PS	1972 -		0,8	BR6HS	3922	BR6HIX	3419
4.9PS	1973 - 1975		0,8	BR5HS	3722		
5.0PS	1969 - 1970		0,8	BR6HS	3922	BR6HIX	3419
6.0PS	1965 - 1967		0,8	BR5HS	3722		
6.6PS	1968 -		0,8	BR6HS	3922	BR6HIX	3419
7.0PS	1969 - 1970		0,8	BR6HS	3922	BR6HIX	3419
9.0PS	1965 -		0,8	BR6S	3522		
9.2PS	1966 - 1967		0,8	BR6S	3522		
10.0PS	1974 - 1978		0,8	BR6HS	3922	BR6HIX	3419
12.9PS	1971 - 1973		0,8	BR6HS	3922	BR6HIX	3419
12PS	1979 -		0,8	BR6HS	3922	BR6HIX	3419
15PS	1974 - 1984		0,8	BR6HS	3922	BR6HIX	3419
20PS	1965 - 1967		0,8	BR6S	3522		
20PS	1968 - 1982		0,8	BR6HS	3922	BR6HIX	3419
25PS	1973 - 1984		0,8	BR6HS	3922	BR6HIX	3419
30PS	1973 - 1982		0,8	BR6HS	3922	BR6HIX	3419
35PS	1965 - 1967		0,8	BR6S	3522		
35PS	1968 - 1984		0,8	BR6HS	3922	BR6HIX	3419
45PS	1965 - 1967		0,8	BR6S	3522		
45PS	1968 - 1984		0,8	BR6HS	3922	BR6HIX	3419



Cyl.



Order No.

Iridium



Order No.

CHRYSLER

45PS Magneto	1971 - 1978	0,8	BR6HS	3922	BR6HIX	3419
50PS	1965 - 1966	0,8	BR6S	3522		
50PS	1981 - 1984	0,8	BR6HS	3922	BR6HIX	3419
55PS Std Ign	1967 - 1976	0,8	B6HS	4510	BR6HIX	3419
55PS Magneto	1969 - 1980		BUHX	2522		
55PS	1980 - 1983		BUHW	2622		
60PS	1974 - 1976		BUHX	2522		
60PS	1984 -		BUHW	2622		
65PS	1977 - 1978		BUHX	2522		
70PS	1969 - 1973		BUHW	2622		
70PS	1979 - 1980		BUHW	2622		
75PS	1966 - 1967	0,8	BR6S	3522		
75PS	1968 -		BUHX	2522		
75PS	1974 - 1984		BUHW	2622		
80PS	1965 -	0,8	BR6S	3522		
85PS	1969 - 1973		BUHW	2622		
85PS	1977 - 1984		BUHW	2622		
90PS	1974 - 1977		BUHW	2622		
90PS	1983 - 1984		BUHW	2622		
100PS	1979 - 1984		BUHW	2622		
105PS	1966 - 1967	0,8	BR6S	3522		
105PS	1968 - 1974		BUHW	2622		
105PS	1975 - 1976		BUHX	2522		
105PS	1976 - 1983		BUHW	2622		
115PS	1977 - 1982		BUHW	2622		
115PS	1983 - 1984		BUHX	2522		
120PS	1977 - 1982		BUHW	2622		
125PS	1981 -		BUHX	2522		
130PS	1972 - 1973		BUHW	2622		
135PS	1969 - 1971		BUHW	2622		
135PS	1974 - 1977		BUHW	2622		
140PS	1978 - 1984		BUHW	2622		
150PS	1972 - 1976		BUHW	2622		

CLINTON

AJ-9, BJ-9, J-200, J-300		0,8	BM6A	5921		
J-350/400/500/700		0,8	BM6A	5921		
J-5		0,8	BM6A	5921		
J-7, J-8		0,8	B6L	3212		
J-9		0,8	B2	3110		
K-150	1976 - 1978	0,6	BM7A	6521		
K-150/200/300/400/990		0,8	BM6A	5921		
K-201	1976 - 1978	0,6	B2	3110		
K-350	1976 - 1978	0,6	BM6A	5921		
K-500, K-700, K-750	1973 -	0,8	BM6A	5921		
K-500, K-700, K-750	1974 - 1975	0,8	BP5S	3011		
K-505, K-550, K-751	1976 - 1978	0,6	BP5S	3011		
K-753, K-900	1976 - 1978	0,6	BP5S	3011		
W-100, W-140, W-250		0,6	B6HS	4510	BR6HIX	3419



Cyl.

Order
No.

Iridium

Order
No.**COAST TO COAST**

4.6 hp

1965 -

0,8

BR6S**3522****COLT**

3.0 hp

1963 -

0,8

BR6S**3522**

5.0 hp

1963 -

0,9

BM4A**5628****COMMODORE**

18.0 hp

0,8

BR6S**3522**

40.0 hp

0,8

BR6S**3522****COV. CLIMAX**

FWA Mk.III, PPF

0,6

B8ES**2411****BR8EIX****5044**

FWM 750 cc

0,6

B6ES**7310****COV. VICTOR**

14 mm, M14 x 12,7

0,6

B6HS**4510****BR6HIX****3419**

14 mm, M14 x 19

0,6

B6ES**7310**

18 mm, M18 X 12

0,5

A6**1010****CRUISE N'CARRY**

1.5 hp

1981 - 1988

0,7

BM4A**5628***Xenoah Engines*

1.75 hp

0,8

BR6S**3522**

2.5 hp

1984 - 1988

0,8

BR6S**3522**

6.0 hp

0,7

BPR5HS**6222****CUYUNA**

40 hp

0,8

BR8ES**5422****BR8EIX****5044****DELFINO**

2.5, 3 PS

0,5

B6S**3510****DM**

DM 5 219cid

0,8

B5HS**4210****DUCATI**

100, 150, 200

0,5

B6HS**4510****BR6HIX****3419**

Bambi 30

0,6

B6HS**4510****BR6HIX****3419**



Cyl.



Order No.

Iridium



Order No.

DUCATI

Cucciolo 5, 10, 15, 20 PS

0,5

B6HS

4510

BR6HIX

3419

DYNAFOIL*Xenoah Engines*

340 cc 3/4 Rch

0,8

BR6ES

4922

440 cc 3/4 Rch

0,8

BR6ES

4922

ELGIN

3.5 hp 6091

0,9

BM4A

5628

3.5 hp 6092

0,9

BM4A

5628

3.5 hp 60900

0,9

BM4A

5628

9.0 hp 6066

0,9

BM4A

5628

9.0 hp 6067

0,9

BM4A

5628

12 hp 6012

1,0

BR6S

3522

14 hp 6013

1,0

BR6S

3522

14 hp 6069

1,0

BR6S

3522

14 hp 6014

1,0

BR6S

3522

14 hp 6015

1,0

BR6S

3522

18 hp 59661

1,0

BR6S

3522

18 hp 59671

1,0

BR6S

3522

25 hp 6028

1,0

BR6S

3522

25 hp 6025

1,0

BR6S

3522

25 hp 6032

1,0

BR6S

3522

27.7 hp 6035

1,0

BR6S

3522

27.7 hp 6033

1,0

BR6S

3522

28 hp 6037

1,0

BR6S

3522

28 hp 6038

1,0

BR6S

3522

28 hp 6036

1,0

BR6S

3522

28 hp 6034

1,0

BR6S

3522

28 hp 6070

1,0

BR6S

3522

40 hp 6040

1,0

BR6S

3522

40 hp 59461

1,0

BR6S

3522

40 hp 6043

1,0

BR6S

3522

40 hp 594011

1,0

BR6S

3522

40 hp 6047

1,0

BR6S

3522

40 hp 594001

1,0

BR6S

3522

40 hp 59471

1,0

BR6S

3522

40 hp 594031

1,0

BR6S

3522

40 hp 59421

1,0

BR6S

3522

43.7 hp 6052

1,0

BR6S

3522

43.7 hp 6053

1,0

BR6S

3522

45 hp 6063

1,0

BR6S

3522

45 hp 6054

1,0

BR6S

3522

45 hp 6055

1,0

BR6S

3522

45 hp 6056

1,0

BR6S

3522

45 hp 6057

1,0

BR6S

3522

45 hp 6062

1,0

BR6S

3522

60 hp 6063

1,0

BR6S

3522

60 hp 6060

1,0

BR6S

3522

60 hp 6061

1,0

BR6S

3522

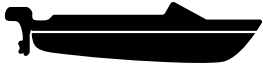

Cyl.



Order No.

Iridium



Order No.

ELGIN

60 hp	6062		1,0	BR6S	3522		
75 hp	6075		1,0	BR6S	3522		
75 hp	6064		1,0	BR6S	3522		
75 hp	6076		1,0	BR6S	3522		
75 hp	6074		1,0	BR6S	3522		
75 hp	6065		1,0	BR6S	3522		
75 hp	6077		1,0	BR6S	3522		
75.2 hp	6072		1,0	BR6S	3522		
75.2 hp	6073		1,0	BR6S	3522		

ELLIOTT

21.1 cc			0,7	BM4A	5628		
40 cc 2.2hp			0,8	BPM6A	7021		

EMERALD BAY

80 hp	Banshee XS	1996 -	0,9	B8ES	2411	BR8EIX	5044
50 hp	Banshee XS	1996 -	0,9	B8ES	2411	BR8EIX	5044

ESKA

1.2, 2.5 PS		1977 - 1978	0,6	BR6S	3522		
1707, 1747, 1777, 1790		1970 - 1974	0,8	BP5S	3011		
3.0, 4.5, 5.5 PS		1975 -	0,8	BP5S	3011		
3.0, 4.5, 5.5, 9.9 PS		1976 -	0,8	XR5	5953	XR5IX	7355
3.5, 4.0, 5.0 PS		1977 - 1978	0,8	XR5	5953	XR5IX	7355
3.5, 5.0, 7.5 PS		1970 - 1974	0,8	BP5S	3011		
7.5, 9.9, 15 PS		1975 -	0,8	BP5S	3011		
7.5, 9.9, 15 PS		1977 - 1978	0,8	XR5	5953	XR5IX	7355
9.5, 14 PS		1970 - 1974	0,8	BP5S	3011		

EVINRUDE

2.0 hp Jr, Colt	1	1971 - 1990	0,8	BR6S	3522		
2.0 hp	1	1991 - 1997	0,8	BPR6HS	7022	BPR6HIX	4085
2.3 hp	1	1991 - 1997	0,8	BPR6HS	7022	BPR6HIX	4085
2.5 hp	1	1987 - 1988	0,8	BR6HS	3922	BR6HIX	3419
3.0 hp	2	1989 - 1997	0,8	BR6HS	3922	BR6HIX	3419
3.3 hp	1	1991 - 1997	0,8	BPR6HS	7022	BPR6HIX	4085
4.0 hp	1	1969 - 1976	0,8	BR6S	3522		
4.0 hp	1	1977 - 1987	0,8	BR6HS	3922	BR6HIX	3419
4.0 hp		1988 -	0,8	BZ7HS-10	3579		
4.0 hp	2	1989 - 1997	0,8	BR6HS	3922	BR6HIX	3419
4.5 hp		1980 - 1985	0,8	BR6HS	3922	BR6HIX	3419
5.0 hp		1990 - 1997	0,8	BR6HS	3922	BR6HIX	3419
5.0 hp (4-stroke) OHC 128cc		1997 -	0,7	DR5HS	4623		
5.0 hp (4-stroke)		1997 -	0,7	D6HA	6512		
6.0 hp (2-stroke)		1977 - 1997	0,8	BR6HS	3922	BR6HIX	3419
6.0 hp (4-stroke)		1997 -	0,7	D6HA	6512		



Cyl.



Order No.

Iridium



Order No.

EVINRUDE

6.0 hp (4-stroke) OHC 128cc		1997 -	0,7	DR5HS	4623		
6.5 hp COM.		1981 - 1993	0,8	BZ7HS-10	3579		
7.5 hp		1977 - 1997	0,8	BR6HS	3922	BR6HIX	3419
8.0 hp		1977 -	0,8	BR6HS	3922	BR6HIX	3419
8.0 hp COM.		1977 - 1997	0,8	BR6HS	3922	BR6HIX	3419
8.0 hp (4-stroke)		1995 - 1997	0,7	D6HA	6512		
8.0 hp (4-stroke) OHC 211cc		1996 -	0,7	DR5HS	4623		
9.9 hp		1974 - 1976	0,8	B7HS	5110	BR7HIX	7067
9.9 hp (2-stroke)		1977 - 1997	0,8	BR6HS	3922	BR6HIX	3419
9.9 hp (4-stroke) OHC		1995 - 1997	0,8	DCPR7E	3932	DCPR7EIX	6046
9.9 hp (4-stroke) 211cc		1996 - 1997	0,7	D6HA	6512		
9.9 hp (4-stroke) OHC 305cc		1998 -	0,8	DCPR7E	3932	DCPR7EIX	6046
10.0 hp COM.		1992 - 1993	0,8	BZ7HS-10	3579		
10.0 hp		1994 - 1997	0,8	BR6HS	3922	BR6HIX	3419
14.0 hp COM.		1981 - 1991	0,8	BZ7HS-10	3579		
14.0 hp		1992 - 1993	0,8	BZ7HS-10	3579		
15.0 hp		1974 - 1976	0,8	B7HS	5110	BR7HIX	7067
15.0 hp		1977 - 1992	0,8	BZ7HS-10	3579		
15.0 hp COM.		1992 - 1993	0,8	BZ7HS-10	3579		
15.0 hp COM.		1994 - 1997	0,8	BR6HS	3922	BR6HIX	3419
15.0 hp (2-stroke)		1994 - 1997	0,8	BR6HS	3922	BR6HIX	3419
15.0 hp (4-stroke) OHC		1995 -	0,8	DCPR7E	3932	DCPR7EIX	6046
15.0 hp Kero		1995 - 1997		BUHXW-1	5526		
18.0 hp		1957 - 1973	0,8	BR6S	3522		
18.0 hp Jet	2	1995 - 1997	0,8	BR6HS	3922	BR6HIX	3419
20.0 hp		1978 - 1993	0,8	BR6HS	3922	BR6HIX	3419
20.0 hp	2	1978 - 1997	0,8	BR6HS	3922	BR6HIX	3419
25.0 hp	2	1977 -	0,8	BR6HS	3922	BR6HIX	3419
25.0 hp	2	1977 - 1997	0,8	BR6HS	3922	BR6HIX	3419
25.0 hp COM.		1981 - 1997		BUHXW-1	5526		
25.0 hp	3	1995 - 1997	0,8	BR6HS	3922	BR6HIX	3419
25.0 hp	3	1998 -	0,8	BR6HS	3922	BR6HIX	3419
28.0 hp	2	1978 - 1997	0,8	BR6HS	3922	BR6HIX	3419
28.0 hp Jet		1992 - 1997	0,8	BPR7HS	6422	BPR7HIX	5944
30.0 hp	2	1978 - 1997	0,8	BR6HS	3922	BR6HIX	3419
30.0 hp		2002 -	0,7	DCPR7E	3932	DCPR7EIX	6046
35.0 hp		1976 -	0,8	B7HS	5110	BR7HIX	7067
35.0 hp	2	1977 - 1997	0,8	BZ7HS-10	3579		
35.0 hp Jet	2	1993 - 1997	0,8	BPR7HS	6422	BPR7HIX	5944
35.0 hp	3	1995 - 1997	0,8	BR6HS	3922	BR6HIX	3419
35.0 hp	3	1998 -	0,8	BR6HS	3922	BR6HIX	3419
40.0 hp		1974 - 1976	0,8	B7HS	5110	BR7HIX	7067
40.0 hp	2	1980 - 1988	0,8	BZ7HS-10	3579		
40.0 hp COM. 43cid		1981 - 1990	0,8	B7HS	5110	BR7HIX	7067
40.0 hp COM. 45cid		1984 - 1997		BUHXW-1	5526		
40.0 hp	2	1989 - 1997	0,8	BPR7HS	6422	BPR7HIX	5944
40.0 hp (4-stroke) DOHC 815cc		1999 -	0,8	DCPR7E	3932	DCPR7EIX	6046
45.0 hp COM.		1986 - 1997		BUHXW-1	5526		
48.0 hp	2	1980 - 1988	0,8	BZ7HS-10	3579		
48.0 hp	2	1989 - 1997	0,8	BPR7HS	6422	BPR7HIX	5944
48.0 hp SPL	2	1994 - 1997	0,8	BPR7HS	6422	BPR7HIX	5944
50.0 hp		1971 - 1975	0,8	BZ7HS-10	3579		



Cyl.

Order
No.

Iridium

Order
No.**EVINRUDE**

50.0 hp	2	1980 - 1988	0,8	BZ7HS-10	3579		
50.0 hp	2	1989 - 1997	0,8	BPR7HS	6422	BPR7HIX	5944
50.0 hp	3	1995 - 1997	0,8	BPR7HS	6422	BPR7HIX	5944
50.0 hp (4-stroke) DOHC 815cc		1999 -	0,8	DCPR7E	3932	DCPR7EIX	6046
55.0 hp	3	1968 - 1969	0,8	BZ7HS-10	3579		
55.0 hp	2	1976 - 1989	0,8	BZ7HS-10	3579		
55.0 hp COM.		1986 - 1997		BUHXW-1	5526		
55.0 hp COM.	2	1994 - 1995	0,8	BPR7HS	6422	BPR7HIX	5944
60.0 hp	3	1970 - 1971	0,8	BZ7HS-10	3579		
60.0 hp	3	1975 - 1993	0,8	BZ7HS-10	3579		
60.0 hp	2	1980 - 1985	0,8	BZ7HS-10	3579		
60.0 hp 56cid	3	1994 - 1997	0,8	BPR7HS	6422	BPR7HIX	5944
65.0 hp	4	1968 -	0,8	BZ7HS-10	3579		
65.0 hp	3	1972 - 1973	0,8	BZ7HS-10	3579		
65.0 hp COM.HC LC		1984 - 1987	0,8	BZ7HS-10	3579		
65.0 hp COM. HC LC		1988 - 1997		BUHXW-1	5526		
65.0 hp Jet	4	1992 - 1997	0,8	BR6HS	3922	BR6HIX	3419
65.0 hp COM.	3	1994 - 1995	0,8	BPR7HS	6422	BPR7HIX	5944
70.0 hp	3	1975 - 1993	0,8	BZ7HS-10	3579		
70.0 hp Backtroller	3	1994 - 1997	0,8	BPR7HS	6422	BPR7HIX	5944
75.0 hp 49cid		1975 - 1989	0,8	BZ7HS-10	3579		
80.0 hp		1966 - 1967	0,8	BR6S	3522		
80.0 hp Jet	4	1979 - 1997	0,8	BR6HS	3922	BR6HIX	3419
85.0 hp		1968 - 1980	0,8	BZ7HS-10	3579		
85.0 hp		1986 - 1993	0,8	BZ7HS-10	3579		
85.0 hp Backtroller	4	1994 - 1995	0,8	BR6HS	3922	BR6HIX	3419
88.0 hp (CV4)	4	1979 - 1997	0,8	BR6HS	3922	BR6HIX	3419
90.0 hp (CV4)	4	1979 - 1997	0,8	BR6HS	3922	BR6HIX	3419
90.0 hp Turbojet		1979 - 1997	0,8	BR6HS	3922	BR6HIX	3419
90.0 hp (LV4)	4	1995 - 1997	0,8	BPR7HS	6422	BPR7HIX	5944
90.0 hp (V4) FFI	4	2000 -	0,8	PZFR6H	7696		
100.0 hp		1967 - 1972	0,8	BZ7HS-10	3579		
100.0 hp	4	1979 - 1980	0,8	BZ7HS-10	3579		
110.0 hp (CV4)	4	1979 - 1997	0,8	BR6HS	3922	BR6HIX	3419
100.0 hp COM.		1984 - 1997		BUHXW-1	5526		
105.0 hp Jet incl COM.	6	1993 - 1997	0,8	BPR7HS	6422	BPR7HIX	5944
105.0 hp (LV4) COM.	4	1997 -	0,8	BPR7HS	6422	BPR7HIX	5944
112.0 hp (CV4)	4	1979 - 1997	0,8	BR6HS	3922	BR6HIX	3419
115.0 hp		1969 - 1970	1,0	B7HS-10	2129		
115.0 hp		1973 - 1984	0,8	BZ7HS-10	3579		
115.0 hp COM.		1975 - 1984	1,0	B7HS-10	2129		
115.0 hp (CV4)	4	1979 - 1997	0,8	BR6HS	3922	BR6HIX	3419
115.0 hp		1985 -		BUHXW-1	5526		
115.0 hp		1986 - 1993	0,8	BZ7HS-10	3579		
115.0 hp Turbojet		1994 - 1997	0,8	BR6HS	3922	BR6HIX	3419
115.0 hp (LV4) Intruder	4	1995 - 1997	0,8	BPR7HS	6422	BPR7HIX	5944
115.0 hp (V4) FFI	4	2000 -	0,8	PZFR6H	7696		
120.0 hp (LV4)	4	1985 - 1997	0,8	BPR7HS	6422	BPR7HIX	5944
125.0 hp		1971 - 1972	1,0	B7HS-10	2129		
130.0 hp (LV4)	4	1985 - 1997	0,8	BPR7HS	6422	BPR7HIX	5944
135.0 hp		1973 - 1984		BUHXW-1	5526		
140.0 hp COM.		1973 - 1984		BUHXW-1	5526		



Cyl.



Order No.

Iridium



Order No.

EVINRUDE

140.0 hp (LV4)	4	1985 - 1997	0,8	BPR7HS	6422	BPR7HIX	5944
150.0 hp (CV6)	6	1978 - 1987		BUHXW-1	5526		
150.0 hp (CV6)	6	1988 - 1991	0,8	BZ7HS-10	3579		
150.0 hp (LV6) Intruder	6	1991 - 1997	0,8	BPR7HS	6422	BPR7HIX	5944
150.0 hp (LV6) COM.	6	1993 -	0,8	BPR7HS	6422	BPR7HIX	5944
150.0 hp (V6) FFI	6	2000 -	0,8	PZFR6H	7696		
155.0 hp (CV6)	6	1978 - 1987		BUHXW-1	5526		
155.0 hp (CV6) COM.	6	1989 - 1992		BUHXW-1	5526		
175.0 hp		1978 - 1987		BUHXW-1	5526		
175.0 hp (CV6)	6	1988 - 1991	0,8	BZ7HS-10	3579		
175.0 hp (LV6) Intruder	6	1991 - 1997	0,8	BPR7HS	6422	BPR7HIX	5944
175.0 hp (V6) FFI	6	2000 -	0,8	PZFR6H	7696		
185 Com.		1990 - 1993	1,0	BZ7HS-10	3579		
185.0 hp		1977 - 1987		BUHXW-1	5526		
185.0 hp COM.	6	1990 - 1993	0,8	BZ7HS-10	3579		
200.0 hp		1976 - 1983		BUHXW-1	5526		
200.0 hp (V6)	6	1986 - 1993	0,8	BZ7HS-10	3579		
200.0 hp COM.		1992 -		BUHXW-1	5526		
200.0 hp (V6) Vindicator	6	1992 - 1998	0,8	BPR7HS	6422	BPR7HIX	5944
200.0 hp COM.		1993 - 1997	0,8	BR6HS	3922	BR6HIX	3419
200.0 hp (V6) FFI	6	1999 -	0,8	PZFR6H	7696		
225.0 hp	6	1986 - 1993	0,8	BZ7HS-10	3579		
225.0 hp (V6) Vindicator	6	1994 - 1997	0,8	BPR7HS	6422	BPR7HIX	5944
225.0 hp (V6) FFI	6	1999 -	0,8	PZFR6H	7696		
235.0 hp		1978 - 1985		BUHXW-1	5526		
250.0 hp (V8)	8	1985 - 1997	0,8	BPR7HS	6422	BPR7HIX	5944
275.0 hp	6	1985 - 1986	0,8	BZ7HS-10	3579		
275.0 hp		1985 - 1988	0,8	BPR7HS	6422	BPR7HIX	5944
300.0 hp	6	1985 - 1986	0,8	BZ7HS-10	3579		
300.0 hp (V8)	8	1985 - 1997	0,8	BPR7HS	6422	BPR7HIX	5944
Sea Drive		1988 - 1992	0,8	BZ7HS-10	3579		
Models with Standard Ignition							
18 mm		1939 - 1950	0,6	A6	1010		
1.0 hp 1R	1	1968 - 1970	0,8	BR6S	3522		
1.2 hp Magneto	1	1986 - 1990	0,8	BR6S	3522		
1.5 hp	1	1968 - 1970	0,8	BR6S	3522		
2.0 hp	1	1966 - 1970	0,8	BM4A	5628		
2.0 hp	1	1968 - 1970	0,8	BR6S	3522		
2.0 hp 2R	1	1971 - 1984	0,8	BR6S	3522		
3.0 hp	1	1952 - 1974	0,8	BR6S	3522		
3.3 hp	1	1948 - 1951	0,8	BR6S	3522		
4.0 hp V4S / VX / VXH	1	1958 - 1967	0,8	BR6S	3522		
4.0 hp V4 / V4A / V4M	1	1958 - 1967	0,8	BR6S	3522		
4.0 hp 4R/4W	1	1969 - 1976	0,8	BR6S	3522		
4.0 hp	1	1981 - 1984	0,8	BZ7HS-10	3579		
5.0 hp	1	1965 - 1968	0,8	BR6S	3522		
5.2 hp	1	1952 - 1974	0,8	BR6S	3522		
5.5 hp	1	1956 - 1964	0,8	BR6S	3522		
6.0 hp	1	1965 - 1976	0,8	BR6S	3522		
6.0 hp 6R / 6RL	1	1971 - 1976	0,8	BR6S	3522		



Cyl.

Order
No.

Iridium

Order
No.**EVINRUDE***Models with Standard Ignition*

7.5 hp	1	1952 - 1958	0,8	BR6S	3522		
9.0 hp 9E / EL / R / RL		1974 -	0,8	BZ7HS-10	3579		
9.5 hp	1	1964 - 1973	0,8	BR6S	3522		
9.7 hp		1942 - 1949	0,8	A7	1110		
10.0 hp	1	1952 - 1963	0,8	BR6S	3522		
10.0 hp 10E / EL / R / RL		1975 - 1976	0,8	BZ7HS-10	3579		
14.0 hp	1	1950 - 1972	0,8	BR6S	3522		
15.0 hp	1	1954 - 1956	0,8	BR6S	3522		
15.0 hp 15E / EL / R / RL		1974 - 1976	0,8	BZ7HS-10	3579		
18.0 hp		1957 - 1973	0,8	BR6S	3522		
20.0 hp		1966 - 1973	0,8	BR6S	3522		
20.0 hp 20R / 20RL		1969 -	0,8	BR6S	3522		
25.0 hp		1952 - 1955	0,8	BR6S	3522		
25.0 hp 25R / 25RL		1969 - 1972	0,8	BR6S	3522		
25.0 hp		1969 - 1976	0,8	BR6S	3522		
25.0 hp 25E / 25EL		1972 -	0,8	BR6S	3522		
25.0 hp 25E / 25EL / 25R / 25RL		1973 - 1976	0,8	BR6S	3522		
28.0 hp		1962 - 1964	0,8	BR6S	3522		
30.0 hp		1956 - 1971	0,8	BR6S	3522		
33.0 hp 33R / 33E		1969 - 1971	0,8	BR6S	3522		
35.0 hp		1957 - 1959	0,8	BR6S	3522		
35.0 hp 35E / EL / R / RL		1976 -	0,8	BZ7HS-10	3579		
40.0 hp		1960 - 1973	0,8	BR6S	3522		
40.0 hp 40ES		1969 - 1971	0,8	BR6S	3522		
40.0 hp 40R / 40E / 40EL / 40RL		1969 - 1973	0,8	BR6S	3522		
40.0 hp 40E / EL / R / RL		1974 - 1976	0,8	BZ7HS-10	3579		
50.0 hp		1958 - 1959	0,8	BR6S	3522		
60.0 hp (V4)		1964 - 1967	0,8	BR6S	3522		
75.0 hp (V4)		1960 - 1965	0,8	BR6S	3522		
80.0 hp		1966 - 1967	0,8	BR6S	3522		
90.0 hp		1964 - 1965	0,8	BR6S	3522		
100.0 hp		1966 -	0,8	BR6S	3522		
Air Buoy Driving Unit			0,8	BM4A	5628		
CD / JH / FD / FDE / JW / MQ		1952 - 1968	0,8	BR6S	3522		
JHF / JWF / LD / SC		1965 - 1968	0,8	BR6S	3522		
RD / RDE / RDS / RJE / RK		1951 - 1968	0,8	BR6S	3522		
RX / RXE /		1962 - 1968	0,8	BR6S	3522		
TN / AD / QD / V4H / V4ML		1952 - 1966	0,8	BR6S	3522		

EXPLORER

3.5 hp		1981 - 1984	0,7	XR4	2637	XR4IX	7189
5.0 hp		1981 - 1984	0,7	XR4	2637	XR4IX	7189
7.5 hp		1981 - 1984	0,7	XR4	2637	XR4IX	7189
9.9 hp		1981 - 1984	0,7	XR4	2637	XR4IX	7189
15.0 hp		1981 - 1984	0,7	XR4	2637	XR4IX	7189

FEDERAL

3.5 hp		1971 - 1974	0,7	XR4	2637	XR4IX	7189
5.0 hp		1971 - 1974	0,7	XR4	2637	XR4IX	7189



Cyl.



Order No.

Iridium



Order No.

FEDERAL

7.0 hp	1971 - 1974	0,7	XR4	2637	XR4IX	7189
--------	-------------	-----	-----	------	-------	------

FIAT NAUTICA

3.5 hp		0,9	BR6HS	3922	BR6HIX	3419
6.0 hp		0,9	BR6HS	3922	BR6HIX	3419
8.0 hp		0,9	BR6HS	3922	BR6HIX	3419
12.0 hp		0,9	BR6HS	3922	BR6HIX	3419
14.0 hp		0,9	BR6HS	3922	BR6HIX	3419
24.0 hp		0,9	BR6HS	3922	BR6HIX	3419

FIRESTONE

Featherweight 5	1966 -	0,8	BR6S	3522		
-----------------	--------	-----	------	------	--	--

FISHER PIERCE

Bearcat 55		0,8	BR6S	3522		
Bearcat 85		0,8	BR8ES	5422	BR8EIX	5044

FLAMBEAU

Single (2.5PS), Double (5 PS)		0,6	B6S	3510		
-------------------------------	--	-----	-----	------	--	--

FLYING-O

3.5 hp	1968 - 1969	0,8	BR6S	3522		
5.0 hp	1968 - 1969	0,8	BR6S	3522		
5.0 hp	1970 - 1974	0,7	XR4	2637	XR4IX	7189
5.5 hp	1975 -	0,7	XR4	2637	XR4IX	7189
7.0 hp	1968 - 1969	0,8	BR6S	3522		
7.0 hp	1970 - 1972	0,7	XR4	2637	XR4IX	7189
7.5 hp	1973 -	0,7	XR4	2637	XR4IX	7189
9.9 hp	1973 - 1974	0,7	XR4	2637	XR4IX	7189
15.0 hp	1973 - 1974	0,7	XR4	2637	XR4IX	7189

FORCE

3 HP	1990 - 1994	1,0	BP6HS-10	6326		
3 M		1,0	BPR6HS-10	2633		
4 HP	1984 - 1987	0,8	B6HS	4510	BR6HIX	3419
5 HP	1988 - 1997	0,8	BP6HS	4511	BPR6HIX	4085
5 M / ML		0,7	B6HS	4510	BR6HIX	3419
7.5 HP	1985 -	0,8	B6HS	4510	BR6HIX	3419
9.9 HP	1984 - 1997	0,8	BP6HS	4511	BPR6HIX	4085
9.9 M / ML		0,7	BP6HS	4511	BPR6HIX	4085
15 HP	1984 - 1997	0,8	BP6HS	4511	BPR6HIX	4085
15 M / ML		0,7	BP6HS	4511	BPR6HIX	4085
25 HP	1989 - 1991	0,8	BR6HS	3922	BR6HIX	3419
25 HP	1996 - 1997	0,8	BP6HS	4511	BPR6HIX	4085



Cyl.

Order
No.

Iridium

Order
No.**FORCE**

35 E / EL / ELT / ELH				BUHW	2622		
35 HP		1989 - 1991	0,8	BR6HS	3922	BR6HIX	3419
40 HP		1992 - 1997		BUZHW	2147		
50 EL / ELPT				BUHW	2622		
50 HP		1984 - 1987	0,8	B7HS	5110	BR7HIX	7067
50 HP Prestolite		1988 - 1991		BUHX	2522		
50 HP Thunderbolt		1991 - 1997		BUZHW	2147		
60 HP		1985 -		BUZHW	2147		
70 EL / ELPT				BUHW	2622		
70 HP		1991 - 1995		BUZHW	2147		
75 HP		1996 - 1997		BUZHW	2147		
85 HP		1983 - 1989		BUHX	2522		
90 ELPT				BUHW	2622		
90 HP Prestolite		1990 - 1991		BUHX	2522		
90 HP Thunderbolt		1991 - 1997		BUZHW	2147		
120 ELPT				BUHW	2622		
120 HP Prestolite		1980 - 1991		BUHX	2522		
120 HP Thunderbolt		1991 - 1997		BUZHW	2147		
125 HP		1983 - 1989		BUHX	2522		
150 ELPT				BUHW	2622		
150 HP Prestolite		1989 - 1991		BUHX	2522		
150 HP		1991 - 1994		BUZHW	2147		

FOREMOST

9.2 hp			0,8	BR6S	3522		
--------	--	--	-----	-------------	-------------	--	--

FRANCHI

6 PS			0,7	B6S	3510		
18 PS, 40 PS			0,7	B6L	3212		

FURY

3.5 hp		1961 -	0,8	BR6S	3522		
--------	--	--------	-----	-------------	-------------	--	--

GALE

Buccaneer 25, 35, 40, 60 PS			0,8	B6S	3510		
Buccaneer 3, 5, 5.5, 12, 15 PS			0,8	B6S	3510		
Sovereign 35, 40, 60 PS			0,8	B6S	3510		

GAMBLES

3.5 hp		- 1969	0,8	BR6S	3522		
3.5 hp		1970 -	0,7	XR4	2637	XR4IX	7189
5.0 hp		- 1969	0,8	BR6S	3522		
5.0 hp		1970 -	0,7	XR4	2637	XR4IX	7189
7.0 hp		1969 -	0,7	XR4	2637	XR4IX	7189



Cyl.

Order
No.

Iridium

Order
No.**GARELLI**

Gari Jet			0,5	B6HS	4510	BR6HIX	3419
----------	--	--	-----	------	------	--------	------

GUAZZONI

Gamberino 4.5 PS			0,5	B6S	3510		
------------------	--	--	-----	-----	------	--	--

HONDA

BF 2 B			0,6	CR5HSB	6535	CR5HIX	7120
BF 2 B			0,6	CR5HSB	6535	CR5HIX	7120
BF 2 / A 4 Stroke Side Valve		1984 -	0,7	BMR4A	5728		
BF 2 D		1999 -	0,6	CR5HSB	6535	CR5HIX	7120
BF 4,5 B			0,8	BPR5ES	7422	BPR5EIX	6597
BF 5 AK			0,8	BPR5ES	7422	BPR5EIX	6597
BF 5 A			0,8	BPR5ES	7422	BPR5EIX	6597
BF 5 4 Stroke Vertical OHV		1984 -	0,8	BPR5ES	7422	BPR5EIX	6597
BF 6			0,6	DR4HS	3326		
BF 6 B		2003 -	0,6	DR4HS	3326		
BF 7,5		1977 -	0,7	DR5HS	4623		
BF 8 B1			0,9	CR5EH-9	6689		
BF 8 D			0,9	CR5EH-9	6689		
BF 8 4 Stroke In-Line OHC		1987 - 2000	0,7	DR5HS	4623		
BF 8 A / B / C		1990 - 2000	0,7	DR5HS	4623		
BF 8		2001 -	0,9	CR5EH-9	6689		
BF 8 D1 8.0HP 4-Stroke	2	2001 -	0,9	CR5EH-9	6689		
BF 9 / A			0,7	DR5HS	4623		
BF 9.9 A / B			0,7	DR5HS	4623		
BF 9.9 4 Stroke In-Line OHC		1987 - 2001	0,7	DR5HS	4623		
BF 9.9 D1 9.9HP 4-Stroke	2	2001 -	0,9	CR5EH-9	6689		
BF 10 / B1		2001 -	0,9	CR5EH-9	6689		
BF 10 D		2001 -	0,9	CR5EH-9	6689		
BF 15 B			0,7	DR5HS	4623		
BF 15 4 Stroke In-Line OHC		1987 - 1990	0,7	DR6HS	4823		
BF 15 A		1996 - 2002	0,7	DR5HS	4623		
BF 15 D		2003 -	0,9	CR5EH-9	6689		
BF 2.3			0,6	CR5HSB	6535	CR5HIX	7120
BF 20 / F 4 Stroke Side Valve		1985 -	0,6	BMR4A	5728		
BF 20		1993 -	0,7	DR7EA	7839		
BF 25 B			0,6	DR7EA	7839		
BF 25 / A 4 Stroke OHC		1993 -	0,7	DR7EA	7839		
BF 28			0,6	CR5HSB	6535	CR5HIX	7120
BF 28 D			0,6	CR5HSB	6535	CR5HIX	7120
BF 30 / A 4 Stroke OHC		1994 -	0,6	DR7EA	7839		
BF 35 / A 4 Stroke OHC		1990 -	0,7	DR7EA	7839		
BF 40 B			0,6	DR7EA	7839		
BF 40 / A 4 Stroke OHC		1994 -	0,7	DR7EA	7839		
BF 45 / A 4 Stroke OHC		1990 -	0,7	DR7EA	7839		
BF 50 / F 4 Stroke Vertical OHV		1985 - 1994	0,7	BPR5ES	7422	BPR5EIX	6597
BF 50 4 Stroke Vertical OHV		1986 -	0,8	BPR5ES	7422	BPR5EIX	6597
BF 50 / A 4 Stroke OHC		1994 -	0,7	DR7EA	7839		
BF 6 CH		2004 -	0,9	CR5EH-9	6689		
BF 70 A 4 Stroke OHC 12Valve			0,6	DR7EA	7839		

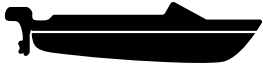

Cyl.

Order
No.

Iridium

Order
No.**HONDA**

BF 75 E	4 Stroke In-Line OHC			0,6	DR5HS	4623		
BF 75 B				0,6	DR7EA	7839		
BF 75	4 Stroke In-Line OHC			0,6	DR5HS	4623		
BF 75 A	4 Stroke OHC 12Valve		1995 -	0,6	DR7EA	7839		
BF 90 / A	4 Stroke OHC 12Valve		1995 -	0,6	DR7EA	7839		
BF 20 D			2003 -	0,9	CR5EH-9	6689		
BF 25 D4			2004 -	0,7	DR7EA	7839		
BF 30 D4			2004 -	0,7	DR7EA	7839		
BF 75			2003 -	0,7	DR7EA	7839		
BF 100 E	4 Stroke In-Line OHC			0,6	DR5HS	4623		
BF 100	4 Stroke In-Line OHC			0,6	DR5HS	4623		
BF 115 / A	4 Stroke OHC	4	1998 -	0,8	ZFR7F	5913		
BF 130 A	4 Stroke OHC	4	1998 -	0,8	ZFR7F	5913		
BF 135 A				1,1	IZFR6K-11	6994		
BF 150 A				1,1	IZFR6K-11	6994		
BF 175 A				1,1	IZFR6K-11	6994		
BF 200 A	V6	6	2002 -	1,1	IZFR6K-11	6994		
BF 225 A	V6	6	2002 -	1,1	IZFR6K-11	6994		
BFP 8D1	8.0HP 4-Stroke	2	2001 -	0,9	CR5EH-9	6689		
BFP 9.9D1	9.9HP 4-Stroke	2	2001 -	0,9	CR5EH-9	6689		
GB-30 (3HP)				0,6	B6HS	4510	BR6HIX	3419
GB-40 (4HP)				0,6	B6HS	4510	BR6HIX	3419

HUSQVARNA

all models				0,5	B6HS	4510	BR6HIX	3419
------------	--	--	--	-----	------	------	--------	------

ITALMARINE

70 hp 920 25 SIL / SITL		3		1,0	BZ7HS-10	3579		
150 hp Ocean Runner V6		6			BUZW	2147		
175 hp Ocean Runner V6		6			BUZW	2147		
200 hp Ocean Runner V6		6		1,0	BZ7HS-10	3579		
225 hp Ocean Runner V6		6		1,0	BZ7HS-10	3579		
250 hp Ocean Runner V6		6		1,0	BZ7HS-10	3579		

J.C.PENNY

3.0 hp			1974 - 1980	0,7	XR4	2637	XR4IX	7189
3.5 hp			1978 - 1980	0,7	XR4	2637	XR4IX	7189
5.0 hp			1979 -	0,7	XR4	2637	XR4IX	7189
5.5 hp			1974 - 1978	0,7	XR4	2637	XR4IX	7189
7.5 hp			1974 - 1979	0,7	XR4	2637	XR4IX	7189
9.9 hp			1975 - 1979	0,7	XR4	2637	XR4IX	7189
15.0 hp			1975 - 1978	0,7	XR4	2637	XR4IX	7189

J.L.O.

Aquascooter				0,5	B6HS	4510	BR6HIX	3419
L-35				0,5	B6HS	4510	BR6HIX	3419



Cyl.

Order
No.

Iridium

Order
No.**JOHNSON**

2.0 hp Jr, Colt	1	1971 - 1990	0,8	BR6S	3522		
2.0 hp	1	1991 -	0,8	BPR6HS	7022	BPR6HIX	4085
2.3 hp	1	1991 - 1997	0,8	BPR6HS	7022	BPR6HIX	4085
2.5 hp	1	1987 - 1988	0,8	BR6HS	3922	BR6HIX	3419
3.0 hp	2	1989 - 1997	0,8	BR6HS	3922	BR6HIX	3419
3.3 hp	1	1991 -	0,8	BPR6HS	7022	BPR6HIX	4085
3.5 hp	1	2001 - 2002	0,8	BPR6HS	7022	BPR6HIX	4085
4.0 hp	1	1969 - 1976	0,8	BR6S	3522		
4.0 hp	1	1977 - 1987	0,8	BR6HS	3922	BR6HIX	3419
4.0 hp Ultra,Excel		1987 - 1988	0,8	BZ7HS-10	3579		
4.0 hp		1988 -	0,8	BZ7HS-10	3579		
4.0 hp	2	1989 -	0,8	BR6HS	3922	BR6HIX	3419
4.5 hp		1980 - 1985	0,8	BR6HS	3922	BR6HIX	3419
5.0 hp		1990 - 1997	0,8	BR6HS	3922	BR6HIX	3419
5.0 hp (4-stroke)		1997 -	0,7	D6HA	6512		
5.0 hp	1	1998 -	0,8	BZ7HS-10	3579		
6.0 hp (2-stroke)		1977 - 1997	0,8	BR6HS	3922	BR6HIX	3419
6.0 hp (4-stroke)		1997 -	0,7	D6HA	6512		
6.5 hp COM.		1981 - 1993	0,8	BZ7HS-10	3579		
7.5 hp		1977 - 1997	0,8	BR6HS	3922	BR6HIX	3419
8.0 hp COM.		1977 -	0,8	BR6HS	3922	BR6HIX	3419
8.0 hp		1977 - 1997	0,8	BR6HS	3922	BR6HIX	3419
8.0 hp (4-stroke)		1995 -	0,7	D6HA	6512		
8.0 hp (2-stroke)		1998 -	0,8	BR6HS	3922	BR6HIX	3419
8.0 hp (4-stroke) SOHC		2002 -	0,7	DR5HS	4623		
9.9 hp		1974 - 1976	0,8	B7HS	5110	BR7HIX	7067
9.9 hp (2-stroke)		1977 -	0,8	BR6HS	3922	BR6HIX	3419
9.9 hp (4-stroke) OHC		1995 - 1997	0,8	DCPR7E	3932	DCPR7EIX	6046
9.9 hp (4-stroke)		1996 -	0,7	D6HA	6512		
9.9 hp (4-stroke) OHC 305cc		1998 -	0,8	DCPR7E	3932	DCPR7EIX	6046
10.0 hp COM.		1992 - 1993	0,8	BZ7HS-10	3579		
10.0 hp COM.		1994 - 1997	0,8	BR6HS	3922	BR6HIX	3419
14.0 hp COM.		1981 - 1991	0,8	BZ7HS-10	3579		
14.0 hp		1988 - 1989	0,8	BZ7HS-10	3579		
15.0 hp		1974 - 1976	0,8	B7HS	5110	BR7HIX	7067
15.0 hp		1977 - 1992	0,8	BZ7HS-10	3579		
15.0 hp COM.		1992 - 1993	0,8	BZ7HS-10	3579		
15.0 hp incl. COM.		1994 - 1997	0,8	BR6HS	3922	BR6HIX	3419
15.0 hp (4-stroke) OHC		1995 -	0,8	DCPR7E	3932	DCPR7EIX	6046
15.0 hp Kero		1995 - 1998		BUHXW-1	5526		
15.0 hp		1998 -	0,8	BR6HS	3922	BR6HIX	3419
18.0 hp		1957 - 1973	0,8	BR6S	3522		
18.0 hp Jet	2	1995 - 1998	0,8	BR6HS	3922	BR6HIX	3419
20.0 hp	1	1978 - 1993	0,8	BR6HS	3922	BR6HIX	3419
20.0 hp	2	1978 - 1997	0,8	BR6HS	3922	BR6HIX	3419
20.0 hp Jet	2	1998 -	0,8	BR6HS	3922	BR6HIX	3419
25.0 hp	2	1977 - 1997	0,8	BR6HS	3922	BR6HIX	3419
28.0 hp SPL	2	1978 - 1997	0,8	BR6HS	3922	BR6HIX	3419
25.0 hp COM.		1981 -		BUHXW-1	5526		
25.0 hp	3	1995 - 1997	0,8	BR6HS	3922	BR6HIX	3419
25.0 hp	2	1998 -	0,8	BR6HS	3922	BR6HIX	3419
25.0 hp	3	1998 -	0,8	BR6HS	3922	BR6HIX	3419



Cyl.

Order
No.

Iridium

Order
No.**JOHNSON**

28.0 hp Jet		1992 - 1997	0,8	BPR7HS	6422	BPR7HIX	5944
30.0 hp	2	1978 -	0,8	BR6HS	3922	BR6HIX	3419
30.0 hp Jet	2	1999 -	0,8	BPR7HS	6422	BPR7HIX	5944
35.0 hp		1976 -	0,8	B7HS	5110	BR7HIX	7067
35.0 hp	2	1977 - 1997	0,8	BZ7HS-10	3579		
35.0 hp Jet	2	1993 - 1997	0,8	BPR7HS	6422	BPR7HIX	5944
35.0 hp	3	1995 -	0,8	BR6HS	3922	BR6HIX	3419
40.0 hp		1974 - 1976	0,8	B7HS	5110	BR7HIX	7067
40.0 hp	2	1980 - 1988	0,8	BZ7HS-10	3579		
40.0 hp COM.		1981 - 1990	0,8	B7HS	5110	BR7HIX	7067
40.0 hp COM.		1984 -		BUHXW-1	5526		
40.0 hp	2	1989 -	0,8	BPR7HS	6422	BPR7HIX	5944
40.0 hp	3	1999 -	0,8	BPR7HS	6422	BPR7HIX	5944
40.0 hp 815cc	3	2002 -	0,7	DCPR7E	3932	DCPR7EIX	6046
45.0 hp COM.		1986 - 1997		BUHXW-1	5526		
48.0 hp	2	1980 - 1988	0,8	BZ7HS-10	3579		
48.0 hp	2	1989 - 1997	0,8	BPR7HS	6422	BPR7HIX	5944
48.0 hp SPL	2	1994 - 1997	0,8	BPR7HS	6422	BPR7HIX	5944
50.0 hp		1971 - 1975	0,8	BZ7HS-10	3579		
50.0 hp	2	1980 - 1988	0,8	BZ7HS-10	3579		
50.0 hp	2	1989 - 1997	0,8	BPR7HS	6422	BPR7HIX	5944
50.0 hp	3	1995 - 1998	0,8	BPR7HS	6422	BPR7HIX	5944
50.0 hp	2	1998 -	0,8	BPR7HS	6422	BPR7HIX	5944
50.0 hp 815cc	3	2002 -	0,7	DCPR7E	3932	DCPR7EIX	6046
55.0 hp	3	1968 - 1969	0,8	BZ7HS-10	3579		
55.0 hp	2	1976 - 1989	0,8	BZ7HS-10	3579		
55.0 hp COM.		1986 - 1997		BUHXW-1	5526		
55.0 hp COM.		1994 - 1995	0,8	BPR7HS	6422	BPR7HIX	5944
60.0 hp	3	1970 - 1971	0,8	BZ7HS-10	3579		
60.0 hp	3	1975 - 1993	0,8	BZ7HS-10	3579		
60.0 hp	2	1980 - 1985	0,8	BZ7HS-10	3579		
60.0 hp	3	1994 - 1998	0,8	BPR7HS	6422	BPR7HIX	5944
65.0 hp	4	1968 -	0,8	BZ7HS-10	3579		
65.0 hp	3	1972 - 1973	0,8	BZ7HS-10	3579		
65.0 hp COM.HC LC		1984 - 1987	0,8	BZ7HS-10	3579		
65.0 hp COM. HC LC		1988 -		BUHXW-1	5526		
65.0 hp Jet (CV4)	4	1992 - 1997	0,8	BR6HS	3922	BR6HIX	3419
65.0 hp COM.	3	1994 - 1995	0,8	BPR7HS	6422	BPR7HIX	5944
70.0 hp	3	1975 - 1993	0,8	BZ7HS-10	3579		
70.0 hp Backtroller	3	1994 - 1997	0,8	BPR7HS	6422	BPR7HIX	5944
70.0 hp	3	1998 -	0,8	BPR7HS	6422	BPR7HIX	5944
75.0 hp	3	1975 - 1989	0,8	BZ7HS-10	3579		
80.0 hp		1966 - 1967	0,8	BR6S	3522		
80.0 hp Jet (CV4)	4	1979 -	0,8	BR6HS	3922	BR6HIX	3419
85.0 hp		1968 - 1980	0,8	BZ7HS-10	3579		
85.0 hp		1986 - 1993	0,8	BZ7HS-10	3579		
85.0 hp Backtroller	4	1994 - 1995	0,8	BR6HS	3922	BR6HIX	3419
88.0 hp SPL	4	1979 - 1997	0,8	BR6HS	3922	BR6HIX	3419
90.0 hp (CV4)	4	1979 - 1998	0,8	BR6HS	3922	BR6HIX	3419
90.0 hp Turbojet		1994 - 1997	0,8	BR6HS	3922	BR6HIX	3419
90.0 hp (LV4)	4	1995 -	0,8	BPR7HS	6422	BPR7HIX	5944
90.0 hp 1950cc	4	2003 -	0,7	BKR6E	6962	BKR6EIX	6418



Cyl.

Order
No.

Iridium

Order
No.**JOHNSON**

100.0 hp		1967 - 1972	0,8	BZ7HS-10	3579		
100.0 hp	4	1979 - 1980	0,8	BZ7HS-10	3579		
110.0 hp (CV4)	4	1979 - 1997	0,8	BR6HS	3922	BR6HIX	3419
100.0 hp COM.		1984 - 1997		BUHXW-1	5526		
100.0 hp COM.		1998 -		BUHXW-1	5526		
105.0 hp (V6) Jet, COM.	6	1993 - 1997	0,8	BPR7HS	6422	BPR7HIX	5944
105.0 hp COM.	6	1997 -	0,8	BPR7HS	6422	BPR7HIX	5944
112.0 hp (CV4)	4	1979 - 1997	0,8	BR6HS	3922	BR6HIX	3419
115.0 hp		1969 - 1970	0,8	BZ7HS-10	3579		
115.0 hp		1973 - 1984	0,8	BZ7HS-10	3579		
115.0 hp COM.		1975 - 1984	1,0	B7HS-10	2129		
115.0 hp (CV4)	4	1979 - 1998	0,8	BR6HS	3922	BR6HIX	3419
115.0 hp		1985 -		BUHXW-1	5526		
115.0 hp		1986 - 1993	0,8	BZ7HS-10	3579		
115.0 hp Turbojet		1994 - 1998	0,8	BR6HS	3922	BR6HIX	3419
115.0 hp (LV4) FastStrike	4	1995 -	0,8	BPR7HS	6422	BPR7HIX	5944
120.0 hp (LV4)	4	1985 - 1997	0,8	BPR7HS	6422	BPR7HIX	5944
125.0 hp (CV6)	6	1971 - 1972	0,8	BZ7HS-10	3579		
130.0 hp (LV4)	4	1985 -	0,8	BPR7HS	6422	BPR7HIX	5944
135.0 hp		1973 - 1984		BUHXW-1	5526		
140.0 hp		1973 - 1984		BUHXW-1	5526		
140.0 hp (LV4)	4	1985 - 1997	0,8	BPR7HS	6422	BPR7HIX	5944
150.0 hp (CV6)	6	1978 - 1987		BUHXW-1	5526		
150.0 hp (CV6)	6	1988 - 1991	0,8	BZ7HS-10	3579		
150.0 hp (LV6) FastStrike	6	1991 -	0,8	BPR7HS	6422	BPR7HIX	5944
150.0 hp (LV6) COM.	6	1993 - 1998	0,8	BPR7HS	6422	BPR7HIX	5944
155.0 hp (CV6)	6	1978 - 1987		BUHXW-1	5526		
155.0 hp (CV6) COM.	6	1989 - 1992		BUHXW-1	5526		
175.0 hp (CV6)	6	1977 - 1987		BUHXW-1	5526		
175.0 hp (CV6)	6	1988 - 1991	0,8	BZ7HS-10	3579		
175.0 hp (LV6) FastStrike	6	1991 -	0,8	BPR7HS	6422	BPR7HIX	5944
185.0 hp		1977 - 1987		BUHXW-1	5526		
185.0 hp COM.	6	1990 - 1993	0,8	BZ7HS-10	3579		
200.0 hp		1976 - 1983		BUHXW-1	5526		
200.0 hp (V6)	6	1986 - 1993	0,8	BZ7HS-10	3579		
200.0 hp COM.		1992 -		BUHXW-1	5526		
200.0 hp COM.		1993 - 1997	0,8	BR6HS	3922	BR6HIX	3419
200.0 hp (LV6) Venom	6	1994 - 1998	0,8	BPR7HS	6422	BPR7HIX	5944
225.0 hp	6	1986 - 1993	0,8	BZ7HS-10	3579		
225.0 hp (LV6) Venom	6	1994 -	0,8	BPR7HS	6422	BPR7HIX	5944
235.0 hp	6	1978 - 1985		BUHXW-1	5526		
250.0 hp (V8)	8	1985 - 1997	0,8	BPR7HS	6422	BPR7HIX	5944
250.0 hp	6	1999 -		BUHXW-1	5526		
275.0 hp		1985 - 1988	0,8	BPR7HS	6422	BPR7HIX	5944
300.0 hp (V8)	8	1985 - 1997	0,8	BPR7HS	6422	BPR7HIX	5944
Sea Drive		1988 - 1992	0,8	BZ7HS-10	3579		
<i>Models with Standard Ignition</i>							
1.0 hp 1R	1	1968 - 1970	0,8	BR6S	3522		
1.2 hp Magneto	1	1986 - 1990	0,8	BR6S	3522		
1.5 hp	1	1968 - 1970	0,8	BR6S	3522		
2.0 hp Aquanaut Driving Unit	1	1966 - 1970	0,8	BM4A	5628		



Cyl.

Order
No.

Iridium

Order
No.**JOHNSON***Models with Standard Ignition*

2.0 hp	1	1968 - 1970	0,8	BR6S	3522		
2.0 hp 2R	1	1971 - 1984	0,8	BR6S	3522		
3.0 hp	1	1952 - 1974	0,8	BR6S	3522		
3.3 hp	1	1948 - 1951	0,8	BR6S	3522		
4.0 hp V4 / V4A / V4M	1	1958 - 1967	0,8	BR6S	3522		
4.0 hp V4S / VX / VXH	1	1958 - 1967	0,8	BR6S	3522		
4.0 hp 4R/4W	1	1969 - 1976	0,8	BR6S	3522		
4.0 hp	1	1981 - 1984	0,8	BZ7HS-10	3579		
5.0 hp	1	1965 - 1968	0,8	BR6S	3522		
5.2 hp	1	1952 - 1974	0,8	BR6S	3522		
5.5 hp	1	1956 - 1964	0,8	BR6S	3522		
6.0 hp	1	1965 - 1976	0,8	BR6S	3522		
6.0 hp 6R / 6RL	1	1971 - 1976	0,8	BR6S	3522		
7.5 hp	1	1952 - 1958	0,8	BR6S	3522		
9.0 hp 9E / EL / R / RL		1974 -	0,8	BZ7HS-10	3579		
9.5 hp	1	1964 - 1973	0,8	BR6S	3522		
9.7 hp		1942 - 1949	0,8	A7	1110		
10.0 hp	1	1952 - 1963	0,8	BR6S	3522		
10.0 hp 10E / EL / R / RL		1975 - 1976	0,8	BZ7HS-10	3579		
14.0 hp	1	1950 - 1972	0,8	BR6S	3522		
15.0 hp	1	1954 - 1956	0,8	BR6S	3522		
18.0 hp		1957 - 1973	0,8	BR6S	3522		
20.0 hp		1966 - 1973	0,8	BR6S	3522		
20.0 hp 20R / 20RL		1969 -	0,8	BR6S	3522		
25.0 hp		1952 - 1955	0,8	BR6S	3522		
25.0 hp 25R / 25RL		1969 - 1972	0,8	BR6S	3522		
25.0 hp		1969 - 1976	0,8	BR6S	3522		
25.0 hp 25E / 25EL		1972 -	0,8	BR6S	3522		
25.0 hp 25E / 25EL / 25R / 25RL		1973 - 1976	0,8	BR6S	3522		
28.0 hp		1962 - 1964	0,8	BR6S	3522		
30.0 hp		1956 - 1971	0,8	BR6S	3522		
33.0 hp 33R / 33E		1969 - 1971	0,8	BR6S	3522		
35.0 hp		1957 - 1959	0,8	BR6S	3522		
35.0 hp 35E / EL / R / RL		1976 -	0,8	BZ7HS-10	3579		
40.0 hp		1960 - 1973	0,8	BR6S	3522		
40.0 hp 40ES		1969 - 1971	0,8	BR6S	3522		
40.0 hp 40R / 40E / 40EL / 40RL		1969 - 1973	0,8	BR6S	3522		
40.0 hp 40E / EL / R / RL		1974 - 1976	0,8	BZ7HS-10	3579		
50.0 hp		1958 - 1959	0,8	BR6S	3522		
60.0 hp (V4)		1964 - 1967	0,8	BR6S	3522		
75.0 hp (V4)		1960 - 1965	0,8	BR6S	3522		
80.0 hp		1966 - 1967	0,8	BR6S	3522		
90.0 hp		1964 - 1965	0,8	BR6S	3522		
100.0 hp		1966 -	0,8	BR6S	3522		
18 mm		1939 - 1950	0,6	A6	1010		
Air Buoy Driving Unit			0,8	BM4A	5628		
CD / JH / FD / FDE/ JW / MQ		1952 - 1968	0,8	BR6S	3522		
JHF / JWF / LD / SC		1965 - 1968	0,8	BR6S	3522		
RD / RDE / RDS / RJE / RK		1951 - 1968	0,8	BR6S	3522		
RX / RXE /		1962 - 1968	0,8	BR6S	3522		
TN / AD / QD / V4H / V4ML		1952 - 1966	0,8	BR6S	3522		



Cyl.



Order No.

Iridium



Order No.

LAURA

Boatmaster		0,5	B6HS	4510	BR6HIX	3419
Boatmaster Sustained full throttle		0,8	BR6HS	3922	BR6HIX	3419

MARINEPOWER

2.5	2-Takt/Stroke		1,0	BPR6HS-10	2633		
3.3	2-Takt/Stroke		1,0	BPR6HS-10	2633		
4	4-Takt/Stroke		0,6	DCPR6E	3481		
4	2-Takt/Stroke		1,0	BPR7HS-10	1092		
5	4-Takt/Stroke		0,8	DCPR6E	3481		
5	2-Takt/Stroke		1,0	BPR7HS-10	1092		
6	2-Takt/Stroke		1,0	BP8HN-10	4838		
6	4-Takt/Stroke		0,8	DCPR6E	3481		
8	2-Takt/Stroke		1,0	BP8HN-10	4838		
8	4-Takt/Stroke		0,9	DPR6EA-9	5531		
9.9	2-Takt/Stroke		1,5	BP8HS-15	6729		
9.9	4-Takt/Stroke		0,9	DPR6EA-9	5531		
15	4-Takt/Stroke		0,9	DPR6EA-9	5531		
25	4-Takt/Stroke		0,9	DPR6EA-9	5531		
30 EFI	4-Takt/Stroke		0,9	DCPR7E	3932	DCPR7EIX	6046
30 Vergaser	4-Takt/Stroke		0,9	DPR6EA-9	5531		
40 Vergaser	4-Takt/Stroke		0,9	DPR6EA-9	5531		
40 EFI	4-Takt/Stroke		0,9	DCPR7E	3932	DCPR7EIX	6046
45	4-Takt/Stroke	- 2001	0,9	DPR6EA-9	5531		
50	4-Takt/Stroke		0,9	DPR6EA-9	5531		
60	4-Takt/Stroke		0,9	DPR6EA-9	5531		
75	4-Takt/Stroke		1,1	LF5A-11	6376		
90	4-Takt/Stroke		1,1	LF5A-11	6376		
XR10	2-Takt/Stroke		1,5	BP8HS-15	6729		
10	Seapro Marathon		1,5	BP8HS-15	6729		
15	Seapro Marathon		1,5	BP8HS-15	6729		
15	2-Takt/Stroke		1,5	BP8HS-15	6729		
20	2-Takt/Stroke		1,0	BP8HN-10	4838		
25	2-Takt/Stroke		1,0	BP8HN-10	4838		
30	2-Takt/Stroke		1,0	BPZ8HN-10	4495		
40	2-Takt/Stroke		1,0	BPZ8HN-10	4495		
50	2-Takt/Stroke		1,0	BPZ8HN-10	4495		
60	2-Takt/Stroke		1,0	BPZ8HN-10	4495		
60	4-Takt/Stroke	- 2001	1,0	BPZ8HN-10	3133		
75	Seapro Marathon	2-Takt/Stroke		BUZHW-2	2173		
75	2-Takt/Stroke			BUZHW-2	2173		
75	Optimax	2004 -	0,8	PZFR6H	7696		
90	2-Takt/Stroke			BUZHW-2	2173		
90	Optimax	2004 -	0,8	PZFR6H	7696		
100	2-Takt/Stroke		1,0	BPZ8HN-10	4495		
115	2-Takt/Stroke		1,0	BPZ8HN-10	4495		
115	4-Takt/Stroke		1,1	LF6A-11	3672		
115	Optimax	- 2000	1,1	PZFR5F-11	4363		
115	Optimax	2004 -	0,8	PZFR6H	7696		
125	2-Takt/Stroke		1,0	BPZ8HN-10	4495		
135	Optimax		1,1	PZFR5F-11	4363		



Cyl.



Order No.

Iridium



Order No.

MARINEPOWER

135	2-Takt/Stroke		- 1999	0,7	BU8H	6431		
140	2-Takt/Stroke		- 2003	1,0	BPZ8HS-10	3133		
140	2-Takt/Stroke		2004 -	1,0	BPZ8HN-10	4495		
150	Optimax			1,1	PZFR5F-11	4363		
150	2-Takt/Stroke		- 1999	0,7	BU8H	6431		
150	2-Takt/Stroke		- 2003	1,0	BPZ8HS-10	3133		
150	2-Takt/Stroke		2004 -	1,0	BPZ8HN-10	4495		
175	Optimax			1,1	PZFR5F-11	4363		
175	2-Takt/Stroke		- 1999	0,7	BU8H	6431		
175	2-Takt/Stroke		- 2003	1,0	BPZ8HS-10	3133		
200	Optimax			1,1	PZFR5F-11	4363		
200	2-Takt/Stroke		- 1999	0,7	BU8H	6431		
200	2-Takt/Stroke		- 2003	1,0	BPZ8HS-10	3133		
200	2-Takt/Stroke		2004 -	1,0	BPZ8HN-10	4495		
Sport Jet 175XR ²				0,8	BUZ8H	7447		
210	Jetdrive			0,8	BUZ8H	7447		
225	Optimax			1,1	PZFR5F-11	4363		
225	2-Takt/Stroke			0,7	BR8HS	4322	BR8HIX	7001
225	4-Takt/Stroke		2004 -	1.1	LF5A-11	6376		
3L	2-Takt/Stroke			0,7	BR8HS	4322	BR8HIX	7001
240	Jetdrive			1,0	BPZ8HS-10	3133		
250	2-Takt/Stroke			0,7	BR8HS	4322	BR8HIX	7001

MARINER

2.0 hp	2A 646 / 2B 6A1		1993 - 1994	0,6	B6HS	4510	BR6HIX	3419
2.5 hp	(2-stroke)75cc 3Kw	1	1989 - 1997	0,6	B6HS	4510	BR6HIX	3419
2.5 hp		1	1998 -	0,8	BPR6HS	7022	BPR6HIX	4085
3.0 hp			1990 - 1992	0,6	B6HS	4510	BR6HIX	3419
3.3 hp	(2-stroke)75cc 3Kw	1	1993 - 1997	0,6	B6HS	4510	BR6HIX	3419
3.3 hp		1	1998 -	0,8	BPR6HS	7022	BPR6HIX	4085
3.5 hp	642		1993 - 1994	0,6	B6HS	4510	BR6HIX	3419
4.0 hp	4A 6E0		1989 - 1996	0,9	BR7HS	4122	BR7HIX	7067
4.0 hp	(2-stroke)		1990 -	0,8	BPR7HS	6422	BPR7HIX	5944
4.0 hp	4		1990 - 1997	0,9	BR7HS	4122	BR7HIX	7067
4.0 hp	(4-stroke) Sailmate 3Kw 123cc	1	1999 -	0,8	DCPR7E	3932	DCPR7EIX	6046
4.0 hp	(4-stroke)		1999 -	0,8	DCPR7E	3932	DCPR7EIX	6046
5.0 hp	(2-stroke) 4Kw 102cc	1	1990 -	0,9	BR7HS	4122	BR7HIX	7067
5.0 hp	5	1	1990 - 1997	0,9	BR7HS	4122	BR7HIX	7067
5.0 hp	5B 661, 5C 6E3	1	1990 - 1997	0,9	BR7HS	4122	BR7HIX	7067
5.0 hp	(4-stroke) 4Kw 123cc	1	1999 -	0,8	DCPR7E	3932	DCPR7EIX	6046
6.0 hp		2	1992 - 1997	0,8	BPR7HS	6422	BPR7HIX	5944
6.0 hp	(2-stroke)	2	1992 - 1999	0,9	BP5HA	7426		
6.0 hp	(2-stroke) 5Kw 210cc	2	1992 - 1999	0,7	BP5HA	7426		
6.0 hp	(4-stroke)	2	1992 - 1999	0,9	DCPR6E	3481		
6.0 hp	6B 678		1993 - 1996	0,9	BR7HS	4122	BR7HIX	7067
6.0 hp	6C 6H8	1	1993 - 1996	0,9	BR7HS	4122	BR7HIX	7067
8.0 hp		2	1987 - 1997	0,8	BPR7HS	6422	BPR7HIX	5944
8.0 hp	K8 680		1991 - 1995	0,9	BR7HS	4122	BR7HIX	7067
8.0 hp	C 6G1		1991 - 1995	0,9	BR7HS	4122	BR7HIX	7067
8.0 hp	B W8 77		1991 - 1995	0,9	BR7HS	4122	BR7HIX	7067



Cyl.



Order No.

Iridium



Order No.

MARINER

8.0 hp Marathon 8 677		1991 - 1995	0,9	BR7HS	4122	BR7HIX	7067
8.0 hp 8A 647,655		1991 - 1995	0,9	BR7HS	4122	BR7HIX	7067
9.9 hp (4-stroke) Bigfoot, sail power		1995 -	0,7	C7HSA	4629		
8.0 hp 8 Bodensee		1995 - 1997	0,7	C7HSA	4629		
9.9 hp (4-stroke)		1995 - 1997	0,7	C7HSA	4629		
8.0 hp	2	1998 -	0,7	BP5HA	7426		
9.9 hp 9.9C 682			0,9	BR7HS	4122	BR7HIX	7067
9.9 hp 9.9C 682 CDI			0,9	BR7HS	4122	BR7HIX	7067
9.9 hp		1987 - 1994	0,8	BPR7HS	6422	BPR7HIX	5944
9.9 hp	2	1995 - 1997	1,0	BPR7HS-10	1092		
9.9 hp	2	1998 -	0,9	BP5HA	7426		
10.0 hp (2-stroke)Magnum/Marathon 7kW 262cc	2	1991 - 1996	1,0	BPR7HS-10	1092		
10.0 hp Magnum/Marathon		1997 -	1,0	BPR7HS-10	1092		
15.0 hp 15A / 15C651,684 /K15669			0,9	BR7HS	4122	BR7HIX	7067
15.0 hp K15 / K15C6K4 / W15684			0,9	BR7HS	4122	BR7HIX	7067
15.0 hp Marathon15/ 15B662,664			0,9	BR7HS	4122	BR7HIX	7067
15.0 hp	2		0,7	BP5HA	7426		
15.0 hp	2	1989 - 1997	1,0	BPR7HS-10	1092		
15.0 hp Marathon 15		1992 -	0,7	BP5HA	7426		
15.0 hp (4-stroke) Bigfoot	2	1998 -	0,9	DCPR6E	3481		
20.0 hp 20A653 / 20C6A9			0,6	B6HS	4510	BR6HIX	3419
20.0 hp	2	1985 -	1,0	BPR7HS-10	1092		
20.0 hp Hi-Igni.		1985 - 1997	0,9	DCPR6E	3481		
20.0 hp 20 Jet		1995 -	1,0	BPR7HS-10	1092		
25.0 hp W25 694 / W25 695			0,8	BZ7HS-10	3579		
25.0 hp 25A 648 /25B 690 /25C 695			0,8	BZ7HS-10	3579		
25.0 hp 25		1985 -	1,0	BPR7HS-10	1092		
25.0 hp K25 6A4 / W25 648		1992 - 1996	0,8	BZ7HS-10	3579		
25.0 hp Marathon 25	2	1993 -	1,0	BPR7HS-10	1092		
25.0 hp Marathon 25 684 / 694 / 695		1993 - 1996	0,8	BZ7HS-10	3579		
25.0 hp (4-stroke) Bigfoot		1998 -	0,9	DCPR6E	3481		
28.0 hp 664			0,9	BR7HS	4122	BR7HIX	7067
30.0 hp Marathon 30 698B			0,9	BR7HS	4122	BR7HIX	7067
30.0 hp 30A689 / W30689A / 689B		1992 - 1997	0,9	BR7HS	4122	BR7HIX	7067
30.0 hp Marathon 30	2	1995 -	1,0	BPR7HS-10	1092		
30.0 hp 30 Jet		1995 -	1,0	BPR7HS-10	1092		
30.0 hp (4-stroke) Bigfoot		2000 -	0,9	DCPR6E	3481		
40.0 hp 40A676A / 40B675			0,6	BR8HS	4322	BR8HIX	7001
40.0 hp Marathon 40 6F6		1985 - 1994	1,0	BR8HS-10	1134		
40.0 hp	4	1989 - 1997		BUZHW-2	2173		
40.0 hp 40C6E9 / W40676A		1992 - 1996	1,0	BR8HS-10	1134		
40.0 hp K406F5 / W40 / W406F6		1992 - 1996	1,0	BPR7HS-10	1092		
40.0 hp Marathon 40	2	1995 -	1,0	BPR7HS-10	1092		
40.0 hp K406F5 / W40 / W406F6		1997 -	0,8	BR6HS	3922	BR6HIX	3419
40.0 hp (2-stroke)	3	1998 -	1,0	BPR7HS-10	1092		
40.0 hp (2-stroke)	2	1998 -	1,0	BPR7HS-10	1092		
40.0 hp 995cc	4	1998 - 2001	0,9	DPR6EA-9	5531		
40.0 hp 747cc .	3	1998 - 2001	0,9	DPR6EA-9	5531		
40.0 hp (4-stroke) Bigfoot 30kW 995cc	4	2000 -	0,9	DCPR6E	3481		
40.0 hp 995cc	4	2002 -	0,9	DCPR7E	3932	DCPR7EIX	6046
40.0 hp 747cc	3	2002 -	0,9	DCPR7E	3932	DCPR7EIX	6046
45.0 hp	4	1986 - 1989		BUZHW-2	2173		



Cyl.



Order No.

Iridium



Order No.

MARINER

45.0 hp 45 Jet		1995 -	1,0	BPR7HS-10	1092		
45.0 hp 45 Bodensee	4	1995 -	0,9	DCPR6E	3481		
48.0 hp 48 / W48 670			0,6	B6HS	4510	BR6HIX	3419
50.0 hp	4	1980 - 1985		BUZHW-2	2173		
50.0 hp	3	1986 - 1990		BUZHW-2	2173		
50.0 hp 849cc	3	1991 -	1,0	BPR7HS-10	1092		
50.0 hp (4-stroke) 935cc		1995 - 1997	0,9	DCPR6E	3481		
50.0 hp (4-stroke) Bigfoot 37kW 995cc	4	2000 -	0,9	DCPR6E	3481		
55.0 hp W55 663			1,0	BR8HS-10	1134		
55.0 hp 55EL S/N			1,0	BR8HS-10	1134		
55.0 hp 55E S/N			1,0	BR8HS-10	1134		
55.0 hp Marathon 55		1991 -	1,0	BPR7HS-10	1092		
55.0 hp M55 663		1993 - 1994	0,9	BR7HS	4122	BR7HIX	7067
60.0 hp (2-stroke) Bigfoot 45kW 967cc	3		1,0	BP7HS-10	7829		
60.0 hp 60EL	2		1,0	BR8HS-10	1134		
60.0 hp 60E	2		1,0	BR8HS-10	1134		
60.0 hp	3	1984 - 1990		BUZHW	2147		
60.0 hp 60 / 6F0		1991 - 1997	1,0	BPR7HS-10	1092		
60.0 hp Bigfoot, Marathon	3	1995 - 1997	1,0	BPR7HS-10	1092		
60.0 hp 60		1998 -	1,0	BPR7HS-10	1092		
60.0 hp Marathon 60	3	1998 -	1,0	BPR7HS-10	1092		
60.0 hp	4	2001 -	0,9	DPR6EA-9	5531		
60.0 hp EFI	4	2002 -	0,9	DCPR7E	3932	DCPR7EIX	6046
65.0 hp Jet	3	1995 - 1997		BUZHW-2	2173		
65.0 hp Jet		1998 -		BUZHW-2	2173		
70.0 hp	3	1978 - 1994		BUZHW-2	2173		
75.0 hp all models				BUZHW-2	2173		
75.0 hp (2-stroke)	3	1987 -		BUZHW-2	2173		
75.0 hp (2-stroke) Marathon 75	3	1991 -		BUZHW-2	2173		
75.0 hp 4-Stroke		2000 -	1,1	LFR5A-11	6376		
80.0 hp all models				BUZHW-2	2173		
80.0 hp Jet	3	1995 - 1997	1,0	BPR7HS-10	1092		
80.0 hp Jet		1998 -	1,0	BPR7HS-10	1092		
85.0 hp				BUZHW-2	2173		
90.0 hp	6			BUHW	2622		
90.0 hp	3	1987 - 1997		BUZHW-2	2173		
90.0 hp (2-stroke)	4	1998 -		BUZHW-2	2173		
90.0 hp (2-stroke)		2000 -	1,1	LFR5A-11	6376		
100.0 hp	4	1988 - 1997	1,0	BPR7HS-10	1092		
105.0 hp Jet 105		1995 - 1999		BU8H	6431		
115.0 hp	6	1979 - 1994		BUZHW	2147		
115.0 hp	4	1989 - 1997	1,0	BPR7HS-10	1092		
115.0 hp (2-stroke) 86kW	4	1998 -	1,0	BPR7HS-10	1092		
125.0 hp (2-stroke) 1848cc 93kW	4	1994 - 1997	1,0	BPR7HS-10	1092		
125.0 hp	4	1998 -	1,0	BPR7HS-10	1092		
135.0 hp 135Marathon / W135 V6	6	1986 - 1997		BU8H	6431		
135.0 hp V6	6	1998 -	1,0	BPR7HS-10	1092		
140.0 hp	6			BUZHW	2147		
140.0 hp Jet 140		1995 - 1997		BU8H	6431		
150.0 hp (2-stroke) V6 Rfi 112kW 2507cc	6			BU8H	6431		
150.0 hp 150 / V150 / W150	6	1979 - 1997		BU8H	6431		
150.0 hp (2-stroke) Magnum Efi,II,III 112kW 2507cc	6	1985 - 1997		BU8H	6431		



Cyl.



Order No.

Iridium



Order No.

MARINER

150.0 hp DFI	6	1997 -	1,1	ZFR6F-11	4291		
150.0 hp (2-stroke) SuperMagnum Efi, 112kW 2507cc	6	1997 -		BU8H	6431		
150.0 hp (2-stroke) V6 EFi 112kW 2507cc	6	2000 -	1,0	BPZ8HS-10	3133		
150.0 hp Magnum Efi I , II	6	2000 -	1,0	BPR7HS-10	1092		
150.0 hp 150 / V150 / W150	6	2000 -	1,0	BPR7HS-10	1092		
175.0 hp V175	6	1978 - 1997		BU8H	6431		
175.0 hp (2-stroke) Magnum Efi,131kW, SKi175 2507cc	6	1989 - 1997		BU8H	6431		
175.0 hp Magnum EFi, 175 Ski	6	2000 -	1,0	BPR7HS-10	1092		
200.0 hp (2-stroke) Magnum /Super-Mag. EFi, V200 2507cc	6	1989 - 1997		BU8H	6431		
200.0 hp DFI 3.0L	6	1997 -	1,1	ZFR6F-11	4291		
200.0 hp Super-Magnum Efi	6	2000 -	1,0	BPR7HS-10	1092		
220.0 hp Magnum Efi, V220	6	1987 - 1988		BU8H	6431		
225.0 hp Marathon	6	1994 -		BR8HS	4322		
225.0 hp 3.0L EFi , Carb	6	1995 - 1997		BR8HS	4322	BR8HIX	7001
225.0 hp (2-stroke) Super-Mag. EFi, 3032cc 168kW	6	1997 -		BU8H	6431		
225.0 hp 3.0L EFi , Carb	6	1998 -		BR8HS	4322		
245.0 hp 2.5L Carb.	6	1995 -		BU8H	6431		
250.0 hp 3.4L	6	1989 - 1990		BU8H	6431		
250.0 hp (2-stroke) 3.0L EFi, 3032cc 186kW	6	1997 -		BR8HS	4322	BR8HIX	7001
250.0 hp 3.0L Efi	6	1998 -		BR8HS	4322		
260.0 hp 2.5L Efi	6	1995 - 1998		BU8H	6431		
265.0 hp 2.5L Efi	6	1997 -		BU8H	6431		
275.0 hp 3.4L	6	1991 - 1994		BU8H	6431		

OptiMax

115.0 hp Optimax		2000 -	1,0	PZFR5F-11	4363	---	---
150.0 hp Optimax 112kW 2507cc	6	1998 -	1,1	PZFR5F-11	4363		
200.0 hp Optimax 149kW 3032cc	6	1998 -	1,1	PZFR5F-11	4363		
225.0 hp Optimax 168kW 3032cc	6		1,1	PZFR5F-11	4363		

RFI

60.0 hp (2-stroke) Bigfoot 45kW 967cc RFI	3		1,0	BPR7HS-10	1092		
---	---	--	-----	-----------	------	--	--

MARTIN

20 (2xPS), 100 (10PS)			0,9	B6S	3510		
40, 45 (4.5PS), 75 (7.5PS)			0,9	B6S	3510		
60, 66 (7.2PS)			0,9	B6S	3510		

McCULLOCH

14 PS			0,9	B6S	3510		
28, 45 PS			0,9	B6S	3510		
4 PS			0,9	BP5S	3011		
590630			0,9	B6S	3510		
9 PS			0,9	BM6A	5921		
9.5 PS			0,9	B6S	3510		



Cyl.

Order
No.

Iridium

Order
No.**MEDINA**

all models

0,8

B6HS**4510****BR6HIX****3419****MERCURY**

Jet 20 M

1,0

BPR7HS-10**1092**

Jet 65 ELPTO

BUZHW-2**2173**

Jet 80 ELPTO

1,0

BPR7HS-10**1092****112KW(2-stroke)2507cc**

150 EFI

6

BU8H**6431**

150 EFI SW

6

BU8H**6431**

150 RFI

6

BU8H**6431**

150 RFI SW

6

BU8H**6431**

150 XR6

6

BU8H**6431**

150 XR6 RFI

6

BU8H**6431****11kW(4-stroke)323cc**

F15EL Bigfoot

2

0,9

DCPR7E**3932****DCPR7EIX****6046**

F15ML Bigfoot

2

0,9

DCPR7E**3932****DCPR7EIX****6046****131KW(2-stroke)2507cc**

175 EFI

6

BU8H**6431**

175 RFI

6

BU8H**6431****168KW(2-stroke)3032cc**

225 EFI

6

0,8

BR8HS**4322****BR8HIX****7001**

225 EFI SW

6

0,8

BR8HS**4322****BR8HIX****7001****186KW(2-stroke)3032cc**

250 EFI SW

6

0,8

BR8HS**4322****BR8HIX****7001****19kW(4-stroke)498cc**

F25E Bigfoot

2

0,9

DCPR7E**3932****DCPR7EIX****6046**

F25EL Bigfoot

2

0,9

DCPR7E**3932****DCPR7EIX****6046**

F25ELPT Bigfoot

2

0,9

DCPR7E**3932****DCPR7EIX****6046**

F25ML Bigfoot

2

0,9

DCPR7E**3932****DCPR7EIX****6046****22kW(4-stroke)747cc**

F30EL Bigfoot

3

0,9

DCPR7E**3932****DCPR7EIX****6046**

F30ELPT Bigfoot

3

0,9

DCPR7E**3932****DCPR7EIX****6046**

F30M Bigfoot

3

0,9

DCPR7E**3932****DCPR7EIX****6046**

F30ML Bigfoot

3

0,9

DCPR7E**3932****DCPR7EIX****6046****30kW(4-stroke)747cc**

F40EL

3

1,0

BPR7HS-10**1092**

F40EL RFI

3

1,0

BPR7HS-10**1092**

F40ELPT

3

1,0

BPR7HS-10**1092**

F40ELPT RFI

3

1,0

BPR7HS-10**1092**

F40ML

3

1,0

BPR7HS-10**1092**

F40ML RFI

3

1,0

BPR7HS-10**1092**



Cyl.



Order No.

Iridium



Order No.

MERCURY

<i>30kW(4-stroke)995cc</i>							
F40ELPT Bigfoot	4	2000 -	0,9	DCPR7E	3932	DCPR7EIX	6046
F40ML Bigfoot	4	2000 -	0,9	DCPR7E	3932	DCPR7EIX	6046
<i>37kW(2-stroke)967cc</i>							
F50ELPTO	3		1,0	BPR7HS-10	1092		
F50ELPTO RFI	3		1,0	BPR7HS-10	1092		
<i>37kW(4-stroke)995cc</i>							
F50ELPT Bigfoot	4	2000 -	0,9	DCPR7E	3932	DCPR7EIX	6046
<i>45kW(2-stroke)967cc</i>							
60ELPTO Bigfoot	3		1,0	BPR7HS-10	1092		
60ELPTO Bigfoot RFI	3		1,0	BPR7HS-10	1092		
<i>67kW(2-stroke)1386cc</i>							
90ELPTO	3			BUHW-2	5626		
90ELPTO RFI	3			BUZHW-2	2173		
<i>7kW(4-stroke)323cc</i>							
F9.9EL	2		0,9	BP5HA	7426		
F9.9EL Bigfoot	2		0,8	C7HSA	4629		
F9.9M	2		0,7	BP5HA	7426		
F9.9M RFI	2		1,0	BPR7HS-10	1092		
<i>93KW(2-stroke)1848cc</i>							
125	4		1,0	BPR7HS-10	1092		
125 RFI	4		1,0	BPR7HS-10	1092		
<i>Customer Performance 209kW</i>							
2.5 EFI Offshore 2507cc		1999 -	0,8	BR8HS	4322	BR8HIX	7001
<i>Jet Series</i>							
25 hp 20 Jet 400cc	2			BUZHW-2	2173		
40 hp 30 Jet 719cc	4			BUZHW	2147		
60 hp 45 Jet 8490cc	3			BUZHW-2	2173		
90 hp 65 Jet 1386cc	4			BUZHW	2147		
115 hp 80 Jet 1848cc	4			BUZHW-2	2173		
<i>Mercury Series with Thunderbolt Ignition</i>							
2.2 hp		1984 - 1989	1,0	BPR6HS-10	2633		
2.5 hp		1993 -	0,8	BPR6HS	7022	BPR6HIX	4085
3.0 hp		1990 - 1992	0,8	BPR7HS	6422	BPR7HIX	5944
3.3 hp		1993 - 1997	0,8	BPR7HS	6422	BPR7HIX	5944
3.3 hp		1998 -	0,8	BPR6HS	7022	BPR6HIX	4085
3.5 hp		1983 - 1985	0,8	BPR7HS	6422	BPR7HIX	5944
3.6 hp		1980 - 1982	0,8	BPR7HS	6422	BPR7HIX	5944
4.0 hp		1970 - 1974		BUZHW-2	2173		
4.0 hp		1976 - 1979	0,6	B6HS	4510	BR6HIX	3419
4.0 hp		1980 - 1982	0,8	BPR7HS	6422	BPR7HIX	5944



Cyl.

Order
No.

Iridium

Order
No.**MERCURY***Mercury Series with Thunderbolt Ignition*

4.0 hp		1986 - 1987		BUZHW-2	2173		
4.0 hp (2-stroke)	1	1988 -	0,8	BPR7HS	6422	BPR7HIX	5944
4.0 hp		1988 - 1997	0,8	BPR7HS	6422	BPR7HIX	5944
4.0 hp (4-stroke)	1	2000 -	0,9	DCPR7E	3932	DCPR7EIX	6046
4.5 hp		1975 - 1985		BUZHW-2	2173		
5.0 hp		1988 - 1997	0,8	BPR7HS	6422	BPR7HIX	5944
5.0 hp (2-stroke)	1	1998 -	0,8	BPR7HS	6422	BPR7HIX	5944
5.0 hp (4-stroke)	1	2000 -	0,9	DCPR7E	3932	DCPR7EIX	6046
6.0 hp		1986 - 1997	0,8	BPR7HS	6422	BPR7HIX	5944
6.0 hp (2-stroke)	2	1998 -	0,7	BP5HA	7426		
6.0 hp (4-stroke)	1	2000 -	0,9	DCPR7E	3932	DCPR7EIX	6046
7.5 hp		1970 - 1978		BUZHW-2	2173		
7.5 hp		1979 - 1985	0,8	BZ7HS-10	3579		
8.0 hp	2	1986 - 1997	0,8	BPR7HS	6422	BPR7HIX	5944
8.0 hp Bodensee		1995 - 1999	0,7	C7HSA	4629		
8.0 hp	2	1998 -	0,9	BP5HA	7426		
9.8 hp		1970 - 1978		BUZHW-2	2173		
9.8 hp		1979 - 1985	0,8	BZ7HS-10	3579		
9.9 hp		1986 - 1994	0,8	BPR7HS	6422	BPR7HIX	5944
9.9 hp (4-stroke)	2	1995 - 1997	0,7	C7HSA	4629		
9.9 hp (2-stroke)	2	1995 - 1997	1,0	BPR7HS-10	1092		
9.9 hp (2-stroke)	2	1998 -	0,9	BP5HA	7426		
9.9 hp (4-stroke)	2	1998 -	0,9	DCPR7E	3932	DCPR7EIX	6046
10.0 hp Sea Pro		1991 - 1996	1,0	BPR7HS-10	1092		
10.0 hp		1991 - 1996	1,0	BPR7HS-10	1092		
10.0 hp Sea Pro		1997 -	1,0	BPR7HS-10	1092		
15.0 hp	2	1989 - 1997	1,0	BPR7HS-10	1092		
15.0 hp Sea Pro		1995 - 1997	1,0	BPR7HS-10	1092		
15.0 hp (4-stroke) Bigfoot		1998 -	0,9	DCPR7E	3932	DCPR7EIX	6046
15.0 hp Sea Pro	2	1998 -	0,9	BP5HA	7426		
15.0 hp (2-stroke)	2	1998 -	0,7	BP5HA	7426		
18.0 hp		1980 - 1985	0,8	BZ7HS-10	3579		
20.0 hp		1970 - 1981		BUZHW-2	2173		
20.0 hp	2	1986 - 1997	0,8	BPR7HS	6422	BPR7HIX	5944
20.0 hp Jet	2	1995 -	0,8	BPR7HS	6422	BPR7HIX	5944
20.0 hp (2-stroke)	2	1998 -	0,8	BPR7HS	6422	BPR7HIX	5944
25.0 hp	2	1980 - 1997	0,8	BPR7HS	6422	BPR7HIX	5944
25.0 hp Sea Pro	2	1993 - 1997	0,8	BPR7HS	6422	BPR7HIX	5944
25.0 hp (4-stroke) Bigfoot		1997 -	0,9	DCPR7E	3932	DCPR7EIX	6046
25.0 hp Sea Pro	2	1998 -	0,8	BPR7HS	6422	BPR7HIX	5944
25.0 hp (4-stroke)		1998 -	0,9	DCPR7E	3932	DCPR7EIX	6046
25.0 hp Sea Pro (2-stroke)	2	1998 -	0,8	BPR7HS	6422	BPR7HIX	5944
30.0 hp (2-stroke)	2	1995 -	0,8	BPR7HS	6422	BPR7HIX	5944
30.0 hp Sea Pro	2	1995 - 1997	0,8	BPR7HS	6422	BPR7HIX	5944
30.0 hp Jet	2	1995 - 1997		BUZHW-2	2173		
30.0 hp Jet	3	1998 -	0,8	BPR7HS	6422	BPR7HIX	5944
30.0 hp Sea Pro	2	1998 -	0,8	BPR7HS	6422	BPR7HIX	5944
30.0 hp (4-stroke)	2	1999 -	0,9	DCPR7E	3932	DCPR7EIX	6046
35.0 hp	2	1984 - 1991		BUZHW	2147		
40.0 hp		1970 - 1983		BUZHW	2147		
40.0 hp	4	1988 - 1997		BUZHW-2	2173		
40.0 hp	2	1995 -	1,0	BPR7HS-10	1092		



Cyl.



Order No.

Iridium



Order No.

MERCURY*Mercury Series with Thunderbolt Ignition*

40.0 hp Sea Pro	2	1995 - 1997	1,0	BPR7HS-10	1092		
40.0 hp Sea Pro	3	1995 - 1997	1,0	BPR7HS-10	1092		
40.0 hp	3	1997 -	1,0	BPR7HS-10	1092		
40.0 hp (4-stroke)Bigfoot D706		1998 -	0,9	DCPR7E	3932	DCPR7EIX	6046
40.0 hp Sea Pro		1998 -	1,0	BPR7HS-10	1092		
45.0 hp		1986 - 1989		BUZHW-2	2173		
45.0 hp 45 Jet		1995 - 1997	1,0	BPR7HS-10	1092		
45.0 hp 45 Bodensee		1995 - 1997	0,9	DCPR7E	3932	DCPR7EIX	6046
45.0 hp 45 Jet	3	1998 -	1,0	BPR7HS-10	1092		
45.0 hp 45 Bodensee	4	1998 -	0,9	DCPR7E	3932	DCPR7EIX	6046
50.0 hp 500SS		1966 - 1969		BUZHW	2147		
50.0 hp		1970 - 1990		BUZHW	2147		
50.0 hp	3	1991 - 1997	1,0	BPR7HS-10	1092		
50.0 hp (4-stroke)Bigfoot	4	1995 -	0,9	DCPR7E	3932	DCPR7EIX	6046
50.0 hp (4-stroke)	4	1995 - 1997	0,9	DCPR7E	3932	DCPR7EIX	6046
50.0 hp (2-stroke)	3	1998 -	1,0	BPR7HS-10	1092		
55.0 hp Sea Pro		1992 -	1,0	BPR7HS-10	1092		
60.0 hp		1980 - 1984		BUZHW	2147		
60.0 hp	3	1991 -	1,0	BPR7HS-10	1092		
60.0 hp Big Foot, Sea Pro	3	1995 - 1997	1,0	BPR7HS-10	1092		
60.0 hp Big Foot	3	1998 -	1,0	BPR7HS-10	1092		
60.0 hp Sea Pro	3	1998 -	1,0	BPR7HS-10	1092		
60.0 hp (4-stroke)	4	2001 -	0,9	DCPR7E	3932	DCPR7EIX	6046
65.0 hp 650SS		1966 - 1969		BUZHW	2147		
65.0 hp		1970 - 1976		BUZHW	2147		
65.0 hp 65 Jet		1995 -		BUZHW-2	2173		
70.0 hp		1977 - 1983		BUZHW	2147		
70.0 hp		1987 - 1989		BUZHW-2	2173		
75.0 hp	4	1984 - 1986		BUZHW-2	2173		
75.0 hp	3	1987 - 1997		BUZHW-2	2173		
75.0 hp Sea Pro		1990 - 1997		BUZHW-2	2173		
75.0 hp (2-stroke) Sea Pro		1998 -		BUZHW-2	2173		
75.0 hp (2-stroke)	3	1998 -		BUZHW-2	2173		
75.0 hp (4-stroke)	4	2000 -	1,1	LFR5A-11	6376		
80.0 hp 800		1966 - 1969		BU8H	6431		
80.0 hp		1969 - 1972		BUZHW	2147		
80.0 hp		1978 - 1989		BUZHW-2	2173		
80.0 hp 80 Jet		1995 - 1997	1,0	BPR7HS-10	1092		
80.0 hp 80 Jet		1998 -	1,0	BPR7HS-10	1092		
85.0 hp		1973 - 1977		BUZHW	2147		
90.0 hp	6	1978 - 1986		BUZHW	2147		
90.0 hp	3	1987 - 1997		BUZHW-2	2173		
90.0 hp (2-stroke)	3	1998 -		BUZHW-2	2173		
90.0 hp (4-stroke)	4	2000 -	1,1	LFR5A-11	6376		
95.0 hp 950, 950SS		1966 - 1969		BU8H	6431		
100.0 hp 1000BP, 1000SS		1966 - 1969		BU8H	6431		
100.0 hp		1988 - 1994	1,0	BPR7HS-10	1092		
100.0 hp		1996 -	1,0	BPR7HS-10	1092		
105.0 hp 105 Jet		1995 - 1997		BU8H	6431		
110.0 hp 1100BP, 1100SS		1966 - 1969		BU8H	6431		
115.0 hp	6	1970 - 1988		BUZHW	2147		
115.0 hp	4	1989 - 1997	1,0	BPR7HS-10	1092		



Cyl.

Order
No.

Iridium

Order
No.**MERCURY***Mercury Series with Thunderbolt Ignition*

115.0 hp (2-stroke)	4	1998 -	1,0	BPR7HS-10	1092		
125.0 hp 1250BP, 1250SS		1966 - 1969		BU8H	6431		
125.0 hp	4	1994 -	1,0	BPR7HS-10	1092		
135.0 hp	6	1970 - 1971		BUZHW	2147		
135.0 hp	6	1986 - 1997		BU8H	6431		
135.0 hp V6	6	2000 -	0,8	BPR7HS	6422	BPR7HIX	5944
140.0 hp	6	1970 - 1980		BUZHW	2147		
140.0 hp 140 Jet	6	1995 - 1997		BU8H	6431		
150.0 hp	6	1973 - 1977		BUZHW	2147		
150.0 hp V6	6	1978 - 1997		BU8H	6431		
150.0 hp V6 XR2, XR4, XR6	6	1985 - 1999		BU8H	6431		
150.0 hp V6 XRI	6	1993 - 1997		BU8H	6431		
150.0 hp V6 Efi	6	2000 -	0,8	BPR7HS	6422	BPR7HIX	5944
175.0 hp V6	6	1976 - 1997		BU8H	6431		
175.0 hp	6	1991 -		BUZHW	2147		
175.0 hp V6 XRI	6	1991 - 1997		BU8H	6431		
175.0 hp V6 XRI EFI	6	2000 -	0,8	BPR7HS	6422	BPR7HIX	5944
200.0 hp V6	6	1978 - 1997		BU8H	6431		
200.0 hp V6 XRI	6	1989 - 1997		BU8H	6431		
200.0 hp	6	1991 -		BUZHW	2147		
200.0 hp V6 DFI 3.0L	6	1996 - 1997	1,1	ZFR6F-11	4291		
200.0 hp XR2 SS EFI 2.0L	6	1997 -		BUZHW	2147		
200.0 hp Deuce High EFI 2.0L	6	1997 -		BUZHW	2147		
200.0 hp SST 120 EFI 2.0L	6	1997 -		BU8H	6431		
200.0 hp V6 XRI EFI	6	2000 -	0,8	BPR7HS	6422	BPR7HIX	5944
200.0 hp V6	6	2000 -	0,8	BPR7HS	6422	BPR7HIX	5944
220.0 hp XRI	6	1987 - 1988		BU8H	6431		
225.0 hp	6	1980 - 1981		BU8H	6431		
225.0 hp 2.5L	6	1991 -		BUZHW	2147		
225.0 hp V6	6	1994 - 1997	1,0	BPR7HS-10	1092		
245.0 hp 2.5L	6	1995 - 1996		BU8H	6431		
225.0 hp V6 XRI EFI	6	1995 - 1997	0,8	BR8HS	4322		
225.0 hp V6 Sea Pro 3.0L	6	1995 - 1997	1,0	BPR7HS-10	1092		
225.0 hp V6 DFI 3.0L	6	1997 -	1,1	ZFR6F-11	4291		
225.0 hp V6 Sea Pro 3.0L	6	1998 -	0,8	BR8HS	4322	BR8HIX	7001
225.0 hp V6	6	1998 -	0,8	BR8HS	4322		
225.0 hp V6 XRI EFI	6	1998 -	0,8	BR8HS	4322		
250.0 hp 3.4L	6	1989 - 1990		BU8H	6431		
250.0 hp V6 XRI EFI	6	1995 -	0,8	BR8HS	4322	BR8HIX	7001
260.0 hp 2.5L Offshore		1995 - 1998		BU8H	6431		
265.0 hp 2.5L SS Drag EFI		1997 -		BU8H	6431		
275.0 hp 3.4L		1984 - 1988		BU8H	6431		
275.0 hp		1989 - 1994		BU8H	6431		
280.0 hp 2.0L F1 EFI		1997 -		BU8H	6431		
300.0 hp		1980 - 1983		BUZHW	2147		
300.0 hp 2.5L S3000 EFI		1997 -		BU8H	6431		

Optimax Dig 85kW

115		2000 -				IZFR5G	5887
-----	--	--------	--	--	--	---------------	-------------



Cyl.



Order No.

Iridium



Order No.

MERCURY

<i>Optimax Dig 101kW 2507cc</i>						
135	6	2000 -	1,1	PZFR5F-11	4363	
135	6	2001 -	1,1	LFR5A-11	6376	
<i>Optimax Dig 101kW 507cc</i>						
135	6	2000 -	1,1	PZFR5F-11	4363	
135	6	2001 -	1,1	LFR5A-11	6376	
<i>Optimax Dig 112kW 2507cc</i>						
150	6	1998 - 2002	1,1	PZFR5F-11	4363	
150	6	2003 -				IZFR5G 5887
<i>Optimax Dig 149kW 3032cc</i>						
200	6	1998 - 2002	1,1	PZFR5F-11	4363	
200	6	2003 -				IZFR5G 5887
<i>Optimax Dig 168kW 3032cc</i>						
225	6	1998 - 2002	1,1	PZFR5F-11	4363	
225	6	2003 -				IZFR5G 5887
<i>Racing 134kW</i>						
SST 120 1998cc RFI				BUZHW	2147	
SST 120 1998cc				BUHW	2622	
<i>Racing 224kW</i>						
2.5 Drag 2507cc				BU8H	6431	
2.5 Drag 2507cc RFI				BU8H	6431	
S3000 2507cc				BU8H	6431	
S3000 2507cc RFI				BU8H	6431	
<i>Sea Pro</i>						
10M RFI			1,0	BPR7HS-10	1092	
10M		1991 - 2000	1,5	BP8HS-15	6729	
10ML RFI			1,0	BPR7HS-10	1092	
10ML		1991 - 2000	1,5	BP8HS-15	6729	
15M			0,9	BP5HA	7426	
15M RFI		1995 - 1996	1,0	BP8HS-10	3823	
15ML			0,9	BP5HA	7426	
15ML RFI		1995 - 1996	1,0	BP8HS-10	3823	
25M RFI			1,0	BPR7HS-10	1092	
25M			1,0	BP7HS-10	7829	
25ML RFI			1,0	BPR7HS-10	1092	
25ML			1,0	BP7HS-10	7829	
40ML			1,0	BP7HS-10	7829	
40ML RFI			1,0	BPR7HS-10	1092	
40MLL			1,0	BP7HS-10	7829	
40MLL RFI			1,0	BPR7HS-10	1092	
55ML			1,0	BP7HS-10	7829	
55ML RFI			1,0	BPR7HS-10	1092	
55MLL			1,0	BP7HS-10	7829	
55MLL RFI			1,0	BPR7HS-10	1092	
60ML RFI			1,0	BPR7HS-10	1092	
60ML			1,0	BP7HS-10	7829	



Cyl.

Order
No.

Iridium

Order
No.**MERCURY***Sea Pro*

60MLL RFI			1,0	BPR7HS-10	1092		
60MLL			1,0	BP7HS-10	7829		
75ELH RFI				BUZHW-2	2173		
75ELH				BUZHW-2	2173		
75ELLH				BUZHW-2	2173		
75ELLH RFI				BUZHW-2	2173		
75ML RFI				BUZHW-2	2173		
75ML				BUZHW-2	2173		
75MLL RFI				BUZHW-2	2173		
75MLL				BUZHW-2	2173		

MIGHTY MITE

1.7hp			0,6	B2	3110		
2.0hp			0,6	B2	3110		

MONO

M-50			0,8	B6S	3510		
M-5A, M-6A			0,8	B6S	3510		
M-75			0,8	BP5S	3011		

MOSKVA

Moskva-25			0,8	BP6HS	4511	BPR6HIX	4085
Moskva-30D			0,8	BP6ES	7811		

NAUTILO

100 (5PS)			0,5	B6HS	4510	BR6HIX	3419
75 (3PS)			0,5	B6HS	4510	BR6HIX	3419

NEPTUNE

1A39			0,6	B6S	3510		
4A39			0,6	B6S	3510		
5A39			0,6	B6S	3510		
9A39			0,6	B6S	3510		
10A1			0,6	B6S	3510		
10A16			0,6	A6	1010		
10A4/A6/A10			0,6	B6S	3510		
11A1			0,6	B4	3210		
11A10			0,6	B6S	3510		
11A12			0,6	A6	1010		
11A16			0,6	A6	1010		
11A3/AA3			0,6	B6S	3510		
11A6/AA6			0,6	B6S	3510		
15A1			0,6	B4	3210		



Cyl.



Order
No.

Iridium



Order
No.

NEPTUNE

15A3/AA3		0,6	B6S	3510		
15A6 / AA6		0,6	B6S	3510		
15A9/AA9		0,6	B6S	3510		
16A39		0,6	A6	1010		
17A1, 17A2, 17A3, A1,AA1, AA1A		0,6	B6S	3510		
101		0,6	B6S	3510		
104		0,6	B6S	3510		
106		0,6	B6S	3510		
111		0,6	B4	3210		
113		0,6	B6S	3510		
114		0,6	B6S	3510		
116		0,6	B6S	3510		
139		0,6	B6S	3510		
189		0,6	B6S	3510		
238		0,6	A6	1010		
239		0,6	A6	1010		
438		0,6	A6	1010		
439		0,6	A6	1010		
539		0,6	B6S	3510		
639		0,6	A6	1010		
938		0,6	B6S	3510		
939		0,6	B6S	3510		
1010		0,6	B6S	3510		
1016		0,6	A6	1010		
1110		0,6	B6S	3510		
1638		0,6	A6	1010		
1639		0,6	A6	1010		
A2		0,6	B6S	3510		
AA2		0,6	B6S	3510		
AA4		0,6	B6S	3510		
AA6		0,6	B6S	3510		
AA10		0,6	B6S	3510		
OB1		0,6	A6	1010		
OB2		0,6	A6	1010		
OB2C		0,6	A6	1010		
OB3		0,6	A6	1010		
OB4		0,6	A6	1010		
OB11		0,6	A6	1010		
OB12		0,6	A6	1010		
OB31		0,6	A6	1010		
OB32		0,6	A6	1010		
OB34		0,6	A6	1010		
OB51		0,6	A6	1010		
OB63		0,6	A6	1010		
OB64		0,6	A6	1010		
OB65		0,6	A6	1010		
OB102		0,6	A6	1010		
OB112		0,6	A6	1010		



Cyl.

Order
No.

Iridium

Order
No.**NISSAN**

NS 2.5A 2.5hp	1985 - 1996	1,0	BP6HS-10	6326
NS 2.5A 2.5hp	1997 - 2001	1,0	BPR6HS-10	2633
NS 3.5A 3.5hp	1985 - 1992	1,0	BP6HS-10	6326
NS 3.5B 3.5hp	1993 - 1996	1,0	BP6HS-10	6326
NS 3.5B 3.5hp	1997 - 2001	1,0	BPR6HS-10	2633
NS 3.5A 3.5hp	1997 - 2001	1,0	BPR6HS-10	2633
NSF 4A 4.0hp	2000 - 2001	0,8	DCPR6E	3481
NS 5 5 hp	1985 - 1996	1,0	BP7HS-10	7829
NS 5B 5.0hp	1997 - 2001	1,0	BPR7HS-10	1092
NSF 5A 5.0hp	1999 - 2001	0,8	DCPR6E	3481
NS 8A 8 hp	1985 - 1986	1,0	BP7HS-10	7829
NS 8B 8.0hp	1987 - 1996	1,0	BP7HS-10	7829
NS 8B 8.0hp	1997 - 2001	1,0	BPR7HS-10	1092
NS 9.8B 9.8hp	1998 - 2001	1,0	BPR7HS-10	1092
NS 9.9B 9.9hp	1985 - 1996	1,0	B7HS-10	2129
NS 9.9B 9.9hp	1997 - 1999	1,0	BP7HS-10	7829
NSF 9.9A 9.9hp	2000 - 2001	0,8	DCPR6E	3481
NS 12 12hp	1985 - 1987	1,0	B7HS-10	2129
NS 12 12hp	1994 -	1,0	B7HS-10	2129
NS 15B 15hp	1985 - 1992	1,0	B7HS-10	2129
NS 15C 15hp	1993 - 1996	1,0	BP7HS-10	7829
NS 15C 15hp	1997 - 1999	1,0	BPR7HS-10	1092
NS 15D 15hp	2000 - 2001	1,0	BPR7HS-10	1092
NS 18C 18hp	1985 - 1992	1,0	B7HS-10	2129
NS 18 18hp	1993 - 1996	1,0	B7HS-10	2129
NS 18 18hp	1997 - 1999	1,0	BR7HS-10	1098
NS 18E 18hp	2000 - 2001	1,0	BPR7HS-10	1092
NS 25 25hp	1986 - 1996	1,0	B7HS-10	2129
NS 25C3 25hp	1997 - 2001	1,0	BR7HS-10	1098
NS 30A 30hp	1986 - 1996	1,0	B7HS-10	2129
NS 30A 30hp	1997 - 2001	1,0	BR7HS-10	1098
NS 35C 35hp	1994 - 1995	1,0	B7HS-10	2129
NS 40C 40hp	1985 - 1992	1,0	B7HS-10	2129
NS 40D 40hp	1991 - 1996	1,0	B7HS-10	2129
NS 40D 40hp	1997 - 2001	1,0	BR7HS-10	1098
NS 45A 45hp	1994 - 1995	1,0	B8HS-10	5126
NS 50C 50hp	1985 - 1992	1,0	B8HS-10	5126
NS 50D 50hp	1991 - 1996	1,0	B8HS-10	5126
NS 50D 50hp	1997 - 2001	1,0	BR8HS-10	1134
NS 55 60hp	1985 - 1986	1,0	B8HS-10	5126
NS 60A 60hp	1987 - 1992	1,0	B8HS-10	5126
NS 60B 60hp	1993 - 1995	1,0	B8HS-10	5126
NS 70B 70hp	1986 - 1996	1,0	B8HS-10	5126
NS 70B 70hp	1997 - 1999	1,0	BR8HS-10	1134
NS 70C 70hp	2000 - 2001	1,0	BR8HS-10	1134
NS 90A 90hp	1987 - 1996	1,0	B8HS-10	5126
NS 90A 90hp	1987 - 1996	1,0	B8HS-10	5126
NS 90A 90hp	1997 - 2001	1,0	BR8HS-10	1134
NS 120A 120hp	1990 - 1996	1,0	B8HS-10	5126
NS 120A 120hp	1997 - 2001	1,0	BR8HS-10	1134
NS 140A 140hp	1990 - 1996	1,0	B8HS-10	5126
NS 140A2 140hp	1997 - 2001	1,0	BR8HS-10	1134



Cyl.



Order No.

Iridium



Order No.

NISSAN

Y9, Y12, Y15

0,7

B6HS**4510****BR6HIX****3419****NORDEC-BOND**2430 PS, 4050 PS
Flat 4

0,6

B6ES**7310**

0,6

B6ES**7310****O.M.C.**

1.5	1968 - 1970	0,7	B6S	3510		
2 Jr.	1971 - 1990	0,7	BR6S	3522		
2.0	1991 -	0,8	BPR6HS	7022	BPR6HIX	4085
2.3	1991 -	0,8	BPR6HS	7022	BPR6HIX	4085
2.5	1987 - 1988	0,8	BR6HS	3922	BR6HIX	3419
3.0	1952 - 1970	0,7	B6S	3510		
3.0	1989 -	0,8	BR6HS	3922	BR6HIX	3419
3.3	1991 -	0,8	BPR6HS	7022	BPR6HIX	4085
4.0	1969 - 1976	0,7	B6S	3510		
4.0	1977 - 1987	0,8	BR6HS	3922	BR6HIX	3419
4.0	1988 -	1,0	BZ7HS-10	3579		
4.0	1989 -	0,8	BR6HS	3922	BR6HIX	3419
4.0 Delux	1989 -	0,8	BR6HS	3922	BR6HIX	3419
4.5	1980 - 1985	0,8	BR6HS	3922	BR6HIX	3419
5.0	1965 - 1968	0,7	B6S	3510		
5.0	1990 -	0,8	BR6HS	3922	BR6HIX	3419
5.0 (4-stroke)	1997 -	0,7	D6HA	6512		
5.5	1954 - 1964	0,7	B6S	3510		
6.0	1965 - 1976	0,7	B6S	3510		
6.0	1977 -	1,0	BZ7HS-10	3579		
6.0 (4-stroke)	1998 -	0,7	D6HA	6512		
6.5 Comm.	1981 - 1993	1,0	BZ7HS-10	3579		
7.5	1952 - 1958	0,7	B6S	3510		
7.5	1977 -	1,0	BZ7HS-10	3579		
8.0 Comm.	1977 -	1,0	BZ7HS-10	3579		
8.0	1977 -	1,0	BZ7HS-10	3579		
8.0 (4-stroke)	1998 -	0,7	D6HA	6512		
9.5	1964 - 1973	0,8	B7S	3710		
9.9	1974 - 1976	0,8	B7HS	5110	BR7HIX	7067
9.9	1977 -	1,0	BZ7HS-10	3579		
9.9 Big Bore	1993 -	0,8	BR6HS	3922	BR6HIX	3419
9.9 (4-stroke) 211cc	1998 -	0,7	D6HA	6512		
9.9 (4-stroke) 305cc	1998 -	0,8	DCPR7E	3932	DCPR7EIX	6046
10.0	1952 - 1958	0,7	B6S	3510		
10.0	1959 - 1963	0,8	B7S	3710		
10.0 Comm.	1992 - 1993	1,0	BZ7HS-10	3579		
10.0 Comm.	1994 -	0,8	BR6HS	3922	BR6HIX	3419
14.0 Comm.	1981 - 1991	1,0	BZ7HS-10	3579		
14.0	1988 - 1989	1,0	BZ7HS-10	3579		
15.0	1954 - 1956	0,7	B6S	3510		
15.0	1974 - 1976	0,8	B7HS	5110	BR7HIX	7067
15.0	1977 - 1992	1,0	BZ7HS-10	3579		



Cyl.

Order
No.

Iridium

Order
No.**O.M.C.**

15.0 Comm.		1992 - 1993	1,0	BZ7HS-10	3579		
15.0 Big Bore		1993 -	0,8	BR6HS	3922	BR6HIX	3419
15.0 Comm.		1994 -	0,8	BR6HS	3922	BR6HIX	3419
15.0 Kero		1995 -		BUHXW-1	5526		
15.0 (4-stroke)		1998 -	0,8	DCPR7E	3932	DCPR7EIX	6046
18.0		1957 - 1973	0,8	B7S	3710		
18.0 Jet 25 h.p.		1995 -	1,0	BZ7HS-10	3579		
20.0		1966 - 1973	0,8	B7S	3710		
20.0		1978 -	1,0	BZ7HS-10	3579		
25.0		1952 - 1955	0,8	B7S	3710		
25.0		1969 - 1976	0,8	B7S	3710		
25.0		1977 -	1,0	BZ7HS-10	3579		
25.0 Comm.		1981 -		BUHXW-1	5526		
25.0	3	1995 - 1997	0,8	BR6HS	3922	BR6HIX	3419
25.0	3	1998 -	0,8	BR6HS	3922	BR6HIX	3419
28.0		1962 - 1964	0,8	B7S	3710		
28.0		1978 -	1,0	BZ7HS-10	3579		
28 Jet 40 h.p.		1992 -	0,8	BPR7HS	6422	BPR7HIX	5944
30.0		1956 -	0,7	B6S	3510		
30.0		1978 -	1,0	BZ7HS-10	3579		
33.0		1965 - 1971	0,8	B7S	3710		
35.0		1957 - 1959	0,7	B6S	3510		
35.0		1976 -	0,8	B7HS	5110	BR7HIX	7067
35.0		1977 -	1,0	BZ7HS-10	3579		
35 Jet 50 h.p.		1993 -	0,8	BPR7HS	6422	BPR7HIX	5944
35.0	3	1995 - 1997	0,8	BR6HS	3922	BR6HIX	3419
35.0	3	1998 -	0,8	BR6HS	3922	BR6HIX	3419
40.0		1960 - 1973	0,8	B7S	3710		
40.0		1974 - 1976	0,8	B7HS	5110	BR7HIX	7067
40.0	2	1980 - 1988		BUZHW-2	2173		
40.0 Comm. 43cu.in.		1981 - 1990	0,8	B7HS	5110	BR7HIX	7067
40.0 Comm. 45cu.in.		1984 -		BUHXW-1	5526		
40.0	2	1989 -	0,8	BPR7HS	6422	BPR7HIX	5944
45.0 Comm.		1986 -		BUHXW-1	5526		
48.0	2	1980 - 1988		BUZHW-2	2173		
48.0	2	1989 -	0,8	BPR7HS	6422	BPR7HIX	5944
50.0 (V4)		1958 - 1959	0,8	B7S	3710		
50.0		1971 - 1975	1,0	BZ7HS-10	3579		
50.0	2	1980 - 1988		BUZHW-2	2173		
50.0	2	1989 -	0,8	BPR7HS	6422	BPR7HIX	5944
50.0	3	1995 -	0,8	BPR7HS	6422	BPR7HIX	5944
55.0	2	1967 - 1989		BUZHW-2	2173		
55.0	3	1968 - 1969		BUHW	2622		
55.0 Comm.		1986 -		BUHXW-1	5526		
60.0 (V4)		1964 - 1967	0,8	B7S	3710		
60.0	3	1970 - 1971		BUHW	2622		
60.0 49 cu.in.	3	1975 - 1989	0,8	B7HS	5110	BR7HIX	7067
60.0	2	1980 - 1985		BUZHW-2	2173		
60.0 56 cu.in.	3	1989 - 1993	0,8	B7HS	5110	BR7HIX	7067
60.0 56 cu.in.	3	1994 -	0,8	BPR7HS	6422	BPR7HIX	5944
65.0 (V4)		1968 -		BUHW	2622		
65.0	3	1972 - 1973	1,0	B7HS-10	2129		



Cyl.



Order No.

Iridium



Order No.

O.M.C.

65.0 Comm.		1984 - 1987		BUZHW-2	2173		
65.0 Comm.		1988 -		BUHXW-1	5526		
65.0 Jet 90 deg.Cross "V"		1992 -	1,0	BZ7HS-10	3579		
70.0 49 cu.in.	3	1975 - 1989	0,8	B7HS	5110	BR7HIX	7067
70.0 56 cu.in.	3	1989 - 1993	0,8	B7HS	5110	BR7HIX	7067
70.0 56 cu.in.	3	1994 -	0,8	BPR7HS	6422	BPR7HIX	5944
75.0 (V4)		1960 - 1965	0,8	B7S	3710		
75.0 49 cu.in.	3	1975 - 1989	0,8	B7HS	5110	BR7HIX	7067
80.0		1966 - 1967	0,8	B7S	3710		
80.0 Jet		1979 -	1,0	BZ7HS-10	3579		
85.0		1968 - 1972		BUHW	2622		
85.0		1973 - 1980	0,8	B7HS	5110	BR7HIX	7067
88.0		1979 -	1,0	BZ7HS-10	3579		
90.0		1964 - 1965	0,8	B7S	3710		
90.0		1979 -	1,0	BZ7HS-10	3579		
90.0 Turbojet 90 deg.Cross "V"		1994 -	1,0	BZ7HS-10	3579		
90.0 60 deg.Loop "V"		1995 -	0,8	BPR7HS	6422	BPR7HIX	5944
100.0		1966 - 1966	0,8	B7S	3710		
100.0		1967 - 1968		BUZHW-2	2173		
100.0		1971 - 1972		BUHW	2622		
100.0 Comm.		1984 -		BUZHW-2	2173		
105.0 Jet 60 deg.Loop "V"		1993 -	0,8	BPR7HS	6422	BPR7HIX	5944
105.0 Comm.60 deg.Loop "V"		1997 -	0,8	BPR7HS	6422	BPR7HIX	5944
110.0		1979 -	1,0	BZ7HS-10	3579		
112.0		1979 -	1,0	BZ7HS-10	3579		
115.0		1969 - 1970		BUHW	2622		
115.0 Comm.		1973 - 1979		BUHXW-1	5526		
115.0 90 deg.C "V"		1979 -	1,0	BZ7HS-10	3579		
115.0 Turbojet 90 deg.Cross "V"		1994 -	1,0	BZ7HS-10	3579		
115.0 60 deg.Loop "V"		1995 -	0,8	BPR7HS	6422	BPR7HIX	5944
120.0 90 deg.Loop "V"		1985 -		BUHXW-1	5526		
125.0		1971 - 1972		BUHW	2622		
130.0 90 deg.Loop "V"		1985 -		BUHXW-1	5526		
135.0		1973 - 1984		BUHXW-1	5526		
140.0		1973 - 1984		BUHXW-1	5526		
140.0 90 deg.Loop "V"		1985 -		BUHXW-1	5526		
150.0 90 deg. Cross "V"		1978 - 1987		BUHXW-1	5526		
150.0 90 deg.Cross "V"		1988 - 1991	1,0	BZ7HS-10	3579		
150.0 .60 deg.Loop "V"		1991 -	0,8	BPR7HS	6422	BPR7HIX	5944
175.0 .60 deg.Loop "V"		1991 -	0,8	BPR7HS	6422	BPR7HIX	5944
150.0 Comm.60 deg.Loop "V"		1993 -	0,8	BPR7HS	6422	BPR7HIX	5944
150.0 FFI 60 deg.Loop "V"		1997 -		PZFR5F-11	4363		
155.0 90 deg. Cross "V"		1978 - 1987		BUHXW-1	5526		
155.0 Comm. 90 deg.Loop "V"		1989 - 1992		BUHXW-1	5526		
175.0		1977 - 1987		BUHXW-1	5526		
175.0 90 deg.Cross "V"		1988 - 1991	1,0	BZ7HS-10	3579		
175.0 FFI 60 deg.Loop "V"		1997 -	1,1	PZFR5F-11	4363		
185.0		1977 - 1987		BUHXW-1	5526		
185.0 Comm.		1990 - 1993		BUHXW-1	5526		
200.0		1976 - 1983		BUHXW-1	5526		
200.0		1986 - 1993	1,0	BZ7HS-10	3579		
200.0 Comm.		1992 -		BUHXW-1	5526		



Cyl.

Order
No.

Iridium

Order
No.**O.M.C.**

200.0 Comm.		1993 -	0,8	BPR7HS	6422	BPR7HIX	5944
200.0		1994 -	0,8	BPR7HS	6422	BPR7HIX	5944
225.0		1986 - 1993	1,0	BZ7HS-10	3579		
225.0		1994 -	0,8	BPR7HS	6422	BPR7HIX	5944
235.0		1978 - 1985		BUHXW-1	5526		
275.0		1985 - 1988	1,0	BR9HS-10	4551		
300.0		1986 - 1989	1,0	BR9HS-10	4551		
Sea Drive		1988 - 1992	1,0	BZ7HS-10	3579		
Ultra, Excel 4		1987 - 1988	1,0	B7HS-10	2129		
all V8 engine	8	1985 -	0,8	BPR7HS	6422	BPR7HIX	5944

OTASCO

5 h.p.		1970 - 1974	0,9	XR4	2637	XR4IX	7189
7 h.p.		1970 - 1974	0,9	XR4	2637	XR4IX	7189
7.5 h.p.		1970 - 1974	0,9	XR4	2637	XR4IX	7189
9.9 h.p.		1970 - 1974	0,9	XR4	2637	XR4IX	7189
15 h.p.		1970 - 1974	0,9	XR4	2637	XR4IX	7189

OTTERBINE

2 h.p.			0,8	BR2LM	5798		
--------	--	--	-----	--------------	-------------	--	--

OUTBOARD JET

J55, J555B (5.5 PS)			0,8	B6S	3510		
---------------------	--	--	-----	------------	-------------	--	--

OUTBOARD MARINE*Sea Drive O.M.C.*

1.6L		1984 - 1992	0,8	BZ7HS-10	3579		
1.8L		1984 - 1992	0,8	BZ7HS-10	3579		
1AA / 2,6L		1981 - 1983		BUZHW	2147		
1AB / 2,5L		1981 - 1983		BUZHW	2147		
2.0L		1990 - 1992	0,8	BZ7HS-10	3579		
2.3L		1990 - 1992	0,8	BZ7HS-10	3579		
2.6L		1984 - 1990	0,8	BZ7HS-10	3579		
2.7L		1984 - 1990	0,8	BZ7HS-10	3579		
3.6L		1984 - 1990	0,8	BZ7HS-10	3579		
4.0L		1990 - 1991	0,8	BZ7HS-10	3579		

PERKINS

4.5 h.p.		1962 - 1965	0,7	BR6S	3522		
6.0 h.p.		1959 - 1961	0,7	BR6S	3522		
6.5 h.p.		1962 - 1965	0,7	BR6S	3522		
30.0 h.p.		1962 - 1965	0,8	BR6HS	3922	BR6HIX	3419
35.0 h.p. 18mm Heads		1959 - 1961	0,8	A6	1010		
35.0 h.p. 14mm Heads		1961 -	0,8	BR6HS	3922	BR6HIX	3419
40.0 h.p.		1959 - 1965	0,8	BR6HS	3922	BR6HIX	3419



Cyl.



Order No.

Iridium



Order No.

PIAGGIO

Moscone

0,5

B6S

3510

PUFFIN

75, 105, 105 De Luxe

0,5

B6ES

7310

SALUT

Salut-E 45cid

0,8

B5HS

4210

SEA KING (Wards)

2.0 hp

1979 - 1980

0,6

B2

3110

3.5 hp

1964 - 1970

0,8

B6L

3212

3.5 hp

1979 - 1980

0,6

BM6A

5921

4.0 hp

1979 - 1986

0,8

B6HS

4510

BR6HIX

3419

5.0 hp

1969 -

0,8

B6S

3510

5.8 hp

1964 - 1970

0,8

B6L

3212

5.9 hp

1979 - 1980

0,6

XR5

5953

XR5IX

7355

6.0 hp

1967 - 1971

0,8

B6L

3212

6.0 hp

1972 - 1976

0,8

B8HS

5510

BR8HIX

7001

7.0 hp

1969 -

0,6

XR5

5953

XR5IX

7355

7.5 hp

1979 - 1986

0,8

B6HS

4510

BR6HIX

3419

9.2 cu in.

1979 - 1980

0,6

XR5

5953

XR5IX

7355

9.6 hp

1968 - 1974

0,8

B8HS

5510

BR8HIX

7001

9.9 hp

1980 - 1986

0,8

B7HS

5110

BR7HIX

7067

10 hp

1974 - 1976

0,8

B8HS

5510

BR8HIX

7001

15 hp

1974 - 1976

0,8

B8HS

5510

BR8HIX

7001

15 hp

1978 - 1986

0,8

B7HS

5110

BR7HIX

7067

20 hp

1968 - 1974

0,8

B8HS

5510

BR8HIX

7001

25 hp

1974 - 1976

0,8

B8HS

5510

BR8HIX

7001

35 hp

1968 - 1975

0,8

B8HS

5510

BR8HIX

7001

35 hp

1978 - 1979

0,8

B8HS

5510

BR8HIX

7001

55 hp

1968 - 1975

0,8

B8HS

5510

BR8HIX

7001

SEA-BEE

3

0,5

B6HS

4510

BR6HIX

3419

4

0,5

B6HS

4510

BR6HIX

3419

Minor

0,5

B6HS

4510

BR6HIX

3419

SEARS

1.2 hp 585120

0,6

BR6S

3522

1.2 hp 585121

0,6

BR6S

3522

1.2 hp 585122

0,6

BMR6A

7421

2.0 hp 58250

0,6

B4

3210

2.0 hp 58241

0,6

B4

3210

3.0 hp 585211

0,7

XR5

5953

XR5IX

7355

3.0 hp 585220

0,7

XR5

5953

XR5IX

7355

3.0 hp 585210

0,7

XR5

5953

XR5IX

7355

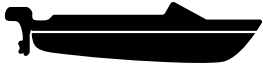

Cyl.

Order
No.

Iridium

Order
No.**SEARS**

3.0 hp 58540			0,7	XR5	5953	XR5IX	7355
3.0 hp 58541			0,7	XR5	5953	XR5IX	7355
3.0 hp 58543			0,7	XR5	5953	XR5IX	7355
3.0 hp 58544			0,7	XR5	5953	XR5IX	7355
3.5 hp 59862			0,7	XR5	5953	XR5IX	7355
3.5 hp 59900			0,6	BM6A	5921		
3.5 hp 60020			0,6	B6L	3212		
3.5 hp 6091			0,6	BM6A	5921		
3.5 hp 60030			0,6	B6L	3212		
3.5 hp 585230			0,7	XR5	5953	XR5IX	7355
3.5 hp 585240			0,7	XR5	5953	XR5IX	7355
3.5 hp 585280			0,7	XR5	5953	XR5IX	7355
3.5 hp 585241			0,7	XR5	5953	XR5IX	7355
3.5 hp 59860			0,6	B6S	3510		
3.5 hp 59501			0,6	BM6A	5921		
3.5 hp 58560			0,7	XR5	5953	XR5IX	7355
3.5 hp 58550			0,7	XR5	5953	XR5IX	7355
3.5 hp 58542			0,7	XR5	5953	XR5IX	7355
3.5 hp 6094			0,6	BM6A	5921		
3.5 hp 6003			0,6	B6L	3212		
3.5 hp 59861			0,6	B6S	3510		
3.5 hp 58510			0,6	B6S	3510		
3.6 hp 6001			0,6	B6L	3212		
3.6 hp 60000			0,6	B6L	3212		
3.6 hp 58514			0,7	XR5	5953	XR5IX	7355
3.6 hp 58513			0,7	XR5	5953	XR5IX	7355
3.6 hp 58511			0,6	B6S	3510		
3.6 hp 58512			0,6	B6S	3510		
4.0 hp 58580			0,7	XR5	5953	XR5IX	7355
4.0 hp 585270			0,7	XR5	5953	XR5IX	7355
4.5 hp 59464			0,7	XR5	5953	XR5IX	7355
4.5 hp 59461			0,7	XR5	5953	XR5IX	7355
4.5 hp 59462			0,7	XR5	5953	XR5IX	7355
4.5 hp 59460			0,7	XR5	5953	XR5IX	7355
4.5 hp 59463			0,7	XR5	5953	XR5IX	7355
4.8 hp 58970			0,7	XR5	5953	XR5IX	7355
4.8 hp 58971			0,7	XR5	5953	XR5IX	7355
5.0 hp 585460			0,7	XR5	5953	XR5IX	7355
5.0 hp 59673			0,7	XR5	5953	XR5IX	7355
5.0 hp 59680			0,7	XR5	5953	XR5IX	7355
5.0 hp 585411			0,7	XR5	5953	XR5IX	7355
5.0 hp 585420			0,7	XR5	5953	XR5IX	7355
5.0 hp 585430			0,7	XR5	5953	XR5IX	7355
5.0 hp 585441			0,7	XR5	5953	XR5IX	7355
5.0 hp 59672			0,6	B6S	3510		
5.0 hp 585470			0,7	XR5	5953	XR5IX	7355
5.0 hp 595410			0,7	XR5	5953	XR5IX	7355
5.0 hp 595431			0,7	XR5	5953	XR5IX	7355
5.0 hp 595440			0,7	XR5	5953	XR5IX	7355
5.0 hp 58962			0,7	XR5	5953	XR5IX	7355
5.0 hp 58610			0,7	XR5	5953	XR5IX	7355
5.0 hp 58991			0,7	XR5	5953	XR5IX	7355



Cyl.

Order
No.

Iridium

Order
No.**SEARS**

5.0 hp 58521		0,7	XR5	5953	XR5IX	7355
5.0 hp 59671		0,6	B6S	3510		
5.0 hp 58620		0,7	XR5	5953	XR5IX	7355
5.0 hp 58960		0,6	B6S	3510		
5.0 hp 58961		0,6	B6S	3510		
5.0 hp 58992		0,7	XR5	5953	XR5IX	7355
5.0 hp 59310		0,7	XR5	5953	XR5IX	7355
5.0 hp 59311		0,7	XR5	5953	XR5IX	7355
5.0 hp 59520		0,6	B6S	3510		
5.0 hp 59670		0,6	B6S	3510		
5.0 hp 58990		0,7	XR5	5953	XR5IX	7355
5.0 hp 58520		0,6	B6S	3510		
5.5 hp 59431		0,7	XR5	5953	XR5IX	7355
5.5 hp 585710		0,7	XR5	5953	XR5IX	7355
5.5 hp 59980		0,7	XR5	5953	XR5IX	7355
5.5 hp 59432		0,7	XR5	5953	XR5IX	7355
5.5 hp 59430		0,7	XR5	5953	XR5IX	7355
5.5 hp 59433		0,7	XR5	5953	XR5IX	7355
6.0 hp 6004		0,6	B6L	3212		
6.0 hp 60060		0,6	B6L	3212		
6.0 hp 6005		0,6	B6L	3212		
7.0 hp 58530		0,7	XR5	5953	XR5IX	7355
7.0 hp 585860		0,7	XR5	5953	XR5IX	7355
7.0 hp 585861		0,7	XR5	5953	XR5IX	7355
7.0 hp 59840		0,7	XR5	5953	XR5IX	7355
7.0 hp 59440		0,7	XR5	5953	XR5IX	7355
7.0 hp 58830		0,7	XR5	5953	XR5IX	7355
7.0 hp 58532		0,7	XR5	5953	XR5IX	7355
7.0 hp 58531		0,7	XR5	5953	XR5IX	7355
7.0 hp 59970		0,7	XR5	5953	XR5IX	7355
7.5 hp 585880		0,7	XR5	5953	XR5IX	7355
7.5 hp 585821		0,7	XR5	5953	XR5IX	7355
7.5 hp 585830		0,7	XR5	5953	XR5IX	7355
7.5 hp 585850		0,7	XR5	5953	XR5IX	7355
7.5 hp 585890		0,7	XR5	5953	XR5IX	7355
7.5 hp 585910		0,7	XR5	5953	XR5IX	7355
7.5 hp 585811		0,7	XR5	5953	XR5IX	7355
7.5 hp 585920		0,7	XR5	5953	XR5IX	7355
7.5 hp 585930		0,7	XR5	5953	XR5IX	7355
7.5 hp 585931		0,7	XR5	5953	XR5IX	7355
7.5 hp 586110		0,7	XR5	5953	XR5IX	7355
7.5 hp 586111		0,7	XR5	5953	XR5IX	7355
7.5 hp 586120		0,7	XR5	5953	XR5IX	7355
7.5 hp 585840		0,7	XR5	5953	XR5IX	7355
7.5 hp 58891		0,7	XR5	5953	XR5IX	7355
7.5 hp 6008		0,6	B6L	3212		
7.5 hp 585780		0,7	XR5	5953	XR5IX	7355
7.5 hp 60100		0,6	B6L	3212		
7.5 hp 60090		0,6	B6L	3212		
7.5 hp 60070		0,6	B6L	3212		
7.5 hp 59491		0,7	XR5	5953	XR5IX	7355
7.5 hp 585911		0,7	XR5	5953	XR5IX	7355



Cyl.

Order
No.

Iridium

Order
No.**SEARS**

7.5 hp	59450		0,7	XR5	5953	XR5IX	7355
7.5 hp	585810		0,7	XR5	5953	XR5IX	7355
7.5 hp	58882		0,7	XR5	5953	XR5IX	7355
7.5 hp	58881		0,7	XR5	5953	XR5IX	7355
7.5 hp	58880		0,7	XR5	5953	XR5IX	7355
7.5 hp	58850		0,7	XR5	5953	XR5IX	7355
7.5 hp	58821		0,7	XR5	5953	XR5IX	7355
7.5 hp	58820		0,7	XR5	5953	XR5IX	7355
7.5 hp	58809		0,7	XR5	5953	XR5IX	7355
7.5 hp	6012		0,6	B6L	3212		
7.5 hp	6010		0,6	B6L	3212		
7.5 hp	59490		0,7	XR5	5953	XR5IX	7355
9.9 hp	586210		0,7	XR5	5953	XR5IX	7355
9.9 hp	586240		0,7	XR5	5953	XR5IX	7355
9.9 hp	586231		0,7	XR5	5953	XR5IX	7355
9.9 hp	586230		0,7	XR5	5953	XR5IX	7355
9.9 hp	58711		0,7	XR5	5953	XR5IX	7355
9.9 hp	58710		0,7	XR5	5953	XR5IX	7355
9.9 hp	586211		0,7	XR5	5953	XR5IX	7355
9.9 hp	586220		0,7	XR5	5953	XR5IX	7355
10.5 hp	58720		0,7	XR5	5953	XR5IX	7355
10.5 hp	58721		0,7	XR5	5953	XR5IX	7355
12 hp	5927		0,6	B6L	3212		
14 hp	6013		0,6	B6S	3510		
14 hp	6014		0,6	B6S	3510		
14 hp	6015		0,6	B6S	3510		
15 hp	58105		0,6	B7HS	5110	BR7HIX	7067
15 hp	586340		0,7	XR5	5953	XR5IX	7355
15 hp	586331		0,7	XR5	5953	XR5IX	7355
15 hp	586330		0,7	XR5	5953	XR5IX	7355
15 hp	586320		0,7	XR5	5953	XR5IX	7355
15 hp	586311		0,7	XR5	5953	XR5IX	7355
15 hp	586310		0,7	XR5	5953	XR5IX	7355
15 hp	58760		0,7	XR5	5953	XR5IX	7355
15 hp	58761		0,7	XR5	5953	XR5IX	7355
25 hp			0,6	B8HS	5510	BR8HIX	7001
27.7 hp	6033		0,6	B6S	3510		
27.7 hp	6035		0,6	B6S	3510		
28 hp	6038		0,6	B6S	3510		
28 hp	60340		0,6	B8S	3810		
28 hp	60360		0,6	B8S	3810		
28 hp	60370		0,6	B8S	3810		
28 hp	60380		0,6	B8S	3810		
28 hp	6037		0,6	B6S	3510		
35 hp	5941		0,6	B8S	3810		
43.7 hp	60541		0,6	B6S	3510		
43.7 hp	60644		0,6	B6S	3510		
43.7 hp	6050		0,6	B6S	3510		
43.7 hp	6045		0,6	B6S	3510		
45 hp	5057		0,6	B8S	3810		
45 hp	5058		0,6	B8S	3810		
45 hp	60540		0,6	B8S	3810		



Cyl.



Order No.

Iridium



Order No.

SEARS

45 hp 60550
 45 hp 5056
 75 hp 60750
 75 hp 6078
 75 hp 60740
 75.2 hp 6077
 75.2 hp 6070
 75.2 hp 6071
 75.2 hp 6076

0,6 **B8S** 3810
 0,6 **B8S** 3810
 0,6 **B8S** 3810
 0,6 **B8S** 3810
 0,6 **B8S** 3810
 0,6 **B8S** 3810
 0,6 **B6S** 3510
 0,6 **B6S** 3510
 0,6 **B8S** 3810

SELVA

2.4 HP Elba 56cc
 2.5 HP S60 SI
 4 / 6 HP models
 5.0 HP Capri 125cc
 5.0 HP S115 / S115 SI
 8.0 HP Izmir 170cc
 8.0 HP S165
 9.9, 15 HP models
 20, 25 HP models
 20.0 HP Rhodes 398cc
 20.0 HP S405
 25.0 HP Antibes 489cc
 25.0 HP Majorca 489cc
 25.0 HP Master
 25.0 HP S1050 Super Best
 25.0 HP S495
 25.0 HP S500 Grand Prix
 25.0 HP S600 Master
 25.0 HP S800 Best
 25.0 HP XS (495CC, 2carb.)
 30.0 HP S505 Antibes 489cc
 35, 50 HP other models,
 35.0 HP S525 Majorca 489cc
 40.0 HP S625 Madeira 684cc
 40.0 HP Saint Tropez 741cc
 50.0 HP S700 Madeira 684cc
 55.0 HP S750
 60.0 HP Saint Tropez 831cc
 65, 80 HP other models
 65.0 HP S850
 70.0 HP Tenerife 831cc
 74.5 HP S1300 Endurance
 75.0 HP Montecarlo 1298cc
 80.0 HP S1000 Potofino 1026cc
 90.0 HP S1350 Montecarlo 1298cc
 100.0 HP S1400 Montecarlo 1368cc
 S130, S135, S165, S170
 S1350, S1400
 S155, S175, S495 XS, S525
 S250, S260, S350

1		0,5	BPMR6A	6726		
		0,5	BPM6A	7021		
1		0,5	BP6HS	4511	BPR6HIX	4085
1		0,8	BPR6HS	7022	BPR6HIX	4085
		0,5	BPR6HS	7022	BPR6HIX	4085
2		0,8	BPR6HS	7022	BPR6HIX	4085
		0,5	BPR6HS	7022	BPR6HIX	4085
2		0,5	BP6HS	4511	BPR6HIX	4085
2		0,5	BP7HS	5111		
2		0,8	BPR6HS	7022	BPR6HIX	4085
		0,5	BPR6HS	7022	BPR6HIX	4085
2		0,8	BPR6HS	7022	BPR6HIX	4085
2	1989 -	0,5	B8HS	5510	BR8HIX	7001
		1,0	B7HS-10	2129		
		0,5	BPR6HS	7022	BPR6HIX	4085
		1,0	B7HS-10	2129		
		1,0	B7HS-10	2129		
		1,0	B7HS-10	2129		
2	1988 -	0,5	BP6HS	4511	BPR6HIX	4085
2		1,0	B7HS-10	2129		
2		0,5	B8HS	5510	BR8HIX	7001
2		1,0	B7HS-10	2129		
2		1,0	B7HS-10	2129		
3		1,0	B7HS-10	2129		
2		1,0	B7HS-10	2129		
		1,0	B7HS-10	2129		
3		1,0	B7HS-10	2129		
3		0,5	B8HS	5510	BR8HIX	7001
		1,0	B7HS-10	2129		
3		1,0	B7HS-10	2129		
		1,0	B7HS-10	2129		
4		1,0	B7HS-10	2129		
3		1,0	B7HS-10	2129		
4		1,0	B7HS-10	2129		
4		1,0	B7HS-10	2129		
3		0,5	BP6HS	4511	BPR6HIX	4085
		0,5	B8HS	5510	BR8HIX	7001
		0,5	BP6HS	4511	BPR6HIX	4085
3		0,5	BP6HS	4511	BPR6HIX	4085



Cyl.

Order
No.

Iridium

Order
No.**SELVA**

S400,S405,S490,S495,S505	3		0,5	BP7HS	5111		
S500	3		0,5	B6HS	4510	BR6HIX	3419
S600 Master, S650 (40HP)			0,5	B8HS	5510	BR8HIX	7001
S650 (50HP), S850			0,5	B8HS	5510	BR8HIX	7001
S650	2	1989 -	0,5	B8HS	5510	BR8HIX	7001
S650, S700, S750, S800	3		0,5	B8HS	5510	BR8HIX	7001
S800 Best, S1000	3		0,5	B8HS	5510	BR8HIX	7001
S85,S95,S110,S120,S125	3		0,5	BP6HS	4511	BPR6HIX	4085
S95 SC,S115 SC,S115,S135 SC			0,5	BP6HS	4511	BPR6HIX	4085

SELVA GEMINI

3, 4.5 PS			0,5	B6S	3510		
6 PS			0,5	B6S	3510		

SOLO

2.5, 4 PS			0,5	B6HS	4510	BR6HIX	3419
55, 70 PS			0,9	B9HS	5810		

SPIRIT

2 PS		1977 -	0,6	B6HS	4510	BR6HIX	3419
4.5 PS		1976 - 1977	0,6	B6HS	4510	BR6HIX	3419
5 PS		1978 -	0,6	B6HS	4510	BR6HIX	3419
9.9 PS		1976 -	0,6	B6HS	4510	BR6HIX	3419
16 PS		1976 -	0,6	B6HS	4510	BR6HIX	3419
20 PS		1976 -	0,6	B6HS	4510	BR6HIX	3419
25 PS		1976 -	0,6	B6HS	4510	BR6HIX	3419
50 PS		1977 -	0,5	B8HS	5510	BR8HIX	7001
65 PS		1978 -	0,6	B8HS	5510	BR8HIX	7001

SPRITE

J-5			0,8	BM6A	5921		
-----	--	--	-----	------	------	--	--

STARLING JET

5 PS			0,6	B2	3110		
------	--	--	-----	----	------	--	--

SUBARU

Y6, Y7.5, Y9, Y9.9, Y12, Y15			0,6	B6HS	4510	BR6HIX	3419
------------------------------	--	--	-----	------	------	--------	------

SUZUKI

9.9Y			0,9	BR6HS	3922	BR6HIX	3419
------	--	--	-----	-------	------	--------	------



Cyl.



Order No.

Iridium



Order No.

SUZUKI

<i>DF</i>								
DF 4	4-Stroke	1	2002 -	0,8	BPR6ES	7822	BPR6EIX	6637
DF 5	4-Stroke	1	2002 -	0,8	BPR6ES	7822	BPR6EIX	6637
DF 6	4-Stroke	1	2002 -	0,8	BPR6ES	7822	BPR6EIX	6637
DF 9.9AEL	4-Stroke	2	1995 -	0,9	DCPR6E	3481		
DF 9.9AES	4-Stroke	2	1995 -	0,9	DCPR6E	3481		
DF 9.9AL	4-Stroke	2	1995 -	0,9	DCPR6E	3481		
DF 9.9AS	4-Stroke	2	1995 -	0,9	DCPR6E	3481		
DF 15AL		2	1995 - 1999	0,9	DCPR6E	3481		
DF 15ARL		2	1995 - 1999	0,9	DCPR6E	3481		
DF 15ARS		2	1995 - 1999	0,9	DCPR6E	3481		
DF 15AS		2	1995 - 1999	0,9	DCPR6E	3481		
DF 25	4-Stroke	3	2000 -	0,9	DCPR6E	3481	---	---
DF 30	4-Stroke	3	2000 -	0,9	DCPR6E	3481	---	---
DF 40	4-Stroke	3	1999 -	0,9	DCPR6E	3481		
DF 50	4-Stroke	3	1999 -	0,9	DCPR6E	3481		
DF 60	4-Stroke	4	1998 -	0,8	BPR6ES	7822	BPR6EIX	6637
DF 70	4-Stroke	4	1998 -	0,8	BPR6ES	7822	BPR6EIX	6637
DF 90	4-Stroke	4	2001 -	0,8	BKR6E	6962	BKR6EIX	6418
DF 115	4-Stroke	4	2001 -	0,8	BKR6E	6962	BKR6EIX	6418
DF 140	4-Stroke	4	2002 -	0,8	BKR6E	6962	BKR6EIX	6418
DF 200	(4-Stroke)	4	2004 -	0,8	BKR6E	6962	BKR6EIX	6418
DF 225	(4-Stroke)	4	2004 -	0,8	BKR6E	6962	BKR6EIX	6418
DF 250	(4-Stroke)	4	2004 -	0,8	BKR6E	6962	BKR6EIX	6418
<i>DT</i>								
DT 2			1986 - 1990	0,6	BR4HS	3322		
DT 2			1991 - 1999	0,7	BR5HS	3722		
DT 2.2			1992 -	0,7	BR5HS	3722		
DT 3,5				0,7	BP6HS	4511	BPR6HIX	4085
DT 4			1988 - 1992	0,7	BP5HS	4111		
DT 4			1993 - 2001	0,7	BPR5HS	6222		
DT 4,5				0,6	BR6HS	3922	BR6HIX	3419
DT 4L/S			- 1993	0,7	BP5HS	4111		
DT 4L/S			1994 -	0,7	BPR5HS	6222		
DT 5			1986 - 1992	0,6	BP6HS	4511	BPR6HIX	4085
DT 5			1993 - 1994	0,9	BPR6HS	7022	BPR6HIX	4085
DT 5			1995 - 2000	0,6	BR6HS	3922	BR6HIX	3419
DT 5 W			1986 - 1992	0,6	BR6HS	3922	BR6HIX	3419
DT 5Y			1998 - 2001	1,0	BPR7HS-10	1092		
DT 6			- 1985	0,6	B6HS	4510	BR6HIX	3419
DT 6			1986 - 1992	1,0	B6HS-10	1052		
DT 6			1993 - 2002	0,6	BR6HS	3922	BR6HIX	3419
DT 6			1995 - 1999	1,0	BR6HS-10	1090		
DT 6L				0,9	BR6HS	3922	BR6HIX	3419
DT 6L /5PS				0,9	BR6HS	3922	BR6HIX	3419
DT 6S				0,9	BR6HS	3922	BR6HIX	3419
DT 6S /5PS			- 1992	0,8	B6HS	4510	BR6HIX	3419
DT 7,5				0,6	BR6HS	3922	BR6HIX	3419
DT 8			1986 - 2002	0,9	BPR6HS	7022	BPR6HIX	4085
DT 8C			1988 - 1997	1,0	BR6HS-10	1090		
DT 8CL				0,9	BR6HS	3922	BR6HIX	3419



Cyl.

Order
No.

Iridium

Order
No.**SUZUKI***DT*

DT 8CS			0,9	BR6HS	3922	BR6HIX	3419
DT 9			0,6	B6HS-10	1052		
DT 9.9		1976 - 1976	0,6	B6HS	4510	BR6HIX	3419
DT 9.9		1977 - 1978	0,6	B7HS	5110	BR7HIX	7067
DT 9.9		1979 - 1984	0,6	BR6HS	3922	BR6HIX	3419
DT 9.9		1986 - 1999	1,0	BR7HS-10	1098		
DT 9.9C		1988 - 1997	1,0	BR6HS-10	1090		
DT 9.9E		1982 -	0,7	B6HS	4510	BR6HIX	3419
DT 9.9E		1983 -	1,0	BR7HS-10	1098		
DT 9.9E		1984 -	0,7	B7HS	5110	BR7HIX	7067
DT 9.9K		- 1985	0,7	BR6HS	3922	BR6HIX	3419
DT 9.9K		1985 - 1986	0,7	B6HS	4510	BR6HIX	3419
DT 9.9K		1986 - 1990	0,7	B6HS	4510	BR6HIX	3419
DT 9.9P		- 1983	0,9	BPR6HS	7022	BPR6HIX	4085
DT 13			0,6	BR7HS	4122	BR7HIX	7067
DT 14			0,6	BR7HS	4122	BR7HIX	7067
DT 15		1986 - 2002	1,0	BR7HS-10	1098		
DT 15C		1989 - 1997	1,0	BR7HS-10	1098		
DT 15K		- 1985	0,7	BR6HS	3922	BR6HIX	3419
DT 15K		1986 -	0,9	B6HS	4510	BR6HIX	3419
DT 16/P			0,7	BR7HS	4122	BR7HIX	7067
DT 20		1997 - 2000	1,0	BR7HS-10	1098		
DT 20/P		- 1985	0,7	BR7HS	4122	BR7HIX	7067
DT 20/P		1986 -	1,0	BR7HS-10	1098		
DT 20K		- 1985	1,0	BR7HS-10	1098		
DT 20K		1986 - 1987	1,0	B7HS-10	2129		
DT 25		- 1985	0,6	BR7HS	4122	BR7HIX	7067
DT 25		2000 - 2001	1,0	BR7HS-10	1098		
DT 25C		1989 - 1997	1,0	BR7HS-10	1098		
DT 25CL			1,0	BR7HS	4122	BR7HIX	7067
DT 25CRL			1,0	BR7HS	4122	BR7HIX	7067
DT 25CRS			1,0	BR7HS	4122	BR7HIX	7067
DT 25CS			1,0	BR7HS	4122	BR7HIX	7067
DT 25E		- 1982	0,7	B7HS	5110	BR7HIX	7067
DT 25E		1983 - 1985	1,0	BPR7HS-10	1092		
DT 25E		1986 -	1,0	BR7HS-10	1098		
DT 25K		1986 -	1,0	BR7HS-10	1098		
DT 28P/ DT 28/ DT 28E ->83			0,7	B7HS	5110	BR7HIX	7067
DT 30		1983 - 1985	1,0	BR7HS-10	1098		
DT 30		1986 -	1,0	BR7HS-10	1098		
DT 30C		1988 - 2000	1,0	BR7HS-10	1098		
DT 30E		1983 -	1,0	BR7HS-10	1098		
DT 40		- 1983	0,9	B8HS	5510	BR8HIX	7001
DT 40/E			0,9	BR8HS	4322	BR8HIX	7001
DT 40C		1986 - 1999	1,0	BR8HS-10	1134		
DT 40C / CR /TC		1998 -	1,0	BR8HS-10	1134		
DT 40CL			1,0	BR8HS	4322	BR8HIX	7001
DT 40CRL			1,0	BR8HS	4322	BR8HIX	7001
DT 40CRS			1,0	BR8HS	4322	BR8HIX	7001
DT 40CS			1,0	BR8HS	4322	BR8HIX	7001
DT 40K/KR			1,0	B7HS-10	2129		
DT 40TCL			1,0	BR8HS	4322	BR8HIX	7001



Cyl.



Order No.

Iridium



Order No.

SUZUKI

<i>DT</i>						
DT 40TCS			1,0	BR8HS	4322	BR8HIX 7001
DT 40W			0,9	B8HS	5510	BR8HIX 7001
DT 40W		1995 -	1,0	B7HS-10	2129	
DT 40WK		- 1997	0,6	B7HS	5110	BR7HIX 7067
DT 40WK		1998 -	1,0	B7HS-10	2129	
DT 48M		- 2000	0,9	B8HS	5510	BR8HIX 7001
DT 48M		2001 -	1,0	B8HS-10	5126	
DT 50		- 1978	0,9	B7HS	5110	BR7HIX 7067
DT 50		1979 - 1983	0,9	B8HS	5510	BR8HIX 7001
DT 50		1984 - 1989	1,0	B8HS-10	5126	
DT 50ACR		1993 - 1993	1,0	BR8HS	4322	BR8HIX 7001
DT 50ACR		1994 - 1996	1,0	B8HS-10	5126	
DT 50C		1984 - 2000	1,0	B8HS-10	5126	
DT 50K			0,9	B7HS	5110	BR7HIX 7067
DT 50M/DT50(W)		1986 - 1989	1,0	B8HS-10	5126	
DT 50M/DT50(W)/DT50T		- 1985	0,9	B8HS	5510	BR8HIX 7001
DT 50M; DT50(W)		2001 -	1,0	BR8HS-10	1134	
DT 55C		1988 - 1998	1,0	BR8HS-10	1134	
DT 55M; MQ		- 2000	0,9	B8HS	5510	BR8HIX 7001
DT 55M; MQ		2001 -	1,0	BR8HS-10	1134	
DT 55TC; CRQ		1998 -	1,0	BR8HS-10	1134	
DT 55TCL			1,0	BR8HS	4322	BR8HIX 7001
DT 55TCS			1,0	BR8HS	4322	BR8HIX 7001
DT 60			1,0	B8HS-10	5126	
DT 60C		1986 - 1987	1,0	B8HS-10	5126	
DT 60C		2001 -	1,0	BR8HS-10	1134	
DT 65/T		- 1983	0,9	BR8HS	4322	BR8HIX 7001
DT 65C		1988 - 1999	1,0	BR8HS-10	1134	
DT 65TC		1994 - 1995	1,0	BR8HS-10	1134	
DT 65TCL			1,0	BR8HS	4322	BR8HIX 7001
DT 65TCS			1,0	BR8HS	4322	BR8HIX 7001
DT 75/85		1990 - 1992	0,9	B8HS	5510	BR8HIX 7001
DT 75/85		1993 - 2000	1,0	BR8HS-10	1134	
DT 75C		1993 - 2000	0,8	BR8HS	4322	BR8HIX 7001
DT 75C		2001 -	1,0	BR8HS-10	1134	
DT 75M		- 2000	0,8	BR8HS	4322	BR8HIX 7001
DT 75M		2001 -	1,0	BR8HS-10	1134	
DT 75TC		- 2000	0,8	B8HS	5510	BR8HIX 7001
DT 75TC		2001 -	1,0	BR8HS-10	1134	
DT 75W			0,8	BR8HS	4322	BR8HIX 7001
DT 85		- 1992	0,8	BR8HS	4322	BR8HIX 7001
DT 85C		- 1992	0,8	BR8HS	4322	BR8HIX 7001
DT 85C		1993 - 2000	0,8	BR8HS	4322	BR8HIX 7001
DT 85C		2001 -	1,0	BR8HS-10	1134	
DT 85M		- 2000	0,8	BR8HS	4322	BR8HIX 7001
DT 85M		2001 -	1,0	BR8HS-10	1134	
DT 85MQ		1995 - 1996	1,0	B8HS-10	5126	
DT 85Q		- 2000	0,8	BR8HS	4322	BR8HIX 7001
DT 85Q		2001 -	1,0	BR8HS-10	1134	
DT 85TC		- 2000	0,9	B8HS	5510	BR8HIX 7001
DT 85TC		2001 -	1,0	BR8HS-10	1134	
DT 85W		- 2000	0,8	BR8HS	4322	BR8HIX 7001

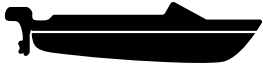

Cyl.

Order
No.

Iridium

Order
No.**SUZUKI***DT*

DT 85W	2001 -	1,0	B8HS-10	5126		
DT 85WT	1995 - 1996	1,0	B8HS-10	5126		
DT 85WT	2001 -	1,0	B8HS-10	5126		
DT 90	- 2000	1,0	BR8HCS-10	1157		
DT 90	2001 -	1,0	BR8HS-10	1134		
DT 90TC	- 1995	1,0	BR8HCS-10	1157		
DT 90TC	1996 - 1997	0,8	BR8HS	4322	BR8HIX	7001
DT 90TC	1998 -	1,0	BR8HS-10	1134		
DT 100	1990 - 1995	1,0	BR8HCS-10	1157		
DT 100	1996 - 2000	1,0	BR8HS-10	1134		
DT 100	2000 - 2000	1,0	BR8HCS-10	1157		
DT 100	2001 -	1,0	BR8HS-10	1134		
DT 100TC	- 1995	1,0	BR8HCS-10	1157		
DT 100TC	1996 - 1997	0,8	BR8HS	4322	BR8HIX	7001
DT 100TC	1998 -	1,0	BR8HS-10	1134		
DT 115	- 1990	0,9	B8HS	5510	BR8HIX	7001
DT 115	1992 -	1,0	BR8HCS-10	1157		
DT 115C	- 1990	0,9	B8HS	5510	BR8HIX	7001
DT 115C	1991 - 1993	1,0	BR8HCS-10	1157		
DT 115C	2001 -	1,0	BR8HS-10	1134		
DT 115S	1996 -	1,0	BR8HS-10	1134		
DT 115STC	1996 -	1,0	BR8HS-10	1134		
DT 115TC (EFI)		1,0	BR8HS-10	1134		
DT 115TC		1,0	BR8HCS-10	1157		
DT 115TC	- 1988	1,0	B8HS-10	5126		
DT 1140	- 1990	0,9	B8HS	5510	BR8HIX	7001
DT 140	1992 -	1,0	BR8HCS-10	1157		
DT 140 EFI	1996 -	1,0	BR8HS-10	1134		
DT 1140C	- 1990	0,9	B8HS	5510	BR8HIX	7001
DT 140C	1991 - 1996	1,0	BR8HCS-10	1157		
DT 140 C EFI	1997 -	1,0	BR8HCS-10	1157		
DT 140T	- 2000	1,0	BR8HCS-10	1157		
DT 140T	2001 -	1,0	BR8HS-10	1134		
DT 140TC	- 2000	1,0	BR8HCS-10	1157		
DT 140TC EFI		1,0	BR8HS-10	1134		
DT 150	1987 - 2002	1,0	BR8HS-10	1134		
DT 150G		1,0	BR8HS-10	1134		
DT 150S		1,0	BR8HS-10	1134		
DT 150SS		1,0	BR8HS-10	1134		
DT 150STC		1,0	BR8HS-10	1134		
DT 150TC	1989 -	1,0	BR8HS-10	1134		
DT 150TC EFI		1,0	BR8HS-10	1134		
DT 175	1989 - 2002	1,0	BR8HS-10	1134		
DT 175TC	- 1988	1,0	B8HS-10	5126		
DT 175TC	1989 -	1,0	BR8HS-10	1134		
DT 200	1989 - 2002	1,0	BR8HS-10	1134		
DT 200G		1,0	BR8HS-10	1134		
DT 200T		1,0	BR8HS-10	1134		
DT 200TC	1989 -	1,0	BR8HS-10	1134		
DT 200V		1,0	BR8HS-10	1134		
DT 225	1991 - 2002	1,0	BR8HS-10	1134		
DT 225TC		1,0	BR8HS-10	1134		



Cyl.



Order No.

Iridium



Order No.

SUZUKI

<i>DT</i>							
DT 225TCL EFI			1,0	BR8HS	4322	BR8HIX	7001
<i>PU</i>							
PU 40		- 1993	0,9	B8HS	5510	BR8HIX	7001
PU 40		1994 -	1,0	BR8HS-10	1134		
PU 55		- 1993	0,9	B8HS	5510	BR8HIX	7001
PU 55		1994 -	1,0	BR8HS-10	1134		
PU 85		- 1993	0,9	B8HS	5510	BR8HIX	7001
PU 85		1994 -	1,0	BR8HS-10	1134		
PU 140		- 1993	0,9	B8HS	5510	BR8HIX	7001
PU 140		1994 -	1,0	BR8HS-10	1134		

TANAKA

Aqua Bug			0,6	BM6A	5921		
Bumble Bee		1992 -	0,6	BM6F	6221		
Super Bug			0,6	BM6A	5921		
TOB 12			0,6	BM6A	5921		
TOB 120			0,6	BMR6A	7421		
TOB 175			0,6	BMR6A	7421		
TOB 25		- 1985	0,6	BM6A	5921		
TOB 25		1986 -	0,6	BMR6A	7421		
TOB 300			0,6	BMR6A	7421		
TOB 550 / L			0,7	BPR7HS	6422	BPR7HIX	5944

TECNAMOTOR

MV85M, MV100M, MV125M			0,6	BM6A	5921		
-----------------------	--	--	-----	------	------	--	--

TOHATSU

2.5 h.p. (2-stroke) M2.5A 75cc	1		0,8	BPR6HS	7022	BPR6HIX	4085
3.5 h.p. (2-stroke) M3.5A / M3.5B 75cc	1		0,8	BPR6HS	7022	BPR6HIX	4085
4.0 h.p. M4C	1		0,8	BPR7HS	6422	BPR7HIX	5944
5.0 h.p. M5B, M5BS	1		0,8	BPR7HS	6422	BPR7HIX	5944
5.0 h.p. B13B , B9B	1		0,8	BR6HS	3922	BR6HIX	3419
5.0 h.p. (4-stroke) 123cc	1		0,9	FR5	4876		
6.0 h.p. M6B	1		0,8	BPR7HS	6422	BPR7HIX	5944
8.0 h.p. B13B , B9B	1		0,8	BR6HS	3922	BR6HIX	3419
8.0 h.p. Proof 8 BEF, 169cc	2		0,8	BPR7HS	6422	BPR7HIX	5944
8.0 h.p. (2-stroke) M8A, M8B 169cc	2		0,7	BPR5HS	6222		
9.8 h.p. B18C , B18D			0,8	BR6HS	3922	BR6HIX	3419
9.9 h.p. M9.9B2 / M9.9C	2		0,8	BR7HS	4122	BR7HIX	7067
12.0 h.p. M12B			1,0	BR7HS-10	1098		
12.0 h.p. B18C , B18D			0,8	BR6HS	3922	BR6HIX	3419
13.0 h.p. M13	2		1,0	BR7HS-10	1098		
15.0 h.p. M15A / M15B2 / M15C / M15D	2		1,0	BR7HS-10	1098		
16.0 h.p. M16			1,0	BR7HS-10	1098		
18.0 h.p. M18A / M18C2 / M18D / M18E / 294cc / (2-stroke)	2		1,0	BR7HS-10	1098		



Cyl.

Order
No.

Iridium

Order
No.**TOHATSU**

20.0 h.p. B40A, B30C			1,0	BR6HS-10	1090		
20.0 h.p. M20			1,0	BR7HS-10	1098		
25.0 h.p. B40A, B30C			1,0	BR6HS-10	1090		
25.0 h.p. M25C, M25C2	2		1,0	BR7HS-10	1098		
25.0 h.p. Proof 25C2, 430cc	2		1,0	BR7HS-10	1098		
30.0 h.p. (2-stroke) M30A / M30A3 / 430cc	2		1,0	BR7HS-10	1098		
35.0 h.p. M35A			0,9	BPR7HS	6422	BPR7HIX	5944
40.0 h.p. Proof 40D Mega / 697cc / EFTO	3		1,0	BPR7HS-10	1092		
40.0 h.p. Proof 40D Mega / 697cc	3		1,0	BPR7HS-10	1092		
40.0 h.p. M40D / 697cc / (2-stroke)	3		0,9	BPR7HS	6422	BPR7HIX	5944
40.0 h.p. M40C / 493cc / (2-stroke)	2		1,0	BPR6HS-10	2633		
40.0 h.p. M40D Mega EPTO / (2-stroke) / 697cc	3		0,6	BR7HS	4122	BR7HIX	7067
50.0 h.p. (2-stroke) / 697cc	3		1,0	BPR7HS-10	1092		
50.0 h.p. M50C / M50D	3		1,0	BPR7HS-10	1092		
55.0 h.p. M55A	3		1,0	BPR7HS-10	1092		
60.0 h.p. (2-stroke) / 938cc / M60A / M60B	3		1,0	BPR7HS-10	1092		
70.0 h.p. (2-stroke) / 938cc / M70A / M70A2 / M70B	3		1,0	BPR7HS-10	1092		
80.0 h.p. M80A			1,0	BPR7HS-10	1092		
90.0 h.p. (2-stroke) / 1267cc / M90A	3		1,0	BPR7HS-10	1092		
115.0 h.p. M115A	4		1,0	BPR7HS-10	1092		
120.0 h.p. (2-stroke) / 1768cc / M120A	4		1,0	BPR7HS-10	1092		
140.0 h.p. (2-stroke) / 1768cc / M140A	4		1,0	BPR7HS-10	1092		
MFS 4A 4 HP		2000 -	0,6	DCPR6E	3481		
MFS 5A		1999 -	0,6	DCPR6E	3481		
MFS 6A		2000 -	0,6	DCPR6E	3481		
MFS 8A		2003 -	0,6	DCPR6E	3481		
MFS 9,8A		2003 -	0,6	DCPR6E	3481		
MFS 9.9A / B 9,9HP		2000 -	0,6	DCPR6E	3481		
MFS 15A 15 HP		2000 -	0,6	DCPR6E	3481		
MFS 18B2		2001 -	0,6	DCPR6E	3481		
MFS 18B4		2001 -	0,6	DCPR6E	3481		
MFS 25A		2002 -	0,6	DCPR6E	3481		
MFS 30A		2002 -	0,6	DCPR6E	3481		

TOMOS

18			1,0	BPR7HS-10	1092		
18E			1,0	BPR7HS-10	1092		
3.0 h.p.			0,6	B6HS	4510	BR6HIX	3419
3.5 h.p.			0,6	B6HS	4510	BR6HIX	3419
4.4 h.p. Electronic / 10 / 10E			0,6	B6HS	4510	BR6HIX	3419
4.5 h.p.			0,6	B6HS	4510	BR6HIX	3419
5.0 h.p.5 / TS4 / Lamo 06N			0,6	BR7HS	4122	BR7HIX	7067
T10			0,6	BR7HS	4122	BR7HIX	7067
T18			0,6	BR7HS	4122	BR7HIX	7067
T4RN			0,6	B6HS	4510	BR6HIX	3419

TRITON

4.0 h.p.			0,8	XR5	5953	XR5IX	7355
5.5 h.p.			0,8	XR5	5953	XR5IX	7355



Cyl.

Order
No.

Iridium

Order
No.**TRITON**

7.5 h.p.			0,8	XR5	5953	XR5IX	7355
----------	--	--	-----	-----	------	-------	------

VALMET

Terhi 3			0,7	BP5S	3011		
Terhi 3.5 PS			0,5	B6S	3510		
Terhi 4.5PS, 9.9PS, 23PS			0,5	B6HS	4510	BR6HIX	3419
Terhi 5, 15, 20, 40			0,5	B6HS	4510	BR6HIX	3419
Terhi 50 PS			0,5	BP5HS	4111		
Tern 6, 17, 25			0,5	B6HS	4510	BR6HIX	3419

VIKING

3.5, 15 PS	1965 - 1971	0,8	B6L	3212			
6 PS	1965 - 1971	0,8	B6L	3212			
9.2 PS	1960 - 1970	0,8	B6S	3510			
9.6, 20, 35, 55 PS	1968 - 1971	0,8	B6HS	4510	BR6HIX		3419

VOLVO PENTA

35	- 1974	1,0	BR7HS-10	1098			
39	- 1974	1,0	BR7HS-10	1098			
39	1975 - 1979	1,0	BR7HS-10	1098			
40	- 1974	1,0	BR7HS-10	1098			
50A	- 1974	1,0	BR7HS-10	1098			
50	- 1974	1,0	BR7HS-10	1098			
51	1975 - 1979	1,0	BR7HS-10	1098			
60	1978 - 1979	1,0	BR7HS-10	1098			
80	- 1974	1,0	BR6HS-10	1090			
90	- 1979	1,0	BR6HS-10	1090			
120	- 1974	1,0	BR6HS-10	1090			
140	- 1979	1,0	BR6HS-10	1090			
200	1976 - 1979	1,0	BPR7HS-10	1092			
250	1975 -	1,0	BPR7HS-10	1092			
252	- 1974	0,9	BPR7HS	6422	BPR7HIX		5944
350	1975 - 1976	1,0	BPR7HS-10	1092			
360	- 1974	1,0	BR7HS-10	1098			
450	- 1974	1,0	BPR7HS-10	1092			
450	1975 - 1976	1,0	BPR7HS-10	1092			
550X	- 1974	1,0	BPR7HS-10	1092			
600	- 1974	1,0	BPR7HS-10	1092			
600	1975 - 1976	1,0	BPR7HS-10	1092			
700	- 1974	1,0	BPR7HS-10	1092			
700	1975 - 1979	1,0	BPR7HS-10	1092			
U22	- 1974	1,0	BR7HS-10	1098			

VOYAGER

1VA, 2VA, 1VB, V-2L/2LL/2N			0,8	A6	1010		
V-3L-GS, V-3N-GS, V-3LL-GS			0,8	B6S	3510		



Cyl.

Order
No.

Iridium

Order
No.**VOYAGER**

V-4L-GS			0,8	A6	1010		
V-4LL-GS, V-4N-GS			0,8	B6S	3510		
V-6LL-GS, V-6N-GS			0,8	B6S	3510		

WEST BEND

18 h.p.		1960 - 1962	0,9	BR6S	3522		
20 h.p.		1961 - 1965	0,9	BR6S	3522		
35 h.p.		1964 - 1965	0,9	BR6S	3522		
40 h.p.		1961 - 1962	0,9	BR6S	3522		
45 h.p.		1961 - 1965	0,9	BR6S	3522		
50 h.p.		1964 - 1965	0,9	BR6S	3522		
80 h.p.		1961 - 1965	0,9	BR6S	3522		

WHITE AUTO STORES

4.5 h.p.		1975 -	0,9	XR4	2637	XR4IX	7189
5.0 h.p.		1972 - 1974	0,9	XR4	2637	XR4IX	7189
5.5 h.p.		1975 -	0,9	XR4	2637	XR4IX	7189
7.0 h.p.		1972 - 1974	0,9	XR4	2637	XR4IX	7189
7.5 h.p.		1972 - 1974	0,9	XR4	2637	XR4IX	7189
7.5 h.p.		1975 -	0,9	XR4	2637	XR4IX	7189
9.9 h.p.		1972 - 1974	0,9	XR4	2637	XR4IX	7189
15.0 h.p.		1972 - 1974	0,9	XR4	2637	XR4IX	7189

WHITEHEAD

W6,W12,W24,W25S,W30 all models			0,5	B6HS	4510	BR6HIX	3419
--------------------------------	--	--	-----	-------------	-------------	---------------	-------------

WIZARD

3.0 h.p.		1976 -	0,9	XR4	2637	XR4IX	7189
3.2 h.p.WD3 / WD35			0,9	BR6S	3522		
3.5 h.p.		1970 - 1974	0,9	XR4	2637	XR4IX	7189
4.5 h.p.		1975 -	0,9	XR4	2637	XR4IX	7189
5.0 h.p.WH6 / WH6-1 / WH6A			0,9	BR6S	3522		
5.0 h.p.		1969 -	0,9	BR6S	3522		
5.0 h.p.		1970 - 1974	0,9	XR4	2637	XR4IX	7189
5.0 h.p.		1977 - 1979	0,9	XR4	2637	XR4IX	7189
5.5 h.p.OC575 / OC585			0,9	BR6S	3522		
5.5 h.p.		1975 -	0,9	XR4	2637	XR4IX	7189
5.5 h.p.		1976 -	0,9	XR4	2637	XR4IX	7189
5.5 h.p.		1977 - 1979	0,9	XR4	2637	XR4IX	7189
6.0 h.p.WD4 / WD4S			0,9	BR6S	3522		
6.0 h.p.WF4 / WGA			0,9	BR6S	3522		
7.0 h.p.		1969 -	0,9	XR4	2637	XR4IX	7189
7.0 h.p.		1970 - 1974	0,9	XR4	2637	XR4IX	7189
7.5 h.p.		1970 - 1979	0,9	XR4	2637	XR4IX	7189
9.2 h.p.		1966 - 1971	0,9	BR6S	3522		
9.9 h.p.		1970 - 1979	0,9	XR4	2637	XR4IX	7189
10.0 h.p.WH7 / WG7A / WJ7			0,9	BR6S	3522		



Cyl.



Order No.

Iridium



Order No.

WIZARD

10.0 h.p.WF7 / WG7			0,9	BR6S	3522		
10.0 h.p.WK7 / WM7 / WM7A			0,9	BR6S	3522		
12.0 h.p.WN7 / WN7A			0,9	BR6S	3522		
12.0 h.p.		1959 - 1964	0,9	BR6S	3522		
14.0 h.p.		1959 - 1964	0,9	BR6S	3522		
20.0 h.p.		1965 - 1967	0,9	BR6S	3522		
20.0 h.p.		1968 - 1971	0,8	BR6HS	3922	BR6HIX	3419
25.0 h.p.WA25 / WA25E			0,9	BR6S	3522		
35.0 h.p. OC3585			0,9	A6	1010		
40.0 h.p.		1959 - 1964	0,9	BR6S	3522		
60.0 h.p.		1959 - 1964	0,9	BR6S	3522		

YAMAHA

2A			0,6	B6HS	4510	BR6HIX	3419
2B		- 1984	0,6	BR5HS	3722		
2B		1985 - 1986	0,6	B7HS	5110	BR7HIX	7067
2B		1987 -	0,6	BR5HS	3722		
2C		1995 -	0,6	B7HS	5110	BR7HIX	7067
3,5A/AC			0,6	B6HS	4510	BR6HIX	3419
3A (Malta)			1,0	BR6HS-10	1090		
4A/AC/AS/BC			0,6	BR7HS	4122	BR7HIX	7067
4A/B		2001 -	0,6	B7HS	5110	BR7HIX	7067
5A/AS			0,6	B7HS	5110	BR7HIX	7067
5B/BS			0,6	B6HS	4510	BR6HIX	3419
5C			0,6	BR7HS	4122	BR7HIX	7067
5D			0,6	B5HS	4210		
6A			0,6	B6HS	4510	BR6HIX	3419
6B			0,6	B5HS	4210		
6C			1,0	BR7HS-10	1098		
6D			1,0	BR6HS-10	1090		
7A			0,6	B6HS	4510	BR6HIX	3419
8A			0,6	B6HS	4510	BR6HIX	3419
8B			0,6	B7HS	5110	BR7HIX	7067
8C			1,0	BR7HS-10	1098		
9.5A			0,6	B7HS	5110	BR7HIX	7067
9.9B			0,6	B7HS	5110	BR7HIX	7067
9.9D			1,0	BR7HS-10	1098		
9.9F		1995 -	1,0	BR7HS-10	1098		
9A			0,6	B6HS	4510	BR6HIX	3419
12A			0,6	B7HS	5110	BR7HIX	7067
13.5A			1,0	BR7HS-10	1098		
13.5F			1,0	B7HS-10	2129		
15 2 stroke 15	2	2004 -	1,0	B7HS-10	2129		
15A			0,6	B7HS	5110	BR7HIX	7067
15B			0,6	B7HS	5110	BR7HIX	7067
15C			0,6	B7HS	5110	BR7HIX	7067
15D			1,0	BR7HS-10	1098		
15F		1995 -	1,0	BR7HS-10	1098		
20A			0,6	B6HS	4510	BR6HIX	3419
20B			0,6	B6HS	4510	BR6HIX	3419
20C (C20)		1999 -	0,6	B7HS	5110	BR7HIX	7067



Cyl.

Order
No.

Iridium

Order
No.**YAMAHA**

20C/CE/CM			1,0	BR7HS-10	1098		
20D			1,0	BR7HS-10	1098		
25A			0,6	B7HS	5110	BR7HIX	7067
25B		- 1994	0,6	B7HS	5110	BR7HIX	7067
25B		2001 -	1,0	BR7HS-10	1098		
25B/25Q		1995 - 2000	1,0	BR7HS-10	1098		
25CMK			0,6	B6HS	4510	BR6HIX	3419
25D (C25)			0,6	B7HS	5110	BR7HIX	7067
25DE			1,0	BR7HS-10	1098		
25J			1,0	BR7HS-10	1098		
25N			1,0	BR7HS-10	1098		
25V (25)		1995 -	1,0	BR7HS-10	1098		
28A/AE			0,6	B7HS	5110	BR7HIX	7067
30A/AE/AM			0,6	B7HS	5110	BR7HIX	7067
30D			1,0	BR7HS-10	1098		
30G		1995 -	1,0	B8HS-10	5126		
30H		2001 -	1,0	B8HS-10	5126		
40AE/AM/AR			0,6	B8HS	5510	BR8HIX	7001
40BE/BM/BR			0,6	B8HS	5510	BR8HIX	7001
40C			0,6	B8HS	5510	BR8HIX	7001
40D		- 1989	0,6	B8HS	5510	BR8HIX	7001
40F			0,6	B8HS	5510	BR8HIX	7001
40FE			1,0	B7HS-10	2129		
40GK			0,6	B7HS	5110	BR7HIX	7067
40H			1,0	BR7HS-10	1098		
40J		2001 -	0,6	B7HS	5110	BR7HIX	7067
40Q (40)		1995 -	0,6	BR8HS	4322	BR8HIX	7001
40V		1995 -	1,0	BR7HS-10	1098		
40X		- 2000	0,6	BR7HS	4122	BR7HIX	7067
40Y (MH)		2001 -	1,0	BR7HS-10	1098		
40Y (ET)		2001 -	1,0	BR8HS-10	1134		
48A/B			0,6	B7HS	5110	BR7HIX	7067
50		2001 -	0,9	B8HS-10	5126	---	---
50 50TLRB		2003 -	1,0	B7HS-10	2129		
50C			0,6	B8HS	5510	BR8HIX	7001
50CE			1,0	B8HS-10	5126		
50D			1,0	BR8HS-10	1134		
50G / 50H		1995 -	1,0	BR8HS-10	1134		
50H		1995 -	1,0	BR8HS-10	1134		
55AE		- 1978	0,6	B8HS	5510	BR8HIX	7001
55AE		1979 -	1,0	B8HS-10	5126		
55AEM/AM/AW			0,6	B8HS	5510	BR8HIX	7001
55B			1,0	B8HS-10	5126		
55B		1990 -	1,0	BR8HS-10	1134		
55B(M)		1995 -	0,6	B8HS	5510	BR8HIX	7001
55BM/BW			0,6	B8HS	5510	BR8HIX	7001
60		2001 -	0,9	B8HS-10	5126	---	---
60 4stroke T60		2004 -	0,9	DPR5EA-9	2887		
60AE		- 1978	0,6	B8HS	5510	BR8HIX	7001
60AE		1979 -	1,0	B8HS-10	5126		
60B			1,0	B8HS-10	5126		
60CE/CET			1,0	B8HS-10	5126		



Cyl.

Order
No.

Iridium

Order
No.**YAMAHA**

60D	1986 -	1,0	BR8HS-10	1134		
60DE		1,0	B8HS-10	5126		
60F		1,0	BR8HS-10	1134		
70B		1,0	BR8HS-10	1134		
70C		1,0	BR8HS-10	1134		
70ETO		1,0	BR8HS-10	1134		
75A		1,0	BR8HS-10	1134		
75B		1,0	BR8HS-10	1134		
75C		1,0	BR8HS-10	1134		
80A		1,0	BR8HS-10	1134		
85A		1,0	BR8HS-10	1134		
90 4stroke F90	2003 -	1,1	LFR5A-11	6376		
90A		1,0	BR8HS-10	1134		
100 F100	1999 - 2002	1,1	LFR5A-11	6376		
100 AETOL	1998 -	1,0	BR8HS-10	1134		
100A		1,0	BR8HS-10	1134		
115 4stroke F115	2004 -	1,1	LFR6A-11	3672		
115A	2004 -	1,0	B8HS-10	5126		
115AE0/AO		1,0	BR8HS-10	1134		
115B/BETO		1,0	BR8HS-10	1134		
115C		1,0	BR8HS-10	1134		
115D	1995 -	1,0	BR8HS-10	1134		
130A		1,0	BR9HS-10	4551		
130B	1995 -	1,0	BR9HS-10	4551		
130BETO		1,0	BR9HS-10	4551		
140A		1,0	BR8HS-10	1134		
140B	- 1988	1,0	BR8HS-10	1134		
140B	1989 -	1,0	BR9HS-10	4551		
140BETO		1,0	BR9HS-10	4551		
140C / L140C	1995 -	1,0	BR9HS-10	4551		
150A	- 1985	1,0	BR7HS-10	1098		
150A	1986 -	1,0	BR8HS-10	1134		
150AETO/C		1,0	BR8HS-10	1134		
150C		1,0	BR8HS-10	1134		
150F / L150F		1,0	BR7HS-10	1098		
150G		1,0	BR7HS-10	1098		
175A		1,0	BR8HS-10	1134		
175B		1,0	BR8HS-10	1134		
175D		1,0	BR8HS-10	1134		
175F		1,0	BR8HS-10	1134		
200A		1,0	BR8HS-10	1134		
200C		1,0	BR9HS-10	4551		
200F (L200F)		1,0	BR8HS-10	1134		
200G		1,0	BR8HS-10	1134		
220A / AET	1986 -	1,0	BR8HS-10	1134		
225AETO		1,0	BR8HS-10	1134		
225A0/BETO/B/C		1,0	BR9HS-10	4551		
225D		1,0	BR8HS-10	1134		
225G		1,0	BR9HS-10	4551		
250A / L250A		1,0	BR8HS-10	1134		
250B / L250B		1,0	BR9HS-10	4551		
D150H		1,0	BR8HS-10	1134		

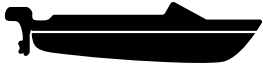

Cyl.

Order
No.

Iridium

Order
No.**YAMAHA**

E 8D			1,0	BR7HS-10	1098		
E40X / 40X			0,6	BR7HS	4122	BR7HIX	7067
E60H			1,0	BR8HS-10	1134		
F 2.5A 4Stroke	1	2002 -	0,8	BR6HS	3922	BR6HIX	3419
F 4A	1	1998 -	0,8	BR6HS	3922	BR6HIX	3419
F 6A 4Stroke	2	2000 -	1,0	BR6HS-10	1090		
F 6B 4-Stroke	2	2001 -	1,0	BR6HS-10	1090	---	---
F 8 4-Stroke 8,0 HP	2	2001 -	0,9	BR6HS-10	1090	---	---
F 8A	2	- 1985	0,6	CR6HS	7023	CR6HIX	7274
F 8A/AM/AEM	2	1986 - 2002	0,6	CR5HS	2874	CR5HIX	7120
F 8B/BM/BE	2	1986 -	0,6	CR5HS	2874	CR5HIX	7120
F 8C 4Stroke	2	2000 -	1,0	BR6HS-10	1090		
F 9.9A	2	1985 - 2000	0,6	CR6HS	7023	CR6HIX	7274
F 9.9B	2	1986 - 2000	0,6	CR6HS	7023	CR6HIX	7274
F 9.9C / D	2	1998 - 2003	0,9	DPR6EA-9	5531		
F 9.9 DE	2		1,0	BR7HS-10	1098		
F 13.5A	2	1998 - 2003	0,9	DPR6EA-9	5531		
F15A	2	1998 - 2003	0,9	DPR6EA-9	5531		
F20A	2	1998 - 2001	0,9	DPR6EA-9	5531		
F25A (MH)			0,9	DPR6EA-9	5531		
F25A (E,ET)	2	1998 - 2002	0,9	DPR6EA-9	5531		
F30 OHC 4-Stroke	3	2001 - 2002	0,9	DPR6EA-9	5531	---	---
F30A 4 Stroke	3	2001 - 2002	0,9	DPR6EA-9	5531		
F40A	3	2000 - 2002	0,9	DPR6EA-9	5531		
F40B 4Stroke	3	2000 - 2002	0,9	DPR6EA-9	5531		
F40C			0,9	DPR5EA-9	2887		
F45A / AETL		1998 -	0,9	DPR6EA-9	5531		
F50A./ B.	4	1995 - 2002	0,9	DPR6EA-9	5531		
F60A 4Stroke	4	2002 -	0,9	DPR5EA-9	2887		
F80A 4Stroke	4	2000 - 2003	1,1	LFR5A-11	6376		
F100A 4Stroke	4	1999 - 2003	1,1	LFR5A-11	6376		
F115 V4 -1,7L	4	1999 - 2003	1,1	LFR6A-11	3672	---	---
F115A 4Stroke (FL115A)	4		1,1	LFR6A-11	3672		
F150A (FL150A)			1,1	LFR5A-11	6376		
F200A 4Stroke (FL200A)	6	2002 -	1,1	LFR5A-11	6376		
F225A 4Stroke (FL225A)	6	2002 -	1,1	LFR5A-11	6376		
FT8D 4Stroke	2		1,0	BR6HS-10	1090		
FT9.9 A...	2	1998 -	0,6	CR6HS	7023	CR6HIX	7274
FT9.9D 4Stroke	2		0,9	DPR6EA-9	5531		
FT25B 4Stroke	2		0,9	DPR6EA-9	5531		
FT50B / BETL	4	1998 -	0,9	DPR6EA-9	5531		
FT50C 4Stroke	4		0,9	DPR6EA-9	5531		
FT60B 4Stroke	4		0,9	DPR5EA-9	2887		
FX700 (FX1)		1995 -	0,6	BR8HS	4322	BR8HIX	7001
L 4 3,0 L. Z-Antrieb			0,6	BR6FS	4323		
L140BETO			1,0	BR9HS-10	4551		
L150A/150C/L150C/150D		1995 -	1,0	BR8HS-10	1134		
L150AETO/CETO			1,0	BR8HS-10	1134		
L150F			1,0	BR7HS-10	1098		
L200A/L200B		1995 -	1,0	BR8HS-10	1134		
L200AETO/BETO			1,0	BR8HS-10	1134		
L200F			1,0	BR8HS-10	1134		



Cyl.



Order No.

Iridium



Order No.

YAMAHA

L225C		1995 -	1,0	BR8HS-10	1134		
LF115 V4 -1,7L	4	2000 -	1,1	LF6A-11	3672	---	---
LS150F			1,0	BR7HS-10	1098		
LZ150P				BKR6EKU	6993		
LZ150TX HPDI (To 800554)		2000 - 2001	1,1	BKR6ES-11	5553	BKR6EIX-11	3764
LZ150TX HPDI (From 800555)		2001 -		BKR6EKU	6993	---	---
LZ200 V6 2,6L	6	2000 -	1,1	BKR7ES-11	2387		
LZ200TX HPDI (2000 to 100874)		2000 - 2001	1,1	BKR7ES-11	2387		
LZ200TX HPDI (From 100875)		2001 -		BKR7EKU	5881	---	---
MJ500S/T			0,6	B7HS	5110	BR7HIX	7067
PRO 100			1,0	BR8HS-10	1134		
PROV200		- 1995	1,0	BR9HS-10	4551		
PROV200		1996 -	1,0	BR8HS-10	1134		
RA1100 (Raider 1100)		1995 -	0,6	BR8HS	4322	BR8HIX	7001
RA700 (Raider)		1995 -	0,6	BR8HS	4322	BR8HIX	7001
RA700A (Raider)		1995 -	0,6	BR8HS	4322	BR8HIX	7001
S150U			1,0	BR7HS-10	1098		
S200F			1,0	BR8HS-10	1134		
SJ650 (Super Jet)		1995 -	0,6	BR8HS	4322	BR8HIX	7001
SJ700 (Super Jet)		1995 -	0,6	BR8HS	4322	BR8HIX	7001
T8 OHV 4-Stroke High Thrust 8,0 HP		2001 -	0,9	BR6HS-10	1090	---	---
T25 OHC 4-Stroke High Thrust 25 HP		2001 -	0,9	DPR6EA-9	5531	---	---
V 6 4,3 L. Z-Antrieb	6		0,6	BR6FS	4323		
V 8 5,0 L. Z-Antrieb	8		0,6	BR6FS	4323		
V 8 5,7 L. Z-Antrieb	8		0,6	BR6FS	4323		
V 8 7,4 L. Z-Antrieb	8		0,6	BR6FS	4323		
V175 V6 2,6L	6	2000 -	0,9	BR8HS-10	1134	---	---
Vmax 150HPDI (Z150Q) 2Stroke				BKR6EKU	6993		
Vmax 150TRP (D150H) 2Stroke			1,0	BR8HS-10	1134		
Vmax 200 (200G) 2Stroke			1,0	BR8HS-10	1134		
Vmax 200HPDI (Z200P) 2Stroke				BKR7EKU	5881		
Vmax 225EFI (225G) 2Stroke			1,0	BR9HS-10	4551		
Vmax 250HPDI (Z250F) 2Stroke				BKR7EKU	5881		
VX150 V6 2,6L	6	2000 -	0,6	BR7HS	4122	BR7HIX	7067
VX200 V760 EFI V6 3,1L	6	2000 -	0,9	BR8HS-10	1134	---	---
VZ150TL HPDI (To 800711)		2000 - 2001	1,1	BKR6ES-11	5553	BKR6EIX-11	3764
VZ150TL HPDI (From 800712)		2001 -		BKR6EKU	6993	---	---
VZ175TL HPDI (From 800202)		2001 -		BKR7EKU	5881	---	---
VZ175TL HPDI (800105 to 800201)		2001 -	1,1	BKR7ES-11	2387		
VZ250		2003 -		BKR7EKU	5881	---	---
VZ250		2004 -		BKR6EKU	6993	---	---
VZ300		2004 -		BKR6EKU	6993	---	---
WB700 (Blaster)		1995 -	0,6	BR8HS	4322	BR8HIX	7001
WJ500/F(89)			0,6	B7HS	5110	BR7HIX	7067
WR500/F(89)			0,6	B7HS	5110	BR7HIX	7067
WRA650 (Runner III)		1995 -	0,6	BR8HS	4322	BR8HIX	7001
WRA700 (Runner III GP)		1995 -	0,6	BR8HS	4322	BR8HIX	7001
WRB650 (VXR)		1995 -	0,6	BR8HS	4322	BR8HIX	7001
WVT700 (Venture)		1995 -	0,6	BR8HS	4322	BR8HIX	7001
Z150P / VZ150Q				BKR6EKU	6993	---	---
Z150TL HPDI (To 800452)		2000 - 2001	1,1	BKR6ES-11	5553	BKR6EIX-11	3764
Z150TL HPDI (From 800453)		2001 -		BKR6EKU	6993	---	---



Cyl.

Order
No.

Iridium

Order
No.**YAMAHA**

Z150TX HPDI (To 851535)		2000 - 2001	1,1	BKR6ES-11	5553	BKR6EIX-11	3764
Z150TX HPDI (From 851536)		2001 -		BKR6EKU	6993	---	---
Z175G / Z175H				BKR7EKU	5881		
Z175TX HPDI (From 800232)		2001 -		BKR7EKU	5881	---	---
Z175TX HPDI (800101 to 800231)		2001 -	1,1	BKR7ES-11	2387		
Z200 V6 2,6L	6	2000 -	1,1	BKR7ES-11	2387		
Z200N (Z200N)				BKR7EKU	5881		
Z200P				BKR7EKU	5881		
Z200TL HPDI (2000 to 150689)		2000 - 2001	1,1	BKR7ES-11	2387		
Z200TL HPDI (From 150690)		2001 -		BKR7EKU	5881	---	---
Z200TX HPDI (2000 to 102420)		2000 - 2001	1,1	BKR7ES-11	2387		
Z200TX HPDI (From 102421)		2001 -		BKR7EKU	5881	---	---
Z250D (LZ250D)				BKR6EKU	6993		
Z250D LZ250D				BKR6EKU	6993		
Z250F				BKR6EKU	6993		
Z300A (LZ300A)				BKR6EKU	6993		

YAMATO

350, 35			0,5	B6HS	4510	BR6HIX	3419
---------	--	--	-----	-------------	-------------	---------------	-------------

ZÜNDAPP

Delphin			0,5	B6HS	4510	BR6HIX	3419
5 CV			0,5	B6HS	4510	BR6HIX	3419
5 PS, 6 PS, type 304			0,5	B6HS	4510	BR6HIX	3419



CCM

Order
No.Platin/
Gold-
PalladiumOrder
No.

Iridium

Order
No.**AQUABUG**

Aquabug 120 1.2HP	120		BP5S	3011	0,8				
Superbug 175 1.75HP	175		BP5S	3011	0,8				
Superbug 300 3.0HP	300		BP5S	3011	0,8				

AQUA-JET

Solution SX1	432		B7ES	1111	0,8	B7EVX	6934		
--------------	-----	--	------	------	-----	-------	------	--	--

AQUASCOOTER

ILO engine	---		B5HS	4210	0,8				
------------	-----	--	------	------	-----	--	--	--	--

ARCTCO

Barracuda	639	1994 -	BR9EV	4725	0,8	BR9EVX	1265	BR9EIX	3981
Daytona	639	1994 -	BR9EV	4725	0,8	BR9EVX	1265	BR9EIX	3981
Monte Carlo	639	1994 -	BR9EV	4725	0,8	BR9EVX	1265	BR9EIX	3981
Montego	639	1995 -	BR9EV	4725	0,8	BR9EVX	1265	BR9EIX	3981
Montego Deluxe	639	1995 -	BR9EV	4725	0,8	BR9EVX	1265	BR9EIX	3981
Tigershark Daytona	639	1993 -	BR9EV	4725	0,8	BR9EVX	1265	BR9EIX	3981
TS 640	640	1998 -	BR9EYA	7548	0,7	BR9EVX	1265		
TS 640 L	640	1998 -	BR9EYA	7548	0,7	BR9EVX	1265		
TS 640 R	640	1998 -	BR9EYA	7548	0,7	BR9EVX	1265		
Montego	644	1994 -	BR9EV	4725	0,8	BR9EVX	1265	BR9EIX	3981
Montego Deluxe	644	1994 -	BR9EV	4725	0,8	BR9EVX	1265	BR9EIX	3981
Tigershark	644	1993 -	BR9EV	4725	0,8	BR9EVX	1265	BR9EIX	3981
Tigershark Daytona	644	1993 -	BR9EV	4725	0,8	BR9EVX	1265	BR9EIX	3981
Daytona 770	768	1996 - 1997	BR9EV	4725	0,8	BR9EVX	1265	BR9EIX	3981
Monte Carlo 770	770	1996 - 1997	BR9EV	4725	0,8	BR9EVX	1265	BR9EIX	3981
TS 770	770	1998 -	BR9EYA	7548	0,7	BR9EVX	1265		
TS 770 L	770	1998 -	BR9EYA	7548	0,7	BR9EVX	1265		
TS 770 R	770	1998 -	BR9EYA	7548	0,7	BR9EVX	1265		
Monte Carlo 900	896	1995 -	BR9EV	4725	0,8	BR9EVX	1265	BR9EIX	3981
Tigershark	900	1995 -	BR9EV	4725	0,8	BR9EVX	1265	BR9EIX	3981
Daytona 1000	1000	1997 -	BR9EV	4725	0,8	BR9EVX	1265	BR9EIX	3981
Monte Carlo 1000	1000	1997 -	BR9EV	4725	0,8	BR9EVX	1265	BR9EIX	3981
TS 1000 L	1000	1998 -	BR9EYA	7548	0,7	BR9EVX	1265		
TS 1000 R	1000	1998 -	BR9EYA	7548	0,7	BR9EVX	1265		

BOMBARDIER

Barracuda Premium 6157/6158		2004 -	BR8ES	5422	0,6	BR8EVX	1262	BR8EIX	5044
Bullet 5599/6115/6162/6163		2004 -	DCPR8E	4339	0,6	DCPR8EVX	2265		
GTI LE 6135/6136		2004 -	BR8ES	5422	0,6	BR8EVX	1262	BR8EIX	5044
GTI STD 6133/6134		2004 -	BR8ES	5422	0,6	BR8EVX	1262	BR8EIX	5044
GTI-RFI LE 6139/6140		2004 -	BR8ES	5422	0,6	BR8EVX	1262	BR8EIX	5044
GTI-RFI STD 6137/6138		2004 -	BR8ES	5422	0,6	BR8EVX	1262	BR8EIX	5044
GTX 4-Tec LTD 6141/6142		2004 -	DCPR8E	4339	0,6	DCPR8EVX	2265		
GTX 4-Tec STD 6147/6148		2004 -	DCPR8E	4339	0,6	DCPR8EVX	2265		
GTX 4-Tec Supercharg 6143/6144		2004 -	DCPR8E	4339	0,6	DCPR8EVX	2265		



ccm

Order
No.Platin/
Gold-
PalladiumOrder
No.

Iridium

Order
No.**BOMBARDIER**

GTX 4-Tec Wake 6149/6150		2004 -	DCPR8E	4339	0,6	DCPR8EVX	2265		
XP-Di STD 6151/6152		2004 -	ZFR4F-11	4043	1,1				
5801	580	1988 -	BR7ES	5122	0,7	BR7EVX	4556		
5802	580	1989 -	BR7ES	5122	0,7	BR7EVX	4556		
5803	580	1990 -	BR7ES	5122	0,7	BR7EVX	4556		
5810	580	1990 -	BR7ES	5122	0,7	BR7EVX	4556		
EXP	580	1993 -	BR7ES	5122	0,7	BR7EVX	4556		
GT	580	1991 -	BR7ES	5122	0,7	BR7EVX	4556		
GTS	580	1992 -	BR7ES	5122	0,7	BR7EVX	4556		
GTX	580	1992 - 1993	BR7ES	5122	0,7	BR7EVX	4556		
SP	580	1991 -	BR7ES	5122	0,7	BR7EVX	4556		
SPi	580	1993 -	BR7ES	5122	0,7	BR7EVX	4556		
SPX	580	1993 -	BR7ES	5122	0,7	BR7EVX	4556		
XP	580	1991 - 1992	BR7ES	5122	0,7	BR7EVX	4556		
GTX	650	1994 -	BR8ES	5422	0,6	BR8EVX	1262	BR8EIX	5044
SPX	650	1994 -	BR8ES	5422	0,6	BR8EVX	1262	BR8EIX	5044
XP	650	1993 -	BR8ES	5422	0,6	BR8EVX	1262	BR8EIX	5044
GS	718	1997 -	BR8ES	5422	0,6	BR8EVX	1262	BR8EIX	5044
GSI	718	1997 -	BR8ES	5422	0,6	BR8EVX	1262	BR8EIX	5044
GTI	718	1996 - 1997	BR8ES	5422	0,6	BR8EVX	1262	BR8EIX	5044
GTI 3	718	1997 -	BR8ES	5422	0,6	BR8EVX	1262	BR8EIX	5044
GTS	718	1997 -	BR8ES	5422	0,6	BR8EVX	1262	BR8EIX	5044
GTS	718	1998 -	BR8ES	5422	0,6	BR8EVX	1262	BR8EIX	5044
HX	718	1995 -	BR8ES	5422	0,6	BR8EVX	1262	BR8EIX	5044
SPX	718	1996 - 1997	BR8ES	5422	0,6	BR8EVX	1262	BR8EIX	5044
XP	718	1995 -	BR8ES	5422	0,6	BR8EVX	1262	BR8EIX	5044
XP 785	781	1995 -	BR8ES	5422	0,6	BR8EVX	1262	BR8EIX	5044
GSX	782	1996 - 1997	BR8ES	5422	0,6	BR8EVX	1262	BR8EIX	5044
GTX	782	1996 - 1997	BR8ES	5422	0,6	BR8EVX	1262	BR8EIX	5044
SP	782	1997 -	BR8ES	5422	0,6	BR8EVX	1262	BR8EIX	5044
SPX	782	1997 -	BR8ES	5422	0,6	BR8EVX	1262	BR8EIX	5044
XP	782	1996 - 1997	BR8ES	5422	0,6	BR8EVX	1262	BR8EIX	5044
GSX Limited	951	1997 -	BR8ES	5422	0,6	BR8EVX	1262	BR8EIX	5044
GTX Limited	951	1998 -	BR8ES	5422	0,6	BR8EVX	1262	BR8EIX	5044
XP Limited	951	1998 -	BR8ES	5422	0,6	BR8EVX	1262	BR8EIX	5044

DOLPHIN

Mark 7 Auxiliary 12HP			B6ES	7310	0,6	B6EVX	5136		
-----------------------	--	--	------	------	-----	-------	------	--	--

FUN BOATS

Pump'r with 60HP			B7HS	5110	1,0	B7HVX	7836	BR7HIX	7067
------------------	--	--	------	------	-----	-------	------	--------	------

HYDRO-DISC

50 HP			B9ES	2611	0,8	B9EVX	7254	BR9EIX	3981
-------	--	--	------	------	-----	-------	------	--------	------

JET BREEZE

Hurricane 50 HP			B9ES	2611	0,8	B9EVX	7254	BR9EIX	3981
-----------------	--	--	------	------	-----	-------	------	--------	------



CCM

Order
No.Platin/
Gold-
PalladiumOrder
No.

Iridium

Order
No.**JET STAR 1250**

Suzuki engine			B6HS	4510	0,8	B6HVX	7435	BR6HIX	3419
---------------	--	--	-------------	-------------	-----	--------------	-------------	---------------	-------------

KAWASAKI

300	300		BR7ES	5122	0,8	BR7EVX	4556		
300SX	300		B7ES	1111	0,8	B7EVX	6934		
JS 400A	400		B7ES	1111	0,8	B7EVX	6934		
440	440		BR7ES	5122	0,8	BR7EVX	4556		
440 SX	440	- 1992	BR7ES	5122	0,8	BR7EVX	4556		
550	550	1986 -	BR8ES	5422	0,8	BR8EVX	1262	BR8EIX	5044
550	550	- 1985	BR7ES	5122	0,8	BR7EVX	4556		
550SX	550		BR8ES	5422	0,8	BR8EVX	1262	BR8EIX	5044
650SC	650		BR7ES	5122	0,8	BR7EVX	4556		
650SX	650		BR7ES	5122	0,8	BR7EVX	4556		
650TS	650		BR7ES	5122	0,8	BR7EVX	4556		
650X-2	650		BR7ES	5122	0,8	BR7EVX	4556		
JB 650 Jet Mate	650	1989 - 1992	BR7ES	5122	0,8	BR7EVX	4556		
JF 650 AX-2	650	1986 - 1995	BR7ES	5122	0,8	BR7EVX	4556		
JF 650 B TS	650	1989 - 1996	BR7ES	5122	0,8	BR7EVX	4556		
Mate	650		BR7ES	5122	0,8	BR7EVX	4556		
750 X4 (JH750E)	750		BR8ES	5422	0,7	BR8EVX	1262	BR8EIX	5044
750 XII (JH750F)	750		BR8ES	5422	0,7	BR8EVX	1262	BR8EIX	5044
750 ZXI (JH750C)	750		BR8ES	5422	0,7	BR8EVX	1262	BR8EIX	5044
750FX	750		BR8ES	5422	0,8	BR8EVX	1262	BR8EIX	5044
750SS	750		BR8ES	5422	0,8	BR8EVX	1262	BR8EIX	5044
750STS (JT750B1)	750		BR8ES	5422	0,8	BR8EVX	1262	BR8EIX	5044
750SX	750		BR9ES	5722	0,8	BR9EVX	1265	BR9EIX	3981
750SXi (JT750B1)	750		BR8ES	5422	0,8	BR8EVX	1262	BR8EIX	5044
750X-4	750		BR8ES	5422	0,8	BR8EVX	1262	BR8EIX	5044
750Xi	750		BR8ES	5422	0,8	BR8EVX	1262	BR8EIX	5044
750ZXi (JH750C1)	750		BR8ES	5422	0,8	BR8EVX	1262	BR8EIX	5044
JH 750 A Super Sport	750	1992 - 1994	BR8ES	5422	0,8	BR8EVX	1262	BR8EIX	5044
JH 750 B Super Sport Xi	750	1993 - 1995	BR8ES	5422	0,8	BR8EVX	1262	BR8EIX	5044
JH 750 E Super Sport	750	1996 - 1998	BR8ES	5422	0,8	BR8EVX	1262	BR8EIX	5044
JH 750 G	750	1998 -	BR8ES	5422	0,8	BR8EVX	1262	BR8EIX	5044
JS 750 A	750	1992 - 1994	BR8ES	5422	0,8	BR8EVX	1262	BR8EIX	5044
JS 750 C SXI	750	1998 -	BR8ES	5422	0,8	BR8EVX	1262	BR8EIX	5044
JS 750 SX (JS750A)	750		BR8ES	5422	0,7	BR8EVX	1262	BR8EIX	5044
JS 750 SXI (JS750B)	750		BR8ES	5422	0,7	BR8EVX	1262	BR8EIX	5044
JT 750 C	750	1998 -	BR8ES	5422	0,8	BR8EVX	1262	BR8EIX	5044
JT 750 Sxi Pro	750	2003 -	BR8ES	5422	0,8	BR8EVX	1262	BR8EIX	5044
JS 800 SX-R	800	2003 -	BR9ES	5722	0,8	BR9EVX	1265	BR9EIX	3981
900 ZXI (JH900A)	900		BR9ES	5722	0,7	BR9EVX	1265	BR9EIX	3981
900ZXi (JH900A1)	900		BR9ES	5722	0,8	BR9EVX	1265	BR9EIX	3981
JT 900 STX	900	1998 -	BR9ES	5722	0,8	BR9EVX	1265	BR9EIX	3981
1100 STX	1071	1998 -	BR9ES	5722	0,8	BR9EVX	1265	BR9EIX	3981
1100 SXI	1071	1998 -	BR9ES	5722	0,8	BR9EVX	1265	BR9EIX	3981
JH 1100-A	1071	1998 -	BR9ES	5722	0,8	BR9EVX	1265	BR9EIX	3981
JT 1100-B	1071	1998 -	BR9ES	5722	0,8	BR9EVX	1265	BR9EIX	3981
1100 STX (JT1100A)	1100		BR9ES	5722	0,7	BR9EVX	1265	BR9EIX	3981
1100 ZXI (JH1100A)	1100		BR9ES	5722	0,7	BR9EVX	1265	BR9EIX	3981
STX 1100 Di	1100	2002 -	BR9ES	5722	0,8	BR9EVX	1265	BR9EIX	3981



ccm

Order
No.Platin/
Gold-
PalladiumOrder
No.

Iridium

Order
No.**KAWASAKI**

STX 1100 Di (C1/F1)	1100	2000 -	PZFR7G-G	4253	0,8				
150Ultra	1200	2004 -	BR9ES	5722	0,8	BR9EVX	1265	BR9EIX	3981
JH 1200 Ultra 150	1200	2000 -	BR9ES	5722	0,8	BR9EVX	1265	BR9EIX	3981
JH 1200 Ultra 150	1200	1999 - 2000	R6918C-9	5196	0,6				
STX 1200	1200	2000 -	BR9ES	5722	0,8	BR9EVX	1265	BR9EIX	3981
STX 1200 12F	1200	2003 -	CR9EK	4548	0,6			CR9EIX	3521
STX 1200 F	1200	2004 -	CR9EK	4548	0,6			CR9EIX	3521
STX 1200 R	1200	2002 -	BR9ES	5722	0,8	BR9EVX	1265	BR9EIX	3981
STX 1500 F	1500	2004 -	CR9EK	4548	0,6			CR9EIX	3521

NAUTICA

Mercury 90HP			BZ7HS-10	3579	1,0				
Mercury 120HP			BZ7HS-10	3579	1,0				

POLARIS

SL	650	1994 - 1995	BPR7ES	2023	0,7	BPR7EVX	5565	BPR7EIX	4055
Delux	700	1997 -	BPR6ES	7822	0,8	BPR6EVX	6764	BPR6EIX	6637
Hurricane	700	1996 - 1997	BPR8ES	3923	0,7	BPR8EVX	5573		
SL-700	700	1996 - 1997	BPR7ES	2023	0,7	BPR7EVX	5565	BPR7EIX	4055
SLR-700	700	1996 - 1997	BPR7ES	2023	0,7	BPR7EVX	5565	BPR7EIX	4055
SLT-700	700	1996 - 1997	BPR7ES	2023	0,7	BPR7EVX	5565	BPR7EIX	4055
SL 750	750	1994 - 1995	BPR7ES	2023	0,7	BPR7EVX	5565	BPR7EIX	4055
SLT 750	750	1995 -	BPR7ES	2023	0,7	BPR7EVX	5565	BPR7EIX	4055
SLX Pro785 EC78PWE 04	778	1998 -	BR9ES	5722	0,8	BR9EVX	1265	BR9EIX	3981
SL-780	780	1996 - 1997	BPR8ES	3923	0,7	BPR8EVX	5573		
SLT-780	780	1996 - 1997	BPR8ES	3923	0,7	BPR8EVX	5573		
SLX EC78ZPWE 04	780	1998 -	BR9ES	5722	0,8	BR9EVX	1265	BR9EIX	3981
SLX-780	780	1996 - 1997	BPR8ES	3923	0,7	BPR8EVX	5573		
SL-900	900	1996 - 1997	BPR8ES	3923	0,7	BPR8EVX	5573		
SLT-1050	1050	1996 - 1997	BPR8ES	3923	0,7	BPR8EVX	5573		
SLTX W 105 TCSP 04	1050	1998 -	BR9ES	5722	0,8	BR9EVX	1265	BR9EIX	3981
SLTX-1050	1050	1996 - 1997	BPR8ES	3923	0,7	BPR8EVX	5573		
SLXH W 9105 TCSP 05	1050	1998 -	BR9ES	5722	0,8	BR9EVX	1265	BR9EIX	3981
SLTX-1051	1051	1999 -	BPR8ES	3923	0,7	BPR8EVX	5573		
SLX-1051	1051	1999 -	BPR8ES	3923	0,7	BPR8EVX	5573		
Genesis 1165	1165	1999 -	BR9ES	5722	0,8	BR9EVX	1265	BR9EIX	3981
Genesis 1165 inj.	1165	2000 -	PZFR6H	7696	0,8				
Pro 1165	1165	2000 -	BR9ES	5722	0,8	BR9EVX	1265	BR9EIX	3981
SLX 1165	1165	2000 -	BR9ES	5722	0,8	BR9EVX	1265	BR9EIX	3981
Virage 1165	1165	2000 -	BR9ES	5722	0,8	BR9EVX	1265	BR9EIX	3981
Virage 1165 inj.	1165	2001 -	PZFR6H	7696	0,8				
X45 1165	1165	1999 -	BR9ES	5722	0,8	BR9EVX	1265	BR9EIX	3981
Genesis 1200 inj.	1200	2000 -	PZFR6H	7696	0,8				

POWER BOARD

Power Board		1989 -	BPR7HS-10	1092	1,0				
-------------	--	--------	-----------	------	-----	--	--	--	--



CCM

Order
No.Platin/
Gold-
PalladiumOrder
No.

Iridium

Order
No.**PROGRESSIVE POWER**

Formula Micro		1987 - 1990	BPM6A	7021	0,6				
---------------	--	-------------	-------	------	-----	--	--	--	--

SEA-DOO

Barracuda Premium		2004 -	BR8ES	5422	0,8	BR8EVX	1262	BR8EIX	5044
GTi STD,LE,Rfi		2004 -	BR8ES	5422	0,8	BR8EVX	1262	BR8EIX	5044
5801	580	1988 - 1995	BR7ES	5122	0,6	BR7EVX	4556		
5802	580	1989 -	BR7ES	5122	0,6	BR7EVX	4556		
5803	580	1990 -	BR7ES	5122	0,6	BR7EVX	4556		
5810	580	1990 -	BR7ES	5122	0,6	BR7EVX	4556		
EXP	580	1993 -	BR7ES	5122	0,6	BR7EVX	4556		
GT	580	1991 -	BR7ES	5122	0,6	BR7EVX	4556		
GTS	580	1992 - 1997	BR7ES	5122	0,6	BR7EVX	4556		
GTX	580	1992 - 1993	BR7ES	5122	0,6	BR7EVX	4556		
SP	580	1991 - 1997	BR7ES	5122	0,6	BR7EVX	4556		
SPI	580	1993 - 1997	BR7ES	5122	0,6	BR7EVX	4556		
SPX	580	1993 -	BR7ES	5122	0,6	BR7EVX	4556		
XP	580	1991 - 1993	BR7ES	5122	0,6	BR7EVX	4556		
GTX 650	650	1994 - 1995	BR8ES	5422	0,8	BR8EVX	1262	BR8EIX	5044
SPX 650	650	1994 - 1995	BR8ES	5422	0,8	BR8EVX	1262	BR8EIX	5044
XP 650	650	1993 - 1995	BR8ES	5422	0,8	BR8EVX	1262	BR8EIX	5044
GS 718	718	1997 -	BR8ES	5422	0,8	BR8EVX	1262	BR8EIX	5044
GSi 718	718	1997 - 1999	BR8ES	5422	0,8	BR8EVX	1262	BR8EIX	5044
GTi 718	718	1996 -	BR8ES	5422	0,8	BR8EVX	1262	BR8EIX	5044
GTi 718 Le,Le Rfi	718	2003 -	BR8ES	5422	0,8	BR8EVX	1262	BR8EIX	5044
GTS 718	718	1997 -	BR8ES	5422	0,8	BR8EVX	1262	BR8EIX	5044
HX 718	718	1995 - 1996	BR8ES	5422	0,8	BR8EVX	1262	BR8EIX	5044
SPX 718	718	1996 - 1997	BR8ES	5422	0,8	BR8EVX	1262	BR8EIX	5044
XP 718	718	1995 -	BR8ES	5422	0,8	BR8EVX	1262	BR8EIX	5044
GSX 782	782	1996 - 1998	BR8ES	5422	0,8	BR8EVX	1262	BR8EIX	5044
GTX 782	782	1996 - 1998	BR8ES	5422	0,8	BR8EVX	1262	BR8EIX	5044
SP 782	782	1997 -	BR8ES	5422	0,8	BR8EVX	1262	BR8EIX	5044
SPX 782	782	1997 - 1998	BR8ES	5422	0,8	BR8EVX	1262	BR8EIX	5044
XP 782	782	1995 - 1997	BR8ES	5422	0,8	BR8EVX	1262	BR8EIX	5044
GTX 947 Di	947	2000 -	ZFR5F	5165	0,8			ZFR5FIX-11	2477
RX 947	947	2000 -	ZFR5F	5165	0,8			ZFR5FIX-11	2477
GSX 951 Limited	951	1997 - 1998	BR8ES	5422	0,8	BR8EVX	1262	BR8EIX	5044
GTX 951 Di	951	2000 -	ZFR5F	5165	0,8			ZFR5FIX-11	2477
LRV 951	951		BR8ES	5422	0,8	BR8EVX	1262	BR8EIX	5044
RX 951 Di	951	2003 -	ZFR4F-11	4043	1,1				
RX 951 Di	951	2001 -	ZFR5F	5165	0,8			ZFR5FIX-11	2477
XP 951	951	1996 -	BR8ES	5422	0,8	BR8EVX	1262	BR8EIX	5044
XP 951 LTD Di	951	2004 -	ZFR4F-11	4043	1,1				

SEAFLASH

Suzuki engine			B6HS	4510	0,8	B6HVX	7435	BR6HIX	3419
---------------	--	--	------	------	-----	-------	------	--------	------

SEA-SOO

Bullet		2004 -	DCPR8E	4339	0,8	DCPR8EVX	2265		
GTX 1494 4TEC Lim.Superchar.	1500	2004 -	DCPR8E	4339	0,8	DCPR8EVX	2265		



ccm

Order
No.Platin/
Gold-
PalladiumOrder
No.

Iridium

Order
No.**SEA-SOO**

GTX 1494 4TEC Superchar.	1500	2004 -	DCPR8E	4339	0,8	DCPR8EVX	2265		
--------------------------	------	--------	--------	------	-----	----------	------	--	--

SKIDADDLE

Aquajet			BR7ES	5122	0,8	BR7EVX	4556		
---------	--	--	-------	------	-----	--------	------	--	--

SKI-FREE

2 Cyl. 40HP			BR8ES	5422	0,6	BR8EVX	1262	BR8EIX	5044
-------------	--	--	-------	------	-----	--------	------	--------	------

SKI-WHEEL

Ski Tow Kohler 440-2LC	440		B9ES	2611	0,6	B9EVX	7254	BR9EIX	3981
------------------------	-----	--	------	------	-----	-------	------	--------	------

SOS EXPRESS

Tide Rider Cuyuna 45HP			BR8ES	5422	0,6	BR8EVX	1262	BR8EIX	5044
------------------------	--	--	-------	------	-----	--------	------	--------	------

SURF- JET

Fuji engine LC 26	255	1980 - 1997	B6HS	4510	0,6	B6HVX	7435	BR6HIX	3419
Fuji engine LC 26	260	1980 - 1997	B6HS	4510	0,6	B6HVX	7435	BR6HIX	3419
Fuji engine LC26	260	1998 -	B7HS	5110	0,6	B7HVX	7836	BR7HIX	7067

SUZUKI

Nomad 292	292		B7HS	5110	0,7	B7HVX	7836	BR7HIX	7067
C340	340		BR9EYA	7548	0,8			BR9EIX	3981
F340	340		BR9EYA	7548	0,8			BR9EIX	3981
Nomad 336	340		B7HS	5110	0,7	B7HVX	7836	BR7HIX	7067
SM10	360		B7HS	5110	0,7	B7HVX	7836	BR7HIX	7067
SM10D	360		B7HS	5110	0,7	B7HVX	7836	BR7HIX	7067
C370	370		BR9EYA	7548	0,8			BR9EIX	3981
F370	370		BR9EYA	7548	0,8			BR9EIX	3981
SM20	395		B7HS	5110	0,7	B7HVX	7836	BR7HIX	7067
SM20 Hop Up Kit	395		B8ES	2411	0,7	B8EVX	7051	BR8EIX	5044
Wide Track 400	395		B7HS	5110	0,7	B7HVX	7836	BR7HIX	7067
XR400	395		B7HS	5110	0,7	B7HVX	7836	BR7HIX	7067
C-ZRV 440	400	2000 -	BR9EYA	7548	0,8			BR9EIX	3981
L / C-ZRV 440	400	1999 -	BR10EYA	6029	0,8	BR10EVX	7613	BR10EIX	6801
L / C-ZRV 440	400	1998 -	BR10ES	4832	0,7	BR10EVX	7613	BR10EIX	6801
L440	400	2000 -	BR9EYA	7548	0,8			BR9EIX	3981
XR440	432		B7HS	5110	0,7	B7HVX	7836	BR7HIX	7067
C440	433		BR9EYA	7548	0,8			BR9EIX	3981
C-LWS 440	433		BR9EYA	7548	0,8			BR9EIX	3981
F / C-C 440	433		BR9ES	5722	0,8	BR9EVX	1265	BR9EIX	3981
F440	433		BR9EYA	7548	0,8			BR9EIX	3981
L440	433		BR9EYA	7548	0,8			BR9EIX	3981
SM 440M	433				0,8	BR9EVX	1265	BR9EIX	3981
F / C 500	500		BR9ES	5722	0,8	BR9EVX	1265	BR9EIX	3981
L / C 500	500		BR9EYA	7548	0,8			BR9EIX	3981
L / C 500	500	2000 -	BR10EYA	6029	0,8	BR10EVX	7613	BR10EIX	6801



CCM

Order
No.Platin/
Gold-
PalladiumOrder
No.

Iridium

Order
No.**SUZUKI**

L / C-EID 500	500		BR9EYA	7548	0,8			BR9EIX	3981
L / C 530	530		BR10ES	4832	0,7	BR10EVX	7613	BR10EIX	6801
L / C 550	530		BR9EYA	7548	0,8			BR9EIX	3981
L / C-EID 580	580		BR9EYA	7548	0,8			BR9EIX	3981
L / C 600	600		BR9EYA	7548	0,8			BR9EIX	3981
L / C-EID 600	600		BR9EYA	7548	0,8			BR9EIX	3981
L / C 650	650		BR10ES	4832	0,7	BR10EVX	7613	BR10EIX	6801
L / C 700	650		BR10ES	4832	0,7	BR10EVX	7613	BR10EIX	6801
F / C 700	700	- 1995	BR9ES	5722	0,8	BR9EVX	1265	BR9EIX	3981
L / C 785	785		BR9EYA	7548	0,8			BR9EIX	3981
L / C 800	800		BR9EYA	7548	0,8			BR9EIX	3981
L / C 900	900		BR9EYA	7548	0,8			BR9EIX	3981
L / C 1000	1000		BR9EYA	7548	0,8			BR9EIX	3981

THUNDER JET

F - II 700			BR8ES	5422	0,6	BR8EVX	1262	BR8EIX	5044
F - II 800			BR8ES	5422	0,6	BR8EVX	1262	BR8EIX	5044
F14			BR8ES	5422	0,6	BR8EVX	1262	BR8EIX	5044
F15			BR8ES	5422	0,6	BR8EVX	1262	BR8EIX	5044

TIDE RIDER

Cuyuna engine 45HP			BR8ES	5422	0,6	BR8EVX	1262	BR8EIX	5044
--------------------	--	--	-------	------	-----	--------	------	--------	------

TIGERSHARK

639	639	1993 - 1997	B9ES	2611	0,6	B9EVX	7254	BR9EIX	3981
644	644	1993 - 1994	B9ES	2611	0,6	B9EVX	7254	BR9EIX	3981
768	768	1997 -	B9ES	2611	0,6	B9EVX	7254	BR9EIX	3981
896	896	1995 - 1997	B9ES	2611	0,6	B9EVX	7254	BR9EIX	3981
999	999	1997 -	B9ES	2611	0,6	B9EVX	7254	BR9EIX	3981

ULTRANAUTICS

Wetbike Suzuki engine			B7HS	5110	1,0	B7HVX	7836	BR7HIX	7067
Seaflash ST Suzuki engine	789		B7HS	5110	1,0	B7HVX	7836	BR7HIX	7067
Seaflash XL Suzuki engine	789		B7HS	5110	1,0	B7HVX	7836	BR7HIX	7067
Seaflash XP Suzuki engine	789		B7HS	5110	1,0	B7HVX	7836	BR7HIX	7067
Mercury engine	1231		BUHW	2622					

WET JET

428	428	1985 -	BR8ES	5422	0,7	BR8EVX	1262	BR8EIX	5044
428 LC	428	1986 - 1988	BR8ES	5422	0,7	BR8EVX	1262	BR8EIX	5044
200 Duo	432	1994 -	BR8ES	5422	0,7	BR8EVX	1262	BR8EIX	5044
432	432	1988 -	BR8ES	5422	0,7	BR8EVX	1262	BR8EIX	5044
432 Brut	432	1988 - 1992	BR8ES	5422	0,7	BR8EVX	1262	BR8EIX	5044
Special Edition Brut	432	1991 - 1992	BR8ES	5422	0,7	BR8EVX	1262	BR8EIX	5044
Sport Brut	432	1992 -	BR8ES	5422	0,7	BR8EVX	1262	BR8EIX	5044
Sport II Brut	432	1990 - 1992	BR8ES	5422	0,7	BR8EVX	1262	BR8EIX	5044



ccm

Order
No.Platin/
Gold-
PalladiumOrder
No.

Iridium

Order
No.**WET JET**

Duo	701	1996 -	BR8HS	4322	0,6	BR8HVX	6265	BR8HIX	7001
Duo 300	701	1995 -	BR8HS	4322	0,6	BR8HVX	6265	BR8HIX	7001
Duo 300ZX	701	1995 -	BR8HS	4322	0,6	BR8HVX	6265	BR8HIX	7001
Duo 300ZX Kraze	701	1995 -	BR8HS	4322	0,6	BR8HVX	6265	BR8HIX	7001
Kraze	701	1996 - 1997	BR8HS	4322	0,6	BR8HVX	6265	BR8HIX	7001
ZX	701	1996 -	BR8HS	4322	0,6	BR8HVX	6265	BR8HIX	7001

WETBIKE

Spirit engine			B7HS	5110	1,0	B7HVX	7836	BR7HIX	7067
Suzuki engine			B6HS	4510	0,8	B6HVX	7435	BR6HIX	3419

WILD CAT

Brute 50HP			B9ES	2611	0,6	B9EVX	7254	BR9EIX	3981
Brute 75HP			B9ES	2611	0,6	B9EVX	7254	BR9EIX	3981

YAMAHA

FX 140 F1B	140	2002 -	CR9EB	6955	0,7				
WJ 500	500	1987 - 1990	B7HS	5110	0,6	B7HVX	7836	BR7HIX	7067
WJ 500	500		B7HS	5110	0,6	B7HVX	7836	BR7HIX	7067
WR 500	500	1987 - 1994	B7HS	5110	0,6	B7HVX	7836	BR7HIX	7067
WR 500	500	1987 - 1993	B7HS	5110	0,6	B7HVX	7836	BR7HIX	7067
MJ 650	650	1989 - 1994	BR8HS	4322	0,6	BR8HVX	6265	BR8HIX	7001
MJ T 650	650	1990 - 1995	BR8HS	4322	0,6	BR8HVX	6265	BR8HIX	7001
MJ TX 650	650	1992 -	BR8HS	4322	0,6	BR8HVX	6265	BR8HIX	7001
SJ 650 Super Jet	650	1990 - 1994	B8HS	5510	0,6	B8HVX	2634	BR8HIX	7001
WR 650	650	1990 - 1992	B8HS	5510	0,6	B8HVX	2634	BR8HIX	7001
WRA 650	650	1995 -	B8HS	5510	0,6	B8HVX	2634	BR8HIX	7001
WRA 650	650	1990 - 1993	BR8HS	4322	0,6	BR8HVX	6265	BR8HIX	7001
WRB 650	650	1991 - 1996	B8HS	5510	0,6	B8HVX	2634	BR8HIX	7001
FX1 FX 700	700	1995 - 1997	B8HS	5510	0,6	B8HVX	2634	BR8HIX	7001
MJ TL 700	700	1993 - 1996	BR8HS	4322	0,6	BR8HVX	6265	BR8HIX	7001
MJ TX 700	700	1993 - 1996	BR8HS	4322	0,6	BR8HVX	6265	BR8HIX	7001
RA 700	700	1994 -	BR8HS	4322	0,6	BR8HVX	6265	BR8HIX	7001
SJ 700 Super Jet	700	1998 -	BR7HS	4122	0,6			BR7HIX	7067
SJ 700 Super Jet	700	1994 - 1995	B8HS	5510	0,6	B8HVX	2634	BR8HIX	7001
SJ A 700	700	1996 -	BR8HS	4322	0,6	BR8HVX	6265	BR8HIX	7001
VN 700	700	1995 -	BR8HS	4322	0,6	BR8HVX	6265	BR8HIX	7001
WAR 700	700	1995 - 1996	BR8HS	4322	0,6	BR8HVX	6265	BR8HIX	7001
WB 700	700	1993 - 1996	B8HS	5510	0,6	B8HVX	2634	BR8HIX	7001
WB A 700	700	1996 - 1999	BR8HS	4322	0,6	BR8HVX	6265	BR8HIX	7001
WRA 700	700	1993 -	BR8HS	4322	0,6	BR8HVX	6265	BR8HIX	7001
WRB 700	700	1993 - 1997	BR8HS	4322	0,6	BR8HVX	6265	BR8HIX	7001
WVT 700	700	1995 -	BR8HS	4322	0,6	BR8HVX	6265	BR8HIX	7001
XL 700	700	1999 -	BR8HS	4322	0,6	BR8HVX	6265	BR8HIX	7001
GP 760	760	1997 - 1999	BR8HS	4322	0,6	BR8HVX	6265	BR8HIX	7001
GP 760 Wave Runner	760		BR8HS	4322	0,6	BR8HVX	6265	BR8HIX	7001



CCM



Order No.

Platin/
Gold-
Palladium

Order No.

Iridium



Order No.

YAMAHA

RA 760	760	1996 - 1999	BR8HS	4322	0,6	BR8HVX	6265	BR8HIX	7001
RA 760 Wave Raider	760		BR8HS	4322	0,6	BR8HVX	6265	BR8HIX	7001
WB 760 Wave Blaster II	760	1996 -	BR8HS	4322	0,6	BR8HVX	6265	BR8HIX	7001
WVT 760 Wave Venture	760	1997 -	BR8HS	4322	0,6	BR8HVX	6265	BR8HIX	7001
XL 760 Waverunner	760	1998 -	BR8HS	4322	0,6	BR8HVX	6265	BR8HIX	7001
GP 800 Waverunner	800	1998 -	BR9ES	5722	0,6	BR9EVX	1265	BR9EIX	3981
WB 800	800	1999 - 2002	BR8ES	5422	0,6	BR8EVX	1262	BR8EIX	5044
XL 800	800	2000 -	BR9ES	5722	0,8	BR9EVX	1265	BR9EIX	3981
XLT 800	800	2002 -	BR8ES	5422	0,6	BR8EVX	1262	BR8EIX	5044
FX 1000	1000	2003 -	CR9EB	6955	0,7				
RA 1100	1100	1995 - 1997	BR8HS	4322	0,6	BR8HVX	6265	BR8HIX	7001
WVT 1100 Wave Venture	1100	1996 - 1998	BR8HS	4322	0,6	BR8HVX	6265	BR8HIX	7001
GP 1200	1200	2003 -	BR8ES-11	7986	1,1				
GP 1200 Wave Runner	1200	1997 - 2000	BR8HS	4322	0,6	BR8HVX	6265	BR8HIX	7001
XL 1200	1200	1999 - 2001	BR8ES-11	7986	1,1				
XL 122 Waverunner	1200	1998 - 1999	BR8HS	4322	0,6	BR8HVX	6265	BR8HIX	7001
XLT 1200	1200	2001 -	BR8ES-11	7986	1,1				
GP R 1300	1300	2003 -	BR8ES-11	7986	1,1				

Order
No.Quick
No.**AL-KO**

KB 3501	BPMR7A	4626	0,5	309
KB 4001	BPMR7A	4626	0,5	309
KB 4501	BPMR7A	4626	0,5	309
KB 5000	BPMR7A	4626	0,5	309

ALLEN

HF 108	BMR6A	7421	0,6	307
HF 750	BM4A	5628	0,6	
HT 230 A	BM7A	6521	0,6	
STP 102	BMR6A	7421	0,6	307

ALPINA

A-35/ -40/E	BPM7A	7321	0,5	305
0-70 / S / -90	BPM7A	7321	0,5	305
Forest 120	BPM7A	7321	0,5	305
160Green / 180Jolly / 210Flex	BM7A	6521	0,5	
330 / 380 Mini	BPM7A	7321	0,5	305
432 / 438 MiniProf	BPM7A	7321	0,5	305
540 Isofloat	BPM7A	7321	0,5	305
MS 540i	BPMR7A	4626	0,7	309
MS 600i	BPMR7A	4626	0,7	309
MS P 34	BPMR7A	4626	0,7	309
MS P 400	BPMR7A	4626	0,7	309
MS P 450	BPMR7A	4626	0,7	309
Prof P34	BPM7A	7321	0,5	305
Prof 34	BPM7A	7321	0,5	305
Prof 41	BPM7A	7321	0,5	305
Prof 45	BPM7A	7321	0,5	305
Prof 55	BPM7A	7321	0,5	305
Prof 56	BPM7A	7321	0,5	305
Prof 65	BPM7A	7321	0,5	305
Prof 66	BPM7A	7321	0,5	305
Prof 70	BPM7A	7321	0,5	305
Prof 90	BPM7A	7321	0,5	305
Prof 120	BPM7A	7321	0,5	305
Prof 200	B6S	3510	0,5	302
Vip 20	BPMR7A	4626	0,5	309
Vip 24	BPMR7A	4626	0,5	309
Vip 32	BPMR7A	4626	0,5	309

BLITZ

B 34 / 35 / 38	BPMR7A	4626	0,5	309
B 42 / 45	BPMR7A	4626	0,5	309
B 50 / 52 / 54 / 55	BPMR7A	4626	0,5	309
B 60	BPMR7A	4626	0,5	309
B 80	BPMR7A	4626	0,5	309
B 100	BPMR7A	4626	0,5	309
B 300 / 304	BPMR7A	4626	0,5	309
B 400 / 404	BPMR7A	4626	0,5	309
B 500 / 502 / 504	BPMR7A	4626	0,5	309
B 600	BPMR7A	4626	0,5	309
B 701 / 702	BPMR7A	4626	0,5	309

Order
No.Quick
No.

		BLITZ		
B 800 / 802 / 804	BPMR7A	4626	0,5	309
		BOLENS		
3300 / 5500 / 5600 / 5700	B4L	3112	0,7	
Swifty 3014	B6S	3510	0,5	302
Thrifty 3010	B6S	3510	0,5	302
		CLINTON		
D 15	BMR6A	7421	0,6	307
D 25	BMR6A	7421	0,6	307
D 35	BR6S	3522	0,6	
D 55	BR6S	3522	0,6	
D 65	BR6S	3522	0,6	
E 10	BM7A	6521	0,6	
E 75	BMR6A	7421	0,6	307
E 95	BMR6A	7421	0,6	307
		DANARM		
110 / 125	BR6S	3522	0,6	
1-36 / 1-36SS / 1-71 / 2-36-SS	BM7A	6521	0,6	
36AV / 55 / 55LH / RH / 76	BM7A	6521	0,6	
		DERBI		
3230	BMR6A	7421	0,6	307
3835	BM7A	6521	0,5	
5240	BMR6A	7421	0,6	307
6240	BM7A	6521	0,5	
		DOLMAR		
100	BPMR6F	1270	0,5	
100s	BPMR6F	1270	0,5	
101	BMR6A	7421	0,5	307
102	BPMR6F	1270	0,5	
103	BMR6A	7421	0,5	307
104	BMR6A	7421	0,5	307
105	BMR6A	7421	0,5	307
106	BMR6A	7421	0,5	307
108	BMR6A	7421	0,5	307
109	BPMR7A	4626	0,5	309
110 (7.86-)	BPMR7A	4626	0,5	309
110 (-6.86)	BMR6F	2144	0,5	
110i	BPMR7A	4626	0,5	309
111	BPMR7A	4626	0,5	309
112 / Super	BPMR7A	4626	0,5	309
113 / Super	BPMR7A	4626	0,5	309
114	BPMR7A	4626	0,5	309
115	BPMR7A	4626	0,5	309
115 i	BPMR7A	4626	0,5	309
116 Si	BPMR7A	4626	0,5	309
117	BPMR7A	4626	0,5	309
118	BM7A	6521	0,5	
118 S	BPM7A	7321	0,5	305

Order
No.Quick
No.**DOLMAR**

119	BPM7A	7321	0,5	305
120 / Si	BPMR7A	4626	0,5	309
120 s 02.87-	BPMR7A	4626	0,5	309
121	BPMR7A	4626	0,5	309
122 / S / SL	BM7A	6521	0,5	
123	BPMR7A	4626	0,5	309
128 KMS4	BM7A	6521	0,5	
133	BPMR7A	4626	0,5	309
133 s	BPMR7A	4626	0,5	309
143	BPMR7A	4626	0,5	309
144	BM7A	6521	0,5	
152	BM6A	5921	0,5	303
153	BPMR7A	4626	0,5	309
160 / 166	BPMR7A	4626	0,5	309
308	BPMR7A	4626	0,5	309
309	BPMR7A	4626	0,5	309
310	BPMR7A	4626	0,5	309
343	BPMR7A	4626	0,5	309
PS-33	BPMR6F	1270	0,5	
PS-330	BPMR6F	1270	0,5	
PS-3300 TH	BMR6A	7421	0,5	307
PS-34	BPMR7A	4626	0,5	309
PS-340	BPMR6F	1270	0,5	
PS-341	BPMR6F	1270	0,5	
PS-344	BPMR6F	1270	0,5	
PS-400	BPMR6F	1270	0,5	
PS-401	BPMR6F	1270	0,5	
PS-410/33	BPMR6F	1270	0,5	
PS-411/33	BPMR6F	1270	0,5	
PS-6000i	BPMR7A	4626	0,5	309
PS-6000i H	BPMR7A	4626	0,5	309
PS-6400	BPMR7A	4626	0,5	309
PS-6800i	BPMR7A	4626	0,5	309
PS-6800i H	BPMR7A	4626	0,5	309
PS-7300	BPMR7A	4626	0,5	309
PS-7900	BPMR7A	4626	0,5	309
PS-9000	BPMR7A	4626	0,5	309
PS-9010	BPMR7A	4626	0,5	309
S6000	BPMR7A	4626	0,5	309

ECHO

CLS-4610	BPM7A	7321	0,6	305
CS-30EVL	BMR6A	7421	0,6	307
CS-60S	BMR6A	7421	0,6	307
CS-280EG / EVL	BMR6A	7421	0,6	307
CS-285EVL	BMR6A	7421	0,6	307
CS-290EVL	BMR6A	7421	0,6	307
CS-300EVL	BPMR6Y	5256	0,6	
CS-320EVL	BMR6A	7421	0,6	307
CS-330EVL	BMR6A	7421	0,6	307
CS-332	BPMR7A	4626	0,6	309
CS-351VL	BMR6A	7421	0,6	307

Order
No.Quick
No.**ECHO**

CS-400EVL	BPM6A	7021	0,6	304
CS-440EVL	BPMR7A	4626	0,6	309
CS-451VL	BMR6A	7421	0,6	307
CS-452VL	BMR6A	7421	0,6	307
CS-500VL / EVL	BPMR6A	6726	0,6	308
CS-510EVL	BPMR7A	4626	0,6	309
CS-600	BMR6A	7421	0,6	307
CS-601/ S / SVL / EVL	BMR6A	7421	0,6	307
CS-602VL	BPMR7A	4626	0,6	309
CS-650EVL	BPMR7A	4626	0,6	309
CS-660EVL	BPMR7A	4626	0,6	309
CS-701 / VL / SVL	BMR6A	7421	0,6	307
CS-702VL / EVL	BPMR7A	4626	0,6	309
CS-750VL / EVL	BPMR7A	4626	0,6	309
CS-900EVL	BPMR7A	4626	0,6	309
CS-1001VL	BMR6A	7421	0,6	307
CS-3000	BPM7A	7321	0,6	305
CS-3400	BPM7A	7321	0,6	305
CS-3600	BPM7A	7321	0,6	305
CS-3900	BPM6A	7021	0,6	304
CS-4000	BPM7A	7321	0,6	305
CS-4400	BPM7A	7321	0,6	305
CS-4500	BPM7A	7321	0,6	305
CS-4600	BPM7A	7321	0,6	305
CS-4601	BPM7A	7321	0,6	305
CS-5500	BPM7A	7321	0,6	305
CS-5501	BPM7A	7321	0,6	305
CS-6700	BPMR7A	4626	0,6	309
CS-6701	BPM7A	7321	0,6	305
CS-8000	BPM7A	7321	0,6	305
CSO-1200	BPMR7A	4626	0,6	309
CST-600EVL	BPMR7A	4626	0,6	309
HC-160 /-210 /-1000 /-1500	BM6A	5921	0,6	303

EFCO

131	BPMR7A	4626	0,6	309
134	BPMR7A	4626	0,6	309
135	BPMR7A	4626	0,6	309
136	BPMR7A	4626	0,6	309
138	BPMR7A	4626	0,6	309
140	BPMR7A	4626	0,6	309
140s	BPMR7A	4626	0,6	309
141	BPMR7A	4626	0,6	309
142	BPMR7A	4626	0,6	309
146	BPMR7A	4626	0,6	309
151	BPMR7A	4626	0,6	309
156	BPMR7A	4626	0,6	309
162	BPMR7A	4626	0,6	309
170	BPMR7A	4626	0,6	309
180	BPMR7A	4626	0,6	309
199	BPMR7A	4626	0,6	309

Order
No.Quick
No.**HERKULES**

ECV 3801	BPM7A	7321	0,5	305
----------	-------	------	-----	-----

HOMELITE

66 / 80 / C72	B6S	3510	0,6	302
135	BM7A	6521	0,6	
150 / 190 / 330	BM6F	6221	0,6	
200	BPM6F	5950	0,6	
240	BMR6F	2144	0,6	
240 SL / 330SL	BPM6F	5950	0,6	
245 HG / SL	BMR6F	2144	0,6	
290	BPMR7A	4626	0,6	309
300	BPM7A	7321	0,6	305
340	BPMR7A	4626	0,6	309
350 / 360 / 360SL	BM7F	6421	0,6	
410	BMR6F	2144	0,6	
410 SL	BPM6F	5950	0,6	
450	BM7F	6421	0,6	
540	BMR6F	2144	0,6	
550 SL / 550	BM7F	6421	0,6	
650 / 750 / 750W	BM7A	6521	0,6	
1000	BMR7A	4226	0,6	
1050 / 1130G / 2100G	BM7A	6521	0,6	
205	BPMR7A	4626	0,6	309
252	BPMR7A	4626	0,6	309
3100G	BM7A	6521	0,6	
8800	BPM7A	7321	0,6	305
DM 20 Multi-Purpose	BM7A	6521	0,6	
DM 40 Multi-Purpose	BPMR6F	1270	0,6	
DM 50 Multi-Purpose	BM7A	6521	0,6	
DM 54 Multi-Purpose	BPMR6F	1270	0,6	
i 3350 b	BPMR7A	4626	0,6	309
i 3850 b	BPMR7A	4626	0,6	309
Super 1050	BPM7A	7321	0,6	305
Super 1130G /2100/EZ-A0	BM7F	6421	0,6	
Super 2	BM6F	6221	0,6	
Super Wiz55 / 66 / 80	B6S	3510	0,6	302
Super XL 925	BPM7A	7321	0,6	305
Super XL-A0	BM7A	6521	0,6	
SXL-922SL	BMR7A	4226	0,6	
SXL-A0	BMR7A	4226	0,6	
SXL-MiniA0	BM7F	6421	0,6	
V1-130SL	BR6S	3522	0,6	
V1-944 / 955	BM7A	6521	0,6	
V1-Super2 / 2SL	BM6F	6221	0,6	
XL	BPMR6F	1270	0,6	
XL Mini / Auto	BM7F	6421	0,6	
XL 1A0	BM7F	6421	0,6	
XL 2	BM6F	6221	0,6	
XL 12	BM6A	5921	0,6	303
XL 76	BR6S	3522	0,6	
XL 98 A Multi-Purpose	BM7A	6521	0,6	
XL 100A	BM6A	5921	0,6	303

Order
No.Quick
No.**HOMELITE**

XL 123	BM7A	6521	0,6	
XL 600F	BM6A	5921	0,6	303
XL 923, -A	BM6A	5921	0,6	303
XLBC 4	BM7A	6521	0,6	

HUSQVARNA

1R	BPM7A	7321	0,5	305
33	BPMR6A	6726	0,5	308
36	BPMR7A	4626	0,5	309
36R	BPM7A	7321	0,5	305
40	BPMR7A	4626	0,5	309
45 / 42D / Spezial	BPMR6A	6726	0,5	308
40P / 44 / 44P	BPM6A	7021	0,5	304
41	BPMR7A	4626	0,5	309
42	BPMR7A	4626	0,5	309
45	BPMR7A	4626	0,5	309
51	BPMR7A	4626	0,5	309
55D / 66	BPMR6A	6726	0,5	308
55	BPMR7A	4626	0,5	309
61	BPMR7A	4626	0,5	309
61D / 61P	BPM7A	7321	0,5	305
65 / 65K	BM7A	6521	0,5	
77SS	BM7A	6521	0,5	
140	BPM6A	7021	0,5	304
140R / 140S	BM7A	6521	0,5	
160S / 162E / FE / FG / SE / SG	BM7A	6521	0,5	
162S	BPM6A	7021	0,5	304
163CD / 163CS / 165R	BM7A	6521	0,5	
181 / CD / SE / SG	BM6F	6221	0,5	
185CD	BM6F	6221	0,5	
234SE / SG	BM7A	6521	0,5	
238SE / SG	BPMR6A	6726	0,5	308
240S / SE / SG	BM7A	6521	0,5	
242XP / 242XPG	BPMR7A	4626	0,5	309
244R	BM7A	6521	0,5	
254XP / 254XPG / 257D	BPMR7A	4626	0,5	309
257	BPMR7A	4626	0,5	309
260CD	BM7A	6521	0,5	
262XP / 262XPG	BPMR7A	4626	0,5	309
263CD	BM7A	6521	0,5	
266FE / FG / SE / SG	BPM7A	7321	0,5	305
266XP / 268 / 268K	BPMR7A	4626	0,5	309
272XP / 272XPG / 272K	BPMR7A	4626	0,5	309
280CD / S / G	BM7A	6521	0,5	
281XP / 288XP / 288XPG	BPMR7A	4626	0,5	309
285CD	BM7A	6521	0,5	
340SE / SG / 344FE / FG	BM7A	6521	0,5	
380CD / K / S	BPM6A	7021	0,5	304
394XP	BPMR7A	4626	0,5	309
444FE / FG / SE / SG	BM7A	6521	0,5	
480CD / K	BM7A	6521	0,5	
1100CD / 2100CD / -W	BM6F	6221	0,5	

Order
No.Quick
No.**HUSQVARNA**

133SE / 133SG	BM7A	6521	0,5	
154SE / 154SG	BM7A	6521	0,5	
180S	BM7A	6521	0,5	
3120XP	BPMR7A	4626	0,5	309
A100	BM7A	6521	0,5	
A65 / B65	BM7A	6521	0,5	
A70	BM7A	6521	0,5	
A77 / B77	BM7A	6521	0,5	
F65 / G65 / K65 / L65 / R65	BPM6A	7021	0,5	304
F70	BM6A	5921	0,5	303
Husky 32	BPM7A	7321	0,5	305
Husky 34 / 34D	BM6F	6221	0,5	
Husky 35 / 35VR	BPM7A	7321	0,5	305
Husky 38 / 38VR	BPM7A	7321	0,5	305
L77	BPM6A	7021	0,5	304
PS50 Astsäge	BPMR6A	6726	0,5	308
Rancher 40 / 50 / 61	BPMR6A	6726	0,5	308

JOHN DEERE

25EV / 28 / 30 / 35EV / 40V	BM6A	5921	0,6	303
46EV / 51SV / 55SV / 60V	BPM7A	7321	0,7	305
50 / 50V	BM6A	5921	0,6	303
55V	BPM6A	7021	0,6	304
61 / 81 / 91	BM7A	6521	0,6	
65SV / 66SV / 70V / 80EV	BPM7A	7321	0,7	305
8/ 9/ 12/ 14/ 15/ 17/ 18/19/23	BM7A	6521	0,6	
80V / 450V / 800V	BPM7A	7321	0,7	305

JONSERED

45E	BPM7A	7321	0,5	305
49SP	BPMR6A	6726	0,5	308
52E / 62 / 66E / 70E / 80 / 90	BPM6F	5950	0,5	
62	BPM6F	5950	0,5	
361/AV	BM7A	6521	0,5	
365 / 370 / 380	BPMR6A	6726	0,5	308
410 / 425	BPM7F	1268	0,5	
435 / 450	BPMR6A	6726	0,5	308
451 E / EV / 452	BPM6F	5950	0,5	
455	BPMR6A	6726	0,5	308
490	BPM6F	5950	0,5	
510 SP	BPM6A	7021	0,5	304
520 SP	BPM6F	5950	0,5	
521 / 525 / 535 / 590	BPMR6A	6726	0,5	308
621	BPM6F	5950	0,5	
625 / 630 / 670 / - Super	BPMR7A	4626	0,5	309
801	BPM6F	5950	0,5	
820 / 830	BPMR6A	6726	0,5	308
910 E	BPM6A	7021	0,5	304
920	BPM6F	5950	0,5	
930 Super	BPMR6A	6726	0,5	308
2036 Turbo / 2040 Turbo / 2045	BPMR7A	4626	0,5	309
2041	BPMR7A	4626	0,5	309

Order
No.Quick
No.

		JONSERED			
2050		BPMR7A	4626	0,5	309
2051 Turbo / 2054 Turbo / 2050		BPMR7A	4626	0,5	309
2055 Turbo		BPMR7A	4626	0,5	309
2077 Turbo / 2095 Turbo		BPMR7A	4626	0,6	309
2083 Turbo		BPMR7A	4626	0,5	309
RS40 / 45 / 51		BPMR6A	6726	0,5	308
RS52E		BPM7A	7321	0,5	305
		LANDONI			
L40		BM6A	5921	0,6	303
L48 / E		BPM6A	7021	0,6	304
L75		BM6F	6221	0,6	
L90		B8HS	5510	0,6	
L98		B7HS	5110	0,6	
L110		B7HS	5110	0,6	
L771 E / S / L772L / S		BPM6A	7021	0,6	304
L773		BM6F	6221	0,6	
LF30 CL / LF36S		BPM6A	7021	0,6	304
		LOMBARD			
3 / 3A / 3-1/2		BM6A	5921	0,6	303
30 / 34 / 35 / 36 / 37		BM6A	5921	0,6	303
4		B7S	3710	0,6	
5,5A		BM6A	5921	0,6	303
648 / 650 / 658		B6S	3510	0,6	302
660		BM6A	5921	0,6	303
68 / 69 / 70		BM6A	5921	0,6	303
7		B7S	3710	0,6	
AL42		BM7A	6521	0,6	
AP22 / AP22-1/ AP22D / AP22D1		BPM7A	7321	0,6	305
AP24 / AP24D		BPM7A	7321	0,6	305
AP42/ AP42-1/ AP42D/ AP42D-AV		BPM7A	7321	0,6	305
AP42SE		BPM7A	7321	0,6	305
Comango		BM7A	6521	0,6	
F54		BM6A	5921	0,6	303
L30 / L50 / L55 / L70		BM6A	5921	0,6	303
L80 / L90 / L100		BM6A	5921	0,6	303
Little Lighting / Deluxe		BPM7A	7321	0,6	305
Pony		BM6F	6221	0,6	
Super AL42 / AL51		BM7A	6521	0,6	
Super AV		BPM7A	7321	0,6	305
Super Comango		BM7A	6521	0,6	
Super L100		BP5S	3011	0,6	
Super L30750/60/70/90		BM6A	5921	0,6	303
Super Lighting		BM7A	6521	0,6	
		MAKITA			
DCS330S	Dolmar engine 33cc	BPMR6F	1270	0,5	
DCS340	Dolmar engine 33cc	BPMR6F	1270	0,5	
DCS341	Dolmar engine 33cc	BPMR6F	1270	0,5	
DCS390	Dolmar engine 39cc	BPMR6F	1270	0,5	
DCS400	Dolmar engine 39cc	BPMR6F	1270	0,5	

Order
No.Quick
No.**MAKITA**

DCS401	Dolmar engine 39cc	BPMR6F	1270	0,5	
DCS430	Dolmar engine 43cc	BPMR7A	4626	0,5	309
DCS431	Dolmar engine 43cc	BPMR7A	4626	0,5	309
DCS5200i	Dolmar engine 52cc	BPMR7A	4626	0,5	309
DCS520i	Dolmar engine 52cc	BPMR7A	4626	0,5	309
DCS6800i	Dolmar engine 68cc	BPMR7A	4626	0,5	309
DCS9000	Dolmar engine 90cc	BPMR7A	4626	0,5	309
DPC7000	Dolmar engine 70cc	BPMR7A	4626	0,5	309
DPC7001	Dolmar engine 70cc	BPMR7A	4626	0,5	309
DPC9500	Dolmar engine 95cc	BPMR7A	4626	0,5	309
DPC9501	Dolmar engine 95cc	BPMR7A	4626	0,5	309

McCULLOCH

1,9		BPM7A	7321	0,6	305
1-10		BM6F	6221	0,6	
2,3		BPM7A	7321	0,6	305
2-10 / A / G		BM6F	6221	0,6	
3-10 / E		BM6F	6221	0,6	
4-10		BM7F	6421	0,6	
5-10 / A / E / G		BM7F	6421	0,6	
6-10 / A		BM7F	6421	0,6	
7-10 / A		BM7F	6421	0,6	
10-10 / A / L		BM6F	6221	0,6	
250		BM6F	6221	0,6	
550 / 640 / 650		BM6F	6221	0,6	
640 / 650		BM6F	6221	0,6	
660		B6S	3510	0,6	302
795 / L / 797		BM6F	6221	0,6	
836		BPMR6F	1270	0,5	
838		BPMR6F	1270	0,5	
895		BM6F	6221	0,6	
895C		BM7F	6421	0,6	
930		BMR6F	2144	0,6	
935		BMR6F	2144	0,6	
940		BMR6F	2144	0,6	
950		BMR6F	2144	0,6	
951		BPMR6F	1270	0,5	
955		BPMR6F	1270	0,5	
960		BMR6F	2144	0,6	
961		BPMR6F	1270	0,5	
970		BMR6F	2144	0,5	
California		BMR6F	2144	0,5	
California 90		BMR6F	2144	0,6	
CP55		BM6F	6221	0,6	
CP70 / L		BM7F	6421	0,6	
CP125 / S		BM7F	6421	0,6	
G70		BM7F	6421	0,6	
LG6		BM7F	6421	0,6	
Mac Cat		BMR6F	2144	0,6	
Mac 1-10		BM6F	6221	0,6	
Mac 2-10 / 2-10A / 2-10G		BM6F	6221	0,6	
Mac 3-10 / 3-10E		BM6F	6221	0,6	

Order
No.Quick
No.**McCULLOCH**

Mac 330 Cat	BMR6F	2144	0,6
Mac 836	BPMR6F	1270	0,6
Mac 838	BPMR6F	1270	0,6
Mac 839 Cat	BPMR6F	1270	0,6
Mac 110 / 120 / 130 / 140	BM6F	6221	0,6
Mac LG6 / S-10A / SLG-6	BM7F	6421	0,6
Might-Might	BM7A	6521	0,6
Mini-Mac1 /1A / 6 / 6A /	BM6F	6221	0,6
Mini-Mac 883	BPMR6F	1270	0,6
Mini-Mac25	BM6F	6221	0,6
Mini-Mac30 / 35 / 35AS /35CP	BM6F	6221	0,6
Mini-Pro25 / 30 / 35	BM6F	6221	0,6
P10-10A	BM6F	6221	0,6
PM 364	BMR6F	2144	0,6
PM 374	BMR6F	2144	0,6
PM 474	BMR6F	2144	0,6
PM 484	BMR6F	2144	0,6
PM 484 X	BMR6F	2144	0,5
Pro-Mac 6 / 6A	BM6F	6221	0,6
Pro-Mac 7	BMR6F	2144	0,5
Pro-Mac 36	BMR6F	2144	0,5
Pro-Mac 40	BMR6F	2144	0,5
Pro-Mac 46	BMR6F	2144	0,5
Pro-Mac 51	BPMR6F	1270	0,5
Pro-Mac 55	BPMR6F	1270	0,5
Pro-Mac 60	BM7F	6421	0,6
Pro-Mac 105	BM7F	6421	0,6
Pro-Mac 140	BM6F	6221	0,6
Pro-Mac 310 / 320 / 330 / 340	BM6F	6221	0,6
Pro-Mac 510	BM7F	6421	0,6
Pro-Mac 555	BM6F	6221	0,6
Pro-Mac 570	BM6F	6221	0,6
Pro-Mac 610 / 650	BM7F	6421	0,6
Pro-Mac 700	BM7F	6421	0,6
Pro-Mac 800	BM6F	6221	0,6
Pro-Mac 850	BM7F	6421	0,6
Pro-Mac 1000 / 1010	BM6F	6221	0,6
S 10-10 / A / E / L / LA	BM6F	6221	0,6
S 2-10A	BM6F	6221	0,6
S 250 / S550 / S797	BM6F	6221	0,6
S 6-10A	BM7F	6421	0,6
SLG 2	BM6F	6221	0,6
SLG 6	BM7F	6421	0,6
SP 40 / 55	BM6F	6221	0,6
SP 60 / 70 / 80 / 81	BM7F	6421	0,6
SP 105 / 125C	BM7F	6421	0,6
SP 125	BM6F	6221	0,6
Timber Bear 842	BPMR6F	1270	0,5
Timber Bear 846	BPMR6F	1270	0,5
Timber Bear 849	BPMR6F	1270	0,5

Order
No.Quick
No.**OLEO-MAC**

233 / 234	BPMR7A	4626	0,5	309
234 F	BPMR6A	6726	0,5	308
240 / 244 /246 FDL	BPMR7A	4626	0,5	309
244 F	BPMR6A	6726	0,5	308
250 A / B / Super E1/	BPMR7A	4626	0,5	309
252 / 252 F/ 254 / 254 F	BPMR7A	4626	0,5	309
260 Auto / 261	BPMR7A	4626	0,5	309
264 F / 272F / 935DF	BPM7A	7321	0,5	305
271 / 272 / 272 F	BPMR7A	4626	0,5	309
280 / 281 / 284	BPMR7A	4626	0,5	309
335	BPMR7A	4626	0,5	309
340 / 340F	BPMR7A	4626	0,5	309
350 / 350 S / 355	BPMR7A	4626	0,5	309
350 AF	BPMR6A	6726	0,5	308
460 S / 460 AS	BPMR7A	4626	0,5	309
480 S / 480 AS	BPMR7A	4626	0,5	309
481	BPMR7A	4626	0,5	309
482 / 482 MP	BPMR7A	4626	0,5	309
930	BPMR7A	4626	0,5	309
935 / 935 DF	BPMR7A	4626	0,5	309
940	BPMR7A	4626	0,5	309
942	BPMR7A	4626	0,5	309
945 / 945 DF	BPMR7A	4626	0,5	309
945 AF	BPMR6A	6726	0,5	308
946	BPMR7A	4626	0,5	309
950 / 950 FS	BPMR7A	4626	0,5	309
950 AF	BPMR6A	6726	0,5	308
951	BPMR7A	4626	0,5	309
999 / 999 F	BPMR7A	4626	0,5	309
AM 150	BPMR7A	4626	0,5	309
AM 180	BPMR7A	4626	0,5	309
S 30	BPMR7A	4626	0,5	309
S 50	BPMR7A	4626	0,5	309
S 80	BPMR7A	4626	0,5	309
S 100	BPMR7A	4626	0,5	309
SA 18	BPMR7A	4626	0,5	309
SA 30	BPMR7A	4626	0,5	309
SA 45	BPMR7A	4626	0,5	309
SC 21	BPMR7A	4626	0,5	309
SC 23	BPMR7A	4626	0,5	309
SC 33	BPMR7A	4626	0,5	309
SC 55	BPMR7A	4626	0,5	309

PARTNER

330 / 340 /	BMR7A	4226	0,5	
345 / 365 / 365CCS / 395	BPMR7A	4626	0,5	309
350	BM6A	5921	0,5	303
360	BPMR7A	4626	0,5	309
400 / 410CCS / 460CCS	BPMR7A	4626	0,5	309
405 / 405CCS / 450 / 465 / 495	BPMR7A	4626	0,5	309
410	BPMR7A	4626	0,5	309
500 Formula / 510CCS	BPMR7A	4626	0,5	309

Order
No.Quick
No.**PARTNER**

540 / 540PRO / 545 / 660PRO	BPMR7A	4626	0,5	309
550	BPMR7A	4626	0,5	309
650	BPMR7A	4626	0,5	309
933 / 944 / 946 / 947	BPM6F	5950	0,5	
1610 / 1611 / 1613	BPM6F	5950	0,5	
1612	BM6F	6221	0,5	
1614 / C , 1616 / C	BPM6F	5950	0,5	
1618	BM6F	6221	0,5	
1629 / 1630 / 1631	BR6S	3522	0,5	
1632 / C	BMR7A	4226	0,5	
1633 B	BM7A	6521	0,5	
1644 / 1645	BR6S	3522	0,5	
1646 / C 1647C / 1655 / B	BMR7A	4226	0,5	
1660 / 1661 / 1690	BR6S	3522	0,5	
1705 / 1712	BPM6F	5950	0,5	
2055 / B	BMR7A	4226	0,5	
351 CCS	BPMR6A	6726	0,5	308
370 CCS	BPMR6A	6726	0,5	308
390 CCS	BPMR6A	6726	0,5	308
420 CCS	BPMR6A	6726	0,5	308
470 CCS	BPMR6A	6726	0,5	308
5000 / Plus	BPM7F	1268	0,5	
5500	BPMR7A	4626	0,5	309
7000	BMR6A	7421	0,5	307
7700 /7700PRO CCS	BPMR7A	4626	0,7	309
B17	BM7A	6521	0,5	
B172 / B173	BM7A	6521	0,5	
B400	BM6A	5921	0,5	303
C-6	BM7A	6521	0,5	
F55 / A	BM7A	6521	0,5	
F65	BM7A	6521	0,5	
K12	BP6HS	4511	0,5	
K12S	BPM7A	7321	0,5	305
K16 / K20 / K40	BM7A	6521	0,5	
K550 / K650 / K700 / K1200	BPMR7A	4626	0,5	309
Mini P / 2	BM7A	6521	0,5	
Mini P3 / 4	BM6F	6221	0,5	
P48 / P49	BM7F	6421	0,5	
P50 / P51 / P65 / P85	BPMR7A	4626	0,5	309
P55 / P70	BMR7A	4226	0,5	
P100 / S	BPMR7A	4626	0,5	309
P500 / P5000	BPM6F	5950	0,5	
P7000	BM7A	6521	0,5	
R11	BM7A	6521	0,5	
R12	BP6HS	4511	0,5	
R14 / TS / R15 / R16 / R17 / T	BM7A	6521	0,5	
R18 / T / R19 / T / R20 / T	BM7A	6521	0,5	
R21 / T	BM6A	5921	0,5	303
R22 / T	BM7A	6521	0,5	
R30	BM6A	5921	0,5	303
R40 / T	BM7A	6521	0,5	
R400	BMR7A	4226	0,5	

Order
No.Quick
No.**PARTNER**

R417 / T	BM7A	6521	0,5	
R420 / T / R421 / T / R440 / T	BM7A	6521	0,5	
R517 / T / R523	BM7A	6521	0,5	
R85	BM7A	6521	0,5	
S50 / S55 / S65	BM7A	6521	0,5	

PIONEER

550 / 600 / 610 / 620 / 650 / 700	B6S	3510	0,6	302
700G / 750 / 800 / 850	B6S	3510	0,6	302
970 / 1072 / 1073 / 2071 / 2073	BM7A	6521	0,6	
1014 / 1074E / 1074UB	BM6A	5921	0,7	303
1074	BM6A	5921	0,6	303
1100	BM6A	5921	0,6	303
1100 / 1110 / 1120 / 1130	BM6A	5921	0,6	303
1150 / 1160 / 1200 / 1200A	BM6A	5921	0,6	303
1410 / 1410A / 1420 / 1450	BM6A	5921	0,6	303
1520 / 1560 / 1750 / 1770 / 1771	BM7A	6521	0,6	
1850 / 2071 / 2073	BM7A	6521	0,6	
2200 / 2270 / 2400 / 2460	BM6A	5921	0,6	303
3071 / 3200 / 3270 / 3270S	BM6A	5921	0,6	303
F / G / M	B4	3210	0,6	
Farmlite	BPMR7A	4626	0,7	309
Farmsasw 2	BMR6A	7421	0,7	307
HA / HB / One Man / Twin Super	B6S	3510	0,6	302
HC / RA / NU-17 / 400 / 410 / 450	B6S	3510	0,6	302
P10	BM7A	6521	0,6	
P11	BPM7A	7321	0,7	305
P20 / P25 / P26S	BM7A	6521	0,6	
P21 / P21S	BM6A	5921	0,6	303
P21B / P21SB / P28E	BM6A	5921	0,7	303
P26	BMR6A	7421	0,6	307
P28 / P28S	BMR6A	7421	0,6	307
P28B / P28SB	BMR6A	7421	0,7	307
P30 / P30S	BMR7A	4226	0,7	
P35 / P35S	BMR6A	7421	0,6	307
P38	BPMR7A	4626	0,7	309
P40 / P50	BM7A	6521	0,6	
P40 Light Service	BM6A	5921	0,6	303
P41 / P41S	BR6S	3522	0,6	
P42 / P42W	BPMR7A	4626	0,7	309
P50	BM7A	6521	0,6	
P51 / P51S	BM7A	6521	0,6	
P52 / P52W	BPMR7A	4626	0,7	309
P55 / P55S	BMR7A	4226	0,6	
P60	BPMR7A	4626	0,6	309
P62 / P62W	BPMR7A	4626	0,7	309
Super Twin	B6S	3510	0,6	302

POULAN

1800 / 2000 / 2300	BM6A	5921	0,6	303
20 / 20D / 25 / 25DA	BM6A	5921	0,6	303
245A / 252A	BM6A	5921	0,6	303



Order No.  Quick No.

POULAN

3400	BPM6A	7021	0,6	304
36 / 306A / 306SA / 361	BM6A	5921	0,6	303
3700	BPM7A	7321	0,6	305
4000	BPM6A	7021	0,6	304
4200	BM7A	6521	0,6	
4200CVA	BPMR7A	4626	0,5	309
4400 / 4900 / 5200CVA	BM6A	5921	0,6	303
5200 / 5400 / 5500 / 6000	BM7A	6521	0,6	
53A / 54	B6S	3510	0,6	302
6000CVA	BPMR7A	4626	0,5	309
6900 / 7700 / 8500	BM7A	6521	0,6	
71A / 72 / 76 / 92 / 100	BM6A	5921	0,6	303
B520	BM4A	5628	0,6	
Log Splitter 19-7 / 26-TM	BM6A	5921	0,6	303
Log Splitter 26-10 / 26-10R	BM6A	5921	0,6	303
Log Splitter P-24-8AR/P-26-15A	BM6A	5921	0,6	303
Micro 25 / 25 Deluxe	BM6A	5921	0,6	303
Micro 25CVA / 25SN/MZ5	BM6A	5921	0,6	303
MicroSuper25/CAV/Deluxe	BM6A	5921	0,6	303
Multipurpose 25-14-12/45-12	BM7A	6521	0,6	
S25CVA / S25DA	BM6A	5921	0,6	303
S33	B6S	3510	0,6	302
S6000/Super 6000CVA	BPMR7A	4626	0,5	309
S68 / S72	BM6A	5921	0,6	303
Super XXV	BM6A	5921	0,6	303

REMINGTON

812/814/816/816AV	BPM6A	7021	0,6	304
840AV/850AV/860AV	BPM6A	7021	0,6	304
Jobmaster	BPM6A	7021	0,6	304
Logger	BM7A	6521	0,6	
Mighty-Mite	BM7A	6521	0,6	
Mighty-Mite 100 / 200 / 300	BPM6A	7021	0,6	304
Mighty-Mite 400 / 500 / 600	BPM6A	7021	0,6	304
Mighty-Mite Bantam / Deluxe	BM7A	6521	0,6	
Mighty-Mite Weekender	BM7A	6521	0,6	
Outdoorsman	BM7A	6521	0,6	
Outdoorsman II	BPM6A	7021	0,6	304
P5A/PL4/PL5/PL6/PL6A	BM7A	6521	0,6	
PL7/PL7A/PL55/PL55A	BM7A	6521	0,6	
Pow-R-Cut	BM7A	6521	0,6	
Rancher	BM7A	6521	0,6	
SL11 / SL11A	BM7A	6521	0,6	
SL14 / SL16 / SL55	BM7A	6521	0,6	
SL4/SL4A/SL7/SL9/SL9A	BM7A	6521	0,6	
SL9 Deluxe /SL10 / SL10A	BM7A	6521	0,6	
Sportsmann	BM7A	6521	0,6	
Sportsmann II	BPM6A	7021	0,6	304
Super 754	B6S	3510	0,6	302
Woodsmann	BM7A	6521	0,6	
Yardmaster	BPM6A	7021	0,6	304

Order
No.Quick
No.**RYOBI**

GTS 28 /32 / 38	BPM7A	7321	0,6	305
GTS 56 /62	BPM7A	7321	0,6	305
RGS 3214 / 3214A	BPM7A	7321	0,6	305
RGS 3816 /4518 / 5418	BPM7A	7321	0,6	305

SHINDAIWA

450 / 451	BPMR6A	6726	0,6	308
460	BPMR6A	6726	0,6	308
440	BPMR6A	6726	0,6	308
488	BPMR6A	6726	0,6	308
300 /S / 345 / 350 / 360 / 377	BPMR6A	6726	0,6	308
400 / 410 / 415 / 416	BPMR6A	6726	0,6	308
420	BPMR6A	6726	0,6	308
500 / 510 / 575 / 577	BPMR6A	6726	0,6	308
580 (-87)	BPMR6A	6726	0,7	308
580 (88)	BPMR7A	4626	0,7	309
680	BPMR6A	6726	0,7	308
685 (-87)	BPMR6A	6726	0,7	308
685 (88)	BPMR7A	4626	0,7	309
695	BPMR6A	6726	0,6	308
757	BPMR6A	6726	0,6	308
CYB350	BPMR6A	6726	0,6	308
DBY354	BMR6A	7421	0,6	307
DBY453	BMR6A	7421	0,6	307
DYB190 / DYB191	BMR6A	7421	0,6	307
DYB200 / DYB201 / DYB202	BMR6A	7421	0,6	307
DYB251 / DYB252 / DYB253	BMR6A	7421	0,6	307
DYB254 / DYB345 / DYB351	BMR6A	7421	0,6	307
E300 / E345 / E350 / E406	BPMR6A	6726	0,7	308
E440 / E480	BPMR6A	6726	0,7	308
E580 (-87)	BPMR6A	6726	0,7	308
E580 (88)	BPMR7A	4626	0,7	309
E680 (-87)	BPMR6A	6726	0,7	308
E680 (88)	BPMR7A	4626	0,7	309
E680EV	BPMR6A	6726	0,7	308
YB291 / YB301 / YB401 / YB501	BPMR6A	6726	0,6	308
YB601 / YB701 / YB901	BPMR6A	6726	0,6	308
YB801 (-87)	BPMR6A	6726	0,6	308
YB801 (88)	BPMR7A	4626	0,6	309

SKIL

255	BM6A	5921	0,6	303
1610 / 1611 / 1612 / 1613	BM6F	6221	0,6	
1614 / 1616	BM6F	6221	0,6	
1620	BM6A	5921	0,6	303
1622 / 1624	BM6A	5921	0,6	303
1629	BR6S	3522	0,6	
1630 / 1631	BR6S	3522	0,6	
1632	BMR7A	4226	0,6	
1634	BM6A	5921	0,6	303
1636	BM6A	5921	0,6	303
1644	BR6S	3522	0,6	

Order
No.Quick
No.**SKIL**

1645	BR6S	3522	0,6	
1646 / 1647	BMR7A	4226	0,6	
1660 / 1661	BR6S	3522	0,6	
1690	BR6S	3522	0,6	
1705 / 1712	BM6F	6221	0,6	

SOLO

600 Mini / 600B	BPM6A	7021	0,5	304
603	BPMR7A	4626	0,5	309
605 (-84)	BPM6A	7021	0,5	304
605AV / 606AV / 616AV / 655AV	BPM6A	7021	0,5	304
606 (-84)	BPM6A	7021	0,5	304
610VA (-84)	BPM6A	7021	0,5	304
611	BPMR7A	4626	0,5	309
615VA (-80)	BPM6A	7021	0,5	304
616 (-80)	BPM6A	7021	0,5	304
620VA (-81)	BPM6A	7021	0,5	304
630	BPMR7A	4626	0,6	309
630 / 632	BM7A	6521	0,5	
633	BPMR7A	4626	0,6	309
634 / 638 / 639	BPMR7A	4626	0,5	309
635	BPMR7A	4626	0,6	309
636	BPMR7A	4626	0,6	309
640	BPMR7A	4626	0,6	309
640 / C	BPM6A	7021	0,5	304
641 / 642	BPMR7A	4626	0,5	309
642 (-78)	BM6A	5921	0,5	303
644 / 644SP / 644 VA	BPMR7A	4626	0,5	309
645 / 647	BPMR7A	4626	0,5	309
650VA (-84)	BPM6A	7021	0,5	304
651 / 651SP / 654	BPMR7A	4626	0,5	309
655AV (-84)	BPM6A	7021	0,5	304
660AV (-83)	BPM6A	7021	0,5	304
662 / 667 / 670 / 673 / 675	BPMR7A	4626	0,5	309
680 / 690	BPMR7A	4626	0,5	309
694	BPMR7A	4626	0,6	309
Twin 100	BM7A	6521	0,5	

STIHL

06 / 07 / 07S / 08	BP6HS	4511	0,5	
08S	B6HS	4510	0,5	
009/AV,010/AV,011/AV,015/AV	BPMR7A	4626	0,5	309
017	BPMR7A	4626	0,5	309
018 C	BPMR7A	4626	0,5	309
019 T	BPMR7A	4626	0,5	309
020 /024/026/028/030/031/032	BPMR7A	4626	0,5	309
020T / 024WB / 026C / 028S	BPMR7A	4626	0,5	309
021/023/C/025/029/039	BPMR7A	4626	0,5	309
023 L	BPMR7A	4626	0,5	309
025 C	BPMR7A	4626	0,5	309
034 /036/038/040/041/042/044	BPMR7A	4626	0,5	309
036 QS	BPMR7A	4626	0,5	309

Order
No.Quick
No.**STIHL**

044 C / 045 / 048 /050/051/056	BPMR7A	4626	0,5	309
046 / C	BPMR7A	4626	0,5	309
046 RHD	BPMR7A	4626	0,5	309
064/066/070/071/075/076/084	BPMR7A	4626	0,5	309
088	BPMR7A	4626	0,5	309
090AV / -N / -S	BPMR7A	4626	0,5	309
1106-CONTRA(G,GS),1601	BPMR6A	6726	0,5	308
BG60E	BMR6A	7421	0,5	307
HS60	BMR6A	7421	0,6	307
HS61	BPMR7A	4626	0,5	309
HS72	BPMR7A	4626	0,5	309
HS74	BPMR7A	4626	0,5	309
HS76	BPMR7A	4626	0,5	309
HS151 / HS202 / HS242	BPMR7A	4626	0,5	309
HS246	BPMR7A	4626	0,5	309
KS43	A6	1010	0,5	
MS 190 T	BPMR7A	4626	0,5	309
MS 210	BPMR7A	4626	0,5	309
MS 210 C	BPMR7A	4626	0,5	309
MS 230 C	BPMR7A	4626	0,5	309
MS 250 C	BPMR7A	4626	0,5	309
MS 270	BPMR7A	4626	0,5	309
MS 270 C	BPMR7A	4626	0,5	309
MS 280	BPMR7A	4626	0,5	309
MS 280 C	BPMR7A	4626	0,5	309
MS 290	BPMR7A	4626	0,5	309
MS 310	BPMR7A	4626	0,5	309
MS 341	BPMR7A	4626	0,5	309
MS 361	BPMR7A	4626	0,5	309
MS 361 C	BPMR7A	4626	0,5	309
MS 361 W	BPMR7A	4626	0,5	309
MS 390	BPMR7A	4626	0,5	309
MS 660	BPMR7A	4626	0,5	309
MS 880	BPMR7A	4626	0,5	309
S10	BPMR6A	6726	0,5	308
TS200 / TS510	BPMR7A	4626	0,5	309
TS350	BPR6HS	7022	0,5	
TS350AVE / TS360AVE	BPMR6A	6726	0,5	308
TS360S / TS760	BPMR6A	6726	0,5	308

TANAKA

ECS 290 / 300 / 307 / 350/ 351	BM6A	5921	0,6	303
ECS 320 / 330 93-	BM6A	5921	0,6	303
ECS 3301	BMR6A	7421	0,7	307
ECS 3351	BMR6A	7421	0,7	307
ECS 35 / 35B	BM6A	5921	0,6	303
ECS 3500 / 4000	BPM6A	7021	0,6	304
ECS 356 / 357	BM6A	5921	0,6	303
ECS 370	BM7A	6521	0,6	
ECS 3801	BPM7A	7321	0,7	305
ECS 405	BM7A	6521	0,6	
ECS 505	BM7A	6521	0,6	



Order No.  Quick No.

TANAKA

ECS 506	BM7A	6521	0,6	
ECS 650	BM7A	6521	0,6	
ECV 3400 / 4501	BPMR7A	4626	0,5	309
EHC 120	BM7A	6521	0,6	
ESC 355	BMR6A	7421	0,5	307
ESC 415	BPMR7A	4626	0,5	309

TONDU

30F	BPM7A	7321	0,6	305
35F	BPM7A	7321	0,6	305
42F	BPM7A	7321	0,6	305

WRIGHT

104 / 104D	BM6A	5921	0,6	303
111 / 121 / 122A / 122CVA	BM6A	5921	0,6	303
136 / 137A / 140 / 141A	BM6A	5921	0,6	303
B316	BP4	2911	0,6	
C40 / C40D	B6S	3510	0,6	302
C50 / C50D / C50SG	B4	3210	0,6	
C70 / C70D / C70G	B6S	3510	0,6	302
GS2016	BP4	2911	0,6	
GS218	B4	3210	0,6	
GS2520	B4	3210	0,6	

Order
No.Quick
No.**AGRIA**

0300 , 1400		B6HS	4510	0,5	
400 Quickly		B4LM	3410	0,6	301
Baby 2100 14mm		B4H	4110	0,5	
Baby 2100 18mm		A6	1010	0,6	
Baby 4000/S		A6	1010	0,5	
Mot. B&S		B4LM	3410	0,5	301
Mot. F&S		B7HS	5110	0,5	
Mot. ILO 14 mm 5.1977 -->		B6HS	4510	0,5	
Mot. ILO 18 mm --> 4.1977		A7	1110	0,5	
Mot. Lombardini		B4H	4110	0,5	
Mot. MAG		B4H	4110	0,5	
Mot. NSU		B4H	4110	0,5	
Mot. Renault		BP6HS	4511	0,7	
Record		A6	1010	0,6	

AL-KO

Aspera		B4LM	3410	0,5	301
B & S 10,5-13,5PS ohne OHV	Aufsitzmäher/Traktor-Motoren	BR2LM	5798	0,5	310
B & S 12,5-17PS OHV	Aufsitzmäher/Traktor-Motoren	BKR5ES	2460	0,7	
B & S 12,5-20PS mit AVS 1&2Zyl	Aufsitzmäher/Traktor-Motoren	BKR5ES	2460	0,7	
B&S 4Takt	Rasenmäher-Motoren	BR4LM	4133	0,5	
Honda 4 Takt	Rasenmäher-Motoren	BPR5ES	7422	0,7	
Tecumseh 4 Takt	Rasenmäher-Motoren	BR6S	3522	0,6	
Tecumseh 11-13PS OHV	Aufsitzmäher/Traktor-Motoren	BR7ES	5122	0,7	

ALLEN

215 , 216 , 218 , 218ILO , 221 , 421		BMR6A	7421	0,7	307
Lawnranger , Parkranger		BMR6A	7421	0,7	307
Merlin , Merlin XL		BMR6A	7421	0,7	307
National 68 (B&S) , Greenfield 12		BMR6A	7421	0,7	307
National 68 (Kawasaki)		BP4HS	3611	0,7	
National 84		B6L	3212	0,7	

ALPINA

Mot. Aspera		B4LM	3410	0,5	301
-------------	--	-------------	-------------	-----	------------

AS MOTOR

21-165/2		B6HS	4510	0,5	
21AH4		B6HS	4510	0,5	
21AH6		B6HS	4510	0,5	
21AH9		B6HS	4510	0,5	
21H3		B6HS	4510	0,5	
21H6		B6HS	4510	0,5	
26AH4		B6HS	4510	0,5	
26AH6		B6HS	4510	0,5	
26AH8		B6HS	4510	0,5	
26AH9		B6HS	4510	0,5	
26H4		B6HS	4510	0,5	
26H6		B6HS	4510	0,5	
26H8		B6HS	4510	0,5	
42B6		B6HS	4510	0,5	
45B2/2		B6HS	4510	0,5	

Order
No.Quick
No.**AS MOTOR**

45B3A	B6HS	4510	0,5	
46B1	B6HS	4510	0,5	
53B1	B6HS	4510	0,5	
53B1R	B6HS	4510	0,5	
53B3	B6HS	4510	0,5	
53B8	B6HS	4510	0,5	
AS 46 B 2	B6HS	4510	0,5	
AS 45 B 4	B6HS	4510	0,5	
AS 53 B 4	B6HS	4510	0,5	
AS 53 B 5	B6HS	4510	0,5	
AS 53 B 5R	B6HS	4510	0,5	
AS 120 A	B6HS	4510	0,6	
AS 120 C, D	B6HS	4510	0,6	
AS 165 A	B6HS	4510	0,6	
AS 165 E	B6HS	4510	0,6	
AS 165 D,F,G	B6HS	4510	0,6	

ASPERA-TECNA

AV 125	BR4LM	4133	0,6	
AV 520	BR4LM	4133	0,6	
AV 600	BR4LM	4133	0,6	
AV 750	BR4LM	4133	0,6	
BV 133	BR4LM	4133	0,6	
BV 150	BR4LM	4133	0,6	
BV 153	BR4LM	4133	0,6	
BV 172	BR4LM	4133	0,6	
BV 173	BR4LM	4133	0,6	
H7HS , HBL	BR4LM	4133	0,6	
H 30 , HB 30	BR4LM	4133	0,6	
H 35 , HB 35	BR4LM	4133	0,6	
HBP 40	BR4LM	4133	0,6	
HS , HLB 30	BR4LM	4133	0,6	
LAV 30	BR4LM	4133	0,6	
LAV 35	BR4LM	4133	0,6	
LAV 40	BR4LM	4133	0,6	
LAV 153	BR4LM	4133	0,6	
LAV 172	BR4LM	4133	0,6	
MV 100	BR4LM	4133	0,6	
MV 100 S	BR4LM	4133	0,6	

ATCO

B&S engine	BR2LM	5798	0,8	310
JAP engine 14mm	B5HS	4210	0,8	
Suffolk engine	B6S	3510	0,8	302
Tecumseh engine	B6S	3510	0,8	302
Villiers engine 18mm	A6	1010	0,8	
Villiers engine 14mm	B5HS	4210	0,8	

B & S MOTOREN

18 mm Heads	A6	1010	0,7	
2.0 HP 69000, 60102	B2LM	1147	0,7	
2.5 HP 80100	B2LM	1147	0,7	

Order
No.Quick
No.**B & S MOTOREN**

3.0 HP 80200, 80202, 80300, 81200	B2LM	1147	0,7	
3.0 HP 81300, 92500,94500,62032,82000	B2LM	1147	0,7	
3.5 HP 93232	BR2LM	5798	0,8	310
3.5 HP 93400	BR2LM	5798	0,8	310
3.5 HP 91200	BR2LM	5798	0,7	310
3.5 HP 92900,93500,94900,95500,90700	B2LM	1147	0,7	
3.5 HP 93900,96500,100708,121700	B2LM	1147	0,7	
4.0 HP 85400 OHV	BCPR5ES	6130	0,7	
4.0 HP 100200,100202,100900,110900	B2LM	1147	0,7	
4.0 HP 110700,112200,95100,96799	B2LM	1147	0,7	
4.0 HP 95700,96700,111700,114700	B2LM	1147	0,7	
4.5 HP 126700	B2LM	1147	0,7	
5.0 HP 133400	BR2LM	5798	0,8	310
5.0 HP 135200	BR2LM	5798	0,8	310
5.0 HP 104700 OHV	BCP5ES	7496	0,7	
5.0 HP 124700,131700	B2LM	1147	0,7	
5.0 HP 130200,130202,130900,131200	B2LM	1147	0,7	
5.0 HP 131400,131900,132200,132900	B2LM	1147	0,7	
5.5 HP 115400 OHV	BCPR5ES	6130	0,7	
6.0 HP 146400,146700	B2LM	1147	0,7	
7.0 HP 170400,170402,170700,171400	B2LM	1147	0,7	
8.0 HP 192400	BR2LM	5798	0,8	310
8.0 HP 196400	BR2LM	5798	0,8	310
8.0 HP 190400,190402,190700,191700	B2LM	1147	0,7	
8.0 HP 195400,200400,192700,193700	B2LM	1147	0,7	
8.5 HP 196707	BR2LM	5798	0,8	310
9.0 HP 185400 OHV	BCPR5ES	6130	0,7	
9.0 HP 19C400	BR2LM	5798	0,8	310
9.0 HP 161400 OHV	BCP5ES	7496	0,7	
9.0 HP 233400	B2LM	1147	0,7	
10.0 HP 19F400	BR2LM	5798	0,8	310
10.0 HP 226400	BR2LM	5798	0,8	310
10.0 HP 243430,251400,251700,222400	B2LM	1147	0,7	
10.0 HP 253700	B2LM	1147	0,7	
10.5 HP 28B707	BR2LM	5798	0,8	310
10.0 HP 220400,220700,221430,243400	B2LM	1147	0,7	
11.0 HP 235400 OHV	BCPR5ES	6130	0,7	
11.0 HP 250400	BR2LM	5798	0,8	310
11.0 HP 256400	BR2LM	5798	0,8	310
11.0 HP 252400,252410,252412,252700	B2LM	1147	0,7	
11.0 HP 253400,253410,253700	B2LM	1147	0,7	
11.5 HP 28D707	BR2LM	5798	0,8	310
12.0 HP 281700	B2LM	1147	0,7	
12.5 HP 286707	BR2LM	5798	0,8	310
12.5 HP 260700,290400	BCP5ES	7496	0,7	
13.0 HP 245400 OHV	BCPR5ES	6130	0,7	
13.0 HP 28M707	BR2LM	5798	0,8	310
13.0 HP 302430	B2LM	1147	0,7	
14.0 HP 28P777 OHV	BCPR5ES	6130	0,7	
14.0 HP 294777 OHV	BCPR5ES	6130	0,7	
14.0 HP 292700,294400 OHV	BCP5ES	7496	0,7	
14.0 HP 294400 OHV	BCPR5ES	6130	0,8	

Order
No.Quick
No.**B & S MOTOREN**

14.0 HP 400437,400707	BR6S	3522	0,7	
15.5 HP 28N707 OHV	BCPR5ES	6130	0,7	
16.0 HP 28Q777 OHV	BCPR5ES	6130	0,7	
16.0 HP 303777 OHV	BCPR5ES	6130	0,7	
16.0 HP 326400	BR2LM	5798	0,8	310
16.0 HP 422437	BR2LM	5798	0,8	310
16.0 HP 422447	BR2LM	5798	0,8	310
16.0 HP 422707	BR2LM	5798	0,8	310
16.0 HP 42B707	BR2LM	5798	0,8	310
16.0 HP 303400 OHV	BCPR5ES	6130	0,8	
16.0 HP 303400,303700 OHV	BCP5ES	7496	0,7	
16.0 HP 326430	B6S	3510	0,7	302
16.0 HP 401400,401417,401700,401707	BR6S	3522	0,7	
16.0 HP 402400,402417,402431,402437	BR6S	3522	0,7	
16.0 HP 402707	BR6S	3522	0,7	
18.0 HP 350400 OHV	BCPR5ES	6130	0,7	
18.0 HP 350777 OHV	BCPR5ES	6130	0,7	
18.0 HP 422437	BR2LM	5798	0,8	310
18.0 HP 422447	BR2LM	5798	0,8	310
18.0 HP 422707	BR2LM	5798	0,8	310
18.0 HP 42B707	BR2LM	5798	0,8	310
18.0 HP 350000 OHV	BCP5ES	7496	0,7	
18.0 HP 421400,421700,422400,422437	BR6S	3522	0,7	
18.0 HP 422431,422700,422707	BR6S	3522	0,7	
20.0 HP 351400 OHV	BCPR5ES	6130	0,7	
20.0 HP 351777 OHV	BCPR5ES	6130	0,7	
20.0 HP 422707	BR2LM	5798	0,8	310
20.0 HP 42B707	BR2LM	5798	0,8	310
Classic 95902	BR2LM	5798	0,8	310
Diamond XTL 60 12J802	BR2LM	5798	0,7	310
Diamond XTS 60 12J802	BR2LM	5798	0,7	310
ES 375 12S707	BR2LM	5798	0,7	310
Europa 99772 OHV	BCPR5ES	6130	0,7	
Intek OHV 121602	BCPR5ES	6130	0,8	
Quantum 128812	BR2LM	5798	0,8	310
Quantum 60XRS 12V802	BR2LM	5798	0,8	310
Quantum XE45 127702	BR2LM	5798	0,8	310
Quantum XM45 12F802	BR2LM	5798	0,8	310
Quantum XM55 129800	BR2LM	5798	0,8	310
Quantum XRS 60 12V802	BR2LM	5798	0,7	310
Quantum XTE50 12F802	BR2LM	5798	0,8	310
Quantum XTL55 128802	BR2LM	5798	0,8	310
Quantum XTS 55 128800	BR2LM	5798	0,7	310
Quattro 38 9C902	BR2LM	5798	0,8	310
Quattro 40 10A902	BR2LM	5798	0,8	310
Quattro 40 10A902	BR2LM	5798	0,7	310
Sprint 375 98902	BR2LM	5798	0,8	310
Sprint LX 40 10C902	BR2LM	5798	0,7	310

BARRUS

Mot. B&S	B4LM	3410	0,5	301
----------	------	------	-----	-----

Order
No.Quick
No.**BOLENS**

Mot. B&S		B4LM	3410	0,5	301
Mot. Products		B6S	3510	0,5	302
Mot. Tecumseh		B4	3210	0,6	

BRILL

102/16	B&S OHV	Aufsitzmäher	BCPR5ES	6130	0,7	
122/20	B&S OHV	Aufsitzmäher	BCPR5ES	6130	0,7	
Mot. Aspera			B4LM	3410	0,5	301
Mot. B&S		Rasenmäher	B4LM	3410	0,5	301
Mot. Honda			BPR5ES	7422	0,7	
Mot. ILO			B5HS	4210	0,5	
Mot. Tecumseh			B4LM	3410	0,5	301

CONCORD

Mot. B&S			B4LM	3410	0,5	301
----------	--	--	-------------	-------------	-----	------------

CRAMER

Cara 38		Vertikutierer	BR4HS	3322	0,6	
Cara 47		Vertikutierer	BR4HS	3322	0,6	
Cara 60		Vertikutierer	BR4HS	3322	0,6	

CRESCENT

Mot. Aspera			B4LM	3410	0,5	301
Mot. B&S			B4LM	3410	0,5	301
Mot. Suffolk			B6S	3510	0,5	302

CROWN

All			B4LM	3410	0,5	301
-----	--	--	-------------	-------------	-----	------------

DOLMAR

LT-30			BPMR7A	4626	0,5	309
MS-220			BMR7A	4226	0,6	
MS-30 C			BPMR7A	4626	0,5	309
PM-4035			B2LM	1147	0,6	
PM-4040			BR2LM	5798	0,6	310
PM-4045 SE			BR2LM	5798	0,6	310
PM-43			BR2LM	5798	0,6	310
PM-4640 HSM			BR2LM	5798	0,6	310
PM-4645			BR2LM	5798	0,6	310
PM-4645 S			BR2LM	5798	0,6	310
PM-4645 S2			BR2LM	5798	0,6	310
PM-4645 S2E			BR2LM	5798	0,6	310
PM-4645 SE			B2LM	1147	0,6	
PM-4650HS	Honda GXV 140		BPR6ES	7822	0,6	
PM-48			BR2LM	5798	0,6	310
PM-48 S			BR2LM	5798	0,6	310
PM-5355 S			B2LM	1147	0,6	
PM-5355 SE			B2LM	1147	0,6	
PM-5360 S3CP			BR2LM	5798	0,6	310
PV-4034		Vertikutierer	BR2LM	5798	0,6	310
TM-102.13		Aufsitzmäher	BKR5ES	2460	0,6	
TM-102.17 H		Aufsitzmäher	BKR5ES	2460	0,6	



Order No.  Quick No.

DOLMAR					
TM-85.13		Aufsitzmäher	BKR5ES	2460	0,6
TM-85.13 H		Aufsitzmäher	BKR5ES	2460	0,6
ECHO					
A-14	B&S 10,6kW	Aufsitzmäher	BCPR5ES	6130	0,7
A-16	B&S 12,1kW	Aufsitzmäher	BCPR5ES	6130	0,7
A-18	B&S 13,2kW	Aufsitzmäher	BCPR5ES	6130	0,7
E-130G		Aufsitzmäher	BR2LM	5798	0,6 310
E-130HY		Aufsitzmäher	BR2LM	5798	0,6 310
E-150HY	B&S 11,1kW	Aufsitzmäher	BCPR5ES	6130	0,7
E-2000HY	B&S 8,5kW	Aufsitzmäher	BR2LM	5798	0,6 310
HO-13-93C	Honda 9,6kW	Aufsitzmäher	BPR5ES	7422	0,6
EFCO					
AR 53 PAL	Tecumseh		BR2LM	5798	0,5 310
AR 53 PB	B&S		BR2LM	5798	0,5 310
AR 53 PBV	B&S		BR2LM	5798	0,5 310
AR 53 TAL	Tecumseh		BR2LM	5798	0,5 310
AR 53 TALV	Tecumseh		BR2LM	5798	0,5 310
AR 53 TB	B&S		BR2LM	5798	0,5 310
AR 53 THX	Honda		BPR6ES	7822	0,6
LR 43 PA	Tecumseh		BR2LM	5798	0,5 310
LR 43 PB	B&S		BR2LM	5798	0,5 310
LR 47 PA	Tecumseh		BR2LM	5798	0,5 310
LR 47 PAL	Tecumseh		BR2LM	5798	0,5 310
LR 47 PAX	Tecumseh		BR2LM	5798	0,5 310
LR 47 PB	B&S		BR2LM	5798	0,5 310
LR 47 PBQ	B&S		BR2LM	5798	0,5 310
LR 47 PBX	B&S		BR2LM	5798	0,5 310
LR 47 PHQ	Honda		BPR6ES	7822	0,6
LR 47 TA	Tecumseh		BR2LM	5798	0,5 310
LR 47 TAL	Tecumseh		BR2LM	5798	0,5 310
LR 47 TAX	Tecumseh		BR2LM	5798	0,5 310
LR 47 TB	B&S		BR2LM	5798	0,5 310
LR 47 TBQ	B&S		BR2LM	5798	0,5 310
LR 47 TBX	B&S		BR2LM	5798	0,5 310
LR 47 THQ	Honda		BPR6ES	7822	0,6
LR 53 PBX	B&S		BR2LM	5798	0,5 310
LR 53 TBX	B&S		BR2LM	5798	0,5 310
LR 53 THX	Honda		BPR6ES	7822	0,6
MR 474 PB	B & S		BR2LM	5798	0,5 310
MR 474 TB , TP	B & S		BR2LM	5798	0,5 310
MR 474 TBV	B & S		BR2LM	5798	0,5 310
MR 474 TBV	B&S		BR2LM	5798	0,5 310
MR 474 TK , 534 TK	Kawasaki		BPR6ES	7822	0,6
MR 534 TB , TBE	B & S		BR2LM	5798	0,5 310
MR 534 TB / TBV	B&S		BR2LM	5798	0,5 310
MR 534 TBVE	B&S		BR2LM	5798	0,5 310
MR 534 TBVI	B&S		BR2LM	5798	0,5 310
MR 534 THV	Honda		BPR6ES	7822	0,6
MR 534 THVX	Honda		BPR6ES	7822	0,6
MR 534 TKV / TKF/ TKVF	Kawasaki		BPR5ES	7422	0,6

Order
No.Quick
No.**ERING**

5,4PS Basisgerät	Balkenmäher	B5HS	4210	0,5	
A 440 H / HV		B4LM	3410	0,7	301
A 443 H		B4LM	3410	0,7	301
A 448 H		B4LM	3410	0,7	301
A 448 H / HV		B4LM	3410	0,7	301
A 448 H-ZH		B4LM	3410	0,7	301
A 448 S		B4LM	3410	0,7	301
ABA 448 H		BR2LM	5798	0,5	310
AH 453 H Alu		B4LM	3410	0,7	301
B 448 H / HV		B4LM	3410	0,7	301
B 448 H Alu		B4LM	3410	0,7	301
BH 448 H Alu		B4LM	3410	0,7	301
CO A 448 S HV		B4LM	3410	0,7	301
G4-87	Balkenmäher	BR2LM	5798	0,5	310
GAN 3748 H ZH		B4LM	3410	0,7	301
GAN 4045 HI ZH		BR2LM	5798	0,5	310
GAN 4048 H ZH / Cat.		B4LM	3410	0,7	301
GT B 4840 P		BR2LM	5798	0,5	310
GT B 4850 T		BR2LM	5798	0,5	310
GT B 5350 ES		BR2LM	5798	0,5	310
GT B 5350 T		BR2LM	5798	0,5	310
H 3581	Balkenmäher	BR2LM	5798	0,5	310
H 448 H HV		BR2LM	5798	0,5	310
Mot. Aspera		B4LM	3410	0,5	301
Mot. B&S		B4LM	3410	0,5	301
Muko A 448 H-ZH		B4LM	3410	0,7	301
R 7608 S	Aufsitzmäher	B4LM	3410	0,7	301
R 7612 S	Aufsitzmäher	B4LM	3410	0,7	301
T 4	Balkenmäher	B4LM	3410	0,7	301
T 1012 S	Aufsitzmäher	B4LM	3410	0,7	301
T 3581	Balkenmäher	BR2LM	5798	0,5	310
Traktor 14PS		B4LM	3410	0,7	301
VBT-40	Vertikutierer	B4LM	3410	0,7	301
VBT-40 H		BR2LM	5798	0,5	310

FICHTEL& SACHS

SB 93		B4H	4110	0,6	
SB 102		B5HS	4210	0,6	
SB 126		B5HS	4210	0,6	
SB 151		B5HS	4210	0,6	
SB 151 A		B5HS	4210	0,6	
ST 76		B5HS	4210	0,6	
ST 96		B5HS	4210	0,6	
ST 102		B7HS	5110	0,6	
ST 126		B7HS	5110	0,6	
ST 151		B7HS	5110	0,6	
ST 203		A7	1110	0,6	
ST 204 mit 14mm		B7HS	5110	0,6	
ST 204 mit 18mm		A7	1110	0,6	
ST 251 mit 14mm		B7HS	5110	0,6	
ST 251 mit 18mm		A7	1110	0,6	
ST 282		A7	1110	0,6	



Order No.  Quick No.

			FLANDRIA			
Mot. B&S			B4LM	3410	0,7	301
			FLYMO			
508 Chief			B2LM	1147	0,7	
Chevron 420GL			BMR6A	7421	0,7	307
Chevron 420GL Autodrive			BM6A	5921	0,6	303
Contractor GCL75			BMR6A	7421	0,7	307
F 20			B2LM	1147	0,7	
GT 2			B7HS	5110	0,5	
GT 2-6 Contractor			B6HS	4510	0,5	
GT 4S			B4LM	3410	0,6	301
L 38 Pilot			B4LM	3410	0,5	301
L 47 Pilot			B4LM	3410	0,5	301
L 50 Contractor			B4LM	3410	0,5	301
L 300			BPMR7A	4626	0,5	309
L 400			BPMR6A	6726	0,5	308
LT 10/36		Traktor	BMR6A	7421	0,7	307
LT 12/36		Traktor	BMR6A	7421	0,7	307
LT 12/38		Traktor	BMR6A	7421	0,7	307
RL 400			B2LM	1147	0,5	
RL 420			BMR6A	7421	0,7	307
RL 420PD			BMR6A	7421	0,7	307
RL 420PDE			BMR6A	7421	0,7	307
RL 500			B2LM	1147	0,7	
RL 550			B2LM	1147	0,7	
RRL 420			B2LM	1147	0,7	
RRL 420PD			B2LM	1147	0,7	
RRL 420PDE			B2LM	1147	0,7	
			GARDEN			
Contractor 760	B&S engine 12,5HP		BR2LM	5798	0,8	310
Contractor 760	Honda GVX 390 engine		BPR5ES	7422	0,8	
Sprint 950	Honda GVX 610 + GVX 620		BPR5ES	7422	0,8	
Sprint 950	Kohler Command 18 OHV		BPR5ES	7422	0,8	
Stingray	Kohler Command 22OHV		BPR5ES	7422	0,8	
Stingray	Honda GVX 620		BPR5ES	7422	0,8	
			GOLF			
Mot. Aspera			B4LM	3410	0,6	301
Mot. B&S			BR4LM	4133	0,5	
Mot. Techna			B4LM	3410	0,5	301
			GUTBROD			
MH 464 RVE 6			B2LM	1147	0,7	
Sprint 1012 S	B&S	Traktor	BR2LM	5798	0,6	310
Sprint 3000		Aufsitzmäher	B2LM	1147	0,7	
1000 E	B&S	Traktor	BR2LM	5798	0,5	310
1002 E	B&S	Traktor	BR2LM	5798	0,5	310
1012 S	B&S	Traktor	BR2LM	5798	0,6	310
1114 AWS	B&S	Traktor	BCPR5ES	6130	0,6	
1400		Aufsitzmäher	BR2LM	5798	0,6	310
170 SD 4	Tecumseh	Traktor	BR4LM	4133	0,5	

Order
No.Quick
No.**GUTBROD**

370 BMR 4 Vantage 35T		Balkenmäher	BR2LM	5798	0,5	310
800		Aufsitzmäher	BR2LM	5798	0,6	310
850		Aufsitzmäher	BR2LM	5798	0,6	310
BM 91 FA130	Kawasaki	Balkenmäher	BM6A	5921	0,6	303
BM 100 2G 1431	Gutbrod	Balkenmäher	B6HS	4510	0,6	
BM 100 2G 1433	Gutbrod	Balkenmäher	B6HS	4510	0,6	
BM 107	Kawasaki	Balkenmäher	BM6A	5921	0,6	303
BM 700 92982	B&S	Balkenmäher	BR4LM	4133	0,5	
BM 700 Vantage B&S		Balkenmäher	BR4LM	4133	0,5	
BM 710	B&S	Balkenmäher	BR4LM	4133	0,5	
ECO B	B&S		BR4LM	4133	0,5	
ECO BR	B&S		BR4LM	4133	0,5	
Euro Class XM35	B&S Quant.		BR2LM	5798	0,5	310
Euro Class XM50	B&S Quant.		BR2LM	5798	0,5	310
Golf BSV 143	Tecna		BR2LM	5798	0,5	310
Golf Prisma 37	Tecna		BR2LM	5798	0,5	310
Golf Prisma 40	Tecna		BR2LM	5798	0,5	310
Golf Vantage	Tecna		BR2LM	5798	0,5	310
HB 42 L	B&S		BR4LM	4133	0,5	
HB 42 LE	B&S		BR4LM	4133	0,5	
HB 42 RL	B&S		BR4LM	4133	0,5	
HB 48	B&S		BR4LM	4133	0,5	
HB 48 L	B&S		BR4LM	4133	0,5	
HB 48 REL	B&S		BR4LM	4133	0,5	
HB 48 RL	B&S		BR4LM	4133	0,5	
HB 53 RL			B2LM	1147	0,7	
HBM 50			B2LM	1147	0,7	
MH 544 R3 / RE	B&S		BR2LM	5798	0,6	310
MH 404	B&S		BR4LM	4133	0,5	
MH 454 B	B&S		BR4LM	4133	0,5	
MH 454 BE	B&S		BR4LM	4133	0,5	
MH 454 RB	B&S		BR4LM	4133	0,5	
MH 454 RBE	B&S		BR4LM	4133	0,5	
MH 454 RSB	B&S		BR4LM	4133	0,5	
MH 454 RSEB	B&S		BR4LM	4133	0,5	
MH 454 RV	Kawasaki		BPR6ES	7822	0,6	
MH 454 SEB	B&S		BR4LM	4133	0,5	
MH 464 B			B2LM	1147	0,7	
MH 464 RV6			B2LM	1147	0,7	
MH 534 PR	Kawasaki		BPR6ES	7822	0,6	
MH 534 RV	Kawasaki		BPR6ES	7822	0,6	
MH 534 RVE	Kawasaki		BPR6ES	7822	0,6	
Mot. MAG			B5HS	4210	0,5	
MV 400	Tecna	Vertikutierer	B4LM	3410	0,5	301
MV 404	Tecna	Vertikutierer	B4LM	3410	0,5	301
MV 504	B&S	Vertikutierer	B4LM	3410	0,5	301
RSB 100-12	B&S	Traktor	BR2LM	5798	0,6	310
RSB 110-16H	B&S	Traktor	BCPR5ES	6130	0,6	
RSB 80-12	B&S	Traktor	BR2LM	5798	0,5	310
SB 46			B2LM	1147	0,7	
SB 48	B&S		BR4LM	4133	0,5	
Sprint 900		Aufsitzmäher	B2LM	1147	0,7	



Order No.  Quick No.

GUTBROD						
Sprint 1002 E	B&S	Traktor	BR2LM	5798	0,6	310
Sprint 2000		Aufsitzmäher	B2LM	1147	0,7	
Sprint 3000	B&S	Aufsitzmäher	BCPR5ES	6130	0,6	
Super Class FC150V	Kawasaki		BPR6ES	7822	0,6	
Super Class XM35	B&S Quant.		BR2LM	5798	0,5	310
Super Class XM50	B&S Quant.		BR2LM	5798	0,5	310
VB 38		Vertikutierer	B2LM	1147	0,7	
HAKO						
120			B4LM	3410	0,6	301
Boy 8610			A6	1010	0,5	
Boy J10 engine			B5HS	4210	0,5	
Combinette 100			B4LM	3410	0,6	301
Combinette 3604			B5HS	4210	0,5	
Gartentrac 1100E			B4LM	3410	0,6	301
Gartentrac 1600E			B4LM	3410	0,6	301
Hakomobil 4000			BP6HS	4511	0,6	
Hakorette 150			B5HS	4210	0,5	
Hakorette 200			BM6A	5921	0,5	303
Hakorette 5003 , 5004 , 5007			A6	1010	0,5	
Hakorette 5008 , 5035			A6	1010	0,5	
Hamster 6206			B6S	3510	0,7	302
Hamster S			B4H	4110	0,7	
Jardinette 3605			B6S	3510	0,7	302
Jonas 1600			B5HS	4210	0,6	
Minette			B4LM	3410	0,6	301
Mot. B&S			B4LM	3410	0,6	301
Mot. ILO 14 mm			B5HS	4210	0,5	
Mot. ILO 18 mm			A6	1010	0,5	
Profi 92 Jlo Engine			B5HS	4210	0,6	
Rasentrac 600			B6S	3510	0,7	302
Rasentrac 708 , 708E , 800, 1000E			B4LM	3410	0,6	301
Rasetta 18L , 20H , 20L , 20N			B4LM	3410	0,6	301
Rasetta 20S , 22R , 22S			B4LM	3410	0,6	301
Trac 1200, 1400			B4H	4110	0,7	
Trac 8014			B6HS	4510	0,6	
Variette			B5HS	4210	0,5	
Variette 3611			B6S	3510	0,7	302
Variette 3615			B6HS	4510	0,5	
HARRY						
302 QZA	Tecna		BR2LM	5798	0,7	310
302 QZB	B&S		BR2LM	5798	0,7	310
302 DFB			B6HS	4510	0,6	
302 EFA			B4LM	3410	0,6	301
302 QFA			B4LM	3410	0,6	301
302 QFB	B&S Quantum		BM6A	5921	0,6	303
313 MZB	B&S		BR2LM	5798	0,7	310
313 QZA	Tecna		BR2LM	5798	0,7	310
313 QFA			B4LM	3410	0,6	301
313 QFB , 314 QFB	B&S Quantum		BM6A	5921	0,6	303
314 EFA			B4LM	3410	0,6	301

Order
No.Quick
No.**HARRY**

322 LFB	B&S Quantum	BM6A	5921	0,6	303
401 LZB	B&S	BR2LM	5798	0,7	310
401 MZB	B&S	BR2LM	5798	0,7	310
401 LFB	B&S Quantum	BM6A	5921	0,6	303
401 QFA		B4LM	3410	0,6	301
411 QZA	Tecna	BR2LM	5798	0,7	310
411 QFA , 411 EFA		B4LM	3410	0,6	301
411 QFB	B&S Quantum	BM6A	5921	0,6	303
424 LFB	B&S Quantum	BM6A	5921	0,6	303
451 LZB , AZB	B&S	BR2LM	5798	0,7	310
451 AFB	B&S Quantum	BM6A	5921	0,6	303
451 DFB		B6HS	4510	0,6	
451 QFA		B4LM	3410	0,6	301
451 QFB , 451 LFB	B&S Quantum	BM6A	5921	0,6	303
471 AZB	B&S	BR2LM	5798	0,7	310
471 PZB	B&S	BR2LM	5798	0,7	310
471 AFB	B&S Quantum	BM6A	5921	0,6	303
471 DFB		B6HS	4510	0,6	
471 DFF		B5HS	4210	0,6	
471 LFB	B&S Quantum	BM6A	5921	0,6	303
471 VFB	B&S OHV	BCPR5ES	6130	0,8	
772 VZB	B&S	BR2LM	5798	0,7	310

HERKULES

11/30		Aufsitzmäher	BR2LM	5798	0,5	310
12/40		Aufsitzmäher	BR2LM	5798	0,5	310
14/40		Aufsitzmäher	BR6S	3522	0,7	
155 6-Speed		Aufsitzmäher	BKR5ES	2460	0,7	
16/43-4WS		Aufsitzmäher	BR2LM	5798	0,5	310
180 Automatic		Aufsitzmäher	BKR5ES	2460	0,7	
200 HXL Automatic		Aufsitzmäher	BKR5ES	2460	0,7	
400B	B&S	Vertikutierer	BR2LM	5798	0,7	310
AR 38	Tecna	Vertikutierer	B4LM	3410	0,6	301
AR 45	B&S	Vertikutierer	BM6A	5921	0,6	303
B400		Vertikutierer	BR2LM	5798	0,7	310
BM 200		Balkenmäher	BR4LM	4133	0,5	
BM200T		Balkenmäher	BR4LM	4133	0,5	
D 3 , D 6	B&S	Balkenmäher	BM6A	5921	0,6	303
E51B	B&S		BR2LM	5798	0,7	310
E51H	Honda		BPR6ES	7822	0,7	
FM 300 H		Balkenmäher	BPR6ES	7822	0,6	
FM 300 T		Balkenmäher	BR4LM	4133	0,5	
GT40T , GT42T	Tecna		BR2LM	5798	0,7	310
GT47SB	B&S		BR2LM	5798	0,7	310
GT47SBM , GT47BM	B&S		BR2LM	5798	0,7	310
GT47T	Tecna		BR2LM	5798	0,7	310
GT48B	B&S		BR2LM	5798	0,7	310
GT53SB	B&S		BR2LM	5798	0,7	310
GT56SBV , GT48SB	B&S		BR2LM	5798	0,7	310
Harry 302 MZB			BR4LM	4133	0,5	
Harry 302 QZA			BR2LM	5798	0,5	310
Harry 302 QZB			BR2LM	5798	0,5	310



Order No.  Quick No.

HERKULES

Harry 313 MZB		BR2LM	5798	0,5	310
Harry 313 QZA		BR4LM	4133	0,5	
Harry 401 LZA		BR4LM	4133	0,5	
Harry 401 LZB		BR4LM	4133	0,5	
Harry 401 MZB		BR4LM	4133	0,5	
Harry 411 QZA		BR2LM	5798	0,5	310
Harry 451 AZB		BR4LM	4133	0,5	
Harry 451 LZB		BR2LM	5798	0,5	310
Harry 471 AZB		BR2LM	5798	0,5	310
Harry 471 PZB		BR2LM	5798	0,5	310
Harry 471 VZA		BR2LM	5798	0,5	310
Harry 772 VZB		BR2LM	5798	0,5	310
HTC 13 Plus	Aufsitzmäher	BR2LM	5798	0,7	310
HTC 13,5 Plus	Aufsitzmäher	BR2LM	5798	0,7	310
HTC 15,5 Plus	Aufsitzmäher	BKR5ES	2460	0,7	
HTC 16 H Plus	Aufsitzmäher	BKR5ES	2460	0,7	
HTC 16 Plus	Aufsitzmäher	BKR5ES	2460	0,7	
HTC 18 H Plus	Aufsitzmäher	BKR5ES	2460	0,7	
HTC 20 H Plus	Aufsitzmäher	BKR5ES	2460	0,7	
HTC Junior 13,00	Aufsitzmäher	BR2LM	5798	0,7	310
MB 410	B&S	BM6A	5921	0,6	303
MB 460 , MB 460S , MB 460ES	B&S	BM6A	5921	0,6	303
MB 462	B&S 2,9kW	B4LM	3410	0,5	301
MB 462 S	B&S 3,3kW	B4LM	3410	0,5	301
MB40ST		BR4LM	4133	0,5	
MB40T		BR4LM	4133	0,5	
MB482SH		BPR6ES	7822	0,7	
MB48SB		BR2LM	5798	0,5	310
MB48SBV		BR2LM	5798	0,5	310
MB48ST		BR4LM	4133	0,5	
MB48T		BR4LM	4133	0,5	
MB532SH		BPR6ES	7822	0,7	
MB53SHV		BPR5ES	7422	0,7	
MB55SBV		BR2LM	5798	0,5	310
MB55SHV		BPR5ES	7422	0,7	
MCB46		BR2LM	5798	0,7	310
MCB46S		BR2LM	5798	0,7	310
MR432		BR2LM	5798	0,7	310
Orec FL 500	Honda GXV160	BPR5ES	7422	0,6	
Orec HR 660 B	Robin 5,5kW	BP6HS	4511	0,6	
Orec SH 60	Kawasaki 4,5kW	BPR5ES	7422	0,6	
Orec SH 70	Honda GXV270	BPR5ES	7422	0,6	
R 434 , R 484TR	B&S	BM6A	5921	0,6	303
TN 195SEK , TN 195SXK		BP6ES	7811	0,8	
TN 215SEK , TN 215SXKE		BP6ES	7811	0,8	
Turbo Cut HTC 120	Aufsitzmäher	BR2LM	5798	0,5	310
Turbo Cut HTC 150	Aufsitzmäher	BCPR5ES	6130	0,7	
Turbo Cut HTC 180 H	Aufsitzmäher	BCPR5ES	6130	0,7	
Twin-Cut 12,5 Plus	Aufsitzmäher	BR2LM	5798	0,5	310
Twin-Cut 15 Plus	Aufsitzmäher	BCPR5ES	6130	0,7	
Twin-Cut 15,5 H Plus	Aufsitzmäher	BCPR5ES	6130	0,7	
Twin-Cut 16 H Plus	Aufsitzmäher	BCPR5ES	6130	0,7	

Order
No.Quick
No.**HERKULES**

Twin-Cut 16Plus	Aufsitzmäher	BCPR5ES	6130	0,7	
Twin-Cut 18 Plus	Aufsitzmäher	BCPR5ES	6130	0,7	
WM60BR	Gestrüppschneider	BR2LM	5798	0,7	310
WM60B	Gestrüppschneider	BKR5ES	2460	0,7	

HOLDER

Mot. B&S		B4LM	3410	0,5	301
Mot. F&S 14 mm		B5HS	4210	0,5	
Mot. F&S 18 mm		A6	1010	0,5	
Mot. ILO 14 mm		B5HS	4210	0,5	
Mot. ILO 18 mm		A7	1110	0,5	
Mot. Intermotor		B4H	4110	0,5	
Mot. Lombardini		B4H	4110	0,7	

HOMELITE

45STD , 45DLX		B2LM	1147	0,6	
HBM21P5-2I		B2LM	1147	0,6	
HCM20 , HCM20P5	Vertikutierer	B2LM	1147	0,6	
HCM20P5G	Vertikutierer	B2LM	1147	0,6	
HMB21P4I		B2LM	1147	0,6	
HMB21P5I		B2LM	1147	0,6	
HSB21		B2LM	1147	0,6	
HSB21P5		B2LM	1147	0,6	
HSB21P5EG		B2LM	1147	0,6	
HSD20P , HSD20V , HSD20K		B2LM	1147	0,6	

HONDA

GXV 120		BPR5ES	7422	0,7	
H 1011H	Aufsitzmäher	BPR5ES	7422	0,7	
H 1011S	Aufsitzmäher	BPR5ES	7422	0,7	
H 2013S	Aufsitzmäher	BPR5ES	7422	0,7	
H 3001/H		BPR5ES	7422	0,7	
H 3009		BPR5ES	7422	0,6	
H 3011		BPR5ES	7422	0,6	
H 3013H		BPR5ES	7422	0,6	
H 4013		BPR5ES	7422	0,7	
H 4013		BPR5ES	7422	0,6	
H 4514	Aufsitzmäher	BPR4ES	7222	0,7	
H 4518	Aufsitzmäher	BPR5ES-11	4424	1,1	
HC 16		BMR4A	5728	0,6	306
HC 20 , HC 26		BPR6ES	7822	0,8	
HF 1211	Aufsitzmäher	BPR5ES	7422	0,7	
HF 1211 H	Aufsitzmäher	BPR5ES	7422	0,7	
HF 1211 S	Aufsitzmäher	BPR5ES	7422	0,7	
HF 2113 H	Aufsitzmäher	BPR6ES	7822	0,7	
HF 2113 S	Aufsitzmäher	BPR6ES	7822	0,7	
HF 2114 S/H	Aufsitzmäher	BPR5ES	7422	0,8	
HF 2200 S/H	Aufsitzmäher	ZGR5A	5839	0,8	
HF 2213	Aufsitzmäher	BPR5ES	7422	0,6	
HF 2213 H	Aufsitzmäher	BPR5ES	7422	0,6	
HF 2213S	Aufsitzmäher	BPR5ES	7422	0,7	
HF 2216 S/H	Aufsitzmäher	BPR5ES	7422	0,8	



Order No.  Quick No.

HONDA

HF 2218 HL	Aufsitzmäher	BPR5ES	7422	0,6	
HF 2218 SL	Aufsitzmäher	BPR5ES	7422	0,6	
HF 2220 HL	Aufsitzmäher	ZGR5A	5839	0,8	
HP 400		BPR4ES	7222	0,7	
HR 17 (GV110)(G100)		BMR4A	5728	0,6	306
HR 17.3 (GV100K1)		BMR4A	5728	0,7	306
HR 19.4 (GXV120)		BPR5ES	7422	0,6	
HR 21 (CDI)		BPMR6A-10	1029	1,0	
HR 21 (MAG.IGN.)		BMR6A	7421	0,6	307
HR 21 K2		BPMR6A-10	1029	1,0	
HR 21.5 (GV200)		BPMR6A	6726	0,6	308
HR 194		BP5ES	6511	0,7	
HR 214 (GXV120)		BPR5ES	7422	0,7	
HR 216 (GXV160)		BPR5ES	7422	0,6	
HR 521		BR4HS	3322	0,7	
HR 1950S		BPR5ES	7422	0,7	
HR 1950SM		BPR5ES	7422	0,7	
HR 1950SX		BPR5ES	7422	0,7	
HR 2150		BPR5ES	7422	0,7	
HR 2160 (GXV160)		BPR5ES	7422	0,7	
HRA 21		BMR6A	7421	0,6	307
HRA 173		BMR4A	5728	0,6	306
HRA 214		BPR5ES	7422	0,6	
HRA 216 (GXV160)		BPR5ES	7422	0,6	
HRA 219		BPR5ES	7422	0,7	
HRA 2150		BPR6ES	7822	0,7	
HRA 2160 (GXV160)		BPR5ES	7422	0,7	
HRA 536 HX		BPR5ES	7422	0,6	
HRB 423SX		BMR4A	5728	0,6	306
HRB 423P / PD		BMR4A	5728	0,6	306
HRB 423S / SD		BMR4A	5728	0,6	306
HRB 425C		BPR6ES	7822	0,7	
HRB 425C PD/SD		BPR6ES	7822	0,7	
HRB 425C PX/SX/QX		BPR6ES	7822	0,7	
HRB 475 HM		BPR5ES	7422	0,7	
HRB 475 SM		BPR5ES	7422	0,6	
HRB 475C PD		BPR6ES	7822	0,7	
HRB 475C SD		BPR6ES	7822	0,7	
HRB 475HX		BPR5ES	7422	0,7	
HRB 475P		BPR5ES	7422	0,7	
HRB 475PD		BPR5ES	7422	0,7	
HRB 475S		BPR5ES	7422	0,7	
HRB 475SD		BPR5ES	7422	0,7	
HRB 475SX		BPR5ES	7422	0,7	
HRB 476 C HX		BPR6ES	7822	0,6	
HRB 476 C TX		BPR6ES	7822	0,6	
HRB 476C PD/SD		BPR6ES	7822	0,7	
HRB 476C PX/SX/HX/QX		BPR6ES	7822	0,7	
HRB 476C HX		BPR6ES	7822	0,7	
HRB 476C SX		BPR6ES	7822	0,7	
HRB 535SX		BPR5ES	7422	0,7	
HRB 536 C TX		BPR6ES	7822	0,6	

Order
No.Quick
No.**HONDA**

HRB 536C HX	BPR6ES	7822	0,7	
HRB 536C SX	BPR6ES	7822	0,7	
HRB 536C TX	BPR6ES	7822	0,7	
HRD 535 TM	BPR4ES	7222	0,6	
HRD 535 HX	BPR5ES	7422	0,7	
HRD 535 SM	BPR5ES	7422	0,7	
HRD 535 SX	BPR5ES	7422	0,7	
HRD 536 HXE	BPR5ES	7422	0,7	
HRD 536 QX	BPR5ES	7422	0,8	
HRD 536C HX	BPR6ES	7822	0,7	
HRD 536C SX	BPR6ES	7822	0,7	
HRD 536C TX	BPR6ES	7822	0,7	
HRD 536 HM	BPR5ES	7422	0,7	
HRD 536 HX	BPR5ES	7422	0,7	
HRF 465	BPR5ES	7422	0,7	
HRF 465P	BPR5ES	7422	0,7	
HRF 465S	BPR5ES	7422	0,7	
HRF 465 PD	BPR5ES	7422	0,6	
HRF 465 SD	BPR5ES	7422	0,6	
HRG 413 PD	BMR4A	5728	0,6	306
HRG 413 SD	BMR4A	5728	0,6	306
HRG 415C	BPR6ES	7822	0,7	
HRG 465 PD	BPR5ES	7422	0,6	
HRG 465 SD	BPR5ES	7422	0,6	
HRG 536C SD	BPR6ES	7822	0,7	
HRH 536 HX	BPR6ES	7822	0,7	
HRH 536 QX	BPR5ES	7422	0,8	
HRM 535SX	BPR5ES	7422	0,7	
HRM 536 C TX	BPR6ES	7822	0,6	
HRM 536C	BPR6ES	7822	0,7	
HRM 536C SX	BPR6ES	7822	0,7	
HRS 21	BR4HS	3322	0,6	
HRS 21 (GXV110)	BR4HS	3322	0,6	
HRS 535C SD	BPR6ES	7822	0,7	
HT 3810 (G400/K1)	BR4HS	3322	0,7	
HT 3813	BPR4HS	7823	0,7	
HT 4518H	BPR5ES-11	4424	1,1	
HTR 3009 (GXV270)	BPR5ES	7422	0,7	
HTR 3811	BPR5ES	7422	0,6	
UM 17	BMR4A	5728	0,6	306
UM 21 (GXV160)	BPR5ES	7422	0,7	
UM 24	BPR5ES	7422	0,6	
UM 28	BPR5ES	7422	0,6	
UM 2160B	BPR5ES	7422	0,7	
UM 2160	BPR5ES	7422	0,7	
UM 2160 (GXV160)	BPR5ES	7422	0,7	
UM 2460	BPR5ES	7422	0,7	
UM 2460 (GXV160)	BPR5ES	7422	0,7	
UM 2460B	BPR5ES	7422	0,7	
UM 516C	BPR6ES	7822	0,7	
UM 536	BPR4ES	7222	0,5	
UM 536 B	BPR4ES	7222	0,5	



Order
No.  Quick
No.

HONDA				
UM 536 EBE	BPR5ES	7422	0,6	
UM 536 EE	BPR5ES	7422	0,6	
UM 616	BPR4ES	7222	0,5	
UM 616 B	BPR4ES	7222	0,5	
UM 616 EBE	BPR5ES	7422	0,6	
UM 616 EE	BPR5ES	7422	0,6	
HUSQVARNA				
46ST , 46SR , 3,5PS B&S	BR4LM	4133	0,5	
48 SEK	BPR6ES	7822	0,6	
53 SEK	BPR6ES	7822	0,6	
400B , 450P , 453D , 3,5PS B&S	BR4LM	4133	0,5	
425 S	BPMR6A	6726	0,6	308
485 K , SK , EK	BPR6ES	7822	0,6	
535 (B&S) Master Garden	BR2LM	5798	0,6	310
543S , 4,0 PS B&S	BR4LM	4133	0,5	
820-8	BM6A	5921	0,7	303
970-12 R / S	BM6A	5921	0,7	303
1200-14	BM6A	5921	0,7	303
LT 10 Q	BR2LM	5798	0,6	310
LT 100 ,LT 120	BM6A	5921	0,7	303
LT 130	BR2LM	5798	0,6	310
LT 4140 G-H	BM6A	5921	0,7	303
LT 960-12	BM6A	5921	0,7	303
Master 46	BR2LM	5798	0,6	310
Master PRO2 , PRO4	BM6A	5921	0,7	303
MK 500	BM6A	5921	0,6	303
Rider 650	B4LM	3410	0,6	301
Rider 850-8 , 850-12	BM6A	5921	0,7	303
Rider 970-12R / S	BM6A	5921	0,7	303
Rider 1000-14	BPR5ES	7422	0,6	
Rider 1200-14	BM6A	5921	0,7	303
Rider 1200-18	BPR5ES	7422	0,6	
Rider YTH 1120-14	BPR5ES	7422	0,7	
Royal 42 , 46 , 48 , 48S , 48SE	BMR6A	7421	0,6	307
Royal 43 / S /SE	BR2LM	5798	0,6	310
Royal 48 SEK /SK	BPR6ES	7822	0,6	
Royal 53 S	BR2LM	5798	0,6	310
Royal 53 SEK	BPR6ES	7822	0,6	
Royal 425	BMR6A	7421	0,6	307
Royal 535 / E	BPR6ES	7822	0,6	
Royal 535EK	BPR6ES	7822	0,6	
Royal 820-8	BM6A	5921	0,7	303
Royal Jet 50R	BR2LM	5798	0,6	310
YTH 1120-14	BPR5ES	7422	0,7	
ILO				
alle Kurzgewinde	B6HS	4510	0,5	
IRUS				
Mot. F&S 14 mm	B7HS	5110	0,5	
Mot. F&S 18 mm	A6	1010	0,5	

Order
No.Quick
No.**IRUS**

Mot. Hirth	A6	1010	0,5	
Mot. ILO	A6	1010	0,5	

JACOBSEN

Mot. B&S	B4LM	3410	0,6	301
Mot. Clinton	B6S	3510	0,6	302
Mot. Jacobsen	B6S	3510	0,6	302
Mot. Kohler	B6S	3510	0,6	302
Mot. Robin	B6HS	4510	0,6	
Mot. Tecumseh	B6S	3510	0,6	302

JET FAST

B&S engine	BMR6A	7421	0,6	307
HR 17	BMR6A	7421	0,6	307
HR 21	BMR6A	7421	0,6	307
HR 21 KS	BMR6A	7421	0,6	307
HR 21 with CDI IGN.	BPM6A-10	6026	1,0	
HR 21,5	BMR6A	7421	0,6	307
HRA 21	BMR6A	7421	0,6	307
Yamaha engine (2stroke)	B6HS	4510	0,7	

KINGCAT

Cheeta 700 Honda GV 400	BMR6A	7421	0,6	307
Cheeta 700 Tecumseh 8HP	B6S	3510	0,8	302
Cougar B&S 16HP	B4	3210	0,6	
Panther B&S 11HP Honda GV 400	BMR6A	7421	0,6	307
Puma 1100 B&S 11HP Honda GV 400	BMR6A	7421	0,6	307

KINGFISHER

Rotovac 18" Tecumseh	BR6S	3522	0,7	
Rotovac 18" Iron Horse (C&D)	B4	3210	0,6	
Rotovac 18" B&S	BR6S	3522	0,7	
Rotovac 18" Iron Horse (F)	BMR4A	5728	0,9	306
Turbo Cut B&S	BR6S	3522	0,7	

KOHLER

CH 5	BCPR5ES	6130	0,7	
CH 6	BCPR5ES	6130	0,7	
CH 18	BCPR5ES	6130	0,7	
CH 20	BCPR5ES	6130	0,7	
CH 22	BCPR5ES	6130	0,7	
CH 25	BCPR5ES	6130	0,7	
CV 11	BCPR5ES	6130	0,7	
CV 12,5	BCPR5ES	6130	0,7	
CV 14	BCPR5ES	6130	0,7	
CV 18	BCPR5ES	6130	0,7	
CV 20	BCPR5ES	6130	0,7	
CV 22	BCPR5ES	6130	0,7	
K 91	B6S	3510	0,6	302
K 141	B6S	3510	0,6	302
K 161	B6S	3510	0,6	302
K 181	B6S	3510	0,6	302



Order No.  Quick No.

KOHLER

K 241		B6L	3212	0,6	
K 301		B6L	3212	0,6	
K 321		B6L	3212	0,6	
K 341		B6L	3212	0,6	
K 361		B6L	3212	0,6	
K 482		B6L	3212	0,6	
K 532		B6L	3212	0,6	
K 582		B6L	3212	0,6	
KT 17		BPR4FS	1127	0,7	
KT 19		BPR4FS	1127	0,7	
KT 21		BPR4FS	1127	0,7	
M 8		BMR6A	7421	0,7	307
M 10		B6L	3212	0,7	
M 12		B6L	3212	0,7	
M 14		B6L	3212	0,7	
M 16		B6L	3212	0,7	
M 18		BPR4FS	1127	0,7	
M 20		BPR4FS	1127	0,7	
MV 16		BPR4FS	1127	0,7	
MV 18		BPR4FS	1127	0,7	
MV 20		BPR4FS	1127	0,7	

KYNAST

Mot. B&S		B4LM	3410	0,6	301
Mot. F&S		B4H	4110	0,6	

LAWNBOY

B&S engine		B6S	3510	0,8	302
Mot. Tecumseh		BM6A	5921	0,6	303
O.M.C. engine -09.76		BMR4A	5728	0,9	306
O.M.C. engine 09.76-		B4	3210	0,6	
Solid state ignition		BMR4A	5728	0,9	306

LAWNMASTER

18" Rotary	Johnson 2 stroke Iron Horse D401+ D500	B2	3110	0,6	
18" Rotary	92900 3,5 HP B&S	B6S	3510	0,8	302
19" Rotary	B&S 2HP 400 60102	B6S	3510	0,8	302
19" Rotary	B&S 3,5HP	BMR6A	7421	0,6	307
19" Rotary	B&S 2HP 350 60102	B6S	3510	0,8	302
19" Rotary	B&S 3,5HP 480 Keystarter	BMR6A	7421	0,6	307
19" Rotary	Iron Horse F serie 480.2F	BMR4A	5728	0,9	306
19" Rotary	B&S 480.4 110900	BMR6A	7421	0,6	307
19" Rotary	B&S 3HP 500 80202	B6S	3510	0,8	302
19" Rotary	B&S 3HP 500 80302	B6S	3510	0,8	302
19" Rotary	500 Contractor Kawasaki KF34D	B6S	3510	0,8	302
500 Golf	Tecumseh 3.5HP TSV 661 2Ventil	B6S	3510	0,8	302
V.I.C. Spezial	B&S 3,5HP	BMR6A	7421	0,6	307
500 Golf	600 Kawasaki 34D 3,5HP	B6S	3510	0,8	302
500 Golf	B&S 100202 4HP	B6S	3510	0,8	302

LEOPARD

Mot. Aspera		B4LM	3410	0,6	301
-------------	--	------	------	-----	-----

Order
No.Quick
No.**LEOPARD**

Mot. B&S		B4LM	3410	0,6	301
----------	--	-------------	-------------	-----	------------

MARUYAMA

MC 260 / C / S / E / D	Multischneider	BPM6Y	4562	0,6	
MC 261	Multischneider	BPM6Y	4562	0,6	

MONARK

Mot. Aspera		B4LM	3410	0,6	301
Mot. B&S		B4LM	3410	0,6	301
Mot. Suffolk		B6S	3510	0,6	302

MOUNTFIELD

Mot. B & S , Tecumseh , Aspera		B6S	3510	0,5	302
Mot. Suzuki 2Takt		BPMR4A	6028	0,7	
Mot. Suzuki 4Takt		BPR6ES	7822	0,8	

MTD

Cub Cadet	Kawasaki Typ FG 230 D CS 50	BP4HS	3611	0,6	
Cub Cadet	Tecumseh Standard/Seitengesteuerte Motoren	BR2LM	5798	0,7	310
Cub Cadet	Kawasaki Typ FE 250 D	BPR5ES	7422	0,6	
Cub Cadet	B&S Standard/IC-Motoren	BR2LM	5798	0,7	310
Cub Cadet	Kohler Comand CV/CH 18--25	BKR5E	7938	0,7	
Cub Cadet	Kohler Comand CV/CH 11--16	BKR5E-11	6953	1,1	
Cub Cadet	B&S Intek Motoren	BKR5E	7938	0,7	
Cub Cadet	Tecumseh OHV Motoren	BR7ES	5122	0,7	
Cub Cadet	B&S Vanguard/Europa OHV Motoren	BKR5E	7938	0,7	
Cub Cadet	B&S Graugubmotoren	BR2LM	5798	0,7	310
Gutbrod	Kohler Comand CV/CH 11--16	BKR5E-11	6953	1,1	
Gutbrod	B&S Graugubmotoren	BR2LM	5798	0,7	310
Gutbrod	B&S Vanguard/Europa OHV Motoren	BKR5E	7938	0,7	
Gutbrod	B&S Intek Motoren	BKR5E	7938	0,7	
Gutbrod	Tecumseh Standard/Seitengesteuerte Motoren	BR2LM	5798	0,7	310
Gutbrod	B&S Standard/IC-Motoren	BR2LM	5798	0,7	310
Gutbrod	Tecumseh OHV Motoren	BR7ES	5122	0,7	
Gutbrod	Kawasaki Typ FE 250 D	BPR5ES	7422	0,6	
Gutbrod	Kohler Comand CV/CH 18--25	BKR5E	7938	0,7	
Gutbrod	Kawasaki Typ FG 230 D CS 50	BP4HS	3611	0,6	
Mot. B&S		B4LM	3410	0,6	301
White	Kawasaki Typ FE 250 D	BPR5ES	7422	0,6	
White	B&S Intek Motoren	BKR5E	7938	0,7	
White	B&S Vanguard/Europa OHV Motoren	BKR5E	7938	0,7	
White	Tecumseh Standard/Seitengesteuerte Motoren	BR2LM	5798	0,7	310
White	B&S Standard/IC-Motoren	BR2LM	5798	0,7	310
White	Tecumseh OHV Motoren	BR7ES	5122	0,7	
White	Kohler Comand CV/CH 11--16	BKR5E-11	6953	1,1	
White	Kohler Comand CV/CH 18--25	BKR5E	7938	0,7	
White	Kawasaki Typ FG 230 D CS 50	BP4HS	3611	0,6	
White	B&S Graugubmotoren	BR2LM	5798	0,7	310
Yard Machines	Tecumseh OHV Motoren	BR7ES	5122	0,7	
Yard Machines	B&S Graugubmotoren	BR2LM	5798	0,7	310
Yard Machines	Kawasaki Typ FE 250 D	BPR5ES	7422	0,6	
Yard Machines	B&S Vanguard/Europa OHV Motoren	BKR5E	7938	0,7	



Order No.  Quick No.

MTD					
Yard Machines	B&S Intek Motoren	BKR5E	7938	0,7	
Yard Machines	Tecumseh Standard/Seitengesteuerte Motoren	BR2LM	5798	0,7	310
Yard Machines	Kohler Comand CV/CH 11--16	BKR5E-11	6953	1,1	
Yard Machines	Kawasaki Typ FG 230 D CS 50	BP4HS	3611	0,6	
Yard Machines	B&S Standard/IC-Motoren	BR2LM	5798	0,7	310
Yard Machines	Kohler Comand CV/CH 18--25	BKR5E	7938	0,7	
Yard Man	B&S Standard/IC-Motoren	BR2LM	5798	0,7	310
Yard Man	Kohler Comand CV/CH 11--16	BKR5E-11	6953	1,1	
Yard Man	Kawasaki Typ FE 250 D	BPR5ES	7422	0,6	
Yard Man	Kawasaki Typ FG 230 D CS 50	BP4HS	3611	0,6	
Yard Man	B&S Graugußmotoren	BR2LM	5798	0,7	310
Yard Man	Kohler Comand CV/CH 18--25	BKR5E	7938	0,7	
Yard Man	B&S Intek Motoren	BKR5E	7938	0,7	
Yard Man	B&S Vanguard/Europa OHV Motoren	BKR5E	7938	0,7	
Yard Man	Tecumseh Standard/Seitengesteuerte Motoren	BR2LM	5798	0,7	310
Yard Man	Tecumseh OHV Motoren	BR7ES	5122	0,7	
NORLETT					
Mot. Aspera		B4LM	3410	0,6	301
Mot. B&S		B4LM	3410	0,6	301
PARTNER					
11- 90 E	Aufsitzmäher	BR4LM	4133	0,5	
12- 90 EH	Aufsitzmäher	BR4LM	4133	0,5	
12-100 E	Aufsitzmäher	BR4LM	4133	0,5	
13- 90 EH	Aufsitzmäher	BR4LM	4133	0,5	
13-105 E	Aufsitzmäher	BR4LM	4133	0,5	
14-105 E	Aufsitzmäher	BR4LM	4133	0,5	
14-105 EH	Aufsitzmäher	BR4LM	4133	0,5	
146		BR2LM	5798	0,5	310
146 C		BR2LM	5798	0,5	310
146 CD		BR2LM	5798	0,5	310
146 CDE		BR2LM	5798	0,5	310
146 E		BR2LM	5798	0,5	310
147 C		BR2LM	5798	0,5	310
147 CD		BR2LM	5798	0,5	310
147 CDE		BR2LM	5798	0,5	310
147 T		BR2LM	5798	0,7	310
148 CD		BR2LM	5798	0,5	310
15-105 EH	Aufsitzmäher	BR4LM	4133	0,5	
150		BR2LM	5798	0,5	310
150 D		BR2LM	5798	0,5	310
150 D		BR2LM	5798	0,7	310
150 H		BR2LM	5798	0,7	310
155 CD		BR2LM	5798	0,5	310
155 CDE		BR2LM	5798	0,5	310
155 D		BR2LM	5798	0,5	310
246		BR2LM	5798	0,5	310
348		BR2LM	5798	0,5	310
350		BR2LM	5798	0,5	310
445 D		BR2LM	5798	0,5	310
550		BR2LM	5798	0,5	310

Order
No.Quick
No.**PARTNER**

555 D		BR2LM	5798	0,5	310
556 DE		BR2LM	5798	0,5	310
K12		BP6HS	4511	0,5	
K12S , K16		BPM7A	7321	0,5	305
K500		BPM7A	7321	0,5	305
K650		BPM7A	7321	0,5	305
K700		BPM7A	7321	0,5	305
K1200		BPM7A	7321	0,5	305
P 115	Aufsitzmäher	BR7ES	5122	0,6	
P 130	Aufsitzmäher	BR2LM	5798	0,5	310
P 214	Balkenmäher	BR2LM	5798	0,5	310

PHÖNIX

AM 51 B	B&S	BR2LM	5798	0,7	310	
BM 104 B	Tecna	Balkenmäher	BR2LM	5798	0,7	310
BM 104 T	Tecna	Balkenmäher	BR2LM	5798	0,7	310
BM 200 T	Tecna	Balkenmäher	BR2LM	5798	0,7	310
PXR 40	B&S	BR2LM	5798	0,7	310	
PXR 45 / R	Tecna	BR2LM	5798	0,7	310	
PXR 48	B&S	BR2LM	5798	0,7	310	
PXR 48 RHV	Honda	BPR5ES	7422	0,7		
PXR 48 RV	B&S	BR2LM	5798	0,7	310	
PXR 48 RVE	B&S	BR2LM	5798	0,7	310	
PXR 55 RV	B&S	BR2LM	5798	0,7	310	
Twin Cut 12,5	B&S	BR2LM	5798	0,7	310	
Twin Cut 15,5	B&S	BR2LM	5798	0,7	310	
Twin Cut 16	B&S	BCPR5ES	6130	0,7		

QUEEN GARDEN

Mot. Aspera		B4LM	3410	0,6	301
-------------	--	------	------	-----	-----

ROBIN MOTOREN

EC02EHR		BM7A	6521	0,6	
EC08D/B		B7HS	5110	0,6	
EC12D/B		BM6A	5921	0,6	303
EH12D/B		B6HS	4510	0,6	
EH17D/B		B6HS	4510	0,6	
EH25D/B		B6HS	4510	0,6	
EH30D/B		BP6ES	7811	0,8	
EH34D/B		BP6ES	7811	0,8	
EY08D/B		BM4A	5628	0,6	
EY15D/B		B6HS	4510	0,6	
EY20D/B		B6HS	4510	0,6	
EY23D/B		BP4HS	3611	0,6	
EY28D/B		BP6HS	4511	0,6	
EY35D/B		B6HS	4510	0,6	
EY40D/B		B6HS	4510	0,6	

SABO

37-2TH	Robin EC 04-3V	BR6HS	3922	0,6	
38-BV	B&S	Vertikutierer	BR4LM	4133	0,7
43-2TH	Suzuki V140X	BPMR4A	6028	0,6	

Order
No.Quick
No.**SABO**

43-4		BR2LM	5798	0,6	310
43-4	Vertikutierer	BR2LM	5798	0,6	310
43-4 A		BR2LM	5798	0,6	310
43-4 EA		BR2LM	5798	0,6	310
43-4TE m.A.	B&S 3 HP	BR2LM	5798	0,6	310
43-4TH	B&S 3 HP	BR2LM	5798	0,6	310
43-4TH m.A.	B&S	BR2LM	5798	0,6	310
43-4THE	Tecna BV153ES	BR6S	3522	0,6	
43-4THE m.A.	Tecna BV153ES	BR6S	3522	0,6	
43-4TS	B&S 3 HP	BR2LM	5798	0,6	310
43-4TSH m.A.	Suzuki V140X	BPR6ES	7822	0,8	
43-96	F&S SB93	B4H	4110	0,7	
43-96H	F&S SB93	B4H	4110	0,7	
43-130	F&S SB130	BP4	2911	0,6	
43-130H	F&S SB130	BP4	2911	0,6	
43-130H m.A.	F&S SB130	BP4	2911	0,6	
43-190	B&S Quantum 4,5 HP	BR2LM	5798	0,6	310
43-OHV / A		BPR5ES	7422	0,6	
43-QHE m.A.	B&S Quantum 3,5 HP	BR2LM	5798	0,6	310
43-S 4	Vertikutierer	BR2LM	5798	0,6	310
43-S 4		BR2LM	5798	0,6	310
43-S 4 A		BR2LM	5798	0,6	310
47-2A	F&S SB140SL	BP4	2911	0,6	
47-4	B&S XM 40	BR2LM	5798	0,6	310
47-4 BCA		BR4LM	4133	0,7	
47-4A	B&S XM 40	BR2LM	5798	0,6	310
47-4EA	B&S XM 40	BR2LM	5798	0,6	310
47-Kat A		BR2LM	5798	0,6	310
47-OHV	B&S Europa OHV	BR6ES	4922	0,6	
47-OHV A		BPR5ES	7422	0,6	
47-OHV A	B&S Europa OHV	BR6ES	4922	0,6	
47-OHV EA	B&S Europa OHV	BR6ES	4922	0,6	
47-OHVE A		BPR5ES	7422	0,6	
50-126 m.A.	F&S SB126	B5HS	4210	0,6	
50-126H m.A.	F&S SB126	B5HS	4210	0,6	
50-4 TH	B&S 3,5 HP	BR2LM	5798	0,6	310
50-4 TH m.A.	B&S 3,5 HP	BR2LM	5798	0,6	310
50-4 TL	B&S 3,5 HP	BR2LM	5798	0,6	310
50-4 TL m.A.	B&S 3,5 HP	BR2LM	5798	0,6	310
52-4 TL m.A.		BR2LM	5798	0,6	310
52-140 m.A.	F&S SB140	BP4	2911	0,6	
52-140H	F&S SB140	BP4	2911	0,6	
52-152 H m.A.		B5HS	4210	0,6	
52-152 m.A.		B5HS	4210	0,5	
52-OHV A		BPR5ES	7422	0,6	
76-320		BMR6A	7421	0,6	307
Clipper 52	Aufsitzmäher	BCPR5ES	6130	0,7	

SABRE

Trike 31& 42 B&S 8HP		BMR6A	7421	0,6	307
Honda GV 400 11HP		BMR6A	7421	0,6	307

Order
No.Quick
No.**SOLO**

102			BM7A	6521	0,6	
103			BM7A	6521	0,6	
106			BM7A	6521	0,6	
107			BM7A	6521	0,6	
111			BM7A	6521	0,6	
114			BM7A	6521	0,6	
518		Vertikutierer	BR2LM	5798	0,5	310
545			B4LM	3410	0,5	301
520			B6HS	4510	0,5	
522	B & S	Balkenmäher	BMR6A	7421	0,5	307
530		Balkenmäher	BR2LM	5798	0,5	310
531 1999-2000		Balkenmäher	BP6ES	7811	0,7	
531 1998-1999		Balkenmäher	BR2LM	5798	0,5	310
532		Balkenmäher	BPR6ES	7822	0,7	
543			B5HS	4210	0,5	
543L			B5HS	4210	0,5	
545			BR2LM	5798	0,5	310
545 R			BR2LM	5798	0,5	310
546 , 546R , 546ZR / 546Z	B & S		BMR6A	7421	0,5	307
546 HR			BPR5ES	7422	0,7	
546S , 546RS	Tec.		BR6S	3522	0,5	
548 R			BPR5ES	7422	0,7	
549			B6HS	4510	0,5	
549 Profit			B6HS	4510	0,6	
550 / 550R / 550RS	B & S		BMR6A	7421	0,5	307
550H / 550HR	Honda		BP5ES	6511	0,5	
551 , 551R	Tec.		BR6S	3522	0,5	
551ZR	B & S		BMR6A	7421	0,5	307
552HR	Honda		BP5ES	6511	0,5	
552R	B & S		BCPR5ES	6130	0,7	
552Z , 552ZR	F & S		B5HS	4210	0,5	
553 S			BKR5ES	2460	0,6	
553SL	Honda		BPR5ES	7422	0,5	
554	B & S		BMR6A	7421	0,5	307
554Z	B & S		BMR6A	7421	0,5	307
555 Sidevalve		Aufsitzmäher	BKR5ES	2460	0,6	
555 OHV		Aufsitzmäher	BR2LM	5798	0,5	310
556 Sidevalve		Aufsitzmäher	BKR5ES	2460	0,6	
556 OHV		Aufsitzmäher	BR2LM	5798	0,5	310
557 Sidevalve		Aufsitzmäher	BKR5ES	2460	0,6	
557 OHV		Aufsitzmäher	BR2LM	5798	0,5	310
558 Sidevalve		Aufsitzmäher	BKR5ES	2460	0,6	
558 OHV		Aufsitzmäher	BR2LM	5798	0,5	310
560 Sidevalve		Aufsitzmäher	BKR5ES	2460	0,6	
560 OHV		Aufsitzmäher	BR2LM	5798	0,5	310
562 Sidevalve		Aufsitzmäher	BKR5ES	2460	0,6	
562 OHV		Aufsitzmäher	BR2LM	5798	0,5	310
563/L			B6HS	4510	0,5	
570 OHV		Aufsitzmäher	BR2LM	5798	0,5	310
570 Sidevalve		Aufsitzmäher	BKR5ES	2460	0,6	
572 Sidevalve		Aufsitzmäher	BKR5ES	2460	0,6	
576 OHV		Aufsitzmäher	BKR5ES	2460	0,6	

Order
No.Quick
No.

					SOLO				
575 OHV	Aufsitzmäher	BKR5ES	2460	0,6					
577		B5HS	4210	0,6					
581		B5HS	4210	0,5					
581 Piano		B5HS	4210	0,6					
582	B&S	BR2LM	5798	0,5	310				
585 HM		BR2LM	5798	0,5	310				
585	B & S	BMR6A	7421	0,5	307				
Mot. Aspera		B4LM	3410	0,6	301				
Piano 549		B6HS	4510	0,5					
					STARK				
Mot. B&S		BM6A	5921	0,6	303				
					STIHL-STIGA				
BA20		B6S	3510	0,5	302				
CB700		BM6A	5921	0,5	303				
Park 20008 , Privat 8E		BM6A	5921	0,5	303				
President, CB700, Pony 6, 8		BM6A	5921	0,5	303				
RA Dino 2T		B6S	3510	0,5	302				
RB Dino 4T		BM6A	5921	0,5	303				
SB50 Vario-speed, BB800		BM6A	5921	0,5	303				
Tornado TB300 , Tornado TB500		BM6A	5921	0,5	303				
					SUFFOLK				
12" Colt 1959-1967		B6S	3510	0,6	302				
12" Super Colt		B6S	3510	0,6	302				
14" Serie 1/1A/2/3/4/5/6/7		B6S	3510	0,6	302				
14" Super Punch		B6S	3510	0,6	302				
16" Suffolk		B6S	3510	0,6	302				
16" Demon de luxe		B6S	3510	0,6	302				
17" Super Punch Serie 1/2/3/4/5/6/		B6S	3510	0,6	302				
19" Demon de luxe		B6S	3510	0,6	302				
19" Side Wheel Mower MK 1/ 2		B6S	3510	0,6	302				
19" Squire Serie 1//2/3		B6S	3510	0,6	302				
Pony 2Ventil Serie 1 / 2		BR5HS	3722	0,6					
					TECUMSEH				
A 220 4,8PS 95-		BR2LM	5798	0,6	310				
ALN 330 7,2PS 95-		BR2LM	5798	0,6	310				
BH 153		BR4LM	4133	0,6					
BH 173		BR4LM	4133	0,6					
BH 35 3,5PS 95-		BR2LM	5798	0,6	310				
BH 40 4PS Konische Ausführung 95-		BR2LM	5798	0,6	310				
BH 40 4PS Zylindrische Ausfüh. 95-		BR2LM	5798	0,6	310				
BV 153		BR2LM	5798	0,6	310				
BVL 153		BR2LM	5798	0,6	310				
BVL 173		BR4LM	4133	0,6					
BVL 198		BR4LM	4133	0,6					
BVS 143		BR2LM	5798	0,6	310				
BVS 153		BR2LM	5798	0,6	310				
H 35		BR4LM	4133	0,6					
H 50		BR4LM	4133	0,6					

Order
No.Quick
No.**TECUMSEH**

H 60	BR4LM	4133	0,6	
H 70	BR4LM	4133	0,6	
H 80	BR4LM	4133	0,6	
HH 100	B6HS	4510	0,6	
HM 70	BR4LM	4133	0,6	
HM 80	BR4LM	4133	0,6	
HM 100	BR4LM	4133	0,6	
HM 100 10PS 95-	BR2LM	5798	0,6	310
HMXL 80 8PS 95-	BR2LM	5798	0,6	310
HS 40	BR4LM	4133	0,6	
HS 50	BR4LM	4133	0,6	
HS 50 5PS Hand+Fernbedienung 95-	BR2LM	5798	0,6	310
LAV 35	BR4LM	4133	0,6	
LAV 40	BR4LM	4133	0,6	
LAV 50	BR4LM	4133	0,6	
MV 100	BR4LM	4133	0,6	
MV 100 S	BR4LM	4133	0,6	
MV 100 S 3,5PS 95-	BR2LM	5798	0,6	310
OH 120	B6HS	4510	0,6	
OH 140	B6HS	4510	0,6	
OH 160	B6HS	4510	0,6	
OH 180	B6HS	4510	0,6	
OHV 4Takt 12,5PS 95-	B7S	3710	0,6	
OVM	B6HS	4510	0,6	
OVRM 40	BR7ES	5122	0,6	
OVRM 50	BR7ES	5122	0,6	
OVXL 120	B6HS	4510	0,6	
OVXL-C 125	B6HS	4510	0,6	
Premier 45 OHV	BR4LM	4133	0,6	
Premier 55 OHV	BR7ES	5122	0,6	
Premier 153	BR4LM	4133	0,6	
Premier 173	BR4LM	4133	0,6	
Prisma	BR4LM	4133	0,6	
Prisma 3,7PS 95-	BR2LM	5798	0,6	310
Prisma 5PS 95-	BR2LM	5798	0,6	310
Prisma Elektrostart	BR4LM	4133	0,6	
RV 173	BR4LM	4133	0,6	
Synergy 40	BR4LM	4133	0,6	
Synergy 40	BR2LM	5798	0,6	310
Synergy 40 4PS 95-	BR2LM	5798	0,6	310
Synergy 55 OHV	BR7ES	5122	0,6	
Synergy OHV	BR7ES	5122	0,6	
TNT 100	BR4LM	4133	0,6	
TNT 120	BR4LM	4133	0,6	
TVM 140	BR4LM	4133	0,6	
TVM 170	BR4LM	4133	0,6	
TVM 195	BR4LM	4133	0,6	
TVM 220	BR4LM	4133	0,6	
TVS 75	BR4LM	4133	0,6	
TVS 90	BR4LM	4133	0,6	
TVS 105	BR4LM	4133	0,6	
TVS 115	BR4LM	4133	0,6	



Order No.  Quick No.

TECUMSEH

TVS 120	BR4LM	4133	0,6	
TVXL	BR4LM	4133	0,6	
TVXL 195 4Takt 8PS 95-	BR2LM	5798	0,6	310
TVXL 840 5PS 95-	BR2LM	5798	0,6	310
V 50	BR4LM	4133	0,6	
V 60	BR4LM	4133	0,6	
V 70	BR4LM	4133	0,6	
V 80	BR4LM	4133	0,6	
Vantage	BR4LM	4133	0,6	
Vantage 3,5PS 95-	BR2LM	5798	0,6	310
Vantage 35	BR4LM	4133	0,6	
Vantage 40	BR4LM	4133	0,6	
VM 70	BR4LM	4133	0,6	
VM 80	BR4LM	4133	0,6	
VM 100	BR4LM	4133	0,6	

TORO

Kohler K141 , K181	BR6S	3522	0,6	
Kohler K321 , K532 , K582, M14	B6L	3212	0,6	
Kohler KT17	B6L	3212	0,6	
Mot. Aspera	B4LM	3410	0,6	301
Mot. B&S	B2LM	1147	0,6	
Mot. Chev 250cu in	BR5FS	4123	0,8	
Mot. Echo	BMR6A	7421	0,6	307
Mot. Kioritz	BM6A	5921	0,6	303
Mot. Onan	BR6ES	4922	0,8	
Mot. Suzuki 2 stroke	BPMR4A	6028	0,7	
Mot. Suzuki 4 stroke	BMR6A	7421	0,6	307
Mot. Tecumseh	B4	3210	0,6	
Mot. Toro	BM6A	5921	0,6	303
Mot. Toro 18 mm	A6	1010	0,6	

TOURNO

95	(GCV 520 Honda)	Frontmäher	BPR5ES	7422	0,5	
115	(GCV 520 Honda)	Frontmäher	BPR5ES	7422	0,5	

VIKING

FM 350	Balkenmäher	BR2LM	5798	0,6	310
FM 480	Balkenmäher	BR2LM	5798	0,6	310
FM 590	Balkenmäher	BR2LM	5798	0,6	310
MB 2 R		BR2LM	5798	0,6	310
MB 3 R		BR2LM	5798	0,6	310
MB 400		BR2LM	5798	0,6	310
MB 410		BR2LM	5798	0,6	310
MB 415		BR2LM	5798	0,6	310
MB 450 / M		BR2LM	5798	0,6	310
MB 455 / E / M		BR2LM	5798	0,6	310
MB 455 BC		BR2LM	5798	0,6	310
MB 460		BR2LM	5798	0,6	310
MB 465		BR2LM	5798	0,6	310
MB 500		BR2LM	5798	0,6	310
MB 505 / E		BR2LM	5798	0,6	310

Order
No.Quick
No.**VIKING**

MB 505 S		BR2LM	5798	0,6	310
MB 555 / E		BR2LM	5798	0,6	310
MB 555 S		BR2LM	5798	0,6	310
MB 6 RC		BR2LM	5798	0,6	310
MR 210	Aufsitzmäher	BR2LM	5798	0,7	310
MR 210	Aufsitzmäher	BCPR5ES	6130	0,7	
MT 410	Aufsitzmäher	BCPR5ES	6130	0,7	
MT 420	Aufsitzmäher	BR2LM	5798	0,7	310
MT 540	Aufsitzmäher	BR2LM	5798	0,7	310
MT 640	Aufsitzmäher	BCPR5ES	6130	0,7	
MT 640	Aufsitzmäher	BCPR5ES	6130	0,7	
MT 680	Aufsitzmäher	BCPR5ES	6130	0,7	
MT 680	Aufsitzmäher	BCPR5ES	6130	0,7	
RL 455 B	Vertikutierer	BR2LM	5798	0,6	310

VOGEL & NOOT

Mot. Bombardier Rotax		A6	1010	0,5	
Mot. MAG		B4	3210	0,5	

WOLF

Cart OHC 2	Aufsitzmäher	BPR5ES	7422	0,8	
Cart SV3	Aufsitzmäher	BR2LM	5798	0,6	310
Concept 43 BA		BR2LM	5798	0,6	310
Concept 43 BAI		BR2LM	5798	0,6	310
Concept 43 BPP		BR2LM	5798	0,6	310
Concept 47 BA		BR2LM	5798	0,6	310
Concept 47 BAM		BR2LM	5798	0,6	310
Esprit 40 B		BR7ES	5122	0,6	
Esprit 46 B		BR7ES	5122	0,6	
Esprit 46 BA		BR7ES	5122	0,6	
Mot. Aspera		B4LM	3410	0,6	301
Mot. B&S		B4LM	3410	0,6	301
Mot. F&S 14 mm		B6HS	4510	0,6	
Mot. F&S 18 mm		A6	1010	0,5	
Mot. Hirth 14 mm		B6HS	4510	0,6	
Mot. Hirth 18 mm		A7	1110	0,5	
PC-FEL	Aufsitzmäher	BMR6A	7421	0,7	307
PC-FL	Aufsitzmäher	BMR6A	7421	0,7	307
PG 47 SL		A6	1010	0,6	
Premio 40 B		BR7ES	5122	0,6	
Premio 40 BA		BR7ES	5122	0,6	
Premio 46 B		BR7ES	5122	0,6	
Premio 46 BA		BR7ES	5122	0,6	
Premio 46 Bai		BR7ES	5122	0,6	
PRO 46		BP4	2911	0,5	
PRO 51		BP4	2911	0,5	
PRO 61		BP4	2911	0,5	
Scooter OHV3	Aufsitzmäher	BR7ES	5122	0,6	
Scooter SV4	Aufsitzmäher	BR2LM	5798	0,6	310
TA 40 CA		BMR6A	7421	0,7	307
TA 40 CF		BP4	2911	0,5	
TA 40 S		BMR6A	7421	0,7	307

Order
No.Quick
No.**WOLF**

TA 40 SF	BP4	2911	0,5	
TA 40 SI	BMR6A	7421	0,7	307
TA 42 SB	BMR6A	7421	0,7	307
TA 42 SF	BP4	2911	0,5	
TA 42 SI	BMR6A	7421	0,7	307
TA 42 SI	BMR6A	7421	0,7	307
TA 42 SM	BMR6A	7421	0,7	307
TA 46 MB	BM6A	5921	0,7	303
TA 52 CB	BMR6A	7421	0,7	307
TA 52 CT	BMR6A	7421	0,7	307
TA 52 SF	BP4	2911	0,5	
TA 52 SI	BMR6A	7421	0,7	307
TA 52 SK	BPR6ES	7822	0,6	
TA 52 SM	BMR6A	7421	0,7	307
TA 52 SO	BR6ES	4922	0,6	
TA 52 ST	BMR6A	7421	0,7	307
TA 52 WB	BM6A	5921	0,7	303
TA 52 WS	B5HS	4210	0,5	
TA 70 S	BMR6A	7421	0,7	307
TA 70 SF	BP4	2911	0,5	
TA 70 SI	BMR6A	7421	0,7	307
TB 40 CBK	BMR6A	7421	0,7	307
TB 40 CFK	BP4	2911	0,5	
TB 40 CL	BMR6A	7421	0,7	307
TB 40 CN	BMR6A	7421	0,7	307
TB 40 CS	BP4	2911	0,5	
TB 40 S	BMR6A	7421	0,7	307
TB 40 SF	BP4	2911	0,5	
TB 42 CB	BMR6A	7421	0,7	307
TB 42 CF	BP4	2911	0,5	
TB 42 CT	BMR6A	7421	0,7	307
TB 42 SF	BP4	2911	0,5	
TB 42 SI	BMR6A	7421	0,7	307
TB 42 SM	BMR6A	7421	0,7	307
TB 42 ST	BMR6A	7421	0,7	307
TB 46 MB	BM6A	5921	0,7	303
TB 46 MI	BMR6A	7421	0,7	307
TB 46 RA	BMR6A	7421	0,7	307
TB 46 RB	BMR6A	7421	0,7	307
TB 46 RBL	BMR6A	7421	0,7	307
TB 46 RF	BMR6A	7421	0,7	307
TB 46 VF	BP4	2911	0,5	
TB 50 S	BMR6A	7421	0,7	307
TB 50 SF	BP4	2911	0,5	
TB 52 CB	BMR6A	7421	0,7	307
TB 52 CT	BMR6A	7421	0,7	307
TB 52 SF	BP4	2911	0,5	
TB 70 S	BMR6A	7421	0,7	307
TB 70 SF	BP4	2911	0,5	
TD 38 L	BMR6A	7421	0,7	307
TD 46 L	BMR6A	7421	0,7	307
TG 38 SLE	A6	1010	0,6	

Order
No.Quick
No.**WOLF**

TG 47 SLE		A6	1010	0,6	
TI 38		BMR6A	7421	0,7	307
TI 38 L		BMR6A	7421	0,7	307
TI 46 C		BMR6A	7421	0,7	307
TI 46 L		BMR6A	7421	0,7	307
TL 38 L		BMR6A	7421	0,7	307
TL 47		BMR6A	7421	0,6	307
TR 46		BMR6A	7421	0,7	307
Trac OHV 6	Aufsitzmäher	BPR5ES	7422	0,8	
Trac OHV 7	Aufsitzmäher	BPR5ES	7422	0,8	
TR-SL		BMR6A	7421	0,7	307
UV 38 BX	Vertikutierer	BR7ES	5122	0,6	

YAMAHA

YLM 342 P / S / SE / PR / SR / SER		BR4ES	1097	0,8	
YLM 346 P / S / SE / SR / SER		BR4ES	1097	0,6	
YLM 446 P / S / SB / SE / SBE		BPR5ES	7422	0,8	
YLM 453 P / S / SB / SE / SBE		BPR5ES	7422	0,8	
YLM 553 S / SB / SE / SBE		BPR5ES	7422	0,8	
MF 150A / S	Mehrzweckmotor	BP6HS	4511	0,6	
MF 180A / AR / S / SR	Mehrzweckmotor	BP6HS	4511	0,6	
MF 180K / AK / SK	Mehrzweckmotor	BP4HS	3611	0,6	
MF 260A / AR / S / SR	Mehrzweckmotor	BP6HS	4511	0,6	
MF 260K / AK / SK	Mehrzweckmotor	BP4HS	3611	0,6	
MF 410 / S / SR	Mehrzweckmotor	BP6HS	4511	0,6	
MF 410 SK	Mehrzweckmotor	BP4HS	3611	0,6	
Midori YMM 135	Balkenmäher	BR4ES	1097	0,7	
MT 110 A / AR	Mehrzweckmotor	B7HS	5110	0,6	
MT 110 VL	Mehrzweckmotor	B7HS	5110	0,6	
YBC 20 S / 20 D		BPMR6A	6726	0,6	308
YBC 30 D		BPMR6A	6726	0,6	308
YBC 40 D		BPMR6A	6726	0,6	308
YBC 50 D		BPMR6A	6726	0,6	308
YLM 653 S		BPR5ES	7422	0,7	
YLM 653 SB		BPR5ES	7422	0,7	
YT 2300		BCPR5ES	6130	1,0	
YT 3600 M		BR4ES	1097	0,8	
YT 3600 N		BPR4ES	7222	0,8	
YT 6800 N		BPR5HS	6222	0,8	

YANMAR

YL-48 (GY35V)		BR4HS	3322	0,7	
YL 480TS / TSE		BR2LM	5798	0,5	310
YL-53 (GE53)		BR4HS	3322	0,7	
YL 530TS / TSE		BR2LM	5798	0,5	310
YL 630TS		BR2LM	5798	0,5	310
YM 12 , 14 (2T75-U)		Y-116V			

ZENOAH

G1A , G1A6	14.9 ccm	Mehrzweckmotor	BM6A	5921	0,6	303
G1E	17.2 ccm	Mehrzweckmotor	BMR6A	7421	0,6	307
G2A	22.5 ccm	Mehrzweckmotor	BM6A	5921	0,6	303

Order
No.Quick
No.**ZENOAH**

G2A16, G2C	22.5 ccm	Mehrzweckmotor	BM7A	6521	0,6	
G2D , G2D30	22.5 ccm	Mehrzweckmotor	BM7A	6521	0,6	
G3C , G3C76	31.7 ccm	Mehrzweckmotor	B6HS	4510	0,7	
G3D10,G3D20	31.7 ccm	Mehrzweckmotor	BPM6A	7021	0,6	304
G3E	25.4 ccm	Mehrzweckmotor	BMR6A	7421	0,6	307
G4C, G4C63	37.4 ccm	Mehrzweckmotor	B6HS	4510	0,7	
G4C76	37.4 ccm	Mehrzweckmotor	B6HS	4510	0,7	
G5C	52.5 ccm	Mehrzweckmotor	BR6S	3522	0,7	
G5E, G5E2	52.5 ccm	Mehrzweckmotor	B6HS	4510	0,7	

ZÜNDAPP

685-015 , -025 , -045			B4	3210	0,6	
685-055 , -035			B4	3210	0,6	

Order
No.Quick
No.**AGRIA**

0300	Rotax	A6	1010	0,5	
3400	Rotax	B6HS	4510	0,6	
3400	MAG	B6HS	4510	0,6	
5100	Kawasaki	BMR6A	7421	0,5	307
5200	B&S	BR2LM	5798	0,5	310
5300	B&S	BR2LM	5798	0,5	310
5400	Rotax	A6	1010	0,5	
5500	Rotax 2takt	B6HS	4510	0,6	
5500	Rotax 4takt	A6	1010	0,5	

AL-KO

18		BM6A	5921	0,6	303
24		BM6A	5921	0,6	303
33		BM6A	5921	0,6	303
40		BM6A	5921	0,6	303
250		BPM6F	5950	0,6	
BC 300	Homelite	BPMR6F	1270	0,6	
BC 330 T	Kawasaki	BM6A	5921	0,6	303
BC 400 T	Kawasaki	BM6A	5921	0,6	303
HS4300		BPMR6F	1270	0,6	
HS5300		BPMR6F	1270	0,6	
LT 250	Homelite	BPMR6F	1270	0,6	

ALLEN

20 SDS		BMR6A	7421	0,5	307
BT 19		BPMR6A	6726	0,7	308
BT 22		BMR6A	7421	0,5	307
Deluxe 22		BMR6A	7421	0,5	307
Domestic 22		BMR6A	7421	0,5	307
Mini 17		BMR6A	7421	0,5	307
Mini 22		BMR6A	7421	0,5	307
Mini 23		BM7A	6521	0,7	
Mini 26		BM7A	6521	0,7	
Pro 26		BM7A	6521	0,7	
Pro 37		B6HS	4510	0,6	
Pro 43		BPMR6A	6726	0,7	308
Reciprocator		BMR6A	7421	0,5	307
Super 22		BM7A	6521	0,7	
Super 657		BMR6A	7421	0,9	307

ALPINA

160 Green		BM7A	6521	0,5	
160 Green		BM6A	5921	0,6	303
180 Jolly		BM7A	6521	0,5	
180 Jolly		BM7A	6521	0,6	
200 Prof		BPMR7A	4626	0,5	309
200 Prof		BPM7A	7321	0,6	305
210 Flex		BM7A	6521	0,5	
210 Flex		BM7A	6521	0,6	
232		BPMR7A	4626	0,5	309
232 / 238 / 332 / 338		BPM7A	7321	0,6	305
238		BPMR7A	4626	0,5	309



Order No.  Quick No.

ALPINA				
332	BPMR7A	4626	0,5	309
338	BPMR7A	4626	0,5	309
540 i	BPMR7A	4626	0,5	309
540i / 600i	BPM7A	7321	0,6	305
600 i	BPMR7A	4626	0,5	309
Elite Sickle Bar	B6S	3510	0,7	302
VIP 21 NG	BPM7A	7321	0,6	305
VIP 21 NG	BPMR7A	4626	0,7	309
VIP 25 DG	BPM7A	7321	0,6	305
VIP 25 DG	BPMR7A	4626	0,7	309
VIP 34 DG	BPMR7A	4626	0,7	309
VIP 34 DG	BPM7A	7321	0,6	305
VIP 42 DG	BPMR7A	4626	0,7	309
VIP 42 DG	BPM7A	7321	0,6	305
BLACK & DECKER				
BDP 175	BPM6F	5950	0,7	
BDP 185	BPM6F	5950	0,7	
BDP 285	BPM6F	5950	0,7	
BDP 385	BPM6F	5950	0,7	
CS 26012	BPM6F	5950	0,7	
CS 31014	BPM6F	5950	0,7	
CS 31016	BPM6F	5950	0,7	
GB 155	BPM6F	5950	0,7	
BLITZ				
27S / D / T	BPM7A	7321	0,6	305
33S / T	BPM7A	7321	0,6	305
40S / T	BPM7A	7321	0,6	305
DANARM				
TM 10C	BM6A	5921	0,6	303
TM 20	BM6A	5921	0,6	303
TM 30 B	BM4A	5628	0,6	
Tornado 18E / 24E / 33E / 40E / 50E	BM6A	5921	0,6	303
Whipper 16 Mk3	BM6A	5921	0,6	303
Whipper 18 E	BM6A	5921	0,6	303
DOLMAR				
BC-210	BMR6F	2144	0,5	
BC-212	BMR6F	2144	0,5	
BC-250	BPMR6F	1270	0,5	
BC-330	BPMR6F	1270	0,5	
BC-400	BPMR6F	1270	0,5	
LT-210	BMR6F	2144	0,5	
LT-250	BMR7A	4226	0,5	
LT-30	BPMR7A	4626	0,5	309
MS-250	BMR7A	4226	0,5	
MS-220	BMR7A	4226	0,5	
MS-2300	BMR7A	4226	0,5	
MS-25 C	BPMR7A	4626	0,5	309
MS-25 U	BPMR6A	6726	0,6	308

Order
No.Quick
No.**DOLMAR**

MS-250.4	CMR6A	1223	0,5	
MS-2600	BPMR7A	4626	0,5	309
MS-290 C	BPMR7A	4626	0,5	309
MS-290 U	BPMR7A	4626	0,5	309
MS-30 U	BPMR7A	4626	0,5	309
MS-30C	BPMR7A	4626	0,5	309
MS-3100	BMR7A	4226	0,5	
MS-3200	BPMR7A	4626	0,5	309
MS-3300	BPMR7A	4626	0,5	309
MS-3310	BPMR7A	4626	0,5	309
MS-340	BPMR7A	4626	0,6	309
MS-4000	BPMR7A	4626	0,5	309
MS-4010	BPMR7A	4626	0,5	309
MS-4500	BPMR7A	4626	0,5	309
MS-4510	BPMR7A	4626	0,5	309

ECHO

CLS-4600	BPM7A	7321	0,6	305
CSAH 302	BMR6A	7421	0,6	307
DM 9	BMR6A	7421	0,6	307
GT 160	BM6A	5921	0,6	303
GT 160A	BMR6A	7421	0,6	307
GT 200	BMR6A	7421	0,6	307
GT 2010	BPM7A	7321	0,6	305
GTL 140A / B	BMR6A	7421	0,6	307
HC 140	BMR6A	7421	0,6	307
HC 160	BMR6A	7421	0,6	307
HC 200	BMR6A	7421	0,6	307
HC 210E	BMR6A	7421	0,6	307
HT 200	BMR6A	7421	0,6	307
PB 9	BR6S	3522	0,6	
PB 200	BMR6A	7421	0,6	307
PB 202	BMR6A	7421	0,6	307
PB 400 / E	BMR6A	7421	0,6	307
PE 2400	BPM7Y	4921	0,6	
RM 303E	BM6A	5921	0,6	303
RM 310	BPM7A	7321	0,6	305
RM 380	BPM7A	7321	0,6	305
RMA 2530	BPM7A	7321	0,6	305
SRA 2190	BPM7A	7321	0,6	305
SRA 2530	BPM7A	7321	0,6	305
SRA 343SL	BPM7A	7321	0,6	305
SRM 140 D / DA	BMR6A	7421	0,6	307
SRM 141 D	BMR6A	7421	0,6	307
SRM 160	BM6A	5921	0,6	303
SRM 200 AE / DA / B / EB	BMR6A	7421	0,6	307
SRM 200BE	BM6A	5921	0,6	303
SRM 200D / DB	BM6A	5921	0,6	303
SRM 201 FA	BMR6A	7421	0,6	307
SRM 202 DA / FA	BMR6A	7421	0,6	307
SRM 210	BMR6A	7421	0,6	307
SRM 250E	BPM7A	7321	0,6	305

Order
No.Quick
No.**ECHO**

SRM 250EL	BPM7A	7321	0,6	305
SRM 300 ADX / AE / E	BMR6A	7421	0,6	307
SRM 302 ADX	BMR6A	7421	0,6	307
SRM 303 E	BMR6A	7421	0,6	307
SRM 310/E	BPM7A	7321	0,6	305
SRM 345SL	BPM7A	7321	0,6	305
SRM 400 AE / E	BPM7A	7321	0,6	305
SRM 501DE	BM6A	5921	0,6	303
SRM 2010	BM6A	5921	0,6	303
SRM 2090	BPM7A	7321	0,6	305
SRM 2300	BPM7A	7321	0,6	305
SRM 2450	BPM7A	7321	0,6	305
SRM 2510	BPM7A	7321	0,6	305
SRM 3150	BPMR7A	4626	0,6	309
SRM 3500	BPM7A	7321	0,6	305
SRM 3550	BPM7A	7321	0,6	305
SRM 3800	BPM7A	7321	0,6	305
SRM 4600	BPM7A	7321	0,6	305

EFCO

8200	BPMR7A	4626	0,6	309
8220	BPMR7A	4626	0,6	309
8250	BPMR7A	4626	0,6	309
8250 IC	BPMR7A	4626	0,6	309
8250 ICD	BPMR7A	4626	0,6	309
8260 Stark 26	BPMR7A	4626	0,6	309
8300	BPMR7A	4626	0,6	309
8350	BPMR7A	4626	0,6	309
8355	BPMR7A	4626	0,6	309
8355	BPMR7A	4626	0,6	309
8400	BPMR7A	4626	0,6	309
8405	BPMR7A	4626	0,6	309
8405	BPMR7A	4626	0,6	309
8425	BPMR7A	4626	0,6	309
8460	BPMR7A	4626	0,6	309
8460 IC	BPMR7A	4626	0,6	309
8465	BPMR7A	4626	0,6	309
8515	BPMR7A	4626	0,6	309
8530	BPMR7A	4626	0,6	309
8530 IC	BPMR7A	4626	0,6	309
8550 Boss	BPMR7A	4626	0,6	309
HC 160A	BM6A	5921	0,6	303
HC 210E	BM6A	5921	0,6	303
HC 1000	BM6A	5921	0,6	303
HC 1500	BPM6A	7021	0,6	304
HC 1600	BM6A	5921	0,6	303
Jet 200	BPM7A	7321	0,5	305
Jet 220	BPM7A	7321	0,5	305
Jet 260	BPM7A	7321	0,5	305
Jet 260D	BPM7A	7321	0,5	305
Jet 261	BPM7A	7321	0,5	305
Jet 300	BPM7A	7321	0,5	305

Order
No.Quick
No.**EFCO**

Jet 310	BPM7A	7321	0,5	305
Jet 400	BPM7A	7321	0,5	305
Jet 410	BPM7A	7321	0,5	305
Jet 460	BPM7A	7321	0,5	305
Jet 8420	BPM7A	7321	0,5	305
Jet 8510	BPM7A	7321	0,5	305
Stark 26	BPMR7A	4626	0,6	309
Stark 26 IC	BPMR7A	4626	0,6	309

FLYMO

Maxi Trim	BMR6A	7421	0,6	307
Maxi Trim 380	BPMR6A	6726	0,5	308
Maxi Trim 430 s	BPMR6A	6726	0,5	308
Maxi Trim 460 s	BPMR6A	6726	0,5	308
Super Maxi Trim	BMR6A	7421	0,6	307

FUJI-ROBIN

NB02 / NB02-2A / NB02-2B	BM7A	6521	0,6	
NB03 / NB04 / NB03-2D	B7HS	5110	0,6	204
NB04-2D / E / F	B7HS	5110	0,6	204
NB16 / NB16Z / NB16F	BM7A	6521	0,6	
NB211 / A/AV/ AW/ NBF211	BM7A	6521	0,6	
NB212 / NB223/ NB232	BM7A	6521	0,6	
NB221	BM7A	6521	0,6	
NB231 / NBF231/ NBK231	BM7A	6521	0,6	
NB251	BM7A	6521	0,6	
NB26 / NB27NB31	BM7A	6521	0,6	
NB262 / NBK262 / NBKA262	BPM7A	7321	0,6	305
NB263 / NBH263 / NB281	BPM7A	7321	0,6	305
NB30	B7HS	5110	0,6	204
NB320 / NB321	BM7A	6521	0,6	
NB351 / NBK351	BPM7A	7321	0,6	305
NB40	B7HS	5110	0,6	204
NB411 / NBK411	BPM7A	7321	0,6	305
NB50 / NB171/ NBF171	BM7A	6521	0,6	
NBE251 / NBF251/ NBF252	BM7A	6521	0,6	
NBK232	BM7A	6521	0,6	
NBT415	BPM7A	7321	0,6	305

HERKULES

AST 250	Astschneider	BPM6A	7021	0,5	304
TBC 2211 N		BPMR6A	6726	0,5	308
TBC 2211 SDH		BPMR6A	6726	0,5	308
TBC 2251		BPMR6A	6726	0,5	308
TBC 270 PF		BMR7A	4226	0,5	
TBC 270 PFD		BMR7A	4226	0,5	
TBC 340 SDH		BM7A	6521	0,5	
TBC 430 PFD		BPMR7A	4626	0,5	309
TBC 600 SDH		BPM6A	7021	0,5	304

HOMELITE

BCH20		BM6A	5921	0,6	303
-------	--	------	------	-----	-----

Order
No.Quick
No.**HOMELITE**

BCH24	BM6A	5921	0,6	303
BCH32C	BM6A	5921	0,6	303
BCH33	BM6A	5921	0,6	303
BCH33B	BM6A	5921	0,6	303
BCH40	BM6A	5921	0,6	303
BCH48	BM6A	5921	0,6	303
HBC 30	BPMR7A	4626	0,6	309
HBC 30B	BPMR7A	4626	0,6	309
HBC-30	BPMR6F	1270	0,6	
HLT-17C	BPMR6F	1270	0,6	
i 625 cd	BPMR7A	4626	0,6	309
i 725 cc	BPMR7A	4626	0,6	309
i 725 ce	BPMR7A	4626	0,6	309
i 725 cea	BPMR7A	4626	0,6	309
i 730 ca	BPMR7A	4626	0,6	309
i 730 cc	BPMR7A	4626	0,6	309
PBC 3600	BPMR7A	4626	0,6	309
PBC 3600 B	BPMR7A	4626	0,6	309
PBC 4000	BPMR7A	4626	0,6	309
PLT-3400	BPMR6F	1270	0,6	
ST80	BM6F	6221	0,6	
ST100	BM6F	6221	0,6	
ST120	BM6F	6221	0,6	
ST 155	BPMR7A	4626	0,6	309
ST160	BM6F	6221	0,6	
ST165	BM6F	6221	0,6	
ST175	BPM6F	5950	0,6	
ST180	BM6F	6221	0,6	
ST185	BPM6F	5950	0,6	
ST200	BM6F	6221	0,6	
ST210	BM6F	6221	0,6	
ST285	BPM6F	5950	0,6	
ST310	BM6F	6221	0,6	
ST 385	BPMR7A	4626	0,6	309

HONDA

UMK 422 D	CR5HSB	6535	0,7	
UMK 422 J	CR5HSB	6535	0,7	
UMK 422 LNC	CR5HSB	6535	0,7	
UMK 422 LNU	CR5HSB	6535	0,7	
UMK 422 LT4	CR5HSB	6535	0,7	
UMK 422 LTE	CR5HSB	6535	0,7	
UMK 422 S	CR5HSB	6535	0,7	
UMK 422 UE	CR5HSB	6535	0,7	
UMK 422 UN4C	CR5HSB	6535	0,7	
UMK 422 UNU	CR5HSB	6535	0,7	
UMK 422 UT4E	CR5HSB	6535	0,7	
UMK 425 L3E	CMR5H	7599		
UMK 425 LE	CMR5H	7599		
UMK 425 U3E	CMR5H	7599		
UMK 425 UE	CMR5H	7599		
UMK 431 D	CR5HSB	6535	0,7	

Order
No.Quick
No.**HONDA**

UMK 431 J	CR5HSB	6535	0,7	
UMK 431 LE	CR5HSB	6535	0,7	
UMK 431 LEB	CR5HSB	6535	0,7	
UMK 431 UE	CR5HSB	6535	0,7	
UMK 431 UEB	CR5HSB	6535	0,7	
UMR 431 LT4	CR5HSB	6535	0,7	
UMS 425 LE	CMR5H	7599		
UMT 20 S	BPMR6A	6726	0,6	308
UMT 24 D	BPMR6A	6726	0,6	308
UMT 24 S	CR5HSB	6535	0,7	
UMT 28 D	BPMR6A	6726	0,6	308
UMT 32 D	BPMR6A	6726	0,6	308
UMT 32 FX	BPMR6A	6726	0,6	308
UMT 40 DP	BPMR7A	4626	0,7	309
UMT 41 DF	BPMR6A	6726	0,6	308
UMT 45 DP	BPMR7A	4626	0,7	309
UMT 51 DF	BPMR6A	6726	0,6	308
UMT 51 FX	BPMR6A	6726	0,6	308

HUSQVARNA

16 H	BMR7A	4226	0,5	
16 R	BM6A	5921	0,6	303
18 H	BMR7A	4226	0,5	
18 R / RL	BMR6A	7421	0,6	307
22 R	BM6A	5921	0,6	303
22 RL	BMR6A	7421	0,6	307
23 LC	BPMR6A	6726	0,5	308
24 H	BMR7A	4226	0,5	
24 R	BMR6A	7421	0,6	307
25 GT	BM4A	5628	0,5	
25 R	BM6A	5921	0,6	303
25 RL	BMR6A	7421	0,6	307
26 L	BPMR6A	6726	0,5	308
26 LC	BPMR6A	6726	0,5	308
26 H	BMR7A	4226	0,5	
26 R	BPMR7A	4626	0,5	309
26 RJ	BMR7A	4226	0,5	
27 GTS	BM4A	5628	0,5	
32 L	BPMR6A	6726	0,6	308
32 R	BPMR6A	6726	0,6	308
36 R, RG	BPMR6A	6726	0,5	308
39 R	BPMR6A	6726	0,5	308
46 MR	BR2LM	5798	0,5	310
65 R	BPMR7A	4626	0,5	309
120L	BMR7A	4226	0,5	
120 L	BPMR7A	4626	0,5	309
122 L	BPM6Y	4562	0,6	
125 RJ	BPMR6Y	5256	0,6	
125 R, RL, RD, RB, L, LD	BPM6Y	4562	0,7	
132 HBV	BMR7A	4226	0,5	
132 R, RB, RD, L, LD	BPM6Y	4562	0,7	
140 R	BPMR7A	4626	0,5	309

Order
No.Quick
No.**HUSQVARNA**

165 R		BPMR7A	4626	0,5	309
165 RX		BPMR6A	6726	0,5	308
225 DR / RT		BMR7A	4226	0,5	
225 L / LD		BPMR7A	4626	0,5	309
225 L , LD		BPMR7A	4626	0,5	309
225 R , RD		BPMR7A	4626	0,5	309
225 RJ		BPMR7A	4626	0,5	309
232 L		BPMR7A	4626	0,5	309
232 L CAT		BPMR7A	4626	0,5	309
232 LR		BMR7A	4226	0,5	
232 R		BPMR7A	4626	0,5	309
232 R CAT		BPMR7A	4626	0,5	309
235 P	Astschneider	BPMR7A	4626	0,5	309
235 R		BPMR7A	4626	0,5	309
235 R CAT		BPMR7A	4626	0,5	309
240 R		BPMR7A	4626	0,5	309
240 RBD		BPMR7A	4626	0,5	309
244 GX		BPMR6A	6726	0,5	308
244 R / RX / RXG		BPMR7A	4626	0,5	309
245 R, RX		BPMR7A	4626	0,5	309
250 PS	Astschneider	BPMR7A	4626	0,5	309
250 R, RX		BPMR7A	4626	0,5	309
265 RX		BPMR7A	4626	0,5	309
268 K		BPMR6A	6726	0,5	308
Mondo		BPM6A	7021	0,5	304

IDEAL

SX 230S		BM6A	5921	0,6	303
SX 260S		BM6A	5921	0,6	303
SX 360S / W		BM6A	5921	0,6	303
SX 430S / W		BM6A	5921	0,6	303
SX 540W		BM6A	5921	0,6	303

ISEKI

ICD20F		BM6	2027	0,5	
ICD22		BM6	2027	0,5	
ICD25A1		BM6	2027	0,5	
ICD35A1		BM6	2027	0,5	
ICD40A1		BM6	2027	0,5	
ICD50		BM6	2027	0,5	

ISHIKAWAJIMA

B18 / B20 / B20DU		BPMR7A	4626	0,7	309
B24 / B24DU / B30 / B31 7 B31DU		BPMR7A	4626	0,7	309
B35 / B35DU		BPMR7A	4626	0,7	309
H18D / H20D / H23D / H26D / H35D		BPMR7A	4626	0,7	309
SB19 / SB20 / SB24 / SB30 / SB40		BM6A	5921	0,6	303
SCK30D		BM6A	5921	0,6	303
SCY24 / SCY24A		BM6A	5921	0,6	303

JOHN DEERE

80G		BM6A	5921	0,6	303
-----	--	------	------	-----	-----

Order
No.Quick
No.**JOHN DEERE**

82G	BM4A	5628	0,6	
83G	BM4A	5628	0,6	
85G	B4LM	3410	0,6	301
90G	BM6A	5921	0,6	303
1032	BR6S	3522	0,5	
110G	BM6A	5921	0,6	303
210G	BM6A	5921	0,6	303
240G	BM6A	5921	0,6	303
260G	BM6A	5921	0,6	303

JONSERED

BP 40	BPMR7A	4626	0,5	309
BP 40 Combi	BPMR7A	4626	0,5	309
GR 24 , L	BM6A	5921	0,6	303
GR 26	BPMR7A	4626	0,5	309
GR 26 Combi	BPMR7A	4626	0,5	309
GR 26 D	BPMR7A	4626	0,5	309
GR 26 L	BPMR7A	4626	0,5	309
GR26C	BPMR6A	6726	0,5	308
GR 28 , L	BM6A	5921	0,6	303
GR 32 D	BPMR7A	4626	0,5	309
GR 32 L	BPMR7A	4626	0,5	309
GR 36	BPMR7A	4626	0,5	309
GR 41	BPMR7A	4626	0,5	309
GR 44	BPMR7A	4626	0,5	309
GR 50	BPMR7A	4626	0,5	309
GR 50 PRO	BPMR7A	4626	0,5	309
GT 21 L	BPM6A	7021	0,5	304
GT 22 L	BPM6A	7021	0,5	304
GT 24 L	BPM6A	7021	0,5	304
GT 26 L	BMR6A	7421	0,5	307
GT 32 L	BMR6A	7421	0,5	307
HP 36	BPMR7A	4626	0,5	309
RS 38	B6HS	4510	0,5	
RS 40	BPMR7A	4626	0,5	309
RS 44	BPMR7A	4626	0,5	309
RS 45	BPMR7A	4626	0,5	309
RS 51 Pro	BPMR7A	4626	0,5	309
RS 52	BPMR7A	4626	0,5	309

KAUZ

J40FD	BM6A	5921	0,6	303
JL1-T200	BM6A	5921	0,6	303
JQ-50	BM6A	5921	0,6	303
JQ-G4K	BM6A	5921	0,6	303
JQ-T200	BM6A	5921	0,6	303
KLQ	BM6A	5921	0,6	303
KQP-LS	BM6A	5921	0,6	303
V15	BM6A	5921	0,6	303
V18	BM6A	5921	0,6	303
V20	BM6A	5921	0,6	303
V25	BM6A	5921	0,6	303



Order No.  Quick No.

KAAZ				
V40	BM6A	5921	0,6	303
KAWASAKI				
KBH 26A	BPMR7A	4626	0,5	309
KBH 33A	BMR6A	7421	0,6	307
KBH 34A	BMR6A	7421	0,6	307
KBH 43A	BMR6A	7421	0,6	307
KBH 48A	BMR6A	7421	0,6	307
KBL 23A	BPMR7A	4626	0,5	309
KBL 26A	BPMR7A	4626	0,5	309
MAKITA				
RBC 220	BM7A	6521	0,7	
RBC 221	BM7A	6521	0,7	
RBC 230	BM7A	6521	0,7	
RBC 250	BM7A	6521	0,7	
RBC 251	BM7A	6521	0,7	
RBC 260	BPM7A	7321	0,7	305
RBC 261	BPM7A	7321	0,7	305
RBC 310	BM7A	6521	0,7	
RBC 311	BM7A	6521	0,7	
RBC 411	BPM7A	7321	0,7	305
RBC 520	BM7A	6521	0,7	
RBK 411	BPM7A	7321	0,7	305
RST 250	BM7A	6521	0,7	
MARUYAMA				
BC 200 / C / C-T	BPM6Y	4562	0,6	
BC 201 / C / C-T	BPM6Y	4562	0,6	
BC 260 / C / H / T	BPM6Y	4562	0,6	
BC 320 / H / T	BPM6Y	4562	0,6	
BC 420 / H	BPM6Y	4562	0,6	
BCF 420 H	BPM6Y	4562	0,6	
M 22	BPM6Y	4562	0,6	
M 28 / F	BPM6Y	4562	0,6	
M 35 / D / F	BPM6Y	4562	0,6	
M 45 / D / F	BPM6Y	4562	0,6	
MC 260 / C / S / E / D	BPM6Y	4562	0,6	
MC 260 / C / S / E / D	BPM6Y	4562	0,6	
MC 261	BPM6Y	4562	0,6	
	Multischneider			
	Multischneider			
McCULLOCH				
BP 26 AV	BMR6F	2144	0,6	
BP 30 AV	BMR6F	2144	0,6	
BP 38 AV	BMR6F	2144	0,6	
BP 30 AV	BMR6A	7421	0,6	307
BP 38 AV	BMR6A	7421	0,6	307
Camargue 26	BMR6F	2144	0,6	
Kentucky 36	BMR6F	2144	0,6	
Mac 17	BMR6F	2144	0,6	
Mac 21	BMR6F	2144	0,6	
Mac 22	BM7A	6521	0,6	

Order
No.Quick
No.**McCULLOCH**

Mac 23	BM7A	6521	0,6	
Mac 25	BMR6F	2144	0,6	
Mac 26	BMR6F	2144	0,6	
Mac 30 / AV	BMR6F	2144	0,6	
Mac 32	B6HS	4510	0,6	
Mac 37	B6HS	4510	0,6	
Mac 38 AV	BMR6F	2144	0,6	
Mac 52	B6S	3510	0,6	302
Mac 60 SX	BMR6F	2144	0,6	
Mac 80 A / SX	BMR6F	2144	0,6	
Mac 90	BMR6F	2144	0,6	
Mac 95	BMR6F	2144	0,6	
MD 290	BMR6F	2144	0,5	
MD 330 AV	BMR6F	2144	0,5	
MT 280 X	BMR6F	2144	0,5	
MT 310 X	BMR6F	2144	0,5	
MT 320	BMR6F	2144	0,5	
PM 2100	BMR6F	2144	0,5	
PM 2600	BMR6F	2144	0,5	
PM 3100	BMR6F	2144	0,5	
PM 3600	BMR6F	2144	0,5	
PM 4100	BMR6F	2144	0,5	
PM 4150	BMR6F	2144	0,5	
PMAC 38 AV	BMR6A	7421	0,6	307
Prater 31	BMR6F	2144	0,6	
Pro Mac 38 AV	BMR6F	2144	0,6	
SMAC 30, AV	BMR6A	7421	0,6	307
Super Mac 28	BMR6F	2144	0,6	
Super Mac 30 AV	BMR6F	2144	0,6	
Super Mac 38 AV	BMR6F	2144	0,6	
Trim Mac 24	BMR6F	2144	0,6	
Trim Mac 24	BMR6A	7421	0,6	307
Trim Mac 26	BMR6F	2144	0,6	
Trim Mac 26	BMR6A	7421	0,6	307
Versailles 41	BMR6F	2144	0,6	
Windsor Kit 28	BMR6F	2144	0,6	

MOUNTFIELD

Multi-trim 16	BMR6A	7421	0,5	307
Multi-trim 18	BMR6A	7421	0,5	307
Multi-trim 23	BMR6A	7421	0,5	307
Multi-trim 24	BMR6A	7421	0,5	307
Multi-trim 31	BR6HS	3922	0,5	
Multi-trim 33	BMR6A	7421	0,5	307
Multi-trim 40	BMR6A	7421	0,5	307

NAUTAC

011F	BPMR7A	4626	0,5	309
011R	BPMR7A	4626	0,5	309
012R	BPMR7A	4626	0,5	309
026R	BPMR7A	4626	0,5	309
026RF	BPMR7A	4626	0,5	309



Order No.  Quick No.

NAUTAC				
1100T	BPMR7A	4626	0,5	309
OLEO - MAC				
433 BP	BPMR7A	4626	0,5	309
721	BPMR7A	4626	0,5	309
727	BPMR7A	4626	0,5	309
727 S	BPMR7A	4626	0,5	309
727 T	BPMR7A	4626	0,5	309
733	BPMR7A	4626	0,5	309
733 S	BPMR7A	4626	0,5	309
PARTNER				
B 180	BMR6A	7421	0,5	307
B 200	BPMR7A	4626	0,5	309
B 205	BPMR7A	4626	0,5	309
B 250	BMR6A	7421	0,5	307
B 265	BPMR6A	6726	0,5	308
B 322	BPMR7A	4626	0,5	309
B 323	BPMR7A	4626	0,5	309
B 325	BPMR7A	4626	0,5	309
B 370	BPMR7A	4626	0,5	309
B 380	BPMR7A	4626	0,5	309
B 400	BPMR7A	4626	0,5	309
B 405	BPMR7A	4626	0,5	309
B 440	BPMR7A	4626	0,5	309
B 450 C	BPMR7A	4626	0,5	309
B 450 G	BPMR7A	4626	0,5	309
B 450 W	BR4LM	4133	0,5	
Colibri	BPMR7A	4626	0,5	309
Colibri Duo	BPMR7A	4626	0,5	309
Colibri Plus	BPMR7A	4626	0,5	309
Prof	BPMR7A	4626	0,5	309
T 180 Colibri	BPMR6A	6726	0,5	308
T 221	BPMR7A	4626	0,6	309
T 225	BMR6A	7421	0,6	307
T 240	BPMR6A	6726	0,5	308
T 250	BMR6A	7421	0,6	307
T 260	BMR6A	7421	0,6	307
T 285	BMR6A	7421	0,6	307
T 321	BPMR7A	4626	0,6	309
SABRE				
B25	BPM6F	5950	0,6	
S25	BPM6F	5950	0,6	
S25C	BPM6F	5950	0,6	
SHINDAIWA				
B 40	BMR6A	7421	0,7	307
B 45	BMR6A	7421	0,6	307
BP 23E	BMR6A	7421	0,6	307
BP 35	BMR6A	7421	0,6	307
C 20	BMR6A	7421	0,7	307

Order
No.Quick
No.**SHINDAIWA**

C 23	BMR6A	7421	0,6	307
C 25	BM6A	5921	0,6	303
C 27	BPMR6A	6726	0,6	308
C 35	BMR6A	7421	0,6	307
C 35	BM6A	5921	0,6	303
C 230	BMR6A	7421	0,6	307
C 250	BMR6A	7421	0,6	307
F 18	BMR6A	7421	0,6	307
F 20	BM6A	5921	0,6	303
F 21	BMR6A	7421	0,7	307
HT2020	BM6A	5921	0,6	303
HT2030	BM6A	5921	0,6	303
LE 250	BMR6A	7421	0,6	307
RC 45	BMR6A	7421	0,6	307
T 20	BM6A	5921	0,6	303
T 23	BMR6A	7421	0,6	307
T 23E	BMR6A	7421	0,6	307
T 25	BM6A	5921	0,6	303
T 230	BMR6A	7421	0,6	307
T 250	BMR6A	7421	0,6	307

SNAPPER

ETC 302 KW	BM6A	5921	0,6	303
------------	------	------	-----	-----

SOLO

105 L	BPMR6A	6726	0,6	308
106 B	BPMR6A	6726	0,6	308
106 L	BPMR6A	6726	0,6	308
106 R	CMR6A	1223	0,6	
117	BPMR7A	4626	0,6	309
118	BPMR6A	6726	0,5	308
119	BPMR6A	6726	0,5	308
120	BPMR7A	4626	0,5	309
121	BPMR7A	4626	0,6	309
123	BM6F	6221	0,5	
124	BPMR7A	4626	0,5	309
125	BM6F	6221	0,5	
126	BPMR7A	4626	0,5	309
127	BPMR6A	6726	0,5	308
128	BPMR7A	4626	0,5	309
129	BPMR7A	4626	0,6	309
129 BTS	BPMR6A	6726	0,6	308
130	BPMR6A	6726	0,5	308
134	BPMR6A	6726	0,5	308
135	BM6A	5921	0,5	303
136	BM6A	5921	0,5	303
137	BPMR6A	6726	0,5	308
140	BPMR6A	6726	0,5	308
141	BPMR6A	6726	0,5	308
664	BPMR7A	4626	0,6	309



Order No.  Quick No.

STIHL

FC 55		BPMR7A	4626	0,5	309
FC 72	Kantenschneider	BPMR7A	4626	0,5	309
FC 75		BPMR7A	4626	0,5	309
FE 55		BPMR7A	4626	0,5	309
FH 75		BPMR7A	4626	0,5	309
FR 106		BPMR7A	4626	0,5	309
FR 350		BPMR7A	4626	0,5	309
FR 450		BPMR7A	4626	0,5	309
FR 85		BPMR7A	4626	0,5	309
FR 108		BPMR7A	4626	0,5	309
FS 100 R / FS 100		CMR6H		0,6	
FS 120		BPMR7A	4626	0,5	309
FS 25-4R/25-4		BPMR7A	4626	0,5	309
FS 300		BPMR7A	4626	0,5	309
FS 300		BPMR7A	4626	0,5	309
FS 350		BPMR7A	4626	0,5	309
FS 350		BPMR7A	4626	0,5	309
FS 36		BMR6A	7421	0,5	307
FS 36		BMR6A	7421	0,6	307
FS 38		BMR6A	7421	0,6	307
FS 40		BMR6A	7421	0,6	307
FS 400		BPMR7A	4626	0,5	309
FS 400 K		BPMR7A	4626	0,5	309
FS 400K/400		BPMR7A	4626	0,5	309
FS 44		BMR6A	7421	0,6	307
FS 45		BPMR7A	4626	0,5	309
FS 45 C		BPMR7A	4626	0,5	309
FS 450		BPMR7A	4626	0,5	309
FS 450 K		BPMR7A	4626	0,5	309
FS 450K/450		BPMR7A	4626	0,5	309
FS 48		BPMR7A	4626	0,5	309
FS 50		BMR6A	7421	0,5	307
FS 51		BMR6A	7421	0,6	307
FS 52		BPMR7A	4626	0,5	309
FS 55 C		BPMR7A	4626	0,5	309
FS 55 RC		BPMR7A	4626	0,5	309
FS 550		BPMR7A	4626	0,5	309
FS 550		BPMR7A	4626	0,5	309
FS 55R/55		BPMR7A	4626	0,5	309
FS 56		BMR6A	7421	0,5	307
FS 60		BMR6A	7421	0,6	307
FS 61		BMR6A	7421	0,6	307
FS 62		BPMR7A	4626	0,5	309
FS 65		BMR6A	7421	0,6	307
FS 65-4R/65-4		BPMR7A	4626	0,5	309
FS 66		BMR6A	7421	0,5	307
FS 74		BPMR7A	4626	0,5	309
FS 75		BPMR7A	4626	0,5	309
FS 80		BMR6A	7421	0,6	307
FS 80R/80		BPMR7A	4626	0,5	309
FS 81		BPMR7A	4626	0,5	309
FS 85		BPMR7A	4626	0,5	309

Order
No.Quick
No.**STIHL**

FS 85R/85	BPMR7A	4626	0,5	309
FS 85RT/85T	BPMR7A	4626	0,5	309
FS 86 --> No.14821680	BMR6A	7421	0,6	307
FS 86 No.15821680 -->	BPMR7A	4626	0,5	309
FS 88	BPMR7A	4626	0,5	309
FS 90	BMR6A	7421	0,6	307
FS 96	BMR6A	7421	0,6	307
FS 106	BPMR7A	4626	0,5	309
FS 150	BPMR7A	4626	0,5	309
FS 160	BPMR7A	4626	0,5	309
FS 200	BPMR7A	4626	0,5	309
FS 220	BPMR7A	4626	0,5	309
FS 280	BPMR7A	4626	0,5	309
FS 410	BPMR7A	4626	0,5	309
FS 420	BPMR7A	4626	0,5	309
KM 100 FS	CMR6H		0,6	
KM 100 R FS	CMR6H		0,6	
KM 100 R HL	CMR6H		0,6	
KM 100 R HT	CMR6H		0,6	
KM 55 C FS	BPMR7A	4626	0,5	309
KM 55 FS	BPMR7A	4626	0,5	309
KM 55 R FS	BPMR7A	4626	0,5	309
KM 55 R HL	BPMR7A	4626	0,5	309
KM 55 R HT	BPMR7A	4626	0,5	309
KM 55 RC FS	BPMR7A	4626	0,5	309
KM 55 RC HL	BPMR7A	4626	0,5	309
KM 55 RC HT	BPMR7A	4626	0,5	309
KM 85 FS	BPMR7A	4626	0,5	309
KM 85 R FS	BPMR7A	4626	0,5	309
KM 85 R HL	BPMR7A	4626	0,5	309
KM 85 R HT	BPMR7A	4626	0,5	309
KW 85	BPMR7A	4626	0,5	309

TANAKA

AST 250	BPM6A	7021	0,6	304
AST 5000	BPM6A	7021	0,6	304
AST 7000	BPM6A	7021	0,6	304
SUM 321 , SUM 351	BM7A	6521	0,6	
SUM 421	BM6A	5921	0,6	303
TBC 220	BPM6A	7021	0,6	304
TBC 250	BPM6A	7021	0,6	304
TBC 265	BM6A	5921	0,6	303
TBC 300	BM7A	6521	0,6	
TBC 322	BM7A	6521	0,6	
TBC 355	BM7A	6521	0,6	
TBC 422	BM6A	5921	0,6	303
TBC 500	BPM6A	7021	0,6	304
TBC 2000	BPM6A	7021	0,6	304
TBC 2200	BPM6A	7021	0,6	304
TBC 2400	BPMR6A	6726	0,5	308
TBC 4000	BPM6A	7021	0,6	304
TBC 4200	BPMR6A	6726	0,5	308



Order No.  Quick No.

TANAKA				
TBC 4500	BPM6A	7021	0,6	304
TBC 5000	BPM6A	7021	0,6	304
TST 218	BM6A	5921	0,6	303
TUM 220	BPM6A	7021	0,6	304
TUM 250	BPM6A	7021	0,6	304
TONDU				
M 18	BM6A	5921	0,6	303
PRO 255	BM6A	5921	0,6	303
PRO 851	BM7A	6521	0,6	
S 180	BM6A	5921	0,6	303
S 255	BM6A	5921	0,6	303
S 260	BM6A	5921	0,6	303
WARRIOR				
E 6 (Robin)	BM6A	5921	0,6	303
E 8 (Robin)	BM6A	5921	0,6	303
E6 (Kawasaki)	BM4A	5628	0,5	
KD 18	BM6A	5921	0,6	303
KD 24 X	BM6A	5921	0,6	303
KD 33XV	BM6A	5921	0,6	303
KD 40 XV (Robin)	BM6A	5921	0,6	303
KD 50 XV (Robin)	BM6A	5921	0,6	303
SU 18 D	BM6A	5921	0,6	303
WESTMAC				
18 / 19	BM6A	5921	0,6	303
24	BM6A	5921	0,6	303
33	BM6A	5921	0,6	303
40 / 48	BM6A	5921	0,6	303
WHIRLYBIRD				
20 / 25	BM6A	5921	0,6	303
35	BM6A	5921	0,6	303
40	BM6A	5921	0,6	303
WOLF				
UV-EB	BMR6A	7421	0,6	307
UV-P	B7HS	5110	0,6	204
WOODLORD				
BC 161 DM	BM6A	5921	0,6	303
BC 241 DX	BM6A	5921	0,6	303
BC 330 DX	BM6A	5921	0,6	303
BC 400 FX	BM6A	5921	0,6	303
BK 331 FX	BM6A	5921	0,6	303
TM 350	BM6A	5921	0,6	303
YAMAHA				
YBC 20 D	BPMR6A	6726	0,6	308
YBC 20 S	BPMR6A	6726	0,6	308
YBC 30 D	BPMR6A	6726	0,6	308



Order
No.



Quick
No.

YAMAHA

YBC 40 D	BPMR6A	6726	0,6	308
YBC 50 D	BPMR6A	6726	0,6	308

ZENOAH

BC 153 E1	BM6A	5921	0,6	303
BC 174 E	BM6A	5921	0,6	303
BC 234 B	BM7A	6521	0,6	
FBC 33	B6S	3510	0,7	302

Order
No.Quick
No.**B & S**

BSQ 1000	BP6HS	4511	0,7	
				HONDA
4500K1 (G400K1)	BPR4HS	7823	0,6	
E 80	C6HSA	3228	0,6	
E 100	C6HSA	3228	0,6	
E 300	C6HSA	3228	0,6	
E 400	C6HSA	3228	0,6	
E 1500 (G200)	BR4HS	3322	0,6	
E 1500 (G200) CDI.IGN	BPR4HS-10	5024	1,0	
E 1500 (G42)	BR6HS	3922	0,6	
E 2500 (G300)	BR4HS	3322	0,6	
E 3000 (GD100) 12V	YS-101	5825		
E 3500	BR4HS	3322	1,0	
E 3500 CDI. IGN.	BPR4HS-10	5024	1,0	
E 4000	YS-101	5825		
E 4500	BPR4HS-10	5024	1,0	
EB 1200X (GX110)	BPR6ES	7822	0,6	
EB 1400X	BPR6ES	7822	0,6	
EB 1500 (GE200)	BPR4HS-10	5024	1,0	
EB 1500X	BPR6ES	7822	0,6	
EB 1800	BPR4HS-10	5024	1,0	
EB 1800X	BPR6ES	7822	0,6	
EB 1900 (GE200)	BPR4HS-10	5024	1,0	
EB 1900X (GX140)	BPR6ES	7822	0,6	
EB 2200X	BPR6ES	7822	0,6	
EB 2800 (GE300)	BPR4HS-10	5024	1,0	
EB 3000	BR4HS	3322	0,6	
EB 3000X	BPR5ES	7422	0,6	
EB 3500X	BPR5ES	7422	0,6	
EB 3800 (G400)	BPR4HS-10	5024	1,0	
EB 4000	BPR4HS-10	5024	1,0	
EB 4500	BPR6ES	7822	0,6	
EB 5000	BPR6ES	7822	0,6	
EBK 2000	BPR4HS-10	5024	1,0	
EBK 2600	BR4HS	3322	0,6	
EBK 3600	BR4HS	3322	0,6	
EC 2100 C	BPR6ES	7822	0,6	
EC 2200	BPR6ES	7822	0,6	
EC 2200L	BPR6ES	7822	0,6	
EC 4000	BPR6ES	7822	0,6	
EC 4500P	BPR6ES	7822	0,6	
EC 6000	BPR6ES	7822	0,6	
ECM 2800	BPR6ES	7822	0,7	
ECMT 6500	BPR6ES	7822	0,7	
ECMT 6500P	BPR6ES	7822	0,7	
ECT 6500	BPR6ES	7822	0,6	
ECT 6500P	BPR6ES	7822	0,6	
ED 250	C6HSA	3228	0,6	
ED 300 Ser. -1138369	BPMR6A-10	1029	1,0	
ED 300 Ser. 1138370-	BPMR4A-10	6328	1,0	
ED 400	BMR4A	5728	0,6	306

Order
No.Quick
No.**HONDA**

ED 1000X	BPR6ES	7822	0,6	
EG 550	BMR4A	5728	0,6	306
EG 650	BMR4A	5728	0,6	306
EG 850X	BPR6ES	7822	0,6	
EG 850Z	BR4HS	3322	0,6	
EG 1000 (G150)	BR4HS	3322	0,6	
EG 1000X	BPR6ES	7822	0,6	
EG 1000Z (GE150)	BR4HS	3322	0,6	
EG 1200	BPR6ES	7822	0,6	
EG 1200X (GX110 , GX120K1)	BPR6ES	7822	0,6	
EG 1200Z	BR4HS	3322	0,6	
EG 1400X	BPR6ES	7822	0,6	
EG 1400Z	BR4HS	3322	0,6	
EG 1500X	BPR6ES	7822	0,6	
EG 1500Z	BR4HS	3322	0,6	
EG 1800X	BPR6ES	7822	0,6	
EG 1800Z	BR4HS	3322	0,6	
EG 1900X (GX140)	BPR6ES	7822	0,6	
EG 1900Z	BR4HS	3322	0,6	
EG 2000X	BPR6ES	7822	0,6	
EG 2200	BPR6ES	7822	0,6	
EG 2200X	BPR6ES	7822	0,6	
EG 2200Z	BR4HS	3322	0,6	
EG 3000	BPR5ES	7422	0,6	
EG 3000 (GX240)	BR4HS	3322	0,6	
EG 3000X	BPR6ES	7822	0,6	
EG 3500X	BPR6ES	7822	0,6	
EG 4000	BR4HS	3322	0,6	
EG 4500	BPR6ES	7822	0,6	
EG 4500 X	BPR5ES-11	4424	1,1	
EG 4500X (GX340 CDI)	BPR5ES	7422	0,8	
EG 5000	BPR6ES	7822	0,6	
EGK 1000	BR4HS	3322	0,6	
EGK 1200	BR4HS	3322	0,6	
EGK 1600	BR4HS	3322	0,6	
EGK 2000	BR4HS	3322	0,6	
EGK 2600	BR4HS	3322	0,6	
EGK 3600	BR4HS	3322	0,6	
EGK 600	BM4A	5628	0,6	
EJ 3	BPR6HS	7022	0,6	
EL 80	C6HSA	3228	0,6	
EL 5000	BPR6HS	7022	0,6	
EM 25	BPR6ES	7822	0,5	
EM 30	BPR6ES	7822	0,5	
EM 300	C6HSA	3228	0,6	
EM 400 (14MM)	C6HSA	3228	0,6	
EM 500 Ser. -1138369	BPMR6A-10	1029	1,0	
EM 500 Ser. 1138370-	BPMR4A-10	6328	1,0	
EM 600	BPMR6A-10	1029	1,0	
EM 650	BMR4A	5728	0,6	306
EM 1200X (GX110)	BPR6ES	7822	0,6	
EM 1400X	BPR6ES	7822	0,6	

Order
No.Quick
No.**HONDA**

EM 1500 (GE200)	BPR4HS-10	5024	1,0	
EM 1500X	BPR6ES	7822	0,6	
EM 1800	BPR4HS-10	5024	1,0	
EM 1800X	BPR6ES	7822	0,6	
EM 1900 (GE200)	BPR4HS-10	5024	1,0	
EM 1900X	BPR6ES	7822	0,6	
EM 2200	BPR6ES	7822	0,6	
EM 2200X	BPR6ES	7822	0,6	
EM 3000	BPR4HS-10	5024	1,0	
EM 3000SX	BPR5ES	7422	0,6	
EM 3000X	BPR5ES	7422	0,6	
EM 3500SX	BPR5ES	7422	0,6	
EM 3500X	BPR5ES	7422	0,6	
EM 4000	BPR4HS-10	5024	1,0	
EM 4500	BPR6ES	7822	0,6	
EM 4500 SX	BPR5ES	7422	0,6	
EM 5000	BPR6ES	7822	0,6	
EM 5000SX	BPR6ES	7822	0,6	
EMS 2800 (GE300)	BPR4HS-10	5024	1,0	
EMS 3000	BPR4HS-10	5024	1,0	
EMS 3800 (G400)	BPR4HS-10	5024	1,0	
EMS 4000	BPR4HS-10	5024	1,0	
ES 3500 K1 (G400K1)	BR4HS	3322	0,6	
ES 3500 (G400)	BPR4HS-10	5024	1,0	
ES 4500 (G400)	BPR4HS-10	5024	1,0	
ES 5500 (GX360)	BPR6HS-10	2633	1,0	
ES 5500 K1 (GX360K1)	BPR6HS	7022	0,6	
ES 6500	BPR6HS	7022	0,6	
ET 4500	BPR4HS-10	5024	1,0	
ET 4500X	BPR6ES	7822	0,6	
EU 10i	CR5HSB	6535	0,7	
EU 19i	CR5HSB	6535	0,7	
EU 20	CR4HSB	4695	0,5	
EU 20 i	CR4HSB	4695	0,5	
EU 26i	BPR5ES	7422	0,6	
EU 30i	BPR5ES	7422	0,6	
EU 30is	BPR5ES	7422	0,6	
EV 3600	BPR6HS-10	2633	1,0	
EV 3610	BPR2HS	7626	0,7	
EV 3610	BPR2HS	7626	0,7	
EV 4000	BPR6HS-10	2633	1,0	
EV 4010	BPR4HS	7823	0,7	
EV 5010	BPR6HS	7022	0,7	
EV 6010	BPR4HS	7823	0,7	
EW 170	BR4HS	3322	0,6	
EW 171	BPR6ES	7822	0,6	
EX 100	BR4HS	3322	0,6	
EX 350	BMR6A	7421	0,6	307
EX 500 Ser. -1138369	BPMR6A-10	1029	1,0	
EX 500 Ser. 1138370-	BPMR4A-10	6328	1,0	
EX 650	BMR4A	5728	0,6	306
EX 800	BPR4HS-10	5024	1,0	

Order
No.Quick
No.**HONDA**

EX 900	BR4HS	3322	0,6	
EX 1000	BR4HS	3322	0,6	
EX 1900	BPR6ES	7822	0,6	
EX 2100	BPR6ES	7822	0,6	
EX 2200	BPR6ES	7822	0,6	
EX 3000	BPR5ES	7422	0,6	
EX 3000S	BPR5ES	7422	0,6	
EX 3300	BPR6ES	7822	0,6	
EX 4000	BPR5ES	7422	0,6	
EX 4000S (GX340)	BPR5ES	7422	0,8	
EX 4500	BPR6ES	7822	0,6	
EX 5500	BPR6HS	7022	0,6	214
EX 7	CR5HSB	6535	0,7	
EXT 12 D	Y-703R	3782		
EZ 2200	BPR5ES	7422	0,7	
EZ 4500	BPR5ES-11	4424	1,1	
G 150 K1	B4H	4110	0,5	
G 200 K1	B4H	4110	0,5	
GCV 520	BPR4HS	7823	0,5	
GCV 530	BPR4HS	7823	0,5	
GD 90 /100	YS-101	5825		
GX 120 /160 /240	BPR6ES	7822	0,7	
GX 270 /340	BPR6ES	7822	0,7	
GX 390 /610 /620	BPR6ES	7822	0,7	
GX 610 K1	BPR6ES	7822	0,5	
GX 620 K1	BPR6ES	7822	0,5	
GXH 50	CR5HSB	6535	0,5	
HS 522	BPR5ES	7422	0,7	
HS 1136 (GX340CDI)	BPR5ES-11	4424	1,1	
W 40	YS-101	5825		
WB 10	BMR4A	5728	0,6	306
WB 15	BMR4A	5728	0,6	306
WH 15X	BPR6ES	7822	0,7	
WH 20X	BPR6ES	7822	0,7	
WP 20	BPR6ES	7822	0,7	
WP 30	BPR6ES	7822	0,7	
WT 30X	BPR6ES	7822	0,7	
WT 40X	BPR6ES	7822	0,7	

JOHN DEERE

225	BMR6A	7421	0,6	307
325	BMR6A	7421	0,6	307
375	BMR6A	7421	0,6	307
500	BMR6A	7421	0,6	307
650	BMR6A	7421	0,6	307
1750W	B4LM	3410	0,6	301
3000W	B4LM	3410	0,6	301
4000W	B4LM	3410	0,6	301
5000W	BR6HS	3922	0,6	

KAWASAKI

GA 550A	BMR6A	7421	0,7	307
---------	-------	------	-----	-----



Order No.  Quick No.

KAWASAKI

GA 1000A	BMR6A	7421	0,7	307
GA 1400A	BMR6A	7421	0,7	307
GA 1800A	BPR4HS	7823	0,7	
GA 2300 -83	B6S	3510	0,8	302
GA 2300A	BPR4HS	7823	0,7	
GA 2300A	BPR4HS	7823	0,8	
GA 3200A	BPR4HS	7823	0,7	
GA 3200AS	BPR4HS	7823	0,7	
GB 2300A	BPR4HS	7823	0,8	
GC 550A	BMR6A	7421	0,7	307
GD 550A	BMR6A	7421	0,7	307
GD 700A	BMR6A	7421	0,7	307
GD 700AS	BMR6A	7421	0,7	307
GE 2200A	BPR5ES	7422	0,7	
GE 2900	BPR5ES	7422	0,8	
GE 2900A	BPR5ES	7422	0,7	
GE 4000	BPR5ES	7422	0,8	
GE 4300 / A	BPR5ES	7422	0,7	
GE 4500 / A	BPR5ES	7422	0,7	
GE 5000 / AS	BPR5ES	7422	0,7	
KG 500	BM6A	5921	0,7	303
KG 550	B6HS	4510	0,7	
KG 550B	BR6HS	3922	0,7	
KG 600	B6HS	4510	0,7	
KG 700	B6HS	4510	0,7	
KG 750	B6HS	4510	0,7	
KG 750B	BR6S	3522	0,7	
KG 900	B6S	3510	0,7	302
KG 1000	B6S	3510	0,7	302
KG 1100B	BR6S	3522	0,7	
KG 1300	B6HS	4510	0,7	
KG 1500	B6HS	4510	0,7	
KG 1600	BR6HS	3922	0,7	
KG 1600B	BR6HS	3922	0,7	
KG 2300 (-83)	B6S	3510	0,7	302
KG 2300	BPR4HS	7823	0,7	
KG 2600	BPR4HS	7823	0,7	
KG 2600 (-83)	B6S	3510	0,7	302
KG 2900	BR6HS	3922	0,7	
KG 4000A	BR6HS	3922	0,7	
KG 4000AS	BR6HS	3922	0,7	
KG 5000 (-83)	BM6A	5921	0,7	303
KG 5000A	BR4HS	3322	0,7	
KG 5000AS	BR4HS	3322	0,7	
KG 5000B	BR4HS	3322	0,7	
KG 5000BS	BR4HS	3322	0,7	

KUBOTA

A 400 (GN550)	BMR4A	5728	0,6	306
A 800 (GN130)	BPR4HS	7823	0,6	
A 1200 (GS130)	BPR4HS	7823	0,6	
A 1800 (GN1850)	BPR4HS-10	5024	1,0	

Order
No.Quick
No.**KUBOTA**

A 2500 (GN2500)	BPR4HS-10	5024	1,0	
A 3050 (GS280)	BPR4HS	7823	0,6	

LZDP

P-10 DU	B5HS	4210	0,7	
P-350	B5HS	4210	0,7	
P-350-1	B5HS	4210	0,7	

MAKITA

G1200R Robin EY15D 143CC	BR6HS	3922	0,6	
G2400R Robin EY20D 183CC	BR6HS	3922	0,6	
G2410R Robin EH17D 172CC	B6HS	4510	0,6	
G3500R Robin EY28D 273CC	BPR6HS	7022	0,6	
G3501R Robin EY28D 273CC	BPR6HS	7022	0,6	
G3510R Robin EH25D 251CC	B6HS	4510	0,6	
G3511R Robin EH25D 251CC	B6HS	4510	0,6	
G5500R Robin EY40D 388CC	BPR4HS	7823	0,6	
G5501R Robin EY40D 388CC	BPR4HS	7823	0,6	
G5710R Robin EH34D 388CC	BR6ES	4922	0,6	
G5711R Robin EH34D 388CC	BR6ES	4922	0,6	

MITSUBISHI

TL 26	BMR6A	7421	0,6	307
TL 33	BMR6A	7421	0,6	307
TL 43	BMR6A	7421	0,6	307
TL 52	BMR6A	7421	0,6	307

NISSAN

D11	BR4ES	1097	0,7	
H20	BR4ES	1097	0,7	
H30	BR4HS	3322	0,7	
J15	BR4ES	1097	0,7	
MA10	BR4ES	1097	0,7	
P40	BR4ES	1097	0,7	

ONAN

0,3TL-212R/1A	B4LM	3410	0,5	301
10JC, 15JC	B6L	3212	0,5	
1B	A6	1010	0,5	
2,7AJ Spec. K-N	BMR6A	7421	0,5	307
3,0AJ	TR5	2238	0,5	
5JB	B6L	3212	0,5	
6,5NH Spec. A-D	B6L	3212	0,5	
6,5NH Spec. J+K	BR6ES	4922	0,5	
AAE / AH / AK	B6L	3212	0,5	
BF Gemini	B6L	3212	0,4	
CCK leichte Belastung	B4L	3112	0,5	
CCK normale Belastung	B6L	3212	0,5	
CK	B6L	3212	0,5	
CUA	B4L	3112	0,6	
CW	A6	1010	0,5	
EC / ED / EF	---			

Order
No.Quick
No.**ONAN**

EL	B6L	3212	0,5	
GO	B6S	3510	0,5	302
H60	B6L	3212	0,5	
HC	A6	1010	0,5	
HH20	B6L	3212	0,5	
HK / HN / HR	A6	1010	0,5	
IC	B6S	3510	0,5	302
J30	B6L	3212	0,5	
JA / JB / JC	B6L	3212	0,5	
JT	A6	1010	0,5	
KA / KB	B6S	3510	0,5	302
KKA	B4L	3112	0,6	
KR	B6S	3510	0,5	302
LK-LKB	B6L	3212	0,5	
MAJ / MCK	B6L	3212	0,5	
MGO	B6S	3510	0,5	302
MJA / MJB / MJC	B6L	3212	0,5	
MKH	B6L	3212	0,5	
MPG	B6S	3510	0,5	302
MTK	A6	1010	0,5	
MUK	B6S	3510	0,5	302
NB	B6L	3212	0,5	
NH Gemini	B6L	3212	0,4	
NHC	BR6ES	4922	0,5	
OTC	B6S	3510	0,5	302
V45	A6	1010	0,5	
W4A	A6	1010	0,5	
WIB	B6S	3510	0,5	302

SUZUKI

SE 400 / A / C / T	BPMR4A	6028	0,7	
SE 500 / A / C	BPMR4A	6028	0,7	
SE 600	BPMR4A	6028	0,6	
SE 700 / A	BPMR6A	6726	0,7	308
SE 800	BPMR4A	6028	0,6	
SE1000	BPR6HS	7022	0,7	
SE1200 / A / L / LA	BPR6HS	7022	0,7	
SE1500	BPR6HS	7022	0,7	
SE1800 / A / K / KL / L / LA	BPR6ES	7822	0,7	
SE2500 / A / K	BPR6HS	7022	0,7	
SE3000 / A	BPR6HS	7022	0,7	
SV 1400	BPR6ES	7822	0,8	
SV 2200	BPR6ES	7822	0,8	
SV 4000	BPR5ES	7422	0,7	
SVW 140	BPR5ES	7422	0,7	
V 270	BPR6HS	7022	0,7	
VM 140	BPMR6A	6726	0,7	308

YAMAHA

EF 600	BPMR6A	6726	0,6	308
EF 1000	BPR6HS	7022	0,6	
EF 1000 B	BPR6HS	7022	0,6	

Order
No.Quick
No.**YAMAHA**

EF 1200 / DV	BPR6HS	7022	0,6
EF 1400	BPR6HS	7022	0,6
EF 1400 / A / DV	BPR6HS	7022	0,6
EF 1400 A	BPR4ES	7222	0,7
EF 1400 X	BPR4ES	7222	0,7
EF 1400K	BPR4HS	7823	0,6
EF 1500S	B7HS	5110	0,7
EF 1600	BPR6HS	7022	0,7
EF 1700 / A / DV	BPR6HS	7022	0,7
EF 1800	BP6HS	4511	0,7
EF 2000 / EF2000DV -84	BP6HS	4511	0,7
EF 2000 / A / DV 85-	BPR6HS	7022	0,7
EF 2000A	BPR6HS	7022	0,7
EF 2000H	BP6HS	4511	0,7
EF 2000HK	BP4HS	3611	0,7
EF 2000K -84	BP4HS	3611	0,7
EF 2000K 85-	BPR4HS	7823	0,7
EF 2100	BPR6HS	7022	0,7
EF 2300 A	BPR4ES	7222	0,7
EF 2300 X	BPR4ES	7222	0,7
EF 2400 A / DV	BPR6HS	7022	0,7
EF 2400 -84	BP6HS	4511	0,7
EF 2500 / R (2100R)	BPR6HS	7022	0,7
EF 2600	BP6HS	4511	0,7
EF 2800 / EF2800DV -84	BP6HS	4511	0,7
EF 2800 / DV 85-	BPR6HS	7022	0,7
EF 2800A	BPR6HS	7022	0,7
EF 2800H	BP6HS	4511	0,7
EF 2800HK	BP4HS	3611	0,7
EF 2800K -84	BP4HS	3611	0,7
EF 2800K 85-	BPR4HS	7823	0,7
EF 3200 / EF 3800	BPR6HS	7022	0,7
EF 3200 E	BPR6HS	7022	0,6
EF 3600(E) / DV(E)	BPR6HS	7022	0,7
EF 3800R (3200R)	BPR6HS	7022	0,7
EF 4000 / DV / E	BPR6HS	7022	0,7
EF 4000 A	BPR4ES	7222	0,7
EF 4000 EX	BPR4ES	7222	0,7
EF 4000 X	BPR4ES	7222	0,7
EF 4000K	BPR4HS	7823	0,7
EF 4300	BPR6HS	7022	0,7
EF 4400 (E) / EF 4400DV (E)	BPR6HS	7022	0,7
EF 4400	BPR6HS	7022	0,7
EF 5000	BPR5ES	7422	0,7
EF 5000(E) / DV(E)	BPR6HS	7022	0,7
EF 5400 / E	BPR5ES	7422	0,7
EF 5500 A	BPR4ES	7222	0,7
EF 5500 EX	BPR4ES	7222	0,7
EF 5500 X	BPR4ES	7222	0,7
EF 6000	BPR5ES	7422	0,7
EFC 1400	BP6HS	4511	0,7
EFC 2000	BP6HS	4511	0,7



Order No.  Quick No.

YAMAHA

EFC 2600	BP6HS	4511	0,7
EFC 2800	BP6HS	4511	0,7
ET 300	BP5HM	7474	0,7
ET 350	B5ES	6410	0,7
ET 500	B5ES	6410	0,7
ET 600 (A)	B5ES	6410	0,7
ET 800	B5ES	6410	0,7
ET 900 (A)	B5ES	6410	0,7
ET 1500 81-	B7HS	5110	0,7
ET 1500 -80	B6HS	4510	0,7
ET 1500D / M / S	B7HS	5110	0,7
MF 150A / S	BP6HS	4511	0,6
MF 180A / AR / S / SR	BP6HS	4511	0,6
MF 180K / AK / SK	BP4HS	3611	0,6
MF 260A / AR / S / SR	BP6HS	4511	0,6
MF 260K / AK / SK	BP4HS	3611	0,6
MF 410 / S / SR	BP6HS	4511	0,6
MF 410SK	BP4HS	3611	0,6
MT 110A / AR	B7HS	5110	0,6
MT 110VL	B7HS	5110	0,6
YG 300S	BPR6HS	7022	0,7
YG 400D	BPR6HS	7022	0,7
YG 500D	BPR5ES	7422	0,8
YG 600D	BPR5ES	7422	0,8
YP 2	B7HS	5110	0,6
YP 3	BP6HS	4511	0,6
YP 10	BR7HS	4122	0,7
YP 10G	BR7HS	4122	0,7
YP 15H	BP6HS	4511	0,6
YP 20	BP4HS	3611	0,6
YP 20G	B7HS	5110	0,6
YP 20G (N)	BP4HS-10	5011	1,0
YP 20GA	BPR6HS	7022	0,7
YP 20GN	BP4HS	3611	0,7
YP 20M /S /Z /H	BP6HS	4511	0,6
YP 20MH	BP6HS	4511	0,6
YP 20NT	BP6HS	4511	0,6
YP 20S	BP6HS	4511	0,7
YP 20TA	BPR6HS	7022	0,7
YP 30	BP5ES	6511	0,6
YP 30E	BP4HS	3611	0,6
YP 30G	BP6HS	4511	0,6
YP 30GA	BPR6HS	7022	0,7
YP 30GK	BP4HS	3611	0,6
YP 30GN -87	BP6HS	4511	0,7
YP 30GN 88-90	BP5ES	6511	0,8
YP 30MH	BP6HS	4511	0,7
YP 30S / T / NT	BP6HS	4511	0,6
YP 30TA	BPR6HS	7022	0,7
YP 40 TA	BPR6HS	7022	0,7



Order
No.



Quick
No.

YANMAR

2TN66E / L	Y-103V	2031		
3T84H	Y-110V			
3TG66 , 72	BPR4ES	7222	0,8	
3TN63L , 66L , 68L , 72L	Y-103V	2031		
3TNA68L , 72E / J / L	Y-103V	2031		
3TNE66E , 68L , 74	Y-103V	2031		
4T112	Y-203VS			
GA 120 , 300	BPR5ES	7422	0,9	
GA 210, 280	BPR5ES	7422	0,9	
GA 90 , 140 , 160 , 180 , 220 , 240	BPR5ES	7422	0,9	
GE 20	BPMR4A	6028	0,7	
GE 50 , 55 , 70 , 77 , 90 , GY35	BPR4HS	7823	0,7	
GY 15 , 20	BPMR4A	6028	0,7	
GY 35	BPR4HS	7823	0,7	
GY 35 (V) , 50 (V)	BR4HS	3322	0,7	
YSG 550E	BPMR4A	6028	0,7	
YSG 750A, AE, E	BPMR4A	6028	0,7	
YSG 1505, 2005, 2505	BPR5ES	7422	0,9	
YSG 1506, 2006, 2506	BPR5ES	7422	0,9	
YSG 3005, 3505	BPR5ES	7422	0,9	
YSG 3006, 3506	BPR5ES	7422	0,9	

Diverse Arbeitsgeräte / Various Tools



Order
No.



Quick
No.

ACME					
A180B		Mehrzweckmotor	BP5HS	4111	0,6
A220B		Mehrzweckmotor	BP5HS	4111	0,6
A230B		Mehrzweckmotor	BP5HS	4111	0,6
A349		Mehrzweckmotor	B4H	4110	0,6
A360		Mehrzweckmotor	B4H	4110	0,6
ACT280 OHC		Mehrzweckmotor	BKR5E	7938	0,6
ACT340 OHC		Mehrzweckmotor	BKR5E	7938	0,6
AL480WB		Mehrzweckmotor	BP5HS	4111	0,6
AL550WB		Mehrzweckmotor	BP5HS	4111	0,6
ALN290WB		Mehrzweckmotor	BP5HS	4111	0,6
ALN330WB		Mehrzweckmotor	BP5HS	4111	0,6
AT220 OHV		Mehrzweckmotor	BP5HS	4111	0,6
AT330 OHV		Mehrzweckmotor	BP5HS	4111	0,6
VT88 OHV		Mehrzweckmotor	BP5HS	4111	0,6
VT94 OHV		Mehrzweckmotor	BP5HS	4111	0,6
AGROS					
Agros			B5HS	4210	0,7
AL-KO					
750 B	Tecna	Laubsauger	BR2LM	5798	0,5 310
Aspera			B4LM	3410	0,5 301
B & S 10,5-13,5PS ohne OHV		Aufsitzmäher/Traktor-Motoren	BR2LM	5798	0,5 310
B & S 12,5-17PS OHV		Aufsitzmäher/Traktor-Motoren	BKR5ES	2460	0,7
B & S 12,5-20PS mit AVS 1&2Zyl		Aufsitzmäher/Traktor-Motoren	BKR5ES	2460	0,7
B&S 4Takt		Rasenmäher-Motoren	BR4LM	4133	0,5
Honda 4 Takt		Rasenmäher-Motoren	BPR5ES	7422	0,7
Tecumseh 11-13PS OHV		Aufsitzmäher/Traktor-Motoren	BR7ES	5122	0,7
Tecumseh 4 Takt		Rasenmäher-Motoren	BR6S	3522	0,6
AS MOTOR					
AS 120 A		Mehrzweckmotor	B6HS	4510	0,6
AS 120 C/D		Mehrzweckmotor	B6HS	4510	0,6
AS 165 A		Mehrzweckmotor	B6HS	4510	0,6
AS 165 D/F		Mehrzweckmotor	B6HS	4510	0,6
AS 165 E		Mehrzweckmotor	B6HS	4510	0,6
AS 165 G		Mehrzweckmotor	B6HS	4510	0,6
AS 165 H		Mehrzweckmotor	B6HS	4510	0,6
AS 165 I		Mehrzweckmotor	B6HS	4510	0,6
AS 165 K		Mehrzweckmotor	B6HS	4510	0,6
AS 165 L		Mehrzweckmotor	B6HS	4510	0,6
AS 165 M		Mehrzweckmotor	B6HS	4510	0,6
AS 165 N		Mehrzweckmotor	B6HS	4510	0,6
S-B 6		Häcksler	B6HS	4510	0,5
B & S					
18 mm Heads			A6	1010	0,7
2.0 HP 69000, 60102			B2LM	1147	0,7
2.5 HP 80100			B2LM	1147	0,7
3.0 HP 80200, 80202, 80300, 81200			B2LM	1147	0,7
3.0 HP 81300, 92500, 94500, 62032, 82000			B2LM	1147	0,7
3.5 HP 93232			BR2LM	5798	0,8 310

Diverse Arbeitsgeräte / Various Tools



Order
No.



Quick
No.

B & S

3.5 HP 93400	BR2LM	5798	0,8	310
3.5 HP 91200	BR2LM	5798	0,7	310
3.5 HP 92900,93500,94900,95500,90700	B2LM	1147	0,7	
3.5 HP 93900,96500,100708,121700	B2LM	1147	0,7	
4.0 HP 85400 OHV	BCPR5ES	6130	0,7	
4.0 HP 100200,100202,100900,110900	B2LM	1147	0,7	
4.0 HP 110700,112200,95100,96799	B2LM	1147	0,7	
4.0 HP 95700,96700,111700,114700	B2LM	1147	0,7	
4.5 HP 126700	B2LM	1147	0,7	
5.0 HP 133400	BR2LM	5798	0,8	310
5.0 HP 135200	BR2LM	5798	0,8	310
5.0 HP 104700	BCP5ES	7496	0,7	
5.0 HP 124700,131700	B2LM	1147	0,7	
5.0 HP 130200,130202,130900,131200	B2LM	1147	0,7	
5.0 HP 131400,131900,132200,132900	B2LM	1147	0,7	
5.5 HP 115400 OHV	BCPR5ES	6130	0,7	
6.0 HP 146400,146700	B2LM	1147	0,7	
7.0 HP 170400,170402,170700,171400	B2LM	1147	0,7	
8.0 HP 196400	BR2LM	5798	0,8	310
8.0 HP 192400	BR2LM	5798	0,8	310
8.0 HP 190400,190402,190700,191700	B2LM	1147	0,7	
8.0 HP 195400,200400,192700,193700	B2LM	1147	0,7	
8.5 HP 196707	BR2LM	5798	0,8	310
9.0 HP 185400 OHV	BCPR5ES	6130	0,7	
9.0 HP 19C400	BR2LM	5798	0,8	310
9.0 HP 161400	BCP5ES	7496	0,7	
9.0 HP 233400	B2LM	1147	0,7	
10.0 HP 19F400	BR2LM	5798	0,8	310
10.0 HP 226400	BR2LM	5798	0,8	310
10.0 HP 243430,251400,251700,222400	B2LM	1147	0,7	
10.0 HP 253700	B2LM	1147	0,7	
10.5 HP 28B707	BR2LM	5798	0,8	310
10.0 HP 220400,220700,221430,243400	B2LM	1147	0,7	
11.0 HP 235400 OHV	BCPR5ES	6130	0,7	
11.0 HP 250400	BR2LM	5798	0,8	310
11.0 HP 256400	BR2LM	5798	0,8	310
11.0 HP 252400,252410,252412,252700	B2LM	1147	0,7	
11.0 HP 253400,253410,253700	B2LM	1147	0,7	
11.5 HP 28D707	BR2LM	5798	0,8	310
12.0 HP 281700	B2LM	1147	0,7	
12.5 HP 286707	BR2LM	5798	0,8	310
12.5 HP 260700,290400 OHV	BCP5ES	7496	0,7	
13.0 HP 245400 OHV	BCPR5ES	6130	0,7	
13.0 HP 28M707	BR2LM	5798	0,8	310
13.0 HP 302430	B2LM	1147	0,7	
14.0 HP 28P777 OHV	BCPR5ES	6130	0,7	
14.0 HP 294777 OHV	BCPR5ES	6130	0,7	
14.0 HP 292700,294400 OHV	BCP5ES	7496	0,7	
14.0 HP 294400 OHV	BCPR5ES	6130	0,8	
14.0 HP 400437,400707	BR6S	3522	0,7	
15.5 HP 28N707 OHV	BCPR5ES	6130	0,7	
16.0 HP 28Q777 OHV	BCPR5ES	6130	0,7	

Diverse Arbeitsgeräte / Various Tools



Order
No.



Quick
No.

B & S

16.0 HP 303777 OHV	BCPR5ES	6130	0,7	
16.0 HP 326400	BR2LM	5798	0,8	310
16.0 HP 422437	BR2LM	5798	0,8	310
16.0 HP 422447	BR2LM	5798	0,8	310
16.0 HP 422707	BR2LM	5798	0,8	310
16.0 HP 42B707	BR2LM	5798	0,8	310
16.0 HP 303400 OHV	BCPR5ES	6130	0,8	
16.0 HP 303400,303700 OHV	BCP5ES	7496	0,7	
16.0 HP 326430	B6S	3510	0,7	302
16.0 HP 401400,401417,401700,401707	BR6S	3522	0,7	
16.0 HP 402400,402417,402431,402437	BR6S	3522	0,7	
16.0 HP 402707	BR6S	3522	0,7	
18.0 HP 350400 OHV	BCPR5ES	6130	0,7	
18.0 HP 350777 OHV	BCPR5ES	6130	0,7	
18.0 HP 422437	BR2LM	5798	0,8	310
18.0 HP 422447	BR2LM	5798	0,8	310
18.0 HP 422707	BR2LM	5798	0,8	310
18.0 HP 42B707	BR2LM	5798	0,8	310
18.0 HP 350000 OHV	BCP5ES	7496	0,7	
18.0 HP 421400,421700,422400,422437	BR6S	3522	0,7	
18.0 HP 422431,422700,422707	BR6S	3522	0,7	
20.0 HP 351400 OHV	BCPR5ES	6130	0,7	
20.0 HP 351777 OHV	BCPR5ES	6130	0,7	
20.0 HP 422707	BR2LM	5798	0,8	310
20.0 HP 42B707	BR2LM	5798	0,8	310
Classic 95902	BR2LM	5798	0,8	310
Diamond XTL 60 12J802	BR2LM	5798	0,7	310
Diamond XTS 60 12J802	BR2LM	5798	0,7	310
ES 375 12S707	BR2LM	5798	0,7	310
Europa 99772 OHV	BCPR5ES	6130	0,7	
Intek EDGE 60 OHV 121602	BCPR5ES	6130	0,8	
Intek OHV 121602	BCPR5ES	6130	0,8	
Intek PRO 65 OHV 122672	BCPR5ES	6130	0,8	
Quantum 128812	BR2LM	5798	0,8	310
Quantum 60XRS 12V802	BR2LM	5798	0,8	310
Quantum XE45 127702	BR2LM	5798	0,8	310
Quantum XM 50 12F802	BR2LM	5798	0,8	310
Quantum XM45 12F802	BR2LM	5798	0,8	310
Quantum XM55 129800	BR2LM	5798	0,8	310
Quantum XRS 60 12V802	BR2LM	5798	0,7	310
Quantum XTE50 12F802	BR2LM	5798	0,8	310
Quantum XTE55 128802	BR2LM	5798	0,8	310
Quantum XTL 55 129802	BR2LM	5798	0,7	310
Quantum XTL55 128802	BR2LM	5798	0,8	310
Quantum XTS 55 128800	BR2LM	5798	0,7	310
Quantum XTS 60 12J802	BR2LM	5798	0,7	310
Quattro 38 9C902	BR2LM	5798	0,8	310
Quattro 40 10A902	BR2LM	5798	0,8	310
Quattro 40 10A902	BR2LM	5798	0,7	310
Sprint 375 98902	BR2LM	5798	0,8	310
Sprint LX 40 10C902	BR2LM	5798	0,7	310

Diverse Arbeitsgeräte / Various Tools



Order
No.



Quick
No.

BOMBARDIER-ROTAX

95	Mehrzweckmotor	B6HS	4510	0,6	
150	Mehrzweckmotor	A6	1010	0,6	
182	Mehrzweckmotor	B6HS	4510	0,6	
232	Mehrzweckmotor	B6HS	4510	0,6	
299	Mehrzweckmotor	A6	1010	0,6	
500	Mehrzweckmotor	A6	1010	0,6	
635	Mehrzweckmotor	A7	1110	0,6	

CRAMER

Tera Cut 3000	Häckseler	BPR6ES	7822	0,7	
Garden Cut 4000	Häckseler	BPR6ES	7822	0,7	
Combi Cut B	Häckseler	BPR6ES	7822	0,7	
CM60	Hacke	BR4HS	3322	0,6	
CM60	Hacke	BR4HS	3322	0,6	
HS 450 BE	Schredder	BPR6ES	7822	0,7	
LS3500	Laubsauger	BR4HS	3322	0,6	
LS5000	Laubsauger	BR4HS	3322	0,6	
LS5000 H	Laubsauger	BR4HS	3322	0,6	

DOLMAR

309 Happy Start	Trennschleifer	BPMR7A	4626	0,5	309
309	Trennschleifer	BPMR7A	4626	0,5	309
343 Happy Start	Trennschleifer	BPMR7A	4626	0,5	309
HT-2256 D	Heckenschere	BMR7A	4226	0,6	
HT-2276 E	Heckenschere	BMR7A	4226	0,6	
PB-250	Gebälse	BMR7A	4226	0,7	
PC-6412	Trennschleifer	BPMR7A	4626	0,5	309
PC-7314	Trennschleifer	BPMR7A	4626	0,5	309
PD-491	Erdbohrer	BPMR7A	4626	0,6	309

ECHO

CLS 4600	Mehrzweckmotor	BPM7A	7321	0,6	305
CLS 4610	Mehrzweckmotor	BPM7A	7321	0,6	305
CS 280 EG	Mehrzweckmotor	BMR6A	7421	0,6	307
CS 3000	Mehrzweckmotor	BPM7A	7321	0,6	305
CS 330 EVL	Mehrzweckmotor	BM6A	5921	0,6	303
CS 3400	Mehrzweckmotor	BPMR7A	4626	0,6	309
CS 3600	Mehrzweckmotor	BPM7A	7321	0,6	305
CS 3900	Mehrzweckmotor	BPM6A	7021	0,6	304
CS 400 EVL	Mehrzweckmotor	BPM6A	7021	0,6	304
CS 4000	Mehrzweckmotor	BPM7A	7321	0,6	305
CS 4200	Mehrzweckmotor	BPM6Y	4562	0,6	
CS 4400	Mehrzweckmotor	BPM7A	7321	0,6	305
CS 4500	Mehrzweckmotor	BPM7A	7321	0,6	305
CS 4601	Mehrzweckmotor	BPM7A	7321	0,6	305
CS 5100	Mehrzweckmotor	BPM8Y	2057	0,6	
CS 5501	Mehrzweckmotor	BPM7A	7321	0,6	305
CS 6701-40	Mehrzweckmotor	BPM7A	7321	0,6	305
CSG 6700	Mehrzweckmotor	BPM6A	7021	0,6	304
ES 1000	Mehrzweckmotor	BPM7A	7321	0,6	305
ES 2000	Mehrzweckmotor	BPM7Y	4921	0,6	
ES 2100	Mehrzweckmotor	BPM7Y	4921	0,6	

Diverse Arbeitsgeräte / Various Tools



Order
No.



Quick
No.

ECHO

ES 2400	Mehrzweckmotor	BPM7Y	4921	0,6	
GT 160	Mehrzweckmotor	BM6A	5921	0,6	303
GT 2010	Mehrzweckmotor	BPM7A	7321	0,6	305
HC 140	Mehrzweckmotor	BM6A	5921	0,6	303
HC 1500	Mehrzweckmotor	BPM6A	7021	0,6	304
HC 160	Mehrzweckmotor	BM6A	5921	0,6	303
HC 1600	Mehrzweckmotor	BPM7A	7321	0,6	305
HC 210 E	Mehrzweckmotor	BM6A	5921	0,6	303
HC 2100	Mehrzweckmotor	BPM7A	7321	0,6	305
HC 2300	Mehrzweckmotor	BPM7A	7321	0,6	305
HC 2410	Mehrzweckmotor	BPM7Y	4921	0,6	
HC-1500	Heckenschere	BPM6A	7021	0,6	304
HC-1600	Heckenschere	BPM7A	7321	0,6	305
HC-2300	Heckenschere	BPM7A	7321	0,6	305
HCA 2410	Mehrzweckmotor	BPM7Y	4921	0,6	
HCR 1500	Mehrzweckmotor	BPMR6A	6726	0,6	308
PB 210 E	Mehrzweckmotor	BPM7A	7321	0,6	305
PB 2405	Mehrzweckmotor	BPM7Y	4921	0,6	
PB 24LN	Mehrzweckmotor	BPM7Y	4921	0,6	
PB 4500	Mehrzweckmotor	BPM7A	7321	0,6	305
PB 46LN	Mehrzweckmotor	BPM7Y	4921	0,6	
PB 6000	Mehrzweckmotor	BPM7Y	4921	0,6	
PB-6000	Kraftgebläse	BPM7Y	4921	0,6	
REC 600	Mehrzweckmotor	BPM7A	7321	0,6	305
RM 310	Mehrzweckmotor	BPM7A	7321	0,6	305
RM 380	Mehrzweckmotor	BPM7A	7321	0,6	305
RM 385	Mehrzweckmotor	BPMR7A	4626	0,6	309
RMA 2530	Mehrzweckmotor	BPM7A	7321	0,6	305
SRA 2190	Mehrzweckmotor	BPM7A	7321	0,6	305
SRM 200BE	Mehrzweckmotor	BM6A	5921	0,6	303
SRM 2010	Mehrzweckmotor	BM6A	5921	0,6	303
SRM 2015	Mehrzweckmotor	BM6A	5921	0,6	303
SRM 2100	Mehrzweckmotor	BPM7A	7321	0,6	305
SRM 2450	Mehrzweckmotor	BPM7Y	4921	0,6	
SRM 2455	Mehrzweckmotor	BPM7Y	4921	0,6	
SRM 250 E	Mehrzweckmotor	BPM7A	7321	0,6	305
SRM 2605	Mehrzweckmotor	BPMR7A	4626	0,6	309
SRM 310 E	Mehrzweckmotor	BPM7A	7321	0,6	305
SRM 3150	Mehrzweckmotor	BPMR7A	4626	0,6	309
SRM 3155	Mehrzweckmotor	BPMR7A	4626	0,6	309
SRM 3800	Mehrzweckmotor	BPM7A	7321	0,6	305
SRM 3805	Mehrzweckmotor	BPM7A	7321	0,6	305
SRM 4600	Mehrzweckmotor	BPM7A	7321	0,6	305
SRM 4605	Mehrzweckmotor	BPM7A	7321	0,6	305
WP 1000	Mehrzweckmotor	BPM7A	7321	0,6	305
WP-1000	Wasserpumpe	BPM7A	7321	0,6	305

EFCO

131	Mehrzweckmotor	BPMR6A	6726	0,6	308
134	Mehrzweckmotor	BPM7A	7321	0,6	305
135	Mehrzweckmotor	BPM7A	7321	0,6	305
136	Mehrzweckmotor	BPM7A	7321	0,6	305

Diverse Arbeitsgeräte / Various Tools



Order
No.



Quick
No.

EFCO

138	Mehrzweckmotor	BPM7A	7321	0,6	305
140	Mehrzweckmotor	BPM7A	7321	0,6	305
140 S	Mehrzweckmotor	BPM7A	7321	0,6	305
142	Mehrzweckmotor	BPM7A	7321	0,6	305
146	Mehrzweckmotor	BPM7A	7321	0,6	305
151	Mehrzweckmotor	BPM7A	7321	0,6	305
156	Mehrzweckmotor	BPM7A	7321	0,6	305
162	Mehrzweckmotor	BPM7A	7321	0,6	305
170	Mehrzweckmotor	BPM7A	7321	0,6	305
171	Mehrzweckmotor	BPM7A	7321	0,6	305
180	Mehrzweckmotor	BPM7A	7321	0,6	305
181	Mehrzweckmotor	BPM7A	7321	0,6	305
8200	Mehrzweckmotor	BPM7A	7321	0,6	305
8220	Mehrzweckmotor	BPM7A	7321	0,6	305
8250 / 8250 IC / D	Mehrzweckmotor	BPM7A	7321	0,6	305
8260 / 8260 D	Mehrzweckmotor	BPM7A	7321	0,6	305
8300	Mehrzweckmotor	BPM7A	7321	0,6	305
8350	Mehrzweckmotor	BPM7A	7321	0,6	305
8400 / 8400 IC	Mehrzweckmotor	BPM7A	7321	0,6	305
8405	Mehrzweckmotor	BPM7A	7321	0,6	305
8420	Mehrzweckmotor	BPM7A	7321	0,6	305
8425	Mehrzweckmotor	BPM7A	7321	0,6	305
8460	Mehrzweckmotor	BPM7A	7321	0,6	305
8465	Mehrzweckmotor	BPM7A	7321	0,6	305
8510	Mehrzweckmotor	BPM7A	7321	0,6	305
8530	Mehrzweckmotor	BPM7A	7321	0,6	305
8550 BOSS	Mehrzweckmotor	BPM7A	7321	0,6	305
AT 2050	Mehrzweckmotor	BPM7A	7321	0,6	305
AT 2080	Mehrzweckmotor	BPM7A	7321	0,6	305
PA 1030	Mehrzweckmotor	BPM7A	7321	0,6	305
PA 1040	Mehrzweckmotor	BPM7A	7321	0,6	305
STARK 26 TR	Mehrzweckmotor	BPM7A	7321	0,6	305
STARK 26/26 IC	Mehrzweckmotor	BPM7A	7321	0,6	305
TR 1540	Mehrzweckmotor	BPM7A	7321	0,6	305
TR 1581 R	Mehrzweckmotor	BPM7A	7321	0,6	305
TS 326	Mehrzweckmotor	BPM7A	7321	0,6	305
TS 326 S	Mehrzweckmotor	BPM7A	7321	0,6	305
TS 330	Mehrzweckmotor	BPM7A	7321	0,6	305
TS 355	Mehrzweckmotor	BPM7A	7321	0,6	305

ERING

5PS RX	Motorhacke	BR2LM	5798	0,5	310
MH-H 15	Motorhacke	BR2LM	5798	0,5	310
T 102155H	Traktor	BKR5ES	2460	0,7	
T 10217 H	Traktor	BKR5ES	2460	0,7	
T 106155 S	Traktor	BKR5ES	2460	0,7	
T 7613 H	Traktor	BR2LM	5798	0,5	310
T 9612 S	Traktor	BR2LM	5798	0,5	310

FLYMO

BVL 320	Luftbesen	BPMR7A	4626	0,5	309
HTL 170	Heckenschere	BPM6A	7021	0,6	304

Diverse Arbeitsgeräte / Various Tools



Order No.  Quick No.

			FLYMO			
HTL 480		Heckenschere	BPMR6A	6726	0,5	308
			FUJI			
DW 67			Y-112T	6327		
DW 100			Y-112T	6327		
DY 40			Y-401-3			
DY 8			Y-401-3			
			GUTBROD			
1100 H	B&S	Traktor	BCPR5ES	6130	0,6	
1200 H	B&S	Traktor	BCPR5ES	6130	0,6	
250 MS 4	Vantage 35T	Motorhacke	BR2LM	5798	0,5	310
G 550	Kawasaki	Motorhacke	B4H	4110	0,6	
G 650	Kawasaki	Motorhacke	B4H	4110	0,6	
G 750	Kawasaki	Motorhacke	BPR5ES	7422	0,6	
GAB 35	B&S	Häcksler	BR2LM	5798	0,5	310
GAB 35	B&S	Häcksler	BR4LM	4133	0,5	
HAE B	B&S	Häcksler	BR2LM	5798	0,5	310
MB 50-35	B&S	Motorhacke	BR4LM	4133	0,5	
MB 62	B&S	Motorhacke	BR2LM	5798	0,5	310
MB 62-35	B&S	Motorhacke	BR4LM	4133	0,5	
MB 62-52	B&S	Motorhacke	BR4LM	4133	0,5	
MB 65-30	Kawasaki	Motorhacke	BM6A	5921	0,6	303
MK 65-30	Kawasaki	Motorhacke	BPR6ES	7822	0,6	
MK 90-50	Kawasaki	Motorhacke	BM6A	5921	0,6	303
			HERKULES			
3500 Kompakt		Schredder	BPR6ES	7822	0,7	
4000 Profi		Schredder	BPR6ES	7822	0,7	
B400		Vertikutierer	BR2LM	5798	0,7	310
FM 300 H		Multitec / Einachser	BPR6ES	7822	0,7	
FM 300 T		Multitec / Einachser	BR4LM	4133	0,5	
KM 450 T		Kehrmaschine	BPMR6A	6726	0,6	307
KM 600 H		Kehrmaschine	BPR6ES	7822	0,7	
KM 600 T		Kehrmaschine	BR2LM	5798	0,7	310
KM 750		Kehrmaschine	BR2LM	5798	0,7	310
MH 202 T		Motorhacke	BPMR6A	6726	0,6	307
MH 300		Motorhacke	B4LM	3410	0,5	301
MH 325 T		Motorhacke	BR2LM	5798	0,7	310
MH 50		Motorhacke	B4LM	3410	0,5	301
MH 50 R		Motorhacke	B4LM	3410	0,5	301
MH 522 BR		Motorhacke	BR2LM	5798	0,7	310
MH 562 HR		Motorhacke	BPR6ES	7822	0,7	
MH 580		Motorhacke	BPR6ES	7822	0,7	
SF 50		Bodenfräse	BPR5ES	7422	0,6	
TBL 4600		Laubsauger / Bläser	BPM6A	7021	0,6	304
TCS 3401		Laubsauger / Bläser	BPMR6A	6726	0,6	307
THB 2510		Laubsauger / Bläser	BPMR6A	6726	0,6	307
THB 2510 V		Laubsauger / Bläser	BPMR6A	6726	0,6	307
TPH 2510		Heckenschere	BPMR6A	6726	0,6	307
TPS 2510		Heckenschere	BPMR6A	6726	0,6	307
UE 500 Super H		Multitec / Einachser	BPR6ES	7822	0,7	

Diverse Arbeitsgeräte / Various Tools



Order
No.



Quick
No.

HERKULES

UE 500 Super T	Multitec / Einachser	BR4LM	4133	0,5	
UE 510 H	Multitec / Einachser	BPR6ES	7822	0,7	
UE 510 Super I	Multitec / Einachser	BR4HS	3322	0,6	
UE 600	Multitec / Einachser	BR4HS	3322	0,6	
UE 600 A	Traktor	B4H	4110	0,6	
UE 600 H	Multitec / Einachser	BPR6ES	7822	0,7	
UE 600 i	Traktor	B4H	4110	0,6	
WM 60BR	Gestrüppschneider	BR2LM	5798	0,7	310
WM 60B	Gestrüppschneider	BKR5ES	2460	0,7	

HINOMOTO

C142, C144, C172, C174	Traktor	Y-112T	6327		INAGUMA
E2302, E2304	Traktor	Y-112T	6327		INAGUMA
E322, E324, E382	Traktor	Y-122	6925		INAGUMA
E384, E392, E394	Traktor	Y-122	6925		INAGUMA
E402, E404	Traktor	Y-112T	6327		INAGUMA
JF-1	Traktor	Y-112T	6327		INAGUMA
JF-1 IC Glow System	Traktor	Y-702R	1065		INAGUMA

HIRTH

04	Mehrzweckmotor	BPMR6A	6726	0,5	308
08	Mehrzweckmotor	B7HS	5110	0,5	
84	Mehrzweckmotor	A6	1010	0,5	
85	Mehrzweckmotor	A6	1010	0,5	
102	Mehrzweckmotor	B5HS	4210	0,5	
112	Mehrzweckmotor	A6	1010	0,5	
150	Mehrzweckmotor	A6	1010	0,5	
151	Mehrzweckmotor	A6	1010	0,5	
152	Mehrzweckmotor	B6HS	4510	0,5	
241	Mehrzweckmotor	B5HS	4210	0,5	
263	Mehrzweckmotor	B7ES	1111	0,5	
1440	Mehrzweckmotor	B6HS	4510	0,5	
1444	Mehrzweckmotor	B6HS	4510	0,5	
2702	Mehrzweckmotor	B8HS	5510	0,5	

HOMELITE

ht 17	Heckenschere	BPMR7A	4626	0,6	309
ht 21	Heckenschere	BPMR7A	4626	0,6	309
HX 16	Heckenschere	BPMR7A	4626	0,6	309

HONDA

90		YS-101	5825		
100		YS-101	5825		
F 110	Hacke	BMR4A	5728	0,6	306
F 210	Hacke	BMR4A	5728	0,6	306
F 220	Hacke	CR4HSB	4695	0,5	
F 325	Hacke	BPR6ES	7822	0,6	
F 360	Hacke	BPR5ES	7422	0,6	
F 501	Hacke	BPR5ES	7422	0,6	
F 560	Hacke	BPR5ES	7422	0,6	
F 660	Hacke	BPR5ES	7422	0,6	
F 810	Hacke	BPR5ES	7422	0,6	

Diverse Arbeitsgeräte / Various Tools



Order
No.



Quick
No.

HONDA

FG 200	Hacke	CR4HSB	4695	0,5	
FG 315	Hacke	BPR6ES	7822	0,7	
FG 500	Hacke	BPR6ES	7822	0,7	
FR 750	Hacke	BPR5ES	7422	0,7	
FU 750 Lucky		BPR6ES	7822	0,6	
G 100 K1		BMR4A	5728	0,7	306
G 100 K2		BPMR4A	6028	0,7	
G 101		BR4HS	3322	0,6	
G 150		BR4HS	3322	0,6	
G 150 CDI		BR4HS	3322	1,0	
G 150 K1		B4	3210	0,6	
G 200		BR4HS	3322	0,6	
G 200 CDI		BPR4HS-10	5024	1,0	
G 200 K1		B4	3210	0,6	
G 300		BR4HS	3322	0,6	
G 300 CDI		BPR4HS-10	5024	1,0	
G 400		BPR4HS-10	5024	1,0	
G 400 K1		BPR4HS	7823	0,6	
G 400 K1 CDI		BPR4HS-10	5024	1,0	
GC 135		BPR6ES	7822	0,7	
GC 160		BPR6ES	7822	0,7	
GC 190		BPR6ES	7822	0,7	
GCV 135		BPR6ES	7822	0,7	
GCV 160		BPR6ES	7822	0,7	
GCV 190		BPR6ES	7822	0,7	
GCV 520		BPR5ES	7422	0,5	
GCV 530		BPR5ES	7422	0,5	
GD90		YS-101	5825		
GD100		YS-101	5825		
GV 100		BMR4A	5728	0,6	306
GV 100 K1		BMR4A	5728	0,6	306
GV 100 K2		BPMR4A	6028	0,6	
GV 150		BMR6A	7421	0,9	307
GV 150 CDI		BPMR6A	6726	0,9	308
GV 200		BMR6A	7421	0,9	307
GV 200 CDI		BPMR6A	6726	0,9	308
GV 400		BMR6A	7421	0,9	307
GV 400 CDI		BPMR6A	6726	0,9	308
GX 22		CR5HSB	6535	0,7	
GX 25		CMR5H	7599	0,6	
GX 25		CMR5H	7599		
GX 30		CR5HSB	6535	0,7	
GX 31		CR5HSB	6535	0,7	
GX 100 TAMP		CR5HSB	6535	0,6	
GX 100		CR5HSB	6535	0,6	
GX 110		BPR6ES	7822	0,6	
GX 120		BPR6ES	7822	0,7	
GX 140		BPR6ES	7822	0,6	
GX 160		BPR6ES	7822	0,7	
GX 160 K1		BPR6ES	7822	0,7	
GX 200		BPR6ES	7822	0,7	
GX 240 K1		BPR6ES	7822	0,7	

Diverse Arbeitsgeräte / Various Tools



Order
No.



Quick
No.

HONDA

GX 240		BPR6ES	7822	0,7	
GX 270		BPR6ES	7822	0,7	
GX 340		BPR6ES-11	4824	1,1	
GX 340 K1		BPR6ES	7822	0,7	
GX 360		BPR4HS	7823	0,6	
GX 360 K1		BPR4HS	7823	0,6	
GX 390		BPR6ES	7822	0,7	
GX 390 K1		BPR6ES	7822	0,7	
GX 610		BPR6ES	7822	0,7	
GX 610K1		ZGR5A	5839	0,6	
GX 620		BPR6ES	7822	0,7	
GX 620K1		ZGR5A	5839	0,6	
GX 640		BPR5ES-11	4424	1,1	
GX 670		ZGR5A	5839	0,6	
GXH 50		CR4HSB	4695	0,5	
GXV 50		CR4HSB	4695	0,7	
GXV 120		BPR5ES	7422	0,7	
GXV 140		BPR5ES	7422	0,7	
GXV 160		BPR5ES	7422	0,7	
GXV 160 K1		BPR5ES	7422	0,7	
GXV 270		BPR5ES	7422	0,7	
GXV 270 K1		BPR5ES	7422	0,7	
GXV 340		BPR5ES	7422	0,7	
GXV 340 K1		BPR5ES	7422	0,7	
GXV 340 K2		BPR5ES	7422	0,7	
GXV 390		BPR5ES	7422	0,7	
GXV 390 K1		BPR5ES	7422	0,7	
GXV 390 K2		BPR5ES	7422	0,7	
GXV 520		BPR5ES	7422	0,7	
GXV 530		BPR5ES	7422	0,7	
GXV 610		BPR5ES	7422	0,7	
GXV 610K1		ZGR5A	5839	0,6	
GXV 620		BPR5ES	7422	0,7	
GXV 620K1		ZGR5A	5839	0,6	
GXV 670		ZGR5A	5839	0,6	
H 5518	Traktor	BPR5ES-11	4424	1,1	
H 5518	Traktor	BPR5ES-11	4424	0,6	
H 6522	Traktor	Y-703R	3782		
HP 250	Allwegtransporter	BMR4A	5728	0,7	306
HP 400	Allwegtransporter	BPR4ES	7222	0,7	
HP 500 BXE	Allwegtransporter	BRP6ES	7822	0,8	
HP 500 NXE	Allwegtransporter	BPR6ES	7822	0,8	
HS 1136G	Schneefräse	BP5ES	6511	0,6	
HS 1180	Schneefräse	BPR5ES	7422	0,5	
HS 1390	Schneefräse	BPR5ES	7422	0,6	
HS 1810	Schneefräse	ZGR5A	5839	0,6	
HS 550	Schneefräse	BPR5ES	7422	0,5	
HS 621	Schneefräse	BPR5ES	7422	0,6	
HS 622T	Schneefräse	BPR5ES	7422	0,6	
HS 622TS	Schneefräse	BPR5ES	7422	0,6	
HS 622W	Schneefräse	BPR5ES	7422	0,6	
HS 624T	Schneefräse	BPR5ES	7422	0,6	

Diverse Arbeitsgeräte / Various Tools



Order
No.



Quick
No.

HONDA

HS 624TS	Schneefräse	BPR5ES	7422	0,6	
HS 624W	Schneefräse	BPR5ES	7422	0,6	
HS 624WS	Schneefräse	BPR5ES	7422	0,6	
HS 760	Schneefräse	BPR5ES	7422	0,6	
HS 828TS	Schneefräse	BPR5ES	7422	0,6	
HS 828W	Schneefräse	BPR5ES	7422	0,6	
HS 828WS	Schneefräse	BPR5ES	7422	0,6	
HS 970	Schneefräse	BPR5ES	7422	0,6	
W40		YS-101	5825		
WB 10	Wasserpumpe	BMR4A	5728	0,7	306
WB 15	Wasserpumpe	BMR4A	5728	0,7	306
WH 15 X	Wasserpumpe	BPR6ES	7822	0,7	
WH 20 X	Wasserpumpe	BPR6ES	7822	0,7	
WMP 20X	Wasserpumpe	BRP6ES	7822	0,8	
WN 20	Wasserpumpen	BRP6ES	7822	0,8	
WP 20 X	Wasserpumpe	BPR6ES	7822	0,7	
WP 30 X	Wasserpumpe	BPR6ES	7822	0,7	
WT 30 X	Wasserpumpe	BPR6ES	7822	0,7	
WT 40 X	Wasserpumpe	BPR6ES	7822	0,7	
WX 10	Wasserpumpe	CR5HSB	6535	0,7	
WX 15	Wasserpumpe	CR5HSB	6535	0,7	

ISHIKAWAJIMA-SHIBAURA

CM224(S753)		Y-701R	7464		
CM274(J823)		Y-701R	7464		
DL, LFD, MWN, LE-892		Y-401-3			
E642 For EU		Y-107V	6628		
E643 For EU		Y-107V	6628		
E643, E673 For USA,CDN		Y-701R	7464		
E672		Y-701R	7464		
H763, H843		Y-107V	6628		
J774, J774T		Y-701R	7464		
J823, J843 For EU		Y-107V	6628		
J823, J843 For USA,CDN		Y-701R	7464		
K713, K773		Y-107V	6628		
LEH822, LEK752C, LEK802D		Y-107V	6628		
LEM754A, LEM754AT		Y-107V	6628		
LEP854A		Y-107V	6628		
LGT(E643)		Y-701R	7464		
LGT16(E673)		Y-701R	7464		
N843, N844 For USA,CDN		Y-701R	7464		
N843,N844,N844-T For USA,CDN		Y-701RS	2765		
N843-DI		Y-119V			
N844 For EU		Y-701R	7464		
N844L For EU		Y-107V	6628		
S723, S753 For USA,CDN		Y-701R	7464		
S723, S753, S773 For EU		Y-107V	6628		
S773L		YE01	2649		
T854B For EU		Y-107V	6628		
T854B, T854BT		Y-701R	7464		
T854B-DI, T854B-DI(T/C)		Y-119V			

Diverse Arbeitsgeräte / Various Tools



Order
No.



Quick
No.

JOHN DEERE

2	Luftbesen	BM6A	5921	0,6	303
4	Luftbesen	BM6A	5921	0,6	303
5	Holzspalter	B6S	3510	0,6	302
320	Schneeräumer	B2	3110	0,6	
321	Schneeräumer	BPMR6A	6726	0,6	308
520	Schneeräumer	BPMR6A	6726	0,6	308
824	Schneeräumer	BPMR6A	6726	0,6	308
1026	Schneeräumer	B4LM	3410	0,6	301
3TN66-UJ		Y-702R	1065		
3TN72-UJ		Y-702R	1065		
B&S	Beschneidemesser	B2LM	1147	0,6	
B&S 116 engine	Kleintraktor	BR6S	3522	0,6	
B&S engine	Schneeräumer	B2LM	1147	0,6	
Kawasaki FA210Y 5.2hp	Beschneidemesser	BMR6A	7421	0,6	307
Kawasaki FB460V 12.5hp	Beschneidemesser	BMR6A	7421	0,6	307
Kawasaki FB540V 17hp	Beschneidemesser	BPR5ES	7422	0,6	
Kawasaki FC290Y 9hp	Beschneidemesser	BPR5ES	7422	0,6	
	Kehrmaschine	B6S	3510	0,6	302
Kioritz	Beschneidemesser	BM6A	5921	0,6	303
Kohler K181 8hp	Beschneidemesser	B6S	3510	0,6	302
Kohler K241 10hp	Beschneidemesser	B6L	3212	0,6	
Kohler K301 12hp	Beschneidemesser	B6L	3212	0,6	
Kohler K321 14hp	Beschneidemesser	B6L	3212	0,6	
Kohler K341 16hp	Beschneidemesser	B6L	3212	0,6	
Kohler KT17 17hp	Beschneidemesser	UR4	4762	0,6	
Kohler K532 20hp	Beschneidemesser	B6L	3212	0,6	
Tecumseh	Beschneidemesser	B6S	3510	0,6	302
Onan 316 engine	Kleintraktor	TR5	7837	0,6	
Onan 318 engine	Kleintraktor	TR5	7837	0,6	
Onan 420 engine	Kleintraktor	TR5	7837	0,6	
	Spreyer	B6S	3510	0,6	302
Tecumseh engine	Schneeräumer	B6S	3510	0,6	302
Yanmar F912	Kleintraktor	BP5ES	6511	0,6	
Yanmar F932	Kleintraktor	BP5ES	6511	0,6	

JONSERED

BV 32	Luftbesen	BPM6A	7021	0,4	304
HT 21	Heckenschere	BPM6A	7021	0,7	304
HT 24	Heckenschere	BPM6A	7021	0,6	304
WP 25	Wasserpumpe	BPM6A	7021	0,6	304

KAWASAKI

TH 26	Vorsatzmotor	BPMR6A	6726	0,5	308
FA 76 -82	Vorsatzmotor	BMR6A	7421	0,7	307
FA 76 83-	Vorsatzmotor	BM4A	5628	0,7	
FA 76, 130, 210	Vorsatzmotor	BP4HS	3611	0,7	
FA 130	Vorsatzmotor	BMR6A	7421	0,7	307
FA 210 -82	Vorsatzmotor	BM6	2027	0,7	
FA 210 83-	Vorsatzmotor	BM6A	5921	0,7	303
FB 460	Vorsatzmotor	BMR4A	5728	0,7	306
FC 150 , 180	Vorsatzmotor	BPR5ES	7422	0,7	
FC 290 V	Mehrzweckmotor	BPR5ES	7422	0,6	

Diverse Arbeitsgeräte / Various Tools



Order
No.



Quick
No.

KAWASAKI

FC 290, 400, 401	Vorsatzmotor	BPR5ES	7422	0,7	
FC 420 V	Mehrzweckmotor	BPR5ES	7422	0,6	
FC 420, 540	Vorsatzmotor	BPR5ES	7422	0,7	
FC 540 V	Mehrzweckmotor	BPR5ES	7422	0,6	
FC150V	Vorsatzmotor	BPR5ES	7422	0,6	
FC180V	Vorsatzmotor	BPR5ES	7422	0,6	
FD 440, 501, 590	Vorsatzmotor	BMR6A	7421	0,7	307
FD590V	Vorsatzmotor	BMR4A	5728	0,6	306
FD611V	Vorsatzmotor	BMR6A	7421	0,6	307
FD 620	Vorsatzmotor	BMR4A	5728	0,7	306
FD661D	Vorsatzmotor	BMR6A	7421	0,6	307
FD 671 D	Mehrzweckmotor	BPR2ES	2264	0,6	
FD 711 D	Mehrzweckmotor	BPR2ES	2264	0,6	
FD 750 D	Mehrzweckmotor	BPR2ES	2264	0,6	
FD 791 DFI	Mehrzweckmotor	BPR4ES	7222	0,6	
FE 120, 170, 250	Vorsatzmotor	BPR5ES	7422	0,7	
FE 290, 350	Vorsatzmotor	BPR5ES	7422	0,7	
FE 400 D	Mehrzweckmotor	BPR5ES	7422	0,6	
FG 110	Vorsatzmotor	BP4HS	3611	0,7	
FG 150	Vorsatzmotor	BPR4HS	7823	0,7	
FG 200, 201, 230	Vorsatzmotor	BP4HS	3611	0,7	
FG 270, 300	Vorsatzmotor	BP4HS	3611	0,7	
FH 381 V	Mehrzweckmotor	BPMR6A	6726	0,6	308
FH 430 V	Mehrzweckmotor	BPMR6A	6726	0,6	308
FH 451 V	Mehrzweckmotor	BPMR6A	6726	0,6	308
FH500V	Vorsatzmotor	BPMR6A	6726	0,6	308
FH 531 V	Mehrzweckmotor	BPMR6A	6726	0,6	308
FH 601 D	Mehrzweckmotor	BPR5ES	7422	0,6	
FH 601 V	Mehrzweckmotor	BPR4ES	7222	0,6	
FH 641 D	Mehrzweckmotor	BPR5ES	7422	0,6	
FH 641 V	Mehrzweckmotor	BPR4ES	7222	0,6	
FH 680 D	Mehrzweckmotor	BPR5ES	7422	0,6	
FH 680 V	Mehrzweckmotor	BPR4ES	7222	0,6	
FH 721 D	Mehrzweckmotor	BPR4ES	7222	0,6	
FH 721 V	Mehrzweckmotor	BPR4ES	7222	0,6	
KF 24, 53,-A, 82	Vorsatzmotor	B6HS	4510	0,7	
KF 64, 140	Vorsatzmotor	B4	3210	0,7	
KF 100	Vorsatzmotor	BR4HS	3322	0,7	
KF 150, 200	Vorsatzmotor	B4H	4110	0,7	
KHD 600A	Heckenschere	BMR4A	5728	0,7	306
KHS 750A	Heckenschere	BMR4A	5728	0,7	306
KRB 400A	Laubbläser	BPMR7A	4626	0,5	309
KRB 400B	Laubbläser	BPMR7A	4626	0,5	309
KT 12	Vorsatzmotor	BM6A	5921	0,7	303
KT 12AD	Vorsatzmotor	BMR6A	7421	0,7	307
KT 12D, -J, 15D	Vorsatzmotor	BM7	6321	0,7	
KT 15J	Vorsatzmotor	B6S	3510	0,7	302
KT 17J	Vorsatzmotor	BM7A	6521	0,7	
KT 18J -82	Vorsatzmotor	B6S	3510	0,7	302
KT 18J 83-	Vorsatzmotor	B4	3210	0,7	
KT 28 -82	Vorsatzmotor	B6S	3510	0,7	302
KT 28 83-	Vorsatzmotor	B4	3210	0,7	

Diverse Arbeitsgeräte / Various Tools



Order
No.



Quick
No.

KAWASAKI

KT 29	Vorsatzmotor	B6HS	4510	0,7	
KT 30J, 35	Vorsatzmotor	B6S	3510	0,7	302
KT 33, 43	Vorsatzmotor	B6HS	4510	0,7	
KWN 10 A	Wasserpumpe	BMR7A	4626	0,5	
KWN 15 A	Wasserpumpe	BMR6A	7421	0,5	307
KWN 20 A	Wasserpumpe	BPR5ES	7422	0,6	
KWN 30 A	Wasserpumpe	BPR5ES	7422	0,6	
KWS 20 A	Wasserpumpe	BPR5ES	7422	0,6	
KWS 30 A	Wasserpumpe	BPR5ES	7422	0,6	
KWT 20 A	Wasserpumpe	BPR5ES	7422	0,6	
KWT 30 A	Wasserpumpe	BPR5ES	7422	0,6	
KWT 40 A	Wasserpumpe	BPR5ES	7422	0,6	
TA 22, 24, 33	Vorsatzmotor	BM7	6321	0,7	
TA 36, 51	Vorsatzmotor	B7S	3710	0,7	
TA 40 -82	Vorsatzmotor	B7S	3710	0,7	
TA 40 83-	Vorsatzmotor	BM7	6321	0,7	
TD 18, 48	Vorsatzmotor	BM6A	5921	0,7	303
TD 24, 33 / -82	Vorsatzmotor	BM7	6321	0,7	
TD 24, 33 / 83-	Vorsatzmotor	BM6A	5921	0,7	303
TD 40, 51 / -82	Vorsatzmotor	BM7	6321	0,7	
TD 40, 51 / 83-	Vorsatzmotor	BM6A	5921	0,7	303
TE 27, 35, 40	Vorsatzmotor	BM7A	6521	0,7	
TE 48, 56	Vorsatzmotor	BM7A	6521	0,7	
TE 59	Vorsatzmotor	BPM7A	7321	0,6	305
TEX45	Vorsatzmotor	BPM7A	7321	0,6	305
TEX 54	Vorsatzmotor	BM6A	5921	0,7	303
TF 22	Vorsatzmotor	BM7A	6521	0,7	
TF 24, 33	Vorsatzmotor	BM7A	6521	0,7	
TG 18, 20, 24	Vorsatzmotor	BM6A	5921	0,7	303
TG 25, 28, 33	Vorsatzmotor	BM6A	5921	0,7	303
TGX 23	Vorsatzmotor	BM6A	5921	0,7	303
TH 23		BPMR6A	6726	0,6	308
TH 26		BPMR6A	6726	0,6	308
TH 34	Mehrzweckmotor	BPMR6A	6726	0,6	308
TH 43, 48	Vorsatzmotor	BM6A	5921	0,7	303

KUBOTA

B 1200 (D750L)	Traktor	Y-103V	2031		
B 1400 (D850L)	Traktor	Y-103V	2031		
B 1402DT (D850L)	Traktor	Y-103V	2031		
B 1500 (D850M)	Traktor	Y-103V	2031		
B 1502DT (D850M)	Traktor	Y-103V	2031		
B 1600 (D950)	Traktor	Y-103V	2031		
B 1702 (D950)	Traktor	Y-103V	2031		
B 1902 (D950)	Traktor	Y-103V	2031		
B 5001 (Z5001-1)	Traktor	Y-103V	2031		
B 5100 (Z500-1A)	Traktor	Y-103K	6325		
B 6100 (D650A)	Traktor	Y-103K	6325		
B 7001 (D750A)	Traktor	Y-103K	6325		
B 7100 (D750A)	Traktor	Y-103K	6325		
B 8200 (D950)	Traktor	Y-103V	2031		
GL 240K (D1463-L-N)	Traktor	Y-716RS	4693		

Diverse Arbeitsgeräte / Various Tools



Order
No.



Quick
No.

KUBOTA

GL 3500 (ZB400GL)	Traktor	Y-103V	2031		
GL 4500 (ZB500GL)	Traktor	Y-103V	2031		
GL 4500S (ZB400GL)	Traktor	Y-103V	2031		
GL 5500 (ZB600GL)	Traktor	Y-103V	2031		
GL 5500S (ZB500GL)	Traktor	Y-103V	2031		
GL 6500S (ZB600GL)	Traktor	Y-103V	2031		
L 175 (Z751)	Traktor	Y-106-1	6525		
L 185 (Z751-A)	Traktor	Y-106-1	6525		
L 245 (D1101-A)	Traktor	Y-106-1	6525		
L 295 (D1301-A)	Traktor	Y-106-1	6525		
L 345 (V1501DA)	Traktor	Y-106-1	6525		
L 1501 (Z751)	Traktor	Y-106-1	6525		
L 1501 (Z751)	Traktor	Y-106-1	6525		
L 1802 (D1102)	Traktor	Y-106V	6926		
L 2002 (D1302)	Traktor	Y-106V	6926		
L 2201 (DH1101)	Traktor	Y-106-1	6525		
L 2201 (DH1101)	Traktor	Y-106-1	6525		
L 2202 (D1402-L)	Traktor	Y-106V	6926		
L 2402 (D1402)	Traktor	Y-106V	6926		
L 245 (D1101-A)	Traktor	Y-106-1	6525		
L 2601 (V1502-L)	Traktor	Y-106V	6926		
L 2602 (VT1502)	Traktor	Y-106V	6926		
L 275 (D1302-A)	Traktor	Y-106V	6926		
L 2802 (V1502)	Traktor	Y-106V	6926		
L 295 (D1301-A)	Traktor	Y-106-1	6525		
L 3001 (V1501-A)	Traktor	Y-106-1	6525		
L 3001 (V1501-A)	Traktor	Y-106-1	6525		
L 305 (D1302-DA)	Traktor	Y-106V	6926		
L 3202 (V1502)	Traktor	Y-106V	6926		
L 345 (V1501-DA)	Traktor	Y-106-1	6525		
L 3602 DT (V1902)	Traktor	Y-106V	6926		
L 4202 (V1502)	Traktor	Y-106V	6926		
L 4202 DT (V1502)	Traktor	Y-106V	6926		
L 4212 (V1502)	Traktor	Y-106V	6926		
M 4000 (S2600)	Traktor	Y-106-1	6525		
M 4000 (S2600)	Traktor	Y-106-1	6525		
M 4030 (S2600-DI)	Traktor	Y-119V			
M 4500 (S2600-A)	Traktor	Y-106-1	6525		
M 4500 (S2600-A)	Traktor	Y-106-1	6525		
M 4950 (S2800)	Traktor	Y-106V	6926		
M 5000 (D3000)	Traktor	Y-203	2532		
M 5030 (S2802-DI)	Traktor	Y-119V			
M 5270 (D3000-1)	Traktor	Y-203V	7728		
M 5500 (D3000-A)	Traktor	Y-203	2532		
M 5950 (D3200)	Traktor	Y-203V	7728		
M 5970 (D3200-1)	Traktor	Y-203V	7728		
M 6000 (V4000-L)	Traktor	Y-203	2532		
M 6030 (D3200)	Traktor	Y-203V	7728		
M 6950 (V4000-2)	Traktor	Y-203V	7728		
M 6970 (V4000-3,V4000-4)	Traktor	Y-203V	7728		
M 7000 (V4000)	Traktor	Y-203	2532		
M 7030 (V3200,V4000)	Traktor	Y-203V	7728		

Diverse Arbeitsgeräte / Various Tools



Order
No.



Quick
No.

KUBOTA

M 7950 (V4300)	Traktor	Y-203V	7728		
M 7970 (V4300-1)	Traktor	Y-203V	7728		
M 8030 (V4300)	Traktor	Y-203V	7728		
M 9750 (V4300-T1)	Traktor	Y-203V	7728		
M 9950 (V4300-T)	Traktor	Y-203V	7728		
M 10570 (F5400)	Traktor	Y-203V	7728		
NX 1000 (Z600)		Y-103V	2031		
NX 1100 (ZB500)		Y-103K	6325		
NX 1300 (ZB600)		Y-103K	6325		
NX 1500 (D850C)		Y-103K	6325		
NX 1600 (D950)		Y-103V	2031		
NX 1800 (D850)		Y-103K	6325		
NX 2000 (D950C)		Y-103V	2031		
NX 2200 (D950)		Y-103V	2031		
NX 3000 (D1301)		Y-106-1	6525		
RX 550 (E75-C2)		Y-103V	2031		
RX 700 (E75-C)		Y-103V	2031		
RX 750 (ZB400-C2)		Y-103V	2031		
RX 900 (ZB400)		Y-103V	2031		
RX 1100 (Z600-C1)		Y-103V	2031		
RX 1300 (Z620-C)		Y-103V	2031		
RX 1450 (D640-C)		Y-103V	2031		
RX 1500 (D750)		Y-103K	6325		
RX 1500 (D750-C)		Y-103V	2031		
RX 1550 (D750-C)		Y-103V	2031		
RX 1900 (D850-C2)		Y-103V	2031		
RX 2100 (D950-C)		Y-103V	2031		
RX 2450 (V1200-C)		Y-103V	2031		
RX 2800 (DH1402-C)		Y-103V	2031		
RX 3250 (D1462DI-C)		Y-119V			
RX 3250 (DH62DI-C)		Y-103V	2031		
ZB 600 C-I	Kühlgerät	Y-149	6766		

LITTLE WONDER

2216 DE	Heckenschere	BPM6A	7021	0,6	304
2224 DE	Heckenschere	BPM6A	7021	0,6	304
2230 DE	Heckenschere	BPM6A	7021	0,6	304
2230 SE	Heckenschere	BPM6A	7021	0,6	304
2242 SE	Heckenschere	BPM6A	7021	0,6	304
9005 P	Luftbesen	B2LM	1147	0,5	
9008 P / IC	Luftbesen	B2LM	1147	0,5	
9333	Luftbesen	BPM7A	7321	0,6	305
9444 E	Luftbesen	BPM7A	7321	0,6	305

LZDP

P-10 DU		B5HS	4210	0,7	
P-350		B5HS	4210	0,7	
P-350-1		B5HS	4210	0,7	

MAG

1014 SRL	Mehrzweckmotor	B4H	4110	0,7	
1017 SRL	Mehrzweckmotor	B4H	4110	0,5	

Diverse Arbeitsgeräte / Various Tools



Order
No.



Quick
No.

MAG

1021 SRL	Mehrzweckmotor	B4H	4110	0,7	
1023 SRL	Mehrzweckmotor	B4H	4110	0,5	
1026 SRL	Mehrzweckmotor	B4H	4110	0,5	
1029 SRL	Mehrzweckmotor	B4H	4110	0,5	
1035 SRL	Mehrzweckmotor	B4H	4110	0,5	
1040 SRL	Mehrzweckmotor	B4H	4110	0,5	
1045 SRL	Mehrzweckmotor	B4H	4110	0,5	
2055 SRL	Mehrzweckmotor	B7HS	5110	0,5	
2076 SRL	Mehrzweckmotor	B4H	4110	0,5	

MARUYAMA

BL 471	Luftbesen	BPM6Y	4562	0,6	
ED 260	Kantenschneider	BPM6Y	4562	0,6	
HT 201D	Heckenschere	BPM6Y	4562	0,6	
HT 260D	Heckenschere	BPM6Y	4562	0,6	
MBS 260	Heckenschere	BPM6Y	4562	0,6	
MC 260 / C / S / E / D	Multischneider	BPM6Y	4562	0,6	
MC 261	Multischneider	BPM6Y	4562	0,6	
MS 056E	Sprayer	BPM6Y	4562	0,6	

McCULLOCH

Tivoli 45	Heckenschere	BMR6F	2144	0,5	
Tivoli 60	Heckenschere	BMR6F	2144	0,5	
Virginia MH 542	Heckenschere	BMR6F	2144	0,5	
Virginia MH 548	Heckenschere	BMR6F	2144	0,5	
Virginia MH 555	Heckenschere	BMR6F	2144	0,5	

MITSUBISHI

G 400	Mehrzweckmotor	BM6A	5921	0,7	303
GM 131	Mehrzweckmotor	BP5ES	6511	0,7	
GM 181	Mehrzweckmotor	BP5ES	6511	0,7	
GM 291	Mehrzweckmotor	BP5ES	6511	0,7	
GM 301	Mehrzweckmotor	BP5ES	6511	0,7	
GM 91	Mehrzweckmotor	BP5ES	6511	0,7	
K2A (S)/ 2B/ C		Y-114T	6528		
K3		Y-110	6825		
K3A /B /C /D /E / F / H /M		Y-114T	6528		
K4A		Y-110	6825		
KE130 / 135		Y-160			
KE140 / 150 06.76-		Y-201	1026		
KE250 / 270		Y-251	2026		
KE31		Y-802-2			
KE55 / 80/ 95/ 130 -05.76		Y-110	6825		
KE70 / 70L / 75 / 75L		Y-110	6825		
T 200	Mehrzweckmotor	BM6A	5921	0,6	303
T 240	Mehrzweckmotor	B4	3210	0,6	
TL 20	Mehrzweckmotor	BM6A	5921	0,6	303
TL 23	Mehrzweckmotor	BM6A	5921	0,6	303
TL 26	Mehrzweckmotor	BMR6A	7421	0,6	307
TL 33	Mehrzweckmotor	BMR6A	7421	0,6	307
TL 43	Mehrzweckmotor	BMR6A	7421	0,6	307
TL 52	Mehrzweckmotor	BMR6A	7421	0,6	307

Diverse Arbeitsgeräte / Various Tools



Order
No.



Quick
No.

MITSUBISHI

TM 18	Mehrzweckmotor	BM6A	5921	0,6	303
TM 21	Mehrzweckmotor	BM6A	5921	0,6	303
TM 24	Mehrzweckmotor	BM6A	5921	0,6	303
TM 33	Mehrzweckmotor	BM6A	5921	0,6	303

MK

MK-1A Krot		BP6HS	4511	0,6	
MK-50		BP6HS	4511	0,6	

MMB

MMB-4		B5HS	4210	0,7	
-------	--	------	------	-----	--

MTD

Cub Cadet	Kohler Comand CV/CH 18--25	BKR5E	7938	0,7	
Cub Cadet	Tecumseh Standard/Seitengesteuerte Motoren	BR2LM	5798	0,7	310
Cub Cadet	B&S Intek Motoren	BKR5E	7938	0,7	
Cub Cadet	Kawasaki Typ FE 250 D	BPR5ES	7422	0,6	
Cub Cadet	B&S Vanguard/Europa OHV Motoren	BKR5E	7938	0,7	
Cub Cadet	B&S Graugußmotoren	BR2LM	5798	0,7	310
Cub Cadet	B&S Standard/IC-Motoren	BR2LM	5798	0,7	310
Cub Cadet	Tecumseh OHV Motore	BR7ES	5122	0,7	
Cub Cadet	Kohler Comand CV/CH 11--16	BKR5E-11	6953	1,1	
Cub Cadet	Kawasaki Typ FG 230 D CS 50	BP4HS	3611	0,6	
Gutbrod	Kohler Comand CV/CH 11--16	BKR5E-11	6953	1,1	
Gutbrod	Kohler Comand CV/CH 18--25	BKR5E	7938	0,7	
Gutbrod	Tecumseh OHV Motoren	BR7ES	5122	0,7	
Gutbrod	B&S Standard/IC-Motoren	BR2LM	5798	0,7	310
Gutbrod	B&S Graugußmotoren	BR2LM	5798	0,7	310
Gutbrod	Kawasaki Typ FE 250 D	BPR5ES	7422	0,6	
Gutbrod	Kawasaki Typ FG 230 D CS 50	BP4HS	3611	0,6	
Gutbrod	B&S Vanguard/Europa OHV Motoren	BKR5E	7938	0,7	
Gutbrod	B&S Intek Motoren	BKR5E	7938	0,7	
Gutbrod	Tecumseh Standard/Seitengesteuerte Motoren	BR2LM	5798	0,7	310
White	Kawasaki Typ FG 230 D CS 50	BP4HS	3611	0,6	
White	Kohler Comand CV/CH 18--25	BKR5E	7938	0,7	
White	Tecumseh OHV Motoren	BR7ES	5122	0,7	
White	Kohler Comand CV/CH 11--16	BKR5E-11	6953	1,1	
White	Kawasaki Typ FE 250 D	BPR5ES	7422	0,6	
White	B&S Standard/IC-Motoren	BR2LM	5798	0,7	310
White	B&S Graugußmotoren	BR2LM	5798	0,7	310
White	B&S Vanguard/Europa OHV Motoren	BKR5E	7938	0,7	
White	B&S Intek Motoren	BKR5E	7938	0,7	
White	Tecumseh Standard/Seitengesteuerte Motoren	BR2LM	5798	0,7	310
Yard Machines	B&S Standard/IC-Motoren	BR2LM	5798	0,7	310
Yard Machines	Tecumseh OHV Motoren	BR7ES	5122	0,7	
Yard Machines	Tecumseh Standard/Seitengesteuerte Motoren	BR2LM	5798	0,7	310
Yard Machines	B&S Intek Motoren	BKR5E	7938	0,7	
Yard Machines	B&S Vanguard/Europa OHV Motoren	BKR5E	7938	0,7	
Yard Machines	Kohler Comand CV/CH 11--16	BKR5E-11	6953	1,1	
Yard Machines	Kohler Comand CV/CH 18--25	BKR5E	7938	0,7	
Yard Machines	B&S Graugußmotoren	BR2LM	5798	0,7	310
Yard Machines	Kawasaki Typ FE 250 D	BPR5ES	7422	0,6	

Diverse Arbeitsgeräte / Various Tools



Order
No.



Quick
No.

MTD

Yard Machines	Kawasaki Typ FG 230 D CS 50	BP4HS	3611	0,6	
Yard Man	Kohler Comand CV/CH 18--25	BKR5E	7938	0,7	
Yard Man	Kawasaki Typ FG 230 D CS 50	BP4HS	3611	0,6	
Yard Man	Kawasaki Typ FE 250 D	BPR5ES	7422	0,6	
Yard Man	B&S Standard/IC-Motoren	BR2LM	5798	0,7	310
Yard Man	B&S Vanguard/Europa OHV Motoren	BKR5E	7938	0,7	
Yard Man	Tecumseh OHV Motoren	BR7ES	5122	0,7	
Yard Man	B&S Intek Motoren	BKR5E	7938	0,7	
Yard Man	Tecumseh Standard/Seitengesteuerte Motoren	BR2LM	5798	0,7	310
Yard Man	B&S Graugußmotoren	BR2LM	5798	0,7	310
Yard Man	Kohler Comand CV/CH 11--16	BKR5E-11	6953	1,1	

NEVA

MB-2K Neva		B5HS	4210	0,7	
------------	--	------	------	-----	--

NISSAN

LD20 / LD28		Y-204TS1	3829		
SD16 / SD22 / SD33	12V	Y-112T	6327		
SD16 / SD22 / SD33	12V QGS	Y-705RS	1249		
SD22 / SD25 / SD33	24V	Y-755RS	7771		
SD33T	24V	Y-177-1	3026		
TD23 / TD27	12V	Y-707RS	4937		

OLEO-MAC

440 BP	Mehrzweckmotor	BPMR7A	4626	0,5	309
720	Mehrzweckmotor	BPMR7A	4626	0,5	309
730 T / S	Mehrzweckmotor	BPMR7A	4626	0,5	309
735 T / S	Mehrzweckmotor	BPMR7A	4626	0,5	309
740 T / S	Mehrzweckmotor	BPMR7A	4626	0,5	309
746 T	Mehrzweckmotor	BPMR7A	4626	0,5	309
750 Master	Mehrzweckmotor	BPMR7A	4626	0,5	309
750 T	Mehrzweckmotor	BPMR7A	4626	0,5	309
825 T / S	Mehrzweckmotor	BPMR7A	4626	0,5	309
931	Mehrzweckmotor	BPMR6A	6726	0,5	308
936	Mehrzweckmotor	BPMR7A	4626	0,5	309
940	Mehrzweckmotor	BPMR7A	4626	0,5	309
940 S	Mehrzweckmotor	BPMR7A	4626	0,5	309
942	Mehrzweckmotor	BPMR7A	4626	0,5	309
946	Mehrzweckmotor	BPMR7A	4626	0,5	309
951	Mehrzweckmotor	BPMR7A	4626	0,5	309
956	Mehrzweckmotor	BPMR7A	4626	0,5	309
962	Mehrzweckmotor	BPMR7A	4626	0,5	309
970 / 971	Mehrzweckmotor	BPMR7A	4626	0,5	309
980 / 981	Mehrzweckmotor	BPMR7A	4626	0,5	309
AM 150	Mehrzweckmotor	BPM7A	7321	0,5	305
AM 180	Mehrzweckmotor	BPM7A	7321	0,5	305
HT 26	Mehrzweckmotor	BPMR7A	4626	0,5	309
HT 26 S	Mehrzweckmotor	BPMR7A	4626	0,5	309
HT 43	Mehrzweckmotor	BPMR7A	4626	0,5	309
MTL 106	Mehrzweckmotor	BPM7A	7321	0,5	305
MTL 30	Mehrzweckmotor	BPM7A	7321	0,5	305
MTL 40	Mehrzweckmotor	BPM7A	7321	0,5	305

Diverse Arbeitsgeräte / Various Tools



Order
No.



Quick
No.

OLEO-MAC

MTL 50	Mehrzweckmotor	BPMR7A	4626	0,5	309
MTL 80	Mehrzweckmotor	BPM7A	7321	0,5	305
MTL 81 R	Mehrzweckmotor	BPMR7A	4626	0,5	309
Sparta 26 / 26 S	Mehrzweckmotor	BPMR7A	4626	0,5	309
Sparta 26TR	Mehrzweckmotor	BPMR7A	4626	0,5	309

PARTNER

31	Motorhacke	BR2LM	5798	0,7	310
3-20	Schneefräse	BR6S	3522	0,7	
3-51	Schneefräse	BR6S	3522	0,7	
5110	Motorhacke	BR2LM	5798	0,7	310
5112	Motorhacke	BR2LM	5798	0,7	310
511 RT	Motorhacke	BR2LM	5798	0,7	310
5510	Motorhacke	BR2LM	5798	0,7	310
GBI 32	Luftbesen	BPMR6A	6726	0,5	308
HG 55-12	Heckenschere	BPMR6A	6726	0,5	308

PHÖNIX

PM 21H		BPMR6A	6726	0,7	308	
Primo 35	B&S	Motorhacke	BR2LM	5798	0,7	310
Primo 500 R	B&S	Motorhacke	BR2LM	5798	0,7	310
Quatro 500 B	B&S	Motorhacke	BR2LM	5798	0,7	310

ROBIN

BH 2500	Mehrzweckmotor	CM6	5812	0,5	
EC 02 EHR	Mehrzweckmotor	BM7A	6521	0,7	
EC 08 D/B	Mehrzweckmotor	B7HS	5110	0,7	
EC 10 D/B	Mehrzweckmotor	B4	3210	0,7	
EC 12 D/B	Mehrzweckmotor	BM6A	5921	0,7	303
EH 12 D/B	Mehrzweckmotor	B6HS	4510	0,7	
EH 17 D/B	Mehrzweckmotor	B6HS	4510	0,7	
EH 25 D/B	Mehrzweckmotor	B6HS	4510	0,7	
EH 30 D/B	Mehrzweckmotor	BP6ES	7811	0,7	
EH 34 D/B	Mehrzweckmotor	BP6ES	7811	0,7	
EY 08 D/B	Mehrzweckmotor	BM4A	5628	0,7	
EY 15 D/B	Mehrzweckmotor	B6HS	4510	0,7	
EY 20 D/B	Mehrzweckmotor	B6HS	4510	0,7	
EY 23 D/B	Mehrzweckmotor	BP4HS	3611	0,7	
EY 28 D/B	Mehrzweckmotor	BP6HS	4511	0,7	
EY 35 D/B	Mehrzweckmotor	B6HS	4510	0,7	
EY 40 D/B	Mehrzweckmotor	B6HS	4510	0,7	
NB 2001	Mehrzweckmotor	BPM7A	7321	0,5	305
NB 211	Mehrzweckmotor	BPM7A	7321	0,5	305
NB 221	Mehrzweckmotor	BM7A	6521	0,5	
NB 223	Mehrzweckmotor	BPM7A	7321	0,5	305
NB 251	Mehrzweckmotor	BM7A	6521	0,5	
NB 253	Mehrzweckmotor	BPM7A	7321	0,5	305
NB 26	Mehrzweckmotor	BM7A	6521	0,5	
NB 31	Mehrzweckmotor	BM7A	6521	0,5	
NB 321	Mehrzweckmotor	BPM7A	7321	0,5	305
NB 40	Mehrzweckmotor	B7HS	5110	0,5	
NB 411	Mehrzweckmotor	BPM7A	7321	0,5	305

Diverse Arbeitsgeräte / Various Tools



Order No.  Quick No.

ROBIN					
NBF 171	Mehrzweckmotor	BPM7A	7321	0,5	305
NBF 252	Mehrzweckmotor	BPM7A	7321	0,5	305
NBT 415	Mehrzweckmotor	BPM7A	7321	0,5	305
SABO					
SB 135 L	Mehrzweckmotor	BP4	2911	0,5	
SB 140 SL	Mehrzweckmotor	BP4	2911	0,5	
SB 152	Mehrzweckmotor	B5HS	4210	0,5	
SALUT					
Salut-5		B5HS	4210	0,7	
SD					
SD1012		BP7HS	5111	0,6	
SOLO					
101	Mehrzweckmotor	BPMR6A	6726	0,5	308
118 / 119	Mehrzweckmotor	BPMR6A	6726	0,5	308
120	Mehrzweckmotor	BPMR6A	6726	0,5	308
124	Mehrzweckmotor	BPMR6A	6726	0,5	308
126	Mehrzweckmotor	BPMR6A	6726	0,5	308
127	Mehrzweckmotor	BPMR6A	6726	0,5	308
127 H	Mehrzweckmotor	C5HSB	6452	0,5	
128	Mehrzweckmotor	BPMR6A	6726	0,5	308
130	Mehrzweckmotor	BPMR6A	6726	0,5	308
130 H	Mehrzweckmotor	C5HSB	6452	0,5	
132	Mehrzweckmotor	BPMR6A	6726	0,5	308
134	Mehrzweckmotor	BPMR6A	6726	0,5	308
140	Mehrzweckmotor	BPMR6A	6726	0,5	308
141	Mehrzweckmotor	BPMR6A	6726	0,5	308
410	Sprayer	B6HS	4510	0,5	
412	Sprayer	B6HS	4510	0,5	
414	Luftbesen	BPMR7A	4626	0,5	309
414	Mehrzweckmotor	BPMR6A	6726	0,5	308
422	Sprayer	BPMR6A	6726	0,5	308
422	Mehrzweckmotor	BPMR6A	6726	0,5	308
423	Sprayer	B6HS	4510	0,5	
436	Sprayer	B7HS	5110	0,5	204
437	Sprayer	B7HS	5110	0,5	204
439	Sprayer	B7HS	5110	0,5	204
441	Laubbläser	BPMR6A	6726	0,6	308
440	Laubbläser	BPMR6A	6726	0,6	308
444	Sprayer	BPMR7A	4626	0,5	309
445	Laubbläser	BPMR7A	4626	0,5	309
450	Sprayer	BPMR7A	4626	0,5	309
459	Sprayer	B7HS	5110	0,5	204
471	Laubbläser	BPMR7A	4626	0,5	309
472	Laubbläser	BPMR7A	4626	0,5	309
501-2T (Solo)	Motorhacke	BPMR6A	6726	0,6	308
502	Motorhacke	CR5HSB	6535	0,5	
503	Motorhacke	BR2LM	5798	0,5	310
504	Motorhacke	BPR6ES	7822	0,7	

Diverse Arbeitsgeräte / Various Tools



Order
No.



Quick
No.

SOLO

508	Motorhacke	BPR6ES	7822	0,7	
603	Mehrzweckmotor	BPMR6A	6726	0,5	308
633	Mehrzweckmotor	BPMR6A	6726	0,5	308
634	Mehrzweckmotor	BPMR6A	6726	0,5	308
636	Mehrzweckmotor	BPMR6A	6726	0,5	308
639 D	Mehrzweckmotor	BPMR6A	6726	0,5	308
641	Mehrzweckmotor	BPMR6A	6726	0,5	308
644	Mehrzweckmotor	BPMR6A	6726	0,5	308
644 SP	Mehrzweckmotor	BPMR6A	6726	0,5	308
645 D	Mehrzweckmotor	BPMR6A	6726	0,5	308
647	Mehrzweckmotor	BPMR6A	6726	0,5	308
651	Mehrzweckmotor	BPMR6A	6726	0,5	308
651 SP	Mehrzweckmotor	BPMR6A	6726	0,5	308
654	Mehrzweckmotor	BPMR6A	6726	0,5	308
662	Mehrzweckmotor	BPMR6A	6726	0,5	308
667	Mehrzweckmotor	BPMR6A	6726	0,5	308
670	Mehrzweckmotor	BPMR6A	6726	0,5	308
680	Mehrzweckmotor	BPMR6A	6726	0,5	308
690	Mehrzweckmotor	BPMR6A	6726	0,5	308

STIHL

BG 45	Laubbläser	BPMR7A	4626	0,5	309
BG 55	Laubbläser	BPMR7A	4626	0,5	309
BG 72	Luftbesen	BPMR7A	4626	0,5	309
BG 75	Luftbesen	BPMR7A	4626	0,5	309
BG 85	Laubbläser	BPMR7A	4626	0,5	309
BR 320L	Laubbläser	BPMR7A	4626	0,5	309
BR 400	Laubbläser	BPMR7A	4626	0,5	309
BR 106 , BR-320 , BR-400	Luftbesen	BPMR7A	4626	0,5	309
BT 106 C	Erdbohrer	BPMR7A	4626	0,5	309
BT 360	Erdbohrer	BPMR7A	4626	0,5	309
HL 45	Heckenschere	BPMR7A	4626	0,5	309
HL 75	Heckenschere	BPMR7A	4626	0,5	309
HLR 85	Heckenschere	BPMR7A	4626	0,5	309
HS 45	Heckenschere	BPMR7A	4626	0,5	309
HS 75	Heckenschere	BPMR7A	4626	0,5	309
HS 80	Heckenschere	BPMR7A	4626	0,5	309
HS 85	Heckenschere	BPMR7A	4626	0,5	309
HT 101	Hochentaster	BPMR7A	4626	0,5	309
HT 70	Heckenschere	BPMR7A	4626	0,5	309
HT 75	Hochentaster	BPMR7A	4626	0,5	309
HTR 85	Heckenschere	BPMR7A	4626	0,5	309
SH 55	Saughäcksler	BPMR7A	4626	0,5	309
SH 85	Saughäcksler	BPMR7A	4626	0,5	309
SR 320 , SR400	Luftbesen	BPMR7A	4626	0,5	309
TS 360 S	Trennschleifer	BPMR7A	4626	0,5	309
TS 400	Trennschleifer	BPMR7A	4626	0,5	309
TS 460	Trennschleifer	BPMR7A	4626	0,5	309
TS 510	Trennschleifer	BPMR7A	4626	0,5	309
TS 760	Trennschleifer	BPMR7A	4626	0,5	309

Diverse Arbeitsgeräte / Various Tools



Order
No.



Quick
No.

TANAKA

AST 250	Mehrzweckmotor	BPM6A	7021	0,6	304
AST 7000	Mehrzweckmotor	BPM6A	7021	0,6	304
ECS 320 / 330	Mehrzweckmotor	BM6A	5921	0,6	303
ECS 3301	Mehrzweckmotor	BM6A	5921	0,6	303
ECS 3351	Mehrzweckmotor	BM6A	5921	0,6	303
ECU 3801	Mehrzweckmotor	BPM7A	7321	0,6	305
ECV 4501	Mehrzweckmotor	BM6A	5921	0,6	303
EHC 120	Mehrzweckmotor	BM7A	6521	0,6	
PM 21	Heckenschere	BPMR6A	6726	0,5	308
PM 21	Mehrzweckmotor	BPM6A	7021	0,6	304
PM 2100	Mehrzweckmotor	BPM6A	7021	0,6	304
TBC 2000	Mehrzweckmotor	BPM6A	7021	0,6	304
TBC 2200	Mehrzweckmotor	BPM6A	7021	0,6	304
TBC 2211	Mehrzweckmotor	BPMR6A	6726	0,6	308
TBC 2251	Mehrzweckmotor	BPMR6A	6726	0,6	308
TBC 2400	Mehrzweckmotor	BPM6A	7021	0,6	304
TBC 250	Mehrzweckmotor	BPM6A	7021	0,6	304
TBC 265	Mehrzweckmotor	BPM6A	7021	0,6	304
TBC 270 PF	Mehrzweckmotor	BMR7A	4226	0,6	
TBC 300	Mehrzweckmotor	BM6A	5921	0,6	303
TBC 355	Mehrzweckmotor	BM7A	6521	0,6	
TBC 4200	Mehrzweckmotor	BPM6A	7021	0,6	304
TBC 422	Mehrzweckmotor	BM7A	6521	0,6	
TBC 430 PF	Mehrzweckmotor	BPMR7A	4626	0,6	309
TBC 4500	Mehrzweckmotor	BPM6A	7021	0,6	304
TBC 500	Mehrzweckmotor	BPM6A	7021	0,6	304
TBH 2500	Mehrzweckmotor	BM7A	6521	0,6	
TBL 505	Mehrzweckmotor	BM6A	5921	0,6	303
TCP 25	Mehrzweckmotor	BPM6A	7021	0,6	304
TCP 381	Mehrzweckmotor	B6S	3510	0,6	302
TEA 500	Mehrzweckmotor	BM6A	5921	0,6	303
TEA 500	Erdbohrer	BM6A	5921	0,6	303
TED 262	Mehrzweckmotor	BM6A	5921	0,6	303
THB 2510	Mehrzweckmotor	BPMR6A	6726	0,6	308
THT 1800	Mehrzweckmotor	BPMR6A	6726	0,6	308
THT 210	Heckenschere	BPM6A	7021	0,6	304
THT 210	Mehrzweckmotor	BM6A	5921	0,6	303
THT 230	Mehrzweckmotor	BM6A	5921	0,6	303
THT 240	Heckenschere	BPM6A	7021	0,6	304
THT 240	Mehrzweckmotor	BPM6A	7021	0,6	304
THT 2510	Mehrzweckmotor	BPMR6A	6726	0,6	308
THT 2520	Mehrzweckmotor	BPMR6A	6726	0,6	308
THT 2530	Mehrzweckmotor	BPMR6A	6726	0,6	308
THT 262	Heckenschere	BM6A	5921	0,6	303
THT 262	Mehrzweckmotor	BM6A	5921	0,6	303
TIA 305	Mehrzweckmotor	BM7A	6521	0,6	
TIA 340	Erdbohrer	BMR6A	7421	0,6	307
TIA 340	Mehrzweckmotor	BM7A	6521	0,6	
TLE 550	Mehrzweckmotor	BM7A	6521	0,6	
TPH 2211	Mehrzweckmotor	BPMR6A	6726	0,6	308
TUM 250	Mehrzweckmotor	BPM6A	7021	0,6	304

Diverse Arbeitsgeräte / Various Tools



Order
No.



Quick
No.

TARPAN

Tarpan	BP6HS	4511	0,6	
--------	-------	------	-----	--

TECNAMOTOR

BH 153	BR4LM	4133	0,6	
BH 173	BR4LM	4133	0,6	
BV 153	BR2LM	5798	0,6	310
BVL 153	BR2LM	5798	0,6	310
BVL 173	BR4LM	4133	0,6	
BVL 198	BR4LM	4133	0,6	
BVS 143	BR2LM	5798	0,6	310
BVS 153	BR2LM	5798	0,6	310
MV 100	BR4LM	4133	0,6	
MV 100 S	BR4LM	4133	0,6	
Premier 45 OHV	BR4LM	4133	0,6	
Premier 55 OHV	BR7ES	5122	0,6	
Premier 153	BR4LM	4133	0,6	
Premier 173	BR4LM	4133	0,6	
RV 173	BR4LM	4133	0,6	
Synergy 40	BR4LM	4133	0,6	
Synergy 55 OHV	BR7ES	5122	0,6	
Vantage 35	BR4LM	4133	0,6	
Vantage 40	BR4LM	4133	0,6	

TECUMSEH

A 220 4,8PS 95-	BR2LM	5798	0,6	310
ALN 330 7,2PS 95-	BR2LM	5798	0,6	310
BH 35 3,5PS 95-	BR2LM	5798	0,6	310
BH 40 4PS Konische Ausführung 95-	BR2LM	5798	0,6	310
BH 40 4PS Zylindrische Ausfüh. 95-	BR2LM	5798	0,6	310
Centura 40	BR2LM	5798	0,5	310
Centura 50	BR2LM	5798	0,5	310
Enduro 11-13 HP	BR7ES	5122	0,8	
Geotec 35	BR2LM	5798	0,5	310
H 35	BR4LM	4133	0,6	
H 50	BR4LM	4133	0,6	
H 60	BR4LM	4133	0,6	
H 70	BR4LM	4133	0,6	
H 80	BR4LM	4133	0,6	
HH 100	B6HS	4510	0,6	
HM 70	BR4LM	4133	0,6	
HM 80	BR4LM	4133	0,6	
HM 100	BR4LM	4133	0,6	
HM 100 10PS 95-	BR2LM	5798	0,6	310
HMXL 80 8PS 95-	BR2LM	5798	0,6	310
HS 40	BR4LM	4133	0,6	
HS 50	BR4LM	4133	0,6	
HS 50 5PS Hand+Fernbedienung 95-	BR2LM	5798	0,6	310
LAV 35	BR4LM	4133	0,6	
LAV 40	BR4LM	4133	0,6	
LAV 50	BR4LM	4133	0,6	
MV 100 S 3,5PS 95-	BR2LM	5798	0,6	310
OH 120	B6HS	4510	0,6	

Diverse Arbeitsgeräte / Various Tools



Order
No.



Quick
No.

TECUMSEH

OH 140		B6HS	4510	0,6	
OH 160		B6HS	4510	0,6	
OH 180		B6HS	4510	0,6	
OHV 4Takt 12,5PS 95-		B7S	3710	0,6	
OVM		B6HS	4510	0,6	
OVRM 40		BR7ES	5122	0,6	
OVRM 50		BR7ES	5122	0,6	
OVXL 120		B6HS	4510	0,6	
OVXL-C 125		B6HS	4510	0,6	
Prisma		BR4LM	4133	0,6	
Prisma 3,7PS 95-		BR2LM	5798	0,6	310
Prisma 5PS 95-		BR2LM	5798	0,6	310
Prisma Elektrostart		BR4LM	4133	0,6	
Synergy 40		BR2LM	5798	0,6	310
Synergy 40 4PS 95-		BR2LM	5798	0,6	310
Synergy OHV		BR7ES	5122	0,6	
TNT 100		BR4LM	4133	0,6	
TNT 120		BR4LM	4133	0,6	
TVM 140		BR4LM	4133	0,6	
TVM 170		BR4LM	4133	0,6	
TVM 195		BR4LM	4133	0,6	
TVM 220		BR4LM	4133	0,6	
TVS 75		BR4LM	4133	0,6	
TVS 90		BR4LM	4133	0,6	
TVS 105		BR4LM	4133	0,6	
TVS 115		BR4LM	4133	0,6	
TVS 120		BR4LM	4133	0,6	
TVXL		BR4LM	4133	0,6	
TVXL 195 4Takt 8PS 95-		BR2LM	5798	0,6	310
TVXL 840 5PS 95-		BR2LM	5798	0,6	310
V 50		BR4LM	4133	0,6	
V 60		BR4LM	4133	0,6	
V 70		BR4LM	4133	0,6	
V 80		BR4LM	4133	0,6	
Vantage		BR4LM	4133	0,6	
Vantage 3,5PS 95-		BR2LM	5798	0,6	310
VM 70		BR4LM	4133	0,6	
VM 80		BR4LM	4133	0,6	
VM 100		BR4LM	4133	0,6	

TOURNO

95	(GCV 520 Honda)	BPR5ES	7422	0,5	
115	(GCV 520 Honda)	BPR5ES	7422	0,5	

URAL

Ural-3		B5HS	4210	0,7	
--------	--	------	------	-----	--

VIKING

VH 300	Motorhacke	BR2LM	5798	0,6	310
VH 340	Motorhacke	BR2LM	5798	0,6	310
VH 450	Motorhacke	BR2LM	5798	0,6	310
VM 550 B	Motorhacke	BR2LM	5798	0,6	310

Diverse Arbeitsgeräte / Various Tools



Order
No.



Quick
No.

YAMAHA

HT 22		Heckenschere	BPM6A	7021	0,6	304
MF 150A / S		Mehrzweckmotor	BP6HS	4511	0,6	
MF 180A / AR / S / SR		Mehrzweckmotor	BP6HS	4511	0,6	
MF 180K / AK / SK		Mehrzweckmotor	BP4HS	3611	0,6	
MF 260A / AR / S / SR		Mehrzweckmotor	BP6HS	4511	0,6	
MF 260K / AK / SK		Mehrzweckmotor	BP4HS	3611	0,6	
MF 410 / S / SR		Mehrzweckmotor	BP6HS	4511	0,6	
MF 410SK		Mehrzweckmotor	BP4HS	3611	0,6	
Midori YRT 335		Motorhacke	BR4ES	1097	0,7	
Midori YRT 550		Motorhacke	BPR5ES	7422	0,7	
MT 110A / AR		Mehrzweckmotor	B7HS	5110	0,6	
MT 110VL		Mehrzweckmotor	B7HS	5110	0,6	
YP 10 GN		Wasserpumpe	BR7HS	4122	0,6	
YP 20 GN		Wasserpumpe	BP4HS	3611	0,9	
YP 30 GN		Wasserpumpe	BP5ES	6511	0,7	
YRT 335		Motorhacke	BR4ES	1097	0,7	
YS 624		Schneefräse	BPR4HS	7823	0,8	
YS 828		Schneefräse	BPR4HS	7823	0,8	
YSDX		Schneefräse	BPR4ES	7222	0,8	

YANMAR

YHB 26		Luftbesen	BPM7A	7321	0,5	305
--------	--	-----------	-------	------	-----	-----

ZENOAH

EB20		Luftbesen	BM7A	6521	0,6	
EB40 , EB43		Luftbesen	B6HS	4510	0,7	
FAG10		Erdbohrer	B6S	3510	0,7	302
G1A , G1A6	14.9 ccm	Mehrzweckmotor	BM6A	5921	0,6	303
G1E	17.2 ccm	Mehrzweckmotor	BMR6A	7421	0,6	307
G230PU		Modellbau	BMR7A	4226	0,7	
G230PUH		Modellbau	BMR7A	4226	0,7	
G230PUM		Modellbau	BMR7A	4226	0,7	
G23LH		Modellbau	BPM7A	7321	0,6	305
G2A	22.5 ccm	Mehrzweckmotor	BM6A	5921	0,6	303
G2A16 , G2C	22.5 ccm	Mehrzweckmotor	BM7A	6521	0,6	
G2D , G2D30	22.5 ccm	Mehrzweckmotor	BM7A	6521	0,6	
G2D70-D		Modellbau	BMR7A	4226	0,7	
G380PU		Modellbau	BPMR7A	4626	0,5	309
G3C , G3C76	31.7 ccm	Mehrzweckmotor	B6HS	4510	0,7	
G3D10,G3D20	31.7 ccm	Mehrzweckmotor	BPM6A	7021	0,6	304
G3E	25.4 ccm	Mehrzweckmotor	BMR6A	7421	0,6	307
G450PU		Modellbau	BPMR7A	4626	0,5	309
G4C, G4C63	37.4 ccm	Mehrzweckmotor	B6HS	4510	0,7	
G4C76	37.4 ccm	Mehrzweckmotor	B6HS	4510	0,7	
G5C	52.5 ccm	Mehrzweckmotor	BR6S	3522	0,7	
G5E, G5E2	52.5 ccm	Mehrzweckmotor	B6HS	4510	0,7	
G620PU		Modellbau	BPMR7A	4626	0,5	309
G800BPU		Modellbau	BPMR7A	4626	0,5	309
MD20AE		Sprayer	BM7A	6521	0,6	
MD40AE		Sprayer	B6HS	4510	0,7	



ccm

Order
No.Platin/
Gold-
PalladiumOrder
No.

Iridium

Order
No.**AKTIV**

A600 Spi. AB50A3		B9ES	2611	0.5	BR9EVX	1265	BR9EIX	3981
Grizzly Spi. AB50A3		B9ES	2611	0.5	BR9EVX	1265	BR9EIX	3981
SC3 Gul Hus.SM 160	160	BPM7A	7321	0,5				
Karibo Rot.277	277	B8ES	2411	0.8	BR8EVX	1262	BR8EIX	5044
A600 SA290	290	A7	1110	0,5				
Grizzly Fuj.432	432	B9ES	2611	0.5	BR9EVX	1265	BR9EIX	3981
Panther Fuj.432	432	B9ES	2611	0.5	BR9EVX	1265	BR9EIX	3981
A600 Rotax 440	440	A8	1210	0,5				
Grizzly Spi. AG440A2	440	B9ES	2611	0.5	BR9EVX	1265	BR9EIX	3981
Alaska	503	B8ES	2411	0.8	BR8EVX	1262	BR8EIX	5044
Alaska XT	503	B8ES	2411	0.8	BR8EVX	1262	BR8EIX	5044
Panther Rot. 503Sca.	503	B8ES	2411	0.8	BR8EVX	1262	BR8EIX	5044
Panther Rot. 503	503	B7ES	1111	0.5	B7EVX	6934		
Grizzly Rot. 503	503	B7ES	1111	0.5	B7EVX	6934		
Grizzly SE Rot. 503us	503	B8ES	2411	0.8	BR8EVX	1262	BR8EIX	5044
Grizzly XP Rot. 503Sca.	503	B8ES	2411	0.8	BR8EVX	1262	BR8EIX	5044

ARCTCO/ARCTIC CAT (Kawasaki Engine)

T5B060S(60cc)	60	BR6HS	3922	0.7			BR6HIX	3419
T1D250F1(245cc)	245	BR8ES	5422	0.7	BR8EVX	1262	BR8EIX	5044
KT150A, KT150B(292cc)	292	A8	1210	0.7				
T4B292S(292cc)	292	B9HS	5810	0.7	B9HVX	2254		
T4C292S1A(292cc)	292	BR9HS	4522	0.7				
T1A340S1(339cc)	339	B8ES	2411	0.7	B8EVX	7051	BR8EIX	5044
T1B340S(339cc)	339	B8ES	2411	0.7	B8EVX	7051	BR8EIX	5044
T1C340S1A(339cc)	339	B8ES	2411	0.7	B8EVX	7051	BR8EIX	5044
T1C340S2A(339cc)	339	B8ES	2411	0.7	B8EVX	7051	BR8EIX	5044
T1D340A2A(339cc)	339	B8ES	2411	0.7	B8EVX	7051	BR8EIX	5044
T1D340F1(339cc)	339	BR8ES	5422	0.7	BR8EVX	1262	BR8EIX	5044
T1A400S1(398cc)	398	B8ES	2411	0.7	B8EVX	7051	BR8EIX	5044
T1B400S(398cc)	398	B8ES	2411	0.7	B8EVX	7051	BR8EIX	5044
T1A440S1(436cc)	436	B8ES	2411	0.7	B8EVX	7051	BR8EIX	5044
T1B440D1A(436cc)	436	BUE	2322	-				
T1B440S(436cc)	436	B8ES	2411	0.7	B8EVX	7051	BR8EIX	5044
T1C440S1A(436cc)	436	B8ES	2411	0.7	B8EVX	7051	BR8EIX	5044
T1C440S2A(436cc)	436	B8ES	2411	0.7	B8EVX	7051	BR8EIX	5044
T1D440A2A(436cc)	436	B8ES	2411	0.7	B8EVX	7051	BR8EIX	5044

ARCTCO/ARCTIC CAT (Racing Engine)

AA25L2(250cc)	250	---		0.5	B10EVX	7335	BR10EIX	6801
340 Mod.Kit(340cc)	340	B10EG	3630	0.5	B10EGV	5927	BR10EIX	6801
AC34L2(340cc)	340	B10EG	3630	0.5	B10EGV	5927	BR10EIX	6801
AD34L1(340cc)	340	B10EG	3630	0.5	B10EGV	5927	BR10EIX	6801
Sno Pro 340 55HP(340cc)	340	B10EG	3630	0.5	B10EGV	5927	BR10EIX	6801
AE44L2(440cc)	440	B10EG	3630	0.5	B10EGV	5927	BR10EIX	6801
Sno Pro 440 70HP(440cc)	440	B10EG	3630	0.5	B10EGV	5927	BR10EIX	6801

ARCTCO/ARCTIC CAT (Spirit(Suzuki)Engine)

AA06A1(60cc)	60	BR6HS	3922	0.6			BR6HIX	3419
AA06A2(60cc)	60	BR6HS	3922	0.5			BR6HIX	3419
AA06A3(60cc)	60	BR6HS	3922	0.5			BR6HIX	3419
AA06A4(60cc)	60	BR6HS	3922	0.5			BR6HIX	3419



ccm

Order
No.Platin/
Gold-
PalladiumOrder
No.

Iridium

Order
No.**ARCTCO/ARCTIC CAT (Spirit(Suzuki)Engine)**

AA06A5(60cc)	60	BR6HS	3922	0.5			BR6HIX	3419
AA06A7(60cc)	60	BR6HS	3922	0.5			BR6HIX	3419
AA06A9(60cc)	60	BR6HS	3922	0.6			BR6HIX	3419
A006A1(60cc)	60	BR6HS	3922	0.7			BR6HIX	3419
A006A2(60cc)	60	BR6HS	3922	0.8			BR6HIX	3419
A006A3(60cc)	60	BR6HS	3922	0.8			BR6HIX	3419
A006A4(60cc)	60	BR6HS	3922	0.8			BR6HIX	3419
A006A5(60cc)	60	BR6HS	3922	0.8			BR6HIX	3419
A006A8(60cc)	60	BR6HS	3922	0.8			BR6HIX	3419
AB25F1(250cc)	250	BR8ES	5422	0.6	BR8EVX	1262	BR8EIX	5044
AB25F3(250cc)	250	BR9ES	5722	0.5	BR9EVX	1265	BR9EIX	3981
AB25F4(250cc)	250	BR8ES	5422	0.5	BR8EVX	1262	BR8EIX	5044
AA28F1(275cc)	275	BR8ES	5422	0.6	BR8EVX	1262	BR8EIX	5044
AA28F2(275cc)	275	BR8ES	5422	0.6	BR8EVX	1262	BR8EIX	5044
AA28F3(275cc)	275	BR8ES	5422	0.5	BR8EVX	1262	BR8EIX	5044
AA28F4(275cc)	275	BR8ES	5422	0.5	BR8EVX	1262	BR8EIX	5044
AA28F5(275cc)	275	BR8ES	5422	0.5	BR8EVX	1262	BR8EIX	5044
AF34A7(339cc)	339	BR8ES	5422	0.7	BR8EVX	1262	BR8EIX	5044
AF34A8(339cc)	339	BR8ES	5422	0.8	BR8EVX	1262	BR8EIX	5044
AF34A9(339cc)	339	BR8ES	5422	0.8	BR8EVX	1262	BR8EIX	5044
AG34A1(339cc)	339	BR8ES	5422	0.5	BR8EVX	1262	BR8EIX	5044
AG34A3(339cc)	339	BR8HS	4322	0.6	BR8HVX	6265	BR8HIX	7001
AG34A3(339cc)	339	BR9ES	5722	0.8	BR9EVX	1265	BR9EIX	3981
AG34A3A(339cc)	339	BR9ES	5722	0.8	BR9EVX	1265	BR9EIX	3981
AG34A5(339cc)	339	BR9ES	5722	0.8	BR9EVX	1265	BR9EIX	3981
AG34A6(339cc)	339	BR9ES	5722	0.8	BR9EVX	1265	BR9EIX	3981
AA34F1(340cc)	340	BR8ES	5422	0.6	BR8EVX	1262	BR8EIX	5044
AA34F2(340cc)	340	BR8ES	5422	0.6	BR8EVX	1262	BR8EIX	5044
AA34F3(340cc)	340	BR8ES	5422	0.5	BR8EVX	1262	BR8EIX	5044
AA34F4(340cc)	340	BR8ES	5422	0.5	BR8EVX	1262	BR8EIX	5044
AA34F5(340cc)	340	BR8ES	5422	0.5	BR8EVX	1262	BR8EIX	5044
AB34F1(340cc)	340	BR9ES	5722	0.6	BR9EVX	1265	BR9EIX	3981
AE34L2(340cc)	340	BR9ES	5722	0.5	BR9EVX	1265	BR9EIX	3981
AF34A1(340cc)	340	BR8ES	5422	0.5	BR8EVX	1262	BR8EIX	5044
AG44A9(431cc)	431	BR9ES	5722	0.7	BR9EVX	1265	BR9EIX	3981
AJ44L1(431cc)	431	BR9ES	5722	0.8	BR9EVX	1265	BR9EIX	3981
AJ44L2(431cc)	431	BR9ES	5722	0.8	BR9EVX	1265	BR9EIX	3981
AJ44L3(431cc)	431	BR9ES	5722	0.8	BR9EVX	1265	BR9EIX	3981
AK44A1(431cc)	431	BR9ES	5722	0.8	BR9EVX	1265	BR9EIX	3981
AK44A7(431cc)	431	BR9ES	5722	0.8	BR9EVX	1265	BR9EIX	3981
AK44A8(431cc)	431	BR9ES	5722	0.8	BR9EVX	1265	BR9EIX	3981
AH44A9(436cc)	436	BR9ES	5722	0.7	BR9EVX	1265	BR9EIX	3981
AH44L6(436cc)	436	BR9ES	5722	0.8	BR9EVX	1265	BR9EIX	3981
AJ44L4(436cc)	436	BR9ES	5722	0.8	BR9EVX	1265	BR9EIX	3981
AJ44L5(436cc)	436	BR9ES	5722	0.8	BR9EVX	1265	BR9EIX	3981
AK44A1A(436cc)	436	BR9ES	5722	0.8	BR9EVX	1265	BR9EIX	3981
AK44A2(436cc)	436	BR9ES	5722	0.8	BR9EVX	1265	BR9EIX	3981
AK44A2A(436cc)	436	BR9ES	5722	0.8	BR9EVX	1265	BR9EIX	3981
AK44A3(436cc)	436	BR9ES	5722	0.8	BR9EVX	1265	BR9EIX	3981
AK44A3A(436cc)	436	BR9ES	5722	0.8	BR9EVX	1265	BR9EIX	3981
AK44A4(436cc)	436	BR9ES	5722	0.8	BR9EVX	1265	BR9EIX	3981
AK44A4A(436cc)	436	BR9ES	5722	0.8	BR9EVX	1265	BR9EIX	3981



ccm

Order
No.Platin/
Gold-
PalladiumOrder
No.

Iridium

Order
No.**ARCTCO/ARCTIC CAT (Spirit(Suzuki)Engine)**

AK44A4B(436cc)	436	BR9ES	5722	0.8	BR9EVX	1265	BR9EIX	3981
AK44A5(436cc)	436	BR9ES	5722	0.8	BR9EVX	1265	BR9EIX	3981
AK44A5A(436cc)	436	BR9ES	5722	0.8	BR9EVX	1265	BR9EIX	3981
AK44A5B(436cc)	436	BR9ES	5722	0.8	BR9EVX	1265	BR9EIX	3981
AL44L1(436cc)	436	BR9ES	5722	0.8	BR9EVX	1265	BR9EIX	3981
AL44L2(436cc)	436	BR9ES	5722	0.8	BR9EVX	1265	BR9EIX	3981
AL44L3(436cc)	436	BR9ES	5722	0.8	BR9EVX	1265	BR9EIX	3981
AL44L5(436cc)	436	BR9ES	5722	0.8	BR9EVX	1265	BR9EIX	3981
AM44L1(436cc)	436	BR9ES	5722	0.8	BR9EVX	1265	BR9EIX	3981
AM44L2(436cc)	436	BR9ES	5722	0.8	BR9EVX	1265	BR9EIX	3981
AN44L1(436cc)	436	BR9ES	5722	0.8	BR9EVX	1265	BR9EIX	3981
AR44L1(436cc)	436	BR9ES	5722	0.8	BR9EVX	1265	BR9EIX	3981
AR44L1(438cc)	438	BR9ES	5722	0.8	BR9EVX	1265	BR9EIX	3981
AB44F1(440cc)	440	BR8ES	5422	0.5	BR8EVX	1262	BR8EIX	5044
AB44F2(440cc)	440	BR9ES	5722	0.6	BR9EVX	1265	BR9EIX	3981
AC44A1(440cc)	440	BR8ES	5422	0.6	BR8EVX	1262	BR8EIX	5044
AC44A2(440cc)	440	BR8ES	5422	0.5	BR8EVX	1262	BR8EIX	5044
AC44A3(440cc)	440	BR9ES	5722	0.5	BR9EVX	1265	BR9EIX	3981
AD44L1(440cc)	440	BR9ES	5722	0.6	BR9EVX	1265	BR9EIX	3981
AF44L1(440cc)	440	BR9ES	5722	0.5	BR9EVX	1265	BR9EIX	3981
AF44L2(440cc)	440	BR9ES	5722	0.5	BR9EVX	1265	BR9EIX	3981
AF44L3(440cc)	440	BR9ES	5722	0.5	BR9EVX	1265	BR9EIX	3981
AG44A1(440cc)	440	BR9ES	5722	0.5	BR9EVX	1265	BR9EIX	3981
AG44A2(440cc)	440	BR9ES	5722	0.5	BR9EVX	1265	BR9EIX	3981
AB50A1(500cc)	500	BR8ES	5422	0.6	BR8EVX	1262	BR8EIX	5044
AB50A2(500cc)	500	BR8ES	5422	0.6	BR8EVX	1262	BR8EIX	5044
AB50A3(500cc)	500	BR9ES	5722	0.5	BR9EVX	1265	BR9EIX	3981
AB50A4(500cc)	500	BR9ES	5722	0.5	BR9EVX	1265	BR9EIX	3981
AC50F1(500cc)	500	BR9ES	5722	0.6	BR9EVX	1265	BR9EIX	3981
AC50F2(500cc)	500	BR9ES	5722	0.6	BR9EVX	1265	BR9EIX	3981
AD50F1(500cc)	500	BR9ES	5722	0.6	BR9EVX	1265	BR9EIX	3981
AD50F2(500cc)	500	BR9ES	5722	0.6	BR9EVX	1265	BR9EIX	3981
AD50F3(500cc)	500	BR9ES	5722	0.5	BR9EVX	1265	BR9EIX	3981
AD50F4(500cc)	500	BR9ES	5722	0.5	BR9EVX	1265	BR9EIX	3981
AD50F5(500cc)	500	BR9ES	5722	0.5	BR9EVX	1265	BR9EIX	3981
AD50F6(500cc)	500	---		0.5	BR10EV	5127	BR10EIX	6801
AE50A1(500cc)	500	BR9ES	5722	0.6	BR9EVX	1265	BR9EIX	3981
AE50A2(500cc)	500	BR9ES	5722	0.5	BR9EVX	1265	BR9EIX	3981
AH50L1(500cc)	500	BR9ES	5722	0.5	BR9EVX	1265	BR9EIX	3981
AH50L2(500cc)	500	BR9ES	5722	0.5	BR9EVX	1265	BR9EIX	3981
AL50A1(500cc)	500	BR9ES	5722	0.5	BR9EVX	1265	BR9EIX	3981
AL50A2(500cc)	500	BR9ES	5722	0.5	BR9EVX	1265	BR9EIX	3981
AL50A7(500cc)	500	BR9ES	5722	0.7	BR9EVX	1265	BR9EIX	3981
AM50A4(500cc)	500	BR9ES	5722	0.7	BR9EVX	1265	BR9EIX	3981
AM50A5(500cc)	500	BR9ES	5722	0.8	BR9EVX	1265	BR9EIX	3981
AA53L3(529cc)	529	---		0.6	BR10EV	5127	BR10EIX	6801
AA53L4(529cc)	529	BR9ES	5722	0.8	BR9EVX	1265	BR9EIX	3981
AB53L5(529cc)	529	BR9ES	5722	0.8	BR9EVX	1265	BR9EIX	3981
AB53L6(529cc)	529	BR9ES	5722	0.8	BR9EVX	1265	BR9EIX	3981
AA55L1(550cc)	550	BR9ES	5722	0.8	BR9EVX	1265	BR9EIX	3981
AA55L2(550cc)	550	BR9ES	5722	0.8	BR9EVX	1265	BR9EIX	3981
AA55L3(550cc)	550	BR9ES	5722	0.8	BR9EVX	1265	BR9EIX	3981



ccm

Order
No.Platin/
Gold-
PalladiumOrder
No.

Iridium

Order
No.**ARCTCO/ARCTIC CAT (Spirit(Suzuki)Engine)**

AA55L5(550cc)	550	BR9ES	5722	0.8	BR9EVX	1265	BR9EIX	3981
AA55L6(550cc)	550	BR9ES	5722	0.8	BR9EVX	1265	BR9EIX	3981
AB55L1(550cc)	550	BR9ES	5722	0.8	BR9EVX	1265	BR9EIX	3981
AB55L2(550cc)	550	BR9ES	5722	0.8	BR9EVX	1265	BR9EIX	3981
AA58L2(580cc)	580	BR9ES	5722	0.8	BR9EVX	1265	BR9EIX	3981
AB58L3(580cc)	580	BR9ES	5722	0.8	BR9EVX	1265	BR9EIX	3981
AB58L4(580cc)	580	BR9ES	5722	0.8	BR9EVX	1265	BR9EIX	3981
AC58L5(580cc)	580	BR9ES	5722	0.8	BR9EVX	1265	BR9EIX	3981
AA60L2(594cc)	594	BR9ES	5722	0.8	BR9EVX	1265	BR9EIX	3981
AA65L1(650cc)	650	---		0.6	BR10EV	5127	BR10EIX	6801
AA65L2(650cc)	650	---		0.7	BR9EVX	1265	BR9EIX	3981
AA65L3(650cc)	650	BR9ES	5722	0.8	BR9EVX	1265	BR9EIX	3981
AA70L5(700cc)	700	BR9ES	5722	0.8	BR9EVX	1265	BR9EIX	3981
AA70L6(700cc)	700	BR9ES	5722	0.8	BR9EVX	1265	BR9EIX	3981
AB70L1(700cc)	700	BR9ES	5722	0.8	BR9EVX	1265	BR9EIX	3981
AB70L2(700cc)	700	BR9ES	5722	0.8	BR9EVX	1265	BR9EIX	3981
AB70L3(700cc)	700	BR9ES	5722	0.8	BR9EVX	1265	BR9EIX	3981
AC70L1(700cc)	700	BR9ES	5722	0.8	BR9EVX	1265	BR9EIX	3981
AC70L2(700cc)	700	BR9ES	5722	0.8	BR9EVX	1265	BR9EIX	3981
AC70L3(700cc)	700	BR9ES	5722	0.8	BR9EVX	1265	BR9EIX	3981
AA80L1(794cc)	794	BR9ES	5722	0.8	BR9EVX	1265	BR9EIX	3981
AA80L2(794cc)	794	BR9ES	5722	0.8	BR9EVX	1265	BR9EIX	3981
AA90L1(896cc)	896	BR9ES	5722	0.8	BR9EVX	1265	BR9EIX	3981
AA90L4(896cc)	896	BR9ES	5722	0.8	BR9EVX	1265	BR9EIX	3981

ARCTIC

Bearcat 660 Wide Track	660	KR8AI	5477	0,8				
------------------------	-----	-------	------	-----	--	--	--	--

BOLENS

292, 295, R295(292cc)	292	B8HS	5510	0.6	B8HVX	2634	BR8HIX	7001
315(310cc)	310	B8HS	5510	0.6	B8HVX	2634	BR8HIX	7001
340, R340(336cc)	336	B8HS	5510	0.6	B8HVX	2634	BR8HIX	7001
399, R399(396cc)	396	B8HS	5510	0.6	B8HVX	2634	BR8HIX	7001
440, R440(438cc)	438	B8HS	5510	0.6	B8HVX	2634	BR8HIX	7001

BOMBARDIER (BSE Engine)

250M(247cc)	247	B7HS	5110	0.6	B7HVX	7836	BR7HIX	7067
296(294cc)	294	B8HS	5510	0.6	B8HVX	2634	BR8HIX	7001
340T, 340SS 12.7mm(1/2") Reach(336cc)	336	B7HS	5110	0.6	B7HVX	7836	BR7HIX	7067
340T, 340SS 19.0mm(3/4") Reach(336cc)	336	B8ES	2411	0.6	B8EVX	7051	BR8EIX	5044
339(399cc)	399	B8ES	2411	0.6	B8EVX	7051	BR8EIX	5044
440T, 440SS 12.7mm(1/2") Reach(435cc)	435	B7HS	5110	0.6	B7HVX	7836	BR7HIX	7067
440T, 440SS 19.0mm(3/4") Reach(435cc)	435	B8ES	2411	0.6	B8EVX	7051	BR8EIX	5044
439(437cc)	437	B8ES	2411	0.6	B8EVX	7051	BR8EIX	5044

BOMBARDIER (Rotax Engine)

Mini Z		BPR6ES	7822	0,7	BPR6EVX	6764	BPR6EIX	6637
250 Deluxe, 250T(247cc)	247	B7HS	5110	0.5	B7HVX	7836	BR7HIX	7067
250(10-12HP) (247cc)	247	A6	1010	0.5				
250(14HP) (247cc)	247	A7	1110	0.5				
250E(247cc)	247	A7	1110	0.5				
250SS(247cc)	247	B8HS	5510	0.5	B8HVX	2634	BR8HIX	7001



ccm

Order
No.Platin/
Gold-
PalladiumOrder
No.

Iridium

Order
No.**BOMBARDIER (Rotax Engine)**

TNT, RV250(247cc)	247	B8ES	2411	0.5	B8EVX	7051	BR8EIX	5044
253 Safari Citation/E(248cc)	248	BR9ES	5722	0.5	BR9EVX	1265	BR9EIX	3981
247 Elan, Spirit(250cc)	250	A7	1110	0.5				
253 Citation L/S(253cc)	253	BR9ES	5722	0.5	BR9EVX	1265	BR9EIX	3981
253 Citation L/S Elec.(253cc)	253	BR9ES	5722	0.5	BR9EVX	1265	BR9EIX	3981
253 Tunda, -LT(253cc)	253	BR9ES	5722	0.5	BR9EVX	1265	BR9EIX	3981
277 Citation 3500(269cc)-->1981	269	B8ES	2411	0.5	B8EVX	7051	BR8EIX	5044
277 Citation 3500(269cc) 1983-82	269	BR8ES	5422	0.5	BR8EVX	1262	BR8EIX	5044
277 Mirage I(269cc)-->1981	269	B8ES	2411	0.5	B8EVX	7051	BR8EIX	5044
277 Mirage I(269cc) 1983-81	269	BR8ES	5422	0.5	BR8EVX	1262	BR8EIX	5044
277 Scandic(269cc) 1983-82	269	BR8ES	5422	0.5	BR8EVX	1262	BR8EIX	5044
Tundra 280F	280	BR9ES	5722	0.5	BR9EVX	1265	BR9EIX	3981
TNT292(292cc)	292	A8	1210	0.5				
TNT294, TNT300SM	292	B8HS	5510	0.5	B8HVX	2634	BR8HIX	7001
300 Citation(294cc)	294	B8HS	5510	0.5	B8HVX	2634	BR8HIX	7001
300SS, 300E, 300 Olym.(294cc)	294	B8HS	5510	0.5	B8HVX	2634	BR8HIX	7001
300(12.0HP) (299cc)	299	A6	1010	0.5				
300(15.0, 16.0HP) (299cc)	299	A7	1110	0.5				
300S(299cc)	299	A7	1110	0.5				
320E(318cc)	318	A7	1110	0.5				
320SS(318cc)	318	A8	1210	0.5				
420(318cc)	318	A7	1110	0.5				
335, 335E(335cc)	335	A7	1110	0.5				
TNT, RV340, Sonic 340(337cc)	337	---		0.5	B10EVX	7335	BR10EIX	6801
TNT340, TNT340SE	337	B8HS	5510	0.5	B8HVX	2634	BR8HIX	7001
340, 340E(339cc)	339	B8HS	5510	0.5	B8HVX	2634	BR8HIX	7001
340, 340E Olym.Ever	339	B9HS	5810	0.5	B9HVX	2254		
340SS(339cc)	339	A8	1210	0.5				
354 Blizzard 6500(339cc)	339	---		0.5	B10EVX	7335	BR10EIX	6801
354 Blizzard 7500, -Plus(339cc)	339	---		0.5	B10EVX	7335	BR10EIX	6801
354 Super Sonic/LC(339cc)	339	---		0.5	B10EVX	7335	BR10EIX	6801
Nuvik(339cc) 1979	339	B9HS	5810	0.5	B9HVX	2254		
TNT340 Free Air(339cc)	339	B9ES	2611	0.5	B9EVX	7254	BR9EIX	3981
TNT340SM(339cc)	339	B8HS	5510	0.5	B8HVX	2634	BR8HIX	7001
370(368cc)	368	B7HS	5110	0.5	B7HVX	7836	BR7HIX	7067
377 Citation 300(368cc) 1982	368	BR8ES	5422	0.5	BR8EVX	1262	BR8EIX	5044
377 Citation 4500(368cc) 1981	368	B8ES	2411	0.5	BR8EVX	1262	BR8EIX	5044
377 Citation 4500(368cc) 1983-82	368	BR8ES	5422	0.5	BR8EVX	1262	BR8EIX	5044
377 Citation 4500E(368cc) 1981	368	B8ES	2411	0.5	BR8EVX	1262	BR8EIX	5044
377 Citation 4500E(368cc) 1983-82	368	BR8ES	5422	0.5	BR8EVX	1262	BR8EIX	5044
377 Citation 4500SS(368cc) 1983-82	368	BR8ES	5422	0.5	BR8EVX	1262	BR8EIX	5044
377 Futura 300(368cc) 1983	368	BR8ES	5422	0.5	BR8EVX	1262	BR8EIX	5044
377 Mirage II(368cc) 1983-82	368	BR8ES	5422	0.5	BR8EVX	1262	BR8EIX	5044
377 Mirage II E(368cc) 1983-82	368	BR8ES	5422	0.5	BR8EVX	1262	BR8EIX	5044
377 Mirage II Special(368cc) 1982	368	BR8ES	5422	0.5	BR8EVX	1262	BR8EIX	5044
377 Nordic(368cc) 1983-82	368	BR8ES	5422	0.5	BR8EVX	1262	BR8EIX	5044
377 Safari Saga(368cc)	368	BR9ES	5722	0.5	BR9EVX	1265	BR9EIX	3981
377 Safari Scout/E(368cc)	368	BR9ES	5722	0.5	BR9EVX	1265	BR9EIX	3981
377 Skandic(368cc) 1984-83	368	BR8ES	5422	0.5	BR8EVX	1262	BR8EIX	5044
371(369cc)	369	B7HS	5110	0.5	B7HVX	7836	BR7HIX	7067
377 Formula S(377cc)	377	BR9ES	5722	0.5	BR9EVX	1265	BR9EIX	3981
377 Mirage III(377cc)	377	BR9ES	5722	0.5	BR9EVX	1265	BR9EIX	3981



ccm

Order
No.Platin/
Gold-
PalladiumOrder
No.

Iridium

Order
No.**BOMBARDIER (Rotax Engine)**

377 Safari, -E(377cc)	377	BR9ES	5722	0.5	BR9EVX	1265	BR9EIX	3981
377 Skandic(377cc) 1985	377	BR8ES	5422	0.5	BR8EVX	1262	BR8EIX	5044
377 Skandic R(377cc) 1985	377	BR8ES	5422	0.5	BR8EVX	1262	BR8EIX	5044
377 Touring E/ELT(377cc)	377	BR9ES	5722	0.4	BR9EVX	1265	BR9EIX	3981
380 Scandic 380(380cc)	380	BR9ES	5722	0.4	BR9EVX	1265	BR9EIX	3981
Legend Fan 380F	380	BR9ES	5722	0.5	BR9EVX	1265	BR9EIX	3981
Legend GT 380F	380	BR9ES	5722	0.5	BR9EVX	1265	BR9EIX	3981
MX Z Fan	380	BR9ES	5722	0.5	BR9EVX	1265	BR9EIX	3981
399(399cc)	399	B8HS	5510	0.5	B8HVX	2634	BR8HIX	7001
400, 400E(399cc)	399	B8HS	5510	0.5	B8HVX	2634	BR8HIX	7001
400, 400E Futura(399cc) 1979	399	B8HS	5510	0.5	B8HVX	2634	BR8HIX	7001
TNT399(399cc)	399	B8HS	5510	0.5	B8HVX	2634	BR8HIX	7001
TNT400 Free Air(399cc)	399	B10ES	7928	0.5	B10EVX	7335	BR10EIX	6801
440 MX-Z 440/F(436cc)	436	BR9ES	5722	0.4	BR9EVX	1265	BR9EIX	3981
444 Elite(436cc)	436	B8ES	2411	0.5	B8EVX	7051	BR8EIX	5044
444LC Everest, Futura(436cc)	436	B8ES	2411	0.5	B8EVX	7051	BR8EIX	5044
440, 440E(437cc)	437	A8	1210	0.5				
440ER, 440R(437cc)	437	A7	1110	0.5				
447 Grand Luxe(437cc)	437	BR8ES	5422	0.5	BR8EVX	1262	BR8EIX	5044
447 Nordic 50(437cc)	437	BR9ES	5722	0.5	BR9EVX	1265	BR9EIX	3981
447 Safari 447(437cc)	437	BR8ES	5422	0.5	BR8EVX	1262	BR8EIX	5044
454 Blizzard 9500/Plus(437cc)	437	---		0.5	B10EVX	7335	BR10EIX	6801
Olympique Plus(437cc)	437	A7	1110	0.5				
TNT440(437cc)	437	A8	1210	0.5				
TNT440 Free Air 14mm Head(437cc)	437	B9ES	2611	0.5	B9EVX	7254	BR9EIX	3981
TNT440 Free Air 18mm Head(437cc)	437	A7	1110	0.5				
TNT440SE(437cc)	437	A8	1210	0.5				
TNT440SM(437cc)	437	A8	1210	0.5				
440 Touring LE(440cc)	440	BR9ES	5722	0.4	BR9EVX	1265	BR9EIX	3981
MX Zx Racing 440	440	BR9ECS	3570	0.5				
Skandic LT 440F	440	BR9ES	5722	0.5	BR9EVX	1265	BR9EIX	3981
Skandic LT(E) 440F	440	BR9ES	5722	0.5	BR9EVX	1265	BR9EIX	3981
443 Touring LE(443cc)	443	BR9ES	5722	0.5	BR9EVX	1265	BR9EIX	3981
447 Safari, -447(447cc) 1986	447	BR9ES	5722	0.5	BR9EVX	1265	BR9EIX	3981
454 MXZ 440(454cc)	454	BR9ES	5722	0.5	BR9EVX	1265	BR9EIX	3981
454 Ultra Sonic(463cc)	463	---		0.5	B10EVX	7335	BR10EIX	6801
462 SS25, SP, SS(463cc)	463	BR8ES	5422	0.5	BR8EVX	1262	BR8EIX	5044
464 Elite(463cc)-->1981	463	B8ES	2411	0.5	B8EVX	7051	BR8EIX	5044
464 Elite(463cc) 1983-82	463	BR8ES	5422	0.5	BR8EVX	1262	BR8EIX	5044
464 Everest LC(463cc) 1983-82	463	BR8ES	5422	0.5	BR8EVX	1262	BR8EIX	5044
464 Everest LC(463cc)-->1981	463	B8ES	2411	0.5	B8EVX	7051	BR8EIX	5044
464 Futura LC(463cc)-->1981	463	B8ES	2411	0.5	B8EVX	7051	BR8EIX	5044
464 Futura LC(463cc) 1983-82	463	BR8ES	5422	0.5	BR8EVX	1262	BR8EIX	5044
494 Formula SLS(494cc)	494	BR9ES	5722	0.5	BR9EVX	1265	BR9EIX	3981
494 Skandic WT LC(494cc)	494	BR8ES	5422	0.5	BR8EVX	1262	BR8EIX	5044
494 Summit 500(494cc)	494	BR9ES	5722	0.5	BR9EVX	1265	BR9EIX	3981
467 Formula MX/LT(496cc)	496	BR9ES	5722	0.5	BR9EVX	1265	BR9EIX	3981
503 Alpine II(496cc)	496	BR8ES	5422	0.5	BR8EVX	1262	BR8EIX	5044
503 Escapade(496cc)	496	BR9ES	5722	0.5	BR9EVX	1265	BR9EIX	3981
503 Nordic 60(496cc)	496	BR9ES	5722	0.5	BR9EVX	1265	BR9EIX	3981
503 Safari 503R(496cc)	496	BR9ES	5722	0.5	BR9EVX	1265	BR9EIX	3981
503 Alpine(497cc) 1986-83	497	BR7ES	5122	0.5	BR7EVX	4556		



ccm

Order
No.Platin/
Gold-
PalladiumOrder
No.

Iridium

Order
No.**BOMBARDIER (Rotax Engine)**

503 Blizzard 5500(497cc) 1981	497	BR8ES	5422	0.5	BR8EVX	1262	BR8EIX	5044
503 Blizzard 5500MX(497cc) 1983-82	497	BR7ES	5122	0.5	BR7EVX	4556		
503 Blizzard MX(497cc) 1984	497	BR8ES	5422	0.5	BR8EVX	1262	BR8EIX	5044
503 Everest 500(497cc) 1985-84, 1982	497	BR7ES	5122	0.5	BR7EVX	4556		
503 Everest 500, -E(497cc) 1981	497	BR8ES	5422	0.5	BR8EVX	1262	BR8EIX	5044
503 Futura 500, -E(497cc) 1983-82	497	BR7ES	5122	0.5	BR7EVX	4556		
503 Grand Prix Spec.(497cc) 1982	497	BR7ES	5122	0.5	BR7EVX	4556		
503 Safari Cheyenne(497cc)	497	BR9ES	5722	0.5	BR9EVX	1265	BR9EIX	3981
503 Safari Escapade(497cc)	497	BR9ES	5722	0.5	BR9EVX	1265	BR9EIX	3981
503 Safari Voyageur(497cc)	497	BR9ES	5722	0.5	BR9EVX	1265	BR9EIX	3981
503 Sonic MX(497cc) 1983	497	BR7ES	5122	0.5	BR7EVX	4556		
500 GT 500(500cc)	500	BR9ES	5722	0.4	BR9EVX	1265	BR9EIX	3981
500 Scandic 500(500cc)	500	BR9ES	5722	0.4	BR9EVX	1265	BR9EIX	3981
GSX Sport 1+1 500 SS	500	BR9ECS	3570	0,5				
GSX Sport 500 SS	500	BR9ECS	3570	0,5				
Legend Sport 500 SS	500	BR9ECS	3570	0,5				
Legend Sport GT 500 SS	500	BR9ECS	3570	0,5				
MX Z Adrenaline 500 SS	500	BR9ECS	3570	0,5				
MX Z Adrenaline 500 SS (E)	500	BR9ECS	3570	0,5				
MX Z Trail 500 SS	500	BR9ECS	3570	0,5				
MX Z Trail 500 SS (E)	500	BR9ECS	3570	0,5				
503 Formula SL(503cc)	503	BR9ES	5722	0.5	BR9EVX	1265	BR9EIX	3981
503 Skandic SWT(503cc)	503	BR8ES	5422	0.5	BR8EVX	1262	BR8EIX	5044
503 Skandic WT503R(503cc)	503	BR9ES	5722	0.5	BR9EVX	1265	BR9EIX	3981
503 Summit 500(503cc)	503	BR9ES	5722	0.5	BR9EVX	1265	BR9EIX	3981
503 Touring SLE(503cc)	503	BR9ES	5722	0.5	BR9EVX	1265	BR9EIX	3981
534 Blizzasd 9700(521cc)-->1983	521	BR8ES	5422	0.5	BR8EVX	1262	BR8EIX	5044
536 Formula Plus/LT(521cc)	521	BR9ES	5722	0.5	BR9EVX	1265	BR9EIX	3981
537 Formula Plus(537cc)	537	BR9ES	5722	0.5	BR9EVX	1265	BR9EIX	3981
Legend Fan 550F	550	BR9ES	5722	0.5	BR9EVX	1265	BR9EIX	3981
Legend GT 550F	550	BR9ES	5722	0.5	BR9EVX	1265	BR9EIX	3981
MX Z Fan 550F	550	BR9ES	5722	0.5	BR9EVX	1265	BR9EIX	3981
Skandic Sport 550F	550	BR9ES	5722	0.5	BR9EVX	1265	BR9EIX	3981
Skandic SUV 550F	550	BR9ES	5722	0.5	BR9EVX	1265	BR9EIX	3981
Skandic SWT 550F	550	BR9ES	5722	0.5	BR9EVX	1265	BR9EIX	3981
Skandic WT 550F	550	BR9ES	5722	0.5	BR9EVX	1265	BR9EIX	3981
Summit Fan 550F	550	BR9ES	5722	0.5	BR9EVX	1265	BR9EIX	3981
583 Formula Mach I(581cc)	581	BR9ES	5722	0.5	BR9EVX	1265	BR9EIX	3981
582 GT 582(582cc)	582	BR9ES	5722	0.4	BR9EVX	1265	BR9EIX	3981
583 Formula STX/STXL/STXLT/Z 583(583cc)	583	BR9ES	5722	0.5	BR9EVX	1265	BR9EIX	3981
583 GT 583	583	BR9ES	5722	0.5	BR9EVX	1265	BR9EIX	3981
583 MX-Z 583(583cc)	583	BR9ES	5722	0.5	BR9EVX	1265	BR9EIX	3981
583 MX-Z LI 583(583cc)	583	BR9ES	5722	0.5	BR9EVX	1265	BR9EIX	3981
583 Summit 583(583cc)	583	BR9ES	5722	0.5	BR9EVX	1265	BR9EIX	3981
599 Formula III/III LT(599cc)	599	BR10ES	4832	0.5	BR10EV	5127	BR10EIX	6801
600 Formula III(600cc)	600	BR10ES	4832	0.5	BR10EV	5127	BR10EIX	6801
GSX Limited 600 HO SDI	600	BR9ECS	3570	0,8				
GSX LTD 1+1 600 HO SDI	600	BR9ECS	3570	0,8				
GSX Sport 1+1 600 HO	600	BR9ECS	3570	0,5				
GSX Sport 1+1 600HO SDI	600	BR9ECS	3570	0,8				
GSX Sport 600 HO	600	BR9ECS	3570	0,5				
GSX Sport 600 HO SDI	600	BR9ECS	3570	0,8				



ccm

Order
No.Platin/
Gold-
PalladiumOrder
No.

Iridium

Order
No.**BOMBARDIER (Rotax Engine)**

Legend SE 600 HO SDI	600	BR9ECS	3570	0,5				
Legend SE GT 600 HO SDI	600	BR9ECS	3570	0,5				
Legend Sport 600 HO SDI	600	BR9ECS	3570	0,5				
Legend Sport GT 600 HO SDI	600	BR9ECS	3570	0,5				
MX Z Renegade X 600 HO SDI	600	BR9ECS	3570	0,8				
MX Z X 600 HO	600	BR9ECS	3570	0,5				
MX Z X 600 HO (E)	600	BR9ECS	3570	0,5				
MX Z X 600 HO SDI	600	BR9ECS	3570	0,8				
MX Z Adrenaline 600 HO	600	BR9ECS	3570	0,5				
MX Z Adrenaline 600 HO (E)	600	BR9ECS	3570	0,5				
MX Z Adrenaline 600 HO SDI	600	BR9ECS	3570	0,8				
MX Z Adrenaline 600 HO SDI (E)	600	BR9ECS	3570	0,8				
MX Z Rene. X 600 HO SDI (E)	600	BR9ECS	3570	0,8				
MX Z Renegade 600 HO	600	BR9ECS	3570	0,5				
MX Z Renegade 600 HO (E)	600	BR9ECS	3570	0,5				
MX Z Renegade X 600 HO	600	BR9ECS	3570	0,5				
MX Z Renegade X 600 HO (E)	600	BR9ECS	3570	0,5				
MX Z Trail 600 HO	600	BR9ECS	3570	0,5				
MX Z Trail 600 HO (E)	600	BR9ECS	3570	0,5				
MX Z X 600 HO SDI (E)	600	BR9ECS	3570	0,8				
Skandic SUV 600	600	BR9ECS	3570	0,5				
Skandic WT LC 600	600	BR9ECS	3570	0,5				
Summit Adrenaline 600 HO	600	BR9ECS	3570	0,5				
Summit X 600 HO	600	BR9ECS	3570	0,5				
640 ER Alpine(635cc)	635	B7HS	5110	0.5	B7HVX	7836	BR7HIX	7067
640, 640ER(635cc)	635	A7	1110	0.5				
TNT640(635cc)	635	A7	1110	0.5				
TNT669(669cc)	669	A7	1110	0.5				
670 Formula SS(670cc)	670	BR9ES	5722	0.5	BR9EVX	1265	BR9EIX	3981
670 GT SE670(670cc)	670	BR9ES	5722	0.5	BR9EVX	1265	BR9EIX	3981
670 Mach 1(670cc)	670	BR10ES	4832	0.5	BR10EV	5127	BR10EIX	6801
670 Summit 670(670cc)	670	BR9ES	5722	0.5	BR9EVX	1265	BR9EIX	3981
699 GT SE(699cc)	699	BR10ES	4832	0.4	BR10EV	5127	BR10EIX	6801
699 Mach 1(699cc)	699	BR10ES	4832	0.4	BR10EV	5127	BR10EIX	6801
Legend SE 700	700	BR9ECS	3570	0,5				
Legend SE GT 700	700	BR9ECS	3570	0,5				
Legend Sport 700	700	BR9ECS	3570	0,5				
Legend Sport GT 700	700	BR9ECS	3570	0,5				
TNT775(771cc)	771	A8	1210	0.5				
779 Mach Z/ZLT(779cc)	779	BR10ES	4832	0.5	BR10EV	5127	BR10EIX	6801
GSX Limited 1+1 800 HO	800	BR9ECS	3570	0,5				
GSX Limited 800 HO	800	BR9ECS	3570	0,5				
Legend SE 800 SDI	800	BR9ECS	3570	0,8				
Legend SE GT 800 SDI	800	BR9ECS	3570	0,8				
MX Z Renegade 800 (E)	800	BR9ECS	3570	0,5				
MX Z X Reneg. 800 HO (E)	800	BR9ECS	3570	0,5				
MX Z Adrenaline 800 (E)	800	BR9ECS	3570	0,5				
MX Z Adrenaline 800 HO	800	BR9ECS	3570	0,5				
MX Z Renegade 800 HO	800	BR9ECS	3570	0,5				
MX Z Renegade X 800 HO	800	BR9ECS	3570	0,5				
MX Z X 800 HO	800	BR9ECS	3570	0,5				
MX Z X 800 HO (E)	800	BR9ECS	3570	0,5				



ccm

Order
No.Platin/
Gold-
PalladiumOrder
No.

Iridium

Order
No.**BOMBARDIER (Rotax Engine)**

Summit Adrenalin 800 HO	800	BR9ECS	3570	0,5				
Summit HM 800 HO	800	BR9ECS	3570	0,5				
Summit HM X 800 HO	800	BR9ECS	3570	0,5				
Summit HM Xtreme 800 HO	800	BR9ECS	3570	0,5				
Summit Sport 800 HO	800	BR9ECS	3570	0,5				
Summit X 800 HO	800	BR9ECS	3570	0,5				
809 Mach Z(809cc)	809	BR10ES	4832	0,4	BR10EV	5127	BR10EIX	6801
Legend SE GT V-1000	1000	DCPR8E	4339	0,8	DCPR8EVX	2265		
Legend SE V-1000	1000	DCPR8E	4339	0,8	DCPR8EVX	2265		

BURAN

PM3-640 20,6kW	640	BP6ES	7811	0,7	BP6EVX	5832		
----------------	-----	-------	------	-----	--------	------	--	--

CANADIAN CURTIS WRIGHT

KEC248(248cc)	248	A7	1110	0,6				
KEC290/2, KEC290/3(290cc)	290	B8HS	5510	0,6	B8HVX	2634	BR8HIX	7001
KEC295RS/2(290cc)	290	BUE	2322	-				
KEC340/2, KEC340/3(339cc)	339	B8HS	5510	0,6	B8HVX	2634	BR8HIX	7001
KEC340/22A(339cc)	339	B8ES	2411	0,6	B8EVX	7051	BR8EIX	5044
KEC340/4(339cc)	339	B8HS	5510	0,6	B8HVX	2634	BR8HIX	7001
KEC340/5(339cc)	339	B8ES	2411	0,6	B8EVX	7051	BR8EIX	5044
KEC340/5A(339cc)	339	B8ES	2411	0,6	B8EVX	7051	BR8EIX	5044
KEC400/2, KEC400/3(398cc)	398	B8HS	5510	0,6	B8HVX	2634	BR8HIX	7001
KEC400/21(398cc)	398	B8HS	5510	0,6	B8HVX	2634	BR8HIX	7001
KEC400/22(398cc)	398	B8ES	2411	0,6	B8EVX	7051	BR8EIX	5044
KEC400/22A(398cc)	398	B8ES	2411	0,6	B8EVX	7051	BR8EIX	5044
KEC400/4(398cc)	398	B8HS	5510	0,6	B8HVX	2634	BR8HIX	7001
KEC440/21(436cc)	436	B8HS	5510	0,6	B8HVX	2634	BR8HIX	7001
KEC440/22(436cc)	436	B8HS	5510	0,6	B8HVX	2634	BR8HIX	7001
KEC440/22A(436cc)	436	B8HS	5510	0,6	B8HVX	2634	BR8HIX	7001
KEC440/3, KEC440/4(436cc)	436	B8HS	5510	0,6	B8HVX	2634	BR8HIX	7001
KEC440/5(436cc)	436	B8ES	2411	0,6	B8EVX	7051	BR8EIX	5044

CHAPARRAL(XENOAH)

250(242cc)	242	B8ES	2411	0,5	B8EVX	7051	BR8EIX	5044
295(292cc)	292	BR7ES	5122	0,5	BR7EVX	4556		
340(338cc)	338	BR7ES	5122	0,5	BR7EVX	4556		
340SS(338cc)	338	B9ES	2611	0,5	B9EVX	7254	BR9EIX	3981
SSX340(338cc)	338	BR8ES	5422	0,5	BR8EVX	1262	BR8EIX	5044
400 19.0mm(3/4") Reach(394cc)	394	B8ES	2411	0,5	B8EVX	7051	BR8EIX	5044
400 12.7mm(1/2") Reach(398cc)	398	B7HS	5110	0,5	B7HVX	7836	BR7HIX	7067
400SS 12.7mm(1/2") Reach(400cc)	400	B8HS	5510	0,5	B8HVX	2634	BR8HIX	7001
400SS 19.0mm(3/4") Reach(400cc)	400	B9ES	2611	0,5	B9EVX	7254	BR9EIX	3981
440 12.7mm(1/2") Reach(438cc)	438	B7HS	5110	0,5	B7HVX	7836	BR7HIX	7067
440 19.0mm(3/4") Reach(438cc)	438	BR7ES	5122	0,5	BR7EVX	4556		
SSX440(438cc)	438	BR8ES	5422	0,5	BR8EVX	1262	BR8EIX	5044
440 Racing, 650 Racing(440cc)	440	---		0,5	B8HVX	2634	BR8HIX	7001
440SS 12.7mm(1/2") Reach(440cc)	440	B8HS	5510	0,5	B8HVX	2634	BR8HIX	7001
440SS 19.0mm(3/4") Reach(440cc)	440	B9ES	2611	0,5	B9EVX	7254	BR9EIX	3981

ECHO (-->KIORITZ)

ECHO (-->KIORITZ)								
-------------------	--	--	--	--	--	--	--	--



ccm

Order
No.Platin/
Gold-
PalladiumOrder
No.

Iridium

Order
No.**EVINRUDE (-->OMC)**

EVINRUDE (-->OMC)

HIRTH

110R(180cc)	180	A7	1110	0.5				
60R(199cc)	199	A7	1110	0.5				
81R, 82R(246cc)	246	A7	1110	0.5				
261R, 261R3, 261R4(292cc)	292	B8ES	2411	0.5	B8EVX	7051	BR8EIX	5044
56R, 193R(292cc)	292	A7	1110	0.5				
190, 191R(300cc)	300	A7	1110	0.5				
52R, 53R, 54R, 55R(300cc)	300	A7	1110	0.5				
192R(317cc)	317	A7	1110	0.5				
194R(338cc)	338	A7	1110	0.5				
260R, 260R3, 260R4(338cc)	338	B8ES	2411	0.5	B8EVX	7051	BR8EIX	5044
160R, 200R(372cc)	372	A7	1110	0.5				
210R, 271R0(399cc)	399	A7	1110	0.5				
211R, 270R, 273R(438cc)	438	A7	1110	0.5				
180R, 220R, 275R(493cc)	493	A7	1110	0.5				
170R(600cc)	600	A7	1110	0.5				
171R(634cc)	634	A7	1110	0.5				
231R(647cc)	647	B8HS	5510	0.5	B8HVX	2634	BR8HIX	7001
280R(649cc)	649	B8ES	2411	0.5	B8EVX	7051	BR8EIX	5044
172R(650cc)	650	A7	1110	0.5				
281R0(650cc)	650	B8ES	2411	0.5	B8EVX	7051	BR8EIX	5044
230R(793cc)	793	B8HS	5510	0.5	B8HVX	2634	BR8HIX	7001

IKAR

PM3-320 11,8kW	320	BP6ES	7811	0,7	BP6EVX	5832		
----------------	-----	-------	------	-----	--------	------	--	--

ILO-ROCKWELL

L99(100cc)	100	B6HS	4510	0.5			BR6HIX	3419
L152(148cc)	148	A6	1010	0.5				
L197(192cc)	192	A6	1010	0.5				
L227, L230(223cc)	223	A7	1110	0.5				
L252(257cc)	257	A6	1010	0.5				
2F295(285cc)	285	B8ES	2411	0.5	B8EVX	7051	BR8EIX	5044
L292, L295(292cc)	292	A7	1110	0.5				
R295, L295/70(292cc)	292	B8ES	2411	0.5	B8EVX	7051	BR8EIX	5044
L297, L300(296cc)	296	A7	1110	0.5				
2F340(337cc)	337	B8ES	2411	0.5	B8EVX	7051	BR8EIX	5044
L340(337cc)	337	A7	1110	0.5				
R340, L340/70, LR340/2(337cc)	337	B8ES	2411	0.5	B8EVX	7051	BR8EIX	5044
L372, L380(372cc)	372	A7	1110	0.5				
L395(396cc)	396	A7	1110	0.5				
L399/2, LR399/2, LR400/2(398cc)	398	B8ES	2411	0.5	B8EVX	7051	BR8EIX	5044

JOHN DEERE (Kawasaki Engine)

TA340A(339cc)	339	BR8ES	5422	0.8	BR8EVX	1262	BR8EIX	5044
TA340A-D202(339cc)	339	BR8ES	5422	0.8	BR8EVX	1262	BR8EIX	5044
TA340A-F202(339cc)	339	BR8ES	5422	0.8	BR8EVX	1262	BR8EIX	5044
TB340A-A202(339cc)	339	BR8ES	5422	0.8	BR8EVX	1262	BR8EIX	5044
TB340A-C202(339cc)	339	BR8ES	5422	0.8	BR8EVX	1262	BR8EIX	5044
All 1981 Models(436cc)	436	BR9ES	5722	0.8	BR9EVX	1265	BR9EIX	3981



ccm

Order
No.Platin/
Gold-
PalladiumOrder
No.

Iridium

Order
No.**JOHN DEERE (Kawasaki Engine)**

TA440A(436cc)	436	BR8ES	5422	0.8	BR8EVX	1262	BR8EIX	5044
TA440A-D202(436cc)	436	BR8ES	5422	0.8	BR8EVX	1262	BR8EIX	5044
TA440A-F202(436cc)	436	BR8ES	5422	0.8	BR8EVX	1262	BR8EIX	5044
TA440B-C202(436cc)	436	BR9ES	5722	0.8	BR9EVX	1265	BR9EIX	3981
TA440B-E202(436cc)	436	BR9ES	5722	0.8	BR9EVX	1265	BR9EIX	3981
TC440A-C202(436cc)	436	BR9ES	5722	0.8	BR9EVX	1265	BR9EIX	3981
TC440A-E202(436cc)	436	BR9ES	5722	0.8	BR9EVX	1265	BR9EIX	3981

JOHN DEERE (Kioritz Engine)

KEC295RS/2(290cc)	290	B10ES	7928	0.6	B10EVX	7335	BR10EIX	6801
KEC340/22A w/C.D.ig.(339cc)	339	B10ES	7928	0.6	B10EVX	7335	BR10EIX	6801
KEC340/22A w/Mag.ig.(339cc)	339	B8ES	2411	0.6	B8EVX	7051	BR8EIX	5044
KEC340/22B, -22C(339cc)	339	B10ES	7928	0.6	B10EVX	7335	BR10EIX	6801
KEC340/23ALC, -23BLC(339cc)	339	B10ES	7928	0.6	B10EVX	7335	BR10EIX	6801
KEC340/23LC(339cc)	339	B10ES	7928	0.6	B10EVX	7335	BR10EIX	6801
KEC340/5A(339cc)	339	B8ES	2411	0.6	B8EVX	7051	BR8EIX	5044
KEC340RS/2(339cc)	339	B10ES	7928	0.6	B10EVX	7335	BR10EIX	6801
KEC340RS/24LC(339cc)	339	B10ES	7928	0.6	B10EVX	7335	BR10EIX	6801
KEC440/22A w/C.D.ig.(436cc)	436	B10ES	7928	0.6	B10EVX	7335	BR10EIX	6801
KEC440/22A w/Mag.ig.(436cc)	436	B8ES	2411	0.6	B8EVX	7051	BR8EIX	5044
KEC440/22B-22C(436cc)	436	B10ES	7928	0.6	B10EVX	7335	BR10EIX	6801
KEC440/23AL, -23BLC(436cc)	436	B10ES	7928	0.6	B10EVX	7335	BR10EIX	6801
KEC440/23LC(436cc)	436	B10ES	7928	0.6	B10EVX	7335	BR10EIX	6801

KIORITZ(ECHO)

KEC295RS(290cc)	290	BUE	2322	-				
KEC340/22A w/C.D.ig.(339cc)	339	BUE	2322	-				
KEC340/22A w/Mag.ig.(339cc)	339	B8ES	2411	0.6	B8EVX	7051	BR8EIX	5044
KEC340/22B w/C.D.ig.(339cc)	339	---		0.6	B10EVX	7335	BR10EIX	6801
KEC340/23LC, 23ALC, 23BLC(339cc)	339	---		0.6	B10EVX	7335	BR10EIX	6801
KEC340/5A(339cc)	339	B8ES	2411	0.6	B8EVX	7051	BR8EIX	5044
KEC340RS/2(339cc)	339	BUE	2322	-				
KEC340RS/24LC(339cc)	339	BUE	2322	-				
KEC440/22A w/C.D.ig.(436cc)	436	BUE	2322	-				
KEC440/22A w/Mag.ig.(436cc)	436	B8ES	2411	0.6	B8EVX	7051	BR8EIX	5044
KEC440/22B w/C.D.ig.(436cc)	436	---		0.6	B10EVX	7335	BR10EIX	6801
KEC440/23LC, -23ALC, -23BLC(436cc)	436	---		0.6	B10EVX	7335	BR10EIX	6801

KOHLER

K141, K161, K181(4 Cycle)		B6S	3510	0.5				
K250-1AM(220cc)	220	B8ES	2411	0.5	B8EVX	7051	BR8EIX	5044
K250-RLC(250cc)	250	BUE	2322	-				
K295-2, K295-2AX(290cc)	290	B8ES	2411	0.5	B8EVX	7051	BR8EIX	5044
K295-2SS(290cc)	290	B10ES	7928	0.5	B10EVX	7335	BR10EIX	6801
K295-2T(292cc)	292	B8ES	2411	0.5	B8EVX	7051	BR8EIX	5044
K295-1, K295-1T(294cc)	294	A7	1110	0.5				
K309-1, K309-1T(309cc)	309	A7	1110	0.5				
K335-1, K335-1T(335cc)	335	A7	1110	0.5				
K340-2, K340-2T(338cc)	338	B8HS	5510	0.5	B8HVX	2634	BR8HIX	7001
K340-2AX(338cc)	338	B8ES	2411	0.5	B8EVX	7051	BR8EIX	5044
K340-2FA(338cc)	338	BR8ES	5422	0.5	BR8EVX	1262	BR8EIX	5044
K340-2SS(338cc)	338	B10ES	7928	0.5	B10EVX	7335	BR10EIX	6801



ccm

Order
No.Platin/
Gold-
PalladiumOrder
No.

Iridium

Order
No.**KOHLER**

K340-2AS, -2RS, -RLC(339cc)	339	BUE	2322	-				
SK340-2AX(339cc)	339	BUE	2322	-				
K399-2, -2T(398cc)	398	A7	1110	0.5				
K399-2AX, RK399-2AX(398cc)	398	B9ES	2611	0.5	B9EVX	7254	BR9EIX	3981
K400-2RS(398cc)	398	BUE	2322	-				
K440-2SS 12.7mm(1/2") Reach(429cc)	429	B9HS	5810	0.5	B9HVX	2254		
K440-2SS 19.0mm(3/4") Reach(429cc)	429	B10ES	7928	0.5	B10EVX	7335	BR10EIX	6801
K440-3RS 12.7mm(1/2") Reach(429cc)	429	B9HS	5810	0.5	B9HVX	2254		
K440-3RS 19.0mm(3/4") Reach(429cc)	429	B10ES	7928	0.5	B10EVX	7335	BR10EIX	6801
K440-2(436cc)	436	A7	1110	0.5				
K440-2AM(436cc)	436	B9ES	2611	0.5	B9EVX	7254	BR9EIX	3981
K440-2AM w/C.D.ig.(436cc)	436	BUE	2322	-				
K440-2AS, -2RS, -RLC(436cc)	436	BUE	2322	-				
K440-2AX(436cc)	436	B8ES	2411	0.5	B8EVX	7051	BR8EIX	5044
K440-2T(436cc)	436	A7	1110	0.5				
RK440-2T(436cc)	436	A8	1210	0.5				
SK440-2LC(436cc)	436	BUE	2322	-				
K539-2(539cc)	539	A7	1110	0.5				
K618-2(618cc)	618	A7	1110	0.5				
K645-3RS 12.7mm(1/2") Reach(645cc)	645	B9HS	5810	0.5	B9HVX	2254		
K645-3RS 19.0mm(3/4") Reach(645cc)	645	B10ES	7928	0.5	B10EVX	7335	BR10EIX	6801
K645-3SS 12.7mm(1/2") Reach(645cc)	645	B9HS	5810	0.5	B9HVX	2254		
K645-3SS 19.0mm(3/4") Reach(645cc)	645	B10ES	7928	0.5	B10EVX	7335	BR10EIX	6801

MERCURY (-->CANADIAN CURTIS WRIGHT, HIRTH, KOHLER)

Hurricane(Mark I, II) (644cc)	644	BUH	2422	-				
-------------------------------	-----	-----	------	---	--	--	--	--

MONARK CRESCENT

380		A8	1210	0.5				
-----	--	----	------	-----	--	--	--	--

MOTO-SKI (-->BOMBARDIER)**NPO SATURN**

Taiga	500	BR9ES	5722	0.5	BR9EVX	1265	BR9EIX	3981
-------	-----	-------	------	-----	--------	------	--------	------

OCKELBO

MAG 2034		B7ES	1111	0.5	B7EVX	6934		
Rotax Ockelbo 600, 800, 8000		B8ES	2411	0.5	B8EVX	7051	BR8EIX	5044
Sachs Wankel KM914		B6HS	4510	0.5			BR6HIX	3419
Sachs SA280	280	A6	1010	0.5				
Sachs SA290	290	A7	1110	0.5				
Sachs SA290SS	290	B8HS	5510	0.5	B8HVX	2634	BR8HIX	7001
JLO LR340/2	340	B8ES	2411	0.5	B8EVX	7051	BR8EIX	5044
Sachs SA340	340	A8	1210	0.5				
Sachs SA340RX	340	B9ES	2611	0.5	B9EVX	7254	BR9EIX	3981
JLO 2F-400	400	B7ES	1111	0.5	B7EVX	6934		
Rotax Ockelbo 400	400	B7ES	1111	0.5	B7EVX	6934		

OMC(JOHNSON-EVINRUDE)

With CDI System		BUHX	2522	-				
M215(362cc)	362	B4	3210	0.8				



ccm

Order
No.Platin/
Gold-
PalladiumOrder
No.

Iridium

Order
No.**OMC(JOHNSON-EVINRUDE)**

M228(399cc)	399	B6S	3510	0.8				
M232, M232E, M235, M237(399cc)	399	B8S	3810	0.8				
M225, M225C(437cc)	437	B6S	3510	0.8				
M226E, M226W, M231E, M231W(437cc)	437	B6S	3510	0.8				
M227(437cc)	437	B7S	3710	0.8				
M229E, M229W, M230, M230E(437cc)	437	B8S	3810	0.8				
M233, M233E, M234E, M236(437cc)	437	B8S	3810	0.8				
M238, M239E, M241E, M245(437cc)	437	B8S	3810	0.8				

POLARIS

PS-06		BR8ES	5422	0.6	BR8EVX	1262	BR8EIX	5044
EC16P(164cc)	164	B7ES	1111	0.4	B7EVX	6934		
EC17P(175cc)	175	B7ES	1111	0.4	B7EVX	6934		
EC17PM(175cc)	175	B7ES	1111	0.4	B7EVX	6934		
EC25PM-01(244cc)	244	BR8ES	5422	0.5	BR8EVX	1262	BR8EIX	5044
EC25PS(244cc)	244	BR8ES	5422	0.5	BR8EVX	1262	BR8EIX	5044
EC25	250	BR8ES	5422	0.6	BR8EVX	1262	BR8EIX	5044
EC25PC(250cc)	250	B9ES	2611	0.5	B9EVX	7254	BR9EIX	3981
EC25PT(250cc)	250	B9ES	2611	0.5	B9EVX	7254	BR9EIX	3981
EC25PT-04(250cc)	250	B8ES	2411	0.5	B8EVX	7051	BR8EIX	5044
EC25PT-05(250cc)	250	B10ES	7928	0.5	B10EVX	7335	BR10EIX	6801
EC25PT-06(250cc)	250	B9ES	2611	0.5	B9EVX	7254	BR9EIX	3981
EC25PT-07(250cc)	250	BR9ES	5722	0.5	BR9EVX	1265	BR9EIX	3981
EC29P(294cc)	294	B7ES	1111	0.5	B7EVX	6934		
EC29PF(294cc)	294	B7ES	1111	0.5	B7EVX	6934		
EC29PM(294cc)	294	B7ES	1111	0.5	B7EVX	6934		
EC29PS(294cc)	294	B8ES	2411	0.5	B8EVX	7051	BR8EIX	5044
EC34-2P-03	333	BR9ES	5722	0.6	BR9EVX	1265	BR9EIX	3981
EC34PL-01(333cc)	333	B9ES	2611	0.5	B9EVX	7254	BR9EIX	3981
EC34PL-02(333cc)	333	BR9ES	5722	0.5	BR9EVX	1265	BR9EIX	3981
EC34PL-03(333cc)	333	---		0.5	B10EVX	7335	BR10EIX	6801
EC34PL-04(333cc)	333	---		0.5	B10EVX	7335	BR10EIX	6801
EC34PL-05(333cc)	333	BR9ES	5722	0.5	BR9EVX	1265	BR9EIX	3981
EC34PM-03(333cc)	333	BR8ES	5422	0.5	BR8EVX	1262	BR8EIX	5044
EC34PM-04(333cc)	333	BR9ES	5722	0.5	BR9EVX	1265	BR9EIX	3981
EC34PM-04-N(333cc)	333	B8ES	2411	0.5	B8EVX	7051	BR8EIX	5044
EC34-2P-02	335	BR9ES	5722	0.6	BR9EVX	1265	BR9EIX	3981
EC34-2PM-01	335	BR9ES	5722	0.6	BR9EVX	1265	BR9EIX	3981
EC34P(335cc)	335	B7ES	1111	0.5	B7EVX	6934		
EC34PF(335cc)	335	B8ES	2411	0.5	B8EVX	7051	BR8EIX	5044
EC34PR-06(335cc)	335	B10ES	7928	0.5	B10EVX	7335	BR10EIX	6801
EC34PS(335cc)	335	B8ES	2411	0.5	B8EVX	7051	BR8EIX	5044
EC34PT-04(335cc)	335	B8ES	2411	0.5	B8EVX	7051	BR8EIX	5044
EC34PT-05(335cc)	335	BR9ES	5722	0.5	BR9EVX	1265	BR9EIX	3981
EC34PT-06	335	B10ES	7928	0.5	B10EVX	7335	BR10EIX	6801
EC34PT-07(335cc)	335	BR9ES	5722	0.5	BR9EVX	1265	BR9EIX	3981
EC34PC(336cc)	336	B8ES	2411	0.5	B8EVX	7051	BR8EIX	5044
EC34PQ(336cc)	336	B8ES	2411	0.5	B8EVX	7051	BR8EIX	5044
EC34-2PM-02(339cc)	339	BR8ES	5422	0.7	BR8EVX	1262	BR8EIX	5044
EC34-2PME-02(339cc)	339	BR8ES	5422	0.7	BR8EVX	1262	BR8EIX	5044
EC37P(372cc)	372	B8ES	2411	0.5	B8EVX	7051	BR8EIX	5044



ccm

Order
No.Platin/
Gold-
PalladiumOrder
No.

Iridium

Order
No.**POLARIS**

EC40P(398cc)	398	B7ES	1111	0.5	B7EVX	6934		
EC40P-03	398	BR9ES	5722	0.6	BR9EVX	1265	BR9EIX	3981
EC40PL-01	398	BR9ES	5722	0.6	BR9EVX	1265	BR9EIX	3981
EC40PL-02/04(398cc)	398	BR8ES	5422	0.6	BR8EVX	1262	BR8EIX	5044
EC40PM(398cc)	398	B7ES	1111	0.5	B7EVX	6934		
EC40PS(398cc)	398	B10ES	7928	0.5	B10EVX	7335	BR10EIX	6801
EC34-2PM-02(432cc)	432	BR8ES	5422	0.7	BR8EVX	1262	BR8EIX	5044
EC44-2PM-1100(432cc)	432	BR9ES	5722	0.5	BR9EVX	1265	BR9EIX	3981
EC44-2PM-2100(432cc)	432	BR9ES	5722	0.5	BR9EVX	1265	BR9EIX	3981
EC44-2PM-3100(432cc)	432	BR9ES	5722	0.5	BR9EVX	1265	BR9EIX	3981
EC44-2PM-3300(432cc)	432	BR9ES	5722	0.5	BR9EVX	1265	BR9EIX	3981
EC44-2PM-4100(432cc)	432	BR9ES	5722	0.6	BR9EVX	1265	BR9EIX	3981
EC44-2PM-5000(432cc)	432	BR9ES	5722	0.5	BR9EVX	1265	BR9EIX	3981
EC44-2PM-5100(432cc)	432	BR9ES	5722	0.5	BR9EVX	1265	BR9EIX	3981
EC44-3PM-01(432cc)	432	BR8ES	5422	0.6	BR8EVX	1262	BR8EIX	5044
EC44PM-01(432cc)	432	BR8ES	5422	0.5	BR8EVX	1262	BR8EIX	5044
EC44PM-02(432cc)	432	BR8ES	5422	0.5	BR8EVX	1262	BR8EIX	5044
EC44PM-03(432cc)	432	BR8ES	5422	0.5	BR8EVX	1262	BR8EIX	5044
EC44PQ(432cc)	432	B8ES	2411	0.5	B8EVX	7051	BR8EIX	5044
EC44PT(432cc)	432	B10ES	7928	0.5	B10EVX	7335	BR10EIX	6801
EC44PT-04(432cc)	432	B10ES	7928	0.5	B10EVX	7335	BR10EIX	6801
EC44PT-05(432cc)	432	BR9ES	5722	0.5	BR9EVX	1265	BR9EIX	3981
EC44PT-06(432cc)	432	B9ES	2611	0.5	B9EVX	7254	BR9EIX	3981
EC44P(436cc)	436	B7ES	1111	0.5	B7EVX	6934		
EC44PS(436cc)	436	B10ES	7928	0.5	B10EVX	7335	BR10EIX	6801
EC45PL-07(439cc)	439	BR8ES	5422	0.7	BR8EVX	1262	BR8EIX	5044
EC45PL-08(439cc)	439	BR8ES	5422	0.7	BR8EVX	1262	BR8EIX	5044
EC45PL-08(439cc)	439	BR9ES	5722	0.6	BR9EVX	1265	BR9EIX	3981
EC45PL-09(439cc)	439	BR8ES	5422	0.7	BR8EVX	1262	BR8EIX	5044
EC45PL-09(439cc)	439	BR8ES	5422	0.6	BR8EVX	1262	BR8EIX	5044
EC50P(488cc)	488	B7ES	1111	0.5	B7EVX	6934		
EC50PL-01/02/04/05/06/(488cc)	488	BR8ES	5422	0.6	BR8EVX	1262	BR8EIX	5044
EC50PL-16/17/18/19/20(488cc)	488	BR8ES	5422	0.6	BR8EVX	1262	BR8EIX	5044
EC50PM-01/02/03/04/05/06(488cc)	488	BR8ES	5422	0.6	BR8EVX	1262	BR8EIX	5044
EC51PL-01(500cc)	500	BR9ES	5722	0.5	BR9EVX	1265	BR9EIX	3981
EC51PL-02(500cc)	500	BR9ES	5722	0.5	BR9EVX	1265	BR9EIX	3981
EC51PS(500cc)	500	B10ES	7928	0.5	B10EVX	7335	BR10EIX	6801
EC51PT(500cc)	500	B9ES	2611	0.5	B9EVX	7254	BR9EIX	3981
EC51PT-04(500cc)	500	B8ES	2411	0.5	B8EVX	7051	BR8EIX	5044
EC54P(530cc)	530	B8ES	2411	0.5	B8EVX	7051	BR8EIX	5044
EC54PM(530cc)	530	B8ES	2411	0.5	B8EVX	7051	BR8EIX	5044
EC60PL-01(530cc)	530	BR9ES	5722	0.5	BR9EVX	1265	BR9EIX	3981
EC60PL-02	530	BR9ES	5722	0.6	BR9EVX	1265	BR9EIX	3981
EC58PL-02/03/07(597cc)	597	BR8ES	5422	0.7	BR8EVX	1262	BR8EIX	5044
EC58PL-08/09/012(597cc)	597	BR9ES	5722	0.7	BR9EVX	1265	BR9EIX	3981
EC59PL-01(597cc)	597	BR9ES	5722	0.7	BR9EVX	1265	BR9EIX	3981
EC65PL-01/02/03/05(648cc)	648	BR9ES	5722	0.6	BR9EVX	1265	BR9EIX	3981
EC66PL-01(679cc)	679	BR8ES	5422	0.7	BR8EVX	1262	BR8EIX	5044
EC66PL-04(679cc)	679	BR8ES	5422	0.7	BR8EVX	1262	BR8EIX	5044
EC68PL-01/03/04(679cc)	679	BR9ES	5722	0.7	BR9EVX	1265	BR9EIX	3981
SN70LCDSP-01/02(701cc)	701	BR9ES	5722	0.7	BR9EVX	1265	BR9EIX	3981
EC74P(744cc)	744	B7ES	1111	0.5	B7EVX	6934		



ccm

Order
No.Platin/
Gold-
PalladiumOrder
No.

Iridium

Order
No.**POLARIS**

EC80P(792cc)	792	B7ES	1111	0.5	B7EVX	6934		
EC80PL-04(794cc)	794	BR7ES	5122	0.7	BR7EVX	4556		
EC80PL-05(794cc)	794	BR7ES	5122	0.7	BR7EVX	4556		

ROLL-O-FLEX(YAMAHA)

292S(292cc)	292	---		0.4	B9EVX	7254	BR9EIX	3981
292Y(292cc)	292	B8ES	2411	0.6	B8EVX	7051	BR8EIX	5044
338S(338cc)	338	---		0.4	B9EVX	7254	BR9EIX	3981
338Y(338cc)	338	B7HS	5110	0.6	B7HVX	7836	BR7HIX	7067
396Y(396cc)	396	B7HS	5110	0.6	B7HVX	7836	BR7HIX	7067
433S(433cc)	433	---		0.4	B9EVX	7254	BR9EIX	3981
433Y(433cc)	433	B7HS	5110	0.6	B7HVX	7836	BR7HIX	7067

RUPP (Tohatsu Engines)

With CDI Systems 12.7mm(1/2") Reach		BUHX	2522	-				
With CDI Systems 19.0mm(3/4") Reach		BUE	2322	-				
TR-295(294cc)	294	B8HS	5510	0.5	B8HVX	2634	BR8HIX	7001
TR-295S(294cc)	294	B9HS	5810	0.5	B9HVX	2254		
TR-340(336cc)	336	B8HS	5510	0.5	B8HVX	2634	BR8HIX	7001
TR-340S(336cc)	336	B9HS	5810	0.5	B9HVX	2254		
TR-400S(339cc)	339	B8HS	5510	0.5	B8HVX	2634	BR8HIX	7001
TR-440(438cc)	438	B8HS	5510	0.5	B8HVX	2634	BR8HIX	7001
TR-440S(438cc)	438	B9HS	5810	0.5	B9HVX	2254		
TR-650(644cc)	644	B9HS	5810	0.5	B9HVX	2254		
TR-650S(644cc)	644	B9HS	5810	0.5	B9HVX	2254		

SACHS

SA280, SA280A(277cc)	277	A7	1110	0.5				
SA2-290 12.7mm(1/2") Reach(291cc)	291	B8HS	5510	0.5	B8HVX	2634	BR8HIX	7001
SA2-290 19.0mm(3/4") Reach(291cc)	291	B8ES	2411	0.5	B8EVX	7051	BR8EIX	5044
SA290(293cc)	293	A7	1110	0.5				
SA290C, SA290R, SA290SS(293cc)	293	B8HS	5510	0.5	B8HVX	2634	BR8HIX	7001
KM914(300cc)	300	B7HS	5110	0.5	B7HVX	7836	BR7HIX	7067
SA320(318cc)	318	A7	1110	0.5				
SA340C, SA340R(334cc)	334	B8HS	5510	0.5	B8HVX	2634	BR8HIX	7001
SA340(336cc)	336	A7	1110	0.5				
SA340SS(336cc)	336	A8	1210	0.5				
SA2-340 12.7mm(1/2") Reach(338cc)	338	B8HS	5510	0.5	B8HVX	2634	BR8HIX	7001
SA2-340 19.0mm(3/4") Reach(338cc)	338	B8ES	2411	0.5	B8EVX	7051	BR8EIX	5044
SA2-340RX, SA2-340C(338cc)	338	B9ES	2611	0.5	B9EVX	7254	BR9EIX	3981
SA370(368cc)	368	A7	1110	0.5				
SA400(396cc)	396	A8	1210	0.5				

SCORPION (Cuyuna Engine)

295(290cc)	290	B8ES	2411	0.5	B8EVX	7051	BR8EIX	5044
2F295-2(294cc) 1978	294	B9ES	2611	0.5	B9EVX	7254	BR9EIX	3981
2F295-2(294cc) 1979	294	B7ES	1111	0.5	B7EVX	6934		
2F340-6(338cc)	338	B8ES	2411	0.5	B8EVX	7051	BR8EIX	5044
2F340-6(338cc) 1979	338	B7ES	1111	0.5	B7EVX	6934		
2F340-6(338cc) 1980	338	BR7ES	5122	0.5	BR7EVX	4556		
340(339cc)	339	B8ES	2411	0.5	B8EVX	7051	BR8EIX	5044
400(339cc)	339	B8ES	2411	0.5	B8EVX	7051	BR8EIX	5044



ccm

Order
No.Platin/
Gold-
PalladiumOrder
No.

Iridium

Order
No.**SCORPION (Cuyuna Engine)**

2F400-A(399cc)	399	B8ES	2411	0.5	B8EVX	7051	BR8EIX	5044
2F440-A(428cc)	428	B8ES	2411	0.5	B8EVX	7051	BR8EIX	5044
440(428cc)	428	B8ES	2411	0.5	B8EVX	7051	BR8EIX	5044

SCORPION (Spirit Suzuki Eng)

AF44L3(436cc)	436	BR9ES	5722	0.5	BR9EVX	1265	BR9EIX	3981
---------------	-----	-------	------	-----	--------	------	--------	------

SKI-DOO (-->BOMBARDIER)

SKI-DOO (-->BOMBARDIER)

SNO JET(KAWASAKI)

SNO JET(KAWASAKI)								
ASTRO 340(339cc)	399	BR8ES	5422	0.7	BR8EVX	1262	BR8EIX	5044
ASTRO 440(436cc)	436	BR8ES	5422	0.7	BR8EVX	1262	BR8EIX	5044

SNO JET(YAMAHA)

S292(292cc)	292	---		0.4	B9EVX	7254	BR9EIX	3981
Y292(292cc)	292	B8ES	2411	0.5	B8EVX	7051	BR8EIX	5044
S338(338cc)	338	---		0.4	B8EVX	7051	BR8EIX	5044
SST340(338cc)	338	---		0.5	B9EVX	7254	BR9EIX	3981
SX338(338cc)	338	---		0.4	B9EVX	7254	BR9EIX	3981
Y338(338cc)	338	B7HS	5110	0.5	B7HVX	7836	BR7HIX	7067
S433(433cc) 1976	433	---		0.5	BR9EVX	1265	BR9EIX	3981
S433(433cc)-->1975	433	---		0.4	B8EVX	7051	BR8EIX	5044
SST440(433cc)	433	---		0.5	B9EVX	7254	BR9EIX	3981
SX433(433cc)	433	---		0.4	B9EVX	7254	BR9EIX	3981
Y433(433cc)	433	B7HS	5110	0.5	B7HVX	7836	BR7HIX	7067

SUZUKI

60F/C		BR6HS	3922	0.7			BR6HIX	3419
292 NOMAD(292cc)	292	B7HS	5110	0.7	B7HVX	7836	BR7HIX	7067
340 NOMAD(336cc)	336	B7HS	5110	0.7	B7HVX	7836	BR7HIX	7067
SM10(360cc)	360	B7HS	5110	0.7	B7HVX	7836	BR7HIX	7067
SM10D(360cc)	360	B7HS	5110	0.7	B7HVX	7836	BR7HIX	7067
400 Wide Track(395cc)	395	B7HS	5110	0.7	B7HVX	7836	BR7HIX	7067
SM20(395cc)	395	B7HS	5110	0.7	B7HVX	7836	BR7HIX	7067
SM20 Hop Up Kit(395cc)	395	B8ES	2411	0.7	B8EVX	7051	BR8EIX	5044
XR400(395cc)	395	B7HS	5110	0.7	B7HVX	7836	BR7HIX	7067
XR440(432cc)	432	B7HS	5110	0.7	B7HVX	7836	BR7HIX	7067
440F/C(433cc)	433	BR9ES	5722	0.6	BR9EVX	1265	BR9EIX	3981
440F/C-CI(433cc)	433	BR9ES	5722	0.6	BR9EVX	1265	BR9EIX	3981
440L/C(433cc)	433	BR9ES	5722	0.6	BR9EVX	1265	BR9EIX	3981
SM440M(433cc)	433	---		0.7	B9EVX	7254	BR9EIX	3981
500F/C(499cc)	499	BR9ES	5722	0.6	BR9EVX	1265	BR9EIX	3981
500L/C(499cc)	499	---		0.6	BR10EV	5127	BR10EIX	6801
530L/C	530	BR10ES	4832	0.7	BR10EV	5127	BR10EIX	6801
650L/C	650	BR10ES	4832	0.7	BR10EV	5127	BR10EIX	6801

YAMAHA

SE80	80	BR8HS	4322	0.7	BR8HVX	6265	BR8HIX	7001
SV80 Series	80	BR8HS	4322	0.7	BR8HVX	6265	BR8HIX	7001
SV125 Series	125	BR8HS	4322	0.7	BR8HVX	6265	BR8HIX	7001



ccm



Order No.

Platin/
Gold-
Palladium

Order No.

Iridium







Order No.

YAMAHA

	ccm	Order No.			Order No.		Order No.	
BR250 Series	250	BR8HS	4322	0.7	BR8HVX	6265	BR8HIX	7001
ET250 Series(exc.ET250A/B)	250	B8HS	5510	0.7	B8HVX	2634	BR8HIX	7001
ET250A/B	250	---		0.6	BR8HVX	6265	BR8HIX	7001
CF300	300	BR8HS	4322	0.7	BR8HVX	6265	BR8HIX	7001
EC300	300	BR9ES	5722	0.8	BR9EVX	1265	BR9EIX	3981
ET300 Series(exc.ET300C)	300	BR9ES	5722	0.8	BR9EVX	1265	BR9EIX	3981
ET300C	300	---		0.6	BR9EVX	1265	BR9EIX	3981
CS340/E	340	BR9ES	5722	0.8	BR9EVX	1265	BR9EIX	3981
EC340 Series	340	BR9ES	5722	0.8	BR9EVX	1265	BR9EIX	3981
ET340 Series(exc.ET340B/C/EC)	340	BR9ES	5722	0.8	BR9EVX	1265	BR9EIX	3981
ET340B/C/EC	340	---		0.6	BR9EVX	1265	BR9EIX	3981
EX340 Series	340	---		0.6	BR9EVX	1265	BR9EIX	3981
S340	340	BR8ES	5422	0.8	BR8EVX	1262	BR8EIX	5044
ET400 Series	400	BR8ES	5422	0.8	BR8EVX	1262	BR8EIX	5044
ET410TR	410	BR9ES	5722	0.8	BR9EVX	1265	BR9EIX	3981
SS440 Series	440	BR9ES	5722	0.8	BR9EVX	1265	BR9EIX	3981
PZ480 Series	480	BR9ES	5722	0.8	BR9EVX	1265	BR9EIX	3981
VT480 Series	480	BR9ES	5722	0.8	BR9EVX	1265	BR9EIX	3981
VK500E	500	BR9ES	5722	0.8	BR9EVX	1265	BR9EIX	3981
VX500 Series	500	BR9ES	5722	0.8	BR9EVX	1265	BR9EIX	3981
SR540 Series 1994-90	540	---		0.6	BR9EVX	1265	BR9EIX	3981
SR540 Series-->1989	540	BR9ES	5722	0.8	BR9EVX	1265	BR9EIX	3981
VK540 Series	540	BR9ES	5722	0.8	BR9EVX	1265	BR9EIX	3981
VMX540 Series 1994-90	540	---		0.6	BR9EVX	1265	BR9EIX	3981
VMX540 Series-->1989	540	BR9ES	5722	0.8	BR9EVX	1265	BR9EIX	3981
XL540 Series	540	BR9ES	5722	0.8	BR9EVX	1265	BR9EIX	3981
EX570 Series	570	BR9ES	5722	0.8	BR9EVX	1265	BR9EIX	3981
VX600 Series	600	BR9ES	5722	0.8	BR9EVX	1265	BR9EIX	3981
VX750 Series	750	BR9ES	5722	0.8	BR9EVX	1265	BR9EIX	3981
VX800 Series	800	BR9ES	5722	0.8	BR9EVX	1265	BR9EIX	3981

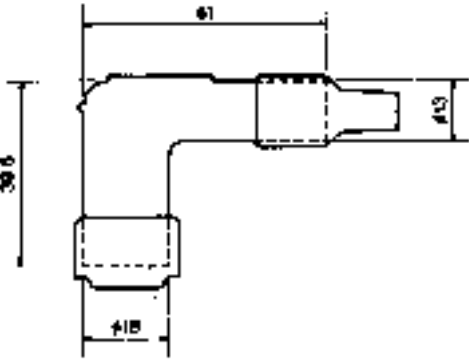
NGK SPARK PLUG RESISTOR COVER

Configuration (applicable plug thread dia, body material) Unit: mm	Type No.	 (KΩ)
 <p data-bbox="247 795 430 940"> LB-type: 14 mm ø thread LZ-type: 10, 12 & 14 mm ø thread Phenolic resin </p> 	<p data-bbox="1029 302 1189 616"> LBE LBEPK LB○E LB○EP LB○EPK LB○FF </p> <p data-bbox="1029 784 1141 828"> LB○E </p>	<p data-bbox="1236 302 1380 616"> No resistor No resistor 1,5,10 1,5 5 1,5,10 </p> <p data-bbox="1236 784 1300 828"> 5,10 </p>

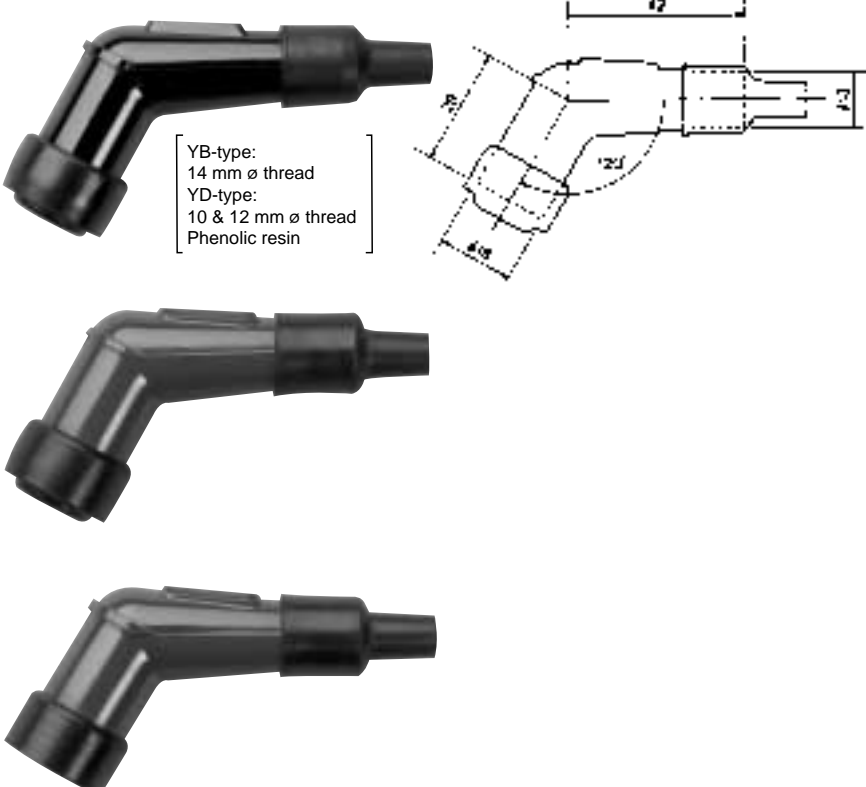

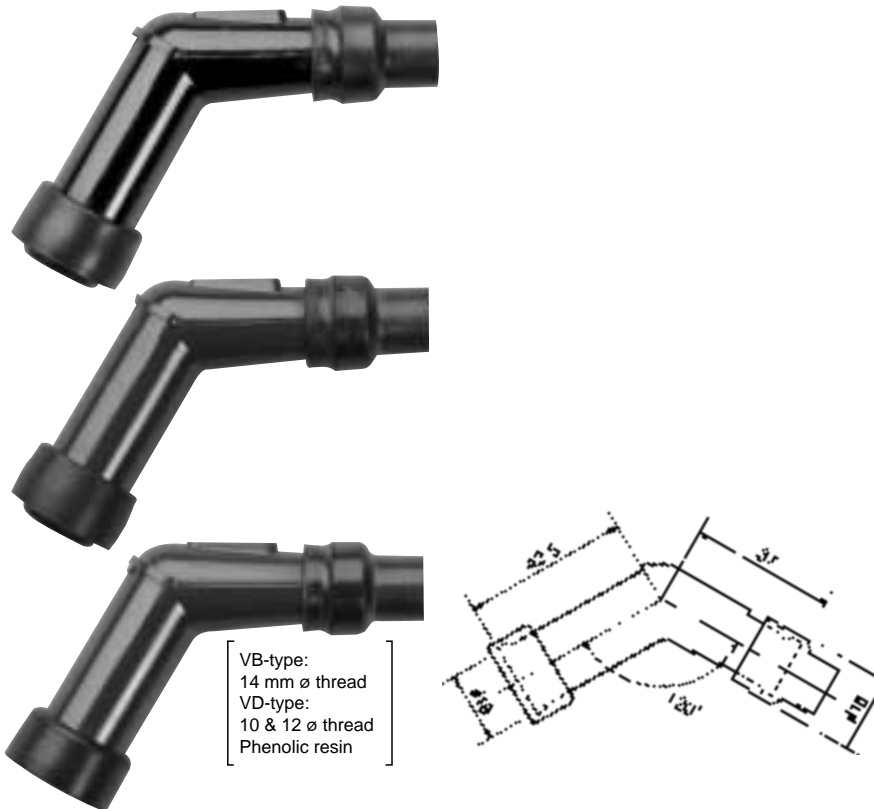

Configuration (applicable plug thread dia, body material) Unit: mm	Type No.	 (KΩ)
 <p data-bbox="287 1433 478 1556"> YB-type: 14 mm ø thread YD-type: 10 & 12 mm ø thread Phenolic resin </p>	<p data-bbox="1029 1310 1141 1411"> YB○F YD○F </p> <p data-bbox="1029 1635 1141 1680"> YB○F </p> <p data-bbox="1029 1904 1141 1948"> YD○F </p>	<p data-bbox="1236 1310 1324 1411"> 1,5,10 1,5 </p> <p data-bbox="1236 1635 1260 1680"> 5 </p> <p data-bbox="1236 1904 1260 1948"> 5 </p>

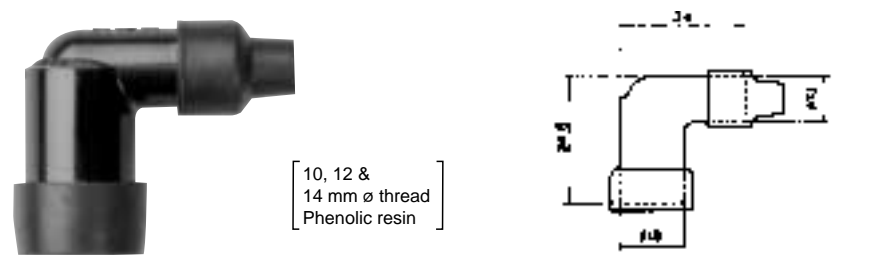
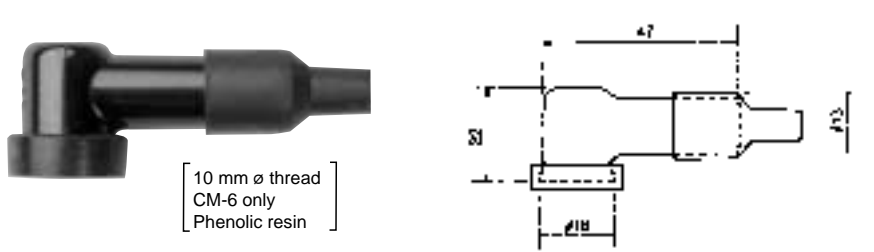
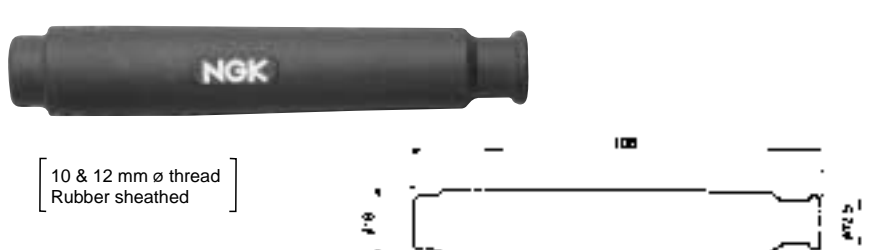



NGK SPARK PLUG RESISTOR COVER

Configuration (applicable plug thread dia, body material) Unit: mm	Type No.	
 <p>VB-type: 14 mm \varnothing thread VD-type: 10 & 12 \varnothing thread Phenolic resin</p>	VB ○ E VB ○ F VB ○ FP VD ○ F VB ○ F VD ○ F	5,1 1,5,10 5 1,5,10 5 5

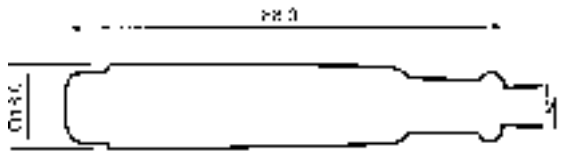



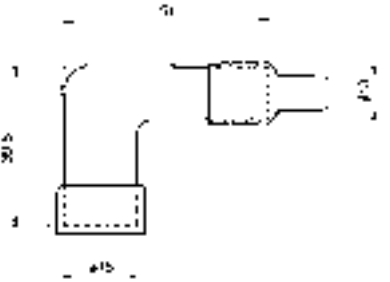

Configuration (applicable plug thread dia, body material) Unit: mm	Type No.	
 <p>10, 12 & 14 mm \varnothing thread Phenolic resin</p>	LZE H LZF H	No resistor No resistor
 <p>10 mm \varnothing thread CM-6 only Phenolic resin</p>	LC ○ E FK	5
 <p>10 & 12 mm \varnothing thread Rubber sheathed</p>	SD ○ F M	5

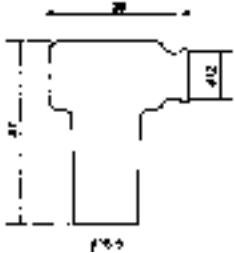

NGK SPARK PLUG RESISTOR COVER

Configuration (applicable plug thread dia, body material) Unit: mm	Type No.	 (KΩ)
  <p data-bbox="287 571 478 627">[10 & 12 mm ø thread Rubber sheathed]</p>	VD○FMH	5
 	SD05FMC	5

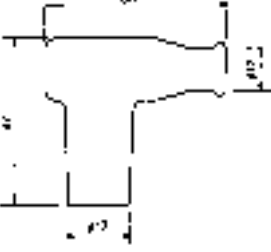

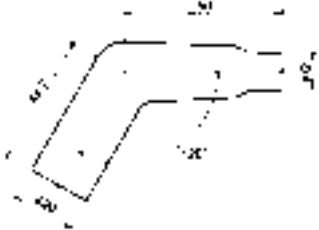

Configuration (applicable plug thread dia, body material) Unit: mm	Type No.	 (KΩ)
   <p data-bbox="646 1915 845 1971">[10 & 12 mm ø thread Phenolic resin]</p>	LDF LD○F LD○F	No resistor 1,5,10 5

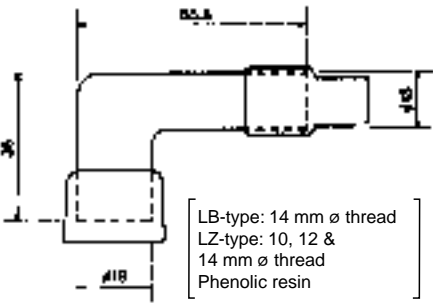

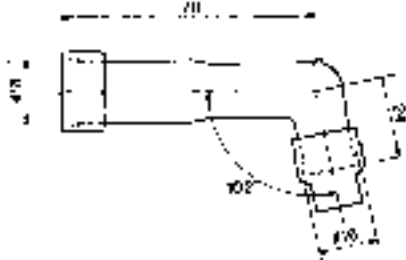

NGK SPARK PLUG RESISTOR COVER

Configuration (applicable plug thread dia, body material) Unit: mm	Type No.	 (KΩ)
 <p data-bbox="443 421 619 477">[14 mm ø thread Rubber sheathed]</p> 	LB○EMH	5
 <p data-bbox="443 712 619 768">[14 mm ø thread Rubber sheathed (Silicon)]</p> 	TB○EM	5
 <p data-bbox="443 987 651 1043">[10 & 12 mm ø thread Rubber sheathed (Silicon)]</p> 	VD○FML	5





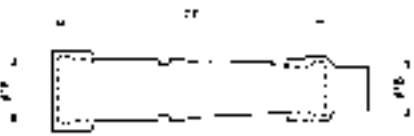

Configuration (applicable plug thread dia, body material) Unit: mm	Type No.	 (KΩ)
  <p data-bbox="815 1503 1038 1592">[LB-type: 14 mm ø thread LZ-type: 10, 12 & 14 mm ø thread Phenolic resin]</p>	LBF LB○F LB○FP LB○EZ LB○F LZ○F	No resistor 1,5,10 1,5,10 5 5,10 5



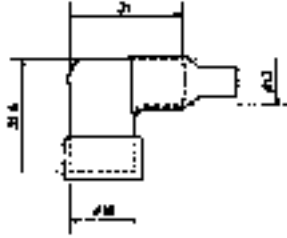

NGK SPARK PLUG RESISTOR COVER

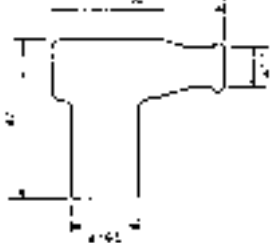
Configuration (applicable plug thread dia, body material) Unit: mm	Type No.	 (KΩ)
 	XB○F	5
 <div data-bbox="582 571 893 683" style="border: 1px solid black; padding: 5px; width: fit-content;"> XB-type: 14 mm ø thread XD-type: 10 & 12 mm ø thread XZ-type: 10, 12 & 14 mm ø thread Phenolic resin </div>	XB○F XB○FP XD○F XZ○F	1,5,10 5 1,5,10 1
	XD○F	1,5,

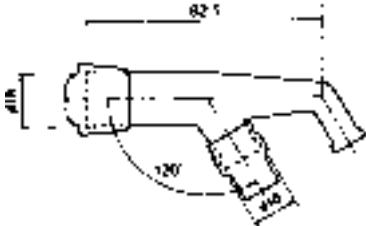

Configuration (applicable plug thread dia, body material) Unit: mm	Type No.	 (KΩ)
 	SB○E SB○F SD○F	1,5,10 1,5,10 1,5,10
 <div data-bbox="694 1624 893 1747" style="border: 1px solid black; padding: 5px; width: fit-content;"> SB-type: 14 mm ø thread SD-type: 10 & 12 mm ø thread Phenolic resin </div>	SB○F	5,10
	SD○F	5

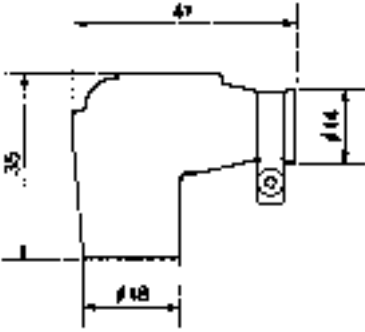

NGK SPARK PLUG RESISTOR COVER

Configuration (applicable plug thread dia, body material) Unit: mm	Type No.	 (KΩ)
 <div style="display: flex; justify-content: space-around; align-items: center;"> <div data-bbox="523 409 722 528" style="border: 1px solid black; padding: 5px;"> LB-type: 14 mm ø thread LD-type: 10 & 12 mm ø thread Phenolic resin </div> <div data-bbox="762 297 1050 533">  </div> </div>	LEH LB○EH LB○EHF LDFH	No resistor 1,5,10 1,5 No resistor
 <div style="display: flex; justify-content: space-around; align-items: center;"> <div data-bbox="523 723 695 786" style="border: 1px solid black; padding: 5px;"> 14 mm ø thread Rubber sheathed </div> <div data-bbox="762 566 1034 808">  </div> </div>	TB○EMA	5
 <div style="display: flex; justify-content: space-around; align-items: center;"> <div data-bbox="523 1010 679 1066" style="border: 1px solid black; padding: 5px;"> 14 mm ø thread Phenolic resin </div> <div data-bbox="699 857 1066 1081">  </div> </div>	VB○EYK	5

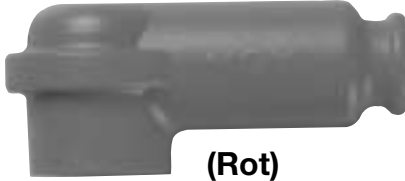
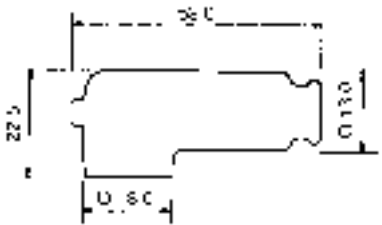

Configuration (applicable plug thread dia, body material) Unit: mm	Type No.	 (KΩ)
 <div style="display: flex; justify-content: space-around; align-items: center;"> <div data-bbox="391 1597 555 1675" style="border: 1px solid black; padding: 5px;"> 14 mm ø thread Rubber sheathed (Silicon) </div> <div data-bbox="678 1323 1045 1653">  </div> </div>	LBER	No resistor
 <div style="display: flex; justify-content: space-around; align-items: center;"> <div data-bbox="240 1939 331 1973" style="font-weight: bold;">(Blau)</div> <div data-bbox="391 1933 790 2101" style="border: 1px solid black; padding: 5px;"> 14 mm ø thread Silicon – Rubber sheathed For spark plug R6120-○, R6120A-○, R6120C-○, R6120M-○ R7282-○, R7282A-○, R7282C-○, R7282M-○ ø 8 mm Kabel </div> <div data-bbox="703 1709 1045 1910">  </div> </div>	TRS1225	5

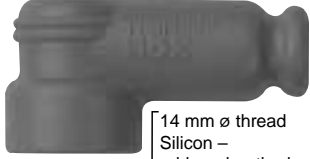
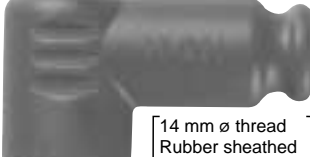
NGK SPARK PLUG RESISTOR COVER

Configuration (applicable plug thread dia, body material) Unit: mm	Type No.	 (KΩ)
 (Gelb)  (Grün)  (Rot)	TRS1233 A TRS1233 B TRS1233 C	5 5 5
 <p data-bbox="646 817 869 1041"> 14 mm ø thread Silicon – Rubber sheathed For spark plug R6120-○, R6120A-○ R6120C-○, R6120M-○ R7282-○, R7282A-○ R7282C-○, R7282M-○ ø 7 mm Kabel </p>		

Configuration (applicable plug thread dia, body material) Unit: mm	Type No.	 (KΩ)
 (Blau) <p data-bbox="263 1400 470 1545"> 14 mm ø thread Silicon – rubber sheathed For spark plug R5300A-○, R5300N-○ ø 8 mm Kabel </p>	TRS1408F	5
 (Rot) <p data-bbox="263 1680 422 1814"> 14 mm ø thread Rubber sheathed Silicon For spark plug R5540F-○ ø 7 mm Kabel </p>	TRS1409	
 (Blau) <p data-bbox="263 1948 646 2094"> 14 mm ø thread Silicon – rubber sheathed For spark plug R6120-○, R6120A-○, R6120C-○, R6120M-○ R7282-○, R7282A-○, R7282C-○, R7282M-○ ø 7 mm Kabel </p>	TRS1505	5

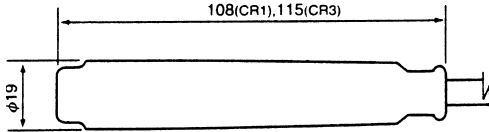
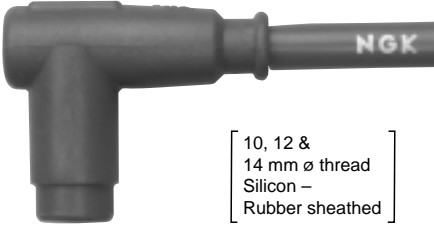
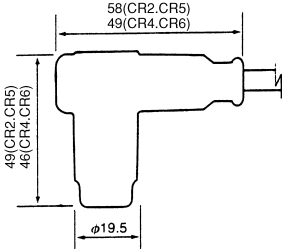
NGK SPARK PLUG RESISTOR COVER

Configuration (applicable plug thread dia, body material) Unit: mm	Type No.	(K)
 <p>[10, 12 & 14 mm ϕ thread Silicon – Rubber sheathed]</p> 	CR1 CR3	5 5
 <p>[10, 12 & 14 mm ϕ thread Silicon – Rubber sheathed]</p> 	CR2 CR4 CR5 CR6	5 5 5 5
Kabelverbinder 	J-1	

Erklärung der Kurzzeichen/Symbol Explanation/Explication des symboles/Sigle commercial

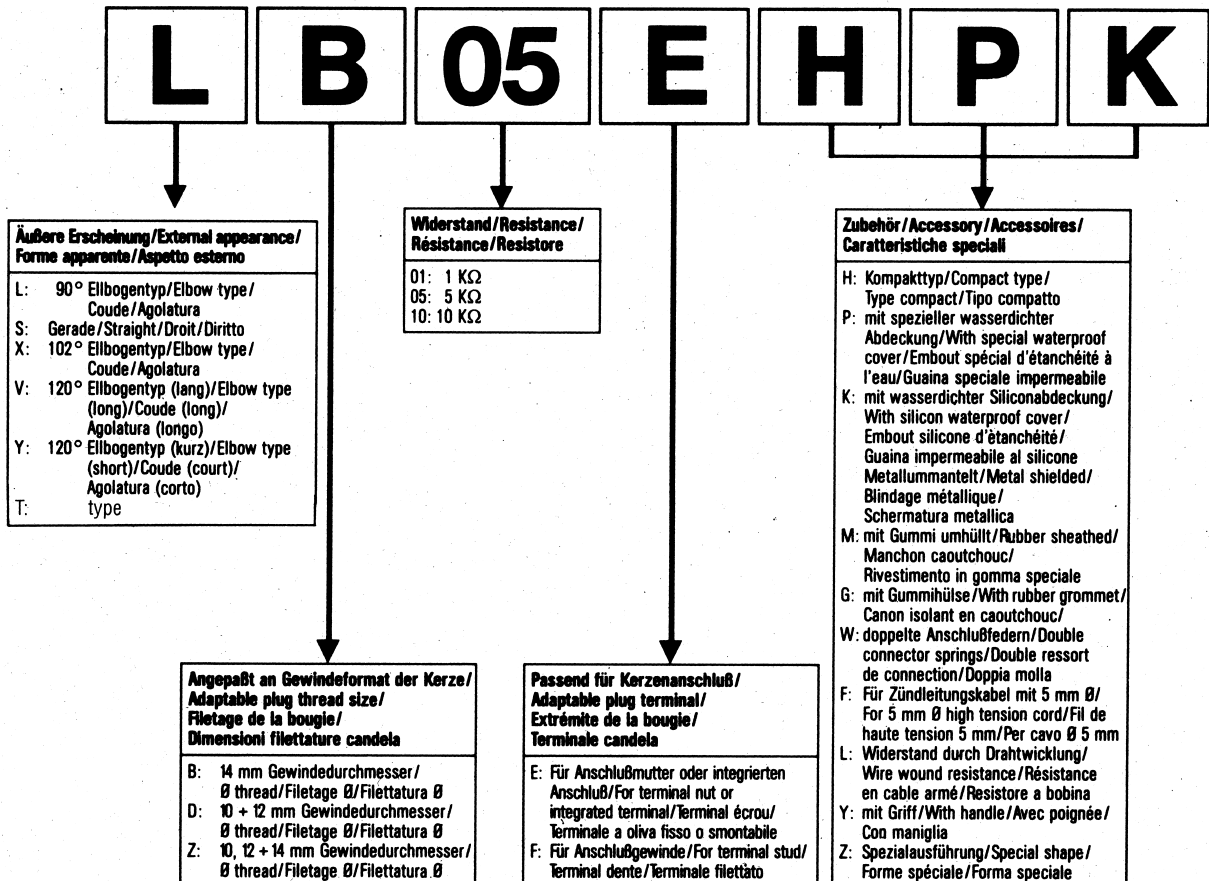

V-Line	BERU	BOSCH	YTTRIUM	CHAMPION
Nr.1 (BUR6ET)	14GH-7DTUR 14-6DTU 14-7DTU Z 51 Z 12 Z 91	W7LTCR W6DTC W7DTC	+2	N7BYC N9BYC OE012 OE044
Nr.2 (BPR6E)	14R-6DU 14R-7DU Z 27 Z 20	WR6DC WR7DC	+1 / +12	RN7YC RN9YC OE018 OE006
Nr.3 (BPR6H)	14R-6BU 14R-7BU Z 19 14-6DU 14-7DU Z 22 Z 10	WR6BC WR7BC	+10	RL82YC RL87YC OE064
Nr.4 (BP6E)	14K-6DU 14K-7DU Z 25 Z 17	W6DC W7DC		N9YC N7YC OE001 OE010
Nr.5 (BP6EF)	14R-8DU 14R-9DU Z 8 Z 82	H6DC H7DC		S7YC S9YC OE050 OE009
Nr.6 (BPR5E)	14KR-6DU 14KR-7DU Z 26 Z 95	WR8DC WR9DC	+3 / +16	RN11YC RN12YC OE051 OE042
Nr.7 (BPR6EF)	14-8DU 14-9DU Z 1 Z 76	HR6DC HR7DC	+5 / +18	RS9YC RS7YC OE011
Nr.8 (BP5E)	14R-8DU Z 8 14-R-7DUX Z 21	W8DC W9DC WR8DC		N11YC N12YC OE065 OE015
Nr.9 (BPR5EY)	14F-6DUX 14F-7DUX Z 99	WR7DCX		RN9YC OE006
Nr.10 (BPR6EY-11)	14F-6DU 14F-7DU Z 63 14R-6DUX 14R-7DUX Z 28 Z 21	FR6DCX FR7DCX		RN9YC4 OE048
Nr.11 (BCPR6E-11)	14FR-7DUX Z 16 14-8LUR Z 3	FR6DC FR7DC		RC9YC4 OE039
Nr.12 (BCPR6E)	14F-6DU 14-7BU Z 48 Z 10	WR6DCX WR7DCX		RC9YC OE005
Nr.13 (BPR6ES-11)	14FR-7DUX Z 16 14-8LUR Z 3	WR6DCX WR7DCX		RN7YC4 OE117
Nr.14 (BKR6E-11)	14F-8DU Z 71 14F-6DU 14F-7DU Z 63	FR7DCX	+11	RC7YC4 OE080
Nr.15 (ZGR5A)	14-8LUR Z 3 14F-8DU Z 71	W8LCR		RN9YC OE003
Nr.16 (BCP5E)	14F-6DU 14F-7DU Z 63 14-6BU 14-7BU Z 48 Z 10	F8DC		C9YC OE003
Nr.17 (BCP6E)	14-6BU 14-7BU Z 48 Z 10	F6DC F7DC		C9BYC
Nr.18 (BP6H)	14R-5DU Z 47 14F-7LDUR 14GH-8DTURX Z 93	W6BC W7BC		L87YC OE007
Nr.19 (BPR7E)	14R-5DU Z 47 14F-7LDUR 14GH-8DTURX Z 93	WR5DC F7LDCR	+15 +7	RN6YC RC8DMC OE116 OE026
Nr.20 (BKR6EK)	14GH-8DTURX Z 93 14GH-8DTUR Z 92	W8LTCR F8LDCR	+4	RN10VTC4 OE027
Nr.21 (BUR5ET)	14FLR-8LDUX 14FGH-7DTURX Z 90	W8LTCR F8LDCR	+9	RN10VTC RC10DMC OE027 OE019
Nr.22 (BUR5ET)	14FGR-6ZPPV Z 97 14FR-7LDU Z 98	F7LTCR HR7MPP	+17	RC8VTC4 RE7YCC OE032
Nr.23 (BKR5EK)	14FR-7LDU Z 98 14FGH-7DTUR	FR7LDC		RC8BYC RC7BMC OE030 OE021
Nr.24 (BKUR6ET-10)	14FR-7DU	FR7LDC		RC8BYC RC7BMC OE030 OE021
Nr.25 (PTR5A-13)	14FR-7DU	...		RC8VTC4 RC7YC4 OE032 OE080
Nr.26 (BKR6EKC)	14FR-7DU	F6DCOR F7DCOR FR6DC FR7DC F8KTCR	+8 / +13	RC8VTC4 RC7YC4 OE032 OE080
Nr.27 (BKUR6ET)	14FR-7DU	...		RC8VTC4 RC7YC4 OE032 OE080
Nr.28 (BKR6E)	14FGH8DTURXO 14FGH-7DTURX 14FGR6KQU	...		RC89TMC OE120
Nr.29 (BKUR5ET)	14FGR6KQU	FGR7KQE0 FGR7KQE FGR7DQP F7LDCR F9LCR F9LCR2 FGR6KQC		...
Nr.30 (BKR6EQUP)	14KR-7DUX 14FR-8DU	HR7DCX FR8LDC FR8DCO FR7DCO		RS9PYP4 RC12YC RC9YCC RC10YC OE131 OE013 OE005 OE088
Nr.31 (PTR5D-10)	14KR-7DUX 14FR-8DU	HR7DCX FR8LDC FR8DCO FR7DCO		RS9PYP4 RC12YC RC9YCC RC10YC OE131 OE013 OE005 OE088
Nr.32 (BCPR5E)	14KR-7DUX 14FR-8DU	HR7DCX FR8LDC FR8DCO FR7DCO		RS9PYP4 RC12YC RC9YCC RC10YC OE131 OE013 OE005 OE088

V-Line No.	Car-Manufacturer	
1	BUR6ET	Audi, Fiat, Lancia, Seat, Skoda, VW
2	BPR6E	Alfa, Romeo, Austin, Autobianchi, BMW, Chrysler, Daewoo, Daihatsu, Fiat, Ford, FSO, Honda, Hyundai, Innocenti, Isuzu, Lada, Lancia, Lotus, Mazda, MG, Mitsubishi, Nissan, Opel, Porsche, Renault, Rover, Seat, Subaru, Suzuki, TVR, Vauxhall, Volvo, Zastava
3	BPR6H	Daewoo, Opel, Vauxhall
4	BP6E	Alfa Romeo, Aston Martin, Audi, Austin, BMW, Citroen, Fiat, FSO, Innocenti, Lada, Lotus, Maserati, Mercedes, Mitsubishi, Morgan, Moskwicz, Nissan, Peugeot, Renault, Rover, Saab, Seat, Subaru, Talbot, Tofas, Volvo, VW, Wartburg, Yugo, Zastava
5	BP6EF	Citroen, Mercedes, Peugeot, Renault, Rover, Talbot
6	BPR5E	Asia, Daihatsu, Fiat, Honda, Innocenti, Mazda, Mitsubishi, Nissan, Opel, Renault, Rolls Royce, Rover, Seat, Suzuki, Toyota, TVR, Vauxhall
7	BPR6EF	Chevrolet, Ford, Lancia, Renault, TVR, Volvo
8	BP5E	BMW, Citroen, Daimler, Isuzu, Jaguar, Mitsubishi, Nissan, Renault, Rover, VW
9	BPR5EY	Daihatsu, Innocenti, Suzuki, Toyota
10	BPR6EY-11	Daihatsu, Honda, Toyota
11	BCPR6E-11	Ford, Honda, Mazda, Nissan, Renault, Rover, Saab, Subaru
12	BCPR6E	Aston Martin, Autobianchi, Chrysler, Citroen, Daimler, Fiat, Ford, FSO, Jaguar, Lada, Lancia, Mazda, Morgan, Nissan, Opel, Peugeot, Porsche, Rover, Skoda, TVR, Volvo
13	BPR6ES-11	Honda, Hyundai, Isuzu, Kia, Mazda, Mitsubishi, Nissan, Opel, Rover, Subaru, Suzuki, Vauxhall
14	BKR6E-11	Daewoo, Daihatsu, Honda, Hyundai, Isuzu, Kia, Lotus, Mazda, Mitsubishi, Nissan, Proton, Rover, Subaru, Suzuki
15	ZGR5A	BMW, Daihatsu
16	BCP5E	Citroen, Mercedes, Nissan, Peugeot, Renault, Ssangyong
17	BCP6E	Alfa Romeo, Citroen, Lada, Mercedes, Nissan, Peugeot, Renault, Rover, Skoda, Ssangyong, Tatra
18	BP6H	Citroen, Dacia, Renault, Seat, Skoda, Z.A.Z., Zastava
19	BPR7E	Alfa Romeo, Austin, Autobianchi, Caterham, Fiat, Ford, Lancia, Lotus, Mitsubishi, Porsche, Renault, Rover, Subaru, Volvo
20	BKR6EK	BMW, Citroen, Fiat, Lancia, Mercedes, Opel, Peugeot, Porsche, Renault, Vauxhall, VW, Wiesmann
21	BUR5ET-10	Audi, Seat, VW
22	BUR5ET	Audi, Seat, VW
23	BKR5EK	Citroen, Daewoo, Fiat, Lancia, Opel, Peugeot, Saab, Vauxhall
24	BKUR6ET-10	Audi, Mercedes, Seat, Skoda, VW
25	PTR5A-13	Ford, Mazda, Morgan
26	BKR6EKC	Fiat, Lancia, Lotus
27	BKUR6ET	Audi, Fiat, Lancia, Seat, Skoda, VW
28	BKR6E	Caterham, Chrysler, Daihatsu, Kia, Lotus, Mazda, Nissan, Opel, Rover, Suzuki
29	BKUR5ET	Mercedes, Seat, VW
30	BKR6EQUP	Alpina, Audi, BMW, Bentley, Land Rover, Mini, Morgan, Porsche, Rolls Royce
31	PTR5D-10	Aston Martin, Ford, Mazda
32	BCPR5ES	Citroen, Nissan, Peugeot, Reliant, Renault, Skoda



A6	AUTOUNION, FSM
A7	ALLARD, AUTOUNION
AP6FS	FORD
APR6FS	FORD
B10EG	ABARTH
B5ES	LAND ROVER
B5HS	ALVIS, BMW, RENAULT, UAZ, VW
B6EFS	JAGUAR
B6ES	ALFA ROMEO, ALLARD, ARM-STRONG-SIDDELEY, LAND ROVER, PANHARD, ROLLS ROYCE, ROVER, VW
B6HS	A.C.BRISTOL, ABARTH, BARKAS, BMW, BORGWARD, DELAHAYE, DKW, FORD, PEUGEOT, VW, WARTBURG AWE
B6L	SCALDIA
B6S	BEDFORD, VOLVO
B7ECS	TVR
B7ES	ALFA ROMEO, AUDI, BMW, FIAT, NSU, PANHARD
B7HS	AUTOBIANCHI, BMW, BORGWARD
B7S	VOLVO
B8ECS	CATERHAM
B8EFS	RENAULT
B8EG	RENAULT
B8EGV	PORSCHE
B8ES	ABARTH, BMW, JAGUAR
B8EVX	ALPINE, LAMBORGHINI, RENAULT
B95EGP	RENAULT

B95EGV	RENAULT
B9EG	RENAULT
BCP5ES	CITROEN, DAEWOO, MERCEDES, NISSAN, PEUGEOT, RENAULT, SSANGYONG
BCP5EVX	SAAB
BCP6ES	ALFA ROMEO, CITROEN, MERCEDES, NISSAN, PEUGEOT, ROVER
BCP6ES-11	NISSAN
BCP6ET	CITROEN, PEUGEOT, RENAULT
BCP6EVX	SAAB
BCP7ES	SEAT
BCP7ET	AUDI, VW
BCP7EVX	SAAB
BCPR5EP-11	TOYOTA
BCPR5EP-8	TOYOTA
BCPR5ES	CITROEN, PEUGEOT, RENAULT, SKODA
BCPR5ES-11	NISSAN
BCPR5EY	TOYOTA
BCPR6E	MAZDA, VOLVO
BCPR6E-11	HONDA, MAZDA, NISSAN, ROVER
BCPR6EP-11	TOYOTA
BCPR6EP-13	TOYOTA
BCPR6ES	AUTOBIANCHI, CHRYSLER, CITROEN, DAIMLER, FIAT, FORD, JAGUAR, LADA, LANCIA, MORGAN, NISSAN, PEUGEOT, ROVER, TVR, VOLVO
BCPR6ES-11	FORD, LADA, NISSAN, SAAB, VAZ



BCPR6ET	CITROEN, LANCIA, PEUGEOT, RENAULT, VOLVO
BCPR6EY	TOYOTA
BCPR6EY-11	TOYOTA
BCPR6EYN-11	HONDA
BCPR7ES	ASTON MARTIN, CATERHAM, FIAT, FORD, LANCIA, SAAB, VOLVO
BCPR7ES-11	FORD, SAAB
BCPR7ET	FIAT, PORSCHE
BCR8ES	FORD
BCRE527Y	TOYOTA
BK5ESZ	RENAULT
BK6E	MITSUBISHI
BKR4EVX	BENTLEY, ROLLS ROYCE
BKR5E	KIA, MAZDA, NISSAN, VW
BKR5E-11	CHRYSLER, HYUNDAI, MAZDA, MITSUBISHI, NISSAN
BKR5EK	CITROEN, DAEWOO, OPEL, PEUGEOT, RENAULT, SAAB, VAUXHALL
BKR5EKB-11	TOYOTA
BKR5EKC	DAIHATSU, PERODUA
BKR5EKU	AMG, MERCEDES, VW
BKR5EKUP	FORD, SEAT, VW
BKR5EP-11	LEXUS, TOYOTA
BKR5ES	KIA
BKR5ES-11	HYUNDAI, KIA
BKR5EVX	BENTLEY, ROLLS ROYCE, VW
BKR5EVXA-13	DAIMLER, JAGUAR



BKR5EY	NISSAN
BKR5EY-11	NISSAN
BKR5EYA	TOYOTA
BKR5EYA-11	TOYOTA
BKR5EZ	CITROEN, FIAT, LANCIA, RENAULT
BKR6E	CATERHAM, CHRYSLER, DAIHATSU, KIA, LADA, MAZDA, NISSAN, ROVER, SUZUKI, VOLGA
BKR6E-11	CHEVROLET, DAEWOO, DAHATSU, HONDA, ISUZU, KIA, MAZDA, MITSUBISHI, NISSAN, PROTON, SUBARU, SUZUKI
BKR6EBPB-11	TOYOTA
BKR6EK	CITROEN, PEUGEOT, RENAULT, ALPINA, BMW, OPEL, PEUGEOT, PORSCHE, VAUXHALL
BKR6EKB-11	TOYOTA
BKR6EKC	FIAT, LANCIA
BKR6EKE	SMART
BKR6EKPA	ALFA ROMEO
BKR6EKPB-11	LEXUS, TOYOTA
BKR6EKUB	AUDI, VOLVO, VW
BKR6EKUE	VW
BKR6EN-11	HONDA
BKR6EP-11	LEXUS, TOYOTA
BKR6EP-13	TOYOTA
BKR6EP-8	TOYOTA
BKR6EQUA	AUDI, VW
BKR6EQUP	ALPINA, AUDI, BENTLEY, BMW, MINI, PORSCHE, ROLLS ROYCE, VAUXHALL



BKR6ES	HYUNDAI, PEUGEOT, RENAULT, ROVER, SKODA, VOLVO
BKR6ES-11	KIA
BKR6ETA-10	SEAT, SKODA, VW
BKR6EVX	SUBARU, VOLVO
BKR6EVX-11	DODGE, FORD
BKR6EVXA-11	JAGUAR
BKR6EVXA-13	JAGUAR
BKR6EY	NISSAN
BKR6EYA	TOYOTA
BKR6EYA-11	TOYOTA
BKR6EZ	CITROEN, FIAT, LANCIA, PEUGEOT, RENAULT
BKR7E	LOTUS
BKR7EN-11	HONDA
BKR7EVX	VOLVO
BKR7EVX-11	FORD
BKUR5ET	MERCEDES, SEAT, VW
BKUR5ET-10	AUDI, MERCEDES, SEAT, SKODA
BKUR6EK	DAIHATSU
BKUR6ET	SEAT, VW
BKUR6ET-10	AUDI, MERCEDES, SEAT, SKODA, VW
BKUR6ETB	LANCIA
BKUR6ETB-10	DAIHATSU
BKUR7ET	AUDI, PEUGEOT, RENAULT, SEAT, VW
BP5E	JAGUAR, LAND ROVER, VOLVO
BP5EFS	ROVER

BP5ES	AUSTIN, BMW, DAIMLER, HYUNDAI, JAGUAR, LAND ROVER, MITSUBISHI, NISSAN, PANTHER, PEUGEOT, RENAULT, ROLLS ROYCE, ROVER, TRIUMPH, VW
BP5ES-11	ISUZU
BP5ESZ	RENAULT
BP5ET	SEAT, VW
BP5ET-10	AUDI, VW
BP5EY	DAIHATSU, TOYOTA
BP6EF	AUSTIN, LEYLAND DAF
BP6EFS	CITROEN, MERCEDES, PEUGEOT, RENAULT, ROVER, TALBOT
BP6ES	ALFA ROMEO, ASTON MARTIN, AUDI, AUSTIN, AVTOVAZ, BEDFORD, BMW, CITROEN, FIAT, FISSORE, FORD, FSO, GLAS, INNOCENTI, ISUZU, KIA, LADA, LAND ROVER, LEYLAND DAF, LOTUS, MASERATI, MATRA, MERCEDES, MG, MITSUBISHI, MORGAN, MOSKWICZ, NISSAN, RENAULT, ROVER, SAAB, SEAT, TALBOT, TOFAS, TRIUMPH, VAUXHALL, VAZ, VOLVO, VW, YUGO, Z.A.Z., ZASTAVA
BP6ES-11	HYUNDAI
BP6ESZ	AUDI, RENAULT, VW
BP6ET	FIAT, FSO, LANCIA, PORSCHE, VW
BP6FS	VAUXHALL
BP6HS	CITROEN, DACIA, DAF, FORD, GAZ, MERCEDES, RENAULT, SKODA, TALBOT, TRIUMPH, VAUXHALL, VOLVO, Z.A.Z., ZASTAVA
BP7EFS	CITROEN, PEUGEOT, RENAULT, SKODA, VOLVO
BP7EFVX	RENAULT



BP7ES	ALFA ROMEO, AUDI, CATERHAM, DAIMLER, FERRARI, FIAT, JAGUAR, LOTUS, MERCEDES, MOSKWICZ, PEUGEOT, PORSCHE, RENAULT, SAAB, SEAT, TALBOT, VW
BP7EVX	AUDI, LAMBORGHINI
BP7HS	FORD, SAAB, SKODA, VOLVO
BP8ES	ABARTH, ALFA ROMEO, MASERATI, MATRA
BP8EVX	FERRARI, LAMBORGHINI, MASERATI
BPR4EVX	BENTLEY, ROLLS ROYCE
BPR4EY	TOYOTA
BPR4FS-11	PONTIAC
BPR5E	NISSAN, VOLVO
BPR5EAL	DAIHATSU, TOYOTA
BPR5EA-L	DAIHATSU, TOYOTA
BPR5EFS-13	CADILLAC, PONTIAC
BPR5EKU	AUDI, VW
BPR5EP-11	TOYOTA
BPR5ES	BENTLEY, BRISTOL, DAEWOO, DAIHATSU, FIAT, GAZ, HONDA, INNOCENTI, MAZDA, MITSUBISHI, NISSAN, OPEL, PROTON, RELIANT, RENAULT, ROLLS ROYCE, ROVER, SEAT, SUZUKI, TOYOTA, VAUXHALL, VOLVO
BPR5ES-11	CHRYSLER, DAEWOO, HYUNDAI, ISUZU, KIA, MAZDA, MITSUBISHI, NISSAN, PROTON
BPR5EV	ASTON MARTIN, BENTLEY, ROLLS ROYCE
BPR5EVX-11	DODGE
BPR5EY	DAIHATSU, INNOCENTI, LUBLIN (Daewoo), SUZUKI, TOYOTA



BPR5EY-11	DAEWOO, DAIHATSU, HONDA, KIA, TOYOTA, VW
BPR6E	ALFA ROMEO
BPR6EFS	FORD, TVR, VOLVO
BPR6EKN	DAIHATSU, LOTUS
BPR6ES	AUSTIN, AUTOBIANCHI, AVTOVAZ, BEDFORD, BMW, CHRYSLER, DAEWOO, DAIHATSU, FIAT, FORD, HONDA, HYUNDAI, INNOCENTI, ISUZU, LADA, LANCIA, LAND ROVER, LOTUS, MAZDA, MITSUBISHI, MORGAN, NISSAN, OPEL, PORSCHE, PROTON, RELIANT, RENAULT, ROVER, SEAT, SUBARU, SUZUKI, TALBOT, TOFAS, TVR, VAUXHALL, VAZ, VOLVO, YUGO, ZASTAVA
BPR6ES-11	AVTOVAZ, HONDA, HYUNDAI, ISUZU, KIA, MAZDA, MITSUBISHI, NISSAN, OPEL, SUBARU, SUZUKI
BPR6EY	DAEWOO, DAIHATSU, HONDA, INNOCENTI, TOYOTA
BPR6EY-11	HONDA, TOYOTA
BPR6FS	BEDFORD, VAUXHALL
BPR6HS	BEDFORD, DAEWOO, OPEL, VAUXHALL
BPR7ES	ALFA ROMEO, CATERHAM, FIAT, FORD, LANCIA, LOTUS, MITSUBISHI, SUBARU, VOLVO
BPR7ES-11	mitsubishi
BPR7HS	FIAT
BPR8ES	ASTON MARTIN
BR6EF	DAIMLER, JAGUAR
BR6ES	HONDA
BR7EF	DAIMLER, JAGUAR, PEUGEOT
BR7EFS	DAIMLER, JAGUAR



BR7ES	MITSUBISHI
BRE527Y-11	TOYOTA
BUR5ET	SEAT, VW
BUR5ET-10	AUDI, VW
BUR6EA-11	MITSUBISHI
BUR6EFSZ	AUDI
BUR6ET	AUDI, FIAT, LANCIA, SEAT, SKODA, VW
D8EVX	FERRARI
D9EVX	LAMBORGHINI
DCPR7E	MASERATI, SUZUKI
DCPR7E-N	FIAT, LANCIA
DCPR7EVX	SUZUKI
DCPR8E	FIAT, LANCIA, MASERATI, TVR
DCPR8EKC	FIAT
DCPR8EKP	BMW
DCPR8E-N	FIAT, LANCIA
DCPR9E	MASERATI
DCPR9EVX	FERRARI
FR4	CHEVROLET, DODGE, JEEP
FR45	CHRYSLER
FR5	DODGE, JEEP, PLYMOUTH
FR5-1	CHRYSLER, DODGE, JEEP
GR4	CHRYSLER, JEEP
GR45	CHRYSLER, DODGE
IFR5A-11	TOYOTA
IFR5D10	AMG, MERCEDES

IFR5E-11	MAZDA, SUZUKI
IFR5J11	SUZUKI
IFR5J-11	SUZUKI
IFR5N10	DAIMLER, JAGUAR
IFR6A-11T	TOYOTA
IFR6D10	MERCEDES
IFR6E-11	SUZUKI
IFR6J-11	SUBARU, SUZUKI
IFR6T-11	LEXUS, TOYOTA
IFR7G-11K	HONDA
ILFR6A	MERCEDES
ILFR6B	SUBARU
ITR6F-13	FORD, MAZDA
IZFR5B	MITSUBISHI
IZFR6B	MITSUBISHI, VOLVO
IZFR6K-11	HONDA
IZKR7B	AUDI, VW
LFR5A-11	NISSAN
LFR5AP-11	NISSAN
LFR5B	CITROEN, PEUGEOT
LFR6B	CITROEN, PEUGEOT
LFR6C-11	TOYOTA
LKR8A	SMART
LZKAR7A	RENAULT
LZTR4A-11	CHRYSLER
PFR5B	AUDI
PFR5B-11	INFINITI, SUBARU



PFR5G-11	ACURA, AMG, CHRYSLER, DODGE, FORD (USA), INFINITI, SAM SUNG
PFR5G-11E	DAIMLER, JAGUAR
PFR5G-13E	DAIMLER, JAGUAR
PFR5J-11	HYUNDAI, MITSUBISHI
PFR5N-11	HYUNDAI, KIA
PFR6A-11	NISSAN
PFR6B	ALFA ROMEO, LANCIA, SUBARU, VOLVO
PFR6B-11	FORD, NISSAN
PFR6E-10	RENAULT
PFR6G	SUBARU, VOLVO
PFR6G-11	HONDA, MITSUBISHI, NISSAN
PFR6G-13E	DAIMLER, JAGUAR
PFR6G-9	RENAULT
PFR6H-10	SAAB
PFR6J-11	DODGE, MITSUBISHI
PFR6N-11	HYUNDAI, KIA, LAND ROVER, MG, MORGAN, ROVER
PFR6Q	AUDI, SEAT, SKODA, VW
PFR6T-10G	SAAB
PFR7B	AUDI, MG
PFR7B-11	FORD
PFR7G-11	HONDA
PFR7H-10	SAAB
PFR7Q	AUDI
PGR6A	ALFA ROMEO
PGR6A-11	MITSUBISHI

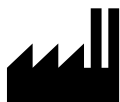

PGR7A	MITSUBISHI
PKR7A	BMW
PKR9B	FERRARI
PLFR5A-11	NISSAN, PEUGEOT, RENAULT
PLFR6A-11	SUBARU, VOLVO
PMR7A	FERRARI
PMR8A	FERRARI, MASERATI
PMR8B	FERRARI, MASERATI
PTR4B-15	BUICK, CHEVROLET, OLDSMOBILE, PONTIAC
PTR5A-10	VAUXHALL
PTR5A-13	FORD, MAZDA
PTR5A-13	FORD
PTR5A-13	MAZDA
PTR5D-10	FORD, MAZDA
PTR6D-13	ASTON MARTIN, JAGUAR
PTR6F-13	FORD
PZFR5D-11	SEAT, SKODA, VW
PZFR5F-11	DODGE
PZFR5N-11TG	AUDI, VW
PZFR6F	MAZDA
PZFR6F-11	HONDA
PZFR6J-11	AUDI, VW
RE8A-L + RE9B-T	MAZDA
TR4	BUICK
TR5	BUICK, FORD (USA)
TR5-1	FORD (USA)

Bic¹⁾

BCP7EVX	AUDI, SAAB, SEAT, VW
BCPR5EIX-11	CITROEN, DAEWOO, MERCEDES, NISSAN, PEUGEOT, RENAULT, SKODA, SSANGYONG, TOYOTA
BCPR5EIX-11 + BCPR6EIX-11	NISSAN
BCPR6EIX-11	ALFA ROMEO, CHRYSLER, CITROEN, DAIMLER, FORD, HONDA, JAGUAR, LADA, MAZDA, MERCEDES, MORGAN, NISSAN, PEUGEOT, RENAULT, ROVER, SAAB, SKODA, TVR, VOLVO
BCPR7EVX-11	FORD, SAAB
BKR5EIX	CITROEN, DAEWOO, KIA, MAZDA, NISSAN, OPEL, PEUGEOT, RENAULT, SAAB
BKR5EIX-11	CHRYSLER, HYUNDAI, MAZDA, MITSUBISHI, NISSAN, SUBARU
BKR6EIX	CATERHAM, CITROEN, DAIHATSU, HYUNDAI, KIA, LADA, LOTUS, MAZDA, NISSAN, PEUGEOT, RENAULT, ROVER, SKODA, SUZUKI, VOLGA, VOLVO
BKR6EIX-11	CHEVROLET, DAEWOO, DAIHATSU, HONDA, HYUNDAI, KIA, MAZDA, MITSUBISHI, NISSAN, PROTON, SUBARU, SUZUKI
BKR6EQUP	ALPINA, AUDI, BMW, CITROEN, OPEL, PEUGEOT, PORSCHE, RENAULT, VW
BKR7EVX	JAGUAR
BPR5EIX	AUSTIN, AVTOVAZ, BMW, DAEWOO, DAIHATSU, DAIMLER, HONDA, HYUNDAI, JAGUAR, LAND ROVER, LUBLIN (Daewoo), MAZDA, MITSUBISHI, MOSKWICZ, NISSAN, OPEL, PANTHER, PEUGEOT, RENAULT, ROLLS-ROYCE, SEAT, SUZUKI, TOYOTA, VW

Bic¹⁾

BPR5EIX-11	CHRYSLER, DAEWOO, DAIHATSU, HONDA, HYUNDAI, ISUZU, KIA, MAZDA, MITSUBISHI, NISSAN, PROTON, TOYOTA, VW
BPR6EIX	AUDI, AUSTIN, AVTOVAZ, BMW, CHRYSLER, CITROEN, DAEWOO, DAIHATSU, FORD, FSO, HONDA, HYUNDAI, ISUZU, KIA, LADA, LAND ROVER, LOTUS, MATRA, MAZDA, MERCEDES, MG, MITSUBISHI, MORGAN, MOSKWICZ, NISSAN, OPEL, PEUGEOT, PORSCHE, RENAULT, ROVER, SAAB, SEAT, SUBARU, SUZUKI, TALBOT, TOFAS, TOYOTA, TVR, VOLVO, VW, Z.A.Z., ZASTAVA
BPR6EIX-11	HONDA, HYUNDAI, ISUZU, KIA, MAZDA, MITSUBISHI, NISSAN, OPEL, SUBARU, TOYOTA
BPR6HIX	CITROEN, DACIA, DAEWOO, OPEL, RENAULT, SKODA, TALBOT, VOLVO, Z.A.Z., ZASTAVA
BPR7EIX	AUDI, CATERHAM, DAIMLER, FORD, LOTUS, MERCEDES, MITSUBISHI, MOSKWICZ, PEUGEOT, PORSCHE, RENAULT, SAAB, SEAT, SUBARU, TALBOT, VOLVO, VW
BR6HIX	BARKAS, DKW, PEUGEOT, VW, WARTBURG AWE
BR8EIX	BMW
DCPR7EIX	SUZUKI
DCPR8EVX	TVR
GR4IX	CHRYSLER, JEEP
PFR6Q	AUDI, MERCEDES, SEAT, SKODA, VW
PFR7Q	AUDI, PEUGEOT, RENAULT, SEAT, VW
PGR6D	AUDI, FSO, PORSCHE, RENAULT, SEAT, SKODA, VW

¹⁾ Bic = Best in class (siehe Seite 3) / (see page 3)

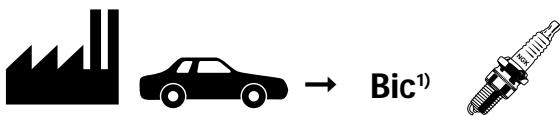

ALFA ROMEO	BCPR6EIX-11
ALPINA	BKR6EQUP
AUDI	BCP7EVX, BKR6EQUP, BPR6EIX, BPR7EIX, PFR6Q, PFR7Q, PGR6D
AUSTIN	BPR5EIX, BPR6EIX
AVTOVAZ	BPR5EIX, BPR6EIX
BARKAS	BR6HIX
BMW	BKR6EQUP, BPR5EIX, BPR6EIX, BR8EIX, ZFR5FIX-11
BUICK	TR4IX, TR55IX, TR5IX, UR45IX
CADILLAC	TR55IX, UR4IX
CATERHAM	BKR6EIX, BPR7EIX
CHEVROLET	BKR6EIX-11, TR55IX, UR45IX, UR4IX, UR5IX
CHRYSLER	BCPR6EIX-11, BKR5EIX-11, BPR5EIX-11, BPR6EIX, GR4IX
CITROEN	BCPR5EIX-11, BCPR6EIX-11, BKR5EIX, BKR6EIX, BKR6EQUP, BPR6EIX, BPR6HIX
DACIA	BPR6HIX
DAEWOO	BCPR5EIX-11, BKR5EIX, BKR6EIX-11, BPR5EIX, BPR5EIX-11, BPR6EIX, BPR6HIX
DAIHATSU	BKR6EIX, BKR6EIX-11, BPR5EIX, BPR5EIX-11, BPR6EIX
DAIMLER	BCPR6EIX-11, BPR5EIX, BPR7EIX
DKW	BR6HIX
FORD	BCPR6EIX-11, BCPR7EVX-11, BPR6EIX, BPR7EIX, TR55IX, TR5IX, ZFR6FIX-11
FORD (USA)	TR5-1IX, TR55IX, TR5IX, UR4IX, UR5IX, WR5IX
FSO	BPR6EIX, PGR6D

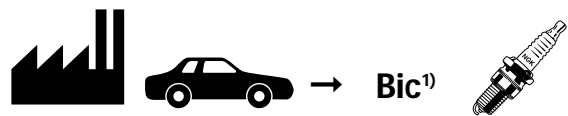

HONDA	BCPR6EIX-11, BKR6EIX-11, BPR5EIX, BPR5EIX-11, BPR6EIX, BPR6EIX-11, ZFR5FIX-11, ZFR6FIX-11
HYUNDAI	BKR5EIX-11, BKR6EIX, BKR6EIX-11, BPR5EIX, BPR5EIX-11, BPR6EIX, BPR6EIX-11
ISUZU	BPR5EIX-11, BPR6EIX, BPR6EIX-11
JAGUAR	BCPR6EIX-11, BKR7EVX, BPR5EIX
JEEP	GR4IX, UR4IX, ZFR5FIX-11
KIA	BKR5EIX, BKR6EIX, BKR6EIX-11, BPR5EIX-11, BPR6EIX, BPR6EIX-11
LADA	BCPR6EIX-11, BKR6EIX, BPR6EIX
LAND ROVER	BPR5EIX, BPR6EIX
LOTUS	BKR6EIX, BPR6EIX, BPR7EIX
LUBLIN (Daewoo)	BPR5EIX
MATRA	BPR6EIX
MAZDA	BCPR6EIX-11, BKR5EIX, BKR5EIX-11, BKR6EIX, BKR6EIX-11, BPR5EIX, BPR5EIX-11, BPR6EIX, BPR6EIX-11, ZFR5FIX-11, ZFR6FIX-11
MERCEDES	BCPR5EIX-11, BCPR6EIX-11, BPR6EIX, BPR7EIX, PFR6Q
MG	BPR6EIX
MITSUBISHI	BKR5EIX-11, BKR6EIX-11, BPR5EIX, BPR5EIX-11, BPR6EIX, BPR6EIX-11, BPR7EIX
MORGAN	BCPR6EIX-11, BPR6EIX
MOSKWICZ	BPR5EIX, BPR6EIX, BPR7EIX

¹⁾ Bic = Best in class (siehe Seite 3) / (see page 3)

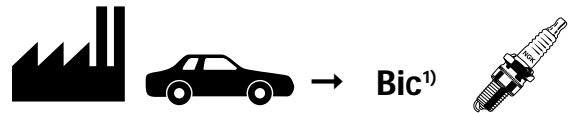
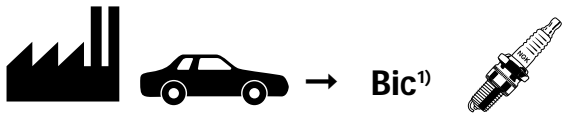

NISSAN	BCPR5EIX-11, BCPR5EIX-11 + BCPR6EIX-11, BCPR6EIX-11, BKR5EIX, BKR5EIX-11, BKR6EIX, BKR6EIX-11, BPR5EIX, BPR5EIX-11, BPR6EIX, BPR6EIX-11
OLDSMOBILE	TR55IX
OPEL	BKR5EIX, BKR6EQUP, BPR5EIX, BPR6EIX, BPR6EIX-11, BPR6HIX, ZFR6FIX-11
PANTHER	BPR5EIX
PEUGEOT	BCPR5EIX-11, BCPR6EIX-11, BKR5EIX, BKR6EIX, BKR6EQUP, BPR5EIX, BPR6EIX, BPR7EIX, BR6HIX, PFR7Q
PONTIAC	TR55IX
PORSCHE	BKR6EQUP, BPR6EIX, BPR7EIX, PGR6D
PROTON	BKR6EIX-11, BPR5EIX-11
RENAULT	BCPR5EIX-11, BCPR6EIX-11, BKR5EIX, BKR6EIX, BKR6EQUP, BPR5EIX, BPR6EIX, BPR6HIX, BPR7EIX, PFR7Q, PGR6D
ROLLS-ROYCE	BPR5EIX
ROVER	BCPR6EIX-11, BKR6EIX, BPR6EIX, ZFR6FIX-11
SAAB	BCP7EVX, BCPR6EIX-11, BCPR7EVX-11, BKR5EIX, BPR6EIX, BPR7EIX
SEAT	BCP7EVX, BPR5EIX, BPR6EIX, BPR7EIX, PFR6Q, PFR7Q, PGR6D
SKODA	BCPR5EIX-11, BCPR6EIX-11, BKR6EIX, BPR6HIX, PFR6Q, PGR6D
SSANGYONG	BCPR5EIX-11
SUBARU	BKR5EIX-11, BKR6EIX-11, BPR6EIX, BPR6EIX-11, BPR7EIX

SUZUKI	BKR6EIX, BKR6EIX-11, BPR5EIX, BPR6EIX, DCPR7EIX
TALBOT	BPR6EIX, BPR6HIX, BPR7EIX
TOFAS	BPR6EIX
TOYOTA	BCPR5EIX-11, BPR5EIX, BPR5EIX-11, BPR6EIX, BPR6EIX-11
TVR	BCPR6EIX-11, BPR6EIX, DCPR8EVX
VOLGA	BKR6EIX
VOLVO	BCPR6EIX-11, BKR6EIX, BPR6EIX, BPR6HIX, BPR7EIX
VW	BCP7EVX, BKR6EQUP, BPR5EIX, BPR5EIX-11, BPR6EIX, BPR7EIX, BR6HIX, PFR6Q, PFR7Q, PGR6D, PZFR5D-11
WARTBURG AWE	BR6HIX
Z.A.Z.	BPR6EIX, BPR6HIX
ZASTAVA	BPR6EIX, BPR6HIX

¹⁾ Bic = Best in class (siehe Seite 3) / (see page 3)

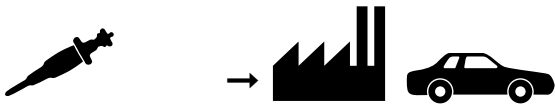

△ Y-925R	MERCEDES
◆ Y-930U	MERCEDES
CY51	NISSAN
CY52	NISSAN
CY53	OPEL, VAUXHALL
CY57	HYUNDAI, MITSUBISHI
DG237	MERCEDES
Y-103	NISSAN
Y-103-1	NISSAN
Y-103-2	NISSAN
Y-107R	MAZDA
Y-107T	KIA, MAZDA
Y-112M1	NISSAN
Y-112R1	NISSAN
Y-112T	NISSAN
Y-115R1	MITSUBISHI
Y-115T1	HYUNDAI, MITSUBISHI
Y-117RS	NISSAN
Y-117SS	NISSAN
Y-118R	TOYOTA
Y-118T1	TOYOTA
Y-128	TOYOTA
Y-128T	DAIHATSU, TOYOTA
Y-146R	DAIHATSU, INNOCENTI, TOYOTA
Y-147T	DAIHATSU, TOYOTA
Y-157R	MAZDA
Y-162R1	NISSAN

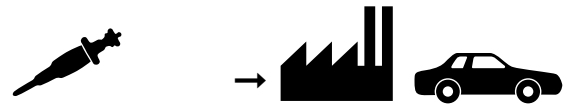

Y-168R	TOYOTA
Y-172	MAZDA
Y-177-1	NISSAN
Y-178	TOYOTA
Y-178T	TOYOTA
Y-181T	NISSAN
Y-197R	HINO, TOYOTA
Y-197T	TOYOTA
Y-202	NISSAN
Y-202-2	NISSAN
Y-204RS	NISSAN
Y-204SS	NISSAN
Y-204TS-1	NISSAN
Y-208T	ALFA ROMEO, AVIA, BEDFORD, CARBODIES, CITROEN, FIAT, FORD, IVECO, LAND ROVER, MAHINDRA, OPEL, PEUGEOT, RENAULT, ROVER, SEAT, TALBOT
Y-222T	NISSAN
Y-271-2	ISUZU
Y-272R-1	NISSAN
Y-302	LEYLAND
Y-306R	ISUZU, OPEL, VAUXHALL
Y-307R	BEDFORD, ISUZU, VAUXHALL
Y-403T	OPEL, ZUK
Y-404	PEUGEOT
Y-405	CITROEN
Y-452-1	TOYOTA
Y-501U	AUDI, VW

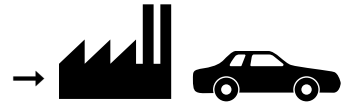

Y-502R	RENAULT
Y-503R	CITROEN, PEUGEOT
Y-504R	CITROEN, FIAT, LANCIA, PEUGEOT
Y-506R	RENAULT
Y-507R	BMW, LAND ROVER, ROVER
Y-515J	NISSAN, RENAULT, VOLVO
Y-516J	RENAULT
Y-517J	RENAULT
Y-519J	NISSAN
Y-523J	OPEL
Y-524J	FORD
Y-525J	FORD
Y-701J	FORD, MAZDA
Y-701R	KIA
Y-703R	DAIHATSU, TOYOTA
Y-705RS	NISSAN
Y-707RS	NISSAN
Y-710J	ISUZU, VAUXHALL
Y-711J	ISUZU
Y-711RS	BEDFORD, VAUXHALL
Y-712RS	NISSAN
Y-715R	TOYOTA
Y-721RS	MAZDA
Y-729U	LAND ROVER
Y-730U	HONDA, RENAULT, ROVER
Y-731U	CITROEN, LADA, PEUGEOT

Y-732U	AUDI, FORD, SEAT, SKODA, VOLVO, VW
Y-733J	MITSUBISHI
Y-738U	CITROEN
Y-739R	FIAT
Y-740U	HONDA, RENAULT
Y-741U	ALFA ROMEO, AUDI, CHRYSLER, FORD, JEEP, VW
Y-745U	MERCEDES
Y-746R	MERCEDES
Y-747U	ALFA ROMEO, FIAT, LANCIA
Y-748U	OPEL, SAAB, VAUXHALL
Y-749J	HYUNDAI
Y-755RS	NISSAN
Y-757RS	NISSAN
Y-771R	MAZDA
Y-810	OPEL, PEUGEOT
Y-902R	ARO, AUVERLAND, BEDFORD, BMW, CITROEN, FIAT, FORD, FREIGHTROVER, LADA, LANCIA, MAHINDRA, MERCEDES, NISSAN (Spain), OPEL, PEUGEOT, ROVER, SEAT, TALBOT, UAZ, VAUXHALL
Y-904M	ISUZU
Y-907R	FORD, LAND ROVER
Y-908R	FIAT, JEEP, RENAULT
Y-909R	ALFA ROMEO, LAND ROVER
Y-910R	FORD
Y-911R	ROVER
Y-913M	RENAULT, VOLVO



Y-914U	FIAT, RENAULT
Y-916R	DAEWOO, MERCEDES, SSANGYONG, STEYR
Y-917U	BMW, LAND ROVER, VAUXHALL
Y-918R	AUDI, MITSUBISHI, NISSAN, SEAT, SKODA, VOLVO, VW
Y-922R	ALFA ROMEO, FIAT, LANCIA
Y-923U	AUVERLAND, CHRYSLER, CITROEN, FIAT, JEEP, LANCIA, LAND ROVER, LEYLAND DAF, MERCEDES, PEUGEOT, SUZUKI
Y-924U	OPEL, VAUXHALL
Y-925R	MERCEDES
Y-927R	RENAULT
Y-928U	FIAT, LANCIA, TOYOTA
Y-929U	MERCEDES
Y-932R	RENAULT, VOLVO
Y-933R	VOLVO
Y-935U	FIAT, RENAULT
Y-937R	FORD
Y-938R	CITROEN, PEUGEOT
Y-955RS	NISSAN
YE04	CITROEN, FORD, PEUGEOT



ALFA ROMEO	Y-208T, Y-741U, Y-747U, Y-909R, Y-922R
ARO	Y-902R
AUDI	Y-501U, Y-732U, Y-741U, Y-918R
AUVERLAND	Y-902R, Y-923U
AVIA	Y-208T
BEDFORD	Y-208T, Y-307R, Y-711RS, Y-902R
BMW	Y-507R, Y-902R, Y-917U
CARBODIES	Y-208T
CHRYSLER	Y-741U, Y-923U
CITROEN	Y-208T, Y-405, Y-503R, Y-504R, Y-731U, Y-738U, Y-902R, Y-923U, Y-938R, YE04
DAEWOO	Y-916R
DAIHATSU	Y-128T, Y-146R, Y-147T, Y-703R
FIAT	Y-208T, Y-504R, Y-739R, Y-747U, Y-902R, Y-908R, Y-914U, Y-922R, Y-923U, Y-928U, Y-935U
FORD	Y-208T, Y-524J, Y-525J, Y-701J, Y-732U, Y-741U, Y-902R, Y-907R, Y-910R, Y-937R, YE04
FREIGHTROVER	Y-902R
HINO	Y-197R
HONDA	Y-730U, Y-740U
HYUNDAI	CY57, Y-115T1, Y-749J
INNOCENTI	Y-146R
ISUZU	Y-271-2, Y-306R, Y-307R, Y-710J, Y-711J, Y-904M
IVECO	Y-208T
JEEP	Y-741U, Y-908R, Y-923U
KIA	Y-107T, Y-701R



LADA	Y-731U, Y-902R
LANCIA	Y-504R, Y-747U, Y-902R, Y-922R, Y-923U, Y-928U
LAND ROVER	Y-208T, Y-507R, Y-729U, Y-907R, Y-909R, Y-917U, Y-923U
LEYLAND	Y-302, Y-302 no longer produced
LEYLAND DAF	Y-923U
MAHINDRA	Y-208T, Y-902R
MAZDA	Y-107R, Y-107T, Y-157R, Y-172, Y-701J, Y-721RS, Y-771R
MERCEDES	△ Y-925R, ◆ Y-930U, DG237, Y-745U, Y-746R, Y-902R, Y-916R, Y-923U, Y-925R, Y-929U
MITSUBISHI	CY57, Y-115R1, Y-115T1, Y-733J, Y-918R
NISSAN	CY51, CY52, Y-103, Y-103-1, Y-103-2, Y-112M1, Y-112R1, Y-112T, Y-117RS, Y-117SS, Y-162R1, Y-177-1, Y-181T, Y-202, Y-202-2, Y-204RS, Y-204SS, Y-204TS-1, Y-222T, Y-272R-1, Y-515J, Y-519J, Y-705RS, Y-707RS, Y-712RS, Y-755RS, Y-757RS, Y-918R, Y-955RS
NISSAN (Spain)	Y-902R
OPEL	CY53, Y-208T, Y-306R, Y-403T, Y-523J, Y-748U, Y-810, Y-902R, Y-924U
PEUGEOT	Y-208T, Y-404, Y-503R, Y-504R, Y-731U, Y-810, Y-902R, Y-923U, Y-938R, YE04
RENAULT	Y-208T, Y-502R, Y-506R, Y-515J, Y-516J, Y-517J, Y-730U, Y-740U, Y-908R, Y-913M, Y-914U, Y-927R, Y-932R, Y-935U
ROVER	Y-208T, Y-507R, Y-730U, Y-902R, Y-911R
SAAB	Y-748U

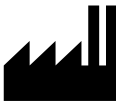

B10EG	APRILIA, KTM, YAMAHA
B10EGV	GAS GAS, SIMONINI IMEA
B10ES	BETA, GARELLI
B4H	PUCH, RIXE, VELOSOLEX
B5ES	BULTACO
B5HS	BULTACO, FANTIC, GILERA, GIMSON, HERCULES, KTM, LEM, MARS, OMER, PEUGEOT, PUCH, RIEJU, RIZZATO, SACHS, TESTI, TORROT
B6ES	BETA, CARABELA, GILERA, KAWASAKI, LEM, MINARELLI, MOTOR HISPANIA, RIEJU, TESTI
B6HS	BATAVUS, BENELLI, BMW, BULTACO, CARABELA, CZ, DUCATI, DUCSON, ENFIELD, ERING, FANTIC, G.A.C. MobyLe., GARELLI, GILERA, HERCULES, HUSQVARNA, JAWA, KTM, LAMBRETTA, MALAGUTI, MBK, MECATECNO, MINARELLI, MONTESA, MOTO GUZZI, MOTOR HISPANIA, OMER, PEUGEOT, POLINI, PUCH, RIEJU, RIXE, RIZZATO, S.I.S., SACHS, SPARTA, STARFLITE, TESTI, TORROT, VELOSOLEX, YAMAHA
B6L	HARLEY-DAVIDSON
B7ES	B.S.A, BENELLI, CARABELA, GILERA, KAWASAKI, LAMBRETTA, MALAGUTI, MINARELLI, MONTESA, MOTO GUZZI, SUZUKI, YAMAHA
B7HS	ATK, BENELLI, BETA, BULTACO, CASAL, DERBI, DKW, DUCATI, FANTIC, G.A.C. MobyLe., HERCULES, KAWASAKI, KTM, LEM, MBK, MONDIAL, MONTESA, MOTOR HISPANIA, PEUGEOT, REGENT, RIXE, S.I.S., SACHS, SUZUKI, TOMOS, TORROT, YAMAHA
B8EG	FANTIC, HUSQVARNA, YAMAHA



B8ES	ALFER, B.S.A, BENELLI, BETA, BULTACO, CAGIVA, CARABELA, DERBI, ENFIELD, FANTIC, GILERA, HARLEY-DAVIDSON, HM RACING, KAWASAKI, LAVERDA, MBK, MINARELLI, MONTESA, MOTO GUZZI, MV AGUSTA, OSSA, PEUGEOT, PUCH, RIZZATO, SUZUKI, TESTI, TRIUMPH, YAMAHA, ZÜNDAPP
B8HS	BMW, CASAL, DERBI, FITE (LEM), GAS GAS, HERCULES, HM RACING, JAWA, KAWASAKI, KTM, MALAGUTI, MBK, MONDIAL, MONTESA, MZ, MZ (TR), PEUGEOT, PUCH, RIXE, S.I.S., SACHS, SIMONINI IMEA, SIMSON, SUZUKI, TESTI, YAMAHA, ZÜNDAPP
B9EG	APRILIA, BULTACO, CAGIVA, CCM, FANTIC, GILERA, HUSQVARNA, KAWASAKI, KTM, TM, YAMAHA
B9ES	APRILIA, BETA, BLATA, BULTACO, CAGIVA, DERBI, GILERA, HARLEY-DAVIDSON, HERCULES, HUSQVARNA, KTM, MAICO, MALAGUTI, MONTESA, MOTO GUZZI, OSSA, PUCH, SACHS, YAMAHA
B9HCS	KTM
B9HS	BULTACO, KAWASAKI, KTM, PUCH
BCP7ET	BMW
BKR5E	POLARIS
BKR6E-11	HONDA
BKR7E	POLARIS
BKR7EKC	BMW, G+G
BP4H	SUZUKI
BP4HS	DNEPR, URAL, YAMAHA
BP5ES	APRILIA, BULTACO, CCM, GAS GAS, HARLEY-DAVIDSON, MECATECNO, MERLIN, MONTESA, OSSA, SCORPA, SHERCO, SWM



BP5HS	CARABELA
BP6ES	BMW, DNEPR, KTM, LEM, MBK, MOTO GUZZI, MOTO-SPEZIAL, SANGLAS, SUZUKI, YAMAHA
BP6HS	ISCH, KTM, MOTOTECHNIKA, MZ, SUZUKI, YAMAHA
BP6HS-10	YAMAHA
BP6HSA	KUANG YANG
BP7ES	BETA, BMW, JCM, KAWASAKI, MOTO GUZZI, MOTO MORINI, SUZUKI, YAMAHA
BP7HS	CAGIVA, DRR, DUCATI, HERCULES, HYOSUNG, ISCH, MINSK, SACHS, URAL AMERICA, YAMAHA, ZID
BP7HS-10	YAMAHA
BP8ES	MOTO GUZZI, MOTO MORINI, MÜNCH, SUZUKI, YAMAHA
BPM6A	SV
BPR4HS	KAWASAKI, SUZUKI
BPR5ES	BULTACO, GAS GAS, KAWASAKI, TITAN
BPR5ES-11	HARLEY-DAVIDSON, INDIAN
BPR5HS	HONDA
BPR6ES	GAS GAS, KAWASAKI, MOTO GUZZI, YAMAHA
BPR6HS	HONDA, PEUGEOT, SIAMOTO, SUZUKI, YAMAHA
BPR6HSA	HONDA
BPR7ES	MONTESA, YAMAHA
BPR7HS	AEON, BOMBARDIER, BSM, DAREN, DUCATI, E-TON, FOX, SUZUKI, TGB, YAMAHA
BPR8ES	KAWASAKI, YAMAHA



BR10EG	APRILIA, HONDA, KTM
BR10ES	KAWASAKI, SUZUKI
BR2LM	TRAILSPOORT
BR5HS	SACHS
BR6ES	ENFIELD, HONDA, KAWASAKI, YAMAHA
BR6HS	COSSACK, ENFIELD, HONDA, SOLO, YAMAHA
BR6HSA	HONDA
BR7ES	KAWASAKI, KTM
BR7HS	BETA, CPI, DUCATI, HONDA, SOLO, SUZUKI, YAMAHA
BR8ECM	KTM
BR8EG	GAS GAS, HONDA, HUSQVARNA, KTM, TM
BR8ES	ALFER, APRILIA, HONDA, HRD, KAWASAKI, MOTO GUZZI, POLARIS, RIEJU, SACHS, SHERCO-HRD, SUZUKI, YAMAHA
BR8HS	HONDA, KTM, UNISOM, YAMAHA
BR8HSA	SAN YANG
BR9ECM	YAMAHA
BR9ECS	BOMBARDIER, HONDA
BR9EG	CAGIVA, HONDA, HUSQVARNA, YAMAHA
BR9ES	CAGIVA, GILERA, HONDA, HUSQVARNA, KAWASAKI, MOTOR HISPANIA, SACHS, SUZUKI, YAMAHA
BR9HS	HONDA, YAMAHA
C6HSA	KAWASAKI, YAMAHA
C7E	HUSQVARNA



C7HSA	YAMAHA
C8E	HUSABERG, NORTON
C8EH-9	DAELIM
C8HSA	MOTO GUZZI
CR10EK	SUZUKI, YAMAHA
CR6E	ARCTIC CAT, SUZUKI
CR6HS	HONDA, YAMAHA
CR6HSA	HONDA, PANDA, YAMAHA
CR7E	ARCTIC CAT, KAWASAKI, SUZUKI, YAMAHA
CR7EB	HUSQVARNA
CR7HS	AEON, HONDA, YAMAHA
CR7HSA	BOMBARDIER, HONDA
CR8E	ARCTIC CAT, BOMBARDIER, CAGIVA, GAS GAS, HYOSUNG, KAWASAKI, MZ, SUZUKI, TM, YAMAHA
CR8EB	HUSQVARNA
CR8EH-9	HONDA, HYOSUNG
CR8EK	CAGIVA, KTM, SUZUKI, VOR
CR8HS	HONDA
CR8HSA	AEON, KAWASAKI
CR9E	ALFER, BIMOTA, DERBI, KAWASAKI, SUZUKI, YAMAHA
CR9EB	GILERA, HRD
CR9EH-9	HONDA
CR9EK	BETA, BIMOTA, CANNONDALE, KAWASAKI, SUZUKI, TRIUMPH, VERTEMATI, YAMAHA
CR9EKB	MV AGUSTA
D7EA	BMW, SUZUKI, YAMAHA

D8EA	APRILIA, ATK, BENELLI, BMW, GILERA, KAWASAKI, KTM, MOTO GUZZI, MZ, SUZUKI, YAMAHA
D9EA	KAWASAKI, LAVERDA, SUZUKI
DCPR6E	HONDA
DCPR7E	BMW, BUELL, HARLEY-DAVIDSON, HARLEY-DAVIDSON
DCPR8E	BOMBARDIER, DUCATI, HUSABERG, KTM
DCPR9E	APRILIA, BUELL
DP7EA-9	SUZUKI
DP8EA-9	CAGIVA, YAMAHA
DP9EA-9	GILERA, KTM, PUCH
DPR5EA-9	KAWASAKI
DPR6EA-9	HONDA, KAWASAKI
DPR7EA-9	HONDA, KAWASAKI, KYMCO, SUZUKI, YAMAHA
DPR8EA-9	BIMOTA, CAGIVA, DERBI, DUCATI, HONDA, KAWASAKI, KTM, LAVERDA, SUZUKI, TRIUMPH, YAMAHA
DPR8Z	HONDA
DPR9EA-9	CAGIVA, HONDA, KAWASAKI, LAVERDA, MZ, SUZUKI, YAMAHA
DPR9Z	HONDA
DR7EA	ARCTIC CAT, BMW, YAMAHA
DR7ES	HONDA, KAWASAKI, SUZUKI, YAMAHA
DR8EA	APRILIA, BETA, BIMOTA, BOMBARDIER, CCM, DAREN, HONDA, HYOSUNG, KAWASAKI, KTM, KYMCO, REX, SUZUKI, YAMAHA
DR8EB	BMW



B10ES	GARELLI
B5HS	PIAGGIO
B6ES	PIAGGIO
B6HS	BAJAJ, BENELLI, ERING, PIAGGIO, WINKING
B7ES	PIAGGIO
B7HS	ATALA, CAGIVA, ITALJET, PEUGEOT, PIAGGIO, SACHS
B8ES	PIAGGIO
B8HS	CAGIVA, DERBI, PEUGEOT, SACHS, SIMSON
B9ES	CAGIVA, DERBI, GILERA, PIAGGIO
B9HS	SIMSON
BP5HS	BAJAJ
BP6HS	BAJAJ, CAGIVA, HYOSUNG, ITALJET, LECSON, PEUGEOT, PGO, SACHS, STEFFEN, T.G.M. Bimota, TGB
BP7HS	CCF, FANTIC, GARELLI, ITALJET, KINETIC, MARS, MBK, PGO, SHE LUNG, TOKAIDO, YAMAHA
BP7HS-10	MBK, YAMAHA
BP8ES	LML- VESPA, PIAGGIO
BPR5HS	BAJAJ
BPR6HS	ATALA, HONDA, ITALJET, MALAGUTI, SACHS, SASY, SIAM, SUZUKI
BPR6HSA	HONDA
BPR7HS	GARELLI, KREIDLER, MBK, PEGASUS, PGO, REX, SUZUKI
BPR8ES	PIAGGIO
BPR8HS	APRILIA, ITALJET
BR10ES	DERBI



BR6HS	PIAGGIO
BR6HSA	HONDA
BR7ES	PIAGGIO
BR7HS	APRILIA, BENELLI, BETA, BUFFALO, CPI, ITALJET, KTM, K-ZWO, LEM, MACAL, MALAGUTI, MBK, MOTRON, MZ, PEUGEOT, PIAGGIO, SACHS, YAMAHA
BR8ES	HONDA, PEUGEOT, PIAGGIO, RIEJU
BR8HS	APRILIA, BENELLI, BETA, DERBI, ITALJET, MALAGUTI, MBK, PEUGEOT, SACHS, YAMAHA
BR8HSA	BS VILLA, CAGIVA, DAELIM, GARELLI, HYOSUNG, KYMCO, SAN YANG, SYM, VILLA BS
BR9ES	APRILIA, DERBI, GILERA, ITALJET, PIAGGIO, RIEJU
BR9HS	GARELLI
C7HSA	KYMCO, K-ZWO, PGO, SAN YANG, SIAMOTO, SYM
CPR8E	APRILIA, PEUGEOT
CR6HSA	YAMAHA
CR7E	APRILIA, CAGIVA, ITALJET, MBK, PIAGGIO, SUZUKI, YAMAHA
CR7EB	PEUGEOT, PIAGGIO
CR7EKB	APRILIA, PIAGGIO, SYM
CR7HSA	ERING, GARELLI, KREIDLER, MALAGUTI, PEGASUS, REX, RIEJU, SUNDIRO, SYM
CR8E	APRILIA, BENELLI, ITALJET, MBK, PEUGEOT, SUZUKI, YAMAHA
CR8EB	APRILIA, BENELLI, BMW, GILERA, MALAGUTI, PIAGGIO
CR8EH-9	DAELIM, HONDA

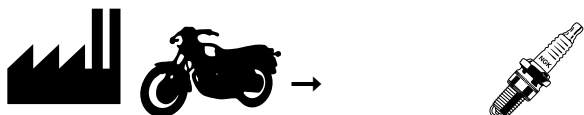

AEON	BPR7HS, CR7HS, CR8HSA
AJP	DR8ES
ALFER	B8ES, BR8ES, CR9E
APRILIA	B10EG, B9EG, B9ES, BP5ES, BR10EG, BR8ES, D8EA, DCPR9E, DR8EA
ARCTIC CAT	CR6E, CR7E, CR8E, DR7EA
ATK	B7HS, D8EA
B.S.A	B7ES, B8ES
BATAVUS	B6HS
BENELLI	B6HS, B7ES, B7HS, B8ES, D8EA
BETA	B10ES, B6ES, B7HS, B8ES, B9ES, BP7ES, BR7HS, CR9EK, DR8EA
BIMOTA	CR9E, CR9EK, DPR8EA-9, DR8EA, DR8ESL
BLATA	B9ES
BMW	B6HS, B8HS, BCP7ET, BKR7EKC, BP6ES, BP7ES, D7EA, D8EA, DCPR7E, DR7EA, DR8EB
BOMBARDIER	BPR7HS, BR9ECS, CR7HSA, CR8E, DCPR8E, DR8EA
BSM	BPR7HS
BUELL	DCPR7E, DCPR9E
BULTACO	B5ES, B5HS, B6HS, B7HS, B8ES, B9EG, B9ES, B9HS, BP5ES, BPR5ES
CAGIVA	B8ES, B9EG, B9ES, BP7HS, BR9EG, BR9ES, CR8E, CR8EK, DP8EA-9, DPR8EA-9, DPR9EA-9
CANNONDALE	CR9EK
CARABELA	B6ES, B6HS, B7ES, B8ES, BP5HS
CASAL	B7HS, B8HS

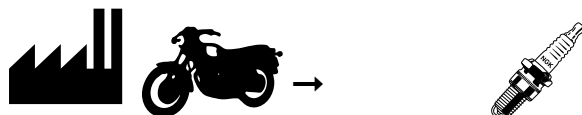

CCM	B9EG, BP5ES, DR8EA
COSSACK	BR6HS
CPI	BR7HS
CZ	B6HS
DAELIM	C8EH-9
DAREN	BPR7HS, DR8EA
DERBI	B7HS, B8ES, B8HS, B9ES, CR9E, DPR8EA-9
DKW	B7HS
DNEPR	BP4HS, BP6ES
DRR	BP7HS
DUCATI	---, B6HS, B7HS, BP7HS, BPR7HS, BR7HS, DCPR8E, DPR8EA-9, R2270-9
DUCSON	B6HS
ENFIELD	B6HS, B8ES, BR6ES, BR6HS
ERING	B6HS
E-TON	BPR7HS
FANTIC	B5HS, B6HS, B7HS, B8EG, B8ES, B9EG
FITE (LEM)	B8HS
FOX	BPR7HS
G.A.C. Mobyte.	B6HS, B7HS
G+G	BKR7EKC
GARELLI	B10ES, B6HS
GAS GAS	B10EGV, B8HS, BP5ES, BPR5ES, BPR6ES, BR8EG, CR8E
GILERA	B5HS, B6ES, B6HS, B7ES, B8ES, B9EG, B9ES, BR9ES, CR9EB, D8EA, DP9EA-9



GIMSON	B5HS
HARLEY-DAVIDSON	B6L, B8ES, B9ES, BP5ES, BPR5ES-11, DCPR7E, XR5
HARLEY-DAVIDSON	DCPR7E
HERCULES	B5HS, B6HS, B7HS, B8HS, B9ES, BP7HS
HM RACING	B8ES, B8HS
HONDA	BKR6E-11, BPR5HS, BPR6HS, BPR6HSA, BR10EG, BR6ES, BR6HS, BR6HSA, BR7HS, BR8EG, BR8ES, BR8HS, BR9ECS, BR9EG, BR9ES, BR9HS, CR6HS, CR6HSA, CR7HS, CR7HSA, CR8EH-9, CR8HS, CR9EH-9, DCPR6E, DPR6EA-9, DPR7EA-9, DPR8EA-9, DPR8Z, DPR9EA-9, DPR9Z, DR7ES, DR8EA, DR8ES, DR8ESL
HRD	BR8ES, CR9EB
HUSABERG	C8E, DCPR8E
HUSQVARNA	B6HS, B8EG, B9EG, B9ES, BR8EG, BR9EG, BR9ES, C7E, CR7EB, CR8EB, R0045J-10
HYOSUNG	BP7HS, CR8E, CR8EH-9, DR8EA
INDIAN	BPR5ES-11
ISCH	BP6HS, BP7HS
JAWA	B6HS, B8HS
JCM	BP7ES
KAWASAKI	B6ES, B7ES, B7HS, B8ES, B8HS, B9EG, B9HS, BP7ES, BPR4HS, BPR5ES, BPR6ES, BPR8ES, BR10ES, BR6ES, BR7ES, BR8ES, BR9ES, C6HSA, CR7E, CR8E, CR8HSA, CR9E, CR9EK, D8EA, D9EA, DPR5EA-9, DPR6EA-9, DPR7EA-9, DPR8EA-9, DPR9EA-9, DR7ES, DR8EA, DR8ES, DR8ESL, DR9EA, R6252K-105



KTM	B10EG, B5HS, B6HS, B7HS, B8HS, B9EG, B9ES, B9HCS, B9HS, BP6ES, BP6HS, BR10EG, BR7ES, BR8ECM, BR8EG, BR8HS, CR8EK, D8EA, DCPR8E, DP9EA-9, DPR8EA-9, DR8EA, DR9EA, R6918B-8, R7234-10
KUANG YANG	BP6HSA
KYMCO	DPR7EA-9, DR8EA
LAMBRETTA	B6HS, B7ES
LAVERDA	B8ES, D9EA, DPR8EA-9, DPR9EA-9
LEM	B5HS, B6ES, B7HS, BP6ES
MAICO	B9ES
MALAGUTI	B6HS, B7ES, B8HS, B9ES
MARS	B5HS
MBK	B6HS, B7HS, B8ES, B8HS, BP6ES
MECATECNO	B6HS, BP5ES
MERLIN	BP5ES
MINARELLI	B6ES, B6HS, B7ES, B8ES
MINSK	BP7HS
MONDIAL	B7HS, B8HS
MONTESA	B6HS, B7ES, B7HS, B8ES, B8HS, B9ES, BP5ES, BPR7ES
MOTO GUZZI	B6HS, B7ES, B8ES, B9ES, BP6ES, BP7ES, BP8ES, BPR6ES, BR8ES, C8HSA, D8EA
MOTO MORINI	BP7ES, BP8ES
MOTOR HISPANIA	B6ES, B6HS, B7HS, BR9ES
MOTO-SPEZIAL	BP6ES
MOTOTECHNIKA	BP6HS
MÜNCH	BP8ES

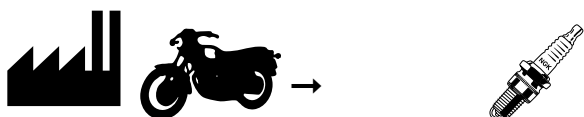

MV AGUSTA	B8ES, CR9EKB
MZ	B8HS, BP6HS, CR8E, D8EA, DPR9EA-9
MZ (TR)	B8HS
NORTON	C8E
OMER	B5HS, B6HS
OSSA	B8ES, B9ES, BP5ES
PANDA	CR6HSA
PEUGEOT	B5HS, B6HS, B7HS, B8ES, B8HS, BPR6HS
POLARIS	BKR5E, BKR7E, BR8ES
POLINI	B6HS
PUCH	B4H, B5HS, B6HS, B8ES, B8HS, B9ES, B9HS, DP9EA-9
REGENT	B7HS
REX	DR8EA
RIEJU	B5HS, B6ES, B6HS, BR8ES
RIXE	B4H, B6HS, B7HS, B8HS
RIZZATO	B5HS, B6HS, B8ES
S.I.S.	B6HS, B7HS, B8HS
SACHS	B5HS, B6HS, B7HS, B8HS, B9ES, BP7HS, BR5HS, BR8ES, BR9ES
SAN YANG	BR8HSA
SANGLAS	BP6ES
SCORPA	BP5ES
SHERCO	BP5ES
SHERCO- HRD	BR8ES
SIAMOTO	BPR6HS
SIMONINI IMEA	B10EGV, B8HS

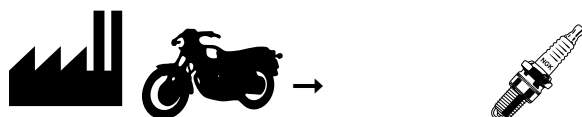

SIMSON	B8HS
SOLO	BR6HS, BR7HS
SPARTA	B6HS
STARFLITE	B6HS
SUZUKI	B7ES, B7HS, B8ES, B8HS, BP4H, BP6ES, BP6HS, BP7ES, BP8ES, BPR4HS, BPR6HS, BPR7HS, BR10ES, BR7HS, BR8ES, BR9ES, CR10EK, CR6E, CR7E, CR8E, CR8EK, CR9E, CR9EK, D7EA, D8EA, D9EA, DP7EA-9, DPR7EA-9, DPR8EA-9, DPR9EA-9, DR7ES, DR8EA, DR8ES, DR8ESL, JR9B, JR9C
SV	BPM6A
SWM	BP5ES
TESTI	B5HS, B6ES, B6HS, B8ES, B8HS
TGB	BPR7HS
TITAN	BPR5ES
TM	B9EG, BR8EG, CR8E
TOMOS	B7HS
TORROT	B5HS, B6HS, B7HS
TRAILSPORT	BR2LM
TRIUMPH	B8ES, CR9EK, DPR8EA-9
UNISOM	BR8HS
URAL	BP4HS
URAL AMERICA	BP7HS
VELOSOLEX	B4H, B6HS
VERTEMATI	CR9EK
VOR	CR8EK

**YAMAHA**

B10EG, B6HS, B7ES, B7HS, B8EG,
B8ES, B8HS, B9EG, B9ES, BP4HS,
BP6ES, BP6HS, BP6HS-10,
BP7ES, BP7HS, BP7HS-10,
BP8ES, BPR6ES, BPR6HS,
BPR7ES, BPR7HS, BPR8ES,
BR6ES, BR6HS, BR7HS, BR8ES,
BR8HS, BR9ECM, BR9EG, BR9ES,
BR9HS, C6HSA, C7HSA, CR10EK,
CR6HS, CR6HSA, CR7E, CR7HS,
CR8E, CR9E, CR9EK, D7EA, D8EA,
DP8EA-9, DPR7EA-9, DPR8EA-9,
DPR9EA-9, DR7EA, DR7ES,
DR8EA, DR8ESL, R6179A-105P,
R7376-10

ZID

BP7HS

ZÜNDAPP

B8ES, B8HS

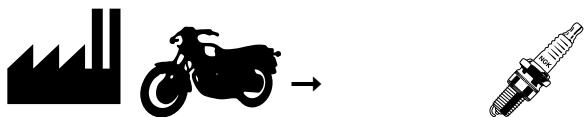

AEON	BPR7HS, CR7HS, CR8HSA
AJP	DR8ES
ALFER	B8ES, BR8ES, CR9E
APRILIA	B10EG, B9EG, B9ES, BP5ES, BR10EG, BR8ES, D8EA, DCPR9E, DR8EA
ARCTIC CAT	CR6E, CR7E, CR8E, DR7EA
ATK	B7HS, D8EA
B.S.A	B7ES, B8ES
BATAVUS	B6HS
BENELLI	B6HS, B7ES, B7HS, B8ES, D8EA
BETA	B10ES, B6ES, B7HS, B8ES, B9ES, BP7ES, BR7HS, CR9EK, DR8EA
BIMOTA	CR9E, CR9EK, DPR8EA-9, DR8EA, DR8ESL
BLATA	B9ES
BMW	B6HS, B8HS, BCP7ET, BKR7EKC, BP6ES, BP7ES, D7EA, D8EA, DCPR7E, DR7EA, DR8EB
BOMBARDIER	BPR7HS, BR9ECS, CR7HSA, CR8E, DCPR8E, DR8EA
BSM	BPR7HS
BUELL	DCPR7E, DCPR9E
BULTACO	B5ES, B5HS, B6HS, B7HS, B8ES, B9EG, B9ES, B9HS, BP5ES, BPR5ES
CAGIVA	B8ES, B9EG, B9ES, BP7HS, BR9EG, BR9ES, CR8E, CR8EK, DP8EA-9, DPR8EA-9, DPR9EA-9
CANNONDALE	CR9EK
CARABELA	B6ES, B6HS, B7ES, B8ES, BP5HS
CASAL	B7HS, B8HS

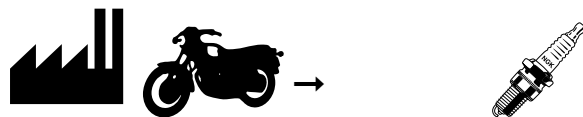

CCM	B9EG, BP5ES, DR8EA
COSSACK	BR6HS
CPI	BR7HS
CZ	B6HS
DAELIM	C8EH-9
DAREN	BPR7HS, DR8EA
DERBI	B7HS, B8ES, B8HS, B9ES, CR9E, DPR8EA-9
DKW	B7HS
DNEPR	BP4HS, BP6ES
DRR	BP7HS
DUCATI	---, B6HS, B7HS, BP7HS, BPR7HS, BR7HS, DCPR8E, DPR8EA-9, R2270-9
DUCSON	B6HS
ENFIELD	B6HS, B8ES, BR6ES, BR6HS
ERING	B6HS
E-TON	BPR7HS
FANTIC	B5HS, B6HS, B7HS, B8EG, B8ES, B9EG
FITE (LEM)	B8HS
FOX	BPR7HS
G.A.C. Mobyte.	B6HS, B7HS
G+G	BKR7EKC
GARELLI	B10ES, B6HS
GAS GAS	B10EGV, B8HS, BP5ES, BPR5ES, BPR6ES, BR8EG, CR8E
GILERA	B5HS, B6ES, B6HS, B7ES, B8ES, B9EG, B9ES, BR9ES, CR9EB, D8EA, DP9EA-9



GIMSON	B5HS
HARLEY-DAVIDSON	B6L, B8ES, B9ES, BP5ES, BPR5ES-11, DCPR7E, XR5
HARLEY-DAVIDSON	DCPR7E
HERCULES	B5HS, B6HS, B7HS, B8HS, B9ES, BP7HS
HM RACING	B8ES, B8HS
HONDA	BKR6E-11, BPR5HS, BPR6HS, BPR6HSA, BR10EG, BR6ES, BR6HS, BR6HSA, BR7HS, BR8EG, BR8ES, BR8HS, BR9ECS, BR9EG, BR9ES, BR9HS, CR6HS, CR6HSA, CR7HS, CR7HSA, CR8EH-9, CR8HS, CR9EH-9, DCPR6E, DPR6EA-9, DPR7EA-9, DPR8EA-9, DPR8Z, DPR9EA-9, DPR9Z, DR7ES, DR8EA, DR8ES, DR8ESL
HRD	BR8ES, CR9EB
HUSABERG	C8E, DCPR8E
HUSQVARNA	B6HS, B8EG, B9EG, B9ES, BR8EG, BR9EG, BR9ES, C7E, CR7EB, CR8EB, R0045J-10
HYOSUNG	BP7HS, CR8E, CR8EH-9, DR8EA
INDIAN	BPR5ES-11
ISCH	BP6HS, BP7HS
JAWA	B6HS, B8HS
JCM	BP7ES
KAWASAKI	B6ES, B7ES, B7HS, B8ES, B8HS, B9EG, B9HS, BP7ES, BPR4HS, BPR5ES, BPR6ES, BPR8ES, BR10ES, BR6ES, BR7ES, BR8ES, BR9ES, C6HSA, CR7E, CR8E, CR8HSA, CR9E, CR9EK, D8EA, D9EA, DPR5EA-9, DPR6EA-9, DPR7EA-9, DPR8EA-9, DPR9EA-9, DR7ES, DR8EA, DR8ES, DR8ESL, DR9EA, R6252K-105



KTM	B10EG, B5HS, B6HS, B7HS, B8HS, B9EG, B9ES, B9HCS, B9HS, BP6ES, BP6HS, BR10EG, BR7ES, BR8ECM, BR8EG, BR8HS, CR8EK, D8EA, DCPR8E, DP9EA-9, DPR8EA-9, DR8EA, DR9EA, R6918B-8, R7234-10
KUANG YANG	BP6HSA
KYMCO	DPR7EA-9, DR8EA
LAMBRETTA	B6HS, B7ES
LAVERDA	B8ES, D9EA, DPR8EA-9, DPR9EA-9
LEM	B5HS, B6ES, B7HS, BP6ES
MAICO	B9ES
MALAGUTI	B6HS, B7ES, B8HS, B9ES
MARS	B5HS
MBK	B6HS, B7HS, B8ES, B8HS, BP6ES
MECATECNO	B6HS, BP5ES
MERLIN	BP5ES
MINARELLI	B6ES, B6HS, B7ES, B8ES
MINSK	BP7HS
MONDIAL	B7HS, B8HS
MONTESA	B6HS, B7ES, B7HS, B8ES, B8HS, B9ES, BP5ES, BPR7ES
MOTO GUZZI	B6HS, B7ES, B8ES, B9ES, BP6ES, BP7ES, BP8ES, BPR6ES, BR8ES, C8HSA, D8EA
MOTO MORINI	BP7ES, BP8ES
MOTOR HISPANIA	B6ES, B6HS, B7HS, BR9ES
MOTO-SPEZIAL	BP6ES
MOTOTECHNIKA	BP6HS
MÜNCH	BP8ES

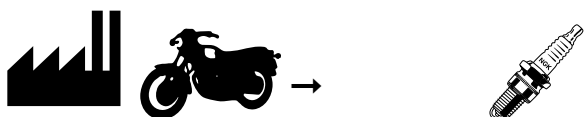

MV AGUSTA	B8ES, CR9EKB
MZ	B8HS, BP6HS, CR8E, D8EA, DPR9EA-9
MZ (TR)	B8HS
NORTON	C8E
OMER	B5HS, B6HS
OSSA	B8ES, B9ES, BP5ES
PANDA	CR6HSA
PEUGEOT	B5HS, B6HS, B7HS, B8ES, B8HS, BPR6HS
POLARIS	BKR5E, BKR7E, BR8ES
POLINI	B6HS
PUCH	B4H, B5HS, B6HS, B8ES, B8HS, B9ES, B9HS, DP9EA-9
REGENT	B7HS
REX	DR8EA
RIEJU	B5HS, B6ES, B6HS, BR8ES
RIXE	B4H, B6HS, B7HS, B8HS
RIZZATO	B5HS, B6HS, B8ES
S.I.S.	B6HS, B7HS, B8HS
SACHS	B5HS, B6HS, B7HS, B8HS, B9ES, BP7HS, BR5HS, BR8ES, BR9ES
SAN YANG	BR8HSA
SANGLAS	BP6ES
SCORPA	BP5ES
SHERCO	BP5ES
SHERCO- HRD	BR8ES
SIAMOTO	BPR6HS
SIMONINI IMEA	B10EGV, B8HS

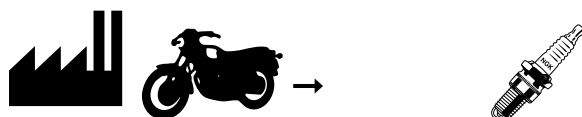

SIMSON	B8HS
SOLO	BR6HS, BR7HS
SPARTA	B6HS
STARFLITE	B6HS
SUZUKI	B7ES, B7HS, B8ES, B8HS, BP4H, BP6ES, BP6HS, BP7ES, BP8ES, BPR4HS, BPR6HS, BPR7HS, BR10ES, BR7HS, BR8ES, BR9ES, CR10EK, CR6E, CR7E, CR8E, CR8EK, CR9E, CR9EK, D7EA, D8EA, D9EA, DP7EA-9, DPR7EA-9, DPR8EA-9, DPR9EA-9, DR7ES, DR8EA, DR8ES, DR8ESL, JR9B, JR9C
SV	BPM6A
SWM	BP5ES
TESTI	B5HS, B6ES, B6HS, B8ES, B8HS
TGB	BPR7HS
TITAN	BPR5ES
TM	B9EG, BR8EG, CR8E
TOMOS	B7HS
TORROT	B5HS, B6HS, B7HS
TRAILSPORT	BR2LM
TRIUMPH	B8ES, CR9EK, DPR8EA-9
UNISOM	BR8HS
URAL	BP4HS
URAL AMERICA	BP7HS
VELOSOLEX	B4H, B6HS
VERTEMATI	CR9EK
VOR	CR8EK

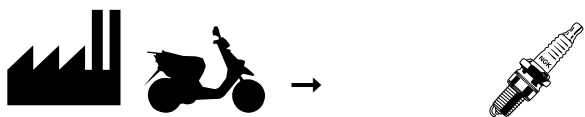

APRILIA	BPR8HS, BR7HS, BR8HS, BR9ES, CPR8E, CR7E, CR7EKB, CR8E, CR8EB, DR8EA
ATALA	B7HS, BPR6HS
BAJAJ	B6HS, BP5HS, BP6HS, BPR5HS
BENELLI	B6HS, BR7HS, BR8HS, CR8E, CR8EB
BETA	BR7HS, BR8HS, DR8EA
BMW	CR8EB
BS VILLA	BR8HSA
BUFFALO	BR7HS
CAGIVA	B7HS, B8HS, B9ES, BP6HS, BR8HSA, CR7E
CCF	BP7HS
CPI	BR7HS
DAELIM	BR8HSA, CR8EH-9
DERBI	B8HS, B9ES, BR10ES, BR8HS, BR9ES, CR9E
ERING	B6HS, CR7HSA
FANTIC	BP7HS
GARELLI	B10ES, BP7HS, BPR7HS, BR8HSA, BR9HS, CR7HSA
GILERA	B9ES, BR9ES, CR8EB
HONDA	BPR6HS, BPR6HSA, BR6HSA, BR8ES, CR8EH-9, DPR6EA-9, DPR7EA-9, ER8EH-N
HYOSUNG	BP6HS, BR8HSA, DR8EA
ITALJET	B7HS, BP6HS, BP7HS, BPR6HS, BPR8HS, BR7HS, BR8HS, BR9ES, CR7E, CR8E, DR8EA
KINETIC	BP7HS
KREIDLER	BPR7HS, CR7HSA

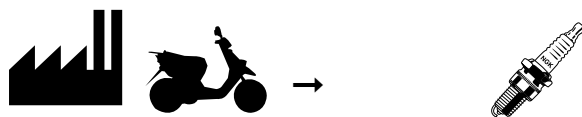

KTM	BR7HS
KYMCO	BR8HSA, C7HSA, DPR7EA-9, DR8EA
K-ZWO	BR7HS, C7HSA
LECSON	BP6HS
LEM	BR7HS
LML - VESPA	BP8ES
MACAL	BR7HS
MALAGUTI	BPR6HS, BR7HS, BR8HS, CR7HSA, CR8EB
MARS	BP7HS
MBK	BP7HS, BP7HS-10, BPR7HS, BR7HS, BR8HS, CR7E, CR8E
MOTRON	BR7HS
MZ	BR7HS
PEGASUS	BPR7HS, CR7HSA
PEUGEOT	B7HS, B8HS, BP6HS, BR7HS, BR8ES, BR8HS, CPR8E, CR7EB, CR8E
PGO	BP6HS, BP7HS, BPR7HS, C7HSA
PIAGGIO	---, B5HS, B6ES, B6HS, B7ES, B7HS, B8ES, B9ES, BP8ES, BPR8ES, BR6HS, BR7ES, BR7HS, BR8ES, BR9ES, CR7E, CR7EB, CR7EKB, CR8EB, CR9E, CR9EB
REX	BPR7HS, CR7HSA
RIEJU	BR8ES, BR9ES, CR7HSA
SACHS	B7HS, B8HS, BP6HS, BPR6HS, BR7HS, BR8HS
SAN YANG	BR8HSA, C7HSA
SASY	BPR6HS
SHE LUNG	BP7HS

Quick-No.

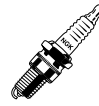

		Order-No.
201	B8ES	1015
202	B9ES	2108
203	B6HS	2417
204	B7HS	2792
205	B8HS	3014
206	BP7ES	3355
207	BR8ES	3639
208	BR9ES	3988
209	BR6HS	4200
210	BR6HSA	4461
211	BR7HS	4737
212	BR8HS	4915
213	BPR8ES	5170
214	BPR6HS	5343
215	BPR7HS	5541

		Order-No.
216	D8EA	1117
217	DR8ES	2204
218	DR8ESL	2556
219	DR9EA	2871
220	DPR7EA-9	3146
221	DPR8EA-9	3483
222	DPR9EA-9	3717
223	CR6HS	4042
224	JR9B	4297
225	CR7E	4509
226	CR8E	4854
227	CR9E	5006
228	CR8EH-9	5219
229	CR9EH-9	5454
230	CR9EK	5600

Quick-No.

Quick-No.	→  
201	ALFER, B.S.A, BENELLI, BETA, BULTACO, CAGIVA, CARABELA, DERBI, ENFIELD, FANTIC, GILERA, HARLEY-DAVIDSON, HM RACING, KAWASAKI, LAVERDA, MBK, MINARELLI, MONTESA, MOTO GUZZI, MV AGUSTA, OSSA, PEUGEOT, PUCH, RIZZATO, SUZUKI, TESTI, TRIUMPH, YAMAHA, ZÜNDAPP
202	APRILIA, BETA, BLATA, BULTACO, CAGIVA, DERBI, GILERA, HARLEY-DAVIDSON, HERCULES, HUSQVARNA, KTM, MAICO, MALAGUTI, MONTESA, MOTO GUZZI, OSSA, PUCH, SACHS, YAMAHA
203	BATAVUS, BENELLI, BMW, BULTACO, CARABELA, CZ, DUCATI, DUCSON, ENFIELD, ERING, FANTIC, G.A.C. Mobyte., GARELLI, GILERA, HERCULES, HUSQVARNA, JAWA, KTM, LAMBRETTA, MALAGUTI, MBK, MECATECNO, MINARELLI, MONTESA, MOTO GUZZI, MOTOR HISPANIA, OMER, PEUGEOT, POLINI, PUCH, RIEJU, RIXE, RIZZATO, S.I.S., SACHS, SPARTA, STARFLITE, TESTI, TORROT, VELOSOLEX, YAMAHA
204	ATK, BENELLI, BETA, BULTACO, CASAL, DERBI, DKW, DUCATI, FANTIC, G.A.C. Mobyte., HERCULES, KAWASAKI, KTM, LEM, MBK, MONDIAL, MONTESA, MOTOR HISPANIA, PEUGEOT, REGENT, RIXE, S.I.S., SACHS, SUZUKI, TOMOS, TORROT, YAMAHA

Quick-No.	→  
205	BMW, CASAL, DERBI, FITE (LEM), GAS GAS, HERCULES, HM RACING, JAWA, KAWASAKI, KTM, MALAGUTI, MBK, MONDIAL, MONTESA, MZ, MZ (TR), PEUGEOT, PUCH, RIXE, S.I.S., SACHS, SIMONINI IMEA, SIMSON, SUZUKI, TESTI, YAMAHA, ZÜNDAPP
206	BETA, BMW, JCM, KAWASAKI, MOTO GUZZI, MOTO MORINI, SUZUKI, YAMAHA
207	ALFER, APRILIA, HONDA, HRD, KAWASAKI, MOTO GUZZI, POLARIS, RIEJU, SACHS, SHERCO- HRD, SUZUKI, YAMAHA
208	CAGIVA, GILERA, HONDA, HUSQVARNA, KAWASAKI, MOTOR HISPANIA, SACHS, SUZUKI, YAMAHA
209	COSSACK, ENFIELD, HONDA, SOLO, YAMAHA
210	HONDA
211	BETA, CPI, DUCATI, HONDA, SOLO, SUZUKI, YAMAHA
212	HONDA, KTM, UNISOM, YAMAHA
213	KAWASAKI, YAMAHA
214	HONDA, PEUGEOT, SIAMOTO, SUZUKI, YAMAHA
215	AEON, BOMBARDIER, BSM, DAREN, DUCATI, E-TON, FOX, SUZUKI, TGB, YAMAHA
216	APRILIA, ATK, BENELLI, BMW, GILERA, KAWASAKI, KTM, MOTO GUZZI, MZ, SUZUKI, YAMAHA
217	AJP, HONDA, KAWASAKI, SUZUKI

Quick-No.



→ Quick-No.

AEON	215
AJP	217
ALFER	201, 207, 227
APRILIA	202, 207, 216
ARCTIC CAT	225, 226
ATK	204, 216
B.S.A	201
BATAVUS	203
BENELLI	201, 203, 204, 216
BETA	201, 202, 204, 206, 211, 230
BIMOTA	218, 221, 227, 230
BLATA	202
BMW	203, 205, 206, 216
BOMBARDIER	215, 226
BSM	215
BULTACO	201, 202, 203, 204
CAGIVA	201, 202, 208, 221, 222, 226
CANNONDALE	230
CARABELA	201, 203
CASAL	204, 205
COSSACK	209
CPI	211
CZ	203
DAREN	215
DERBI	201, 202, 204, 205, 221, 227
DKW	204



→ Quick-No.

DUCATI	203, 204, 211, 215, 221
DUCSON	203
ENFIELD	201, 203, 209
ERING	203
E-TON	215
FANTIC	201, 203, 204
FITE (LEM)	205
FOX	215
G.A.C. Mobyte.	203, 204
GARELLI	203
GAS GAS	205, 226
GILERA	201, 202, 203, 208, 216
HARLEY-DAVIDSON	201, 202
HERCULES	202, 203, 204, 205
HM RACING	201, 205
HONDA	207, 208, 209, 210, 211, 212, 214, 217, 218, 220, 221, 222, 223, 227, 228, 229
HRD	207
HUSQVARNA	202, 203, 208
HYOSUNG	226, 228
JAWA	203, 205
JCM	206
KAWASAKI	201, 204, 205, 206, 207, 208, 213, 216, 217, 218, 219, 220, 221, 222, 225, 226, 227, 230
KTM	202, 203, 204, 205, 212, 216, 219, 221

Quick-No.

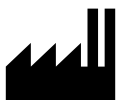

Quick-No.

KYMCO	220
LAMBRETTA	203
LAVERDA	201, 221, 222
LEM	204
MAICO	202
MALAGUTI	202, 203, 205
MBK	201, 203, 204, 205
MECATECNO	203
MINARELLI	201, 203
MONDIAL	204, 205
MONTESA	201, 202, 203, 204, 205
MOTO GUZZI	201, 202, 203, 206, 207, 216
MOTO MORINI	206
MOTOR HISPANIA	203, 204, 208
MV AGUSTA	201
MZ	205, 216, 222, 226
MZ (TR)	205
OMER	203
OSSA	201, 202
PEUGEOT	201, 203, 204, 205, 214
POLARIS	207
POLINI	203
PUCH	201, 202, 203, 205
REGENT	204
RIEJU	203, 207
RIXE	203, 204, 205
RIZZATO	201, 203



Quick-No.

S.I.S.	203, 204, 205
SACHS	202, 203, 204, 205, 207, 208
SHERCO- HRD	207
SIAMOTO	214
SIMONINI IMEA	205
SIMSON	205
SOLO	209, 211
SPARTA	203
STARFLITE	203
SUZUKI	201, 204, 205, 206, 207, 208, 211, 214, 215, 216, 217, 218, 220, 221, 222, 224, 225, 226, 227, 230
TESTI	201, 203, 205
TGB	215
TM	226
TOMOS	204
TORROT	203, 204
TRAILSPORT	310
TRIUMPH	201, 221, 230
UNISOM	212
VELOSOLEX	203
VERTEMATI	230
YAMAHA	201, 202, 203, 204, 205, 206, 207, 208, 209, 211, 212, 213, 214, 215, 216, 218, 220, 221, 222, 223, 225, 226, 227, 230
ZÜNDAPP	201, 205

Quick-No.



→ Quick-No.



→ Quick-No.

APRILIA	208, 211, 212, 225, 226
ATALA	204, 214
BAJAJ	203
BENELLI	203, 211, 212, 226
BETA	211, 212
BUFFALO	211
CAGIVA	202, 204, 205, 225
CPI	211
DAELIM	228
DERBI	202, 205, 208, 212, 227
ERING	203
GARELLI	215
GILERA	202, 208
HONDA	207, 210, 214, 220, 228
ITALJET	204, 208, 211, 212, 214, 225, 226
KREIDLER	215
KTM	211
KYMCO	220
K-ZWO	211
LEM	211
MACAL	211
MALAGUTI	211, 212, 214
MBK	211, 212, 215, 225, 226
MOTRON	211
MZ	211
PEGASUS	215

PEUGEOT	204, 205, 207, 211, 212, 226
PGO	215
PIAGGIO	201, 202, 203, 204, 207, 208, 209, 211, 225, 227
REX	215
RIEJU	207, 208
SACHS	204, 205, 211, 212, 214
SASY	214
SIAM	214
SIMSON	205
SUZUKI	214, 215, 225, 226
WINKING	203
YAMAHA	211, 212, 225, 226



BKR5EIX	POLARIS
BKR6EIX-11	HONDA
BKR7EIX	POLARIS
BPR5EIX	APRILIA, BULTACO, CCM, GAS GAS, HARLEY-DAVIDSON, KAWASAKI, MECATECNO, MERLIN, MONTESA, OSSA, SCORPA, SHERCO, SWM, TITAN
BPR5EIX-11	HARLEY-DAVIDSON, INDIAN
BPR6EIX	BMW, DNEPR, GAS GAS, KAWASAKI, KTM, LEM, MBK, MOTO GUZZI, MOTO-SPEZIAL, SANGLAS, SUZUKI, YAMAHA
BPR6HIX	HONDA, ISCH, KTM, KUANG YANG, MOTOTECHNIKA, MZ, PEUGEOT, SIAMOTO, SUZUKI, YAMAHA
BPR7EIX	BETA, BMW, JCM, KAWASAKI, MONTESA, MOTO GUZZI, MOTO MORINI, SUZUKI, YAMAHA
BPR7HIX	AEON, BOMBARDIER, BSM, CAGIVA, DAREN, DRR, DUCATI, E-TON, FOX, HERCULES, HYOSUNG, ISCH, MINSK, SACHS, SUZUKI, TGB, URAL AMERICA, YAMAHA, ZID
BPR8HIX	YAMAHA
BR10EIX	BETA, GARELLI, KAWASAKI, SUZUKI, YAMAHA
BR6HIX	BATAVUS, BENELLI, BMW, BULTACO, CARABELA, COSSACK, CZ, DUCATI, DUCSON, ENFIELD, ERING, FANTIC, G.A.C. MobyLe., GARELLI, GILERA, HERCULES, HONDA, HUSQVARNA, JAWA, KTM, LAMBRETTA, MALAGUTI, MBK, MECATECNO, MINARELLI, MONTESA, MOTO GUZZI, MOTOR HISPANIA, OMER, PEUGEOT, POLINI, PUCH, RIEJU, RIXE, RIZZATO, S.I.S., SACHS, SOLO, SPARTA, STARFLITE, TESTI, TORROT, VELOSOLEX, YAMAHA



BR7HIX	ATK, BENELLI, BETA, BULTACO, CASAL, CPI, DERBI, DKW, DUCATI, FANTIC, G.A.C. MobyLe., HERCULES, HONDA, KAWASAKI, KTM, LEM, MBK, MONDIAL, MONTESA, MOTOR HISPANIA, PEUGEOT, POLINI, REGENT, RIXE, S.I.S., SACHS, SOLO, SUZUKI, TOMOS, TORROT, YAMAHA
BR8EIX	ALFER, APRILIA, B.S.A, BENELLI, BETA, BULTACO, CAGIVA, CARABELA, CCM, DERBI, ENFIELD, FANTIC, GILERA, HARLEY-DAVIDSON, HM RACING, HONDA, HRD, KAWASAKI, KTM, LAVERDA, MBK, MINARELLI, MONTESA, MOTO GUZZI, MV AGUSTA, OSSA, PEUGEOT, POLARIS, PUCH, RIEJU, RIZZATO, SACHS, SHERCO- HRD, SUZUKI, TESTI, TRIUMPH, YAMAHA, ZÜNDAPP
BR8HIX	BMW, CASAL, DERBI, FITE (LEM), GAS GAS, HERCULES, HM RACING, HONDA, JAWA, KAWASAKI, KTM, MALAGUTI, MBK, MONDIAL, MONTESA, MZ, MZ (TR), PEUGEOT, PUCH, RIXE, S.I.S., SACHS, SAN YANG, SIMONINI IMEA, SIMSON, SUZUKI, TESTI, UNISOM, YAMAHA, ZÜNDAPP
BR9EIX	APRILIA, BETA, BLATA, BULTACO, CAGIVA, CCM, DERBI, FANTIC, GAS GAS, GILERA, HARLEY-DAVIDSON, HERCULES, HONDA, HUSQVARNA, KAWASAKI, KTM, MAICO, MALAGUTI, MONTESA, MOTO GUZZI, MOTOR HISPANIA, OSSA, PUCH, SACHS, SUZUKI, TM, YAMAHA
CR6HIX	HONDA, KAWASAKI, PANDA, SUZUKI, YAMAHA
CR7EIX	ARCTIC CAT, HUSQVARNA, KAWASAKI, SUZUKI, YAMAHA
CR7HIX	AEON, BOMBARDIER, HONDA, YAMAHA
CR8EHIX-9	DAELIM, HONDA, HYOSUNG



AEON	BPR7HIX, CR7HIX, CR8HIX
AJP	DR8EIX
ALFER	BR8EIX, CR9EIX
APRILIA	BPR5EIX, BR8EIX, BR9EIX, DR8EIX
ARCTIC CAT	CR7EIX, CR8EIX
ATK	BR7HIX, DR8EIX
B.S.A	BR8EIX
BATAVUS	BR6HIX
BENELLI	BR6HIX, BR7HIX, BR8EIX, DR8EIX
BETA	BPR7EIX, BR10EIX, BR7HIX, BR8EIX, BR9EIX, CR9EIX, DR8EIX
BIMOTA	CR9EIX, DPR8EIX-9, DR8EIX
BLATA	BR9EIX
BMW	BPR6EIX, BPR7EIX, BR6HIX, BR8HIX, DCPR7EIX, DR8EIX
BOMBARDIER	BPR7HIX, CR7HIX, CR8EIX, DR8EIX
BSM	BPR7HIX
BUELL	DCPR7EIX
BULTACO	BPR5EIX, BR6HIX, BR7HIX, BR8EIX, BR9EIX
CAGIVA	BPR7HIX, BR8EIX, BR9EIX, CR8EIX, DPR8EIX-9, DPR9EIX-9
CANNONDALE	CR9EIX
CARABELA	BR6HIX, BR8EIX
CASAL	BR7HIX, BR8HIX
CCM	BPR5EIX, BR8EIX, BR9EIX, DR8EIX
COSSACK	BR6HIX
CPI	BR7HIX



CZ	BR6HIX
DAELIM	CR8EHIX-9
DAREN	BPR7HIX, DR8EIX
DERBI	BR7HIX, BR8EIX, BR8HIX, BR9EIX, CR9EIX, DPR8EIX-9
DKW	BR7HIX
DNEPR	BPR6EIX
DRR	BPR7HIX
DUCATI	BPR7HIX, BR6HIX, BR7HIX, DPR8EIX-9, DR9EIX
DUCCSON	BR6HIX
ENFIELD	BR6HIX, BR8EIX
ERING	BR6HIX
E-TON	BPR7HIX
FANTIC	BR6HIX, BR7HIX, BR8EIX, BR9EIX
FITE (LEM)	BR8HIX
FOX	BPR7HIX
G.A.C. Mobyte.	BR6HIX, BR7HIX
GARELLI	BR10EIX, BR6HIX
GAS GAS	BPR5EIX, BPR6EIX, BR8HIX, BR9EIX, CR8EIX
GILERA	BR6HIX, BR8EIX, BR9EIX, CR9EIX, DPR9EIX-9, DR8EIX
HARLEY-DAVIDSON	BPR5EIX, BPR5EIX-11, BR8EIX, BR9EIX, DCPR7EIX, XR5IX
HARLEY-DAVIDSON	DCPR7EIX
HERCULES	BPR7HIX, BR6HIX, BR7HIX, BR8HIX, BR9EIX
HM RACING	BR8EIX, BR8HIX
HONDA	BKR6EIX-11, BPR6HIX, BR6HIX,



HONDA	BR7HIX, BR8EIX, BR8HIX, BR9EIX, CR6HIX, CR7HIX, CR8EHIX-9, CR8HIX, CR9EHIX-9, DPR7EIX-9, DPR8EIX-9, DPR9EIX-9, DR8EIX, IFR9H-11, IJR8B-9, IMR9C-9H
HRD	BR8EIX, CR9EIX
HUSABERG	CR8EIX
HUSQVARNA	BR6HIX, BR9EIX, CR7EIX, CR8EIX
HYOSUNG	BPR7HIX, CR8EHIX-9, CR8EIX, DR8EIX
INDIAN	BPR5EIX-11
ISCH	BPR6HIX, BPR7HIX
JAWA	BR6HIX, BR8HIX, DR8EIX
JCM	BPR7EIX
KAWASAKI	BPR5EIX, BPR6EIX, BPR7EIX, BR10EIX, BR7HIX, BR8EIX, BR8HIX, BR9EIX, CR6HIX, CR7EIX, CR8EIX, CR8HIX, CR9EIX, DPR7EIX-9, DPR8EIX-9, DPR9EIX-9, DR8EIX, DR9EIX
KTM	BPR6EIX, BPR6HIX, BR6HIX, BR7HIX, BR8EIX, BR8HIX, BR9EIX, DPR8EIX-9, DPR9EIX-9, DR8EIX, DR9EIX
KUANG YANG	BPR6HIX
KYMCO	DPR7EIX-9, DR8EIX
LAMBRETTA	BR6HIX
LAVERDA	BR8EIX, DPR8EIX-9, DPR9EIX-9, DR9EIX
LEM	BPR6EIX, BR7HIX
MAICO	BR9EIX
MALAGUTI	BR6HIX, BR8HIX, BR9EIX
MBK	BPR6EIX, BR6HIX, BR7HIX, BR8EIX, BR8HIX



MECATECNO	BPR5EIX, BR6HIX
MERLIN	BPR5EIX
MINARELLI	BR6HIX, BR8EIX
MINSK	BPR7HIX
MONDIAL	BR7HIX, BR8HIX
MONTESA	BPR5EIX, BPR7EIX, BR6HIX, BR7HIX, BR8EIX, BR8HIX, BR9EIX
MOTO GUZZI	BPR6EIX, BPR7EIX, BR6HIX, BR8EIX, BR9EIX, CR8HIX, DR8EIX, DR9EIX
MOTO MORINI	BPR7EIX
MOTOR HISPANIA	BR6HIX, BR7HIX, BR9EIX
MOTO-SPEZIAL	BPR6EIX
MOTOTECHNIKA	BPR6HIX
MV AGUSTA	BR8EIX
MZ	BPR6HIX, BR8HIX, CR8EIX, DPR9EIX-9, DR8EIX
MZ (TR)	BR8HIX
NORTON	CR8EIX
OMER	BR6HIX
OSSA	BPR5EIX, BR8EIX, BR9EIX
PANDA	CR6HIX
PEUGEOT	BPR6HIX, BR6HIX, BR7HIX, BR8EIX, BR8HIX
POLARIS	BKR5EIX, BKR7EIX, BR8EIX
POLINI	BR6HIX, BR7HIX
PUCH	BR6HIX, BR8EIX, BR8HIX, BR9EIX, DPR9EIX-9
REGENT	BR7HIX
REX	DR8EIX

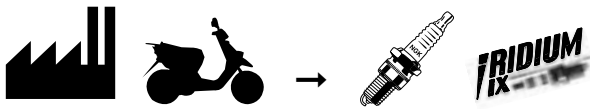

APRILIA	BPR8HIX, BR7HIX, BR8HIX, BR9EIX, CR7EIX, CR8EIX, DR8EIX
ATALA	BPR6HIX, BR7HIX
BAJAJ	BPR6HIX, BR6HIX
BENELLI	BR6HIX, BR7HIX, BR8HIX, CR8EIX
BETA	BR7HIX, BR8HIX, DR8EIX
BMW	CR8EIX
BS VILLA	BR8HIX
BUFFALO	BR7HIX
CAGIVA	BPR6HIX, BR7HIX, BR8HIX, BR9EIX, CR7EIX
CCF	BPR7HIX
CPI	BR7HIX
DAELIM	BR8HIX, CR8EHIX-9
DERBI	BR10EIX, BR8HIX, BR9EIX, CR9EIX
ERING	BR6HIX, CR7HIX
FANTIC	BPR7HIX
GARELLI	BPR7HIX, BR10EIX, BR8HIX, CR7HIX
GILERA	BR9EIX, CR8EIX
HONDA	BPR6HIX, BR6HIX, BR8EIX, CR8EHIX-9, DPR7EIX-9
HYOSUNG	BPR6HIX, BR8HIX, DR8EIX
ITALJET	BPR6HIX, BPR7HIX, BPR8HIX, BR7HIX, BR8HIX, BR9EIX, CR7EIX, CR8EIX, DR8EIX
KINETIC	BPR7HIX
KREIDLER	BPR7HIX, CR7HIX
KTM	BR7HIX

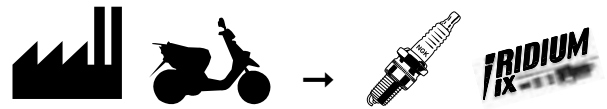

KYMCO	BR6HIX, BR8HIX, CR7HIX, DPR7EIX-9, DR8EIX
K-ZWO	BR7HIX, CR7HIX
LECSON	BPR6HIX
LEM	BR7HIX
MACAL	BR7HIX
MALAGUTI	BPR6HIX, BR6HIX, BR7HIX, BR8HIX, CR7HIX, CR8EIX
MARS	BPR7HIX
MBK	BPR7HIX, BR7HIX, BR8HIX, CR7EIX, CR8EIX
MOTRON	BR7HIX
MZ	BR7HIX
PEGASUS	BPR7HIX, CR7HIX
PEUGEOT	BPR6HIX, BR7HIX, BR8EIX, BR8HIX, CR8EIX
PGO	BPR6HIX, BPR7HIX, CR7HIX
PIAGGIO	BR6HIX, BR7HIX, BR8EIX, BR9EIX, CR7EIX, CR8EIX, CR9EIX
REX	BPR7HIX, CR7HIX
RIEJU	BR8EIX, BR9EIX, CR7HIX
SACHS	BPR6HIX, BR7HIX, BR8HIX, CR7HIX
SAN YANG	BR8HIX, CR7HIX
SASY	BPR6HIX
SHE LUNG	BPR7HIX
SIAM	BPR6HIX
SIAMOTO	CR7HIX
SIMSON	BR8HIX
STEFFEN	BPR6HIX



A6	AGRIA, B & S MOTORE, HAKO, IRUS, ONAN, WOLF
A7	FICHTEL& SACHS
B2LM	B & S MOTORE, DOLMAR, FLYMO, GUTBROD, HOMELITE, JOHN DEERE, LITTLE WONDER
B4	KAWASAKI, ZÜNDAPP
B4H	AGRIA, GUTBROD, HAKO, HERKULES, HOLDER, HONDA, KAWASAKI, SABO
B4L	ONAN
B4LM	AGRIA, ALKO, BRILL, CRESCENT, ERING, FLYMO, GOLF, GUTBROD, HAKO, HARRY, HERKULES, JOHN DEERE, LEOPARD, MONARK, NORLETT, WOLF
B5ES	YAMAHA
B5HS	FICHTEL& SACHS, HAKO, HOLDER, SABO, SOLO
B6HS	AGRIA, AS MOTOR, GUTBROD, HAKO, HARRY, ILO, KAWASAKI, MAKITA, McCULLOCH, ROBIN MOTOREN, SOLO, TECUMSEH, WOLF, ZENOAH
B6L	JOHN DEERE, KOHLER, ONAN, TORO
B6S	B & S MOTORE, HAKO, HOMELITE, JACOBSEN, JOHN DEERE, KAWASAKI, KOHLER, McCULLOCH, ONAN, PIONEER, STIHL-STIGA, ZENOAH
B7HS	FICHTEL& SACHS, LANDONI, YAMAHA
B7S	KAWASAKI, TECUMSEH
BCP5ES	B & S MOTORE
BCPR5ES	B & S MOTORE, BRILL, ECHO, GUTBROD, HERKULES, KOHLER, VIKING
BKR5E	MTD
BKR5E-11	MTD
BKR5ES	ERING
BM4A	HUSQVARNA, JOHN DEERE, KAWASAKI
BM6	ISEKI, KAWASAKI



BM6A	ALKO, DANARM, ECHO, EFCO, GUTBROD, HARRY, HERKULES, HOMELITE, HUSQVARNA, IDEAL, JOHN DEERE, JONSERED, KAAZ, KAWASAKI, PARTNER, PIONEER, SHINDAIWA, SKIL, SOLO, STIHL-STIGA, TANAKA, TONDU, TORO, WARRIOR, WESTMAC, WHIRLYBIRD, WOLF, WOODLORD, ZENOAH
BM6F	HOMELITE, HUSQVARNA, LANDONI, McCULLOCH, PARTNER, SKIL, SOLO
BM7	KAWASAKI
BM7A	ALLEN, ALPINA, DERBI, DOLMAR, HOMELITE, HUSQVARNA, KAWASAKI, MAKITA, McCULLOCH, PARTNER, PIONEER, SOLO, TANAKA, ZENOAH
BM7F	HOMELITE, McCULLOCH
BMR4A	HONDA, KAWASAKI
BMR6A	ALLEN, CLINTON, DERBI, DOLMAR, ECHO, FLYMO, HONDA, HUSQVARNA, JOHN DEERE, JONSERED, KAWASAKI, McCULLOCH, MITSUBISHI, MOUNTFIELD, PARTNER, PIONEER, SHINDAIWA, SOLO, STIHL, TANAKA, TORO, WOLF, ZENOAH
BMR6F	DOLMAR, HOMELITE, McCULLOCH
BMR7A	DOLMAR, HOMELITE, HUSQVARNA, PARTNER, PIONEER, SKIL
BP4	SABO, WOLF
BP4HS	KAWASAKI, MTD, YAMAHA
BP5ES	HONDA, JOHN DEERE, SOLO, YAMAHA
BP6ES	HERKULES, ROBIN MOTOREN
BP6HS	PARTNER, YAMAHA
BPM6A	ECHO, HUSQVARNA, JONSERED, LANDONI, LITTLE WONDER, SOLO, TANAKA, ZENOAH
BPM6F	HOMELITE, JONSERED, PARTNER, SABRE
BPM6Y	HUSQVARNA, MARUYAMA
BPM7A	ALPINA, BLITZ, DOLMAR, ECHO, EFCO, HOMELITE, HUSQVARNA, JONSERED, KAWASAKI, LITTLE WONDER, MAKITA, McCULLOCH, PARTNER, TONDU



BPM7Y	ECHO
BPMR4A	HONDA, SUZUKI, YANMAR
BPMR4A-10	HONDA
BPMR6A	ALLEN, FLYMO, HONDA, HUSQVARNA, JOHN DEERE, JONSERED, KAWASAKI, OLEO-MAC, PARTNER, SHINDAIWA, SOLO, STIHL, SUZUKI, TANAKA, YAMAHA
BPMR6A-10	HONDA
BPMR6F	ALKO, DOLMAR, HOMELITE, McCULLOCH
BPMR7A	ALKO, ALPINA, BLITZ, DOLMAR, ECHO, EFCO, FLYMO, HOMELITE, HONDA, HUSQVARNA, JONSERED, NAUTAC, OLEO - MAC, OLEO-MAC, PARTNER, PIONEER, SHINDAIWA, SOLO, STIHL
BPR2HS	HONDA
BPR4ES	HONDA, YAMAHA
BPR4FS	KOHLER
BPR4HS	HONDA, KAWASAKI, KUBOTA, MAKITA, YAMAHA, YANMAR
BPR4HS-10	HONDA, KUBOTA
BPR5ES	HERKULES, HONDA, HUSQVARNA, JOHN DEERE, KAWASAKI, MTD, SABO, SUZUKI, YAMAHA, YANMAR
BPR5ES-11	HONDA
BPR6ES	EFCO, GUTBROD, HERKULES, HONDA, HUSQVARNA, SUZUKI
BPR6HS	HONDA, MAKITA, SUZUKI, YAMAHA
BPR6HS-10	HONDA
BR2LM	AGRIA, B & S MOTORE, ECHO, EFCO, ERING, GUTBROD, HARRY, HERKULES, HUSQVARNA, MTD, PARTNER, PHÖNIX, SABO, TECNAMOTOR, TECUMSEH, VIKING
BR4ES	NISSAN, YAMAHA
BR4HS	HONDA, KAWASAKI, YANMAR



BR4LM	ASPERA-TECNA, GUTBROD, HERKULES, HUSQVARNA, PARTNER, SABO, TECNAMOTOR, TECUMSEH
BR6ES	MAKITA, ONAN, SABO
BR6HS	KAWASAKI, MAKITA
BR6S	B & S MOTORE, CLINTON, HOMELITE, JOHN DEERE, KAWASAKI, PARTNER, SABO, SKIL, SOLO, ZENOAH
BR7ES	MTD, TECNAMOTOR, TECUMSEH
BR7HS	YAMAHA
BRP6ES	HONDA
C6HSA	HONDA
CR5HSB	HONDA
TR5	JOHN DEERE
Y-103K	KUBOTA
Y-103V	KUBOTA, YANMAR
Y-106-1	KUBOTA
Y-106V	KUBOTA
Y-110	MITSUBISHI
Y-112T	FUJI
Y-114T	MITSUBISHI
Y-119V	KUBOTA
Y-203	KUBOTA
Y-203V	KUBOTA
Y-401-3	FUJI
Y-702R	JOHN DEERE
Y-703R	HONDA
YS-101	HONDA

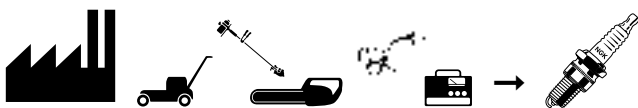

AGRIA	A6, B4H, B4LM, B6HS, BR2LM
ALKO	B4LM, BM6A, BPMR6F, BPMR7A
ALLEN	BM7A, BMR6A, BPMR6A
ALPINA	BM7A, BPM7A, BPMR7A
AS MOTOR	B6HS
ASPERA-TECNA	BR4LM
B & S MOTORE	A6, B2LM, B6S, BCP5ES, BCPR5ES, BR2LM, BR6S
BLITZ	BPM7A, BPMR7A
BRILL	B4LM, BCPR5ES
CLINTON	BMR6A, BR6S
CRESCENT	B4LM
DANARM	BM6A
DERBI	BM7A, BMR6A
DOLMAR	B2LM, BM7A, BMR6A, BMR6F, BMR7A, BPM7A, BPMR6F, BPMR7A
ECHO	BCPR5ES, BM6A, BMR6A, BPM6A, BPM7A, BPM7Y, BPMR7A, BR2LM
EFCO	BM6A, BPM7A, BPMR7A, BPR6ES, BR2LM
ERING	B4LM, BKR5ES, BR2LM
FICHTEL&SACHS	A7, B5HS, B7HS
FLYMO	B2LM, B4LM, BMR6A, BPMR6A, BPMR7A
FUJI	Y-112T, Y-401-3
GOLF	B4LM
GUTBROD	B2LM, B4H, B4LM, B6HS, BCPR5ES, BM6A, BPR6ES, BR2LM, BR4LM
HAKO	A6, B4H, B4LM, B5HS, B6HS, B6S
HARRY	B4LM, B6HS, BM6A, BR2LM

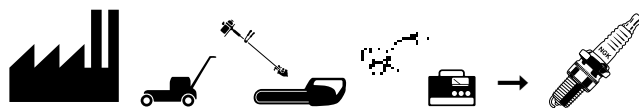

HERKULES	B4H, B4LM, BCPR5ES, BM6A, BP6ES, BPR5ES, BPR6ES, BR2LM, BR4LM
HOLDER	B4H, B5HS
HOMELITE	B2LM, B6S, BM6A, BM6F, BM7A, BM7F, BMR6F, BMR7A, BPM6F, BPM7A, BPMR6F, BPMR7A, BR6S
HONDA	B4H, BMR4A, BMR6A, BP5ES, BPMR4A, BPMR4A-10, BPMR6A, BPMR6A-10, BPMR7A, BPR2HS, BPR4ES, BPR4HS, BPR4HS-10, BPR5ES, BPR5ES-11, BPR6ES, BPR6HS, BPR6HS-10, BR4HS, BRP6ES, C6HSA, CR5HSB, Y-703R, YS-101
HUSQVARNA	BM4A, BM6A, BM6F, BM7A, BMR6A, BMR7A, BPM6A, BPM6Y, BPM7A, BPMR6A, BPMR7A, BPR5ES, BPR6ES, BR2LM, BR4LM
IDEAL	BM6A
ILO	B6HS
IRUS	A6
ISEKI	BM6
JACOBSEN	B6S
JOHN DEERE	B2LM, B4LM, B6L, B6S, BM4A, BM6A, BMR6A, BP5ES, BPMR6A, BPR5ES, BR6S, TR5, Y-702R
JONSERED	BM6A, BMR6A, BPM6A, BPM6F, BPM7A, BPMR6A, BPMR7A
KAAZ	BM6A
KAWASAKI	B4, B4H, B6HS, B6S, B7S, BM4A, BM6, BM6A, BM7, BM7A, BMR4A, BMR6A, BP4HS, BPM7A, BPMR6A, BPR4HS, BPR5ES, BR4HS, BR6HS, BR6S
KOHLER	B6L, B6S, BCPR5ES, BPR4FS
KUBOTA	BPR4HS, BPR4HS-10, Y-103K, Y-103V, Y-106-1, Y-106V, Y-119V, Y-203, Y-203V

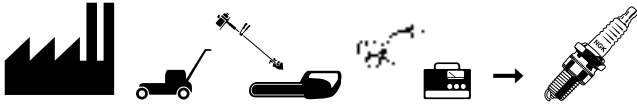

LANDONI	B7HS, BM6F, BPM6A
LEOPARD	B4LM
LITTLE WONDER	B2LM, BPM6A, BPM7A
MAKITA	B6HS, BM7A, BPM7A, BPR4HS, BPR6HS, BR6ES, BR6HS
MARUYAMA	BPM6Y
McCULLOCH	B6HS, B6S, BM6F, BM7A, BM7F, BMR6A, BMR6F, BPM7A, BPMR6F
MITSUBISHI	BMR6A, Y-110, Y-114T
MONARK	B4LM
MOUNTFIELD	BMR6A
MTD	BKR5E, BKR5E-11, BP4HS, BPR5ES, BR2LM, BR7ES
NAUTAC	BPMR7A
NISSAN	BR4ES
NORLETT	B4LM
OLEO - MAC	BPMR7A
OLEO-MAC	BPMR6A, BPMR7A
ONAN	A6, B4L, B6L, B6S, BR6ES
PARTNER	BM6A, BM6F, BM7A, BMR6A, BMR7A, BP6HS, BPM6F, BPM7A, BPMR6A, BPMR7A, BR2LM, BR4LM, BR6S
PHÖNIX	BR2LM
PIONEER	B6S, BM6A, BM7A, BMR6A, BMR7A, BPMR7A
ROBIN MOTOREN	B6HS, BP6ES
SABO	B4H, B5HS, BP4, BPR5ES, BR2LM, BR4LM, BR6ES, BR6S
SABRE	BPM6F
SHINDAIWA	BM6A, BMR6A, BPMR6A, BPMR7A

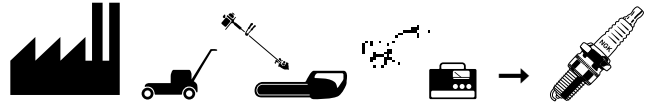

SKIL	BM6A, BM6F, BMR7A, BR6S
SOLO	B5HS, B6HS, BM6A, BM6F, BM7A, BMR6A, BP5ES, BPM6A, BPMR6A, BPMR7A, BR6S
STIHL	BMR6A, BPMR6A, BPMR7A
STIHL-STIGA	B6S, BM6A
SUZUKI	BPMR4A, BPMR6A, BPR5ES, BPR6ES, BPR6HS
TANAKA	BM6A, BM7A, BMR6A, BPM6A, BPMR6A
TECNAMOTOR	BR2LM, BR4LM, BR7ES
TECUMSEH	B6HS, B7S, BR2LM, BR4LM, BR7ES
TONDU	BM6A, BPM7A
TORO	B6L, BM6A, BMR6A
VIKING	BCPR5ES, BR2LM
WARRIOR	BM6A
WESTMAC	BM6A
WHIRLYBIRD	BM6A
WOLF	A6, B4LM, B6HS, BM6A, BMR6A, BP4
WOODLORD	BM6A
YAMAHA	B5ES, B7HS, BP4HS, BP5ES, BP6HS, BPMR6A, BPR4ES, BPR4HS, BPR5ES, BPR6HS, BR4ES, BR7HS
YANMAR	BPMR4A, BPR4HS, BPR5ES, BR4HS, Y-103V
ZENOAH	B6HS, B6S, BM6A, BM7A, BMR6A, BPM6A, BR6S
ZÜNDAPP	B4



A6	AILSA CRAIG, BRIT. SEAGULL, NEPTUNE, VOYAGER
B2	CLINTON, MIGHTY MITE
B4	NEPTUNE, SEARS
B5HS	YAMAHA
B6ES	NORDEC-BOND
B6HS	BRITISH ANZANI, CARNITI, DUCATI, FORCE, HONDA, J.L.O., MARINER, NAUTILO, SEA KING (Wards), SEA-BEE, SPIRIT, SUZUKI, TOMOS, VALMET, YAMAHA, ZÜNDAPP
B6HS-10	SUZUKI
B6L	SEA KING (Wards), SEARS, VIKING
B6S	AIRBOY, GALE, MARTIN, McCULLOCH, MONO, NEPTUNE, O.M.C., SEARS, SELVA GEMINI, VOYAGER
B7ES	BRIT. SEAGULL
B7HS	EVINRUDE, JOHNSON, O.M.C., SEA KING (Wards), SUZUKI, YAMAHA
B7HS-10	EVINRUDE, NISSAN, O.M.C., SELVA, SUZUKI, YAMAHA
B7S	O.M.C.
B8ES	EMERALD BAY
B8HS	CARNITI, SEA KING (Wards), SELVA, SPIRIT, SUZUKI, YAMAHA
B8HS-10	NISSAN, SUZUKI, YAMAHA
B8S	SEARS
BKR6E	SUZUKI
BKR6EKU	YAMAHA
BKR6ES-11	YAMAHA
BKR7EKU	YAMAHA



BKR7ES-11	YAMAHA
BM4A	ELGIN, EVINRUDE, JOHNSON
BM6A	AERO MARINE, CHIEF, CLINTON, SEARS, TANAKA
BMR4A	HONDA
BMR6A	TANAKA
BP5HA	MARINER, MERCURY
BP5HS	SUZUKI
BP5S	AERO MARINE, CHIEF, CLINTON, ESKA
BP6HS	FORCE, SELVA, SUZUKI
BP6HS-10	NISSAN
BP7HS	SELVA
BP7HS-10	MERCURY, NISSAN
BP8HN-10	MARINEPOWER
BP8HS-10	MERCURY
BP8HS-15	MARINEPOWER, MERCURY
BPR5ES	HONDA
BPR5HS	SUZUKI
BPR6ES	SUZUKI
BPR6HS	EVINRUDE, JOHNSON, MARINER, MERCURY, O.M.C., SELVA, SUZUKI, TOHATSU
BPR6HS-10	MARINEPOWER, NISSAN
BPR7HS	EVINRUDE, JOHNSON, MARINER, MERCURY, O.M.C., TOHATSU
BPR7HS-10	MARINEPOWER, MARINER, MERCURY, NISSAN, SUZUKI, TOHATSU, TOMOS, VOLVO PENTA
BPZ8HN-10	MARINEPOWER



BPZ8HS-10	MARINEPOWER
BR5HS	CHRYSLER, SUZUKI, YAMAHA
BR6ES	DYNAFOIL
BR6FS	YAMAHA
BR6HS	CHRYSLER, EVINRUDE, FIAT NAUTICA, FORCE, JOHNSON, O.M.C., PERKINS, SUZUKI, TOHATSU, YAMAHA
BR6HS-10	SUZUKI, TOHATSU, VOLVO PENTA, YAMAHA
BR6S	APACHE, CHRYSLER, COMMODORE, CRUISE N' CARRY, ELGIN, EVINRUDE, FLYING-O, GAMBLES, JOHNSON, PERKINS, SEARS, WEST BEND, WIZARD
BR7HS	MARINER, SUZUKI, TOHATSU, TOMOS, YAMAHA
BR7HS-10	NISSAN, SUZUKI, TOHATSU, VOLVO PENTA, YAMAHA
BR8HCS-10	SUZUKI
BR8HS	MARINEPOWER, MARINER, MERCURY, SUZUKI, YAMAHA
BR8HS-10	MARINER, NISSAN, SUZUKI, YAMAHA
BR9HS-10	O.M.C., YAMAHA
BU8H	MARINEPOWER, MARINER, MERCURY
BUHW	CHRYSLER, FORCE, O.M.C.
BUHX	CHRYSLER, FORCE
BUHXW-1	EVINRUDE, JOHNSON, O.M.C.
BUZ8H	MARINEPOWER
BUZHW	FORCE, MARINER, MERCURY, OUTBOARD MARINE
BUZHW-2	MARINEPOWER, MARINER,

BUZHW-2	MERCURY, O.M.C.
BUZW	ITALMARINE
BZ7HS-10	EVINRUDE, ITALMARINE, JOHNSON, MARINER, MERCURY, O.M.C., OUTBOARD MARINE
C7HSA	MARINER, MERCURY
CR5EH-9	HONDA
CR5HS	YAMAHA
CR5HSB	HONDA
CR6HS	YAMAHA
D6HA	EVINRUDE, JOHNSON, O.M.C.
DCPR6E	MARINEPOWER, MARINER, NISSAN, SUZUKI, TOHATSU
DCPR7E	EVINRUDE, JOHNSON, MARINEPOWER, MARINER, MERCURY, O.M.C.
DCPR8E	BOMBARDIER
DPR5EA-9	YAMAHA
DPR6EA-9	MARINEPOWER, MARINER, YAMAHA
DR4HS	HONDA
DR5HS	EVINRUDE, HONDA
DR7EA	HONDA
IZFR6K-11	HONDA
LFR5A-11	MARINEPOWER, MARINER, MERCURY, YAMAHA
LFR6A-11	YAMAHA
PZFR5F-11	MARINEPOWER, MARINER, MERCURY, O.M.C.
PZFR6H	EVINRUDE, MARINEPOWER



AERO MARINE	BM6A, BP5S
AILSACRAIG	A6
AIRBOY	B6S
APACHE	BR6S
BEAVER	XR4
BOMBARDIER	DCPR8E
BRIT. SEAGULL	A6, B7ES
BRITISH ANZANI	B6HS
CARNITI	B6HS, B8HS
CHIEF	BM6A, BP5S
CHRYSLER	BR5HS, BR6HS, BR6S, BUHW, BUHX
CLINTON	B2, BM6A, BP5S
COMMODORE	BR6S
CRUISE N`CARRY	BR6S
DUCATI	B6HS
DYNAFOIL	BR6ES
ELGIN	BM4A, BR6S
EMERALD BAY	B8ES
ESKA	BP5S, XR5
EVINRUDE	B7HS, B7HS-10, BM4A, BPR6HS, BPR7HS, BR6HS, BR6S, BUHXW-1, BZ7HS-10, D6HA, DCPR7E, DR5HS, PZFR6H
EXPLORER	XR4
FEDERAL	XR4
FIAT NAUTICA	BR6HS
FLYING-O	BR6S, XR4



FORCE	B6HS, BP6HS, BR6HS, BUHW, BUHX, BUZHW
GALE	B6S
GAMBLES	BR6S, XR4
HONDA	B6HS, BMR4A, BPR5ES, CR5EH-9, CR5HSB, DR4HS, DR5HS, DR7EA, IZFR6K-11, ZFR7F
ITALMARINE	BUZW, BZ7HS-10
J.C.PENNY	XR4
J.L.O.	B6HS
JOHNSON	B7HS, BM4A, BPR6HS, BPR7HS, BR6HS, BR6S, BUHXW-1, BZ7HS-10, D6HA, DCPR7E
MARINEPOWER	BP8HN-10, BP8HS-15, BPR6HS-10, BPR7HS-10, BPZ8HN-10, BPZ8HS-10, BR8HS, BU8H, BUZ8H, BUZHW-2, DCPR6E, DCPR7E, DPR6EA-9, LFR5A-11, PZFR5F-11, PZFR6H
MARINER	B6HS, BP5HA, BPR6HS, BPR7HS, BPR7HS-10, BR7HS, BR8HS, BR8HS-10, BU8H, BUZHW, BUZHW-2, BZ7HS-10, C7HSA, DCPR6E, DCPR7E, DPR6EA-9, LFR5A-11, PZFR5F-11, ZFR6F-11
MARTIN	B6S
McCULLOCH	B6S
MERCURY	BP5HA, BP7HS-10, BP8HS-10, BP8HS-15, BPR6HS, BPR7HS, BPR7HS-10, BR8HS, BU8H, BUZHW, BUZHW-2, BZ7HS-10, C7HSA, DCPR7E, LFR5A-11, PZFR5F-11, ZFR6F-11
MIGHTY MITE	B2
MONO	B6S
NAUTILO	B6HS
NEPTUNE	A6, B4, B6S

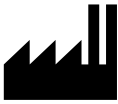

A6	ALBIN, BOG MARIN, BRIT. SEAGULL, GOTA, GRAYMARINE
A7	GRAYMARINE, VOLVO PENTA
A8	GRAYMARINE
AB6	GRAYMARINE
AR6FS	BERKELEY, CRUSADER, FORD, INTERCEPTOR, MERCUISER, PCM, PMC, WAUKESHA
B4	FLAGSHIP
B5HS	VOLVO PENTA
B6ES	B.L.M.C., BRIT. LEYLAND, CRUSADER, O.M.C., ROLLS ROYCE
B6HS	ALBIN, STUART TURNER, VALMET
B6L	CHRIS-CRAFT
B6S	B & W, BOG MARIN, CRUSADER, EVINRUDE, FAGEOL, KOHLER, O.M.C., PALMER-GREENW., UNIVERSAL
B7ES	DAYTONA, PIAGGIO
B7HS	CHRYSLER
B7S	MERCUISER
B8S	CRUSADER, O.M.C.
BP4	BARR (Conversions)
BP5ES	BMW
BP6ES	BMW, CHRYSLER
BP6HS	DIESEL-TECHNIEK
BP7ES	BPM
BP7HS	MARINE DRIVE SYSTEMS

BPR5ES	BARR (Conversions), CHEVROLET (Marine Conversions), MARINE POWER, MARINE REPOWER, MARINETEK, PANTER, PMC, WORTHAM BLAKE
BPR5FS	BARR (Conversions), CHEVROLET (Marine Conversions)
BPR6EFS	CHRIS-CRAFT, INDMAR, VOLVO PENTA
BPR6ES	AERO MARINE, CHRYSLER, VOLVO PENTA
BPR6FS	CRUSADER, REDLINE
BPR6HS	O.M.C., VOLVO PENTA
BPR7HS	INTERCEPTOR, VOLVO PENTA
BR6ES	AERO MARINE, AUSTIN, CHRIS-CRAFT, CHRYSLER, FLAGSHIP, FORD, MARINE POWER, MERCUISER
BR6FS	CRUSADER, INDMAR, KODIAK, MERCUISER, O.M.C., US MARINE, YAMAHA
BR6HS	VOLVO PENTA
BR6S	CHRIS-CRAFT, CHRYSLER, FLAGSHIP, GRAYMARINE, VOLVO PENTA
BR7HS	ALBIN, CHRYSLER-VOLVO, VOLVO PENTA
BR8ES	BOMBARDIER (Sea-Doo), PERFORMANCE JET SYSTEM
BR8HS	YAMAHA
BR9ES	IMC
BU8H	MERCUISER
BZ7HS-10	MERCUISER, MERCURY, O.M.C.
GR4	GRAYMARINE

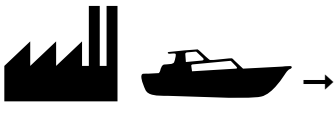

AERO MARINE	BPR6ES, BR6ES, UR4, XR5
ALBIN	A6, B6HS, BR7HS
AMECO	WR5
AMERICAN CHALLENGER	UR5
AUSTIN	BR6ES
B & W	B6S
B.L.M.C.	B6ES
BARR (Conversions)	BP4, BPR5ES, BPR5FS, UR4, XR4
BERKELEY	AR6FS, UR5, YR5
BMW	BP5ES, BP6ES
BOG MARIN	A6, B6S
BOMBARDIER (Sea-Doo)	BR8ES
BPM	BP7ES
BRIT. LEYLAND	B6ES
BRIT. SEAGULL	A6
CHEVROLET (Marine Conversions)	BPR5ES, BPR5FS, UR4, XR4
CHRIS-CRAFT	B6L, BPR6EFS, BR6ES, BR6S, UR4, UR6, WR5, XR5
CHRYSLER	B7HS, BP6ES, BPR6ES, BR6ES, BR6S, XR5
CHRYSLER-VOLVO	BR7HS
CRUSADER	AR6FS, B6ES, B6S, B8S, BPR6FS, BR6FS, R5674-7, UR5, UR6, XR5
DAYTONA	B7ES
DIESEL-TECHNIEK	BP6HS
EVINRUDE	B6S, XR4
FAGEOL	B6S

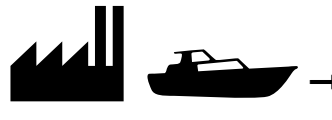

FLAGSHIP	B4, BR6ES, BR6S, R5673-10, R5673-7, R5673-8, R5674-7, UR5, UR6
FORD	AR6FS, BR6ES, GR5, UR5
GOFF	XR4
GOTA	A6
GRAYMARINE	A6, A7, A8, AB6, BR6S, GR4, XR5
GUARDIAN MARINE	UR5
HARDIN	UR5, XR5, YR5
HARMAN HOUSE	UR5
HUSTLER	UR6
IMC	BR9ES
INDMAR	BPR6EFS, BR6FS, UR5, XR4
INTERCEPTOR	AR6FS, BPR7HS, WR5
JOHNSON	XR4
KING	XR4
KODIAK	BR6FS
KOHLER	B6S
MARINE DRIVE SYSTEMS	BP7HS
MARINE POWER	BPR5ES, BR6ES, TR4, UR4, UR5
MARINE REPOWER	BPR5ES, UR4, UR5
MARINETEK	BPR5ES, UR4, UR5, WR5, XR4
MERCUISER	AR6FS, B7S, BR6ES, BR6FS, BU8H, BZ7HS-10, GR5, R5673-7, TR4, UR4, UR5, XR5
MERCURY	BZ7HS-10, R5673-7
O.M.C.	B6ES, B6S, B8S, BPR6HS, BR6FS, BZ7HS-10, TR5, UR4, UR5, XR5
PALMER-GREENW.	B6S

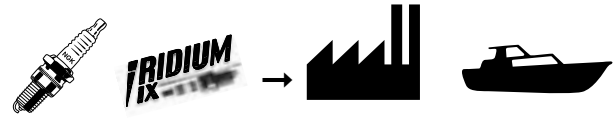
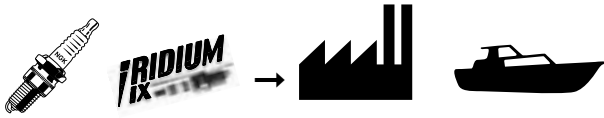

BPR5EIX	BARR (Conversions), BMW, CHEVROLET (Marine Conversions), MARINE POWER, MARINE REPOWER, MARINETEK, PANTER, PMC, WORTHAM BLAKE
BPR6EIX	AERO MARINE, BMW, CHRYSLER, VOLVO PENTA
BPR6HIX	DIESEL-TECHNIEK, O.M.C., VOLVO PENTA
BPR7EIX	BPM
BPR7HIX	INTERCEPTOR, VOLVO PENTA
BR6HIX	ALBIN, STUART TURNER, VALMET
BR7HIX	ALBIN, CHRYSLER-VOLVO, VOLVO PENTA
BR8EIX	BOMBARDIER (Sea-Doo), PERFORMANCE JET SYSTEM
BR8HIX	YAMAHA
BR9EIX	IMC
GR4IX	GRAYMARINE
GR5IX	FORD, MERCUISER, VOLVO PENTA, WORTHAM BLAKE
IFR6T-11	TOYOTA
TR4IX	MARINE POWER, MERCUISER, PCM, VOLVO PENTA
TR5IX	CRUSADER, O.M.C.
UR4IX	AERO MARINE, BARR (Conversions), CHEVROLET (Marine Conversions), CHRIS-CRAFT, MARINE POWER, MARINE REPOWER, MARINETEK, MERCUISER, O.M.C., PANTER, PCM, PMC, US MARINE, VOLVO PENTA

UR5IX	AMERICAN CHALLENGER, BERKELEY, CRUSADER, FLAGSHIP, FORD, GUARDIAN MARINE, HARDIN, HARMAN HOUSE, INDMAR, MARINE POWER, MARINE REPOWER, MARINETEK, MERCUISER, O.M.C., PANTER, US MARINE, WAUKESHA
UR6IX	CHRIS-CRAFT, CRUSADER, FLAGSHIP, HUSTLER, VOLVO PENTA
WR5IX	AMECO, CHRIS-CRAFT, INTERCEPTOR, MARINETEK, UNIVERSAL
XR4IX	BARR (Conversions), CHEVROLET (Marine Conversions), EVINRUDE, GOFF, INDMAR, JOHNSON, KING, MARINETEK, PMC
XR5IX	AERO MARINE, CHRIS-CRAFT, CHRYSLER, CRUSADER, GRAYMARINE, HARDIN, MERCUISER, O.M.C., UNIVERSAL, VOLVO PENTA
YR5IX	BERKELEY, HARDIN

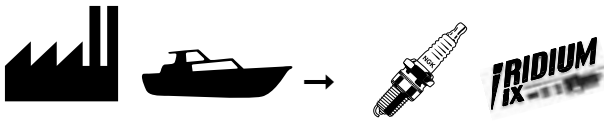

AERO MARINE	BPR6EIX, UR4IX, XR5IX
ALBIN	BR6HIX, BR7HIX
AMECO	WR5IX
AMERICAN CHALLENGER	UR5IX
BARR (Conversions)	BPR5EIX, UR4IX, XR4IX
BERKELEY	UR5IX, YR5IX
BMW	BPR5EIX, BPR6EIX
BOMBARDIER (Sea-Doo)	BR8EIX
BPM	BPR7EIX
CHEVROLET (Marine Conversions)	BPR5EIX, UR4IX, XR4IX
CHRIS-CRAFT	UR4IX, UR6IX, WR5IX, XR5IX
CHRYSLER	BPR6EIX, XR5IX
CHRYSLER-VOLVO	BR7HIX
CRUSADER	TR5IX, UR5IX, UR6IX, XR5IX
DIESEL-TECHNIEK	BPR6HIX
EVINRUDE	XR4IX
FLAGSHIP	UR5IX, UR6IX
FORD	GR5IX, UR5IX
GOFF	XR4IX
GRAYMARINE	GR4IX, XR5IX
GUARDIAN MARINE	UR5IX
HARDIN	UR5IX, XR5IX, YR5IX
HARMAN HOUSE	UR5IX
HUSTLER	UR6IX
IMC	BR9EIX
INDMAR	UR5IX, XR4IX

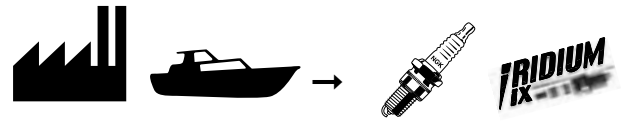

INTERCEPTOR	BPR7HIX, WR5IX
JOHNSON	XR4IX
KING	XR4IX
MARINE POWER	BPR5EIX, TR4IX, UR4IX, UR5IX
MARINE REPOWER	BPR5EIX, UR4IX, UR5IX
MARINETEK	BPR5EIX, UR4IX, UR5IX, WR5IX, XR4IX
MERCUISER	GR5IX, TR4IX, UR4IX, UR5IX, XR5IX
O.M.C.	BPR6HIX, TR5IX, UR4IX, UR5IX, XR5IX
PANTER	BPR5EIX, UR4IX, UR5IX
PCM	TR4IX, UR4IX
PERFORMANCE JET SYSTEM	BR8EIX
PMC	BPR5EIX, UR4IX, XR4IX
STUART TURNER	BR6HIX
TOYOTA	IFR6T-11
UNIVERSAL	WR5IX, XR5IX
US MARINE	UR4IX, UR5IX
VALMET	BR6HIX
VOLVO PENTA	BPR6EIX, BPR6HIX, BPR7HIX, BR7HIX, GR5IX, TR4IX, UR4IX, UR6IX, XR5IX
WAUKESHA	UR5IX
WORTHAM BLAKE	BPR5EIX, GR5IX
YAMAHA	BR8HIX

Conversion Chart

Vergleichsliste

Tableau de comparaison thermique

Tabla de conversión equivalencias

Jämförelsetabell

Převodní tabulky

Note: This chart is furnished as a guide. Due to differences in design, materials, etc., plugs produced by various manufacturers do not have exactly the same heat range. See recommendations sections for specific engine application.

Anmerkung: Diese Liste dient nur zur Information. Wegen der Unterschiede von Konstruktion, Werkstoffen usw. haben die Zündkerzen von verschiedenen Herstellern keinen miteinander übereinstimmenden Wärmebereich. Siehe unsere Empfehlungen für die richtige Anwendung der Zündkerzen.

Notes: Cette liste est donnée comme guide. A cause de la différence en dessin, matériels etc., les bougies d'allumage produites par divers fabricans n'ont pas exactement la même gamme thermique. Voir section d'affectations pour utilisation exacte.

Notas: Este cuadro se sirve de quia. Bujías que se producen por varios fabricantes no poseen exactamente el mismo alcance térmico debido a las diferencias en diseño, materiales etc. Véase sección de aplicaciones para el uso correcto.

Observera: Denna tabell är endast avsedd som vägledning. På grund av avvikelser i utförande, material m.m. kan tändstift av olika fabrikat ej ha exakt samma värmetal. Se rekommendations-tabellen för respektive motor.

Upozornění: Převodní tabulky slouží pouze pro srovnávací účely. Zapalovací svíčky od různých výrobců nemají kvůli rozdílné konstrukci, použitému materiálu apod. srovnatelný rozsah tepelných hodnot. Pro správný výběr zapalovací svíčky je třeba se řídit doporučeními firmy NGK v aplikačních tabulkách tohoto katalogu.



AC	→ NGK	V-Line
40TS	BP7FS	
41-2XLS	BP7ES	
41-4XLS	BP6ES	4
41-600	TR55	
41-601	TR55	
41-602	FR5	
41-603	FR4	
41-606	TR55	
41-608	FR45	
41-610	FR4	
41-611	FR45	
41-628	FR4	
41-900	TR5	
41-902	TR55	
41-904	TR5	
41-905	UR4	
41-906	TR5	
41-907	TR5	
41-910	TR5	
41-913	TR55	
41-919	TR55	
41-921	TR55	
41-928	TR55-1	
41-929	TR55	
41-932	TR55	
41-936	TR55	
41-940	TR55	
41-942	TR55	
41-943	TR55	
41-947	TR55	
41TS	BP6FS	
41XL	B9ES	
41XLS	BP7ES	
420Z	B-4H	
422Z	B5HS	
425Z	B6HS	
42-6FS	BP6HS	18
42F	B6HS	
42FS	BP6HS	18
42S	BP6S	
42TS	BP6FS	
42XL	B8ES	
42XLS	BP6ES	4
430Z	B7HS	
436XLS	BP9ES	
438XLS	BP8ES	
43FS	BP6HS	18
43N	B7ES	
43S	BP6S	
43TS	BP6FS	
43XL	B7ES	
43XLS	BP6ES	4

AC	→ NGK	V-Line
44	B6S	
440T	B7FS	
440XLS	BP8ES	
445Z	B8HS	
44F	B5HS	
44FFS	BP5HS	
44N	B6ES	
44NS	BP5ES	8
44S	BP5S	
44TS	BP5FS	
44XL	B6ES	
44XLO	BP5ES	8
44XLS	BP5ES	8
45	B4	
45F	B5HS	
45FFS	BP5HS	
45L	B4L	
45NS	BP5ES	8
45S	BP5S	
45TS	BP4FS	
45XL	B6ES	
45XLS	BP5ES	8
46	B4	
46F	B5HS	
46FFS	BP5HS	
46N	B5ES	
46S	BP5S	
46TS	BP4FS	
46XL	B5ES	
46XLS	BP4ES	
47XL	B4ES	
83CTS	AP6FS	
83TS	AP6FS	
84T	A6FS	
84TS	AP5FS	
85T	A5FS	
85TS	AP5FS	
86TS	AP5FS	
B4031	B4	
B43	B6S	
B44S	BP5S	
B45	B4	
C42-1	B6S	
C42CFS	BP6HS	18
C42CLTS	BP6EFS	5
C42CXLS	BP6ES	4
C42LTS	BP6EFS	5
C42N	B7ES	
C42XLS	BP5ES	8
C43	B6S	
C43CXLS	BP6ES	4
C43L	B6L	



AC	→ NGK	V-Line
C43N	B6ES	
C44	B6S	
C44N	B6ES	
C44NS	BP5ES	8
C44S	BP5S	
C44XL	B6ES	
C45	B4	
C45L	B4L	
C49	B-2	
C73	G2Z	
C75	G2Z	
C81	A8	
C82	A7	
C83	A7	
C83T	A6FS	
C84T	A6FS	
C85TS	AP5FS	
C86	A6	
C87	A6	
C88	AB2	
C88L	AB2	
CFR1CLS	BCPR7ES	
CFR2CLS	BKR6E	28
CR42CFS	BPR6FS	
CR42CXLS	BPR6ES	2
CR42N	BR7ES	
CR43	BR6S	
CR43CXLS	BPR6ES	2
CR43K	BR6S	
CR43N	BR6ES	
CR43S	BP6S	
CR43TS	BPR5FS-11	
CR43TSM	BPR5FS-11	
CR44N	BR6ES	
CR44NS	BPR5ES	6
CR44TS	BPR5FS-11	
CR83T	AR6FS	
CS40	BM7A	
CS41	BM7A	
CS41T	BM7F	
CS42	BM7A	
CS42S	BM7A	
CS42T	BM6F	
CS45	BM6A	
CS45T	BM6F	
CS49	BM4A	
CSR45	BMR6A	
FR2LS	BKR6E	28
FR2LSK	BKR6E	28
FR3CLS	BKR5ES	
FR3CLS6	BKR5ES-11	
FR3LM	ZFR5A-11	

AC	→ NGK	V-Line
FR3LS	BKR5ES	
FR3LS6	BKR5ES-11	
FR3LSJ	BKR4E-11	
FR3LSK	BKR5ES	
FR4LE	ZFR4F-11	
FR4LSJ	BKR4E-11	
FR5LS	BCPR5ES	
LM46	B4LM	
LM49	B4LM	
M40FFX	B9HS-10	
M41FF	B8HS	
M41K	B8S	
M42FF	B7HS	
M42K	B7S	
M43FF	B6HS	
M43S	BP6S	
M44C	B6S	
M44L	B6L	
M45	B4	
M45FF	B5HS	
M47	B4	
MB42K	B6S	
MR42K	BR6S	
MR43LTS	BPR6EFS	7
MR43T	BR6FS	
MR44C	BR6S	
MR44T	BR5FS	
R41-5TS	BPR6FS	
R41CF	BR7HS	
R41CXL	BR9ES	
R41CXLS	BPR7ES	19
R41TS	BPR6FS	
R42-5LTS	BPR6EFS	7
R42-5TS	BPR6FS	
R42-6FS	BPR6HS	3
R42CF	BR6HS	
R42CFS	BPR6HS	3
R42CLTS	BPR6EFS	7
R42CT	BR6FS	
R42CTS	BPR6FS	
R42CXL	BR8ES	
R42CXLS	BPR6ES	2
R42FS	BPR6HS	3
R42LTS	BPR6EFS	7
R42LTSM	BPR5EFS-13	
R42S	BP6S	
R42T	BR6FS	
R42TS	BPR6FS	
R42TSM	BPR6FS	
R42TX	BR6FS-15	
R42XL	BR8ES	
R42XLS	BPR6ES	2



AC	→ NGK	V-Line
R42XLSM	ZGR5C	
R43	BR6S	
R43C	BR6S	
R43CFS	BPR6HS	3
R43CNTSE	TR5-1/SR5	
R43CS	BP6S	
R43CT	BR6FS	
R43CTS	BPR6FS	
R43CTS6	BPR6FS	
R43CXL	BR7ES	
R43CXLS	BPR6ES	2
R43FS	BPR6HS	3
R43LTS	BPR6EFS	7
R43LTSE	TR4-2	
R43LTSX	BPR6EFS-13	
R43N	BR7ES	
R43NTSE	TR5-1/SR5	
R43S	BP6S	
R43T	BR6FS	
R43TS	BPR6FS	
R43TSK	BPR6FS	
R43TSX	BPR6FS	
R43TX	BR6FS-15	
R43XL	BR7ES	
R43XLS	BPR6ES	2
R44	BR6S	
R44CF	BR5HS	
R44CNTSE	TR5-1/SR5	
R44CXL	BR6ES	
R44CXLS	BPR5ES	6
R44F	BR5HS	
R44LTS	BPR5EFS	
R44LTS6	BPR5EFS-13	
R44LTS6K	BPR5EFS-13	
R44LTSM	TR4-2	
R44LTSM6	TR4-2	
R44N	BR6ES	
R44NS	BPR5ES	6
R44NTSE	TR5-1/SR5	
R44S	BP5S	
R44T	BR5FS	
R44TS	BPR5FS	
R44TSX	BPR5FS-15	
R44TX	BR5FS-15	
R44XL	BR6ES	
R44XLS	BPR5ES	6
R44XLS6	BPR4ES-13	
R44XLSE	ZGR5C	
R44XLSM	ZGR5C	
R45LTS6	BPR5EFS-13	
R45LTS6K	BPR5EFS-13	
R45NS	BPR5ES	6

AC	→ NGK	V-Line
R45NSX	BPR5ES-13	
R45NTSE	TR5-1/SR5	
R45S	BP5S	
R45T	BR5FS	
R45TS	BPR4FS	
R45TSX	BPR4FS-15	
R45XL	BR6ES	
R45XLS	BPR5ES	6
R46	BR6S	
R46LTS	BPR5EFS	
R46N	BR5ES	
R46S	BP4	
R46T	BR5FS	
R46TS	BPR4FS	
R46TSX	BPR4FS-15	
R46TX	BR5FS-15	
R46XL	BR5ES	
R46XLS	BPR4ES	
R47S	BP4	
R83CT	AR6FS	
R83CTS	APR6FS	
R83TS	APR6FS	
R84TS	APR5FS	
R85TS	APR5FS	
S102F	C7HSA	
S104F	C6HSA	
S121F	D8HA	
S121XL	D8EA	
S122F	D8HA	
S123XL	D7EA	
S124FS	D6HA	
S404XLG	B10EG	
S408XLG	B9EG	
S40F	B9HS	
S40FR	BR9HS	
S40XL	B10ES	
S40XLG	B9ECS	
S40XLR	BR8ES	
S41F	B8HS	
S41FG	B7HCS	
S41FR	BR8HS	
S41XL	B9ES	
S41XLG	B8ECS	
S41XLR	BR9ES	
S42	B7S	
S42F	B7HS	
S42FR	BR7HS	
S42XL	B8ES	
S42XLR	BR8ES	
S43XL	B7ES	
S43XLR	BR7ES	
S44	B6S	



AC	→ NGK	V-Line
S44F	B5HS	
S44XL	B6ES	
S45F	B5HS	
S46	B4	
S81F	A8	
S82F	A8	
S83F	A7	
S85F	A6	
SB41	B7S	
SV41XL	BUE	
V40FFK	BUHW-2	
V40FFM	BUHW	
V40FFS	BUH	
VB40FFM	BUHW-1	
VR40FFK	BUZHW-2	
VR40FFM	BUZHW	
ALFA ROMEO	→ NGK	V-Line
4644 9690	BKR6EKPA	
6056 9086	PGR6A	
6056 9957	PFR6B	
6057 9903	PFR6B	
6059 9495	PMR7A	
APRILIA	→ NGK	V-Line
0297542	DR8EA	
0297830	BR10EG	
0297921	CR8E	
0297942	DCPR9E	
0297945	R0045J-10	
0897055	BR8ES	
2BEN000088	BPR8HS	
2BEN000181	CPR8E	
8122586	DR7EA	
8206870	BR7HS	
8206871	BR8HS	
8550352	CR7E	
8600008	BR9ECM	
APS	→ NGK	V-Line
A11	B5HS	
A11P	BR5HS	
A14B	BP5HS	
A14B-2	BP5HS	
A14BM	BP5HS	
A14BP	BPR5HS	
A14DB	BP5ES	
A14DBP	BPR5ES	
A14DBPM	BPR5ES	
A17B	BP6HS	
A17DB	BP6ES	
A17DB-10	BP6ES	

APS	→ NGK	V-Line
A17DBM	BP6ES	
A17DBP	BPR6ES	
A17DBPM	BPR6ES	
A20D	B7ES	
A23-2	B7HS	
A23B	BP7HS	
AY17DBPM	BCPR6ES-11	
AUTOLITE/TUNER	→ NGK	V-Line
12	BP7FS	
13	BP6FS	
14	BP6FS	
15	BP5FS	
16	BP4FS	
23	BPR6FS	
24	BPR6FS	
25	BPR5FS	
26	BPR4FS-15	
27	BPR4FS-15	
34	AP6FS	
35	AP5FS	
36	AP5FS	
37	AP5FS	
43	APR6FS	
44	APR6FS	
45	APR5FS	
46	APR5FS	
52	BP7ES	
53	BP6ES	4
54	BP6ES	4
55	BP5ES	8
56	BP5ES	8
57	BP4ES	
62	BP7ES	
63	BPR6ES	2
64	BPR6ES	2
65	BPR5ES	6
66	BPR5ES	6
67	BPR4ES	
74	BP6S	
75	BP5S	
76	BP5S	
77	BP4	
84	BP6S	
85	BP5S	
86	BP4	
87	BP4	
94	BP7EFS	
102	BP7EFS	
103	BPR6EFS	7
104	BPR6EFS	7
105	BPR5EFS	



AUTOLITE/TUNER	→ NGK	V-Line
106	BPR5EFS	
115	A6FS	
117	A6FS	
124	AR6FS	
135	B7FS	
136	B6FS	
143	BR6FS	
144	BR6FS	
145	BR6FS	
146	BR5FS	
147	BR5FS	
156	AP5FS	
166	APR5FS	
175	BP5S	
203	BPR6FS	
215	B6L	
216	B6L	
217	B4L	
218	B4L	
235	BM6A	
245	BMR6A	
253	BM7A	
254	BM6A	
255	BM6A	
258	BM4A	
273	BP6HS	18
274	BP6HS	18
275	BP5HS	
276	BP5HS	
283	BPR7HS	
284	BPR6HS	3
292	B8S	
294	B6S	
295	B4	
297	B4	
298	B2	
302	BR6S	
303	BR6S	
304	BR6S	
306	B4	
308	B2	
312	B8S	
313	B7S	
314	B6S	
315	B6S	
316	B6S	
317	B4	
318	B2	
344	AR6FS	
353	B8S	
354	B6S	
355	B6S	

AUTOLITE/TUNER	→ NGK	V-Line
356	B4	
357	B4	
358	B2	
363	BR6S	
372	A8	
373	A7	
374	A7	
375	A6	
376	A6	
377	A6	
378	A6	
379	AB2	
386	A6	
393	B7ES	
394	B6ES	
395	B5ES	
396	B5ES	
397	B5ES	
398	B4ES	
402	BR8ES	
403	BR6ES	
404	BR6ES	
405	BR5ES	
406	BR5ES	
411	B9HS	
413	B7HS	
414	B6HS	
415	B5HS	
416	B5HS	
417	B4H	
424	B6HS	
425	BR5HS	
426	BR5HS	
436	B6L	
437	B4L	
456	B4LM	
458	B2LM	
483	BR7EFS	
494	B6L	
495	B6L	
497	B4L	
517	BP4H	
536	B4H	
584	AR6FS	
603	BPR6EFS-13	
604	BPR6EFS-13	
605	BPR6EFS-13	
646	BPR5ES-15	
664	BPR6FS	
665	BPR5FS-15	
666	BPR4FS-15	
667	BPR4FS-15	



AUTOLITE/TUNER	→ NGK	V-Line
683	BR6FS-15	
684	BR6FS-15	
685	BR6FS-15	
687	BR5FS-15	
723	BPR6FS	
724	BPR6FS	
725	BPR5FS-11	
726	BPR4FS	
727	BPR4FS-11	
744	APR5FS	
746	APR5FS	
747	APR5FS	
763	TR5-1/SR5	
764	BPR6EFS	7
765	BPR5EFS	
766	BPR5EFS	
784	AR6FS	
804	AR6FS	
865	BPR5EFS	
884	BPR6EFS-13	
915	ZGR5C	
925	ZGR5C	
935	BPR5ES	6
945	BPR5ES	6
985	ZF4A-11	
996	B6L	
2413	B10EGP	
2414	B10EG	
2415	B9EG	
2416	B8EG	
2417	B7ECS	
2543	TR5-1/SR5	
2544	TR5-1/SR5	
2545	TR5-1/SR5	
2546	TR5-1/SR5	
2585	BPR5ES	6
2592	B10ES	
2593	B9ES	
2594	B9ES	
2611	B10ES	
2612	B9ES	
2613	B9ES	
2614	B8ES	
2615	B7ES	
2616	B6ES	
2634	B9HS-10	
2635	B8HS	
2636	B7HS	
2652	B9HS-10	
2653	B7HS	
2654	B7HS	
2655	B6HS	

AUTOLITE/TUNER	→ NGK	V-Line
2656	B5HS	
2675	B6L	
2676	B6L	
2695	A8	
2696	A7	
2697	A6	
2715	D8HA	
2716	D6HA	
2735	D6HA	
2755	D8EA	
2772	A8	
2775	A6	
2794	C8HSA	
2795	C7HSA	
2796	C6HSA	
2852	BUH	
2872	BUHW	
2892	BUHX	
2932	BUE	
2954	BM7F	
2956	BM6F	
2974	BPM7A	
2976	BPMR7A	
3013	B7S	
3014	B6S	
3035	A6	
3036	BPR4FS-15	
3055	A6FS	
3074	G2Z	
3075	G2Z	
3116	A6	
3203	BPR6ES	2
3204	BPR6ES	2
3205	BPR5ES	6
3206	BPR5ES	6
3207	BPR5ES	6
3224	BP6S	
3225	BP5S	
3226	BP5S	
3227	BP5S	
3243	BPR6EFS	7
3244	BPR6EFS	7
3245	BPR5EFS	
3246	BPR5EFS	
3264	B7FS	
3265	BR6FS	
3266	BR5FS	
3267	BR5FS	
3286	APR6FS	
3303	BPR6FS	
3325	B6L	
3327	B4L	



AUTOLITE/TUNER	→ NGK	V-Line
3345	BMR7A	
3364	BPR6HS	3
3382	BR6S	
3383	BR6S	
3384	BR6S	
3386	BR6S	
3388	BR6S	
3404	AR6FS	
3423	B8S	
3426	BR6S	
3446	AR6	
3462	BR7ES	
3463	BR6ES	
3464	BR6ES	
3465	BR5ES	
3466	BR5ES	
3485	BR5HS	
3486	BR5HS	
3507	B6L	
3565	BPR5EFS	
3586	BPR5ES-15	
3604	BPR5FS-15	
3605	BPR4FS-15	
3606	BPR4FS-15	
3607	BPR4FS-15	
3624	BR6FS	
3625	BR6FS-15	
3627	BR5FS-15	
3666	B4LM	
3684	BR7HS	
3686	BR6HS	
3702	BR9ES	
3703	BR9ES	
3704	BR8ES	
3705	BR6ES	
3706	BR6ES	
3724	BPR5EFS	
3885	ZGR5C	
3896	ZGR5C	
3922	BCPR7ES	
3924	BKR6E	28
3926	BKR5ES	
3954	D8EA	
3964	DR8ESL	
3985	BPR5FS-15	
4043	BPR6ES-11	13
4052	B9ES	
4053	B9ES	
4054	B8ES	
4055	B7ES	
4056	B6ES	
4062	BR9ES	

AUTOLITE/TUNER	→ NGK	V-Line
4063	BR9ES	
4092	B7HS	
4093	B7HS	
4113	BP6HS	18
4114	BP6HS	18
4123	BPR6HS	3
4132	D8EA	
4143	DR8ESL	
4152	DP9EA-9	
4153	DP8EA-9	
4162	DPR9EA-9	
4163	DR8ESL	
4164	D7EA	
4173	D8HA	
4193	C7HSA	
4203	CR7HS	
4251	BP8ES	
4252	BP7ES	
4253	BP6ES	4
4263	BPR6ES	2
4265	BPR5ES	6
4275	BP5S	
5143	TR5-1	
9062	BP6ET	
9063	BP6ET	
9064	BP5ET	
9921	BCPR6ET	
AP63	PFR6B	
BERU	→ NGK	V-Line
125/14/3	B5ES	
125/14/3A	BP5ES	8
12-5DU	D7EA	
14-10A	B4H	
14-10B	BP4HS	
14-10C	B4ES	
14-10D	BP4ES	
14-10E	B4	
14-10F	BP4	
14-2AS1	B9HCS	
14-3A1	B8HS	
14-3AS1	B8HVX	
14-3AU	B8HS	
14-3CS1	B8EVX	
14-3DP2	B8EVX	
14-4A1	B8HS	
14-4A2	B7HS	
14-4AS1	B8HVX	
14-4AU	B7HS	
14-4B2	BP7HS	
14-4C1	B8ES	
14-4C2	B7ES	



BERU	→ NGK	V-Line
14-4CS1	B8EVX	
14-4DPO	BP7ES	
145/14	B5HS	
145/14/3	B5ES	
145/14/3A	BP5ES	8
145/14/5	B4	
145/14/5A	BP5S	
145/14/5AMX	BPM6A	
145/18	A6	
145/18K	AP5FS	
145/1A	BP5HS	
14-5A	B7HS	
14-5AU	B7HS	
14-5B	BP7HS	
14-5BU	BP7HS	
14-5C	B7ES	
14-5CS	B7ECS	
14-5D	BP7ES	
14-5D1	BP7ES	
14-5DP1	BP7ES	
14-5DTU	BP6ET	
14-5DU	BP7ES	
14-5DU0	BP7ES	
14-5E	B7S	
14-5F	BP6S	
14-6B	BP6HS	18
14-6BU	BP6HS	18
14-6C	B6ES	
14-6D	BP6ES	4
14-6D1	BP6ES	4
14-6DPO	BP6ES	4
14-6DTU	BP6ET	
14-6DU	BP6ES	4
14-6DU0	BP6ESZ	
14-7A	B6HS	
14-7AU	B6HS	
14-7B	BP6HS	18
14-7BU	BP6HS	18
14-7C	B6ES	
14-7CU	B6ES	
14-7D	BP6ES	4
14-7DTU	BP6ET	
14-7DU	BP6ES	4
14-7DU0	BP6ESZ	
14-7E	B6S	
14-7F	BP6S	
14-8A	B5HS	
14-8AU	B5HS	
14-8B	BP5HS	
14-8BU	BP5HS	
14-8C	B5ES	
14-8C1	B6ES	

BERU	→ NGK	V-Line
14-8D	BP5ES	8
14-8DTU	BP5ET	
14-8DTU EA1,0	BP5ET-10	
14-8DU	BP5ES	8
14-8DU0	BP5ES	8
14-8E	B4	
14-8F	BP5S	
14-8LUR	ZGR5A	15
14-9C	B5ES	
14-9D	BP5ES	8
14-9DTU	BP5ET	
14-9DU	BP5ES	8
14-9DU0	BP5ES	8
14-9EU0	B4LM	
14F-03DAR	BKR6EK	20
14F-5DU	BCP7ES	
14F-6DSR	BKR6E	28
14F-6DTU	BCP6ET	
14F-6DU0	BCP6ES	17
14F-6DUOR	BKR6E	28
14F-7DPVRXZ	IFR6D10	
14F-7DU	BCP6ES	17
14F-7DU0	BCP6ES	17
14F-7DUOR	BKR6E	28
14F-7LDUR	BKR6EK	20
14F-7LDUR4	BKR6EK	20
14F-8DU	BCP5ES	16
14F-8DU4	BCP5ES	
14F-8DU0	BCP5ES	16
14F-8LDUSR	BKR6EK	20
14F-8LUR	ZFR5F	
14F-9DU0	BCP5ES	16
14FGH-6DTUR	BKUR7ET	
14FGH-7DTURX	BKUR6ET-10	24
14FGH-8DPURX2	IFR5D10	
14FGH-8DTURXO	BKUR5ET	
14FGH-8DTURXO	BKUR5ET only Mercedes	
14FGR-6DDU	BKR6EKUB	
14FGR-7CTU	BCPR7ET	
14FLR-8LDUX	BKR5EK	23
14FR-5DTU	BCPR7ET	
14FR-5DU	BCPR7ES	
14FR-6DU	BKR6E	28
14FR-6DUX	BCPR6ES-11	11
14FR-6LDU3	BKR6EKE Smart	
14FR-7DU	BKR6E	28
14FR-7DUX	BKR6E-11	14
14FR-7DUX	BKR6ES-11	
14FR-7KPU	BKR6EP-8	
14FR-7KPUV	BCPR6EP-11	
14FR-7KPUX	BCPR6EP-11	
14FR-7KU	BKR6EY	



BERU	→ NGK	V-Line
14FR-7KUO	BKR6EYA	
14FR-7KUOX	BKR6EYA-11	
14FR-7LDU	BKR6EKC	26
14FR-7LUX	ZFR6F-11	
14FR-8DU	BKR5E	
14FR-8DU	BCPR5ES	
14FR-8DUX	BCPR5ES-11	
14FR-8HU	BCRE527Y	
14FR-8KU	BKR5EY	
14FR-8KUO	BKR5EYA	
14G-8DTU	BP6ET	
14GH-7DTUR	BUR6ET	1
14GH-8DTUR	BUR5ET	22
14GH-8DTUREA	BUR5ET	
14GH-8DTURX	BUR5ET-10	21
14GR-8DTU	BPR5EKU	
14K-5DU	BP7EFS	
14K-5DUO	BP7EFS	
14K-6D	BP6EFS	5
14K-6DU	BP6EFS	5
14K-6DUO	BP6EFS	5
14K-7D	BP6EFS	5
14K-7DU	BP6EFS	5
14K-7DUO	BP6EFS	5
14K-8DU	BP5EFS	
14K-8DUO	BP5EFS	
14K-9DU	BP5EFS	
14K-9DUO	BP5EFS	
14KGR-6KQU	BUR6EFSZ	
14KR-6BU	BPR6FS	
14KR-6DU	BPR6EFS	7
14KR-6ZPPV	PTR5A-13	25
14KR-7DUX	BPR6EFS	7
14KR-8DPUOV	TR55	
14KR-8MUUV	PTR5A-13	25
14R-11F	BP4	
14R-5DU	BPR7ES	19
14R-6B	BPR6HS	3
14R-6BU	BPR6HS	3
14R-6D	BPR6ES	2
14R-6DU	BPR6ES	2
14R-6DUX	BUR6EA-11	
14R-6DUX	BPR6ES-11	13
14R-7B	BPR6HS	3
14R-7BU	BPR6HS	3
14R-7CU	BR6ES	
14R-7D	BPR6ES	2
14R-7DU	BPR6ES	2
14R-7DUX	BPR6EY-11	10
14R-8DU	BPR5EY	9
14R-8DUX	BPR5ES-11	
14R-9DU	GR4	

BERU	→ NGK	V-Line
14R-9DU	BPR5ES	6
14R-9EUO	BR4LM	
14S-5A	BL6H	
14S-5F	BPM7A	
14S-7A	BL6H	
14S-7F	BPM6A	
14S-8F	BPM6A	
14SR-6F	BPMR6A	
14-XAU	B6HS	
14Z-2C1	B9EVX	
14Z-3A1	B9HS	
14Z-3AU	B8HS	
14Z-3C1	B9ES	
14Z-3CU	B8ES	
14Z-4AU	B8HS	
14Z-6A2	B6HS	
14Z-7AU	B7HS	
160/14/3	B6ES	
175/14	B6HS	
175/14/3	B6ES	
175/14/3A	BP6ES	4
175/14/5	B6S	
175/14/5A	BP6S	
175/14/5AMX	BPM6A	
175/14/UK4	BL6H	
175/14A	BP6HS	18
175/18	A6	
175/18K	AP6FS	
18-10A	A6	
18-10AU	A6	
18-12B	AB2	
18-4A1	A7	
18-4A2	A7	
18-5A	A7	
18-5AS	A7	
18-5AU	A7	
18-7A	A6	
18-7AU	A7	
18-8A	A6	
18K-12B	AP5FS	
18K-6BU	AP6FS	
18K-7B	AP6FS	
18K-7BU	AP6FS	
18K-8B	AP5FS	
18K-8BU	AP5FS	
190/14Z	B6HS	
200/14/3	B6ES	
200/14/3A	BP6ES	4
200/14/3K	BP6EFS	5
200/14A	BP6HS	18
215/14/3A	BP6ES	4
225/14	B7HS	



BERU	→ NGK	V-Line
225/14/3	B7ES	
225/14/3A	BP7ES	
225/14/3S	B7ECS	
225/14/5	B7S	
225/14/5A	BP6S	
225/14/5AMX	BPM7A	
225/14/UK4	BL6H	
225/14A	BP7HS	
225/18	A7	
225/18S	A7	
230/14/3A	BP7ES	
235/14/3P	BP7ES	
240/14	B7HS	
240/14/3	B7ES	
240/14A	BP7HS	
240/14S	B8HVX	
240/18	A7	
260/14	B8HS	
260/14/3	B8ES	
260/14S	B8HVX	
260/18	A8	
265/14/3P	B8EVX	
280/14	B8HS	
280/14/3S	B8EVX	
280/14/3Z	B9ES	
280/14Z	B9HS	
310/14/3Z	B9EVX	
310/14S	B9HCS	
45/18	AP5FS	
95/14	B4H	
95/14/3	B4ES	
95/14/3A	BP4ES	
95/14/5	B4	
95/14/5A	BP-4	
95/14A	BP4HS	
95/18	A6	
D 215/14/3 (14/5/C)	B7ES	
D175/14	B6HS	
D175/14/3	B6ES	
D200/14/3A	BP6ES	4
D215/14/3	BP6ES	4
D230/14/3A	BP7ES	
G 3/18	A9EFP	
G 5	---	
G 6	---	
RS16	BP6HVX	
RS18	BP7HVX	
RS33	BPR5EVX	
RS35	BP6EVX	
RS37	BP7EVX	
RS39	BP7EVX	
Z 1	BP5ES	8

BERU	→ NGK	V-Line
Z 2	BP5ET	
Z 3	ZGR5A	15
Z 4	ZFR5F	
Z 5	BCP5ES	16
Z 6	BP5EFS	
Z 7	BP5EFS	
Z 8	BPR5ES	6
Z 9	BPR5ES-11	
Z 10	BP6HS	18
Z 11	BP6ES	4
Z 12	BP6ET	
Z 13	BKR6E	28
Z 14	BKR6EK	20
Z 15	BKR6E	28
Z 16	BCPR6ES-11	11
Z 17	BP6EFS	5
Z 18	BP6EFS	5
Z 19	BPR6HS	3
Z 20	BPR6ES	2
Z 21	BPR6ES-11	13
Z 22	BP6ES	4
Z 23	BKR6E	28
Z 24	BKR6E	28
Z 25	BP6EFS	5
Z 26	BPR6EFS	7
Z 27	BPR6ES	2
Z 28	BPR6ES-11	13
Z 29	BCP7ES	
Z 30	BCPR7ES	
Z 31	BP7EFS	
Z 32	AP6FS	
Z 33	AP6FS	
Z 35	D7EA	
Z 36	D7EA	
Z 37	B9HS	
Z 38	B9ES	
Z 39	B8HS	
Z 40	B7HS	
Z 41	BP7HS	
Z 42	BP7ES	
Z 43	BP7ES	
Z 44	BP6ET	
Z 45	BCPR7ET	
Z 46	BP7EFS	
Z 47	BPR7ES	19
Z 48	BP6HS	18
Z 49	BPR6FS	
Z 50	BP6ESZ	
Z 51	BP6ET	
Z 52	BCP6ET	
Z 53	BCP6ET	
Z 54	BCP6ES	17



BERU	→ NGK	V-Line
Z 55	BP6EFS	5
Z 56	BP6EFS	5
Z 57	B6HS	
Z 58	B6ES	
Z 59	BR6ES	
Z 60	BCPR7ET	
Z 61	BP6ESZ	
Z 62	BP6ESZ	
Z 63	BCP6ES	17
Z 64	BCP6ES	17
Z 66	BP6EFS	5
Z 67	BPR6EFS-13	
Z 68	B5HS	
Z 69	BP5ESZ	
Z 70	BP5ESZ	
Z 71	BCP5ES	16
Z 72	BCPR5ES	
Z 73	BCPR5ES-11	
Z 74	BKR5EK	23
Z 75	BUR5ET	22
Z 76	BP5ES	8
Z 77	BP5ESZ	
Z 78	BP5ET	
Z 79	BCP5ES	16
Z 80	BP5EFS	
Z 81	BP5EFS	
Z 82	BPR5ES	6
Z 83	B4LM	
Z 84	BR4LM	
Z 85	B6HS	
Z 86	A7	
Z 87	A7	
Z 88	A6	
Z 89	BKUR6ET	27
Z 90	BKUR6ET-10	24
Z 91	BUR6ET	1
Z 92	BUR5ET	22
Z 93	BUR5ET-10	21
Z 94	BPR5EKU	
Z 95	BPR6EFS	7
Z 97	PTR5A-13	25
Z 99	BCPR6ES-11	11
Z 100	BKR6ES	28
Z 101	BKR6EK	20
Z 103	BP7ES	
Z 104	BP6ES	4
Z 105	BKR6E	28
Z 107	BP4	
Z 112	B4	
Z 144	BUR6EFSZ	
Z 145	BKR6EKUB	
Z 148	TR55	

BERU	→ NGK	V-Line
Z 149	BCPR6EP-11	
Z 150	BCPR6EP-11	
Z 151	BKR6EP-8	
Z 152	BCRE527Y	
Z 153	BKR5EY	
Z 154	BKR5EYA	
Z 155	BKR6EY	
Z 156	BKR6EYA	
Z 157	BKR6EYA-11	
Z 158	ZFR6F-11	
BM3 (Bulgaria)	→ NGK	V-Line
L15Y	BP6ES	4
N15	B7HS	
N15Y	BP6HS	18
N17	B6HS	
BM3 / VMZ	→ NGK	V-Line
L15Y	BP6ES	4
N15	B7HS	
N15Y	BP6HS	18
N17	B6HS	
BMW	→ NGK	V-Line
12 12 0 141 871	BKR6EQUP	
12 12 1 435 955	BKR6EQUP	
12 12 2 343 144	D8EA	
12 12 7 653 439	CR8EB	
12 12 7 653 771	BKR7EKC	
12 12 9 061 870	ZFR5F	
12 12 9 063 428	BKR6EK	20
12 12 9 064 617	BKR6EK	20
12 12 9 064 619	BKR6EK	20
12 12 9 064 656	BKR6EK	20
12 12 9 065 366	BKR6EK	20
12 12 9 069 048	PKR7A	
12 12 9 071 003	BKR6EQUP	
7 650 676	BKR7EKC	
7 653 771	BKR7EKC	
BOSCH	→ NGK	V-Line
0241235715	PZFR5D-11	
0242235642	BKR6EKUB	
D10B	AP5FS	
D10BC	AP5FS	
D6B	AP6FS	
D6BC	AP6FS	
D6BP	AP6FS	
D7A	A6FS	
D7AC	A6FS	
D7B	AP6FS	
D7BC	AP6FS	



BOSCH	→ NGK	V-Line
D7BP	AP6FS	
D8A	A5FS	
D8AC	A5FS	
D8B	AP5FS	
D8BC	AP5FS	
D8BP	AP5FS	
D9B	AP5FS	
D9BC	AP5FS	
DR10B	APR5FS	
DR10BC	APR5FS	
DR6BC	APR6FS	
DR6BP	APR6FS	
DR7BC	APR6FS	
DR7BP	APR6FS	
DR8B	APR5FS	
DR8BC	APR5FS	
DR8BP	APR5FS	
DR9B	APR5FS	
DR9BC	APR5FS	
F04DAR	BKR6EK	20
F09CS	R7114-10	not resistor
F09CS	R7115-10	resistor
F2CS	R7114-9	ex R6205-9
F3CS	R7114-9	ex R6205-9
F4CS	R6205-8	
F5DC	BCP7ES	
F5DP	BCP7ES	
F5DPOR	PFR7B	
F5DTC	BCP7ET	
F6DC	BCP6ES	17
F6DCO	BCP6ES	17
F6DCOR	BKR6E	28
F6DCX	BCP6ES-11	
F6DP	BCP6ES	17
F6DPOR	PFR6Q	
F6DPX	BCP6ES-11	
F6DSR	BKR6EVX	
F6DTC	BCP6ET	
F6LTCR	BKUR7ET	
F7DC	BCP6ES	17
F7DCO	BCP6ES	17
F7DCOR	BKR6E	28
F7DCX	BCP6ES-11	
F7DP	BCP6ES	17
F7DPP332	IFR6D10	
F7DTC	BCP6ET	
F7HER2	ZFR5P-G	
F7HPP22	BKUR6ET-10	
F7KTCR	BKUR6ET-10	only Mercedes
F7LCOR2	ZFR6F-11	
F7LCR	ZFR6A-11	
F7LDCR	BKR6EK	20

BOSCH	→ NGK	V-Line
F7LTCR	BKUR6ET-10	24
F8DC	BCP5ES	16
F8DC4	BCP5ES	16
F8DCO	BCP5ES	16
F8DCOR	BCPR5ES	
F8DCX	BCP5ES-11	
F8DPER	IFR5D10	
F8DPP332	IFR5D10	
F8KTCR	BKUR5ET	only Mercedes
F8LCR	ZFR5F	
F8LCR2	ZFR5F	
F8LDCR	BKR6EK	20
F9DCO	BCP4ES	
F9LCR	ZFR4F-11	
FGR6KQC	BKR6EQUP	
FGR6KQE	BKR6EQUP	
FGR7DQEO	BKR6EKUB	
FGR7DQEO	BKR6EKUB	
FGR7DQP	BKR6EQUP	
FGR7KQC	BKR6EQUP	
FGR7KQE	BKR6EQUP	
FGR7KQEO	BKR6EQUP	
FGR8MQPE	PLFR5A-11	
FLR8LDCU	BKR5EK	23
F03DAR	BCPR7ER / BKR6EK	
FR10DCX	BCPR4ES-11	
FR10DX	BCPR4ES-11	
FR5DC	BCPR7ES	
FR5DCX	BCPR7ES-11	
FR5DP	BCPR7ES	
FR5DTC	BCPR7ET	
FR5LDC	BKR7EKC	
FR6DC	BKR6E	28
FR6DC2 0,7	BKR6E	28
FR6DCO	BKR6EK	
FR6DCX	BCPR6ES-11	11
FR6DDC	BKR7EKC	
FR6DP	BKR6E	28
FR6DP1X	PFR6J-11	
FR6DPX	BCPR6ES-11	11
FR6DTC	BCPR6ET	
FR6DTCW	BKR5EKC	
FR6KDC	BKR6EK	20
FR6KTC	BKUR6ETB	
FR6LDC	BKR6EKC	26
FR6LDC	BKR6EK	20
FR7DC	BKR6E	28
FR7DC2	BKR6E	28
FR7DCO	BKR6E	28
FR7DCX	BCPR6ES-11	11
FR7DE	BKR6EZ	
FR7DP	BKR6E	28



BOSCH	→ NGK	V-Line
FR7DP1X	PFR6B-11	
FR7DPP10	BKR6EVX	
FR7DPX	BCPR6ES-11	11
FR7DTC	BCPR6ET	
FR7KCW	BKR6EP-13	
FR7KDC	BKR6EK	20
FR7LC2	BKR6E	28
FR7LCX	ZFR6F-11	
FR7LDC	BKR6EKC	26
FR8DC	BKR5ES	
FR8DC0	BKR5ES	
FR8DCX	BKR5ES-11	
FR8DPX	BKR5ES-11	
FR8DS	BKR5EVX	
FR8DX	BKR5ES-11	
FR8HP	ZFR5F-11	
FR8KCU	BKR5EYA-11	
FR8LCX	ZFR6F-11	
FR8LDC	BKR5EK	23
FR8LDC4	BKR5EK	
FR8ME	LFR5B	
FR9DCX	BCPR4ES-11	
FR9HC	ZFR4F-11	
H10B	BP4FS	
H10BC	BP4FS	
H2CS	B9EFS	
H3CS	B8EFS	
H5D	BP7EFS	
H5DC	BP7EFS	
H5DC0	BP7EFS	
H5DP	BP7EFS	
H6B	BP6FS	
H6BC	BP6FS	
H6D	BP6EFS	5
H6DC	BP6EFS	5
H6DC0	BP6EFS	5
H6DP	BP6EFS	5
H7CC	B6EFS	
H7CP	B6EFS	
H7D	BP6EFS	5
H7DC	BP6EFS	5
H7DC0	BP6EFS	5
H7DCY	BP6EFS-13	
H7DP	BP6EFS	5
H7DPY	BP6EFS-13	
H8B	BP5FS	
H8BC	BP5FS	
H8BP	BP5FS	
H8DC	BP5EFS	
H8DC0	BP5EFS	
H8DCX	BP5EFS-13	
H8DP	BP5EFS	

BOSCH	→ NGK	V-Line
H9B	BP4FS	
H9BC	BP4FS	
H9BCY	BPR4FS-15	
H9DC	BP5EFS	
H9DC0	BP5EFS	
H9HP	BP5EFS	
HGR6KQC	BUR6EFSZ	
HGR7KQC	BUR6EFSZ	
HR10A	BR5FS	
HR10AC	BR5FS	
HR10ACY	BR5FS-15	
HR10AY	BR5FS-15	
HR10B	BPR4FS	
HR10BC	BPR4FS	
HR10BCX	BPR4FS-11	
HR10BCY	BPR4FS-15	
HR10BX	BPR4FS-11	
HR10BY	BPR4FS-15	
HR6B	BPR6FS	
HR6BC	BPR6FS	
HR6BP	BPR6FS	
HR6D	BPR6EFS	7
HR6DC	BPR6EFS	7
HR6DP	BPR6EFS	7
HR6DS	BPR6EFS	7
HR7DC	BPR6EFS	7
HR7MPP	PTR5A-13	25
HR8A	BR5FS	
HR8AC	BR5FS	
HR8ACY	BR5FS-15	
HR8AP	BR5FS	
HR8APY	BR5FS-15	
HR8AY	BR5FS-15	
HR8B	BPR5FS	
HR8BC	BPR5FS	
HR8BCY	BPR5FS-15	
HR8BP	BPR5FS	
HR8BPX	BPR5FS-11	
HR8BPY	BPR5FS-15	
HR8BY	BPR5FS-15	
HR8LCO	TR5-1/SR5	
HR8LPO	TR5-1/SR5	
HR9A	BR5FS	
HR9AC	BR5FS	
HR9ACY	BR5FS-15	
HR9AP	BR5FS	
HR9APY	BR5FS-15	
HR9AY	BR5FS-15	
HR9B	BPR4FS	
HR9BC	BPR4FS	
HR9BCY	BPR4FS-15	
HR9BPX	BPR4FS-11	



BOSCH	→ NGK	V-Line
HR9BPY	BPR4FS-15	
HR9BY	BPR4FS-15	
HR9D	BPR5EFS	
HR9DC	BPR5EFS	
HR9DCX	BPR5EFS-13	
HS5E	BM7F	
HS8E	BM6F	
M10A	A6	
M10AC	A6	
M10ACO	A6	
M10AO	A6	
M12B	A6	
M145T1	A6	
M145T5	A6	
M175T1	A6	
M225T1	A7	
M240T1	A7	
M280T1	A8	
M45T1	A6	
M4A	A7	
M4A1	A8	
M4A2	A7	
M4AC	A7	
M5A	A7	
M5AC	A7	
M7A	A6	
M7AC	A7	
M8A	A6	
M8AC	A6	
M8AO	A6	
M95T1	A6	
M95T5	A6	
MA145T1	A5FS	
MA145T7	AP5FS	
MA145TR7	APR5FS	
MA175T1	A6FS	
MA175T7	AP6FS	
MA200T7	AP6FS	
UR2AS	CR8HS	
UR3AS	CR7HS	
UR4AS	CR6HS	
W06AS	B10HVX	
W06CS	B11EGV	
W07AS	B10HVX	
W07CS	B10EGV	
W08AS	B9HVX	
W08CS	B10EGV	
W10A	B4H	
W10AC	B4H	
W10C	B4ES	
W10CC	B4ES	
W10D	BP4ES	

BOSCH	→ NGK	V-Line
W10DC	BP4ES	
W10E	B4	
W10F	BP4	
W10FC	BP4	
W125T1	B4H	
W125T2	B4ES	
W125T3	B4	
W125T30	BP5ES	8
W125T4	B4H	
W125TR2	BR5ES	
W125TR3	BR6S	
W125TR30	BPR5ES	6
W12A	B4H	
W12E	B2	
W145T1	B5HS	
W145T1.1	B5HS	
W145T2	B5ES	
W145T3	B6S	
W145T30	BP5ES	8
W145T35	BP5HS	
W145TR2	BR5ES	
W145TR3	BR6S	
W145TR30	BPR5ES	6
W175T1	B6HS	
W175T2	B6ES	
W175T3	B6S	
W175T30	BP6ES	4
W175T35	BP6HS	18
W175T6	BP6S	
W175T7	BP6HS	
W175TR1	BR6HS	
W175TR30	BPR6ES	2
W175Z1	B6HS	
W190M11S	B6HVX	
W200T27	BP6ES	
W200T30	BP6ES	4
W200T35	BP6HS	18
W200TR30	BPR6ES	2
W215P21	BP7EVX / BPR7EIX	
W215T30	BP6ES	4
W225T1	B7HS	
W225T2	B7ES	
W225T3	B7S	
W225T35	BP7HS	
W225TR30	BPR7ES	19
W230T30	BP7ES	
W240M1	B8HS	
W240MZ1	B8HS	
W240T1	B8HS	
W240T2	B8ES	
W240T3	B7S	
W250P21	BP7ES	



BOSCH	→ NGK	V-Line
W250T1	B8HS	
W250T2	B8ES	
W255T30	BP7ES	
W260M1	B8HS	
W260MZ1	B8HS	
W260MZ2	B9ES	
W260S1S	B8HVX	
W260S2S	B8EVX	
W260T1	B8HS	
W260T2	B9ES	
W260T20	B8ES	
W275T1	B8HS	
W275T2	B9ES	
W280MZ1	B8HS	
W280MZ2	B9ES	
W280S1S	B9HVX	
W280S2S	B9EVX	
W280T30	BP8ES	
W2A	B9HS	
W2AC	B9HS	
W2AS	B9HVX	
W2C	B10ES	
W2CC	B10ES	
W2CO	B10ES	
W2CS	B10EVX	
W2D	BP9ES	
W300MZ2	B10ES	
W300T1	B9HS	
W300T2	B10ES	
W300T30	BP9ES	
W310S1S	B9HVX	
W310S2S	B10EVX	
W3A	B8HS	
W3AC	B8HS	
W3A0	B8HS	
W3AP	B8HS	
W3AS	B8HVX	
W3C	B9ES	
W3CC	B9ES	
W3CO	B9ES	
W3CP	B9ES	
W3CS	B9EVX	
W3D	BP8ES	
W3DP	BP8EVX	
W3DP2	BP8ES	
W3DP0	BP8EVX	
W45T1	B4H	
W4A	B8HS	
W4A1	B8HS	
W4A2	B8HS	
W4A5	B8HS	
W4AC	B8HS	

BOSCH	→ NGK	V-Line
W4AP	B8HS	
W4AS	B8HVX	
W4C	B8ES	
W4C1	B8ES	
W4C2	B7ES	
W4C3	B7HS	
W4CC	B8ES	
W4CP	B8EVX	
W4CPX	B8ES-11	
W4CS	B8EVX	
W4DP	BP7EVX	
W4DP0	BP7EVX / PFR7B	
W4E2	B7S	
W5A	B7HS	
W5AC	B7HS	
W5AP	B7HS	
W5AS	B7HVX	
W5B	BP7HS	
W5BC	BP7HS	
W5BP	BP7HS	
W5C	B7ES	
W5CC	B7ES	
W5CCX	B7ES-11	
W5CP	B7ES	
W5CPX	B7ES-11	
W5CS	B7EVX	
W5D	BP7ES	
W5D1	BP7ES	
W5DC	BP7ES	
W5DC0	BP7ES	
W5DCX	BP7ES-11	
W5DP	BP7ES	
W5DP0	BP7EVX	
W5DPX	BP7ES-11	
W5DTC	BP6ET	
W5E	B7S	
W5EC	B7S	
W5EP	B7S	
W6AS	B6HVX	
W6B	BP6HS	18
W6BC	BP6HS	18
W6BP	BP6HS	18
W6D	BP6ES	4
W6D1	BP6ES	4
W6DC	BP6ES	4
W6DC 0,8	BP6ES	4
W6DC0	BP6ES	4
W6DC0 0,8	BP6ESZ	
W6DCX	BP6ES-11	
W6DP	BP6EVX	
W6DP0	BP6EVX	
W6DPX	BP6EVX (1,1)	



BOSCH	→ NGK	V-Line
W6DTC	BP6ET	
W7A	B6HS	
W7AC	B6HS	
W7AO	B6HS	
W7AP	B6HS	
W7B	BP6HS	18
W7BC	BP6HS	18
W7BP	BP6HS	18
W7C	B6ES	
W7CC	B6ES	
W7CCO	B6ES	
W7CCX	B6ES-11	
W7CP	B6ES	
W7CPX	B6ES-11	
W7CX	B6ES-11	
W7D	BP6ES	4
W7DO	BP6ES	4
W7DC	BP6ES	4
W7DCO	BP6ESZ	
W7DCR	BPR6ES	2
W7DCX	BP6ES-11	
W7DO	BP6ES	4
W7DP	BP6ES	4
W7DPX	BP6ES-11	
W7DTC	BP6ET	
W7DTC 1,0	BP6ET	
W7DX	BP6ES-11	
W7E	B6S	
W7EC	B6S	
W7EP	B6S	
W7F	BP6S	
W7FC	BP6S	
W7LTCR	BUR6ET	1
W8A	B5HS	
W8AC	B5HS	
W8AO	B5HS	
W8AP	B5HS	
W8B	BP5HS	
W8BC	BP5HS	
W8BP	BP5HS	
W8C	B5ES	
W8CC	B5ES	
W8CCX	B5ES-11	
W8CO	B5ES	
W8CP	B5ES	
W8D	BP5ES	8
W8DC	BP5ES	8
W8DCO	BP5ES	8
W8DCX	BP5ES-11	
W8DCY	BP5ES-13	
W8DP	BP5ES	8
W8DPX	BP5ES-11	

BOSCH	→ NGK	V-Line
W8DTC	BP5ET	
W8DX	BP5ES-11	
W8E	B6S	
W8EC	B6S	
W8F	BP5S	
W8FC	BP5S	
W8LCR	ZGR5A	15
W8LDCR	BUR6ET	1
W8LPR	ZGR5A	15
W8LTCR	BUR5ET/BPR5EKU	
	only VAG Cars	
W8LTCR 1,0	BUR5ET-10	21
W8LTCREA	BUR5ET	
W95T1	B4H	
W95T2	B4ES	
W95T3	B4	
W95T30	BP4ES	
W95T6	BP4	
W9A	B4H	
W9AC	B5HS	
W9ACO	B5HS	
W9AO	B4H	
W9C	B4ES	
W9CC	B4ES	
W9D	BP5ES	8
W9DC	BP5ES	8
W9DCX	BP5ES-11	
W9DP	BP5ES	8
W9DPX	BP5ES-11	
W9DTC	BP5ET	
W9E	B4	
W9EC	B4	
W9ECO	B4LM	
W9EO	B4LM	
W9F	BP5S	
W9FC	BP5S	
W9LC	ZGR5A	15
WA125TR30	BPR5EFS	
WA200T30	BP6EFS	5
WA200TR30	BPR6EFS	7
WA225T30	BP7EFS	
WAK145T3	BM6F	
WAK225T3	BM7F	
WEA	BUH	
WEC	BUE	
WET1	BUH	
WET2	BUE	
WKA145T3	BM6A	
WKA145T6	BPM6A	
WKA175T3	BM6A	
WKA175T6	BPM6A	
WKA200TR6	BPMR6A	



BOSCH	→ NGK	V-Line
WKA225T3	BM7A	
WKA225T6	BPM7A	
W06CS	B11EGV	
WR10A	BR4HS	
WR10AC	BR4HS	
WR10E	BR6S	
WR10F	BP4	
WR10FC	BP4	
WR10FCY	BPR4S-15	
WR10FY	BPR4S-15	
WR10LCV	BPR4ES-13	
WR11EO	BR4LM	
WR4AC	BR8HS	
WR4CC	BR8ES	
WR4CP	BR8EVX	
WR5A	BR7HS	
WR5AC	BR7HS	
WR5CC	BR7ES	
WR5CP	BR7ES	
WR5D	BPR7ES	19
WR5DC	BPR7ES	19
WR5DP	BPR7ES	19
WR5DS	BPR7EVX	
WR6D	BPR6ES	2
WR6DC	BPR6ES	2
WR6DCX	BPR6ES-11	13
WR6DP	BPR6ES	2
WR6DPX	BPR6ES-11	13
WR6DS	BPR6EVX	
WR6DTC	BUR6ETB-10	
WR6DTC	BP6ET	
WR7A	BR6HS	
WR7AC	BR6HS	
WR7B	BPR6HS	3
WR7BC	BPR6HS	3
WR7BP	BPR6HS	3
WR7C	BR6ES	
WR7CC	BR6ES	
WR7CCX	BR6ES-11	
WR7CP	BR6ES	
WR7CPX	BR6ES-11	
WR7D	BPR6ES	2
WR7DC	BPR6ES	2
WR7DCX	BPR6ES-11	13
WR7DP	BPR6EVX	
WR7DS	BPR6ES	2
WR7F	BPR6S	
WR7F	BP6S	
WR8AC	BR5HS	
WR8C	BR5ES	
WR8CC	BR5ES	
WR8CP	BR5ES	

BOSCH	→ NGK	V-Line
WR8D	BPR5ES	6
WR8DC	BPR5ES	6
WR8DC0	BPR5ES	6
WR8DCX	BPR5ES-11	
WR8DP	BPR5ES	6
WR8DPX	BPR5ES-11	
WR8DPY	BPR5ES-15	
WR8DS	BPR5EVX	
WR8E	BR6S	
WR8EC	BR6S	
WR8EP	BR6S	
WR8F	BPR5S	
WR8F	BP5S	
WR8FC	BPR5S	
WR8FC	BP5S	
WR8FP	BP5S	
WR8FP	BPR5S	
WR8FPY	BPR5S-15	
WR8HP	ZGR5C	
WR9A0	BR5HS	
WR9C	BR5ES	
WR9CC	BR5ES	
WR9D	BPR5ES	6
WR9DC	BPR5ES	6
WR9DCY	BPR5ES-15	
WR9DP	BPR5ES	6
WR9DPX	BPR5ES-11	
WR9DS	BPR5EVX	
WR9DY	BPR5ES-15	
WR9E	BR6S	
WR9EC	BR6S	
WR9ECO	BR6S / BM6	
WR9EO	BR6S	
WR9F	BP5S	
WR9F	BPR5S	
WR9FC	BP5S	
WR9FC	BPR5S	
WR9FCY	BPR5S-15	
WR9FP	BP5S	
WR9FPY	BPR5S-15	
WR9FY	BPR5S-15	
WR9HC	ZGR5C	
WR9HP	ZGR5C	
WR9LS	ZGR5A	15
WS5F	BPMR7A	
WS5E	BM7A	
WS5F	BPM7A	
WS7E	BM6A	
WS7F	BPM6A	
WS8E	BM6A	
WS8F	BPM6A	
WSR5F	BPMR7A	



BOSCH	→ NGK	V-Line
WSR6F	BPMR6A	
WSR8F	BPMR6A	
WSR9E	BMR4A	
X3CPO	D9EA	
X4CS	D8EA	
X5DC	D7EA	
XR2AS	DR8HS	
XR2CS	DR8ES	
XR4AS	DR8HS	
XR4CS	DR8ES	
XR5DC	DR7EA	
Y6DC	---	
YR7DE	DCPR8EN	
ZR8TPP15	LFR5B	
BRISK	→ NGK	V-Line
B12YC	DP9EA-9	
B14YC	DP8EA-9	
B15YC	DP7EA-9	
D12YC	BCP7ES	
D14Y	BKR6E	28
D14YC	BCP7ES	
D15Y	BKR6E	28
D15YC	BCP6ES	17
D17Y	BKR5E	
D17YC	BCP5ES	16
DR12YC	BKR7E	
DR12ZC-1	---	
DR14YC	BCPR7ES	
DR14ZC	ZFR7F-11	
DR14ZC-1	BCPR7ES-11	
DR15TC	BKUR5ET-10	
DR15YC	BKR6E	28
DR15Z	BKR6E	28
DR15Z-1	BCPR6ES-11	11
DR17YC	BCPR5ES	
F14YC	AP7FS	
F15YC	AP6FS	
FR14YC	APR6FS	
FR15YC	APR6FS	
G12YC	BP7EFS	
G14Y	BP7EFS	
G14YC	BP7EFS	
G15Y	BP6EFS	5
G15YC	BP6EFS	5
G17Y	BP5EFS	
G17YC	BP5EFS	
GR12YC	BPR7EFS	
GR14YC	BPR7EFS	
GR15YC	BPR6EFS	7
GR17YC	BPR5EFS	
J17	B4LM	

BRISK	→ NGK	V-Line
J19	B2LM	
JR17	BR4LM	
JR19	BR2LM	
K15YC	BP6S	
K17C	B6S	
K17Y	BP5S	
K19	B4	
L08JW	B10EGV	
L08W	B11EGV	
L10JW	B8EGV	
L12W	B9EVX	
L12Y	BP9ES	
L12YC	BP9ES	
L14	B8ES	
L14C	B8ES	
L14Y	BP6ES	4
L14YC	BP7ES	
L15	B7ES	
L15C	B7ES	
L15W	B8EVX	
L15Y	BP6ES	4
L15YC	BP6ES	4
L17	B6ES	
L17C	B6ES	
L17W	B7EVX	
L17Y	BP5ES	8
L17YC	BP5ES	8
L19	B4E	
L19C	B5ES	
LR12YC	BPR8ES	
LR12ZC	BPR8ES	
LR12ZC-1	---	
LR14TXS	BUR6ET	1
LR14YC	BPR7ES	19
LR14ZC	BPR7ES	19
LR14ZC-1	BPR7ES-11	
LR15TXS	BP5ET	
LR15YC	BPR6ES	2
LR15Z	BPR6ES	2
LR15Z-1	BPR6ES-11	13
LR17YC	BPR5ES	6
N08W	B10HVX	
N12W	B9HVX	
N12Y	BP8HS	
N12YC	BP8HS	
N14	B8HS	
N14C	B9HS	
N14Y	BP6HS	18
N14YC	BP7HS	
N15	B6HS	
N15C	B7HS	
N15W	B8HVX	



BRISK	→ NGK	V-Line
N15Y	BP6HS	18
N15YC	BP6HS	18
N17	B5HS	
N17C	B6HS	
N17W	B7HVX	
N17Y	BP4HS	
N17YC	BP5HS	
N19	B5HS	
N19C	B5HS	
NR12YC	BPR8HS	
NR15YC	BPR6HS	3
P15	BM7A	
P15Y	BPM7A	
P17	BM6A	
P17Y	BPM6A	
PR15Y	BPMR7A	
PR17Y	BPMR6A	
U15	BM7F	
U17	BM6F	
CARLTON	→ NGK	V-Line
71010	BM7F	
71015	BM6F	
71020	BM7A	
71025	BPM7A	
71030	BM7A	
71035	BPM7A	
71040	BM6A	
71045	BPM6A	
71050	B6HS	
71055	B5HS	
71060	B4	
71065	B4H	
71070	BPMR6A	
C10S	B4H	
C7S	B6HS	
C8S	B5HS	
C9	B4	
CA5E	BM7A	
CA5Y	BPM7A	
CA6	BPMR6A	
CA7E	BM7A	
CA7Y	BPM7A	
CA8E	BM6A	
CA8Y	BPM6A	
CN6E	BM7F	
CN8E	BM6F	
CHAMPION	→ NGK	V-Line
5828 / QL77JC4	BZ7HS-10	
5838 / QL78V	BUZHW-2	
5883 / QL78C	BR7HS	

CHAMPION	→ NGK	V-Line
5898 / QL76V	BUZHW	
5931 / RL82C	BR6HS	
5933 / L86CC	B6HS	
5939 / QL78YC	BPR7HS	
5942 / RV15YC4	BPR4FS-11	
860	A6FS	
870	A5FS	
A10	D7EA	
A4HC	DP9EA-9	
A50R	R2525-11	
A50R	R2198-12P	
A51R	R2525-10	
A51R	R2198-11P	
A53C	R2525-11	
A53R	R2198-10P	
A53R	R2525-11	
A55C	R2525-10	
A55R	R2525-10	
A55V	R2270-11	
A57C	R2525-10	
A57G	R2525-10	
A57R	R2525-10	
A59C	R2525-9	
A59C	D9EA	
A59G	R2525-9	
A59G	D9EVX	
A59GC	DCPR9EVX	
A59GC	R2430-9 (Ducati)	
A5YC	DP9EA-9	
A6	D8EA	
A61	D9EA	
A61G	D9EVX	
A6G	D8EVX	
A6GC	D8EVX	
A6HC	DP8EA-9	
A6Y	DP8EA-9	
A6YC	DP8EA-9	
A8	D7EA	
A8Y	DP7EA-9	
A8YC	DP7EA-9	
BL11Y	BP5FS	
BL13Y	BP5FS	
BL4	B7FS	
BL5	B7FS	
BL6	B6FS	
BL7Y	BP7FS	
BL8	B6FS	
BL9Y	BP6FS	
BN12Y	BP5EFS	
BN2	B9EFS	
BN6Y	BP7EFS	
BN7Y	BP6EFS	5



CHAMPION	→ NGK	V-Line
BN89Y	BP6EFS	5
BN9Y	BP6EFS	5
C10YCC	BCP6ES	17
C10YCC	BCP5ES	
C11YCC	BCP5ES	16
C281YC	BCP6ES	17
C55	R7234-10	exR5686-11
C55 R	R7234-10	exR5686-11
C57	R7234-9	exR5686-9
C57C	R7234-9	exR5686-9
C59	R7234-9	exR5686-9
C59C	R7234-9	
C59YC	R5672A-9	ex R5672-9
C61	R7234-8	
C6BYC	BCP7ET	
C6VPYC	BKR7EVX-11	
C6YCC	BCP7ES	
C7Y	BCP7ES	
C7YC	BCP7ES	
C7YCC	BCP7ES	
C7YCX	BCP7ES	
C9MCC	ZFR5F	
C9Y	BCP6ES	17
C9YC	BCP6ES	17
C9YCC	BCP6ES	17
C9YCX	BCP6ES	17
CJ11	BM6A	
CJ14	BM4A	
CJ17LM	B4LM	
CJ3	BM7A	
CJ4	BM7A	
CJ6	BM7A	
CJ6Y	BPM7A	
CJ7Y	BPM7A	
CJ8	BM6A	
CJ86	BM6A	
CJ8Y	BPM6A	
D10	A6	
D14	A6	
D16	A6	
D16J	A6	
D21	A6	
D6	A8	
D9	A6	
D9J	A6	
DJ6J	BM7F	
DJ6Y	BPM7F	
DJ7J	BM6F	
DJ7Y	BPM6F	
DJ8J	BM6F	
F10	A6FS	
F10C	A6FS	

CHAMPION	→ NGK	V-Line
F11Y	AP5FS	
F11YC	AP5FS	
F14Y	AP5FS	
F62Y	AP8FS	
F7Y	AP7FS	
F7YC	AP7FS	
F7YCC	AP7FS	
F81Y	AP8FS	
F-82	A8F	
F83Y	AP8FS	
F9Y	AP6FS	
F9YC	AP6FS	
FN507Y	BCP7ES	
G 56 R	R 016-10	ex R015-10
G 63 R	R 016-8	
G1	C9E	
G2	C8E	
G54V	R0045J-10	
G55	C9E	
G58	C9E	
G59C	C7E	
G61	C8E	
G63	C8E	
H03	B6S	
H10	B6L	
H10C	B6L	
H10J	B6L	
H11	B4L	
H12	B4L	
H8	B6L	
H8C	B6L	
H8J	B6L	
J10Y	BP6S	
J11	B4	
J11C	B4	
J11J	B4	
J11Y	BP5S	
J12J	B2	
J12Y	BP5S	
J12YC	BP5S	
J13Y	BP5S	
J14J	B2	
J14Y	BP5S	
J14YC	BP5S	
J17LM	B4LM	
J18Y	BP4	
J18YC	BP4	
J19LM	B2LM	
J2J	B9S	
J4	B7S	
J4C	B7S	
J4J	B7S	



CHAMPION	→ NGK	V-Line
J5	B7S	
J6	B6S	
J6C	B6S	
J6J	B6S	
J7	B6S	
J7J	B6S	
J8	B6S	
J8C	B6S	
J8J	B6S	
K13	A6	
K15J	A6	
K3G	A8	
K5G	A8	
K7	A8	
K-8	A8	
K8G	A8	
K9	A7	
L10	B6HS	
L12Y	BP5HS	
L14	B4H	
L15Y	BP4HS	
L19V	BUH	
L20V	BUH	
L288	B5HS	
L2G	B9HVX	
L3G	B8HVX	
L4G	B7HVX	
L4J	B7HS	
L5	B7HS	
L55G	B10HVX	
L61Y	BP8HS	
L64Y	BP7HS	
L66Y	BP6HS	18
L6G	B7HVX	
L6VC	BU8H	
L76V	BUHW	
L77J	B7HS	
L77J4	B7HS-10	
L77JC	B7HS	
L77JC4	B7HS-10	
L77V	BUHW	
L78	B7HS	
L78C	B7HS	
L78V	BUHW-2	
L78YC	BP7HS-10	
L78YC6	BP8HS-15	
L7J	B6HS	
L81	B7HS	
L81Y	BP7HS	
L82	B6HS	
L82C	B6HS	
L82Y	BP6HS	18

CHAMPION	→ NGK	V-Line
L82YC	BP6HS	18
L82YCC	BP6HS	18
L85	B6HS	
L85Y	BP6HS	18
L86	B6HS	
L86C	B6HS	
L86CC	B6HS	
L87Y	BP6HS	18
L87YC	BP6HS	18
L87YCC	BP6HS	18
L89CM	BP5HS	
L90	B5HS	
L90C	B5HS	
L92LCC	BP5HA	
L92Y	BP5HS	
L92YC	BP5HS	
L95Y	BP4HS	
L9G	B6HVX	
L9J	B6HS	
N1	B10ES	
N10PY	BP6EVX	
N10Y	BP6ES	4
N10Y4	BP6ES-11	
N11Y	BP5ES	8
N11YC	BP5ES	8
N11YC4	BP5ES-11	
N11YCC	BP5ES	8
N12Y	BP5ES	8
N12YC	BP5ES	8
N12YCC	BP5ES	8
N13L	ZGR5C	
N13Y	BP5ES	8
N14LY	ZGR5C	
N14Y	BP5ES	8
N16Y	BP4ES	
N16YC	BP4ES	
N178B	B8EM	
N180B	B7EM	
N19V	BUE	
N1C	B10ES	
N2	B9ES	
N21	B4ES	
N279YC	BP7ES	
N281YC	BP6ES	4
N288	B5ES	
N2C	B9ES	
N2G	B9EVX	
N3	B8ES	
N3C	B8ES	
N3G	B8EVX	
N4	B7ES	
N4C	B7ES	



CHAMPION	→ NGK	V-Line
N4G	B7EVX	
N4YC	BP9ES	
N5	B6ES	
N52R	-----	
N54R	B10EG	
N55G	B105EGV	
N56R	B105EGP	
N57	B10ES	
N57G	B105EGV	
N57R	B10EG	
N59G	B95EGV	
N5C	B6ES	
N5G	B6EVX	
N6	B6ES	
N60	B9ES	
N60R	B8EG	
N60Y	BPR10EVX	
N62R	B8EG	
N63Y	BP9ES	
N64Y	BP8ES	
N65Y	BP7ES	
N66Y	BP6ES	4
N6BYC	BP6ET	
N6GY	BP8EVX	
N6Y	BP8ES	
N6YC	BP8ES	
N6YCC	BP8ES	
N7	B7ES	
N74C	BUR6EB-11/B6EB-11	
N79Y	BP6ES	4
N7BMC	BP6ET	
N7BYC	BP6ET	
N7GY	BP7EVX	
N7Y	BP7ES	
N7YC	BP7ES	
N7YCC	BP7ES	
N7YCX	BP7ES	
N8	B6ES	
N80	B10EG	
N80G	B11EGV	
N82	B10EG	
N82G	B105EGV	
N84	B9EG	
N84G	B95EGV	
N86	B9EG	
N86G	B9EGV	
N87	B8EG	
N87G	B8EGV	
N8GY	BP6EVX	
N8L	ZGR5C	
N8Y	BP6ES	4
N9BMC	BPR5EKU	

CHAMPION	→ NGK	V-Line
N9BYC	BP6ET	
N9BYC4	BP5ET-10	
N9Y	BP6ES	4
N9YC	BP6ES	4
N9YC4	BP6ES-11	
N9YCC	BP6ES	4
N9YCX	BP6ES	4
OBL9Y	BPR6FS	
OJ11Y	BP6S	
OJ12Y	BP5S	
OJ13Y	BP5S	
ON11Y	BPR5ES	6
ON12Y	BPR5ES	6
ON3	BR8ES	
P10Y	D6HA	
P7	D8HA	
P7G	DR8HS	
P8Y	D6HA	
PG2PHP	PMR8A	
PG4PHP	PMR7A	
PZ7HC	C7HSA	
QC12PEP	PZFR6H	
QC12YC	BKR5ES	
QL16V	BUZ8H	
QL6VC	BU8H	
QL76V	BUZHW	
QL77CC	BR8HS	
QL77J4	BZ7HS-10	
QL77JC4	BZ7HS-10	
QL78C	BR7HS	
QL78V	BUZHW-2	
QL78YC	BPR7HS	
QL7J5	BR6HS	
QL81Y	BPZ7HS-10	
QL82C	BR6HS	
QL82YC	BPR6HS	3
QL86	BR6HS	
QL87YC	BPR6HS	3
QL92LCC	BP8HS-10	
QN2	BR9ES	
QN2C	BR9ES	
QN2G	BR9EVX	
QN3	BR8ES	
QN3C	BR8ES	
QN84	BR9EG	
QN86	BR8EG	
R10	D6EA	
R54G	R 217-11	
R6	D8EA	
R6G	D8EVX	
R8	D7EA	
RA2HC	DPR9EA-9	



CHAMPION	→ NGK	V-Line
RA4HC	DCPR9E	
	16er Schlüsselweite	
RA4HC	DPR9EA-9	
	18er Schlüsselweite	
RA4HCC	DCPR8E	
RA59GC	DCPR9EVX	
RA59PP	D9EVX	
RA6	DR8ESL	
RA6HC	DPR8EA-9	
RA6HC	DCPR8E	
RA6Y	DPR8EA-9	
RA6YC	DPR8EA-9	
RA8HC	DCPR7E	
RA8Y	DPR7EA-9	
RA8YC	DPR7EA-9	
RBL11Y	BPR5FS	
RBL11Y6	BPR5FS-15	
RBL12	BR5FS	
RBL12-6	BR5FS-15	
RBL13Y	BPR5FS	
RBL13Y6	BPR5FS-15	
RBL15Y	BPR4FS	
RBL15Y4	BPR4FS-11	
RBL15Y6	BPR4FS-15	
RBL16Y	BPR4FS	
RBL17Y	BPR4FS	
RBL17Y6	BPR4FS-15	
RBL8	BR6FS	
RBL8-6	BR6FS-15	
RBL9Y	BPR6FS	
RBN12Y	BPR5EFS	
RBN13Y	BPR5EFS	
RBN14Y	BPR5EFS	
RBN9Y	BPR6EFS	7
RC10DMC	BKR5EK	23
RC10ECC	ZFR6F-11	
RC10PYC	BKR6EVX	0,8
RC10PYP4	PFR5J-11	
RC10PYP4	PFR5G	
RC10VTYC4	BPR5EKUP	
RC10YC4	BCPR6ES-11	11
RC10YCC	BKR6E	28
RC11LCC4	BRE527Y-11	
RC12LYC	ZFR5F	
RC12MC4	PZFR5F-11	
RC12MC5	ZFR5F-11	
RC12PYP	PFR5J-11	
RC12YC	BKR5ES	
RC12YC5	FR45	
RC14YC	BKR5ES	
RC14YC4	BKR5E-11	
RC6VPYC	BKR7EVX-11	

CHAMPION	→ NGK	V-Line
RC6YC	BCPR7ES	
RC7BMC	BCPR6ET	
RC7BYC4	BCPR6ET	
RC7GYC	BKR7EVX-11	
RC7Y	BCPR7ES	
RC7YC	BCPR7ES	
RC7YC4	BKR7ES-11	
RC7YCC	BCPR7ES	
RC7YCC4	BKR7ES-11	
RC87PYC	BKUR6ET-10	24
RC87YCL	BKR6EZ	
RC87YCL	PFR6G-9	
RC89PYC	BKUR5ET-10	
RC89YCC	BKR5EZ	
RC8BYC	BKR6EKC	26
RC8DMC	BKR6EK	20
RC8PYCB	PFR6G-9	
RC8PYP	PFR6J-11	
RC8PYPB4	PFR5G-13E	
RC8PYX	FR7KDC	
RC8VTYC4	BUR6ET-10	
RC8VTYC4	BKUR6ET-10	24
RC8YC4	BKR5E-11	
RC8YCL	BKR6ES	28
RC9BMC	BKR5EKU	only VAG
RC9MC4	ZFR5F-11	
RC9MCC	ZFR6F	
RC9Y	BKR6E	28
RC9YC	BKR6E	28
RC9YC4	BCPR6ES-11	11
RC9YCC	BKR6E	28
RCJ4	BMR7A	
RCJ6	BMR7A	
RCJ6Y	BPMR7A	
RCJ7Y	BPMR7A	
RCJ8	BMR6A	
RCJ8Y	BPMR6A	
RD14	A6	
RD16	A6	
RD16J	A6	
RD9	A6	
RDJ6J	BM7F	
RDJ7J	BMR6F	
RDJ7Y	BPMR6F	
RDJ8J	BMR6F	
RE10LC	SR5	
RE14MCC5	LZTR4A-11	
RE7PYC5	PTR5A-13	25
RE7YCC	PTR5A-13	25
REA8MCL	LZKAR7A	
REC10PYC4	LFR5AP-11	
REC9YCL	LFR5B	



CHAMPION	→ NGK	V-Line
RES9YCC4	PTR5A-13	25
RF10	AR6FS	
RF10C	AR6FS	
RF11Y	APR6FS	
RF11YC	WR5	
RF11YC	APR6FS	
RF12-5	AR5FS-11	
RF14Y	APR5FS	
RF7YC	APR6FS	
RF7YCC	APR6FS	
RF9Y	APR6FS	
RF9Y5	APR6FS	
RF9YC	APR6FS	
RF9YC	WR5	
RFN14LY	ZFR4F-11	
RG2PHP	CR8EVX	
RG4HC	CR9E	
RG4PHP	PMR7A	Ferrari
RG4PHP	PMR8A	
RG6YC	CR8EB	
RG6YCH	CPR8E	
RG94C	CR8E	
RH10C	B6L	
RH10C	B6L	
RH8C	----	
RJ10Y	BP6S	
RJ11	BR6S	
RJ11Y	BP5S	
RJ12C	BR6S	
RJ12Y	BP5S	
RJ12YC	BP5S	
RJ12YC	XR5	
RJ12YC	XR5	
RJ14CC	XR4	
RJ14Y	BP5S	
RJ14YC	XR4	
RJ14YC	XR4	
RJ14YC	BP5S	
RJ17LM	BR4LM	
RJ18Y	BP4	
RJ18YC	BP4	
RJ18YC	XR4	
RJ19LM	BR2LM	
RJ20Y	BP4	
RJ6	BR6S	
RJ6C	BR6S	
RJ6J	BR6S	
RJ7	BR6S	
RJ8	BR6S	
RJ8C	BR6S	
RJ8J	BR6S	
RL12Y	BPR6HS	3

CHAMPION	→ NGK	V-Line
RL19	BR5HS	
RL4J	BR7HS	
RL77J	BR7HS	
RL78	BR7HS	
RL78C	BR7HS	
RL7J	BR6HS	
RL82	BR6HS	
RL82C	BR6HS	
RL82Y	BPR6HS	3
RL82YC	BPR6HS	3
RL82YCC	BPR6HS	3
RL85	BR6HS	
RL85G	---	
RL86	BR6HS	
RL86C	BR6HS	
RL87Y	BPR6HS	3
RL87YC	BPR6HS	3
RL90	BR5HS	
RL95YC	BPR5HS	
RN10GY	BPR6EVX	
RN10VTYC	BUR5ET	22
RN10VTYC4	BUR5ET-10	21
RN10Y	BPR6ES	2
RN10Y4	BPR6ES-11	13
RN11Y	BPR5ES	6
RN11YC	BPR5ES	6
RN11YC4	BPR5ES-11	
RN11YCC	BPR5ES	6
RN12GY	BPR5EVX	
RN12MC4	BPR4EY-11	
RN12Y	BPR5ES	6
RN12YC	BPR5ES	6
RN12YC4	BPR5ES-11	
RN12YC6	BPR5ES-13	
RN12YCC	BPR5ES	6
RN13L	ZGR5C	
RN13LYC	ZGR5C	
RN14LY	ZGR5C	
RN14MC5	BPR4EY-11	
RN14PMP5	GR4	
RN14Y	BPR5ES	6
RN14Y6	BPR5ES-13	
RN14YC	GR4	
RN16Y	BPR4ES	
RN16YC5	BPR4ES-13	
RN180B	BR7EM	
RN1C	BR10ES	
RN2	BR9ES	
RN2C	BR9ES	
RN2G	BR9EVX	
RN3	BR8ES	
RN3C	BR8ES	



CHAMPION	→ NGK	V-Line
RN3G	BR8EVX	
RN4	BR7ES	
RN49G	---	
RN4C	BR7ES	
RN5	BR6ES	
RN57YC	BR10EG	
RN5C	BR6ES	
RN6	BR6ES	
RN6Y	BPR8ES	
RN6YC	BPR8ES	
RN74C	BR6EB-11	
RN79G	---	
RN7GY	BPR7EVX	
RN7Y	BPR7ES	19
RN7YC	BPR7ES	19
RN7YCC	BPR7ES	19
RN7YCC4	BPR7ES-11	
RN8	BR5ES	
RN8L	ZGR5C	
RN8VTYC4	BUR6ET	1
RN9GY	BPR6EVX	
RN9LCC	ZGR5B	
RN9LCC	---	
RN9Y	BPR6ES	2
RN9YC	BPR6ES	2
RN9YC	GR5	
RN9YC4	BPR6ES-11	13
RN9YCC	BPR6ES	2
RN9YCC	GR5	
RP10HC	DR5HS	
RP7	DR8HS	
RS10LC	TR5-1	
RS12YC	BPR5EFS	
RS12YC	TR4	
RS12YC6	BPR5EFS-13	
RS13LYC	TR4-2	
RS14LC	TR5-1	
RS14LYC	TR4-2	
RS14YC	BPR5EFS	
RS15LYC	TR4-2	
RS17YX	TR4	
RS5C	BR7EFS	
RS7YC	BPR7EFS	
RS9YC	BPR6EFS	7
RS9YCC	BPR6EFS	7
RV12C	BR5FS	
RV12C6	BR5FS-15	
RV12YC	BPR5FS	
RV12YC	UR5	
RV12YC6	BPR5FS-15	
RV15YC	BPR4FS	
RV15YC4	UR4	

CHAMPION	→ NGK	V-Line
RV15YC4	BPR4FS-11	
RV15YC6	BPR4FS-15	
RV17YC	BPR4FS	
RV17YC6	BPR4FS-15	
RV8C	BR6FS	
RV8C6	BR6FS-15	
RV91MC	BR6FS	
RV92YC	BPR5FS	
RV9YC	UR6	
RV9YC	BPR6FS	
RZ7C	CMR7H	
RZN12Y	BPR5EFS	
RZN12Y5	BPR5EFS	
S10YCC	BP5EFS	
S12YC	BP5EFS	
S279YC	BP6EFS	5
S281YC	BP6EFS	5
S379YC	BP7EFS	
S59C	R5724-9	
S6YC	BP7EFS	
S7YC	BP7EFS	
S7YCC	BP7EFS	
S9YC	BP6EFS	5
S9YCC	BP6EFS	5
UD16	A6	
UJ12	B2	
UJ2J	B8S	
UJ4J	B7S	
UJ6	B6S	
UJ8	B6S	
UJ81C	B7S	
UJ81J	B7S	
UK10	A6	
UL17V	BUHXW-1	
UL18V	BUHX	
UL4J	B7HS	
UL77V	BUHXW-1	
UL81C	B7HS	
UL81J	B7HS	
UN19V	BUE	
UN79Y	BP6ES	4
UY6	---	
V12YC	BP5FS	
V4C	B7FS	
V63C	R5673-7	
V9YC	BP6FS	
W16Y	---	
XC12PEPB	PZFR6H	
XJ10Y	BP6S	
Y82	CM6	
Z10	C6HSA	
Z10G	C7HVX	



CHAMPION	→ NGK	V-Line
Z12	C6HSA	
Z6	C8HSA	
Z7G	C7HVX	
Z8	C7HSA	
Z9Y	C7HSA	
CHRYSLER	→ NGK	V-Line
04606402AB	LZTR4A-11	
CITROEN	→ NGK	V-Line
59622A	BPR6ES	2
59622T	BKR6EKC	26
59622X	BKR6E	28
5962IA	BP5ET	
5962IK	BKR6EK	20
5962IL	BKR5EK	23
5962OE	BKR6EK	20
5962S7	BP5ES	8
5962TO	BKR6E	28
5962W1	BCPR5ES	
5962X8	BCP6ES	17
5962Z1	BKR6EK	20
5962Z6	BKR5EK	23
95496692	BP6HS	18
95605398	B6HS	
95611941	BP6EFS	5
95619043	BP6ES	4
96000090	BCP5ES	16
96037952	BCP5ES	16
96039962	BCP6ET	
96064890	BCPR5ES	
96097486	BCP7ET	
96145071	BCPR6ET	
97533994	BP7EFS	
AM212207A	B6HS	
MKP00073	BP7ES	
ZC9862090U	BP5ES	8
ZCT000011	BP6HS	18
ZCT000012	BP7ES	
DAIHATSU	→ NGK	V-Line
90048-51006-000	B8ES	
90048-51008-000	B7ES	
90048-51015-000	B6ES	
90048-51020-000	B4H	
90048-51022-000	B6HS	
90048-51033-000	B5ES	
90048-51034-000	BP6ES	4
90048-51034-010	BP6ES	4
90048-51040-000	BP6EK	
90048-51047-010	BP5EAL	
90048-51048-000	BPR5EAL	

DAIHATSU	→ NGK	V-Line
90048-51050-000	BPR5EA-11	
90048-51053-000	BP5EY	
90048-51054-000	BPR5EY	9
90048-51058-000	BE527Y-11	
90048-51059-000	BPR6EY	
90048-51063-000	BP5EJ	
90048-51068-000	BP6EJ	
90048-51069-000	BP6EY	
90048-51072-000	BP5ES	8
90048-51074-000	BP6EKA	
90048-51077-000	BPR6EKN	
90048-51081-000	BPR5EA-11	
90048-51087-000	BPR6EKA	
90048-51093-000	BPR5EY-11	
90048-51096-000	BPR6ES	2
90048-51097-000	BP2E	
90048-51100-000	BKR6E-11	14
90048-51101-000	BP5EKN	
90048-51102-000	BP6EKN	
90048-51103-000	BP7EKN	
90048-51104-000	BPR6EKN	
90048-51105-000	BPR7EKN	
90048-51108-000	BPR6EKBL	
90048-51109-000	2G-7	
90048-51114-000	BPR5ES	6
90048-51118-000	PFR6B-11	
90048-51121-000	BPR4EY	
90048-51126-000	BPR5EJ	
90048-51128-000	R 6469-9	
90048-51131-000	BPR5EKB	
90048-51136-000	BKUR6EK	
90048-51137-000	BKUR6EK	
90048-51152-000	BKR6E	28
90048-51169-000	BKUR6ETB-10	
90919-01026-000	BP5ESL	
90919-01042-000	BP5EZ	
90919-01060-000	BP5EA	
90919-01061-000	BP5EAL	
90919-01086-000	BP5EA-11	
90919-01087-000	BP5EKA	
90919-01106-000	BP4EY-11	
90919-01116-000	BPR5EP-11	
90919-01118-000	BE529Y-11	
991-1339-2361-0	AB6	
991-2311-2361-00	AB7	
992-5130-2001-00	B4	
995-2021-2361-32	B8HS	
999-3400-6911-00	BP6EVX	
999-3401-6911-00	BP5EVX	
999-3402-6911-00	B6EVX	
999-3403-6911-00	B7EVX	
999-3405-6911-00	BP5ES-11	



DAIHATSU	→ NGK	V-Line
999-3406-6911-00	BP6ES-11	
999-3407-6911-00	BP5HS	
999-3408-6911-00	BP5ES-13	
999-3409-6911-00	BP6HS	18
999-3410-6911-00	BP4EY	
DENSO	→ NGK	V-Line
9807B-5615P	ZFR6K-11	
9807B-5615W	IZFR6K-11	
J16AR-U11	BRE527Y-11	
J16A-U11	BE527Y-11	
J16AY	BP5EJ	
J16AYR	BPR5EJ	
J16BR-U	BRE529Y	
J16B-U11	BE529Y-11	
J16CRU	ZGR5E	
K14PRU-11	BKR4E-11	
K14P-U11	BKR5E-11	
K16PRP11	BKR5EVX	
K16PR-U	BKR5E	
K16PR-U11	BKR5E-11	
K16R-U	BKR5EYA	
K16R-U11	BKR5EYA-11	
K16TNRS9	BKR5EKC	
K16TR-11	BKR5EKB-11	
K20DTR-S11	ZFR6G	
K20PBR-S10	BKUR6ET-10	24
K20PR-L11	BKR6EN-11	
K20PR-TP11	BKR6EVX-11	
K20PR-U	BKR6E	28
K20PR-U11	BKR6E-11	14
K20P-U	BK6E	
K20P-U11	BK6E-11	
K20R-U	BKR6EYA	
K20R-U11	BKR6EY-11	
K20TMR11	BKR6EKC-N-11	
K20TNR-S	BKUR6EK	
K20TR-11	BKR6EKB-11	
K20TRX	BKR6EKU	
K22PB	BCP7ET	
K22PR-L11	BKR7EN-11	
K22PR-U	BKR7E	
K22PR-U11	BKR7E-11	
K22P-U11	BK7E-11	
K22TM11	BK7EK-N-11	
K22TMR	BKR7EKC-N	
K22TMR11	BKR7EKC-N-11	
K22TNR-S	BKUR7EK	
K29A-Z	R7117-10	
KJ16CR-L11	ZFR5J-11	
KJ16CR-L11	ZFR5F-11 / ZFR5J-11	
KJ206CR-L11	ZFR6F-11	

DENSO	→ NGK	V-Line
KJ20CR-L11	ZFR6F-11/ZFR6J-11	
KJ20DR-M11	ZFR6K-11	
KJ20DR-M11	ZFR6K-11	
KJ22CR-L11	ZFR7F-11 / ZFR7J-11	
KJ22CRL8	ZFR7F	
L14-U	A6	
M17	A6	
M22	A7	
M24S	A8	
MA14P-U	AP5FS	
MA16PR-U	APR5FS	
MA16PR-U11	APR5FS	
MA16PR-U15	APR5FS	
MA16P-U	AP5FS	
MA17P-U	AP6FS	
MA20PR-U	APR6FS	
MA20P-U	AP6FS	
MA20R-U	AR6FS	
MA20R-U11	AR6FS	
MA9P-U	AP4FS	
P16R	BPR5EP-11	
P16R-13	BPR5EP-13	
P20PR11	PGR6A-11	
P20R8	BPR6EP-8	
PK16PR11	PFR5B-11	
PK16PR-P11	PFR5J-11	
PK16R11	BKR5EP-11	
PK16TR11	BKR5EKP-11	
PK20GR8	BKR6EPA-8	
PK20PR11	PFR6B-11	
PK20PR-L11	PFR6G-11	
PK20PR-P	PFR6J	
PK20PR-P11	PFR6J-11	
PK20PR-TP	PFR6M	
PK20R11	BKR6EP-11	
PK20R-13	BKR6EP-13	
PK20R8	BKR6EP-8	
PK20R-P8	BKR6EP-N-8	
PK20TR11	BKR6EKP-11	
PK22PR11	PFR7B-11	
PK22PR-L11	PZFR6F-11 Honda Accord	
PK22PR-L11	PFR7G-11	
PK22PR-L11	PFR7G-11	
PK22PR-TP	PFR7M	
PKJ16CR8	PZFR5F	
PKJ16CR-L11	PZFR5F-11	
PKJ20CR8	PZFR6F	
PKJ20CR-L11	PZFR6F-11	
PQ16R	BCPR5EP-11	
PQ16R13	BCPR5EP-13	
PQ16R8	BCPR5EP-8	
PQ20R	BCPR6EP-11	



DENSO	→ NGK	V-Line
PQ20R13	BCPR6EP-13	
PQ20R8	BCPR6EP-8	
PQ20R-P11	BCPR6EP-N-11	
PQ20R-P8	BCPR6EP-N-8	
PT16EPRL13	PTR5D-10	
PT16VR-13	PTR5A-13	25
Q14R-U11	BCPR4EY-11	
Q16PR-U	BCPR5E	
Q16PR-U11	BCPR5EY-11	
Q16P-U11	BCP5EY-11	
Q16RU	BCPR5EY	
Q16RU-11	BCPR5EY-11	
Q16-U	BCP5EY	
Q20PR-P11	BCPR6EVX-11	
Q20PR-U	BKR6E	28
Q20PR-U11	BCPR6EY-11	
Q20P-U	BCP6ES	17
Q20P-U11	BCP6E-11	
Q20R-U11	BCPR6EY-11	
Q22PR-U	BCPR7ES	
Q22PR-U11	BCPR7ES-11	
Q22P-U	BCP7ES	
Q22P-U11	BCP7ES-11	
Q27A-Z	R7232-9	ex R 5400-9
QJ16AR-U	BCRE527Y	
QJ20CR-11	ZFR6A-11	
S27	SD9A	
S29	SD10A	
S29A	SD10A	
SD29A	SD10A	
SF-10	BUHX	
SF-50	BUHW	
SF-51	BUHW-2	
SK16PR-E11	IFR5E-11/ BKR5EIX-11P	
SK16PR-L11	IFR5G-11K	
SK16RP8	IFR5T-8N	
SK20BR11	IFR6A-11T	
SK20R11	IFR6A11	
SK22PR-M11	IFR7G-11K	
SKJ20DRM11	IZFR6K11	
SKJ20DR-M11	IZFR6K-11	
SVK20R-Z8	BKR6EP-8	
T14PR-U	BPR4FS	
T14PR-U15	BPR4FS-15	
T16EPR-U	BPR5EFS	
T16EX-U	BP5EFS	
T16PR-U	BPR5FS	
T16PR-U11	BPR5FS-11	
T16PR-U15	BPR5FS-15	
T16P-U	BP5FS	
T16R-U	BR5FS	
T16R-U15	BR5FS-15	

DENSO	→ NGK	V-Line
T20EPR-U	BPR6EFS	7
T20EP-U	BP6EFS	5
T20EX-U	BP6EFS	5
T20MP-U	BPM6F	
T20M-U	BM6F	
T20PR-U	BPR6FS	
T20PR-U11	BPR6FS-11	
T20PR-U15	BPR6FS	
T20P-U	BP6FS	
T20R-U	BR6FS	
T22EP-U	BP7EFS	
T22MP-U	BPM7F	
T22M-U	BM7F	
TR20	B6HS	
TR22	B7HS	
TR22-10	B7HS-10	
TR24	B8HS	
TR24-10	B8HS-10	
U14FSRUB	CR4HSB	
U16FS-L	C5HSA	
U16FSR-L	CR5HSA	
U16FSR-U	CR5HSA	
U16FSR-UB	CR5HSB	
U16FS-U	C5HSA	
U16FS-UB	C5HSB	
U17F	C5HSA	
U20FS	C6HSA	
U20FS-L	C6HSA	
U20FSR-U	CR6HSA	
U20FS-U	C6HSA	
U20M-U	CM6	
U22ESR-N	CR7E	
U22FS	C7HSA	
U22FS-GU	C7HVX	
U22FS-L	C7HSA	
U22FSR-L	CR7HS	
U22FS-U	C7HSA	
U24ES-N	C8E	
U24ESR-N	CR8E	
U24ETR	CR8EK	
U24FE9	C8EH-9	
U24FER9	CR8EH-9	
U24FS	C8HSA	
U24FS-C	L8A	
U24FS-L	C8HSA	
U24FSR-C	LR8A	
U24FSR-U	CR8HS	
U24FS-U	C8HSA	
U27ES-N	C9E	
U27ESR-N	CR9E	
U27ETR	CR9EK	
U27FE9	C9EH-9	



DENSO	→ NGK	V-Line
U27FER-9	CR9EH-9	
U31ESR-N	CR10E	
U31ETR	CR10EK	
VUH27D	IMR9C-9H	
W14	B4	
W14E	B4ES	
W14EPR-U	BPR4ES	
W14EP-U	BP4ES	
W14EXR-U	BPR4EY	
W14EXR-U11	BPR4EY-11	
W14EX-U	BP4EY	
W14EX-U11	BP4EY-11	
W14F	B4H	
W14FP	BP4H	
W14FP-L	BP4HS	
W14FPR	BPR4H	
W14FPR-L	BPR4HS	
W14FPR-UL	BPR4HS	
W14FPR-UL10	BPR4HS-10	
W14FP-U	BP4H	
W14FP-UL	BP4HS	
W14FP-UL10	BP4HS-10	
W14FR-U	BR4HS	
W14F-U	B4H	
W14F-U10	B4H-10	
W14L	B4L	
W14LMR-US	BR4LM	
W14LM-U	B4LM	
W14LM-US	B4LM	
W14MPR-U10	BPMR4A	
W14MP-U10	BPM4A-10	
W14MR-U	BMR4A	
W14M-U	BM4A	
W14M-US	BM4A	
W14P	BP5S	
W14PR-U	BP4	
W14-U	B4	
W14-US	B4	
W16EKR-S11	BUR5EB-11	
W16EK-S11	BUR5EB-11/BU5EB-11	
W16EP-GU	BP5EVX	
W16EPR-S11	BUR5EA-11	
W16EPR-U	BPR5ES	6
W16EPR-U11	BPR5ES-11	
W16EP-U	BP5ES	8
W16EP-U10	BP5ES-11	
W16EP-ZU	BP5EVX	
W16ES	B5ES	
W16ES-L	BR5ES/BR5EB	
W16ES-L11	BUR5EB-11/BR5EB-11	
W16ESR-U	BR5ES	
W16ES-U	B5ES	

DENSO	→ NGK	V-Line
W16ETR-S	BPR5EKA	
W16ET-S	BP5EKA	
W16EXR-U	BPR5EY	9
W16EXR-U11	BPR5EY-11	
W16EX-U	BP5EAL	
W16EX-U11	BP5EA-L-11	
W16EX-U13	BP5ES-13	
W16FP	BP5HS	
W16FP-L	BP5HA	
W16FPR	BPR5HS	
W16FPR-U	BPR5HS	
W16FP-U	BP5HS	
W16FP-U10	BP5HS-10	
W16FP-UL	BP5HA	
W16FS	B5HS	
W16FSR	BR5HS	
W16FS-U	B5HS	
W16LS	B6L	
W16PR-U	BPR5S	
W16P-U	BP5S	
W17P	BP6S	
W17PR-U	BP6S	
W20DTR-S	BKR6EKB	
W20DTR-SA	BPR6EKB-L	
W20EA	B6EM	
W20EAR	BR6EM	
W20EKR-S11	BUR6EB-11	
W20EK-S11	BUR6EB-11/BU6EB-11	
W20EP	B6ES	
W20EPB	BP6ET	
W20EPBRS	BUR6ET	1
W20EP-GU	BP6EVX	
W20EPRS-11	BUR6EA-11	
W20EPR-U	BPR6ES	2
W20EPR-U10	BPR6ES-11	13
W20EPR-U11	BPR6ES-11	13
W20EP-S11	BU6EA-11	
W20EP-U	BP6ES	4
W20EP-U11	BP6ES-11	
W20EP-ZU	BP6EVX	
W20ES	B6ES	
W20ES-GU	B6EVX	
W20ES-L	BR6ES/B6EB	
W20ES-L11	BUR6EB-11/B6EB-11	
W20ESR	BR6ES	
W20ESR-L	BR6ES/BR6EB	
W20ESR-L11	BUR6EB-11/BR6EB-11	
W20ES-U	B6ES	
W20ES-U11	B6ES-11	
W20ES-ZU	B6EVX	
W20ET	BP6EK	
W20ET-L	BP6EKN	



DENSO	→ NGK	V-Line
W20ETR-L	BPR6EKN	
W20ETR-S	BPR6EK-A	
W20ET-S	BP6EK-A	
W20EXR-U	BPR6EY	
W20EXR-U11	BPR6EY-11	10
W20EX-U	BP6EY	
W20EX-U11	BP6EY-11	
W20EX-U13	BP6ES-13	
W20FP	BP6HS	18
W20FP-L	BP6HSA	
W20FPR	BPR6HS	3
W20FPR-U	BPR6HS	3
W20FP-U	BP6HS	18
W20FP-U10	BP6HS-10	
W20FS	B6HS	
W20FS-GU	B6HVX	
W20FSR	BR6HS	
W20FSR-U	BR6HS	
W20FS-U	B6HS	
W20FS-ZU	B6HVX	
W20M	BM6A	
W20MP-U	BPM6A	
W20MP-U10	BPM6A-10	
W20MR-U	BMR6A	
W20M-U	BM6A	
W20M-US	BM6A	
W20S	B6S	
W20SR-U	BR6S	
W20S-U	B6S	
W21ES-L11	BR6EB-L-11/B6EB-L-11	
W21ESR-L11	BR6EB-L-11	
W22EA	B7EM	
W22EAR	BR7EM	
W22EB	BR7ET/B7ET	
W22EBR	BR7ET	
W22EDR	BR7EQ	
W22EDR14	BR7EQ-14	
W22EK-S11	BUR7EB-11/BU7EB-11	
W22EP	BP7ES	
W22EP11	BP7ES-11	
W22EP-GU	BP7EVX	
W22EPR-U	BPR7ES	19
W22EP-S11	BU7EA-11	
W22EP-U	BP7ES	
W22EP-ZU	BP7EVX	
W22ES	B7ES	
W22ES-GU	B7EVX	
W22ES-L	B7EB	
W22ES-L11	B7EB-11	
W22ESR	BR7ES	
W22ESR-L	BR7EB	
W22ESR-L11	BR7EB-11	

DENSO	→ NGK	V-Line
W22ESR-U	BR7ES	
W22ES-U	B7ES	
W22ES-U11	B7ES-11	
W22ES-ZU	B7EVX	
W22FP	BP7HS	
W22FPR-U	BPR7HS	
W22FP-U	BP7HS	
W22FP-U10	BP7HS-10	
W22FS	B7HS	
W22FS-GU	B7HVX	
W22FSR	BR7HS	
W22FS-U	B7HS	
W22FS-ZU	B7HVX	
W22M	BM7A	
W22MP-U	BPM7A	
W22MP-US	BPM7A	
W22M-U	BM7A	
W22M-US	BM7A	
W22S	B7S	
W22S-U	B7S	
W24EP	BP8ES	
W24EP-11	BP8ES	
W24EP-U	BP8ES	
W24ES	B8ES	
W24ES-GU	B8EVX	
W24ESR	BR8ES	
W24ESR-U	BR8ES	
W24ES-U	B8ES	
W24ES-U11	B8ES-11	
W24ES-V	B8EG	
W24ES-ZU	B8EGV	
W24FP-L	BP8HSA	
W24FP-U	BP8HS	
W24FS	B8HS	
W24FS-GU	B8HVX	
W24FSR	BR8HS	
W24FS-U	B8HS	
W24FS-U10	B8HS-10	
W24FS-ZU	B8HVX	
W24S	B8S	
W24S-U	B8S	
W25EA	B8EM	
W25EAR	BR8EM	
W25EB	BR8ET/B8ET	
W25EBR	BR8ET	
W25EDR	BR8EQ	
W25EDR14	BR8EQ-14	
W25EN	B8EG	
W25EPT	B8EGP	
W25FC	B8HCS	
W25FN	B8HVX	
W27EBR	BR9ET	



DENSO	→ NGK	V-Line
W27EDR14	BR9EQ-14	
W27EMR-C	BR9ECM	
W27EN	B9EG	
W27EPT	B9EGP	
W27ES	B9ES	
W27ES-GU	B9EVX	
W27ESR	BR9ES	
W27ES-U	B9ES	
W27ES-V	B9EG	
W27ES-ZU	B9EGV	
W27FC	B9HCS	
W27FS	B9HS	
W27FS-GU	B9HVX	
W27FSR	BR9HS	
W27FS-U	B9HS	
W27FS-U10	B9HS-10	
W27FS-ZU	B9HVX	
W27S	B9S	
W27S-U	B9S	
W29EPT	B95EGP	
W29ES-GU	B95EGV	
W29ES-ZU	B95EGV	
W31EN	B10EG	
W31EPT	B10EGP	
W31ES	B10ES	
W31ES-GU	B10EVX	
W31ES-U	B10ES	
W31ES-ZU	B10EGV	
W31FS	B10HS	
W31FS-GU	B10HVX	
W31FS-ZU	B10HVX	
W32EPT	B105EGP	
W34ES-ZU	B11EGV	
W9	B2	
W9EP	BP2E	
W9EXR-U	BPR2ES	
W9EX-U	BP2E	
W9FP	BP2H	
W9FP-L	BP2HS	
W9FP-UL	BP2HS	
W9LMR-US	BR2LM	
W9LM-US	B2LM	
W9P	BP4	
W9-U	B2	
WA20M	BM6F	
WA20M-U	BM6F	
WA22M	BM7F	
WA22M-U	BM7F	
X16FSR-U	DR5HS	
X20EPR-GL	PJR6A	
X20FS-GU	D6HVX	
X20FSR-U	DR6HS	

DENSO	→ NGK	V-Line
X20FS-U	D6HA	
X22EPR-GL	PJR7A	
X22EPR-U9	DPR7EA-9	
X22EP-U9	DP7EA-9	
X22ES-GU	D7EVX	
X22ESR-U	DR7ES	
X22ES-U	D7EA	
X24EPR-GL	PJR8A	
X24EPR-U9	DPR8EA-9	
X24EP-U9	DP8EA-9	
X24ES-GU	D8EVX	
X24ESR-U	DR8ESL	
X24ES-U	D8EA	
X24FSR-U	DR8HS	
X24FS-U	D8HA	
X24GPR-U	DPR8Z	
X24GP-U	DP8Z	
X27EPR-U9	DPR9EA-9	
X27EP-U9	DP9EA-9	
X27ESR-U	DR8ES	
X27ES-U	D9EA	
X27GPR-U	DPR9Z	
X27GP-U	DP9Z	
X31ES-U	D10EA	
XU20EPR-U	DCPR6E	
XU20EP-U	DCP6E	
XU22EPR-U	DCPR7E	
XU22EPR-ZU	DCPR7EVX	
XU22EP-U	DCP7E	
XU22EP-ZU	DCP7EVX	
XU24EPR-U	DCPR8E	
XU24EPR-ZU	DCPR8EVX	
XU24EP-U	DCP8E	
XU24EP-ZU	DCP8EVX	
Y27FER	ER9EH	
Z20ES-U	D6EA	
ENKER / BOSNA	→ NGK	V-Line
F100C	B8HS	
F45CP	BP4HS	
F50C	B5HS	
F55CP	BP5HS	
F65CP	BP6HS	18
F75C	B6HS	
F80C	B7HS	
F85CP	BP7HS	
FA50	B4L	
FA70	B6L	
FE100C	B9ES	
FE30C	B4ES	
FE35CP	BP4ES	
FE45CP	BP5ES	8



ENKER / BOSNA	→ NGK	V-Line
FE50C	B5ES	
FE55CP	BP5ES	8
FE55CPD	BP5ET	
FE65CP	BP6ES	4
FE65CPD	BP6ET	
FE70C	B6ES	
FE75C	B7ES	
FE80C	B8ES	
FE85CP	BP7ES	
FE85CPD	BP7ET	
FE85CPU	BP7ET	
FE95CP	BP8ES	
FET65CP	BP5EFS	
FET75CP	BP6EFS	5
FS20	B2	
FS30	B4	
FS35CP	BP4S	
FS50CP	BP5S	
FS55CP	BP6S	
FS70	B6S	
FS75C	B7S	
FS80	B8S	
FSC50C	BM6A	
FSC50P	BPM6A	
FSC70P	BPM6A	
FSC75CP	BPM7A	
FT45CP	BP5FS	
FT55CP	BP6FS	
FT85CP	BP7FS	
M30	AB2	
M60	A6	
M75	A7	
M80	A8	
MT45CP	AP5FS	
MT55CP	AP6FS	
MT65CP	AP7FS	
SFE55CP	BCPR5ES	
SFE65CP	BCPR6ES	
SFE65CPD	BCP6ET	
SFE85CP	BCPR7ES	
SFE85CPD	BCP7ET	
T70	C6HSA	
T90	C7HSA	
EVINRUDE	→ NGK	V-Line
204470091	BR7ES	
278000237	BR7ES	
278000608	BR7ES	
278000609	BR8ES	
MCBR10EG	BR10EG	
MCBR8EG	BR8EG	
MCBR8HS	BR8HS	

EVINRUDE	→ NGK	V-Line
MCBR9EG	BR9EG	
MCBR9ES	BR9ES	
EYQUEM	→ NGK	V-Line
1000	B8HS	
1000 MOTO	B8HS	
1000CM	B7S	
1000L	B8ES	
1000L MOTO	B8HS	
1000M	B8HS	
100M	B8HS	
1100	B9HS	
1100L	B8ES	
1100L MOTO	B8ES	
1150L	B9ES	
200	B4H	
202CT	B2LM	
300AM	B4L	
30AM	B4L	
400J	BR5FS	
406	BP6HS	18
450JS	BPR4FS-15	
450L	B5ES	
480CS	BP5S	
500AM	B6L	
500C	B6S	
500CJT	BM6F	
500CM	B6S	
500CS	BP5S	
500CT	BM6A	
500J	BR6FS	
500JS	BPR4FS	
500M	B5HS	
502 MOTO	B4H	
502CT	B4LM	
505JS	BP5FS	
50AM	B-6L	
50M	B5HS	
520CS	BP5S	
550CS	BP5S	
550JS	BPR5FS	
550LS	BP5ES	8
550S	BP4HS	
580LS	BP5ES	8
580S	BP4HS	
600CS	BP5S	
600JS	BPR6FS	
600L	B6ES	
600LS	BP6ES	4
600S	BP5HS	
700	B6HS	
700 MOTO	B6HS	



EYQUEM	→ NGK	V-Line
700CM	B6S	
700CTS	BPM6A	
705JS	BP7FS	
705L	B6ES	
705L MOTO	B6ES	
705S	BP6HS	18
705S MOBY MOTO	B5HS	
707LS	BP6ES	4
70M	B6HS	
750	BP6HS	18
750L	B6ES	
750LJS	BP6EFS	5
750LS	BP6ES	4
753LJS	BP6EFS	5
755	B6HS	
755 MOTO	B6HS	
755CJT	BM7F	
755CM	B6S	
755CT	BM7A	
755L	B6ES	
755L MOTO	B6ES	
755LJS	BP6EFS	5
755LS	BP6ES	4
755LS MOTO	BP6ES	4
755M	B6HS	
755S	BP6HS	18
75LM	B6ES	
75M	B6HS	
775SX	BP6HS	18
775X	B6HS	
800L	B6ES	
800LJS	BP6EFS	5
800LS	BP6ES	4
800LS MOTO	BP6ES	4
802L	B6ES	
803LJS	BP6EFS	5
805L	B6ES	
805L MOTO	B6ES	
805LJS	BP7EFS	
805LJSP	BP7EFVX	
805LP	B8EVX	
850	B7HS	
850 MOTO	B7HS	
850LS	BP7ES	
883LJP	B8EFS	
C32	B5HS	
C32LS	BP5ES	8
C32S	BP5HS	
C42LJS3	BP6EFS	5
C42S	BP6HS	18
C52LS	BP5ES	8
C62	B7HS	

EYQUEM	→ NGK	V-Line
C62LJS	BP6EFS	5
C62LJS	BP6EF	
C62LS	BP6ES	4
C62LS	BP6E	
C62LS3X	BP5ET	
C62S	BP7HS	
C72LJS	BP7EFS	
C72LS	BP7ES	
C72LS3X	BP6ET	
C82LJS	BP7EFS	
C82LS	BP7ES	
C82LS3X	BP7ET	
C92LS	BP8ES	
D1000	D8HA	
D1000 MOTO	D8HA	
D1000L	D9EA	
D1050L	D9EA	
D755 MOTO	D6HA	
D775	D6HA	
D800L	D7EA	
D800L MOTO	D7EA	
D900L	D8EA	
FC42LS	BCP5ES	
FC52LS	BCP5ES	16
FC52LS	BCP5E	
FC58LS	BCP6ES	17
FC62LS	BCP6ES	17
FC62LS2	BCP6ES	17
FC62LS3	BCP6ET	
FC62LS3X	BCP6ET	
FC72LS	BCP7ES	
FC82LS	BCP7E	
FC82LS1	BCP7ES	
FC82LS2	BCP7ES	
FN52LS	BK5ESZ	
K200M	A6	
K300J	A5FS	
K300JS	AP5FS	
K300M	A6	
K350JS	AP5FS	
K450JS	AP5FS	
K500M	A6	
K550JS	AP6FS	
K600M	A6	
K750M	A7	
KC62JS	AP6FS	
R1000	BR8HS	
R1000L	BR8ES	
R850	BR7HS	
RC32LS5	BPR4ES-11	
RC42S	BPR6HS	3
RC52LS	BPR5EA	



EYQUEM	→ NGK	V-Line
RC52LS5	BPR5EA-11	
RC52LZ3EX	BUR5ET	22
RC52LZE	ZGR5A	
RC58LZ3EX	BUR6ET	1
RC62HJSDP	PTR5A-13	25
RC62LJS	BPR6EFS	7
RC62LS	BPR6ES	2
RC62LS5	BPR6ES-11	13
RC62S	BPR7HS	
RC82LS	BPR7ES	19
RC82LS5	BPR7EY-11	
RFC42LS	BCPR5ES	
RFC42LS2E	BKR5EK	23
RFC50LZ2E	BKR5EK	23
RFC52LS	BCPR5ES	
RFC52LS3	BCPR5ET	
RFC52LS5	BCPR5ES-11	
RFC52LS5	BKR5E-11	
RFC52LSP	BKR6EK	
RFC52LZE	ZFR5F	
RFC52LZK	BKR5EZ	
RFC57LS3	BCPR6ET	
RFC58LS	BKR6E	28
RFC58LS2E	BKR6EK	20
RFC58LS3	BCPR6ET	
RFC58LS5	BKR6ES-11	
RFC58LS5	BCPR6ES-11	11
RFC58LSP	BKR6EZ	
RFC58LZ	BKR6EY	
RFC58LZ2	BKR6EKC	26
RFC58LZ2E	BKR5EZ	
RFC58LZ3EX	BKUR6ET	27
RFC58LZ5	BKR6EY-11	
RFC58LZE5	ZFR6F-11	
RFC62LS3X	BCPR6ET	
RFC62LS5	BCPR6ES-11	11
RFC62LZ3X	BKUR7ET	
RFC82LS	BCPR7ES	
RFC82LS5	BCPR7ES-11	
RFN52HZ	LFR5B	
RFN58HZ	LFR6B	
RFN58LZ	BKR6EK	
T850	C7HSA	
XKC62JS	APR6FS	
FERRARI	→ NGK	V-Line
192637	PMR8B	
FIAT	→ NGK	V-Line
46144731	DCPR8E	
46229251	BP6ES	4
46417010	BKR6E	28

FIAT	→ NGK	V-Line
46449690	BKR6EKPA	
46463801	BKR6EKC	26
46471078	BKUR6ETB	
46472021	BKR6EKC	26
46475164	BCPR7ET	
46521529	BKR6EKPA	
46521530	PMR7A	
46531917	DCPR8EKC	
46550992	CR7EKC	
5894585	BPR7ES	19
5894586	BKR6E	28
5894588	BCPR7ES	
5896824	BKR6EKC	26
5984036	BPR6ES	2
60504563	BP6ES	4
60512848	BCP6ET	
60512929	B7ES	
60569957	PFR6B	
60597490	BCP7ES	
60800325	BPR7ES	19
60806024	BP6ET	
60810689	PFR6B	
71711638	BKR6E	28
71711639	BPR6ES	2
71711640	BPR6ES	2
71711806	BPR6ES	2
71711808	BKR6E	28
7546519	BKR6E	28
7554436	BPR7ES	19
7554442	BP6ES	4
7554444	BPR6ES	2
7554445	BP6HS	18
7565476	BR8ES	
7686643	BP6ET	
7760381	BPR7ES	19
7760382	BPR6ES	2
7760383	BKR6E	28
7760384	BCPR7ES	
7769243	BCPR6ET	
7772453	BKR6E	28
7772515	BPR7ES	19
7910247204	BPR6EFS	7
7FYSR	BPR7ES	19
7FYSSR	BPR7ES	19
7GBYSR4	BCPR7ET	
7GYSSR	BCPR7ES	
9614738680	BKR6EK	20
9618494580	BKR5EK	23
9618571880	BKR6EK	20
9619624580	BKR5EK	23
9FYSSR	BPR6ES	2
9GYSSR	BKR6E	28



FORD	→ NGK	V-Line
1032705	BKR5EKUP	
1032705	BKR5EKUP	
1077002	PTR5A-13	25
1120170	PZFR5D-11	
1202935	PLTR6A-10G	
1204572	PTR6F-13	
1219309	TR5B-13	
AGFS22FE13J	PTR6F-13	
AGPR32PD	BKR5EKUP	
AGPS44F	PZFR5D-11	
AYFS22FE1J	PLTR6A-10G	
AYFS32CJ	TR5B-13	
FUJI	→ NGK	V-Line
065-01400-10	B4	
065-01400-20	B4H	
065-01400-31	B6HS	
065-01400-41	B7HS	
065-01400-50	B7ES	
065-01400-60	B6HS	
065-01400-80	B4	
065-01400-90	B7HS	
065-01401-00	B6ES	
065-01401-10	B4H	
065-01401-30	B7ES	
065-01401-40	B8ES	
065-01401-50	BR6HS	
065-01401-60	B9ES	
065-01401-70	BP4H	
065-01401-80	BR7HS	
065-01401-90	BP4HS	
065-01402-10	BP6HS	18
065-01402-20	B10EVX	
065-01402-30	BP5ES	8
065-01402-40	BR8ES	
065-01402-50	BR9ES	
065-01402-60	BP5HS	
065-01402-70	BPR4HS	
065-01402-80	BPR5ES	6
065-01403-00	BP6ES	4
065-01403-10	BR4HS	
065-01403-20	BPR4HS-10	
065-01403-30	BPR4ES	
065-01403-40	BP2HS	
065-01403-60	BP2H	
065-01403-70	BM4A	
065-01403-80	BMR4A	
065-01403-90	BP4HS	
065-01404-10	B2H	
065-01404-20	BPR6HS	3
065-01404-30	BPM6A	
065-01404-60	BM6A	

FUJI	→ NGK	V-Line
065-01404-70	BMR6A	
065-01405-00	B9HS	
065-01405-10	BR6HS	
932-05410-00	B5ES	
942-05449-00	B4E	
982-05486-00	B6ES	
GUTBROD	→ NGK	V-Line
000.80.071	B6HS	
000.81.345	B4LM	
090.33.668	B4H	
090.50.572	B4HS	
090.50.805	BPR6ES	2
092.05.406	BR2LM	
092.05.900	B6S	
092.13.609	BR4LM	
092.25.081	BP5ES	8
092.32.278	BCPR5ES	
092.38.072	BPR5ES	6
092.38.467	BM6A	
092.40.182	BPR5EFS	
HARLEY-DAVIDSON	→ NGK	V-Line
10R12A	DCPR9E	
3	B6L	
3-4	BP5S	
4	B6L	
4-5	BP7HS	
4R	B6L	
4R5	BPR7HS-10	
5	B6S	
5A6	BP5EY	
5R6	BPR5EY	9
5R6A	BPR5EY-11	
5RL	ZGR5C	
6R12	DPR7EA-9	
8	B10EGV	
HONDA	→ NGK	V-Line
12290-PNE-0030	ZFR6K-11	
12290-PRB-A01	IFR7G-11K	
31911-MBW-E11	IMR8C-9H	
31912-MBW-E110	IMR9C-9H	
31912-MCW-0030	IMR9B-9H	
31914-ZOH-003	CMR4H	
31915-ZOH-003	CMR5H	
31916-ZOH-003	CMR6H	
31918-MEB-671	IFR8H11	
31988-GEV-761	ER8EH-N	
94701-00408	CR9EIA-9	
98049-58716	ER8EH	
98049-59716	ER9EH	



HONDA	→ NGK	V-Line
98049-60716	ER10EH	
98052-56471	CM6	
98056-54717	C4HA	
98056-54718	CR4HSA	
98056-55713	C5HSA	
98056-55717	C5HA	
98056-55718	CR5HSA	
98056-55777	CR5HSB	
98056-56713	C6HSA	
98056-56716	CR6HS	
98056-56717	C6HA	
98056-56718	CR6HSA	
98056-57713	C7HSA	
98056-57716	CR7HS	
98056-57717	C7HA	
98056-57718	CR7HSA	
98056-58713	C8HSA	
98056-58716	CR8HS	
98056-58717	C8HA	
98056-58718	CR8HSA	
98059-55916	CR5EH-9	
98059-57910	C7EH-9	
98059-57916	CR7EH-9	
98059-58910	C8EH-9	
98059-58916	CR8EH-9	
98059-59910	C9EH-9	
98059-59916	CR9EH-9	
98059-5991F	CR9EHVX-9	
98059-5991U	IMR9A-9H	
98059-599U	CR9EHI-9	
98059-60916	CR10EH-9	
98061-57611	DP7Z	
98061-57616	DPR7Z	
98061-58616	DPR8Z	
98061-59616	DPR9Z	
98066-54716	DR4HS	
98066-55710	D5HS	
98066-55716	DR5HS	
98066-56710	D6HS	
98066-56716	DR6HS	
98066-56717	D6HA	
98066-58714	D8HS	
98066-58716	DR8HS	
98066-58717	D8HA	
98066-60714	D10HS	
98069-38716	DR8ESL	
98069-55911	DP5EA-9	
98069-55916	DPR5EA-9	
98069-56716	DR6ES	
98069-56717	D6EA	
98069-56718	DR6EA	
98069-56911	DP6EA-9	

HONDA	→ NGK	V-Line
98069-56916	DPR6EA-9	
98069-57716	DR7ES	
98069-57717	D7EA	
98069-5771P	DR7EA	
98069-57726	DR7EA	
98069-57911	DPR7EA-9	
98069-57911	DP7EA-9	
98069-57912	DPR7EVX-9	
98069-57916	DPR7EA-9	
98069-5791U	IJR7A9	
98069-58716	DR8ES	
98069-58717	D8EA	
98069-58911	DP8EA-9	
98069-58912	DPR8EVX-9	
98069-58916	DPR8EA-9	
98069-59717	D9EA	
98069-59911	DP9EA-9	
98069-59912	DPR9EVX-9	
98069-59916	DPR9EA-9	
98069-5991F	DPR9EVX-9	
98069-60711	D10ES	
98069-60717	D10EA	
98069-63410	D13E	
98073-52710	B2	
98073-54710	B4	
98073-54740	BM4A	
98073-54744	BMR4A	
98073-54771	BPM4A	
98073-54776	BPMR4A	
98073-54941	BPM4A-10	
98073-54944	BPMR4A-10	
98073-56740	BM6A	
98073-56741	BPM6A	
98073-56744	BMR6A	
98073-56941	BPM6A-10	
98073-56944	BPMR6A-10	
98076-52711	BP2HS	
98076-52716	BPR2HS	
98076-5401G	BR4HSA-10	
98076-54710	B4H	
98076-54711	BP4HS	
98076-54713	BP4HSA	
98076-54715	BPR4HSA	
98076-54716	BR4HS	
98076-54717	BPR4HS	
98076-5471G	BR4HSA	
98076-54746	BR4HS	
98076-54747	BPR4HS	
98076-54911	BP4HS-10	
98076-54914	BPR4HS-10	
98076-54944	BPR4HS-10	
98076-55711	BP5HS	



HONDA	→ NGK	V-Line
98076-55716	BR5HS	
98076-55717	BPR5HS	
98076-55719	BP5HS	
98076-55747	BPR5HS	
98076-5601G	BR6HSA-10	
98076-56711	B6HS	
98076-56713	BP6HSA	
98076-56715	BPR6HSA	
98076-56716	BR6HS	
98076-56717	BPR6HS	3
98076-56719	BP6HS	18
98076-5671G	BR6HSA	
98076-5671M	B6HSA	
98076-56741	B6HS	
98076-56747	BPR6HS	3
98076-56917	BPR6HS-10	
98076-57710	B7HS	
98076-57711	BP7HS	
98076-57716	BR7HS	
98076-57717	BPR7HS	
98076-57740	B7HS	
98076-5801G	BR8HSA-10	
98076-58710	B8HS	
98076-58711	BP8HS	
98076-58713	BP8HSA	
98076-58715	BPR8HSA	
98076-58716	BR8HS	
98076-58717	BPR8HS	
98076-5871G	BR8HSA	
98076-5871M	B8HSA	
98076-58740	B8HS	
98076-58747	BPR8HS	
98076-59710	B9HS	
98076-59716	BR9HS	
98079-54148	BCPR4E-11	
98079-5414G	ZFR4F-11	
98079-54173	BUR4EB-11	
98079-54817	BPR4ES	
98079-54841	BP4ES	
98079-54846	BPR4ES	
98079-55140	BCP5EY-11	
98079-55141	BP5EY-11	
98079-55144	BP5ES-11	
98079-55145	BPR5ES-11	
98079-55146	BPR5EY-11	
98079-55147	BCPR5ES-11	
98079-55148	BCPR5E-11	
98079-55149	BCPR5EY-11	
98079-5514A	BCPR5EYN-11	
98079-5514B	BCP5E-11	
98079-5514E	BKR5E-11	
98079-5514F	BCPR5EVX-11	

HONDA	→ NGK	V-Line
98079-5514H	PFR5G-11	
98079-5514J	BKR5EN-11	
98079-5514P	ZFR5J-11	
98079-5515G	ZFR6F-11	
98079-55173	BUR5EB-11	
98079-55174	BU5EB-11	
98079-55176	BR5EB-11	
98079-55178	B5EB-11	
98079-55810	B5ES	
98079-55811	BP5ES	8
98079-55816	BR5ES	
98079-55817	BPR5ES	6
98079-55840	B5ES	
98079-55841	BP5ES	8
98079-55844	BP5EVX	
98079-55846	BPR5ES	6
98079-55847	BR5ES	
98079-55848	B5EB	
98079-55849	BR5EB	
98079-5585V	ZGR5A	
98079-5587V	ZGR5A	
98079-55941	BP5EY	
98079-55946	BPR5EY	9
98079-56140	BCP6EY-11	
98079-56144	BP6ES-11	
98079-56145	BPR6ES-11	13
98079-56146	BPR6EY-11	10
98079-56147	BCPR6ES-11	11
98079-56148	BCPR6E-11	11
98079-56149	BCPR6EY-11	
98079-5614A	BCPR6EYN-11	
98079-5614B	BCP6E-11	
98079-5614E	BKR6E-11	14
98079-5614F	BCPR6EVX-11	
98079-5614G	ZFR6F-11	
98079-5614H	PFR6G-11	
98079-5614J	BKR6EN-11	
98079-5614N	PZFR6F-11	
98079-5614P	ZFR6J-11	
98079-5615G	ZFR6F-11	
98079-5615N	PZFR6F-11	
98079-56173	BUR6EB-11	
98079-56174	BU6EB-11	
98079-56175	BP6EY-11	
98079-56178	B6EB-11	
98079-56179	BR6EB-11	
98079-5617U	IFR6L11	
98079-5617U	IFR6L11	
98079-56614	B6EVX	
98079-56810	B6ES	
98079-56811	BP6ES	4
98079-56817	BR6ES	



HONDA	→ NGK	V-Line
98079-56840	B6ES	
98079-56841	BP6ES	4
98079-56844	BP6EVX	
98079-56846	BPR6ES	2
98079-56847	BR6ES	
98079-56848	B6EB	
98079-56849	BR6EB	
98079-56941	BP6EY	
98079-56946	BPR6EY	
98079-569BU	IFR6C-S	
98079-57140	BCP7EY-11	
98079-57144	BP7ES-11	
98079-57145	BPR7ES-11	
98079-57146	BPR7EY-11	
98079-57147	BCPR7ES-11	
98079-57148	BCPR7E-11	
98079-57149	BCPR7EY-11	
98079-5714A	BCPR7EYN-11	
98079-5714B	BCP7E-11	
98079-5714E	BKR7E-11	
98079-5714F	BCPR7EVX-11	
98079-5714G	ZFR7F-11	
98079-5714H	PFR7G-11	
98079-5714J	BKR7EN-11	
98079-5715H	PFR7G-11	
98079-57173	BUR7EB-11	
98079-57174	BU7EB-11	
98079-57175	BR6EBL-11	
98079-57176	B6EBL-11	
98079-57177	BR7EB-11	
98079-57178	B7EB-11	
98079-57179	BP7EY-11	
98079-5717U	IFR7L11	
98079-57614	B7EVX	
98079-57810	B7ES	
98079-57811	BP7ES	
98079-57816	BR7ES	
98079-57840	B7ES	
98079-57841	BP7ES	
98079-57846	BPR7ES	19
98079-57847	BR7ES	
98079-57848	B7EB	
98079-57849	BR7EB	
98079-5785G	ZFR7F	
98079-57876	BR7ES	
98079-57877	BR7ES	
98079-5787G	ZFR7F	
98079-57941	BP7EY	
98079-57946	BPR7EY	
98079-5814E	BKR8E-11	
98079-58644	B8EVX	
98079-58646	BR8EVX	

HONDA	→ NGK	V-Line
98079-58648	B8EG	
98079-58649	BR8EG	
98079-58678	B8EG	
98079-58679	BR8EG	
98079-58810	B8ES	
98079-58816	BR8ES	
98079-58819	BR8ECS	
98079-58840	B8ES	
98079-58842	B8ECS	
98079-58845	BR8ECM	
98079-58846	BR8ES	
98079-58847	BPR8ES	
98079-58870	B8ES	
98079-58876	BR8ES	
98079-59644	B9EVX	
98079-59646	BR9EVX	
98079-59648	B9EG	
98079-59649	BR9EG	
98079-59678	B9EG	
98079-59679	BR9EG	
98079-59810	B9ES	
98079-59811	B9ES	
98079-59816	BR9ES	
98079-59819	BR9ECS	
98079-59842	B9ECS	
98079-59845	BR9ECM	
98079-59847	BR9ES	
98079-59870	B9ES	
98079-59876	BR9ES	
98079-60616	BR10EVX	
98079-60646	BR10EVX	
98079-60648	B10EG	
98079-60649	BR10EG	
98079-60676	BR10EVX	
98079-60678	B10EG	
98079-60679	BR10EG	
98079-60817	BR10ES	
98079-60819	BR10ECS	
98079-60842	B10ECS	
98079-60845	BR10ECM	
9807B-5615W	IZFR6K11	
9807B-5617W	IZFR6K11	
98179-56841	BP6ES	4
ISKRA	→ NGK	V-Line
F100RS	BR8HS	
F100S	B8HS	
F20	B4H	
F50	B5HS	
F55PS	BP5HS	
F65PRS	BPR6HS	3
F65PS	BP6HS	18



ISKRA	→ NGK	V-Line
F70	B5HS	
F75RS	BR6HS	
F75S	B6HS	
F805RS	BR7HS	
F80S	B7HS	
F85PS	BP7HS	
F95PS	BP7HS	
FE100RS	BR9ES	
FE100S	B9ES	
FE145P	BP9ES	
FE155P	BP8EVX	
FE45P	BP5ES	8
FE50	B5ES	
FE55LRS	ZGR5A	
FE55LTXS	BUR5ET	22
FE55LXS	ZGR5A	
FE55PRS	BPR5ES	6
FE55PS	BP5ES	8
FE55PTS	BP5ET	
FE65LTXS	BUR6ET	1
FE65PP2	BP6EVX	
FE65PRP2	BPR6ES	2
FE65PRS	BPR6ES	2
FE65PS	BP6ES	4
FE65PTRS	BPR6ET	
FE65PTS	BP6ET	
FE75RS	BR7ES	
FE75S	B7ES	
FE80RS	BR8ES	
FE80S	B8ES	
FE85PRS	BPR7ES	19
FE85PS	BP7ES	
FE85PTRS	BP7ET	
FE85PTS	BP7ET	
FET55PRS	BPR5EFS	
FET55PS	BP5EFS	
FET65PRS	BPR6EFS	7
FET65PS	BP6EFS	5
FET75PRS	BPR7EFS	
FET75PS	BP7EFS	
FS50KR	BR2LM	
FS55P	BP6S	
FS70	B6S	
FS70C	BPM6A	
FS75	B7S	
FS75C	BPM7A	
FT65PS	BP6FS	
FT95PS	BP8FS	
FUT55PRP2-13	PTR5A-13	25
M60	A6	
M75	A7	
M80	A8	

ISKRA	→ NGK	V-Line
MT65PRS	APR6FS	
MT65PS	AP6FS	
SFE55LRS	ZFR5F	
SFE55LXS	ZFR5F	
SFE55PRS	BKR5ES	
SFE55PRS	BCPR5ES	
SFE55PS	BCP5ES	16
SFE55PTRS	BCPR5ET	
SFE55PTS	BCP5ET	
SFE65LDRS	BKR5EK	23
SFE65LRS	ZFR6A-11	
SFE65LTXS	BKUR6ET	27
SFE65LXS	ZFR6A-11	
SFE65PDRS	BKR6EKC	26
SFE65PRS	BKR6ES	28
SFE65PRS	BKR6E	28
SFE65PS	BCP6ES	17
SFE65PTRS	BCPR6ET	
SFE65PTS	BCP6ET	
SFE85LDRS	BKR6EK	20
SFE85LTRS	BKUR7ET	
SFE85PR5	BKR7ES	
SFE85PRS	BCPR7ES	
SFE85PS	BCP7ES	
SFE85PTRS	BCPR7ET	
SFE85PTS	BCP7ET	
T90	C7HSA	
TWE85PRS	DCPR8E	
TWE85PS	DCP7E	
ISOLATOR	→ NGK	V-Line
6B	BP6HS	18
7A	B6HS	
7B	BP6HS	18
7D	BP6ES	4
A5D	BP7EFS	
A7D	BP6EFS	5
FM14-145/2	BP5ES	8
FM14-175/2	BP6ES	4
FM14-200/2	BP6ES	4
FM14-225/2	BP7ES	
M14-145	B5HS	
M14-175	B6HS	
M14-175/2	B6ES	
M14-225	B7HS	
M14-240	B8HS	
M14-260	B9HS	
M14-95	B4H	
M18-225	A7	
M18-240	A7	
PM14-225	BP7HS	
U7D	BCP6ES	17



ISOLATOR	→ NGK	V-Line
U8D	BCP5ES	16
ZM14-260	B8HS	
ISUZU	→ NGK	V-Line
5-81380001-0	BPR5ES	6
5-81380003-0	BP5EVX	
5-81380004-0	BP6EVX	
5-81380012-0	BP5EY	
5-81380013-0	BP6EY	
8-94120560-0	BPR5ES-11	
8-94217232-0	BPR6ES-11	13
8-94219943-0	BPR6ES	2
8-94235966-0	BP5ES-11	
8-94241059-0	BP6ES-11	
8-94328372-0	BKR6-11	
8-94328373-0	BKR7E-11	
8-97012928-0	BKR6E	28
9-82513103-0	BP6ES	4
9-82513105-0	B6ES	
9-82513106-0	BP5ES	8
9-82513107-0	B5ES	
9-82513113-0	B7ES	
ITALJET	→ NGK	V-Line
94004	BR7HS	
94015	DR8EA	
94025	BR8HS	
94029	BR9ES	
94032	CR7E	
JAPCAR	→ NGK	V-Line
123762	BP5ES	8
123770	BP6ES	4
123778	BPR5ES	6
123789	BPR6ES	2
123801	BPR7ES	19
123825	BPR5ES-11	
123834	BPR6ES-11	13
123887	BPR5ES	6
123899	BPR6ES	2
123908	BPR7ES	19
123932	BPR5ES-11	
123940	BPR6ES-11	13
123993	BPR7ES-11	
123996	BR7ES	
124040	BPR7ES-11	
124144	BPR6ES-11	13
166573	BPR6ES	2
167605	PFR6J-11	
170006	BPR6ES-11	13
172988	BPR5ES	6
172994	PGR6A-11	

JAPCAR	→ NGK	V-Line
172996	PGR6B	
172998	PGR6A-11	
173939	BKR6E-11	14
177391	BKR6E-11	14
207417	PFR6J-11	
239214	PFR5J-11	
277200	BKR5E-11	
277201	BKR5E-11	
279427	PFR5J-11	
JOHNSON	→ NGK	V-Line
204470091	BR7ES	
278000237	BR7ES	
278000608	BR7ES	
278000609	BR8ES	
MCBR10EG	BR10EG	
MCBR8EG	BR8EG	
MCBR8HS	BR8HS	
MCBR9EG	BR9EG	
MCBR9ES	BR9ES	
K & N	→ NGK	V-Line
XP422	PFR6G-11	
KAWASAKI	→ NGK	V-Line
92070-2077	BPR6ES	2
E92070001	B7HS	
E92070014	B6ES	
E92070015	B7ES	4mm Anschluß
E92070036	B9HS	
E92070037	B8ES	
E92070037	B8ES	
E92070054	B9ES	
E92070054	B9ES	
E920701002	B7ES	SAE Anschluß
E920701019	DR8ES	
E920701019	DR8ES	
E920701024	BP6ES	4
E920701025	BPR6ES	2
E920701025	BPR6ES	2
E920701026	BP7ES	
E920701027	BPR7ES	19
E920701034	D9EA	
E920701034	D9EA	
E920701044	BPR8ES	
E920701065	DPR8EA-9	
E920701065	DPR8EA-9	
E920701066	DP8EA-9	
E920701068	DPR9EA-9	
E920701068	DPR9EA-9	
E920701109	BR9ES	
E920701109	BR9ES	



KAWASAKI	→ NGK	V-Line
E920701113	DR7ES	
E920701114	C6HSA	
E920701116	DR8ESL	
E920701116	DR8ESL	
E920701125	DPR7EA-9	
E920701125	DPR7EA-9	
E920701138	DPR6EA-9	
E920701143	CR9E	
E920701143	CR9E	
E920701145	CR9EK	
E920701145	CR9EK	
E920701154	CR7HSA	
E920701155	CR8HSA	
E920701155	CR8HSA	
E920701158	CR8EK	
E920701158	CR8EK	
E920701169	CR8E	
E920701169	CR8E	
E920701173	BR10ES	
E920701189	DR9EA	
E920701189	DR9EA	
E920701199	DR8EA	
E920701199	DR8EA	
E920701209	CR7E	
E920701209	CR7E	
E920701250	DPR5EA-9	
E920701250	DPR5EA-9	
E920701254	CR9EKPA	
E920701255	CR8EKPA	
E920702078	BR8ES	
E920702078	BR8ES	
KIA	→ NGK	V-Line
OK558 18110	PFR6N-11	
KLG	→ NGK	V-Line
F100	B8HS	
F20	B4H	
F220	B9HS	
F50	B5HS	
F55P	BP5HS	
F65P	BP6HS	18
F70	B5HS	
F75	B6HS	
F80	B7HS	
F85P	BP6HS	18
F95P	BP7HS	
FA50	B4L	
FA70	B6L	
FE100	B8ES	
FE125P	BP6ES	4
FE135P	BP7ES	

KLG	→ NGK	V-Line
FE145P	BP8ES	
FE155P	BP8ES	
FE220	B9ES	
FE30	B4ES	
FE45P	BP5ES	8
FE50	B5ES	
FE55P	BP5ES	8
FE65P	BP6ES	4
FE70	B5ES	
FE75	B6ES	
FE80	B7ES	
FE85P	BP6ES	4
FE95P	BP7ES	
FS100	B8S	
FS100H	B9S	
FS20	B2	
FS30	B4	
FS35P	BP4	
FS45P	BP5S	
FS50	B6S	
FS55P	BP6S	
FS70	B6S	
FS75	B7S	
FS75H	B7S	
FT55P	BP5FS	
FT65P	BP5FS	
FT85P	BP6FS	
FT95P	BP7FS	
GT4S	BP5S	
GT4T	AP5FS	
GT5	BP5HS	
GT5L	BP5ES	8
GT5T	AP5FS	
GT6	BP6HS	18
GT6L	BP6ES	4
GT6T	AP6FS	
GT7	BP7HS	
GT7L	BP7ES	
GT8L	BP8ES	
M30	AB2	
M50	A6	
M60	A6	
M75	A7	
M80	A8	
MT45P	AP5FS	
MT55P	AP5FS	
MT65P	AP5FS	
MT75P	AP6FS	
MT85P	AP6FS	
T90	C7HSA	
TMT50	A5FS	
TW270	D6HA	



KLG	→ NGK	V-Line
TW275	D6HA	
TW280	D8HA	
TWE270	D8EA	
TWE275	D9EA	
KUBOTA	→ NGK	V-Line
07909-2225-0	BM6A	
07909-2226-0	BM7A	
10101-6771-6	G27	
10202-6771-6	AB6	
10261-6771-6	G2Z	
12168-6771-1	BP4HS-10	
12268-6771-1	BP2E	
12273-6771-1	BP5HM	
12366-6771-6	BR4HS	
12392-6771-1	BP5ES	8
12581-6771-1	BCP6ES-11	
12647-6771-1	BPR6HS	3
12681-6774-1	BR5ES	
12691-6771-1	BCP4ES-11	
12863-6771-1	BP5ES	8
12866-6771-1	BP5ES	8
12992-6771-1	BPR5ES	6
13078-6771-6	BP6ES	4
13157-6771-2	BM4A	
13173-6771-6	B4H-10	
13193-6771-1	B4H-10	
13211-6771-6	B4	
13281-6771-6	B4H	
13301-6771-6	AB2	
13373-6774-1	BMR4A	
13374-6774-1	BPR4HS	
13375-6774-0	BP5ES	8
13375-6774-1	BPR4HS-10	
13401-6771-6	B6S	
13412-6771-6	B7S	
13451-6771-6	B6HS	
13581-6771-6	B7HS	
13582-6771-1	B6HS	
13641-6771-1	B4H	
13711-6771-6	B4-10	
13742-6771-6	BP4HS-10	
13901-6771-6	BP6HS	18
13979-6771-1	BP4HS	
LODGE	→ NGK	V-Line
15HLNY	BP6ES	4
25HLD	BCP6ET	
25HLNY	BP7ES	
25XL	BP6ES	4
2BTNY	AP5FS	
2H	B7HS	

LODGE	→ NGK	V-Line
2H12	D8HA	
2HA	B6S	
2HL	B7ES	
2HL10	C7HSA	
2HLD	BCP6ES	17
2HL-E	B7ES	
2HLN	B7ES	
2HLNY	BP7ES	
2HN	B7HS	
2HNY	BP7HS	
2H-TNY	AP7FS	
2HTY	BP6FS	
2HV	A8	
2XL	BP6ES	4
3B-TY	BP4FS	
3HAN	B8S	
3HAN/M	B9S	
3HLN	B8ES	
3HLNY	BP7ES	
3HN	B8HS	
3HNY	BP8ES	
4HLNY	BP8ES	
5HLNY	BP8ES	
BAN	B4	
BANY	BP5S	
BBANY	BP4	
BBNY	BP4H	
BLN	B4ES	
BLNY	BP5ES	8
BLTY	BPR5EFS	
BN	B4H	
BTNY	AP5FS	
B-TY	BP5FS	
BV	AB2	
C3	A5FS	
CAN	B6S	
CANB	BPM6A	
CANC	BM6A	
CANY	BP6S	
CL14	B5ES	
CLN	B6ES	
CLN14P	B5ES	
CLNH	B5ES	
CLNY	BP5ES	8
CN	B5HS	
CNY	BP5HS	
CSN	B4L	
CTN18	A5FS	
CTNY	AP5FS	
CTY	BP5FS	
CV	A6	
H	B6HS	



LODGE	→ NGK	V-Line
H12	D6HA	
H18	A7	
HA	B7S	
HAN	B7S	
HAN/M	B7S	
HB12	D6HA	
HBAN	B6S	
HBL12	D8EA	
HBLN	B5ES	
HBN	B5HS	
HBSN	B6L	
HBTNY	AP6FS	
HBTY	BP5FS	
HBV	A6	
HL	B6ES	
HL12	D9EA	
HL14	B6ES	
HL-E	B6ES	
HLN	B6ES	
HLNP	B6ES	
HLNY	BP6ES	4
HN	B6HS	18
HNY	BP6HS	
HT14	BP5FS	
HT18	AP6FS	
HTNY	AP6FS	
H-TY	BP6FS	
HV	A7	
MARCHAL/VALEO	→ NGK	V-Line
17C	A7	
19C	A7	
19E	A7	
19L	A7	
2/13	A8	
2/32	B8HS	
2/32H	B8ES	
2/33	B8HS	
2/33H	B7ES	
20C	A6	
20E	A6	
20L	A6	
21C	A6	
21E	A6	
21L	A6	
22L	AB2	
22LM	AB2	
23F	A6FS	
34/5HS	BP6ES	4
34C	B7S	
34CM	B7S	
34HS	B7ES	

MARCHAL/VALEO	→ NGK	V-Line
34HSM	B7ES	
34S	B7HS	
35	B6HS	
35/1	BP6HS	18
35/1B	BP6HS	18
35/1D	BP6HS	18
35/36D	B6HS	
35/36P	B6HS	
35/36R	B6HS	
35B	B6HS	
35C	B6S	
35CM	B6S	
35HA	BP6ES	4
35HS	B6ES	
35M	B6HS	
35P	B6HS	
36	B5HS	
36B	B5HS	
36C	B4	
36CM	B4	
36D	B5HS	
36HS	B5ES	
36M	B5HS	
36P	B5HS	
37S	B5HS	
4N	B7HS	
5H	B7ES	
5N	BP6HS	18
5N CYCLO	BP6HS	18
64H	BP7ES	
67HP	B8EVX	
6H	BP7ES	
6N	BP5HS	
70H	BP6ES	4
76H	BP5ES	8
7H	BP6ES	4
84H	BP5ES	8
88N	B5HS	
8H	BP6ES	4
9H	BP5ES	8
C64H	BP6EFS	5
C68H	BP6EFS	5
C7H	BP6EFS	5
F70H	BCP7ES	
F74H	BCP6ES	17
F80H	BCP7ES	
GT34	BP7HS	
GT34/2H	BP6ES	4
GT34/5	BP6HS	18
GT34/5D	BP6HS	18
GT34/5H	BP6ES	4
GT34/5HA	BP6ES	4



MARCHAL/VALEO	→ NGK	V-Line
GT34/5HD	BP6ES	4
GT34D	BP7HS	
GT34H	BP7ES	
GT34HD	BP6ES	4
GT35	BP5HS	
GT35D	BP5HS	
GT35H	BP5ES	8
GT35HD	BP5ES	8
H32RG	B9EG	
H33RG	B8EG	
H34F	B8ES	
HA32/2	B8ES	
HA32RS	B9EG	
HF34	B7ES	
HF34F	B8ES	
RR31HS	B10EG	
RR32HS	B9EGV	
RR33HSS	B8EGV	
SCGT34/5H	BP6EFS	5
SCGT35H	BP6EFS	5
V36A	B5HS	
V6N SOLEX	B5HS	

MARELLI	→ NGK	V-Line
7LCR	BKR6E	28
7LPR	BKR6E	28
8LCR	BCPR7ES	
8LDCR	PTR5A-13	25
8LPR	BCPR7ES	
AW56C	BM7A	
AW5C	BM6A	
CM1N	AB2	
CM2N	AB2	
CM3N	A6	
CM4N	A6	
CM5N	A6	
CM6N	A7	
CU7N	C7HSA	
CW101L	B85EGV	
CW10L	B8EG	
CW112L	B9EG	
CW11L	B9EG	
CW12L	B9EG	
CW12NV	BUH	
CW13L	B10EG	
CW14L	B10EG	
CW225A	B6HS	
CW250A	B7HS	
CW25N	B4H	
CW260N	B7HS	
CW2C	B2	
CW2CJ	B2	

MARELLI	→ NGK	V-Line
CW2L	B4ES	
CW2N	B4H	
CW3C	B4	
CW3CJ	B4	
CW3CP	BP4	
CW3L	B4ES	
CW3N	B4H	
CW4A	B5ES	
CW4C	B4	
CW4CJ	B4	
CW4CP	BP4	
CW4L	B4ES	
CW4LP	BP4ES	
CW4N	B4H	
CW4NJ	B4H	
CW55N	B5HS	
CW5C	B4	
CW5CP	BP5S	
CW5L	B5ES	
CW5LJ	B5ES	
CW5LP	BP5ES	8
CW5LS	B5ES	
CW5LSZ	B5ES	
CW5N	B5HS	
CW5NJ	B5HS	
CW5NP	BP5HS	
CW5NR	BR5HS	
CW5NS	B5HS	
CW5NSZ	B5HS	
CW67L	B6ES	
CW67LP	BP6ES	4
CW67N	BP6HS	18
CW67NJ	B6HS	
CW67NR	BR6HS	
CW67P	BP5ES	8
CW6C	B6S	
CW6CE	BM6A	
CW6CJ	B6S	
CW6L	B5ES	
CW6LJ	B5ES	
CW6LP	BP5ES	8
CW6LR	BR5ES	
CW6LS	B5ES	
CW6LSZ	B5ES	
CW6N	B6HS	
CW6NE	BM6A	
CW6NJ	B6HS	
CW6NP	BP6HS	18
CW6NPR	BPR6HS	3
CW6NR	BR6HS	
CW75LP	BP6ES	4
CW78L	B6ES	



MARELLI	→ NGK	V-Line
CW78LP	BP6ES	4
CW78LPR	BPR6ES	2
CW78LPS	BP6ES	4
CW7C	B6S	
CW7L	B6ES	
CW7LCR	BKR6E	28
CW7LJ	B6ES	
CW7LP	BP6ES	4
CW7LPH	BP6ES	4
CW7LPR	BPR6ES	2
CW7LR	BR6ES	
CW7N	B6HS	
CW7NJ	B6HS	
CW7NP	BP6HS	18
CW7NPR	BPR6HS	3
CW7NR	BR6HS	
CW89LP	BP7ES	
CW8CJ	B7S	
CW8L	B7ES	
CW8LCR	BCPR7ES	
CW8LJ	B7ES	
CW8LP	BP7ES	
CW8LPR	BPR7ES	19
CW8LPS	BP7ES	
CW8N	B7HS	
CW8NP	BP7HS	
CW8NR	BR7HS	
CW9L	B8ES	
CW9LJ	B8ES	
CW9LP	BP8ES	
CW9N	B8HS	
CWC12NJ	B8HS	
CWC67NJ	B6HS	
CWC6NJ	B6HS	
CWC7NJ	B6HS	
CWC9NJ	B7HS	
CWF11L	B8EVX	
CWP10L	B9EVX	
CWP10N	B9HVX	
CWP11L	B10EGV	
CWP5N	B6HVX	
CWP6N	B6HVX	
CWP7L	B6EVX	
CWP7N	B6HVX	
CWP8L	B7EVX	
CWP8N	B7HVX	
CWP9L	B8EVX	
CWP9N	B8HVX	
CX6N	D6HA	
CX8L	D8EA	
CX8N	D8HA	
DW4CJR	BR6S	

MARELLI	→ NGK	V-Line
F6NC	BP5HS	
F6NCR	BPR5HS	
F7LC	BP6ES	4
F7LCR	BPR6ES	2
F7NC	BP6HS	18
F7NCR	BPR6HS	3
F8LC	BP7ES	
F8LCR	BPR7ES	19
FC6N	B5HS	
FC7N	B6HS	
FC9L	BP8ES	
SW5C	BM6F	
T7LC	BP6EFS	5
T7LCR	BPR6EFS	7
T8LC	BP7EFS	
T8LCR	BPR7EFS	
TM2NP	AP5FS	
TM3N	A5FS	
TM3NP	A5FS	
TM4N	A5FS	
TM4NP	AP6FS	
TW4LP	BP5EFS	
TW5NP	BP5FS	
TW6NP	BP6FS	
TW78LP	BP6EFS	5
TW78LPR	BPR6EFS	7
TW78NPR	BPR6FS	
TW7LP	BP6EFS	5
TW7LPR	BPR6EFS	7
TW7NP	BP6FS	
MAZDA	→ NGK	V-Line
0190 18 110	B6HS	
0243 18 110	C6M	
0243 18 110	C6HA	
0259 18 110	BP6ES	4
0370 18 110	BP6EVX	
0371 18 110	BP5EVX	
0376 18 110	BP7EVX	
0419 18 110	B7ES	
0420 18 110	B8ES	
0512 18 110	B6ES	
0660 18 110	BP5ES	8
0745 18 110	BP7ES	
0801 18 600	BR6EM	
0802 18 600	BR7EM	
0803 18 600	BR8EM	
0822 78 455	B10EPD	
0822 78 456	B105EPD	
0822 78 457	B11EPD	
0865 18 600	B6EM	
0866 18 600	B7EM	



MAZDA	→ NGK	V-Line
0867 18 600	B8EM	
0868 18 600	B9EM	
1001 77 550	BP4EY	
1002 77 550	BP5EY	
1003 77 550	BP6EY	
1410 18 110	BP5ES-13	
1482 18 600A	BR8EQ	
1690 18 110	BPR6ES	2
1757 18 600	B7EMV	
2182 18 600	BR8EM	
2328 18 600	B7EM	
2359 18 600	B8EM	
3648 18 600	BR7ET	
3649 18 600	BR8ET	
3710 18 110	BP6ES-13	
3743 18 600	B7ET	
3744 18 600	B8ET	
4075 18 110	BP4ES	
4885 18 110	BPR2E	
4894 18 110	BP2E	
8182 18 600	BR7EQ	
8248 18 600	BRE813L	
8344 18 600	BR9ET	
8914 18 110	BPR5ES	6
A501 18 110	BP6E	
AY02 18 110	DCP7E	
AZ08 18 110	BPR5E	
B601 18 110	BPR5ES-11	
B64N 18 110	BRE527Y-11	
B660 18 110	BCP6E-11	
B695 18 110	BCPR6E	12
B6B3 18 110	BCPR5E-11	
BP01 18 110	BKR5E-11	
BP03 18 110	BKR6E-11	14
BP05 18 110	BKR7E-11	
BP47 18 110	BKR5E	
BP49 18 110	BKR6E	28
BP51 18 110	BKR7E	
E356 18 110	BE527Y-11	
F201 18 110	ZFR6A-11	
F203 18 110	ZFR5A-11	
F205 18 110	ZFR7A-11	
F210 18 110	BCPR5E	
F220 18 110	BCPR6E-11	11
F285 18 110	ZFR6F-11	
F287 18 110	ZFR5F-11	
F289 18 110	ZFR7F-11	
FE6E 18 110	BCPR7E-11	
FE79 18 110	BPR6ES-11	13
JE03 18 110	BCPR7E	
JE41 18 110	BKR5EVX-11	
JE43 18 110	BKR6EVX-11	

MAZDA	→ NGK	V-Line
JE45 18 110	BKR7EVX-11	
KJ11 18 110	PZFR6F	
KJ13 18 110	PZFR5F	
L813 18 110	ITR6F13	
N201 18 600	BR8EQ-14	
N212 18 600	BR7EQ-14	
N322 18 110	BR10ET	
N329 18 110	BUR6EQ	
N333 18 110	SD11A	
N338 18 110	SD11A	
N339 18 110	SD10A	
N342 18 110	BUR9EQ	
N343 18 110	BUR7EQ	
N3A1 18 110	BUR9EQP	
N3A3 18 110	BUR8EQP	
MCC	→ NGK	V-Line
000 3085 V005	BKR6EKE	
A 003 159 82 03	BKR6EZA	
A 003 159 92 03	BKR6EKE	
MEGA FIRE	→ NGK	V-Line
SE8JC	BM6A	
MERCEDES	→ NGK	V-Line
002 159 18 03	BP7ES	
002 159 22 03	BP5ES	8
002 159 24 03	BP6ES	4
002 159 27 03	BP7ES	
002 159 28 03	BP6ES	4
002 159 29 03	BP5ES	8
002 159 31 03	BP5ES	8
002 159 41 03	BP6ES	4
002 159 42 03	BP6ES	4
002 159 48 03	BP5ES	8
002 159 49 03	BP6EFS	5
002 159 56 03	BP6EFS	5
002 159 57 03	BP5EFS	
002 159 58 03	BP5EFS	
002 159 64 03	BP7EFS	
002 159 65 03	BP7EFS	
002 159 68 03	BP6EFS	5
002 159 69 03	BP6EFS	5
002 159 76 03	BP5EFS	
002 159 77 03	BCP5ES	16
003 159 04 03	BP5EFS	
003 159 05 03	BP5EFS	
003 159 06 03	BP6EFS	5
003 159 07 03	BP6EFS	5
003 159 08 03	BP7EFS	
003 159 10 03	BP5ESZ	
003 159 11 03	BP5ESZ	



MERCEDES	→ NGK	V-Line
003 159 12 03	BP6ESZ	
003 159 13 03	BP6ESZ	
003 159 14 03	BP7ES	
003 159 16 03	BCP6ES	17
003 159 30 03	BCP5ES	16
003 159 31 03	BCP6ES	17
003 159 33 03	BP7EFS	
003 159 34 03	BP6EFS	5
003 159 35 03	BP6EFS	5
003 159 36 03	BP5EFS	
003 159 37 03	BCP5ES	16
003 159 40 03	BP5EFS	
003 159 41 03	BP5EFS	
003 159 42 03	BCP5ES	16
003 159 45 03	BP6ESZ	
003 159 46 03	BP5ESZ	
003 159 47 03	BP5ESZ	
003 159 56 03	BP7ES	
003 159 57 03	BP6ESZ	
003 159 78 03	BKR6ES	28
003 159 96 03	IFR5D10	
003 159 97 03	IFR6D10	
004 159 19 03	IFR5D10	

MERCURISER	→ NGK	V-Line
33-104	BR7ES	
33-11458M	B6HS-10	
33-12127	BP6HS-10	
33-123	BR6ES	
33-12343	BP8HS-10	
33-12343B	BP8HS-10	
33-129	AR6FS	
33-136862	BU8H	
33-136862B	BU8H	
33-14	BP5S	
33-14103550	BUZHW	
33-14103568	BUZ8H	
33-14103570	BUZHW-2	
33-14814548	BPZ8HS-10	
33-14814568	BPZ8HS-15	
33-17719547	BPR7HS-10	
33-18	BPR4FS-11	
33-18S	BPR4FS-11	
33-19424	BP8HS-15	
33-19796	BPR6HS-10	
33-306	B6HS	
33-312	BP6HS-10	
33-327	BPR6HS	3
33-328	BP7HS	
33-400	UR5	
33-400	BR6FS	
33-400S	BR6FS	

MERCURISER	→ NGK	V-Line
33-401	BP6EFS	5
33-406	BPR6FS	
33-41263B	B7HS-10	
33-41263M	B7HS-10	
33-592	BR6S	
33-59571	BR6FS	
33-59571B	BR6FS	
33-63	BP5S	
33-670	R5673-8	
33-802	R5673-7	
33-803507	DCPR6E	
33-807C	B8HS	
33-807S	B8HS	
33-809679	BR9ES	
33-809679B	BR9ES	
33-809680	BR8ES	
33-809680B	BR8ES	
33-811	B7HS	
33-811S	B7HS	
33-8134101	UR5	
33-813413	B7S	
33-8134141	BP7HS	
33-813415	B8S	
33-813421	R5673-8	
33-813423	BPR6HS	3
33-813425	AR6FS	
33-813469	B6S	
33-8134711	BR6ES	
33-814	BPR7HS-10	
33-816336	BPR6EFS	7
33-8167372	BP8HN-10	
33-8167372B	BP8HN-10	
33-8168372	BPZ8HN-10	
33-8168372B	BPZ8HN-10	
33-818	BR9ES	
33-818S	BR9ES	
33-821916	BR7HS	
33-821C	B9HS-10	
33-821S	B9HS-10	
33-823	B6S	
33-82370M1	B6HS	
33-82371B	B7HS	
33-82371M	B7HS	
33-82372M	B8HS	
33-823S	B6S	
33-824	BUHX	
33-825C	B7S	
33-825S	B7S	
33-827858	DPR6EA-9	
33-827859	CR6HS	
33-827C	BUHW	
33-827S	BUHW	



MERCUISER	→ NGK	V-Line
33-828C	BZ7HS-10	
33-828S	BZ7HS-10	
33-833C	BUHW-2	
33-833S	BUHW-2	
33-838	BUZHW-2	
33-841C	B6S	
33-84409B	B8HS-10	
33-84409M	B8HS-10	
33-84675M	B5HS	
33-8556721	PZFR5F-11	
33-8557171	ZFR5F-11	
33-859495	LFR5A-11	
33-874	BR7HS	
33-876	BUZ8H	
33-880	BR8ES	
33-881284	LFR6A-11	
33-883	BR7HS	
33-885C	BU8H	
33-885S	BU8H	
33-886	BUZ8H	
33-896	B5HS	
33-898	BUZHW	
33-918	ZFR6F-11	
33-924	BP8HS-15	
33-936C	BP8HS-10	
33-936S	BP8HS-10	
33-938	BPZ8HS-10	
33-939	BPZ8HS-15	
33-941	BR8HS	
33-97180	BUHW	
33-97180B	BUHW	
33-97182	BUHW-2	
33-97182B	BUHW-2	
33-97184	BP7HS-10	
33-97186	B9HS-10	
33-97186B	B9HS-10	
33-97389	UR5	
33-97389	BPR6FS	
MITSUBISHI	→ NGK	V-Line
30L66-00400	Y-723U	
MD 313 443	PFR6G-11	
MD 336 367	PZFR6B	
MD 360 019	IZFR6B	
MS 851 022	BP5ES	8
MS 851 023	BP6ES	4
MS 851 024	BP7ES	
MS 851 027	BP5ES-11	
MS 851 028	BP6ES-11	
MS 851 029	BP7ES-11	
MS 851 102	BP5EY	
MS 851 104	BP6EY	

MITSUBISHI	→ NGK	V-Line
MS 851 111	B4	
MS 851 113	B6S	
MS 851 121	BP4	
MS 851 126	BPR6E	
MS 851 132	B5HS	
MS 851 133	B6HS	
MS 851 134	B7HS	
MS 851 162	B5ES	
MS 851 163	B6ES	
MS 851 164	B7ES	
MS 851 165	B8ES	
MS 851 174	BR7ES	
MS 851 181	BP4ES	
MS 851 182	BP5ES	8
MS 851 183	BP6ES	4
MS 851 184	BP7ES	
MS 851 187	BP5ES-11	
MS 851 188	BP6ES-11	
MS 851 189	BP7ES-11	
MS 851 192	BP6ES	4
MS 851 232	BPR5ES	6
MS 851 233	BPR6ES	2
MS 851 234	BPR7ES	19
MS 851 235	BPR5ES	6
MS 851 236	BPR6ES	2
MS 851 237	BPR5ES-11	
MS 851 238	BPR6ES-11	13
MS 851 239	BPR7ES-11	
MS 851 242	BP5EA	
MS 851 243	BP5EAL	
MS 851 244	BP6EA	
MS 851 246	BP5EA-11	
MS 851 247	BP5EAL-11	
MS 851 248	BP6EA-11	
MS 851 253	BU6EA-11	
MS 851 254	BU7EA-11	
MS 851 263	G2Z	
MS 851 264	G27	
MS 851 272	BUR5EA-11	
MS 851 273	BUR6EA-11	
MS 851 274	BUR7EA-11	
MS 851 283	BP6E	
MS 851 286	BP5EY	
MS 851 287	BP6EY	
MS 851 292	PGR6B	
MS 851 301	PGR5A-11	
MS 851 302	PGR6A-11	
MS 851 317	DCPR7E	
MS 851 327	DCPR7EVX	
MS 851 332	PFR6B-11	
MS 851 335	PFR5J-11	
MS 851 336	PFR6J-11	



MITSUBISHI	→ NGK	V-Line
MS 851 351	BK5E	
MS 851 352	BK6E	
MS 851 357	BKR5E-11	
MS 851 358	BKR6E-11	14
MS 851 362	BK6E-11	
MS 851 367	BKR5E	
MS 851 368	BKR6E	28
MS 851 403	BPR6ES-11	13
MS 851 408	BPR6ES-11	13
MS 851 412	BPR5ES	6
MS 851 413	BPR6ES	2
MS 851 414	BPR7ES	19
MS 851 417	BPR5ES-11	
MS 851 418	BPR6ES-11	13
MS 851 419	BPR7ES-11	
MS 851 454	BR7ES	
MS 851 463	PGR6B	
MS 851 473	PFR6J-11	
MS 851 473	PFR6B-11	
MS 851 478	BPR6ES-11	13
MS 851 502	PFR6J-11	
MS 851 721	BK5E	
MS 851 722	BK6E	
MS 851 727	BKR5E-11	
MS 851 728	BKR6E-11	14
MS 851 732	BK6E-11	
MS 851 737	BKR5E	
MS 851 738	BKR6E	28
MS 851 882	BPR7EKN	
Z 2152 944	BPR6ES-11	13
Z 2152 945	BPR6ES	2
Z 2152 946	BR7ES	
Z 2152 947	BPR7ES	19
Z 2152 948	BPR7ES-11	
Z 2152 949	BCPR7ES-11	
Z 2152 950	BCPR6ES-11	11

MITSUBISHI/CLARK	→ NGK	V-Line
30 666 52 300	---	
34 466 31 300	---	

MOTORCRAFT	→ NGK	V-Line
A11	B2	
A11NX	BM4A	
A11U	B2	
A11X	B2	
A1CU	B8S	
A21X	B8S	
A22	BP6S	
A22CU	BP6S	
A22NX	BPM7A	
A2NX	BM7A	

MOTORCRAFT	→ NGK	V-Line
A32	BP6S	
A3CU	B6S	
A3NX	BM6A	
A3X	B6S	
A42	BP5S	
A42CU	BP5S	
A5	B6S	
A52	BP5S	
A52CU	BP5S	
A5CU	B6S	
A5X	B6S	
A7	B4	
A7LM	B4LM	
A7N	BM6A	
A7NU	BM6A	
A7NX	BM6A	
A7U	B4	
A7X	B4	
A82	BP4	
A9	B4	
A901	B8S	
A9X	B4	
AE1C	B7HS	
AE1X	B7HS	
AE2	B7HS	
AE22	BP6HS	18
AE22C	BP6HS	18
AE2C	B7HS	
AE2X	B7HS	
AE3	B6HS	
AE32	BP6HS	18
AE32C	BP6HS	18
AE3C	B6HS	
AE3X	B6HS	
AE4	B5HS	
AE42	BP5HS	
AE4X	B5HS	
AE6	B5HS	
AE62	BP5HS	
AE7	B4H	
AE901	B9HS	
AE901X	B9HS-10	
AER32	BPR6HS	3
AER4	BR5HS	
AER4X	BR5HS	
AF12	BP7FS	
AF-2	B7FS	
AF22	BP6FS	
AF-3	B6FS	
AF32	BP6FS	
AF3NX	BM7F	
AF42	BP5FS	



MOTORCRAFT	→ NGK	V-Line
AF52	BP4FS	
AF5NX	BM6F	
AG1	B8ES	
AG12	BP7ES	
AG12C	BP7ES	
AG12CU	BP7ES	
AG1C	B8ES	
AG1X	B8ES	
AG2	B7ES	
AG203	B11EGP	
AG22	BP6ES	4
AG22-4	BP6ES-11	
AG22C	BP6ES	4
AG22CU	BP6ES	4
AG23	B7ECS	
AG252	BP6ES	4
AG252C	BP6ES	4
AG25C	B7EM	
AG2C	B7ES	
AG2CU	B7ES	
AG2X	B7ES	
AG3	B6ES	
AG32A	BP6ES	4
AG32C	BP6ES	4
AG32CU	BP6ES	4
AG34CU	BP6EA	
AG34CU11	BP6EA-11	
AG3C	B6ES	
AG3X	B6ES	
AG4	B5ES	
AG403	B10EGP	
AG403C	B10EGP	
AG42	BP5ES	8
AG42CU	BP5ES	8
AG44	ZGR5C	
AG44CU	BP5EA-L	
AG5	B5ES	
AG501	B10ES	
AG501X	B10EGV	
AG52	BP5ES	8
AG54	ZGR5C	
AG54CU	BP5EA	
AG5CU	B5ES	
AG603	B9EGP	
AG603C	B9EGP	
AG7	B5ES	
AG701	B9ES	
AG701C	B9ES	
AG701CU	B9ES	
AG701X	B9EGV	
AG82	BP4ES	
AG9	B4ES	

MOTORCRAFT	→ NGK	V-Line
AG901	B9ES	
AG901C	B9ES	
AG901CU	B9ES	
AG901X	B8EGV	
AG902	BP8ES	
AG903	B8EG	
AG9U	B4ES	
AGF12	BP7EFS	
AGF12C	BP7EFS	
AGF22C	BP6EFS	5
AGF32CU	BP6EFS	5
AGFS22YPC	ITR6F-13	
AGKO	BUE	
AGN42	BP5ES	8
AGP12C	BCP7ES	
AGP22C	BCP6ES	17
AGP701C	R7234-10	ex R5686-10
AGPR12C	BCPR7ES	
AGPR12P 1,0	BKR7EVX-11	
AGPR12PP 1,0	PFR7B-11	
AGPR12PP11	PFR7B-11	
AGPR12PP8	PFR7B	
AGPR22C	BCPR6ES	
AGPR22C	BKR6E	28
AGPR22C1	BCPR6ES-11	11
AGPR22CD	BKR6E	28
AGPR22CD1	BCPR6ES-11	11
AGPR22P 1,0	BKR6EVX-11	
AGPR22PP	PFR6B-11	
AGPR22PPJ	PFR6B-11	
AGPR32C	BKR6E	28
AGPR32CD1	BCPR6ES-11	11
AGPR32PD	BKR5EKUP	
AGPR602P	----	
AGPR701C	----	
AGPR902C	BCPR9ES-11	
AGPR902P	R7234-9	ex R5686-9
AGPS22C1	BCPR6ES-11	
AGPS22PP1	PFR6B-11	
AGPS32C	BCPR6ES	
AGPS44F11J	PZFR5D-11	
AGR12C	BPR7ES	19
AGR16C	BR8ET	
AGR1X	BR8ES	
AGR21	BR6ES	
AGR22	BPR6ES	2
AGR22C	BPR6ES	2
AGR22CU	BPR6ES	2
AGR2C	BR7ES	
AGR31	BR6ES	
AGR32	BPR6ES	2
AGR32C	BPR6ES	2



MOTORCRAFT	→ NGK	V-Line
AGR32CU	BPR6ES	2
AGR34CU	BPR6EY	
AGR3X	BR6ES	
AGR41	BR5ES	
AGR42	BPR5ES	6
AGR42C	BPR5ES	6
AGR42CU	BPR5ES	6
AGR44CU	BPR5EY	9
AGR44CU-11	BPR5EY-11	
AGR47CU11	ZGR5B-11	
AGR51	BR5ES	
AGR52	BPR5ES	6
AGR54CU	BPR5EA	
AGR701X	BR9EVX	
AGR82	BPR4ES	
AGR901X	BR8EVX	
AGRF22	BPR6EFS	7
AGRF22-6	BPR6EFS-13	
AGRF22C	BPR6EFS	7
AGRF22C1	BPR6EFS	7
AGRF22PP1	PTR5D-10	
AGRF32	BPR6EFS	7
AGRF32-6	BPR6EFS-13	
AGRF32C1	BPR6EFS	7
AGRF42	BPR5EFS	
AGRF52	BPR5EFS	
AGRP52	ZFR4F-11/ZF4A-11	
AGS32C	BPR5ES	6
AGS32C-11	BPR5ES-11	
AGSF22PPJ	PTR6F-13	
AGSF24C	TR5-1	
AGSF32C	BPR5EFS	
AGSF32WM	ITR6F-13	
AGSF34C	TR5-1	
AGSP32	BCPR6ES-11	11
AGSP32C	BCPR6ES-11	11
AGSP33C	ZFR6F-11	
AGSP52	BKR5ES	
AL11	B4L	
AL5	B6L	
AL5X	B6L	
AL7	B6L	
AL7U	B6L	
AL7X	B6L	
AL9	B4L	
AL9X	B4L	
AR21X	BR6S	
AR31	BR6S	
AR32	BP6S	
AR41	BR6S	
AR42	BP5S	
AR51	BR6S	

MOTORCRAFT	→ NGK	V-Line
AR52	BP5S	
AR7N	BMR6A	
AR82	BP4	
ARF2	BR6FS	
ARF22	BPR6FS	
ARF22C	BPR6FS	
ARF22CU	BPR6FS	
ARF2-6	BR6FS-15	
ARF3	BR6FS	
ARF32	BPR6FS	
ARF32-6	BPR6FS	
ARF32C-6	BPR6FS	
ARF32M	BPR6FS	
ARF3-6	BR6FS-15	
ARF4	BR5FS	
ARF41CU15	BR5FS-15	
ARF42	BPR5FS	
ARF42-6	BPR5FS-15	
ARF42CU	BPR5FS	
ARF4-6	BR5FS-15	
ARF52	BPR4FS	
ARF52-6	BPR4FS-15	
ARF6	BR5FS	
ARF62	BPR4FS	
ARF62-6	BPR4FS-15	
ARF8	BR5FS	
ARF8-6	BR5FS-15	
ASF32	BPR6FS	
ASF32C	BPR6FS	
ASF32M	BPR6FS	
ASF42	BPR5FS-11	
ASF42-6C	BPR5FS-15	
ASF42C	BPR5FS-11	
ASF52	BPR4FS	
ASF52-6	BPR4FS-15	
AT1	B8S	
AT10	B2	
AT2	B7S	
AT3	B6S	
AT4	B6S	
AT42	BP5S	
AT6	B6S	
AT8	B4	
ATL3	B6L	
ATL4	B6L	
ATL8	B4L	
AV1X	B8HS	
AV22CU	BP6HS	18
AV2CU	B7HS	
AV2X	B7HS	
AV3CU	B6HS	
AV4	B5HS	



MOTORCRAFT	→ NGK	V-Line
AV42	BP5HS	
AV52	BP5HS	
AV6	B4H	
AV6CU	B4H	
AV701CU10	B9HS-10	
AV82	BP4H	
AV901CU	B9HS	
AV901X-4	B9HS-10	
AVKO	BUH	
AVKOD	BUHW	
AVZKO	BUHX	
AWRF32	BPR6EFS	7
AWRF32-5	BPR6EFS-13	
AWRF42	BPR5EFS	
AWSF22C	BPR6EFS	7
AWSF22F	PTR6D-13	
AWSF24C	TR5-1	
AWSF32	BPR6EFS	7
AWSF32C	BPR6EFS	7
AWSF32F	TR55	
AWSF32PP	---	
AWSF34	TR5-1	
AWSF34C	TR5-1	
AWSF42	BPR5EFS	
AWSF42C	BPR5EFS	
AWSF44C	TR5-1	
AWSF52C	BPR5EFS	
AWSF54	TR5-1	
AWSF54C	TR5-1	
AWSFA32C	BPR5EFS	
AYFS22FE1J	PLTR6A-10G	
AYFS22FPM1	PTR5A-13	
AYFS22PP1	PTR5A-13	
AYFS32CJ	PTR5A-13	
AYRF22PP	PTR5A-13	25
AZ2	B7S	
AZ3	B6S	
AZ9	B4	
AZ901	B8S	
AZFS22C	PTR5A-13	25
AZFS32FE	PTR5A-13	
B2W	A8	
B3W	A7	
B3X	A7	
B4X	A7	
B6W	A6	
B8X	A6	
BF12	AP8FS	
BF22	AP6FS	
BF22C	AP6FS	
BF22CU	AP6FS	
BF22CX	AP6FS	

MOTORCRAFT	→ NGK	V-Line
BF22X	AP6FS	
BF32	AP6FS	
BF32CU	AP6FS	
BF32CX	AP6FS	
BF32X	AP6FS	
BF42	AP5FS	
BF42CU	AP5FS	
BF82	AP5FS	
BF92	AP5FS	
BR8	A6	
BRF22	APR6FS	
BRF22C	APR6FS	
BRF31	AR6FS	
BRF31-4	AR6FS	
BRF32	APR6FS	
BRF3M	AR6FS	
BRF42	APR5FS	
BRF82	APR5FS	
BSF31	AR6FS	
BSF31-4	AR6FS	
BSF82	APR5FS	
BSF92	APR5FS	
BT10	A6	
BT15	AB2	
BT2	A8	
BT3	A7	
BT4	A7	
BT6	A6	
BT8	A6	
BT9	A6	
BTF3	A6FS	
BTF31	A6FS	
BTF42	AP5FS	
BTF6	A6FS	
BTRF42	APR5FS	
BZ8	A6	
HG2	D8EA	
HG22	D8EA	
HG2CU	D8EA	
HGR2C	DR8ESL	
HV2	D8HA	
HV22	D6HA	
HV3	D6HA	
PV2	C7HSA	
PV3	C6HSA	
TT4	G2Z	
TT8	G2Z	
NISSAN	→ NGK	V-Line
-01P14	BCPR4ES-11	
-01P15	BCPR5ES-11	
-01P16	BCPR6ES-11	11



NISSAN	→ NGK	V-Line
-01P17	BCPR7ES-11	
-02P15	BCPR5E-11	
-02P16	BCPR6E-11	11
-02P17	BCPR7E-11	
-10F15	BCP5ES	16
-10F16	BCP6ES	17
-10F17	BCP7ES	
-12E14	BCPR4ES	
-12E15	BCPR5ES	
-12E16	BKR6E	28
-12E17	BCPR7ES	
-1P115	PFR5G-11	
-1P116	PFR6G-11	
-1P117	PFR7G-11	
-20J05	BKR5E	
-20J06	BKR6E	28
-20J07	BKR7E	
-30R14	ZFR4E-11	
-30R15	ZFR5E-11	
-30R16	ZFR6E-11	
-50Y04	BKR4E-11	
-50Y05	BKR5E-11	
-50Y06	BKR6E-11	14
-53J04	BKR4EY	
-53J05	BKR5EY	
-53J06	BKR6EY	
-53J07	BKR7EY	
-53J16	PFR6B-9	
-53J17	PFR7B-9	
-53J65	PFR5B-9	
-53J66	PFR6B-9	
-53J67	PFR7B-9	
-54C68	PFR8B-9	
-58S15	PFR5A-11	
-58S16	PFR6A-11	
-58S17	PFR7A-11	
-85E15	BKR5ES-11	
-85E16	BKR6ES-11	
-85E17	BKR7ES-11	
-8H315	LFR5AP-11	
-99B07	BCPR7ES-11	
-99B09	BCPR6ES-11	11
-99B12	BCPR5ES-11	
-99B17	---	
-99B19	---	
-99B22	---	
-F2000	BPR4ES	
-P8314	BPR4ES-11	
-P8315	BPR5ES-11	
-P8316	BPR6ES-11	13
-P8317	BPR7ES-11	
-P8616	BR6ES-11	

NISSAN	→ NGK	V-Line
-P9616	BPR6ESN-11	
-S2000	BPR5ES	6
-S2100	BPR6ES	2
-V1414	BPR4ES	
-V1415	BPR5ES	6
-V1416	BPR6ES	2
-V1417	BPR7ES	19
-W8914	BP4ES	
-W8915	BP5ES	8
-W8916	BP6ES	4
-W8917	BP7ES	
OMC	→ NGK	V-Line
115206	BP6HS	18
387694	B7HS	
437929	BPR7HS	
445098	D6HA	
502177	B6HS	
502194	B7HS-10	
502196	BR6S	
502894	BUZ8H	
503948	BPR6HS	3
503949	BR6HS	
503950	BR6HS	
504082	BR6HS	
509921	BUHW	
509922	BUHW-2	
509924	BUZ8H	
509925	BZ7HS-10	
509926	BUHXW-1	
509928	B6S	
509929	B7HS	
584918	DCPR7E	
771770	BUZHW-2	
OPEL	→ NGK	V-Line
90 239 568	BPR6ES	2
90 239 569	BPR6HS	3
90 336 461	BKR6ES	28
90 338 179	BCPR6ET	
90 355 136	BPR6ES	2
90 356 323	BPR5ES	6
90 357 729	BKR6EK	20
90 357 780	BKR6ES	28
90 423 215	BKR6ES	28
90 512 989	BKR5EK	23
PAL	→ NGK	V-Line
14-5	B4H	
14-5Y	BP4H	
14-7	B5HS	
14-7Y	BP5HS	



PAL	→ NGK	V-Line
14-8	B6HS	
14-8R	BR6HS	
14-8Y	BP6HS	18
14-9	B8HS	
14-9R	BR7HS	
14-9Y	BP7HS	
14K-5	B4	
14K-5Y	BP4	
14K-7Y	BP5S	
14K-8	B6S	
14L-5	B5ES	
14L-5R	BR5ES	
14L-5Y	BP5ES	8
14L-7	B6ES	
14L-7R	BR6ES	
14L-7Y	BP6ES	4
14L-8	B6ES	
14L-8Y	BP6ES	4
14L-9	B7ES	
14L-9Y	BP7ES	
17-9	B7HS	
18-5	A6	
18-5R	A6	
18-7	A7	
18-8W	A8	
18F-5	A5FS	
B12YC	DP9EA-9	
B14YC	DP8EA-9	
B15YC	DP7EA-9	
D14YC	BCP7ES	
D15YC	BCP6ES	17
D17YC	BCP5ES	16
DR14YC	BCPR7ES	
DR15YC	BKR6E	28
DR17YC	BCPR5ES	
G14YC	BP7EFS	
G15YC	BP6EFS	5
G17YC	BP5EFS	
K15YC	BP6S	
K17C	B6S	
K17Y	BP5S	
K19	B4	
L08JW	B11EN	
L08W	B11EGV	
L10JW	B95EN	
L12W	B9EVX	
L12YC	BP9ES	
L14C	B8ES	
L14YC	BP7ES	
L15C	B7ES	
L15W	B8EVX	
L15YC	BP6ES	4

PAL	→ NGK	V-Line
L17C	B6ES	
L17Y	BP4E	
L17YC	BP5ES	8
L19	B4E	
L19C	B5ES	
L5Y	BP5ES	8
L7Y	BP6ES	4
L8	B6ES	
L8Y	BP6ES	4
L9Y	BP7ES	
LR12YC	BPR8ES	
LR14YC	BPR7ES	19
LR15YC	BPR6ES	2
N12YC	BP8ES	
N14C	B9HS	
N14YC	BP7HS	
N15C	B7ES	
N15YC	BP6HS	18
N17C	B6HS	
N17Y	BP4H	
N17YC	BP5HS	
N19	B4H	
N19C	B5HS	
N7	B6HS	
N7Y	BP6HS	18
N8	B7HS	
N8Y	BP7HS	
NR12YC	BPR8HS	
NR15YC	BPR6HS	3
P15	BM7A	
P15Y	BPM7A	
P17	BM6A	
P17Y	BPM6A	
PR15Y	BPMR7A	
PR17Y	BPMR6A	
S14L-13	B8EG	
S14L-15	B9EG	
S14L-17	B10EG	
U17	BM6F	
PEUGEOT	→ NGK	V-Line
1173702700	BPR5HS	
5962.05	BP6EFS	5
5962.09	BP6EFS	5
5962.13	BP6ES	4
5962.14	BP6EFS	5
5962.15	BP6EFS	5
5962.16	BP6ES	4
5962.21	BP6ET	
5962.22	BPR6EVX	
5962.71	BKR6ES	28
5962.72	BP6EFS	5



PEUGEOT	→ NGK	V-Line
5962.80	BP6HS	18
5962.82	BP6ES	4
5962.87	BP6EFS	5
5962.88	BP8ES	
5962.90	BP6HS	18
5962.94	BP7ES	
5962.98	BP7ES	
5962.A1	BP7ES	
5962.A2	BP6ES	4
5962.A3	BP6HS	18
5962.A0	BP7ES	
5962.C5	BKR6ES	28
5962.C6	BKR6ES	28
5962.C0	BP5EFS	
5962.E2	BCP6ES	17
5962.F7	BCP6ES	17
5962.F8	BCP6ES	17
5962.G8	BP7ES	
5962.H2	BKR6ES	28
5962.H8	BKR5ES	
5962.H9	BCPR5ES	
5962.J9	BKR6ES	28
5962.J0	BCP6ES	17
5962.K1	BCPR7ES	
5962.K3	BCP7ET	
5962.K4	BKR6ES	28
5962.K6	BKR6ES	28
5962.K7	BCPR6ET	
5962.K0	BCPR7ES	
5962.R5	BCPR6ET	
5962.R9	BKR6ES	28
5962.S2	BKR6E	28
5962.S4	BKR5ES	
5962.T8	BKR6ES	28
5962.V6	BKR5ES	
5962.V7	BKR6ES	28
5962.V8	BCPR7ES	
5962.W4	BCPR6ET	
5962.W6	BCPR7ES	
5962.W7	BCPR7ES	
5962.W9	BKR5EK	23
5962.X5	BCP6ES	17
5962.Y2	BKR5EK	23
5962.Y8	BKR6EK	20
5962.Z0	BKR6EK	20
PRESTOLITE	→ NGK	V-Line
10E2	C7HSA	
10E3	C7HSA	
10E4	C6HSA	
12E2	D8HA	
12E22	D6HA	

PRESTOLITE	→ NGK	V-Line
12E3	D8HA	
12E42	D6HA	
12G2	D8EA	
12G3	D8EA	
14-01	B9S	
14-11	B2	
14-11N	BPM6A	
14-11X	B2	
14-2X	B6S	
14-3	B6S	
14-32	BP6S	
14-3N	BM7A	
14-3X	B6S	
14-4	B6S	
14-42	BP5S	
14-5	B6S	
14-52	BP5S	
14-5X	B6S	
14-7	B4	
14-7N	BM6A	
14-7X	B4	
14-82	BP4	
14-9	B4	
14-9X	B4	
14E01	BUH	
14E1	B8HS	
14E2	B7HS	
14E22	BP7HS	
14E3	B6HS	
14E32	BP6HS	18
14E4	B5HS	
14E42	BP6HS	18
14E52	BP5HS	
14E6	B5HS	
14E62	BP5HS	
14E82	BP4H	
14ER4	BR6HS	
14ER6	BR6HS	
14F22	BP6FS	
14F32	BP6FS	
14F3N	BM7F	
14F42	BP5FS	
14F52	BPR4FS	
14F7N	BM6F	
14G01	BUE	
14G1	B8ES	
14G12	BP8ES	
14G2	B7ES	
14G22	BP6ES	4
14G3	B6ES	
14G32	BP5ES	8
14G4	B6ES	



PRESTOLITE	→ NGK	V-Line
14G42	BP5ES	8
14G5	B5ES	
14G52	BP5ES	8
14G7	B5ES	
14G82	BP4ES	
14G902	BP8ES	
14GF22	BP6EFS	5
14GR22	BPR6ES	2
14GR32	BPR5ES	6
14GR4	BR6ES	
14GR42	BPR5ES	6
14GR52	BPR4ES	
14GR52-6	BPR4ES-11	
14GR52A	BPR4ES-11	
14GR53	ZGR5C	
14GR7	BR5ES	
14GRF22	BPR6EFS	7
14GRF32	BPR5EFS	
14GRF52	BPR5EFS	
14L4	B6L	
14L7	B6L	
14L9	B4L	
14R3	BR6S	
14R32	BP5S	
14R4	BR6S	
14R42	BP5S	
14R5	BR6S	
14R52	BP4	
14R53	BP4	
14R7N	BM6A	
14R8	B6S	
14RF22	BPR6FS	
14RF32	BPR5FS	
14RF32-6	BPR5FS-15	
14RF32A	BPR5FS-15	
14RF42	BPR5FS	
14RF42-6	BPR5FS-15	
14RF42A	BPR5FS-15	
14RF52	BPR4FS	
14RF52-6	BPR4FS-15	
14RF52A	BPR4FS-15	
14RF62	BPR4FS	
14RF62-6	BPR4FS-15	
14RF62A	BPR4FS-15	
18-10	A6	
18-3	A6	
18-4	A6	
18-8	A6	
18-9	A6	
18F22	AP6FS	
18F3	A6FS	
18F32	AP6FS	

PRESTOLITE	→ NGK	V-Line
18F42	AP5FS	
18F6	A6FS	
18F82	AP5FS	
18RF3	AR6FS	
18RF32	APR6FS	
18RF42	APR6FS	
18RF82	APR6FS	
78-10	G2Z	
78-8	G2Z	

PROTECNICA	→ NGK	V-Line
4708	BR2LM	
4843	BPM7A	

RENAULT	→ NGK	V-Line
74 39 146 775	BCPR5ET	
77 00 101 401	BCPR5ES	
77 00 103 502	BPR5ES	6
77 00 103 503	BPR5ES	6
77 00 103 533	BKR5EK	23
77 00 107 916	BKR5EK	23
77 00 260 637	BCP7ET	
77 00 266 295	BPR6EFS	7
77 00 267 140	BPR6EFS	7
77 00 267 805	BP7EFVX	
77 00 273 462	BKR6E	28
77 00 273 698	BKR6EVX	
77 00 553 622	BP6ES	4
77 00 565 155	B9EVX	
77 00 587 168	BP6HS	18
77 00 714 540	BPR6EFS	7
77 00 722 095	BP6EFS	5
77 00 724 821	BP6ES	4
77 00 725 302	BPR5ES	6
77 00 726 503	BP7EFS	
77 00 727 383	BPR6ES	2
77 00 731 583	BP7EFS	
77 00 732 626	BP8ES	
77 00 733 422	BP5HS	
77 00 736 149	BP7EFS	
77 00 736 150	BP7EFS	
77 00 737 457	BP7EFS	
77 00 737 458	BP6EFS	5
77 00 737 459	BP7ES	
77 00 737 612	BCP5ES	16
77 00 742 094	BPR7ES	19
77 00 743 137	BCP5ES	16
77 00 743 920	BP5ES	8
77 00 749 163	BCP5ES	16
77 00 824 821	BP6ES	4
77 00 852 522	BP6EFS	5
77 00 852 543	BP7EFVX	



RENAULT	→ NGK	V-Line
77 00 855 463	BCP6ET	
77 00 855 918	BP5EFS	
77 00 856 342	BCP6ET	
77 00 859 910	BCP5ES	16
77 00 859 967	BP5ES	8
77 00 860 235	BP5ESZ	
77 00 861 471	BP7ES	
77 00 861 472	BP6ESZ	
77 00 862 054	BP5ES	8
77 00 868 864	BPR7ES	19
77 00 869 200	BK5ESZ	
77 00 871 617	BCPR6ET	
77 01 021 767	BP6EFS	5
77 01 041 214	BP5ES	8
77 01 041 215	BP6EFS	5
77 01 042 816	BKR6E	28
77 01 043 624	BCPR6ET	
77 01 045 018	BP7EFS	
77 01 366 057	BP6HS	18
77 01 366 084	B8EVX	
77 01 366 085	B7EVX	
77 01 366 086	BP6ES	4
77 01 366 087	BP7ES	
77 01 366 137	BP6EFS	5
77 01 366 267	BP6HS	18
77 01 366 268	BP7ES	
77 01 366 269	BP6ES	4
77 01 366 270	BP6EFS	5
77 01 366 513	BP5HS	
77 01 366 514	BP6EFS	5
77 01 366 515	BP6HS	18
77 01 366 516	BP6ES	4
77 01 366 533	B6HS	
77 01 366 539	BP5ES	8
77 01 366 903	BP5ES	8
77 01 414 022	BP5HS	
77 01 414 025	BP6ES	4
77 01 414 026	BP7EFS	
77 01 414 027	BP7EFS	
77 01 414 031	BPR6ES	2
77 01 414 105	BP5ESZ	
83 04 504 277	ZFR5F	
89 33 003 862	BKR6ES	28
96 26 575 480	BKR6EK	20
96 32 182 880	BKR6EK	20
96 32 182 880	PF6E-10	
SEAT	→ NGK	V-Line
101 000 000AB	BP6ESZ	
101 000 001AB	BP6ET	
101 000 001AC	BP6ET	
101 000 001AD	BP5ET-10	

SEAT	→ NGK	V-Line
101 000 001AE	BP5ET	
101 000 002AB	BP6ESZ	
101 000 003AA	BCP7ET	
101 000 004AA	BCP7ET	
101 000 005AA	BP6ET	
101 000 005AB	BP6ET	
101 000 005AD	BP5ET-10	
101 000 005AE	BP5ET	
101 000 006AC	BP6ESZ	
101 000 007AA	BP6ET	
101 000 007AB	BP6ET	
101 000 007AC	BP5ET-10	
101 000 007AD	BP6ET	
101 000 017AA	BCP7ET	
101 000 026AA	BPR5EKU	
101 000 026AB	BUR6ET	1
101 000 027AA	BP6ET	
101 000 027AB	BP5ET	
101 000 027AC	BP5ET-10	
101 000 028AA	BCP7ET	
101 000 029AA	BU6EFSZ	
101 000 029AB	BUR6EFSZ	
101 000 033AA	BKUR6ET-10	24
101 000 033AB	BKUR7ET	
101 000 033AC	BKUR5ET	
101 000 033AF	BKUR6ET	27
101 000 034AA	BP6ESZ	
101 000 035 HJ	BKR6EKUB	
101 000 035AA	BK5EKU	
101 000 035AB	BKR5EKU	
101 000 035AE	BK7EKU	
101 000 035AF	BKR7EKU	
101 000 035AH	BKR5EKUP	
101 000 036AA	BUR6ET	1
101 000 036AB	BUR5ET	22
101 000 036AC	BUR5ET-10	21
101 000 038AA	BPR5EKU	
101 000 038AB	BPR5EKU	
101 000 039AA	BPR5EKU	
101 000 039AB	BPR5EKU	
101 000 040AC	BUR5ET	22
101 000 040AD	BUR6ET	1
101 000 040AE	BUR5ET-10	21
101 000 041AC	BKUR6ET-10	24
101 000 041AD	BKUR6ET	27
101 000 041AE	BKUR7ET	
101 000 050AA	BPR5EKU	
101 000 050AB	BUR5ET	22
101 000 050AC	BUR6ET	1
101 000 051AA	BKUR6ET-10	24
101 000 051AB	BKUR7ET	
101 000 055 AA	BKR6EK	20



SPLITFIRE	→ NGK	V-Line
TP006A	BP8EVX	
TP006B	BP7EVX	
TP006C	BP6EVX	
TP006D	BP5EVX	
TP006E	BP5EVX	
TP406B	B9EVX	
TP406B	BR9EVX	
TP406C	BR8EVX	
TP406C	B8EVX	
TP416B	DP9EVX-9	
TP416C	DP8EVX-9	
TP430B	CR9EVX	
TP430C	CR8EVX	

SUBARU	→ NGK	V-Line
22401AA000	BP5ES-11	
22401AA010	BP6ES-11	
22401AA020	BP6ES	4
22401AA090	BP7ES	
22401AA100	BE527Y-11	
22401AA120	BPR6ES-11	13
22401AA220	BPR6ES	2
22401AA230	BPR7E	19
22401AA310	BKR6E-11	14
22401AA370	PFR6B-11	
22401AA380	BRE527Y-11	
22401AA400	PFR6B	
22401AA480	BPR5ES-11	
22401AA500	BKR6EVX-11	
22401AA510	BKR6EVX	
22401KA000	BU6EA-11	
22401KA010	BCP6E-11	
22401KA050	BUR6EA-11	
22401KA080	BKR6E	28
22401KA100	BCPR6E	12
22401KA140	ZFR6G	
22401KA170	ZFR5G	
22401KA210	BKR5E-11	
320540800	B6ES	
320541110	B7ES	
320541120	B7EVX	
320541320	B6EVX	
320545700	BR6ES	
382420800	B5ES	
420543200	BP5ES	8
420545800	BE529Y-11	
490010003	BP5EVX	
490010013	BP6EVX	
490010023	BP7EVX	
490010033	BPR5ES	6
490010043	BP5EY	
490010053	BP6EY	

SUBARU	→ NGK	V-Line
820541810	B6HS	
820546010	B8HS	
820547820	B6HVX	
820548020	B8HVX	
820549310	B7HS	
820549320	B7HVX	
882417800	B5HS	
890573400	B6S	

SUZUKI	→ NGK	V-Line
09482-00036	BP4H	
09482-00066	B9ES	
09482-00082	B7HS	
09482-00084	BP6HS	18
09482-00088	BR6HS	
09482-00089	B7ES	
09482-00091	B8ES	
09482-00095	B6HS	
09482-00098	BR9ES	
09482-00102	BR8HS	
09482-00105	BP7HS	
09482-00111	AU10EFP	
09482-00115	BR9EVX	
09482-00116	BR7HS	
09482-00117	BR7ES	
09482-00118	BP6ES	4
09482-00121	BR8ES	
09482-00124	BP5HS	
09482-00127	BR9ES	
09482-00131	BP5ES	8
09482-00136	BPR4H	
09482-00139	BP7ES	
09482-00141	BPR6HS	3
09482-00143	BR5HS	
09482-00144	D8EA	
09482-00147	BPR5HS	
09482-00149	DR8ESL	
09482-00155	BPR5ES	6
09482-00157	BR8HS	
09482-00163	BP5HA	
09482-00175	BP8ES	
09482-00177	BP6ES	4
09482-00181	BR10EV	
09482-00182	D7EA	
09482-00184	D9EA	
09482-00198	B8HS	
09482-00205	BPR4HS	
09482-00208	B8EGV	
09482-00209	B9EGV	
09482-00210	B10EGV	
09482-00220	DR7ES	
09482-00221	DR8ES	



SUZUKI	→ NGK	V-Line
09482-00229	BPR6ES	2
09482-00230	BR8HS 0,8	
09482-00237	B8HS	
09482-00239	BPR8ES	
09482-00255	BPR7HS	
09482-00258	BPMR6A	
09482-00259	BP6HS	18
09482-00261	BPMR4A	
09482-00262	BP5HS-10	
09482-00264	BP6HS-10	
09482-00269	B7HS-10	
09482-00277	BR7HS-10	
09482-00278	B8HS-10	
09482-00279	B8HS-10	
09482-00280	BR8HS-10	
09482-00285	BPR6ES-11	13
09482-00287	BP5ES-11	
09482-00290	BP4H	
09482-00294	C6HA	
09482-00299	BPR6ES	2
09482-00316	BPR5HS	
09482-00317	C8HA	
09482-00321	C8HSA	
09482-00327	BR6HS-10	
09482-00328	DP9EA-9	
09482-00330	DPR9EA-9	
09482-00332	DP8EA-9	
09482-00334	DPR8EA-9	
09482-00338	B6HS-10	
09482-00340	CR6HS	
09482-00341	BR6HS-10	
09482-00348	BR8ES	
09482-00349	BR9ES	
09482-00351	B9ES	
09482-00352	DP7EA-9	
09482-00354	DPR7EA-9	
09482-00358	BR4HS	
09482-00359	BPR5HS	
09482-00360	BR10ES	
09482-00365	J9A	
09482-00366	JR9A	
09482-00367	BPR4HS	
09482-00370	BR8HS-10	
09482-00371	J10A	
09482-00375	B8HS-10	
09482-00380	PJR6A	
09482-00381	PJR7A	
09482-00384	DCP8EVX	
09482-00385	BP7ES	
09482-00389	JR9B	
09482-00391	JR10B	
09482-00397	JR9C	

SUZUKI	→ NGK	V-Line
09482-00398	DR7EA	
09482-00399	DR8EA	
09482-00400	DR9EA	
09482-00401	JR8C	
09482-00406	CR6HSA	
09482-00408	CR7HSA	
09482-00410	CR9EK	
09482-00412	CR8EK	
09482-00414	CR7EK	
09482-00426	BK6E	
09482-00427	BKR6E	28
09482-00432	BPR5E	
09482-00433	BPR5EY-11	
09482-00446	DCPR6E	
09482-00448	DCPR7E	
09482-00450	DCPR8E	
09482-00456	CR8E	
09482-00458	CR9E	
09482-00460	CR10E	
09482-00462	CR10EK	
09482-00463	CR10EK	
09482-00464	BR8HCS-10	
09482-00467	BR9HS-10	
09482-00470	BR8ECM	
09482-00472	BR9ECM	
09482-00474	BR10ECM	
09482-00477	BKR5E	
09482-00478	B10ES	
09482-00479	DCPR7EVX	
09482-00481	DCPR8EVX	
09482-00485	CR8HSA	
09482-00486	BR8HCS-10	
09482-00487	BPR6ES	2
09482-00491	JR9B	
09482-00493	BPR5E-11	
09482-00494	BKR6E-11	14
09482-00495	BPR7ES	19
09482-00499	R 4118-S8	
09482-00500	R 4118-S9	
09482-00504	BPR5EY	
09482-00509	R 6918B-8	
09482-00511	R 6918B-7	
09482-00513	R0045J-10	
09482-00514	R0045J-11	
09482-00516	CR7E	
09482-00519	BR9EYA	
09482-00521	PGR5A	
09482-00522	BPR7HS-10	
09482-00523	BPR8HS	
09482-00526	BR10EYA	
09482-00528	CR6E	
09482-00530	BPR6HS	3



SUZUKI	→ NGK	V-Line
09482-00531	BP6HS	18
09482-00532	B7HS-10	
09482-00533	BR7HS-10	
09482-00534	B6HS-10	
09482-00535	BR6HS-10	
09482-00537	DCPR9EVX	
09482-00547	IFR5E-11	
09482-00548	IFR6E-11	
09482-00549	IFR5J-11	
09482-00550	IFR6J-11	
09482-00561	BR8EG	
09482-00564	BR9EYA	
09482-69001	BPR6HS	3

SUZUKI AUTO	→ NGK	V-Line
09482-00167-000	BPR5EAL	
09482-00167-001	BPR5ES	6
09482-00299-000	BPR6ES	2
09482-00409-001	BPR6ES	2
09482-00429-000	BKR6E	28
09482-00429-001	BKR6E	28

TOYOTA	→ NGK	V-Line
90919-01210	IFR6T-11	
90919-01215	IFR5T-8N	

UNIPART	→ NGK	V-Line
GSP130	B5ES	
GSP131	BP5ES	8
GSP141	BP5ES	8
GSP151	BP6ES	4
GSP160	B6ES	
GSP163	BP6ES	4
GSP171	BP6ES	4
GSP181	BP7ES	
GSP191	BP8ES	
GSP244	BPR5ES	6
GSP263	BPR6ES	2
GSP264	BPR5ES	6
GSP281	BPR7ES	19
GSP30	B6S	
GSP331	BP5EFS	
GSP351	BP5EFS	
GSP361	BP6EFS	5
GSP381	BP7EFS	
GSP4154	AP6FS	
GSP4266	B5HS	
GSP4352	BP6ES	4
GSP4356	BP6HS	18
GSP4362	BP6ES	4
GSP4366	BP6HS	18
GSP4372	BP5ES	8

UNIPART	→ NGK	V-Line
GSP4376	BP5HS	
GSP4382	BP5ES	8
GSP4452	BPR7ES	19
GSP4462	BPR6ES	2
GSP4472	BPR5ES	6
GSP4552	BCP7ES	
GSP4562	BCP6ES	17
GSP4563	BP6EFS	5
GSP4573	BP5EFS	
GSP461	BPR6EFS	7
GSP4652	BCPR7ES	
GSP4662	BKR6E	28
GSP4663	BPR6EFS	7
GSP531	BP5HS	
GSP540	B5HS	
GSP541	BP6HS	18
GSP550	B6HS	
GSP560	B7HS	
GSP571	BP7HS	
GSP634	BCPR5ES	
GSP664	BKR6E	28
GSP665	BCP6ES	17
GSP6652	BKR6E	28
GSP6662	BKR6E	28
GSP684	BCPR7ES	
GSP685	BCP7ES	
GSP761	BP6FS	
GSP881	BPR6FS	
GSP96SZ	PFR6N-11	
GSP981	AP6FS	

VOLVO	→ NGK	V-Line
13 67 528	BPR6ES	2
13 67 529	BPR6ES	2
271 603	BKR6E	28
271 727	BKR6E	28
271 758	BKR7EVX-11	
35 17 980	BKR6E	28

VW / AUDI	→ NGK	V-Line
101 000 000AB	BP6ESZ	
101 000 001AA	-----	
101 000 001AB	BP6ET	
101 000 001AC	BP6ET	
101 000 001AD	BP5ET-10	
101 000 001AE	BP5ET	
101 000 002AB	BP6ESZ	
101 000 003AA	BCP7ET	
101 000 004AA	BCP7ET	
101 000 005AA	BP6ET	
101 000 005AB	BP6ET	
101 000 005AC	BP7ET	



VW / AUDI	→ NGK	V-Line
101 000 005AD	BP5ET-10	
101 000 005AE	BP5ET	
101 000 005AF	BP5ET	
101 000 006AB	BP6ESZ	
101 000 006AC	BP6ESZ	
101 000 007AA	BP6ET	
101 000 007AB	BP6ET	
101 000 007AC	BP5ET-10	
101 000 007AD	BP6ET	
101 000 016AA	PFR7B	
101 000 016AB	PFR6Q	
101 000 017AA	BCP7ET	
101 000 026AA	BPR5EKU	AAF engine
101 000 026AA	BUR5ET	22
101 000 026AB	BUR6ET	1
101 000 027AA	BP6ET	
101 000 027AB	BP5ET	
101 000 027AC	BP5ET-10	
101 000 028AA	BCP7ET	
101 000 029AB	BUR6EFSZ	
101 000 033AA	BKUR6ET-10	24
101 000 033AB	BKUR7ET	
101 000 033AC	BKUR5ET	
101 000 033AF	BKUR6ET	27
101 000 033AG	BKUR5ET-10	
101 000 034AA	BP6ESZ	
101 000 035AB	BKR5EKU	
101 000 035AH	BKR5EKUP	
101 000 035HJ	BKR6EKUB	
101 000 036AA	BUR6ET	1
101 000 036AB	BUR5ET	22
101 000 036AC	BUR5ET-10	21
101 000 038AA	BPR5EKU	
101 000 038AB	BPR5EKU	
101 000 039AA	BPR5EKU	
101 000 039AB	BPR5EKU	
101 000 040AC	BUR5ET	22
101 000 040AD	BUR6ET	1
101 000 040AE	BUR5ET-10	21
101 000 041AC	BKUR6ET-10	24
101 000 041AD	BKUR6ET	27
101 000 041AE	BKUR7ET	
101 000 044AA	----- nur für USA	
101 000 047AA	BP5ESA	
101 000 047AB	PGR6D	
101 000 049AD	BKR6ETA-10	
101 000 050AA	BUR5ET	22
101 000 050AB	BUR5ET-10	21
101 000 050AC	BUR6ET	1
101 000 051AA	BKUR6ET-10	24
101 000 051AB	BKUR7ET	
101 000 052AA	BUR6EFSZ	

VW / AUDI	→ NGK	V-Line
101 000 054AC	BKR6EQUPA	
101 000 055AA	BKR6EK	20
101 000 060AA	BKUR5ET-10	
101 000 062AA	PZFR6D-11	
101 000 062AB	PZFR5D-11	
101 000 063AA	PFR6Q	
101 000 065AA	BKR6ETA-10	
101 000 067AA	BKR6EQUPA	
101 905 600	PZFR5J-11	
101 905 600 A	PZFR6J-11	
101 905 601	PZFR5D-11	
101 905 606	IZKR7B	
101 905 607	BKR6EKUE	
101 905 611	PFR6U-11G	
101 905 617	ZFR5P-G	

WOLF	→ NGK	V-Line
1015 306	A6	
1018 301	BM6A	
1022 304	A6	
2000 305	BMR6A	
2012 310	BPR4S	
2016 301	B7HS	
2050 324	BMR6A	
2085 300	BR6ES	
2090 306	BPR6ES	2

YAMAHA	→ NGK	V-Line
90793 20029	B95EGV	
90793 20030	B105EGV	
90793 20032	B10EG	
90890 78082	B10EGV	
94701 00039	B6HS	
94701 00040	B7HS	
94701 00041	B8HS	
94701 00042	B9HS	
94701 00043	B6ES	
94701 00044	B7ES	
94701 00045	B8ES	
94701 00046	B9ES	
94701 00048	B8HCS	
94701 00050	BP7HS	
94701 00061	B8EVX	
94701 00063	B9EVX	
94701 00069	B5HS	
94701 00078	B5ES	
94701 00108	BP6HS	18
94701 00110	BR7HS	
94701 00111	BR6ES	
94701 00112	BR7ES	
94701 00113	BR8EVX	
94701 00116	BP6ES	4



YAMAHA	→ NGK	V-Line
94701 00117	BP7ES	
94701 00118	BP8ES	
94701 00148	B8HVX	
94701 00157	D8EA	
94701 00159	BP4HS	
94701 00160	B8HS-10	
94701 00168	BP5HS	
94701 00188	BR9ES	
94701 00189	D7EA	
94701 00190	BP5HA	
94701 00193	BR9EVX	
94701 00194	BPR5HS	
94701 00195	BR8HS	
94701 00198	BPR6HS	3
94701 00203	DR8ESL	
94701 00204	BR8ES	
94701 00208	DR7ES	
94701 00217	B7HS-10	
94701 00218	BPR7ES	19
94701 00219	BPR8ES	
94701 00227	BPR7HS	
94701 00232	BP6HS-10	
94701 00234	BPR6ES	2
94701 00237	BP8HS-10	
94701 00241	DPR8EA-9	
94701 00248	BR6HS	
94701 00250	CR7HS	
94701 00251	BR9HS	
94701 00254	C7HSA	
94701 00256	C6HSA	
94701 00258	BPR4HS	
94701 00262	DPR7EA-9	
94701 00263	DP7EA-9	
94701 00264	BP7HS-10	
94701 00266	D9EA	
94701 00267	BP8ES-11	
94701 00268	BP8HS	
94701 00273	B6HS-10	
94701 00274	BR6HS-10	
94701 00275	DP8EA-9	
94701 00280	BPR8HS	
94701 00282	CR6HS	
94701 00284	BP6EVX	
94701 00285	BPR6EVX	
94701 00287	DR8ES	
94701 00292	BPR6HS-10	
94701 00300	CR5HS	
94701 00301	B6EVX	
94701 00309	BR9HS-10	
94701 00311	BR5ES	
94701 00318	CR9E	
94701 00328	BPR5ES	6

YAMAHA	→ NGK	V-Line
94701 00330	CR8E	
94701 00332	R5184-105	
94701 00333	DR8EA	
94701 00340	DR9EA	
94701 00345	DR7EA	
94701 00353	CR7E	
94701 00354	CR4HSA	
94701 00361	DPR9EA-9	
94701 00365	BR6FS	
94701 00372	CR6HSA	
94701 00375	DPR6EA-9	
94701 00395	CR9EK	
94701 00403	CR9EK	
94701 00406	DPR5EA-9	
94701 00408	CR9EIA-9	
94702 00044	B7ES	
94702 00045	B8ES	
94702 00046	B9ES	
94702 00149	B7HS	
94702 00188	BR9ES	
94702 00193	BR9EVX	
94702 00195	BR8HS	
94702 00204	BR8ES	
94702 00211	BPMR6A	
94702 00247	BR8HS-10	
94702 00248	BR6HS	
94702 00249	BR5HS	
94702 00271	BR7HS-10	
94702 00272	BR7HS	
94702 00274	BR6HS-10	
94702 00309	BR9HS-10	
94702 00317	B9HS-10	
94702 00323	B8EG	
94702 00324	BR9EG	
94702 00325	B9EG	
94702 00326	BR8EG	
94702 00331	BPR4ES	
94702 00343	BR4ES	
94702 00348	BPR2ES	
94702 00349	BR7ES	
94702 00357	BR9ECM	
94702 00367	B10EG	
94702 00391	LFR5A-11	
94702 00400	LFR6A-11	
94702 00404	BKR7EKU	
94702 00405	BKR6EKU	
94702 00409	CR9EB	
94702 00418	DPR6EB-9	
94702 00419	CR4HSB	
94702 00N01	BP5HM	
94703 00277	B9EGV	
94703-00420	CPR7EA-9	



BERU	→ NGK
0100101305	DG-237
0100101306	DG-237
0100220113	Y-204RS
0100220114	Y-112M1
0100220115	Y-112R1
0100220118	Y-705RS
0100220206	Y-403T
0100221101	Y-302
0100221102	Y-208T
0100221103	Y-208T
0100221106	Y-208T
0100221107	Y-902R
0100221125	Y-902R
0100221132	Y-907R
0100221132	Y-902R
0100221133	Y-902R
0100221135	Y-908R
0100221141	Y-909R
0100221144	Y-911R
0100221145	Y-902R
0100221146	Y-910R
0100221147	Y-115T1
0100221148	Y-128T
0100221149	Y-117RS
0100221151	Y-118T
0100221152	Y-204TS1
0100221154	Y-107R
0100221163	Y-917U
0100221206	Y-404
0100221210	Y-405
0100221301	Y-811
0100222101	Y-118R
0100222102	Y-168R
0100222301	Y-810
0100222301	Y-403
0100222302	Y-810
0100226129	Y-729U
0100226163	Y-913M
0100226173	Y-918R
0100226180	Y-146R
0100226182	Y-147T
0100226183	Y-115R1
0100226184	Y-730U
0100226185	Y-922R
0100226186	Y-923U
0100226188	Y-731U
0100226189	Y-914U
0100226194	Y-707RS
0100226198	Y-935U
0100226227	Y-732U
0100226227	Y-732U
0100226229	Y-924U

BERU	→ NGK
0100226234	Y-916R
0100226235	Y-925R
0100230101	Y-181T
0100230102	Y-162R1
0100231104	Y-157R
0100231107	Y-197R
0100231109	Y-757RS
105MJ	Y-403
105MN	Y-208T
107M	Y-810
130MJ	Y-405
141MJ	Y-207T
151MJ	Y-208T
155MJ	Y-404
161MJ	Y-208T
162MJ	Y-207T
170MJ	Y-811
171MJ	Y-810
601MJ	Y-901R
609MJ	Y-902R
613MJ	Y-902R
624MJ	Y-902R
633MJ	Y-902R
950MJ	Y-732U
G 1	---
G 2	Y-902R
G 3	Y-902R
G 4	Y-907R
G 5	---
G 6	---
GD348	DG-237
GD382	DG-237
GN003	Y-745U
GN007	Y-741U
GN008	Y-501U
GN010	Y-746R
GN012	Y-502R
GN013	Y-938R
GN016	Y-503R
GN017	Y-747U
GN018	Y-515J
GN022	Y-937R
GN024	Y-507R
GN027	Y-504R
GN035	Y-749J
GN855	Y-732U
GN857	Y-918R
GN858	Y-916R
GN860	Y-930U
GN905	Y-730U
GN908	Y-922R
GN909	Y-923U



BERU	→ NGK
GN912	Y-731U
GN917	Y-914U
GN925	Y-926U
GN927	Y-935U
GN948	Y-925R
GN954	Y-924U
GN959	Y-932R
GN961	Y-929U
GN963	Y-506R
GN964	Y-738U
GN970	Y-928U
GN991	Y-927R
GN992	Y-748U
GN999	Y-740U
GV105	Y-208T
GV106	Y-403-1
GV107	Y-810
GV108	Y-810
GV112	Y-302
GV137	Y-403T
GV151	Y-208T
GV155	Y-404
GV602	Y-208T
GV603	Y-902R
GV624	Y-902R
GV631	Y-907R
GV636	Y-902R
GV642	Y-908R
GV657	Y-909R
GV661	Y-911R
GV663	Y-920R
GV666	Y-910R
GV673	Y-115T
GV678	Y-128T
GV685	Y-117RS
GV688	Y-118T
GV689	Y-204TS1
GV705	Y-107R
GV719	Y-917U
GV730	Y-739R
GV749	Y-306R not Opel/Isuzu
GV783	Y-729U
GV844	Y-933R
GV852	Y-913M
GV880	Y-157R
GV886	Y-146R
GV887	Y-181T
GV888	Y-204RS
GV889	Y-112M1
GV890	Y-162R1
GV892	Y-112R1
GV894	Y-118R

BERU	→ NGK
GV895	Y-197R
GV896	Y-168R
GV897	Y-147T
GV898	Y-115R1
GV920	Y-705RS
GV921	Y-707RS
GV922	Y-757RS
GV945	Y-307R
GV946	Y-742U
GV947	Y-743U

BOSCH	→ NGK
0250001008	DG-237
0250001012	DG-237
0250001016	DG-237
0250001416	DG-237
0250200013	Y-811
0250200014	Y-810
0250200020	Y-810
0250200035	Y-302
0250200037	Y-404
0250200046	Y-403-1
0250200048	Y-405
0250200049	Y-207T
0250200051	Y-403T
0250200052	Y-207T
0250200053	Y-909R
0250200054	Y-208T
0250200055	Y-810
0250200056	Y-208T
0250200058	Y-208T
0250200059	Y-208T
0250200060	Y-208T
0250200063	Y-207T
0250200065	Y-208T
0250200068	Y-208T
0250200069	Y-908R
0250200420	Y-810
0250200451	Y-403T
0250200454	Y-208T
0250200456	Y-208T
0250200465	Y-208T
0250200468	Y-208T
0250201001	Y-902R
0250201004	Y-901R
0250201005	Y-902R
0250201006	Y-908R
0250201008	Y-902R
0250201009	Y-902R
0250201011	Y-901R
0250201012	Y-909R
0250201013	Y-902R



BOSCH	→ NGK
0250201015	Y-901R
0250201017	Y-907R
0250201019	Y-902R
0250201021	Y-901R
0250201026	Y-916R
0250201029	Y-913M
0250201032	Y-918R
0250201033	Y-923U
0250201035	Y-930U
0250201038	Y-925R
0250201039	Y-902R
0250201405	Y-902R
0250201415	Y-901R
0250202003	Y-115T1
0250202004	Y-128T
0250202005	Y-117RS
0250202006	Y-118T1
0250202007	Y-107T
0250202009	Y-732U
0250202018	Y-910R
0250202022	Y-732U
0250202024	Y-927R
0250202087	---
0250202092	Y-733J
0250202094	Y-722J
0250312001	CY51
0250312002	CY52
0250312003	CY53
0250312007	CY57
BRISK → NGK	
21N01	Y-204TS
21N21	Y-208T
21N22	Y-208T
21N51	Y-909R
21R01	Y-901R
21R02	Y-907R
21R06	Y-918R
21R21	Y-902R
21R22	Y-908R
21R23	Y-902R
21R26	Y-913M
21R51	Y-909R
21R71	Y-910R
21R71	Y-911R
41N71	Y-403T
81P71	Y-811
81P71	Y-810
CATERPILLAR/MITSUBIS → NGK	
3S9624X	Y-171
4N360X	Y-159

CATERPILLAR/MITSUBIS	→ NGK
9N194X	Y-109
CHAMPION → NGK	
AG32	Y-302
AG44	Y-811
CH 32	Y-302
CH 44	Y-811
CH 60	Y-207T
CH 61	DG-237
CH 63	Y-208T
CH 64	Y-404
CH 65	Y-810
CH 66	Y-403T
CH 68	Y-902R
CH 69	Y-901R
CH 70	Y-909R
CH 79	Y-907R
CH 87	Y-208T
CH 88	Y-902R
CH 94	Y-115T1
CH 95	Y-146R
CH 96	Y-204RS
CH 97	Y-107R
CH 98	Y-117RS
CH 99	Y-117SS
CH101	Y-115R1
CH102	Y-112M1
CH103	Y-118T1
CH104	Y-197R
CH105	Y-204SS
CH110	Y-104R
CH121	Y-118T1
CH137	Y-908R
CH147	Y-910R
CITROEN → NGK	
95493206	Y-208T
95534788	Y-208T
HG2621	Y-810
DAIHATSU → NGK	
19850-54030-000	Y-118T
19850-54050-000	Y-118R
19850-54070-000	* only O/E
19850-54071-000	Y-146R
19850-54090-000	Y-715R
19850-56010-000	Y-178
19850-56012-000	Y-178T
19850-58030-000	Y-128T
19850-58040-000	Y-178T
19850-64010-000	Y-146R
19850-64020-000	Y-703R



DAIHATSU	→ NGK
19850-68010-000	Y-147T
19850-68040-000	Y-178T
19850-68060-000	Y-197R
19850-87303-000	Y-108
19850-87309-000	Y-128T
19850-87311-000	Y-178TS1
19850-87312-000	Y-178TS2
19850-87701-000	Y-146R
19850-87702-000	Y-703R
19850-87703-000	* only O/E
DENSO	
	→ NGK
067100-0160	DG-211
067100-1042	Y-402-2
067100-1043	Y-452-1
067100-1070	Y-176
067100-1071	Y-176
067100-1090	Y-108
067100-1120	Y-178
067100-1130	Y-128
067100-1161	Y-178T
067100-1170	Y-128T
067100-1171	Y-128T
067100-1270	Y-118T1
067100-1330	Y-147T
067100-1340	Y-197T
067100-1350	Y-128T
067100-1360	Y-178T
067100-1370	Y-118R
067100-1380	Y-168R
067100-1430	Y-146R
067100-1460	Y-197R
067100-1530	Y-146R
067100-1630	Y-118T1
EIKO	
	→ NGK
GD-901	Y-108
GF-101	Y-175-2
GF-102	Y-201
GF-103	Y-274
GF-104	Y-172
GF-105	Y-172
GF-106	Y-102
GF-108	Y-251
GF-109	Y-251
GF-110	Y-180
GF-111	Y-802-2
GF-112	Y-115T1
GH-401	Y-173
GH-402	Y-176
GI-001	Y-874-1
GI-002	Y-808-1

EIKO	→ NGK
GI-003	Y-104
GI-005	Y-104R
GI-006	Y-154R
GI-007	Y-154
GI-008	Y-271-2
GI-009	Y-154R
GM-501	Y-107T
GM-502	Y-107R
GM-503	Y-157R
GM-504	Y-172
GN-301	Y-803-1
GN-302	Y-103
GN-303	Y-103-2
GN-304	Y-202
GN-305	Y-252
GN-306	Y-112T
GN-307	Y-117-1
GN-308	Y-181T
GN-309	Y-204TS1
GN-310	Y-103-1
GN-311	Y-272R1
GT-201	Y-402-2
GT-202	Y-452-1
GT-203	Y-128
GT-204	Y-178
GT-205	Y-118T
GT-207	Y-178T
GT-208	Y-128T
GT-211	DG-211
GT-212	Y-146R
EUROCARB	
	→ NGK
111	Y-918R
FORD	
	→ NGK
1148105	YE04
EZD40	YE04
FUJI	
	→ NGK
211-72802-00	Y-401-3
233-72801-00	Y-113V
HINO	
	→ NGK
191101040	Y-176
1985A56010	Y-178
1985A56012	Y-178T
1985A56022	Y-128T
1985A68060	Y-197R
6054330901	Y-173
6301330010	Y-176



HKT	→ NGK
CP-01	CY51
CP-02	CY52
PD-190	Y-146R
PD-191	Y-703R
PD-99	Y-108
PH-20	Y-173
PH-21	Y-176
PI-12	DG-200A-1
PI-13	DG-205
PI-40	Y-874-1
PI-41	Y-808-1
PI-42	Y-104
PI-43	Y-154
PI-44	Y-271-2
PI-46	Y-104R
PI-47	Y-154R
PI-48	Y-154RS
PI-49	Y-904M
PI-50	Y-954M
PI-57	Y-711RS
PI-58	Y-710R
PK-111	Y-159
PK-98	Y-171
PM-160	Y-274R
PM-161	Y-115R1
PM-60	Y-172
PM-61	Y-175-2
PM-61	Y-175S2
PM-62	Y-102
PM-63	Y-201
PM-64	Y-802-2
PM-65	Y-251
PM-66	Y-180
PM-71	Y-172
PM-73	Y-274
PM-75	Y-115T1
PM-78	Y-971M
PM-79	Y-114T
PN- 81	Y-103
PN- 82	Y-252
PN- 84	Y-202
PN- 85	Y-103-1
PN- 86	Y-103-2
PN- 87	Y-112T
PN- 88	Y-177-1
PN- 89	Y-204TS1
PN-120	Y-181T
PN-121	Y-204RS
PN-122	Y-202-2
PN-123	Y-112M1
PN-124	Y-162R1
PN-125	Y-272R1

HKT	→ NGK
PN-126	Y-117RS
PN-127	Y-117SS
PN-128	Y-112R1
PN-129	Y-204SS
PN-130	Y-272T
PN-131	Y-755RS
PN-132	Y-705RS
PN-133	Y-144SS
PN-134	Y-144RS
PN-135	Y-707RS
PN-136	Y-757RS
PN-137	Y-955RS
PN-138	Y-712RS
PS-201	Y-103V
PS-202	Y-106V
PS-204	Y-106-1
PS-206	YE01
PS-207	Y-709R
PS-209	Y-119V
PS-210	Y-702U
PT- 90	Y-402-2
PT- 93	Y-128
PT- 94	Y-178
PT-100	Y-128T
PT-101	Y-178T
PT-103	Y-118T1
PT-104	Y-128T
PT-107	Y-146R
PT-108	Y-197T
PT-109	Y-178T
PT-140	Y-118R
PT-141	Y-197R
PT-142	Y-168R
PT-144	Y-118T1
PT-145	Y-147T
PT-147	Y-146R
PT-150	Y-703R
PT-151	Y-715R
PZ-30	Y-107T
PZ-31	Y-157R
PZ-33	Y-107R
PZ-34	Y-122
HONDA	→ NGK
ZA8-97044037-0	Y-719RS
HYUNDAI	→ NGK
36710-27000	Y-749J
36710-42000	Y-722J
36710-42500	CY57



ISHIKAWAJIMA SHIBAUR → NGK	
18536-6010	Y-401-3
18536-6020	Y-122
18536-6040	Y-107-1
18536-6060	Y-107V
18536-6080	Y-107R
ISUZU → NGK	
5-81410055-2	Y-154R
5-81410056-3	Y-154RS
5-81410057-2	Y-154R
5-81410058-3	Y-154RS
8-84402303-1	Y-711R
8-94135377-3	Y-954M
8-94135377-3	Y-945M1
8-94175158-0	Y-904M
8-94221719-3	Y-954M1
8-94241449-0	Y-104R
8-94241449-1	Y-104R
8-94255588-0	Y-104R
8-94319700-1	Y-710R
8-94319700-2	Y-710R
8-94439218-1	Y-104R
8-94481972-0	Y-711RS
8-97028369-0	Y-718RS
8-97033761-0	Y-945M1
8-97043744-0	Y-719R
8-97044037-0	Y-719RS
9-82511945-0	Y-874-1
9-82511978-0	Y-104
9-82511978-1	Y-104
9-82511994-0	Y-874-1
9-82513928-2	Y-271-2
9-82513959-0	Y-154
KIA → NGK	
36710-4A000	Y-508J
KOMATSU → NGK	
6004-50-4111	Y-872 S
6004-50-5001	YS-871T
6008-15-2110	DG-183 F
6008-15-2180	DG-183 FH
6008-15-2310	Y-174S
6008-15-2320	Y-174S1
6008-15-2650	Y-174TS
6008-15-2660	Y-174TS1
KUBOTA → NGK	
11000-4313-1	DG-235-1
15014-6551-1	DG-205
15101-6551-1	DG-220 A
15109-6559-1	Y-809-1

KUBOTA → NGK	
15204-6551-1	Y-110
15221-6551-3	Y-106-1
15231-6551-2	Y-107-1
15261-6551-2	Y-103K
15451-6551-1	Y-203
15521-6551-0	Y-106V
15521-6551-1	Y-106
15571-6551-1	Y-203V
15694-6551-2	Y-702R
15806-6551-2	Y-706R
15951-6551-1	Y-103V
15951-6551-2	Y-103V
16241-6551-1	Y-709R
16292-6551-1	Y-709RS
16415-6551-1	Y-713R
16851-6551-0	YE01
17331-6551-1	Y-119V
19077-6551-1	Y-716RS
19215-6551-1	Y-149
19821-6551-1	Y-301V
19872-6551-1	Y-756M
19883-6551-1	Y-752M
8412	Y-103K
YF04 / 95Y4	Y-E01
LUCAS → NGK	
DS001	Y-902R
DS002	Y-901R
DS003	Y-902R
DS006	Y-208T
DS101	DG-237
HDS217	Y-901R
HDS218	Y-907R
HDS218	Y-902R
HDS220	Y-403T
HDS221	Y-208T
HDS221	Y-206T
HDS224	Y-405
HDS225	Y-908R
HDS225	Y-810
HDS226	Y-204
HDS226	Y-404
HDS227	Y-302
HDS230	Y-117RS
HDS231	Y-204RS
HDS232	Y-115T1
HDS232	Y-115T
HDS233	Y-146R
HDS234	Y-118T
HDS235	Y-118R
HDS236	Y-178
HDS237	Y-197T



LUCAS	→ NGK
HDS238	Y-178T
HDS239	Y-112M1
HDS240	Y-162R1
HDS241	Y-107R
HDS242	Y-197R
HDS243	Y-112T
HDS244	Y-157R
HDS245	Y-128T
HDS246	Y-181T
HDS247	Y-104R
HDS248	Y-103
HDS248	Y-103K
HDS249	Y-104
HDS250	Y-160
HDS250	Y-251
HDS251	Y-203
HDS252	Y-128
HDS253	Y-117SS
HDS254	Y-204SS
HDS256	Y-103-1
HDS256	Y-301-1
HDS257	Y-103-2
HDS258	Y-204TS1
HDS259	Y-144RS
HDS262	Y-128T
HDS262	Y-715R
HDS267	Y-909R
HDS268	Y-147T
HDS269	Y-274
HDS270	Y-115R1
HDS272	Y-107T
HDS273	Y-910R
HDS275	Y-703R
HDS276	Y-707RS
HDS280	Y-112R1
HDS282	Y-108
HDS283	Y-705RS
HDS284	Y-168R
HDS291	Y-177-1
HDS294	Y-757RS
HDS295	Y-920R
HDS316	DG-237
HDS337	Y-907R
HDS338	Y-711R
HDS339	Y-911R
HDS340	Y-755RS
HDS343	Y-901R
HDS343	Y-207T
HDS343	Y-207TS
HDS343	Y-204V
HDS345	Y-710R
HDS346	Y-711RS

LUCAS	→ NGK
HDS347	Y-913M
MARELLI	→ NGK
TIX1A	Y-207T
TIX2A	Y-208T
TIX4A	Y-208T
TIX6A	Y-208T
UX1A	Y-901R
UX2A	Y-902R
UX4A	Y-902R
MAZDA	→ NGK
1304-18140	Y-172
1353-18140	Y-107T
1353-18140A	Y-107T
1456-18101A	YD-802
1456-18101B	YD-803
1470-18101	YD-802B
1470-18101A	YD-803B
4869-18140	Y-122
RFJ5-18601	Y-701R
S201-18140	Y-107R
S501-18140A	Y-107R
SE01-18140A	Y-157R
SEM1-18601	Y-771R
VS01-18601	Y-721RS
WL03-18-601	Y-701J
Y701-18-601	*CX03
MERCEDES	→ NGK
001 159 2001	Y-925R
MITSUBISHI	→ NGK
31366-02100	Y-251
31366-02109	Y-251
31366-14300	Y-201
31366-14301	Y-201
31366-14302	Y-201
31366-14701	Y-251
36710-42500	CY57
M 8 167 32	Y-932R
MD 014 997	Y-115R1
MD 050 212	Y-115T1
MD 092 392	---
MD 344 469	Y-733J
ME 007 649	---
ME 017 009	Y-274R
ME 017 010	Y-274
ME 017 013	Y-274
ME 017 057	Y-971M
ME 200 970	*CY05
ME 201 638	CY55



mitsubishi	→ NGK
ME 202 785	---
ME 203 754	CY55
MM 105 560	Y-251
MR 577131	Y-733J
MOTORCRAFT → NGK	
EZD1	Y-810
EZD10	Y-901R
EZD18	Y-115T1
EZD19	Y-128T
EZD20	Y-117RS
EZD21	Y-118T1
EZD22	Y-107T
EZD24	Y-104R
EZD5	Y-902R
NISSAN → NGK	
11065-02T00	Y-955RS
11065-10G00	Y-705RS
11065-10T01	Y-757RS
11065-16A00	Y-117SS
11065-16A01	Y-144SS
11065-16A05	Y-117RS
11065-16A06	Y-144RS
11065-16A10	Y-117SS
11065-16A11	Y-144SS
11065-16A15	Y-117RS
11065-16A16	Y-144RS
11065-29W00	Y-112RS1
11065-31N00	Y-712RS
11065-31W00	Y-112T
11065-31W01	Y-112T
11065-31W02	Y-112TS
11065-34W00	Y-112M1
11065-37501	Y-803
11065-37503	Y-805
11065-37506	Y-103
11065-37507	Y-103
11065-43G01	Y-707RS
11065-57J00	CY52
11065-63G00	Y-707RS
11065-AD220	Y-519J
11065-C0300	Y-177
11065-C8600	Y-755RS
11065-D2800	Y-120RS
11065-G2460	Y-712RS
11065-G2460	Y-712RS
11065-G5501	CY51
11065-J2000	Y-202
11065-J5500	Y-202-1
11065-J5501	Y-202-2
11065-J5502	Y-202-2

NISSAN	→ NGK
11065-J5503	Y-252-1
11065-J5504	Y-252-1
11065-J5570	Y-222T
11065-J6500	Y-272T
11065-K6700	Y-160
11065-OW801	CY58
11065-Q4000	Y-103-2A
11065-Q4001	Y-112T1
11065-T3400	Y-177-1
11065-T3401	Y-177-1
11065-T3470	Y-181T
11065-T8200	Y-112R1
11065-T8201	Y-162R1
11065-T8202	Y-112R1
11065-T8202	Y-112R1
11065-T8203	Y-162R1
11065-T9000	Y-272R1
11065-T9001	Y-272R1
11065-V0700	Y-204TS1
11065-V0710	Y-204TS1
11065-V7202	CX51
11065-V7203	CZ51
11065-W2500	Y-204RS
11065-W2510	Y-204RS
11065-W3400	Y-204SS
11065-W3410	Y-204SS
11065-Y1400	Y-103-1
11065-Y1401	Y-103-1
11065-Y1402	Y-103-2
11065-Y1403	Y-103-2
11065-Y1404	Y-103-2
11065-Z5000	Y-252
RFJ5 18 601	Y-701R
OPEL → NGK	
1214301	*
1214304	Y-208T
1214305	Y-902R
1214310	Y-711RS
1214311	Y-710R
1214315	Y-719RS
1214316	CY53
1214321	Y-904M
90093897	Y-208T
97080554	CY53
PEUGEOT → NGK	
5960.12	YE04
596122	Y-810
596135	Y-810
596139	Y-902R
596153	Y-208T

DISCONTINUED SPARK PLUGS
NICHT MEHR PRODUZIERTE ZÜNDKERZEN
RÉFÉRENCES PLUS FABRIQUÉES
BUJÍAS FUERA DE PRODUCCIÓN
TÄNDSTIFT SOM UTGÅTT UR SORTMENTET

Note : This list contains spark plug types that have been discontinued since 1989. Please make an inquiry concerning these discontinued plugs to our Authorized Representative in your country.

Anmerkung : Diese Liste enthält Zündkerzen, die im Zeitraum von 1989 bis heute nicht mehr produziert werden. Bei Fragen bzgl. dieser Typen kontaktieren Sie bitte Ihren autorisierten NGK-Fachhändler.

Notes : Cette liste contient les références de bougies qui ne sont plus fabriquées depuis 1989. Merci de vous renseigner auprès de notre représentant NGK dans votre pays concernant ces références.

Notas : Esta lista, contiene bujías cuya producción fue interrumpida en 1989. Rogamos consulte a nuestros distribuidores autorizados.

Observera : Denna lista innehåller tändstifts typer som utgått ur produktion och sortiment sedan 1989. Var vänlig vänd Dig till den auktoriserade representanten i Ditt land med eventuella förfrågningar.

Discontinued Plug	Replaced Plug
A-7F	A7FS
A-8F	A8FS
A-9F	A9FS
A5FS	-
A8V	A-8
A9EFP	-
A9V	A-8
AP7FVX	-
APR5FS-11	APR5FS
APR5FS-15	APR5FS
APR6F(Resistor Type)	APR6S(Non-resistor Type)
AR5FS	-
AU10EFP	-
B-8HN	R5525-8/R5530-8
B-9HN	R5525-9/R5530-9
B-10H	B10HS
B-10HN	R5525-10/R5530-10
B-105HN	R5525-10/R5530-10
B-11HN	R5525-11/R5530-11
B6HV	B6HVX
B7HV	B7HVX
B9HV	B9HVX
B10HV	B10HVX
B4ES-11	B4ES
B4HV	B-4H
B5EB	BR5ES
B5EB-11	BUR5EB-11
B5ES-11	B5ES
B5EV	B5EVX
B6EV	B6EVX
B7EV	B7EVX
B6EB	BR6ES
B6EB-11	BUR6EB-11
B6EB-L-11	BR6EB-L-11
B6EMV	B6EM
B6ET	B6EM
B7EB	BR7ES
B7EB-11	BUR7EB-11
B7EMV	BR7ET
B7ET	BR7ET
B8EMV	BR8ET
B8ES-11	B8ES
B8ET	BR8ET

Discontinued Plug	Replaced Plug
B9S	-
BC9ECS	-
BCP5EV-11	BCP5EVX-11
BCP6EV-11	BCP6EVX-11
BCPR4E-11	BCPR4ES-11
BCPR4ES	BCPR4ES-11
BCPR6ER	BKR6EK
BCPR7ER	BKR6EK
BK5EKU	BKR5EKU
BKR7EY-11	BKR7E-11
BM4A-10	BM4A
BMR7F(Resistor Type)	BM7F(Non-resistor Type)
BP2HA	BP2HS
BP4EQ-13	BP4ES-11/BPR4ES-13
BP4ES-13	BPR4ES-13
BP4HK	BP4HSA
BP5EQ-13	BP5ES-13
BP5ES-L	BP5EY
BP6EQ-13	BP6ES-11/BP6ES-13
BP6HK	BP6HSA
BP7EFS-13	BP7EFS
BP7EQ-13	BP7ES-11
BP7EY-11	BPR7EY-11
BP7HV	BP7HVX
BP6HV	BP6HVX
BP8ES-11	BP8ES
BP5EV	BP5EVX
BP7EV	BP7EVX
BP8EV	BP8EVX
BP8HK	BP8HSA
BP9EV	BPR9EVX
BP10ES	BPR10EVX
BP10EV	BPR10EVX
BPM7	BPM7A
BPR4ES-L-11	BPR5ES-11
BPR4FS-20	BPR4FS-15
BPR4S(Resistor Type)	BP-4(Non-resistor Type)
BPR4S-15(Resistor Type)	BP-4(Non-resistor Type)
BPR4S-20	-
BR8HV	BR8HVX
BPR5EV	BPR5EVX
BPR6EV	BPR6EVX
BPR5ES-15	BPR5ES-13

Discontinued Plug	Replaced Plug
BPR5ES-15	BPR5ES-13
BPR5S(Resistor Type)	BP5S(Non-resistor Type)
BPR5S-15(Resistor Type)	BP5S(Non-resistor Type)
BPR6ES-N-11	BPR6ES-11
BPR6FS-10	BPR6FS
BPR6FS-15	BPR6FS
BPR6S(Resistor Type)	BP6S(Non-resistor Type)
BPS-6E	-
BPZ9H-N-10	-
BR4ES-11	BR4ES
BR5EB	BR5ES
BR5EB-11	BUR5EB-11
BR5ES-11	BR5ES
BR6EB	BR6ES
BR6EB-11	BUR6EB-11
BR6EB-L	BR7ES
BR7EB	BR7ES
BR7EB-11	BUR7EB-11
BR7ES-11	BR7ES
BS-7HR	-
BU5EB-11	BUR5EB-11
BU6EB-11	BUR6EB-11
BU7EB-11	BUR7EB-11
BU8ET-Q	BP8ES
BU10H	-
BUEW	BUE
BZ8ES	BR8ES
BZ9ES	BR9ES
BZ9EV	BR9EVX
C-6M(Thread reach 13.7mm)	C6HSA(Thread reach 12.7mm)
C-10H	-
C-12H	-
C-13H	-
C-14H	-
C7HV	C7HVX
C8HV	C8HVX
D-12E	R216-12/R217-12
D-12H	-
D-13E	-
D-14E	-
D7EV	D7EVX
D8EV	D8EVX
D9EV	D9EVX

Discontinued Plug	Replaced Plug
D10HS	-
DP7EV-9	DPR7EVX-9
DP8EV-9	DP8EVX-9
DP9EV-9	DP9EVX-9
F23	-
J9B	JR9B
J10B	JR10B
JR9A	JR9B
JR10A	JR10B
L8A	C8HSA
R016-8	-
R016-9	R0373A-9
R016-10	R0373A-10
R016-11	R0373A-11
R017-7	-
R017-8	-
R017-9	R0373A-9
R017-10	R0373A-10
R017-11	R0373A-11
R017-12	-
R2098-10N	-
R2098-11N	-
R4118M-7	R4118S-7
R4118M-75	R4118S-75
R4118M-8	R4118S-8
R4118M-85	R4118S-85
R4118M-9	R4118S-9
R4118M-95	R4118S-95
R4118M-10	R4118S-10
R4118M-105	R4118S-105
R4118M-11	R4118S-11
R4339-8	B8EG
R4339-9	B9EG
R4339-10	B10EG
R4468-9	R6725-9
R4468-10	R6725-10
R4468-105	R6725-105
R4468-11	R6725-11
R4468-115	R6725-115
R4468A-9	R6725-9
R4468A-10	R6725-10
R4468A-105	R6725-105
R4468A-11	R6725-11
R4468A-115	R6725-115
R4630A-8	R7376-8
R4630A-85	-
R4630A-9	R7376-9
R4630A-95	-
R4630A-10	R7376-10
R4630A-105	-
R4630A-11	-
R5400-7	R7232-7
R5400-8	R7232-8
R5400-9	R7232-9
R5400-10	R7232-10
R5540-95	R5540F-10
R5540-10	R5540F-10
R5540-105	R5540F-105

Discontinued Plug	Replaced Plug
R5540B-105	R5540F-105
R5686-8	R7234-8
R5686-9	R7234-9
R5686-10	R7234-10
R5686-11	-
R5687-8	R7238-8
R5687-9	R7238-9
R5687-10	R7238-10
R5687-11	-
R6120-10	R7282-10
R6120-105	R7282-105
R6120-11	R7282-11
R6120A-10	R7282A-10
R6120A-105	R7282A-105
R6120A-11	R7282A-11
R6120C-105	R7282C-105
R6120C-11	R7282C-11
R6120M-10	R7282M-10
R6120M-105	R7282M-105
R6120M-11	R7282M-11
R6255-7	R7112-7
R6255-8	R7112-8
R6255-9	R7112-9
R6255-10	R7112-10
R8102-8	R8102A-8
R8102-9	R8102A-9
R8102-10	R8102A-10
SD8	BUR7EQ/BUR9EQ
SD9	BUR7EQ/BUR9EQ
SD10	BUR7EQ/BUR9EQ
SR5 [V-POWER PLUG]	TR5-1IX
SR5-1VX [V-POWER PLUG]	TR5IX
SR5VX [V-POWER PLUG]	TR5-1IX
TR4-2 [V-POWER PLUG]	TR4IX
TR4-2VX [V-POWER PLUG]	TR4IX
U0019	-
XFR5A-11	PFR5G-11
XFR5B-11	-
XFR6A-11	PFR6G-11
XFR6B-11	-
ZF4A-11	ZFR4F-11
ZF5A-11	ZFR5F-11
ZF7A-11	ZFR7F-11
ZFR4D-11	-
ZFR7A-11	ZFR7F-11
ZG5A	ZGR5A
ZTR7A	BR7EF

Discontinued Plug	Replaced Plug

TIGHTENING TORQUES FOR SPARK PLUGS

ANZIEHDREHMOMENTE DER ZÜNDKERZEN

COUPLES DE SERRAGE DES BOUGIES

PAR DE APRIETE PARA LAS BUJÍAS DE ENCENDIDO

ÅTDRAGNINGSMOMENT VID TÄNDSTIFTSMONTERING



	Flat seat type (with gasket) Zündkerze mit flachem Sitz (mit Dichtung) Modèle à siège plat (avec joint) Tipo de asiento plano (con emPaquetadura) Tändstift med packning					Conical seat type Zündkerze mit konischem Sitz. Modèle à siège conique Tipo de asiento cónico För koniskt säte	
	18 mm	14 mm	12 mm	10 mm	8 mm	18 mm	14 mm
Cast iron head Gußeisenkopf Culasse en fonte Culata de hierro fundido Cylinderlock av gjutjärn	35-45 N·m (3,5-4,5 m·kg) (25.3-32.5 lbs·ft.)	25-35 N·m (2,5-3,5 m·kg) (18.0-25.3 lbs·ft.)	15-25 N·m (1,5-2,5 m·kg) (10.8-18.0 lbs·ft.)	10-15 N·m (1,0-1,5 m·kg) (7.2-10.8 lbs·ft.)	—	20-30 N·m (2,0-3,0 m·kg) (14.5-21.6 lbs·ft.)	15-25 N·m (1,5-2,5 m·kg) (10.8-18.0 lbs·ft.)
Aluminium head Aluminiumkopf Culasse en aluminium Culata de aluminio Cylinderlock av lättmetall	35-40 N·m (3,5-4,0 m·kg) (25.3-28.9 lbs·ft.)	25-30 N·m (2,5-3,0 m·kg) (18.0-21.6 lbs·ft.)	15-20 N·m (1,5-2,0 m·kg) (10.8-14.5 lbs·ft.)	10-12 N·m (1,0-1,2 m·kg) (7.2-8.7 lbs·ft.)	8-10 N·m (0,8-1,0 m·kg) (5.8-7.2 lbs·ft.)	20-30 N·m (2,0-3,0 m·kg) (14.5-21.6 lbs·ft.)	10-20 N·m (1,0-2,0 m·kg) (7.2-14.5 lbs·ft.)

To install new spark plugs in the engine, first tighten them by fingers, then retighten the plug using a plug wrench. (See below)

Spark plug thread size	Plug wrench	
Gasket type	New gasket	Used gasket
18mm, 14mm	1/2 to 2/3 turn (180 to 240 degrees)	1/12 turn (30 degrees)
12mm, 10mm	1/2 turn (180 degrees)	1/12 turn (30 degrees)
8mm	1/3 turn (120 degrees)	1/12 turn (30 degrees)
Conical seat type	No gasket	
18mm, 14mm	1/12 turn (30 degrees)	

Para instalar bujías nuevas en el motor, primero apriéte las a mano, y luego vuelva a apretarlas con una llave de bujías. (Véase la siguiente tabla.)

Tamaño de rosca de bujías	Llave de bujías	
Tipo junta	Junta nueva	Junta reutilizada
18mm, 14 mm	1/2 a 2/3 vuelta (180 a 240 grados)	1/12 vuelta (30 grados)
12mm, 10 mm	1/2 vuelta (180 grados)	1/12 vuelta (30 grados)
8mm	1/3 vuelta (120 grados)	1/12 vuelta (30 grados)
Tipo asiento cónico	Sin junta	
18mm, 14mm	1/12 vuelta (30 grados)	

Zum Installieren der neuen Zündkerzen in den Motor, diese zuerst mit der Hand festziehen und dann mit einem Zündkerzenschlüssel festziehen. (Siehe unten.)

Zündkerzen-Gewindedurchmesser	Drehmomentschlüssel	
Dichtungstyp	Neue Dichtung	Alte Dichtung
18mm, 14mm	1/2 bis 2/3 Umdrehung (180 to 240 Grad)	1/12 Umdrehung (30 Grad)
12mm, 10mm	1/2 Umdrehung (180 Grad)	1/12 Umdrehung (30 Grad)
8mm	1/3 Umdrehung (120 Grad)	1/12 Umdrehung (30 Grad)
Kegeldichtstyp	Keine Dichtung	
18mm, 14mm	1/12 Umdrehung (30 Grad)	

Montera nya tändstift i motorn genom att först skruva i dem för hand och sedan dra åt dem med hjälp av en tändstiftsnyckel (se nedan).

Gängstorlek på tändstift	Tändstiftsnyckel	
Tändstift med packning	Ny packning	Använd packning
18mm, 14mm	1/2 till 2/3 varv (180-240°)	1/12 varv (30°)
12mm, 10mm	1/2 varv (180°)	1/12 varv (30°)
8mm	1/3 varv (120°)	1/12 varv (30°)
Tändstift med koniskt säte	Ingen packning	
18mm, 14mm	1/12 varv (30°)	

Pour mettre en place des bougies sur le moteur, visser d'abord chacune à la main, puis serrer la bougie en utilisant une clé à bougie. (voir le tableau ci-dessous).

Diamètre de filetage	Clé à bougie	
Type avec joint	Joint nouvel	Joint existant
18mm, 14mm	1/2 à 2/3 tour (180 a 240 degrés)	1/12 tour (30 degrés)
12mm, 10mm	1/2 tour (180 degrés)	1/12 tour (30 degrés)
8mm	1/3 tour (120 degrés)	1/12 tour (30 degrés)
Bougie à siège conique	Sans joint	
18mm, 14mm	1/12 tour (30 degrés)	

CONVERSION TABLE, MM ↔ Inch

UMWANDLUNGSTABELLE, mm ↔ Zoll

TABLE DE CONVERSION, mm ↔ pouce

TABLA DE CONVERSION, mm ↔ PULGADAS

OMVANDLINGSTABELL, mm ↔ TUM

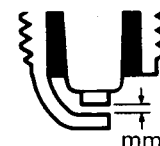

Inch																
Zoll																
pouce																
PULGADAS	0.016	0.024	0.032	0.040	0.048	0.056	0.080									
TUM	0.020	0.028	0.036	0.044	0.052	0.060										
MM	0.40	0.50	0.60	0.70	0.80	0.90	1.00	1.10	1.20	1.30	1.40	1.50	2.00			

PS/HP ↔ kW

PS/HP	kW	kW	PS/HP
1	0,736	1	1,360
30	22,065	20	27,192
35	25,742	25	33,991
40	29,420	30	40,789
45	33,097	35	47,587
50	36,775	40	54,385
55	40,452	45	61,183
60	44,130	50	67,981
65	47,807	55	74,779
70	51,485	60	81,577
75	55,162	65	88,375
80	58,840	70	95,173
85	62,517	75	101,972
90	66,195	80	108,770
95	69,872	85	115,568
100	73,550	90	122,366
105	77,227	95	129,162
110	80,905	100	135,962
115	84,582	105	142,760
120	88,260	110	149,558
125	91,937	115	156,356
130	95,615	120	163,154
135	99,292	125	169,953
140	102,970	130	176,751
145	106,647	135	183,549
150	110,325	140	190,347
155	114,002	145	197,145
160	117,680	150	203,943
165	121,357	155	210,741
170	125,035	160	217,539
175	128,712	165	224,337
180	132,390	170	231,135
185	136,067	175	237,934
190	139,745	180	244,732
195	143,422	185	251,530
200	147,100	190	258,328
205	150,777	195	265,126
210	154,455	200	271,924
215	158,132	205	278,722
220	161,810	210	285,520
225	165,487	215	292,318
230	169,165	220	299,116
235	172,842	225	305,915
240	176,520	230	312,713
245	180,197	235	319,511
250	183,875	240	326,309
255	187,552	245	333,107
260	191,230	250	339,905
265	194,907	255	346,703
270	198,585	260	353,501
275	202,263	265	360,299

INFO

Übersetzung/Translation

D	GB	D	GB
* nur über Vertragshändler	only by car dealer	Langgewinde	3/4 Reach
◆ ohne Wegfahrsperre	without immobilizer	Laubsauger	Vacuum Cleaners
△ mit Wegfahrsperre	with immobilizer	Luftbesen	Air Blower
AGR (Abgasrückführung)	exhaust-gas recirculation	Magermix	Lean Burn
alle Modelle	all Models	Mehrzweckmotor	Multiengine
Allwegtransporter	Allwaytransporters	mit	with
APS (Klopffregelung)	knock control	mit 3 Wege Cat.	with 3 way cat.
Astschneider	Treecutter	Modell	Model
Aufsitzmäher	Ride-on-mower	Mot./Motor	engine
Balkenmäher	Brush cutter	Motorhacke	Cultivators
Cat.	Catalytic converter	Multischneider	Multicutter
DI (Stecker-Spulen-Einheit)	direct ignition	o. Cat.	without Catalyst
EGR (Abgasrückführung)	exhaust-gas recirculation	ohne	without
Erdbohrer	Earthbore	ohne 3 Wege Cat.	without 3 way cat.
Fernbedienung	Remote Control	PS	horse power
Fgst (Fahrgestellnummer)	Chassis No.	QGS Typ	quick glow system
Gartentraktor	Power-Cart	Rasentraktor	Turf-Tractor
Gebälse	Power Blowers	Schneefräse	Snow Thrower
Hacke	Motor Hoe	Sprayer	Sprayer
Häcksler	Grinder	Traktor	Tractor
Heckenschere	Hedgwe trimmer	Trennsäge	Cut Off Saw
Holzspalter	Wood Splitters	Trennschleifer	Cut Off Saw
Kantenschneider	Edge Trimmers	Vertikutierer	Lawn Scanifiers
Katalysator	Catalytic converter	Vorsatzmotor	Multiengine
Konisch	Conical seat	Wasserpumpe	Waterpump
Kraftgebläse	Power Blowers	Wiesenmäher	Turf-Cutters
Kühlaggregat	Refrigeration engine	Zylinder	cylinder
Kurzgewinde	1/2 Reach	Zylindrisch	Flat seat

SERIES OF NGK RACING SPARK PLUGS

Blue colour indicates resistor plugs.

Thread size (Hexagon size)	Spark plug type		Spark plug number	Heat rating	Firing end appearance	Electrode material	
						Center	Ground
φ 14×19mm (20.8mm)	BP-E		R4304A	7,8,9,10	(A) ①	Gold Palladium	Nickel Alloy
		B-E		R6918B	7,8,9	(B) ①	Platinum
			R6918C	9	(B) ①	Platinum	Nickel Alloy
			R6021E	7,7.5,8,8.5,9,10,10.5	(B) ①	Nickel Alloy	Nickel Alloy
			R6061	7,8,9,10,11	(G) ①	Nickel Alloy	Nickel Alloy
			R6252E	9,10.5 Gap0.6	(C) ①	Nickel Alloy	Nickel Alloy
			R6252K	10.5 Gap0.8	(C) ①	Nickel Alloy	Nickel Alloy
			R6254E	9,10.5 Gap0.6	(C) ①	Nickel Alloy	Nickel Alloy
			R6254K	10.5 Gap0.8	(C) ①	Nickel Alloy	Nickel Alloy
			R7376	7,8,9,10	(C) ①	Iridium	Platinum
			Semi surface discharge	R5649	9,10,11	(E) ①	Nickel Alloy
		Semi surface discharge	R6712	9,10	(E) ①	Nickel Alloy	—
		Short	R6179A	10,10.5,11	(C) ②	Platinum	Platinum
φ 14×22mm (20.8mm)		Short	R6179C	10.5	(C) ②	Platinum	Platinum
			R7376B	9,10	(C) ①	Iridium	Platinum
		Short	R7282A	10,10.5,11	(C) ③	Iridium	Platinum
φ 14×19mm (16.0mm)		Short	R7282	7,8,9,10,10.5,11	(C) ③	Iridium	Platinum
		Short	R7282C	10.5,11 No gasket type	(C) ③	Iridium	Platinum
		Short	R7282M	10.5,11,11.5	(C) ③	Iridium	Platinum
	BK-E (ISO)※1		R6888A	8,9,10	(F) ④	Nickel Alloy	Nickel Alloy
			R7433	8,9,10	(A) ⑤	Iridium	Nickel Alloy
	BC-E (ISO) ※1		R7434	8,9,10	(C) ⑤	Iridium	Platinum
			R7279	10	(D) ⑤	Iridium	Platinum
		Semi surface discharge	R6601	8,9,10,11	(E) ⑤	Nickel Alloy	—
		Semi surface discharge	R6711	9,10	(E) ⑤	Nickel Alloy	—
	BCE-E (JIS)		R7435	8,9,10	(A) ④	Iridium	Nickel Alloy
	BC-E (JIS)		R7436	8,9,10	(C) ④	Iridium	Platinum
		Semi surface discharge	R5883	9,10,11	(E) ④	Nickel Alloy	—
		Semi surface discharge	R6690	9,10,11	(E) ④	Nickel Alloy	—
φ 14×26.5mm (16.0mm)	LFR	Extra long reach	R7437	8,9,10	(A) ⑥	Iridium	Nickel Alloy
		Extra long reach	R7438	8,9,10	(C) ⑥	Iridium	Platinum
φ 14×12.7mm (20.8mm)	B-H		R5525	7,8,9,10,11	(B) ⑦	Gold Palladium	Nickel Alloy
			R5530	8,9,10,11	(D) ⑦	Gold Palladium	Platinum
φ 14×21.5mm (20.8mm)	Rotary Engine RX-7		R6725	9,10,10.5,11,11.5	(D) ⑥	Platinum	Platinum
			R7420	9,10,10.5,11	(D) ⑥	Iridium	Platinum
φ 14×21mm (20.8mm)	Rotary Engine RX-8 L		R7440A	9,10	(C) ⑧	Iridium	Platinum
φ 14×19mm (20.8mm)	Rotary Engine RX-8 T		R7440B	10,11	(C) ⑧	Iridium	Platinum
φ 12×19mm (16.0mm)	DC-E	Semi surface discharge	R2349	9,10,11	(E) ⑥	Nickel Alloy	—
			R2525	9,10,11	(C) ⑥	Platinum	Nickel Alloy
φ 10×19mm (16.0mm)	C-E		R0373A	9,10	(C) ⑨	Iridium	Platinum
		Semi surface discharge	R0045G	10,11 GAP1.4	(E) ⑨	Nickel Alloy	—
		Semi surface discharge	R0045J	9,10,11,12 GAP1.1	(E) ⑨	Nickel Alloy	—
		Semi surface discharge	R0045Q	10,11 GAP1.1	(E) ⑨	Nickel Alloy	—
φ 10×19mm Half thread (16.0mm)	C-EH		* R0379A	10	(C) ⑩	Iridium	Platinum
			R0409B	8,9,10	(C) ⑩	Iridium	Nickel Alloy
φ 10×12.7mm (16.0mm)	C-H		R0161	9,10,11	(B) ⑩	Nickel Alloy	Nickel Alloy
φ 8×19.0mm (13.0mm)	E-EH	Semi surface discharge	R847	10,11	(E) ⑪	Nickel Alloy	—

- 1) ISO: The length from gasket to terminal of ISO type spark plugs is 50.5mm which is 2.5mm shorter than BCE-E or BC-E type spark plugs.
- 2) Resistor spark plugs are recommended for cars originally equipped with resistor spark plugs.
When nonresistor spark plugs are installed in such cars, there is some possibility that the electric devices in the car, such as the audio system or the engine management system, would be affected by noise.
- 3) Marked * part number will be discontinued when the current stock is over.

APPEARANCE

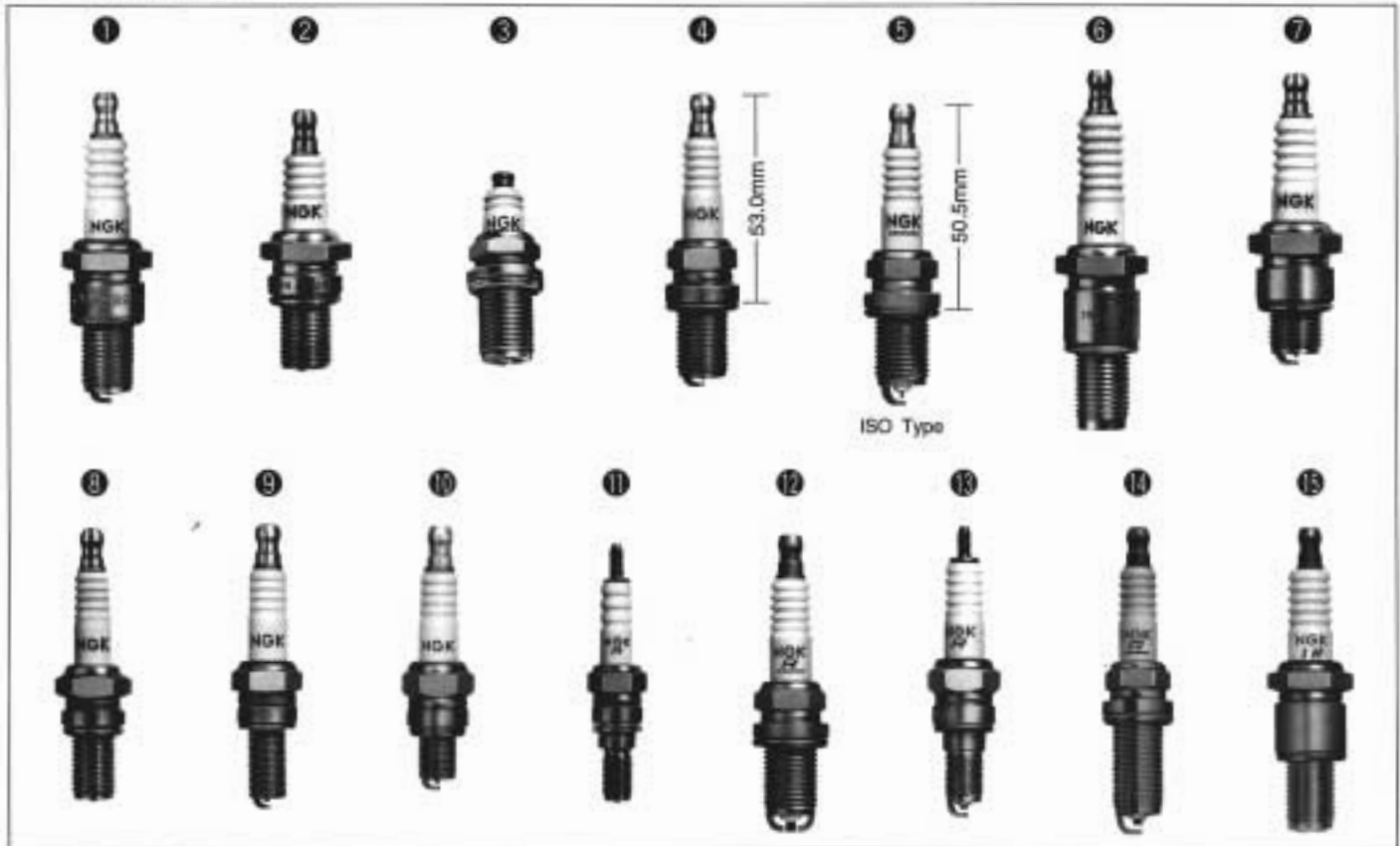

FIRING END

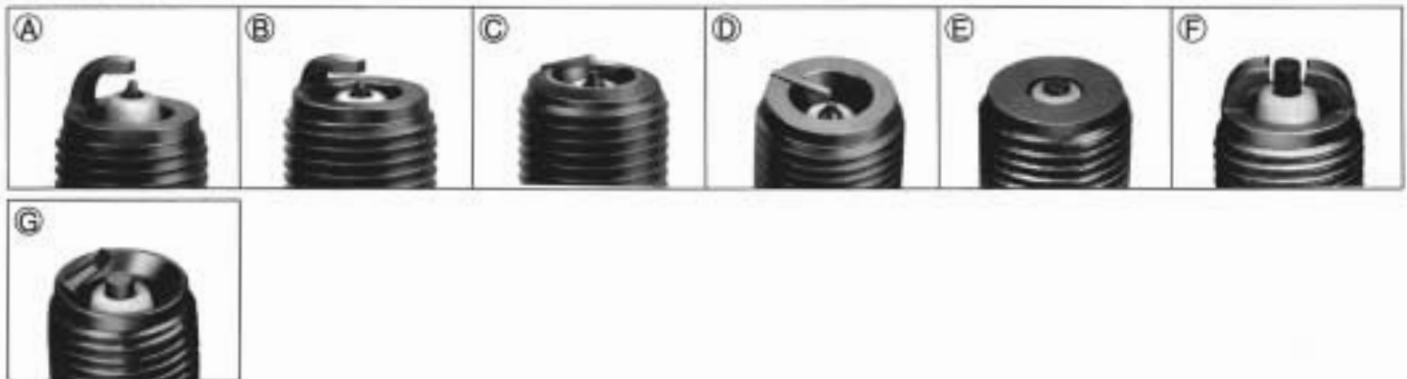

⚠ Notice

• Choose appropriate heat range and firing end of racing spark plugs according to engine modification or driving condition.

(Generally, the more a firing position is projected into the combustion chamber, spark plug's ignitability is improved. However, a projected ground electrode tends to be exposed to high-temperature combustion gases and will possibly cause troubles because of over-heating. Therefore, when an engine is modified tougher, non-projected type spark plugs should be installed to keep the firing end's insulator and the ground electrode from exposed to high-temperature combustion gases. Also, colder type spark plugs should be chosen for high-modified engine.)

● DISCONTINUED PLUG TYPES

Blue colour indicates resistor plugs.

Old part number	New part number
R6255-○, R6255F-○, R6326-○	→ R7433-○
R6205-○, R6241-○	→ R7433-○
R6206-○, R6242-○	→ R7434-○
R5400-○, R5400F-○, R6337-○	→ R7435-○
R5686-○	→ R7435-○
R5830-○	→ R7436-○
R5687-○	→ R7436-○

Old part number	New part number
R6120-○	→ R7282-○
R6120A-○	→ R7282A-○
R6120C-○	→ R7282C-○
R6120M-○	→ R7282M-○
R4630A-○, R6385-○P	→ R7376-○
R216-○, R217-○	→ R2525-○
R2270-○, R2430-○	→ R2349-○
R016-○, R017-○	→ R0373A-○

RECOMMENDATION CHART OF NGK RACING SPARK PLUGS

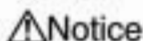

It is essential to use racing spark plugs that fit a specific engine and its conditions of use.

MOTORCYCLES



Blue colour indicates resistor plugs.

Manufacturer		Model	Spark plug Number	Racing spark plug IX, VX spark plug	
HONDA	Road race	CB1300, X-4, CB1000SF	DPR8EA-9	R2525-10	
		CBR1100XX, X11	CR9EHVX-9	R0045Q-10	
		VTR1000SP-1	FR9BI-11	R7279-10	
		VTR1000F/Fire Storm	DPR9EVX-9	R2525-10	
		CBR1000RR	R0409B-10	R0045Q-10	
		CBR954RR(Fire Blade)	IMR9C-9H	R0045Q-10	
		CBR900RR	CR9EH-9	R0045Q-10	
		CBR600RR/F4i	IMR9C-9H	R0409B-10	
		CBR400RR, CB400SF/R/S	CR8EH-9	R0409B-10	
		NSR250R/SP/SE	BR9ECM	BR10ECMVX	
		NSR80/50, NS-1	BR8ES	BR8EIX	
		Z50J	CR8HSA	R0161-10, CR9HIX, CR8HIX	
		RS250R	R6120-105	R7282-105, ※R7282A-105	
		NSR150	B8ES, B9ES	BR9EIX	
		RS125R	R6385-105P	R7376-10, ※R7282A-105	
		NS50R	BR9ES	BR9EIX, R7282-10	
		Motocross	CRF450R	IFR8H11	R7433-8
	CRF250R		IMR8C-9H	-	
	CR250R		BR8EG	BR8EIX, R7376-8	
	CR125R		BR9EG	BR9EIX, R7376-9	
	CR80R/R2, CR85R/R2		BR10EG	BR10EIX, R7376-10	
	Trial	TLM220R	BR8ES	BR8EIX	
	KAWASAKI	Road race	ZRX1100/II, ZX-9R, ZX-12R	CR9E	R0373A-10
ZX-10R			CR9E	R0373A-10, R0045Q-10	
GPZ900R			DR9FA	R2525-10	
NinjaZX-7RR			CR9E	R0045Q-10	
NinjaZX-6			CR9E	R0373A-10	
ZZ-R600/400			CR9E	R0373A-10	
ZXR400R, ZX-6R			CR9EK	R0373A-10	
Motocross			KLX300R, KLX250	CR8E	CR8EIX
		KX250F	CR8EB	-	
		KX250	BR8EIX	BR8EIX, R7376-8	
		KX125	BR9EIX	BR9EIX, R7376-9	
		KX80/II, KX85/II	R6254K-105	BR10EIX, R7376-10	
SUZUKI		Road race	TL1000S/R	CR9E	CR9EIX, R0373A-10
	GSX1300R		CR9E	CR9EIX, R0373A-10	
	GSX-R1000		CR9E	R0373A-10, R0045Q-10	
	GSX-R750/SP		CR9E	R0045Q-10	
	GSX-R600, GSX-R400R		CR9E, CR8EK	R0373A-10	
	GSX400Impulse/S		CR8E	R0373A-10	
	RGV250Γ/SP, RGV125Γ		BR9ECM	BR10ECMVX	
	Motocross	RM-Z250	CR8EB	-	
		RM250	R6918B-7	←	
		RM125	R6918B-8	←	
RM80/L, RM85/L	R6918B-9	←			
YAMAHA	Road race	YZF-R1/R6	CR9EK, CR10EK	R0373A-10, R0045Q-10	
		YZF-R7	CR9E	R0045Q-10	
		YZF1000R	DR8EA	R2525-10	
		TRX850, TDM850	DPR8EA-9	R2525-10	
		YZF750R/SP	CR9E	R0045Q-10	
		YZF600R	CR9E	R0373A-10	
		FZR400RR-SP	CR8E	R0373A-10	
		TZR250SPR	BR8ECM	BR10ECMVX	
		TZR125	BR9ES	BR9EIX	
		TZ250	R6179A-105P	R6179A-105P, ※R6179C-105PA	
		TZ125R	R6385-105P	R7376-10, ※R7376B-10	
		TZ50	BR9EV	BR9EIX	
		Motocross	YZ450F, YZ426F, YZ400F	CR8E	CR8EIX
			YZ250F	CR8E	CR8EIX
			YZ250	BR8EG	BR8EIX, R7376-8
	YZ125		BR9EG	BR9EIX, R7376-9	
	YZ80/LW, YZ85/LW		BR10EG	BR10EIX, R7376-10	
	Trial	TY250Z	BP6EV	BPR6EIX	
	DUCATI	Road race	996, 916	-	R2349-10



※The thread length is longer than the normal type due to setting the detonation counter.



Last Info

	ℓ	kW			Cyl.		Order- No.	 VLINE No.	Bic ¹⁾	Order- No.
ALFA ROMEO										
147 JTS	2.0	125	10.00-	937A1000	4	0,9	BKR6EKPA	2513		
GT	1.8	103	12.03-	AR32205	4	0,7+	BKR6EKPA+	2513+		
						0,9	PMR7A	4259		
ALPINA										
Roadster S	3.4	221	05.04-		6		BKR6EQU	3199	30	BKR6EQU 3199
AUDI										
A 6 FSI	3.2	188	04.04-		6		PFR7W-T			
BMW										
316 i Touring	E46/3	1.8	85	03.04-	N46 B18	4		IZFR6H11		
316 i	E46/4	1.6	85	03.04-	N45 B16	4		IZFR6H11		
316 i	E46/4	1.8	85	03.04-	N46 B18	4		IZFR6H11		
316 ti Compact	E46/5	1.8	85	03.04-	N46 B18	4		IZFR6H11		
318 Ci	E46/2	2.0	105	03.04-	N46 B20	4		IZFR6H11		
318 i	E46/4	2.0	105	03.04-	N46 B20	4		IZFR6H11		
318 ti Compact	E46/5	2.0	105	03.04-	N46 B20	4		IZFR6H11		
M5	E60	5.0	368	11.04-	S85 B50	10		LKR8AP		
M6	E 63	5.0	368	11.04-	S85 B50	10		LKR8AP		
Z 4	E85	2.0	110	09.04-	N46 B20	4		IZFR6H11		
Z 4	E85	2.2	125	09.03-	M54 B22	6		BKR6EQU	3199	30
CHRYSLER										
300 C / M	3.5	183	07.04-	V6 G FI	6	1,3	ZFR5LP-13G			
300 C	5.7	250	07.04-		8	1,1	LZTR4A-11	5444		LZTR4AIX-13
Voyager 4	3.3	128	03.01-		6	1,1	LZTR4A-11	5444		LZTR4AIX-13
FIAT										
Doblò			12.04-		4	1,0	DCPR7E-N-10			
Idea	1.4		12.04-		4	1,0	DCPR7E-N-10			
Nuova Panda	1.1		12.04-		4	1,0	DCPR7E-N-10			
Nuova Panda	1.2		12.04-		4	1,0	DCPR7E-N-10			
Punto 16V	1.2		12.04-		4	1,0	DCPR7E-N-10			
Punto 8V	1.2		12.04-		4	1,0	DCPR7E-N-10			
Punto	1.4		12.04-		4	1,0	DCPR7E-N-10			
Seicento	1.1		12.04-		4	1,0	DCPR7E-N-10			
Stilo	1.4		12.04-		4	1,0	DCPR7E-N-10			
Ulysse V6	3.0	150	06.02-	XFW	6	1,1	PLFR5A-11	6240		
LANCIA										
Musa	1.4		04-		4	1,0	DCPR7E-N-10			
Ypsilon	1.2				4	1,0	DCPR7E-N-10			
Ypsilon	1.2				4	1,0	DCPR7E-N-10			
Ypsilon	1.2				4	1,0	DCPR7E-N-10			
MERCEDES										
CLS 350	(219)	3.5	200	04-	M 272.964	6		PLKR6A		
VOLVO										
S 40 2.4	2.4	103	01.04-	B5244	5		LFR6D			
S 40 2.4i	2.4	125	01.04-	B5244	5		LFR6D			

¹⁾ Bic = Best in class (siehe Seite 3) / (see page 3)

Neue Zündkerzen / new Spark Plugs

			Order- No.
LANCIA	Musa, Ypsilon	DCPR7E-N-10	
FIAT	Doblo, Idea, Panda, Punto, Seicento, Stilo	DCPR7E-N-10	
FORD (USA)	Thunderbird	FR5AP-10	
TOYOTA	Hi-Ace (RCH 13, 19, 23, 29)	IFR5A-11	
TOYOTA	Avensis (ZZT250, 251)(AZT250)	IFR6A-11T	
SUZUKI	Escudo	IFR6E-11	6741
ACURA	RSX	IFR7G-11K	4965
BMW	E46 / E85	IZFR6H11	
TOYOTA	4 Runner (GRN210, 215)	LFR6C-11	
VOLVO	S40	LFR6D	
BMW	M5 / M6	LKR8AP	
RENAULT	Laguna 2 / Estate Turbo	PFR6G-9	4377
MERCEDES	CLS (219)	PLKR6A	
FIAT	Ulysse	PLFR5A-11	6240
MASERATI	Gransport	PMR8B	6378
VW	1.6 FSI	ZFR6S-Q	6449
AUDI	A6	PFR7W-T	
VW	2.0 FSI	PZFR5N-11TG	

			Order- No.
HONDA	CBR 1000 Fireblade (G)	IMR9C-9HES	
HONDA	CBF 500 (ED)	CR8EH-9S	
YAMAHA	YP 250 Grand Majesty	CPR7EA-9	
PEUGEOT	Satelis 125	CR7EB	4663
PEUGEOT	Ludix 125	CR7EB	4663
PIAGGIO	X 9 EVO (4T)	CR7EKB	4455
PIAGGIO	Gandturismo	CR9EB	6955
HONDA	Zoomer	ER8EH-N	
HONDA	DIO 50	ER8EH-N	