



2005/2006



Anmerkungen D

Diese Anwendungsliste dient nur der Typenauswahl.
Mit Veröffentlichung dieser Ausgabe verlieren alle vorhergehenden Anwendungslisten ihre Gültigkeit.
Ein Rechtsanspruch kann aus dem Inhalt nicht begründet werden.
Empfehlungen gemäß der FAA-Richtlinien für Luftfahrttriebwerke sind in dieser Ausgabe nicht enthalten.

Comments: GB

This application list is only valid for type identification.
This catalogue supersedes all previous catalogues.
We do not accept any responsibility in respect of legal claims arising out of the contents of this list.
Spark Plug recommendations regarding FAA guidelines for aeroplane power units are not included in this edition.

Informations: F

Ce catalogue doit être utilisé en tant que manuel de référence. Des bougies d'allumage plus froides ou plus chaudes devront être utilisées selon le style de conduite et l'usure du moteur.
La dernière version du guide NGK doit être consultée à tout moment, étant donné qu'elle contient les plus récentes caractéristiques de bougies et de moteurs.
Ce catalogue ne concerne pas les moteurs qui équipent les avions.

Opmerkingen: NL

Deze catalogus geldt alleen voor het uitzoeken van bougiereferenties.
Bij publicatie van deze uitgave komen alle vorige catalogi te vervallen.
Wettige aanspraak volgens FAA richtlijnen voor vliegtuigmotoren is in deze uitgave niet opgenomen.

Comentarios: E

Esta lista de aplicaciones es solamente válida para la identificación de los tipos.
Consulte siempre la última lista de aplicaciones.
No nos responsabilizamos de casos de aplicaciones que no estén incluidas en esta lista.
En esta edición no están incluidas las aplicaciones de bujías para motores FAA de aviación.

Die im Katalog aufgeführten Zündkerzen, Glühkerzen, Stecker können in den Motoren entsprechend unserer Katalogempfehlung verwendet werden.
Erkennbarer Irrtum sowie offensichtliche Druckfehler unterliegen der Sorgfaltspflicht des Anwenders.
Für die Fehlerfreiheit und die zugesagten Eigenschaften leistet NGK Gewähr entsprechend dem jeweiligen Stand der Technik. Grundvoraussetzung dafür ist die sachgemäße Handhabung der NGK-Produkte. Die Gewährleistungspflicht für Materialfehler oder mangelhafte Ausführung beträgt 24 Monate ab Kaufdatum, sofern die vom Fahrzeughersteller vorgeschriebenen Wechselintervalle nicht betroffen sind.
Ausgenommen davon ist der normale Verschleiß sowie jeglicher Racingeinsatz.

The spark plugs, glow plugs, and caps listed in our Catalogue can be used in the engines which we recommend in our catalogue.
Recognizable mistakes, such as printing errors are subject to careful scrutiny by the user. NGK safeguards for accuracy and the mentioned characteristics in accordance with the current state of the art technology.
Basic condition for this is the proper use of the NGK product.
The seller's warranty period for faults in material or unsatisfactory performance is 24 months from the date of purchase, provided the prescribed interval changes from the vehicle manufacturer are adhered to.
Excluded from this is normal wear and tear and any form of racing activities.

Les bougies d'allumage, bougies de préchauffage, embouts, mentionnés dans notre catalogue peuvent être utilisés dans les moteurs selon notre recommandation.
Des erreurs reconnaissables, ainsi que des erreurs évidentes d'impression sont sous la propre responsabilité de l'utilisateur.
NGK se porte garant quant au soin dans l'exécution ainsi que pour les qualités effectives correspondant à l'état respectif de la technique. La condition de base requise est une manipulation objective et correcte des produits NGK. Le délai de la garantie pour les défauts d'usure ou d'usure imparfait est de 24 mois à partir de la date d'achat, pour autant que les intervalles de services prescrits par le fabricant d'automobile ne soient pas mis en cause.
Est également exclu de la garantie, l'usure normale, ainsi que toute application dans le domaine de la course automobile.

The spark plugs, glow plugs, and caps listed in our Catalogue can be used in the engines which we recommend in our catalogue.
Recognizable mistakes, such as printing errors are subject to careful scrutiny by the user. NGK safeguards for accuracy and the mentioned characteristics in accordance with the current state of the art technology.
Basic condition for this is the proper use of the NGK product.
The seller's warranty period for faults in material or unsatisfactory performance is 24 months from the date of purchase, provided the prescribed interval changes from the vehicle manufacturer are adhered to.
Excluded from this is normal wear and tear and any form of racing activities.

Las bujías de encendido, calentadores diesel y pipas de bujía que aparecen en nuestro Catálogo pueden utilizarse en aquellos motores que recomendamos en el mismo.
Los errores reconocibles, como los de impresión, están sujetos a un reconocimiento exhaustivo por parte del usuario.
NGK vela por la precisión y las características mencionadas de acuerdo con la tecnología de última generación.
Una condición básica para ello es la correcta utilización del producto NGK.
El período de garantía del vendedor en relación con defectos de material o rendimiento insatisfactorio es de 24 meses a partir de la fecha de compra, siempre y cuando se observen los cambios de intervalo prescritos por parte del fabricante del vehículo.
Quedan excluidos de este punto el desgaste normal y cualquier forma de actividades deportivas.

Comentários:**P**

Esta lista de aplicações é válida apenas para a identificação de tipos. Este catálogo substitui todos os anteriores catálogos. Não nos responsabilizamos pelos casos de aplicações que não estejam contidos nesta lista. Nesta edição não estão incluídas as aplicações de velas de ignição para motores FAA de aviação.

As velas de ignição, velas de resistência eléctrica, e cachimbos apresentados no nosso Catálogo podem ser utilizados nos motores recomendados no próprio documento. Erros reconhecíveis, como gralhas, deverão estar sujeitos a cuidadoso escrutínio pelo utilizador. NGK garante a exactidão e as características mencionadas de acordo com a actual tecnologia de ponta. Uma condição básica para isso é a utilização correcta dos produtos NGK. O período de garantia do vendedor para defeitos no material ou performance insatisfatória é de 24 meses a contar da data de venda, sempre que se tenham respeitado os intervalos de mudança prescritos pelo fabricante do veículo. Desta garantia encontra-se excluído o desgaste normal do produto e qualquer forma de actividade competitiva.

Importante:**I**

Questo catalogo deve essere utilizzato come indicazione generica. Differenti condizioni di guida possono richiedere candele più fredde. Questa edizione annulla quelle precedenti. Non si assume alcuna responsabilità causata o derivata dal presente catalogo. Le applicazioni di questo catalogo non devono essere riferite a motori installati su velivoli.

Le candele di qualsiasi genere, ed i cavi elettrici notati nel catalogo, possono essere inseriti nei motori da noi consigliati. Errori evidenti, o errori nel catalogo, devono essere controllati da colui che fa uso di questi pezzi. Per la correttezza delle informazioni ed attributi, la NGK garantisce nello standard tecnico di loro conoscenza. Requisito unico, è l'uso corretto delle informazioni tecniche. Il periodo di risarcimento è di 24 mesi a partire dall'acquisto. Questo verrà eseguito per materiale errato, fermo restando che i periodi d'intervallo non vengano toccati. Esclusi sono il normale consumo delle candele ed i kit Racing.

Kommentarer:**DK**

Denne anvendelsesliste kan kun bruges til type-identifikation. Kun denne anvendelsesliste er gældende. Der kan ikke gøres juridiske krav gældende på baggrund af denne liste. Anbefalinger af tændrør til flymotorer i henhold til FAA retningslinjer er ikke indeholdt i denne udgave.

De tændrør, gløderør og tændrørshætter, der er anført i vort katalog, kan monteres i de motorer, som anbefales i kataloget. Tydelige fejl som f.eks. trykfejl bør nøje undersøges af brugeren. NGK garanterer for nøjagtighed, og at de nævnte egenskaber er i overensstemmelse med den nyeste, teknologiske udvikling. Den grundlæggende forudsætning herfor er korrekt brug af NGK's produkter. Garantien for fejl i materialer eller for utilfredstillende udførelse gælder i 24 måneder fra købsdato, forudsat at producentens foreskrevne udskiftningsintervaller er overholdt. Undtaget er normal slitage og enhver form for racing aktiviteter.

Kommentarer:**N**

Opplysningsene i katalogen kan bare brukes til typeidentifikasjon. Denne katalogen erstatter alle tidligere utgaver. Innholdet i denne listen er ikke juridisk bindende. Tennplugganbefalinger i forbindelse med FAA-retningslinjer for flymotorer er ikke tatt med i denne utgaven.

De tennplugger, glødeplugger og pluggetter som vises i katalogen, kan benyttes i motorer i henhold til de anbefalinger som gis i katalogen. Gjenkjennelige feil, slik som åpenbare trykkfeil, er underlagt brukerens undersøkelsesplikt. NGK garanterer for feilfrihet og de egenskaper som beskrives i henhold til gjeldende teknologisk standard. Forutsetningen for dette er at NGK produktet benyttes på en korrekt måte. Garantiperioden for materialfeil eller feilkonstruksjon løper i 24 måneder fra kjøpsdato, så lenge dette ikke kommer i konflikt med bytteintervallene som kjøretøysprodusenten opererer med. Unntatt fra dette er normal slitasje så vel som racingbruk.

Huomioitavaa: (FIN)

Tämän luettelon suositukset koskevat vain tyyppiltään tunnistettavia moottoreita. Tämä luettelo kumoaa ja korvaa kaikki aikaisemmat luettelot.

Emme vastaa minkäänlaisista tämän luettelon julkaisemisesta johtuvista korvausvaatimuksista.

Tässä luettelossa olevat sytytystulppa-suositukset eivät koske lentokoneisiin asennettuja FAA:n hyväksymiä lentokonemoottoreita.

Luettelossa mainittuja sytytystulppia, hehkutulppia ja tulpan liittimiä voidaan käyttää vain moottoreissa, joita luettelon suositukset koskevat.

Luettelon käyttäjän tulee noudattaa huolellisuutta ja kiinnittää huomiota havaittavissa oleviin, mahdollisiin virheisiin kuten painovirheisiin.

NGK takaa tarkkuuden ja mainittujen ominaisuuksien yhdenmukaisuuden nykyisen, ajanmukaisen tuotantoteknologian mahdollistamalla tavalla. Perusedellytyksenä tälle on NGK-tuotteen oikea käyttö. Valmistajan takuu aika tuotteen materiaali- ja toimintavirheille on 24 kuukautta tuotteen ostopäivästä lukien. Takuun edellytyksenä on, että noudatetaan ajoneuvon valmistajan määrittelemää tuotteen vaihtoväliä. Takuu ei korvaa normaalista kulumisesta eikä mistään kilpailukäytöstä johtuvaa vauriota.

Tähelepanu: (EST)

Käesolev kataloog on ette nähtud ainult küünla tüübi määramiseks.

Kataloogis antud küünalde sobivused ei ole siduvad / kohustuslikud. Samas ei vastuta tootja võimalike kahjude eest juhul, kui ei ole arvestatud käesoleva kataloogi soovitusi.

Kataloogis antud soovitus ei kehti lennukitele paigaldatud, FAA poolt heaks kiidetud mootoritele.

Käesolevast kataloogist leiate süüteküünalde, eelsüüteküünalde ja küünlapiipude sobivuse, mis on ranges kooskõlas vastava mootori tootja nõuetega.

Kuna NGK on paljudele suurtele autotootjatele süüteküünalde esmavalmistaja on tagatud toote kõrge kvaliteet ja valmistamise täpsus.

Müüja poolne garantiiperiood materjalivigade või mitterahuldava töötamise osas on 24 kuud toote ostmise hetkest, eeldusel et täpselt on järgitud tootjapoolset süüteküünla soovitustabelit ja vahetusintervalli.

Arusaadavalt ei kuulu garantii alla süüteküünla normaalne kulumine, mis on otseses seoses sõiduki kasutamise aktiivsusega.

Upozornění: (CZ)

Aplikační tabulka slouží pouze pro výběr svíčky

Zveřejněním tohoto vydání ztrácí dříve vydané aplikační tabulky platnost

Na údaje obsažené v katalogu nelze uplatňovat právní nárok

V tomto vydání nejsou obsaženy doporučení podle směrnic FAA pro letecké pohony

Zapalovací, žhavicí svíčky a svíčkové fajfky uvedené v našem katalogu doporučujeme použít výhradně pro motory uvedené v katalogu.

NGK nenese zodpovědnost za rozpoznatelné chyby, jako například tiskové chyby.

Za bezchybnost a přislíbené vlastnosti ručí NGK v souladu se stávajícím stavem techniky. Základním předpokladem pro toto je odborné zacházení s produkty NGK. Záruka na vady materiálu, či nedostatečný výkon je 24 měsíců od data prodeje, pokud byl dodržen interval výměny předepsaný výrobcem vozidla.

Záruka se nevztahuje na vady vzniklé běžným použitím a na jakékoliv užití při sportovních aktivitách.

Uwagi: (PL)

Lista zastosowań służy wyłącznie wyborowi typów.

Przez publikację niniejszego wydania wszystkie uprzednie listy zastosowań tracą ważność.

Treść nie jest podstawą jakichkolwiek roszczeń prawnych.

Niniejsze wydanie nie zawiera poleceń dla lotniczych zespołów napędowych według wytycznych FAA.

Nie podlega gwarancji przy normalnym zużyciu lub wykorzystywaniu w sporcie.

Świece zapłonowe, świece żarowe, końcówki przewodów zapłonowych mogą być zastosowane zgodnie z przyporządkowaniem w naszym katalogu.

Widoczne pomyłki i błędy w druku podlegają szczególnej uwadze użytkowników.

NGK gwarantuje bezbłądność oraz właściwości produktów odpowiadające obecnemu poziomowi techniki. Gwarancja obowiązuje tylko w przypadku prawidłowej eksploatacji produktów NGK. Gwarancja na błędy materiałowe wynosi 24 miesiące od dnia zakupu, jeżeli określone przez producenta pojazdu okresy wymiany nie zostały przekroczone.

Wyłączone z tego są: normalne zużycie oraz produkty eksploatowane w sporcie motorowym.

Примечания: (RUS)

Данный перечень спецификаций предназначен только для выбора типа свечей.

С опубликованием данного издания все предшествующие перечни спецификаций теряют силу. Содержание списка не может послужить основой для возникновения правоприятия.

Рекомендации для авиационных двигателей согласно директивам FAA в данное издание не включены.

Свечи зажигания, свечи накаливания и наконечники, приведенные в каталоге, могут быть установлены на конкретные двигатели в соответствии с рекомендациями в каталоге.

Видимые ошибки и очевидные опечатки подлежат проверке со стороны пользователей.

Отсутствие брака и правильность параметров продукции компания NGK гарантирует в соответствии с развитием техники. Гарантия действует только при надлежащей эксплуатации продукции компании NGK. Гарантия на отсутствие заводского брака и на качество используемых материалов действует 24 месяца с момента покупки товара, если иное не предписано производителем автомобиля. Исключение составляет нормальный износ а также использования продукции в гоночных двигателях.

Megjegyzések: (H)

Ez a katalógus csak a típusok kiválasztására szolgál.

Megjelenésével minden korábbi kiadás érvényét veszti.

Tartalma nem ad alapot jogigény benyújtására.

Nem tartalmazza a repülőgép hajtóművekre vonatkozó FAA szerinti ajánlásokat.

Fentiek alól kivételt képez a természetes felhasználás, illetve a sportcélú felhasználás esete.

A katalógusunkban felsorolt gyújtógyertyák, izzítógyertyák és gyertyapipák csak a katalógusban ajánlott motorokhoz használhatók.

Észlelhető eltérések, úgymint nyomtatási hibák esetén a felhasználó kötelessége körültekintően eljárni.

Az NGK garantálja a termék minőségét és az említett jellemzőket a műszaki tudományok jelenlegi állása szerint. Ennek alapvető feltétele az NGK termék megfelelő használata. A garancia anyag-, vagy gyártási hibára vonatkozóan 24 hónap az eladástól számítva, feltételezve a járműgyártó által előírt csereintervallum betartását.

A garancia nem érvényes normál felhasználásra és bármilyen versenyzés esetén.

Σχόλια: (GR)

Αυτός ο κατάλογος εφαρμογών ισχύει μόνο για αναγνώριση τύπου.

Αυτός ο κατάλογος αντικαθιστά όλους τους προηγούμενους καταλόγους.

Δεν φέρουμε καμία ευθύνη σε θέματα εγγυήσεων που αφορούν εφαρμογές που δεν αναφέρονται στον κατάλογο εφαρμογών.

Μπουζί για αεροπορικές εφαρμογές δεν περιέχονται σ' αυτόν τον κατάλογο εφαρμογών.

Τα γπουζί, οι προθερμάνσεις και τα καλύμματα μπουζί που περιέχονται στον κατάλογο μπορούν να χρησιμοποιηθούν στους κινητήρες που προτείνονται στον κατάλογο.

Τα αναγνωρισικά λάθη, όπως τα λάθη εκτύπωσης πρέπει να απομονώνονται από τον χρήστη.

Η NGK παρακολουθεί την ακρίβεια και τα αναφερόμενα χαρακτηριστικά σύμφωνα με τη διαθέσιμη τεχνολογία. Βασική συνθήκη για αυτό είναι η κατάλληλη χρήση του προϊόντος NGK. Η περίοδος εγγύησης για προβλήματα στο υλικό ή για μειωμένη απόδοση είναι 24 μήνες από την ημερομηνία αγοράς, με την προϋπόθεση ότι τηρούνται τα διαστήματα αντικατάστασης που είναι καθορισμένα από τον κατασκευαστή του οχήματος.

Εξαιρούνται από αυτό η φυσιολογική φθορά και οποιαδήποτε μορφή αγωνιστικών δραστηριοτήτων.

Not (TR)

Bu liste sadece tiplerin belirlenmesinde kullanılır.

Bu baskının yayınlanmasıyla önceden yayınlanan tüm listelerin hükümleri ortadan kalkmış olur.

İçerikten dolayı hiçbir yasal hak talep edilemez.

Havacılıkta kullanılan motorlarla ilgili FAA'nın talimatları doğrultusundaki tavsiyeler bu baskıda mevcut değildir.

Önemli Not

Katalogda belirtilen bujiler, kızdırma bujileri ve bağlantı elemanları katalog tavsiyeleri doğrultusunda motorlarda kullanılabilir.

Yanlış anlamalardan ve baskıdan kaynaklanan hatalarda sorumluluk tamamen uygulayıcıya aittir.

Ürünün hatasız ve belirtilen özelliklere sahip oluşuyla ilgili olarak NGK, içerisinde bulunan teknolojik gelişmelerin güncelliğine bağlı kalmak kaydıyla, sorumluluk taşır. Bunun geçerliliği için temel koşul NGK ürününün doğru uygulanmış olmasıdır.

Malzeme hatası yada hatalı ürün kapsamındaki garanti süresi, otomobil üreticisinin ön gördüğü periyodik değiştirme süresi aşılması taktirde, satınalma tarihinden itibaren 24 aydır.

Doğal aşınmaya bağlı eskime ve her türlü modifikasyon uygulaması (Racing, vb.) garanti kapsamının dışındadır.



6



7-21



23-66

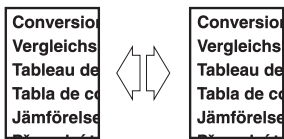

67-78

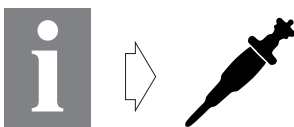

79-95

PS (HP) <--> kW

96

Standard-Typ	D-Power No.	D-Power Typ	Order No.
Y-902R			
Y-908R			
Y-914U			
Y-917U			
Y-920R	D-Power 1	Y-924J	7906
Y-922R			
Y-923U			
Y-924U			
Y-938R			
Y-918R	D-Power 2	Y-918J	6285
Y-910R	D-Power 3	Y-910J	3617
Y-732U	D-Power 4	Y-732U	6001
Y-937R	D-Power 5	Y-937J	7503
Y-916R	D-Power 6	Y-916J	5906
Y-506R	D-Power 7	Y-506J	2419
CY53	D-Power 8	CY53	6160
Y-731U	D-Power 9	Y-731U	6281
Y-503R	D-Power 10	Y-503J	1009
Y-745U	D-Power 11	Y-745U	6346
Y-516J	D-Power 12	Y-516J	6416
Y-733J	D-Power 13	Y-733J	6592
Y-748U	D-Power 14	Y-748U	6649
Y-913M	D-Power 15	Y-913J	5317
Y-925R	D-Power 16	Y-925J	6848
Y-730U	D-Power 17	Y-730U	6704
Y-515J	D-Power 18	Y-515J	6892
Y-927R	D-Power 19	Y-927J	4916
Y-741U	D-Power 20	Y-741U	6943
CY57	D-Power 21	CY57	4994
Y-740U	D-Power 22	Y-740U	4818
Y-935U	D-Power 23	Y-935U	4791
Y-504R	D-Power 24	Y-504J	1441
Y-932R	D-Power 25	Y-933J	7947
Y-933R		Y-933J	
Y-747U	D-Power 26	Y-747U	4694
Y-524J	D-Power 27	Y-524J	4520
Y-711J	D-Power 28	Y-711J	4467
Y-928U	D-Power 29	Y-928U	4389
Y-930U	D-Power 30	Y-930U	4275
Y-501U	D-Power 31	Y-501U	4187
Y-507R	D-Power 32	Y-507J	2691
Y-911R	D-Power 33	Y-911J	4290
Y-729U	D-Power 34	Y-729U	4119
Y-525J	D-Power 35	Y-525J	4090
Y-534J	D-Power 36	Y-534J	3413
Y-523J	D-Power 37	Y-523J	6298
Y-746R	D-Power 38	Y-746J	3078

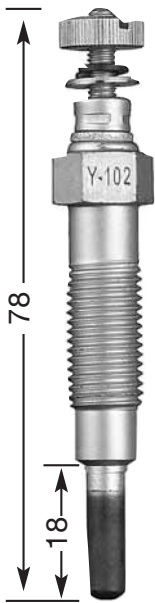

Y-102
M 10 x 1.25
12 Hex
10,5 V



Y-103
M 10 x 1.25
12 Hex
10,5 V

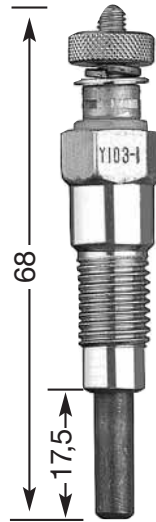

Y-103-1
M 10 x 1.25
12 Hex

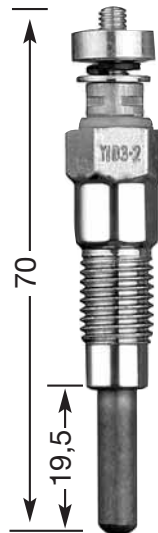

Y-103-2
M 10 x 1.25
12 Hex

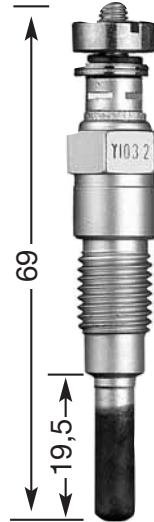

Y-103-2A
M 10 x 1.25
12 Hex



Y-103 K
M 10 x 1.25
12 Hex
10,5 V

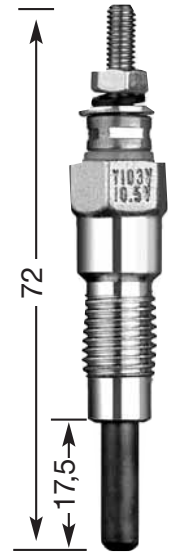

Y-103 V
M 10 x 1.25
12 Hex
10,5 V

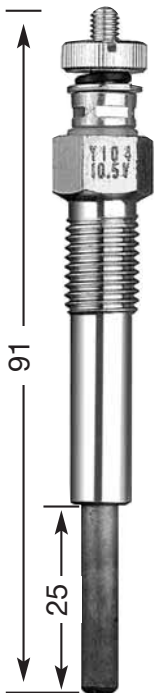

Y-104
M 10 x 1.25
12 Hex
10,5 V



Y-106-1
M 10 x 1.25
12 Hex
10,5 V



Y-106 V
M 10 x 1.25
12 Hex
10,5 V

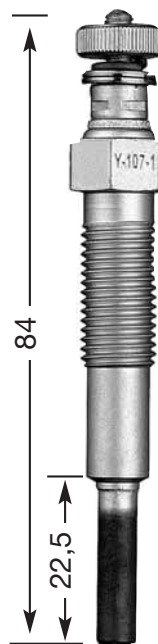

Y-107-1
M 10 x 1.25
12 Hex
10,5 V

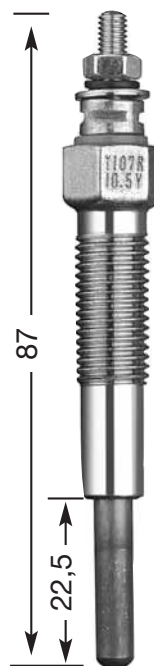

Y-107 R
M 10 x 1.25
12 Hex
10,5 V

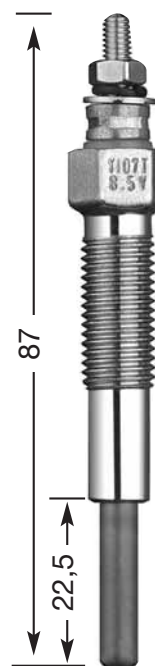

Y-107 T
M 10 x 1.25
12 Hex
8,5 V

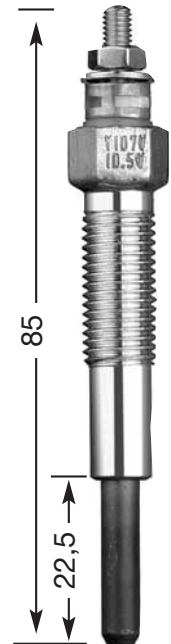

Y-107 V
M 10 x 1.25
12 Hex
10,5 V

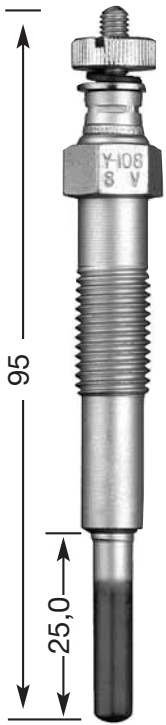

Y-108
M 10 x 1.25
12 Hex
8 V

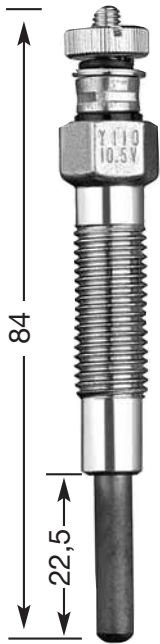

Y-110
M 10 x 1.25
12 Hex
10,5 V

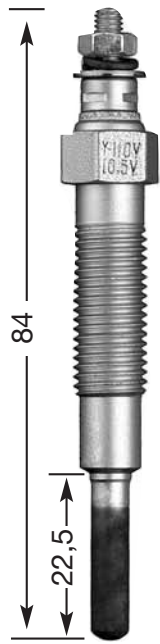

Y-110 V
M 10 x 1.25
12 Hex
10,5 V

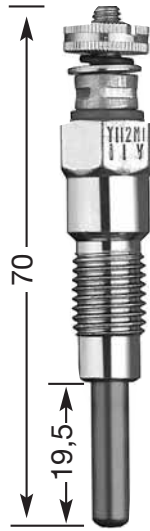

Y-112 M1
M 10 x 1.25
12 Hex
11 V

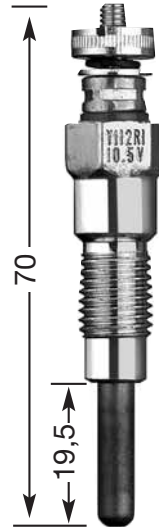

Y-112 R1
M 10 x 1.25
12 Hex
10,5 V

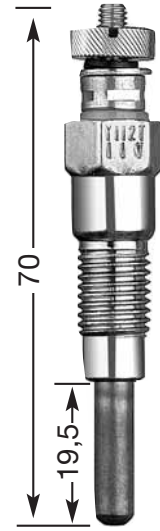

Y-112 T
M 10 x 1.25
12 Hex
11 V

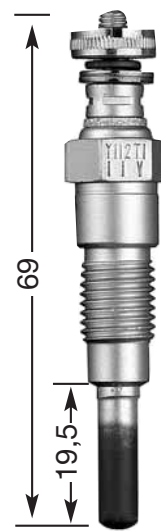

Y-112 T1
M 10 x 1.25
12 Hex
11 V

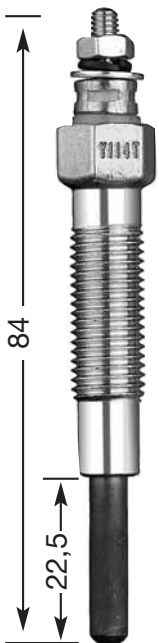

Y-114 T
M 10 x 1.25
12 Hex

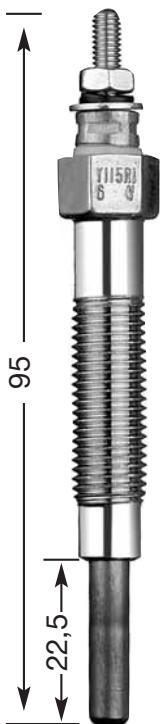

Y-115 R1
M 10 x 1.25
12 Hex
6 V

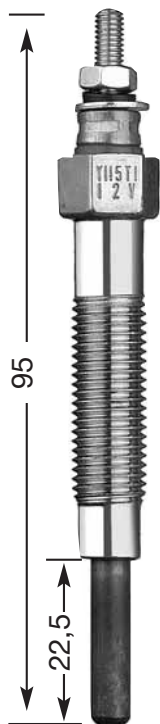

Y-115 T1
M 10 x 1.25
12 Hex
12 V

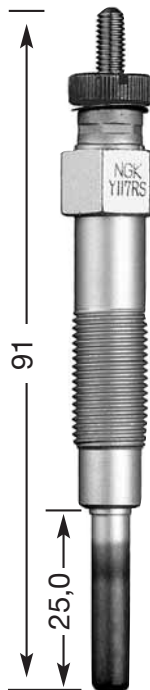

Y-117 RS
M 10 x 1
12 Hex
6,5 V

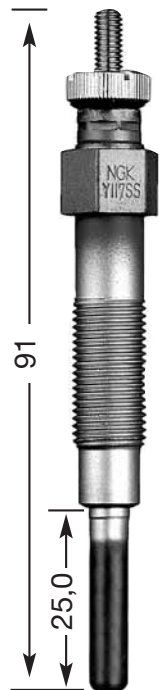

Y-117 SS
M 10 x 1
12 Hex
8,5 V

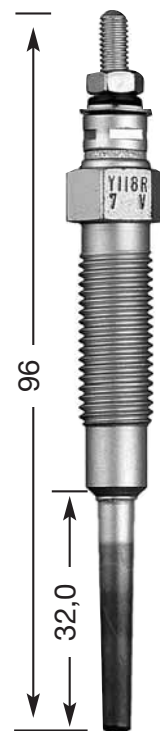

Y-118 R
M 10 x 1.25
12 Hex
7 V

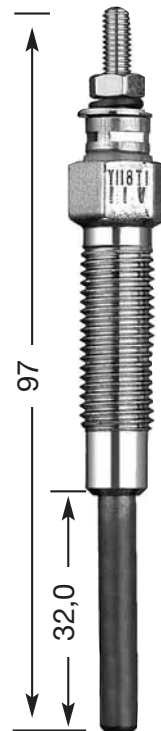

Y-118 T1
M 10 x 1.25
12 Hex
11 V

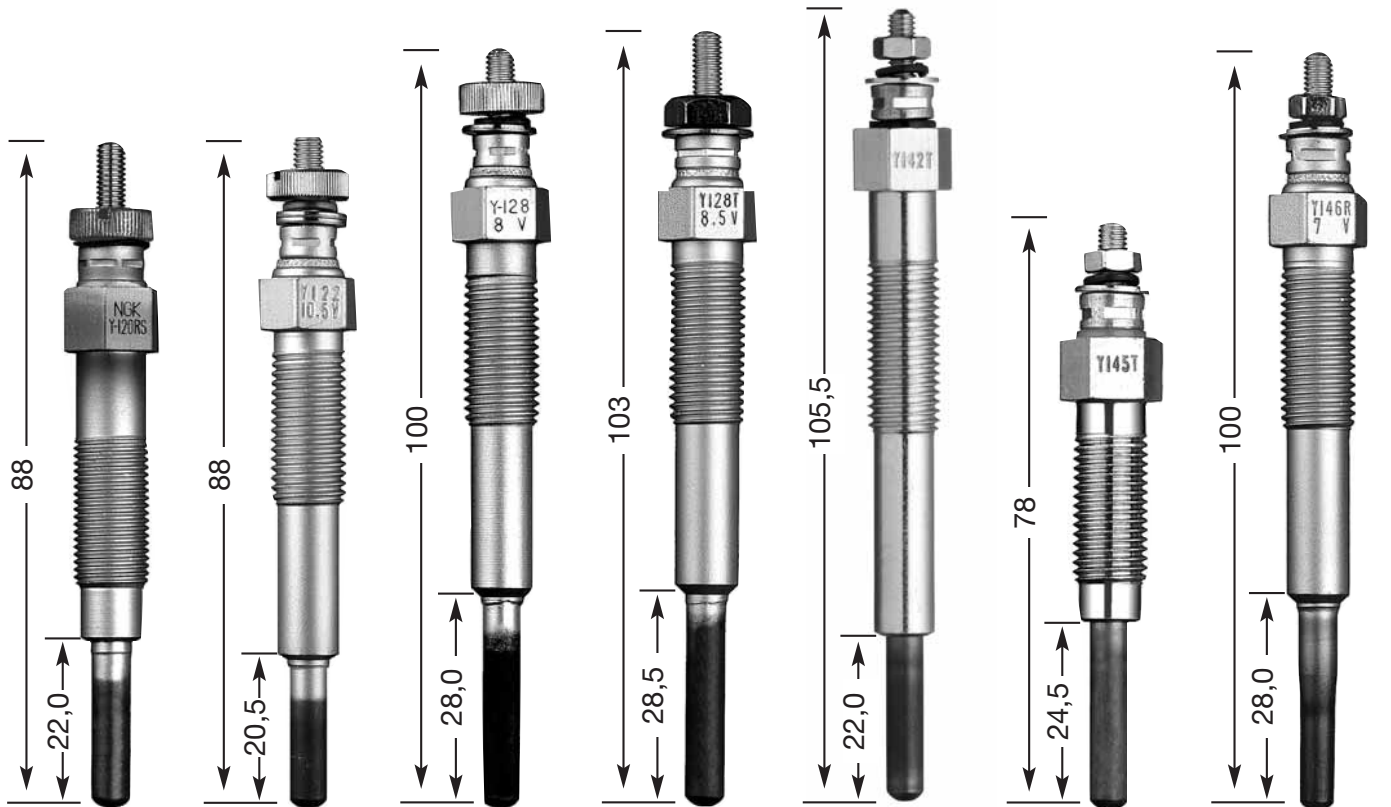

Y-120 RS
M 10 x 1
12 Hex
6,5 V

Y-122
M 10 x 1.25
12 Hex
10,5 V

Y-128
M 10 x 1.25
12 Hex
8 V

Y-128 T
M 10 x 1.25
12 Hex
8,5 V

Y-142 T
M 10 x 1.25
12 Hex

Y-145 T
M 10 x 1.25
12 Hex

Y-146 R
M 10 x 1.25
12 Hex
7 V

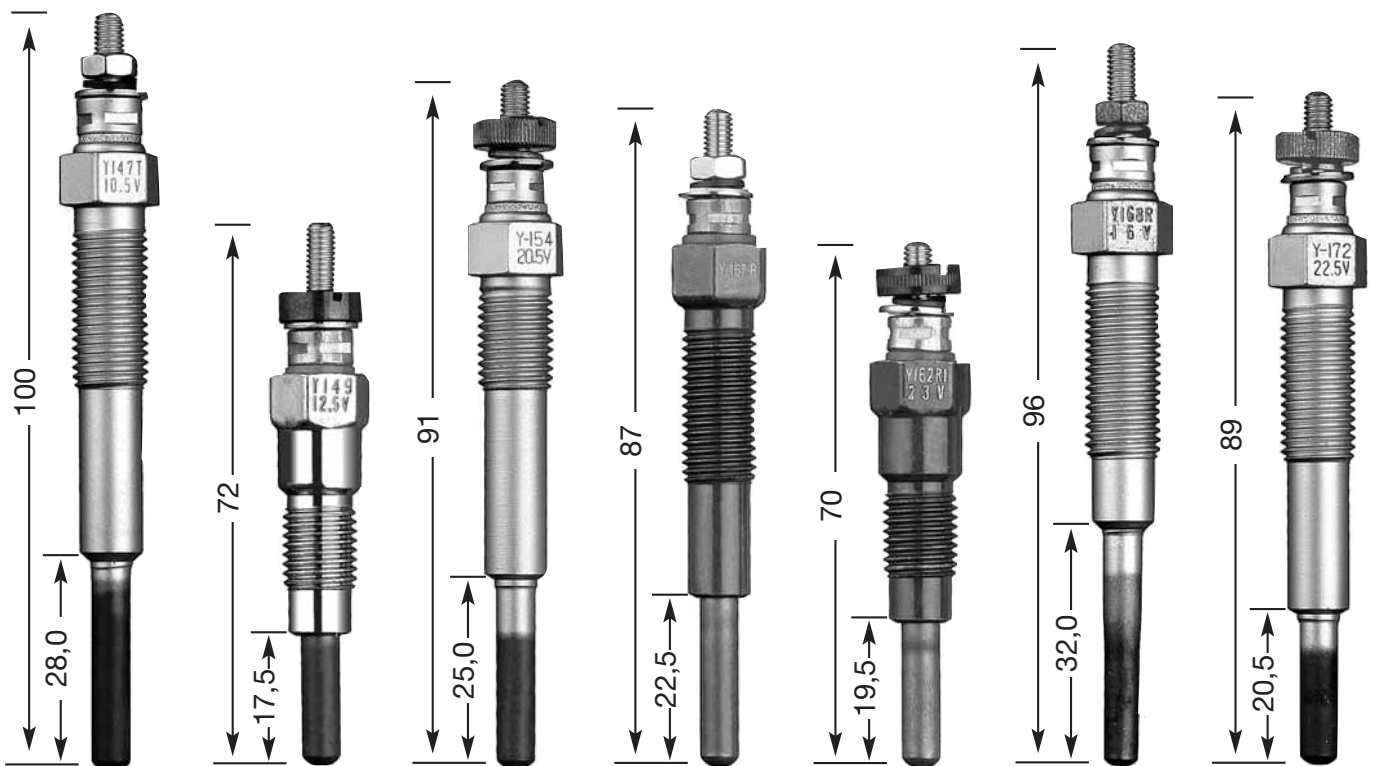

Y-147 T
M 10 x 1.25
12 Hex
10,5 V

Y-149
M 10 x 1.25
12 Hex
12,5 V

Y-154
M 10 x 1.25
12 Hex
20,5 V

Y-157 R
M 10 x 1.25
12 Hex
23 V

Y-162 R1
M 10 x 1.25
12 Hex
23 V

Y-168 R
M 10 x 1.25
12 Hex
16 V

Y-172
M 10 x 1.25
12 Hex
22,5 V

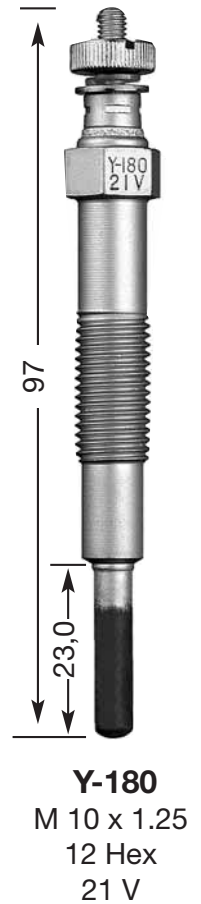
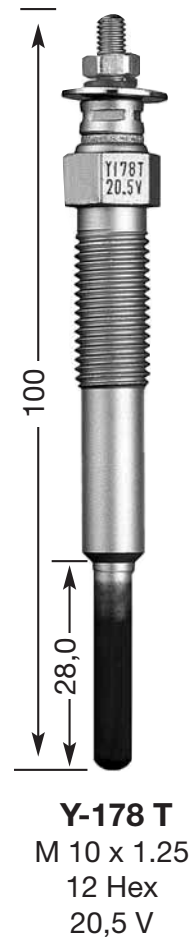
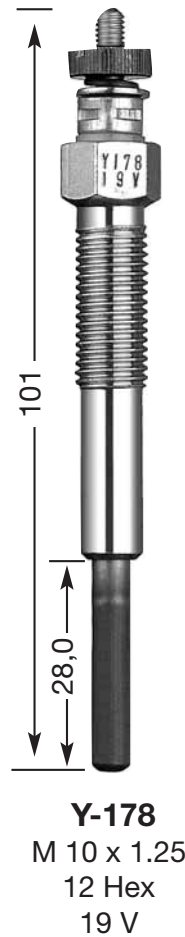
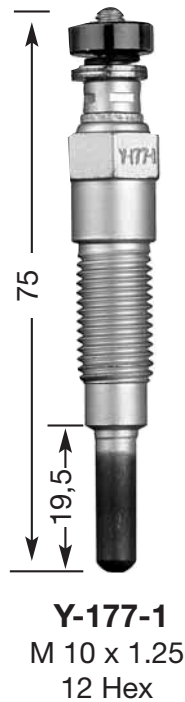
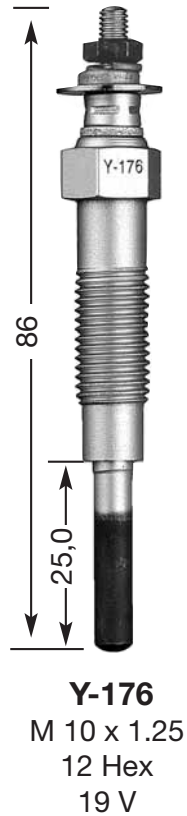
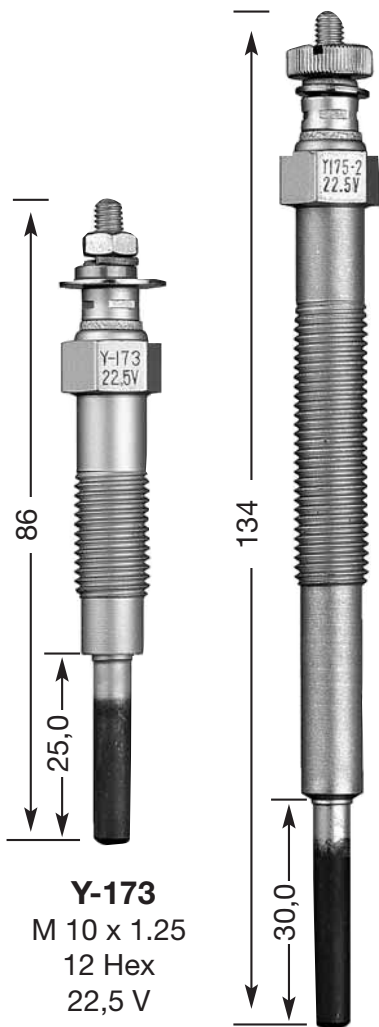

Y-181 T
M 10 x 1.25
12 Hex
23 V

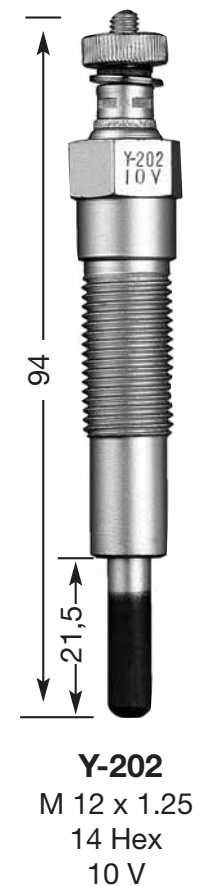
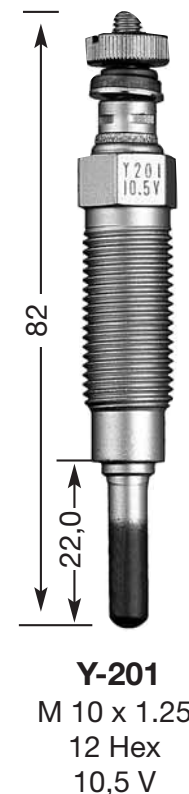
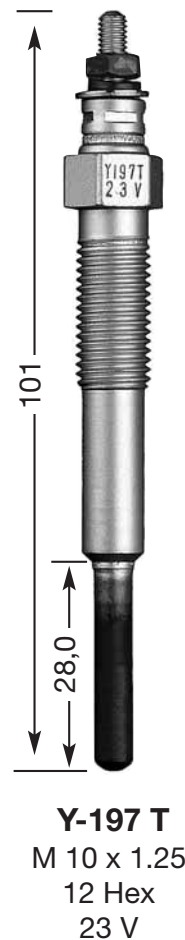
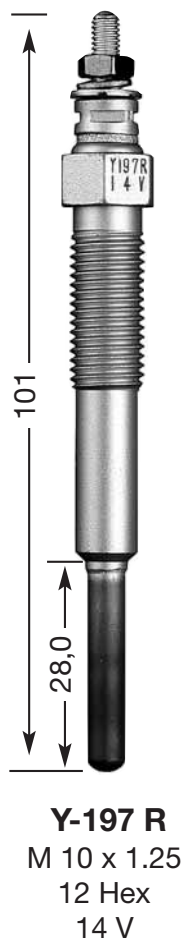
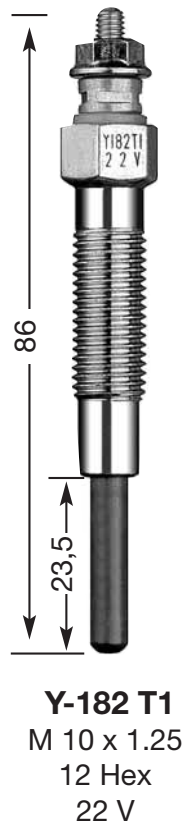
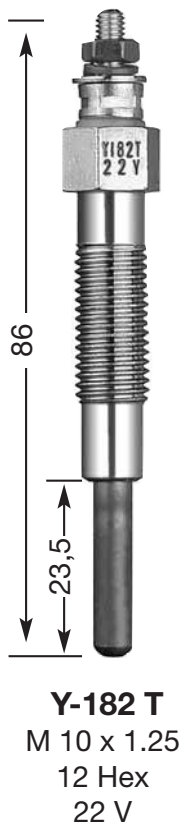
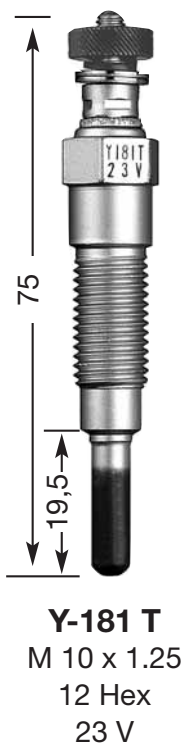

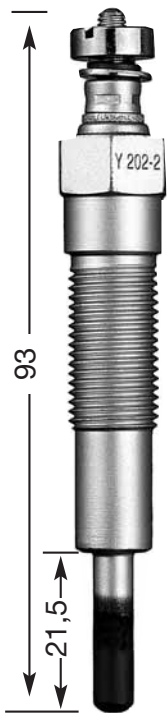

Y-202-2
M 12 x 1.25
14 Hex

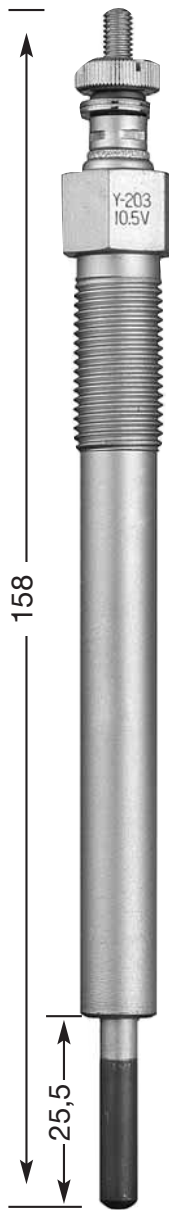

Y-203
M 12 x 1.25
14 Hex
10,5 V

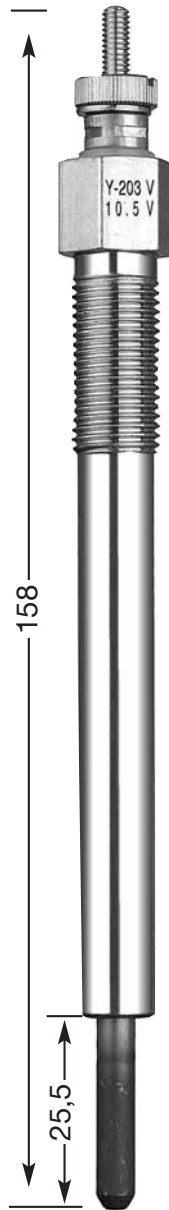

Y-203 V
M 12 x 1.25
14 Hex
10,5 V

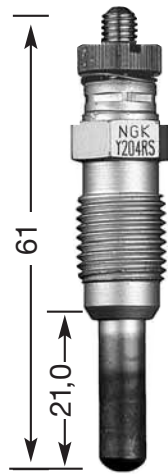

Y-204 RS
M 12 x 1.25
12 Hex
6,5 V



Y-204 SS
M 12 x 1.25
12 Hex
8,5 V

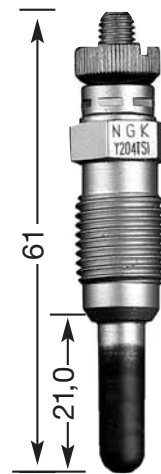

Y-204 TS1
M 12 x 1.25
12 Hex
11 V

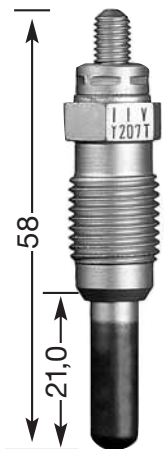

Y-207 T
M 12 x 1.25
12 Hex
11 V

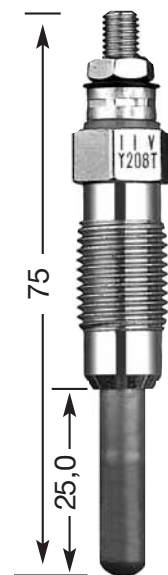

Y-208 T
M 12 x 1.25
12 Hex
11 V

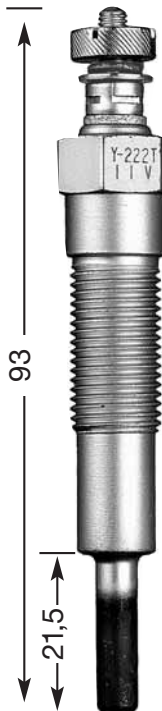

Y-222 T
M 12 x 1.25
14 Hex
11 V

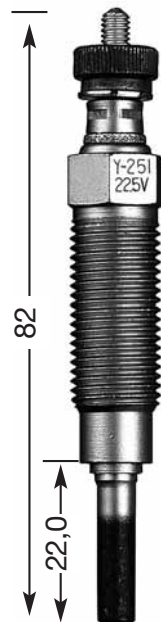

Y-251
M 12 x 1.25
12 Hex
22,5 V

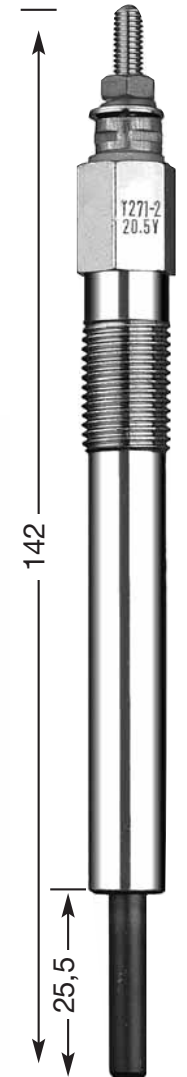

Y-271-2
M 12 x 1.25
12 Hex
20,5 V

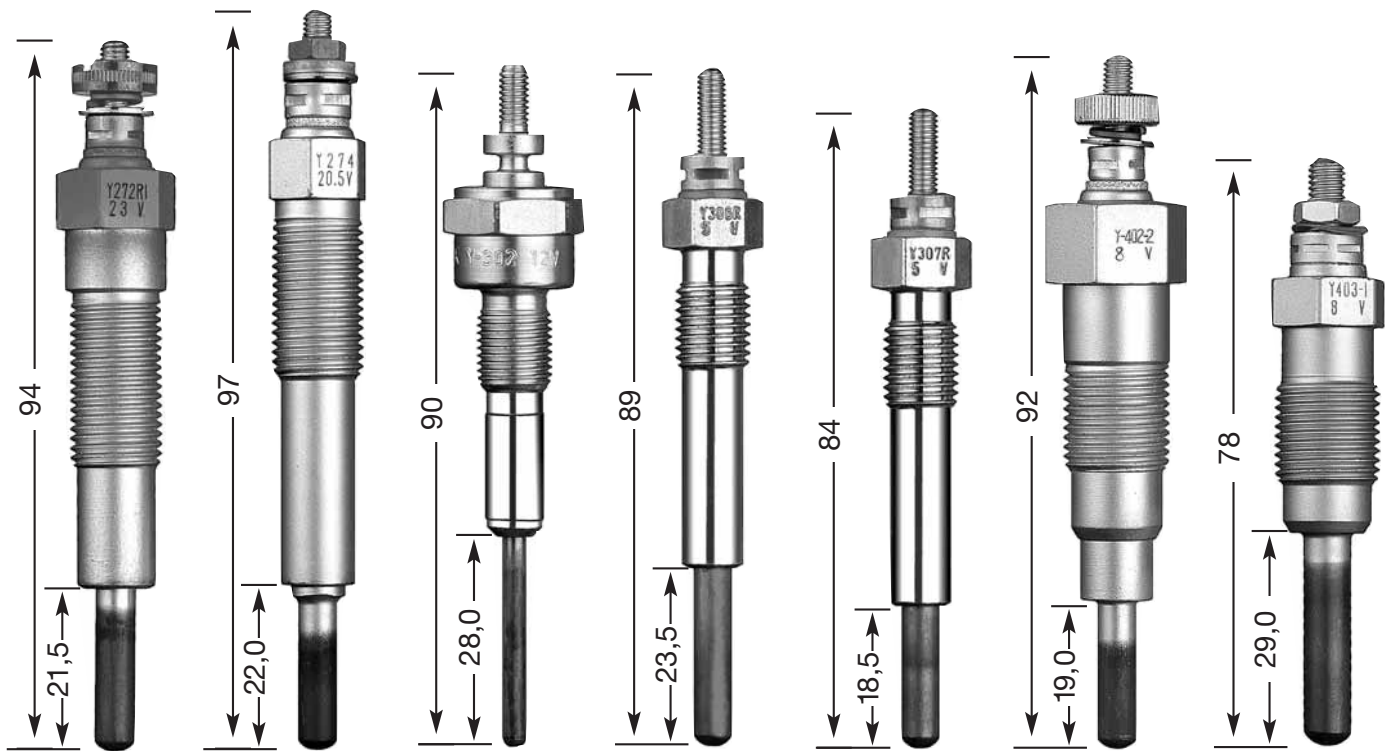

Y-272 R1

M 12 x 1.25
14 Hex
23 V

Y-274

M 12 x 1.25
12 Hex
20,5 V

Y-302

M 10 x 1
17 Hex
12 V

Y-306 R

M 10 x 1.25
12 Hex
5 V

Y-307 R

M 10 x 1.25
12 Hex
5 V

Y-402-2

M 14 x 1.25
17 Hex
8 V

Y-403-1

M 14 x 1.25
14 Hex
8 V

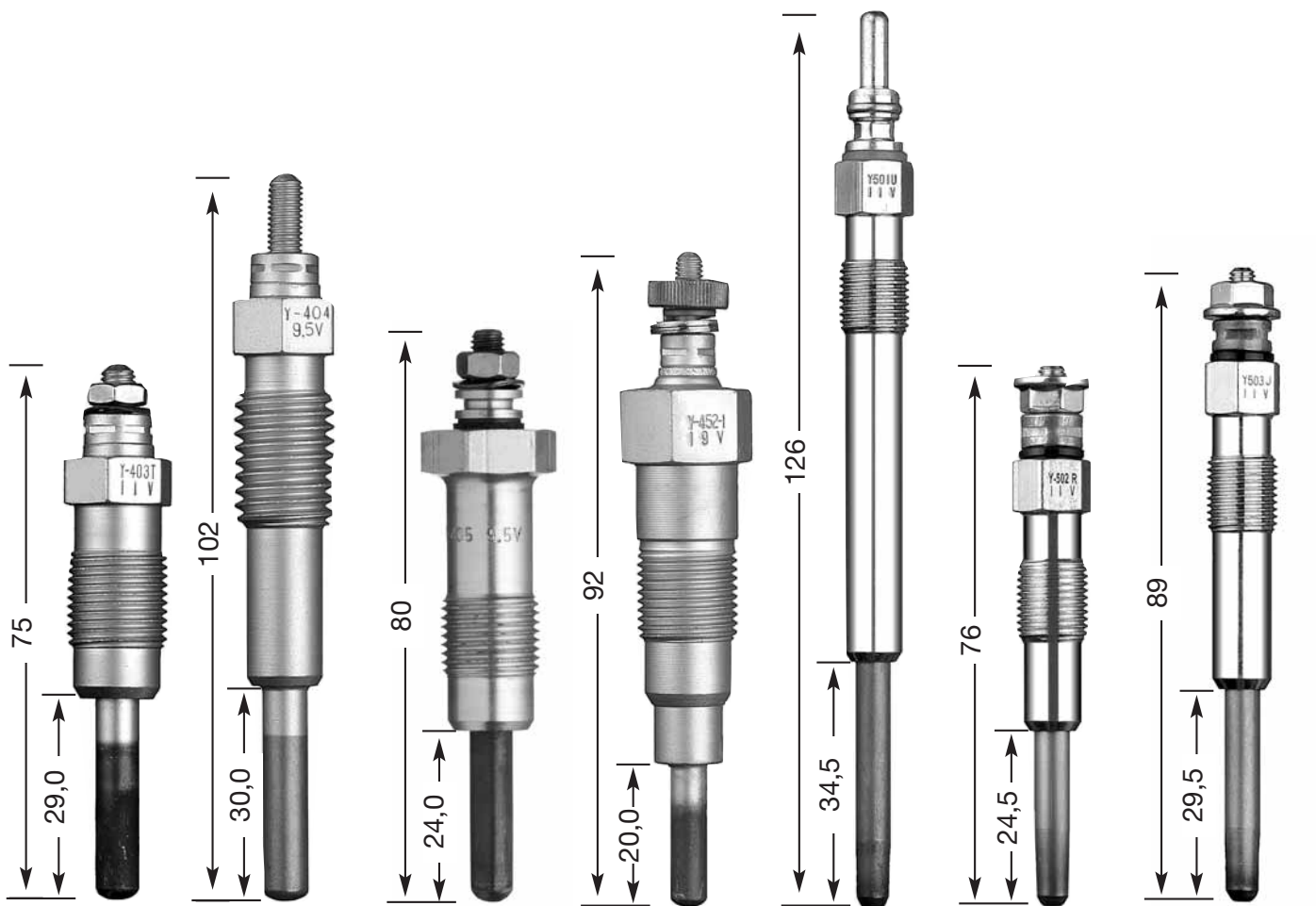

Y-403 T

M 14 x 1.25
14 Hex
11 V

Y-404

M 14 x 2
14 Hex
9,5 V

Y-405

M 14 x 1.25
17 Hex
9,5 V

Y-452-1

M 14 x 1.25
17 Hex
19 V

Y-501-U

M 10 x 1
10 Hex
11 V

Y-502 R

M 10 x 1
10 Hex
11 V

Y-503 J

M 10 x 1
10 Hex
11 V

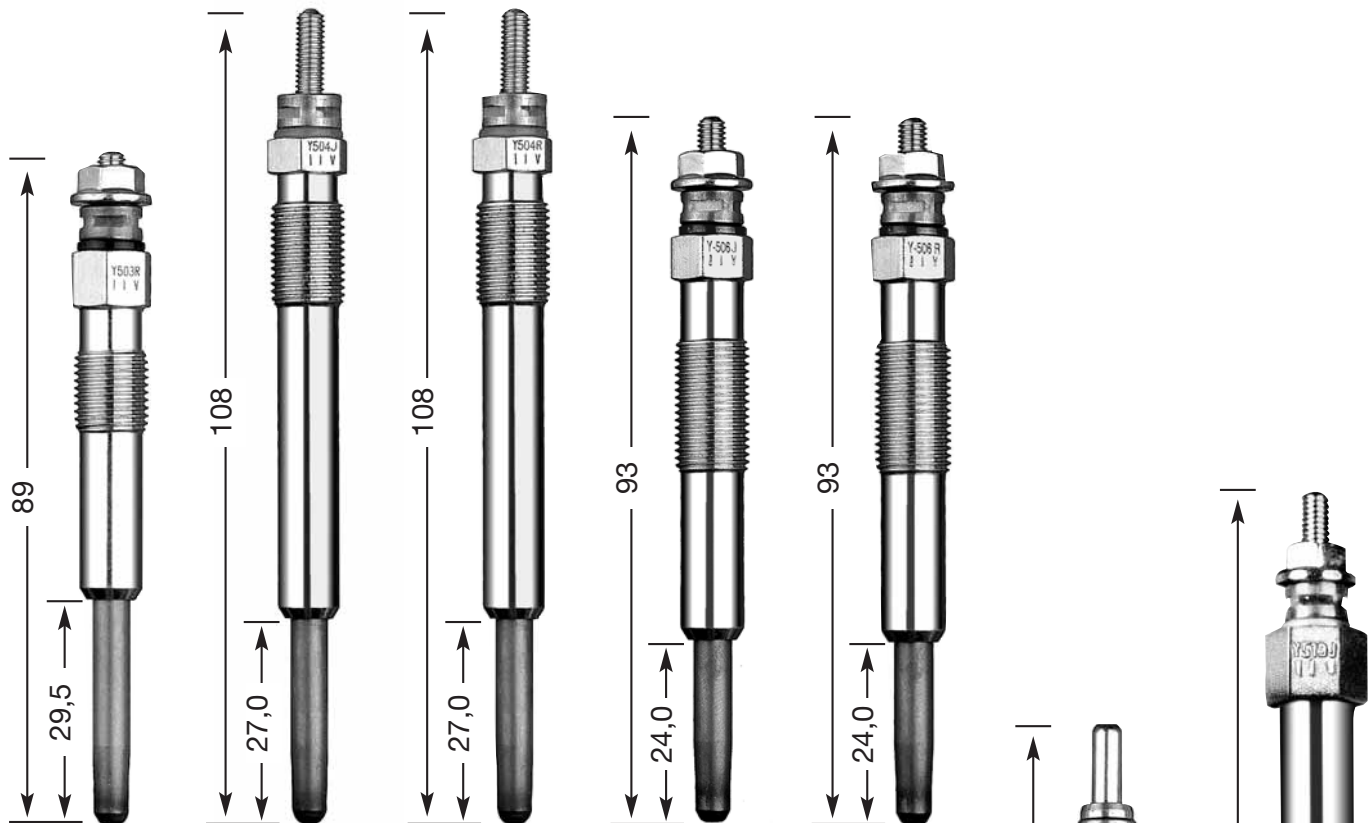

Y-503 R
M 10 x 1
10 Hex
11 V

Y-504 J
M 10 x 1
10 Hex
11 V

Y-504 R
M 10 x 1
10 Hex
11 V

Y-506 J
M 10 x 1
10 Hex
11 V

Y-506 R
M 10 x 1
10 Hex
11 V

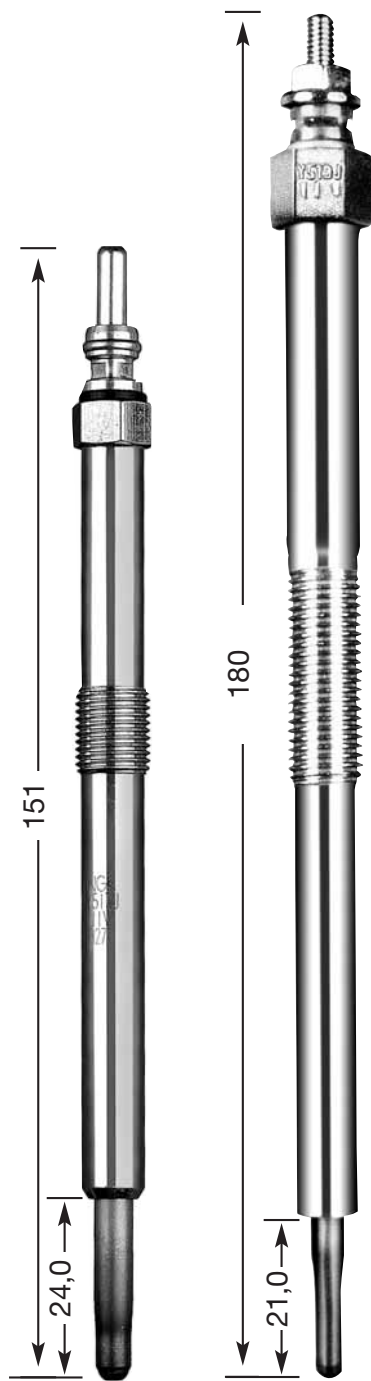

Y-517 J
M 10 x 1
10 Hex
11 V

Y-519 J
M 10 x 1
10 Hex
11 V

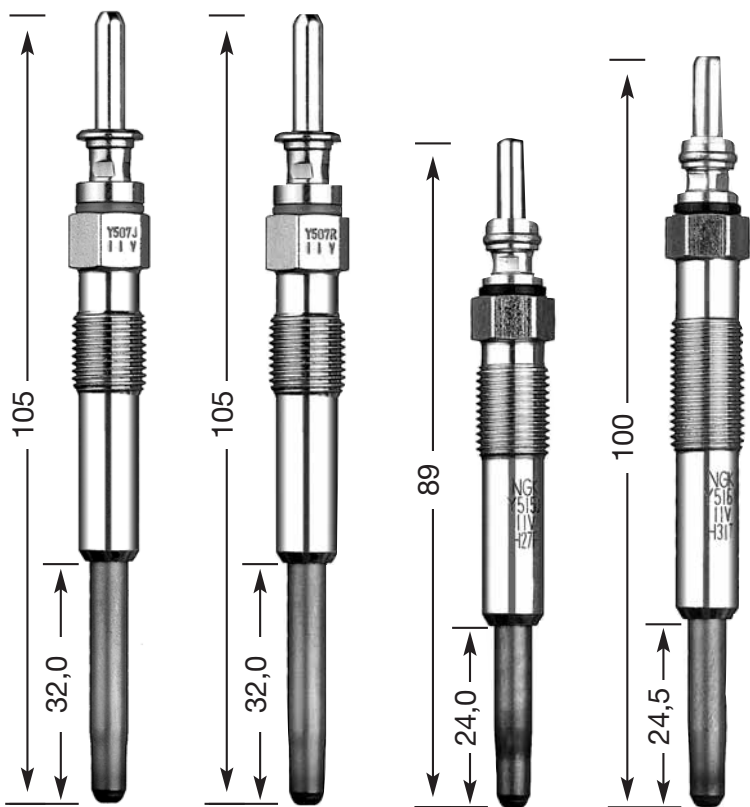

Y-507 J
M 10 x 1
10 Hex
11 V

Y-507 R
M 10 x 1
10 Hex
11 V

Y-515 J
M 10 x 1
10 Hex
11 V

Y-516 J
M 10 x 1
10 Hex
11 V

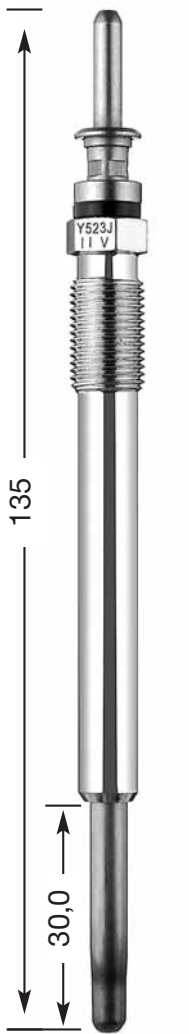

Y-523 J
M 10 x 1,25
10 Hex
11 V



Y-524 J
M 10 x 1,25
10 Hex
10 V

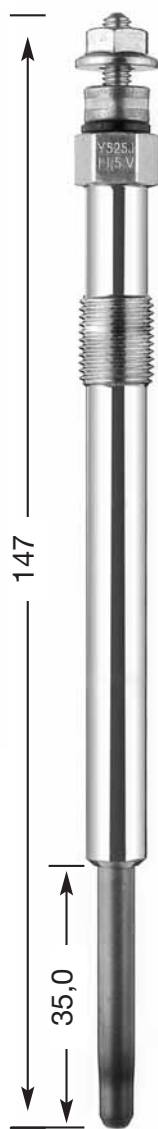

Y-525 J
M 10 x 1,25
10 Hex
11,5 V

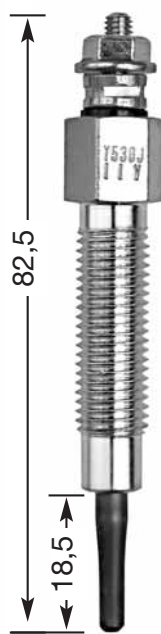

Y-530 J
M 10 x 1,25
12 Hex
11 V

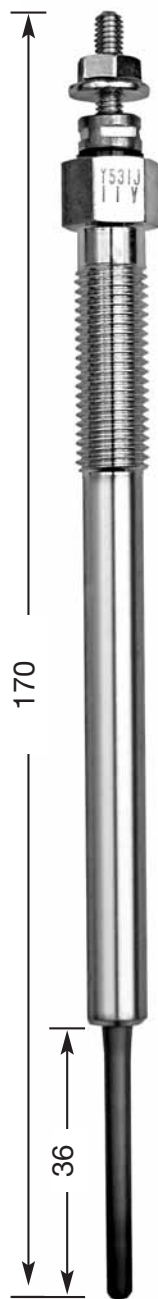

Y-531 J
M 10 x 1,25
12 Hex
11 V

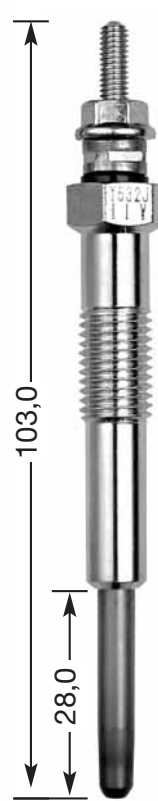

Y-532 J
M 10 x 1,25
12 Hex
11 V



Y-534 J
M 10 x 1,0
10 Hex
11 V

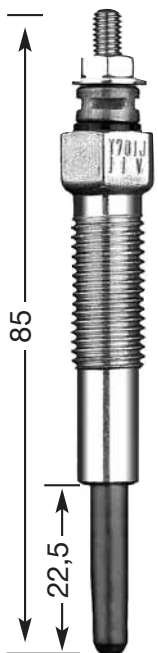

Y-701 J
M 10 x 1,25
12 Hex
11 V

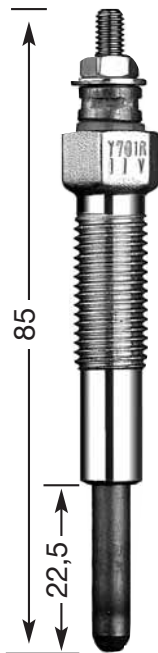

Y-701 R
M 10 x 1,25
12 Hex
11 V

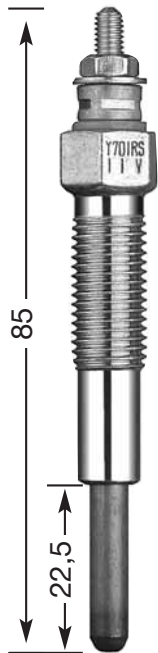

Y-701 RS
M 10 x 1,25
12 Hex
11 V



Y-701 U
M 10 x 1,25
12 Hex
10 V

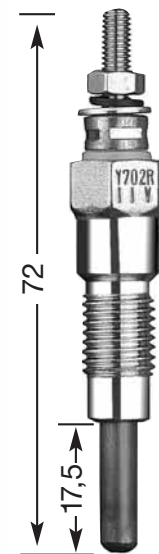

Y-702 R
M 10 x 1,25
12 Hex
11 V

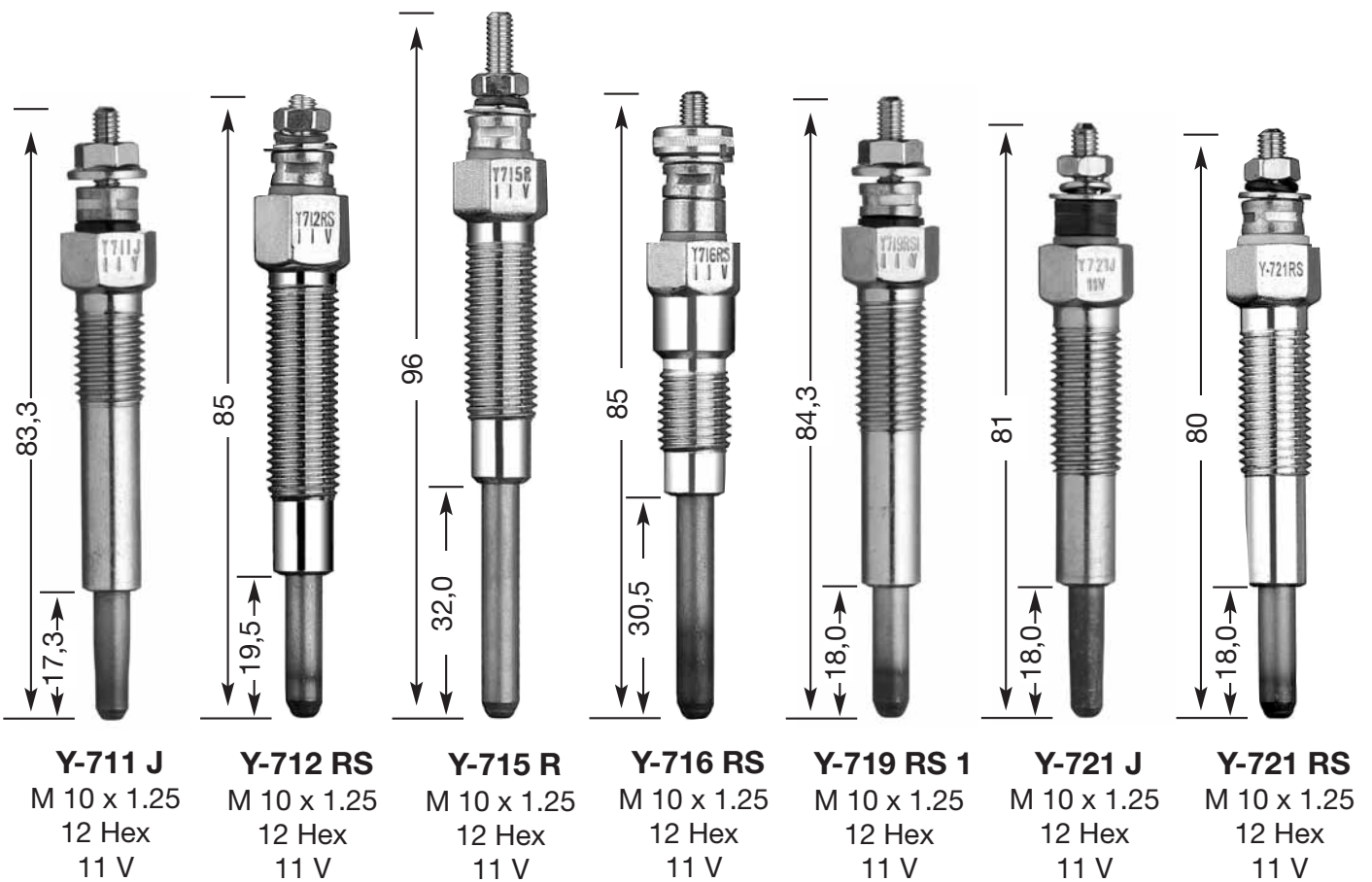
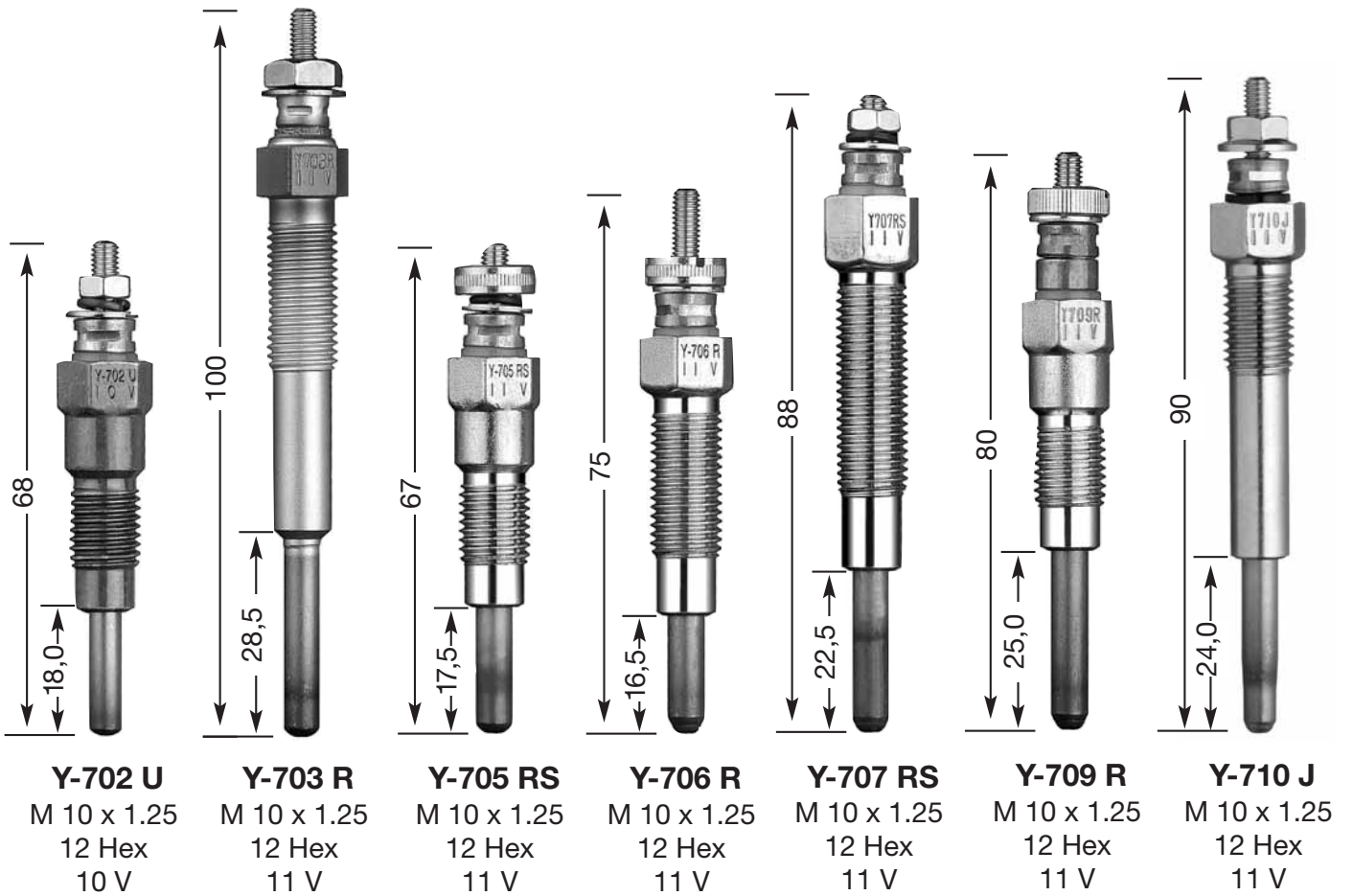

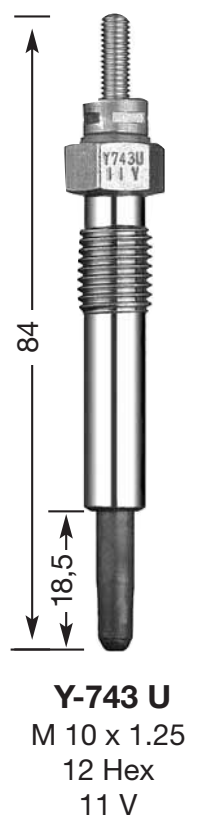
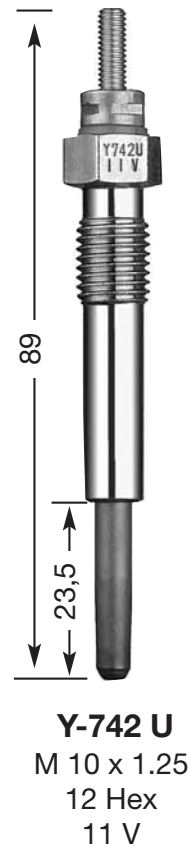
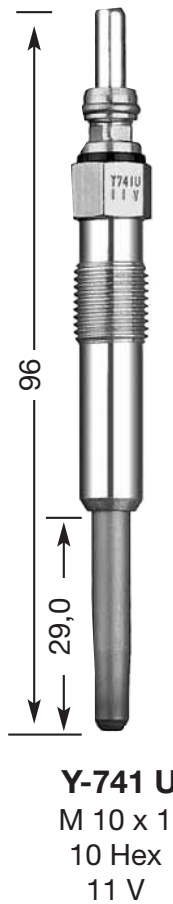
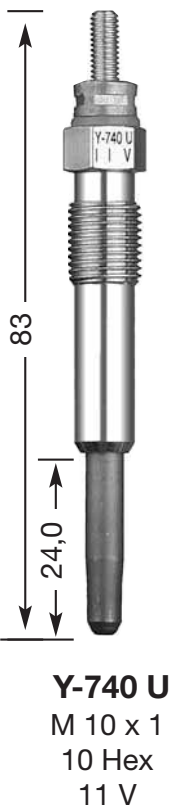
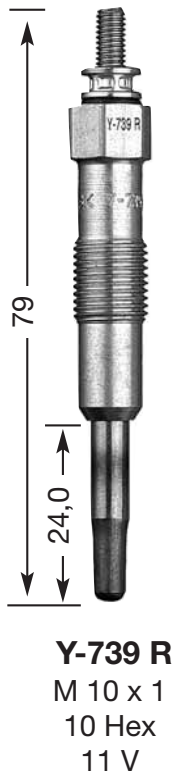
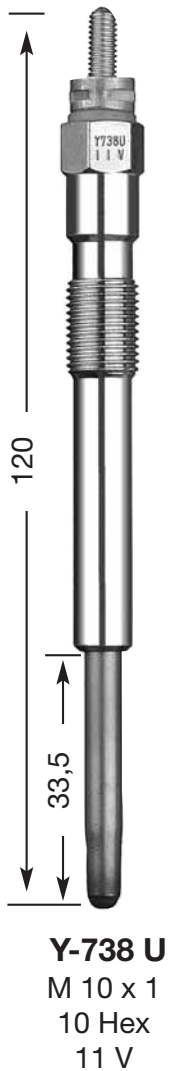
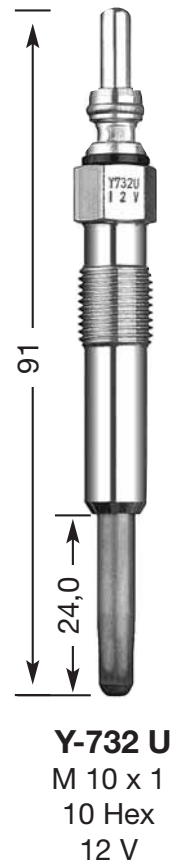
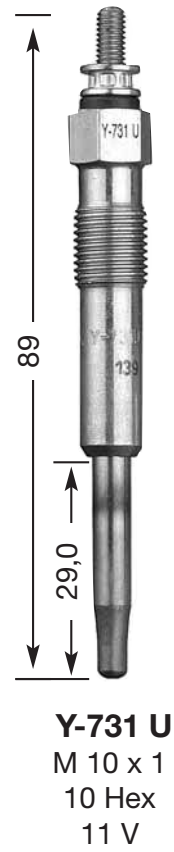
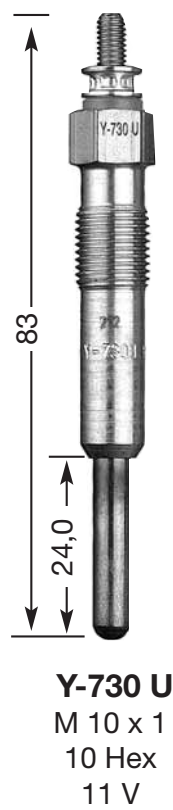
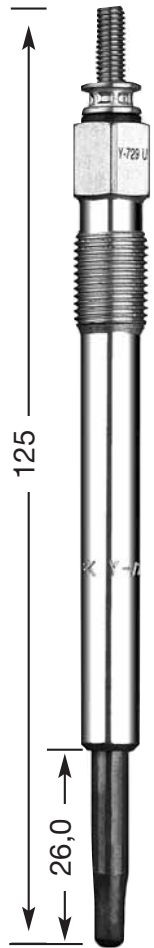
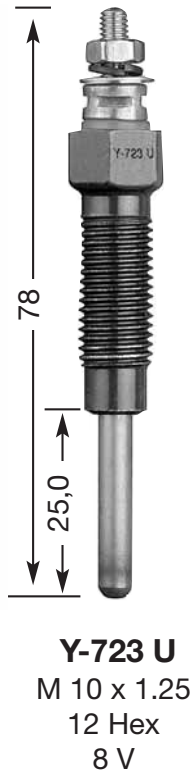
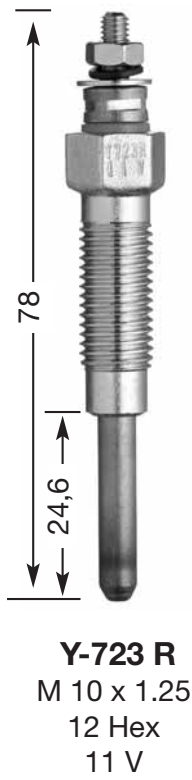

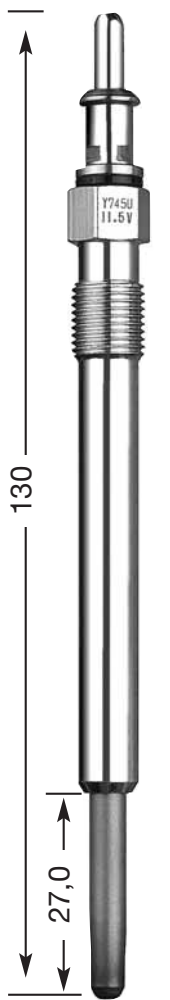

Y-745 U
M 10 x 1
10 Hex
11,5 V

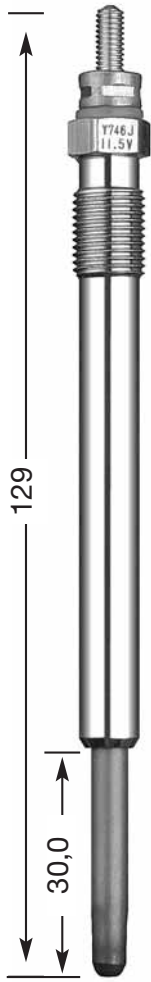

Y-746 J
M 10 x 1
10 Hex
11,5 V

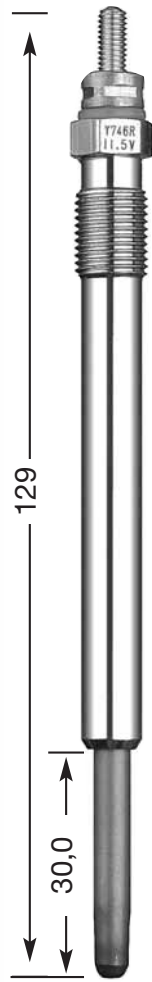

Y-746 R
M 10 x 1
10 Hex
11,5 V

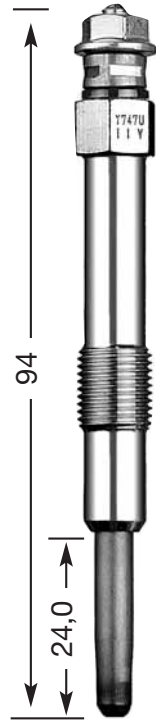

Y-747 U
M 10 x 1
10 Hex
11 V

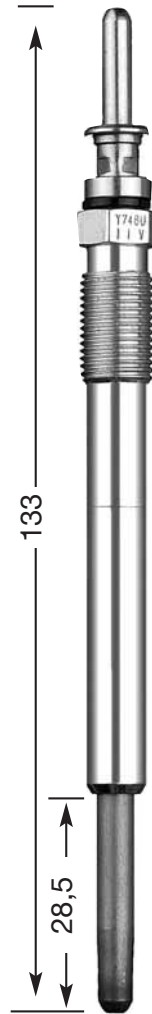

Y-748 U
M 10 x 1
10 Hex
11 V

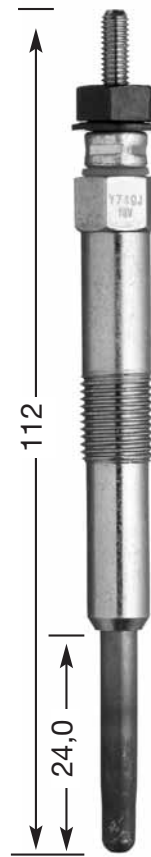

Y-749 J
M 10 x 1.0
10 Hex
11 V

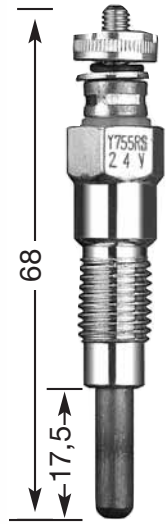

Y-755 RS
M 10 x 1.25
12 Hex
24 V

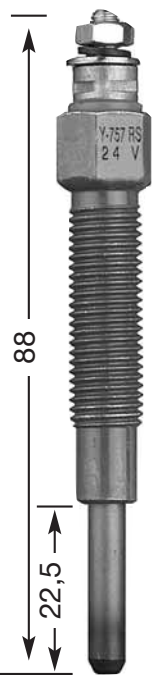

Y-757 RS
M 10 x 1.25
12 Hex
24 V

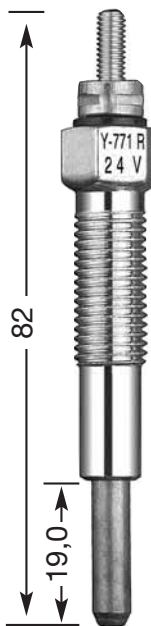

Y-771 R
M 10 x 1.25
12 Hex
24 V



Y-810
M 18 x 1.5
20.6 Hex
10,5 V



Y-811
M 18 x 1.5
20.6 Hex
10,5 V

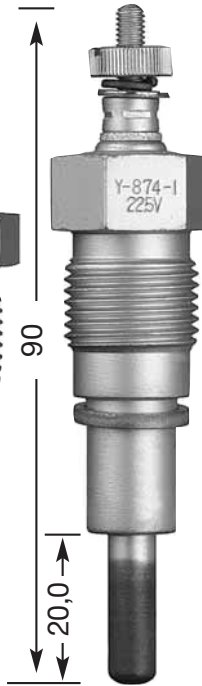

Y-874-1
M 18 x 1.5
19 Hex
22,5 V

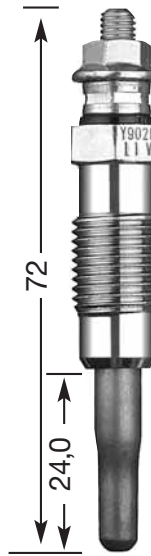

Y-902 R
M 12 x 1.25
12 Hex
11 V

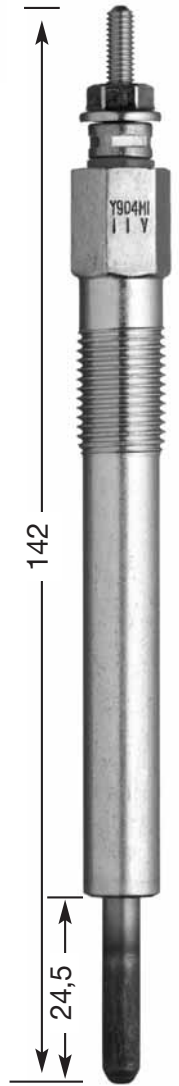

Y-904 M1
M 12 x 1.25
12 Hex
11 V

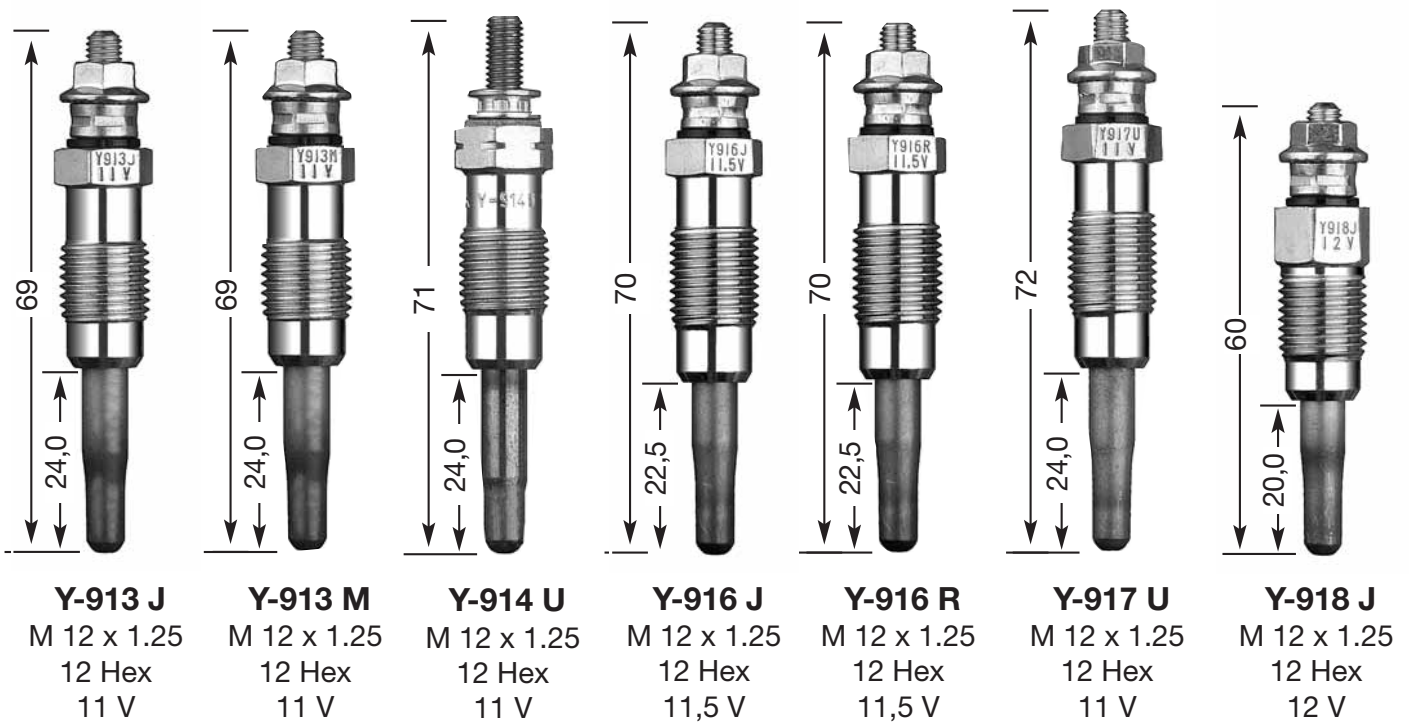
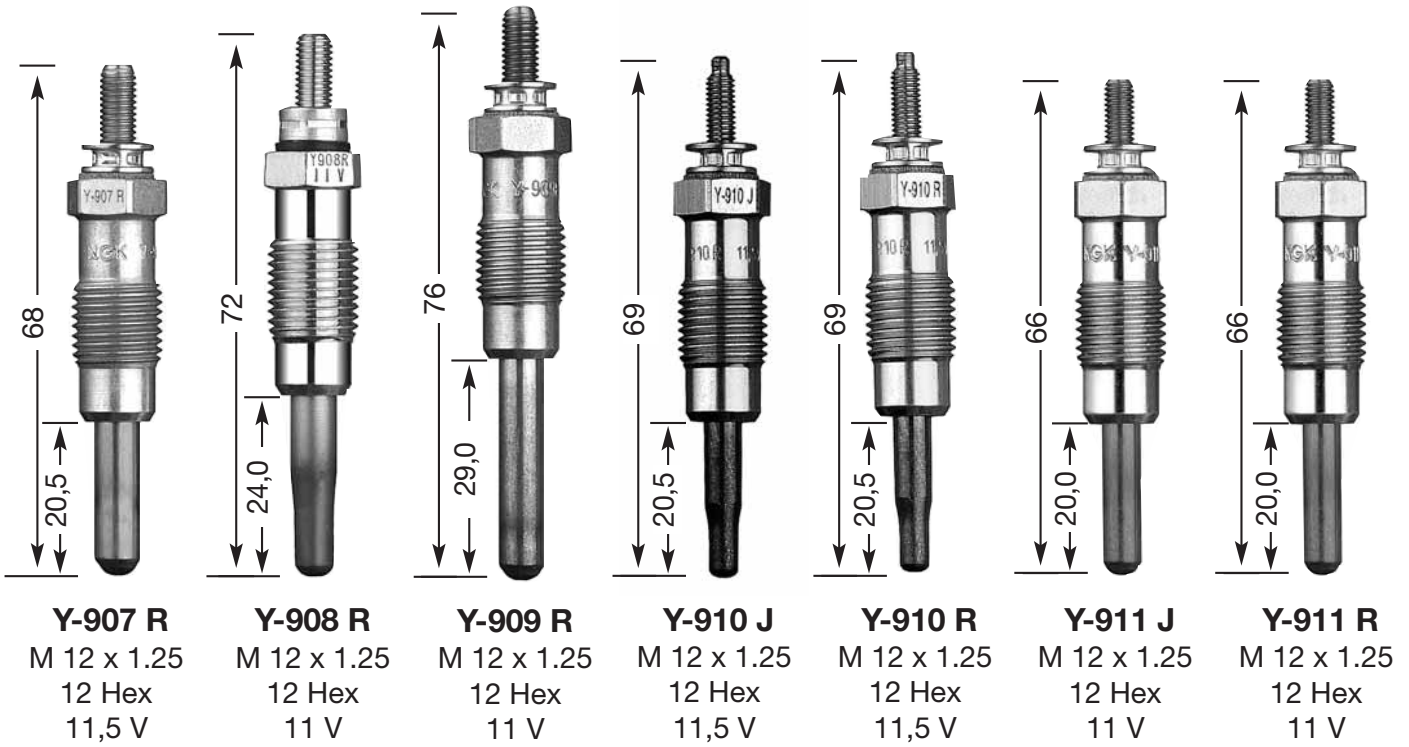

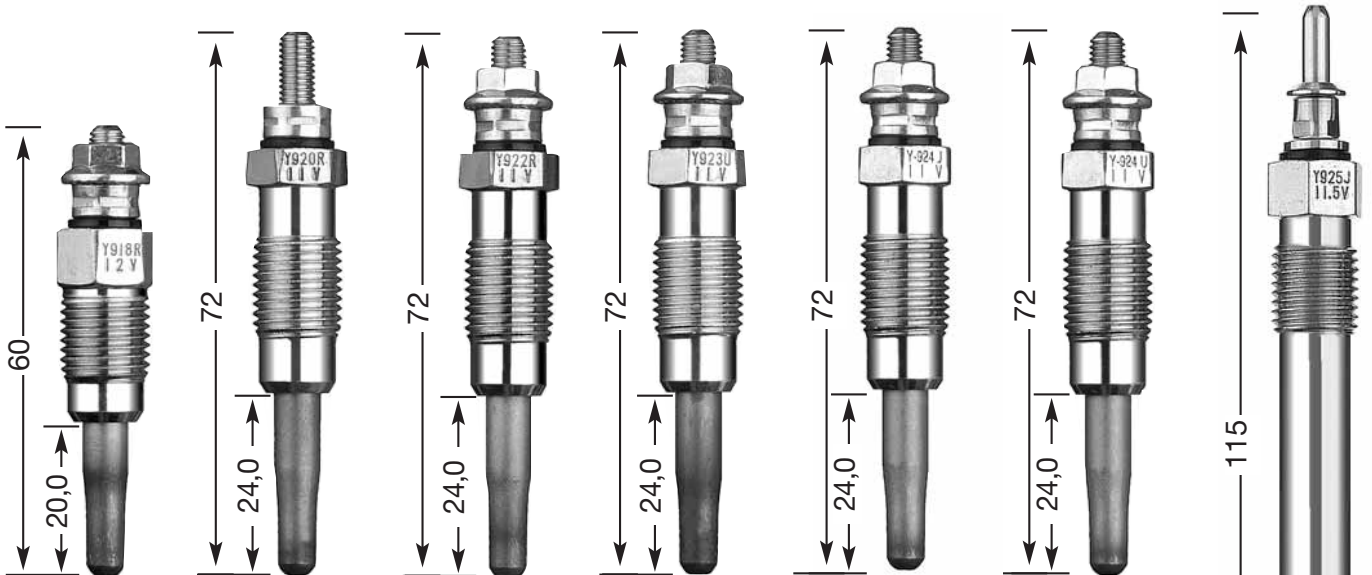

Y-918 R
M 12 x 1.25
12 Hex
12 V

Y-920 R
M 12 x 1.25
12 Hex
11 V

Y-922 R
M 12 x 1.25
12 Hex
11 V

Y-923 U
M 12 x 1.25
12 Hex
11 V

Y-924 J
M 12 x 1.25
12 Hex
11 V

Y-924 U
M 12 x 1.25
12 Hex
11 V

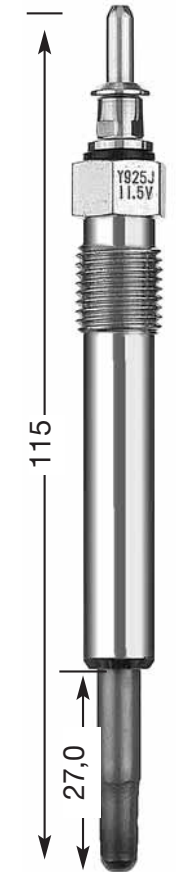

Y-925 J
M 12 x 1.25
12 Hex
11,5 V

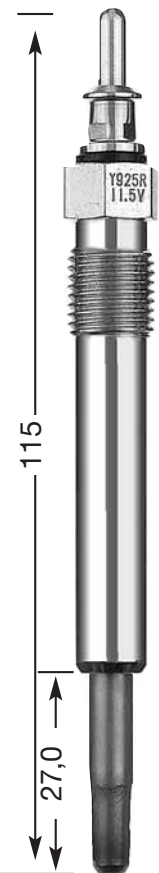

Y-925 R
M 12 x 1.25
12 Hex
11,5 V



Y-926 U
M 12 x 1.25
12 Hex
11 V

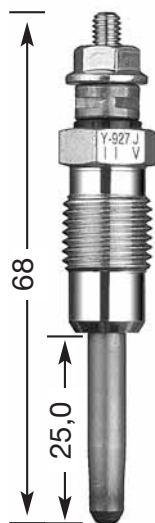

Y-927 J
M 12 x 1.25
12 Hex
11 V

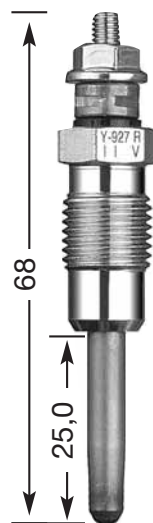

Y-927 R
M 12 x 1.25
12 Hex
11 V

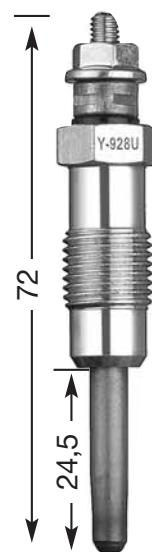

Y-928 U
M 12 x 1.25
12 Hex
11 V

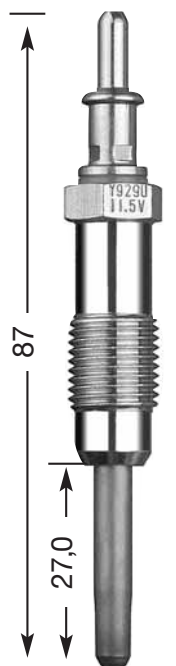

Y-929 U
M 12 x 1.25
12 Hex
11,5 V

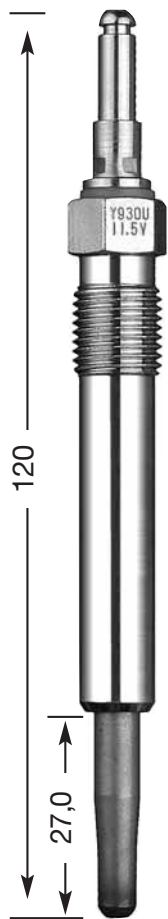

Y-930 U
M 12 x 1.25
12 Hex
11,5 V

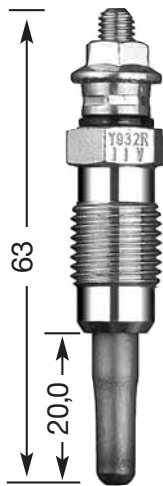

Y-932 R
M 12 x 1.25
12 Hex
11 V

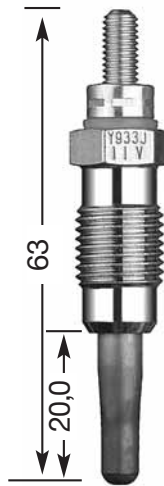

Y-933 J
M 12 x 1.25
12 Hex
11 V

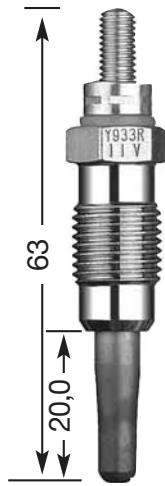

Y-933 R
M 12 x 1.25
12 Hex
11 V

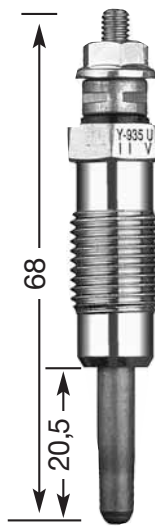

Y-935 U
M 12 x 1.25
12 Hex
11 V

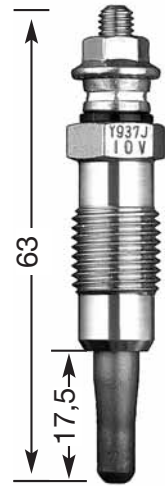

Y-937 J
M 12 x 1.25
12 Hex
10 V

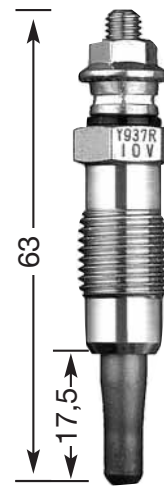

Y-937 R
M 12 x 1.25
12 Hex
10 V

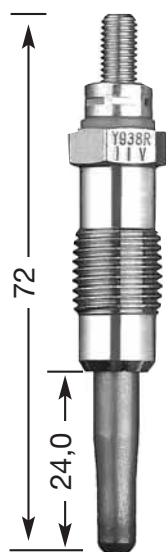

Y-938 R
M 12 x 1.25
12 Hex
11 V

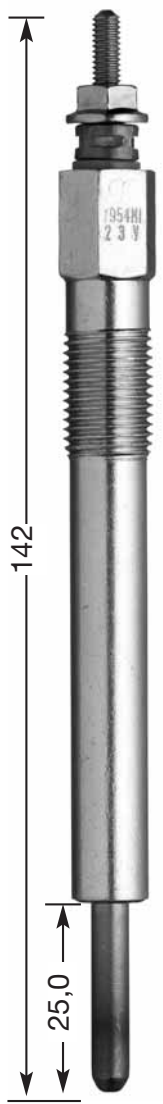

Y-954 M1
M 12 x 1.25
12 Hex
23 V



Y-955 RS
M 12 x 1.25
14 Hex
24 V

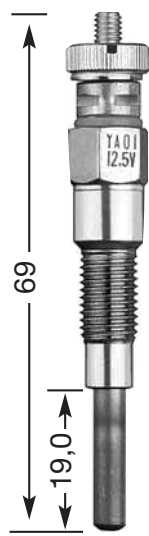

YA 01
M 8 x 1
10 Hex
12,5 V

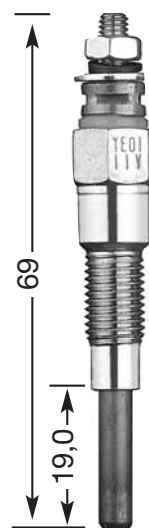

YE 01
M 8 x 1
10 Hex
11 V

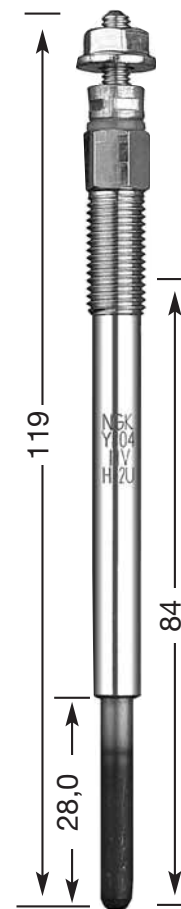

YE 04
M 8 x 1
8 Hex
11 V



DG-211
M 18 x 1.5
25 Hex

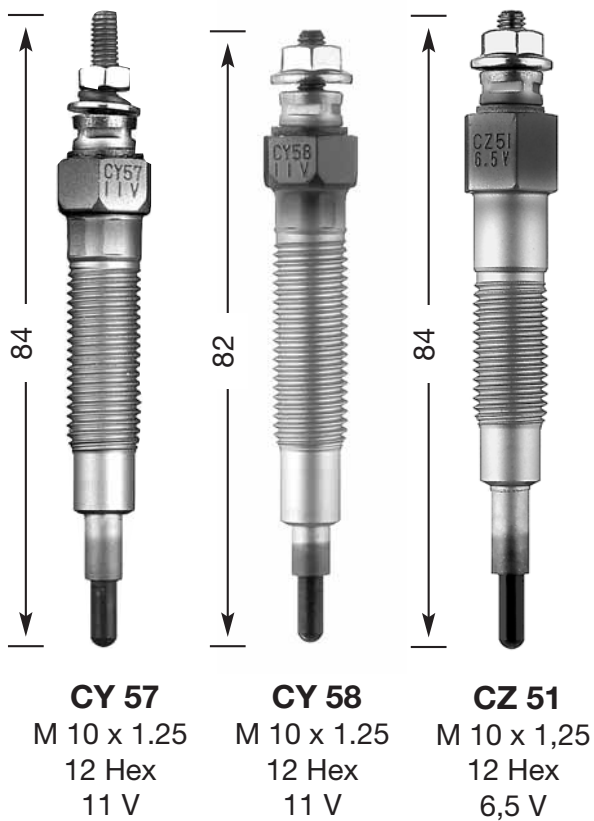
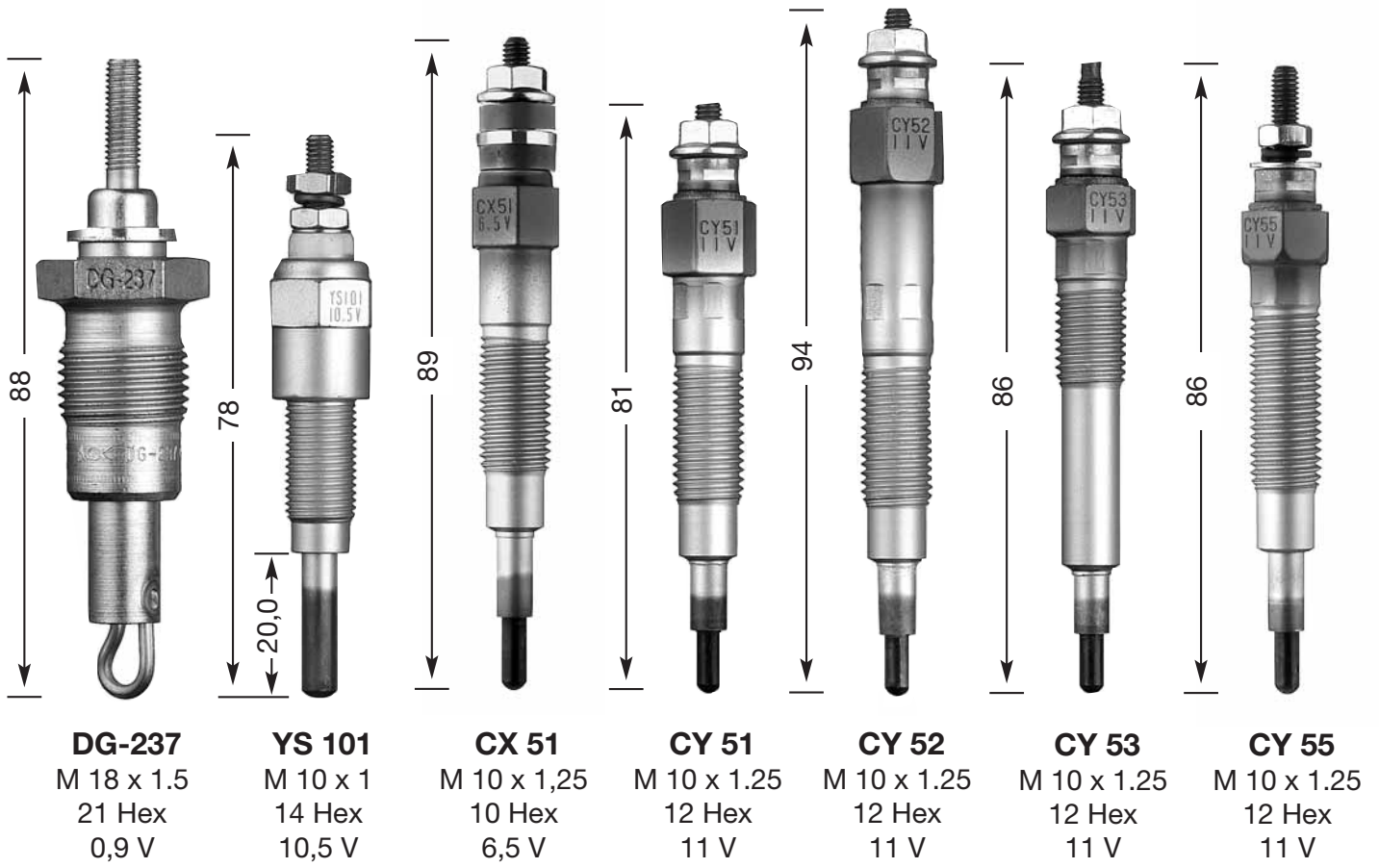

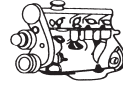

ℓ kW

Cyl. **D-POWER**Order-
No.**ALFA ROMEO**

6 TD	2.5	77	06.1983 -02.1987	VM HR 588HT	6		Y-909R	4602
10 AR 6, 13 AR 6 D	2.5	53	04.1985 -02.1986		4		Y-208T	1250
30 AR 8, 35 AR 8, 40 AR 8 D	2.5	53	02.1980 -06.1982	Sofim 8140.61.200	4		Y-208T	1250
30 AR 8, 35 AR 8, 40 AR 8 D	2.5	53	07.1982 -09.1983	Sofim 8140.61.200	4		Y-208T	1250
30 AR 8, 35 AR 8, 40 AR 8 D	2.5	53	10.1983 -12.1989	Sofim 8140.61.200	4	DP 1	Y-908R	4585
32 AR 8 D	2.5	53	02.1980 -09.1980	Sofim 8140.61.200	4		Y-208T	1250
33 TD	1.8	55	09.1986 -03.1994		4		Y-909R	4602
33 TD	1.8	62	09.1986 -03.1994	VM HR-392	3		Y-909R	4602
33 TD Sport Wagon	1.8	62	01.1990 -03.1994	VM 96 A	4		Y-909R	4602
33 TD	1.8	62	02.1990 -03.1994	VM 82 A	4		Y-909R	4602
75 TD	2.0	70	05.1985 -02.1992	VM 80 A	4		Y-909R	4602
75 TD	2.4	81	10.1988 -02.1992	VM 81 A	4		Y-909R	4602
90 TD	2.4	81	10.1984 -01.1987	VM 81 A	4		Y-909R	4602
145 TD	1.9	66	04.1994 -09.1996	AR67.501	4	DP 1	Y-922R	4356
145 TD	1.9	66	10.1996 -09.1997	AR33.601	4	DP 1	Y-922R	4356
145 JTD	1.9	77	05.1998 -11.1999	AR32.302	4	DP26	Y-747U	4951
146 TD	1.9	66	02.1995 -09.1996	AR67 501	4	DP 1	Y-922R	4356
146 TD	1.9	66	10.1996 -09.1997	AR33.601	4	DP 1	Y-922R	4356
146 JTD	1.9	77	05.1998 -11.1999	AR32.302	4	DP26	Y-747U	4951
147 JTD	1.9	85	11.2000 -	937A2000	4	DP36	Y-534J	5540
147 JTD	1.9	74	11.2000 -	182B9000	4	DP36	Y-534J	5540
155 TD	1.9	68	04.1993 -04.1996	AR67.501	4	DP 1	Y-902R	2237
155 TD	2.0	66	08.1993 -04.1996	AR67.502	4	DP 1	Y-922R	4356
155 TD	2.5	92	04.1993 -04.1995	VM 425 CLIEA	4	DP 1	Y-922R	4356
155 TD	2.5	92	05.1995 -10.1997	VM 425 CLIEA	4	DP20	Y-741U	5065
156 JTD	1.9	85	10.1997 -09.2000	AR32.302	4	DP26	Y-747U	4951
156 JTD	1.9	81	01.1998 -09.2000	AR32.302	4	DP26	Y-747U	4951
156 JTD	1.9	85	10.2000 -	AR32.302	4	DP36	Y-534J	5540
156 JTD	2.4	100	10.1997 -09.2000	AR32.501	5	DP26	Y-747U	4951
164 TD	2.5	85	06.1987 -08.1992	VM 84 A	4		Y-909R	4602
164 TD Super	2.5	92	09.1992 -04.1995	VM 425-SLIRA	4	DP 1	Y-922R	4356
164 TD	2.5	92	05.1995 -10.1998	VM 425 SLIRA	4	DP20	Y-741U	5065
166 JTD	2.4	103	10.1998 -11.1999	AR34.202	5	DP26	Y-747U	4951
Alfetta TD	2.0	60	10.1979 -03.1983	VM 4 HAT /2	4		Y-909R	4602
Alfetta TD	2.4	69	04.1983 -12.1984	VM 4 HT 2.4	4		Y-909R	4602
Giulietta TD	2.0	61	03.1983 -04.1985	VM 4 HT	4		Y-909R	4602

ARO

10.1, 10.2, 10.3, 10.4 D	1.9	47		Renault F8Q248	4	DP 1	Y-908R	4585
240, 241, 242, 243, 244, 246 D	2.5	70		Peugeot XD 3TP	6	DP 1	Y-902R	2237
240, 241, 242, 243, 244, 246 D	2.5	55		Peugeot XD 3P	6	DP 1	Y-902R	2237
Turbo 10	1.9	68		F8Q Turbo	4	DP25	Y-932R	4956

ASIA

Rocsta	2.2		03.1994 -12.1997	R2	4		Y-107R	1229
--------	-----	--	------------------	----	---	--	--------	------

AUDI

A 2 TDI	1.2	45	03.2001 -	ANY	3	DP20	Y-741U	5065
A 2	1.4	55	06.2000 -08.2003	AMF	3	DP20	Y-741U	5065
A 2 TDI	1.4	55	05.2003 -	BAY	4	DP 4	Y-732U	2408
A 2	1.4	55	09.2003 -	BHC	3	DP20	Y-741U	5065
A 3	1.9	66	09.1996 -08.2000	AGR	4	DP 4	Y-732U	2408



ℓ kW

Cyl. **D-POWER**Order-
No.**AUDI**

A 3	1.9	66	08.1997 -06.2001	ALH	4	DP 4	Y-732U	2408
A 3 TDI	1.9	81	01.1997 -04.2002	AHF	4	DP 4	Y-732U	2408
A 3 TDI	1.9	81	09.1999 -06.2001	ASV	4	DP 4	Y-732U	2408
A 3 TDI Fgst 8L-2-037-878 -->	1.9	96	05.2000 -06.2003	ASZ	4	DP20	Y-741U	5065
A 3 TDI Fgst --> 8L-2-037-877	1.9	96	05.2000 -06.2003	ASZ	4	DP 4	Y-732U	2408
A 3 TDI Fgst --> 8L-2-037-877	1.9	74	01.2001 -06.2003	ATD	4	DP 4	Y-732U	2408
A 3 TDI Fgst 8L-2-037-878 -->	1.9	74	11.2001 -06.2003	AXR	4	DP20	Y-741U	5065
A 3 TDI Fgst 8L-2-037-878 -->	1.9	74	01.2001 -06.2003	ATD	4	DP20	Y-741U	5065
A 3 TDI Fgst --> 8L-2-037-877	1.9	74	11.2001 -06.2003	AXR	4	DP 4	Y-732U	2408
A 4	1.9	66	11.1994 -07.1996	1Z	4	DP 4	Y-732U	2408
A 4	1.9	55	03.1996 -06.2000	AFF	4	DP 4	Y-732U	2408
A 4 TDI	1.9	66	08.1996 -06.2000	AHU	4	DP 4	Y-732U	2408
A 4	1.9	81	02.1996 -07.1999	AFN	4	DP 4	Y-732U	2408
A 4 TDI	1.9	66	04.1997 -09.2001	AHH	4	DP 4	Y-732U	2408
A 4	1.9	85	08.1998 -09.2001	AJM	4	DP 4	Y-732U	2408
A 4 TDI	1.9	81	08.1999 -06.2000	AVG	4	DP 4	Y-732U	2408
A 4 TDI Fgst 8E-2-148-698 -->	1.9	96	11.2000 -12.2004	AVF	4	DP20	Y-741U	5065
A 4 TDI Fgst 8E-2-148-698 -->	1.9	96	12.2000 -06.2003	AWX	4	DP20	Y-741U	5065
A 4 TDI	1.9	85	01.2000 -09.2001	ATJ	4	DP 4	Y-732U	2408
A 4 TDI Fgst --> 8E-2-148-697	1.9	96	11.2000 -12.2004	AVF	4	DP 4	Y-732U	2408
A 4 TDI Fgst --> 8E-2-148-697	1.9	96	12.2000 -06.2003	AWX	4	DP 4	Y-732U	2408
A 4 TDI Fgst --> 8E-2-148-697	1.9	74	04.2001 -05.2004	AVB	4	DP 4	Y-732U	2408
A 4 TDI Fgst 8E-2-148-698 -->	1.9	74	04.2001 -05.2004	AVB	4	DP20	Y-741U	5065
A 4 TDI	2.5	110	11.1997 -06.2000	AFB	6	DP31	Y-501U	3786
A 4	2.5	110	07.1998 -09.2001	AKN	6	DP31	Y-501U	3786
A 4 TDI	2.5	132	12.2000 -05.2003	AKE	6	DP31	Y-501U	3786
A 4 TDI	2.5	114	04.2001 -06.2002	AYM	6	DP31	Y-501U	3786
A 4	2.5	120	07.2002 -05.2003	BFC	6	DP31	Y-501U	3786
A 4 TDI	2.5	120	06.2003 -	BCZ	6	DP31	Y-501U	3786
A 4	2.5	132	06.2003 -12.2004	BAU	6	DP31	Y-501U	3786
A 4 TDI	2.5	132	06.2003 -12.2004	BDH	6	DP31	Y-501U	3786
A 4 TDI	2.5	120	06.2003 -	BDG	6	DP31	Y-501U	3786
A 6	1.9	66	07.1994 -06.1996	1Z	4	DP 4	Y-732U	2408
A 6 TDI	1.9	66	07.1996 -10.1997	AHU	4	DP 4	Y-732U	2408
A 6	1.9	81	04.1997 -04.2001	AFN	4	DP 4	Y-732U	2408
A 6 TDI	1.9	81	08.1999 -10.2000	AVG	4	DP 4	Y-732U	2408
A 6	1.9	85	11.2000 -04.2001	AJM	4	DP20	Y-741U	5065
A 6 TDI	1.9	96	06.2001 -01.2005	AVF	4	DP 4	Y-732U	2408
A 6 TDI	1.9	96	06.2001 -01.2005	AWX	4	DP20	Y-741U	5065
A 6	2.5	85	06.1994 -10.1997	AAT	5	DP 4	Y-732U	2408
A 6 TDI	2.5	103	10.1994 -10.1997	AEL	5	DP 4	Y-732U	2408
A 6 TDI	2.5	110	04.1997 -05.2000	AFB	6	DP31	Y-501U	3786
A 6	2.5	110	10.1998 -05.2001	AKN	6	DP31	Y-501U	3786
A 6 TDI	2.5	132	11.1999 -08.2003	AKE	6	DP31	Y-501U	3786
A 6 TDI	2.5	114	06.2001 -06.2002	AYM	6	DP31	Y-501U	3786
A 6	2.5	120	07.2002 -08.2003	BFC	6	DP31	Y-501U	3786
A 6	2.5	132	02.2003 -	BAU	6	DP31	Y-501U	3786
A 6 TDI	2.5	120	02.2003 -	BCZ	6	DP31	Y-501U	3786
A 6	2.5	120	02.2003 -01.2005	BDG	6	DP31	Y-501U	3786
A 6 TDI	2.5	132	02.2003 -01.2005	BDH	6	DP31	Y-501U	3786
A 8	2.5	110	11.1997 -09.2002	AKN	6	DP31	Y-501U	3786
A 8 TDI	2.5	110	06.1997 -04.2000	AFB	6	DP31	Y-501U	3786

Fgst = Chassis No.



l kW

Cyl. **D-POWER**Order-
No.**AUDI**

A 8 TDI	2.5	132	11.1999 -09.2002	AKE	6	DP31	Y-501U	3786
A 8 TDI	3.3	165	12.1999 -09.2002	AKF	8	DP31	Y-501U	3786
A 8	4.0	202	05.2003 -	ASE	8	DP31	Y-501U	3786
80 D,TD	1.6	40	08.1980 -07.1982	CR	4	DP 2	Y-918R	4182
80 D,TD	1.6	37	08.1981 -08.1991		4	DP 2	Y-918R	4182
80 TD	1.6	51	02.1982 -03.1987	CY	4	DP 2	Y-918R	4182
80	1.6	40	08.1982 -07.1989	JK	4	DP 2	Y-918R	4182
80 TD	1.6	59	04.1989 -12.1991	SB	4	DP 2	Y-918R	4182
80	1.9	47	08.1989 -12.1991	1Y	4	DP 2	Y-918R	4182
80 TD	1.9	55	09.1991 -07.1995	AAZ	4	DP 2	Y-918R	4182
80 TDi	1.9	66	09.1991 -07.1995	1Z	4	DP 4	Y-732U	2408
90 TD	1.6	59	07.1987 -12.1991	SB	4	DP 2	Y-918R	4182
100 5D	2.0	51	08.1978 -07.1982		5	DP 2	Y-918R	4182
100 D,TD	2.0	51	08.1982 -11.1990		4	DP 2	Y-918R	4182
100 D	2.4	60	08.1989 -12.1990	3D	5	DP 2	Y-918R	4182
100	2.4	60	05.1991 -07.1994	AAS	5	DP 2	Y-918R	4182
100 TDI	2.5	88	01.1990 -12.1990	1T	5	DP 4	Y-732U	2408
100 TDI	2.5	85	08.1991 -07.1994	AAT	5	DP 4	Y-732U	2408
100 TDI	2.5	85	04.1991 -07.1992	ABP	5	DP 4	Y-732U	2408
Cabrio	1.9	66	07.1995 -07.1996	1Z	4	DP 4	Y-732U	2408
Cabrio	1.9	66	07.1996 -08.2000	AHU	4	DP 4	Y-732U	2408

AUSTIN

Austin TAXI			08.1983 -		4		Y-208T	1250
-------------	--	--	-----------	--	---	--	--------	------

AUVERLAND

A3 TD	1.9	67		PSA engine	4	DP 1	Y-923U	3380
A3 D	1.9	51		PSA engine	4	DP 1	Y-902R	2237
A4 TD	1.9	67		PSA engine	4	DP 1	Y-923U	3380
A4 D	1.9	51		PSA engine	4	DP 1	Y-902R	2237

AVIA

A21.1 D			10.1990 -		4		Y-208T	1250
Avia D	3.6	65	-01.1993	D407	4		Y-208T	1250

BEDFORD

97000 Series	2.0		11.1979 -12.1980		4		Y-208T	1250
Astra Max D	1.6		02.1985 -	16D OHC	4	DP 1	Y-902R	2237
Astra Van D	1.6		03.1982 -	16D OHC	4	DP 1	Y-902R	2237
Brava Pickup 4x4	2.2		12.1998 -				Y-306R	6244
CF D	2.0		- 1979		4		Y-403T	7494
CF D	2.0		10.1979 - 1981		4		Y-208T	1250
CF D	2.3		1981 -		4	DP 1	Y-902R	2237
CF D Van	2.3		09.1980 -	Opel 23D OHC	6		Y-208T	1250
Midi 2.0TD	2.0	50	03.1988 -05.1990		4		Y-307R	5837
Midi 2.0TD	2.0		03.1988 -05.1990		4		Y-711RS	4444
Midi 2.2D	2.2		03.1988 -05.1990		4		Y-711RS	4444
Midi 2.2D	2.2	44	03.1988 -05.1990		4		Y-307R	5837

BMW

318 d Touring	E46/3	2.0	85	09.2001 -11.2003	M47 D20	4	DP32	Y-507R	4600
318 d	E46/4	2.0	85	09.2001 -11.2003	M47 D20	4	DP32	Y-507R	4600

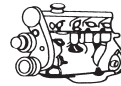

ℓ kW

Cyl. **D-POWER**Order-
No.**BMW**

318 Tds	E36	1.8	66	11.1994 -02.1998	M41 D18	4	DP 1	Y-917U	3219
320 d Touring	E46/3	2.0	100	09.2000 -08.2001	M47 D20	4	DP32	Y-507R	4600
320 d	E46/4	2.0	100	04.1998 -08.2001	M47 D20	4	DP32	Y-507R	4600
324 d	E30	2.4	63	09.1985 -08.1991	M21 D24	6	DP 1	Y-902R	2237
324 Td	E30	2.4	85	09.1987 -12.1993	M21 D24	6	DP 1	Y-917U	3219
325 Td	E36	2.5	85	01.1991 -02.1998	M51 D25	6	DP 1	Y-917U	3219
325 Tds	E36	2.5	105	06.1993 -05.1999	M51 D25	6	DP 1	Y-917U	3219
330 d Touring	E46/3	3.0	135	02.2000 -11.2003	M57 D30	6	DP32	Y-507R	4600
330 d	E46/4	3.0	135	09.2000 -11.2003	M57 D30	6	DP32	Y-507R	4600
330 Xd Touring	E46/3	3.0	135	09.2000 -11.2003	M57 D30	6	DP32	Y-507R	4600
330 Xd	E46/4	3.0	135	09.2000 -11.2003	M57 D30	6	DP32	Y-507R	4600
520 d	E39	2.0	100	09.1999 -08.2003	M47 D20	4	DP32	Y-507R	4600
520 d Touring	E39	2.0	100	09.1999 -08.2003	M47 D20	4	DP32	Y-507R	4600
524 d	E28	2.4	63	09.1983 -12.1987	M21 D24	6	DP 1	Y-902R	2237
524 Td	E28	2.4	85	09.1983 -12.1987	M21 D24	6	DP 1	Y-902R	2237
524 Td	E34	2.4	85	03.1988 -08.1991	M21 D24	6	DP 1	Y-917U	3219
525 d Touring	E39/2	2.5	120	03.2000 -12.2003	M57 D25	6	DP32	Y-507R	4600
525 d	E39	2.5	120	03.2000 -12.2003	M57 D25	6	DP32	Y-507R	4600
525 Td	E34	2.5	85	06.1992 -06.1996	M51 D25	6	DP 1	Y-917U	3219
525 Tds	E34	2.5	105	01.1990 -06.1996	M51 D25	6	DP 1	Y-917U	3219
525 Tds	E39	2.5	105	03.1995 -10.2000	M51 D25	6	DP 1	Y-917U	3219
530 d	E39	3.0	142	09.1998 -12.2003	M57 D30	6	DP32	Y-507R	4600
530 d Touring	E39/2	3.0	142	02.1999 -03.2004	M57 D30	6	DP32	Y-507R	4600
725 Tds	E38	2.5	105	09.1995 -11.2000	M51 D25	6	DP 1	Y-917U	3219
730 d	E38	3.0	142	09.1998 -12.2001	M57 D30	6	DP32	Y-507R	4600
X 5 4x4	E53	3.0	142	08.2001 -11.2003	M57 D30	6	DP32	Y-507R	4600

CARBODIES

FL2/R Hire Car			08.1983 -					Y-208T	1250
FX4 2.25 Taxi		2.2	1979 - 1989	22E				Y-208T	1250
FX4 2.5 Taxi		2.5	1979 - 1989	25V				Y-208T	1250
FX4R 2.25 Taxi		2.2	08.1983 -					Y-208T	1250

CHRYSLER

Cherokee		2.5	04.1992 -04.1995	VM	4	DP 1	Y-923U	3380
Cherokee		2.5	05.1995 -07.1999	VM	4	DP20	Y-741U	5065
Grand Cherokee		2.5	02.1997 -07.1999	VM	4	DP20	Y-741U	5065
Grand Cherokee		3.1	11.1998 -	EXA	5	DP20	Y-741U	5065
PT Cruiser GRD		2.2	89 03.2002 -		4	DP11	Y-745U	4705
Voyager 2		2.5	88 04.1992 -04.1995	VM HR-492	4	DP 1	Y-923U	3380
Voyager 2		2.5	88 04.1992 -04.1995	VM 425 CLIRE	4	DP 1	Y-923U	3380
Voyager 3		2.5	88 05.1995 -01.2001	VM HR425 CLIEE	4	DP20	Y-741U	5065

CITROEN

AX D		1.4	39 09.1988 -09.1994	TUD 3 L	4	DP33	Y-911R	4544
AX D		1.5	40 10.1994 -12.1999	TUD 5 VJZ	4	DP 9	Y-731U	5274
Berlingo		1.8	43 07.1996 -08.1998	XUD7 A9A	4	DP 1	Y-923U	3380
Berlingo		1.8	50 09.1998 -03.1999	DW8 WJZ	4	DP10	Y-503R	4279
Berlingo		1.8	66 09.1998 -03.1999	DW8TD	4	DP10	Y-503R	4279
Berlingo		1.8	43 09.1998 -03.1999	XUD7 A9A	4	DP 1	Y-938R	5267
Berlingo		1.9	50 07.1996 -09.1998	XUD9A D9B / DJY	4	DP 1	Y-923U	3380
Berlingo		1.9	52 09.1998 -12.2002	XUD9A	4	DP 1	Y-938R	5267

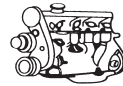

ℓ kW

Cyl. **D-POWER**Order-
No.**CITROËN**

Berlingo HDI	2.0	66	10.1999 -	DW10TD	4	DP24	Y-504R	4359
Berlingo Multispace	1.9	50	01.1997 -09.1998	XUD9A D9B / DJY	4	DP 1	Y-923U	3380
Berlingo Multispace	1.9	50	09.1998 -12.2002	DW8 WJZ	4	DP10	Y-503R	4279
Berlingo Multispace HDI	2.0	66	10.1999 -	DW10TD	4	DP24	Y-504R	4359
BX 17 D	1.8	44	07.1985 -01.1993	XUD 7	4	DP 1	Y-902R	2237
BX 17 TD, TRD	1.8	66	03.1988 -01.1993	XUD 7 TE	4	DP 1	Y-902R	2237
BX 19 D RD, TD, TRD	1.9	47	09.1983 -12.1987	XUD 9	4	DP 1	Y-902R	2237
BX 19 D TD, TRD	1.9	51	03.1987 -	XUD 9 A/L	4	DP 1	Y-902R	2237
C 3 HDI 16V	1.4	68	07.2002 -	DV4TED4	4		YE04	1101
C 3 HDI	1.4	52	04.2002 -	DV4TD	4		YE04	1101
C 3 X-TR 16V	1.4		2004 -	DV4ETD4	4		YE04	1101
C 5 HDI	2.0	81	02.2001 -	DW10ATED	4	DP24	Y-504R	4359
C 5 HDI	2.0	66	06.2002 -	DW10ATD	4	DP24	Y-504R	4359
C 5 HDI 16V	2.2	100	02.2001 -	DW12TED4	4	DP24	Y-504R	4359
C 8 Hdi 16V	2.0	80	07.2002 -	DW10TED4/RHT	4	DP24	Y-504R	4359
C 8 Hdi 16V	2.2	94	07.2002 -	DW12TED4/4HW	4	DP24	Y-504R	4359
C 8 HDI	2.2	0	2002 -	DW12	4	DP24	Y-504R	4359
C 15 D	1.8	44	10.1984 -05.1995	XUD7	4	DP 1	Y-902R	2237
C 15 D	1.8	44	06.1995 -	XUD7	4	DP 1	Y-938R	5267
C 25 D	1.9	51	07.1987 -01.1994	D9B	4	DP 1	Y-902R	2237
C 25 D	2.5	54	07.1981 -01.1994	CRD93	4		Y-208T	1250
C 25 TD	2.5	70	08.1987 -01.1994	CRD93LS	4		Y-208T	1250
C 32 / 6C 35 D	2.2	45	09.1973 -07.1979	CRD90	4		Y-405	5471
C 32 D	2.2	45	08.1979 -12.1979	CRD90	4		Y-208T	1250
C 35 D	2.2	45	08.1979 -12.1979	CRD90	4		Y-208T	1250
C 35 D	2.5	50	01.1980 -01.1991	CRD93B	4		Y-208T	1250
C 45 D	2.5	50	06.1982 -01.1991	CRD93B	4		Y-208T	1250
CX 2200 D Break	2.2	48	10.1975 -02.1979		4		Y-405	5471
CX 2200 D	2.2	48	10.1975 -02.1979	M22 621	4		Y-405	5471
CX 25 D	2.5	54	07.1982 -06.1988	M25 660	4		Y-208T	1250
CX 25	2.5	54	07.1982 -12.1992	M25 660	4	DP 1	Y-902R	2237
CX 25 Turbo	2.5		04.1983 -12.1986	M25 648	4		Y-208T	1250
CX 25 TD Turbo 2	2.5	78	01.1987 -12.1992	M25 669/671	4		Y-208T	1250
CX 2500 D	2.5	55	02.1978 -07.1979	M25 629	4		Y-405	5471
CX 2500 / Reflex D	2.5	55	08.1979 -06.1982	M25 629	4		Y-208T	1250
Dispatch	1.9		09.1996 -07.1998	XUD9A, XUD9TF	4	DP 1	Y-923U	3380
Dispatch	1.9		09.1998 -	XUD9A, XUD9TF	4	DP 1	Y-938R	5267
Dispatch	1.9		09.1998 -	DW8, DW8TD	4	DP10	Y-503R	4279
Dispatch	2.0		03.2000 -	DW10	4	DP24	Y-504R	4359
Evasion TD	1.9	66	03.1994 -08.1998	XUD9TF	4	DP 1	Y-923U	3380
Evasion	1.9	67	09.1998 -09.2002	XUD9TF, XUD9BTF	4	DP 1	Y-938R	5267
Evasion Hdi	2.0	81	09.1998 -09.2002	DW10ATED	4	DP24	Y-504R	4359
Evasion TD	2.1	80	05.1996 -04.1997	XUD11BTE	4	DP 1	Y-923U	3380
Evasion TD	2.1	80	05.1997 -12.1998	XUD11BTE	4	DP 1	Y-938R	5267
Jumper D	1.9	51	03.1994 -05.1995	XUD9AU	4	DP 1	Y-923U	3380
Jumper TD	1.9	68	03.1994 -08.1998	XUD9TF	4	DP 1	Y-923U	3380
Jumper	1.9	52	06.1995 -	XUD9AU	4	DP 1	Y-938R	5267
Jumper	1.9	67	09.1998 -	XUD9TF	4	DP 1	Y-938R	5267
Jumper HDI	2.0	66	09.1998 -	DW10TD	4	DP24	Y-504R	4359
Jumper Hdi	2.2	76	09.1998 -	DW10TED4	4	DP24	Y-504R	4359
Jumper HDI	2.2	100	09.1998 -	DW12TED4	4	DP24	Y-504R	4359
Jumper D	2.5	63	03.1994 -	DJ5	4	DP 1	Y-923U	3380



ℓ kW

Cyl. **D-POWER**Order-
No.**CITROËN**

Jumper TD	2.5	76	03.1994 -08.1996	DJ5T	4	DP 1	Y-923U	3380
Jumper Tdi	2.5	78	09.1996 -	DJ5TED	4		Y-738U	5390
Jumper HDI	2.8	93	09.2000 -04.2002	4HY	4		Y-502R	3852
Jumpy	1.8	50	09.1998 -	DW8	4	DP10	Y-503R	4279
Jumpy TD	1.9	68	01.1996 -08.1998	XUD9TF/BTF	4	DP 1	Y-923U	3380
Jumpy D	1.9	51	01.1996 -08.1998	XUD9A	4	DP 1	Y-923U	3380
Jumpy	1.9	68	09.1996 -	XUD9TF/BTF	4	DP 1	Y-938R	5267
Jumpy	1.9	51	09.1998 -	XUD9A	4	DP 1	Y-938R	5267
Jumpy HDI	2.0	70	02.2000 -	DW10TED	4	DP24	Y-504R	4359
Jumpy HDI	2.0	81	02.2000 -	DW10ATED	4	DP24	Y-504R	4359
Relay	1.9		03.1994 -08.1998	XUD9TF, 9AU	4	DP 1	Y-923U	3380
Relay	1.9		09.1998 -	XUD9TF	4	DP 1	Y-938R	5267
Relay	2.0		09.1998 -	DW10TED/DU	4	DP24	Y-504R	4359
Relay	2.5		03.1994 -	DJ5, DJ5T	4	DP 1	Y-923U	3380
Relay	2.5		09.1996 -	DJ5TED 12V	4		Y-738U	5390
Saxo 1	1.5	43	05.1996 -08.1999	TUD 5	4	DP 9	Y-731U	5274
Saxo 2	1.5	43	09.1999 -05.2003	TUD 5	4	DP 9	Y-731U	5274
Synergie	1.9		10.1995 -08.1998	XUD9BTF/L3	4	DP 1	Y-923U	3380
Synergie	1.9		09.1998 -10.2000	XUD9TF, XUD9BTF	4	DP 1	Y-938R	5267
Synergie	2.0		08.1999 -	DW10TED	4	DP24	Y-504R	4359
Visa 17 D	1.8	44	04.1984 -03.1991	161A	4	DP 1	Y-902R	2237
Xantia D	1.9	51	03.1993 -01.1996	XUD 9 A/L	4	DP 1	Y-902R	2237
Xantia TD	1.9	68	06.1993 -08.1998	XUD9TF	4	DP 1	Y-923U	3380
Xantia	1.9	55	05.1994 -	XUD9A	4	DP 1	Y-938R	5267
Xantia TDX	1.9	55	02.1996 -04.1994	XUD9SD	4	DP 1	Y-923U	3380
Xantia	1.9	55	09.1998 -	XUD9A/L	4	DP 1	Y-938R	5267
Xantia	1.9	67	09.1998 -12.2000	XUD9BTF, XUD9BSD	4	DP 1	Y-938R	5267
Xantia HDI	2.0	66	10.1998 -	DW10TD	4	DP24	Y-504R	4359
Xantia HDI	2.0	81	10.1998 -12.2001	DW10ATED	4	DP24	Y-504R	4359
Xantia TD	2.1	80	06.1995 -08.1998	XUD11BTE	4	DP 1	Y-923U	3380
Xantia	2.1	80	09.1998 -	XUD11BTF	4	DP 1	Y-938R	5267
XM D 12 D	2.1	60	05.1989 -06.1994	XUD11A/L	4	DP 1	Y-902R	2237
XM D 12 TD	2.1	80	05.1989 -08.1998	XUD11ATE/L/BTE	4	DP 1	Y-923U	3380
XM	2.1	80	09.1998 -12.2000	XUD11ATE/L/BTE	4	DP 1	Y-938R	5267
XM TD	2.5	96	07.1994 -12.2000	DK5ATE	4	DP 1	Y-923U	3380
Xsara	1.5	43	09.1997 -08.2000	TUD5	4	DP 9	Y-731U	5274
Xsara	1.8	43	10.1997 -09.2000	XUD7	4	DP 1	Y-938R	5267
Xsara TD	1.9	66	10.1997 -09.2000	XUD9TE DHY	4	DP 1	Y-938R	5267
Xsara	1.9	92	09.1997 -09.2000	XUD9A DJY	4	DP 1	Y-938R	5267
Xsara	1.9	51	06.1999 -08.2000	DW8	4	DP10	Y-503R	4279
Xsara HDI	2.0	66	04.1999 -08.2000	DW10TD	4	DP24	Y-504R	4359
Xsara 2 HDI	1.4	0	02.2003 -	DV4TD	4		YE04	1101
Xsara 2	1.5	43	09.2000 -	TUD5	4	DP 9	Y-731U	5274
Xsara 2	1.9	52	09.2000 -	DW8 WJZ	4	DP10	Y-503R	4279
Xsara 2 HDI	2.0	66	09.2000 -12.2002	DW10TD RHY	4	DP24	Y-504R	4359
Xsara 2 HDI	2.0	81	05.2001 -	DW10ATED RHZ	4	DP24	Y-504R	4359
Xsara Picasso HDI	2.0	66	01.2000 -	DW10TD	4	DP24	Y-504R	4359
ZX D	1.8	44	03.1991 -04.1994	XUD 7 A9A	4	DP 1	Y-902R	2237
ZX D	1.9	47	03.1991 -04.1994	XUD 9 A/L D9B	4	DP 1	Y-902R	2237
ZX TD	1.9	68	09.1992 -04.1994	XUD 9 T/L D8A	4	DP 1	Y-923U	3380
ZX Reflex D	1.8	44	03.1991 -	XUD 7 A9A	4	DP 1	Y-902R	2237

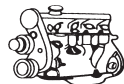

l kW

Cyl. **D-POWER**Order-
No.**DACIA**

Duster	1.6		1992 - 1999		4	DP 1	Y-908R	4585
--------	-----	--	-------------	--	---	-------------	--------	------

DAEWOO

Korando TD	2.3		04.2000 -		4	DP 6	Y-916R	2785
Korando TD, Cabriolet	2.9	88	04.2000 -		5	DP 6	Y-916R	2785
Korando	2.9		04.2000 -		4	DP 6	Y-916R	2785
Musso SLTD	2.3	74	04.2000 -		4	DP 6	Y-916R	2785
Musso	2.9		04.2000 -		4	DP 6	Y-916R	2785
Musso SELTD	2.9	88	04.2000 -		5	DP 6	Y-916R	2785
Rexton 290 RX Td	2.9	87	05.2002 -	Mercedes	5		Y-929U	6003

DAIHATSU

Charade CL10,60 / G30	1.0	27	10.1983 -02.1987	CL	4		Y-146R	7492
Charade CL10,60	1.0	27	1986 -	CL	4		Y-703R	3782
Charade CL50	1.0		- 1985	CL	4		Y-146R	7492
Charade CL50	1.0		1986 -	CL	4		Y-703R	3782
Delta Truck D			08.1977 -	DG	4		Y-128T	7227
Delta Truck D			02.1983 -	DL40	4		Y-128T	7227
Delta Truck D (3B)			02.1983 -	3 B	4		Y-147T	7493
Delta Truck D (B)			02.1983 -	B	4		Y-147T	7493
F 50, 55, 60, 65	2.5	46	08.1978 -08.1980	DG	4		Y-128T	7227
Fourtrak	2.8		- 1984	DL40	4		Y-128T	7227
Fourtrak	2.8		1984 - 1993	DL50	4		Y-146R	7492
Fourtrak	2.8		10.1989 - 1993	DL-T	4		Y-146R	7492
Hijet S77/N				CL20	4		Y-146R	7492
Rocky 4WD TD				DL42	4		Y-146R	7492
Rocky 4WD			1985 -	DL40	4		Y-128T	7227
Rocky 4WD D	2.8	54	1985 -	DL50	4		Y-146R	7492
Rocky	2.8	67	12.1987 -04.1993	DL51	4		Y-146R	7492
Taft 4WD D			10.1982 -	DL40	4		Y-128T	7227
Taft D	2.5	46	08.1978 -03.1984	DG	4		Y-128T	7227

FIAT

127 D	1.3	33	06.1983 -12.1986		4	DP 1	Y-902R	2237
127 D	1.3	33	04.1983 -02.1987	127 A., 127 A 5.	4		Y-208T	1250
131 Mirafiori D	2.0	44	03.1978 -01.1984	8144.65	4	DP 1	Y-908R	4585
131 Mirafiori D	2.5	53	08.1978 -12.1984	8144.61	4	DP 1	Y-908R	4585
132 D	2.0	44	03.1978 -05.1981	8144.65	4	DP 1	Y-908R	4585
132 D	2.5	53	03.1978 -05.1981	8144.61	4	DP 1	Y-908R	4585
176 TD	1.7		06.1993 -		4	DP 1	Y-922R	4356
242/15, 18 D	2.5	50	05.1974 -08.1979		4		Y-405	5471
28 F 8 Daily D		53	04.1978 -06.1982		4		Y-208T	1250
28.40 F 8 Daily D			07.1982 -12.1982		4		Y-208T	1250
30 F 8 Daily D			04.1978 -06.1982		4		Y-208T	1250
32 F 8 Daily D			04.1978 -06.1982		4		Y-208T	1250
35 F 8 Daily D			04.1978 -06.1982		4		Y-208T	1250
40 F 8 Daily D			04.1978 -06.1982		4		Y-208T	1250
Argenta D	2.5	53	06.1981 -11.1985	B 144.61	4	DP 1	Y-908R	4585
Argenta TD	2.4	66	06.1981 -11.1985	B 144.81	4	DP 1	Y-908R	4585
Brava 1,9 JTD	1.9	77	12.1998 -11.1999	182B4.000	4	DP26	Y-747U	4951
Brava / Bravo / JTD	1.9	77	12.1999 -12.2001	182B4.000	4	DP36	Y-534J	5540
Brava / Bravo D	2.0	74	09.1995 -07.1996		4	DP 1	Y-923U	3380



ℓ kW

Cyl. **D-POWER**Order-
No.**FIAT**

Brava / Bravo D	1.9	55	09.1995 - 10.1996	160A7.000	4	DP 1	Y-920R	3645
Brava / Bravo D; TD	1.9	55	04.1996 - 11.1999		4	DP29	Y-928U	5700
Bravo 1,9 JTD	1.9	77	12.1998 - 11.1999	182B4.000	4	DP26	Y-747U	4951
Campagnola D	2.5	53	06.1979 - 10.1986	B 142.61	4		Y-208T	1250
Croma Turbo D	1.9	66	03.1988 - 06.1990	154 B	4		Y-739R	6639
Croma TD (TDId)	1.9	69	07.1990 - 1998	154 C6.000; 154 D 1.000	4		Y-739R	6639
Croma TD	2.5	74	12.1985 - 02.1989	8144.91.200	4	DP 1	Y-908R	4585
Croma D	2.5	55	12.1985 - 12.1989	8144.67	4	DP 1	Y-902R	2237
Croma Td	2.5	85	02.1989 - 12.1992	8144.97.200/.2200	4	DP 1	Y-908R	4585
Croma	2.5	90	01.1993 - 12.1993		4	DP 1	Y-914U	2643
Croma TD	2.5	85	01.1994 - 1999				Y-926U	7119
Croma 2.5L	2.5	90	01.1994 - 1998		4	DP 1	Y-914U	2643
Doblò JTD	1.9	77	01.2004 -	182B9000	4	DP36	Y-534J	5540
Ducato 10, 13 D	2.5	53	-06.1982		4		Y-208T	1250
Ducato 10, 13 D	2.5	53	07.1982 - 12.1985		4		Y-208T	1250
Ducato TD	2.5	68	01.1986 - 02.1994		4	DP 1	Y-908R	4585
Ducato (230) 2,8D	2.8	64	02.1998 -				Y-502R	3852
Ducato 10TD	1.9	59	03.1994 -	Kat.	4	DP 1	Y-922R	4356
Ducato 10D D	1.9	51	03.1994 -		4	DP 1	Y-914U	2643
Ducato 10TD	1.9	60	03.1994 -		4	DP 1	Y-914U	2643
Ducato 10 D	2.0	52	02.1987 -	149 B1.000	4	DP 1	Y-902R	2237
Ducato 10 TD	2.0	60	01.1990 - 02.1994	280 A1.000	4	DP 1	Y-914U	2643
Ducato 10 D	2.5	53	01.1986 - 02.1994	8144.67	4	DP 1	Y-908R	4585
Ducato 14 TD	1.9	60	01.1990 - 02.1994	280 A 1.000	4	DP 1	Y-914U	2643
Ducato 14 TD	2.4	68	01.1986 - 02.1994	8144.21.220	4	DP 1	Y-908R	4585
Ducato 14 D	2.4		01.1986 - 02.1994		4	DP 1	Y-908R	4585
Ducato 14 D	2.5	55	01.1986 - 02.1994	8144.67.220	4	DP 1	Y-908R	4585
Ducato 14 D 4x4	2.5	55	01.1989 - 02.1994	8144.67.220	4	DP 1	Y-908R	4585
Ducato 14 TD 4x4	2.5	68	01.1989 - 02.1994	8144.21.220	4	DP 1	Y-914U	2643
Ducato 14 TDi	2.5	81	03.1994 -	8140.47.2280 Kat.		DP23	Y-935U	5915
Ducato 14 Di	2.5	85	03.1994 -	8140.47.2200		DP23	Y-935U	5915
Ducato 14 TD	2.5	62	03.1994 -	8140.67.2200	4	DP 1	Y-922R	4356
Ducato 18 Maxi TD	2.5	68	01.1986 - 02.1994	8144.21.220	4	DP 1	Y-908R	4585
Ducato 18 Maxi D	2.5	55	01.1986 - 02.1994			DP23	Y-935U	5915
Duna DS D	1.7	44	10.1986 - 12.1990		4	DP 1	Y-902R	2237
Fiorino D	1.3	33	03.1982 - 10.1982		4		Y-208T	1250
Fiorino D	1.3	33	11.1982 - 12.1987		4	DP 1	Y-902R	2237
Fiorino D	1.3	33	06.1990 - 08.1993	146 B1.000	4	DP 1	Y-902R	2237
Fiorino D	1.7	43	12.1987 -	149 B3.000	4	DP 1	Y-902R	2237
Fiorino D	1.7	42	01.1988 -	149 B4.046	4	DP 1	Y-902R	2237
Marea	1.9	74	09.1996 - 12.2000	182 A7.000	4	DP29	Y-928U	5700
Marea	1.9	55	09.1996 - 12.2000	182 A8.000	4	DP29	Y-928U	5700
Marea JTD	1.9	77	12.1998 - 11.1999	186A6.000	4	DP26	Y-747U	4951
Marea JTD / Marengo	1.9	80	12.1999 - 12.2002	186A6.000	4	DP36	Y-534J	5540
Marea	2.4	91	09.1996 - 12.2000	185 A2.000	5	DP29	Y-928U	5700
Marea JTD	2.4	96	03.1999 - 11.1999	185 A6.000	5	DP26	Y-747U	4951
Marengo TD	1.9	66	01.1992 -	160 A 6.000	4	DP 1	Y-902R	2237
Marengo D	1.9	66	01.1992 -	160 A 6.000	4	DP 1	Y-902R	2237
Marengo D	1.9	48	01.1992 -	160 A 7.000	4	DP 1	Y-902R	2237
Marengo D	2.0	48	01.1986 - 07.1989		4	DP 1	Y-902R	2237
Marengo D	2.5	53	05.1980 - 07.1989	8144.61	4		Y-208T	1250
Multipla JTD	1.9	77	11.1998 - 11.1999	182B4.000	4	DP26	Y-747U	4951

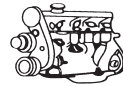

ℓ kW

Cyl. **D-POWER**Order-
No.**FIAT**

Multipla JTD	1.9	81	11.1998 - 11.1999	182B4.000	4	DP26	Y-747U	4951
Multipla JTD	1.9	85	12.1999 -	182B4.000	4	DP36	Y-534J	5540
Palio TD	1.7	51	1997 -		4	DP 1	Y-922R	4356
Panda D	1.3	27	03.1986 - 12.1989	156A 5.000	4	DP 1	Y-902R	2237
Punto S, SX, ELX TD	1.7	53	06.1993 - 09.1996	176 TD, 1697 TT	4	DP 1	Y-922R	4356
Punto D	1.7	42	11.1994 -	176 A 3.000	4	DP 1	Y-902R	2237
Punto S, SX, ELX TD	1.7	53	10.1996 - 12.1999		4	DP29	Y-928U	5700
Punto 70 TD	1.7	53	10.1996 - 12.1999		4	DP29	Y-928U	5700
Punto JTD	1.9	59	10.1999 - 12.2000	188A2.000	4	DP36	Y-534J	5540
Punto JTD	1.9	63	01.2001 -	188A7.000	4	DP36	Y-534J	5540
Regata D	1.7	43	09.1983 - 05.1987	138 B., 149 B 3.	4	DP 1	Y-902R	2237
Regata D	1.7	43	06.1987 -		4	DP 1	Y-902R	2237
Regata D	1.9	48	04.1984 - 05.1987	149 A 1.	4	DP 1	Y-902R	2237
Regata TD	1.9	59	06.1986 - 07.1989		4	DP 1	Y-902R	2237
Regata D	1.9	48	06.1987 -		4	DP 1	Y-902R	2237
Ritmo D	1.7	43	10.1979 - 09.1982		4		Y-208T	1250
Ritmo D	1.7	43	10.1982 -		4	DP 1	Y-902R	2237
Ritmo TD	1.9	59	12.1985 - 12.1987	831 D 1.	4	DP 1	Y-902R	2237
Scudo D	1.9	51	03.1996 -		4	DP 1	Y-923U	3380
Scudo TD	1.9	68	03.1996 -		4	DP 1	Y-923U	3380
Stilo 1.9 JTD 80 CV	1.9	59	09.2001 -	192.A3000	4	DP36	Y-534J	5540
Stilo 1.9 JTD 115 CV	1.9	85	09.2001 -	192.A1000	4	DP36	Y-534J	5540
Stilo 1.9 JTD SW	1.9	86	09.2002 -	192.A1000	4	DP36	Y-534J	5540
Strada D	1.7	43	10.1979 - 09.1982		4		Y-208T	1250
Strada D	1.7	43	10.1982 -		4	DP 1	Y-902R	2237
Talento D	1.9	51	03.1988 -		4	DP 1	Y-902R	2237
Tempra TD /SW	1.9	66	02.1990 -	160 A6.000	4	DP 1	Y-902R	2237
Tempra TD	1.9	59	07.1990 -	160 B6.046	4	DP 1	Y-902R	2237
Tempra D - SW	1.9	48	02.1990 - 06.1996	160 A7.000	4	DP 1	Y-902R	2237
Tempra TD	1.9	68	06.1993 - 09.1996	160 D1.000	4	DP 1	Y-922R	4356
Tipo D	1.7	42	07.1987 - 03.1993	149 B 4.000	4	DP 1	Y-902R	2237
Tipo TD	1.9	66	07.1987 -	160 D1.000	4	DP 1	Y-902R	2237
Tipo TD	1.9	68	07.1987 - 03.1993	149 A 1.000	4	DP 1	Y-902R	2237
Tipo D	1.9	48	07.1989 - 03.1993	149 A1.000	4	DP 1	Y-902R	2237
Tipo TD	1.9	68	06.1993 - 12.1994		4	DP 1	Y-922R	4356
Ulysse TD	1.9	68	09.1994 -	XUD 9 TU	4	DP 1	Y-923U	3380
Ulysse TD	2.1	80	07.1996 -	XUD11ATE	4	DP 1	Y-923U	3380
Uno 60 D	1.3	33	06.1983 - 08.1989	127 A 5.	4	DP 1	Y-902R	2237
Uno 45 D	1.3	33	06.1983 - 08.1989	127 A 5.	4	DP 1	Y-902R	2237
Uno 70 TD	1.4	51	03.1986 - 08.1989	146 A 653, 146 B.	4	DP 1	Y-902R	2237
Uno 60 TD	1.4	51	03.1986 - 09.1992	146 B	4	DP 1	Y-902R	2237
Uno TD	1.4	52	09.1989 - 12.1995	146 B3.000	4	DP 1	Y-902R	2237
Uno 60 D	1.7	44	07.1986 - 08.1989	149 B 3.	4	DP 1	Y-902R	2237
Uno D Van	1.7	42	09.1989 - 03.1996	146 B2.000	4	DP 1	Y-902R	2237
Uno D	1.7		10.1989 -		4	DP 1	Y-902R	2237
Uno 60 D	1.7	40	09.1989 - 09.1992	146 B 2.000	4	DP 1	Y-902R	2237
Uno D	1.7		01.1991 -		4	DP 1	Y-902R	2237

FISSORE

Magnum 4x4 TD	2.4	77	07.1984 - 04.1986		6	DP 1	Y-908R	4585
Rayton 4x4 TD	2.4	82	03.1988 -	HR 492 HIM	6		Y-909R	4602



ℓ kW

Cyl. **D-POWER**Order-
No.**FORD**

A-Series	2.4			4AA YORK-D			Y-208T	1250
A-Series	3.6			8AA YORK-D			Y-208T	1250
Courier D	1.8	66	03.1993 -		4	DP 3	Y-910R	4751
Econovan	2.0	41	09.1985 -	RF	4		Y-107R	1229
Escort '81	1.6	40	08.1980 -12.1985	LTA	4		Y-907R	4479
Escort '81 Express Van 55	1.6	40	04.1984 -07.1990	LTA	4		Y-907R	4479
Escort '86	1.6	40	01.1986 -07.1990	LTC	4		Y-907R	4479
Escort '86	1.8	44	01.1986 -07.1990	RTB	4	DP 3	Y-910R	4751
Escort '86	1.8	44	01.1986 -07.1990	RTA	4	DP 3	Y-910R	4751
Escort '91 TD	1.8	51	08.1990 -09.2001	RVA Endura-DE (TC)	4	DP 5	Y-937R	5148
Escort '91	1.8	66	08.1990 -09.2001	RFK	4	DP 3	Y-910R	4751
Escort '91	1.8	44	08.1990 -09.2001	RTH	4	DP 3	Y-910R	4751
Escort '91	1.8	44	08.1990 -09.2001	RTE	4	DP 3	Y-910R	4751
Escort '91	1.8	66	08.1990 -09.2001	RFS Endura-DE (TC)	4	DP 5	Y-937R	5148
Escort '91	1.8	66	08.1990 -09.2001	RFD	4	DP 3	Y-910R	4751
Escort '91	1.8	44	08.1990 -09.2001	RTF	4	DP 3	Y-910R	4751
Fiesta '01 TDCI	1.4	50	11.2001 -	F6JA DuraTorq-TDCi	4		YE04	1101
Fiesta '01 TDCI	1.4	50	11.2001 -	F6JB DuraTorq-TDCi	4		YE04	1101
Fiesta '83	1.6	40	08.1983 -01.1987	LTB D	4		Y-907R	4479
Fiesta '87	1.6	40	02.1987 -02.1989	LTB D	4		Y-907R	4479
Fiesta '89	1.8	44	03.1989 -06.1996	RTG D	4	DP 3	Y-910R	4751
Fiesta '89	1.8	44	03.1989 -06.1996	RTC D	4	DP 3	Y-910R	4751
Fiesta '89	1.8	44	03.1989 -06.1996	RTD D	4	DP 3	Y-910R	4751
Fiesta '96	1.6		1996 -		4	DP 3	Y-910R	4751
Fiesta '96	1.8	44	11.1995 -02.2002	RTJ	4	DP 5	Y-937R	5148
Fiesta '96	1.8	44	11.1995 -02.2002	RTK	4	DP 5	Y-937R	5148
Focus / C-Max TDCI	1.6	80	06.2003 -	G8DA DuraTorq-TDCi	4		YE04	1101
Focus '98	1.8	66	08.1998 -	C9DB Endura-DI	4	DP27	Y-524J	5986
Focus '98	1.8	55	08.1998 -	BHDA Endura-DI	4	DP27	Y-524J	5986
Focus '98	1.8	85	08.1998 -	F9DB DuraTorq-TDCi	4	DP27	Y-524J	5986
Focus '98 TDCi	1.8	85	08.1998 -	F9DA DuraTorq-TDCi	4	DP27	Y-524J	5986
Focus '98	1.8	55	08.1998 -	BHDB Endura-DI	4	DP27	Y-524J	5986
Focus '98 Turbo Di	1.8	66	08.1998 -	C9DC Endura-DI	4	DP27	Y-524J	5986
Focus '98	1.8	66	08.1998 -	C9DA Endura-DI	4	DP27	Y-524J	5986
Focus '98	1.8	74	08.1998 -	FFDA DuraTorq-TDCi	4	DP27	Y-524J	5986
Fusion TDCI	1.4	50	06.2002 -	F6JB DuraTorq-TDCi	4		YE04	1101
Fusion TDCi	1.4	50	06.2002 -	F6JA DuraTorq-TDCi	4		YE04	1101
Galaxy TDI	1.9		06.1995 -	AJM	4	DP 4	Y-732U	2408
Galaxy TDI	1.9	81	02.1995 -08.1999	AFN	4	DP 4	Y-732U	2408
Galaxy TDI	1.9	66	02.1995 -03.2000	ANU	4	DP 4	Y-732U	2408
Galaxy TDI	1.9	66	02.1995 -02.1996	1Z	4	DP 4	Y-732U	2408
Galaxy TDI	1.9	66	03.1996 -03.2000	1Z	4	DP 4	Y-732U	2408
Galaxy TDI	1.9	66	09.1996 -03.2000	AHU	4	DP 4	Y-732U	2408
Galaxy TDI	1.9	81	09.1999 -03.2000	AVG	4	DP 4	Y-732U	2408
Galaxy /2 TDI	1.9	85	04.2000 -	AUY	4	DP 4	Y-732U	2408
Galaxy /2 TDI	1.9	96	04.2000 -	ASZ	4	DP 4	Y-732U	2408
Galaxy /2 TDI	1.9	66	04.2000 -	ANU	4	DP 4	Y-732U	2408
Granada '82	2.5		08.1981 -04.1985	STP D	4	DP 1	Y-902R	2237
Granada '85	2.5	68	05.1985 -10.1994	SFA D TURBO	4	DP 1	Y-902R	2237
Granada '85	2.5	51	05.1985 -10.1994	STR D	4	DP 1	Y-902R	2237
Granada '85	2.5	68	05.1985 -10.1994	SFB D TURBO	4	DP 1	Y-902R	2237
Maverick '93	2.7	74	04.1993 -04.1998	TD27	4		Y-712RS	6140

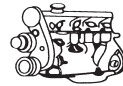

ℓ kW

Cyl. **D-POWER**Order-
No.**FORD**

Maverick '93	2.7	92	05.1996 -04.1998	TD27E	4		CY58	5486
Mondeo '01 TDCi	2.0	85	10.2000 -	D6BA DuraTorq-DI	4	DP35	Y-525J	7925
Mondeo '01 TDCi	2.0	96	10.2000 -	FMBA DuraTorq-TDCi	4	DP35	Y-525J	7925
Mondeo '01 TDCi	2.0	66	10.2000 -	D5BA DuraTorq-DI	4	DP35	Y-525J	7925
Mondeo '01 TDCi	2.0	85	10.2000 -	HJBC DuraTorq-TDCi	4	DP35	Y-525J	7925
Mondeo '01 TDCi	2.0	96	10.2000 -	N7BA DuraTorq-TDCi	4	DP35	Y-525J	7925
Mondeo '01 TDCi	2.0	85	10.2000 -	HJBA DuraTorq-TDCi	4	DP35	Y-525J	7925
Mondeo '01 TDCi	2.0	85	10.2000 -	HJBB DuraTorq-TDCi	4	DP35	Y-525J	7925
Mondeo '93	1.8	65	01.1993 -07.1996	RFM D TCI	4	DP 3	Y-910R	4751
Mondeo '93	1.8	65	01.1993 -07.1996	RFN D TCI	4	DP 3	Y-910R	4751
Mondeo '97	1.8	66	08.1996 -09.2000	RFN Endura-De TCI	4	DP 5	Y-937R	5148
Orion '86	1.6	40	01.1986 -07.1990	LTC	4		Y-907R	4479
Orion '86	1.8	44	01.1986 -07.1990	RTA	4	DP 3	Y-910R	4751
Orion '86	1.8	44	01.1986 -07.1990	RTB	4	DP 3	Y-910R	4751
Orion '91	1.8	44	08.1990 -07.1993	RTF	4	DP 3	Y-910R	4751
Orion '91	1.8	44	08.1990 -07.1993	RTE	4	DP 3	Y-910R	4751
Orion '91	1.8	44	08.1990 -07.1993	RTH	4	DP 3	Y-910R	4751
Orion '91	1.8	66	08.1990 -07.1993	RFD	4	DP 3	Y-910R	4751
Orion '91	1.8	66	08.1990 -07.1993	RFK	4	DP 3	Y-910R	4751
P 100	2.3		1982 -			DP 1	Y-902R	2237
P 100 Turbo	1.8		1989 -		4	DP 3	Y-910R	4751
P 100 Pick-Up	1.8	55	10.1987 -12.1992	RFA DT	4	DP 3	Y-910R	4751
Ranger Pick Up	2.5	80	05.1999 -	WL-T	4		Y-701J	5116
Ranger Pick Up	2.5	57	05.1999 -	WL	4		Y-701J	5116
Scorpio '85	2.5	68	05.1985 -10.1994	SFA D TURBO	4	DP 1	Y-902R	2237
Scorpio '85	2.5	51	05.1985 -10.1994	STR D	4	DP 1	Y-902R	2237
Scorpio '85	2.5	68	05.1985 -10.1994	SFB D TURBO	4	DP 1	Y-902R	2237
Scorpio '85	2.5		11.1994 -07.1998	SCB	4	DP20	Y-741U	5065
Scorpio '95	2.5	92	10.1994 -06.1998	SCD TCI	4	DP20	Y-741U	5065
Scorpio '95	2.5	85	10.1994 -06.1998	SCC TCI	4	DP20	Y-741U	5065
Sierra '83	2.3	49	08.1982 -01.1987	YTT	4	DP 1	Y-902R	2237
Sierra '87	1.8	55	01.1987 -12.1992	RFA	4	DP 3	Y-910R	4751
Sierra '87	1.8	55	01.1987 -12.1992	RFB	4	DP 3	Y-910R	4751
Sierra '87	1.8	55	01.1987 -12.1992	RFL	4	DP 3	Y-910R	4751
Sierra '87	2.3	49	01.1987 -12.1992	YTR	4	DP 1	Y-902R	2237
Tourneo Connect	1.8	66	06.2002 -	HCPB Duratorq-TDCi	4	DP27	Y-524J	5986
Tourneo Connect	1.8	66	06.2002 -	HCPA Duratorq-TDCi	4	DP27	Y-524J	5986
Tourneo Connect	1.8	55	06.2002 -	BHPA Endura-DI	4	DP27	Y-524J	5986
Transit Connect	1.8	66	06.2002 -	HCPA Duratorq-TDCi	4	DP27	Y-524J	5986
Transit Connect	1.8	55	06.2002 -	BHPA Endura-DI	4	DP27	Y-524J	5986
Transit Connect	1.8	66	06.2002 -	HCPB Duratorq-TDCi	4	DP27	Y-524J	5986
Transit '85	2.4	46	08.1983 -12.1985	4AA YORK-D	4		Y-208T	1250
Transit 2000.5 (Vorderradantrieb)	2.0	74	08.2000 -	ABFA	4	DP35	Y-525J	7925
Transit 2000.5 (Vorderradantrieb)	2.0	55	08.2000 -	D3FA	4	DP35	Y-525J	7925
Transit 2000.5 (Vorderradantrieb)	2.0	92	08.2000 -	F1FA	4	DP35	Y-525J	7925
Transit 2000.5 (Vorderradantrieb)	2.0	63	08.2000 -	F3FA	4	DP35	Y-525J	7925
Transit 2000.5 (Hinterradantrieb)	2.4	55	01.2000 -	F4FA	4	DP35	Y-525J	7925
Transit 2000.5 (Hinterradantrieb)	2.4	92	01.2000 -	DOFA	4	DP35	Y-525J	7925
Transit 2000.5 (Hinterradantrieb)	2.4	66	01.2000 -	D2FA	4	DP35	Y-525J	7925
Transit 2000.5 (Hinterradantrieb)	2.4	88	01.2000 -	D4FA	4	DP35	Y-525J	7925



ℓ kW

Cyl. **D-POWER**Order-
No.**FREIGHTROVER**

Sherpa D	2.0		05.1986 -03.1991	Perkins - Prima 65	4	DP 1	Y-902R	2237
Sherpa Van DI D	2.5		01.1987 -		4	DP 1	Y-902R	2237

FSO

Polonez D	1.6	37	01.1986 -	VW - Motor	4	DP 2	Y-918R	4182
Polonez Caro D	1.9	51	10.1992 -	XUD Kat.	4	DP 1	Y-902R	2237

HINO

Ranger			1978 -	DG	4		Y-128T	7227
Ranger	3.0	60	01.1978 -12.1982	B	4		Y-178	7825
Ranger (B) D	3.0	60	01.1983 -07.1988	B	4		Y-197R	2188
Ranger	3.4	70	01.1979 -12.1982	3 B	4		Y-178T	3030
Ranger (3B) D	3.4	70	01.1983 -07.1988	3 B	4		Y-197R	2188

HONDA

Accord iTD LS	2.0	77	09.1995 -08.1999	20TN2	4	DP22	Y-740U	5104
Accord TDi	2.0	77	05.1995 -08.1999	Rover (L-Serie)	4	DP17	Y-730U	2273
Accord TDi CF1	2.0	77	09.1999 -	20TN2	4	DP17	Y-730U	2273
Civic iTD LS	2.0	63	1996 - 1997		4	DP17	Y-730U	2273
Civic iTD LS	2.0	63	05.1997 - 2001	20T2R	4	DP22	Y-740U	5104
Concerto TD	1.8	64	10.1994 -12.1995	XUD 7 TE	4	DP 1	Y-902R	2237

HYUNDAI

Accent 12V CRDi	1.5	60	04.2002 -	D3-EA	3		Y-749J	5013
Accent TDI	1.5	55	04.2002 -		3		Y-749J	5013
Elantra CRDI	2.0	83	2001 -	D4EA	4		Y-749J	5013
Galloper	2.5	57	-01.1994	4D55	4		Y-115T1	2189
Galloper TC,TCI	2.5	65	11.1995 -	4D56	4	DP21	CY57	5287
Galloper TD 3/5p GLS, Inovation	2.5	74	01.1999 -		4	DP21	CY57	5287
Getz D	1.5	60	07.2003 -	D3EA	3		Y-749J	5013
Grace H100	2.5			4D55	4		Y-115T1	2189
H 100 D	2.5	57	- 1996	4D56	4	DP21	CY57	5287
H 100 D	2.5	57	- 1996	D4BA 4D55	4		Y-115T1	2189
H 100 D intercooler	2.5	63	07.1994 -	D4BF	4		Y-722J	2686
Lantra D	1.9	50	1998 -	XUD9A	4	DP 1	Y-938R	5267
Matrix CRDI	1.5	60	09.2001 -	D3EA	3		Y-749J	5013
Porter H100	2.5			4D55	4		Y-115T1	2189
Santa Fe CRDI	2.0	83	04.2001 -	4DEA	4		Y-749J	5013
Santa Fe	2.0	92	2005 -		4		Y-749J	5013
Terracan CRDI	2.9	110	10.2001 -		4	DP21	CY57	5287
Trajet CRDI	2.0	83	04.2001 -	4DEA	4		Y-749J	5013
Tucson D	2.0	83	09.2004 -		4		Y-749J	5013

INNOCENTI

3-Cylinder D CL-001				CL-001	3		Y-146R	7492
Elba D	1.7	42	09.1992 -	146 B 2.000	4	DP 1	Y-902R	2237
Mini 990 D	1.0	27	01.1982 -12.1990	Daihatsu	4		Y-146R	7492

ISUZU

Florian	2.0		11.1977 -03.1983	C190			Y-306R	6244
Gemini FR				4FB1			Y-306R	6244
Gemini D	1.5		10.1985 -11.1988	4EC1			Y-306R	6244

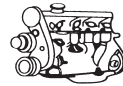

ℓ kW

Cyl. **D-POWER**Order-
No.**ISUZU**

Gemini TD	1.5		12.1988 -	4EC1T	4	DP28	Y-711J	5264
Gemini FF Turbo	1.5		12.1988 -	4EC1	4	DP28	Y-711J	5264
Gemini D	1.5	40	12.1988 -	4EC1	4		Y-710J	7880
Gemini TD	1.5	49	02.1988 -12.1988	4EC1T	4		Y-307R	5837
Gemini FF D	1.5		12.1988 -	4EC1	4		Y-710J	7880
Light Bus BE			1976 -	6BB1			Y-271-2	7467
Light Bus BE			1976 -	6BD1			Y-271-2	7467
Light Bus BE			1980 -	4BD1			Y-271-2	7467
Light Bus BL			07.1981 -	4BC2			Y-271-2	7467
Light Bus BL			07.1981 -	4BC1			Y-271-2	7467
Light Bus CCM			07.1978 -	6BF1			Y-271-2	7467
Light Bus CCM			07.1979 -	6BD1			Y-271-2	7467
Midi TD 5V	2.0	51	01.1986 -		4		Y-307R	5837
Midi TD 11V	2.0	51	01.1986 -		4	DP28	Y-711J	5264
Midi D 5V	2.2	45	01.1986 -		4		Y-307R	5837
Midi D 11V	2.2	45	01.1986 -		4	DP28	Y-711J	5264
Pickup D	2.0		01.1983 -	C190	4		Y-306R	6244
Pickup D	2.2		08.1986 -08.1987	C223	4		Y-306R	6244
Pickup D	2.2	53	08.1987 -10.1988	C223	4		Y-710J	7880
Trooper D	2.3		02.1981 -07.1987	C223	4		Y-306R	6244
Trooper TD	2.3		02.1981 -07.1987	C223T	4		Y-306R	6244
Trooper D	2.3	39	08.1987 -10.1988	C223	4		Y-710J	7880
Trooper TD	2.3	53	08.1987 -10.1988	C223T	4		Y-710J	7880
Trooper TD	2.8	71	10.1987 -12.1991	4JB1T	4		Y-904M1	7995
Trooper TD	2.8	78	10.1988 -12.1991	4JB1TC	4		Y-904M1	7995
Trooper TD	3.1	83	06.1992 -	4JG2T	4	DP28	Y-711J	5264

IVECO

242/15 18 D	2.5	50	05.1974 -08.1979				Y-405	5471
242/15 18 D	2.5	50	09.1979 -				Y-208T	1250
Daily 40 F 8			04.1978 -06.1982				Y-208T	1250
Daily 35 F 8			04.1978 -06.1982				Y-208T	1250
Daily 30 F 8			04.1978 -06.1982				Y-208T	1250
Daily 28 F 8			04.1978 -06.1982				Y-208T	1250
Daily 32 F 8			04.1978 -06.1982				Y-208T	1250
Daily 28.40 F 8			07.1982 -12.1982				Y-208T	1250
Daily D30/35/40-8	2.4	53	04.1978 -09.1983	Sofim 8140.61.200	4		Y-208T	1250
Daily D30/35/40-8	2.4	53	10.1983 -06.1989	Sofim 8140.61.200	4	DP 1	Y-908R	4585
Daily	2.5				4		Y-907R	4479
Daily TDi	2.8	90	09.1997 -		6		Y-502R	3852

JEEP

Cherokee Td			04.1984 -12.1987	Renault		DP 1	Y-908R	4585
Cherokee TD	2.1	65	01.1987 -01.1991	Renault J8S 814, J8S 890	4	DP 1	Y-908R	4585
Cherokee TD	2.1	59	01.1988 -		6	DP 1	Y-908R	4585
Cherokee TD	2.5	85	10.1994 -	VM HR 425	4	DP 1	Y-923U	3380
Grand Cherokee TD	2.5	88	01.1993 -	VM HR 425 CLIRE	4	DP 1	Y-923U	3380
Grand Cherokee TD	2.5	88	01.1993 -	VM HR-492	4	DP 1	Y-923U	3380
Grand Cherokee TD	2.5	110	04.1999 -	ENC	4	DP20	Y-741U	5065
Grand Cherokee CRD	2.7	120	01.2002 -	CDI Mercedes	5	DP11	Y-745U	4705
Grand Cherokee TD / Limited	3.1	103	04.1998 -	EXA	5	DP20	Y-741U	5065
Grand Voyager 2.5 Td Le	2.5	88	05.1995 -	VM HR425 CLIEE	4	DP20	Y-741U	5065



ℓ kW

Cyl. **D-POWER**Order-
No.**JEEP**

Wrangler Laredo, Sahara, Texan TD	2.1	65	07.1988 -		4	DP 1	Y-908R	4585
Wrangler	2.5		07.1988 -		6	DP 1	Y-908R	4585
Wrangler,Laredo,Sahara	2.5		07.1988 -		6	DP 1	Y-908R	4585
Wrangler,Texan D	2.5		07.1988 -		6	DP 1	Y-908R	4585
XJ Cherokee TD	2.0	64	04.1984 - 12.1987	Renault J8S-814	4	DP 1	Y-908R	4585
XJ Cherokee TD	2.4	64	04.1984 - 12.1987		4	DP 1	Y-908R	4585

KIA

Besta	2.2	52	03.1990 - 07.1999	HW	4		Y-701R	7464
Besta	2.7	60	03.1990 - 07.1999	VN	4		Y-701R	7464
Bongo	2.4			E-2400	4		Y-107T	1253
Carens 2.0 CRDI EX	2.0	83	2002 -		4		Y-749J	5013
Power Bango	2.4			E-2400	4		Y-107R	1229
Pregio	2.7	60	06.1996 -	J2	4		Y-701R	7464
Pregio	3.0	66	06.1997 -	W3 / NB9	4		Y-701J	5116
Retona	2.0	61	04.2000 -		4		Y-721J	6919
Sorento CRDi	2.5	103	2002 -		4		Y-508J	
Sportage TD	2.0	61	07.1996 -	Mazda engine	4		Y-701R	7464
Sportage TD	2.0	0	11.2004 -		4		Y-749J	5013
Super Titan	3.0			E-3000	6		Y-107T	1253
Titan	2.5			E-2500	4		Y-107T	1253

LADA (AVTOVAZ)

Aleko D	1.8	44	01.1987 -	Ford RTE, RTS	4	DP 3	Y-910R	4751
Niva D	1.9	47	10.1993 -	Peugeot XUD 9L	4	DP 1	Y-902R	2237
Sagona D	1.5	40	01.1995 -	TUD5	4	DP 9	Y-731U	5274
Samara D	1.5	40	01.1995 -	TUD 5	4	DP 9	Y-731U	5274

LANCIA

Dedra TD	1.9	66	03.1989 - 09.1994	835 A 4.000	4	DP 1	Y-902R	2237
Dedra Eco LE TD	1.9	68	06.1993 -	160 D 1.000	4	DP 1	Y-922R	4356
Dedra TD ds	1.9	66	10.1994 -	160 D 1.000	4	DP 1	Y-922R	4356
Delta TD	1.9	59	06.1986 - 06.1991	831 D 1.000	4	DP 1	Y-902R	2237
Delta TD ds	1.9	66	10.1994 -	160 D 1.000	4	DP 1	Y-922R	4356
Delta TD- ds LE	1.9	66	10.1994 -	160 D 1.000	4	DP 1	Y-922R	4356
Delta TD LS	1.9	66	10.1994 -	160 D 1.000	4	DP 1	Y-922R	4356
Delta HPE TD	1.9	66	10.1994 -	160 D 1.000	4	DP 1	Y-922R	4356
Delta HPE Td	1.9	66	10.1996 -		4	DP29	Y-928U	5700
Kappa TD	2.4		10.1994 - 12.1998	838 A3.000		DP23	Y-935U	5915
Kappa	2.4	91	11.1994 - 06.1996	838.A3.000		DP29	Y-928U	5700
Kappa / SW (838A) 2,4 JTD	2.4	100	06.1998 - 11.1999	838 A8.000	5	DP26	Y-747U	4951
Lybra 1.9 JTD	1.9	77	09.1999 - 11.1999	AR 32302	4	DP26	Y-747U	4951
Lybra 1.9 JTD	1.9	85	12.1999 -	AR 37101	4	DP36	Y-534J	5540
Lybra 2.4 JTD	2.4	99	09.1999 - 11.1999	AR 32501	5	DP26	Y-747U	4951
Lybra 2.4 JTD	2.4	110	12.1999 -	839 A6.000	5	DP36	Y-534J	5540
Phedra JTD	2.0	80	09.2002 -	DW10ATED4/RHT, RHW	4	DP24	Y-504R	4359
Phedra JTD	2.2	94	06.2003 -	DW12ATED4/4HW	4	DP24	Y-504R	4359
Prisma TD	1.9	48	06.1984 - 12.1989	831 D. 000	4	DP 1	Y-902R	2237
Prisma TD	1.9	59	07.1985 -		4	DP 1	Y-908R	4585
Prisma TD ds	1.9	59	05.1985 - 12.1989	831 D.	4	DP 1	Y-902R	2237
Thema TD	2.4	74	01.1993 -		4	DP 1	Y-914U	2643
Thema TD	2.5	85	01.1994 - 12.1994				Y-926U	7119

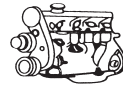

l kW

Cyl. **D-POWER**Order-
No.**LANCIA**

Thesis 2.4 JTD	2.4	110	11.2002 -	841N 000	5	DP36	Y-534J	5540
Z TD	1.9	68	04.1995 -	XUD 9TE	4	DP 1	Y-923U	3380
Z TD	2.1	80	07.1996 -	XUD11ATE	4	DP 1	Y-923U	3380

LAND ROVER

90			1983 -		4		Y-907R	4479
110			1983 -		4		Y-907R	4479
Country TD	2.5	83	01.1989 -		4		Y-909R	4602
Defender TDI	2.5	83	11.1989 - 10.1998	200/300 Gemini 1	4	DP34	Y-729U	2203
Defender TDI 90 & 110	2.5	102	01.1999 -		4	DP 1	Y-917U	3219
Discovery TDi ES	2.5	83	09.1989 -		4	DP34	Y-729U	2203
Discovery TDI	2.5	83	09.1989 - 01.1999	200/300 Gemini 1	4	DP34	Y-729U	2203
Discovery TDi Vogue ES	2.5	90	10.1993 -		4	DP34	Y-729U	2203
Discovery & Restylé TD5	2.5	102	01.1999 -		5	DP 1	Y-917U	3219
Freelander TDI	2.0	71	10.1997 - 08.1998	20 T2R	4	DP17	Y-730U	2273
Freelander TD4	2.0	80	08.1998 -	M47D20 (BMW)	4	DP32	Y-507R	4600
Freelander TDi	2.5	102	05.1998 -		5	DP 1	Y-917U	3219
Land Rover County D			01.1989 -				Y-909R	4602
Land Rover (90,110)	2.25		1983 -				Y-208T	1250
Land Rover (90,110)	2.5		1983 -				Y-208T	1250
Range Rover TDI	2.5	83	01.1986 - 12.1994	ETC 9091 N	4	DP34	Y-729U	2203
Range Rover	2.5	66	04.1986 - 10.1992	VM UNIT (NOT GEMINI ENG.)	4		Y-909R	4602
Range Rover	2.5		09.1989 -	200/300 Gemini 1	4	DP34	Y-729U	2203
Range Rover Vogue TD	2.5	87	01.1990 - 09.1994	VM HR-492	4	DP 1	Y-923U	3380
Range Rover Vogue TD	2.5	87	01.1990 - 09.1994	VM 425 SLIRR	4	DP 1	Y-923U	3380
Range Rover	2.5	100	09.1994 -	M51 D25 (BMW)	6	DP 1	Y-917U	3219
Range Rover III	3.0	130	03.2002 -	M57 D30 BMW	6	DP32	Y-507R	4600

LEYLAND

400-Serie LTD DI	2.5		01.1987 -		5	DP 1	Y-902R	2237
EA Range	1.8				4		Y-302	2100
Readline					4		Y-302	2100

LEYLAND DAF

Pilot	1.9		1996 -	PEUGEOT	4	DP 1	Y-923U	3380
Sherpa	1.8		1974 - 1986		4		Y-909R	4602
Sherpa	2.0		1986 - 1988	PERKINS PRIMA	4	DP 1	Y-902R	2237
Sherpa	2.5		04.1986 - 1989		4		Y-208T	1250
Sherpa	2.5		1989 -	PEUGEOT ENGINE	4	DP 1	Y-923U	3380

MAHINDRA

CJ 340 Classic D	2.1	48	1993 -	XD 4.90	4		Y-208T	1250
CJ 540 D	2.1	48	1993 -	XD 4.90	4		Y-208T	1250
CJ3			04.1986 -	Peugeot	4	DP 1	Y-902R	2237
CJ5			04.1986 -	Peugeot	4	DP 1	Y-902R	2237

MAZDA

121	1.8	44	03.1996 -	RTJ	4	DP 3	Y-910R	4751
323	1.7				4	DP 8	CY53	4315
626	2.0	53	11.1982 - 08.1985	RF46	4		Y-107R	1229
929	2.0			S 2	4		Y-107T	1253
B 2200	2.0		08.1984 -	F 2	4		Y-107R	1229



ℓ kW

Cyl. **D-POWER**Order-
No.**MAZDA**

B 2200	2.2			S 2	4		Y-107T	1253
B 2200	2.2		-10.1996	R 2	4		Y-107R	1229
B 2500 UF Fgst 702487-->	2.5	57	1999 -	WL			Y-701J	5116
B Serie			1997 -11.2002	WLT			Y-701J	5116
Boxer 3700 / 5500			11.1974 -	XC / ZC			Y-172	7325
E Serie				RF / RF Turbo / R2			Y-701R	7464
E Serie			1997 -	R2			Y-721RS	3687
E 2000	2.0		1993 -	RF	4		Y-107R	1229
E 2200	2.2		02.1983 -	F2	4		Y-107R	1229
E 2200	2.2		1993 -	R2	4		Y-107R	1229
E 3000	3.0		1993 -	VS			Y-721RS	3687
E 3000	3.0		1993 -	L4DE			Y-721RS	3687
Light Bus Parkway			10.1980 -	HA 12V			Y-107R	1229
Light Bus Parkway			10.1980 -	HA 24V			Y-157R	2029
MPV	2.0	100	1997 -06.2002	WLT	4		Y-701J	5116
Ranger				S 2			Y-107T	1253
T 2500	2.5		10.1980 -	XA 12V			Y-107R	1229
T 2500	2.5		10.1980 -	XA 24V			Y-157R	2029
T 3000	3.0		10.1980 - 1992	HA 12V			Y-107R	1229
T 3000	3.0		10.1980 - 1992	HA 24V			Y-157R	2029
T 3000	3.0		1993 -	L4DE			Y-771R	4262
T 3000	3.0		1993 -	HA			Y-771R	4262
T 3700			04.1976 -	XC			Y-172	7325
T 4100	4.1		10.1980 -	ZB 12V			Y-107R	1229
T 4100	4.1		10.1980 -	ZB 24V			Y-157R	2029
T 5500			1975 -	ZC			Y-172	7325
T Serie			1997 -	VS			Y-771R	4262

MERCEDES

180 D (120)	1.8	29	01.1953 -07.1959	OM 636.930	4		DG237	4826
180 D (120)	2.0	35	1953 - 1962	OM 621	4		DG237	4826
190 D (201)	2.0	53	02.1983 -01.1989	OM 601.911	4	DP 1	Y-902R	2237
190 D (201)	2.5	66	04.1985 -01.1989	OM 602.911	5	DP 1	Y-902R	2237
190 D (201)	2.5	90	02.1988 -01.1989	OM 602.961	5	DP 1	Y-902R	2237
190 D (201)	2.5	90	02.1989 -05.1993	OM 602.961	5	DP 6	Y-916R	2785
190 D (201)	2.5	66	02.1989 -05.1993	OM 602.911	5	DP 6	Y-916R	2785
190 D (201)	2.0	53	02.1989 -05.1993	OM 601.911	4	DP 6	Y-916R	2785
190 D (121)	1.9	37	1959 - 1962	OM 621	4		DG237	4826
190 DT (201)	2.5	90	02.1989 -05.1993	OM 602.961	5	DP 2	Y-918R	4182
200 D (/8) (115)	2.0	40	01.1968 -01.1977	OM 615.913	4		DG237	4826
200 D (123)	2.0	44	08.1980 -11.1985	OM 615.940	4	DP 1	Y-902R	2237
200 D,TD (124)	2.0	53	12.1984 -01.1989	OM 601.912	4	DP 1	Y-902R	2237
200 D,TD (124)	2.0	53	02.1989 -06.1993	OM 601.912	4	DP 6	Y-916R	2785
207 / 307 /407	2.4	48	05.1977 -08.1982	OM 616.	4		DG237	4826
207 D	2.4	53	09.1982 -09.1988	OM 616.	4	DP 1	Y-902R	2237
208 D	2.3	58	10.1988 -03.1995	OM 601.	4	DP 6	Y-916R	2785
209 D	3.0	65	04.1982 -09.1988	OM 617.	4	DP 1	Y-902R	2237
210 D	2.9	70	10.1988 -	OM 602.	5	DP 6	Y-916R	2785
220 D (/8) (115)	2.2	44	01.1968 -01.1977	OM 615.912	4		DG237	4826
240 D (/8) (115)	2.4	48	08.1973 -01.1977	OM 616.916	4		DG237	4826
240 D (/8) 3.0 (115)	3.0	59	08.1974 -11.1976	OM 617.910	5		DG237	4826
240 D,TD (123)	2.4	46	08.1980 -11.1984	OM 616.912	4	DP 1	Y-902R	2237

Fgst = Chassis No.

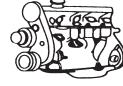

ℓ kW

Cyl. **D-POWER**Order-
No.**MERCEDES**

240 GD (460)	2.4	53	03.1979 -08.1987	OM 616.936	4	DP 1	Y-902R	2237
250 D,TD (124)	2.5	66	04.1985 -01.1989	OM 602.912	5	DP 1	Y-902R	2237
250 D,TD (124)	2.5	66	02.1989 -06.1993	OM 602.912	5	DP 6	Y-916R	2785
250 DT (124)	2.5	93	09.1988 -01.1989	OM 602.962	5	DP 1	Y-902R	2237
250 DT (124)	2.5	93	02.1989 -06.1993	OM 602.962	5	DP 6	Y-916R	2785
250 GD (460)	2.5	69	09.1987 -01.1989	OM 602.930	5	DP 1	Y-902R	2237
250 GD (460)	2.5	69	02.1989 -12.1992	OM 602.930	5	DP 6	Y-916R	2785
250 GD (463)	2.5	69	06.1990 -	OM 602.931	4	DP 6	Y-916R	2785
290 GD (461)	2.9	70	04.1992 -	OM 602.942	5	DP 6	Y-916R	2785
300 D (124)	3.0	80	12.1984 -01.1989	OM 603.912	6	DP 1	Y-902R	2237
300 D (124)	3.0	80	02.1989 -06.1993	OM 603.912	6	DP 6	Y-916R	2785
300 D (123)	3.0	57	08.1980 -08.1981	OM 617A	5	DP 1	Y-902R	2237
300 D 4-Mat. (124)	3.0	80	09.1986 -01.1989	OM 603.913	6	DP 1	Y-902R	2237
300 D 4-Mat. (124)	3.0	80	02.1989 -06.1993	OM 603.913	6	DP 6	Y-916R	2785
300 D,TD (123)	3.0	59	08.1980 -11.1985	OM 617.912	6	DP 1	Y-902R	2237
300 GD (463)	3.0	83	02.1989 -06.1993	OM 603.931	6	DP 6	Y-916R	2785
300 GD (460)	3.0	65	12.1979 -12.1991	OM 617.931	5	DP 1	Y-902R	2237
300 GD (460)	3.0	83	03.1979 -01.1989	OM 603.912	6	DP 1	Y-902R	2237
300 SD (140)	3.0	110	02.1992 -04.1993	OM 603.971	6	DP 6	Y-916R	2785
300 SED (140)	3.0		02.1991 -		6	DP 6	Y-916R	2785
300 TD (126)	3.0	107	11.1985 -12.1987	OM 603.961	6	DP 1	Y-902R	2237
300 TD (124)	3.0	108	01.1988 -01.1989	OM 603.960	6	DP 1	Y-902R	2237
300 TD (123)	3.0	92	10.1980 -11.1985	OM 617.952	5	DP 1	Y-902R	2237
300 TD (124)	3.0	108	02.1989 -06.1993	OM 603.960	6	DP 6	Y-916R	2785
300 TD (124)	3.0	92	12.1984 -01.1989	OM 603.960	6	DP 1	Y-902R	2237
300 TD (124)	3.0	92	02.1989 -06.1993	OM 603.960	6	DP 6	Y-916R	2785
300 TD 4Mat. (124)	3.0	105	09.1986 -01.1989	OM 603.963	6	DP 1	Y-902R	2237
300 TD 4Mat. (124)	3.0	105	02.1989 -06.1993	OM 603.963	6	DP 6	Y-916R	2785
300 TD SD (126)	3.0	110	08.1980 -10.1985	OM 617.951	5	DP 1	Y-902R	2237
307 D	2.4	53	09.1982 -09.1988	OM 616.	4	DP 1	Y-902R	2237
308 D	2.3	58	10.1988 -03.1995	OM 601.	4	DP 6	Y-916R	2785
309 D	3.0	65	04.1982 -09.1988	OM 617.	4	DP 1	Y-902R	2237
310 D	2.9	70	10.1988 -	OM 602.	5	DP 6	Y-916R	2785
350 D (126)	3.5	115	02.1989 -06.1991	OM 603.		DP 6	Y-916R	2785
350 D,TD (126)	3.5	100	03.1990 -06.1991	OM 603.970	6	DP 6	Y-916R	2785
350 GD (463)	3.5	100	09.1991 -06.1993	OM 603.972	6	DP 6	Y-916R	2785
407 D	2.4	53	07.1981 -09.1988	OM 616.	4	DP 1	Y-902R	2237
408 D	2.3	58	10.1988 -	OM 601.	4	DP 6	Y-916R	2785
409 D	3.0	65	04.1982 -08.1988	OM 617.	4	DP 1	Y-902R	2237
410 D	2.9	70	10.1988 -	OM 602.	5	DP 6	Y-916R	2785
507 D	2.4	53	04.1982 -09.1988	OM 616.	4	DP 1	Y-902R	2237
508 D	2.3	58	03.1989 -	OM 601.	4	DP 6	Y-916R	2785
A 160 CDi (168)	1.7	44	10.1997 -02.2001	OM 668.941	4	DP38	Y-746R	4842
A 160 CDi (168)	1.7	55	02.2001 -	OM 668.940	4	DP38	Y-746R	4842
A 170 CDi (168)	1.7	66	08.1998 -02.2001	OM 668.940	4	DP38	Y-746R	4842
A 170 CDi (168)	1.7	70	02.2001 -	OM 668.942	4	DP38	Y-746R	4842
all models			12.1967 -07.1980	Diesel engine	4		DG237	4826
C 180 D (202)	1.8	65	10.1998 -05.2000	OM 604.	4	DP16	Y-925R	5045
C 200 CDI (202)	2.2	75	03.1998 -05.2000	OM 611.960	4	DP11	Y-745U	4705
C 200 CDI (203)	2.2	85	05.2000 -	OM 611.962	4	DP11	Y-745U	4705
C 200 CDI (203)	2.2	90	04.2003 -	OM 646.962	4	DP11	Y-745U	4705
C 200 D (202)	2.0	55	07.1993 -05.2000	OM 601.913	4	DP 6	Y-916R	2785



ℓ kW

Cyl. **D-POWER**Order-
No.**MERCEDES**

C 200 D (202)	2.0	65	10.1996 -05.2000	OM 604.915	4	DP16	△ Y-925R	5045
C 220 CDI (202)	2.2	75	06.1998 -	OM 611.961	4	DP11	Y-745U	4705
C 220 CDI (203)	2.2	105	05.2000 -	OM 611.962	4	DP11	Y-745U	4705
C 220 CDI (203)	2.2	110	05.2002 -	OM 646.963	4	DP11	Y-745U	4705
C 220 CDI (202)	2.2	92	09.1997 -05.2000	OM 611.960	4	DP11	Y-745U	4705
C 220 D (202)	2.2	70	07.1993 -05.1995	OM 604.910	4		◆ Y-930U	5568
C 220 D (202)	2.2	70	06.1995 -05.2000	OM 604.910	4	DP16	△ Y-925R	5045
C 250 D (202)	2.5	83	02.1995 -08.1995	OM 605.910	5	DP16	△ Y-925R	5045
C 250 D (202)	2.5	83	07.1993 -01.1995	OM 605.910	5		◆ Y-930U	5568
C 250 Td (202)	2.5	110	05.1996 -05.2000	OM 605.960	5	DP16	△ Y-925R	5045
C 270 CDI (203)	2.7	125	12.2000 -	OM 612.962	5	DP11	Y-745U	4705
CLK 270 CDI (209)	2.7	125	10.2002 -	OM 612.967	5	DP11	Y-745U	4705
CLK 270 CDI (209)	2.7	125	10.2002 -	OM 612.962	5	DP11	Y-745U	4705
E 200 D (124)	2.0	53	07.1993 -05.1995	OM 601.912	4	DP 6	Y-916R	2785
E 200 D (210)	2.0	65	01.1996 -03.2002	OM 604.917	4	DP16	△ Y-925R	5045
E 200 CDI (210)	2.2	75	06.1998 -06.1999	OM 611.961	4	DP11	Y-745U	4705
E 200 CDI (210)	2.2	85	07.1999 -	OM 611.961	4	DP11	Y-745U	4705
E 200 CDI (211)	2.0	90	07.2002 -	OM 646.951	4	DP11	Y-745U	4705
E 220 D (210)	2.2	70	03.1995 -	OM 604.912	4	DP16	△ Y-925R	5045
E 220 D (210)	2.2	55	05.1996 -	OM 611.913	4	DP16	△ Y-925R	5045
E 220 CDI (210)	2.2	92	06.1998 -06.1999	OM 611.961	4	DP11	Y-745U	4705
E 220 CDI (210)	2.2	105	07.1999 -	OM 611.961	4	DP11	Y-745U	4705
E 220 D (210)	2.2	105	07.1999 -	OM 611.962	4	DP11	Y-745U	4705
E 220 CDI (211)	2.1	110	03.2003 -	OM 646.961	4	DP11	Y-745U	4705
E 250 D (124)	2.5	66	07.1993 -	OM 602.912/962	5	DP 6	Y-916R	2785
E 250 T,TD (124)	2.5	66	07.1993 -	OM 602.962	5	DP 6	Y-916R	2785
E 250 TD (124)	2.5	93	07.1993 -05.1995	OM 602.962	5	DP16	Y-925R	5045
E 250 D (124)	2.5	83	07.1993 -05.1995	OM 605.911	5		◆ Y-930U	5568
E 250 D (124)	2.5	83	07.1993 -04.1996	OM 605.911/912	5	DP16	△ Y-925R	5045
E 250 D (210)	2.5	83	03.1995 -	OM 605.912	5	DP16	Y-925R	5045
E 250 TD (210)	2.5	150	06.1997 -07.1999	OM 605.962	5	DP16	Y-925R	5045
E 270 CDI (210)	2.7	105	07.1999 -	OM 612.961	5	DP11	Y-745U	4705
E 270 CDI (211)	2.7	130	03.2003 -	OM 647.961	5	DP11	Y-745U	4705
E 280 CDI (211)	3.2	130	05.2004 -	OM 648.961	6	DP11	Y-745U	4705
E 290 TD (210)	2.9	95	06.1995 -	OM 602.982	5		Y-929U	6003
E 300 TD (124)	3.0	108	07.1993 -	OM 603.960	6	DP 6	Y-916R	2785
E 300 D (124)	3.0	100	07.1993 -05.1995	OM 606.910	6	DP30	Y-930U	5568
E 300 TD (124)	3.0	100	07.1993 -05.1995	OM 606.910	6		◆ Y-930U	5568
E 300 TD (124)	3.0	100	06.1995 -06.1996	OM 606.910	6	DP16	△ Y-925R	5045
E 300 D (210)	3.0	100	03.1995 -	OM 606.912	6	DP16	Y-925R	5045
E 300 Td T (210)	3.0	130	03.1997 -	OM 606.962	6	DP16	△ Y-925R	5045
E 300 Td T (210)	3.0	130	03.1997 -	OM 606.962	6		◆ Y-930U	5568
E 320 CDI (210)	3.2	145	07.1999 -	OM 613.961	6	DP11	Y-745U	4705
E 320 CDI (211)	3.2	150	03.2003 -	OM 648.961	6	DP11	Y-745U	4705
E 400 CDI (211)	4.0	191	02.2003 -	OM 628.961	8	DP11	Y-745U	4705
G 270 CDI (461)	2.7	0		OM 612.966	5	DP11	Y-745U	4705
G 270 CDI (461)	2.7	115		OM 612.965	5	DP11	Y-745U	4705
G 270 CDI (461)	2.7	0		OM 612.963	5	DP11	Y-745U	4705
G 270 CDI (463)	2.7	115	10.2001 -	OM 612.965	5	DP11	Y-745U	4705
290 GDT (461)	2.9	72	08.1993 -10.1994	OM 602.942/947	6	DP 6	Y-916R	2785
290 GDT (461)	2.9	90	07.1997 -	OM 602.983	5		Y-929U	6003
G 300 D (463)	3.0	83	08.1993 -	OM 603.931	6	DP 6	Y-916R	2785

△ ◆ siehe ab Seite 79 / see at page 79



ℓ kW

Cyl. **D-POWER**Order-
No.**MERCEDES**

G 300 TD (463)	3.0	130	08.1996 -	OM 606.964	6	DP16	Y-925R	5045
G 400 CDI (463)	4.0	184	12.2000 -	OM 628.962	8	DP11	Y-745U	4705
MB 100 D	2.4	56	09.1987 -01.1989	OM 616.963	4	DP 1	Y-902R	2237
MB 100	2.4	43	02.1989 -	OM 615.970	4	DP 1	Y-902R	2237
MB 100 D	2.4	56	02.1989 -	OM 616.963	4	DP 6	Y-916R	2785
ML 270 CDI (163)	2.7	120	12.1999 -	OM 612.963	5	DP11	Y-745U	4705
ML 400 CDI (163)	4.0	184	09.2000 -	OM 628.963	8	DP11	Y-745U	4705
S 300 (140)	3.0	130	05.1996 -10.1998	OM 606.961	6		◆ Y-930U	5568
S 300 (140)	3.0	130	05.1996 -10.1998	OM 606.961	6	DP16	△ Y-925R	5045
S 320 CDI (220)	3.2	145	11.1999 -	OM 648.960	6	DP11	Y-745U	4705
S 350 TD (140)	3.5	110	1993 -		6	DP 6	Y-916R	2785
S 400 CDI (220)	4.0	184	2000 -	OM 628.960	8	DP11	Y-745U	4705
Sprinter 208 CDI	2.1	60	04.2000 -			DP11	Y-745U	4705
Sprinter 208 D	2.3	58	04.1995 -	OM 601.	4	DP 6	Y-916R	2785
Sprinter 211 CDI	2.1	80	04.2000 -			DP11	Y-745U	4705
Sprinter 212 D	2.9	90	04.1995 -	OM 602.980.10 DELA 9850->	5		Y-929U	6003
Sprinter 212 D	2.9	90	04.1995 -	OM 602.980.12 DELA ->136	5	DP 1	Y-923U	3380
Sprinter 212 D	2.9	90	04.1995 -	OM 602.980.12 DELA 137 ->	5		Y-929U	6003
Sprinter 212 D	2.9	90	04.1995 -	OM 602.980.10 DELA ->9849	5	DP 1	Y-923U	3380
Sprinter 213 CDI	2.1	95	04.2000 -			DP11	Y-745U	4705
Sprinter 216 CDI	2.7	115	04.2000 -			DP11	Y-745U	4705
Sprinter 308 CDI	2.1	60	04.2000 -			DP11	Y-745U	4705
Sprinter 308 D	2.3	58	04.1995 - 2000	OM 601.	4	DP 6	Y-916R	2785
Sprinter 311 CDI	2.1	80	04.2000 -	OM 611.981	4	DP11	Y-745U	4705
Sprinter 312 D	2.9	90	04.1995 -	OM 602.980.12 DELA ->136	5	DP 1	Y-923U	3380
Sprinter 312 D	2.9	90	04.1995 -	OM 602.980.10 DELA9850->	5		Y-929U	6003
Sprinter 312 D	2.9	90	04.1995 -	OM 602.980.12 DELA 137 ->	5		Y-929U	6003
Sprinter 312 D	2.9	90	04.1995 -	OM 602.980.10 DELA ->9849	5	DP 1	Y-923U	3380
Sprinter 313 CDI	2.1	95	04.2000 -			DP11	Y-745U	4705
Sprinter 316 CDI	2.7	115	04.2000 -			DP11	Y-745U	4705
Sprinter 412 D	2.9	90	04.1995 -	OM 602.980.12 DELA 137 ->	5		Y-929U	6003
Sprinter 412 D	2.9	90	04.1995 -	OM 602.980.12 DELA ->136	5	DP 1	Y-923U	3380
Sprinter 412 D	2.9	90	04.1995 -	OM 602.980.10 DELA ->9849	5	DP 1	Y-923U	3380
Sprinter 412 D	2.9	90	04.1995 -	OM 602.980.10 DELA 9850 ->	5		Y-929U	6003
Unimog 100 L	2.9	71	11.1992 -	OM 602.948	5	DP 6	Y-916R	2785
Unimog 421	2.0	34	01.1966 -	OM 621.	4		DG237	4826
Unimog 600/650	2.4	38	01.1988 -	OM 616.	4	DP 1	Y-902R	2237
Unimog U 90	3.0	65	11.1992 -	OM 602.941	5	DP 6	Y-916R	2785
Unimog U34	1.8	25	01.1965 -09.1975	OM 636.914	4		DG237	4826
Unimog U52	2.5	38	05.1969 -12.1976	OM 616.915	4		DG237	4826
Unimog U60	2.5	44	05.1969 -12.1976	OM 616.930	5		DG237	4826
V 220 CDI	2.2	90	03.1999 -	OM 611.980	4	DP11	Y-745U	4705
V 230 TD	2.3	72	09.1996 -	OM 601.970	4	DP 6	Y-916R	2785
Vaneo CDI (414)	1.7	67	01.2002 -	OM 668	4	DP11	Y-745U	4705
Vaneo CDI (414)	1.7	55	01.2002 -	OM 668	4	DP11	Y-745U	4705
Vito 108 D	2.3	60	02.1996 -	OM 601.942	4	DP 6	Y-916R	2785
Vito 110 CDI	2.1	72	02.1996 -	OM 601.970	4	DP 6	Y-916R	2785

MITSUBISHI

1300 Mini Bus / Van				4D56S-QGS Type	4		*	
1300 Mini Bus / Van				4D56	4		Y-115T1	2189
Canter				4D56	4		Y-115T1	2189

* nur über Vertragshändler zu beziehen!

* only available through appointed OE retailer!

△ ◆ siehe ab Seite 79 / see at page 79

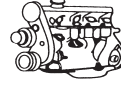

ℓ kW

Cyl. **D-POWER**Order-
No.**MITSUBISHI**

Canter				4DR51	4		Y-251	2026
Canter			1978 -	4D30	4		Y-274	2165
Carisma	1.9	59		F9QT	4	DP18	Y-515J	1019
Carisma TD	1.9	66	10.1996 -	F8Q	4	DP25	Y-932R	4956
Carisma 1.9 DI-D(DA..)	1.9	75	09.2000 -		4	DP18	Y-515J	1019
Carisma 1.9 DI-D(DA..)	1.9	85	09.2000 -		4	DP18	Y-515J	1019
Challenger	2.5		11.1998 -		4	DP13	Y-733J	8944
Galant TD (E5..8)	2.0	66	12.1993-10.1996	4D68 SOHC	4	DP21	CY57	5287
Galant TD (EA)	2.0	66	10.1996-02.2000	4D68	4	DP21	CY57	5287
Galant / Sigma			1980 -	4D55	4		Y-115T1	2189
Galant / Sigma QGS Typ			1980 -	4D55 / T	4		Y-115R1	2161
Galant Station Wagon QGS Typ			1983 -	4D55	4		Y-115R1	2161
Galant Wagon TD (EA)	2.0	66	10.1996-02.2000	4D68	4	DP21	CY57	5287
Galloper Td	2.5	73	1998 -	D4BH	4	DP21	CY57	5287
L200	2.5		- 1993	4D5	4		Y-115T1	2189
L200 (KOT-K3T) ohne Schnellstartanlage	2.5	51	11.1993-05.1994	4D56 without QGS	4	DP13	Y-733J	8944
L200 (KOT-K3T)	2.5	51	06.1994-08.1996	4D56 SOHC	4	DP21	CY57	5287
L200	2.5		1999 -	4D56	4	DP13	Y-733J	8944
L200 / 4WD	2.3		04.1983-10.1986	4D55	4		Y-115T1	2189
L300	2.5		- 1992	4D5	4		Y-115T1	2189
L300 TD (P)	2.5	64	06.1993- 1996	4D56 SOHC	4	DP21	CY57	5287
L300	2.5		1997 -	4D56	4	DP13	Y-733J	8944
L300 / 4WD	2.3		04.1983 -	4D55	4		Y-115T1	2189
L300 / 4WD QGS Type	2.3			4D55	4		Y-115R1	2161
L400			1995 - 1997	4D56	4	DP21	CY57	5287
L400 TD	2.5	73	12.1994 -	4D56	4	DP21	CY57	5287
L400	2.5		1998 -	4D56	4	DP13	Y-733J	8944
Lancer (CB/CD)	2.0	50	12.1993-06.1996	4D68	4	DP21	CY57	5287
Montero			1983 -	4D55 QGS Type	4		Y-115R1	2161
Montero			1983 -	4D55	4		Y-115T1	2189
Montero			1985 -	4D55T	4		*	
Montero			1992 - 1993	4D56	4		Y-115T1	2189
Montero			1994 - 1995	4D56	4	DP21	CY57	5287
Montero			1996 -	4D56	4	DP13	Y-733J	8944
Multicar M25		40	01.1991 -	VW028B-1Y	4	DP 2	Y-918R	4182
Multicar M26		40	01.1991 -	VW028B-1Y	4	DP 2	Y-918R	4182
Pajero				4D56 S-QGS Type	4		*	
Pajero			1985 -	4D55T	4		*	
Pajero			1992 - 1993	4D56	4		Y-115T1	2189
Pajero Sport			1997 -	4D56-QGS	4		*	
Pajero	2.3	62	1983 - 1984	4D55	4		Y-115T1	2189
Pajero TD not QGS Type	2.5	62	06.1986 -	4D56 Turbo not QGS Type	4		Y-115T1	2189
Pajero TD Intercooler (V)	2.5	73	11.1993-01.1998	4D56 T	4	DP21	CY57	5287
Pajero TD Intercooler (IV)	2.5	62	08.1993-05.1999	4D56 T	4	DP13	Y-733J	8944
Pajero (V4..)	2.8	92	06.1994-04.2000	4M40	4		CY55	3861
Pajero / Montero QGS Type			1983 - 1984	4D55	4		Y-115R1	2161
Shogun	2.3		01.1984-09.1986	4D55	4		Y-115R1	2161
Shogun	2.3		01.1984-09.1986	4D55	4		Y-115T1	2189
Shogun	2.5		1985-12.1990	4D56	4		Y-115T1	2189
Shogun	2.5		1994 - 1995	4D56	4	DP21	CY57	5287
Shogun	2.5		01.1996-03.2000	4D56	4	DP13	Y-733J	8944
Sigma			1980 -	4D55 / T QGS Type	4		Y-115R1	2161

* nur über Vertragshändler zu beziehen!

* only available through appointed OE retailer!



l kW

Cyl. **D-POWER**Order-
No.**MITSUBISHI**

Sigma			1980 -	4D55			Y-115T1	2189
Space Gear	2.5	73	12.1994 -	4D56	4	DP21	CY57	5287
Space Gear	2.5	73	06.1994 - 05.1995	4D56 Turbo	4	DP13	Y-733J	8944
Space Gear	2.5		1998 -	4D56 Turbo	4	DP13	Y-733J	8944
Space Runner	2.0	60	06.1993 -	4D68	4	DP21	CY57	5287
Space Star	1.9	59		F9QT	4	DP18	Y-515J	1019
Space Star 1.9 DI-D	1.9	75	2000 -	DCI Renault	4	DP18	Y-515J	1019
Space Wagon (N)	2.0	60	06.1993 -	4D68	4	DP21	CY57	5287
Truck / 4WD			1983 -	4D55T			Y-115R1	2161

NISSAN

Almera N15 / Hatchback	2.0	55	07.1995 - 2000	CD20E	4		CY52	3017
Almera dCi N16	1.5	60	01.2003 -	K9K	4	DP18	Y-515J	1019
Almera N16	2.2	82	02.2000 - 2003	YD22DDT	4		Y-519J	2500
Almera Tino 2.2 VDI	2.2	84	04.2002 -	YD22ET	4		Y-519J	2500
Bluebird/819/910	2.0		05.1980 - 12.1981	LD20, LD20T	4		Y-204TS-1	3829
Bluebird/819/910	2.8		06.1980 - 08.1981	LD28			Y-204TS-1	3829
Bluebird/819/910	2.0		01.1982 - 1987	LD20, LD20T	4		Y-204RS	4573
Bluebird/819/910 T12	2.0	47	12.1985 - 02.1990	LD20	4		CY51	2696
Bluebird/819/910 T72	2.0	49	09.1988 - 04.1990	LD20	4		CY51	2696
Bluebird/819/910 QGS Type 1	2.0		01.1981 -	LD20, LD20T	4		Y-204RS	4573
Bluebird/819/910 QGS Type 1	2.8		08.1981 -	LD28			Y-204RS	4573
Bluebird/819/910 QGS Type 2	2.0		01.1981 -	LD20, LD20T	4		Y-204SS	7629
Bluebird/819/910 QGS Type 2	2.8		08.1981 -	LD28			Y-204SS	7629
Bluebird/Hatchback T12	2.0	47	12.1985 - 02.1990	LD20	4		CY51	2696
Bluebird/Hatchback T72	2.0	49	09.1988 - 04.1990	LD20	4		CY51	2696
Brougham	2.3		1993 -	TD23			Y-707RS	4937
C120 / Vanette	2.0		06.1981 - 09.1982	LD20			Y-204TS-1	3829
C120 / Vanette	2.0		1987 -	LD20			CY51	2696
C120 / Vanette QGS Type 1	2.0		09.1982 -	LD20			Y-204RS	4573
Caball	2.2		1967 - 12.1972	SD22			Y-103	6125
Caball	2.2		1982 -	SD22			Y-112R1	1032
Caball	3.0		01.1973 - 10.1976	ED30			Y-202	1226
Caball	3.0		10.1976 - 09.1977	ED30			Y-202-2	3626
Caball	3.0		10.1977 - 05.1980	ED30			Y-202-2	3626
Caball	3.0		06.1980 - 12.1981	ED30			Y-222T	7628
Caball	3.0		12.1981 -	ED30			Y-272R-1	2731
Cabstar	2.2		01.1976 - 08.1977	SD22			Y-103	6125
Cabstar	2.2		11.1977 - 09.1979	SD22			Y-103-2	2926
Cabstar	2.2		08.1977 - 11.1977	SD22			Y-103-1	6225
Cabstar	2.2		11.1977 - 09.1979	SD22			Y-177-1	3026
Cabstar	2.2		09.1979 - 01.1982	SD22			Y-112T	6327
Cabstar	2.2		09.1979 - 01.1982	SD22			Y-181T	2728
Cabstar	2.2		01.1982 -	SD22			Y-112R1	1032
Cabstar	2.3			TD23			Y-707RS	4937
Cabstar	2.3			SD23			Y-112M1	2531
Cabstar	2.5			SD25			Y-112M1	2531
Cabstar	2.5			TD25			Y-707RS	4937
Cabstar	2.7			TD27			Y-707RS	4937
Cabstar	3.3			ED33			Y-955RS	4995
Cabstar	3.3			ED33			Y-272R-1	2731
Cabster	2.3			TD23			Y-707RS	4937

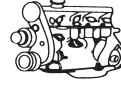

ℓ kW

Cyl. **D-POWER**Order-
No.**NISSAN**

Cabster	3.3			ED33			Y-955RS	4995
Cabster F23 & H41	2.5			TD25			Y-707RS	4937
Cabster F23 & H41	2.7			TD27			Y-707RS	4937
Cedric/220C/280C	2.0		-06.1977	SD20			Y-103	6125
Cedric/220C/280C	2.0		06.1977 - 10.1977	SD20			Y-103-1	6225
Cedric/220C/280C	2.0		10.1977 - 06.1979	SD20			Y-103-2	2926
Cedric/220C/280C	2.0		06.1979 -	SD20			Y-112T	6327
Cedric/220C/280C	2.2		10.1977 - 06.1979	SD22			Y-103-2	2926
Cedric/220C/280C	2.2		06.1977 - 10.1977	SD22			Y-103-1	6225
Cedric/220C/280C	2.2		06.1979 -	SD22			Y-112T	6327
Cedric/220C/280C	2.3			TD23			Y-707RS	4937
Cedric/220C/280C	2.3		1984 -	SD23			Y-112R1	1032
Cedric/220C/280C	2.8		11.1979 - 06.1982	LD28			Y-204TS-1	3829
Cedric/220C/280C QGS Type 1	2.8		06.1982 -	LD28			Y-204RS	4573
Cedric/220C/280C QGS Type 1	2.8		06.1982 -	LD28			Y-204RS	4573
Cedric/220C/280C QGS Type 2	2.8		06.1982 -	LD28			Y-204SS	7629
Cherry N12	1.7	45	1987 -	CD17	4		CY51	2696
Chery N12 QGS Type 2	1.7		10.1982 -	CD17			Y-117SS	2231
Chery N12 QGS Type 1	1.7		10.1982 -	CD17			Y-117RS	2930
Civilian	2.2		1967 - 12.1972	SD22			Y-103	6125
Civilian	2.2		1982 -	SD22			Y-112R1	1032
Civilian	3.0		01.1973 - 10.1976	ED30			Y-202	1226
Civilian	3.0		10.1977 - 05.1980	ED30			Y-202-2	3626
Civilian	3.0		06.1980 - 12.1981	ED30			Y-222T	7628
Civilian	3.0		12.1981 -	ED30			Y-272R-1	2731
Civilian	3.3		1987 - 1987	ED33			Y-272R-1	2731
Civilian	3.3		04.1988 -	ED33			Y-955RS	4995
Clipper	2.2		1967 - 12.1972	SD22			Y-103	6125
Clipper	2.2		1982 -	SD22			Y-112R1	1032
Clipper	3.0		01.1973 - 10.1976	ED30			Y-202	1226
Clipper	3.0		10.1977 - 05.1980	ED30			Y-202-2	3626
Clipper	3.0		06.1980 - 12.1981	ED30			Y-222T	7628
Clipper	3.0		12.1981 -	ED30			Y-272R-1	2731
D21	2.5		1993 -	TD25			Y-707RS	4937
D21	2.7		1993 -	TD27			Y-707RS	4937
D21	2.7		1993 -	TD27T			Y-712RS	6140
F22	2.3			TD23			Y-707RS	4937
F22	2.3			SD23			Y-162R1	2431
F22	2.5			TD25			Y-707RS	4937
F22	2.5			SD25			Y-162R1	2431
F22	2.5		12.1981 -	SD25			Y-112M1	2531
F22	2.7			TD27			Y-707RS	4937
F22	3.3			ED33			Y-955RS	4995
F22 QGS Type 1	2.3		02.1982 -	SD23			Y-112RS1	1132
Hommer	2.2		01.1976 - 08.1977	SD22			Y-103	6125
Hommer	2.2		11.1977 - 09.1979	SD22			Y-177-1	3026
Hommer	2.2		08.1977 - 11.1977	SD22			Y-103-1	6225
Hommer	2.2		11.1977 - 09.1979	SD22			Y-103-2	2926
Hommer	2.2		09.1979 - 01.1982	SD22			Y-181T	2728
Hommer	2.2		09.1979 - 01.1982	SD22			Y-112T	6327
Hommer	2.2		01.1982 -	SD22			Y-112R1	1032
Junior	2.2		1968 - 1983	SD22			Y-103	6125

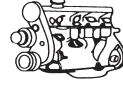

ℓ kW

Cyl. **D-POWER**Order-
No.**NISSAN**

Junior	2.2		1984 - 1984	SD22			Y-112T	6327
Junior	2.5			SD25			Y-112M1	2531
Laurel	2.0		11.1978 - 09.1979	SD20			Y-103-2	2926
Laurel	2.0		09.1979 - 11.1980	SD20			Y-112T1	6728
Laurel	2.0		11.1980 - 09.1981	LD20			Y-204TS-1	3829
Laurel	2.8		11.1980 - 09.1981	LD28	6		Y-204TS-1	3829
Laurel C32 (4,5,6 Cyl CX51.)(1,2,3 Cyl.CZ51)	2.8		02.1987 -	RD28T	6		CX51+	2896+
							CZ51	3209
Laurel QGS Type 1	2.8		10.1981 -	LD28	6		Y-204RS	4573
Laurel QGS Type 2	2.8		10.1981 -	LD28	6		Y-204SS	7629
Micra K9	1.5		04.1984 -	TUD5	4	DP 9	Y-731U	5274
Micra dCi K12	1.5	60	09.2003 -	K9K	4	DP18	Y-515J	1019
Micra dCi K12	1.5	48	04.2003 -	K9K	4	DP18	Y-515J	1019
Nomad	2.0			LD20			CY51	2696
Pathfinder D21	2.5		1993 -	TD25	4		Y-707RS	4937
Pathfinder D21	2.7		1993 -	TD27	4		Y-707RS	4937
Pathfinder D21	2.7		1993 -	TD27T	4		Y-712RS	6140
Patrol	2.7		02.1993 -	TD27	6		Y-707RS	4937
Patrol / 160/Y60 (4,5,6 Cyl CX51.)(1,2,3 Cyl.CZ51)	2.8			RD28T	6		CX51+	2896+
							CZ51	3209
Patrol Y61 (4,5,6 Cyl CX51.)(1,2,3 Cyl.CZ51)	2.8	95	04.1998 -	RD28	6		CX51+	2896+
							CZ51	3209
Patrol	3.3		-06.1980	SD33	6		Y-103	6125
Patrol	3.3		-11.1984	SD33T 12V	6		Y-112M1	2531
Patrol	3.3		-11.1984	SD33T 24V	6		Y-162R1	2431
Patrol	3.3		06.1980 - 08.1982	SD33	6		Y-181T	2728
Patrol	3.3		08.1982 - 11.1984	SD33 12V	6		Y-112M1	2531
Patrol	3.3		08.1982 - 11.1984	SD33 24V	6		Y-162R1	2431
Patrol	3.3		11.1984 -	SD33T 24V	6		Y-755RS	7771
Patrol	3.3		11.1984 -	SD33T 12V	6		Y-705RS	1249
Patrol	3.3		11.1984 -	SD33 12V	6		Y-705RS	1249
Patrol	3.3		11.1984 -	SD33 24V	6		Y-755RS	7771
Patrol	4.2			TD42 24V	6		Y-757RS	4018
Patrol	4.2			TD42 12V	6		Y-707RS	4937
Patrol 160	4.2		-12.1998	TD42 24V	6		Y-757RS	4018
Patrol 160	4.2		-12.1998	TD42 12V	6		Y-707RS	4937
Pick-Up / 720	2.2		11.1978 - 09.1979	SD22	4		Y-103-2	2926
Pick-Up / 720	2.2		10.1979 - 01.1982	SD22	4		Y-112T	6327
Pick-Up QGS Type 2	2.3		1984 - 1986	SD23	4		Y-112M1	2531
Pick-Up / 720 QGS Type 1	2.3		1984 - 1986	SD23	4		Y-112R1	1032
Pick-Up / 720	2.3		1987 -	SD23	4		Y-705RS	1249
Pick-Up / 720	2.5			TD25	4		Y-707RS	4937
Pick-Up / 720 QGS Type 1	2.5		1983 - 1986	SD25	4		Y-112R1	1032
Pick-Up QGS Type 2	2.5		1984 - 1986	SD25	4		Y-112M1	2531
Pick-Up / 720	2.5		1987 -	SD25	4		Y-705RS	1249
Pick-Up	2.7			TD27T	4		Y-712RS	6140
Pick-Up / 720	2.7			TD27	4		Y-707RS	4937
Primera 1.9 dCi	1.9	88	09.2003 -	F9Q...	4	DP18	Y-515J	1019
Primera P10E	2.0	55	01.1991 - 06.1996	CD20	4		CY52	3017
Primera Di	2.2	93	03.2002 -	YD22ET	4		Y-519J	2500
Primera / Wagon W10	2.0	55	07.1990 - 04.1996	CD20	4		CY52	3017
Pulsar / Cherry / N12 QGS Type 1	1.7		10.1982 - 1987	CD17	4		Y-117RS	2930

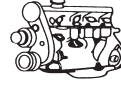

ℓ kW

Cyl. **D-POWER**Order-
No.**NISSAN**

Pulsar / Cherry / N12 QGS Type 2	1.7		10.1982 - 1987	CD17	4		Y-117SS	2231
Pulsar / Cherry / N13	1.7	41	05.1986 - 08.1990	CD17	4		CY51	2696
Santana Turbo	1.6	53	01.1984 - 01.1987	CY	4	DP 2	Y-918R	4182
Sentra QGS Type 1	1.7		10.1982 - 1986	CD17	4		Y-117RS	2930
Sentra QGS Type 2	1.7		10.1982 - 1986	CD17	4		Y-117SS	2231
Sentra	1.7		1987 -	CD17	4		CY51	2696
Serena C23	2.3	55	01.1995 - 02.1998	LD23	4		Y-712RS	6140
Serena C23M	2.0	49	07.1992 - 01.1996	LD20	4		CY51	2696
Skyline / 180K	2.0		06.1980 - 09.1981	LD20	4		Y-204TS-1	3829
Skyline / 180K	2.8		06.1980 - 09.1981	LD28			Y-204TS-1	3829
Skyline / 180K QGS Type 1	2.0		10.1981 -	LD20	4		Y-204RS	4573
Skyline / 180K QGS Type 1	2.8		10.1981 -	LD28			Y-204RS	4573
Skyline / 180K QGS Type 2	2.0		10.1981 -	LD20	4		Y-204SS	7629
Skyline / 180K QGS Type 2	2.8		08.1981 -	LD28			Y-204SS	7629
Stanza / T11	1.7			CD17T	4		Y-120RS	7463
Stanza / T11	2.0		1987 -	LD20	4		CY51	2696
Sunny / Sentra / B11 QGS Type 1	1.7		10.1982 - 1984	CD17	4		Y-117RS	2930
Sunny Y10 / B13	1.7	40	1993 - 1996	CD17	4		CY51	2696
Sunny B14	2.0			CD20	4		CY51	2696
Sunny N13/ B12	1.7		06.1986 - 08.1990	CD17	4		CY51	2696
Sunny N14	1.7		1991 - 1991	CD17	4		CY52	3017
Sunny Y11	1.7	40	05.1992 - 04.1998	CD17	4		CY51	2696
Sunny QGS Type 2	1.7		10.1982 - 1984	CD17	4		Y-117SS	2231
Sunny N14 / Y10 / N15 / B14	2.0	55	10.1990 -	CD20	4		CY52	3017
Terrano 1	2.5			TD25	4		Y-707RS	4937
Terrano 1	2.7			TD27	4		Y-707RS	4937
Terrano 2 not Europe	2.7		07.1993 -	TD27T	4		Y-712RS	6140
Terrano 2 only Europa	2.7	92	05.1996 -	TD27T For EU	4		CY58	5486
Tino 2.0 16V V10	2.2	84	07.2000 -	YD22DT	4		Y-519J	2500
Trade JX1100	2.0		03.1985 -	LD20	4		Y-204RS	4573
Trade PF1104	2.0	46	10.1987 -	LD20IIE	4	DP 2	Y-918R	4182
Urvan E24L	2.5		1993 -	TD25	4		Y-707RS	4937
Urvan QGS Type 2	2.0		05.1982 -	LD20T	4		Y-204SS	7629
Urvan QGS Type 2	2.3		05.1982 -	SD23	4		Y-112M1	2531
Urvan / E20 / E23 / E24	2.2		03.1978 - 08.1980	SD22	4		Y-177-1	3026
Urvan / E20 / E23 / E24	2.2		03.1978 - 08.1980	SD22	4		Y-103-2	2926
Urvan / E20 / E23 / E24	2.2		09.1980 -	SD22	4		Y-112T	6327
Urvan / E20 / E23 / E24	2.2		09.1980 -	SD22	4		Y-181T	2728
Urvan / E20 / E23 / E24	2.3			TD23	4		Y-707RS	4937
Urvan / E20 / E23 / E24	2.3		05.1982 -	SD23	4		Y-162R1	2431
Urvan / E20 / E23 / E24	2.7		1987 -	TD27	4		Y-707RS	4937
Urvan / E20 / E23 / E24 QGS Type 1	2.0		05.1982 -	LD20T	4		Y-204RS	4573
Urvan / E20 / E23 / E24 QGS Type 1	2.3		05.1982 -	SD23	4		Y-112R1	1032
Vanette	2.0			CD20	4		CY52	3017
Vanette	2.0		06.1981 - 09.1982	LD20	4		Y-204TS-1	3829
Vanette C220	2.0	44	04.1987 - 11.1994	LD20 II OHV	4		CY51	2696
Vanette C220	2.0	47	01.1991 - 11.1994	LD20 IIL	4		CY51	2696
Vanette GC22	2.0	47	09.1986 - 03.1993	LD20 OHV	4		CY51	2696
Vanette QGS Type 1	2.0		09.1982 - 1986	LD20	4		Y-204RS	4573
Vanette QGS Type 2	2.0		09.1982 - 1986	LD20	4		Y-204SS	7629
Vanette Cargo	2.0	49	07.1992 - 09.1994	LD20 OHV	4		CY51	2696

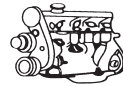

l kW

Cyl. **D-POWER**Order-
No.**NISSAN (Spain)**

L 35 D	2.9	56	05.1985 -		6	DP 1	Y-902R	2237
Mot. A 4.28 D	2.8	62	09.1987 -05.1993	A 4.28	4	DP 1	Y-902R	2237
Patrol			-03.1988			DP 1	Y-902R	2237
Patrol D	2.8	62	09.1987 -	A 4.28	4	DP 1	Y-902R	2237
Trade D	2.8	62	09.1987 -	A 4.28	4	DP 1	Y-902R	2237

OPEL

Arena 1.9D	1.9	44	01.1998 -	F8Q M6	4	DP 7	Y-506R	4409
Arena 2.5D	2.5	55	07.1998 -	S8U V7	4	DP 1	Y-908R	4585
Ascona B	2.0	43	08.1978 -10.1979	B 20 D --> Mot.-Nr. 90309	4		Y-403T	7494
Ascona B	2.0	43	11.1979 -08.1981	B 20 D Mot.-Nr. 90310 -->	4		Y-208T	1250
Ascona C	1.6		- 1983		4	DP 1	Y-902R	2237
Ascona C	1.6	40	03.1982 -09.1988	16 D, DA OHC	4	DP 1	Y-924U	4950
Astra F TD	1.7	60	12.1991 -02.1998	17DT TC4 EE1 OHC Isuzu				
				Mot.956633-->	4	DP 8	CY53	4315
Astra F	1.7	42	09.1991 -09.1992	17 D OHC II	4	DP 1	Y-924U	4950
Astra F	1.7	44	09.1992 -08.1994	17 DR	4	DP 1	Y-924U	4950
Astra F Eco D	1.7	50	08.1994 -02.1998	X17 DTL	4	DP 1	Y-924U	4950
Astra F TD	1.7	60	04.1996 -02.1998	X17DT TC4 EE1 OHC Isuzu				
				Mot.956633-->	4	DP 8	CY53	4315
Astra G D	1.7	50	02.1998 -	X17DTL	4	DP 1	Y-924U	4950
Astra G DTI 16V	1.7	55	09.1999 -	Y17DT	4		*CZ22	
Astra G DTI 16V	2.0	60	02.1998 -	X20DTL SOHC	4	DP14	Y-748U	5000
Astra G DTI II	2.0	60	08.2000 -	Y20DTL	4	DP14	Y-748U	5000
Astra G DTI II 16V	2.0	74	08.2000 -	Y20DTH	4	DP37	Y-523J	3703
Astra G	2.2	92	2003 -	Y22DTR	4	DP37	Y-523J	3703
Astra H CDTI	1.7	74	03.2004 -	Z17DHT	4		*CZ22	
Astra H CDTI	1.7	59	03.2004 -	Z17DLT	4		*CZ22	
Astra H CDTI 16V	1.9	110	09.2004 -	Z19DHT Fiat	4	DP36	Y-534J	5540
Astra H CDTI 16V	1.9	88	03.2004 -	Z19DLT Fiat	4	DP36	Y-534J	5540
Bedford Blitz D		46	09.1980 -		4		Y-208T	1250
Bedford Blitz D	2.0	44	09.1975 -09.1978	21 D Serie 97000	4		Y-403T	7494
Bedford Blitz D	2.0	44	10.1978 -12.1980	Serie 97000	4		Y-208T	1250
Bedford Blitz D	2.1	44	05.1975 -01.1979	Mot.-Nr. 21 DT-36243 -->	4		Y-403T	7494
Bedford Blitz D	2.1	44	05.1975 -01.1979	--> Mot.-Nr. 21 DT-36242	4		Y-810	6929
Blitz D	2.1	44	01.1969 -12.1974	XPD 4.90	4		Y-810	6929
Campo TDS	3.1	80	09.1992 -	4JG2T (31 TD/TDS)	4		Y-719RS1	6900
Combo	1.7	44	07.1994 -	17D 4EE1 OHC	4	DP 8	CY53	4315
Combo	1.7	44	04.1996 -	X17D (4EE1)/OHC	4	DP 8	CY53	4315
Corsa A D (Isuzu-Mot.)	1.5	37	09.1987 -03.1993	15 D/4 EC1 AAD				
				--> Motor 804 794	4		Y-306R	6244
Corsa B TD	1.5	49	03.1993 -08.2000	X/15DT (T4EC1) OHC Isuzu	4	DP 8	CY53	4315
Corsa B D	1.5	37	03.1993 -08.2000	15D (4EC1) OHC Isuzu	4	DP 8	CY53	4315
Corsa B	1.5	49	04.1996 -08.2001	X15DT 4EE1 OHC	4	DP 8	CY53	4315
Corsa B TD	1.7	44	03.1993 -08.2000	17D (4EE1)/OHC	4	DP 8	CY53	4315
Corsa B D	1.7	44	04.1996 -08.2001	X17D (4EE1)/OHC	4	DP 8	CY53	4315
Corsa C DTI 16V	1.7	55	08.2000 -	Y17DT	4		*CZ22	
Corsa C DI 16V	1.7	50	08.2000 -	Y17DTL	4		*CZ22	
Frontera A 2,3 TD Intercooler	2.3	74	09.1991 -02.1995	23 DTR OHC	4	DP 1	Y-924U	4950
Frontera A TD Intercool	2.3	74	03.1992 -09.1995	DTR OHC	4	DP 1	Y-924U	4950
Frontera A TDI	2.5	85	09.1996 -10.1998	25TD/TDS/OHC	4	DP20	Y-741U	5065
Frontera A TDI	2.5	85	06.1996 -08.1998	25TD VM41B (25TDS)	4	DP20	Y-741U	5065

* nur über Vertragshändler zu beziehen!

* only available through appointed OE retailer!

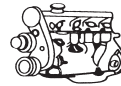

ℓ kW

Cyl. **D-POWER**Order-
No.**OPEL**

Frontera A TDI	2.8	83	02.1995 - 11.1998	28TD 4JB1T (28TDI) Isuzu	4		Y-904M1	7995
Frontera B DTI 16V	2.2	85	06.1998 - 08.2000	X22DTH	4	DP14	Y-748U	5000
Frontera B DTI 16V	2.2	85	08.2000 -	Y22DTH	4	DP37	Y-523J	3703
Kadett			- 1983		4	DP 1	Y-902R	2237
Kadett D D	1.6	40	03.1982 - 09.1984	16D OHC	4	DP 1	Y-924U	4950
Kadett E D (Isuzu-Mot.)	1.5	37	09.1984 - 08.1991	4 EC1 Isuzu --> Mot. 804 794	4		Y-306R	6244
Kadett E D	1.6	40	09.1984 - 02.1989	16 D, DA OHC	4	DP 1	Y-924U	4950
Kadett E D	1.7	42	02.1989 - 09.1992	17 D OHC II	4	DP 1	Y-924U	4950
Kadett E D	1.7	44	09.1992 - 09.1993	17 DR	4	DP 1	Y-924U	4950
Meriva DTI	1.7	55	09.2003 -	Y17DT	4		*CZ22	
Monterey TD	3.1	84	11.1991 - 02.1998	4JG2-TC (3.1 D)	4		Y-719RS1	6900
Movano 1.9 DTI	1.9	59	10.2000 -	F9Q M7	4	DP18	Y-515J	1019
Movano 2.2 DTI	2.2	66	09.2000 -	G9T C7	4		Y-517J	3319
Movano 2.5 D	2.5	59	10.1998 - 10.2000	S8U W7	4	DP23	Y-935U	5915
Omega A D	2.3	54	09.1986 - 02.1994	23 YD OHC	4	DP 1	Y-924U	4950
Omega A D	2.3	66	09.1986 - 09.1988	23 YDT OHC	4	DP 1	Y-924U	4950
Omega A TD	2.3	74	09.1988 - 02.1994	23 DTR OHC	4	DP 1	Y-924U	4950
Omega B DI 16V	2.0	74	09.1997 -	X20DILC	4	DP14	Y-748U	5000
Omega B D	2.0	74	10.1998 - 09.2000	X20DTH OHC	4	DP14	Y-748U	5000
Omega B DTI	2.0	74	09.1999 -	Y20DTH	4	DP37	Y-523J	3703
Omega B DTI 16V	2.2	88	05.2001 -	Y22DTR	4	DP37	Y-523J	3703
Omega B DTI 16V	2.2	88	08.2001 -	Y22DTH	4	DP37	Y-523J	3703
Omega B TD	2.5	96	02.1994 - 02.1996	U25TD (Mot. BMW)	6	DP 1	Y-917U	3219
Omega B TD	2.5	96	08.1996 - 10.2001	X25DT OHC	6	DP 1	Y-917U	3219
Rekord D D	2.0	40	08.1974 - 08.1977	20 D	4		Y-403T	7494
Rekord D D	2.1	44	09.1972 - 09.1977	21 D	4		Y-403T	7494
Rekord D D	2.3		- 1983		4	DP 1	Y-902R	2237
Rekord E D	2.0	43	09.1977 - 10.1982	--> Mot.-Nr. 90309	4		Y-403T	7494
Rekord E D	2.0		09.1977 - 10.1982	Mot.-Nr. 90310 -->	4		Y-208T	1250
Rekord E D	2.0	43	09.1977 - 10.1979	20 D	4		Y-403T	7494
Rekord E D	2.0	43	11.1979 - 08.1981	20 D	4		Y-208T	1250
Rekord E D	2.1	44	09.1977 - 07.1978	21 D	4		Y-403T	7494
Rekord E D	2.3	48	08.1978 - 10.1982	--> Mot.-Nr. 40018	4		Y-403T	7494
Rekord E D	2.3	48	08.1978 - 10.1979	23 D	4		Y-403T	7494
Rekord E D	2.3	48	11.1979 - 09.1986	23 D	4		Y-208T	1250
Rekord E D	2.3	48	11.1982 - 08.1986	Mot.-Nr. 40019 -->	4		Y-208T	1250
Rekord E TD	2.3	63	05.1984 - 09.1986	23 DT	4	DP 1	Y-924U	4950
Senator A D	2.0			Mot.-Nr. 90310 -->	4		Y-208T	1250
Senator A D	2.0			--> Mot.-Nr. 90309	4		Y-403T	7494
Senator A D	2.3	64	11.1984 - 08.1987	--> Mot.-Nr. 40018	4		Y-403T	7494
Senator A TD	2.3	64	11.1984 - 08.1987	Mot.-Nr. 121527 -->	4	DP 1	Y-924U	4950
Senator A D	2.3	70	03.1985 - 07.1986	23 TDC	4	DP 1	Y-924U	4950
Signum CDTI	1.9	88	04.2004 -	Z19DLT Fiat	4	DP36	Y-534J	5540
Signum CDTI 16V	1.9	110	04.2004 -	Z19DHT Fiat	4	DP36	Y-534J	5540
Signum DTI 16V	2.0	74	05.2003 -	Y20DTH	4	DP37	Y-523J	3703
Signum DTI 16V	2.2	92	05.2003 -	Y22DTR	4	DP37	Y-523J	3703
Signum V6 CDTI	3.0	130	09.2003 -	Y30DT	6		*CZ24	
Sintra TDI	2.2	85	01.1998 -	X22DTH	4	DP14	Y-748U	5000
Vectra	1.7		- 1983		4	DP 1	Y-902R	2237
Vectra A D	1.7	42	02.1988 - 09.1992	17D OHC II	4	DP 1	Y-924U	4950
Vectra A TD	1.7	60	03.1990 -	Isuzu TC4EC1 817253-->	4		Y-743U	5642
Vectra A TD	1.7	60	10.1992 - 08.1995	X17DT Isuzu TC4EE1	4	DP 8	CY53	4315

* nur über Vertragshändler zu beziehen!

* only available through appointed OE retailer!

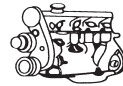

l kW

Cyl. **D-POWER**Order-
No.**OPEL**

Vectra A TD	1.7	60	10.1992 -08.1995	17DT Isuzu TC4EE1	4	DP 8	CY53	4315
Vectra B TD	1.7	60	08.1995 -	X17TD/TC4 EE1 Isuzu	4	DP 8	CY53	4315
Vectra B DTI	2.0	74	08.1997 -	X20DTH OHC	4	DP14	Y-748U	5000
Vectra B DTI 16V	2.0	74	09.1997 -07.1999	X20DILC	4	DP14	Y-748U	5000
Vectra B Di	2.0	60	08.1999 -	X20DTL SOHC	4	DP14	Y-748U	5000
Vectra B DTI 16V	2.0	74	08.2000 -	Y20DTH	4	DP37	Y-523J	3703
Vectra B DTI 16V	2.2	92	08.2000 -	Y22DTR	4	DP37	Y-523J	3703
Vectra C CDTI 16V	1.9	110	04.2004 -	Z19DHT Fiat	4	DP36	Y-534J	5540
Vectra C CDTI	1.9	88	04.2004 -	Z19DLT Fiat	4	DP36	Y-534J	5540
Vectra C DTI	2.0	74	04.2002 -	Y20DTH	4	DP37	Y-523J	3703
Vectra C DTI	2.2	92	04.2002 -	Y22DTR	4	DP37	Y-523J	3703
Vectra C V6 CDTI	3.0	130	2003 -	Y30DT	6		*CZ24	
Vivaro DTI	1.9	74	09.2001 -	F9Q 760	4	DP18	Y-515J	1019
Vivaro DI	1.9	60	09.2001 -		4	DP18	Y-515J	1019
Zafira DTI 16V	2.0	74	04.1999 -	X20DILC	4	DP14	Y-748U	5000
Zafira DTI 16V	2.0	74	08.1999 -	Y20DTL	4	DP14	Y-748U	5000
Zafira DI 16V	2.0	60	09.1999 -11.2000	X20DTL	4	DP14	Y-748U	5000
Zafira DTI 16V	2.0	74	08.2000 -	Y20DTH	4	DP37	Y-523J	3703

OTOSAN

600 Pickup D	1.9			ERK 1.9	4	DP 1	Y-902R	2237
--------------	-----	--	--	---------	---	-------------	--------	------

PEUGEOT

106 D	1.4	37	08.1991 -06.1994	TUD3/L	4	DP33	Y-911R	4544
106 D	1.5	42	07.1994 -03.1996	TUD5	4	DP 9	Y-731U	5274
106 D	1.5	42	04.1996 -10.2003	TUD5	4	DP 9	Y-731U	5274
204	1.3	28	07.1967 -07.1973	XLD	4		Y-404	6829
204 D	1.4	33	07.1973 -07.1977	XL4D	4		Y-404	6829
205 D	1.8	44	10.1983 -08.1998	XUD7	4	DP 1	Y-902R	2237
205 TD	1.8	58	07.1985 -08.1998	XUD7T	4	DP 1	Y-902R	2237
205 D	1.8	44	09.1998 -12.1999	XUD7	4	DP 1	Y-938R	5267
205	1.8	58	09.1998 -12.1999	XUD7T	4	DP 1	Y-938R	5267
205 D	1.9	47	10.1987 -08.1998	XUD9	4	DP 1	Y-902R	2237
205	1.9	51	09.1998 -12.1999	XUD9A	4	DP 1	Y-938R	5267
206 & SW HDI	1.4	51	11.2001 -	DV4TD	4		YE04	1101
206 D	1.9	51	09.1998 -	DW8/ DW8B	4	DP10	Y-503R	4279
206 & SW HDI	2.0	66	10.1999 -	DW10TD	4	DP24	Y-504R	4359
206 & SW HDI	1.6		2004 -	DV6TED4	4		YE04	1101
304 D	1.4	30	08.1976 -08.1979	XL4D	4		Y-404	6829
304 D	1.5	32	02.1979 -08.1980	XIDL	4		Y-208T	1250
305 D	1.6	32	11.1977 -06.1981	XID	4		Y-208T	1250
305 D	1.6	32	07.1981 -10.1983	XID	4	DP 1	Y-902R	2237
305 D	1.8	44	10.1982 -06.1988	XUD7	4	DP 1	Y-902R	2237
305 D	1.9	47	10.1982 -06.1988	XUD 9	4	DP 1	Y-902R	2237
306	1.8	43	10.1993 -08.1998	XUD7	4	DP 1	Y-902R	2237
306 D	1.8	44	09.1998 -07.2002	DW8	4	DP10	Y-503R	4279
306 TD	1.8	59	09.1998 -07.2002	DW8TD	4	DP10	Y-503R	4279
306	1.8	44	09.1998 -	XUD7	4	DP 1	Y-938R	5267
306 D	1.9	51	02.1993 -08.1998	XUD9A	4	DP 1	Y-902R	2237
306 D	1.9	68	03.1993 -08.1998	XUD9TE	4	DP 1	Y-923U	3380
306	1.9	51	09.1998 -12.1999	XUD9A/XUD9BSD	4	DP 1	Y-938R	5267
306 D	1.9	68	09.1998 -12.1999	XUD9TE	4	DP 1	Y-938R	5267

* nur über Vertragshändler zu beziehen!

* only available through appointed OE retailer!



ℓ kW

Cyl. **D-POWER**Order-
No.**PEUGEOT**

306	1.9	51	09.1998 -07.2002	DW8	4	DP10	Y-503R	4279
306 D	2.0	80	09.1998 -	DW10TD	4	DP24	Y-504R	4359
306 HDI	2.0	66	04.1999 -07.2002	DW10TD	4	DP24	Y-504R	4359
307 HDI	1.4	51	01.2002 -	DV4TD	4		YE04	1101
307 & SW HDI	2.0	66	04.2001 -	DW10TD	4	DP24	Y-504R	4359
307 & SW HDI	2.0	81	09.2001 -	DW10ATED	4	DP24	Y-504R	4359
307 & SW HDI	1.6		03.2004 -	DV6TED4	4		YE04	1101
307 & SW HDI	2.0		03.2004 -	DW10TED	4	DP24	Y-504R	4359
309	1.5	42	03.1994 -12.1995	TUD5	4	DP 9	Y-731U	5274
309 D	1.8	44	06.1986 -12.1993	XUD7	4	DP 1	Y-902R	2237
309 TD	1.8	58	11.1989 -12.1993	XUD7T	4	DP 1	Y-902R	2237
309 D	1.9	47	06.1986 -12.1993	XUD9 / XUD9Y	4	DP 1	Y-902R	2237
404	2.0		10.1963 -06.1975	XD4.88	4		Y-810	6929
405 TD	1.8	68	03.1988 -12.1992	XUD7TE	4	DP 1	Y-902R	2237
405 D	1.9	51	03.1988 -	XUD9A	4	DP 1	Y-902R	2237
405 GLD	1.9	47	07.1988 -12.1992	XUD9Y	4	DP 1	Y-902R	2237
405 TD	1.9	68	09.1992 -12.1997	XUD9TE / XUD9TF	4	DP 1	Y-923U	3380
405	1.9	55	10.1995 -	XUD9SD	4	DP 1	Y-923U	3380
405	1.9	51	09.1998 -12.1999	XUD9A	4	DP 1	Y-938R	5267
406 TD	1.9	68	10.1995 -08.1998	XUD9TE/TF/BTF	4	DP 1	Y-923U	3380
406	1.9	68	09.1998 -12.1999	XUD9TE /TF/BTF	4	DP 1	Y-938R	5267
406 HDI	2.0	81	12.1998 -04.2004	DW10ATED	4	DP24	Y-504R	4359
406 TD	2.1	80	10.1995 -08.1998	XUD11BTE	4	DP 1	Y-923U	3380
406	2.1	80	09.1998 -12.1999	XUD11BTE	4	DP 1	Y-938R	5267
406 Coupé	2.2	100	03.2001 -	DW12TED4	4	DP24	Y-504R	4359
406 TD Phase 2	2.0	66	04.1999 -04.2004	DW10TD	4	DP24	Y-504R	4359
406 TD Phase 2	2.0	81	04.1999 -04.2004	DW10ATED	4	DP24	Y-504R	4359
406 HDI Phase 2	2.2	100	09.2000 -05.2003	DW12TED4	4	DP24	Y-504R	4359
407 HDI	1.6		04.2004 -	DV6TED	4		YE04	1101
407 HDI	2.0		04.2004 -	DW10TED	4	DP24	Y-504R	4359
504 D	1.9	36	04.1971 -05.1978	XD 4.88	4		Y-810	6929
504 D	1.9	36	06.1978 -04.1981	XD 4.88	4		Y-208T	1250
504	1.9		05.1981 -06.1987	XD4.88	4	DP 1	Y-902R	2237
504 D	2.1	43	10.1970 -05.1978	XD 4.90	4		Y-810	6929
504 D	2.1	43	06.1978 -04.1981	XD 4.90	4		Y-208T	1250
504 D	2.1	43	05.1981 -09.1981	XD 4.90	4	DP 1	Y-902R	2237
504 D	2.3	47	08.1976 -05.1978	XD 2	4		Y-810	6929
504 D	2.3	47	06.1978 -04.1981	XD 2	4		Y-208T	1250
504 D	2.3	47	05.1981 -06.1983	XD 2	4	DP 1	Y-902R	2237
504 D Pick Up	2.3	47	07.1984 -12.1990	XD 2	4	DP 1	Y-902R	2237
505 D	2.3	44	09.1979 -09.1986	XD 2	4		Y-208T	1250
505 TD	2.3	54	09.1980 -06.1986	XD 2 S	4		Y-208T	1250
505 TD	2.5	66	10.1983 -12.1993	XD 3 T	4	DP 1	Y-902R	2237
505 TD	2.5	77	10.1986 -12.1993	XD 3 TE	4	DP 1	Y-902R	2237
505 D	2.5	51	06.1987 -12.1993	XD 3	4	DP 1	Y-902R	2237
604 TD	2.3	54	02.1979 -04.1981	XD 2 S	4		Y-208T	1250
604	2.3		05.1981 -06.1983	XD2S	4	DP 1	Y-902R	2237
604 TD	2.5	66	07.1983 -06.1986	XD 3 T	4	DP 1	Y-902R	2237
605 TD	2.1	80	09.1989 -06.1994	XUD11ATE/L, BTE	4	DP 1	Y-923U	3380
605 D	2.1	60	09.1989 -06.1994	XUD11A/L	4	DP 1	Y-902R	2237
605 TD	2.1	80	09.1998 -07.2000	XUD11ATE/BTE	4	DP 1	Y-938R	5267
605 TD	2.5	96	07.1994 -05.1999	DK5ATE	4	DP 1	Y-923U	3380

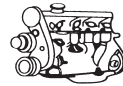

ℓ kW

Cyl. **D-POWER**Order-
No.**PEUGEOT**

607 HDI	2.0			DW10TED	4	DP24	Y-504R	4359
607 HDI 16V	2.2	100	05.2000 -	DW12TED4	4	DP24	Y-504R	4359
806 TD	1.9	68	06.1994 -08.1998	XUD9TF	4	DP 1	Y-923U	3380
806 D	1.9	68	09.1998 -	XUD9BTF	4	DP 1	Y-938R	5267
806 D	1.9	68	09.1998 -01.2001	XUD9TF	4	DP 1	Y-938R	5267
806 D	2.0	80	09.1998 -	DW10TED	4	DP24	Y-504R	4359
806 D HDI	2.0	81	09.1999 -	DW10ATED	4	DP24	Y-504R	4359
806 D	2.1	80	06.1996 -08.1998	XUD11BTE	4	DP 1	Y-923U	3380
806 TD	2.1	80	07.1996 -	XUD11ATE	4	DP 1	Y-923U	3380
806 D	2.1	80	09.1998 -01.2001	XUD11BTE	4	DP 1	Y-938R	5267
807 Hdi	2.0	80	06.2002 -	DW10ATED4/RHT	4	DP24	Y-504R	4359
807 Hdi	2.2	94	06.2002 -	DW12TED4/4HW	4	DP24	Y-504R	4359
Boxer D	1.8	44	09.1998 -	XUD7	4	DP 1	Y-938R	5267
Boxer TD	1.9	67	03.1994 -08.1998	XUD9TF	4	DP 1	Y-923U	3380
Boxer D	1.9	51	03.1994 -08.1998	XUD9A	4	DP 1	Y-923U	3380
Boxer	1.9	68	09.1998 -	XUD9TF	4	DP 1	Y-938R	5267
Boxer D	1.9	51	09.1998 -	XUD9AU	4	DP 1	Y-938R	5267
Boxer	2.5	63	03.1994 -08.1998	DJ5	4	DP 1	Y-923U	3380
Boxer TD	2.5	76	03.1994 -08.1996	DJ5T	4	DP 1	Y-923U	3380
Boxer Tdi	2.5	76	09.1996 -	DJ5TED	4		Y-738U	5390
Boxer HDI	2.8	93	10.1997 -	Sofim	4	DP 1	Y-924U	4950
Boxer 2 HDI	2.0	80	09.1998 -	DW10TD	4	DP24	Y-504R	4359
Boxer 2 HDI	2.2	100	03.2001 -	DW10TED4	4	DP24	Y-504R	4359
Expert TD	1.8	59	09.1998 -	DW8TD	4	DP10	Y-503R	4279
Expert	1.8	44	09.1998 -	DW8	4	DP10	Y-503R	4279
Expert TD	1.9	66	09.1995 -08.1998	XUD 9TE	4	DP 1	Y-923U	3380
Expert	1.9	68	01.1996 -08.1998	XUD9TF	4	DP 1	Y-923U	3380
Expert	1.9	51	01.1996 -08.1998	XUD9A	4	DP 1	Y-923U	3380
Expert	1.9	68	01.1996 -08.1998	XUD9BTF	4	DP 1	Y-923U	3380
Expert TD	1.9	66	09.1998 -	XUD9BTF	4	DP 1	Y-938R	5267
Expert	1.9	51	09.1998 -	XUD9A	4	DP 1	Y-938R	5267
Expert TD	1.9	66	09.1998 -	XUD9TF	4	DP 1	Y-938R	5267
Expert HDI	2.0	70	02.2000 -	DW10TED	4	DP24	Y-504R	4359
Expert HDI	2.0	81	02.2000 -	DW10ATED	4	DP24	Y-504R	4359
Expert	2.1	80	07.1996 -	XUD11ATE	4	DP 1	Y-923U	3380
J 5 D	1.9	51	11.1987 -	XUD9A	4	DP 1	Y-902R	2237
J 5 D	2.5	54	09.1981 -06.1991	CRD93	4		Y-208T	1250
J 5 TD	2.5	70	07.1987 -06.1991	CRD93LS	4		Y-208T	1250
J 7 D	1.8	44	10.1967 -10.1978	XDP88	4		Y-810	6929
J 7 D	2.1	55	10.1970 -10.1978	XDP90	4		Y-810	6929
J 7 D	2.3	49	10.1978 -10.1979	XD2P94	4		Y-810	6929
J 7 D	2.3	49	11.1979 -09.1980	XD2P94	4		Y-208T	1250
J 9 Transporter D		59	10.1980 -04.1981		4		Y-208T	1250
J 9 Transporter D		59	05.1981 -		4	DP 1	Y-902R	2237
J 9 Transporter D	2.1	41	10.1980 -10.1982	XDP4.90	4		Y-208T	1250
J 9 Transporter D	2.1	41	10.1980 -04.1981	XDP 4.90	4		Y-208T	1250
J 9 Transporter D	2.1	41	05.1981 -	XDP4.90	4	DP 1	Y-902R	2237
J 9 Transporter D	2.3	48	10.1980 -10.1982	XD2P	4		Y-208T	1250
J 9 Transporter D	2.5	53	10.1980 -10.1982	XD3P	4		Y-208T	1250
J 9 Transporter D	2.5	53	10.1982 -	XD3P	4	DP 1	Y-902R	2237
Partner Combi	1.8	43	07.1996 -08.1998	XUD7	4	DP 1	Y-923U	3380
Partner Combi	1.8	59	09.1998 -03.2002	DW8TD	4	DP10	Y-503R	4279

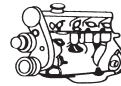

ℓ kW

Cyl. **D-POWER**Order-
No.**PEUGEOT**

Partner Combi	1.8	44	09.1998 -03.2002	XUD7	4	DP 1	Y-938R	5267
Partner Combi	1.8	44	09.1998 -03.2002	DW8	4	DP10	Y-503R	4279
Partner Combi	1.9	51	07.1996 -08.1998	XUD9A	4	DP 1	Y-923U	3380
Partner Combi	1.9	51	09.1998 -03.2002	DW8 / DW8B	4	DP10	Y-503R	4279
Partner Combi	1.9	51	09.1998 -03.2002	XUD9A	4	DP 1	Y-938R	5267
Partner Combi HDI	2.0	66	10.1999 -03.2002	DW10TD	4	DP24	Y-504R	4359
Partner Multispace	1.9	51	01.1997 -09.1998	XUD9A	4	DP 1	Y-923U	3380
Partner Multispace	1.9	51	09.1998 -	DW8 / DW8B	4	DP10	Y-503R	4279
Partner Multispace HDI	2.0	66	10.1999 -	DW10TD	4	DP24	Y-504R	4359

PIAGGIO

Ape Car D	0.5	11	01.1983 -			DP 2	Y-918R	4182
-----------	-----	----	-----------	--	--	-------------	--------	------

RENAULT

Avantime	2.2	110	06.2002 - 2003		4		Y-517J	3319
Cavalier D					4	DP 1	Y-902R	2237
Cherokee D	2.1	59			4	DP 1	Y-908R	4585
Clio	1.9	47	05.1990 -02.1991		4	DP 1	Y-908R	4585
Clio	1.9	48	05.1990 -02.1991	F8Q-714/730/732	4	DP15	Y-913M	3965
Clio	1.9	48	03.1991 -08.1998	F8Q676/678/692/696	4	DP19	Y-927R	5171
Clio 2	1.9	48	03.1998 -12.2003	F8Q630/662 BBOEOF	4	DP 7	Y-506R	4409
Clio 2 dTi	1.9	59	01.1999 -06.2001	F9Q782	4	DP22	Y-740U	5104
Clio 2 dTi	1.9	59	03.1999 -12.2003	F9Q780	4	DP18	Y-515J	1019
Clio 2	1.9	48	03.1999 -12.2003	F8Q632	4	DP12	Y-516J	1436
Clio 2 Phase 2 dCi	1.5	59	11.2001 -	K9K702	4	DP18	Y-515J	1019
Clio 2 Phase 2 dCi	1.5	48	06.2001 -	K9K704, 710	4	DP18	Y-515J	1019
Clio 2 Phase 2 dCi	1.5	0	2004 -		4	DP18	Y-515J	1019
Grand Espace dci	2.2		2003 -	G9T	4		Y-517J	3319
Espace 1	2.1	65	10.1984 -10.1990	J8S240/774	4	DP 1	Y-908R	4585
Espace 2	2.2	85	1991 -10.1996	G8T-714/716/760	4	DP17	Y-730U	2273
Espace 3 dCi	1.9	74	02.1999 -12.2002	F9Q-722	4	DP18	Y-515J	1019
Espace 3 dTi	1.9	74	02.1999 -12.2002	F9Q716/730/734	4	DP22	Y-740U	5104
Espace 3 dT	2.2	81	01.1997 -08.2000	G8T-714/716	4	DP17	Y-730U	2273
Espace 3 dCi	2.2	96	06.2000 -12.2002		4		Y-517J	3319
Espace 3 dCi	2.2	85	06.2000 -12.2002	G9T-710	4		Y-517J	3319
Espace 4 DCI	1.9	0	10.2002 -	F9Q	4	DP18	Y-515J	1019
Grand Espace 4 DCI	1.9	0	10.2002 -	F9Q	4	DP18	Y-515J	1019
Grand Espace 4 DCI	2.2	0	10.2002 -		4		Y-517J	3319
Espace 4 dci	2.2	110	2003 -	G9T	4		Y-517J	3319
Espace 4 dCi	3.0	132	10.2002 -	P9X701	6		*CZ24	
Express	1.6	40	07.1986 -03.1997	F8M-720/730/736/760	4	DP15	Y-913M	3965
Express	1.9	48	09.1991 -08.1994	F8Q-684/722/724/774/776	4	DP15	Y-913M	3965
Express	1.9	48	09.1994 -12.1995	F8Q-640/644/646/648	4	DP19	Y-927R	5171
Express	1.9	48	01.1996 -	F8Q-640/680/682	4	DP19	Y-927R	5171
Fuego D, TD	2.1	65	10.1982 -07.1984	J8S	4	DP 1	Y-908R	4585
Grand Scenic DCI	1.5	0	03.2004 -	K9K	4	DP18	Y-515J	1019
Grand Scenic DCI	1.9	0	03.2004 -	F9Q	4	DP18	Y-515J	1019
Kangoo dCi	1.5	59	06.2001 -	K9K	4	DP18	Y-515J	1019
Kangoo dCi	1.5	48	06.2001 -	K9K	4	DP18	Y-515J	1019
Kangoo dTi	1.9	59	03.1998 -	F9Q780	4	DP18	Y-515J	1019
Kangoo Express D	1.9	40	03.1998 -	F8Q-662	4	DP 7	Y-506R	4409
Kangoo Express D	1.9	48	03.1998 -	F8Q-630	4	DP 7	Y-506R	4409

* nur über Vertragshändler zu beziehen!

* only available through appointed OE retailer!

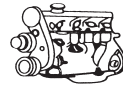

ℓ kW

Cyl. **D-POWER**Order-
No.**RENAULT**

Kangoo Express D	1.9	48	03.1999 -	F8Q-632	4	DP12	Y-516J	1436
Kangoo dCi 4X4	1.9	59	11.2001 -		4	DP18	Y-515J	1019
Kangoo Express DCi	1.5	0	07.2003 -	K9K	4	DP18	Y-515J	1019
Kangoo Express DCi	1.5	0	2004 -	K9K	4	DP18	Y-515J	1019
Kangoo Express DCi	1.9	0	2004 -	F9Q	4	DP18	Y-515J	1019
Laguna / Nevada D	2.2	62	09.1994 -	G8T...	4	DP17	Y-730U	2273
Laguna / Nevada dT	2.2	85	03.1996 -	G8T.Turbo	4	DP17	Y-730U	2273
Laguna 2 / Estate dCi	1.9	74	03.1999 -	F9Q710/717/718	4	DP18	Y-515J	1019
Laguna 2 / Estate dCi	1.9	81	03.2001 -		4	DP18	Y-515J	1019
Laguna 2 / Estate dCi	1.9	88	01.2001 -	F9QC750	4	DP18	Y-515J	1019
Laguna 2 / Estate dCi	2.2	110	01.2002 -	G9T710	4		Y-517J	3319
Laguna / Nevada Phase2 dTi	1.9	74	10.1997 -	F9Q-716/730/734	4	DP22	Y-740U	5104
Laguna / Nevada Phase2 dCi	1.9	81	01.2000 -	F9Q718	4	DP18	Y-515J	1019
Laguna / Nevada Phase2 dT	2.2	80	04.1998 -	G8T-Turbo	4	DP17	Y-730U	2273
Master T28 , T33 , T35			07.1998 -		4		Y-502R	3852
Master dCi	1.9	59	06.2000 -	F9Q-770	4	DP18	Y-515J	1019
Master D	2.1		09.1980 -11.1981	852	4		Y-208T	1250
Master D T30	2.1	45	11.1981 - 1996	852	4	DP 1	Y-908R	4585
Master dCi	2.2	85	2000 -	G9T-710	4		Y-517J	3319
Master dCi 16S	2.2	66	05.2001 -		4		Y-517J	3319
Master D	2.4		09.1980 -05.1982	8140 / S8U	4		Y-208T	1250
Master D T 30	2.4	52	06.1982 - 1996	8140 / S8U	4	DP 1	Y-908R	4585
Master D	2.5		09.1980 -05.1982	8140 / S8U	4		Y-208T	1250
Master D T28	2.5	57	01.1981 -12.1985	Sofim	4	DP 1	Y-914U	2643
Master Turbo D T 35	2.5	55	06.1982 - 1996	S9U	4	DP 1	Y-908R	4585
Master D	2.5	69	09.1997 -	S8V-748	4	DP23	Y-935U	5915
Master D	2.5	59	07.1998 -	S8U-770/772	4		Y-502R	3852
Master dCi 16S	2.5	88	10.2000 -		4		Y-517J	3319
Master dTi	2.8	85	09.1997 -	S9W-700/702	4		Y-502R	3852
Mégane / Classic dTi	1.9	74	01.1996 -	F9Q716/730/734	4	DP22	Y-740U	5104
Mégane / Classic di	1.9	66	01.1996 -08.1999	F9Q730/734	4	DP22	Y-740U	5104
Mégane / Classic D	1.9	48	01.1996 -	F8Q620/624	4	DP19	Y-927R	5171
Mégane / Classic dT	1.9	66	01.1996 -	F8Q784/786	4	DP25	Y-932R	4956
Mégane / Classic D	1.9	48	03.1998 -	F8Q788	4	DP 7	Y-506R	4409
Mégane / Classic dCi	1.9	77	03.1999 -	F9Q731/732/736/740	4	DP18	Y-515J	1019
Mégane / Classic D	1.9	48	03.1999 -02.2001	F8Q622	4	DP12	Y-516J	1436
Mégane 2 1.5 dCi	1.5	60	09.2003 -	K9K722	4	DP18	Y-515J	1019
Mégane 2 1.5 dCi	1.5	60	09.2003 -	K9K722	4	DP18	Y-515J	1019
Mégane 2 Coupé	1.5	0	2004 -	K9K	4	DP18	Y-515J	1019
Mégane 2 Coupe dci	1.9	88	09.2002 -	F9Q800	4	DP18	Y-515J	1019
Mégane 2 1.5 dCi	1.5	60	09.2002 -	K9K722	4	DP18	Y-515J	1019
Mégane Phase 2 dTi	1.9	74	01.1996 -	F9Q716/730/734	4	DP22	Y-740U	5104
Mégane Phase 2 dCi	1.9	77	03.1999 -	F9Q718/722/731/736/780	4	DP18	Y-515J	1019
Mégane Phase 2 D	1.9	48	03.1999 -	F8Q622/790	4	DP12	Y-516J	1436
Mégane Phase 2 D	1.9	48	09.1999 -	F8Q620/624	4	DP19	Y-927R	5171
Mégane Phase 2 dTi	1.9	59	04.2001 -	F9QT770	4	DP18	Y-515J	1019
Mégane Scenic dTi	1.9	74	01.1996 -	F9Q716/730/734	4	DP22	Y-740U	5104
Mégane Scenic	1.9	66	01.1996 -	F8Q784/786	4	DP25	Y-932R	4956
Mégane Scenic di	1.9	66	10.1996 -08.1999	F9Q716/730/734	4	DP22	Y-740U	5104
Mégane Scenic	1.9	48	10.1996 -08.1999	F8Q620/624	4	DP19	Y-927R	5171
Mégane Scenic	1.9	48	03.1998 -	F8Q788	4	DP 7	Y-506R	4409
Mégane Scenic	1.9	48	03.1999 -	F8Q622/790	4	DP12	Y-516J	1436



ℓ kW

Cyl. **D-POWER**Order-
No.**RENAULT**

Modus Dci	1.5	59	09.2004 -	K9K	4	DP18	Y-515J	1019
Modus Dci	1.5	48	09.2004 -	K9K	4	DP18	Y-515J	1019
Super 5	1.6	40	09.1985 -12.1990	F8M720/730	4	DP15	Y-913M	3965
R 9 D	1.6	40	01.1983 -03.1991	F8M700/730	4	DP15	Y-913M	3965
R 11 D	1.6	40	01.1983 -08.1989	F8M700/730	4	DP15	Y-913M	3965
R 18 D	2.1	48	08.1980 -02.1986	J8S	4	DP 1	Y-908R	4585
R 18 D	2.1	50	04.1984 -02.1986	J8S	4	DP 1	Y-908R	4585
R 18 TD	2.1	65	04.1984 -02.1986	J8S	4	DP 1	Y-908R	4585
R 19 D	1.9	48	06.1988 -02.1991	F8Q	4	DP 1	Y-908R	4585
R 19 tD	1.9	66	09.1990 -06.1996	F8Q610/740/744/768	4	DP25	Y-933R	6136
R 19 D	1.9	48	03.1991 -12.1995	F8Q706/742/764	4	DP15	Y-913M	3965
R 20 D	2.1	47	12.1979 -04.1981		4		Y-208T	1250
R 20 D	2.1	47	05.1981 -12.1983	J8S736	4	DP 1	Y-908R	4585
R 20 TD	2.1	63	10.1982 -12.1983	J8S	4	DP 1	Y-908R	4585
R 21 D / Nevada	1.9	48	09.1989 -02.1991	F8Q	4	DP 1	Y-908R	4585
R 21 D / Nevada	1.9	48	03.1991 - 1995	F8Q710	4	DP 1	Y-908R	4585
R 21 TD / Nevada	2.1	65	03.1986 -12.1993	J8S...	4	DP 1	Y-908R	4585
R 21 D / Nevada	2.1	53	09.1989 -12.1993	J8S...	4	DP 1	Y-908R	4585
R 25 TD	2.1	63	01.1984 -12.1992	J8S-708-/-738	4	DP 1	Y-908R	4585
R 25 D	2.1	47	01.1984 -12.1992	J8S-736	4	DP 1	Y-908R	4585
R 30 TD	2.1	85	09.1981 -12.1983	J8S	4	DP 1	Y-908R	4585
Rapid	1.9		03.1986 -		4	DP15	Y-913M	3965
Rapid Express	1.9		09.1994 -	F8Q640	4	DP19	Y-927R	5171
Safrane dT	2.1	65	06.1992 -09.1996	J8S760	4	DP 1	Y-908R	4585
Safrane dT	2.5	83	03.1993 -09.1996	S8U762/763	4	DP 1	Y-914U	2643
Safrane Phase 2 dT	2.2	85	10.1996 -11.2000	G8T740	4	DP17	Y-730U	2273
Scenic D	1.9	48	10.1996 -08.1999	F8Q-620/624	4	DP19	Y-927R	5171
Scenic di	1.9	66	10.1996 -08.1999	F9Q-716730/734	4	DP22	Y-740U	5104
Scenic dTi	1.9	74	01.1996 -	F9Q-716/730/734	4	DP22	Y-740U	5104
Scenic D	1.9	48	03.1998 -	F8Q-788	4	DP 7	Y-506R	4409
Scenic D	1.9	48	03.1999 -	F8Q-622/790	4	DP12	Y-516J	1436
Scenic dT	1.9	66	01.1996 -	F8Q-784/786	4	DP25	Y-932R	4956
Scenic dci RX4	1.9	75	1999 -		4	DP18	Y-515J	1019
Scénic 2 dci	1.5	59	2003 -	K9K	4	DP18	Y-515J	1019
Scénic 2 dci	1.9	88	2003 -	F9Q	4	DP18	Y-515J	1019
Scenic Phase 2 dTi	1.9	74	09.1999 -	F9Q-730/734	4	DP22	Y-740U	5104
Scenic Phase 2 dCi	1.9	77	03.1999 -	F9Q718/731/736	4	DP18	Y-515J	1019
Scenic Phase 2 D	1.9	48	09.1999 -		4	DP19	Y-927R	5171
Scenic Phase 2 dCi RX4	1.9	77	09.2000 -	F9Q....	4	DP18	Y-515J	1019
Scenic Phase 2 dTi	1.9	59	06.2001 -	F9Q-T770	4	DP18	Y-515J	1019
Super 5 D	1.6	40	09.1985 -12.1990	F8M-720/730	4	DP15	Y-913M	3965
Supercinc D	1.6	40	09.1985 -		4	DP15	Y-913M	3965
Trafic D T 1000	1.9	45	11.1997 -	F8Q-600/606	4	DP 7	Y-506R	4409
Trafic dCi	1.9	60	05.2001 -	F9Q762	4	DP18	Y-515J	1019
Trafic dCi	1.9	74	05.2001 -	F9Q760	4	DP18	Y-515J	1019
Trafic D T800, T1000, T1200	2.1	43	09.1980 -10.1997	J8S-620/758	4	DP 1	Y-908R	4585
Trafic D P1000, P1200, 4x4	2.1	43	11.1981 -10.1997	852/720/750	4	DP 1	Y-908R	4585
Trafic D T 1000	2.1	56	11.1997 -	S8U-758/780/782	4	DP23	Y-935U	5915
Trafic D	2.5	52	10.1982 -10.1997	S8U	4		Y-208T	1250
Trafic D	2.5	55	03.1990 -10.1997	Sofim 8140	4	DP 1	Y-908R	4585
Vel Satis DCI	2.2	0	03.2002 -12.2003	G9T	4		Y-517J	3319
Vel Satis dCI	2.2	110	03.2002 -12.2003	G9T702	4		Y-517J	3319

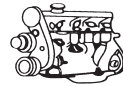

l kW

Cyl. **D-POWER**Order-
No.**RENAULT**

Vel Satis dCi	2.2	85	03.2002 -		4		Y-517J	3319
Vel Satis dCi V6	3.0	132	03.2002 - 12.2003	P9X (Isuzu)	6		*CZ24	
Winnebago	2.1	43	04.1982 - 06.1987	J8S 232, J8S 234	4	DP 1	Y-908R	4585

ROVER

25 TD	2.0	74	11.1999 -		4	DP17	Y-730U	2273
45 TD	2.0	73	11.1999 -		4	DP17	Y-730U	2273
90, 110 D			01.1983 -		4		Y-208T	1250
114 D	1.4	39		Peugeot TUD 3	4	DP33	Y-911R	4544
115 SD/CSD	1.5	57	01.1995 - 1998	TUD 5	4	DP 9	Y-731U	5274
217 SD, 218 SD/SLD	1.9	49	09.1991 -	XUD 9	4	DP 1	Y-902R	2237
218 TD	1.8	65	09.1991 -	XUD 7 TE	4	DP 1	Y-902R	2237
218 D	1.9	49	09.1991 -	XUD 9	4	DP 1	Y-902R	2237
220 SDi	2.0	77	10.1995 -	20T2N (Intercooled)	4	DP17	Y-730U	2273
220 SDi	2.0	63	10.1995 -	20 T2R	4	DP17	Y-730U	2273
400 D			01.1987 -			DP 1	Y-902R	2237
418 SLD/GSD TD	1.8	65	09.1991 - 03.1996	XUD 7 T	4	DP 1	Y-902R	2237
420 D / SD	2.0	63	07.1995 -		4	DP17	Y-730U	2273
420 Di / Sdi	2.0	77	07.1995 -		4	DP17	Y-730U	2273
825 D/SD/SLD	2.5		1990 - 03.1996	VM	4	DP 1	Y-902R	2237
825 SD TD	2.5	87	01.1993 -	VM HR-492/VM 425 SLIRR	4	DP 1	Y-923U	3380
2400 TD			1982 -		4	DP 1	Y-902R	2237
2400 TD SDi	2.4		1982 - 1986		4		Y-909R	4602
420 SDi, SLDi TD	2.0		10.1995 - 1999	20 T2R, 20T2N (Intercooled)	4	DP17	Y-730U	2273
620 SDi, SLDi TD	2.0		10.1995 - 1999	20 T2R, 20T2N (Intercooled)	4	DP17	Y-730U	2273
75 2.0 CDT	2.0	85	1999 -	M47R	4	DP32	Y-507R	4600
75	2.0		02.1999 -	M47R (BMW)	4	DP32	Y-507R	4600
825	2.5		03.1996 - 10.1999	VM	4	DP20	Y-741U	5065
FL 2 / R (Hire Car) D			08.1983 -				Y-208T	1250
FX 4R Taxi D			08.1983 -				Y-208T	1250
Maestro 500/700 D			1986 - 1989		4	DP 1	Y-902R	2237
Maestro Van TD	2.0	60	01.1986 -		4	DP 1	Y-902R	2237
Maestro TD	2.0	60	07.1989 -	Perkins-Prima 80 T	4	DP 1	Y-902R	2237
Metro D	1.4	39	01.1992 - 01.1995	Peugeot TUD 3	4	DP33	Y-911R	4544
Montego TD	2.0	60	09.1988 -	Perkins-Prima 80 T	4	DP 1	Y-902R	2237

SAAB

9-3 TiD	2.2	85	09.1998 -	X22DTH Opel		DP14	Y-748U	5000
9-5 TiD	2.2	88	01.2002 -		4	DP14	Y-748U	5000
9-5 TiD V6	3.0	129	09.2001 -		6		*CZ24	

SEAT

131 D	2.5	52	06.1982 - 12.1984		4		Y-208T	1250
Alhambra TDI	1.9	66	04.1995 -	1Z	4	DP 4	Y-732U	2408
Alhambra TDI	1.9	66	07.1996 - 02.2000	AHU	4	DP 4	Y-732U	2408
Alhambra TDI	1.9	81	1997 -	AFN	4	DP 4	Y-732U	2408
Alhambra TDI	1.9	85	06.2000 -	AUY	4	DP 4	Y-732U	2408
Alhambra	1.9	66	06.2000 -	ANU	4	DP 4	Y-732U	2408
Arosa TDI	1.4	55	09.1999 -	AMF	3	DP 4	Y-732U	2408
Arosa SDI	1.7	44	08.1997 - 04.1998	AKU	4	DP 4	Y-732U	2408
Cordoba / Vario D	1.9	47	02.1993 -	1Y	4	DP 2	Y-918R	4182
Cordoba / Vario TD	1.9	55	02.1993 - 08.1997	AAZ	4	DP 2	Y-918R	4182
Cordoba / Vario TDI	1.9	66	07.1995 - 12.1996	1Z	4	DP 4	Y-732U	2408

* nur über Vertragshändler zu beziehen!

* only available through appointed OE retailer!



ℓ kW

Cyl. **D-POWER**Order-
No.**SEAT**

Cordoba / Vario SDI	1.9	47	07.1996 -	AEY	4	DP 4	Y-732U	2408
Cordoba / Vario TDI	1.9	66	12.1996 -	AHU	4	DP 4	Y-732U	2408
Cordoba / Vario TDI	1.9	81	03.1997 -	AFN	4	DP 4	Y-732U	2408
Cordoba SDI	1.9	50	04.1999 -	AGP	4	DP 4	Y-732U	2408
Cordoba TDI	1.9	81	03.1999 -	ASV	4	DP 4	Y-732U	2408
Cordoba SDI	1.9	50	06.1999 -	AQM	4	DP 4	Y-732U	2408
Cordoba TDI	1.9	66	10.1999 -	ALH	4	DP 4	Y-732U	2408
Cordoba TDI	1.9	66	04.1999 -	AGR	4	DP 4	Y-732U	2408
Ibiza D	1.7	40	06.1984 -08.1987		4		Y-208T	1250
Ibiza D	1.7		09.1987 -		4	DP 1	Y-902R	2237
Ibiza D	1.9	47	02.1993 -	1Y	4	DP 2	Y-918R	4182
Ibiza TD	1.9	55	02.1993 -08.1997	AAZ	4	DP 2	Y-918R	4182
Ibiza TDI	1.9	66	12.1996 -	AHU	4	DP 4	Y-732U	2408
Ibiza TDI	1.9	66	07.1996 -12.1996	1Z	4	DP 4	Y-732U	2408
Ibiza SDI	1.9	47	07.1996 -	AEY	4	DP 4	Y-732U	2408
Ibiza TDI	1.9	81	03.1997 -	AFN	4	DP 4	Y-732U	2408
Ibiza TDI	1.9	66	04.1999 -	AGR	4	DP 4	Y-732U	2408
Ibiza SDI	1.9	50	04.1999 -	AGP	4	DP 4	Y-732U	2408
Ibiza SDI	1.9	50	05.1999 -	AQM	4	DP 4	Y-732U	2408
Ibiza TDI	1.9	81	03.1999 -	ASV	4	DP 4	Y-732U	2408
Ibiza TDI	1.9	66	05.1999 -	ALH	4	DP 4	Y-732U	2408
Inca D	1.7	42	07.1996 -09.2000	AHB	4	DP 2	Y-918R	4182
Inca SDI	1.9	47	11.1995 -09.2000	AEY	4	DP 4	Y-732U	2408
Inca D	1.9	47	11.1995 -	1Y	4	DP 2	Y-918R	4182
Inca SDI	1.9	47	09.2000 -	AYQ	4	DP 4	Y-732U	2408
León TDI	1.9	81	10.1998 -	AHF	4	DP 4	Y-732U	2408
León TDI	1.9	66	03.1999 -	ALH	4	DP 4	Y-732U	2408
León TDI	1.9	81	11.1999 -	ASV	4	DP 4	Y-732U	2408
León TD	1.9	66	04.1999 -	AGR	4	DP 4	Y-732U	2408
León TDI	1.9	110	09.2000 -	ARL	4	DP 4	Y-732U	2408
León SDI	1.9	50	03.2000 -	AQM	4	DP 4	Y-732U	2408
Malaga D	1.7	40	05.1985 -08.1987		4		Y-208T	1250
Malaga D	1.7		09.1987 -08.1991		4	DP 1	Y-902R	2237
Ritmo D	1.7	40	09.1980 -08.1988		4		Y-208T	1250
Ronda D	1.7	40	06.1982 -12.1986	138 A5	4		Y-208T	1250
Ronda D	1.7		09.1987 -08.1988		4	DP 1	Y-902R	2237
Terra D	1.4	35	10.1990 -		4	DP 2	Y-918R	4182
Terra D	1.4	35	01.1990 -		4	DP 2	Y-918R	4182
Terra Kombi D	1.4		10.1991 -	1W	4	DP 2	Y-918R	4182
Toledo D	1.9	47	03.1991 -	1Y	4	DP 2	Y-918R	4182
Toledo TD	1.9	55	03.1991 -	AAZ	4	DP 2	Y-918R	4182
Toledo Tdi	1.9	66	08.1993 -	1Z	4	DP 4	Y-732U	2408
Toledo TDI	1.9	81	1997 -	AFN	4	DP 4	Y-732U	2408
Toledo TDI	1.9	66	03.1999 -	ALH	4	DP 4	Y-732U	2408
Toledo TDI	1.9	81	10.1999 -	ASV	4	DP 4	Y-732U	2408
Toledo TDI	1.9	66	05.1999 -	AGR	4	DP 4	Y-732U	2408
Toledo TDI	1.9	81	05.1999 -	AHF	4	DP 4	Y-732U	2408
Toledo TDI	1.9	110	10.2000 -	ARL	4	DP 4	Y-732U	2408
Toledo SDI	1.9	50	05.2001 -	AQM	4	DP 4	Y-732U	2408

SKODA

Fabia	1.4	55	04.2003 -	AMF	3	DP20	Y-741U	5065
-------	-----	----	-----------	-----	---	-------------	--------	------

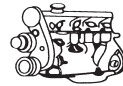

ℓ kW

Cyl. **D-POWER**Order-
No.**SKODA**

Fabia SDI	1.9	47	11.1999 -	ASY	4	DP 4	Y-732U	2408
Fabia TDI PD	1.9	74	01.2000 -	ATD 6Y-2-451088 -->	4	DP20	Y-741U	5065
Fabia TDI PD	1.9	74	01.2000 -	ATD -->6Y-2-451087	4	DP 4	Y-732U	2408
Fabia	1.9	96	06.2003 -	ASZ	4	DP20	Y-741U	5065
Felicia D	1.9	47	10.1995 -08.2001	AEF	4	DP 2	Y-918R	4182
Felicia D	1.9	47	1997 -	AEY	4	DP 4	Y-732U	2408
Octavia SDI	1.9	47	09.1996 -	AEY	4	DP 4	Y-732U	2408
Octavia TD	1.9	66	10.1996 -	AGR	4	DP 4	Y-732U	2408
Octavia TDI	1.9	81	08.1997 -	AHF	4	DP 4	Y-732U	2408
Octavia TDI	1.9	81	1997 -	AFN	4	DP 4	Y-732U	2408
Octavia SDI	1.9	50	05.1997 -	AGP	4	DP 4	Y-732U	2408
Octavia TDI	1.9	66	1997 -	1Z	4	DP 4	Y-732U	2408
Octavia TD (SK)	1.9	50	1997 -		4	DP 2	Y-918R	4182
Octavia TDI	1.9	74	08.2000 -	ATD	4	DP 4	Y-732U	2408
Octavia TDI	1.9	81	10.2000 -	ASV	4	DP 4	Y-732U	2408
Octavia SDI	1.9	50	08.2000 -12.2003	AQM	4	DP 4	Y-732U	2408
Octavia TDI	1.9	66	08.2000 -	ALH	4	DP 4	Y-732U	2408
Octavia TDI	1.9	96	09.2002 -09.2004	ASZ	4	DP20	Y-741U	5065
Pickup	1.9	47	1997 -	AEY	4	DP 4	Y-732U	2408
Superb TDI PD	1.9	96	12.2001 -	AWX	4	DP20	Y-741U	5065
Superb	1.9	74	06.2002 -	AVB	4	DP20	Y-741U	5065
Superb	1.9	96	01.2004 -	AVF	4	DP20	Y-741U	5065
Superb	2.5	114	12.2001 -08.2003	AYM	6	DP31	Y-501U	3786
Superb	2.5	120	06.2003 -	BDG	6	DP31	Y-501U	3786

SSANGYONG

Korando D	2.2	51	01.1993 -	DC 23	4		Y-710J	7880
Korando D	2.3	55	03.1997 -	OM 601 DM	4	DP 6	Y-916R	2785
Korando TD	2.3	73	03.1999 -03.2000		4	DP 6	Y-916R	2785
Korando D	2.9	73	12.1996 -	MB-OM 602	5	DP 6	Y-916R	2785
Korando TD	2.9	88	03.1999 -03.2000		5	DP 6	Y-916R	2785
Musso 601 D	2.3	58	07.1993 -01.2000	MB-OM 601	4	DP 6	Y-916R	2785
Musso TD	2.3	73	03.1999 -03.2000		4	DP 6	Y-916R	2785
Musso 602 D	2.9	73	07.1993 -01.2000	MB-OM 602	5	DP 6	Y-916R	2785
Musso TD	2.9	88	03.1999 -		5	DP 6	Y-916R	2785
Musso Sports 290S TD	2.9	88	03.2004 -		5	DP 6	Y-916R	2785
Rexton RX 270XDI	2.7	115	07.2004 -		5	DP11	Y-745U	4705
Rexton RX 290s	2.9	88			5	DP 6	Y-916R	2785

STEYR

Puch 290 GD	2.9	72	08.1993 -	OM602	5	DP 6	Y-916R	2785
Puch 300 GD	3.0	83	09.1989 -	OM617/603	6	DP 6	Y-916R	2785
Puch 350 GTD	3.5	100	09.1991 -	OM617/603	6	DP 6	Y-916R	2785

SUZUKI

Baleno D	1.9	46	1998 -		4	DP 1	Y-923U	3380
Baleno TD	1.9	55	1998 -		4	DP 1	Y-923U	3380
Grand Vitara D	2.0	81	04.2001 -	HDi PSA	4	DP24	Y-504R	4359
Samurai TD	1.9	46	09.1998 -		4	DP 1	Y-923U	3380
Vitara TD	1.9	50	04.1996 -03.1998		4	DP 1	Y-938R	5267
Vitara TD	1.9	55	1997 - 1998		4	DP 1	Y-923U	3380
Vitara TD	1.9	66	05.2000 -	XUD... PSA Group	4	DP 1	Y-923U	3380



ℓ kW

Cyl. **D-POWER**Order-
No.**SUZUKI**

Vitara D	2.0	52	1995 -	RFL-4	4		Y-701R	7464
----------	-----	----	--------	-------	---	--	--------	------

TALBOT

Express D	1.9	51	11.1987 -	XUD 9 A	4	DP 1	Y-902R	2237
Express D	2.5	55	09.1981 - 10.1993	CRD 93	4		Y-208T	1250
Express TD	2.5	70	09.1981 - 10.1993	CRD 93 LS	4		Y-208T	1250
Horizon D	1.9	47	07.1982 - 06.1986	XUD9	4	DP 1	Y-902R	2237
Horizon D	1.9	51	11.1987 -	XUD9A	4	DP 1	Y-902R	2237
Tagora TD	2.3	59	09.1981 - 06.1983	XD2S	4	DP 1	Y-902R	2237

TAXI

Fairway	2.7			NISSAN	4		Y-707RS	4937
---------	-----	--	--	--------	---	--	---------	------

TOYOTA

4 Runner D	2.4			2L	4		Y-118R	2187
4 Runner TD	2.4		01.1990 - 12.1996	2L-T	4		Y-715R	5376
4 Runner D	2.5		01.1993 -	2L-T	4		Y-715R	5376
4 Runner	2.8			2L	4		Y-168R	2162
4 Runner D	2.8		01.1993 -	3L	4		Y-715R	5376
4 Runner	2.8		1993 -	3L	4		Y-715R	5376
4 Runner (.../KZN185)	3.0	92	10.1993 -	1KZ-T	4		Y-715R	5376
Avensis (CT220)	2.0	66	01.1998 -	2C-T	4		Y-532J	7782
Avensis (CDT220)	2.0	81	07.2000 -	1CD-FTV	4		Y-531J	2979
Camry	2.0		- 1992	1-CT	4		Y-146R	7492
Camry	2.0	62	1990 - 1991	2C-T	4		Y-703R	3782
Carina E	1.8	48	04.1982 - 09.1983	1C	4		Y-146R	7492
Carina E	2.0		02.1992 -	2C	4		Y-703R	3782
Carina II	2.0		- 1992	2C	4		Y-146R	7492
Carina II	2.0		1993 -	2C	4		Y-703R	3782
Coaster			- 1993	13B			Y-147T	7493
Coaster			- 1993	13B			Y-197T	2190
Coaster			02.1972 - 10.1974	B, 2B, 3B	4		Y-128	6426
Coaster			02.1972 - 10.1974	B, 2B, 3B	4		Y-178	7825
Coaster			11.1974 - 04.1982	B, 2B, 3B	4		Y-128T	7227
Coaster			11.1974 - 04.1982	B, 2B, 3B	4		Y-178T	3030
Coaster			05.1982 -	B, 2B, 3B	4		Y-197R	2188
Coaster	4.0		05.1982 -	2H	6		Y-197R	2188
Corolla	1.5			1N,1NT	4		Y-118R	2187
Corolla	1.8		- 1992	1C	4		Y-146R	7492
Corolla	1.8		12.1992 -	1C	4		Y-703R	3782
Corona	2.0		- 1992	2C	4		Y-146R	7492
Corona	2.0		1993 -	2C	4		Y-703R	3782
Corona	2.2		08.1982 -	L	4		Y-118T1	2951
Corona Super Glow System	2.2		08.1982 -	L	4		Y-118R	2187
Corona	2.4			2L / 2L-T	4		Y-118R	2187
Cressida Super Glow System	2.2		08.1982 -	L	4		Y-118R	2187
Cressida	2.2		08.1982 -	L	4		Y-118T1	2951
Cressida	2.5		1993 -	2L	4		Y-715R	5376
Crown			09.1983 - 1991	2L	4		Y-118T1	2951
Crown	2.2		08.1980 -	L	4		Y-118T1	2951
Crown Super Glow System	2.2		08.1980 -	L	4		Y-118R	2187
Crown	2.5		1993 -	2L	4		Y-715R	5376



ℓ kW

Cyl. **D-POWER**Order-
No.**TOYOTA**

Dyna (KDY220,230,250,260)	2.5	0	08.2001 -	2KD-FTV	4		Y-531J	2979
Dyna 2500				2L			Y-118R	2187
Dyna 2500				2L			Y-168R	2162
Dyna 2500			1993 -	2L			Y-715R	5376
Dyna 2800	2.8		1993 -	3L	4		Y-715R	5376
Dyna 3000			08.1977 - 08.1980	2B			Y-128T	7227
Dyna 3000			08.1980 -	2B			Y-197T	2190
Dyna 3000			08.1980 - 04.1982	3B	4		Y-178T	3030
Dyna 3000			04.1982 -	3B	4		Y-197T	2190
Dyna 3000	3.0		02.1972 - 10.1974	B	4		Y-178	7825
Dyna 3000	3.0		02.1972 - 10.1974	B	4		Y-128	6426
Dyna 3000	3.0		10.1974 - 08.1980	B	4		Y-128T	7227
Dyna 3000	3.0		08.1980 - 04.1982	B	4		Y-178T	3030
Dyna 3000	3.0		04.1982 -	B	4		Y-147T	7493
Dyna 3000	3.0		05.1982 - 1989	B	4		Y-197R	2188
Dyna 3000	3.0		1990 - 1991	B	4		Y-178T	3030
Dyna 3000	3.0		1993 -	B / 11B	4		Y-147T	7493
Dyna 3000	3.0		1993 -	B / 11B	4		Y-197T	2190
Dyna 3700			02.1969 - 05.1974	H, 2H	6		Y-452-1	5026
Dyna 3700			02.1969 - 01.1973	2J			Y-402-2	4926
Dyna 3700			02.1969 - 01.1973	2J			Y-452-1	5026
Dyna 3700			05.1972 - 10.1974	H, 2H	6		Y-178	7825
Dyna 3700			01.1973 - 10.1974	2J			Y-178T	3030
Dyna 3700			01.1973 - 10.1974	2J			Y-128T	7227
Dyna 3700			10.1974 - 04.1982	H, 2H	6		Y-178T	3030
Dyna 3700			04.1982 -	H, 2H	6		Y-197R	2188
Dyna 3700			1993 -	14B			Y-197T	2190
Dyna 3700			1993 -	14B			Y-147T	7493
Hiace 3700			1993 -	14B 24V			Y-197T	2190
Hiace 3700			1993 -	14B 12V			Y-147T	7493
Hiace	2.2		07.1979 -	L	4		Y-118T1	2951
Hiace Super Glow System	2.2		07.1979 -	L	4		Y-118R	2187
Hiace	2.4		- 1992	2L 12V	4		Y-118R	2187
Hiace	2.4		- 1992	2L 24V	4		Y-168R	2162
Hiace Super Glow System	2.4		09.1983 - 1992	2L	4		Y-118R	2187
Hiace Super Glow System	2.4		09.1983 - 1992	2L	4		Y-118R	2187
Hiace	2.4		09.1983 - 1992	2L	4		Y-118T1	2951
Hiace 2500 (LH102-104,112-115,125)	2.4		1993 -	2L	4		Y-715R	5376
Hiace (LH102-104,112-115,125)	2.5		1998 -	2L	4		Y-715R	5376
Hiace (KLH 12, 22 28)	2.5	0	08.2001 -	2KD-FTV	4		Y-531J	2979
Hiace 2800	2.8		1993 -	3L	4		Y-715R	5376
Hiace (LH102-104,112-115,125)	2.8		1998 -	3L	4		Y-715R	5376
Hiace 3000	3.0		1993 -	B / 11B 12V	4		Y-147T	7493
Hiace 3000	3.0		1993 -	B / 11B 24V	4		Y-197T	2190
Hilux 2500			- 1990	2C	4		Y-703R	3782
Hilux			09.1983 - 1992	2L	4		Y-118T1	2951
Hilux Super Glow System			09.1983 - 1992	2L	4		Y-118R	2187
Hilux Super Glow System	2.2		07.1979 -	L	4		Y-118R	2187
Hilux	2.2		07.1979 -	L	4		Y-118T1	2951
Hilux	2.4		- 1992	2L 24V	4		Y-168R	2162
Hilux	2.4		- 1992	2L 12V	4		Y-118R	2187
Hilux Super Glow System	2.4		09.1983 - 1992	2L	4		Y-118R	2187



ℓ kW

Cyl. **D-POWER**Order-
No.**TOYOTA**

Hilux 2500	2.4		1993 -	2L	4		Y-715R	5376
Hilux (KDN145,150,165,170,190)	2.5	0	08.2001 -	2KD-FTV	4		Y-531J	2979
Hilux 2800	2.8		1993 -	3L	4		Y-715R	5376
Land Cruiser				3B 4 Zyl., 2H 6Zyl.	6		Y-147T	7493
Land Cruiser			10.1974 -04.1982	H / 2H	6		Y-178T	3030
Land Cruiser			02.1979 -10.1981	2B			Y-178T	3030
Land Cruiser			08.1980 -10.1981	3B 4 Zyl., 2H 6Zyl.			Y-197R	2188
Land Cruiser			10.1981 -	2B			Y-197R	2188
Land Cruiser			05.1982 -	H / 2H	6		Y-197R	2188
Land Cruiser	2.4			2L 2.4L	4		Y-118R	2187
Land Cruiser (HZJ70,73,75)	2.5			2L-T	4		Y-715R	5376
Land Cruiser	2.5		1990 -	2L 2.5L	4		Y-715R	5376
Land Cruiser	2.5		1993 -	2L-T	4		Y-715R	5376
Land Cruiser	2.8		1993 -	3L	4		Y-715R	5376
Land Cruiser (LJ90,95)	2.8		1998 -	3L	4		Y-715R	5376
Land Cruiser (KZJ90,95)	2.8		1998 -	3L	4		Y-715R	5376
Land Cruiser	3.0		02.1974 -01.1975	B	4		Y-128	6426
Land Cruiser	3.0		02.1974 -01.1975	B	4		Y-178	7825
Land Cruiser	3.0		01.1975 -02.1979	B	4		Y-128T	7227
Land Cruiser	3.0		01.1975 -02.1979	B	4		Y-178T	3030
Land Cruiser	3.0		08.1980 -03.1981	B	4		Y-197R	2188
Land Cruiser D4D	3.0	120	2002 -	1KD-FTV	4		Y-531J	2979
Land Cruiser (KDJ 120,125)	3.0	0	09.2002 -	1KD-FTV			Y-531J	2979
Land Cruiser (KZJ120)	3.0	0	09.2002 -	1KD-FTV			Y-531J	2979
Land Cruiser (LJ120,125)	3.0	0	09.2002 -	1KD-FTV			Y-531J	2979
Land Cruiser (HDJ100)	4.2		1998 -	1HD-T	6		Y-532J	7782
Land Cruiser (HZJ105)	4.2		1998 -	1HD-T	6		Y-532J	7782
Liteace 2000	1.8			1C	4		Y-146R	7492
Liteace 2000	2.0			2C	4		Y-703R	3782
Model F / Tarago	2.0			2C	4		Y-146R	7492
Pick-up Super Glow System	2.2		08.1982 -	L	4		Y-118R	2187
Pick-up	2.2		08.1982 -	L	4		Y-118T1	2951
Previa 2.0 D	2.0	85	04.2001 -	1CD-FTV	4		Y-531J	2979
RAV 4 2.0 D	2.0	85	10.2001 -	1CD-FTV	4		Y-531J	2979
Starlet (P7)	1.5	40	12.1986 -11.1989	1N	4		Y-118R	2187
Starlet	1.5		1990 - 1992	1N	4		Y-715R	5376
Starlet	1.5		1993 -	1N	4		Y-715R	5376
Tagora TD		59	09.1981 -06.1983		4	DP 1	Y-902R	2237
Tamarrow	2.2		08.1982 -08.1983	L	4		Y-118T1	2951
Tamarrow Super Glow System	2.2		08.1982 -08.1983	L	4		Y-118R	2187
Tarago	2.0			2C	4		Y-146R	7492
Toyo-Ace			07.1972 -04.1974	2L			Y-178	7825
Toyo-Ace			07.1972 -04.1974	2J			Y-128	6426
Toyo-Ace			04.1974 -08.1980	2L	4		Y-178T	3030
Toyo-Ace			04.1974 -08.1980	2J			Y-128T	7227
Toyo-Ace			08.1980 -01.1982	2J			Y-197T	2190
Toyo-Ace			08.1980 -01.1982	2J			Y-147T	7493
Toyo-Ace			01.1982 -	2L			Y-197R	2188
Toyo-Ace			09.1983 -	2L			Y-168R	2162
Toyo-Ace Super Glow System			09.1983 -	2L			Y-118R	2187
Toyo-Ace			09.1983 -	2L			Y-118R	2187
Toyo-Ace	2.2		04.1974 -08.1980	L	4		Y-178T	3030

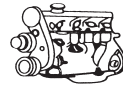

ℓ kW

Cyl. **D-POWER**Order-
No.**TOYOTA**

Toyo-Ace Super Glow System	2.2		03.1979 -	L	4		Y-118R	2187
Toyo-Ace Super Glow System	2.2		03.1979 -	L	4		Y-118R	2187
Toyo-Ace	2.2		03.1979 -	L	4		Y-118T1	2951
Toyo-Ace	2.2		08.1980 -01.1982	L	4		Y-197T	2190
Toyo-Ace	3.0		09.1980 -01.1982	B	4		Y-147T	7493
Toyo-Ace	3.0		09.1980 -01.1982	B	4		Y-197T	2190
Toyo-Ace	3.0		01.1982 -	B	4		Y-197R	2188
Truck			02.1973 -	2L			Y-168R	2162
Truck			02.1973 -	2L			Y-118R	2187

UAZ

425 PP Promiscuo D			08.1981 -	Peugeot	4	DP 1	Y-902R	2237
469 B TD	2.4		-04.1986	VM	4		Y-909R	4602
469 B D	2.5		-11.1985	Peugeot	4	DP 1	Y-902R	2237

VAUXHALL

Astra D	1.6	40	09.1984 -01.1989	16 D, DA OHC	4	DP 1	Y-924U	4950
Astra D	1.7	42	01.1989 -08.1991	17 D OHC II	4	DP 1	Y-924U	4950
Astra D	1.7	42	10.1991 -		4	DP 1	Y-924U	4950
Astra D	1.7	60	10.1991 -		4	DP 1	Y-924U	4950
Astra E D	1.5	37	09.1984 -08.1991	4 EC1 Isuzu --> Mot. 804794	4		Y-306R	6244
Belmont 1.6D	1.6		01.1986 -01.1989		4	DP 1	Y-924U	4950
Brava Pick-up DI D	2.5	56	03.1992 -		6	DP 1	Y-924U	4950
Carlton TD	2.3	74	03.1992 -	23 DTR	6	DP 1	Y-924U	4950
Cavalier D	1.6	40	03.1982 -08.1988	16 D,DA OHC	4	DP 1	Y-924U	4950
Cavalier D	1.7	42	09.1988 -	17 D	4	DP 1	Y-924U	4950
Corsa D	1.5	37	09.1987 -02.1993	15 D/4 EC1 AAD --> Mot. 804 794	4		Y-306R	6244
Frontera Estate TD	2.3	74	01.1992 -	23 DTR	6	DP 1	Y-924U	4950
Nova D, TD	1.5	37	07.1987 -	15D	4	DP 1	Y-902R	2237
Omega TD	2.5	96	02.1994 -	Mot. BMW	6	DP 1	Y-917U	3219

VOLVO

240 D	2.0	50	08.1979 -09.1981	D 20	4	DP 2	Y-918R	4182
240 D	2.4	60	08.1979 -08.1993	D 24	4	DP 2	Y-918R	4182
340 D	1.6	40	09.1984 -07.1991	D 16	4	DP15	Y-913M	3965
360 D	1.6		07.1984 -	D 16	4	DP15	Y-913M	3965
440 TD	1.9	66	01.1993 -12.1996	Renault F8Q Turbo	4	DP25	Y-933R	6136
460 TD	1.9	66	06.1994 -08.1997	D 19 T	4	DP25	Y-933R	6136
740 D	2.4	60	04.1984 -07.1992	D 24	6	DP 2	Y-918R	4182
740 TD (air condition)	2.4	85	08.1987 -07.1992	D 24 TIC	6	DP 2	Y-918R	4182
740 TD	2.4	80	04.1987 -07.1992	D 24 T	6	DP 2	Y-918R	4182
760 TD	2.4	80	08.1982 -07.1987	D 24 T	6	DP 2	Y-918R	4182
760 TD	2.4	85	08.1987 -07.1992	D 24 TIC	6	DP 2	Y-918R	4182
780 TD	2.4	85	08.1985 -	D 24 TIC	6	DP 2	Y-918R	4182
850 TDi	2.5	103		D5252 (Audi)	5	DP 4	Y-732U	2408
940 TD	2.4	80	09.1990 -08.1993	D 24 T	6	DP 2	Y-918R	4182
940 GL, GLE TD	2.4	85	09.1990 -	D 24 TIC	6	DP 2	Y-918R	4182
940 TD Interc., Kombi	2.4	90	01.1994 -	D 24 T	6	DP 2	Y-918R	4182
960 TD Interc.	2.4	85	09.1991 -	D 24 TIC	6	DP 2	Y-918R	4182
F 407/408	3.6	80	04.1978 -02.1986	TD 40A	6		Y-909R	4602
S 40 1.9D	1.9	66	05.1996 -	D4192T	4	DP25	Y-932R	4956
S 40 1.9D	1.9	75	09.2000 -	D4192T4/Di	4	DP18	Y-515J	1019

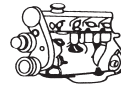

ℓ kW

Cyl. **D-POWER**Order-
No.**VOLVO**

S 40 1.9D	1.9	85	07.2000 -	D4192T3/DI	4	DP18	Y-515J	1019
S 70	2.5	103	01.1997 -	D5252T	5	DP 4	Y-732U	2408
S 70 TDi	2.5	103	01.1997 -	D5252 (Audi)	5	DP 4	Y-732U	2408
S 80 2.5D	2.5	103	01.1999 -	D5252T	5	DP 4	Y-732U	2408
V 40 1.9D	1.9	66	02.1996 -	D4192T	4	DP25	Y-932R	4956
V 40 1.9DCI	1.9		07.2000 -	dCi Renault	4	DP18	Y-515J	1019
V 70 2.5D	2.5	103	01.1997 -03.2000	D5252T	5	DP 4	Y-732U	2408

VW

Beetle TDI	1.9	66	01.1998 -06.2004	ALH	4	DP 4	Y-732U	2408
Beetle TDI	1.9	74	10.2000 -	ATD	4	DP 4	Y-732U	2408
Beetle TDI	1.9	74	06.2003 -	AXR	4	DP20	Y-741U	5065
Bora	1.9	66	10.1998 -09.2002	AGR	4	DP 4	Y-732U	2408
Bora TDI	1.9	66	09.1998 -05.2003	ALH	4	DP 4	Y-732U	2408
Bora TDI	1.9	81	09.1998 -05.2005	AHF	4	DP 4	Y-732U	2408
Bora	1.9	85	11.1998 -07.2001	AJM	4	DP 4	Y-732U	2408
Bora SDI	1.9	50	11.1998 -05.2005	AQM	4	DP 4	Y-732U	2408
Bora TDI Fgst 1J-2-600001 -->	1.9	74	05.2000 -05.2005	ATD	4	DP20	Y-741U	5065
Bora TDI Fgst --> 1J-2-600000	1.9	110	09.2000 -	ARL	4	DP 4	Y-732U	2408
Bora	1.9	50	05.2000 -04.2001	AGP	4	DP 4	Y-732U	2408
Bora TDI Fgst --> 1J-2-600000	1.9	74	05.2000 -05.2005	ATD	4	DP 4	Y-732U	2408
Bora TDI	1.9	81	05.2000 -05.2005	ASV	4	DP 4	Y-732U	2408
Bora TDI Fgst 1J-2-600001 -->	1.9	110	09.2000 -	ARL	4	DP20	Y-741U	5065
Bora TDI	1.9	85	05.2000 -07.2001	AUY	4	DP 4	Y-732U	2408
Bora TDI Fgst --> 1J-2-600000	1.9	74	05.2001 -05.2003	AXR	4	DP 4	Y-732U	2408
Bora TDI Fgst --> 1J-2-600000	1.9	96	04.2001 -05.2005	ASZ	4	DP 4	Y-732U	2408
Bora TDI Fgst 1J-2-600001 -->	1.9	74	05.2001 -05.2003	AXR	4	DP20	Y-741U	5065
Bora TDI Fgst 1J-2-600001 -->	1.9	96	04.2001 -05.2005	ASZ	4	DP20	Y-741U	5065
Caddy	1.6	40	10.1982 -07.1990	JK	4	DP 2	Y-918R	4182
Caddy	1.6	40	08.1990 -07.1992	ME	4	DP 2	Y-918R	4182
Caddy	1.7	42	07.1996 -09.2000	AHB	4	DP 2	Y-918R	4182
Caddy	1.9	47	11.1995 -09.2000	AEY	4	DP 4	Y-732U	2408
Caddy	1.9	47	11.1995 -	1Y	4	DP 2	Y-918R	4182
Caddy	1.9	47	06.1996 -12.2000	AEF	4	DP 2	Y-918R	4182
Caddy TDI	1.9	66	10.1996 -09.2000	AHU	4	DP 4	Y-732U	2408
Caddy SDI	1.9	47	07.1996 -09.2001	AGD	4	DP 4	Y-732U	2408
Caddy TDI	1.9	66	09.1997 -09.2000	ALE	4	DP 4	Y-732U	2408
Caddy SDI	1.9	47	09.2000 -06.2003	AYQ	4	DP 4	Y-732U	2408
Caddy TDI	1.9	66	09.2000 -06.2003	ALH	4	DP 4	Y-732U	2408
Caddy SDI	2.0	51	02.2004 -	BDJ	4	DP20	Y-741U	5065
Golf 1 D	1.5	37	08.1976 -07.1980	CK	4	DP 2	Y-918R	4182
Golf 1	1.6	40	08.1980 -07.1982	CR	4	DP 2	Y-918R	4182
Golf 1 D,TD	1.6	40	08.1980 -10.1991		4	DP 2	Y-918R	4182
Golf 1/ Jetta	1.6	40	08.1982 -12.1984	JK	4	DP 2	Y-918R	4182
Golf 1 TD	1.6	51	03.1982 -12.1983	CY	4	DP 2	Y-918R	4182
Golf 2 D,TD	1.6	40	01.1984 -10.1991		4	DP 2	Y-918R	4182
Golf 2/ Jetta	1.6	59	08.1989 -10.1991	SB	4	DP 2	Y-918R	4182
Golf 2/ Jetta	1.6	44	08.1998 -07.1992	1V	4	DP 2	Y-918R	4182
Golf 3 TD	1.9	55	11.1991 -08.1998	AAZ	4	DP 2	Y-918R	4182
Golf 3 SDI	1.9	47	11.1991 -08.1998	1Y	4	DP 2	Y-918R	4182
Golf 3 TDI	1.9	66	07.1993 -07.1996	1Z	4	DP 4	Y-732U	2408
Golf 3	1.9	47	07.1995 -02.1999	AEY	4	DP 4	Y-732U	2408

Fgst = Chassis No.

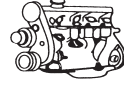

ℓ kW

Cyl. **D-POWER**Order-
No.**VW**

Golf 3 TDI	1.9	66	07.1996 -06.2000	AHU	4	DP 4	Y-732U	2408
Golf 3/ Vento TDI	1.9	66	05.1996 -12.2001	ALE	4	DP 4	Y-732U	2408
Golf 3 TDI	1.9	81	02.1996 -08.1999	AFN	4	DP 4	Y-732U	2408
Golf 4 TDI	1.9	66	10.1997 -05.2003	ALH	4	DP 4	Y-732U	2408
Golf 4 TDI	1.9	66	10.1997 -09.2002	AGR	4	DP 4	Y-732U	2408
Golf 4 TDI	1.9	81	10.1997 -	AHF	4	DP 4	Y-732U	2408
Golf 4 SDI	1.9	50	10.1997 -04.2001	AGP	4	DP 4	Y-732U	2408
Golf 4 SDI	1.9	50	11.1998 -	AQM	4	DP 4	Y-732U	2408
Golf 4 TDI	1.9	85	05.1999 -07.2001	AJM	4	DP 4	Y-732U	2408
Golf 4 TDI	1.9	81	08.1999 -10.2000	AVG	4	DP 4	Y-732U	2408
Golf 4 TDI Fgst 1J-2-600001 -->	1.9	74	02.2000 -	ATD	4	DP20	Y-741U	5065
Golf 4 TDI	1.9	81	05.2000 -	ASV	4	DP 4	Y-732U	2408
Golf 4 TDI Fgst --> 1J-2-600000	1.9	110	09.2000 -	ARL	4	DP 4	Y-732U	2408
Golf 4 TDI	1.9	85	01.2000 -07.2001	AUY	4	DP 4	Y-732U	2408
Golf 4 TDI Fgst 1J-2-600001 -->	1.9	110	09.2000 -	ARL	4	DP20	Y-741U	5065
Golf 4 TDI Fgst --> 1J-2-600000	1.9	74	02.2000 -	ATD	4	DP 4	Y-732U	2408
Golf 4 TDI Fgst --> 1J-2-600000	1.9	74	05.2001 -	AXR	4	DP 4	Y-732U	2408
Golf 4 TDI Fgst --> 1J-2-600000	1.9	96	04.2001 -	ASZ	4	DP 4	Y-732U	2408
Golf 4 TDI Fgst 1J-2-600001 -->	1.9	96	04.2001 -	ASZ	4	DP20	Y-741U	5065
Golf 4 TDI Fgst 1J-2-600001 -->	1.9	74	05.2001 -	AXR	4	DP20	Y-741U	5065
Jetta	1.6	40	08.1980 -02.1984	CR	4	DP 2	Y-918R	4182
Jetta TD	1.6	51	08.1982 -02.1984	CY	4	DP 2	Y-918R	4182
Jetta D,TD	1.6	40	01.1984 -10.1991		4	DP 2	Y-918R	4182
LT	2.4	55	08.1978 -03.1996		5	DP 2	Y-918R	4182
LT TD	2.4	55	07.1978 -11.1982	CP	6	DP 2	Y-918R	4182
LT TD	2.4	55	08.1978 -03.1996		5	DP 2	Y-918R	4182
LT TD	2.4	55	12.1982 -07.1992	DW	6	DP 2	Y-918R	4182
LT TD	2.4	75	12.1982 -07.1992	DV	6	DP 2	Y-918R	4182
LT TD	2.4	68	12.1982 -03.1996		5	DP 2	Y-918R	4182
LT TD 4X4	2.4	55	09.1985 -03.1996		5	DP 2	Y-918R	4182
LT Td	2.4	68	08.1988 -07.1991	1G	6	DP 2	Y-918R	4182
LT	2.4	51	08.1989 -03.1996		5	DP 2	Y-918R	4182
LT TD	2.4	70	08.1991 -12.1995	ACL	6	DP 2	Y-918R	4182
LT	2.4	51	08.1992 -12.1995	ACT	6	DP 2	Y-918R	4182
LT TD	2.5	75	08.1995 -04.1996	ACV	5	DP 4	Y-732U	2408
LT TDI	2.5	75	05.1996 -05.1999	AHD	5	DP 4	Y-732U	2408
LT	2.5	80	05.1999 -	ANJ	5	DP 4	Y-732U	2408
LT	2.5	66	05.1999 -04.2001	APA	4	DP 4	Y-732U	2408
LT TDI	2.5	70	04.2001 -	BBF	5	DP 4	Y-732U	2408
LT TDI	2.5	61	04.2001 -	BBE	5	DP 4	Y-732U	2408
LT TDI	2.5	80	12.2002 -	AVR	5	DP 4	Y-732U	2408
LT 28 D	2.4	55	08.1978 -		6	DP 2	Y-918R	4182
LT 28 D TD	2.4	68	12.1982 -		6	DP 2	Y-918R	4182
LT 28 D	2.4	51	08.1988 -12.1995	1S	6	DP 2	Y-918R	4182
LT 28 SDI	2.5	55	05.1996 -		5	DP 4	Y-732U	2408
LT 28 TDi	2.8	92	05.1996 -		6	DP 4	Y-732U	2408
LT 31 D	2.4	55	08.1978 -		6	DP 2	Y-918R	4182
LT 31 D TD	2.4	68	12.1982 -		6	DP 2	Y-918R	4182
LT 31 D	2.4	51	08.1988 -12.1995	1S	6	DP 2	Y-918R	4182
LT 35 SDI	2.5	55	05.1996 -04.2001	AGX	5	DP 4	Y-732U	2408
LT 35 TDi	2.8	92	05.1996 -		5	DP 4	Y-732U	2408
LT 40 D	2.4	55	08.1978 -		6	DP 2	Y-918R	4182

Fgst = Chassis No.



ℓ kW

Cyl. **D-POWER**Order-
No.

VW								
LT 40 D TD	2.4	68	12.1982 -		4	DP 2	Y-918R	4182
LT 40 D / TD 4X4	2.4	55	09.1985 -		4	DP 2	Y-918R	4182
LT 40 D	2.4	51	08.1988 - 12.1995	1S	6	DP 2	Y-918R	4182
LT 45 D / TD 4X4	2.4	55	08.1978 -		4	DP 2	Y-918R	4182
LT 45 D / TD	2.4	55	09.1985 -		4	DP 2	Y-918R	4182
LT 50 D / TD	2.4	55	08.1978 -		4	DP 2	Y-918R	4182
LT 55 D / TD	2.4	55	08.1978 -		4	DP 2	Y-918R	4182
Lupo TDI	1.2	45	06.1999 - 11.2000	ANY	3	DP 4	Y-732U	2408
Lupo TDI 6x-2-005 001>>	1.2	45	11.2000 -	AYZ	3	DP20	Y-741U	5065
Lupo TDI >>6x-2-005 000	1.2	45	11.2000 -	AYZ	3	DP 4	Y-732U	2408
Lupo TDI 6x-2-005 001>>	1.4	55	05.1999 -	AMF	4	DP20	Y-741U	5065
Lupo TDI >>6x-2-005 000	1.4	55	05.1999 -	AMF	4	DP 4	Y-732U	2408
Lupo SDI	1.7	42	10.1998 -	AKU	3	DP 4	Y-732U	2408
Passat 1 (Typ 32/33) D	1.5	37	08.1977 - 07.1980	CK	4	DP 2	Y-918R	4182
Passat 1 (Typ 32/33) D	1.6	40	08.1980 - 07.1982	CR	4	DP 2	Y-918R	4182
Passat 1 (Typ 32/33) D	1.6	40	08.1980 - 07.1991		4	DP 2	Y-918R	4182
Passat 1 (Typ 32/33)	1.6	40	08.1981 - 03.1988	JK	4	DP 2	Y-918R	4182
Passat 2 (Typ 32B) TD	1.6	51	12.1981 - 03.1988	CY	4	DP 2	Y-918R	4182
Passat 3 (Typ 35i) TD	1.6	59	08.1989 - 10.1993	SB	4	DP 2	Y-918R	4182
Passat 3 (Typ 35i) D,TD	1.9	47	05.1989 - 10.1993	1Y	4	DP 2	Y-918R	4182
Passat 3 (Typ 35i) TDI	1.9	66	08.1989 - 12.1996	1Z	4	DP 4	Y-732U	2408
Passat 3 (Typ 35i) TD	1.9	55	03.1991 - 12.1996	AAZ	4	DP 2	Y-918R	4182
Passat 3 (Typ 35i) TDI	1.9	66	08.1996 - 08.2000	AHU	4	DP 4	Y-732U	2408
Passat 3 (Typ 35i) TDI	1.9	81	03.1996 - 08.1999	AFN	4	DP 4	Y-732U	2408
Passat 4 (Typ 3B) TDI	1.9	66	05.1998 - 08.2000	AHH	4	DP 4	Y-732U	2408
Passat 4 (Typ 3B) TDI	1.9	81	08.1999 - 08.2000	AVG	4	DP 4	Y-732U	2408
Passat 4 (Typ 3B) TDI	1.9	85	01.1999 - 12.1999	AJM	4	DP 4	Y-732U	2408
Passat 4 (Typ 3B) TDI Fgst 3B-2-350-001 -->	1.9	96	10.2000 - 05.2005	AWX	4	DP20	Y-741U	5065
Passat 4 (Typ 3B) TDI Fgst 3B-2-350-001 -->	1.9	96	10.2000 -	AVF	4	DP20	Y-741U	5065
Passat 4 (Typ 3B) TDI Fgst --> 3B-2-350-000	1.9	96	10.2000 - 05.2005	AWX	4	DP 4	Y-732U	2408
Passat 4 (Typ 3B) TDI	1.9	85	01.2000 - 08.2000	ATJ	4	DP 4	Y-732U	2408
Passat 4 (Typ 3B) TDI Fgst --> 3B-2-350-000	1.9	74	10.2000 - 05.2005	AVB	4	DP 4	Y-732U	2408
Passat 4 (Typ 3B) TDI Fgst --> 3B-2-350-000	1.9	96	10.2000 - 05.2005	AVF	4	DP 4	Y-732U	2408
Passat 4 (Typ 3B) TDI Fgst 3B-2-350-001 -->	1.9	74	10.2000 - 05.2005	AVB	4	DP20	Y-741U	5065
Passat 4 (Typ 3B) TDI V6	2.5	110	08.1998 - 08.2000	AFB	6	DP31	Y-501U	3786
Passat 4 (Typ 3B) TDI V6	2.5	110	05.1999 - 05.2003	AKN	6	DP31	Y-501U	3786
Passat 4 (Typ 3B) TDI	2.5	132	01.2003 - 05.2005	BAU	6	DP31	Y-501U	3786
Passat 4 (Typ 3B) TDI	2.5	132	01.2003 - 05.2005	BDH	6	DP31	Y-501U	3786
Passat 4 (Typ 3B) TDI	2.5	120	05.2003 - 05.2005	BDG	6	DP31	Y-501U	3786
Phaeton TDI	5.0	230	12.2002 -	AJS	10	DP20	Y-741U	5065
Polo 2 (Typ 86C..) D	1.3	33	08.1985 - 07.1990	MN	4	DP 2	Y-918R	4182
Polo 2 (Typ 86C..) D	1.4	35	10.1990 - 07.1994	1W	4	DP 2	Y-918R	4182
Polo 3 (Typ 6...) TDI	1.4	55	10.1999 - 05.2005	AMF	3	DP20	Y-741U	5065
Polo 3 (Typ 6...) TDI	1.4	66	01.2000 - 04.2000	ATL	3	DP20	Y-741U	5065
Polo 3 (Typ 6...) SDI	1.7	44	11.1997 - 08.1999	AKW	4	DP 4	Y-732U	2408
Polo 3 (Typ 6...) SDI	1.7	42	04.1997 - 12.1999	AHG	4	DP 4	Y-732U	2408
Polo 3 (Typ 6...) SDI	1.7	42	08.1997 - 04.2000	AKU	3	DP 4	Y-732U	2408
Polo 3 (Typ 6...)	1.9	47	10.1994 - 12.1999	AEF	4	DP 2	Y-918R	4182
Polo 3 (Typ 6...)	1.9	47	12.1995 - 08.1999	AEY	4	DP 4	Y-732U	2408
Polo 3 (Typ 6...) SDI	1.9	47	07.1996 - 09.2001	AGD	4	DP 4	Y-732U	2408
Polo 3 (Typ 6...)	1.9	47	01.1996 - 10.1996	1Y	4	DP 2	Y-918R	4182
Polo 3 (Typ 6...) TDI	1.9	66	01.1997 - 08.1999	AHU	4	DP 4	Y-732U	2408

Fgst = Chassis No.

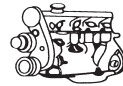

ℓ kW

Cyl. **D-POWER**Order-
No.**VW**

Polo 3 (Typ 6...) TDI	1.9	66	11.1997 -08.1999	ALE	4	DP 4	Y-732U	2408
Polo 3 (Typ 6...) TDI	1.9	81	08.1998 -	AHF	4	DP 4	Y-732U	2408
Polo 3 (Typ 6...) TDI	1.9	81	06.1998 -08.1999	AFN	4	DP 4	Y-732U	2408
Polo 3 (Typ 6...) TDI	1.9	66	10.1999 -09.2001	AGR	4	DP 4	Y-732U	2408
Polo 3 (Typ 6...) SDI	1.9	50	10.1999 -09.2001	AQM	4	DP 4	Y-732U	2408
Polo 3 (Typ 6...) TDI	1.9	66	10.1999 -09.2001	ALH	4	DP 4	Y-732U	2408
Polo 3 (Typ 6...) SDI	1.9	47	10.1999 -09.2001	ASX	4	DP 4	Y-732U	2408
Polo 3 (Typ 6...) TDI	1.9	81	10.1999 -09.2001	ASV	4	DP 4	Y-732U	2408
Polo 3 (Typ 6...) SDI	1.9	50	10.1999 -09.2001	AGP	4	DP 4	Y-732U	2408
Polo 4 TDI	1.4	55	11.2001 -05.2005	BAY	3	DP 4	Y-732U	2408
Polo 4 TDI	1.4	51	04.2005 -	BNM	3	DP20	Y-741U	5065
Polo 4 TDI	1.4	58	04.2005 -	BNV	3	DP20	Y-741U	5065
Polo 4 SDI	1.9	47	11.2001 -05.2005	ASY	4	DP 4	Y-732U	2408
Polo 4 TDI	1.9	74	11.2001 -05.2005	AXR	4	DP20	Y-741U	5065
Polo 4 TDI	1.9	74	11.2001 -05.2005	ATD	4	DP20	Y-741U	5065
Polo 4 TDI	1.9	96	11.2003 -05.2005	ASZ	4	DP 4	Y-732U	2408
Santana D,TD	1.6	40	08.1981 -12.1984		4	DP 2	Y-918R	4182
Santana TD	1.6	51	12.1981 -12.1984	CY	4	DP 2	Y-918R	4182
Santana	1.6	40	08.1981 -07.1982	CR	4	DP 2	Y-918R	4182
Santana	1.6	40	08.1982 -12.1984	JK	4	DP 2	Y-918R	4182
Sharan TDI	1.9	66	09.1995 -07.1996	IZ	4	DP 4	Y-732U	2408
Sharan TDI	1.9	81	02.1996 -07.1999	AFN	4	DP 4	Y-732U	2408
Sharan TDI	1.9	66	08.1996 -02.2000	AHU	4	DP 4	Y-732U	2408
Sharan TDI Fgst--> 7M-2-030-004	1.9	66	03.1999 -05.2005	ANU	4	DP 4	Y-732U	2408
Sharan TDI Fgst 7M-2-030-005 -->	1.9	66	03.1999 -05.2005	ANU	4	DP20	Y-741U	5065
Sharan TDI	1.9	81	08.1999 -02.2000	AVG	4	DP 4	Y-732U	2408
Sharan TDI Fgst 7M-2-030-005 -->	1.9	85	04.2000 -05.2005	AUY	4	DP20	Y-741U	5065
Sharan TDI Fgst --> 7M-2-030-004	1.9	85	04.2000 -05.2005	AUY	4	DP 4	Y-732U	2408
Sharan TDI	1.9	96	11.2002 -05.2005	ASZ	4	DP20	Y-741U	5065
T 2 D	1.6	37	01.1981 -08.1990		4	DP 2	Y-918R	4182
T 2	1.7	42	10.1986 -08.1990		4	DP 2	Y-918R	4182
T 4 D	1.9	44	09.1990 -12.1995	1X	4	DP 2	Y-918R	4182
T 4 TD	1.9	50	10.1992 -04.2002	ABL	4	DP 2	Y-918R	4182
T 4 D	2.4	57	09.1990 -04.1998	AAB	5	DP 2	Y-918R	4182
T 4	2.4	55	04.1997 -06.2003	AJA	5	DP 2	Y-918R	4182
T 4 TDI	2.5	75	05.1997 -11.1999	ACV	5	DP 4	Y-732U	2408
T 4	2.5	65	05.1998 -09.2003	AJT	5	DP 4	Y-732U	2408
T 4	2.5	75	11.1999 -09.2003	AUF	5	DP 4	Y-732U	2408
T 4	2.5	111	07.1999 -09.2000	AHY	5	DP 4	Y-732U	2408
T 4 TDI	2.5	111	09.2000 -09.2003	AXG	5	DP 4	Y-732U	2408
T 4	2.5	75	04.2001 -09.2003	AXL	5	DP 4	Y-732U	2408
T 4 TDI	2.5	75	04.2001 -09.2003	AYC	5	DP 4	Y-732U	2408
Touareg TDI	2.5	128	01.2003 -05.2005	BAC	5	DP20	Y-741U	5065
Touareg TDI	5.0	230	11.2002 -05.2005	AYH	10	DP20	Y-741U	5065
Transporter TDI	1.9	77	04.2003 -	AXB	4	DP20	Y-741U	5065
Transporter TDI	1.9	63	04.2003 -05.2005	AXC	4	DP20	Y-741U	5065
Transporter TDI	2.5	128	04.2003 -	AXE	5	DP20	Y-741U	5065
Transporter TDI	2.5	96	04.2003 -	AXD	5	DP20	Y-741U	5065
Vento TD	1.9	55	01.1992 -12.1997	AAZ	4	DP 2	Y-918R	4182
Vento D	1.9	47	01.1992 -12.1997	1Y	4	DP 2	Y-918R	4182
Vento TDI	1.9	66	07.1993 -07.1996	IZ	4	DP 4	Y-732U	2408
Vento SDI	1.9	47	07.1995 -12.1997	AEY	4	DP 4	Y-732U	2408

Fgst = Chassis No.

Conversion Chart

Vergleichsliste

Tableau de comparaison thermique

Tabla de conversión equivalencias

Jämförelsetabell

Převodní tabulky



BERU	→ NGK	D-POWER
0100101305	DG-237	
0100101306	DG-237	
0100220113	Y-204RS	
0100220114	Y-112M1	
0100220115	Y-112R1	
0100220118	Y-705RS	
0100220206	Y-403T	
0100221101	Y-302	
0100221102	Y-208T	
0100221103	Y-208T	
0100221106	Y-208T	
0100221107	Y-902R	DP 1
0100221125	Y-902R	DP 1
0100221132	Y-902R	DP 1
0100221133	Y-902R	DP 1
0100221135	Y-908R	DP 1
0100221141	Y-909R	
0100221144	Y-911R	DP 33
0100221145	Y-902R	DP 1
0100221146	Y-910R	DP 3
0100221147	Y-115T1	
0100221148	Y-128T	
0100221149	Y-117RS	
0100221151	Y-118T1	
0100221152	Y-204TS1	
0100221154	Y-107R	
0100221163	Y-917U	DP 1
0100221206	Y-404	
0100221210	Y-405	
0100221301	Y-811	
0100222101	Y-118R	
0100222102	Y-168R	
0100222301	Y-403-1	
0100222301	Y-810	
0100222302	Y-810	
0100226129	Y-729U	DP 34
0100226163	Y-913M	DP 15
0100226173	Y-918R	DP 2
0100226180	Y-146R	

BERU	→ NGK	D-POWER
0100226182	Y-147T	
0100226183	Y-115R1	
0100226184	Y-730U	DP 17
0100226185	Y-922R	DP 1
0100226186	Y-923U	DP 1
0100226188	Y-731U	DP 9
0100226189	Y-914U	DP 1
0100226194	Y-707RS	
0100226198	Y-935U	DP 23
0100226227	Y-732U	DP 4
0100226227	Y-732U	DP 4
0100226229	Y-924U	DP 1
0100226234	Y-916R	DP 6
0100226235	Y-925R	DP 16
0100230101	Y-181T	
0100230102	Y-162R1	
0100231104	Y-157R	
0100231107	Y-197R	
0100231109	Y-757RS	
105MJ	Y-403-1	
107M	Y-810	
130MJ	Y-405	
141MJ	Y-207T	
151MJ	Y-208T	
155MJ	Y-404	
161MJ	Y-208T	
162MJ	Y-207T	
170MJ	Y-811	
171MJ	Y-810	
601MJ	Y-918R	DP 2
609MJ	Y-902R	DP 1
613MJ	Y-902R	DP 1
624MJ	Y-902R	DP 1
633MJ	Y-902R	DP 1
950MJ	Y-732U	DP 4
G 2	Y-902R	DP 1
G 3	Y-902R	DP 1
G 4	Y-907R	
GD348	DG-237	



BERU	→ NGK	D-POWER
GD368	DG-237	
GD382	DG-237	
GN003	Y-745U	DP 11
GN005	Y-701J	
GN007	Y-741U	DP 20
GN008	Y-501U	DP 31
GN010	Y-746R	DP 38
GN012	Y-502R	
GN013	Y-938R	DP 1
GN016	Y-503R	DP 10
GN017	Y-747U	DP 26
GN018	Y-515J	DP 18
GN019	Y-516J	DP 12
GN022	Y-937R	DP 5
GN024	Y-507R	DP 32
GN026	Y-517J	
GN027	Y-504R	DP 24
GN033	Y-523J	DP 37
GN035	Y-749J	
GN039	Y-530J	
GN041	Y-534J	DP 36
GN043	Y-532J	
GN044	Y-755RS	
GN047	YE04	
GN853	Y-712RS	
GN854	Y-712RS	
GN855	Y-732U	DP 4
GN857	Y-918R	DP 2
GN858	Y-916R	DP 6
GN860	Y-930U	DP 30
GN905	Y-730U	DP 17
GN908	Y-922R	DP 1
GN909	Y-923U	DP 1
GN912	Y-731U	DP 9
GN917	Y-914U	DP 1
GN921	Y-722J	
GN925	Y-926U	
GN927	Y-935U	DP 23
GN939	Y-525J	DP 35
GN948	Y-925R	DP 16
GN954	Y-924U	DP 1
GN959	Y-932R	DP 25
GN961	Y-929U	
GN963	Y-506R	DP 7
GN964	Y-738U	
GN970	Y-928U	DP 29
GN991	Y-927R	DP 19
GN992	Y-748U	DP 14
GN993	Y-524J	DP 27
GN999	Y-740U	DP 22
GV105	Y-208T	
GV106	Y-403-1	

BERU	→ NGK	D-POWER
GV107	Y-810	
GV108	Y-810	
GV112	Y-302	
GV130	Y-405	
GV137	Y-403T	
GV151	Y-208T	
GV155	Y-404	
GV602	Y-208T	
GV603	Y-902R	DP 1
GV624	Y-902R	DP 1
GV631	Y-907R	
GV636	Y-902R	DP 1
GV642	Y-908R	DP 1
GV657	Y-909R	
GV661	Y-911R	DP 33
GV663	Y-920R	DP 1
GV666	Y-910R	DP 3
GV673	Y-115T1	
GV678	Y-128T	
GV685	Y-117RS	
GV688	Y-118T1	
GV689	Y-204TS1	
GV705	Y-107R	
GV719	Y-917U	DP 1
GV730	Y-739R	
GV749	Y-306R not Opel/Isuzu	
GV783	Y-729U	DP 34
GV844	Y-933R	DP 25
GV852	Y-913M	DP 15
GV880	Y-157R	
GV886	Y-146R	
GV887	Y-181T	
GV888	Y-204RS	
GV889	Y-112M1	
GV890	Y-162R1	
GV892	Y-112R1	
GV894	Y-118R	
GV895	Y-197R	
GV896	Y-168R	
GV897	Y-147T	
GV898	Y-115R1	
GV920	Y-705RS	
GV921	Y-707RS	
GV922	Y-757RS	
GV945	Y-307R	
GV946	Y-742U	
GV947	Y-711J	DP 28
GV968	Y-715R	
BMW	→ NGK	D-POWER
12 23 1 288 245	Y-902R	DP 1
12 23 2 241 389	Y-917U	DP 1



BMW	→ NGK	D-POWER
12 23 2 248 059	Y-507R	DP 32
BOSCH	→ NGK	D-POWER
0250001008	DG-237	
0250001012	DG-237	
0250001016	DG-237	
0250001416	DG-237	
0250200013	Y-811	
0250200014	Y-810	
0250200020	Y-810	
0250200035	Y-302	
0250200037	Y-404	
0250200046	Y-403-1	
0250200048	Y-405	
0250200049	Y-207T	
0250200051	Y-403T	
0250200052	Y-207T	
0250200053	Y-909R	
0250200054	Y-208T	
0250200055	Y-810	
0250200056	Y-208T	
0250200058	Y-208T	
0250200059	Y-208T	
0250200060	Y-208T	
0250200063	Y-207T	
0250200065	Y-208T	
0250200068	Y-208T	
0250200069	Y-908R	DP 1
0250200420	Y-810	
0250200451	Y-403T	
0250200454	Y-208T	
0250200456	Y-208T	
0250200465	Y-208T	
0250200468	Y-208T	
0250201001	Y-902R	DP 1
0250201004	Y-918R	DP 2
0250201005	Y-902R	DP 1
0250201006	Y-908R	DP 1
0250201008	Y-902R	DP 1
0250201009	Y-902R	DP 1
0250201011	Y-918R	DP 2
0250201012	Y-909R	
0250201013	Y-902R	DP 1
0250201015	Y-918R	DP 2
0250201017	Y-907R	
0250201019	Y-902R	DP 1
0250201021	Y-918R	DP 2
0250201026	Y-916R	DP 6
0250201027	Y-917U	DP 1
0250201029	Y-913M	DP 15
0250201032	Y-918R	DP 2
0250201033	Y-923U	DP 1

BOSCH	→ NGK	D-POWER
0250201034	Y-909R	
0250201035	Y-930U	DP 30
0250201038	Y-925R	DP 16
0250201039	Y-902R	DP 1
0250201041	Y-916R	DP 6
0250201043	Y-913M	DP 15
0250201049	Y-937R	DP 5
0250201050	Y-932R	DP 25
0250201405	Y-902R	DP 1
0250201415	Y-918R	DP 2
0250202001	Y-907R	
0250202002	Y-739R	
0250202003	Y-115T1	
0250202004	Y-128T	
0250202005	Y-117RS	
0250202006	Y-118T1	
0250202007	Y-107T	
0250202009	Y-732U	DP 4
0250202013	Y-204RS	
0250202017	Y-112R1	
0250202018	Y-910R	DP 3
0250202020	Y-503R	DP 10
0250202022	Y-732U	DP 4
0250202023	Y-741U	DP 20
0250202024	Y-927R	DP 19
0250202025	Y-730U	DP 17
0250202026	Y-929U	
0250202028	Y-504R	DP 24
0250202029	Y-745U	DP 11
0250202032	Y-504R	DP 24
0250202034	Y-928U	DP 29
0250202035	Y-506R	DP 7
0250202036	Y-534J	DP 36
0250202040	Y-729U	DP 34
0250202041	Y-746R	DP 38
0250202042	Y-748U	DP 14
0250202043	Y-523J	DP 37
0250202051	Y-146R	
0250202054	Y-118R	
0250202064	Y-755RS	
0250202065	Y-904M1	
0250202069	Y-112M1	
0250202076	Y-197R	
0250202077	Y-705RS	
0250202085	Y-742U	
0250202086	Y-306R	
0250202087	Y-711J	DP 28
0250202089	Y-701J	
0250202092	Y-733J	DP 13
0250202093	Y-712RS	
0250202094	Y-722J	
0250202095	Y-532J	



BOSCH	→ NGK	D-POWER
0250202096	Y-715R	
0250202102	Y-501U	DP 31
0250202103	Y-507R	DP 32
0250202119	Y-178T	
0250202125	Y-531J	
0250202128	Y-517J	
0250202129	Y-516J	DP 12
0250202131	Y-524J	DP 27
0250312001	CY51	
0250312002	CY52	
0250312003	CY53	DP 8
0250312007	CY57	DP 21
BRISK	→ NGK	D-POWER
21N01	Y-204TS	
21N21	Y-208T	
21N22	Y-208T	
21N51	Y-909R	
21R01	Y-901R	
21R02	Y-907R	
21R06	Y-918R	DP 2
21R21	Y-902R	DP 1
21R22	Y-908R	DP 1
21R23	Y-902R	DP 1
21R26	Y-913M	DP 15
21R51	Y-909R	
21R71	Y-910R	DP 3
21R71	Y-911R	DP 33
41N71	Y-403T	
81P71	Y-811	
81P71	Y-810	
CASE	→ NGK	D-POWER
MM 431439	Y-142T	
CATERPILLAR/ MITSUBISI	→ NGK	D-POWER
3S9624X	Y-171	
4N360X	Y-159	
9N194X	Y-109	
CHAMPION	→ NGK	D-POWER
AG32	Y-302	
AG44	Y-811	
CH 32	Y-302	
CH 44	Y-811	
CH 60	Y-207T	
CH 61	DG-237	
CH 63	Y-208T	
CH 64	Y-404	
CH 65	Y-810	

CHAMPION	→ NGK	D-POWER
CH 66	Y-403T	
CH 68	Y-902R	DP 1
CH 68 / 002	Y-523J	DP 37
CH 69	Y-901R	
CH 70	Y-909R	
CH 79	Y-907R	
CH 87	Y-208T	
CH 88	Y-902R	DP 1
CH 90	Y-739R	
CH 94	Y-115T1	
CH 95	Y-146R	
CH 95 / 302	Y-703R	
CH 96	Y-204RS	
CH 97	Y-107R	
CH 98	Y-117RS	
CH 99	Y-117SS	
CH101	Y-115R1	
CH102	Y-112M1	
CH103	Y-118T1	
CH104	Y-197R	
CH105	Y-204SS	
CH110	Y-104R	
CH121	Y-118T1	
CH137	Y-908R	DP 1
CH147	Y-910R	DP 3
CH154	Y-715R	
CH158	Y-711J	DP 28
CH159	Y-917U	DP 1
CH160	Y-918R	DP 2
CH161	Y-755RS	
CH162	Y-707RS	
CH163	Y-405	
CH163	Y-923U	DP 1
CH166	Y-747U	DP 26
CH167/302	Y-928U	DP 29
CH169	Y-730U	DP 17
CH170	Y-504R	DP 24
CH171	Y-732U	DP 4
CH172	Y-740U	DP 22
CH173	Y-913M	DP 15
CH174	Y-914U	DP 1
CH175	Y-930U	DP 30
CH176	Y-916R	DP 6
CH176/177	Y-925R	DP 16
CH178	Y-729U	DP 34
CH179	Y-932R	DP 25
CH181	Y-741U	DP 20
CH184	Y-515J	DP 18
CH185	Y-503R	DP 10
CH189	Y-938R	DP 1
CH196	Y-524J	DP 27
CH203	Y-507R	DP 32



CHAMPION	→ NGK	D-POWER
CH204	Y-929U	
CH205	Y-937R	DP 5
CH206	Y-927R	DP 19
CH207	Y-748U	DP 14
CH208	Y-738U	
CH215	Y-501U	DP 31
CH216	Y-502R	
CH217	Y-506R	DP 7
CH218	Y-745U	DP 11
CH219	Y-746R	DP 38
CH600	CY52	
CH601	CY53	DP 8
CH602	CY57	DP 21
CITROEN → NGK D-POWER		
5960.19	YE04	
5962.2Z	Y-503R	DP 10
95493206	Y-208T	
95534788	Y-208T	
HG2621	Y-810	
DAIHATSU → NGK D-POWER		
19850-54030-000	Y-118T	
19850-54050-000	Y-118R	
19850-54070-000	* only O/E	
19850-54071-000	Y-146R	
19850-54090-000	Y-715R	
19850-56010-000	Y-178	
19850-56012-000	Y-178T	
19850-58030-000	Y-128T	
19850-58040-000	Y-178T	
19850-64010-000	Y-146R	
19850-64020-000	Y-703R	
19850-68010-000	Y-147T	
19850-68040-000	Y-178T	
19850-68060-000	Y-197R	
19850-87303-000	Y-108	
19850-87309-000	Y-128T	
19850-87311-000	Y-178TS1	
19850-87312-000	Y-178TS2	
19850-87701-000	Y-146R	
19850-87702-000	Y-703R	
19850-87703-000	* only O/E	
DENSO → NGK D-POWER		
067100-0160	DG-211	
067100-1042	Y-402-2	
067100-1043	Y-452-1	
067100-1070	Y-176	
067100-1071	Y-176	
067100-1090	Y-108	
067100-1120	Y-178	

DENSO	→ NGK	D-POWER
067100-1130	Y-128	
067100-1161	Y-178T	
067100-1170	Y-128T	
067100-1171	Y-128T	
067100-1270	Y-118T1	
067100-1330	Y-147T	
067100-1340	Y-197T	
067100-1350	Y-128T	
067100-1360	Y-178T	
067100-1370	Y-118R	
067100-1380	Y-168R	
067100-1430	Y-146R	
067100-1460	Y-197R	
067100-1530	Y-146R	
067100-1630	Y-118T1	
EIKO → NGK D-POWER		
GD-901	Y-108	
GF-101	Y-175-2	
GF-102	Y-201	
GF-103	Y-274	
GF-104	Y-172	
GF-105	Y-172	
GF-106	Y-102	
GF-108	Y-251	
GF-109	Y-251	
GF-110	Y-180	
GF-111	Y-802-2	
GF-112	Y-115T1	
GH-401	Y-173	
GH-402	Y-176	
GI-001	Y-874-1	
GI-002	Y-808-1	
GI-003	Y-104	
GI-005	Y-104R	
GI-006	Y-154R	
GI-007	Y-154	
GI-008	Y-271-2	
GI-009	Y-154R	
GM-501	Y-107T	
GM-502	Y-107R	
GM-503	Y-157R	
GM-504	Y-172	
GN-301	Y-803-1	
GN-302	Y-103	
GN-303	Y-103-2	
GN-304	Y-202	
GN-305	Y-252	
GN-306	Y-112T	
GN-307	Y-117-1	
GN-308	Y-181T	
GN-309	Y-204TS1	

* nur über Vertragshändler zu beziehen!

* only available through appointed OE retailer!



EIKO	→ NGK	D-POWER
GN-310	Y-103-1	
GN-311	Y-272R1	
GT-201	Y-402-2	
GT-202	Y-452-1	
GT-203	Y-128	
GT-204	Y-178	
GT-205	Y-118T	
GT-207	Y-178T	
GT-208	Y-128T	
GT-211	DG-211	
GT-212	Y-146R	

EUROCARB	→ NGK	D-POWER
-----------------	--------------	----------------

111	Y-918R	DP 2
-----	--------	-------------

FIAT	→ NGK	D-POWER
-------------	--------------	----------------

46447610	Y-928U	DP 29
46451951	Y-504R	DP 24
46754154	Y-534J	DP 36
60812292	Y-922R	DP 1
60814613	Y-747U	DP 26
71719015	Y-920R	DP 1
7735920	Y-922R	DP 1
9633214380	Y-938R	DP 1
9638985980	Y-504R	DP 24
98462492	Y-926U	

FUJI	→ NGK	D-POWER
-------------	--------------	----------------

211-72802-00	Y-401-3	
233-72801-00	Y-113V	

HINO	→ NGK	D-POWER
-------------	--------------	----------------

191101040	Y-176	
1985A56010	Y-178	
1985A56012	Y-178T	
1985A56022	Y-128T	
1985A68060	Y-197R	
6054330901	Y-173	
6301330010	Y-176	

HKT	→ NGK	D-POWER
------------	--------------	----------------

CP-01	CY51	
CP-02	CY52	
PD-190	Y-146R	
PD-191	Y-703R	
PD-99	Y-108	
PH-20	Y-173	
PH-21	Y-176	
PI-12	DG-200A-1	
PI-13	DG-205	
PI-40	Y-874-1	
PI-41	Y-808-1	

HKT	→ NGK	D-POWER
------------	--------------	----------------

PI-42	Y-104	
PI-43	Y-154	
PI-44	Y-271-2	
PI-46	Y-104R	
PI-47	Y-154R	
PI-48	Y-154RS	
PI-49	Y-904M	
PI-50	Y-954M	
PI-57	Y-711RS	
PI-58	Y-710R	
PK-111	Y-159	
PK-98	Y-171	
PM-160	Y-274R	
PM-161	Y-115R1	
PM-60	Y-172	
PM-61	Y-175S2	
PM-61	Y-175-2	
PM-62	Y-102	
PM-63	Y-201	
PM-64	Y-802-2	
PM-65	Y-251	
PM-66	Y-180	
PM-71	Y-172	
PM-73	Y-274	
PM-75	Y-115T1	
PM-78	Y-971M	
PM-79	Y-114T	
PN- 81	Y-103	
PN- 82	Y-252	
PN- 84	Y-202	
PN- 85	Y-103-1	
PN- 86	Y-103-2	
PN- 87	Y-112T	
PN- 88	Y-177-1	
PN- 89	Y-204TS1	
PN-120	Y-181T	
PN-121	Y-204RS	
PN-122	Y-202-2	
PN-123	Y-112M1	
PN-124	Y-162R1	
PN-125	Y-272R1	
PN-126	Y-117RS	
PN-127	Y-117SS	
PN-128	Y-112R1	
PN-129	Y-204SS	
PN-130	Y-272T	
PN-131	Y-755RS	
PN-132	Y-705RS	
PN-133	Y-144SS	
PN-134	Y-144RS	
PN-135	Y-707RS	
PN-136	Y-757RS	



HKT	→ NGK	D-POWER
PN-137	Y-955RS	
PN-138	Y-712RS	
PS-201	Y-103V	
PS-202	Y-106V	
PS-204	Y-106-1	
PS-206	YE01	
PS-207	Y-709R	
PS-209	Y-119V	
PS-210	Y-702U	
PT- 90	Y-402-2	
PT- 93	Y-128	
PT- 94	Y-178	
PT-100	Y-128T	
PT-101	Y-178T	
PT-103	Y-118T1	
PT-104	Y-128T	
PT-107	Y-146R	
PT-108	Y-197T	
PT-109	Y-178T	
PT-140	Y-118R	
PT-141	Y-197R	
PT-142	Y-168R	
PT-144	Y-118T1	
PT-145	Y-147T	
PT-147	Y-146R	
PT-150	Y-703R	
PT-151	Y-715R	
PZ-30	Y-107T	
PZ-31	Y-157R	
PZ-33	Y-107R	
PZ-34	Y-122	
HONDA → NGK D-POWER		
31800-706-000	YS101	
ZA8-97044037-0	Y-719RS	
HYUNDAI → NGK D-POWER		
36710-27000	Y-749J	
36710-42000	Y-722J	
36710-42020	Y-722J	
36710-42500	CY57	DP 21
36710-42510	CY57	DP 21
ISHIKAWAJIMA		
SHIBAUR → NGK D-POWER		
18536-6010	Y-401-3	
18536-6020	Y-122	
18536-6040	Y-107-1	
18536-6060	Y-107V	
18536-6080	Y-107R	

ISUZU	→ NGK	D-POWER
105MN	Y-208T	
5-81410055-2	Y-154R	
5-81410056-3	Y-154RS	
5-81410057-2	Y-154R	
5-81410058-3	Y-154RS	
8-84402303-1	Y-711R	
8-94135377-3	Y-945M1	
8-94135377-3	Y-954M	
8-94175158-0	Y-904M	
8-94221719-3	Y-954M1	
8-94241449-0	Y-104R	
8-94241449-1	Y-104R	
8-94255588-0	Y-104R	
8-94319700-1	Y-710R	
8-94319700-2	Y-710R	
8-94439218-1	Y-104R	
8-94481972-0	Y-711RS	
8-97028369-0	Y-718RS	
8-97033761-0	Y-945M1	
8-97043744-0	Y-719R	
8-97044037-0	Y-719RS	
9-4175158	Y-904M1	
9-82511945-0	Y-874-1	
9-82511978-0	Y-104	
9-82511978-1	Y-104	
9-82511994-0	Y-874-1	
9-82513928-2	Y-271-2	
9-82513959-0	Y-154	
KIA → NGK D-POWER		
OK04S-18140A	Y-721J	
OK054 18140	Y-701J	
36710-27010	Y-749J	
36710-4A000	Y-508J	
KOMATSU → NGK D-POWER		
6004-50-4111	Y-872 S	
6004-50-5001	YS-871T	
6008-15-2110	DG-183 F	
6008-15-2180	DG-183 FH	
6008-15-2310	Y-174S	
6008-15-2320	Y-174S1	
6008-15-2650	Y-174TS	
6008-15-2660	Y-174TS1	
KUBOTA → NGK D-POWER		
11000-4313-1	DG-235-1	
15014-6551-1	DG-205	
15101-6551-1	DG-220 A	
15109-6559-1	Y-809-1	
15204-6551-1	Y-110	
15221-6551-3	Y-106-1	



KUBOTA	→ NGK	D-POWER
15231-6551-2	Y-107-1	
15261-6551-2	Y-103K	
15261-6551-4	Y-103K	
15451-6551-1	Y-203	
15521-6551-0	Y-106V	
15521-6551-1	Y-106	
15521-6551-2	Y-106V	
15571-6551-1	Y-203V	
15571-6551-2	Y-203V	
15694-6551-2	Y-702R	
15806-6551-2	Y-706R	
15806-6551-3	Y-706R	
15951-6551-1	Y-103V	
15951-6551-2	Y-103V	
15951-6551-3	Y-103V	
16241-6551-1	Y-709R	
16241-6551-2	Y-709R	
16292-6551-1	Y-709RS	
16415-6551-1	Y-713R	
16665-6551-2	Y-766MS	
16851-6551-0	YE01	
16851-6551-2	YE01	
17331-6551-1	Y-119V	
17529-6551-1	YA01	
19077-6551-1	Y-716RS	
19077-6551-3	Y-716RS	
19215-6551-1	Y-149	
19215-6551-3	Y-149	
19821-6551-1	Y-301V	
19872-6551-1	Y-756M	
19883-6551-1	Y-752M	
8412	Y-103K	
YF04 / 95Y4	Y-E01	
KYATAPIRA	→ NGK	D-POWER
9N-0194	Y-108	
LUCAS	→ NGK	D-POWER
DS001	Y-902R	DP 1
DS002	Y-901R	
DS003	Y-902R	DP 1
DS006	Y-208T	
DS101	DG-237	
HDS217	Y-901R	
HDS218	Y-907R	
HDS218	Y-902R	DP 1
HDS220	Y-403T	
HDS221	Y-206T	
HDS221	Y-208T	
HDS224	Y-405	
HDS225	Y-908R	DP 1
HDS225	Y-810	

LUCAS	→ NGK	D-POWER
HDS226	Y-204	
HDS226	Y-404	
HDS227	Y-302	
HDS230	Y-117RS	
HDS231	Y-204RS	
HDS232	Y-115T1	
HDS232	Y-115T	
HDS233	Y-146R	
HDS234	Y-118T	
HDS235	Y-118R	
HDS236	Y-178	
HDS237	Y-197T	
HDS238	Y-178T	
HDS239	Y-112M1	
HDS240	Y-162R1	
HDS241	Y-107R	
HDS242	Y-197R	
HDS243	Y-112T	
HDS244	Y-157R	
HDS245	Y-128T	
HDS246	Y-181T	
HDS247	Y-104R	
HDS248	Y-103K	
HDS248	Y-103	
HDS249	Y-104	
HDS250	Y-160	
HDS250	Y-251	
HDS251	Y-203	
HDS252	Y-128	
HDS253	Y-117SS	
HDS254	Y-204SS	
HDS256	Y-103-1	
HDS256	Y-301-1	
HDS257	Y-103-2	
HDS258	Y-204TS1	
HDS259	Y-144RS	
HDS262	Y-715R	
HDS262	Y-128T	
HDS267	Y-909R	
HDS268	Y-147T	
HDS269	Y-274	
HDS270	Y-115R1	
HDS272	Y-107T	
HDS273	Y-910R	DP 3
HDS275	Y-703R	
HDS276	Y-707RS	
HDS280	Y-112R1	
HDS282	Y-108	
HDS283	Y-705RS	
HDS284	Y-168R	
HDS291	Y-177-1	
HDS294	Y-757RS	



LUCAS	→ NGK	D-POWER
HDS295	Y-920R	DP 1
HDS316	DG-237	
HDS337	Y-907R	
HDS338	Y-711R	
HDS339	Y-911R	DP 33
HDS340	Y-755RS	
HDS343	Y-901R	
HDS343	Y-204V	
HDS343	Y-207TS	
HDS343	Y-207T	
HDS345	Y-710R	
HDS346	Y-711RS	
HDS347	Y-913M	DP 15
MARELLI	→ NGK	D-POWER
TIX1A	Y-207T	
TIX2A	Y-208T	
TIX4A	Y-208T	
TIX6A	Y-208T	
UX1A	Y-901R	
UX2A	Y-902R	DP 1
UX4A	Y-902R	DP 1
MAZDA	→ NGK	D-POWER
1304-18140	Y-172	
1304-18-140	Y-172	
1353-18140	Y-107T	
1353-18140A	Y-107T	
1456-18101A	YD-802	
1456-18101B	YD-803	
1470-18101	YD-802B	
1470-18101A	YD-803B	
4869-18140	Y-122	
4869-18-140A	Y-122	
R2L2-18-601	Y-721RS	
RFG1-18-601	Y-701J	
RFJ5-18601	Y-701R	
RFJ5-18-601	Y-701R	
S201-18140	Y-107R	
S210-18140	Y-701J	
S501-18140A	Y-107R	
SE01-18140A	Y-157R	
SE01-18-140A	Y-157R	
SEM1 18601	Y-771R	
SEM1-18601	Y-771R	
VS01-18601	Y-721RS	
WL03-18.601	Y-701J	
WL03-18-601	Y-701J	
Y701-18-601	*CX03	

MERCEDES	→ NGK	D-POWER
000 159 61 01	DG-237	
000 159 81 01	Y-902R	DP 1
001 159 15 01	Y-930U	DP 30
001 159 20 01	Y-925R	DP 16
001 159 21 01	Y-925R	DP 16
001 159 26 01	Y-929U	
001 159 27 01	Y-746R	DP 38
001 159 28 01	Y-745U	DP 11
001 159 35 01	Y-923U	DP 1
001 159 36 01	Y-916R	DP 6
MITSUBISHI	→ NGK	D-POWER
30666-57301	Y-114T	
30L66-00300	Y-723R	
30L66-00301	Y-723R	
30L66-00302	Y-723R	
30L66-00400	Y-723U	
30L66-00401	Y-723U	
30L66-00402	Y-723U	
31366-02100	Y-251	
31366-02109	Y-251	
31366-14300	Y-201	
31366-14301	Y-201	
31366-14302	Y-201	
31366-14701	Y-251	
31A66-03100	Y-701U	
32A66-07200	Y-954M1	
34466-21301	Y-182T	
34466-31301	Y-182T1	
36710-42500	CY57	DP 21
M 816 732	Y-932R	DP 25
MD 014 997	Y-115R1	
MD 050 212	Y-115T1	
MD 077167	Y-707RS	
MD 301 950	Y-733J	DP 13
MD 344 469	Y-733J	DP 13
ME 017 009	Y-274R	
ME 017 010	Y-274	
ME 017 013	Y-274	
ME 017 057	Y-971M	
ME 200 970	CY55	
ME 201 638	CY55	
ME 203 539	Y-532J	
ME 203 754	CY55	
MM 105 560	Y-251	
MM 401 621	Y-110	
MM 432 148	Y-145T	
MR 577 131	Y-733J	DP 13
MOTORCRAFT	→ NGK	D-POWER
EZD 1	Y-810	
EZD 5	Y-902R	DP 1

* nur über Vertragshändler zu beziehen!

* only available through appointed OE retailer!



MOTORCRAFT	→ NGK	D-POWER
EZD10	Y-901R	
EZD18	Y-115T1	
EZD19	Y-128T	
EZD20	Y-117RS	
EZD21	Y-118T1	
EZD22	Y-107T	
EZD24	Y-104R	
EZD40	YE04	
1 037 204	Y-732U	DP 4
1 056 857	Y-937R	DP 5
1 079 401	Y-524J	DP 27
1 096 527	Y-525J	DP 35
1 148 105	YE04	
1 690 048	Y-741U	DP 20
2S6Q 6M090 AA	YE04	
3 252 725	Y-107R	
4 025 139	Y-701J	
5 023 372	Y-208T	
5 031 006	Y-923U	DP 1
6 132 246	Y-907R	
6 154 593	Y-902R	DP 1
7 088 988	Y-910R	DP 3
84BB 6M090 AA	Y-902R	DP 1
84FF 6M090 B2A	Y-907R	
93 FF 6M090 AA	Y-910R	DP 3
95VW 6M090 AB	Y-732U	DP 4
96FF 6M090 CA	Y-937R	DP 5
V94DX 6M090 AA	Y-923U	DP 1
V95DD 6M090 AA	Y-741U	DP 20
XM34 12A342 BA	Y-701J	
XS4U 6M090 AB	Y-524J	DP 27
XS7U 6M090 BA	Y-525J	DP 35
NGK	→ NGK	D-POWER
CY53	CY53	DP 8
CY57	CY57	DP 21
Y-501U	Y-501U	DP 31
Y-503R	Y-503J	DP 10
Y-504R	Y-504J	DP 24
Y-506R	Y-506J	DP 7
Y-507R	Y-507J	DP 32
Y-515J	Y-515J	DP 18
Y-516J	Y-516J	DP 12
Y-523J	Y-523J	DP 37
Y-524J	Y-524J	DP 27
Y-525J	Y-525J	DP 35
Y-534J	Y-534J	DP 36
Y-711J	Y-711J	DP 28
Y-729U	Y-729U	DP 34
Y-730U	Y-730U	DP 17
Y-731U	Y-731U	DP 9

NGK	→ NGK	D-POWER
Y-732U	Y-732U	DP 4
Y-733J	Y-733J	DP 13
Y-740U	Y-740U	DP 22
Y-741U	Y-741U	DP 20
Y-745U	Y-745U	DP 11
Y-746R	Y-746J	DP 38
Y-747U	Y-747U	DP 26
Y-748U	Y-748U	DP 14
Y-902R	Y-924J	DP 1
Y-908R	Y-924J	DP 1
Y-910R	Y-910J	DP 3
Y-911R	Y-911J	DP 33
Y-913M	Y-913J	DP 15
Y-914U	Y-924J	DP 1
Y-916R	Y-916J	DP 6
Y-917U	Y-924J	DP 1
Y-918R	Y-918J	DP 2
Y-920R	Y-924J	DP 1
Y-922R	Y-924J	DP 1
Y-923U	Y-924J	DP 1
Y-924U	Y-924J	DP 1
Y-925R	Y-925J	DP 16
Y-927R	Y-927J	DP 19
Y-928U	Y-928U	DP 29
Y-930U	Y-930U	DP 30
Y-932R	Y-933J	DP 25
Y-933R	Y-933J	DP 25
Y-935U	Y-935U	DP 23
Y-937R	Y-937J	DP 5
Y-938R	Y-924J	DP 1
NISSAN	→ NGK	D-POWER
11065-02T00	Y-955RS	
11065-0W801	CY58	
11065-10G00	Y-705RS	
11065-10T01	Y-757RS	
11065-16A00	Y-117SS	
11065-16A01	Y-144SS	
11065-16A05	Y-117RS	
11065-16A06	Y-144RS	
11065-16A10	Y-117SS	
11065-16A11	Y-144SS	
11065-16A15	Y-117RS	
11065-16A16	Y-144RS	
11065-29W00	Y-112RS1	
11065-31N00	Y-712RS	
11065-31W00	Y-112T	
11065-31W01	Y-112T	
11065-31W02	Y-112TS	
11065-34W00	Y-112M1	
11065-37501	Y-803	
11065-37503	Y-805	



NISSAN	→ NGK	D-POWER
11065-37506	Y-103	
11065-37507	Y-103	
11065-43G01	Y-707RS	
11065-57J00	CY52	
11065-5C900	CY52	
11065-63G00	Y-707RS	
11065-65N01	CY58	
11065-7C000	Y-530J	
11065-9C600	Y-712RS	
11065-AD200	Y-519J	
11065-AD220	Y-519J	
11065-C0300	Y-177	
11065-C8600	Y-755RS	
11065-D2800	Y-120RS	
11065-G2400	Y-712RS	
11065-G2460	Y-712RS	
11065-G5501	CY51	
11065-J2000	Y-202	
11065-J5500	Y-202-1	
11065-J5501	Y-202-2	
11065-J5502	Y-202-2	
11065-J5503	Y-252-1	
11065-J5504	Y-252-1	
11065-J5570	Y-222T	
11065-J6500	Y-272T	
11065-K6700	Y-160	
11065-OW801	CY58	
11065-Q4000	Y-103-2A	
11065-Q4001	Y-112T1	
11065-T3400	Y-177-1	
11065-T3401	Y-177-1	
11065-T3470	Y-181T	
11065-T8200	Y-112R1	
11065-T8201	Y-162R1	
11065-T8202	Y-112R1	
11065-T8203	Y-162R1	
11065-T9000	Y-272R1	
11065-T9001	Y-272R1	
11065-V0700	Y-204TS1	
11065-V0710	Y-204TS1	
11065-V7202	CX51	
11065-V7203	CZ51	
11065-W2500	Y-204RS	
11065-W2510	Y-204RS	
11065-W3400	Y-204SS	
11065-W3410	Y-204SS	
11065-Y1400	Y-103-1	
11065-Y1401	Y-103-1	
11065-Y1402	Y-103-2	
11065-Y1403	Y-103-2	
11065-Y1404	Y-103-2	
11065-Z5000	Y-252	

NISSAN	→ NGK	D-POWER
82 00 012 099	Y-517J	
RFJ5 18 601	Y-701R	
OPEL	→ NGK	D-POWER
1214300	Y-810	
1214302	Y-403-1	
1214303	Y-403T	
1214304	Y-208T	
1214305	Y-523J	DP 37
1214305	Y-902R	DP 1
1214308	Y-306R	
1214309	Y-307R	
1214310	Y-719RS1	
1214311	Y-710R	
1214311	Y-742U	
1214315	Y-719RS	
1214316	CY53	DP 8
1214319	Y-924U	DP 1
1214321	Y-904M	
1214324	Y-917U	DP 1
1214427	Y-741U	DP 20
1214457	Y-748U	DP 14
4403145	Y-935U	DP 23
90093897	Y-208T	
94133759	Y-904M1	
94481972	Y-719RS1	
97044037	Y-719RS1	
97080554	CY53	DP 8
PEUGEOT	→ NGK	D-POWER
5960.12	YE04	
5961.16	Y-404	
596122	Y-810	
596135	Y-810	
596139	Y-902R	DP 1
596153	Y-208T	
596154	Y-208T	
596158	Y-208T	
5962.03	Y-503R	DP 10
5962.1Q	Y-738U	
5962.2Y	Y-731U	DP 9
5962.3C	Y-504R	DP 24
5962.3H	Y-938R	DP 1
5962.J3	Y-911R	DP 33
5962.T1	Y-911R	DP 33
5962.T2	Y-933R	DP 25
7932565882	Y-810	
7932567718	Y-208T	
9150860280	Y-902R	DP 1
9190861080	Y-902R	DP 1

Codes für Profis:

So erkennen Sie den NGK Glühkerzentyp

Der jeweilige Typ einer NGK Glühkerze entschlüsselt sich anhand entsprechender Kurzbezeichnungen.

Stabglühkerzen



Y, YS:
Stabglühkerzen

YD:
Stabglühkerzen mit
doppelten Isolatoren

Unterschiedliche
Gewindedurchmesser:
1:10 mm
2:12 mm
3:10 mm
4:14 mm
5:10 mm (2 Wendel)
7:10 mm (2 Wendel)
8:18 mm
9:12 mm (2 Wendel)

Anmerkung:
Y-109, Y-159 und
Y-171 für Caterpillar
Mitsubishi haben
einen Gewindedurch-
messer von 3/8"
(= ca. 9,5 mm)

Batteriespannung:
0-4: 12 V
5-9: 24 V

Diese Ziffer ist die
Seriennummer.

Temperaturanstieg:

V:
Schnellstart
T:
Schnellstart (außer YS-
871T, das ist eine
Standard-Glühkerze)

R, M:
QGS (auch Y-117SS
und Y-204SS)

J:
SRM

K oder kein Buchstabe:
Standard

B:
Änderung

U:
QGS

Material des
Glühstabs

Modifikation

Glühwendeltyp



Y: Stabglühkerze

E: 8 mm
(QGS oder SRM)

Die letzten beiden Ziffern bilden die Serien-
nummer.



DG: Wendeltyp

Diese drei Ziffern
bilden die
Seriennummer.

Keramikglühkerzen



C: Keramikglühkerze

Y: SRC
Z: QGS
X: QGS mit
doppelten
Isolatoren

Die letzten beiden Ziffern bilden die Serien-
nummer.

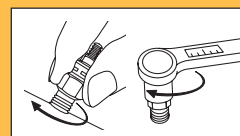

Anmerkungen zur Tabelle

△ = nur für Fahrzeuge mit Wegfahrsperre!

◆ = nur für Fahrzeuge ohne Wegfahrsperre!

* = nur über Vertragshändler zu beziehen!

Abbildungen siehe ab Seite 7

Pictures look at page 7

Ø	
10mm	15~20N·m (1.5~2.0Kgm)
12mm	20~25N·m (2.0~2.5Kgm)
14mm	20~25N·m (2.0~2.5Kgm)
18mm	20~30N·m (2.0~3.0Kgm)

Design symbols used in NGK glow plugs

Sheated types



Y, YS:
Body earth type
YD:
Insulated type

Thread size and
Number of coils
1.3: Ø 10 mm
(Single)
2: Ø 12 mm
(Single)
3: Ø 10 mm
(Single)
4: Ø 14 mm
(Single)
5: Ø 10 mm
(Double)
7: Ø 10 mm
(Double)
8: Ø 18 mm
(Single)
9: Ø 12 mm
(Double)

Battery voltage:
0---4: 12 V
5---9: 24 V

Serial number

Temperature
characteristic
None: standard type
T: rapid glow type
R: Q.G.S. Type

Material in tube
none: normal
S: Special material
Against heat

Revisions Number



Y: Body earth type

E: 8 mm
(QGS or SRM)

Serial number



C: Ceramic

Y: SRC
Z: QGS
X: QGS

Serial number

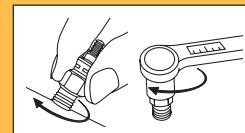

Remarks to the table

- △ = Only for vehicles with anti-drive-off theft protection.
- ◆ = Only for vehicles without anti-drive-off theft protection.
- ※ = only available through appointed retailer.

Abbildungen siehe ab Seite 7
Pictures look at page 7

Ø	
10mm	15~20N·m (1.5~2.0Kgm)
12mm	20~25N·m (2.0~2.5Kgm)
14mm	20~25N·m (2.0~2.5Kgm)
18mm	20~30N·m (2.0~3.0Kgm)

Symbols utilisé

Y-204T S1

Y: Type à masse par le culot YD:	Taille de filetage et nombre d'éléments 1:10 mm Chauffant seul 2:12 mm Chauffant seul 3:10 mm Chauffant seul 4:14 mm Chauffant seul 5:10 mm Chauffant seul (Double) 7:10 mm Chauffant seul (Double) 8:18 mm Chauffant seul 9:12 mm Chauffant seul (Double)	Tension batterie 0-4: 12 V 5-9: 24 V	Numéro de serie	Caractéristique thermique Rien: Type classique (800 °C in 20-25 sec.) T: Type à chauffage rapide (800 °C in 13-15 sec.) R: Type Q.G.S. (900 °C in 06 sec.)	Matériaux du tube d'incandescence Rien: Normal S: Matériau special très hautes températures	indice d'évolution
--	---	---	------------------------	---	--	---------------------------

Y E 0 1

Y: Type à masse par le culot	E: 8 mm	Numéro de serie
--	----------------	------------------------

DG 237

DG: Bougie céramique	Numéro de série
--------------------------------	------------------------

C Y 0 1

Bougies Céramiques	Numéro de serie
---------------------------	------------------------

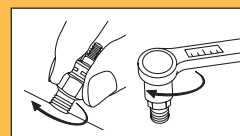

- △ = Seulement pour voitures avec anti demarrage.
- ◆ = Seulement pour voitures sans anti demarrage.
- * = disponible uniquement dans le reseau constructeur.

Abbildungen siehe ab Seite 7
Pictures look at page 7

Ø	
10mm	15~20N·m (1.5~2.0Kgm)
12mm	20~25N·m (2.0~2.5Kgm)
14mm	20~25N·m (2.0~2.5Kgm)
18mm	20~30N·m (2.0~3.0Kgm)

Symbolverklaring

Y-204T S 1

Y, YS: Gloeibougjie
YD:

Draaddiameter
1: Ø 10 mm
2: Ø 12 mm
4: Ø 14 mm
8: Ø 18 mm

Accuspanning
0-4: 12 Volt
5-9: 24 Volt

Serienummer

Voorgloeitijd

Geen: Normaal
(800 °C in 20-25 sec.)

V: Kort starten
(800 °C in 15-17 sec.)

T: Kort starten
(800 °C in 13-15 sec.)

R: Snel starten
(900 °C in 06 sec.)

S/M: Snel starten
(900 °C in 10 sec.)

S wordt niet meer
gebruikt, behalve
Y-204 SS.

Materiaal in het
omhulsel

Geen: Normaal
S: Speciaal mate-
riaal tegen
oververhitting
Materiale

Wijzigingsnummer

Y E 0 1

Y, YS: Gloeibougjie
YD:

E: 8 mm

Serienummer

DG 237

DG: Gloeispiraal
bougjie
(Draaddiameter
bij alle typen
Ø 18 mm)

Serienummer

C Y 0 1

C: Ceramic

Y: SRC
Z: QGS
X: QGS

Serienummer

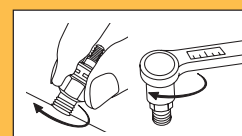

△ = Alleen voor auto's met start onderbreking.

◆ = Alleen voor auto's zonder start onderbreking.

* = deze gemerkte gloei bougies zijn alleen verkrijgbaar via de dealers
= van het automerk.

Abbildungen siehe ab Seite 7

Pictures look at page 7

Ø	
10mm	15~20N·m (1.5~2.0Kg)
12mm	20~25N·m (2.0~2.5Kg)
14mm	20~25N·m (2.0~2.5Kg)
18mm	20~30N·m (2.0~3.0Kg)

Explicación de la codificación

Y-204TSS1

Y:
Bujía de calentamiento

Tamaño de la rosca

1: Ø 10 mm
2: Ø 12 mm
4: Ø 14 mm
8: Ø 18 mm

Voltaje de la batería

0 - 4 : 12 Volt
5 - 9 : 24 Volt

Número de serie

Tiempo de precalentamiento

Nada: Normal
(800 °C en 20-25 sec.)

V : Rápido
(800 °C en 15-17 sec.)

R : Super rápido
(900 °C en 06 sec.)

S/M : Super rápido
(900 °C en 10 sec.)

S no utilizado actualmente excepto para Y-204 SS.

Material del tubo

Nada: Normal
S : Material especial contra el sobrecalentamiento

Número de modificación del proyecto

YE01

Y:
Bujía de calentamiento

E: 8 mm

Número de serie

DG 237

DG: Bujías de calentamiento tipo espiral

Número de serie

(Únicamente rosca de Ø 18 mm)

CY01

C: Ceramics

Y: SRC
Z: QGS
Y: QGS

Número de serie

* Marcados con * calentadores que están disponibles solamente a través de las redes concesionarias de automóviles de algunas marcas en concreto.

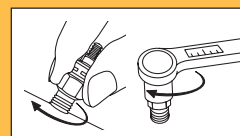

- △ = Only for cars with immobilizer
- ◆ = Only for cars without immobilizer
- * = marked g glow plugs are only available by special dealers of automobile manufacturer.

Abbildungen siehe ab Seite 7
Pictures look at page 7

Ø	
10mm	15~20N·m (1.5~2.0Kgm)
12mm	20~25N·m (2.0~2.5Kgm)
14mm	20~25N·m (2.0~2.5Kgm)
18mm	20~30N·m (2.0~3.0Kgm)

Explicação da codificação



Y: Vela incandescente	Tamanho da rosca 1 : Ø 10 mm 2 : Ø 12 mm 4 : Ø 14 mm 8 : Ø 18 mm	Voltagem da bateria 0 - 4 : 12 Volt 5 - 9 : 24 Volt	Número de serie	Tempo de pré-aquecimento Nada: Normal (800 °C em 20-25 seg.) V: Rápido (800 °C em 15-17 seg.) T: Rápido (800 °C em 13-15 seg.) R: Super rápido (900 °C em 06 seg.) S/M: Super rápido (900 °C em 10 seg.) S não utilizado atualmente exceto para Y-204 SS.	Material do tubo Nada: Normal S: Material especial contra superaquecimento	Número de alteração do projeto
---------------------------------	---	--	------------------------	--	---	---------------------------------------



Y: Vela incandescente	E: 8 mm	Número de serie
---------------------------------	----------------	------------------------



DG: Vela incandescente tipo espiral (Unicamente rosca de Ø 18 mm)	Número de série
--	------------------------



C: Ceramics	Y: SRC Z: QGS Y: QGS	Número de serie
--------------------	-------------------------------------	------------------------

* Marcado com * velas incandescentes que são disponíveis somente através das redes concessionárias de automóveis de algumas marcas especiais.

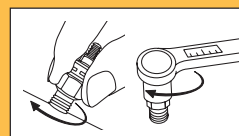

Remarks to the table

- △ = Sólo para coches con inmovilizador electrónico
- ◆ = Sólo para coches sin inmovilizador electrónico
- * = Marcados con g calentadores que están disponibles solamente a través de las redes concesionarias de automóviles de algunas marcas en concreto

Abbildungen siehe ab Seite 7
Pictures look at page 7

Ø	Torque
10mm	15~20N·m (1.5~2.0Kgm)
12mm	20~25N·m (2.0~2.5Kgm)
14mm	20~25N·m (2.0~2.5Kgm)
18mm	20~30N·m (2.0~3.0Kgm)

DECODIFICA DEI CODICI CANDELETTE AD INCANDESCENZA

CANDELETTA CON BULBO METALLICO

In questo tipo di candelella la spirale di riscaldamento è protetta da un bulbo metallico con elevata resistenza alle alte temperature: la spirale non viene esposta ai gas di combustione migliorandone la durata.



Y,YS: bulbo metallico
YD: bulbo metallico e doppio isolatore

Filettatura
1 o 3: 10mm – spirale singola
2: 12mm – spirale singola
4: 14mm – spirale singola
7: 10mm – spirale doppia (auto regolante)
8: 18mm – spirale singola
9: 12mm – spirale singola (auto regolante)
Nota: Y-109, Y-159 e Y-171 per le macchine movimento terra Mitsubishi hanno una filettatura di 3/8" (ca 9,5mm)

Voltaggio
0-4: 12V
5-9: 24V

N° di serie

Caratteristiche di temperatura
V, T: tipo a riscaldamento rapido (ad eccezione di YS-871T, di tipo standard)

R, M, U: tipo QGS (includendo Y-117SS e Y-204SS, ad eccezione di Y-700R e Y-900R che sono del tipo auto regolante)

J: tipo auto regolante

K o nessuna lettera: tipo standard

Materiale del bulbo metallico
Nessuna lettera: standard
S: materiale speciale termoresistente

Esponente di modifica

Nota: QGS è l'abbreviazione di Quick Glow System che significa sistema di preriscaldamento rapido. Questo sistema è composto da un controller che gestisce la tensione di preriscaldamento in funzione di diversi parametri.

CANDELETTA CON RESISTENZA ESTERNA

In questo tipo di candelella la spirale di riscaldamento si estende al di fuori del corpo metallico.

CANDELETTA CON FILETTATURA RIDOTTA



Y: Bulbo metallico

E: 8 mm (Tipo QGS o SRM)

N° di serie

N° di serie



Resistenza a spirale (diametro solo 18mm)

N° di serie

CANDELETTA CON BULBO CERAMICO

L'utilizzo di materiale ceramico consente un riscaldamento più rapido e una maggiore resistenza alle alte temperature.





Bulbo ceramico

Y: tipo auto regolante
Z: tipo QGS
X: tipo QGS (doppio isolatore)

N° di serie

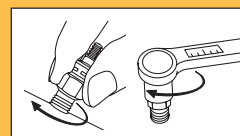
N° di serie



Ø	
10mm	15~20N·m (1.5~2.0Kgm)
12mm	20~25N·m (2.0~2.5Kgm)
14mm	20~25N·m (2.0~2.5Kgm)
18mm	20~30N·m (2.0~3.0Kgm)

Legenda specifica per applicazioni Mercedes

△ = SOLO PER VETTURE EQUIPAGGiate CON IMMOBILIZER

◆ = SOLO PER VETTURE NON EQUIPAGGiate CON IMMOBILIZER

Tegn Forklaring Gløderør:

Y-204T S1

Y, YS: Gløderør
YD:

Gevind
1: Ø 10 mm
2: Ø 12 mm
4: Ø 14 mm
8: Ø 18 mm

Batterispænding
0-4: 12 Volt
5-9: 24 Volt

Serienummer

Glødetid
Ingen: Normal
(800 °C i 20-25 sec.)
V: Kort start
(800 °C i 15-17 sec.)
T: Kort start
(800 °C i 13-15 sec.)
R: Hurlig start
(900 °C i 06 sec.)
S/M: Hurlig start
(900 °C i 10 sec.)
S er ikke nødvendig
mere kun Y-204 SS.

Materiale
Intel: Normal
S: Speciel
materiale som
forhindrer
overhedning.

Ændringsnummer

Y E 0 1

Y, YS: Gløderør

E: 8 mm

Serienummer

DG 237

DG: spiralgløderør
(Gevind altid
Ø 18 mm)

Serienummer

C Y 0 1

C: Keramik

Y: SRC
Z: QGS
X: QGS

Serienummer

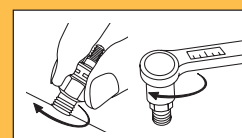

- △ = Til Biler med fabriksmonteret stærtspærre
- ◆ = til biler uden stærtspærre
- * = Mærke *) gløderør fås kun hos oe forhandlere

Abbildungen siehe ab Seite 7
Pictures look at page 7

Ø	
10mm	15~20N·m (1.5~2.0Kgm)
12mm	20~25N·m (2.0~2.5Kgm)
14mm	20~25N·m (2.0~2.5Kgm)
18mm	20~30N·m (2.0~3.0Kgm)

Forklaring av symboler

Y-204TSS1

Y, YS: Glødeplugg
YD:

Gjengestørrelse
1: Ø 10 mm
2: Ø 12 mm
4: Ø 14 mm
8: Ø 18 mm

Batterispenning
0-4: 12 Volt
5-9: 24 Volt

Serinummer

Forvarmingstid
Ingen: Normal
(800 °C in 20-25 sec.)
V: Kortstart
(800 °C in 15-17 sec.)
T: Kortstart
(800 °C in 13-15 sec.)
R: Hurtigstart
(900 °C in 06 sec.)
S/M: Hurtigstart
(900 °C in 10 sec.)
S er ikke lenger nød-
vendig kun Y-204 SS.

Materiale i skallet
Ingen: Normal
S: Spesialmateriale
mot
overoppheting

Skiftende nummer

YE01

Y, YS: Glødeplugg

E: 8 mm

Serinummer

DG 237

DG: Glødespiralplugg
(Gjengestørrelse alltid
Ø 18 mm)

Serinummer

CY01

C: Ceramic

Y: SRC
Z: QGS
X: QGS

Serinummer

* Glødeplugg merket * er bare tilgjengelige
gjennom bilprodusentens merkeforhandlere.

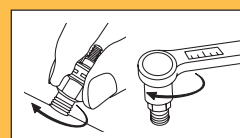

- △ = only for cars with immobilizer
- ◆ = only for cars without immobilizer
- * = marked g glow plugs are only available by special dealers
of automobile manufacturer.

Abbildungen siehe ab Seite 7
Pictures look at page 7

Ø	
10mm	15~20N·m (1.5~2.0Kgm)
12mm	20~25N·m (2.0~2.5Kgm)
14mm	20~25N·m (2.0~2.5Kgm)
18mm	20~30N·m (2.0~3.0Kgm)

Merkkien selvitykset



Y: Hehkutulppa

Kierteen mitta

Akun jännite

Sarjanumero

Esihehkutusaika

Kuoren aine

Muutosnumero

1: Ø 10 mm
2: Ø 12 mm
4: Ø 14 mm
8: Ø 18 mm

0 - 4: 12 Volt
5 - 9: 24 Volt

ei merkkiä: normaali (800 °C in 20-25 sec.)
Ei merkkiä: Normaali S: ylikuumenemisen kestävä erikoisaine
V: lyhyt käynnistys (800 °C in 15-17 sec.)
T: lyhyt käynnistys (800 °C in 13-15 sec.)
R: nopea käynnistys (900 °C in 06 sec.)
S/M: nopea käynnistys (900 °C in 10 sec.)
S ei käytetä enää muulloin kuin Y-204SS.



Y: Hehkutulppa

E: 8 mm

Sarjanumero



DG: Hehkukierretulppa (Kierrekoko aina Ø 18 mm)

Sarjanumero



Keraaminen

Y: SRC
Z: QGS
X: QGS

Sarjanumero

*) merkitty *) Hehkutulpat saatavana ainoastaan autonvalmistajan jälleenmyyjiltä

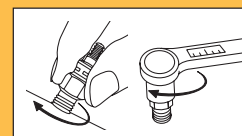

- △ = Only for cars with immobilizer
- ◆ = Only for cars without immobilizer
- * = marked g glow plugs are only available by special dealers of automobile manufacturer.

Abbildungen siehe ab Seite 7
Pictures look at page 7

Ø	
10mm	15~20N·m (1.5~2.0Kgm)
12mm	20~25N·m (2.0~2.5Kgm)
14mm	20~25N·m (2.0~2.5Kgm)
18mm	20~30N·m (2.0~3.0Kgm)

Sümbolite selgitus

Y-204TSS1

Y, YS:
Eelsüüteküünlad

Keerme läbimõõt
1: Ø 10 mm
2: Ø 12 mm
4: Ø 14 mm
8: Ø 18 mm

Aku pinges:
0-4: 12 V
5-9: 24 V

Seerianumber

Eelsüüte pikkus

Ilma tähiseta:
Normaalne
(800 °C in 20-25 sec.)

V: Lühike käivitus
(800 °C in 15-17 sec.)

T: Lühike käivitus
(800 °C in 13-15 sec.)

R: Kiirkäivitus
(900 °C in 06 sec.)

S/M: Kiirkäivitus
(900 °C in 10 sec.)

Ei kasutata mujal, kui
Y-204SS

Töösa materjal

Ilma tähiseta:
Normaalne
S: Kuumuskindel
erisulam

Versiooni number

YE01

Y, YS:
Eelsüüteküünlad

E: 8 mm

Seerianumber

DG 237

DG: Spiraaliga
eelsüüteküünal
(Keermed kõigil
18 mm)

Seerianumber

CY01

Keraamiline

Y: SRC
Z: QGS
X: QGS

Seerianumber

*) = Eelsüüteküünlad saadaval ainult automargi esindustes.

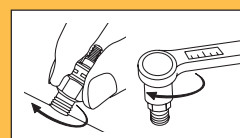

- △ = Only for cars with immobilizer
- ◆ = Only for cars without immobilizer
- * = marked g glow plugs are only available by special dealers of automobile manufacturer.

Abbildungen siehe ab Seite 7
Pictures look at page 7

Ø	
10mm	15~20N·m (1.5~2.0Kgm)
12mm	20~25N·m (2.0~2.5Kgm)
14mm	20~25N·m (2.0~2.5Kgm)
18mm	20~30N·m (2.0~3.0Kgm)

VYSVĚTLENÍ OZNAČENÍ NA ŽHAVICÍCH SVÍČKÁCH NGK

Y-204T S1

Y: UKOSTŘENÁ SOUSTAVA
YD: IZOLOVANÁ SOUSTAVA

PRŮMĚR ZÁVITU A TYP ŽHAVICÍ SPIRÁLY

1.3: Ø 10 mm jednoduchá
2: Ø 12 mm jednoduchá
4: Ø 14 mm jednoduchá
7: Ø 10 mm dvojitá
8: Ø 18 mm jednoduchá
9: Ø 12 mm dvojitá

PROVOZNÍ NAPĚTÍ

0---4: 12 V
5---9: 24 V

TYP

DRUH

ŽÁDNÉ OZNAČENÍ: TYČINKOVÁ ŽHAVICÍ SVÍČKA

T: RYCHLÁ ŽHAVICÍ SVÍČKA

R: ULTRARYCHLÁ ŽHAVICÍ SVÍČKA

MATERIÁL POUZDRA

ŽÁDNÉ OZNAČENÍ: NORMÁLNÍ

S: SPECIÁLNÍ MATERIÁL ODOLNÝ VŮČI PŘEHŘÁTÍ

REVIZNÍ ČÍSLO

Y E 0 1

Y: UKOSTŘENÁ SOUSTAVA

E: 8 mm

TYP

DG 237

C Y 0 1

C: CERAMICS

Y: SRC
Z: QGS
X: QGS

TYP

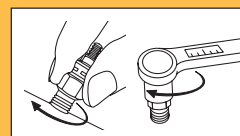

UPOZORNĚNÍ

- △ = POUZE PRO VOZIDLA S IMOBILIZÉREM
- ◆ = POUZE PRO VOZIDLA BEZ IMOBILIZÉRU
- * = K DOSTÁNÍ POUZE U ORIGINÁLNÍCH SERVISŮ!

Abbildungen siehe ab Seite 7
Pictures look at page 7

Ø	
10mm	15~20N·m (1.5~2.0Kgm)
12mm	20~25N·m (2.0~2.5Kgm)
14mm	20~25N·m (2.0~2.5Kgm)
18mm	20~30N·m (2.0~3.0Kgm)

OZNAKOWANIE NA ŚWIECACH ŻAROWYCH NGK

ŚWIECE ŻAROWE PRĘTOWE

Y	-2	0	4	T	S	1
Y: JEDNOBIEGUNOWA YD: DWUBIEGUNOWA, DLA IZOLOWANEGO PRZEWODU POWROTNEGO MASY	ŚREDNICA GWINTU I LICZBA SKRĘTEK GRZEJNYCH 1.3 Ø 10 mm POJEDYŃCZO 2 Ø 12 mm POJEDYŃCZO 4 Ø 14 mm POJEDYŃCZO 7 Ø 10 mm PODWÓJNIE 8 Ø 18 mm POJEDYŃCZO 9 Ø 12 mm PODWÓJNIE	NAPIĘCIE ROBOCZE 0---4: 12 V 5---9: 24 V	TYP	RODZAJ BUDOWY BRAK: PRĘTOWA ŚWIECA ŻAROWA T: ŚWIECA ŻAROWA SZYBKODZIAŁAJĄCA R: ŚWIECA ŻAROWA SZYBKODZIAŁAJĄCA „ULTRA“	MATERIAŁ W OBUDOWIE BRAK: NORMALNY S: MATERIAŁ SPECJALNY PRZECIWKO PRZEGRZANIU	NUMER REWIZYJNY

Y	E	0	1	DG	237
Y: JEDNOBIEGUNOWA	E: 8mm		TYP	DG: typ świecy z zewnętrzną spiralą grzejną	DG Typ

C	Y	0	1
C: ceramika	Y: SRC Z: QGS X: QGS		TYP

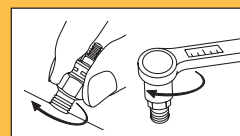

- △ = TYLKO DLA POJAZDÓW Z IMMOBILIZEREM
- ◆ = TYLKO DLA POJAZDÓW BEZ IMMOBILIZERA
- * = DYSTRYBUCJA WYŁĄCZNIE PRZEZ AUTORYZOWANYCH DEALERÓW!

Abbildungen siehe ab Seite 7
Pictures look at page 7

Ø	
10mm	15~20N·m (1.5~2.0Kgm)
12mm	20~25N·m (2.0~2.5Kgm)
14mm	20~25N·m (2.0~2.5Kgm)
18mm	20~30N·m (2.0~3.0Kgm)

МАРКИРОВОЧНЫЕ МЕТКИ НА СВЕЧАХ НАКАЛИВАНИЯ ФИРМЫ NGK

СТЕРЖНЕВЫЕ СВЕЧИ НАКАЛИВАНИЯ



Y:
однополюсная
YD:
двухполюсная с
изолированным
массовым
проводом

диаметр резьбы и
число
нагревательных
спиралей
1.3: Ø 10 мм
одиночная
2: Ø 12 мм
одиночная
4: Ø 14 мм
одиночная
7: Ø 10 мм
двоинная
8: Ø 18 мм
одиночная
9: Ø 12 мм
двоинная

рабочее
напряжение
0---4: 12 В
5---9: 24 В

Тип

исполнение:
стержневая свеча
--: накаливания
T: свеча
накаливания
быстрого пуска
R: свеча
накаливания
„Ультра“
Быстрого пуска

материал в
корпусе
без: нормальный
S: специальный
материал,
предотвращающий
перегрев

номер
модификаций



Y:
однополюсная

Тип



керамика

Тип

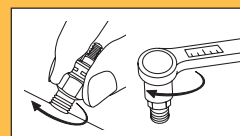

Примечания к таблице

- △ = Только для автомобилей с противоугонным устройством!
- ◆ = Только для автомобилей без противоугонного устройства!
- * = Поставка только через договорные торговые организации!

i.V.: на подготовительной стадии

Abbildungen siehe ab Seite 7
Pictures look at page 7

Ø	
10mm	15~20N·m (1.5~2.0Kgm)
12mm	20~25N·m (2.0~2.5Kgm)
14mm	20~25N·m (2.0~2.5Kgm)
18mm	20~30N·m (2.0~3.0Kgm)

NGK IZZÍTÓGYERTYÁK JELÖLÉSEI

ZÁRT IZZÍTÓGYERTYÁK



Y: egypólusú (testelt) YD: kétpólusú (szigetelt test-visszavezetés)	Menetméret és a fűtőtekercecsek száma 1.3: ø 10 mm 1 2: ø 12 mm 1 4: ø 14 mm 1 7: ø 10 mm 2 8: ø 18 mm 1 9: ø 12 mm 2	Üzemi feszültség 0---4: 12 V 5---9: 24 V	Sorszám	Felfűtési karakterisztika nincs betű: normál T: gyors R: "ultra" gyors	Anyag a gyertyatesten belül nincs betű: normál S: speciális anyag túlmelegedés ellen	Ellenőrző szám
--	--	---	----------------	--	--	-----------------------



Y: egypólusú (testelt)	E: 8 mm	Sorszám
-------------------------------	----------------	----------------



C: Kerámia	Y: SRC Z: QGS X: QGS	Sorszám
-------------------	---	----------------

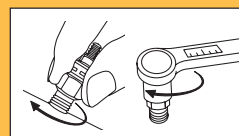

MEGJEGYZÉSEK A KATALÓGUSHOZ

△ = CSAK INDÍTÁSGÁTLÓVAL SZERELT JÁRMŰVEKHEZ!

◆ = CSAK INDÍTÁSGÁTLÓ NÉLKÜLI JÁRMŰVEKHEZ!

* = CSAK MÁRKAKÉPVISELETNÉL KAPHATÓ!

Abbildungen siehe ab Seite 7

Pictures look at page 7

Ø	
10mm	15~20N·m (1.5~2.0Kgm)
12mm	20~25N·m (2.0~2.5Kgm)
14mm	20~25N·m (2.0~2.5Kgm)
18mm	20~30N·m (2.0~3.0Kgm)

Explanation of symbols

Y	-	2	0	4	T	S	1
Y: Glow plug		Thread size and number of coils 1.3: Ø 10 mm Single 2: Ø 12 mm Single 4: Ø 14 mm Single 7: Ø 10 mm Double 8: Ø 18 mm Single 9: Ø 12 mm Double	Battery voltage 0-4: 12 Volt 5-9: 24 Volt	Serial number	Temperature characteristic None: standard type T: rapid glow type R: Q.G.S. type (900 °C in 06 sec.)	Material in tube None: Normal S: Special Material against heat	Revision number

Example of Type description:

Y	E	0	1
Y: Glow plug	E: 8 mm (QGS or SRM)	Serial number	

DG	237
DG: Glow Spiral Plug (Thread Size always Ø 18 mm)	Serial number

C	Y	0	1
C: Ceramics	Y: SRC Z: QGS X: QGS	Serial number	

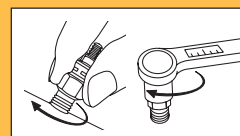

- △ = only for cars with immobilizer
- ◆ = only for cars without immobilizer
- * = marked g glow plugs are only available by special dealers of automobile manufacturer.

Abbildungen siehe ab Seite 7
Pictures look at page 7

Ø	
10mm	15~20N·m (1.5~2.0Kgm)
12mm	20~25N·m (2.0~2.5Kgm)
14mm	20~25N·m (2.0~2.5Kgm)
18mm	20~30N·m (2.0~3.0Kgm)

Profesyoneller için kodların açıklamaları: NGK kızdırma bujisinde kullanılan kodlar ve anlamları

İlgili NGK kızdırma bujisinin tanımı belirtilen kısaltmalardan yola çıkılarak tespit edilmektedir.

Kızdırma Bujisi

Y	-2	0	4	T	S	1
Y, YS: Kızdırma Bujisi YD: Çift izolatörlü Kızdırma Bujisi	Çap: 1:10 mm 2:12 mm 3:10 mm 4:14 mm 5:10 mm (2 Rezistanslı) 7:10 mm (2 Rezistanslı) 8:18 mm 9:12 mm (2 Rezistanslı) Açıklama: Caterpillar Mitsubishi için Y.109, Y-159 ve Y-171' in çapı 3/8" (yaklaşık 9,5 mm)	Akü Gerilimi: 0-4: 12 V 5-9: 24 V	Bu rakam seri numarasını belirtir	Sıcaklık artışı: V: Hızlı çalıştırma T: Hızlı çalıştırma (standart kızdırma bujisi YS-871T hariç) R, M: QGS (Y-117SS ve Y-204SS için ayrıca geçerli) J: SRM K yada işaretsiz: Standart olduğunu belirtir B: Değişiklik U: QGS	Malzeme tanımı	Modifikasyon tanımı

Kızdırıcı Rezistans Tipi

Y	E	0	1	DG	237
Y: Kızdırma Bujisi	E: 8 mm (QGS ve SRM)	Son iki rakam seri numarasını belirtir		DG: Rezistans tipi	Bu üç rakam seri numarasını belirtir

Seramik Kızdırma Bujisi

C	Y	0	1
C: Seramik Kızdırma Bujisi	Y: SRC Z: QGS X: Çift izolatörlü QGS	Son iki rakam seri numarasını belirtir	

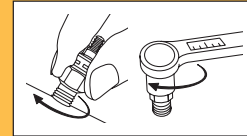

Açıklamalar

- △ = Sadece İmobilizer' li araçlar için geçerlidir!
- ◆ = Sadece İmobilizer' sız araçlar için geçerlidir!
- * = Sadece yetkili satıcılardan temin edilebilir!

Resimler 7. sayfadan itibaren
Pictures look at page 7

Ø	
10mm	15~20N·m (1.5~2.0Kgm)
12mm	20~25N·m (2.0~2.5Kgm)
14mm	20~25N·m (2.0~2.5Kgm)
18mm	20~30N·m (2.0~3.0Kgm)

PS/HP ↔ kW

PS/HP	kW	kW	PS/HP
1	0,736	1	1,360
30	22,065	20	27,192
35	25,742	25	33,991
40	29,420	30	40,789
45	33,097	35	47,587
50	36,775	40	54,385
55	40,452	45	61,183
60	44,130	50	67,981
65	47,807	55	74,779
70	51,485	60	81,577
75	55,162	65	88,375
80	58,840	70	95,173
85	62,517	75	101,972
90	66,195	80	108,770
95	69,872	85	115,568
100	73,550	90	122,366
105	77,227	95	129,162
110	80,905	100	135,962
115	84,582	105	142,760
120	88,260	110	149,558
125	91,937	115	156,356
130	95,615	120	163,154
135	99,292	125	169,953
140	102,970	130	176,751
145	106,647	135	183,549
150	110,325	140	190,347
155	114,002	145	197,145
160	117,680	150	203,943
165	121,357	155	210,741
170	125,035	160	217,539
175	128,712	165	224,337
180	132,390	170	231,135
185	136,067	175	237,934
190	139,745	180	244,732
195	143,422	185	251,530
200	147,100	190	258,328
205	150,777	195	265,126
210	154,455	200	271,924
215	158,132	205	278,722
220	161,810	210	285,520
225	165,487	215	292,318
230	169,165	220	299,116
235	172,842	225	305,915
240	176,520	230	312,713
245	180,197	235	319,511
250	183,875	240	326,309
255	187,552	245	333,107
260	191,230	250	339,905
265	194,907	255	346,703
270	198,585	260	353,501
275	202,263	265	360,299