

TAUNTON'S

# Fine Woodworking

Tool Test: Router combo kits

December 2004

No. 173

## Build a tilt-top table

The right way  
to sand wood

Fitting drawers

5 tips for better  
bandsawing

Impressive  
moldings  
with router bits

How to keep  
finishes fresh



\$7.99/Canada \$8.99



0 74470 03447 6

## Departments

- 6 Contributors
- 8 Letters
- 14 Methods of Work  
Workbench extension lengthens clamping capacity; Shop-built sharpener; Clip-on light for router
- 22 Notes & Comment  
Ancient lumber; Steel price hike affects tool prices
- 26 Rules of Thumb  
Three ways to raise a panel
- 32 Tools & Materials  
Ridgid's new contractor's saw; Highlights from the International Woodworking Fair
- 92 Current Work  
A gallery of our readers' woodworking
- 100 Questions & Answers  
A finish free of brush marks; Controlling plane-blade chatter; How can I bend ebony?
- 108 Master Class  
Low-tech method for veneered columns
- 121 Finish Line  
Keep your finish fresh



How to make drawers fit perfectly, p. 80



Carvings that personalize furniture, p. 86



Sanding basics, p. 40



**On the Cover:**  
Contributing editor Mario Rodriguez crafts an elegant, Federal-style tilt-top table. See p. 72  
Photo: Matt Berger

## Articles

### 40 Sanding Basics

Combine power- and hand-sanding for good results with no wasted time

BY DAVID SORG

### 46 18th-Century Pipe Box Provides Elegant Storage

Simple construction makes this an easy project

BY LONNIE BIRD

### 50 TOOL TEST Router Combo Kits

A pair of bases with an interchangeable motor gets you two different machines for little more than the price of one

BY TOM BEGNAL

### 56 Built-Up Moldings

Construct impressive moldings with just a router and off-the-shelf wood

BY ALAN CHARNEY

### 60 Flattening Tabletops

Surface large slabs and panels without big machines

BY ROB HARE

### 65 Use a belt sander to finish the job

### 66 Five Tips for Better Bandsawing

No-hassle approach delivers smooth, straight cuts

BY MICHAEL FORTUNE

### 72 Tilt-Top Table

Elegant project builds hand-tool and machine skills

BY MARIO RODRIGUEZ

### 80 Fitting Drawers

You don't need a perfect drawer or case to get perfect results

BY PHILIP C. LOWE

### 84 Fitting problem drawers

### 86 Personalize Your Furniture

Three decorative carvings that are easy to do and require few tools

BY CHARLES SHACKLETON

ON OUR WEB SITE: Watch the author demonstrate his carving techniques



Flatten large slabs without big machines, p. 60



Router combo kits, p. 50

Visit our Web site: [www.finewoodworking.com](http://www.finewoodworking.com)



The Taunton Press  
Inspiration for hands-on living®

# Methods of Work

EDITED AND DRAWN BY JIM RICHEY

## Workbench extension lengthens clamping capacity

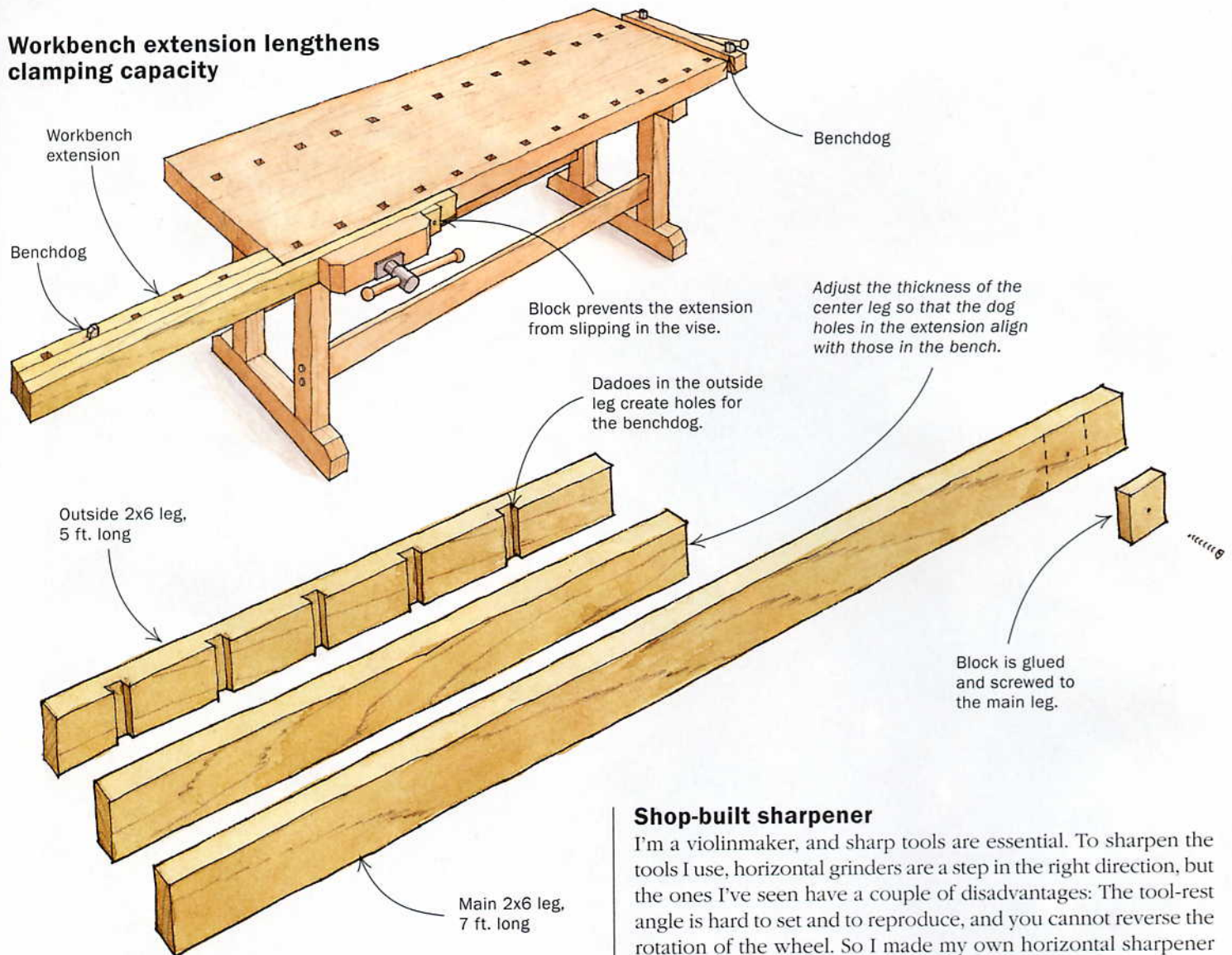

A few years ago, one of my customers wanted a 12-ft.-long tapered flagpole. My plan was to make an octagonal blank and then use a handplane to shape it into a tapered cylinder. But the pole was 5 ft. longer than my bench, and that introduced a clamping problem.

My solution was this workbench extension that effectively lengthened clamping capacity by several feet. Now that I have the extension, I use it whenever I have a workpiece longer than my bench, such as bedposts, tabletops, and countertops.

—Aurelio Bolognesi, Hardwick, Mass.

## Shop-built sharpener

I'm a violinmaker, and sharp tools are essential. To sharpen the tools I use, horizontal grinders are a step in the right direction, but the ones I've seen have a couple of disadvantages: The tool-rest angle is hard to set and to reproduce, and you cannot reverse the rotation of the wheel. So I made my own horizontal sharpener from a reversible-gear motor, a sanding disk, and a wooden box. It takes standard grinding wheels and performs beautifully.

The gear motor, which turns at a much slower speed than conventional electric motors, powers the sharpener. I used a parallel-shaft, reversible, AC gear motor (Bodine 34R-W series, Model No. 0480), which is rated to run at slightly less than 125 rpm. For the gear motor to work properly, you have to wire a separate switch to do the reversing. Be sure to use a switch that has three positions—clockwise, off, and counterclockwise—not just two positions. If you switch directly from clockwise to counterclockwise while the



## A new reward for the best tip

When a customer wanted a 12-ft.-long tapered flagpole, Aurelio Bolognesi realized he had a problem: His bench was too short to allow him to plane the full length of the pole. His solution is shown above. For his winning tip, Bolognesi receives a pair of 14-in. tenon saws (one rip, one crosscut) made by Adria Toolworks ([www.adriatools.com](http://www.adriatools.com)); a total value of \$300. Send your tip (along with a photo or sketch) to: Methods of Work, Fine Woodworking, PO Box 5506, Newtown, CT 06470. If published, we pay \$50 for an unillustrated tip, \$100 for an illustrated one. And if your tip is picked as the winner, you get the tenon saws, too.



# Methods of Work (continued)

motor is turning, you could damage it. When using the sharpener, there'll be water near the motor, so use a three-prong plug and ground the green wire to the motor's case.

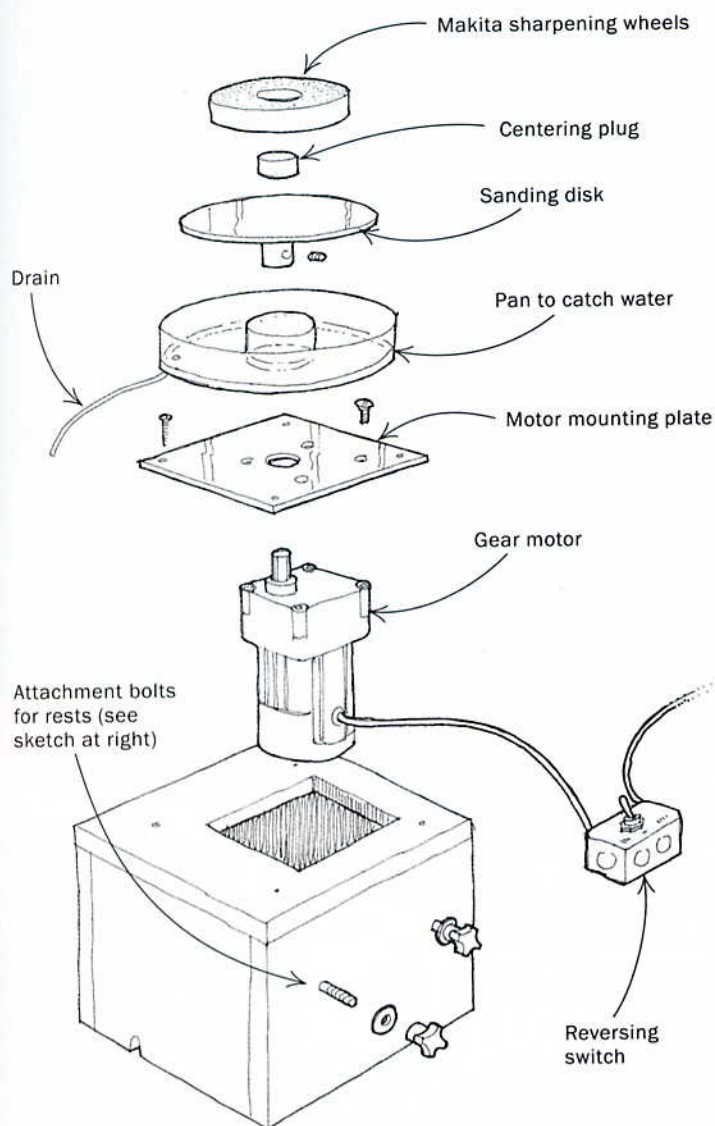

I screwed the motor to an aluminum mounting plate, attached to the wooden box (see the drawing above). On the shaft of the motor, I mounted an ordinary 8-in.-dia. sanding disk (available from Woodcraft Supply for about \$16), and simply tightened a setscrew to fasten the disk to the shaft. Abrasive sharpening wheels fit on top of the sanding disk.

I use 1,000- and 6,000-grit sharpening wheels made for the Makita No. 9820-2 blade sharpener (available from Highland Hardware). For fine polishing, I also use an 8-in. Plexiglas disk with a sheet of 0.5-micron (approximately 9,000-grit) abrasive film on an adhesive back (available from Lee Valley) attached to the disk. The Makita wheels have a  $\frac{3}{4}$ -in.-dia. center hole plus a little tab. I screwed a  $\frac{3}{4}$ -in.-dia. plug to the center of the sanding disk and made a depression in it to catch the tab. If you find this drive arrangement unsatisfactory, it is easy to install a pin or a key so the wheels won't slip on the sanding disk.

I simply enclosed the gear motor within the wooden box and built several interchangeable tool rests—one for each sharpening angle that I use (see the drawing below). The number of rests you need may vary. I needed four: one at 15° to sharpen my knife, one at 30° for my instrument-plane blades, one at 45° for round-edge scrapers, and one at 90° for straight-edge scrapers. The 15° rest for my knife extends down below the level of the grinding surface on each side of the wheel for support. The rests pop on or off in seconds, and they can be adjusted to place the cutting edge of the tool at just the right location.

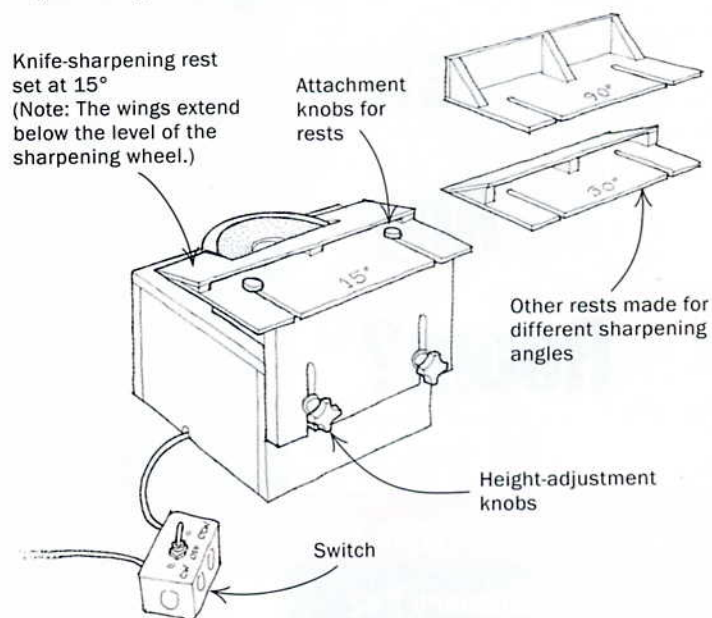

One more thing: As I'm sharpening, I dribble water onto the abrasive wheel through a tube from an old plastic milk bottle. I installed a pan to catch the water and keep it from flinging across the room or dribbling down into the bearings of the motor. The pan is simply a ring of Plexiglas with strips of flexible plastic glued to the inside and outside edges to form raised lips. This pan is mounted under the sanding disk to catch the water.

To use the sharpener, I first set the rotation so the wheel turns into the edge of the cutting tool, which pushes the tool against the rest and holds the angle well. With the 9,000-grit abrasive paper, I reverse the motor so the disk turns away from the edge.

—David Golber, Medford, Mass.

**Quick tip:** One day, by mistake, I dropped a 6-in. self-adhesive sanding disk on the floor of my shop and discovered that the disk provided very solid, nonslip footing. So I placed two of the disks at the front of my table saw where I stand. The disks improve my footing, and they're easy to replace when they wear out.

—Steven Coleman, Tucson, Ariz.

## Using band clamps for squaring during glue-up

Here is a simple technique to pull a case square after you've applied glue and clamped it together. Pass a band clamp behind the clamps diagonally across the case in whatever direction you need to pull the case to square it up. If a lot of force is needed to square up a case, then use the ratchet mechanism of the band clamp. More

# Methods of Work (continued)

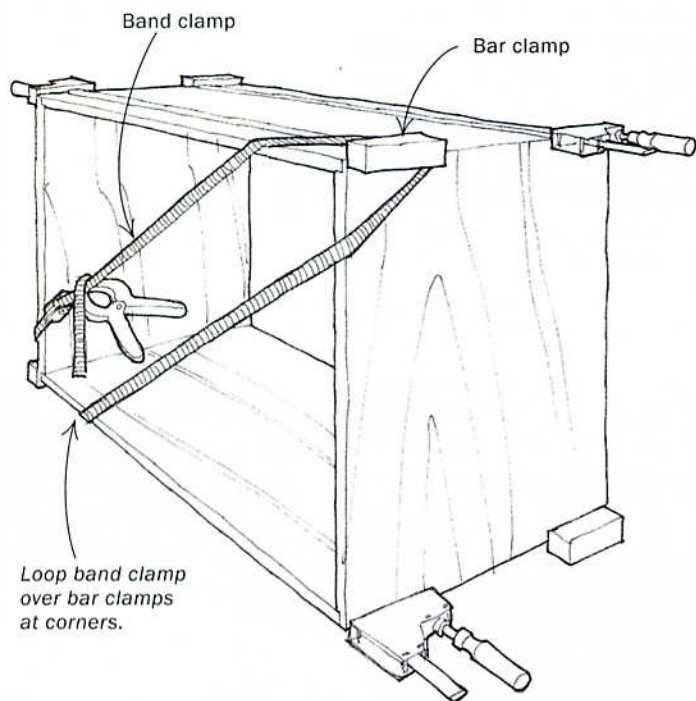

likely, however, a small amount of force is all you'll need. So you simply can pull on the two ends of the band clamp until the case is square, and then snap on a spring clamp to hold the band clamp in position.

—Marshall W. Fletcher, *Dover, Del.*

## Holding a workpiece for angled mortises

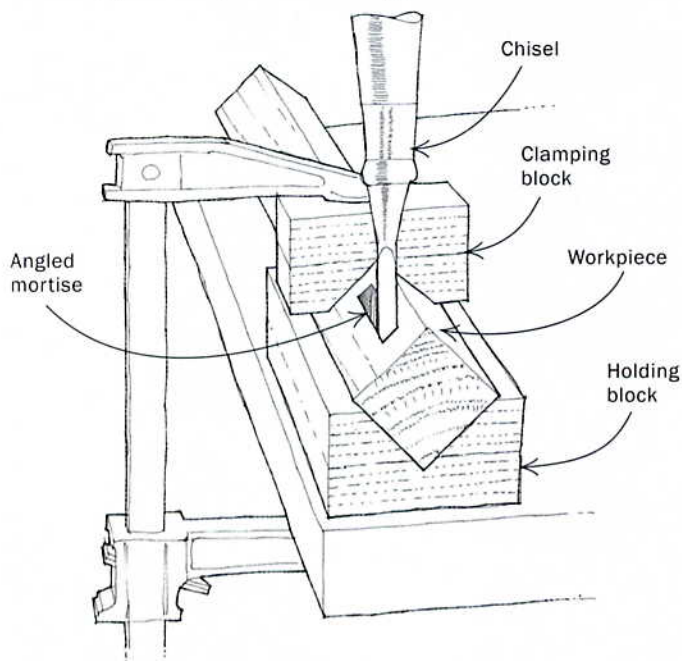

I recently built a corner table that required mortises to be chopped into the legs at a 45° angle to the square face of the leg. First, I clamped the workpiece square to the benchtop and held the chisel at 45°. That didn't work. After chasing my workpiece all around the benchtop, I finally built a jig that solved the problem.

I made the jig by laminating pieces of plywood to form a blank

2 in. thick by 3½ in. wide by 14 in. long. Then I cut a 45° groove 1 in. deep down the length of the blank and cut off a 2-in. section to serve as a clamping block.

I mount the stock to be mortised in the holding block of the jig and clamp it to the bench. Because the workpiece is held at 45°, I can hold the chisel 90° to the bench and chop the mortises the usual way.

—Tim Uli, *Topsham, Maine*

## Clip-on light for router

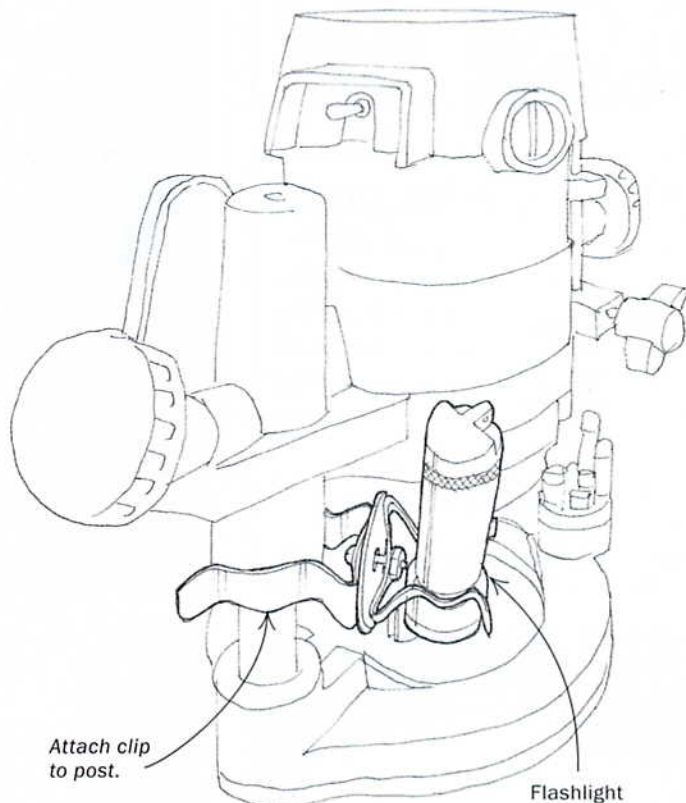
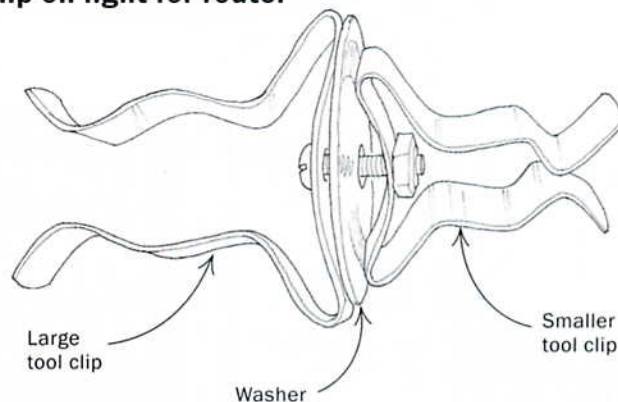

Even with good eyes and good lighting in the workshop, there are times when you need more concentrated light on a workpiece. Because my router does not have an on-board light, I made one with a small flashlight and two tool clips (available at [www.toolclip.com](http://www.toolclip.com)). One clip holds the flashlight, and the other snaps onto the post of my plunge router. Attach the two clips back to back with a small bolt.

—Mark Thorsell, *Golden Valley, Minn.*

# Notes & Comment

## Ancient lumber from New Zealand and South Carolina

You may have been excited to pick up some lumber reclaimed from a neighbor's barn, but those boards are young compared with some of the wood surfacing recently. In the last few years, excavators in South Carolina and New Zealand have pulled workable logs from soggy ground that has preserved some of them for up to 50,000 years. This wood is now reaching the market.

For more than 30 years, excavators at a South Carolina sandpit had been ignoring the logs they were hitting 40 ft. below the surface. In June 2003, Ricky Cox sent a sample of the unearthed wood to the University of Georgia for carbon dating. The sample was at least 44,000 years old, notable even to the Smithsonian Institution.

The wood is related to modern bald cypress, a species known for its decay resistance. It can be used both outdoors and indoors in many of the ways modern cypress is used, including furniture. Like modern cypress, the ancient wood has a regular, straight grain, but its growth-ring structure appears tighter than that of many modern samples.

Cox said he plans to sell the wood at \$100 a board foot through J. Alexander Wood Products (jawp@directus.net; 828-439-



**A gem in the rough.** Salvaged from peat bogs, ancient kauri is said to have an iridescent, lit-from-within appearance when polished.



9761). Keith Smith of J. Alexander anticipates interest from artists and firms involved in high-end architectural millwork. He also said the wood varies in strength, with the average board as strong as yellow poplar.

But ancient lumber is, so to speak, nothing new. In the late 1980s, New Zealanders started putting ancient kauri logs on the market. The logs, long buried in the peat swamps of New Zealand, appear at the surface as the swamps drain. Excavators are brought in to dig out the well-preserved logs, some as large as 8 ft. in diameter.

Wisconsin cabinetmaker and co-owner of Ancientwood, Ltd., Robert Teisberg described the wood as having a unique iridescence and coloration. Teisberg said that when finely sanded (past 600 grit) and polished, the wood seems to glow, as if there were a light behind it. The wood, carbon-dated by the University of Waikato in Hamilton, New Zealand, to be more than 50,000 years old, machines similarly to cherry and is just a bit softer.

Prices run about \$25 a board foot. (For more information, go to [www.ancientwood.com](http://www.ancientwood.com).)

—Matthew Gardner



**Out of its sand trap.** Unearthed from the depths of a sandpit, 40,000-year-old cypress is straight grained and decay resistant.

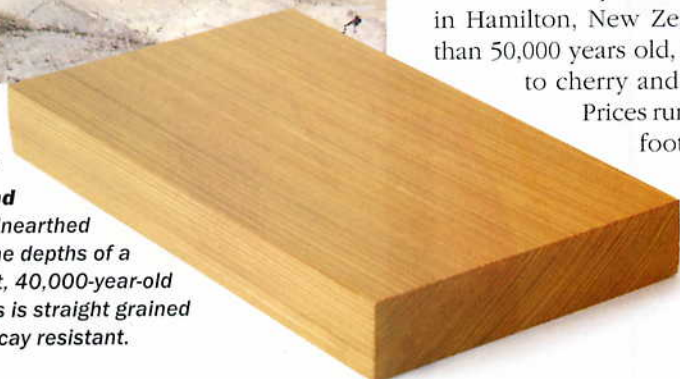

## Steel price hike affects tool prices

After months of climbing steel costs, tool manufacturers and distributors have begun raising prices on stationary power tools. Scott Box, vice president of WMH Tool Group, which owns Jet and Powermatic, said, "There is an overall average price increase of 8% for both Asian and domestic products." In August, street prices for Jet and Powermatic cabinet saws were about \$1,700 and \$1,950, respectively, and were set to go up.

Box said costs for cast iron (for which scrap steel is used) were still rising in the first half of 2004 but appeared to be stabilizing as of late summer.

Steel isn't the only culprit, though.

Christian Chénier, vice president and part owner of General International, said costlier paint, plastics, and oil also are behind an increase in his company's prices. A General cabinet saw priced at \$1,949 before July 1 now retails for closer to \$2,100.

—Marcia Ryan, assistant editor

## Three ways to raise a panel

Frame-and-panel construction is among the woodworker's greatest inventions. Not only does it solve many of the problems we encounter with wood movement, but it also looks good, creating visual interest by adding shadow lines and reflecting light across different planes.

There are almost as many ways to cut raised panels as there are tools in the workshop. While the shaper is probably the most efficient, many woodworkers don't own a shaper. Depending on the piece I'm building and the number of panels I have to cut, I use one of three methods—hand tools, a router table, or a tablesaw outfitted with a panel-raising jig. Whatever method you choose, start with a panel that is sized to the opening in the frame plus the depth of the grooves—minus just a little in the width to account for wood movement. The panels built for this article actually are both raised and fielded: The bevel makes it a raised panel, and the shouldered step up to the center, known as the field, makes it fielded.

### A traditional look with hand tools

If you're not in a rush, are aiming for a traditional look, or simply want to hone your hand-tool skills, raising panels by hand is a good option. The only tools you'll need are a cutting gauge and a rabbet plane (a Stanley No. 78, a Record No. 778, or similar).

Start by laying out the field and tongue. Scribe layout lines on the face of the panel with a cutting gauge, then deepen them with a marking knife and a straightedge. Now scribe the edge of the panel to determine the thickness of the tongue. The goal is to plane away the material on a bevel with the two scribe lines as your boundaries. When laying out the bevel, aim for an angle that is between 15° and 25°. Use shallower angles with larger panels to increase the width of the bevel.

The first cut is a simple rabbet, establishing a shoulder to separate the bevel from the field. Set the depth stop on the rabbet plane to cut a rabbet about 3/16 in. deep, and adjust the

### METHOD 1

### RAISE A PANEL BY HAND

Lay out the field and bevels with scribe lines and handplane them to completion.



**Establish the bevel.** Use a marking gauge to lay out the tongue thickness (above) and the field (right) with scribe lines.



**Plane a rabbet and then cut the bevel.** Cut the cross-grain ends first, with scrap material on the trailing edge to prevent tearout as the plane exits the panel. After cutting the rabbet, readjust the fence to cut the bevel, working down to both the tongue thickness and the shoulder of the field, holding the plane at an angle.

**Check the fit as you go.** Stop before the tongue bottoms out in the groove. If all sides are raised equally, the intersecting bevels will create a straight line at the corners.



### TWO TYPES OF TONGUES

#### BEVELED TONGUE

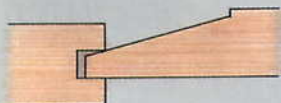

When cut with hand tools or on the tablesaw, the tongue is an extension of the bevel.

#### FLAT TONGUE

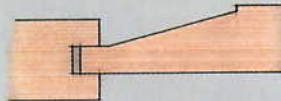

A raised panel cut with a router bit has a flat tongue, which allows the panel to shrink and expand more freely inside the frame.



# Rules of Thumb (continued)

## METHOD 2

### RAISE A PANEL AT THE ROUTER TABLE

Panel-raising router bits come in two styles, both of which create a flat tongue and a bevel. With each bit, take multiple passes and increase the depth of the cut with each pass.

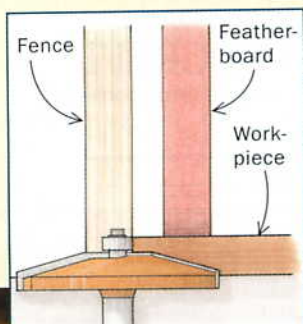

#### HORIZONTAL ROUTER BIT

These large-diameter bits require a variable-speed router set at 10,000 rpm. Use a featherboard to keep the panel flat against the table.

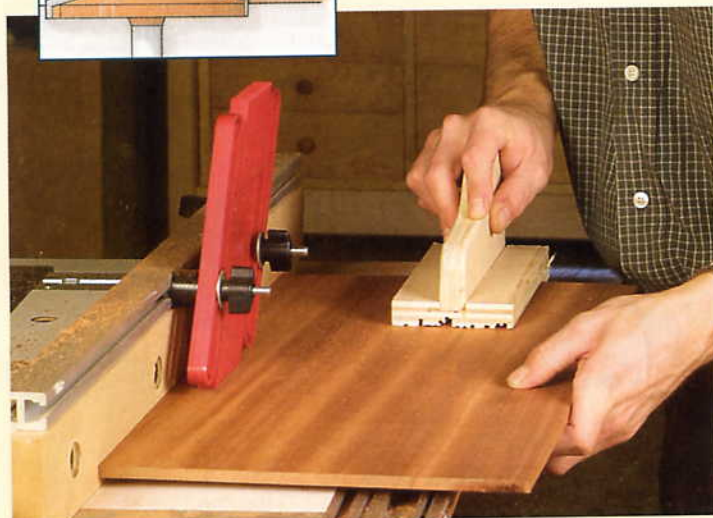

**Cut the long-grain sides after the cross-grain ends to clean up any tearout.** Use a push block and a steady feed rate on the final pass for a smooth finish.

fence so that the width of the rabbet reaches the scribe lines on the panel's face. Begin by planing the cross-grain ends. Use a backer board to prevent tearout where the plane exits the workpiece. However, if there still is tearout, you can clean up the unsightly edges when you plane the long-grain sides. There's no need to use a backer board as you plane the long grain.

With a rabbet on all four sides, begin on the bevel. Again, bevel the cross-grain ends first and then finish up with the long-grain sides. Hold the plane at an angle and make passes until the bevel spans from the shoulder to the scribe lines on the edge of the panel. If you encounter a troublesome area, plane in the other direction using a rabbeting block plane registered against the shoulder. Finally, use a card scraper to smooth the bevel to a finish.

#### Two methods at the router table

When raising panels on a router table, you can use a horizontal router bit or a vertical router bit. Either method has advantages over using hand tools (or the tablesaw, for that matter)—the router bits cut a flat tongue on the edge of the panel, rather than a beveled tongue, allowing the panel to float more freely in the frame as it expands and contracts with changes in humidity.

**Face on the table**—Raising a panel with a horizontal router bit is safe and efficient, but it calls for a variable-speed router. Because panel-raising bits are so large in diameter, you'll need to dial back the router to about 10,000 rpm.

If you're raising multiple panels of the same size, you need to mark out only the thickness to be removed on the first panel. The width of the bevel is determined by the bearing on the router bit. Scribe a line on the edge of the panel to indicate the tongue's thickness. You are somewhat limited by the thickness of the panel. If it's too thick, the bit produces either an overly pronounced shoulder or a thick tongue. Alternatively, you can cut a rabbet on the back of each panel's edge to reduce the thickness of the tongue.

Start routing on the cross-grain ends and then raise the long-grain sides. Take three to five passes—depending on the density and thick-

#### VERTICAL ROUTER BIT

These bits should be run between 18,000 rpm and 22,000 rpm. Use a featherboard to keep the panel snug against the tall fence.

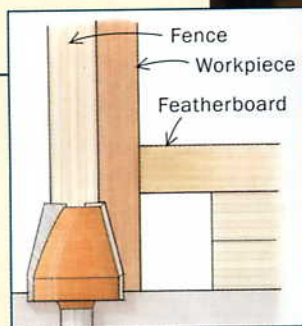

**Take light passes with a vertical panel-raising bit.** They tend to produce a rougher surface than a horizontal bit, but a card scraper or sandpaper will clean things up.

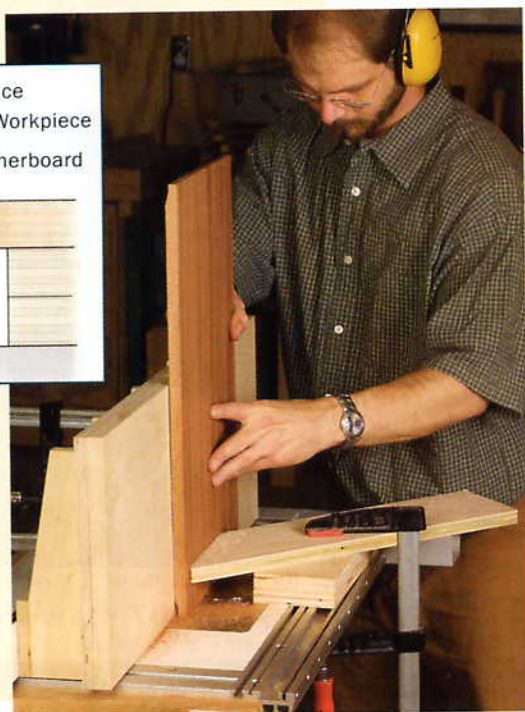

**A perfect fit.** The flat tongue should fit snugly in the thickness of the groove.

## METHOD 3

### RAISE A PANEL ON THE TABLESAW

Set the tablesaw blade to 90° and build a tablesaw jig that holds the panel at an angle. In this case, a 75° jig creates a 15° bevel. Before cutting the panels, make test cuts with scrapwood.



**Establish the field.** Score a 3/16-in.-deep shoulder around the field using the tablesaw.

ness of the wood—raising the bit with each pass until you reach the final depth. If you're raising more than one panel, rout each panel in order before raising the bit. To guarantee a clean cut, make sure your last pass is a shallow one, removing no more than 1/16 in.

**Face against the fence**—You can raise a panel at the router table using a vertical panel-raising bit buried in a tall auxiliary fence. This method requires you to take light passes, and your router should be running at 18,000 rpm to 22,000 rpm, which is in the range of many single-speed routers.

Again, cut the cross-grain ends before the long-grain sides and take several passes, exposing more of the bit after each cut by moving the tall fence. For safety's sake, use a featherboard mounted high on the panel to ensure that the workpiece stays snug against the tall fence as you cut.

### BUILD A PANEL-RAISING JIG

This jig is relatively straightforward but makes raising a panel at the tablesaw speedy and safe. It's made of 3/4-in.-thick plywood and assembled with 1 5/8-in. drywall screws. Build the jig first, then attach the arm so that it's snug over the tablesaw fence.

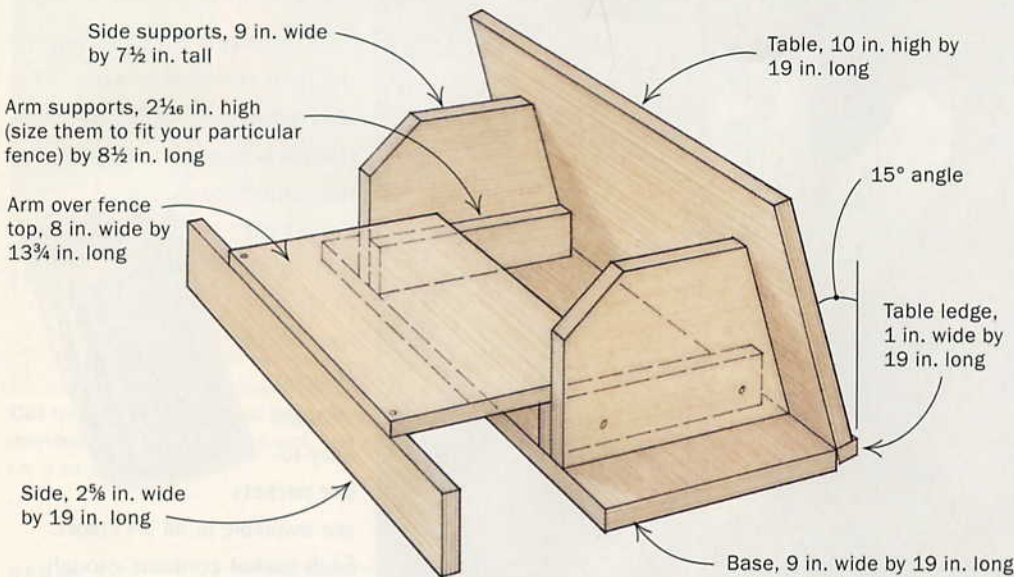

### Panel-raising on the tablesaw

Finally, you can raise panels on the tablesaw. Similar to the hand-tool method, this method produces a beveled tongue.

Rather than tilting the blade to cut a bevel, I use a shopmade jig (left) that holds the panel at a 15° angle and straddles the tablesaw fence. It alleviates almost any chance of kickback and allows you to secure the panel to the jig with clamps so that your hands are out of danger when making the cut. Also, it is easy to adjust for different size panels. Just raise and lower the blade or move the fence.

### Raise the panel

Once you've built a jig to the specifications included in the drawing above, you can begin cutting the panel. First, cut a test bevel using scrap material that is the same thickness as the panel. Aim to create a tongue that fits in the groove of your frame and will leave some room inside the groove for the panel to expand. Then measure the width of the bevel to determine the location of the shoulder.

Start by establishing the shoulder on the tablesaw. Set the tablesaw fence to the width of the bevel on your test cut, and raise the blade to about 3/16 in. Then run all four sides of the panel through the tablesaw.

After establishing the shoulder, clamp the panel to the jig and align the fence for the correct tongue thickness. Raise the blade so that it just reaches the shoulder and begin cutting.

The tablesaw is far and away the fastest way to raise panels. If you have more than two or three panels, you'll make up the time spent building a panel-raising jig. And once you've built the jig, you can use it again and again. I use mine not only for raising panels but also for cutting wide chamfers on the top or bottom of small tabletops. □

### Clamp the panel to the jig and cut.

Raise the blade so that it reaches the shoulder. Make the cross-grain passes before cutting the long-grain sides. A steady feed rate and a sharp blade reduce burn marks. Leftover marks can be cleaned up with a scraper.



# Tools & Materials

## Ridgid's beefier contractor's saw offers excellent value

Ridgid's new contractor's saw (model No. TS3650) is a true furniture maker's tool on a par, in all but horsepower, with full-size cabinet saws. It looks like any other contractor's saw, but many of the important details have been redesigned.

The trunnion assembly is a one-piece iron casting that is much stiffer than the small castings and connecting rods of the older designs. The pivoting arm that supports the saw's arbor also is a beefy casting, and it's attached to the main casting in a way that eliminates any play between the two. In another improvement, the main casting wraps around the blade, allowing fairly effective sawdust collection through a built-in 2½-in.-dia. port.

As on most contractor's saws, the trunnions are mounted to the underside of the table, but this saw also has a simple cam and lever built into the rear trunnion. The cam makes it possible to align the blade parallel to the miter-gauge slot in just a few minutes. Both the 45° and 90° blade-tilt stops are adjustable from above the table with setscrews on both sides of the insert plate. The blade-tilt and height controls worked smoothly, and one nice feature—not seen even on much pricier saws—is a blade-angle lock on the front trunnion.

The standard, vibration-prone V-belt drive has been replaced on this saw with a flat, automotive-style poly V-belt running on machined steel pulleys, which reduces noise and vibration. The motor is a 1½-hp, totally enclosed unit that should provide adequate power for most ripping operations.



**Adjusting blade alignment.** A cam and lever on the rear trunnion make it easy to align the blade to the miter-gauge slot.

The aluminum rip fence locks down at both ends, and it was sturdy, accurate, and slid smoothly on the rails. As shown above, the rails are set up for a rip capacity of 12 in. to the left of the blade and 36 in. to the right, but you can shift the rails farther right to expand the ripping capacity to more than 50 in. Out of the box, the fence was very close to parallel to the blade, but fine-tuning the alignment was a hunt-and-peck process.

Ridgid's designers improved many other functions of the



### RIDGID TS3650

Street price	\$547
Motor	1½ hp/13 amps at 120v
Blade tilt	Left
Maximum rip capacity	36 in.
Runout at rim of 10-in. testing disc	0.001 in.
Blade alignment	0.002 in. out of parallel
Dust collection	Shroud around blade with vacuum port

machine. The miter gauge uses screws for adjusting the 45° and 90° angle stops. The saw uses two wrenches for blade changing—no more nicked fingers. The base has a built-in retractable caster system that worked better than any I've ever seen. The power switch has a large paddle handle (easy to turn off), and the switch can be mounted anywhere in a T-slot along the front fence rail. The two

cast-iron wings have large, open slots that make it easier to clamp accessory fences or featherboards to the tabletop.

Overall, the fit and finish of this saw were very good. The table flatness, runout, and initial alignment all tested out to be better than average. The machine had a nice, heavy feel to it because the steel used in the stand and base is thicker than that on many other contractor's saws.

On the downside, the splitter and guard assemblies were awkward to set up and difficult to align with the blade. The standard insert plate and an accessory dado insert plate are sturdy metal castings, but the plastic zero-clearance throat plates are flimsy.

The saw is sold at The Home Depot. At \$547, it is an impressive machine for the money.

—John White is Fine Woodworking's shop manager.



**Retractable casters.** A foot pedal controls a scissors lift that activates four retractable rubber wheels.

## Hole-saw accessory ejects plugs

Removing a stuck plug from a hole saw is frustrating. Although there are ways to avoid a stuck plug, such as drilling halfway through from one side and then completing the operation from the reverse side, in many situations that approach isn't feasible.

Phantom Innovations has brought a plug-ejecting hole-saw arbor to the market. The Twister ezeOUT comes equipped with a 1/8-in.-dia. brad-point pilot bit and accepts all common hole saws 1 1/4 in. dia. and larger. After drilling, simply put the drill in reverse, grab hold of a knurled knob, and watch as a pair of rods ejects the plug. The brad-point bit increased the accuracy of hole placement when compared to the twist bits found in other arbors. When used on a drill press, the auto-eject feature must be operated manually, but it takes just seconds. The only drawback is that the plug-ejecting arbor is nearly 2 1/2 in. longer than a standard arbor. That added length might limit its ability to drill in tight quarters.

Twister ezeOUT sells for about \$30. For more information, call 612-270-4223 or visit [www.johnsspecialtytools.com](http://www.johnsspecialtytools.com).

—Eric Rimel is a student at the University of Idaho.



**Ease out the plug.** To remove a plug from a hole saw using the Twister ezeOUT, simply squeeze the drill's trigger.

## The 2004 International Woodworking Fair

The biannual IWF show, held in August at the Georgia World Congress Center in Atlanta, had a record 1,372 exhibitors displaying the newest technology in machinery, supplies, and services.

For those who've made the trek to Atlanta before, you know only too well how exciting and—at the same

time—exhausting this show can be. For those who have never been, you ought to make the pilgrimage at least once, just for the thrill of it all. The exhibitors run the gamut from the high-tech machines that have a footprint exceeding the square footage of some houses to the tiny booths occupied by a lone inventor who has risked his life savings on bringing a new woodworking widget to market. Not all of the products are new, of course; many of the displays featured well-established tools and machinery. What follows is a random selection of some products that caught the eye of the four editors from *Fine Woodworking* who attended the show.



### Bosch's new impact drivers

The new line of Impactor fastening drivers (most other manufacturers call them impact drivers) from Bosch offers more torque than standard drills. The Impactor drivers are battery powered and come in 9.6v, 12v, and 14.4v sizes (models 23609, 23612, and 23614, respectively), offering 950 in./lb., 1050 in./lb., and 1150 in./lb. of torque, respectively. Each tool features a variable-speed trigger and a built-in LED work light for dim conditions, and comes with two batteries, a charger, and a carrying case (877-267-2499; [www.boschtools.com](http://www.boschtools.com)).



### Amana router bits solve the problem of loose panels

Amana Tools has introduced the In-Stile & Rail System for shaping cabinet door frames with cope-and-stick patterns and cutting the groove for flat panels. This system is designed to accommodate varying thicknesses of plywood, and it enables you to adjust the cut of the groove to match the thickness of the plywood. The cutter sets are available in two sizes for 1/4-in.- and 1/2-in.-thick plywood panels (cutting grooves from 3/16 in. to 1/8 in. and from 7/16 in. to 1 1/2 in., respectively). Cutter patterns are

## 2004 IWF (continued)

available in three profiles, and the two-piece sets sell for about \$155 (800-445-0077; [www.amanatool.com](http://www.amanatool.com)).

### Jet adds convenience to dust collectors

Remote-control starters have been added to six of Jet's dust collectors. Now, users can keep a remote-control switch in their pocket or place it strategically in the shop, and with the press of a button, turn the collector on and off. A timer has been built into the electronics, allowing you to leave the shop and set the collector to run for 1 to 99 minutes before shutting down.

Jet also has upgraded its 18-in. bandsaw (reviewed in FWW #170) by adding a more powerful 1¾-hp motor and beefier trunnions, and by increasing the resaw capacity to 1.2 in. The saw sells for about \$1,250 (800-274-6848; [www.jettools.com](http://www.jettools.com)).

### Delta Shopmaster sanding table

Delta has come out with an inexpensive downdraft dust-collection table (model No. AP075) designed to collect sanding dust at the source. It comes completely assembled with a port for a standard 4-in.-dia. hose, and it will work with a 1-hp or larger dust collector. Rubber pads on the bottom hold the Shopmaster firmly to a work-surface, and it comes with two adjustable stops that fit into grooves in the top of the table. The top is 20 in. by 40 in., and the unit sells for \$149 (800-438-2486; [www.deltawoodworking.com](http://www.deltawoodworking.com)).

### Laguna offers sliding tables for bandsaws

For woodworkers who cut heavy timbers, resaw large logs, or simply prefer the safety of ripping with a bandsaw rather than a table-saw, Laguna is offering sliding-table attachments in three different sizes, at prices that range from \$850 to \$1,400 (800-234-1976; [www.lagunatools.com](http://www.lagunatools.com)). "We have essentially turned a bandsaw into a tablesaw by kitting it with our new sliding table system. This gives woodworkers the ability to cross-cut in addition to rip with our bandsaws," said Torben Helshoj, president of Laguna Tools.

### Hitachi tools get a makeover

If you like the high-tech look of the latest athletic shoes, Hitachi's re-designed tools just might suit your tastes. Besides the bold graphics and colors, though, substan-



**What they offer.** Miller dowels come in a variety of wood species and three different sizes of stepped dowels, along with a separate drill bit for each size.

## A better dowel system

When I first started making furniture, I was intrigued by the simplicity of dowel joints, but I soon discovered that they have some serious limitations. First, a dowel joint is weak because it depends entirely on a small amount of glued surface, some of it end grain. Second, driving a dowel home can be very difficult because the glue can grab too fast and seize up before the dowel is fully seated.

With its new system, the Miller Dowel Co. has reinvented how a dowel joint is made. Their modified, stepped dowel preserves the simplicity of dowel joinery, without the drawbacks experienced with plain dowel joints. The secret is that it changes in diameter in three equal steps over its length. A specially made stepped drill bit creates a hole through both pieces being joined, to match the shape of the dowels. Because of the steps, the dowel drops by most of its length into the matching hole before there is any resistance, and driving the dowel home takes little effort with a light hammer-blow.

Once seated, because the full-diameter head of the dowel seats before the other portions do, it works just like a screw head, pulling the joint tight. And because of the larger glued surface, you get a stronger joint. In working with these dowels, I found that the glue grabbed and held the dowel solidly as soon as I drove it home, allowing quick assembly for projects. The finished joint resembled a traditional plugged screw hole.

To test the strength of the dowels, I used them to build a large clamp-storage rack made of 2x6 Douglas fir that was still fairly green. The joints in the rack were all butt joints that depended entirely on the dowels for their strength. As the assembled rack dried out in the shop, the wood visibly shrank and cupped, but the joints stayed tight despite the stresses on them.

You can buy the dowels in three sizes and several wood species. They come in packs of 25 or 40, or in larger bulk quantities, and you can purchase the bits separately from most woodworking-supply catalogs. For more information, call 866-966-3734 ([www.millerdowel.com](http://www.millerdowel.com)).

—J.W.

## 2004 IWF (continued)

tial mechanical changes have been made. For example, the new 12-in. compound-miter saw (model No. C12LCH) comes outfitted with a laser sight and a digital readout that displays the exact miter and bevel angle. It sells for \$369 (800-829-4752; [www.hi-tachi.us/hpt](http://www.hi-tachi.us/hpt)).

### Freud's antivibration, thin-kerf sawblade

Freud, which has been making carbide cutting tools for more than 50 years, has introduced its new antivibration, thin-kerf sawblade (No. LU83R, 10-in. 50T). Laser-cut, antivibration slots cut into it allow the blade to expand when it heats up during use, without distorting its shape. The blade is coated with what Freud calls Perma-shield—a nonstick coating that reduces friction, heat, gum buildup, and rust, prolonging the life of the blade. An additional benefit

of this design is that the blade generates a lot less noise when it is running. A 10-in. combination, thin-kerf blade sells for \$50 (800-472-7307; [www.freudtools.com](http://www.freudtools.com)).

### New router lift eliminates backlash and has a digital readout

The SmartLift Digital, from Jointech, uses a series of gears in a direct-drive system to raise and lower the router carriage, and it has a digital height gauge built into a 3/8-in.-thick aluminum mounting plate. The lift is designed to eliminate backlash, and the digital encoder reads the actual position of the carriage, so you can be sure the router bit is exactly where the gauge says it is, to within 0.001 in. The lift is solidly built and features multiple insert rings to change the size of the bit opening. The mounting plate has corner leveling pads. The digital measuring system comes from Accurate Technology and is designed to resist dust contamination.

The SmartLift Digital soon will be available direct from Jointech for \$430 (210-377-1288; [www.jointech.com](http://www.jointech.com)). Lower prices may be offered at woodworking shows. As designed, the lift fits Porter-Cable, DeWalt, Bosch, and Makita fixed-base router bodies.

### A new sustainably grown hardwood

Lyptus, a hybrid of two eucalyptus species that grows rapidly in sustainable forest plantations, combines the grain of mahogany with a range of color similar to the pulpwood and heartwood of cherry. Distributed by Weyerhaeuser in the United States and Canada, lyptus costs 20% to 40% less than mahogany and cherry.

Lyptus is appropriate for furniture, flooring, millwork, and cabinets, and is available as plywood and veneer, as well as solid lumber in thicknesses up to 8/4. Call 877-235-6873 or log on to [www.weyerhaeuser.com/wbm](http://www.weyerhaeuser.com/wbm) to find a retail outlet near you.

## No-hassle layout squares

With most layout squares, it is difficult to hold the square securely while marking a line. Pat Warner ([www.patwarner.com](http://www.patwarner.com)), a frequent contributor to *Fine Woodworking*, is offering a layout square that solves this problem. Because of its size and balance, the square rests securely on a workpiece and allows you to use both hands to hold additional angle jigs or to reach for clamps.

The long and short blades, made of 1/4-in.-thick aluminum, are reversible, with no loss in accuracy, and are parallel to each other. The blades can be removed and retrued if the tool is dropped. Warner guarantees that the square is accurate to within 0.001 in. The price, \$60, includes shipping.

—Philip Stivers teaches woodworking and cabinetmaking at Palomar Community College in San Marcos, Calif.



**A straightedge for more than layout.** The 1/4-in.-thick aluminum blades also can be used as a fence for short router cuts.

## Space-saving power-cord reel

For many woodworkers, extension cords sometimes make the shop floor look like a plate of pasta. Mounting power-cord reels keeps an extension cord neatly coiled on a spring-loaded winder until it's needed. Woodhead's new PowerHouse retractable outlet, designed specifically for residential applications, can be mounted on a wall or sunk flush into the wall, secured directly to the studs.

The unit I tested has a 25-ft., 14-ga. grounded cord rated for motors that draw up to 15 amps. A built-in circuit-breaker adds overload protection. The reel is contained in a sturdy 14-in.-square by 3/2-in.-deep sheet-steel frame that mounts to a wall with four screws. A 38-in.-long cord plugs directly into a nearby electrical outlet to provide power for the unit. When pulled out, the cord locked in place, and a tug on the cord started the rewind, although sluggishly.

The PowerHouse costs \$49.95 and is available at The Home Depot.

—Tom Begnal is an associate editor.



**A plug where you need it.** The PowerHouse outlet mounts to the wall and has a built-in circuit breaker and retractable extension cord.

# Sanding Basics

Combine power-  
and hand-sanding  
for good results  
with no wasted time

BY DAVID SORG

The course of true love never did run smooth, according to Shakespeare, and smoothing wood true rarely causes love to course, it would seem. Boredom and fear are more common feelings among woodworkers when sanding their projects. But proper sanding is a crucial part of woodworking, so please read on for some tips and techniques that will turn your boredom into serenity, and your fear into fun.

I'll stick my neck out and state that no project should be finished without first being sanded. Even if you are a hero with the handplane or skilled with the scraper, you won't be able to get a surface that is uniformly smooth and with an even sheen. Inevitably, there will be tiny depth changes from adjoining passes of the blade, while the sole of the plane can burnish strips of wood that may show up after a stain or a clear finish has been applied.

Those who rely solely on power tools will inevitably be left with planer- and jointer-knife marks and fibers crushed by the feed rollers. Router tables can leave gouges and scratches, and assembly often produces

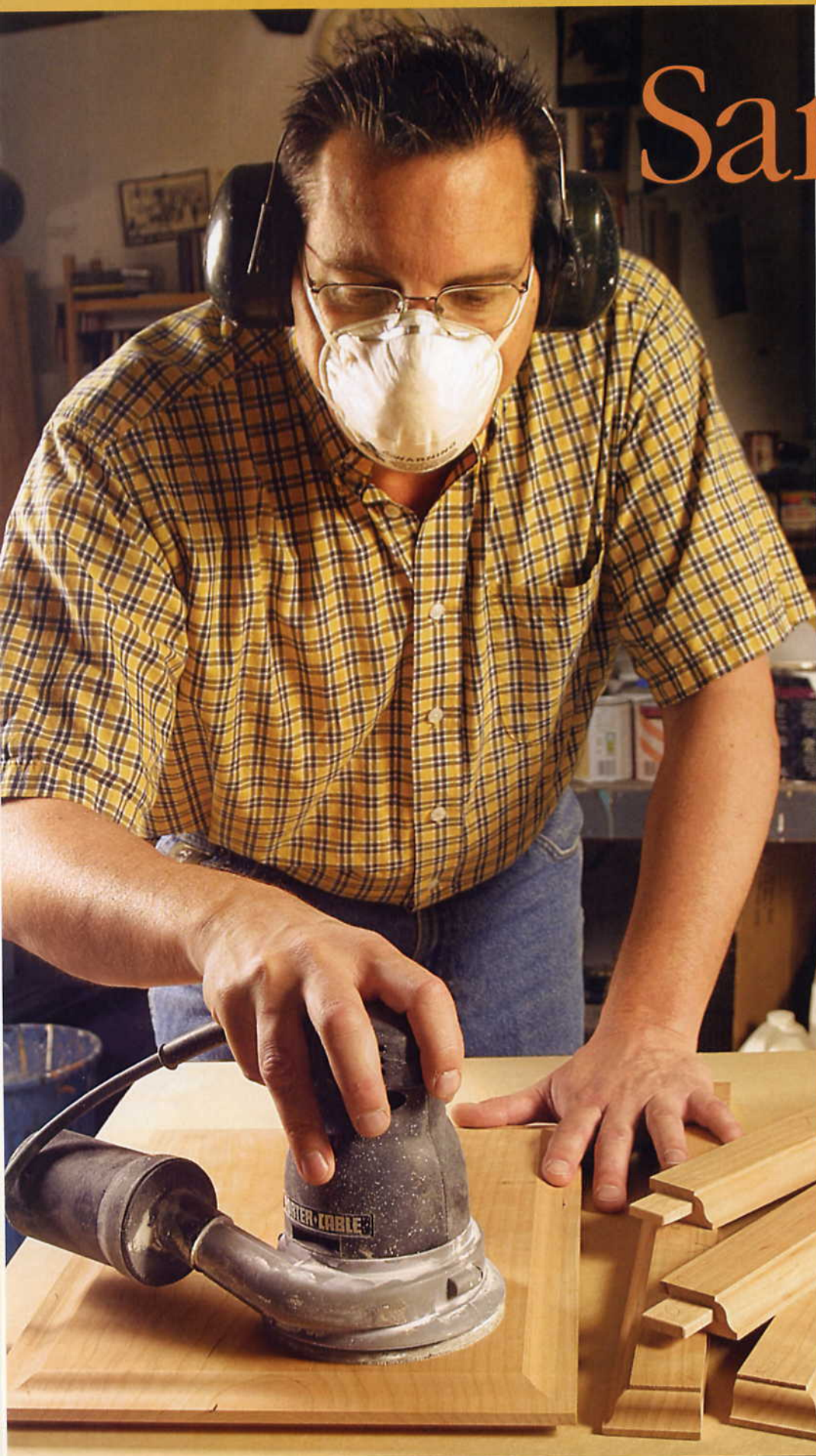

some errant glue splashes. All of these blemishes should be removed before a finish is applied, and sanding is the best way to achieve this. The most efficient way to sand a surface is with a combination of power-sanding and hand-sanding

### Power-sanding comes first

Of course, you could do all of your sanding by hand, but why? Even if you use power sanders wherever practical, there will be enough hand-sanding on almost any project to give you plenty of hand-done satisfaction. Power sanders deliver results with much greater speed, and with minimal practice they'll also deliver a flatter surface than sanding by hand alone.

The good news is that unlike much of your other shop equipment, quality sanding tools will not cost you much. I strongly suggest you get a random-orbit sander. A pad sander also is useful, and I'll explain why a detail sander is optional. Don't forget a dust mask and hearing protection.

**Fast stock removal with a random-orbit sander**—Random-orbit sanders are wonderful machines. The pad has dual motion: It spins in a circle as well as in an eccentric orbit. These sanders are great for rapidly smoothing and leveling raw wood. Five-in.-dia., palm-held models are most common, but you also can buy 6-in.-dia., two-handed versions.

Most random-orbit sanders have holes in the pad (and, of course, in the sandpaper) for dust extraction. The sanding disks are backed with either pressure-sensitive adhesive (PSA), which is cheaper, or reusable hook-and-loop systems.

Older sanders need to be switched on when already resting on the surface of the wood, or they will spin too fast and gouge the wood when you try to bring them in

### HAND-SANDING TOOLS

Sand by hand to finish the job. For flat areas, use a backing block made from cork or rubber to prevent your fingers from applying uneven pressure. To keep moldings crisp, use commercial rubber profiles or shop-made foam ones to back the sandpaper.

## TOOLS FOR SANDING

Achieving a well-sanded surface in the most efficient way requires a combination of power-sanding and hand-sanding.

### RANDOM-ORBIT SANDERS

These machines are great for removing large amounts of wood from large surfaces. They are less suitable for small areas, and their shape prevents them from reaching into inside corners.



### PAD SANDERS

Less aggressive than random-orbit sanders, pad sanders are easier to control, which makes them suitable for narrower and more confined areas such as table legs and the insides of cabinets.



# Sanding with power

## POWER-SANDING FLAT SURFACES



### LARGE PANELS

With their wide contact surfaces, random-orbit sanders are naturally at home on large panels.

### NARROW PARTS

On smaller pieces such as the parts for a frame, a pad sander gives more control than a random-orbit sander.



### WIDE PARTS

Again, a random-orbit sander does well here. Note: It is easier to sand parts such as table aprons before assembly.

or table legs, as well as on the insides of cabinets and in other confined spaces.

### The right grit from start to finish—

With either type of sander, I'd rather start with 150-grit than 120-grit paper on most pieces, even though it may take longer to remove some milling marks. For wood that is already in good shape, especially with thin-veneered sheet goods, I start with 180-grit paper.

Note: The grits I refer to here are based on the FEPA scale, which uses the prefix P, rather than the alternate CAMI, or C, scale. In the 150 to 220 range, the grits are nearly equivalent, but it's best to work with the paper from one scale.

Don't continue using a piece of sandpaper until the sand is all gone and there isn't anything left but the paper. That's a false economy if you're charging for your time; and if you're woodworking for fun, well, you're taking away a bunch of it. Move to a fresh section of sandpaper as soon as you feel it stop cutting or start to clog, or when it requires you to exert more pressure.

Having experienced this the hard way, let me assure you that it's very important to vacuum and/or blow off the entire piece between grits. I do both, then wipe it with a tack cloth. One piece of 150 grit being

for a landing. Most new models have electronic speed control, which allows you to lift the sander to apply it to an adjacent surface without having to turn it off and restart it each time.

Random-orbit sanders will do a speedy job on large surfaces and bring two pieces of wood into the same plane. However, at the edges of a workpiece, keep the majority of the pad on the wood, or you'll risk dishing or rounding over the edge. By the same token, keep these sanders moving; don't concentrate on one spot, or you could create a little bowl.

Orient your project, if you can, so that you're working horizontally. By letting the weight of the sander work for you, you'll

gain more control with less fatigue. Also, sand subassemblies before glue-up. It's much easier to sand a frame-and-panel, the aprons of a table, or a drawer's parts before they're assembled.

### Pad sanders give more control in small areas—

Pad sanders, also called palm sanders or finish sanders, use a simple orbital pattern, and the pad does not rotate, giving a much slower sanding action but greater control. The square pad allows the tool to get fairly close to inside corners (but beware getting it too close, where it quickly can chew up the adjacent surface). This type of sander works well on smaller surfaces like the edges of shelves



### CHECK YOUR PROGRESS

With the workpiece lit by a strong light, wipe the wood with some mineral spirits and check the surface for obvious scratches and rough areas.

swirled around on your 220-grit pad will make you curse when you see the results.

**Tips for efficient sanding**—With a cabinet, begin sanding on the inside: If you start with the inside while you're fresh, you'll take a few extra minutes to do it right instead of skimping on it at the end.

For veneered plywood, you can start and stop with 180-grit paper if the inside will be minimally seen or used. Use a hand-sanding block on the corners and on any more visible areas such as solid-wood edging.

Devote more time to visible areas and those likely to be touched. Ending with 180-grit paper is fine for softwoods, but go to 220 grit for hardwoods. On end grain, go one grade finer so that it doesn't absorb the stain or clear finish as deeply.

How do you know when you're finished power-sanding? Wipe some mineral spirits on the surface and sight across the wood toward a strong light. Pay no attention to the beautiful color that appears; instead, look at the surface for telltale scratches, especially the ugly orbital kind. You would like to see a uniform appearance with no rough areas or single outstanding scratches. Sometimes it's easiest to see this right at the moment of evaporation, when the ruts of



### SANDING DETAILS



**A quicker way to sand moldings.** Detail sanders come with an assortment of different pads designed to fit most molding profiles. The radius on this pad matches the bead of the apron (left). One disadvantage of detail sanders is that the adhesive-backed sandpaper frequently comes away from the pad (above).

# Sanding by hand

## HAND-SANDING FLAT SURFACES



### FLAT AREAS

To maintain a flat surface, you should always use a backing block when sanding large areas.

### END GRAIN

To lessen end grain's darker appearance when the workpiece is finished, burnish the wood and fill the pores by sanding end grain up to 320-grit paper.



### EDGES

Break the edges on a project not only to reduce future damage but also to prevent finish from forming a mound at the edges.

the scratches will still be shiny with fluid while the top surface is dull with dryness. If you take this step, you'll avoid the agony that many experience when they apply a stain only to see the scratches jump out.

### Sanding details and molding

After sanding the wide-open areas, how should you sand profiled areas? Manufacturers advertise detail sanders as the answer to sanding any shape and any confined space. These sanders come with a variety of pads designed to fit different profiles. Although I own a couple of detail sanders, I could live without them, mostly because it's too much trouble to constantly change the paper on them; by their nature, they put their sanding action into a small area of sandpaper that wears very quickly.

Most of the time I think it's quicker to do moldings, interior corners, and other small areas by hand. To keep the moldings crisp, use commercial rubber profiles that cover most convex and concave shapes, or you can make your own profile blocks from pieces of foam-insulation panel.

The end grain on raised panels requires a special sanding sequence to tone it into the rest of the panel. Start by sanding across the grain with 150- or 180-grit paper to deal with the rough texture. Then sand the en-

### SANDING AFTER GLUE-UP

No matter how thoroughly you sand parts prior to assembly, there still will be small areas to touch up by hand-sanding with 220- or 320-grit paper. Areas where glue was removed with a damp cloth may need smoothing (top), or there may be two pieces that don't join in a perfect plane (bottom). To avoid cross-sanding where grain intersects, mask off one of the pieces.



## HAND-SANDING DETAILS



**Rubber profiles.** Using a rubber pad that fits the molding helps keep the edges of the profile sharp.



**Sanding curves by hand.** Contour the paper to fit curves in the wood.

tire profile on all four sides of the panel with 180- or 220-grit paper. Last, sand just the end grain with 320-grit paper, going with the grain in short strokes to eliminate any cross-grain scratches and to lessen the end grain's ability to absorb finish.

### Final hand-sanding gives a finishing touch

No matter how much you are able to use machines for the initial stages of sanding, you'll want to give each surface some final sanding by hand. Primarily, this is to get rid of the small orbital scratches left by the machines, replacing them with smaller, finer scratches that are all parallel to the grain of the wood and hence less noticeable.

You should back up the sandpaper with a sanding block wherever possible to maintain a flat surface. I find the palm-sized rubber blocks most convenient because

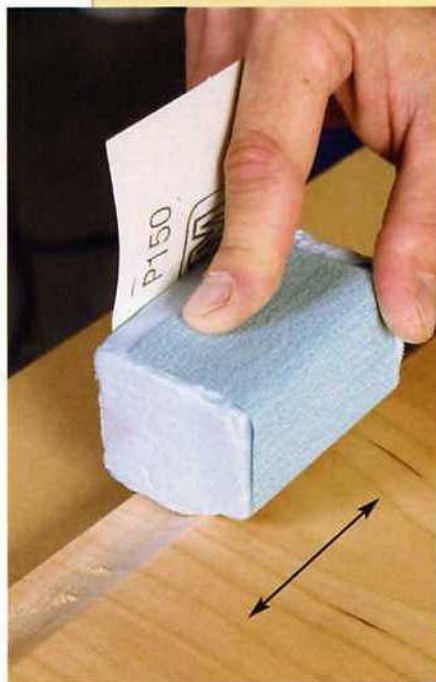

### CURVE CONSCIOUS

Insulation foam shaped to match the panel's profile makes a good backing for sandpaper (above). The end grain may need to be sanded with paper that is one grade coarser than that used on the rest of the panel, in this case, 150 grit (left). Then sand the entire panel with 220 grit before removing any cross-grain scratches on the end-grain sides using 320-grit paper with the grain.

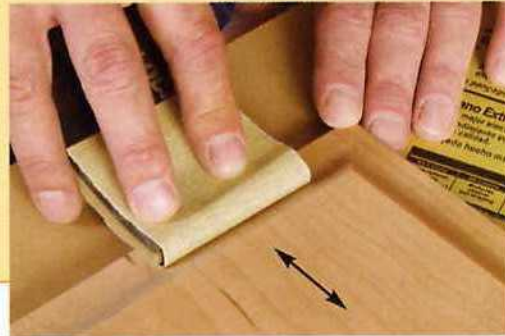

they also can be used for wet-sanding between coats of finish. Other choices include cork blocks or wood blocks faced with a sheet of cork.

If you plan to use a water-based stain or clear finish, there are a couple of extra steps. After the final hand-sanding, wipe down the piece with a damp sponge. After the wood dries, very lightly sand with the same-grade paper you finished with, but be careful to remove only the raised grain. Watch out for sandpaper coated with stearates: Although they do a better job at preventing clogging,

allowing the sandpaper to last longer and sand more smoothly, stearates are waxy and interfere with many water-based finishes, causing fisheyes on the surface. If you're planning to use a water-based finish, check with the manufacturer to see whether the finish is compatible with stearated sandpaper. Last, as I recommend for all finishing methods, test each sanding step on a sample board. □

*David Sorg is a finisher and artist who lives in Denver, Colo.*

# 18th-Century Pipe Box Provides Elegant Storage

Simple construction makes  
this an easy project

BY LONNIE BIRD

Smoking was a popular social custom in the Colonies. As a result, Colonial craftsmen fashioned small, detailed boxes for holding long-stemmed clay pipes and tobacco. Today, these boxes are a great way to store items such as candles and matches.

Curly maple is authentic for this reproduction piece, but you can use any wood. Here's an opportunity to practice resawing, dimensioning and routing small parts, scrollsawing, and drawer making.

## Cut the parts and assemble the case

The drawer front is  $\frac{3}{4}$  in. thick, and the base is  $\frac{3}{8}$  in. thick, but the rest of the stock needed to build this project is only  $\frac{1}{4}$  in. thick.

After milling and sizing each part to its rough dimensions, rip  $\frac{1}{4}$  in. from the forward edge of each side of the box, stopping at the drawer location. Then crosscut the ends of the stopped cuts to square them up. The front of the box will fit in these notches.

The next step is to lay out the scalloped shapes in the front, back, and sides. Cut the shapes on a scrollsaw, making relief cuts to each inside corner to avoid trapping the blade. To cut a smooth, fair curve, leave enough wood to support the blade on both sides. To cut the hole at the top of the back, use a  $\frac{1}{2}$ -in. Forstner bit.

Now cut a  $\frac{1}{4}$ -in. half-round profile along the side and front edges of the base. Leave the back edge square so that it can be mounted flush to the back of the case and hung flat against a wall.

**Be gentle during assembly**—Assemble the box by gluing the back and front to the

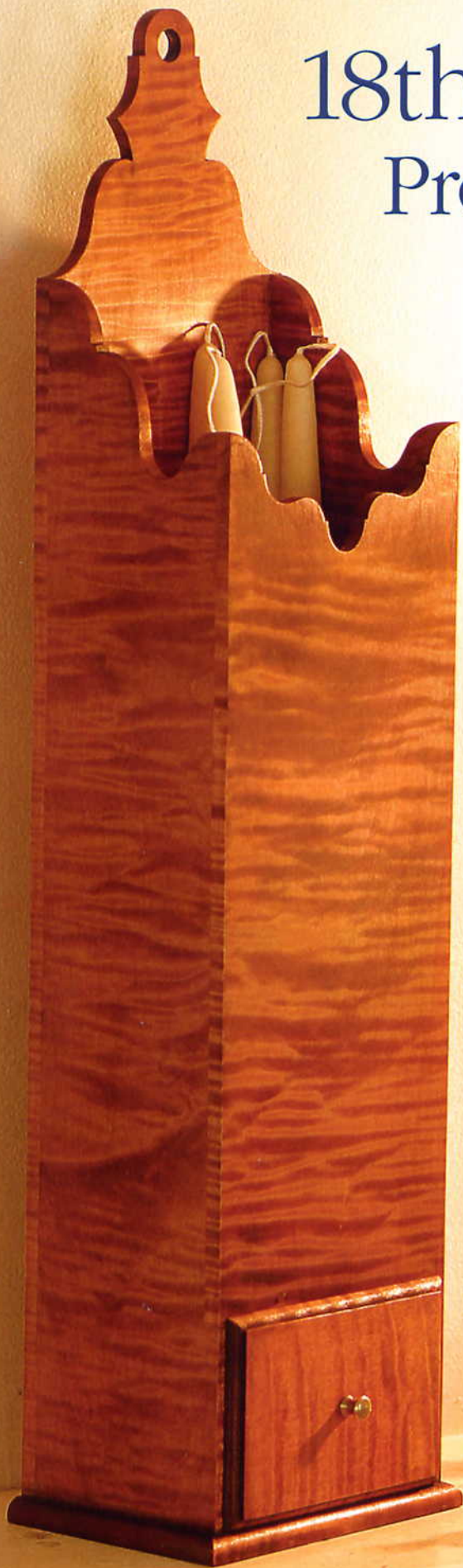

## PIPE-BOX CONSTRUCTION

The primary wood for this pipe box is curly maple, and the secondary wood is poplar. Use templates to lay out the scalloped shapes on the front, back, and sides of the box. The patterns here are drawn on a ¼-in. grid.

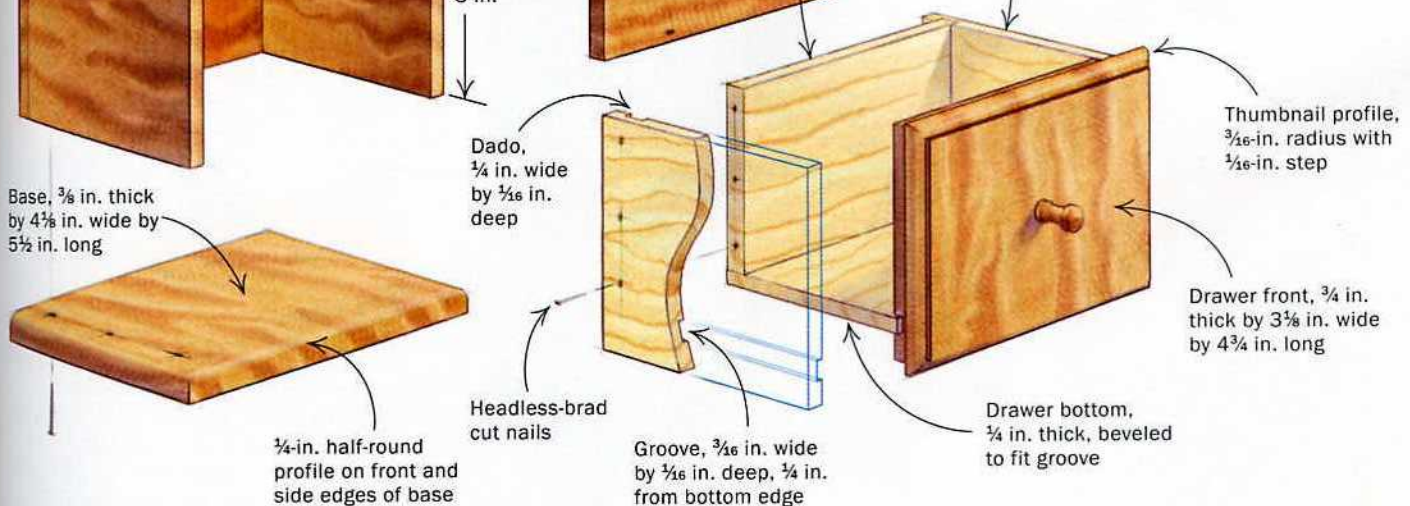
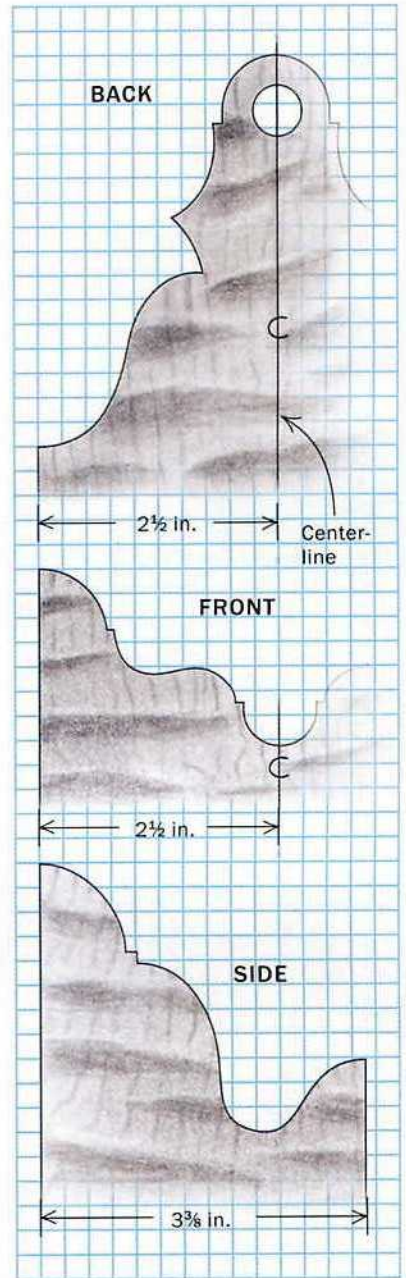
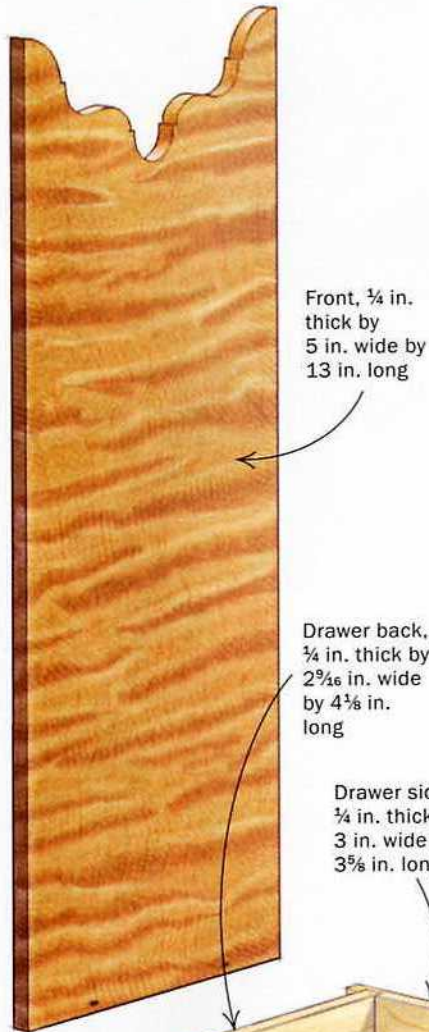

## CUT THE SCROLLWORK AND ASSEMBLE THE CASE

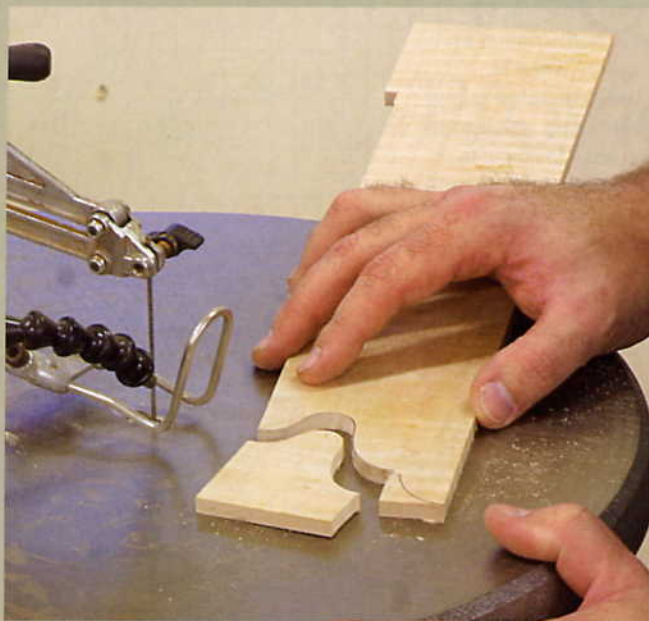

**With a scrollsaw and files, prepare the curves.** Make relief cuts to the inside corners of the pattern, then cut each sweeping curve to the relief cut (left). Clean up the sawmarks with half-round bastard and smooth files (above).



sides, and clamp with light pressure. The face-grain joints where the sides meet the front and back are strong enough with glue alone. Trim the sides flush to the front and back using a card scraper. Then glue the base to the bottom of the case and drill pilot holes on the underside of the base for  $\frac{7}{8}$ -in. headless brad cut nails.

Next, install the bottom of the pipe compartment. Dab a little glue above the drawer opening and then slide the bottom into place. To keep the compartment bottom square and perpendicular to the case sides while the glue sets, place  $\frac{1}{4}$ -in.-thick plywood spacers along the inside walls of the drawer opening that are as high and deep as the opening. Once the compartment bottom is flat and in the right spot, drill two pilot holes in the front and back and then drive in the cut nails.

### Build the drawer

The drawer is assembled with simple but long-lasting glue-and-nail construction. The front has a  $\frac{1}{8}$ -in. lip on the top and sides (but not on the bottom) that covers the reveal around the opening.

Carefully measure the opening and add  $\frac{1}{4}$  in. to the length of the drawer front and  $\frac{1}{8}$  in. to its width, and cut the piece to size.

Use a router to cut the rabbets along the sides and top of the drawer front. Allow for clearance by cutting the top rabbet a little wider than the lip thickness, and the side rabbets a little wider than the overall thickness of the drawer side and lip:  $\frac{1}{32}$ -in. clearance above and  $\frac{1}{16}$ -in. clearance on each side of the drawer will leave enough



**Gentle glue-up.** Light clamping pressure is all that's needed for the front and back side joints (left). When installing the compartment bottom, use spacers to hold it square while the glue dries, then reinforce with nails set below the surface.

## BUILD THE DRAWER WITH RABBETS AND CUT NAILS

The lip on the drawer front covers the top and side edges of the opening. The side rabbets are deep enough to accommodate the thickness of the drawer sides, and the thumbnail profile on the drawer front complements the one on the base.

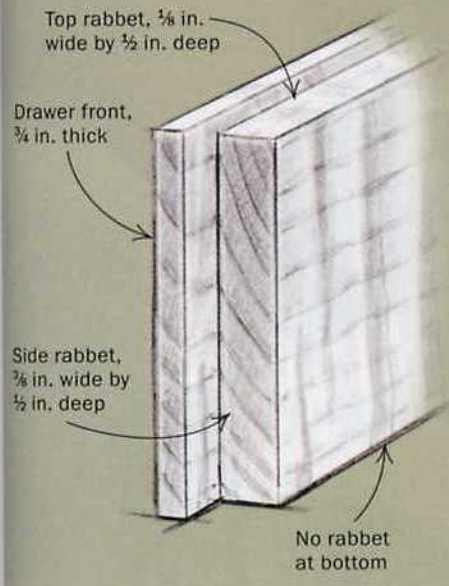

**Rout the rabbets and profile.** Use a straight bit to rabbet the sides and top of the drawer front (left). Next, use a  $\frac{3}{16}$ -in.-radius roundover bit to rout the thumbnail profile on the drawer face (above). Start with the left edge and work in a clockwise direction to remove any crosscut tearout. A zero-clearance fence helps reduce tearout.

space for a drawer this small. Next, with a  $\frac{3}{16}$ -in.-radius roundover bit, cut the profile, with a  $\frac{1}{16}$ -in. step, on all four sides of the drawer face.

Once the drawer front has been fitted to the opening, cut parts for the sides and the back. The width of the side and back parts matches the long edge of the side rabbet, and the length of the back matches the length of the top rabbet plus twice the depth of each dado. To prevent the drawer from striking the back of the pipe box, cut the back end of the drawer sides  $\frac{1}{16}$  in. shorter than the depth of the opening.

Cut  $\frac{3}{16}$ -in.-wide by  $\frac{1}{16}$ -in.-deep grooves in the sides and the front for the drawer bottom. Then raise the blade slightly and rip the drawer back. The width of the drawer back matches the distance between the

top of the side and the top of the drawer-bottom groove. Finally, cut  $\frac{1}{4}$ -in.-wide by  $\frac{1}{16}$ -in.-deep dados into the sides for the back of the drawer.

After the drawer has been assembled, bevel the front and side edges of the drawer bottom, slide it into position, and drive a cut nail from the bottom into the drawer back. Glue the front edge and the first  $\frac{1}{2}$  in. of the sides of the bottom to force the wood movement to the back of the drawer. Finally, cover visible nail heads with wood putty that will accept stain. Finish the box with an aniline dye, followed by several coats of amber shellac, and install a brass drawer pull to complete the project. □

For more information on Lonnie Bird's woodworking classes, visit [www.lonniebird.com](http://www.lonniebird.com).

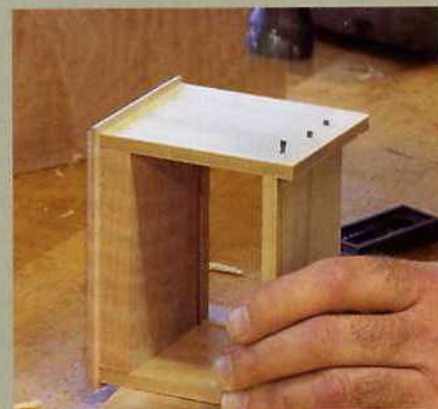
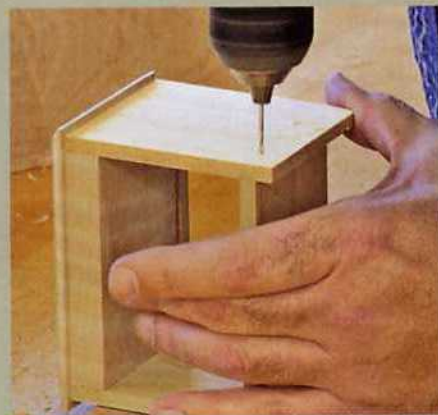

**Pilot holes prevent splitting.** Drill pilot holes after gluing and before nailing the sides to the front. Glue the back to the sides, drill pilot holes (top), and nail (bottom).



### A traditional option

If you want a challenge, you can build the drawer for the pipe box using dovetails and add a Massachusetts shell carving. For more on making a dovetailed drawer, see *FWW* #157, pp. 78-83; for more on making a shell carving, see *FWW* #119, pp. 52-58.



# Router Combo Kits

A pair of bases with an interchangeable motor gets you two different machines for little more than the price of one

BY TOM BEGNAL



## Fixed-base mode

With the motor mounted in the fixed base, the router is relatively lighter and more compact than when it's in plunge mode (right). Plus, in the fixed-base mode, the router has a low center of gravity that makes it easier to control.

**P**lunge routers and fixed-base routers have more similarities than differences. Why, then, do many woodworkers purchase one of each? Because each type has its advantages.

A plunge router lowers, or plunges, a spinning bit straight down into the workpiece to start a cut, and then raises the bit out of the workpiece at the end of the cut. It also makes it very easy to lower the bit after each pass and make successively deeper cuts. Because the base of the router remains firmly on the workpiece, the plunge router is the best choice for making a stopped cut—one that does not extend all the way to the edges or ends of a workpiece. So any time a stopped cut is required, whether it's a groove, a dado, a rabbet, or a mortise, I reach for the plunge router. On the other hand, a fixed-base router is lighter and more compact than a plunge router with the same horsepower.

So it's my router of choice for the 90% of my work that doesn't involve stopped cuts.

The big drawback of owning both types of router used to be that you had to open your wallet extrawide to pay for them. But with the relatively recent advent of router combination kits, it's a lot cheaper to own both a fixed-base and a plunge router. These unique kits come with two bases and one motor to service both. The net result is two routers for not much more than the price of one.

### What's new on the market

Currently, six manufacturers offer router combination kits. They include the Bosch 1617EVSPK, DeWalt DW618PK, Makita RF1101KIT2, Porter-Cable 895PK, Ryobi RE1803BK, and Skil 1825. Each has a motor that falls into the 2-hp to 2½-hp range, which is enough muscle for most any task. Porter-Cable also offers another combo kit, model 693VSPK; it wasn't included in this review because it has a smaller (1½-hp) motor.

All of these routers have variable-speed motors, so you can reduce the speed (rpm) when running large bits. To limit the tendency of a router to twist in your hand at start-up, all but the Skil have motors with a soft-start feature. Also, except for the Skil, each router has a constant speed-control feature that helps the motor maintain its speed even when the bit runs into a tough area or is asked to make a deep cut.

The bases in most of these combination kits, especially the plunge bases, are not exact copies of the manufacturers' dedi-



### Plunge-base mode

Mount the motor in the plunge base, and the router immediately becomes well suited for making stopped cuts. That's because a plunge base allows the router bit to be lowered straight down into a workpiece and then raised up at the end of the cut.

## Features at a glance



**Sweet switch.** A conveniently located toggle switch on the DeWalt allows you to keep both hands on the handles when turning the router on or off in plunge or fixed mode.



**Best for bit changing.** Lots of open space around the collet and a one-wrench changing system made the Ryobi a favorite when it came to removing or replacing a bit in either plunge or fixed mode.



**A lock for the bases.** The oversize lever on Porter-Cable's fixed and plunge bases helped make it easy to lock the motor in each base.

cated versions with the same horsepower rating. One exception is Makita, whose combination and dedicated routers are twins. The fixed bases of the Bosch and Porter-Cable combination kits are identical to the companies' dedicated routers, but the plunge bases differ. And both bases in the DeWalt, Ryobi, and Skil router combination kits differ from their companies' dedicated versions of each router.

As a general rule, when the bases on a combination kit and a dedicated router differ, the dedicated version is going to have the better features. At the end of the day, though, they both get the job done.

Each of these routers accepts bits with shanks of either 1/4 in. dia. or 1/2 in. dia. Except for the Ryobi and the Skil, all of the combination kits include both 1/4-in. and 1/2-in. collets. The Ryobi and Skil kits are sold with a 1/2-in. collet as well as an adapter for 1/4-in.-shank bits.

If you prefer a D-handle router for an extra measure of comfort and control, the Ryobi kit includes a D-handle base, while the DeWalt, Makita, and Porter-Cable are available with an optional D-handle accessory. DeWalt also sells a kit that includes a D-handle base along with a fixed and a plunge base (model DW618B3). And the Porter-Cable 894PK kit comes with a D-handle and a plunge base.

### Combo kits put to the test

To compare performance, I gave each router combination kit a hands-on evaluation in the *Fine Woodworking* shop. First, I looked at how they performed in their fixed bases, and then I tested

them in their plunge bases. Finally, because routers often end up in router tables, I gave some consideration to how each behaved upside down.

In the process, I looked at motor-changing ease, along with comfort and convenience of the handles and controls. I also measured the routers for runout, vibration, and noise. Plus, I made test cuts to get a sense of power and cut quality. (For the results of each test, see the chart on pp. 54-55.)

**Measuring vibration and noise**—All routers vibrate in use; there's no way to avoid it. But a router with minimal vibration not only is going to make smoother cuts, but it also will feel better in your hands. In the vibration test, the Bosch, DeWalt, Makita, Porter-Cable, and Skil routers garnered excellent scores. The Ryobi came away with a grade of fair.

In use, all routers are noisy enough to require you to wear ear protection, but a relatively quiet router gets bonus points over one that sends the family dog fleeing to the neighbor's yard. When it came to noise, the Makita and Porter-Cable were relatively quiet, with a decibel (db.) rating of 86 and 87, respectively. The Bosch, DeWalt, Ryobi, and Skil were noisier, at 91 db., 93 db., 91 db., and 96 db., respectively. But those results compare to an average rating of 93.6 db. measured during the last *Fine Woodworking* router test a few years ago (see "Midsized Plunge Routers," *FWW* #149, pp. 46-53).

**Cutting tests**—Once a router is turned on, I want it to do mainly two things: cut without bogging down easily, and produce good-

## FIXED-BASE DEPTH ADJUSTMENT

In the fixed-base mode, depth-adjustment mechanisms come in two basic types: dials (left) and rings (below).



**Micro-adjust is best.** With a micro-adjust dial reading to  $\frac{1}{256}$  in., the Bosch fixed base proved to be the favorite for setting bit depth.



**Eye strainer.** The black-on-black depth-adjustment ring on Makita's fixed base makes your eyes work way too hard.

## PLUNGE-BASE DEPTH ADJUSTMENT

Except for the Ryobi model, all of the router kits made bit-depth adjustments using some sort of multistop system that's part of the plunge base.



**Multistop system.** The Makita (shown) and Porter-Cable plunge bases have three adjustable stops to fine-tune plunge depths.



**Thumb's the word.** A unique system on Porter-Cable's plunge base lets you change to a new bit stop just by turning a shaft with your thumb.

quality cuts. To get a sense of motor power, I set up each router in its fixed base and installed a new  $\frac{1}{2}$ -in.-dia. straight router bit. With the bit set to make a  $\frac{1}{2}$ -in.-deep cut, I made several full-depth passes along the grain in poplar and red oak. Despite the heavy cut, all of the routers were up to the task, and none showed any signs of bogging down. By the way, Ryobi recommends not making any cuts that exceed a depth of  $\frac{1}{8}$  in. per pass.

Next, I ran a simple test to see if there would be any noticeable difference in cut quality from one router to another. Starting with the fixed-base versions, I equipped each router with a new  $\frac{1}{2}$ -in.-dia. straight bit. Then, with the base of the router held firmly against the fence, I trimmed  $\frac{1}{8}$  in. of stock from the edge of  $1\frac{1}{2}$ -in.-thick soft maple.

Then I changed the motors to the plunge bases, lowered the bit a full  $\frac{1}{2}$  in. in a single plunge, and cut an 8-in.-long groove in the soft maple. After each cut I checked the groove with calipers to see how close the cuts came to the measured diameter of the bit. Any number beyond that figure represented a less-than-ideal cut.

All of the routers did well in both tests. As a result, I rated the cut quality for all of them as very good.

**Checking for stickiness**—Some plunge routers I've used have tended to stick somewhat as they move up and down. A sticky plunge action not only is annoying, but it also can affect the accuracy of a cut, mainly because the focus of concentration goes from the cutting process to getting the housing to plunge.

On each router in this test, I used a  $\frac{1}{2}$ -in.-dia. straight bit to make three progressively deeper plunge cuts. While making the cuts, I

## Router-table convenience

When the Porter-Cable is mounted to a router table in the fixed-base mode, a special wrench (included) lets you change bits and adjust the collet height from above the table.



was careful to note the stickiness factor. The Bosch router was the slickest operator here, with a comfortably smooth up-and-down sliding action; the DeWalt was almost as good. The Makita and Porter-Cable moved exceptionally smoothly when the same amount of downward pressure was applied to each of the handles. However, as soon as the pressure became unbalanced, with more pressure on one handle than on the other, the plunge mechanism immediately became sticky.

### How the kits measured up

After reviewing the pros and cons of each router, I awarded Best Overall to both the Bosch and the Porter-Cable. If I had no plans to use a router table, I'd choose the Bosch. On the other hand, if the router were going to see regular use in a table, the Porter-Cable is an easy first choice.

The Bosch got high marks in many areas: handle comfort;



**BOSCH 1617EVSPK**

877-267-2499 [www.boschtools.com](http://www.boschtools.com)

	Model	Price	Motor	Amps	Vibration	Quality of cut	Noise level	D-handle included	Edge guide included	Ease of base changes
<b>BEST OVERALL CHOICE</b>	<b>BOSCH 1617EVSPK</b>	\$230	2¼ hp	12	Excellent	Very good	91 db.	No	No, \$40 accessory	Very good
	<b>DeWALT DW618PK</b>	\$240	2¼ hp	12	Excellent	Very good	93 db.	No, \$75 accessory	No, \$40 accessory	Very good
	<b>MAKITA RF1101KIT2</b>	\$250	2¼ hp	11	Excellent	Very good	86 db.	No, \$138 accessory	No, \$22 accessory	Very good
<b>BEST OVERALL CHOICE</b>	<b>PORTER-CABLE 895PK</b>	\$270	2¼ hp	12	Excellent	Very good	87 db.	No	No, \$39 accessory	Excellent
	<b>RYOBI RE1803BK</b>	\$150	2 hp	9½	Fair	Very good	91 db.	Yes	Yes	Fair
<b>BEST VALUE</b>	<b>SKIL 1825</b>	\$100	2¼ hp	11	Excellent	Very good	96 db.	No	No, \$15 accessory	Fair

fixed-mode bit changing; plunge-lock convenience; bit-depth setting in the fixed mode; and vibration. The Porter-Cable placed first or second in a number of other categories, including switch convenience in the router table; bit changing in the router table; housing lock; ease of changing from one mode to another; setting the bit depth in fixed, plunge, and table modes; vibration; and noise.

If a D-handle is important to you, the DeWalt and Makita are your best options; both offer a D-handle as an accessory. And like the Bosch and Porter-Cable, the DeWalt and Makita are routers built to run every day.

If you're on a tight budget, and if you run a router only a few hours a year, the Ryobi and Skil are worth considering. The Ryobi combination kit is the only one that includes a D-handle. And the Skil gets you both a plunge and a fixed base for less than I've paid for a few good router bits. Its low price makes it the Best Value. □

*Tom Begnal is an associate editor.*



**PORTER-CABLE 895PK**

800-368-1487  
[www.porter-cable.com](http://www.porter-cable.com)

Photo, this page (top): Tom Begnal



**DEWALT DW618PK**

800-433-9258 www.dewalt.com



**MAKITA RF1101KIT2**

800-462-5482 www.makitausa.com

Router-table suitability	FIXED-BASE RATINGS				PLUNGE-BASE RATINGS					
	Handle comfort	Ease of bit changes	Ease of setting bit depth	Switch convenience	Handle comfort	Ease of bit changes	Ease of setting bit depth	Switch convenience	Plunge performance	Stop system
Very good	Very good	Very good	Very good	Good	Excellent	Very good	Good	Good	Excellent	Good
Very good	Good	Good	Good	Very good	Good	Very good	Good	Very good	Very good	Good
Very good	Good	Very good	Fair	Fair	Good	Very good	Fair	Fair	Fair	Very good
Excellent	Good	Good	Good	Good	Good	Very good	Good	Good	Fair	Excellent
Good	Fair	Excellent	Good	Good	Very good	Excellent	Fair	Good	Fair	Fair
Good	Excellent	Good	Good	Very good	Very good	Excellent	Fair	Very good	Fair	Fair



**RYOBI RE1803BK**

800-525-2579 www.ryobitools.com



**SKIL 1825**

877-754-5999 www.skil.com

# Built-Up Moldings

Construct impressive moldings with just a router and off-the-shelf wood

BY ALAN CHARNEY

**M**y shop is small, with only the most basic equipment. I also have limited sources of hardwood, confining me to  $\frac{3}{4}$ -in.- or 1-in.-thick stock. However, these obstacles haven't stopped me from tackling ambitious projects, such as the crown molding on a secretary I built. Lacking thick slabs of wood and a shaper, I built up the molding from smaller strips, which I profiled individually using a router. When glued together, the individual strips formed a molding that looked like it was milled from one piece of solid stock.

Following my approach, using just a basic router, a few router bits, and a shopmade router table, you can create moldings of almost infinite variety, which will enhance the appearance of your work.

## Make templates from the router-bit profiles

There are two ways to choose appropriate moldings for a project. One is to research the moldings traditionally used on the style of furniture you are building and to make something similar. The second way is to create your own design. A deep molding creates an elegant concave profile suitable for more formal, detailed furniture. A convex shape makes a bolder statement more suitable to heavier, country-style furniture.

After you have a general design, draw a full-scale rectangle that matches the height and depth of the molding. Then lay the router bits you intend to use against some thin cardboard and trace their



## DESIGN THE MOLDING

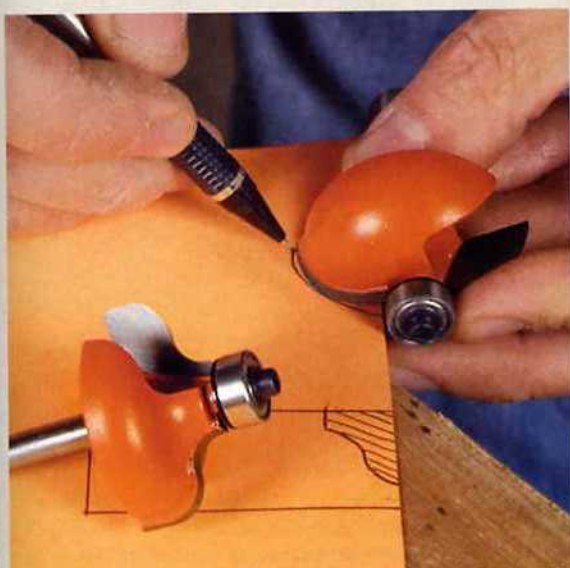

**Make templates.** Trace the profile of each router bit on thin cardboard to create templates for the molding.

profiles with a pencil. Cut out each profile to create templates that can be arranged on the full-scale rectangle until you arrive at a design that matches your goal.

Play with the depths of cut and the positions of each cut, and also try flipping some bits by 90°. The most useful router bits are S-shaped, meaning they follow a curve, going from thick to thin. These include edge-forming bits, such as ogee, roundover, and cove bits, plus panel-raising bits. Round-nose and V-groove style bits also work well for creating profiles.

### Choose stock with uniform grain and color

To make the molding look as if it were created from a single piece of wood, the strips need to match in color and grain pattern. The easiest way to achieve this is to take all of the strips from one wide board that is uniform in appearance. Another way is to use boards that were cut from the same tree, preferably in sequence.

Some router bits, such as panel raisers, have longer profiles and sometimes require a thicker board than I have on hand. If you need to join together two boards, matching the grain is crucial. Cut a straight-grain board in half, and then flip over one of the halves onto the other to create two adjacent layers with matching grain and color. You can use the same trick with figured boards, but because perfect grain-matching is almost impossible, you may have to rely on small steps, or reveals, between layers of molding to conceal contrasting grain patterns.

### Cut profiles on the router table

There is no need for an expensive or sophisticated router table. Mine has short legs that allow me to place it on top of my bench when in use and store it away when I'm done. Most of the bits I use have bearings, and often I use them without a fence. For safety's sake, however, you can use a fence for the first few intermediate cuts and then move it just beyond the bearing for the final cut. Make

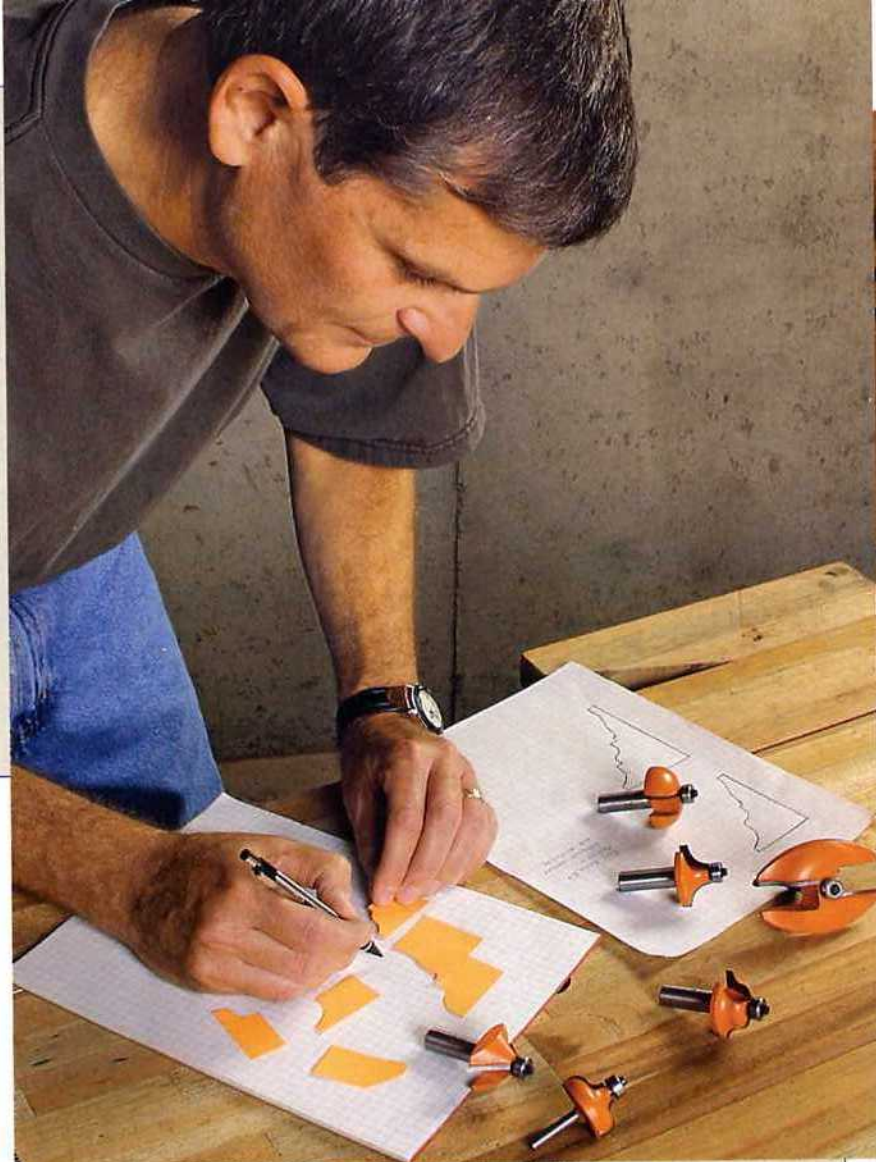

### Use the templates to build up different molding designs.

Experiment with a combination of profiles to arrive at the perfect design for the molding.

### DIVIDE THE DESIGN INTO SECTIONS

Divide the molding into slices that each router bit can cut. Solid lines divide the pieces routed separately, and the dashed line shows where two boards must be glued together to create the necessary thickness for a large router-bit profile.

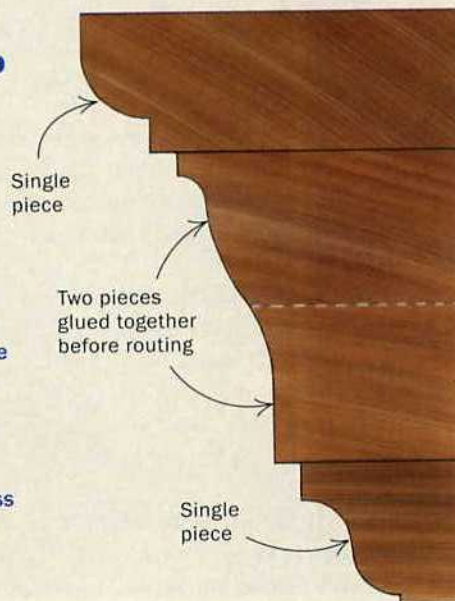



## ROUT THE PROFILES



**Route the first section.** The top section of the molding is a piece of wood large enough to be cut safely without the addition of a scrapwood backing block. For safety's sake, though, you can use a fence for the first few intermediate cuts; then move the fence beyond the bearing for the final cut.

Feed the stock from right to left when facing the router. Guide the workpiece free-hand, making several passes to remove only small amounts of wood each time. On only the last cut or two is the wood guided by the router bearing.

### WIDE PROFILES



**Align the workpiece and router bit.** Instead of lowering the bit and creating a large hole in the router table, raise the workpiece by running it across a thin sheet of medium-density fiberboard (MDF) or hardboard clamped to the table.

### NARROW PROFILES



**Small boards need backing blocks.** Because the lowest section of the molding is so narrow, a piece of scrapwood should be attached to it to keep fingers away from the router bit.

### THE IMPORTANCE OF BACKING BOARDS

Because of the amount of wood to be removed by the panel-raising bit, this section requires that several pieces of scrapwood be glued to it for stability during routing.

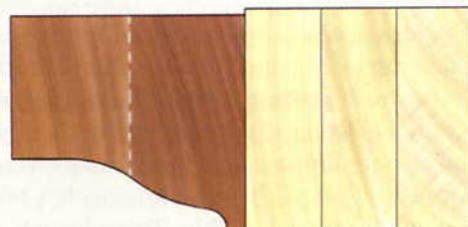

Any wide piece of scrapwood can be used as a backing board for a narrow molding. But make sure the molding is held in the correct orientation to the router bit.



sure you have enough depth adjustment on your router, once it's mounted under the table, to get the profile you want.

**Tips for router safety**—To prevent the small strip from being thrown from the router with your fingers only inches from its 25,000-rpm spindle, glue scrapwood to the back of the workpiece, which makes the piece safer and more stable, as well as less prone to vibration and chatter.

Also, don't cut the full depth of the profile at once; instead, take several passes. As well, use earplugs and all required safety equipment. Make sure the router bit is tightened. Never push your fingers toward the spindle; make sure they push parallel to the wood's movement. This allows them to go past the spindle and not into the bit if the wood should shoot out suddenly.

### Assemble the strips into one molding

After cutting the profiles, rip away the scrapwood backing pieces. Don't worry about getting an even surface on the back of the molding; that will come later.

Refer to the full-size drawing to determine the depth of the reveal between layers of molding. It is important that this small overlap be uniform along the length of the molding. The best way to ensure this at glue-up is to place a length of scrap on the bars of the clamps to shim one section of the profile (see the photos on the facing page). Also, put the glue bead toward the back of the overlapped surfaces to avoid squeeze-out in the reveal in front, where it is hard to remove.

Never glue up more than two pieces at once: This way you can concentrate on one overlap at a time to prevent mistakes. As you tighten the clamps, make sure the pieces don't slide out of alignment. Use as many clamps as necessary to prevent an unsightly gap from appearing in the middle of the molding.

Last, rip the finished molding to the correct width shown on the original drawing, establishing a flat back that can be glued or otherwise attached to your project. □

*Alan Charney is an engineering manager and amateur woodworker who lives near South Bend, Ind.*

## GLUE UP THE STRIPS

Before the strips of molding are glued together, you need to rip away the scrap-wood backing blocks.



**One step at a time.** Glue together only two sections at a time (above) and check the joint carefully as pressure is applied. To establish the reveal between two sections of molding, use a spacer of the correct thickness (right).

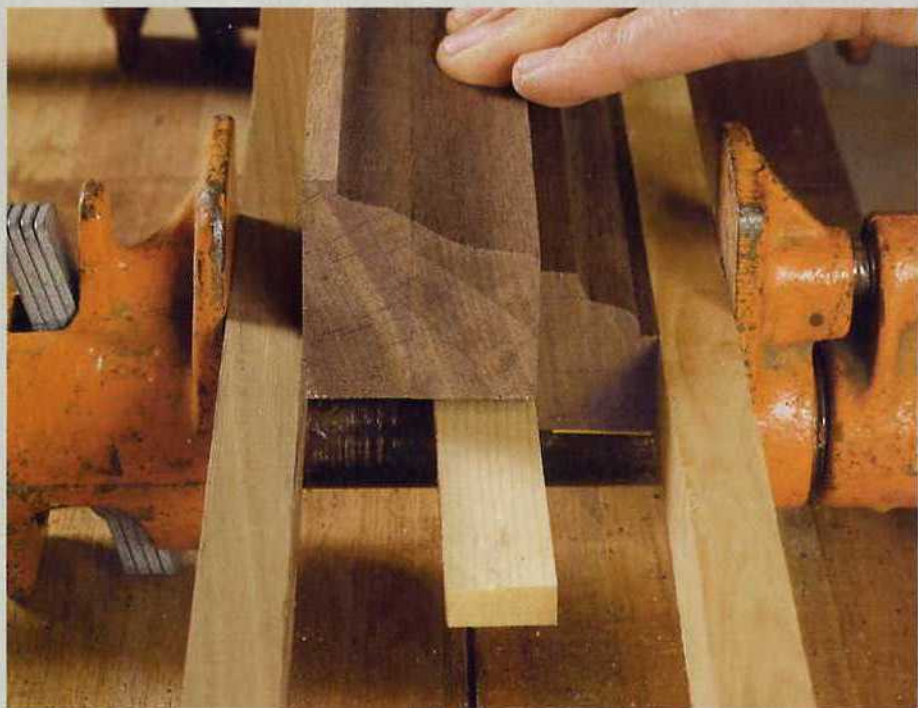

**Continue adding sections.** Because any gaps between sections of molding will be conspicuous, use numerous clamps to apply even pressure over the whole length.



# Flattening Tabletops

Surface large slabs and panels without big machines

BY ROB HARE

I build furniture that incorporates large slabs of wood. Early in my career, I had no access to large machines, so I developed a method for flattening large planks using winding sticks, a power planer, a marking gauge, a belt sander, and a palm sander. The process is so reliable and efficient that I continue to use it for most wide panels, even for small tabletops. While this article focuses on a thick, wide plank, a slight variation of the technique will work for glued-up panels and slabs, such as the top of a workbench or trestle table.

## Inspect the slab before planing it

Begin by assessing the curvature and grain pattern of the plank to gain insight into how the tree has grown and how the wood has moved up to this point. Then sight down the surface of the rough plank to get a feel for where wood needs to be removed and how the plank might respond to being cut. Also, measure the edges, looking for variations in sawn thickness. Be aware that variations at the edges can be deceiving, leading one to think the plank is stressed and twisted rather than just unevenly sawn.

If the piece of wood is to be cut down in width or length, do that before attempting to flatten it. Try to eliminate the areas that are the most twisted or seem the most stressed, based on your initial survey. Leave an extra ½ in. of length and width on all four edges, to be trimmed off later. The additional surface area at the edges will add stability for the planer and sander.

Placing the slab on sawhorses keeps the



**Too big for a jointer or planer.** You can take all the warp or twist out of a large tabletop using handheld power tools.

## READ THE SURFACE

**A rough idea.** Lay winding sticks at each end of the plank and sight over the tops of them to get a general idea of where cupping, bowing, and twisting are occurring.



work at a comfortable height. I often cover the sawhorses with moving blankets to protect the edges and surfaces of the wood. Do not clamp the plank to the sawhorses, which will restrict the wood and give inaccurate readings as the plank is being flattened. You can fasten stops to the horses or on your workbench to keep the workpiece from shifting.

### Winding sticks are your guide

You'll need a set of three shopmade winding sticks, 1 in. wide by 2 in. thick, and 12 in. longer than the width of the plank. Winding sticks point out inconsistencies in a surface: twist, when the four corners of the surface are not in the same plane; bow, which is curvature along the length; and cup, which is curvature across the width.

To see how winding sticks work, lay all three at equal intervals across a known flat surface, such as a tablesaw or workbench top, and sight across the tops. Note how the top edges of all three sticks are parallel. Then place a 1/4-in.-thick scrap under the end of one stick and sight across them again. The difference should be easy to see.

Now you are ready to work on your rough slab or warped glue-up. Place a winding stick at each end of the workpiece, perpendicular to the grain. Lay the third stick across the middle and slide it end to end on the plank. You usually will see some cupping across the

width. Place the plank convex-side-up on the sawhorses, use a well-placed wedge to minimize rocking, and mark the high areas with a lumber crayon.

### Power-planing is a gradual process

It is important to remember that, even though the plank may be considered dry, it will react (change shape) as wood is removed. Removing the outer growth rings from the convex side will relieve some of the pressure that has been causing the wood to cup, reversing the cupping as you work. It is easy to remove too much wood from one side and have a plank go from convex to concave. That is why flattening a slab is a process, involving partially leveling the high areas on one side, checking



**Use a third stick to find high spots.** Move a third winding stick up and down the plank to find high spots, and mark them with a lumber crayon.

**Rough the slab to size.** If possible, cut away the most stressed or warped areas. Also, leave 1/2 in. of extra material on each edge.



## START ON THE CONVEX SIDE



**Ease the ends of the planer blades.** To avoid very deep ridges when power-planing, relieve the corners of the planer blades. Grind back the last  $\frac{1}{4}$  in. of each corner by about  $\frac{1}{16}$  in., but maintain sharpness.

your progress, flipping the plank, and repeating the process.

The handheld power planer can remove a lot of volume in short order, so make a habit of planing less than you think is necessary. After each series of passes, sweep chips and dust off the top and check your progress using the winding sticks.

**Each pass guides the next one**—For flattening a large plank, I use a power planer that has a  $3\frac{1}{2}$ -in.-wide base. It weighs only about 6 lb., so it remains easy to handle as I make pass after pass over a big slab. I relieve the ends of each blade about  $\frac{1}{16}$  in., starting about  $\frac{3}{8}$  in. from each end, to stop the corners from digging into the wood.

For the flattest possible cut, each stroke should slightly overlap the previous one, with the heel of the machine skewed slightly (see the drawing and photos at right). Also, make each series of passes from right to left so that the chips are ejected away from the area to be planed next. After making a series of cuts in one direction, make the next series perpendicular to the previous cuts. You should see a crosshatch pattern.

**Flip the plank, and repeat**—After taking off less than half of the necessary material

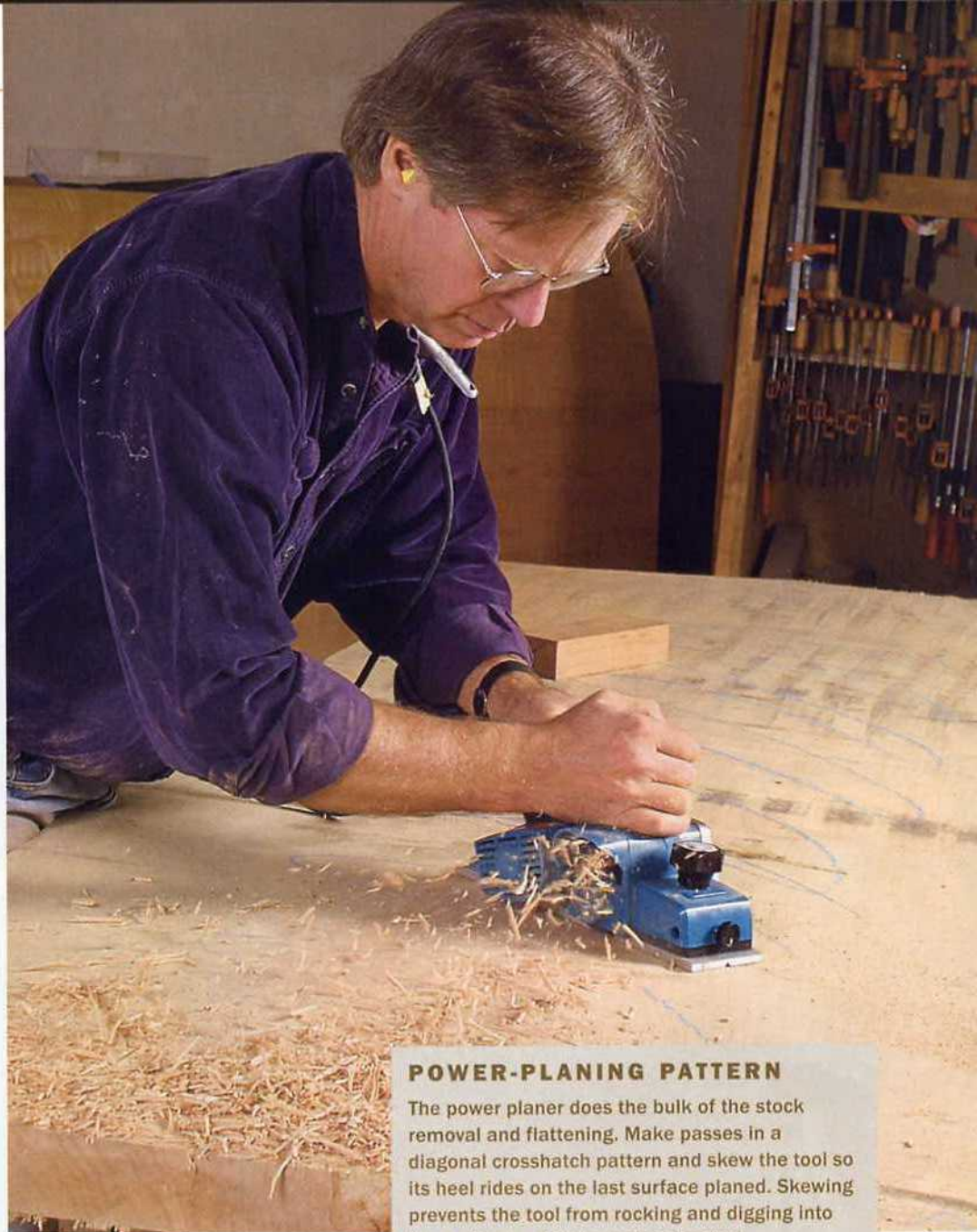

**Hit the high spots.** Make passes diagonally, skewing the planer so that its heel rides partially on the previous cut.



**A second pass.** This pass should be perpendicular to the first, creating a crosshatch pattern.

### POWER-PLANING PATTERN

The power planer does the bulk of the stock removal and flattening. Make passes in a diagonal crosshatch pattern and skew the tool so its heel rides on the last surface planed. Skewing prevents the tool from rocking and digging into the surface and helps reduce tearout.

Make the first series of passes diagonally to the grain.

Overlap the previous cuts slightly, skewing the planer so its heel rides on the last cut.

Make the second passes perpendicular to the first.

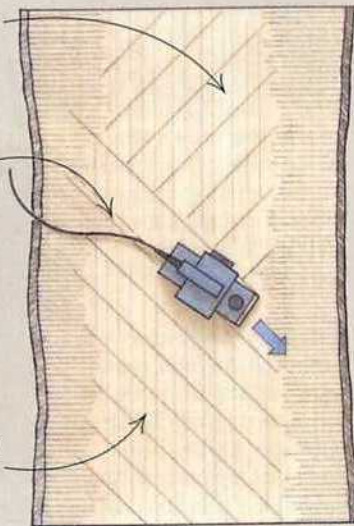

## SECOND SIDE AND BEYOND

**Go to work on the flip side.** With some of the crown removed from the plank, it's time to flip the plank to begin removal of the cup.



on the convex side, flip over the plank so that the concave side is up. Check for flatness, mark the high spots, and plane them with the crosshatch pattern. Work the power planer from the center toward the edges. Again, take off less wood than seems necessary.

Now flip over the piece so that the convex side is up and check the surface again with the winding sticks. You'll find that the planing done on the opposite side has relieved some pressure and already improved the flatness of this initial side of the plank.

Repeat the process of planing the high



**Use winding sticks again.** Planing done on the opposite side relieves stresses in the plank's interior, leaving less work to do on the cupped side.

**Work from the center out to remove the high spots along the edges.** Again, remove less than half of the high areas. Flip the plank and repeat the process repeatedly, creeping up on a flat, stable slab.



spots, inspecting with the winding sticks, remarking high spots with a crayon, and flipping the plank. It's helpful to spread this process over three days or more to allow the slab time to adjust. With large planks, you'll need a few breaks. Even a one-hour lunch break can result in visible change.

Note: It's important to check thickness throughout the process. Correct problems as you go, checking the surfaces with winding sticks and measuring thickness at

the edges to be sure you are working toward a flat slab of uniform thickness.

Continue to plane, inspect, and flip until both surfaces show no more than  $\frac{1}{16}$ -in. variation in twist, bow, cup, or thickness. Take lighter and longer passes until there is just a hint of the original surface in the lowest area of each side of the plank. Inspect yet again with the winding sticks.

**Scribe final thickness and take a few light passes**—At this stage, if the plank is more than  $\frac{1}{8}$  in. thicker than the desired finished thickness, continue to plane, inspect, and flip the plank until it is just  $\frac{1}{8}$  in. oversize—again, remembering to proceed slowly. Be on the lookout for movement.

At this point, the grain patterns of both sides are visible. Select the top, or show, face of the plank. Then set a marking gauge  $\frac{1}{16}$  in. beyond the finished thickness and scribe around the edges of the plank, working from the bottom edge upward, leaving the waste on the show face. Then, taking shallow passes with the heel of the planer riding on the previous cut, plane the show side to the scribed line.

### Sand to final thickness

Begin with an 80-grit belt and work your way up through 100, 120, and 150 grits, moving the sander straight across the plank but keeping it in line with the grain, with each pass overlapping the last one by 50%. (See the drawings at right for my sanding pattern.) I usually trim the plank to size after sanding with 120-grit paper.

Finally, use a random-orbit palm sander, starting with 120 and 150 grits and finishing with 180 grit. Watch for belt-sanding marks you may have missed in earlier passes. If they are deep, you may have to retreat to 100 grit with the belt sander. The key is to use these machines uniformly. A belt sander can leave deep scratches, and a palm sander can leave dimples, both of which will show up dramatically when finish is applied.

If the plank must be stored before it is finished and tied into a piece of furniture, it can be stood on end or stickered; just make sure to leave room for free air movement on all sides. □

*Rob Hare is a furniture maker who lives in Ulster Park, N.Y.*

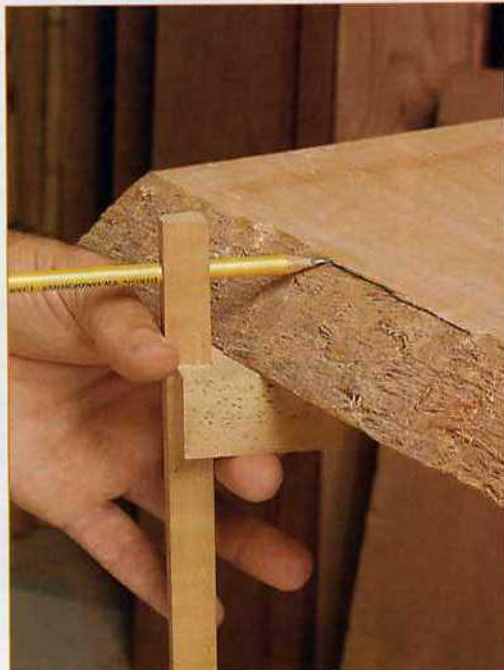

**Scribe  $\frac{1}{16}$  in. over final thickness.** Pick a show face and scribe from the bottom of the plank for your final passes with the power planer. Hare uses a shopmade marking gauge to work around live edges.

## PLANE AND SAND TO FINAL THICKNESS



**Watch chip output to determine flatness.** Set the planer to a lighter cut. If the surface is flat, the planer should send out a steady stream of fine shavings.

## Use a belt sander to finish the job

A belt sander maintains the flat surface left by the power planer while removing the ridges. Progressing through successively finer grits removes the deep scratches left by the rougher sanding belts. In both cases the belt sander is always held in line with the grain and is never lifted. Finish with a palm sander, working through 120 to 180 grits.



### ROUGH SANDING (80 AND 100 GRITS)

Move the sander from side to side on the slab while keeping it aligned with the grain. Each pass should overlap the previous one by about a third.

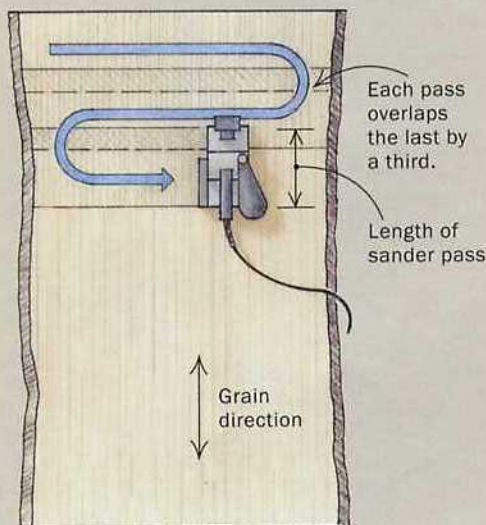

### FINE SANDING (120 AND 180 GRITS)

Make continuous 2-ft. to 3-ft. strokes in the direction of the grain, working your way across the slab. Each pass should overlap the previous one by about a third.

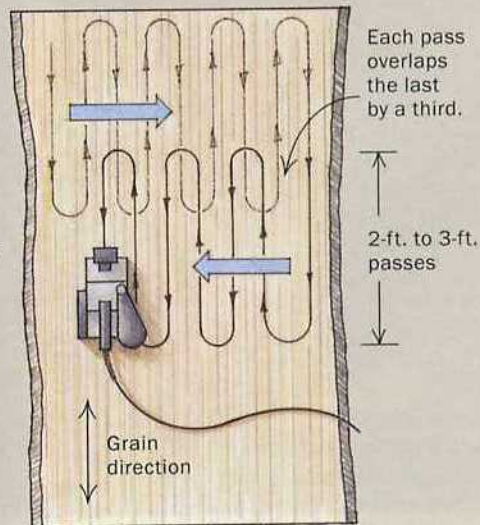



# Five Tips for Better Bandsawing

No-hassle approach  
delivers smooth,  
straight cuts

BY MICHAEL FORTUNE

In my first year of design school in the early 1970s, I remember the shop manager telling me that the bandsaw was the most useful piece of equipment in a woodshop. This struck me as a dubious statement, given that we were standing in a workshop filled with state-of-the-art European woodworking equipment. But time and again he proved it.

After I graduated in 1974, my first purchase was a 15-in. General bandsaw. However, I soon realized I could achieve



**Precise cuts are easier than you think.** It doesn't take a high-end blade, high tension, replacement guides, or a special fence to get excellent cuts.

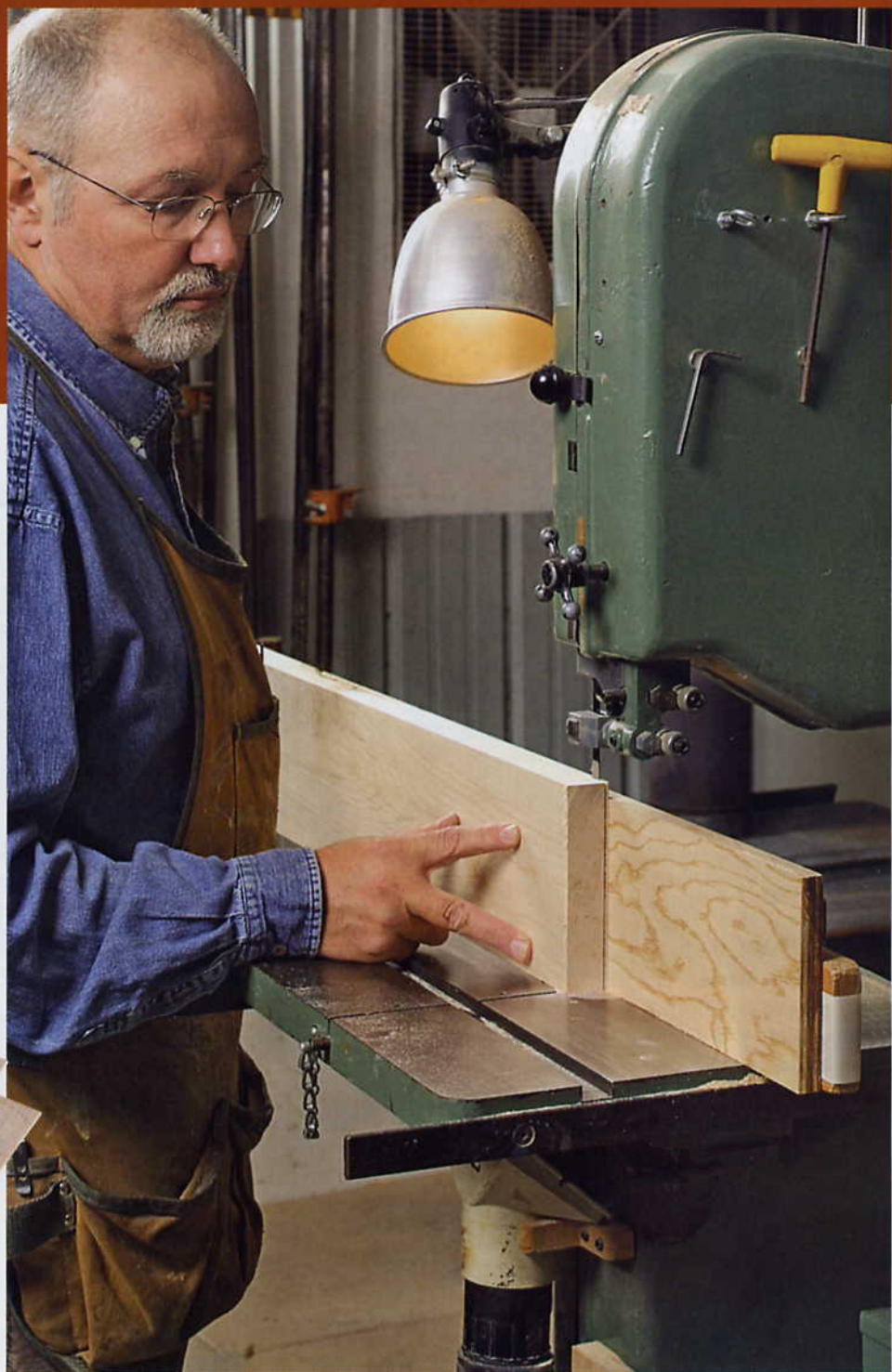

the accuracy and versatility I had experienced at school only if I set up the saw the way my shop manager did.

Once I figured out the keys to success, I came to rely on that bandsaw. With a single blade, I routinely cut smooth tenon cheeks, fine inlay stringing, and perfect veneers that use the entire height capacity of my machine.

I also do all of my ripping on that 15-in. bandsaw. The task is safer and requires less horsepower than the tablesaw, and the narrow kerf consumes less wood. New employees and students are surprised at first by my preference for ripping on the bandsaw, but they are converted quickly. Although I have three excellent industrial tablesaws in my shop, they are used almost exclusively for dadoing, squaring panels, and cutting shoulders on joints.

There are three key elements to getting the most from your bandsaw: blade type, blade alignment, and moderate tension. My approach contradicts some of the common advice for setting up bandsaws. It does not require high blade tension, special equipment, exotic blades, high horsepower, or continual fence adjustments to accommodate blade drift.

### Start with a coarse blade

During teaching assignments, I run into many woodworkers experiencing difficulties with their bandsaws. They complain about severely cupped kerfs, poor tracking, and saws that seem underpowered, so their bandsaws are relegated to cutting curves in thin stock.

The number-one culprit behind all of these difficulties is a bandsaw blade that has too many teeth, with small gullets in between. Sawdust generated in the kerf must be removed efficiently. A tremendous amount of heat is created by the friction from the sawdust that is jam-packed in each small gullet right at the point where the wood fibers are being cut. The intense heat can cause the blade to lose its temper and dull prematurely. The heat and pressure buildup also can cause the blade to flex sideways and backward, creating a dished cut. A typical reaction here is to tighten the tension on the blade. But over-tensioning the blade creates a whole new set of problems (see Tip 2).

My bandsaw does everything, every day: cutting joints, resawing wide laminates in exotic woods, making curved patterns in

# Tip 1

## A SINGLE BLADE CAN HANDLE MOST TASKS

**A ½-in.-wide, 3-tpi blade—properly set up—will handle general ripcuts, resawing, and even cutting curves in thin stock, not to mention cutting precise tenons.**

Standard ½-in.-wide carbon-steel blade

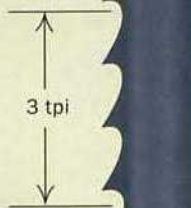

Large gullets clear chips efficiently. Finer blades, with more teeth per inch, have smaller gullets where chips get packed, causing the blade to cut poorly and to flex sideways.

### RIPPING



### RESAWING



### CUTTING CURVES



# Tip 2

## HIGH BLADE TENSION IS NOT NECESSARY

High tension eventually will groove the tires, pulling the blade out of alignment (for more on blade alignment, see Tip 3). High tension even can flex the machine's frame out of alignment.

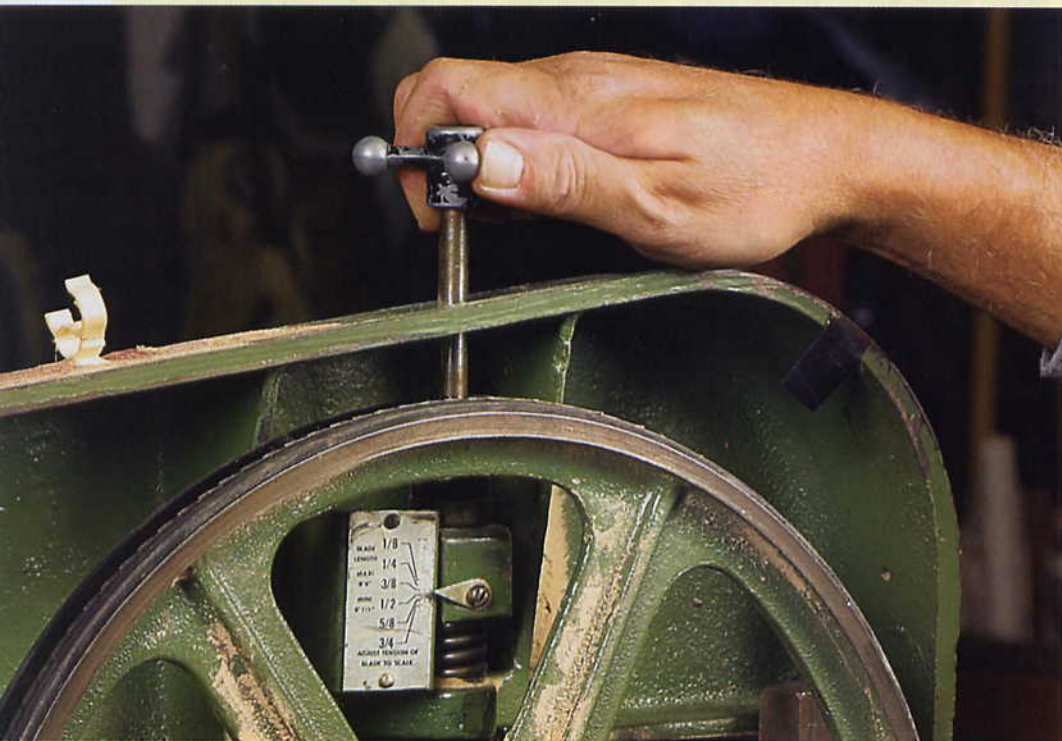

**Use less than the recommended tension.** For a 1/2-in.-wide blade, turn the tension gauge (above) to the setting for a 3/8-in.-wide blade. The first step in overhauling a bandsaw is to check the tires for grooves (right). If necessary, replace them.

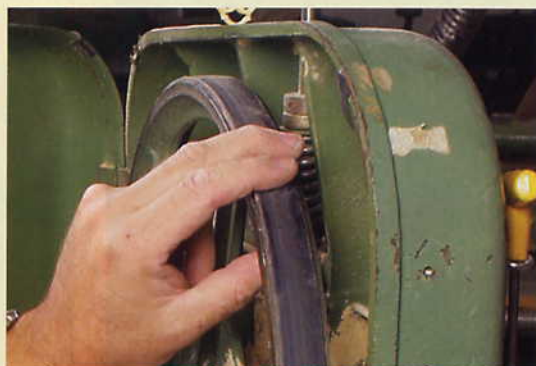

1/8-in.-thick stock. It is not practical to change the blade and the guide blocks for each situation, nor is it necessary, in fact.

With rare exception, a standard carbon-steel 1/2-in.-wide, 3-tpi, skip-tooth blade installed on my bandsaw performs all of the above tasks.

**Blades are inexpensive, so keep a sharp one loaded**—The blades I use are made by Starrett but are welded and distributed by BC Saw and Tool in Canada (888-251-2236; [www.bcsaw.com](http://www.bcsaw.com)). By delightful coincidence, these blades are rela-

tively inexpensive. It helps that I buy them in groups of 10, which earns me a 25% discount. For example, 94 1/2-in.-long blades, which fit a 14-in. bandsaw, cost about \$6.71 (U.S.) each, or \$8.95 if purchased one at a time. This is one of the rare cases when inexpensive equals good.

Unfortunately, not all blade distributors weld bandsaw blades properly. A poorly welded, misaligned sawblade will not give you the smooth and effortless results you are after.

Simply using a 3-tpi blade, with its larger gullets, will eliminate many problems.

Even 4 tpi is too fine a tooth pattern for general woodworking and resawing. If you want a fine cut, use a coarse blade, even on thin stock. In my experience, the old rule of thumb about having two teeth engaged in the stock at all times is bogus. The reason I use a 1/2-in.-wide blade is that it is stiff enough to resaw but flexible enough to follow a curve down to a 2 1/2-in. radius. A cautionary note: Cutting particle-board is extremely hard on carbon-steel bandsaw blades and can reduce their life by 75%.

**High horsepower is another myth**—For most 14-in. bandsaws with a 1/2-in.-wide, 3-tpi blade, a 1/2-hp motor is fine. The same saw with a riser block in the column could use a 1/2-hp motor for big resawing tasks, but anything larger is overkill. If the motor is bogging down, you are either forcing the cut or using a dull blade.

### Don't overtension the blade

It is important that the tires on the bandsaw remain in excellent shape. Grooves in the rubber tire on either the upper or the lower wheel will make it impossible to keep the blade on the centerline, in line with the rip fence. And the most common cause of grooves in the tires is overtensioned blades. Very high tension even can flex the saw frame out of alignment.

I slightly undertension my 1/2-in.-wide blade. Because of its excellent ability to clear sawdust, the blade is not inclined to flex, wander, or heat up. For the 1/2-in.-wide blade I adjust the tension scale to the 3/8-in. setting. If no scale is present on the machine, I tighten the adjustment knob (with the machine off and unplugged) until the blade deflects about 1/4 in. to the side without making my fingertips go white.

A side benefit of lower blade tension is that I seldom have to release the tension on the saw, as is commonly recommended to prolong blade life.

### Align the blade to eliminate drift

When I bought my bandsaw in 1974, I set the fence parallel to the miter-gauge slot in the table, and I haven't had to adjust it since. The reason is that I use the tracking adjustment on the upper bandsaw wheel to align the blade (see the drawings on the facing page). A nightmare of fence adjust-

# Tip 3

## YOU CAN ELIMINATE BLADE DRIFT BY ADJUSTING THE TRACKING

Advice on blade alignment usually centers on the rip fence instead of the blade. You can eliminate blade drift by adjusting the position of the blade on the upper wheel.

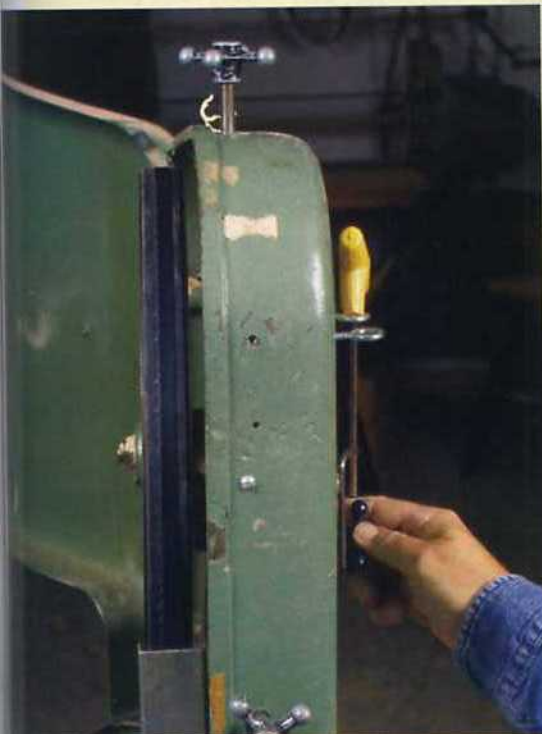

**A simple adjustment.** Adjust the angle of the upper wheel so the blade rides at the center, which on most small bandsaws is crowned slightly.

### ADJUST THE ALIGNMENT OF THE BLADE, NOT THE FENCE

First, align the rip fence parallel with the miter-gauge slot and leave it there. Then eliminate blade drift by centering the blade on the upper wheel. The upper wheel has a slight crown on it. Therefore, if the blade is close to the front of the upper wheel, it will be angled on the wheels, causing the saw to cut to the right. If the blade is close to the back of the wheel, the reverse will be true.

#### CENTERED BLADE

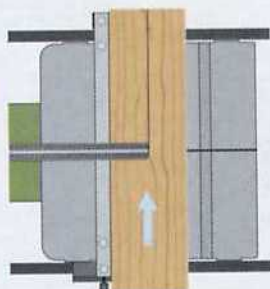

Saw will cut straight.

#### BLADE TOO FAR FORWARD

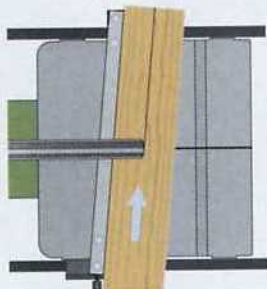

The fence must be angled to the right for a straight cut.

#### BLADE TOO FAR BACK

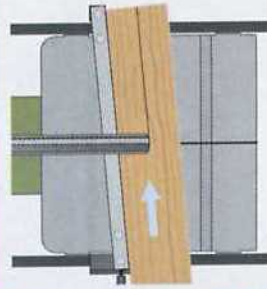

The fence must be angled to the left for a straight cut.

### ALIGN THE FENCE JUST ONCE

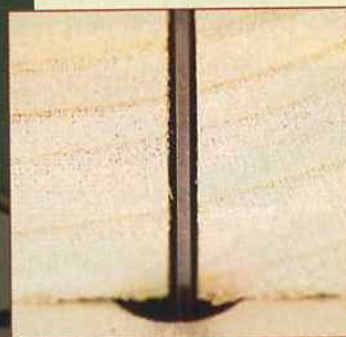
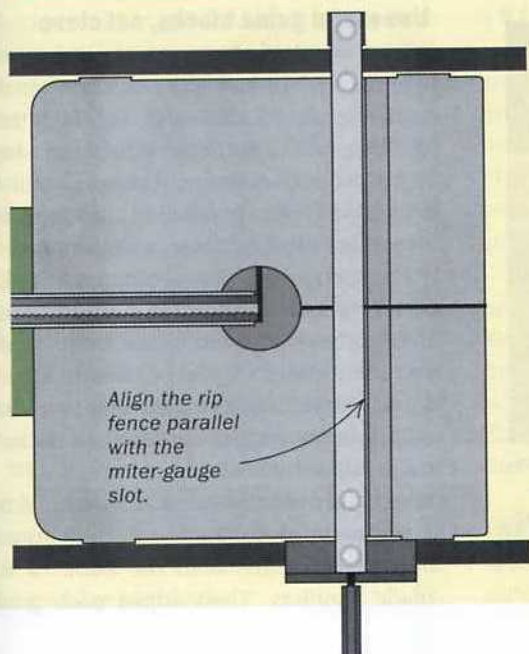

**Now push gently and let the blade do the work.** Pushing too hard will make the blade flex sideways, which will cause it both to overheat and to drift off line. With the blade, fence, and guides properly aligned and adjusted, the back of the blade should be centered in its kerf (inset).

# Tip 4

## REPLACEMENT GUIDES AREN'T NECESSARY

A set of metal guide blocks will keep your blades on track for many years. The key is to set them very close to the blade and just behind the gullets.

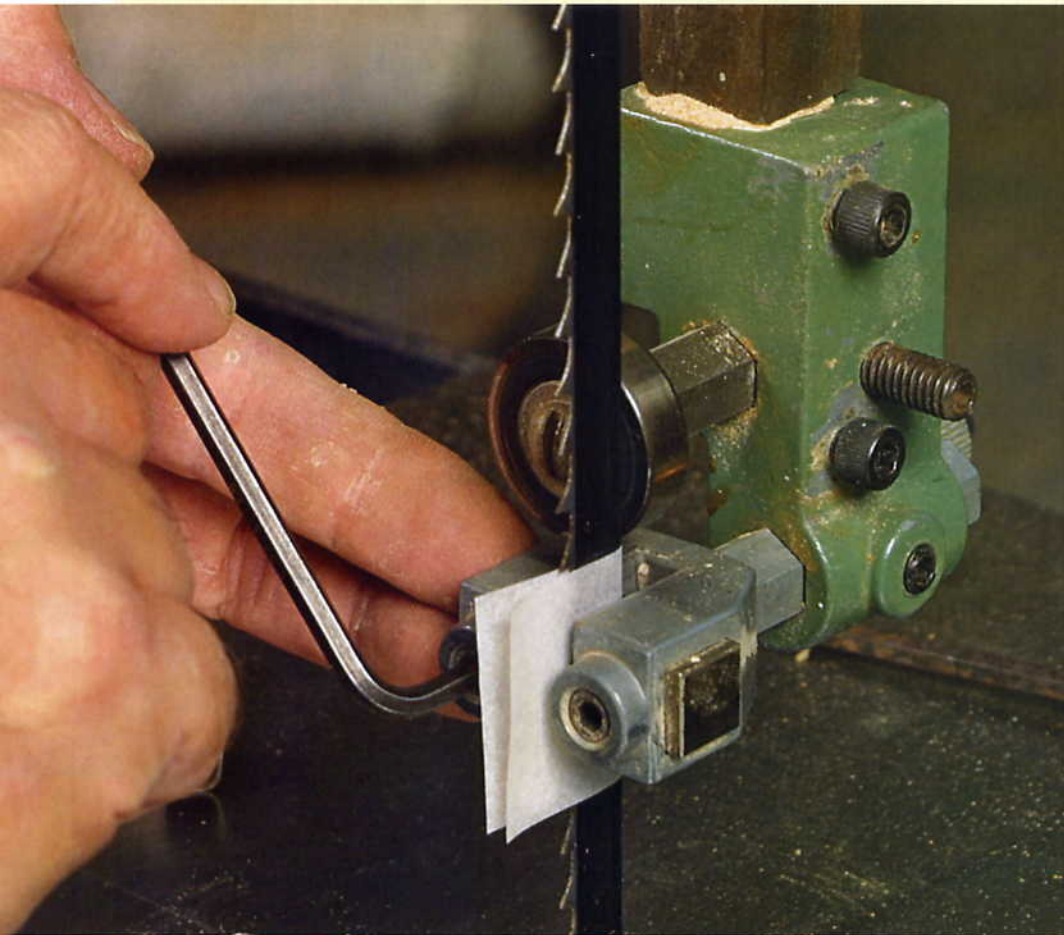

**Closer than you might think.** Many people use a dollar bill for setting the blocks, which keeps them 0.003 in. away from each side. Cigarette paper (or a feeler gauge) will set each block closer to 0.001 in. away, resulting in smoother, more precise cuts.



**The blade weld must be smooth.** A good sawblade company will weld blades precisely and grind the welded area flat. After setting the guides, turn the wheel by hand to be sure the weld passes through the guides smoothly.

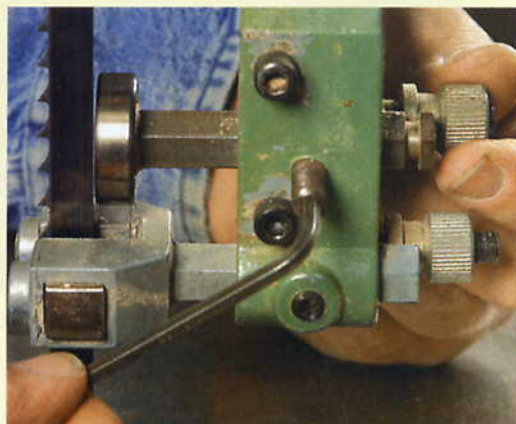

**Other important guide settings.** The guide assembly should be adjusted so that the metal blocks remain just behind the blade's gullets. Then the thrust bearing is set  $\frac{1}{2}$  in. behind the blade, as shown, so it contacts the blade only during use.

ments ensues if each new blade is allowed to track differently.

Simply by keeping the centerline of the blade (regardless of width) in line with the centerline of the upper wheel, I am able to keep the blade aligned correctly at the blade guides.

The relationship between tracking the blade on the centerline of the upper wheel and having the fence aligned parallel to the miter slot should produce a kerf with equal space on either side of the blade.

Much has been made in books and articles of the alignment of the two wheels to each other. In my shop and in my travels to schools around North America, I have never found this to be a problem. Tracking the blade properly on the upper wheel has always been enough, except in the case of a severely damaged bandsaw.

**Now square the table and align the fence**—The table is now aligned with the cutting direction, but it also should be adjusted so that it is square with the vertical line of the blade.

Last, the fence should be aligned parallel to the blade and square to the table. I use a  $3\frac{1}{2}$ -in.-high birch plywood rip fence screwed onto the metal fence. I have shimmed the plywood with masking tape to get it perpendicular to the table. Taller plywood fences can be screwed to the existing plywood fence, but I use these only when I am resawing to the maximum capacity of my bandsaw, about  $6\frac{1}{2}$  in.

### Use metal guide blocks, set close

Again, simple is the way to go. When setting up my bandsaw in 1974, I took out the metal guide blocks and squared their working faces against the side of the wheel on my bench grinder, being careful to check the blocks for square. I have not had to replace them or resquare them since.

The sequence for setting the guide blocks is as follows. Unplug the saw, pull the guides well back, tension the blade, and then spin it a few times backward and forward by hand. Now turn on the saw and adjust the tracking of the blade to center it on the upper wheel.

Next, turn off the saw again, and bring the guide assembly forward so that the front of the blocks aligns with the back of the blade's gullets. Then adjust each guide

# Tip 5

## ADD DUST COLLECTION TO KEEP YOUR SAW RUNNING WELL

Sawdust extraction is very important. Wood dust will get compressed onto the lower wheel by the revolving blade. The resulting bumps will cause the blade to vibrate and wander off center.

Many saws provide for some dust extraction directly below the cutting area, but that isn't enough. Attach a second dust pickup at the lower left corner, where the air current generated by the lower wheel makes dust accumulate.

Also, attach a wooden brush with stiff natural bristles to the frame of the saw so that it continually cleans off the lower wheel. The lower dust port will catch the debris.

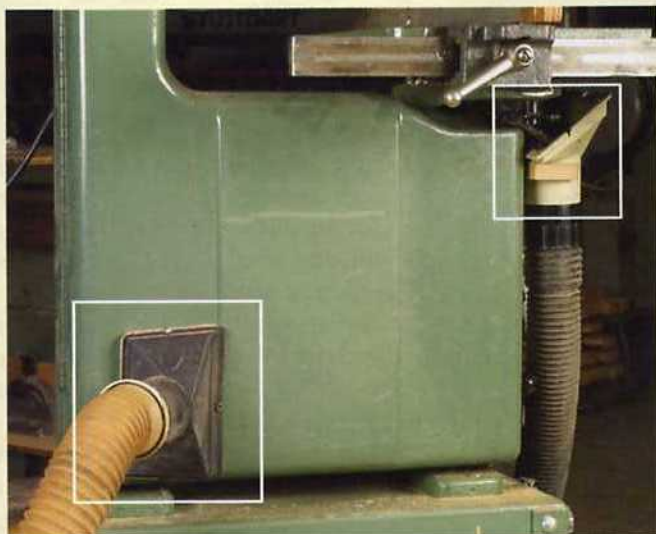

**Collect dust at two points.** Many bandsaws have dust collection below the cutting area, but Fortune also recommends installing a vacuum port at the bottom left of the lower wheel. If dust and pitch build up on the tires, the blade will not track properly. Install a brush (right) to remove dust from the lower wheel.

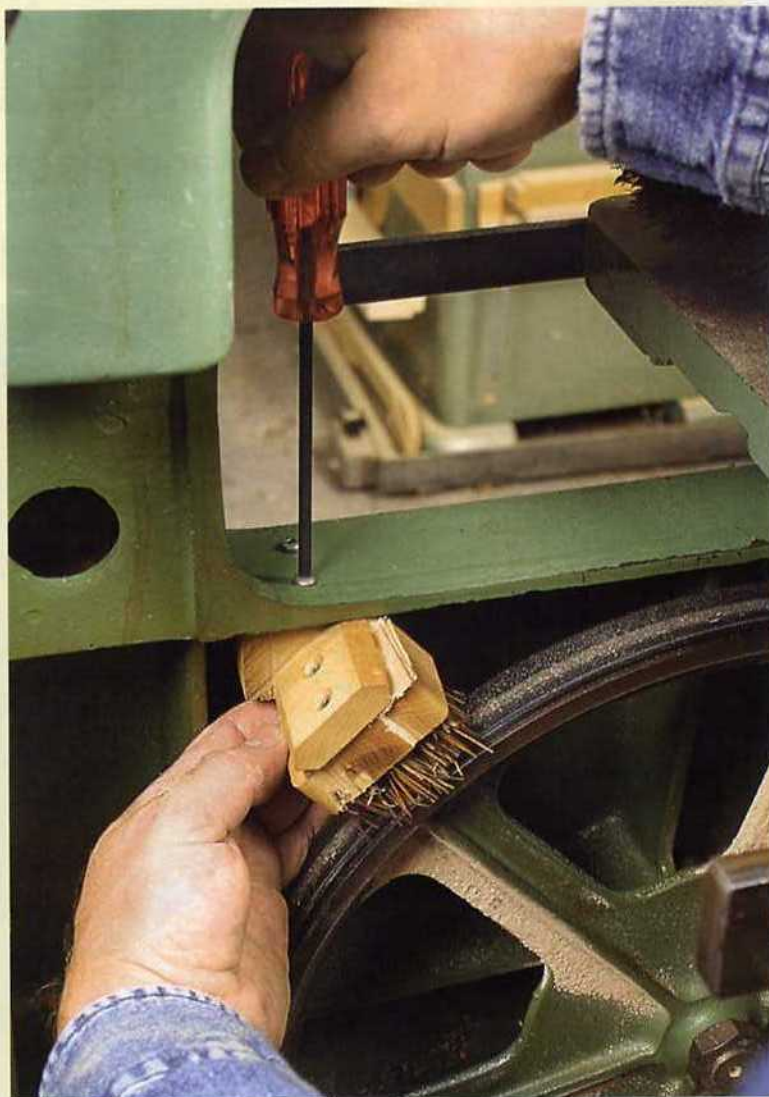

block to within the thickness of cigarette paper, or 0.001 in., of the blade. The Allen screw might pull the blocks in or out when they are tightened, so this process could require one or two attempts. With practice, you will be able to adjust the guides by eye, looking for the smallest crack of light between the blade and the guide blocks.

Last, bring the thrust bearing in the rear to within  $\frac{1}{2}$  in. of the blade. This bearing is the only part that requires replacing, when it becomes stiff or scarred. But it is a standard part and can be bought in most automotive- or bearing-supply houses.

With the guide blocks set this close, and with the back of the gullets just aligned with the front of the blocks, there is no room for the blade to twist or for the teeth to hit the metal guide blocks.

If I thought there was some advantage to replacing the guides or the blocks, then I would, but I find the original system gives me excellent results. With the blade and fence aligned properly, the metal guide blocks are not rubbing constantly against one side of the blade or the other and creating friction heat.

The lower guides are set in the same way as the upper ones, though I often leave them backed slightly away from the blade, unless I am resawing particularly difficult wood. I have worked in several shops in Europe, and none of the bandsaws I used there had lower bearing assemblies.

### Feed stock with mild pressure

With the saw properly set up, it is necessary to place only two of your fingers

against the workpiece: You should be able to use one finger to push the stock and the other to hold it against the rip fence. If you have to use the butt of your hand to push the stock, something is wrong—either the blade is dull or it is no longer tracking on the centerline of the upper wheel and is misaligned with the fence, causing the wood to bind.

Use mild but consistent feed pressure, allowing the blade to do the work. The sawdust must have a chance to be cleared from the kerf. For safety, once your pushing fingers are within 6 in. of the blade, use a push stick. □

*Michael Fortune designs and builds furniture in Lakefield, Ont., Canada, and teaches throughout North America.*

# Tilt-Top Table

Elegant project builds hand-tool  
and machine skills

BY MARIO RODRIGUEZ



**A**s a woodworking instructor, I'm always looking for interesting and challenging projects to present in my classes. This Federal tilt-top tea table satisfies all of my criteria for an intermediate-level project: It's neat and compact with only a few parts, and the construction introduces students to both machine- and hand-

tool techniques. The bonus is that the finished product is graceful in design and fits into almost any interior space.

In the 18th century, many of these small tables were made with local hardwoods, and there are a number of period examples in maple, walnut, and cherry. My version is made of mahogany, which is available from most commercial suppliers in the required thicknesses, from  $\frac{3}{4}$  to  $1\frac{1}{4}$ . I find mahogany ideal for the turning required in this project, and it takes a finish beautifully.

## Begin by turning the column on the lathe

The profile of the column is provided at half scale in the drawing on the facing page. The drawing can be enlarged 200% to full size on a copy machine and used as a pattern. Prepare the turning blank thick enough to accommodate a maximum diameter of roughly  $2\frac{3}{4}$  in. I recommend using a solid piece, although gluing up two pieces is an option; however, you'll be left with a seam down the center of the column.

Prior to mounting the blank on the lathe, lop off the long corners on the bandsaw by either tilting the bandsaw table to  $45^\circ$  or holding the workpiece at  $45^\circ$  in a carriage. Once it's on the

lathe, rough the blank into a cylinder with an even  $2\frac{3}{4}$ -in. diameter. Use a parting tool and your pattern to set up the diameters of all of the various elements on the column. Establish all of the flats first, then turn the coves and beads with a spindle gouge and a skew chisel. Finally, sand the column smooth.

**Turn column ends precisely**—Two critical portions of the column require careful attention. The diameter of the tenon at the top of the column, which engages the pivot block, must exactly match the  $\frac{1}{2}$ -in.-dia. hole drilled through the pivot block. Because I make this table so often in my classes, I made a plywood gauge that gives me the right diameter. However, you can just as well use a set of calipers.

The other critical area is the bottom portion of the column where the legs are attached. This end doesn't have to be turned to a precise diameter; just make sure it's straight and uniform. Any dips or a taper will create gaps where the column receives the three dovetailed legs. A nonuniform surface also will have a detrimental effect on the fit of the legs.

## Make a carriage for the sliding dovetails

The traditional and most effective method of joining the legs to the column is with sliding dovetails. Once the legs have been attached, the flair of the dovetails prevents the legs from loosening over time. The key to achieving snug and handsome joints is to cut the slots first and then make the dovetails to fit.

To cut the joinery, you'll have to remove the turning from the lathe. Set up each cut carefully. I built a plywood carriage jig (see the drawing on p. 74) that supports the column while I rout the dovetail slots. Each slot should be



# MAHOGANY TEA TABLE

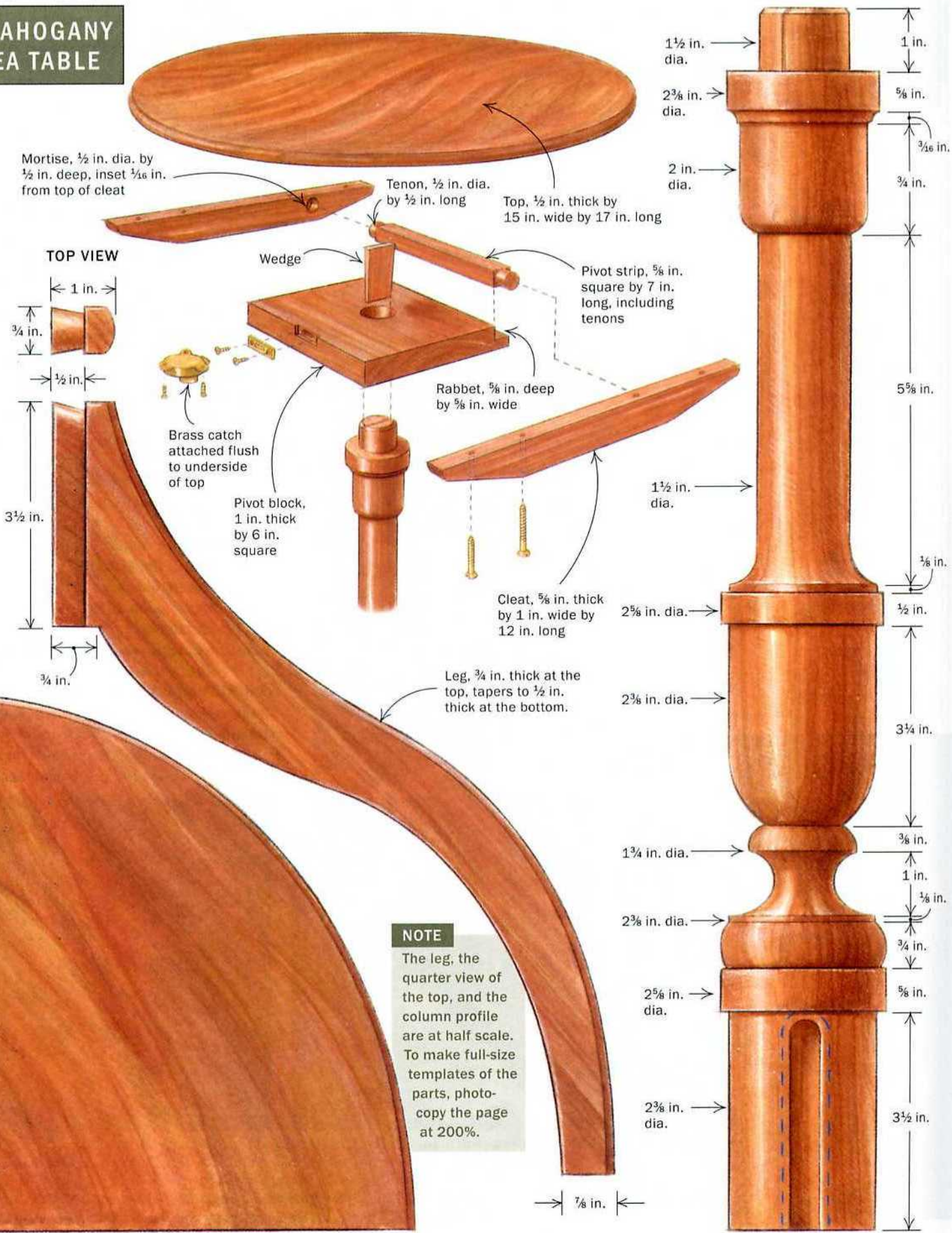

**NOTE**  
 The leg, the quarter view of the top, and the column profile are at half scale. To make full-size templates of the parts, photocopy the page at 200%.



## A JIG FOR ROUTING THE COLUMN

Stop, 1½ in. wide by 7½ in. long

Sharpened hex-head bolt, ½ in. dia. by 6 in. long

Inset hex nut

Back end, 6 in. wide by 4⅞ in. tall

Stop block, 6 in. wide by 5 in. long

Sides, 25⅞ in. long by 5⅝ in. tall

Built from ¾-in.-thick plywood and modified off-the-shelf hardware, this jig is used to orient and support the column and guide the router when cutting the three dovetail slots for the legs.

Router baseplate, 6 in. square

Cleats, ½ in. thick by 1 in. wide by 14½ in. long

Index block, 3½ in. dia., with 1½-in.-dia. mortise for column

Wood screw

½-in.-dia. dowel

Wood screw

Front end, 6 in. wide by 5⅝ in. tall

Bottom, 6 in. wide by 23⅝ in. long

120° apart on center, and the jig is equipped with an index block to align the column correctly for each slot. Match the 120° marks on the index block to a corresponding mark on the jig. A wood screw secures it in each position for cutting.

### Cut the slots with three router bits—

There are three steps to cutting the dovetail slots. First, establish a flat edge on the column for the shoulder of the leg. Use a 1-in.-dia. straight router bit, and set up the cut to trim a flat surface just wide enough for the thickness of the leg. It's better to cut this a little too wide than too narrow. A wide flat can be rounded with a file, but a narrow flat will create a gap where the leg meets the column. The stop block on the router jig should be set so the dovetail slot stops just short of the column shoulder.

After cutting a flat edge for the three legs—rotating the column in the jig for each cut—switch to a 7/16-in. straight bit and hog out most of the waste for each slot. This second step reduces the stress on the router and the wear on the dovetail bit. Finally, change router bits again to a dovetail bit (mine is an 11° bit) and take a final pass on each slot. Set the column aside until you're ready to cut the dovetails on the table legs.

### Shape the legs on the bandsaw

The three legs are rough-cut on the bandsaw and taken to their final shape with hand tools. To begin, enlarge the scale

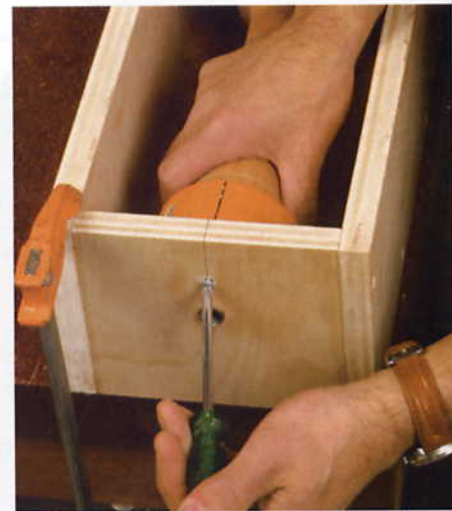

**Mount the column in the router jig.** First, insert the column into the index block and secure it with a wood screw to keep it from rotating within the block (left). Align the base of the column in the jig using the dimple created by the lathe and hold it in place by tightening the sharpened hex bolt (center). Finally, locate the column for routing by aligning one of the three scribe lines on the index block with the centerline on the jig and fasten it with a screw (right).



## ROUT THE DOVETAIL SLOTS IN THREE STEPS

### 1. ROUT A FLAT SHOULDER

Trim a  $\frac{3}{4}$ -in. flat centered over each of the slots so that the legs will join flush to the column.

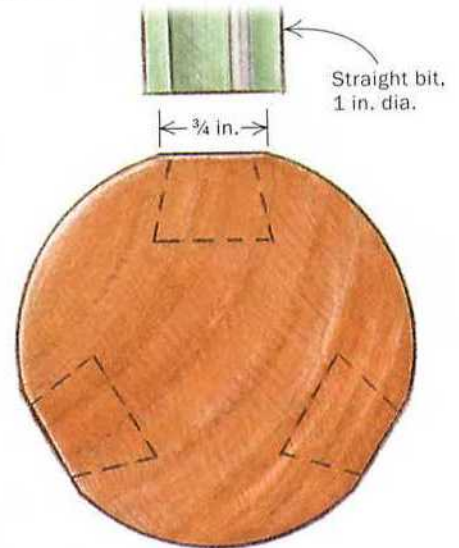

drawing to 200% to make a template with  $\frac{1}{4}$ -in.-thick plywood, and then draw the leg shape directly onto the three workpieces with the grain running lengthwise. I made the pattern about 1 in. longer than is found on period examples of the table so that it could be built for a standard 29-in. height. However, to build a more accurate reproduction, you simply can cut off the extra inch from the foot without greatly affecting the appearance of the table.

Once each leg has been rough-cut to about  $\frac{1}{16}$  in. to the line, gang the legs together with a clamp and clean up the front and back edges with a spokeshave followed by a cabinet scraper. Clamping all three legs together makes it easier to keep the edges square, and it reduces tearout at the edges. Also, always cut in the direction of the grain with the spokeshave, even if it requires repositioning the legs in the vise.

**Cut the dovetails**—To cut the dovetails on the legs, set up the router table with a fence and the same dovetail bit used for the slots. Before cutting into the real legs, use a cutoff from the leg material of the exact same thickness and make test cuts to fine-tune the fit of the dovetail into the column base. Carefully pass the stock upright along the fence to cut one cheek of the dovetail. Flip it over to cut the other side. I



### 2. HOG OUT THE WASTE

Set the bit to cut  $\frac{1}{2}$  in. deep and stop just short of the column shoulder.

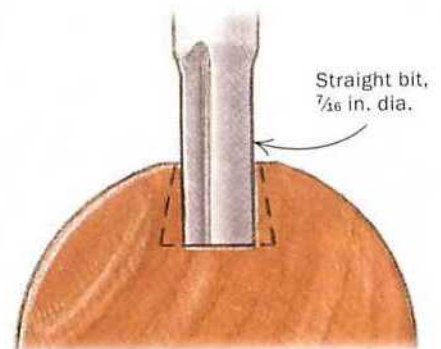

### 3. ROUT THE DOVETAIL PROFILE

Take your final pass and wait until the bit stops spinning before backing it out of the cut.

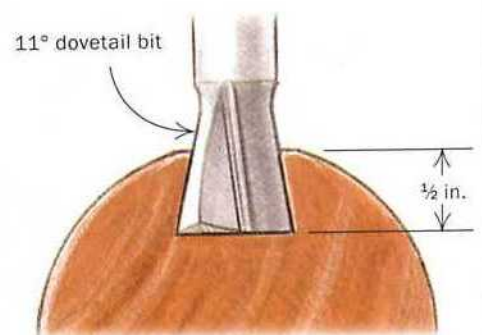

## SHAPE THE LEGS AND CUT THE DOVETAILS



**Shape all three legs at once.** Gang the legs together with clamps and use a spokeshave and card scraper to clean up the bandsaw marks.

**Make a jig for routing the dovetails.** A jig, made using the leg template, supports the leg while routing. The sides of the jig ride on a supplemental fence screwed to the router-table fence. Put steady pressure against the fence as you rout to ensure a clean cut and tight fit.



made a jig using my leg template that rides along the router-table fence and holds the leg steady. If you discover that a dovetail doesn't fit right in the column, run it back across the bit and apply more pressure against the fence. It might take off just enough to make the fit easier.

Next, make a slight roundover along the front edge of each leg one at a time. Draw a pencil line down the center of the leg as well as lines on both sides that follow the profile of the leg about  $\frac{1}{8}$  in. from the edge. Then use a spokeshave to round over the edge to your guidelines. Finish off to a nice profile with files, a scraper, and sandpaper.

**Taper the legs**—The three legs taper from  $\frac{3}{4}$  in. thick at the dovetail to  $\frac{1}{2}$  in. thick at the foot. I made a pair of sleds that help me create this taper with a thickness planer (see the top right photos on the facing page), though careful handplaning also would work. The first sled elevates the foot of the leg  $\frac{1}{8}$  in., creating one side of the taper when it is run through the planer. The second sled raises the foot of the leg  $\frac{1}{4}$  in., so when you flip it over, an even taper is cut on both sides. Be careful not to plane off too much, or you will damage the dovetail.

### Create the tilting mechanism

The pivot system for the tilting tabletop consists of a pivot block that fits over the column tenon and two cleats that attach to the underside of the tabletop. Two round tenons extend off one end of the pivot block and are set into holes in the two cleats, allowing the tabletop to pivot.





**Round the front edge of the legs.** To guide your progress, mark the leg with a centerline and two guidelines along the sides about  $\frac{1}{8}$  in. from the edge.

Make the two cleats and then drill the holes for the round tenons, locating them as close to the top edge of each cleat as possible; I aim for about  $\frac{1}{16}$  in. This will ensure that the tabletop lies properly against the pivot block when it is horizontal, and stands perfectly plumb when vertical.

There are two ways you can approach the pivot block. The traditional method is to cut the round tenons out of the pivot block with a single piece of wood. But the easiest method is to make a pivot block with a rabbet cut into one edge, and then glue in a separate strip sized to the dimensions of the rabbet with round tenons cut on each end. You will need to plane the pivot strip flush with the surface and the back edge of the pivot block.

Turn the round tenons on the lathe, and aim carefully for a squeaky-tight fit in the cleats. As the top is tilted, there should be some resistance on the pivot. That way, when the top is vertical, it will stay there.

### Prepare the oval top

The tabletop measures about 15 in. wide by 17 in. long, so you may have to glue up two pieces to make it.

Use the scale drawing to make a  $\frac{1}{2}$ -in.-thick birch plywood template, trace an outline of the tabletop onto the workpiece,



### USE A PAIR OF SLEDS TO TAPER THE LEGS

Taper the legs with a thickness planer. Cut one side of the taper with a sled that raises the foot of the leg  $\frac{1}{8}$  in. Use a second sled to taper the other side. This time the foot is raised  $\frac{1}{4}$  in. so that it is evenly tapered.



### Glue the legs in the column.

Apply glue liberally to each dovetail and tap it into the slot until it's fully set.

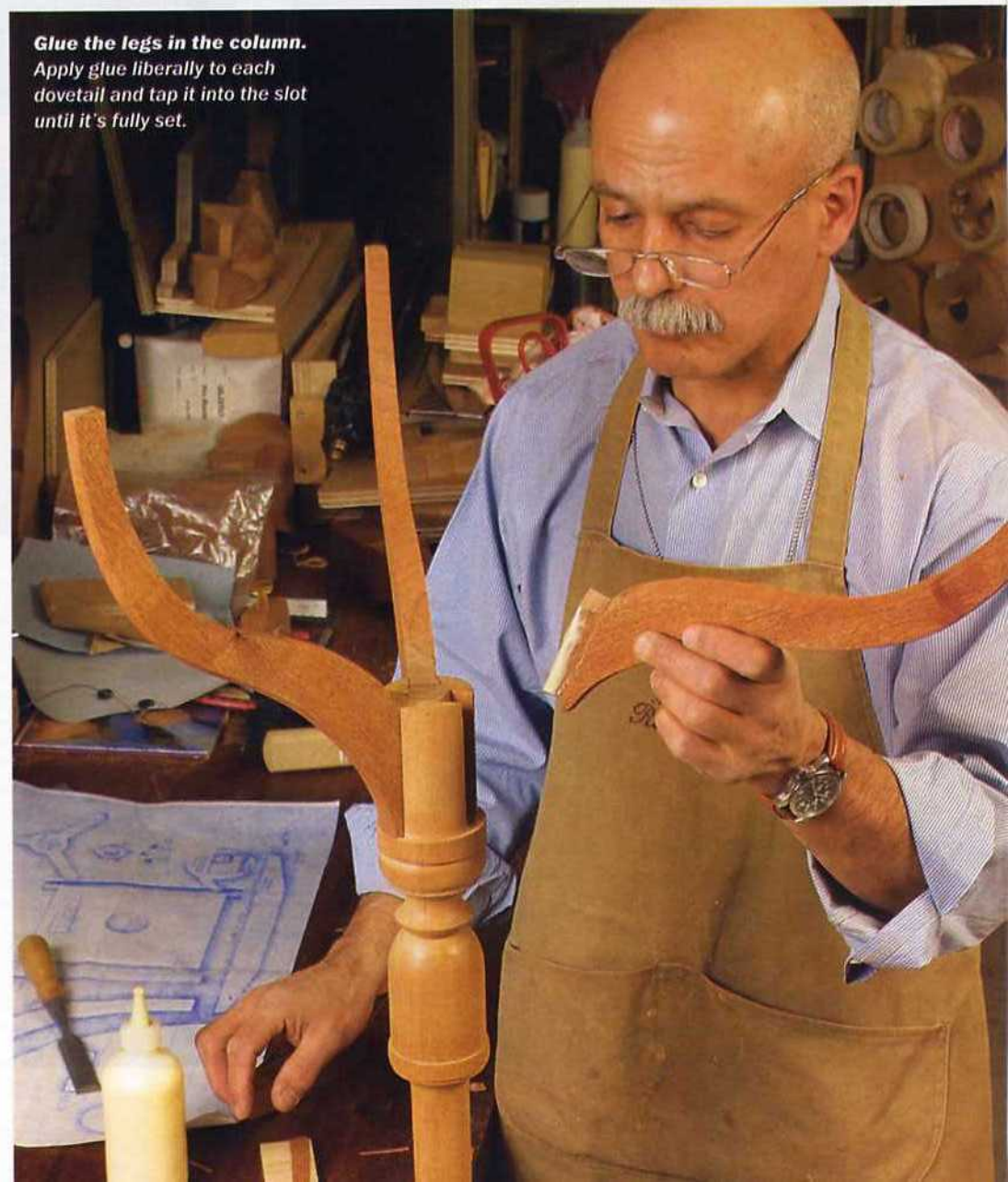

## BUILD THE TILT MECHANISM



**Assemble the pivot block.** Glue a separate strip with round tenoned ends into a rabbet cut in the pivot block. Then round the corner of the block to allow the table to tilt properly.

**Align the block before securing it.** Align the pivot block on end while two legs are flat against the workbench. This will ensure that the legs are properly aligned with the oval top.

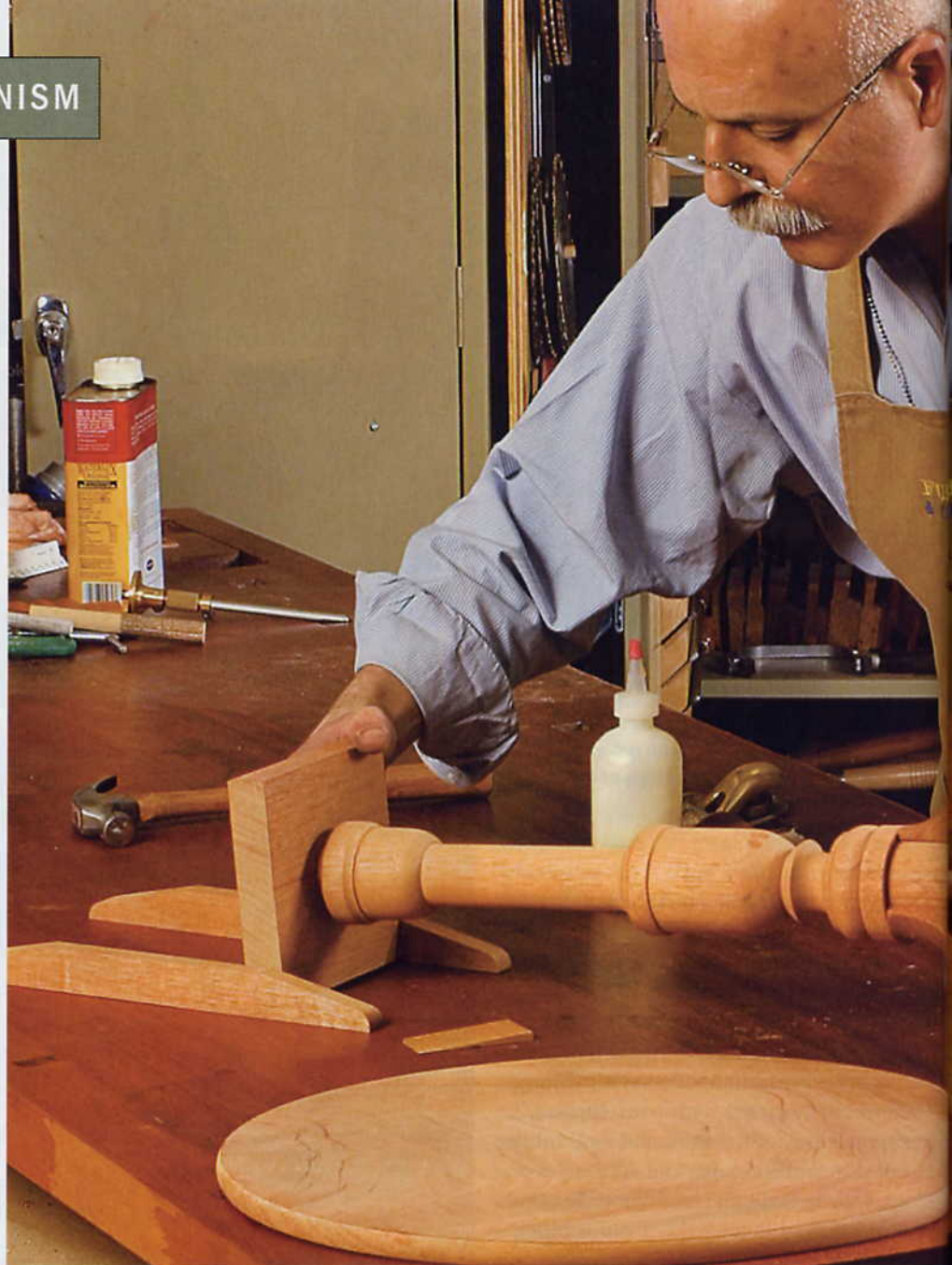

and cut it out on the bandsaw just outside of the line. Next, rout the oval shape on a router table with a bearing-guided bit (see *FWW* #170, pp. 72-75, on changing the direction of the cut to avoid tearout). The tabletop edges are slightly rounded over to match the rounded profile of the legs.

### Assemble the table, apply a finish, and attach the hardware

Once all of the parts have been prepared, assembly should go pretty smoothly. First, attach the legs to the column, checking for a tight fit and a clean joint between the shoulder of the legs and the column. The legs should go on without incident if you care-

fully cut the dovetails on the router table. Although not required, you can reinforce the leg joints with a metal brace called a table spider—available from Horton Brasses (800-754-9127; [www.horton-brasses.com](http://www.horton-brasses.com)).

Once the legs have been glued in place, use a wedge to attach the pivot block to the top of the column. Saw down the center of the column tenon to make a kerf for the wedge. It should run perpendicular to the direction of the grain on the pivot block so the block doesn't split when you drive home the wedge. The pivot block must be positioned so that when the tabletop is in the upright position, one leg is pointing straight back. This way the table can fit in-

to a corner. To achieve the proper orientation, set the column onto a workbench so that two legs rest on the workbench (above). Then attach the pivot block with the round tenons flat on the workbench.

Next, screw on the tabletop. With the top upside down on your workbench and the pivot block centered on it, set the cleats onto the pivot-block tenons with a  $\frac{1}{16}$ -in. gap between. Then drive #8 screws through the cleats and into the underside of the tabletop.

All of the parts should be sanded through to 220-grit abrasive before assembly. I stained the table with a mixture of cherry and walnut Behlen Solar-Lux stains (Garrett



Wade; 800-221-2942; [www.garrettwade.com](http://www.garrettwade.com)). Then I brushed on several thin coats of shellac. Sand lightly after the first coat of shellac and allow each subsequent coat to dry thoroughly. Finally, rub out the finish with fine steel wool.

The last step is to apply a glaze coat. I used McCloskey glaze with raw umber Japan pigment added. Once the glaze dried, I waxed and buffed the table.

Finally, install a good reproduction catch (307-739-9478; [www.whitechapel-ltd.com](http://www.whitechapel-ltd.com)) to keep the top secure and level when the table is in use. □

Mario Rodriguez is a contributing editor.

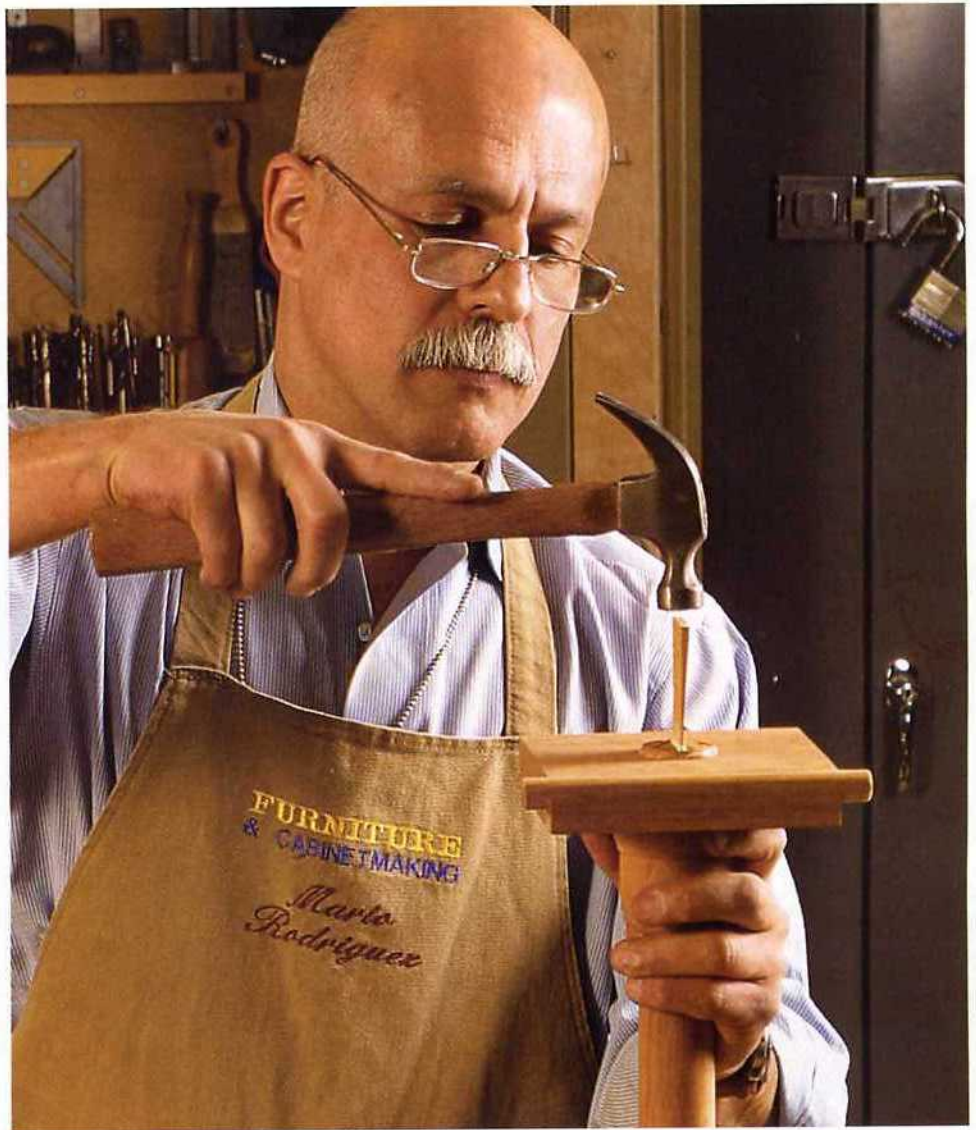

**A wedge secures the pivot block.** Orient the slot in the tenon perpendicular to the grain of the block to avoid splitting the block as you drive in the wedge.



**Screw the cleats to the tabletop.** Slide the cleats onto the round tenons of the pivot block and center the base assembly along the long axis of the tabletop. Attach the catch after the finish has been applied.

# Fitting Drawers

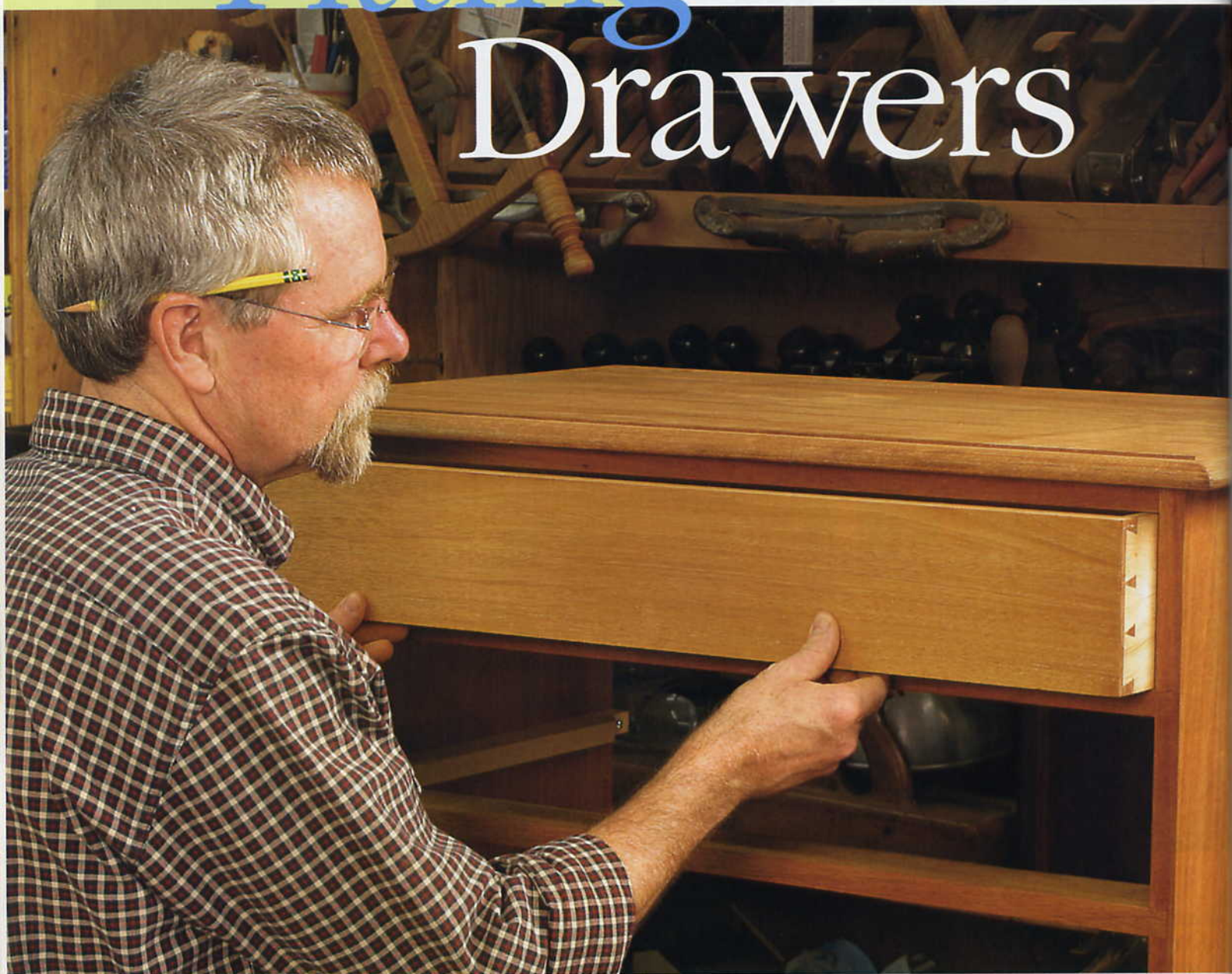

You don't need a perfect  
drawer or case to get  
perfect results

BY PHILIP C. LOWE

A well-fitted inset drawer is one of the hallmarks of fine furniture, separating hand-crafted work from factory made. The hands and eyes go naturally to such a drawer, trying its piston fit and appreciating the fine gap around its edges. Articles and books have addressed the fitting of drawers, but most have focused on the best-case scenario, ignoring a common situation: fitting a slightly imperfect drawer into a slightly imperfect opening.

Ideally, a drawer should slide smoothly into place, with a thin, uniform gap all around and the drawer front aligned perfectly with the front of the case. However, there will be times when a case or a drawer box ends up a bit crooked, warped, or twisted. Sometimes fitting becomes problematic because a drawer divider has warped

## FIT THE DRAWER PARTS BEFORE CUTTING THE JOINERY

The most important steps in fitting an inset drawer happen before the drawer box is even assembled.

### 3 FIT THE DRAWER SIDES

Plane the sides to fit the opening. Also, mark and cut them to length, allowing for the half-blind dovetails at the front ends.

### 4 CUT THE DRAWER BACK TO SIZE

Cut the back  $\frac{1}{16}$  in. shorter than the front to allow for easier final fitting.

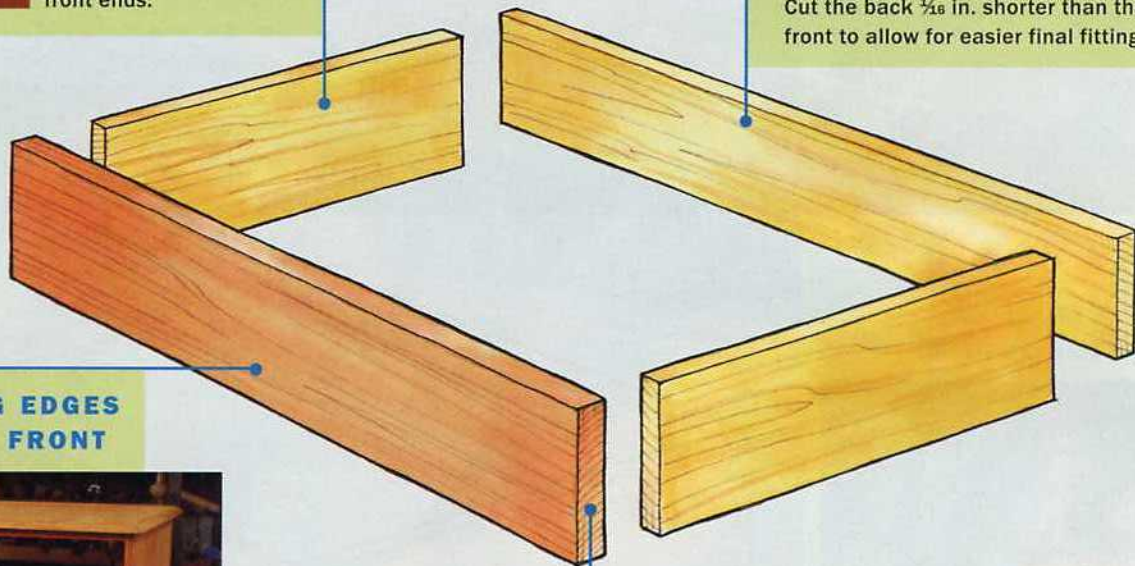

### 1 PLANE THE LONG EDGES OF THE DRAWER FRONT



Start with stock  $\frac{1}{16}$  in. too wide. Before planing to fit, check the opening with a straightedge (top). If the dividers or the case is bowed, plane the long edges of the drawer front to match (bottom).

### 2 FIT THE ENDS OF THE DRAWER FRONT



Plane one end to fit the case (above). Then set the drawer front in the case and mark the other end for length at both the top and bottom edges (right). Aim for a snug fit at this point in the process.







## FINE-TUNE THE FIT AFTER GLUING UP THE DRAWER

Provided you cut the drawer back slightly short as recommended and that the glue-up went well, only the front end of the drawer will need to be fitted to the opening.

1

### GLUE UP THE DRAWER

Careful assembly is essential. Glue up the drawer box on a flat surface and measure diagonals to ensure that the box goes together square.

2

### CLEAN UP THE JOINTS

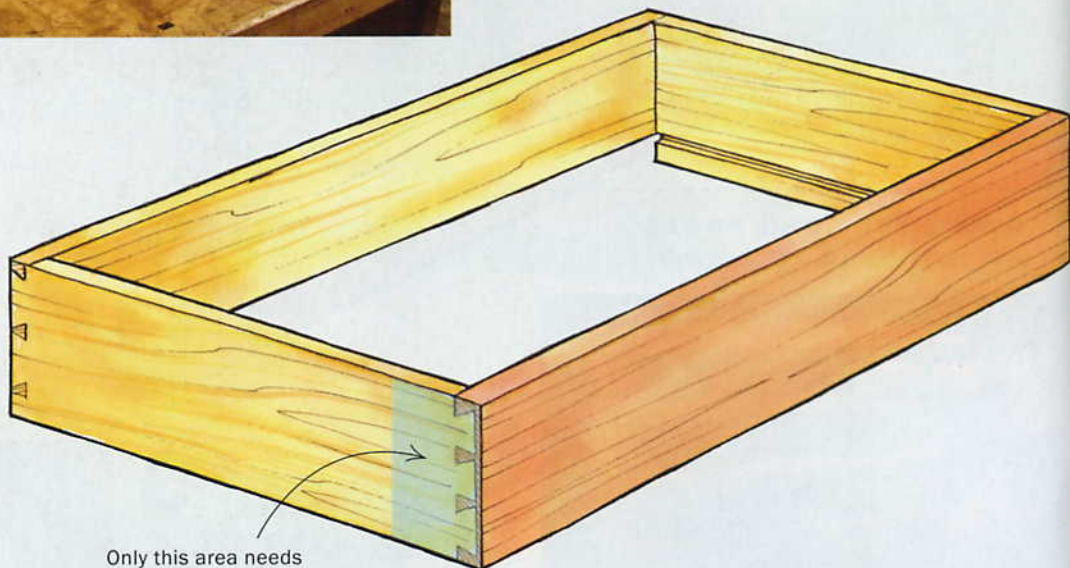

Only this area needs to be planed to fit the drawer.

3

### FIT THE FRONT OF THE DRAWER BOX



All but the last few inches of the drawer should slide in easily at this point. Level the dovetails at the front of the drawer box and continue planing those areas until you achieve a  $\frac{1}{32}$ -in. gap at each end. Also, touch up the top edge for the same gap.



Lightly plane the bottom edges flush with each other (top) and then plane the rear dovetails flush (bottom).





4

#### PLANE THE BOTTOM OF THE DRAWER FRONT

Relieve the bottom edge of the drawer front. Use a rabbet plane to create a  $\frac{1}{2}$ -in. lip (left and drawing below). This will create an even gap on all sides of the drawer (below) and prevent the drawer front from catching on the case.

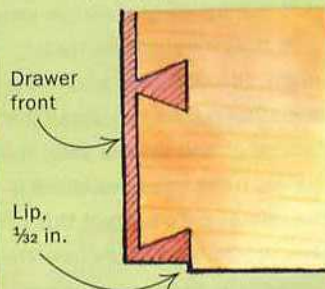

slightly after the case was assembled. Regardless of the cause, it's possible to get perfect-looking results even when a drawer or case is less than perfect.

#### Fit the drawer front and sides before assembly

The process for fitting a traditional inset drawer begins while the drawer still is in pieces. The drawer front should be trimmed to fit the opening in the case—be it square or ever-so-slightly askew. The drawer front will then determine the shape of the drawer box.

Start by checking the drawer opening to see whether there is any bow to the dividers or case. If the dividers are straight, rip the drawer front  $\frac{1}{16}$  in. oversize in width. If the dividers are not straight, you may have to leave the drawer front a bit more oversize.

Joint away the saw marks and then fit the drawer front to the height of the opening. If the case or horizontal drawer divider has a bow, start planing this shape from one end of the drawer front to the other. Then plane one end to fit the vertical member it must match (this could be out of square), checking it by sliding just that end into position.

Next, fit the other end of the drawer front. Place most of the front into the opening and use a knife to mark its length at the top and bottom edges. Connect these two marks with a straightedge. After squaring this line around the entire end, make a square crosscut on the tablesaw to the longest length if the scribe line is not square,

and then use a handplane to trim the end until it fits into the opening. Aim for a snug fit of the drawer front in the opening. You should be able to slide it into place without pushing very hard.

Once the drawer front fits perfectly, work on the sides and back of the box. Orient the grain of the drawer sides so that it will be easy to plane the outside faces from front to back during final fitting. When fitting the sides, follow this sequence: Joint the bottom edges straight and rip the sides  $\frac{1}{16}$  in. wider than the opening. Remove the saw marks and plane the pieces evenly until they slide into the opening.

Now, resting the sides against the bottom of the drawer opening, slide them into place. Use the front edge of the case to mark the length of the sides, adjusting for joinery that will be at the front corners. If you're using half-blind dovetails, stop them at least  $\frac{3}{16}$  in. from the face of the drawer front. This allows plenty of room for planing this face flush with the case later, especially if the drawer ends up slightly twisted or crooked. For that reason, I usually start with an extrathick drawer front, say  $\frac{1}{16}$  in. or  $\frac{7}{8}$  in.

As for the back of the drawer, a tried-and-true method is to



# Fitting problem drawers

## TWISTED DRAWERS

A twisted drawer is easy to spot. Place it on a flat surface (below) and look for a gap under one of the corners. It is best to remove as much of the twist as possible from the bottom of one drawer side before the final-fitting stage. Plane from the front of the drawer to the back, tapering the drawer side until the entire drawer sits flat. Then continue with the fitting process as usual.

If the twist is more than slight, the situation gets more complicated. As you plane the bottom of one drawer side, the drawer front becomes tilted in the opening. To correct this problem, you may have to plane the front of the drawer surface to line it up with the opening.

1

### PLANE THE DRAWER SIDE TO REMOVE THE TWIST

Locate the low corner of the drawer and relieve the opposite corner. Try to maintain a straight edge as you plane it, continuing until the drawer sits flat.

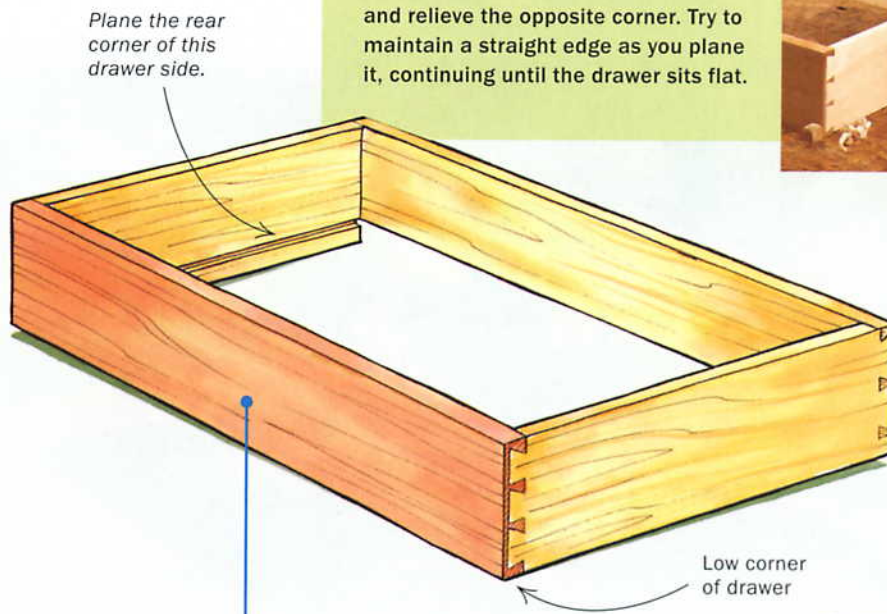

2

### PLANE THE FRONT, IF NEEDED

If the drawer is tilted noticeably, you must plane the face to bring it plumb with the case front. Plane very carefully to maintain a flat face.

Plane the lower section of the drawer front.



cut the back  $\frac{1}{16}$  in. shorter than the width of the opening. By cutting the back shorter, you intentionally make the drawer box a slight trapezoid, which makes for easier fitting. The slight play at the back also will allow you to adjust a crooked drawer in the opening so that its face ends up flush.

At this point, dovetail the drawer parts together and glue them up as square and as flat as possible.

### Fine-tune the fit after assembly

Once the drawer has been glued up and the clamps have been removed, the final fitting begins. You should be able to handle most

problems at this point, ending up with a great fit. However, there will be times when a drawer ends up so twisted or crooked that it must be scrapped altogether.

First, check the drawer for twist. You can do this using winding sticks, or you can place the drawer on a flat surface, such as a saw table, to see whether it rocks. Sometimes I use the top surface of the cabinet or chest I am working on, if I know it is flat.

If the drawer is flat, the task of fitting it should be straightforward. The first steps are merely to clean up the joinery. Begin by taking a couple of consistent plane shavings to clean up the dovetails at the back corners. Also, lightly plane the bottom

## CROOKED DRAWERS

Another problem that can occur at glue-up is a drawer box slipping out of square (forming a parallelogram in a top view). If the drawer front does not line up across the opening, you have a few options. If the misalignment is minimal, there might be enough play at the back of the drawer to correct the alignment by simply adjusting the drawer stops.

If the drawer can't be pushed into alignment, you will have to plane some material from the back corner, allowing the drawer box to pivot sideways and the drawer front to come back into alignment. Again, you will have to align the drawer stops to bring the drawer front square when it is pushed in.

**Beware:** If you have to remove too much material from a



drawer side, it can become too thin at the groove or rabbet that was cut to house the drawer bottom, weakening the construction. If you feel this happening, stop removing material from the back corner and begin planing the drawer face where it protrudes from the case.

I've also used a tight-fitting drawer bottom to push a crooked box back toward square, or tapered the drawer guide (when there was one). A last resort is to plane a taper into the actual case side, which can be a nightmarish task.

edges of the drawer sides flush with the bottom edge of the drawer front.

Because the back is shorter across than the front, the box should go into the opening almost all of the way. Then, with two or three passes of the plane at the ends of the drawer front, take off an even thickness. Maintain the angles of the ends as they were fitted to the opening, and the drawer should slide home.

If you push the drawer into its opening and notice that the front is not parallel with the dividers, see "Crooked drawers" (above). If not, continue planing to create a consistent, fine gap— $\frac{1}{32}$  in. or less—at each end of the drawer.

1

### PLANE THE REAR CORNER

Locate the protruding end of the drawer. Then plane the back corner of the opposite side to allow the drawer box to pivot so that the front is flush with the case front.

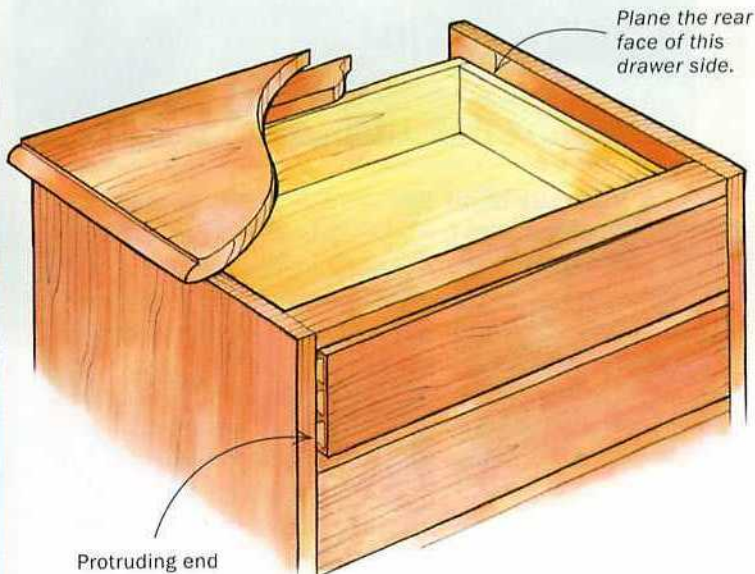

2

### ADJUST THE STOP BLOCKS

Glue stop blocks to the front divider so they stop the drawer front when it is flush with the case.



With the ends finished, work on the long edges. Plane away a consistent amount from the top of the drawer. Finally, use a rabbet plane to relieve the bottom edge of the drawer front. Take three or four shavings, leaving the drawer sides resting on the drawer runners but creating a consistent, fine gap all around the drawer front. The lip created by the plane also prevents the bottom edge of the drawer front from catching when the drawer is slid shut. □

*Philip C. Lowe is a furniture maker and teacher in Beverly, Mass., where he runs The Furniture Institute of Massachusetts. For information on classes, go to [www.furnituremakingclasses.com](http://www.furnituremakingclasses.com).*

# Personalize Your Furniture



DIAMOND BEADING

A trademark of my furniture is evidence of the hand-tool work that goes into each piece. It can be as subtle as the variations of a handplaned surface, or as deliberate as hand-carved embellishments. These details catch the eye, add a pleasing effect to the overall design, and make each piece unique.

Diamond beading, curls, and rosettes are three carvings that occur frequently in my furniture, in numerous variations. Cutting these designs mechanically would require an expensive and complex tool, but carving them by hand is done easily—even if you're a novice carver—and requires only a modest investment in tools.

While you must work to the nearest  $\frac{1}{2}$  in. for a mortise-and-tenon, and to even tighter tolerances for a perfect dovetail, carving is your chance to cut loose from the bonds of the ruler and marking knife. You purposely are avoiding

Three decorative carvings  
that are easy to do  
and require few tools

BY CHARLES  
SHACKLETON



CURLS

the perfect symmetry left by a machine and are seeking the unique marks left by a carver. I hope these examples will encourage you to take up carving and add an extra dimension to your furniture making. The only limit is your imagination.

## A carved surface is all about texture

Many beginners try to achieve an almost flat surface, whether with multiple strokes of the carving tool or by sanding the wood. Everyone's taste varies in how textured a carved surface should be; I think you should aim for a surface with some inconsistency but not too much. I find that running my hands over the surface is a good way to locate rough areas that need another stroke of the tool. Above all, don't touch the carved wood with sandpaper after you put down your carving tools.

*The author is the owner of Charles Shackleton Furniture in Bridgewater, Vt.*



ROSETTES

## DIAMOND BEADING DRESSES UP MOLDINGS

A few simple tools—a block plane, a thin-kerf saw, and a ½-in. bench chisel—are all you need to form this diamond beading.

TOP VIEW

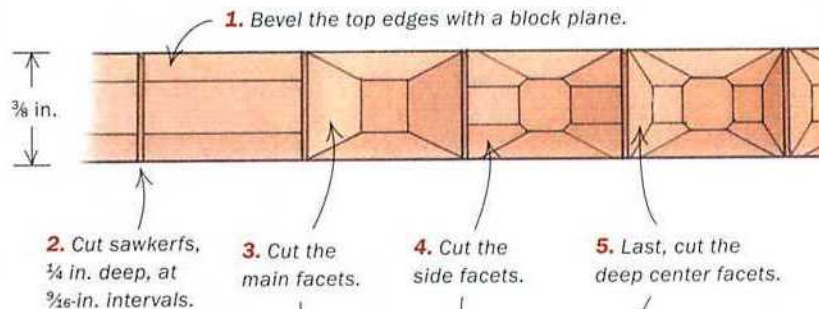

SIDE VIEW

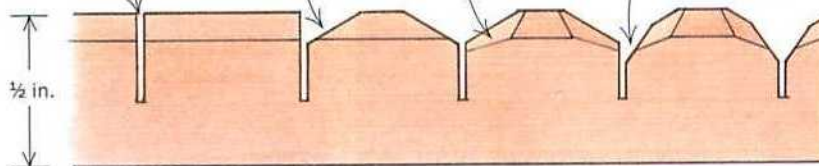

This decoration started out as a crude rendition of a berry molding. That design normally is a string of pure round beads, but my version came out in a faceted, hand-carved form. Creating this carving is an incredibly satisfying, soothing, easy, and quiet process, and it doesn't take that long. Diamond beading can add sparkle without overwhelming a design.

I use variations of the diamond, including one that looks like a row of four-sided pyramids (see the photo on the facing page). I think a furniture maker in my shop misinterpreted the original idea, or perhaps got bored, and this new version was born. That's how ideas come about: They evolve through mistakes, misinterpretations, experimentation, or just playing around.

Start with a piece of wood ½ in. thick by

¾ in. wide, and slightly longer than you'll need, to allow for mitering. Bevel the two top edges with a block plane, but don't aim for perfect facets. Mark the length

every ⅛ in. and cut down roughly ¼ in. with a thin-kerf saw.

With a ½-in. bench chisel, remove the wood in the order shown in the illustration. Some carvers perform the first cut along the whole piece before starting the second cut, for consistency's sake, but don't strive for perfectly matching beads.

1. BEVEL THE TOP EDGES



2. DEFINE THE BEADS



1. Use a block plane to bevel the top side of a strip of wood. Aim for a multifaceted arc rather than a smooth curve. 2. Then define each bead by making ¼-in.-deep cuts every ⅛ in., preferably with a thin-kerf saw.

3. CUT MAIN FACETS



4. CUT SIDE FACETS



5. CUT DEEP FACETS



3. Using a ½-in. bench chisel, start the first cut a little over a third of the way onto the top of the bead, angled at about 30° toward the sawkerf. 4. Cut the two side facets with the chisel angled to each side of the bead. 5. Lift the chisel to about 60° and cut the final facet about halfway down the first cut.

### Watch it on the Web

To see the author demonstrate his carving techniques, go to [www.finewoodworking.com](http://www.finewoodworking.com).

## CURLS ADD DIMENSION



I originally came up with this design for the arm of an upholstered dining chair. It gave the chair a look similar to the ram's horn curl on the top of a Greek Ionic column. Even though this chair was nearly twice the price of one of my side chairs, it sold well. It was almost as if the carving let the customer know how much handwork had gone into each piece.

With carving in general, you can use the profile of a tool to design the carving rather than designing the carving and then buying tools to execute it. Once you have a rough sketch of the carving, walk the gouge along the line, tracing the path with a pencil. Then cut along the line with a knife, lay the template on the wood, and trace the line onto the wood.

First define the outline of the curl by driving the gouge straight down into the wood with a mallet. Chisel away the waste, working from the outside of the curl toward the center. When cutting across or against the grain, take lighter cuts to avoid going too deep. The center of the curl can be slightly hollowed to avoid leaving a flat spot on the carving.

Deepen the outline until you reach a depth you find pleasing. The depth should be roughly uniform over most of the curl but gradually taper until it disappears in the center. When you remove wood where the curl joins the rest of the piece, try to have a slightly irregular transition from the smooth surface to the carved area. This will add to the pleasing hand-crafted appearance of the piece.

### 1. DESIGN WITH TOOLS IN MIND

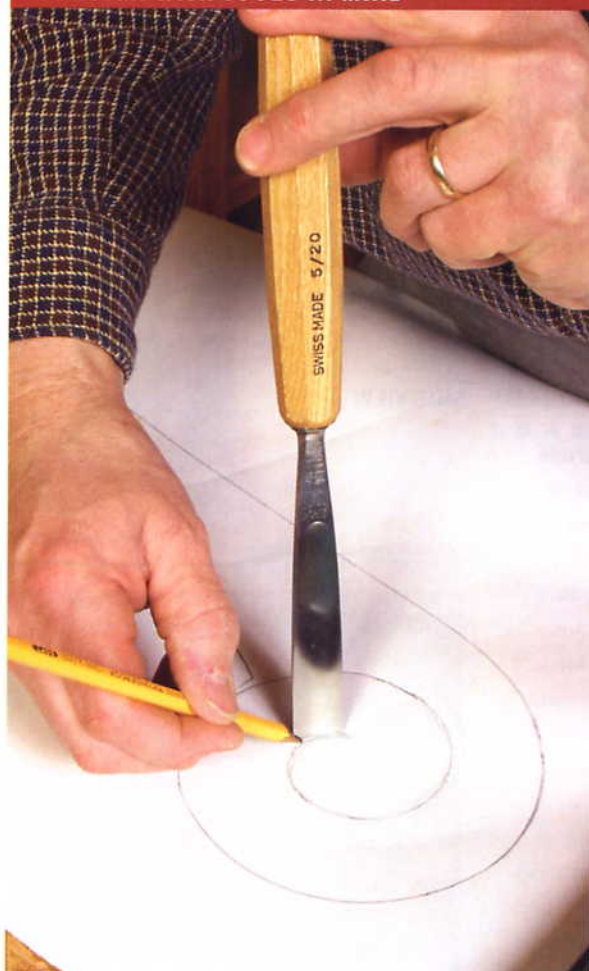

### 2. DEFINE THE CURL



**1.** Use the sweep of a gouge you already own to draw the final shape of the curl. Then transfer the design to the workpiece by cutting around the curl with a knife and tracing the design with a pencil onto the wood. **2.** Use a mallet to drive the gouge into the wood following the line of the curl. Don't try to cut down to the final depth at this stage.

## Buy your carving tools as you need them

Resist the urge to buy an economical starter set of carving tools. You will end up hardly using some of them, while those you do use will cut poorly and never hold an edge. Instead, purchase top-of-the-line tools as you need them. I prefer the Pfeil brand ([www.woodcarvingsupplies.com](http://www.woodcarvingsupplies.com)). The first number on the handle refers to the sweep, or curve, of the gouge, while the second number is the width of the tool in millimeters. Besides the sharpening stones you use with your bench chisels, you will need a leather strop and some honing compound. A few quick strokes on the strop will keep your tools cutting cleanly and effortlessly and will lengthen the time between each honing of a fresh edge.



**Maintain a sharp edge.** Hone the blade on a leather strop to maintain the perfect edge needed for effortless, clean carving.



### 3. RELIEVE THE CUT

Work your way around the curl, driving the gouge in from close to the edge up to the previously cut outline.



### 4. RECESS THE CENTER

To avoid leaving a flat section of wood that will detract from the carving, slightly recess the center of the curl.



### 5. AIM FOR A TEXTURE

This one gouge carved the curl from start to finish. The sharp edges of the curl can be sanded slightly, but the scalloped pattern left by the gouge should not be touched.



## ROSETTES ADD ELEGANCE



**A** lot of design originates from natural forms (evidence suggests that the Corinthian column evolved from the stem of the giant hogweed, or its Greek counterpart). Go for a hike and see what inspires you. There might be an idea hiding in a bush right outside your shop.

This rosette design may have originated as a dogwood flower or perhaps as a wild rose, but despite its intricate appearance, it is no more difficult to create than the previous two carvings.

This carving is deceptively simple because the majority of the profile is cut either on the lathe or using a cutterhead

mounted in a drill press. The former method offers more flexibility in terms of design and size, but if you don't possess turning skills, the drill press can produce blanks very quickly.

Once the blank has been cut or turned, divide it into four quadrants by drawing curved lines from the midpoint to the edge. At the edge, remove four triangles of waste by pushing down on the gouge and at the same time angling it toward the rim. Then use the smaller of the two gouges to cut the curving line from the center to each triangle. Don't make the line too pronounced; an oil finish will enhance the line when penetrating the cut wood. Last, with a sharp scribe or the edge of a chisel, scratch in the vein running down the middle of each leaf.

When mounted in shallow holes, the rosettes appear carved into the solid wood of the workpiece. I have used both large and small rosettes on the legs of coffee tables, as centers for drawer pulls on bedside tables, and to adorn kitchen dressers and mirror frames.



**Highlighting a leg.** By inserting the rosette into a perfectly matched hole, it appears that the leg itself was carved.

### 1. TURN ROSETTE BLANKS



Rosette blanks turned on a lathe have a limitless number of profile and size possibilities.

### ROSETTE PROFILE

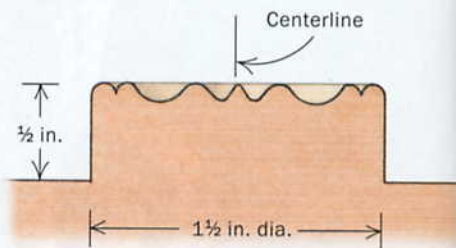

### A drill-press option for cutting rosettes



If you don't own a lathe, mount a rosette cutter ([www.micswoodworking.com](http://www.micswoodworking.com)) in a drill press. Use a fly cutter with the center bit removed to cut the outside of the rosette block, removing it from the blank.

## 2. MOUNT THE TURNINGS FOR CARVING

A carving's three dimensions are best illuminated with a bright light shining from one side. Here, Shackleton has prepared several blanks with double-faced tape on the lathe and mounted them on a piece of scrap board to ready them for carving.



## 3. DRAW IN THE FLOWER PETALS

Divide the face of the turning into four parts by drawing the curved outline of the petals.



## 4. CARVE THE PETAL CORNERS

Angle the gouge down and outward to cut away a small triangle of waste, which defines the corners of the petals.

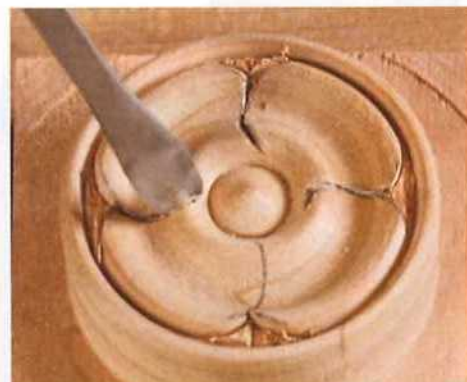

## 5. DEFINE WHERE THE PETALS MEET

Push the curve of the gouge into the wood enough to show the edges of the petals.



## 6. ADD THE VEINS

Use the edge of a chisel to scribe the thin vein in the center of each petal.

# Current Work

Current Work provides design inspiration by showcasing the work of our readers. For more details and an entry form, visit our Web site at [www.finewoodworking.com](http://www.finewoodworking.com). Send photos and entry forms to Current Work, *Fine Woodworking*, 63 S. Main St., Newtown, CT 06470, or email digital images to [fw@taunton.com](mailto:fw@taunton.com).

## John Packard Sea Cliff, N.Y. ▶

Packard had always wanted to make a round dining-room table for himself, and when the right materials came to hand, he built this figured mahogany one to complement a set of 19th-century Regency chairs he had purchased in Paris. The table (60 in. dia. by 30 in. tall) showcases satinwood, holly, and ebony bandings and took about 275 hours to complete. It has a rubbed-out lacquer finish. Photo by Steve Ogilvy



## Greg Arceneaux Covington, La. ▲

This French-Creole style petite armoire (24 in. deep by 36 in. wide by 60 in. tall) is made of cypress. "From 1725 to 1825, this style was indigenous to the Mississippi River Valley," Arceneaux noted, "and now can only be seen in private collections and museums because there are so few surviving pieces." The armoire has a Danish-oil and wax finish.

## Dan Gindling San Diego, Calif. ▶

Gindling designed this chest of drawers to store CDs and DVDs in his home. The cabinet (19 in. deep by 22 in. wide by 64 in. tall) is made of urban walnut and quarter-sawn sycamore, and the top tray features three lights that illuminate the lower drawers. The piece is finished with polyurethane.



**Frank Hickman** ▶  
Shaker Heights, Ohio

Hickman's "great chair project" began with a curiosity of what a small production run would be like. Thirteen years and 22 chairs later, Hickman said he has more than satisfied his curiosity, having made 18 of these side chairs (25 in. deep by 18 in. wide by 46 in. tall) and four rockers. Sixteen of the chairs were constructed of walnut, and six of cherry. Hickman used linen seat covers and finished the chairs with tung oil.

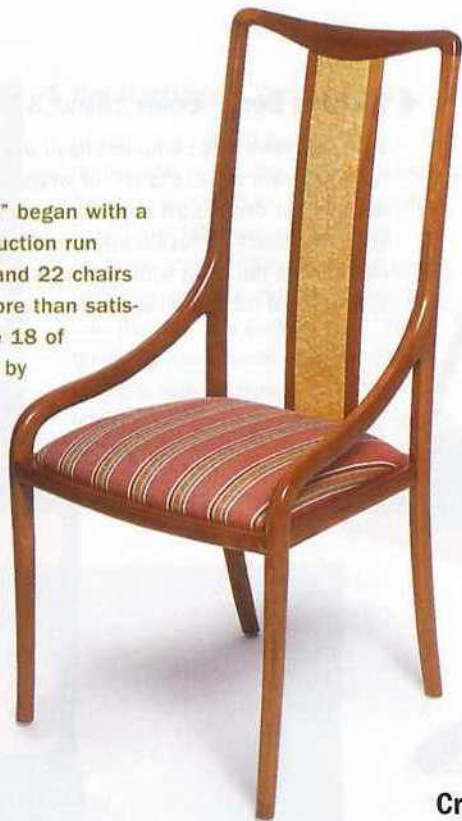

**Craig Barnett** Fresno, Calif. ▶

Barnett was commissioned to build this Royal Clock reproduction (18 in. deep by 21 in. wide by 122 in. tall) for a client who had seen the original 30 years ago and had never gotten the chance to build it himself. Based on the Thomas Tompion 1699 original on display at the DeWitt Wallace Decorative Arts Gallery at Colonial Williamsburg in Virginia, the clock is constructed of solid walnut with walnut burl and crotch veneers. The piece showcases 97 separate castings and 12 milled moldings, each made of a silver bearing alloy plated with pure 24-karat gold. Barnett completed the clock in 1,600 hours. It has a shellac and lacquer finish.



**Barry Daggett** Northampton, Mass. ▲

"I had book-matched several pieces of walnut crotch I had in my shop," Daggett said, "and began playing with the four pieces like a puzzle." Once he found the right balance among the pieces, Daggett let that configuration inspire the design of this walnut storage cabinet (20 in. deep by 40 in. wide by 32 in. tall). The piece features ebony pulls and is finished with an oil-based varnish and wax. Photo by John Polak



◀ **Richard Best** Bowen Island, B.C., Canada

Best designed this computer desk after Gustav Stickley's fall-front desk. Crafted of white oak with ebony details, the desk is 18 in. deep by 42 in. wide by 60 in. tall and boasts a black-leather writing surface. Best first fumed the desk with ammonia and then finished it with hand-rubbed oil and wax.



**Tor Faegre** Evanston, Ill. ▲

"I like furniture that is light in weight, so light that it looks like it will float off," said Faegre, who got the idea for his "floating table" when he saw a grove of young cottonwoods springing up in a field. The peeled willow legs are nailed and glued to the pine tabletop. The table stands 16 in. deep by 44 in. wide by 36 in. tall and is finished with acrylic.



**Mark Edmundson** Sandpoint, Idaho ▲

Edmundson made the Twister cabinet (11 in. deep by 18 in. wide by 32 in. tall) for his favorite customer—his mother—who commissioned it upon her retirement. The front slats rotate 360° to reveal either a wenge or spalted-maple veneered surface, as well as an illuminated interior for displaying special objects. The interior is accessed through frame-and-panel doors on each side, and the veneered door panels also rotate 360° inside the frames to reveal a wenge or spalted-maple surface.



◀ **Jim Hartlage** Niskayuna, N.Y.

Based on an 1810 design, this maple and pine table (21 in. deep by 34 in. wide by 28 in. tall) keeps to traditional Windsor construction methods by having each of the four legs through-tenoned and wedged into the top. The underside of the thick top has a wide chamfer to make it look thinner. The table is finished with Lexington-green milk paint with an oil topcoat.



**Loran Smith** New Durham, N.H. ▲

When U.S. Senator Judd Gregg (R-N.H.) commissioned Smith to build this secretary (24½ in. deep by 41½ in. wide by 87¾ in. tall), he had a few requirements. The desk was to be built in the Dunlap style, instantly recognizable for its ties to New Hampshire; it was to be constructed of curly maple, with ball-and-claw feet and a carved state seal; and it was to have "lots of character." The latter was up to Smith, who incorporated eight fan carvings, flowered ogee moldings, and an amphitheater-style gallery, complete with a hidden drawer. The piece is finished with hand-brushed varnish.



**Scott Grove** Rochester, N.Y. ▲

Grove describes his table (12 in. deep by 42 in. wide by 38 in. tall) as "discovering an antique in your grandmother's attic that's been covered with a sheet for years, and you pull it back and discover a missing link." The legs are fashioned from ebonized mahogany. The linenfold section of the top is carved spalted beech; the "uncovered" section consists of sterling silver, brass, copper, opal, onyx, mother-of-pearl, gold stone, lapis, malachite, amethyst, turquoise, and azurite set in epoxy resin. The piece is finished with lacquer and wax.

## A finish free of brush marks

**Q** I use water-based polyurethane varnish, and the brush marks keep showing—in other words, I end up with a rough finish. Can you help?

—Hobart Belknap, Austin, Minn.

**A Chris A. Minick replies:** Brush marks in the finish film result when the finish dries before it has had a chance to level. Usually this is a result of insufficient wet-finish thickness or poor brushing technique or a combination of both. Apply a smooth, even layer of finish, the thickness of three sheets of paper, with a minimum of brush strokes. The brush marks at this thickness will flow together before the finish dries.

From the start, I always measure the viscosity of the finish. High-viscosity finishes show brush marks and streaks, while low-viscosity finishes tend to run, sag, and drip. With most finishes, a viscosity of roughly that of half-and-half cream flows well. Thinning the finish with the manufacturer's recommended solvent, which is water for water-based finishes, sometimes is necessary to achieve the proper brushing viscosity.

Before dipping the brush into the varnish, I wet the bristles in the solvent, which prevents dried finish from building up at the base of the brush. The material should flow from the brush onto the wood in an even sheet of wet finish. (For more on brushing techniques, see the drawing below and *FWW* #156, pp. 38-43.)

After coating the whole panel, level out the uneven areas by lightly dragging the bristle tips of the unloaded brush through the wet finish.

Between each coat, I normally scuff-sand with 220-grit paper to remove nibs or dust specks. Three or four coats of finish are about right for most projects.

[Chris A. Minick is a consulting editor.]

### A COMPLETE SIDE-TO-SIDE STROKE

The first stroke is short, followed by a longer stroke in the opposite direction. By increasing the bristle angle of the brush at the end of the long stroke, more varnish from the reservoir flows onto the surface. Repeat these steps until the surface is covered.

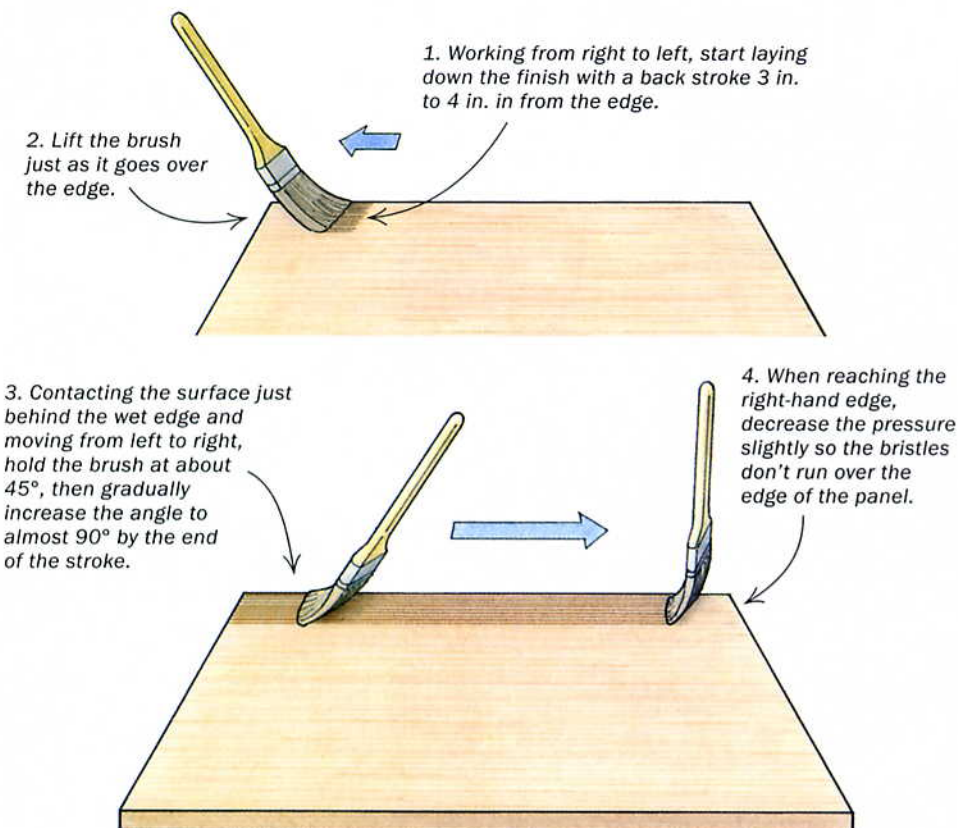

## Controlling blade chatter

**Q** I recently purchased a shoulder plane and am having difficulty controlling blade chatter. When I clamp the blade in the tool, I find that the cutting edge is lifted off the frog. Any suggestions?

—Bryan Lyden, Port Orchard, Wash.

**A Garrett Hack replies:** A blade not firmly supported will flex and chatter. You might need to flatten the back of the iron, level the bed it rests on, reposition the screw cap that holds the iron snug against the bed, or all three. Try moving the screw cap first. Push it as far forward as possible so that it applies pressure close to the bevel of the cutting edge. To level the bed, disassemble the plane and, with a fine jeweler's or needle file, flatten any high spots or roughness. Take off as little as necessary and check the flatness often with a small straightedge. Last, make sure that the back of the iron is not convex but flat for at least the last ½ in. [Garrett Hack is a contributing editor.]

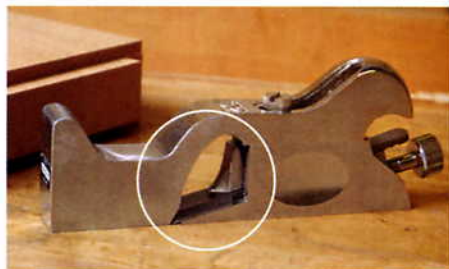

**Move the screw cap forward to eliminate blade chatter.** The screw cap on this Stanley No. 92 (top) is positioned too far back from the cutting edge. Adjust it forward (bottom) so that the pressure is concentrated near the blade's bevel.

## Looking for a nonyellowing finish

**Q** I'm building kitchen cabinets with quilted white-ash veneered panels. I'd like a clear and nonyellowing finish that brings out the grain. What should I use?

—Randy Osborne, Clyde, N.C.

**A** Jeff Jewitt replies: Acrylic and certain urethane finishes are clear and nonyellowing, and both types are available in water base and solvent base.

Most water-based finishes contain acrylic and what's called an aliphatic or linear urethane. One example is the Polycrylic Protective Finish by Minwax, available at hardware stores. For solvent-based finishes, the best choices are acrylic lacquers formulated with cellulose-acetate-butylate (CAB-acrylic lacquer). One example is the Sher-Wood CAB-Acrylic Lacquer System, available at some Sherwin-Williams stores. However, unless you have adequate means of exhausting hazardous vapors, I'd avoid the use of solvent-based products.

To bring out the grain, use a sealer coat of dewaxed ultraclear shellac, available in platina, super-blond, and ultrapale grades, before applying the finish. All of the solvent- and water-based finishes mentioned will work fine over shellac as long as it's dewaxed. [Jeff Jewitt is a frequent contributor to *Fine Woodworking* on finishing topics.]



**Shellac and acrylic for a clear and nonyellowing finish.** Sealing with shellac will bring out the grain, and a water-based acrylic finish will keep white ash from yellowing.

## Bandsaw blade tension

**Q** Could you share with your readers the psi tensioning values for the bandsaw blades that you tested (FWW #169, pp. 76-79)?

—John Grew-Sheridan, San Francisco

**A** John White replies: We tested the blades at the tension recommended by the manufacturers. We then looked for the optimum tension. With one exception, we found that the higher the tension, the better the blade cut. Based on this, we set the blade tension to 15,000 psi for demanding work such as resawing. The exception was the Highland Hardware Wood Slicer blade, which cut better at lower tensions. By the way, tension is one of the less important factors that affect the quality of a bandsaw's cut; the correct setup and a sharp blade are more important factors.

[John White is the author of *Care and Repair of Shop Machines* (The Taunton Press, 2002).]

## How can I bend ebony?

**Q** I want to inlay ebony in a rabbeted edge of a demilune table. I cut some ebony into strips and made little bites with my chisel along their lengths to accommodate the bend. Even though this is a gentle bend, the ebony breaks. Is there an alternative?

—Stephen Wetmore, South Strafford, Vt.

**A** Garrett Hack replies: You can bend ebony several ways. The easiest is to bend a strip dry if you can. Two things will help: Cut a straight-grain ebony piece, slightly thicker and wider than your rabbet, and handplane it very smooth. Any cut or torn-out areas create weak places where the strip will snap. Make sure you can make the bend before gluing. When gluing, go slowly and evenly, holding the strip in place with masking tape as you move along the edge.

If this doesn't work, prebend the strip by wetting it. The moisture makes the ebony about twice as flexible. Wet a strip and bend it around the table edge (not the rabbet), protecting the edge with a layer or two of kraft paper, or bend it around a form of similar shape. Gently hold the strip in place with masking tape or a few clamps and let it dry overnight. After it has dried, glue the strip in place with yellow glue and bind it with masking tape.

[Garrett Hack is a contributing editor.]

**Wet ebony is twice as flexible.** Once you wet the ebony strip, ease it around a form, hold it in place with tape, and let it dry overnight. Once dried, the ebony partly holds the curve and bends to fit the demilune tabletop edge.







**WOODCRAFT**  
UNIVERSITY

**T**here's a  
*Woodcraft University*  
location near you

**Alabama**  
Birmingham Area

**Arizona**  
Tucson

**California**  
Orange County  
Sacramento  
San Francisco/Dublin  
Santa Rosa

**Colorado**  
Colorado Springs  
Denver

**Connecticut**  
Hartford Area  
Orange

**Delaware**  
Wilmington

**Florida**  
Casselberry  
Clearwater  
Jacksonville  
Fort Lauderdale

**Georgia**  
Atlanta Area

**Hawaii**  
Honolulu

**Idaho**  
Boise

**Illinois**  
Palatine  
Peoria

**Indiana**  
Evansville  
Indianapolis

**Kansas**  
Lenexa

**Kentucky**  
Louisville

**Maryland**  
Towson

**Massachusetts**  
West Springfield  
Woburn

**Michigan**  
Canton  
Sterling Heights

**Minnesota**  
Bloomington

**Missouri**  
St. Louis Area

**New Hampshire**  
Portsmouth Area

**New Mexico**  
Albuquerque

**New York**

Albany

Rochester

**North Carolina**

Charlotte Area

Greensboro

Raleigh

**Ohio**

Cincinnati Area

Cleveland Area

Columbus Area

Dayton

**Oklahoma**

Oklahoma City

Tulsa

**Oregon**

Eugene

Portland Area

**Pennsylvania**

Harrisburg

Philadelphia Area

Pittsburgh Area

**Rhode Island**

East Greenwich

**South Carolina**

Charleston

**Tennessee**

Johnson City

Knoxville

Nashville

**Texas**

Austin

Dallas Area

Fort Worth

Houston

San Antonio

**Utah**

Salt Lake City Area

**Virginia**

Richmond

Roanoke

Virginia Beach

Washington D.C. Area

**Washington**

Seattle

**West Virginia**

Parkersburg

**Wisconsin**

Appleton/Fox Cities Area

Madison

Milwaukee Area

**Woodworker's Club:**

**Connecticut**

Norwalk

**Maryland**

Rockville

**WOODCRAFT**

For your local Woodcraft store,  
visit [www.woodcraft.com](http://www.woodcraft.com),  
or for a free catalog, call  
800 542-9115

Dept.04WW12BE  
READER SERVICE NO. 150

## Q & A (continued)

### How to secure stock between centers on a lathe

**Q** I recently purchased a minilathe for spindle turning. The manual instructs to always have the rim of the cup center embedded at least  $\frac{1}{8}$  in. into the work. I attempted this procedure with a piece of Douglas fir, which split with just a dim circle appearing. I am convinced that some part of the lathe would be destroyed if I were to follow the manual's instructions. What do you think?

—M. Truman, Arroyo Grande, Calif.

**A** **Mario Rodriguez replies:** When I turn between centers, I follow a careful procedure to ensure that I have embedded the drive and tail centers properly.

After finding the centers of my workpiece by drawing crosshairs on the ends of the piece or blank, I stamp a strong impression of the drive center into one end with a second drive center that I keep with my lathe tools.

Next, I set the blank between centers on the lathe, making sure the drive center on the lathe engages the marked center on the blank. Then I carefully crank the tailstock center into the other end, until the rim of the cup center is slightly embedded, lock it down, and manually check for any play. Depending on the wood, the rim of the cup center can be embedded as little as  $\frac{1}{32}$  in. For large hardwood blanks, I predrill the centers to allow the points to penetrate more deeply. Bearings on a lathe can withstand considerable pressure, but be aware that excessive pressure can cause stock to split and thin stock to bow.

When I'm satisfied that the blank is secure, I step to the side and turn on the lathe, then quickly turn it off. Finally, after rechecking the workpiece again, I'm ready to begin turning.

I follow the same procedure when using single-point centers on the tailstock, with the exception that the point is driven more deeply into the blank. [Mario Rodriguez is a contributing editor.]



#### SETTING UP A BLANK FOR TURNING

Before you position the blank on the lathe, imprint the drive center from the headstock assembly into the workpiece (right). Next, with minimal pressure, carefully crank the tailstock so that the rim of the cup center is slightly embedded into the workpiece and there is no play when you turn the blank by hand (below).



# Master Class

## Low-tech method for veneered columns

BY W. PATRICK EDWARDS



**Seamless columns, exotic woods.** This entire desk, including the two sets of columns, is veneered with plum-pudding Cuban mahogany. For more on this piece, see the back cover.

During the early 19th century, American and European furniture makers commonly used veneered columns as both structural and decorative elements. When I began to restore antiques more than 30 years ago, I wondered how the columns were made. My research originally suggested that the turned columns were coated with hot animal glue, and then wrapped with veneer followed by wet jute webbing. When the column was rotated in front of a fire, the webbing would heat and shrink, effectively clamping the veneer in place.

Unfortunately, my early efforts to duplicate this method met with such dramatic failures that I abandoned the idea for 20 years. It remained one of the mysteries of the trade, and I continued to search for answers to the problem.

I joined an international conservation group in France about 10 years ago, which was researching how protein glues could be modified with urea to make them liquid at room temperature. A lightbulb went off in my head. Finally, I was able to see how the early woodworkers could easily wrap veneers around columns using animal glue. They modified the glue!

I began my own research and eventually found a glue recipe and veneering method that work perfectly. Using this method I have veneered a wide variety of columns, ranging from a diameter of about 1 in. to as large as 12 in. The process is simple and effective, and it adds a dimension to my work that makes it dramatic and unique.

### Use elastic bands and liquid hide glue

After making my glue discovery, my next attempt at gluing veneer to columns employed rubber inner tubes cut into strips, but they left marks and produced uneven pressure. Then I discovered Rep Bands at



### GET COLUMN AND VENEER READY



**Turn a straight column and secure it well.** Glue cloth-backed sandpaper to a square of plywood to make a low-tech smoother for turnings. To secure the column, make a set of extralong benchdogs (right), with a screw tip poking out of each. Also, tape off the tenon areas of the column.



**Cut the veneer to size.** Make a paper template rather than bending the dry, brittle veneer. The veneer should overlap  $\frac{1}{2}$  in. at the seam.

## VENEERING IS A 10-MINUTE JOB

**Wet the veneer, warm the glue.** Soak the veneer first in warm water, rolling it loosely so that it will fit into a large pot. Place the glue bottle in hot tap water to raise the glue above 80°F before applying it to the glue face.



**Heat the column and apply glue.** To maximize the working time, dampen the column and preheat it with a hot-air gun. Note that the tenon areas are wrapped with tape for easy glue cleanup. Brush on the warm glue quickly.



a medical-supply outlet. These 4-in.-wide elastic bands are sold in 50-yd. (part #A518015) and 6-yd. (part #A508805) rolls by Sammons Preston Rolyan (800-558-8633). I use the plum color, which is the strongest, and I cut lengths according to the job.

For liquid hide glue I use Old Brown Glue, which is a modified liquid animal glue that I make and sell (619-298-0864; [www.wpatrickedwards.com](http://www.wpatrickedwards.com)). You also may experiment with Milligan and Higgins 192-gram glue (518-762-4638; [www.milligan1868.com](http://www.milligan1868.com)) by adding common urea (sold at chemical-supply outlets as a fertilizer) until it remains liquid at room temperature.

To thin it to a runny viscosity for this job, Old Brown Glue should be warmed above 80°F. A bath of hot tap water works fine. By the way, the bottled glue can be rewarmed many times without losing its effectiveness.

You also will need a single piece of veneer large enough to cover the column and a solid wood turning for the core. I prefer to use either poplar or Honduras mahogany for the core wood, depending on the quality of the project. Mahogany turns and takes glue slightly better than poplar.

To work properly, the veneer shouldn't have any cracks or flaws, and the grain should run lengthwise along the column. It is possi-

ble to use burl veneer or veneer with seams, but that method is too complicated to cover in this short article.

### Turn a column and secure it to the bench

Turn the solid-wood column using normal lathe tools, producing either a straight column or a straight-tapered column. It is extremely important that the column be smooth, because any bumps or dips will telegraph through the veneer.

I mount most of my columns in metal capitals, which means that I turn slightly smaller tenons at each end of the column.

To hold columns for veneering, I made long, oak benchdogs and drove a long wood screw into the tip of each one, with the point protruding on the face (left). I adjusted the clamping pressure to allow the work to be rotated with some resistance. Mount the column so that it is about 6 in. above the bench. Place newspaper under the column to protect the bench from drips.

Be sure to tape off the tenon areas to protect them from the mess.

### Apply the veneer

First, wrap a paper template around the column to help you size the piece of veneer. Soak the veneer in a tray of hot water for about 15 minutes.

Remove the veneer from the hot-water bath and use paper towels to soak up the excess water on the surface. Next, apply a generous coating of glue (using a brush or a roller) to the glue face of the veneer. I also like to heat up the wood column, using a hot-air gun, before the glue. Now wrap the veneer around



**Wrap the veneer.** Making sure the veneer ends are aligned, hold it in place as you turn the column and wrap the banding. Anchor the elastic beyond the veneered area before wrapping it over the veneer. Overlap each previous wrap by half, creating a smooth double layer, and anchor the ends with tape.



# Master Class (continued)

## TRIM THE SEAM AND ENDS

**Cut a straight seam.** Tape a straightedge over the center of the overlap and pull it against the tape to stabilize it. Use a veneer saw or sharp knife to trim through both layers of veneer.



**Heat the seam to loosen the glue.** Use a veneering iron or a household iron on a low setting to heat the seam area (left). Remove the excess veneer. One piece will fall off the outside, but the other strip must be pried out from beneath the seam (right).

the column, holding it in place with your hands.

Start wrapping a length of the elastic band evenly from one end of the column to the other, allowing the excess glue to squeeze out onto the newspaper.

The start is critical. It helps to have a raw wood area—the tenon areas work well for this—in which to anchor the wide elastic band before it contacts the veneer. Also, don't allow the veneer to twist as you wrap the rubber banding; it will be impossible to cut the seam on a spiral.

Overlap each previous layer by almost half, so you get almost a double layer of banding along the column. If the wrapping doesn't go as planned, unwrap it and start again. You have about 10 minutes of open time before the glue starts to become gummy. The elastic band will not stick to the glue, and excess glue can be cleaned up with cold water.

### Wait a day, and then fix the seam

Modified animal-protein glue is ideal for this application because it takes longer than synthetic glue to set up and cure. During the

first 24 hours, the animal glue remains flexible enough to allow the wood to shrink as it loses moisture.

After 24 hours the veneer will have shrunk enough to allow you to cut an accurate seam. First, remount the column in the benchdogs and remove the elastic band. Dampen an abrasive pad (3M makes these) with cold water to remove as much excess glue as possible at this point, to avoid later sanding. Wipe the surface dry immediately.

Place a straightedge along the center of the seam overlap and hold it in place with either spring clamps or tape. Using a veneer saw, cut along the straightedge through both layers of veneer. If you use a knife, watch its tendency to follow the grain.

Now use a warm iron or another heat source to heat the area along this cut. To test the temperature of your iron, hold it near your face. If it feels dangerous—warmer than hot tea—lower its temperature. When the glue loosens along the seam, reach under the veneer to remove the small scrap of veneer that remains, then brush a bit more glue under the seam, reheat the joint, and use a veneer hammer to press the joint closed. Replace the elastic band and place the column aside for another 24 hours. When the column is completely dry, remove the elastic band, and wipe off any leftover glue residue with a damp, cool abrasive pad. Finally, sand the dry surface. □



**Repair the seam.** Apply warm glue again (above) and reheat the seam with the iron, then use a veneer hammer (right) to press it down as it cools. Rewrap the column with the banding and wait.



**Trick for trimming the ends without splintering.** Mount the column in the lathe and turn it by hand while stabilizing a sharp knife against the tool rest. Scribe lightly at first and then increase the pressure to finish the job.

## Keep your finish fresh

Your shop probably has a shelf cluttered with cans, jars, and bottles of finish left over from previous projects. Some of the containers aren't labeled, so the contents are a mystery; others are so old that the lids and tops are either glued on tight or won't seal at all. These leftovers represent a waste of material and space, because the fact is you shouldn't let the vast majority of old finishes anywhere near your next project.

Although there are ways to preserve finishes for a time and to determine whether leftovers are still viable, minimizing waste starts at the time of purchase. You should make a habit of buying the smallest amount of finish you need for the job at hand. That way, you won't have to store a lot of material for a long time. In fact, it may be a false economy to buy a gallon of finish once instead of smaller containers on different occasions.

### All finishes have a shelf life

It might be better if woodworkers treated finishes as they do food: You don't expect that slab of cheese in the fridge to be edi-

ble a year from now. Would you risk your health eating a dubious piece of steak rather than buying more? Of course not. Yet woodworkers happily keep cans of varnish for years and think nothing of finishing their latest masterpiece with old shellac rather than mixing a new batch.

Even when stored unopened in ideal conditions, finishes deteriorate. In the case of varnish, the metallic driers gradually lose

their effectiveness. The deterioration is faster with semigloss and satin varnishes as the flattening agents react with the driers. If satin varnish from a fresh can dries in two to three hours, varnish from a two-year-old can probably will take an hour or two longer; varnish that's beyond three years old probably never will cure fully.

In his article about shellac (*Finish Line*, *FWW* #134, pp. 129-130), Chris A. Minick



### LIMIT CONTACT WITH OXYGEN

To reduce the amount of oxygen in the can of finish, transfer the contents of a half-empty can into smaller containers (left). Another option is to fill the empty space in the can with Bloxygen, an inert gas that prevents oxygen from coming in contact with the finish (below).





**False economies of scale.** *Buying a gallon of finish may be cheaper than buying four quarts, but not if you have to dispose of half the contents in the gallon container because you kept it too long.*

explains how shellac starts to deteriorate as soon as the flakes are dissolved in alcohol. Chemical changes make the shellac increasingly less water resistant and unable to form a hard finish. For this reason, I follow Minick's advice and make all of my shellac from dry flakes. I toss any leftover liquid shellac after six months.

Precatalyzed lacquers last about a year, so buy them from a source with high turnover and write the purchase date on the lid.

## Ways to preserve finishes

Although the aging of finishes is inevitable, there are ways to slow it down. Keeping oxygen away from the finish is key. Make sure you have a tight seal on the container, which requires a clean rim and lid. If you are working right from the can, don't drag the brush across the rim; instead, tap it on the inside edge of the can. Ideally, you should not work directly from the can. Rather, pour the amount of finish you need into a smaller container. Doing so helps reduce the chance of introducing contaminants into the clean finish in the can.

Air trapped in a can causes some finishes to skim over and some cans to rust. If you are left with a can of finish that is more air than liquid, you could transfer the finish to

smaller containers to preserve its useful life. But be careful what kind of container you choose. While coffee cans are good for storing dirty solvents, I would not recommend them for holding any type of finish. Coffee cans may react with the finish, or rust, contaminating the liquid. This is especially true for water-based products.

Glass jars are good storage containers, but make sure the lids create a tight seal and aren't prone to rusting. Jars that once contained acidic products such as pickles generally have well-protected lids.

I work extensively with water-based products and have found that the one-quart and one-pint plastic containers available at any grocery-store salad bar or deli are perfect for storing these finishes.

When transferring finishes to different containers, be sure to apply a clearly written label that will not fade or fall off. The label should include what is in the container, the recipe if it is a mix, and the date you filled the container.

If the original can still has a good seal, there are two other ways to reduce or eliminate air from the container. You can raise the level of finish by adding solid objects such as glass marbles. A less messy way is to spray an inert gas such as Bloxy-

gen into the can, creating a barrier that protects the finish from oxygen.

## Determining whether the finish is bad

There are telltale signs that a finish is no longer usable. In some cases, the consistency will have changed. The solids may have settled to the bottom of the can, and no amount of stirring will mix them properly. When a water-based finish has been frozen, the material becomes thick or even congeals.

Shellac and varnish present a different problem because there are no readily visible signs that they have outlived their useful life. The best way to test these products is to put a few drops on a hard, impermeable surface, such as metal or glass. If the drops solidify completely over the next several hours, the shellac or varnish is still good. However, if the drops remain soft, gooey, or sticky after 24 hours, the finish is too old to use.

With any finish product, there's one rule to follow: When in doubt, throw it out. It simply doesn't make sense to risk ruining a project in which you have invested time and money, simply to avoid spending \$20 on a new can of finish.

Just remember to dispose of the material in accordance with local environmental regulations (see *FWW* #160, pp. 133-134). □



## TESTING SHELLAC

*Shellac that has been around for a while should be tested before use. Place a drop of it on a piece of glass. If the shellac is still sticky to the touch after 24 hours, throw it away. This test also works with varnishes.*



# French Empire Reenacted



When W. Patrick Edwards built this French Empire *bonheur du jour*, he not only reproduced the appearance of the original, but he also reenacted the process of its making. For Edwards, this is business as usual. He has been repairing, conserving, and reproducing antique furniture without the use of modern machines for 35 years.

His passion for French Empire furniture takes him to France twice a year in search of veneer and hardware. He brought his hardware supplier in Paris photos and measurements of the original gilt-bronze locks and keys, column capitals, and bases and discovered that the pieces were practically stock items. His supplier, it turned out, had made the original hardware two centuries before.

Meant as a place to read or write letters, the *bonheur du jour* is mounted on wheels so it can be rolled into the best light. Edwards veneered it with plum-pudding Cuban mahogany and gave it a French-polish finish. For more on how Edwards veneered the columns, see Master Class, p. 108.

—Jonathan Binzen

Photo: Glenn Cormier