

OBD (On-Board Diagnostic System, Generation 1)

In April 1985, the California Air Resources Board (CARB) approved On-Board Diagnostic system regulations, referred to as OBD. These regulations, which apply to almost all 1988 and newer cars and light trucks marketed in the State of California, require that the engine control module (ECM) monitor critical emission related components for proper operation and illuminate a malfunction indicator lamp (MIL) on the instrument panel when a malfunction is detected. The OBD system also provides for a system of Diagnostic Trouble Codes (DTC) and fault isolation logic charts in the repair manual, to assist technicians in determining the likely cause of engine control and emissions system malfunctions. The basic objectives of this regulation are twofold:

- To improve in-use emissions compliance by alerting the vehicle operator when a malfunction exists.
- To aid automobile repair technicians in identifying and repairing malfunctioning circuits in the emissions control system.

OBD self diagnosis applies to systems which are considered to be most likely to cause a significant increase in exhaust emissions if a malfunction occurs.

Most notably, this includes:

- All major engine sensors
- The fuel metering system
- Exhaust gas recirculation (EGR) function

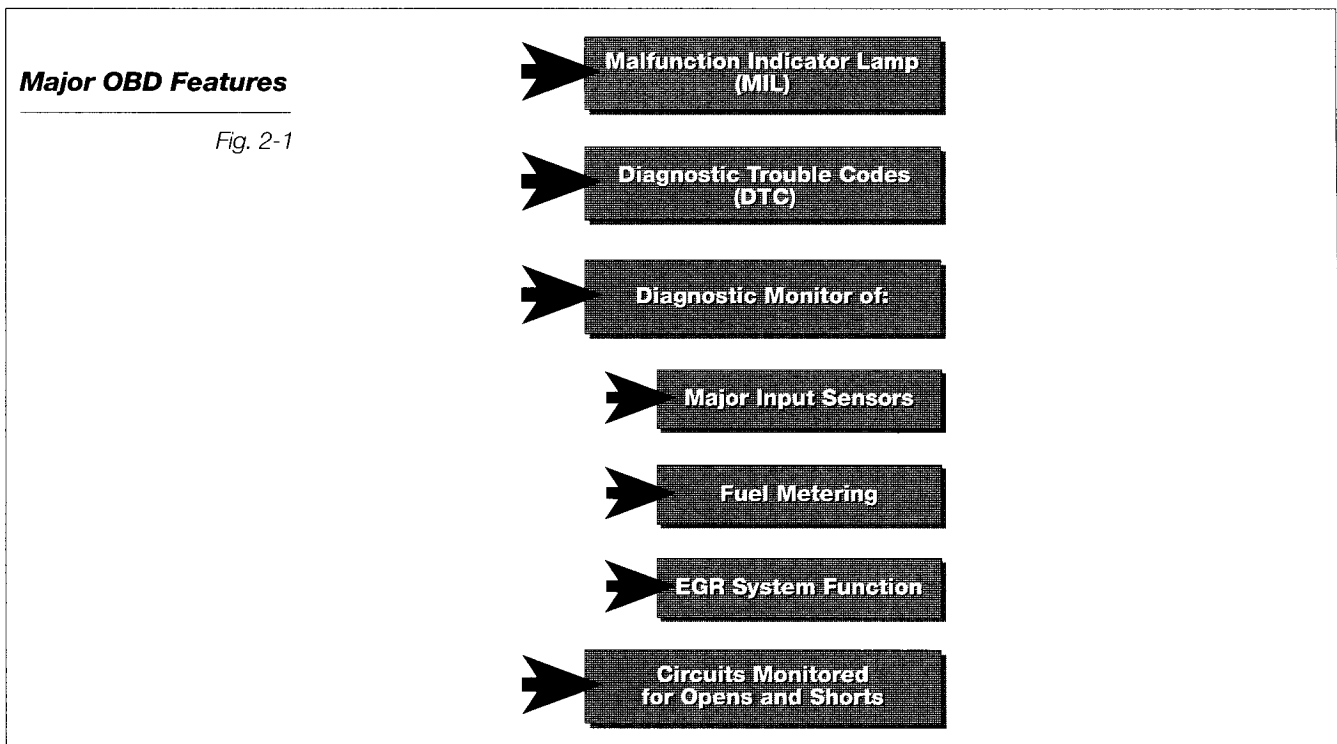

OVERVIEW OF OBD AND REGULATIONS

Malfunction Indicator Light (MIL)

When a malfunction occurs, the MIL remains illuminated as long as the fault is detected and goes off once normal conditions return, leaving a Diagnostic Trouble Code (DTC) stored in the ECM memory. Circuits are monitored for continuity, shorts, and in some cases, normal parameter range.

The Malfunction Indicator Light (MIL) is also a visual inspection item in most emissions inspection and maintenance programs (U/M), allowing the emissions inspector to make a quick visual determination whether the engine control/emissions system is functioning normally. During the visual inspection phase of the I/M test, the inspector must observe the MIL during a "key on bulb check" and again with the engine running. The MIL should be on during the bulb check and go off when the engine starts. When a vehicle passes this check, it is highly probable that the engine control system is functioning normally.

Although the OBD regulation applies only to California emissions certified vehicles, some or all of the OBD system features are found on Federal emissions certified vehicles as well.

OBD Diagnostic Trouble Codes (DTC)

Diagnostic Trouble Codes or DTCs are generated by the on-board diagnostic system and stored in the ECM memory. They indicate the circuit in which a fault has been detected. DTC information remains stored in the ECM long term memory regardless of whether a continuous (hard) fault or intermittent fault caused the code to set. Toyota products with OBD will continue to store a DTC in the ECM long term memory until the code is cleared by removing power from the ECM BATT terminal. In most cases, the EFI fuse powers this keep alive memory.

OVERVIEW OF OBD AND REGULATIONS

Serial Data Streams

Although not required by the OBD regulation, the use of serial data accessible by special scan tools, has been introduced by some manufacturers. Serial data is electronic information about sensors, actuators, and ECM fuel/spark strategy, which is accessed from a single wire coming from the ECM. The term **serial data** implies that the information is digitally coded and transmitted in a series of **data words**. The data words are decoded and displayed by a **scan tool**.

The typical Toyota OBD serial data stream consists of up to 20 data words including sensor values, switch status, actuator status, and other engine operating data.

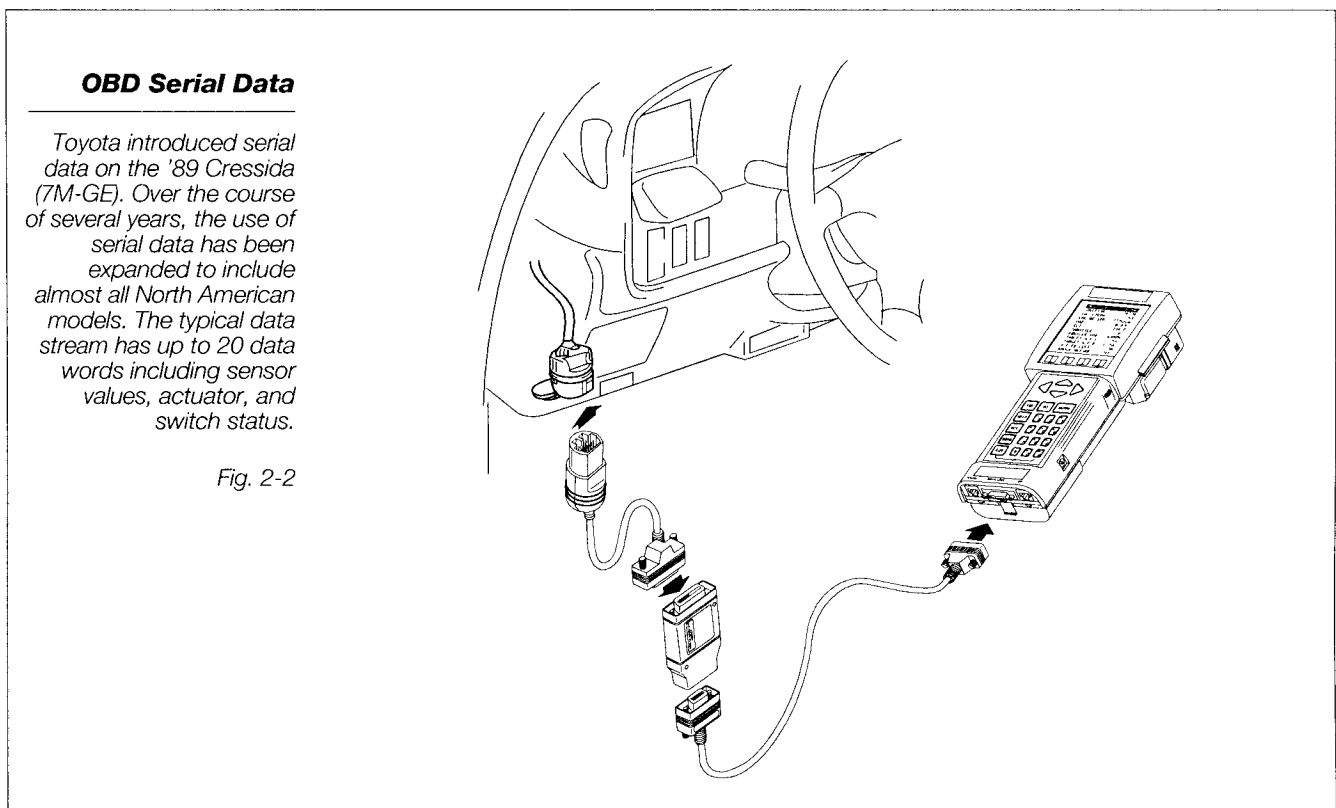

OBD-II (On-Board Diagnostic System, Generation 2)

Although OBD supplies valuable information about a number of critical emissions related systems and components, there are several important items which were not incorporated into the OBD standard due to technical limitations at the time that the system was phased into production (during the 1988 model year.) Since the introduction of OBD, several technical breakthroughs have occurred. For example, the technology to monitor engine misfire and catalyst efficiency has been developed and implemented on production vehicles.

OBD-II (On-Board Diagnostic System, Generation 2) Continued

As a result of these technical breakthroughs and because existing I/M programs have proven to be less effective than desired in detecting critical emissions control system defects which occur during normal road load operation, a more comprehensive OBD system was developed under the direction of CARB.

OBD-II, which is implemented over the 1994 through 1996 model years, adds catalyst efficiency monitoring, engine misfire detection, canister purge system monitoring, secondary air system monitoring, and EGR system flow rate monitoring. Additionally, a serial data stream consisting of twenty basic data parameters and diagnostic trouble codes is a required part of the diagnostic system.

In addition to the basic required OBD-II data stream, Toyota has an enhanced data stream which consists of approximately 60 additional data words. Access to all OBD-II data is made by connecting a generic scan tool to a standardized Data Link Connector (DLC) located under the left side of the instrument panel. The standards for data, the scan tool, diagnostic test modes, diagnostic trouble codes, and everything related to the introduction of the OBD-II regulation are established by the Society of Automotive Engineers.

The goal of the OBD-II regulation is to provide the vehicle with an on-board diagnostic system which is capable of continuously monitoring the efficiency of the emissions control system, and to improve diagnosis and repair efficiency when system failures occur. In essence, an emissions I/M station will be programmed into every OBD-II equipped vehicle.

OBD-II Features

The following information will familiarize you with the highlights of the OBD-II system features:

Oxygen Sensor (O₂S) Diagnostics

Enhanced diagnostics for the oxygen sensor(s) include monitoring for degradation and contamination by monitoring switching frequency and lean-rich, rich-lean switch time.

Fuel System Monitoring

Most fuel systems continually shift their base calibration to compensate for changes in atmospheric pressure, temperature, fuel composition, component variations, and other factors. This adaptive behavior is normal as long as it remains within the design limits of the system.

When conditions occur which cause the fuel system to operate outside of its design parameters, for example, a skewed air flow meter signal, incorrect fuel pressure, or other mechanical problems, the OBD-II system is designed to detect this abnormal operating condition. If the condition occurs for longer than a specified amount of time, a DTC will be stored. When a DTC stores, the engine speed, load, and warm-up status is stored in a retrievable serial data **freeze frame**.

OVERVIEW OF OBD AND REGULATIONS

Major OBD-II Features

Fig. 2-3

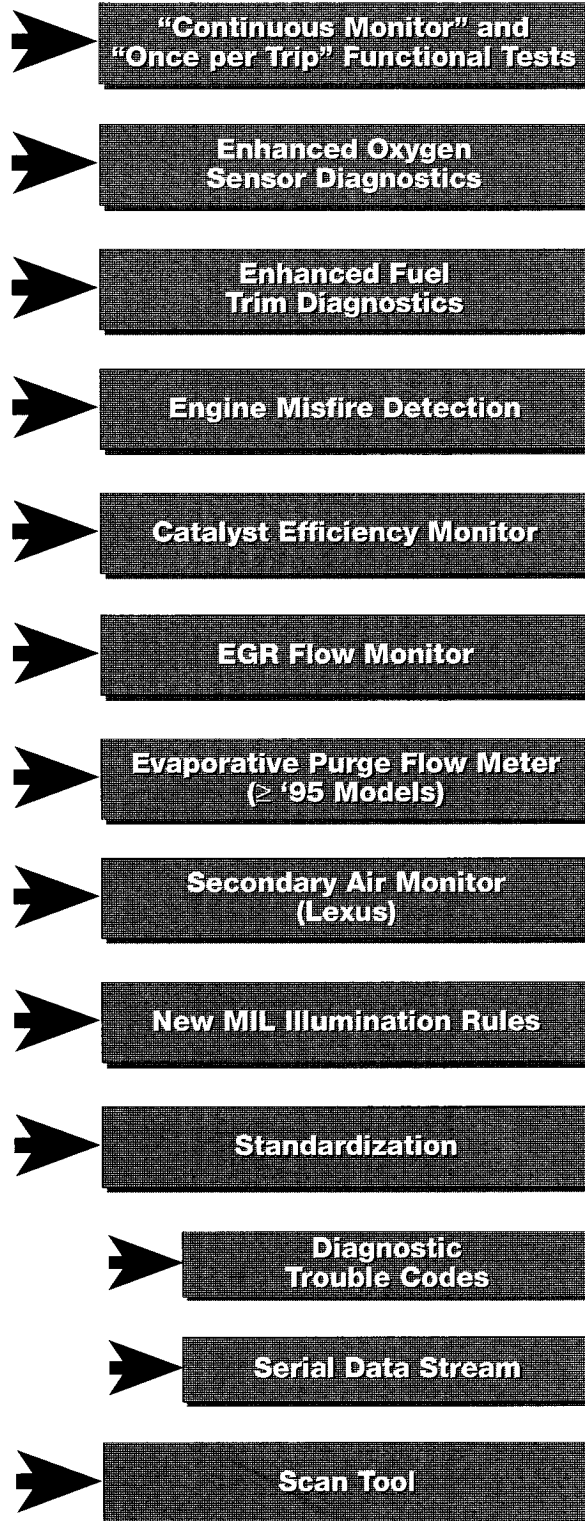

Misfire Monitoring

By using a high frequency crankshaft position signal, the ECM can closely monitor crankshaft speed variations during individual cylinder power strokes. When an engine is firing cleanly on all cylinders, the crankshaft speeds up with each power stroke. When misfire occurs, crankshaft speed increase is effected for that cylinder.

Toyota OBD-II engines use a **36 minus 2 tooth Ne** sensor which directly measures crankshaft speed and position. This information is processed by the ECM to determine if misfire occurs, which cylinder it is occurring in, and the degree of misfire.

When a misfire of any significance is detected, a DTC is stored and the engine speed, load and warm-up status at the time of misfire will be stored. Additionally, the vehicle operator will be alerted to the condition by a rapidly flashing MIL during periods when significant misfire is occurring.

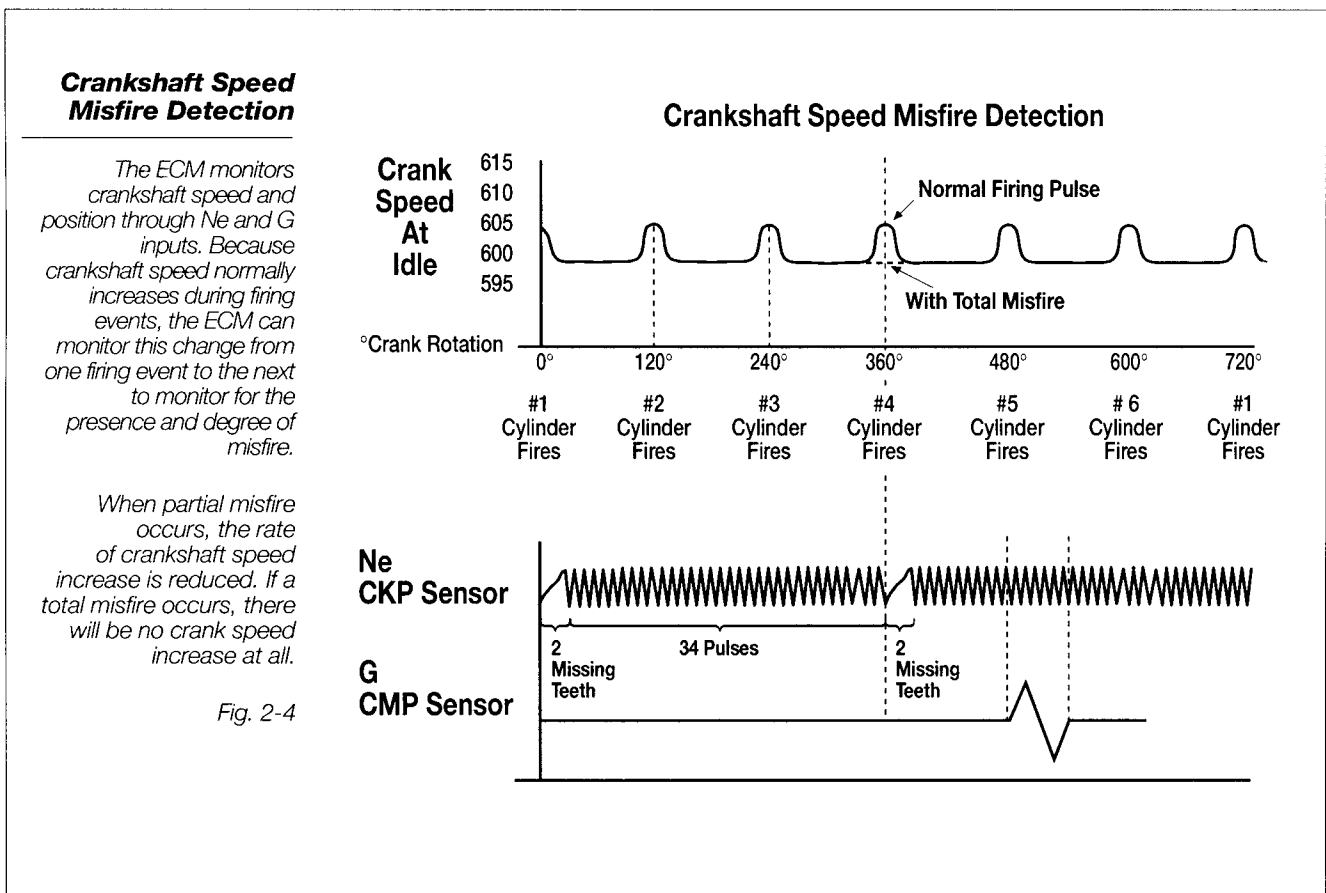

Catalyst Monitoring

A sub-oxygen sensor (S2) placed downstream, at the outlet of the catalytic converter, is monitored for switching frequency and compared to the switching frequency of the main oxygen sensor (S1), placed upstream of the catalyst. The oxidation efficiency of the catalyst can be determined by comparing the switching frequency of these two sensors. As the catalyst conversion efficiency declines, the switching frequency of sensor 2 increases, approaching that of sensor 1. In addition to being used for diagnostics, sensor 2 also assists in maintaining optimum fuel control when the catalyst begins to degrade.

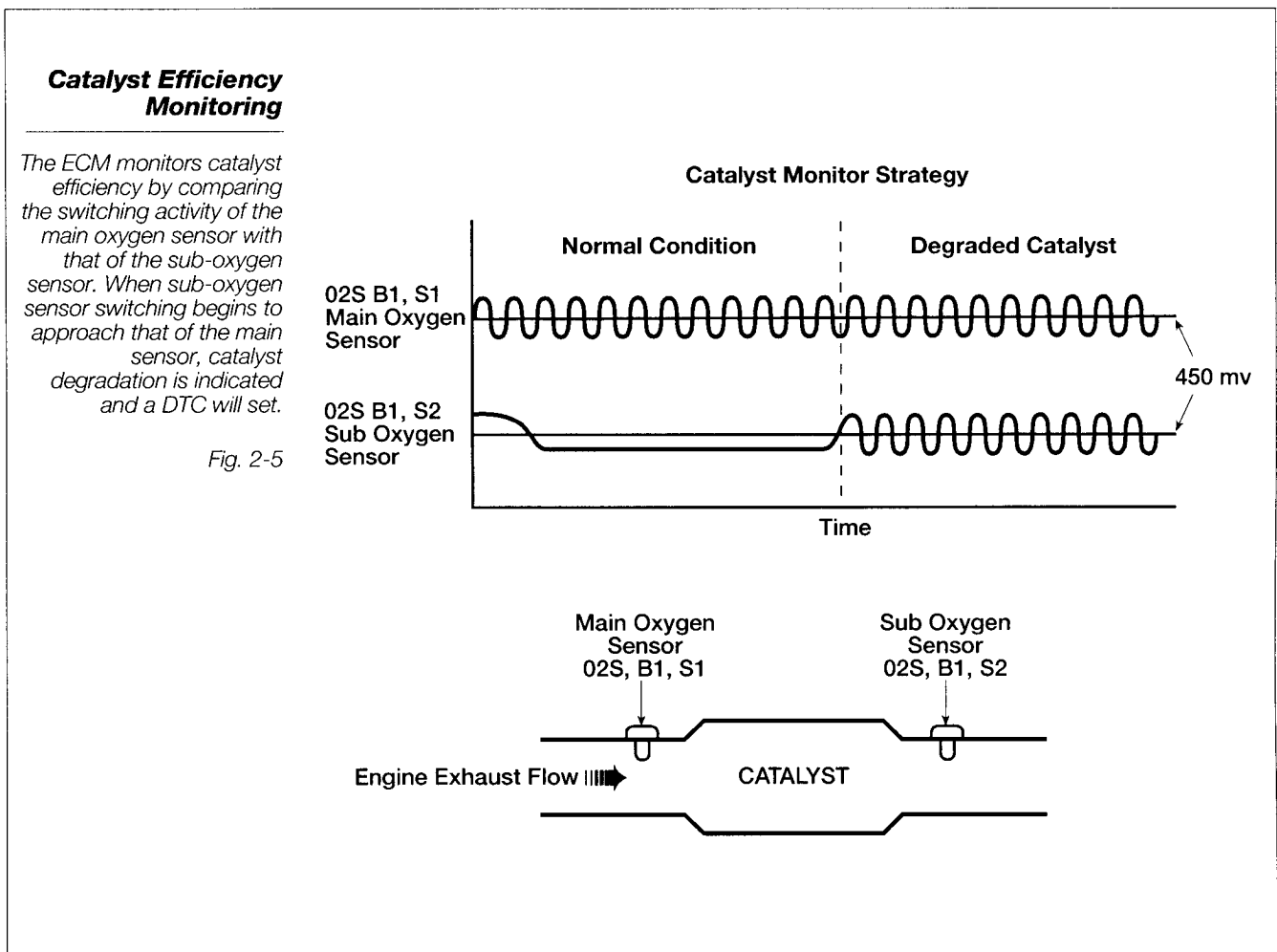

EGR System Monitoring

Enhanced monitoring of EGR flow rate characteristics include the ability to detect flow rates which are above or below the design flow rate for a given engine operating condition. One method of accomplishing this is to simply monitor the change in temperature on the intake side of the EGR passage. Another method is to measure the degree of rich correction to the fuel delivery system as EGR flow is momentarily inhibited.

Evaporative Purge System Monitoring

By monitoring the oxygen sensor and injection pulse width as the canister is being purged, the ECM can detect the reduction of exhaust oxygen content and corresponding decrease in injection pulse width to correct for this momentary rich condition. In this manner, the ECM can detect a failure in the canister purge control system and store a DTC to alert the vehicle operator of the malfunction. Purge flow monitoring is only used on 95 and later OBD-II equipped vehicles.

Secondary Air System Monitoring

By switching secondary air upstream of the oxygen sensor momentarily during closed loop operation, the ECM can monitor the oxygen sensor response and corresponding injection pulse width increase to determine if the secondary air system is functioning normally.

Malfunction Indicator Light Illumination

Once a malfunction has been established (two trip detection logic where applicable) the MIL will illuminate and remain illuminated even if the condition is intermittent. The MIL will remain on after subsequent restarts even if the malfunction condition is no longer present. The OBD-II system can only extinguish the MIL if the malfunction does not reoccur during three subsequent sequential trip cycles.

The OBD-II system can only erase a stored DTC if the malfunction is not detected during forty sequential trip cycles. Toyota systems do not erase the code, but rather place a flag on any code which does not reoccur during 40 subsequent trip cycles.

DTCs can be erased using the generic scan tool or by removing power from the ECM BATT terminal.

Readiness Test

The OBD-II diagnostic system continually monitors for misfire and fuel system faults. It also performs a functional test on the catalyst, EGR system, and oxygen sensors once during every driving cycle or "trip". Certain driving conditions must be encountered before these systems can be confirmed as operating normally. For example, the engine must be fully warmed up, throttle angle must have exceeded a specified angle, the engine must have achieved a specified load, and so on.

In the event that these driving conditions have not been met, the ECM will not have completed its "readiness test", and is not capable of displaying supported test data. Under these conditions, the scan tool will display a message indicating that "not all supported readiness tests are complete", warning the operator that this test data is not available.

Readiness Test Continued

The readiness test is a flag which is used during I/M inspections to indicate that the vehicle on-board diagnostic system cannot supply information required during the test. In this case, the vehicle must be operated until all readiness testing conditions have been satisfied.

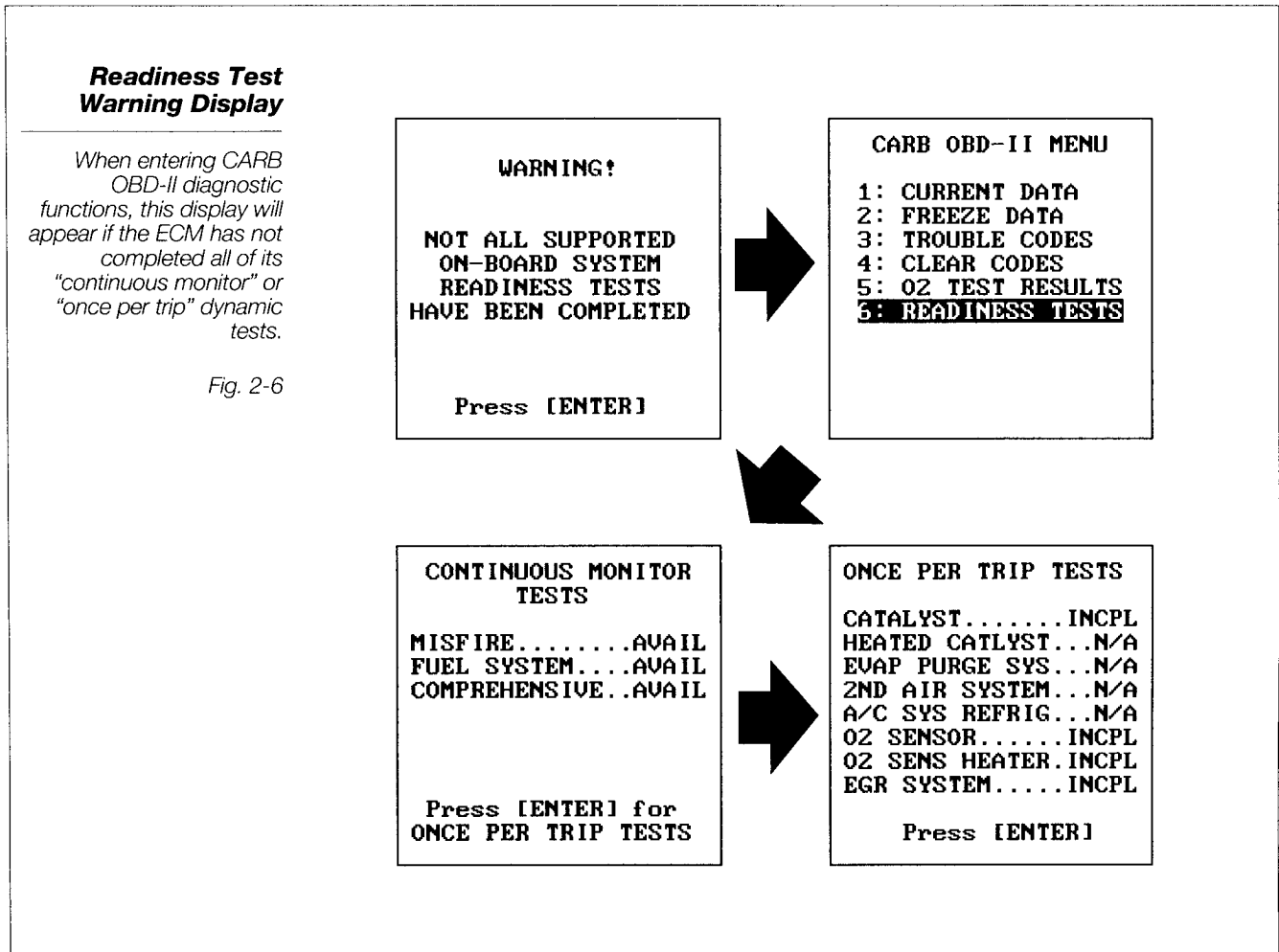

Stored Engine Freeze Frame Data

Upon detection of a malfunction, the OBD-II system will store all data at the time that the DTC set. This freeze frame data can be retrieved using the generic scan tool.

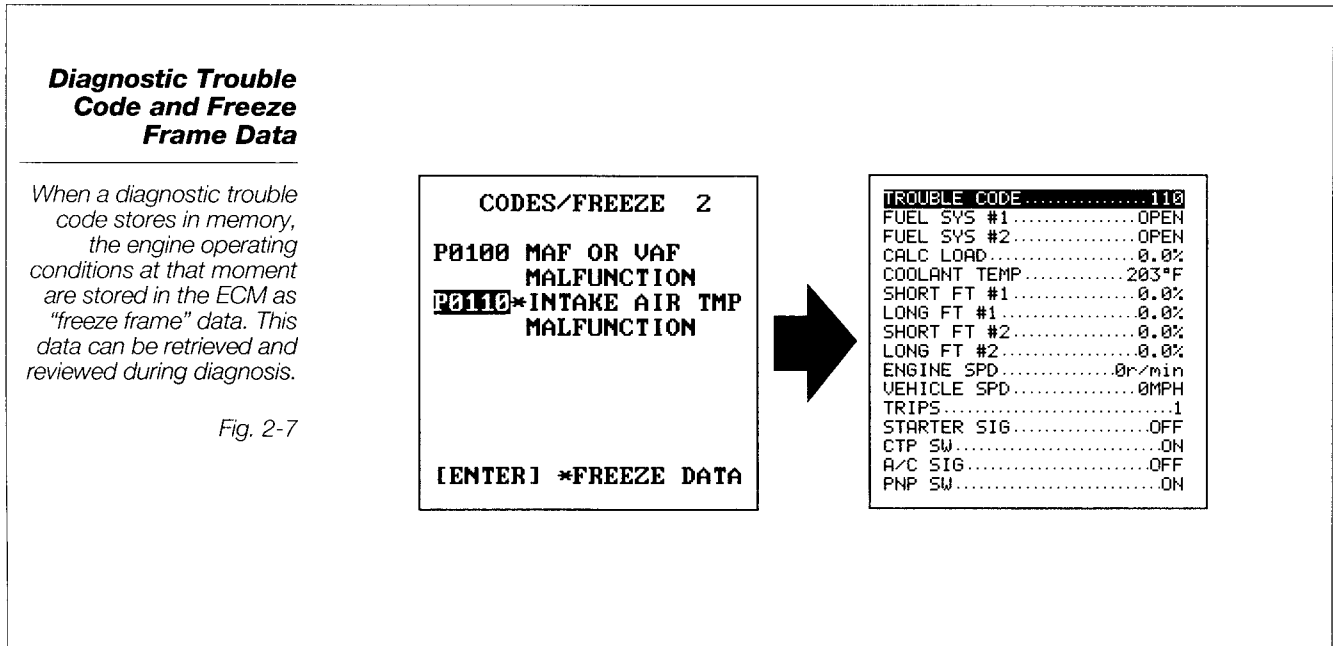

Standardization of Service Information and DTCs

Under the provisions of OBD-II regulations, emissions related diagnostic and service information will be readily available to the service industry, from the vehicle manufacturer. This information includes procedures and specifications necessary to diagnose the engine control system. Although enhanced diagnostics may be available using special equipment and procedures, at a minimum, repair procedures will be written using the generic scan tool and other commonly available test equipment like multimeters; and oscilloscopes.

In an effort to simplify diagnostics, OBD-II requires that all manufacturers standardize DTCs on OBD-II equipped vehicles. Eventually, all emissions related service information will be standardized in format and available through an electronic media.

OVERVIEW OF OBD AND REGULATIONS

Clean Air Act Amendments of 1990

On November 15, 1990, the Clean Air Act was amended, directing the Environmental Protection Agency (EPA) to promote new regulations, under section 207(a), requiring automobile manufacturers to install on-board diagnostic systems capable of.

- Identifying deterioration or malfunction of major emissions components which could result in vehicle failure to comply with federal emissions standards.
- Alerting the vehicle operator of the need to maintain and/or repair emissions related components and/or systems.
- Storing DTCs and providing access to vehicle on-board information.

Additionally, manufacturers will:

- Make available to all interested parties, all necessary emissions maintenance and repair information.

Adoption of these provisions was prompted by the fact that in 1990, 96 urban areas in the U.S. were in violation of National Ambient Air Quality Standards (NAAQS) for ozone and 41 areas for carbon monoxide.

Although CAAA'90 regulations vary slightly from CARB OBD-II, EPA has elected to adopt California OBD-II for Federal emissions certification, effective with the '96 model year. Beginning in the '98 model year, a new Federal OBD standard will be adopted, effectively eliminating the different status between California and Federal emissions certification.

