

Click on your vehicle's MANUFACTURER'S NAME to go directly to application page

AC.....1	Ginetta.....76-77	Mitsubishi Commercial.....138	Skoda Commercial.....212
Aixam - Mega.....2	Glas.....77	Mitsubishi (SA).....139	Smart.....212
Alfa Romeo.....2-7	Gordon Keeble.....77	Mitsubishi (J).....139	Ssangyong.....212-213
Alvis.....7	Grinnall.....77-78	Mitsubishi (Malaysia and the Philippines).....139-140	Strathcarron.....213
Ariel.....7-8	GTM.....78	Morgan.....78	Subaru.....213-215
Asia Motors.....8	HMC.....78-79	Moskvitch.....140	Subaru Commercial.....215-216
Aston Martin.....8-9	Holden.....79-80	NSU.....141	Subaru (Aust/NZ).....216
Audi.....9-17	Holden (Aust/NZ).....79-80	Nissan.....141-147	Suzuki.....216-218
Audi (Aust).....17	Honda.....80-85	Nissan Commercial.....148-149	Suzuki Commercial.....219
Autobianchi.....17-18	Honda Commercial.....85	Nissan (Aust/NZ).....149-151	Talbot.....219-223
BMW.....18-25	Honda (Aust/NZ).....85-86	Nissan (Malaysia and the Philippines).....151-152	Talbot Commercial.....223
Bitter.....25-26	Honda (Malaysia and the Philippines).....86	Nissan (SA).....152	Tata.....223-224
Bond.....26	Hyundai.....86-88	Nissan (Japan).....152-153	Tatra.....224
Bristol.....26-27	Hyundai Commercial.....89	Noble.....153	Taxi.....224
Bugatti.....27	Hyundai (Korea).....89	Onyx.....153	Tiger.....224-225
Cadillac.....27	Hyundai (SA).....89-90	Opel.....153-162	Toyota.....225-232
Caterham.....27-28	Innocenti.....90-91	Opel (Malaysia and the Philippines).....162	Toyota Commercial.....232-233
Chatenet.....28	Iso.....91	Opel (SA).....162	Toyota (Malaysia and the Philippines).....234
Chevrolet.....28	Isuzu.....91-92	Panther.....163	Toyota (SA).....234-235
Chrysler (USA).....29-30	Jaguar/Daimler.....92-95	Peerless.....163	Toyota (Japan).....235
Citroen.....30-38	Jensen.....95	Perodua.....163-164	Trabant.....235
Citroen Commercial.....38-40	Kia.....95-97	Peugeot.....164-172	Trident.....235
Clan.....40	Lada.....97	Peugeot Commercial.....172-174	TVR.....235-237
Commer/Dodge.....40-41	Lamborghini.....98	Piaggio.....175	Vauxhall.....237-245
Dacia.....41	Lancia.....99-103	Porsche.....175-177	Vauxhall Commercial.....245-248
Daewoo.....41-42	Landrover.....103-105	Proteus.....177	Venturi.....248
Daewoo (SA).....42-43	Lexus.....105-106	Proton.....177-178	Volkswagen.....248-258
DAF.....43	Light Car Company.....106-107	Proton (Aust/NZ).....178	Volkswagen Commercial.....258-262
Daihatsu.....43-46	Ligier.....107	Proton (Malaysia and the Philippines).....178-179	Volvo.....262-268
Daihatsu Commercial.....46	Lotus.....107-109	Quantum.....179	Wartburg.....268
De Lorean.....47	McLaren.....109	Qvale.....179	Westfield.....269-270
De Tomaso.....47	Mahindra.....109	Reliant.....179	Yugo.....270
Dodge (USA).....47-48	Marcos.....110	Renault.....180-191	
Elva.....48	Marlin.....110-111	Renault Commercial.....191-194	Buyers Guides.....271-283
Facel Vega.....48	Maserati.....111-112	Rochdale.....194	VVA to EBC
Fairthorpe.....48-49	Maybach.....112	Rover.....194-202	Cross Reference.....284-288
Ferrari.....49-50	Mazda.....112-117	Rover Commercial.....202-204	
Fiat.....50-57	Mazda Commercial.....117-118	Saab.....204-206	
Fiat Commercial.....57-61	Mazda (SA).....118-119	Sao.....206	
Ford.....61-70	Mazda (Malaysia and the Philippines).....119	Seat.....206-209	
Ford Commercial.....70-73	Mercedes-Benz.....119-129	Seat Commercial.....210	
Ford (SA).....73-74	Mercedes Commercial.....129-132	Skoda.....210-211	
Ford (Aust/NZ).....74-75	Microcar.....132		
FSO.....75	Mitsubishi.....132-138		
FSO Commercial.....75			
Gilbern.....76			

Explanation of Suffixes and Symbols

A after shoe number means adjuster mechanism fitted.	(K) after disc pad or shoe number means Kelsey Hayes Brake System.
(B) after disc pad or shoe number means Bendix Brake System.	(L) after disc pad or shoe number means Lockheed Brake System.
(BR) after disc pad or shoe number means Brembo Brake System.	NL after shoe number means narrow lining.
(C) after disc pad or shoe number means Citroen Brake System.	SL after shoe number means short lining.
(G) after disc pad or shoe number means Lucas Brake System.	(T) after disc pad or shoe number means ATE Brake System.

Copyright The part numbers and letters included in this booklet are copyrighted by EBC Brakes and may not be reproduced without their written permission.

Disclaimer Whilst every effort has been made to give accurate application information, Freeman Automotive (UK) Ltd, or EBC Brakes, are not responsible for claims or costs arising from non-fits. Check pad or shoe form using illustrations. No claims for Labour charges will be entertained.

Car Registration Letters This cross reference is intended to assist in the dating of a vehicle from its U.K. registration plate.

SUFFIX

A Feb 63-Dec 63	B Jan 64-Dec 64	C Jan 65-Dec 65	D Jan 66-Dec 66	E Jan 67-Jul 67
F Aug 67-Jul 68	G Aug 68-Jul 69	H Aug 69-Jul 70	J Aug 70-Jul 71	K Aug 71-Jul 72
L Aug 72-Jul 73	M Aug 73-Jul 74	N Aug 74-Jul 75	P Aug 75-Jul 76	R Aug 76-Jul 77
S Aug 77-Jul 78	T Aug 78-Jul 79	V Aug 79-Jul 80	W Aug 80-Jul 81	X Aug 81-Jul 82
Y Aug 82-Jul 83				

PREFIX









A Aug 83-Jul 84	B Aug 84-Jul 85	C Aug 85-Jul 86	D Aug 86-Jul 87	E Aug 87-Jul 88
F Aug 88-Jul 89	G Aug 89-Jul 90	H Aug 90-Jul 91	J Aug 91-Jul 92	K Aug 92-Jul 93
L Aug 93-Jul 94	M Aug 94-Jul 95	N Aug 95-Jul 96	P Aug 96-Jul 97	R Aug 97-Jul 98
S Aug 98-Feb 99	T Mar 99-Aug 99	V Sept 99-Feb 2000	W Mar 2000-Aug 2000	X Sept 2000-Feb 2001
Y Mar 2001-Aug 2001	51 Sept 01-Feb 02	02 Mar 02-Aug 02	52 Sept 02-Feb 03	03 Mar 03-Aug 03
53 Sept 03-Feb 04	04 Mar 04-Aug 04			

BRAKE PADS & SHOES - APPLICATIONS

Bremsbeläge / Plaquettes + Bremsbacken / Machoires

EBC





BRAKES

Make/Model/Engine Hersteller/Modell/Motor Modèles	Year Jahr Années	Pads  Front / Vorn / Avant		Shoes	Pads  Rear / Hinten / Arrière		Shoes
		Original Quality ECE R90* Approved 	Upgrade Quality Tuning/Sportbeläge ECE R90* Approved 	Bremsbacken Machoires 	Original Quality ECE R90* Approved 	Upgrade Quality Tuning/Sportbeläge ECE R90* Approved 	Bremsbacken Machoires 
AC							
70				5137			5137
Invalid Carriage	71-						
428							
7.0	67-74		DP 2108			DP 2101	
3000							
3.0	75-86		DP 2291			DP 2101	
Ace							
3.5 Twin Turbo	2000-2002						
4.6	99-2002						
5.0	93-99	DP 2473	DP 3605/2		DP 2617	DP 3617	
5.0	93-99	DP 2956	DP 3956		DP 2617	DP 3617	
Cobra							
4.2	62-63	DP 2291	DP 3291		DP 2101	DP 3101	
4.7	63-69	DP 2291	DP 3291		DP 2101	DP 3101	
7.0	64-66	DP 2108	DP 3108		DP 2101	DP 3101	
Cobra CRS							
4.9	2000-2002						
Cobra 212							
3.5 Twin Turbo	2001-2002						
Cobra II							
4.7	2002-						
Cobra III							
7.0	2002-						
Greyhound							
	64-68		DP 2100				
Superblower							
4.9	97-2002	DP 2002	DP 3002		DP 2617	DP 3617	



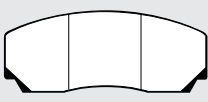

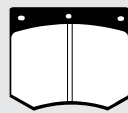
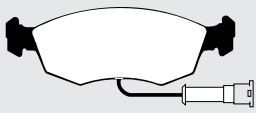

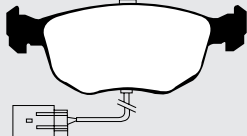

Standard Quality - ECE R90 Approved with similar performance to original equipment brake pads.
 Upgrade Quality (Tuning/ Sportbeläge) - ECE R90 Approved but with higher friction and improved performance for faster street use.
 Verbesserte Qualität - mit ECE R90 Freigabe aber mit höherem Reibwert und verbesserter Bremsleistung für den schnellen Strasseninsatz.

Qualité standard - Approuvée par la norme ECE R90 - Des performances équivalentes à l'origine.
 Qualité améliorée - Approuvée par la norme ECE R90 - Un coefficient de friction supérieur et des performances accrues pour pilotage rapide sur route.
 Calidad Mejorada - Aprobación CEE R90 con prestaciones similares a las pastillas originales.
 Calidad Mejorada - Aprobación CEE R90 pero con un coeficiente de fricción más elevado y prestaciones mejoradas para un uso deportivo en carretera.

Pad Illustrations for AC

<p>2100</p>  <p>100 x 66 x 16mm</p>	<p>2002</p>  <p>132 x 54 x 17mm</p>	<p>2101</p>  <p>80 x 66 x 15mm</p>	<p>2108</p>  <p>98 x 68 x 16mm</p>
<p>2291</p>  <p>78 x 66 x 15mm</p>	<p>2473</p>  <p>151 x 55 x 18mm</p>	<p>2617</p>  <p>90 x 54 x 13mm</p>	<p>2956</p>  <p>156 x 60 x 19mm</p>

*Every EBC pad and shoe requiring ECE R-90 is available with approval subject to stock rotation - check box end label.
 Models listed by Engine Size. Only listed by trim level where pads differ, (16v, GL, GT, etc).

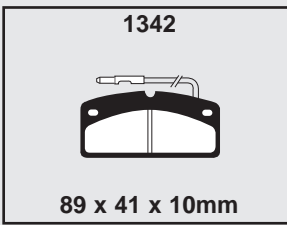
Make/Model/Engine	Year	Pads  Front / Vorn / Avant		Shoes	Pads  Rear / Hinten / Arrière		Shoes
Hersteller/Modell/Motor	Jahr	Plaquettes / Bremsbeläge		Bremsbacken Machoires	Plaquettes / Bremsbeläge		Bremsbacken Machoires
Modelos	Années	Original Quality ECE R90* Approved 	Upgrade Quality Tuning/Sportbeläge ECE R90* Approved 	 ECE R90* Approved	Original Quality ECE R90* Approved 	Upgrade Quality Tuning/Sportbeläge ECE R90* Approved 	 ECE R90* Approved
AIXAM-MEGA							
400/500							
0.4D	2000-	DP 1342					
0.5D	2000-	DP 1342					
Pad Illustrations for Aixam-Mega							
 <p>1342</p> <p>89 x 41 x 10mm</p>							
ALFA ROMEO							
Alfasud							
1.2	71-84	DP 193	DP 2104		DP 192		
1.3	71-84	DP 193	DP 2104		DP 192		
1.5	71-84	DP 193	DP 2104		DP 192		
Alfetta							
1.6	72-83	DP 104	DP 2104		DP 218	DP 2105	
1.6	83-86	DP 507	DP 2104		DP 508	DP 2105	
1.8	72-83	DP 104	DP 2104		DP 218	DP 2105	
1.8	83-86	DP 507	DP 2104		DP 508	DP 2105	
2.0	72-83	DP 104	DP 2104		DP 218	DP 2105	
2.0	83-86	DP 507	DP 2104		DP 508	DP 2105	
2.5	83-86	DP 507	DP 2104		DP 508	DP 2105	
Alfa 6							
2.0	80-87	DP 282	DP 2753		DP 311	DP 2104	
2.0	80-87	DP 197	DP 2197		DP 218	DP 2105	
2.5	80-87	DP 282	DP 2753		DP 311	DP 2104	
2.5	80-87	DP 197	DP 2197		DP 218	DP 2105	
Alfa 33							
1.3	83-85	DP 625(T)					5072(B)
1.3	83-85	DP 317(B)	DP 2317				5072(B)
1.3	86-88	DP 653(B)	DP 2317				6555(B)
1.3	86-88	DP 625(T)					6555(B)
1.3	88-90	DP 653(B)	DP 2317				6556(B)
1.3	88-90	DP 625(T)					6556(B)
1.5	83-85	DP 625(T)					5072(B)
1.5	83-85	DP 317(B)	DP 2317				5072(B)
1.5	86-88	DP 653(B)	DP 2317				6555(B)
1.5	86-88	DP 625(T)					6555(B)
1.5	88-90	DP 653(B)	DP 2317				6556(B)
1.5	88-90	DP 625(T)					6556(B)
1.5	90-93	DP 835					6556(B)
1.7	86-88	DP 717			DP 370		6555(B)
1.7	88-90	DP 717			DP 370		6556(B)
1.7	90-93	DP 1011			DP 596		6341(T)
1.7 4WD	86-90	DP 835			DP 370		
1.7 4WD	90-94	DP 1011			DP 596		
1.7 16v	87-90	DP 717			DP 370		
1.7 16v	90-94	DP 1011			DP 596		
1.8TD	86-88	DP 653(B)	DP 2317				6555(B)
1.8TD	86-88	DP 625(T)					6555(B)
1.8TD	88-90	DP 653(B)	DP 2317				6556(B)
1.8TD	88-90	DP 625(T)					6556(B)

*Every EBC pad and shoe requiring ECE R-90 is available with approval subject to stock rotation - check box end label.







Models listed by Engine Size. Only listed by trim level where pads differ, (16v, GL, GT, etc).

BRAKE PADS & SHOES - APPLICATIONS

Bremsbeläge / Plaquettes + Bremsbacken / Machoires









EBC

BRAKES

Make/Model/Engine Hersteller/Modell/Motor Modèles	Year Jahr Années	Pads  Front / Vorn / Avant		Shoes	Pads  Rear / Hinten / Arrière		Shoes
		Plaquettes / Bremsbeläge Original Quality ECE R90* Approved 		Bremsbacken Machoires  ECE R90* Approved	Plaquettes / Bremsbeläge Upgrade Quality Tuning/Sportbeläge ECE R90* Approved 		Bremsbacken Machoires  ECE R90* Approved
ALFA ROMEO Contd.							
Alfa 75							
1.8	86-90	DP 507	DP 2104		DP 508	DP 2105	
1.8 Turbo	86-92	DP 912	DP 2197		DP 916	DP 2105	
2.0	85-90	DP 507	DP 2104		DP 508	DP 2105	
2.0	90-92	DP 913	DP 2104		DP 916	DP 2105	
2.0 TS	85-90	DP 578	DP 2197		DP 508	DP 2105	
2.0 TS	90-92	DP 912	DP 2197		DP 916	DP 2105	
2.5 V6	86-92	DP 578	DP 2197		DP 508	DP 2105	
3.0 V6	87-90	DP 578	DP 2197		DP 508	DP 2105	
3.0 V6	90-92	DP 820/2	DP 2820		DP 508	DP 2105	
Alfa 90							
1.8	84-87	DP 578(T)	DP 2197		DP 508	DP 2105	
1.8	84-87	DP 717(G)			DP 508		
2.0	84-87	DP 578(T)	DP 2197		DP 508	DP 2105	
2.0	84-87	DP 717(G)			DP 508		
2.5 V6	84-87	DP 578(T)	DP 2197		DP 508	DP 2105	
2.5 V6	84-87	DP 717(G)			DP 508		
3.0 V6	87-89	DP 733	DP 2733		DP 508	DP 2105	
Alfa 145							
1.4	94-96	DP 420/2	DP 2420/2		DP 596		6345
1.4	96-	DP 1059	DP 21059		DP 1214		6554
1.6	94-96	DP 420/2	DP 2420/2		DP 596		6345
1.6	96-98	DP 1059	DP 21059		DP 1214		
1.6 TS	97-2001	DP 1060	DP 21060		DP 1214		6554
1.7 16v	94-96	DP 420/2	DP 2420/2		DP 596		6345
1.7 16v	96-98	DP 1060	DP 21060		DP 1214		
1.8 TS	97-2001	DP 1061	DP 21061		DP 1214		
2.0	95-2001	DP 1061	DP 21061		DP 1214		
1.9 TD	94-96	DP 420/2	DP 2420/2		DP 596		6345
1.9 TD	96-2001	DP 1059	DP 21059		DP 1214		6554
Alfa 146							
1.4	95-96	DP 420/2	DP 2420/2		DP 596		6345
1.4	96-2001	DP 1059	DP 21059		DP 1214		6554
1.6	95-96	DP 420/2	DP 2420/2		DP 596		6345
1.6	96-98	DP 1059	DP 21059		DP 1214		
1.6 TS	97-2001	DP 1060	DP 21060		DP 1214		6554
1.7 16v	95-96	DP 420/2	DP 2420/2		DP 596		6345
1.7 16v	96-98	DP 1060	DP 21060		DP 1214		
1.8 TS	97-2001	DP 1061	DP 21061		DP 1214		
2.0	95-2001	DP 1061	DP 21061		DP 1214		
1.9 TD	95-96	DP 420/2	DP 2420/2		DP 596		6345
1.9 TD	96-2001	DP 1059	DP 21059		DP 1214		6554
Alfa 147							
1.6	2000-	DP 1061	DP 21061		DP 1430		
1.6	2000-	DP 1153	DP 21153		DP 1430		
2.0	2000-	DP 1061	DP 21061		DP 1430		
3.2	2002-	DP 21031	DP 31031		DP 1430		
1.9 TD	2000-	DP 1061	DP 21061		DP 1430		
Alfa 155							
1.8 TS	92-97	DP 420/2	DP 2420/2		DP 596		
2.0 TS	92-97	DP 733	DP 2733		DP 596		
2.0 Turbo	92-94	DP 2733	DP 3733		DP 596		
2.0 Turbo	95-97	DP 21061	DP 31061		DP 596		
2.5 V6	92-97	DP 733	DP 2733		DP 596		
1.9 TD	92-97	DP 420/2	DP 2420/2		DP 596		

*Every EBC pad and shoe requiring ECE R-90 is available with approval subject to stock rotation - check box end label.
Models listed by Engine Size. Only listed by trim level where pads differ, (16v, GL, GT, etc).

Standard Quality - ECE R90 Approved with similar performance to original equipment brake pads.
Upgrade Quality (Tuning/ Sportbeläge) - ECE R90 Approved but with higher friction and improved performance for faster street use.
Verbesserte Qualität - mit ECE R90 Freigabe und ähnlicher Bremsleistung wie die Original Bremsbeläge.
Standard Qualität - mit ECE R90 Freigabe und ähnlicher Bremsleistung wie die Original Bremsbeläge.
Qualité standard - Approuvée par la norme ECE R90 - Des performances équivalentes à l'origine.
Qualité améliorée - Approuvée par la norme ECE R90 - Un coefficient de friction supérieur et des performances accrues pour pilotage rapide sur route.
Calidad Estándar - Aprobación CEE R90 con prestaciones similares a las pastillas originales.
Calidad Mejorada - Aprobación CEE R90 pero con un coeficiente de fricción más elevado y prestaciones mejoradas para un uso deportivo en carretera.

Make/Model/Engine Hersteller/Modell/Motor Modèles	Year Jahr Années	Pads  Front / Vorn / Avant		Shoes	Pads  Rear / Hinten / Arrière		Shoes
		Original Quality ECE R90* Approved 	Upgrade Quality Tuning/Sportbeläge ECE R90* Approved 	Bremsbacken Machoires 	Original Quality ECE R90* Approved 	Upgrade Quality Tuning/Sportbeläge ECE R90* Approved 	Bremsbacken Machoires 
ALFA ROMEO Contd.							
Alfa 156							
1.6	97-2000	DP 1061	DP 21061		DP 1096		
1.6	2000-2001	DP 1153	DP 21153		DP 1096		
1.6	2001-2002	DP 1061	DP 21061		DP 1096		
1.6	2002-	DP 1061	DP 21061		DP 1430		
1.8	97-2000	DP 1061	DP 21061		DP 1096		
1.8	2000-2001	DP 1153	DP 21153		DP 1096		
1.8	2001-2002	DP 1061	DP 21061		DP 1096		
1.8	2002-	DP 1061	DP 21061		DP 1430		
2.0	97-2000	DP 1153	DP 21153		DP 1096		
2.0	2000-2002	DP 1061	DP 21061		DP 1096		
2.0	2002-	DP 1061	DP 21061		DP 1430		
2.5	97-2000	DP 1153	DP 21153		DP 1096		
2.5	2000-2002	DP 1061	DP 21061		DP 1096		
2.5	2002-	DP 1061	DP 21061		DP 1430		
3.2	2002-	DP 21031	DP 31031		DP 1430		
1.9 TD	97-2000	DP 1061	DP 21061		DP 1096		
1.9 TD	2000-2001	DP 1153	DP 21153		DP 1096		
1.9 TD	2001-2002	DP 1061	DP 21061		DP 1096		
1.9 TD	2002-	DP 1061	DP 21061		DP 1430		
2.4 TD	97-2000	DP 1153	DP 21153		DP 1096		
2.4 TD	2000-2002	DP 1061	DP 21061		DP 1096		
2.4 TD	2002-	DP 1061	DP 21061		DP 1430		
Alfa 164							
2.0 TS	87-89	DP 616/2	DP 2420/2		DP 370	DP 2370	
2.0 TS	89-93	DP 820/2	DP 2820		DP 370	DP 2370	
2.0 TS	93-98	DP 820	DP 2820		DP 370	DP 2370	
2.0 Turbo	91-98	DP 733/3	DP 2733/3		DP 370	DP 2370	
3.0 V6	87-98	DP 733/3	DP 2733/3		DP 370	DP 2370	
2.5 TD	87-98	DP 733/3	DP 2733/3		DP 370	DP 2370	
Alfa 166							
2.0	99-	DP 1227	DP 21061		DP 1096		
2.5	99-	-	DP 21210		DP 1096		
3.0	99-	-	DP 21210		DP 1096		
Arna							
1.2	83-85	DP 506(T)					6330
1.2	83-86	DP 317(B)	DP 2317				6330
1.2	85-86	DP 625(T)					6330
1.3	83-85	DP 506(T)					6330
1.3	83-86	DP 317(B)	DP 2317				6330
1.3	85-86	DP 625(T)					6330
1.5	83-85	DP 506(T)					6330
1.5	83-86	DP 317(B)	DP 2317				6330
1.5	85-86	DP 625(T)					6330
GTV							
2.0	80-83	DP 104	DP 2104		DP 218	DP 2105	
2.0	83-86	DP 507	DP 2104		DP 508	DP 2105	
2.0	86-87	DP 578	DP 2197		DP 508	DP 2105	
2.0	95-96	DP 733	DP 2733		DP 596		
2.0	96-	DP 1061	DP 21061		DP 1214		
2.5	80-83	DP 104	DP 2104		DP 218	DP 2105	
2.5	83-86	DP 507	DP 2104		DP 508	DP 2105	
2.5	86-87	DP 578	DP 2197		DP 508	DP 2105	
3.0	97-	DP 21031	DP 31031		DP 1214		

Standard Quality - ECE R90 Approved with similar performance to original equipment brake pads.
 Upgrade Quality (Tuning / Sportbeläge) - ECE R90 Approved but with higher friction and improved performance for faster street use.

Standard Qualität - mit ECE R90 Freigabe und ähnlicher Bremsleistung wie die Original Bremsbeläge.
 Verbesserte Qualität - mit ECE R90 Freigabe aber mit höherem Reibwert und verbesserter Bremsleistung für den schnellen Strasseninsatz.

Qualité standard - Approuvée par la norme ECE R90 - Des performances équivalentes à l'origine.
 Qualité améliorée - Approuvée par la norme ECE R90 - Un coefficient de friction supérieur et des performances accrues pour pilotage rapide sur route.

Calidad Estándar - Aprobación CEE R90 con prestaciones similares a las pastillas originales.
 Calidad Mejorada - Aprobación CEE R90 pero con un coeficiente de fricción más elevado y prestaciones mejoradas para un uso deportivo en carretera.

*Every EBC pad and shoe requiring ECE R-90 is available with approval subject to stock rotation - check box end label.
 Models listed by Engine Size. Only listed by trim level where pads differ, (16v, GL, GT, etc).

BRAKE PADS & SHOES - APPLICATIONS

Bremsbeläge / Plaquettes + Bremsbacken / Machoires

EBC



BRAKES

Make/Model/Engine Hersteller/Modell/Motor Modèles	Year Jahr Années	Pads Front / Vorn / Avant Plaquettes / Bremsbeläge		Shoes Bremsbacken Machoirs	Pads Rear / Hinten / Arrière Plaquettes / Bremsbeläge		Shoes Bremsbacken Machoirs
		Original Quality ECE R90* Approved	Upgrade Quality Tuning/Sportbeläge ECE R90* Approved	ECE R90* Approved	Original Quality ECE R90* Approved	Upgrade Quality Tuning/Sportbeläge ECE R90* Approved	ECE R90* Approved
ALFA ROMEO Contd.							
Giulia							
1.3	66-76	DP 104	DP 2104		DP 105	DP 2105	
1.6	66-76	DP 104	DP 2104		DP 105	DP 2105	
2.0	66-76	DP 103	DP 2103		DP 105	DP 2105	
Giulietta							
1.3	77-80	DP 104	DP 2104		DP 218	DP 2105	
1.3	80-83	DP 193	DP 2104		DP 218	DP 2105	
1.3	83-86	DP 507	DP 2104		DP 508	DP 2105	
1.6	77-80	DP 104	DP 2104		DP 218	DP 2105	
1.6	80-83	DP 193	DP 2104		DP 218	DP 2105	
1.6	83-86	DP 507	DP 2104		DP 508	DP 2105	
1.8	77-80	DP 104	DP 2104		DP 218	DP 2105	
1.8	80-83	DP 193	DP 2104		DP 218	DP 2105	
1.8	83-86	DP 507	DP 2104		DP 508	DP 2105	
2.0	77-80	DP 104	DP 2104		DP 218	DP 2105	
2.0	80-83	DP 193	DP 2104		DP 218	DP 2105	
2.0	83-86	DP 507	DP 2104		DP 508	DP 2105	
Junior							
1.3 GT	66-78	DP 104	DP 2104		DP 105	DP 2105	
Montreal							
2.6	70-77	DP 103	DP 2103		DP 105	DP 2105	
Handbrake shoes	70-77						5124
RZ							
3.0	90-92	DP 578	DP 2197		DP 508	DP 2105	
3.0	92-94	DP 733	DP 2733		DP 508	DP 2105	
Spider							
1.75	68-90	DP 103	DP 2103		DP 105	DP 2105	
2.0	68-90	DP 103	DP 2103		DP 105	DP 2105	
2.0	90-94	DP 103	DP 2103		DP 105	DP 2105	
2.0 TS	95-	DP 733	DP 2733		DP 1214		
3.0	97-	DP 21061	DP 31061		DP 1214		
Handbrake shoes	68-90						5124
Sprint							
1.3	76-83	DP 193(T)	DP 2104		DP 192		
1.3	83-85	DP 317(B)	DP 2317		DP 192		
1.3	83-85	DP 625(T)			DP 192		
1.3	85-89	DP 653(B)			DP 192		
1.3	85-89	DP 625(T)			DP 192		
1.5	83-85	DP 625(T)			DP 192		
1.5	83-85	DP 317(B)	DP 2317		DP 192		
1.5	85-89	DP 653(B)			DP 192		
1.5	85-89	DP 625(T)			DP 192		
1.7	87-89	DP 717(G)			DP 192		
SZ Coupe							
3.0	90-92	DP 578	DP 2197		DP 508	DP 2105	
3.0	92-94	DP 733	DP 2733		DP 508	DP 2105	
2600							
2.6	64-77	DP 108	DP 2108		DP 101	DP 2101	









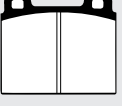
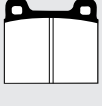

*Every EBC pad and shoe requiring ECE R-90 is available with approval subject to stock rotation - check box end label.
Models listed by Engine Size. Only listed by trim level where pads differ, (16v, GL, GT, etc).

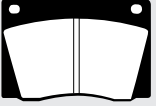
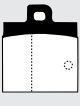
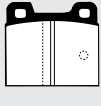
Standard Quality - ECE R90 Approved with similar performance to original equipment brake pads.
Upgrade Quality (Tuning/ Sportbeläge) - ECE R90 Approved but with higher friction and improved performance for faster street use.
Verbesserte Qualität - mit ECE R90 Freigabe aber mit höherem Reibwert und verbesserter Bremsleistung für den schnellen Strasseninsatz.

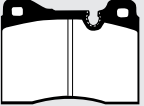
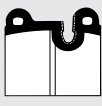
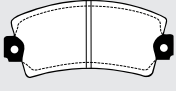
Standard Qualität - mit ECE R90 Freigabe und ähnlicher Bremsleistung wie die Original Bremsbeläge.
Upgrade Qualität (Tuning/ Sportbeläge) - ECE R90 Approved but with higher friction and improved performance for faster street use.
Qualité standard - Approuvée par la norme ECE R90 - Des performances équivalentes à l'origine.
Qualité améliorée - Approuvée par la norme ECE R90 - Un coefficient de friction supérieur et des performances accrues pour pilotage rapide sur route.
Calidad Estándar - Aprobación CEE R90 con prestaciones similares a las pastillas originales.
Calidad Mejorada - Aprobación CEE R90 pero con un coeficiente de fricción más elevado y prestaciones mejoradas para un uso deportivo en carretera.

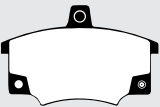
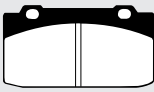
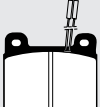
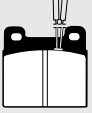
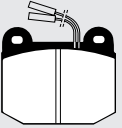
Make/Model/Engine	Year	Pads	Front / Vorn / Avant	Shoes	Pads	Rear / Hinten / Arrière	Shoes
Hersteller/Modell/Motor	Jahr	Plaquettes / Bremsbeläge		Bremsbacken Machoires	Plaquettes / Bremsbeläge		Bremsbacken Machoires
Modelos	Années	Original Quality ECE R90* Approved	Upgrade Quality Tuning/Sportbeläge ECE R90* Approved	 ECE R90* Approved	Original Quality ECE R90* Approved	Upgrade Quality Tuning/Sportbeläge ECE R90* Approved	 ECE R90* Approved

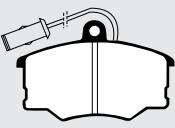
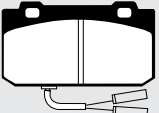
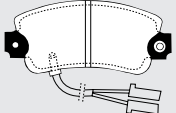
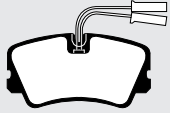
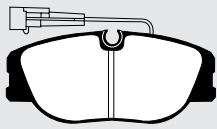
Pad Illustrations for Alfa Romeo

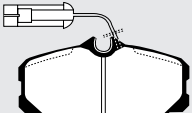
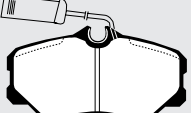
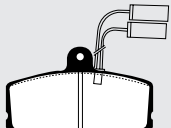
101  80 x 66 x 15mm	103  76 x 70 x 15mm	104  61 x 56 x 15mm	105  56 x 53 x 15mm
108  98 x 68 x 16mm	192  49 x 58 x 15mm	193  61 x 57 x 15mm	197  76 x 65 x 16mm
218  55 x 54 x 15mm	282  90 x 70 x 15mm	311  61 x 56 x 17mm	317  108 x 49 x 15mm
370  87 x 62 x 16mm	420/2  104 x 66 x 17mm	506  100 x 54 x 16mm	507  61 x 56 x 15mm
508  55 x 53 x 15mm	578  76 x 65 x 16mm	596  87 x 44 x 14mm	616/2  104 x 66 x 17mm
625  100 x 54 x 18mm	653  108 x 49 x 15mm	717  95 x 49 x 16mm	733  130 x 59 x 18mm
733/3  130 x 59 x 18mm	820  110 x 56 x 18mm	820/2  110 x 58 x 18mm	835  95 x 61 x 16mm

Standard Quality - ECE R90 Approved with similar performance to original equipment brake pads.
Upgrade Quality (Tuning / Sportbeläge) - ECE R90 Approved but with higher friction and improved performance for faster street use.

Standard Qualität - mit ECE R90 Freigabe und ähnlicher Bremsleistung wie die Original Bremsbeläge.
Verbesserte Qualität - mit ECE R90 Freigabe aber mit höherem Reibwert und verbesserter Bremsleistung für den schnellen Strasseneinsatz.

Qualité standard - Approuvée par la norme ECE R90 - Des performances équivalentes à l'origine.
Qualité améliorée - Approuvée par la norme ECE R90 - Un coefficient de friction supérieur et des performances accrues pour pilotage rapide sur route.

Calidad Estándar - Aprobación CEE R90 con prestaciones similares a las pastillas originales.
Calidad Mejorada - Aprobación CEE R90 pero con un coeficiente de fricción más elevado y prestaciones mejoradas para un uso deportivo en carretera.

BRAKE PADS & SHOES - APPLICATIONS

Bremsbeläge / Plaquettes + Bremsbacken / Machoires

EBC

BRAKES

Make/Model/Engine	Year	Pads	Front / Vorn / Avant	Shoes	Pads	Rear / Hinten / Arrière	Shoes
Hersteller/Modell/Motor	Jahr	Plaquettes / Bremsbeläge		Bremsbacken	Plaquettes / Bremsbeläge		Bremsbacken
Modelos	Années	Original Quality ECE R90* Approved	Upgrade Quality Tuning/Sportbeläge ECE R90* Approved	Machoires ECE R90* Approved	Original Quality ECE R90* Approved	Upgrade Quality Tuning/Sportbeläge ECE R90* Approved	Machoires ECE R90* Approved

Pad Illustrations for Alfa Romeo Contd.

912 76 x 60 x 15mm	913 61 x 57 x 15mm	916 56 x 53 x 15mm	1011 95 x 49 x 16mm
1031 110 x 69 x 17mm	1059 151 x 52 x 17mm	1060 156 x 52 x 17mm	1061 156 x 58 x 19mm
1096 90 x 50 x 16mm	1153 155 x 59 x 19mm	1214 87 x 44 x 14mm	1227 156 x 58 x 19mm
1430 96 x 44 x 16mm	21210 131 x 75 x 15mm		

ALVIS					
TD21					
3.0	62-63	DP 120	DP 2120	DP 120	DP 2120
TE21					
3.0	64-66	DP 120	DP 2120	DP 120	DP 2120
TF21					
3.0	66-68	DP 120	DP 2120	DP 120	DP 2120

Pad Illustrations for Alvis



120 47 x 63 x 17mm

ARIEL					
Atom					
1.8	98-	DP 817	DP 2817	DP 662/2	DP 2662/2

*Every EBC pad and shoe requiring ECE R-90 is available with approval subject to stock rotation - check box end label. Models listed by Engine Size. Only listed by trim level where pads differ, (16v, GL, GT, etc).

Standard Quality - ECE R90 Approved with similar performance to original equipment brake pads.
 Upgrade Quality (Tuning/ Sportbeläge) - ECE R90 Approved but with higher friction and improved performance for faster street use.
 Verbesserte Qualität - mit ECE R90 Freigabe aber mit höherem Reibwert und verbesserter Bremsleistung für den schnellen Strasseninsatz.

Qualité standard - Approuvée par la norme ECE R90 - Des performances équivalentes à l'origine.
 Qualité améliorée - Approuvée par la norme ECE R90 - Un coefficient de friction supérieur et des performances accrues pour pilotage rapide sur route.
 Calidad Mejorada - Aprobación CEE R90 con prestaciones similares a las pastillas originales.
 Calidad Mejorada - Aprobación CEE R90 pero con un coeficiente de fricción más elevado y prestaciones mejoradas para un uso deportivo en carretera.

Make/Model/Engine	Year	Pads	Front / Vorn / Avant	Shoes	Pads	Rear / Hinten / Arrière	Shoes
Hersteller/Modell/Motor	Jahr	Plaquettes / Bremsbeläge		Bremsbacken Machoires	Plaquettes / Bremsbeläge		Bremsbacken Machoires
Modelos	Années	Original Quality ECE R90* Approved	Upgrade Quality Tuning/Sportbeläge ECE R90* Approved	 ECE R90* Approved	Original Quality ECE R90* Approved	Upgrade Quality Tuning/Sportbeläge ECE R90* Approved	 ECE R90* Approved

Pad Illustrations for Ariel

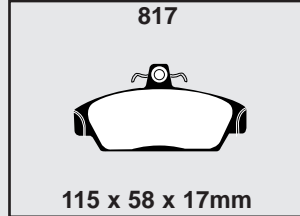
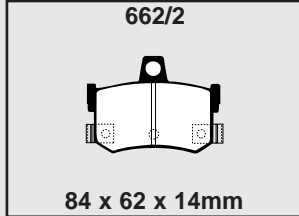

ASIA MOTORS

Rocsta

1.8	92-	DP 289					5256
2.2D	92-	DP 289					5256

Hi-Topic

2.7D	93-	DP 599					6429
------	-----	--------	--	--	--	--	-------------

Pad Illustrations for Asia Motors

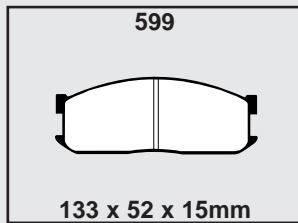
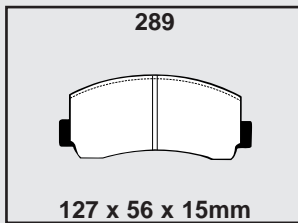

ASTON MARTIN

DB4	59-65	DP 120	DP 2120	DP 120	DP 2120
DB4 GT	60-63	-	DP 2223	-	DP 2141
DB5	63-65	DP 2108	DP 3108	DP 2101	DP 3101
DBSV8					
5.3	69-74	DP 2223	DP 3223	DP 2101	DP 3101
DB6	65-70	DP 2108	DP 3108	DP 2101	DP 3101
DB7					
3.2	93-97	DP 2262	DP 3262	DP 2690/2	DP 3690/2
3.2	93-97	DP 2689/2	DP 3689/2	DP 2690/2	DP 3690/2
3.2	97-	DP 2002	DP 3002		
6.0	99-	DP 21110	DP 31110		
Lagonda					
5.3	76-78	DP 2223	DP 3223	DP 2101	DP 3101
5.3	78-90	DP 2262	DP 3262	DP 2101	DP 3101
Handbrake Pads	76-90			DP 709	
Vanquish					
6.0	2001-				
Vantage					
5.3	88-93	DP 2223	DP 3223	DP 2101	DP 3101
5.3	93-97	DP 2002	DP 3002	DP 21165	DP 31165
5.3	93-97	DP 2011	DP 3011	DP 21165	DP 31165
5.3	96-97	DP 21131	DP 31131	DP 21503	DP 31503
5.3	97-				

BRAKE PADS & SHOES - APPLICATIONS









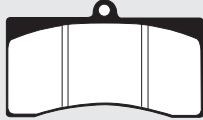

Bremsbeläge / Plaquettes + Bremsbacken / Machoires

EBC

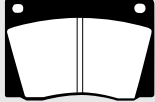
BRAKES

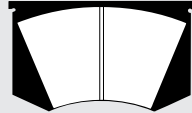
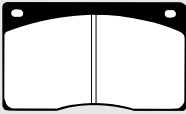
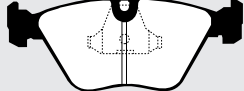
Make/Model/Engine Hersteller/Modell/Motor Modelos	Year Jahr Années	Pads Front / Vorn / Avant Plaquettes / Bremsbeläge		Shoes Bremsbacken Machoirs	Pads Rear / Hinten / Arrière Plaquettes / Bremsbeläge		Shoes Bremsbacken Machoirs
		Original Quality ECE R90* Approved	Upgrade Quality Tuning/Sportbeläge ECE R90* Approved	ECE R90* Approved	Original Quality ECE R90* Approved	Upgrade Quality Tuning/Sportbeläge ECE R90* Approved	ECE R90* Approved
ASTON MARTIN Contd.							
Virage							
5.3	89-93	DP 2262	DP 3262		DP 2101	DP 3101	
5.3	93-	DP 2002	DP 3002		DP 21165	DP 31165	
5.3	93-	DP 2011	DP 3011		DP 21165	DP 31165	
5.3	96-	DP 21131	DP 31131		DP 21503	DP 31503	
Handbrake Pads	89-				DP 709		
Volante							
5.3	76-93	DP 2223	DP 3223		DP 2101	DP 3101	
5.3	93-	DP 2002	DP 3002		DP 21165	DP 31165	
5.3	94-	DP 2011	DP 3011		DP 21165	DP 31165	
5.3	96-	DP 21131	DP 31131		DP 21503	DP 31503	
Handbrake Pads	76-				DP 709		
V8							
5.3	73-82	DP 2223	DP 3223		DP 2101	DP 3101	
Zagato							
5.3	85-88	DP 2223	DP 3223		DP 2101	DP 3101	

Pad Illustrations for Aston Martin

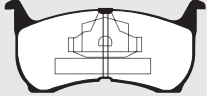
120  47 x 63 x 17mm	709  40 x 39 x 13mm	2002  132 x 54 x 17mm	2011  130 x 78 x 25mm
2101  80 x 66 x 15mm	2108  98 x 68 x 16mm	2141  73 x 53 x 15mm	2223  122 x 73 x 19mm
2262  119 x 71 x 15mm	2689/2  156 x 63 x 16mm	2690/2  123 x 44 x 17mm	21131  171 x 51 x 16mm
21165  144 x 56 x 15mm	21503  133 x 62 x 13mm		









AUDI							
50	74-77	DP 174					5205
	75-77	DP 174					5236
	77-79	DP 174					5264

*Every EBC pad and shoe requiring ECE R-90 is available with approval subject to stock rotation - check box end label.
Models listed by Engine Size. Only listed by trim level where pads differ, (16v, GL, GT, etc).

Standard Quality - ECE R90 Approved with similar performance to original equipment brake pads.
Upgrade Quality (Tuning/ Sportbeläge) - ECE R90 Approved but with higher friction and improved performance for faster street use.
Verbesserte Qualität - mit ECE R90 Freigabe aber mit höherem Reibwert und verbesserter Bremsleistung für den schnellen Strasseninsatz.
Standard Qualität - mit ECE R90 Freigabe und ähnlicher Bremsleistung wie die Original Bremsbeläge.
Qualité standard - Approuvée par la norme ECE R90 - Des performances équivalentes à l'origine.
Qualité améliorée - Approuvée par la norme ECE R90 - Un coefficient de friction supérieur et des performances accrues pour pilotage rapide sur route.
Calidad Estándar - Aprobación CEE R90 con prestaciones similares a las pastillas originales.
Calidad Mejorada - Aprobación CEE R90 pero con un coeficiente de fricción más elevado y prestaciones mejoradas para un uso deportivo en carretera.

Standard Quality - ECE R90 Approved with similar performance to original equipment brake pads.
 Upgrade Quality (Tuning / Sportbeläge) - ECE R90 Approved but with higher friction and improved performance for faster street use.

Calidad Estándar - Aprobación CEE R90 con prestaciones similares a las pastillas originales.
 Calidad Mejorada - Aprobación CEE R90 pero con un coeficiente de fricción más elevado y prestaciones mejoradas para un uso deportivo en carretera.

Make/Model/Engine Hersteller/Modell/Motor Modèles	Year Jahr Années	Pads  Front / Vorn / Avant		Shoes	Pads  Rear / Hinten / Arrière		Shoes
		Original Quality ECE R90* Approved 	Upgrade Quality Tuning/Sportbeläge ECE R90* Approved 	Bremsbacken Machoires 	Original Quality ECE R90* Approved 	Upgrade Quality Tuning/Sportbeläge ECE R90* Approved 	Bremsbacken Machoires 
AUDI Contd.							
60, 75	66-72	DP 104	DP 2104				5126
80							
1.5 Manual	72-74	DP 174					5127
1.5 Auto	72-74	DP 194					5183
1.6 Manual	72-74	DP 174					5127
1.6 Auto	72-74	DP 194					5183
1.6 Manual	74-79	DP 174					5205
1.6 Auto	74-79	DP 194					5186
1.6 Manual	79-86	DP 310	DP 2310				5264
1.6 Auto	79-86	DP 310/2	DP 2310/2				5269
1.6	86-91	DP 369	DP 2369/2				5269
1.6	92-95	DP 486	DP 2486		DP 370	DP 2370	6498
1.8	79-84	DP 310	DP 2310				5264
1.8	84-87	DP 310/2	DP 2310/2				5269
1.8	86-89	DP 486	DP 2486		DP 370	DP 2370	5269
1.8	89-90	DP 486	DP 2486		DP 370	DP 2370	6447
1.8	90-92	DP 486	DP 2486		DP 370	DP 2370	5269
1.9	81-84	DP 310	DP 2310				5264
1.9	86-91	DP 486	DP 2486		DP 370	DP 2370	
2.0	82-84	DP 310	DP 2310				5269
2.0	86-87	DP 310/2	DP 2310/2				5269
2.0	87-91	DP 486	DP 2486		DP 370	DP 2370	
2.0	91-95	DP 486	DP 2486		DP 370	DP 2370	6498
2.3	91-94	DP 486	DP 2486		DP 370	DP 2370	
2.3 20v	91-94	DP 711	DP 2711		DP 370	DP 2370	
2.6	93-95	DP 486	DP 2486		DP 370	DP 2370	
2.8	91-95	DP 711	DP 2711		DP 370	DP 2370	
1.6 D	87-89	DP 369	DP 2369/2				5269
1.6 TD	88-89	DP 369	DP 2369/2				5269
1.6 TD	89-90	DP 369	DP 2369/2				6447
1.6 TD	90-91	DP 369	DP 2369/2				5269
1.9 D	89-90	DP 369	DP 2369/2				6447
1.9 D	90-91	DP 369	DP 2369/2				5269
1.9 TD	91-93	DP 486	DP 2486				6498
1.9 TD	93-95	DP 486	DP 2486		DP 370	DP 2370	
80 Quattro							
1.8	82-86	DP 369/2	DP 2369/2		DP 370	DP 2370	
1.8	86-90	DP 486	DP 2486		DP 370	DP 2370	
1.9	86-88	DP 486	DP 2486		DP 370	DP 2370	
2.0	82-86	DP 369/2	DP 2369/2		DP 370	DP 2370	
2.0	86-93	DP 486	DP 2486		DP 370	DP 2370	
2.2	84-86	DP 369/2	DP 2369/2		DP 370	DP 2370	
2.3	91-94	DP 486	DP 2486		DP 370	DP 2370	
2.6	92-95	DP 486	DP 2486		DP 370	DP 2370	
2.8	91-95	DP 711	DP 2711		DP 370	DP 2370	
90							
2.0	84-86	DP 369/2	DP 2369/2				5269
2.0	86-91	DP 486/2	DP 2369/2		DP 370	DP 2370	
2.2	84-87	DP 369/2	DP 2369/2		DP 370	DP 2370	
2.2	87-89	DP 486/2	DP 2369/2		DP 370	DP 2370	
2.3	87-91	DP 486	DP 2486		DP 370	DP 2370	
2.3 20v	89-91	DP 711	DP 2711		DP 370	DP 2370	
90 Quattro							
2.2	84-87	DP 486/2	DP 2369/2		DP 370	DP 2370	
2.2	87-91	DP 486	DP 2486		DP 370	DP 2370	
2.3	87-91	DP 486	DP 2486		DP 370	DP 2370	
2.3 20v	89-91	DP 711	DP 2711		DP 370	DP 2370	

*Every EBC pad and shoe requiring ECE R-90 is available with approval subject to stock rotation - check box end label.
 Models listed by Engine Size. Only listed by trim level where pads differ, (16v, GL, GT, etc).

BRAKE PADS & SHOES - APPLICATIONS

Bremsbeläge / Plaquettes + Bremsbacken / Machoires

EBC

BRAKES

Make/Model/Engine Hersteller/Modell/Motor Modèles	Year Jahr Années	Pads Front / Vorn / Avant		Shoes	Pads Rear / Hinten / Arrière		Shoes
		Original Quality ECE R90* Approved	Upgrade Quality Tuning/Sportbeläge ECE R90* Approved	Bremsbacken Machoirs ECE R90* Approved	Original Quality ECE R90* Approved	Upgrade Quality Tuning/Sportbeläge ECE R90* Approved	Bremsbacken Machoirs ECE R90* Approved
AUDI Contd.							
100							
1.6 Manual	68-74	DP 104	DP 2104				5126
1.6 Auto	69-72	DP 126	DP 2126				5126
1.6	74-79	DP 220/2	DP 2220				5242
1.6	79-82	DP 310	DP 2310				5269
1.8	82-84	DP 486	DP 2486				5267
1.8	84-89	DP 486	DP 2486		DP 370	DP 2370	5267
1.8	89-90	DP 486	DP 2486		DP 370	DP 2370	6498
1.9 Manual	68-74	DP 104	DP 2104				5126
1.9 Auto	69-72	DP 126	DP 2126				5126
1.9 Auto	72-74	DP 179					5183
1.9	79-81	DP 310	DP 2310				5269
1.9	81-82	DP 369	DP 2369/2				5267
1.9	82-84	DP 486	DP 2486				5267
2.0	76-78	DP 220/2	DP 2220				5242
2.0	84-89	DP 486	DP 2486		DP 370	DP 2370	5267
2.0	89-90	DP 486	DP 2486		DP 370	DP 2370	6498
2.0	90-93	DP 836	DP 2836		DP 370	DP 2370	6498
2.0	93-95	DP 836	DP 2836		DP 370	DP 2370	
2.2	77-79	DP 274					5268
2.2	77-79	DP 310	DP 2310				5268
2.2	79-82	DP 310	DP 2310				5269
2.2	79-82	DP 369	DP 2369/2				5267
2.2	82-86	DP 486	DP 2486		DP 370	DP 2370	5267
2.2	86-89	DP 711	DP 2711		DP 370	DP 2370	
2.2 Turbo	86-90	DP 2711	DP 3711		DP 2370	DP 3370	
2.3	88-90	DP 486	DP 2486		DP 370	DP 2370	
2.3	90-94	DP 836	DP 2836		DP 370	DP 2370	
2.6	92-95	DP 836	DP 2836		DP 370	DP 2370	
2.8	90-95	DP 836	DP 2836		DP 370	DP 2370	
2.0 D	84-89	DP 486	DP 2486		DP 370	DP 2370	5267
2.0 D	89-90	DP 486	DP 2486		DP 370	DP 2370	6498
2.0 TD	84-89	DP 486	DP 2486		DP 370	DP 2370	5267
2.0 TD	89-91	DP 486	DP 2486		DP 370	DP 2370	6498
2.4 D	89-90	DP 486	DP 2486		DP 370	DP 2370	6498
2.4 D	90-93	DP 836	DP 2836		DP 370	DP 2370	6498
2.4 D	93-94	DP 836	DP 2836		DP 370	DP 2370	
2.5 TD	90-91	DP 711	DP 2711		DP 370	DP 2370	
2.5 TD	91-95	DP 836	DP 2836		DP 370	DP 2370	
100 Quattro							
1.8	84-90	DP 486	DP 2486		DP 370	DP 2370	
2.0	84-86	DP 486	DP 2486		DP 370	DP 2370	
2.0	86-87	DP 711	DP 2711		DP 370	DP 2370	
2.0	90-94	DP 836	DP 2836		DP 370	DP 2370	
2.2	84-86	DP 486	DP 2486		DP 370	DP 2370	
2.2	86-90	DP 711	DP 2711		DP 370	DP 2370	
2.2 Turbo	86-90	DP 2711	DP 3711		DP 2370	DP 3370	
2.2 Turbo	86-90	DP 2689/2	DP 3689/2		DP 2370	DP 3370	
2.3	88-90	DP 486	DP 2486		DP 370	DP 2370	
2.3	90-94	DP 836	DP 2836		DP 370	DP 2370	
2.6	92-94	DP 836	DP 2836		DP 370	DP 2370	
2.8	90-95	DP 836	DP 2836		DP 370	DP 2370	
200							
2.2	79-85	DP 486	DP 2486		DP 370	DP 2370	
2.2	86-90	DP 711	DP 2711		DP 370	DP 2370	
2.2 Turbo	83-86	DP 486	DP 2486		DP 370	DP 2370	
2.2 Turbo	86-90	DP 2711	DP 3711		DP 2370	DP 3370	
2.2 Turbo	86-90	DP 2689/2	DP 3689/2		DP 2370	DP 3370	
2.3 Turbo	89-90	DP 2711	DP 3711		DP 2370	DP 3370	









*Every EBC pad and shoe requiring ECE R-90 is available with approval subject to stock rotation - check box end label.
Models listed by Engine Size. Only listed by trim level where pads differ, (16v, GL, GT, etc).

Standard Quality - ECE R90 Approved with similar performance to original equipment brake pads.
Upgrade Quality (Tuning/ Sportbeläge) - ECE R90 Approved but with higher friction and improved performance for faster street use.
Verbesserte Qualität - mit ECE R90 Freigabe und ähnlicher Bremsleistung wie die Original Bremsbeläge.
Standard Qualität - mit ECE R90 Freigabe und ähnlicher Bremsleistung wie die Original Bremsbeläge.
Qualité standard - Approuvée par la norme ECE R90 - Des performances équivalentes à l'origine.
Qualité améliorée - Approuvée par la norme ECE R90 - Un coefficient de friction supérieur et des performances accrues pour pilotage rapide sur route.
Calidad Estándar - Aprobación CEE R90 con prestaciones similares a las pastillas originales.
Calidad Mejorada - Aprobación CEE R90 pero con un coeficiente de fricción más elevado y prestaciones mejoradas para un uso deportivo en carretera.

Standard Quality - ECE R90 Approved with similar performance to original equipment brake pads.
 Upgrade Quality (Tuning / Sportbeläge) - ECE R90 Approved but with higher friction and improved performance for faster street use.

Standard Qualität - mit ECE R90 Freigabe und ähnlicher Bremsleistung wie die Original Bremsbeläge.
 Verbesserte Qualität - mit ECE R90 Freigabe aber mit höherem Reibwert und verbesserter Bremsleistung für den schnellen Strasseninsatz.

Calidad Estándar - Aprobación CEE R90 con prestaciones similares a las pastillas originales.
 Calidad Mejorada - Aprobación CEE R90 pero con un coeficiente de fricción más elevado y prestaciones mejoradas para un uso deportivo en carretera.

Make/Model/Engine Hersteller/Modell/Motor Modèles	Year Jahr Années	Pads  Front / Vorn / Avant		Shoes	Pads  Rear / Hinten / Arrière		Shoes
		Original Quality ECE R90* Approved 	Upgrade Quality Tuning/Sportbeläge ECE R90* Approved 	Bremsbacken Machoires 	Original Quality ECE R90* Approved 	Upgrade Quality Tuning/Sportbeläge ECE R90* Approved 	Bremsbacken Machoires 
AUDI Contd.							
200 Quattro							
2.2	84-85	DP 486	DP 2486		DP 370	DP 2370	
2.2	86-90	DP 711	DP 2711		DP 370	DP 2370	
2.2 Turbo	84-85	DP 2486	DP 3486		DP 2370	DP 3370	
2.2 Turbo	86-90	DP 2711	DP 3711		DP 2370	DP 3370	
2.2 Turbo	86-90	DP 2689/2	DP 3689/2		DP 2370	DP 3370	
2.3 Turbo	89-90	DP 2711	DP 3711		DP 2370	DP 3370	
All Road Quattro							
2.7 Twin Turbo	2000-	DP 21348	DP 31348		DP 2680	DP 3680	
2.5 TD	2000-	DP 21348	DP 31348		DP 2680	DP 3680	
4.2	2003-						
Cabriolet							
1.8	97-99	DP 486	DP 2486		DP 370	DP 2370	
1.8 Turbo	2002-	DP 1483	DP 21483		DP 680	DP 2680	
2.0	93-98	DP 486	DP 2486		DP 370	DP 2370	
2.3	92-94	DP 486	DP 2486		DP 370	DP 2370	
2.4	2002-	DP 1483	DP 21483		DP 680	DP 2680	
2.6	94-99	DP 486	DP 2486		DP 370	DP 2370	
2.8	92-99	DP 711	DP 2711		DP 370	DP 2370	
3.0	2002-	DP 21483	DP 31483		DP 2680	DP 3680	
2.5 TD	2002-	DP 1483	DP 21483		DP 680	DP 2680	
Coupe 100S							
1.9 Manual	69-72	DP 104	DP 2104				5126
1.9 Manual	72-73	DP 126	DP 2126				5126
1.9 Manual	73-74	DP 126	DP 2126				5183
1.9 Manual	74-76	DP 220/2	DP 2220				5183
1.9 Auto	72-74	DP 179					5183
1.9 Auto	74-76	DP 220/2	DP 2220				5183
Coupe							
1.8	82-84	DP 310	DP 2310				5264
1.8	84-86	DP 310/2	DP 2310/2				5269
1.8	86-89	DP 369/2	DP 2369/2				5269
1.9	80-83	DP 310	DP 2310				5269
2.0	83-84	DP 310	DP 2310				5269
2.0	84-87	DP 369/2	DP 2369/2				5269
2.0	87-97	DP 486	DP 2486		DP 370	DP 2370	5269
2.2	81-84	DP 310/2	DP 2310/2				5269
2.2	84-88	DP 369/2	DP 2369/2		DP 370	DP 2370	5269
2.2	88-89	DP 486	DP 2486		DP 370	DP 2370	
2.3	87-88	DP 369/2	DP 2369/2		DP 370	DP 2370	
2.3	88-94	DP 486	DP 2486		DP 370	DP 2370	
2.3 20v	89-94	DP 711	DP 2711		DP 370	DP 2370	
2.6	92-97	DP 486	DP 2486		DP 370	DP 2370	
2.8	91-93	DP 711	DP 2711		DP 370	DP 2370	
Coupe Quattro							
2.0	88-96	DP 711	DP 2711		DP 370	DP 2370	
2.2	84-87	DP 486/2	DP 2369/2		DP 370	DP 2370	
2.2	88-89	DP 486	DP 2486		DP 370	DP 2370	
2.3	88-89	DP 486	DP 2486		DP 370	DP 2370	
2.3 20v	89-92	DP 711	DP 2711		DP 370	DP 2370	
2.6	92-96	DP 486	DP 2486		DP 370	DP 2370	
2.8	91-96	DP 711	DP 2711		DP 370	DP 2370	

*Every EBC pad and shoe requiring ECE R-90 is available with approval subject to stock rotation - check box end label.









Models listed by Engine Size. Only listed by trim level where pads differ, (16v, GL, GT, etc).

BRAKE PADS & SHOES - APPLICATIONS

Bremsbeläge / Plaquettes + Bremsbacken / Machoires

EBC









BRAKES

Make/Model/Engine Hersteller/Modell/Motor Modèles	Year Jahr Années	Pads  Front / Vorn / Avant		Shoes	Pads  Rear / Hinten / Arrière		Shoes
		Original Quality ECE R90* Approved 	Upgrade Quality Tuning/Sportbeläge ECE R90* Approved 	Bremsbacken Machoires 	Original Quality ECE R90* Approved 	Upgrade Quality Tuning/Sportbeläge ECE R90* Approved 	Bremsbacken Machoires 
AUDI Contd.							
Quattro Turbo							
2.2 Turbo (WR)	80-82	DP 2369/2	DP 3486		DP 2370	DP 3370	
2.2 Turbo (WR)	82-86	DP 2486	DP 3486		DP 2370	DP 3370	
2.2 Turbo (WR)	86-87	DP 2711	DP 3711		DP 2370	DP 3370	
2.2 Turbo (MB)	87-90	DP 2711	DP 3711		DP 2370	DP 3370	
2.2 20v Turbo (RR)	89-	DP 2711	DP 3711		DP 2370	DP 3370	
A2							
1.4	2000-	DP 1329	DP 21329				6447
1.6	2002-	DP 1329	DP 21329		DP 680	DP 2680	
1.2 TD	2001-	DP 1432					
1.4 TD	2000-	DP 1329	DP 21329				6447
A3							
1.6	96-99	DP 1117	DP 21117		DP 1230	DP 21230	
1.6	99-2003	DP 1329	DP 21329		DP 1230	DP 21230	
1.6	2003-						
1.8	96-99	DP 1117	DP 21117		DP 1230	DP 21230	
1.8	99-2003	DP 1329	DP 21329		DP 1230	DP 21230	
1.8 Turbo	96-99	DP 1324	DP 21324		DP 1230	DP 21230	
1.8 Turbo	99-2003	DP 1330	DP 21330		DP 1230	DP 21230	
2.0	2003-						
1.9 TD (90)	96-99	DP 1117	DP 21117		DP 1230	DP 21230	
1.9 TD (110)	96-99	DP 1117	DP 21117		DP 1230	DP 21230	
1.9 TD (90)(110)	99-2000	DP 1329	DP 21329		DP 1230	DP 21230	
1.9 TD (130)(100)	2000-2003	DP 1329	DP 21329		DP 1230	DP 21230	
2.0 TD	2003-						
A3 Quattro							
1.8 Turbo	99-2003	DP 1330	DP 21330		DP 1230	DP 21230	
3.2	2003-						
1.9 TD	2001-2003	DP 1330	DP 21330		DP 1230	DP 21230	
A4							
1.6	95-97	DP 486	DP 2486		DP 370	DP 2370	
1.6	97-2000	DP 1112	DP 21112		DP 680	DP 2680	
1.6	2001-	DP 1351	DP 21351		DP 680	DP 2680	
1.8	95-97	DP 836	DP 2836		DP 370	DP 2370	
1.8	97-2000	DP 1112	DP 21112		DP 680	DP 2680	
1.8 Turbo	95-97	DP 836	DP 2836		DP 370	DP 2370	
1.8 Turbo	97-99	DP 836	DP 2836		DP 680	DP 2680	
1.8 Turbo	99-	DP 1114	DP 21114		DP 680	DP 2680	
2.0	2001-	DP 1114	DP 21114		DP 680	DP 2680	
2.0	2001-	DP 1114	DP 21114		DP 680	DP 2680	
2.4	97-99	DP 836	DP 2836		DP 680	DP 2680	
2.4	99-2002	DP 1114	DP 21114		DP 680	DP 2680	
2.4	2002-						
2.6	95-97	DP 836	DP 2836		DP 370	DP 2370	
2.6	97-99	DP 836	DP 2836		DP 680	DP 2680	
2.6	99-2000	DP 1114	DP 21114		DP 680	DP 2680	
2.8	96-97	DP 836	DP 2836		DP 370	DP 2370	
2.8	97-99	DP 836	DP 2836		DP 680	DP 2680	
2.8	99-2000	DP 1114	DP 21114		DP 680	DP 2680	
1.9 TD (90)	95-97	DP 486	DP 2486		DP 370	DP 2370	
1.9 TD (90)	97-2000	DP 1112	DP 21112		DP 680	DP 2680	
1.9 TD (110)	96-97	DP 836	DP 2836		DP 370	DP 2370	
1.9 TD (110)	97-99	DP 836	DP 2836		DP 680	DP 2680	
1.9 TD (110)	99-2000	DP 1114	DP 21114		DP 680	DP 2680	
1.9 TD (115)(100)	2001-	DP 1351	DP 21351		DP 680	DP 2680	
1.9 TD (130)	2001-	DP 1114	DP 21114		DP 680	DP 2680	
2.5 TD	98-99	DP 836	DP 2836		DP 680	DP 2680	
2.5 TD	99-	DP 1114	DP 21114		DP 680	DP 2680	

*Every EBC pad and shoe requiring ECE R-90 is available with approval subject to stock rotation - check box end label.
Models listed by Engine Size. Only listed by trim level where pads differ, (16v, GL, GT, etc).

Standard Quality - ECE R90 Approved with similar performance to original equipment brake pads.
Upgrade Quality (Tuning/ Sportbeläge) - ECE R90 Approved but with higher friction and improved performance for faster street use.
Verbesserte Qualität - mit ECE R90 Freigabe und ähnlicher Bremsleistung wie die Original Bremsbeläge.

Qualité standard - Approuvée par la norme ECE R90 - Des performances équivalentes à l'origine.
Qualité améliorée - Approuvée par la norme ECE R90 - Un coefficient de friction supérieur et des performances accrues pour pilotage rapide sur route.
Calidad Estándar - Aprobación CEE R90 con prestaciones similares a las pastillas originales.
Calidad Mejorada - Aprobación CEE R90 pero con un coeficiente de fricción más elevado y prestaciones mejoradas para un uso deportivo en carretera.

Make/Model/Engine Hersteller/Modell/Motor Modelos	Year Jahr Années	Pads  Front / Vorn / Avant		Shoes	Pads  Rear / Hinten / Arrière		Shoes
		Original Quality ECE R90* Approved 	Upgrade Quality Tuning/Sportbeläge ECE R90* Approved 	Bremsbacken Machoires 	Original Quality ECE R90* Approved 	Upgrade Quality Tuning/Sportbeläge ECE R90* Approved 	Bremsbacken Machoires 
AUDI Contd.							
A4 Quattro							
1.8	95-99	DP 836	DP 2836		DP 370	DP 2370	
1.8	99-2000	DP 1114	DP 21114		DP 680	DP 2680	
1.8 Turbo	95-99	DP 836	DP 2836		DP 370	DP 2370	
1.8 Turbo	99-	DP 1114	DP 21114		DP 680	DP 2680	
2.6	95-99	DP 836	DP 2836		DP 370	DP 2370	
2.6	99-2000	DP 1114	DP 21114		DP 680	DP 2680	
2.8	96-99	DP 2836	DP 3836		DP 2370	DP 3370	
2.8	99-2000	DP 21114	DP 31114		DP 2680	DP 3680	
3.0	2001-	DP 21114	DP 31114		DP 2680	DP 3680	
1.9 TD	2001-	DP 1114	DP 21114		DP 680	DP 2680	
2.5 TD	98-99	DP 836	DP 2836		DP 370	DP 2370	
2.5 TD	99-	DP 1114	DP 21114		DP 680	DP 2680	
A6							
1.8	95-98	DP 836	DP 2836		DP 370	DP 2370	
1.8	97-2001	DP 1114	DP 21114		DP 680	DP 2680	
1.8 Turbo	97-2001	DP 1114	DP 21114		DP 680	DP 2680	
1.8 Turbo	2001-	DP 1483	DP 21483		DP 680	DP 2680	
2.0	94-98	DP 836	DP 2836		DP 370	DP 2370	
2.0	99-2001	DP 1114	DP 21114		DP 680	DP 2680	
2.0	2001-	DP 1483	DP 21483		DP 680	DP 2680	
2.4	97-2001	DP 1114	DP 21114		DP 680	DP 2680	
2.4	2001-	DP 1483	DP 21483		DP 680	DP 2680	
2.6	94-98	DP 836	DP 2836		DP 370	DP 2370	
2.8	94-98	DP 836	DP 2836		DP 370	DP 2370	
2.8	97-2001	DP 1114	DP 21114		DP 680	DP 2680	
2.8	2001-	DP 1483	DP 21483		DP 680	DP 2680	
1.9 TD	95-98	DP 836	DP 2836		DP 370	DP 2370	
1.9 TD	97-2001	DP 1114	DP 21114		DP 680	DP 2680	
1.9 TD	2001-	DP 1483	DP 21483		DP 680	DP 2680	
2.5 TD	94-98	DP 836	DP 2836		DP 370	DP 2370	
2.5 TD	97-2001	DP 1114	DP 21114		DP 680	DP 2680	
2.5 TD	2001-	DP 1483	DP 21483		DP 680	DP 2680	
A6 Quattro							
1.8 Turbo	2001-		DP 21348		DP 1230	DP 21230	
1.8 Turbo	2001-	DP 1114	DP 21114		DP 1230	DP 21230	
2.4	98-	DP 1114	DP 21114		DP 680	DP 2680	
2.7 Twin Turbo	99-2000	DP 21012	DP 31012		DP 2680	DP 3680	
2.7 Twin Turbo	2000-2001	DP 21348	DP 31348		DP 2680	DP 3680	
2.7 Twin Turbo	2001-	DP 21510	DP 31510		DP 2680	DP 3680	
2.8	94-98	DP 2836	DP 3836		DP 2370	DP 3370	
2.8	97-	DP 21114	DP 31114		DP 2680	DP 3680	
3.0	2001-	DP 21114	DP 31114		DP 21230	DP 3680	
3.0	2001-	DP 21348	DP 31348		DP 21230	DP 3680	
3.0 (Avant)	2001-	DP 21510	DP 31510		DP 21230	DP 3680	
4.2	99-	DP 21348	DP 31348		DP 2680	DP 3680	
2.5 TD	95-98	DP 836	DP 2836		DP 370	DP 2370	
2.5 TD	97-	DP 1114	DP 21114		DP 680	DP 2680	
A8							
2.8	94-98	-	DP 21012		DP 370	DP 2370	
2.8	98-	-	DP 21328		DP 1230	DP 21230	
3.7	95-98	DP 21012	DP 31012		DP 2370	DP 3370	
A8 Quattro							
2.8	2001-	DP 21328	DP 31328		DP 21230	DP 3680	
3.7	99-	DP 21328	DP 31328		DP 21230	DP 3680	
4.2	94-98	DP 21012	DP 31012		DP 2370	DP 3370	
4.2	98-	DP 21328	DP 31328		DP 21230	DP 3680	
6.0 W12	2001-	DP 21328	DP 31328		DP 21230	DP 3680	

Standard Quality - ECE R90 Approved with similar performance to original equipment brake pads.

Upgrade Quality (Tuning / Sportbeläge) - ECE R90 Approved but with higher friction and improved performance for faster street use.

Standard Qualität - mit ECE R90 Freigabe und ähnlicher Bremsleistung wie die Original Bremsbeläge.

Verbesserte Qualität - mit ECE R90 Freigabe aber mit höherem Reibwert und verbesserter Bremsleistung für den schnellen Strasseninsatz.

Calidad Estándar - Aprobación CEE R90 con prestaciones similares a las pastillas originales.

Calidad Mejorada - Aprobación CEE R90 pero con un coeficiente de fricción más elevado y prestaciones mejoradas para un uso deportivo en carretera.

*Every EBC pad and shoe requiring ECE R-90 is available with approval subject to stock rotation - check box end label.









Models listed by Engine Size. Only listed by trim level where pads differ, (16v, GL, GT, etc).

BRAKE PADS & SHOES - APPLICATIONS

Bremsbeläge / Plaquettes + Bremsbacken / Machoires

EBC

BRAKES

Make/Model/Engine Hersteller/Modell/Motor Modèles	Year Jahr Années	Pads  Front / Vorn / Avant		Shoes	Pads  Rear / Hinten / Arrière		Shoes
		Original Quality ECE R90* Approved 	Upgrade Quality Tuning/Sportbeläge ECE R90* Approved 	Bremsbacken Machoires 	Original Quality ECE R90* Approved 	Upgrade Quality Tuning/Sportbeläge ECE R90* Approved 	Bremsbacken Machoires 
AUDI Contd.							
RS2 2.2 20v Turbo	93-96	DP 21014	DP 31014		DP 21013	DP 31013	
RS4 2.7 Twin Turbo	2000-2002	-	DP 31035		-	DP 31412	
RS6 4.2	2002-				-	DP 31470	
S2 2.2 20v Turbo	90-96	DP 2711	DP 3711		DP 2370	DP 3370	
S3 1.8 Turbo	99-	DP 21330	DP 31330		DP 2680	DP 3680	
S4 2.2 20v Turbo (UFO DISC)	91-94	DP 883	DP 3883		DP 370	DP 3370	
2.7 Twin Turbo	97-99	DP 21012	DP 31012		DP 2370	DP 3370	
2.7 Twin Turbo	99-	DP 21348	DP 31348				
S6 2.3 20v Turbo	94-98	DP 21012	DP 31012		DP 2370	DP 3370	
4.2	99-2000	DP 21328	DP 31328		DP 21230	DP 3680	
4.2	2000-	DP 21348	DP 31348		DP 21230	DP 3680	
S8 4.2	97-98	DP 21012	DP 31012		DP 2370	DP 3370	
4.2	98-	-	DP 31327		-	DP 3680	
TT Coupe / Roadster 1.8 20v Turbo	99-	DP 21330	DP 31330		DP 2680	DP 3680	
3.2	2003-						
V8 3.6	90-92	DP 883	DP 3883		DP 370	DP 3370	
4.2	91-94	DP 883	DP 3883		DP 370	DP 3370	

AUDI PAD IDENTIFICATION

369	19mm thick 15mm shoulder no wear indicator	1324	43mm clip no lead
369/2	16mm thick 15mm shoulder no wear indicator	1330	43mm clip rectangular wear lead connectors with opposite connectors to 1114
486	19mm thick 15mm shoulder standard wear indicator	1351	19mm thick 9mm shoulder rectangular wear indicator
486/2	16mm thick 15mm shoulder standard wear indicator		
836	46mm clip round wear lead connector		
1112	16mm thick 9mm shoulder no lead		
1114	46mm clip rectangular wear lead connector		

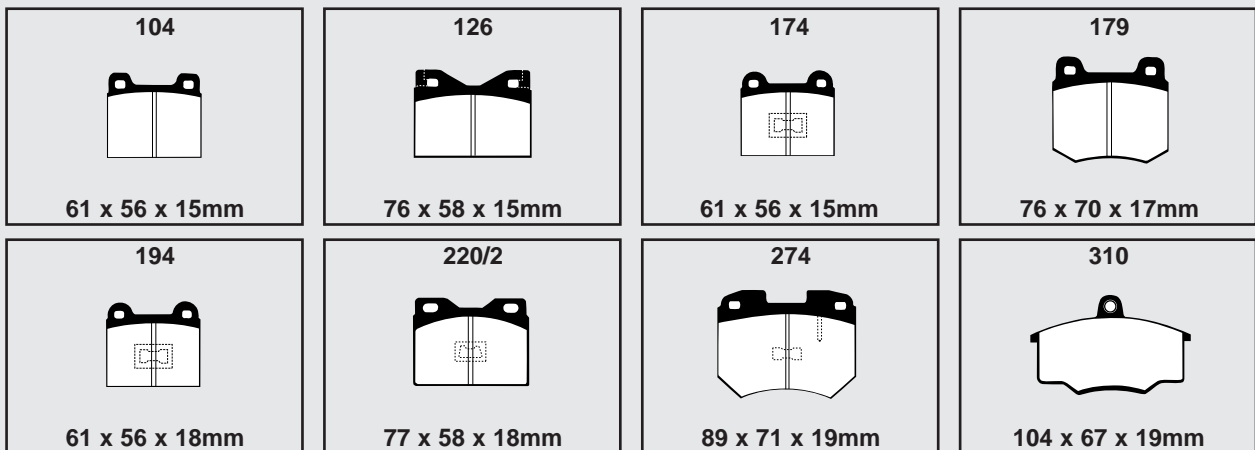

Pad Illustrations for Audi











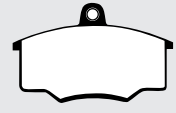
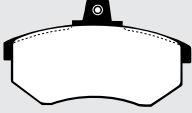
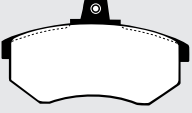
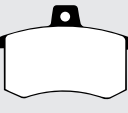
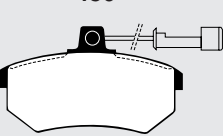
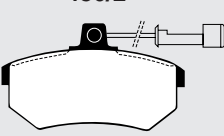
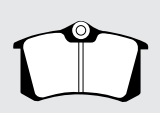
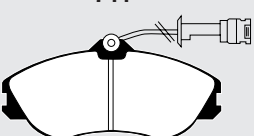
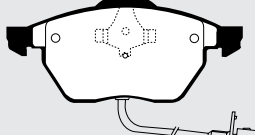
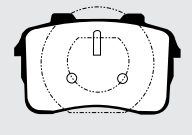
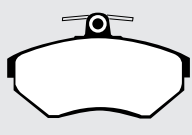
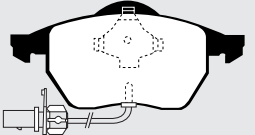
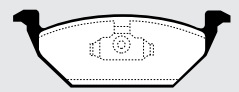

*Every EBC pad and shoe requiring ECE R-90 is available with approval subject to stock rotation - check box end label.
Models listed by Engine Size. Only listed by trim level where pads differ, (16v, GL, GT, etc).

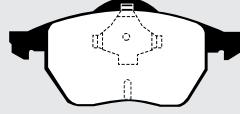
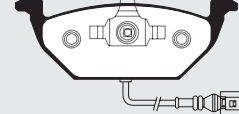
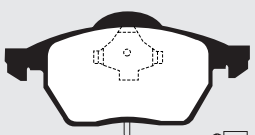
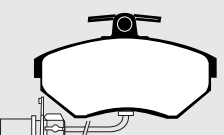
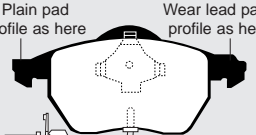
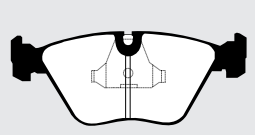
Standard Quality - ECE R90 Approved with similar performance to original equipment brake pads.
Upgrade Quality (Tuning/ Sportbeläge) - ECE R90 Approved but with higher friction and improved performance for faster street use.
Verbesserte Qualität - mit ECE R90 Freigabe und ähnlicher Bremsleistung wie die Original Bremsbeläge.
Standard Qualität - mit ECE R90 Freigabe und ähnlicher Bremsleistung wie die Original Bremsbeläge.

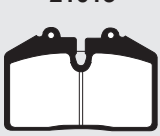
Qualité standard - Approuvée par la norme ECE R90 - Des performances équivalentes à l'origine.
Qualité améliorée - Approuvée par la norme ECE R90 - Un coefficient de friction supérieur et des performances accrues pour pilotage rapide sur route.
Calidad Mejorada - Aprobación CEE R90 pero con un coeficiente de fricción más elevado y prestaciones mejoradas para un uso deportivo en carretera.
Calidad Estándar - Aprobación CEE R90 con prestaciones similares a las pastillas originales.

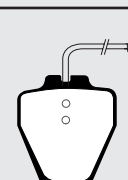
Make/Model/Engine	Year	Pads	Front / Vorn / Avant	Shoes	Pads	Rear / Hinten / Arrière	Shoes
Hersteller/Modell/Motor	Jahr	Plaquettes / Bremsbeläge		Bremsbacken Machoires	Plaquettes / Bremsbeläge		Bremsbacken Machoires
Modelos	Années	Original Quality ECE R90* Approved	Upgrade Quality Tuning/Sportbeläge ECE R90* Approved	 ECE R90* Approved	Original Quality ECE R90* Approved	Upgrade Quality Tuning/Sportbeläge ECE R90* Approved	 ECE R90* Approved

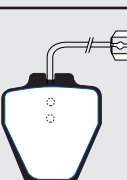
Pad Illustrations for Audi Contd.

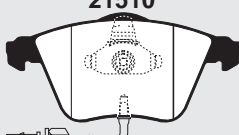
310/2  104 x 67 x 15mm	369  120 x 69 x 19mm	369/2  120 x 69 x 16mm	370  87 x 62 x 16mm
486  120 x 69 x 19mm	486/2  120 x 69 x 16mm	680  87 x 53 x 15mm	711  145 x 67 x 18mm
836  156 x 75 x 19mm	883  107 x 68 x 18mm	1112  118 x 69 x 16mm	1114  156 x 74 x 20mm
1117  145 x 55 x 20mm	1230  87 x 53 x 17mm	1324  156 x 74 x 20mm	1329  146 x 54 x 19mm
1330  156 x 74 x 20mm	1351  118 x 69 x 19mm	1483  156 x 74 x 20mm Plain pad profile as here Wear lead pads profile as here	2689/2  156 x 63 x 17mm
21012  76 x 90 x 18mm	21013  97 x 65 x 16mm	21014  131 x 70 x 16mm	
21328  63 x 75 x 18mm	21328  77 x 74 x 18mm	21348  63 x 75 x 18mm	21348  77 x 74 x 18mm
			21510  155 x 73 x 20mm

Standard Quality - ECE R90 Approved with similar performance to original equipment brake pads.
Upgrade Quality (Tuning / Sportbeläge) - ECE R90 Approved but with higher friction and improved performance for faster street use.

Standard Qualität - mit ECE R90 Freigabe und ähnlicher Bremsleistung wie die Original Bremsbeläge.
Verbesserte Qualität - mit ECE R90 Freigabe aber mit höherem Reibwert und verbesserter Bremsleistung für den schnellen Strasseninsatz.

Calidad Estándar - Aprobación CEE R90 con prestaciones similares a las pastillas originales.
Calidad Mejorada - Aprobación CEE R90 pero con un coeficiente de fricción más elevado y prestaciones mejoradas para un uso deportivo en carretera.

BRAKE PADS & SHOES - APPLICATIONS

Bremsbeläge / Plaquettes + Bremsbacken / Machoires

EBC

BRAKES

Make/Model/Engine	Year	Pads	Front / Vorn / Avant	Shoes	Pads	Rear / Hinten / Arrière	Shoes
Hersteller/Modell/Motor	Jahr	Plaquettes / Bremsbeläge		Bremsbacken Machoirs	Plaquettes / Bremsbeläge		Bremsbacken Machoirs
Modelos	Années	Original Quality ECE R90* Approved	Upgrade Quality Tuning/Sportbeläge ECE R90* Approved	Original Quality ECE R90* Approved	Upgrade Quality Tuning/Sportbeläge ECE R90* Approved	Original Quality ECE R90* Approved	Upgrade Quality Tuning/Sportbeläge ECE R90* Approved

Pad Illustrations for Audi Contd.

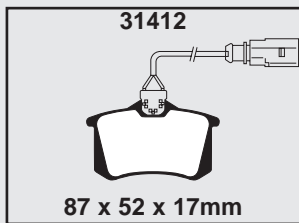
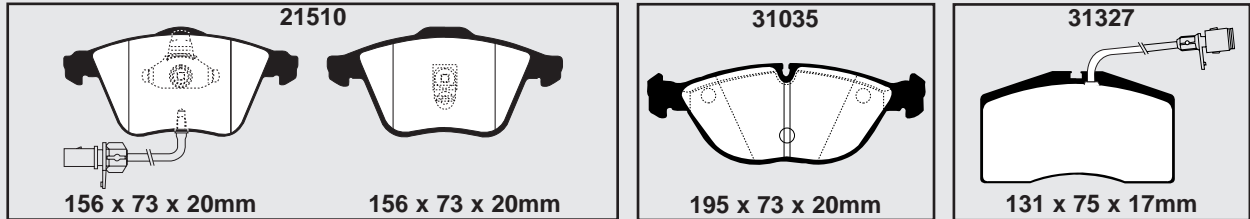

Audi / VW Wear sensor plug designs

A062

DP 2836
DP 21012
DP 21328



A076

DP 21114
DP 21348
DP 21351
DP 21483



A700

DP 21329
DP 21330



AUDI (AUSTRALIA)

Allroad

2.7 Twin Turbo

2003-

DP 21510

DP 31510

DP 2680

DP 3680

Pad Illustrations for Audi (Australia)

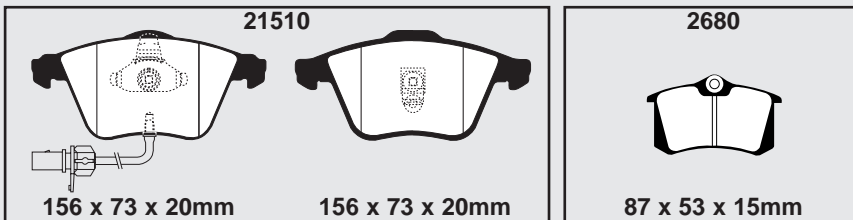

AUTOBIANCHI

A111

1.4

69-73

DP 116

DP 2116

DP 130

A112

0.9

81-84

DP 410

5031

1.0

80-84

DP 410

5031

Primula

1.2

64-71

DP 116

DP 2116

DP 130

Y10

1.0

85-93

DP 485

5031

1.1

89-96

DP 485

5031

1.1

89-96

DP 420/2

5031

1.3

87-93

DP 420/2

5031

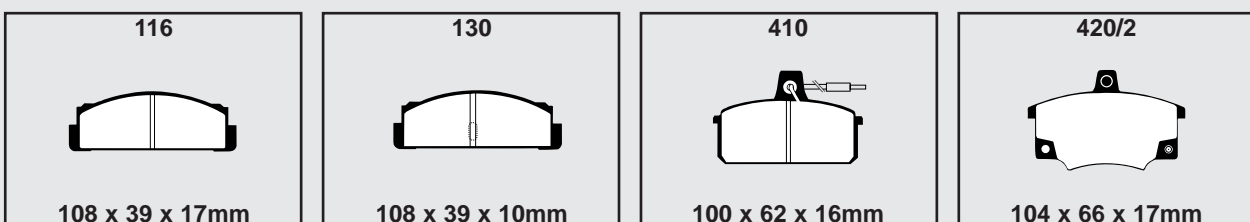

Pad Illustrations for Autobianchi



*Every EBC pad and shoe requiring ECE R-90 is available with approval subject to stock rotation - check box end label.
Models listed by Engine Size. Only listed by trim level where pads differ, (16v, GL, GT, etc).

Standard Quality - ECE R90 Approved with similar performance to original equipment brake pads.
Upgrade Quality (Training / Sportbeläge) - ECE R90 Approved but with higher friction and improved performance for faster street use.
Verbesserte Qualität - mit ECE R90 Freigabe aber mit höherem Reibwert und verbesserter Bremsleistung für den schnellen Strasseninsatz.

Qualité standard - Approuvée par la norme ECE R90 - Des performances équivalentes à l'origine.
Qualité améliorée - Approuvée par la norme ECE R90 - Un coefficient de friction supérieur et des performances accrues pour pilotage rapide sur route.
Calidad Mejorada - Aprobación CEE R90 pero con un coeficiente de fricción más elevado y prestaciones mejoradas para un uso deportivo en carretera.

Make/Model/Engine	Year	Pads	Front / Vorn / Avant	Shoes	Pads	Rear / Hinten / Arrière	Shoes
Hersteller/Modell/Motor	Jahr	Plaquettes / Bremsbeläge		Bremsbacken Machoires	Plaquettes / Bremsbeläge		Bremsbacken Machoires
Modelos	Années	Original Quality ECE R90* Approved	Upgrade Quality Tuning/Sportbeläge ECE R90* Approved		Original Quality ECE R90* Approved	Upgrade Quality Tuning/Sportbeläge ECE R90* Approved	

Pad Illustrations for Autobianchi Contd.

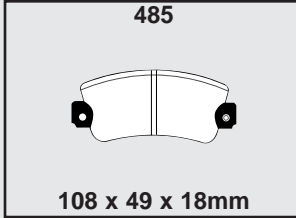









BMW							
507	56-59	DP 120	DP 2120				
700	60-65	DP 120	DP 2120				
1500							
1.5	66-72	DP 104	DP 2104				5094
1502							
1.6	72-77	DP 104	DP 2104				5094
1600							
1.6	69-71	DP 126	DP 2126				5094
1.6	69-73	DP 126	DP 2126				5126
1602							
1.6	67-69	DP 104	DP 2104				5126
1.6	69-75	DP 126	DP 2126				5126
1800							
1.8	66-72	DP 126	DP 2126				5092
1.8	71-75	DP 126	DP 2126				5094
1802							
1.8	69-75	DP 126	DP 2126				5094
2000							
2.0	66-69	DP 103	DP 2103				
2.0	69-71	DP 125	DP 2753				5092
2.0	69-73	DP 126	DP 2126				5094
2002							
2.0 Ti/Tii	69-75	DP 126	DP 2126				5094
2.0	70-75	DP 126	DP 2126				5094
2.0 Turbo	73-75	DP 125	DP 2753		DP 105	DP 2105	
2500							
2.5	69-77	DP 125	DP 2753		DP 105	DP 2105	
Handbrake shoes	69-77						5124
2600							
2.6	61-66	DP 120	DP 2120				
2800							
2.8	70-76	DP 125	DP 2753		DP 105	DP 2105	
2.8	76-77	DP 282/2	DP 2753		DP 105	DP 2105	
Handbrake shoes							5124
3.0							
3.0	71-76	DP 125	DP 2753		DP 105	DP 2105	
3.0	76-77	DP 282/2	DP 2753		DP 105	DP 2105	
Handbrake shoes	71-77						5124

BRAKE PADS & SHOES - APPLICATIONS

Bremsbeläge / Plaquettes + Bremsbacken / Machoires

EBC









BRAKES

Make/Model/Engine Hersteller/Modell/Motor Modèles	Year Jahr Années	Pads  Front / Vorn / Avant		Shoes	Pads  Rear / Hinten / Arrière		Shoes
		Plaquettes / Bremsbeläge		Bremsbacken Machoires	Plaquettes / Bremsbeläge		Bremsbacken Machoires
		Original Quality ECE R90* Approved 	Upgrade Quality Tuning/Sportbeläge ECE R90* Approved 	 ECE R90* Approved	Original Quality ECE R90* Approved 	Upgrade Quality Tuning/Sportbeläge ECE R90* Approved 	 ECE R90* Approved
BMW Contd.							
3200							
3.2	60-66	DP 120	DP 2120				
3.3							
3.3	71-76	DP 125	DP 2753		DP 105	DP 2105	
3.3	76-77	DP 282/2	DP 2753		DP 105	DP 2105	
Handbrake shoes	71-77						5124
316							
1.6 (E21)	75-78	DP 197	DP 2197				5092
1.6 (E21)	79-82	DP 341	DP 2197				5092
1.6 (E30)	82-90	DP 779 (G)	DP 2779 (G)		DP 447	DP 2447	6338
1.6 (E36)	91-99	DP 914 (T)	DP 2914 (T)		DP 1079	DP 21079	6497
1.6 Est (E30)	91-93	DP 779 (G)	DP 2779 (G)		DP 447	DP 2447	
1.8 (E21)	80-83	DP 341	DP 2197				5092
1.8 (E30)	83-88	DP 779 (G)	DP 2779 (G)		DP 447	DP 2447	
1.8 (E46)	2001-	DP 1211	DP 21211		DP 1289	DP 21289	
1.9 (E46)	99-2001	DP 1211	DP 21211		DP 1289	DP 21289	
Handbrake shoes	82-93						5124
Handbrake shoes	92-99						6544
Handbrake shoes (E46)	98-						6579
318							
1.8 (E21)	75-78	DP 197	DP 2197				5092
1.8 (E21)	79-82	DP 341	DP 2197				5092
1.8 (E30) inc. Estate	82-93	DP 779 (G)	DP 2779 (G)		DP 447	DP 2447	6338
1.8 (E36)	91-98	DP 914 (T)	DP 2914 (T)		DP 1079	DP 21079	6497
1.9 16v (E36)	94-99	DP 914 (T)	DP 2914 (T)		DP 1079	DP 21079	
1.9 (E46)	98-99	DP 914 (T)	DP 2914 (T)		DP 1289	DP 21289	
1.9 (E46)	99-2001	DP 1211	DP 21211		DP 1289	DP 21289	
2.0 (E46)	2001-	DP 1211	DP 21211		DP 1289	DP 21289	
1.7 TD (E36)	95-98	DP 914 (T)	DP 2914 (T)		DP 1079	DP 21079	6497
Handbrake shoes	82-91						5124
Handbrake shoes	91-99						6544
Handbrake shoes (E46)	98-						6579
320							
2.0 (E21)	75-78	DP 197	DP 2197				5092
2.0 (E21)	79-82	DP 341	DP 2197				5092
2.0 (E30)	82-90	DP 779 (G)	DP 2779 (G)		DP 447	DP 2447	6338
2.0 Est (E30)	88-93	DP 779 (G)	DP 2779 (G)		DP 447	DP 2447	
2.0 (E36)	91-98	DP 914 (T)	DP 2914 (T)		DP 1079	DP 21079	
2.2 (E46)	2000-	DP 1211	DP 21211		DP 1289	DP 21289	
2.0 TD (E46)	99-2002	DP 914 (T)	DP 2914 (T)		DP 1289	DP 21289	
Handbrake shoes	82-93						5124
Handbrake shoes	92-98						6544
Handbrake shoes (E46)	98-						6579
323							
2.3 (E21)	78-79	DP 197	DP 2197		DP 342		
2.3 (E21)	79-82	DP 341	DP 2197		DP 342		
2.3 (E30)	82-85	DP 779 (G)	DP 2779 (G)		DP 447	DP 2447	
2.5 (E36)	95-98	DP 914 (T)	DP 2914 (T)		DP 1079	DP 21079	
2.5 (E46)	98-	DP 1211	DP 21211		DP 1289	DP 21289	
Handbrake shoes	78-85						5124
Handbrake shoes	95-98						6544
Handbrake shoes (E46)	98-						6579

Standard Quality - ECE R90 Approved with similar performance to original equipment brake pads.
 Upgrade Quality (Tuning/ Sportbeläge) - ECE R90 Approved but with higher friction and improved performance for faster street use.
 Verbesserte Qualität - mit ECE R90 Freigabe aber mit höherem Reibwert und verbesserter Bremsleistung für den schnellen Strasseninsatz.

Qualité standard - Approuvée par la norme ECE R90 - Des performances équivalentes à l'origine.
 Qualité améliorée - Approuvée par la norme ECE R90 - Un coefficient de friction supérieur et des performances accrues pour pilotage rapide sur route.
 Calidad Mejorada - Aprobación CEE R90 con prestaciones similares a las pastillas originales.
 Calidad Mejorada - Aprobación CEE R90 pero con un coeficiente de fricción más elevado y prestaciones mejoradas para un uso deportivo en carretera.

*Every EBC pad and shoe requiring ECE R-90 is available with approval subject to stock rotation - check box end label.
 Models listed by Engine Size. Only listed by trim level where pads differ, (16v, GL, GT, etc).

Make/Model/Engine Hersteller/Modell/Motor Modelos	Year Jahr Années	Pads  Front / Vorn / Avant		Shoes	Pads  Rear / Hinten / Arrière		Shoes
		Original Quality ECE R90* Approved 	Upgrade Quality Tuning/Sportbeläge ECE R90* Approved 	Bremsbacken Machoires 	Original Quality ECE R90* Approved 	Upgrade Quality Tuning/Sportbeläge ECE R90* Approved 	Bremsbacken Machoires 
BMW Contd.							
325							
2.5 (E30) inc. Estate	87-93	DP 779 (G)	DP 2779 (G)		DP 447	DP 2447	
2.5 (E36)	90-98	DP 914 (T)	DP 2914 (T)		DP 1079	DP 21079	
2.5 (E46)	2000-	DP 1211	DP 21211		DP 1289	DP 21289	
2.7 (E30)	85-87	DP 779 (G)	DP 2779 (G)		DP 447	DP 2447	
2.5 TD (E36)	93-98	DP 914 (T)	DP 2914 (T)		DP 1079	DP 21079	
Handbrake shoes	85-92						5124
Handbrake shoes	92-98						6544
Handbrake shoes	2000-						6579
328							
2.8 (E36)	95-98	DP 914	DP 2914		DP 1079	DP 21079	
2.8 (E46)	98-2000	DP 1211	DP 21211		DP 1289	DP 21289	
Handbrake shoes	95-98						6544
Handbrake shoes(E46)	98-2000						6579
330							
3.0	2000-	DP 21089	DP 31089		DP 21118	DP 31118	
2.9 D	2000-	DP 21089	DP 31089		DP 21118	DP 31118	
Handbrake shoes	2000-						6545
518							
1.8 (E12)	74-76	DP 125	DP 2753				5092
1.8 (E12)	76-79	DP 125/2	DP 2753				5092
1.8 (E12)	79-81	DP 282/2	DP 2753				5092
1.8 (E28)	81-87	DP 414	DP 2414		DP 447	DP 2447	5004
1.8 (E34)	88-96	DP 689	DP 2689		DP 690	DP 2690	5004
Handbrake shoes	81-96						6409
520							
2.0 (E12)	72-76	DP 125	DP 2753				5092
2.0 (E12)	76-79	DP 125/2	DP 2753				5092
2.0 (E12)	79-81	DP 282/2	DP 2753				5092
2.0 (E28)	81-87	DP 414	DP 2414		DP 447	DP 2447	5004
2.0 (E34)	88-96	DP 689	DP 2689		DP 690	DP 2690	5004
2.0 (E39)	96-	DP 1089	DP 21089		DP 1091	DP 21091	5004
2.2	2000-	DP 1089	DP 21089		DP 1091	DP 21091	5004
Handbrake shoes	81-96						6409
Handbrake shoes	96-						6545
523							
2.5 (E39)	96-	DP 1089	DP 21089		DP 1091	DP 21091	5004
Handbrake shoes	96-						6545
525							
2.5 (E12)	73-76	DP 125	DP 2753		DP 105	DP 2105	
2.5 (E12)	77-78	DP 125/2	DP 2753		DP 105	DP 2105	
2.5 (E12)	79-81	DP 282/2	DP 2753		DP 283		
2.5 (E28)	81-88	DP 414	DP 2414		DP 447	DP 2447	
2.5 (E34)	88-96	DP 689	DP 2689		DP 690	DP 2690	
2.5	2000-	DP 1089	DP 21089		DP 1091	DP 21091	
2.7 (E34)	87-88	DP 414	DP 2414		DP 447	DP 2447	
2.5 TD (E34)	93-96	DP 689	DP 2689		DP 690	DP 2690	
2.5 TD (E39)	96-	DP 1089	DP 21089		DP 1091	DP 21091	
Handbrake shoes	73-81						5124
Handbrake shoes	81-96						6409
Handbrake shoes	96-						6545

Standard Quality - ECE R90 Approved with similar performance to original equipment brake pads.
Upgrade Quality (Tuning / Sportbeläge) - ECE R90 Approved but with higher friction and improved performance for faster street use.

Standard Qualität - mit ECE R90 Freigabe und ähnlicher Bremsleistung wie die Original Bremsbeläge.
Verbesserte Qualität - mit ECE R90 Freigabe aber mit höherem Reibwert und verbesserter Bremsleistung für den schnellen Strasseninsatz.

Calidad Estándar - Aprobación CEE R90 con prestaciones similares a las pastillas originales.
Calidad Mejorada - Aprobación CEE R90 pero con un coeficiente de fricción más elevado y prestaciones mejoradas para un uso deportivo en carretera.

*Every EBC pad and shoe requiring ECE R-90 is available with approval subject to stock rotation - check box end label.









Models listed by Engine Size. Only listed by trim level where pads differ, (16v, GL, GT, etc).

BRAKE PADS & SHOES - APPLICATIONS

Bremsbeläge / Plaquettes + Bremsbacken / Machoires

EBC

BRAKES









Make/Model/Engine Hersteller/Modell/Motor Modèles	Year Jahr Années	Pads  Front / Vorn / Avant		Shoes	Pads  Rear / Hinten / Arrière		Shoes
		Original Quality ECE R90* Approved 	Upgrade Quality Tuning/Sportbeläge ECE R90* Approved 	Bremsbacken Machoires 	Original Quality ECE R90* Approved 	Upgrade Quality Tuning/Sportbeläge ECE R90* Approved 	Bremsbacken Machoires 
BMW Contd.							
528							
2.8 (E12)	73-76	DP 125	DP 2753		DP 105	DP 2105	
2.8 (E12)	77-78	DP 125/2	DP 2753		DP 105	DP 2105	
2.8 (E12)	79-81	DP 282/2	DP 2753		DP 283		
2.8 (E28)	81-88	DP 414	DP 2414		DP 447	DP 2447	
2.8 (E34)	88-96	DP 689	DP 2689		DP 690	DP 2690	
2.8 (E39)	96-	DP 1089	DP 21089		DP 1091	DP 21091	
Handbrake shoes	73-81						5124
Handbrake shoes	81-96						6409
Handbrake shoes	96-						6545
530							
3.0 (E34)	88-96	DP 689	DP 2689		DP 690	DP 2690	
3.0 (E39)	96-2000	DP 1089	DP 21089		DP 1091	DP 21091	
3.0	2001-	DP 1036	DP 21036		DP 1091	DP 21091	
2.9 D	98-2000	DP 1089	DP 21089		DP 1091	DP 21091	
2.9 D	2001-	DP 1036	DP 21036		DP 1091	DP 21091	
Handbrake shoes	88-96						6409
Handbrake shoes	96-						6545
535							
3.5 (E12)	79-81	DP 282	DP 2753		DP 283		
3.5 (E28)	81-88	DP 414	DP 2414		DP 447	DP 2447	
3.5 (E34)	88-96	DP 2689	DP 3689		DP 2690	DP 3690	
3.5 (E39)	96-98	DP 21089	DP 31089		DP 21091	DP 31091	
3.5 (E39)	98-	DP 21036	DP 31036		DP 21091	DP 31091	
Handbrake shoes	81-96						6409
Handbrake shoes	96-						6545
540							
4.0 (E34)	92-96	DP 2689	DP 3689		DP 2690	DP 3690	
4.4 (E39)	96-	DP 21036	DP 31036		DP 21091	DP 31091	
Handbrake shoes	92-96						6409
Handbrake shoes	96-						6545
628							
2.8 (E24)	76-82	DP 2753	DP 3753		DP 283		
2.8 (E24)	82-88	DP 2414	DP 3414		DP 2447	DP 3447	
Handbrake shoes	76-82						5124
Handbrake shoes	82-88						6409
630							
3.0 (E24)	76-76	DP 2753	DP 3753		DP 283		
3.0 (E24)	76-79	DP 2753	DP 3753		DP 283		
Handbrake shoes	76-79						5124
633							
3.3 (E24)	76-76	DP 2753	DP 3753		DP 283		
3.3 (E24)	76-82	DP 2753	DP 3753		DP 283		
Handbrake shoes	76-82						5124
635							
3.5 (E24)	76-82	DP 2753	DP 3753		DP 283		
3.5 (E24)	82-90	DP 2414	DP 3414		DP 2447	DP 3447	
Handbrake shoes	76-82						5124
Handbrake shoes	82-90						6409
725							
2.5 TD (E38)	96-	DP 1032	DP 21032		DP 1118	DP 21118	
Handbrake shoes	96-						6409

Standard Quality - ECE R90 Approved with similar performance to original equipment brake pads.
 Upgrade Quality (Tuning/ Sportbeläge) - ECE R90 Approved but with higher friction and improved performance for faster street use.
 Verbesserte Qualität - mit ECE R90 Freigabe aber mit höherem Reibwert und verbesserter Bremsleistung für den schnellen Strasseninsatz.

Standard Qualität - mit ECE R90 Freigabe und ähnlicher Bremsleistung wie die Original Bremsbeläge.
 Upgrade Qualität (Tuning/ Sportbeläge) - ECE R90 Approved but with higher friction and improved performance for faster street use.
 Verbesserte Qualität - mit ECE R90 Freigabe aber mit höherem Reibwert und verbesserter Bremsleistung für den schnellen Strasseninsatz.

Qualité standard - Approuvée par la norme ECE R90 - Des performances équivalentes à l'origine.
 Qualité améliorée - Approuvée par la norme ECE R90 - Un coefficient de friction supérieur et des performances accrues pour pilotage rapide sur route.
 Calidad Mejorada - Aprobación CEE R90 con prestaciones similares a las pastillas originales.
 Calidad Mejorada - Aprobación CEE R90 pero con un coeficiente de fricción más elevado y prestaciones mejoradas para un uso deportivo en carretera.

*Every EBC pad and shoe requiring ECE R-90 is available with approval subject to stock rotation - check box end label.
 Models listed by Engine Size. Only listed by trim level where pads differ, (16v, GL, GT, etc).

Make/Model/Engine Hersteller/Modell/Motor Modelos	Year Jahr Années	Pads  Front / Vorn / Avant		Shoes	Pads  Rear / Hinten / Arrière		Shoes
		Plaquettes / Bremsbeläge Original Quality ECE R90* Approved 		Bremsbacken Machoires  ECE R90* Approved	Plaquettes / Bremsbeläge Original Quality ECE R90* Approved 		Bremsbacken Machoires  ECE R90* Approved
		Upgrade Quality Tuning/Sportbeläge ECE R90* Approved 			Upgrade Quality Tuning/Sportbeläge ECE R90* Approved 		
BMW Contd.							
728							
2.8 (E23)	77-78	DP 125/2	DP 2753		DP 104	DP 2104	
2.8 (E23)	77-82	DP 282/2	DP 2753		DP 311	DP 2104	
2.8 (E23)	82-86	DP 282/2	DP 2753		DP 447	DP 2447	
2.8 (E32)	87-94	DP 689	DP 2689		DP 690	DP 2690	
2.8 (E38)	95-	DP 1032	DP 21032		DP 1118	DP 21118	
Handbrake shoes	77-81						5124
Handbrake shoes	82-						6409
730							
3.0 (E23)	76-79	DP 282/2	DP 2753		DP 311	DP 2104	
3.0 (E32)	87-93	DP 689	DP 2689		DP 690	DP 2690	
3.0 (E38)	94-2002	DP 1032	DP 21032		DP 1118	DP 21118	
3.0	2003-	DP 21449	DP 31449		DP 21450	DP 31450	
3.0 D (E38)	98-2002	DP 1032	DP 21032		DP 1118	DP 21118	
3.0 D	2003-	DP 21449	DP 31449		DP 21450	DP 31450	
Handbrake shoes	76-79						5124
Handbrake shoes	87-						6409
732							
3.2 (E23)	79-82	DP 282/2	DP 2753		DP 311	DP 2104	
3.2 (E32)	87-93	DP 689	DP 2689		DP 690	DP 2690	
Handbrake shoes	79-82						5124
Handbrake shoes	87-93						6409
733							
3.3 (E23)	76-82	DP 282/2	DP 2753		DP 311	DP 2104	
Handbrake shoes	76-82						5124
735							
3.5 (E23)	79-81	DP 2753	DP 3753		DP 2104	DP 3104	
3.5 (E23)	81-86	DP 2753	DP 3753		DP 2447	DP 3447	
3.5 (E32)	87-93	DP 2689	DP 3689		DP 2690	DP 3690	
3.5 (E38)	96-2002	DP 21032	DP 31032		DP 21118	DP 31118	
3.6 (E65)	2002-	DP 21449	DP 31449		DP 21450	DP 31450	
Handbrake shoes	79-81						5124
Handbrake shoes	81-2002						6409
Handbrake shoes	2002-						6601
740							
4.0 (E32)	92-94	DP 2689	DP 3689		DP 2690	DP 3690	
4.0 (E38)	94-96	DP 21036	DP 31036		DP 21118	DP 31118	
4.4 (E38)	96-2001	DP 21036	DP 31036		DP 21118	DP 31118	
Handbrake shoes	92-2001						6409
745							
4.4 (E65)	2002-	DP 21449	DP 31449		DP 21451	DP 31451	
4.5 (E23)	80-81	DP 2753	DP 3753		DP 2104	DP 3104	
4.5 (E23)	81-86	DP 2753	DP 3753		DP 2447	DP 3447	
Handbrake shoes	80-81						5124
Handbrake shoes	81-86						6409
Handbrake shoes	2002-						6601
750							
5.0 (E32)	87-91	DP 2689	DP 3689		DP 2690	DP 3690	
5.0 (E32)	91-94	DP 2886	DP 3886		DP 2690	DP 3690	
5.4 (E38)	94-2001	DP 21035	DP 31035		DP 21118	DP 31118	
Handbrake shoes	87-2001						6409
760							
6.0	2003-	DP 21482	DP 31482		DP 21451	DP 31451	

Standard Quality - ECE R90 Approved with similar performance to original equipment brake pads.
Upgrade Quality (Tuning / Sportbeläge) - ECE R90 Approved but with higher friction and improved performance for faster street use.

Standard Qualität - mit ECE R90 Freigabe und ähnlicher Bremsleistung wie die Original Bremsbeläge.
Verbesserte Qualität - mit ECE R90 Freigabe aber mit höherem Reibwert und verbesserter Bremsleistung für den schnellen Strasseninsatz.

Qualité standard - Approuvée par la norme ECE R90 - Des performances équivalentes à l'origine.
Qualité améliorée - Approuvée par la norme ECE R90 - Un coefficient de friction supérieur et des performances accrues pour pilotage rapide sur route.

Calidad Estándar - Aprobación CEE R90 con prestaciones similares a las pastillas originales.
Calidad Mejorada - Aprobación CEE R90 pero con un coeficiente de fricción más elevado y prestaciones mejoradas para un uso deportivo en carretera.

*Every EBC pad and shoe requiring ECE R-90 is available with approval subject to stock rotation - check box end label.









Models listed by Engine Size. Only listed by trim level where pads differ, (16v, GL, GT, etc).

BRAKE PADS & SHOES - APPLICATIONS

Bremsbeläge / Plaquettes + Bremsbacken / Machoires

EBC



BRAKES

Make/Model/Engine Hersteller/Modell/Motor Modèles	Year Jahr Années	Pads  Front / Vorn / Avant		Shoes	Pads  Rear / Hinten / Arrière		Shoes
		Original Quality ECE R90* Approved 	Upgrade Quality Tuning/Sportbeläge ECE R90* Approved 	Bremsbacken Machoires 	Original Quality ECE R90* Approved 	Upgrade Quality Tuning/Sportbeläge ECE R90* Approved 	Bremsbacken Machoires 
BMW Contd.							
840							
4.0 (E31)	93-94	DP 870	DP 3870		DP 871	DP 3871	
4.0 (E31)	94-97	DP 21032	DP 31032		DP 2871	DP 3871	
4.4 (E31)	97-99	DP 21032	DP 31032		DP 2871	DP 3871	
Handbrake shoes	93-99						6409
850							
5.0 (E31)	91-94	DP 870	DP 3870		DP 871	DP 3871	
5.0 (E31)	93-94	DP 2886	DP 3886		DP 2871	DP 3871	
5.6 (E31)	93-94	DP 2886	DP 3886		DP 2871	DP 3871	
5.6 (E31)	94-96	DP 21032	DP 31032		DP 2871	DP 3871	
Handbrake shoes	91-96						6409
M1							
3.5	78-82	DP 2753	DP 3753		DP 2104	DP 3104	
M3							
2.3 (E30)	87-91	DP 2414	DP 3414		DP 2690	DP 3690	
2.5 (E30)	90-91	DP 2414	DP 3414		DP 2690	DP 3690	
3.0 (E36)	92-96	DP 2689	DP 3689		DP 2690	DP 3690	
3.2 (E36)	96-2000	DP 2689	DP 3689		DP 2690	DP 3690	
3.2 (E46)	2000-	DP 2689	DP 3689		DP 21118	DP 31118	
Handbrake shoes	87-91						5124
Handbrake shoes	92-2000						6409
Handbrake shoes	2000-						6601
M5							
3.5 (E28)	85-87	DP 2753	DP 3753		DP 2447	DP 3447	
3.5 (E34)	88-92	DP 2689	DP 3689		DP 2690	DP 3690	
3.8 (E34)	92-94	DP 2689	DP 3689		DP 2690	DP 3690	
3.8 (E34)	94-95	DP 2886	DP 3886		DP 2871	DP 3871	
3.8 (E34)	94-98	DP 21032	DP 31032		DP 2871	DP 3871	
4.9 (E39)	99-	DP 21036	DP 31036		DP 21118	DP 31118	
Handbrake shoes	85-98						6409
Handbrake shoes	99-						6601
M6							
3.5	85-89	DP 2753	DP 3753		DP 2447	DP 3447	
Handbrake shoes	85-89						6409
Mini							
1.6	2001-	DP 1388	DP 21388		DP 1389	DP 21389	
1.4 TD	2003-						
M-Roadster / Coupe							
3.2	98-	DP 2689	DP 3689		DP 2690	DP 3690	
Handbrake shoes	98-						6409
X5							
3.0	2000-	DP 1036	DP 61036		DP 1118	DP 21118	
4.4	2000-	DP 1036	DP 61036		DP 1118	DP 21118	
4.6	2002-	DP 1472	DP 61472		DP 1118	DP 21118	
2.9 D	2001-	DP 1036	DP 61036		DP 1118	DP 21118	
Handbrake shoes	2000-						6601
Z1							
2.5	88-92	DP 779	DP 2779		DP 447	DP 2447	
Handbrake shoes	88-90						5124
Handbrake shoes	90-92						6544

Standard Quality - ECE R90 Approved with similar performance to original equipment brake pads.
 Upgrade Quality (Tuning/ Sportbeläge) - ECE R90 Approved but with higher friction and improved performance for faster street use.
 Verbesserte Qualität - mit ECE R90 Freigabe aber mit höherem Reibwert und verbesserter Bremsleistung für den schnellen Strasseninsatz.

Qualité standard - Approuvée par la norme ECE R90 - Des performances équivalentes à l'origine.
 Qualité améliorée - Approuvée par la norme ECE R90 - Un coefficient de friction supérieur et des performances accrues pour pilotage rapide sur route.
 Calidad Mejorada - Aprobación CEE R90 con prestaciones similares a las pastillas originales.
 Calidad Mejorada - Aprobación CEE R90 pero con un coeficiente de fricción más elevado y prestaciones mejoradas para un uso deportivo en carretera.

*Every EBC pad and shoe requiring ECE R-90 is available with approval subject to stock rotation - check box end label.
 Models listed by Engine Size. Only listed by trim level where pads differ, (16v, GL, GT, etc).

Make/Model/Engine Hersteller/Modell/Motor Modelos	Year Jahr Années	Pads  Front / Vorn / Avant		Shoes	Pads  Rear / Hinten / Arrière		Shoes
		Original Quality ECE R90* Approved	Upgrade Quality Tuning/Sportbeläge ECE R90* Approved	Bremsbacken Machoires ECE R90* Approved	Original Quality ECE R90* Approved	Upgrade Quality Tuning/Sportbeläge ECE R90* Approved	Bremsbacken Machoires ECE R90* Approved
BMW Contd.							
Z3							
1.9	97-	DP 914	DP 2914		DP 1289	DP 21289	
2.0	99-2000	DP 1211	DP 21211		DP 1289	DP 21289	
2.2	2000-	DP 1211	DP 21211		DP 1289	DP 21289	
2.8	97-98	DP 2914	DP 3914		DP 21289	DP 31289	
2.8	98-2000	DP 21211	DP 31211		DP 21289	DP 31289	
3.0	2000-	DP 21211	DP 31211		DP 21289	DP 31289	
Handbrake shoes	97-						6544
Z4							
2.5	2003-	DP 1211	DP 21211		DP 1289	DP 21289	
3.0	2003-	DP 21211	DP 31211		DP 21289	DP 31289	
Handbrake Shoes 2.5	2003-						6544
Handbrake Shoes 3.0	2003-						6579
Z8							
5.0	2000-	DP 21035	DP 31035		DP 21118	DP 31118	
Handbrake Shoes	2000-						6409

Pad Illustrations for BMW

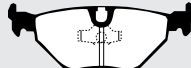
103  76 x 70 x 15mm	104  61 x 56 x 15mm	105  56 x 53 x 15mm	120  47 x 63 x 17mm
125  90 x 70 x 15mm	125/2  90 x 70 x 19mm	126  76 x 58 x 15mm	197  76 x 65 x 16mm
282  90 x 70 x 15mm	282/2  90 x 70 x 19mm	283  55 x 53 x 15mm	311  61 x 56 x 17
311/2  61 x 56 x 15mm	341  76 x 65 x 16mm	342  61 x 44 x 15mm	414  158 x 57 x 19mm
447  125 x 38 x 17mm	463/2 Use DP 779  95 x 51 x 17mm	689  2 Pads with Piston Clip 48mm Ø 156 x 63 x 19mm	690  123 x 44 x 17mm

BRAKE PADS & SHOES - APPLICATIONS











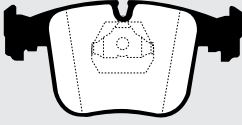
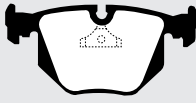
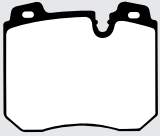
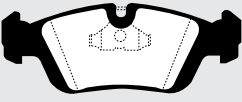
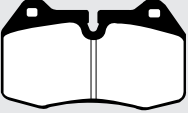
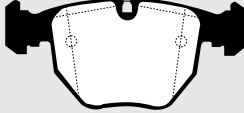

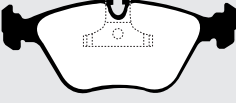

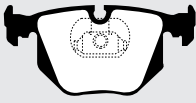
Bremsbeläge / Plaquettes + Bremsbacken / Machoires

EBC

BRAKES

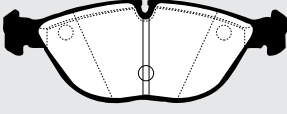
Make/Model/Engine	Year	Pads	Front / Vorn / Avant	Shoes	Pads	Rear / Hinten / Arrière	Shoes
Hersteller/Modell/Motor	Jahr	Plaquettes / Bremsbeläge		Bremsbacken	Plaquettes / Bremsbeläge		Bremsbacken
Modelos	Années	Original Quality ECE R90* Approved	Upgrade Quality Tuning/Sportbeläge ECE R90* Approved	Machoires ECE R90* Approved	Original Quality ECE R90* Approved	Upgrade Quality Tuning/Sportbeläge ECE R90* Approved	Machoires ECE R90* Approved

Pad Illustrations for BMW Contd.

779 Girling  95 x 51 x 17mm	870  156 x 74 x 19mm	871  123 x 59 x 17mm	886  100 x 83 x 18mm
914 ATE  151 x 57 x 16mm	1032  120 x 71 x 17mm	1036  156 x 73 x 18mm	1079  123 x 43 x 16mm
1089  2 Pads with Piston Clip 51mm Ø 156 x 64 x 20mm	1091  122 x 45 x 16mm	1118  123 x 58 x 17mm	1211  150 x 57 x 18mm
1289  123 x 45 x 17mm	1388  140 x 60 x 18mm	1389  123 x 43 x 16mm	
1472  193 x 82 x 20mm	1472  193 x 82 x 20mm	21035  195 x 73 x 20mm	21449  155 x 68 x 19mm
21450  123 x 58 x 17mm	21451  139 x 68 x 16mm	21482 Picture unavailable at time of press.	

BITTER					
CD					
5.4	73-79	DP 103	DP 2103	DP 104	DP 2104
SC					
3.0	81-88	DP 754		DP 104	
3.8	81-88	DP 754		DP 104	

*Every EBC pad and shoe requiring ECE R-90 is available with approval subject to stock rotation - check box end label. Models listed by Engine Size. Only listed by trim level where pads differ, (16v, GL, GT, etc).

Standard Quality - ECE R90 Approved with similar performance to original equipment brake pads.
 Upgrade Quality (Tuning/ Sportbeläge) - ECE R90 Approved but with higher friction and improved performance for faster street use.
 Standard Qualität - mit ECE R90 Freigabe und ähnlicher Bremsleistung wie die Original Bremsbeläge.
 Verbesserte Qualität - mit ECE R90 Freigabe aber mit höherem Reibwert und verbesserter Bremsleistung für den schnellen Strasseninsatz.
 Qualité standard - Approuvée par la norme ECE R90 - Des performances équivalentes à l'origine.
 Qualité améliorée - Approuvée par la norme ECE R90 - Un coefficient de friction supérieur et des performances accrues pour pilotage rapide sur route.
 Calidad Estándar - Aprobación CEE R90 con prestaciones similares a las pastillas originales.
 Calidad Mejorada - Aprobación CEE R90 pero con un coeficiente de fricción más elevado y prestaciones mejoradas para un uso deportivo en carretera.

Make/Model/Engine	Year	Pads	Front / Vorn / Avant	Shoes	Pads	Rear / Hinten / Arrière	Shoes
Hersteller/Modell/Motor	Jahr	Plaquettes / Bremsbeläge		Bremsbacken Machoires	Plaquettes / Bremsbeläge		Bremsbacken Machoires
Modelos	Années	Original Quality ECE R90* Approved	Upgrade Quality Tuning/Sportbeläge ECE R90* Approved	ECE R90* Approved	Original Quality ECE R90* Approved	Upgrade Quality Tuning/Sportbeläge ECE R90* Approved	ECE R90* Approved

Pad Illustrations for Bitter

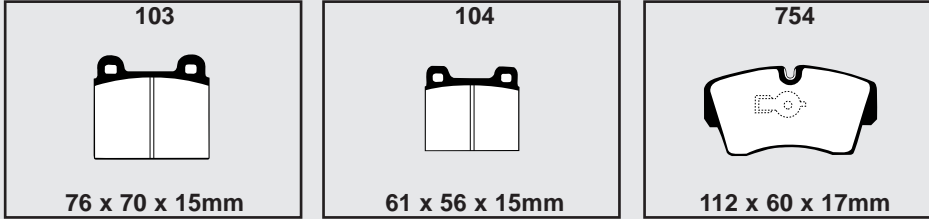

BOND					
875	65-75			5141	5142
Bug	70-75			5145B	5146
Equipe					
1.2	63-67	DP 142			5137
1.2	67-73	DP 142			5137
1.3	67-69	DP 142			5137
1.3	69-70	DP 114	DP 2114		5137
2.0	67-70	DP 101	DP 2101		5129

Pad Illustrations for Bond

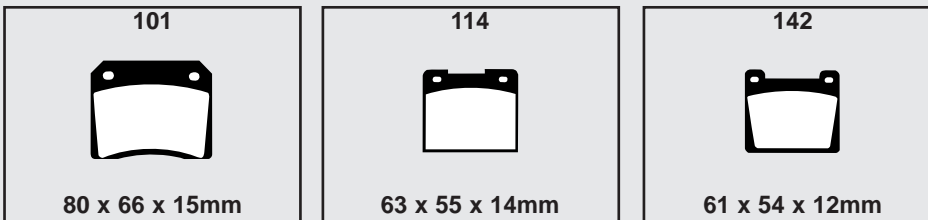

BRISTOL					
406	58-61	DP 120	DP 2120	DP 120	DP 2120
407	62-63	DP 120	DP 2120	DP 120	DP 2120
408	64-65	DP 120	DP 2120	DP 120	DP 2120
409	66-67	DP 108	DP 2108	DP 101	DP 2101
410	68-69	DP 108	DP 2108	DP 101	DP 2101
411					
6.3	70-76	DP 108	DP 2108	DP 101	DP 2101
6.5	70-76	DP 108	DP 2108	DP 101	DP 2101
412					
5.9	75-82	DP 108	DP 2108	DP 101	DP 2101
603					
5.9	78-83	DP 108	DP 2108	DP 101	DP 2101
Beaufighter					
5.9	80-83	DP 108	DP 2108	DP 101	DP 2101
5.9	83-97	DP 678		DP 101	DP 2101
Blenheim					
5.9	98-	-	DP 2108	-	DP 2458/3













*Every EBC pad and shoe requiring ECE R-90 is available with approval subject to stock rotation - check box end label.
Models listed by Engine Size. Only listed by trim level where pads differ, (16v, GL, GT, etc).

BRAKE PADS & SHOES - APPLICATIONS

Bremsbeläge / Plaquettes + Bremsbacken / Machoires

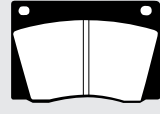
EBC

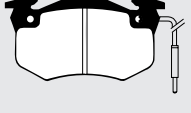
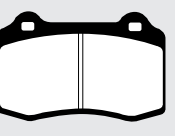







BRAKES

Make/Model/Engine Hersteller/Modell/Motor Modèles	Year Jahr Années	Pads  Front / Vorn / Avant		Shoes	Pads  Rear / Hinten / Arrière		Shoes
		Original Quality ECE R90* Approved 	Upgrade Quality Tuning/Sportbeläge ECE R90* Approved 	Bremsbacken Machoires 	Original Quality ECE R90* Approved 	Upgrade Quality Tuning/Sportbeläge ECE R90* Approved 	Bremsbacken Machoires 
BRISTOL Contd.							
Brigand 5.9	83-97	DP 678			DP 101		
Britannia 5.9	83-97	DP 678			DP 101		
Fighter 8.0	2002-						
Pad Illustrations for Bristol							
		 80 x 66 x 15mm	 98 x 68 x 16mm	 47 x 63 x 17mm	 142 x 60 x 18mm		
		 106 x 56 x 14mm					
BUGATTI							
EB110	91-95	-	DP 31031		-	DP 31031	
Pad Illustrations for Bugatti							
		 110 x 69 x 17mm					
CADILLAC							
Seville 4.6	99-	-	DP 21100		-	DP 21621	
Pad Illustrations for Cadillac							
		 148 x 63 x 18mm	 108 x 42 x 14mm				
CATERHAM							
JPE 2.0 3.9	92- 94-	- -	DP 2003 DP 2003		DP 102 DP 102	DP 2102 DP 2102	

Standard Quality - ECE R90 Approved with similar performance to original equipment brake pads.
Upgrade Quality (Tuning/ Sportbeläge) - ECE R90 Approved but with higher friction and improved performance for faster street use.
Verbesserte Qualität - mit ECE R90 Freigabe aber mit höherem Reibwert und verbesserter Bremsleistung für den schnellen Strasseninsatz.

Qualité standard - Approuvée par la norme ECE R90 - Des performances équivalentes à l'origine.
Qualité améliorée - Approuvée par la norme ECE R90 - Un coefficient de friction supérieur et des performances accrues pour pilotage rapide sur route.
Calidad Mejorada - Aprobación CEE R90 pero con un coeficiente de fricción mas elevado y prestaciones mejoradas para un uso deportivo en carretera.

*Every EBC pad and shoe requiring ECE R-90 is available with approval subject to stock rotation - check box end label.
Models listed by Engine Size. Only listed by trim level where pads differ, (16v, GL, GT, etc).

Make/Model/Engine	Year	Pads  Front / Vorn / Avant		Shoes	Pads  Rear / Hinten / Arrière		Shoes
Hersteller/Modell/Motor	Jahr	Plaquettes / Bremsbeläge		Bremsbacken Machoires	Plaquettes / Bremsbeläge		Bremsbacken Machoires
Modelos	Années	Original Quality ECE R90* Approved 	Upgrade Quality Tuning/Sportbeläge ECE R90* Approved 	 ECE R90* Approved	Original Quality ECE R90* Approved 	Upgrade Quality Tuning/Sportbeläge ECE R90* Approved 	 ECE R90* Approved
CATERHAM Contd.							
Seven							
1.4	94-	DP 114	DP 2114		DP 617	DP 2617	5132
1.6	74-81	DP 114	DP 2114				5133
1.6	81-94	DP 114	DP 2114				5132
1.6	94-	DP 114	DP 2114		DP 617	DP 2617	
1.7	86-	DP 114	DP 2114		DP 617	DP 2617	5132
1.8	98-	DP 114	DP 2114		DP 617	DP 2617	
C21							
1.6	94-	-	DP 2003		DP 102	DP 2102	
1.8	94-	-	DP 2003		DP 102	DP 2102	

Pad Illustrations for Caterham

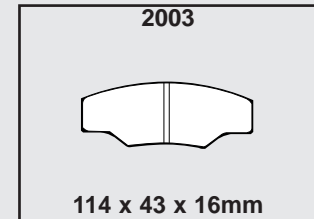
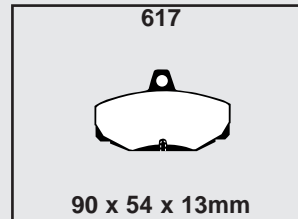
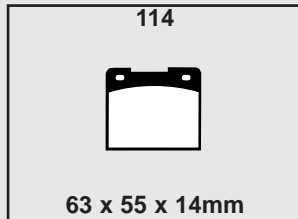
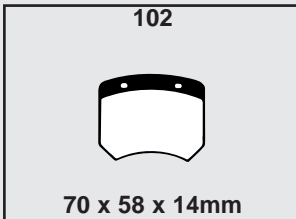

CHATENET

0.5	98-	DP 1342					
-----	-----	---------	--	--	--	--	--

Pad Illustrations for Chatenet

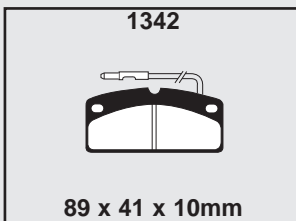

CHEVROLET

Camaro							
3.8	98-	DP 21239	DP 31239		DP 21323	DP 31323	
5.7	98-	DP 21239	DP 31239		DP 21323	DP 31323	
Blazer							
4.3	99-	-	DP 61256		-	DP 61602	
Corvette							
5.7	99-	DP 21162	DP 31162		DP 21160	DP 31160	
Tahoe							
5.3	2000-	-	DP 61304		-	DP 61635	

Pad Illustrations for Chevrolet

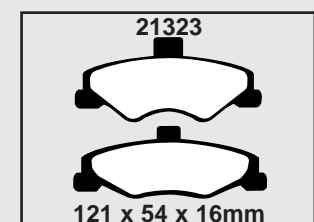
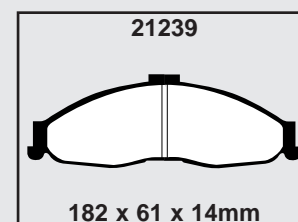
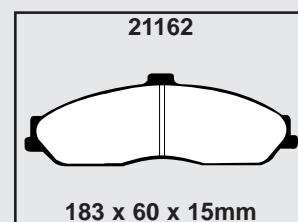
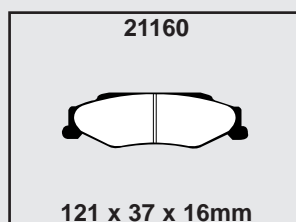

Qualité standard - Approuvée par la norme ECE R90 - Des performances équivalentes à l'origine.
Qualité améliorée - Approuvée par la norme ECE R90 - Un coefficient de friction supérieur et des performances accrues pour pilotage rapide sur route.

Calidad Estándar - Aprobación CEE R90 con prestaciones similares a las pastillas originales.
Calidad Mejorada - Aprobación CEE R90 pero con un coeficiente de fricción más elevado y prestaciones mejoradas para un uso deportivo en carretera.









Standard Quality - ECE R90 Approved with similar performance to original equipment brake pads.
Upgrade Quality (Tuning / Sportbeläge) - ECE R90 Approved but with higher friction and improved performance for faster street use.
Standard Qualität - mit ECE R90 Freigabe und ähnlicher Bremsleistung wie die Original Bremsbeläge.
Verbesserte Qualität - mit ECE R90 Freigabe aber mit höherem Reibwert und verbesserter Bremsleistung für den schnellen Strasseneinsatz.

BRAKE PADS & SHOES - APPLICATIONS

Bremsbeläge / Plaquettes + Bremsbacken / Machoires

EBC

BRAKES

Make/Model/Engine Hersteller/Modell/Motor Modèles	Year Jahr Années	Pads  Front / Vorn / Avant		Shoes	Pads  Rear / Hinten / Arrière		Shoes
		Original Quality ECE R90* Approved 	Upgrade Quality Tuning/Sportbeläge ECE R90* Approved 	Bremsbacken Machoires 	Original Quality ECE R90* Approved 	Upgrade Quality Tuning/Sportbeläge ECE R90* Approved 	Bremsbacken Machoires 
CHRYSLER (USA)							
Crossfire							
3.2	2003-						
Grand Voyager							
3.3	97-2000	DP 1065	DP 61065				6548
3.3 (LTD)	2001-	DP 1427	DP 61427		DP 1629	DP 61629	
3.3	2001-	DP 1613	DP 61613		DP 1629	DP 61629	
2.5 TD	98-2000	DP 1065	DP 61065				6548
2.5 TD	2001-	DP 1613	DP 61613		DP 1629	DP 61629	
2.5 TD	2001-	DP 1612	DP 61612		DP 1629	DP 61629	
Jeep Cherokee							
2.4	2001-	DP 1255	DP 61255				6510
2.5	85-93	DP 813					6509
2.5	93-96	DP 1022	DP 61022				6510
2.5	97-2001	DP 1255	DP 61255				6510
3.7	2001-	DP 1255	DP 61255				6510
4.0	85-93	DP 813					6509
4.0	93-96	DP 1022	DP 61022				6510
4.0	97-2001	DP 1255	DP 61255				6510
2.5 TD	95-96	DP 1022	DP 61022				6510
2.5 TD	97-	DP 1255	DP 61255				6510
Jeep Grand Cherokee							
4.0	96-99	DP 1255	DP 61255		DP 1130	DP 61130	
4.0	99-	DP 1312	DP 61312		DP 1606	DP 61606	
4.7	99-	DP 1312	DP 61312		DP 1606	DP 61606	
5.2	94-96	DP 1022	DP 61022		DP 1129	DP 61129	
5.2	96-99	DP 1255	DP 61255		DP 1130	DP 61130	
5.9	97-99	DP 1255	DP 61255		DP 1130	DP 61130	
2.7 TD	2001-	DP 1312	DP 61312		DP 1606	DP 61606	
3.1 TD	99-	DP 1312	DP 61312		DP 1606	DP 61606	
Jeep Wrangler							
2.5	93-96	DP 1022	DP 61022				6510
2.5	97-	DP 1255	DP 61255				6510
4.0	93-96	DP 1022	DP 61022				6510
4.0	97-	DP 1255	DP 61255				6510
Neon							
2.0 (5 Stud)	96-	DP 1065	DP 21065		DP 1066	DP 21066	
2.0 (4 Stud)	96-98	DP 1202			DP 1066		
PT Cruiser							
2.0	2000-	DP 1357	DP 21357		DP 1066	DP 21066	6592
2.2TD	2002-	DP 1357	DP 21357		DP 1066	DP 21066	
Voyager							
2.0	97-2000	DP 1065	DP 61065				6548
2.4	2001-	DP 1612	DP 61612		DP 1629	DP 61629	
2.5	97-98	DP 1065	DP 61065				6548
3.3	97-2000	DP 1065	DP 61065				6548
3.3	2001-	DP 1613	DP 61613		DP 1629	DP 61629	
2.5 TD	97-2000	DP 1065	DP 61065				6548
2.5 TD	2001-	DP 1613	DP 61613		DP 1629	DP 61629	
2.5 TD	2001-	DP 1612	DP 61612		DP 1629	DP 61629	
Sebring							
2.0	2001-	-	DP 21611		DP 1066	DP 21066	
2.7	2001-	-	DP 21611		DP 1066	DP 21066	

Standard Quality - ECE R90 Approved with similar performance to original equipment brake pads.
 Upgrade Quality (Tuning/ Sportbeläge) - ECE R90 Approved but with higher friction and improved performance for faster street use.
 Verbesserte Qualität - mit ECE R90 Freigabe aber mit höherem Reibwert und verbesserter Bremsleistung für den schnellen Strasseninsatz.

Qualité standard - Approuvée par la norme ECE R90 - Des performances équivalentes à l'origine.
 Qualité améliorée - Approuvée par la norme ECE R90 - Un coefficient de friction supérieur et des performances accrues pour pilotage rapide sur route.
 Calidad Mejorada - Aprobación CEE R90 con prestaciones similares a las pastillas originales.
 Calidad Mejorada - Aprobación CEE R90 pero con un coeficiente de fricción más elevado y prestaciones mejoradas para un uso deportivo en carretera.

*Every EBC pad and shoe requiring ECE R-90 is available with approval subject to stock rotation - check box end label.
 Models listed by Engine Size. Only listed by trim level where pads differ, (16v, GL, GT, etc).

Make/Model/Engine	Year	Pads	Front / Vorn / Avant	Shoes	Pads	Rear / Hinten / Arrière	Shoes
Hersteller/Modell/Motor	Jahr	Plaquettes / Bremsbeläge		Bremsbacken Machoires	Plaquettes / Bremsbeläge		Bremsbacken Machoires
Modelos	Années	Original Quality ECE R90* Approved		Upgrade Quality Tuning/Sportbeläge ECE R90* Approved		Original Quality ECE R90* Approved	Upgrade Quality Tuning/Sportbeläge ECE R90* Approved

Pad Illustrations for Chrysler (USA)

813 176 x 56 x 16mm	1022 177 x 55 x 17mm	1065 164 x 51 x 15mm	1066 133 x 39 x 16mm
1129 140 x 47 x 15mm	1130 140 x 48 x 15mm	1202 165 x 43 x 16mm	
1255 177 x 54 x 17mm		1312 193 x 54 x 18mm	1357 124 x 63 x 20mm
1427 172 x 69 x 6mm	1606 140 x 50 x 17mm	1612 146 x 59 x 17mm	1613 172 x 64 x 18mm
1629 156 x 50 x 16	21611 155 x 60 x 20mm		

CHRYSLER (UK) See Talbot				
CITROEN				
2CV				
0.4	55-63		5035	5036
0.5	63-73		5038	5036
0.6	63-73		5038	5036
0.6	74-81		5035	5036
0.6	81-84	DP 131		5036
0.6	84-90	DP 411		5036
Handbrake	81-90	DP 177		
Ami				
0.6	63-73		5038	5036
0.6	73-77	DP 190		5036
1.0	73-77	DP 190		5036

*Every EBC pad and shoe requiring ECE R-90 is available with approval subject to stock rotation - check box end label.

Models listed by Engine Size. Only listed by trim level where pads differ, (16v, GL, GT, etc).

BRAKE PADS & SHOES - APPLICATIONS

Bremsbeläge / Plaquettes + Bremsbacken / Machoires









EBC

BRAKES

Make/Model/Engine Hersteller/Modell/Motor Modèles	Year Jahr Années	Pads Plaquettes / Bremsbeläge		Shoes Bremsbacken Machoires	Pads Plaquettes / Bremsbeläge		Shoes Bremsbacken Machoires
		Original Quality ECE R90* Approved	Upgrade Quality Tuning/Sportbeläge ECE R90* Approved	ECE R90* Approved	Original Quality ECE R90* Approved	Upgrade Quality Tuning/Sportbeläge ECE R90* Approved	ECE R90* Approved
CITROEN Contd.							
Berlingo Multispace							
1.4	99-	DP 1104	DP 21104				6547
1.6	2001-	DP 1104	DP 21104				6547
1.6	2001-	DP 1374	DP 21374				6547
1.8	99-2000	DP 1104	DP 21104				6547
1.9 D	99-2001	DP 1104	DP 21104				6547
1.9 D	2001-	DP 1374	DP 21374				6547
2.0 D	2002-	DP 1104	DP 21104				6547
2.0 D	2002-	DP 1374	DP 21374				6547
Dyane							
0.5	63-73			5038			5036
0.5	74-82	DP 131					5036
0.6	63-73			5038			5036
0.6	74-82	DP 131					5036
Pluriel							
1.4	2003-	DP 1434	DP 21434		DP 1230	DP 21230	
1.6	2003-	DP 1435	DP 21435		DP 1230	DP 21230	
Saxo							
1.0	97-	DP 656(T)	DP 2656				6403
1.0	97-	DP 545 (B)	DP 2545				6340/1
1.1	96-	DP 545 (B)	DP 2545				6340/1
1.1	96-	DP 656(T)	DP 2656				6403
1.4	96-	DP 545 (B)	DP 2545				6340/1
1.4	96-	DP 545 (B)	DP 2545				6526
1.6	96-	DP 948 (T)	DP 2948		DP 458/2	DP 2458/2	6526
1.6	96-	DP 948 (T)	DP 2948		DP 458/2	DP 2458/2	6340/1
1.6 16v	96-	DP 948 (T)	DP 2948		DP 458/2	DP 2458/2	
1.6 16v	96-	DP 687(G)	DP 2687		DP 458/2	DP 2458/2	
1.5 D	96-	DP 545 (B)	DP 2545				6526
1.5 D	96-	DP 545 (B)	DP 2545				6340/1
Synergie/Evasion							
2.0	95-	DP 1108	DP 2733		DP 1040		6516
1.9TD	95-	DP 1108	DP 2733		DP 1040		6516
2.0 D	99-	DP 1108	DP 2733		DP 1040		
Handbrake shoes	95-						6546
Visa							
0.7	78-83	DP 349(C)					6306(B)
0.7	78-83	DP 269(B)					5243(G)
0.7	84-86	DP 651(B)					6306(B)
0.7	84-86	DP 651(B)					5243/1(G)
0.7	83-86	DP 220/9(T)	DP 2220				5243/1(G)
1.0	84-86	DP 651(B)					6306(B)
1.0	84-86	DP 651(B)					5243/1(G)
1.0	83-86	DP 220/9(T)	DP 2220				6306(B)
1.1	78-83	DP 349(C)					6306(B)
1.1	78-83	DP 269(B)					5243/1(G)
1.1	84-86	DP 651(B)					6306(B)
1.1	83-86	DP 220/9(T)	DP 2220				6306(B)
1.1	86-87	DP 349(C)					6306(B)
1.2	78-83	DP 349(C)					6306(B)
1.2	78-83	DP 269(B)					5243(G)
1.2	84-86	DP 651(B)					6306(B)
1.2	84-86	DP 651(B)					5243/1(G)
1.2	83-86	DP 220/9(T)	DP 2220				6306(B)
1.2	86-87	DP 349(C)					6306(B)
1.4	84-86	DP 651(B)					5243/1(G)
1.4	83-86	DP 220/9(T)	DP 2220				6306(B)

*Every EBC pad and shoe requiring ECE R-90 is available with approval subject to stock rotation - check box end label.
Models listed by Engine Size. Only listed by trim level where pads differ, (16v, GL, GT, etc).

Standard Quality - ECE R90 Approved with similar performance to original equipment brake pads.
Upgrade Quality (Tuning/ Sportbeläge) - ECE R90 Approved but with higher friction and improved performance for faster street use.
Verbesserte Qualität - mit ECE R90 Freigabe und ähnlicher Bremsleistung wie die Original Bremsbeläge.
Standard Qualität - mit ECE R90 Freigabe und ähnlicher Bremsleistung wie die Original Bremsbeläge.
Qualité standard - Approuvée par la norme ECE R90 - Des performances équivalentes à l'origine.
Qualité améliorée - Approuvée par la norme ECE R90 - Un coefficient de friction supérieur et des performances accrues pour pilotage rapide sur route.
Calidad Estándar - Aprobación CEE R90 con prestaciones similares a las pastillas originales.
Calidad Mejorada - Aprobación CEE R90 pero con un coeficiente de fricción más elevado y prestaciones mejoradas para un uso deportivo en carretera.

Make/Model/Engine Hersteller/Modell/Motor Modelos	Year Jahr Années	Pads  Front / Vorn / Avant		Shoes	Pads  Rear / Hinten / Arrière		Shoes
		Original Quality ECE R90* Approved 	Upgrade Quality Tuning/Sportbeläge ECE R90* Approved 	Bremsbacken Machoires 	Original Quality ECE R90* Approved 	Upgrade Quality Tuning/Sportbeläge ECE R90* Approved 	Bremsbacken Machoires 
CITROEN Contd.							
Visa Contd.							
1.4	86-87	DP 349(C)					6306(B)
1.6 GTi	83-87	DP 575(G)	DP 2626				6523(B)
1.6 GTi	83-87	DP 458(B)	DP 2458				5243/1(G)
1.8 D	83-86	DP 575(G)	DP 2626				6523(B)
1.8 D	83-86	DP 458(B)	DP 2458				5243/1(G)
Xantia							
1.6	93-98	DP 942			DP 795		
1.8	93-	DP 942			DP 795		
1.8 Est	95-	DP 943			DP 1226		
2.0	93-98	DP 942			DP 795		
2.0 Est	95-98	DP 943			DP 1226		
2.0 16v	93-	DP 943			DP 795		
2.0 16v Est	95-	DP 943			DP 1226		
2.0 Turbo	95-99	DP 1077	DP 21077		DP 795		
2.0 Turbo Est	95-99	DP 1077	DP 21077		DP 1226		
2.0 Turbo	99-	DP 1188			DP 795		
2.0 Turbo Est	99-	DP 1188			DP 1226		
3.0	97-	DP 1188			DP 795		
3.0 Est	97-	DP 1188			DP 1226		
1.9 D	93-99	DP 942			DP 795		
1.9 D Est	95-99	DP 943			DP 1226		
1.9 TD	93-2000	DP 942			DP 795		
1.9 TD Est	95-98	DP 943			DP 1226		
1.9 TD Est	98-99	DP 1188			DP 1226		
2.0 TD (90)	99-	DP 942			DP 795		
2.0 TD (90) Est	98-	DP 943			DP 1226		
2.0 TD (110)	98-	DP 1188			DP 795		
2.0 TD (110) Est	98-	DP 1188			DP 1226		
2.1 TD	97-99	DP 1077	DP 21077		DP 795		
2.1 TD Est	97-99	DP 1077	DP 21077		DP 1226		
2.1 TD	99-2000	DP 1188			DP 795		
2.1 TD Est	99-2000	DP 1188			DP 1226		
Xsara							
1.4	97-2000	DP 948	DP 2948				6526(G)
1.4	97-2000	DP 948	DP 2948				6557(B)
1.4	97-2000	DP 1136	DP 21136				6395(G)
1.4	2000-	DP 1374	DP 21374				6526(G)
1.6	97-2000	DP 948	DP 2948				6557(B)
1.6	97-2000	DP 948	DP 2948				6526(G)
1.6	97-2000	DP 1136	DP 21136				6395(G)
1.6	2000-	DP 1374	DP 21374		DP 458/2	DP 2458/2	6557(B)
1.8	97-2000	DP 948	DP 2948				6557(B)
1.8	97-2000	DP 948	DP 2948				6526(G)
1.8	97-2000	DP 1234	DP 21234		DP 458/2	DP 2458/2	
1.8	97-2000	DP 1136	DP 21136				6395(G)
1.8 16v	97-2000	DP 1104	DP 21104		DP 458/2	DP 2458/2	
1.8 16v	98-2000	DP 1234	DP 21234		DP 458/2	DP 2458/2	
2.0 16v	98-2000	DP 1047	DP 21047		DP 458/2	DP 2458/2	
2.0 16v	2000-2001	DP 1374	DP 21374		DP 458/2	DP 2458/2	6557(B)
1.4 TD	2003-	DP 1136	DP 21136				6526(G)
1.4 TD	2003-	DP 1136	DP 21136				6557(B)
1.9 D	97-2000	DP 1136	DP 21136				6395(G)
1.9 D	97-2000	DP 948	DP 2948				6557(B)
1.9 D	97-2000	DP 948	DP 2948				6526(G)
1.9 TD	97-2000	DP 1136	DP 21136				6395(G)
1.9 TD	97-2000	DP 948	DP 2948				6557(B)
1.9 TD	97-2000	DP 948	DP 2948				6526(G)
2.0 TD (90)	99-2000	DP 948	DP 2948		DP 458/2	DP 2458/2	
2.0 TD (90)	99-2000	DP 1136	DP 21136		DP 458/2	DP 2458/2	

*Every EBC pad and shoe requiring ECE R-90 is available with approval subject to stock rotation - check box end label.







Models listed by Engine Size. Only listed by trim level where pads differ, (16v, GL, GT, etc).

BRAKE PADS & SHOES - APPLICATIONS

Bremsbeläge / Plaquettes + Bremsbacken / Machoires

EBC

BRAKES

Make/Model/Engine Hersteller/Modell/Motor Modelos	Year Jahr Années	Pads  Front / Vorn / Avant		Shoes	Pads  Rear / Hinten / Arrière		Shoes
		Plaquettes / Bremsbeläge Original Quality ECE R90* Approved 		Bremsbacken Machoires ECE R90* Approved 	Plaquettes / Bremsbeläge Upgrade Quality Tuning/Sportbeläge ECE R90* Approved 		Bremsbacken Machoires ECE R90* Approved 
CITROEN Contd.							
Xsara Contd.							
2.0 TD (90)	2000-	DP 1374	DP 21374		DP 458/2	DP 2458/2	
2.0 TD (110)	2001-	DP 1374	DP 21374		DP 458/2	DP 2458/2	
Xsara Estate							
1.4	98-2000	DP 948	DP 2948				6200
1.4	98-2000	DP 1136	DP 21136				6200
1.4	2000-2001	DP 1374	DP 21374				6200
1.6	98-2000	DP 948	DP 2948				6200
1.6	98-2000	DP 1136	DP 21136				6200
1.6	2000-	DP 1374	DP 21374		DP 458/2	DP 2458/2	6200
1.8	98-2000	DP 1104	DP 21104				6200
1.8	98-2000	DP 1234	DP 21234		DP 458/2	DP 2458/2	
1.8 16v	98-2000	DP 1104	DP 21104		DP 458/2	DP 2458/2	
1.8 16v	98-2000	DP 1234	DP 21234		DP 458/2	DP 2458/2	
1.9 D	98-2000	DP 948	DP 2948				6200
1.9 D	98-2000	DP 1234	DP 21234				6200
1.9 D	98-2000	DP 1136	DP 21136				6200
1.9 TD	98-2000	DP 1104	DP 21104				6200
1.9 TD	98-2000	DP 1234	DP 21234				6200
1.9 TD	98-2000	DP 948	DP 2948				6200
2.0 TD (90)	99-2000	DP 948	DP 2948		DP 458/2	DP 2458/2	
2.0 TD (90)	99-2000	DP 1104	DP 21104		DP 458/2	DP 2458/2	
2.0 TD (90)	99-2000	DP 1234	DP 21234		DP 458/2	DP 2458/2	
2.0 TD (90)	2000-	DP 1374	DP 21374		DP 458/2	DP 2458/2	
2.0 TD (110)	2001-	DP 1374	DP 21374		DP 458/2	DP 2458/2	
Xsara Picasso							
1.6	2000-	DP 1346	DP 21346				6540
1.6	2000-	DP 1374	DP 21374				6540
1.8	2000-	DP 1346	DP 21346				6540
1.8	2000-	DP 1374	DP 21374				6540
2.0 TD	2000-	DP 1346	DP 21346				6540
2.0 TD	2000-	DP 1374	DP 21374				6540
AX							
1.0	87-97	DP 656(T)	DP 2656				6403
1.0	89-97	DP 1111(T)	DP 2656				6403
1.0	92-97	DP 656(T)	DP 2656				6340/1
1.1	87-97	DP 656(T)	DP 2656				6403
1.1	89-97	DP 1111(T)	DP 2656				6403
1.1	88-97	DP 656(T)	DP 2656				6340/1
1.4	87-97	DP 656(T)	DP 2656				6403
1.4	89-96	DP 1111(T)	DP 2656				6403
1.4	89-96	DP 656(T)	DP 2656				6340/1
1.4 GT	87-91	DP 656(T)	DP 2656				6403
1.4 GT	91-96	DP 1111(T)	DP 2656				6340/1
1.4 GT	91-96	DP 545/4(B)	DP 2545				6340/1
1.4 GTi	91-96	DP 575(G)	DP 2626				6340/1
1.4 GTi	91-96	DP 545/4(B)	DP 2545				6340/1
1.4 4WD	86-92	DP 575(G)	DP 2626				6408
1.4 4WD	92-96	DP 575/4(G)	DP 2626				6408
1.4 D	87-91	DP 656(T)	DP 2656				6403
1.4 D	89-91	DP 1111(T)	DP 2656				6403
1.4 D	87-96	DP 545/4(B)	DP 2545				6403
1.5 D	94-97	DP 575/4(G)	DP 2626				6403
1.5 D	94-97	DP 545/4(B)	DP 2545				6403
1.5 D	94-97	DP 1111(T)	DP 2656				6403

*Every EBC pad and shoe requiring ECE R-90 is available with approval subject to stock rotation - check box end label.
Models listed by Engine Size. Only listed by trim level where pads differ, (16v, GL, GT, etc).

Standard Quality - ECE R90 Approved with similar performance to original equipment brake pads.
Upgrade Quality (Tuning/ Sportbeläge) - ECE R90 Approved but with higher friction and improved performance for faster street use.
Verbesserte Qualität - mit ECE R90 Freigabe aber mit höherem Reibwert und verbesserter Bremsleistung für den schnellen Strasseninsatz.

Standard Qualität - mit ECE R90 Freigabe und ähnlicher Bremsleistung wie die Original Bremsbeläge.
Qualité améliorée - Approuvée par la norme ECE R90 - Un coefficient de friction supérieur et des performances accrues pour pilotage rapide sur route.
Calidad Mejorada - Aprobación CEE R90 con prestaciones similares a las pastillas originales.
Calidad Estándar - Aprobación CEE R90 con prestaciones similares a las pastillas originales.
Calidad Mejorada - Aprobación CEE R90 pero con un coeficiente de fricción más elevado y prestaciones mejoradas para un uso deportivo en carretera.

Standard Quality - ECE R90 Approved with similar performance to original equipment brake pads.

Upgrade Quality (Tuning / Sportbeläge) - ECE R90 Approved but with higher friction and improved performance for faster street use.

Standard Qualität - mit ECE R90 Freigabe und ähnlicher Bremsleistung wie die Original Bremsbeläge.









Verbesserte Qualität - mit ECE R90 Freigabe aber mit höherem Reibwert und verbesserter Bremsleistung für den schnellen Strasseninsatz.

Qualité standard - Approuvée par la norme ECE R90 - Des performances équivalentes à l'origine.

Qualité améliorée - Approuvée par la norme ECE R90 - Un coefficient de friction supérieur et des performances accrues pour pilotage rapide sur route.

Calidad Estandar - Aprobacion CEE R90 con prestaciones similares a las pastillas originales.

Calidad Mejorada - Aprobacion CEE R90 pero con un coeficiente de friccion mas elevado y prestaciones mejoradas para un uso deportivo en carretera.









Make/Model/Engine Hersteller/Modell/Motor Modelos	Year Jahr Années	Pads  Front / Vorn / Avant		Shoes	Pads  Rear / Hinten / Arrière		Shoes
		Original Quality ECE R90* Approved 	Upgrade Quality Tuning/Sportbeläge ECE R90* Approved 	Bremsbacken Machoires 	Original Quality ECE R90* Approved 	Upgrade Quality Tuning/Sportbeläge ECE R90* Approved 	Bremsbacken Machoires 
CITROEN Contd.							
BX							
1.4	82-93	DP 458(B)	DP 2458		DP 350		
1.6	82-93	DP 458(B)	DP 2458		DP 350		
1.9	82-93	DP 458(B)	DP 2458		DP 350		
1.7D	82-93	DP 458(B)	DP 2458		DP 350		
1.7TD	82-94	DP 458(B)	DP 2458		DP 350		
1.9D	82-94	DP 458(B)	DP 2458		DP 350		
1.9TD	82-94	DP 458(B)	DP 2458		DP 350		
C3							
1.1	2002-	DP 1434	DP 21434		DP 1230	DP 21230	
1.4	2002-	DP 1434	DP 21434		DP 1230	DP 21230	
1.6	2002-	DP 1435	DP 21435		DP 1230	DP 21230	
1.4 D (70)	2002-	DP 1434	DP 21434		DP 1230	DP 21230	
1.4 D (92)	2002-	DP 1435	DP 21435		DP 1230	DP 21230	
C5							
1.8 Sal	2001-	DP 1370	DP 21370		DP 1373		
1.8 Est	2001-	DP 1371	DP 21371		DP 1373		
2.0	2001-	DP 1371	DP 21371		DP 1373		
3.0	2001-	DP 1372	DP 21372		DP 1373		
2.0 TD (90)	2001-	DP 1371	DP 21371		DP 1373		
2.0 TD (110)	2001-	DP 1371	DP 21371		DP 1373		
2.2 TD	2001-	DP 1372	DP 21372		DP 1373		
C8							
2.0	2003-	DP 1466	DP 21466		DP 1230	DP 21230	
2.2	2003-	DP 1466	DP 21466		DP 1230	DP 21230	
2.0 TD	2003-	DP 1466	DP 21466		DP 1230	DP 21230	
2.2 TD	2003-	DP 1466	DP 21466		DP 1230	DP 21230	
CX							
2.0 Sal	74-78	DP 221			DP 222		
2.0 Sal	78-89	DP 221			DP 350		
2.0 Est	75-92	DP 221			DP 227		
2.2 Sal	74-78	DP 221			DP 222		
2.2 Sal	78-89	DP 221			DP 350		
2.2 Est	75-92	DP 221			DP 227		
2.5 Sal	74-78	DP 221			DP 222		
2.5 Sal	78-89	DP 221			DP 350		
2.5 Turbo Sal	78-89	DP 221			DP 350		
2.5 Est	75-92	DP 221			DP 227		
2.2 D Sal	74-78	DP 221			DP 222		
2.5 D Sal	74-78	DP 221			DP 222		
2.5 D Sal	78-89	DP 221			DP 350		
2.5 D Est	75-92	DP 221			DP 227		
2.5 TD Sal	78-89	DP 221			DP 350		
2.5 TD Est	75-92	DP 221			DP 227		
Handbrake pads	74-92	DP 248					
DS							
1.9	55-67	DP 113					
1.9 Sal	68-75	DP 132					5039
1.9 Est	68-75	DP 132					5040
2.0 Sal	68-75	DP 132					5039
2.0 Est	68-75	DP 132					5040
2.2 Sal	68-75	DP 132					5039
2.2 Est	68-75	DP 132					5040
2.3 Sal	68-75	DP 132					5039
2.3 Est	68-75	DP 132					5040
Handbrake pads	68-75	DP 178					

BRAKE PADS & SHOES - APPLICATIONS

Bremsbeläge / Plaquettes + Bremsbacken / Machoires

EBC

BRAKES

Make/Model/Engine Hersteller/Modell/Motor Modelos	Year Jahr Années	Pads  Front / Vorn / Avant		Shoes	Pads  Rear / Hinten / Arrière		Shoes
		Original Quality ECE R90* Approved 	Upgrade Quality Tuning/Sportbeläge ECE R90* Approved 	Bremsbacken Machoires 	Original Quality ECE R90* Approved 	Upgrade Quality Tuning/Sportbeläge ECE R90* Approved 	Bremsbacken Machoires 
CITROEN Contd.							
GS							
1.0	70-72	DP 140			DP 137		
1.0	72-73	DP 140			DP 191		
1.0	73-80	DP 190			DP 191		
1.1	73-80	DP 190			DP 191		
1.2	73-80	DP 190			DP 191		
Handbrake pads	70-72	DP 177					
Handbrake pads	72-80	DP 246					
GSA							
1.0	79-80	DP 190			DP 191		
1.1	79-80	DP 190			DP 191		
1.1	81-86	DP 406			DP 191		
1.2	79-80	DP 190			DP 191		
1.2	81-86	DP 406			DP 191		
1.3	81-86	DP 406			DP 191		
Handbrake pads	79-86	DP 246					
LN, LNA							
0.6	78-81	DP 349(C)					5243(G)
0.6	78-81	DP 269(B)					6306(B)
0.7	78-81	DP 349(C)					5243(G)
0.7	78-81	DP 269(B)					6306(B)
0.7	82-86	DP 349(C)					5243/1(G)
0.7	82-86	DP 269(B)					6306(B)
1.1	82-86	DP 269(B)					6306(B)
1.1	82-86	DP 349(C)					5243/1(G)
SM							
2.7	71-74	DP 132			DP 244		
2.7	74-75	DP 132			DP 245		
Handbrake pads	71-75	DP 465					
XM							
2.0 Sal	89-91	DP 794			DP 795		
2.0 Sal	91-2000	DP 882			DP 795		
2.0 Est	92-2000	DP 882			DP 227		
2.0 Turbo Sal	91-2000	DP 882			DP 795		
2.0 Turbo Est	92-2000	DP 882			DP 227		
3.0 Sal	89-91	DP 794(B)			DP 795		
3.0 Sal	90-96	DP 881(T)			DP 795		
3.0 Sal	91-96	DP 882			DP 795		
3.0 Sal	97-2000	DP 1188			DP 795		
3.0 Est	92-97	DP 882(B)			DP 227		
3.0 Est	92-97	DP 881(T)			DP 227		
3.0 Est	97-2000	DP 1188			DP 227		
2.1 TD Sal	90-91	DP 794			DP 795		
2.1 TD Sal	91-97	DP 882			DP 795		
2.1 TD Est	92-97	DP 882			DP 227		
2.5 TD Sal	94-98	DP 882			DP 795		
2.5 TD Sal	98-2000	DP 1188			DP 795		
2.5 TD Est	94-98	DP 882			DP 227		
2.5 TD Est	98-2000	DP 1188			DP 227		
ZX							
1.4	91-98	DP 426/4(G)	DP 2426				6395(G)
1.4	91-98	DP 545/4(B)	DP 2545				6557(B)
1.4	91-98	DP 545/4(B)	DP 2545				6329
1.4	95-98	DP 426/4(G)	DP 2426				6526(G)
1.4	95-98	DP 545/4(B)	DP 2545				6526(G)
1.6	91-98	DP 426/4(G)	DP 2426		DP 458/2	DP 2458/2	6395(G)
1.6	91-98	DP 545/4(B)	DP 2545		DP 458/2	DP 2458/2	6557(B)

*Every EBC pad and shoe requiring ECE R-90 is available with approval subject to stock rotation - check box end label.
Models listed by Engine Size. Only listed by trim level where pads differ, (16v, GL, GT, etc).



Standard Quality - ECE R90 Approved with similar performance to original equipment brake pads.
Upgrade Quality (Tuning/ Sportbeläge) - ECE R90 Approved but with higher friction and improved performance for faster street use.
Verbesserte Qualität - mit ECE R90 Freigabe und ähnlicher Bremsleistung wie die Original Bremsbeläge.

Standard Qualität - mit ECE R90 Freigabe und ähnlicher Bremsleistung wie die Original Bremsbeläge.













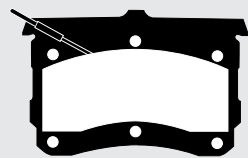

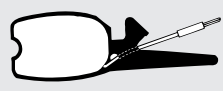
Standard Quality - ECE R90 Approved with similar performance to original equipment brake pads.

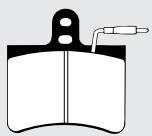
Qualité standard - Approuvée par la norme ECE R90 - Des performances équivalentes à l'origine.
Qualité améliorée - Approuvée par la norme ECE R90 - Un coefficient de friction supérieur et des performances accrues pour pilotage rapide sur route.
Calidad Mejorada - Aprobación CEE R90 con prestaciones similares a las pastillas originales.

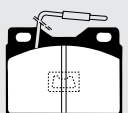
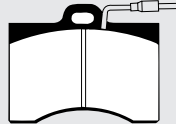
Calidad Estándar - Aprobación CEE R90 con prestaciones similares a las pastillas originales.

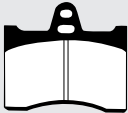
Make/Model/Engine Hersteller/Modell/Motor Modelos	Year Jahr Années	Pads  Front / Vorn / Avant		Shoes	Pads  Rear / Hinten / Arrière		Shoes
		Original Quality ECE R90* Approved	Upgrade Quality Tuning/Sportbeläge ECE R90* Approved	Bremsbacken Machoires ECE R90* Approved	Original Quality ECE R90* Approved	Upgrade Quality Tuning/Sportbeläge ECE R90* Approved	Bremsbacken Machoires ECE R90* Approved
CITROEN Contd.							
ZX Contd.							
1.6	91-98	DP 545/4(B)	DP 2545		DP 458/2	DP 2458/2	6329
1.6	95-98	DP 426/4(G)	DP 2426		DP 458/2	DP 2458/2	6526(G)
1.6	95-98	DP 545/4(B)	DP 2545		DP 458/2	DP 2458/2	6526(G)
1.8	92-98	DP 426/4(G)	DP 2426		DP 458/2	DP 2458/2	6395(G)
1.8	92-98	DP 545/4(B)	DP 2545		DP 458/2	DP 2458/2	6557(B)
1.8	92-98	DP 545/4(B)	DP 2545		DP 458/2	DP 2458/2	6329
1.8	95-98	DP 426/4(G)	DP 2426		DP 458/2	DP 2458/2	6526(G)
1.8	95-98	DP 545/4(B)	DP 2545		DP 458/2	DP 2458/2	6526(G)
1.9	91-94	DP 426/4(G)	DP 2426		DP 458/2	DP 2458/2	
2.0	91-98	DP 426/4(G)	DP 2426		DP 458/2	DP 2458/2	
2.0 16v	92-98	DP 1080(G)	DP 2687		DP 458/2	DP 2458/2	
1.9 D	91-98	DP 545/4(B)	DP 2545		DP 458/2	DP 2458/2	6557(B)
1.9 D	91-98	DP 545/4(B)	DP 2545		DP 458/2	DP 2458/2	6329
1.9 D	91-98	DP 575/4(G)	DP 2626		DP 458/2	DP 2458/2	6395(G)
1.9 D	95-98	DP 545/4(B)	DP 2545		DP 458/2	DP 2458/2	6526(G)
1.9 D	95-98	DP 575/4(G)	DP 2626		DP 458/2	DP 2458/2	6526(G)
1.9 TD	91-98	DP 426/4(G)	DP 2426		DP 458/2	DP 2458/2	6557(B)
1.9 TD	91-98	DP 426/4(G)	DP 2426		DP 458/2	DP 2458/2	6329
1.9 TD	95-98	DP 426/4(G)	DP 2426		DP 458/2	DP 2458/2	6395(G)
ZX Estate							
1.4	94-98	DP 575/4(G)	DP 2626				5200(B)
1.6	94-98	DP 426/4(G)	DP 2426				5200(B)
1.8	94-98	DP 426/4(G)	DP 2426				5200(B)
1.9 D	94-98	DP 426/4(G)	DP 2426				5200(B)
1.9 TD	94-98	DP 426/4(G)	DP 2426		DP 458/2	DP 2458/2	5200(B)

Pad Illustrations for Citroen

 113 148 x 57 x 15mm	 131 89 x 38 x 12mm	 132 145 x 95 x 30mm	 137 50 x 44 x 12mm
 140 136 x 44 x 13mm	 177 30mm radius	 178 37 x 146 x 10mm	 190 77 x 83 x 16mm
 191 54 x 60 x 12mm	 220/9 77 x 58 x 16mm	 221 99 x 80 x 15mm	 222 54 x 69 x 16mm
 227 82 x 71 x 16mm	 244 49 x 59 x 12mm	 245 54 x 69 x 12mm	 246 37 x 41 x 9mm

BRAKE PADS & SHOES - APPLICATIONS











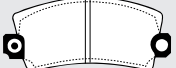
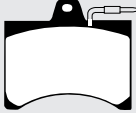

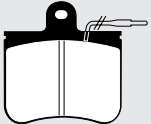
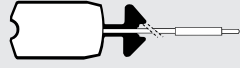
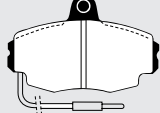
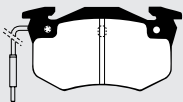
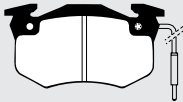
Bremsbeläge / Plaquettes + Bremsbacken / Machoires

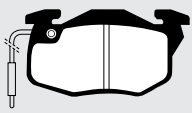
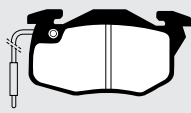
EBC

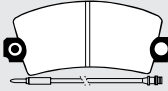
BRAKES

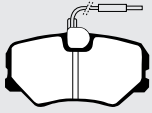
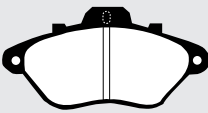
Make/Model/Engine	Year	Pads	Front / Vorn / Avant	Shoes	Pads	Rear / Hinten / Arrière	Shoes
Hersteller/Modell/Motor	Jahr	Plaquettes / Bremsbeläge		Bremsbacken	Plaquettes / Bremsbeläge		Bremsbacken
Modelos	Années	Original Quality ECE R90* Approved	Upgrade Quality Tuning/Sportbeläge ECE R90* Approved	Machoires ECE R90* Approved	Original Quality ECE R90* Approved	Upgrade Quality Tuning/Sportbeläge ECE R90* Approved	Machoires ECE R90* Approved

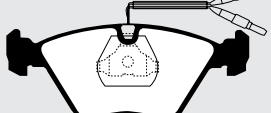
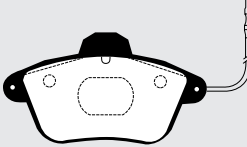
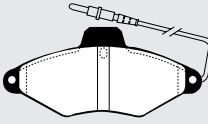
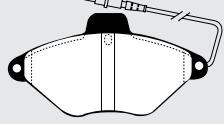
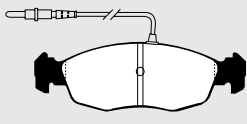
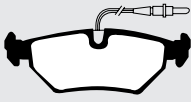
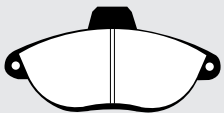
Pad Illustrations for Citroen Contd.

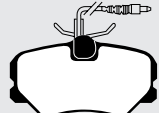
248  41 x 39 x 7mm	269  108 x 49 x 15mm	349  84 x 73 x 12mm	350  54 x 65 x 17mm
406  77 x 81 x 15mm	411  89 x 38 x 13mm	426/4  100 x 65 x 16mm	458  106 x 56 x 18mm
458/2  106 x 56 x 11mm	465  146 x 37 x 10mm	545  105 x 55 x 18mm	545/4  105 x 55 x 18mm (4 wires)
575  90 x 63 x 17mm	575/4  90 x 63 x 17mm (4 wires)	651  108 x 49 x 15mm	656  72 x 61 x 16mm
687  95 x 50 x 18mm	794  130 x 69 x 17mm	795  54 x 65 x 15mm	881  156 x 63 x 18mm
882  131 x 73 x 17mm	942  130 x 53 x 17mm	943  130 x 65 x 16mm	948  140 x 48 x 17mm
1040  123 x 43 x 17mm	1053  140 x 69 x 18mm	1077  130 x 71 x 17mm	1080  95 x 49 x 18mm

Standard Quality - ECE R90 Approved with similar performance to original equipment brake pads.
Upgrade Quality (Tuning/ Sportbeläge) - ECE R90 Approved but with higher friction and improved performance for faster street use.
Standard Qualität - mit ECE R90 Freigabe und ähnlicher Bremsleistung wie die Original Bremsbeläge.
Verbesserte Qualität - mit ECE R90 Freigabe aber mit höherem Reibwert und verbesserter Bremsleistung für den schnellen Strasseninsatz.

Qualité standard - Approuvée par la norme ECE R90 - Des performances équivalentes à l'origine.
Qualité améliorée - Approuvée par la norme ECE R90 - Un coefficient de friction supérieur et des performances accrues pour pilotage rapide sur route.
Calidad Estándar - Aprobación CEE R90 con prestaciones similares a las pastillas originales.
Calidad Mejorada - Aprobación CEE R90 pero con un coeficiente de fricción más elevado y prestaciones mejoradas para un uso deportivo en carretera.

*Every EBC pad and shoe requiring ECE R-90 is available with approval subject to stock rotation - check box end label.
Models listed by Engine Size. Only listed by trim level where pads differ, (16v, GL, GT, etc).

Make/Model/Engine	Year	Front / Vorn / Avant	Shoes	Rear / Hinten / Arrière	Shoes
Hersteller/Modell/Motor	Jahr	Plaquettes / Bremsbeläge	Bremsbacken Machoires	Plaquettes / Bremsbeläge	Bremsbacken Machoires
Modelos	Années	Original Quality ECE R90* Approved	Upgrade Quality Tuning/Sportbeläge ECE R90* Approved	Original Quality ECE R90* Approved	Upgrade Quality Tuning/Sportbeläge ECE R90* Approved

Pad Illustrations for Citroen Contd.

1104 130 x 56 x 19mm	1108 130 x 58 x 19mm	1111 71 x 60 x 17mm	1136 131 x 48 x 18mm
1188 169 x 62 x 17mm	1226 83 x 75 x 16mm	1234 130 x 50 x 17mm	1346 130 x 56 x 19mm
1370 149 x 50 x 18mm	1371 149 x 59 x 18mm	1372 169 x 61 x 18mm	1373 73 x 71 x 15mm
1374 137 x 51 x 19mm	1434 122 x 53 x 5mm	1435 128 x 56 x 5mm	1466 147 x 59 x 19mm

CITROEN COMMERCIAL

Berlingo

1.1	96-	DP 1104	6547
1.1	2002-	DP 1374	6547
1.4	96-	DP 1104	6547
1.4	2002-	DP 1374	6547
1.8 D	96-	DP 1104	6547
1.9 D	96-	DP 1104	6547
1.9 D	2002-	DP 1374	6547
2.0 D	99-	DP 1104	6547
2.0 D	2002-	DP 1374	6547

C15

1.0	84-87		5071	5187/2
1.0	84-87	DP 349(C)		5187/2
1.0	84-87	DP 489(B)		5187/2
1.0	87-96	DP 575(G)		5187/2
1.1	84-87	DP 349(C)		5187/2
1.1	84-87	DP 489(B)		5187/2
1.1	87-96	DP 575(G)		5187/2
1.3	84-87	DP 349(C)		5187/2
1.3	84-87	DP 489(B)		5187/2
1.4	84-87	DP 349(C)		5187/2
1.4	84-87	DP 489(B)		5187/2
1.4	87-96	DP 575(G)		5187/2
1.8 D	84-	DP 575(G)		5187/2
1.8 D	84-	DP 545(B)		5187/2

*Every EBC pad and shoe requiring ECE R-90 is available with approval subject to stock rotation - check box end label.









Models listed by Engine Size. Only listed by trim level where pads differ, (16v, GL, GT, etc).

BRAKE PADS & SHOES - APPLICATIONS

Bremsbeläge / Plaquettes + Bremsbacken / Machoires



EBC

BRAKES







Make/Model/Engine Hersteller/Modell/Motor Modelos	Year Jahr Années	Pads  Front / Vorn / Avant		Shoes	Pads  Rear / Hinten / Arrière		Shoes
		Original Quality ECE R90* Approved 	Upgrade Quality Tuning/Sportbeläge ECE R90* Approved 	Bremsbacken Machoires 	Original Quality ECE R90* Approved 	Upgrade Quality Tuning/Sportbeläge ECE R90* Approved 	Bremsbacken Machoires 
CITROEN COMM Contd.							
C22							
1.8	81-92	DP 425					6322
2.5 D	81-92	DP 425					6322
C25							
1.8	81-92	DP 425					6322
2.0	81-92	DP 425					6322
1.9 D	81-92	DP 425					6322
2.5 D	81-92	DP 425					6322
2.5 TD	87-92	DP 425					6322
C25 1.8 Ton							
2.0	81-94	DP 735					6322
2.5 TD	81-94	DP 735					6322
C32							
2.0 D	74-78	DP 395			DP 190		
C35							
2.0 D	74-78	DP 395			DP 190		
2.2 D	74-78	DP 395			DP 190		
2.5 D	79-94	DP 395			DP 190		
Handbrake pads	74-94	DP 249					
Dispatch/Jumpy							
1.6	95-	DP 1053(B)					6516
1.6	95-	DP 1108(G)					6516
1.9 D	96-	DP 1053(B)					6516
1.9 D	96-	DP 1108(G)					6516
1.9 TD	95-2000	DP 1053(B)					6516
1.9 TD	95-2000	DP 1108(G)					6516
2.0 D	2000-	DP 1053(B)					6516
2.0 D	2000-	DP 1108(G)					6516
Relay (Q14)/Jumper							
2.0	94-2001	DP 1024					6506
2.0	2001-	DP 1380			DP 1378		
1.9 TD	94-2001	DP 1024					6506
2.0 TD	2001-	DP 1380			DP 1378		
2.2 TD	2001-	DP 1380			DP 1378		
2.5 D	94-2001	DP 1024					6506
2.5 TD	94-2001	DP 1024					6507
2.8 TD	98-2001	DP 1024					6507
Relay (Q18)/Jumper							
2.0	94-2001	DP 1025					6507
2.5 D	94-2001	DP 1025					6507
2.5 TD	94-2001	DP 1025					6507
2.8 TD	98-2001	DP 1025					6507
2.8 TD	2001-	DP 1379			DP 1378		
Xsara Enterprise							
2.0 TD	2003-	DP 1374					
Xsara Van							
1.9 D	98-	DP 948					
1.9 D	98-	DP 1136					

Standard Quality - ECE R90 Approved with similar performance to original equipment brake pads.
 Upgrade Quality (Tuning/ Sportbeläge) - ECE R90 Approved but with higher friction and improved performance for faster street use.
 Verbesserte Qualität - mit ECE R90 Freigabe und ähnlicher Bremsleistung wie die Original Bremsbeläge.
 Standard Qualität - mit ECE R90 Freigabe und ähnlicher Bremsleistung wie die Original Bremsbeläge.
 Upgrade Quality (Tuning/ Sportbeläge) - ECE R90 Approved but with higher friction and improved performance for faster street use.
 Verbesserte Qualität - mit ECE R90 Freigabe aber mit höherem Reibwert und verbesserter Bremsleistung für den schnellen Strasseninsatz.
 Calidad Estándar - Aprobación CEE R90 con prestaciones similares a las pastillas originales.
 Calidad Mejorada - Aprobación CEE R90 pero con un coeficiente de fricción más elevado y prestaciones mejoradas para un uso deportivo en carretera.
 Qualité standard - Approuvée par la norme ECE R90 - Des performances équivalentes à l'origine.
 Qualité améliorée - Approuvée par la norme ECE R90 - Un coefficient de friction supérieur et des performances accrues pour pilotage rapide sur route.

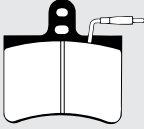
*Every EBC pad and shoe requiring ECE R-90 is available with approval subject to stock rotation - check box end label.
 Models listed by Engine Size. Only listed by trim level where pads differ, (16v, GL, GT, etc).

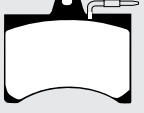
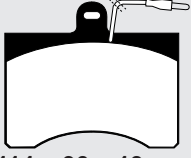
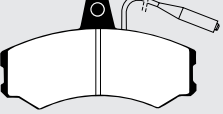
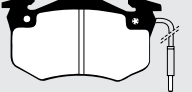
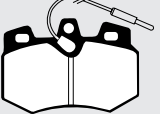
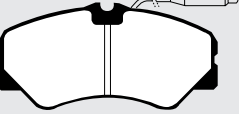
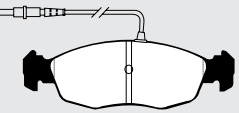
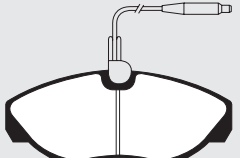
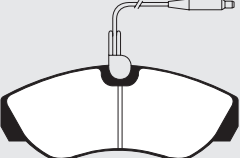
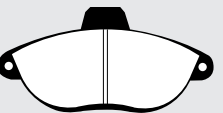
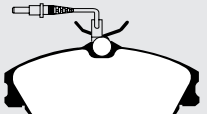
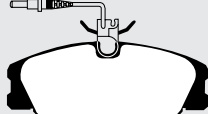
Make/Model/Engine	Year	Pads	Front / Vorn / Avant	Shoes	Pads	Rear / Hinten / Arrière	Shoes
Hersteller/Modell/Motor	Jahr	Plaquettes / Bremsbeläge		Bremsbacken Machoires	Plaquettes / Bremsbeläge		Bremsbacken Machoires
Modelos	Années	Original Quality ECE R90* Approved	Upgrade Quality Tuning/Sportbeläge ECE R90* Approved	 ECE R90* Approved	Original Quality ECE R90* Approved	Upgrade Quality Tuning/Sportbeläge ECE R90* Approved	 ECE R90* Approved

Pad Illustrations for Citroen Commercial

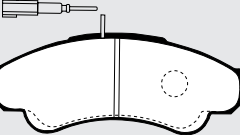
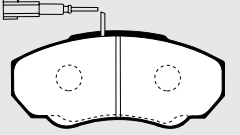
190  77 x 83 x 16mm	249  37 x 66 x 10mm	349  84 x 73 x 12mm	395  114 x 96 x 19mm
425  130 x 74 x 19mm	489  106 x 56 x 18mm	575  90 x 63 x 17mm	735  145 x 71 x 19mm
948  140 x 48 x 17mm	1024  145 x 62 x 19mm	1025  160 x 65 x 19mm	1053  140 x 69 x 18mm
1104  130 x 56 x 19mm	1108  130 x 58 x 19mm	1136  131 x 48 x 18mm	1374  137 x 51 x 19mm
1378  109 x 49 x 20mm	1379  164 x 69 x 19mm	1380  140 x 65 x 19mm	

CLAN				
Crusader				
0.8	71-75		5141	5142
COMMER/DODGE				
50				
S46	87-93	DP 462		
S56	87-93	DP 462		
PA				
15cwt	60-67		6260	6260
1ton	60-67		6260	6260
PB				
15cwt (Manual)	68-76		5239	6246
15cwt (Auto)	68-76		5239	6260
1ton	68-76		5239	6260

*Every EBC pad and shoe requiring ECE R-90 is available with approval subject to stock rotation - check box end label.

Models listed by Engine Size. Only listed by trim level where pads differ, (16v, GL, GT, etc).

BRAKE PADS & SHOES - APPLICATIONS

Bremsbeläge / Plaquettes + Bremsbacken / Machoires

EBC

BRAKES

Make/Model/Engine	Year	Pads	Front / Vorn / Avant	Shoes	Pads	Rear / Hinten / Arrière	Shoes
Hersteller/Modell/Motor	Jahr	Plaquettes / Bremsbeläge		Bremsbacken Machoires	Plaquettes / Bremsbeläge		Bremsbacken Machoires
Modèles	Années	Original Quality ECE R90* Approved	Upgrade Quality Tuning/Sportbeläge ECE R90* Approved	ECE R90* Approved	Original Quality ECE R90* Approved	Upgrade Quality Tuning/Sportbeläge ECE R90* Approved	ECE R90* Approved
COMMER/DODGE Contd.							
Spacevan							
15cwt	76-81			5239			6246
1 ton	76-81			5239			6260

Pad Illustrations for Commer/Dodge

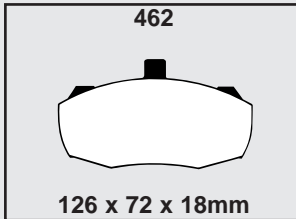

DACIA							
Denem							
1.3	82-85	DP 417					5190A
Duster							
1.4	84-93	DP 417					5190A
1.6 D	90-92	DP 417					5190A

Pad Illustrations for Dacia

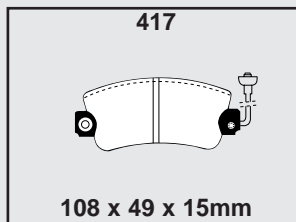









DAEWOO							
Espero							
1.5	95-97	DP 940	DP 2940				6481
1.8	95-97	DP 760	DP 2760				6482
2.0	95-97	DP 760	DP 2760				6482
Kalos							
1.4	2002-						
Korando							
2.3	99-	DP 1126			DP 1132		5117
2.9 TD	99-	DP 1126			DP 1132		5117
Lanos							
1.4	97-	DP 940	DP 2940				6482
1.4	97-	DP 1212					6482
1.6	97-	DP 1196					6482
1.6	97-	DP 760	DP 2760				6482
Leganza							
2.0	97-	DP 1209			DP 1197		
Matiz							
0.8	98-	DP 1212					6572
1.0	2003-						

*Every EBC pad and shoe requiring ECE R-90 is available with approval subject to stock rotation - check box end label.
Models listed by Engine Size. Only listed by trim level where pads differ, (16v, GL, GT, etc).

Standard Quality - ECE R90 Approved with similar performance to original equipment brake pads.
Upgrade Quality (Tuning/ Sportbeläge) - ECE R90 Approved but with higher friction and improved performance for faster street use.
Verbesserte Qualität - mit ECE R90 Freigabe aber mit höherem Reibwert und verbesserter Bremsleistung für den schnellen Strasseninsatz.

Qualité standard - Approuvée par la norme ECE R90 - Des performances équivalentes à l'origine.
Qualité améliorée - Approuvée par la norme ECE R90 - Un coefficient de friction supérieur et des performances accrues pour pilotage rapide sur route.
Calidad Estándar - Aprobación CEE R90 con prestaciones similares a las pastillas originales.
Calidad Mejorada - Aprobación CEE R90 pero con un coeficiente de fricción más elevado y prestaciones mejoradas para un uso deportivo en carretera.

Make/Model/Engine	Year	Pads  Front / Vorn / Avant		Shoes	Pads  Rear / Hinten / Arrière		Shoes
Hersteller/Modell/Motor	Jahr	Plaquettes / Bremsbeläge		Bremsbacken Machoires	Plaquettes / Bremsbeläge		Bremsbacken Machoires
Modelos	Années	Original Quality ECE R90* Approved 	Upgrade Quality Tuning/Sportbeläge ECE R90* Approved 	 ECE R90* Approved	Original Quality ECE R90* Approved 	Upgrade Quality Tuning/Sportbeläge ECE R90* Approved 	 ECE R90* Approved
DAEWOO Contd.							
Musso							
2.3	99-2001	DP 1126			DP 1132		
2.3	2001-				DP 1477		
3.2	99-2001	DP 1126			DP 1132		
2.9 TD	99-2001	DP 1126			DP 1132		
2.9 TD	2001-				DP 1477		
Nexia							
1.5 GL	95-97	DP 325	DP 2325				6481
1.5 16v	95-97	DP 940	DP 2940				6481
1.5 16v	95-97	DP 760	DP 2760				6482
1.5 (Auto)	95-97	DP 940	DP 2940				6482
1.5 (Auto)	95-97	DP 760	DP 2760				6482
Nubira							
1.6	97-	DP 1196			DP 1197		
2.0	97-	DP 1196			DP 1197		
Tacuma							
1.8	2000-	DP 1209			DP 1197		
2.0	2000-	DP 1209			DP 1197		

Pad Illustrations for Daewoo

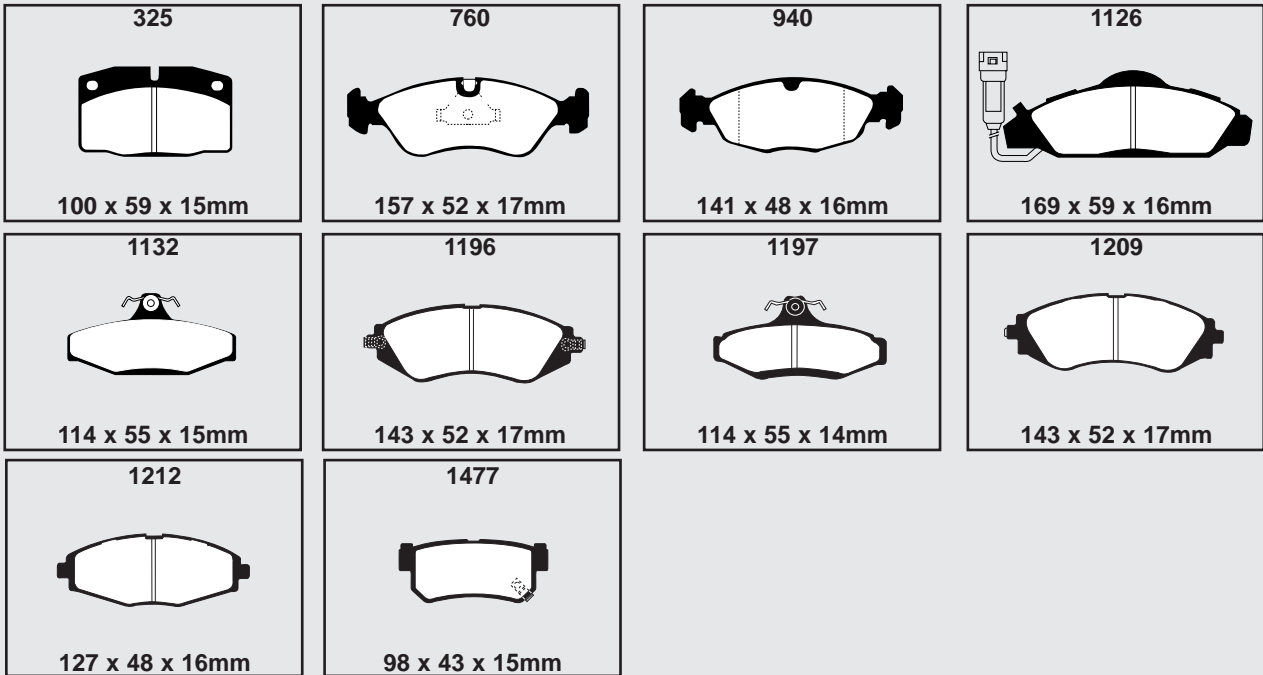

DAEWOO (SA)							
Cielo							
	96-	DP 325	DP 2325				
	96-	DP 415	DP 2415				
	96-	DP 1196					

*Every EBC pad and shoe requiring ECE R-90 is available with approval subject to stock rotation - check box end label.

Models listed by Engine Size. Only listed by trim level where pads differ, (16v, GL, GT, etc).

Standard Quality - ECE R90 Approved with similar performance to original equipment brake pads.
Upgrade Quality (Tuning / Sportbeläge) - ECE R90 Approved but with higher friction and improved performance for faster street use.

Standard Qualität - mit ECE R90 Freigabe und ähnlicher Bremsleistung wie die Original Bremsbeläge.
Verbesserte Qualität - mit ECE R90 Freigabe aber mit höherem Reibwert und verbesserter Bremsleistung für den schnellen Strasseneinsatz.

Calidad Estándar - Aprobación CEE R90 con prestaciones similares a las pastillas originales.
Calidad Mejorada - Aprobación CEE R90 pero con un coeficiente de fricción más elevado y prestaciones mejoradas para un uso deportivo en carretera.

BRAKE PADS & SHOES - APPLICATIONS

Bremsbeläge / Plaquettes + Bremsbacken / Machoires

EBC

BRAKES

Make/Model/Engine	Year	Pads	Front / Vorn / Avant	Shoes	Pads	Rear / Hinten / Arrière	Shoes
Hersteller/Modell/Motor	Jahr	Plaquettes / Bremsbeläge		Bremsbacken	Plaquettes / Bremsbeläge		Bremsbacken
Modelos	Années	Original Quality ECE R90* Approved	Upgrade Quality Tuning/Sportbeläge ECE R90* Approved	Machoires ECE R90* Approved	Original Quality ECE R90* Approved	Upgrade Quality Tuning/Sportbeläge ECE R90* Approved	Machoires ECE R90* Approved

Pad Illustrations for Daewoo (SA)

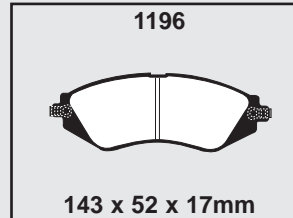
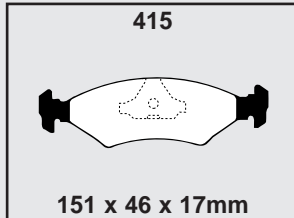
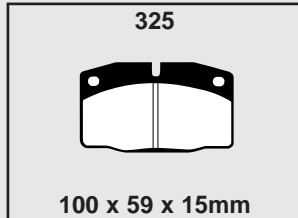

DAF					
33					
0.7	67-75			5146	5146
44					
0.8	66-75			5126/1	5126
45					
0.8	66-75	DP 105	DP 2105	5126/1	5126
46					
0.8	75-76	DP 105	DP 2105	5215	5216
55					
1.1	66-75	DP 105	DP 2105		5126
66					
1.1	72-75	DP 105	DP 2105	5126/1	5146
1.1	73-75	DP 105	DP 2105	5126/1	5216
1.3	72-75	DP 105	DP 2105		5146
1.3	73-75	DP 105	DP 2105		5216

Pad Illustrations for Daf

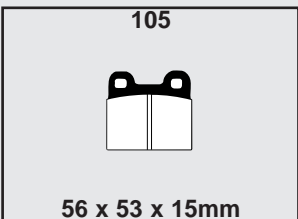

DAIHATSU					
Appause					
1.6 (A10)	89-92	DP 765			6485
1.6 (A11)	89-95	DP 765		DP 828	
Charade					
1.0 (G10)	77-82	DP 329			6281
1.0 (G11)	83-87	DP 475			6372
1.0 (G100)	87-93	DP 765			6448
1.0 Turbo (G11)	83-87	DP 475			6372
1.0 Turbo (G100)	87-89	DP 765			6448
1.0 GTti (G100)	87-93	DP 765		DP 768	
1.3 (G102)	87-93	DP 765			6448
1.3 (G200)	93-	DP 1015		DP 673	6448
1.5 (G203)	94-	DP 1015		DP 673	6448
1.6 (G201)	93-97	DP 1015		DP 673	
1.0 D (G30)	83-87	DP 475			6372
1.0 TD (G30)	85-87	DP 475			6372
1.0 TD (G101)	87-93	DP 765			6448

*Every EBC pad and shoe requiring ECE R-90 is available with approval subject to stock rotation - check box end label.
Models listed by Engine Size. Only listed by trim level where pads differ, (16v, GL, GT, etc).

Standard Quality - ECE R90 Approved with similar performance to original equipment brake pads.
Upgrade Quality (Tuning/ Sportbeläge) - ECE R90 Approved but with higher friction and improved performance for faster street use.
Verbesserte Qualität - mit ECE R90 Freigabe und ähnlicher Bremsleistung wie die Original Bremsbeläge.
Standard Qualität - mit ECE R90 Freigabe und ähnlicher Bremsleistung wie die Original Bremsbeläge.









Qualité standard - Approuvée par la norme ECE R90 - Des performances équivalentes à l'origine.
Qualité améliorée - Approuvée par la norme ECE R90 - Un coefficient de friction supérieur et des performances accrues pour pilotage rapide sur route.
Calidad Mejorada - Aprobación CEE R90 pero con un coeficiente de fricción más elevado y prestaciones mejoradas para un uso deportivo en carretera.
Calidad Estándar - Aprobación CEE R90 con prestaciones similares a las pastillas originales.

Standard Quality - ECE R90 Approved with similar performance to original equipment brake pads.
 Upgrade Quality (Tuning / Sportbeläge) - ECE R90 Approved but with higher friction and improved performance for faster street use.

Standard Qualität - mit ECE R90 Freigabe und ähnlicher Bremsleistung wie die Original Bremsbeläge.
 Verbesserte Qualität - mit ECE R90 Freigabe aber mit höherem Reibwert und verbesserter Bremsleistung für den schnellen Strasseninsatz.

Quality standard - Approuvée par la norme ECE R90 - Des performances équivalentes à l'origine.
 Qualité améliorée - Approuvée par la norme ECE R90 - Un coefficient de friction supérieur et des performances accrues pour pilotage rapide sur route.

Calidad Estándar - Aprobación CEE R90 con prestaciones similares a las pastillas originales.
 Calidad Mejorada - Aprobación CEE R90 pero con un coeficiente de fricción más elevado y prestaciones mejoradas para un uso deportivo en carretera.

Make/Model/Engine Hersteller/Modell/Motor Modèles	Year Jahr Années	Pads  Front / Vorn / Avant		Shoes	Pads  Rear / Hinten / Arrière		Shoes
		Original Quality ECE R90* Approved 	Upgrade Quality Tuning/Sportbeläge ECE R90* Approved 	Bremsbacken Machoires 	Original Quality ECE R90* Approved 	Upgrade Quality Tuning/Sportbeläge ECE R90* Approved 	Bremsbacken Machoires 
DAIHATSU Contd.							
Charmant							
1.2	74-78	DP 144					5170
1.3	74-78	DP 144					5170
1.3 (A35)	82-83	DP 196					5170
1.3 (A35)	83-87	DP 532					5170
1.4	76-81	DP 314					5169
1.6	76-81	DP 200					5169
1.6 (A45)	82-83	DP 196					5170
1.6 (A45)	83-85	DP 532					5170
1.6 (A60)	83-87	DP 532					5169
Compagno							
1.0	65-69	DP 136					
Consorte							
1.0	70-71	DP 144					5170
1.0	72-75	DP 195					5170
1.0	76-78	DP 329					5170
1.2	70-71	DP 144					5170
1.2	72-75	DP 195					5170
1.2	76-78	DP 329					5170
Copen							
0.7 Turbo	2003-						
Cuore							
0.6 Turbo	97-99	DP 1016					
0.8	97-	DP 1016					6533
1.0	98-	DP 1335					6533
Domino							
0.5 (L55)	81-82			6308			6281
0.5 (L60)	82-85	DP 542					6281
0.6 (L60)	82-85	DP 542					6281
0.8 (L80)	86-90	DP 685					6466
Feroza							
1.6	88-97	DP 799					6426
Fourtrak							
1.6 (F20 F25)	79-82			6279			6279
1.6 (F20 F25)	82-84	DP 541					6279
2.0 (F80 F85 F87)	84-89	DP 541					6426
2.0 (F80 F85 F87)	89-92	DP 799					6426
2.2 (F95 F98)	91-	DP 799					6426
2.5 D (F50 F55)	79-82			6279			6279
2.5 D (F50 F55)	82-84	DP 541					6279
2.8 D (F70 F75 F77)	84-89	DP 541					6426
2.8 D (F70 F75 F77)	89-93	DP 799					6426
2.8 TD (F70 F75 F77)	84-89	DP 541					6426
2.8 TD (F70 F75 F77) (F73 F78)	89-	DP 799					6426
Transmission Brake	79-84						6334
Grand Move							
1.5	97-	DP 1015			DP 673		
1.6	98-	DP 1015			DP 673		
Mira							
0.8 (L201)	93-96	DP 1016					6533
0.8 (L201)	93-96	DP 1016					6500

*Every EBC pad and shoe requiring ECE R-90 is available with approval subject to stock rotation - check box end label.









Models listed by Engine Size. Only listed by trim level where pads differ, (16v, GL, GT, etc).

BRAKE PADS & SHOES - APPLICATIONS

Bremsbeläge / Plaquettes + Bremsbacken / Machoires







EBC

BRAKES

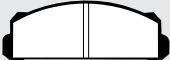
Make/Model/Engine Hersteller/Modell/Motor Modèles	Year Jahr Années	Pads  Front / Vorn / Avant		Shoes	Pads  Rear / Hinten / Arrière		Shoes
		Original Quality ECE R90* Approved 	Upgrade Quality Tuning/Sportbeläge ECE R90* Approved 	Bremsbacken Machoirs 	Original Quality ECE R90* Approved 	Upgrade Quality Tuning/Sportbeläge ECE R90* Approved 	Bremsbacken Machoirs 
DAIHATSU Contd.							
Move							
0.8	96-99	DP 1120					6466
1.0	98-	DP 1217					6466
Rocky							
2.0	87-89	DP 541					6426
2.0	89-93	DP 799					6426
2.8 D	87-89	DP 541					6426
2.8 D	89-93	DP 799					6426
2.8 TD	87-89	DP 541					6426
2.8 TD	89-	DP 799					6426
Sirion							
1.0	98-2000	DP 1217					6558
1.0	2000-	DP 1217					6466
1.3	2000-	DP 1217					6466
Sportrak							
1.6 (F300)	89-97	DP 799					6426
Terios							
1.3	97-	DP 1063	DP 21063				6518
Wildcat							
2.8 D	85-87	DP 541					6426
2.8 TD	85-87	DP 541					6426
YRV							
1.3	2000-	DP 1217					

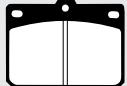
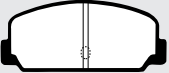
Standard Quality - ECE R90 Approved with similar performance to original equipment brake pads.
 Upgrade Quality (Tuning/ Sportbeläge) - ECE R90 Approved but with higher friction and improved performance for faster street use.
 Standard Qualität - mit ECE R90 Freigabe und ähnlicher Bremsleistung wie die Original Bremsbeläge.
 Verbesserte Qualität - mit ECE R90 Freigabe aber mit höherem Reibwert und verbesserter Bremsleistung für den schnellen Strasseninsatz.

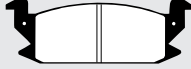
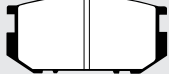
Pad Illustrations for Daihatsu

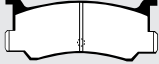



<p>136</p>  <p>52 x 52 x 15mm</p>	<p>144</p>  <p>108 x 38 x 14mm</p>	<p>195</p>  <p>77 x 61 x 13mm</p>	<p>196</p>  <p>78 x 59 x 14mm</p>
<p>200</p>  <p>108 x 47 x 14mm</p>	<p>314</p>  <p>108 x 46 x 14mm</p>	<p>329</p>  <p>79 x 63 x 13mm</p>	<p>475</p>  <p>124 x 44 x 14mm</p>
<p>532</p>  <p>106 x 52 x 14mm</p>	<p>541</p>  <p>127 x 52 x 15mm</p>	<p>542</p>  <p>97 x 35 x 14mm</p>	<p>673</p>  <p>101 x 42 x 13mm</p>

Qualité standard - Approuvée par la norme ECE R90 - Des performances équivalentes à l'origine.
 Qualité améliorée - Approuvée par la norme ECE R90 - Un coefficient de friction supérieur et des performances accrues pour pilotage rapide sur route.
 Calidad Estándar - Aprobación CEE R90 con prestaciones similares a las pastillas originales.
 Calidad Mejorada - Aprobación CEE R90 pero con un coeficiente de fricción más elevado y prestaciones mejoradas para un uso deportivo en carretera.

*Every EBC pad and shoe requiring ECE R-90 is available with approval subject to stock rotation - check box end label.
 Models listed by Engine Size. Only listed by trim level where pads differ, (16v, GL, GT, etc).

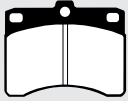
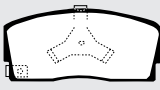
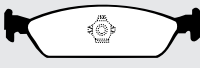
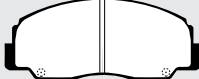
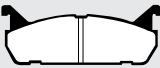
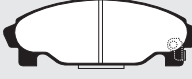
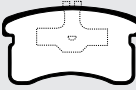
Make/Model/Engine	Year	Front / Vorn / Avant	Shoes	Rear / Hinten / Arrière	Shoes
Hersteller/Modell/Motor	Jahr	Plaquettes / Bremsbeläge	Bremsbacken Machoires	Plaquettes / Bremsbeläge	Bremsbacken Machoires
Modelos	Années	Original Quality ECE R90* Approved	Upgrade Quality Tuning/Sportbeläge ECE R90* Approved	Original Quality ECE R90* Approved	Upgrade Quality Tuning/Sportbeläge ECE R90* Approved



Pad Illustrations for Daihatsu Contd.

685  79 x 63 x 13mm	765  102 x 47 x 14mm	768  128 x 35 x 14mm	799  127 x 52 x 14mm
828  102 x 39 x 12mm	1015  125 x 45 x 15mm	1016  90 x 50 x 14mm	1063  114 x 50 x 15mm
1120  104 x 45 x 13mm	1217  115 x 51 x 16mm	1335  79 x 58 x 14mm	

DAIHATSU COMMERCIAL

550				
0.5 (S60)	78-81		6308	6281
0.5 (S65)	81-83		6308	6281
850				
0.8 (S70)	82-83		6414	6281
0.8 (S70)	83-86		6414	6415
0.8 (S84)	86-89		6414	6468
Hi-Jet				
0.8	86-87	DP 685	6414	6415
1.0 (S85) (S86)	86-94	DP 685		6434
1.0	90-94	DP 685		6501
1.0 (S85)	94-98	DP 685		6434
1.3 (S85)	98-	DP 685		6559
1.2 D (S85)	95-98	DP 685		6434
1.4 D	98-	DP 685		6559
Taft 4WD				
1.6 (F20)	79-80		6279	6279
1.6 (F25)	80-81		6279	6279
1.6 (F25)	81-83	DP 541		6279
2.5 D (F50, F55)	80-81		6279	6279
2.5 D (F50, F55)	81-84	DP 541		6279

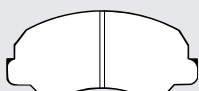







Pad Illustrations for Daihatsu Commercial

541  127 x 52 x 15mm	685  79 x 63 x 13mm
--	---

BRAKE PADS & SHOES - APPLICATIONS

Bremsbeläge / Plaquettes + Bremsbacken / Machoires

EBC
BRAKES

Make/Model/Engine Hersteller/Modell/Motor Modèles	Year Jahr Années	Pads  Front / Vorn / Avant		Shoes	Pads  Rear / Hinten / Arrière		Shoes
		Original Quality ECE R90* Approved 	Upgrade Quality Tuning/Sportbeläge ECE R90* Approved 	Bremsbacken Machoirs 	Original Quality ECE R90* Approved 	Upgrade Quality Tuning/Sportbeläge ECE R90* Approved 	Bremsbacken Machoirs 

DE LOREAN						
DMC-12	81-83	DP 291	DP 2291		DP 101	DP 2101

Pad Illustrations for De Lorean

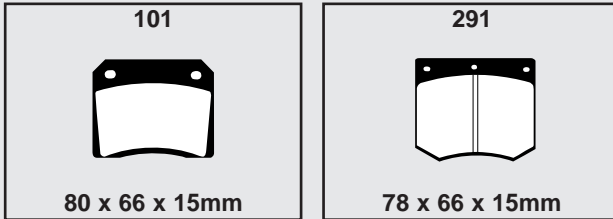

DE TOMASO						
Deauville	70-85	DP 2223	DP 3223		DP 2101	DP 3101
Guara 4.0	96-					
Longchamps 5.7	72-89	DP 2223	DP 3223		DP 2101	DP 3101
Mangusta	67-71	DP 2223	DP 3223		DP 2101	DP 3101
Pantera 5.0	91-	DP 21140	DP 31140			
5.7	70-73	DP 2180	DP 3180		DP 163	
5.7 GTS / GT5	73-90	DP 2180	DP 3180		DP 2162	DP 3162

Pad Illustrations for De Tomaso

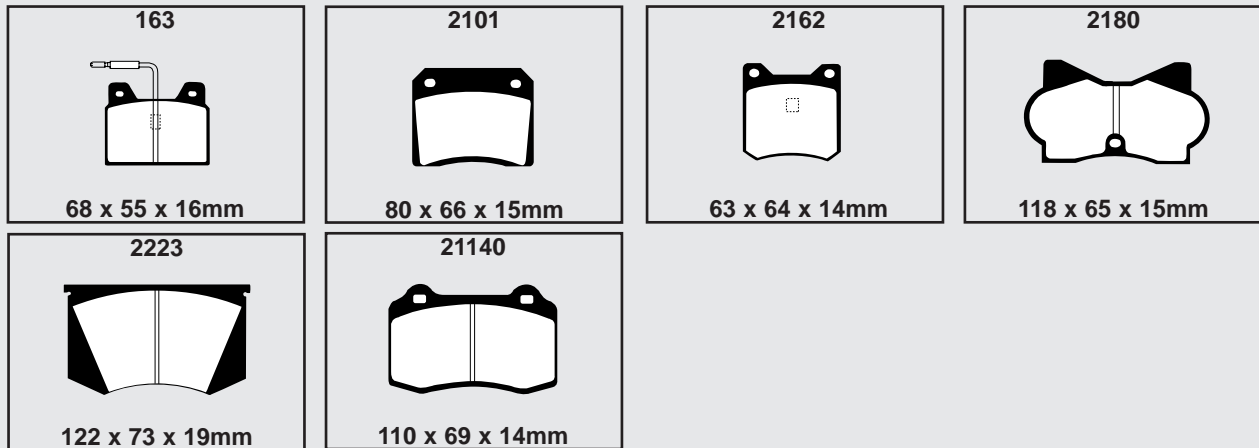





DODGE (USA)						
Viper 8.0	92-99	DP 21031	DP 31031		DP 2885	DP 3885
8.0	2000-2002	DP 21031	DP 31031		DP 21164	DP 31164
8.3	2002-	DP 21110	DP 31110		DP 21110	DP 31110



*Every EBC pad and shoe requiring ECE R-90 is available with approval subject to stock rotation - check box end label.
Models listed by Engine Size. Only listed by trim level where pads differ, (16v, GL, GT, etc).

Standard Quality - ECE R90 Approved with similar performance to original equipment brake pads.
Upgrade Quality (Tuning/ Sportbeläge) - ECE R90 Approved but with higher friction and improved performance for faster street use.
Verbesserte Qualität - mit ECE R90 Freigabe aber mit höherem Reibwert und verbesserter Bremsleistung für den schnellen Strasseninsatz.

Qualité standard - Approuvée par la norme ECE R90 - Des performances équivalentes à l'origine.
Qualité améliorée - Approuvée par la norme ECE R90 - Un coefficient de friction supérieur et des performances accrues pour pilotage rapide sur route.
Calidad Estándar - Aprobación CEE R90 con prestaciones similares a las pastillas originales.
Calidad Mejorada - Aprobación CEE R90 pero con un coeficiente de fricción más elevado y prestaciones mejoradas para un uso deportivo en carretera.

Make/Model/Engine	Year	Pads	Front / Vorn / Avant	Shoes	Pads	Rear / Hinten / Arrière	Shoes			
Hersteller/Modell/Motor	Jahr	Plaquettes / Bremsbeläge		Bremsbacken Machoires	Plaquettes / Bremsbeläge		Bremsbacken Machoires			
Modelos	Années	Original Quality ECE R90* Approved		Upgrade Quality Tuning/Sportbeläge ECE R90* Approved		Original Quality ECE R90* Approved		Upgrade Quality Tuning/Sportbeläge ECE R90* Approved		Original Quality ECE R90* Approved

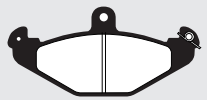
Pad Illustrations for Dodge (USA)

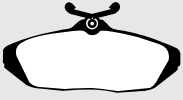
2885	21031	21110	21164
			
123 x 59 x 15mm	110 x 69 x 17mm	132 x 67 x 16mm	114 x 47 x 16mm

ELVA

Courier

1.5	62-65	-	DP 2141
1.6	62-65	-	DP 2141
1.8	62-65	-	DP 2141

Pad Illustrations for Elva

2141

73 x 53 x 15mm

FACEL VEGA

Excellence

5.9	59-64	DP 120	DP 2120	DP 120	DP 2120
6.3	59-64	DP 120	DP 2120	DP 120	DP 2120
6.4	59-64	DP 120	DP 2120	DP 120	DP 2120

Facellia

1.6	59-64	DP 120	DP 2120	DP 120	DP 2120
-----	-------	--------	---------	--------	---------

HK 500

5.9	57-61	DP 120	DP 2120	DP 120	DP 2120
6.3	57-61	DP 120	DP 2120	DP 120	DP 2120

Pad Illustrations for Facel Vega

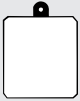
120

47 x 63 x 17mm

FAIRTHORPE

Electron Minor

0.9	67-73	DP 114	DP 2114
1.1	67-73	DP 114	DP 2114
1.3	67-73	DP 114	DP 2114

Standard Quality - ECE R90 Approved with similar performance to original equipment brake pads.
Upgrade Quality (Tuning / Sportbeläge) - ECE R90 Approved but with higher friction and improved performance for faster street use.

Standard Qualität - mit ECE R90 Freigabe und ähnlicher Bremsleistung wie die Original Bremsbeläge.
Verbesserte Qualität - mit ECE R90 Freigabe aber mit höherem Reibwert und verbesserter Bremsleistung für den schnellen Strasseninsatz.

Qualité standard - Approuvée par la norme ECE R90 - Des performances équivalentes à l'origine.
Qualité améliorée - Approuvée par la norme ECE R90 - Un coefficient de friction supérieur et des performances accrues pour pilotage rapide sur route.











Calidad Estándar - Aprobación CEE R90 con prestaciones similares a las pastillas originales.
Calidad Mejorada - Aprobación CEE R90 pero con un coeficiente de fricción más elevado y prestaciones mejoradas para un uso deportivo en carretera.

BRAKE PADS & SHOES - APPLICATIONS

Bremsbeläge / Plaquettes + Bremsbacken / Machoires

EBC

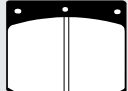

BRAKES

Make/Model/Engine Hersteller/Modell/Motor Modèles	Year Jahr Années	Pads  Front / Vorn / Avant		Shoes	Pads  Rear / Hinten / Arrière		Shoes
		Original Quality ECE R90* Approved 	Upgrade Quality Tuning/Sportbeläge ECE R90* Approved 	Bremsbacken Machoirs 	Original Quality ECE R90* Approved 	Upgrade Quality Tuning/Sportbeläge ECE R90* Approved 	Bremsbacken Machoirs 
FAIRTHORPE Contd.							
TX							
1.3	67-74	DP 169					
1.3	75-76	DP 258	DP 2291				
2.0	67-74	DP 169					
2.0	75-76	DP 258	DP 2291				
2.5	67-74	DP 169					
2.5	75-76	DP 258	DP 2291				
Pad Illustrations for Fairthorpe							
114		169		258		2291	
							
63 x 55 x 14mm		78 x 64 x 15mm		78 x 66 x 15mm		78 x 66 x 15mm	
FERRARI							
246							
2.4	69-73	DP 2103	DP 3103		DP 2104	DP 3104	
308							
3.0	73-85	DP 2103	DP 3103		DP 2104	DP 3104	
328							
3.2	85-89	DP 2414	DP 3414		DP 2415	DP 3415	
330 GTC / GTS							
4.0	66-68	DP 2223	DP 3223		DP 2101	DP 3101	
348							
3.4	89-94	DP 2612	DP 3612		DP 2612	DP 3612	
355							
3.5	94-99	DP 2612	DP 3612		DP 2612	DP 3612	
360							
3.6	99-	DP 21140	DP 31140		DP 21140	DP 31140	
365							
	66-67				DP 120		
	67-76	DP 2223	DP 3223		DP 2101	DP 3101	
	67-76	DP 2753	DP 3753		DP 2126	DP 3126	
400							
4.8	76-85	DP 2753	DP 3753		DP 2126	DP 3126	
412							
4.9	85-89	DP 2753	DP 3753		DP 2126	DP 3126	
456							
5.5	94-				DP 2612	DP 3612	
512BB							
5.0	76-85	DP 2753	DP 3753		DP 2126	DP 3126	
512TR							
5.0	92-96				DP 2612	DP 3612	

Standard Quality - ECE R90 Approved with similar performance to original equipment brake pads.
 Upgrade Quality (Tuning/ Sportbeläge) - ECE R90 Approved but with higher friction and improved performance for faster street use.
 Verbesserte Qualität - mit ECE R90 Freigabe aber mit höherem Reibwert und verbesserter Bremsleistung für den schnellen Strasseninsatz.

Qualité standard - Approuvée par la norme ECE R90 - Des performances équivalentes à l'origine.
 Qualité améliorée - Approuvée par la norme ECE R90 - Un coefficient de friction supérieur et des performances accrues pour pilotage rapide sur route.
 Calidad Mejorada - Aprobación CEE R90 con prestaciones similares a las pastillas originales.
 Calidad Mejorada - Aprobación CEE R90 pero con un coeficiente de fricción más elevado y prestaciones mejoradas para un uso deportivo en carretera.

*Every EBC pad and shoe requiring ECE R-90 is available with approval subject to stock rotation - check box end label.
 Models listed by Engine Size. Only listed by trim level where pads differ, (16v, GL, GT, etc).

Make/Model/Engine Hersteller/Modell/Motor Modelos	Year Jahr Années	Pads  Front / Vorn / Avant		Shoes	Pads  Rear / Hinten / Arrière		Shoes
		Original Quality ECE R90* Approved	Upgrade Quality Tuning/Sportbeläge ECE R90* Approved	Bremsbacken Machoires ECE R90* Approved	Original Quality ECE R90* Approved	Upgrade Quality Tuning/Sportbeläge ECE R90* Approved	Bremsbacken Machoires ECE R90* Approved
FERRARI Contd.							
550 5.5	97-2002	DP 2110	DP 3110				
575M 5.7	2002-						
365 Daytona	68-73	DP 2753	DP 3753		DP 2126	DP 3126	
Enzo 6.0	2003-						
GTO 2.9 Turbo	83-87	DP 2753	DP 3753		DP 2220	DP 3220	
Mondial 2.9	81-85	DP 2414	DP 3414		DP 2415	DP 3415	
	85-89	DP 2414	DP 3414		DP 2415	DP 3415	
	89-93	DP 2612	DP 3612		DP 2612	DP 3612	
Testarossa 4.9	84-91	DP 2753	DP 3753		DP 2220	DP 3220	
F40 2.9 Twin Turbo	87-93	DP 2110	DP 3110		DP 2110	DP 3110	
F50 4.7	96-	DP 2110	DP 3110				

Pad Illustrations for Ferrari

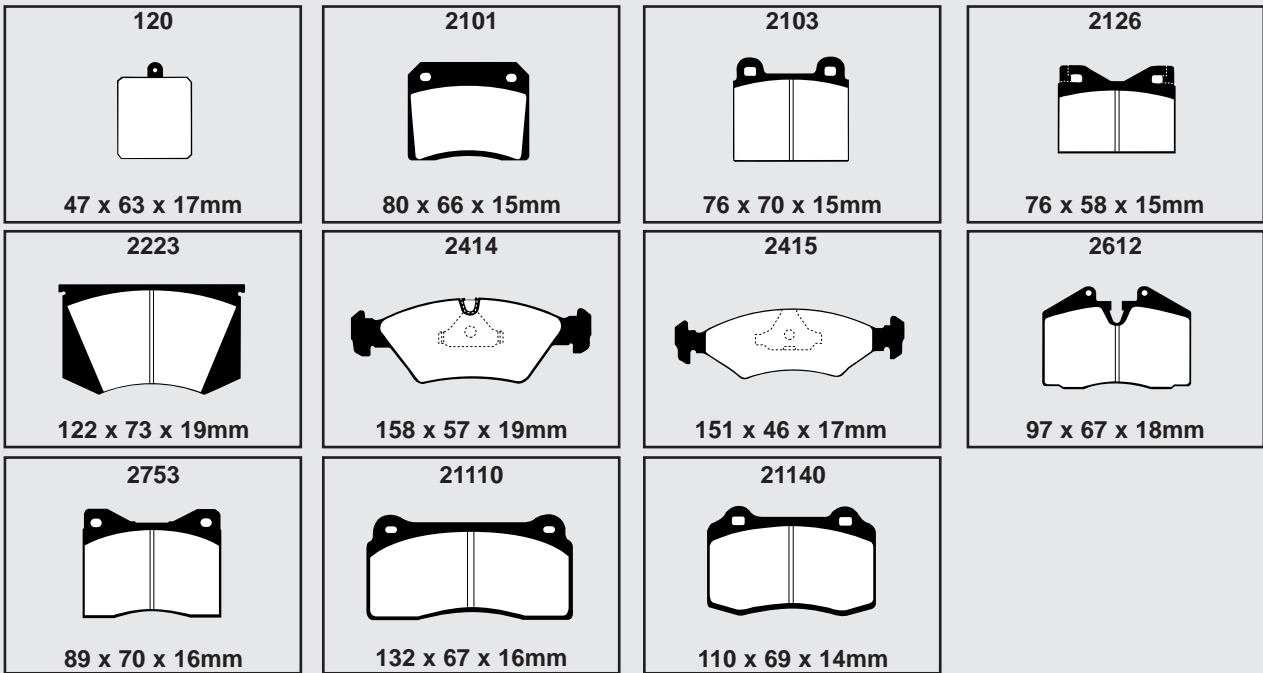

FIAT							
124 1.6	67-72			5034			5034
	72-76	DP 116	DP 2116		DP 130		
	72-76	DP 116	DP 2116		DP 130		
	77-80	DP 116	DP 2116		DP 130		
	77-80	DP 116	DP 2116		DP 130		

*Every EBC pad and shoe requiring ECE R-90 is available with approval subject to stock rotation - check box end label.

Models listed by Engine Size. Only listed by trim level where pads differ, (16v, GL, GT, etc).

BRAKE PADS & SHOES - APPLICATIONS

Bremsbeläge / Plaquettes + Bremsbacken / Machoires

EBC

BRAKES

Make/Model/Engine Hersteller/Modell/Motor Modèles	Year Jahr Années	Pads Plaquettes / Bremsbeläge		Shoes Bremsbacken Machoires	Pads Plaquettes / Bremsbeläge		Shoes Bremsbacken Machoires
		Original Quality ECE R90* Approved	Upgrade Quality Tuning/Sportbeläge ECE R90* Approved	ECE R90* Approved	Original Quality ECE R90* Approved	Upgrade Quality Tuning/Sportbeläge ECE R90* Approved	ECE R90* Approved
FIAT Contd.							
126							
0.6	72-78			5034			5034
0.7	78-92			5031			5031
127							
0.9	71-76			5031			5031
0.9	76-86	DP 116	DP 2116				5031
1.0	76-86	DP 116	DP 2116				5031
1.3	76-86	DP 116	DP 2116				5031
128							
1.1	69-84	DP 116	DP 2116				5031
1.3	69-84	DP 116	DP 2116				5031
130							
	66-70	DP 267			DP 151		
	70-71	DP 267			DP 154		
	71-78	DP 181*			DP 173		
* 2 Sets required							
131 Mirafiori							
1.3	74-81	DP 116	DP 2116				5187/2
1.3	81-82	DP 372	DP 2116				5187/2
1.4	81-82	DP 372	DP 2116				5187/2
1.4	82-83	DP 485	DP 2485				5187/2
1.6	74-81	DP 116	DP 2116				5187/2
1.6	81-82	DP 372	DP 2116				5187/2
1.6	82-83	DP 485	DP 2485				5187/2
2.0	74-81	DP 116	DP 2116				5187/2
2.0	81-82	DP 372	DP 2116				5187/2
2.0	82-83	DP 485	DP 2485				5187/2
2.0	84-85	DP 372	DP 2116				5187/2
132							
1.6	72-77	DP 116	DP 2116		DP 130		
1.6	78-81	DP 116	DP 2116				5187/2
2.0	72-77	DP 116	DP 2116		DP 130		
2.0	78-81	DP 116	DP 2116				5187/2
500							
0.5	69-71			5013			5013
0.5	72-75			5034			5034
0.6	69-71			5013			5013
0.6	72-75			5034			5034
850							
0.9	65-67	DP 110					5017
0.9	67-68	DP 110					5025
0.9	68-73	DP 112					5025
X1/9							
1.3	72-82	DP 116	DP 2116		DP 130		
1.5	79-82	DP 116	DP 2116		DP 130		
1.5	83-89	DP 372	DP 2116		DP 130		
Argenta							
1.6	81-82	DP 420	DP 2420/2				5072
1.6	83-84	DP 420/2	DP 2420/2		DP 501		5072
2.0	81-82	DP 420	DP 2420/2				5072
2.0	83-84	DP 420/2	DP 2420/2		DP 501		5072
2.0	83-86	DP 420/2	DP 2420/2		DP 501		5072
2.4 D	83-84	DP 420/2	DP 2420/2		DP 501		5072
2.4 TD	83-86	DP 420/2	DP 2420/2		DP 501		5072









*Every EBC pad and shoe requiring ECE R-90 is available with approval subject to stock rotation - check box end label.
Models listed by Engine Size. Only listed by trim level where pads differ, (16v, GL, GT, etc).

Standard Quality - ECE R90 Approved with similar performance to original equipment brake pads.
Upgrade Quality (Tuning/ Sportbeläge) - ECE R90 Approved but with higher friction and improved performance for faster street use.
Verbesserte Qualität - mit ECE R90 Freigabe aber mit höherem Reibwert und verbesserter Bremsleistung für den schnellen Strasseninsatz.
Standard Qualität - mit ECE R90 Freigabe und ähnlicher Bremsleistung wie die Original Bremsbeläge.
Qualité standard - Approuvée par la norme ECE R90 - Des performances équivalentes à l'origine.
Qualité améliorée - Approuvée par la norme ECE R90 - Un coefficient de friction supérieur et des performances accrues pour pilotage rapide sur route.
Calidad Estándar - Aprobación CEE R90 con prestaciones similares a las pastillas originales.
Calidad Mejorada - Aprobación CEE R90 pero con un coeficiente de fricción más elevado y prestaciones mejoradas para un uso deportivo en carretera.

Standard Quality - ECE R90 Approved with similar performance to original equipment brake pads.
 Upgrade Quality (Tuning / Sportbeläge) - ECE R90 Approved but with higher friction and improved performance for faster street use.

Standard Qualität - mit ECE R90 Freigabe und ähnlicher Bremsleistung wie die Original Bremsbeläge.
 Verbesserte Qualität - mit ECE R90 Freigabe aber mit höherem Reibwert und verbesserter Bremsleistung für den schnellen Strasseninsatz.

Calidad Estándar - Aprobacion CEE R90 con prestaciones similares a las pastillas originales.
 Calidad Mejorada - Aprobacion CEE R90 pero con un coeficiente de friccion mas elevado y prestaciones mejoradas para un uso deportivo en carretera.

Make/Model/Engine Hersteller/Modell/Motor Modèles	Year Jahr Années	Pads  Front / Vorn / Avant		Shoes	Pads  Rear / Hinten / Arrière		Shoes
		Original Quality ECE R90* Approved 	Upgrade Quality Tuning/Sportbeläge ECE R90* Approved 	Bremsbacken Machoires 	Original Quality ECE R90* Approved 	Upgrade Quality Tuning/Sportbeläge ECE R90* Approved 	Bremsbacken Machoires 
FIAT Contd.							
Barchetta							
1.8	95-99	DP 1060	DP 21060			DP 596	
1.8	99-	DP 1060	DP 21060			DP 1214	
Brava/Bravo							
1.2	99-2002	DP 1059	DP 21059				6503
1.2	99-2002	DP 1059	DP 21059				6552
1.4	95-2002	DP 1059	DP 21059				6503
1.6	95-97	DP 1059	DP 21059				6554
1.6	97-2002	DP 1059	DP 21059				6552
1.8	95-97	DP 1060	DP 21060				6554
1.8	97-2002	DP 1060	DP 21060				6552
2.0	95-2002	DP 1061	DP 21061			DP 596	
2.0	97-2002	DP 1061	DP 21061			DP 1214	
1.9 D	95-96	DP 1059	DP 21059				6503
1.9 TD (75)	95-96	DP 1059	DP 21059				6554
1.9 TD (75)	96-2002	DP 1059	DP 21059				6552
1.9 TD (100)	95-96	DP 1060	DP 21060				6554
1.9 TD (100)	97-2002	DP 1060	DP 21060				6552
Cinquecento							
0.9	93-98	DP 944	DP 2944				5031
1.1	95-98	DP 944	DP 2944				5031
Coupe							
2.0 16v	95-97	DP 1061	DP 21061			DP 596	
2.0 16v	95-97	DP 733(G)	DP 2733			DP 596	
2.0 20v	96-2000	DP 1061	DP 21061			DP 1214	
2.0 16v Turbo	95-97	DP 733(G)	DP 2733			DP 596	
2.0 16v Turbo	95-97	DP 1061(T)	DP 21061			DP 596	
2.0 20v Turbo	96-2000	DP 21031	DP 31031			DP 1214	
Croma							
1.6	86-88	DP 616	DP 2420/2			DP 501(B)	
1.6	86-88	DP 616	DP 2420/2			DP 370(G)	DP 2370
1.6	89-93	DP 820	DP 2820			DP 370(G)	DP 2370
1.6	89-93	DP 820	DP 2820			DP 501(B)	
2.0	86-88	DP 616	DP 2420/2			DP 501(B)	
2.0	86-88	DP 616	DP 2420/2			DP 370(G)	DP 2370
2.0	89-93	DP 820	DP 2820			DP 370(G)	DP 2370
2.0	89-93	DP 820	DP 2820			DP 501(B)	
2.0 Turbo	86-88	DP 616	DP 2420/2			DP 501(B)	
2.0 Turbo	86-88	DP 616	DP 2420/2			DP 370(G)	DP 2370
2.0 Turbo	89-93	DP 820	DP 2820			DP 370(G)	DP 2370
2.0 Turbo	89-93	DP 820	DP 2820			DP 501(B)	
1.9TD	89-93	DP 820	DP 2820			DP 370(G)	DP 2370
1.9TD	89-93	DP 820	DP 2820			DP 501(B)	
2.5D	86-88	DP 616	DP 2420/2			DP 501(B)	
2.5D	86-88	DP 616	DP 2420/2			DP 370(G)	DP 2370
2.5D	89-93	DP 820	DP 2820			DP 370(G)	DP 2370
2.5D	89-93	DP 820	DP 2820			DP 501(B)	
2.5TD	89-93	DP 820	DP 2820			DP 370(G)	DP 2370
2.5TD	89-93	DP 820	DP 2820			DP 501(B)	
Dino							
2.0	65-71	DP 108	DP 2108			DP 101	DP 2101
2.4	72-75	-	DP 2180			-	DP 2162
Doblo							
1.2	2001-	DP 1337	DP 21337				6617
1.9 D	2001-	DP 1337	DP 21337				6617
1.9TD	2002-	DP 1337	DP 21337				6617

*Every EBC pad and shoe requiring ECE R-90 is available with approval subject to stock rotation - check box end label.





Models listed by Engine Size. Only listed by trim level where pads differ, (16v, GL, GT, etc).

BRAKE PADS & SHOES - APPLICATIONS

Bremsbeläge / Plaquettes + Bremsbacken / Machoires









EBC

BRAKES

Make/Model/Engine	Year	Pads  Front / Vorn / Avant		Shoes	Pads  Rear / Hinten / Arrière		Shoes
Hersteller/Modell/Motor	Jahr	Plaquettes / Bremsbeläge		Bremsbacken Machoirs	Plaquettes / Bremsbeläge		Bremsbacken Machoirs
Modelos	Années	Original Quality ECE R90* Approved	Upgrade Quality Tuning/Sportbeläge ECE R90* Approved	 ECE R90* Approved	Original Quality ECE R90* Approved	Upgrade Quality Tuning/Sportbeläge ECE R90* Approved	 ECE R90* Approved
FIAT Contd.							
Marea							
1.6	96-97	DP 1059	DP 21059				5345
1.6	96-97	DP 1059	DP 21059				6554
1.6	96-97	DP 1059	DP 21059				6345
1.6	96-97	DP 1059	DP 21059				6554
1.6	97-	DP 1059	DP 21059				6552
1.6 Auto	96-97	DP 1060	DP 21060				5345
1.6 Auto	96-97	DP 1060	DP 21060				6345
1.6 Auto	97-	DP 1060	DP 21060				6552
1.8	96-97	DP 1060	DP 21060		DP 596		6554
1.8	97-	DP 1060	DP 21060		DP 1214		6552
2.0	96-97	DP 1061	DP 21061		DP 596		
2.0	97-	DP 1061	DP 21061		DP 1214		
1.9 TD (75)	96-97	DP 1059	DP 21059				6554
1.9 TD (75)	97-	DP 1059	DP 21059				6552
1.9 TD (100)	96-97	DP 1060	DP 21060				6554
1.9 TD (100)	97-	DP 1060	DP 21060				6552
2.4 TD	96-97	DP 1061	DP 21061		DP 596		
2.4 TD	97-	DP 1061	DP 21061		DP 1214		
Marea Weekend							
1.6	96-97	DP 1059	DP 21059				5345
1.6	96-97	DP 1059	DP 21059				6345
1.6	97-	DP 1059	DP 21059				6553
1.6 Auto	96-97	DP 1060	DP 21060				5345
1.6 Auto	96-97	DP 1060	DP 21060				6345
1.6 Auto	97-	DP 1060	DP 21060				6553
1.8	96-97	DP 1060	DP 21060		DP 596		6553
1.8	97-	DP 1060	DP 21060		DP 1214		
2.0	96-97	DP 1061	DP 21061		DP 596		
2.0	97-	DP 1061	DP 21061		DP 1214		
1.9 TD (75)	96-97	DP 1059	DP 21059				6345
1.9 TD (75)	97-	DP 1059	DP 21059				6553
1.9 TD (100)	96-97	DP 1060	DP 21060				6345
1.9 TD (100)	97-	DP 1060	DP 21060				6553
2.4 TD	96-97	DP 1061	DP 21061		DP 596		
2.4 TD	97-	DP 1061	DP 21061		DP 1214		
Multipla							
1.6	99-	DP 1061	DP 21061				6553
1.9 TD	99-	DP 1061	DP 21061				6553
Panda							
0.7	80-82	DP 116	DP 2116				5031
0.7	83-92	DP 485	DP 2485				5031
0.8	80-82	DP 116	DP 2116				5031
0.8	83-92	DP 485	DP 2485				5031
0.8	92-96	DP 718					6502
0.9	80-82	DP 116	DP 2116				5031
0.9	83-92	DP 485	DP 2485				5031
0.9	92-96	DP 718					6502
1.0	80-82	DP 116	DP 2116				5031
1.0	83-92	DP 485	DP 2485				5031
1.0	92-96	DP 718					6502
1.1	93-96	DP 718					6502
Punto							
1.1	94-98	DP 945	DP 2945				6503(L)
1.1	94-98	DP 945	DP 2945				6329(B)
1.2 (60, 75)	94-99	DP 945	DP 2945				6503(L)
1.2 (60, 75)	94-99	DP 945	DP 2945				6329(B)
1.2 (60)	99-	DP 945	DP 2945				6583

*Every EBC pad and shoe requiring ECE R-90 is available with approval subject to stock rotation - check box end label.
Models listed by Engine Size. Only listed by trim level where pads differ, (16v, GL, GT, etc).

Standard Quality - ECE R90 Approved with similar performance to original equipment brake pads.
Upgrade Quality (Tuning/ Sportbeläge) - ECE R90 Approved but with higher friction and improved performance for faster street use.
Verbesserte Qualität - mit ECE R90 Freigabe und ähnlicher Bremsleistung wie die Original Bremsbeläge.
Standard Qualität - mit ECE R90 Freigabe und ähnlicher Bremsleistung wie die Original Bremsbeläge.
Qualité standard - Approuvée par la norme ECE R90 - Des performances équivalentes à l'origine.
Qualité améliorée - Approuvée par la norme ECE R90 - Un coefficient de friction supérieur et des performances accrues pour pilotage rapide sur route.
Calidad Mejorada - Aprobación CEE R90 pero con un coeficiente de fricción mas elevado y prestaciones mejoradas para un uso deportivo en carretera.
Calidad Estándar - Aprobación CEE R90 con prestaciones similares a las pastillas originales.

Make/Model/Engine Hersteller/Modell/Motor Modelos	Year Jahr Années	Pads  Front / Vorn / Avant		Shoes	Pads  Rear / Hinten / Arrière		Shoes
		Original Quality ECE R90* Approved 	Upgrade Quality Tuning/Sportbeläge ECE R90* Approved 	Bremsbacken Machoires 	Original Quality ECE R90* Approved 	Upgrade Quality Tuning/Sportbeläge ECE R90* Approved 	Bremsbacken Machoires 
FIAT Contd.							
Punto Contd.							
1.2 (60)	99-	DP 945	DP 2945				6584
1.2 (80)	99-	DP 1336	DP 21336				6583
1.2 (80)	99-	DP 1336	DP 21336				6584
1.2 Selecta	94-99	DP 945	DP 2945				6503(L)
1.2 16v (85)	97-99	DP 1141	DP 21059				6329(B)
1.2 16v (85)	97-99	DP 1141	DP 21059				6503(L)
1.4 Turbo	94-97	DP 420/2	DP 2420/2		DP 596		
1.4 Turbo	97-99	DP 1060	DP 21060		DP 1214		
1.6	95-97	DP 420/2	DP 2420/2		DP 596		6503(L)
1.6	95-97	DP 420/2	DP 2420/2				6329(B)
1.6	97-99	DP 420/2	DP 2420/2		DP 1214		
1.8 16v	99-	DP 1337	DP 21337		DP 1338		
1.7 D	95-98	DP 945	DP 2945				6503(L)
1.7 D	95-98	DP 945	DP 2945				6329(B)
1.7 TD	94-99	DP 420/2	DP 2420/2		DP 596		
1.7 TD	97-99	DP 1141	DP 21059		DP 1214		6503(L)
1.7 TD	97-99	DP 1141	DP 21059		DP 1214		6329(B)
1.9 D	99-	DP 1336	DP 21336				6583
1.9 TD	99-	DP 1336	DP 21336				6583
Regata							
1.3	84-90	DP 485(B)	DP 2485				5031
1.3	84-90	DP 420/2(G)	DP 2420/2				5031
1.5	84-90	DP 485(B)	DP 2485				5031
1.5	84-90	DP 420/2(G)	DP 2420/2				5031
1.6	84-90	DP 485(B)	DP 2485				5031
1.6	84-90	DP 420/2(G)	DP 2420/2				5031
1.7 D	84-90	DP 485(B)	DP 2485				5031
1.7 D	84-90	DP 420/2(G)	DP 2420/2				5031
1.9 D	84-90	DP 485(B)	DP 2485				5031
1.9 D	84-90	DP 420/2(G)	DP 2420/2				5031
1.9 TD	84-90	DP 485(B)	DP 2485				5031
1.9 TD	84-90	DP 420/2(G)	DP 2420/2				5031
Seicento							
0.9	98-	DP 944	DP 2944				5031
1.1	98-	DP 944	DP 2944				5031
Stilo							
1.2	2001-	DP 1384	DP 21384		DP 1381		
1.6	2001-	DP 1384	DP 21384		DP 1381		
1.8	2001-	DP 1383	DP 21383		DP 1381		
2.4	2001-	DP 1382	DP 21382		DP 1381		
1.9 TD	2001-	DP 1383	DP 21383		DP 1381		
Strada/Ritmo							
1.1	79-81	DP 116	DP 2116				5031
1.1	81-83	DP 372	DP 2116				5031
1.1	83-87	DP 485	DP 2485				5031
1.3	79-81	DP 116	DP 2116				5031
1.3	81-83	DP 372	DP 2116				5031
1.3	83-87	DP 485	DP 2485				5031
1.5	79-81	DP 116	DP 2116				5031
1.5	81-83	DP 372	DP 2116				5031
1.5	83-87	DP 485	DP 2485				5031
1.6	81-83	DP 372	DP 2116				5031
1.6	83-87	DP 485	DP 2485				5031
1.6 (105TC)	82-87	DP 420/2	DP 2420/2				5031
2.0 (125TC)	82-87	DP 417	DP 2317				5031
2.0 (130TC)	82-87	DP 417	DP 2317				5031

Standard Quality - ECE R90 Approved with similar performance to original equipment brake pads.
 Upgrade Quality (Tuning / Sportbeläge) - ECE R90 Approved but with higher friction and improved performance for faster street use.

Standard Qualität - mit ECE R90 Freigabe und ähnlicher Bremsleistung wie die Original Bremsbeläge.
 Verbesserte Qualität - mit ECE R90 Freigabe aber mit höherem Reibwert und verbesserter Bremsleistung für den schnellen Strasseninsatz.

Quality Standard - Approuvée par la norme ECE R90 - Des performances équivalentes à l'origine.
 Qualité améliorée - Approuvée par la norme ECE R90 - Un coefficient de friction supérieur et des performances accrues pour pilotage rapide sur route.

Calidad Estándar - Aprobación CEE R90 con prestaciones similares a las pastillas originales.
 Calidad Mejorada - Aprobación CEE R90 pero con un coeficiente de fricción más elevado y prestaciones mejoradas para un uso deportivo en carretera.









*Every EBC pad and shoe requiring ECE R-90 is available with approval subject to stock rotation - check box end label.
 Models listed by Engine Size. Only listed by trim level where pads differ, (16v, GL, GT, etc).

BRAKE PADS & SHOES - APPLICATIONS

Bremsbeläge / Plaquettes + Bremsbacken / Machoires

EBC

BRAKES







Make/Model/Engine Hersteller/Modell/Motor Modelos	Year Jahr Années	Pads  Front / Vorn / Avant		Shoes	Pads  Rear / Hinten / Arrière		Shoes
		Original Quality ECE R90* Approved 	Upgrade Quality Tuning/Sportbeläge ECE R90* Approved 	Bremsbacken Machoires 	Original Quality ECE R90* Approved 	Upgrade Quality Tuning/Sportbeläge ECE R90* Approved 	Bremsbacken Machoires 
FIAT Contd.							
Tempra							
1.4	90-92	DP 718					5329(B) 6329
1.4	90-92	DP 718					5329(B) 6329
1.6	90-96	DP 718					5329(B) 6329
1.6	90-96	DP 718					5329(B) 6329
1.6	90-96	DP 420/2	DP 2420/2				6503(L) 5345(B) 6345
1.6 Est	90-96	DP 420/2	DP 2420/2				5345(B) 6345
1.6 Est	90-96	DP 420/2	DP 2420/2				5345(B) 6345
1.6 (ABS)	90-96	DP 420/2	DP 2420/2		DP 596		5345(B) 6345
1.6 (Auto)	90-96	DP 420/2	DP 2420/2				5345(B) 6345
1.6 (Auto)	90-96	DP 420/2	DP 2420/2				5345(B) 6345
1.8	90-92	DP 718					5345(B) 6345
1.8	90-92	DP 718					5345(B) 6345
1.8 (ABS)	90-92	DP 420/2	DP 2420/2		DP 596		5345(B) 6345
2.0	90-96	DP 420/2	DP 2420/2		DP 596		5345(B) 6345
1.9 D	90-96	DP 420/2	DP 2420/2				5345(B) 6345
1.9 D	90-96	DP 420/2	DP 2420/2				5345(B) 6345
1.9 D (ABS)	90-96	DP 420/2	DP 2420/2		DP 596		5345(B) 6345
1.9 TD	90-96	DP 420/2	DP 2420/2				5345(B) 6345
1.9 TD	90-96	DP 420/2	DP 2420/2				5345(B) 6345
1.9 TD (ABS)	90-96	DP 420/2	DP 2420/2		DP 596		5345(B) 6345
Tipo							
1.4	88-95	DP 718					5329(B) 6329
1.4	88-95	DP 718					5329(B) 6329
1.4	92-95	DP 420/2	DP 2420/2				6503(L)
1.4 (ABS)	88-96	DP 420/2	DP 2420/2		DP 596		5329(B) 6329
1.6	88-95	DP 718					5329(B) 6329
1.6	88-95	DP 718					5329(B) 6329
1.6	92-95	DP 420/2	DP 2420/2				6503(L)
1.6 (ABS)	88-95	DP 420/2	DP 2420/2		DP 596		5345(B) 6345
1.6 (Auto)	90-94	DP 420/2	DP 2420/2				5345(B) 6345
1.6 (Auto)	90-94	DP 420/2	DP 2420/2				5345(B) 6345
1.8	88-95	DP 420/2	DP 2420/2		DP 596		5345(B) 6345
1.8	88-95	DP 420/2	DP 2420/2		DP 596		5345(B) 6345
1.8 16v	92-95	DP 733	DP 2733		DP 596		5345(B) 6345
2.0	88-96	DP 420/2	DP 2420/2		DP 596		5345(B) 6345
2.0 16v	92-95	DP 733	DP 2733		DP 596		5345(B) 6345
1.7 D	88-92	DP 718					5329(B) 6329
1.7 D	88-92	DP 718					5329(B) 6329
1.7 D	92-95	DP 420/2	DP 2420/2				6503(L)
1.9 TD	88-95	DP 420/2	DP 2420/2				5345(B) 6345
1.9 TD	88-95	DP 420/2	DP 2420/2				5345(B) 6345
1.9 TD (ABS)	88-95	DP 420/2	DP 2420/2		DP 596		5345(B) 6345
Ulysse							
1.7	96-2000	DP 1053			DP 1040		6516
2.0 Turbo	94-2000	DP 1108	DP 2733		DP 1040		6516
2.0	94-2003	DP 1108	DP 2733		DP 1040		6516
2.0	2003-	DP 1466	DP 21466		DP 1230	DP 21230	6516
1.9 TD	94-2000	DP 1108	DP 2733		DP 1040		6516
2.0 D	2000-2003	DP 1108	DP 2733		DP 1040		6516
2.0 TD	2003-	DP 1466	DP 21466		DP 1230	DP 21230	6516
2.1 TD	95-2000	DP 1108	DP 2733		DP 1040		6516
2.2 TD	2003-	DP 1466	DP 21466		DP 1230	DP 21230	6516
Handbrake shoes	94-2003						6546

Standard Quality - ECE R90 Approved with similar performance to original equipment brake pads.
 Upgrade Quality (Tuning/ Sportbeläge) - ECE R90 Approved but with higher friction and improved performance for faster street use.
 Verbesserte Qualität - mit ECE R90 Freigabe und ähnlicher Bremsleistung wie die Original Bremsbeläge.
 Standard Qualität - mit ECE R90 Freigabe und ähnlicher Bremsleistung wie die Original Bremsbeläge.
 Calidad Estándar - Aprobación CEE R90 con prestaciones similares a las pastillas originales.
 Calidad Mejorada - Aprobación CEE R90 pero con un coeficiente de fricción más elevado y prestaciones mejoradas para un uso deportivo en carretera.
 Qualité standard - Approuvée par la norme ECE R90 - Des performances équivalentes à l'origine.
 Qualité améliorée - Approuvée par la norme ECE R90 - Un coefficient de friction supérieur et des performances accrues pour pilotage rapide sur route.

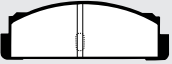
*Every EBC pad and shoe requiring ECE R-90 is available with approval subject to stock rotation - check box end label.
 Models listed by Engine Size. Only listed by trim level where pads differ, (16v, GL, GT, etc).

Make/Model/Engine Hersteller/Modell/Motor Modelos	Year Jahr Années	Pads Plaquettes / Bremsbeläge		Shoes Bremsbacken Machoires	Pads Plaquettes / Bremsbeläge		Shoes Bremsbacken Machoires
		Original Quality ECE R90* Approved	Upgrade Quality Tuning/Sportbeläge ECE R90* Approved	ECE R90* Approved	Original Quality ECE R90* Approved	Upgrade Quality Tuning/Sportbeläge ECE R90* Approved	ECE R90* Approved
FIAT Contd.							
Uno							
0.9	83-93	DP 485(B)	DP 2485				5031
1.0	83-92	DP 485(B)	DP 2485				5031
1.0	93-95	DP 485(B)	DP 2485				6502
1.0	93-95	DP 420/2(G)	DP 2420/2				6502
1.1	83-92	DP 485(B)	DP 2485				5031
1.1	92-95	DP 485(B)	DP 2485				6502
1.1 Selecta	90-94	DP 420/2(G)	DP 2420/2		DP 596		
1.3	83-89	DP 485(B)	DP 2485				5031
1.3	92-95	DP 485(B)	DP 2485				6502
1.3 Turbo	85-89	DP 420/2(G)	DP 2420/2		DP 596		
1.4	89-92	DP 420/2(G)	DP 2420/2				5031
1.4	92-95	DP 420/2(G)	DP 2420/2				6502
1.4 Selecta	90-94	DP 420/2(G)	DP 2420/2		DP 596		
1.4 Turbo	90-94	DP 420/2(G)	DP 2420/2		DP 596		
1.7 D	84-92	DP 420/2(G)	DP 2420/2				5031
1.7 D	92-94	DP 420/2(G)	DP 2420/2				6502

Pad Illustrations for Fiat

<p>101</p>  <p>80 x 66 x 15mm</p>	<p>108</p>  <p>98 x 68 x 16mm</p>	<p>110</p>  <p>95 x 40 x 12/13mm</p>	<p>112</p>  <p>108 x 39 x 12mm</p>
<p>116</p>  <p>108 x 39 x 17mm</p>	<p>130</p>  <p>108 x 39 x 10mm</p>	<p>151</p>  <p>109 x 49 x 12mm</p>	<p>154</p>  <p>109 x 49 x 15mm</p>
<p>162</p>  <p>63 x 64 x 14mm</p>	<p>173</p>  <p>104 x 52 x 15mm</p>	<p>2180</p>  <p>118 x 65 x 15mm</p>	<p>181</p>  <p>118 x 56 x 18mm</p>
<p>267</p>  <p>156 x 59 x 18mm</p>	<p>370</p>  <p>87 x 62 x 16mm</p>	<p>372</p>  <p>108 x 39 x 17mm</p>	<p>417</p>  <p>108 x 49 x 15mm</p>
<p>420</p>  <p>104 x 66 x 19mm</p>	<p>420/2</p>  <p>104 x 66 x 17mm</p>	<p>485</p>  <p>108 x 49 x 18mm</p>	<p>501</p>  <p>108 x 47 x 12mm</p>

BRAKE PADS & SHOES - APPLICATIONS

Bremsbeläge / Plaquettes + Bremsbacken / Machoires

EBC

BRAKES

Make/Model/Engine	Year	Pads	Front / Vorn / Avant	Shoes	Pads	Rear / Hinten / Arrière	Shoes
Hersteller/Modell/Motor	Jahr	Plaquettes / Bremsbeläge		Bremsbacken	Plaquettes / Bremsbeläge		Bremsbacken
Modelos	Années	Original Quality ECE R90* Approved	Upgrade Quality Tuning/Sportbeläge ECE R90* Approved	Original Quality ECE R90* Approved	Upgrade Quality Tuning/Sportbeläge ECE R90* Approved	Original Quality ECE R90* Approved	Upgrade Quality Tuning/Sportbeläge ECE R90* Approved

Pad Illustrations for Fiat Contd.

596 87 x 44 x 14mm	616 104 x 66 x 17mm	718 90 x 63 x 17mm	733 130 x 59 x 18mm
820 110 x 56 x 18mm	944 115 x 55 x 16mm	945 115 x 55 x 16mm	1031 110 x 69 x 17mm
1040 123 x 43 x 17mm	1053 140 x 69 x 18mm	1059 151 x 52 x 17mm	1060 156 x 52 x 17mm
1061 156 x 58 x 19mm	1108 130 x 58 x 19mm	1141 151 x 52 x 18mm	1214 87 x 44 x 14mm
1336 151 x 52 x 17mm	1337 151 x 52 x 18mm	1338 95 x 43 x 13mm	1381 95 x 42 x 15mm
1382 151 x 57 x 18mm	1383 137 x 57 x 18mm	1384 123 x 53 x 17mm	1466 147 x 59 x 19mm

FIAT COMMERCIAL					
242					
1.6	74-83	DP 395		DP 190	
1.8	74-83	DP 395		DP 190	
2.0	74-83	DP 395		DP 190	
2.2 D	74-83	DP 395		DP 190	
2.4 D	74-83	DP 395		DP 190	
Citivan					
1.1	89-	DP 704			5031
1.7 D	89-	DP 704			5031

*Every EBC pad and shoe requiring ECE R-90 is available with approval subject to stock rotation - check box end label.
Models listed by Engine Size. Only listed by trim level where pads differ, (16v, GL, GT, etc).









Standard Quality - ECE R90 Approved with similar performance to original equipment brake pads.
Upgrade Quality (Tuning/ Sportbeläge) - ECE R90 Approved but with higher friction and improved performance for faster street use.
Verbesserte Qualität - mit ECE R90 Freigabe aber mit höherem Reibwert und verbesserter Bremsleistung für den schnellen Strasseninsatz.
Standard Qualität - mit ECE R90 Freigabe und ähnlicher Bremsleistung wie die Original Bremsbeläge.
Qualité standard - Approuvée par la norme ECE R90 - Des performances équivalentes à l'origine.
Qualité améliorée - Approuvée par la norme ECE R90 - Un coefficient de friction supérieur et des performances accrues pour pilotage rapide sur route.
Calidad Estándar - Aprobación CEE R90 con prestaciones similares a las pastillas originales.
Calidad Mejorada - Aprobación CEE R90 pero con un coeficiente de fricción más elevado y prestaciones mejoradas para un uso deportivo en carretera.

Qualité standard - Approuvée par la norme ECE R90 - Des performances équivalentes à l'origine.
Qualité améliorée - Approuvée par la norme ECE R90 - Un coefficient de friction supérieur et des performances accrues pour pilotage rapide sur route.

Calidad Estándar - Aprobación CEE R90 con prestaciones similares a las pastillas originales.
Calidad Mejorada - Aprobación CEE R90 pero con un coeficiente de fricción más elevado y prestaciones mejoradas para un uso deportivo en carretera.

Standard Quality - ECE R90 Approved with similar performance to original equipment brake pads.
Upgrade Quality (Tuning / Sportbeläge) - ECE R90 Approved but with higher friction and improved performance for faster street use.

Standard Qualität - mit ECE R90 Freigabe und ähnlicher Bremsleistung wie die Original Bremsbeläge.
Verbesserte Qualität - mit ECE R90 Freigabe aber mit höherem Reibwert und verbesserter Bremsleistung für den schnellen Strasseninsatz.









Make/Model/Engine Hersteller/Modell/Motor Modèles	Year Jahr Années	Pads  Front / Vorn / Avant		Shoes	Pads  Rear / Hinten / Arrière		Shoes
		Original Quality ECE R90* Approved 	Upgrade Quality Tuning/Sportbeläge ECE R90* Approved 	Bremsbacken Machoires 	Original Quality ECE R90* Approved 	Upgrade Quality Tuning/Sportbeläge ECE R90* Approved 	Bremsbacken Machoires 
FIAT COMM Contd.							
Daily							
27, 30	78-81	DP 241					5115
35, 40	78-82	DP 241					5282
27, 32, 30.9	82-89	DP 472					5115
28.8-32.9	86-90	DP 622					5282
28.8-32.9	86-90	DP 702					5282
30.9 Chassis Cab	82-89	DP 472					5282
28.8-32.9	90-	DP 622					6384
28.8-32.9	90-	DP 702					6531
35.8, 35.9, 40	82-83	DP 472					5282
35.8, 40.8	84-86	DP 510					6384
35.8, 40.8	87-90	DP 702					6384
35.8, 40.8	87-90	DP 622					6384
35.8, 40.8	90-	DP 622					6384
35.8, 40.8	90-	DP 702					6531
40.8TD	86-87	DP 720					6384
40.8TD	87-	DP 721					6384
4.9 ton/79.14 Truck	83-86	DP 715/2					6384
30/32 F7	89-91	DP 702					6384
35/40 F8/9	90-	DP 702					6531
35.10, 45.10 (C) (L)	96-	DP 1294			DP 1294		
35.11 (S)	2001-	DP 1294/2			DP 1440		
Doblo							
1.2	2000-	DP 1337					6617
1.9 D	2000-	DP 1337					6617
1.9 TD	2000-	DP 1337					6617
Ducato							
1.8	81-87	DP 425					6322
1.8	87-94	DP 735					6322
2.0	81-87	DP 425					6322
2.0	87-94	DP 735					6322
1.9 D	87-94	DP 735					6322
2.5 D	81-87	DP 425					6322
2.5 D	87-94	DP 735					6322
2.5 TD	81-87	DP 425					6322
2.5 TD	87-94	DP 735					6322
Ducato Maxi							
2.0	88-94	DP 735					6484
1.9 D	88-94	DP 735					6484
1.9 TD	88-94	DP 735					6484
2.4 TD	88-94	DP 735					6484
2.5 D	88-94	DP 735					6484
2.5 TD	88-94	DP 735					6484
Ducato							
2.0	94-2001	DP 1024					6506
2.0	99-2001	DP 1417					6506
2.0	2001-	DP 1380			DP 1378		
1.9 D	94-2001	DP 1024					6506
1.9 D	99-2001	DP 1417					6506
1.9 D	2001-	DP 1380			DP 1378		
1.9 TD	94-2001	DP 1024					6506
1.9 TD	99-2001	DP 1417					6506
2.5 D	94-2001	DP 1024					6506
2.5 D	99-2001	DP 1417					6506
2.5 TD	94-2001	DP 1024					6506
2.5 TD	99-2001	DP 1417					6506
2.8 TD	98-2001	DP 1024					6506
2.8 TD	99-2001	DP 1417					6506

BRAKE PADS & SHOES - APPLICATIONS

Bremsbeläge / Plaquettes + Bremsbacken / Machoires

EBC

BRAKES

Make/Model/Engine Hersteller/Modell/Motor Modelos	Year Jahr Années	Pads  Front / Vorn / Avant		Shoes	Pads  Rear / Hinten / Arrière		Shoes
		Original Quality ECE R90* Approved 	Upgrade Quality Tuning/Sportbeläge ECE R90* Approved 	Bremsbacken Machoirs 	Original Quality ECE R90* Approved 	Upgrade Quality Tuning/Sportbeläge ECE R90* Approved 	Bremsbacken Machoirs 
FIAT COMM Contd.							
Ducato Contd.							
2.8 TD	2001-	DP 1380			DP 1378		
Ducato (1.8 ton)							
2.0	94-2001	DP 1025					6507
2.0	99-2001	DP 1418					6507
2.0	2001-	DP 1379			DP 1378		
2.5 D	94-2001	DP 1025					6507
2.5 D	99-2001	DP 1418					6507
2.5 TD	94-2001	DP 1025					6507
2.5 TD	99-2001	DP 1418					6507
2.8 TD	98-2001	DP 1025					6507
2.8 TD	99-2001	DP 1418					6507
2.8 TD	2001-	DP 1379			DP 1378		
850, 900T							
Caravanette	56-79			6285			6285
900 E	80-85	DP 116					5031
Fiorino							
1.0	78-87	DP 116					5031
1.0	82-87	DP 378					5031
1.1	88-93	DP 704					5031
1.3	88-93	DP 704					5031
1.4	93-	DP 704					6553
1.5	88-93	DP 704					5031
1.6	93-	DP 704					6553
1.3 D	78-87	DP 116					5031
1.3 D	82-87	DP 378					5031
1.3 D	88-93	DP 704					5031
1.7 D	88-93	DP 704					5031
1.7 D	93-	DP 704					6553
Panda Van							
1.0	86-93	DP 485					5031
1.0	93-96	DP 718					6502
Punto Van							
1.2	2000-	DP 1336					6583
1.2	2000-	DP 1336					6584
1.7 TD	96-2000	DP 1141					6503(L)
1.7 TD	96-2000	DP 1141					6329(B)
1.9 D	2000-	DP 1336					6583
1.9 D	2000-	DP 1336					6584
Scudo							
1.6	95-2000	DP 1053(B)					6516
1.6	95-2000	DP 1108(G)					6516
1.9 D	95-	DP 1053(B)					6516
1.9 D	95-	DP 1108(G)					6516
1.9 TD	95-2000	DP 1053(B)					6516
1.9 TD	95-2000	DP 1108(G)					6516
2.0 TD	99-	DP 1053(B)					6516
2.0 TD	99-	DP 1108(G)					6516
Strada Pick-up							
1.2	99-	DP 1337					
1.7 TD	99-	DP 1337					
1.9 D	99-	DP 1337					

Standard Quality - ECE R90 Approved with similar performance to original equipment brake pads.
 Upgrade Quality (Tuning/ Sportbeläge) - ECE R90 Approved but with higher friction and improved performance for faster street use.
 Standard Qualität - mit ECE R90 Freigabe und ähnlicher Bremsleistung wie die Original Bremsbeläge.
 Verbesserte Qualität - mit ECE R90 Freigabe aber mit höherem Reibwert und verbesserter Bremsleistung für den schnellen Strasseninsatz.
 Qualité standard - Approuvée par la norme ECE R90 - Des performances équivalentes à l'origine.
 Qualité améliorée - Approuvée par la norme ECE R90 - Un coefficient de friction supérieur et des performances accrues pour pilotage rapide sur route.
 Calidad Estándar - Aprobación CEE R90 con prestaciones similares a las pastillas originales.
 Calidad Mejorada - Aprobación CEE R90 pero con un coeficiente de fricción mas elevado y prestaciones mejoradas para un uso deportivo en carretera.

*Every EBC pad and shoe requiring ECE R-90 is available with approval subject to stock rotation - check box end label.
 Models listed by Engine Size. Only listed by trim level where pads differ, (16v, GL, GT, etc).

Make/Model/Engine	Year	Pads	Front / Vorn / Avant	Shoes	Pads	Rear / Hinten / Arrière	Shoes
Hersteller/Modell/Motor	Jahr	Plaquettes / Bremsbeläge		Bremsbacken Machoires	Plaquettes / Bremsbeläge		Bremsbacken Machoires
Modelos	Années	Original Quality ECE R90* Approved	Upgrade Quality Tuning/Sportbeläge ECE R90* Approved		Original Quality ECE R90* Approved	Upgrade Quality Tuning/Sportbeläge ECE R90* Approved	
FIAT COMM Contd.							
Uno Van							
1.0	83-92	DP 485					5031
1.0	93-95	DP 485					6502
1.0	93-95	DP 420/2					6502
1.7 D	84-92	DP 420/2					5031
1.7 D	92-95	DP 420/2					6502

Pad Illustrations for Fiat Commercial

 116 108 x 39 x 17mm	 190 77 x 83 x 16mm	 241 105 x 75 x 18mm	 378 89 x 58 x 16mm
 395 114 x 96 x 19mm	 420/2 104 x 66 x 17mm	 425 130 x 74 x 19mm	 472 105 x 74 x 18mm
 485 108 x 49 x 18mm	 510 109 x 73 x 18mm	 622 105 x 75 x 18mm	 702 109 x 73 x 18mm
 704 151 x 49 x 17mm	 715/2 191 x 87 x 23mm	 718 90 x 63 x 17mm	 720 149 x 69 x 18mm
 721 149 x 69 x 18	 735 145 x 71 x 19mm	 1024 145 x 62 x 19mm	 1025 160 x 65 x 19mm
 1053 140 x 69 x 18mm	 1108 130 x 58 x 19mm	 1141 151 x 52 x 18mm	 1294 165 x 67 x 19mm

Qualité standard - Approuvée par la norme ECE R90 - Des performances équivalentes à l'origine.
Qualité améliorée - Approuvée par la norme ECE R90 - Un coefficient de friction supérieur et des performances accrues pour pilotage rapide sur route.

Calidad Estándar - Aprobación CEE R90 con prestaciones similares a las pastillas originales.
Calidad Mejorada - Aprobación CEE R90 pero con un coeficiente de fricción más elevado y prestaciones mejoradas para un uso deportivo en carretera.

Standard Quality - ECE R90 Approved with similar performance to original equipment brake pads.
Upgrade Quality (Tuning / Sportbeläge) - ECE R90 Approved but with higher friction and improved performance for faster street use.

Standard Qualität - mit ECE R90 Freigabe und ähnlicher Bremsleistung wie die Original Bremsbeläge.
Verbesserte Qualität - mit ECE R90 Freigabe aber mit höherem Reibwert und verbesserter Bremsleistung für den schnellen Strasseninsatz.

BRAKE PADS & SHOES - APPLICATIONS

Bremsbeläge / Plaquettes + Bremsbacken / Machoires

EBC

BRAKES

Make/Model/Engine	Year	Pads	Front / Vorn / Avant	Shoes	Pads	Rear / Hinten / Arrière	Shoes
Hersteller/Modell/Motor	Jahr	Plaquettes / Bremsbeläge		Bremsbacken	Plaquettes / Bremsbeläge		Bremsbacken
Modelos	Années	Original Quality ECE R90* Approved	Upgrade Quality Tuning/Sportbeläge ECE R90* Approved	Machoires ECE R90* Approved	Original Quality ECE R90* Approved	Upgrade Quality Tuning/Sportbeläge ECE R90* Approved	Machoires ECE R90* Approved

Pad Illustrations for Fiat Commercial Contd.

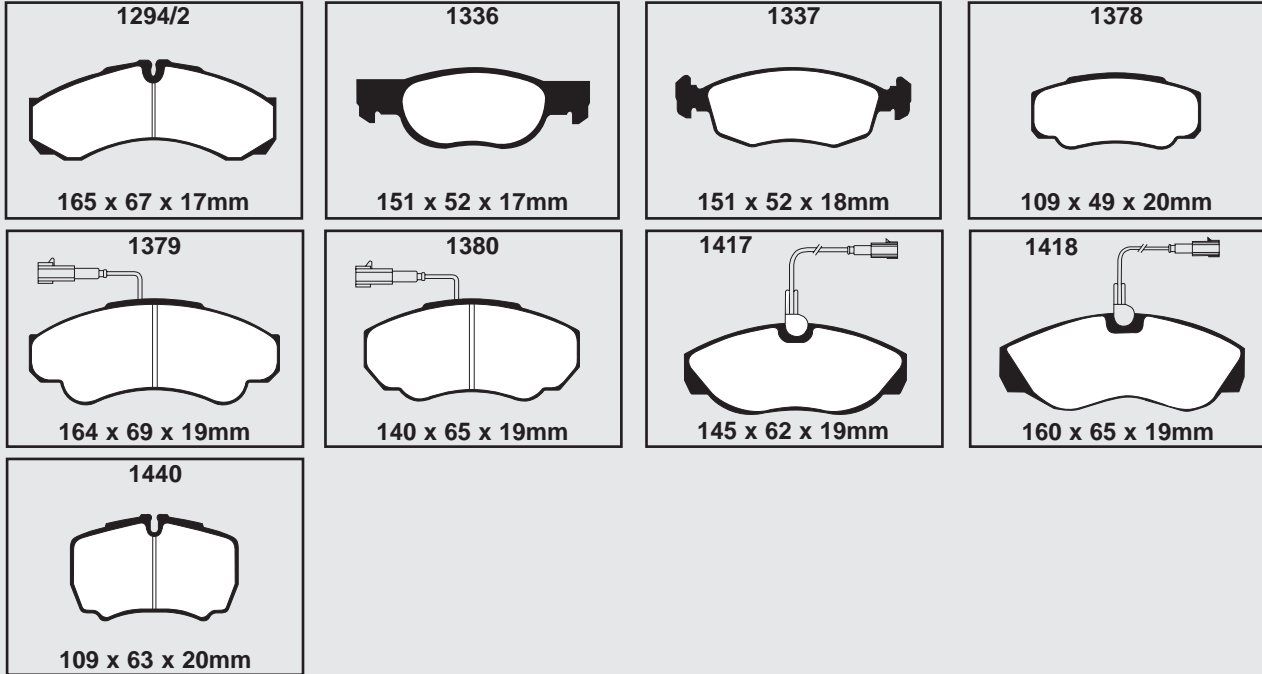

FORD					
Anglia					
1.0	59-67			5128	5129
1.2	62-67			5130SL	5142
Capri Mk1					
1.3 L	69-75	DP 106	DP 2106		5110
1.3 GT	69-71	DP 169			5133
1.3 GT	72-73	DP 291	DP 2291		5133
1.6	69-75	DP 106	DP 2106		5110
1.6 GT	69-71	DP 169			5133
1.6 L	72-75	DP 291	DP 2291		5133
2.0	69-71	DP 169			5133
2.0	72-75	DP 291	DP 2291		5133
2.6 RS	70-74	DP 291	DP 2291		5135
3.0	69-71	DP 169			5135
3.0	72-75	DP 291	DP 2291		5135
3.1 RS	73-74	DP 291	DP 2291		5135
Capri Mk2					
1.3	76-78	DP 291	DP 2291		5216
1.6	76-78	DP 291	DP 2291		5223
2.0	76-78	DP 291	DP 2291		5223
3.0	76-78	DP 291	DP 2291		5221
Capri Mk3					
1.6	78-83	DP 291	DP 2291		5216
1.6	84-87	DP 291	DP 2291		5223
2.0	78-87	DP 291	DP 2291		5223
2.8	82-87	DP 291	DP 2291		5221
3.0	78-81	DP 291	DP 2291		5221
Consul Capri					
1.3	61-64	-	DP 2141		
1.5	61-64	-	DP 2141		









*Every EBC pad and shoe requiring ECE R-90 is available with approval subject to stock rotation - check box end label.
Models listed by Engine Size. Only listed by trim level where pads differ, (16v, GL, GT, etc).

Standard Quality - ECE R90 Approved with similar performance to original equipment brake pads.
Upgrade Quality (Tuning/ Sportbeläge) - ECE R90 Approved but with higher friction and improved performance for faster street use.
Verbesserte Qualität - mit ECE R90 Freigabe aber mit höherem Reibwert und verbesserter Bremsleistung für den schnellen Strasseninsatz.

Qualité standard - Approuvée par la norme ECE R90 - Des performances équivalentes à l'origine.
Qualité améliorée - Approuvée par la norme ECE R90 - Un coefficient de friction supérieur et des performances accrues pour pilotage rapide sur route.
Calidad Mejorada - Aprobación CEE R90 con prestaciones similares a las pastillas originales.
Calidad Estándar - Aprobación CEE R90 con prestaciones similares a las pastillas originales.

Standard Quality - ECE R90 Approved with similar performance to original equipment brake pads.
 Upgrade Quality (Tuning / Sportbeläge) - ECE R90 Approved but with higher friction and improved performance for faster street use.

Calidad Estándar - Aprobación CEE R90 con prestaciones similares a las pastillas originales.
 Calidad Mejorada - Aprobación CEE R90 pero con un coeficiente de fricción más elevado y prestaciones mejoradas para un uso deportivo en carretera.

Make/Model/Engine Hersteller/Modell/Motor Modèles	Year Jahr Années	Pads  Front / Vorn / Avant		Shoes	Pads  Rear / Hinten / Arrière		Shoes
		Original Quality ECE R90* Approved 	Upgrade Quality Tuning/Sportbeläge ECE R90* Approved 	Bremsbacken Machoires 	Original Quality ECE R90* Approved 	Upgrade Quality Tuning/Sportbeläge ECE R90* Approved 	Bremsbacken Machoires 
FORD Contd.							
Consul							
	57-62			6236			5139
2.0 V4	72-74	DP 291	DP 2291				5111
2.0 OHC	72-75	DP 179					5117
2.5	72-75	DP 179					5117
3.0	72-75	DP 179					5117
Consul Classic							
1.3	61-64	-	DP 2141				
1.5	61-64	-	DP 2141				
Corsair							
1.5	63-65	-	DP 2141				6300
2.0	65-70	DP 169					5133
Cortina Mk1							
1.2	62-64			5130SL			5132
1.2	64-66	DP 114	DP 2114				5132
1.5	62-64			6235			5142
1.5	64-66	DP 114	DP 2114				5132
1.5 (Lotus)	63-66	-	DP 2141				6300
1.5 GT	63-66	-	DP 2141				6260
Cortina Mk2							
1.3	66-70	DP 106	DP 2106				5110
1.6	66-70	DP 106	DP 2106				5110
1.6 (Lotus)	66-70	DP 169					5133
1.6 GT	68-70	DP 169					5133
1.6 E	68-70	DP 169					5133
Cortina Mk3							
1.3	71-74	DP 291	DP 2291				5112
1.3	74-75	DP 291	DP 2291				5213
1.6	71-74	DP 291	DP 2291				5112
1.6	74-75	DP 291	DP 2291				5213
1.6 GT	70-76	DP 291	DP 2291				5111
2.0	70-76	DP 291	DP 2291				5111
2.0 Est	71-75	DP 296	DP 2296				5111
Cortina Mk4, 5							
1.3	76-79	DP 291	DP 2291				5213
1.6	76-79	DP 291	DP 2291				5213
1.6	79-82	DP 291	DP 2291				5291
2.0	76-79	DP 291	DP 2291				5111
2.0	79-82	DP 291	DP 2291				5291
Cortina Mk4, 5							
2.3	76-79	DP 291	DP 2291				5111
2.3	79-82	DP 291	DP 2291				5291
Cougar							
2.0	98-	DP 950	DP 2955		DP 960	DP 2965	
2.5	98-	DP 955	DP 2955		DP 965	DP 2965	
Escort Mk1							
0.9	68-70	DP 114	DP 2114	5141			5142
0.9	71-74	DP 114	DP 2114	5141			5132
1.1 Est	68-69			5130SL			5142
1.1 Sal	68-70	DP 114	DP 2114	5141			5142
1.1 Est	69-70			5130SL			5132
1.1 Est	71-74	DP 114	DP 2114	5130			5132
1.1 Sal	71-74	DP 114	DP 2114	5141			5132

*Every EBC pad and shoe requiring ECE R-90 is available with approval subject to stock rotation - check box end label.









Models listed by Engine Size. Only listed by trim level where pads differ, (16v, GL, GT, etc).

BRAKE PADS & SHOES - APPLICATIONS

Bremsbeläge / Plaquettes + Bremsbacken / Machoires

EBC

BRAKES









Make/Model/Engine Hersteller/Modell/Motor Modèles	Year Jahr Années	Pads  Front / Vorn / Avant		Shoes	Pads  Rear / Hinten / Arrière		Shoes
		Original Quality ECE R90* Approved 	Upgrade Quality Tuning/Sportbeläge ECE R90* Approved 	Bremsbacken Machoires 	Original Quality ECE R90* Approved 	Upgrade Quality Tuning/Sportbeläge ECE R90* Approved 	Bremsbacken Machoires 
FORD Contd.							
Escort Mk1 Contd.							
1.3	68-69			5130SL			5142
1.3	69-70			5130SL			5132
1.3	70-74	DP 114	DP 2114	5130			5132
1.6 RS	70-72	DP 169					5133
1.6 Mexico	70-72	DP 169					5133
1.6 Mexico	72-74	DP 291	DP 2291				5133
2.0 RS	73-75	DP 291	DP 2291				5112
Escort Mk2							
0.9	75-80			5130			5216
1.1 Popular	75-80			5130			5216
1.1	75-80	DP 291	DP 2291				5216
1.3	75-80	DP 291	DP 2291				5216
1.6	75-80	DP 291	DP 2291				5223
1.6 Mexico	75-78	DP 291	DP 2291				5223
1.8 RS	75-77	DP 291	DP 2291				5223
2.0 RS	75-80	DP 291	DP 2291				5223
Escort Mk3/Orion							
1.1	81-85	DP 415	DP 2415				5290
1.3 L	80-85	DP 415	DP 2415				5290
1.3 GL	80-85	DP 389	DP 2389				5290
1.6 L	80-85	DP 415	DP 2415				5290
1.6 GL Ghia	80-85	DP 389	DP 2389				5290
1.6 RS	82-84	DP 389	DP 2389				6273
1.6 RS Turbo	84-86	DP 389	DP 2389				6273
1.6 XR3	80-81	DP 389	DP 2389				5290
1.6 XR3i	82-85	DP 389	DP 2389				6273
1.6 D	83-85	DP 415	DP 2415				5290
Escort/Orion							
1.1	86-90	DP 415	DP 2415				5290
1.3	86-90	DP 415	DP 2415				5290
1.3	90-95	DP 837	DP 2837				6449
1.3 Est	90-95	DP 837	DP 2837				6451
1.3	95-98	DP 837	DP 2837				6525
1.3	98-2001	DP 837/2	DP 2837/2				6525
1.4	86-90	DP 415	DP 2415				5290
1.4	90-95	DP 837	DP 2837				6449
1.4	95-98	DP 837	DP 2837				6525
1.4	97-2001	DP 837/2	DP 2837/2				6525
1.4 Est	90-95	DP 837	DP 2837				6451
1.4 Est	95-98	DP 837	DP 2837				6525
1.4 Est	95-98	DP 837	DP 2837				6529
1.4 Auto	90-95	DP 837	DP 2837				6451
1.4 Auto	95-98	DP 837	DP 2837				6525
1.4 Auto	95-98	DP 837	DP 2837				6529
1.6	86-90	DP 415	DP 2415				5290
1.6	86-90	DP 415	DP 2415				6273
1.6i	86-90	DP 415	DP 2415				6273
1.6	90-95	DP 837	DP 2837				6449
1.6	90-95	DP 837	DP 2837				6451
1.6	95-98	DP 837	DP 2837				6525
1.6	95-98	DP 837	DP 2837				6529
1.6	97-2001	DP 837/2	DP 2837/2				6525
1.6	97-2001	DP 837/2	DP 2837/2				6529
1.6 XR3i	86-90	DP 415	DP 2415				6273
1.6 RS Turbo	85-86	DP 415	DP 2415				6446
1.6 RS Turbo	86-91	DP 605/2	DP 2605/2				6446
1.8	90-95	DP 837	DP 2837				6451
1.8	91-2001	DP 473	DP 2473		DP 953	DP 2953	

*Every EBC pad and shoe requiring ECE R-90 is available with approval subject to stock rotation - check box end label.
Models listed by Engine Size. Only listed by trim level where pads differ, (16v, GL, GT, etc).

Standard Quality - ECE R90 Approved with similar performance to original equipment brake pads.
Upgrade Quality (Tuning/ Sportbeläge) - ECE R90 Approved but with higher friction and improved performance for faster street use.
Verbesserte Qualität - mit ECE R90 Freigabe aber mit höherem Reibwert und verbesserter Bremsleistung für den schnellen Strasseninsatz.
Standard Qualität - mit ECE R90 Freigabe und ähnlicher Bremsleistung wie die Original Bremsbeläge.
Qualité standard - Approuvée par la norme ECE R90 - Des performances équivalentes à l'origine.
Qualité améliorée - Approuvée par la norme ECE R90 - Un coefficient de friction supérieur et des performances accrues pour pilotage rapide sur route.
Calidad Estándar - Aprobación CEE R90 con prestaciones similares a las pastillas originales.
Calidad Mejorada - Aprobación CEE R90 pero con un coeficiente de fricción más elevado y prestaciones mejoradas para un uso deportivo en carretera.

Standard Quality - ECE R90 Approved with similar performance to original equipment brake pads.
 Upgrade Quality (Tuning / Sportbeläge) - ECE R90 Approved but with higher friction and improved performance for faster street use.

Standard Qualität - mit ECE R90 Freigabe und ähnlicher Bremsleistung wie die Original Bremsbeläge.
 Verbesserte Qualität - mit ECE R90 Freigabe aber mit höherem Reibwert und verbesserter Bremsleistung für den schnellen Strasseninsatz.

Make/Model/Engine Hersteller/Modell/Motor Modelos	Year Jahr Années	Pads  Front / Vorn / Avant		Shoes	Pads  Rear / Hinten / Arrière		Shoes
		Original Quality ECE R90* Approved 	Upgrade Quality Tuning/Sportbeläge ECE R90* Approved 	Bremsbacken Machoires 	Original Quality ECE R90* Approved 	Upgrade Quality Tuning/Sportbeläge ECE R90* Approved 	Bremsbacken Machoires 
FORD Contd.							
Escort/Orion Contd.							
1.8	95-97	DP 837	DP 2837		DP 953	DP 2953	6529
1.8	95-97	DP 837	DP 2837		DP 953	DP 2953	6525
1.8	97-2001	DP 837/2	DP 2837/2		DP 953	DP 2953	6529
1.8	97-2001	DP 837/2	DP 2837/2		DP 953	DP 2953	6525
2.0 RS	91-95	DP 473	DP 2473		DP 953	DP 2953	
2.0 Cosworth	92-95	DP 2956	DP 3956		DP 2617	DP 3617	
1.6 D	86-88	DP 415	DP 2415				5290
1.8 D	88-90	DP 415	DP 2415				6273
1.8 D	91-95	DP 837	DP 2837				6451
1.8 D	95-98	DP 837	DP 2837				6529
1.8 D	95-98	DP 837	DP 2837				6525
1.8 TD	93-95	DP 837	DP 2837				6451
1.8 TD	95-98	DP 837	DP 2837				6529
1.8 TD	95-98	DP 837	DP 2837				6525
1.8 TD	97-2001	DP 837/2	DP 2837/2				6529
1.8 TD	97-2001	DP 837/2	DP 2837/2				6525
Handbrake Shoes	91-2001						6483
Explorer							
4.0	94-97	DP 1085	DP 61085				6549
4.0	97-	DP 1199	DP 61199		DP 1201	DP 61201	
Fiesta							
0.9	76-83	DP 270					5224
1.0	76-83	DP 270					5224
1.0	83-89	DP 512	DP 2512				6347
1.0	89-92	DP 769	DP 2769				6439
1.1	76-83	DP 270					5224
1.1	83-89	DP 512	DP 2512				6347
1.1	89-95	DP 769	DP 2769				6439
1.1	93-95	DP 415	DP 2415				6439
1.1 Classic	95-97	DP 769	DP 2769				6439
1.1 Classic	95-97	DP 415	DP 2415				6439
1.25	95-99	DP 1050	DP 21050				6525
1.25 (CTX Auto)	95-99	DP 1051	DP 21051				6525
1.25	2000-	DP 1300	DP 21300				6588
1.25 (ABS)	2000-	DP 1320	DP 21320				6589
1.3	76-83	DP 270					5224
1.3	83-89	DP 512	DP 2512				6347
1.3	89-95	DP 769	DP 2769				6439
1.3	93-95	DP 415	DP 2415				6439
1.3 Classic	95-97	DP 769	DP 2769				6439
1.3 Classic	95-97	DP 415	DP 2415				6439
1.3	95-99	DP 1050	DP 21050				6525
1.3	2000-	DP 1300	DP 21300				6588
1.3	2000-	DP 1320	DP 21320				6589
1.4	83-89	DP 512	DP 2512				6347
1.4	89-95	DP 769	DP 2769				6439
1.4	93-95	DP 415	DP 2415				6439
1.4	96-99	DP 1050	DP 21050				6525
1.4	96-99	DP 1051	DP 21051				6525
1.4	2002-	DP 1320	DP 21320				6589
1.6 XR2	82-83	DP 415	DP 2415				5224
1.6 XR2	83-89	DP 415	DP 2415				6347
1.6 XR2i	89-92	DP 389	DP 2389				6440
1.6	89-95	DP 389	DP 2389				6440
1.6 RS Turbo	90-91	DP 415	DP 2415				6440
1.6 RS Turbo	91-93	DP 389	DP 2389				6440
1.6	2000-2002	DP 1320	DP 21320				6589
1.6	2002-	DP 1320	DP 21320				6589
1.8 16v	92-95	DP 389	DP 2389				6440

*Every EBC pad and shoe requiring ECE R-90 is available with approval subject to stock rotation - check box end label.

Models listed by Engine Size. Only listed by trim level where pads differ, (16v, GL, GT, etc).

BRAKE PADS & SHOES - APPLICATIONS

Bremsbeläge / Plaquettes + Bremsbacken / Machoires

EBC









BRAKES

Make/Model/Engine Hersteller/Modell/Motor Modelos	Year Jahr Années	Pads Plaquettes / Bremsbeläge		Shoes Bremsbacken Machoires	Pads Plaquettes / Bremsbeläge		Shoes Bremsbacken Machoires
		Original Quality ECE R90* Approved	Upgrade Quality Tuning/Sportbeläge ECE R90* Approved	ECE R90* Approved	Original Quality ECE R90* Approved	Upgrade Quality Tuning/Sportbeläge ECE R90* Approved	ECE R90* Approved
FORD Contd.							
Fiesta Contd.							
1.8 XR2	93-95	DP 389	DP 2389				6440
1.4 TD	2002-	DP 1320	DP 21320				6589
1.6 D	83-89	DP 512	DP 2512				6347
1.8 D	89-95	DP 769	DP 2769				6439
1.8 D	93-95	DP 415	DP 2415				6439
1.8 D Classic	95-97	DP 769	DP 2769				6439
1.8 D Classic	95-97	DP 415	DP 2415				6439
1.8 D	95-99	DP 1050	DP 21050				6525
1.8 D	95-99	DP 1051	DP 21051				6525
1.8 TD	2000-2002	DP 1300	DP 21300				6588
1.8 TD	2000-2002	DP 1320	DP 21320				6589
Focus							
1.4	98-	DP 1185	DP 21185				6560
1.6	98-	DP 1185	DP 21185				6560
1.8	98-	DP 1185	DP 21185		DP 1218	DP 21218	6560
2.0	98-	DP 1185	DP 21185		DP 1218	DP 21218	
2.0 RS	2002-	DP 21031	DP 31031		DP 21218	DP 31218	
2.0(ST 170)	2002-	DP 1641	DP 21641		DP 1218	DP 21218	
1.8 TD	98-	DP 1185	DP 21185				6560
Focus C-Max							
1.8	2003-						
1.6 TD	2003-						
2.0 TD	2003-						
Fusion							
1.4	2002-	DP 1320	DP 21320				
1.6	2002-	DP 1320	DP 21320				
1.4TD	2002-	DP 1320	DP 21320				
Galaxy							
2.0	94-2000	DP 1074	DP 21074		DP 680	DP 2680	
2.3	97-2000	DP 1074	DP 21074		DP 680	DP 2680	
2.3	2000-2002	DP 1368	DP 21368		DP 1412	DP 21412	
2.3	2003-	DP 1413	DP 21413		DP 1412	DP 21412	
2.8	94-2000	DP 1074	DP 21074		DP 680	DP 2680	
2.8	2000-	DP 1413	DP 21413		DP 1412	DP 21412	
2.8	2000-	DP 1413	DP 21413		DP 1445		
1.9 TD	94-2000	DP 1074	DP 21074		DP 680	DP 2680	
1.9 TD	2000-2002	DP 1368	DP 21368		DP 1412	DP 21412	
1.9 TD	2003-	DP 1413	DP 21413		DP 1412	DP 21412	
Granada/Scorpio							
1.8	85-92	DP 473	DP 2473		DP 571	DP 2617	
2.0 Sal	75-79	DP 291	DP 2291				5116
2.0 Est	75-79	DP 291	DP 2291				5116
2.0 Sal	77-81	DP 291	DP 2291				5290
2.0 Sal	81-85	DP 436	DP 2291				5293
2.0 Est	79-81	DP 291	DP 2291				5292
2.0 Est	81-85	DP 436	DP 2291				5292
2.0 L	85-92	DP 605/2	DP 2605/2		DP 617	DP 2617	
2.0 GL	85-92	DP 473	DP 2473		DP 571	DP 2617	
2.0 Ghia	85-92	DP 473	DP 2473		DP 571	DP 2617	
2.0 Scorpio	85-92	DP 473	DP 2473		DP 571	DP 2617	
2.0 (ABS)	85-92	DP 473	DP 2473		DP 571	DP 2617	
2.0	92-94	DP 961	DP 2605/2		DP 571/2	DP 2617	
2.0	94-98	DP 955	DP 2955		DP 571/2	DP 2617	
2.3 Sal	77-79	DP 291	DP 2291				5116
2.3 Sal	79-81	DP 291	DP 2291				5293
2.3 Sal	82-85	DP 436	DP 2291				5293

*Every EBC pad and shoe requiring ECE R-90 is available with approval subject to stock rotation - check box end label.
Models listed by Engine Size. Only listed by trim level where pads differ, (16v, GL, GT, etc).

Standard Quality - ECE R90 Approved with similar performance to original equipment brake pads.
Upgrade Quality (Tuning/ Sportbeläge) - ECE R90 Approved but with higher friction and improved performance for faster street use.
Verbesserte Qualität - mit ECE R90 Freigabe und ähnlicher Bremsleistung wie die Original Bremsbeläge.
Standard Qualität - mit ECE R90 Freigabe und ähnlicher Bremsleistung wie die Original Bremsbeläge.

Qualité standard - Approuvée par la norme ECE R90 - Des performances équivalentes à l'origine.
Qualité améliorée - Approuvée par la norme ECE R90 - Un coefficient de friction supérieur et des performances accrues pour pilotage rapide sur route.
Calidad Estándar - Aprobación CEE R90 con prestaciones similares a las pastillas originales.
Calidad Mejorada - Aprobación CEE R90 pero con un coeficiente de fricción más elevado y prestaciones mejoradas para un uso deportivo en carretera.

Make/Model/Engine Hersteller/Modell/Motor Modèles	Year Jahr Années	Pads  Front / Vorn / Avant		Shoes	Pads  Rear / Hinten / Arrière		Shoes
		Original Quality ECE R90* Approved 	Upgrade Quality Tuning/Sportbeläge ECE R90* Approved 	Bremsbacken Machoires 	Original Quality ECE R90* Approved 	Upgrade Quality Tuning/Sportbeläge ECE R90* Approved 	Bremsbacken Machoires 
FORD Contd.							
Granada/Scorpio Contd.							
2.3 Est	77-79	DP 291	DP 2291				5117
2.3 Est	79-81	DP 291	DP 2291				5292
2.3 Est	81-85	DP 436	DP 2291				5292
2.3	96-99	DP 955	DP 2955		DP 571/2	DP 2617	
2.4	87-90	DP 473	DP 2473		DP 571	DP 2617	
2.5 Sal	72-75	DP 179					5116
2.5 Sal	76-78	DP 291	DP 2291				5116
2.5 Est	72-75	DP 179					5117
2.5 Est	76-77	DP 291	DP 2291				5117
2.6	72-75	DP 179					5111
2.6	76-77	DP 291	DP 2291				5116
2.8 Sal	77-79	DP 296	DP 2296				5116
2.8 Sal	79-82	DP 296	DP 2296				5293
2.8 Sal	82-85	DP 437	DP 2296				5293
2.8 Est	77-79	DP 296	DP 2296				5117
2.8 Est	79-82	DP 296	DP 2296				5292
2.8 Est	82-85	DP 437	DP 2296				5292
2.8	85-87	DP 605/2	DP 2605/2		DP 617	DP 2617	
2.8	85-87	DP 473	DP 2473		DP 571	DP 2617	
2.9	87-92	DP 473	DP 2473		DP 571	DP 2617	
2.9	92-94	DP 961	DP 2605/2		DP 571/2	DP 2617	
2.9	94-96	DP 955	DP 2955		DP 571/2	DP 2617	
2.9 Cosworth	91-92	DP 2956	DP 3956		DP 2617	DP 3617	
2.9 Cosworth	92-98	DP 2956	DP 3956		DP 2617	DP 3617	
2.9 24v	92-94	DP 910/2	DP 2956		DP 571	DP 2617	
2.9 24v	95-99	DP 956	DP 2956		DP 571/2	DP 2617	
3.0 Sal	72-75	DP 179					5116
3.0 Sal	76-77	DP 291	DP 2291				5116
3.0 Est	72-75	DP 179					5117
3.0 Est	76-79	DP 291	DP 2291				5117
2.1 D	79-81	DP 291	DP 2291				5292
2.1 D Sal	82-85	DP 436	DP 2291				5293
2.1 D Est	82-85	DP 436	DP 2291				5292
2.5 D	82-85	DP 437	DP 2296				5292
2.5 LD	85-92	DP 605/2	DP 2605/2		DP 617	DP 2617	
2.5 TD	88-92	DP 473	DP 2473		DP 571	DP 2617	
2.5 TD	92-94	DP 961	DP 2605/2		DP 571/2	DP 2617	
2.5 TD	94-99	DP 955	DP 2955		DP 571/2	DP 2617	
Ka							
1.3	96-2000	DP 1050	DP 21050				6525
1.3	2000-	DP 1300	DP 21300				6588
Maverick							
2.0	2002-	DP 1616	DP 61616				6581
2.4	93-99	DP 947			DP 1000		6505
2.7 TD	93-99	DP 947			DP 1000		6505
3.0	2002-	DP 1616	DP 61616				6581
Mondeo (Saloon & Hatch)							
1.6	93-94	DP 950	DP 2955		DP 960	DP 2965	6480
1.6	94-2000	DP 950	DP 2955		DP 960	DP 2965	6479
1.8	93-94	DP 955	DP 2955		DP 965	DP 2965	6480
1.8	94-2000	DP 955	DP 2955		DP 965	DP 2965	6479
1.8	2000-	DP 1322	DP 21322		DP 1350	DP 21350	
2.0	93-2000	DP 955	DP 2955		DP 965	DP 2965	6480
2.0 4WD	95-2000	DP 956	DP 2956		DP 965	DP 2965	
2.0	2000-	DP 1322	DP 21322		DP 1350	DP 21350	
2.5	94-2000	DP 2956	DP 3956		DP 2965	DP 3965	
2.5	98-2000	DP 2955	DP 3955		DP 2965	DP 3965	
2.5	2000-	DP 1322	DP 21322		DP 1350	DP 21350	

*Every EBC pad and shoe requiring ECE R-90 is available with approval subject to stock rotation - check box end label.









Models listed by Engine Size. Only listed by trim level where pads differ, (16v, GL, GT, etc).

BRAKE PADS & SHOES - APPLICATIONS

Bremsbeläge / Plaquettes + Bremsbacken / Machoires

EBC

BRAKES



Make/Model/Engine Hersteller/Modell/Motor Modèles	Year Jahr Années	Pads  Front / Vorn / Avant		Shoes	Pads  Rear / Hinten / Arrière		Shoes
		Original Quality ECE R90* Approved 	Upgrade Quality Tuning/Sportbeläge ECE R90* Approved 	Bremsbacken Machoires 	Original Quality ECE R90* Approved 	Upgrade Quality Tuning/Sportbeläge ECE R90* Approved 	Bremsbacken Machoires 
FORD Contd.							
Mondeo (Saloon & Hatch) Contd.							
3.0	2002-	DP 21322	DP 31322		DP 21350	DP 31350	
1.8 TD	93-94	DP 950	DP 2955		DP 960	DP 2965	6480
1.8 TD	94-2000	DP 950	DP 2955		DP 960	DP 2965	6479
2.0 TD	2000-	DP 1322	DP 21322		DP 1350	DP 21350	
Mondeo (Estate)							
1.6	93-2000	DP 950	DP 2955		DP 960	DP 2965	6480
1.8	93-2000	DP 950	DP 2955		DP 960	DP 2965	6480
1.8	2000-	DP 1322	DP 21322		DP 1350	DP 21350	
2.0	93-2000	DP 955	DP 2955		DP 965	DP 2965	6480
2.0 4WD	95-2000	DP 956	DP 2956		DP 965	DP 2965	
2.0	2000-	DP 1322	DP 21322		DP 1350	DP 21350	
2.5	94-2000	DP 2956	DP 3956		DP 2965	DP 3965	
2.5	2000-	DP 1322	DP 21322		DP 1350	DP 21350	
3.0	2002-	DP 21322	DP 31322		DP 21350	DP 31350	
1.8 TD	93-2000	DP 950	DP 2955		DP 960	DP 2965	6480
2.0 TD	2000-	DP 1322	DP 21322		DP 1350	DP 21350	
Probe							
2.0	94-98	DP 971	DP 2971		DP 972	DP 2972	
2.5	94-98	DP 971	DP 2971		DP 972	DP 2972	
Puma							
1.4	98-99	DP 1051	DP 21051				6525
1.6	2001-	DP 1320	DP 21320				6589
1.7 16v	97-99	DP 1051	DP 21051				6525
1.7 16v Racing	99-2000		DP 21013				
1.7 16v	2000-	DP 1320	DP 21320				6589
Sierra/Sapphire							
1.3	82-85	DP 438	DP 2438				6323A
1.3	85-86	DP 438	DP 2438				6323A
1.6 L	82-85	DP 438	DP 2438				6323A
1.6 L	85-86	DP 438	DP 2438				6323A
1.6 L Est	82-86	DP 438	DP 2438				6324
1.6 GL & Ghia	82-85	DP 455	DP 2438				6323A
1.6 GL & Ghia	85-86	DP 455	DP 2438				6323A
1.6 GL & Ghia Est	82-86	DP 455	DP 2438				6324
1.6 Est	87-93	DP 415	DP 2415				6324
1.6 Sal	87-91	DP 415	DP 2415				6323A
1.6 Sal	91-93	DP 389	DP 2389				6323A
1.8	82-87	DP 389	DP 2389				6324
1.8	87-90	DP 415	DP 2415				6324
1.8 (ABS)	87-93	DP 473	DP 2473		DP 571	DP 2617	
1.8	90-93	DP 389	DP 2389				6324
2.0	82-87	DP 389	DP 2389				6324
2.0	87-90	DP 415	DP 2415				6324
2.0	90-93	DP 389	DP 2389		DP 571	DP 2617	6324
2.0i	90-93	DP 473	DP 2473		DP 571	DP 2617	
2.0 (ABS)	87-93	DP 473	DP 2473		DP 571	DP 2617	
2.0 Cosworth	85-90	DP 2753	DP 3753		DP 2617	DP 3617	
2.0 Cosworth 4x4	90-93	DP 2956	DP 3956		DP 2617	DP 3617	
2.8 XR4i	82-85	DP 473	DP 2473				6328
2.8 XR 4x4	85-87	DP 473	DP 2473		DP 571	DP 2617	
2.8	87-93	DP 473	DP 2473		DP 571	DP 2617	
2.9	87-93	DP 473	DP 2473		DP 571	DP 2617	
2.9 XR 4x4	87-93	DP 473	DP 2473		DP 571	DP 2617	
1.8 TD	90-93	DP 415	DP 2415				6324
2.3 D	82-87	DP 389	DP 2389				6324
2.3 D	87-90	DP 415	DP 2415				6324

*Every EBC pad and shoe requiring ECE R-90 is available with approval subject to stock rotation - check box end label.
Models listed by Engine Size. Only listed by trim level where pads differ, (16v, GL, GT, etc).









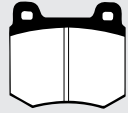
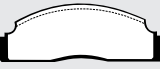
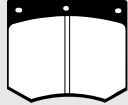
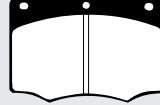

Standard Quality - ECE R90 Approved with similar performance to original equipment brake pads.
Upgrade Quality (Tuning/ Sportbeläge) - ECE R90 Approved but with higher friction and improved performance for faster street use.
Verbesserte Qualität - mit ECE R90 Freigabe aber mit höherem Reibwert und verbesserter Bremsleistung für den schnellen Strasseninsatz.

Standard Qualität - mit ECE R90 Freigabe und ähnlicher Bremsleistung wie die Original Bremsbeläge.
Upgrade Qualität (Tuning/ Sportbeläge) - ECE R90 Approved but with higher friction and improved performance for faster street use.
Verbesserte Qualität - mit ECE R90 Freigabe aber mit höherem Reibwert und verbesserter Bremsleistung für den schnellen Strasseninsatz.

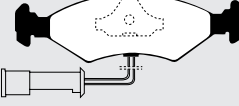
Qualité standard - Approuvée par la norme ECE R90 - Des performances équivalentes à l'origine.
Qualité améliorée - Approuvée par la norme ECE R90 - Un coefficient de friction supérieur et des performances accrues pour pilotage rapide sur route.
Calidad Mejorada - Aprobación CEE R90 con prestaciones similares a las pastillas originales.
Calidad Mejorada - Aprobación CEE R90 pero con un coeficiente de fricción más elevado y prestaciones mejoradas para un uso deportivo en carretera.

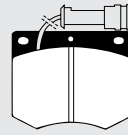
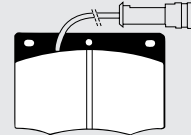
Make/Model/Engine Hersteller/Modell/Motor Modelos	Year Jahr Années	Pads  Front / Vorn / Avant		Shoes	Pads  Rear / Hinten / Arrière		Shoes
		Original Quality ECE R90* Approved	Upgrade Quality Tuning/Sportbeläge ECE R90* Approved	Bremsbacken Machoires ECE R90* Approved	Original Quality ECE R90* Approved	Upgrade Quality Tuning/Sportbeläge ECE R90* Approved	Bremsbacken Machoires ECE R90* Approved
FORD Contd.							
SportKa 1.6	2003-						
StreetKa 1.6	2003-						
Zephyr 1.6	57-62			6236			5139
	62-66	-	DP 2134				6300
	66-72	DP 169			DP 316		
Zodiac 1.6	57-62			6236			5139
	62-66	-	DP 2134				6300
	66-72	DP 169			DP 316		

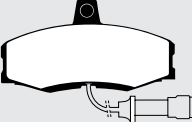
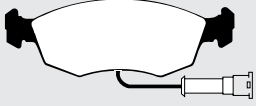
Pad Illustrations for Ford

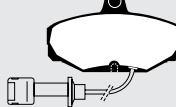
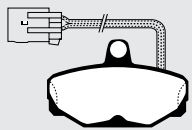
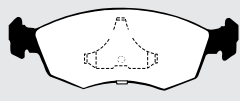
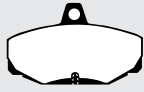
106  63 x 63 x 14mm	114  63 x 55 x 14mm	169  78 x 64 x 15mm	179  76 x 70 x 17mm
270  108 x 38 x 17mm	291  78 x 66 x 15mm	296  98 x 68 x 15mm	316  107 x 52 x 17/12mm
389  151 x 46 x 17mm	415  151 x 46 x 17mm	436  78 x 66 x 15mm	437  98 x 68 x 15mm
438  115 x 61 x 17mm	455  115 x 61 x 17mm	473  151 x 55 x 18mm	512  141 x 42 x 17mm
571  90 x 54 x 13mm	571/2  90 x 54 x 13mm	605/2  151 x 55 x 18mm	617  90 x 54 x 13mm

Standard Quality - ECE R90 Approved with similar performance to original equipment brake pads.
Upgrade Quality (Tuning / Sportbeläge) - ECE R90 Approved but with higher friction and improved performance for faster street use.

Standard Qualität - mit ECE R90 Freigabe und ähnlicher Bremsleistung wie die Original Bremsbeläge.
Verbesserte Qualität - mit ECE R90 Freigabe aber mit höherem Reibwert und verbesserter Bremsleistung für den schnellen Strasseneinsatz.

Qualité standard - Approuvée par la norme ECE R90 - Des performances équivalentes à l'origine.
Qualité améliorée - Approuvée par la norme ECE R90 - Un coefficient de friction supérieur et des performances accrues pour pilotage rapide sur route.

Calidad Estándar - Aprobación CEE R90 con prestaciones similares a las pastillas originales.
Calidad Mejorada - Aprobación CEE R90 pero con un coeficiente de fricción más elevado y prestaciones mejoradas para un uso deportivo en carretera.

BRAKE PADS & SHOES - APPLICATIONS











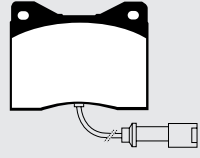
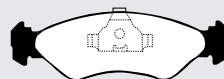



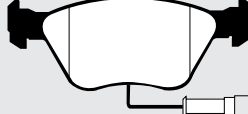
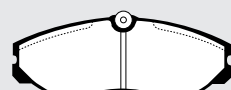

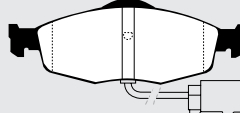
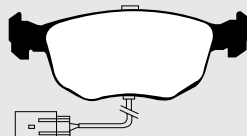
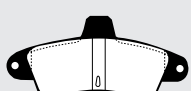
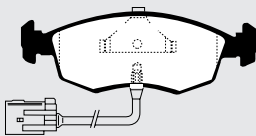
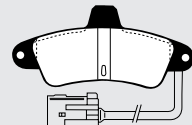

Bremsbeläge / Plaquettes + Bremsbacken / Machoires

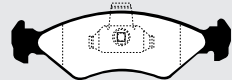
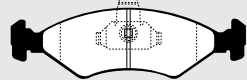
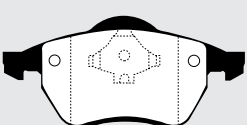
EBC

BRAKES

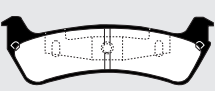
Make/Model/Engine	Year	Pads	Front / Vorn / Avant	Shoes	Pads	Rear / Hinten / Arrière	Shoes
Hersteller/Modell/Motor	Jahr	Plaquettes / Bremsbeläge		Bremsbacken	Plaquettes / Bremsbeläge		Bremsbacken
Modelos	Années	Original Quality ECE R90* Approved	Upgrade Quality Tuning/Sportbeläge ECE R90* Approved	Original Quality ECE R90* Approved	Upgrade Quality Tuning/Sportbeläge ECE R90* Approved	Original Quality ECE R90* Approved	Upgrade Quality Tuning/Sportbeläge ECE R90* Approved



Pad Illustrations for Ford Contd.

680  87 x 53 x 15mm	753  89 x 70 x 16mm	769  141 x 45 x 17mm	837  131 x 57 x 19mm
837/2  131 x 57 x 19mm	910  156 x 60 x 18mm	910/2  156 x 60 x 18mm	947  145 x 55 x 16mm
950  156 x 58 x 18mm	953  62 x 51 x 15mm	955  156 x 58 x 18mm	956  156 x 60 x 19mm
960  116 x 53 x 15mm	961  150 x 53 x 18mm	965  116 x 53 x 15mm	971  132 x 51 x 15mm
972  100 x 43 x 14mm	1000  115 x 45 x 16mm	1050  141 x 44 x 17mm	1051  151 x 46 x 18mm
1074  156 x 74 x 19mm	1085  160 x 63 x 15mm	1185  178 x 58 x 19mm	1199  154 x 55 x 17mm
1201  140 x 45 x 15mm	1218  87 x 41 x 15mm	1300  151 x 54 x 18mm	1320  151 x 61 x 18mm







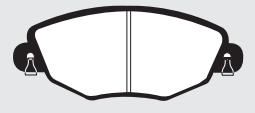

*Every EBC pad and shoe requiring ECE R-90 is available with approval subject to stock rotation - check box end label.
Models listed by Engine Size. Only listed by trim level where pads differ, (16v, GL, GT, etc).

Standard Quality - ECE R90 Approved with similar performance to original equipment brake pads.
Upgrade Quality (Tuning/ Sportbeläge) - ECE R90 Approved but with higher friction and improved performance for faster street use.
Verbesserte Qualität - mit ECE R90 Freigabe aber mit höherem Reibwert und verbesserter Bremsleistung für den schnellen Strasseninsatz.

Qualité standard - Approuvée par la norme ECE R90 - Des performances équivalentes à l'origine.
Qualité améliorée - Approuvée par la norme ECE R90 - Un coefficient de friction supérieur et des performances accrues pour pilotage rapide sur route.
Calidad Estándar - Aprobación CEE R90 con prestaciones similares a las pastillas originales.
Calidad Mejorada - Aprobación CEE R90 pero con un coeficiente de fricción más elevado y prestaciones mejoradas para un uso deportivo en carretera.

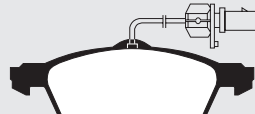
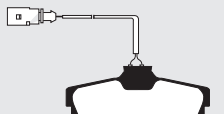
Make/Model/Engine	Year	Pads	Front / Vorn / Avant	Shoes	Pads	Rear / Hinten / Arrière	Shoes
Hersteller/Modell/Motor	Jahr	Plaquettes / Bremsbeläge		Bremsbacken Machoires	Plaquettes / Bremsbeläge		Bremsbacken Machoires
Modelos	Années	Original Quality ECE R90* Approved		Upgrade Quality Tuning/Sportbeläge ECE R90* Approved		Original Quality ECE R90* Approved	Upgrade Quality Tuning/Sportbeläge ECE R90* Approved

Pad Illustrations for Ford Contd.

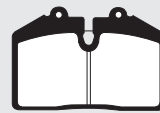
1322  148 x 60 x 18mm	1350  115 x 50 x 16mm	1368  156 x 80 x 18mm	1412  87 x 52 x 17mm
1413  161 x 74 x 20mm	1445  94 x 51 x 17mm	1616  156 x 64 x 20mm	1641  156 x 67 x 16mm
2134  78 x 58 x 16mm	2141  73 x 53 x 15mm	21013  97 x 65 x 16mm	

FORD COMMERCIAL							
Cargo	87-90	DP 714				DP 714	
	91-	DP 900				DP 900	
Courier							
1.3	91-95	DP 415					6440
1.3	95-2000	DP 1051					6529
1.3	2000-	DP 1300					
1.8 D	91-95	DP 415					6440
1.8 D	95-2000	DP 1051					6529
1.8 D	2000-	DP 1300					
1.8 TD	2000-	DP 1300					
Escort							
6 cwt.	68-74			5130			5132
8 cwt.	68-74	DP 114					5132
30	75-80	DP 291		5130			5216
33	81-90	DP 415					6273
35	75-80	DP 291		5130			5216
40	90-98	DP 837					6450
45	75-80	DP 291					5223
55	81-90	DP 415					6273
55	90-98	DP 837					6450
55	98-	DP 837/2					6450
60	90-98	DP 837					6450
75	95-98	DP 837					6450
75	98-	DP 837/2					6450
Fiesta							
1.0	78-83	DP 270					5224
1.0	83-88	DP 512					6347
1.0	89-96	DP 769					6439
1.1	78-83	DP 270					5224
1.1	83-88	DP 512					6347
1.1	89-96	DP 769					6439
1.3	96-99	DP 1050					6525

*Every EBC pad and shoe requiring ECE R-90 is available with approval subject to stock rotation - check box end label.
Models listed by Engine Size. Only listed by trim level where pads differ, (16v, GL, GT, etc).

BRAKE PADS & SHOES - APPLICATIONS

Bremsbeläge / Plaquettes + Bremsbacken / Machoires

EBC









BRAKES

Make/Model/Engine	Year	Pads Front / Vorn / Avant	Shoes Rear / Hinten / Arrière	Pads Rear / Hinten / Arrière	Shoes
Hersteller/Modell/Motor	Jahr	Plaquettes / Bremsbeläge		Bremsbacken Machoires	
Modelos	Années	Original Quality ECE R90* Approved	Upgrade Quality Tuning/Sportbeläge ECE R90* Approved	Original Quality ECE R90* Approved	Upgrade Quality Tuning/Sportbeläge ECE R90* Approved
FORD COMM Contd.					
Fiesta Contd.					
1.6 D	83-88	DP 512			6347
1.8 D	89-96	DP 415			6440
1.8 D	96-99	DP 1051			6529
1.8 TD	2000-	DP 1300			6588
1.8 TD	2000-	DP 1320			6589
P100 Pick-Up					
1.6	82-87	DP 296			5117
2.0	87-89	DP 650			6381
2.0	87-89	DP 415			6381
2.0	89-93	DP 415			6382
2.0	89-93	DP 650			6382
1.8 TD	87-89	DP 650			6381
1.8 TD	87-89	DP 3415			6381
1.8 TD	89-93	DP 650			6382
1.8 TD	89-93	DP 3415			6382
Ranger					
2.5 D	99-	DP 1349			
2.5 D	99-	DP 1199			
2.5 TD	99-	DP 1199			
2.5 TD	99-	DP 1349			
Tourneo					
2.0	94-98	DP 920			6476
2.5	94-98	DP 920			6476
Transit					
75	70-77			5238	5113
80	77-85	DP 240		5238	5240
80	77-85				5113
80	86-91	DP 650			6380
80	91-95	DP 918			6475
80	95-98	DP 918			6527
80	98-2000	DP 918/2			6527
90	70-77			5238	5113
100 Parcel Van	70-76			5114	5113
100	76-85	DP 240			5240
100	76-85			5238	5113
100 (short WB)	86-91	DP 650			6380
100 (long WB)	86-91	DP 240			6381
100	91-95	DP 918			6475
100	95-98	DP 918			6527
100	98-2000	DP 918/2			6527
115	70-80	DP 240			5240
115	86-91	DP 650			6380
120	78-86	DP 240			5240
120	86-91	DP 650			6380
120	91-95	DP 918			6475
120	95-98	DP 918			6527
120	98-2000	DP 918/2			6527
125	74-76	DP 240			5240
125	76-78	DP 240			6239
130	70-76			5114	5239
130	70-76			5114	5115
130	76-86	DP 240			6239
130	86-91	DP 240			6381
130	91-95	DP 920			6476
130	95-98	DP 920			6528
130	98-2000	DP 920/2			6528
150	70-76			5114	5115

*Every EBC pad and shoe requiring ECE R-90 is available with approval subject to stock rotation - check box end label. Models listed by Engine Size. Only listed by trim level where pads differ, (16v, GL, GT, etc).

Standard Quality - ECE R90 Approved with similar performance to original equipment brake pads.
 Upgrade Quality (Tuning/ Sportbeläge) - ECE R90 Approved but with higher friction and improved performance for faster street use.
 Verbesserte Qualität - mit ECE R90 Freigabe aber mit höherem Reibwert und verbesserter Bremsleistung für den schnellen Strasseninsatz.

Qualité standard - Approuvée par la norme ECE R90 - Des performances équivalentes à l'origine.
 Qualité améliorée - Approuvée par la norme ECE R90 - Un coefficient de friction supérieur et des performances accrues pour pilotage rapide sur route.
 Calidad Mejorada - Aprobación CEE R90 con prestaciones similares a las pastillas originales.
 Calidad Mejorada - Aprobación CEE R90 pero con un coeficiente de fricción más elevado y prestaciones mejoradas para un uso deportivo en carretera.

Make/Model/Engine Hersteller/Modell/Motor Modelos	Year Jahr Années	Pads  Front / Vorn / Avant		Shoes	Pads  Rear / Hinten / Arrière		Shoes
		Original Quality ECE R90* Approved 	Upgrade Quality Tuning/Sportbeläge ECE R90* Approved 	Bremsbacken Machoires 	Original Quality ECE R90* Approved 	Upgrade Quality Tuning/Sportbeläge ECE R90* Approved 	Bremsbacken Machoires 
FORD COMM Contd.							
Transit Contd.							
150	76-86	DP 241					6239NL
150	91-95	DP 920					6476
150	95-	DP 920					6528
150	98-2000	DP 920/2					6528
160	76-86	DP 240					6239
175	70-76			5114			5115
175	76-86	DP 241					6239
190	76-86	DP 241					6239
190	86-91	DP 241					6382
190	91-95	DP 920					6476
190	95-98	DP 920					6528
190	98-2000	DP 920/2					6528
260 15"	2000-	DP 1367					6603
280 15"	2000-	DP 1367					6603
300 15"	2000-	DP 1367					6603
300 16"	2000-	DP 1297					6595
330 16"	2000-	DP 1297					6595
350 16"	2000-	DP 1297					6595
425 16"	2000-	DP 1297					6595
Transit Connect							
1.8	2002-	DP 1444			DP 1448		
1.8 TD	2002-	DP 1444			DP 1448		
Transit Minibus							
100 Minibus	76-86	DP 241					5240
115 Minibus	76-78	DP 241					5240
130 Minibus	76-86	DP 241					6239
130 9 Seat Minibus	86-91	DP 241					6382
130 15 & 17 Seat Minibus	86-91	DP 240					6381
160 9 Seat Minibus	86-91	DP 241					6382
Minibus 13 Seat	74-77	DP 240					5240
Minibus 15 Seat	70-78			5237			5239
Crewbus 17 Seat	70-76			5114			5115

Pad Illustrations for Ford Commercial

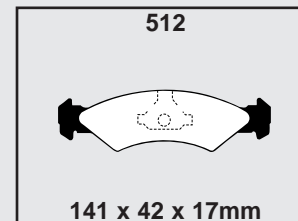
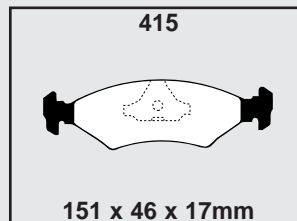
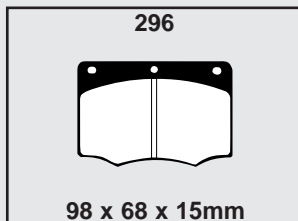
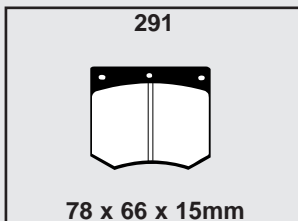
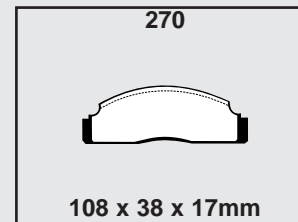
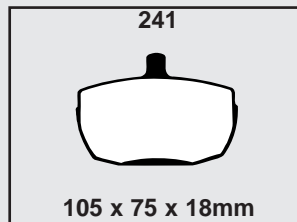
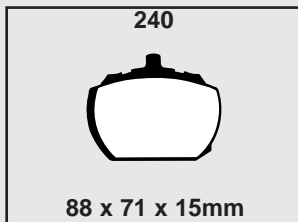
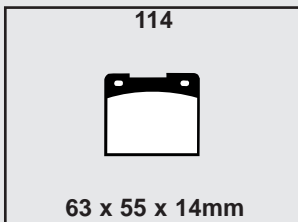

Standard Quality - ECE R90 Approved with similar performance to original equipment brake pads.
Upgrade Quality (Tuning / Sportbeläge) - ECE R90 Approved but with higher friction and improved performance for faster street use.

Standard Qualität - mit ECE R90 Freigabe und ähnlicher Bremsleistung wie die Original Bremsbeläge.
Verbesserte Qualität - mit ECE R90 Freigabe aber mit höherem Reibwert und verbesserter Bremsleistung für den schnellen Strasseninsatz.





Calidad Estándar - Aprobación CEE R90 con prestaciones similares a las pastillas originales.
Calidad Mejorada - Aprobación CEE R90 pero con un coeficiente de fricción más elevado y prestaciones mejoradas para un uso deportivo en carretera.

BRAKE PADS & SHOES - APPLICATIONS











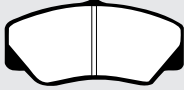
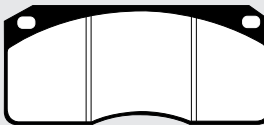
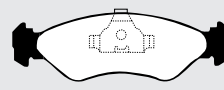

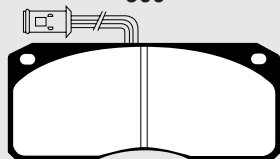
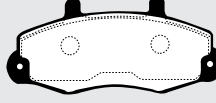
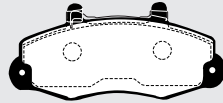
Bremsbeläge / Plaquettes + Bremsbacken / Machoires

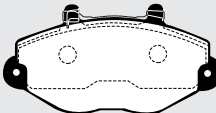
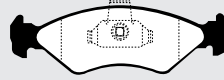
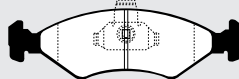
EBC

BRAKES

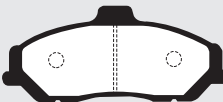
Make/Model/Engine	Year	Pads	Shoes	Pads	Shoes
Hersteller/Modell/Motor	Jahr	Plaquettes / Bremsbeläge	Bremsbacken Machoires	Plaquettes / Bremsbeläge	Bremsbacken Machoires
Modelos	Années	Original Quality ECE R90* Approved 	Upgrade Quality Tuning/Sportbeläge ECE R90* Approved 	Original Quality ECE R90* Approved 	Upgrade Quality Tuning/Sportbeläge ECE R90* Approved 

Pad Illustrations for Ford Commercial Contd.

650  117 x 57 x 18mm	714  177 x 78 x 22mm	769  141 x 45 x 17mm	837  131 x 57 x 19mm
837/2  131 x 57 x 19mm	900  176 x 78 x 22mm	918  139 x 64 x 18mm	918/2  139 x 64 x 18mm
920  139 x 72 x 18mm	920/2  139 x 72 x 18mm	1050  141 x 44 x 17mm	1051  151 x 46 x 18mm
1199  154 x 55 x 17mm	1297  169 x 65 x 18mm	1300  151 x 54 x 18mm	1320  151 x 61 x 18mm
1349  152 x 60 x 15mm	1367  169 x 64 x 18mm	1444  156 x 67 x 16mm	1448  123 x 51 x 16mm

FORD (SA)					
Courier					
1.8	97-	DP 538	DP 6538		
2.2	97-	DP 538	DP 6538		
3.4 (4x2)	97-	DP 538	DP 6538		
2.5 TD (4x2)	97-	DP 538	DP 6538		
Falcon/Fairmont	96-	DP 21503	DP 31503		
Laser	86-	DP 884	DP 2884	DP 673	
Meteor	86-	DP 884	DP 2884	DP 673	
Telstar	93-	DP 971	DP 2971	DP 972	DP 2972

*Every EBC pad and shoe requiring ECE R-90 is available with approval subject to stock rotation - check box end label. Models listed by Engine Size. Only listed by trim level where pads differ, (16v, GL, GT, etc).

Standard Quality - ECE R90 Approved with similar performance to original equipment brake pads.
 Upgrade Quality (Tuning/ Sportbeläge) - ECE R90 Approved but with higher friction and improved performance for faster street use.
 Verbesserte Qualität - mit ECE R90 Freigabe aber mit höherem Reibwert und verbesserter Bremsleistung für den schnellen Strasseninsatz.

Qualité standard - Approuvée par la norme ECE R90 - Des performances équivalentes à l'origine.
 Qualité améliorée - Approuvée par la norme ECE R90 - Un coefficient de friction supérieur et des performances accrues pour pilotage rapide sur route.
 Calidad Mejorada - Aprobación CEE R90 con prestaciones similares a las pastillas originales.
 Calidad Mejorada - Aprobación CEE R90 pero con un coeficiente de fricción más elevado y prestaciones mejoradas para un uso deportivo en carretera.

Make/Model/Engine	Year	Front / Vorn / Avant	Shoes	Rear / Hinten / Arrière	Shoes
Hersteller/Modell/Motor	Jahr	Plaquettes / Bremsbeläge	Bremsbacken Machoires	Plaquettes / Bremsbeläge	Bremsbacken Machoires
Modelos	Années	Original Quality ECE R90* Approved	Upgrade Quality Tuning/Sportbeläge ECE R90* Approved	Original Quality ECE R90* Approved	Upgrade Quality Tuning/Sportbeläge ECE R90* Approved

Pad Illustrations for Ford (SA)

538 130 x 49 x 16mm	673 101 x 42 x 13mm	884 91 x 64 x 15mm	971 132 x 51 x 15mm
972 100 x 43 x 14mm	1503 133 x 62 x 13mm		

FORD (Aust/NZ)					
Falcon					
EA - ED	88-94	DP 21503		DP 21504	
EF - AUI	95-99	DP 21503		DP 21501	
BA					
Tickford					
AU XR6-XR8 Premium		DP 21131	DP 31131	DP 21501	DP 31501
AU T - Series Premium		DP 21131	DP 31131	DP 21501	DP 31501
AU T - Series Brembo		DP 21110	DP 31110	DP 21140	DP 31140
FPV					
BA XR8 Upgrade					
BA GT					
BA GT Brembo		DP 21110	DP 31110	DP 21140	DP 31140
Focus					
2.0	98-	DP 1185	DP 21185	DP 1218	DP 21218

Pad Illustrations for Ford (Aust/NZ)

1185 178 x 58 x 19mm	1218 87 x 41 x 15mm	21110 132 x 67 x 17mm
21131 171 x 51 x 16mm	21140 110 x 69 x 14mm	21501 116 x 54 x 14mm

Standard Quality - ECE R90 Approved with similar performance to original equipment brake pads.
 Upgrade Quality (Tuning / Sportbeläge) - ECE R90 Approved but with higher friction and improved performance for faster street use.
 Qualité standard - Approuvée par la norme ECE R90 - Des performances équivalentes à l'origine.
 Qualité améliorée - Approuvée par la norme ECE R90 - Un coefficient de friction supérieur et des performances accrues pour pilotage rapide sur route.

Standard Qualität - mit ECE R90 Freigabe und ähnlicher Bremsleistung wie die Original Bremsbeläge.
 Verbesserte Qualität - mit ECE R90 Freigabe aber mit höherem Reibwert und verbesserter Bremsleistung für den schnellen Strasseninsatz.
 Calidad Estándar - Aprobación CEE R90 con prestaciones similares a las pastillas originales.
 Calidad Mejorada - Aprobación CEE R90 pero con un coeficiente de fricción más elevado y prestaciones mejoradas para un uso deportivo en carretera.

BRAKE PADS & SHOES - APPLICATIONS

Bremsbeläge / Plaquettes + Bremsbacken / Machoires

EBC

BRAKES

Make/Model/Engine	Year	Pads	Front / Vorn / Avant	Shoes	Pads	Rear / Hinten / Arrière	Shoes
Hersteller/Modell/Motor	Jahr	Plaquettes / Bremsbeläge		Bremsbacken	Plaquettes / Bremsbeläge		Bremsbacken
Modelos	Années	Original Quality ECE R90* Approved		Upgrade Quality Tuning/Sportbeläge ECE R90* Approved		Original Quality ECE R90* Approved	
						Upgrade Quality Tuning/Sportbeläge ECE R90* Approved	

Pad Illustrations for Ford (Aust/NZ) Contd.

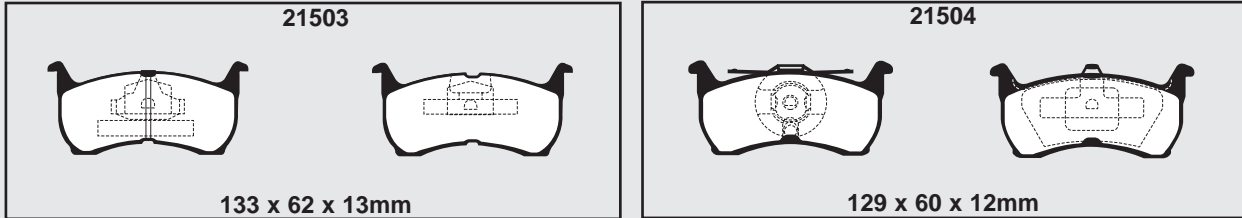

FSO					
125P					
1.3	76-91	DP 116		DP 130	
1.5	76-91	DP 116		DP 130	
Caro					
1.5	94-96	DP 1052		DP 130	
1.5	94-96	DP 116		DP 130	
1.9 D	94-95	DP 116		DP 130	
1.9 D	94-	DP 1052		DP 130	
Polonez/Prima					
1.5	77-88	DP 116		DP 130	
1.5 Est	77-88	DP 116			5031
1.5	88-91	DP 116		DP 130	
1.6	87-94	DP 116		DP 130	
1.6	94-	DP 1052		DP 130	
1.9 D	91-95	DP 116		DP 130	
1.9 D	94-	DP 1052		DP 130	

Pad Illustrations for FSO

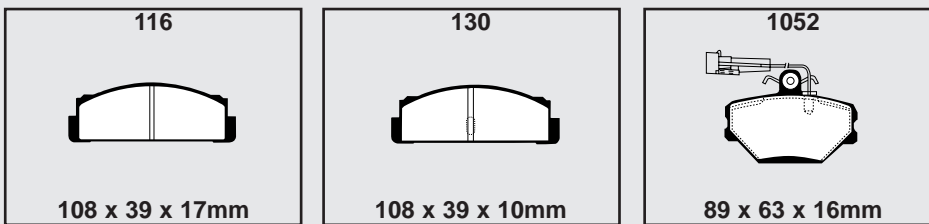

FSO Commercial					
125P Pick-up					
1.3	75-90	DP 116		DP 130	
1.5	75-90	DP 116		DP 130	
Cargo Van					
1.5	92-96	DP 1052		DP 130	
1.9 D	92-	DP 1052		DP 130	



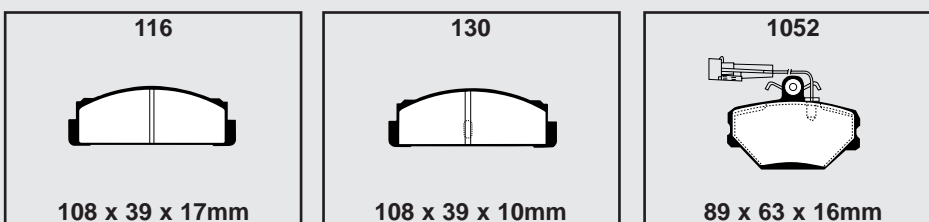





Pad Illustrations for FSO Commercial



*Every EBC pad and shoe requiring ECE R-90 is available with approval subject to stock rotation - check box end label.
Models listed by Engine Size. Only listed by trim level where pads differ, (16v, GL, GT, etc).

Standard Quality - ECE R90 Approved with similar performance to original equipment brake pads.
Upgrade Quality (Training / Sportbeläge) - ECE R90 Approved but with higher friction and improved performance for faster street use.
Verbesserte Qualität - mit ECE R90 Freigabe aber mit höherem Reibwert und verbesserter Bremsleistung für den schnellen Strasseninsatz.

Qualité standard - Approuvée par la norme ECE R90 - Des performances équivalentes à l'origine.
Qualité améliorée - Approuvée par la norme ECE R90 - Un coefficient de friction supérieur et des performances accrues pour pilotage rapide sur route.
Calidad Mejorada - Aprobación CEE R90 con prestaciones similares a las pastillas originales.
Calidad Mejorada - Aprobación CEE R90 pero con un coeficiente de fricción más elevado y prestaciones mejoradas para un uso deportivo en carretera.

Make/Model/Engine	Year	Pads  Front / Vorn / Avant		Shoes	Pads  Rear / Hinten / Arrière		Shoes
Hersteller/Modell/Motor	Jahr	Plaquettes / Bremsbeläge		Bremsbacken Machoires	Plaquettes / Bremsbeläge		Bremsbacken Machoires
Modelos	Années	Original Quality ECE R90* Approved 	Upgrade Quality Tuning/Sportbeläge ECE R90* Approved 	 ECE R90* Approved	Original Quality ECE R90* Approved 	Upgrade Quality Tuning/Sportbeläge ECE R90* Approved 	 ECE R90* Approved
GILBERN							
Invader							
3.0	70-72	DP 169					5133
3.0	72-75	DP 291	DP 2291				5111

Pad Illustrations for Gilbern

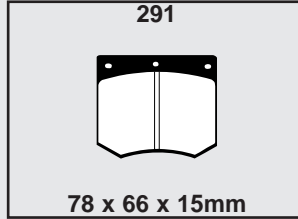
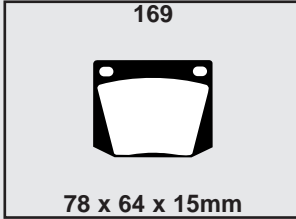

GINETTA							
G4 (DARE)							
1.8	98-	DP 114	DP 2114		DP 617	DP 2617	
G12 (DARE)							
2.0	98-	-	DP 2003		-	DP 2617	
G15							
	67-73	DP 142					5142
G20							
	2000-	DP 296	DP 2296		DP 617	DP 2617	
G26							
2.0	85-86	DP 291	DP 2291				
G27							
1.6	94-97	DP 473	DP 2473				5223
1.8	97-	DP 473	DP 2473		DP 617	DP 2617	5223
2.0	97-	-	DP 2008		DP 617	DP 2617	
G32							
1.6	89-92	DP 389	DP 2389		DP 617	DP 2617	
1.8	89-92	DP 389	DP 2389		DP 617	DP 2617	
G33							
2.0 Turbo	94-	DP 753	DP 2753		DP 617	DP 2617	
3.9	90-	DP 753	DP 2753		DP 617	DP 2617	
G34							
2.0 Turbo	94-	DP 753	DP 2753		DP 617	DP 2617	

Pad Illustrations for Ginetta

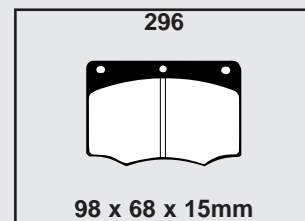
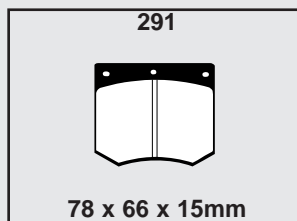
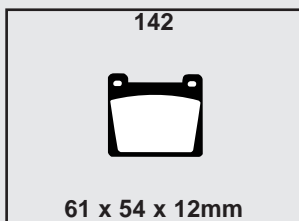
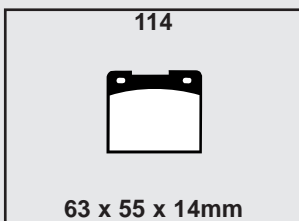

BRAKE PADS & SHOES - APPLICATIONS

Bremsbeläge / Plaquettes + Bremsbacken / Machoires

EBC

BRAKES

Make/Model/Engine	Year	Front / Vorn / Avant	Shoes	Rear / Hinten / Arrière	Shoes
Hersteller/Modell/Motor	Jahr	Plaquettes / Bremsbeläge	Bremsbacken Machoirs	Plaquettes / Bremsbeläge	Bremsbacken Machoirs
Modelos	Années	Original Quality ECE R90* Approved	Upgrade Quality Tuning/Sportbeläge ECE R90* Approved	Original Quality ECE R90* Approved	Upgrade Quality Tuning/Sportbeläge ECE R90* Approved

Standard Quality - ECE R90 Approved with similar performance to original equipment brake pads.
 Upgrade Quality (Tuning/ Sportbeläge) - ECE R90 Approved but with higher friction and improved performance for faster street use.
 Verbesserte Qualität - mit ECE R90 Freigabe aber mit höherem Reibwert und verbesserter Bremsleistung für den schnellen Strasseninsatz.

Qualité standard - Approuvée par la norme ECE R90 - Des performances équivalentes à l'origine.
 Qualité améliorée - Approuvée par la norme ECE R90 - Un coefficient de friction supérieur et des performances accrues pour pilotage rapide sur route.
 Calidad Estándar - Aprobación CEE R90 con prestaciones similares a las pastillas originales.
 Calidad Mejorada - Aprobación CEE R90 pero con un coeficiente de fricción más elevado y prestaciones mejoradas para un uso deportivo en carretera.

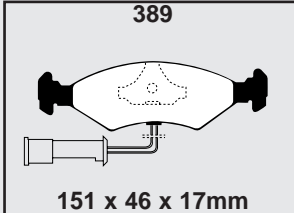
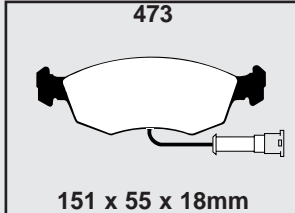
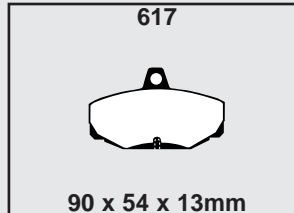
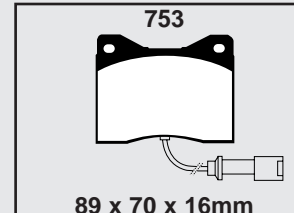
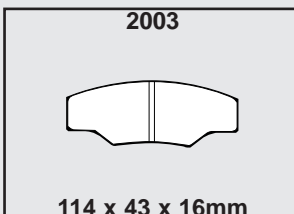
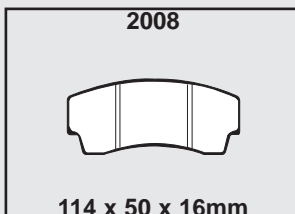
Pad Illustrations for Ginetta Contd.					
					
389 151 x 46 x 17mm	473 151 x 55 x 18mm	617 90 x 54 x 13mm	753 89 x 70 x 16mm		
					
2003 114 x 43 x 16mm	2008 114 x 50 x 16mm				
GLAS					
1300	63-67	DP 105	DP 2105		
2600 GT	65-67	DP 103	DP 2103	DP 105	DP 2105
3000 GT	67-69	DP 103	DP 2103	DP 105	DP 2105

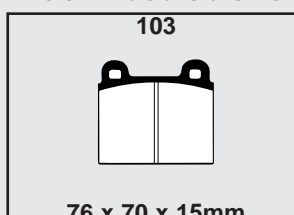
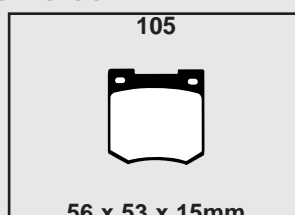
Pad Illustrations for Glas					
					
103 76 x 70 x 15mm	105 56 x 53 x 15mm				
GORDON KEEBLE					
5.3	64-67			-	DP 2141

Pad Illustrations for Gordon Keeble					
					
2141 73 x 53 x 15mm					
GRINNALL					
Scorpion 3	92-	-	DP 21031		
Scorpion 4 2.0T	2000-	-	DP 21031	DP 1218	DP 21218









*Every EBC pad and shoe requiring ECE R-90 is available with approval subject to stock rotation - check box end label.
 Models listed by Engine Size. Only listed by trim level where pads differ, (16v, GL, GT, etc).

Qualité standard - Approuvée par la norme ECE R90 - Des performances équivalentes à l'origine.
 Qualité améliorée - Approuvée par la norme ECE R90 - Un coefficient de friction supérieur et des performances accrues pour pilotage rapide sur route.

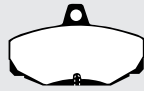
Calidad Estándar - Aprobación CEE R90 con prestaciones similares a las pastillas originales.
 Calidad Mejorada - Aprobación CEE R90 pero con un coeficiente de fricción más elevado y prestaciones mejoradas para un uso deportivo en carretera.

Standard Quality - ECE R90 Approved with similar performance to original equipment brake pads.
 Upgrade Quality (Tuning / Sportbeläge) - ECE R90 Approved but with higher friction and improved performance for faster street use.

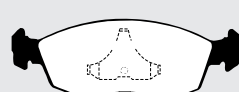
Standard Qualität - mit ECE R90 Freigabe und ähnlicher Bremsleistung wie die Original Bremsbeläge.
 Verbesserte Qualität - mit ECE R90 Freigabe aber mit höherem Reibwert und verbesserter Bremsleistung für den schnellen Strasseninsatz.

Make/Model/Engine	Year	Pads  Front / Vorn / Avant		Shoes	Pads  Rear / Hinten / Arrière		Shoes
Hersteller/Modell/Motor	Jahr	Plaquettes / Bremsbeläge		Bremsbacken Machoires	Plaquettes / Bremsbeläge		Bremsbacken Machoires
Modelos	Années	Original Quality ECE R90* Approved	Upgrade Quality Tuning/Sportbeläge ECE R90* Approved	ECE R90* Approved	Original Quality ECE R90* Approved	Upgrade Quality Tuning/Sportbeläge ECE R90* Approved	ECE R90* Approved
GRINNALL Contd.							
Trike							
1.2					DP 617	DP 2617	
Pad Illustrations for Grinnall							
617		1218		21031			
							
90 x 54 x 13mm		87 x 41 x 15mm		110 x 69 x 17mm			
GTM							
Libra	98-	DP 817	DP 2817				
Spyder	2002-	DP 817	DP 2817				
Pad Illustrations for GTM							
817							
							
115 x 58 x 17mm							
HMC							
HMC SE							
4.0	85-	DP 605/2	DP 2605/2		DP 617	DP 2617	
4.6		DP 605/2	DP 2605/2		DP 617	DP 2617	
Pad Illustrations for HMC							
605/2		617					
							
151 x 55 x 18mm		90 x 54 x 13mm					
HOLDEN							
Grange							
5.7	2001-						
GTS							
5.7	99-	DP 21014	DP 31014		DP 21013	DP 31013	

BRAKE PADS & SHOES - APPLICATIONS

Bremsbeläge / Plaquettes + Bremsbacken / Machoires

EBC

BRAKES

Make/Model/Engine	Year	Pads	Front / Vorn / Avant	Shoes	Pads	Rear / Hinten / Arrière	Shoes
Hersteller/Modell/Motor	Jahr	Plaquettes / Bremsbeläge		Bremsbacken	Plaquettes / Bremsbeläge		Bremsbacken
Modelos	Années	Original Quality ECE R90* Approved	Upgrade Quality Tuning/Sportbeläge ECE R90* Approved	Machoires ECE R90* Approved	Original Quality ECE R90* Approved	Upgrade Quality Tuning/Sportbeläge ECE R90* Approved	Machoires ECE R90* Approved

Pad Illustrations for Holden

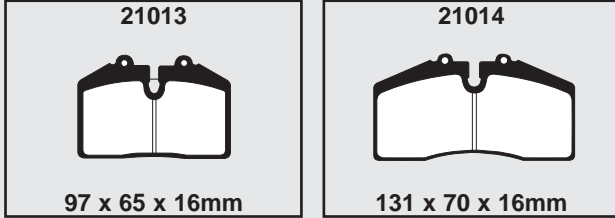

HOLDEN (Aust/NZ)					
Astra					
1.6	96-98	DP 940	DP 2940		
ABS	98-	DP 1183	DP 21183	DP 1186	DP 21186
Non ABS	98-	DP 1184	DP 21184	DP 1186	DP 21186
Conv, SRi, Turbo	2002-	DP 1062	DP 21062		
Barina					
B	94-2000	DP 940	DP 2940		
C	2000-	DP 1341	DP 21341		
Commodore					
VB-VS	78-97	DP 21502		DP 21501	
VT-VY	98-2003	DP 21505	DP 31505	DP 21506	DP 31506
Monaro CV6 CV8		DP 21505	DP 31505	DP 21506	DP 31506
Rodeo					
		-	DP 61256		
Vectra					
	97-	DP 1062	DP 21062	DP 675	
HSV					
VN - VS Premium	89-97	DP 21131	DP 31131	DP 21167	DP 31167
VT - VX Clubsport	98-2002	DP 21505	DP 31505	DP 21506	DP 31506
VT - VX Clubsport Perf	98-2002	DP 21162	DP 31162	DP 21506	DP 31506
VT - VX GTS R8 Premium	98-2002	DP 21014	DP 31014	DP 21013	DP 31013
VT - VX Monaro GTO		DP 21162	DP 31162	DP 21506	DP 31506
VT - VX Monaro GTS (AP 6 Piston)					
VX Premium		DP 21014	DP 31014	DP 21013	DP 31013
VX Ultimate (AP 6 Piston)					
Harrop					
4 Piston		DP 2767	DP 3767	DP 2612	DP 3612
6 Piston		DP 2006	DP 3006		



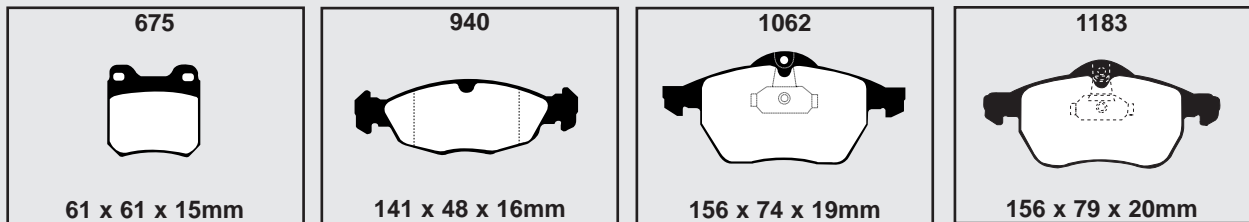

Pad Illustrations for Holden (Aust/NZ)











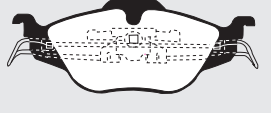

*Every EBC pad and shoe requiring ECE R-90 is available with approval subject to stock rotation - check box end label.
Models listed by Engine Size. Only listed by trim level where pads differ, (16v, GL, GT, etc).

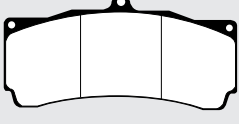
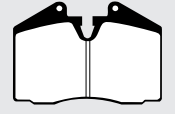
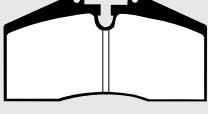
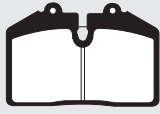
Standard Quality - ECE R90 Approved with similar performance to original equipment brake pads.
Upgrade Quality (Training / Sportbeläge) - ECE R90 Approved but with higher friction and improved performance for faster street use.
Verbesserte Qualität - mit ECE R90 Freigabe und ähnlicher Bremsleistung wie die Original Bremsbeläge.
Standard Qualität - mit ECE R90 Freigabe und ähnlicher Bremsleistung wie die Original Bremsbeläge.

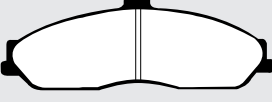
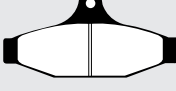
Qualité standard - Approuvée par la norme ECE R90 - Des performances équivalentes à l'origine.
Qualité améliorée - Approuvée par la norme ECE R90 - Un coefficient de friction supérieur et des performances accrues pour pilotage rapide sur route.
Calidad Mejorada - Aprobación CEE R90 con prestaciones similares a las pastillas originales.
Calidad Estándar - Aprobación CEE R90 con prestaciones similares a las pastillas originales.

Make/Model/Engine	Year	Pads  Front / Vorn / Avant		Shoes	Pads  Rear / Hinten / Arrière		Shoes
Hersteller/Modell/Motor	Jahr	Plaquettes / Bremsbeläge		Bremsbacken Machoires	Plaquettes / Bremsbeläge		Bremsbacken Machoires
Modelos	Années	Original Quality ECE R90* Approved	Upgrade Quality Tuning/Sportbeläge ECE R90* Approved	 ECE R90* Approved	Original Quality ECE R90* Approved	Upgrade Quality Tuning/Sportbeläge ECE R90* Approved	 ECE R90* Approved

Pad Illustrations for Holden (Aust/NZ) Contd.

1184  178 x 62 x 19mm	1186  105 x 41 x 16mm	1341  131 x 51 x 17mm	2006  152 x 80 x 18mm
2612  97 x 67 x 18mm	2767  131 x 71 x 18mm	21013  97 x 65 x 16mm	21014  131 x 70 x 16mm
21131  171 x 51 x 16mm	21162  183 x 60 x 15mm	21167  144 x 56 x 12mm	21501  116 x 54 x 14mm
21502  138 x 59 x 14mm	21505  184 x 64 x 15mm		21506  114 x 58 x 17mm
61256  167 x 57 x 15mm			

Make/Model/Engine	Year	Front Pads	Rear Pads	Front Shoes	Rear Shoes
HONDA					
S2000					
2.0	99-	DP 21254	DP 31254		DP 21193 DP 31193
600					
0.6	69-74	DP 158			5219
Accord					
1.6 (SJ)	77-81	DP 281			6276
1.6 (SY)	82-84	DP 432			5341
1.6 (SY)	82-84	DP 450	DP 2570		5341
1.6 (AC)	84-86	DP 556			5341
1.6 (AC)	84-86	DP 450	DP 2570		5341
1.8 (AD)	84-86	DP 556		DP 514	5341
1.8 (AD)	84-86	DP 570	DP 2570		5341
1.8 (CE7)	96-98	DP 975	DP 2975	DP 781	DP 21193
1.8 (CE7) (ABS)	96-98	DP 872	DP 2872	DP 781	DP 21193
1.8 (CG)	98-2003	DP 1339	DP 21339	DP 1216	
2.0 (SOHC) (CA4/5)	85-88	DP 623	DP 2623	DP 642	DP 2642/2 6401

BRAKE PADS & SHOES - APPLICATIONS

Bremsbeläge / Plaquettes + Bremsbacken / Machoires

EBC

BRAKES







Make/Model/Engine Hersteller/Modell/Motor Modèles	Year Jahr Années	Pads Plaquettes / Bremsbeläge		Shoes Bremsbacken Machoires	Pads Plaquettes / Bremsbeläge		Shoes Bremsbacken Machoires
		Original Quality ECE R90* Approved	Upgrade Quality Tuning/Sportbeläge ECE R90* Approved	ECE R90* Approved	Original Quality ECE R90* Approved	Upgrade Quality Tuning/Sportbeläge ECE R90* Approved	ECE R90* Approved
HONDA Contd.							
Accord Contd.							
2.0 (SOHC) (CA4/5)	89-90	DP 719/2	DP 2719/2		DP 642	DP 2642/2	6401
2.0 (DOHC) (CA4/5)	86-90	DP 719/2	DP 2719/2		DP 642	DP 2642/2	
2.0 (CB3)	89-94	DP 812	DP 2812		DP 781	DP 21193	6452
2.0 (CC7) Man	93-96	DP 975	DP 2975		DP 781	DP 21193	
2.0 (CC7) Auto	93-96	DP 872	DP 2872		DP 781	DP 21193	
2.0 (CE8)	96-98	DP 975	DP 2975		DP 781	DP 21193	
2.0 (CE8) (ABS)	96-98	DP 872	DP 2872		DP 781	DP 21193	
2.0 (CG)	98-2003	DP 1339	DP 21339		DP 1216		
2.0	2003-						
2.2 4WS (CB7)	89-94	DP 818			DP 781		
2.2 (CE9)	96-98	DP 872	DP 2872		DP 781	DP 21193	
2.3 (CC7)	93-96	DP 872	DP 2872		DP 781	DP 21193	
2.4	2003-						
2.0 TD (CF1)	96-98	DP 975	DP 2975		DP 781	DP 21193	
2.0 TD (CF1) (ABS)	96-98	DP 872	DP 2872		DP 781	DP 21193	
Accord Aerodeck							
2.0 (CA4/5)	85-88	DP 623	DP 2623		DP 642	DP 2642/2	6401
2.0 (CA4/5)	89-90	DP 719/2	DP 2719/2		DP 642	DP 2642/2	6401
2.0 (CB3)	89-94	DP 812	DP 2812		DP 781	DP 21193	
2.0 (CE2)	94-98	DP 872	DP 2872		DP 781	DP 21193	
2.2 (CB8)	91-94	DP 872	DP 2872		DP 781	DP 21193	
2.2 (CE1)	94-98	DP 872	DP 2872		DP 781	DP 21193	
Accord Coupe							
2.0 (CD9)	94-98	DP 872	DP 2872		DP 781	DP 21193	
2.0 (CH)	99-	DP 872	DP 2872		DP 781	DP 21193	
2.2 (CD7)	94-98	DP 872	DP 2872		DP 781	DP 21193	
3.0 (CH)	98-	DP 2872	DP 3872		DP 21193	DP 31193	
Accord Type-R							
2.2 (CF)	99-	DP 2872	DP 3872		DP 1216		
Accord Type-V							
2.3	2001-	DP 872	DP 2872				
Ballade							
1.3	84-89	DP 432					6350
1.5	84-89	DP 606					6350
Beat							
0.6	91-95	DP 529			DP 642/2		
City							
1.1	84-86	DP 529					6276
1.2	84-86	DP 529					6276
Civic							
1.2	73-75	DP 237					5219
1.2	76-79	DP 238					5219
1.3 (SL) (SS)	80-83	DP 374	DP 2374				6276
1.3 (AG)	84-87	DP 432					6350
1.3 (EC)	87-91	DP 450	DP 2570				6350
1.3 (EG3)	91-93	DP 570	DP 2570				6513
1.3 (EG3)	93-95	DP 985	DP 2911				6513
1.3	2003-						
1.4 (AG)	84-87	DP 432					6350
1.4 (EC)	87-91	DP 450	DP 2570				6350
1.4 Auto	87-91	DP 706	DP 2706				6350
1.4 (EJ9)	96-99	DP 890	DP 2890				6401
1.4 (EJ9)	98-99	DP 891	DP 2891				6401

*Every EBC pad and shoe requiring ECE R-90 is available with approval subject to stock rotation - check box end label.
Models listed by Engine Size. Only listed by trim level where pads differ, (16v, GL, GT, etc).

Standard Quality - ECE R90 Approved with similar performance to original equipment brake pads.
Upgrade Quality (Tuning/ Sportbeläge) - ECE R90 Approved but with higher friction and improved performance for faster street use.
Verbesserte Qualität - mit ECE R90 Freigabe aber mit höherem Reibwert und verbesserter Bremsleistung für den schnellen Strasseninsatz.
Standard Qualität - mit ECE R90 Freigabe und ähnlicher Bremsleistung wie die Original Bremsbeläge.
Qualité standard - Approuvée par la norme ECE R90 - Des performances équivalentes à l'origine.
Qualité améliorée - Approuvée par la norme ECE R90 - Un coefficient de friction supérieur et des performances accrues pour pilotage rapide sur route.
Calidad Estándar - Aprobación CEE R90 con prestaciones similares a las pastillas originales.
Calidad Mejorada - Aprobación CEE R90 pero con un coeficiente de fricción más elevado y prestaciones mejoradas para un uso deportivo en carretera.

Standard Quality - ECE R90 Approved with similar performance to original equipment brake pads.
 Upgrade Quality (Tuning / Sportbeläge) - ECE R90 Approved but with higher friction and improved performance for faster street use.

Standard Qualität - mit ECE R90 Freigabe und ähnlicher Bremsleistung wie die Original Bremsbeläge.
 Verbesserte Qualität - mit ECE R90 Freigabe aber mit höherem Reibwert und verbesserter Bremsleistung für den schnellen Strasseninsatz.

Make/Model/Engine Hersteller/Modell/Motor Modelos	Year Jahr Années	Pads  Front / Vorn / Avant		Shoes	Pads  Rear / Hinten / Arrière		Shoes
		Original Quality ECE R90* Approved 	Upgrade Quality Tuning/Sportbeläge ECE R90* Approved 	Bremsbacken Machoires 	Original Quality ECE R90* Approved 	Upgrade Quality Tuning/Sportbeläge ECE R90* Approved 	Bremsbacken Machoires 
HONDA Contd.							
Civic Contd.							
1.4 (MA8)	95-99	DP 815	DP 2815		DP 984/2	DP 2642/2	6437
1.4	2001-	DP 815	DP 2815		DP 1193	DP 21193	
1.5	76-80	DP 238					5219
1.5	80-84	DP 560	DP 2374				6346
1.5 (AH)	85-87	DP 432					6350
1.5 (EG4)	91-95	DP 890	DP 2890				6513
1.5 (EG8)	91-95	DP 890	DP 2890				6452
1.5 (EK3)	96-99	DP 890	DP 2890				6401
1.5 (EK3)	98-99	DP 891	DP 2891				6401
1.5 (MA9)	95-99	DP 815	DP 2815		DP 984/2	DP 2642/2	6437
1.5	99-2001	DP 891	DP 2891		DP 984/2	DP 2642/2	
1.6 (ED)	89-91	DP 706	DP 2706		DP 642/2	DP 2642/2	
1.6 (EE)	90-91	DP 719/2	DP 2719/2		DP 642/2	DP 2642/2	
1.6 ESi (EG5 EH9)	91-95	DP 890	DP 2890		DP 984/2	DP 2642/2	
1.6 VTi (EG6 EH9)(EG9)	91-95	DP 891	DP 2891		DP 984/2	DP 2642/2	
1.6 (MB1)	95-97	DP 815	DP 2815		DP 984/2	DP 2642/2	
1.6 VTec (EK1)	96-99	DP 890	DP 2890		DP 984/2	DP 2642/2	
1.6 VTec (EK1)	98-99	DP 891	DP 2891		DP 984/2	DP 2642/2	
1.6 VTi VTec (EK4)	96-2001	DP 891	DP 2891		DP 984/2	DP 2642/2	
1.6	2001-	DP 815	DP 2815		DP 1193	DP 21193	
1.8 VTi VTec (MB)	97-2001	DP 872	DP 2872		DP 781	DP 21193	
2.0 VTec TYPE-R	2001-	DP 21254	DP 31254		DP 21193	DP 31193	
2.0 TYPE-S	2003-						
1.7 TD	2002-	-	DP 21254		DP 1193	DP 21193	
2.0 TD (MB)	97-99	DP 815	DP 2815		DP 642/2	DP 2642/2	
Civic Aerodeck							
1.5	98-2001	DP 815	DP 2815				6437
1.6	98-2001	DP 815	DP 2815				6437
1.8	98-2001	DP 815	DP 2815		DP 984/2	DP 2642/2	
1.8	98-2001	DP 872	DP 2872		DP 781	DP 21193	
Civic Coupe							
1.5 (EJ2)	94-95	DP 890	DP 2890				6452
1.6 (EJ6)	96-2001	DP 890	DP 2890				6401
1.6 (EJ8)	96-2001	DP 891	DP 2891				6401
1.7	2001-						
Civic CRX							
1.5 (AF5)	84-86	DP 432					6350
1.6 (AS5)	86-87	DP 623	DP 2623				6350
1.6 (ED9)	87-91	DP 706	DP 2706		DP 642/2	DP 2642/2	
1.6 VTec (EE8)	90-92	DP 719/2	DP 2719/2		DP 642/2	DP 2642/2	
1.6 ESi VTec (EH6)	92-97	DP 891	DP 2891		DP 984/2	DP 2642/2	6513
1.6 VTi VTec (EG2)	92-97	DP 891	DP 2891		DP 984/2	DP 2642/2	
Civic Shuttle							
1.4 (EE)	88-91	DP 911	DP 2911				6366
1.5 2WD (AN)	85-87	DP 1034					6366
1.5 4WD (AR)	85-87	DP 432					6366
1.6 4WD (EE)	88-91	DP 706	DP 2706				6366
Concerto							
1.4	89-95	DP 815	DP 2815				6437
1.5	92-95	DP 815	DP 2815				6437
1.6	89-95	DP 815	DP 2815		DP 642/2	DP 2642/2	
CR-V							
2.0	97-	DP 872	DP 6872				6452

*Every EBC pad and shoe requiring ECE R-90 is available with approval subject to stock rotation - check box end label.









Models listed by Engine Size. Only listed by trim level where pads differ, (16v, GL, GT, etc).

BRAKE PADS & SHOES - APPLICATIONS

Bremsbeläge / Plaquettes + Bremsbacken / Machoires

EBC

BRAKES













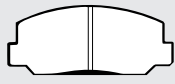

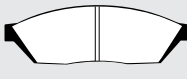
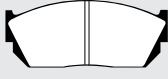

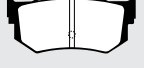

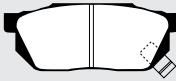
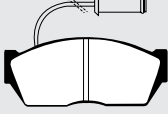

Make/Model/Engine Hersteller/Modell/Motor Modèles	Year Jahr Années	Pads  Front / Vorn / Avant		Shoes	Pads  Rear / Hinten / Arrière		Shoes
		Original Quality ECE R90* Approved 	Upgrade Quality Tuning/Sportbeläge ECE R90* Approved 	Bremsbacken Machoires 	Original Quality ECE R90* Approved 	Upgrade Quality Tuning/Sportbeläge ECE R90* Approved 	Bremsbacken Machoires 
HONDA Contd.							
HR-V							
1.6	99-	DP 872	DP 6872				6401
Insight							
1.0	2000-	DP 1355					6591
Integra							
1.5	86-89	DP 623	DP 2623				6366
1.6	86-89	DP 623	DP 2623		DP 642	DP 2642/2	
1.6	90-91	DP 719	DP 2719/2		DP 642	DP 2642/2	
Integra-R							
1.8 (Import)	97-98	-	DP 21206		DP 984/2	DP 2642/2	
1.8	98-	DP 872	DP 2872		DP 1216		
1.8	98-	DP 872	DP 2872		DP 1193	DP 21193	
Jazz							
1.2	84-86	DP 529					6276
1.4	2002-	DP 1340					
Legend							
2.5 (SA)	86-88	DP 630	DP 2630		DP 662		
2.7 (SA)	87-88	DP 630	DP 2630		DP 662		
2.7 (KA3)	87-92	DP 719/2	DP 2719/2		DP 781	DP 21193	
3.2 (KA7, 8)	91-96	DP 872	DP 2872		DP 781/2		
3.5 (KA9)	96-99	DP 872	DP 2872		DP 781/2		
3.5 (KA9)	99-	DP 1610	DP 21610		DP 781/2		
Handbrake Shoes	96-						6605
Logo							
1.3	2000-2001	DP 1340					6585
NSX							
3.0	90-99	DP 2872	DP 3872		DP 873		
3.2	98-	DP 2872	DP 3872		DP 873		
Prelude							
1.6 (SN)	79-83	DP 344			DP 514		6346
1.8 (AB)	83-87	DP 570	DP 2570		DP 642		
2.0 (BA1)	85-87	DP 639			DP 642/2	DP 2642/2	
2.0 (BA4) (EX)	88-92	DP 706	DP 2706		DP 642/2	DP 2642/2	
2.0 (BA4) (SE)	88-92	DP 719/2	DP 2719/2		DP 642/2	DP 2642/2	
2.0 (BB)	92-97	DP 975	DP 2975		DP 781	DP 21193	
2.0 (BB)	97-2001	DP 975	DP 2975		DP 1193	DP 21193	
2.2 Vtec (BB)	93-97	DP 2872	DP 3872		DP 21193	DP 31193	
2.2 (BB)	97-	DP 2872	DP 3872		DP 21193	DP 31193	
2.3 16v (BB)	92-97	DP 2872	DP 3872		DP 21193	DP 31193	
Quintet							
1.6	80-81	DP 344					6276
1.6	81-84	DP 344					6346
Shuttle							
2.2	95-97	DP 872	DP 2872		DP 781/2		
2.3	98-2001	DP 872	DP 2872		DP 781/2		
Handbrake Shoes	95-2001						6605
Stream							
1.7	2001-	DP 1610	DP 21610		DP 1193	DP 21193	
2.0	2001-	DP 1610	DP 21610		DP 1193	DP 21193	

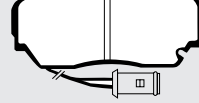
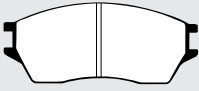
Standard Quality - ECE R90 Approved with similar performance to original equipment brake pads.
 Upgrade Quality (Tuning/ Sportbeläge) - ECE R90 Approved but with higher friction and improved performance for faster street use.
 Standard Qualität - mit ECE R90 Freigabe und ähnlicher Bremsleistung wie die Original Bremsbeläge.
 Verbesserte Qualität - mit ECE R90 Freigabe aber mit höherem Reibwert und verbesserter Bremsleistung für den schnellen Strasseninsatz.
 Qualité standard - Approuvée par la norme ECE R90 - Des performances équivalentes à l'origine.
 Qualité améliorée - Approuvée par la norme ECE R90 - Un coefficient de friction supérieur et des performances accrues pour pilotage rapide sur route.
 Calidad Estándar - Aprobación CEE R90 con prestaciones similares a las pastillas originales.
 Calidad Mejorada - Aprobación CEE R90 pero con un coeficiente de fricción más elevado y prestaciones mejoradas para un uso deportivo en carretera.

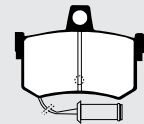
*Every EBC pad and shoe requiring ECE R-90 is available with approval subject to stock rotation - check box end label.
 Models listed by Engine Size. Only listed by trim level where pads differ, (16v, GL, GT, etc).

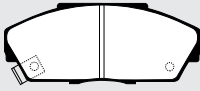
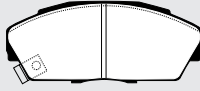
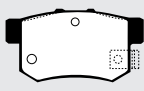
Make/Model/Engine	Year	Pads	Front / Vorn / Avant	Shoes	Pads	Rear / Hinten / Arrière	Shoes
Hersteller/Modell/Motor	Jahr	Plaquettes / Bremsbeläge		Bremsbacken Machoires	Plaquettes / Bremsbeläge		Bremsbacken Machoires
Modelos	Années	Original Quality ECE R90* Approved	Upgrade Quality Tuning/Sportbeläge ECE R90* Approved	Original Quality ECE R90* Approved	Upgrade Quality Tuning/Sportbeläge ECE R90* Approved	Original Quality ECE R90* Approved	Upgrade Quality Tuning/Sportbeläge ECE R90* Approved

Pad Illustrations for Honda

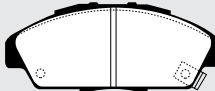
158  53 x 49 x 15mm	237  58 x 53 x 14mm	238  63 x 52 x 14mm	281  108 x 45 x 14mm
344  111 x 42 x 15mm	374  119 x 38 x 15mm	432  107 x 45 x 14mm	450  115 x 46 x 14mm
514  85 x 38 x 12mm	529  104 x 40 x 15mm	556  127 x 50 x 14mm	560  119 x 38 x 15mm
570  115 x 46 x 14mm	606  107 x 45 x 14mm	623  127 x 48 x 14mm	630  129 x 73 x 17mm
639  127 x 54 x 17mm	642  89 x 35 x 13mm	642/2  89 x 35 x 13mm	662  84 x 62 x 14mm
706  132 x 50 x 15mm	719  129 x 53 x 17mm	719/2  129 x 53 x 17mm	781  88 x 48 x 14mm
781/2  88 x 48 x 14mm	812  138 x 53 x 19mm	815  129 x 69 x 17mm	818  140 x 55 x 18mm

Standard Quality - ECE R90 Approved with similar performance to original equipment brake pads.
Upgrade Quality (Tuning / Sportbeläge) - ECE R90 Approved but with higher friction and improved performance for faster street use.

Standard Qualität - mit ECE R90 Freigabe und ähnlicher Bremsleistung wie die Original Bremsbeläge.
Verbesserte Qualität - mit ECE R90 Freigabe aber mit höherem Reibwert und verbesserter Bremsleistung für den schnellen Strasseninsatz.

Qualité standard - Approuvée par la norme ECE R90 - Des performances équivalentes à l'origine.
Qualité améliorée - Approuvée par la norme ECE R90 - Un coefficient de friction supérieur et des performances accrues pour pilotage rapide sur route.





Calidad Estándar - Aprobación CEE R90 con prestaciones similares a las pastillas originales.
Calidad Mejorada - Aprobación CEE R90 pero con un coeficiente de fricción más elevado y prestaciones mejoradas para un uso deportivo en carretera.

BRAKE PADS & SHOES - APPLICATIONS

Bremsbeläge / Plaquettes + Bremsbacken / Machoires

EBC

BRAKES

Make/Model/Engine	Year	Pads  Front / Vorn / Avant		Shoes	Pads  Rear / Hinten / Arrière		Shoes
Hersteller/Modell/Motor	Jahr	Plaquettes / Bremsbeläge		Bremsbacken Machoirs	Plaquettes / Bremsbeläge		Bremsbacken Machoirs
Modelos	Années	Original Quality ECE R90* Approved	Upgrade Quality Tuning/Sportbeläge ECE R90* Approved	 ECE R90* Approved	Original Quality ECE R90* Approved	Upgrade Quality Tuning/Sportbeläge ECE R90* Approved	 ECE R90* Approved

Pad Illustrations for Honda Contd.





872  148 x 59 x 17mm	873  111 x 58 x 15mm	890  131 x 54 x 15mm	891  136 x 57 x 16mm
911  128 x 48 x 15mm	975  138 x 53 x 19mm	984/2  89 x 34 x 13mm	985  128 x 50 x 15mm
1034  111 x 46 x 15mm	1193  89 x 48 x 15mm	1206  129 x 55 x 15mm	1216  87 x 53 x 14mm
1339  131 x 58 x 17mm	1340  131 x 54 x 15mm	1355  118 x 49 x 13mm	1610  149 x 60 x 16mm
21254  135 x 52 x 16mm			

HONDA COMMERCIAL							
TN7							
Van	76-80			6277			5219
Acty							
0.6	79-88			6278			5219
HONDA (Aust/NZ)							
Integra Type-R							
	98-2001	DP 2872	DP 3872		DP 21193	DP 31193	

*Every EBC pad and shoe requiring ECE R-90 is available with approval subject to stock rotation - check box end label.
Models listed by Engine Size. Only listed by trim level where pads differ, (16v, GL, GT, etc).

Standard Quality - ECE R90 Approved with similar performance to original equipment brake pads.
Upgrade Quality (Tuning / Sportbeläge) - ECE R90 Approved but with higher friction and improved performance for faster street use.
Verbesserte Qualität - mit ECE R90 Freigabe aber mit höherem Reibwert und verbesserter Bremsleistung für den schnellen Strasseninsatz.

Qualité standard - Approuvée par la norme ECE R90 - Des performances équivalentes à l'origine.
Qualité améliorée - Approuvée par la norme ECE R90 - Un coefficient de friction supérieur et des performances accrues pour pilotage rapide sur route.
Calidad Estándar - Aprobación CEE R90 con prestaciones similares a las pastillas originales.
Calidad Mejorada - Aprobación CEE R90 pero con un coeficiente de fricción más elevado y prestaciones mejoradas para un uso deportivo en carretera.

Make/Model/Engine	Year	Pads  Front / Vorn / Avant		Shoes	Pads  Rear / Hinten / Arrière		Shoes
Hersteller/Modell/Motor	Jahr	Plaquettes / Bremsbeläge		Bremsbacken Machoires	Plaquettes / Bremsbeläge		Bremsbacken Machoires
Modelos	Années	Original Quality ECE R90* Approved	Upgrade Quality Tuning/Sportbeläge ECE R90* Approved	 ECE R90* Approved	Original Quality ECE R90* Approved	Upgrade Quality Tuning/Sportbeläge ECE R90* Approved	 ECE R90* Approved

Pad Illustrations for Honda (Aust/NZ)

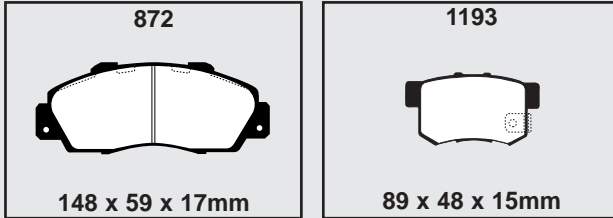

HONDA (Malaysia & The Philippines)

Civic

Model	Year	Front Pads	Rear Pads	Front Shoes	Rear Shoes
DX	92-95	DP 450		DP 2570	
LXi	97-	DP 890		DP 2890	
VTEC VT	97-	DP 890		DP 2890	
SiR	97-	DP 891		DP 2891	DP 984/2 DP 2642/2

Pad Illustrations for Honda (Malaysia & The Philippines)

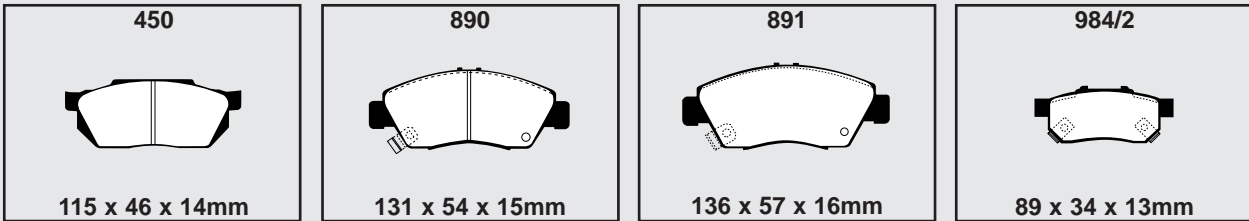

HYUNDAI

Accent

Model	Year	Front Pads	Rear Pads	Front Shoes	Rear Shoes
1.3	94-99	DP 803			6514
1.3	2000-2003	DP 803			
1.3	2003-				
1.5	94-99	DP 803			6514
1.5	2000-2003	DP 803			
1.6	2003-				
1.5 TD	2002-2003	DP 803			
1.5 TD	2003-				

Amica

1.0	2000-	DP 1203			6568
-----	-------	---------	--	--	------

Atoz

1.0	98-	DP 1203			6568
-----	-----	---------	--	--	------

Coupe

1.6	97-99	DP 1358	DP 21358		DP 528 6477
1.6	2002-	DP 1358	DP 21358		
2.0	96-2002	DP 1358	DP 21358		DP 528
2.0	2002-	DP 1358	DP 21358		
2.7	2002-	DP 1358	DP 21358		

Elantra

1.6	2000-	DP 1358	DP 21358		6477
2.0	2000-	DP 1358	DP 21358		DP 528
2.0TD	2002-				

Getz

1.1	2002-				
1.3	2002-				
1.6	2002-				

*Every EBC pad and shoe requiring ECE R-90 is available with approval subject to stock rotation - check box end label.









Models listed by Engine Size. Only listed by trim level where pads differ, (16v, GL, GT, etc).

BRAKE PADS & SHOES - APPLICATIONS

Bremsbeläge / Plaquettes + Bremsbacken / Machoires

EBC

BRAKES

Make/Model/Engine Hersteller/Modell/Motor Modèles	Year Jahr Années	Pads  Front / Vorn / Avant		Shoes	Pads  Rear / Hinten / Arrière		Shoes
		Original Quality ECE R90* Approved 	Upgrade Quality Tuning/Sportbeläge ECE R90* Approved 	Bremsbacken Machoires 	Original Quality ECE R90* Approved 	Upgrade Quality Tuning/Sportbeläge ECE R90* Approved 	Bremsbacken Machoires 
HYUNDAI Contd.							
Lantra							
1.5	93-95	DP 803					6477
1.6	91-95	DP 1358	DP 21358				6477
1.6	95-2001	DP 1358	DP 21358		DP 528		
1.8	92-95	DP 1358	DP 21358				6477
1.8	95-97	DP 1358	DP 21358		DP 528		
2.0	96-2001	DP 1358	DP 21358		DP 528		
Matrix							
1.6	2001-	DP 1358	DP 21358				
1.8	2001-	DP 1358	DP 21358				
1.5 TD	2001-	DP 1358	DP 21358				
Pony							
1.2	79-85	DP 196					5260
1.3	82-85	DP 196					5260
1.3	85-90	DP 196					6274
1.4	79-85	DP 196					5260
1.5	82-85	DP 196					5260
1.5	85-90	DP 196					6274
Pony X2							
1.3	89-90	DP 556					6453
1.3	90-94	DP 803					6455
1.5	89-90	DP 556					6453
1.5	90-94	DP 803					6455
Santa Fe							
2.4	2000-	DP 1332	DP 21332		DP 1392		6593
2.7	2000-	DP 1332	DP 21332		DP 1392		6593
2.0 TD	2001-	DP 1332	DP 21332		DP 1392		
Sonata							
1.8	88-94	DP 792	DP 2792				5291
1.8	88-94	DP 792	DP 2792				6385
2.0	88-92	DP 792	DP 2792				5291
2.0	88-92	DP 792	DP 2792				6385
2.0	92-96	DP 792	DP 2792		DP 1017		
2.0	96-98	DP 1358	DP 21358		DP 1017		
2.0	98-2002	DP 1358	DP 21358		DP 631		
2.0	98-2002	DP 1358	DP 21358		DP 1333		
2.0	2002-	DP 1358	DP 21358		DP 1333		
2.4	88-92	DP 792	DP 2792				5291
2.4	88-92	DP 792	DP 2792				6385
2.5	98-2002	DP 1358	DP 21358		DP 631		
2.5	98-2002	DP 1358	DP 21358		DP 1333		
2.7	2002-	DP 1358	DP 21358		DP 1333		
3.0	94-96	DP 792	DP 2792		DP 1017		
3.0	96-98	DP 1358	DP 21358		DP 1017		
Stellar							
1.6	84-86	DP 291	DP 2291				5291
1.6	86-87	DP 291	DP 2291				6385
1.6	87-91	DP 556					6339
2.0	84-86	DP 291	DP 2291				5291
2.0	86-87	DP 436	DP 2291				6385
2.0	87-91	DP 556					6339

Standard Quality - ECE R90 Approved with similar performance to original equipment brake pads.
 Upgrade Quality (Tuning/ Sportbeläge) - ECE R90 Approved but with higher friction and improved performance for faster street use.
 Verbesserte Qualität - mit ECE R90 Freigabe aber mit höherem Reibwert und verbesserter Bremsleistung für den schnellen Strasseninsatz.

Qualité standard - Approuvée par la norme ECE R90 - Des performances équivalentes à l'origine.
 Qualité améliorée - Approuvée par la norme ECE R90 - Un coefficient de friction supérieur et des performances accrues pour pilotage rapide sur route.
 Calidad Mejorada - Aprobación CEE R90 con prestaciones similares a las pastillas originales.
 Calidad Mejorada - Aprobación CEE R90 pero con un coeficiente de fricción más elevado y prestaciones mejoradas para un uso deportivo en carretera.

*Every EBC pad and shoe requiring ECE R-90 is available with approval subject to stock rotation - check box end label.
 Models listed by Engine Size. Only listed by trim level where pads differ, (16v, GL, GT, etc).

Make/Model/Engine Hersteller/Modell/Motor Modelos	Year Jahr Années	Pads Plaquettes / Bremsbeläge		Shoes Bremsbacken Machoires	Pads Plaquettes / Bremsbeläge		Shoes Bremsbacken Machoires
		Original Quality ECE R90* Approved	Upgrade Quality Tuning/Sportbeläge ECE R90* Approved	ECE R90* Approved	Original Quality ECE R90* Approved	Upgrade Quality Tuning/Sportbeläge ECE R90* Approved	ECE R90* Approved
HYUNDAI Contd.							
'S' Coupe							
1.5	90-91	DP 556					6274
1.5	91-92	DP 803					6453
1.5	92-96	DP 919					6455
1.5 Turbo	92-96	DP 919					6455
Trajet							
2.0	2000-	DP 1480	DP 21480		DP 1391		
2.7	2000-	DP 1480	DP 21480		DP 1391		
2.7	2000-	DP 1480	DP 21480		DP 1391		
2.0 TD	2003-						
XG 30							
3.0	2000-	DP 1480	DP 21480		DP 1333		

Pad Illustrations for Hyundai

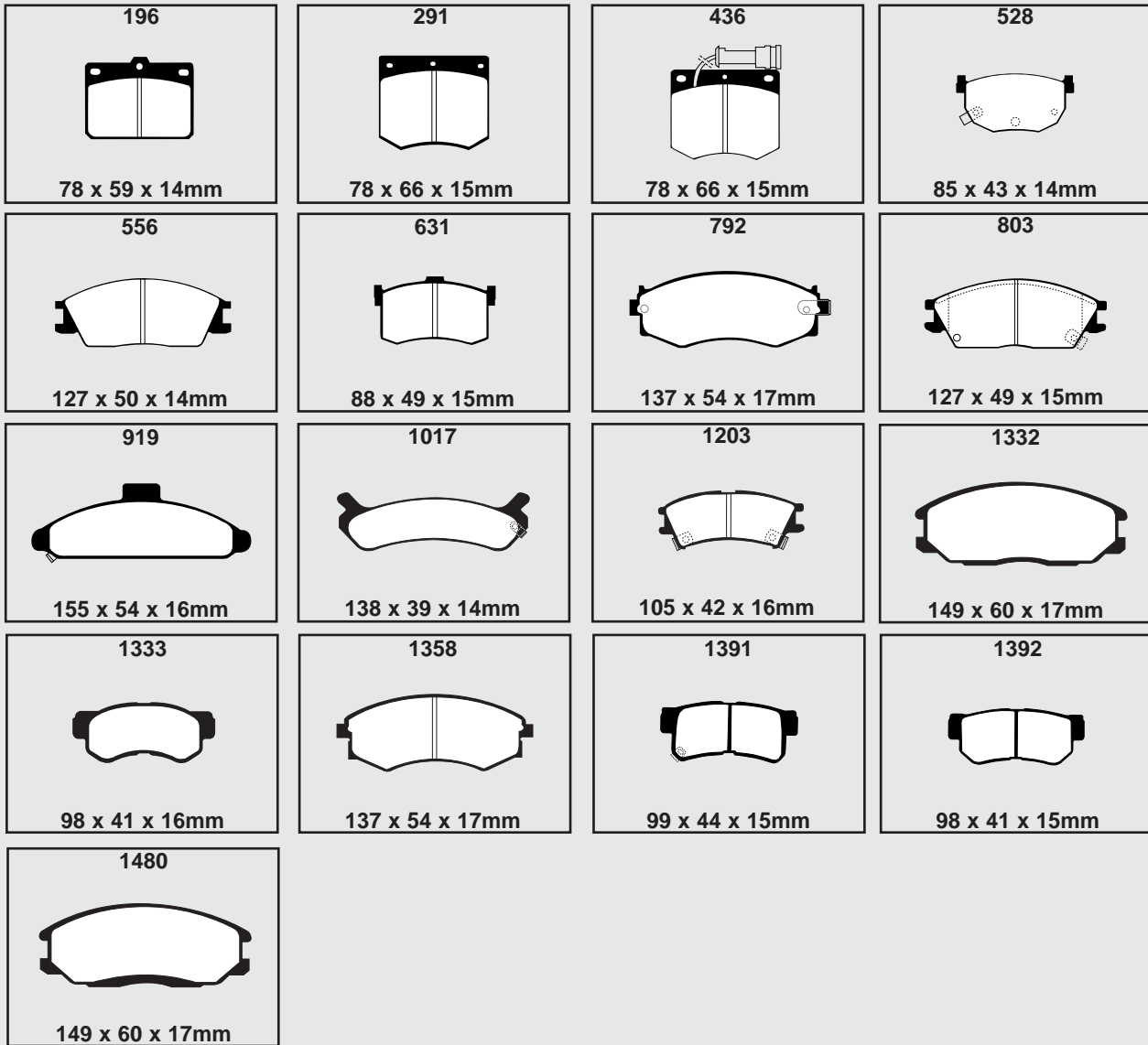









BRAKE PADS & SHOES - APPLICATIONS

Bremsbeläge / Plaquettes + Bremsbacken / Machoires

EBC

BRAKES

Make/Model/Engine Hersteller/Modell/Motor Modèles	Year Jahr Années	Pads  Front / Vorn / Avant		Shoes	Pads  Rear / Hinten / Arrière		Shoes
		Original Quality ECE R90* Approved 	Upgrade Quality Tuning/Sportbeläge ECE R90* Approved 	Bremsbacken Machoirs 	Original Quality ECE R90* Approved 	Upgrade Quality Tuning/Sportbeläge ECE R90* Approved 	Bremsbacken Machoirs 
HYUNDAI COMMERCIAL							
H100							
2.4	95-	DP 1086					5117
2.5D	95-	DP 1086					5117
H150							
2.5 D SWB	95-	DP 1086					6576
2.5 D LWB	95-	DP 1086					6445
H200							
2.4	97-	DP 1281					
2.5 D SWB	95-97	DP 1086					6576
2.5 D SWB	97-	DP 1281					
2.5 D LWB	95-97	DP 1086					6445
Pony Pick-Up							
1.2	79-82	DP 196					5260
1.3	82-86	DP 106	DP 2106				5216
1.4	79-82	DP 196					5260
1.5	82-86	DP 106	DP 2106				5216

Pad Illustrations for Hyundai Commercial

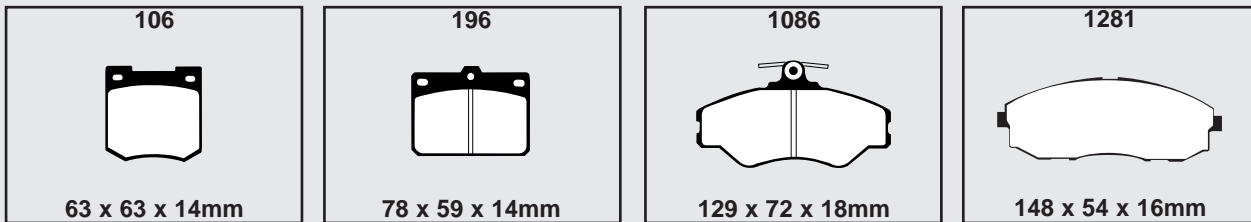

HYUNDAI (Korea)							
Granduer							
2.5	2000-	DP 1332					
3.0	96-	DP 1359					
3.0	2000-	DP 1332					

Pad Illustrations for Hyundai (Korea)

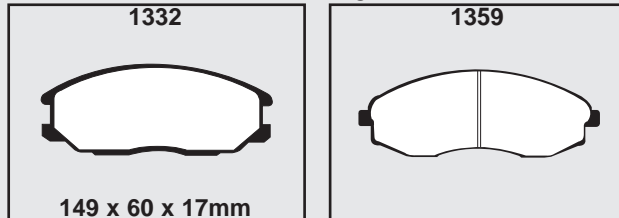



HYUNDAI (SA)							
Elantra							
	93-	DP 792	DP 2792			DP 528	
Tiburon							
	96-	DP 792	DP 2792			DP 528	

*Every EBC pad and shoe requiring ECE R-90 is available with approval subject to stock rotation - check box end label.
Models listed by Engine Size. Only listed by trim level where pads differ, (16v, GL, GT, etc).

Standard Quality - ECE R90 Approved with similar performance to original equipment brake pads.
Upgrade Quality (Tuning/ Sportbeläge) - ECE R90 Approved but with higher friction and improved performance for faster street use.
Verbesserte Qualität - mit ECE R90 Freigabe aber mit höherem Reibwert und verbesserter Bremsleistung für den schnellen Strasseninsatz.

Qualité standard - Approuvée par la norme ECE R90 - Des performances équivalentes à l'origine.
Qualité améliorée - Approuvée par la norme ECE R90 - Un coefficient de friction supérieur et des performances accrues pour pilotage rapide sur route.
Calidad Mejorada - Aprobación CEE R90 con prestaciones similares a las pastillas originales.
Calidad Mejorada - Aprobación CEE R90 pero con un coeficiente de fricción más elevado y prestaciones mejoradas para un uso deportivo en carretera.

Make/Model/Engine	Year	Pads	Front / Vorn / Avant	Shoes	Pads	Rear / Hinten / Arrière	Shoes
Hersteller/Modell/Motor	Jahr	Plaquettes / Bremsbeläge		Bremsbacken Machoires	Plaquettes / Bremsbeläge		Bremsbacken Machoires
Modelos	Années	Original Quality ECE R90* Approved	Upgrade Quality Tuning/Sportbeläge ECE R90* Approved		Original Quality ECE R90* Approved	Upgrade Quality Tuning/Sportbeläge ECE R90* Approved	

Pad Illustrations for Hyundai (SA)

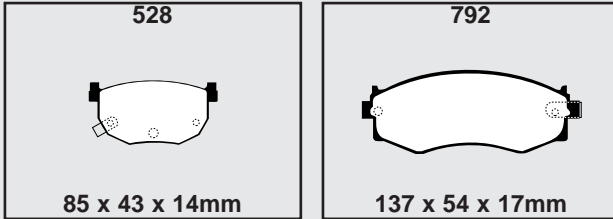

Make/Model/Engine	Year	Front Pads	Rear Pads	Front Shoes	Rear Shoes
INNOCENTI					
90					
1.0	74-86	DP 127		DP 2127	5146
120					
1.3	74-86	DP 127		DP 2127	5146
500					
0.5	87-90	DP 127		DP 2127	5031
650					
0.6	79-88	DP 127		DP 2127	5031
990					
1.0	86-91	DP 127		DP 2127	5031
1.0 D	86-91	DP 127		DP 2127	5031
Elba					
1.3	90-93	DP 704			5031
1.4	92-97	DP 704			5031
1.5	92-94	DP 704			5031
1.6	93-97	DP 704			5031
1.7 D	91-97	DP 704			5031
Mille					
1.0	93-94	DP 704			5031
Mille Clip					
1.0	94-98	DP 485			6503
1.4	94-98	DP 485			6503
1.7 D	94-98	DP 718			6503
Mini					
1.0	74-83	DP 127		DP 2127	5146
1.3	74-83	DP 127		DP 2127	5146
1.0 D	74-83	DP 127		DP 2127	5146
Minitre					
1.0	82-86	DP 127		DP 2127	5031
1.0 D	82-86	DP 127		DP 2127	5031
Minitre Tomaso					
1.0	83-86	DP 127		DP 2127	5031
Small					
0.7	90-95	DP 127		DP 2127	5031
1.0	90-93	DP 127		DP 2127	5031
Tomaso					
1.0	78-84	DP 127		DP 2127	5146
1.3	74-86	DP 127		DP 2127	5146

BRAKE PADS & SHOES - APPLICATIONS

Bremsbeläge / Plaquettes + Bremsbacken / Machoires

EBC

BRAKES

Make/Model/Engine	Year	Pads	Front / Vorn / Avant	Shoes	Pads	Rear / Hinten / Arrière	Shoes
Hersteller/Modell/Motor	Jahr	Plaquettes / Bremsbeläge		Bremsbacken	Plaquettes / Bremsbeläge		Bremsbacken
Modelos	Années	Original Quality ECE R90* Approved	Upgrade Quality Tuning/Sportbeläge ECE R90* Approved	Machoires ECE R90* Approved	Original Quality ECE R90* Approved	Upgrade Quality Tuning/Sportbeläge ECE R90* Approved	Machoires ECE R90* Approved

Pad Illustrations for Innocenti

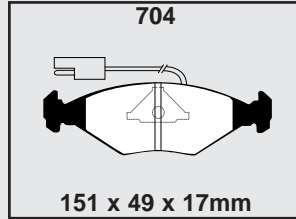
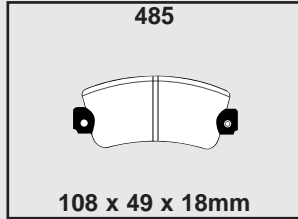
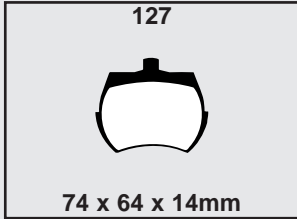

ISO					
Fidia					
5.4	67-68			DP 120	
5.4	68-74	DP 2223	DP 3223	DP 2101	DP 3101
5.7	67-68			DP 120	
5.7	68-74	DP 2223	DP 3223	DP 2101	DP 3101
5.8	67-68			DP 120	
5.8	68-74	DP 2223	DP 3223	DP 2101	DP 3101
Grifo					
5.4	63-68			DP 120	
5.4	68-74	DP 2223	DP 3223	DP 2101	DP 3101
5.7	63-68			DP 120	
5.7	68-74	DP 2223	DP 3223	DP 2101	DP 3101
7.0	69-74	DP 2223	DP 3223	DP 2101	DP 3101
7.4	69-74	DP 2223	DP 3223	DP 2101	DP 3101
Lele					
5.4	69-74	DP 2223	DP 3223	DP 2101	DP 3101
5.8	69-74	DP 2223	DP 3223	DP 2101	DP 3101
Rivolta					
5.4	62-68			DP 120	
5.4	68-70	DP 2223	DP 3223	DP 2101	DP 3101

Pad Illustrations for ISO

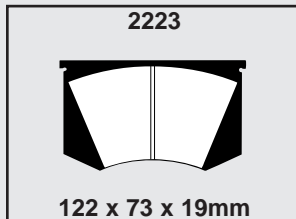
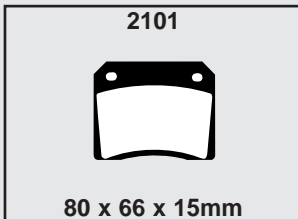
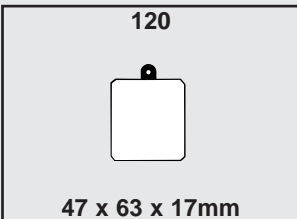

ISUZU					
Piazza					
2.0 Turbo	81-86	DP 531		DP 466	
2.0 Turbo	86-91	DP 568		DP 569	
2.0 Turbo (Lotus)	88-91	DP 746		DP 569	
Trooper					
2.3 (UBS16)	87-88	DP 746	DP 6746		6404
2.6 (UBS52)	88-92	DP 746	DP 6746	DP 777	
3.2 (UBS25)	92-98	DP 973	DP 6973	DP 974	DP 6974
3.5 (UBS26)	98-	DP 973	DP 6973	DP 974	DP 6974
2.3 TD (UBS52)	87-88	DP 746	DP 6746		6404
2.8 TD (UBS52)	88-92	DP 746	DP 6746	DP 777	
3.0 TD (UBS73)	98-	DP 973	DP 6973	DP 974	DP 6974
3.1 TD (UBS69)	92-98	DP 973	DP 6973	DP 974	DP 6974









*Every EBC pad and shoe requiring ECE R-90 is available with approval subject to stock rotation - check box end label.
Models listed by Engine Size. Only listed by trim level where pads differ, (16v, GL, GT, etc).

Standard Quality - ECE R90 Approved with similar performance to original equipment brake pads.
Upgrade Quality (Tuning / Sportbeläge) - ECE R90 Approved but with higher friction and improved performance for faster street use.
Verbesserte Qualität - mit ECE R90 Freigabe aber mit höherem Reibwert und verbesserter Bremsleistung für den schnellen Strasseninsatz.

Qualité standard - Approuvée par la norme ECE R90 - Des performances équivalentes à l'origine.
Qualité améliorée - Approuvée par la norme ECE R90 - Un coefficient de friction supérieur et des performances accrues pour pilotage rapide sur route.
Calidad Estándar - Aprobación CEE R90 con prestaciones similares a las pastillas originales.
Calidad Mejorada - Aprobación CEE R90 pero con un coeficiente de fricción más elevado y prestaciones mejoradas para un uso deportivo en carretera.

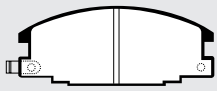
Make/Model/Engine	Year	Pads	Front / Vorn / Avant	Shoes	Pads	Rear / Hinten / Arrière	Shoes
Hersteller/Modell/Motor	Jahr	Plaquettes / Bremsbeläge		Bremsbacken Machoires	Plaquettes / Bremsbeläge		Bremsbacken Machoires
Modelos	Années	Original Quality ECE R90* Approved	Upgrade Quality Tuning/Sportbeläge ECE R90* Approved	Original Quality ECE R90* Approved	Upgrade Quality Tuning/Sportbeläge ECE R90* Approved	Original Quality ECE R90* Approved	Upgrade Quality Tuning/Sportbeläge ECE R90* Approved

Pad Illustrations for Isuzu

466  98 x 39 x 13mm	531  112 x 46 x 12mm	568  112 x 45 x 13mm	569  106 x 38 x 15mm
746  127 x 51 x 16mm	777  131 x 42 x 13mm	973  138 x 59 x 16mm	974  110 x 43 x 15mm









JAGUAR/DAIMLER					
Dart	59-63	-	DP 2134	-	DP 2141
SP250	60-64	-	DP 2134	-	DP 2141
E-Type					
3.8	62-68	DP 120	DP 2120	DP 120	DP 2120
4.2	62-68	DP 120	DP 2120	DP 120	DP 2120
4.2	69-75	DP 108	DP 2108	DP 101	DP 2101
5.3	69-75	DP 108	DP 2108	DP 101	DP 2101
Handbrake Pads	68-75			DP 709	
Majestic					
4.6	66-69	DP 120	DP 2120	DP 120	DP 2120
Mk2					
2.4	59-67	DP 120	DP 2120	DP 120	DP 2120
3.4	59-67	DP 120	DP 2120	DP 120	DP 2120
3.8	59-67	DP 120	DP 2120	DP 120	DP 2120
Mk10					
3.8	61-65			DP 709	
3.8	65-70	DP 108	DP 2108	DP 101	DP 2101
Limousine					
4.2	68-85	DP 262	DP 2262	DP 101	DP 2101
S-Type					
2.5	2002-	DP 1220	DP 21220	DP 1221	DP 21221
3.0	99-	DP 1220	DP 21220	DP 1221	DP 21221
4.0	99-2002	DP 21220	DP 31220	DP 21221	DP 31221
4.2	2002-	DP 21220	DP 31220	DP 21221	DP 31221
4.2 R	2002-	DP 21462	DP 31462	DP 21140	DP 31140
XJ					
3.0	2003-				
3.5	2003-				
4.2	2003-				
4.2 S/C	2003-				

BRAKE PADS & SHOES - APPLICATIONS

Bremsbeläge / Plaquettes + Bremsbacken / Machoires









EBC

BRAKES









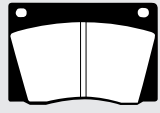
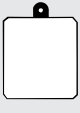
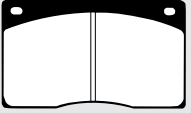
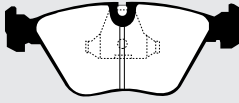

Make/Model/Engine Hersteller/Modell/Motor Modèles	Year Jahr Années	Pads  Front / Vorn / Avant		Shoes	Pads  Rear / Hinten / Arrière		Shoes
		Original Quality ECE R90* Approved 	Upgrade Quality Tuning/Sportbeläge ECE R90* Approved 	Bremsbacken Machoires 	Original Quality ECE R90* Approved 	Upgrade Quality Tuning/Sportbeläge ECE R90* Approved 	Bremsbacken Machoires 
JAGUAR/DAIMLER Contd.							
XJ6/Sovereign							
2.8	68-73	DP 108	DP 2108		DP 101	DP 2101	
2.8	73-75	DP 262	DP 2262		DP 101	DP 2101	
2.9	86-87	DP 756	DP 2756		DP 757		
2.9	87-89	DP 756/2	DP 2756/2		DP 757/2		
2.9	89-90	DP 689/2	DP 2689/2		DP 690/2	DP 2690/2	
3.2	90-97	DP 689/2	DP 2689/2		DP 690/2	DP 2690/2	
3.2 sport	94-97	DP 1009	DP 21009		DP 1198	DP 21198	
3.4	75-86	DP 262	DP 2262		DP 101	DP 2101	
3.6	86-87	DP 756	DP 2756		DP 757		
3.6	87-89	DP 756/2	DP 2756/2		DP 757/2		
4.0	90-97	DP 689/2	DP 2689/2		DP 690/2	DP 2690/2	
4.0 sport	94-97	DP 21009	DP 31009		DP 21198	DP 31198	
4.2	68-73	DP 108	DP 2108		DP 101	DP 2101	
4.2	73-86	DP 262	DP 2262		DP 101	DP 2101	
Handbrake Pads	68-86				DP 709		
XJ8							
3.2	97-	DP 689/2	DP 2689/2		DP 1198	DP 21198	
3.2 sport	97-	DP 1009	DP 21009		DP 1198	DP 21198	
4.0	97-	DP 689/2	DP 2689/2		DP 1198	DP 21198	
4.0 sport	97-	DP 21009	DP 31009		DP 21198	DP 31198	
XJ12/Double Six							
5.3	68-73	DP 108	DP 2108		DP 101	DP 2101	
5.3	73-93	DP 262	DP 2262		DP 101	DP 2101	
6.0	94-	DP 21009	DP 31009		DP 21198	DP 31198	
6.0	93-94	DP 21009	DP 31009		DP 2690/2	DP 3690/2	
Handbrake Pads	68-93				DP 709		
XJ220							
3.5 Twin Turbo	88-	-	DP 3002		-	DP 3002	
XJR							
3.6	88-89	DP 756/2	DP 2756/2		DP 757/2		
4.0	89-93	DP 262	DP 2262		DP 101	DP 2101	
4.0	89-93	DP 689/2	DP 2689/2		DP 690/2	DP 2690/2	
4.0 Supercharged	94-	DP 2689/2	DP 3689/2		DP 2690/2	DP 3690/2	
4.0 Supercharged (Brembo)	94-	DP 21110	DP 31110		DP 21140	DP 31140	
XJR-S							
5.3	89-91	DP 2262	DP 3262		DP 2101	DP 3101	
6.0	89-93	DP 2689/2	DP 3689/2		DP 2690/2	DP 3690/2	
6.0	89-93	DP 2262	DP 3262		DP 2101	DP 3101	
XJS							
3.6	75-91	DP 262	DP 2262		DP 101	DP 2101	
4.0	91-94	DP 689/2	DP 2689/2		DP 690/2	DP 2690/2	
4.0	95-96	DP 1009	DP 21009		DP 1198	DP 21198	
5.3	75-91	DP 2262	DP 3262		DP 2101	DP 3101	
5.3	91-93	DP 2689/2	DP 3689/2		DP 2690/2	DP 3690/2	
6.0	93-96	DP 2689/2	DP 3689/2		DP 2690/2	DP 3690/2	
Handbrake Pads	75-91				DP 709		
XK150							
3.4	58-59	DP 120	DP 2120		DP 120	DP 2120	
3.8	59-60	DP 120	DP 2120		DP 120	DP 2120	
XK8							
4.0	96-	DP 689/2	DP 2689/2		DP 1198	DP 21198	

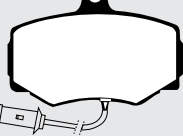
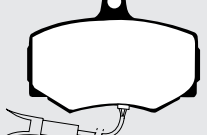
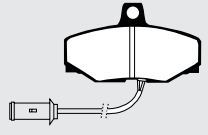
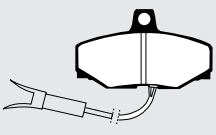
*Every EBC pad and shoe requiring ECE R-90 is available with approval subject to stock rotation - check box end label.
Models listed by Engine Size. Only listed by trim level where pads differ, (16v, GL, GT, etc).

Standard Quality - ECE R90 Approved with similar performance to original equipment brake pads.
Upgrade Quality (Tuning/ Sportbeläge) - ECE R90 Approved but with higher friction and improved performance for faster street use.
Verbesserte Qualität - mit ECE R90 Freigabe aber mit höherem Reibwert und verbesserter Bremsleistung für den schnellen Strasseninsatz.
Standard Qualität - mit ECE R90 Freigabe und ähnlicher Bremsleistung wie die Original Bremsbeläge.
Qualité standard - Approuvée par la norme ECE R90 - Des performances équivalentes à l'origine.
Qualité améliorée - Approuvée par la norme ECE R90 - Un coefficient de friction supérieur et des performances accrues pour pilotage rapide sur route.
Calidad Estándar - Aprobación CEE R90 con prestaciones similares a las pastillas originales.
Calidad Mejorada - Aprobación CEE R90 pero con un coeficiente de fricción más elevado y prestaciones mejoradas para un uso deportivo en carretera.

Make/Model/Engine Hersteller/Modell/Motor Modelos	Year Jahr Années	Pads  Front / Vorn / Avant		Shoes	Pads  Rear / Hinten / Arrière		Shoes
		Original Quality ECE R90* Approved 	Upgrade Quality Tuning/Sportbeläge ECE R90* Approved 	Bremsbacken Machoires 	Original Quality ECE R90* Approved 	Upgrade Quality Tuning/Sportbeläge ECE R90* Approved 	Bremsbacken Machoires 
JAGUAR/DAIMLER Contd.							
XKR							
4.0 Supercharged	98-	DP 2689/2	DP 3689/2		DP 21198	DP 31198	
4.0 Supercharged (Brembo)	98-	DP 21110	DP 31110		DP 21140	DP 31140	
X Type							
2.0	2002-	DP 1322	DP 21322		DP 1350	DP 21350	
2.0 sport	2002-						
2.5	2001-	DP 1322	DP 21322		DP 1350	DP 21350	
2.5 sport	2001-						
3.0	2001-	DP 21322	DP 31322		DP 21350	DP 31350	
3.0 sport	2001-						
2.0 TD	2003-						

Pad Illustrations for Jaguar/Daimler

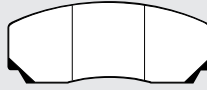
101  80 x 66 x 15mm	108  98 x 68 x 16mm	120  47 x 63 x 17mm	262  119 x 71 x 15mm
689/2  156 x 63 x 17mm	690/2  123 x 44 x 17mm	709  40 x 39 x 13mm	756  114 x 81 x 17mm
756/2  114 x 81 x 17mm	757  90 x 53 x 13mm	757/2  90 x 53 x 13mm	1009  194 x 64 x 18mm
1198  141 x 48 x 16mm	1220  163 x 57 x 17mm	1221  114 x 50 x 17mm	1322  148 x 60 x 18mm
1350  115 x 50 x 16mm	2134  78 x 58 x 16mm	2141  73 x 53 x 15mm	3002  132 x 54 x 17mm

Standard Quality - ECE R90 Approved with similar performance to original equipment brake pads.
Upgrade Quality (Tuning / Sportbeläge) - ECE R90 Approved but with higher friction and improved performance for faster street use.

Standard Qualität - mit ECE R90 Freigabe und ähnlicher Bremsleistung wie die Original Bremsbeläge.
Verbesserte Qualität - mit ECE R90 Freigabe aber mit höherem Reibwert und verbesserter Bremsleistung für den schnellen Strasseneinsatz.

Calidad Estándar - Aprobación CEE R90 con prestaciones similares a las pastillas originales.
Calidad Mejorada - Aprobación CEE R90 pero con un coeficiente de fricción más elevado y prestaciones mejoradas para un uso deportivo en carretera.

BRAKE PADS & SHOES - APPLICATIONS

Bremsbeläge / Plaquettes + Bremsbacken / Machoires

EBC
BRAKES

Make/Model/Engine	Year	Pads	Front / Vorn / Avant	Shoes	Pads	Rear / Hinten / Arrière	Shoes
Hersteller/Modell/Motor	Jahr	Plaquettes / Bremsbeläge		Bremsbacken	Plaquettes / Bremsbeläge		Bremsbacken
Modelos	Années	Original Quality ECE R90* Approved	Upgrade Quality Tuning/Sportbeläge ECE R90* Approved	Machoires ECE R90* Approved	Original Quality ECE R90* Approved	Upgrade Quality Tuning/Sportbeläge ECE R90* Approved	Machoires ECE R90* Approved

Pad Illustrations for Jaguar/Daimler Contd.

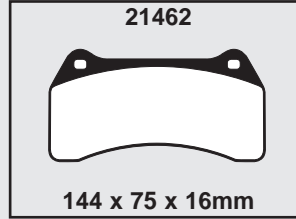
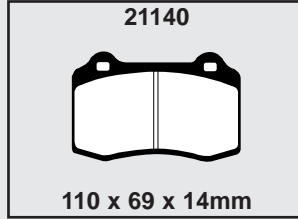
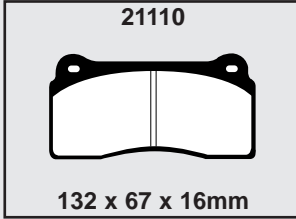

JENSEN						
CV8	62-66	DP 120	DP 2120		DP 120	DP 2120
Healey 2.0	72-76	DP 106	DP 2106			5229
Healey GT 2.0	75-76	DP 106	DP 2106			5234
Interceptor 6.3	66-68	DP 120	DP 2120		DP 120	DP 2120
6.3	69-72	DP 2108	DP 3108		DP 2101	DP 3101
7.2	72-76	DP 2108	DP 3108		DP 2101	DP 3101
Handbrake Pads	69-72				DP 709	
SP V8 7.2	71-76	DP 2108	DP 3108		DP 2101	DP 3101
FF Handbrake Pads	66-72	DP 2108	DP 3108		DP 2101	DP 3101
66-72					DP 709	
SV8 4.6	2000-					

Pad Illustrations for Jensen

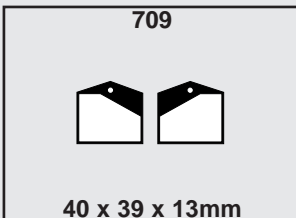
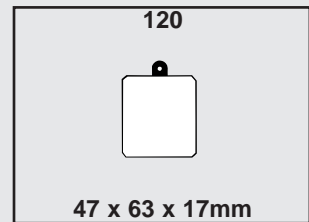
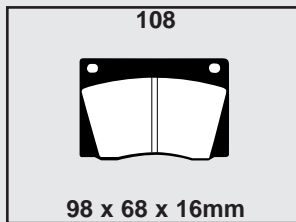
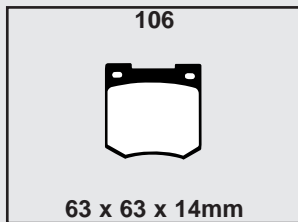
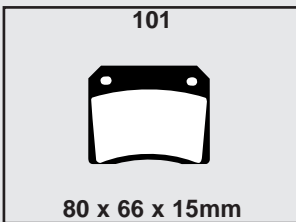









KIA						
Carens 1.8	2000-	DP 1236			DP 1235	6578
2.0 TD	2002-					

*Every EBC pad and shoe requiring ECE R-90 is available with approval subject to stock rotation - check box end label. Models listed by Engine Size. Only listed by trim level where pads differ, (16v, GL, GT, etc).

Standard Quality - ECE R90 Approved with similar performance to original equipment brake pads.
Upgrade Quality (Tuning/ Sportbeläge) - ECE R90 Approved but with higher friction and improved performance for faster street use.
Verbesserte Qualität - mit ECE R90 Freigabe aber mit höherem Reibwert und verbesserter Bremsleistung für den schnellen Strasseninsatz.

Qualité standard - Approuvée par la norme ECE R90 - Des performances équivalentes à l'origine.
Qualité améliorée - Approuvée par la norme ECE R90 - Un coefficient de friction supérieur et des performances accrues pour pilotage rapide sur route.
Calidad Estándar - Aprobación CEE R90 con prestaciones similares a las pastillas originales.
Calidad Mejorada - Aprobación CEE R90 pero con un coeficiente de fricción más elevado y prestaciones mejoradas para un uso deportivo en carretera.

Make/Model/Engine	Year	Pads  Front / Vorn / Avant		Shoes	Pads  Rear / Hinten / Arrière		Shoes
Hersteller/Modell/Motor	Jahr	Plaquettes / Bremsbeläge		Bremsbacken Machoires	Plaquettes / Bremsbeläge		Bremsbacken Machoires
Modelos	Années	Original Quality ECE R90* Approved 	Upgrade Quality Tuning/Sportbeläge ECE R90* Approved 	 ECE R90* Approved	Original Quality ECE R90* Approved 	Upgrade Quality Tuning/Sportbeläge ECE R90* Approved 	 ECE R90* Approved
KIA Contd.							
Clarus							
1.8	96-99	DP 1356			DP 1235		6578
1.8	99-	DP 1236			DP 1235		6578
2.0	96-99	DP 1356			DP 1235		
2.0	99-	DP 1236			DP 1235		
Magentis							
2.0	2003-	DP 1358	DP 21358		DP 1333		
2.5	2001-	DP 1358	DP 21358		DP 1333		
Mentor							
1.5	96-2001	DP 1001					6504
1.6	94-99	DP 1001			DP 953		6504
1.6	2001-						
Pride							
1.1	91-94	DP 737					6430
1.3	91-2000	DP 737					6430
Rio							
1.3	2001-	DP 884	DP 2884				6616
1.5	2001-	DP 884	DP 2884				6616
Sedona							
2.5	99-2000	DP 1022	DP 21022				6548
2.5	2000-	DP 1423	DP 21423				6548
2.9 TD	99-2000	DP 1022	DP 21022				6548
2.9 TD	2000-	DP 1423	DP 21423				6548
Sephia							
1.5	96-	DP 1001					6504
1.6	94-	DP 1001			DP 953		6504
Shuma							
1.5	99-2001	DP 1237			DP 1235		6504
1.6	2001-	DP 1475			DP 1235		
1.8	99-2002	DP 1237			DP 1235		6504
1.8	2002-						
Sorento							
3.5	2003-						
2.5 D	2003-						
Sportage							
2.0	94-99	DP 1073					6550
2.0	99-	DP 1404					

Pad Illustrations for Kia

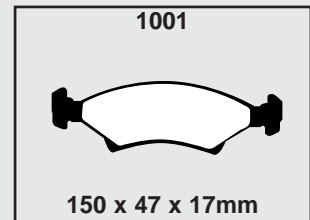
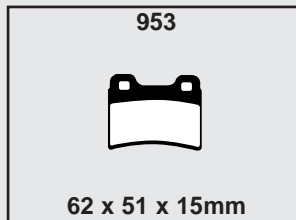
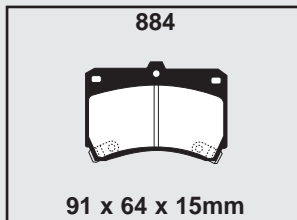
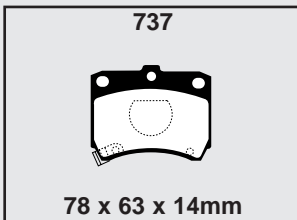

Standard Quality - ECE R90 Approved with similar performance to original equipment brake pads.
Upgrade Quality (Tuning / Sportbeläge) - ECE R90 Approved but with higher friction and improved performance for faster street use.

Standard Qualität - mit ECE R90 Freigabe und ähnlicher Bremsleistung wie die Original Bremsbeläge.
Verbesserte Qualität - mit ECE R90 Freigabe aber mit höherem Reibwert und verbesserter Bremsleistung für den schnellen Strasseninsatz.





Calidad Estandar - Aprobacion CEE R90 con prestaciones similares a las pastillas originales.
Calidad Mejorada - Aprobacion CEE R90 pero con un coeficiente de friccion mas elevado y prestaciones mejoradas para un uso deportivo en carretera.

BRAKE PADS & SHOES - APPLICATIONS





Bremsbeläge / Plaquettes + Bremsbacken / Machoires

EBC

BRAKES

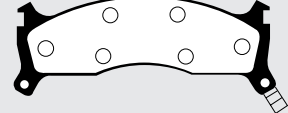
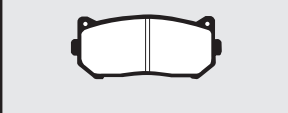
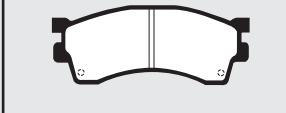
Make/Model/Engine	Year	Pads	Shoes	Pads	Shoes
Hersteller/Modell/Motor	Jahr	Plaquettes / Bremsbeläge	Bremsbacken Machoires	Plaquettes / Bremsbeläge	Bremsbacken Machoires
Modelos	Années	Original Quality ECE R90* Approved 	Upgrade Quality Tuning/Sportbeläge ECE R90* Approved 	Original Quality ECE R90* Approved 	Upgrade Quality Tuning/Sportbeläge ECE R90* Approved 

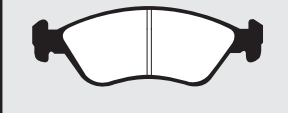
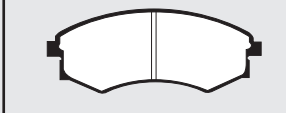

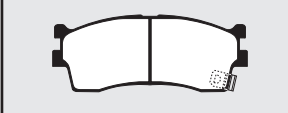

Pad Illustrations for Kia Contd.

1022  177 x 55 x 17mm	1073  174 x 67 x 17mm	1235  98 x 41 x 16mm	1236  129 x 51 x 16mm
1237  151 x 46 x 17mm	1333  98 x 41 x 16mm	1356  151 x 53 x 18mm	1358  137 x 54 x 17mm
1404  149 x 53 x 16mm	1423  154 x 56 x 17mm	1475  129 x 51 x 16mm	

LADA

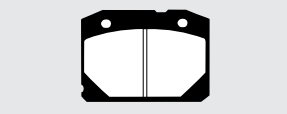
1200	71-82	DP 172			5022
1300	71-82	DP 172			5022
1500	75-82	DP 172			5218
1600	75-82	DP 172			5218
Niva					
1.6	77-95	DP 309			5022
1.7	95-	DP 309			5022
1.9 D	77-89	DP 309			5022
Riva					
1.2	82-89	DP 172			5022
1.3	82-93	DP 172			5022
1.5	82-97	DP 172			5022
1.6	82-93	DP 172			5022
Samara					
1.1	90-95	DP 637			6420
1.1	95-	DP 1192			6420
1.3	87-95	DP 637			6420
1.3	95-	DP 1192			6420
1.5	88-95	DP 637			6420
1.5	95-	DP 1192			6420

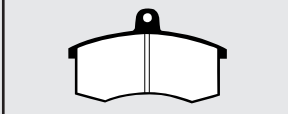







Pad Illustrations for Lada

172  83 x 60 x 15mm	309  126 x 45 x 16mm	637  104 x 62 x 17mm	1192  104 x 62 x 17mm
---	--	---	---



*Every EBC pad and shoe requiring ECE R-90 is available with approval subject to stock rotation - check box end label.
 Models listed by Engine Size. Only listed by trim level where pads differ, (16v, GL, GT, etc).

Standard Quality - ECE R90 Approved with similar performance to original equipment brake pads.
 Upgrade Quality (Tuning/ Sportbeläge) - ECE R90 Approved but with higher friction and improved performance for faster street use.
 Verbesserte Qualität - mit ECE R90 Freigabe aber mit höherem Reibwert und verbesserter Bremsleistung für den schnellen Strasseninsatz.

Qualité standard - Approuvée par la norme ECE R90 - Des performances équivalentes à l'origine.
 Qualité améliorée - Approuvée par la norme ECE R90 - Un coefficient de friction supérieur et des performances accrues pour pilotage rapide sur route.
 Calidad Mejorada - Aprobación CEE R90 con prestaciones similares a las pastillas originales.
 Calidad Mejorada - Aprobación CEE R90 pero con un coeficiente de fricción más elevado y prestaciones mejoradas para un uso deportivo en carretera.

Make/Model/Engine Hersteller/Modell/Motor Modèles	Year Jahr Années	Pads  Front / Vorn / Avant		Shoes	Pads  Rear / Hinten / Arrière		Shoes
		Original Quality ECE R90* Approved 	Upgrade Quality Tuning/Sportbeläge ECE R90* Approved 	Bremsbacken Machoires 	Original Quality ECE R90* Approved 	Upgrade Quality Tuning/Sportbeläge ECE R90* Approved 	Bremsbacken Machoires 
LAMBORGHINI							
350 GT	64-66				DP 101		
400 GT	66-68				DP 101		
Countach							
4.0	74-81						
4.8	81-85						
5.2	85-89	DP 2753	DP 3753		DP 2104	DP 3104	
5.2	89-90	DP 2753	DP 3753		DP 2753	DP 3753	
Diablo							
5.7	90-96	DP 21032	DP 31032		DP 2612	DP 3612	
5.7	90-96	DP 2753	DP 3753		DP 2345	DP 3345	
5.7	97-99	DP 21110	DP 31110				
6.0	99-2002	DP 21110	DP 31110				
Espada							
3.9	68-78	DP 2223	DP 3223		DP 2101	DP 3101	
Gallardo							
5.0	2003-						
Islero							
3.9	68-69	DP 2223	DP 3223		DP 2101	DP 3101	
Jalpa							
3.5	85-92	DP 2753	DP 3753		DP 2104	DP 3104	
Jarama							
3.9	70-78	DP 2223	DP 3223		DP 2101	DP 3101	
Muirra							
3.9	66-72	DP 2223	DP 3223		DP 2101	DP 3101	
Murcielago							
6.2	2002-						
Silhouette							
3.0	76-79	DP 2753	DP 3753		DP 2126	DP 3126	
Urraco							
3.0	70-79	DP 2753	DP 3753		DP 2126	DP 3126	

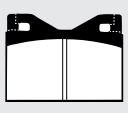
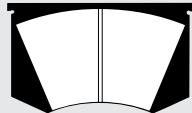
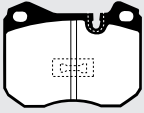
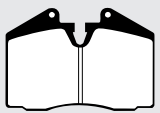
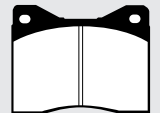
Pad Illustrations for Lamborghini

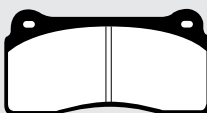





101  80 x 66 x 15mm	2126  76 x 58 x 15mm	2223  122 x 73 x 19mm	2345  89 x 70 x 19mm
2612  97 x 67 x 18mm	2753  89 x 70 x 16mm	21032  120 x 71 x 17mm	21110  132 x 67 x 16mm

BRAKE PADS & SHOES - APPLICATIONS

Bremsbeläge / Plaquettes + Bremsbacken / Machoires

EBC









BRAKES

Make/Model/Engine Hersteller/Modell/Motor Modèles	Year Jahr Années	Pads  Front / Vorn / Avant		Shoes	Pads  Rear / Hinten / Arrière		Shoes
		Plaquettes / Bremsbeläge Original Quality ECE R90* Approved 		Bremsbacken Machoirs Upgrade Quality Tuning/Sportbeläge ECE R90* Approved 	Plaquettes / Bremsbeläge Original Quality ECE R90* Approved 	Bremsbacken Machoirs Upgrade Quality Tuning/Sportbeläge ECE R90* Approved 	
LANCIA							
O37 Rally							
2.0 Supercharged	82-83						
2000							
2.0	71-74	DP 188			DP 114		
Beta							
1.3	73-85	DP 230			DP 231		
1.4	73-85	DP 230			DP 231		
1.6	73-85	DP 230			DP 231		
1.8	73-85	DP 230			DP 231		
2.0	73-85	DP 230			DP 231		
Beta Monte Carlo							
2.0	74-84	DP 116	DP 2116		DP 130		
Dedra							
1.6	90-94	DP 718					5329
1.6	90-94	DP 718					6329
1.6	90-94	DP 420/2	DP 2420/2		DP 596		
1.6	96-99	DP 1059	DP 21059		DP 596		
1.8	90-95	DP 420/2	DP 2420/2		DP 596		
1.8	96-99	DP 1060	DP 21060		DP 596		
1.8	96-99	DP 1060	DP 21060		DP 501		
2.0	90-94	DP 420/2	DP 2420/2		DP 596		
2.0	96-99	DP 1061	DP 21061		DP 596		
2.0 Turbo Integrale	91-94	DP 733	DP 2733		DP 370	DP 2370	
1.9 TD	90-96	DP 420/2	DP 2420/2		DP 596		
1.9 TD	96-99	DP 1060	DP 21060		DP 596		
Dedra							
1.9 TD	96-99	DP 1060	DP 21060		DP 501		
Delta							
1.3	80-84	DP 410					5031
1.3	84-93	DP 410/2					5031
1.5	80-84	DP 410					5031
1.5	84-93	DP 410/2					5031
1.6 GT	83-93	DP 420/4	DP 2420/2		DP 231		
1.6	93-97	DP 420/2	DP 2420/2				5329
1.6	93-97	DP 420/2	DP 2420/2				6329
1.6	97-2000	DP 1059	DP 21059		DP 1214		
1.6 Turbo	83-93	DP 420/4	DP 2420/2		DP 231		
1.6 HF Turbo	87-94	DP 420/2	DP 2420/2		DP 231(B)		
1.6 HF Turbo	87-94	DP 420/4	DP 2420/2		DP 370(G)	DP 2370	
1.8	94-97	DP 420/2	DP 2420/2		DP 596		
1.8	97-2000	DP 1060	DP 21060		DP 1214		
2.0	94-96	DP 420/2	DP 2420/2		DP 596		
2.0	96-2000	DP 1061	DP 21061		DP 596		
2.0	96-2000	DP 733	DP 2733		DP 596		
2.0 HF Integrale	87-89	DP 2733	DP 3733		DP 231		
2.0 HF Integrale	90-92	DP 2733	DP 3733		DP 231		
2.0 HF Integrale Evolution	92-94	DP 21031	DP 31031		DP 999		
1.9 TD	86-89	DP 420/2	DP 2420/2		DP 231		
Flaminia							
2.5	58-63	DP 120	DP 2120		DP 120	DP 2120	
2.8	63-70	DP 120	DP 2120		DP 120	DP 2120	

*Every EBC pad and shoe requiring ECE R-90 is available with approval subject to stock rotation - check box end label.
Models listed by Engine Size. Only listed by trim level where pads differ, (16v, GL, GT, etc).

Standard Quality - ECE R90 Approved with similar performance to original equipment brake pads.
Upgrade Quality (Tuning/ Sportbeläge) - ECE R90 Approved but with higher friction and improved performance for faster street use.
Verbesserte Qualität - mit ECE R90 Freigabe aber mit höherem Reibwert und verbesserter Bremsleistung für den schnellen Strasseninsatz.

Standard Qualität - mit ECE R90 Freigabe und ähnlicher Bremsleistung wie die Original Bremsbeläge.
Qualité améliorée - Approuvée par la norme ECE R90 - Un coefficient de friction supérieur et des performances accrues pour pilotage rapide sur route.
Calidad Estándar - Aprobación CEE R90 con prestaciones similares a las pastillas originales.
Calidad Mejorada - Aprobación CEE R90 pero con un coeficiente de fricción más elevado y prestaciones mejoradas para un uso deportivo en carretera.

Make/Model/Engine Hersteller/Modell/Motor Modelos	Year Jahr Années	Pads  Front / Vorn / Avant		Shoes	Pads  Rear / Hinten / Arrière		Shoes
		Original Quality ECE R90* Approved 	Upgrade Quality Tuning/Sportbeläge ECE R90* Approved 	Bremsbacken Machoires 	Original Quality ECE R90* Approved 	Upgrade Quality Tuning/Sportbeläge ECE R90* Approved 	Bremsbacken Machoires 
LANCIA Contd.							
Flavia							
1.5	61-67	DP 120	DP 2120		DP 120	DP 2120	
1.8	63-68	DP 120	DP 2120		DP 120	DP 2120	
2.0	69-76	DP 188			DP 114		
Fulvia							
1.1	63-69	DP 120	DP 2120		DP 120	DP 2120	
1.2	63-69	DP 120	DP 2120		DP 120	DP 2120	
1.3	63-69	DP 120	DP 2120		DP 120	DP 2120	
1.3	70-75	DP 188			DP 114		
1.6	65-69	DP 120	DP 2120		DP 120	DP 2120	
1.6	70-75	DP 188			DP 114		
Gamma							
2.0	76-85	DP 297			DP 298		
2.5	76-85	DP 297			DP 298		
Kappa							
2.0	95-98	DP 1109	DP 2733		DP 1096		
2.0	98-2001	DP 1227	DP 21061		DP 1096		
2.0 Turbo	95-98	DP 1109	DP 2733		DP 1096		
2.0 Turbo	98-2001		DP 21210		DP 1096		
2.4	95-98	DP 1109	DP 2733		DP 1096		
2.4	98-2001	DP 1227	DP 21061		DP 1096		
3.0	95-98	DP 1109	DP 2733		DP 1096		
3.0	98-2001		DP 21210		DP 1096		
2.4 TD	95-98	DP 1109	DP 2733		DP 1096		
2.4 TD	98-2001	DP 1227	DP 21061		DP 1096		
Lybria							
1.6	99-	DP 1061	DP 21061		DP 1430		
1.7	99-	DP 1061	DP 21061		DP 1430		
2.0	99-	DP 1061	DP 21061		DP 1430		
1.9 TD	99-	DP 1061	DP 21061		DP 1430		
2.4 TD	99-	DP 1061	DP 21061		DP 1430		
Phedra							
2.0	2002-	DP 1466	DP 21466		DP 1230	DP 21230	
3.0	2002-	DP 1466	DP 21466		DP 1230	DP 21230	
2.0 TD	2002-	DP 1466	DP 21466		DP 1230	DP 21230	
2.2 TD	2002-	DP 1466	DP 21466		DP 1230	DP 21230	
Primula							
1.2	64-71	DP 116	DP 2116		DP 130		
Prisma							
1.3	80-84	DP 410					5031
1.3	84-93	DP 410/2					5031
1.5	80-84	DP 410					5031
1.5	84-93	DP 410/2					5031
1.6	83-93	DP 420/4	DP 2420/2		DP 501		
Stratos							
2.4	74-75	DP 2103	DP 3103		DP 2104	DP 3104	
Thema							
2.0	84-87	DP 616	DP 2420/2		DP 501(B)		
2.0	84-87	DP 616	DP 2420/2		DP 370(G)	DP 2370	
2.0 Turbo 8v	85-87	DP 616	DP 2420/2		DP 370(G)	DP 2370	
2.0 Turbo 16v	87-92	DP 820	DP 2820		DP 370(G)	DP 2370	
2.0 Turbo 16v	92-94	DP 733	DP 2733		DP 370(G)	DP 2370	
2.0	88-94	DP 820	DP 2820		DP 370(G)	DP 2370	

Standard Quality - ECE R90 Approved with similar performance to original equipment brake pads.
Upgrade Quality (Tuning / Sportbeläge) - ECE R90 Approved but with higher friction and improved performance for faster street use.

Standard Qualität - mit ECE R90 Freigabe und ähnlicher Bremsleistung wie die Original Bremsbeläge.
Verbesserte Qualität - mit ECE R90 Freigabe aber mit höherem Reibwert und verbesserter Bremsleistung für den schnellen Strasseninsatz.

Quality standard - Approuvée par la norme ECE R90 - Des performances équivalentes à l'origine.
Qualité améliorée - Approuvée par la norme ECE R90 - Un coefficient de friction supérieur et des performances accrues pour pilotage rapide sur route.

Calidad Estandar - Aprobacion CEE R90 con prestaciones similares a las pastillas originales.
Calidad Mejorada - Aprobacion CEE R90 pero con un coeficiente de friccion mas elevado y prestaciones mejoradas para un uso deportivo en carretera.

*Every EBC pad and shoe requiring ECE R-90 is available with approval subject to stock rotation - check box end label.
Models listed by Engine Size. Only listed by trim level where pads differ, (16v, GL, GT, etc).

BRAKE PADS & SHOES - APPLICATIONS

Bremsbeläge / Plaquettes + Bremsbacken / Machoires

EBC

BRAKES

Make/Model/Engine Hersteller/Modell/Motor Modèles	Year Jahr Années	Pads Plaquettes / Bremsbeläge		Shoes Bremsbacken Machoires	Pads Plaquettes / Bremsbeläge		Shoes Bremsbacken Machoires
		Original Quality ECE R90* Approved	Upgrade Quality Tuning/Sportbeläge ECE R90* Approved	ECE R90* Approved	Original Quality ECE R90* Approved	Upgrade Quality Tuning/Sportbeläge ECE R90* Approved	ECE R90* Approved
LANCIA Contd.							
Thema Contd.							
2.0	88-94	DP 820	DP 2820		DP 231(B)		
2.8	84-87	DP 616	DP 2420/2		DP 501(B)		
2.8	84-87	DP 616	DP 2420/2		DP 370(G)	DP 2370	
2.8	88-94	DP 820	DP 2820		DP 370(G)	DP 2370	
2.8	88-94	DP 820	DP 2820		DP 231(B)		
2.9 32v (Ferrari Eng)	88-94	DP 2733	DP 3733		DP 2370	DP 3370	
3.0	92-94	DP 2733	DP 3733		DP 2370	DP 3370	
2.5 TD	84-87	DP 616	DP 2420/2		DP 501(B)		
2.5 TD	84-87	DP 616	DP 2420/2		DP 370(G)	DP 2370	
2.5 TD	88-94	DP 820	DP 2820		DP 370(G)	DP 2370	
2.5 TD	88-94	DP 820	DP 2820		DP 231(B)		
Thesis							
2.0 Turbo	2001-	DP 1424			DP 1425		
2.4	2001-	DP 1424			DP 1425		
3.0	2001-	DP 1424			DP 1425		
3.2	2003-						
2.4 TD	2001-	DP 1424			DP 1425		
Trevi							
1.3	80-85	DP 230(B)			DP 231(B)		
1.3	80-85	DP 420/2(G)	DP 2420/2		DP 370(G)	DP 2370	
1.6	80-85	DP 230(B)			DP 231(B)		
1.6	80-85	DP 420/2(G)	DP 2420/2		DP 370(G)	DP 2370	
2.0	80-85	DP 230(B)			DP 231(B)		
2.0	80-85	DP 420/2(G)	DP 2420/2		DP 370(G)	DP 2370	
Y10							
1.0	85-89	DP 485	DP 2485				5031
1.0	89-92	DP 718					5031
1.1	85-89	DP 485	DP 2485				5031
1.1	89-95	DP 718					5031
1.1	93-95	DP 718					6503
1.1 Turbo	85-89	DP 420/2	DP 2420/2		DP 596		
1.3 GT	89-92	DP 718					5031
1.3 GT	92-95	DP 420/2	DP 2420/2				5031
1.3 GT	93-95	DP 420/2	DP 2420/2				6503
Y							
1.1	97-	DP 944	DP 2944				6329
1.2	96-	DP 944	DP 2944				6329
1.2 16v	97-	DP 420/2(G)	DP 2420/2				6329
1.2 16v	98-	DP 1141(T)	DP 21059				6329
1.4	96-	DP 420/2	DP 2420/2				6329
Zeta							
2.0	94-	DP 1108	DP 2733		DP 1040		6516
2.0 Turbo	94-99	DP 1108	DP 2733		DP 1040		
2.0 D	2000-	DP 1108	DP 2733		DP 1040		
2.1 TD	96-2000	DP 1108	DP 2733		DP 1040		

Standard Quality - ECE R90 Approved with similar performance to original equipment brake pads.
 Upgrade Quality (Tuning/ Sportbeläge) - ECE R90 Approved but with higher friction and improved performance for faster street use.
 Verbesserte Qualität - mit ECE R90 Freigabe aber mit höherem Reibwert und verbesserter Bremsleistung für den schnellen Strasseninsatz.

Qualité standard - Approuvée par la norme ECE R90 - Des performances équivalentes à l'origine.
 Qualité améliorée - Approuvée par la norme ECE R90 - Un coefficient de friction supérieur et des performances accrues pour pilotage rapide sur route.
 Calidad Mejorada - Aprobación CEE R90 con prestaciones similares a las pastillas originales.
 Calidad Mejorada - Aprobación CEE R90 pero con un coeficiente de fricción más elevado y prestaciones mejoradas para un uso deportivo en carretera.

Pad Illustrations for Lancia

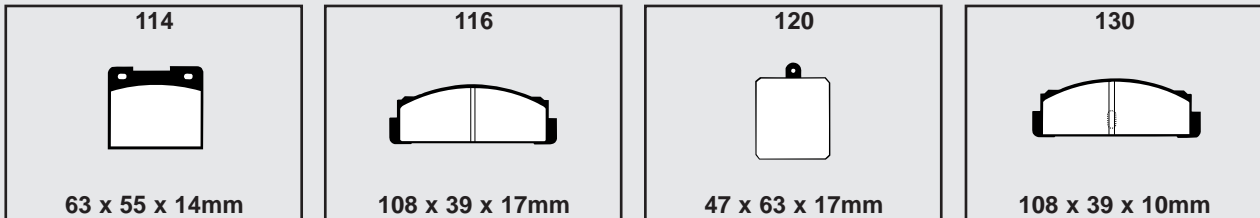

*Every EBC pad and shoe requiring ECE R-90 is available with approval subject to stock rotation - check box end label.
 Models listed by Engine Size. Only listed by trim level where pads differ, (16v, GL, GT, etc).

Make/Model/Engine	Year	Front / Vorn / Avant	Shoes	Rear / Hinten / Arrière	Shoes
Hersteller/Modell/Motor	Jahr	Plaquettes / Bremsbeläge	Bremsbacken Machoires	Plaquettes / Bremsbeläge	Bremsbacken Machoires
Modelos	Années	Original Quality ECE R90* Approved	Upgrade Quality Tuning/Sportbeläge ECE R90* Approved	Original Quality ECE R90* Approved	Upgrade Quality Tuning/Sportbeläge ECE R90* Approved

Pad Illustrations for Lancia Contd.

188 107 x 66 x 15mm	230 108 x 53 x 17mm	231 108 x 49 x 12mm	297 122 x 58 x 18mm
298 88 x 53 x 16mm	370 87 x 62 x 16mm	410 100 x 62 x 16mm	410/2 100 x 61 x 16mm
420/2 104 x 66 x 17mm	420/4 104 x 66 x 17mm	485 108 x 49 x 18mm	501 108 x 47 x 12mm
596 87 x 44 x 14mm	616 104 x 66 x 17mm	718 90 x 63 x 17mm	733 130 x 59 x 18mm
733/2 130 x 59 x 18mm	820 110 x 56 x 18mm	944 115 x 55 x 16mm	999 87 x 53 x 14mm
1031 110 x 69 x 17mm	1040 123 x 43 x 17mm	1059 151 x 52 x 17mm	1060 156 x 52 x 17mm
1061 156 x 58 x 19mm	1096 90 x 50 x 16mm	1108 130 x 58 x 19mm	1109 130 x 58 x 19mm

Standard Quality - ECE R90 Approved with similar performance to original equipment brake pads.
Upgrade Quality (Tuning / Sportbeläge) - ECE R90 Approved but with higher friction and improved performance for faster street use.

Standard Qualität - mit ECE R90 Freigabe und ähnlicher Bremsleistung wie die Original Bremsbeläge.
Verbesserte Qualität - mit ECE R90 Freigabe aber mit höherem Reibwert und verbesserter Bremsleistung für den schnellen Strasseneinsatz.

Calidad Estándar - Aprobación CEE R90 con prestaciones similares a las pastillas originales.
Calidad Mejorada - Aprobación CEE R90 pero con un coeficiente de fricción más elevado y prestaciones mejoradas para un uso deportivo en carretera.





*Every EBC pad and shoe requiring ECE R-90 is available with approval subject to stock rotation - check box end label.
Models listed by Engine Size. Only listed by trim level where pads differ, (16v, GL, GT, etc).

BRAKE PADS & SHOES - APPLICATIONS









Bremsbeläge / Plaquettes + Bremsbacken / Machoires

EBC

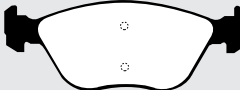
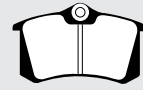
BRAKES

Make/Model/Engine	Year	Pads  Front / Vorn / Avant		Shoes	Pads  Rear / Hinten / Arrière		Shoes
Hersteller/Modell/Motor	Jahr	Plaquettes / Bremsbeläge		Bremsbacken Machoirs	Plaquettes / Bremsbeläge		Bremsbacken Machoirs
Modelos	Années	Original Quality ECE R90* Approved	Upgrade Quality Tuning/Sportbeläge ECE R90* Approved	 ECE R90* Approved	Original Quality ECE R90* Approved	Upgrade Quality Tuning/Sportbeläge ECE R90* Approved	 ECE R90* Approved

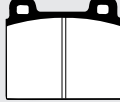
Pad Illustrations for Lancia Contd.









1141  151 x 52 x 18mm	1214  87 x 44 x 14mm	1227  156 x 58 x 19mm	1230  87 x 53 x 17mm
1424  146 x 61 x 18mm	1425  116 x 50 x 17mm	1430  96 x 44 x 16mm	1466  147 x 59 x 19mm
2103  76 x 70 x 15mm	2104  61 x 56 x 15mm	21210  131 x 75 x 15mm	

LANDROVER					
Landrover 88					
2.3	50-80			6252	6252
2.3 D	50-80			6252	6252
2.3	80-85			6256	6256
2.3 D	80-85			6256	6256
Transmission Brake	50-83				5139H
Transmission Brake	83-85				6417
Landrover 90					
2.3	84-86	DP 622	DP 6622		6258
2.5	84-86	DP 622	DP 6622		6258
2.3 D	84-86	DP 622	DP 6622		6258
2.5 D	84-86	DP 622	DP 6622		6258
3.5	84-86	DP 622	DP 6622		6258
2.3	87-90	DP 713	DP 6814		6258
2.5	87-90	DP 713	DP 6814		6258
2.3 D	87-90	DP 713	DP 6814		6258
2.5 D	87-90	DP 713	DP 6814		6258
2.5 TD	87-90	DP 713	DP 6814		6258
3.5	87-90	DP 713	DP 6814		6258
Transmission Brake	84-90				6417
Landrover 109					
2.3	50-85			6256	6258
2.3 D	50-85			6256	6258
2.5 D	61-85			6259	6258
3.5 V8	71-85			6259	6258
Transmission Brake	50-83				5139H
Transmission Brake	83-85				6417

*Every EBC pad and shoe requiring ECE R-90 is available with approval subject to stock rotation - check box end label.
Models listed by Engine Size. Only listed by trim level where pads differ, (16v, GL, GT, etc).

Standard Quality - ECE R90 Approved with similar performance to original equipment brake pads.
Upgrade Quality (Tuning/ Sportbeläge) - ECE R90 Approved but with higher friction and improved performance for faster street use.
Verbesserte Qualität - mit ECE R90 Freigabe aber mit höherem Reibwert und verbesserter Bremsleistung für den schnellen Strasseninsatz.

Standard Qualität - mit ECE R90 Freigabe und ähnlicher Bremsleistung wie die Original Bremsbeläge.
Qualität amifiorde - Approuvé par la norme ECE R90 - Un coefficient de friction supérieur et des performances accrues pour pilotage rapide sur route.
Calidad Mejorada - Aprobacion CEE R90 con prestaciones similares a las pastillas originales.
Calidad Mejorada - Aprobacion CEE R90 pero con un coeficiente de friccion mas elevado y prestaciones mejoradas para un uso deportivo en carretera.

Make/Model/Engine Hersteller/Modell/Motor Modèles	Year Jahr Années	Pads  Front / Vorn / Avant		Shoes	Pads  Rear / Hinten / Arrière		Shoes
		Original Quality ECE R90* Approved 	Upgrade Quality Tuning/Sportbeläge ECE R90* Approved 	Bremsbacken Machoires 	Original Quality ECE R90* Approved 	Upgrade Quality Tuning/Sportbeläge ECE R90* Approved 	Bremsbacken Machoires 
LANDROVER Contd.							
Landrover 110							
2.3	83-85	DP 462					6258
2.5	83-85	DP 462					6258
2.3 D	83-85	DP 462					6258
2.5 D	83-85	DP 462					6258
3.5	83-85	DP 462					6258
2.3	86-90	DP 708	DP 6708				6258
2.5	86-90	DP 708	DP 6708				6258
2.3 D	86-90	DP 708	DP 6708				6258
2.5 D	86-90	DP 708	DP 6708				6258
2.5 TD	86-90	DP 708	DP 6708				6258
3.5	86-90	DP 708	DP 6708				6258
Transmission Brake	83-90						6417
Landrover Defender							
90 2.5	90-93	DP 814	DP 6814				6258
90 2.5 D	90-93	DP 814	DP 6814				6258
90 2.5 TD	90-93	DP 814	DP 6814				6258
90 2.5	93-98	DP 708	DP 6708		DP 294		
90 2.5 D	93-98	DP 708	DP 6708		DP 294		
90 2.5 TD	93-98	DP 708	DP 6708		DP 294		
90 2.5 TD	98-	DP 708	DP 6708		DP 1033	DP 61033	
110, 130 2.5	90-93	DP 708	DP 6708				6258
110, 130 2.5	93-	DP 708	DP 6708		DP 1033	DP 61033	
110, 130 2.5 D	90-93	DP 708	DP 6708				6258
110, 130 2.5 D	93-	DP 708	DP 6708		DP 1033	DP 61033	
110, 130 2.5 TD	90-93	DP 708	DP 6708				6258
110, 130 2.5 TD	93-	DP 708	DP 6708		DP 1033	DP 61033	
110, 130 3.5	90-93	DP 708	DP 6708				6258
110, 130 3.5	93-	DP 708	DP 6708		DP 1033	DP 61033	
Transmission Brake	90-93						6417
Transmission Brake	93-						6615
Landrover Discovery							
2.0	93-98	DP 713	DP 6814		DP 294		
2.5 TD	89-90	DP 622	DP 6622		DP 663	DP 6663	
2.5 TD	89-98	DP 814	DP 6814		DP 663	DP 6663	
2.5 TD	98-	DP 1037	DP 61037		DP 1038	DP 61038	
3.5	89-93	DP 814	DP 6814		DP 663	DP 6663	
3.9	93-98	DP 814	DP 6814		DP 663	DP 6663	
3.9	98-	DP 1037	DP 61037		DP 1038	DP 61038	
Transmission Brake	89-93						6417
Transmission Brake	93-						6615
Landrover Freelander							
1.8	97-2000	DP 1415	DP 61415				6567
1.8	2000-	DP 1352	DP 61352				6608
2.0 TD	97-2000	DP 1415	DP 61415				6567
2.0 TD	2000-	DP 1352	DP 61352				6608
2.5	2000-	DP 1352	DP 61352				6608
Range Rover							
3.5	70-85	DP 241	DP 6622		DP 294		
3.5	86-89	DP 622	DP 6622		DP 663	DP 6663	
3.9	89-94	DP 814	DP 6814		DP 663	DP 6663	
3.9	94-96	DP 1037	DP 61037		DP 1038	DP 61038	
4.0	96-2002	DP 1037	DP 61037		DP 1038	DP 61038	
4.2	92-94	DP 814	DP 6814		DP 663	DP 6663	
4.4	2002-	DP 1463	DP 61463		DP 1118	DP 61118	
4.6	94-2002	DP 1037	DP 61037		DP 1038	DP 61038	
2.4 TD	87-89	DP 713	DP 6814		DP 663	DP 6663	
2.5 TD	89-94	DP 814	DP 6814		DP 663	DP 6663	

Standard Quality - ECE R90 Approved with similar performance to original equipment brake pads.
 Upgrade Quality (Tuning / Sportbeläge) - ECE R90 Approved but with higher friction and improved performance for faster street use.

Standard Qualität - mit ECE R90 Freigabe und ähnlicher Bremsleistung wie die Original Bremsbeläge.
 Verbesserte Qualität - mit ECE R90 Freigabe aber mit höherem Reibwert und verbesserter Bremsleistung für den schnellen Strasseninsatz.

Qualité standard - Approuvée par la norme ECE R90 - Des performances équivalentes à l'origine.
 Qualité améliorée - Approuvée par la norme ECE R90 - Un coefficient de friction supérieur et des performances accrues pour pilotage rapide sur route.

Calidad Estándar - Aprobación CEE R90 con prestaciones similares a las pastillas originales.
 Calidad Mejorada - Aprobación CEE R90 pero con un coeficiente de fricción más elevado y prestaciones mejoradas para un uso deportivo en carretera.









*Every EBC pad and shoe requiring ECE R-90 is available with approval subject to stock rotation - check box end label.
 Models listed by Engine Size. Only listed by trim level where pads differ, (16v, GL, GT, etc).

BRAKE PADS & SHOES - APPLICATIONS

Bremsbeläge / Plaquettes + Bremsbacken / Machoires











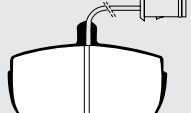

EBC

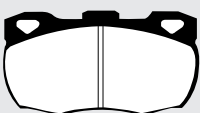
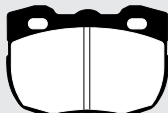
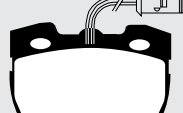
BRAKES

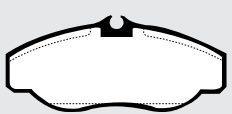
Make/Model/Engine	Year	Pads  Front / Vorn / Avant		Shoes	Pads  Rear / Hinten / Arrière		Shoes
Hersteller/Modell/Motor	Jahr	Plaquettes / Bremsbeläge		Bremsbacken Machoires	Plaquettes / Bremsbeläge		Bremsbacken Machoires
Modelos	Années	Original Quality ECE R90* Approved 	Upgrade Quality Tuning/Sportbeläge ECE R90* Approved 	 ECE R90* Approved	Original Quality ECE R90* Approved 	Upgrade Quality Tuning/Sportbeläge ECE R90* Approved 	 ECE R90* Approved

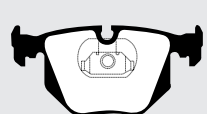
LANDROVER Contd.							
Range Rover Contd.							
2.5 TD	94-2002	DP 1037	DP 61037		DP 1038	DP 61038	
2.9TD	2002-	DP 1463	DP 61463		DP 1118	DP 61118	
Handbrake Shoes	70-85						6297
Handbrake Shoes	86-89						6417
Handbrake Shoes	89-2001						6615

Pad Illustrations for Landrover











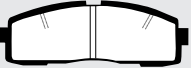
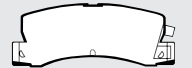
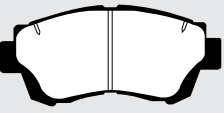
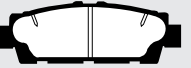
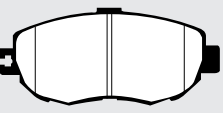

241  105 x 75 x 18mm	294  88 x 70 x 15mm	462  126 x 72 x 18mm	622  105 x 75 x 18mm
663  88 x 72 x 15mm	708  126 x 68 x 18mm	713  105 x 72 x 17mm	814  105 x 72 x 17mm
1033  85 x 75 x 14mm	1037  145 x 67 x 19mm	1038  95 x 52 x 16mm	1118  123 x 58 x 17mm
1352  131 x 62 x 17mm	1415  129 x 70 x 18mm	1463  155 x 73 x 19mm	

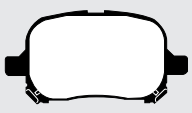
LEXUS							
IS200							
2.0	99-	DP 1223	DP 21223		DP 1224	DP 21224	
GS300							
3.0	93-97	DP 874	DP 2874		DP 608/2		
3.0	93-97	DP 1006	DP 21006		DP 1008		
3.0	98-	DP 1223	DP 21223		DP 1224	DP 21224	
Handbrake Shoes	93-97						6604
IS300							
3.0	2001-	DP 1223	DP 21223		DP 1224	DP 21224	
Handbrake Shoes	2001-						6604
RX300							
3.0	2000-	DP 1133	DP 61133		DP 628	DP 6628	
3.0	2000-	DP 1426	DP 61426		DP 628	DP 6628	

*Every EBC pad and shoe requiring ECE R-90 is available with approval subject to stock rotation - check box end label.
Models listed by Engine Size. Only listed by trim level where pads differ, (16v, GL, GT, etc).

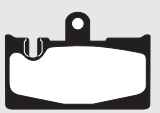
Standard Quality - ECE R90 Approved with similar performance to original equipment brake pads.
Upgrade Quality (Tuning/ Sportbeläge) - ECE R90 Approved but with higher friction and improved performance for faster street use.
Verbesserte Qualität - mit ECE R90 Freigabe aber mit höherem Reibwert und verbesserter Bremsleistung für den schnellen Strasseninsatz.

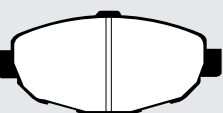
Qualité standard - Approuvée par la norme ECE R90 - Des performances équivalentes à l'origine.
Qualité améliorée - Approuvée par la norme ECE R90 - Un coefficient de friction supérieur et des performances accrues pour pilotage rapide sur route.
Calidad Estándar - Aprobación CEE R90 con prestaciones similares a las pastillas originales.
Calidad Mejorada - Aprobación CEE R90 pero con un coeficiente de fricción más elevado y prestaciones mejoradas para un uso deportivo en carretera.

Make/Model/Engine Hersteller/Modell/Motor Modèles	Year Jahr Années	Pads  Front / Vorn / Avant		Shoes	Pads  Rear / Hinten / Arrière		Shoes
		Original Quality ECE R90* Approved	Upgrade Quality Tuning/Sportbeläge ECE R90* Approved	Bremsbacken Machoires ECE R90* Approved	Original Quality ECE R90* Approved	Upgrade Quality Tuning/Sportbeläge ECE R90* Approved	Bremsbacken Machoires ECE R90* Approved
LEXUS Contd.							
LS400							
4.0	90-92	DP 874	DP 2874		DP 875		
4.0	93-95	DP 1006	DP 21006		DP 1008		
4.0	95-2000	DP 1154	DP 21154		DP 1008		
Handbrake Shoes	93-2000						6604
LS430							
4.3	2000-	-	DP 21622		DP 1397		
GS430							
4.3	2000-	DP 1223	DP 21223		DP 1224	DP 21224	
SC400							
4.0	94-	-	DP 21007		DP 875		
SC430							
4.3	2001-	DP 1223	DP 21223		DP 1224	DP 21224	
Pad Illustrations for Lexus							
608/2		628		874		875	
							
125 x 42 x 15mm		107 x 42 x 15mm		141 x 63 x 17mm		117 x 40 x 15mm	
1006		1008		1133		1154	
							
146 x 62 x 18mm		123 x 41 x 16mm		116 x 59 x 17mm		116 x 78 x 17mm	
1223		1224		1397		1426	
							
144 x 66 x 17mm		57 x 58 x 15mm		96 x 62 x 14mm		135 x 57 x 18mm	
21007		21622					
							
150 x 69 x 18mm		119 x 78 x 16mm					
LIGHT CAR COMPANY							
Rocket							
1.0	92-	DP 102	DP 2102		DP 128	DP 2128	

Standard Quality - ECE R90 Approved with similar performance to original equipment brake pads.
 Upgrade Quality (Tuning / Sportbeläge) - ECE R90 Approved but with higher friction and improved performance for faster street use.

Standard Qualität - mit ECE R90 Freigabe und ähnlicher Bremsleistung wie die Original Bremsbeläge.
 Verbesserte Qualität - mit ECE R90 Freigabe aber mit höherem Reibwert und verbesserter Bremsleistung für den schnellen Strasseneinsatz.

Qualité standard - Approuvée par la norme ECE R90 - Des performances équivalentes à l'origine.
 Qualité améliorée - Approuvée par la norme ECE R90 - Un coefficient de friction supérieur et des performances accrues pour pilotage rapide sur route.

Calidad Estándar - Aprobación CEE R90 con prestaciones similares a las pastillas originales.
 Calidad Mejorada - Aprobación CEE R90 pero con un coeficiente de fricción más elevado y prestaciones mejoradas para un uso deportivo en carretera.

BRAKE PADS & SHOES - APPLICATIONS

Bremsbeläge / Plaquettes + Bremsbacken / Machoires

EBC

BRAKES

Make/Model/Engine	Year	Pads	Front / Vorn / Avant	Shoes	Pads	Rear / Hinten / Arrière	Shoes
Hersteller/Modell/Motor	Jahr	Plaquettes / Bremsbeläge		Bremsbacken	Plaquettes / Bremsbeläge		Bremsbacken
Modelos	Années	Original Quality ECE R90* Approved	Upgrade Quality Tuning/Sportbeläge ECE R90* Approved	Machoires ECE R90* Approved	Original Quality ECE R90* Approved	Upgrade Quality Tuning/Sportbeläge ECE R90* Approved	Machoires ECE R90* Approved

Pad Illustrations for Light Car Company

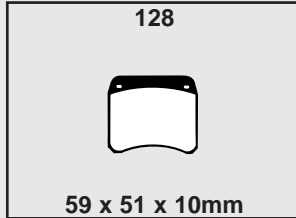
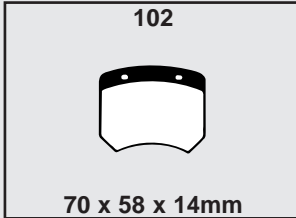

LIGIER							
Ambra	99-2000	DP 1342					
Nova	2000-						

Pad Illustrations for Ligier

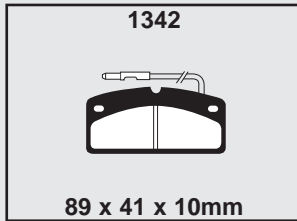

LOTUS							
Eclat							
2.0 (Alloy wheels)	75-80	DP 108	DP 2108				5135
2.0 (Steel wheels)	75-80	DP 258	DP 2291				5135
2.2 (Alloy wheels)	80-82	DP 108	DP 2108				5135
2.2 (Steel wheels)	80-82	DP 258	DP 2291				5135
Elan							
1.5	62-65	DP 142			DP 145		
1.6	66-74	DP 114	DP 2114		DP 145		
1.6	89-94	DP 325	DP 2325		DP 978		
1.6 Turbo	89-97	DP 325	DP 2325		DP 978		
Elan 2+2							
1.6	67-71	DP 169			DP 145		
1.6 130/4	71-74	DP 258	DP 2291		DP 145		
1.6 130/5	72-75	DP 291	DP 2291		DP 145		
Elise							
1.8	96-	DP 197/2	DP 2197/2		DP 885/2	DP 2885/2	
1.8 VVC	99-	DP 197/2	DP 2197/2		DP 885/2	DP 2885/2	
Elite							
1.5	58-64	DP 142			DP 145		
2.0 (Alloy wheels)	74-80	DP 108	DP 2108				5135
2.0 (Steel wheels)	74-80	DP 258	DP 2291				5135
2.2 (Alloy wheels)	80-82	DP 108	DP 2108				5135
2.2 (Steel wheels)	80-82	DP 258	DP 2291				5135

*Every EBC pad and shoe requiring ECE R-90 is available with approval subject to stock rotation - check box end label.
Models listed by Engine Size. Only listed by trim level where pads differ, (16v, GL, GT, etc).

Standard Quality - ECE R90 Approved with similar performance to original equipment brake pads.
Upgrade Quality (Tuning/ Sportbeläge) - ECE R90 Approved but with higher friction and improved performance for faster street use.
Verbesserte Qualität - mit ECE R90 Freigabe aber mit höherem Reibwert und verbesserter Bremsleistung für den schnellen Strasseninsatz.









Qualité standard - Approuvée par la norme ECE R90 - Des performances équivalentes à l'origine.
Qualité améliorée - Approuvée par la norme ECE R90 - Un coefficient de friction supérieur et des performances accrues pour pilotage rapide sur route.
Calidad Mejorada - Aprobación CEE R90 con prestaciones similares a las pastillas originales.
Calidad Mejorada - Aprobación CEE R90 pero con un coeficiente de fricción más elevado y prestaciones mejoradas para un uso deportivo en carretera.

Qualité standard - Approuvée par la norme ECE R90 - Des performances équivalentes à l'origine.
Qualité améliorée - Approuvée par la norme ECE R90 - Un coefficient de friction supérieur et des performances accrues pour pilotage rapide sur route.

Calidad Estándar - Aprobación CEE R90 con prestaciones similares a las pastillas originales.
Calidad Mejorada - Aprobación CEE R90 pero con un coeficiente de fricción más elevado y prestaciones mejoradas para un uso deportivo en carretera.

Standard Quality - ECE R90 Approved with similar performance to original equipment brake pads.
Upgrade Quality (Tuning / Sportbeläge) - ECE R90 Approved but with higher friction and improved performance for faster street use.

Standard Qualität - mit ECE R90 Freigabe und ähnlicher Bremsleistung wie die Original Bremsbeläge.
Verbesserte Qualität - mit ECE R90 Freigabe aber mit höherem Reibwert und verbesserter Bremsleistung für den schnellen Strasseninsatz.

Make/Model/Engine Hersteller/Modell/Motor Modèles	Year Jahr Années	Pads  Front / Vorn / Avant		Shoes	Pads  Rear / Hinten / Arrière		Shoes
		Original Quality ECE R90* Approved 	Upgrade Quality Tuning/Sportbeläge ECE R90* Approved 	Bremsbacken Machoires 	Original Quality ECE R90* Approved 	Upgrade Quality Tuning/Sportbeläge ECE R90* Approved 	Bremsbacken Machoires 
LOTUS Contd.							
Esprit							
2.0	75-80	DP 197	DP 2197		DP 298		
2.0 Turbo	75-80	DP 2197	DP 3197		DP 298		
2.0 GT3	96-	DP 21140	DP 31140		DP 2885	DP 3885	
2.2	80-85	DP 197	DP 2197		DP 298		
2.2	85-93	DP 456	DP 2456		DP 189	DP 2189	
2.2 Turbo	80-85	DP 2197	DP 3197		DP 298		
2.2 Turbo	85-94	DP 2456	DP 3456		DP 2189	DP 3189	
2.2 Turbo	94-	DP 21140	DP 31140		DP 2885	DP 3885	
3.5 V8 Turbo	95-	-	DP 31140		-	DP 3885	
Esprit Sport 300							
2.2 Turbo	93-97	-	DP 3002		-	DP 3008	
Esprit 350							
3.5 V8 Turbo	97-	-	DP 3002		-	DP 3008	
Europa							
1.5	66-67	DP 106	DP 2106				5129
1.5	67-72	DP 114	DP 2114				5129
1.6	67-72	DP 114	DP 2114				5129
1.6	72-75	DP 114	DP 2114				5110
Excel							
2.2	82-92	DP 456	DP 2456		DP 457		
Exige							
1.8	2000-	DP 197/2	DP 2197/2		DP 885/2	DP 2885/2	
Seven							
1.5	57-63			5128			5137
1.5	63-67	-	DP 2141				5133
1.6	68-74	DP 114	DP 2114				5142
Super Seven							
1.6	71-74	DP 114	DP 2114				5133
340R							
1.8	2000-	DP 197/2	DP 2197/2		DP 885/2	DP 2885/2	

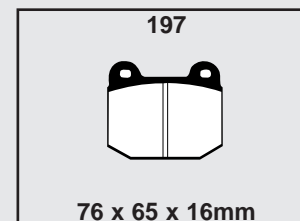
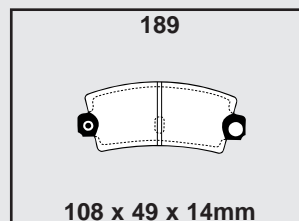
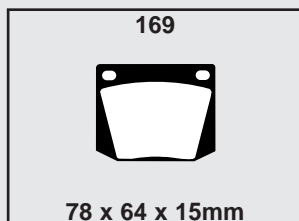
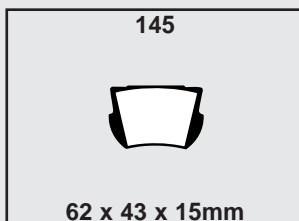
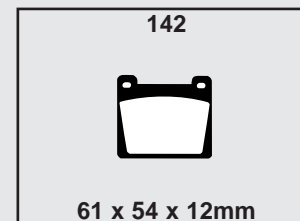
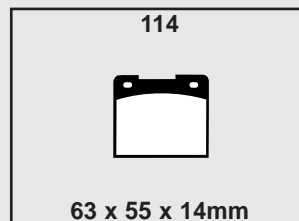
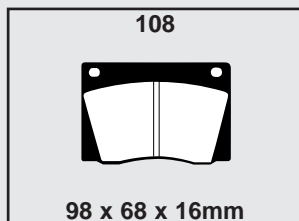
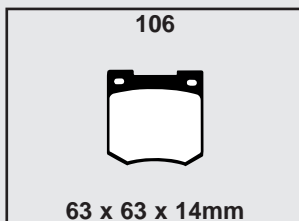

Pad Illustrations for Lotus



BRAKE PADS & SHOES - APPLICATIONS

Bremsbeläge / Plaquettes + Bremsbacken / Machoires

EBC
BRAKES

Make/Model/Engine	Year	Pads	Front / Vorn / Avant	Shoes	Pads	Rear / Hinten / Arrière	Shoes
Hersteller/Modell/Motor	Jahr	Plaquettes / Bremsbeläge		Bremsbacken Machoires	Plaquettes / Bremsbeläge		Bremsbacken Machoires
Modèles	Années	Original Quality ECE R90* Approved	Upgrade Quality Tuning/Sportbeläge ECE R90* Approved	 ECE R90* Approved	Original Quality ECE R90* Approved	Upgrade Quality Tuning/Sportbeläge ECE R90* Approved	 ECE R90* Approved

Pad Illustrations for Lotus Contd.

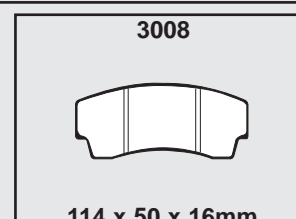
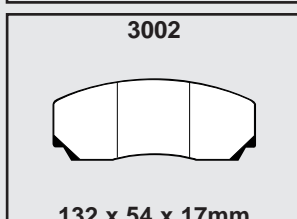
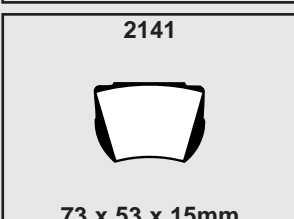
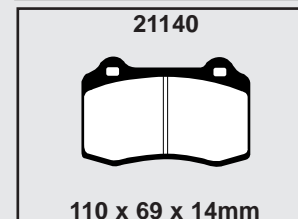
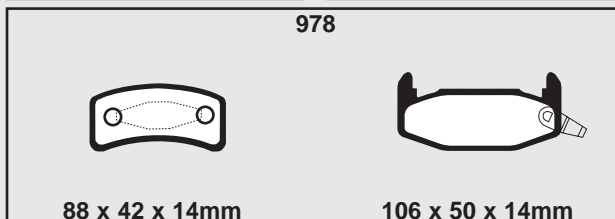
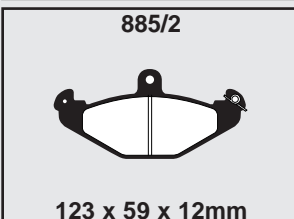
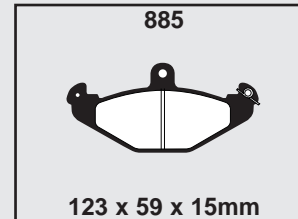
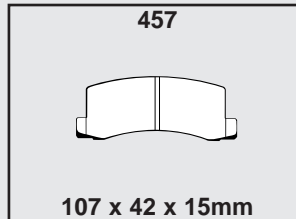
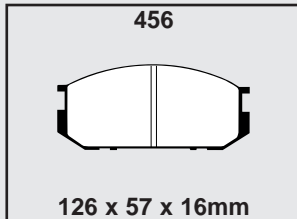
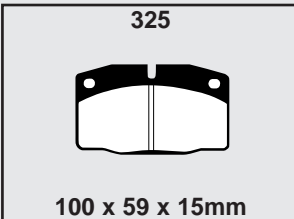
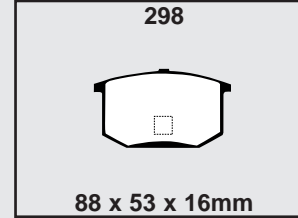
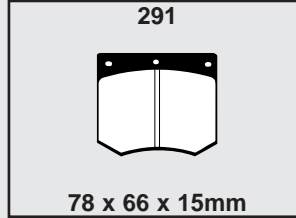
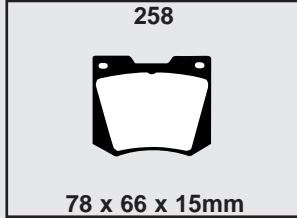
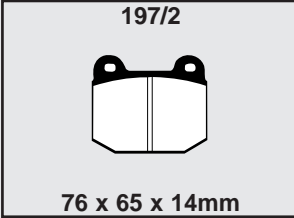

McLAREN							
F-1							
6.1	92-98	-	DP 31110	-	DP 31110		

Pad Illustrations for McLaren

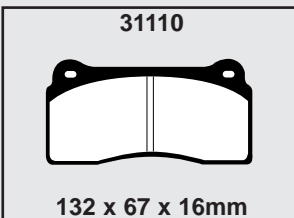



MAHINDRA							
CJ3							
2.1 D	87-			5048		5066	
CJ5							
2.1 D	87-			5048		5066	

*Every EBC pad and shoe requiring ECE R-90 is available with approval subject to stock rotation - check box end label.
Models listed by Engine Size. Only listed by trim level where pads differ, (16v, GL, GT, etc).

Standard Quality - ECE R90 Approved with similar performance to original equipment brake pads.
Upgrade Quality (Tuning / Sportbeläge) - ECE R90 Approved but with higher friction and improved performance for faster street use.
Verbesserte Qualität - mit ECE R90 Freigabe aber mit höherem Reibwert und verbesserter Bremsleistung für den schnellen Strasseninsatz.

Qualité standard - Approuvée par la norme ECE R90 - Des performances équivalentes à l'origine.
Qualité améliorée - Approuvée par la norme ECE R90 - Un coefficient de friction supérieur et des performances accrues pour pilotage rapide sur route.
Calidad Mejorada - Aprobación CEE R90 con prestaciones similares a las pastillas originales.
Calidad Mejorada - Aprobación CEE R90 pero con un coeficiente de fricción más elevado y prestaciones mejoradas para un uso deportivo en carretera.

Make/Model/Engine Hersteller/Modell/Motor Modèles	Year Jahr Années	Pads  Front / Vorn / Avant		Shoes	Pads  Rear / Hinten / Arrière		Shoes
		Original Quality ECE R90* Approved	Upgrade Quality Tuning/Sportbeläge ECE R90* Approved	Bremsbacken Machoires ECE R90* Approved	Original Quality ECE R90* Approved	Upgrade Quality Tuning/Sportbeläge ECE R90* Approved	Bremsbacken Machoires ECE R90* Approved
MARCOS							
1.6	67-	DP 169					
1.8 GT	64-66	DP 142					
2.0	67-	DP 169					
3.0	69-	DP 169					
GTS							
2.0	97-	-	DP 2002		DP 617	DP 2617	
Mantis							
2.5	70-72	DP 169					
4.6	97-	DP 2002	DP 3002		DP 2617	DP 3617	
Mantara							
2.0	92-	DP 2612	DP 3612		DP 2617	DP 3617	
2.0	92-	DP 2002	DP 3002		DP 2617	DP 3617	
4.0	92-	DP 2002	DP 3002		DP 2617	DP 3617	
4.5	92-	DP 2002	DP 3002		DP 2617	DP 3617	
LM							
4.0	97-	DP 2002	DP 3002		DP 2617	DP 3617	
4.6	99-	DP 2002	DP 3002		DP 2617	DP 3617	
5.0	94-	DP 2002	DP 3002		DP 2617	DP 3617	
6.0	2000-	DP 2002	DP 3002		DP 2617	DP 3617	
Mantaray							
4.0	99-	DP 2002	DP 3002		DP 2617	DP 3617	
4.6	99-	DP 2002	DP 3002		DP 2617	DP 3617	
Marcasite TS250							
2.5	2002-						

Pad Illustrations for Marcos

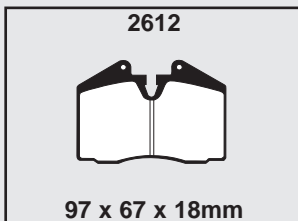
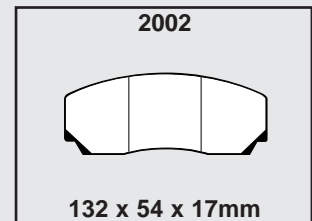
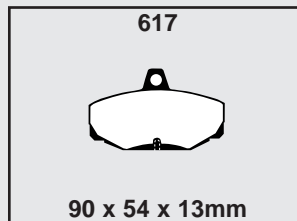
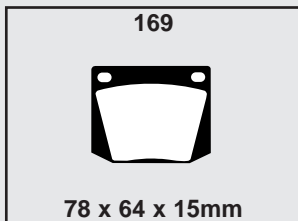
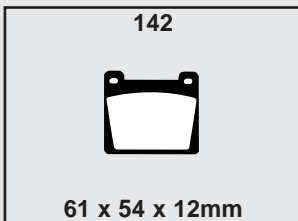

MARLIN							
Cabriolet							
2.3		DP 605/2	DP 2605/2		DP 617	DP 2617	
3.5		DP 605/2	DP 2605/2		DP 617	DP 2617	
Sportster							
2.3	98-	DP 291	DP 2291		DP 617	DP 2617	
2.3	98-	DP 627	DP 2627		DP 617	DP 2617	
3.5	98-	DP 291	DP 2291		DP 617	DP 2617	
3.5	98-	DP 627	DP 2627		DP 617	DP 2617	

*Every EBC pad and shoe requiring ECE R-90 is available with approval subject to stock rotation - check box end label.

Models listed by Engine Size. Only listed by trim level where pads differ, (16v, GL, GT, etc).

BRAKE PADS & SHOES - APPLICATIONS

Bremsbeläge / Plaquettes + Bremsbacken / Machoires

EBC

BRAKES

Make/Model/Engine	Year	Pads	Front / Vorn / Avant	Shoes	Pads	Rear / Hinten / Arrière	Shoes
Hersteller/Modell/Motor	Jahr	Plaquettes / Bremsbeläge		Bremsbacken	Plaquettes / Bremsbeläge		Bremsbacken
Modelos	Années	Original Quality ECE R90* Approved	Upgrade Quality Tuning/Sportbeläge ECE R90* Approved	Machoires ECE R90* Approved	Original Quality ECE R90* Approved	Upgrade Quality Tuning/Sportbeläge ECE R90* Approved	Machoires ECE R90* Approved



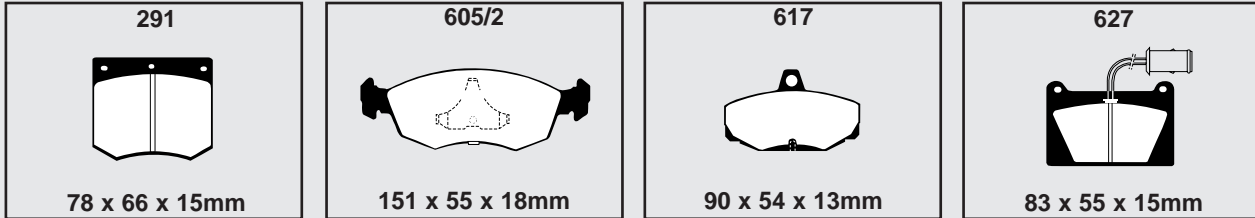







Pad Illustrations for Marlin



MASERATI					
Biturbo					
2.0 Twin Turbo	81-87	DP 2753	DP 3753	DP 2104	DP 3104
2.5 Twin Turbo	83-88	DP 2753	DP 3753	DP 2104	DP 3104
2.8 Twin Turbo	87-94	DP 2414	DP 3414	DP 2104	DP 3104
Bora					
4.7	71-78	DP 2180	DP 3180	DP 2101	DP 3104
4.9	77-79	DP 2180	DP 3180	DP 2101	DP 3104
Coupe					
3.2	98-	DP 21032	DP 31032	DP 2612	DP 3612
Ghibli					
2.8	92-93	DP 2414	DP 3414	DP 2104	DP 3104
2.8	93-98	DP 21032	DP 31032	DP 21118	DP 31118
4.7	68-73	DP 2223	DP 3223	DP 2101	DP 3101
4.9	70-73	DP 2223	DP 3223	DP 2101	DP 3101
Indy					
4.2	68-70	DP 2223	DP 3223	DP 2101	DP 3101
4.7	70-73	DP 2223	DP 3223	DP 2101	DP 3101
4.9	73-75	DP 2223	DP 3223	DP 2101	DP 3101
Karif					
2.8	89-93	DP 2414	DP 3414	DP 2104	DP 3104
Khamsin					
4.9	73-82	DP 2223	DP 3223	DP 2101	DP 3101
Kyalami					
4.1	75-83	DP 2180	DP 3180	DP 2101	DP 3101
4.9	75-83	DP 2180	DP 3180	DP 2101	DP 3101
Merak					
3.0	71-83	DP 2180	DP 3180	DP 2101	DP 3101
Mexico					
4.1	65-73	DP 2223	DP 3223	DP 2101	DP 3101
4.7	65-73	DP 2223	DP 3223	DP 2101	DP 3101
Mistral					
64-69		DP 2223	DP 3223	DP 2101	DP 3101
Quattroporte					
2.8 Twin Turbo	96-99	DP 870	DP 3870	DP 871	DP 3871
3.0	74-75	DP 132		DP 245	
3.2 V8	98-99	DP 21032	DP 31032	DP 2612	DP 3612
4.1	63-70	DP 2223	DP 3223	DP 2101	DP 3101
4.1	76-88	DP 2223	DP 3223	DP 2101	DP 3101
4.7	66-70	DP 2223	DP 3223	DP 2101	DP 3101
4.9	76-88	DP 2223	DP 3223	DP 2101	DP 3101

*Every EBC pad and shoe requiring ECE R-90 is available with approval subject to stock rotation - check box end label.
Models listed by Engine Size. Only listed by trim level where pads differ, (16v, GL, GT, etc).

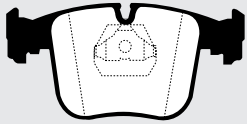
Standard Quality - ECE R90 Approved with similar performance to original equipment brake pads.
Upgrade Quality (Tuning / Sportbeläge) - ECE R90 Approved but with higher friction and improved performance for faster street use.
Verbesserte Qualität - mit ECE R90 Freigabe aber mit höherem Reibwert und verbesserter Bremsleistung für den schnellen Strasseninsatz.
Standard Qualität - mit ECE R90 Freigabe und ähnlicher Bremsleistung wie die Original Bremsbeläge.
Qualité standard - Approuvée par la norme ECE R90 - Des performances équivalentes à l'origine.
Qualité améliorée - Approuvée par la norme ECE R90 - Un coefficient de friction supérieur et des performances accrues pour pilotage rapide sur route.
Calidad Estándar - Aprobación CEE R90 con prestaciones similares a las pastillas originales.
Calidad Mejorada - Aprobación CEE R90 pero con un coeficiente de fricción más elevado y prestaciones mejoradas para un uso deportivo en carretera.

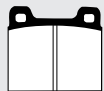
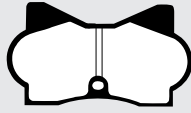
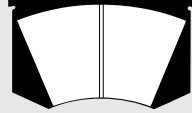
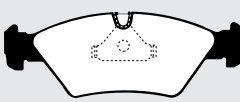
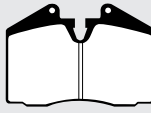
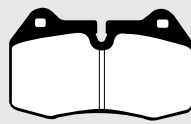
Make/Model/Engine Hersteller/Modell/Motor Modelos	Year Jahr Années	Pads  Front / Vorn / Avant		Shoes	Pads  Rear / Hinten / Arrière		Shoes
		Original Quality ECE R90* Approved 	Upgrade Quality Tuning/Sportbeläge ECE R90* Approved 	Bremsbacken Machoires 	Original Quality ECE R90* Approved 	Upgrade Quality Tuning/Sportbeläge ECE R90* Approved 	Bremsbacken Machoires 
MASERATI Contd.							
Sebring	63-69	DP 2223	DP 3223		DP 2101	DP 3101	
Shamal 3.2	89-97	DP 2414	DP 3414				
Spyder 2.8 4.2	89-99 2002-	DP 2414	DP 3414		DP 2104	DP 3104	
3200 GT 3.2	99-	DP 21032	DP 31032		DP 2612	DP 3612	
3500 GT 3.5	61-64	DP 2223	DP 3223		DP 2101	DP 3101	
4200 Coupe 4.2	2002-						
Pad Illustrations for Maserati							
870  156 x 74 x 19mm		871  123 x 59 x 17mm		2101  80 x 66 x 15mm		2104  61 x 56 x 15mm	
2180  118 x 65 x 15mm		2223  122 x 73 x 19mm		2414  158 x 57 x 19mm		2612  97 x 67 x 18mm	
21032  120 x 71 x 17mm							
MAYBACH							
57 5.5 Twin Turbo	2002-						
62 5.5 Twin Turbo	2002-						
MAZDA							
2 1.25 1.4 1.6 1.4 TD	2003- 2003- 2003- 2003-						

Standard Quality - ECE R90 Approved with similar performance to original equipment brake pads.
Upgrade Quality (Tuning / Sportbeläge) - ECE R90 Approved but with higher friction and improved performance for faster street use.

Standard Qualität - mit ECE R90 Freigabe und ähnlicher Bremsleistung wie die Original Bremsbeläge.
Verbesserte Qualität - mit ECE R90 Freigabe aber mit höherem Reibwert und verbesserter Bremsleistung für den schnellen Strasseninsatz.

Qualité standard - Approuvée par la norme ECE R90 - Des performances équivalentes à l'origine.
Qualité améliorée - Approuvée par la norme ECE R90 - Un coefficient de friction supérieur et des performances accrues pour pilotage rapide sur route.

Calidad Estándar - Aprobación CEE R90 con prestaciones similares a las pastillas originales.
Calidad Mejorada - Aprobación CEE R90 pero con un coeficiente de fricción más elevado y prestaciones mejoradas para un uso deportivo en carretera.







*Every EBC pad and shoe requiring ECE R-90 is available with approval subject to stock rotation - check box end label.
Models listed by Engine Size. Only listed by trim level where pads differ, (16v, GL, GT, etc).

BRAKE PADS & SHOES - APPLICATIONS

Bremsbeläge / Plaquettes + Bremsbacken / Machoires

EBC

BRAKES









Make/Model/Engine Hersteller/Modell/Motor Modelos	Year Jahr Années	Pads  Front / Vorn / Avant		Shoes	Pads  Rear / Hinten / Arrière		Shoes
		Original Quality ECE R90* Approved 	Upgrade Quality Tuning/Sportbeläge ECE R90* Approved 	Bremsbacken Machoires 	Original Quality ECE R90* Approved 	Upgrade Quality Tuning/Sportbeläge ECE R90* Approved 	Bremsbacken Machoires 
MAZDA Contd.							
6							
1.8	2002-	DP 1464	DP 21464		DP 1222		
2.0	2002-	DP 1465	DP 21465		DP 1222		
2.3	2002-	DP 1465	DP 21465		DP 1222		
2.0 TD (121)	2002-	DP 1464	DP 21464		DP 1222		
2.0 TD (136)	2002-	DP 1465	DP 21465		DP 1222		
1000							
1.0	70-77	DP 138					5171
1300							
1.3	70-77	DP 138					5171
121							
1.1 (DA)	88-91	DP 737					6430
1.25 (JA JB)	96-2000	DP 1050	DP 21050				6525
1.25 (Auto) (JA JB)	96-2000	DP 1051	DP 21051				6525
1.3 (DA)	88-91	DP 737					6430
1.3 (DB)	91-96	DP 884	DP 2884				6458
1.3 (JA JB)	96-2000	DP 1050	DP 21050				6525
1.8 D (JA JB)	96-97	DP 1050	DP 21050				6525
323							
1.0 (FA4)	77-81	DP 271					5171
1.1 (BD)	81-85	DP 387					5276
1.1 (BF1)	85-87	DP 655					6424
1.3 (FA4)	77-81	DP 271					5171
1.3 (BD)	81-85	DP 387					5276
1.3 (BF1)	85-89	DP 655					6424
1.3 (BG1)	89-91	DP 884	DP 2884				6457
1.3 (BG1)	91-95	DP 884	DP 2884				6522
1.3 (BA1)	95-98	DP 884	DP 2884				6522
1.3 (BJ)	98-	DP 1302			DP 1222		6522
1.3 Est (BD)	81-85	DP 271					5277
1.3 Est (BW1)	86-91	DP 655					6425
1.4 (FA4)	77-82	DP 271					5171
1.5 (BD)	81-85	DP 387					5276
1.5 (BF1)	85-89	DP 655					6424
1.5 (BA1)	94-98	DP 884	DP 2884				6522
1.5 (BJ)	98-	DP 1302			DP 1222		6522
1.5 Est (BV)	82-85	DP 271					5277
1.5 Est (BW1)	86-91	DP 655					6425
1.6 (BF1)	85-88	DP 655			DP 673		
1.6 Turbo (BF8) 4WD	85-89	DP 655			DP 673		
1.6 4WD (BF)	86-89	DP 640			DP 673		
1.6 16v (BG1)	89-91	DP 884	DP 2884		DP 6457		
1.6 Est (BW1)	90-94	DP 655					6425
1.6 (BG1)	91-94	DP 884	DP 2884		DP 828	DP 2828	6522
1.6	2001-	DP 1409	DP 21409				
1.8 GTi 16v (BG1)	89-94	DP 824	DP 2824		DP 828	DP 2828	
1.8 (BA1)	94-98	DP 824	DP 2824				6522
1.8 (BJ)	98-2001	DP 971	DP 2971		DP 1222		
2.0 (BA1)	94-98	DP 1103			DP 1003		
2.0	2001-	DP 1411	DP 21411				
1.7 D Sal	86-91	DP 607					6424
1.7L D Est	86-91	DP 607					6457
1.7LX D Est	87-91	DP 655					6425
1.7GLX D Est	89-91	DP 824	DP 2824				6457
2.0 TD (BJ)	99-	DP 1409	DP 21409		DP 1222		6522

Standard Quality - ECE R90 Approved with similar performance to original equipment brake pads.
 Upgrade Quality (Tuning/ Sportbeläge) - ECE R90 Approved but with higher friction and improved performance for faster street use.
 Standard Qualität - mit ECE R90 Freigabe und ähnlicher Bremsleistung wie die Original Bremsbeläge.
 Verbesserte Qualität - mit ECE R90 Freigabe aber mit höherem Reibwert und verbesserter Bremsleistung für den schnellen Strasseninsatz.
 Qualité standard - Approuvée par la norme ECE R90 - Des performances équivalentes à l'origine.
 Qualité améliorée - Approuvée par la norme ECE R90 - Un coefficient de friction supérieur et des performances accrues pour pilotage rapide sur route.
 Calidad Estándar - Aprobación CEE R90 con prestaciones similares a las pastillas originales.
 Calidad Mejorada - Aprobación CEE R90 pero con un coeficiente de fricción más elevado y prestaciones mejoradas para un uso deportivo en carretera.

*Every EBC pad and shoe requiring ECE R-90 is available with approval subject to stock rotation - check box end label.
 Models listed by Engine Size. Only listed by trim level where pads differ, (16v, GL, GT, etc).

Standard Quality - ECE R90 Approved with similar performance to original equipment brake pads.
 Upgrade Quality (Tuning / Sportbeläge) - ECE R90 Approved but with higher friction and improved performance for faster street use.

Calidad Estándar - Aprobación CEE R90 con prestaciones similares a las pastillas originales.
 Calidad Mejorada - Aprobación CEE R90 pero con un coeficiente de fricción más elevado y prestaciones mejoradas para un uso deportivo en carretera.

Make/Model/Engine Hersteller/Modell/Motor Modèles	Year Jahr Années	Pads  Front / Vorn / Avant		Shoes	Pads  Rear / Hinten / Arrière		Shoes
		Original Quality ECE R90* Approved 	Upgrade Quality Tuning/Sportbeläge ECE R90* Approved 	Bremsbacken Machoires 	Original Quality ECE R90* Approved 	Upgrade Quality Tuning/Sportbeläge ECE R90* Approved 	Bremsbacken Machoires 
MAZDA Contd.							
616							
1.6	70-76	DP 207					5191
1.6	76-79	DP 207					5192
626 Montrose							
1.6 (CB2)	78-81	DP 327					5192
1.6 (CB2)	81-83	DP 327					6339
1.8 (CB2)	78-81	DP 327					5192
1.8 (CB2)	81-83	DP 327					6339
2.0 (CB2)	78-81	DP 326					5192
2.0 (CB2)	81-83	DP 326					6339
626							
1.6 (GC1)	83-87	DP 490					6369
1.8 (GD1)	87-92	DP 705	DP 2705		DP 739		6431
1.8 (GE)	92-97	DP 971	DP 2971		DP 972	DP 2972	
1.8 (GF)	97-	DP 1409	DP 21409		DP 1222		6581
2.0 (GC1)	83-87	DP 490					6369
2.0 (GC1)	87-90	DP 705	DP 2705		DP 442		6431
2.0 (GD1 GV1)	87-92	DP 705	DP 2705		DP 739		6431
2.0 (GE)	92-97	DP 971	DP 2971		DP 972	DP 2972	
2.0 (GF) (GW)	97-99	DP 1409	DP 21409		DP 1222		
2.0	99-2002	DP 1411	DP 21411		DP 1222		
2.2 (GV1) (GD7)	90-92	DP 705	DP 2705		DP 729	DP 2729	
2.5 (GE)	92-97	DP 971	DP 2971		DP 972	DP 2972	
2.0 D (GE)	94-97	DP 971	DP 2971		DP 972	DP 2972	
2.0 TD (GF) (GW)	98-2002	DP 1411	DP 21411		DP 1222		
808							
1.3	71-76	DP 196					5191
818							
1.3	76-79	DP 196					5192
1.6	76-79	DP 196					5192
929							
1.8 (LA2)	73-79	DP 207					6339
2.0 (LA4)	79-82	DP 318					5192
2.0 (LA4)	81-82	DP 318					6396
2.0 (HV1)	82-86	DP 441			DP 442		6339
2.0 (HV1)	82-86	DP 318			DP 442		6339
2.0 (HV1)	87-88	DP 730			DP 740		6339
AZ-1							
0.6	93-	DP 1301			DP 528		
Cosmos							
	76-78	DP 264					
Demio							
1.3	98-2002	DP 884	DP 2884				6561
1.5	2000-2002	DP 884	DP 2884				6561
MPV							
2.0	99-2001	DP 1121			DP 740		
2.3	2002-						
2.0 TD	2002-						
MX3							
1.6	91-	DP 824	DP 2824		DP 673		
1.8	91-	DP 824	DP 2824		DP 673		

*Every EBC pad and shoe requiring ECE R-90 is available with approval subject to stock rotation - check box end label.







Models listed by Engine Size. Only listed by trim level where pads differ, (16v, GL, GT, etc).

BRAKE PADS & SHOES - APPLICATIONS

Bremsbeläge / Plaquettes + Bremsbacken / Machoires

EBC

BRAKES

Make/Model/Engine Hersteller/Modell/Motor Modelos	Year Jahr Années	Pads  Front / Vorn / Avant		Shoes	Pads  Rear / Hinten / Arrière		Shoes
		Plaquettes / Bremsbeläge Original Quality ECE R90* Approved 		Bremsbacken Machoires ECE R90* Approved 	Plaquettes / Bremsbeläge Upgrade Quality Tuning/Sportbeläge ECE R90* Approved 		Bremsbacken Machoires ECE R90* Approved 
MAZDA Contd.							
MX5							
1.6	89-98	DP 802	DP 2802		DP 828	DP 2828	
1.6	98-2001	DP 1002	DP 21002		DP 1003	DP 21003	
1.6	2001-	DP 1002	DP 21002		DP 1003	DP 21003	
1.8	94-2001	DP 1002	DP 21002		DP 1003	DP 21003	
1.8	2001-	DP 1452	DP 21452		DP 1453	DP 21453	
MX6							
2.5	92-	DP 971	DP 2971		DP 972	DP 2972	
Premacy							
1.8	99-	DP 1409	DP 21409				6581
2.0	2001-	DP 1411	DP 21411				6581
2.0 TD	99-	DP 1409	DP 21409				6581
RX2							
0.9	71-76	DP 207					5191
RX3							
1.3	71-76	DP 196					5191
1.5	71-76	DP 196					5191
RX4							
1.9	73-78	DP 207					5192
1.9	79-81	DP 318					5192
RX5							
1.3	76-80	DP 264			DP 265		
1.8	76-80	DP 264			DP 265		
RX7							
2.3	79-83	DP 207			DP 466		5192
2.3	84-85	DP 264			DP 729		
2.4	86-89	DP 763	DP 2763		DP 729	DP 2729	
2.4 Turbo	89-92	DP 2763	DP 3763		DP 2729	DP 3729	
2.6 Turbo	92-97	DP 2763	DP 3763		DP 2729	DP 3729	
RX8							
2.6	2003-						
Tribute							
2.0	2000-	DP 1616	DP 61616				6581
3.0	2000-	DP 1616	DP 61616				6581
Xedos 6							
1.6	93-2000	DP 971	DP 2971		DP 972	DP 2972	
2.0	92-2000	DP 971	DP 2971		DP 972	DP 2972	
Xedos 9							
2.3 supercharged	98-2002	DP 1019			DP 740		
2.5	94-2002	DP 1019			DP 740		

Pad Illustrations for Mazda

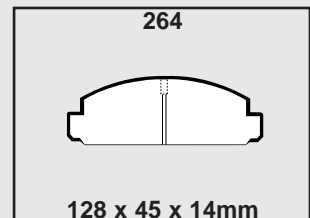
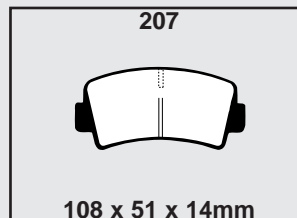
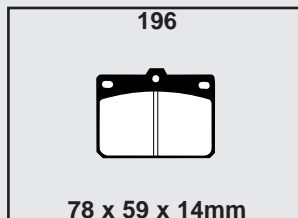
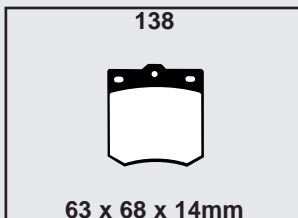











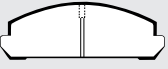
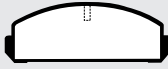

*Every EBC pad and shoe requiring ECE R-90 is available with approval subject to stock rotation - check box end label.
Models listed by Engine Size. Only listed by trim level where pads differ, (16v, GL, GT, etc).

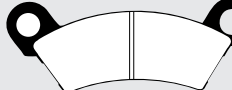
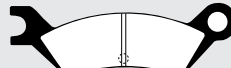
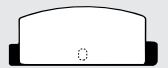
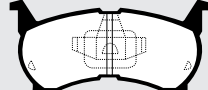
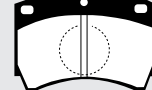
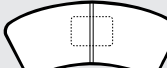
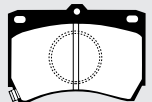
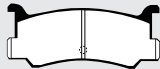
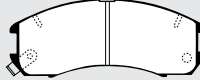
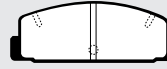
Standard Quality - ECE R90 Approved with similar performance to original equipment brake pads.
Upgrade Quality (Tuning/ Sportbeläge) - ECE R90 Approved but with higher friction and improved performance for faster street use.
Verbesserte Qualität - mit ECE R90 Freigabe und ähnlicher Bremsleistung wie die Original Bremsbeläge.
Standard Qualität - mit ECE R90 Freigabe und ähnlicher Bremsleistung wie die Original Bremsbeläge.

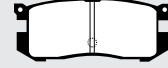
Qualité standard - Approuvée par la norme ECE R90 - Des performances équivalentes à l'origine.
Qualité améliorée - Approuvée par la norme ECE R90 - Un coefficient de friction supérieur et des performances accrues pour pilotage rapide sur route.
Calidad Estándar - Aprobación CEE R90 con prestaciones similares a las pastillas originales.
Calidad Mejorada - Aprobación CEE R90 pero con un coeficiente de fricción más elevado y prestaciones mejoradas para un uso deportivo en carretera.

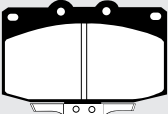
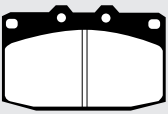
Make/Model/Engine	Year	Front / Vorn / Avant	Shoes	Rear / Hinten / Arrière	Shoes
Hersteller/Modell/Motor	Jahr	Plaquettes / Bremsbeläge	Bremsbacken Machoires	Plaquettes / Bremsbeläge	Bremsbacken Machoires
Modelos	Années	Original Quality ECE R90* Approved	Upgrade Quality Tuning/Sportbeläge ECE R90* Approved	Original Quality ECE R90* Approved	Upgrade Quality Tuning/Sportbeläge ECE R90* Approved

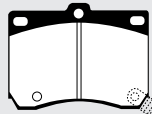
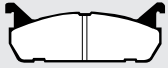
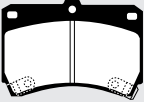
Pad Illustrations for Mazda Contd.

<p>265</p>  <p>108 x 37 x 11mm</p>	<p>271</p>  <p>108 x 37 x 14mm</p>	<p>318</p>  <p>126 x 46 x 14mm</p>	<p>326</p>  <p>105 x 47 x 15mm</p>
<p>327</p>  <p>105 x 47 x 15mm</p>	<p>387</p>  <p>95 x 45 x 14mm</p>	<p>441</p>  <p>151 x 61 x 14mm</p>	<p>442</p>  <p>150 x 48 x 12mm</p>
<p>466</p>  <p>98 x 39 x 13mm</p>	<p>490</p>  <p>131 x 61 x 14mm</p>	<p>607</p>  <p>91 x 65 x 15mm</p>	<p>640</p>  <p>103 x 54 x 15mm</p>
<p>655</p>  <p>91 x 65 x 15mm</p>	<p>673</p>  <p>101 x 42 x 13mm</p>	<p>705</p>  <p>130 x 52 x 15mm</p>	<p>729</p>  <p>107 x 39 x 13mm</p>
<p>730</p>  <p>116 x 55 x 15mm</p>	<p>737</p>  <p>78 x 63 x 14mm</p>	<p>739</p>  <p>104 x 42 x 13mm</p>	<p>740</p>  <p>117 x 42 x 13mm</p>
<p>763</p>  <p>106 x 76 x 15mm</p>	<p>796</p>  <p>107 x 67 x 14mm</p>	<p>802</p>  <p>110 x 46 x 14mm</p>	<p>824</p>  <p>119 x 62 x 14mm</p>
<p>828</p>  <p>102 x 39 x 12mm</p>	<p>884</p>  <p>91 x 64 x 15mm</p>	<p>971</p>  <p>132 x 51 x 15mm</p>	<p>972</p>  <p>100 x 43 x 14mm</p>

Standard Quality - ECE R90 Approved with similar performance to original equipment brake pads.
 Upgrade Quality (Tuning / Sportbeläge) - ECE R90 Approved but with higher friction and improved performance for faster street use.

Standard Qualität - mit ECE R90 Freigabe und ähnlicher Bremsleistung wie die Original Bremsbeläge.
 Verbesserte Qualität - mit ECE R90 Freigabe aber mit höherem Reibwert und verbesserter Bremsleistung für den schnellen Strasseneinsatz.

Calidad Estándar - Aprobación CEE R90 con prestaciones similares a las pastillas originales.
 Calidad Mejorada - Aprobación CEE R90 pero con un coeficiente de fricción más elevado y prestaciones mejoradas para un uso deportivo en carretera.

BRAKE PADS & SHOES - APPLICATIONS

Bremsbeläge / Plaquettes + Bremsbacken / Machoires

EBC

BRAKES

Make/Model/Engine	Year	Pads	Front / Vorn / Avant	Shoes	Pads	Rear / Hinten / Arrière	Shoes
Hersteller/Modell/Motor	Jahr	Plaquettes / Bremsbeläge		Bremsbacken	Plaquettes / Bremsbeläge		Bremsbacken
Modelos	Années	Original Quality ECE R90* Approved	Upgrade Quality Tuning/Sportbeläge ECE R90* Approved	Machoires ECE R90* Approved	Original Quality ECE R90* Approved	Upgrade Quality Tuning/Sportbeläge ECE R90* Approved	Machoires ECE R90* Approved

Pad Illustrations for Mazda Contd.

1002 114 x 58 x 14mm	1003 104 x 43 x 13mm	1019 142 x 60 x 17mm	1050 141 x 44 x 17mm
1051 151 x 46 x 18mm	1103 128 x 53 x 16mm	1121 139 x 60 x 16mm	1222 108 x 41 x 15mm
1301 108 x 39 x 14mm	1302 123 x 52 x 15mm	1409 131 x 51 x 16mm	1411 132 x 57 x 16mm
1452 123 x 58 x 16mm	1453 102 x 39 x 13mm	1464 131 x 56 x 17mm	1465 132 x 59 x 19mm
1616 156 x 64 x 20mm			

MAZDA COMMERCIAL			
Panel Van			
E 1.6	81-83	DP 451	6368
E 1.6	81-84	DP 451	6486
E 2.0 (Twin rear wheel)	85-	DP 599	6445
E 2.0 (Single rear wheel)	84-86	DP 599	6429
E 2.0 (Single rear wheel)	86-	DP 683	6429
E 2.2 D (Single rear wheel)	85-86	DP 599	6406
E 2.2 (Single rear wheel)	86-	DP 683	6429
E 2.2 (Twin rear wheel)	85-	DP 599	6445
323 Van			
1.5	87-90	DP 640	6425
1.6	90-	DP 824	DP 2824
1.7 D	87-90	DP 640	6425
1.7 D	90-	DP 824	DP 2824

*Every EBC pad and shoe requiring ECE R-90 is available with approval subject to stock rotation - check box end label.
Models listed by Engine Size. Only listed by trim level where pads differ, (16v, GL, GT, etc).

Standard Quality - ECE R90 Approved with similar performance to original equipment brake pads.
Upgrade Quality (Tuning/ Sportbeläge) - ECE R90 Approved but with higher friction and improved performance for faster street use.
Verbesserte Qualität - mit ECE R90 Freigabe aber mit höherem Reibwert und verbesserter Bremsleistung für den schnellen Strasseninsatz.

Qualité standard - Approuvée par la norme ECE R90 - Des performances équivalentes à l'origine.
Qualité améliorée - Approuvée par la norme ECE R90 - Un coefficient de friction supérieur et des performances accrues pour pilotage rapide sur route.
Calidad Estándar - Aprobación CEE R90 con prestaciones similares a las pastillas originales.
Calidad Mejorada - Aprobación CEE R90 pero con un coeficiente de fricción más elevado y prestaciones mejoradas para un uso deportivo en carretera.

Make/Model/Engine	Year	Pads	Front / Vorn / Avant	Shoes	Pads	Rear / Hinten / Arrière	Shoes
Hersteller/Modell/Motor	Jahr	Plaquettes / Bremsbeläge		Bremsbacken Machoires	Plaquettes / Bremsbeläge		Bremsbacken Machoires
Modelos	Années	Original Quality ECE R90* Approved	Upgrade Quality Tuning/Sportbeläge ECE R90* Approved	ECE R90* Approved	Original Quality ECE R90* Approved	Upgrade Quality Tuning/Sportbeläge ECE R90* Approved	ECE R90* Approved
MAZDA COMM Contd.							
Pick Up							
B1.6	71-80			5256			5256
B1.6	82-85	DP 541					6370
B1.8	71-80			5256			5256
B1.8	77-81	DP 207					5256
B1.8	82-85	DP 541					6370
B2.0	82-85	DP 541					6370
B2.0	85-96	DP 657					6478
B2.2	82-85	DP 541					6370
B2.2 D	86-96	DP 657					6478
B2.5 D 2WD	96-99	DP 1189					
B2.5 D 4WD	96-99	DP 1199					
B2.5 2WD/4WD	99-	DP 1349					

Pad Illustrations for Mazda Commercial

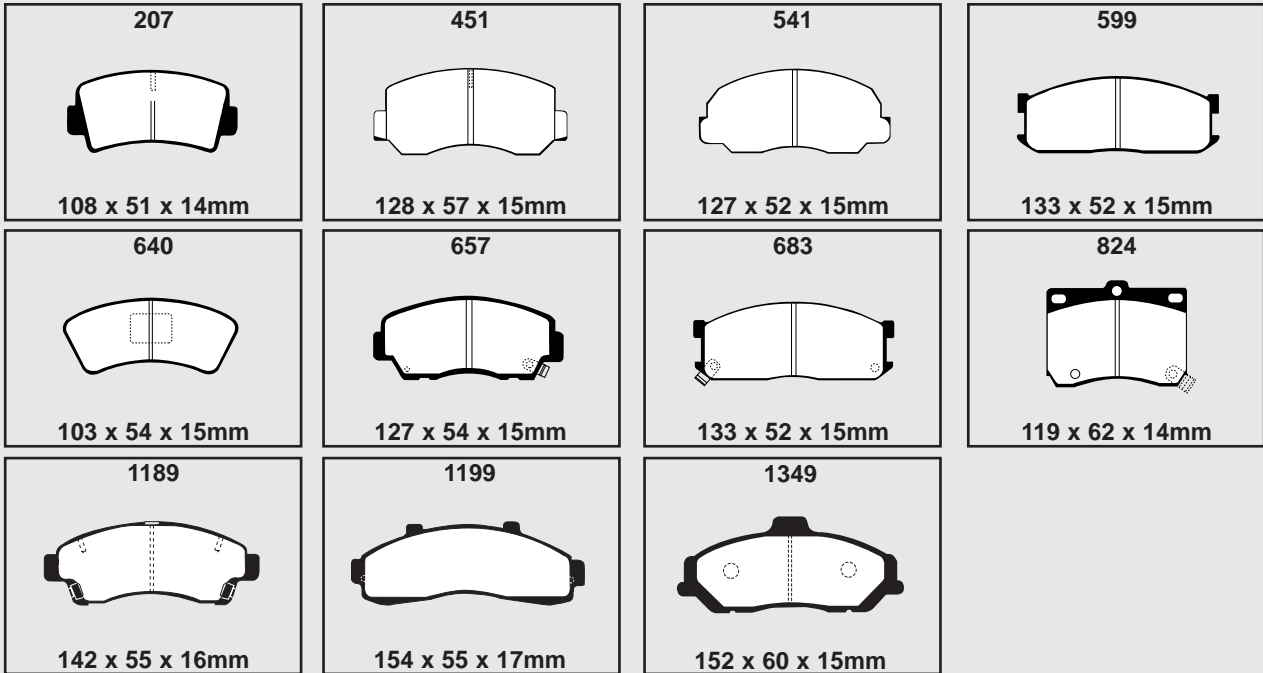

Make/Model/Engine	Year	Pads	Front / Vorn / Avant	Shoes	Pads	Rear / Hinten / Arrière	Shoes
MAZDA (SA)							
Astina							
	95-	DP 824		DP 2824			
B-Series							
1.8	97-	DP 538		DP 6538			
2.2	97-	DP 538		DP 6538			
3.4 (4x2)	97-	DP 538		DP 6538			
2.5 TD (4x2)	97-	DP 538		DP 6538			
Etude							
	95-	DP 824		DP 2824			
Soho							
	97-	DP 769		DP 2769			

*Every EBC pad and shoe requiring ECE R-90 is available with approval subject to stock rotation - check box end label.

Models listed by Engine Size. Only listed by trim level where pads differ, (16v, GL, GT, etc).

BRAKE PADS & SHOES - APPLICATIONS

Bremsbeläge / Plaquettes + Bremsbacken / Machoires

EBC

BRAKES

Make/Model/Engine	Year	Pads	Front / Vorn / Avant	Shoes	Pads	Rear / Hinten / Arrière	Shoes
Hersteller/Modell/Motor	Jahr	Plaquettes / Bremsbeläge		Bremsbacken	Plaquettes / Bremsbeläge		Bremsbacken
Modelos	Années	Original Quality ECE R90* Approved	Upgrade Quality Tuning/Sportbeläge ECE R90* Approved	Machoires ECE R90* Approved	Original Quality ECE R90* Approved	Upgrade Quality Tuning/Sportbeläge ECE R90* Approved	Machoires ECE R90* Approved

Pads Illustrations for Mazda (SA)

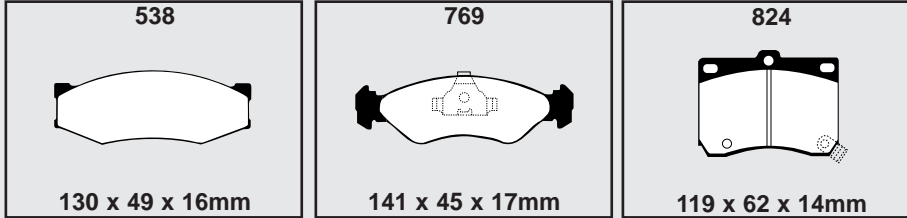

MAZDA

(Malaysia & The Philippines)

Miata

1.6	97-	DP 802	DP 2802	DP 828	DP 2828
1.8	97-	DP 1002	DP 21002	DP 1003	DP 21003

Pads Illustrations for Mazda (Malaysia & The Philippines)

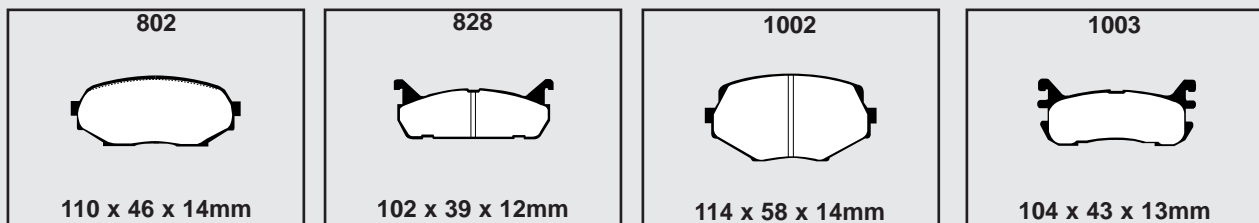

MERCEDES - BENZ

A-Class

1.4	98-	DP 1170	DP 21170		6551
1.6	98-2000	DP 1170	DP 21170		6551
1.6	2001-	DP 1170	DP 21170	DP 1438	
1.9	99-2000	DP 1170	DP 21170	DP 1438	
1.9	2001-	DP 1170	DP 21170	DP 1438	
2.1	2002-	DP 1170	DP 21170	DP 1438	
1.6 TD	2003-				
1.7 TD	98-2000	DP 1170	DP 21170		6551
1.7 TD	2001-	DP 1170	DP 21170	DP 1438	

C-Class (W202) (T202) (W203)

C180	93-96	DP 962	DP 2962	DP 671	
C180 Sal	96-2000	DP 962	DP 2962	DP 1135	
C180 Est	97-2000	DP 962	DP 2962	DP 1191	
C180 Sal	2000-	DP 1365	DP 21365	DP 1191	
C180 Est	2000-	DP 1365	DP 21365	DP 1441	
C180 K	2002-	DP 1365	DP 21365	DP 1191	
C200	94-96	DP 962	DP 2962	DP 671	
C200 Sal	96-2000	DP 962	DP 2962	DP 1135	
C200 Est	97-2000	DP 962	DP 2962	DP 1191	
C200 Sal	2000-	DP 1365	DP 21365	DP 1191	
C200 Est	2000-	DP 1365	DP 21365	DP 1441	
C200 K	2000-	DP 1365	DP 21365	DP 1191	
C200 D	94-96	DP 962	DP 2962	DP 671	
C200 D Sal	96-2000	DP 962	DP 2962	DP 1135	
C200 D Est	97-2000	DP 962	DP 2962	DP 1191	
C220	93-96	DP 962	DP 2962	DP 671	
C220 Sal	96-2000	DP 962	DP 2962	DP 1135	
C220 Est	97-2000	DP 962	DP 2962	DP 1191	
C220 D	93-96	DP 962	DP 2962	DP 671	
C220 D Sal	96-2000	DP 962	DP 2962	DP 1135	

*Every EBC pad and shoe requiring ECE R-90 is available with approval subject to stock rotation - check box end label.
Models listed by Engine Size. Only listed by trim level where pads differ, (16v, GL, GT, etc).

Standard Quality - ECE R90 Approved with similar performance to original equipment brake pads.
Upgrade Quality (Tuning/ Sportbeläge) - ECE R90 Approved but with higher friction and improved performance for faster street use.
Verbesserte Qualität - mit ECE R90 Freigabe aber mit höherem Reibwert und verbesserter Bremsleistung für den schnellen Strasseninsatz.









Qualité standard - Approuvée par la norme ECE R90 - Des performances équivalentes à l'origine.
Qualité améliorée - Approuvée par la norme ECE R90 - Un coefficient de friction supérieur et des performances accrues pour pilotage rapide sur route.
Calidad Mejorada - Aprobación CEE R90 con prestaciones similares a las pastillas originales.
Calidad Mejorada - Aprobación CEE R90 pero con un coeficiente de fricción más elevado y prestaciones mejoradas para un uso deportivo en carretera.

Standard Quality - ECE R90 Approved with similar performance to original equipment brake pads.
 Upgrade Quality (Tuning / Sportbeläge) - ECE R90 Approved but with higher friction and improved performance for faster street use.

Standard Qualität - mit ECE R90 Freigabe und ähnlicher Bremsleistung wie die Original Bremsbeläge.
 Verbesserte Qualität - mit ECE R90 Freigabe aber mit höherem Reibwert und verbesserter Bremsleistung für den schnellen Strasseninsatz.

Quality standard - Approuvée par la norme ECE R90 - Des performances équivalentes à l'origine.
 Qualité améliorée - Approuvée par la norme ECE R90 - Un coefficient de friction supérieur et des performances accrues pour pilotage rapide sur route.

Calidad Estándar - Aprobación CEE R90 con prestaciones similares a las pastillas originales.
 Calidad Mejorada - Aprobación CEE R90 pero con un coeficiente de fricción más elevado y prestaciones mejoradas para un uso deportivo en carretera.

Make/Model/Engine Hersteller/Modell/Motor Modelos	Year Jahr Années	Pads  Front / Vorn / Avant		Shoes	Pads  Rear / Hinten / Arrière		Shoes
		Original Quality ECE R90* Approved 	Upgrade Quality Tuning/Sportbeläge ECE R90* Approved 	Bremsbacken Machoires 	Original Quality ECE R90* Approved 	Upgrade Quality Tuning/Sportbeläge ECE R90* Approved 	Bremsbacken Machoires 
MERCEDES - BENZ Contd.							
C-Class (W202) (T202) (W203) Contd.							
C220 D Est	97-2000	DP 962	DP 2962		DP 1191		
C220 TD Sal	2000-	DP 1365	DP 21365		DP 1191		
C220 TD Est	2000-	DP 1365	DP 21365		DP 1441		
C230	96-2000	DP 962	DP 2962		DP 1135		
C230	96-2000	DP 1055	DP 21055		DP 1191		
C230K	95-96	DP 962	DP 2962		DP 846		
C230K	96-2000	DP 1055	DP 21055		DP 1191		
C230K	2000-	DP 1365	DP 21365		DP 1191		
C240	95-96	DP 1055	DP 21055		DP 846		
C240	96-2000	DP 1055	DP 21055		DP 1191		
C240	2000-	DP 1365	DP 21365		DP 1441		
C250 D	93-96	DP 962	DP 2962		DP 671		
C250 D	96-97	DP 962	DP 2962		DP 1135		
C250 D	96-2000	DP 1055	DP 21055		DP 1191		
C250 TD	96-2000	DP 1055	DP 21055		DP 846		
C270 D	2001-	DP 1365	DP 21365		DP 1441		
C280	94-96	DP 962	DP 2962		DP 1026		
C280	96-2000	DP 962	DP 2962		DP 1135		
C280	96-2000	DP 1055	DP 21055		DP 1191		
C320	2000-	DP 1365	DP 21365		DP 1441		
C32 AMG	2002-	DP 21363	DP 31363		DP 887		
C36 AMG	94-95	DP 2927/2	DP 3927/2		DP 1026		
C36 AMG	95-97	DP 2927/2	DP 3927/2		DP 887		
C43 AMG	96-2000	DP 21035	DP 31035		DP 887		
With ASR	93-96				DP 1026		
Handbrake shoes	93-2000						5005
Handbrake shoes	2000-						6521
CL-Class (C140)							
CL420	96-99	DP 963	DP 2963		DP 887		
CL500	96-99	DP 963	DP 2963		DP 887		
CL500	2000-2002	DP 21363	DP 31363		DP 1364		
CL500	2002-	DP 21363	DP 31363		DP 1428		
CL55 AMG	2000-	DP 21035	DP 31035		DP 887		
CL600	96-99	DP 963	DP 2963		DP 887		
CL600	2000-	DP 21363	DP 31363		DP 1364		
Handbrake shoes	96-99						6521
Handbrake shoes	2000-						6611
CLK (C208)							
2.0 Conv	98-	DP 21075	DP 31075		DP 887		
2.0 Coupe	97-	DP 1055	DP 21055		DP 887		
2.3 Conv	98-	DP 21075	DP 31075		DP 887		
2.3 Coupe	97-	DP 1055	DP 21055		DP 887		
2.6	2002-						
3.2	97-	DP 21075	DP 31075		DP 887		
4.3	98-	DP 2927	DP 3927		DP 887		
4.3	98-	DP 21075	DP 31075		DP 887		
5.0	2002-						
55 AMG	99-	DP 21035	DP 31035		DP 887		
2.7 D	2002-						
Handbrake shoes	97-						5005
E-Class (W124) (W210) (S210)							
E200 Sal	93-95	DP 577	DP 2577		DP 671		
E200 Est	93-95	DP 577	DP 2577		DP 846		
E200	96-	DP 1055	DP 21055		DP 846		
E200	96-	DP 1055	DP 21055		DP 1191		
E200	97-	DP 1075	DP 21075		DP 1288		
E200 K	2000-	DP 1075	DP 21075		DP 1191		
E200 D	93-95	DP 577	DP 2577		DP 671		

*Every EBC pad and shoe requiring ECE R-90 is available with approval subject to stock rotation - check box end label.

Models listed by Engine Size. Only listed by trim level where pads differ, (16v, GL, GT, etc).

BRAKE PADS & SHOES - APPLICATIONS

Bremsbeläge / Plaquettes + Bremsbacken / Machoires









EBC

BRAKES

Make/Model/Engine Hersteller/Modell/Motor Modèles	Year Jahr Années	Pads Plaquettes / Bremsbeläge		Shoes Bremsbacken Machoires	Pads Plaquettes / Bremsbeläge		Shoes Bremsbacken Machoires
		Original Quality ECE R90* Approved	Upgrade Quality Tuning/Sportbeläge ECE R90* Approved	ECE R90* Approved	Original Quality ECE R90* Approved	Upgrade Quality Tuning/Sportbeläge ECE R90* Approved	ECE R90* Approved
MERCEDES - BENZ Contd.							
E-Class (W124) (W210) (S210) Contd.							
E220 Sal	93-95	DP 577	DP 2577		DP 671		
E220 Est	93-95	DP 577	DP 2577		DP 846		
E220	96-	DP 1055	DP 21055		DP 846		
E220	96-	DP 1055	DP 21055		DP 1191		
E220 D	95-96	DP 1055	DP 21055		DP 846		
E220 D	96-	DP 1055	DP 21055		DP 1191		
E220 TD	98-	DP 1055	DP 21055		DP 1191		
E220 TD	2002-				DP 1428		
E230	95-	DP 1055	DP 21055		DP 846		
E230	95-	DP 1055	DP 21055		DP 1191		
E240	97-	DP 1055	DP 21055		DP 846		
E240	97-	DP 1055	DP 21055		DP 1191		
E240	97-	DP 1075	DP 21075		DP 887		
E240	97-	DP 1075	DP 21075		DP 1288		
E240	2002-				DP 1428		
E250 D Sal	93-95	DP 577	DP 2577		DP 671		
E250 D Sal	95-96	DP 1055	DP 21055		DP 846		
E250 D Sal	96-	DP 1055	DP 21055		DP 1191		
E250 D Est	93-95	DP 577	DP 2577		DP 846		
E250 D Est	95-	DP 1055	DP 21055		DP 846		
E250 D Est	95-	DP 1055	DP 21055		DP 1191		
E250 Turbo D Sal	93-95	DP 577	DP 2577		DP 671		
E250 Turbo D Sal	95-96	DP 1055	DP 21055		DP 846		
E250 Turbo D Sal	96-	DP 1055	DP 21055		DP 1191		
E250 Turbo D Est	93-95	DP 577	DP 2577		DP 846		
E250 Turbo D Est	95-96	DP 1055	DP 21055		DP 846		
E250 Turbo D Est	95-96	DP 1055	DP 21055		DP 1191		
E250	96-	DP 1055	DP 21055		DP 846		
E250	96-	DP 1055	DP 21055		DP 1191		
E270 TD	2002-				DP 1428		
E280 Sal	93-95	DP 577	DP 2577		DP 671		
E280 Sal (ASR)	93-95	DP 577	DP 2577		DP 1026		
E280 Est	93-95	DP 577	DP 2577		DP 846		
E280	96-	DP 21075	DP 31075		DP 887		
E280 4 Matic	97-	DP 21075	DP 31075		DP 1288		
E300 Sal	93-95	DP 577	DP 2577		DP 671		
E300 Est	93-95	DP 577	DP 2577		DP 846		
E300	95-	DP 1055	DP 21055		DP 846		
E300 D Sal	93-95	DP 577	DP 2577		DP 671		
E300 D Sal	95-96	DP 1055	DP 21055		DP 846		
E300 D Sal	96-	DP 1055	DP 21055		DP 1191		
E300 D Est	93-95	DP 577	DP 2577		DP 846		
E300 D Est	95-96	DP 1055	DP 21055		DP 846		
E300 D Est	96-	DP 1055	DP 21055		DP 1191		
E300 Turbo D Sal	93-95	DP 577	DP 2577		DP 671		
E300 Turbo D Sal	95-	DP 1075	DP 21075		DP 671		
E300 TD	97-	DP 1075	DP 21075		DP 1288		
E300 Turbo D Est	93-95	DP 577	DP 2577		DP 846		
E300 Turbo D Est	95-	DP 1075	DP 21075		DP 846		
E320	93-97	DP 2927/2	DP 3927/2		DP 846		
E320	95-	DP 21075	DP 31075		DP 887		
E320	96-	DP 21075	DP 31075		DP 1288		
E320	2002-				DP 1428		
E320 TD	2002-				DP 1428		
E420	93-95	DP 2927	DP 3927		DP 846		
E420	95-	DP 2927	DP 3927		DP 887		
E420 (S210) (W210)	96-	DP 21075	DP 31075		DP 887		
E420	96-	DP 21075	DP 31075		DP 1288		
E430	97-	DP 2927	DP 3927		DP 887		
E430	97-	DP 2927	DP 3927		DP 1288		
E500	93-95	DP 2927	DP 3927		DP 887		

*Every EBC pad and shoe requiring ECE R-90 is available with approval subject to stock rotation - check box end label.
Models listed by Engine Size. Only listed by trim level where pads differ, (16v, GL, GT, etc).

Standard Quality - ECE R90 Approved with similar performance to original equipment brake pads.
Upgrade Quality (Tuning/ Sportbeläge) - ECE R90 Approved but with higher friction and improved performance for faster street use.
Verbesserte Qualität - mit ECE R90 Freigabe aber mit höherem Reibwert und verbesserter Bremsleistung für den schnellen Strasseninsatz.
Standard Qualität - mit ECE R90 Freigabe und ähnlicher Bremsleistung wie die Original Bremsbeläge.
Qualité standard - Approuvée par la norme ECE R90 - Des performances équivalentes à l'origine.
Qualité améliorée - Approuvée par la norme ECE R90 - Un coefficient de friction supérieur et des performances accrues pour pilotage rapide sur route.
Calidad Mejorada - Aprobación CEE R90 pero con un coeficiente de fricción mas elevado y prestaciones mejoradas para un uso deportivo en carretera.
Calidad Estándar - Aprobación CEE R90 con prestaciones similares a las pastillas originales.

Make/Model/Engine Hersteller/Modell/Motor Modelos	Year Jahr Années	Pads  Front / Vorn / Avant		Shoes	Pads  Rear / Hinten / Arrière		Shoes
		Original Quality ECE R90* Approved 	Upgrade Quality Tuning/Sportbeläge ECE R90* Approved 	Bremsbacken Machoires 	Original Quality ECE R90* Approved 	Upgrade Quality Tuning/Sportbeläge ECE R90* Approved 	Bremsbacken Machoires 
MERCEDES - BENZ Contd.							
E-Class (W124) (W210) (S210) Contd.							
E500	2002-					DP 1428	
E36 AMG	94-97	DP 2927/2	DP 3927/2			DP 887	
E50 AMG	96-98	DP 21035	DP 31035			DP 1288	
E55 AMG	97-	DP 21035	DP 31035			DP 1288	
Handbrake shoes	93-						5005
M-Class							
3.2	98-99	DP 1232	DP 61232			DP 1233	DP 61233
3.2	99-2003	DP 1232	DP 61232			DP 1437	
3.7	2003-						
4.3	98-99	DP 1232	DP 61232			DP 1233	DP 61233
4.3	99-2001	DP 1363	DP 61363			DP 1395	
5.0	2001-	DP 1363	DP 61363			DP 1395	
5.4 AMG	2000-	DP 1363	DP 61363			DP 1395	
2.7 TD	2000-	DP 1232	DP 61232			DP 1437	
S-Class (W140)							
S280	93-98	DP 963	DP 2963			DP 887	
S300 Turbo D	96-98	DP 963	DP 2963			DP 887	
S320	93-98	DP 963	DP 2963			DP 887	
S350 Turbo D	93-96	DP 963	DP 2963			DP 887	
S420	93-98	DP 963	DP 2963			DP 887	
S500	93-98	DP 963	DP 2963			DP 887	
S500C	93-96	DP 963	DP 2963			DP 887	
S600	93-98	DP 963	DP 2963			DP 887	
S600C	93-96	DP 963	DP 2963			DP 887	
Handbrake shoes	93-98						6521
S-Class (W220)							
S280	99-2002	DP 1363	DP 21363			DP 1364	
S280	2002-	DP 1363	DP 21363			DP 1428	
S320	99-2002	DP 1363	DP 21363			DP 1364	
S320	2002-	DP 1363	DP 21363			DP 1428	
S320 D	99-2002	DP 1363	DP 21363			DP 1364	
S320 D	2002-	DP 1363	DP 21363			DP 1428	
S350	2002-	DP 21363	DP 31363			DP 1428	
S430	99-2002	DP 21363	DP 31363			DP 1364	
S430	2002-	DP 21363	DP 31363			DP 1428	
S500	99-2002	DP 21363	DP 31363			DP 1364	
S500	2002-	DP 21363	DP 31363			DP 1428	
S55 AMG	2000-	DP 21035	DP 31035			DP 887	
S600	2000-2002	DP 21363	DP 31363			DP 887	
S600	2002-	DP 21363	DP 31363			DP 1428	
Handbrake shoes	99-						6611
SL-Class (R129)							
SL280	93-96	DP 927	DP 2927			DP 846	
SL280	96-99	DP 927	DP 2927			DP 1026	
SL280	96-99	DP 927	DP 2927			DP 887	
SL280	99-	DP 1363	DP 21363			DP 887	
SL320	93-96	DP 927	DP 2927			DP 846	
SL320	96-99	DP 927	DP 2927			DP 1026	
SL320	96-99	DP 927	DP 2927			DP 887	
SL320	99-	DP 21363	DP 31363			DP 887	
SL350	2003-						
SL500	93-96	DP 2927	DP 3927			DP 846	
SL500	96-99	DP 2927	DP 3927			DP 1026	
SL500	96-99	DP 2927	DP 3927			DP 887	
SL500	99-2002	DP 21363	DP 31363			DP 887	
SL500	2001-	DP 21363	DP 31363			DP 1428	
SL600	93-2001	DP 2927	DP 3927			DP 887	

Standard Quality - ECE R90 Approved with similar performance to original equipment brake pads.
Upgrade Quality (Tuning / Sportbeläge) - ECE R90 Approved but with higher friction and improved performance for faster street use.

Standard Qualität - mit ECE R90 Freigabe und ähnlicher Bremsleistung wie die Original Bremsbeläge.
Verbesserte Qualität (Tuning / Sportbeläge) - mit ECE R90 Freigabe aber mit höherem Reibwert und verbesserter Bremsleistung für den schnellen Strasseninsatz.

Qualité standard - Approuvée par la norme ECE R90 - Des performances équivalentes à l'origine.
Qualité améliorée - Approuvée par la norme ECE R90 - Un coefficient de friction supérieur et des performances accrues pour pilotage rapide sur route.

Calidad Estándar - Aprobación CEE R90 con prestaciones similares a las pastillas originales.
Calidad Mejorada - Aprobación CEE R90 pero con un coeficiente de fricción más elevado y prestaciones mejoradas para un uso deportivo en carretera.

*Every EBC pad and shoe requiring ECE R-90 is available with approval subject to stock rotation - check box end label.









Models listed by Engine Size. Only listed by trim level where pads differ, (16v, GL, GT, etc).

BRAKE PADS & SHOES - APPLICATIONS

Bremsbeläge / Plaquettes + Bremsbacken / Machoires







EBC

BRAKES

Make/Model/Engine Hersteller/Modell/Motor Modèles	Year Jahr Années	Pads  Front / Vorn / Avant		Shoes	Pads  Rear / Hinten / Arrière		Shoes
		Original Quality ECE R90* Approved 	Upgrade Quality Tuning/Sportbeläge ECE R90* Approved 	Bremsbacken Machoires 	Original Quality ECE R90* Approved 	Upgrade Quality Tuning/Sportbeläge ECE R90* Approved 	Bremsbacken Machoires 
MERCEDES - BENZ Contd.							
SL-Class (R129) Contd.							
SL600	2003-						
SL55 AMG	99-	DP 2927	DP 3927		DP 1026		
SL60 AMG	95-99	DP 2927	DP 3927		DP 887		
SL73 AMG	99-2001	-	DP 3927		DP 887		
Handbrake shoes	93-						5005
SLK (R170)							
2.0	2000-	DP 1055	DP 21055		DP 1191		
2.3	96-97	DP 1055	DP 21055		DP 846		
2.3	97-	DP 1055	DP 21055		DP 1191		
2.3 (ASR)	96-97	DP 1055	DP 21055		DP 1026		
3.2	99-	DP 21075	DP 31075		DP 1191		
3.2 AMG	2000-	DP 21035	DP 31035		DP 887		
Handbrake shoes	96-						6521
SLR							
5.5 Supercharged	2003-						
Vaneo							
1.6	2002-	DP 1365	DP 21365		DP 1438		
1.9	2002-	DP 1365	DP 21365		DP 1438		
1.7 D	2002-	DP 1365	DP 21365		DP 1438		
V-Class							
V200	96-2002	DP 1071			DP 1090		
V200	98-2002	DP 1292			DP 1343		
V230	96-	DP 1071			DP 1090		
V230	98-	DP 1292			DP 1343		
V280	98-2002	DP 1071			DP 1090		
V280	98-2002	DP 1292			DP 1343		
V220 TD	98-	DP 1071			DP 1090		
V220 TD	98-	DP 1292			DP 1343		
V230 TD	96-98	DP 1071			DP 1090		
V230 TD	98-2002	DP 1292			DP 1343		
Handbrake shoes	96-						6580
190/190E (W201)							
1.8	90-93	DP 778	DP 2778		DP 464		
2.0	82-93	DP 778	DP 2778		DP 464		
2.3	83-93	DP 778	DP 2778		DP 464		
2.3 16v	84-88	DP 577	DP 2577		DP 671		
2.5 16v	88-93	DP 577	DP 2577		DP 671		
2.5 16v Evolution	89-93	DP 2927	DP 3927		DP 846		
2.6	86-93	DP 778	DP 2778		DP 464		
2.0 D	83-85	DP 778	DP 2778		DP 464		
2.5 D	85-93	DP 778	DP 2778		DP 464		
2.5 Turbo D	87-93	DP 778	DP 2778		DP 464		
With ASR	83-93				DP 1026		
Handbrake shoes	82-93						5005
(W108)							
250 S	65-69	DP 103	DP 2103		DP 104	DP 2104	
250 SE	65-68	DP 103	DP 2103		DP 104	DP 2104	
280 S	67-72	DP 103	DP 2103		DP 104	DP 2104	
280 SE	67-72	DP 103	DP 2103		DP 104	DP 2104	
280 SEL	68-71	DP 103	DP 2103		DP 104	DP 2104	
280 SEL 3.5	71-72	DP 103	DP 2103		DP 104	DP 2104	
300 SEb	65-67	DP 103	DP 2103		DP 104	DP 2104	
Handbrake shoes	65-72						5125

*Every EBC pad and shoe requiring ECE R-90 is available with approval subject to stock rotation - check box end label.
Models listed by Engine Size. Only listed by trim level where pads differ, (16v, GL, GT, etc).

Standard Quality - ECE R90 Approved with similar performance to original equipment brake pads.
Upgrade Quality (Tuning/ Sportbeläge) - ECE R90 Approved but with higher friction and improved performance for faster street use.
Verbesserte Qualität - mit ECE R90 Freigabe aber mit höherem Reibwert und verbesserter Bremsleistung für den schnellen Strasseninsatz.
Standard Qualität - mit ECE R90 Freigabe und ähnlicher Bremsleistung wie die Original Bremsbeläge.
Qualité standard - Approuvée par la norme ECE R90 - Des performances équivalentes à l'origine.
Qualité améliorée - Approuvée par la norme ECE R90 - Un coefficient de friction supérieur et des performances accrues pour pilotage rapide sur route.
Calidad Estándar - Aprobación CEE R90 con prestaciones similares a las pastillas originales.
Calidad Mejorada - Aprobación CEE R90 pero con un coeficiente de fricción más elevado y prestaciones mejoradas para un uso deportivo en carretera.

Make/Model/Engine Hersteller/Modell/Motor Modelos	Year Jahr Années	Pads  Front / Vorn / Avant		Shoes	Pads  Rear / Hinten / Arrière		Shoes
		Original Quality ECE R90* Approved 	Upgrade Quality Tuning/Sportbeläge ECE R90* Approved 	Bremsbacken Machoires 	Original Quality ECE R90* Approved 	Upgrade Quality Tuning/Sportbeläge ECE R90* Approved 	Bremsbacken Machoires 
MERCEDES - BENZ Contd.							
(W109)							
300 SEL	65-67	DP 103	DP 2103		DP 104	DP 2104	
300 SEL 2.8	67-70	DP 103	DP 2103		DP 104	DP 2104	
300 SEL 3.5	69-72	DP 103	DP 2103		DP 104	DP 2104	
300 SEL 6.3	67-72	DP 103	DP 2103		DP 104	DP 2104	
Handbrake shoes	65-72						5125
(W110)							
190	59-65	DP 103	DP 2103		DP 104	DP 2104	
190 D	59-65	DP 103	DP 2103		DP 104	DP 2104	
200	65-68	DP 103	DP 2103		DP 104	DP 2104	
200 D	65-68	DP 103	DP 2103		DP 104	DP 2104	
230	65-68	DP 103	DP 2103		DP 104	DP 2104	
(W111)							
220 b	59-65	DP 103	DP 2103				
220 Sb	59-65	DP 103	DP 2103				
220 SEb	59-65	DP 103	DP 2103				
230 S	65-68	DP 103	DP 2103		DP 104	DP 2104	
280 SE/C	67-71	DP 103	DP 2103		DP 104	DP 2104	
280 SE/C 3.5	69-71	DP 103	DP 2103		DP 104	DP 2104	
Handbrake shoes	59-71						5125
(W112)							
300 SE	61-63	DP 120	DP 2120		DP 120	DP 2120	
300 SE	64-65	DP 103	DP 2103		DP 120	DP 2120	
(W113)							
230SL	63-65	DP 103	DP 2103				
250SL	66-68	DP 103	DP 2103		DP 104	DP 2104	
280SL	67-71	DP 103	DP 2103		DP 104	DP 2104	
Handbrake shoes	63-71						5125
(W114)							
230.6	67-71	DP 103	DP 2103		DP 104	DP 2104	
230.6	71-76	DP 261	DP 2261		DP 104	DP 2104	
250	67-76	DP 103	DP 2103		DP 104	DP 2104	
250 C	68-71	DP 103	DP 2103		DP 104	DP 2104	
250 C	71-76	DP 261	DP 2261		DP 104	DP 2104	
250 CE	68-71	DP 103	DP 2103		DP 104	DP 2104	
250 CE	71-72	DP 261	DP 2261		DP 104	DP 2104	
280	72-76	DP 261	DP 2261		DP 104	DP 2104	
280 C	72-76	DP 261	DP 2261		DP 104	DP 2104	
280 CE	72-76	DP 261	DP 2261		DP 104	DP 2104	
280 E	72-76	DP 261	DP 2261		DP 104	DP 2104	
Handbrake shoes	67-76						5125
(W115)							
200	67-76	DP 103	DP 2103		DP 104	DP 2104	
200 D	67-76	DP 103	DP 2103		DP 104	DP 2104	
220	67-76	DP 103	DP 2103		DP 104	DP 2104	
220 D	67-76	DP 103	DP 2103		DP 104	DP 2104	
230.4	73-76	DP 103	DP 2103		DP 104	DP 2104	
240 D	73-76	DP 103	DP 2103		DP 104	DP 2104	
240 D 3.0	74-76	DP 261	DP 2261		DP 104	DP 2104	
Handbrake shoes	67-76						5125

Standard Quality - ECE R90 Approved with similar performance to original equipment brake pads.
Upgrade Quality (Tuning / Sportbeläge) - ECE R90 Approved but with higher friction and improved performance for faster street use.

Standard Qualität - mit ECE R90 Freigabe und ähnlicher Bremsleistung wie die Original Bremsbeläge.
Verbesserte Qualität - mit ECE R90 Freigabe aber mit höherem Reibwert und verbesserter Bremsleistung für den schnellen Strasseninsatz.









Calidad Estándar - Aprobación CEE R90 con prestaciones similares a las pastillas originales.
Calidad Mejorada - Aprobación CEE R90 pero con un coeficiente de fricción más elevado y prestaciones mejoradas para un uso deportivo en carretera.

BRAKE PADS & SHOES - APPLICATIONS

Bremsbeläge / Plaquettes + Bremsbacken / Machoires









EBC

BRAKES

Make/Model/Engine Hersteller/Modell/Motor Modèles	Year Jahr Années	Pads  Front / Vorn / Avant		Shoes	Pads  Rear / Hinten / Arrière		Shoes
		Original Quality ECE R90* Approved 	Upgrade Quality Tuning/Sportbeläge ECE R90* Approved 	Bremsbacken Machoires 	Original Quality ECE R90* Approved 	Upgrade Quality Tuning/Sportbeläge ECE R90* Approved 	Bremsbacken Machoires 
MERCEDES - BENZ Contd.							
(W116)							
280 S	72-80	DP 261	DP 2261		DP 104	DP 2104	
280 SE	72-80	DP 261	DP 2261		DP 104	DP 2104	
280 SEL	74-80	DP 261	DP 2261		DP 104	DP 2104	
350 SE	72-80	DP 261	DP 2261		DP 104	DP 2104	
350 SEL	73-80	DP 261	DP 2261		DP 104	DP 2104	
450 SE	72-80	DP 261	DP 2261		DP 104	DP 2104	
450 SEL	73-80	DP 261	DP 2261		DP 104	DP 2104	
450 SEL 6.9	75-80	DP 261	DP 2261		DP 104	DP 2104	
Handbrake shoes	72-80						5125
(W123)							
200	76-79	DP 261	DP 2261		DP 104	DP 2104	
200	79-85	DP 261/2	DP 2261		DP 104	DP 2104	
200 D	76-79	DP 261	DP 2261		DP 104	DP 2104	
200 D	76-79	DP 261/2	DP 2261		DP 104	DP 2104	
200 T (Est)	80-85	DP 261/2	DP 2261		DP 104	DP 2104	
220 D	76-79	DP 261	DP 2261		DP 104	DP 2104	
230	76-79	DP 261	DP 2261		DP 104	DP 2104	
230	79-81	DP 261/2	DP 2261		DP 104	DP 2104	
230 C	76-79	DP 261	DP 2261		DP 104	DP 2104	
230 C	79-80	DP 261/2	DP 2261		DP 104	DP 2104	
230 CE	80-85	DP 261/2	DP 2261		DP 104	DP 2104	
230 E	80-85	DP 261/2	DP 2261		DP 104	DP 2104	
230 T (Est)	78-79	DP 261	DP 2261		DP 104	DP 2104	
230 T (Est)	79-80	DP 261/2	DP 2261		DP 104	DP 2104	
230 TE (Est)	80-85	DP 261/2	DP 2261		DP 104	DP 2104	
240 D	79-79	DP 261	DP 2261		DP 104	DP 2104	
240 D	79-85	DP 261/2	DP 2261		DP 104	DP 2104	
240 TD (Est)	78-79	DP 261	DP 2261		DP 104	DP 2104	
240 TD (Est)	79-85	DP 261/2	DP 2261		DP 104	DP 2104	
250	76-79	DP 261	DP 2261		DP 104	DP 2104	
250	79-85	DP 261/2	DP 2261		DP 104	DP 2104	
250 T (Est)	78-79	DP 261	DP 2261		DP 104	DP 2104	
250 T (Est)	79-82	DP 261/2	DP 2261		DP 104	DP 2104	
280	76-79	DP 261	DP 2261		DP 104	DP 2104	
280	79-81	DP 261/2	DP 2261		DP 104	DP 2104	
280 C	77-79	DP 261	DP 2261		DP 104	DP 2104	
280 C	79-80	DP 261/2	DP 2261		DP 104	DP 2104	
280 CE	77-79	DP 261	DP 2261		DP 104	DP 2104	
280 CE	79-85	DP 261/2	DP 2261		DP 104	DP 2104	
280 E	76-79	DP 261	DP 2261		DP 104	DP 2104	
280 E	79-85	DP 261/2	DP 2261		DP 104	DP 2104	
280 TE (Est)	78-79	DP 261	DP 2261		DP 104	DP 2104	
280 TE (Est)	79-85	DP 261/2	DP 2261		DP 104	DP 2104	
300 D	76-79	DP 261	DP 2261		DP 104	DP 2104	
300 D	79-85	DP 261/2	DP 2261		DP 104	DP 2104	
300 TD (Est)	78-79	DP 261	DP 2261		DP 104	DP 2104	
300 TD (Est)	79-85	DP 261/2	DP 2261		DP 104	DP 2104	
300 TD - Turbo (Est)	80-85	DP 261/2	DP 2261		DP 104	DP 2104	
Handbrake shoes	76-85						5125
(W124)							
200	85-90	DP 577	DP 2577		DP 671		
200 CE	90-93	DP 577	DP 2577		DP 671		
200 D	85-93	DP 577	DP 2577		DP 671		
200 E	85-93	DP 577	DP 2577		DP 671		
200 T (Est)	85-90	DP 577	DP 2577		DP 846		
200 TD (Est)	85-91	DP 577	DP 2577		DP 846		
200 TE (Est)	88-93	DP 577	DP 2577		DP 846		
220 CE	92-93	DP 577	DP 2577		DP 671		
220 E	92-93	DP 577	DP 2577		DP 671		

*Every EBC pad and shoe requiring ECE R-90 is available with approval subject to stock rotation - check box end label.
Models listed by Engine Size. Only listed by trim level where pads differ, (16v, GL, GT, etc).

Standard Quality - ECE R90 Approved with similar performance to original equipment brake pads.
Upgrade Quality (Tuning/ Sportbeläge) - ECE R90 Approved but with higher friction and improved performance for faster street use.
Verbesserte Qualität - mit ECE R90 Freigabe und ähnlicher Bremsleistung wie die Original Bremsbeläge.
Standard Qualität - mit ECE R90 Freigabe und ähnlicher Bremsleistung wie die Original Bremsbeläge.
Qualité standard - Approuvée par la norme ECE R90 - Des performances équivalentes à l'origine.
Qualité améliorée - Approuvée par la norme ECE R90 - Un coefficient de friction supérieur et des performances accrues pour pilotage rapide sur route.
Calidad Estándar - Aprobación CEE R90 con prestaciones similares a las pastillas originales.
Calidad Mejorada - Aprobación CEE R90 pero con un coeficiente de fricción más elevado y prestaciones mejoradas para un uso deportivo en carretera.

Make/Model/Engine Hersteller/Modell/Motor Modelos	Year Jahr Années	Pads  Front / Vorn / Avant		Shoes	Pads  Rear / Hinten / Arrière		Shoes
		Original Quality ECE R90* Approved 	Upgrade Quality Tuning/Sportbeläge ECE R90* Approved 	Bremsbacken Machoires 	Original Quality ECE R90* Approved 	Upgrade Quality Tuning/Sportbeläge ECE R90* Approved 	Bremsbacken Machoires 
MERCEDES - BENZ Contd.							
(W124) Contd.							
220 TE (Est)	92-93	DP 577	DP 2577		DP 846		
230 CE, E	85-92	DP 577	DP 2577		DP 671		
230 TE (Est)	85-92	DP 577	DP 2577		DP 846		
250 D	85-93	DP 577	DP 2577		DP 671		
250 TD (Est)	85-93	DP 577	DP 2577		DP 846		
250 D - Turbo	88-93	DP 577	DP 2577		DP 671		
250 TD - Turbo (Est)	90-93	DP 577	DP 2577		DP 846		
260 E	85-92	DP 577	DP 2577		DP 671		
260 E (ASR)	89-92	DP 577	DP 2577		DP 1026		
260 E (Est)	85-92	DP 577	DP 2577		DP 846		
280 E	92-93	DP 577	DP 2577		DP 671		
280 E (ASR)	92-93	DP 577	DP 2577		DP 1026		
280 E (Est)	92-93	DP 927	DP 2927		DP 846		
280 TE (Est)	92-93	DP 577	DP 2577		DP 846		
300 E	85-93	DP 577	DP 2577		DP 671		
300 E (ASR)	89-92	DP 577	DP 2577		DP 1026		
300 E 24v	89-92	DP 927	DP 2927		DP 846		
300 CE	87-92	DP 577	DP 2577		DP 671		
300 CE (ASR)	89-92	DP 577	DP 2577		DP 1026		
300 CE 24v	89-93	DP 927	DP 2927		DP 846		
300 TE (Est)	85-93	DP 577	DP 2577		DP 846		
300 TE 24v (Est)	89-92	DP 927	DP 2927		DP 846		
300 D	85-93	DP 577	DP 2577		DP 671		
300 TD (Est)	86-93	DP 577	DP 2577		DP 846		
300 D Turbo	87-93	DP 577	DP 2577		DP 671		
300 TD Turbo (Est)	85-93	DP 577	DP 2577		DP 846		
320 E	92-93	DP 927	DP 2927		DP 846		
320 CE	92-93	DP 927	DP 2927		DP 846		
320 TE (Est)	92-93	DP 927	DP 2927		DP 846		
400 E	91-93	DP 2927	DP 3927		DP 846		
500 E -B927760	91-93	DP 2927	DP 3927		DP 846		
500 E B927761-	92-93	DP 2927	DP 3927		DP 887		
Handbrake shoes	85-93						5005
(W126)							
260 SE	85-91	DP 261/2	DP 2261		DP 104	DP 2104	
280 S	80-85	DP 261/2	DP 2261		DP 104	DP 2104	
280 SE	80-85	DP 261/2	DP 2261		DP 104	DP 2104	
280 SEL	80-85	DP 261/2	DP 2261		DP 104	DP 2104	
300 SE	85-91	DP 261/2	DP 2261		DP 104	DP 2104	
300 SEL	85-91	DP 261/2	DP 2261		DP 104	DP 2104	
380 SE	80-85	DP 261/2	DP 2261		DP 104	DP 2104	
380 SEL	80-85	DP 261/2	DP 2261		DP 104	DP 2104	
380 SEC	81-85	DP 443			DP 104		
420 SE	85-91	DP 261/2	DP 2261		DP 104	DP 2104	
420 SEL	85-91	DP 261/2	DP 2261		DP 104	DP 2104	
420 SEC	85-91	DP 261/2	DP 2261		DP 104	DP 2104	
500 SE	80-91	DP 261/2	DP 2261		DP 104	DP 2104	
500 SEC	81-85	DP 443			DP 104		
500 SEC	85-91	DP 261/2	DP 2261		DP 104	DP 2104	
500 SEL	80-91	DP 261/2	DP 2261		DP 104	DP 2104	
560 SE	88-91	DP 261/2	DP 2261		DP 104	DP 2104	
560 SEC	85-91	DP 261/2	DP 2261		DP 104	DP 2104	
560 SEL	85-91	DP 261/2	DP 2261		DP 104	DP 2104	
With ASR	80-91				DP 1027		
Handbrake shoes	80-91						5125

Standard Quality - ECE R90 Approved with similar performance to original equipment brake pads.
 Upgrade Quality (Tuning / Sportbeläge) - ECE R90 Approved but with higher friction and improved performance for faster street use.

Standard Qualität - mit ECE R90 Freigabe und ähnlicher Bremsleistung wie die Original Bremsbeläge.
 Verbesserte Qualität - mit ECE R90 Freigabe aber mit höherem Reibwert und verbesserter Bremsleistung für den schnellen Strasseninsatz.

Qualité standard - Approuvée par la norme ECE R90 - Des performances équivalentes à l'origine.
 Qualité améliorée - Approuvée par la norme ECE R90 - Un coefficient de friction supérieur et des performances accrues pour pilotage rapide sur route.

Calidad Estándar - Aprobación CEE R90 con prestaciones similares a las pastillas originales.
 Calidad Mejorada - Aprobación CEE R90 pero con un coeficiente de fricción más elevado y prestaciones mejoradas para un uso deportivo en carretera.









*Every EBC pad and shoe requiring ECE R-90 is available with approval subject to stock rotation - check box end label.
 Models listed by Engine Size. Only listed by trim level where pads differ, (16v, GL, GT, etc).

BRAKE PADS & SHOES - APPLICATIONS

Bremsbeläge / Plaquettes + Bremsbacken / Machoires



EBC

BRAKES











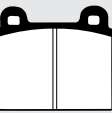

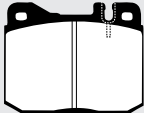
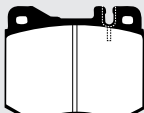
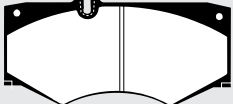

Make/Model/Engine Hersteller/Modell/Motor Modèles	Year Jahr Années	Pads  Front / Vorn / Avant		Shoes	Pads  Rear / Hinten / Arrière		Shoes
		Original Quality ECE R90* Approved 	Upgrade Quality Tuning/Sportbeläge ECE R90* Approved 	Bremsbacken Machoires 	Original Quality ECE R90* Approved 	Upgrade Quality Tuning/Sportbeläge ECE R90* Approved 	Bremsbacken Machoires 
MERCEDES - BENZ Contd.							
(W140)							
300 SE 2.8	92-93	DP 963	DP 2963		DP 887		
300 SE 3.2-A023718-A050547	91-93	DP 888			DP 887		
300 SE 3.2-A023719-A050548-	91-93	DP 963	DP 2963		DP 887		
300 SEL 3.2-A023718-A050547	91-93	DP 888			DP 887		
300 SEL 3.2-A023719-A050548-	91-93	DP 963	DP 2963		DP 887		
300 SD Turbo	92-93	DP 963	DP 2963		DP 887		
400 SE	91-93	DP 963	DP 2963		DP 887		
400 SEL	91-93	DP 963	DP 2963		DP 887		
500 SE	91-93	DP 963	DP 2963		DP 887		
500 SEC	92-93	DP 963	DP 2963		DP 887		
500 SEL	91-93	DP 963	DP 2963		DP 887		
600 SE V12	91-93	DP 963	DP 2963		DP 887		
600 SEC V12	92-93	DP 963	DP 2963		DP 887		
600 SEL V12	91-93	DP 963	DP 2963		DP 887		
Handbrake shoes	91-93						6521
(R107)							
280SL -007869	74-85	DP 261	DP 2261		DP 104	DP 2104	
280SL 007870-	74-85	DP 261/2	DP 2261		DP 104	DP 2104	
280SLC -008365	74-80	DP 261	DP 2261		DP 104	DP 2104	
280SLC 008366-	74-80	DP 261/2	DP 2261		DP 104	DP 2104	
300SL	85-89	DP 681			DP 104		
350SL -009599	71-80	DP 261	DP 2261		DP 104	DP 2104	
350SL 009600-	71-80	DP 261/2	DP 2261		DP 104	DP 2104	
350SLC -005715	71-80	DP 261	DP 2261		DP 104	DP 2104	
350SLC 005716-	71-80	DP 261/2	DP 2261		DP 104	DP 2104	
380SL	80-85	DP 261/2	DP 2261		DP 104	DP 2104	
380SLC	80-81	DP 261/2	DP 2261		DP 104	DP 2104	
420SL	85-89	DP 681			DP 104		
450SL -062584	73-80	DP 261	DP 2261		DP 104	DP 2104	
450SL 062585	73-80	DP 261/2	DP 2261		DP 104	DP 2104	
450SLC -030280	73-80	DP 261	DP 2261		DP 104	DP 2104	
450SLC 030281-	73-80	DP 261/2	DP 2261		DP 104	DP 2104	
450SLC 5.0 -001627	78-80	DP 261	DP 2261		DP 104	DP 2104	
450SLC 5.0 001628-	78-80	DP 261/2	DP 2261		DP 104	DP 2104	
500SL	80-85	DP 261/2	DP 2261		DP 104	DP 2104	
500SL	85-89	DP 681			DP 104		
500SLC -001627	78-81	DP 261	DP 2261		DP 104	DP 2104	
500SLC 001628-	78-81	DP 261/2	DP 2261		DP 104	DP 2104	
560SL	81-89	DP 681			DP 104		
Handbrake shoes	71-89						5125
(R113)							
230SL	63-65	DP 103	DP 2103				
250SL	66-68	DP 103	DP 2103		DP 104	DP 2104	
280SL	67-71	DP 103	DP 2103		DP 104	DP 2104	
Handbrake shoes	63-71						5125
(R129)							
300SL	89-93	DP 927	DP 2927		DP 928		
300SL	89-93	DP 927	DP 2927		DP 846		
300SL 24v	89-93	DP 927	DP 2927		DP 928		
300SL 24v	89-93	DP 927	DP 2927		DP 846		
500SL	89-93	DP 2927	DP 3927		DP 846		
600SL V12	92-93	DP 2927	DP 3927		DP 887		
Handbrake shoes	89-93						5005

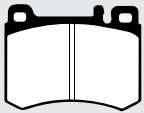
Standard Quality - ECE R90 Approved with similar performance to original equipment brake pads.
 Upgrade Quality (Tuning/ Sportbeläge) - ECE R90 Approved but with higher friction and improved performance for faster street use.
 Standard Qualität - mit ECE R90 Freigabe und ähnlicher Bremsleistung wie die Original Bremsbeläge.
 Verbesserte Qualität - mit ECE R90 Freigabe aber mit höherem Reibwert und verbesserter Bremsleistung für den schnellen Strasseninsatz.
 Qualité standard - Approuvée par la norme ECE R90 - Des performances équivalentes à l'origine.
 Qualité améliorée - Approuvée par la norme ECE R90 - Un coefficient de friction supérieur et des performances accrues pour pilotage rapide sur route.
 Calidad Estándar - Aprobación CEE R90 con prestaciones similares a las pastillas originales.
 Calidad Mejorada - Aprobación CEE R90 pero con un coeficiente de fricción más elevado y prestaciones mejoradas para un uso deportivo en carretera.

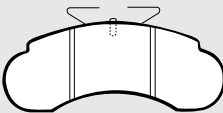
*Every EBC pad and shoe requiring ECE R-90 is available with approval subject to stock rotation - check box end label.
 Models listed by Engine Size. Only listed by trim level where pads differ, (16v, GL, GT, etc).

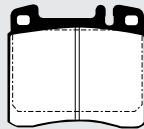
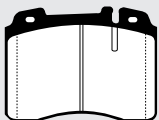
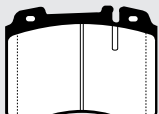
Make/Model/Engine	Year	Pads  Front / Vorn / Avant	Shoes	Pads  Rear / Hinten / Arrière	Shoes
Hersteller/Modell/Motor	Jahr	Plaquettes / Bremsbeläge		Bremsbacken Machoires	
Modelos	Années	Original Quality ECE R90* Approved	Upgrade Quality Tuning/Sportbeläge ECE R90* Approved	Original Quality ECE R90* Approved	Upgrade Quality Tuning/Sportbeläge ECE R90* Approved
MERCEDES - BENZ Contd.					
G-Wagon					
200 GE	86-93	DP 413			
230 G	79-90	DP 413			
230 GE	82-93	DP 413			
240 GD	79-90	DP 413			
250 GD	87-93	DP 413			
280 GE	79-90	DP 413			
280 GD	79-90	DP 413			
300 GD	79-93	DP 413			
300 GE	90-93	DP 413			
G300	93-	DP 413(P)			
G300	93-	DP 832(G)			
G300D	93-	DP 413(P)			
G300D	93-	DP 832(G)			

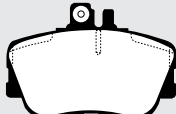
Pad Illustrations for Mercedes-Benz

 103 76 x 70 x 15mm	 104 61 x 56 x 15mm	 261 90 x 73 x 15mm	 261/2 90 x 73 x 18mm
 413 149 x 69 x 18mm	 443 115 x 58 x 18mm	 464 61 x 54 x 13mm	 577 108 x 61 x 18mm
 671 61 x 55 x 15mm	 681 90 x 70 x 17mm	 778 95 x 55 x 17mm	 832 145 x 59 x 14mm
 846 62 x 58 x 15mm	 887 61 x 69 x 15mm	 888 89 x 81 x 18mm	 927 100 x 73 x 17mm
 927/2 100 x 73 x 16mm	 928 62 x 57 x 15mm	 962 110 x 75 x 20mm	 963 100 x 86 x 18mm

Standard Quality - ECE R90 Approved with similar performance to original equipment brake pads.
Upgrade Quality (Tuning / Sportbeläge) - ECE R90 Approved but with higher friction and improved performance for faster street use.

Standard Qualität - mit ECE R90 Freigabe und ähnlicher Bremsleistung wie die Original Bremsbeläge.
Verbesserte Qualität - mit ECE R90 Freigabe aber mit höherem Reibwert und verbesserter Bremsleistung für den schnellen Strasseninsatz.

Calidad Estándar - Aprobación CEE R90 con prestaciones similares a las pastillas originales.
Calidad Mejorada - Aprobación CEE R90 pero con un coeficiente de fricción más elevado y prestaciones mejoradas para un uso deportivo en carretera.

*Every EBC pad and shoe requiring ECE R-90 is available with approval subject to stock rotation - check box end label.

Models listed by Engine Size. Only listed by trim level where pads differ, (16v, GL, GT, etc).

BRAKE PADS & SHOES - APPLICATIONS

Bremsbeläge / Plaquettes + Bremsbacken / Machoires

EBC

BRAKES

Make/Model/Engine	Year	Pads	Front / Vorn / Avant	Shoes	Pads	Rear / Hinten / Arrière	Shoes
Hersteller/Modell/Motor	Jahr	Plaquettes / Bremsbeläge		Bremsbacken Machoires	Plaquettes / Bremsbeläge		Bremsbacken Machoires
Modelos	Années	Original Quality ECE R90* Approved		Upgrade Quality Tuning/Sportbeläge ECE R90* Approved		Original Quality ECE R90* Approved	

Pad Illustrations for Mercedes-Benz Contd.









1026 62 x 54 x 15mm	1027 62 x 57 x 15mm	1055 151 x 60 x 20mm	1071 156 x 64 x 20mm
1075 156 x 69 x 20mm	1090 64 x 57 x 15mm	1135 64 x 63 x 15mm	1170 117 x 56 x 17mm
1191 64 x 73 x 14mm	1232 188 x 59 x 17mm	1233 140 x 50 x 16mm	1288 63 x 74 x 15mm
1292 134 x 66 x 20mm	1343 104 x 53 x 17mm	1363 119 x 71 x 17mm	1364 69 x 72 x 16mm
1365 131 x 69 x 18mm	1395 76 x 65 x 15mm	1428 Picture unavailable at time of press.	1437 140 x 50 x 17mm 140 x 60 x 17mm
1438 95 x 41 x 14mm	1441 63 x 78 x 15mm	21035 195 x 73 x 20mm	

MERCEDES COMMERCIAL					
Transporter (BM)					
207, 208, 210, 307, 308, 309, 310	77-81	DP 413			
207, 208, 210, 307, 308	82-95	DP 413			
207, 208, 210, 307, 308	86-95	DP 786			
309, 310, 407, 408, 409, 410	82-95	DP 413			
309, 310, 407, 408, 409, 410	86-95	DP 786			
507, 508, 510	82-95	DP 413			
507, 508, 510	86-95	DP 786			
609D, 709D, 711D, 809D, 811D, 814D	86-	DP 632			

*Every EBC pad and shoe requiring ECE R-90 is available with approval subject to stock rotation - check box end label.
Models listed by Engine Size. Only listed by trim level where pads differ, (16v, GL, GT, etc).

Standard Quality - ECE R90 Approved with similar performance to original equipment brake pads.
Upgrade Quality (Tuning/ Sportbeläge) - ECE R90 Approved but with higher friction and improved performance for faster street use.
Verbesserte Qualität - mit ECE R90 Freigabe aber mit höherem Reibwert und verbesserter Bremsleistung für den schnellen Strasseninsatz.

Qualité standard - Approuvée par la norme ECE R90 - Des performances équivalentes à l'origine.
Qualité améliorée - Approuvée par la norme ECE R90 - Un coefficient de friction supérieur et des performances accrues pour pilotage rapide sur route.
Calidad Estándar - Aprobación CEE R90 con prestaciones similares a las pastillas originales.
Calidad Mejorada - Aprobación CEE R90 pero con un coeficiente de fricción más elevado y prestaciones mejoradas para un uso deportivo en carretera.

Make/Model/Engine Hersteller/Modell/Motor Modelos	Year Jahr Années	Pads  Front / Vorn / Avant		Shoes	Pads  Rear / Hinten / Arrière		Shoes
		Original Quality ECE R90* Approved 	Upgrade Quality Tuning/Sportbeläge ECE R90* Approved 	Bremsbacken Machoires 	Original Quality ECE R90* Approved 	Upgrade Quality Tuning/Sportbeläge ECE R90* Approved 	Bremsbacken Machoires 
MERCEDES COMM Contd.							
MB80							
2.4 D	92-95	DP 832					5117
MB100D							
2.4 D	87-96	DP 832					5117
Sprinter 208D							
2.5 ton	95-	DP 1071			DP 1081		
2.8 ton	95-	DP 1071			DP 1069		
Handbrake Shoes							6610
Sprinter 211D							
	2000-	DP 1071			DP 1081		
	2000-	DP 1071			DP 1069		
Handbrake Shoes							6610
Sprinter 212D							
2.5 ton	95-	DP 1071			DP 1081		
2.8 ton	95-	DP 1071			DP 1069		
Handbrake Shoes							6610
Sprinter 213D							
	2000-	DP 1071			DP 1081		
	2000-	DP 1071			DP 1069		
Handbrake Shoes							6610
Sprinter 214							
2.5 ton	95-	DP 1071			DP 1081		
2.8 ton	95-	DP 1071			DP 1069		
Handbrake Shoes							6610
Sprinter 216D							
	2000-	DP 1071			DP 1081		
	2000-	DP 1071			DP 1069		
Handbrake Shoes							6610
Sprinter 308D							
3.5 ton	95-	DP 1071			DP 1070		
3.5 ton	95-	DP 1071			DP 1298		
Handbrake Shoes							6610
Sprinter 310D							
	2000-	DP 1071			DP 1070		
	2000-	DP 1071			DP 1298		
Handbrake Shoes							6610
Sprinter 311D							
	2000-	DP 1071			DP 1070		
	2000-	DP 1071			DP 1298		
Handbrake Shoes							6610
Sprinter 312D							
3.5 ton	95-	DP 1071			DP 1070		
3.5 ton	95-	DP 1071			DP 1298		
Handbrake Shoes							6610
Sprinter 313D							
	2000-	DP 1071			DP 1070		
	2000-	DP 1071			DP 1298		
Handbrake Shoes							6610

Standard Quality - ECE R90 Approved with similar performance to original equipment brake pads.
 Upgrade Quality (Tuning / Sportbeläge) - ECE R90 Approved but with higher friction and improved performance for faster street use.

Standard Qualität - mit ECE R90 Freigabe und ähnlicher Bremsleistung wie die Original Bremsbeläge.
 Verbesserte Qualität - mit ECE R90 Freigabe aber mit höherem Reibwert und verbesserter Bremsleistung für den schnellen Strasseninsatz.

Qualité standard - Approuvée par la norme ECE R90 - Des performances équivalentes à l'origine.
 Qualité améliorée - Approuvée par la norme ECE R90 - Un coefficient de friction supérieur et des performances accrues pour pilotage rapide sur route.









Calidad Estándar - Aprobación CEE R90 con prestaciones similares a las pastillas originales.
 Calidad Mejorada - Aprobación CEE R90 pero con un coeficiente de fricción mas elevado y prestaciones mejoradas para un uso deportivo en carretera.

BRAKE PADS & SHOES - APPLICATIONS

Bremsbeläge / Plaquettes + Bremsbacken / Machoires

EBC

BRAKES

Make/Model/Engine Hersteller/Modell/Motor Modèles	Year Jahr Années	Pads  Front / Vorn / Avant		Shoes	Pads  Rear / Hinten / Arrière		Shoes
		Original Quality ECE R90* Approved 	Upgrade Quality Tuning/Sportbeläge ECE R90* Approved 	Bremsbacken Machoirs 	Original Quality ECE R90* Approved 	Upgrade Quality Tuning/Sportbeläge ECE R90* Approved 	Bremsbacken Machoirs 
MERCEDES COMM Contd.							
Sprinter 314							
3.5 ton	95-	DP 1071			DP 1070		
3.5 ton	95-	DP 1071			DP 1298		
Handbrake Shoes							6610
Sprinter 316D							
	2000-	DP 1071			DP 1070		
	2000-	DP 1071			DP 1298		
Handbrake Shoes							6610
Sprinter 408D							
4.6 ton	95-	DP 1054			DP 1054		
Handbrake Shoes							6610
Sprinter 410D							
Handbrake Shoes	2000-	DP 1054			DP 1054		6610
Sprinter 411D							
Handbrake Shoes	2000-	DP 1054			DP 1054		6610
Sprinter 412D							
4.6 ton	95-	DP 1054			DP 1054		
Handbrake Shoes							6610
Sprinter 413D							
Handbrake Shoes	2000-	DP 1054			DP 1054		6610
Sprinter 414							
4.6 ton	95-	DP 1054			DP 1054		
Handbrake Shoes							6610
Sprinter 416D							
Handbrake Shoes	2000-	DP 1054			DP 1054		6610
Vito							
2.0	96-	DP 1071			DP 1090		
2.0	98-	DP 1292			DP 1343		
2.3	96-	DP 1071			DP 1090		
2.3	98-	DP 1292			DP 1343		
2.3 D	96-	DP 1071			DP 1090		
2.3 D	98-	DP 1292			DP 1343		
Handbrake Shoes	98-						6580

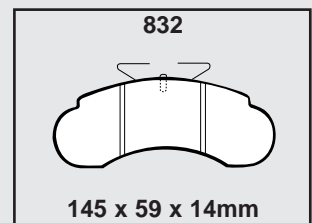
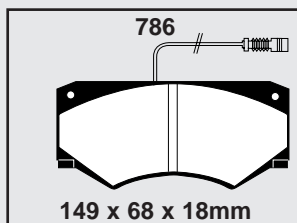
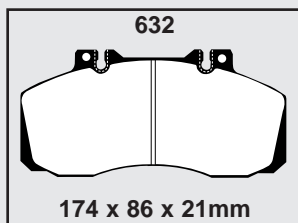
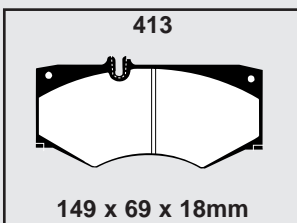

Pad Illustrations for Mercedes Commercial









*Every EBC pad and shoe requiring ECE R-90 is available with approval subject to stock rotation - check box end label.
Models listed by Engine Size. Only listed by trim level where pads differ, (16v, GL, GT, etc).

Standard Quality - ECE R90 Approved with similar performance to original equipment brake pads.
Upgrade Quality (Tuning/ Sportbeläge) - ECE R90 Approved but with higher friction and improved performance for faster street use.
Verbesserte Qualität - mit ECE R90 Freigabe aber mit höherem Reibwert und verbesserter Bremsleistung für den schnellen Strasseneinsatz.

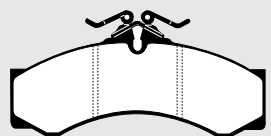
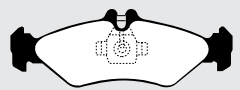
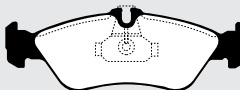
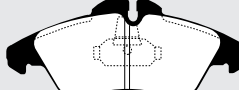
Standard Qualität - mit ECE R90 Freigabe und ähnlicher Bremsleistung wie die Original Bremsbeläge.
Qualité standard - Approuvée par la norme ECE R90 - Des performances équivalentes à l'origine.
Qualité améliorée - Approuvée par la norme ECE R90 - Un coefficient de friction supérieur et des performances accrues pour pilotage rapide sur route.
Calidad Estándar - Aprobación CEE R90 con prestaciones similares a las pastillas originales.
Calidad Mejorada - Aprobación CEE R90 pero con un coeficiente de fricción más elevado y prestaciones mejoradas para un uso deportivo en carretera.

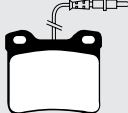
Make/Model/Engine	Year	Pads	Front / Vorn / Avant	Shoes	Pads	Rear / Hinten / Arrière	Shoes
Hersteller/Modell/Motor	Jahr	Plaquettes / Bremsbeläge		Bremsbacken Machoires	Plaquettes / Bremsbeläge		Bremsbacken Machoires
Modelos	Années	Original Quality ECE R90* Approved		Upgrade Quality Tuning/Sportbeläge ECE R90* Approved		Original Quality ECE R90* Approved	Upgrade Quality Tuning/Sportbeläge ECE R90* Approved

Pad Illustrations for Mercedes Commercial Contd.

1054  164 x 73 x 19mm	1069  141 x 50 x 17mm	1070  156 x 54 x 18mm	1071  156 x 64 x 20mm
1081  64 x 57 x 17mm	1090  64 x 57 x 15mm	1292  134 x 66 x 20mm	1298  126 x 63 x 17mm
1343  104 x 53 x 17mm			

MG (See ROVER)

MICROCAR

Virgo

0.5 98- DP 1342

Pad Illustrations for Microcar

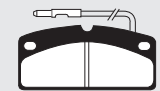
1342  89 x 41 x 10mm
--

MITSUBISHI

Carisma

1.6	95-2000	DP 1039		DP 986		6496
1.6	2000-	DP 1039		DP 1076		
1.8	95-2000	DP 1045	DP 21045	DP 986	DP 2986	
1.8	2000-	DP 1045	DP 21045	DP 1076		
1.9 TD	97-2000	DP 1039		DP 986		6496
1.9 TD (ABS)	97-2000	DP 1045	DP 21045	DP 986	DP 2986	
1.9 TD	2000-	DP 1039		DP 1076		6496

Celeste

1.6	76-81	DP 196				5260
1.6 GSR	76-80	DP 196				5261
2.0	76-81	DP 196				5261

Challenger

3.0	99-2000	DP 954	DP 6954	DP 1228		6575
2.5 TD	99-2000	DP 954	DP 6954	DP 1228		6575
Handbrake Shoes	99-2000					6606

*Every EBC pad and shoe requiring ECE R-90 is available with approval subject to stock rotation - check box end label.









Models listed by Engine Size. Only listed by trim level where pads differ, (16v, GL, GT, etc).

BRAKE PADS & SHOES - APPLICATIONS

Bremsbeläge / Plaquettes + Bremsbacken / Machoires

EBC







BRAKES

Make/Model/Engine	Year	Pads  Front / Vorn / Avant		Shoes	Pads  Rear / Hinten / Arrière		Shoes
Hersteller/Modell/Motor	Jahr	Plaquettes / Bremsbeläge		Bremsbacken Machoires	Plaquettes / Bremsbeläge		Bremsbacken Machoires
Modèles	Années	Original Quality ECE R90* Approved 	Upgrade Quality Tuning/Sportbeläge ECE R90* Approved 	 ECE R90* Approved	Original Quality ECE R90* Approved 	Upgrade Quality Tuning/Sportbeläge ECE R90* Approved 	 ECE R90* Approved
MITSUBISHI Contd.							
Colt							
1.2	81-82	DP 387					6274
1.2	83-88	DP 537					6421
1.3 (C51A)	88-90	DP 537					6421
1.3 12v (C51A)	90-92	DP 941	DP 21063				6495
1.3 (CA1A) (CJ1A)	92-	DP 1063	DP 21063				6495
1.4 (C12A)	81-82	DP 387					6274
1.4 (C12A)	83-90	DP 537					6421
1.5 (C12A)	83-90	DP 537					6421
1.5 (C52A)	88-90	DP 537					6421
1.5 12v (C52A)	90-92	DP 941	DP 21063				6495
1.6 Turbo (C13A)	84-88	DP 461					6421
1.6 GTi (C53A)	88-90	DP 461			DP 576		
1.6 (CA4A)	92-96	DP 1063	DP 21063		DP 986	DP 2986	6496
1.6 (CJ4A)	96-	DP 1063	DP 21063				6495
1.8 GTi (C58A)	90-92	DP 830	DP 2830		DP 576		
1.8 GTi (CA5A)	92-96	DP 830	DP 2830		DP 986	DP 2986	
1.8 D (C14A)	84-88	DP 461					6421
Cordia							
1.4	82-85	DP 460					6355
1.6	82-84	DP 460					6355
1.6	84-85	DP 460					6422
1.6 Turbo	82-84	DP 461					6355
1.6 Turbo	84-85	DP 461					6422
1.8 Turbo	85-88	DP 461					6422
Eclipse							
2.0 2WD	91-	DP 830	DP 2830		DP 738	DP 2738	
FTO							
1.8	91-95	DP 830	DP 2830		DP 986	DP 2986	
1.8	95-	DP 830	DP 2830		DP 987		
2.0 (GPX GP GPR)	92-	DP 954	DP 2954		DP 986	DP 2986	
2.0 (GPX GP GPR)	92-	DP 954	DP 2954		DP 987		
2.0 (GR GX)	92-	DP 830	DP 2830		DP 986	DP 2986	
2.0 (GR GX)	92-	DP 830	DP 2830		DP 987		
Galant							
1.6	74-78	DP 196					5260
1.6 (A161A, V)	80-81	DP 667					6313
1.6 (A161A, V)	81-84	DP 667					5261
1.6 (E11A)	84-88	DP 461					6422
1.8 (E32A)	87-88	DP 461					6422
1.8 (E32A)	88-90	DP 461					6496
1.8 (E32A)	90-92	DP 830	DP 2830		DP 576		6496
1.8 (E52A)	93-97	DP 830	DP 2830		DP 738	DP 2738	6496
2.0	74-79	DP 196					5261
2.0 (A164A)	80-84	DP 667			DP 290		
2.0 Est (A163V)	80-84	DP 667					5261
2.0 Turbo (A164A)	80-84	DP 433			DP 290		
2.0 Turbo (E15A)	85-88	DP 461			DP 576		
2.0 (E15A)	84-88	DP 461			DP 576		
2.0 (E33A)	88-90	DP 461			DP 576		
2.0 (E33A)	90-93	DP 830	DP 2830		DP 576		
2.0 GTi 4WD (E39A)	89-90	DP 461			DP 576		
2.0 GTi 4WD/4WS (E39A)	90-92	DP 830	DP 2830		DP 576		
2.0 GLSi (E33A)	90-93	DP 830	DP 2830		DP 576		
2.0 (E55A)	93-97	DP 830	DP 2830		DP 738	DP 2738	
2.0 V6 (E54A)	93-97	DP 830	DP 2830		DP 738	DP 2738	
2.0 (EA2)	97-2001	DP 830	DP 2830		DP 738	DP 2738	
2.4	2001-	DP 1614	DP 21614		DP 738	DP 2738	

*Every EBC pad and shoe requiring ECE R-90 is available with approval subject to stock rotation - check box end label.
Models listed by Engine Size. Only listed by trim level where pads differ, (16v, GL, GT, etc).

Standard Quality - ECE R90 Approved with similar performance to original equipment brake pads.
Upgrade Quality (Tuning/ Sportbeläge) - ECE R90 Approved but with higher friction and improved performance for faster street use.
Verbesserte Qualität - mit ECE R90 Freigabe und ähnlicher Bremsleistung wie die Original Bremsbeläge.
Standard Qualität - mit ECE R90 Freigabe und ähnlicher Bremsleistung wie die Original Bremsbeläge.

Qualité standard - Approuvée par la norme ECE R90 - Des performances équivalentes à l'origine.
Qualité améliorée - Approuvée par la norme ECE R90 - Un coefficient de friction supérieur et des performances accrues pour pilotage rapide sur route.
Calidad Estándar - Aprobación CEE R90 con prestaciones similares a las pastillas originales.
Calidad Mejorada - Aprobación CEE R90 pero con un coeficiente de fricción más elevado y prestaciones mejoradas para un uso deportivo en carretera.

Make/Model/Engine Hersteller/Modell/Motor Modelos	Year Jahr Années	Pads  Front / Vorn / Avant		Shoes	Pads  Rear / Hinten / Arrière		Shoes
		Plaquettes / Bremsbeläge Original Quality ECE R90* Approved 		Bremsbacken Machoires  ECE R90* Approved	Plaquettes / Bremsbeläge Upgrade Quality Tuning/Sportbeläge ECE R90* Approved 		Bremsbacken Machoires  ECE R90* Approved
MITSUBISHI Contd.							
Galant Contd.							
2.5 VR4	90-	DP 2954	DP 3954		DP 576		
2.5 V6 (E88A)	93-96	DP 954	DP 2954		DP 987		
2.5 (EA5)	97-98	DP 830	DP 2830		DP 738	DP 2738	
2.5 (EA5)	99-2001	DP 954	DP 2954		DP 738	DP 2738	
2.5	2001-	DP 1614	DP 21614		DP 738	DP 2738	
1.8 TD (E14A) (E34A)	84-88	DP 461					6422
1.8 TD (E34A)	89-90	DP 461					6496
1.8 TD (E34A)	90-93	DP 830	DP 2830				6496
Lancer							
1.2	76-79	DP 196					5260
1.2	76-79	DP 196					5261
1.2	80-84	DP 383					6313
1.2	84-88	DP 537					6421
1.3	88-90	DP 461					6421
1.3	90-92	DP 941	DP 21063				6495
1.4	76-79	DP 196					5260
1.4	76-79	DP 196					5261
1.4	80-84	DP 383					6313
1.5 (C12A)	84-89	DP 537					6421
1.5 (C12V)	85-89	DP 537					6422
1.5 (C62A)	88-90	DP 537					6421
1.5 12v (C62A)	90-93	DP 941	DP 21063				6495
1.6	76-79	DP 196					5261
1.6	80-84	DP 383			DP 392		6421
1.6	84-88	DP 461					6421
1.6 GTi	88-90	DP 461			DP 576		
1.6	92-96	DP 1063	DP 21063				6495
1.6 (ABS)	92-96	DP 830	DP 2830		DP 576		
1.6	2000-2001	DP 830	DP 2830				
1.8 4WD	88-90	DP 461					6496
1.8 4WD	90-93	DP 941	DP 21063				6496
1.8	88-90	DP 461			DP 576		
1.8	90-96	DP 830	DP 2830		DP 576		
2.0 Turbo	80-84	DP 433			DP 290		
1.8 D	84-90	DP 461					6421
1.8 D	85-89	DP 461					6422
1.8 D	90-92	DP 941	DP 21063				6495
Lancer Evo 1	88-92	DP 2830	DP 3830		DP 576		
Lancer Evo 2	88-92	DP 2830	DP 3830		DP 576		
	88-92	DP 2954	DP 3954		DP 986		
Lancer Evo 3							
2.0	92-95	DP 2954	DP 3954		DP 986		
Lancer Evo 4							
2.0	95-98		DP 3954		DP 987		
Lancer Evo 5							
2.0 RS	98-99		DP 3954		DP 987		
2.0 GSR	98-99		DP 31210			DP 3197/2	
Lancer Evo 6							
2.0	99-2001		DP 31210			DP 3197/2	
Lancer Evo 7							
2.0	2001-2003		DP 31210			DP 3197/2	

Standard Quality - ECE R90 Approved with similar performance to original equipment brake pads.
Upgrade Quality (Tuning / Sportbeläge) - ECE R90 Approved but with higher friction and improved performance for faster street use.

Calidad Estándar - Aprobación CEE R90 con prestaciones similares a las pastillas originales.
Calidad Mejorada - Aprobación CEE R90 pero con un coeficiente de fricción más elevado y prestaciones mejoradas para un uso deportivo en carretera.

Standard Qualität - mit ECE R90 Freigabe und ähnlicher Bremsleistung wie die Original Bremsbeläge.
Verbesserte Qualität - mit ECE R90 Freigabe aber mit höherem Reibwert und verbesserter Bremsleistung für den schnellen Strasseninsatz.

*Every EBC pad and shoe requiring ECE R-90 is available with approval subject to stock rotation - check box end label.









Models listed by Engine Size. Only listed by trim level where pads differ, (16v, GL, GT, etc).

BRAKE PADS & SHOES - APPLICATIONS

Bremsbeläge / Plaquettes + Bremsbacken / Machoires

EBC









BRAKES

Make/Model/Engine	Year	Pads  Front / Vorn / Avant		Shoes	Pads  Rear / Hinten / Arrière		Shoes
Hersteller/Modell/Motor	Jahr	Plaquettes / Bremsbeläge		Bremsbacken Machoires	Plaquettes / Bremsbeläge		Bremsbacken Machoires
Modelos	Années	Original Quality ECE R90* Approved 	Upgrade Quality Tuning/Sportbeläge ECE R90* Approved 	 ECE R90* Approved	Original Quality ECE R90* Approved 	Upgrade Quality Tuning/Sportbeläge ECE R90* Approved 	 ECE R90* Approved
MITSUBISHI Contd.							
Lancer Evo 8							
2.0	2003-		DP 31210			DP 3197/2	
Mirage							
1.2	79-84	DP 196					6274
1.4	79-84	DP 196					6274
1.4 Turbo	82-84	DP 461					6274
Outlander							
2.4	2003-						
Sapporro							
1.6	82-84	DP 383			DP 290		
2.0	78-84	DP 667			DP 290		
2.0 Turbo	82-85	DP 433			DP 290		
2.4	86-90	DP 679			DP 738		
Shogun							
2.6 (L042) (L047)	83-87	DP 667					6356
2.6 (L042) (L047)	87-91	DP 716					6356
3.0 (L146)	89-91	DP 716					6356
3.0 (V23W) (V43W)	91-99	DP 954	DP 6954		DP 958	DP 6958	
3.5 (V25W) (V45W)	94-99	DP 954	DP 6954		DP 958	DP 6958	
3.5 (V65 V75)	2000-	DP 1619	DP 61619		DP 1407		
2.3 TD (L043) (L048)	83-86	DP 667					6356
2.5 TD (L044) (L049)	84-87	DP 667					6356
2.5 TD (L044) (L049) (L149)	87-91	DP 716					6356
2.5 TD (V24W) (V44W)	91-99	DP 954	DP 6954		DP 958	DP 6958	
2.8 TD (V46W)	94-99	DP 954	DP 6954		DP 958	DP 6958	
3.2 TD (V68 V78)	2000-	DP 1619	DP 61619		DP 1407		
Handbrake Shoes	91-99						6606
Shogun Pinin							
1.8	2000-2001	DP 1347			DP 738		
1.8	2001-	DP 1347			DP 1484		
2.0	2001-	DP 1347			DP 1484		
Shogun Sport							
3.0	2000-	DP 954	DP 6954		DP 1228		
2.5 TD	2000-	DP 954	DP 6954		DP 1228		
Sigma							
1.6	77-80	DP 196					5261
1.6	80-81	DP 383					5261
2.0	77-80	DP 196					5261
2.0	80-81	DP 383					5261
3.0 V6	90-92	DP 954	DP 2954		DP 738	DP 2738	
3.0 V6	92-	DP 954	DP 2954		DP 987		
3.0 Est	93-	DP 954	DP 2954		DP 738	DP 2738	
Spacegear							
2.0	95-	DP 1124					6586
2.0	95-	DP 830	DP 2830		DP 958		
2.4	95-	DP 1124					6586
2.4	95-	DP 830	DP 2830		DP 958		
2.5 TD	95-	DP 830	DP 2830		DP 958		
2.5 D	95-	DP 1124					6586
2.5 D	95-	DP 830	DP 2830		DP 958		

Standard Quality - ECE R90 Approved with similar performance to original equipment brake pads.
 Upgrade Quality (Tuning/ Sportbeläge) - ECE R90 Approved but with higher friction and improved performance for faster street use.
 Verbesserte Qualität - mit ECE R90 Freigabe aber mit höherem Reibwert und verbesserter Bremsleistung für den schnellen Strasseninsatz.

Qualité standard - Approuvée par la norme ECE R90 - Des performances équivalentes à l'origine.
 Qualité améliorée - Approuvée par la norme ECE R90 - Un coefficient de friction supérieur et des performances accrues pour pilotage rapide sur route.
 Calidad Mejorada - Aprobación CEE R90 con prestaciones similares a las pastillas originales.
 Calidad Mejorada - Aprobación CEE R90 pero con un coeficiente de fricción más elevado y prestaciones mejoradas para un uso deportivo en carretera.

*Every EBC pad and shoe requiring ECE R-90 is available with approval subject to stock rotation - check box end label.
 Models listed by Engine Size. Only listed by trim level where pads differ, (16v, GL, GT, etc).

Make/Model/Engine Hersteller/Modell/Motor Modèles	Year Jahr Années	Pads  Front / Vorn / Avant		Shoes	Pads  Rear / Hinten / Arrière		Shoes
		Original Quality ECE R90* Approved 	Upgrade Quality Tuning/Sportbeläge ECE R90* Approved 	Bremsbacken Machoires 	Original Quality ECE R90* Approved 	Upgrade Quality Tuning/Sportbeläge ECE R90* Approved 	Bremsbacken Machoires 
MITSUBISHI Contd.							
Spacerunner							
1.8	91-	DP 830	DP 2830				
1.8 (ABS)	91-	DP 830	DP 2830		DP 738	DP 2738	6496
2.0 TD	92-	DP 830	DP 2830		DP 738	DP 2738	6496
Spacestar							
1.3	99-2001	DP 1045	DP 21045				6574
1.3	2001-	DP 1045	DP 21045		DP 1076		
1.6	2001-	DP 1045	DP 21045		DP 1076		
1.8	99-2001	DP 1045	DP 21045				6574
1.8	2001-2002	DP 1045	DP 21045		DP 1076		
1.9 D	2002-						
Space Wagon							
1.8	84-90	DP 461					6422
1.8 (4WD)	85-90	DP 461					6460
1.8	91-93	DP 830	DP 2830		DP 738	DP 2738	6496
2.0 (4WD)	85-90	DP 461					6460
2.0	92-99	DP 830	DP 2830		DP 738	DP 2738	6496
2.0	2001-	DP 1442					
2.4	98-2000	DP 954	DP 2954		DP 987		
2.4	2001-	DP 1442					
1.8 TD	85-90	DP 461					6422
2.0 TD	95-96	DP 830	DP 2830		DP 738	DP 2738	6496
Starion							
2.0 Turbo	82-88	DP 433			DP 290		
2.6 Turbo	89-90	DP 433			DP 290		
Tredia							
1.4	82-84	DP 460					6355
1.6	82-84	DP 460					6355
1.6 Turbo	82-84	DP 461					6355
1.8	85-88	DP 461					6422
1.8 (4WD)	85-88	DP 461					6355
3000 GT							
3.0 Twin Turbo	92-	-	DP 31097		-	DP 31098	
3000 GTO							
	90-	-	DP 31200		DP 987		

Pad Illustrations for Mitsubishi

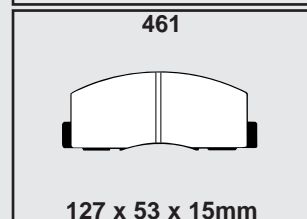
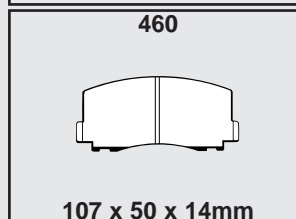
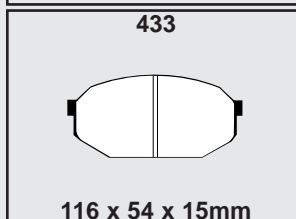
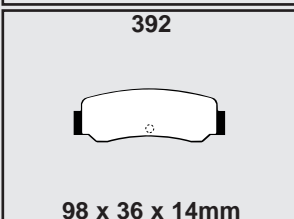
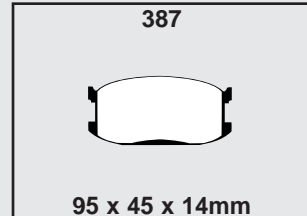
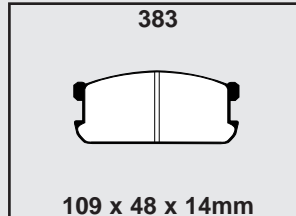
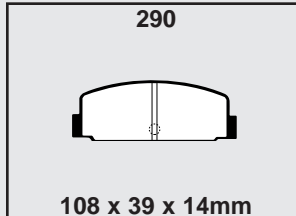
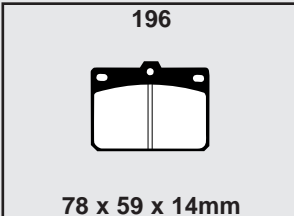

Standard Quality - ECE R90 Approved with similar performance to original equipment brake pads.
Upgrade Quality (Tuning / Sportbeläge) - ECE R90 Approved but with higher friction and improved performance for faster street use.

Standard Qualität - mit ECE R90 Freigabe und ähnlicher Bremsleistung wie die Original Bremsbeläge.
Verbesserte Qualität - mit ECE R90 Freigabe aber mit höherem Reibwert und verbesserter Bremsleistung für den schnellen Strasseninsatz.

BRAKE PADS & SHOES - APPLICATIONS











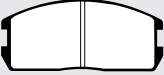

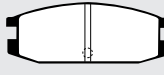
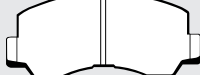
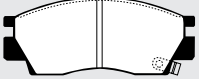

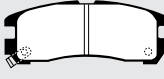



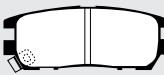
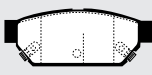

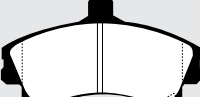

Bremsbeläge / Plaquettes + Bremsbacken / Machoires

EBC

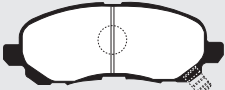
BRAKES

Make/Model/Engine	Year	Front / Vorn / Avant	Shoes	Rear / Hinten / Arrière	Shoes
Hersteller/Modell/Motor	Jahr	Plaquettes / Bremsbeläge	Bremsbacken Machoires	Plaquettes / Bremsbeläge	Bremsbacken Machoires
Modelos	Années	Original Quality ECE R90* Approved	Upgrade Quality Tuning/Sportbeläge ECE R90* Approved	Original Quality ECE R90* Approved	Upgrade Quality Tuning/Sportbeläge ECE R90* Approved

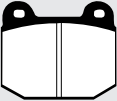
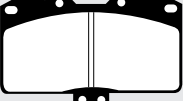
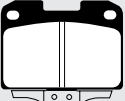
Pad Illustrations for Mitsubishi

537  108 x 48 x 15mm	576  98 x 44 x 14mm	611  108 x 40 x 13mm	667  128 x 57 x 15mm
679  128 x 52 x 17mm	716  127 x 57 x 17mm	738  107 x 41 x 15mm	830  128 x 51 x 16mm
941  115 x 50 x 15mm	954  150 x 59 x 16mm	958  108 x 44 x 15mm	986  99 x 37 x 14mm
987  108 x 46 x 16mm	1039  119 x 68 x 15mm	1045  130 x 73 x 16mm	1063  114 x 50 x 15mm
1124  137 x 55 x 15mm	1228  79 x 58 x 14mm	1347  123 x 49 x 15mm	1407  91 x 46 x 15mm
1442  145 x 56 x 16mm	1484  103 x 39 x 15mm	1614  145 x 56 x 16mm	1619  139 x 57 x 15mm
3197/2  76 x 65 x 14mm	31097  119 x 74 x 14mm	31098  81 x 69 x 16mm	31200  120 x 70 x 14mm

*Every EBC pad and shoe requiring ECE R-90 is available with approval subject to stock rotation - check box end label.
Models listed by Engine Size. Only listed by trim level where pads differ, (16v, GL, GT, etc).

Standard Quality - ECE R90 Approved with similar performance to original equipment brake pads.
Upgrade Quality (Tuning / Sportbeläge) - ECE R90 Approved but with higher friction and improved performance for faster street use.
Verbesserte Qualität - mit ECE R90 Freigabe aber mit höherem Reibwert und verbesserter Bremsleistung für den schnellen Strasseninsatz.

Qualité standard - Approuvée par la norme ECE R90 - Des performances équivalentes à l'origine.
Qualité améliorée - Approuvée par la norme ECE R90 - Un coefficient de friction supérieur et des performances accrues pour pilotage rapide sur route.
Calidad Mejorada - Aprobación CEE R90 con prestaciones similares a las pastillas originales.
Calidad Mejorada - Aprobación CEE R90 pero con un coeficiente de fricción más elevado y prestaciones mejoradas para un uso deportivo en carretera.

Make/Model/Engine	Year	Pads	Front / Vorn / Avant	Shoes	Pads	Rear / Hinten / Arrière	Shoes
Hersteller/Modell/Motor	Jahr	Plaquettes / Bremsbeläge		Bremsbacken Machoires	Plaquettes / Bremsbeläge		Bremsbacken Machoires
Modelos	Années	Original Quality ECE R90* Approved	Upgrade Quality Tuning/Sportbeläge ECE R90* Approved	Original Quality ECE R90* Approved	Upgrade Quality Tuning/Sportbeläge ECE R90* Approved	Original Quality ECE R90* Approved	Upgrade Quality Tuning/Sportbeläge ECE R90* Approved

Pad Illustrations for Mitsubishi Contd.

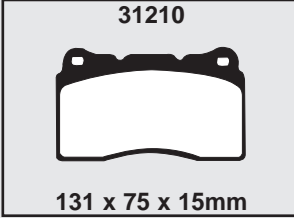

MITSUBISHI COMMERCIAL

L 200

1.6 (L021P)	79-82	DP 667					6357
2.0 (K12T K22T)	86-96	DP 716					6356
2.0	96-2001	DP 1124					6356
3.0	2001-						
2.5 D (K14T)	86-96	DP 716					6356
2.5 TD (K24T)	92-96	DP 716					6356
2.5 TD (K34T)	95-97	DP 716					6356
2.5 TD (K74T)	97-2002	DP 1124					6356
2.5 TD	2002-	DP 1481					

L 300

1.6 (L032P)	79-81	DP 446					6389
1.6 (L032P)	81-86	DP 667					6356
1.6 (L062P)	83-91	DP 667					6356
1.6 (P02V) (P12V)	86-94	DP 716					6356
2.0 (P03V) (P13V)	94-	DP 716					6356
2.0	94-	DP 1124					6356
2.4	94-	DP 1124					6356
2.5 D (L039P)	87-91	DP 667					6356
2.5 D (P05V) (P15V)	86-94	DP 716					6356
2.5 D	94-	DP 1124					6356
2.5 TD	94-	DP 1124					6356

L 400

2.5 TD	96-	DP 1124			DP 958		
--------	-----	---------	--	--	--------	--	--

Minibus

1.6 (LO32P)	87-89	DP 667					6356
2.0 (PO3W)	87-90	DP 716					6356
2.0 4WD (P23W)	87-94	DP 716					6467
2.4 (P24W)	87-94	DP 716					6467
2.5 D (PO5W)	87-89	DP 667					6356
2.5 D (LO39P)	87-89	DP 667					6356

Pad Illustrations for Mitsubishi Commercial

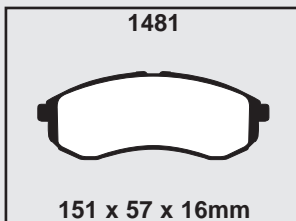
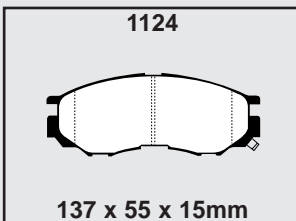
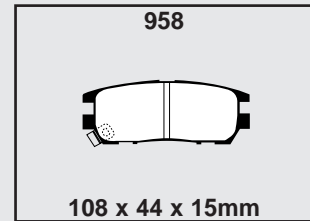
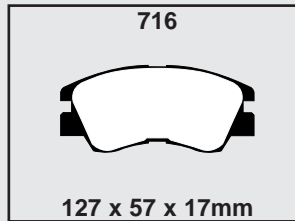
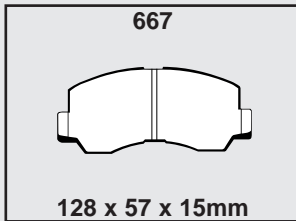
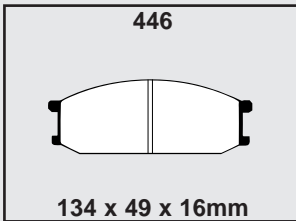

Standard Quality - ECE R90 Approved with similar performance to original equipment brake pads.
Upgrade Quality (Tuning / Sportbeläge) - ECE R90 Approved but with higher friction and improved performance for faster street use.

Standard Qualität - mit ECE R90 Freigabe und ähnlicher Bremsleistung wie die Original Bremsbeläge.
Verbesserte Qualität - mit ECE R90 Freigabe aber mit höherem Reibwert und verbesserter Bremsleistung für den schnellen Strasseninsatz.

Quality standard - Approuvée par la norme ECE R90 - Des performances équivalentes à l'origine.
Qualité améliorée - Approuvée par la norme ECE R90 - Un coefficient de friction supérieur et des performances accrues pour pilotage rapide sur route.

Calidad Estándar - Aprobación CEE R90 con prestaciones similares a las pastillas originales.
Calidad Mejorada - Aprobación CEE R90 pero con un coeficiente de fricción más elevado y prestaciones mejoradas para un uso deportivo en carretera.





*Every EBC pad and shoe requiring ECE R-90 is available with approval subject to stock rotation - check box end label.

Models listed by Engine Size. Only listed by trim level where pads differ, (16v, GL, GT, etc).

BRAKE PADS & SHOES - APPLICATIONS

Bremsbeläge / Plaquettes + Bremsbacken / Machoires

EBC BRAKES

Make/Model/Engine	Year	Pads  Front / Vorn / Avant		Shoes	Pads  Rear / Hinten / Arrière		Shoes
Hersteller/Modell/Motor	Jahr	Plaquettes / Bremsbeläge		Bremsbacken Machoires	Plaquettes / Bremsbeläge		Bremsbacken Machoires
Modèles	Années	Original Quality ECE R90* Approved	Upgrade Quality Tuning/Sportbeläge ECE R90* Approved	 ECE R90* Approved	Original Quality ECE R90* Approved	Upgrade Quality Tuning/Sportbeläge ECE R90* Approved	 ECE R90* Approved
MITSUBISHI (SA)							
Colt Rodeo							
3.0	98-	DP 538	DP 6538				
2.8 D	98-	DP 538	DP 6538				
2.8 TD	98-	DP 538	DP 6538				

Pad Illustrations for Mitsubishi (SA)

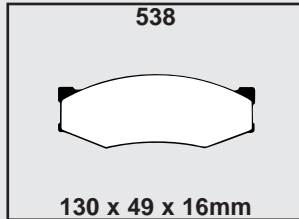

MITSUBISHI (J)							
Legnum							
2.5 Turbo		DP 2954	DP 3954		DP 738	DP 2738	

Pad Illustrations for Mitsubishi (J)

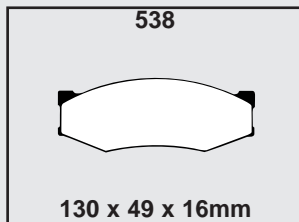

MITSUBISHI (Malaysia & The Philippines)							
Lancer							
	90-93	DP 941					
	93-2001	DP 1063	DP 21063				
MX	99-2001	DP 830	DP 2830		DP 986	DP 2986	
Galant							
SS	88-93	DP 461					
GTi	90-93	DP 830	DP 2830		DP 576		
	93-98	DP 830	DP 2830		DP 738	DP 2738	
VR	93-98	DP 954	DP 2954		DP 576		

Pad Illustrations for Mitsubishi (Malaysia & The Philippines)

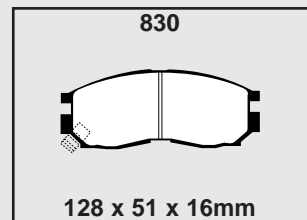
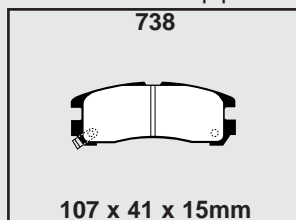
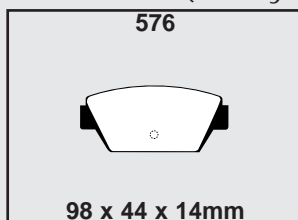
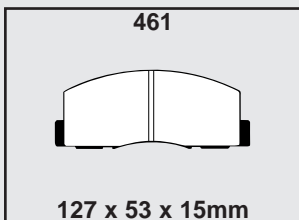

Standard Quality - ECE R90 Approved with similar performance to original equipment brake pads.
Upgrade Quality (Tuning/ Sportbeläge) - ECE R90 Approved but with higher friction and improved performance for faster street use.
Verbesserte Qualität - mit ECE R90 Freigabe aber mit höherem Reibwert und verbesserter Bremsleistung für den schnellen Strasseninsatz.

Qualité standard - Approuvée par la norme ECE R90 - Des performances équivalentes à l'origine.
Qualité améliorée - Approuvée par la norme ECE R90 - Un coefficient de friction supérieur et des performances accrues pour pilotage rapide sur route.
Calidad Mejorada - Aprobación CEE R90 con prestaciones similares a las pastillas originales.
Calidad Mejorada - Aprobación CEE R90 pero con un coeficiente de fricción más elevado y prestaciones mejoradas para un uso deportivo en carretera.

*Every EBC pad and shoe requiring ECE R-90 is available with approval subject to stock rotation - check box end label.
Models listed by Engine Size. Only listed by trim level where pads differ, (16v, GL, GT, etc).

Make/Model/Engine	Year	Front / Vorn / Avant	Shoes	Rear / Hinten / Arrière	Shoes
Hersteller/Modell/Motor	Jahr	Plaquettes / Bremsbeläge	Bremsbacken Machoires	Plaquettes / Bremsbeläge	Bremsbacken Machoires
Modelos	Années	Original Quality ECE R90* Approved	Upgrade Quality Tuning/Sportbeläge ECE R90* Approved	Original Quality ECE R90* Approved	Upgrade Quality Tuning/Sportbeläge ECE R90* Approved

Pad Illustrations for Mitsubishi (Malaysia & The Philippines) Contd.

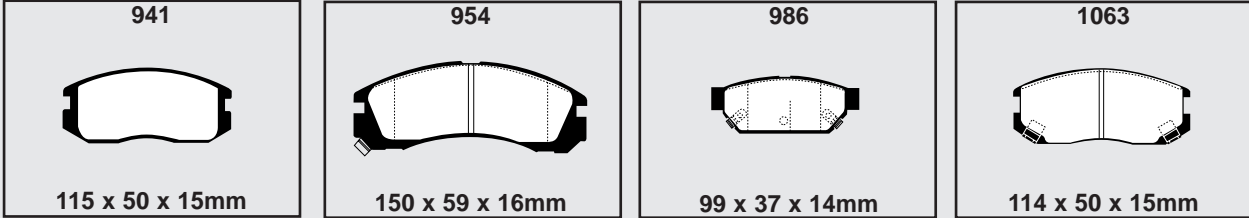

MORGAN

4/4	59-66	-	DP 2141		
1.6	66-94	DP 106	DP 2106		5139
1.8	93-	DP 243	DP 2243		6380
2.0	66-94	DP 106	DP 2106		5139
Plus 4					
	59-66	-	DP 2141		
1.6	66-	DP 106	DP 2106		
2.0	85-94	DP 106	DP 2106		5139
2.0	94-	DP 243	DP 2243		6380
Plus 8					
3.5	66-73	DP 169	DP 2291		5139
3.5	74-78	DP 258	DP 2291		5139
3.5	78-90	DP 197	DP 2197		5139
3.9	90-94	DP 197	DP 2197		5139
3.9	94-	DP 243	DP 2243		6380
4.6	97-	DP 243	DP 2243		6380
Aero 8					
4.4	2000-	DP 2036	DP 3036	DP 2102	DP 3102

Pad Illustrations for Morgan

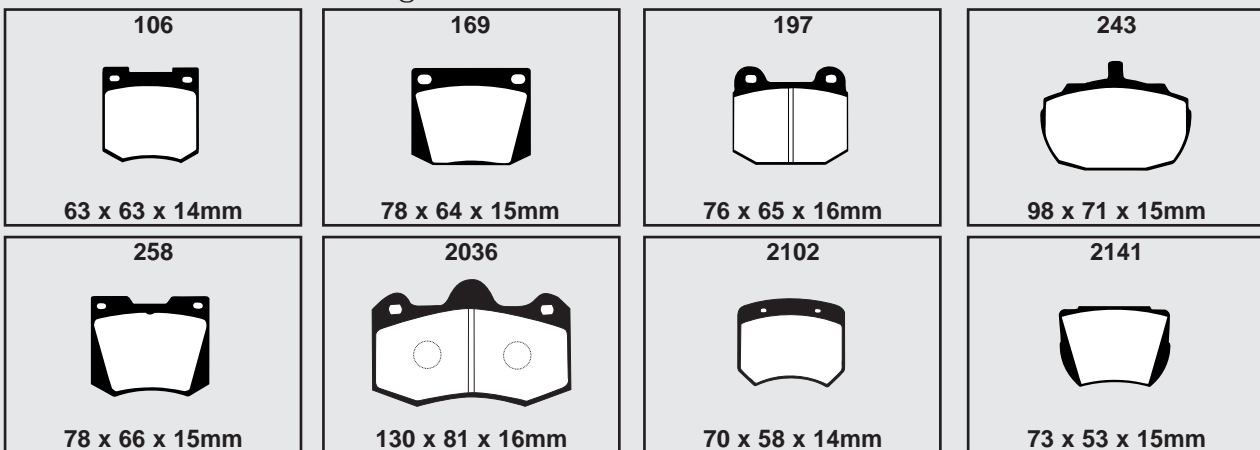

MOSKVITCH

1.5	65-78		5165		5165
1.5	78-				5165

*Every EBC pad and shoe requiring ECE R-90 is available with approval subject to stock rotation - check box end label.









Models listed by Engine Size. Only listed by trim level where pads differ, (16v, GL, GT, etc).

BRAKE PADS & SHOES - APPLICATIONS

Bremsbeläge / Plaquettes + Bremsbacken / Machoires

EBC

BRAKES

Make/Model/Engine	Year	Pads  Front / Vorn / Avant		Shoes	Pads  Rear / Hinten / Arrière		Shoes
Hersteller/Modell/Motor	Jahr	Plaquettes / Bremsbeläge		Bremsbacken Machoires	Plaquettes / Bremsbeläge		Bremsbacken Machoires
Modelos	Années	Original Quality ECE R90* Approved 	Upgrade Quality Tuning/Sportbeläge ECE R90* Approved 	 ECE R90* Approved	Original Quality ECE R90* Approved 	Upgrade Quality Tuning/Sportbeläge ECE R90* Approved 	 ECE R90* Approved
NSU							
Prinz							
1.0	67-73	DP 105	DP 2105	5104/1			5104
1.0	67-77	DP 105	DP 2105	5126/1			5126
1.2	67-77	DP 105	DP 2105	5126/1			5126
R080							
2.0	68-77	DP 125	DP 2753		DP 105	DP 2105	
Handbrake shoes	68-77			5124			

Pad Illustrations for NSU

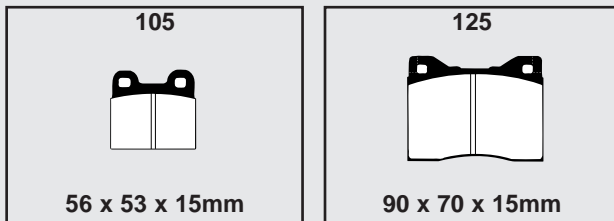

NISSAN							
Almera							
1.4	95-2000	DP 1044	DP 21044		DP 1067	DP 21067	6491
1.4	97-2000	DP 1360			DP 1067		6491
1.4	97-2000	DP 1360			DP 889		6491
1.5	2000-	DP 833	DP 2833		DP 834		
1.6	95-2000	DP 1044	DP 21044		DP 1067	DP 21067	6491
1.6	97-2000	DP 1360			DP 1067		6491
1.6	97-2000	DP 1360			DP 889		6491
1.8	2000-	DP 1238	DP 21238		DP 834		
2.0	2000-2002	DP 1238	DP 21238		DP 834		
2.0 GTi	96-2000	DP 1101	DP 2839		DP 889	DP 2889	
2.0 D	95-2000	DP 1044	DP 21044		DP 1067	DP 21067	6491
2.0 D	97-2000	DP 1360			DP 1067		6491
2.0 D	97-2000	DP 1360			DP 889		6491
2.2 D	2000-	DP 1238	DP 21238		DP 834		
Almera Tino							
1.8	2000-	DP 1339	DP 21339		DP 834		
2.0	2000-	DP 1339	DP 21339		DP 834		
2.2 D	2000-	DP 1339	DP 21339		DP 834		
Bluebird							
1.6 (610)	71-75	DP 129					5176
1.6 (610)	75-76	DP 201					5176
1.6 (510)	76-80	DP 286					5176
1.6 (810)	76-80	DP 273					5262
1.6 (910)	80-84	DP 365			DP 468		5262
1.6 (T12) (T72)	86-90	DP 538	DP 2538				6385
1.8 (610)	71-75	DP 129					5176
1.8 (610)	75-76	DP 201					5176
1.8 (510)	76-80	DP 286					5176
1.8 (810)	76-80	DP 273	DP 2273				5262
1.8 (910)	80-84	DP 365			DP 468		5262
1.8 (U11)	84-86	DP 538	DP 2538				5262
1.8 (T12) (T72)	86-90	DP 538	DP 2538		DP 528		6385
1.8 Turbo (U11)	84-86	DP 538	DP 2538		DP 528		
1.8 Turbo (T72) (T12)	86-90	DP 538	DP 2538		DP 528		
2.0 (U11)	84-90	DP 538	DP 2538				5262
2.0 (T12) (T72)	86-90	DP 538	DP 2538		DP 528		6385
2.0 D (T12) (T72)	86-90	DP 538	DP 2538		DP 528		6385









*Every EBC pad and shoe requiring ECE R-90 is available with approval subject to stock rotation - check box end label.
Models listed by Engine Size. Only listed by trim level where pads differ, (16v, GL, GT, etc).

Standard Quality - ECE R90 Approved with similar performance to original equipment brake pads.
Upgrade Quality (Tuning/ Sportbeläge) - ECE R90 Approved but with higher friction and improved performance for faster street use.
Verbesserte Qualität - mit ECE R90 Freigabe aber mit höherem Reibwert und verbesserter Bremsleistung für den schnellen Strasseninsatz.

Standard Qualität - mit ECE R90 Freigabe und ähnlicher Bremsleistung wie die Original Bremsbeläge.
Qualité améliorée - Approuvée par la norme ECE R90 - Un coefficient de friction supérieur et des performances accrues pour pilotage rapide sur route.
Calidad Mejorada - Aprobación CEE R90 con prestaciones similares a las pastillas originales.
Calidad Mejorada - Aprobación CEE R90 pero con un coeficiente de fricción más elevado y prestaciones mejoradas para un uso deportivo en carretera.

Standard Quality - ECE R90 Approved with similar performance to original equipment brake pads.
 Upgrade Quality (Tuning / Sportbeläge) - ECE R90 Approved but with higher friction and improved performance for faster street use.

Standard Qualität - mit ECE R90 Freigabe und ähnlicher Bremsleistung wie die Original Bremsbeläge.
 Verbesserte Qualität - mit ECE R90 Freigabe aber mit höherem Reibwert und verbesserter Bremsleistung für den schnellen Strasseninsatz.

Make/Model/Engine Hersteller/Modell/Motor Modelos	Year Jahr Années	Pads  Front / Vorn / Avant		Shoes	Pads  Rear / Hinten / Arrière		Shoes
		Original Quality ECE R90* Approved 	Upgrade Quality Tuning/Sportbeläge ECE R90* Approved 	Bremsbacken Machoires 	Original Quality ECE R90* Approved 	Upgrade Quality Tuning/Sportbeläge ECE R90* Approved 	Bremsbacken Machoires 
NISSAN Contd.							
C Series							
240C	72-80	DP 273	DP 2273				6269
260C	72-80	DP 273	DP 2273				6269
280C	72-80	DP 273	DP 2273				6269
280C (430) Sal	80-81	DP 352	DP 2352		DP 367		
280C (430) Sal	81-84	DP 365			DP 367		
280C (430) Est	80-84	DP 562					6360
280C (Y30)	83-88	DP 527	DP 2538		DP 367		
300C (Y30)	84-88	DP 527	DP 2538		DP 367		6360
300C Est (Y30)	84-88	DP 527	DP 2538				6360
Cherry							
1.0	71-78			5178			5179
1.0 (E10) Sal	71-76	DP 144					5179
1.0 (E10) Est	71-76			5178			5179
1.0 (F10, F11)	76-79	DP 139					5179
1.0 (N10)	79-83	DP 139					5265
1.0 (N12)	82-86	DP 452	DP 2452				6330
1.2 (E10) Sal	71-76	DP 144					5179
1.2 (E10) Est	71-76			5178			5179
1.2 (F10, F11)	76-79	DP 139					5179
1.2 (N10)	79-83	DP 139					5265
1.3 (N10)	79-83	DP 139					5265
1.3 (N12)	82-86	DP 452	DP 2452				6330
1.5 (N12)	82-86	DP 452	DP 2452				6330
1.5 (N12) Turbo ZX	83-85	DP 452	DP 2452				6330
Cherry Europe							
1.2	83-85	DP 506(T)					6330
1.2	83-85	DP 317(B)	DP 2317				6330
1.5	83-85	DP 506(T)					6330
1.5	83-85	DP 317(B)	DP 2317				6330
Figaro							
1.0	91-92	DP 452	DP 2452				
Laurel							
2.0 (C130)	73-77	DP 273	DP 2273				5176
2.0 (C230)	77-81	DP 273	DP 2273				5262
2.0 (C31)	81-84	DP 365					5262
2.4 (C230)	77-81	DP 287					5262
2.4 (C31)	81-86	DP 365					5262
2.4 (C32)	85-89	DP 538	DP 2538	686/2			6385
Maxima							
3.0 V6	88-91	DP 775	DP 2775		DP 528		
3.0 V6	91-94	DP 1046			DP 889		
Maxima QX							
2.0	2000-	DP 1471			DP 889		
3.0	2000-	DP 1471			DP 889		
Micra							
1.0 (K10)	82-89	DP 484					6335
1.0 (K10)	89-92	DP 636					6335
1.0 (K11)	93-2000	DP 946	DP 2946		DP 998		6490
1.0	2000-2003	DP 946	DP 2946		DP 998		
1.0	2003-	DP 1485	DP 21485				
1.2 (K10)	89-93	DP 636					6335
1.2	2003-	DP 1485	DP 21485				
1.3 (K11)	93-2000	DP 946	DP 2946		DP 998		6490
1.4	2000-2003	DP 946	DP 2946		DP 998		

*Every EBC pad and shoe requiring ECE R-90 is available with approval subject to stock rotation - check box end label.









Models listed by Engine Size. Only listed by trim level where pads differ, (16v, GL, GT, etc).

BRAKE PADS & SHOES - APPLICATIONS

Bremsbeläge / Plaquettes + Bremsbacken / Machoires

EBC

BRAKES









Make/Model/Engine Hersteller/Modell/Motor Modèles	Year Jahr Années	Pads  Front / Vorn / Avant		Shoes	Pads  Rear / Hinten / Arrière		Shoes
		Original Quality ECE R90* Approved 	Upgrade Quality Tuning/Sportbeläge ECE R90* Approved 	Bremsbacken Machoirs 	Original Quality ECE R90* Approved 	Upgrade Quality Tuning/Sportbeläge ECE R90* Approved 	Bremsbacken Machoirs 
NISSAN Contd.							
Micra Contd.							
1.4	2003-	DP 1485	DP 21485				
1.5 TD	2003-	DP 1485	DP 21485				
Patrol							
2.8 (160) (260)	82-90	DP 445	DP 6445				6387
3.0 (260)	90-92	DP 445	DP 6445				6511
4.2 (Y60)	92-98	DP 1020			DP 688		
2.8 TD (Y743)	90-92	DP 445	DP 6445				6511
2.8 TD	96-98	DP 445	DP 6445		DP 688		
2.8 TD	98-2001	DP 1280					1279
3.0 D	2000-	DP 1280					1279
3.3 TD (160) (260)	82-90	DP 445	DP 6445				6387
4.2 TD (Y60)	93-98	DP 445	DP 6445		DP 688		
Prairie							
1.5 (M10)	82-87	DP 365					6361
1.8 (M10)	84-89	DP 365					6361
2.0 (M11)	89-92	DP 792	DP 2792				6385
Primera							
1.6 (P10)	90-96	DP 839	DP 2839				6461
1.6 (W10)	91-98	DP 792	DP 2792				6385
1.6 (W11)	99-2002	DP 1238	DP 21238		DP 834		
1.6 (W11)	98-99	DP 833	DP 2833		DP 834		
1.6 (P10)	93-96	DP 833	DP 2833		DP 834		
1.6 (P11)	96-98	DP 833	DP 2833		DP 834		
1.6 (P11)	98-2002	DP 1238	DP 21238		DP 834		
1.8 (W11)	98-99	DP 833	DP 2833		DP 834		
1.8 (P11) (W11)	98-2002	DP 1238	DP 21238		DP 834		
1.8	2002-	DP 1339	DP 21339		DP 1354	DP 21354	
2.0 (P10) (P11)	90-99	DP 833	DP 2833		DP 834		
2.0 (W10)	91-98	DP 792	DP 2792		DP 889	DP 2889	
2.0 (P11) (W11)	96-2002	DP 1238(G)	DP 21238(G)		DP 834		
2.0 (P11) (W11)	99-2002	DP 1376(T)	DP 21376(T)		DP 834		
2.0	2002-	DP 1339	DP 21339		DP 1354	DP 21354	
2.0 D (P10)	90-93	DP 839	DP 2839				6461
2.0 D (P10)	93-96	DP 833	DP 2833		DP 834		
2.0 D (P11)	96-99	DP 833	DP 2833		DP 834		
2.0 D (W10)	95-98	DP 792	DP 2792		DP 889	DP 2889	
2.0 TD (P11) (W11)	96-99	DP 1238	DP 21238		DP 834		
2.0 TD (W11)	98-99	DP 833	DP 2833		DP 834		
2.0 TD	99-2002	DP 1238	DP 21238		DP 834		
2.2 TD	2002-	DP 1339	DP 21339		DP 1354	DP 21354	
QX							
2.0	95-2000	DP 775	DP 2775		DP 889	DP 2889	
3.0	95-2000	DP 1082			DP 889		
Serena							
1.6	93-2000	DP 947					6505
2.0	93-2000	DP 947					6505
2.0 D	93-95	DP 947					6505
2.3 D	94-2001	DP 947					6505
Silvia							
1.8 ZX Turbo	84-89	DP 527	DP 2538		DP 528		
2.0 ZX	84-89	DP 538	DP 2538		DP 528		

Standard Quality - ECE R90 Approved with similar performance to original equipment brake pads.
 Upgrade Quality (Tuning/ Sportbeläge) - ECE R90 Approved but with higher friction and improved performance for faster street use.
 Verbesserte Qualität - mit ECE R90 Freigabe und ähnlicher Bremsleistung wie die Original Bremsbeläge.
 Standard Qualität - mit ECE R90 Freigabe und ähnlicher Bremsleistung wie die Original Bremsbeläge.
 Calidad Estándar - Aprobación CEE R90 con prestaciones similares a las pastillas originales.
 Qualité standard - Approuvée par la norme ECE R90 - Des performances équivalentes à l'origine.
 Calidad Mejorada - Aprobación CEE R90 pero con un coeficiente de fricción más elevado y prestaciones mejoradas para un uso deportivo en carretera.
 Qualité améliorée - Approuvée par la norme ECE R90 - Un coefficient de friction supérieur et des performances accrues pour pilotage rapide sur route.

*Every EBC pad and shoe requiring ECE R-90 is available with approval subject to stock rotation - check box end label.
 Models listed by Engine Size. Only listed by trim level where pads differ, (16v, GL, GT, etc).

Standard Quality - ECE R90 Approved with similar performance to original equipment brake pads.
 Upgrade Quality (Tuning / Sportbeläge) - ECE R90 Approved but with higher friction and improved performance for faster street use.

Calidad Estandar - Aprobacion CEE R90 con prestaciones similares a las pastillas originales.
 Calidad Mejorada - Aprobacion CEE R90 pero con un coeficiente de friccion mas elevado y prestaciones mejoradas para un uso deportivo en carretera.

Make/Model/Engine Hersteller/Modell/Motor Modelos	Year Jahr Années	Pads  Front / Vorn / Avant		Shoes	Pads  Rear / Hinten / Arrière		Shoes
		Original Quality ECE R90* Approved 	Upgrade Quality Tuning/Sportbeläge ECE R90* Approved 	Bremsbacken Machoires 	Original Quality ECE R90* Approved 	Upgrade Quality Tuning/Sportbeläge ECE R90* Approved 	Bremsbacken Machoires 
NISSAN Contd.							
Skyline							
240K (C110)	68-75	DP 198					5176
240K (C110, C111)	75-77	DP 273	DP 2273				5176
240K (C210)	77-82	DP 273	DP 2273		DP 331		6390
240K GT	82-85	DP 418			DP 528		
Skyline R32 GTR							
	92-95	-	DP 31032		-	DP 3197/2	
Skyline GTR 33							
	95-97	-	DP 31032		-	DP 3197/2	
Skyline GT-R 34							
2.6 Twin Turbo	97-	-	DP 31032		-	DP 3197/2	
Stanza							
1.6	82-85	DP 365					5265
1.6	85-86	DP 526					5265
1.8	81-85	DP 418					5265
Sunny							
1.2 (B110, 210) Sal	71-75	DP 139					5174
1.2 (B110, 210) Est	71-75			5173			5174
1.2 (B210, 120 Y) Sal	76-78	DP 201					5174
1.2 (B210, 120 Y) Est	75-78	DP 201					5265
1.2 (B310, 120 Y)	76-80	DP 201					5265
1.2 (B310, 120 Y)	80-82	DP 286					5265
1.3 (B11)	82-86	DP 452	DP 2452				6330
1.3 (B12) (N13)	86-92	DP 452	DP 2452				6330
1.4 (140 Y) (B310)	78-80	DP 201					5265
1.4 (140 Y) (B310)	80-82	DP 286					5265
1.4 (B12) (N13)	86-92	DP 452	DP 2452				6330
1.4 (N14)	91-95	DP 892			DP 889		6491
1.5 (B310)	81-82	DP 286					5265
1.5 (B11)	82-86	DP 452	DP 2452				6330
1.6 4WD (B12) (N13)	83-87	DP 665	DP 2665				6330
1.6 4WD	87-91	DP 665	DP 2665				6385
1.6 (B12) (N13)	86-92	DP 452	DP 2452				6330
1.6 LX (B12) (N13)	86-92	DP 665	DP 2665				6330
1.6 ZX (B12) (N13)	86-92	DP 665	DP 2665				6330
1.6 GTi	86-92	DP 665	DP 2665		DP 682		
1.6 (Y10) Est	90-95	DP 988					6385
1.6 (N14)	91-95	DP 892			DP 889		6491
1.8 (B12)	89-91	DP 665	DP 2665		DP 682		
1.8 GTi (N13)	86-92	DP 665	DP 2665		DP 682		
2.0 GTi (N14)	92-95	DP 1101	DP 2839		DP 889		
2.0 GTi R (N14)	92-93	DP 2839	DP 3839		DP 889		
1.7 D (B12) (N13)	86-91	DP 665	DP 2665				6330
2.0 D (N14)	92-95	DP 892			DP 889		6491
2.0 D (N14) Est	92-95	DP 988					6491
Terrano II							
2.4	93-2000	DP 947			DP 1000		6505
2.7 TD	93-	DP 947			DP 1000		6505
3.0 D	2002-	DP 947					

*Every EBC pad and shoe requiring ECE R-90 is available with approval subject to stock rotation - check box end label.









Models listed by Engine Size. Only listed by trim level where pads differ, (16v, GL, GT, etc).

BRAKE PADS & SHOES - APPLICATIONS

Bremsbeläge / Plaquettes + Bremsbacken / Machoires

EBC

BRAKES

Make/Model/Engine Hersteller/Modell/Motor Modèles	Year Jahr Années	Pads  Front / Vorn / Avant		Shoes	Pads  Rear / Hinten / Arrière		Shoes
		Original Quality ECE R90* Approved 	Upgrade Quality Tuning/Sportbeläge ECE R90* Approved 	Bremsbacken Machoires 	Original Quality ECE R90* Approved 	Upgrade Quality Tuning/Sportbeläge ECE R90* Approved 	Bremsbacken Machoires 
NISSAN Contd.							
Violet							
1.4 (710)	73-75	DP 129					5176
1.4 (710)	75-77	DP 201					5176
1.4 (A10)	77-81	DP 286					5265
1.6 (710)	73-75	DP 129					5176
1.6 (710)	75-77	DP 201					5176
1.6 (A10)	77-81	DP 286					5262
X-Trail							
2.0	2001-	-	DP 61247				
2.5	2003-						
2.2 D	2001-	-	DP 61247				
100NX							
1.6	91-94	DP 892			DP 889		6491
200SX							
1.8 Turbo	88-91	DP 792	DP 2792		DP 686/2		
1.8 Turbo	91-94	DP 775	DP 2775		DP 686/2		
2.0 Turbo	94-2001	DP 21200	DP 31200		DP 1105		
240Z							
2.4	70-73	DP 273	DP 2273				5177
260Z							
2.6	73-76	DP 273	DP 2273				5177
2.6	76-78	DP 273	DP 2273				5262
280ZX							
2.8	78-81	DP 352	DP 2352		DP 331		
2.8	81-83	DP 352	DP 2352		DP 468		
300ZX							
3.0	83-89	DP 527	DP 2538		DP 528		
3.0 Turbo	84-87	DP 527	DP 2538		DP 528		
3.0 Turbo	87-89	DP 736	DP 2736		DP 528		
3.0 Twin Turbo	90-94	DP 21200	DP 31200		DP 2826	DP 3826	
350Z							
3.5	2003-	DP 21644	DP 31644		DP 2197/2	DP 3197/2	



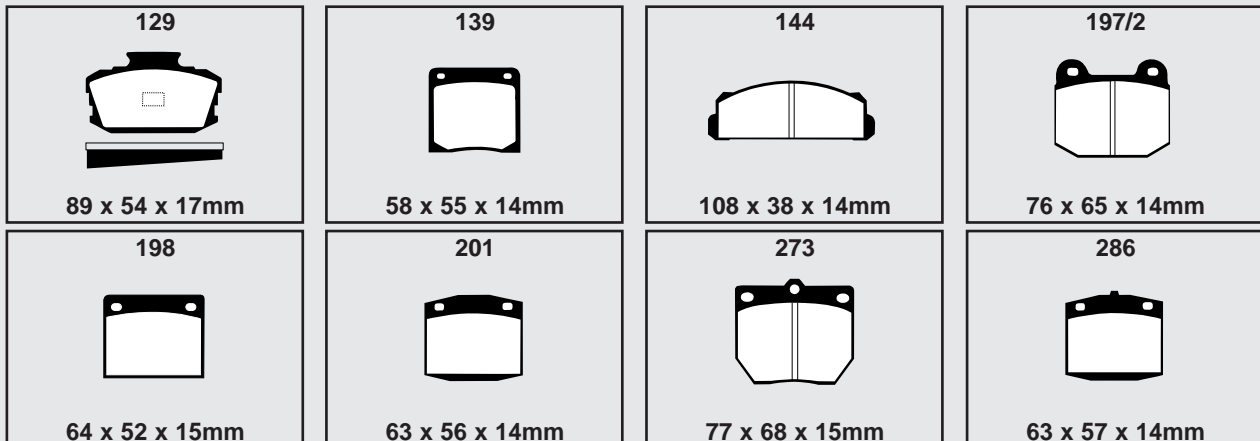

Pad Illustrations for Nissan













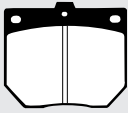
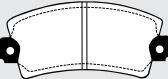

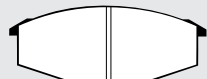
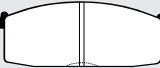







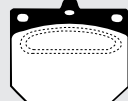

*Every EBC pad and shoe requiring ECE R-90 is available with approval subject to stock rotation - check box end label.
Models listed by Engine Size. Only listed by trim level where pads differ, (16v, GL, GT, etc).

Standard Quality - ECE R90 Approved with similar performance to original equipment brake pads.
Upgrade Quality (Tuning/ Sportbeläge) - ECE R90 Approved but with higher friction and improved performance for faster street use.
Verbesserte Qualität - mit ECE R90 Freigabe aber mit höherem Reibwert und verbesserter Bremsleistung für den schnellen Strasseninsatz.

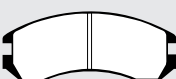
Standard Qualität - mit ECE R90 Freigabe und ähnlicher Bremsleistung wie die Original Bremsbeläge.
Qualité améliorée - Approuvée par la norme ECE R90 - Un coefficient de friction supérieur et des performances accrues pour pilotage rapide sur route.
Calidad Mejorada - Aprobación CEE R90 con prestaciones similares a las pastillas originales.
Calidad Mejorada - Aprobación CEE R90 pero con un coeficiente de fricción más elevado y prestaciones mejoradas para un uso deportivo en carretera.

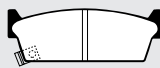
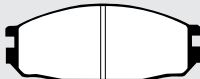
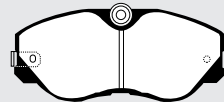
Make/Model/Engine	Year	Pads  Front / Vorn / Avant		Shoes	Pads  Rear / Hinten / Arrière		Shoes
Hersteller/Modell/Motor	Jahr	Plaquettes / Bremsbeläge		Bremsbacken Machoires	Plaquettes / Bremsbeläge		Bremsbacken Machoires
Modelos	Années	Original Quality ECE R90* Approved	Upgrade Quality Tuning/Sportbeläge ECE R90* Approved	 ECE R90* Approved	Original Quality ECE R90* Approved	Upgrade Quality Tuning/Sportbeläge ECE R90* Approved	 ECE R90* Approved

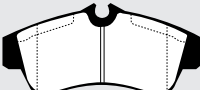
Pad Illustrations for Nissan Contd.

287  78 x 68 x 14mm	317  108 x 49 x 15mm	331  58 x 55 x 14mm	352  130 x 54 x 16mm
365  111 x 44 x 14mm	367  63 x 56 x 14mm	418  111 x 44 x 14mm	445  142 x 53 x 16mm
452  108 x 40 x 15mm	468  85 x 43 x 15mm	484  108 x 46 x 15mm	506  100 x 54 x 16mm
526  109 x 43 x 14mm	527  130 x 49 x 16mm	528  85 x 43 x 14mm	538  130 x 48 x 15mm
562  78 x 70 x 14mm	636  108 x 46 x 15mm	665  115 x 47 x 16mm	682  98 x 34 x 14mm
686/2  98 x 34 x 16mm	688  127 x 50 x 19mm	736  137 x 59 x 17mm	775  137 x 53 x 17mm
792  137 x 54 x 17mm	833  129 x 57 x 16mm	834  82 x 57 x 15mm	839  128 x 51 x 16mm

Standard Quality - ECE R90 Approved with similar performance to original equipment brake pads.
Upgrade Quality (Tuning / Sportbeläge) - ECE R90 Approved but with higher friction and improved performance for faster street use.

Standard Qualität - mit ECE R90 Freigabe und ähnlicher Bremsleistung wie die Original Bremsbeläge.
Verbesserte Qualität - mit ECE R90 Freigabe aber mit höherem Reibwert und verbesserter Bremsleistung für den schnellen Strasseneinsatz.

Quality standard - Approuvée par la norme ECE R90 - Des performances équivalentes à l'origine.
Qualité améliorée - Approuvée par la norme ECE R90 - Un coefficient de friction supérieur et des performances accrues pour pilotage rapide sur route.

Calidad Estándar - Aprobación CEE R90 con prestaciones similares a las pastillas originales.
Calidad Mejorada - Aprobación CEE R90 pero con un coeficiente de fricción más elevado y prestaciones mejoradas para un uso deportivo en carretera.

BRAKE PADS & SHOES - APPLICATIONS











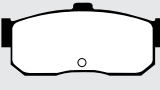

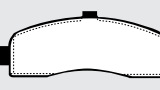
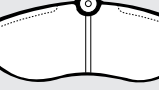



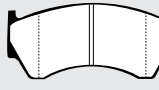
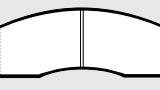
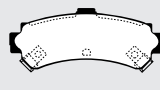
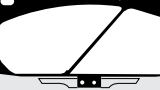
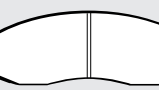





Bremsbeläge / Plaquettes + Bremsbacken / Machoires

EBC

BRAKES

Make/Model/Engine	Year	Pads	Front / Vorn / Avant	Shoes	Pads	Rear / Hinten / Arrière	Shoes
Hersteller/Modell/Motor	Jahr	Plaquettes / Bremsbeläge		Bremsbacken	Plaquettes / Bremsbeläge		Bremsbacken
Modelos	Années	Original Quality ECE R90* Approved	Upgrade Quality Tuning/Sportbeläge ECE R90* Approved	Machoires ECE R90* Approved	Original Quality ECE R90* Approved	Upgrade Quality Tuning/Sportbeläge ECE R90* Approved	Machoires ECE R90* Approved









Pad Illustrations for Nissan Contd.

889  105 x 47 x 16mm	892  108 x 48 x 16mm	946  121 x 45 x 15mm	947  145 x 55 x 16mm
988  115 x 51 x 16mm	1000  115 x 45 x 16mm	1020  170 x 55 x 18mm	1044  108 x 48 x 16mm
1046  151 x 49 x 17mm	1067  99 x 40 x 14mm	1072  119 x 71 x 15mm	1082  151 x 53 x 17mm
1101  127 x 51 x 15mm	1105  85 x 42 x 14mm	1238  124 x 60 x 17mm	1279  121 x 50 x 16mm
1339  131 x 58 x 17mm	1360  131 x 50 x 16mm	1376  155 x 65 x 17mm	1471  139 x 59 x 14mm
1485  116 x 52 x 17mm	2197/2  76 x 65 x 14mm	2826  73 x 54 x 16mm	21200  120 x 70 x 14mm
21644  120 x 71 x 15mm	31032  120 x 71 x 17mm	61247  158 x 56 x 16mm	

Standard Quality - ECE R90 Approved with similar performance to original equipment brake pads.
Upgrade Quality (Tuning/ Sportbeläge) - ECE R90 Approved but with higher friction and improved performance for faster street use.
Verbesserte Qualität - mit ECE R90 Freigabe aber mit höherem Reibwert und verbesserter Bremsleistung für den schnellen Strasseninsatz.

Qualité standard - Approuvée par la norme ECE R90 - Des performances équivalentes à l'origine.
Qualité améliorée - Approuvée par la norme ECE R90 - Un coefficient de friction supérieur et des performances accrues pour pilotage rapide sur route.
Calidad Estándar - Aprobación CEE R90 con prestaciones similares a las pastillas originales.
Calidad Mejorada - Aprobación CEE R90 pero con un coeficiente de fricción más elevado y prestaciones mejoradas para un uso deportivo en carretera.

*Every EBC pad and shoe requiring ECE R-90 is available with approval subject to stock rotation - check box end label.
 Models listed by Engine Size. Only listed by trim level where pads differ, (16v, GL, GT, etc).

Make/Model/Engine Hersteller/Modell/Motor Modelos	Year Jahr Années	Pads  Front / Vorn / Avant		Shoes	Pads  Rear / Hinten / Arrière		Shoes
		Original Quality ECE R90* Approved 	Upgrade Quality Tuning/Sportbeläge ECE R90* Approved 	Bremsbacken Machoires 	Original Quality ECE R90* Approved 	Upgrade Quality Tuning/Sportbeläge ECE R90* Approved 	Bremsbacken Machoires 
NISSAN COMMERCIAL							
Cabstar							
2.0 (F20)	76-78			6318			6293
2.0 (F20)	78-82			6358			6292
2.0 (F22)	82-89	DP 641					6387
2.0 (F22)	89-92	DP 968					6387
2.0 Van	82-89	DP 641					6462
2.0 (F23)	92-	DP 968					6511
2.3 D (F22)	85-89	DP 641					6387
2.3 D Van	87-89	DP 641					6462
2.5 D (F22)	85-88	DP 641					6387
2.5 D Van	85-89	DP 641					6462
2.5 D (F22)	89-92	DP 968					6511
2.5 D (F23)	93-2001	DP 968					6511
Cabstar E							
2.7 TD (E95)	2002-						
3.0 D (E120)	2002-						
Interstar							
1.9 D	2002-	DP 1386			DP 1385		
2.2 D	2002-	DP 1386			DP 1385		
2.5 D	2002-	DP 1386			DP 1385		
Navara							
2.5 TD	2003-						
Pick Up							
1.5 (620)	75-77			6290			6293
1.5 (620)	77-79			6287			6293
1.6 (720)	79-81	DP 562					6317
1.6 (720)	81-82	DP 562					6359
1.6 (720)	83-86	DP 538					6359
1.8 (720)	79-82	DP 562					6317
1.8 (720)	82-83	DP 562					6359
1.8 (720)	83-86	DP 538					6359
2.0 (D21)	85-88	DP 527					6359
2.0 (D21)	88-97	DP 538					6435
2.0 (D22)	97-	DP 691					6435
2.2 (720)	83-86	DP 538					6359
2.4 (D21) 4WD	86-88	DP 527					6392
2.4 (D21)	88-92	DP 538					6535
2.4 (D21) 4WD	88-92	DP 538					6535
2.4 (D21) 4WD	92-97	DP 691					6535
2.4 (D22) 4WD	97-	DP 691					6535
2.5 TD (D21)	87-88	DP 527					6359
2.5 TD (D21)	88-97	DP 538					6435
2.5 TD (D22)	97-	DP 691					6435
2.5 TD (D21) 4WD	87-88	DP 527					6392
2.5 TD (D21) 4WD	88-97	DP 538					6535
2.5 TD (D22) 4WD	97-	DP 691					6535
Primastar							
1.9 D	2002-	DP 1393			DP 1284		
Sunny Van							
1.3	83-92	DP 452					6330
1.5	81-83	DP 273					5265
1.7 D	92-	DP 988					6385
Terrano Van							
2.7 TD	2002-	DP 947					
3.0 D	2002-	DP 947					

Standard Quality - ECE R90 Approved with similar performance to original equipment brake pads.
Upgrade Quality (Tuning / Sportbeläge) - ECE R90 Approved but with higher friction and improved performance for faster street use.

Standard Qualität - mit ECE R90 Freigabe und ähnlicher Bremsleistung wie die Original Bremsbeläge.
Verbesserte Qualität - mit ECE R90 Freigabe aber mit höherem Reibwert und verbesserter Bremsleistung für den schnellen Strasseninsatz.

Quality standard - Approuvée par la norme ECE R90 - Des performances équivalentes à l'origine.
Qualité améliorée - Approuvée par la norme ECE R90 - Un coefficient de friction supérieur et des performances accrues pour pilotage rapide sur route.

Calidad Estándar - Aprobación CEE R90 con prestaciones similares a las pastillas originales.
Calidad Mejorada - Aprobación CEE R90 pero con un coeficiente de fricción más elevado y prestaciones mejoradas para un uso deportivo en carretera.

BRAKE PADS & SHOES - APPLICATIONS

Bremsbeläge / Plaquettes + Bremsbacken / Machoires











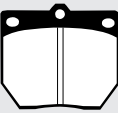

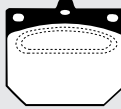
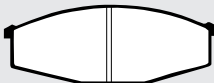
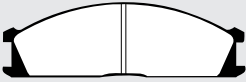

EBC

BRAKES

Make/Model/Engine	Year	Front / Vorn / Avant	Shoes	Rear / Hinten / Arrière	Shoes
Hersteller/Modell/Motor	Jahr	Plaquettes / Bremsbeläge		Plaquettes / Bremsbeläge	
Modelos	Années	Original Quality ECE R90* Approved	Upgrade Quality Tuning/Sportbeläge ECE R90* Approved	Original Quality ECE R90* Approved	Upgrade Quality Tuning/Sportbeläge ECE R90* Approved
		Bremsbacken Machoirs		Bremsbacken Machoirs	
		ECE R90* Approved		ECE R90* Approved	
NISSAN COMM Contd.					
Urvan					
2.0 (E20) (H20)	75-81			6287	
2.0 (E23) (H20)	81-82	DP 352			6293
2.0 (E23) (Z20)	82-87	DP 352			6317
2.0 (E24)	87-95	DP 691			6359
2.3 D (E23)	84-87	DP 352			6435
2.3 TD (E24)	87-89	DP 691			6359
2.5 TD (E24)	89-	DP 691			6435
Vanette					
1.5	85-87	DP 365			5262
1.5	87-94	DP 538			5262
2.0 D	86-94	DP 538			5262
Vanette Cargo					
1.6	95-	DP 947			6505
2.3 D	95-98	DP 947			6505
2.3 D	98-	DP 538			6505

Standard Quality - ECE R90 Approved with similar performance to original equipment brake pads.
 Upgrade Quality (Tuning/ Sportbeläge) - ECE R90 Approved but with higher friction and improved performance for faster street use.
 Verbesserte Qualität - mit ECE R90 Freigabe und ähnlicher Bremsleistung wie die Original Bremsbeläge.
 Standard Qualität - mit ECE R90 Freigabe und ähnlicher Bremsleistung wie die Original Bremsbeläge.

Pad Illustrations for Nissan Commercial

273  77 x 68 x 15mm	352  130 x 54 x 16mm	365  111 x 44 x 14mm	452  108 x 40 x 15mm
527  130 x 49 x 16mm	538  130 x 49 x 16mm	562  78 x 70 x 14mm	641  142 x 53 x 16mm
691  160 x 51 x 17mm	947  145 x 55 x 16mm	968  140 x 54 x 17mm	988  115 x 51 x 16mm
1284  95 x 58 x 16mm	1385  115 x 51 x 19mm	1386  138 x 79 x 18mm	1393  145 x 63 x 18mm

NISSAN (Aust/NZ)					
180 SX					
1.8 Turbo (RS13)	88-91	DP 665	DP 2665	DP 528	
2.0 Turbo (S13)	91-	DP 775	DP 2775	DP 528	









*Every EBC pad and shoe requiring ECE R-90 is available with approval subject to stock rotation - check box end label.
 Models listed by Engine Size. Only listed by trim level where pads differ, (16v, GL, GT, etc).

Qualité standard - Approuvée par la norme ECE R90 - Des performances équivalentes à l'origine.
 Qualité améliorée - Approuvée par la norme ECE R90 - Un coefficient de friction supérieur et des performances accrues pour pilotage rapide sur route.
 Calidad Mejorada - Aprobación CEE R90 con prestaciones similares a las pastillas originales.
 Calidad Estándar - Aprobación CEE R90 con prestaciones similares a las pastillas originales.

Standard Quality - ECE R90 Approved with similar performance to original equipment brake pads.
 Upgrade Quality (Tuning / Sportbeläge) - ECE R90 Approved but with higher friction and improved performance for faster street use.

Calidad Estándar - Aprobación CEE R90 con prestaciones similares a las pastillas originales.
 Calidad Mejorada - Aprobación CEE R90 pero con un coeficiente de fricción más elevado y prestaciones mejoradas para un uso deportivo en carretera.





Standard Qualität - mit ECE R90 Freigabe und ähnlicher Bremsleistung wie die Original Bremsbeläge.
 Verbesserte Qualität - mit ECE R90 Freigabe aber mit höherem Reibwert und verbesserter Bremsleistung für den schnellen Strasseninsatz.











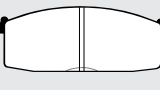

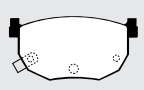

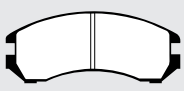
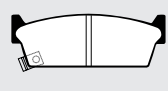
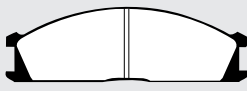
Make/Model/Engine Hersteller/Modell/Motor Modèles	Year Jahr Années	Pads  Front / Vorn / Avant		Shoes	Pads  Rear / Hinten / Arrière		Shoes
		Original Quality ECE R90* Approved 	Upgrade Quality Tuning/Sportbeläge ECE R90* Approved 	Bremsbacken Machoires 	Original Quality ECE R90* Approved 	Upgrade Quality Tuning/Sportbeläge ECE R90* Approved 	Bremsbacken Machoires 
NISSAN (Aust/NZ) Contd.							
200 SX							
2.0 Turbo (S13)	91-	DP 775	DP 2775		DP 528		
2.0 Turbo (S14)	94-	DP 825	DP 21200		DP 1105		
300 ZX							
2.0 (Z31) Inc. Turbo	84-89	DP 538	DP 2538		DP 528		
2.0 (Z32) Inc. Turbo	89-94	DP 825	DP 21200		DP 826	DP 2826	
Fairlady							
2.0 Turbo	83-87	DP 538	DP 2538		DP 528		
Navara							
	86-97	DP 538	DP 6538				
	96-2000	DP 691	DP 6691				
Pulsar							
2.0 GTi - R	90-93	DP 839	DP 2839		DP 889	DP 2889	
Silvia							
1.8 (S110)	80-83	DP 238					
1.8 Turbo (S12)	83-87	DP 365			DP 528		
1.8 Turbo (S13)	88-	DP 665	DP 2665		DP 528		
2.0 (S12)	84-86	DP 365			DP 528		
2.0 (PS13)	91-93	DP 665	DP 2665		DP 528		
2.0 (KPS13) (KS13)	91-93	DP 775	DP 2775		DP 528		
2.0 (S13)	91-	DP 775	DP 2775		DP 528		
2.0 (S14)	93-	DP 1279	DP 21279		DP 528		
2.0 Turbo (S12)	83-85	DP 538	DP 2538		DP 528		
Skyline							
1.8 (R30)	81-89	DP 365					
1.8 (R31)	81-89	DP 538	DP 2538				
1.8 (R32)	89-93	DP 1279	DP 21279				
2.0 (R30)	83-87	DP 365			DP 528		
2.0 (R31)	85-89	DP 538	DP 2538				
2.0 (HR32)	89-90	DP 792	DP 2792		DP 686/2		
2.0 (HCR32)	89-90	DP 775	DP 2775		DP 686/2		
2.0 (HR32)	90-93	DP 792	DP 2792		DP 464		
2.0 (HCR32)	90-93	DP 775	DP 2775		DP 464		
2.0 (R33)	93-	DP 792	DP 2792		DP 686/2		
2.0 Turbo (R30) (L20ET)	81-85	DP 365			DP 528		
2.0 Turbo (R30) (FJ20DET)	83-85	DP 538	DP 2538		DP 528		
2.0 Turbo (R31)	85-87	DP 538	DP 2538		DP 686/2		
2.0 Turbo (HCR32)	89-90	DP 775	DP 2775		DP 686/2		
2.0 Turbo (HNR32)	89-93	DP 775	DP 2775		DP 826	DP 2826	
2.0 Turbo (HCR32)	90-93	DP 775	DP 2775		DP 464		
2.5 (R32)	91-93	DP 775	DP 2775		DP 686/2		
2.5 (R33)	93-	DP 1046			DP 686/2		
2.5 (R33)	93-	DP 1082			DP 686/2		
2.5 Turbo (R33)	93-98	DP 21200	DP 31200		DP 2826	DP 3826	
2.6 GTR Twin Turbo (R32)	89-95	DP 21200	DP 31200		DP 2826	DP 3826	
3.0 (R31)	87-91	DP 21502	DP 31502		DP 21501	DP 31501	
Brembo		DP 21032	DP 31032		DP 2197/2	DP 3197/2	

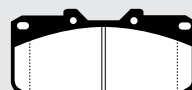
BRAKE PADS & SHOES - APPLICATIONS

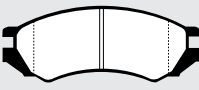
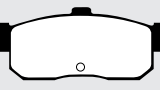
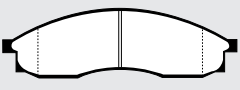
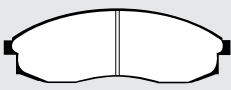
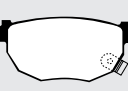
Bremsbeläge / Plaquettes + Bremsbacken / Machoires



EBC
BRAKES

Make/Model/Engine	Year	Pads	Shoes	Pads	Shoes
Hersteller/Modell/Motor	Jahr	Plaquettes / Bremsbeläge	Bremsbacken Machoires	Plaquettes / Bremsbeläge	Bremsbacken Machoires
Modelos	Années	Original Quality ECE R90* Approved 	Upgrade Quality Tuning/Sportbeläge ECE R90* Approved 	Original Quality ECE R90* Approved 	Upgrade Quality Tuning/Sportbeläge ECE R90* Approved 

Pad Illustrations for Nissan (Aust/NZ)					
238  63 x 52 x 14mm	365  111 x 44 x 14mm	464  61 x 54 x 13mm	528  85 x 43 x 14mm		
538  130 x 49 x 16mm	665  115 x 47 x 16mm	686/2  98 x 34 x 16mm	691  160 x 51 x 17mm		
775  137 x 53 x 17mm	792  137 x 54 x 17mm	825  119 x 62 x 14mm	826  73 x 54 x 16mm		
839  128 x 51 x 16mm	889  105 x 47 x 16mm	1046  151 x 49 x 17mm	1082  151 x 53 x 17mm		
1105  85 x 42 x 14mm	1279  121 x 50 x 16mm	2197/2  76 x 65 x 16mm	21032  120 x 71 x 17mm		
21200  120 x 70 x 14mm	21501  116 x 54 x 14mm	21502  138 x 59 x 14mm			
NISSAN (Malaysia & The Philippines)					
Cefiro	96-	DP 775	DP 2775		DP 889
Sentra	90-91	DP 892			
	91-99	DP 665	DP 2665		DP 682

*Every EBC pad and shoe requiring ECE R-90 is available with approval subject to stock rotation - check box end label. Models listed by Engine Size. Only listed by trim level where pads differ, (16v, GL, GT, etc).

Standard Quality - ECE R90 Approved with similar performance to original equipment brake pads.
 Upgrade Quality (Tuning/ Sportbeläge) - ECE R90 Approved but with higher friction and improved performance for faster street use.
 Verbesserte Qualität - mit ECE R90 Freigabe aber mit höherem Reibwert und verbesserter Bremsleistung für den schnellen Strasseninsatz.
 Standard Qualität - mit ECE R90 Freigabe und ähnlicher Bremsleistung wie die Original Bremsbeläge.
 Qualité standard - Approuvée par la norme ECE R90 - Des performances équivalentes à l'origine.
 Qualità migliorata - Approvata per la norme ECE R90 - Un coefficient di frizione superiore et des performances accrues pour pilotage rapide sur route.
 Calidad Mejorada - Aprobación CEE R90 con prestaciones similares a las pastillas originales.
 Calidad Mejorada - Aprobación CEE R90 pero con un coeficiente de fricción mas elevado y prestaciones mejoradas para un uso deportivo en carretera.

Make/Model/Engine	Year	Pads	Front / Vorn / Avant	Shoes	Pads	Rear / Hinten / Arrière	Shoes
Hersteller/Modell/Motor	Jahr	Plaquettes / Bremsbeläge		Bremsbacken Machoires	Plaquettes / Bremsbeläge		Bremsbacken Machoires
Modelos	Années	Original Quality ECE R90* Approved	Upgrade Quality Tuning/Sportbeläge ECE R90* Approved	 ECE R90* Approved	Original Quality ECE R90* Approved	Upgrade Quality Tuning/Sportbeläge ECE R90* Approved	 ECE R90* Approved

Pad Illustrations for Nissan (Malaysia & The Philippines)

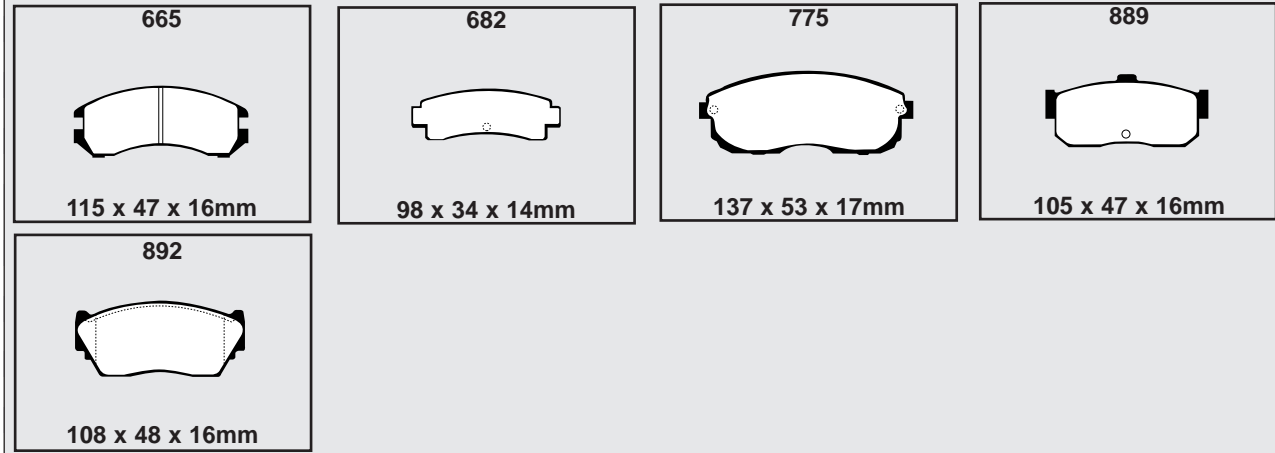

NISSAN (SA)					
1 Tonner	89-	DP 691	DP 6691		
Hi-Rider	90-	DP 691	DP 6691		
Sani	91-	DP 691	DP 6691		
Sentra	92-97	DP 892			
200 GSi	97-	DP 839	DP 2839	DP 889	
200 STi	92-	DP 839	DP 2839	DP 889	
Sentra Sabre					
1.6	94-97	DP 892			
2.0	94-	DP 839	DP 2839	DP 889	

Pad Illustrations for Nissan (SA)

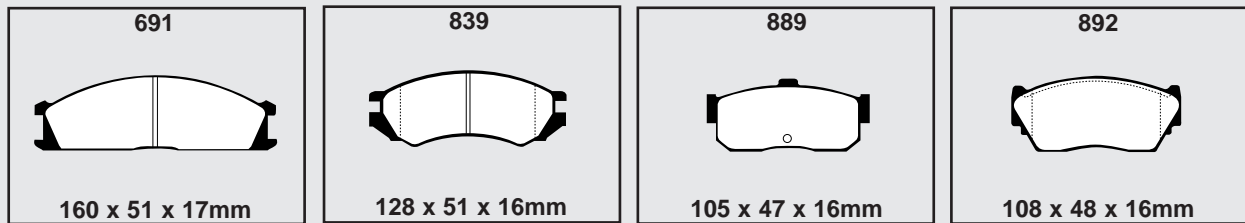

NISSAN (Japan)					
Skyline GT-R	99-	DP 21032	DP 31032	DP 2197/2	DP 3197/2
Silvia	96-99	DP 2792	DP 3792		
Silvia R Turbo	99-	DP 21200	DP 31200		
180 SX	91-99	DP 2775	DP 3775		

Standard Quality - ECE R90 Approved with similar performance to original equipment brake pads.
 Upgrade Quality (Tuning / Sportbeläge) - ECE R90 Approved but with higher friction and improved performance for faster street use.

Standard Qualität - mit ECE R90 Freigabe und ähnlicher Bremsleistung wie die Original Bremsbeläge.
 Verbesserte Qualität - mit ECE R90 Freigabe aber mit höherem Reibwert und verbesserter Bremsleistung für den schnellen Strasseninsatz.









Quality standard - Approuvée par la norme ECE R90 - Des performances équivalentes à l'origine.
 Qualité améliorée - Approuvée par la norme ECE R90 - Un coefficient de friction supérieur et des performances accrues pour pilotage rapide sur route.
 Calidad Estandar - Aprobacion CEE R90 con prestaciones similares a las pastillas originales.
 Calidad Mejorada - Aprobacion CEE R90 pero con un coeficiente de friccion mas elevado y prestaciones mejoradas para un uso deportivo en carretera.

BRAKE PADS & SHOES - APPLICATIONS

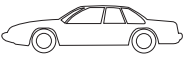
Bremsbeläge / Plaquettes + Bremsbacken / Machoires

EBC

BRAKES

Make/Model/Engine	Year	Pads  Front / Vorn / Avant	Shoes  Rear / Hinten / Arrière	Pads  Rear / Hinten / Arrière	Shoes
Hersteller/Modell/Motor	Jahr	Plaquettes / Bremsbeläge	Bremsbacken	Plaquettes / Bremsbeläge	Bremsbacken
Modelos	Années	Original Quality ECE R90* Approved	Upgrade Quality Tuning/Sportbeläge ECE R90* Approved	Original Quality ECE R90* Approved	Upgrade Quality Tuning/Sportbeläge ECE R90* Approved
					

Pad Illustrations for Nissan (Japan)

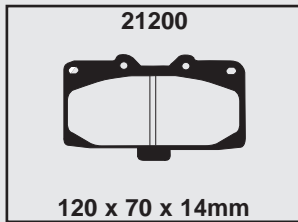
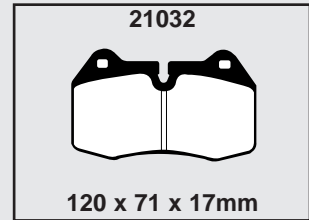
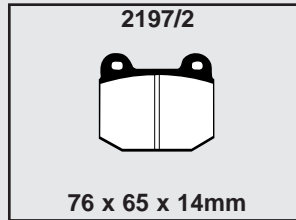
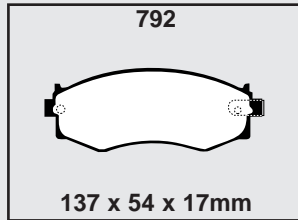
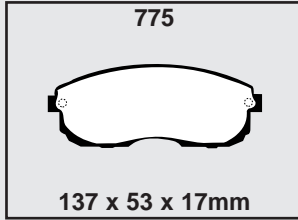

NOBLE

M12 GTO

2.6 Twin Turbo
3.0 Twin Turbo

99-
99-

DP 2002
DP 2002

DP 3002
DP 3002

DP 2008
DP 2008

DP 3008
DP 3008

Pad Illustrations for Noble

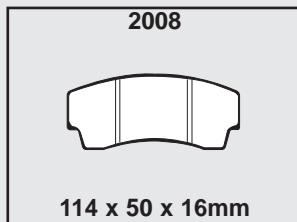
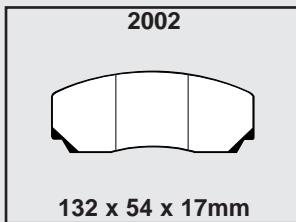

ONYX

Bobcat 4

DP 817
DP 627

DP 2817
DP 2627

Pad Illustrations for Onyx

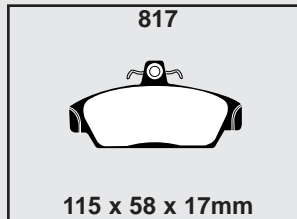
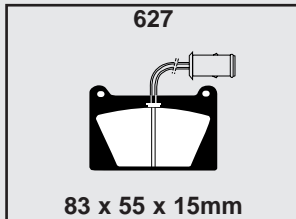

OPEL

Admiral

2.8

69-77

DP 103

DP 2103

DP 104

DP 2104

Agila

1.0

2000-

DP 1291

6590

1.0

2001-

DP 1361

6590

1.2

2000-

DP 1291

6590

1.2

2001-









DP 1361

6590

*Every EBC pad and shoe requiring ECE R-90 is available with approval subject to stock rotation - check box end label.
Models listed by Engine Size. Only listed by trim level where pads differ, (16v, GL, GT, etc).

Standard Quality - ECE R90 Approved with similar performance to original equipment brake pads.
Upgrade Quality (Tuning / Sportbeläge) - ECE R90 Approved but with higher friction and improved performance for faster street use.
Verbesserte Qualität - mit ECE R90 Freigabe aber mit höherem Reibwert und verbesserter Bremsleistung für den schnellen Strasseninsatz.

Qualité standard - Approuvée par la norme ECE R90 - Des performances équivalentes à l'origine.
Qualité améliorée - Approuvée par la norme ECE R90 - Un coefficient de friction supérieur et des performances accrues pour pilotage rapide sur route.
Calidad Estándar - Aprobación CEE R90 con prestaciones similares a las pastillas originales.
Calidad Mejorada - Aprobación CEE R90 pero con un coeficiente de fricción más elevado y prestaciones mejoradas para un uso deportivo en carretera.

Make/Model/Engine Hersteller/Modell/Motor Modelos	Year Jahr Années	Pads  Front / Vorn / Avant		Shoes	Pads  Rear / Hinten / Arrière		Shoes
		Original Quality ECE R90* Approved 	Upgrade Quality Tuning/Sportbeläge ECE R90* Approved 	Bremsbacken Machoires 	Original Quality ECE R90* Approved 	Upgrade Quality Tuning/Sportbeläge ECE R90* Approved 	Bremsbacken Machoires 
OPEL Contd.							
Ascona							
1.2	70-75	DP 104	DP 2104				5211G
1.2	75-81	DP 197	DP 2197				5211G
1.3	74-81	DP 197	DP 2197				5211G
1.3	79-81	DP 325	DP 2325				5103G
1.3	81-83	DP 325	DP 2325				5255G
1.3	84-88	DP 325	DP 2325				5351G
1.6	70-75	DP 104	DP 2104				5211G
1.6	70-75	DP 104	DP 2104				5103G
1.6	75-81	DP 197	DP 2197				5211G
1.6	75-81	DP 197	DP 2197				5103G
1.6	81-84	DP 325	DP 2325				5103G
1.6	84-88	DP 325	DP 2325				5351G
1.7	70-74	DP 104	DP 2104				5103G
1.8	81-84	DP 325	DP 2325				5103G
1.8	84-88	DP 325	DP 2325				5351G
1.9	70-75	DP 104	DP 2104				5103G
1.9	75-78	DP 197	DP 2197				5103G
2.0	78-84	DP 325	DP 2325				5103G
2.0	84-88	DP 325	DP 2325				5351G
1.6 D	82-83	DP 325	DP 2325				5255G
1.6 D	83-88	DP 325	DP 2325				5351G
Astra							
1.2	98-	DP 1184	DP 21184				6538
1.4	91-98	DP 940	DP 2940				6481
1.4	95-98	DP 940	DP 2940				6482
1.4	98-	DP 1184	DP 21184				6538
1.4 (ABS)	98-	DP 1184	DP 21184		DP 1186	DP 21186	
1.4 Est	91-94	DP 940	DP 2940				6482
1.4 Est	95-98	DP 940	DP 2940				6538
1.6	91-98	DP 940	DP 2940				6481
1.6 16v	93-98	DP 760	DP 2760				6482
1.6	98-	DP 1184	DP 21184				6538
1.6 16v	98-	DP 1183	DP 21183		DP 1186	DP 21186	
1.6 Est	91-95	DP 940	DP 2940				6482
1.6 Est	95-98	DP 940	DP 2940				6538
1.8	91-98	DP 940	DP 2940				6482
1.8	91-98	DP 760	DP 2760		DP 761	DP 2761	
1.8	98-2001	DP 1183	DP 21183		DP 1186	DP 21186	
1.8	2001-	DP 1183	DP 21183		DP 1447	DP 21447	
1.8 Est	91-94	DP 760	DP 2760				6482
1.8 Est	95-98	DP 760	DP 2760				6538
2.0	91-98	DP 760	DP 2760		DP 761	DP 2761	6482
2.0 Est	91-94	DP 760	DP 2760				6482
2.0 Est	95-98	DP 760	DP 2760				6538
2.0 (OPC)	99-	DP 1443	DP 21443		DP 1186	DP 21186	
2.0 Turbo	2000-2001	DP 1183	DP 21183		DP 1186	DP 21186	
2.0 Turbo	2001-	DP 1183	DP 21183		DP 1447	DP 21447	
1.7 D	91-94	DP 940	DP 2940				6481
1.7 D	95-98	DP 940	DP 2940				6482
1.7 D Est	91-94	DP 760	DP 2760				6482
1.7 D Est	95-98	DP 760	DP 2760				6538
1.7 TD	91-94	DP 940	DP 2940				6482
1.7 TD	95-98	DP 760	DP 2760				6482
1.7 TD	98-	DP 1184	DP 21184				6538
1.7 TD Est	91-94	DP 760	DP 2760				6482
1.7 TD Est	95-98	DP 760	DP 2760				6538
2.0 D	98-2001	DP 1183	DP 21183		DP 1186	DP 21186	
2.0 TD	2001-	DP 1183	DP 21183		DP 1447	DP 21447	

Standard Quality - ECE R90 Approved with similar performance to original equipment brake pads.
Upgrade Quality (Tuning / Sportbeläge) - ECE R90 Approved but with higher friction and improved performance for faster street use.

Standard Qualität - mit ECE R90 Freigabe und ähnlicher Bremsleistung wie die Original Bremsbeläge.
Verbesserte Qualität - mit ECE R90 Freigabe aber mit höherem Reibwert und verbesserter Bremsleistung für den schnellen Strasseninsatz.

Qualité standard - Approuvée par la norme ECE R90 - Des performances équivalentes à l'origine.
Qualité améliorée - Approuvée par la norme ECE R90 - Un coefficient de friction supérieur et des performances accrues pour pilotage rapide sur route.

Calidad Estándar - Aprobación CEE R90 con prestaciones similares a las pastillas originales.
Calidad Mejorada - Aprobación CEE R90 pero con un coeficiente de fricción más elevado y prestaciones mejoradas para un uso deportivo en carretera.

*Every EBC pad and shoe requiring ECE R-90 is available with approval subject to stock rotation - check box end label.









Models listed by Engine Size. Only listed by trim level where pads differ, (16v, GL, GT, etc).

BRAKE PADS & SHOES - APPLICATIONS

Bremsbeläge / Plaquettes + Bremsbacken / Machoires

EBC

BRAKES









Make/Model/Engine Hersteller/Modell/Motor Modèles	Year Jahr Années	Pads  Front / Vorn / Avant		Shoes	Pads  Rear / Hinten / Arrière		Shoes
		Original Quality ECE R90* Approved 	Upgrade Quality Tuning/Sportbeläge ECE R90* Approved 	Bremsbacken Machoires 	Original Quality ECE R90* Approved 	Upgrade Quality Tuning/Sportbeläge ECE R90* Approved 	Bremsbacken Machoires 
OPEL Contd.							
Calibra							
2.0	89-96	DP 760	DP 2760		DP 761	DP 2761	
2.0 16v	89-96	DP 760	DP 2760		DP 761	DP 2761	
2.0 Turbo	89-96	DP 2976	DP 3976		DP 2761	DP 3761	
2.0 Turbo	95-96	DP 21062	DP 31062		DP 2761	DP 3761	
2.5	89-96	DP 976	DP 2976		DP 761	DP 2761	
2.5	95-96	DP 1062	DP 21062		DP 761	DP 2761	
Campo							
2.3	92-96	DP 746					6512
2.2 D	92-96	DP 746					6512
2.5 D	92-96	DP 746					6512
2.5 TD	92-	DP 746					6512
3.1 TD	92-	DP 746					6512
Combo (Astra)							
1.4	91-95	DP 940					6482
1.4	95-96	DP 940					6538
1.6	91-96	DP 940					6482
1.6	2001-	DP 1341					6538
1.7 D	91-95	DP 940					6482
1.7 D	95-96	DP 940					6538
1.7 D	2001-	DP 1341					6538
1.7 TD	2001-	DP 1341					6538
Combo (Corsa)							
1.2	93-2001	DP 940					5353G
1.4	93-2001	DP 940					5353G
1.7 D	93-2001	DP 940					5353G
Combo (Kadett)							
1.3	84-89	DP 325					6337
1.4	89-92	DP 325					6337
1.6	84-87	DP 325					5351/G
1.6 D	84-89	DP 325					6337
1.7 D	89-92	DP 325					6337
Commodore							
2.5	72-78	DP 197	DP 2197		DP 104	DP 2104	5099
2.8	70-78	DP 103	DP 2103		DP 104	DP 2104	
2.8	78-83	DP 103	DP 2103				5103G
Handbrake Shoes	70-78						5271
Corsa							
1.0	82-83	DP 325	DP 2325				5254
1.0	84-91	DP 325	DP 2325				6337
1.0	91-92	DP 940	DP 2940				6481
1.0	2000-	DP 1341	DP 21341				6596
1.2	82-83	DP 325	DP 2325				5254
1.2	84-91	DP 325	DP 2325				6337
1.2	91-92	DP 940	DP 2940				6481
1.2	93-2001	DP 940	DP 2940				6481
1.2	2000-	DP 1341	DP 21341				6596
1.3	82-83	DP 325	DP 2325				5254
1.3	84-91	DP 325	DP 2325				6337
1.3	91-92	DP 940	DP 2940				6481
1.4	82-83	DP 325	DP 2325				5254
1.4	84-91	DP 325	DP 2325				6337
1.4	91-92	DP 940	DP 2940				6481
1.4	93-2001	DP 940	DP 2940				6481
1.4	2000-	DP 1341	DP 21341				6596
1.4	2000-	DP 1341	DP 21341				6597

*Every EBC pad and shoe requiring ECE R-90 is available with approval subject to stock rotation - check box end label.
Models listed by Engine Size. Only listed by trim level where pads differ, (16v, GL, GT, etc).

Standard Quality - ECE R90 Approved with similar performance to original equipment brake pads.
Upgrade Quality (Tuning/ Sportbeläge) - ECE R90 Approved but with higher friction and improved performance for faster street use.
Verbesserte Qualität - mit ECE R90 Freigabe aber mit höherem Reibwert und verbesserter Bremsleistung für den schnellen Strasseninsatz.

Standard Qualität - mit ECE R90 Freigabe und ähnlicher Bremsleistung wie die Original Bremsbeläge.
Upgrade Qualität (Tuning/ Sportbeläge) - ECE R90 Approved aber mit höherer Reibung und verbesserter Bremsleistung für den schnellen Strasseninsatz.
Verbesserte Qualität - mit ECE R90 Freigabe aber mit höherem Reibwert und verbesserter Bremsleistung für den schnellen Strasseninsatz.

Qualité standard - Approuvée par la norme ECE R90 - Des performances équivalentes à l'origine.
Qualité améliorée - Approuvée par la norme ECE R90 - Un coefficient de friction supérieur et des performances accrues pour pilotage rapide sur route.
Calidad Estándar - Aprobación CEE R90 con prestaciones similares a las pastillas originales.
Calidad Mejorada - Aprobación CEE R90 pero con un coeficiente de fricción más elevado y prestaciones mejoradas para un uso deportivo en carretera.

Make/Model/Engine Hersteller/Modell/Motor Modelos	Year Jahr Années	Pads  Front / Vorn / Avant		Shoes	Pads  Rear / Hinten / Arrière		Shoes
		Original Quality ECE R90* Approved 	Upgrade Quality Tuning/Sportbeläge ECE R90* Approved 	Bremsbacken Machoires 	Original Quality ECE R90* Approved 	Upgrade Quality Tuning/Sportbeläge ECE R90* Approved 	Bremsbacken Machoires 
OPEL Contd.							
Corsa Contd.							
1.6	88-91	DP 325	DP 2325				6337
1.6	91-92	DP 940	DP 2940				6481
1.6	93-2001	DP 940	DP 2940				6481
1.8	2000-	DP 1341	DP 21341		DP 1410		
1.5 D	87-91	DP 325	DP 2325				6337
1.5 D	91-92	DP 940	DP 2940				6481
1.5 TD	88-91	DP 325	DP 2325				6337
1.5 TD	91-92	DP 940	DP 2940				6481
1.5 TD	93-2001	DP 940	DP 2940				6481
1.7 D	2000-	DP 1341	DP 21341				6596
1.7 TD	2000-	DP 1341	DP 21341				6596
Diplomat							
2.8	69-77	DP 103	DP 2103		DP 104	DP 2104	
5.4	69-77	DP 103	DP 2103		DP 104	DP 2104	
Frontera							
2.0	92-95	DP 746	DP 6746				6512
2.0	95-98	DP 973	DP 6973		DP 974	DP 6974	
2.2	95-98	DP 973	DP 6973		DP 974	DP 6974	
2.2	98-	DP 973/2	DP 6973		DP 974	DP 6974	
2.4	92-95	DP 746	DP 6746		DP 777		
3.2	98-	DP 973/2	DP 6973		DP 974	DP 6974	
2.2 TD	98-	DP 973/2	DP 6973		DP 974	DP 6974	
2.3 TD	92-95	DP 746	DP 6746				6512
2.8 TD	95-98	DP 973	DP 6973		DP 974	DP 6974	
GT							
1.9	69-73	DP 104	DP 2104				5099
Kadett							
1.0	74-79	DP 104	DP 2104				5096
1.0	79-81	DP 325	DP 2325				5254
1.0	81-83	DP 325	DP 2325				5255G
1.0	83-84	DP 325	DP 2325				5351G
1.1	65-74	DP 105	DP 2105				5096
1.1	74-79	DP 104	DP 2104				5096
1.2	65-74	DP 105	DP 2105				5096
1.2	74-79	DP 104	DP 2104				5096
1.2	79-81	DP 325	DP 2325				5254
1.2	81-83	DP 325	DP 2325				5255G
1.2	83-84	DP 325	DP 2325				5351G
1.2	84-91	DP 325	DP 2325				6337
1.2	84-91	DP 325	DP 2325				5351G
1.2 Est	84-91	DP 325	DP 2325				5351G
1.2 Est	84-91	DP 325	DP 2325				5353G
1.3	79-81	DP 325	DP 2325				5254
1.3	81-83	DP 325	DP 2325				5255G
1.3	83-84	DP 325	DP 2325				5351G
1.3	84-91	DP 325	DP 2325				6337
1.3	84-91	DP 325	DP 2325				5351G
1.3 Est	84-91	DP 325	DP 2325				5351G
1.3 Est	84-91	DP 325	DP 2325				5353G
1.3 Est Auto	79-83	DP 325	DP 2325				5103G
1.3 Est Auto	83-84	DP 325	DP 2325				5353G
1.4	89-91	DP 325	DP 2325				6337
1.4	89-91	DP 325	DP 2325				5351G
1.4 Est	89-91	DP 325	DP 2325				5351G
1.4 Est	89-91	DP 325	DP 2325				5353G
1.6	74-79	DP 104	DP 2104				5103G
1.6	82-84	DP 325	DP 2325				5255G

Standard Quality - ECE R90 Approved with similar performance to original equipment brake pads.
Upgrade Quality (Tuning / Sportbeläge) - ECE R90 Approved but with higher friction and improved performance for faster street use.

Standard Qualität - mit ECE R90 Freigabe und ähnlicher Bremsleistung wie die Original Bremsbeläge.
Verbesserte Qualität - mit ECE R90 Freigabe aber mit höherem Reibwert und verbesserter Bremsleistung für den schnellen Strasseninsatz.

Qualité standard - Approuvée par la norme ECE R90 - Des performances équivalentes à l'origine.
Qualité améliorée - Approuvée par la norme ECE R90 - Un coefficient de friction supérieur et des performances accrues pour pilotage rapide sur route.

Calidad Estandar - Aprobacion CEE R90 con prestaciones similares a las pastillas originales.
Calidad Mejorada - Aprobacion CEE R90 pero con un coeficiente de friccion mas elevado y prestaciones mejoradas para un uso deportivo en carretera.

*Every EBC pad and shoe requiring ECE R-90 is available with approval subject to stock rotation - check box end label.









Models listed by Engine Size. Only listed by trim level where pads differ, (16v, GL, GT, etc).

BRAKE PADS & SHOES - APPLICATIONS

Bremsbeläge / Plaquettes + Bremsbacken / Machoires

EBC

BRAKES

Make/Model/Engine Hersteller/Modell/Motor Modèles	Year Jahr Années	Pads  Front / Vorn / Avant		Shoes	Pads  Rear / Hinten / Arrière		Shoes
		Original Quality ECE R90* Approved 	Upgrade Quality Tuning/Sportbeläge ECE R90* Approved 	Bremsbacken Machoires 	Original Quality ECE R90* Approved 	Upgrade Quality Tuning/Sportbeläge ECE R90* Approved 	Bremsbacken Machoires 
OPEL Contd.							
Kadett Contd.							
1.6	83-84	DP 325	DP 2325				5351G
1.6	84-91	DP 325	DP 2325				5351G
1.6 Est	82-83	DP 325	DP 2325				5103G
1.6 Est	83-84	DP 325	DP 2325				5353G
1.6 Est	84-91	DP 325	DP 2325				5351G
1.6 Est	84-91	DP 325	DP 2325				5353G
1.8	82-83	DP 325	DP 2325				5255G
1.8	83-84	DP 325	DP 2325				5351G
1.8	84-91	DP 325	DP 2325				5351G
1.8 Est	84-91	DP 325	DP 2325				5351G
1.8 Est	84-91	DP 325	DP 2325				5353G
1.9	67-73	DP 104	DP 2104				5103G
1.9	73-79	DP 197	DP 2197				5103G
2.0	73-79	DP 197	DP 2197				5103G
2.0	87-91	DP 760	DP 2760				5351G
2.0 16v	87-91	DP 760	DP 2760		DP 761	DP 2761	
2.0 Est	87-91	DP 760	DP 2760				5351G
2.0 Est	87-91	DP 760	DP 2760				5353G
1.5 TD	88-91	DP 325	DP 2325				5351G
1.6 D	82-83	DP 325	DP 2325				5255G
1.6 D	83-84	DP 325	DP 2325				5351G
1.6 D	84-88	DP 325	DP 2325				5351G
1.6 D	84-88	DP 325	DP 2325				6337
1.6 D Est	82-83	DP 325	DP 2325				5103G
1.6 D Est	83-84	DP 325	DP 2325				5353G
1.6 D Est	84-88	DP 325	DP 2325				5351G
1.6 D Est	84-88	DP 325	DP 2325				5353G
1.7 D	88-91	DP 325	DP 2325				6337
1.7 D	88-91	DP 325	DP 2325				5351G
1.7 D Est	88-91	DP 325	DP 2325				5351G
1.7 D Est	88-91	DP 325	DP 2325				5353G
Kapitan							
2.8	68-72	DP 103	DP 2103		DP 104	DP 2104	
Manta							
1.2	70-75	DP 104	DP 2104				5211G
1.2	75-81	DP 197	DP 2197				5211G
1.2	78-88	DP 325	DP 2325				5103G
1.3	80-81	DP 197	DP 2197				5211G
1.3	80-86	DP 325	DP 2325				5211G
1.3 Auto	80-81	DP 197	DP 2197				5103G
1.3 Auto	81-83	DP 325	DP 2325				5103G
1.3 Auto	83-86	DP 325	DP 2325				5353G
1.6	70-75	DP 104	DP 2104				5211G
1.6	70-75	DP 104	DP 2104				5103G
1.6	75-81	DP 197	DP 2197				5211G
1.6	78-82	DP 325	DP 2325				5103G
1.8	82-83	DP 325	DP 2325				5103G
1.8	83-88	DP 325	DP 2325				5353G
1.9	70-74	DP 104	DP 2104				5103G
1.9	75-77	DP 197	DP 2197				5103G
2.0	77-81	DP 197	DP 2197				5103G
2.0	78-88	DP 325	DP 2325				5353G
2.4	81-86	DP 325	DP 2325				5353G
Monterey							
3.2	92-	DP 973	DP 6973		DP 974	DP 6974	
3.1 TD	91-	DP 973	DP 6973		DP 974	DP 6974	









Standard Quality - ECE R90 Approved with similar performance to original equipment brake pads.
 Upgrade Quality (Tuning/ Sportbeläge) - ECE R90 Approved but with higher friction and improved performance for faster street use.
 Verbesserte Qualität - mit ECE R90 Freigabe und ähnlicher Bremsleistung wie die Original Bremsbeläge.

Qualité standard - Approuvée par la norme ECE R90 - Des performances équivalentes à l'origine.
 Qualité améliorée - Approuvée par la norme ECE R90 - Un coefficient de friction supérieur et des performances accrues pour pilotage rapide sur route.
 Calidad Mejorada - Aprobación CEE R90 pero con un coeficiente de fricción más elevado y prestaciones mejoradas para un uso deportivo en carretera.

*Every EBC pad and shoe requiring ECE R-90 is available with approval subject to stock rotation - check box end label.
 Models listed by Engine Size. Only listed by trim level where pads differ, (16v, GL, GT, etc).

Standard Quality - ECE R90 Approved with similar performance to original equipment brake pads.
 Upgrade Quality (Tuning / Sportbeläge) - ECE R90 Approved but with higher friction and improved performance for faster street use.

Standard Qualität - mit ECE R90 Freigabe und ähnlicher Bremsleistung wie die Original Bremsbeläge.
 Verbesserte Qualität - mit ECE R90 Freigabe aber mit höherem Reibwert und verbesserter Bremsleistung für den schnellen Strasseninsatz.

Make/Model/Engine Hersteller/Modell/Motor Modelos	Year Jahr Années	Pads  Front / Vorn / Avant		Shoes	Pads  Rear / Hinten / Arrière		Shoes
		Original Quality ECE R90* Approved 	Upgrade Quality Tuning/Sportbeläge ECE R90* Approved 	Bremsbacken Machoires 	Original Quality ECE R90* Approved 	Upgrade Quality Tuning/Sportbeläge ECE R90* Approved 	Bremsbacken Machoires 
OPEL Contd.							
Monza							
2.5	79-83	DP 103	DP 2103		DP 104	DP 2104	
2.5	83-85	DP 754	DP 2754		DP 104	DP 2104	
2.8	79-83	DP 103	DP 2103		DP 104	DP 2104	
3.0	79-83	DP 103	DP 2103		DP 104	DP 2104	
3.0	83-85	DP 754	DP 2754		DP 104	DP 2104	
Handbrake shoes	79-85						5271
Movano							
1.9 D	2000-	DP 1182					6528
1.9 TD	2000-	DP 1386					6528
2.2 TD	2000-	DP 1386			DP 1385		6528
2.5 TD (15")	98-	DP 1182					6528
2.5 TD (16")	2000-	DP 1386			DP 1385		6528
2.8 TD (15")	98-	DP 1182					6528
2.8 TD (16")	2000-	DP 1386			DP 1385		6528
Omega							
1.8	86-87	DP 325	DP 2325		DP 676		
1.8	87-89	DP 325	DP 2325		DP 675		
1.8	89-93	DP 760	DP 2760		DP 675		
2.0	86-87	DP 325	DP 2325		DP 676		
2.0	87-89	DP 325	DP 2325		DP 675		
2.0	89-93	DP 760	DP 2760		DP 675		
2.0	94-95	DP 976	DP 2976		DP 675		
2.0	95-2000	DP 937	DP 2937		DP 675		
2.0 16v	93-95	DP 976	DP 2976		DP 675		
2.0 16v	95-2000	DP 937	DP 2937		DP 675		
2.2	99-	DP 937	DP 2937		DP 675		
2.4	87-93	DP 760	DP 2760		DP 675		
2.5	93-2000	DP 937	DP 2937		DP 675		
2.6	90-93	DP 937	DP 2937		DP 675		
2.6	2001-	DP 937	DP 2937		DP 675		
3.0	86-88	DP 754	DP 2754		DP 675		
3.0	88-93	DP 937	DP 2937		DP 675		
3.0	93-2000	DP 2937	DP 3937		DP 675		
3.0 24v	89-93	DP 2937	DP 3937		DP 675		
3.2	2001-	DP 2937	DP 3937		DP 675		
3.6 Twin Turbo (Lotus)	90-94	-	DP 3002			DP 3102	
2.0 D	97-99	DP 937	DP 2937		DP 675		
2.3 D	86-87	DP 325	DP 2325		DP 676		
2.3 D	87-89	DP 325	DP 2325		DP 675		
2.3 D	89-93	DP 760	DP 2760		DP 675		
2.2 TD	2000-	DP 937	DP 2937		DP 675		
2.3 TD	86-87	DP 325	DP 2325		DP 676		
2.3 TD	87-89	DP 325	DP 2325		DP 675		
2.3 TD	89-93	DP 760	DP 2760		DP 675		
2.5 TD	93-2000	DP 937	DP 2937		DP 675		
Rekord							
1.7	72-73	DP 104	DP 2104				5103G
1.7	73-81	DP 197	DP 2197				5103G
1.7	74-82	DP 325	DP 2325				5103G
1.7	82-86	DP 325	DP 2325				5353G
1.8	82-86	DP 325	DP 2325				5353G
1.9	72-73	DP 104	DP 2104				5103G
1.9	73-81	DP 197	DP 2197				5103G
1.9	79-82	DP 325	DP 2325				5103G
1.9	82-86	DP 325	DP 2325				5353G
2.0	72-73	DP 104	DP 2104				5103G
2.0	73-81	DP 197	DP 2197				5103G
2.0	79-82	DP 325	DP 2325				5103G









*Every EBC pad and shoe requiring ECE R-90 is available with approval subject to stock rotation - check box end label.
 Models listed by Engine Size. Only listed by trim level where pads differ, (16v, GL, GT, etc).

BRAKE PADS & SHOES - APPLICATIONS

Bremsbeläge / Plaquettes + Bremsbacken / Machoires

EBC









BRAKES

Make/Model/Engine Hersteller/Modell/Motor Modèles	Year Jahr Années	Pads  Front / Vorn / Avant		Shoes	Pads  Rear / Hinten / Arrière		Shoes
		Original Quality ECE R90* Approved 	Upgrade Quality Tuning/Sportbeläge ECE R90* Approved 	Bremsbacken Machoires 	Original Quality ECE R90* Approved 	Upgrade Quality Tuning/Sportbeläge ECE R90* Approved 	Bremsbacken Machoires 
OPEL Contd.							
Rekord Contd.							
2.0	82-86	DP 325	DP 2325				5353G
2.2	85-86	DP 325	DP 2325				5353G
2.0 D	81-82	DP 197	DP 2197				5103G
2.0 D	82-86	DP 325	DP 2325				5353G
2.1 D	77-80	DP 197	DP 2197				5103G
2.1 D	79-80	DP 325	DP 2325				5353G
2.3 D	79-82	DP 197	DP 2197				5103G
2.3 D	79-86	DP 325	DP 2325				5353G
2.3 TD	84-86	DP 325	DP 2325				5353G
Senator							
2.0	82-84	DP 103	DP 2103		DP 104		
2.0	84-85	DP 754			DP 104		
2.2	84-87	DP 754			DP 104		
2.5	78-85	DP 103	DP 2103		DP 104		
2.5	85-87	DP 754			DP 104		
2.5	87-90	DP 754			DP 675		
2.5	90-93	DP 937	DP 2937		DP 675		
2.6	90-91	DP 754			DP 675		
2.6	90-93	DP 937	DP 2937		DP 675		
2.8	78-81	DP 103	DP 2103		DP 104		
3.0	78-85	DP 103	DP 2103		DP 104		
3.0	85-87	DP 754			DP 104		
3.0	87-90	DP 754			DP 675		
3.0	90-94	DP 2937	DP 3937		DP 675		
3.0 24v	89-94	DP 2937	DP 3937		DP 675		
2.3 TD	84-87	DP 754			DP 104		
Signum							
2.0 Turbo	2003-	DP 1414	DP 21414		DP 1354	DP 21354	
2.2	2003-	DP 1414	DP 21414		DP 1354	DP 21354	
3.2 -31068238	2003-	DP 21414	DP 31414		DP 21354	DP 31354	
3.2 31068239-	2003-	DP 21416	DP 31416		DP 21354	DP 31354	
2.0 TD	2003-	DP 1414	DP 21414		DP 1354	DP 21354	
2.2 TD	2003-	DP 1414	DP 21414		DP 1354	DP 21354	
3.0 TD -31068238	2003-	DP 1414	DP 21414		DP 1354	DP 21354	
3.0 TD 31068239-	2003-	DP 1416	DP 21416		DP 1354	DP 21354	
Sintra							
2.2	96-2000	DP 1100	DP 21100		DP 1122	DP 21122	
3.0	96-2000	DP 1100	DP 21100		DP 1122	DP 21122	
2.2 TD	99-2000	DP 1100	DP 21100		DP 1122	DP 21122	
Speedster							
2.2	2000-	DP 197/2	DP 2197/2		DP 885/2	DP 2885/2	
2.0 Turbo	2003-	DP 197/2	DP 2197/2		DP 885/2	DP 2885/2	
Tigra							
1.4	94-2001	DP 940	DP 2940				6481
1.6	94-2001	DP 940	DP 2940				6481
Vectra							
1.4	88-91	DP 325	DP 2325				5351G
1.4	92-95	DP 940	DP 2940				6482
1.6	88-91	DP 325	DP 2325				5351G
1.6	92-95	DP 940	DP 2940				6482
1.6	95-2000	DP 1087	DP 21087				6538
1.6 16v	95-2000	DP 1087	DP 21087		DP 675		
1.6 16v	2000-2002	DP 1062	DP 21062		DP 675		
1.8	88-91	DP 325	DP 2325				5351G
1.8	91-95	DP 940	DP 2940				6482

*Every EBC pad and shoe requiring ECE R-90 is available with approval subject to stock rotation - check box end label.
Models listed by Engine Size. Only listed by trim level where pads differ, (16v, GL, GT, etc).

Standard Quality - ECE R90 Approved with similar performance to original equipment brake pads.
Upgrade Quality (Tuning/ Sportbeläge) - ECE R90 Approved but with higher friction and improved performance for faster street use.
Verbesserte Qualität - mit ECE R90 Freigabe und ähnlicher Bremsleistung wie die Original Bremsbeläge.
Standard Qualität - mit ECE R90 Freigabe und ähnlicher Bremsleistung wie die Original Bremsbeläge.

Qualité standard - Approuvée par la norme ECE R90 - Des performances équivalentes à l'origine.
Qualité améliorée - Approuvée par la norme ECE R90 - Un coefficient de friction supérieur et des performances accrues pour pilotage rapide sur route.
Calidad Mejorada - Aprobación CEE R90 con prestaciones similares a las pastillas originales.
Calidad Estándar - Aprobación CEE R90 con prestaciones similares a las pastillas originales.

Make/Model/Engine Hersteller/Modell/Motor Modelos	Year Jahr Années	Pads  Front / Vorn / Avant		Shoes	Pads  Rear / Hinten / Arrière		Shoes
		Original Quality ECE R90* Approved 	Upgrade Quality Tuning/Sportbeläge ECE R90* Approved 	Bremsbacken Machoires 	Original Quality ECE R90* Approved 	Upgrade Quality Tuning/Sportbeläge ECE R90* Approved 	Bremsbacken Machoires 
OPEL Contd.							
Vectra Contd.							
1.8	95-2000	DP 1087	DP 21087		DP 675		
1.8	2000-2002	DP 1062	DP 21062		DP 675		
1.8	2002-	DP 1414	DP 21414		DP 1354	DP 21354	
1.8 4x4	88-90	DP 760	DP 2760		DP 761	DP 2761	
1.8 Auto	91-95	DP 760	DP 2760				6482
1.8 16v	95-2000	DP 1087	DP 21087		DP 675		
2.0	88-95	DP 760	DP 2760		DP 761	DP 2761	
2.0	95-2000	DP 1087	DP 21087		DP 675		
2.0	2002-	DP 1414	DP 21414		DP 1354	DP 21354	
2.0 16v	88-95	DP 760	DP 2760		DP 761	DP 2761	
2.0 16v	95-2000	DP 1062	DP 21062		DP 675		
2.0 Turbo	92-95	DP 760	DP 2760		DP 761	DP 2761	
2.0 Turbo	2003-	DP 1414	DP 21414		DP 1354	DP 21354	
2.2	2000-2002	DP 1062	DP 21062		DP 675		
2.2	2002-	DP 1414	DP 21414		DP 1354	DP 21354	
2.5	93-95	DP 760	DP 2760		DP 761	DP 2761	
2.5	95-2000	DP 1062	DP 21062		DP 675		
2.6	2000-2002	DP 1062	DP 21062		DP 675		
3.2 -38047797	2002-2003	DP 21414	DP 31414		DP 21354	DP 31354	
3.2 38047798-	2003-	DP 21416	DP 31416		DP 21354	DP 31354	
1.7 TD	95-96	DP 1087	DP 21087		DP 675		6538
2.0 D	96-2000	DP 1087	DP 21087		DP 675		6538
2.0 D	2002-	DP 1414	DP 21414		DP 1354	DP 21354	
2.0 D Est	96-2000	DP 1087	DP 21087		DP 675		6538
2.0 TD	97-2000	DP 1087	DP 21087		DP 675		6538
2.0 TD	2000-2002	DP 1062	DP 21062		DP 675		
2.2 TD	2000-2002	DP 1062	DP 21062		DP 675		
2.2 D	2002-	DP 1414	DP 21414		DP 1354	DP 21354	
3.0 TD -31070293	2003-	DP 1414	DP 21414		DP 1354	DP 21354	
3.0 TD 31070294-	2003-	DP 1416	DP 21416		DP 1354	DP 21354	
Handbrake Shoes	95-						5271
Vivaro							
1.9 TD	2001-	DP 1393			DP 1284		
Zafira							
1.6	99-2001	DP 1183	DP 21183		DP 1186	DP 21186	6538
1.6	2001-	DP 1183	DP 21183		DP 1447		6538
1.8	99-2001	DP 1183	DP 21183		DP 1186	DP 21186	
1.8	2001-	DP 1183	DP 21183		DP 1447		
2.0 Turbo	2001-	DP 1183	DP 21183		DP 1447		
2.2	2000-2001	DP 1183	DP 21183		DP 1186	DP 21186	
2.2	2001-	DP 1183	DP 21183		DP 1447		
2.0 D	99-2000	DP 1183	DP 21183		DP 1186	DP 21186	
2.0 TD	2000-2001	DP 1183	DP 21183		DP 1186	DP 21186	
2.0 TD	2001-	DP 1183	DP 21183		DP 1447		

Pad Illustrations for Opel

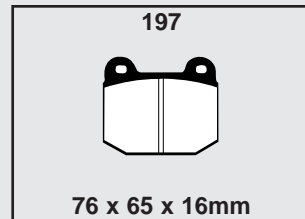
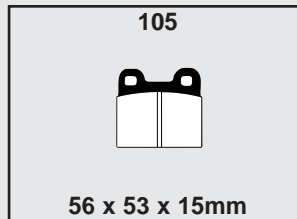
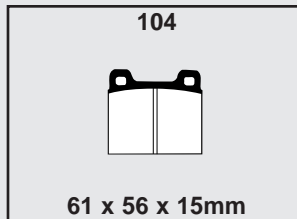
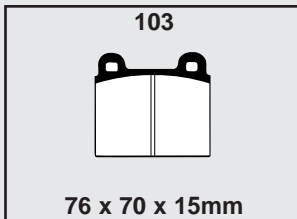

Standard Quality - ECE R90 Approved with similar performance to original equipment brake pads.
Upgrade Quality (Tuning / Sportbeläge) - ECE R90 Approved but with higher friction and improved performance for faster street use.

Calidad Estandar - Aprobacion CEE R90 con prestaciones similares a las pastillas originales.
Calidad Mejorada - Aprobacion CEE R90 pero con un coeficiente de friccion mas elevado y prestaciones mejoradas para un uso deportivo en carretera.

Standard Qualität - mit ECE R90 Freigabe und ähnlicher Bremsleistung wie die Original Bremsbeläge.
Verbesserte Qualität - mit ECE R90 Freigabe aber mit höherem Reibwert und verbesserter Bremsleistung für den schnellen Strasseninsatz.













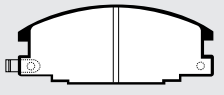



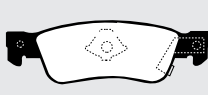
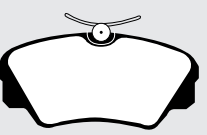









BRAKE PADS & SHOES - APPLICATIONS

Bremsbeläge / Plaquettes + Bremsbacken / Machoires

EBC
BRAKES

Make/Model/Engine	Year	Pads	Front / Vorn / Avant	Shoes	Pads	Rear / Hinten / Arrière	Shoes
Hersteller/Modell/Motor	Jahr	Plaquettes / Bremsbeläge		Bremsbacken	Plaquettes / Bremsbeläge		Bremsbacken
Modelos	Années	Original Quality ECE R90* Approved	Upgrade Quality Tuning/Sportbeläge ECE R90* Approved	Machoires ECE R90* Approved	Original Quality ECE R90* Approved	Upgrade Quality Tuning/Sportbeläge ECE R90* Approved	Machoires ECE R90* Approved



Pad Illustrations for Opel Contd.

325  100 x 59 x 15mm	675 [37mm]  61 x 61 x 15mm	676 [31mm]  61 x 61 x 15mm	746  127 x 51 x 16mm
754  112 x 60 x 17mm	760  157 x 52 x 17mm	761  60 x 57 x 15mm	777  131 x 42 x 13mm
937  127 x 68 x 20mm	940  141 x 48 x 16mm	973  138 x 59 x 16mm	973/2  138 x 59 x 16mm
974  110 x 43 x 15mm	976  156 x 61 x 18mm	1062  156 x 74 x 19mm	1087  157 x 52 x 17mm
1100  148 x 63 x 18mm	1122  108 x 41 x 15mm	1183  156 x 71 x 20mm	1184  178 x 62 x 19mm
1186  105 x 41 x 16mm	1284  95 x 58 x 16mm	1291  106 x 49 x 15mm	1341  131 x 51 x 17mm
1361  130 x 44 x 15mm	1393  145 x 63 x 18mm	1414  148 x 72 x 20mm	1414  147 x 68 x 20mm

Standard Quality - ECE R90 Approved with similar performance to original equipment brake pads.
Upgrade Quality (Tuning/ Sportbeläge) - ECE R90 Approved but with higher friction and improved performance for faster street use.
Standard Qualität - mit ECE R90 Freigabe und ähnlicher Bremsleistung wie die Original Bremsbeläge.
Verbesserte Qualität - mit ECE R90 Freigabe aber mit höherem Reibwert und verbesserter Bremsleistung für den schnellen Strasseninsatz.

Qualité standard - Approuvée par la norme ECE R90 - Des performances équivalentes à l'origine.
Qualité améliorée - Approuvée par la norme ECE R90 - Un coefficient de friction supérieur et des performances accrues pour pilotage rapide sur route.
Calidad Estándar - Aprobación CEE R90 con prestaciones similares a las pastillas originales.
Calidad Mejorada - Aprobación CEE R90 pero con un coeficiente de fricción más elevado y prestaciones mejoradas para un uso deportivo en carretera.

*Every EBC pad and shoe requiring ECE R-90 is available with approval subject to stock rotation - check box end label.
Models listed by Engine Size. Only listed by trim level where pads differ, (16v, GL, GT, etc).

Make/Model/Engine	Year	Pads	Front / Vorn / Avant	Shoes	Pads	Rear / Hinten / Arrière	Shoes
Hersteller/Modell/Motor	Jahr	Plaquettes / Bremsbeläge		Bremsbacken Machoires	Plaquettes / Bremsbeläge		Bremsbacken Machoires
Modelos	Années	Original Quality ECE R90* Approved	Upgrade Quality Tuning/Sportbeläge ECE R90* Approved		Original Quality ECE R90* Approved	Upgrade Quality Tuning/Sportbeläge ECE R90* Approved	

Pad Illustrations for Opel Contd.

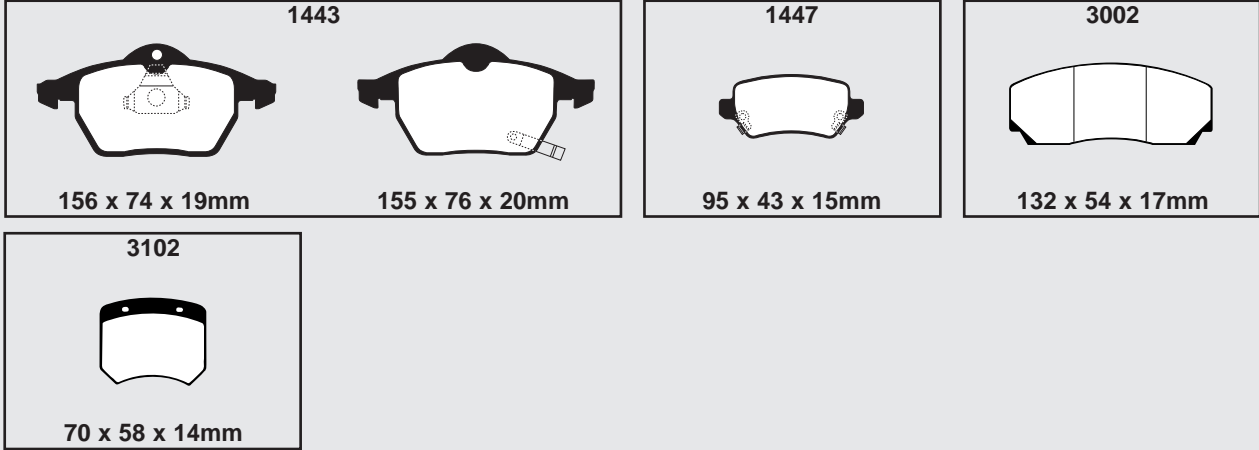

OPEL (Malaysia & The Philippines)

Model	Year	Front Pads	Rear Pads
Astra	98-	DP 1184	DP 21184
Omega	97-	DP 937	DP 2937
			DP 675
Vectra	97-	DP 1062	DP 21062
			DP 675

Pad Illustrations for Opel (Malaysia & The Philippines)

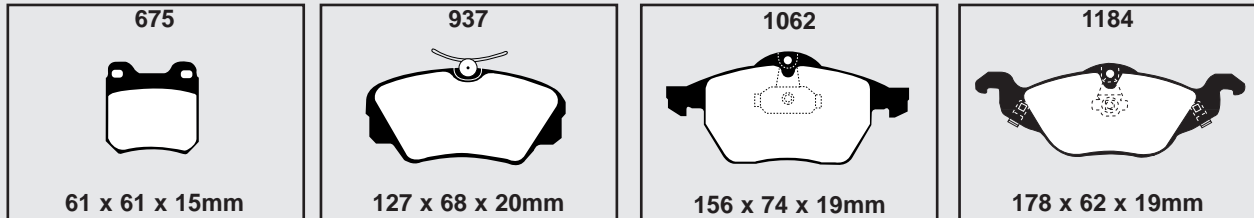

OPEL (SA)

Model	Year	Front Pads	Rear Pads
Corsa	96-	DP 415	DP 2415
Astra/Kadett	93-	DP 415	DP 2415
	93-	DP 760	DP 2760
			DP 761
			DP 2761

Pad Illustrations for Opel (SA)

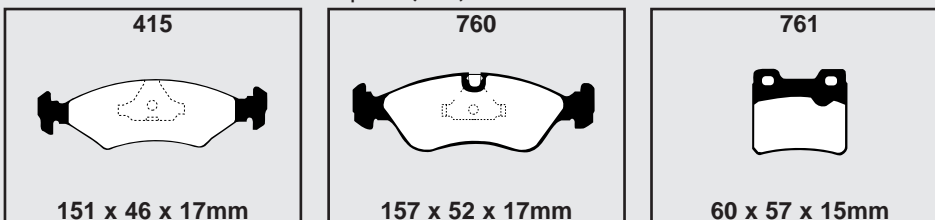

Standard Quality - ECE R90 Approved with similar performance to original equipment brake pads.
Upgrade Quality (Tuning / Sportbeläge) - ECE R90 Approved but with higher friction and improved performance for faster street use.

Standard Qualität - mit ECE R90 Freigabe und ähnlicher Bremsleistung wie die Original Bremsbeläge.
Verbesserte Qualität - mit ECE R90 Freigabe aber mit höherem Reibwert und verbesserter Bremsleistung für den schnellen Strasseneinsatz.

Calidad Estándar - Aprobacion CEE R90 con prestaciones similares a las pastillas originales.
Calidad Mejorada - Aprobacion CEE R90 pero con un coeficiente de friccion mas elevado y prestaciones mejoradas para un uso deportivo en carretera.

*Every EBC pad and shoe requiring ECE R-90 is available with approval subject to stock rotation - check box end label.
Models listed by Engine Size. Only listed by trim level where pads differ, (16v, GL, GT, etc).

BRAKE PADS & SHOES - APPLICATIONS

Bremsbeläge / Plaquettes + Bremsbacken / Machoires

EBC

BRAKES

Make/Model/Engine Hersteller/Modell/Motor Modèles	Year Jahr Années	Pads Front / Vorn / Avant		Shoes	Pads Rear / Hinten / Arrière		Shoes
		Original Quality ECE R90* Approved	Upgrade Quality Tuning/Sportbeläge ECE R90* Approved	Bremsbacken Machoirs ECE R90* Approved	Original Quality ECE R90* Approved	Upgrade Quality Tuning/Sportbeläge ECE R90* Approved	Bremsbacken Machoirs ECE R90* Approved
PANTHER							
De Ville	75-85	DP 262	DP 2262		DP 101	DP 2101	
J72	72-81	DP 240	DP 2240		DP 101	DP 2101	
Kallista							
1.6	83-90	DP 415	DP 2415				6323A 6324
2.0	90-93	DP 415	DP 2415				
2.8	83-90	DP 473	DP 2473		DP 617	DP 2617	
2.9	88-98	DP 473	DP 2473		DP 617	DP 2617	
Lima	76-83	DP 106	DP 2106				
Rio	75-77	DP 106	DP 2106				
Solo	89-93	DP 753	DP 2753		DP 617	DP 2617	

Pad Illustrations for Panther

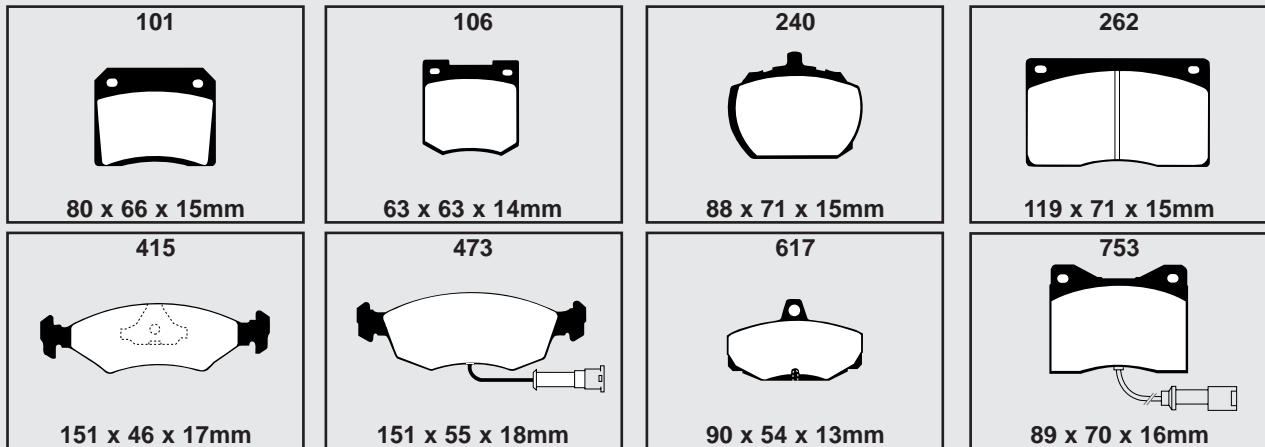

PEERLESS							
2.0	58-60	-	DP 2100				

Pad Illustrations for Peerless

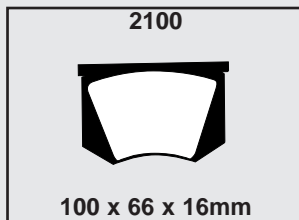

PERODUA							
Kelisa							
1.0	2002-						
Kenari							
1.0	2000-	DP 1217					
Nippa							
0.8	97-2001	DP 1016					6533 6533
0.8	97-2001	DP 685					

*Every EBC pad and shoe requiring ECE R-90 is available with approval subject to stock rotation - check box end label.
Models listed by Engine Size. Only listed by trim level where pads differ, (16v, GL, GT, etc).

Standard Quality - ECE R90 Approved with similar performance to original equipment brake pads.
Upgrade Quality (Tuning/ Sportbeläge) - ECE R90 Approved but with higher friction and improved performance for faster street use.
Verbesserte Qualität - mit ECE R90 Freigabe aber mit höherem Reibwert und verbesserter Bremsleistung für den schnellen Strasseninsatz.

Qualité standard - Approuvée par la norme ECE R90 - Des performances équivalentes à l'origine.
Qualité améliorée - Approuvée par la norme ECE R90 - Un coefficient de friction supérieur et des performances accrues pour pilotage rapide sur route.
Calidad Estándar - Aprobación CEE R90 con prestaciones similares a las pastillas originales.
Calidad Mejorada - Aprobación CEE R90 pero con un coeficiente de fricción más elevado y prestaciones mejoradas para un uso deportivo en carretera.

Make/Model/Engine	Year	Front / Vorn / Avant	Shoes	Rear / Hinten / Arrière	Shoes
Hersteller/Modell/Motor	Jahr	Plaquettes / Bremsbeläge	Bremsbacken Machoires	Plaquettes / Bremsbeläge	Bremsbacken Machoires
Modelos	Années	Original Quality ECE R90* Approved	Upgrade Quality Tuning/Sportbeläge ECE R90* Approved	Original Quality ECE R90* Approved	Upgrade Quality Tuning/Sportbeläge ECE R90* Approved

Pad Illustrations for Perodua

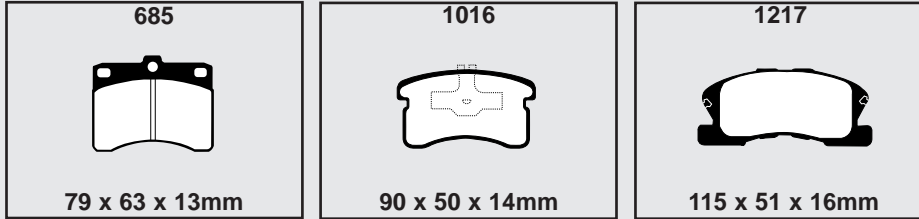

PEUGEOT					
104					
1.0	72-77	DP 269(B)			5190(B)
1.0	72-77	DP 220(T)	DP 2220		5226/1(G)
1.0	78-81	DP 269(B)			6306(B)
1.0	78-81	DP 220(T)	DP 2220		5243(G)
1.0	82-83	DP 651(B)			5243/1(G)
1.0	82-83	DP 220(T)	DP 2220		5243/1(G)
1.0	83-85	DP 220/8(T)	DP 2220		5226/1(G)
1.0	83-85	DP 651(B)			5243/1(G)
1.1	72-77	DP 269(B)			5190(B)
1.1	72-77	DP 220(T)	DP 2220		5226/1(G)
1.1	78-81	DP 269(B)			6306(B)
1.1	78-81	DP 220(T)	DP 2220		5243(G)
1.1	82-83	DP 651(B)			5243/1(G)
1.1	82-83	DP 220(T)	DP 2220		5243/1(G)
1.1	83-85	DP 220/8(T)	DP 2220		5226/1(G)
1.1	83-85	DP 651(B)			5243/1(G)
1.2	72-77	DP 269(B)			5190(B)
1.2	72-77	DP 220(T)	DP 2220		5226/1(G)
1.2	78-81	DP 269(B)			6306(B)
1.2	78-81	DP 220(T)	DP 2220		5243(G)
1.2	82-83	DP 651(B)			5243/1(G)
1.2	82-83	DP 220(T)	DP 2220		5243/1(G)
1.2	83-85	DP 220/8(T)	DP 2220		5226/1(G)
1.2	83-85	DP 651(B)			5243/1(G)
1.4	72-77	DP 269(B)			5190(B)
1.4	72-77	DP 220(T)	DP 2220		5226/1(G)
1.4	78-81	DP 269(B)			6306(B)
1.4	78-81	DP 220(T)	DP 2220		5243(G)
1.4	82-83	DP 651(B)			5243/1(G)
1.4	82-83	DP 220(T)	DP 2220		5243/1(G)
1.4	83-85	DP 220/8(T)	DP 2220		5226/1(G)
1.4	83-85	DP 651(B)			5243/1(G)
106					
1.0	91-97	DP 545/4(B)	DP 2545		6340/1
1.0	91-97	DP 656 (T)	DP 2656		6403
1.1	91-	DP 545/4(B)	DP 2545		6340/1
1.1	91-	DP 656 (T)	DP 2656		6403
1.3	91-96	DP 545/4 (B)	DP 2545		6340/1
1.3	91-96	DP 626 (G)	DP 2626		6340/1
1.4	91-96	DP 545/4 (B)	DP 2545		6340/1
1.4	91-96	DP 626 (G)	DP 2626		6340/1
1.4	96-	DP 545/4 (B)	DP 2545		6340/1
1.4	96-	DP 948 (T)	DP 2948		6340/1
1.4	96-	DP 948 (T)	DP 2948		6526
1.6	94-96	DP 626 (G)	DP 2626		6340/1
1.6	94-96	DP 545/4 (B)	DP 2545	DP 458/2	DP 2458/2
1.6	96-	DP 948 (T)	DP 2948	DP 458/2	DP 2458/2
1.6 16v	96-	DP 948 (T)	DP 2948	DP 458/2	DP 2458/2
1.4 D	92-94	DP 545/4 (B)	DP 2545		6340/1

*Every EBC pad and shoe requiring ECE R-90 is available with approval subject to stock rotation - check box end label.









Models listed by Engine Size. Only listed by trim level where pads differ, (16v, GL, GT, etc).

BRAKE PADS & SHOES - APPLICATIONS

Bremsbeläge / Plaquettes + Bremsbacken / Machoires

EBC

BRAKES









Make/Model/Engine Hersteller/Modell/Motor Modèles	Year Jahr Années	Pads  Front / Vorn / Avant		Shoes	Pads  Rear / Hinten / Arrière		Shoes
		Original Quality ECE R90* Approved 	Upgrade Quality Tuning/Sportbeläge ECE R90* Approved 	Bremsbacken Machoires 	Original Quality ECE R90* Approved 	Upgrade Quality Tuning/Sportbeläge ECE R90* Approved 	Bremsbacken Machoires 
PEUGEOT Contd.							
106 Contd.							
1.5 D	94-	DP 545/4 (B)	DP 2545				6340/1
1.5 D	96-	DP 948 (T)	DP 2948				6340/1
1.5 D	96-	DP 948 (T)	DP 2948				6526
204							
1.1	70-72	DP 121(B)					5062
1.1	70-72	DP 124(G)					5062
1.1	73-75	DP 124(G)					5071
1.1	73-75	DP 121(B)					5071
1.1	75-76	DP 124(G)					5212A(G)
1.1	75-76	DP 121(B)					5072(B)
1.1	75-76	DP 220/3(T)	DP 2220				5072
1.4	70-72	DP 121(B)					5062
1.4	70-72	DP 124(G)					5062
1.4	73-75	DP 124(G)					5071
1.4	73-75	DP 121(B)					5071
1.4	75-76	DP 124(G)					5212A(G)
1.4	75-76	DP 121(B)					5072(B)
1.4	75-76	DP 220/3(T)	DP 2220				5072
205							
1.0	83-87	DP 489(B)					6340/1(B)
1.0	83-92	DP 626(G)	DP 2626				6395(G)
1.0	88-92	DP 545(B)	DP 2545				6340/1(B)
1.1	83-96	DP 545(B)	DP 2545				6340/1(B)
1.1	83-96	DP 626(G)	DP 2626				6395(G)
1.4	83-95	DP 545(B)	DP 2545				6340/1(B)
1.4	83-95	DP 626(G)	DP 2626				6395(G)
1.4 Cabriolet	88-95	DP 545(B)	DP 2545				6343(G)
1.4 Cabriolet	88-95	DP 626(G)	DP 2626				5095(B)
1.6 CTi	84-93	DP 545(B)	DP 2545				6343(G)
1.6 CTi	84-93	DP 626(G)	DP 2626				5095(B)
1.6 GTi	84-93	DP 545(B)	DP 2545				6343(G)
1.6 GTi	84-93	DP 626(G)	DP 2626				5095(B)
1.6	94-97	DP 545(B)	DP 2545				5095(B)
1.6	94-97	DP 626(G)	DP 2626				6343(G)
1.7 D	83-85	DP 489(B)					6340/1(B)
1.7 D	85-96	DP 545(B)	DP 2545				6340/1(B)
1.7 D	85-96	DP 626(G)	DP 2626				6395(G)
1.8 D	83-97	DP 545(B)	DP 2545				6340/1(B)
1.8 D	83-97	DP 626(G)	DP 2626				6395(G)
1.9 D	89-95	DP 626(G)	DP 2626				6395(G)
1.9 D	89-95	DP 545(B)	DP 2545				6340/1(B)
1.8 TD	91-96	DP 545(B)	DP 2545				6340/1(B)
1.8 TD	91-96	DP 626(G)	DP 2626				6395(G)
1.9 GTi	86-95	DP 426(G)	DP 2426		DP 458/2	DP 2458/2	
1.9 GTi	86-95	DP 545(B)	DP 2545		DP 458/2	DP 2458/2	
1.9 CTi	87-95	DP 426(G)	DP 2426				5095(B)
1.9 CTi	87-95	DP 545(B)	DP 2545				6343(G)
206							
1.1	98-	DP 1366	DP 21366				6526(G)
1.1	98-	DP 1366	DP 21366				6577(B)
1.4	98-	DP 1366	DP 21366				6526(G)
1.4	98-	DP 1366	DP 21366				6577(B)
1.6	98-	DP 1366	DP 21366				6526(G)
1.6	98-	DP 1366	DP 21366				6577(B)
1.6	2000-	DP 1374	DP 21374		DP 458/2	DP 2458/2	
2.0 16v	99-2000	DP 1234	DP 21234		DP 458/2	DP 2458/2	
2.0 16v	2000-	DP 1374	DP 21374		DP 458/2	DP 2458/2	
1.4 TD	2002-	DP 1366	DP 21366				6526(G)

Standard Quality - ECE R90 Approved with similar performance to original equipment brake pads.
 Upgrade Quality (Tuning/ Sportbeläge) - ECE R90 Approved but with higher friction and improved performance for faster street use.
 Verbesserte Qualität - mit ECE R90 Freigabe aber mit höherem Reibwert und verbesserter Bremsleistung für den schnellen Strasseninsatz.
 Standard Qualität - mit ECE R90 Freigabe und ähnlicher Bremsleistung wie die Original Bremsbeläge.
 Calidad Estandar - Aprobación CEE R90 con prestaciones similares a las pastillas originales.
 Qualité améliorée - Approuvée par la norme ECE R90 - Un coefficient de friction supérieur et des performances accrues pour pilotage rapide sur route.
 Calidad Mejorada - Aprobación CEE R90 pero con un coeficiente de fricción mas elevado y prestaciones mejoradas para un uso deportivo en carretera.

*Every EBC pad and shoe requiring ECE R-90 is available with approval subject to stock rotation - check box end label.
 Models listed by Engine Size. Only listed by trim level where pads differ, (16v, GL, GT, etc).

Standard Quality - ECE R90 Approved with similar performance to original equipment brake pads.
 Upgrade Quality (Tuning / Sportbeläge) - ECE R90 Approved but with higher friction and improved performance for faster street use.

Standard Qualität - mit ECE R90 Freigabe und ähnlicher Bremsleistung wie die Original Bremsbeläge.
 Verbesserte Qualität - mit ECE R90 Freigabe aber mit höherem Reibwert und verbesserter Bremsleistung für den schnellen Strasseninsatz.

Make/Model/Engine Hersteller/Modell/Motor Modelos	Year Jahr Années	Pads  Front / Vorn / Avant		Shoes	Pads  Rear / Hinten / Arrière		Shoes
		Original Quality ECE R90* Approved 	Upgrade Quality Tuning/Sportbeläge ECE R90* Approved 	Bremsbacken Machoires 	Original Quality ECE R90* Approved 	Upgrade Quality Tuning/Sportbeläge ECE R90* Approved 	Bremsbacken Machoires 
PEUGEOT Contd.							
206 Contd.							
1.4 TD	2002-	DP 1366	DP 21366				6557(B)
1.9 D	98-	DP 1366	DP 21366				6526(G)
1.9 D	98-	DP 1366	DP 21366				6577(B)
2.0 TD	99-2000	DP 1234	DP 21234		DP 458/2	DP 2458/2	6526(G)
2.0 TD	2000-	DP 1374	DP 21374		DP 458/2	DP 2458/2	6526(G)
206CC							
1.6	2001-	DP 1234	DP 21234		DP 458/2	DP 2458/2	
1.6	2001-	DP 1374	DP 21374		DP 458/2	DP 2458/2	
2.0 16v	2001-	DP 1374	DP 21374		DP 458/2	DP 2458/2	
304							
1.1	70-72	DP 124					5062
1.1	73-75	DP 124					5071
1.1	75-80	DP 124(G)					5212A(G)
1.1	75-80	DP 121(B)					5072(B)
1.1	75-80	DP 220/2(T)	DP 2220				5072(B)
1.3	70-72	DP 124					5062
1.3	73-75	DP 124					5071
1.3	75-80	DP 124(G)					5212A(G)
1.3	75-80	DP 121(B)					5072(B)
1.3	75-80	DP 220/2(T)	DP 2220				5072(B)
305							
1.3	76-82	DP 269(B)					5072(B)
1.3	76-82	DP 220/3(T)	DP 2220				5212A(G)
1.3	76-82	DP 220/3(T)	DP 2220				6341(T)
1.3	82-89	DP 545(B)	DP 2545				5072(B)
1.5	76-82	DP 269(B)					5072(B)
1.5	76-82	DP 220/3(T)	DP 2220				5212A(G)
1.5	76-82	DP 220/3(T)	DP 2220				6341(T)
1.5	82-89	DP 545(B)	DP 2545				5072(B)
1.6	76-82	DP 269(B)					5072(B)
1.6	76-82	DP 220/3(T)	DP 2220				5212A(G)
1.6	76-82	DP 220/3(T)	DP 2220				6341(T)
1.6	82-89	DP 545(B)	DP 2545				5072(B)
1.8 D	78-82	DP 220/4(T)	DP 2220				6341(T)
1.8 D	82-89	DP 545(B)	DP 2545				5072(B)
1.8 D	82-89	DP 545(B)	DP 2545				5212A(G)
1.9 D	87-89	DP 545(B)	DP 2545				5072(B)
1.9 D	87-89	DP 545(B)	DP 2545				5212A(G)
1.9	82-89	DP 545(B)	DP 2545				5072(B)
1.9	82-89	DP 426(G)	DP 2426				5212A(G)
306							
1.4	93-97	DP 545/4(B)	DP 2545				5200(B)
1.4	93-97	DP 545/4(B)	DP 2545				6557(B)
1.4	93-97	DP 545/4(B)	DP 2545				6329(B)
1.4	95-97	DP 545/4(B)	DP 2545				6526(G)
1.4	97-	DP 948(T)	DP 2948				6395(G)
1.4	97-	DP 1104(G)	DP 21104				6200(B)
1.4	97-2000	DP 1366(B)	DP 21366				6557(B)
1.4	97-2000	DP 1366(B)	DP 21366				6329(B)
1.6	93-	DP 948(T)	DP 2948				6395(G)
1.6	93-	DP 948(T)	DP 2948				5200(B)
1.6	93-	DP 948(T)	DP 2948				6557(B)
1.6	93-	DP 948(T)	DP 2948				6329(B)
1.6	95-	DP 948(T)	DP 2948				6526(G)
1.6	97-	DP 1366(B)	DP 21366				6557(B)
1.6	97-	DP 1366(B)	DP 21366				6329(B)
1.6	97-	DP 1104(G)	DP 21104				6200(B)

*Every EBC pad and shoe requiring ECE R-90 is available with approval subject to stock rotation - check box end label.
 Models listed by Engine Size. Only listed by trim level where pads differ, (16v, GL, GT, etc).

BRAKE PADS & SHOES - APPLICATIONS

Bremsbeläge / Plaquettes + Bremsbacken / Machoires

EBC









BRAKES

Make/Model/Engine Hersteller/Modell/Motor Modèles	Year Jahr Années	Pads Plaquettes / Bremsbeläge		Shoes Bremsbacken Machoires	Pads Plaquettes / Bremsbeläge		Shoes Bremsbacken Machoires
		Original Quality ECE R90* Approved	Upgrade Quality Tuning/Sportbeläge ECE R90* Approved	ECE R90* Approved	Original Quality ECE R90* Approved	Upgrade Quality Tuning/Sportbeläge ECE R90* Approved	ECE R90* Approved
PEUGEOT Contd.							
306 Contd.							
1.8	93-	DP 948(T)	DP 2948		DP 458/2(B)	DP 2458/2	6395(G) 5200(B)
1.8	93-	DP 948(T)	DP 2948				6557(B)
1.8	93-	DP 948(T)	DP 2948				6329(B)
1.8	93-	DP 948(T)	DP 2948				6526(G)
1.8	95-	DP 948(T)	DP 2948		DP 458/2(B)	DP 2458/2	6200(B)
1.8	97-	DP 1366(B)	DP 21366		DP 458/2(B)	DP 2458/2	6200(B)
1.8	97-	DP 1104(G)	DP 21104		DP 680(G)	DP 2680	
1.8	97-	DP 1080(G)	DP 2687		DP 458/2	DP 2458/2	
1.8	2000-	DP 1234(B)	DP 21234		DP 458/2(B)	DP 2458/2	
2.0	93-97	DP 687(G)	DP 2687		DP 458/2(B)	DP 2458/2	
2.0	97-2001	DP 1104(G)	DP 21104		DP 458/2(B)	DP 2458/2	
2.0	2000-2001	DP 1234(B)	DP 21234		DP 458/2	DP 2458/2	
2.0 16v	93-95	DP 1080(G)	DP 2687		DP 458/2	DP 2458/2	
2.0 16v	95-97	DP 1021(G)			DP 458/2	DP 2458/2	
2.0 16v	97-2001	DP 1047(G)	DP 21047		DP 458/2	DP 2458/2	
2.0 16v	97-2001	DP 1104(G)	DP 21104		DP 458/2	DP 2458/2	
2.0 GTi-6	96-2001	DP 1047(G)	DP 21047		DP 458/2	DP 2458/2	
1.9 D	93-97	DP 948(T)	DP 2948				5200(B)
1.9 D	93-2001	DP 948(T)	DP 2948				6395(G)
1.9 D	93-2001	DP 948(T)	DP 2948				6557(B)
1.9 D	93-2001	DP 948(T)	DP 2948				6329(B)
1.9 D	95-2001	DP 948(T)	DP 2948				6526(G)
1.9 D	97-2001	DP 948(T)	DP 2948				6200(B)
1.9 D	2000-	DP 1234(B)	DP 21234				6329(B)
1.9 D	2000-	DP 1104(G)	DP 21104				6526(G)
1.9 TD	93-99	DP 948(T)	DP 2948				6395(G)
1.9 TD	93-99	DP 948(T)	DP 2948				5200(B)
1.9 TD	93-99	DP 948(T)	DP 2948				6557(B)
1.9 TD	93-99	DP 948(T)	DP 2948				6329(B)
1.9 TD	93-99	DP 948(T)	DP 2948				6526(G)
1.9 TD	95-99	DP 948(T)	DP 2948				6200(B)
1.9 TD	97-2001	DP 1104(G)	DP 21104				6526(G)
2.0 TD	99-2000	DP 948(T)	DP 2948		DP 458/2(B)	DP 2458/2	6200(B)
2.0 TD	99-2000	DP 1234(B)	DP 21234		DP 458/2(B)	DP 2458/2	6526(G)
2.0 TD	99-2000	DP 1234(B)	DP 21234		DP 458/2(B)	DP 2458/2	6200(B)
2.0 TD	99-	DP 1104(G)	DP 21104		DP 680(G)	DP 2680	6200(B)
2.0 TD	2000-	DP 1234(B)	DP 21234		DP 458/2(B)	DP 2458/2	
307							
1.4	2001-	DP 1374	DP 21374		DP 1230	DP 21230	
1.6	2001-	DP 1375	DP 21375		DP 1230	DP 21230	
2.0	2001-	DP 1375	DP 21375		DP 1230	DP 21230	
1.4 TD	2001-	DP 1374	DP 21374		DP 1230	DP 21230	
2.0 TD (90)	2001-	DP 1375	DP 21375		DP 1230	DP 21230	
2.0 TD (110)	2001-	DP 1375	DP 21375		DP 1230	DP 21230	
307 CC							
2.0	2003-						
309							
1.1	86-89	DP 626(G)	DP 2626				6343(G)
1.1	86-89	DP 545(B)	DP 2545				5095(B)
1.1	89-93	DP 545(B)	DP 2545				6340/1(B)
1.1	89-93	DP 626(G)	DP 2626				6395(G)
1.3	86-89	DP 626(G)	DP 2626				5095(B)
1.3	86-89	DP 626(G)	DP 2626				6343(G)
1.3	86-89	DP 545(B)	DP 2545				5095(B)
1.3	89-93	DP 545(B)	DP 2545				6340/1(B)
1.3	89-93	DP 626(G)	DP 2626				6395(G)
1.6	86-89	DP 626(G)	DP 2626				5095(B)
1.6	86-93	DP 626(G)	DP 2626				6343(G)
1.6	86-89	DP 545(B)	DP 2545				5095(B)

*Every EBC pad and shoe requiring ECE R-90 is available with approval subject to stock rotation - check box end label.
Models listed by Engine Size. Only listed by trim level where pads differ, (16v, GL, GT, etc).

Standard Quality - ECE R90 Approved with similar performance to original equipment brake pads.
Upgrade Quality (Tuning/ Sportbeläge) - ECE R90 Approved but with higher friction and improved performance for faster street use.
Verbesserte Qualität - mit ECE R90 Freigabe aber mit höherem Reibwert und verbesserter Bremsleistung für den schnellen Strasseninsatz.

Qualité standard - Approuvée par la norme ECE R90 - Des performances équivalentes à l'origine.
Qualité améliorée - Approuvée par la norme ECE R90 - Un coefficient de friction supérieur et des performances accrues pour pilotage rapide sur route.
Calidad Estándar - Aprobación CEE R90 con prestaciones similares a las pastillas originales.
Calidad Mejorada - Aprobación CEE R90 pero con un coeficiente de fricción más elevado y prestaciones mejoradas para un uso deportivo en carretera.

Make/Model/Engine Hersteller/Modell/Motor Modelos	Year Jahr Années	Pads  Front / Vorn / Avant		Shoes	Pads  Rear / Hinten / Arrière		Shoes
		Original Quality ECE R90* Approved 	Upgrade Quality Tuning/Sportbeläge ECE R90* Approved 	Bremsbacken Machoires 	Original Quality ECE R90* Approved 	Upgrade Quality Tuning/Sportbeläge ECE R90* Approved 	Bremsbacken Machoires 
PEUGEOT Contd.							
309 Contd.							
1.6	89-93	DP 545(B)	DP 2545				6343(G)
1.9 GTi	87-93	DP 426(G)	DP 2426		DP 458/2	DP 2458/2	
1.8 TD	86-93	DP 545(B)	DP 2545				5095(B)
1.8 TD	86-93	DP 626(G)	DP 2626				6343(G)
1.9 D	86-93	DP 545(B)	DP 2545				5095(B)
1.9 D	86-93	DP 626(G)	DP 2626				6343(G)
404							
1.5	69-79	DP 121					5048
1.6	69-79	DP 121					5048
405							
1.4	87-96	DP 545(B)	DP 2545				5200(B)
1.4 Est	92-94	DP 545(B)	DP 2545				6338(G)
1.4 Est	94-96	DP 545(B)	DP 2545				6540(G)
1.6	87-96	DP 545(B)	DP 2545				5200(B)
1.6 Est	88-94	DP 545(B)	DP 2545				6338(G)
1.6 Est	94-96	DP 545(B)	DP 2545				6540(G)
1.8	92-96	DP 545(B)	DP 2545				5200(B)
1.8	92-96	DP 687(G)	DP 2687				6338(G)
1.8 Est	92-94	DP 545(B)	DP 2545				6338(G)
1.8 Est	94-96	DP 545(B)	DP 2545				6540(G)
1.9	87-96	DP 687(G)	DP 2687		DP 680	DP 2680	5200(B)
1.9	87-96	DP 545(B)	DP 2545		DP 680	DP 2680	5200(B)
1.9 Est	87-94	DP 687(G)	DP 2687		DP 680	DP 2680	6338(G)
1.9 Est	87-94	DP 545(B)	DP 2545		DP 680	DP 2680	6338(G)
1.9 Est	94-96	DP 687(G)	DP 2687		DP 680	DP 2680	6540(G)
2.0	92-96	DP 687(G)	DP 2687		DP 680	DP 2680	
1.8 TD	87-92	DP 545(B)	DP 2545		DP 680	DP 2680	5200(B)
1.8 TD Est	87-92	DP 545(B)	DP 2545		DP 680	DP 2680	6338(G)
1.9 D	87-96	DP 545(B)	DP 2545		DP 680	DP 2680	5200(B)
1.9 D	87-96	DP 687(G)	DP 2687		DP 680	DP 2680	5200(B)
1.9 D Est	87-94	DP 545(B)	DP 2545		DP 680	DP 2680	6338(G)
1.9 D Est	87-94	DP 687(G)	DP 2687		DP 680	DP 2680	6338(G)
1.9 D Est	94-96	DP 687(G)	DP 2687		DP 680	DP 2680	6540(G)
1.9 TD	91-96	DP 687(G)	DP 2687		DP 680	DP 2680	6338(G)
1.9 TD	91-96	DP 545(B)	DP 2545		DP 680	DP 2680	5200(B)
1.9 TD Est	91-94	DP 545(B)	DP 2545		DP 680	DP 2680	5200(B)
1.9 TD Est	91-94	DP 687(G)	DP 2687		DP 680	DP 2680	6338(G)
1.9 TD Est	94-96	DP 687(G)	DP 2687		DP 680	DP 2680	6540(G)
406							
1.8	95-98	DP 1049	DP 21049		DP 1048		6537
1.8 (ABS)	95-	DP 1047	DP 21047		DP 1048		6537
2.0	95-	DP 1047	DP 21047		DP 1048		
2.0 Turbo	96-2000	DP 1047	DP 21047		DP 1048		
2.2	2000-2002	DP 1047	DP 21047		DP 1048		
3.0	97-2002	DP 1047	DP 21047		DP 1048		
1.9 TD	95-98	DP 1049	DP 21049		DP 1048		6537
1.9 TD (ABS)	95-2000	DP 1047	DP 21047		DP 1048		6537
2.0 TD (90)	99-	DP 1049	DP 21049		DP 1048		6537
2.0 TD (110)	99-	DP 1047	DP 21047		DP 1048		6537
2.1 TD	95-2000	DP 1047	DP 21047		DP 1048		
2.2 TD	2000-	DP 1047	DP 21047		DP 1048		
Handbrake Shoes	95-						6602

Standard Quality - ECE R90 Approved with similar performance to original equipment brake pads.
 Upgrade Quality (Tuning / Sportbeläge) - ECE R90 Approved but with higher friction and improved performance for faster street use.

Standard Qualität - mit ECE R90 Freigabe und ähnlicher Bremsleistung wie die Original Bremsbeläge.
 Verbesserte Qualität - mit ECE R90 Freigabe aber mit höherem Reibwert und verbesserter Bremsleistung für den schnellen Strasseninsatz.

Qualité standard - Approuvée par la norme ECE R90 - Des performances équivalentes à l'origine.
 Qualité améliorée - Approuvée par la norme ECE R90 - Un coefficient de friction supérieur et des performances accrues pour pilotage rapide sur route.

Calidad Estándar - Aprobación CEE R90 con prestaciones similares a las pastillas originales.
 Calidad Mejorada - Aprobación CEE R90 pero con un coeficiente de fricción más elevado y prestaciones mejoradas para un uso deportivo en carretera.







*Every EBC pad and shoe requiring ECE R-90 is available with approval subject to stock rotation - check box end label.
 Models listed by Engine Size. Only listed by trim level where pads differ, (16v, GL, GT, etc).

BRAKE PADS & SHOES - APPLICATIONS

Bremsbeläge / Plaquettes + Bremsbacken / Machoires

EBC

BRAKES

Make/Model/Engine Hersteller/Modell/Motor Modèles	Year Jahr Années	Pads  Front / Vorn / Avant		Shoes	Pads  Rear / Hinten / Arrière		Shoes
		Plaquettes / Bremsbeläge Original Quality ECE R90* Approved 		Bremsbacken Machoires  ECE R90* Approved	Plaquettes / Bremsbeläge Upgrade Quality Tuning/Sportbeläge ECE R90* Approved 		Bremsbacken Machoires  ECE R90* Approved
PEUGEOT Contd.							
406 Coupe							
2.0	97-	DP 1047	DP 21047		DP 1048		
2.2	2002-	DP 1047	DP 21047		DP 1048		
3.0	97-	DP 1031/2	DP 21031		DP 680	DP 2680	
3.0	97-	DP 1031/2	DP 21031		DP 1048		
2.2 TD	2001-	DP 1047	DP 21047		DP 1048		
Handbrake Shoes	97-						6602
504							
1.8 Sal	68-71	DP 123(G)			DP 122		
1.8 Sal	71-78	DP 123(G)			DP 163		
1.8 Sal	79-86	DP 123(G)					5270(G) 5207(B)
1.8 Sal	79-86	DP 239(T)					
2.0 Sal	68-71	DP 123(G)			DP 122		
2.0 Sal	71-86	DP 123(G)			DP 163		
2.0 Sal	79-86	DP 239(T)			DP 163		
2.0 Est	71-86	DP 123(G)					5056
2.7 Sal	71-86	DP 123(G)			DP 163		
2.7 Sal	79-86	DP 239(T)			DP 163		
1.9 D Sal	71-86	DP 123(G)			DP 163		
1.9 D Sal	79-86	DP 239(T)			DP 163		
2.1 D Sal	71-86	DP 123(G)			DP 163		
2.1 D Sal	79-86	DP 239(T)			DP 163		
2.1 D Est	71-86	DP 123(G)					5056
2.3 D Sal	71-86	DP 123(G)			DP 163		
2.3 D Sal	79-86	DP 239(T)			DP 163		
2.3 D Est	71-86	DP 123(G)			DP 163		
505							
1.8	79-80	DP 546(B)					5207(B)
1.8	79-80	DP 239(T)					5270(G)
2.0	79-92	DP 546(B)					5207(B)
2.0	79-92	DP 239(T)					5270(G)
2.0	81-92	DP 546(B)					6248(B)
2.0 Est	81-92	DP 546(B)					6344(G)
2.0 Est	81-92	DP 239(T)					6344(G)
2.2	80-92	DP 546(B)					5207(B)
2.2	80-92	DP 239(T)					5270(G)
2.2	81-92	DP 546(B)					6248(B)
2.2 Est	81-92	DP 546(B)					6344(G)
2.2 Est	81-92	DP 239(T)					6344(G)
2.2i	79-92	DP 546(B)			DP 163		
2.2i	79-92	DP 239(T)			DP 163		
2.2 Turbo	79-92	DP 546(B)			DP 163		
2.2 Turbo	79-92	DP 239(T)			DP 163		
2.8	79-92	DP 546(B)			DP 163		
2.8	79-92	DP 239(T)			DP 163		
2.3 D	79-80	DP 239(T)					6248(B)
2.3 D	80-92	DP 546(B)					5207(B)
2.3 D	80-92	DP 239(T)					5270(G)
2.3 D	81-92	DP 546(B)					6248(B)
2.3 D Est	81-92	DP 546(B)					6344(G)
2.3 D Est	81-92	DP 239(T)					6344(G)
2.5 D	80-92	DP 546(B)					5207(B)
2.5 D	80-92	DP 239(T)					5270(G)
2.5 D	81-92	DP 546(B)					6248(B)
2.5 D Est	81-92	DP 546(B)					6344(G)
2.5 D Est	81-92	DP 239(T)					6344(G)
2.5 TD	79-92	DP 546(B)			DP 163		
2.5 TD	79-92	DP 239(T)			DP 163		

Standard Quality - ECE R90 Approved with similar performance to original equipment brake pads.
 Upgrade Quality (Tuning/ Sportbeläge) - ECE R90 Approved but with higher friction and improved performance for faster street use.
 Verbesserte Qualität - mit ECE R90 Freigabe aber mit höherem Reibwert und verbesserter Bremsleistung für den schnellen Strasseninsatz.

Standard Qualität - mit ECE R90 Freigabe und ähnlicher Bremsleistung wie die Original Bremsbeläge.
 Upgrade Qualität (Tuning/ Sportbeläge) - ECE R90 Approved aber mit höherer Reibwert und verbesserter Bremsleistung für den schnellen Strasseninsatz.
 Calidad Estándar - Aprobación CEE R90 con prestaciones similares a las pastillas originales.
 Calidad Mejorada - Aprobación CEE R90 pero con un coeficiente de fricción más elevado y prestaciones mejoradas para un uso deportivo en carretera.

Qualité standard - Approuvée par la norme ECE R90 - Des performances équivalentes à l'origine.
 Qualité améliorée - Approuvée par la norme ECE R90 - Un coefficient de friction supérieur et des performances accrues pour pilotage rapide sur route.
 Calidad Mejorada - Aprobación CEE R90 pero con un coeficiente de fricción más elevado y prestaciones mejoradas para un uso deportivo en carretera.









*Every EBC pad and shoe requiring ECE R-90 is available with approval subject to stock rotation - check box end label.
 Models listed by Engine Size. Only listed by trim level where pads differ, (16v, GL, GT, etc).

Qualité standard - Approuvée par la norme ECE R90 - Des performances équivalentes à l'origine.
Qualité améliorée - Approuvée par la norme ECE R90 - Un coefficient de friction supérieur et des performances accrues pour pilotage rapide sur route.

Calidad Estándar - Aprobación CEE R90 con prestaciones similares a las pastillas originales.
Calidad Mejorada - Aprobación CEE R90 pero con un coeficiente de fricción más elevado y prestaciones mejoradas para un uso deportivo en carretera.

Standard Quality - ECE R90 Approved with similar performance to original equipment brake pads.
Upgrade Quality (Tuning / Sportbeläge) - ECE R90 Approved but with higher friction and improved performance for faster street use.

Standard Qualität - mit ECE R90 Freigabe und ähnlicher Bremsleistung wie die Original Bremsbeläge.
Verbesserte Qualität - mit ECE R90 Freigabe aber mit höherem Reibwert und verbesserter Bremsleistung für den schnellen Strasseninsatz.

Make/Model/Engine Hersteller/Modell/Motor Modèles	Year Jahr Années	Pads  Front / Vorn / Avant		Shoes	Pads  Rear / Hinten / Arrière		Shoes
		Original Quality ECE R90* Approved 	Upgrade Quality Tuning/Sportbeläge ECE R90* Approved 	Bremsbacken Machoires 	Original Quality ECE R90* Approved 	Upgrade Quality Tuning/Sportbeläge ECE R90* Approved 	Bremsbacken Machoires 
PEUGEOT Contd.							
604							
2.0	75-86	DP 239(T)			DP 163		
2.7	77-83	DP 239(T)			DP 163		
2.7	77-83	DP 546(B)			DP 163		
2.8	83-86	DP 239(T)			DP 163		
2.8	83-86	DP 546(B)			DP 163		
2.3 D	78-83	DP 239(T)			DP 163		
2.5 TD	83-86	DP 239(T)			DP 163		
605							
2.0	89-91	DP 794/2(B)			DP 816		
2.0	91-99	DP 882/2(B)			DP 816		
2.0 Turbo	93-99	DP 882/2(B)			DP 816		
3.0	89-91	DP 794/2(B)			DP 816		
3.0	91-2000	DP 881(T)			DP 816		
2.1 TD	89-91	DP 794/2(B)			DP 816		
2.1 TD	91-2000	DP 882/2(B)			DP 816		
Handbrake shoes	89-2000						6489
607							
2.0	2001-	DP 1396	DP 21396		DP 816		
2.2	2000-	DP 1396	DP 21396		DP 816		
3.0	2000-	DP 1419	DP 21419		DP 816		
2.0 TD	2001-	DP 1396	DP 21396		DP 816		
2.2 TD	2000-	DP 1396	DP 21396		DP 816		
Handbrake shoes	2000-						6602
806							
2.0	94-2002	DP 1108	DP 2733		DP 1040		6516
1.9 TD	94-2000	DP 1108	DP 2733		DP 1040		6516
2.0 TD	2000-2002	DP 1108	DP 2733		DP 1040		
Handbrake shoes	94-2002						6546
807							
2.0	2003-	DP 1466	DP 21466		DP 1230	DP 21230	
2.2	2003-	DP 1466	DP 21466		DP 1230	DP 21230	
2.0 TD	2003-	DP 1466	DP 21466		DP 1230	DP 21230	
2.2 TD	2003-	DP 1466	DP 21466		DP 1230	DP 21230	
Partner Combi							
1.4	2001-	DP 1104	DP 21104				6547
1.6	2003-	DP 1374	DP 21374				6547
1.9 D	2001-	DP 1104	DP 21104				6547
2.0 TD	2003-	DP 1374	DP 21374				6547

Pad Illustrations for Peugeot

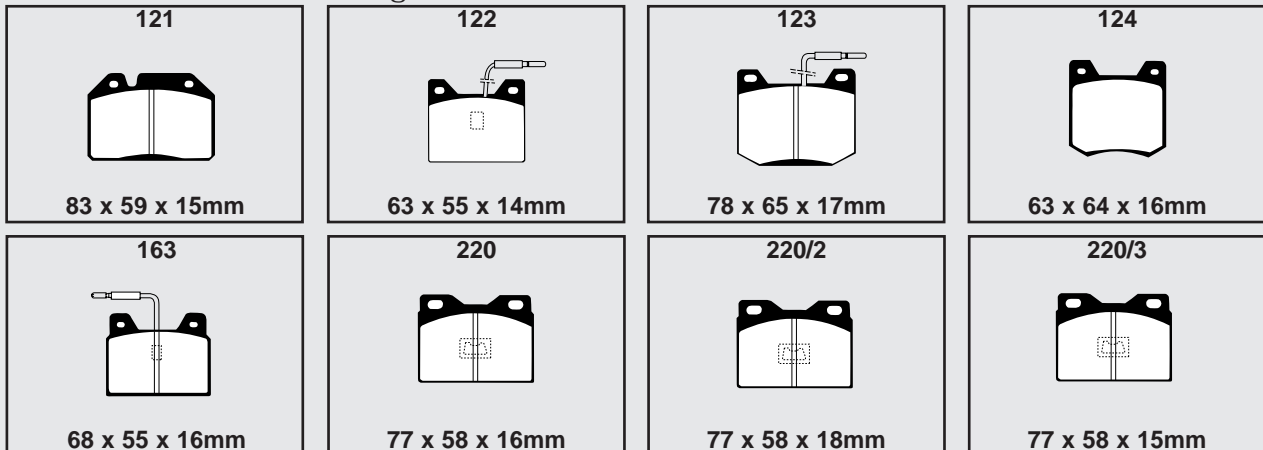

*Every EBC pad and shoe requiring ECE R-90 is available with approval subject to stock rotation - check box end label.









Models listed by Engine Size. Only listed by trim level where pads differ, (16v, GL, GT, etc).

BRAKE PADS & SHOES - APPLICATIONS

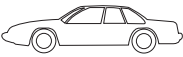
Bremsbeläge / Plaquettes + Bremsbacken / Machoires

EBC

BRAKES

Make/Model/Engine	Year	Pads  Front / Vorn / Avant	Shoes	Pads  Rear / Hinten / Arrière	Shoes
Hersteller/Modell/Motor	Jahr	Plaquettes / Bremsbeläge	Bremsbacken Machoires	Plaquettes / Bremsbeläge	Bremsbacken Machoires
Modelos 	Années 	Original Quality ECE R90* Approved 	Upgrade Quality Tuning/Sportbeläge ECE R90* Approved 	Original Quality ECE R90* Approved 	Upgrade Quality Tuning/Sportbeläge ECE R90* Approved 

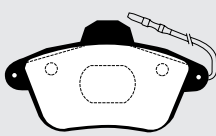
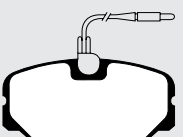

Pad Illustrations for Peugeot Contd.

220/4  76 x 58 x 15mm	220/8  77 x 58 x 16mm	239  89 x 70 x 18mm	269  108 x 49 x 15mm
426  100 x 65 x 18mm	458/2  106 x 56 x 11mm	489  106 x 56 x 18mm	545  105 x 55 x 18mm
545/4  105 x 55 x 18mm	546  105 x 65 x 18mm	626  90 x 63 x 17mm	651  108 x 49 x 15mm
656  72 x 61 x 16mm	680  87 x 53 x 15mm	687  95 x 50 x 18mm	794/2  130 x 69 x 17mm
816  64 x 57 x 17mm	881  156 x 63 x 18mm	882/2  131 x 73 x 17mm	948  140 x 48 x 17mm
1021  110 x 57 x 19mm	1031/2  110 x 69 x 17mm	1040  123 x 43 x 17mm	1047  130 x 56 x 19mm
1048  63 x 57 x 16mm	1049  130 x 53 x 19mm	1053  140 x 69 x 18mm	1080  95 x 49 x 18mm







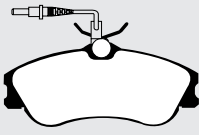
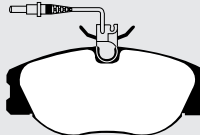

Standard Quality - ECE R90 Approved with similar performance to original equipment brake pads.
Upgrade Quality (Tuning/ Sportbeläge) - ECE R90 Approved but with higher friction and improved performance for faster street use.
Verbesserte Qualität - mit ECE R90 Freigabe aber mit höherem Reibwert und verbesserter Bremsleistung für den schnellen Strasseninsatz.

Qualité standard - Approuvée par la norme ECE R90 - Des performances équivalentes à l'origine.
Qualité améliorée - Approuvée par la norme ECE R90 - Un coefficient de friction supérieur et des performances accrues pour pilotage rapide sur route.
Calidad Estándar - Aprobación CEE R90 con prestaciones similares a las pastillas originales.
Calidad Mejorada - Aprobación CEE R90 pero con un coeficiente de fricción más elevado y prestaciones mejoradas para un uso deportivo en carretera.

*Every EBC pad and shoe requiring ECE R-90 is available with approval subject to stock rotation - check box end label.
 Models listed by Engine Size. Only listed by trim level where pads differ, (16v, GL, GT, etc).

Make/Model/Engine	Year	Pads	Front / Vorn / Avant	Shoes	Pads	Rear / Hinten / Arrière	Shoes
Hersteller/Modell/Motor	Jahr	Plaquettes / Bremsbeläge		Bremsbacken Machoires	Plaquettes / Bremsbeläge		Bremsbacken Machoires
Modelos	Années	Original Quality ECE R90* Approved		Upgrade Quality Tuning/Sportbeläge ECE R90* Approved		Original Quality ECE R90* Approved	Upgrade Quality Tuning/Sportbeläge ECE R90* Approved

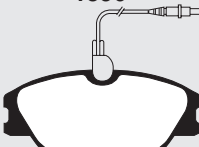
Pad Illustrations for Peugeot Contd.

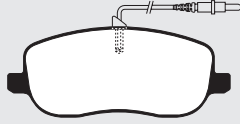
1104  130 x 56 x 19mm	1108  130 x 58 x 19mm	1230  87 x 53 x 17mm	1234  130 x 50 x 17mm
1366  131 x 48 x 18mm	1374  137 x 51 x 19mm	1375  137 x 57 x 19mm	1396  130 x 57 x 19mm
1419  1419	1466  147 x 59 x 19mm		

PEUGEOT COMMERCIAL

Boxer

2.0	94-2001	DP 1024			6506
2.0 (1.8 Ton)	94-2001	DP 1025			6507
1.9 D	94-2001	DP 1024			6506
1.9 TD	94-2001	DP 1024			6506
2.0 D	2001-	DP 1380		DP 1378	
2.2 TD	2001-	DP 1380		DP 1378	
2.4 D	94-2001	DP 1024			6506
2.4 D (1.8 Ton)	94-2001	DP 1025			6507
2.4 TD	94-2001	DP 1024			6506
2.4 TD (1.8 Ton)	94-2001	DP 1025			6507
2.8 TD (1.8 Ton)	2001-	DP 1379		DP 1378	

Expert

1.6	95-	DP 1053			6516
1.6	95-	DP 1108			6516
1.8	97-	DP 1053			6516
1.8	97-	DP 1108			6516
1.9 D	95-	DP 1053			6516
1.9 D	95-	DP 1108			6516
1.9 TD	96-	DP 1053			6516
1.9 TD	96-	DP 1108			6516
2.0 TD	2000-	DP 1053			6516
2.0 TD	2000-	DP 1108			6516

Partner

1.1	96-	DP 1104			6547
1.1	2001-	DP 1374			6547
1.4	96-	DP 1104			6547
1.4	2001-	DP 1374			6547
1.8 D	96-2000	DP 1104			6547
1.9 D	96-	DP 1104			6547
1.9 D	2001-	DP 1374			6547
2.0 TD	2000-	DP 1104			6547
2.0 TD	2000-	DP 1374			6547
2.0 TD	2001-	DP 1374			6547

Standard Quality - ECE R90 Approved with similar performance to original equipment brake pads.
Upgrade Quality (Tuning / Sportbeläge) - ECE R90 Approved but with higher friction and improved performance for faster street use.

Standard Qualität - mit ECE R90 Freigabe und ähnlicher Bremsleistung wie die Original Bremsbeläge.
Verbesserte Qualität - mit ECE R90 Freigabe aber mit höherem Reibwert und verbesserter Bremsleistung für den schnellen Strasseninsatz.







Calidad Estándar - Aprobación CEE R90 con prestaciones similares a las pastillas originales.
Calidad Mejorada - Aprobación CEE R90 pero con un coeficiente de fricción más elevado y prestaciones mejoradas para un uso deportivo en carretera.

BRAKE PADS & SHOES - APPLICATIONS

Bremsbeläge / Plaquettes + Bremsbacken / Machoires

EBC

BRAKES

Make/Model/Engine Hersteller/Modell/Motor Modèles	Year Jahr Années	Pads  Front / Vorn / Avant		Shoes	Pads  Rear / Hinten / Arrière		Shoes
		Original Quality ECE R90* Approved 	Upgrade Quality Tuning/Sportbeläge ECE R90* Approved 	Bremsbacken Machoires 	Original Quality ECE R90* Approved 	Upgrade Quality Tuning/Sportbeläge ECE R90* Approved 	Bremsbacken Machoires 
PEUGEOT COMM Contd.							
J5							
1.8	80-94	DP 425					6322
2.0	81-94	DP 425					6322
1.9 D	87-94	DP 425					6322
2.5 D	81-94	DP 425					6322
2.0 (1.8 Ton)	81-94	DP 735					6322
2.5 D (1.8 Ton)	81-94	DP 735					6322
2.5 TD (1.8 Ton)	81-94	DP 735					6322
J7							
1.6	73-79	DP 252					5209
2.0	73-79	DP 252					5209
1.9 D	73-79	DP 252					5209
2.1 D	73-79	DP 252					5209
2.3 D	73-79	DP 252					5209
2.5 D	73-79	DP 252					5209
J9							
1.6	80-85	DP 252					5209
1.6	85-91	DP 652					5209
2.0	80-85	DP 252					5209
2.0	85-91	DP 652					5209
2.1 D	80-85	DP 252					5209
2.1 D	85-91	DP 652					5209
2.3 D	80-85	DP 252					5209
2.3 D	85-91	DP 652					5209
2.5 D	80-85	DP 252					5209
2.5 D	85-91	DP 652					5209
106 Van							
1.4	94-	DP 545/4(B)					6340/1
1.5 D	94-	DP 545/4(B)					6340/1
1.5 D	94-	DP 948(T)					6340/1
205 Van							
1.0	83-90	DP 489(B)					6340/1(B)
1.0	90-96	DP 545(B)					6340/1(B)
1.0	83-96	DP 626(G)					6395(G)
1.1	83-90	DP 489(B)					6340/1(B)
1.1	90-96	DP 545(B)					6340/1(B)
1.1	83-96	DP 626(G)					6395(G)
1.8 D	83-90	DP 489(B)					6340/1(B)
1.8 D	90-96	DP 545(B)					6340/1(B)
1.8 D	83-96	DP 626(G)					6395(G)
206 Van							
1.4 TD	2002-	DP 1366					6526(G)
1.4 TD	2002-	DP 1366					6577(B)
1.9 D	98-	DP 1366					6526(G)
1.9 D	98-	DP 1366					6577(B)
305 Van							
1.5	80-85	DP 489(B)					5072(B)
1.5	80-85	DP 220/3(T)					6341(T)
1.5	80-85	DP 626(G)					5212A(G)
1.5	85-90	DP 545(B)					5072(B)

Standard Quality - ECE R90 Approved with similar performance to original equipment brake pads.
 Upgrade Quality (Tuning/ Sportbeläge) - ECE R90 Approved but with higher friction and improved performance for faster street use.
 Standard Qualität - mit ECE R90 Freigabe und ähnlicher Bremsleistung wie die Original Bremsbeläge.
 Verbesserte Qualität - mit ECE R90 Freigabe aber mit höherem Reibwert und verbesserter Bremsleistung für den schnellen Strasseninsatz.

Qualité standard - Approuvée par la norme ECE R90 - Des performances équivalentes à l'origine.
 Qualité améliorée - Approuvée par la norme ECE R90 - Un coefficient de friction supérieur et des performances accrues pour pilotage rapide sur route.
 Calidad Estándar - Aprobación CEE R90 con prestaciones similares a las pastillas originales.
 Calidad Mejorada - Aprobación CEE R90 pero con un coeficiente de fricción más elevado y prestaciones mejoradas para un uso deportivo en carretera.

*Every EBC pad and shoe requiring ECE R-90 is available with approval subject to stock rotation - check box end label.
 Models listed by Engine Size. Only listed by trim level where pads differ, (16v, GL, GT, etc).

Make/Model/Engine Hersteller/Modell/Motor Modèles	Year Jahr Années	Pads Plaquettes / Bremsbeläge		Shoes Bremsbacken Machoires	Pads Plaquettes / Bremsbeläge		Shoes Bremsbacken Machoires
		Original Quality ECE R90* Approved	Upgrade Quality Tuning/Sportbeläge ECE R90* Approved	ECE R90* Approved	Original Quality ECE R90* Approved	Upgrade Quality Tuning/Sportbeläge ECE R90* Approved	ECE R90* Approved
PEUGEOT COMM Contd.							
504 Pick Up							
1.6	79-82			5052			5056
1.8	79-82			5052			5056
1.8	83-94	DP 123(G)					5056
1.8	83-94	DP 239(T)					6344
2.0	79-82			5052			5056
2.0	83-94	DP 123(G)					5056
2.0	83-94	DP 239(T)					6344
2.3 D	79-82			5052			5056
2.3 D	83-94	DP 123(G)					5056
2.3 D	83-94	DP 239(T)					6344

Pad Illustrations for Peugeot Commercial

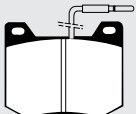
 123 78 x 65 x 17mm	 220/3 77 x 58 x 15mm	 239 89 x 70 x 18mm	 252 142 x 59 x 15mm
 425 130 x 74 x 19mm	 489 106 x 56 x 18mm	 545 105 x 55 x 18mm	 545/4 105 x 55 x 18mm
 626 90 x 63 x 17mm	 652 144 x 58 x 15mm	 735 145 x 71 x 19mm	 948 140 x 48 x 17mm
 1024 145 x 62 x 19mm	 1025 160 x 65 x 19mm	 1053 140 x 69 x 18mm	 1104 130 x 56 x 19mm
 1108 130 x 58 x 19mm	 1366 131 x 48 x 18mm	 1374 137 x 51 x 19mm	 1378 109 x 49 x 20mm
 1379 164 x 69 x 19mm	 1380 140 x 65 x 19mm		

Standard Quality - ECE R90 Approved with similar performance to original equipment brake pads.
Upgrade Quality (Tuning / Sportbeläge) - ECE R90 Approved but with higher friction and improved performance for faster street use.

Standard Qualität - mit ECE R90 Freigabe und ähnlicher Bremsleistung wie die Original Bremsbeläge.
Verbesserte Qualität - mit ECE R90 Freigabe aber mit höherem Reibwert und verbesserter Bremsleistung für den schnellen Strasseninsatz.

Standard Quality - ECE R90 Approved with similar performance to original equipment brake pads.
Upgrade Quality (Tuning / Sportbeläge) - ECE R90 Approved but with higher friction and improved performance for faster street use.





Standard Qualität - mit ECE R90 Freigabe und ähnlicher Bremsleistung wie die Original Bremsbeläge.
Verbesserte Qualität - mit ECE R90 Freigabe aber mit höherem Reibwert und verbesserter Bremsleistung für den schnellen Strasseninsatz.

BRAKE PADS & SHOES - APPLICATIONS

Bremsbeläge / Plaquettes + Bremsbacken / Machoires

EBC

BRAKES

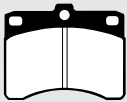
Make/Model/Engine	Year	Pads  Front / Vorn / Avant		Shoes	Pads  Rear / Hinten / Arrière		Shoes
Hersteller/Modell/Motor	Jahr	Plaquettes / Bremsbeläge		Bremsbacken Machoirs	Plaquettes / Bremsbeläge		Bremsbacken Machoirs
Modelos	Années	Original Quality ECE R90* Approved	Upgrade Quality Tuning/Sportbeläge ECE R90* Approved	 ECE R90* Approved	Original Quality ECE R90* Approved	Upgrade Quality Tuning/Sportbeläge ECE R90* Approved	 ECE R90* Approved
PIAGGIO							
Porter							
1.4 D	2001-	DP 685					6559
Pad Illustrations for Piaggio							
<div style="border: 1px solid black; padding: 5px; width: fit-content; margin: 0 auto;"> <p>685</p>  <p>79 x 63 x 13mm</p> </div>							
PORSCHE							
356							
1.6	59-65	DP 104	DP 2104		DP 105/4		
911							
2.0	64-69	DP 103	DP 2103		DP 104	DP 2104	
2.2	69-71	DP 103	DP 2103		DP 104	DP 2104	
2.2	71-77	DP 103	DP 2103		DP 311/2	DP 2104	
2.4	71-73	DP 103	DP 2103		DP 104	DP 2104	
2.4	73-77	DP 103	DP 2103		DP 311/2	DP 2104	
2.7	72-77	DP 103	DP 2103		DP 311/2	DP 2104	
2.8	72-73	DP 103	DP 2103		DP 311/2	DP 2104	
3.0	73-83	DP 103	DP 2103		DP 311/2	DP 2104	
3.0 Turbo	74-77	DP 2103	DP 3103		DP 2104	DP 3104	
3.2	84-88	DP 2103	DP 3103		DP 2104	DP 3104	
3.3 Turbo	77-89	DP 2612	DP 3612		DP 2612	DP 3612	
3.3 Turbo (964)	90-93	DP 2767	DP 3767		DP 2612	DP 3612	
3.4 (996)	97-2001	DP 21278	DP 31278		DP 21208	DP 31208	
3.4 Carrera 2 (996)	97-	DP 21207	DP 31207		DP 21208	DP 31208	
3.4 Carrera 4 (996)	97-2001	DP 21278	DP 31278		DP 21208	DP 31208	
3.6 Turbo (964)	92-95	DP 2997	DP 3997		DP 2612	DP 3612	
3.6 Turbo (993)	95-98	DP 2997	DP 3997		DP 2767	DP 3767	
3.6 Turbo (996)	99-	DP 21454	DP 31454		DP 21278	DP 31278	
3.6 Carrera 2 (964)	89-91	DP 2612	DP 3612		DP 996		
3.6 Carrera 2 (964)	91-93	DP 2612	DP 3612		DP 2612	DP 3612	
3.6 Carrera 2 (964)	93-95	DP 2767	DP 3767		DP 2612	DP 3612	
3.6 Carrera 2 (993)	95-97	DP 2997	DP 3997		DP 2767	DP 3767	
3.6 Carrera 2 (996)	2001-						
3.6 Carrera 4 (964)	88-93	DP 2612	DP 3612		DP 2612	DP 3612	
3.6 Carrera 4 (993)	93-95	DP 2767	DP 3767		DP 2612	DP 3612	
3.6 Carrera 4 (993)	95-98	DP 2997	DP 3997		DP 2612	DP 3612	
3.6 Carrera 4 (996)	2001-						
3.6 Carrera RS (964)	91-95	DP 2767	DP 3767		DP 2612	DP 3612	
3.6 GT 2 (993)	95-98	DP 2997	DP 3997		DP 2612	DP 3612	
3.6 GT 3 (996)	99-	DP 21454	DP 31454		DP 21278	DP 31278	
3.8 RS (993)	95-98	DP 2997	DP 3997		DP 2767	DP 3767	
912							
2.7	65-70	DP 104	DP 2104		DP 105	DP 2105	
3.0	65-70	DP 104	DP 2104		DP 105	DP 2105	
914							
1.7	70-72	DP 104	DP 2104		DP 218	DP 2105	
1.7	72-75	DP 185			DP 218		
2.0	70-72	DP 104	DP 2104		DP 218	DP 2105	
2.0	72-75	DP 185			DP 218		

*Every EBC pad and shoe requiring ECE R-90 is available with approval subject to stock rotation - check box end label.
Models listed by Engine Size. Only listed by trim level where pads differ, (16v, GL, GT, etc).

Standard Quality - ECE R90 Approved with similar performance to original equipment brake pads.
Upgrade Quality (Tuning/ Sportbeläge) - ECE R90 Approved but with higher friction and improved performance for faster street use.
Verbesserte Qualität - mit ECE R90 Freigabe aber mit höherem Reibwert und verbesserter Bremsleistung für den schnellen Strasseninsatz.
Standard Qualität - mit ECE R90 Freigabe und ähnlicher Bremsleistung wie die Original Bremsbeläge.
Qualité standard - Approuvée par la norme ECE R90 - Des performances équivalentes à l'origine.
Qualité améliorée - Approuvée par la norme ECE R90 - Un coefficient de friction supérieur et des performances accrues pour pilotage rapide sur route.
Calidad Estándar - Aprobación CEE R90 con prestaciones similares a las pastillas originales.
Calidad Mejorada - Aprobación CEE R90 pero con un coeficiente de fricción más elevado y prestaciones mejoradas para un uso deportivo en carretera.

Make/Model/Engine Hersteller/Modell/Motor Modelos	Year Jahr Années	Pads Plaquettes / Bremsbeläge		Shoes Bremsbacken Machoires	Pads Plaquettes / Bremsbeläge		Shoes Bremsbacken Machoires
		Original Quality ECE R90* Approved	Upgrade Quality Tuning/Sportbeläge ECE R90* Approved	ECE R90* Approved	Original Quality ECE R90* Approved	Upgrade Quality Tuning/Sportbeläge ECE R90* Approved	ECE R90* Approved
PORSCHE Contd.							
924							
2.0	75-76	DP 220/2	DP 2220				5083
2.0	76-83	DP 220/2	DP 2220				5083
2.0 Lux	77-79	DP 220/2	DP 2220				5083
2.0 Lux	79-85	DP 220/2	DP 2220		DP 104	DP 2104	
2.0 Turbo	79-88	DP 2345	DP 3345		DP 2220	DP 3220	
2.5 S	79-88	DP 2345	DP 3345		DP 2220	DP 3220	
928							
4.5	77-79	DP 2345	DP 3345		DP 2220	DP 3220	
4.7	79-85	DP 2414	DP 3414		DP 2220	DP 3220	
4.7	85-86	DP 2767	DP 3767		DP 2612	DP 3612	
5.0	85-92	DP 2767	DP 3767		DP 2612	DP 3612	
5.4	92-95	DP 2997	DP 3997		DP 2612	DP 3612	
944							
2.5	82-89	DP 2345	DP 3345		DP 2220	DP 3220	
2.5 Turbo	85-88	DP 2612	DP 3612		DP 2612	DP 3612	
2.5 Turbo	88-91	DP 2767	DP 3767		DP 2612	DP 3612	
2.7	87-89	DP 2345	DP 3345		DP 2220	DP 3220	
3.0	89-93	DP 2612	DP 3612		DP 2612	DP 3612	
959							
3.0	87-91	DP 2767	DP 3767		DP 2767	DP 3767	
968							
3.0	91-95	DP 2612	DP 3612		DP 2612	DP 3612	
3.0 Sport	92-95	DP 2767	DP 3767		DP 2612	DP 3612	
Boxster							
2.5	97-99	DP 21207	DP 31207		DP 21208	DP 31208	
2.7	99-	DP 21278	DP 31278		DP 21208	DP 31208	
3.2	99-	DP 21278	DP 31278		DP 21208	DP 31208	
Carrera GT							
5.7	2003-						
Cayenne							
4.5	2003-	DP 21473	DP 31473		DP 21474	DP 31474	
4.5 Turbo	2003-	DP 21473	DP 31473		DP 21474	DP 31474	

Pad Illustrations for Porsche

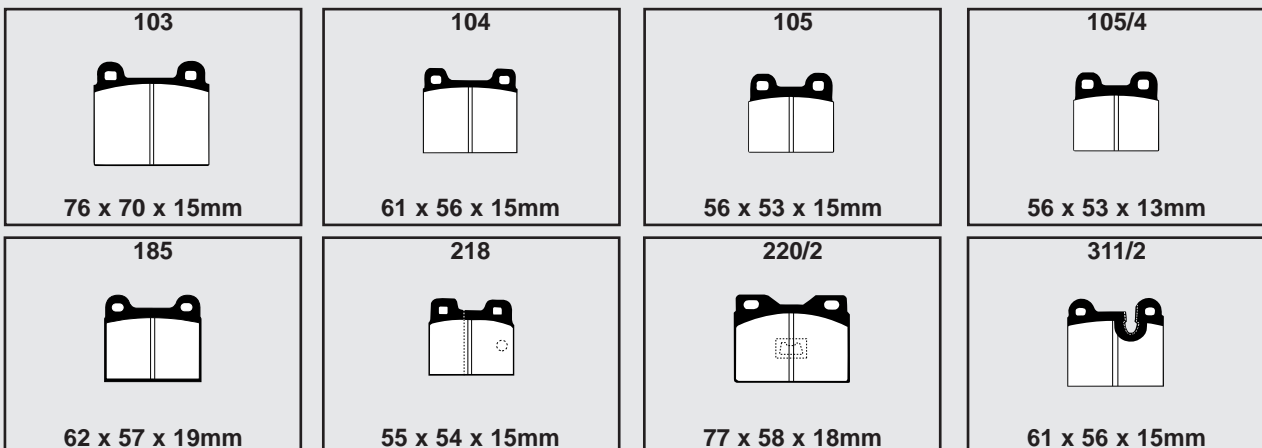

*Every EBC pad and shoe requiring ECE R-90 is available with approval subject to stock rotation - check box end label.

Models listed by Engine Size. Only listed by trim level where pads differ, (16v, GL, GT, etc).

BRAKE PADS & SHOES - APPLICATIONS

Bremsbeläge / Plaquettes + Bremsbacken / Machoires

EBC

BRAKES

Make/Model/Engine	Year	Pads	Front / Vorn / Avant	Shoes	Pads	Rear / Hinten / Arrière	Shoes
Hersteller/Modell/Motor	Jahr	Plaquettes / Bremsbeläge		Bremsbacken	Plaquettes / Bremsbeläge		Bremsbacken
Modelos	Années	Original Quality ECE R90* Approved	Upgrade Quality Tuning/Sportbeläge ECE R90* Approved	Machoires ECE R90* Approved	Original Quality ECE R90* Approved	Upgrade Quality Tuning/Sportbeläge ECE R90* Approved	Machoires ECE R90* Approved

Pad Illustrations for Porsche Contd.

996 63 x 65 x 15mm	2345 89 x 70 x 19mm	2414 158 x 57 x 19mm	2612 97 x 67 x 18mm
2767 131 x 71 x 18mm	2997 131 x 75 x 17mm	21207 114 x 78 x 16mm	21208 112 x 78 x 16mm
21278 121 x 84 x 16mm	21454 140 x 88 x 17mm	21473 190 x 107 x 16mm	21474 112 x 70 x 16mm

PROTEUS

DP 262

DP 2262

Pad Illustrations for Proteus

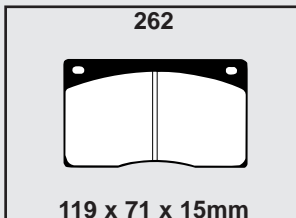









PROTON					
Compact					
1.3 (C96A)	95-2000	DP 1063	DP 21063		6495
1.5 (C97A)	95-2000	DP 1063	DP 21063		6495
1.6 (C98A)	95-2000	DP 830	DP 2830	DP 986	DP 2986
Coupe					
1.8	97-2001	DP 830	DP 2830	DP 986	DP 2986
Impian					
1.6	2001-	DP 1063	DP 21063	DP 1076	6495
Persona					
1.3	97-2000	DP 1063	DP 21063		6495
1.5 (C97A)	93-2000	DP 1063	DP 21063		6495
1.6 (C98A)	93-2000	DP 830	DP 2830	DP 986	DP 2986
1.8 (C99A)	96-2000	DP 830	DP 2830	DP 986	DP 2986
2.0 D (C95A)	96-98	DP 1063	DP 21063		6495
2.0 TD	97-2000	DP 1063	DP 21063		6495

*Every EBC pad and shoe requiring ECE R-90 is available with approval subject to stock rotation - check box end label.
Models listed by Engine Size. Only listed by trim level where pads differ, (16v, GL, GT, etc).

Standard Quality - ECE R90 Approved with similar performance to original equipment brake pads.
Upgrade Quality (Tuning/ Sportbeläge) - ECE R90 Approved but with higher friction and improved performance for faster street use.
Verbesserte Qualität - mit ECE R90 Freigabe aber mit höherem Reibwert und verbesserter Bremsleistung für den schnellen Strasseninsatz.

Qualité standard - Approuvée par la norme ECE R90 - Des performances équivalentes à l'origine.
Qualité améliorée - Approuvée par la norme ECE R90 - Un coefficient de friction supérieur et des performances accrues pour pilotage rapide sur route.
Calidad Estándar - Aprobación CEE R90 con prestaciones similares a las pastillas originales.
Calidad Mejorada - Aprobación CEE R90 pero con un coeficiente de fricción más elevado y prestaciones mejoradas para un uso deportivo en carretera.

Make/Model/Engine	Year	Pads  Front / Vorn / Avant		Shoes	Pads  Rear / Hinten / Arrière		Shoes
Hersteller/Modell/Motor	Jahr	Plaquettes / Bremsbeläge		Bremsbacken Machoires	Plaquettes / Bremsbeläge		Bremsbacken Machoires
Modelos	Années	Original Quality ECE R90* Approved 	Upgrade Quality Tuning/Sportbeläge ECE R90* Approved 	 ECE R90* Approved	Original Quality ECE R90* Approved 	Upgrade Quality Tuning/Sportbeläge ECE R90* Approved 	 ECE R90* Approved
PROTON Contd.							
Proton							
1.3 (C21A)	88-90	DP 537					6421
1.3 (C21A)	91-93	DP 941	DP 21063				6495
1.3 (C22A)	91-96	DP 941	DP 21063				6495
1.5 (C22A)	88-90	DP 537					6421
1.5 (C22A)	91-96	DP 941	DP 21063				6495
Satria							
1.3	2000-	DP 1063	DP 21063				6495
1.5	2000-	DP 1063	DP 21063				6495
1.6	2000-	DP 1063	DP 21063		DP 986	DP 2986	
1.8	2000-	DP 1063	DP 21063		DP 986	DP 2986	
1.8 (ABS)	2000-	DP 830	DP 2830		DP 986	DP 2986	
Wira							
1.3	2000-	DP 1063	DP 21063				6495
1.5	2000-	DP 1063	DP 21063				6495
1.6	2000-	DP 830	DP 2830		DP 986	DP 2986	
1.8	2000-	DP 830	DP 2830		DP 986	DP 2986	

Pad Illustrations for Proton

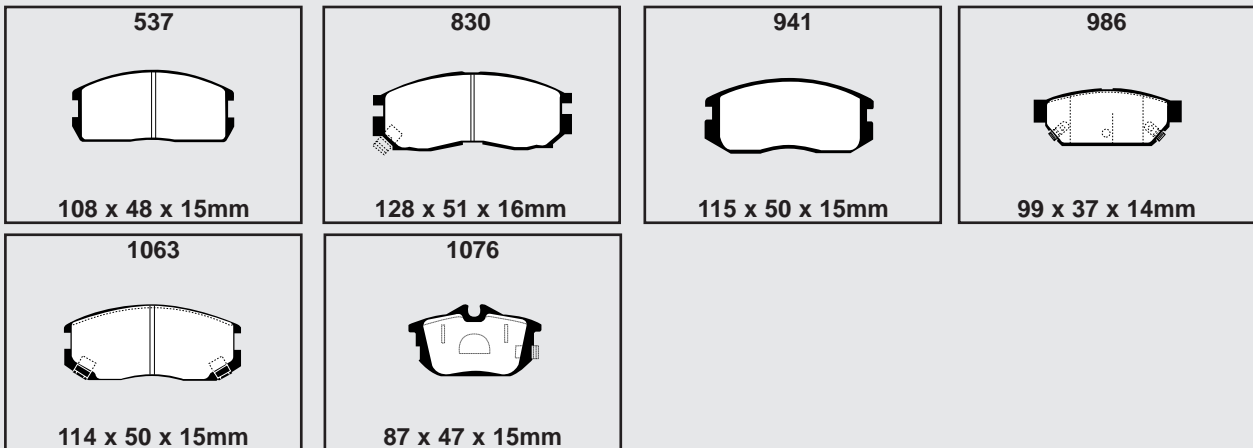

PROTON (Aust/NZ)							
Satria							
	98-	DP 830	DP 2830		DP 986	DP 2986	

Pad Illustrations for Proton (Aust/NZ)

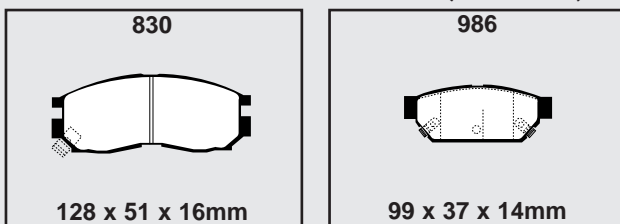

PROTON (Malaysia & The Philippines)							
Perdana							
		DP 830	DP 2830		DP 738	DP 2738	

Standard Quality - ECE R90 Approved with similar performance to original equipment brake pads.
 Upgrade Quality (Tuning / Sportbeläge) - ECE R90 Approved but with higher friction and improved performance for faster street use.

Standard Qualität - mit ECE R90 Freigabe und ähnlicher Bremsleistung wie die Original Bremsbeläge.
 Verbesserte Qualität - mit ECE R90 Freigabe aber mit höherem Reibwert und verbesserter Bremsleistung für den schnellen Strasseneinsatz.

Qualité standard - Approuvée par la norme ECE R90 - Des performances équivalentes à l'origine.
 Qualité améliorée - Approuvée par la norme ECE R90 - Un coefficient de friction supérieur et des performances accrues pour pilotage rapide sur route.







Calidad Estándar - Aprobación CEE R90 con prestaciones similares a las pastillas originales.
 Calidad Mejorada - Aprobación CEE R90 pero con un coeficiente de fricción más elevado y prestaciones mejoradas para un uso deportivo en carretera.

BRAKE PADS & SHOES - APPLICATIONS

Bremsbeläge / Plaquettes + Bremsbacken / Machoires

EBC

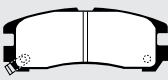

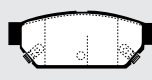
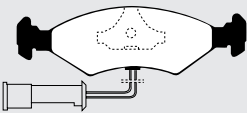
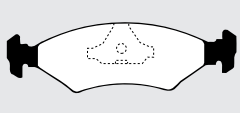





BRAKES

Make/Model/Engine	Year	Pads  Front / Vorn / Avant		Shoes	Pads  Rear / Hinten / Arrière		Shoes
Hersteller/Modell/Motor	Jahr	Plaquettes / Bremsbeläge		Bremsbacken Machoirs	Plaquettes / Bremsbeläge		Bremsbacken Machoirs
Modelos	Années	Original Quality ECE R90* Approved	Upgrade Quality Tuning/Sportbeläge ECE R90* Approved	 ECE R90* Approved	Original Quality ECE R90* Approved	Upgrade Quality Tuning/Sportbeläge ECE R90* Approved	 ECE R90* Approved
PROTON Contd. (Malaysia & The Philippines)							
Satria	98-	DP 830	DP 2830		DP 986	DP 2986	
Waja	2000-						
Pad Illustrations for Proton (Malaysia & The Philippines)							
738		830		986			
							
107 x 41 x 15mm		128 x 51 x 16mm		99 x 37 x 14mm			
QUANTUM							
H4	97-	DP 415	DP 2415				
Xtreme	2.0	DP 389	DP 2389				
Pad Illustrations for Quantum							
389		415					
							
151 x 46 x 17mm		151 x 46 x 17mm					
QVALE							
Mangusta	2000-						
RELIANT							
Kitten	75-82			5145			5146
Rebel	64-73			5128			5137
Regal	62-65			6299			5137
	65-73			5130B			5137
Rialto	81-94			6250			5137
	94-			5145B			5146
Robin	73-94			6250			5137
	94-			5145B			5146

Standard Quality - ECE R90 Approved with similar performance to original equipment brake pads.
 Upgrade Quality (Tuning/ Sportbeläge) - ECE R90 Approved but with higher friction and improved performance for faster street use.
 Verbesserte Qualität - mit ECE R90 Freigabe aber mit höherem Reibwert und verbesserter Bremsleistung für den schnellen Strasseninsatz.

Qualité standard - Approuvée par la norme ECE R90 - Des performances équivalentes à l'origine.
 Qualité améliorée - Approuvée par la norme ECE R90 - Un coefficient de friction supérieur et des performances accrues pour pilotage rapide sur route.
 Calidad Mejorada - Aprobación CEE R90 con prestaciones similares a las pastillas originales.
 Calidad Mejorada - Aprobación CEE R90 pero con un coeficiente de fricción más elevado y prestaciones mejoradas para un uso deportivo en carretera.

*Every EBC pad and shoe requiring ECE R-90 is available with approval subject to stock rotation - check box end label.
 Models listed by Engine Size. Only listed by trim level where pads differ, (16v, GL, GT, etc).

Make/Model/Engine Hersteller/Modell/Motor Modelos	Year Jahr Années	Pads  Front / Vorn / Avant		Shoes	Pads  Rear / Hinten / Arrière		Shoes
		Original Quality ECE R90* Approved 	Upgrade Quality Tuning/Sportbeläge ECE R90* Approved 	Bremsbacken Machoires 	Original Quality ECE R90* Approved 	Upgrade Quality Tuning/Sportbeläge ECE R90* Approved 	Bremsbacken Machoires 
RELIANT Contd.							
Sabre							
1.4	93-96	DP 627	DP 2627				5146
1.8 Turbo	92-96	DP 467	DP 2467				5146
Scimitar							
2.8	76-90	DP 240	DP 2240				6234
3.0 GT	65-76	DP 108	DP 2108				5139
3.0 GTE	72-76	DP 315	DP 2108				5139
3.0	76-80	DP 240	DP 2240				6234
Scimitar SSI							
1.3	85-90	DP 627	DP 2627				5146
1.4	85-90	DP 627	DP 2627				5146
1.6	85-90	DP 627	DP 2627				5146
1.8 Turbo	86-92	DP 627	DP 2627				5146
Scimitar SST							
1.4	90-93	DP 627	DP 2627				5146
1.8 Turbo	90-93	DP 467	DP 2467				5146

Pad Illustrations for Reliant

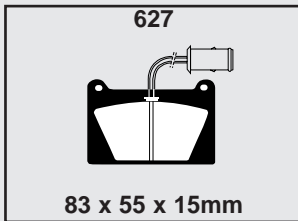
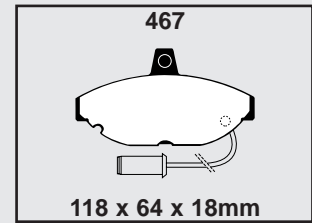
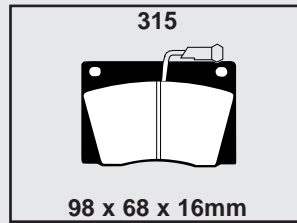
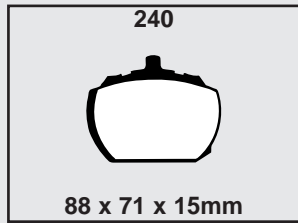
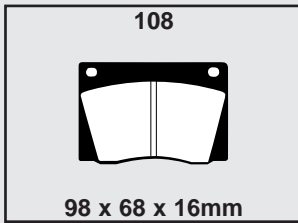

RENAULT							
Alpine							
1.6	69-77	DP 269			DP 189		
2.5 Turbo	86-90	DP 426(G)	DP 2426		DP 458	DP 2458	
2.5 Turbo	90-94	DP 547(G)	DP 2547		DP 458	DP 2458	
2.5 Turbo	90-94	DP 604(B)	DP 2604		DP 458	DP 2458	
2.7 V6 (A310)	77-80	DP 269			DP 189		
2.7 V6 (A310)	80-84	DP 546(B)	DP 2546		DP 546	DP 2546	
2.8 V6 GTA	84-89	DP 604(B)	DP 2604		DP 458	DP 2458	
2.8 V6 GTA	84-89	DP 426(G)	DP 2426		DP 458	DP 2458	
3.0 (A610)	91-92	DP 547(G)	DP 2547		DP 794		
3.0 (A610)	92-96	DP 547(G)	DP 2547		DP 882		
Avantime							
2.0 Turbo	2002-2003	DP 1461	DP 21461		DP 680	DP 2680	
3.0	2002-2003	DP 1461	DP 21461		DP 680	DP 2680	
2.2 D	2002-2003	DP 1461	DP 21461		DP 680	DP 2680	

BRAKE PADS & SHOES - APPLICATIONS

Bremsbeläge / Plaquettes + Bremsbacken / Machoires

EBC









BRAKES

Make/Model/Engine Hersteller/Modell/Motor Modelos	Year Jahr Années	Pads Plaquettes / Bremsbeläge		Shoes Bremsbacken Machoires	Pads Plaquettes / Bremsbeläge		Shoes Bremsbacken Machoires
		Original Quality ECE R90* Approved	Upgrade Quality Tuning/Sportbeläge ECE R90* Approved	ECE R90* Approved	Original Quality ECE R90* Approved	Upgrade Quality Tuning/Sportbeläge ECE R90* Approved	ECE R90* Approved
RENAULT Contd.							
Clio							
1.0	90-92	DP 545/2(B)					6410(B)
1.1	90-92	DP 545/2(B)					6410(B)
1.1	92-94	DP 545(B)	DP 2545				6410(B)
1.2	90-98	DP 545(B)	DP 2545				6410(B)
1.2	92-98	DP 959(G)	DP 2959				6343(G)
1.2	98-	DP 1136(B)	DP 21136		DP 1078		6526(G)
1.2	98-	DP 1136(B)	DP 21136		DP 1078		6582(B)
1.2	98-	DP 959(G)	DP 2959		DP 1078		6526(G)
1.2	98-	DP 959(G)	DP 2959		DP 1078		6582(B)
1.4	90-92	DP 426(G)	DP 2426				6343(G)
1.4	90-98	DP 545(B)	DP 2545				6410(B)
1.4	92-98	DP 959(G)	DP 2959				6343(G)
1.4	98-	DP 959(G)	DP 2959		DP 1078		6526(G)
1.4	98-	DP 959(G)	DP 2959		DP 1078		6582(B)
1.4	98-	DP 1136(B)	DP 21136		DP 1078		6526(G)
1.4	98-	DP 1136(B)	DP 21136		DP 1078		6582(B)
1.4	2000-	DP 959(G)	DP 2959				6612(B)
1.6	98-	DP 959(G)	DP 2959		DP 1078		6526(G)
1.6	2000-	DP 959(G)	DP 2959				6612(B)
1.6	98-	DP 1136(B)	DP 21136		DP 1078		6582(B)
1.8	90-98	DP 545(B)	DP 2545				6410(B)
1.8	90-92	DP 426(G)	DP 2426				6343(G)
1.8	92-98	DP 959(G)	DP 2959		DP 983	DP 2983	6343(G)
1.8 16v	90-92	DP 426(G)	DP 2426		DP 458/2	DP 2458/2	
1.8 16v	92-97	DP 959(G)	DP 2959		DP 983	DP 2983	
2.0 16v	93-96	DP 959(G)	DP 2959		DP 983	DP 2983	
2.0 16v	2000-	DP 1369(G)	DP 21369		DP 1078		
3.0	2001-	DP 2036	DP 3036		DP 882/2		
1.5 D	2001-	DP 959(G)	DP 2959(G)				6526(G)
1.5 D	2001-	DP 1136(B)	DP 21136(B)				6612(B)
1.9 D	90-98	DP 545(B)	DP 2545		DP 983	DP 2983	6410(B)
1.9 D	90-92	DP 426(G)	DP 2426				6343(G)
1.9 D	92-98	DP 959(G)	DP 2959		DP 983	DP 2983	6343(G)
1.9 D	98-2001	DP 1136(B)	DP 21136		DP 1078		6526(G)
1.9 D	98-2001	DP 1136(B)	DP 21136		DP 1078		6582(B)
1.9 D	98-2001	DP 959(G)	DP 2959		DP 1078		6526(G)
1.9 D	98-2001	DP 959(G)	DP 2959		DP 1078		6582(B)
1.9 D	2000-2001	DP 959(G)	DP 2959				6612(B)
Dauphine	61-71	DP 119			DP 118		
Espace							
2.0	84-91	DP 545(B)	DP 2545				5072A(B)
2.0	84-91	DP 426(G)	DP 2426		DP 189(B)	DP 2189	5212A(G)
2.0 Quadra	88-91	DP 545(B)	DP 2545		DP 189(B)	DP 2189	
2.0 Quadra	88-91	DP 426(G)	DP 2426		DP 189(B)	DP 2189	
2.0 (ABS)	91-96	DP 547(G)	DP 2547		DP 885(BR)	DP 2885	
2.0 (ABS)	91-96	DP 547(G)	DP 2547		DP 189(B)	DP 2189	
2.0	91-96	DP 952(G)	DP 2952				5072A(B)
2.0	91-96	DP 952(G)	DP 2952				5212A(G)
2.0	96-97	DP 1128	DP 21128				6600
2.0	97-2000	DP 1128	DP 21128		DP 885(BR)	DP 2885	6600
2.0	97-2000	DP 1128	DP 21128		DP 189(B)	DP 2189	6600
2.0	2000-2002	DP 1461	DP 21461		DP 680	DP 2680	
2.0	2003-	DP 1353	DP 21353		DP 1354	DP 21354	
2.0 Turbo	2003-	DP 1353	DP 21353		DP 1354	DP 21354	
2.2	84-91	DP 426(G)	DP 2426		DP 189(B)	DP 2189	5212A(G)
2.2 Quadra	88-91	DP 545(B)	DP 2545		DP 189(B)	DP 2189	
2.2 Quadra	88-91	DP 426(G)	DP 2426		DP 189(B)	DP 2189	
2.2 (ABS)	91-96	DP 547(G)	DP 2547		DP 885(BR)	DP 2885	
2.2 (ABS)	91-96	DP 547(G)	DP 2547		DP 189(B)	DP 2189	

*Every EBC pad and shoe requiring ECE R-90 is available with approval subject to stock rotation - check box end label.
Models listed by Engine Size. Only listed by trim level where pads differ, (16v, GL, GT, etc).

Standard Quality - ECE R90 Approved with similar performance to original equipment brake pads.
Upgrade Quality (Tuning/ Sportbeläge) - ECE R90 Approved but with higher friction and improved performance for faster street use.
Verbesserte Qualität - mit ECE R90 Freigabe aber mit höherem Reibwert und verbesserter Bremsleistung für den schnellen Strasseninsatz.

Qualité standard - Approuvée par la norme ECE R90 - Des performances équivalentes à l'origine.
Qualité améliorée - Approuvée par la norme ECE R90 - Un coefficient de friction supérieur et des performances accrues pour pilotage rapide sur route.
Calidad Mejorada - Aprobación CEE R90 con prestaciones similares a las pastillas originales.
Calidad Mejorada - Aprobación CEE R90 pero con un coeficiente de fricción más elevado y prestaciones mejoradas para un uso deportivo en carretera.

Make/Model/Engine Hersteller/Modell/Motor Modelos	Year Jahr Années	Pads  Front / Vorn / Avant		Shoes	Pads  Rear / Hinten / Arrière		Shoes
		Original Quality ECE R90* Approved 	Upgrade Quality Tuning/Sportbeläge ECE R90* Approved 	Bremsbacken Machoires 	Original Quality ECE R90* Approved 	Upgrade Quality Tuning/Sportbeläge ECE R90* Approved 	Bremsbacken Machoires 
RENAULT Contd.							
Espace Contd.							
2.2	91-96	DP 952(G)	DP 2952				5072A(B)
2.2	91-96	DP 952(G)	DP 2952				5212A(G)
2.2	96-97	DP 1128	DP 21128				6600
2.2 Quadra	91-96	DP 547(G)	DP 2547		DP 189(B)	DP 2189	
2.9 V6	91-96	DP 547(G)	DP 2547		DP 189(B)	DP 2189	
3.0	97-2000	DP 1128	DP 21128		DP 885(BR)	DP 2885	
3.0	97-2000	DP 1128	DP 21128		DP 189(B)	DP 2189	
3.0	2000-2002	DP 1461	DP 21461		DP 680	DP 2680	
3.0	2003-	DP 1353	DP 21353		DP 1354	DP 21354	
3.5	2003-	DP 1353	DP 21353		DP 1354	DP 21354	
1.9 TD	2003-	DP 1353	DP 21353		DP 1354	DP 21354	
2.1 TD	84-91	DP 545(B)	DP 2545				5072A(B)
2.1 TD	84-91	DP 426(G)	DP 2426		DP 189(B)	DP 2189	5212A(G)
2.1 TD	91-96	DP 952(G)	DP 2952				5072A(B)
2.1 TD	91-96	DP 952(G)	DP 2952				5212A(G)
2.1 TD (ABS)	91-96	DP 547(G)	DP 2547		DP 885(BR)	DP 2885	
2.1 TD (ABS)	91-96	DP 547(G)	DP 2547		DP 189(B)	DP 2189	
2.2 TD	97-2000	DP 1128	DP 21128		DP 885(BR)	DP 2885	
2.2 TD	2000-2002	DP 1461	DP 21461		DP 680	DP 2680	
2.2 TD	2003-	DP 1353	DP 21353		DP 1354	DP 21354	
3.0 TD	2003-						
Florde							
	61-71	DP 119			DP 118		
Fuego							
1.4	80-81	DP 545(B)	DP 2545				5190(B)
1.4	80-81	DP 426(G)	DP 2426				5226/1(G)
1.4	81-86	DP 545(B)	DP 2545				5190(B)
1.4	81-86	DP 426(G)	DP 2426				5226/1(G)
1.6 Turbo	83-86	DP 426(G)	DP 2426		DP 189	DP 2189	
1.7	80-81	DP 545(B)	DP 2545				5190(B)
1.7	80-81	DP 426(G)	DP 2426				5226/1(G)
1.7	81-86	DP 545(B)	DP 2545				5190(B)
1.7	81-86	DP 426(G)	DP 2426				5226/1(G)
2.0	80-81	DP 545(B)	DP 2545				5190(B)
2.0	81-86	DP 545(B)	DP 2545				5190(B)
2.1 TD	80-82	DP 426(G)	DP 2426				5072(B)
2.1 TD	82-86	DP 426(G)	DP 2426				5187/2(B)
2.1 TD	80-86	DP 426(G)	DP 2426				5212A(G)
Grand Espace							
2.0	99-2000	DP 1128	DP 21128		DP 885	DP 2885	6600
2.0	2000-2002	DP 1461	DP 21461		DP 680	DP 2680	
2.0 Turbo	2003-	DP 1353	DP 21353		DP 1354	DP 21354	
3.0	99-2000	DP 1128	DP 21128		DP 885	DP 2885	
3.0	2000-2002	DP 1461	DP 21461		DP 680	DP 2680	
3.0	2003-	DP 1353	DP 21353		DP 1354	DP 21354	
3.5	2003-	DP 1353	DP 21353		DP 1354	DP 21354	
2.2 TD	98-2000	DP 1128	DP 21128				6600
2.2 TD	2000-2002	DP 1461	DP 21461		DP 680	DP 2680	
2.2 TD	2003-	DP 1353	DP 21353		DP 1354	DP 21354	
3.0 TD	2003-						
Kangoo							
1.2	2002-	DP 1406					6564
1.2	2002-	DP 1406					6613
1.4	99-2001	DP 1136	DP 21136				6564
1.6	2001-	DP 1406					6613
1.5 D	2002-	DP 1406					6564
1.9 D	99-2001	DP 1136	DP 21136				6564

Standard Quality - ECE R90 Approved with similar performance to original equipment brake pads.
 Upgrade Quality (Tuning / Sportbeläge) - ECE R90 Approved but with higher friction and improved performance for faster street use.

Standard Qualität - mit ECE R90 Freigabe und ähnlicher Bremsleistung wie die Original Bremsbeläge.
 Verbesserte Qualität - mit ECE R90 Freigabe aber mit höherem Reibwert und verbesserter Bremsleistung für den schnellen Strasseninsatz.

Qualité standard - Approuvée par la norme ECE R90 - Des performances équivalentes à l'origine.
 Qualité améliorée - Approuvée par la norme ECE R90 - Un coefficient de friction supérieur et des performances accrues pour pilotage rapide sur route.









Calidad Estándar - Aprobación CEE R90 con prestaciones similares a las pastillas originales.
 Calidad Mejorada - Aprobación CEE R90 pero con un coeficiente de fricción más elevado y prestaciones mejoradas para un uso deportivo en carretera.

BRAKE PADS & SHOES - APPLICATIONS

Bremsbeläge / Plaquettes + Bremsbacken / Machoires

EBC

BRAKES

Make/Model/Engine Hersteller/Modell/Motor Modèles	Year Jahr Années	Pads  Front / Vorn / Avant		Shoes	Pads  Rear / Hinten / Arrière		Shoes
		Original Quality ECE R90* Approved 	Upgrade Quality Tuning/Sportbeläge ECE R90* Approved 	Bremsbacken Machoirs 	Original Quality ECE R90* Approved 	Upgrade Quality Tuning/Sportbeläge ECE R90* Approved 	Bremsbacken Machoirs 
RENAULT Contd.							
Kangoo Contd.							
1.9 D	2001-	DP 1406					6564
1.9 TD	2001-2002	DP 1406					6564
Laguna Saloon							
1.6	98-2000	DP 949	DP 2949		DP 1190		6526
1.6	2001-	DP 1353	DP 21353		DP 1354	DP 21354	
1.6 Authentique	2001-	DP 1394	DP 21394		DP 1354	DP 21354	
1.8	94-95	DP 980			DP 951(B)		6526
1.8	94-98	DP 949	DP 2949		DP 885(BR)	DP 2885	6526
1.8	98-2000	DP 949	DP 2949		DP 1190		6526
1.8	2001-	DP 1353	DP 21353		DP 1354	DP 21354	
1.8 Authentique (Man)	2001-	DP 1394	DP 21394		DP 1354	DP 21354	
1.8 Authentique (Auto)	2001-	DP 1353	DP 21353		DP 1354	DP 21354	
2.0	94-95	DP 949	DP 2949		DP 951(B)		6526
2.0	94-98	DP 949	DP 2949		DP 885(BR)	DP 2885	6526
2.0	98-2000	DP 949	DP 2949		DP 1190		
2.0	2001-	DP 1353	DP 21353		DP 1354	DP 21354	
2.0 Turbo	2003-						
2.0 16v	95-98	DP 949	DP 2949		DP 885(BR)	DP 2885	
2.0 16v	98-2000	DP 949	DP 2949		DP 1190		
2.9	2001-	DP 1353	DP 21353		DP 1354	DP 21354	
3.0	94-98	DP 949	DP 2949		DP 885(BR)	DP 2885	
3.0	97-2000	DP 949	DP 2949		DP 1190		
1.9 TD	98-2000	DP 949	DP 2949		DP 1190		6526
1.9 TD	99-2000	DP 1369	DP 21369		DP 1190		
1.9 TD	2001-	DP 1353	DP 21353		DP 1354	DP 21354	
1.9 TD	2001-	DP 1394	DP 21394		DP 1354	DP 21354	
2.2 D	94-98	DP 949	DP 2949		DP 885(BR)	DP 2885	6526
2.2 TD	96-99	DP 949	DP 2949		DP 885(BR)	DP 2885	
2.2 TD	97-99	DP 949	DP 2949		DP 1190		
2.2 TD	2002-	DP 1353	DP 21353		DP 1354	DP 21354	
Laguna Estate							
1.6	98-2000	DP 949	DP 2949				6543
1.8	95-96	DP 949	DP 2949		DP 885	DP 2885	6543
1.8	96-2000	DP 949	DP 2949		DP 1190		6543
1.8	2001-	DP 1353	DP 21353		DP 1354	DP 21354	
2.0	95-96	DP 949	DP 2949		DP 885	DP 2885	6543
2.0	96-2000	DP 949	DP 2949		DP 1190		6543
2.0	2001-	DP 1353	DP 21353		DP 1354	DP 21354	
2.0 Turbo	2003-						
2.0 16v	95-96	DP 949	DP 2949		DP 885	DP 2885	
2.0 16v	95-2000	DP 949	DP 2949		DP 1190		
2.9	2001-	DP 1353	DP 21353		DP 1354	DP 21354	
3.0	97-98	DP 949	DP 2949		DP 1190		
1.9 TD	98-2000	DP 949	DP 2949		DP 1190		6543
1.9 TD	99-2000	DP 1369	DP 21369		DP 1190		
1.9 TD	2001-	DP 1353	DP 21353		DP 1354	DP 21354	
2.2 D	95-98	DP 949	DP 2949		DP 885	DP 2885	6543
2.2 D	96-98	DP 949	DP 2949		DP 1190		6543
2.2 TD	96-99	DP 949	DP 2949		DP 885	DP 2885	6543
2.2 TD	96-99	DP 949	DP 2949		DP 1190		
2.2 TD	2002-	DP 1353	DP 21353		DP 1354	DP 21354	
Megane							
1.4	96-2002	DP 959	DP 2959				6539
1.4	2002-	DP 1467	DP 21467				
1.6	96-2002	DP 959	DP 2959				6539
1.6	99-2002	DP 1369	DP 21369		DP 1078		
1.6	2002-	DP 1468	DP 21468		DP 680	DP 2680	
1.8	2000-2002	DP 1369	DP 21369		DP 1078		

*Every EBC pad and shoe requiring ECE R-90 is available with approval subject to stock rotation - check box end label.
Models listed by Engine Size. Only listed by trim level where pads differ, (16v, GL, GT, etc).









Standard Quality - ECE R90 Approved with similar performance to original equipment brake pads.
Upgrade Quality (Tuning/ Sportbeläge) - ECE R90 Approved but with higher friction and improved performance for faster street use.
Verbesserte Qualität - mit ECE R90 Freigabe aber mit höherem Reibwert und verbesserter Bremsleistung für den schnellen Strasseninsatz.

Standard Qualität - mit ECE R90 Freigabe und ähnlicher Bremsleistung wie die Original Bremsbeläge.
Upgrade Qualität (Tuning/ Sportbeläge) - ECE R90 Approved but with higher friction and improved performance for faster street use.
Verbesserte Qualität - mit ECE R90 Freigabe aber mit höherem Reibwert und verbesserter Bremsleistung für den schnellen Strasseninsatz.

Qualité standard - Approuvée par la norme ECE R90 - Des performances équivalentes à l'origine.
Qualité améliorée - Approuvée par la norme ECE R90 - Un coefficient de friction supérieur et des performances accrues pour pilotage rapide sur route.
Calidad Mejorada - Aprobación CEE R90 con prestaciones similares a las pastillas originales.
Calidad Mejorada - Aprobación CEE R90 pero con un coeficiente de fricción más elevado y prestaciones mejoradas para un uso deportivo en carretera.

Standard Quality - ECE R90 Approved with similar performance to original equipment brake pads.
 Upgrade Quality (Tuning / Sportbeläge) - ECE R90 Approved but with higher friction and improved performance for faster street use.

Calidad Estándar - Aprobación CEE R90 con prestaciones similares a las pastillas originales.
 Calidad Mejorada - Aprobación CEE R90 pero con un coeficiente de fricción más elevado y prestaciones mejoradas para un uso deportivo en carretera.

Make/Model/Engine Hersteller/Modell/Motor Modèles	Year Jahr Années	Pads  Front / Vorn / Avant		Shoes	Pads  Rear / Hinten / Arrière		Shoes
		Original Quality ECE R90* Approved 	Upgrade Quality Tuning/Sportbeläge ECE R90* Approved 	Bremsbacken Machoires 	Original Quality ECE R90* Approved 	Upgrade Quality Tuning/Sportbeläge ECE R90* Approved 	Bremsbacken Machoires 
RENAULT Contd.							
Megane Contd.							
2.0	96-99	DP 949	DP 2949				6539
2.0 16v	96-99	DP 949	DP 2949		DP 1078		
2.0 16v	99-2002	DP 1369	DP 21369		DP 1078		
2.0	2002-	DP 1468	DP 21468		DP 680	DP 2680	
1.5 D	2002-	DP 1468	DP 21468		DP 680	DP 2680	
1.9 D	96-2002	DP 959	DP 2959				6539
1.9 TD	96-99	DP 949	DP 2949		DP 1078		6539
1.9 TD	96-2002	DP 959	DP 2959				6539
1.9 TD	99-2002	DP 1369	DP 21369				6539
1.9 TD	2002-	DP 1468	DP 21468		DP 680	DP 2680	
Megane Scenic							
1.4	96-99	DP 959	DP 2959				6539
1.4	96-99	DP 959	DP 2959				6543
1.4	99-2002	DP 1369	DP 21369		DP 680	DP 2680	
1.6	96-99	DP 959	DP 2959		DP 1078		6543
1.6	99-2002	DP 1369	DP 21369		DP 680	DP 2680	
1.8	2001-2002	DP 1369	DP 21369		DP 680	DP 2680	
2.0	96-99	DP 949	DP 2949		DP 1078		6543
2.0	99-2002	DP 1369	DP 21369		DP 680	DP 2680	
2.0 16v	96-99	DP 949	DP 2949		DP 1078		6543
1.9 D	96-99	DP 959	DP 2959				6543
1.9 D	99-2002	DP 1369	DP 21369				6543
1.9 TD	96-99	DP 949	DP 2949				6543
1.9 TD	99-2002	DP 1369	DP 21369		DP 680	DP 2680	6543
Safrane							
2.0	92-96	DP 949	DP 2949		DP 885(BR)	DP 2885	6338
2.0	96-99	DP 949	DP 2949		DP 885(BR)	DP 2885	
2.0	99-2000	DP 1369	DP 21369		DP 885	DP 2885	
2.2	92-96	DP 949	DP 2949		DP 951(B)		6338
2.2 (ABS)	92-96	DP 949	DP 2949		DP 885(BR)	DP 2885	
2.5	96-99	DP 949	DP 2949		DP 885(BR)	DP 2885	
2.5	99-2000	DP 1369	DP 21369		DP 885	DP 2885	
3.0	92-96	DP 949	DP 2949		DP 885(BR)	DP 2885	
3.0 Quadra	92-96	DP 949	DP 2949		DP 983(B)	DP 2983	
3.0 Turbo	92-96	DP 949	DP 2949		DP 885(BR)	DP 2885	
2.1 TD	92-96	DP 949	DP 2949		DP 951(B)		6338
2.1 TD (ABS)	92-96	DP 949	DP 2949		DP 885(BR)	DP 2885	
2.2 TD	96-99	DP 949	DP 2949		DP 885(BR)	DP 2885	
2.2 TD	99-2000	DP 1369	DP 21369		DP 885	DP 2885	
2.5 TD	92-96	DP 949	DP 2949		DP 885(BR)	DP 2885	
Scenic							
1.4	2002-						
1.6	2002-						
1.8	2002-						
2.0	2002-						
1.9 TD	2002-						
Scenic RX4							
2.0	2000-	DP 1369	DP 21369		DP 680	DP 2680	
1.9 TD	2000-	DP 1369	DP 21369		DP 680	DP 2680	
Spider							
2.0	96-99	DP 949	DP 2949		DP 882/2		

*Every EBC pad and shoe requiring ECE R-90 is available with approval subject to stock rotation - check box end label.









Models listed by Engine Size. Only listed by trim level where pads differ, (16v, GL, GT, etc).

BRAKE PADS & SHOES - APPLICATIONS

Bremsbeläge / Plaquettes + Bremsbacken / Machoires









EBC

BRAKES

Make/Model/Engine Hersteller/Modell/Motor Modelos	Year Jahr Années	Pads  Front / Vorn / Avant		Shoes	Pads  Rear / Hinten / Arrière		Shoes
		Original Quality ECE R90* Approved 	Upgrade Quality Tuning/Sportbeläge ECE R90* Approved 	Bremsbacken Machoires 	Original Quality ECE R90* Approved 	Upgrade Quality Tuning/Sportbeläge ECE R90* Approved 	Bremsbacken Machoires 
RENAULT Contd.							
Twingo							
1.2 (Man)	93-	DP 489/2(B)					6410
1.2 (Man)	93-	DP 489/2(B)					6526
1.2 (Auto)	96-	DP 426(G)	DP 2426				6410
1.2 (Auto)	96-	DP 426(G)	DP 2426				6526
1.3	96-	DP 489/2(B)					6410
1.3	96-	DP 489/2(B)					6526
Vel Satis							
2.0 Turbo	2002-	DP 1353	DP 21353		DP 1354	DP 21354	
3.5	2002-	DP 1353	DP 21353		DP 1354	DP 21354	
2.2 TD	2002-	DP 1353	DP 21353		DP 1354	DP 21354	
3.0 TD	2002-	DP 1353	DP 21353		DP 1354	DP 21354	
4							
0.9	65-71			5064			5060
0.9	71-81			5071			5060
0.9	77-81			5071			6306(B)
0.9	82-86	DP 269(B)					6306(B)
0.9	82-86	DP 284(G)					5243/1(G)
1.0	82-86	DP 284(G)					5243/1(G)
1.0	82-86	DP 269(B)					6306(B)
1.1	71-81			5071			5060
1.1	77-81			5071			6306(B)
1.1	82-86	DP 269(B)					6306(B)
1.1	82-86	DP 284(G)					5243/1(G)
5							
0.9	72-79			5064			5060
0.9	79-82			5071			5060
0.9	82-84	DP 269(B)					6306(B)
0.9	82-84	DP 284(G)					5243/1(G)
1.0	72-84	DP 269(B)					5069(B)
1.0	72-84	DP 284(G)					5243/1(G)
1.0	85-90	DP 668(G)					6410(B)
1.0	85-87	DP 489/2(B)					5095(B)
1.0	87-90	DP 545/2(B)					5095(B)
1.0	85-90	DP 426(G)	DP 2426				6343(G)
1.1	72-81	DP 269(B)					5069(B)
1.1	72-86	DP 284(G)					5243/1(G)
1.1	82-84	DP 269(B)					6306(B)
1.1	82-84	DP 284(G)					5243/1(G)
1.1	85-87	DP 489/2(B)					5095(B)
1.1	85-94	DP 668(G)					6343(G)
1.1	87-96	DP 545/2(B)					5095(B)
1.1	85-96	DP 426(G)	DP 2426				6343(G)
1.2	85-90	DP 545/2(B)					5095(B)
1.2	85-90	DP 426(G)	DP 2426				5095(B)
1.2	87-90	DP 668(G)					6410(B)
1.2	87-90	DP 426(G)	DP 2426				6343(G)
1.3	74-82	DP 269(B)					5069(B)
1.3	74-82	DP 284(G)					5243/1(G)
1.3	82-84	DP 269(B)					6306(B)
1.3	82-84	DP 354(G)					5243/1(G)
1.4	76-82	DP 269(B)					5069(B)
1.4	76-82	DP 284(G)					5243/1(G)
1.4	82-84	DP 269(B)					6306(B)
1.4	82-84	DP 354(G)					5243/1(G)
1.4	85-90	DP 668(G)					6410(B)
1.4	85-90	DP 545/2(B)					5095(B)
1.4	85-90	DP 426(G)	DP 2426				6343(G)
1.4	85-90	DP 545(B)	DP 2545				6410(B)

*Every EBC pad and shoe requiring ECE R-90 is available with approval subject to stock rotation - check box end label.
Models listed by Engine Size. Only listed by trim level where pads differ, (16v, GL, GT, etc).

Standard Quality - ECE R90 Approved with similar performance to original equipment brake pads.
Upgrade Quality (Tuning/ Sportbeläge) - ECE R90 Approved but with higher friction and improved performance for faster street use.
Verbesserte Qualität - mit ECE R90 Freigabe aber mit höherem Reibwert und verbesserter Bremsleistung für den schnellen Strasseninsatz.
Standard Qualität - mit ECE R90 Freigabe und ähnlicher Bremsleistung wie die Original Bremsbeläge.
Qualité standard - Approuvée par la norme ECE R90 - Des performances équivalentes à l'origine.
Qualité améliorée - Approuvée par la norme ECE R90 - Un coefficient de friction supérieur et des performances accrues pour pilotage rapide sur route.
Calidad Estándar - Aprobación CEE R90 con prestaciones similares a las pastillas originales.
Calidad Mejorada - Aprobación CEE R90 pero con un coeficiente de fricción más elevado y prestaciones mejoradas para un uso deportivo en carretera.

Make/Model/Engine Hersteller/Modell/Motor Modelos	Year Jahr Années	Pads  Front / Vorn / Avant		Shoes	Pads  Rear / Hinten / Arrière		Shoes
		Original Quality ECE R90* Approved 	Upgrade Quality Tuning/Sportbeläge ECE R90* Approved 	Bremsbacken Machoires 	Original Quality ECE R90* Approved 	Upgrade Quality Tuning/Sportbeläge ECE R90* Approved 	Bremsbacken Machoires 
RENAULT Contd.							
5 Contd.							
1.4	90-96	DP 545(B)	DP 2545				5095(B)
1.4	90-96	DP 426(G)	DP 2426				6343(G)
1.4 Turbo (Mid Eng)		DP 2546	DP 3546		DP 2546	DP 3546	
1.4 GT Turbo	81-84	DP 354(G)			DP 189		
1.4 GT Turbo	85-91	DP 426(G)	DP 2426		DP 458/2	DP 2458/2	
1.7	85-90	DP 545/2(B)			DP 458/2	DP 2458/2	5095(B)
1.7	85-90	DP 426(G)	DP 2426		DP 458/2	DP 2458/2	6343(G)
6							
0.9	69-80			5062			5060
0.9	69-80			5071			5060
1.1	70-74	DP 269(B)					5069
1.1	74-80	DP 269(B)					6306(B)
1.1	74-80	DP 284(G)					5243(G)
8							
1.1	62-75	DP 119			DP 118		
9							
1.1	81-86	DP 489(B)					5095(B)
1.1	81-86	DP 426(G)	DP 2426				6343(G)
1.2	86-89	DP 545(B)	DP 2545				6343(G)
1.2	86-89	DP 426(G)	DP 2426				6410(B)
1.2	86-89	DP 545(B)	DP 2545				5095(B)
1.4	81-86	DP 426(G)	DP 2426				6343(G)
1.4	81-86	DP 489(B)					6325(B)
1.4	87-89	DP 545(B)	DP 2545				6343(G)
1.4	87-89	DP 426(G)	DP 2426				6410(B)
1.4	87-89	DP 545(B)	DP 2545				5095(B)
1.4 Turbo	84-89	DP 426(G)	DP 2426		DP 458/2	DP 2458/2	
1.7	87-89	DP 545(B)	DP 2545				6343(G)
1.7	87-89	DP 426(G)	DP 2426				6410(B)
1.7	87-89	DP 545(B)	DP 2545				5095(B)
1.6 D	83-86	DP 489(B)					6325(B)
1.6 D	83-86	DP 426(G)	DP 2426				6343(G)
1.6 D	87-89	DP 545(B)	DP 2545				6343(G)
1.6 D	87-89	DP 426(G)	DP 2426				6410(B)
1.6 D	87-89	DP 545(B)	DP 2545				5095(B)
10							
1.1	62-75	DP 119			DP 118		
11							
1.1	83-84	DP 489(B)					5095(B)
1.1	83-84	DP 426(G)	DP 2426				6343(G)
1.1	84-87	DP 545(B)	DP 2545				5095(B)
1.1	84-87	DP 426(G)	DP 2426				6343(G)
1.2	86-89	DP 545(B)	DP 2545				5095(B)
1.2	86-89	DP 545(B)	DP 2545				6343(G)
1.2	86-89	DP 426(G)	DP 2426				6410(B)
1.4	83-84	DP 489(B)					5095(B)
1.4	83-84	DP 426(G)	DP 2426				6343(G)
1.4	84-86	DP 545(B)	DP 2545				5095(B)
1.4	84-86	DP 426(G)	DP 2426				6343(G)
1.4	87-89	DP 545(B)	DP 2545				6343(G)
1.4	87-89	DP 426(G)	DP 2426				6410(B)
1.4 Turbo	84-89	DP 426(G)	DP 2426		DP 458/2	DP 2458/2	
1.7	84-86	DP 545(B)	DP 2545				5095(B)
1.7	84-86	DP 426(G)	DP 2426				6343(G)
1.7	87-89	DP 545(B)	DP 2545				6343(G)
1.7	87-89	DP 426(G)	DP 2426				6410(B)

Standard Quality - ECE R90 Approved with similar performance to original equipment brake pads.

Upgrade Quality (Tuning / Sportbeläge) - ECE R90 Approved but with higher friction and improved performance for faster street use.

Standard Qualität - mit ECE R90 Freigabe und ähnlicher Bremsleistung wie die Original Bremsbeläge.

Verbesserte Qualität - mit ECE R90 Freigabe aber mit höherem Reibwert und verbesserter Bremsleistung für den schnellen Strasseninsatz.

Quality standard - Approuvée par la norme ECE R90 - Des performances équivalentes à l'origine.

Qualité améliorée - Approuvée par la norme ECE R90 - Un coefficient de friction supérieur et des performances accrues pour pilotage rapide sur route.

Calidad Estandar - Aprobacion CEE R90 con prestaciones similares a las pastillas originales.

Calidad Mejorada - Aprobacion CEE R90 pero con un coeficiente de friccion mas elevado y prestaciones mejoradas para un uso deportivo en carretera.









*Every EBC pad and shoe requiring ECE R-90 is available with approval subject to stock rotation - check box end label.

Models listed by Engine Size. Only listed by trim level where pads differ, (16v, GL, GT, etc).

BRAKE PADS & SHOES - APPLICATIONS

Bremsbeläge / Plaquettes + Bremsbacken / Machoires









EBC
BRAKES

Make/Model/Engine Hersteller/Modell/Motor Modèles	Year Jahr Années	Pads  Front / Vorn / Avant		Shoes	Pads  Rear / Hinten / Arrière		Shoes
		Original Quality ECE R90* Approved 	Upgrade Quality Tuning/Sportbeläge ECE R90* Approved 	Bremsbacken Machoires 	Original Quality ECE R90* Approved 	Upgrade Quality Tuning/Sportbeläge ECE R90* Approved 	Bremsbacken Machoires 
RENAULT Contd.							
11 Contd.							
1.6 D	84-86	DP 545(B)	DP 2545				5095(B)
1.6 D	84-86	DP 426(G)	DP 2426				6343(G)
1.6 D	87-89	DP 545(B)	DP 2545				6343(G)
1.6 D	87-89	DP 426(G)	DP 2426				6410(B)
12							
1.3	70-73	DP 269(B)					5066
1.3 Est	70-74	DP 269(B)					5072(B)
1.3 Sal	74-79	DP 269(B)					5066(B)
1.3 Sal	74-79	DP 354(G)					5226/1(G)
1.3 Est	74-80	DP 269(B)					5072(B)
1.3 Est	74-80	DP 354(G)					5072(B)
1.4 Sal	74-79	DP 269(B)					5066(B)
1.4 Sal	74-79	DP 354(G)					5226/1(G)
1.4 Est	74-80	DP 269(B)					5072(B)
1.4 Est	74-80	DP 354(G)					5072(B)
1.6	70-74	DP 269(B)			DP 189		
14							
1.2	76-83	DP 220(T)	DP 2220				5226/1(G)
1.2	76-83	DP 269(B)					5190(B)
1.4	76-83	DP 220(T)	DP 2220				5226/1(G)
1.4	76-83	DP 269(B)					5190(B)
15							
1.3	71-79	DP 269					5066(B)
1.3	71-79	DP 269					5226/1(G)
1.6	71-79	DP 269					5066(B)
1.6	71-79	DP 269					5226/1(G)
1.6 TS	72-79	DP 269					5072(B)
16							
1.6	65-67	DP 150					5062
1.6	67-72	DP 156(G)					5067
1.6	72-80	DP 156(G)					5212A(G)
1.6	72-80	DP 269(B)					5065
1.6	72-80	DP 269(B)					5067(B)
17							
1.6	72-76	DP 269					5072
1.6	76-79	DP 269			DP 189		5072
1.7	72-76	DP 269					5072
1.7	76-79	DP 269			DP 189		5072
18							
1.4	78-82	DP 269(B)					5190(B)
1.4	78-82	DP 354(G)					5226/1(G)
1.4	82-86	DP 545(B)	DP 2545				5190(B)
1.4 Est	79-82	DP 269(B)					5072(B)
1.4 Est	79-82	DP 354(G)					5212A(G)
1.4 Est	82-83	DP 489(B)					5072(B)
1.4 Est	82-85	DP 426(G)	DP 2426				5212A(G)
1.4 Est	83-85	DP 545(B)	DP 2545				5072(B)
1.6 Turbo	82-86	DP 426(G)	DP 2426		DP 189	DP 2189	
1.7	79-82	DP 269(B)					5190(B)
1.7	79-82	DP 354(G)					5226/1(G)
1.7	83-86	DP 545(B)	DP 2545				5226/1(G)
1.7	83-86	DP 545(B)	DP 2545				5072(B)
1.7	83-86	DP 426(G)	DP 2426				5226/1(G)
1.7	83-86	DP 426(G)	DP 2426				5212A(G)
1.7 Est	79-82	DP 269(B)					5072(B)

Standard Quality - ECE R90 Approved with similar performance to original equipment brake pads.
 Upgrade Quality (Tuning/ Sportbeläge) - ECE R90 Approved but with higher friction and improved performance for faster street use.
 Verbesserte Qualität - mit ECE R90 Freigabe aber mit höherem Reibwert und verbesserter Bremsleistung für den schnellen Strasseninsatz.

Qualité standard - Approuvée par la norme ECE R90 - Des performances équivalentes à l'origine.
 Qualité améliorée - Approuvée par la norme ECE R90 - Un coefficient de friction supérieur et des performances accrues pour pilotage rapide sur route.
 Calidad Mejorada - Aprobación CEE R90 con prestaciones similares a las pastillas originales.
 Calidad Mejorada - Aprobación CEE R90 pero con un coeficiente de fricción más elevado y prestaciones mejoradas para un uso deportivo en carretera.

*Every EBC pad and shoe requiring ECE R-90 is available with approval subject to stock rotation - check box end label.
 Models listed by Engine Size. Only listed by trim level where pads differ, (16v, GL, GT, etc).

Make/Model/Engine Hersteller/Modell/Motor Modelos	Year Jahr Années	Pads  Front / Vorn / Avant		Shoes	Pads  Rear / Hinten / Arrière		Shoes
		Original Quality ECE R90* Approved 	Upgrade Quality Tuning/Sportbeläge ECE R90* Approved 	Bremsbacken Machoires 	Original Quality ECE R90* Approved 	Upgrade Quality Tuning/Sportbeläge ECE R90* Approved 	Bremsbacken Machoires 
RENAULT Contd.							
18 Contd.							
1.7 Est	79-82	DP 354(G)					5212A(G)
1.7 Est	82-83	DP 489(B)					5072(B)
1.7 Est	82-85	DP 426(G)	DP 2426				5212A(G)
1.7 Est	83-85	DP 545(B)	DP 2545				5072(B)
2.0	81-86	DP 545(B)	DP 2545				5072(B)
2.0	81-86	DP 426(G)	DP 2426				5212A(G)
2.0 Est	79-82	DP 269(B)					5072(B)
2.0 Est	79-82	DP 354(G)					5212A(G)
2.0 Est	82-83	DP 489(B)					5072(B)
2.0 Est	82-85	DP 426(G)	DP 2426				5212A(G)
2.0 Est	83-85	DP 545(B)	DP 2545				5072(B)
2.1 D Est	82-85	DP 545(B)	DP 2545				5212A(G)
2.1 D	83-86	DP 426(G)	DP 2426				5226/1(G)
2.1 D	83-86	DP 545(B)	DP 2545				5226/1(G)
19/Chamade							
1.4	88-92	DP 426(G)	DP 2426				6343(G)
1.4	88-92	DP 545(B)	DP 2545				6410(B)
1.4	92-96	DP 959(G)	DP 2959				6343(G)
1.4	92-96	DP 959(G)	DP 2959				6410(B)
1.4 (ABS)	92-96	DP 959(G)	DP 2959		DP 983	DP 2983	
1.7	88-92	DP 426(G)	DP 2426				6343(G)
1.7	88-92	DP 545(B)	DP 2545				6410(B)
1.7	92-96	DP 959(G)	DP 2959				6408(B)
1.7 (ABS)	92-96	DP 959(G)	DP 2959		DP 983	DP 2983	
1.8	88-92	DP 426(G)	DP 2426		DP 983	DP 2983	
1.8	92-96	DP 959(G)	DP 2959		DP 983	DP 2983	6408(B)
1.8 16v	91-92	DP 426(G)	DP 2426		DP 983	DP 2983	
1.8 16v	92-96	DP 959(G)	DP 2959		DP 983	DP 2983	
1.9 D	88-92	DP 426(G)	DP 2426				6410(B)
1.9 D	88-92	DP 545(B)	DP 2545				6410(B)
1.9 D	92-97	DP 959(G)	DP 2959				6408(B)
1.9 D (ABS)	92-97	DP 959(G)	DP 2959		DP 983	DP 2983	
1.9 TD	90-92	DP 426(G)	DP 2426				6410(B)
1.9 TD	90-92	DP 426(G)	DP 2426				6343(G)
1.9 TD	92-96	DP 959(G)	DP 2959				6408(B)
20							
1.7	75-80	DP 269(B)					5072(B)
1.7	75-80	DP 269(B)					5212A(G)
1.7	80-81	DP 489(B)					5072(B)
1.7	80-81	DP 489(B)					5212A(G)
2.0	77-80	DP 324(B)					5072(B)
2.0	77-80	DP 324(B)					5212A(G)
2.0	80-84	DP 489(B)					5072(B)
2.0	80-84	DP 489(B)					5212A(G)
2.2	80-84	DP 324(B)					5072(B)
2.2	80-84	DP 324(B)					5212A(G)
2.1 D	80-84	DP 545(B)	DP 2545				5072(B)
2.1 D	80-84	DP 426(G)	DP 2426				5212A(G)
2.1 TD	80-84	DP 426(G)	DP 2426				5212A(G)
21							
1.4	88-96	DP 545(B)	DP 2545				6410(B)
1.4	88-96	DP 426(G)	DP 2426				6343(G)
1.6	88-96	DP 545(B)	DP 2545				6410(B)
1.6	88-96	DP 426(G)	DP 2426				6343(G)
1.6 Est	86-96	DP 545(B)	DP 2545				5072(B)
1.6 Est	86-96	DP 426(G)	DP 2426				5212A(G)
1.7	86-96	DP 545(B)	DP 2545				6410(B)
1.7	86-96	DP 426(G)	DP 2426				6343(G)

Standard Quality - ECE R90 Approved with similar performance to original equipment brake pads.
Upgrade Quality (Tuning / Sportbeläge) - ECE R90 Approved but with higher friction and improved performance for faster street use.

Standard Qualität - mit ECE R90 Freigabe und ähnlicher Bremsleistung wie die Original Bremsbeläge.
Verbesserte Qualität (Tuning / Sportbeläge) - mit ECE R90 Freigabe aber mit höherem Reibwert und verbesserter Bremsleistung für den schnellen Strasseninsatz.

Qualité standard - Approuvée par la norme ECE R90 - Des performances équivalentes à l'origine.
Qualité améliorée - Approuvée par la norme ECE R90 - Un coefficient de friction supérieur et des performances accrues pour pilotage rapide sur route.

Calidad Estándar - Aprobación CEE R90 con prestaciones similares a las pastillas originales.
Calidad Mejorada - Aprobación CEE R90 pero con un coeficiente de fricción más elevado y prestaciones mejoradas para un uso deportivo en carretera.

*Every EBC pad and shoe requiring ECE R-90 is available with approval subject to stock rotation - check box end label.

Models listed by Engine Size. Only listed by trim level where pads differ, (16v, GL, GT, etc).

BRAKE PADS & SHOES - APPLICATIONS

Bremsbeläge / Plaquettes + Bremsbacken / Machoires

EBC

BRAKES

Make/Model/Engine Hersteller/Modell/Motor Modelos	Year Jahr Années	Pads Front / Vorn / Avant		Shoes	Pads Rear / Hinten / Arrière		Shoes
		Original Quality ECE R90* Approved	Upgrade Quality Tuning/Sportbeläge ECE R90* Approved	Bremsbacken Machoires ECE R90* Approved	Original Quality ECE R90* Approved	Upgrade Quality Tuning/Sportbeläge ECE R90* Approved	Bremsbacken Machoires ECE R90* Approved
RENAULT Contd.							
21 Contd.							
1.7 Est	86-96	DP 545(B)	DP 2545				5212A(G)
1.7 Est	86-96	DP 426(G)	DP 2426				5072(B)
2.0	86-96	DP 604(B)	DP 2604		DP 189	DP 2189	5072(B)
2.0	86-96	DP 426(G)	DP 2426		DP 189	DP 2189	5212A(G)
2.0 Est	86-96	DP 604(B)	DP 2604		DP 189	DP 2189	5212A(G)
2.0 Est	86-96	DP 604(B)	DP 2604		DP 189	DP 2189	5072(B)
2.0 Est	87-96	DP 426(G)	DP 2426		DP 189	DP 2189	5072(B)
2.0 Est	87-96	DP 426(G)	DP 2426		DP 189	DP 2189	5212A(G)
2.0 Turbo & Quadra	88-96	DP 604(B)	DP 2604		DP 189(B)	DP 2189	
2.0 Turbo & Quadra	88-96	DP 604(B)	DP 2604		DP 885(BR)	DP 2885	
2.2	86-96	DP 604(B)	DP 2604		DP 189	DP 2189	
2.2 Est	87-96	DP 604(B)	DP 2604		DP 189	DP 2189	5072(B)
2.2 Est	87-96	DP 604(B)	DP 2604		DP 189	DP 2189	5212A(G)
1.9 D	89-96	DP 426(G)	DP 2426				6410(B)
1.9 D Est	89-96	DP 426(G)	DP 2426				5072(B)
1.9 D Est	89-96	DP 545(B)	DP 2545				5212A(G)
2.1 D	86-96	DP 604(B)	DP 2604		DP 189	DP 2189	
2.1 D Est	87-96	DP 604(B)	DP 2604		DP 189	DP 2189	5072(B)
2.1 D Est	87-96	DP 604(B)	DP 2604		DP 189	DP 2189	5212A(G)
2.1 TD	86-96	DP 604(B)	DP 2604		DP 189	DP 2189	5072(B)
2.1 TD	86-96	DP 604(B)	DP 2604		DP 189	DP 2189	5212A(G)
2.1 TD Est	87-96	DP 604(B)	DP 2604		DP 189	DP 2189	5072(B)
2.1 TD Est	87-96	DP 604(B)	DP 2604		DP 189	DP 2189	5212A(G)
25							
2.0	84-92	DP 426	DP 2426		DP 189	DP 2189	5072(B)
2.0	84-92	DP 426	DP 2426		DP 189	DP 2189	5187/2(B)
2.0	84-92	DP 426	DP 2426		DP 189	DP 2189	5212A(G)
2.1 D	84-92	DP 426	DP 2426		DP 189	DP 2189	5072(B)
2.1 TD	84-92	DP 426	DP 2426		DP 189	DP 2189	5187/2(B)
2.2	84-92	DP 426	DP 2426		DP 189	DP 2189	5072(B)
2.2	84-92	DP 426	DP 2426		DP 189	DP 2189	5187/2(B)
2.2	84-92	DP 426	DP 2426		DP 189	DP 2189	5212A(G)
2.5	84-92	DP 547	DP 2547		DP 189	DP 2189	
2.7	84-92	DP 547	DP 2547		DP 189	DP 2189	
2.9	84-92	DP 547	DP 2547		DP 189	DP 2189	
30							
2.7 V6	75-84	DP 267			DP 189		
2.1 TD	81-84	DP 426(G)	DP 2426				5072(B)
2.1 TD	81-84	DP 426(G)	DP 2426				5187/2(B)
2.1 TD	81-84	DP 545(B)	DP 2545				5212A(G)

Pad Illustrations for Renault

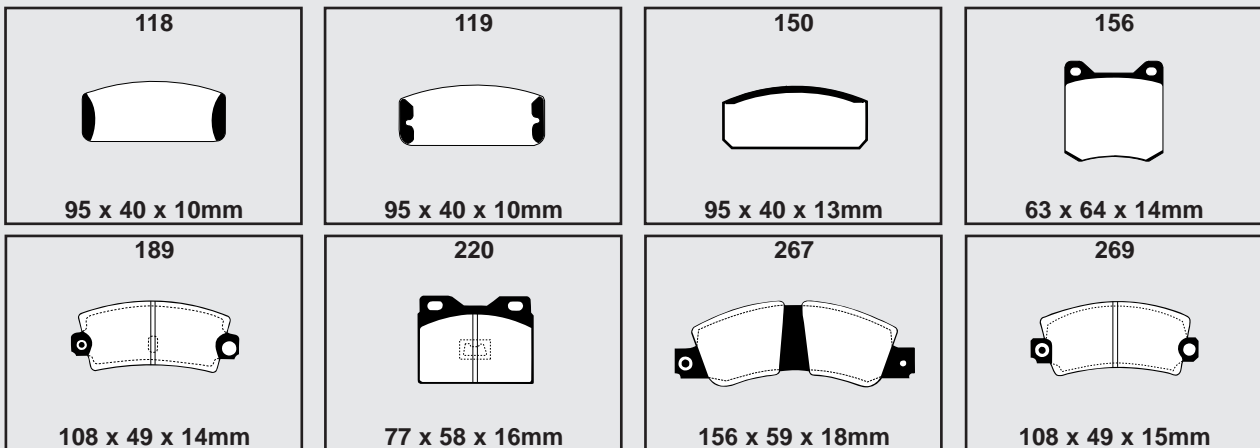

*Every EBC pad and shoe requiring ECE R-90 is available with approval subject to stock rotation - check box end label.
Models listed by Engine Size. Only listed by trim level where pads differ, (16v, GL, GT, etc).

Standard Quality - ECE R90 Approved with similar performance to original equipment brake pads.
Upgrade Quality (Tuning/ Sportbeläge) - ECE R90 Approved but with higher friction and improved performance for faster street use.
Verbesserte Qualität - mit ECE R90 Freigabe und ähnlicher Bremsleistung wie die Original Bremsbeläge.
Standard Qualität - mit ECE R90 Freigabe und ähnlicher Bremsleistung wie die Original Bremsbeläge.

Qualité standard - Approuvée par la norme ECE R90 - Des performances équivalentes à l'origine.
Qualité améliorée - Approuvée par la norme ECE R90 - Un coefficient de friction supérieur et des performances accrues pour pilotage rapide sur route.
Calidad Estándar - Aprobación CEE R90 con prestaciones similares a las pastillas originales.
Calidad Mejorada - Aprobación CEE R90 pero con un coeficiente de fricción más elevado y prestaciones mejoradas para un uso deportivo en carretera.

Make/Model/Engine	Year	Front / Vorn / Avant	Shoes	Rear / Hinten / Arrière	Shoes
Hersteller/Modell/Motor	Jahr	Plaquettes / Bremsbeläge	Bremsbacken Machoires	Plaquettes / Bremsbeläge	Bremsbacken Machoires
Modelos	Années	Original Quality ECE R90* Approved	Upgrade Quality Tuning/Sportbeläge ECE R90* Approved	Original Quality ECE R90* Approved	Upgrade Quality Tuning/Sportbeläge ECE R90* Approved

Pad Illustrations for Renault Contd.

284 93 x 56 x 15mm	324 109 x 58 x 18mm	354 98 x 64 x 16mm	426 100 x 65 x 18mm
458 106 x 56 x 18mm	458/2 106 x 56 x 11mm	489 106 x 56 x 18mm	489/2 106 x 56 x 15mm
545 105 x 55 x 18mm	545/2 105 x 55 x 15mm	546 105 x 65 x 18mm	547 130 x 56 x 18mm
604 122 x 49 x 16mm	668 90 x 67 x 15mm	680 87 x 53 x 15mm	794/2 130 x 69 x 17mm
882/2 131 x 73 x 17mm	885 123 x 59 x 15mm	949 130 x 55 x 17mm	951 105 x 56 x 15mm
952 110 x 68 x 17mm	959 100 x 65 x 18mm	980 110 x 65 x 17mm	983 105 x 55 x 11mm
1078 105 x 54 x 11mm	1128 130 x 63 x 18mm	1190 126 x 63 x 15mm	

Standard Quality - ECE R90 Approved with similar performance to original equipment brake pads.
Upgrade Quality (Tuning / Sportbeläge) - ECE R90 Approved but with higher friction and improved performance for faster street use.

Standard Qualität - mit ECE R90 Freigabe und ähnlicher Bremsleistung wie die Original Bremsbeläge.
Verbesserte Qualität - mit ECE R90 Freigabe aber mit höherem Reibwert und verbesserter Bremsleistung für den schnellen Strasseninsatz.

Qualité standard - Approuvée par la norme ECE R90 - Des performances équivalentes à l'origine.
Qualité améliorée - Approuvée par la norme ECE R90 - Un coefficient de friction supérieur et des performances accrues pour pilotage rapide sur route.

Calidad Estándar - Aprobación CEE R90 con prestaciones similares a las pastillas originales.
Calidad Mejorada - Aprobación CEE R90 pero con un coeficiente de fricción más elevado y prestaciones mejoradas para un uso deportivo en carretera.

BRAKE PADS & SHOES - APPLICATIONS

Bremsbeläge / Plaquettes + Bremsbacken / Machoires

EBC

BRAKES

Make/Model/Engine	Year	Pads	Front / Vorn / Avant	Shoes	Pads	Rear / Hinten / Arrière	Shoes
Hersteller/Modell/Motor	Jahr	Plaquettes / Bremsbeläge		Bremsbacken	Plaquettes / Bremsbeläge		Bremsbacken
Modelos	Années	Original Quality ECE R90* Approved	Upgrade Quality Tuning/Sportbeläge ECE R90* Approved	Machoires ECE R90* Approved	Original Quality ECE R90* Approved	Upgrade Quality Tuning/Sportbeläge ECE R90* Approved	Machoires ECE R90* Approved

Pad Illustrations for Renault Contd.

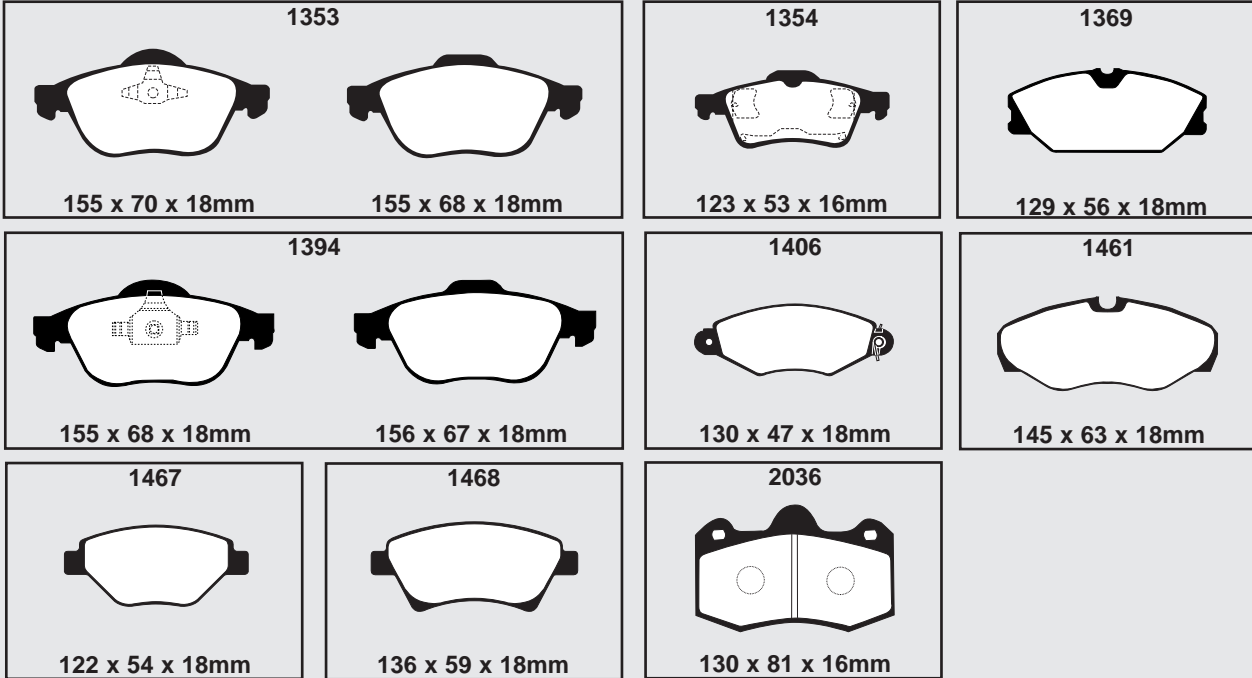







RENAULT COMMERCIAL					
4 Van					
7 cwt.	72-82			5067	5069
7 cwt.	82-86			5071	5069
9 cwt.	80-82			5067	6306(B)
9 cwt.	83-86	DP 269(B)			6306(B)
9 cwt.	83-86	DP 284(G)			5243/1(G)
5 Van					
1.1	85-90	DP 489/2(B)			6408
1.1	85-90	DP 545/2(B)			6408
1.2	85-90	DP 489/2(B)			6408
1.2	85-90	DP 545/2(B)			6408
1.6 D	85-90	DP 489/2(B)			6408
1.6 D	85-90	DP 545/2(B)			6408
Clio Van					
1.1	90-92	DP 545/2			6410
1.1	92-94	DP 545			6410
1.2	90-98	DP 545			6410
1.2	92-98	DP 959			6343
1.2	98-	DP 959			6526
1.2	98-	DP 959			6582
1.2	2001-	DP 959			6612
1.5 D	2001-	DP 959			6526
1.5 D	2001-	DP 959			6582
1.5 D	2001-	DP 959			6612
1.9 D	90-98	DP 545			6410
1.9 D	90-92	DP 426			6343
1.9 D	92-98	DP 959			6343
1.9 D	98-2001	DP 959			6526
1.9 D	98-2001	DP 959			6582
1.9 D	98-2001	DP 1136			6526
1.9 D	98-2001	DP 1136			6582
1.9 D	2000-2001	DP 959			6612

*Every EBC pad and shoe requiring ECE R-90 is available with approval subject to stock rotation - check box end label.
Models listed by Engine Size. Only listed by trim level where pads differ, (16v, GL, GT, etc).

Standard Quality - ECE R90 Approved with similar performance to original equipment brake pads.
Upgrade Quality (Training / Sportbeläge) - ECE R90 Approved but with higher friction and improved performance for faster street use.
Verbesserte Qualität - mit ECE R90 Freigabe aber mit höherem Reibwert und verbesserter Bremsleistung für den schnellen Strasseninsatz.

Standard Qualität - mit ECE R90 Freigabe und ähnlicher Bremsleistung wie die Original Bremsbeläge.
Qualität amfiorde - Approuvé par la norme ECE R90 - Un coefficient de friction supérieur et des performances accrues pour pilotage rapide sur route.
Calidad Estándar - Aprobación CEE R90 con prestaciones similares a las pastillas originales.
Calidad Mejorada - Aprobación CEE R90 pero con un coeficiente de fricción más elevado y prestaciones mejoradas para un uso deportivo en carretera.

Qualité standard - Approuvée par la norme ECE R90 - Des performances équivalentes à l'origine.
Qualité améliorée - Approuvée par la norme ECE R90 - Un coefficient de friction supérieur et des performances accrues pour pilotage rapide sur route.
Calidad Estándar - Aprobación CEE R90 con prestaciones similares a las pastillas originales.
Calidad Mejorada - Aprobación CEE R90 pero con un coeficiente de fricción más elevado y prestaciones mejoradas para un uso deportivo en carretera.

Make/Model/Engine	Year	Pads  Front / Vorn / Avant	Shoes	Pads  Rear / Hinten / Arrière	Shoes
Hersteller/Modell/Motor	Jahr	Plaquettes / Bremsbeläge		Bremsbacken Machoires	
Modelos	Années	Original Quality ECE R90* Approved 	Upgrade Quality Tuning/Sportbeläge ECE R90* Approved 	Original Quality ECE R90* Approved 	Upgrade Quality Tuning/Sportbeläge ECE R90* Approved 
RENAULT COMM Contd.					
Extra Express Rapid					
1.0	85-91	DP 426(G)			6343(G)
1.0	85-91	DP 668(G)			6343(G)
1.0	85-91	DP 545/2(B)			6410(B)
1.1	85-91	DP 426(G)			6343(G)
1.1	85-95	DP 668(G)			6343(G)
1.1	85-95	DP 545/2(B)			6410(B)
1.1	91-95	DP 545(B)			6408(B)
1.2	91-98	DP 959(G)			6408(B)
1.2	91-98	DP 545(B)			6408(B)
1.4	85-91	DP 426(G)			6338(G)
1.4	85-91	DP 545(B)			6408(B)
1.4	85-91	DP 545/2(B)			6408(B)
1.4	91-98	DP 959(G)			6338(G)
1.4	91-98	DP 545(B)			6408(B)
1.6 D	85-86	DP 545/2(B)			6410(B)
1.6 D	86-91	DP 426(G)			6338(G)
1.6 D	91-95	DP 959(G)			6338(G)
1.6 D	91-98	DP 545(B)			6408(B)
1.9 D	91-98	DP 959(G)			6338(G)
1.9 D	91-98	DP 545(B)			6408(B)
Kangoo					
1.2	97-99	DP 1136			6564
1.2	99-2001	DP 1406			6564
1.2	2001-	DP 1406			6564
1.2	2001-	DP 1406			6613
1.4	98-99	DP 1136			6564
1.4	99-2001	DP 1406			6564
1.6	2001-	DP 1406			6613
1.5 D	2001-	DP 1406			6564
1.9 D	98-99	DP 1136			6564
1.9 D	99-2002	DP 1406			6564
1.9 TD	2001-2002	DP 1406			6564
Master					
2.0	80-86	DP 262			5117
2.0	86-94	DP 581			5117
2.0	94-97	DP 581			6541
1.9 TD	2000-	DP 1386		DP 1385	
2.2 D	2000-	DP 1386		DP 1385	
2.4 D	86-88	DP 633			5117
2.5 D	80-86	DP 262			5117
2.5 D	85-88	DP 510			5117
2.5 D	86-94	DP 581			5117
2.5 D	88-94	DP 633/2			5117
2.5 D	94-97	DP 633/2			6541
2.5 D	94-97	DP 581			6541
2.5 D	97-2000	DP 1182			6528
2.5 TD	88-94	DP 633/2			5117
2.5 TD	94-97	DP 633/2			6541
2.5 TD	97-2000	DP 1182			6528
2.8 TD	97-2000	DP 1182			6528
2.8 TD	2000-	DP 1386		DP 1385	
Trafic					
1.4 (T800)	80-84	DP 324			6321
1.4 (T800)	84-89	DP 544			6321A
1.4 (T900)	89-91	DP 544			5117
1.6 (P1000)	80-84	DP 267			6321
1.6 (P1000)	84-89	DP 544			6321A
1.7 (T1000)	80-84	DP 324			6321

Standard Quality - ECE R90 Approved with similar performance to original equipment brake pads.
 Upgrade Quality (Tuning / Sportbeläge) - ECE R90 Approved but with higher friction and improved performance for faster street use.

Standard Qualität - mit ECE R90 Freigabe und ähnlicher Bremsleistung wie die Original Bremsbeläge.
 Verbesserte Qualität - mit ECE R90 Freigabe aber mit höherem Reibwert und verbesserter Bremsleistung für den schnellen Strasseninsatz.

Calidad Estándar - Aprobacion CEE R90 con prestaciones similares a las pastillas originales.
 Calidad Mejorada - Aprobacion CEE R90 pero con un coeficiente de friccion mas elevado y prestaciones mejoradas para un uso deportivo en carretera.

*Every EBC pad and shoe requiring ECE R-90 is available with approval subject to stock rotation - check box end label.









Models listed by Engine Size. Only listed by trim level where pads differ, (16v, GL, GT, etc).

BRAKE PADS & SHOES - APPLICATIONS

Bremsbeläge / Plaquettes + Bremsbacken / Machoires

EBC

BRAKES

Make/Model/Engine Hersteller/Modell/Motor Modelos	Year Jahr Années	Pads  Front / Vorn / Avant		Shoes	Pads  Rear / Hinten / Arrière		Shoes
		Original Quality ECE R90* Approved 	Upgrade Quality Tuning/Sportbeläge ECE R90* Approved 	Bremsbacken Machoirs 	Original Quality ECE R90* Approved 	Upgrade Quality Tuning/Sportbeläge ECE R90* Approved 	Bremsbacken Machoirs 
RENAULT COMM Contd.							
Traffic Contd.							
1.7 (T1000)	84-89	DP 544					6321A
1.7 (T1000D)	84-89	DP 544					5117
1.7 (T1000)	89-91	DP 544					5117
1.7 (T1100)	89-91	DP 544					5117
2.0 (P1000D)	80-84	DP 267					6321
2.0 (P1200D)	84-89	DP 544					6321A
2.0 (T1400)	89-94	DP 544					5117
2.0 (P35 4WD)	89-94	DP 633					5117
2.0	94-98	DP 544					6321A
2.0	94-98	DP 633					6541
2.0	2001-	DP 1393			DP 1284		
2.1 (P1400)	89-94	DP 544					5117
2.1 (T1100D)	89-94	DP 544					6321A
2.1 (T1300D)	89-94	DP 544					5117
2.1 (T1600D)	89-94	DP 544					5117
2.1	94-98	DP 544					6321A
2.1	94-98	DP 633					6541
1.9 D (T1000)	98-	DP 633/2					6321A
1.9 D	2001-	DP 1393			DP 1284		
2.5 D	89-94	DP 633					5117
2.5 D	89-94	DP 633					6321A
2.5 D	94-98	DP 544					6321A
2.5 D	94-98	DP 633					6541
2.5 D	98-2001	DP 633/2					5117

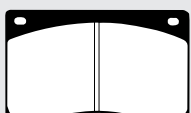
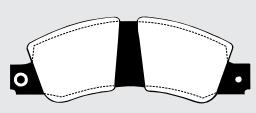
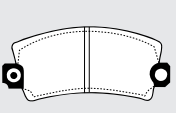
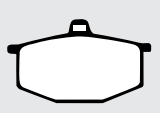
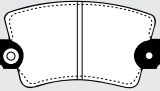
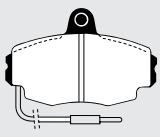
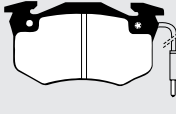
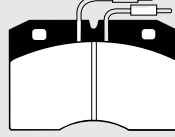
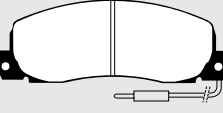
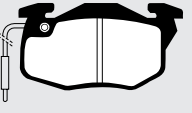
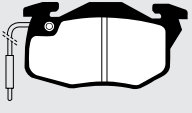
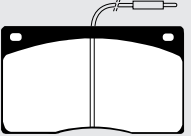
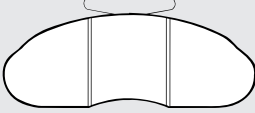
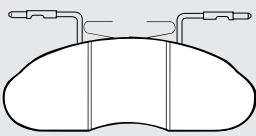
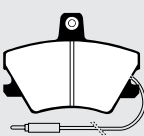
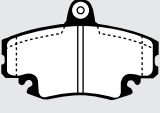

Standard Quality - ECE R90 Approved with similar performance to original equipment brake pads.
 Upgrade Quality (Tuning/ Sportbeläge) - ECE R90 Approved but with higher friction and improved performance for faster street use.
 Standard Qualität - mit ECE R90 Freigabe und ähnlicher Bremsleistung wie die Original Bremsbeläge.
 Verbesserte Qualität - mit ECE R90 Freigabe aber mit höherem Reibwert und verbesserter Bremsleistung für den schnellen Strasseninsatz.

Pad Illustrations for Renault Commercial

 262 119 x 71 x 15mm	 267 156 x 59 x 18mm	 269 108 x 49 x 15mm	 284 93 x 56 x 15mm
 324 109 x 58 x 18mm	 426 100 x 65 x 18mm	 489/2 106 x 56 x 15mm	 510 109 x 73 x 18mm
 544 155 x 56 x 18mm	 545 105 x 55 x 18mm	 545/2 105 x 55 x 15mm	 581 119 x 71 x 15mm
 633 166 x 62 x 17mm	 633/2 166 x 62 x 17mm	 668 90 x 67 x 15mm	 959 100 x 65 x 18mm

Qualité standard - Approuvée par la norme ECE R90 - Des performances équivalentes à l'origine.
 Qualité améliorée - Approuvée par la norme ECE R90 - Un coefficient de friction supérieur et des performances accrues pour pilotage rapide sur route.
 Calidad Estándar - Aprobación CEE R90 con prestaciones similares a las pastillas originales.
 Calidad Mejorada - Aprobación CEE R90 pero con un coeficiente de fricción más elevado y prestaciones mejoradas para un uso deportivo en carretera.

*Every EBC pad and shoe requiring ECE R-90 is available with approval subject to stock rotation - check box end label.
 Models listed by Engine Size. Only listed by trim level where pads differ, (16v, GL, GT, etc).

Make/Model/Engine	Year	Pads	Front / Vorn / Avant	Shoes	Pads	Rear / Hinten / Arrière	Shoes
Hersteller/Modell/Motor	Jahr	Plaquettes / Bremsbeläge		Bremsbacken Machoires	Plaquettes / Bremsbeläge		Bremsbacken Machoires
Modelos	Années	Original Quality ECE R90* Approved	Upgrade Quality Tuning/Sportbeläge ECE R90* Approved		Original Quality ECE R90* Approved	Upgrade Quality Tuning/Sportbeläge ECE R90* Approved	

Pad Illustrations for Renault Commercial Contd.

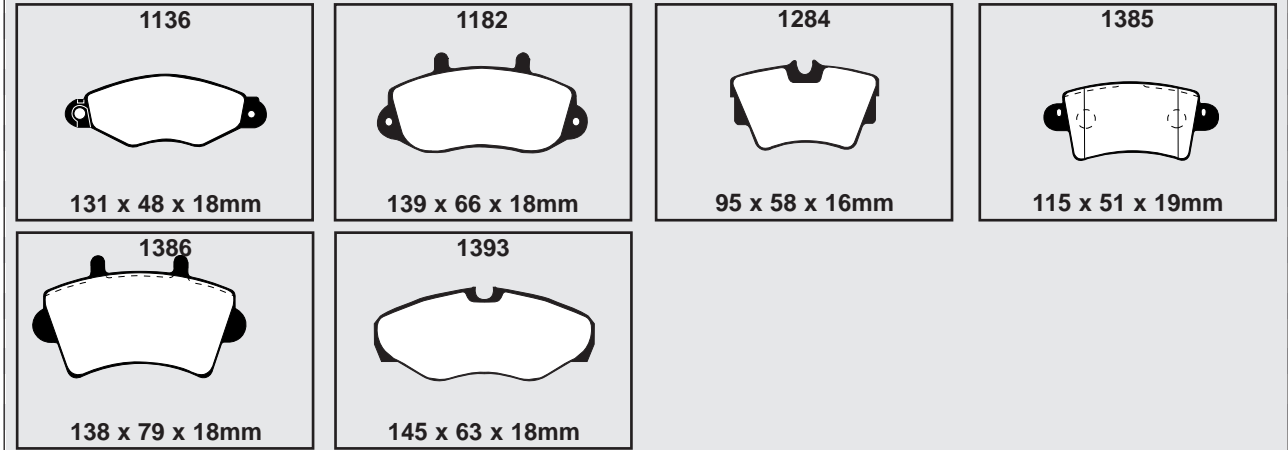

Make/Model/Engine	Year	Front Pads	Rear Pads	Front Shoes	Rear Shoes
ROCHDALE					
Olympic					
1.5	63-73				
ROVER					
INC (Austin Morris, M.G, Rover, Riley, Triumph, Vanden Plas, Wolseley)					
Austin Morris					
A30	56-58			6245	6245
A35	56-58			6245	6245
A40	56-60			5147	6245
A40	61-68			5147	5146
A50	56-59			6236	5139
A55	56-59			6236	5139
A55	59-70			6236	5139
A60	59-70			6236	5139
1100	64-68	DP 127	DP 2127		5144
1100	68-74	DP 155	-		5144
1300	68-74	DP 155	-		5144
1800	69-72	DP 169	DP 2291		5139
1800	72-75	DP 258	DP 2291		5139
1800 S	69-75	DP 108	DP 2108		5139
2200	69-75	DP 108	DP 2108		5139
3 Litre	68-71	DP 108	DP 2108		6258
Allegro					
1.1	73-82	DP 106	DP 2106		5142
1.3	73-82	DP 106	DP 2106		5142
1.5	73-82	DP 106	DP 2106		5142
1.75	73-82	DP 106	DP 2106		5142
Ambassador					
1.7	82-84	DP 471	DP 2243		5245
2.0	82-84	DP 471	DP 2243		5245
Healey Sprite					
58-61		DP 145		6242	6237
62-71		DP 127	DP 2127		5146
Healey					
3000	61-64	-	DP 2141		6296
3000	64-67	DP 169			6296

Standard Quality - ECE R90 Approved with similar performance to original equipment brake pads.
 Upgrade Quality (Tuning / Sportbeläge) - ECE R90 Approved but with higher friction and improved performance for faster street use.

Standard Qualität - mit ECE R90 Freigabe und ähnlicher Bremsleistung wie die Original Bremsbeläge.
 Verbesserte Qualität - mit ECE R90 Freigabe aber mit höherem Reibwert und verbesserter Bremsleistung für den schnellen Strasseninsatz.

Quality standard - Approuvée par la norme ECE R90 - Des performances équivalentes à l'origine.
 Qualité améliorée - Approuvée par la norme ECE R90 - Un coefficient de friction supérieur et des performances accrues pour pilotage rapide sur route.

Calidad Estándar - Aprobación CEE R90 con prestaciones similares a las pastillas originales.
 Calidad Mejorada - Aprobación CEE R90 pero con un coeficiente de fricción más elevado y prestaciones mejoradas para un uso deportivo en carretera.









*Every EBC pad and shoe requiring ECE R-90 is available with approval subject to stock rotation - check box end label.
 Models listed by Engine Size. Only listed by trim level where pads differ, (16v, GL, GT, etc).

BRAKE PADS & SHOES - APPLICATIONS

Bremsbeläge / Plaquettes + Bremsbacken / Machoires

EBC

BRAKES

Make/Model/Engine Hersteller/Modell/Motor Modèles	Year Jahr Années	Pads  Front / Vorn / Avant		Shoes	Pads  Rear / Hinten / Arrière		Shoes
		Original Quality ECE R90* Approved 	Upgrade Quality Tuning/Sportbeläge ECE R90* Approved 	Bremsbacken Machoires 	Original Quality ECE R90* Approved 	Upgrade Quality Tuning/Sportbeläge ECE R90* Approved 	Bremsbacken Machoires 
ROVER Contd.							
INC (Austin Morris, M.G, Rover, Riley, Triumph, Vanden Plas, Wolseley)							
Ital							
1.3	80-84	DP 106	DP 2106				5132
1.7	80-84	DP 106	DP 2106				5132
Maestro							
1.3	83-94	DP 467	DP 2467				6342
1.6	83-93	DP 467	DP 2467				6342
2.0	83-93	DP 467	DP 2467				6342
2.0 Turbo	89-91	DP 467	DP 2467				6342
2.0 D	86-93	DP 467	DP 2467				6342
2.0 TD	92-94	DP 467	DP 2467				6342
Marina							
1.3	71-72			5130			5132
1.3	72-75	DP 106	DP 2106				5132
1.7	78-80	DP 106	DP 2106				5132
1.8	71-72	DP 106	DP 2106				5110
1.8	72-78	DP 106	DP 2106				5132
Maxi							
1.5	69-82	DP 106	DP 2106				5142
1.75	69-82	DP 106	DP 2106				5142
Metro							
1.0	80-84	DP 398(T)					5146
1.0	80-90	DP 627(L)	DP 2627				5146
1.1	90-95	DP 817(G)	DP 2817				5146
1.3	80-84	DP 398(T)					5146
1.3	80-90	DP 627(L)	DP 2627				5146
1.3	90-95	DP 817(G)	DP 2817				5146
1.3 Turbo	80-84	DP 398(T)					5146
1.3 Turbo	80-90	DP 627(L)	DP 2627				5146
1.4	90-95	DP 817(G)	DP 2817				5146
1.4 D	90-95	DP 817(G)	DP 2817				5146
(L) - Lockheed system denoted by letter 'A' under bonnet							
(T) - Teves system denoted by letter 'B' under bonnet							
MG							
MGA	59-62	-	DP 2109				
MGB 1.8	62-81	DP 107	DP 2107				6234
MGB GT 1.8	62-81	DP 107	DP 2107				6234
MGB GT 3.5 V8	73-76	DP 240	DP 2240				6234
MGC GT 3.0	68-72	DP 169					5135
MGF 1.6	2001-2002	DP 817	DP 2817		DP 662/2	DP 2662/2	
MGF 1.8	95-2002	DP 817	DP 2817		DP 662/2	DP 2662/2	
MGF 1.8 (160)	2001-2002	DP 1377	DP 21377		DP 662/2	DP 2662/2	
MGR V8 3.9	92-96	DP 243	DP 2243				5240
Magnette 1.7	61-68			6236			5139
Midget 0.9	61-62			6242			6237
Midget 1.1	62-63			6242			5146
Midget 1.1	63-65	DP 127	DP 2127				5146
Midget 1.3	65-73	DP 127	DP 2127				5146
Midget 1.5	73-80	DP 127	DP 2127				5146

Standard Quality - ECE R90 Approved with similar performance to original equipment brake pads.
 Upgrade Quality (Tuning/ Sportbeläge) - ECE R90 Approved but with higher friction and improved performance for faster street use.
 Standard Qualität - mit ECE R90 Freigabe und ähnlicher Bremsleistung wie die Original Bremsbeläge.
 Verbesserte Qualität - mit ECE R90 Freigabe aber mit höherem Reibwert und verbesserter Bremsleistung für den schnellen Strasseninsatz.
 Qualité standard - Approuvée par la norme ECE R90 - Des performances équivalentes à l'origine.
 Qualité améliorée - Approuvée par la norme ECE R90 - Un coefficient de friction supérieur et des performances accrues pour pilotage rapide sur route.
 Calidad Estándar - Aprobación CEE R90 con prestaciones similares a las pastillas originales.
 Calidad Mejorada - Aprobación CEE R90 pero con un coeficiente de fricción más elevado y prestaciones mejoradas para un uso deportivo en carretera.

*Every EBC pad and shoe requiring ECE R-90 is available with approval subject to stock rotation - check box end label.
 Models listed by Engine Size. Only listed by trim level where pads differ, (16v, GL, GT, etc).

Standard Quality - ECE R90 Approved with similar performance to original equipment brake pads.
 Upgrade Quality (Tuning / Sportbeläge) - ECE R90 Approved but with higher friction and improved performance for faster street use.

Standard Qualität - mit ECE R90 Freigabe und ähnlicher Bremsleistung wie die Original Bremsbeläge.
 Verbesserte Qualität - mit ECE R90 Freigabe aber mit höherem Reibwert und verbesserter Bremsleistung für den schnellen Strasseninsatz.

Make/Model/Engine Hersteller/Modell/Motor Modelos	Year Jahr Années	Pads Plaquettes / Bremsbeläge		Shoes Bremsbacken Machoires	Pads Plaquettes / Bremsbeläge		Shoes Bremsbacken Machoires
		Original Quality ECE R90* Approved	Upgrade Quality Tuning/Sportbeläge ECE R90* Approved	ECE R90* Approved	Original Quality ECE R90* Approved	Upgrade Quality Tuning/Sportbeläge ECE R90* Approved	ECE R90* Approved
ROVER Contd.							
INC (Austin Morris, M.G, Rover, Riley, Triumph, Vanden Plas, Wolseley)							
MG TF							
1.6 (115)	2002-	DP 817	DP 2817		DP 662/2	DP 2662/2	
1.8 (120)	2002-	DP 817	DP 2817		DP 662/2	DP 2662/2	
1.8 (135) (240mm Disc)	2002-	DP 817	DP 2817		DP 662/2	DP 2662/2	
1.8 (135) (304mm Disc)	2002-	DP 1377	DP 21377		DP 662/2	DP 2662/2	
1.8 (160)	2002-	DP 1377	DP 21377		DP 662/2	DP 2662/2	
MG XPOWER SV							
4.6	2003-						
5.0	2003-						
MG XPOWER ZT							
4.6	2003-						
MG ZR							
1.4	2001-	DP 815	DP 2815				6437
1.8 (120)	2001-	DP 815	DP 2815		DP 642/2	DP 2642/2	
1.8 (160)	2001-	DP 1339	DP 21339		DP 1193	DP 21193	
2.0 TD	2001-	DP 815	DP 2815				6437
MG ZS							
1.8	2001-	DP 815	DP 2815		DP 642/2	DP 2642/2	
2.5	2001-	DP 1339	DP 21339		DP 1193	DP 21193	
2.0 TD	2002-	DP 815	DP 2815		DP 642/2	DP 2642/2	
MG ZT							
1.8 Turbo	2002-	DP 1219	DP 21219		DP 1289	DP 21289	
2.5 (160)	2002-	DP 1219	DP 21219		DP 1289	DP 21289	
2.5 (180)	2001-	DP 1219	DP 21219		DP 1289	DP 21289	
2.5 (190)	2001-	DP 1089	DP 21089		DP 1289	DP 21289	
2.0 TD	2002-	DP 1219	DP 21219		DP 1289	DP 21289	
MG ZT-T							
1.8 Turbo	2002-	DP 1219	DP 21219		DP 1289	DP 21289	
2.5 (160)	2002-	DP 1219	DP 21219		DP 1289	DP 21289	
2.5 (180)	2001-	DP 1219	DP 21219		DP 1289	DP 21289	
2.5 (190)	2001-	DP 1089	DP 21089		DP 1289	DP 21289	
2.0 TD	2002-	DP 1219	DP 21219		DP 1289	DP 21289	
Mini							
850	59-64			5146			5146
850	65-80			5145			5146
1000	70-84			5145			5146
1.0	84-92	DP 127	DP 2127				5146
Cooper	63-69	DP 128	DP 2128				5146
Cooper S	63-71	DP 102	DP 2102				5146
1275 GT (10" wheels)	70-73	DP 102	DP 2102				5146
1275 GT (13" wheels)	74-80	DP 127	DP 2127				5146
1.3	90-2002	DP 127	DP 2127				5146
Minor							
1000	57-62			6242			6237
1000	63-71			5147			6237









*Every EBC pad and shoe requiring ECE R-90 is available with approval subject to stock rotation - check box end label.
 Models listed by Engine Size. Only listed by trim level where pads differ, (16v, GL, GT, etc).

BRAKE PADS & SHOES - APPLICATIONS

Bremsbeläge / Plaquettes + Bremsbacken / Machoires

EBC

BRAKES









Make/Model/Engine Hersteller/Modell/Motor Modèles	Year Jahr Années	Pads  Front / Vorn / Avant		Shoes	Pads  Rear / Hinten / Arrière		Shoes
		Original Quality ECE R90* Approved 	Upgrade Quality Tuning/Sportbeläge ECE R90* Approved 	Bremsbacken Machoires 	Original Quality ECE R90* Approved 	Upgrade Quality Tuning/Sportbeläge ECE R90* Approved 	Bremsbacken Machoires 
ROVER Contd.							
INC (Austin Morris, M.G, Rover, Riley, Triumph, Vanden Plas, Wolseley)							
Montego							
1.3	84-88	DP 467	DP 2467				6342
1.6	84-93	DP 467	DP 2467				6342
2.0	84-95	DP 467	DP 2467				6342
2.0 Turbo	84-91	DP 467	DP 2467				6342
2.0 D	84-95	DP 467	DP 2467				6342
2.0 TD	88-95	DP 467	DP 2467				6342
Oxford							
1.6	62-71			6236			5139
Princess							
1.7	78-82	DP 243	DP 2243				5245
1.8	75-78	DP 243	DP 2243				5245
2.0	78-82	DP 243	DP 2243				5245
2.2	75-78	DP 243	DP 2243				5245
Westminster							
2.9 (A99)	59-61						6294
2.9 (A110)	61-68						6294
Riley							
1.5	57-65			6298			5142
4/68	61-69	DP 107	DP 2107				5139
4/72	61-69			6236			5139
Elf	61-63			5146			5146
Elf	63-69			5145			5146
Kestrel 1100	65-67	DP 127	DP 2127				5144
1100	67-69	DP 155					5144
1300	67-69	DP 155					5144
Rover							
2000 (P6)	63-65	DP 120	DP 2120		DP 120	DP 2120	
2000 (P6)	66-72	DP 169			DP 316		
2000 (P6)	72-73	DP 258	DP 2291		DP 316		
2200 (P6)	72-76	DP 258	DP 2291		DP 316		
3000 (P5)	58-67	-	DP 2199				6258
3500 (P5B)	66-73	-	DP 2199				6258
3500 V8 (P6)	68-69	DP 108	DP 2108		DP 316		
3500S V8 (P6)	69-76	DP 315	DP 2108		DP 316		
SD1							
2.0	82-84	DP 474	DP 2240				6240
2.0	84-86	DP 622	DP 2241				6240
2.3	77-81	DP 240	DP 2240				6240
2.3	82-84	DP 474	DP 2240				6240
2.3	84-86	DP 622	DP 2241				6240
2.6	77-81	DP 240	DP 2240				6240
2.6	82-84	DP 474	DP 2240				6240
2.6	84-86	DP 622	DP 2241				6240
3.5	77-81	DP 240	DP 2240				6240
3.5	82-84	DP 474	DP 2240				6240
3.5	84-86	DP 622	DP 2241				6240
2.4 D	82-84	DP 474	DP 2240				6240
2.4 D	84-86	DP 622	DP 2241				6240

Standard Quality - ECE R90 Approved with similar performance to original equipment brake pads.
 Upgrade Quality (Tuning/ Sportbeläge) - ECE R90 Approved but with higher friction and improved performance for faster street use.
 Standard Qualität - mit ECE R90 Freigabe und ähnlicher Bremsleistung wie die Original Bremsbeläge.
 Verbesserte Qualität - mit ECE R90 Freigabe aber mit höherem Reibwert und verbesserter Bremsleistung für den schnellen Strasseninsatz.
 Qualité standard - Approuvée par la norme ECE R90 - Des performances équivalentes à l'origine.
 Qualité améliorée - Approuvée par la norme ECE R90 - Un coefficient de friction supérieur et des performances accrues pour pilotage rapide sur route.
 Calidad Estándar - Aprobación CEE R90 con prestaciones similares a las pastillas originales.
 Calidad Mejorada - Aprobación CEE R90 pero con un coeficiente de fricción más elevado y prestaciones mejoradas para un uso deportivo en carretera.

*Every EBC pad and shoe requiring ECE R-90 is available with approval subject to stock rotation - check box end label.
 Models listed by Engine Size. Only listed by trim level where pads differ, (16v, GL, GT, etc).

Standard Quality - ECE R90 Approved with similar performance to original equipment brake pads.
 Upgrade Quality (Tuning / Sportbeläge) - ECE R90 Approved but with higher friction and improved performance for faster street use.

Standard Qualität - mit ECE R90 Freigabe und ähnlicher Bremsleistung wie die Original Bremsbeläge.
 Verbesserte Qualität - mit ECE R90 Freigabe aber mit höherem Reibwert und verbesserter Bremsleistung für den schnellen Strasseninsatz.

Make/Model/Engine Hersteller/Modell/Motor Modelos	Year Jahr Années	Pads  Front / Vorn / Avant		Shoes	Pads  Rear / Hinten / Arrière		Shoes
		Original Quality ECE R90* Approved 	Upgrade Quality Tuning/Sportbeläge ECE R90* Approved 	Bremsbacken Machoires 	Original Quality ECE R90* Approved 	Upgrade Quality Tuning/Sportbeläge ECE R90* Approved 	Bremsbacken Machoires 
ROVER Contd.							
INC (Austin Morris, M.G, Rover, Riley, Triumph, Vanden Plas, Wolseley)							
25							
1.1	2001-	DP 815	DP 2815				6437
1.4	99-	DP 815	DP 2815				6437
1.6	99-	DP 815	DP 2815				6437
1.8	99-	DP 815	DP 2815		DP 642/2	DP 2642/2	
2.0 TD	99-	DP 815	DP 2815				6437
45							
1.4	99-	DP 815	DP 2815				6437
1.6	99-	DP 815	DP 2815				6437
1.8	99-	DP 815	DP 2815		DP 642/2	DP 2642/2	
2.0	2001-	DP 815	DP 2815		DP 642/2	DP 2642/2	
2.0 TD	99-	DP 815	DP 2815				6437
75							
1.8	99-	DP 1219	DP 21219		DP 1289	DP 21289	
2.5	99-	DP 1219	DP 21219		DP 1289	DP 21289	
2.0 TD	99-	DP 1219	DP 21219		DP 1289	DP 21289	
95/100/110 (P4)	59-63	-	DP 2199				6258
100							
1.1	94-98	DP 817	DP 2817				5146
1.4	94-98	DP 817	DP 2817				5146
1.5 D	94-98	DP 817	DP 2817				5146
200							
1.1	99-2000	DP 815	DP 2815		DP 642/2	DP 2642/2	
1.3	84-90	DP 606					6350
1.4	89-94	DP 810	DP 2810				6437
1.4 (ABS)	89-94	DP 815	DP 2815		DP 642/2	DP 2642/2	
1.4	95-2000	DP 815	DP 2815				6437
1.4 (ABS)	95-2000	DP 815	DP 2815		DP 642/2	DP 2642/2	
1.6	84-90	DP 606					6350
1.6	89-94	DP 815	DP 2815				6437
1.6 (ABS)	89-94	DP 815	DP 2815		DP 642/2	DP 2642/2	
1.6	95-2000	DP 815	DP 2815				6437
1.6 (ABS)	95-2000	DP 815	DP 2815		DP 642/2	DP 2642/2	
1.8	96-2000	DP 815	DP 2815		DP 642/2	DP 2642/2	
2.0	91-2000	DP 815	DP 2815		DP 642/2	DP 2642/2	
2.0 Turbo	91-95	DP 2815	DP 3815		DP 2642/2	DP 3642/2	
1.8 TD	91-96	DP 815	DP 2815				6437
1.8 TD (ABS)	91-96	DP 815	DP 2815		DP 642/2	DP 2642/2	
1.9 D	91-95	DP 815	DP 2815				6437
1.9 D	91-95	DP 815	DP 2815		DP 642/2	DP 2642/2	
2.0 TD	95-2000	DP 815	DP 2815		DP 642/2	DP 2642/2	6437
400							
1.4	90-94	DP 810	DP 2810				6437
1.4 (ABS)	90-94	DP 815	DP 2815		DP 642/2	DP 2642/2	
1.4	95-2000	DP 815	DP 2815				6437
1.4 (ABS)	95-2000	DP 815	DP 2815		DP 642/2	DP 2642/2	
1.6	90-94	DP 815	DP 2815				6437
1.6 (ABS)	90-94	DP 815	DP 2815		DP 642/2	DP 2642/2	
1.6	95-2000	DP 815	DP 2815				6437
1.6 (ABS)	95-2000	DP 815	DP 2815		DP 642/2	DP 2642/2	
1.8	96-2000	DP 815	DP 2815		DP 642/2	DP 2642/2	
2.0	90-2000	DP 815	DP 2815		DP 642/2	DP 2642/2	
2.0 Turbo	92-95	DP 2815	DP 3815		DP 2642/2	DP 3642/2	
1.8 TD	91-96	DP 815	DP 2815				6437









*Every EBC pad and shoe requiring ECE R-90 is available with approval subject to stock rotation - check box end label.
 Models listed by Engine Size. Only listed by trim level where pads differ, (16v, GL, GT, etc).

BRAKE PADS & SHOES - APPLICATIONS

Bremsbeläge / Plaquettes + Bremsbacken / Machoires









EBC

BRAKES

Make/Model/Engine Hersteller/Modell/Motor Modèles	Year Jahr Années	Pads  Front / Vorn / Avant		Shoes	Pads  Rear / Hinten / Arrière		Shoes
		Original Quality ECE R90* Approved 	Upgrade Quality Tuning/Sportbeläge ECE R90* Approved 	Bremsbacken Machoires 	Original Quality ECE R90* Approved 	Upgrade Quality Tuning/Sportbeläge ECE R90* Approved 	Bremsbacken Machoires 
ROVER Contd.							
INC (Austin Morris, M.G, Rover, Riley, Triumph, Vanden Plas, Wolseley)							
400 Contd.							
1.8 TD (ABS)	91-96	DP 815	DP 2815		DP 642/2	DP 2642/2	
1.9 D	91-95	DP 815	DP 2815				6437
1.9 D (ABS)	91-95	DP 815	DP 2815		DP 642/2	DP 2642/2	
2.0 TD	95-2000	DP 815	DP 2815		DP 642/2	DP 2642/2	6437
600							
1.8	96-2000	DP 975	DP 2975		DP 781	DP 21193	
1.8 (ABS)	96-2000	DP 872	DP 2872		DP 781	DP 21193	
2.0 Man	93-96	DP 975	DP 2975		DP 781	DP 21193	
2.0 Man	96-2000	DP 872	DP 2872		DP 781	DP 21193	
2.0 Auto	93-2000	DP 872	DP 2872		DP 781	DP 21193	
2.0 (ABS)	93-2000	DP 872	DP 2872		DP 781	DP 21193	
2.0 Turbo	94-2000	DP 2872	DP 3872		DP 21193	DP 31193	
2.3	93-2000	DP 872	DP 2872		DP 781	DP 21193	
2.0 TD	95-96	DP 975	DP 2975		DP 781	DP 21193	
2.0 TD	96-2000	DP 872	DP 2872		DP 781	DP 21193	
2.0 TD (ABS)	95-2000	DP 872	DP 2872		DP 781	DP 21193	
800							
2.0	86-92	DP 643	DP 2643		DP 662		
2.0	93-2000	DP 815	DP 2815		DP 662/2	DP 2662/2	
2.0 Turbo	91-2000	DP 2815	DP 3815		DP 2662/2	DP 3662/2	
2.5	86-92	DP 630	DP 2630		DP 662		
2.5	96-2000	DP 815	DP 2815		DP 662/2	DP 2662/2	
2.7	86-92	DP 630	DP 2630		DP 662		
2.7	93-97	DP 815	DP 2815		DP 662/2	DP 2662/2	
2.5 D	92-97	DP 815	DP 2815		DP 662/2	DP 2662/2	
2.5 TD	90-92	DP 643	DP 2643		DP 662		
2.5 TD	92-2000	DP 815	DP 2815		DP 662/2	DP 2662/2	
Triumph							
GT6	66-71	DP 169					5129
GT6	72-74	DP 258	DP 2291				5110
TR3, TR3A	59-61	-	DP 2100				5139
TR4	61-64	-	DP 2100				5139
TR4A	65-69	DP 169					5139
TR5	65-69	DP 169					5139
TR6	69-72	DP 169					5139
TR6	72-75	DP 258	DP 2291				5139
TR7 4 Speed	75-81	DP 127	DP 2127				6230
TR7 Auto	75-81	DP 127	DP 2127				6230
TR7 5 Speed	75-81	DP 127	DP 2127				5234
TR8 3.5 V8	80-81	DP 240	DP 2240				5234
1300 TC	65-70	DP 114	DP 2114				5129
1500	71-72	DP 114	DP 2114				5132
1500	72-76	DP 106	DP 2106				5132
1500 TC	70-73	DP 106	DP 2106				5110
1500 TC	72-75	DP 169					5110
2000	63-64	DP 107	DP 2107				5138
2000	64-69	DP 161					5138
2000	69-70	DP 240	DP 2240				5234
2.5 Pi	68-69	DP 161					5138
2.5 Pi	69-77	DP 240	DP 2240				5234
Acclaim	81-84	DP 374	DP 2374				6276
Dolomite 1300	75-82	DP 106	DP 2106				5132
Dolomite 1500	75-82	DP 106	DP 2106				5110
Dolomite 1850	72-82	DP 106	DP 2106				5110
Dolomite Sprint 2.0	72-82	DP 106	DP 2106				5133
Herald	59-71			5128			5137

Standard Quality - ECE R90 Approved with similar performance to original equipment brake pads.
 Upgrade Quality (Tuning/ Sportbeläge) - ECE R90 Approved but with higher friction and improved performance for faster street use.
 Standard Qualität - mit ECE R90 Freigabe und ähnlicher Bremsleistung wie die Original Bremsbeläge.
 Verbesserte Qualität - mit ECE R90 Freigabe aber mit höherem Reibwert und verbesserter Bremsleistung für den schnellen Strasseninsatz.
 Qualité standard - Approuvée par la norme ECE R90 - Des performances équivalentes à l'origine.
 Qualité améliorée - Approuvée par la norme ECE R90 - Un coefficient de friction supérieur et des performances accrues pour pilotage rapide sur route.
 Calidad Estándar - Aprobación CEE R90 con prestaciones similares a las pastillas originales.
 Calidad Mejorada - Aprobación CEE R90 pero con un coeficiente de fricción más elevado y prestaciones mejoradas para un uso deportivo en carretera.

*Every EBC pad and shoe requiring ECE R-90 is available with approval subject to stock rotation - check box end label.
 Models listed by Engine Size. Only listed by trim level where pads differ, (16v, GL, GT, etc).

Make/Model/Engine Hersteller/Modell/Motor Modelos	Year Jahr Années	Pads  Front / Vorn / Avant		Shoes	Pads  Rear / Hinten / Arrière		Shoes
		Original Quality ECE R90* Approved 	Upgrade Quality Tuning/Sportbeläge ECE R90* Approved 	Bremsbacken Machoires 	Original Quality ECE R90* Approved 	Upgrade Quality Tuning/Sportbeläge ECE R90* Approved 	Bremsbacken Machoires 
ROVER Contd.							
INC (Austin Morris, M.G, Rover, Riley, Triumph, Vanden Plas, Wolseley)							
Triumph Contd.							
Herald 12/50	63-67	DP 142					5137
Herald 13/60	68-71	DP 114	DP 2114				5137
Spitfire 1.1	62-67	DP 142					5137
Spitfire 1.1	67-74	DP 114	DP 2114				5137
Spitfire 1.3	67-74	DP 114	DP 2114				5137
Spitfire 1.5	75-80	DP 114	DP 2114				5137
Stag	70-78	DP 240	DP 2240				5140
Toledo 1300	70-72			6235			5132
Toledo 1300	72-74	DP 106	DP 2106				5132
Vitesse 1.6	62-66	DP 142					5129
Vitesse 2.0	66-71	DP 169					5129
Vanden Plas							
1100	64-68	DP 127	DP 2127				5144
1300	68-74	DP 155					5144
1500	73-74	DP 106	DP 2106				5142
Wolseley							
Hornet	61-63			5146			5146
Hornet	63-68			5145			5146
1100	65-68	DP 127	DP 2127				5144
1300	68-73	DP 155					5144
1500	59-65						5147
15/60	59-71			6236			5139
16/60	62-65			6236			5139A
18/85	67-68	DP 169					6234
18/85S	69-72	DP 108	DP 2108				6234
2200	75-80	DP 243	DP 2243				5245
Six	72-80	DP 108	DP 2108				5139A

Pad Illustrations for Rover

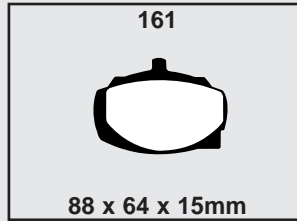
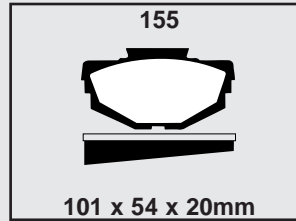
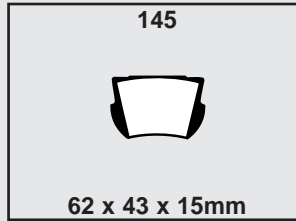
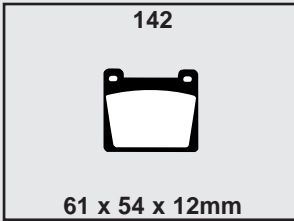
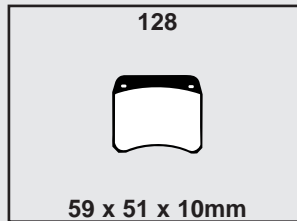
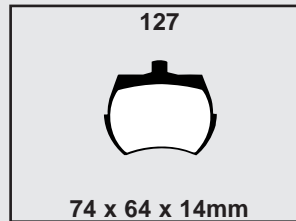
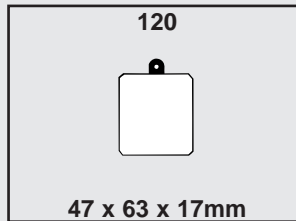
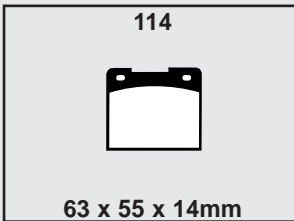
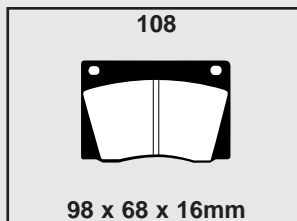
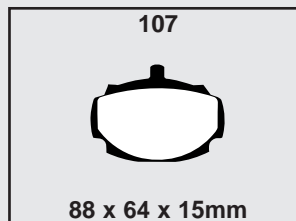
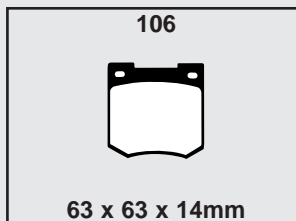
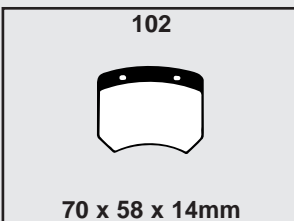

Standard Quality - ECE R90 Approved with similar performance to original equipment brake pads.
Upgrade Quality (Tuning / Sportbeläge) - ECE R90 Approved but with higher friction and improved performance for faster street use.





Standard Qualität - mit ECE R90 Freigabe und ähnlicher Bremsleistung wie die Original Bremsbeläge.
Verbesserte Qualität - mit ECE R90 Freigabe aber mit höherem Reibwert und verbesserter Bremsleistung für den schnellen Strasseninsatz.

BRAKE PADS & SHOES - APPLICATIONS

Bremsbeläge / Plaquettes + Bremsbacken / Machoires

EBC

BRAKES

Make/Model/Engine	Year	Pads  Front / Vorn / Avant		Shoes	Pads  Rear / Hinten / Arrière		Shoes
Hersteller/Modell/Motor	Jahr	Plaquettes / Bremsbeläge		Bremsbacken	Plaquettes / Bremsbeläge		Bremsbacken
Modelos	Années	Original Quality ECE R90* Approved	Upgrade Quality Tuning/Sportbeläge ECE R90* Approved	 ECE R90* Approved	Original Quality ECE R90* Approved	Upgrade Quality Tuning/Sportbeläge ECE R90* Approved	 ECE R90* Approved

Pad Illustrations for Rover Contd.

169  78 x 64 x 15mm	240  88 x 71 x 15mm	241  105 x 75 x 18mm	243  98 x 71 x 15mm
258  78 x 66 x 15mm	294  88 x 70 x 15mm	315  98 x 68 x 16mm	316  107 x 52 x 17/12mm
374  119 x 38 x 15mm	398  83 x 59 x 14mm	467  118 x 64 x 18mm	471  98 x 71 x 15mm
474  87 x 70 x 15mm	606  107 x 45 x 14mm	622  105 x 75 x 18mm	627  83 x 55 x 15mm
630  129 x 73 x 17mm	642/2  89 x 35 x 13mm	643  129 x 68 x 17mm	662  84 x 62 x 14mm
662/2  84 x 62 x 14mm	781  88 x 48 x 14mm	810  118 x 65 x 17mm	815  129 x 69 x 17mm
817  115 x 58 x 17mm	872  148 x 59 x 17mm	975  138 x 53 x 19mm	1193  89 x 48 x 15mm









Standard Quality - ECE R90 Approved with similar performance to original equipment brake pads.
Upgrade Quality (Tuning/ Sportbeläge) - ECE R90 Approved but with higher friction and improved performance for faster street use.
Verbesserte Qualität - mit ECE R90 Freigabe aber mit höherem Reibwert und verbesserter Bremsleistung für den schnellen Strasseninsatz.

Qualité standard - Approuvée par la norme ECE R90 - Des performances équivalentes à l'origine.
Qualité améliorée - Approuvée par la norme ECE R90 - Un coefficient de friction supérieur et des performances accrues pour pilotage rapide sur route.
Calidad Estándar - Aprobación CEE R90 con prestaciones similares a las pastillas originales.
Calidad Mejorada - Aprobación CEE R90 pero con un coeficiente de fricción más elevado y prestaciones mejoradas para un uso deportivo en carretera.

*Every EBC pad and shoe requiring ECE R-90 is available with approval subject to stock rotation - check box end label.
 Models listed by Engine Size. Only listed by trim level where pads differ, (16v, GL, GT, etc).

Make/Model/Engine	Year	Front / Vorn / Avant	Shoes	Rear / Hinten / Arrière	Shoes
Hersteller/Modell/Motor	Jahr	Plaquettes / Bremsbeläge	Bremsbacken Machoires	Plaquettes / Bremsbeläge	Bremsbacken Machoires
Modelos	Années	Original Quality ECE R90* Approved	Upgrade Quality Tuning/Sportbeläge ECE R90* Approved	Original Quality ECE R90* Approved	Upgrade Quality Tuning/Sportbeläge ECE R90* Approved

Pad Illustrations for Rover Contd.

1219  157 x 68 x 18mm	1289  123 x 45 x 17mm	1339  151 x 52 x 18mm	1377  113 x 60 x 15mm
2100  100 x 66 x 16mm	2109  108 x 59 x 16mm	2141  73 x 53 x 15mm	2199  93 x 66 x 19mm

ROVER COMMERCIAL					
Commerce					
1.4	2003-	DP 815			6437
2.0 TD	2003-	DP 815			6437
Convoy (SW)					
2.5 D	96-	DP 241			5239
2.5 TD	96-	DP 241			5239
Convoy (TW)					
2.5 D	96-	DP 462			6379
2.5 TD	96-	DP 462			6379
Cub					
2.3 D	98-	DP 641			
2.3 D	98-	DP 947			
Mini Van					
	70-79		5145		5146
Marina Van					
7 cwt	72-73		5130		5132
7 cwt	73-75		6232		5132
7 cwt	75-81	DP 106			5132
10 cwt.	72-81		6235		5139
10 cwt.	72-81	DP 106			5139
Ital Van					
440	82-84	DP 106			5132
575	82-84	DP 106			5139
Metro Van					
1.0	84-89	DP 627			5146
1.0	89-92	DP 817			5146
1.3	89-92	DP 817			5146
Maestro Van					
1.3	84-95	DP 467			6351
1.6	84-95	DP 467			6351
2.0 D	84-95	DP 467			6351
MG Express					
1.4	2003-	DP 815			6437
1.8	2003-	DP 815		DP 642/2	
2.0 TD	2003-	DP 815			6437

Standard Quality - ECE R90 Approved with similar performance to original equipment brake pads.
Upgrade Quality (Tuning / Sportbeläge) - ECE R90 Approved but with higher friction and improved performance for faster street use.

Standard Qualität - mit ECE R90 Freigabe und ähnlicher Bremsleistung wie die Original Bremsbeläge.
Verbesserte Qualität - mit ECE R90 Freigabe aber mit höherem Reibwert und verbesserter Bremsleistung für den schnellen Strasseninsatz.

Calidad Estándar - Aprobación CEE R90 con prestaciones similares a las pastillas originales.
Calidad Mejorada - Aprobación CEE R90 pero con un coeficiente de fricción más elevado y prestaciones mejoradas para un uso deportivo en carretera.

*Every EBC pad and shoe requiring ECE R-90 is available with approval subject to stock rotation - check box end label.

Models listed by Engine Size. Only listed by trim level where pads differ, (16v, GL, GT, etc).

BRAKE PADS & SHOES - APPLICATIONS

Bremsbeläge / Plaquettes + Bremsbacken / Machoires

EBC





BRAKES

Make/Model/Engine Hersteller/Modell/Motor Modèles	Year Jahr Années	Pads Front / Vorn / Avant		Shoes	Pads Rear / Hinten / Arrière		Shoes
		Original Quality ECE R90* Approved	Upgrade Quality Tuning/Sportbeläge ECE R90* Approved	Bremsbacken Machoirs ECE R90* Approved	Original Quality ECE R90* Approved	Upgrade Quality Tuning/Sportbeläge ECE R90* Approved	Bremsbacken Machoirs ECE R90* Approved
ROVER COMM Contd.							
Sherpa Van							
185 Petrol	74-78			5238			5113
185 Diesel	74-78			5114			5113
215, 220, 240, 250	74-81			5114			5113
200, 230, 250, 255	81-82	DP 240		5114			5113
200, 230, 250, 280	83-84	DP 240					5113
280 Kombi	83-84	DP 241					5113
200, 230, 250, 280, Kombi	85-89	DP 240					5240
285, 310, 350,(sw)	83-89	DP 241					5239
350 (tw)	83-89	DP 241					6379
350 (tw)	83-89	DP 241					6376
350 Minibus	86-89	DP 462					6379
200 (2.0)	89-96	DP 240					5240
200 (2.3)	89-96	DP 240					5240
200 (2.5)	89-96	DP 240					5240
200 (2.8)	89-96	DP 241					5240
400 (SW)	89-96	DP 241					5239
400 (TW)	89-96	DP 241					6379
400 Minibus	89-96	DP 462					6379
(sw) Single rear wheel (tw) Twin rear wheel							
Pilot							
1.9 D	96-	DP 241					5240
Roadrunner							
8.10	86-	DP 715/2					
8.12	86-	DP 715/2					
10.12	86-	DP 715					



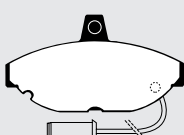
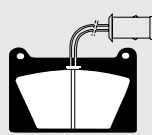
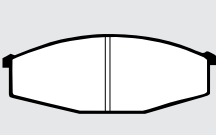
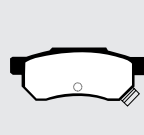
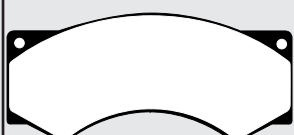
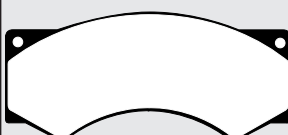
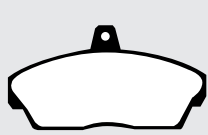
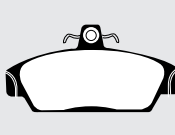

Standard Quality - ECE R90 Approved with similar performance to original equipment brake pads.
 Upgrade Quality (Tuning/ Sportbeläge) - ECE R90 Approved but with higher friction and improved performance for faster street use.
 Verbesserte Qualität - mit ECE R90 Freigabe aber mit höherem Reibwert und verbesserter Bremsleistung für den schnellen Strasseninsatz.

Qualité standard - Approuvée par la norme ECE R90 - Des performances équivalentes à l'origine.
 Qualité améliorée - Approuvée par la norme ECE R90 - Un coefficient de friction supérieur et des performances accrues pour pilotage rapide sur route.
 Calidad Mejorada - Aprobación CEE R90 con prestaciones similares a las pastillas originales.
 Calidad Mejorada - Aprobación CEE R90 pero con un coeficiente de fricción más elevado y prestaciones mejoradas para un uso deportivo en carretera.

Pad Illustrations for Rover Commercial

<p>106</p>  <p>63 x 63 x 14mm</p>	<p>240</p>  <p>88 x 71 x 15mm</p>	<p>241</p>  <p>105 x 75 x 18mm</p>	<p>462</p>  <p>126 x 72 x 18mm</p>
<p>467</p>  <p>118 x 64 x 18mm</p>	<p>627</p>  <p>83 x 55 x 15mm</p>	<p>641</p>  <p>142 x 53 x 16mm</p>	<p>642/2</p>  <p>89 x 35 x 13mm</p>
<p>715</p>  <p>191 x 87 x 25mm</p>	<p>715/2</p>  <p>191 x 87 x 23mm</p>	<p>815</p>  <p>129 x 69 x 17mm</p>	<p>817</p>  <p>115 x 58 x 17mm</p>

*Every EBC pad and shoe requiring ECE R-90 is available with approval subject to stock rotation - check box end label.
 Models listed by Engine Size. Only listed by trim level where pads differ, (16v, GL, GT, etc).

Make/Model/Engine	Year	Pads  Front / Vorn / Avant		Shoes	Pads  Rear / Hinten / Arrière		Shoes
Hersteller/Modell/Motor	Jahr	Plaquettes / Bremsbeläge		Bremsbacken Machoires	Plaquettes / Bremsbeläge		Bremsbacken Machoires
Modelos	Années	Original Quality ECE R90* Approved	Upgrade Quality Tuning/Sportbeläge ECE R90* Approved	 ECE R90* Approved	Original Quality ECE R90* Approved	Upgrade Quality Tuning/Sportbeläge ECE R90* Approved	 ECE R90* Approved

Pad Illustrations for Rover Commercial Contd.

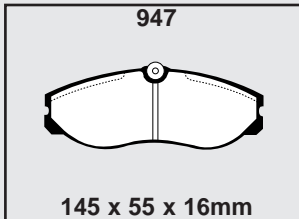

SAAB							
Sonnett	67-75	DP 149					5157
90							
2.0	85-87	DP 216	DP 2291		DP 105/4		
95							
1.5	67-78	DP 149					5157
96							
1.5	67-80	DP 149					5157
99							
2.0	67-74	DP 104	DP 2104		DP 105/4		
2.0	74-75	DP 216	DP 2291		DP 217		
2.0	75-87	DP 216	DP 2291		DP 105/4		
2.0 Turbo	75-87	DP 216	DP 2291		DP 105/4		
Handbrake Shoes	67-87						5159
900							
2.0	79-87	DP 216	DP 2291		DP 105/4		
2.0	88-92	DP 779(G)	DP 2779(G)		DP 635	DP 2635	
2.0	93-96	DP 976(T)	DP 2976(T)		DP 990		
2.0	96-98	DP 1062	DP 21062		DP 990		
2.0 Turbo	79-87	DP 216	DP 2291		DP 105/4		
2.0 Turbo	88-92	DP 779(G)	DP 2779(G)		DP 635	DP 2635	
2.0 Turbo	93-96	DP 976(T)	DP 2976(T)		DP 990		
2.0 Turbo	96-98	DP 1062	DP 21062		DP 990		
2.3	93-96	DP 976(T)	DP 2976(T)		DP 990		
2.3	96-98	DP 1062	DP 21062		DP 990		
2.5 V6	93-96	DP 976(T)	DP 2976(T)		DP 990		
2.5 V6	96-98	DP 1062	DP 21062		DP 990		
Handbrake Shoes	79-92						5159
Handbrake Shoes	93-98						5271
9000							
2.0	84-86	DP 779(G)	DP 2779(G)		DP 635	DP 2635	
2.0	86-89	DP 779(G)	DP 2779(G)		DP 635	DP 2635	
2.0	90-91	DP 779(G)	DP 2779(G)		DP 635	DP 2635	
2.0	91-94	DP 779(G)	DP 2779(G)		DP 635	DP 2635	
2.0	89-94	DP 751(T)	DP 2751		DP 635	DP 2635	
2.0	94-97	DP 751	DP 2751		DP 990		
2.0	94-97	DP 751	DP 2751		DP 635	DP 2635	
2.0 Turbo	84-86	DP 779(G)	DP 2779(G)		DP 105/4		
2.0 Turbo	86-90	DP 779(G)	DP 2779(G)		DP 635	DP 2635	
2.0 Turbo	88-94	DP 751(T)	DP 2751		DP 635	DP 2635	
2.0 Turbo	94-97	DP 751	DP 2751		DP 990		
2.0 Turbo	94-97	DP 751	DP 2751		DP 635	DP 2635	
2.3	88-94	DP 751	DP 2751		DP 635	DP 2635	
2.3	94-96	DP 751	DP 2751		DP 990		
2.3	94-96	DP 751	DP 2751		DP 635	DP 2635	
2.3 Turbo	88-94	DP 2751	DP 3751		DP 2635	DP 3635	

*Every EBC pad and shoe requiring ECE R-90 is available with approval subject to stock rotation - check box end label.

Models listed by Engine Size. Only listed by trim level where pads differ, (16v, GL, GT, etc).

BRAKE PADS & SHOES - APPLICATIONS









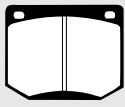

Bremsbeläge / Plaquettes + Bremsbacken / Machoires

EBC

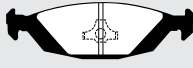
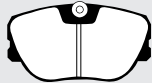
BRAKES

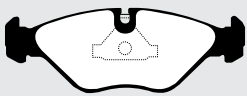
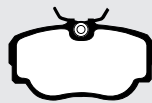
Make/Model/Engine Hersteller/Modell/Motor Modèles	Year Jahr Années	Pads Plaquettes / Bremsbeläge		Shoes Bremsbacken Machoirs	Pads Plaquettes / Bremsbeläge		Shoes Bremsbacken Machoirs
		Original Quality ECE R90* Approved	Upgrade Quality Tuning/Sportbeläge ECE R90* Approved		Original Quality ECE R90* Approved	Upgrade Quality Tuning/Sportbeläge ECE R90* Approved	
SAAB Contd.							
9000 Contd.							
2.3 Turbo	94-97	DP 2751	DP 3751		DP 990		
2.3 Turbo	94-97	DP 2751	DP 3751		DP 2635	DP 3635	
3.0	94-97	DP 2751	DP 3751		DP 990		
3.0	94-97	DP 2751	DP 3751		DP 2635	DP 3635	
9-3							
1.8 Turbo	2002-	DP 1414	DP 21414		DP 1354	DP 21354	
2.0	98-2002	DP 1187	DP 21062		DP 675		
2.0 Turbo	98-2002	DP 1187	DP 21062		DP 675		
2.0 Turbo	2002-	DP 1414	DP 21414		DP 1354	DP 21354	
2.0 Turbo Aero	2003-	DP 21416	DP 31416		DP 21354	DP 31354	
2.3	98-2002	DP 1187	DP 21062		DP 675		
2.3 Turbo	99-	DP 21062	DP 31062		DP 675		
2.2 TD	98-2002	DP 1187	DP 21062		DP 675		
2.2 TD	2002-	DP 1414	DP 21414		DP 1354	DP 21354	
9-5							
2.0 Turbo	97-99	DP 1187	DP 21062		DP 675		
2.0 Turbo	99-	DP 1187	DP 21062		DP 1405		
2.3 Turbo	97-99	DP 1187	DP 21062		DP 675		
2.3 Turbo	99-	DP 1187	DP 21062		DP 1405		
3.0 Turbo	97-99	DP 21062	DP 31062		DP 675		
3.0 Turbo	99-	DP 21062	DP 31062		DP 1405		
2.2 TD	2002-	DP 1187	DP 21062		DP 1405		
3.0 TD	2002-	DP 1187	DP 21062		DP 1405		

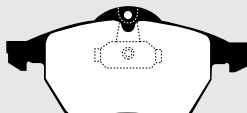
Pad Illustrations for Saab

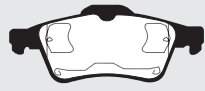
<p>104</p>  <p>61 x 56 x 15mm</p>	<p>105/4</p>  <p>56 x 53 x 13mm</p>	<p>149</p>  <p>96 x 55 x 18mm</p>	<p>216</p>  <p>78 x 64 x 16mm</p>
<p>217</p>  <p>59 x 46 x 11mm</p>	<p>463/2 Use DP 779</p>  <p>94 x 51 x 17mm</p>	<p>635</p>  <p>125 x 38 x 15mm</p>	<p>666 Use DP 779</p>  <p>94 x 51 x 17mm</p>
<p>675</p>  <p>61 x 61 x 15mm</p>	<p>751</p>  <p>156 x 54 x 18mm</p>	<p>779</p>  <p>94 x 51 x 17mm</p>	<p>976</p>  <p>156 x 61 x 18mm</p>
<p>990</p>  <p>62 x 57 x 15mm</p>	<p>1062</p>  <p>156 x 74 x 19mm</p>	<p>1187</p>  <p>156 x 74 x 20mm</p>	<p>1354</p>  <p>123 x 53 x 16mm</p>

*Every EBC pad and shoe requiring ECE R-90 is available with approval subject to stock rotation - check box end label.
Models listed by Engine Size. Only listed by trim level where pads differ, (16v, GL, GT, etc).

Standard Quality - ECE R90 Approved with similar performance to original equipment brake pads.
Upgrade Quality (Tuning/ Sportbeläge) - ECE R90 Approved but with higher friction and improved performance for faster street use.
Verbesserte Qualität - mit ECE R90 Freigabe aber mit höherem Reibwert und verbesserter Bremsleistung für den schnellen Strasseninsatz.

Qualité standard - Approuvée par la norme ECE R90 - Des performances équivalentes à l'origine.
Qualité améliorée - Approuvée par la norme ECE R90 - Un coefficient de friction supérieur et des performances accrues pour pilotage rapide sur route.
Calidad Estándar - Aprobación CEE R90 con prestaciones similares a las pastillas originales.
Calidad Mejorada - Aprobación CEE R90 pero con un coeficiente de fricción más elevado y prestaciones mejoradas para un uso deportivo en carretera.

Make/Model/Engine	Year	Front / Vorn / Avant	Shoes	Rear / Hinten / Arrière	Shoes
Hersteller/Modell/Motor	Jahr	Plaquettes / Bremsbeläge	Bremsbacken Machoires	Plaquettes / Bremsbeläge	Bremsbacken Machoires
Modelos	Années	Original Quality ECE R90* Approved	Upgrade Quality Tuning/Sportbeläge ECE R90* Approved	Original Quality ECE R90* Approved	Upgrade Quality Tuning/Sportbeläge ECE R90* Approved

Pad Illustrations for Saab Contd.

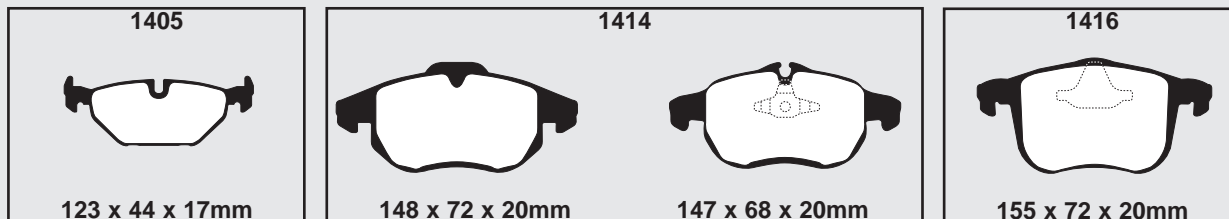

SAO					
Penza					
1.3	91-93	DP 655			6424

Pad Illustrations for Sao

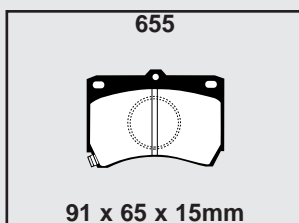

SEAT					
Alhambra					
1.8	98-2000	DP 1074	DP 21074	DP 680	DP 2680
1.8 Turbo 15"	2000-2002	DP 1368	DP 21368	DP 1412	DP 21412
1.8 Turbo 16"	2000-	DP 1413	DP 21413	DP 1285	
2.0	95-2000	DP 1074	DP 21074	DP 680	DP 2680
2.0	2001-2002	DP 1368	DP 21368	DP 1412	DP 21412
2.0	2002-	DP 1413	DP 21413	DP 1285	
2.8	2000-	DP 1413	DP 21413	DP 1285	
2.8	2000-	DP 1413	DP 21413	DP 1445	
1.9 TD	95-2000	DP 1074	DP 21074	DP 680	DP 2680
1.9 TD 15"	2001-2002	DP 1368	DP 21368	DP 1412	DP 21412
1.9 TD 16"	2001-	DP 1413	DP 21413	DP 1285	
Arosa					
1.0	97-	DP 1064	DP 21064		5264
1.0	97-	DP 1064	DP 21064		6447
1.4	97-	DP 1064	DP 21064		5264
1.4	97-	DP 1064	DP 21064		6447
1.4 (100)	98-	DP 1112	DP 21112	DP 680	DP 2680
1.4 TD	2001-	DP 1064	DP 21064		6447
1.7 D	98-2000	DP 1064	DP 21064		5264
1.7 D	98-2000	DP 1064	DP 21064		6447
Cordoba					
1.4	95-96	DP 515			5264
1.4	96-99	DP 1056	DP 21056		6447
1.4	99-2002	DP 1137	DP 21137		6447
1.4	2002-				
1.6	94-95	DP 517/2	DP 2517/2		5264
1.6	96-99	DP 1056	DP 21056		6447
1.6	99-2001	DP 1137	DP 21137		6447
1.8	94-96	DP 517	DP 2517		6447
1.8	96-97	DP 1056	DP 21056		6447
1.8 16v	95-97	DP 841	DP 2841	DP 680	DP 2680
2.0	94-97	DP 841	DP 2841	DP 680	DP 2680







*Every EBC pad and shoe requiring ECE R-90 is available with approval subject to stock rotation - check box end label.
Models listed by Engine Size. Only listed by trim level where pads differ, (16v, GL, GT, etc).

BRAKE PADS & SHOES - APPLICATIONS

Bremsbeläge / Plaquettes + Bremsbacken / Machoires









EBC

BRAKES

Make/Model/Engine Hersteller/Modell/Motor Modèles	Year Jahr Années	Pads  Front / Vorn / Avant		Shoes	Pads  Rear / Hinten / Arrière		Shoes
		Plaquettes / Bremsbeläge Original Quality ECE R90* Approved 		Bremsbacken Machoirs ECE R90* Approved 	Plaquettes / Bremsbeläge Upgrade Quality Tuning/Sportbeläge ECE R90* Approved 		Bremsbacken Machoirs ECE R90* Approved 
SEAT Contd.							
Cordoba Contd.							
2.0 16v	97-99	DP 841	DP 2841		DP 680	DP 2680	
1.9 D	94-95	DP 517	DP 2517				6447
1.9 D	96-99	DP 1056	DP 21056				6447
1.9 D	98-99	DP 1137	DP 21137				6447
1.9 TD	94-95	DP 517	DP 2517				6447
1.9 TD	96-99	DP 1056	DP 21056				6447
1.9 TD	99-2002	DP 1137	DP 21137				6447
1.9 TD	2002-						
Fura							
1.0	82-86	DP 116(B)	DP 2116				5031
1.0	82-86	DP 368(G)					5031
1.4	82-86	DP 116(B)	DP 2116				5031
1.4	82-86	DP 368(G)					5031
Ibiza							
0.9	83-93	DP 410(G)					5031
0.9	83-93	DP 485(B)	DP 2485				5031
1.0	93-96	DP 515					5264
1.0	96-98	DP 1056	DP 21056				5264
1.0	98-99	DP 1137	DP 21137				6447
1.2	83-93	DP 410(G)					5031
1.2	83-93	DP 485(B)	DP 2485				5031
1.2	2002-	DP 1436	DP 21436		DP 680	DP 2680	
1.3	93-94	DP 515					5264
1.4	94-96	DP 515					5264
1.4	96-98	DP 1056	DP 21056				5264
1.4	98-2002	DP 1137	DP 21137				6447
1.4	2002-	DP 1436	DP 21436		DP 680	DP 2680	
1.5	83-93	DP 410(G)					5031
1.5	83-93	DP 485(B)	DP 2485				5031
1.6	93-96	DP 517	DP 2517				5264
1.6	96-98	DP 1056	DP 21056				5264
1.6	98-2002	DP 1137	DP 21137				6447
1.7	90-93	DP 485	DP 2485				5031
1.8	93-95	DP 517	DP 2517				6447
1.8 16v	93-97	DP 841	DP 2841		DP 680	DP 2680	
1.8 Turbo	99-2002	DP 841/2	DP 2841/2		DP 680	DP 2680	
1.8 Turbo-R	2001-2002	DP 21140	DP 31140		DP 21230	DP 3680	
2.0 8v	93-96	DP 841	DP 2841		DP 680	DP 2680	
2.0 8v	97-99	DP 1112	DP 21112		DP 680	DP 2680	
2.0 16v	93-96	DP 841	DP 2841		DP 680	DP 2680	
2.0 16v	97-99	DP 1112	DP 21112		DP 680	DP 2680	
1.7 D	83-93	DP 410(G)					5031
1.7 D	83-93	DP 485(B)	DP 2485				5031
1.9 D	93-96	DP 517	DP 2517				6447
1.9 D	96-98	DP 1056	DP 21056				6447
1.9 D	98-2000	DP 1137	DP 21137				6447
1.9 TD	93-96	DP 517	DP 2517				6447
1.9 TD (ABS)	93-96	DP 841	DP 2841		DP 680	DP 2680	
1.9 TD	96-2002	DP 1112	DP 21112		DP 680	DP 2680	6447
1.9 TD	99-2002	DP 1137	DP 21137				6447
1.9 TD	2002-	DP 1436	DP 21436		DP 680	DP 2680	
Leon							
1.4	2000-	DP 1117	DP 21117		DP 1230	DP 21230	
1.4	2000-	DP 1329	DP 21329		DP 1230	DP 21230	
1.6	2000-	DP 1117	DP 21117		DP 1230	DP 21230	
1.6	2000-	DP 1329	DP 21329		DP 1230	DP 21230	
1.8	2000-	DP 1329	DP 21329		DP 1230	DP 21230	
1.8 Turbo	2000-	DP 1330	DP 21330		DP 1230	DP 21230	

Standard Quality - ECE R90 Approved with similar performance to original equipment brake pads.
 Upgrade Quality (Tuning/ Sportbeläge) - ECE R90 Approved but with higher friction and improved performance for faster street use.
 Standard Qualität - mit ECE R90 Freigabe und ähnlicher Bremsleistung wie die Original Bremsbeläge.
 Verbesserte Qualität - mit ECE R90 Freigabe aber mit höherem Reibwert und verbesserter Bremsleistung für den schnellen Strasseninsatz.
 Qualité standard - Approuvée par la norme ECE R90 - Des performances équivalentes à l'origine.
 Qualité améliorée - Approuvée par la norme ECE R90 - Un coefficient de friction supérieur et des performances accrues pour pilotage rapide sur route.
 Calidad Estándar - Aprobación CEE R90 con prestaciones similares a las pastillas originales.
 Calidad Mejorada - Aprobación CEE R90 pero con un coeficiente de fricción más elevado y prestaciones mejoradas para un uso deportivo en carretera.

*Every EBC pad and shoe requiring ECE R-90 is available with approval subject to stock rotation - check box end label.
 Models listed by Engine Size. Only listed by trim level where pads differ, (16v, GL, GT, etc).

Make/Model/Engine Hersteller/Modell/Motor Modelos	Year Jahr Années	Pads  Front / Vorn / Avant		Shoes	Pads  Rear / Hinten / Arrière		Shoes
		Original Quality ECE R90* Approved 	Upgrade Quality Tuning/Sportbeläge ECE R90* Approved 	Bremsbacken Machoires 	Original Quality ECE R90* Approved 	Upgrade Quality Tuning/Sportbeläge ECE R90* Approved 	Bremsbacken Machoires 
SEAT Contd.							
Leon Contd.							
1.8 Turbo Cupra	2000-	DP 1330	DP 21330		DP 1230	DP 21230	
1.8 Turbo Cupra R	2002-	DP 21140	DP 31140		DP 21230	DP 3680	
1.9 TD (90)	2000-	DP 1117	DP 21117		DP 1230	DP 21230	
1.9 TD (90)	2000-	DP 1329	DP 21329		DP 1230	DP 21230	
1.9 TD (110)	2000-	DP 1117	DP 21117		DP 1230	DP 21230	
1.9 TD (110)	2000-	DP 1329	DP 21329		DP 1230	DP 21230	
Malaga							
1.2	86-92	DP 410(G)					5031
1.5	86-92	DP 410(G)					5031
1.5	86-92	DP 485(B)	DP 2485				5031
1.7 D	86-92	DP 410(G)					5031
1.7 D	86-92	DP 485(B)	DP 2485				5031
Marbella							
0.8	87-93	DP 485(B)	DP 2485				5031
0.9	87-93	DP 485(B)	DP 2485				5031
Ronda							
1.2	79-87	DP 410(G)					5031
1.2	79-87	DP 485(B)	DP 2485				5031
1.5	79-87	DP 410(G)					5031
1.5	79-87	DP 485(B)	DP 2485				5031
1.6	79-87	DP 410(G)					5031
1.6	79-87	DP 485(B)	DP 2485				5031
1.7 D	83-87	DP 385					5031
Toledo							
1.6	91-95	DP 517/2	DP 2517/2				5264
1.6	95-99	DP 1056	DP 21056				6447
1.6	99-2000	DP 1117	DP 21117		DP 1230	DP 21230	
1.6	2000-2001	DP 1329	DP 21329		DP 1230	DP 21230	
1.6 (ABS)	91-97	DP 841	DP 2841		DP 680	DP 2680	
1.6 (ABS)	97-99	DP 1056	DP 21056		DP 1230	DP 21230	
1.6 (ABS)	99-2002	DP 1117	DP 21117		DP 1230	DP 21230	
1.6 (ABS)	99-2002	DP 1329	DP 21329		DP 1230	DP 21230	
1.8	91-95	DP 517/2	DP 2517/2				6447
1.8	95-96	DP 1056	DP 21056				6447
1.8 (ABS)	91-97	DP 841	DP 2841		DP 680	DP 2680	
1.8 16v	91-96	DP 841	DP 2841		DP 680	DP 2680	
1.8	99-	DP 1117	DP 21117		DP 1230	DP 21230	
1.8	99-	DP 1329	DP 21329		DP 1230	DP 21230	
1.8 Turbo	2003-						
2.0	91-97	DP 841	DP 2841		DP 680	DP 2680	
2.0	97-98	DP 841	DP 2841		DP 1230	DP 21230	
2.0 GTi	94-97	DP 841/2	DP 2841/2		DP 680	DP 2680	
2.0 GTi	97-99	DP 841/2	DP 2841/2		DP 1230	DP 21230	
2.3	99-	DP 1330	DP 21330		DP 1230	DP 21230	
1.9 D	91-95	DP 517/2	DP 2517/2				6447
1.9 D	95-97	DP 1056	DP 21056		DP 680	DP 2680	6447
1.9 D	97-98	DP 1056	DP 21056		DP 1230	DP 21230	
1.9 TD	91-95	DP 517/2	DP 2517/2				6447
1.9 TD	95-97	DP 1056	DP 21056				6447
1.9 TD	95-97	DP 841/2	DP 2841/2				6447
1.9 TD	97-99	DP 1112	DP 21112		DP 1230	DP 21230	
1.9 TD	99-2000	DP 1117	DP 21117		DP 1230	DP 21230	
1.9 TD	2000-	DP 1329	DP 21329		DP 1230	DP 21230	

Standard Quality - ECE R90 Approved with similar performance to original equipment brake pads.
Upgrade Quality (Tuning / Sportbeläge) - ECE R90 Approved but with higher friction and improved performance for faster street use.

Standard Qualität - mit ECE R90 Freigabe und ähnlicher Bremsleistung wie die Original Bremsbeläge.
Verbesserte Qualität (Tuning / Sportbeläge) - mit ECE R90 Freigabe aber mit höherem Reibwert und verbesserter Bremsleistung für den schnellen Strasseninsatz.

Calidad Estándar - Aprobacion CEE R90 con prestaciones similares a las pastillas originales.
Calidad Mejorada - Aprobacion CEE R90 pero con un coeficiente de friccion mas elevado y prestaciones mejoradas para un uso deportivo en carretera.

*Every EBC pad and shoe requiring ECE R-90 is available with approval subject to stock rotation - check box end label.









Models listed by Engine Size. Only listed by trim level where pads differ, (16v, GL, GT, etc).

BRAKE PADS & SHOES - APPLICATIONS

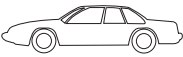









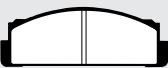
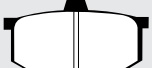
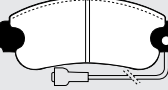
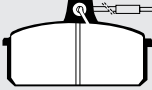



Bremsbeläge / Plaquettes + Bremsbacken / Machoires

EBC

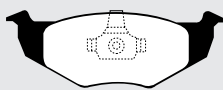
BRAKES

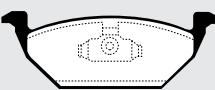
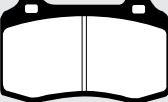
Make/Model/Engine	Year	Pads  Front / Vorn / Avant	Shoes	Pads  Rear / Hinten / Arrière	Shoes
Hersteller/Modell/Motor	Jahr	Plaquettes / Bremsbeläge	Bremsbacken Machoires	Plaquettes / Bremsbeläge	Bremsbacken Machoires
Modelos 	Années 	Original Quality ECE R90* Approved 	Upgrade Quality Tuning/Sportbeläge ECE R90* Approved 	Original Quality ECE R90* Approved 	Upgrade Quality Tuning/Sportbeläge ECE R90* Approved 

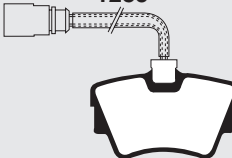
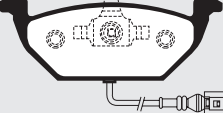
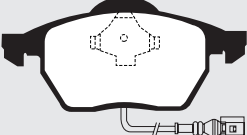
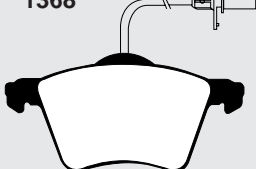
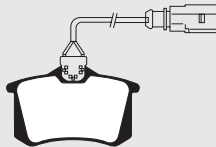
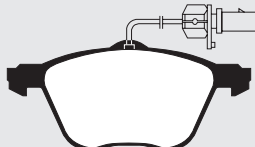

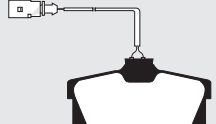
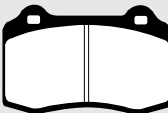
Pad Illustrations for Seat

116  108 x 39 x 17mm	368  93 x 52 x 16mm	385  115 x 49 x 17mm	410  100 x 62 x 16mm
485  108 x 49 x 18mm	515  138 x 51 x 17mm	517  138 x 49 x 15mm	517/2  138 x 49 x 19mm
680  87 x 53 x 15mm	841  119 x 70 x 16mm	841/2  119 x 70 x 19mm	1056  141 x 50 x 19mm
1064  141 x 50 x 17mm	1074  156 x 74 x 19mm	1112  118 x 69 x 16mm	1117  145 x 55 x 20mm
1140  110 x 69 x 14mm	1230  87 x 53 x 17mm	1285  95 x 58 x 16mm	1329  146 x 54 x 19mm
1330  156 x 74 x 20mm	1368  156 x 80 x 18mm	1412  87 x 52 x 17mm	1413  161 x 74 x 20mm
1436  131 x 62 x 18mm	1445  94 x 51 x 17mm	21140  110 x 69 x 14mm	

Standard Quality - ECE R90 Approved with similar performance to original equipment brake pads.
 Upgrade Quality (Tuning/ Sportbeläge) - ECE R90 Approved but with higher friction and improved performance for faster street use.
 Verbesserte Qualität - mit ECE R90 Freigabe aber mit höherem Reibwert und verbesserter Bremsleistung für den schnellen Strasseninsatz.

Qualité standard - Approuvée par la norme ECE R90 - Des performances équivalentes à l'origine.
 Qualité améliorée - Approuvée par la norme ECE R90 - Un coefficient de friction supérieur et des performances accrues pour pilotage rapide sur route.
 Calidad Mejorada - Aprobación CEE R90 con prestaciones similares a las pastillas originales.
 Calidad Mejorada - Aprobación CEE R90 pero con un coeficiente de fricción más elevado y prestaciones mejoradas para un uso deportivo en carretera.

*Every EBC pad and shoe requiring ECE R-90 is available with approval subject to stock rotation - check box end label.
 Models listed by Engine Size. Only listed by trim level where pads differ, (16v, GL, GT, etc).

Make/Model/Engine Hersteller/Modell/Motor Modèles	Year Jahr Années	Pads  Front / Vorn / Avant		Shoes	Pads  Rear / Hinten / Arrière		Shoes
		Original Quality ECE R90* Approved	Upgrade Quality Tuning/Sportbeläge ECE R90* Approved	Bremsbacken Machoires ECE R90* Approved	Original Quality ECE R90* Approved	Upgrade Quality Tuning/Sportbeläge ECE R90* Approved	Bremsbacken Machoires ECE R90* Approved
SEAT COMMERCIAL							
Inca							
1.4	95-97	DP 841/2					6498
1.4	97-99	DP 1112					6498
1.4	99-2002	DP 1112					6565
1.6	95-97	DP 841/2					6498
1.9 D	95-97	DP 841/2					6498
1.9 D	97-99	DP 1112					6498
1.9 D	99-	DP 1112					6565
Terra							
0.9	87-	DP 485					5031
1.3 D	87-	DP 485					5031
1.4 D	87-	DP 485					5031

Pad Illustrations for Seat Commercial

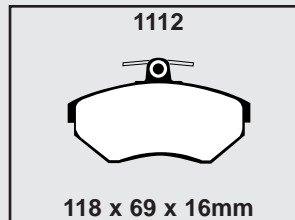
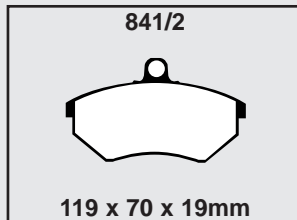
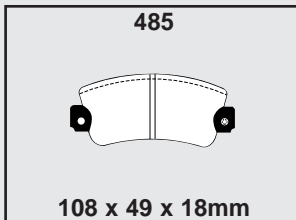

SKODA							
Estelle							
100	70-76	DP 159					5161
105	77-90	DP 159					5161
110	77-89	DP 275					5161
120	77-90	DP 159					5161
Fabia							
1.2	2003-						
1.4	2000-	DP 1329	DP 21329		DP 1230	DP 21230	6447
1.4 16v	2000-	DP 1329	DP 21329		DP 1230	DP 21230	
2.0	2000-	DP 1436	DP 21436		DP 1230	DP 21230	
2.0	2001-	DP 1479	DP 21479		DP 1230	DP 21230	
1.9 D	2000-	DP 1329	DP 21329				6447
1.9 TD	2000-	DP 1329	DP 21329		DP 1230	DP 21230	
Favorit							
1.3	88-93	DP 438	DP 2438				6441
1.3	93-95	DP 438	DP 2438				6447
Felicia							
1.3	94-	DP 1064(K)	DP 21064				6447
1.3	94-	DP 438(G)	DP 2438				6447
1.6	96-	DP 1064(K)	DP 21064				6447
1.6	96-	DP 438(G)	DP 2438				6447
1.9 D	96-	DP 1064(K)	DP 21064				6447
1.9 D	96-	DP 438(G)	DP 2438				6447
Microbus							
	82-91	DP 634					5161
Octavia							
1.4	2000-	DP 1329	DP 21329		DP 1230	DP 21230	6565
1.6	98-2000	DP 1117	DP 21117		DP 1230	DP 21230	6565
1.6	2000-	DP 1329	DP 21329		DP 1230	DP 21230	
1.6 16v	98-2000	DP 1117	DP 21117		DP 1230	DP 21230	6565
1.6 16v	2000-2002	DP 1329	DP 21329		DP 1230	DP 21230	
1.8 20v	98-2000	DP 1330	DP 21330		DP 1230	DP 21230	

*Every EBC pad and shoe requiring ECE R-90 is available with approval subject to stock rotation - check box end label.

Models listed by Engine Size. Only listed by trim level where pads differ, (16v, GL, GT, etc).

BRAKE PADS & SHOES - APPLICATIONS









Bremsbeläge / Plaquettes + Bremsbacken / Machoires

EBC

BRAKES

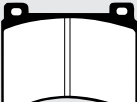
Make/Model/Engine Hersteller/Modell/Motor Modèles	Year Jahr Années	Pads Front / Vorn / Avant Plaquettes / Bremsbeläge		Shoes Bremsbacken Machoires	Pads Rear / Hinten / Arrière Plaquettes / Bremsbeläge		Shoes Bremsbacken Machoires
		Original Quality ECE R90* Approved	Upgrade Quality Tuning/Sportbeläge ECE R90* Approved	ECE R90* Approved	Original Quality ECE R90* Approved	Upgrade Quality Tuning/Sportbeläge ECE R90* Approved	ECE R90* Approved
SKODA Contd.							
Octavia Contd.							
1.8 Turbo	2000-2001	DP 1324	DP 21324		DP 1230	DP 21230	
1.8 Turbo	2001-	DP 1330	DP 21330		DP 1230	DP 21230	
2.0	2001-	DP 1330	DP 21330		DP 1230	DP 21230	
1.9 D (68)	99-2000	DP 1117	DP 21117				6565
1.9 D (68)	2000-	DP 1329	DP 21329				6565
1.9 TD (90)	98-2000	DP 1117	DP 21117		DP 1230	DP 21230	6565
1.9 TD (90)	2000-	DP 1329	DP 21329		DP 1230	DP 21230	
1.9 TD (110)	98-2000	DP 1117	DP 21117		DP 1230	DP 21230	6565
1.9 TD (110)	2000-	DP 1329	DP 21329		DP 1230	DP 21230	
1.9 TD (110)	2000-	DP 1330	DP 21330		DP 1230	DP 21230	
Rapid							
130	82-91	DP 288					5161
136	88-91	DP 288					5161
Superb							
1.8 Turbo	2002-	DP 1483	DP 21483		DP 680	DP 2680	
2.0	2002-	DP 1483	DP 21483		DP 680	DP 2680	
2.8	2002-	DP 1483	DP 21483		DP 680	DP 2680	
1.9 TD	2002-	DP 1483	DP 21483		DP 680	DP 2680	
2.5 TD	2002-	DP 1483	DP 21483		DP 680	DP 2680	

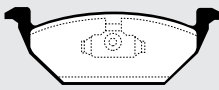
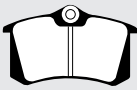
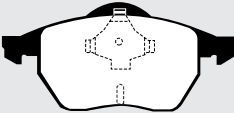
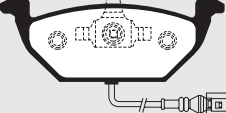
Pad Illustrations for Skoda

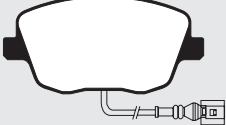
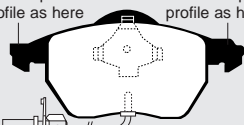
<p>159</p>  <p>50 x 48 x 15mm</p>	<p>275</p>  <p>50 x 48 x 15mm</p>	<p>288</p>  <p>84 x 57 x 15mm</p>	<p>438</p>  <p>115 x 61 x 17mm</p>
<p>634</p>  <p>90 x 70 x 15mm</p>	<p>680</p>  <p>87 x 53 x 15mm</p>	<p>1117</p>  <p>145 x 55 x 20mm</p>	<p>1230</p>  <p>87 x 53 x 17mm</p>
<p>1324</p>  <p>156 x 74 x 20mm</p>	<p>1329</p>  <p>146 x 54 x 19mm</p>	<p>1330</p>  <p>156 x 74 x 20mm</p>	<p>1436</p>  <p>131 x 62 x 18mm</p>
<p>1479</p>  <p>131 x 62 x 18mm</p>	<p>1483</p> <p>Plain pad profile as here</p>  <p>Wear lead pads profile as here</p> <p>156 x 74 x 20mm</p>		









*Every EBC pad and shoe requiring ECE R-90 is available with approval subject to stock rotation - check box end label. Models listed by Engine Size. Only listed by trim level where pads differ, (16v, GL, GT, etc).

Standard Quality - ECE R90 Approved with similar performance to original equipment brake pads.
 Upgrade Quality (Tuning/ Sportbeläge) - ECE R90 Approved but with higher friction and improved performance for faster street use.
 Standard Qualität - mit ECE R90 Freigabe und ähnlicher Bremsleistung wie die Original Bremsbeläge.
 Verbesserte Qualität - mit ECE R90 Freigabe aber mit höherem Reibwert und verbesserter Bremsleistung für den schnellen Strasseninsatz.

Qualité standard - Approuvée par la norme ECE R90 - Des performances équivalentes à l'origine.
 Qualité améliorée - Approuvée par la norme ECE R90 - Un coefficient de friction supérieur et des performances accrues pour pilotage rapide sur route.
 Calidad Estándar - Aprobación CEE R90 con prestaciones similares a las pastillas originales.
 Calidad Mejorada - Aprobación CEE R90 pero con un coeficiente de fricción más elevado y prestaciones mejoradas para un uso deportivo en carretera.

Standard Quality - ECE R90 Approved with similar performance to original equipment brake pads.
 Upgrade Quality (Tuning / Sportbeläge) - ECE R90 Approved but with higher friction and improved performance for faster street use.

Standard Qualität - mit ECE R90 Freigabe und ähnlicher Bremsleistung wie die Original Bremsbeläge.
 Verbesserte Qualität - mit ECE R90 Freigabe aber mit höherem Reibwert und verbesserter Bremsleistung für den schnellen Strasseninsatz.

Make/Model/Engine Hersteller/Modell/Motor Modelos	Year Jahr Années	Pads  Front / Vorn / Avant		Shoes	Pads  Rear / Hinten / Arrière		Shoes
		Original Quality ECE R90* Approved 	Upgrade Quality Tuning/Sportbeläge ECE R90* Approved 	Bremsbacken Machoires 	Original Quality ECE R90* Approved 	Upgrade Quality Tuning/Sportbeläge ECE R90* Approved 	Bremsbacken Machoires 
SKODA COMMERCIAL							
Favorit Foreman							
1.3	93-	DP 438					6441
1.3	93-	DP 438					6447
Felicia Pick-Up							
1.3	96-	DP 438					6441
1.6	96-	DP 438					6441
1.9 D	96-	DP 438					6441
Cube Van							
1.9 D	98-	DP 1084					5264
1.9 D (ABS)	98-	DP 1084					6447

Pad Illustrations for Skoda Commercial

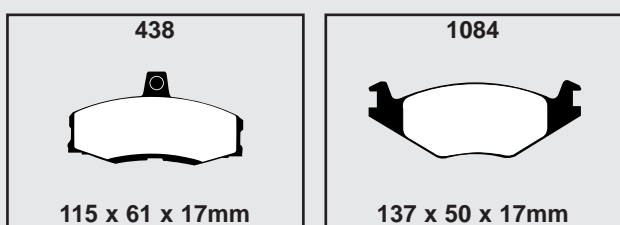

SMART							
City Coupe / Cabriolet							
0.6	98-	DP 1287	DP 21287				6598
0.8 D	99-	DP 1287	DP 21287				6598
Roadster / Roadster Coupe							
	2003-	DP 1287	DP 21287				6598

Pad Illustrations for Smart

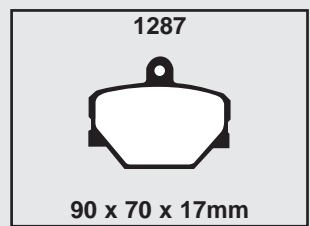

SSANGYONG							
Korando							
2.3	97-98	DP 1126			DP 1132		5117
2.9 D	97-98	DP 1126			DP 1132		5117
Musso							
2.3	97-99	DP 1126			DP 1132		
3.2	95-99	DP 1126			DP 1132		
2.9 D	94-97	DP 1126			DP 1132		
2.9 TD	97-99	DP 1126			DP 1132		

*Every EBC pad and shoe requiring ECE R-90 is available with approval subject to stock rotation - check box end label.
 Models listed by Engine Size. Only listed by trim level where pads differ, (16v, GL, GT, etc).

BRAKE PADS & SHOES - APPLICATIONS

Bremsbeläge / Plaquettes + Bremsbacken / Machoires

EBC

BRAKES

Make/Model/Engine	Year	Pads	Front / Vorn / Avant	Shoes	Pads	Rear / Hinten / Arrière	Shoes
Hersteller/Modell/Motor	Jahr	Plaquettes / Bremsbeläge		Bremsbacken	Plaquettes / Bremsbeläge		Bremsbacken
Modelos	Années	Original Quality ECE R90* Approved	Upgrade Quality Tuning/Sportbeläge ECE R90* Approved	Machoires ECE R90* Approved	Original Quality ECE R90* Approved	Upgrade Quality Tuning/Sportbeläge ECE R90* Approved	Machoires ECE R90* Approved

Pad Illustrations for Ssangyong

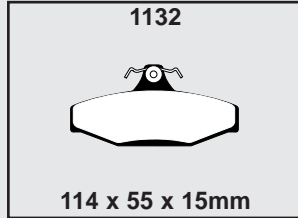
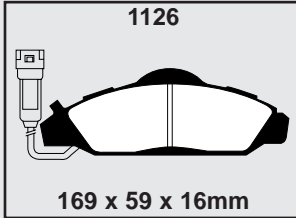

STRATHCARRON

SC-5A

1.2	2000-	DP 197/2	DP 2197/2		DP 885/2	DP 2885/2
-----	-------	----------	-----------	--	----------	-----------

Pad Illustrations for Strathcarbon

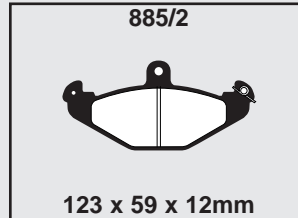
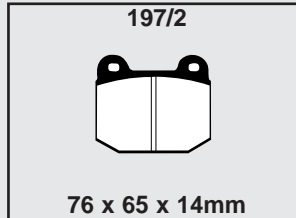

SUBARU

1000

1.0	68-73	DP 133				
-----	-------	--------	--	--	--	--

Series 1/2/L

1.6 (A33, A66, A67)	77-80	DP 200				5257
1.6 (AF2, AB2)	79-84	DP 469				5257
1.6 (AF2, AB2)	84-86	DP 615				6413
1.6 (AW2, AB3)	79-81	DP 469				5257
1.6 (AM2, AM3)	79-84	DP 469				5257
1.6 (AN3) Est	84-91	DP 582				6413
1.6 (AC2) Saloon	84-91	DP 582				6280
1.6 (AN2) Est	84-91	DP 582				6280
1.6 (AG2)	85-91	DP 582				6280
1.8 (AB4, AW4)	79-84	DP 469				5257
1.8 (AB4, AW4)	84-86	DP 615				6413
1.8 GLF, (AB5, AF5)	79-84	DP 469				5257
1.8 GLF, (AB5, AF5)	84-86	DP 615				6413
1.8 GL Est, (AM5)	80-82	DP 469				5257
1.8 GLF Est, (AJ5)	82-84	DP 469				5257
1.8 (AN4) Est	84-90	DP 582				6413
1.8 (AC4) Saloon	84-90	DP 582				6280
1.8 GT, (AC4, AG4, AG5)	84-90	DP 582			DP 674	
1.8 (AC5, AG4)	84-90	DP 582			DP 674	
1.8 Est (AN4)	85-88	DP 582				6280
1.8 DL Est, (AN5)	84-91	DP 582				6413
1.8 GL Est, (AK5)	84-90	DP 582				6413
1.8 XT Coupe (AX4, AX7)	84-90	DP 582			DP 674	
1.8 Turbo (AC7, AG5, AK7)	84-91	DP 582			DP 674	









Forester

2.0	97-	DP 966	DP 2966			6463
2.0	97-	-	DP 21134		DP 821	DP 2821
2.0 Turbo	98-	-	DP 21134		DP 821	DP 2821

*Every EBC pad and shoe requiring ECE R-90 is available with approval subject to stock rotation - check box end label.
Models listed by Engine Size. Only listed by trim level where pads differ, (16v, GL, GT, etc).

Standard Quality - ECE R90 Approved with similar performance to original equipment brake pads.
Upgrade Quality (Tuning / Sportbeläge) - ECE R90 Approved but with higher friction and improved performance for faster street use.
Verbesserte Qualität - mit ECE R90 Freigabe und ähnlicher Bremsleistung wie die Original Bremsbeläge.
Standard Qualität - mit ECE R90 Freigabe und ähnlicher Bremsleistung wie die Original Bremsbeläge.

Qualité standard - Approuvée par la norme ECE R90 - Des performances équivalentes à l'origine.
Qualité améliorée - Approuvée par la norme ECE R90 - Un coefficient de friction supérieur et des performances accrues pour pilotage rapide sur route.
Calidad Mejorada - Aprobación CEE R90 pero con un coeficiente de fricción más elevado y prestaciones mejoradas para un uso deportivo en carretera.
Calidad Estándar - Aprobación CEE R90 con prestaciones similares a las pastillas originales.

Make/Model/Engine Hersteller/Modell/Motor Modelos	Year Jahr Années	Pads  Front / Vorn / Avant		Shoes	Pads  Rear / Hinten / Arrière		Shoes
		Original Quality ECE R90* Approved 	Upgrade Quality Tuning/Sportbeläge ECE R90* Approved 	Bremsbacken Machoires 	Original Quality ECE R90* Approved 	Upgrade Quality Tuning/Sportbeläge ECE R90* Approved 	Bremsbacken Machoires 
SUBARU Contd.							
Impreza							
1.5	93-96	DP 819	DP 2819				6463
1.6	93-97	DP 819	DP 2819		DP 821	DP 2821	6463
1.6	2001-	DP 1138	DP 21138		DP 821	DP 2821	
1.8	93-97	DP 819	DP 2819		DP 821	DP 2821	6463
2.0	96-98	DP 1138	DP 21138		DP 821	DP 2821	
2.0	99-	-	DP 21138		-	DP 21293	
2.0 Sport	96-98	-	DP 2966		DP 821	DP 2821	
2.0 Sport	99-	-	DP 2966		-	DP 21293	
2.0 Turbo	94-96	DP 2966	DP 3966		DP 2821	DP 3821	
2.0 Turbo	96-98	DP 21134	DP 31134		DP 2821	DP 3821	
2.0 Turbo (Not UK)	98-2002	DP 21200	DP 31200		DP 2826	DP 3826	
2.0 Turbo (UK)	98-2002	DP 21200	DP 31200		DP 21293	DP 31293	
2.0 Turbo WRX	2002-	DP 21200	DP 31200		DP 21293	DP 31293	
2.0 Turbo STi	2002-	-	DP 31210		-	DP 3197/2	
Handbrake Shoe	96-2000						6607
Justy							
1.0	89-96	DP 822					6412
1.2	84-89	DP 452	DP 2452				6412
1.2	89-96	DP 1029					6412
1.3	96-2001	DP 762	DP 2762				6485
Legacy							
1.8 (BC3) (BF3)	89-92	DP 819	DP 2819				6463
2.0 (BC5) (BF5)	91-94	DP 819	DP 2819				6463
2.0 Turbo (BC5) (BF5)	91-94	DP 2966	DP 3966		DP 2821	DP 3821	
2.0 (BD5) (BG5)	94-96	DP 819	DP 2819		DP 821	DP 2821	
2.0	96-98	DP 1138	DP 21138		DP 821	DP 2821	
2.0	2000-	-	DP 21138		-	DP 21293	
2.2 (BC7) (BF7)	89-94	DP 819	DP 2819		DP 821	DP 2821	
2.2 (BD7) (BG7)	94-96	DP 819	DP 2819		DP 821	DP 2821	
2.2	96-98	DP 1138	DP 21138		DP 821	DP 2821	
2.2	98-2000	-	DP 21134		DP 821	DP 2821	
2.5 (BD9) (BG9)	96-99	DP 966	DP 2966		DP 821	DP 2821	
2.5	96-99	-	DP 21134		DP 821	DP 2821	
2.5	2000-	-	DP 21134		-	DP 21293	
3.0	2000-	-	DP 21134		-	DP 21293	
Handbrake Shoe	96-99						6607
SVX							
3.3	92-98	DP 691	DP 2691		DP 821	DP 2821	
Vivio							
0.7	92-96	DP 1023					6470

Pad Illustrations for Subaru

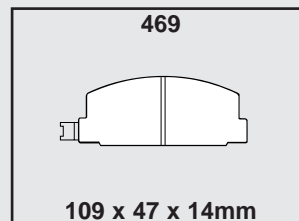
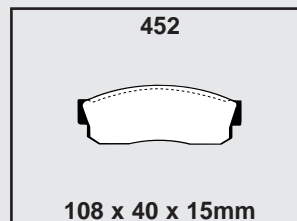
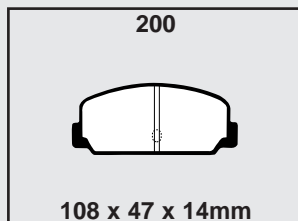
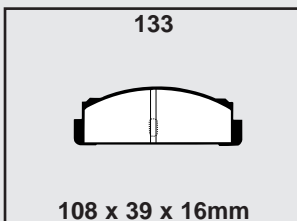

Standard Quality - ECE R90 Approved with similar performance to original equipment brake pads.
Upgrade Quality (Tuning / Sportbeläge) - ECE R90 Approved but with higher friction and improved performance for faster street use.

Standard Qualität - mit ECE R90 Freigabe und ähnlicher Bremsleistung wie die Original Bremsbeläge.
Verbesserte Qualität - mit ECE R90 Freigabe aber mit höherem Reibwert und verbesserter Bremsleistung für den schnellen Strasseninsatz.

Calidad Estándar - Aprobación CEE R90 con prestaciones similares a las pastillas originales.
Calidad Mejorada - Aprobación CEE R90 pero con un coeficiente de fricción más elevado y prestaciones mejoradas para un uso deportivo en carretera.

*Every EBC pad and shoe requiring ECE R-90 is available with approval subject to stock rotation - check box end label.

Models listed by Engine Size. Only listed by trim level where pads differ, (16v, GL, GT, etc).

BRAKE PADS & SHOES - APPLICATIONS

Bremsbeläge / Plaquettes + Bremsbacken / Machoires

EBC

BRAKES

Make/Model/Engine	Year	Pads	Front / Vorn / Avant	Shoes	Pads	Rear / Hinten / Arrière	Shoes
Hersteller/Modell/Motor	Jahr	Plaquettes / Bremsbeläge		Bremsbacken	Plaquettes / Bremsbeläge		Bremsbacken
Modelos	Années	Original Quality ECE R90* Approved	Upgrade Quality Tuning/Sportbeläge ECE R90* Approved	Machoires ECE R90* Approved	Original Quality ECE R90* Approved	Upgrade Quality Tuning/Sportbeläge ECE R90* Approved	Machoires ECE R90* Approved

Pad Illustrations for Subaru





582 126 x 54 x 17mm	615 106 x 53 x 15mm	674 85 x 38 x 15mm	691 160 x 51 x 17mm
762 107 x 44 x 15mm	819 128 x 53 x 17mm	821 108 x 39 x 15mm	822 108 x 48 x 15mm
996 63 x 65 x 15mm	1023 112 x 39 x 14mm	1029 127 x 49 x 15mm	1138 138 x 54 x 17mm
3103 76 x 70 x 15mm	3197/2 76 x 65 x 14mm	3826 73 x 54 x 16mm	21134 138 x 60 x 17mm
21200 120 x 70 x 14mm	21293 108 x 41 x 14mm	31210 131 x 75 x 15mm	

SUBARU COMMERCIAL				
MV				
1.6 Pick Up	77-80	DP 200		5257
1.6 4WD	80-82	DP 469		5257
1.6	81-85	DP 319		5257
1.8	80-81	DP 469		5257
1.8	81-85	DP 319		5257
1.8	85-90	DP 615		5257
1.8 4WD	81-90	DP 469		5257
Mini Jumbo Van				
0.7	88-	DP 840		6470
0.8	88-	DP 840		6470
Sumo Van				
1.0	88-89	DP 452		6470
1.0	89-95	DP 452		6536
1.2	88-89	DP 452		6470
1.2	89-95	DP 452		6536

*Every EBC pad and shoe requiring ECE R-90 is available with approval subject to stock rotation - check box end label.
Models listed by Engine Size. Only listed by trim level where pads differ, (16v, GL, GT, etc).



Standard Quality - ECE R90 Approved with similar performance to original equipment brake pads.
Upgrade Quality (Tuning / Sportbeläge) - ECE R90 Approved but with higher friction and improved performance for faster street use.
Verbesserte Qualität - mit ECE R90 Freigabe aber mit höherem Reibwert und verbesserter Bremsleistung für den schnellen Strasseninsatz.

Qualité standard - Approuvée par la norme ECE R90 - Des performances équivalentes à l'origine.
Qualité améliorée - Approuvée par la norme ECE R90 - Un coefficient de friction supérieur et des performances accrues pour pilotage rapide sur route.
Calidad Estándar - Aprobación CEE R90 con prestaciones similares a las pastillas originales.
Calidad Mejorada - Aprobación CEE R90 pero con un coeficiente de fricción más elevado y prestaciones mejoradas para un uso deportivo en carretera.

Make/Model/Engine	Year	Pads  Front / Vorn / Avant		Shoes	Pads  Rear / Hinten / Arrière		Shoes
Hersteller/Modell/Motor	Jahr	Plaquettes / Bremsbeläge		Bremsbacken Machoires	Plaquettes / Bremsbeläge		Bremsbacken Machoires
Modelos	Années	Original Quality ECE R90* Approved	Upgrade Quality Tuning/Sportbeläge ECE R90* Approved	 ECE R90* Approved	Original Quality ECE R90* Approved	Upgrade Quality Tuning/Sportbeläge ECE R90* Approved	 ECE R90* Approved

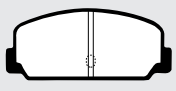
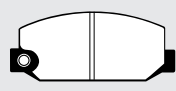
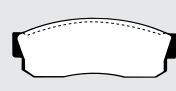
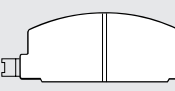
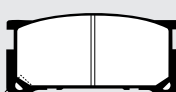

SUBARU COMM Contd.							
700 Van							
0.7	84-88			6471			6472

Pad Illustrations for Subaru Commercial

200  108 x 47 x 14mm	319  108 x 46 x 14mm	452  108 x 40 x 15mm	469  109 x 47 x 14mm
615  106 x 53 x 15mm	840  103 x 38 x 14mm		

SUBARU (Aust/NZ)							
B4 Legacy/Liberty							
96-	DP 21134	DP 31134			DP 21293	DP 31293	
Outback							
2.5	DP 21134	DP 31134			DP 21293	DP 31293	

Pad Illustrations for Subaru (Aust/NZ)

21134  138 x 60 x 17mm	21293  108 x 41 x 14mm
---	---

SUZUKI							
Alto							
0.8 (SS80)	80-86	DP 374	DP 2374				6412
0.8 (FX Coupe)	81-85	DP 329					6283
0.8 (4WD)	84-88	DP 766					6487
0.8 (SB308)	86-96	DP 374	DP 2374				6487
1.0	97-2003	DP 762	DP 2762				6573
1.1	2003-						
Baleno							
1.3	95-99	DP 1041					6517
1.3	95-99	DP 1041					6485
1.3	99-2001	DP 1299					6485
1.6	95-99	DP 1041					6517
1.6	95-99	DP 1041					6485
1.6	99-2001	DP 1299					6485
1.8	96-99	DP 1041			DP 828		6517
1.8	96-99	DP 1041			DP 828		6485
1.8	99-2001	DP 1299			DP 828		

*Every EBC pad and shoe requiring ECE R-90 is available with approval subject to stock rotation - check box end label.
Models listed by Engine Size. Only listed by trim level where pads differ, (16v, GL, GT, etc).

Standard Quality - ECE R90 Approved with similar performance to original equipment brake pads.
Upgrade Quality (Tuning / Sportbeläge) - ECE R90 Approved but with higher friction and improved performance for faster street use.

Standard Qualität - mit ECE R90 Freigabe und ähnlicher Bremsleistung wie die Original Bremsbeläge.
Verbesserte Qualität - mit ECE R90 Freigabe aber mit höherem Reibwert und verbesserter Bremsleistung für den schnellen Strasseneinsatz.

Calidad Estándar - Aprobación CEE R90 con prestaciones similares a las pastillas originales.
Calidad Mejorada - Aprobación CEE R90 pero con un coeficiente de fricción más elevado y prestaciones mejoradas para un uso deportivo en carretera.

Qualité standard - Approuvée par la norme ECE R90 - Des performances équivalentes à l'origine.
Qualité améliorée - Approuvée par la norme ECE R90 - Un coefficient de friction supérieur et des performances accrues pour pilotage rapide sur route.









Calidad Estándar - Aprobación CEE R90 con prestaciones similares a las pastillas originales.
Calidad Mejorada - Aprobación CEE R90 pero con un coeficiente de fricción más elevado y prestaciones mejoradas para un uso deportivo en carretera.

BRAKE PADS & SHOES - APPLICATIONS

Bremsbeläge / Plaquettes + Bremsbacken / Machoires

EBC

BRAKES

Make/Model/Engine Hersteller/Modell/Motor Modelos	Year Jahr Années	Pads  Front / Vorn / Avant		Shoes	Pads  Rear / Hinten / Arrière		Shoes
		Original Quality ECE R90* Approved 	Upgrade Quality Tuning/Sportbeläge ECE R90* Approved 	Bremsbacken Machoires 	Original Quality ECE R90* Approved 	Upgrade Quality Tuning/Sportbeläge ECE R90* Approved 	Bremsbacken Machoires 
SUZUKI Contd.							
Cappuccino							
0.6 Turbo	94-96	DP 762	DP 2762		DP 1093		
Cara							
	93-94	DP 1301			DP 528		
Grand Vitara							
1.6	2001-	DP 979	DP 6979				6570
2.0	99-	DP 1099	DP 61099				6570
2.5	98-2001	DP 1099	DP 61099				6570
2.7	2001-						
2.0 TD	98-	DP 1099	DP 61099				6570
Ignis							
1.3	2000-	DP 1344					
Jeep							
0.8 (LJ80)	79-82			6301			6301
1.0 (SJ410)	82-84			6336			6336
1.0 (SJ410)	84-85	DP 534					6393
1.0 (SJ410)	85-87	DP 534					6394
1.0 (SJ410) Santana	87-93	DP 534					6393
1.0 (SJ410) Santana	87-93	DP 410					6338
1.3 (SJ413)	85-88	DP 534					6402
1.3 (SJ413) Samurai	86-91	DP 741					6416
1.3 (SJ413)	88-91	DP 410					6338
1.3 (SJ413)	91-98	DP 410					6416
Transmission Brake	79-						6283
Jimny							
1.3	98-	DP 534					6452
Liana							
1.6	2001-	DP 1390					6485
SC Coupe							
1.0	79-82	DP 329					6283
Swift							
1.0 (SA310) (AA41S)	84-86	DP 613					6394
1.0 (AA44S)	95-97	DP 762	DP 2762				6487
1.0	97-	DP 1345					6487
1.3 (SA310) (AA51S)	84-86	DP 613					6394
1.3 (SA413) (AA53S)	86-89	DP 762	DP 2762				6487
1.3 GTi (SF413) (AA33S)	86-88	DP 762	DP 2762				6487
1.3 GTi (SF413) (AA34S)	89-97	DP 665	DP 2665		DP 514/2		6487
1.3 GLX (SF413) (AB35S)	89-97	DP 762	DP 2762				6487
1.3 GLS, GLX, GX	97-2000	DP 1345					6487
1.3 GL (SF413)	89-92	DP 977					6487
1.3 GSi (SF413) (AA35S)	92-98	DP 762	DP 2762				6487
1.6 GTi (SF416)	89-93	DP 665	DP 2665		DP 514/2		6487
1.6 GLX (SF416) (AJ14S)	90-93	DP 665	DP 2665				6485
Vitara							
1.6 (TA01)	88-91	DP 774					6459
1.6 (TA02)	91-2001	DP 774					6493
1.6 (TD01)	91-97	DP 979	DP 6979				6494
1.6 (SJJ)	89-2001	DP 410					6338
2.0 (TD11W)	95-98	DP 1099	DP 61099				6494
2.0 (TA52)	99-2001	DP 1099	DP 61099				6493
2.0 TD (TD31W)	96-2001	DP 1099	DP 61099				6493











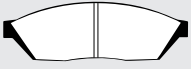
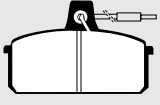
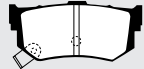

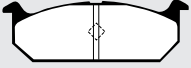

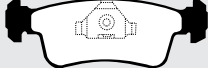
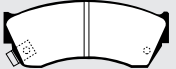

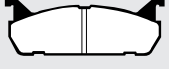
*Every EBC pad and shoe requiring ECE R-90 is available with approval subject to stock rotation - check box end label.
Models listed by Engine Size. Only listed by trim level where pads differ, (16v, GL, GT, etc).

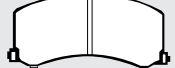
Standard Quality - ECE R90 Approved with similar performance to original equipment brake pads.
Upgrade Quality (Tuning/ Sportbeläge) - ECE R90 Approved but with higher friction and improved performance for faster street use.
Verbesserte Qualität - mit ECE R90 Freigabe aber mit höherem Reibwert und verbesserter Bremsleistung für den schnellen Strasseninsatz.

Standard Qualität - mit ECE R90 Freigabe und ähnlicher Bremsleistung wie die Original Bremsbeläge.
Qualité améliorée - Approuvée par la norme ECE R90 - Un coefficient de friction supérieur et des performances accrues pour pilotage rapide sur route.
Calidad Estándar - Aprobación CEE R90 con prestaciones similares a las pastillas originales.
Calidad Mejorada - Aprobación CEE R90 pero con un coeficiente de fricción más elevado y prestaciones mejoradas para un uso deportivo en carretera.

Make/Model/Engine	Year	Front / Vorn / Avant	Shoes	Rear / Hinten / Arrière	Shoes
Hersteller/Modell/Motor	Jahr	Plaquettes / Bremsbeläge		Bremsbacken Machoires	
Modelos	Années	Original Quality ECE R90* Approved	Upgrade Quality Tuning/Sportbeläge ECE R90* Approved	Original Quality ECE R90* Approved	Upgrade Quality Tuning/Sportbeläge ECE R90* Approved
SUZUKI Contd.					
Wagon-R					
1.0	97-98	DP 762			6569
1.0	97-98	DP 1291			6569
1.2	98-2000	DP 762			6569
1.2	98-2000	DP 1291			6569
1.3	2000-	DP 1291			6590
1.3	2000-	DP 1361			6590
X-90					
1.6 (LA115)	96-99	DP 774			6493
1.6 4WD (LB115)	96-99	DP 774			6493

Pad Illustrations for Suzuki









<p>329</p>  <p>79 x 63 x 13mm</p>	<p>374</p>  <p>119 x 38 x 15mm</p>	<p>410</p>  <p>100 x 62 x 16mm</p>	<p>514/2</p>  <p>85 x 38 x 12mm</p>
<p>534</p>  <p>110 x 41 x 15mm</p>	<p>613</p>  <p>123 x 41 x 15mm</p>	<p>665</p>  <p>115 x 47 x 16mm</p>	<p>741</p>  <p>131 x 46 x 15mm</p>
<p>762</p>  <p>107 x 44 x 15mm</p>	<p>766</p>  <p>141 x 39 x 15mm</p>	<p>774</p>  <p>103 x 43 x 15mm</p>	<p>828</p>  <p>102 x 39 x 12mm</p>
<p>977</p>  <p>109 x 44 x 14mm</p>	<p>979</p>  <p>117 x 45 x 15mm</p>	<p>1041</p>  <p>110 x 49 x 15mm</p>	<p>1093</p>  <p>115 x 44 x 12mm</p>
<p>1099</p>  <p>110 x 55 x 14mm</p>	<p>1291</p>  <p>106 x 49 x 15mm</p>	<p>1299</p>  <p>109 x 49 x 15mm</p>	<p>1344</p>  <p>109 x 45 x 15mm</p>
<p>1345</p>  <p>130 x 44 x 15mm</p>	<p>1361</p>  <p>130 x 44 x 15mm</p>	<p>1390</p>  <p>136 x 53 x 16mm</p>	

BRAKE PADS & SHOES - APPLICATIONS

Bremsbeläge / Plaquettes + Bremsbacken / Machoires

EBC









BRAKES

Make/Model/Engine Hersteller/Modell/Motor Modèles	Year Jahr Années	Pads  Front / Vorn / Avant		Shoes	Pads  Rear / Hinten / Arrière		Shoes
		Plaquettes / Bremsbeläge Original Quality ECE R90* Approved 		Bremsbacken Machoirs ECE R90* Approved 	Plaquettes / Bremsbeläge Upgrade Quality Tuning/Sportbeläge ECE R90* Approved 		Bremsbacken Machoirs ECE R90* Approved 
SUZUKI COMMERCIAL							
Carry							
0.8 (ST 80)	76-81			6301			6301
0.8 (ST 90)	80-86			6336			6336
Super Carry							
1.0 (SK410-DA21) (Van)	85-87	DP 374	DP 2374				6499
1.0 (SK410-DA21) (Van)	87-94	DP 374	DP 2374				6459
1.0 (SK410-DA21) (Pick-Up)	86-94	DP 374	DP 2374				6459
1.0 (SK410-DA51) (Van)	94-99	DP 1106					6459
1.0 (DA51) (Pick-Up)	95-99	DP 1106					6499
1.3 (DF 51)	99-	DP 1344					6452
Pad Illustrations for Suzuki Commercial							
374		1106		1344			
							
119 x 38 x 15mm		102 x 40 x 15mm		109 x 45 x 15mm			
TALBOT							
INC (Chrysler, Hillman, Humber, Matra, Singer, Simca, Sunbeam)							
Chrysler							
160	71-72	DP 146					5065
160	72-75	DP 123/2					5072
160 GT	71-72	DP 146			DP 147		
180	71-72	DP 146			DP 147		
160 GT	72-79	DP 123/3			DP 147		
180	72-79	DP 123/3			DP 147		
Hillman							
Imp 0.8	63-76			5141			5142
Avenger 1.25	70-73	DP 114	DP 2114				5112
Avenger 1.3	70-73	DP 114	DP 2114				5112
Avenger 1.3	73-74	DP 106	DP 2106	6249			7230
Avenger 1.3	75-78	DP 106	DP 2106				5112
Avenger 1.5	70-73	DP 114	DP 2114				5112
Avenger 1.5	75-78	DP 106	DP 2106				5112
Avenger 1.6	75-78	DP 106	DP 2106				5112
Hunter 1.5	67-68	DP 161					5228
Hunter 1.5	69-75	DP 161					5143
Hunter 1.7	67-68	DP 161					5228
Hunter 1.7	69-75	DP 161					5143
Minx 1.5	67-70	DP 161					5228
Minx 1.5	67-70	DP 161					5143
Minx 1.6	60-63			6246			6246
Minx 1.6	63-64	DP 107	DP 2107				6246
Minx 1.6	64-66	DP 107	DP 2107				5228
Minx 1.7	67-70	DP 161					5228
Minx 1.7	67-70	DP 161					5143
Humber							
Sceptre 1.6	63-66	DP 107	DP 2107				
Sceptre 1.7	67-68	DP 161					5228
Sceptre 1.7	69-76	DP 161					5143
Hawk	59-60						6260

Standard Quality - ECE R90 Approved with similar performance to original equipment brake pads.
 Upgrade Quality (Tuning/ Sportbeläge) - ECE R90 Approved but with higher friction and improved performance for faster street use.
 Verbesserte Qualität - mit ECE R90 Freigabe aber mit höherem Reibwert und verbesserter Bremsleistung für den schnellen Strasseninsatz.

Qualité standard - Approuvée par la norme ECE R90 - Des performances équivalentes à l'origine.
 Qualité améliorée - Approuvée par la norme ECE R90 - Un coefficient de friction supérieur et des performances accrues pour pilotage rapide sur route.
 Calidad Mejorada - Aprobación CEE R90 con prestaciones similares a las pastillas originales.
 Calidad Mejorada - Aprobación CEE R90 pero con un coeficiente de fricción más elevado y prestaciones mejoradas para un uso deportivo en carretera.

*Every EBC pad and shoe requiring ECE R-90 is available with approval subject to stock rotation - check box end label.
 Models listed by Engine Size. Only listed by trim level where pads differ, (16v, GL, GT, etc).

Make/Model/Engine Hersteller/Modell/Motor Modelos	Year Jahr Années	Pads  Front / Vorn / Avant		Shoes	Pads  Rear / Hinten / Arrière		Shoes
		Original Quality ECE R90* Approved 	Upgrade Quality Tuning/Sportbeläge ECE R90* Approved 	Bremsbacken Machoires 	Original Quality ECE R90* Approved 	Upgrade Quality Tuning/Sportbeläge ECE R90* Approved 	Bremsbacken Machoires 
TALBOT Contd.							
INC (Chrysler, Hillman, Humber, Matra, Singer, Simca, Sunbeam)							
Matra Bagheera							
1.3	72-78	DP 295	DP 2104		DP 189	DP 2189	
1.4	78-80	DP 295	DP 2104		DP 189	DP 2189	
Matra Murena							
1.6	80-83	DP 417	DP 2317		DP 189	DP 2189	
2.2	80-83	DP 417	DP 2317		DP 189	DP 2189	
2.2 Turbo	80-83	DP 417	DP 2317		DP 189	DP 2189	
Matra Rancho							
1.4	78-81	DP 292(G)					5212A(G)
1.4	78-81	DP 295(T)					5072(B)
1.4	81-84	DP 332(B)					5212A(G)
1.4	81-84	DP 428(G)					5072(B)
Simca							
1.1	68-76	DP 105	DP 2105				5046
1.1	73-78	DP 104(T)	DP 2104				5072(B)
1.4	68-76	DP 105	DP 2105				5046
1.3	68-78	DP 105	DP 2105	5045			5046
1.3	72-78	DP 104	DP 2104		DP 103	DP 2103	
1.3	73-78	DP 104(T)	DP 2104				5072(B)
1.3	73-78	DP 114(G)	DP 2114				5212A(G)
1.3	68-73	DP 104	DP 2104				5048
1.3	75-80	DP 385(B)					5212A(G)
1.3	75-80	DP 220/4(T)	DP 2220				5072(B)
1.4	73-78	DP 104(T)	DP 2104				5072(B)
1.4	73-78	DP 114(G)	DP 2114				5212A(G)
1.4	68-73	DP 104	DP 2104				5048
1.4	75-80	DP 385(B)					5212A(G)
1.4	75-80	DP 220/4(T)	DP 2220				5072(B)
1.6	73-78	DP 114(G)	DP 2114				5212A(G)
1.6	68-73	DP 104	DP 2104				5048
1.6	73-78	DP 104	DP 2104				5072(B)
1.6	75-80	DP 385(B)					5212A(G)
1.6	75-80	DP 220/4(T)	DP 2220				5072(B)
Singer							
Chamois 0.8	64-70			5141			5142
Gazelle 1.6	63-67	DP 107	DP 2107				5228
Gazelle 1.7 (Non Servo)	67-70	DP 161					5228
Gazelle 1.7 (Servo)	67-70	DP 161					5143
Vogue 1.6	62-64	DP 107	DP 2107				6246
Vogue 1.6	64-67	DP 107	DP 2107				5228
Vogue 1.7 (Non Servo)	67-70	DP 161					5228
Vogue 1.7 (Servo)	67-70	DP 161					5143
Sunbeam							
Stilletto 0.8	67-76			5141			5142
Rapier 1.7	68-76	DP 161					5143
Alpine 1.7	69-75	DP 161					5143
Tiger							
4.3	64-66	DP 169					5139
4.7	67-68	DP 106	DP 2106				5112

Standard Quality - ECE R90 Approved with similar performance to original equipment brake pads.
Upgrade Quality (Tuning / Sportbeläge) - ECE R90 Approved but with higher friction and improved performance for faster street use.

Standard Qualität - mit ECE R90 Freigabe und ähnlicher Bremsleistung wie die Original Bremsbeläge.
Verbesserte Qualität - mit ECE R90 Freigabe aber mit höherem Reibwert und verbesserter Bremsleistung für den schnellen Strasseninsatz.

Qualité standard - Approuvée par la norme ECE R90 - Des performances équivalentes à l'origine.
Qualité améliorée - Approuvée par la norme ECE R90 - Un coefficient de friction supérieur et des performances accrues pour pilotage rapide sur route.









Calidad Estándar - Aprobación CEE R90 con prestaciones similares a las pastillas originales.
Calidad Mejorada - Aprobación CEE R90 pero con un coeficiente de fricción más elevado y prestaciones mejoradas para un uso deportivo en carretera.

BRAKE PADS & SHOES - APPLICATIONS

Bremsbeläge / Plaquettes + Bremsbacken / Machoires









EBC

BRAKES

Make/Model/Engine Hersteller/Modell/Motor Modèles	Year Jahr Années	Pads  Front / Vorn / Avant		Shoes	Pads  Rear / Hinten / Arrière		Shoes
		Original Quality ECE R90* Approved 	Upgrade Quality Tuning/Sportbeläge ECE R90* Approved 	Bremsbacken Machoires 	Original Quality ECE R90* Approved 	Upgrade Quality Tuning/Sportbeläge ECE R90* Approved 	Bremsbacken Machoires 
TALBOT Contd.							
INC (Chrysler, Hillman, Humber, Matra, Singer, Simca, Sunbeam)							
Alpine							
1.3	75-77	DP 220/4(T)	DP 2220				5212A(G)
1.3	75-77	DP 269(B)					5072(B)
1.3	78-80	DP 220/4(T)	DP 2220				5212(G)
1.3	75-80	DP 417(B)	DP 2317				5072(B)
1.3	75-80	DP 417(B)	DP 2317				6341(T)
1.3	80-84	DP 385(B)					5072(B)
1.3	80-84	DP 384(T)					6341(T)
1.5	75-80	DP 417(B)	DP 2317				5072(B)
1.5	75-80	DP 417(B)	DP 2317				6341(T)
1.5	75-77	DP 220/4(T)	DP 2220				5212A(G)
1.5	75-77	DP 269(B)					5072(B)
1.5	78-80	DP 220/4(T)	DP 2220				5212(G)
1.5	80-84	DP 385(B)					5072(B)
1.5	80-84	DP 384(T)					6341(T)
1.6	80-84	DP 385(B)					5072(B)
1.6	80-84	DP 384(T)					6341(T)
Avenger							
1.3	79-82	DP 353	DP 2106				5112
1.6	79-82	DP 353	DP 2106				5112
Horizon							
1.1	78-81	DP 292(G)					5212A(G)
1.1	78-85	DP 332(B)					5072(B)
1.1	78-85	DP 295(T)	DP 2104				6341(T)
1.1	81-85	DP 428(G)					5212A(G)
1.3	78-81	DP 292(G)					5212A(G)
1.3	78-85	DP 332(B)					5072(B)
1.3	78-85	DP 295(T)	DP 2104				6341(T)
1.3	81-85	DP 428(G)					5212A(G)
1.5	81-85	DP 428(G)					5212A(G)
1.5	81-85	DP 332(B)					5072(B)
1.6	81-85	DP 428(G)					5212A(G)
1.6	81-85	DP 332(B)					5072(B)
1.9 D	82-85	DP 428(G)					5212A(G)
Samba							
1.0	82-86	DP 269(B)					6306(B)
1.0	82-86	DP 220/3(T)	DP 2220				5243(G)
1.1	82-86	DP 269(B)					6306(B)
1.1	82-86	DP 220/3(T)	DP 2220				5243(G)
1.4	82-86	DP 269(B)					6306(B)
1.4	82-86	DP 220/3(T)	DP 2220				5243(G)
Solara							
1.3	79-80	DP 220/4(T)	DP 2220				6341(T)
1.3	79-80	DP 417(B)	DP 2317				5072(B)
1.3	79-80	DP 220/4(T)	DP 2220				5212A(G)
1.3	80-82	DP 384(T)					6341(T)
1.3	80-82	DP 385(B)					5072(B)
1.3	80-82	DP 384(T)					5212A(G)
1.6	79-80	DP 220/4(T)	DP 2220				6341(T)
1.6	79-80	DP 417(B)	DP 2317				5072(B)
1.6	79-80	DP 220/4(T)	DP 2220				5212A(G)
1.6	80-86	DP 384(T)					6341(T)
1.6	80-86	DP 385(B)					5072(B)
1.6	80-86	DP 384(T)					5212A(G)

Standard Quality - ECE R90 Approved with similar performance to original equipment brake pads.
 Upgrade Quality (Tuning/ Sportbeläge) - ECE R90 Approved but with higher friction and improved performance for faster street use.
 Verbesserte Qualität - mit ECE R90 Freigabe aber mit höherem Reibwert und verbesserter Bremsleistung für den schnellen Strasseninsatz.
 Standard Qualität - mit ECE R90 Freigabe und ähnlicher Bremsleistung wie die Original Bremsbeläge.
 Qualité standard - Approuvée par la norme ECE R90 - Des performances équivalentes à l'origine.
 Qualité améliorée - Approuvée par la norme ECE R90 - Un coefficient de friction supérieur et des performances accrues pour pilotage rapide sur route.
 Calidad Estándar - Aprobación CEE R90 con prestaciones similares a las pastillas originales.
 Calidad Mejorada - Aprobación CEE R90 pero con un coeficiente de fricción más elevado y prestaciones mejoradas para un uso deportivo en carretera.

*Every EBC pad and shoe requiring ECE R-90 is available with approval subject to stock rotation - check box end label.
 Models listed by Engine Size. Only listed by trim level where pads differ, (16v, GL, GT, etc).

Make/Model/Engine Hersteller/Modell/Motor Modelos	Year Jahr Années	Pads  Front / Vorn / Avant		Shoes	Pads  Rear / Hinten / Arrière		Shoes
		Original Quality ECE R90* Approved 	Upgrade Quality Tuning/Sportbeläge ECE R90* Approved 	Bremsbacken Machoires 	Original Quality ECE R90* Approved 	Upgrade Quality Tuning/Sportbeläge ECE R90* Approved 	Bremsbacken Machoires 
TALBOT Contd.							
INC (Chrysler, Hillman, Humber, Matra, Singer, Simca, Sunbeam)							
Sunbeam							
0.9	79-81	DP 353	DP 2106				5112
1.3	79-81	DP 353	DP 2106				5112
1.6	79-81	DP 353	DP 2106				5112
Sunbeam Lotus							
2.2	80-83	DP 429	DP 2291				5112
Tagora							
2.2	81-84	DP 239(T)			DP 163		6248
2.2	81-84	DP 546(B)			DP 163		5270
2.2	81-84	DP 546(B)			DP 163		5072
2.7	81-84	DP 239(T)			DP 163		6248
2.7	81-84	DP 546(B)			DP 163		5270
2.7	81-84	DP 546(B)			DP 163		5072

Pad Illustrations for Talbot

 103 76 x 70 x 15mm	 104 61 x 56 x 15mm	 105 56 x 53 x 15mm	 106 63 x 63 x 14mm
 107 88 x 64 x 15mm	 114 63 x 55 x 14mm	 123/2 78 x 64 x 15mm	 123/3 78 x 65 x 15mm
 146 76 x 70 x 15mm	 147 97 x 42 x 15mm	 161 88 x 64 x 15mm	 163 68 x 55 x 16mm
 189 108 x 49 x 14mm	 220/3 77 x 58 x 15mm	 220/4 76 x 58 x 15mm	 239 89 x 70 x 18mm
 269 108 x 49 x 15mm	 292 63 x 55 x 14mm	 295 61 x 56 x 15mm	 332 84 x 55 x 15mm

Standard Quality - ECE R90 Approved with similar performance to original equipment brake pads.
Upgrade Quality (Tuning / Sportbeläge) - ECE R90 Approved but with higher friction and improved performance for faster street use.

Standard Qualität - mit ECE R90 Freigabe und ähnlicher Bremsleistung wie die Original Bremsbeläge.
Verbesserte Qualität - mit ECE R90 Freigabe aber mit höherem Reibwert und verbesserter Bremsleistung für den schnellen Strasseninsatz.

Qualité standard - Approuvée par la norme ECE R90 - Des performances équivalentes à l'origine.
Qualité améliorée - Approuvée par la norme ECE R90 - Un coefficient de friction supérieur et des performances accrues pour pilotage rapide sur route.

Standard Quality - ECE R90 Approved with similar performance to original equipment brake pads.
Upgrade Quality (Tuning / Sportbeläge) - ECE R90 Approved but with higher friction and improved performance for faster street use.

Standard Qualität - mit ECE R90 Freigabe und ähnlicher Bremsleistung wie die Original Bremsbeläge.
Verbesserte Qualität - mit ECE R90 Freigabe aber mit höherem Reibwert und verbesserter Bremsleistung für den schnellen Strasseninsatz.

Qualité standard - Approuvée par la norme ECE R90 - Des performances équivalentes à l'origine.
Qualité améliorée - Approuvée par la norme ECE R90 - Un coefficient de friction supérieur et des performances accrues pour pilotage rapide sur route.

*Every EBC pad and shoe requiring ECE R-90 is available with approval subject to stock rotation - check box end label.

Models listed by Engine Size. Only listed by trim level where pads differ, (16v, GL, GT, etc).

BRAKE PADS & SHOES - APPLICATIONS

Bremsbeläge / Plaquettes + Bremsbacken / Machoires

EBC
BRAKES

Make/Model/Engine	Year	Pads	Front / Vorn / Avant	Shoes	Pads	Rear / Hinten / Arrière	Shoes
Hersteller/Modell/Motor	Jahr	Plaquettes / Bremsbeläge		Bremsbacken Machoirs	Plaquettes / Bremsbeläge		Bremsbacken Machoirs
Modelos	Années	Original Quality ECE R90* Approved	Upgrade Quality Tuning/Sportbeläge ECE R90* Approved	Original Quality ECE R90* Approved	Upgrade Quality Tuning/Sportbeläge ECE R90* Approved	Original Quality ECE R90* Approved	Upgrade Quality Tuning/Sportbeläge ECE R90* Approved

Pad Illustrations for Talbot

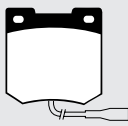
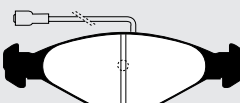
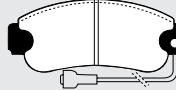
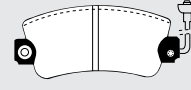
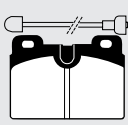
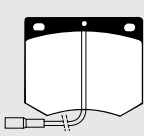
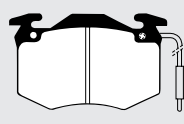
353  63 x 63 x 14mm	384  158 x 51 x 17mm	385  115 x 49 x 17mm	417  108 x 49 x 15mm
428  76 x 56 x 16mm	429  78 x 66 x 15mm	546  105 x 65 x 18mm	

TALBOT COMMERCIAL					
Dodge					
1100 Van	76-81	DP 104			5046
Express					
1.8	81-94	DP 425			6322
2.0	81-94	DP 425			6322
2.0 (1.8 Ton)	81-94	DP 735			6322
1.9 D	81-94	DP 425			6322
2.5 D	81-94	DP 425			6322
2.5 D (1.8 Ton)	81-94	DP 735			6322
2.5 TD (1.8 Ton)	81-94	DP 735			6322

Pad Illustrations for Talbot Commercial

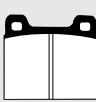
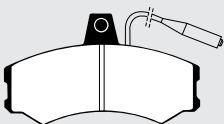
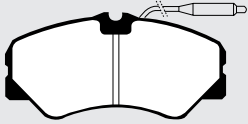
104  61 x 56 x 15mm	425  130 x 74 x 19mm	735  145 x 71 x 19mm
--	---	--

TATA					
Gurkha					
1.9 D	95-	DP 643	DP 2643		
2.0 TD	98-	DP 643	DP 2643		
Loadbeta					
2.0 D	94-	DP 643	DP 2643		
Safari					
2.0 TD	2000-	DP 643	DP 2643		

*Every EBC pad and shoe requiring ECE R-90 is available with approval subject to stock rotation - check box end label.
Models listed by Engine Size. Only listed by trim level where pads differ, (16v, GL, GT, etc).

Standard Quality - ECE R90 Approved with similar performance to original equipment brake pads.
Upgrade Quality (Tuning / Sportbeläge) - ECE R90 Approved but with higher friction and improved performance for faster street use.
Verbesserte Qualität - mit ECE R90 Freigabe aber mit höherem Reibwert und verbesserter Bremsleistung für den schnellen Strasseninsatz.

Qualité standard - Approuvée par la norme ECE R90 - Des performances équivalentes à l'origine.
Qualité améliorée - Approuvée par la norme ECE R90 - Un coefficient de friction supérieur et des performances accrues pour pilotage rapide sur route.
Calidad Mejorada - Aprobación CEE R90 pero con un coeficiente de fricción más elevado y prestaciones mejoradas para un uso deportivo en carretera.

Make/Model/Engine	Year	Pads	Front / Vorn / Avant	Shoes	Pads	Rear / Hinten / Arrière	Shoes
Hersteller/Modell/Motor	Jahr	Plaquettes / Bremsbeläge		Bremsbacken Machoires	Plaquettes / Bremsbeläge		Bremsbacken Machoires
Modelos	Années	Original Quality ECE R90* Approved	Upgrade Quality Tuning/Sportbeläge ECE R90* Approved	Original Quality ECE R90* Approved	Upgrade Quality Tuning/Sportbeläge ECE R90* Approved	Original Quality ECE R90* Approved	Upgrade Quality Tuning/Sportbeläge ECE R90* Approved

Pad Illustrations for Tata

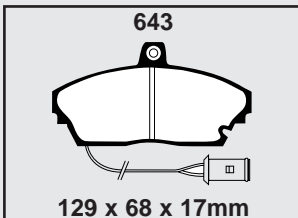

TATRA

613

3.5	68-	DP 634			DP 288
-----	-----	--------	--	--	--------

613/5

3.5	93-	DP 282	DP 2753		DP 288
-----	-----	--------	---------	--	--------

Pad Illustrations for Tatra

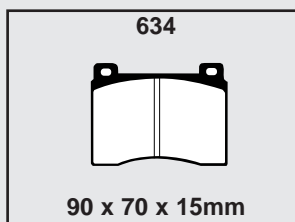
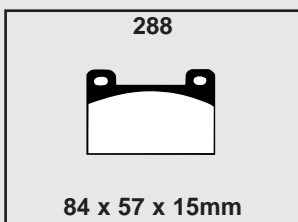
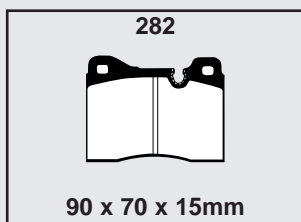

TAXI

Fairway Driver	92-96	DP 814	DP 2814		6382
Fairway Driver	96-	DP 622	DP 2241		6382
FX4 (Disc Conv.)	88-92	DP 1028	DP 2108		
Metrocab	91-	DP 814	DP 2814		6382
TXI	96-	DP 622	DP 2241		6382

Pad Illustrations for Taxi

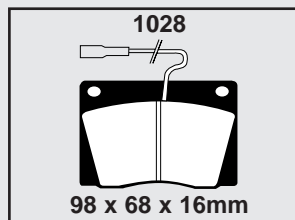
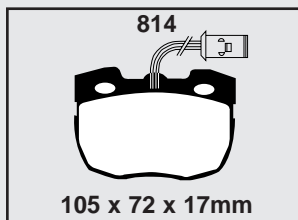
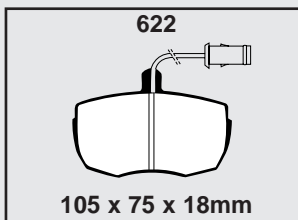

TIGER

Super Six

89-	DP 366	DP 2366
-----	--------	---------

Cat

95-	DP 438	DP 2438
95-	DP 415	DP 2415
95-	DP 473	DP 2473

Qualité standard - Approuvée par la norme ECE R90 - Des performances équivalentes à l'origine.
Qualité améliorée - Approuvée par la norme ECE R90 - Un coefficient de friction supérieur et des performances accrues pour pilotage rapide sur route.
Calidad Estándar - Aprobación CEE R90 con prestaciones similares a las pastillas originales.
Calidad Mejorada - Aprobación CEE R90 pero con un coeficiente de fricción más elevado y prestaciones mejoradas para un uso deportivo en carretera.

Standard Quality - ECE R90 Approved with similar performance to original equipment brake pads.
Upgrade Quality (Tuning / Sportbeläge) - ECE R90 Approved but with higher friction and improved performance for faster street use.
Standard Qualität - mit ECE R90 Freigabe und ähnlicher Bremsleistung wie die Original Bremsbeläge.
Verbesserte Qualität - mit ECE R90 Freigabe aber mit höherem Reibwert und verbesserter Bremsleistung für den schnellen Strasseninsatz.

BRAKE PADS & SHOES - APPLICATIONS

Bremsbeläge / Plaquettes + Bremsbacken / Machoires

EBC

BRAKES

Make/Model/Engine	Year	Pads	Front / Vorn / Avant	Shoes	Pads	Rear / Hinten / Arrière	Shoes
Hersteller/Modell/Motor	Jahr	Plaquettes / Bremsbeläge		Bremsbacken	Plaquettes / Bremsbeläge		Bremsbacken
Modelos	Années	Original Quality ECE R90* Approved	Upgrade Quality Tuning/Sportbeläge ECE R90* Approved	Machoires ECE R90* Approved	Original Quality ECE R90* Approved	Upgrade Quality Tuning/Sportbeläge ECE R90* Approved	Machoires ECE R90* Approved

Pad Illustrations for Tiger

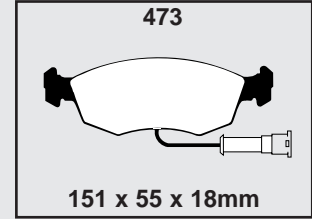
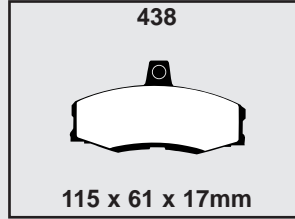
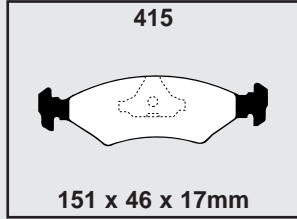
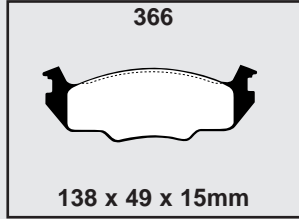

TOYOTA						
1000						
1.0	70-76	DP 195				5170
1.0	77-78	DP 329				5170
4 Runner						
3.0	93-95	DP 991	DP 6807			6473
3.0	93-95	DP 807	DP 6807			6473
3.0 TD	93-	DP 807	DP 6807			6473
Avensis						
1.6	98-2002	DP 1171				6562
1.6	2002-	DP 1421		DP 1422		6562
1.8	98-2002	DP 1171				6562
1.8	2002-	DP 1421		DP 1422		6562
2.0	98-2002	DP 1171				6562
2.0	2002-	DP 1421		DP 1422		6562
2.0 TD	98-2002	DP 1171				6562
2.0 TD	2002-	DP 1421		DP 1422		6562
Avensis Verso						
2.0	2001-	DP 1455		DP 1401		6604
2.0 TD	2001-	DP 1455		DP 1401		6604
Handbrake Shoes	2001-					6604
Camry						
1.8 (SV10R)	82-87	DP 453	DP 2453			6331
2.0i (SV11R)	84-87	DP 453	DP 2453			6331
2.0 GLi Sal (SV21R)	87-92	DP 725	DP 2725			6331
2.0 GLi Est (SV21R)	87-92	DP 725	DP 2725			6427
2.0 GLi Est EX (SV21R)	87-92	DP 847		DP 628		6427
2.0 4WD (SV25R)	87-90	DP 847		DP 628		6427
2.2 (SVX10R)	91-96	DP 964	DP 2964	DP 628	DP 2628	6427
2.2 (SVX20R)	96-2001	DP 964	DP 2964	DP 628	DP 2628	6427
2.4	2001-	DP 1642	DP 21642	DP 1456		6427
2.5 V6 (VZV21R)	88-92	DP 725	DP 2725	DP 628	DP 2628	6427
2.5 V6 (ABS) (VZV21R)	88-92	DP 847		DP 628	DP 2628	6427
3.0 V6 (VCV10R)	92-96	DP 874	DP 2874	DP 628	DP 2628	6427
3.0 (MCV20R)	96-2001	DP 1133	DP 21133	DP 628	DP 2628	6427
3.0 (MCV30)	2001-	DP 1642	DP 21642	DP 1456		6427
1.8 TD (CV10R)	84-86	DP 453	DP 2453			6331
2.0 TD (CV11R)	85-87	DP 453	DP 2453			6331
2.0 TD (CV20R)	87-88	DP 725	DP 2725			6331
Handbrake Shoes	87-92					6609
Carina						
1.6 (TA 10, TA 12)	70-77	DP 314				5169
1.6 (TA 40)	77-81	DP 323				5169
1.6 (TA60)	81-83	DP 532				5169
1.6 (AT151)	84-88	DP 453	DP 2453			6331
1.6 (AT171)	88-92	DP 453	DP 2453			6331
1.8 (TA47)	77-81	DP 323				5169

*Every EBC pad and shoe requiring ECE R-90 is available with approval subject to stock rotation - check box end label.
Models listed by Engine Size. Only listed by trim level where pads differ, (16v, GL, GT, etc).









Standard Quality - ECE R90 Approved with similar performance to original equipment brake pads.
Upgrade Quality (Tuning/ Sportbeläge) - ECE R90 Approved but with higher friction and improved performance for faster street use.
Verbesserte Qualität - mit ECE R90 Freigabe aber mit höherem Reibwert und verbesserter Bremsleistung für den schnellen Strasseninsatz.
Standard Qualität - mit ECE R90 Freigabe und ähnlicher Bremsleistung wie die Original Bremsbeläge.
Qualité standard - Approuvée par la norme ECE R90 - Des performances équivalentes à l'origine.
Qualité améliorée - Approuvée par la norme ECE R90 - Un coefficient de friction supérieur et des performances accrues pour pilotage rapide sur route.
Calidad Estándar - Aprobación CEE R90 con prestaciones similares a las pastillas originales.
Calidad Mejorada - Aprobación CEE R90 pero con un coeficiente de fricción más elevado y prestaciones mejoradas para un uso deportivo en carretera.

Qualité standard - Approuvée par la norme ECE R90 - Des performances équivalentes à l'origine.
Qualité améliorée - Approuvée par la norme ECE R90 - Un coefficient de friction supérieur et des performances accrues pour pilotage rapide sur route.

Calidad Estándar - Aprobación CEE R90 con prestaciones similares a las pastillas originales.
Calidad Mejorada - Aprobación CEE R90 pero con un coeficiente de fricción más elevado y prestaciones mejoradas para un uso deportivo en carretera.

Standard Quality - ECE R90 Approved with similar performance to original equipment brake pads.
Upgrade Quality (Tuning / Sportbeläge) - ECE R90 Approved but with higher friction and improved performance for faster street use.

Standard Qualität - mit ECE R90 Freigabe und ähnlicher Bremsleistung wie die Original Bremsbeläge.
Verbesserte Qualität - mit ECE R90 Freigabe aber mit höherem Reibwert und verbesserter Bremsleistung für den schnellen Strasseninsatz.

Make/Model/Engine	Year	Pads  Front / Vorn / Avant		Shoes	Pads  Rear / Hinten / Arrière		Shoes
		Original Quality ECE R90* Approved 	Upgrade Quality Tuning/Sportbeläge ECE R90* Approved 	Bremsbacken Machoires 	Original Quality ECE R90* Approved 	Upgrade Quality Tuning/Sportbeläge ECE R90* Approved 	Bremsbacken Machoires 
TOYOTA Contd.							
Carina Contd.							
1.8 (TA62)	81-83	DP 532					5169
2.0 GLi (ST171)	88-92	DP 453	DP 2453				6331
2.0 GLi Exec (ST171)	88-92	DP 725	DP 2725		DP 628	DP 2628	
2.0 D (CT150)	84-88	DP 453	DP 2453				6331
2.0 D (CT170)	88-92	DP 453	DP 2453				6331
Handbrake Shoes	88-92						6609
Carina E							
1.6 (AT190)	92-96	DP 964	DP 2964		DP 628	DP 2628	6331
1.6 (AT190)	95-98	DP 964	DP 2964		DP 628	DP 2628	6599
1.8 (AT191)	95-96	DP 964	DP 2964		DP 628	DP 2628	6331
1.8 (AT191)	95-98	DP 964	DP 2964		DP 628	DP 2628	6599
2.0 (ST191)	92-96	DP 964	DP 2964		DP 628	DP 2628	6331
2.0 (ST191)	95-98	DP 964	DP 2964		DP 628	DP 2628	6599
2.0 GTi (ST191)	92-98	DP 995	DP 2995		DP 628	DP 2628	
2.0 D (CT190)	92-96	DP 964	DP 2964				6331
2.0 D (CT190)	95-98	DP 964	DP 2964				6599
2.0 TD	96-98	DP 964	DP 2964		DP 628	DP 2628	
Celica							
1.6 (TA22) (TA40)	70-81	DP 314					5169
1.6 (TA40B)	77-82	DP 323					5169
1.6 (TA60)	82-89	DP 402					5169
1.8 (AT200)	95-99	DP 964	DP 2964		DP 608/2		
1.8 (140)	99-	DP 1295	DP 21295		DP 1326	DP 21326	
1.8 (190)	2000-	DP 1325	DP 21325		DP 1326	DP 21326	
2.0 (RA28)	70-77	DP 289					5169
2.0 (RA40)	77-82	DP 320					5169
2.0 (RA60)	82-86	DP 456	DP 2456		DP 469		5169
2.0 (RA61)	82-86	DP 456	DP 2456				6427
2.0 XT (RA61)	82-86	DP 456	DP 2456		DP 376		
2.0 (RA63)	82-86	DP 456	DP 2456		DP 457		
2.0 GT (ST162)	85-88	DP 453	DP 2453		DP 628	DP 2628	
2.0 GT (ST162 ST182)	88-93	DP 725	DP 2725		DP 628	DP 2628	
2.0 GTi Cabriolet	88-90	DP 847			DP 628		
2.0 GT (ST202)	93-99	DP 874	DP 2874		DP 628	DP 2628	
2.0 GT4 (ST165)	88-90	DP 847			DP 628		
2.0 GT4 (ST185)	90-94	DP 725	DP 2725		DP 628	DP 2628	
2.0 GT4 (ST205)	94-99	DP 21004	DP 31004		DP 21005	DP 31005	
Handbrake Shoes (ST162)	88-89						6609
Corolla							
1.1	66-70	DP 144		5166			5167
1.2 (KE20)	70-74	DP 314					5170
1.2 (KE25)	70-71	DP 314					5170
1.2 (KE25)	72-74	DP 166					5170
1.2 (KE30, 35, 36)	74-80	DP 166					5170
1.3 GL (KE70)	80-83	DP 196					5170
1.3 GL & GL Estate (AE80) (EE80)	83-87	DP 453	DP 2453				6399
1.3 DX Estate (KE70)	80-83	DP 196					5170
1.3 DX Estate (KE70)	83-86	DP 532					5170
1.3 (EE90)	87-92	DP 453	DP 2453				6399
1.3 (EE101)	92-97	DP 964	DP 2964				6399
1.3 (EE111)	97-2000	DP 1431	DP 21431				6399
1.4 (TE25)	70-74	DP 314					5169
1.4 (ZZE111)	99-2002	DP 1431	DP 21431		DP 629	DP 2629	6399
1.4 (ZZE120)	2002-	DP 1457	DP 21457		DP 1458	DP 21458	
1.6 (TE27, 28)	70-76	DP 314					5169
1.6 (TE51)	77-80	DP 323					5169
1.6 (TE71)	80-81	DP 196					5169
1.6 Coupe (TE71)	80-83	DP 196					5169

*Every EBC pad and shoe requiring ECE R-90 is available with approval subject to stock rotation - check box end label.

Models listed by Engine Size. Only listed by trim level where pads differ, (16v, GL, GT, etc).

BRAKE PADS & SHOES - APPLICATIONS

Bremsbeläge / Plaquettes + Bremsbacken / Machoires



EBC

BRAKES

Make/Model/Engine Hersteller/Modell/Motor Modèles	Year Jahr Années	Pads Front / Vorn / Avant Plaquettes / Bremsbeläge		Shoes Bremsbacken Machoirs	Pads Rear / Hinten / Arrière Plaquettes / Bremsbeläge		Shoes Bremsbacken Machoirs
		Original Quality ECE R90* Approved	Upgrade Quality Tuning/Sportbeläge ECE R90* Approved	ECE R90* Approved	Original Quality ECE R90* Approved	Upgrade Quality Tuning/Sportbeläge ECE R90* Approved	ECE R90* Approved
TOYOTA Contd.							
Corolla Contd.							
1.6 Coupe (AE86)	84-87	DP 532			DP 392		
1.6 GT (FWD) (AE82)	84-87	DP 453	DP 2453		DP 629	DP 2629	
1.6 GTi 16v (FWD) (AE92)	87-92	DP 453	DP 2453		DP 629	DP 2629	
1.6 4WD Est (AE95)	87-92	DP 453	DP 2453				6464
1.6 GTi (RWD) (AE92)	87-92	DP 453	DP 2453		DP 629	DP 2629	
1.6 Executive & GL (AE92)	87-92	DP 453	DP 2453				6399
1.6 (AE101)	92-97	DP 964	DP 2964				6399
1.6 (AE111)	97-2000	DP 1431	DP 21431				6399
1.6 (ZZE112)	99-2002	DP 1431	DP 21431				6399
1.6 (ZZE121)	2002-	DP 1457	DP 21457		DP 1458	DP 21458	
1.8 (AE102)	93-97	DP 964	DP 2964		DP 629	DP 2629	
1.8 Turbo (ZZE123)	2002-	DP 1457	DP 21457		DP 1458	DP 21458	
2.0 D (CE100)	93-97	DP 964	DP 2964				6399
2.0 D (CE110)	97-2002	DP 1431	DP 21431				6399
2.0 D (89)	2002-	DP 1457	DP 21457		DP 1458	DP 21458	
2.0 D (109)	2002-	DP 1457	DP 21457		DP 1458	DP 21458	
Corolla Verso							
1.6	2002-	DP 1459	DP 21459		DP 1326	DP 21326	
1.8	2002-	DP 1325	DP 21325		DP 1326	DP 21326	
2.0 D (89)	2002-	DP 1325	DP 21325		DP 1326	DP 21326	
Corona							
1.5	67-70	DP 138					5168
1.6 (RT40,60,70)	70-71	DP 138					5169
1.6	82-83	DP 469					5169
1.6	83-85	DP 453	DP 2453				6331
1.8 (TT132)	78-81	DP 273					5169
1.8	82-83	DP 469					5169
1.8	83-85	DP 453	DP 2453				6331
2.0 (RT40,60,70)	70-71	DP 138					5169
2.0 (RX12, 28)	73-75	DP 273					5169
2.0 (RT104, 118)	74-78	DP 273					5169
Cressida							
2.0 (RX30)	77-81	DP 273					5169
2.0 (RX35)	77-81	DP 273					5169
2.0 (RX60)	81-83	DP 419					5169
2.8 (MX72/3)	84-86	DP 419					5169
2.8 (MX72/3)	86-88	DP 453	DP 2453		DP 608/2		
2.2 D (LX60)	81-85	DP 419					5169
Crown							
2.6	71-75	DP 273	DP 2273				6310
2.6	75-78	DP 273	DP 2273		DP 376		6263
2.6	78-79	DP 352	DP 2352		DP 376		6263
2.8	79-84	DP 352	DP 2352		DP 376		6263
2.8	83-87	DP 610	DP 2610		DP 608/2		
Landcruiser							
3.4 (VZJ95R)	96-2002	DP 992	DP 6992		DP 993	DP 6993	
4.0	2003-						
4.2 (FJ45) (FJ55)	77-81			6272			6272
4.5 (FZJ80R)	95-98	DP 992	DP 6992		DP 993	DP 6993	
4.7 (UZJ)	98-	DP 1319	DP 61319		DP 1282	DP 61282	
2.4 TD (LJ70)	88-90	DP 380					5175
2.4 TD (LJ70)	90-93	DP 994					5175
3.0 TD (KZJ)	93-96	DP 994			DP 993		
3.0 TD	96-97	DP 807	DP 6807		DP 993	DP 6993	
3.0 TD	2003-						
4.0 D 4WD (HJ60)	81-91	DP 380					6362

*Every EBC pad and shoe requiring ECE R-90 is available with approval subject to stock rotation - check box end label.
Models listed by Engine Size. Only listed by trim level where pads differ, (16v, GL, GT, etc).

Standard Quality - ECE R90 Approved with similar performance to original equipment brake pads.
Upgrade Quality (Tuning/Sportbeläge) - ECE R90 Approved but with higher friction and improved performance for faster street use.
Verbesserte Qualität - mit ECE R90 Freigabe aber mit höherem Reibwert und verbesserter Bremsleistung für den schnellen Strasseninsatz.
Standard Qualität - mit ECE R90 Freigabe und ähnlicher Bremsleistung wie die Original Bremsbeläge.
Qualité standard - Approuvée par la norme ECE R90 - Des performances équivalentes à l'origine.
Qualité améliorée - Approuvée par la norme ECE R90 - Un coefficient de friction supérieur et des performances accrues pour pilotage rapide sur route.
Calidad Estándar - Aprobación CEE R90 con prestaciones similares a las pastillas originales.
Calidad Mejorada - Aprobación CEE R90 pero con un coeficiente de fricción más elevado y prestaciones mejoradas para un uso deportivo en carretera.

Make/Model/Engine Hersteller/Modell/Motor Modelos	Year Jahr Années	Pads  Front / Vorn / Avant		Shoes	Pads  Rear / Hinten / Arrière		Shoes
		Original Quality ECE R90* Approved	Upgrade Quality Tuning/Sportbeläge ECE R90* Approved	Bremsbacken Machoires ECE R90* Approved	Original Quality ECE R90* Approved	Upgrade Quality Tuning/Sportbeläge ECE R90* Approved	Bremsbacken Machoires ECE R90* Approved
TOYOTA Contd.							
Landcruiser Contd.							
4.2 TD (HDJ)	90-98	DP 992	DP 6992		DP 993	DP 6993	
4.2 TD (HDJ10)	98-	DP 1319	DP 61319		DP 1282	DP 61282	
Handbrake shoes	80-						6400
MR2							
1.6 (AW11)	84-90	DP 453	DP 2453		DP 602		
1.8	2000-	DP 1295	DP 21295		DP 1107		
2.0 (SW20)	90-92	DP 936	DP 2936		DP 1107		
2.0 (SW20)	92-2000	DP 995	DP 2995		DP 1107		
Paseo							
1.5	96-97	DP 453	DP 2453				6530
1.5	96-99	DP 964	DP 2964				6530
Picnic							
2.0	96-2001	DP 964	DP 2964				6563
2.2 TD	97-2001	DP 964	DP 2964				6563
Previa							
2.4	90-93	DP 876					5175
2.4	90-97	DP 876			DP 878		
2.4 (ABS)	90-97	DP 877	DP 2456		DP 878		
2.4	97-2000	DP 1204			DP 878		
2.4	2001-2002	DP 1399			DP 1401		
2.4	2002-	DP 1420			DP 1401		
2.0 TD	2001-2002	DP 1399			DP 1401		
2.0 TD	2002-	DP 1420			DP 1401		
Prius							
1.5	2000-	DP 1295	DP 21295		DP 1326	DP 21326	
Rav 4							
1.8	2000-	DP 1402			DP 1403		
2.0	93-2000	DP 964	DP 6964				6518
2.0	2000-	DP 1402			DP 1403		
2.0 D	2001-	DP 1402			DP 1403		
Space Cruiser							
1.8 (YR20)	83-85	DP 536					6263
2.0 (YR21)	84-90	DP 743					6263
Starlet							
1.0 (KP 60)	78-85	DP 322					5275
1.0 (EP 70, 71)	84-88	DP 638					6405
1.0 (EP 70, 71)	88-90	DP 879					6405
1.0 (EP80)	90-93	DP 879					6530
1.2 (KP 62)	78-85	DP 322					5275
1.3 (KP61)	82-83	DP 322					5275
1.3 (EP80)	90-93	DP 879					6530
1.3 (EP81)	93-96	DP 879					6530
1.3 Turbo (EP82)		DP 453	DP 2453				
1.3 (EP91)	96-99	DP 453	DP 2453				6530
1.3 (EP91) (ABS)	96-99	DP 964	DP 2964				6530
Supra							
2.8	81-84	DP 456	DP 2456		DP 457		
2.8	84-86	DP 877	DP 2456		DP 457		
3.0	86-93	DP 610	DP 2610		DP 608/2		
3.0 Turbo	89-93	DP 2610	DP 3610		DP 608/2		
3.0 Twin Turbo	93-96	DP 21004	DP 31004		DP 21005	DP 31005	

Standard Quality - ECE R90 Approved with similar performance to original equipment brake pads.
Upgrade Quality (Tuning / Sportbeläge) - ECE R90 Approved but with higher friction and improved performance for faster street use.

Calidad Estandar - Aprobacion CEE R90 con prestaciones similares a las pastillas originales.
Calidad Mejorada - Aprobacion CEE R90 pero con un coeficiente de friccion mas elevado y prestaciones mejoradas para un uso deportivo en carretera.

Standard Qualität - mit ECE R90 Freigabe und ähnlicher Bremsleistung wie die Original Bremsbeläge.
Verbesserte Qualität - mit ECE R90 Freigabe aber mit höherem Reibwert und verbesserter Bremsleistung für den schnellen Strasseninsatz.

*Every EBC pad and shoe requiring ECE R-90 is available with approval subject to stock rotation - check box end label.









Models listed by Engine Size. Only listed by trim level where pads differ, (16v, GL, GT, etc).

BRAKE PADS & SHOES - APPLICATIONS









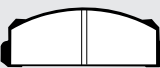

Bremsbeläge / Plaquettes + Bremsbacken / Machoires

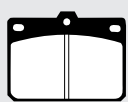
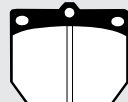
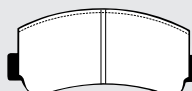
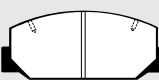
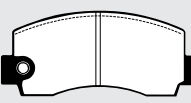
EBC

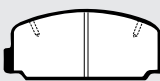
BRAKES

Make/Model/Engine Hersteller/Modell/Motor Modèles	Year Jahr Années	Pads  Front / Vorn / Avant		Shoes	Pads  Rear / Hinten / Arrière		Shoes
		Original Quality ECE R90* Approved 	Upgrade Quality Tuning/Sportbeläge ECE R90* Approved 	Bremsbacken Machoirs 	Original Quality ECE R90* Approved 	Upgrade Quality Tuning/Sportbeläge ECE R90* Approved 	Bremsbacken Machoirs 
TOYOTA Contd.							
Tercel							
1.3	80-82	DP 322					5274
1.3	82-85	DP 453	DP 2453				6377
1.5 4WD Est	82-89	DP 453	DP 2453				5275
Yaris							
1.0	99-2001	DP 1225	DP 21225				6566
1.0 (ABS)	2001-	DP 1446	DP 21446				6614
1.0 (ABS)	99-	DP 1295	DP 21295		DP 1326	DP 21326	
1.3	99-	DP 1295	DP 21295		DP 1326	DP 21326	
1.5	2001-	DP 1295	DP 21295		DP 1326	DP 21326	
1.4 D	2002-	DP 1295	DP 21295		DP 1326	DP 21326	
Yaris Verso							
1.3	99-	DP 1295	DP 21295		DP 1326	DP 21326	6566
1.4 D	2002-	DP 1295	DP 21295		DP 1326	DP 21326	

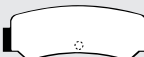
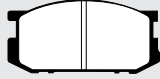

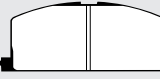
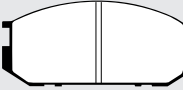



Pad Illustrations for Toyota

138  63 x 68 x 14mm	144  108 x 38 x 14mm	166  78 x 55 x 14mm	195  77 x 61 x 13mm
196  78 x 59 x 14mm	273  77 x 68 x 15mm	289  127 x 56 x 15mm	314  108 x 46 x 14mm
320  128 x 56 x 15mm	322  97 x 44 x 13mm	323  107 x 45 x 14mm	329  79 x 63 x 13mm
352  130 x 54 x 16mm	376  96 x 51 x 15mm	380  107 x 66 x 15mm	392  98 x 36 x 14mm
402  106 x 49 x 14mm	419  116 x 49 x 15mm	453  119 x 46 x 15mm	456  126 x 57 x 16mm











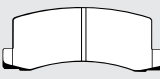

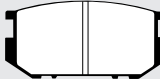

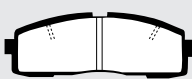



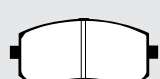

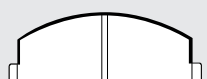
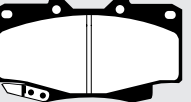
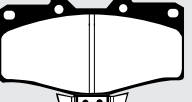
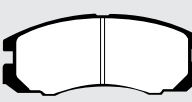
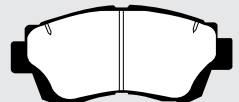
*Every EBC pad and shoe requiring ECE R-90 is available with approval subject to stock rotation - check box end label.
Models listed by Engine Size. Only listed by trim level where pads differ, (16v, GL, GT, etc).

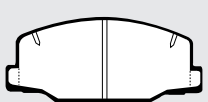
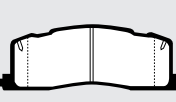
Standard Quality - ECE R90 Approved with similar performance to original equipment brake pads.
Upgrade Quality (Tuning/ Sportbeläge) - ECE R90 Approved but with higher friction and improved performance for faster street use.
Verbesserte Qualität - mit ECE R90 Freigabe aber mit höherem Reibwert und verbesserter Bremsleistung für den schnellen Strasseninsatz.

Qualité standard - Approuvée par la norme ECE R90 - Des performances équivalentes à l'origine.
Qualité améliorée - Approuvée par la norme ECE R90 - Un coefficient de friction supérieur et des performances accrues pour pilotage rapide sur route.
Calidad Mejorada - Aprobación CEE R90 con prestaciones similares a las pastillas originales.
Calidad Mejorada - Aprobación CEE R90 pero con un coeficiente de fricción más elevado y prestaciones mejoradas para un uso deportivo en carretera.

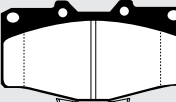
Make/Model/Engine Hersteller/Modell/Motor Modèles	Year Jahr Années	Front / Vorn / Avant Plaquettes / Bremsbeläge Original Quality ECE R90* Approved	Shoes Bremsbacken Machoires ECE R90* Approved	Rear / Hinten / Arrière Plaquettes / Bremsbeläge Original Quality ECE R90* Approved	Shoes Bremsbacken Machoires ECE R90* Approved
		 Upgrade Quality Tuning/Sportbeläge ECE R90* Approved		 Upgrade Quality Tuning/Sportbeläge ECE R90* Approved	

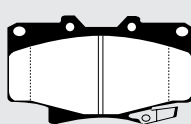
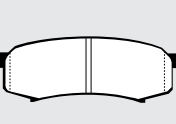
Pad Illustrations for Toyota Contd.

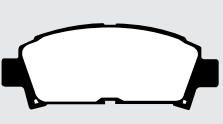
457  107 x 42 x 15mm	469  109 x 47 x 14mm	532  106 x 52 x 14mm	536  129 x 52 x 15mm
602  98 x 47 x 16mm	608/2  125 x 42 x 15mm	610  125 x 56 x 15mm	628  107 x 42 x 15mm
629  107 x 42 x 15mm	638  97 x 44 x 13mm	725  120 x 54 x 15mm	743  128 x 52 x 15mm
807  119 x 64 x 15mm	 119 x 72 x 15mm	847  127 x 53 x 15mm	874  141 x 63 x 17mm
876  137 x 55 x 15mm	877  128 x 55 x 15mm	878  119 x 43 x 15mm	879  106 x 46 x 13mm
936  140 x 52 x 15mm	964  133 x 53 x 18mm	991  119 x 77 x 15mm	 119 x 72 x 15mm
992  119 x 72 x 15mm	993  116 x 44 x 15mm	994  107 x 70 x 15mm	995  141 x 57 x 15mm

Standard Quality - ECE R90 Approved with similar performance to original equipment brake pads.
Upgrade Quality (Tuning / Sportbeläge) - ECE R90 Approved but with higher friction and improved performance for faster street use.

Standard Qualität - mit ECE R90 Freigabe und ähnlicher Bremsleistung wie die Original Bremsbeläge.
Verbesserte Qualität - mit ECE R90 Freigabe aber mit höherem Reibwert und verbesserter Bremsleistung für den schnellen Strasseneinsatz.

Calidad Estándar - Aprobación CEE R90 con prestaciones similares a las pastillas originales.
Calidad Mejorada - Aprobación CEE R90 pero con un coeficiente de fricción más elevado y prestaciones mejoradas para un uso deportivo en carretera.

BRAKE PADS & SHOES - APPLICATIONS

Bremsbeläge / Plaquettes + Bremsbacken / Machoires

EBC

BRAKES

Make/Model/Engine	Year	Front / Vorn / Avant	Shoes	Rear / Hinten / Arrière	Shoes
Hersteller/Modell/Motor	Jahr	Plaquettes / Bremsbeläge	Bremsbacken Machoires	Plaquettes / Bremsbeläge	Bremsbacken Machoires
Modelos	Années	Original Quality ECE R90* Approved	Upgrade Quality Tuning/Sportbeläge ECE R90* Approved	Original Quality ECE R90* Approved	Upgrade Quality Tuning/Sportbeläge ECE R90* Approved



Pad Illustrations for Toyota Contd.

<p>1004</p>  <p>122 x 83 x 18mm</p>	<p>1005</p>  <p>80 x 66 x 16mm</p>	<p>1107</p>  <p>116 x 47 x 15mm</p>	<p>1133</p>  <p>116 x 59 x 17mm</p>
<p>1171</p>  <p>156 x 55 x 18mm</p>	<p>1195</p>  <p>117 x 55 x 17mm</p>	<p>1204</p>  <p>128 x 52 x 15mm</p>	<p>1225</p>  <p>112 x 45 x 16mm</p>
<p>1282</p>  <p>124 x 46 x 17mm</p>	<p>1295</p>  <p>116 x 51 x 16mm</p>	<p>1319</p>  <p>1319</p>	<p>1325</p>  <p>117 x 58 x 17mm</p>
<p>1326</p>  <p>78 x 55 x 14mm</p>	<p>1396</p>  <p>130 x 57 x 19mm</p>	<p>1399</p>  <p>117 x 60 x 17mm</p>	<p>1401</p>  <p>113 x 43 x 16mm</p>
<p>1402</p>  <p>123 x 60 x 17mm</p>		<p>1403</p>  <p>78 x 54 x 14mm</p>	<p>1420</p> <p>Picture unavailable at time of press.</p>
<p>1431</p>  <p>131 x 52 x 18mm</p>	<p>1446</p>  <p>130 x 52 x 17mm</p>		<p>1455</p>  <p>123 x 59 x 17mm</p>
<p>1456</p>  <p>83 x 38 x 15mm</p>	<p>1457</p>  <p>131 x 57 x 17mm</p>	<p>1458</p>  <p>95 x 38 x 15mm</p>	

*Every EBC pad and shoe requiring ECE R-90 is available with approval subject to stock rotation - check box end label. Models listed by Engine Size. Only listed by trim level where pads differ, (16v, GL, GT, etc).

Standard Quality - ECE R90 Approved with similar performance to original equipment brake pads.
 Upgrade Quality (Tuning/ Sportbeläge) - ECE R90 Approved but with higher friction and improved performance for faster street use.
 Verbesserte Qualität - mit ECE R90 Freigabe aber mit höherem Reibwert und verbesserter Bremsleistung für den schnellen Strasseninsatz.

Qualité standard - Approuvée par la norme ECE R90 - Des performances équivalentes à l'origine.
 Qualité améliorée - Approuvée par la norme ECE R90 - Un coefficient de friction supérieur et des performances accrues pour pilotage rapide sur route.
 Calidad Estándar - Aprobación CEE R90 con prestaciones similares a las pastillas originales.
 Calidad Mejorada - Aprobación CEE R90 pero con un coeficiente de fricción más elevado y prestaciones mejoradas para un uso deportivo en carretera.

Make/Model/Engine	Year	Pads	Front / Vorn / Avant	Shoes	Pads	Rear / Hinten / Arrière	Shoes
Hersteller/Modell/Motor	Jahr	Plaquettes / Bremsbeläge		Bremsbacken Machoires	Plaquettes / Bremsbeläge		Bremsbacken Machoires
Modelos	Années	Original Quality ECE R90* Approved		Upgrade Quality Tuning/Sportbeläge ECE R90* Approved		Original Quality ECE R90* Approved	Upgrade Quality Tuning/Sportbeläge ECE R90* Approved

Pad Illustrations for Toyota Contd.

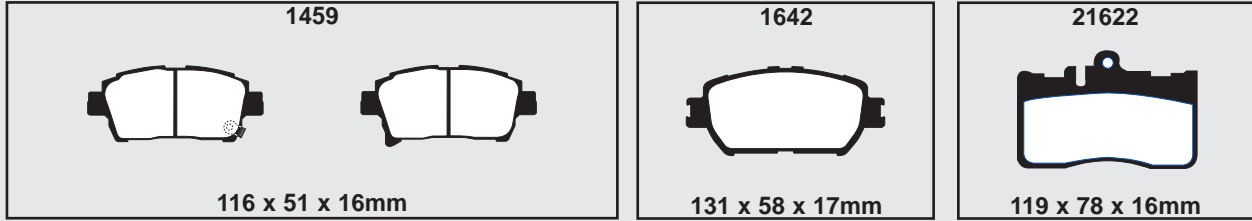

TOYOTA COMMERCIAL				
Hi-Ace				
1.6 (RH11)	67-73		6270	6270
1.6 (RH11)	73-75		6271	6270
1.6 (RH11)	75-77		6266	6304
1.6 (RH11)	77-86	DP 321	6266	6265P
1.6 (RH20)	77-86	DP 321	6266	6265P
1.8 (YH60)	83-84	DP 539		6265P
2.0 (RH32)	78-83	DP 321		6265P
2.0 (YH61)	84-85	DP 539		6265P
2.0 (YH61)	85-89	DP 539		5175
2.0 (YH61)	87-89	DP 722		6265P
2.0 (RZH112)	89-93	DP 787		6488
2.0 (RZH113)	93-96	DP 722		6488
2.4 (RCH12)	95-96	DP 722		6488
2.2 D (LH11)	80-86	DP 321		6265P
2.2 D (LH60)	83-84	DP 539		6265P
2.4 D (LH61)	84-85	DP 539		6265P
2.4 D (LH61)	85-89	DP 539		5175
2.4 D (LH61)	87-89	DP 722		6265P
2.4 D (LH112)	89-93	DP 787		6488
2.4 D (LH112)	93-96	DP 722		6488
2.4 D (LH102)	94-95	DP 722		6488
2.4 D (LXH12)	95-96	DP 722		6488
Hi-Ace (Power Van) (Compact)				
2.4	95-98	DP 722		6587
2.7	98-	DP 722		6587
2.4 D	94-95	DP 722		6488
2.4 D	95-2001	DP 722		6587
2.5 TD	2001-	DP 722		6587
Hi-Lux				
1.6 (RN25)	72-78		6264	6265P
1.6 (RN25)	78-80		6264	6304
1.6 (RN40)	78-83		6266	6427
1.6 (RN40)	78-83	DP 321		6265P
1.8 (YN56)	84-88	DP 539		6265P
1.8 (YN85)	89-97	DP 539		6265P
1.8 (YN85)	89-97	DP 797		6265P
2.0 (RN46)	79-84	DP 380		6265P
2.0 (YN65)	84-86	DP 380		6265P
2.2 (YN67)	86-88	DP 380		6265P
2.2 (YN106)	89-97	DP 807		6473
2.4 D (LN65)	84-88	DP 380		6265P
2.4 D (LN105)	89-97	DP 807		6473
2.4 D (LN85)	93-97	DP 539		6265P
2.4 TD (LN165)	98-2002	DP 807		6587
2.4 TD (LN145)	98-2002	DP 787		
2.5 D (KDN145 150)	2001-	DP 787		
2.5 D (KDN165)	2001-	DP 807		

Standard Quality - ECE R90 Approved with similar performance to original equipment brake pads.
 Upgrade Quality (Tuning / Sportbeläge) - ECE R90 Approved but with higher friction and improved performance for faster street use.

Standard Qualität - mit ECE R90 Freigabe und ähnlicher Bremsleistung wie die Original Bremsbeläge.
 Verbesserte Qualität - mit ECE R90 Freigabe aber mit höherem Reibwert und verbesserter Bremsleistung für den schnellen Strasseninsatz.

Qualité standard - Approuvée par la norme ECE R90 - Des performances équivalentes à l'origine.
 Qualité améliorée - Approuvée par la norme ECE R90 - Un coefficient de friction supérieur et des performances accrues pour pilotage rapide sur route.

Calidad Estándar - Aprobación CEE R90 con prestaciones similares a las pastillas originales.
 Calidad Mejorada - Aprobación CEE R90 pero con un coeficiente de fricción más elevado y prestaciones mejoradas para un uso deportivo en carretera.









*Every EBC pad and shoe requiring ECE R-90 is available with approval subject to stock rotation - check box end label.
 Models listed by Engine Size. Only listed by trim level where pads differ, (16v, GL, GT, etc).

BRAKE PADS & SHOES - APPLICATIONS

Bremsbeläge / Plaquettes + Bremsbacken / Machoires

EBC

BRAKES

Make/Model/Engine	Year	Pads  Front / Vorn / Avant		Shoes	Pads  Rear / Hinten / Arrière		Shoes
Hersteller/Modell/Motor	Jahr	Plaquettes / Bremsbeläge		Bremsbacken Machoirs	Plaquettes / Bremsbeläge		Bremsbacken Machoirs
Modelos	Années	Original Quality ECE R90* Approved 	Upgrade Quality Tuning/Sportbeläge ECE R90* Approved 	 ECE R90* Approved	Original Quality ECE R90* Approved 	Upgrade Quality Tuning/Sportbeläge ECE R90* Approved 	 ECE R90* Approved

TOYOTA COMM Contd.							
Lite-Ace							
1.5	83-92	DP 536					5169
1.5	92-94	DP 747					6263
2.0 D	92-94	DP 747					6263

Pad Illustrations for Toyota Commercial

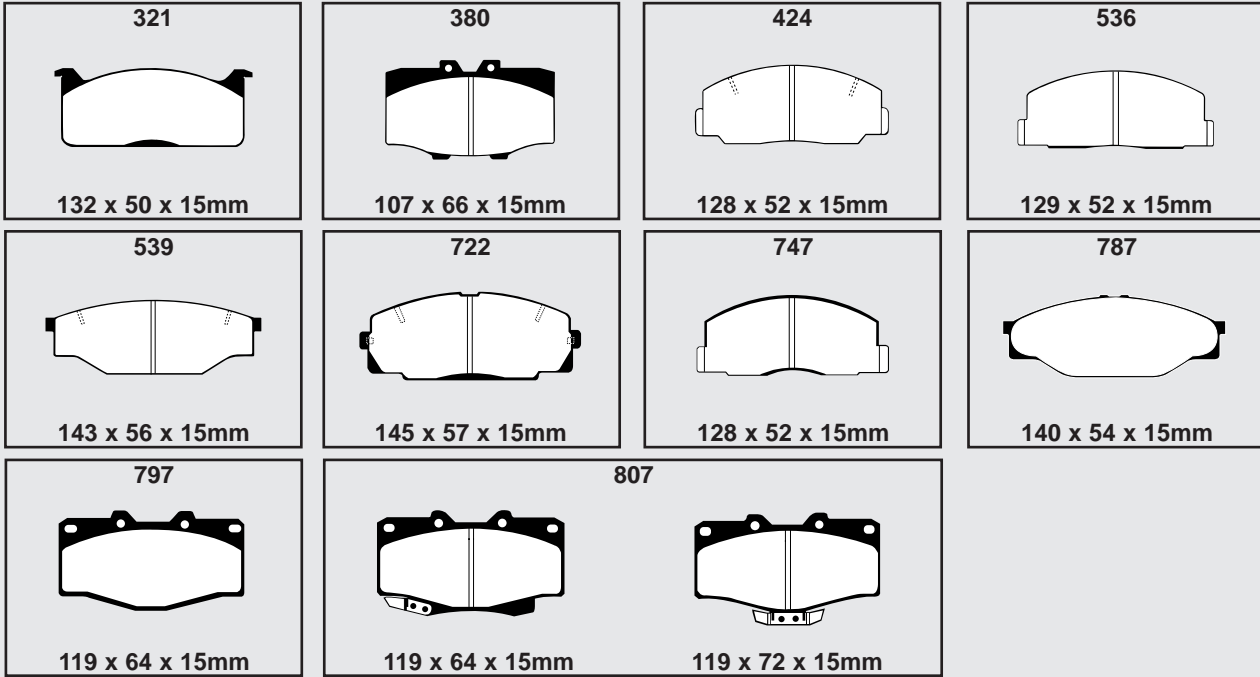

TOYOTA (Australia / NZ)							
Sera (EXY10) 92-96 DP 453 DP 2453							
Soarer							
2.0 (GZ10)	84-86	DP 419				DP 376	
2.0 (MZ10)	85-88	DP 610	DP 2610			DP 608/2	
2.0 (GZ20) Inc. T/Turbo	84-86	DP 610	DP 2610			DP 608/2	
2.0 Turbo (MZ10)	84-86	DP 419				DP 376	
2.5 Twin Turbo (UJZZ30)	91	DP 1223	DP 21223			DP 1008	
2.5 Twin Turbo (UJZZ30)	91	DP 874	DP 2874			DP 1008	
2.8 (MZ10/11)	81-86	DP 419				DP 376	
3.0 (MZ20/21)	86-89	DP 610	DP 2610			DP 608/2	
4.0 (UZZ31)	91	-	DP 21007			DP 1008	
Supra							
2.0 Inc. T & T/Turbo (GA70)	86-91	DP 610	DP 2610			DP 608/2	
2.0 Twin Turbo (JZA70)	91	DP 610	DP 2610			DP 608/2	
3.0 (JZA80)	93-97	DP 1223	DP 21223			DP 1008	
3.0 (JZA80)	93-97	DP 1004	DP 21004			DP 1005	DP 21005
3.0 & Turbo (MA70)	86-92	DP 610	DP 2610			DP 608/2	







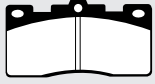

*Every EBC pad and shoe requiring ECE R-90 is available with approval subject to stock rotation - check box end label. Models listed by Engine Size. Only listed by trim level where pads differ, (16v, GL, GT, etc).

Standard Quality - ECE R90 Approved with similar performance to original equipment brake pads.
Upgrade Quality (Tuning/ Sportbeläge) - ECE R90 Approved but with higher friction and improved performance for faster street use.
Verbesserte Qualität - mit ECE R90 Freigabe aber mit höherem Reibwert und verbesserter Bremsleistung für den schnellen Strasseninsatz.

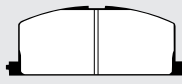
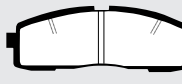
Qualité standard - Approuvée par la norme ECE R90 - Des performances équivalentes à l'origine.
Qualité améliorée - Approuvée par la norme ECE R90 - Un coefficient de friction supérieur et des performances accrues pour pilotage rapide sur route.
Calidad Mejorada - Aprobación CEE R90 con prestaciones similares a las pastillas originales.

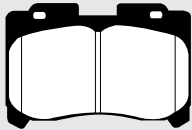
Make/Model/Engine	Year	Pads	Front / Vorn / Avant	Shoes	Pads	Rear / Hinten / Arrière	Shoes
Hersteller/Modell/Motor	Jahr	Plaquettes / Bremsbeläge		Bremsbacken Machoires	Plaquettes / Bremsbeläge		Bremsbacken Machoires
Modelos	Années	Original Quality ECE R90* Approved	Upgrade Quality Tuning/Sportbeläge ECE R90* Approved	Original Quality ECE R90* Approved	Upgrade Quality Tuning/Sportbeläge ECE R90* Approved	Original Quality ECE R90* Approved	Upgrade Quality Tuning/Sportbeläge ECE R90* Approved

Pad Illustrations for Toyota (Australia / NZ)

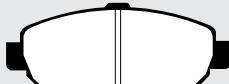
376  96 x 51 x 15mm	419  116 x 49 x 15mm	453  119 x 46 x 15mm	608/2  125 x 42 x 15mm
610  125 x 56 x 15mm	874  141 x 63 x 17mm	1004  122 x 83 x 18mm	1005  83 x 70 x 16mm
1008  123 x 41 x 16mm	1223  144 x 66 x 17mm	21007  150 x 69 x 18mm	

TOYOTA (Malaysia & The Philippines)

Corolla

XL	DP 964	DP 2964		
GL	DP 453	DP 2453		
GL	DP 964	DP 2964		



Camry

97-	DP 964	DP 2964		DP 628
-----	--------	---------	--	--------

Corona

Sedan Ex Exsior	97-	DP 964	DP 2964		DP 628
-----------------	-----	--------	---------	--	--------

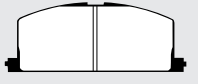
Pad Illustrations for Toyota (Malaysia & The Philippines)

453  119 x 46 x 15mm	628  107 x 42 x 15mm	964  133 x 53 x 18mm
---	---	--

TOYOTA (SA)

Conquest RSi	93-94	DP 453	DP 2453		
Corolla	98-	DP 453	DP 2453		

Standard Quality - ECE R90 Approved with similar performance to original equipment brake pads.
Upgrade Quality (Tuning / Sportbeläge) - ECE R90 Approved but with higher friction and improved performance for faster street use.

Standard Qualität - mit ECE R90 Freigabe und ähnlicher Bremsleistung wie die Original Bremsbeläge.
Verbesserte Qualität - mit ECE R90 Freigabe aber mit höherem Reibwert und verbesserter Bremsleistung für den schnellen Strasseninsatz.

Quality standard - Approuvée par la norme ECE R90 - Des performances équivalentes à l'origine.
Qualité améliorée - Approuvée par la norme ECE R90 - Un coefficient de friction supérieur et des performances accrues pour pilotage rapide sur route.

Calidad Estándar - Aprobación CEE R90 con prestaciones similares a las pastillas originales.
Calidad Mejorada - Aprobación CEE R90 pero con un coeficiente de fricción más elevado y prestaciones mejoradas para un uso deportivo en carretera.

BRAKE PADS & SHOES - APPLICATIONS

Bremsbeläge / Plaquettes + Bremsbacken / Machoires

EBC

BRAKES

Make/Model/Engine	Year	Pads	Front / Vorn / Avant	Shoes	Pads	Rear / Hinten / Arrière	Shoes
Hersteller/Modell/Motor	Jahr	Plaquettes / Bremsbeläge		Bremsbacken	Plaquettes / Bremsbeläge		Bremsbacken
Modelos	Années	Original Quality ECE R90* Approved	Upgrade Quality Tuning/Sportbeläge ECE R90* Approved	Machoires ECE R90* Approved	Original Quality ECE R90* Approved	Upgrade Quality Tuning/Sportbeläge ECE R90* Approved	Machoires ECE R90* Approved

Pad Illustrations for Toyota (SA)

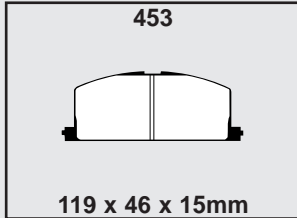

TOYOTA (Japan)					
Altezza					
15" Wheels	98-	DP 874	DP 2874	DP 1224	DP 21224
Altezza					
17" Wheels	98-	DP 1223	DP 21223	DP 1224	DP 21224
MR-S	99-				

Pad Illustrations for Toyota (Japan)

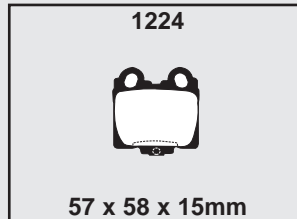
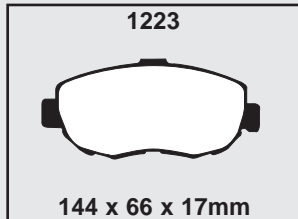
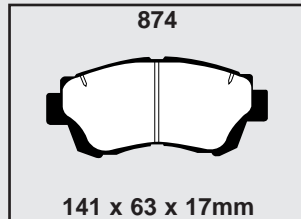

TRABANT					
501	71-90			6519	6520
601	71-90			6519	6520
604	71-90			6519	6520
1100 VW	90-92				6520
TRIDENT					
Iceni					
3.2	2000-				
TVR					
Cerbera					
4.0 (Speed Six)	98-	DP 2002	DP 3002	DP 2102	DP 3102
4.2	94-	DP 2002	DP 3002	DP 2102	DP 3102
4.5	97-	DP 2002	DP 3002	DP 2102	DP 3102
5.0	94-98	DP 2002	DP 3002	DP 2102	DP 3102
Chimaera					
4.0	93-97	DP 2002	DP 3002	DP 2617	DP 3617
4.0	93-97	DP 2415	DP 3415	DP 2617	DP 3617
4.3	93-98	DP 2002	DP 3002	DP 2617	DP 3617
4.3	93-98	DP 2415	DP 3415	DP 2617	DP 3617
4.5	97-	DP 2002	DP 3002	DP 2617	DP 3617
4.5	97-	DP 2415	DP 3415	DP 2617	DP 3617
5.0	94-97	DP 2002	DP 3002	DP 2617	DP 3617
5.0	94-97	DP 2415	DP 3415	DP 2617	DP 3617









*Every EBC pad and shoe requiring ECE R-90 is available with approval subject to stock rotation - check box end label.
Models listed by Engine Size. Only listed by trim level where pads differ, (16v, GL, GT, etc).

Standard Quality - ECE R90 Approved with similar performance to original equipment brake pads.
Upgrade Quality (Tuning/ Sportbeläge) - ECE R90 Approved but with higher friction and improved performance for faster street use.
Verbesserte Qualität - mit ECE R90 Freigabe und ähnlicher Bremsleistung wie die Original Bremsbeläge.
Standard Qualität - mit ECE R90 Freigabe und ähnlicher Bremsleistung wie die Original Bremsbeläge.

Qualité standard - Approuvée par la norme ECE R90 - Des performances équivalentes à l'origine.
Qualité améliorée - Approuvée par la norme ECE R90 - Un coefficient de friction supérieur et des performances accrues pour pilotage rapide sur route.
Calidad Mejorada - Aprobación CEE R90 pero con un coeficiente de fricción más elevado y prestaciones mejoradas para un uso deportivo en carretera.
Calidad Estándar - Aprobación CEE R90 con prestaciones similares a las pastillas originales.

Standard Quality - ECE R90 Approved with similar performance to original equipment brake pads.
 Upgrade Quality (Tuning / Sportbeläge) - ECE R90 Approved but with higher friction and improved performance for faster street use.

Standard Qualität - mit ECE R90 Freigabe und ähnlicher Bremsleistung wie die Original Bremsbeläge.
 Verbesserte Qualität - mit ECE R90 Freigabe aber mit höherem Reibwert und verbesserter Bremsleistung für den schnellen Strasseninsatz.

Make/Model/Engine Hersteller/Modell/Motor Modelos	Year Jahr Années	Pads  Front / Vorn / Avant		Shoes	Pads  Rear / Hinten / Arrière		Shoes
		Original Quality ECE R90* Approved 	Upgrade Quality Tuning/Sportbeläge ECE R90* Approved 	Bremsbacken Machoires 	Original Quality ECE R90* Approved 	Upgrade Quality Tuning/Sportbeläge ECE R90* Approved 	Bremsbacken Machoires 
TVR Contd.							
Grantura							
1.8	58-68	-	DP 2141				
Griffith							
4.7	63-69	-	DP 2141				
5.0	93-	DP 2002	DP 3002		DP 2617	DP 3617	
5.0	93-	DP 2473	DP 3605/2		DP 2617	DP 3617	
Speed Twelve							
7.7 V12	98-						
Tuscan							
2500M, 3000M	70-79	DP 258	DP 2291				5139
3.6	2001-	-	DP 2036				
4.0	2001-	-	DP 2036				
Taimar							
3.0	76-81	DP 258	DP 2291				5139
Tamora							
3.6	2001-						
T350							
4.0	2002-						
Tasmin							
100	79-81	DP 291	DP 2291		DP 101	DP 2101	
200	81-84	DP 291	DP 2291		DP 101	DP 2101	
280	81-86	DP 291	DP 2291		DP 101	DP 2101	
350	83-86	DP 291	DP 2291		DP 101	DP 2101	
Handbrake Pads	79-86				DP 709		
T440 R							
4.0	2002-						
S							
2.9	88-93	DP 389	DP 2389				6324
350							
3.5	83-86	DP 291	DP 2291		DP 101	DP 2101	
3.5	86-88	DP 296	DP 2296		DP 571	DP 2617	
390							
3.9	86-89	DP 296	DP 2296		DP 571	DP 2617	
400							
4.0	89-92	DP 296	DP 2296		DP 571	DP 2617	
4.0	89-92	DP 241	DP 2241		DP 571	DP 2617	
4.0	89-92	DP 243	DP 2243		DP 571	DP 2617	
420							
4.2	86-89	DP 296	DP 2296		DP 571	DP 2617	
4.2	86-89	DP 243	DP 2243				
450							
4.5	89-92	DP 296	DP 2296		DP 571	DP 2617	
4.5	89-92	DP 241	DP 2241		DP 571	DP 2617	
4.5	89-92	DP 243	DP 2243		DP 571	DP 2617	
Vixen							
1.6	68-73	DP 258	DP 2291				5139

BRAKE PADS & SHOES - APPLICATIONS











Bremsbeläge / Plaquettes + Bremsbacken / Machoires

EBC

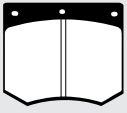
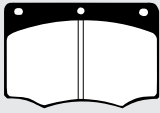
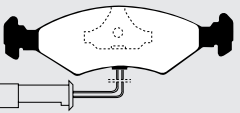
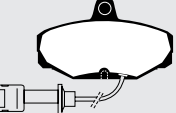
BRAKES

Make/Model/Engine	Year	Pads	Front / Vorn / Avant	Shoes	Pads	Rear / Hinten / Arrière	Shoes
Hersteller/Modell/Motor	Jahr	Plaquettes / Bremsbeläge		Bremsbacken	Plaquettes / Bremsbeläge		Bremsbacken
Modelos	Années	Original Quality ECE R90* Approved	Upgrade Quality Tuning/Sportbeläge ECE R90* Approved	Machoires ECE R90* Approved	Original Quality ECE R90* Approved	Upgrade Quality Tuning/Sportbeläge ECE R90* Approved	Machoires ECE R90* Approved

Pad Illustrations for TVR









101  80 x 66 x 15mm	241  105 x 75 x 18mm	243  98 x 71 x 15mm	258  78 x 66 x 15mm
291  78 x 66 x 15mm	296  98 x 68 x 15mm	389  151 x 46 x 17mm	571  90 x 54 x 13mm
709  40 x 39 x 13mm	2002  132 x 54 x 17mm	2036  130 x 81 x 16mm	2102  70 x 58 x 14mm
2141  73 x 53 x 15mm			

VAUXHALL							
Agila							
1.0	2000-	DP 1291					6590
1.0	2001-	DP 1361					6590
1.2	2000-	DP 1291					6590
1.2	2001-	DP 1361					6590
Astra/Belmont							
1.2 Sal	79-81	DP 325	DP 2325				5254
1.2 Sal	81-84	DP 325	DP 2325				5255G
1.2 Est	79-83	DP 325	DP 2325				5255G
1.2 S	84-91	DP 325	DP 2325				5254
1.2 S Est	84-91	DP 325	DP 2325				5353G
1.2 Est Merit	84-91	DP 325	DP 2325				5351G
1.2	98-	DP 1184	DP 21184				6538
1.3 Est	79-83	DP 325	DP 2325				5255G
1.3 Sal	79-81	DP 325	DP 2325				5254
1.3 Sal	81-84	DP 325	DP 2325				5255G
1.3	84-91	DP 325	DP 2325				5351G
1.4	84-91	DP 325	DP 2325				5351G
1.4	91-98	DP 940	DP 2940				6481
1.4 Est	91-95	DP 940	DP 2940				6482
1.4 Est	95-98	DP 940	DP 2940				6538
1.4	98-	DP 1184	DP 21184				6538
1.4 (ABS)	98-	DP 1184	DP 21184		DP 1186	DP 21186	
1.6	81-84	DP 325	DP 2325				5255G
1.6 Sal	84-91	DP 325	DP 2325				5351G
1.6 Est	84-91	DP 325	DP 2325				5353G

*Every EBC pad and shoe requiring ECE R-90 is available with approval subject to stock rotation - check box end label. Models listed by Engine Size. Only listed by trim level where pads differ, (16v, GL, GT, etc).

Standard Quality - ECE R90 Approved with similar performance to original equipment brake pads.
Upgrade Quality (Tuning/ Sportbeläge) - ECE R90 Approved but with higher friction and improved performance for faster street use.
Verbesserte Qualität - mit ECE R90 Freigabe aber mit höherem Reibwert und verbesserter Bremsleistung für den schnellen Strasseninsatz.

Qualité standard - Approuvée par la norme ECE R90 - Des performances équivalentes à l'origine.
Qualité améliorée - Approuvée par la norme ECE R90 - Un coefficient de friction supérieur et des performances accrues pour pilotage rapide sur route.
Calidad Mejorada - Aprobación CEE R90 con prestaciones similares a las pastillas originales.
Calidad Mejorada - Aprobación CEE R90 pero con un coeficiente de fricción más elevado y prestaciones mejoradas para un uso deportivo en carretera.

Make/Model/Engine Hersteller/Modell/Motor Modèles	Year Jahr Années	Pads  Front / Vorn / Avant		Shoes	Pads  Rear / Hinten / Arrière		Shoes
		Original Quality ECE R90* Approved 	Upgrade Quality Tuning/Sportbeläge ECE R90* Approved 	Bremsbacken Machoires 	Original Quality ECE R90* Approved 	Upgrade Quality Tuning/Sportbeläge ECE R90* Approved 	Bremsbacken Machoires 
VAUXHALL Contd.							
Astra/Belmont Contd.							
1.6	91-95	DP 940	DP 2940				6481
1.6	93-95	DP 760	DP 2760				6482
1.6	95-98	DP 1087	DP 21087				6538
1.6	98-	DP 1184	DP 21184				6538
1.6 (ABS)	98-	DP 1183	DP 21183		DP 1186	DP 21186	
1.8	83-91	DP 325	DP 2325				5351G
1.8 Est	83-91	DP 325	DP 2325				5353G
1.8	91-95	DP 940	DP 2940				6482
1.8 16v	93-95	DP 760	DP 2760		DP 761	DP 2761	
1.8	95-98	DP 1087	DP 21087		DP 761	DP 2761	
1.8	98-2001	DP 1184	DP 21184				6538
1.8 (ABS)	98-2001	DP 1183	DP 21183		DP 1186	DP 21186	
1.8	2001-	DP 1183	DP 21183		DP 1447	DP 21447	
2.0	87-91	DP 325	DP 2325				5351G
2.0 Est	87-91	DP 325	DP 2325				5353G
2.0	91-95	DP 760	DP 2760		DP 761	DP 2761	6482
2.0 16v	88-91	DP 760	DP 2760		DP 761	DP 2761	
2.0 16v	91-95	DP 760	DP 2760		DP 761	DP 2761	
2.0	95-98	DP 1087	DP 21087		DP 761	DP 2761	
2.0 (OPC)	95-98	DP 1443	DP 21443		DP 1186	DP 21186	
2.0 16v	98-2001	DP 1183	DP 21183		DP 1186	DP 21186	
2.0 16v	2001-	DP 1183	DP 21183		DP 1447	DP 21447	
2.0 Turbo	2002-	DP 1183	DP 21183		DP 1447	DP 21447	
2.2	2000-2001	DP 1183	DP 21183		DP 1186	DP 21186	
2.2	2001-	DP 1183	DP 21183		DP 1447	DP 21447	
1.7 D	89-91	DP 325	DP 2325				5351G
1.7 D	91-95	DP 940	DP 2940				6481
1.7 D Est	91-95	DP 940	DP 2940				6482
1.7 D	95-98	DP 940	DP 2940				6538
1.7 TD	91-98	DP 940	DP 2940				6482
1.7 TD	95-98	DP 940	DP 2940				6538
1.7 TD	98-2001	DP 1184	DP 21184				6538
1.7 TD (ABS)	98-2001	DP 1184	DP 21184		DP 1186	DP 21186	
1.7 TD	2001-	DP 1184	DP 21184		DP 1447	DP 21447	
2.0 TD	98-2001	DP 1183	DP 21183		DP 1186	DP 21186	
2.0 TD	2001-	DP 1183	DP 21183		DP 1447	DP 21447	
Handbrake shoes	88-98						5271
Astra Coupe							
1.8	2000-2001	DP 1183	DP 21183		DP 1186	DP 21186	
1.8	2001-	DP 1183	DP 21183		DP 1447	DP 21447	
2.0 Turbo	2000-2001	DP 1183	DP 21183		DP 1186	DP 21186	
2.0 Turbo	2001-	DP 1183	DP 21183		DP 1447	DP 21447	
2.2	2000-2001	DP 1183	DP 21183		DP 1186	DP 21186	
2.2	2001-	DP 1183	DP 21183		DP 1447	DP 21447	
Calibra							
2.0	90-94	DP 760	DP 2760		DP 761	DP 2761	
2.0	94-98	DP 1087	DP 21087		DP 761	DP 2761	
2.0 Turbo	92-96	DP 2976	DP 3976		DP 2761	DP 3761	
2.0 Turbo	95-98	DP 21062	DP 31062		DP 2761	DP 3761	
2.5 V6	93-95	DP 2976	DP 3976		DP 2761	DP 3761	
2.5 V6	95-98	DP 21062	DP 31062		DP 2761	DP 3761	
Handbrake shoes	90-98						5271

Standard Quality - ECE R90 Approved with similar performance to original equipment brake pads.
Upgrade Quality (Tuning / Sportbeläge) - ECE R90 Approved but with higher friction and improved performance for faster street use.

Standard Qualität - mit ECE R90 Freigabe und ähnlicher Bremsleistung wie die Original Bremsbeläge.
Verbesserte Qualität - mit ECE R90 Freigabe aber mit höherem Reibwert und verbesserter Bremsleistung für den schnellen Strasseninsatz.

Qualité standard - Approuvée par la norme ECE R90 - Des performances équivalentes à l'origine.
Qualité améliorée - Approuvée par la norme ECE R90 - Un coefficient de friction supérieur et des performances accrues pour pilotage rapide sur route.





Calidad Estándar - Aprobación CEE R90 con prestaciones similares a las pastillas originales.
Calidad Mejorada - Aprobación CEE R90 pero con un coeficiente de fricción más elevado y prestaciones mejoradas para un uso deportivo en carretera.

BRAKE PADS & SHOES - APPLICATIONS

Bremsbeläge / Plaquettes + Bremsbacken / Machoires

EBC

BRAKES

Make/Model/Engine	Year	Pads  Front / Vorn / Avant		Shoes	Pads  Rear / Hinten / Arrière		Shoes
Hersteller/Modell/Motor	Jahr	Plaquettes / Bremsbeläge		Bremsbacken Machoirs	Plaquettes / Bremsbeläge		Bremsbacken Machoirs
Modèles	Années	Original Quality ECE R90* Approved	Upgrade Quality Tuning/Sportbeläge ECE R90* Approved	 ECE R90* Approved	Original Quality ECE R90* Approved	Upgrade Quality Tuning/Sportbeläge ECE R90* Approved	 ECE R90* Approved
VAUXHALL Contd.							
Carlton							
1.7	77-82	DP 197	DP 2197				5103G
1.8	82-86	DP 325	DP 2325				5353G
1.8	86-88	DP 325	DP 2325		DP 676		
1.8 Est	86-88	DP 325	DP 2325		DP 675		
1.8	88-89	DP 325	DP 2325		DP 675		
1.8	89-92	DP 760	DP 2760		DP 675		
1.9	77-82	DP 197	DP 2197				5103G
1.9	82-86	DP 325	DP 2325				5353G
2.0	77-82	DP 197	DP 2197				5103G
2.0	82-86	DP 325	DP 2325				5353G
2.0	86-88	DP 325	DP 2325		DP 676		
2.0 Est	86-88	DP 325	DP 2325		DP 675		
2.0	88-94	DP 760	DP 2760		DP 675		
2.2	84-86	DP 325	DP 2325				5353G
2.6	90-94	DP 937	DP 2937		DP 675		
3.0	86-90	DP 754			DP 675		
3.0	90-94	DP 2937	DP 3937		DP 675		
3.0 24v	89-94	DP 2937	DP 3937		DP 675		
3.6 (Lotus twin turbo)	90-94	-	DP 3002		-	DP 3102	
2.0 D	81-82	DP 197	DP 2197				5103G
2.0 D	82-86	DP 325	DP 2325				5353G
2.3 D	79-82	DP 197	DP 2197				5103G
2.3 D	82-86	DP 325	DP 2325				5353G
2.3 D	86-88	DP 325	DP 2325		DP 676		
2.3 D	88-89	DP 325	DP 2325		DP 675		
2.3 D	89-94	DP 760	DP 2760		DP 675		
2.3 TD	89-94	DP 760	DP 2760		DP 675		
Handbrake shoes	86-94						5271
Cavalier							
1.3	77-78	DP 197	DP 2197				5211G
1.3	78-81	DP 325	DP 2325				5211G
1.3	81-83	DP 325	DP 2325				5255G
1.3	84-88	DP 325	DP 2325				5351G
1.4	88-92	DP 325	DP 2325				5351G
1.4	92-95	DP 940	DP 2940				6481
1.4 Est	92-95	DP 940	DP 2940				6482
1.6	75-78	DP 197	DP 2197				5103G
1.6	78-81	DP 325	DP 2325				5103G
1.6	81-83	DP 325	DP 2325				5255G
1.6	84-88	DP 325	DP 2325				5351G
1.6 Est	84-85	DP 325	DP 2325				5353G
1.6 Est	85-88	DP 325	DP 2325				6375
1.6	88-92	DP 325	DP 2325				5351G
1.6	92-95	DP 940	DP 2940				6481
1.6 Est	92-95	DP 940	DP 2940				6482
1.8	81-83	DP 325	DP 2325				5255G
1.8	84-92	DP 325	DP 2325				5351G
1.8	92-95	DP 940	DP 2940				6482
1.8 Auto	92-95	DP 760	DP 2760				6482
1.8 4x4	91-94	DP 760	DP 2760		DP 761	DP 2761	
1.8 4x4	94-95	DP 1087	DP 21087		DP 761	DP 2761	
1.9	75-78	DP 197	DP 2197				5103G
2.0	78-78	DP 197	DP 2197				5103G
2.0	78-81	DP 325	DP 2325				5103G
2.0	84-88	DP 325	DP 2325				5351G
2.0	88-94	DP 760	DP 2760		DP 761	DP 2761	
2.0	94-95	DP 1087	DP 21087		DP 761	DP 2761	
2.0 Turbo	92-95	DP 2976	DP 3976		DP 2761	DP 3761	
2.5 V6	93-95	DP 2976	DP 3976		DP 2761	DP 3761	
1.6 D	82-88	DP 325	DP 2325				5351G

*Every EBC pad and shoe requiring ECE R-90 is available with approval subject to stock rotation - check box end label.
Models listed by Engine Size. Only listed by trim level where pads differ, (16v, GL, GT, etc).

Standard Quality - ECE R90 Approved with similar performance to original equipment brake pads.
Upgrade Quality (Tuning/ Sportbeläge) - ECE R90 Approved but with higher friction and improved performance for faster street use.
Verbesserte Qualität - mit ECE R90 Freigabe aber mit höherem Reibwert und verbesserter Bremsleistung für den schnellen Strasseninsatz.

Qualité standard - Approuvée par la norme ECE R90 - Des performances équivalentes à l'origine.
Qualité améliorée - Approuvée par la norme ECE R90 - Un coefficient de friction supérieur et des performances accrues pour pilotage rapide sur route.
Calidad Mejorada - Aprobación CEE R90 con prestaciones similares a las pastillas originales.
Calidad Mejorada - Aprobación CEE R90 pero con un coeficiente de fricción más elevado y prestaciones mejoradas para un uso deportivo en carretera.

Qualité standard - Approuvée par la norme ECE R90 - Des performances équivalentes à l'origine.

Qualité améliorée - Approuvée par la norme ECE R90 - Un coefficient de friction supérieur et des performances accrues pour pilotage rapide sur route.

Calidad Estándar - Aprobación CEE R90 con prestaciones similares a las pastillas originales.









Calidad Mejorada - Aprobación CEE R90 pero con un coeficiente de fricción más elevado y prestaciones mejoradas para un uso deportivo en carretera.

Standard Quality - ECE R90 Approved with similar performance to original equipment brake pads.

Upgrade Quality (Tuning / Sportbeläge) - ECE R90 Approved but with higher friction and improved performance for faster street use.

Standard Qualität - mit ECE R90 Freigabe und ähnlicher Bremsleistung wie die Original Bremsbeläge.

Verbesserte Qualität - mit ECE R90 Freigabe aber mit höherem Reibwert und verbesserter Bremsleistung für den schnellen Strasseninsatz.









Make/Model/Engine Hersteller/Modell/Motor Modelos	Year Jahr Années	Pads  Front / Vorn / Avant		Shoes	Pads  Rear / Hinten / Arrière		Shoes
		Original Quality ECE R90* Approved 	Upgrade Quality Tuning/Sportbeläge ECE R90* Approved 	Bremsbacken Machoires 	Original Quality ECE R90* Approved 	Upgrade Quality Tuning/Sportbeläge ECE R90* Approved 	Bremsbacken Machoires 
VAUXHALL Contd.							
Cavalier Contd.							
1.7 D	88-92	DP 325	DP 2325				5351G
1.7 D	92-95	DP 940	DP 2940				6481
1.7 D Est	92-95	DP 940	DP 2940				6482
1.7 TD	92-95	DP 940	DP 2940				6482
1.7 TD Est	92-95	DP 940	DP 2940				6482
Handbrake Shoes	88-95						5271
Chevette							
1.3	74-75	DP 104	DP 2104				5211G
1.3	76-84	DP 104	DP 2104				5232G
2.3	77-84	DP 197	DP 2197				5103G
Corsa							
1.0	97-2000	DP 940	DP 2940				6481
1.0	2000-	DP 1341	DP 21341				6596
1.2	93-2000	DP 940	DP 2940				6481
1.2	98-2000	DP 940	DP 2940				6481
1.2	2000-	DP 1341	DP 21341				6596
1.4	93-2000	DP 940	DP 2940				6481
1.4	2000-	DP 1341	DP 21341				6596
1.4 (ABS)	2000-	DP 1341	DP 21341				6597
1.6	93-2000	DP 940	DP 2940				6481
1.8	2000-	DP 1341	DP 21341		DP 1410		
1.5 D	93-97	DP 940	DP 2940				6481
1.5 TD	93-2000	DP 940	DP 2940				6481
1.7 D	96-2000	DP 940	DP 2940				6481
1.7 D	2000-	DP 1341	DP 21341				6596
1.7 TD	2000-2002	DP 1341	DP 21341				6596
1.7 TD (ABS)	2000-2002	DP 1341	DP 21341				6597
1.7 TD	2002-	DP 1476	DP 21476				
Cresta							
	63-65	DP 107	DP 2107				
	66-72	DP 182					5228
Firenza							
1.6	71-72	DP 114(G)	DP 2114				5129(G)
1.6	71-72	DP 127(L)	DP 2127				5230(L)
1.8	72-73	DP 106	DP 2106				5229
2.3	72-73	DP 106	DP 2106				5229
2.3	73-76	DP 169	DP 2291				5234
Frontera							
2.0	91-95	DP 746	DP 6746				6512
2.0	95-98	DP 973	DP 6973		DP 974	DP 6974	
2.2	95-98	DP 973	DP 6973		DP 974	DP 6974	
2.2	98-	DP 973/2	DP 6973		DP 974	DP 6974	
2.4	91-95	DP 746	DP 6746		DP 777		
3.2	98-	DP 973/2	DP 6973		DP 974	DP 6974	
2.2 TD	98-	DP 973/2	DP 6973		DP 974	DP 6974	
2.3 TD	91-95	DP 746	DP 6746				6512
2.5 TD	96-98	DP 973	DP 6973		DP 974	DP 6974	
2.8 TD	95-97	DP 973	DP 6973		DP 974	DP 6974	
Magnum							
1.8	73-78	DP 106	DP 2106				5234
2.3	73-78	DP 106	DP 2106				5234
Meriva							
1.6	2003-	DP 1341	DP 21341				
1.8	2003-						

BRAKE PADS & SHOES - APPLICATIONS

Bremsbeläge / Plaquettes + Bremsbacken / Machoires

EBC

BRAKES

Make/Model/Engine Hersteller/Modell/Motor Modèles	Year Jahr Années	Pads  Front / Vorn / Avant		Shoes	Pads  Rear / Hinten / Arrière		Shoes
		Original Quality ECE R90* Approved 	Upgrade Quality Tuning/Sportbeläge ECE R90* Approved 	Bremsbacken Machoires 	Original Quality ECE R90* Approved 	Upgrade Quality Tuning/Sportbeläge ECE R90* Approved 	Bremsbacken Machoires 
VAUXHALL Contd.							
Monaro							
5.7	2004-						
Monterey							
3.2	94-99	DP 973	DP 6973		DP 974	DP 6974	
3.1 TD	94-99	DP 973	DP 6973		DP 974	DP 6974	
Nova							
1.0	82-83	DP 325	DP 2325				5254
1.0	84-91	DP 325	DP 2325				6337
1.0	91-93	DP 940	DP 2940				6481
1.2	82-83	DP 325	DP 2325				5254
1.2	84-91	DP 325	DP 2325				6337
1.2	91-93	DP 940	DP 2940				6481
1.3	82-83	DP 325	DP 2325				5254
1.3	84-91	DP 325	DP 2325				6337
1.4	84-91	DP 325	DP 2325				6337
1.4	91-93	DP 940	DP 2940				6481
1.6	84-91	DP 325	DP 2325				6337
1.6	91-93	DP 940	DP 2940				6481
1.5 D	91-93	DP 940	DP 2940				6481
1.5 TD	90-91	DP 325	DP 2325				6337
1.5 TD	91-93	DP 940	DP 2940				6481
Omega							
2.0	94-97	DP 976	DP 2976		DP 675		
2.0	97-2000	DP 937	DP 2937		DP 675		
2.2	99-	DP 937	DP 2937		DP 675		
2.5	94-2000	DP 937	DP 2937		DP 675		
2.6	2001-	DP 937	DP 2937		DP 675		
3.0	94-2000	DP 2937	DP 3937		DP 675		
3.2	2001-	DP 2937	DP 3937		DP 675		
2.0 TD	98-99	DP 937	DP 2937		DP 675		
2.2 TD	2001-	DP 937	DP 2937		DP 675		
2.5 TD	94-2000	DP 937	DP 2937		DP 675		
Handbrake shoes	94-						5271
Royale							
2.8	79-83	DP 103	DP 2103		DP 104	DP 2104	
3.0	79-83	DP 103	DP 2103		DP 104	DP 2104	
Handbrake Shoes	79-83						5271
Senator							
2.5	78-85	DP 103	DP 2103		DP 104	DP 2104	
2.5	85-86	DP 754			DP 104		
2.5	87-88	DP 754			DP 676		
2.5	89-90	DP 754			DP 675		
2.5	90-93	DP 937	DP 2937		DP 675		
2.6	90-93	DP 937	DP 2937		DP 675		
3.0	78-85	DP 103	DP 2103		DP 104	DP 2104	
3.0	85-86	DP 754			DP 104		
3.0	87-88	DP 754			DP 676		
3.0	89-90	DP 754			DP 675		
3.0	90-93	DP 2937	DP 3937		DP 675		
3.0 24v	90-93	DP 2937	DP 3937		DP 675		
Handbrake Shoes	78-93						5271









Standard Quality - ECE R90 Approved with similar performance to original equipment brake pads.
 Upgrade Quality (Tuning/ Sportbeläge) - ECE R90 Approved but with higher friction and improved performance for faster street use.
 Verbesserte Qualität - mit ECE R90 Freigabe aber mit höherem Reibwert und verbesserter Bremsleistung für den schnellen Strasseninsatz.

Qualité standard - Approuvée par la norme ECE R90 - Des performances équivalentes à l'origine.
 Qualité améliorée - Approuvée par la norme ECE R90 - Un coefficient de friction supérieur et des performances accrues pour pilotage rapide sur route.
 Calidad Mejorada - Aprobación CEE R90 con prestaciones similares a las pastillas originales.
 Calidad Mejorada - Aprobación CEE R90 pero con un coeficiente de fricción más elevado y prestaciones mejoradas para un uso deportivo en carretera.

*Every EBC pad and shoe requiring ECE R-90 is available with approval subject to stock rotation - check box end label.
 Models listed by Engine Size. Only listed by trim level where pads differ, (16v, GL, GT, etc).

Standard Quality - ECE R90 Approved with similar performance to original equipment brake pads.
 Upgrade Quality (Tuning / Sportbeläge) - ECE R90 Approved but with higher friction and improved performance for faster street use.

Calidad Estandar - Aprobacion CEE R90 con prestaciones similares a las pastillas originales.
 Calidad Mejorada - Aprobacion CEE R90 pero con un coeficiente de friccion mas elevado y prestaciones mejoradas para un uso deportivo en carretera.







Make/Model/Engine Hersteller/Modell/Motor Modelos	Year Jahr Années	Pads  Front / Vorn / Avant		Shoes	Pads  Rear / Hinten / Arrière		Shoes
		Original Quality ECE R90* Approved 	Upgrade Quality Tuning/Sportbeläge ECE R90* Approved 	Bremsbacken Machoires 	Original Quality ECE R90* Approved 	Upgrade Quality Tuning/Sportbeläge ECE R90* Approved 	Bremsbacken Machoires 
VAUXHALL Contd.							
Signum							
2.0 Turbo	2003-	DP 1414	DP 21414		DP 1354	DP 21354	
2.2	2003-	DP 1414	DP 21414		DP 1354	DP 21354	
3.2 -31068238	2003-	DP 21414	DP 31414		DP 21354	DP 31354	
3.2 31068239-	2003-	DP 21416	DP 31416		DP 21354	DP 31354	
2.0 TD	2003-	DP 1414	DP 21414		DP 1354	DP 21354	
2.2 TD	2003-	DP 1414	DP 21414		DP 1354	DP 21354	
3.0 TD -31068238	2003-	DP 1414	DP 21414		DP 1354	DP 21354	
3.0 TD 31068239-	2003-	DP 1416	DP 21416		DP 1354	DP 21354	
Sintra							
2.2	96-2000	DP 1100	DP 21100		DP 1122	DP 21122	
3.0	96-2000	DP 1100	DP 21100		DP 1122	DP 21122	
2.2 TD	99-2000	DP 1100	DP 21100		DP 1122	DP 21122	
Tigra							
1.4	94-2001	DP 940	DP 2940				6481
1.6	94-2001	DP 940	DP 2940				6482
Vectra							
1.6	95-2000	DP 1087	DP 21087				6538
1.6 16v	95-2000	DP 1087	DP 21087		DP 675		
1.6 16v	2000-2002	DP 1062	DP 21062		DP 675		
1.8	95-2000	DP 1087	DP 21087		DP 675		
1.8	2000-2002	DP 1062	DP 21062		DP 675		
1.8	2002-	DP 1414	DP 21414		DP 1354	DP 21354	
2.0	95-2000	DP 1087	DP 21087		DP 675		
2.0	2002-	DP 1414	DP 21414		DP 1354	DP 21354	
2.0 16v	95-2000	DP 1062	DP 21062		DP 675		
2.0 Turbo	2003-	DP 1414	DP 21414		DP 1354	DP 21354	
2.2	2000-2002	DP 1062	DP 21062		DP 675		
2.2	2002-	DP 1414	DP 21414		DP 1354	DP 21354	
2.5	95-2000	DP 1062	DP 21062		DP 675		
2.6	2000-2002	DP 1062	DP 21062		DP 675		
3.2 -38047797	2002-2003	DP 21414	DP 31414		DP 21354	DP 31354	
3.2 38047798-	2003-	DP 21416	DP 31416		DP 21354	DP 31354	
1.7 TD	95-96	DP 1087	DP 21087		DP 675		6538
2.0 D	96-2000	DP 1087	DP 21087		DP 675		6538
2.0 D	2002-	DP 1414	DP 21414		DP 1354	DP 21354	
2.0 TD	97-2000	DP 1087	DP 21087		DP 675		6538
2.0 TD	2000-2002	DP 1062	DP 21062		DP 675		
2.2 D	2002-	DP 1414	DP 21414		DP 1354	DP 21354	
2.2 TD	2000-2002	DP 1062	DP 21062		DP 675		
3.0 TD -31070293	2003-	DP 1414	DP 21414		DP 1354	DP 21354	
3.0 TD 31070294-	2003-	DP 1416	DP 21416		DP 1354	DP 21354	
Handbrake Shoes	95-						5271
Velox							
	63-65	DP 107	DP 2107				
	66-72	DP 182					5228
Ventora							
3.3	68-72	DP 169					5229
3.3	68-72	DP 169					5229
3.3	72-75	DP 240	DP 2240				5233
Viceroy							
2.5	80-82	DP 103	DP 2103				5103G

BRAKE PADS & SHOES - APPLICATIONS

Bremsbeläge / Plaquettes + Bremsbacken / Machoires

EBC

BRAKES











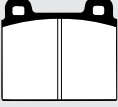
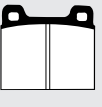







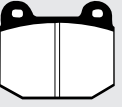
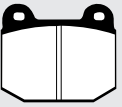

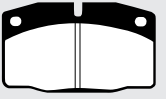

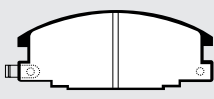

Make/Model/Engine Hersteller/Modell/Motor Modèles	Year Jahr Années	Pads  Front / Vorn / Avant		Shoes	Pads  Rear / Hinten / Arrière		Shoes
		Plaquettes / Bremsbeläge Original Quality ECE R90* Approved 		Bremsbacken Machoires ECE R90* Approved 	Plaquettes / Bremsbeläge Upgrade Quality Tuning/Sportbeläge ECE R90* Approved 		Bremsbacken Machoires ECE R90* Approved 
VAUXHALL Contd.							
Victor							
1.5	64-67	DP 114	DP 2114				
1.6	63-65	DP 107	DP 2107				
1.6	64-67	DP 114	DP 2114				
1.6	66-72	DP 182					5228
1.8	72-74	DP 182					5233
1.8	74-79	DP 240	DP 2240				5233
2.3	72-74	DP 182					5233
2.3	74-79	DP 240	DP 2240				5233
3.3	72-74	DP 182					5233
3.3	74-79	DP 240	DP 2240				5233
Viscount							
	63-65	DP 107	DP 2107				
	66-72	DP 182					5228
Viva							
	63-66	DP 142		5136(G)			5129(G)
1.2	66-73	DP 114(G)	DP 2114	5136(G)			5129(G)
1.2	66-73	DP 127(L)	DP 2127	5230(L)			5230(L)
1.2	73-79	DP 114(G)	DP 2114				5129(G)
1.2	73-79	DP 127(L)	DP 2127				5230(L)
1.3	66-73	DP 114(G)	DP 2114	5136(G)			5129(G)
1.3	66-73	DP 127(L)	DP 2127	5230(L)			5230(L)
1.3	73-79	DP 114(G)	DP 2114				5129(G)
1.3	73-79	DP 127(L)	DP 2127				5230(L)
1.6	66-73	DP 114(G)	DP 2114	5136(G)			5129(G)
1.6	66-73	DP 127(L)	DP 2127	5230(L)			5230(L)
1.6	73-79	DP 114(G)	DP 2114				5129(G)
1.6	73-79	DP 127(L)	DP 2127				5230(L)
1.8	72-75	DP 127(L)	DP 2127				5229(G)
1.8	72-75	DP 106(G)	DP 2106				5234(L)
2.3	72-75	DP 127(L)	DP 2127				5229(G)
2.3	72-75	DP 106(G)	DP 2106				5234(L)
VX							
4/90	65-67	DP 114	DP 2114				
4/90	67-70	DP 106	DP 2106				5229
4/90	70-71	DP 127	DP 2127				5228
4/90	72-74	DP 182					5233
4/90	74-75	DP 240	DP 2240				5233
1.8	76-78	DP 240	DP 2240				5233
2.3	76-78	DP 240	DP 2240				5233
VX220							
2.0 Turbo	2003-	DP 197/2	DP 2197/2		DP 885/2	DP 2885/2	
2.2	2000-	DP 197/2	DP 2197/2		DP 885/2	DP 2885/2	
Zafira							
1.6	99-2001	DP 1183	DP 21183				6538
1.6	2001-	DP 1183	DP 21183				6538
1.8	99-2001	DP 1183	DP 21183		DP 1186	DP 21186	
1.8	2001-	DP 1183	DP 21183		DP 1447	DP 21447	
2.0 Turbo	2001-	DP 1183	DP 21183		DP 1447	DP 21447	
2.2	2000-2001	DP 1183	DP 21183		DP 1186	DP 21186	
2.2	2001-	DP 1183	DP 21183		DP 1447	DP 21447	
2.0 D	99-2000	DP 1183	DP 21183		DP 1186	DP 21186	
2.0 TD	2000-2001	DP 1183	DP 21183		DP 1186	DP 21186	
2.0 TD	2001-	DP 1183	DP 21183		DP 1447	DP 21447	

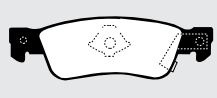
Standard Quality - ECE R90 Approved with similar performance to original equipment brake pads.
Upgrade Quality (Tuning/ Sportbeläge) - ECE R90 Approved but with higher friction and improved performance for faster street use.
Verbesserte Qualität - mit ECE R90 Freigabe und ähnlicher Bremsleistung wie die Original Bremsbeläge.
Standard Qualität - mit ECE R90 Freigabe und ähnlicher Bremsleistung wie die Original Bremsbeläge.
Qualité standard - Approuvée par la norme ECE R90 - Des performances équivalentes à l'origine.
Qualité améliorée - Approuvée par la norme ECE R90 - Un coefficient de friction supérieur et des performances accrues pour pilotage rapide sur route.
Calidad Estándar - Aprobación CEE R90 con prestaciones similares a las pastillas originales.
Calidad Mejorada - Aprobación CEE R90 pero con un coeficiente de fricción más elevado y prestaciones mejoradas para un uso deportivo en carretera.

*Every EBC pad and shoe requiring ECE R-90 is available with approval subject to stock rotation - check box end label.
 Models listed by Engine Size. Only listed by trim level where pads differ, (16v, GL, GT, etc).

Make/Model/Engine	Year	Pads	Front / Vorn / Avant	Shoes	Pads	Rear / Hinten / Arrière	Shoes
Hersteller/Modell/Motor	Jahr	Plaquettes / Bremsbeläge		Bremsbacken Machoires	Plaquettes / Bremsbeläge		Bremsbacken Machoires
Modelos	Années	Original Quality ECE R90* Approved	Upgrade Quality Tuning/Sportbeläge ECE R90* Approved	Original Quality ECE R90* Approved	Upgrade Quality Tuning/Sportbeläge ECE R90* Approved	Original Quality ECE R90* Approved	Upgrade Quality Tuning/Sportbeläge ECE R90* Approved

Pad Illustrations for Vauxhall

103  76 x 70 x 15mm	104  61 x 56 x 15mm	106  63 x 63 x 14mm	107  88 x 64 x 15mm
114  63 x 55 x 14mm	127  74 x 64 x 14mm	142  61 x 54 x 12mm	169  78 x 64 x 15mm
182  88 x 70 x 15mm	197  76 x 65 x 16mm	197/2  76 x 65 x 14mm	240  88 x 71 x 15mm
325  100 x 59 x 15mm	675 [37mm]  61 x 61 x 15mm	676 [31mm]  61 x 61 x 15mm	746  127 x 51 x 16mm
754  112 x 60 x 17mm	760  157 x 52 x 17mm	761  60 x 57 x 15mm	777  131 x 42 x 13mm
885/2  123 x 59 x 12mm	937  127 x 68 x 20mm	940  141 x 58 x 16mm	973  138 x 59 x 16mm
973/2  138 x 59 x 16mm	974  110 x 43 x 15mm	976  156 x 61 x 18mm	1042 Use DP 675  61 x 61 x 15mm

Standard Quality - ECE R90 Approved with similar performance to original equipment brake pads.
Upgrade Quality (Tuning / Sportbeläge) - ECE R90 Approved but with higher friction and improved performance for faster street use.

Standard Qualität - mit ECE R90 Freigabe und ähnlicher Bremsleistung wie die Original Bremsbeläge.
Verbesserte Qualität - mit ECE R90 Freigabe aber mit höherem Reibwert und verbesserter Bremsleistung für den schnellen Strasseneinsatz.

Qualité standard - Approuvée par la norme ECE R90 - Des performances équivalentes à l'origine.
Qualité améliorée - Approuvée par la norme ECE R90 - Un coefficient de friction supérieur et des performances accrues pour pilotage rapide sur route.

Calidad Estándar - Aprobación CEE R90 con prestaciones similares a las pastillas originales.
Calidad Mejorada - Aprobación CEE R90 pero con un coeficiente de fricción más elevado y prestaciones mejoradas para un uso deportivo en carretera.

*Every EBC pad and shoe requiring ECE R-90 is available with approval subject to stock rotation - check box end label.
Models listed by Engine Size. Only listed by trim level where pads differ, (16v, GL, GT, etc).

BRAKE PADS & SHOES - APPLICATIONS

Bremsbeläge / Plaquettes + Bremsbacken / Machoires

EBC

BRAKES

Make/Model/Engine	Year	Pads	Front / Vorn / Avant	Shoes	Pads	Rear / Hinten / Arrière	Shoes
Hersteller/Modell/Motor	Jahr	Plaquettes / Bremsbeläge		Bremsbacken	Plaquettes / Bremsbeläge		Bremsbacken
Modelos	Années	Original Quality ECE R90* Approved	Upgrade Quality Tuning/Sportbeläge ECE R90* Approved	Machoires ECE R90* Approved	Original Quality ECE R90* Approved	Upgrade Quality Tuning/Sportbeläge ECE R90* Approved	Machoires ECE R90* Approved

Pad Illustrations for Vauxhall Contd.

1062 156 x 74 x 19mm	1087 157 x 52 x 17mm	1100 148 x 63 x 18mm	1122 108 x 41 x 15mm
1183 156 x 79 x 20mm	1184 178 x 62 x 19mm	1186 105 x 41 x 16mm	1291 106 x 49 x 15mm
1341 131 x 51 x 17mm	1354 123 x 51 x 16mm	1361 130 x 44 x 15mm	
1414 148 x 72 x 20mm	1443 147 x 68 x 20mm	1443 156 x 74 x 19mm	1443 155 x 76 x 20mm
1447 95 x 43 x 15mm	1476 131 x 55 x 16mm	1476 131 x 55 x 16mm	3002 132 x 54 x 17mm
3102 70 x 58 x 14mm	21416 155 x 72 x 20mm		

VAUXHALL COMMERCIAL (Inc Bedford)					
Arena					
1.9 D	97-	DP 633			6541
1.9 D	97-	DP 544			6321A
2.5 D	97-	DP 544			6321A
2.5 D	97-	DP 633			6541

*Every EBC pad and shoe requiring ECE R-90 is available with approval subject to stock rotation - check box end label.
Models listed by Engine Size. Only listed by trim level where pads differ, (16v, GL, GT, etc).

Standard Quality - ECE R90 Approved with similar performance to original equipment brake pads.
Upgrade Quality (Tuning/ Sportbeläge) - ECE R90 Approved but with higher friction and improved performance for faster street use.
Verbesserte Qualität - mit ECE R90 Freigabe aber mit höherem Reibwert und verbesserter Bremsleistung für den schnellen Strasseninsatz.









Qualité standard - Approuvée par la norme ECE R90 - Des performances équivalentes à l'origine.
Qualité améliorée - Approuvée par la norme ECE R90 - Un coefficient de friction supérieur et des performances accrues pour pilotage rapide sur route.
Calidad Estándar - Aprobación CEE R90 con prestaciones similares a las pastillas originales.
Calidad Mejorada - Aprobación CEE R90 pero con un coeficiente de fricción más elevado y prestaciones mejoradas para un uso deportivo en carretera.

Standard Quality - ECE R90 Approved with similar performance to original equipment brake pads.
 Upgrade Quality (Tuning / Sportbeläge) - ECE R90 Approved but with higher friction and improved performance for faster street use.

Standard Qualität - mit ECE R90 Freigabe und ähnlicher Bremsleistung wie die Original Bremsbeläge.
 Verbesserte Qualität - mit ECE R90 Freigabe aber mit höherem Reibwert und verbesserter Bremsleistung für den schnellen Strasseninsatz.

Quality standard - Approuvée par la norme ECE R90 - Des performances équivalentes à l'origine.
 Qualité améliorée - Approuvée par la norme ECE R90 - Un coefficient de friction supérieur et des performances accrues pour pilotage rapide sur route.

Calidad Estándar - Aprobación CEE R90 con prestaciones similares a las pastillas originales.
 Calidad Mejorada - Aprobación CEE R90 pero con un coeficiente de fricción más elevado y prestaciones mejoradas para un uso deportivo en carretera.

Make/Model/Engine Hersteller/Modell/Motor Modelos	Year Jahr Années	Pads  Front / Vorn / Avant		Shoes	Pads  Rear / Hinten / Arrière		Shoes
		Original Quality ECE R90* Approved 	Upgrade Quality Tuning/Sportbeläge ECE R90* Approved 	Bremsbacken Machoires 	Original Quality ECE R90* Approved 	Upgrade Quality Tuning/Sportbeläge ECE R90* Approved 	Bremsbacken Machoires 
VAUXHALL COMM Contd. (Inc Bedford)							
Astra Van & Astra Max							
1.2	82-83	DP 325					5103G
1.3	82-83	DP 325					5103G
1.3	84-91	DP 325					5353G
1.4	86-91	DP 325					5353G
1.4	91-95	DP 940					6482
1.4	95-98	DP 940					6538
1.6	82-83	DP 325					5103G
1.6	84-91	DP 325					5353G
1.6	91-95	DP 940					6482
1.6	95-98	DP 940					6538
1.6	98-	DP 1184					6538
1.6 D	82-83	DP 325					5103G
1.6 D	84-88	DP 325					5353G
1.7 D	88-91	DP 325					5353G
1.7 D	91-95	DP 940					6482
1.7 D	95-98	DP 940					6538
1.7 TD	95-98	DP 940					6538
1.7 TD	98-	DP 1184					6538
2.0 TD	98-	DP 1184					6538
2.0 TD	98-	DP 1183			DP 1186		6538
Brava							
2.3	87-96	DP 746					6404
2.2 D	88-90	DP 746					6404
2.3 TD	96-	DP 746					6404
2.5 D	90-96	DP 746					6404
CF Van							
14, 18, 22 cwt./220	69-77			5238			5113
22, 25 cwt./230, 250, 280	70-83			5114			5239
CF 2 Van							
18, 22, 26 cwt./230, 250, 280	84-87	DP 755					6383
35 cwt./340,350	84-87			6378			6379
Chevanne							
1.3	76-82	DP 104					5232G
Combo							
1.4	93-95	DP 940					5353G
1.4	95-2002	DP 1087					6538
1.6	2002-	DP 1341					6538
1.7 D	93-95	DP 940					5353G
1.7 D	96-2002	DP 1087					6538
1.7 D	2002-	DP 1341					6538
1.7 TD	2002-	DP 1341					6538
Corsa Van							
1.2	94-2000	DP 940					6481
1.2	2000-	DP 1341					6596
1.4	94-2000	DP 940					6481
1.7 D	94-2000	DP 940					6482
1.7 D	2000-	DP 1341					6596
1.7 TD	2000-	DP 1341					6596
HA Van							
6/8 cwt.	64-70	DP 114		5136			5129
6/8 cwt.	71-84	DP 114		5130			5142

*Every EBC pad and shoe requiring ECE R-90 is available with approval subject to stock rotation - check box end label.









Models listed by Engine Size. Only listed by trim level where pads differ, (16v, GL, GT, etc).

BRAKE PADS & SHOES - APPLICATIONS

Bremsbeläge / Plaquettes + Bremsbacken / Machoires

EBC









BRAKES

Make/Model/Engine Hersteller/Modell/Motor Modèles	Year Jahr Années	Pads  Front / Vorn / Avant		Shoes	Pads  Rear / Hinten / Arrière		Shoes
		Original Quality ECE R90* Approved 	Upgrade Quality Tuning/Sportbeläge ECE R90* Approved 	Bremsbacken Machoirs 	Original Quality ECE R90* Approved 	Upgrade Quality Tuning/Sportbeläge ECE R90* Approved 	Bremsbacken Machoirs 
VAUXHALL COMM Contd. (Inc Bedford)							
KB Pick Ups							
1.6 (KB25)	79-80	DP 448					6326
1.6 (KB26)	81-88	DP 454					6327
1.6 (KB41)	82-88	DP 649					6404
2.0 D (KB26)	81-88	DP 454					6327
2.0 D (KB41)	82-88	DP 649					6404
Midi Van							
1.8	85-88	DP 535					6327
2.0	88-94	DP 535					6327
2.0 D	85-88	DP 535					6327
2.2 D	88-94	DP 535					6327
2.4 D	94-	DP 535					6327
2.0 TD	88-90	DP 535					6327
Movano							
2.2 TD	2000-	DP 1386			DP 1385		6528
2.5 TD 15"	99-	DP 1182					6528
2.5 TD 16"	2000-	DP 1386			DP 1385		6528
2.5 TD 15"	99-	DP 1182					6528
2.8 TD 16"	2000-	DP 1386			DP 1385		6528
Nova Van							
1.2	91-94	DP 325					6481
1.5 D	91-94	DP 325					6481
Rascal Van							
1.0	85-93	DP 374					6407
Rascal Pick-Up							
1.0	86-93	DP 374					6459
Vivaro							
1.9 TD	2001-	DP 1393			DP 1284		

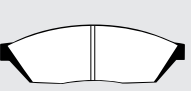

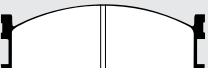

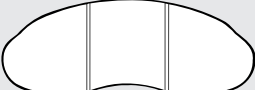
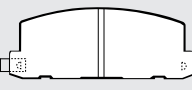
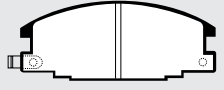
Standard Quality - ECE R90 Approved with similar performance to original equipment brake pads.
 Upgrade Quality (Tuning/ Sportbeläge) - ECE R90 Approved but with higher friction and improved performance for faster street use.
 Standard Qualität - mit ECE R90 Freigabe und ähnlicher Bremsleistung wie die Original Bremsbeläge.
 Verbesserte Qualität - mit ECE R90 Freigabe aber mit höherem Reibwert und verbesserter Bremsleistung für den schnellen Strasseninsatz.

Qualité standard - Approuvée par la norme ECE R90 - Des performances équivalentes à l'origine.
 Qualité améliorée - Approuvée par la norme ECE R90 - Un coefficient de friction supérieur et des performances accrues pour pilotage rapide sur route.
 Calidad Estándar - Aprobación CEE R90 con prestaciones similares a las pastillas originales.
 Calidad Mejorada - Aprobación CEE R90 pero con un coeficiente de fricción más elevado y prestaciones mejoradas para un uso deportivo en carretera.







Pad Illustrations for Vauxhall Commercial

<p>104</p>  <p>61 x 56 x 15mm</p>	<p>114</p>  <p>63 x 55 x 14mm</p>	<p>325</p>  <p>100 x 59 x 15mm</p>	<p>374</p>  <p>119 x 38 x 15mm</p>
<p>448</p>  <p>128 x 45 x 16mm</p>	<p>454</p>  <p>115 x 49 x 15mm</p>	<p>535</p>  <p>134 x 47 x 16mm</p>	<p>544</p>  <p>155 x 56 x 18mm</p>
<p>633</p>  <p>166 x 62 x 17mm</p>	<p>649</p>  <p>120 x 48 x 15mm</p>	<p>746</p>  <p>127 x 51 x 16mm</p>	<p>755</p>  <p>89 x 72 x 15mm</p>

*Every EBC pad and shoe requiring ECE R-90 is available with approval subject to stock rotation - check box end label.
 Models listed by Engine Size. Only listed by trim level where pads differ, (16v, GL, GT, etc).

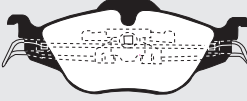
Make/Model/Engine	Year	Pads  Front / Vorn / Avant		Shoes	Pads  Rear / Hinten / Arrière		Shoes
Hersteller/Modell/Motor	Jahr	Plaquettes / Bremsbeläge		Bremsbacken Machoires	Plaquettes / Bremsbeläge		Bremsbacken Machoires
Modelos	Années	Original Quality ECE R90* Approved	Upgrade Quality Tuning/Sportbeläge ECE R90* Approved	 ECE R90* Approved	Original Quality ECE R90* Approved	Upgrade Quality Tuning/Sportbeläge ECE R90* Approved	 ECE R90* Approved

Pad Illustrations for Vauxhall Commercial Contd.

940  141 x 48 x 16mm	1087  157 x 52 x 17mm	1182  139 x 66 x 18mm	1184  178 x 62 x 19mm
1284  95 x 58 x 16mm	1385  115 x 51 x 19mm	1386  138 x 79 x 18mm	1393  145 x 63 x 18mm

VENTURI

210					
2.5	-94	DP 547	DP 2547	DP 189	DP 2189
260					
2.8	92-96	DP 547	DP 2547	DP 189	DP 2189
Atlantique					
3.0	98-				
3.0 Turbo	97-				

Pad Illustrations for Venturi

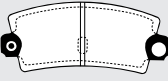
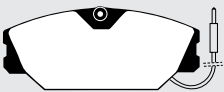
189  108 x 49 x 14mm	547  130 x 56 x 18mm
---	---

VOLKSWAGEN









411/412					
1.8	68-72	DP 104	DP 2104		5077
1.8	72-74	DP 194			5077
K70					
1.6	70-75	DP 126	DP 2126		5083
1.8	70-75	DP 126	DP 2126		5083
Beetle					
1.2 (1200)	65-67			5083	5080
1.2 (1200)	68-74			5083	5083
1.3 (1300)	65-67			5083	5080
1.3 (1300)	67-70	DP 111		5083	5083
1.3 (1300)	70-71	DP 111		5077	5083
1.3 (1300)	71-79	DP 105		2105	5083
1.3 (1300)	72-79	DP 184		5077	5083
1.5 (1300)	67-70	DP 111		5083	5083
1.6 (1302)	70-71	DP 111		5077	5083
1.6 (1302)	71-79	DP 105	DP 2105		5083
1.6 (1303)	72-79	DP 184		5077	5083

BRAKE PADS & SHOES - APPLICATIONS

Bremsbeläge / Plaquettes + Bremsbacken / Machoires

EBC

BRAKES









Make/Model/Engine	Year	Pads  Front / Vorn / Avant		Shoes	Pads  Rear / Hinten / Arrière		Shoes
Hersteller/Modell/Motor	Jahr	Plaquettes / Bremsbeläge		Bremsbacken Machoirs	Plaquettes / Bremsbeläge		Bremsbacken Machoirs
Modelos	Années	Original Quality ECE R90* Approved 	Upgrade Quality Tuning/Sportbeläge ECE R90* Approved 	 ECE R90* Approved	Original Quality ECE R90* Approved 	Upgrade Quality Tuning/Sportbeläge ECE R90* Approved 	 ECE R90* Approved
VOLKSWAGEN Contd.							
Beetle Contd.							
1.6 (1600)	65-71	DP 111					5089
1.6 (1600)	71-73	DP 104	DP 2104				5089
1.6	2000-	DP 1329	DP 21329		DP 680	DP 2680	
1.8 Turbo	2001-	DP 1330	DP 21330		DP 680	DP 2680	
2.0	99-	DP 1329	DP 21329		DP 680	DP 2680	
2.3	2001-	DP 1330	DP 21330		DP 680	DP 2680	
3.2	2001-	DP 21330	DP 31330		DP 2680	DP 3680	
1.9 TD	99-	DP 1329	DP 21329		DP 680	DP 2680	
Bora							
1.6	99-	DP 1329	DP 21329		DP 1230	DP 21230	
1.8 Turbo	2001-	DP 1330	DP 21330		DP 1230	DP 21230	
2.0	99-	DP 1330	DP 21330		DP 1230	DP 21230	
2.3	99-	DP 1330	DP 21330		DP 1230	DP 21230	
2.8	2000-	DP 1330	DP 21330		DP 1230	DP 21230	
1.9 TD (90)	99-	DP 1329	DP 21329		DP 1230	DP 21230	
1.9 TD (110)	99-	DP 1329	DP 21329		DP 1230	DP 21230	
1.9 TD (130) (150)	2001-	DP 1330	DP 21330		DP 1230	DP 21230	
Caddy Kombi							
1.4	2001-	DP 1137	DP 21137				6565
1.9 D	2001-	DP 1137	DP 21137				6565
1.9 TD	2001-	DP 1112	DP 21112				6565
Caravelle							
1.6	82-90	DP 183	DP 2103				6311
1.8	90-95	DP 654					5259A
1.9	82-90	DP 183	DP 2103				6311
1.9	95-99	DP 1030					6492
2.0	90-95	DP 654					5259A
2.0	95-96	DP 1030					6492
2.0	96-98	DP 1030			DP 1102		
2.0	98-99	DP 1030			DP 1284		
2.0	99-	DP 1030/2			DP 1445		
2.4	95-96	DP 1030					6492
2.4	96-98	DP 1030			DP 1102		
2.4	98-99	DP 1030			DP 1284		
2.4	99-	DP 1030/2			DP 1445		
2.5	90-95	DP 939					5259A
2.5	95-96	DP 939					6492
2.5	96-99	DP 1116			DP 1102		
2.5	96-99	DP 1115			DP 1102		
2.5	99-	DP 1398			DP 1445		
2.5	99-	DP 1429			DP 1445		
2.8	96-98	DP 1030(G)			DP 1102		
2.8	96-98	DP 1116(G)			DP 1102		
2.8	98-99	DP 1286			DP 1285		
2.8	98-99	DP 1115			DP 1284		
2.8	98-99	DP 1116			DP 1284		
2.8	99-	DP 1398			DP 1445		
2.8	99-	DP 1368			DP 1285		
1.9 D	90-95	DP 654					5259A
2.4 D	90-95	DP 939					5259A
2.5 TD	95-98	DP 1030(G)			DP 1102		
2.5 TD	95-98	DP 1115(T)			DP 1102		
2.5 TD	98-99	DP 1286			DP 1285		
2.5 TD	98-99	DP 1115			DP 1284		
2.5 TD	98-99	DP 1116			DP 1284		
2.5 TD	99-	DP 1398			DP 1445		
2.5 TD	99-	DP 1368			DP 1285		
2.5 TD	99-	DP 1429			DP 1445		

*Every EBC pad and shoe requiring ECE R-90 is available with approval subject to stock rotation - check box end label.
Models listed by Engine Size. Only listed by trim level where pads differ, (16v, GL, GT, etc).

Standard Quality - ECE R90 Approved with similar performance to original equipment brake pads.
Upgrade Quality (Tuning/ Sportbeläge) - ECE R90 Approved but with higher friction and improved performance for faster street use.
Verbesserte Qualität - mit ECE R90 Freigabe aber mit höherem Reibwert und verbesserter Bremsleistung für den schnellen Strasseninsatz.

Standard Qualität - mit ECE R90 Freigabe und ähnlicher Bremsleistung wie die Original Bremsbeläge.
Upgrade Qualität (Tuning/ Sportbeläge) - ECE R90 Approved but with higher friction and improved performance for faster street use.
Verbesserte Qualität - mit ECE R90 Freigabe aber mit höherem Reibwert und verbesserter Bremsleistung für den schnellen Strasseninsatz.

Qualité standard - Approuvée par la norme ECE R90 - Des performances équivalentes à l'origine.
Qualité améliorée - Approuvée par la norme ECE R90 - Un coefficient de friction supérieur et des performances accrues pour pilotage rapide sur route.
Calidad Mejorada - Aprobación CEE R90 con prestaciones similares a las pastillas originales.
Calidad Mejorada - Aprobación CEE R90 pero con un coeficiente de fricción más elevado y prestaciones mejoradas para un uso deportivo en carretera.

Make/Model/Engine Hersteller/Modell/Motor Modelos	Year Jahr Années	Pads  Front / Vorn / Avant		Shoes	Pads  Rear / Hinten / Arrière		Shoes
		Original Quality ECE R90* Approved 	Upgrade Quality Tuning/Sportbeläge ECE R90* Approved 	Bremsbacken Machoires 	Original Quality ECE R90* Approved 	Upgrade Quality Tuning/Sportbeläge ECE R90* Approved 	Bremsbacken Machoires 
VOLKSWAGEN Contd.							
Corrado							
1.8 16v	89-90	DP 517	DP 2517		DP 680	DP 2680	
1.8 16v	90-92	DP 841	DP 2841		DP 680	DP 2680	
1.8 G60	89-90	DP 369	DP 2369/2		DP 680	DP 2680	
1.8 G60	90-92	DP 841/2	DP 2841/2		DP 680	DP 2680	
2.0	94-96	DP 982/2	DP 2841		DP 680	DP 2680	
2.0 16v	91-96	DP 982/2	DP 2841		DP 680	DP 2680	
2.9 VR6	92-96	DP 2981	DP 3841		DP 2680	DP 3680	
Derby							
0.9	75-78	DP 174					5205
0.9	79-83	DP 174					5264
1.0	79-83	DP 174					5264
1.0	83-88	DP 515					5264
1.1	75-78	DP 174					5205
1.1	79-83	DP 174					5264
1.1	83-88	DP 515					5264
1.3	83-88	DP 515					5264
Golf							
1.1	74-75			5202			5205
1.1	75-78	DP 174					5205
1.1	78-83	DP 174					5264
1.1	83-90	DP 515					5264
1.3	78-83	DP 174					5264
1.3	83-90	DP 515					5264
1.4	92-95	DP 517/2	DP 2517/2				6447
1.4	95-97	DP 1056	DP 21056				6447
1.4	96-97	DP 1112	DP 21112				6447
1.4	97-	DP 1137	DP 21137				6447
1.4 16v	98-99	DP 1117	DP 21117		DP 1230	DP 21230	
1.4 16v	99-	DP 1329	DP 21329		DP 1230	DP 21230	
1.5	74-78	DP 194					5205
1.5	78-81	DP 174					5264
1.5	81-83	DP 366/2	DP 2366				5264
1.6	74-78	DP 194					5205
1.6	78-79	DP 174					5264
1.6	79-83	DP 366/2	DP 2366				5264
1.6	83-91	DP 517/2	DP 2517/2				5264
1.6	92-95	DP 517/2	DP 2517/2				6447
1.6 GT	92-95	DP 841	DP 2841		DP 680	DP 2680	6447
1.6	95-97	DP 1056	DP 21056				6447
1.6	95-97	DP 841	DP 2841				6447
1.6 (ABS)	95-97	DP 1112	DP 21112				6447
1.6	97-	DP 1137	DP 21137		DP 1230	DP 21230	
1.6	98-99	DP 1117	DP 21117		DP 1230	DP 21230	
1.6	99-	DP 1329	DP 21329		DP 1230	DP 21230	
1.6 GTi	75-78	DP 174					5236
1.6 GTi	78-79	DP 174					5264
1.6 GTi	80-83	DP 366	DP 2366				5264
1.8	79-83	DP 366	DP 2366				5264
1.8	83-92	DP 517/2	DP 2517/2		DP 680	DP 2680	5264
1.8i	84-92	DP 517	DP 2517		DP 680	DP 2680	5264
1.8	92-95	DP 517/2	DP 2517/2				6447
1.8 Est	93-95	DP 841/2	DP 2841/2				6447
1.8	95-97	DP 1056	DP 21056				6447
1.8 (ABS)	95-97	DP 841	DP 2841		DP 680	DP 2680	
1.8 (ABS)	96-97	DP 1112	DP 21112		DP 680	DP 2680	6447
1.8 GTi 8v	82-83	DP 366	DP 2366				5264
1.8 GTi 8v	84-92	DP 517	DP 2517		DP 680	DP 2680	
1.8 GTi 8v	92-97	DP 982/2	DP 2841		DP 680	DP 2680	6447
1.8 GTi 16v	84-89	DP 517	DP 2517		DP 680	DP 2680	

Standard Quality - ECE R90 Approved with similar performance to original equipment brake pads.
Upgrade Quality (Tuning / Sportbeläge) - ECE R90 Approved but with higher friction and improved performance for faster street use.

Standard Qualität - mit ECE R90 Freigabe und ähnlicher Bremsleistung wie die Original Bremsbeläge.
Verbesserte Qualität - mit ECE R90 Freigabe aber mit höherem Reibwert und verbesserter Bremsleistung für den schnellen Strasseninsatz.

Quality standard - Approuvée par la norme ECE R90 - Des performances équivalentes à l'origine.
Qualité améliorée - Approuvée par la norme ECE R90 - Un coefficient de friction supérieur et des performances accrues pour pilotage rapide sur route.

Calidad Estandar - Aprobacion CEE R90 con prestaciones similares a las pastillas originales.
Calidad Mejorada - Aprobacion CEE R90 pero con un coeficiente de friccion mas elevado y prestaciones mejoradas para un uso deportivo en carretera.









*Every EBC pad and shoe requiring ECE R-90 is available with approval subject to stock rotation - check box end label.
Models listed by Engine Size. Only listed by trim level where pads differ, (16v, GL, GT, etc).

BRAKE PADS & SHOES - APPLICATIONS

Bremsbeläge / Plaquettes + Bremsbacken / Machoires

EBC









BRAKES

Make/Model/Engine	Year	Pads  Front / Vorn / Avant		Shoes	Pads  Rear / Hinten / Arrière		Shoes
		Plaquettes / Bremsbeläge		Bremsbacken Machoires	Plaquettes / Bremsbeläge		Bremsbacken Machoires
Hersteller/Modell/Motor	Jahr	Original Quality ECE R90* Approved	Upgrade Quality Tuning/Sportbeläge ECE R90* Approved	 ECE R90* Approved	Original Quality ECE R90* Approved	Upgrade Quality Tuning/Sportbeläge ECE R90* Approved	 ECE R90* Approved
Modèles	Années						
VOLKSWAGEN Contd.							
Golf Contd.							
1.8 GTi 16v	89-92	DP 982/2	DP 2841		DP 680	DP 2680	
1.8 GT	92-97	DP 841/3	DP 2841		DP 680	DP 2680	
1.8 GTi	97-99	DP 1117	DP 21117		DP 1230	DP 21230	
1.8 GTi	99-	DP 1329	DP 21329		DP 1230	DP 21230	
1.8 G60	89-95	DP 841/2	DP 2841/2		DP 680	DP 2680	
1.8 G60 Syncro	89-92	DP 841/2	DP 2841/2		DP 680	DP 2680	
1.8 Syncro	85-95	DP 517/2	DP 2517/2				6498
1.8 Syncro	95-97	DP 841/2	DP 2841/2		DP 680	DP 2680	
1.8 Turbo	97-99	DP 1324	DP 21324		DP 1230	DP 21230	
1.8 Turbo	99-	DP 1330	DP 21330		DP 1230	DP 21230	
2.0	92-97	DP 841	DP 2841		DP 680	DP 2680	
2.0	97-98	DP 1112	DP 21112		DP 1230	DP 21230	
2.0	99-	DP 1329	DP 21329		DP 1230	DP 21230	
2.0 GTi	92-96	DP 981	DP 2981		DP 680	DP 2680	
2.0 GTi	96-99	DP 1324	DP 21324		DP 1230	DP 21230	
2.0 GTi	99-	DP 1330	DP 21330		DP 1230	DP 21230	
2.3 V5	97-99	DP 1324	DP 21324		DP 1230	DP 21230	
2.3 V5	99-	DP 1330	DP 21330		DP 1230	DP 21230	
2.8 VR6	92-95	DP 2981	DP 3841		DP 2680	DP 3680	
2.8 VR6	95-98	DP 21324	DP 31324		DP 2680	DP 3680	
2.8	99-	DP 21330	DP 31330		DP 21230	DP 3680	
3.2	2002-						
1.5 D	76-80	DP 174					5264
1.6 D	80-83	DP 174					5264
1.6 D	83-91	DP 515					5264
1.6 TD	82-83	DP 366/2	DP 2366				5264
1.6 TD	83-91	DP 517/2	DP 2517/2				5264
1.9 D	92-96	DP 517/2	DP 2517/2				6447
1.9 D (ABS)	95-96	DP 1112	DP 21112				6447
1.9 D	96-97	DP 1056	DP 21056				6447
1.9 D (ABS)	96-97	DP 1137	DP 21137				6447
1.9 D	97-99	DP 1117	DP 21117		DP 1230	DP 21230	
1.9 D	99-	DP 1329	DP 21329		DP 1230	DP 21230	
1.9 TD (75)	91-96	DP 517/2	DP 2517/2				6447
1.9 TD (90)	93-95	DP 841/2	DP 2841/2		DP 680	DP 2680	6447
1.9 TD (75)	96-97	DP 1056	DP 21056				6447
1.9 TD (ABS) (75)	96-99	DP 1137	DP 21137		DP 1230	DP 21230	6447
1.9 TD (90) (110)	96-99	DP 1112	DP 21112		DP 1230	DP 21230	
1.9 TD (90) (110)	97-99	DP 1117	DP 21117		DP 1230	DP 21230	
1.9 TD (90) (110)	97-2001	DP 1329	DP 21329		DP 1230	DP 21230	
1.9 TD (110)	99-2001	DP 1112	DP 21112		DP 1230	DP 21230	
1.9 TD (100)	2001-	DP 1112	DP 21112		DP 1230	DP 21230	
1.9 TD (130)	2001-	DP 1330	DP 21330		DP 1230	DP 21230	
1.9 TD (150)	2002-	DP 1330	DP 21330		DP 1230	DP 21230	
Golf Cabriolet							
1.6	83-92	DP 517/2	DP 2517/2				5264
1.8	82-93	DP 517	DP 2517				5264
1.8	93-98	DP 841/2	DP 2841/2				6447
2.0	93-98	DP 841	DP 2841				6447
Jetta							
1.1	74-78	DP 174					5205
1.1	79-83	DP 174					5264
1.1	83-92	DP 515					5264
1.3	79-83	DP 174					5264
1.3	83-92	DP 515					5264
1.5	80-83	DP 366/2	DP 2366				5264
1.5	84-92	DP 517/2	DP 2517/2				5264
1.6	80-83	DP 366/2	DP 2366				5264
1.6	83-87	DP 517/2	DP 2517/2				5264

*Every EBC pad and shoe requiring ECE R-90 is available with approval subject to stock rotation - check box end label.
Models listed by Engine Size. Only listed by trim level where pads differ, (16v, GL, GT, etc).

Standard Quality - ECE R90 Approved with similar performance to original equipment brake pads.
Upgrade Quality (Tuning/ Sportbeläge) - ECE R90 Approved but with higher friction and improved performance for faster street use.
Verbesserte Qualität - mit ECE R90 Freigabe und ähnlicher Bremsleistung wie die Original Bremsbeläge.

Qualité standard - Approuvée par la norme ECE R90 - Des performances équivalentes à l'origine.
Qualité améliorée - Approuvée par la norme ECE R90 - Un coefficient de friction supérieur et des performances accrues pour pilotage rapide sur route.
Calidad Estándar - Aprobación CEE R90 con prestaciones similares a las pastillas originales.
Calidad Mejorada - Aprobación CEE R90 pero con un coeficiente de fricción más elevado y prestaciones mejoradas para un uso deportivo en carretera.

Make/Model/Engine Hersteller/Modell/Motor Modelos	Year Jahr Années	Pads  Front / Vorn / Avant		Shoes	Pads  Rear / Hinten / Arrière		Shoes
		Original Quality ECE R90* Approved 	Upgrade Quality Tuning/Sportbeläge ECE R90* Approved 	Bremsbacken Machoires 	Original Quality ECE R90* Approved 	Upgrade Quality Tuning/Sportbeläge ECE R90* Approved 	Bremsbacken Machoires 
VOLKSWAGEN Contd.							
Jetta Contd.							
1.6	87-92	DP 517	DP 2517				5264
1.8	79-83	DP 366	DP 2366				5264
1.8	83-92	DP 517/2	DP 2517/2				5264
1.8i	84-92	DP 517	DP 2517				5264
1.8 GTi 16v	84-92	DP 517/2	DP 2517/2		DP 680	DP 2680	
1.8 Syncro	88-92	DP 517	DP 2517				6498
1.8 16v	88-89	DP 369/2	DP 2369/2		DP 680	DP 2680	
1.8 16v (ABS)	89-92	DP 841	DP 2841		DP 680	DP 2680	
1.6 D	84-92	DP 515					5264
1.6 TD	84-92	DP 517/2	DP 2517/2				5264
Karmann Ghia							
1.6	70-71	DP 105	DP 2105				5083
1.6	72-78	DP 184					5083
Lupo							
1.0	99-	DP 1064	DP 21064				5264
1.4 (75)	99-	DP 1064	DP 21064				6447
1.4 (100)	99-	DP 1112	DP 21112		DP 1230	DP 21230	6447
1.6	2000-	DP 1112	DP 21112		DP 1230	DP 21230	
1.2 TD	2002-	DP 1433					
1.4 TD	2000-	DP 1064	DP 21064				6447
1.7 D	99-	DP 1064	DP 21064				5264
Passat							
1.3 Manual	73-79	DP 174					5205
1.3 Auto	73-79	DP 174					5186
1.3 Est	73-79	DP 194					5269
1.3	79-82	DP 174					5264
1.3 Est	79-82	DP 366/2	DP 2366				5269
1.3	82-83	DP 366/2	DP 2366				5264
1.3	84-88	DP 517/2	DP 2517/2				5264
1.3 Est	84-88	DP 517/2	DP 2517/2				5269
1.5	73-75	DP 194					5205
1.5 Est	73-75	DP 194					5186
1.6	75-79	DP 194					5205
1.6 Est	75-79	DP 194					5269
1.6	79-80	DP 366	DP 2366				5264
1.6	79-82	DP 174					5264
1.6 Est	79-82	DP 366/2	DP 2366				5269
1.6	82-83	DP 366/2	DP 2366				5264
1.6 Est	84-88	DP 517/2	DP 2517/2				5269
1.6	84-88	DP 517/2	DP 2517/2				5264
1.6	88-92	DP 517	DP 2517				6447
1.6	89-96	DP 841/2	DP 2841/2				6498
1.6	96-2000	DP 1113	DP 21113		DP 1230	DP 21230	
1.8	79-83	DP 366/2	DP 2366				5264
1.8	84-88	DP 517/2	DP 2517/2				5264
1.8	88-89	DP 517/2	DP 2517/2				5267
1.8	89-96	DP 841/2	DP 2841/2		DP 680	DP 2680	6498
1.8	97-2000	DP 1113	DP 21113		DP 1230	DP 21230	
1.8	2000-2001	DP 1351	DP 21351		DP 1230	DP 21230	
1.8 Turbo	97-2000	DP 836	DP 2836		DP 1230	DP 21230	
1.8 Turbo	2000-2001	DP 1114	DP 21114		DP 1230	DP 21230	
1.8 Turbo	2001-	DP 1483	DP 21483		DP 1230	DP 21230	
1.9 Sal	81-83	DP 366	DP 2366				5264
1.9 Est	81-83	DP 366	DP 2366				5269
2.0	84-88	DP 517	DP 2517				5269
2.0	88-96	DP 841	DP 2841		DP 680	DP 2680	
2.0	93-96	DP 1112	DP 21112		DP 680	DP 2680	
2.0 16v	93-96	DP 836	DP 2836		DP 680	DP 2680	

Standard Quality - ECE R90 Approved with similar performance to original equipment brake pads.
Upgrade Quality (Tuning / Sportbeläge) - ECE R90 Approved but with higher friction and improved performance for faster street use.

Standard Qualität - mit ECE R90 Freigabe und ähnlicher Bremsleistung wie die Original Bremsbeläge.
Verbesserte Qualität - mit ECE R90 Freigabe aber mit höherem Reibwert und verbesserter Bremsleistung für den schnellen Strasseninsatz.

Quality standard - Approuvée par la norme ECE R90 - Des performances équivalentes à l'origine.
Qualité améliorée - Approuvée par la norme ECE R90 - Un coefficient de friction supérieur et des performances accrues pour pilotage rapide sur route.

Calidad Estándar - Aprobación CEE R90 con prestaciones similares a las pastillas originales.
Calidad Mejorada - Aprobación CEE R90 pero con un coeficiente de fricción mas elevado y prestaciones mejoradas para un uso deportivo en carretera.

*Every EBC pad and shoe requiring ECE R-90 is available with approval subject to stock rotation - check box end label.

Models listed by Engine Size. Only listed by trim level where pads differ, (16v, GL, GT, etc).

BRAKE PADS & SHOES - APPLICATIONS

Bremsbeläge / Plaquettes + Bremsbacken / Machoires

EBC

BRAKES

Make/Model/Engine Hersteller/Modell/Motor Modèles	Year Jahr Années	Pads Plaquettes / Bremsbeläge		Shoes Bremsbacken Machoires	Pads Plaquettes / Bremsbeläge		Shoes Bremsbacken Machoires
		Original Quality ECE R90* Approved	Upgrade Quality Tuning/Sportbeläge ECE R90* Approved	ECE R90* Approved	Original Quality ECE R90* Approved	Upgrade Quality Tuning/Sportbeläge ECE R90* Approved	ECE R90* Approved
VOLKSWAGEN Contd.							
Passat Contd.							
2.0	96-2000	DP 836	DP 2836		DP 1230	DP 21230	
2.0	2000-2001	DP 1114	DP 21114		DP 1230	DP 21230	
2.0	2001-	DP 1483	DP 21483		DP 1230	DP 21230	
2.0 Synchro	85-88	DP 369/2	DP 2369/2		DP 680	DP 2680	
2.2	81-84	DP 517	DP 2517				5269
2.2	85-88	DP 369/2	DP 2369/2		DP 680	DP 2680	
2.3 V5	96-2000	DP 836	DP 2836		DP 1230	DP 21230	
2.3 V5	2000-2001	DP 1114	DP 21114		DP 1230	DP 21230	
2.3 V5	2001-	DP 1483	DP 21483		DP 1230	DP 21230	
2.8 VR6	92-93	DP 981	DP 2981		DP 680	DP 2680	
2.8 VR6	93-96	DP 836	DP 2836		DP 680	DP 2680	
2.8 V6	96-2000	DP 836	DP 2836		DP 1230	DP 21230	
2.8 V6	2000-2001	DP 1114	DP 21114		DP 1230	DP 21230	
2.8	2001-	DP 1483	DP 21483		DP 1230	DP 21230	
4.0 W8	2002-	DP 21328	DP 31328		DP 2680	DP 3680	
4.0 W8	2002-	DP 21483	DP 31483		DP 2680	DP 3680	
1.5 D	77-78	DP 174					5205
1.5 D	78-80	DP 174					5264
1.5 D Est	77-78	DP 194					5186
1.5 D Est	78-80	DP 194					5269
1.5 D Est	80-81	DP 366/2	DP 2366				5269
1.6 D	80-84	DP 366/2	DP 2366				5264
1.6 D	84-88	DP 517/2	DP 2517/2				5264
1.6 D	88-89	DP 369	DP 2369/2				5267
1.6 TD	81-88	DP 517/2	DP 2517/2				5264
1.6 TD	89-93	DP 841/2	DP 2841/2				6498
1.9 D	89-97	DP 841/2	DP 2841/2		DP 680	DP 2680	6498
1.9 TD (75)	89-93	DP 841/2	DP 2841/2				6498
1.9 TD (90)	93-96	DP 1112	DP 21112		DP 680	DP 2680	
1.9 TD (90)	96-2000	DP 1113	DP 21113		DP 1230	DP 21230	
1.9 TD (110) (115)	96-2000	DP 836	DP 2836		DP 1230	DP 21230	
1.9 TD (100)	2000-	DP 1351	DP 21351		DP 1230	DP 21230	
1.9 TD (130)	2000-2001	DP 1114	DP 21114		DP 1230	DP 21230	
1.9 TD (130)	2001-	DP 1483	DP 21483		DP 1230	DP 21230	
2.5 TD	99-2001	DP 1114	DP 21114		DP 1230	DP 21230	
2.5 TD	2001-	DP 1483	DP 21483		DP 1230	DP 21230	
Phaeton							
3.2	2002-	DP 21348	DP 31348		DP 21470	DP 31470	
4.2	2003-						
6.0 W12	2002-	-	DP 31469		-	DP 31470	
2.5 TD	2004-						
5.0 TD	2004-	-	DP 31469		-	DP 31470	
Polo							
0.8	75-78	DP 174					5205
0.9	75-78	DP 174					5205
0.9	79-85	DP 174					5264
1.0	75-78	DP 174					5205
1.0	79-85	DP 174					5264
1.0	85-94	DP 515					5264
1.0	94-96	DP 1084	DP 21084				6447
1.0	96-2001	DP 1064	DP 21064				6447
1.0	96-2001	DP 1064	DP 21064				5264
1.1	75-78	DP 174					5205
1.1	79-85	DP 174					5264
1.1	85-90	DP 515					5264
1.2	2002-	DP 1329	DP 21329		DP 680	DP 2680	
1.3	75-78	DP 174					5205
1.3	79-85	DP 174					5264
1.3	85-90	DP 517	DP 2517				5264

*Every EBC pad and shoe requiring ECE R-90 is available with approval subject to stock rotation - check box end label.
Models listed by Engine Size. Only listed by trim level where pads differ, (16v, GL, GT, etc).

Standard Quality - ECE R90 Approved with similar performance to original equipment brake pads.
Upgrade Quality (Tuning/ Sportbeläge) - ECE R90 Approved but with higher friction and improved performance for faster street use.
Verbesserte Qualität - mit ECE R90 Freigabe und ähnlicher Bremsleistung wie die Original Bremsbeläge.
Standard Qualität - mit ECE R90 Freigabe und ähnlicher Bremsleistung wie die Original Bremsbeläge.
Qualité standard - Approuvée par la norme ECE R90 - Des performances équivalentes à l'origine.
Qualité améliorée - Approuvée par la norme ECE R90 - Un coefficient de friction supérieur et des performances accrues pour pilotage rapide sur route.
Calidad Mejorada - Aprobación CEE R90 con prestaciones similares a las pastillas originales.
Calidad Estándar - Aprobación CEE R90 con prestaciones similares a las pastillas originales.
Calidad Mejorada - Aprobación CEE R90 pero con un coeficiente de fricción más elevado y prestaciones mejoradas para un uso deportivo en carretera.

Make/Model/Engine Hersteller/Modell/Motor Modelos	Year Jahr Années	Pads Plaquettes / Bremsbeläge		Shoes Bremsbacken Machoires	Pads Plaquettes / Bremsbeläge		Shoes Bremsbacken Machoires
		Original Quality ECE R90* Approved	Upgrade Quality Tuning/Sportbeläge ECE R90* Approved	ECE R90* Approved	Original Quality ECE R90* Approved	Upgrade Quality Tuning/Sportbeläge ECE R90* Approved	ECE R90* Approved
VOLKSWAGEN Contd.							
Polo Contd.							
1.3	90-94	DP 517	DP 2517				5264
1.3 G40	90-94	DP 517	DP 2517		DP 680	DP 2680	6447
1.3	94-96	DP 1084	DP 21084				6447
1.3	94-96	DP 1084	DP 21084				5264
1.3	94-96	DP 1084	DP 21084				5264
1.4	95-96	DP 1084	DP 21084				5264
1.4 Classic	96-99	DP 1084	DP 21084				5264
1.4 Classic (ABS)	96-99	DP 1056	DP 21056				6447
1.4	96-2000	DP 1064	DP 21064				6447
1.4	96-2000	DP 1064	DP 21064				5264
1.4	2000-2001	DP 1137	DP 21137		DP 680	DP 2680	6447
1.4	2002-	DP 1329	DP 21329		DP 680	DP 2680	
1.4 16v	96-2001	DP 1112	DP 21112		DP 680	DP 2680	6447
1.4 16v	96-2001	DP 1112	DP 21112		DP 680	DP 2680	5264
1.4 16v	2002-	DP 1329	DP 21329		DP 680	DP 2680	
1.6	94-96	DP 1084	DP 21084				6447
1.6	94-96	DP 1084	DP 21084				5264
1.6	96-97	DP 1064	DP 21064				6447
1.6	96-97	DP 1064	DP 21064				5264
1.6	97-2000	DP 1137	DP 21137				6447
1.6 Classic	96-99	DP 1112	DP 21112				5264
1.6 Classic (ABS)	96-99	DP 1112	DP 21112				6447
1.6 GTi	2000-	DP 1112	DP 21112		DP 680	DP 2680	
1.3 D	85-90	DP 515					5264
1.4 D	90-94	DP 515					5264
1.4 D	94-96	DP 1084	DP 21084				6447
1.4 TD	2000-	DP 1329	DP 21329		DP 680	DP 2680	6447
1.7 D Classic	97-99	DP 1056	DP 21056				6447
1.7 D	97-99	DP 1064	DP 21064				5264
1.7 D	97-99	DP 1064	DP 21064				6447
1.9 D Classic	95-99	DP 1056	DP 21056				6447
1.9 D	94-96	DP 1084	DP 21084				6447
1.9 D	94-96	DP 1084	DP 21084				5264
1.9 D	96-97	DP 1064	DP 21064				6447
1.9 D	96-97	DP 1064	DP 21064				5264
1.9 D	97-2001	DP 1137	DP 21137				6447
1.9 D	97-2001	DP 1137	DP 21137				5264
1.9 D	2002-	DP 1329	DP 21329		DP 680	DP 2680	
1.9 TD	98-99	DP 1056	DP 21056				6447
1.9 TD Classic	97-99	DP 1112	DP 21112				6447
1.9 TD	99-2002	DP 1112	DP 21112		DP 680	DP 2680	
1.9 TD	2002-	DP 1329	DP 21329		DP 680	DP 2680	
Santana							
1.3	84-85	DP 517/2	DP 2517/2				5269
1.6	82-83	DP 366	DP 2366				5269
1.6	84-85	DP 517/2	DP 2517/2				5269
1.8	82-83	DP 366	DP 2366				5269
1.8	84-85	DP 517/2	DP 2517/2				5269
2.0	84-85	DP 517	DP 2517				5269
Scirocco							
1.1	74-75			5202			5205
1.1	75-78	DP 194					5205
1.1	79-80	DP 366	DP 2366				5264
1.3	73-80	DP 194					5205
1.3	80-83	DP 366/2	DP 2366				5264
1.3	84-88	DP 517/2	DP 2517/2				5264
1.3	84-88	DP 369/2	DP 2369/2				5264
1.5	73-79	DP 194					5264
1.5	79-83	DP 366/2	DP 2366				5264

Standard Quality - ECE R90 Approved with similar performance to original equipment brake pads.
 Upgrade Quality (Tuning / Sportbeläge) - ECE R90 Approved but with higher friction and improved performance for faster street use.

Standard Qualität - mit ECE R90 Freigabe und ähnlicher Bremsleistung wie die Original Bremsbeläge.
 Verbesserte Qualität - mit ECE R90 Freigabe aber mit höherem Reibwert und verbesserter Bremsleistung für den schnellen Strasseninsatz.

Quality standard - Approuvée par la norme ECE R90 - Des performances équivalentes à l'origine.
 Qualité améliorée - Approuvée par la norme ECE R90 - Un coefficient de friction supérieur et des performances accrues pour pilotage rapide sur route.

Calidad Estándar - Aprobación CEE R90 con prestaciones similares a las pastillas originales.
 Calidad Mejorada - Aprobación CEE R90 pero con un coeficiente de fricción más elevado y prestaciones mejoradas para un uso deportivo en carretera.

*Every EBC pad and shoe requiring ECE R-90 is available with approval subject to stock rotation - check box end label.









Models listed by Engine Size. Only listed by trim level where pads differ, (16v, GL, GT, etc).

BRAKE PADS & SHOES - APPLICATIONS

Bremsbeläge / Plaquettes + Bremsbacken / Machoires

EBC









BRAKES

Make/Model/Engine	Year	Pads  Front / Vorn / Avant		Shoes	Pads  Rear / Hinten / Arrière		Shoes
		Plaquettes / Bremsbeläge		Bremsbacken Machoires	Plaquettes / Bremsbeläge		Bremsbacken Machoires
Hersteller/Modell/Motor	Jahr	Original Quality ECE R90* Approved	Upgrade Quality Tuning/Sportbeläge ECE R90* Approved	 ECE R90* Approved	Original Quality ECE R90* Approved	Upgrade Quality Tuning/Sportbeläge ECE R90* Approved	 ECE R90* Approved
Modèles	Années						
VOLKSWAGEN Contd.							
Scirocco Contd.							
1.6	73-78	DP 194					5205
1.6	78-80	DP 194					5264
1.6	80-83	DP 366	DP 2366				5264
1.6	84-92	DP 517	DP 2517				5264
1.7	79-83	DP 366	DP 2366				5264
1.8	81-83	DP 366	DP 2366				5264
1.8	84-92	DP 517	DP 2517				5264
1.8 16v	84-89	DP 369/2	DP 2369/2		DP 680	DP 2680	
1.8 16v	89-92	DP 841	DP 2841		DP 680	DP 2680	
Sharan							
1.8 Turbo	98-2000	DP 1074	DP 21074		DP 680	DP 2680	
1.8 Turbo	2001-	DP 1368	DP 21368		DP 1412	DP 21412	
1.8 Turbo	2001-	DP 1413	DP 21413		DP 1285		
2.0	95-2000	DP 1074	DP 21074		DP 680	DP 2680	
2.0	2001-	DP 1368	DP 21368		DP 1412	DP 21412	
2.8	95-2000	DP 1074	DP 21074		DP 680	DP 2680	
2.8	2001-	DP 1413	DP 21413		DP 1285		
2.8	2001-	DP 1413	DP 21413		DP 1445		
1.9 TD	95-2000	DP 1074	DP 21074		DP 680	DP 2680	
1.9 TD (115)	2001-	DP 1368	DP 21368		DP 1412	DP 21412	
1.9 TD (115)	2001-	DP 1413	DP 21413		DP 1285		
1.9 TD (130)	2003-	DP 1368	DP 21368		DP 1412	DP 21412	
1.9 TD (130)	2003-	DP 1413	DP 21413		DP 1285		
Touareg							
3.2	2003-						
4.2	2003-						
2.5 TD	2003-						
5.0 TD	2003-						
Touran							
1.6	2003-						
1.9 TD	2003-						
2.0 TD	2003-						
Vento							
1.6	93-97	DP 1056	DP 21056				6447
1.6	93-95	DP 517/2	DP 2517/2				6447
1.6	95-97	DP 841	DP 2841		DP 680	DP 2680	
1.8	92-99	DP 1056	DP 21056				6447
1.8	92-99	DP 841/2	DP 2841/2				6447
1.8	92-95	DP 517/2	DP 2517/2				6447
1.8	95-97	DP 841	DP 2841		DP 680	DP 2680	
1.8	95-99	DP 1056	DP 21056				6447
1.8	97-99	DP 1112	DP 21112		DP 1230	DP 21230	6447
1.8 GT	92-97	DP 841	DP 2841		DP 680	DP 2680	
2.0 GT	92-96	DP 981	DP 2981		DP 680	DP 2680	
2.0 GT	96-98	DP 836	DP 2836		DP 1230	DP 21230	
2.0	92-97	DP 841	DP 2841		DP 680	DP 2680	
2.0	97-98	DP 1112	DP 21112		DP 1230	DP 21230	
2.8 VR6	92-95	DP 2841	DP 3841		DP 2680	DP 3680	
2.8 VR6	92-95	DP 2981	DP 3841		DP 2680	DP 3680	
2.8 VR6	95-98	DP 2836	DP 3836		DP 21230	DP 3680	
1.9 D	92-99	DP 1056	DP 21056				6447
1.9 D	92-95	DP 517/2	DP 2517/2				6447
1.9 D (ABS)	95-96	DP 1112	DP 21112		DP 680	DP 2680	6447
1.9 D	95-97	DP 1056	DP 21056				6447
1.9 D (ABS)	96-99	DP 1137	DP 21137		DP 1230	DP 21230	6447
1.9 TD	92-93	DP 517/2	DP 2517/2				6447
1.9 TD	93-97	DP 841/2	DP 2841/2		DP 680	DP 2680	

*Every EBC pad and shoe requiring ECE R-90 is available with approval subject to stock rotation - check box end label.
Models listed by Engine Size. Only listed by trim level where pads differ, (16v, GL, GT, etc).

Standard Quality - ECE R90 Approved with similar performance to original equipment brake pads.
Upgrade Quality (Tuning/ Sportbeläge) - ECE R90 Approved but with higher friction and improved performance for faster street use.
Verbesserte Qualität - mit ECE R90 Freigabe und ähnlicher Bremsleistung wie die Original Bremsbeläge.
Standard Qualität - mit ECE R90 Freigabe und ähnlicher Bremsleistung wie die Original Bremsbeläge.

Qualité standard - Approuvée par la norme ECE R90 - Des performances équivalentes à l'origine.
Qualité améliorée - Approuvée par la norme ECE R90 - Un coefficient de friction supérieur et des performances accrues pour pilotage rapide sur route.
Calidad Estandar - Aprobación CEE R90 con prestaciones similares a las pastillas originales.
Calidad Mejorada - Aprobación CEE R90 pero con un coeficiente de fricción más elevado y prestaciones mejoradas para un uso deportivo en carretera.









Make/Model/Engine	Year	Pads  Front / Vorn / Avant		Shoes	Pads  Rear / Hinten / Arrière		Shoes
Hersteller/Modell/Motor	Jahr	Plaquettes / Bremsbeläge		Bremsbacken Machoires	Plaquettes / Bremsbeläge		Bremsbacken Machoires
Modelos	Années	Original Quality ECE R90* Approved 	Upgrade Quality Tuning/Sportbeläge ECE R90* Approved 	 ECE R90* Approved	Original Quality ECE R90* Approved 	Upgrade Quality Tuning/Sportbeläge ECE R90* Approved 	 ECE R90* Approved
VOLKSWAGEN Contd.							
Vento Contd.							
1.9 TD	96-99	DP 1112	DP 21112		DP 1230	DP 21230	

VW PAD IDENTIFICATION

369 - 19mm thick 15mm shoulder no wear indicator
 369/2 - 16mm thick 15mm shoulder no wear indicator
 486 - 19mm thick 15mm shoulder standard wear indicator
 486/2 - 16mm thick 15mm shoulder standard wear indicator
 836 - 46mm clip round wear lead connector
 841 - 16mm thick 12mm shoulder no wear indicator
 841/2 - 19mm thick 12mm shoulder no wear indicator
 841/3 - 16mm thick 12mm shoulder square wear indicator
 981 - 19mm thick 12mm shoulder square wear indicator
 982 - 19mm thick 12mm shoulder standard wear indicator
 982/2 - 16mm thick 12mm shoulder standard wear indicator
 1112 - 16mm thick 9mm shoulder no wear indicator

1113 - 19mm thick 9mm shoulder no wear indicator
 1114 - 46mm clip rectangular wear lead connector
 1324 - 43mm clip no wear lead
 1330 - 43mm clip lead connectors opposite to 1114
 1351 - 19mm thick 9mm shoulder rectangular wear lead connector

Pad Illustrations for Volkswagen

 104 61 x 56 x 15mm	 105 56 x 53 x 15mm	 111 49 x 58 x 15mm	 126 76 x 58 x 15mm
 174 61 x 56 x 15mm	 183 76 x 70 x 19mm	 184 63 x 52 x 16mm	 194 61 x 56 x 18mm
 366 138 x 49 x 15mm	 366/2 138 x 49 x 19mm	 369 120 x 69 x 19mm	 369/2 120 x 69 x 16mm
 515 138 x 51 x 17mm	 517 138 x 49 x 15mm	 517/2 138 x 49 x 19mm	 654 130 x 58 x 19mm
 680 87 x 53 x 15mm	 836 156 x 75 x 19mm	 841 119 x 70 x 16mm	 841/2 119 x 70 x 19mm

Standard Quality - ECE R90 Approved with similar performance to original equipment brake pads.
 Upgrade Quality (Tuning / Sportbeläge) - ECE R90 Approved but with higher friction and improved performance for faster street use.

Standard Qualität - mit ECE R90 Freigabe und ähnlicher Bremsleistung wie die Original Bremsbeläge.
 Verbesserte Qualität - mit ECE R90 Freigabe aber mit höherem Reibwert und verbesserter Bremsleistung für den schnellen Strasseninsatz.

Calidad Estándar - Aprobación CEE R90 con prestaciones similares a las pastillas originales.
 Calidad Mejorada - Aprobación CEE R90 pero con un coeficiente de fricción más elevado y prestaciones mejoradas para un uso deportivo en carretera.

BRAKE PADS & SHOES - APPLICATIONS

Bremsbeläge / Plaquettes + Bremsbacken / Machoires

EBC

BRAKES

Make/Model/Engine	Year	Pads	Front / Vorn / Avant	Shoes	Pads	Rear / Hinten / Arrière	Shoes
Hersteller/Modell/Motor	Jahr	Plaquettes / Bremsbeläge		Bremsbacken	Plaquettes / Bremsbeläge		Bremsbacken
Modelos	Années	Original Quality ECE R90* Approved	Upgrade Quality Tuning/Sportbeläge ECE R90* Approved	Original Quality ECE R90* Approved	Upgrade Quality Tuning/Sportbeläge ECE R90* Approved	Original Quality ECE R90* Approved	Upgrade Quality Tuning/Sportbeläge ECE R90* Approved









Pad Illustrations for Volkswagen Contd.

841/3 119 x 70 x 16mm	939 91 x 80 x 18mm	981 119 x 69 x 20mm	982 119 x 69 x 20mm
982/2 119 x 69 x 16mm	1030 130 x 64 x 19mm	1030/2 130 x 64 x 19mm	1056 141 x 50 x 19mm
1064 141 x 50 x 17mm	1074 156 x 74 x 19mm	1084 137 x 50 x 17mm	1102 95 x 57 x 17mm
1112 118 x 69 x 16mm	1113 118 x 69 x 20mm	1114 156 x 74 x 20mm	1115 156 x 68 x 19mm
1116 91 x 80 x 18mm	1117 145 x 55 x 20mm	1137 141 x 51 x 15mm	1230 87 x 53 x 17mm
1284 95 x 58 x 16mm	1285 95 x 58 x 16mm	1286 156 x 80 x 18mm	1324 156 x 74 x 20mm
1329 146 x 54 x 19	1330 156 x 74 x 20mm	1351 118 x 69 x 19mm	1368 156 x 80 x 18mm

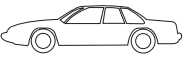







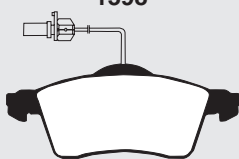
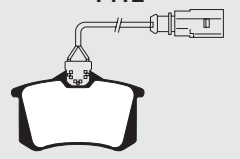
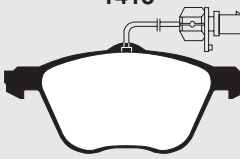
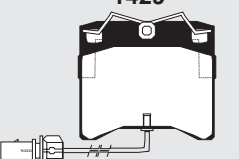
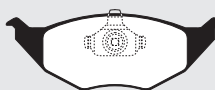

Standard Quality - ECE R90 Approved with similar performance to original equipment brake pads.
 Upgrade Quality (Tuning/ Sportbeläge) - ECE R90 Approved but with higher friction and improved performance for faster street use.
 Verbesserte Qualität - mit ECE R90 Freigabe aber mit höherem Reibwert und verbesserter Bremsleistung für den schnellen Strasseninsatz.

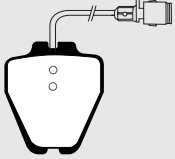
Qualité standard - Approuvée par la norme ECE R90 - Des performances équivalentes à l'origine.
 Qualité améliorée - Approuvée par la norme ECE R90 - Un coefficient de friction supérieur et des performances accrues pour pilotage rapide sur route.
 Calidad Mejorada - Aprobación CEE R90 con prestaciones similares a las pastillas originales.
 Calidad Mejorada - Aprobación CEE R90 pero con un coeficiente de fricción mas elevado y prestaciones mejoradas para un uso deportivo en carretera.

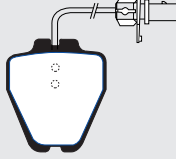
*Every EBC pad and shoe requiring ECE R-90 is available with approval subject to stock rotation - check box end label.
 Models listed by Engine Size. Only listed by trim level where pads differ, (16v, GL, GT, etc).

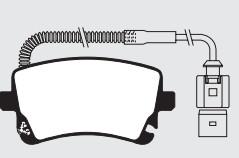
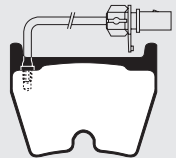
Make/Model/Engine	Year	Pads  Front / Vorn / Avant	Shoes	Pads  Rear / Hinten / Arrière	Shoes
Hersteller/Modell/Motor	Jahr	Plaquettes / Bremsbeläge	Bremsbacken Machoires	Plaquettes / Bremsbeläge	Bremsbacken Machoires
Modelos 	Années 	Original Quality ECE R90* Approved 	Upgrade Quality Tuning/Sportbeläge ECE R90* Approved 	Original Quality ECE R90* Approved 	Upgrade Quality Tuning/Sportbeläge ECE R90* Approved 

Pad Illustrations for Volkswagen Contd.

1398  156 x 68 x 20mm	1412  87 x 52 x 17mm	1413  161 x 74 x 20mm	1429  90 x 80 x 18mm
1433  141 x 47 x 14mm	 141 x 50 x 14mm	1483  156 x 74 x 20mm Plain pad profile as here Wear lead pads profile as here	
21328  63 x 75 x 18mm	 77 x 74 x 18mm	21348  63 x 75 x 18mm	 77 x 74 x 18mm
21470  116 x 59 x 17mm	31469  97 x 74 x 16mm	Audi / VW Wear sensor plug designs <div style="display: flex; justify-content: space-around;"> <div style="text-align: center;"> A062  end view </div> <div style="text-align: center;"> A076  end view </div> <div style="text-align: center;"> A700  end view </div> </div>	

VOLKSWAGEN COMMERCIAL			
Caddy			
1.4	95-97	DP 841/2	6498
1.4	96-97	DP 1084	6498
1.4	97-99	DP 1112	6498
1.4	99-	DP 1112	6565
1.5	84-91	DP 517	5267
1.6	84-91	DP 517	5267
1.6	95-97	DP 841/2	6498
1.6	97-99	DP 1112	6498
1.6	99-	DP 1112	6565
1.6 D	84-91	DP 517	5267
1.6 D	91-95	DP 517	6498
1.7 D	96-99	DP 1112	6498
1.7 D	99-	DP 1112	6565
1.9 D	95-97	DP 841/2	6498
1.9 D	97-99	DP 1112	6498
1.9 D	99-	DP 1112	6565
1.9 TD	97-99	DP 1112	6498
1.9 TD	99-	DP 1112	6565
Caddy Pick-Up			
1.4	95-	DP 438	6498
1.6	95-	DP 438	6498
1.9 D	95-	DP 438	6498

*Every EBC pad and shoe requiring ECE R-90 is available with approval subject to stock rotation - check box end label.





Models listed by Engine Size. Only listed by trim level where pads differ, (16v, GL, GT, etc).

BRAKE PADS & SHOES - APPLICATIONS

Bremsbeläge / Plaquettes + Bremsbacken / Machoires

EBC

BRAKES







Make/Model/Engine	Year	Pads Front / Vorn / Avant	Shoes Rear / Hinten / Arrière	Pads Rear / Hinten / Arrière	Shoes
Hersteller/Modell/Motor	Jahr	Plaquettes / Bremsbeläge Original Quality ECE R90* Approved	Bremsbacken Machoires Upgrade Quality Tuning/Sportbeläge ECE R90* Approved	Plaquettes / Bremsbeläge Original Quality ECE R90* Approved	Bremsbacken Machoires Upgrade Quality Tuning/Sportbeläge ECE R90* Approved
Modelos	Années				
VOLKSWAGEN COMM Contd.					
Golf Van					
1.3	84-91	DP 515			5264
1.3 Auto	84-91	DP 517/2			5264
1.6 D	84-91	DP 515			5264
1.6 TD	90-92	DP 517/2			5264
1.9 D	92-95	DP 517/2			6447
1.9 D	95-	DP 1056			6447
1.9 TD	92-	DP 841			6447
1.9 TD	92-	DP 841			6498
LT					
28, 31	75-96	DP 175/2			5206
28	97-	DP 1071		DP 1069	
31	80-96	DP 175/2			5206
35, 40, 45	79-81	DP 175/2			5259°
35, 40, 45	79-85	DP 175/2			5259A°
35, 40, 45	85-90	DP 261/2			5259A°
35, 40, 45	85-90	DP 654			5259A°
35, 40, 45	90-97	DP 261/2			6542
35, 40, 45	90-97	DP 654			6542
35	97-	DP 1071		DP 1069	
35	97-	DP 1071		DP 1298	
40, 45 4WD	82-96	DP 413			5259A°
46	97-	DP 1071		DP 1070	
46	97-	DP 1054		DP 1054	
50	82-90	DP 654			5259A°
50	82-90	DP 261/2			5259A°
50	90-96	DP 654			6542
50	90-96	DP 261/2			6542
55	85-96	DP 654			5259A°
55	85-96	DP 261/2			5259A°
Handbrake Shoes	97-				6610
<p>° - CAUTION, these shoes are almost identical but do not interchange. Check web thickness to avoid fitment problems. 5259 = 3.6 mm 5259A = 4.5 mm</p>					
Polo Van					
0.9	83-95	DP 515			5264
1.0	83-95	DP 515			5264
1.1	83-95	DP 515			5264
1.3	83-95	DP 515			5264
1.6	95-96	DP 517/2			6447
1.9 D	95-2000	DP 517/2			6447
Taro					
1.8	89-94	DP 539			6265P
2.2	89-94	DP 807			6473
2.4 D	89-94	DP 807			6473
Transporter (Kombi)					
1.2	63-70		5087		5088
1.6	68-72	DP 103			5090
1.6	72-74	DP 183			5091
1.6	74-79	DP 183			5184
1.7	86-92	DP 654			6311
1.8	68-72	DP 103			5090
1.8	72-74	DP 183			5091
1.8	74-79	DP 183			5184
1.9	79-85	DP 183			6311
1.9	86-92	DP 654			6311

*Every EBC pad and shoe requiring ECE R-90 is available with approval subject to stock rotation - check box end label.
Models listed by Engine Size. Only listed by trim level where pads differ, (16v, GL, GT, etc).

Standard Quality - ECE R90 Approved with similar performance to original equipment brake pads.
Upgrade Quality (Tuning/ Sportbeläge) - ECE R90 Approved but with higher friction and improved performance for faster street use.
Verbesserte Qualität - mit ECE R90 Freigabe aber mit höherem Reibwert und verbesserter Bremsleistung für den schnellen Strasseninsatz.

Standard Qualität - mit ECE R90 Freigabe und ähnlicher Bremsleistung wie die Original Bremsbeläge.
Qualité améliorée - Approuvée par la norme ECE R90 - Un coefficient de friction supérieur et des performances accrues pour pilotage rapide sur route.
Calidad Mejorada - Aprobación CEE R90 pero con un coeficiente de fricción más elevado y prestaciones mejoradas para un uso deportivo en carretera.

Standard Quality - ECE R90 - Des performances équivalentes à l'origine.
Qualité améliorée - Approuvée par la norme ECE R90 - Un coefficient de friction supérieur et des performances accrues pour pilotage rapide sur route.
Calidad Mejorada - Aprobación CEE R90 pero con un coeficiente de fricción más elevado y prestaciones mejoradas para un uso deportivo en carretera.

Make/Model/Engine Hersteller/Modell/Motor Modelos	Year Jahr Années	Pads  Front / Vorn / Avant		Shoes  Rear / Hinten / Arrière		
		Original Quality ECE R90* Approved 	Upgrade Quality Tuning/Sportbeläge ECE R90* Approved 	Bremsbacken Machoires 	Original Quality ECE R90* Approved 	Upgrade Quality Tuning/Sportbeläge ECE R90* Approved 
VOLKSWAGEN COMM Contd.						
Transporter (Kombi) Contd.						
2.0	68-72	DP 103				5090
2.0	72-74	DP 183				5091
2.0	74-79	DP 183				5184
2.0	79-85	DP 183				6311
2.0 14" (T4)	90-96	DP 967				6492
2.0 15" (T4)	95-98	DP 1030		DP 1102		
2.0 15" (T4)	95-98	DP 1030/2		DP 1102		
2.0 (T4)	96-98	DP 1115		DP 1102		
2.0 (T4)	98-99	DP 1030		DP 1284		
2.0 (T4)	99-	DP 1030/2		DP 1445		
2.1	86-92	DP 654				6311
2.5 14" (T4)	90-95	DP 967				6492
2.5 15" (T4)	90-95	DP 939				6492
2.5 15" (T4)	93-95	DP 1030				6492
2.5 15" (T4)	93-95	DP 1030/2				6492
2.5 15" (T4)	95-98	DP 1030		DP 1102		
2.5 15" (T4)	95-98	DP 1030/2		DP 1102		
2.5 (T4)	96-98	DP 1115		DP 1102		
2.5 (T4)	98-99	DP 1115		DP 1284		
2.5 (T4)	98-99	DP 1116		DP 1284		
2.5	99-2000	DP 1286		DP 1285		
2.5	99-	DP 1368		DP 1285		
2.5	99-	DP 1398		DP 1445		
2.5	99-	DP 1429		DP 1445		
2.8 (T4)	96-98	DP 1030		DP 1102		
2.8 (T4)	96-98	DP 1030/2		DP 1102		
2.8 (T4)	96-98	DP 1116		DP 1102		
2.8 (T4)	98-99	DP 1115		DP 1284		
2.8 (T4)	98-99	DP 1116		DP 1284		
2.8 (T4)	99-2000	DP 1286		DP 1285		
2.8	99-	DP 1398		DP 1445		
2.8	99-	DP 1368		DP 1285		
1.6 D	72-74	DP 183				5091
1.6 D	74-79	DP 183				5184
1.6 D	79-85	DP 183				6311
1.6 D	86-92	DP 654				6311
1.6 TD	79-85	DP 183				6311
1.9 D 14" (T4)	90-96	DP 967				6492
1.9 D 15" (T4)	90-95	DP 939				6492
1.9 D 15" (T4)	93-95	DP 1030				6492
1.9 D 15" (T4)	93-95	DP 1030/2				6492
1.9 D 15" (T4)	95-96	DP 1030		DP 1102		
1.9 D 15" (T4)	95-96	DP 1030/2		DP 1102		
1.9 TD 15" (T4)	93-95	DP 1030				6492
1.9 TD 15" (T4)	93-95	DP 1030/2				6492
1.9 TD 15" (T4)	96-98	DP 1030		DP 1102		
1.9 TD 15" (T4)	96-98	DP 1030/2		DP 1102		
1.9 TD (T4)	98-	DP 1030		DP 1284		
1.9 TD (T4)	98-	DP 1030/2		DP 1284		
2.4 D 14" (T4)	90-96	DP 967				6492
2.4 D 15" (T4)	90-95	DP 939				6492
2.4 D 15" (T4)	93-95	DP 1030				6492
2.4 D 15" (T4)	93-95	DP 1030/2				6492
2.4 D 15" (T4)	95-98	DP 1030		DP 1102		
2.4 D 15" (T4)	95-98	DP 1030/2		DP 1102		
2.4 D (T4)	96-98	DP 1115		DP 1102		
2.4 D (T4)	98-	DP 1030		DP 1284		
2.4 D (T4)	98-	DP 1030/2		DP 1445		
2.4 D (T4)	98-99	DP 1115		DP 1284		
2.4 D (T4)	98-	DP 1116		DP 1284		
2.4 D	99-	DP 1398		DP 1445		

*Every EBC pad and shoe requiring ECE R-90 is available with approval subject to stock rotation - check box end label.









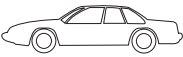

Models listed by Engine Size. Only listed by trim level where pads differ, (16v, GL, GT, etc).

BRAKE PADS & SHOES - APPLICATIONS











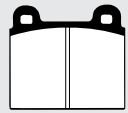
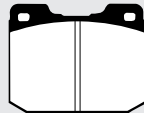
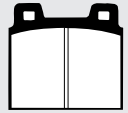
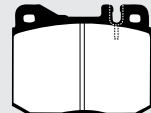
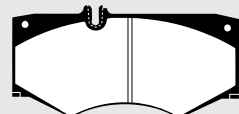
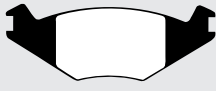

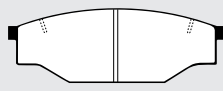

Bremsbeläge / Plaquettes + Bremsbacken / Machoires

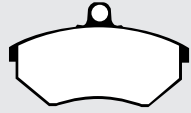
EBC

BRAKES

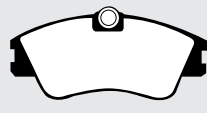
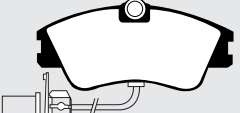
Make/Model/Engine	Year	Pads  Front / Vorn / Avant	Shoes  Rear / Hinten / Arrière
Hersteller/Modell/Motor	Jahr	Plaquettes / Bremsbeläge	Bremsbacken Machoires
Modelos 	Années 	Original Quality ECE R90* Approved 	Upgrade Quality Tuning/Sportbeläge ECE R90* Approved 
		Original Quality ECE R90* Approved 	Upgrade Quality Tuning/Sportbeläge ECE R90* Approved 
		Bremsbacken Machoires ECE R90* Approved 	Bremsbacken Machoires ECE R90* Approved 
VOLKSWAGEN COMM Contd.			
Transporter (Kombi) Contd.			
2.4 D	99-	DP 1429	DP 1445
2.5 TD (T4)	95-98	DP 1030	DP 1102
2.5 TD (T4)	95-98	DP 1030/2	DP 1102
2.5 TD (T4)	96-98	DP 1115	DP 1102
2.5 TD (T4)	98-99	DP 1115	DP 1284
2.5 TD (T4)	98-99	DP 1116	DP 1284
2.5 TD	99-	DP 1368	DP 1285
2.5 TD	99-	DP 1398	DP 1445
2.5 TD	99-	DP 1429	DP 1445

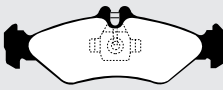
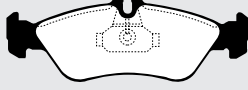
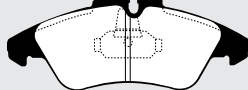
Pad Illustrations for Volkswagen Commercial

103  76 x 70 x 15mm	175/2  90 x 73 x 18mm	183  76 x 70 x 19mm	261/2  90 x 73 x 18mm
413  149 x 69 x 18mm	515  138 x 51 x 17mm	517  138 x 49 x 15mm	517/2  138 x 49 x 19mm
539  143 x 56 x 15mm	654  130 x 58 x 19mm	807  119 x 64 x 15mm	 119 x 72 x 15mm
841  119 x 70 x 16mm	841/2  119 x 70 x 19mm	939  91 x 80 x 18mm	967  130 x 52 x 19mm
1030  130 x 64 x 19mm	1030/2  130 x 64 x 19mm	1054  164 x 73 x 19mm	1056  141 x 50 x 19mm
1069  141 x 50 x 17mm	1070  156 x 54 x 18mm	1071  156 x 64 x 20mm	1084  137 x 50 x 17mm

*Every EBC pad and shoe requiring ECE R-90 is available with approval subject to stock rotation - check box end label.
Models listed by Engine Size. Only listed by trim level where pads differ, (16v, GL, GT, etc).

Standard Quality - ECE R90 Approved with similar performance to original equipment brake pads.
Upgrade Quality (Tuning/ Sportbeläge) - ECE R90 Approved but with higher friction and improved performance for faster street use.
Verbesserte Qualität - mit ECE R90 Freigabe aber mit höherem Reibwert und verbesserter Bremsleistung für den schnellen Strasseninsatz.

Qualité standard - Approuvée par la norme ECE R90 - Des performances équivalentes à l'origine.
Qualité améliorée - Approuvée par la norme ECE R90 - Un coefficient de friction supérieur et des performances accrues pour pilotage rapide sur route.
Calidad Mejorada - Aprobación CEE R90 con prestaciones similares a las pastillas originales.
Calidad Mejorada - Aprobación CEE R90 pero con un coeficiente de fricción más elevado y prestaciones mejoradas para un uso deportivo en carretera.

Make/Model/Engine	Year	Front / Vorn / Avant	Shoes	Rear / Hinten / Arrière	Shoes
Hersteller/Modell/Motor	Jahr	Plaquettes / Bremsbeläge	Bremsbacken Machoires	Plaquettes / Bremsbeläge	Bremsbacken Machoires
Modelos	Années	Original Quality ECE R90* Approved	Upgrade Quality Tuning/Sportbeläge ECE R90* Approved	Original Quality ECE R90* Approved	Upgrade Quality Tuning/Sportbeläge ECE R90* Approved

Pad Illustrations for Volkswagen Commercial Contd.

1102 95 x 57 x 17mm	1112 118 x 69 x 16mm	1115 156 x 68 x 19mm	1116 91 x 80 x 18mm
1284 95 x 58 x 16mm	1285 95 x 58 x 16mm	1286 156 x 80 x 18mm	1298 126 x 63 x 17mm
1368 156 x 80 x 18mm	1398 156 x 68 x 20mm	1429 90 x 80 x 18mm	
1445 94 x 51 x 17mm			

VOLVO							
Amazon							
1.8	61-69	DP 108	DP 2108				
66							5216V
1.3	75-80	DP 105	DP 2105				
120							5152
1.8	61-69	DP 108	DP 2108				5152
1.8	69-71	DP 143	DP 2143				
140							
2.0	67-75	DP 143(G)	DP 2143	DP 114(G)	DP 2114		
2.0	67-75	DP 135(T)		DP 104(T)			
Handbrake Shoes	67-72						5155
Handbrake Shoes	72-75						5196
160							
3.0	67-75	DP 143(G)	DP 2143	DP 114(G)	DP 2114		
3.0	67-75	DP 135(T)		DP 104(T)			
Handbrake Shoes	67-72						5155
Handbrake Shoes	72-75						5196









*Every EBC pad and shoe requiring ECE R-90 is available with approval subject to stock rotation - check box end label.

Models listed by Engine Size. Only listed by trim level where pads differ, (16v, GL, GT, etc).

BRAKE PADS & SHOES - APPLICATIONS

Bremsbeläge / Plaquettes + Bremsbacken / Machoires

EBC
BRAKES









Make/Model/Engine Hersteller/Modell/Motor Modèles	Year Jahr Années	Pads  Front / Vorn / Avant		Shoes	Pads  Rear / Hinten / Arrière		Shoes
		Original Quality ECE R90* Approved 	Upgrade Quality Tuning/Sportbeläge ECE R90* Approved 	Bremsbacken Machoirs 	Original Quality ECE R90* Approved 	Upgrade Quality Tuning/Sportbeläge ECE R90* Approved 	Bremsbacken Machoirs 
VOLVO Contd.							
240, 260							
1.7	74-82	DP 135(T)			DP 104(T)		
1.7	82-86	DP 143(G)	DP 2143		DP 104(T)	DP 2104	
1.7	74-86	DP 143(G)	DP 2143		DP 114(G)	DP 2114	
1.9	74-82	DP 135(T)			DP 104(T)		
1.9	82-85	DP 143(G)	DP 2143		DP 104(T)	DP 2104	
1.9	74-85	DP 143(G)	DP 2143		DP 114(G)	DP 2114	
1.9 Turbo	80-82	DP 135(T)			DP 104(T)		
1.9 Turbo	82-93	DP 143(G)	DP 2143		DP 104(T)	DP 2104	
1.9 Turbo	80-93	DP 143(G)	DP 2143		DP 114(G)	DP 2114	
2.0	74-82	DP 135(T)			DP 104(T)		
2.0	82-93	DP 143(G)	DP 2143		DP 104(T)	DP 2104	
2.0	74-93	DP 143(G)	DP 2143		DP 114(G)	DP 2114	
2.1	74-82	DP 135(T)			DP 104(T)		
2.1	82-84	DP 143(G)	DP 2143		DP 104(T)	DP 2104	
2.1	74-84	DP 143(G)	DP 2143		DP 114(G)	DP 2114	
2.1 Turbo	82-85	DP 143(G)	DP 2143		DP 104(T)	DP 2104	
2.1 Turbo	82-85	DP 143(G)	DP 2143		DP 114(G)	DP 2114	
2.3	78-82	DP 135(T)			DP 104(T)		
2.3	82-93	DP 143(G)	DP 2143		DP 104(T)	DP 2104	
2.3	78-93	DP 143(G)	DP 2143		DP 114(G)	DP 2114	
2.7	74-82	DP 135(T)			DP 104(T)		
2.7	82-85	DP 143(G)	DP 2143		DP 104(T)	DP 2104	
2.7	74-85	DP 143(G)	DP 2143		DP 114(G)	DP 2114	
2.8	74-82	DP 135(T)			DP 104(T)		
2.8	82-85	DP 143(G)	DP 2143		DP 104(T)	DP 2104	
2.8	74-85	DP 143(G)	DP 2143		DP 114(G)	DP 2114	
2.4 D	78-82	DP 135(T)			DP 104(T)		
2.4 D	82-93	DP 143(G)	DP 2143		DP 104(T)	DP 2104	
2.4 D	78-93	DP 143(G)	DP 2143		DP 114(G)	DP 2114	
Handbrake Shoes	74-75						5196
Handbrake Shoes	75-93						5214
340							
1.4	76-79	DP 106	DP 2106				5216V
1.4	79-90	DP 310	DP 2310				5216V
1.6	79-92	DP 310	DP 2310				5216V
1.7	79-92	DP 310	DP 2310				5216V
360							
2.0	82-92	DP 310	DP 2310				6338
440							
1.6	91-98	DP 838(G)					6465
1.6 (ABS)	91-98	DP 989(T)			DP 447/2		
1.7	88-92	DP 838(G)					6465
1.7 (ABS)	88-92	DP 989(T)			DP 447/2		
1.7 Turbo	88-96	DP 989(T)			DP 447/2		
1.8	92-98	DP 989(T)			DP 447/2		
2.0	92-98	DP 989(T)			DP 447/2		
1.9 TD	94-98	DP 838(G)					6465
1.9 TD (ABS)	94-98	DP 989(T)			DP 447/2		

*Every EBC pad and shoe requiring ECE R-90 is available with approval subject to stock rotation - check box end label.
Models listed by Engine Size. Only listed by trim level where pads differ, (16v, GL, GT, etc).

Standard Quality - ECE R90 Approved with similar performance to original equipment brake pads.
Upgrade Quality (Tuning/ Sportbeläge) - ECE R90 Approved but with higher friction and improved performance for faster street use.
Verbesserte Qualität - mit ECE R90 Freigabe aber mit höherem Reibwert und verbesserter Bremsleistung für den schnellen Strasseninsatz.
Standard Qualität - mit ECE R90 Freigabe und ähnlicher Bremsleistung wie die Original Bremsbeläge.
Qualité standard - Approuvée par la norme ECE R90 - Des performances équivalentes à l'origine.
Qualité améliorée - Approuvée par la norme ECE R90 - Un coefficient de friction supérieur et des performances accrues pour pilotage rapide sur route.
Calidad Estándar - Aprobación CEE R90 con prestaciones similares a las pastillas originales.
Calidad Mejorada - Aprobación CEE R90 pero con un coeficiente de fricción más elevado y prestaciones mejoradas para un uso deportivo en carretera.

Standard Quality - ECE R90 Approved with similar performance to original equipment brake pads.
 Upgrade Quality (Tuning / Sportbeläge) - ECE R90 Approved but with higher friction and improved performance for faster street use.

Standard Qualität - mit ECE R90 Freigabe und ähnlicher Bremsleistung wie die Original Bremsbeläge.
 Verbesserte Qualität - mit ECE R90 Freigabe aber mit höherem Reibwert und verbesserter Bremsleistung für den schnellen Strasseninsatz.

Make/Model/Engine Hersteller/Modell/Motor Modelos	Year Jahr Années	Pads  Front / Vorn / Avant		Shoes	Pads  Rear / Hinten / Arrière		Shoes
		Original Quality ECE R90* Approved 	Upgrade Quality Tuning/Sportbeläge ECE R90* Approved 	Bremsbacken Machoires 	Original Quality ECE R90* Approved 	Upgrade Quality Tuning/Sportbeläge ECE R90* Approved 	Bremsbacken Machoires 
VOLVO Contd.							
460							
1.6	93-98	DP 989(T)					6465
1.7	89-92	DP 838(G)					6465
1.7 (ABS)	88-92	DP 989(T)			DP 447/2		
1.7 Turbo	89-96	DP 989(T)			DP 447/2		
1.8	91-98	DP 838(G)			DP 447/2		6465
1.8 (ABS)	91-98	DP 989(T)			DP 447/2		
2.0	91-98	DP 989(T)			DP 447/2		
1.9 TD	94-98	DP 838(G)					6465
1.9 TD (ABS)	94-98	DP 989(T)			DP 447/2		
480							
1.7	86-88	DP 779/2(G)			DP 447/2		
1.7	88-95	DP 838(G)			DP 447/2		
1.7 (ABS)	90-95	DP 989(T)			DP 447/2		
1.7 Turbo	89-95	DP 838(G)			DP 447/2		
1.7 Turbo	90-95	DP 989(T)			DP 447/2		
2.0	92-95	DP 989(T)			DP 447/2		
740							
2.0	84-91	DP 435(G)	DP 2435		DP 104(T)	DP 2104	
2.0	84-87	DP 511(B)	DP 2800		DP 104(T)	DP 2104	
2.0	87-91	DP 800(B)	DP 2800		DP 104(T)	DP 2104	
2.0	91-92	DP 842(G)	DP 21095		DP 104(T)	DP 2104	
2.0 (ABS)	91-92	DP 1095(G)	DP 21095		DP 104(T)	DP 2104	
2.0 Turbo	84-91	DP 435(G)	DP 2435		DP 104(T)	DP 2104	
2.0 Turbo	84-87	DP 511(B)	DP 2800		DP 104(T)	DP 2104	
2.0 Turbo	87-91	DP 800(B)	DP 2800		DP 104(T)	DP 2104	
2.0 Turbo	91-92	DP 842(G)	DP 21095		DP 104(T)	DP 2104	
2.0 Turbo (ABS)	91-92	DP 1095(G)	DP 21095		DP 104(T)	DP 2104	
2.3	84-92	DP 435(G)	DP 2435		DP 104(T)	DP 2104	
2.3	84-87	DP 511(B)	DP 2800		DP 104(T)	DP 2104	
2.3	87-92	DP 800(B)	DP 2800		DP 104(T)	DP 2104	
2.3 (ABS)	87-92	DP 1095(G)	DP 21095		DP 104(T)	DP 2104	
2.3 Turbo	84-92	DP 435(G)	DP 2435		DP 104(T)	DP 2104	
2.3 Turbo	84-87	DP 511(B)	DP 2800		DP 104(T)	DP 2104	
2.3 Turbo	87-92	DP 800(B)	DP 2800		DP 104(T)	DP 2104	
2.3 Turbo (ABS)	87-92	DP 1095(G)	DP 21095		DP 104(T)	DP 2104	
2.4 D	84-92	DP 435(G)	DP 2435		DP 104(T)	DP 2104	
2.4 D	84-87	DP 511(B)	DP 2800		DP 104(T)	DP 2104	
2.4 D	87-92	DP 800(B)	DP 2800		DP 104(T)	DP 2104	
2.4 D (ABS)	88-92	DP 1095(G)	DP 21095		DP 793(G)		
2.4 TD	84-92	DP 435(G)	DP 2435		DP 104(T)	DP 2104	
2.4 TD	84-87	DP 511(B)	DP 2800		DP 104(T)	DP 2104	
2.4 TD	87-92	DP 800(B)	DP 2800		DP 104(T)	DP 2104	
2.4 TD (ABS)	87-92	DP 1095(G)	DP 21095		DP 793(G)		
Handbrake Shoes	83-92						5214
Handbrake Shoes (Multi Link Susp)	87-92						6524
760							
2.3	82-87	DP 435(G)	DP 2435		DP 104(T)	DP 2104	
2.3	82-87	DP 511(B)	DP 2800		DP 104(T)	DP 2104	
2.3	88-90	DP 800(B)	DP 2800		DP 104(T)	DP 2104	
2.3	88-90	DP 800(B)	DP 2800		DP 793(G)		
2.3 Turbo	84-87	DP 435(G)	DP 2435		DP 104(T)	DP 2104	
2.3 Turbo	84-87	DP 511(B)	DP 2800		DP 104(T)	DP 2104	
2.3 Turbo	88-90	DP 800(B)	DP 2800		DP 104(T)	DP 2104	
2.3 Turbo	88-90	DP 800(B)	DP 2800		DP 793(G)		
2.8	82-90	DP 435(G)	DP 2435		DP 104(T)	DP 2104	
2.8	82-87	DP 511(B)	DP 2800		DP 104(T)	DP 2104	
2.8	88-90	DP 800(B)	DP 2800		DP 104(T)	DP 2104	
2.8	88-90	DP 800(B)	DP 2800		DP 793(G)		

*Every EBC pad and shoe requiring ECE R-90 is available with approval subject to stock rotation - check box end label.

Models listed by Engine Size. Only listed by trim level where pads differ, (16v, GL, GT, etc).

BRAKE PADS & SHOES - APPLICATIONS

Bremsbeläge / Plaquettes + Bremsbacken / Machoires

EBC

BRAKES









Make/Model/Engine Hersteller/Modell/Motor Modèles	Year Jahr Années	Pads Front / Vorn / Avant		Shoes	Pads Rear / Hinten / Arrière		Shoes
		Original Quality ECE R90* Approved	Upgrade Quality Tuning/Sportbeläge ECE R90* Approved	Bremsbacken Machoires ECE R90* Approved	Original Quality ECE R90* Approved	Upgrade Quality Tuning/Sportbeläge ECE R90* Approved	Bremsbacken Machoires ECE R90* Approved
VOLVO Contd.							
760 Contd.							
2.4 TD	82-87	DP 435(G)	DP 2435		DP 104(T)	DP 2104	
2.4 TD	82-87	DP 511(B)	DP 2800		DP 104(T)	DP 2104	
2.4 TD	88-90	DP 800(B)	DP 2800		DP 104(T)	DP 2104	
2.4 TD	88-90	DP 800(B)	DP 2800		DP 793(G)		
Handbrake Shoes EST	87-90						5214
Handbrake Shoes SALOON	82-90						6524
780							
2.0 Turbo	85-87	DP 435(G)	DP 2435		DP 104(T)	DP 2104	
2.0 Turbo	85-87	DP 511(B)	DP 2800		DP 104(T)	DP 2104	
2.0 Turbo	88-90	DP 800(B)	DP 2800		DP 793(G)		
2.4 TD	85-87	DP 435(G)	DP 2435		DP 104(T)	DP 2104	
2.4 TD	85-87	DP 511(B)	DP 2800		DP 104(T)	DP 2104	
Handbrake Shoes	85-90						5214
850							
2.0	92-97	DP 880	DP 2880		DP 1043	DP 2104	
2.3 Turbo	93-97	DP 2880	DP 3880		DP 2104	DP 3104	
2.5	92-97	DP 880	DP 2880		DP 1043	DP 2104	
2.5 4WD	96-97	DP 880	DP 2880		DP 793		
2.5 TD	96-97	DP 880	DP 2880		DP 1043	DP 2104	
Handbrake Shoes	92-97						6532
940							
2.0	90-97	DP 800(B)	DP 2800		DP 969(G)	DP 2114	
2.0	90-97	DP 435(G)	DP 2435		DP 1043(T)	DP 2104	
2.0 (ABS)	90-94	DP 842(G)	DP 21095		DP 793(G)		
2.0	94-97	DP 1095(G)	DP 21095		DP 793(G)		
2.0 Turbo (ABS)	91-97	DP 842(G)	DP 21095		DP 793(G)		
2.3	90-97	DP 800(B)	DP 2800		DP 969(G)	DP 2114	
2.3	90-97	DP 435(G)	DP 2435		DP 1043(T)	DP 2104	
2.3 (ABS)	90-94	DP 842(G)	DP 21095		DP 793(G)		
2.3	94-97	DP 1095(G)	DP 21095		DP 793(G)		
2.3 16v	90-97	DP 842(G)	DP 21095		DP 969(G)	DP 2114	
2.3 16v (ABS)	90-97	DP 842(G)	DP 21095		DP 793(G)		
2.3 Turbo (ABS)	90-97	DP 842(G)	DP 21095		DP 793(G)		
2.4 TD	90-97	DP 435(G)	DP 2435		DP 1043(T)	DP 2104	
2.4 TD	90-97	DP 800(B)	DP 2800		DP 1043(T)	DP 2104	
2.4 TD (INTC)	90-97	DP 842(G)	DP 21095		DP 969(G)	DP 2114	
2.4 TD (ABS)	90-94	DP 842(G)	DP 21095		DP 793(G)		
2.4 TD	94-97	DP 1095(G)	DP 21095		DP 793(G)		
Handbrake Shoes (Multi Link Susp)	90-93						6524
Handbrake Shoes	90-97						5214
960							
2.3 Turbo	92-98	DP 435(G)	DP 2435		DP 1043(T)	DP 2104	
2.3 Turbo	92-98	DP 800(B)	DP 2800		DP 1043(T)	DP 2104	
2.3 Turbo (ABS)	92-98	DP 842(G)	DP 21095		DP 793(G)		
2.5	94-97	DP 1095(G)	DP 21095		DP 793(G)		
3.0	90-94	DP 842(G)	DP 21095		DP 969(G)	DP 2114	
3.0	94-97	DP 1095(G)	DP 21095		DP 793(G)		
Handbrake Shoes 3.0 (Multi Link Susp)	90-93						6524
Handbrake Shoes 3.0	90-93						5214
Handbrake Shoes SALOON	93-97						6524
Handbrake Shoes ESTATE	93-97						5214

*Every EBC pad and shoe requiring ECE R-90 is available with approval subject to stock rotation - check box end label.
Models listed by Engine Size. Only listed by trim level where pads differ, (16v, GL, GT, etc).

Standard Quality - ECE R90 Approved with similar performance to original equipment brake pads.
Upgrade Quality (Tuning/ Sportbeläge) - ECE R90 Approved but with higher friction and improved performance for faster street use.
Verbesserte Qualität - mit ECE R90 Freigabe aber mit höherem Reibwert und verbesserter Bremsleistung für den schnellen Strasseninsatz.

Standard Qualität - mit ECE R90 Freigabe und ähnlicher Bremsleistung wie die Original Bremsbeläge.
Upgrade Qualität (Tuning/ Sportbeläge) - ECE R90 Approved but with higher friction and improved performance for faster street use.
Verbesserte Qualität - mit ECE R90 Freigabe aber mit höherem Reibwert und verbesserter Bremsleistung für den schnellen Strasseninsatz.

Qualité standard - Approuvée par la norme ECE R90 - Des performances équivalentes à l'origine.
Qualité améliorée - Approuvée par la norme ECE R90 - Un coefficient de friction supérieur et des performances accrues pour pilotage rapide sur route.
Calidad Mejorada - Aprobación CEE R90 con prestaciones similares a las pastillas originales.
Calidad Mejorada - Aprobación CEE R90 pero con un coeficiente de fricción más elevado y prestaciones mejoradas para un uso deportivo en carretera.

Make/Model/Engine Hersteller/Modell/Motor Modelos	Year Jahr Années	Pads  Front / Vorn / Avant		Shoes	Pads  Rear / Hinten / Arrière		Shoes
		Original Quality ECE R90* Approved 	Upgrade Quality Tuning/Sportbeläge ECE R90* Approved 	Bremsbacken Machoires 	Original Quality ECE R90* Approved 	Upgrade Quality Tuning/Sportbeläge ECE R90* Approved 	Bremsbacken Machoires 
VOLVO Contd.							
1800							
1.8	64-68	DP 108	DP 2108				
1.8 S	68-70	DP 143	DP 2143		DP 114	DP 2114	
1.8 E	70-71	DP 143	DP 2143		DP 114	DP 2114	
1.8 ES	70-71	DP 135			DP 104	DP 2104	
1.8 ES	72-73	DP 143	DP 2143		DP 114	DP 2114	
C70							
2.0 Turbo	99-	DP 880	DP 2880		DP 1043	DP 2104	
2.3 Turbo T5	97-	DP 2880	DP 3880		DP 2104	DP 3104	
2.3 Turbo T5	97-	DP 21362	DP 31362		DP 2104	DP 3104	
2.4 Turbo	99-	DP 880	DP 2880		DP 1043	DP 2104	
2.5 Turbo	97-	DP 880	DP 2880		DP 1043	DP 2104	
Handbrake Shoes	97-						6532
S40							
1.6	97-98	DP 1045	DP 21045		DP 1076		
1.6	98-	DP 1139	DP 21139		DP 1076		
1.8	95-98	DP 1045	DP 21045		DP 1076		
1.8	99-	DP 1139	DP 21139		DP 1076		
1.9 Turbo T4 (200 BHP)	97-	DP 21139	DP 31139		DP 1076		
2.0	95-98	DP 1045	DP 21045		DP 1076		
2.0	98-	DP 1139	DP 21139		DP 1076		
2.0 Turbo (160 BHP)	97-	DP 1139	DP 21139		DP 1076		
1.9 TD	96-98	DP 1045	DP 21045		DP 1076		
1.9 TD	98-	DP 1139	DP 21139		DP 1076		
S60							
2.0 Turbo	2000-	DP 1229	DP 21229		DP 1231		
2.3 Turbo T5	2000-	DP 21229	DP 31229		DP 1231		
2.4	2000-	DP 1229	DP 21229		DP 1231		
2.4 Turbo	2000-	DP 1229	DP 21229		DP 1231		
2.5 Turbo	2003-	DP 21229	DP 31229		DP 1231		
2.4 TD	2001-	DP 1229	DP 21229		DP 1231		
Handbrake Shoes	2000-						6594
S70							
2.0	97-2000	DP 880	DP 2880		DP 1043	DP 2104	
2.3 Turbo T5	97-2000	DP 2880	DP 3880		DP 2104	DP 3104	
2.3 Turbo T5R	97-2000	DP 21362	DP 31362		DP 2104	DP 3104	
2.4	99-2000	DP 880	DP 2880		DP 1043	DP 2104	
2.4 Turbo	99-2000	DP 880	DP 2880		DP 1043	DP 2104	
2.5	97-2000	DP 880	DP 2880		DP 1043	DP 2104	
2.5 Turbo	97-2000	DP 880	DP 2880		DP 1043	DP 2104	
2.5 4WD	97-2000	DP 880	DP 2880		DP 793		
2.5 TD	97-2000	DP 880	DP 2880		DP 1043	DP 2104	
Handbrake Shoes	97-2000						6532
S80							
2.4	98-	DP 1229	DP 21229		DP 1231		
2.5 Turbo	2002-	DP 1229	DP 21229		DP 1231		
2.9 Turbo T6	98-	DP 21229	DP 31229		DP 1231		
2.9	98-	DP 21229	DP 31229		DP 1231		
2.4 TD	2001-	DP 1229	DP 21229		DP 1231		
2.5 TD	98-2001	DP 1229	DP 21229		DP 1231		
Handbrake Shoes	98-						6594
S90							
3.0	97-	DP 1095	DP 21095		DP 793		
Handbrake Shoes	97-						6532

Standard Quality - ECE R90 Approved with similar performance to original equipment brake pads.
Upgrade Quality (Tuning / Sportbeläge) - ECE R90 Approved but with higher friction and improved performance for faster street use.

Standard Qualität - mit ECE R90 Freigabe und ähnlicher Bremsleistung wie die Original Bremsbeläge.
Verbesserte Qualität - mit ECE R90 Freigabe aber mit höherem Reibwert und verbesserter Bremsleistung für den schnellen Strasseninsatz.

Calidad Estándar - Aprobación CEE R90 con prestaciones similares a las pastillas originales.
Calidad Mejorada - Aprobación CEE R90 pero con un coeficiente de fricción más elevado y prestaciones mejoradas para un uso deportivo en carretera.









*Every EBC pad and shoe requiring ECE R-90 is available with approval subject to stock rotation - check box end label.
Models listed by Engine Size. Only listed by trim level where pads differ, (16v, GL, GT, etc).

BRAKE PADS & SHOES - APPLICATIONS

Bremsbeläge / Plaquettes + Bremsbacken / Machoires

EBC

BRAKES

Make/Model/Engine Hersteller/Modell/Motor Modèles	Year Jahr Années	Pads  Front / Vorn / Avant		Shoes	Pads  Rear / Hinten / Arrière		Shoes
		Original Quality ECE R90* Approved 	Upgrade Quality Tuning/Sportbeläge ECE R90* Approved 	Bremsbacken Machoires 	Original Quality ECE R90* Approved 	Upgrade Quality Tuning/Sportbeläge ECE R90* Approved 	Bremsbacken Machoires 
VOLVO Contd.							
V40							
1.8	96-98	DP 1045	DP 21045		DP 1076		
1.8	98-	DP 1139	DP 21139		DP 1076		
1.9 Turbo T4 (200 BHP)	97-	DP 21139	DP 31139		DP 1076		
2.0	96-98	DP 1045	DP 21045		DP 1076		
2.0	98-	DP 1139	DP 21139		DP 1076		
2.0 Turbo (160 BHP)	97-	DP 1139	DP 21139		DP 1076		
1.9 D	99-	DP 1139	DP 21139		DP 1076		
1.9 TD	96-98	DP 1045	DP 21045		DP 1076		
1.9 TD	98-	DP 1139	DP 21139		DP 1076		
V70							
2.0	97-2000	DP 880	DP 2880		DP 1043	DP 2104	
2.3 Turbo T5	97-2000	DP 2880	DP 3880		DP 2104	DP 3104	
2.3 Turbo T5	97-2000	DP 21362	DP 31362		DP 2104	DP 3104	
2.3 Turbo T5	2000-	DP 21229	DP 31229		DP 1231		
2.4	2000-	DP 1229	DP 21229		DP 1231		
2.4 Turbo	2000-	DP 1229	DP 21229		DP 1231		
2.5	97-2000	DP 880	DP 2880		DP 1043	DP 2104	
2.5 Turbo	97-2000	DP 880	DP 2880		DP 1043	DP 2104	
2.5 Turbo	2001-	DP 1229	DP 21229		DP 1231		
2.5 Turbo R	2003-	DP 21229	DP 31229		DP 1231		
2.4 TD	2000-	DP 1229	DP 21229		DP 1231		
2.5 TD	97-2000	DP 880	DP 2880		DP 1043	DP 2104	
Handbrake Shoes	97-						6532
V70 XC							
2.4 Turbo	97-2000	DP 880	DP 2880		DP 793		
Handbrake Shoes							6532
V90							
3.0	97-	DP 1095	DP 21095		DP 793		
Handbrake Shoes	97-						6532
XC 70							
2.5 Turbo	2002-	DP 1229	DP 21229		DP 1231		
2.4 TD	2002-	DP 1229	DP 21229		DP 1231		
XC 90							
2.9 T6	2002-	DP 21229	DP 31229		DP 1231		
2.4 TD	2002-	DP 1229	DP 21229		DP 1231		
Cross Country							
2.4 Turbo	2001-2002	DP 1229	DP 21229		DP 1231		

Pad Illustrations for Volvo

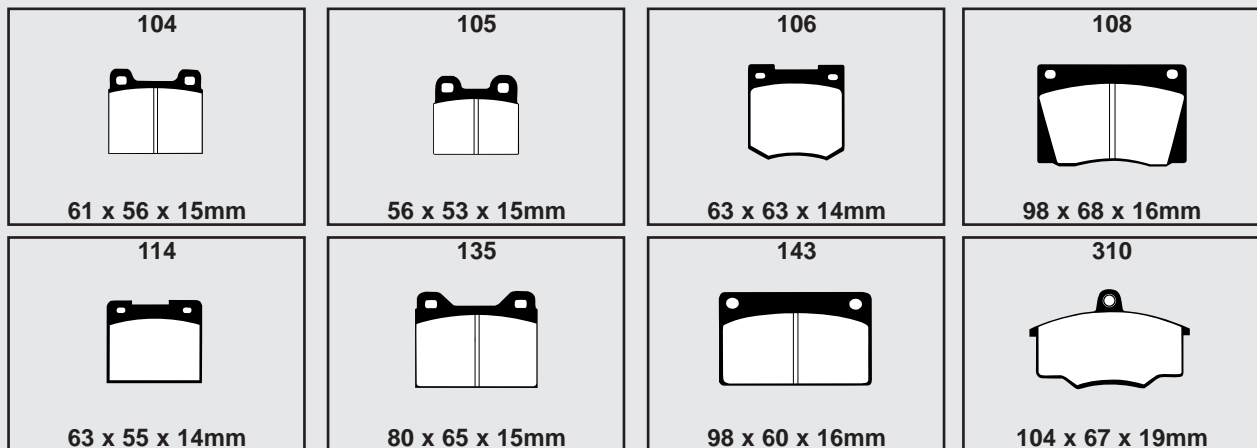

*Every EBC pad and shoe requiring ECE R-90 is available with approval subject to stock rotation - check box end label.
Models listed by Engine Size. Only listed by trim level where pads differ, (16v, GL, GT, etc).

Standard Quality - ECE R90 Approved with similar performance to original equipment brake pads.
Upgrade Quality (Tuning/ Sportbeläge) - ECE R90 Approved but with higher friction and improved performance for faster street use.
Verbesserte Qualität - mit ECE R90 Freigabe aber mit höherem Reibwert und verbesserter Bremsleistung für den schnellen Strasseninsatz.

Standard Qualität - mit ECE R90 Freigabe und ähnlicher Bremsleistung wie die Original Bremsbeläge.
Upgrade Qualität (Tuning/ Sportbeläge) - ECE R90 Approved but with higher friction and improved performance for faster street use.
Qualité standard - Approuvée par la norme ECE R90 - Des performances équivalentes à l'origine.
Qualité améliorée - Approuvée par la norme ECE R90 - Un coefficient de friction supérieur et des performances accrues pour pilotage rapide sur route.
Calidad Mejorada - Aprobación CEE R90 con prestaciones similares a las pastillas originales.
Calidad Mejorada - Aprobación CEE R90 pero con un coeficiente de fricción más elevado y prestaciones mejoradas para un uso deportivo en carretera.

Make/Model/Engine	Year	Pads	Front / Vorn / Avant	Shoes	Pads	Rear / Hinten / Arrière	Shoes
Hersteller/Modell/Motor	Jahr	Plaquettes / Bremsbeläge		Bremsbacken Machoires	Plaquettes / Bremsbeläge		Bremsbacken Machoires
Modelos	Années	Original Quality ECE R90* Approved		Upgrade Quality Tuning/Sportbeläge ECE R90* Approved		Original Quality ECE R90* Approved	
						Upgrade Quality Tuning/Sportbeläge ECE R90* Approved	

Pad Illustrations for Volvo

435 127 x 66 x 16mm	447/2 125 x 38 x 14mm	511 114 x 51 x 16mm	793 90 x 54 x 13mm
779/2 94 x 51 x 15mm	800 113 x 62 x 16mm	838 109 x 67 x 17mm	842 129 x 65 x 18mm
880 156 x 63 x 18mm	969 63 x 55 x 12mm	989 151 x 51 x 17mm	1043 62 x 57 x 14mm
1045 130 x 73 x 16mm	1076 87 x 47 x 15mm	1095 128 x 64 x 18mm	1139 130 x 78 x 17mm
1229 155 x 72 x 18mm	1231 123 x 53 x 17mm		

WARTBURG

311				
1.1	83-	DP 288		
353				
1.3	65-88	DP 288		

Pad Illustrations for Wartburg

288 84 x 57 x 15mm

Standard Quality - ECE R90 Approved with similar performance to original equipment brake pads.
Upgrade Quality (Tuning / Sportbeläge) - ECE R90 Approved but with higher friction and improved performance for faster street use.

Standard Qualität - mit ECE R90 Freigabe und ähnlicher Bremsleistung wie die Original Bremsbeläge.
Verbesserte Qualität - mit ECE R90 Freigabe aber mit höherem Reibwert und verbesserter Bremsleistung für den schnellen Strasseneinsatz.

Quality standard - Approuvée par la norme ECE R90 - Des performances équivalentes à l'origine.
Qualité améliorée - Approuvée par la norme ECE R90 - Un coefficient de friction supérieur et des performances accrues pour pilotage rapide sur route.











Calidad Estándar - Aprobación CEE R90 con prestaciones similares a las pastillas originales.
Calidad Mejorada - Aprobación CEE R90 pero con un coeficiente de fricción más elevado y prestaciones mejoradas para un uso deportivo en carretera.

BRAKE PADS & SHOES - APPLICATIONS

Bremsbeläge / Plaquettes + Bremsbacken / Machoires

EBC

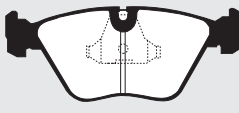
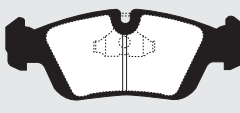
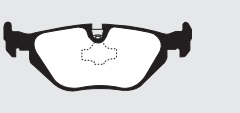
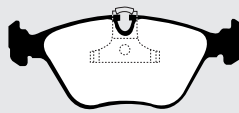
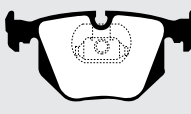
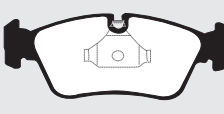

BRAKES

Make/Model/Engine	Year	Pads  Front / Vorn / Avant	Shoes 	Pads  Rear / Hinten / Arrière	Shoes 		
Hersteller/Modell/Motor	Jahr	Plaquettes / Bremsbeläge		Bremsbacken Machoires			
Modelos	Années	Original Quality ECE R90* Approved 	Upgrade Quality Tuning/Sportbeläge ECE R90* Approved 	Original Quality ECE R90* Approved 	Upgrade Quality Tuning/Sportbeläge ECE R90* Approved 		
WARWICK							
2.0	60-62	-	DP 2100				
Pad Illustrations for Warwick							
<div style="border: 1px solid black; padding: 5px; width: fit-content; margin: 0 auto;"> <p>2100</p>  <p>100 x 66 x 16mm</p> </div>							
WEISMANN							
GT							
4.4	2003-						
MF 25							
2.5	93-2000	DP 2914	DP 3914	DP 21079	DP 31079		
MF 28							
2.8	97-2000	DP 2914	DP 3914	DP 21079	DP 31079		
2.8	2000-2002	DP 21211	DP 31211	DP 21289	DP 31289		
MF 3							
3.2	2003-	DP 2689	DP 3689	DP 21118	DP 31118		
MF 30							
3.0	2003-	DP 21089	DP 31089	DP 21118	DP 31118		
Pad Illustrations for Weismann							
<div style="border: 1px solid black; padding: 5px; width: fit-content; margin: 0 auto;"> <p>2689</p>  <p>156 x 63 x 19mm</p> </div>		<div style="border: 1px solid black; padding: 5px; width: fit-content; margin: 0 auto;"> <p>2914</p>  <p>151 x 57 x 16mm</p> </div>		<div style="border: 1px solid black; padding: 5px; width: fit-content; margin: 0 auto;"> <p>21079</p>  <p>123 x 43 x 16mm</p> </div>		<div style="border: 1px solid black; padding: 5px; width: fit-content; margin: 0 auto;"> <p>21089</p>  <p>156 x 64 x 20mm</p> </div>	
<div style="border: 1px solid black; padding: 5px; width: fit-content; margin: 0 auto;"> <p>21118</p>  <p>123 x 58 x 17mm</p> </div>		<div style="border: 1px solid black; padding: 5px; width: fit-content; margin: 0 auto;"> <p>21211</p>  <p>150 x 57 x 18mm</p> </div>		<div style="border: 1px solid black; padding: 5px; width: fit-content; margin: 0 auto;"> <p>21289</p>  <p>123 x 45 x 17mm</p> </div>			
WESTFIELD							
1.6	82-	DP 114	DP 2114		5135		
1.6	82-	DP 291	DP 2291		5135		
SEi							
2.0 Turbo	94-	DP 415	DP 2415	DP 617	DP 2617		
SEiGHT							
	91-	DP 415	DP 2415	DP 617	DP 2617		
ZEi							
1.8	92-	DP 415	DP 2415		5223		



Standard Quality - ECE R90 Approved with similar performance to original equipment brake pads.
 Upgrade Quality (Tuning/ Sportbeläge) - ECE R90 Approved but with higher friction and improved performance for faster street use.
 Standard Qualität - mit ECE R90 Freigabe und ähnlicher Bremsleistung wie die Original Bremsbeläge.
 Verbesserte Qualität - mit ECE R90 Freigabe aber mit höherem Reibwert und verbesserter Bremsleistung für den schnellen Strasseninsatz.

Qualité standard - Approuvée par la norme ECE R90 - Des performances équivalentes à l'origine.
 Qualité améliorée - Approuvée par la norme ECE R90 - Un coefficient de friction supérieur et des performances accrues pour pilotage rapide sur route.
 Calidad Estándar - Aprobación CEE R90 con prestaciones similares a las pastillas originales.
 Calidad Mejorada - Aprobación CEE R90 pero con un coeficiente de fricción más elevado y prestaciones mejoradas para un uso deportivo en carretera.

*Every EBC pad and shoe requiring ECE R-90 is available with approval subject to stock rotation - check box end label.
 Models listed by Engine Size. Only listed by trim level where pads differ, (16v, GL, GT, etc).

Make/Model/Engine	Year	Pads	Front / Vorn / Avant	Shoes	Pads	Rear / Hinten / Arrière	Shoes
Hersteller/Modell/Motor	Jahr	Plaquettes / Bremsbeläge		Bremsbacken Machoires	Plaquettes / Bremsbeläge		Bremsbacken Machoires
Modelos	Années	Original Quality ECE R90* Approved	Upgrade Quality Tuning/Sportbeläge ECE R90* Approved	 ECE R90* Approved	Original Quality ECE R90* Approved	Upgrade Quality Tuning/Sportbeläge ECE R90* Approved	 ECE R90* Approved

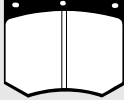
Pad Illustrations for Westfield

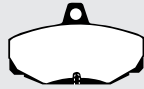
114	291	415	617
			
63 x 55 x 14mm	78 x 66 x 15mm	151 x 46 x 17mm	90 x 54 x 13mm

YUGO

1.1	71-77	DP 116			
1.3	70-79	DP 101			
1.3	79-83	DP 116			5031
1.5	70-83	DP 101		DP 130	5031
311					
1.1	83-90	DP 116			5031
313					
1.3	83-90	DP 116			5031
411					
1.1	83-90	DP 116			5031
511					
1.1	83-90	DP 116			5031
413/513					
1.3	83-90	DP 116			5031
45					
0.9	81-91	DP 116			5031
55					
1.1	81-91	DP 116			5031
65					
1.3	88-91	DP 116			5031
Sana					
1.4	89-93	DP 718/2			5329
Tempo					
0.9	91-93	DP 116			5031
1.1	91-93	DP 116			5031
1.3	91-93	DP 116			5031

Pad Illustrations for Yugo

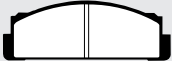
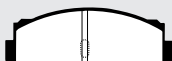
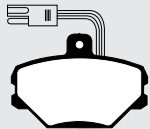
101	116	130	718/2
			
80 x 66 x 15mm	108 x 39 x 17mm	108 x 39 x 10mm	90 x 64 x 16mm

Standard Quality - ECE R90 Approved with similar performance to original equipment brake pads.
Upgrade Quality (Tuning / Sportbeläge) - ECE R90 Approved but with higher friction and improved performance for faster street use.

Standard Qualität - mit ECE R90 Freigabe und ähnlicher Bremsleistung wie die Original Bremsbeläge.
Verbesserte Qualität - mit ECE R90 Freigabe aber mit höherem Reibwert und verbesserter Bremsleistung für den schnellen Strasseninsatz.

Calidad Estándar - Aprobación CEE R90 con prestaciones similares a las pastillas originales.
Calidad Mejorada - Aprobación CEE R90 pero con un coeficiente de fricción más elevado y prestaciones mejoradas para un uso deportivo en carretera.

BRAKE PAD & SHOE - BUYERS GUIDE

EBC
BRAKES

PAD SET NO	APPLICATION	PAD SET NO	APPLICATION	PAD SET NO	APPLICATION
101	Jaguar, Aston Martin	175	Mercedes	274	Audi
102	Rover	175/2	Volkswagen	275	Skoda
103	Alfa, Porsche, Vauxhall	177	Citroen	281	Honda
104	Alfa, BMW, Audi, Mercedes, VW, Volvo, Vauxhall	178	Citroen	282	Alfa, BMW
105	Volkswagen, Volvo, Alfa, BMW, Porsche	179	Audi, Ford	282/2	BMW
105/4	Saab	180	Maserati, De Tomaso	283	BMW
106	Ford, Rover, Talbot, Volvo	181	Fiat	284	Renault
107	Rover	182	Vauxhall	285	Use 413
108	Aston Martin, Lotus, Jaguar, Rover	183	Volkswagen	286	Nissan
110	Fiat	184	Volkswagen	287	Nissan
111	Volkswagen	185	Porsche	288	Wartburg, Skoda
112	Fiat	188	Lancia	289	Toyota
113	Citroen	189	Renault, Lotus	290	Mitsubishi
114	Ford, Volvo, Lotus	190	Fiat, Citroen	291	Ford, Hyundai
115	Use 143	191	Citroen	292	Talbot
116	Fiat, Seat, Yugo	192	Alfa	293	Use 417
118	Renault	193	Alfa, Lancia	294	Rover
119	Renault	194	Audi, VW	295	Talbot
120	Aston Martin, Lancia, Jaguar, Rover	195	Toyota	296	Ford
121	Peugeot	196	Hyundai, Mazda, Toyota, Mitsubishi	297	Lancia
122	Peugeot	197	BMW, Lotus, Vauxhall	298	Lancia, Lotus
123	Peugeot	197/2	Lotus	309	Lada
123/2	Talbot	198	Nissan	310	Audi, Volvo
123/3	Talbot	200	Subaru	310/2	Audi
124	Peugeot	201	Nissan	311	Alfa, BMW
125	BMW	207	Mazda	311/2	Porsche
125/2	BMW	216	Saab	314	Daihatsu, Toyota
126	Audi, BMW, Volkswagen	217	Saab	315	Jensen, Rover
127	Rover, Vauxhall	218	Alfa	316	Rover
128	Rover	220	Renault	317	Alfa, Nissan
129	Nissan	220/2	Audi, Porsche	318	Mazda
130	Fiat	220/3	Citroen, Talbot, Peugeot	319	Subaru
131	Citroen	220/4	Talbot	320	Toyota
132	Citroen	220/5	Use 220/3	321	Toyota
133	Subaru	220/6	Use 220/3	322	Toyota
135	Volvo	220/8	Peugeot, Citroen	323	Toyota
136	Daihatsu	220/9	Citroen	324	Renault
137	Citroen	221	Citroen	325	Vauxhall
138	Mazda, Toyota	222	Citroen	326	Mazda
139	Nissan	223	Roadsport Only	327	Mazda
140	Citroen	225	Use 125	329	Daihatsu, Toyota
141	Ford	227	Citroen	331	Nissan
142	Rover, Vauxhall	230	Lancia	332	Talbot
143	Volvo	231	Lancia	332/2	Use 332
144	Nissan	237	Honda	341	BMW
145	Lotus	238	Honda	342	BMW
146	Talbot	239	Peugeot, Talbot	343	Use 342
147	Talbot	240	Ford, Rover, Vauxhall	344	Honda
148	Use 316	241	Fiat, Ford, Rover	345	Porsche
149	Saab	242	Use 240	346	Porsche
150	Renault	243	Rover	347	Use 612
151	Fiat	244	Citroen	348	Use 546
154	Fiat	245	Citroen	349	Citroen, Peugeot
155	Rover	246	Citroen	350	Citroen
156	Renault	248	Citroen	352	Nissan, Toyota
158	Honda	249	Citroen	353	Talbot
159	Skoda	250	Use 395	354	Renault
160	Porsche	252	Peugeot	365	Nissan
161	Talbot, Rover	258	Rover, Lotus	366	Volkswagen
162	Fiat, De Tomaso	261	Mercedes	366/2	Volkswagen
163	Peugeot	261/2	Mercedes	367	Nissan
164	Use 161	262	Jaguar, Renault	368	Seat
166	Toyota	263	Use 273	369	Audi, VW
169	Rover, Ford, Talbot, Lotus, Vauxhall	264	Mazda	369/2	Audi, VW, Seat
171	Use 207	265	Mazda	370	VW, Audi, Lancia, Alfa
172	Lada	266	Use 189	371	Use 130
173	Fiat	267	Renault, Fiat	372	Fiat, Seat
174	Audi/VW	268	Use 190	374	Suzuki, Rover, Honda
		269	Citroen, Renault	376	Toyota
		270	Ford	378	Fiat
		271	Mazda	380	Toyota
		273	Nissan, Toyota	383	Mitsubishi

PAD SET NO	APPLICATION	PAD SET NO	APPLICATION	PAD SET NO	APPLICATION
384	Talbot	473	Ford	582	Subaru
385	Talbot	474	Rover	596	Fiat
386	Use 489	475	Daihatsu	599	Mazda
387	Mazda	483	Use 485	602	Toyota
389	Ford	484	Nissan	603	Use 622
392	Toyota, Mitsubishi	485	Fiat, Lancia, Seat	604	Renault
393	Use 627	486	Audi	605/2	Ford
395	Citroen, Fiat	486/2	Audi	606	Rover
398	Rover	489	Peugeot, Renault	607	Mazda
401	Use 240	489/2	Renault	608	Use 608/2
402	Toyota	489/4	Use 458/2	608/2	Toyota
406	Citroen	490	Mazda	610	Toyota
407	Use 344	501	Fiat, Lancia	611	Mitsubishi
410	Lancia, Seat	504	Use 616	612	Porsche
410/2	Lancia	506	Alfa, Nissan	613	Suzuki
411	Citroen	507	Alfa	615	Subaru
413	Mercedes	508	Alfa	616	Fiat, Lancia
414	BMW, Porsche	509	Maserati	616/2	Alfa Romeo
415	Ford, Ferrari	510	Fiat	617	Ford
417	Fiat, Talbot	511	Volvo	622	Rover
418	Nissan	512	Ford	623	Honda
419	Toyota	514	Honda	624	Use 501
420	Fiat, Lancia	514/2	Suzuki	625	Alfa Romeo
420/2	Fiat	515	Volkswagen, Seat	626	Peugeot
420/4	Lancia	517	Volkswagen, Seat	627	Rover, Reliant
424	Toyota	517/2	Volkswagen, Seat	628	Toyota
425	Citroen, Fiat, Peugeot, Talbot	526	Nissan	629	Toyota
426	Peugeot, Renault	527	Nissan	630	Honda, Rover
426/4	Citroen	528	Nissan	631	Honda
428	Talbot	529	Honda	632	Mercedes
429	Talbot	530	Use 352	633	Renault
432	Honda	531	Isuzu	633/2	Renault
432/2	Use 606	532	Toyota, Daihatsu	634	Skoda, Tatra
433	Mitsubishi	534	Suzuki	635	Saab
435	Volvo	535	Bedford	636	Nissan
436	Ford	536	Toyota	637	Lada
437	Ford	537	Mitsubishi, Proton	638	Toyota
438	Ford	538	Nissan	639	Honda
439	Mazda	539	Toyota	640	Mazda
441	Mazda	540	Porsche	641	Nissan
442	Mazda	541	Mazda, Daihatsu	642	Honda
443	Mercedes	542	Daihatsu	642/2	Rover, Honda
445	Nissan	544	Renault	643	Rover
446	Mits.	545	Renault	649	Vauxhall
447	BMW	545/2	Renault	650	Ford
447/2	Volvo	545/4	Citroen, Peugeot	651	Citroen, Peugeot
448	Vauxhall	546	Peugeot	652	Peugeot
450	Honda	547	Renault	653	Alfa
451	Mazda	553	Use 754	654	Volkswagen
452	Nissan, Subaru	556	Hyundai, Honda	655	Mazda
453	Toyota	558	Use 877	656	Peugeot, Citroen
454	Vauxhall	560	Honda	657	Mazda
455	Ford	562	Nissan	662	Rover, Honda
456	Toyota, Lotus	563	Use 352	662/2	Rover
457	Toyota	564	Use 432	663	Rover
458	Citroen	567	Nissan	665	Nissan, Suzuki
458/2	Renault, Peugeot	568	Isuzu	666	Use 779
458/3	Bristol	569	Isuzu	666/2	Use 779/2
459	Use 489	570	Honda	667	Mitsubishi
460	Mitsubishi	571	Ford, TVR	668	Renault
461	Mitsubishi	571/2	Ford	671	Mercedes
462	Rover	572	Use 406	673	Mazda
463/2	Use 779	573	Citroen	674	Subaru
464	Mercedes	574	Use 410	675	Vauxhall
465	Citroen	575	Citroen	676	Vauxhall
466	Mazda/Isuzu	575/4	Citroen	677	Use 458/2
467	Rover	576	Mitsubishi	678	Bristol
468	Nissan	577	Mercedes	679	Mitsubishi
469	Subaru	578	Alfa	680	Peugeot, VW, Seat
470	Use 147	579	Use 547	681	Mercedes
471	Rover	580	Use 426	682	Nissan
472	Fiat	581	Renault	683	Mazda

BRAKE PAD & SHOE - BUYERS GUIDE

EBC
BRAKES

PAD SET NO	APPLICATION	PAD SET NO	APPLICATION	PAD SET NO	APPLICATION
684	Use 410	779	BMW	887	Mercedes
685	Daihatsu	779/2	Volvo	888	Mercedes
686/2	Nissan	781	Honda, Rover	889	Nissan
687	Peugeot	781/2	Honda	890	Honda
688	Nissan	786	Mercedes	891	Honda
689	BMW	787	Toyota	892	Nissan
689/2	Jaguar	792	Nissan, Hyundai	900	Ford
690	BMW	793	Volvo	910	Ford
690/2	Jaguar	794	Citroen	910/2	Ford
691	Nissan, Subaru	794/2	Peugeot	911	Honda
702	Fiat	795	Citroen	912	Alfa
704	Fiat	796	Mazda	913	Alfa
705	Mazda	797	Toyota	914	BMW
706	Honda	799	Daihatsu	916	Alfa
708	Rover	800	Volvo	918	Ford
709	Jaguar	802	Mazda	918/2	Ford
711	Audi	803	Hyundai	919	Hyundai
713	Rover	807	Toyota	920	Ford
714	Ford/Volvo	810	Rover, Honda	920/2	Ford
715	Rover	812	Honda	927	Mercedes
715/2	Rover, Fiat	813	Chrysler (USA)	927/2	Mercedes
716	Mitsubishi	814	Rover	928	Mercedes
717	Alfa Romeo	815	Rover, Honda	936	Toyota
718	Fiat	816	Peugeot	937	Vauxhall
718/2	Yugo	817	Rover	938	Use DP2002/3002
719	Honda	818	Honda	939	Volkswagen
719/2	Honda, Rover	819	Subaru	940	Vauxhall
720	Fiat	820	Fiat, Lancia	941	Proton, Mitsubishi
721	Fiat	820/2	Alfa	942	Citroen
722	Toyota	821	Subaru	943	Citroen
723	Honda	822	Subaru	944	Fiat
725	Toyota	824	Mazda	945	Fiat
729	Mazda	825	Nissan	946	Nissan
730	Mazda	826	Nissan	947	Nissan, Ford
733	Alfa, Lancia	828	Daihatsu, Mazda	948	Peugeot
733/2	Lancia	830	Mitsubishi, Proton	949	Renault
733/3	Alfa, Fiat	831	Use 818	950	Ford
734	Use 735	832	Mercedes	951	Renault
735	Talbot/Fiat	833	Nissan	952	Renault
736	Nissan	834	Nissan	953	Ford
737	Mazda	835	Alfa	954	Mitsubishi
738	Mitsubishi	836	Audi, VW	955	Ford
739	Mazda	837	Ford	956	Ford
740	Mazda	837/2	Ford	957	Use 370
741	Suzuki	838	Volvo	958	Mitsubishi
743	Toyota	839	Nissan	959	Renault
746	Isuzu, Vauxhall	840	Subaru	960	Ford
747	Toyota	841	VW, Seat	961	Ford
751	Saab	841/2	Volkswagen	962	Mercedes
753	Ford	841/3	Volkswagen	963	Mercedes
754	Vauxhall	842	Volvo	964	Toyota
755	Vauxhall	846	Mercedes	965	Ford
756	Jaguar	847	Toyota	966	Subaru
756/2	Jaguar	870	BMW	967	Volkswagen
757	Jaguar	871	BMW	968	Nissan
757/2	Jaguar	872	Honda, Rover	969	Volvo
760	Vauxhall	873	Honda	970	Aston Martin
761	Vauxhall	874	Toyota	971	Mazda
762	Suzuki	875	Toyota	972	Madza
763	Mazda	876	Toyota	973	Isuzu, Vauxhall
764	Use 792	877	Toyota	973/2	Isuzu, Vauxhall
765	Daihatsu	878	Toyota	974	Isuzu, Vauxhall
766	Suzuki	879	Toyota	975	Honda, Rover
767	Porsche	880	Volvo	976	Vauxhall, Saab
768	Daihatsu	881	Peugeot	977	Suzuki
769	Ford	882	Citroen	978	Lotus
773	Use 528	882/2	Peugeot, Renault	979	Suzuki
774	Suzuki	883	Audi	980	Renault
775	Nissan	884	Mazda	981	VW
776	Use 528	885	Renault, Lotus	982	VW
777	Isuzu	885/2	Lotus	982/2	VW
778	Mercedes	886	BMW	983	Renault

PAD SET NO	APPLICATION	PAD SET NO	APPLICATION	PAD SET NO	APPLICATION
984	Use 984/2	1053	Citroen, Fiat, Peugeot	1127	Use 1137
984/2	Honda	1054	Mercedes	1128	Renault
985	Honda	1055	Mercedes	1129	Chrysler (USA)
986	Mitsubishi	1056	Seat, VW	1130	Chrysler (USA)
987	Mitsubishi	1057	Use 545	1131	Aston Martin, Chevrolet
988	Nissan	1058	Use 948	1132	Ssangyong
989	Volvo	1059	Fiat	1133	Toyota
990	Saab	1060	Fiat	1134	Subaru
991	Toyota	1061	Fiat	1135	Mercedes
992	Toyota	1062	Vauxhall, Saab	1136	Citroen, Renault
993	Toyota	1063	Mits, Proton	1136/2	Use 1366
994	Toyota	1064	Seat, VW	1137	VW
995	Toyota	1065	Chrysler (USA)	1138	Subaru
996	Porsche	1066	Chrysler (USA)	1139	Volvo
997	Porsche	1067	Nissan	1140	Lotus, Dodge
998	Nissan	1068	Use 689/2	1141	Fiat
999	Lancia	1069	Mercedes	1144	To fit Wilwood (Dynalite Single)
1000	Ford, Nissan	1070	Mercedes	1146	Chevrolet
1001	Kia	1071	Mercedes	1148	To fit Wilwood (GN)
1002	Mazda	1072	Nissan	1153	Alfa
1003	Mazda	1073	Kia	1154	Toyota
1004	Toyota	1074	Ford, Seat, VW	1160	Chevrolet
1005	Toyota	1075	Mercedes	1162	Chevrolet
1006	Toyota	1076	Volvo	1170	Mercedes
1007	Use 21007	1077	Citroen	1171	Toyota
1008	Toyota	1078	Renault	1182	Renault
1009	Jaguar	1079	BMW	1183	Vauxhall
1010	Use 995	1080	Citroen	1184	Vauxhall
1011	Alfa	1081	Mercedes	1185	Ford
1012	Audi	1082	Nissan	1186	Vauxhall
1013	Audi	1083	Use 708	1187	Saab
1014	Audi	1084	VW	1188	Citroen
1015	Daihatsu	1085	Ford	1189	Mazda
1016	Daihatsu	1086	Hyundai	1190	Renault
1017	Hyundai	1087	Vauxhall	1191	Mercedes
1018	Use 971	1089	BMW	1192	Lada
1019	Mazda	1090	Mercedes	1193	Honda
1020	Nissan	1091	BMW	1194	Chrysler (USA)
1021	Peugeot	1092	Use 887	1195	Toyota
1022	Chrysler (USA), Kia	1093	Suzuki	1196	Daewoo
1023	Subaru	1095	Volvo	1197	Daewoo
1024	Citroen	1096	Alfa	1198	Jaguar
1025	Citroen	1097	Mitsubishi	1199	Ford
1026	Mercedes	1098	Mitsubishi	1200	Roadsport Only
1027	Mercedes	1099	Suzuki	1201	Ford
1028	Rover	1100	Vauxhall	1202	Chrysler (USA)
1029	Subaru	1101	Nissan	1203	Hyundai
1030	VW	1102	VW	1204	Toyota
1030/2	VW	1103	Mazda	1205	Use 458/2
1031	Lancia, Fiat	1104	Citroen, Peugeot	1206	Roadsport Only
1031/2	Peugeot	1105	Nissan	1207	Porsche
1032	BMW	1106	Suzuki	1208	Porsche
1033	Rover	1107	Toyota	1209	Daewoo
1034	Honda	1108	Citroen, Fiat, Peugeot	1210	Roadsport Only
1035	BMW, Mercedes, Audi	1109	Fiat, Lancia	1211	BMW
1036	BMW	1110	Roadsport Only	1212	Daewoo
1037	Rover	1111	Citroen	1214	Alfa, Fiat
1038	Rover	1112	VW	1216	Honda
1039	Mitsubishi	1113	VW	1217	Daihatsu
1040	Citroen, Fiat, Peugeot	1114	Audi	1218	Ford
1041	Suzuki	1115	VW	1219	Rover
1042	Use 675	1116	VW	1220	Jaguar
1043	Volvo	1117	Audi, Skoda	1221	Jaguar
1044	Nissan	1118	BMW	1222	Mazda
1045	Volvo, Mitsubishi	1119	Chrysler (USA)	1223	Toyota
1046	Nissan	1120	Daihatsu	1224	Toyota
1047	Peugeot	1121	Mazda	1225	Toyota
1048	Peugeot	1122	Vauxhall	1226	Citroen
1049	Peugeot	1123	Chrysler (USA)	1227	Alfa
1050	Ford	1124	Mitsubishi	1228	Mitsubishi
1051	Ford	1125	Use 438	1229	Volvo
1052	FSO	1126	Ssangyong	1230	Audi, VW, Peugeot, Skoda, Seat

BRAKE PAD & SHOE - BUYERS GUIDE

EBC
BRAKES

PAD SET NO	APPLICATION	PAD SET NO	APPLICATION	PAD SET NO	APPLICATION
1231	Volvo	1355	Honda	1429	VW
1232	Mercedes	1356	Kia	1430	Alfa
1233	Mercedes	1357	Chrysler	1431	Toyota
1234	Peugeot	1358	Hyundai	1432	Audi
1235	Kia	1359	Hyundai (Korea)	1433	VW
1236	Kia	1360	Nissan	1434	Citroen
1237	Kia	1361	Vauxhall	1435	Citroen
1238	Nissan	1362	Volvo	1436	Skoda, Seat
1239	Chevrolet	1363	Mercedes	1437	Mercedes
1254	Honda	1364	Mercedes	1438	Mercedes
1255	Jeep	1365	Mercedes	1439	Volvo
1256	Use 61256	1366	Peugeot	1440	Fiat
1278	Use 21278/31278	1367	Ford	1441	Mercedes
1279	Nissan	1368	Ford, Seat, VW	1442	Mitsubishi
1280	Nissan	1369	Renault	1443	Vauxhall
1281	Hyundai	1370	Citroen	1444	Ford
1282	Toyota	1371	Citroen	1445	VW
1283	Toyota	1372	Citroen	1446	Toyota
1284	VW	1373	Citroen	1447	Vauxhall
1285	VW	1374	Peugeot	1448	Ford
1286	VW	1375	Peugeot	1449	Use 21449
1287	Smart	1376	Nissan	1450	Use 21450
1288	Mercedes	1377	MG	1451	Use 21451
1289	BMW	1378	Fiat	1452	Mazda
1291	Suzuki	1379	Fiat	1453	Mazda
1292	Mercedes	1380	Fiat	1454	Use 21454
1293	Use 21293/31293	1381	Fiat	1455	Toyota
1294	Iveco	1382	Fiat	1456	Toyota
1295	Toyota	1383	Fiat	1457	Toyota
1297	Ford	1384	Fiat	1458	Toyota
1298	Mercedes	1385	Renault, Vauxhall	1459	Toyota
1299	Suzuki	1386	Renault, Vauxhall	1460	Use 1325
1300	Ford	1387	Use 1344	1461	Renault
1301	Mazda	1388	BMW (Mini)	1462	Use 21462
1302	Mazda	1389	BMW (Mini)	1463	Range Rover
1312	Jeep	1390	Suzuki	1464	Mazda
1315	Use 61619	1391	Hyundai	1465	Mazda
1319	Toyota	1392	Hyundai	1466	Citroen, Peugeot
1320	Ford	1393	Renault, Vauxhall	1467	Renault
1322	Ford	1394	Renault	1468	Renault
1323	Use 21323	1395	Mercedes	1469	Use 31469
1324	Audi, VW, Seat, Skoda	1396	Peugeot	1470	Use 21470/31470
1325	Toyota	1397	Toyota	1471	Nissan
1326	Toyota	1398	VW	1472	BMW
1327	Audi	1399	Toyota	1473	Use 21473
1328	Audi	1401	Toyota	1474	Use 21474
1329	Audi	1402	Toyota	1475	Kia
1330	Audi, VW, Seat	1403	Toyota	1476	Vauxhall
1331	Use 1295	1404	Kia	1477	Daewoo
1332	Hyundai	1405	Saab	1479	Skoda
1333	Hyundai	1406	Renault	1480	Hyundai
1334	Use 1358	1407	Mitsubishi	1481	Mitsubishi
1335	Daihatsu	1409	Mazda	1482	Use 21482
1336	Fiat	1410	Vauxhall	1483	Audi, Skoda, VW
1337	Fiat	1411	Mazda	1484	Mitsubishi
1338	Fiat	1412	Ford, Seat, VW	1485	Nissan
1339	Honda, Nissan, MG Rover	1413	Ford, Seat, VW	1510	Audi,
1340	Honda	1414	Vauxhall, Saab	1606	Chrysler
1341	Vauxhall	1415	Landrover	1610	Honda
1342	Aixam, Ligier	1416	Vauxhall	1611	Use 21611
1343	Mercedes	1417	Fiat	1612	Chrysler
1344	Suzuki	1418	Fiat	1613	Chrysler
1345	Suzuki	1419	Peugeot	1614	Mitsubishi
1346	Citroen	1420	Toyota	1616	Mazda
1347	Mitsubishi	1421	Toyota	1619	Mitsubishi
1348	Audi	1422	Toyota	1622	Use 21622
1349	Mazda	1423	Kia	1621	Use 21621
1350	Ford	1424	Lancia	1629	Chrysler
1351	Audi	1425	Lancia	1641	Ford
1352	Landrover	1426	Lexus	1642	Toyota
1353	Renault	1427	Chrysler	1644	Nissan
1354	Renault, Nissan, Vauxhall	1428	Mercedes		GREENSTUFF ROADSPORT

PAD SET NO	APPLICATION	PAD SET NO	APPLICATION	PAD SET NO	APPLICATION
2001	To fit Wilwood Dynalite	2325	Vauxhall	2751	Saab
2002	To fit AP Racing caliper CP3215D50	2345	Porsche	2753	Ford
2003	To fit AP Racing caliper CP2340D43	2346	Use 2220	2756	Jaguar
2004	To fit AP Racing caliper CP2340D51	2352	Nissan	2756/2	Jaguar
2005	To fit AP Racing caliper CP3894D51	2366	VW	2760	Vauxhall
2006	To fit AP Racing caliper CP3894D54	2369/2	Audi, VW	2761	Vauxhall
2007	To fit Wilwood Superlite	2370	Audi, Alfa	2762	Suzuki
2008	To fit AP Racing CP3345D44	2374	Honda	2763	Mazda
2009	To fit AP Racing CP3558D54	2389	Ford	2767	Porsche
2010	To fit Wilwood Bridgebolt	2414	BMW, Porsche, Ferrari	2769	Ford
2011	To fit AP Racing CP 3714	2415	Ford, Ferrari	2775	Nissan
2012	To fit AP Racing CP 3894 D46	2420/2	Fiat, Lancia	2778	Mercedes
2013	To fit Alcon 4441 25mm	2426	Peugeot, Renault	2779	BMW
2014	To fit Alcon 4441 20mm	2435	Volvo	2792	Nissan, Hyundai
2015	To fit Alcon 4441 18mm	2438	Ford	2800	Volvo
2016	To fit Alcon 4441 16mm	2447	BMW	2802	Mazda
2017	To fit Alcon 4441 15mm	2447/2	Volvo, Saab	2807	Use 6807
2018	To fit Alcon 4448 32mm	2452	Nissan	2810	Rover
2019	To fit Alcon 4448 25mm	2453	Toyota	2812	Honda
2020	To fit Alcon 4448 20mm	2456	Lotus, Toyota	2814	Use 6814
2021	To fit Alcon 4448 17.5mm	2458	Citroen	2815	Rover, Honda
2022	To fit Alcon 4464 30mm	2458/2	Renault	2817	Rover
2023	To fit Alcon 4464 16mm	2458/3	Bristol	2819	Subaru
2024	To fit Alcon 4476 20mm	2463/2	Use 2779	2820	Alfa, Fiat, Lancia
2025	To fit Alcon 4476 19mm	2466	Mazda	2821	Subaru
2026	To fit Alcon 4476 18mm	2467	Rover	2824	Mazda
2027	To fit Alcon 4476 16mm	2473	Ford	2825	Use 21200
2028	To fit Alcon 4476 15mm	2485	Fiat, Lancia, Seat	2826	Nissan
2029	To fit CPFC 7768.90.16.4	2486	Audi	2828	Daihatsu, Mazda
2030	To fit CPFC 770 25mm	2512	Ford	2830	Mitsubishi
2031	CP3215 D46	2517	VW	2833	Nissan
2032	CP3894 D51 16mm	2517/2	VW	2836	Audi, VW
2036	Morgan, Renault	2538	Nissan	2837	Ford
2037	Wilwood	2545	Citroen, Peugeot, Renault	2837/2	Ford
2100	Rover (Triumph)	2547	Renault	2839	Nissan
2101	Jaguar, Aston Martin	2570	Honda	2841	VW
2102	Rover, Vauxhall	2577	Mercedes	2841/2	VW
2103	Alfa, Porsche	2604	Renault	2872	Honda, Rover
2104	Alfa, BMW, Merc, Volvo	2605/2	Ford	2874	Toyota
2105	VW, Volvo, Alfa, BMW, Porsche	2610	Toyota	2880	Volvo
2106	Ford, Rover	2612	Ferrari, Porsche	2884	Mazda
2107	Rover	2617	Ford	2885	Renault, Lotus
2108	Aston Martin, Jaguar, Lotus	2623	Honda	2885/2	Lotus
2109	Rover (MG)	2626	Peugeot	2886	BMW
2114	Ford, Lotus	2627	Rover	2889	Nissan
2116	Fiat	2628	Toyota	2890	Honda
2120	Jaguar	2629	Toyota	2891	Honda
2126	BMW	2630	Rover	2911	Honda
2127	Rover	2635	Saab	2914	BMW
2128	Rover	2642/2	Rover, Honda	2927	Mercedes
2134	Ford	2643	Rover	2927/2	Mercedes
2141	Ford	2656	Citroen, Peugeot	2936	Toyota
2143	Volvo	2662/2	Rover	2937	Vauxhall
2180	De Tomaso	2663	Use 6663	2938	Use 2002
2189	Renault, Lotus	2665	Nissan, Suzuki	2940	Vauxhall
2197	BMW, Alfa, Lotus	2680	VW, Peugeot	2944	Fiat
2197/2	Lotus	2687	Peugeot	2945	Fiat
2199	Rover	2689	BMW	2946	Nissan
2220	Audi, Porsche	2689/2	Jaguar	2948	Citroen, Peugeot
2223	Aston Martin, Lamborghini, Maserati	2690	BMW	2949	Renault
2240	Ford, Rover	2690/2	Jaguar	2952	Renault
2241	Ford, Rover	2691	Subaru	2953	Ford
2243	Rover	2705	Mazda	2954	Mitsubishi
2261	Mercedes	2706	Honda	2955	Ford
2262	Jaguar	2711	Audi	2956	Ford
2273	Nissan	2719/2	Honda, Rover	2959	Renault
2291	Ford, Lotus	2725	Toyota	2962	Mercedes
2296	Ford	2729	Mazda	2963	Mercedes
2310	Audi, Volvo	2733	Alfa, Fiat, Lancia	2964	Toyota
2310/2	Audi	2733/3	Alfa	2965	Ford
2317	Alfa, Fiat	2736	Nissan	2966	Subaru
		2738	Mitsubishi	2971	Ford, Mazda

BRAKE PAD & SHOE - BUYERS GUIDE

EBC
BRAKES

PAD SET NO	APPLICATION	PAD SET NO	APPLICATION	PAD SET NO	APPLICATION
2972	Ford	21138	Subaru	21362	Volvo
2975	Honda, Rover	21139	Volvo	21363	Mercedes
2976	Vauxhall	21140	Lotus	21365	Mercedes
2981	VW	21144	To fit Wilwood (Dynalite Single)	21366	Peugeot
2983	Renault	21148	To fit Wilwood (GN)	21368	Ford, Seat, VW
2986	Mitsubishi	21153	Alfa	21369	Renault
2995	Toyota	21154	Toyota	21370	Citroen
2997	Porsche	21160	Chevrolet	21371	Citroen
21002	Mazda	21162	Chevrolet	21372	Citroen
21003	Mazda	21164	Dodge	21374	Peugeot
21004	Toyota	21170	Mercedes	21375	Peugeot
21005	Toyota	21183	Vauxhall	21376	Nissan
21006	Toyota	21184	Vauxhall	21377	MG
21007	Toyota	21185	Ford	21382	Fiat
21009	Jaguar	21186	Vauxhall	21383	Fiat
21012	Audi	21187	Use 21062	21384	Fiat
21013	Audi	21193	Honda	21388	BMW (Mini)
21014	Audi	21195	Toyota	21389	BMW (Mini)
21022	Use 61022	21198	Jaguar	21394	Renault
21031	Lancia, Fiat, Peugeot	21199	Ford	21396	Peugeot
21032	BMW	21200	Subaru	21409	Mazda
21035	BMW, Mercedes, Audi	21206	Honda	21411	Mazda
21036	BMW	21207	Porsche	21412	Audi, Ford, Seat, VW
21037	Use 61037	21208	Porsche	21413	Ford, Seat, VW
21038	Use 61038	21210	Alfa	21414	Vauxhall, Saab
21044	Nissan	21211	BMW	21416	Vauxhall, Saab
21045	Volvo, Mitsubishi	21218	Ford	21419	Peugeot
21047	Peugeot	21219	Rover	21423	Kia
21049	Peugeot	21220	Jaguar	21431	Toyota
21050	Ford	21221	Jaguar	21434	Citroen
21051	Ford	21223	Toyota	21435	Citroen
21055	Mercedes	21224	Toyota	21436	Seat, Skoda
21056	VW, Seat	21225	Toyota	21443	Vauxhall
21059	Fiat	21229	Volvo	21446	Toyota
21060	Alfa, Fiat	21230	Audi, VW, Skoda, Seat	21452	Mazda
21061	Alfa, Fiat	21232	Mercedes	21453	Mazda
21062	Saab, Vauxhall	21234	Peugeot	21454	Porsche
21063	Mitsubishi	21238	Nissan	21456	Toyota
21064	Seat, VW	21239	Chevrolet	21457	Toyota
21065	Chrysler (USA)	21254	Honda	21458	Toyota
21066	Chrysler (USA)	21255	Use 61255	21459	Toyota
21067	Nissan	21278	Porsche	21460	Use 21325
21072	Nissan	21287	Smart	21461	Renault
21074	Ford, VW, Seat	21289	BMW, Rover	21464	Mazda
21075	Mercedes	21293	Subaru	21465	Mazda
21077	Citroen	21295	Toyota	21466	Citroen, Peugeot
21079	BMW	21300	Ford	21467	Renault
21084	VW	21312	Use 61312	21468	Renault
21085	Use 61085	21320	Ford	21472	BMW
21087	Vauxhall	21322	Ford	21473	Porsche
21089	BMW	21323	Chevrolet	21474	Porsche
21091	BMW	21324	Audi, VW	21476	Vauxhall
21095	Volvo	21325	Toyota	21479	Skoda
21097	Mitsubishi	21326	Toyota	21480	Hyundai
21098	Mitsubishi	21327	Audi	21482	BMW
21100	Vauxhall	21328	Audi	21483	Audi, Skoda, VW
21104	Citroen, Peugeot	21329	Audi	21485	Nissan
21110	Ferrari, Aston Martin	21330	Audi, VW, Seat	21510	Audi
21112	VW	21332	Hyundai	21610	Honda
21113	VW	21336	Fiat	21611	Chrysler
21114	Audi	21337	Fiat	21621	Chevrolet
21117	Audi, Skoda, VW	21339	Honda, Nissan, MG	21622	Lexus
21118	BMW, Audi	21341	Vauxhall	21641	Ford
21122	Vauxhall	21346	Citroen	21642	Toyota
21123	Chrysler (USA)	21348	Audi	21644	Nissan
21128	Renault	21350	Ford		
21131	Aston Martin, Chevrolet	21351	Audi		
21133	Toyota	21352	Landrover		
21134	Subaru	21353	Renault		
21136	Citroen, Renault	21354	Vauxhall, Nissan, Renault		
21136/2	Use 21366	21357	Chrysler		
21137	VW	21358	Hyundai		

PAD SET NO	APPLICATION	PAD SET NO	APPLICATION	PAD SET NO	APPLICATION
REDSTUFF COMPETITION		3463/2	Use 3779	3956	Ford
3001	To fit Wilwood Dynalite	3467	Rover	3965	Ford
3002	To fit AP Racing caliper CP3215D50	3486	Audi	3966	Subaru
3003	To fit AP Racing caliper CP2340D43	3517	VW	3971	Ford Mazda
3004	To fit AP Racing caliper CP2340D51	3517/2	VW	3972	Ford, Mazda
3005	To fit AP Racing caliper CP3894D51	3545	Peugeot, Renault	3975	Rover
3006	To fit AP Racing caliper CP3894D54	3605/2	Ford	3976	Vauxhall
3007	To fit Wilwood Superlite	3610	Toyota	3995	Toyota
3008	To fit AP Racing CP3345D44	3612	Porsche, Ferrari	3997	Porsche
3009	To fit AP Racing CP3558D54	3617	Ford	31002	Mazda
3010	To fit Wilwood Bridgebolt	3626	Peugeot	31003	Mazda
3011	To fit AP Racing CP 3714	3627	Rover	31004	Toyota
3012	To fit AP Racing CP 3894 D46	3635	Saab	31005	Toyota
3013	To fit Alcon 4441 25mm	3642/2	Honda, Rover	31006	Lexus
3014	To fit Alcon 4441 20mm	3656	Citroen, Peugeot	31007	Lexus
3015	To fit Alcon 4441 18mm	3662/2	Rover	31009	Jaguar
3016	To fit Alcon 4441 16mm	3680	VW, Peugeot	31012	Audi
3017	To fit Alcon 4441 15mm	3687	Peugeot	31013	Audi
3018	To fit Alcon 4448 32mm	3689	BMW	31014	Audi
3019	To fit Alcon 4448 25mm	3689/2	Jaguar	31031	Dodge, Fiat, Peugeot, Lancia
3020	To fit Alcon 4448 20mm	3690	BMW	31032	BMW
3021	To fit Alcon 4448 17.5mm	3690/2	Jaguar	31035	Audi, BMW, Mercedes
3022	To fit Alcon 4464 30mm	3706	Honda	31036	BMW
3023	To fit Alcon 4464 16mm	3711	Audi	31047	Peugeot
3024	To fit Alcon 4476 20mm	3719/2	Honda	31050	Ford
3025	To fit Alcon 4476 19mm	3725	Toyota	31051	Ford
3026	To fit Alcon 4476 18mm	3729	Mazda	31061	Alfa, Fiat
3027	To fit Alcon 4476 16mm	3733	Alfa, Fiat, Lancia	31062	Saab, Vauxhall
3028	To fit Alcon 4476 15mm	3738	Mitsubishi	31075	Mercedes
3029	To fit CPFC 7768.90.16.4	3751	Saab	31079	BMW
3030	To fit CPFC 770 25mm	3753	Ford	31089	BMW
3031	To fit CP3215 D46	3760	Vauxhall	31091	BMW
3034	Girling NR	3761	Vauxhall	31097	Mitsubishi
3035	Girling AR	3762	Suzuki	31098	Mitsubishi
3036	Renault, Morgan	3763	Mazda	31110	Ferrari, Aston Martin
3037	Wilwood	3767	Porsche	31112	VW
3101	Jaguar, Aston Martin	3775	Nissan	31114	Audi, VW
3102	Rover, Vauxhall	3779	BMW	31118	BMW
3103	Porsche	3792	Nissan	31131	Aston Martin
3104	Alfa, BMW, Mercedes, Volvo	3802	Mazda	31134	Subaru
3105	Porsche	3812	Honda	31138	Subaru
3106	Ford, Rover	3815	Rover	31139	Volvo
3108	Jaguar, Rover, Lotus	3817	Rover	31140	Lotus
3114	Ford, Lotus	3819	Subaru	31144	To fit Wilwood (Dynalite Single)
3127	Rover	3821	Subaru	31148	To fit Wilwood (GN)
3128	Rover	3826	Nissan	31160	Chevrolet
3143	Volvo	3828	Mazda	31162	Chevrolet
3180	De Tomaso	3830	Mitsubishi	31164	Chrysler
3189	Lotus, Renault	3836	Audi, VW	31185	Ford
3197	BMW, Alfa, Lotus	3839	Nissan	31193	Honda, Rover
3197/2	Mitsubishi	3841	VW	31198	Jaguar
3220	Audi, Porsche	3841/2	VW	31200	Subaru
3223	Aston Martin	3870	BMW	31206	Honda
3240	Ford, Rover	3871	BMW	31207	Porsche
3241	Rover	3872	Honda, Rover	31208	Porsche
3243	Rover	3880	Volvo	31210	Mitsubishi, Subaru
3262	Jaguar	3883	Audi	31211	BMW
3291	Ford, Lotus	3885	Dodge	31218	Ford
3310	Audi	3886	BMW	31220	Jaguar
3317	Alfa, Fiat	3890	Honda	31221	Jaguar
3325	Vauxhall	3891	Honda	31229	Volvo
3345	Porsche	3911	Honda	31234	Peugeot
3370	Audi	3914	BMW	31239	Chevrolet
3414	BMW, Porsche	3927	Mercedes	31254	Honda
3415	Ford, Ferrari	3927/2	Mercedes	31278	Porsche
3426	Peugeot, Renault	3936	Toyota	31289	BMW, Rover
3447	BMW	3937	Vauxhall	31293	Subaru
3447/2	Volvo	3940	Vauxhall	31322	Ford, Jaguar
3452	Nissan	3948	Citroen, Peugeot	31323	Chevrolet
3453	Toyota	3949	Renault	31324	Audi, VW
3456	Toyota, Lotus	3954	Mitsubishi	31325	Toyota
3458/2	Renault	3955	Ford	31327	Audi

BRAKE PAD & SHOE - BUYERS GUIDE

EBC
BRAKES

PAD SET NO	APPLICATION	PAD SET NO	APPLICATION	PAD SET NO	APPLICATION
31328	Audi	YELLOWSTUFF COMPETITION		4689	BMW
31330	Audi, VW	4001	To fit Wilwood Dynalite	4689/2	Jaguar
31348	Audi	4002	To fit AP Racing caliper CP3215D50	4690	BMW
31350	Ford, Jaguar	4003	To fit AP Racing caliper CP2340D43	4711	Audi
31353	Renault	4004	To fit AP Racing caliper CP2340D51	4719/2	Honda
31354	Vauxhall	4005	To fit AP Racing caliper CP3894D51	4733	Alfa, Fiat, Lancia
31362	Volvo	4006	To fit AP Racing caliper CP3894D54	4751	Saab
31363	Mercedes	4007	To fit Wilwood Superlite	4753	Ford
31365	Mercedes	4008	To fit AP Racing CP3345D44	4760	Vauxhall
31388	BMW (Mini)	4009	To fit AP Racing CP3558D54	4763	Mazda
31389	BMW (Mini)	4010	To fit Wilwood Bridgebolt	4767	Porsche
31412	Audi, VW	4011	To fit AP Racing CP 3714	4779	BMW
31414	Vauxhall, Saab	4012	To fit AP Racing CP 3894 D46	4802	Mazda
31416	Vauxhall, Saab	4013	To fit Alcon 4441 25mm	4815	Rover
31419	Peugeot	4014	To fit Alcon 4441 20mm	4817	Rover
31449	BMW	4015	To fit Alcon 4441 18mm	4821	Subaru
31450	BMW	4016	To fit Alcon 4441 16mm	4828	Mazda
31451	BMW	4017	To fit Alcon 4441 15mm	4830	Mitsubishi
31454	Porsche	4018	To fit Alcon 4448 32mm	4836	Audi
31473	Porsche	4019	To fit Alcon 4448 25mm	4841	VW
31474	Porsche	4020	To fit Alcon 4448 20mm	4841/2	VW
31482	BMW	4021	To fit Alcon 4448 17.5mm	4872	Honda, Rover
31483	Audi, VW	4022	To fit Alcon 4464 30mm	4880	Volvo
31510	Audi	4023	To fit Alcon 4464 16mm	4885	Chrysler
31644	Nissan	4024	To fit Alcon 4476 20mm	4890	Honda
		4025	To fit Alcon 4476 19mm	4891	Honda
		4026	To fit Alcon 4476 18mm	4914	BMW
		4027	To fit Alcon 4476 16mm	4927	Mercedes
		4028	To fit Alcon 4476 15mm	4937	Vauxhall
		4029	To fit CPFC 7768.90.16.4	4940	Vauxhall
		4030	To fit CPFC 770 25mm	4948	Citroen, Peugeot
		4034	Girling NR	4949	Renault
		4035	Girling AR	4954	Mitsubishi
		4037	Wilwood	4956	Ford
		4101	Jaguar	4966	Subaru
		4102	Rover, Vauxhall	4976	Vauxhall
		4103	Porsche	4997	Porsche
		4104	Alfa, BMW, Mercedes, Volvo	41002	Mazda
		4106	Ford	41003	Mazda
		4114	Lotus	41009	Jaguar
		4127	Rover	41013	Audi
		4128	Rover	41014	Audi
		4143	Volvo	41031	Dodge
		4197	BMW, Alfa, Lotus	41032	BMW
		4197/2	Mitsubishi	41035	Mercedes, BMW, Audi
		4220	Audi, Porsche	41036	BMW
		4240	Ford, Rover	41061	Alfa, Fiat
		4243	Rover	41079	BMW
		4262	Jaguar	41089	BMW
		4291	Ford, Lotus	41091	BMW
		4325	Vauxhall	41097	Mitsubishi
		4345	Porsche	41110	Ferrari, Aston Martin
		4414	BMW, Porsche	41118	BMW
		4415	Ford, Ferrari	41134	Subaru
		4426	Peugeot, Renault	41139	Volvo
		4447	BMW	41140	Lotus
		4453	Toyota	41144	To fit Wilwood (Dynalite Single)
		4458/2	Peugeot	41148	To fit Wilwood (GN)
		4463/2	Use 4779	41162	Chevrolet
		4467	Rover	41164	Chrysler
		4517	VW	41193	Honda, Rover
		4545	Peugeot, Renault	41200	Subaru
		4605/2	Ford	41206	Honda
		4612	Porsche, Ferrari	41210	Mitsubishi
		4617	Ford	41211	BMW
		4626	Peugeot	41234	Peugeot
		4627	Rover	41254	Honda
		4642/2	Honda, Rover	41293	Subaru
		4656	Citroen, Peugeot	41330	Audi
		4662/2	Rover	41339	Rover
		4680	VW, Peugeot	41388	BMW (Mini)
		4687	Peugeot	41389	BMW (Mini)

PAD SET NO	APPLICATION	PAD SET NO	APPLICATION	SHOE SET NO	APPLICATION
BLUESTUFF ENDURANCE		SUV & 4 X 4		5004	BMW
DP5001	To fit Wilwood Dynalite	DP6445	Nissan	5005	Mercedes
DP5002	To fit AP Racing caliper CP3215D50	DP6538	Mits (SA), Nissan, Isuzu,	5013	Fiat
DP5003	To fit AP Racing caliper CP2340D43		Mazda (SA) Ford (SA)	5017	Fiat
DP5005	To fit AP Racing caliper CP3894D51	DP6622	Landrover	5022	Lada
DP5006	To fit AP Racing caliper CP3894D54	DP6663	Landrover	5025	Fiat
DP5007	To fit Wilwood Superlite	DP6691	Nissan	5031	Fiat, Seat
DP5008	To fit AP Racing caliper CP3345D44	DP6708	Rover	5034	Fiat
DP5009	To fit AP Racing CP3558D54	DP6746	Vauxhall, Holden, Isuzu	5035	Citroen
DP5010	To fit Wilwood Bridgebolt	DP6807	Toyota	5036	Citroen
DP5033	CP6210 D54 25mm	DP6814	Rover	5038	Citroen
DP5101	Jaguar	DP6872	Honda	5039	Citroen
DP5102	Rover, Vauxhall	DP6954	Holden, Mitsubishi	5040	Citroen
DP5108	Jaguar	DP6958	Mitsubishi	5045	Talbot
DP5114	Ford, Lotus	DP6964	Toyota	5046	Talbot
DP5127	Rover	DP6973	Vauxhall, Holden, Isuzu	5048	Mahindra, Peugeot, Talbot
DP5128	Rover	DP6974	Vauxhall	5051	Peugeot
DP5143	Volvo	DP6979	Suzuki	5052	Peugeot
DP5197	BMW, Lotus	DP6992	Toyota	5056	Peugeot
DP5197/2	Mitsubishi, Lotus	DP6993	Toyota	5060	Renault
DP5220	Audi, Porsche	DP61022	Chrysler USA	5062	Peugeot, Renault
DP5243	Rover	DP61033	Landrover	5064	Renault
DP5291	Ford, Lotus	DP61036	BMW	5065	Renault
DP5415	Ford, Ferrari	DP61037	Landrover	5066	Renault
DP5426	Peugeot, Renault	DP61038	Landrover	5067	Renault
DP5453	Toyota	DP61065	Chrysler USA	5069	Renault
DP5517	VW	DP61085	Ford	5071	Peugeot, Renault
DP5545	Peugeot, Renault	DP61099	Suzuki	5072	Peugeot, Renault, Talbot
DP5605/2	Ford	DP61118	BMW, Landrover	5072A	Renault
DP5612	Porsche, Ferrari	DP61129	Chrysler	5077	VW
DP5617	Ford	DP61130	Chrysler	5080	VW
DP5627	Rover	DP61133	Toyota	5083	VW
DP5642/2	Rover, Honda	DP61199	Ford, Mazda	5087	VW
DP5687	Peugeot	DP61201	Ford	5088	VW
DP5733	Alfa, Lancia	DP61232	Mercedes	5089	VW
DP5753	Ford	DP61233	Mercedes	5090	VW
DP5760	Vauxhall	DP61255	Chrysler USA	5091	VW
DP5763	Mazda	DP61256	Chevrolet	5092	BMW
DP5767	Porsche	DP61282	Toyota	5093	BMW
DP5779	BMW	DP61312	Chrysler USA	5093/1	BMW
DP5830	Mitsubishi	DP61319	Toyota	5094	BMW
DP5841	VW	DP61352	Landrover	5095	Peugeot, Renault
DP5872	Honda	DP61363	Mercedes	5096	Vauxhall
DP5885	Chrysler, Dodge	DP61415	Landrover	5099	Vauxhall
DP5891	Honda	DP61427	Chrysler	5100G	Vauxhall
DP5914	BMW	DP61502	Holden	5103G	Vauxhall
DP5948	Citroen, Peugeot	DP61503	Ford (Aust/NZ)	5104	NSU
DP5954	Mitsubishi	DP61606	Chrysler	5104/1	NSU
DP5956	Ford	DP61612	Chrysler	5110	Rover, Ford, Lotus
DP5997	Porsche	DP61613	Chrysler	5111	Ford
DP51014	Audi	DP61616	Ford, Mazda	5112	Ford, Talbot
DP51031	Chrysler	DP61619	Mitsubishi	5113	Vauxhall, Ford
DP51032	BMW	DP61629	Chrysler	5114	Vauxhall, Ford
DP51061	Alfa			5115	Vauxhall, Ford
DP51079	BMW			5116	Ford
DP51110	Ferrari, Aston Martin			5117	Ford, Mercedes, Renault
DP51131	Aston Martin			5118	Renault
DP51134	Subaru			5124	Alfa Romeo, BMW
DP51148	To fit Wilwood (GN)			5125	Mercedes
DP51193	Honda, Rover			5126	Audi, Daf
DP51200	Subaru			5126/1	Daf
DP51210	Mitsubishi			5127	Audi
DP51211	BMW			5128	Rover, Reliant, Ford
				5129	Rover, Vauxhall
				5129A	Rover, Vauxhall
				5130	Ford
				5130B	Reliant
				5130S/L	Ford
				5132	Rover, Ford
				5133	Ford
				5135	Rover, Ford, Lotus
				5136	Vauxhall

BRAKE PAD & SHOE - BUYERS GUIDE

EBC
BRAKES

SHOE SET NO	APPLICATION	SHOE SET NO	APPLICATION	SHOE SET NO	APPLICATION
5137	Bond, Rover	5236	Audi, VW	6269	Nissan
5138	Rover	5237	Ford	6270	Toyota
5139	Rover, Talbot	5238	Ford	6271	Toyota
5139A	Rover, Talbot	5239	Ford	6272	Toyota
5139H	Rover	5240	Ford, Rover	6273	Ford
5140	Rover	5242	Audi	6274	Mitsubishi
5141	Ford, Talbot	5243	Renault	6276	Honda
5142	Rover, Ford, Lotus, Talbot	5243/1	Peugeot	6277	Honda
5143	Talbot	5245	Rover	6278	Honda
5144	Rover	5254	Vauxhall	6279	Daihatsu
5145	Rover	5255G	Vauxhall	6280	Subaru
5145B	Reliant	5256	Mazda	6281	Daihatsu
5146	Rover, Daf	5257	Subaru	6283	Suzuki
5147	Rover	5259	VW	6284	Suzuki
5147H	Rover	5259A	VW	6285	Fiat (Alloy Shoe)
5152	Volvo	5260	Mitsubishi	6287	Nissan
5155	Volvo	5261	Mitsubishi	6290	Nissan
5157	Saab	5262	Nissan	6291	Nissan
5159	Saab	5263	Renault, Fiat	6292	Nissan
5161	Skoda	5264	Audi, VW, Seat	6293	Nissan
5165	Moskvitch	5265	Nissan	6294	Rover
5166	Toyota	5266	Honda	6296	Rover
5167	Toyota	5267	Audi, VW	6297	Rover
5168	Toyota	5268	Audi	6298	Rover
5169	Toyota	5269	Audi, VW	6299	Reliant
5170	Toyota	5270	Peugeot	6300	Ford
5171	Mazda	5271	Vauxhall, Saab	6301	Suzuki
5173	Nissan	5274	Toyota	6304	Toyota
5174	Nissan	5275	Toyota	6305	Use 5072
5175	Toyota	5276	Mazda, SAO	6306	Renault, Peugeot
5176	Nissan	5277	Mazda	6308	Daihatsu
5177	Nissan	5282	Fiat	6310	Toyota
5178	Nissan	5282A	Use 5282	6311	VW
5179	Nissan	5290	Ford	6313	Mitsubishi
5183	Audi	5291	Ford	6317	Nissan
5184	VW	5292	Ford	6318	Nissan
5186	Audi, VW	5293	Ford	6321	Renault
5187/2	Fiat	5311	Use 6321	6322	Fiat, Citroen, Peugeot
5190	Peugeot, Renault	5329	Fiat, Yugo	6323	Ford
5190A	Dacia	5341	Honda	6323A	Ford
5191	Mazda	5345	Fiat	6324	Ford
5192	Mazda	5351G	Vauxhall	6325	Renault
5196	Volvo	5353G	Vauxhall	6325A	Use 5095
5198	Toyota	6200	Citroen, Peugeot	6326	Vauxhall
5200	Peugeot	6230	Rover	6327	Vauxhall
5202	VW	6231	Rover	6328	Ford
5205	Audi, VW	6232	Rover	6329	Fiat, Lancia
5206	VW	6234	Rover, Reliant	6330	Nissan
5207	Peugeot	6235	Rover	6331	Toyota
5209	Peugeot	6236	Rover	6333	Suzuki
5210	Use 5243	6237	Rover	6334	Daihatsu
5211G	Vauxhall	6239	Ford	6335	Nissan
5212A	Talbot, Renault, Peugeot	6239NL	Ford	6336	Suzuki
5213	Ford	6240	Rover	6337	Vauxhall
5214	Volvo	6242	Rover	6338	BMW, Volvo, Renault, Suzuki
5215	Daf	6244	Vauxhall	6339	Mazda
5216	Daf, Ford, Hyundai	6245	Rover	6340	Peugeot
5216V	Volvo	6246	Commer, Talbot	6340/1	Peugeot
5218	Lada	6247	Vauxhall, Rover	6341	Peugeot, Talbot
5219	Honda	6248	Peugeot, Talbot	6342	Rover
5221	Ford	6249	Talbot	6343	Renault
5223	Ford	6250	Reliant	6344	Peugeot
5224	Ford	6252	Rover	6345	Fiat, Alfa
5225	Nissan	6256	Rover	6346	Honda
5226	Peugeot	6258	Rover	6347	Ford
5226/1	Renault	6259	Rover	6350	Rover, Honda
5228	Vauxhall, Talbot	6260	Commer	6351	Rover
5229	Vauxhall	6263	Toyota	6355	Mitsubishi
5230	Vauxhall	6264	Toyota	6356	Mitsubishi
5232G	Vauxhall	6265	Use 6265P	6357	Mitsubishi
5233	Vauxhall	6265P	Toyota	6358	Nissan
5234	Vauxhall, Talbot, Rover	6266	Toyota	6359	Nissan

SHOE SET NO	APPLICATION	SHOE SET NO	APPLICATION	SHOE SET NO	APPLICATION
6360	Nissan	6445	Mazda	6518	Toyota
6361	Nissan	6446	Ford	6519	Trabant
6362	Toyota	6447	Audi, VW, Seat	6520	Trabant
6363	Toyota	6448	Daihatsu	6521	Mercedes
6365	Use 6350	6449	Ford	6522	Mazda
6366	Honda	6450	Ford	6523	Citroen
6367	Use 5277	6451	Ford	6524	Volvo
6368	Mazda	6452	Honda, Suzuki	6525	Ford
6369	Mazda	6453	Hyundai	6526	Citroen, Peugeot, Renault
6370	Mazda	6454	Use 5291	6527	Ford
6372	Daihatsu	6455	Hyundai	6528	Ford
6375	Vauxhall	6456	Use 6421	6529	Ford
6376	Rover	6457	Mazda	6530	Toyota
6377	Toyota	6458	Mazda	6531	Fiat
6378	Vauxhall	6459	Suzuki	6532	Volvo
6379	Vauxhall	6460	Mitsubishi	6533	Daihatsu
6380	Ford	6461	Nissan	6535	Nissan
6381	Ford	6462	Nissan	6536	Subaru
6382	Ford	6463	Subaru	6537	Peugeot
6383	Vauxhall	6464	Toyota	6538	Vauxhall
6384	Fiat	6465	Volvo	6539	Renault
6385	Nissan	6466	Daihatsu	6540	Peugeot
6387	Nissan	6467	Mitsubishi	6541	Renault
6389	Mitsubishi	6468	Daihatsu	6542	VW
6390	Nissan	6469	Subaru	6543	Renault
6391	Nissan	6470	Subaru	6544	BMW
6392	Nissan	6471	Subaru	6545	BMW
6393	Suzuki	6472	Subaru	6546	Citroen, Fiat, Peugeot
6394	Suzuki	6473	VW, Toyota	6547	Citroen, Peugeot
6395	Peugeot	6475	Ford	6548	Chrysler (USA), Kia
6396	Mazda	6476	Ford	6549	Ford
6399	Toyota	6477	Hyundai	6550	Kia
6400	Toyota	6478	Mazda	6551	Mercedes
6401	Honda	6479	Ford	6552	Fiat
6402	Suzuki	6480	Ford	6553	Fiat
6403	Citroen	6481	Vauxhall	6554	Fiat
6404	Vauxhall, Isuzu	6482	Vauxhall	6555	Alfa
6405	Toyota	6483	Ford	6556	Alfa
6406	Mazda	6484	Fiat	6557	Citroen, Peugeot
6407	Vauxhall	6485	Daihatsu	6558	Daihatsu
6408	Renault	6486	Mazda	6559	Daihatsu
6409	BMW	6487	Suzuki	6560	Ford
6410	Renault	6488	Toyota	6561	Mazda
6411	Use 5072	6489	Peugeot	6562	Toyota
6412	Subaru, Suzuki	6490	Nissan	6563	Toyota
6413	Subaru	6491	Nissan	6564	Renault
6414	Daihatsu	6492	Volkswagen	6565	Skoda
6415	Daihatsu	6493	Suzuki	6566	Toyota
6416	Suzuki	6494	Suzuki	6567	Rover
6417	Rover	6495	Mitsubishi	6568	Hyundai
6420	Lada	6496	Mitsubishi	6569	Suzuki
6421	Mitsubishi, Hyundai	6497	BMW	6570	Suzuki
6422	Mitsubishi	6498	Audi, VW, Seat	6571	Use 6452
6423	Use 6460	6499	Suzuki	6572	Daewoo
6424	Mazda	6500	Daihatsu	6573	Suzuki
6425	Mazda	6501	Daihatsu	6574	Mitsubishi
6426	Daihatsu	6502	Fiat	6575	Mitsubishi
6427	Toyota	6503	Fiat	6576	Hyundai
6429	Mazda	6504	Kia	6577	Peugeot
6430	Mazda	6505	Ford/Nissan	6578	Kia
6431	Mazda	6506	Peugeot, Citroen	6579	BMW
6432	Use 5095	6507	Peugeot	6580	Mercedes
6433	Toyota	6508	Use 6526	6581	Mazda
6434	Daihatsu	6509	Chrysler (USA)	6582	Renault
6435	Ford, Nissan	6510	Chrysler (USA)	6583	Fiat
6437	Rover, Honda	6511	Nissan	6584	Fiat
6438	Use 5146	6512	Vauxhall	6585	Honda
6439	Ford	6513	Honda	6586	Mitsubishi
6440	Ford	6514	Hyundai	6587	Toyota
6441	Skoda	6515	Mitsubishi	6588	Ford
6442	Use 6412	6516	Citroen, Fiat, Peugeot	6589	Ford
6444	Use 6429	6517	Suzuki	6590	Vauxhall, Suzuki

WVA No.	EBC No.	WVA No.	EBC No.	WVA No.	EBC No.
20002 14.50	DP599	20218 17.80	DP129	20436 14.70	DP283
20002 14.50	DP683	20228 15.00	DP174	20437 15.00	DP282
20004 15.50	DP608/2	20228 18.00	DP194	20437 19.00	DP282/2
20005 17.00	DP120	20229 15.00	DP135	20442 18.50 / 20154 18.50	DP267
20007 15.50	DP101	20232 17.00 / 21174 17.00		20455 19.00 / 20454 19.00	
20008 13.00	DP673	/ 21175 17.00	DP756	/ 20452 19.00	DP239
20009 13.00 / 20010 13.00	DP105/4	20233 13.00	DP757/2	20464 18.50 / 20484 18.50	
20009 15.00 / 20010 15.00	DP105	20233 13.00 / 21177 13.00	DP757	/ 20483 18.50	DP274
20011 15.00 / 20468 15.00	DP103	20236 18.00	DP952	20480 15.50	DP284
20011 18.50	DP160 / DP183	20239 15.00 / 20176 15.00	DP193	20481 19.00	DP345
20027 16.00	DP1028	20246 15.00	DP147	20482 18.50	DP346
20027 16.00	DP108	20251 14.50	DP138	20485 14.00	DP238
20029 14.00 / 20078 14.00	DP631	20252 17.00	DP179	20491 15.00	DP291
20030 15.50	DP169	20253 16.00	DP163	20535 14.00	DP281
20031 13.00 / 20593 13.00		20260 15.00	DP220/3	20539 14.00	DP264
/ 20328 13.00	DP729	20260 15.00 / 20506 15.00		20540 14.00 / 20539 14.00	DP318
20034 14.50 / 20107 14.50		/ 20572 15.00	DP220/4	20547 16.50 / 21353 16.50	
/ 20755 14.50 / 20630 14.50		20260 16.50 / 20913 16.50		/ 21311 16.50	DP940
/ 20397 14.50	DP104	/ 20373 16.50	DP220	20548 14.50 / 20034 14.50	DP295
20037 15.00	DP107	20260 18.00	DP220/2	20560 13.50	DP329
20038 13.50	DP127	20280 18.50 / 20392 18.50	DP175/2	20561 15.00	DP288
20039 15.00 / 21277 15.00	DP655	20281 15.00 / 20282 15.00	DP192	20563 14.00	DP200
20047 15.50	DP667	20285 07.00	DP177	20564 14.00	DP271
20053 10.00	DP128	20287 16.00	DP268	20570 18.50 / 20488 18.50	DP324
20054 14.50	DP102	20288 16.00 / 20667 16.00	DP190	20573 15.00	DP332
20059 13.50	DP709	20289 15.30	DP273	20573 17.00	DP332/2
20066 13.00	DP611	20292 17.00	DP230	20574 15.00	DP310/2
20073 12.50	DP112	20296 16.00	DP184	20574 19.30	DP310
20073 14.00	DP144	20297 12.00	DP191	20575 16.50	DP350
20073 17.00 / 20647 17.00	DP372	20298 16.00	DP222	20576 15.50	DP159
20073 17.50	DP116	20302 14.50	DP166	20577 15.00	DP243
20074 10.00	DP130	20307 09.00	DP246	20577 15.00 / 20893 15.00	DP471
20075 15.00 / 20070 15.00	DP111	20309 18.00 / 21364 18.00	DP886	20578 15.00	DP296
20076 15.50	DP628	20313 14.30 / 20736 14.30	DP207	20578 15.00 / 20791 15.00	DP437
20083 17.50 / 20086 17.50	DP630	20315 15.00	DP951	20579 14.50	DP292
20087 14.00 / 20091 14.00	DP662	20323 14.50	DP197/2	20587 15.00 / 20486 15.00	DP342
20088 14.00	DP114	20323 16.50	DP197	20588 16.50	DP341
20089 14.70	DP106	20323 16.50 / 20379 16.50		20594 12.70	DP349
20089 14.70	DP353	/ 20373 16.50	DP913	20596 15.30	DP366
20092 15.00	DP125	20323 16.50 / 20997 16.50		20596 19.70	DP366/2
20092 18.50	DP125/2	/ 20998 16.50	DP578	20599 13.80	DP314
20098 19.00	DP688	20338 14.00 / 20336 14.00	DP189	20601 16.50	DP368
20099 15.00	DP723	20341 17.50	DP261/2	20605 13.50	DP322
20104 15.00 / 20099 15.00	DP623	20344 15.00	DP294 / DP182	20628 15.00	DP352
20112 18.00	DP582	20344 16.00 / 21237 16.00	DP663	20629 19.30	DP414
20124 18.00	DP967	20347 14.00 / 20494 14.00		20631 18.00	DP546
20126 15.00	DP126	/ 20710 14.00 / 20140 14.00	DP269	20635 18.00	DP458
20128 14.50 / 20529 14.50	DP139 / DP237	20356 15.50	DP221	20641 15.00 / 20174 15.00	DP218
20132 17.50	DP316	20359 18.00	DP241	20643 14.50	DP286
20133 15.00	DP161	20359 18.00	DP472	20645 14.50 / 20593 14.50	DP290
20135 18.50	DP149	20359 18.00	DP622	20649 18.00 / 20734 18.00	DP384
20140 15.00 / 20347 15.00		20359 18.00 / 20653 18.00	DP622	20652 18.00	DP939
/ 20494 15.00	DP269	20361 16.50 / 21165 16.50	DP1011	20655 19.50	DP250
20145 15.00	DP123/3	20364 15.00	DP240	20655 19.50	DP395
20145 17.50	DP123	20366 14.50	DP252	20660 16.50	DP309
20147 17.00	DP989	20366 18.00	DP652	20669 16.00	DP369/2
20151 15.50	DP121	20371 07.50	DP248	20669 16.00 / 20901 16.00	DP486/2
20161 16.50	DP124	20375 16.50	DP378	20669 19.50	DP369
20162 15.50	DP795	20380 15.50	DP262	20669 19.50 / 20901 19.50	DP486
20164 17.50 / 20163 17.50	DP842	20389 16.00	DP227	20671 16.50	DP354
20166 16.00	DP172	20391 14.40	DP201	20674 15.00 / 20964 15.00	
20168 16.00	DP841	20392 15.00 / 29581 15.00	DP261	/ 20965 15.00	DP457
20168 16.00	DP982/2	20401 12.00	DP217	20675 14.80	DP447/2
20168 16.00	DP841/3	20402 15.00	DP216	20675 16.00	DP447
20168 19.30	DP841/2	20404 16.00 / 20027 16.00	DP315	20676 19.30 / 21639 19.30	DP836
20168 19.30	DP982	20410 12.00 / 20358 12.00		20685 15.00 / 20696 15.00	DP326
20168 19.30 / 21366 19.30	DP981	/ 21964 12.00	DP885/2	20687 13.50 / 20758 13.50	DP464
20180 16.50 / 20181 16.50		20410 15.00 / 20358 15.00		20687 15.00 / 20758 15.00	DP671
/ 21607 16.50	DP1079	/ 21964 15.00	DP885	20690 16.00	DP406
20182 15.50	DP536	20420 15.00 / 20922 15.00	DP540	20703 14.50	DP196
20200 16.00 / 20153 16.00	DP143	20421 15.00 / 20533 15.00	DP417	20708 16.50 / 20847 16.50	DP410/2
20207 12.00	DP131	20422 17.50	DP270	20714 12.50 / 20207 12.50	DP411

WVA-EBC CROSS REFERENCE



WVA No.	EBC No.	WVA No.	EBC No.	WVA No.	EBC No.
20718 14.50	DP365	20911 15.00	DP507	21084 17.50 / 21085 17.50	DP467
20718 14.50	DP526	20912 15.00	DP508	21088 17.00 / 20097 17.00	DP753
20719 19.50	DP420	20913 16.00	DP220/8	21089 15.00	DP635
20724 15.40	DP383	20916 18.50 / 20919 18.50	DP547	21093 17.00 / 21095 17.40	DP616
20729 15.00	DP321	20926 18.50 / 20928 18.50	DP544	21096 15.00 / 20634 15.00	DP489/2
20731 15.50	DP374	20937 18.00 / 20772 18.00		21099 17.00 / 21229 17.00	DP538
20735 15.00 / 21045 15.00	DP344	/ 20478 18.00	DP426	21100 17.00 / 21105 17.00	DP718
20740 16.10 / 21266 16.10	DP435	20939 15.40	DP325	21103 14.50	DP596
20741 19.00	DP425	20939 15.40	DP325P	21107 12.00 / 20841 12.00	DP501
20749 17.00 / 20890 17.00	DP463/2	20941 19.40 / 21028 19.40	DP577	21109 15.50 / 20476 15.50	DP451
20751 18.50	DP443	20944 16.00	DP506	21110 15.50 / 20380 15.50	DP581
20753 18.00 / 20783 18.00		20944 16.00 / 21098 16.00	DP625	21112 12.50	DP531
/ 20640 18.00	DP415	20950 18.00 / 20775 18.00		21115 16.00	DP535
20754 14.50	DP627	/ 20776 18.00	DP485	21119 17.00 / 21099 17.00	
20760 14.30	DP387	20950 18.00 / 20951 18.00		/ 20098 17.00	DP527
20761 14.50 / 20763 14.50	DP398	/ 20776 18.00	DP485	21122 15.00	DP468
20766 15.00 / 20854 15.00	DP469	20953 18.00	DP767	21125 14.50	DP576
20767 15.00	DP615	20954 13.00	DP466	21126 15.00	DP537
20780 13.50	DP685	20955 15.00	DP461	21127 15.00	DP606
20783 18.00 / 20640 18.00	DP389	20956 15.00	DP460	21133 15.00 / 21131 15.00	
20784 18.00 / 20465 18.00	DP285	20957 16.00	DP484	/ 20775 15.00	DP317
20784 18.00 / 21186 18.00	DP786	20957 16.00	DP636	21133 15.00 / 21131 15.00	
20784 18.00 / 29784 18.00	DP413	20958 16.00	DP452	/ 20775 15.00	DP653
20788 17.00	DP511	20959 15.00	DP450	21138 19.00	DP711
20793 15.00 / 20491 15.00	DP436	20961 15.00 / 20960 15.00	DP680	21138 19.00	DP711
20833 17.00 / 20838 17.00	DP420/2	20961 17.00 / 20960 17.00	DP1230	21140 15.50	DP761 / DP990
20837 17.00 / 20836 17.00	DP420/4	20966 18.00 / 21096 18.00		21141 18.00	DP650
20841 12.00 / 20293 12.00	DP231	/ 20636 18.00	DP489	21142 15.00	DP534
20845 16.50	DP428	20968 19.50 / 21677 19.50		21144 16.50	DP370
20850 14.80	DP331	/ 21064 19.50	DP689	21147 18.00	DP733/3
20851 16.00	DP446	20973 10.50 / 20635 10.50	DP458/2	21147 18.00	DP733/3
20852 15.00	DP380	20973 11.00 / 20635 11.00	DP458/2	21153 16.00	DP927/2
20853 14.50 / 20718 14.50	DP418	20974 10.50 / 20635 10.50		21153 17.50	DP927
20854 14.00	DP402 / DP532	/ 21597 10.50 / 20315 10.50	DP983 / DP1078	21154 19.50	DP751
20857 17.25	DP512	20979 19.50	DP654	21156 17.00	DP616/2
20861 17.50 / 20862 17.50	DP455	20981 13.50	DP617	21158 15.00	DP539
20861 17.50 / 21662 17.50	DP438	20981 13.50 / 21729 13.50	DP571/2	21159 14.00	DP475
20861 17.50 / 21662 17.50	DP438	20981 13.50 / 21729 13.50		21160 18.00	DP622
20863 16.50	DP445	/ 21079 13.50	DP571	21165 16.50	DP717
20863 16.50 / 20972 16.50	DP445	20988 17.50 / 20989 17.50		21170 17.30	DP637
20864 14.50	DP392	/ 21080 17.50	DP626	21171 17.80	DP837
20866 15.00	DP220/9	20989 17.50 / 21023 17.50		21171 17.80	DP837
20870 15.00	DP453	/ 20923 17.50	DP575	21173 17.00	DP779
20871 17.80 / 20661 17.80	DP385	20994 16.50	DP912	21173 17.00	DP779
20877 18.00	DP612	20996 16.00 / 20995 16.00		21174 17.00	DP756/2
20879 14.50	DP763	/ 20180 16.00	DP690	21179 16.50	DP1111
20881 15.50 / 20880 15.50		21005 15.50	DP529	21179 16.50	DP1111
/ 20882 15.50	DP649	21006 18.00 / 20465 18.00	DP720	21183 19.40 / 21182 19.40	DP820/2
20887 15.50 / 20888 15.50	DP517	21010 15.50	DP666/2	21185 19.00 / 21182 19.00	DP820
20887 15.50 / 20888 15.50	DP517	21011 16.00	DP424	21188 18.30 / 21048 18.30	DP702
20887 17.00	DP1084	21012 14.80	DP803	21190 18.00	DP760
20887 19.50 / 20888 19.50	DP517/2	21012 15.00	DP556	21195 18.00	DP704
20887 19.50 / 20888 19.50	DP517/2	21016 16.50	DP604	21197 15.00	DP846
20889 17.30	DP515	21024 17.50	DP681	21199 15.00 / 20387 15.00	
20889 17.50	DP515	21027 15.50	DP1027	/ 21590 15.00	DP916
20892 15.00 / 21537 15.00		21037 14.50	DP441	21202 17.20	DP769
/ 21318 15.00	DP730	21041 15.00	DP490	21205 18.00 / 21066 18.00	DP735
20894 15.00	DP401	21042 15.50	DP419	21209 19.00	DP687
20895 15.00	DP432	21043 13.00	DP514	21211 17.50	DP881
20899 12.50	DP442	21043 13.00	DP514/2	21217 17.25	DP838
20904 18.00	DP462	21046 14.50	DP392	21219 17.50	DP883
20904 18.00	DP462	21049 18.30 / 21048 18.30	DP510	21224 16.00 / 20958 16.00	DP567
20905 15.00 / 20986 15.00		21050 15.00 / 20902 15.00	DP675	21226 17.50 / 21225 17.50	DP754
/ 21061 15.00	DP545/2	21050 17.50	DP1042	21233 16.50	DP800
20905 18.00	DP1057	21055 17.25	DP778	21243 14.00	DP541
20905 18.00 / 20986 18.00		21057 15.00	DP325/2	21244 14.00	DP542
/ 21061 18.00	DP545	21061 18.00 / 20906 18.00	DP545/4	21245 17.50 / 21246 17.50	DP643
20907 18.00 / 20908 18.00	DP605/2	21061 18.00 / 20906 18.00		21248 16.00 / 21250 16.00	DP456
20907 18.00 / 20908 18.00		/ 21609 18.00	DP545/4	21249 15.50 / 21369 15.50	DP743
/ 20909 18.00	DP473	21061 18.00 / 21414 18.00		21252 15.00	DP613
20907 18.00 / 21625 18.00	DP961	/ 20906 18.00	DP545/4	21254 15.00 / 21255 15.00	DP454
20910 16.50 / 20467 16.50	DP311	21068 17.00	DP666	21256 15.00	DP668

WVA No.	EBC No.	WVA No.	EBC No.	WVA No.	EBC No.
21267 16.50 / 21179 16.50	DP656	21469 18.00	DP920	21670 19.30	DP1075
21271 17.00	DP835	21470 18.00	DP918/2	21674 17.50 / 21886 17.50	DP1047
21273 19.30	DP880	21470 18.00	DP918	21674 19.00	DP1396
21275 17.00	DP1040	21471 18.00	DP1032	21680 15.00 / 21679 15.00	DP807
21275 17.00 / 21934 17.00	DP690/2	21479 18.30	DP1030	21682 14.00	DP662/2
21278 16.00	DP816	21479 18.30	DP1030/2	21688 15.30	DP878
21278 16.00	DP1048	21481 15.50	DP947	21689 15.50	DP787
21280 15.75	DP839	21482 17.00	DP966	21691 16.50	DP1091
21282 17.00	DP871	21484 20.00	DP1035	21696 16.50 / 21694 16.50	DP891
21284 19.50	DP870	21486 19.00	DP1036	21699 15.00 / 21697 15.00	DP890
21296 17.00	DP794	21487 17.00	DP1118	21700 18.00	DP818
21298 17.00	DP794/2	21496 17.00 / 21495 17.00	DP819	21705 14.80 / 21703 14.80	DP821
21301 15.00	DP1026	21499 15.00 / 21497 15.00	DP812/2	21708 15.50 / 21706 15.50	DP738
21303 18.50	DP963	21499 18.00 / 21497 18.00	DP812	21709 15.50 / 21711 15.50	DP1029
21304 18.50	DP888	21502 15.00 / 21500 15.00	DP774	21712 14.00	DP799
21305 16.00 / 21287 16.00	DP887	21504 17.00 / 21505 17.00	DP882	21713 16.00	DP889
21307 15.00	DP825	21507 17.00 / 21508 17.00	DP882/2	21718 16.00 / 21716 16.00	DP988
21312 12.50	DP642	21515 17.50 / 21516 17.50	DP1415	21721 14.50 / 21719 14.50	
21313 12.50 / 21312 12.50	DP642/2	21515 17.50 / 21516 17.50	DP815	/ 21720 14.50	DP781
21319 13.00 / 21320 13.00	DP740	21518 17.00	DP817	21724 18.50	DP1049
21322 15.00 / 21323 15.00	DP706	21519 18.00	DP708	21727 17.00 / 21725 17.00	DP1358
21329 14.00 / 21121 14.00	DP528	21520 17.50	DP810	21728 17.50 / 20164 17.50	DP1095
21331 15.00 / 21330 15.00		21523 17.00	DP639	21730 14.00	DP977
/ 21332 15.00	DP911 / DP985	21527 17.00 / 21526 17.00	DP792	21738 12.50	DP984/2
21333 15.00 / 21334 15.00	DP762	21529 16.00	DP919	21745 17.00	DP679
21336 15.00	DP741	21533 17.00	DP718/2	21755 15.00	DP971
21339 14.00 / 21338 14.00		21539 15.00	DP824	21759 15.00 / 21760 15.00	DP602
/ 21340 14.00	DP765	21542 14.00	DP840	21762 14.50	DP936
21341 15.00	DP686	21544 16.50 / 21467 16.50		21763 15.50	DP847
21341 16.00	DP686/2	/ 21543 16.50	DP746	21766 13.50	DP972
21344 16.00	DP665	21545 15.50	DP834	21769 15.70 / 21363 15.70	
21347 17.00	DP691	21546 16.50	DP833	/ 21768 15.70	DP954
21351 15.00 / 20959 15.00	DP570	21549 14.80 / 21547 14.80	DP822	21770 14.50	DP1017
21355 14.00	DP737	21551 15.00 / 21550 15.00	DP640	21775 15.00	DP992
21358 18.80 / 21583 18.80	DP910	21552 14.00	DP802	21777 15.00	DP994
21368 19.00	DP937	21553 14.00	DP773	21784 15.00	DP797
21372 15.00	DP725	21557 18.00 / 21383 18.00	DP733	21786 15.50	DP1008
21373 16.20	DP716	21557 18.00 / 21383 18.00	DP733	21788 17.00	DP1006
21374 14.00	DP682	21558 13.00	DP739	21790 15.50	DP875
21376 15.50 / 21187 15.50	DP610	21559 12.50	DP828	21791 16.50	DP874
21378 15.40	DP705	21561 17.00	DP775	21792 15.50	DP1208
21381 14.00	DP1140	21563 13.20	DP777	21801 18.00	DP1108
21382 17.00 / 21381 17.00	DP1031	21571 16.80	DP1019	21812 18.00	DP1194 /
21382 17.00 / 21381 17.00	DP21031	21573 14.00 / 20932 14.00	DP832	DP1249	
21385 13.00	DP793	21576 19.30	DP1071	21815 17.00	DP1119 /
21386 15.00	DP1101	21583 18.80 / 21910 18.80	DP956	DP1250	
21388 17.80 / 20916 17.80		21586 15.00	DP965	21820 17.00	DP813
/ 20919 17.80	DP949	21586 15.00	DP960	21822 17.00	DP1022
21391 14.00	DP638	21592 18.00	DP1070	21832 15.00	DP953
21396 18.50 / 21394 18.50	DP950	21601 17.30 / 21603 17.30	DP964	21833 15.00	DP628
21402 17.50	DP997	21606 16.00	DP1096	21837 15.50 / 21835 15.50	
21411 17.50 / 21413 17.50	DP976	21614 17.50	DP575/4	/ 21836 15.50	DP876
21423 18.00 / 21595 18.00	DP980	21621 16.60	DP1069	21839 14.00 / 21838 14.00	DP768
21430 17.00 / 21432 17.00	DP948	21626 15.00	DP946	21842 15.50 / 21840 15.50	DP958
21436 17.00 / 21365 17.00	DP944	21627 19.00 / 21797 19.00	DP1024	21844 15.00 / 21525 15.00	DP674
21436 17.00 / 21437 17.00	DP945	21629 19.00 / 21799 19.00	DP1025	21847 16.50 / 21845 16.50	DP973
21439 19.00	DP962	21631 17.00	DP942	21848 19.50 / 21624 19.50	DP1074
21440 19.00 / 21403 19.00	DP1009	21632 16.00	DP943	21849 19.50 / 21938 19.50	
21443 19.00 / 21444 19.00	DP1021	21634 18.00 / 21635 18.00	DP1116	/ 23018 19.50 / 20676 19.50	DP1114
21445 15.00	DP1097	21636 18.00 / 21637 18.00	DP1061	21854 14.50	DP1072
21447 17.50 / 21446 17.50		21643 16.40 / 21292 16.40		21861 15.00	DP1076
/ 20067 17.50	DP719/2	/ 21916 16.40	DP914	21862 18.00	DP1087
21454 18.50	DP1012	21645 17.00	DP733/2	21866 15.00	DP1137
21459 18.00	DP713	21647 16.00	DP830	21866 17.00	DP1064
21459 18.00	DP814	21650 15.00	DP941	21866 19.00	DP1056
21459 18.00 / 21897 18.00	DP814	21650 15.00	DP1063	21873 14.20 / 21872 14.20	DP986
21460 18.00	DP426/4	21652 18.50 / 21651 18.50		21875 16.00	DP974
21463 18.00	DP959	/ 21653 18.50 / 20081 18.50	DP872	21879 18.50 / 21881 18.50	DP975
21465 14.50	DP755	21655 15.00 / 21654 15.00		21882 17.00 / 21748 17.00	DP1102
21466 16.00	DP448	/ 21656 15.00	DP884	21883 20.00 / 21884 20.00	
21468 15.50	DP722	21657 15.00	DP892	/ 21885 20.00	DP1115
21469 18.00	DP920/2	21664 19.00 / 21795 19.00	DP1055	21885 20.00	DP1398

WVA-EBC CROSS REFERENCE



WVA No.	EBC No.	WVA No.	EBC No.	WVA No.	EBC No.
21888 18.00 / 21887 18.00	DP1128	23106 19.00	DP1439	23346 17.50 / 23124 17.5	DP1346
21892 18.50	DP1073	23114 18.50 / 23112 18.50		23348 16.00	DP1225
21899 15.70 / 21898 15.70	DP1288	/ 23113 18.50	DP1219	23353 14.00	DP1218
21900 15.50	DP1135	23115 19.30 / 21829 19.30	DP1062	23354 14.00	DP1002
21904 17.00 / 21572 17.00	DP1090	23116 19.60 / 23060 19.60		23355 15.00	DP873
21907 15.00	DP979	/ 23056 19.60	DP1183	23358 19.00	DP1100
21910 18.80 / 21358 18.80	DP910/2	23124 17.5	DP1104	23361 14.50	DP1122 /
21911 19.30	DP1324	23126 17.50 / 20968 17.50		DP1621	
21919 15.50	DP1191	/ 21211 17.50 / 21064 17.50	DP689/2	23373 15.00	DP987
21920 15.00	DP1045	23129 17.00	DP1077	23379 14.00	DP1023
21927 17.00 / 21928 17.00	DP1060	23130 20.00	DP1329/2	23381 16.00 / 21580 16.00	DP826
21929 17.00	DP1060	23130 20.00 / 21974 20.00	DP1117	23384 18.00	DP1001 / DP1237
21930 17.40 / 21931 17.40		23131 20.00	DP1329	23387 13.00	DP1003
/ 21932 17.40	DP1059	23135 17.00	DP1188	23392 19.30 / 21911 19.30	DP1330
21930 17.40 / 21931 17.40		23138 14.60	DP1438	23394 14.50	DP1433
/ 21932 17.40	DP1141	23140 19.00	DP1153	23395 14.50	DP1432
21932 17.40 / 21930 17.40		23144 19.50	DP1365	23396 17.00 / 23332 17.00	DP1234
/ 21931 17.40	DP1059	23154 18.30	DP1185	23400 16.50	DP1041
21933 17.00 / 21934 17.00	DP1289	23157 16.00	DP1395	23402 20.00 / 23403 20.00	DP1414
21934 16.00	DP1405	23160 16.50	DP1376	23404 20.00 / 23405 20.00	DP1416
21937 16.20	DP1207	23169 19.00	DP1080	23407 19.00 / 23406 19.00	DP1434
21942 17.00	DP1278	23172 18.00	DP1369	23409 19.00 / 23408 19.00	DP1435
21945 16.00	DP1112	23176 18.00 / 21634 18.00		23416 15.00	DP1447
21945 19.30	DP1113	/ 21635 18.00	DP1429	23420 16.00	DP1247
21945 19.30	DP1351	23177 14.00	DP1214	23424 17.00	DP1221
21947 15.00	DP993	23181 17.50	DP1336	23434 18.00	DP1367
21948 13.00	DP879	23189 16.70	DP1233	23440 17.50	DP1444
21952 15.50	DP1015	23190 16.70	DP1437	23440 17.50	DP1448
21955 16.00	DP1005	23193 16.30	DP1232	23440 17.50	DP1641
21957 17.00	DP1004	23197 18.50	DP818	23442 17.00	DP1404
21961 15.00	DP995	23200 18.00	DP1300	23447 17.00	DP1450
21965 15.00	DP1190	23202 18.00	DP1320	23452 18.00	DP1037
21968 14.30	DP1016	23205 18.00	DP1366	23454 15.00	DP998
21975 17.50	DP1171	23215 18.30	DP1394	23455 16.00	DP1235
21978 18.00 / 21980 18.00		23224 17.30	DP1445	23458 15.50	DP1038
/ 23205 18.00	DP1136	23225 17.00 / 23226 17.00	DP1341	23463 17.00	DP1238
21978 18.00 / 21980 18.00		23230 15.80	DP1126	23471 14.50	DP1033
/ 23205 18.00	DP1406	23234 17.00	DP1209	23472 17.50	DP1199
21983 17.30	DP1139	23234 17.00 / 29112 17.00	DP1196	23482 16.80	DP1354
21990 19.30 / 21677 19.30		23237 14.00	DP1197	23487 15.50	DP1347
/ 23183 19.00	DP1089	23238 16.00	DP1203	23488 16.00	DP1315
21999 15.60	DP1287	23241 16.00	DP1212	23489 16.30	DP1220
23003 18.30 / 23042 18.00	DP1053	23242 14.60	DP1132	23490 16.00	DP1302
23004 16.00	DP1044	23248 18.33	DP1353	23494 14.00	DP1335
23009 16.00	DP877	23253 15.50	DP1361	23497 15.50	DP1217
23020 18.00	DP1343	23258 17.00 / 21991 17.00		23502 16.00	DP1360
23021 18.50	DP1298	/ 23052 17.00	DP1186	23507 15.00	DP1344 /
23022 20.50	DP1292	23269 20.00 / 23270 20.00	DP1413	DP1387	
23024 15.00 / 23023 15.00	DP1067	23271 17.80 / 23045 17.80	DP1363	23510 16.50	DP1295 /
23032 15.50	DP1204	23273 18.00	DP1372	DP1331	
23034 18.50	DP1368	23276 17.50	DP1370	23513 17.00	DP1399
23034 18.50	DP1286	23277 17.50	DP1371	23515 16.00	DP1121
23043 17.00	DP1065	23279 17.50	DP1322	23517 16.50	DP1430
23057 20.30	DP1187	23281 18.00	DP1388	23521 14.00	DP1326
23063 17.00	DP1184	23284 14.00	DP1410	23524 17.70	DP1283
23070 17.00	DP1170	23287 17.50 / 21643 17.50		23526 17.50	DP1325
23071 18.50 / 21582 18.50		/ 21292 17.50 / 21916 17.50	DP1211	23527 14.00	DP1216
/ 21395 18.50 / 21396 18.50	DP955	23290 17.00	DP1124	23532 20.00	DP1357
23072 18.60 / 23073 18.60	DP1229	23294 16.50	DP1195	23536 15.50	DP1281
23076 17.00	DP1231	23295 16.00	DP1103	23539 17.50	DP1282
23078 16.00	DP1428	23296 15.00	DP1345	23543 15.00	DP1392
23080 15.00	DP1039	23300 18.50	DP837/2	23552 18.00	DP1337
23083 19.00 / 23081 19.00	DP1086	23302 18.00	DP1182	23554 17.00 / 20961 17.00	DP1412
23088 17.50	DP1431	23305 15.50	DP1373	23557 16.80	DP1350
23092 15.00	DP1210	23309 17.00	DP1451	23558 17.00 / 21915 17.00	DP1134
23094 17.00	DP1339	23312 20.00	DP1449	23561 17.00	DP1066
23099 18.00	DP1393	23334	DP1478	23566 17.00	DP1206
23099 18.00	DP1461	23314 14.50	DP1099	23569 17.00	DP1332
23102 17.20 / 23101 17.20		23331 16.00	DP1622	23572 14.50	DP1293
/ 21202 17.20	DP1050	23332 18.00	DP1408	23575 15.00 / 23092 15.00	DP1419
23104 18.00 / 23103 18.00		23334 16.00	DP1364	23577 18.00 / 23430 18.00	DP1297
/ 20753 18.00	DP1051	23339 17.00	DP1606	23581 18.80	DP1436

