



OE

MITSUBISHI

3000 GT (Z16A)









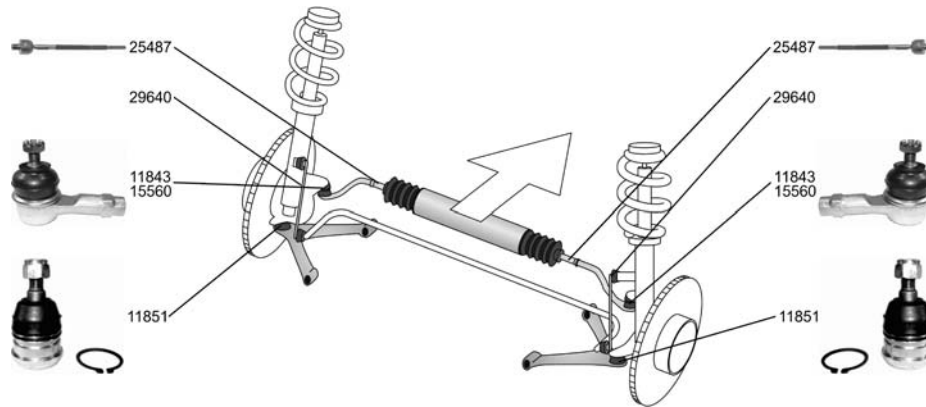

06.92 -

	Stange/Strebe, Stabilisator / Rod/Strut, stabiliser Pendelstange / Suspension Rod		29663	MB 892 982
	ALL TYPES			

CARISMA (DA_)

07.95 -



Spurstangenkopf / Tie-rod End Gewindeart: mit Rechtsgewinde / Thread Type: with right-hand thread Innengewinde [mm] / Inner Thread [mm]:M12x1,25 ALL TYPES ausser/except for : 1.6, 76 kW 09.00 -		11843 MB 912076 
Spurstangenkopf / Tie-rod End Gewindeart: mit Rechtsgewinde / Thread Type: with right-hand thread Innengewinde [mm] / Inner Thread [mm]:M12x1,25 ALL TYPES ausser/except for : 1.6, 76 kW 09.00 -		15560 MB 241982 
Axialgelenk, Spurstange / Axial Rod, tie rod 1.6, 66 kW 07.95 - 1.6, 73 kW 05.97 - 1.8 07.95 - 1.8 16V GDI 09.97 - 1.8 16V 07.95 - 1.9 TD 10.96 - 09.00	 ->02.1999	25487 
Trag-/Führungsgelenk / Support-/ Steering Link 1.6, 66 kW 07.95 - 1.6, 70 kW 12.98 - 1.6, 73 kW 05.97 - 1.8 07.95 - 1.8 16V GDI 09.97 - 1.8 16V 07.95 - 1.9 TD 10.96 - 09.00	 ->02.1999	11851 MB 303375 
Stange/Strebe, Stabilisator / Rod/Strut, stabiliser Pendelstange / Suspension Rod Gewindemaß / Thread Size:M10x1,25 ALL TYPES		29640 MR-272116
Faltenbalsatz, Lenkung / Bellow Kit, steering system Innendurchmesser 1 [mm] / Inner Diameter 1 [mm]:11 Innendurchmesser 2 [mm] / Inner Diameter 2 [mm]:41 ALL TYPES		30220 









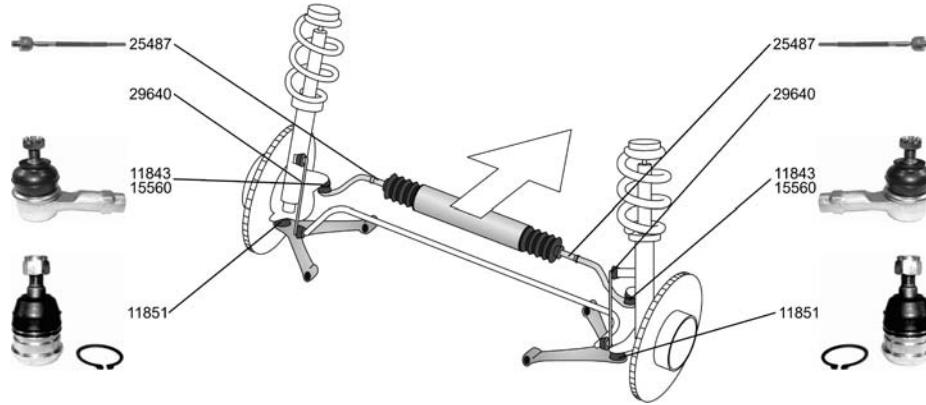



MITSUBISHI

CARISMA Stufenheck/Saloon/avec coffre (DA_)

09.96 -





<p>Spurstangenkopf / Tie-rod End Gewindeart: mit Rechtsgewinde / Thread Type: with right-hand thread Innengewinde [mm] / Inner Thread [mm]:M12x1,25 ALL TYPES ausser/except for : 1.6, 76 kW 09.00 -</p>		<p>11843 MB 912076</p> 
<p>Spurstangenkopf / Tie-rod End Gewindeart: mit Rechtsgewinde / Thread Type: with right-hand thread Innengewinde [mm] / Inner Thread [mm]:M12x1,25 ALL TYPES ausser/except for : 1.6, 76 kW 09.00 -</p>		<p>15560 MB 241982</p> 
<p>Axialgelenk, Spurstange / Axial Rod, tie rod 1.6, 66 kW 09.96 - 1.6, 73 kW 05.97 - 1.8 09.96 - 1.8 16V GDI 09.97 - 1.9 TD 10.96 - 09.00</p>	 <p>->02.1999</p>	<p>25487</p> 
<p>Trag-/Führungsgelenk / Support-/ Steering Link 1.6, 66 kW 09.96 - 1.6, 70 kW 12.98 - 1.6, 73 kW 05.97 - 1.8 09.96 - 1.8 16V GDI 09.97 - 1.9 TD 10.96 - 09.00</p>	 <p>->02.1999</p>	<p>11851 MB 303375</p> 
<p>Stange/Strebe, Stabilisator / Rod/Strut, stabiliser Pendelstange / Suspension Rod Gewindemaß / Thread Size:M10x1,25 ALL TYPES</p>		<p>29640 MR-272116</p>
<p>Faltenbalgsatz, Lenkung / Bellow Kit, steering system Innendurchmesser 1 [mm] / Inner Diameter 1 [mm]:11 Innendurchmesser 2 [mm] / Inner Diameter 2 [mm]:41 ALL TYPES</p>		<p>30220</p> 

COLT II (C1_A)

02.84 - 04.88



<p>Spurstangenkopf / Tie-rod End Gewindeart: mit Rechtsgewinde / Thread Type: with right-hand thread Innengewinde [mm] / Inner Thread [mm]:M12x1,25 1.2 EL, GL (C15A), 44 kW 09.86 - 04.88 1.3 EL, GL (C11A) 06.86 - 04.88 1.6 Turbo ECi (C13A), 77 kW 07.86 - 04.88 1.8 GL Diesel (C14A), 44 kW 09.86 - 04.88</p>		<p>11843 MB 912076</p> 
---	---	---

















OE

MITSUBISHI

COLT II (C1_A)

02.84 - 04.88

<p> Spurstangenkopf / Tie-rod End Gewindeart: mit Rechtsgewinde / Thread Type: with right-hand thread Innengewinde [mm] / Inner Thread [mm]:M12x1,25</p> <table border="1"> <tr><td>1.2 EL, GL (C15A)</td><td>02.84 - 04.88</td></tr> <tr><td>1.3 EL, GL (C11A)</td><td>06.86 - 04.88</td></tr> <tr><td>1.5 GLX (C12A)</td><td>09.84 - 04.88</td></tr> <tr><td>1.6 Turbo ECI (C13A)</td><td>02.84 - 04.88</td></tr> <tr><td>1.8 GL Diesel (C14A), 44 kW</td><td>09.86 - 04.88</td></tr> <tr><td>1.8 GL Diesel (C14A), 43 kW</td><td>02.84 - 09.86</td></tr> </table>	1.2 EL, GL (C15A)	02.84 - 04.88	1.3 EL, GL (C11A)	06.86 - 04.88	1.5 GLX (C12A)	09.84 - 04.88	1.6 Turbo ECI (C13A)	02.84 - 04.88	1.8 GL Diesel (C14A), 44 kW	09.86 - 04.88	1.8 GL Diesel (C14A), 43 kW	02.84 - 09.86		<p>15560 MB 241982</p> 
1.2 EL, GL (C15A)	02.84 - 04.88													
1.3 EL, GL (C11A)	06.86 - 04.88													
1.5 GLX (C12A)	09.84 - 04.88													
1.6 Turbo ECI (C13A)	02.84 - 04.88													
1.8 GL Diesel (C14A), 44 kW	09.86 - 04.88													
1.8 GL Diesel (C14A), 43 kW	02.84 - 09.86													
<p>Axialgelenk, Spurstange / Axial Rod, tie rod Gewindeart: mit Rechtsgewinde / Thread Type: with right-hand thread Gewindemaß / Thread Size:M12x1,25 ALL TYPES</p>		<p>11856 MB 532046</p> 												
<p>Axialgelenk, Spurstange / Axial Rod, tie rod Gewindeart: mit Rechtsgewinde / Thread Type: with right-hand thread Gewindemaß / Thread Size:M12x1,25 ALL TYPES</p>	<p>LHD </p>	<p>15564 MB 501530</p> 												
<p>Trag-/Führungsgelenk / Support-/ Steering Link</p> <table border="1"> <tr><td>1.2 EL, GL (C15A), 44 kW</td><td>09.86 - 04.88</td></tr> <tr><td>1.3 EL, GL (C11A)</td><td>06.86 - 04.88</td></tr> <tr><td>1.8 GL Diesel (C14A), 44 kW</td><td>09.86 - 04.88</td></tr> </table>	1.2 EL, GL (C15A), 44 kW	09.86 - 04.88	1.3 EL, GL (C11A)	06.86 - 04.88	1.8 GL Diesel (C14A), 44 kW	09.86 - 04.88		<p>11851 MB 303375</p> 						
1.2 EL, GL (C15A), 44 kW	09.86 - 04.88													
1.3 EL, GL (C11A)	06.86 - 04.88													
1.8 GL Diesel (C14A), 44 kW	09.86 - 04.88													
<p>Faltenbalgsatz, Lenkung / Bellow Kit, steering system ALL TYPES ausser/except for : 1.3 EL, GL (C11A) 06.86 - 04.88</p>		<p>30143 MB 347365</p> 												
<p>Faltenbalgsatz, Lenkung / Bellow Kit, steering system ALL TYPES ausser/except for : 1.3 EL, GL (C11A) 06.86 - 04.88</p>		<p>30144 MB 501711</p> 												
<p>Faltenbalgsatz, Lenkung / Bellow Kit, steering system ALL TYPES ausser/except for : 1.3 EL, GL (C11A) 06.86 - 04.88</p>		<p>30173 MB 347364</p> 												







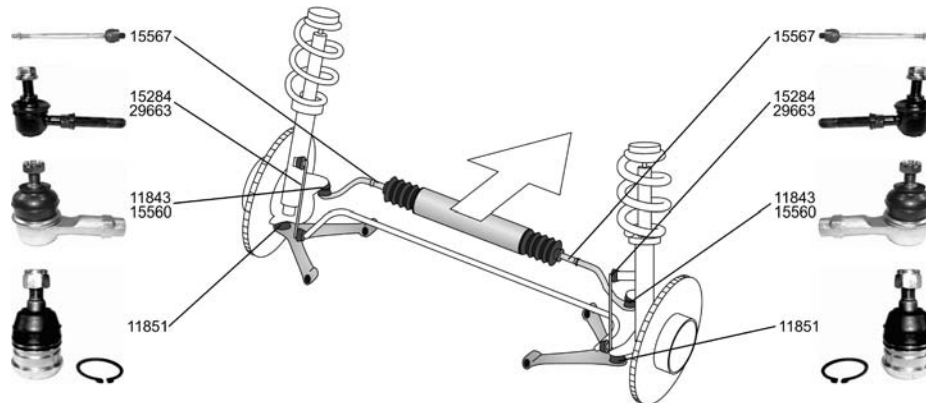

MITSUBISHI

COLT III (C5_A)

04.88 - 05.92







<p>Spurstangenkopf / Tie-rod End Gewindeart: mit Rechtsgewinde / Thread Type: with right-hand thread Innengewinde [mm] / Inner Thread [mm]:M12x1,25</p> <p>ALL TYPES ausser/except for :</p> <table border="1"> <tr> <td>1.5 GL, GLX (C50)</td> <td>07.88 - 12.91</td> </tr> <tr> <td>1.8 Diesel ELD, GLD (C50)</td> <td>07.88 - 12.91</td> </tr> </table>	1.5 GL, GLX (C50)	07.88 - 12.91	1.8 Diesel ELD, GLD (C50)	07.88 - 12.91	<p>▲↻⊙</p>	<p>11843 MB 912076</p> 												
1.5 GL, GLX (C50)	07.88 - 12.91																	
1.8 Diesel ELD, GLD (C50)	07.88 - 12.91																	
<p>Spurstangenkopf / Tie-rod End Gewindeart: mit Rechtsgewinde / Thread Type: with right-hand thread Innengewinde [mm] / Inner Thread [mm]:M12x1,25</p> <p>ALL TYPES ausser/except for :</p> <table border="1"> <tr> <td>1.5 GL, GLX (C50)</td> <td>07.88 - 12.91</td> </tr> <tr> <td>1.8 Diesel ELD, GLD (C50)</td> <td>07.88 - 12.91</td> </tr> </table>	1.5 GL, GLX (C50)	07.88 - 12.91	1.8 Diesel ELD, GLD (C50)	07.88 - 12.91	<p>↻⊙</p>	<p>15560 MB 241982</p> 												
1.5 GL, GLX (C50)	07.88 - 12.91																	
1.8 Diesel ELD, GLD (C50)	07.88 - 12.91																	
<p>Axialgelenk, Spurstange / Axial Rod, tie rod Gewindeart: mit Rechtsgewinde / Thread Type: with right-hand thread Gewindemaß / Thread Size:M12x1,25</p> <p>ALL TYPES ausser/except for :</p> <table border="1"> <tr> <td>1.5 GL, GLX (C50)</td> <td>07.88 - 12.91</td> </tr> <tr> <td>1.8 Diesel ELD, GLD (C50)</td> <td>07.88 - 12.91</td> </tr> </table>	1.5 GL, GLX (C50)	07.88 - 12.91	1.8 Diesel ELD, GLD (C50)	07.88 - 12.91	<p>↻⊙</p>	<p>15567 MB 553249</p> 												
1.5 GL, GLX (C50)	07.88 - 12.91																	
1.8 Diesel ELD, GLD (C50)	07.88 - 12.91																	
<p>Trag-/Führungsgelenk / Support-/ Steering Link</p> <table border="1"> <tr> <td>1.3 GL</td> <td>04.88 - 12.90</td> </tr> <tr> <td>1.3 (C51A)</td> <td>04.88 - 05.92</td> </tr> <tr> <td>1.5 GLXi (C52A)</td> <td>04.88 - 05.92</td> </tr> <tr> <td>1.5 (C52A) KAT</td> <td>07.90 - 05.92</td> </tr> <tr> <td>1.6 GTi 16V (C53A)</td> <td>04.88 - 05.90</td> </tr> <tr> <td>1.8 GTi 16V (C58A) KAT</td> <td>06.90 - 05.92</td> </tr> <tr> <td>1.8 Diesel GLX (C54A)</td> <td>04.88 - 05.92</td> </tr> <tr> <td>1.3 12V (C51A)</td> <td>04.88 - 05.92</td> </tr> </table>	1.3 GL	04.88 - 12.90	1.3 (C51A)	04.88 - 05.92	1.5 GLXi (C52A)	04.88 - 05.92	1.5 (C52A) KAT	07.90 - 05.92	1.6 GTi 16V (C53A)	04.88 - 05.90	1.8 GTi 16V (C58A) KAT	06.90 - 05.92	1.8 Diesel GLX (C54A)	04.88 - 05.92	1.3 12V (C51A)	04.88 - 05.92	<p>▽↻</p>	<p>11851 MB 303375</p> 
1.3 GL	04.88 - 12.90																	
1.3 (C51A)	04.88 - 05.92																	
1.5 GLXi (C52A)	04.88 - 05.92																	
1.5 (C52A) KAT	07.90 - 05.92																	
1.6 GTi 16V (C53A)	04.88 - 05.90																	
1.8 GTi 16V (C58A) KAT	06.90 - 05.92																	
1.8 Diesel GLX (C54A)	04.88 - 05.92																	
1.3 12V (C51A)	04.88 - 05.92																	
<p>Stange/Strebe, Stabilisator / Rod/Strut, stabiliser Pendelstange / Suspension Rod</p> <table border="1"> <tr> <td>1.3 GL</td> <td>04.88 - 12.90</td> </tr> <tr> <td>1.3 (C51A)</td> <td>04.88 - 05.92</td> </tr> <tr> <td>1.5 GLXi (C52A)</td> <td>04.88 - 05.92</td> </tr> <tr> <td>1.5 (C52A) KAT</td> <td>07.90 - 05.92</td> </tr> <tr> <td>1.3 12V (C51A)</td> <td>04.88 - 05.92</td> </tr> </table>	1.3 GL	04.88 - 12.90	1.3 (C51A)	04.88 - 05.92	1.5 GLXi (C52A)	04.88 - 05.92	1.5 (C52A) KAT	07.90 - 05.92	1.3 12V (C51A)	04.88 - 05.92	<p>↻</p>	<p>15284 MB 518780</p> 						
1.3 GL	04.88 - 12.90																	
1.3 (C51A)	04.88 - 05.92																	
1.5 GLXi (C52A)	04.88 - 05.92																	
1.5 (C52A) KAT	07.90 - 05.92																	
1.3 12V (C51A)	04.88 - 05.92																	
<p>Stange/Strebe, Stabilisator / Rod/Strut, stabiliser Pendelstange / Suspension Rod</p> <table border="1"> <tr> <td>1.3 GL</td> <td>04.88 - 12.90</td> </tr> <tr> <td>1.3 (C51A)</td> <td>04.88 - 05.92</td> </tr> <tr> <td>1.5 GLXi (C52A)</td> <td>04.88 - 05.92</td> </tr> <tr> <td>1.5 (C52A) KAT</td> <td>07.90 - 05.92</td> </tr> <tr> <td>1.6 GTi 16V (C53A)</td> <td>04.88 - 05.90</td> </tr> <tr> <td>1.8 GTi 16V (C58A) KAT</td> <td>06.90 - 05.92</td> </tr> <tr> <td>1.8 Diesel GLX (C54A)</td> <td>04.88 - 05.92</td> </tr> <tr> <td>1.3 12V (C51A)</td> <td>04.88 - 05.92</td> </tr> </table>	1.3 GL	04.88 - 12.90	1.3 (C51A)	04.88 - 05.92	1.5 GLXi (C52A)	04.88 - 05.92	1.5 (C52A) KAT	07.90 - 05.92	1.6 GTi 16V (C53A)	04.88 - 05.90	1.8 GTi 16V (C58A) KAT	06.90 - 05.92	1.8 Diesel GLX (C54A)	04.88 - 05.92	1.3 12V (C51A)	04.88 - 05.92	<p>↻</p>	<p>29663 MB 892 982</p> 
1.3 GL	04.88 - 12.90																	
1.3 (C51A)	04.88 - 05.92																	
1.5 GLXi (C52A)	04.88 - 05.92																	
1.5 (C52A) KAT	07.90 - 05.92																	
1.6 GTi 16V (C53A)	04.88 - 05.90																	
1.8 GTi 16V (C58A) KAT	06.90 - 05.92																	
1.8 Diesel GLX (C54A)	04.88 - 05.92																	
1.3 12V (C51A)	04.88 - 05.92																	
<p>Faltenbalgsatz, Lenkung / Bellow Kit, steering system</p> <p>ALL TYPES ausser/except for :</p> <table border="1"> <tr> <td>1.5 GL, GLX (C50)</td> <td>07.88 - 12.91</td> </tr> <tr> <td>1.5 (C52A) KAT</td> <td>07.90 - 05.92</td> </tr> <tr> <td>1.8 Diesel ELD, GLD (C50)</td> <td>07.88 - 12.91</td> </tr> </table>	1.5 GL, GLX (C50)	07.88 - 12.91	1.5 (C52A) KAT	07.90 - 05.92	1.8 Diesel ELD, GLD (C50)	07.88 - 12.91	<p>⌚↻</p>	<p>30143 MB 347365</p> 										
1.5 GL, GLX (C50)	07.88 - 12.91																	
1.5 (C52A) KAT	07.90 - 05.92																	
1.8 Diesel ELD, GLD (C50)	07.88 - 12.91																	



OE









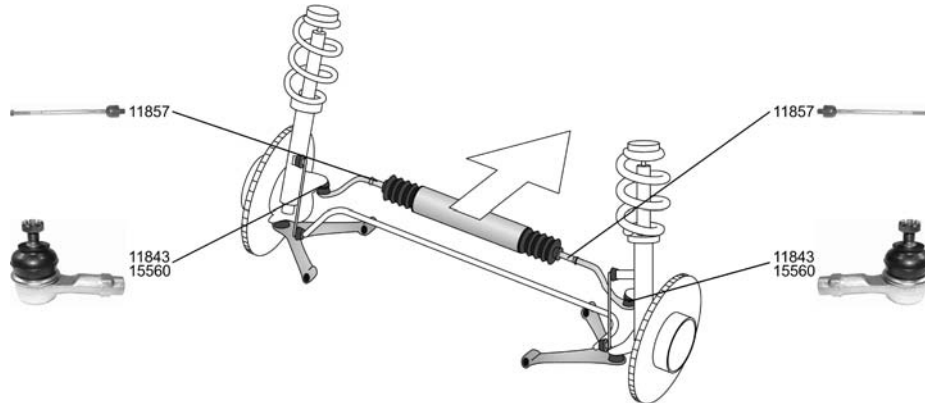



MITSUBISHI

COLT III (C5_A) 04.88 - 05.92

 Faltenbalgsatz, Lenkung / Bellow Kit, steering system ALL TYPES ausser/except for : 1.5 GL,GLX (C50) 07.88 - 12.91 1.5 (C52A) KAT 07.90 - 05.92 1.8 Diesel ELD, GLD (C50) 07.88 - 12.91	 	30173 MB 347364 

COLT IV (CA_A) 04.92 - 08.95



Spurstangenkopf / Tie-rod End Gewindeart: mit Rechtsgewinde / Thread Type: with right-hand thread Innengewinde [mm] / Inner Thread [mm]:M12x1,25 1.3 GLi 12V (CA1A) 04.92 - 04.96 1.6 02.94 - 04.96 1.6 GLXi 16V (CA4A) 04.92 - 04.96 1.8 GTi 16V (CA5A) 04.92 - 04.96		11843 MB 912076 
Spurstangenkopf / Tie-rod End Gewindeart: mit Rechtsgewinde / Thread Type: with right-hand thread Innengewinde [mm] / Inner Thread [mm]:M12x1,25 1.3 GLi 12V (CA1A) 04.92 - 04.96 1.6 02.94 - 04.96 1.6 GLXi 16V (CA4A) 04.92 - 04.96 1.8 GTi 16V (CA5A) 04.92 - 04.96		15560 MB 241982 
Axialgelenk, Spurstange / Axial Rod, tie rod 1.3 GLi 12V (CA1A) 04.92 - 04.96 1.6 02.94 - 04.96 1.6 GLXi 16V (CA4A) 04.92 - 04.96 1.8 GTi 16V (CA5A) 04.92 - 04.96		11857 MR 297969 
Faltenbalgsatz, Lenkung / Bellow Kit, steering system 1.3 GLi 12V (CA1A) 04.92 - 04.96 1.6 02.94 - 04.96 1.6 GLXi 16V (CA4A) 04.92 - 04.96 1.8 GTi 16V (CA5A) 04.92 - 04.96	 	30143 MB 347365 
Faltenbalgsatz, Lenkung / Bellow Kit, steering system 1.3 GLi 12V (CA1A) 04.92 - 04.96 1.6 02.94 - 04.96 1.6 GLXi 16V (CA4A) 04.92 - 04.96 1.8 GTi 16V (CA5A) 04.92 - 04.96	 	30173 MB 347364 



MITSUBISHI

COLT V (CJ_A)

09.95 -

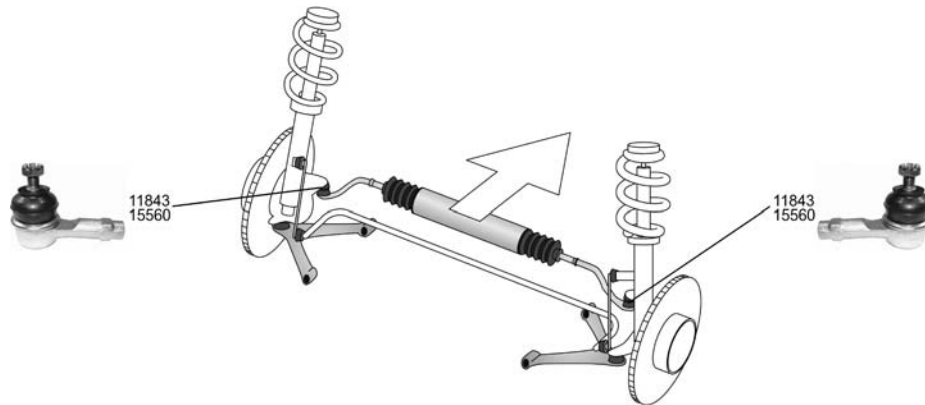

<p>Spurstangenkopf / Tie-rod End Gewindeart: mit Rechtsgewinde / Thread Type: with right-hand thread Innengewinde [mm] / Inner Thread [mm]:M12x1,25</p>		<p>11843 MB 912076</p>
<p>ALL TYPES</p>		
<p>Spurstangenkopf / Tie-rod End Gewindeart: mit Rechtsgewinde / Thread Type: with right-hand thread Innengewinde [mm] / Inner Thread [mm]:M12x1,25</p>		<p>15560 MB 241982</p>
<p>ALL TYPES</p>		
<p>Faltenbalgsatz, Lenkung / Bellow Kit, steering system</p>		<p>30143 MB 347365</p>
<p>ALL TYPES</p>		
<p>Faltenbalgsatz, Lenkung / Bellow Kit, steering system</p>		<p>30173 MB 347364</p>
<p>ALL TYPES</p>		

COLT VI

06.04 -

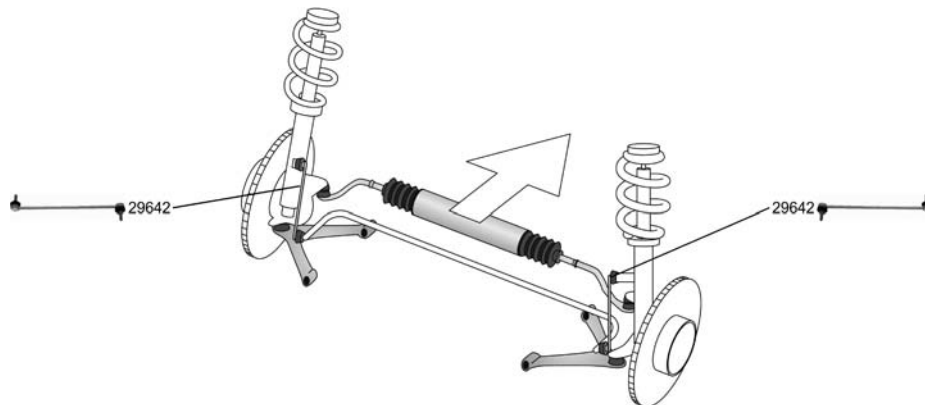

<p>Stange/Strebe, Stabilisator / Rod/Strut, stabiliser Pendelstange / Suspension Rod Rohr-Ø [mm] / Pipe Ø [mm]:9</p>		<p>29642 MR-961477</p>
<p>ALL TYPES</p>		















OE

MITSUBISHI

CORDIA (A21_A)





10.82 - 12.86

 Spurstangenkopf / Tie-rod End Gewindeart: mit Rechtsgewinde / Thread Type: with right-hand thread Innengewinde [mm] / Inner Thread [mm]:M14x1,5 ALL TYPES ausser/except for : 1.6 SR (A212A) 09.82 - 12.87		11841 MB 912519 
Axialgelenk, Spurstange / Axial Rod, tie rod Gewindeart: mit Rechtsgewinde / Thread Type: with right-hand thread Gewindemaß / Thread Size:M14x1,5 ALL TYPES ausser/except for : 1.6 SR (A212A) 09.82 - 12.87	 	15561 MB 243329 
Trag-/Führungsgelenk / Support-/ Steering Link ALL TYPES ausser/except for : 1.6 SR (A212A) 09.82 - 12.87		11851 MB 303375 
Faltenbalgsatz, Lenkung / Bellow Kit, steering system ALL TYPES ausser/except for : 1.6 SR (A212A) 09.82 - 12.87		30142 MB 266166 
Faltenbalgsatz, Lenkung / Bellow Kit, steering system ALL TYPES ausser/except for : 1.6 SR (A212A) 09.82 - 12.87		30144 MB 501711 

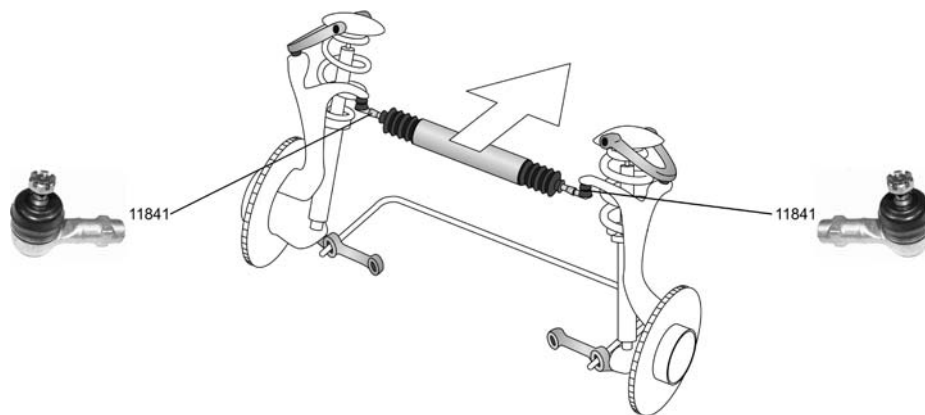
ECLIPSE I (D2_A)

04.91 - 12.95



Spurstangenkopf / Tie-rod End Gewindeart: mit Rechtsgewinde / Thread Type: with right-hand thread Innengewinde [mm] / Inner Thread [mm]:M14x1,5 ALL TYPES		11841 MB 912519 
Stange/Strebe, Stabilisator / Rod/Strut, stabiliser Pendelstange / Suspension Rod ALL TYPES		29660 MB 892 981
Faltenbalgsatz, Lenkung / Bellow Kit, steering system ALL TYPES		30144 MB 501711 





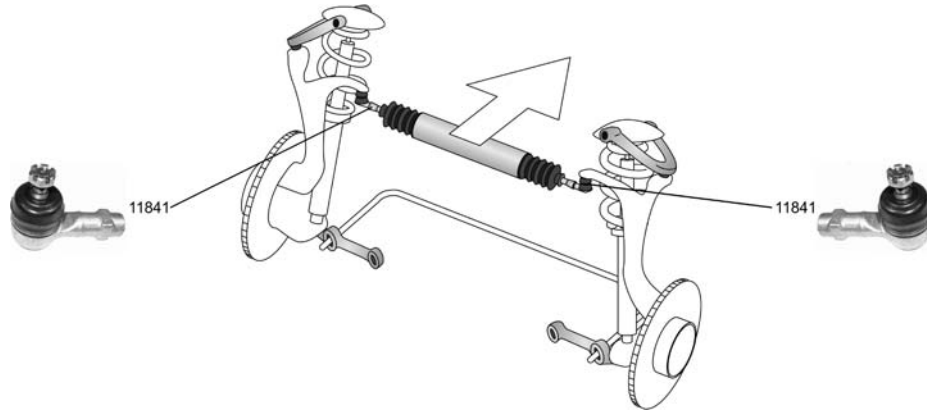

MITSUBISHI

ECLIPSE II (D3_)

12.95 -













<p>Spurstangenkopf / Tie-rod End Gewindeart: mit Rechtsgewinde / Thread Type: with right-hand thread Innengewinde [mm] / Inner Thread [mm]:M14x1,5</p>		<p>11841 MB 912519</p> 
<p>ALL TYPES</p>		
<p>Stange/Strebe, Stabilisator / Rod/Strut, stabiliser Pendelstange / Suspension Rod</p>		<p>29660 MB 892 981</p>
<p>Faltenbalgsatz, Lenkung / Bellow Kit, steering system ALL TYPES</p>	 ->02.1999	<p>30144 MB 501711</p> 

GALANT III (E1_A)

06.84 - 12.87



<p>Spurstangenkopf / Tie-rod End Gewindeart: mit Rechtsgewinde / Thread Type: with right-hand thread Innengewinde [mm] / Inner Thread [mm]:M14x1,5</p>		<p>11841 MB 912519</p> 
<p>ALL TYPES ausser/except for : 1.8 (E14A) 08.84 - 09.87 2.3 TD (E14A) 08.84 - 09.87</p>		
<p>Axialgelenk, Spurstange / Axial Rod, tie rod Gewindeart: mit Rechtsgewinde / Thread Type: with right-hand thread Gewindemaß / Thread Size:M16x1,5</p>		<p>11855 MB 350577</p> 
<p>ALL TYPES ausser/except for : 1.8 (E14A) 08.84 - 09.87 2.3 TD (E14A) 08.84 - 09.87</p>		
<p>Trag-/Führungsgelenk / Support-/ Steering Link ALL TYPES ausser/except for : 1.8 (E14A) 08.84 - 09.87 2.3 TD (E14A) 08.84 - 09.87</p>		<p>11851 MB 303375</p> 
<p>ALL TYPES ausser/except for : 1.8 (E14A) 08.84 - 09.87 2.3 TD (E14A) 08.84 - 09.87</p>		
<p>Faltenbalgsatz, Lenkung / Bellow Kit, steering system ALL TYPES ausser/except for : 1.8 (E14A) 08.84 - 09.87 2.3 TD (E14A) 08.84 - 09.87</p>		<p>30142 MB 266166</p> 
<p>ALL TYPES ausser/except for : 1.8 (E14A) 08.84 - 09.87 2.3 TD (E14A) 08.84 - 09.87</p>		
<p>Faltenbalgsatz, Lenkung / Bellow Kit, steering system ALL TYPES ausser/except for : 1.8 (E14A) 08.84 - 09.87 2.3 TD (E14A) 08.84 - 09.87</p>		<p>30144 MB 501711</p> 
<p>ALL TYPES ausser/except for : 1.8 (E14A) 08.84 - 09.87 2.3 TD (E14A) 08.84 - 09.87</p>		











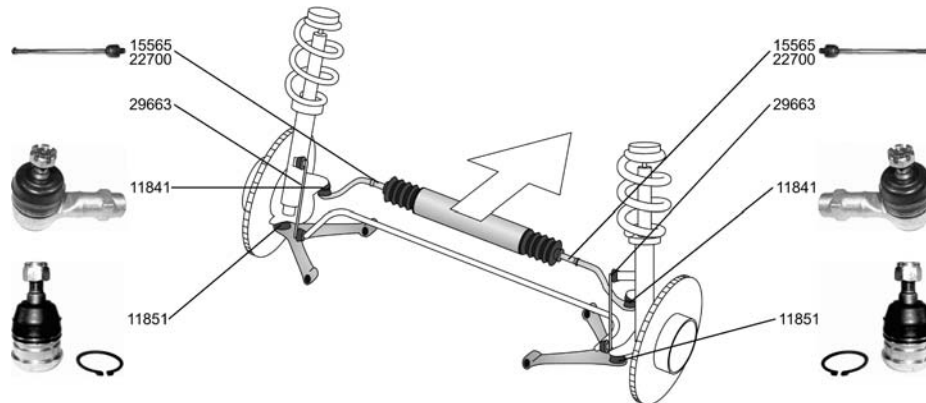





OE

MITSUBISHI

GALANT IV (E3_A)

11.88 - 12.92



<p>Spurstangenkopf / Tie-rod End Gewindeart: mit Rechtsgewinde / Thread Type: with right-hand thread Innengewinde [mm] / Inner Thread [mm]:M14x1,5</p> <p>ALL TYPES ausser/except for :</p> <table border="1"> <tr><td>1.6 L, GL (E31A)</td><td>10.87 - 10.92</td></tr> <tr><td>1.8 (E34A)</td><td>03.88 - 10.92</td></tr> <tr><td>1.8</td><td>11.88 - 10.92</td></tr> </table>	1.6 L, GL (E31A)	10.87 - 10.92	1.8 (E34A)	03.88 - 10.92	1.8	11.88 - 10.92		<p>11841 MB 912519</p> 
1.6 L, GL (E31A)	10.87 - 10.92							
1.8 (E34A)	03.88 - 10.92							
1.8	11.88 - 10.92							
<p>Axialgelenk, Spurstange / Axial Rod, tie rod Gewindemaß / Thread Size:M14x1,5 Gewindeart: mit Rechtsgewinde / Thread Type: with right-hand thread</p> <p>ALL TYPES ausser/except for :</p> <table border="1"> <tr><td>1.6 L, GL (E31A)</td><td>10.87 - 10.92</td></tr> <tr><td>1.8 (E34A)</td><td>03.88 - 10.92</td></tr> <tr><td>1.8</td><td>11.88 - 10.92</td></tr> </table>	1.6 L, GL (E31A)	10.87 - 10.92	1.8 (E34A)	03.88 - 10.92	1.8	11.88 - 10.92		<p>15565 MB 532281</p> 
1.6 L, GL (E31A)	10.87 - 10.92							
1.8 (E34A)	03.88 - 10.92							
1.8	11.88 - 10.92							
<p>Axialgelenk, Spurstange / Axial Rod, tie rod</p> <p>ALL TYPES ausser/except for :</p> <table border="1"> <tr><td>1.6 L, GL (E31A)</td><td>10.87 - 10.92</td></tr> <tr><td>1.8 (E34A)</td><td>03.88 - 10.92</td></tr> <tr><td>1.8</td><td>11.88 - 10.92</td></tr> </table>	1.6 L, GL (E31A)	10.87 - 10.92	1.8 (E34A)	03.88 - 10.92	1.8	11.88 - 10.92		<p>22700 MB 949343</p> 
1.6 L, GL (E31A)	10.87 - 10.92							
1.8 (E34A)	03.88 - 10.92							
1.8	11.88 - 10.92							
<p>Trag-/Führungsgelenk / Support-/ Steering Link</p> <p>ALL TYPES ausser/except for :</p> <table border="1"> <tr><td>1.6 L, GL (E31A)</td><td>10.87 - 10.92</td></tr> <tr><td>1.8 (E34A)</td><td>03.88 - 10.92</td></tr> <tr><td>1.8</td><td>11.88 - 10.92</td></tr> </table>	1.6 L, GL (E31A)	10.87 - 10.92	1.8 (E34A)	03.88 - 10.92	1.8	11.88 - 10.92		<p>11851 MB 303375</p> 
1.6 L, GL (E31A)	10.87 - 10.92							
1.8 (E34A)	03.88 - 10.92							
1.8	11.88 - 10.92							
<p>Stange/Strebe, Stabilisator / Rod/Strut, stabiliser Pendelstange / Suspension Rod</p> <p>ALL TYPES ausser/except for :</p> <table border="1"> <tr><td>1.6 L, GL (E31A)</td><td>10.87 - 10.92</td></tr> <tr><td>1.8 (E34A)</td><td>03.88 - 10.92</td></tr> <tr><td>1.8</td><td>11.88 - 10.92</td></tr> </table>	1.6 L, GL (E31A)	10.87 - 10.92	1.8 (E34A)	03.88 - 10.92	1.8	11.88 - 10.92		<p>29663 MB 892 982</p> 
1.6 L, GL (E31A)	10.87 - 10.92							
1.8 (E34A)	03.88 - 10.92							
1.8	11.88 - 10.92							
<p>Faltenbalgsatz, Lenkung / Bellow Kit, steering system</p> <p>ALL TYPES ausser/except for :</p> <table border="1"> <tr><td>1.6 L, GL (E31A)</td><td>10.87 - 10.92</td></tr> <tr><td>1.8 (E34A)</td><td>03.88 - 10.92</td></tr> <tr><td>1.8</td><td>11.88 - 10.92</td></tr> </table>	1.6 L, GL (E31A)	10.87 - 10.92	1.8 (E34A)	03.88 - 10.92	1.8	11.88 - 10.92		<p>30142 MB 266166</p> 
1.6 L, GL (E31A)	10.87 - 10.92							
1.8 (E34A)	03.88 - 10.92							
1.8	11.88 - 10.92							
<p>Faltenbalgsatz, Lenkung / Bellow Kit, steering system</p> <p>ALL TYPES ausser/except for :</p> <table border="1"> <tr><td>1.6 L, GL (E31A)</td><td>10.87 - 10.92</td></tr> <tr><td>1.8 (E34A)</td><td>03.88 - 10.92</td></tr> <tr><td>1.8</td><td>11.88 - 10.92</td></tr> </table>	1.6 L, GL (E31A)	10.87 - 10.92	1.8 (E34A)	03.88 - 10.92	1.8	11.88 - 10.92		<p>30144 MB 501711</p> 
1.6 L, GL (E31A)	10.87 - 10.92							
1.8 (E34A)	03.88 - 10.92							
1.8	11.88 - 10.92							



MITSUBISHI

GALANT IV Stufenheck/Saloon/avec coffre (E3_A)

11.87 - 10.92

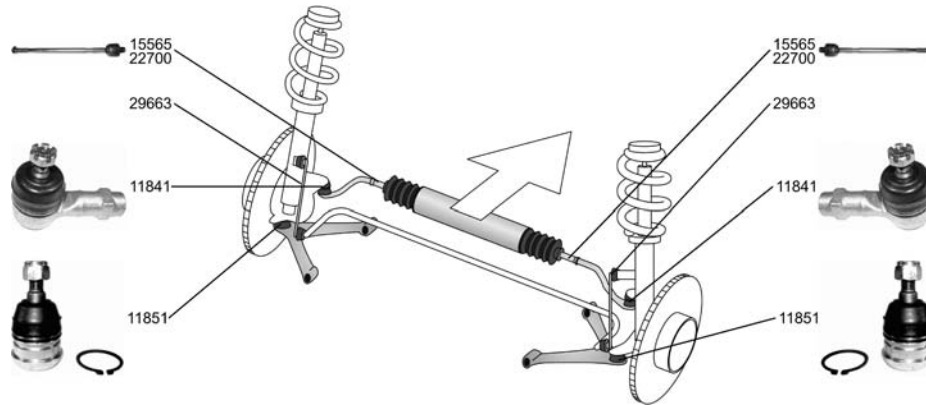

<p>Spurstangenkopf / Tie-rod End Gewindeart: mit Rechtsgewinde / Thread Type: with right-hand thread Innengewinde [mm] / Inner Thread [mm]:M14x1,5</p> <p>ALL TYPES ausser/except for :</p> <table border="1"> <tr> <td>1.6 (E31A)</td> <td>10.87 - 10.92</td> </tr> <tr> <td>2.0 GTi 16V</td> <td>11.88 - 10.92</td> </tr> </table>	1.6 (E31A)	10.87 - 10.92	2.0 GTi 16V	11.88 - 10.92		<p>11841 MB 912519</p> 
1.6 (E31A)	10.87 - 10.92					
2.0 GTi 16V	11.88 - 10.92					
<p>Axialgelenk, Spurstange / Axial Rod, tie rod Gewindemaß / Thread Size:M14x1,5 Gewindeart: mit Rechtsgewinde / Thread Type: with right-hand thread</p> <p>ALL TYPES ausser/except for :</p> <table border="1"> <tr> <td>1.6 (E31A)</td> <td>10.87 - 10.92</td> </tr> <tr> <td>2.0 GTi 16V</td> <td>11.88 - 10.92</td> </tr> </table>	1.6 (E31A)	10.87 - 10.92	2.0 GTi 16V	11.88 - 10.92		<p>15565 MB 532281</p> 
1.6 (E31A)	10.87 - 10.92					
2.0 GTi 16V	11.88 - 10.92					
<p>Axialgelenk, Spurstange / Axial Rod, tie rod</p> <p>ALL TYPES ausser/except for :</p> <table border="1"> <tr> <td>1.6 (E31A)</td> <td>10.87 - 10.92</td> </tr> <tr> <td>2.0 GTi 16V</td> <td>11.88 - 10.92</td> </tr> </table>	1.6 (E31A)	10.87 - 10.92	2.0 GTi 16V	11.88 - 10.92		<p>22700 MB 949343</p> 
1.6 (E31A)	10.87 - 10.92					
2.0 GTi 16V	11.88 - 10.92					
<p>Trag-/Führungsgelenk / Support-/ Steering Link</p> <p>ALL TYPES ausser/except for :</p> <table border="1"> <tr> <td>1.6 (E31A)</td> <td>10.87 - 10.92</td> </tr> <tr> <td>2.0 GTi 16V</td> <td>11.88 - 10.92</td> </tr> </table>	1.6 (E31A)	10.87 - 10.92	2.0 GTi 16V	11.88 - 10.92		<p>11851 MB 303375</p> 
1.6 (E31A)	10.87 - 10.92					
2.0 GTi 16V	11.88 - 10.92					
<p>Stange/Strebe, Stabilisator / Rod/Strut, stabiliser Pendelstange / Suspension Rod</p> <p>ALL TYPES ausser/except for :</p> <table border="1"> <tr> <td>1.6 (E31A)</td> <td>10.87 - 10.92</td> </tr> </table>	1.6 (E31A)	10.87 - 10.92		<p>29663 MB 892 982</p> 		
1.6 (E31A)	10.87 - 10.92					
<p>Faltenbalgsatz, Lenkung / Bellow Kit, steering system</p> <p>ALL TYPES ausser/except for :</p> <table border="1"> <tr> <td>1.6 (E31A)</td> <td>10.87 - 10.92</td> </tr> </table>	1.6 (E31A)	10.87 - 10.92		<p>30142 MB 266166</p> 		
1.6 (E31A)	10.87 - 10.92					
<p>Faltenbalgsatz, Lenkung / Bellow Kit, steering system</p> <p>ALL TYPES ausser/except for :</p> <table border="1"> <tr> <td>1.6 (E31A)</td> <td>10.87 - 10.92</td> </tr> </table>	1.6 (E31A)	10.87 - 10.92		<p>30144 MB 501711</p> 		
1.6 (E31A)	10.87 - 10.92					









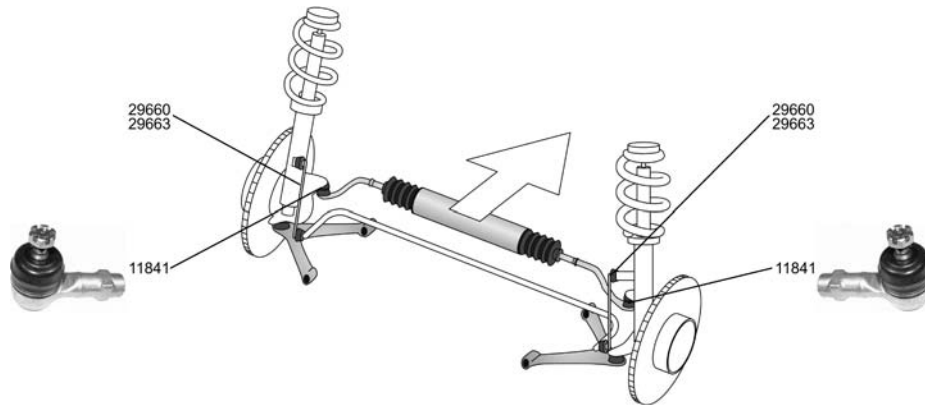

OE

MITSUBISHI

GALANT V (E5_A, E7_A, E8_A)

11.92 - 08.96



<p>Spurstangenkopf / Tie-rod End Gewindeart: mit Rechtsgewinde / Thread Type: with right-hand thread Innengewinde [mm] / Inner Thread [mm]:M14x1,5 ALL TYPES ausser/except for : 2.0 24V (4WS) (E64A) 11.92 - 08.96</p>		<p>11841 MB 912519</p> 
<p>Stange/Strebe, Stabilisator / Rod/Strut, stabiliser Pendelstange / Suspension Rod ALL TYPES ausser/except for : 2.0 24V (4WS) (E64A) 11.92 - 08.96</p>		<p>29660 MB 892 981</p>
<p>Stange/Strebe, Stabilisator / Rod/Strut, stabiliser Pendelstange / Suspension Rod ALL TYPES ausser/except for : 2.0 24V (4WS) (E64A) 11.92 - 08.96</p>		<p>29663 MB 892 982</p>
<p>Faltenbaldsatz, Lenkung / Bellow Kit, steering system ALL TYPES ausser/except for : 2.0 24V (4WS) (E64A) 11.92 - 08.96 2.5 V6-24 4x4 (E88A) 11.92 - 08.96</p>		<p>30142 MB 266166</p> 
<p>Faltenbaldsatz, Lenkung / Bellow Kit, steering system ALL TYPES ausser/except for : 2.0 24V (4WS) (E64A) 11.92 - 08.96 2.5 V6-24 4x4 (E88A) 11.92 - 08.96</p>		<p>30144 MB 501711</p> 









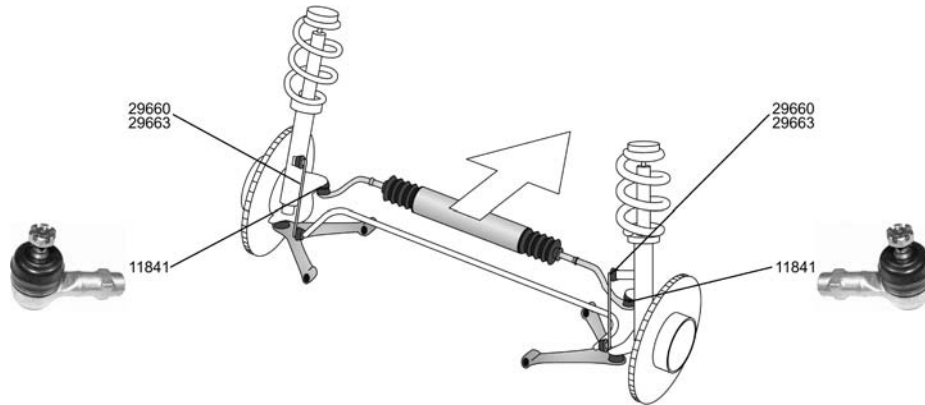



mitsubishi

GALANT V Stufenheck/Saloon/avec coffre (E5_A, E7_A, E8_A)

11.92 - 08.96





Spurstangenkopf / Tie-rod End Gewindeart: mit Rechtsgewinde / Thread Type: with right-hand thread Innengewinde [mm] / Inner Thread [mm]:M14x1,5 ALL TYPES		11841 MB 912519 
Stange/Strebe, Stabilisator / Rod/Strut, stabiliser Pendelstange / Suspension Rod ALL TYPES		29660 MB 892 981 
Stange/Strebe, Stabilisator / Rod/Strut, stabiliser Pendelstange / Suspension Rod ALL TYPES		29663 MB 892 982 
Faltenbalsatz, Lenkung / Bellow Kit, steering system ALL TYPES ausser/except for : 2.5 V6-24 4x4 (E88A) 11.92 - 08.96		30142 MB 266166 
Faltenbalsatz, Lenkung / Bellow Kit, steering system ALL TYPES ausser/except for : 2.5 V6-24 4x4 (E88A) 11.92 - 08.96		30144 MB 501711 

GALANT VI (EA_)

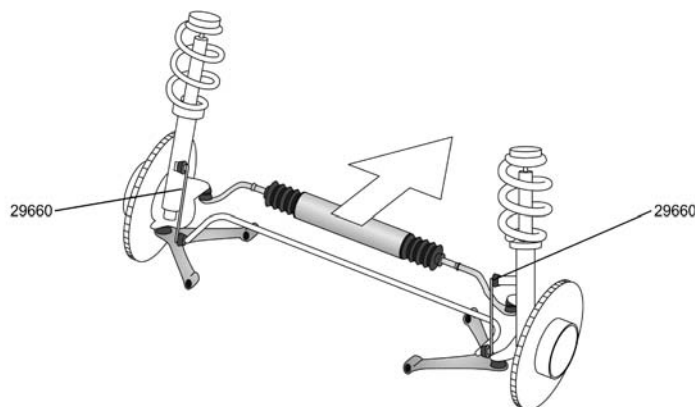
09.96 -









Stange/Strebe, Stabilisator / Rod/Strut, stabiliser Pendelstange / Suspension Rod 2.0 (EA2A) 09.96 - 09.00 2.5 V6 24V (EA5A) 09.96 - 09.00 2.0 TDI (EA6A) 09.96 -		29660 MB 892 981 
--	---	--



OE







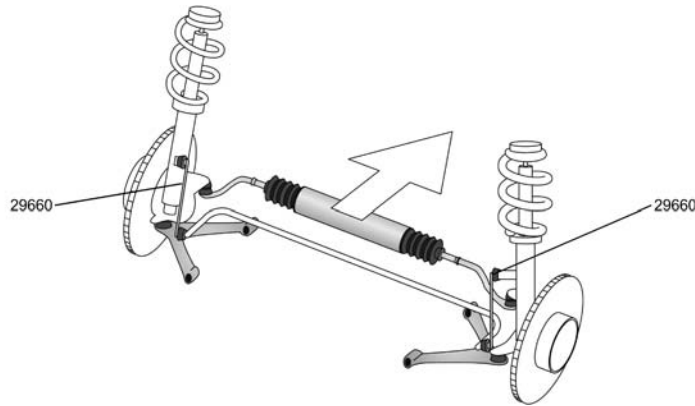

MITSUBISHI

GALANT VI (EA_) 09.96 -

 Faltenbalgsatz, Lenkung / Bellow Kit, steering system 2.0 (EA2A) 09.96 - 09.00 2.4 GDI, 110 kW 02.99 - 09.00 2.5 V6 24V (EA5A) 09.96 - 09.00 2.0 TDI (EA6A) 09.96 -		30142 MB 266166 
		30144 MB 501711 
Faltenbalgsatz, Lenkung / Bellow Kit, steering system 2.0 (EA2A) 09.96 - 09.00 2.4 GDI, 110 kW 02.99 - 09.00 2.5 V6 24V (EA5A) 09.96 - 09.00 2.0 TDI (EA6A) 09.96 -		30142 MB 266166 
		30144 MB 501711 

GALANT VI Station Wagon/Estate/Break (EA_) 09.96 -



Stange/Strebe, Stabilisator / Rod/Strut, stabiliser Pendelstange / Suspension Rod 2.0 (EA2W) 09.96 - 09.00 2.5 V6 24V (EA5W) 09.96 - 09.00 2.0 TDI (EA6W) 09.96 -		29660 MB 892 981
		30142 MB 266166 
Faltenbalgsatz, Lenkung / Bellow Kit, steering system 2.0 (EA2W) 09.96 - 09.00 2.4 GDI, 110 kW 02.99 - 09.00 2.5 V6 24V (EA5W) 09.96 - 09.00 2.0 TDI (EA6W) 09.96 -		30142 MB 266166 
		30144 MB 501711 
Faltenbalgsatz, Lenkung / Bellow Kit, steering system 2.0 (EA2W) 09.96 - 09.00 2.4 GDI, 110 kW 02.99 - 09.00 2.5 V6 24V (EA5W) 09.96 - 09.00 2.0 TDI (EA6W) 09.96 -		30142 MB 266166 
		30144 MB 501711 







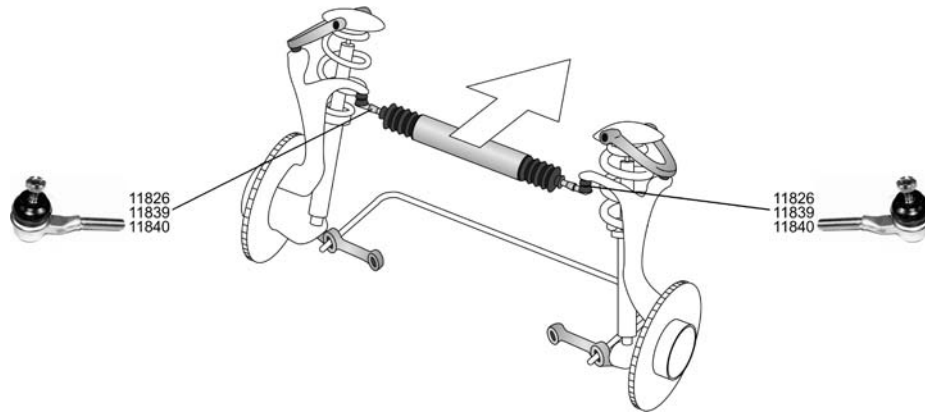

MITSUBISHI

L 200 Pick-Up (K_4T)

11.86 - 08.96











<p>Spurstangenkopf / Tie-rod End Gewindeart: mit Linksgewinde / Thread Type: With left-hand thread Gewindemaß / Thread Size:M14x1,5 2.5 D (K14T) 11.86 - 08.96</p>		<p>11826 MB 378704</p> 
<p>Spurstangenkopf / Tie-rod End Gewindeart: mit Linksgewinde / Thread Type: With left-hand thread Aussengewinde [mm] / Outer Thread [mm]:M16x1,5 2.5 D 4WD (K24T) 12.87 - 05.93 2.5 TD 4WD (K34T) 11.92 - 08.96</p>		<p>11839 MB 315775</p> 
<p>Spurstangenkopf / Tie-rod End Gewindeart: mit Rechtsgewinde / Thread Type: with right-hand thread Aussengewinde [mm] / Outer Thread [mm]:M16x1,5 2.5 D 4WD (K24T) 12.87 - 05.93 2.5 TD 4WD (K34T) 11.92 - 08.96</p>		<p>11840 MB 315776</p> 

L 300 Bus/Familial (LO3_P/G, L0_2P)

05.80 - 02.87



<p>Spurstangenkopf / Tie-rod End Gewindemaß / Thread Size:M14x1,5 Gewindeart: mit Rechtsgewinde / Thread Type: with right-hand thread 1.6 (L032P, L062P), 48 kW 09.81 - 10.86</p>	 <p>->12.1981</p>	<p>11838</p> 
<p>Spurstangenkopf / Tie-rod End Gewindeart: mit Rechtsgewinde / Thread Type: with right-hand thread Innengewinde [mm] / Inner Thread [mm]:M14x1,5 1.6 (L032P, L062P), 48 kW 09.81 - 10.86 2.3 D (L038P) 04.83 - 10.86</p>	 <p>01.1982-></p>	<p>11841 MB 912519</p> 
<p>Spurstangenkopf / Tie-rod End Gewindeart: mit Rechtsgewinde / Thread Type: with right-hand thread Innengewinde [mm] / Inner Thread [mm]:M14x1,5 1.6 (L032P, L062P), 51 kW 11.84 - 02.87 1.8 4x4 (L035G) 08.84 - 02.87 2.0 4x4 (L037G) 11.86 - 02.87</p>		<p>11842 MB 864164</p> 
<p>Spurstangenkopf / Tie-rod End Gewindeart: mit Rechtsgewinde / Thread Type: with right-hand thread 1.6 (L032P, L062P), 48 kW 09.81 - 10.86</p>	 <p>->12.1981</p>	<p>15450 MB 315629</p> 





















OE

MITSUBISHI

**L 300 Bus/Familial (LO3_P/G,
L0_2P)**

05.80 - 02.87

<p> Spurstangenkopf / Tie-rod End Gewindemaß / Thread Size:M14x1,5 Gewindeart: mit Linksgewinde / Thread Type: With left-hand thread</p> <table border="1"> <tr> <td>1.6 (L032P, L062P), 48 kW</td> <td>09.81 - 10.86</td> <td>01.1982-></td> </tr> <tr> <td>2.3 D (L038P)</td> <td>04.83 - 10.86</td> <td></td> </tr> </table>	1.6 (L032P, L062P), 48 kW	09.81 - 10.86	01.1982->	2.3 D (L038P)	04.83 - 10.86			<p>15562 MB 288119</p> 			
1.6 (L032P, L062P), 48 kW	09.81 - 10.86	01.1982->									
2.3 D (L038P)	04.83 - 10.86										
<p>Axialgelenk, Spurstange / Axial Rod, tie rod Gewindeart: mit Rechtsgewinde / Thread Type: with right-hand thread Gewindemaß / Thread Size:M14x1,5</p> <table border="1"> <tr> <td>1.6 (L032P, L062P), 51 kW</td> <td>11.84 - 02.87</td> <td></td> </tr> <tr> <td>1.8 4x4 (L035G)</td> <td>08.84 - 02.87</td> <td></td> </tr> <tr> <td>2.0 4x4 (L037G)</td> <td>11.86 - 02.87</td> <td></td> </tr> </table>	1.6 (L032P, L062P), 51 kW	11.84 - 02.87		1.8 4x4 (L035G)	08.84 - 02.87		2.0 4x4 (L037G)	11.86 - 02.87			<p>15566 MB 532971</p> 
1.6 (L032P, L062P), 51 kW	11.84 - 02.87										
1.8 4x4 (L035G)	08.84 - 02.87										
2.0 4x4 (L037G)	11.86 - 02.87										
<p>Trag-/Führungsgelenk / Support-/ Steering Link</p> <table border="1"> <tr> <td>1.6 (L032P, L062P), 48 kW</td> <td>09.81 - 10.86</td> <td></td> </tr> <tr> <td>2.3 D (L038P)</td> <td>04.83 - 10.86</td> <td>->10.1983</td> </tr> </table>	1.6 (L032P, L062P), 48 kW	09.81 - 10.86		2.3 D (L038P)	04.83 - 10.86	->10.1983		<p>11847 MB 175544</p> 			
1.6 (L032P, L062P), 48 kW	09.81 - 10.86										
2.3 D (L038P)	04.83 - 10.86	->10.1983									
<p>Trag-/Führungsgelenk / Support-/ Steering Link Konusmaß [mm] / Cone Size [mm]:19,4</p> <table border="1"> <tr> <td>1.8 4x4 (L035G)</td> <td>08.84 - 02.87</td> <td>->12.1985</td> </tr> </table>	1.8 4x4 (L035G)	08.84 - 02.87	->12.1985		<p>11848 MB 176308</p> 						
1.8 4x4 (L035G)	08.84 - 02.87	->12.1985									
<p>Trag-/Führungsgelenk / Support-/ Steering Link Konusmaß [mm] / Cone Size [mm]:15,9</p> <table border="1"> <tr> <td>1.6 (L032P, L062P), 48 kW</td> <td>09.81 - 10.86</td> <td></td> </tr> <tr> <td>2.3 D (L038P)</td> <td>04.83 - 10.86</td> <td>11.1983-></td> </tr> </table>	1.6 (L032P, L062P), 48 kW	09.81 - 10.86		2.3 D (L038P)	04.83 - 10.86	11.1983->		<p>11849</p> 			
1.6 (L032P, L062P), 48 kW	09.81 - 10.86										
2.3 D (L038P)	04.83 - 10.86	11.1983->									
<p>Trag-/Führungsgelenk / Support-/ Steering Link</p> <table border="1"> <tr> <td>1.6 (L032P, L062P), 51 kW</td> <td>11.84 - 02.87</td> <td></td> </tr> <tr> <td>1.8 4x4 (L035G)</td> <td>08.84 - 02.87</td> <td></td> </tr> <tr> <td>2.0 4x4 (L037G)</td> <td>11.86 - 02.87</td> <td></td> </tr> </table>	1.6 (L032P, L062P), 51 kW	11.84 - 02.87		1.8 4x4 (L035G)	08.84 - 02.87		2.0 4x4 (L037G)	11.86 - 02.87			<p>11852 MB 527350</p> 
1.6 (L032P, L062P), 51 kW	11.84 - 02.87										
1.8 4x4 (L035G)	08.84 - 02.87										
2.0 4x4 (L037G)	11.86 - 02.87										
<p>Trag-/Führungsgelenk / Support-/ Steering Link</p> <table border="1"> <tr> <td>1.6 (L032P, L062P), 51 kW</td> <td>11.84 - 02.87</td> <td></td> </tr> <tr> <td>2.0 4x4 (L037G)</td> <td>11.86 - 02.87</td> <td></td> </tr> <tr> <td>1.8 4x4 (L035G)</td> <td>08.84 - 02.87</td> <td>01.1986-></td> </tr> </table>	1.6 (L032P, L062P), 51 kW	11.84 - 02.87		2.0 4x4 (L037G)	11.86 - 02.87		1.8 4x4 (L035G)	08.84 - 02.87	01.1986->		<p>11853</p> 
1.6 (L032P, L062P), 51 kW	11.84 - 02.87										
2.0 4x4 (L037G)	11.86 - 02.87										
1.8 4x4 (L035G)	08.84 - 02.87	01.1986->									







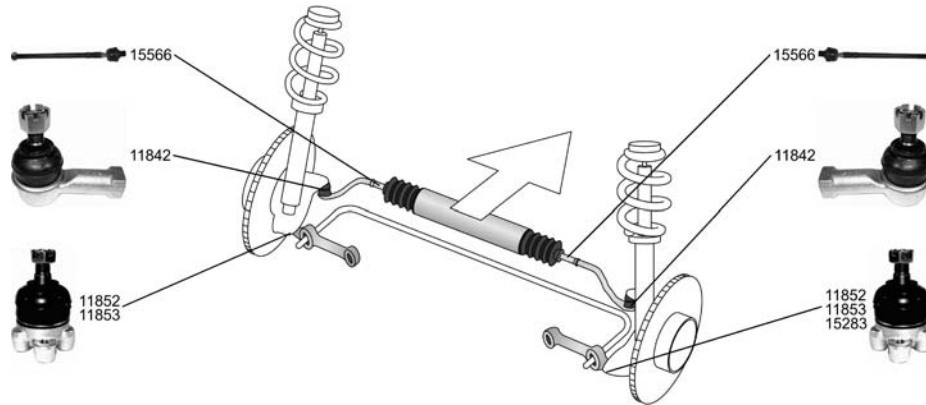

mitsubishi

L 300 Bus/Familial (P0_W, P1_W, P2_W)

11.86 -



<p>Spurstangenkopf / Tie-rod End Gewindeart: mit Rechtsgewinde / Thread Type: with right-hand thread Innengewinde [mm] / Inner Thread [mm]:M14x1,5</p>		<p>11842 MB 864164</p>
<p>ALL TYPES</p>		
<p>Axialgelenk, Spurstange / Axial Rod, tie rod Gewindeart: mit Rechtsgewinde / Thread Type: with right-hand thread Gewindemaß / Thread Size:M14x1,5</p>		<p>15566 MB 532971</p>
<p>ALL TYPES</p>		
<p>Trag-/Führungsgelenk / Support-/ Steering Link ALL TYPES ausser/except for : 2.0 (P00W) 07.96 -</p>		<p>11852 MB 527350</p>
<p>Trag-/Führungsgelenk / Support-/ Steering Link ALL TYPES ausser/except for : 2.0 (P00W) 07.96 -</p>		<p>11853</p>
<p>Trag-/Führungsgelenk / Support-/ Steering Link 2.0 4WD (P23V, P23W) 12.86 - 2.0 4WD (P23W) 11.86 - 2.4 4WD (P24W, P24V) 11.86 - 12.90 2.5 TD 4WD (P25W, P25V) 11.88 -</p>		<p>15283 MB 527352</p>











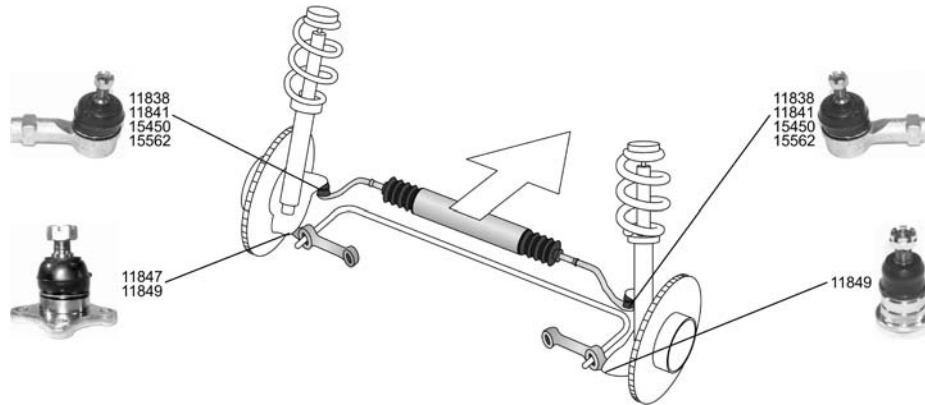



OE

MITSUBISHI

**L 300 Kasten/Box/Furgón/Van
(L03_P)**

05.80 - 02.87



<p>Spurstangenkopf / Tie-rod End Gewindemaß / Thread Size:M14x1,5 Gewindeart: mit Rechtsgewinde / Thread Type: with right-hand thread 1.6 (L032P, L062P) 05.80 - 10.86</p>	<p></p> <p>->12.1981</p>	<p>11838</p> 
<p>Spurstangenkopf / Tie-rod End Gewindeart: mit Rechtsgewinde / Thread Type: with right-hand thread Innengewinde [mm] / Inner Thread [mm]:M14x1,5 2.3 D (L038P, L068P) 09.83 - 10.86</p>	<p></p>	<p>11841 MB 912519</p> 
<p>Spurstangenkopf / Tie-rod End Gewindeart: mit Rechtsgewinde / Thread Type: with right-hand thread 1.6 (L032P, L062P) 05.80 - 10.86</p>	<p></p> <p>->12.1981</p>	<p>15450 MB 315629</p> 
<p>Spurstangenkopf / Tie-rod End Gewindemaß / Thread Size:M14x1,5 Gewindeart: mit Linksgewinde / Thread Type: With left-hand thread 2.3 D (L038P, L068P) 09.83 - 10.86</p>	<p></p>	<p>15562 MB 288119</p> 
<p>Trag-/Führungsgelenk / Support-/ Steering Link 1.6 (L032P, L062P) 05.80 - 10.86</p>	<p></p> <p>->10.1983</p>	<p>11847 MB 175544</p> 
<p>Trag-/Führungsgelenk / Support-/ Steering Link Konusmaß [mm] / Cone Size [mm]:15,9 1.6 (L032P, L062P) 05.80 - 10.86 2.3 D (L038P, L068P) 09.83 - 10.86</p>	<p></p> <p>11.1983-></p>	<p>11849</p> 









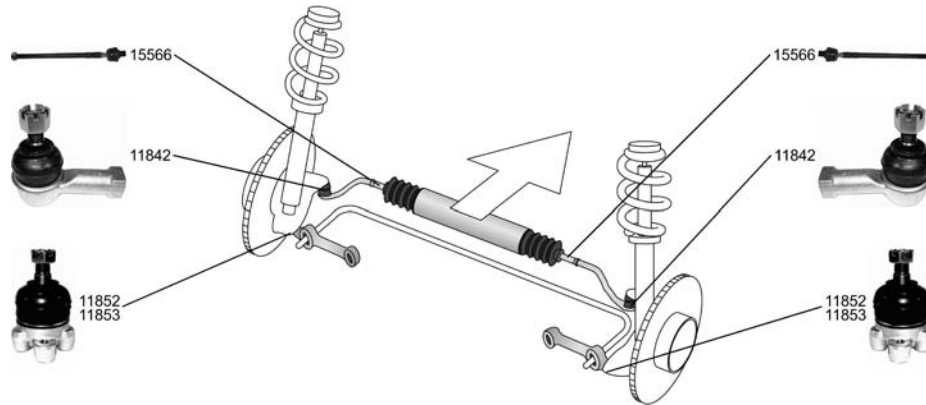

MITSUBISHI

L 300 Kasten/Box/Furgón/Van
(P0_W, P1_W)

11.86 -



<p>Spurstangenkopf / Tie-rod End Gewindeart: mit Rechtsgewinde / Thread Type: with right-hand thread Innengewinde [mm] / Inner Thread [mm]:M14x1,5</p> <p>1.6 (P12V, P02V) 11.90 - 2.0 (P03V, P13V) 11.86 - 2.5 D (P05V, P05W, P15V) 11.86 -</p>		<p>11842 MB 864164</p> 
<p>Axialgelenk, Spurstange / Axial Rod, tie rod Gewindeart: mit Rechtsgewinde / Thread Type: with right-hand thread Gewindemaß / Thread Size:M14x1,5</p> <p>1.6 (P12V, P02V) 11.90 - 2.0 (P03V, P13V) 11.86 - 2.5 D (P05V, P05W, P15V) 11.86 -</p>	 	<p>15566 MB 532971</p> 
<p>Trag-/Führungsgelenk / Support-/ Steering Link</p> <p>1.6 (P12V, P02V) 11.90 - 2.0 (P03V, P13V) 11.86 - 2.5 D (P05V, P05W, P15V) 11.86 -</p>		<p>11852 MB 527350</p> 
<p>Trag-/Führungsgelenk / Support-/ Steering Link</p> <p>1.6 (P12V, P02V) 11.90 - 2.0 (P03V, P13V) 11.86 - 2.5 D (P05V, P05W, P15V) 11.86 -</p>		<p>11853</p> 







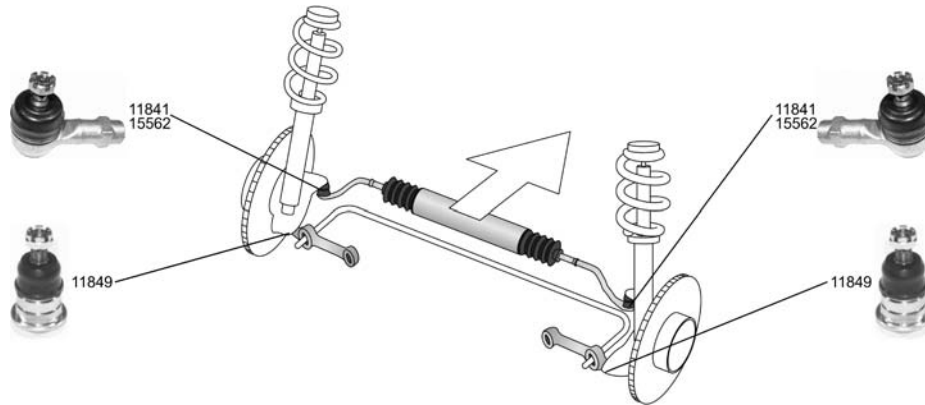

OE

MITSUBISHI

L 300 Pritsche, Fahrgestell / Flatbed, Chassis (L03_P)

05.80 - 04.94





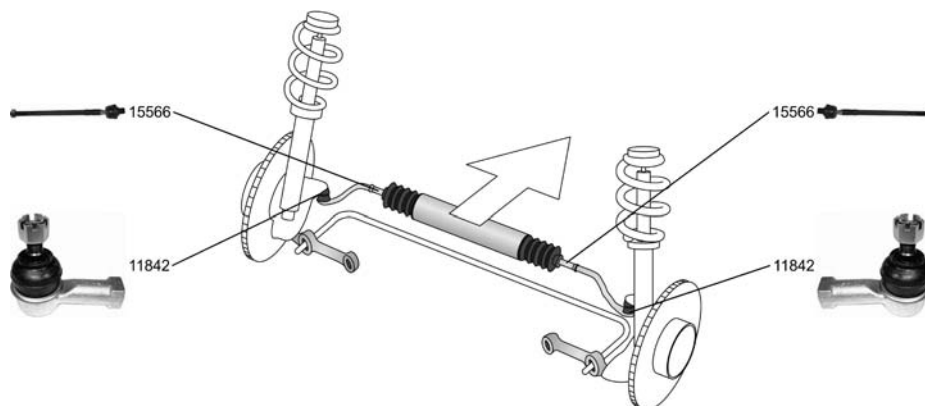

<p>Spurstangenkopf / Tie-rod End Gewindeart: mit Rechtsgewinde / Thread Type: with right-hand thread Innengewinde [mm] / Inner Thread [mm]: M14x1,5 ALL TYPES</p>		<p>11841 MB 912519</p> 
<p>ALL TYPES</p>		
<p>Spurstangenkopf / Tie-rod End Gewindemaß / Thread Size: M14x1,5 Gewindeart: mit Linksgewinde / Thread Type: With left-hand thread ALL TYPES</p>		<p>15562 MB 288119</p> 
<p>ALL TYPES</p>		
<p>Trag-/Führungsgelenk / Support-/ Steering Link Konusmaß [mm] / Cone Size [mm]: 15,9 ALL TYPES</p>		<p>11849</p> 
<p>ALL TYPES</p>		

L 300 Pritsche, Fahrgestell / Flatbed, Chassis (P1_T)

04.94 -



















<p>Spurstangenkopf / Tie-rod End Gewindeart: mit Rechtsgewinde / Thread Type: with right-hand thread Innengewinde [mm] / Inner Thread [mm]: M14x1,5 ALL TYPES</p>		<p>11842 MB 864164</p> 
<p>ALL TYPES</p>		
<p>Axialgelenk, Spurstange / Axial Rod, tie rod Gewindeart: mit Rechtsgewinde / Thread Type: with right-hand thread Gewindemaß / Thread Size: M14x1,5 ALL TYPES</p>		<p>15566 MB 532971</p> 
<p>ALL TYPES</p>		



MITSUBISHI

LANCER III (C1_A, C6_A)

11.83 - 04.88

 Spurstangenkopf / Tie-rod End Gewindeart: mit Rechtsgewinde / Thread Type: with right-hand thread Innengewinde [mm] / Inner Thread [mm]:M12x1,25		11843 MB 912076 
1.2 (C65A) 08.86 - 04.88 1.8 Diesel (C14AS), 44 kW 09.86 - 04.88		
Spurstangenkopf / Tie-rod End Gewindeart: mit Rechtsgewinde / Thread Type: with right-hand thread Innengewinde [mm] / Inner Thread [mm]:M12x1,25 ALL TYPES		15560 MB 241982 
Axialgelenk, Spurstange / Axial Rod, tie rod Gewindeart: mit Rechtsgewinde / Thread Type: with right-hand thread Gewindemaß / Thread Size:M12x1,25 ALL TYPES		11856 MB 532046 
Axialgelenk, Spurstange / Axial Rod, tie rod Gewindeart: mit Rechtsgewinde / Thread Type: with right-hand thread Gewindemaß / Thread Size:M12x1,25 ALL TYPES		15564 MB 501530 
1.2 GL (C15AS) 01.84 - 10.86 1.2 (C65A) 08.86 - 04.88 1.5 GLX (C12AS), 55 kW 11.83 - 04.88 1.8 Diesel (C14AS) 01.84 - 04.88 1.5 GLX (C12AS), 51 kW 06.85 - 04.88	LHD 	->09.1986
Faltenbalgsatz, Lenkung / Bellow Kit, steering system ALL TYPES		30143 MB 347365 
Faltenbalgsatz, Lenkung / Bellow Kit, steering system ALL TYPES		30144 MB 501711 
Faltenbalgsatz, Lenkung / Bellow Kit, steering system ALL TYPES		30173 MB 347364 











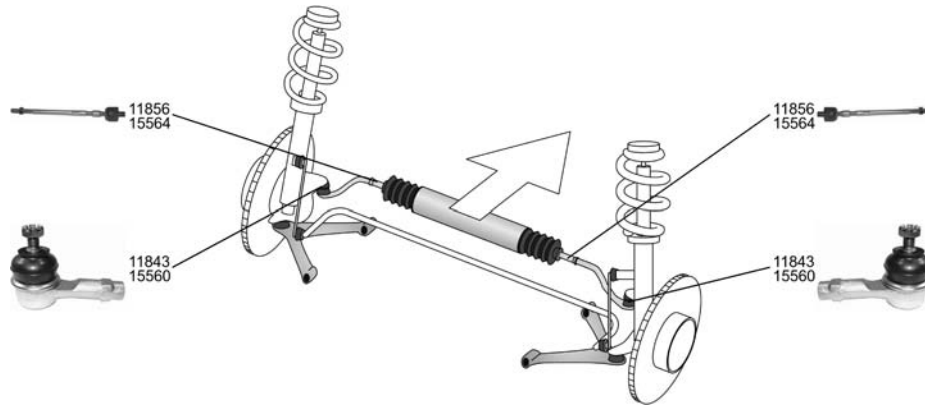





OE

MITSUBISHI

LANCER III Station Wagon/Estate/Break (C1_V, C3_V)

09.85 - 06.92



<p>Spurstangenkopf / Tie-rod End Gewindeart: mit Rechtsgewinde / Thread Type: with right-hand thread Innengewinde [mm] / Inner Thread [mm]:M12x1,25</p>		<p>11843 MB 912076</p>
<p>ALL TYPES ausser/except for : 1.5 (C12V), 51 kW 09.85 - 08.89 1.5 (C12V), 55 kW 09.85 - 12.87 1.8 D (C14V), 43 kW 09.85 - 09.86</p>		
<p>Spurstangenkopf / Tie-rod End Gewindeart: mit Rechtsgewinde / Thread Type: with right-hand thread Innengewinde [mm] / Inner Thread [mm]:M12x1,25</p>		<p>15560 MB 241982</p>
<p>ALL TYPES</p>		
<p>Axialgelenk, Spurstange / Axial Rod, tie rod Gewindeart: mit Rechtsgewinde / Thread Type: with right-hand thread Gewindemaß / Thread Size:M12x1,25</p>		<p>11856 MB 532046</p>
<p>1.5 (C12V) 09.85 - 12.90 1.5 12V (C12V) 09.90 - 12.91 1.8 D (C14V) 09.85 - 06.92</p>		
<p>Axialgelenk, Spurstange / Axial Rod, tie rod Gewindeart: mit Rechtsgewinde / Thread Type: with right-hand thread Gewindemaß / Thread Size:M12x1,25</p>		<p>15564 MB 501530</p>
<p>1.5 (C12V), 51 kW 09.85 - 08.89 1.5 (C12V), 55 kW 09.85 - 12.87 1.5 (C12V), 61 kW 09.88 - 12.90 1.5 12V (C12V) 09.90 - 12.91 1.8 D (C14V) 09.85 - 06.92</p>	<p>->09.1986</p>	
<p>Faltenbalgsatz, Lenkung / Bellow Kit, steering system</p>		<p>30143 MB 347365</p>
<p>ALL TYPES</p>		
<p>Faltenbalgsatz, Lenkung / Bellow Kit, steering system</p>		<p>30144 MB 501711</p>
<p>ALL TYPES</p>		
<p>Faltenbalgsatz, Lenkung / Bellow Kit, steering system</p>		<p>30173 MB 347364</p>
<p>ALL TYPES</p>		









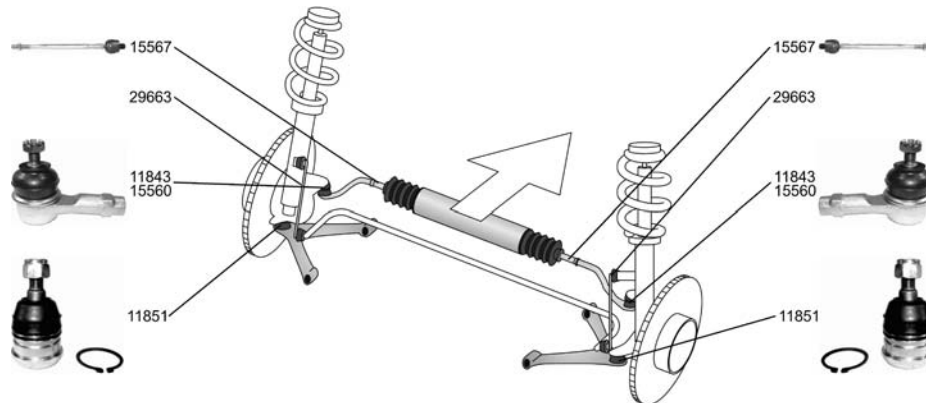



MITSUBISHI

LANCER IV (C6_A, C7_A)

04.88 - 05.94







<p>Spurstangenkopf / Tie-rod End Gewindeart: mit Rechtsgewinde / Thread Type: with right-hand thread Innengewinde [mm] / Inner Thread [mm]:M12x1,25</p> <table border="1"> <tr><td>1.3 12V (C61A)</td><td>06.92 - 05.94</td></tr> <tr><td>1.5 12V (C62A)</td><td>05.89 - 05.92</td></tr> <tr><td>1.6 GLi 16V (C66A)</td><td>06.92 - 05.94</td></tr> <tr><td>1.8 GLXi 4x4 (C77A)</td><td>09.89 - 06.92</td></tr> <tr><td>1.8 GTi 16V (C68A)</td><td>11.89 - 05.92</td></tr> <tr><td>1.8 GTi 16V (C69A)</td><td>06.92 - 12.93</td></tr> <tr><td>1.8 Diesel (C64A)</td><td>04.88 - 05.92</td></tr> </table>	1.3 12V (C61A)	06.92 - 05.94	1.5 12V (C62A)	05.89 - 05.92	1.6 GLi 16V (C66A)	06.92 - 05.94	1.8 GLXi 4x4 (C77A)	09.89 - 06.92	1.8 GTi 16V (C68A)	11.89 - 05.92	1.8 GTi 16V (C69A)	06.92 - 12.93	1.8 Diesel (C64A)	04.88 - 05.92		<p>11843 MB 912076</p> 
1.3 12V (C61A)	06.92 - 05.94															
1.5 12V (C62A)	05.89 - 05.92															
1.6 GLi 16V (C66A)	06.92 - 05.94															
1.8 GLXi 4x4 (C77A)	09.89 - 06.92															
1.8 GTi 16V (C68A)	11.89 - 05.92															
1.8 GTi 16V (C69A)	06.92 - 12.93															
1.8 Diesel (C64A)	04.88 - 05.92															
<p>Spurstangenkopf / Tie-rod End Gewindeart: mit Rechtsgewinde / Thread Type: with right-hand thread Innengewinde [mm] / Inner Thread [mm]:M12x1,25</p> <table border="1"> <tr><td>1.3 12V (C61A)</td><td>06.92 - 05.94</td></tr> <tr><td>1.5 12V (C62A)</td><td>05.89 - 05.92</td></tr> <tr><td>1.6 GLi 16V (C66A)</td><td>06.92 - 05.94</td></tr> <tr><td>1.8 GLXi 4x4 (C77A)</td><td>09.89 - 06.92</td></tr> <tr><td>1.8 GTi 16V (C68A)</td><td>11.89 - 05.92</td></tr> <tr><td>1.8 GTi 16V (C69A)</td><td>06.92 - 12.93</td></tr> <tr><td>1.8 Diesel (C64A)</td><td>04.88 - 05.92</td></tr> </table>	1.3 12V (C61A)	06.92 - 05.94	1.5 12V (C62A)	05.89 - 05.92	1.6 GLi 16V (C66A)	06.92 - 05.94	1.8 GLXi 4x4 (C77A)	09.89 - 06.92	1.8 GTi 16V (C68A)	11.89 - 05.92	1.8 GTi 16V (C69A)	06.92 - 12.93	1.8 Diesel (C64A)	04.88 - 05.92		<p>15560 MB 241982</p> 
1.3 12V (C61A)	06.92 - 05.94															
1.5 12V (C62A)	05.89 - 05.92															
1.6 GLi 16V (C66A)	06.92 - 05.94															
1.8 GLXi 4x4 (C77A)	09.89 - 06.92															
1.8 GTi 16V (C68A)	11.89 - 05.92															
1.8 GTi 16V (C69A)	06.92 - 12.93															
1.8 Diesel (C64A)	04.88 - 05.92															
<p>Axialgelenk, Spurstange / Axial Rod, tie rod Gewindeart: mit Rechtsgewinde / Thread Type: with right-hand thread Gewindemaß / Thread Size:M12x1,25</p> <table border="1"> <tr><td>1.3 12V (C61A)</td><td>06.92 - 05.94</td></tr> <tr><td>1.5 12V (C62A)</td><td>05.89 - 05.92</td></tr> <tr><td>1.6 GLi 16V (C66A)</td><td>06.92 - 05.94</td></tr> <tr><td>1.8 GLXi 4x4 (C77A)</td><td>09.89 - 06.92</td></tr> <tr><td>1.8 GTi 16V (C68A)</td><td>11.89 - 05.92</td></tr> <tr><td>1.8 GTi 16V (C69A)</td><td>06.92 - 12.93</td></tr> <tr><td>1.8 Diesel (C64A)</td><td>04.88 - 05.92</td></tr> </table>	1.3 12V (C61A)	06.92 - 05.94	1.5 12V (C62A)	05.89 - 05.92	1.6 GLi 16V (C66A)	06.92 - 05.94	1.8 GLXi 4x4 (C77A)	09.89 - 06.92	1.8 GTi 16V (C68A)	11.89 - 05.92	1.8 GTi 16V (C69A)	06.92 - 12.93	1.8 Diesel (C64A)	04.88 - 05.92		<p>15567 MB 553249</p> 
1.3 12V (C61A)	06.92 - 05.94															
1.5 12V (C62A)	05.89 - 05.92															
1.6 GLi 16V (C66A)	06.92 - 05.94															
1.8 GLXi 4x4 (C77A)	09.89 - 06.92															
1.8 GTi 16V (C68A)	11.89 - 05.92															
1.8 GTi 16V (C69A)	06.92 - 12.93															
1.8 Diesel (C64A)	04.88 - 05.92															
<p>Trag-/Führungsgelenk / Support-/ Steering Link</p> <table border="1"> <tr><td>1.3 12V (C61A)</td><td>06.92 - 05.94</td></tr> <tr><td>1.5 12V (C62A)</td><td>05.89 - 05.92</td></tr> <tr><td>1.6 GLi 16V (C66A)</td><td>06.92 - 05.94</td></tr> <tr><td>1.8 GLXi 4x4 (C77A)</td><td>09.89 - 06.92</td></tr> <tr><td>1.8 GTi 16V (C68A)</td><td>11.89 - 05.92</td></tr> <tr><td>1.8 GTi 16V (C69A)</td><td>06.92 - 12.93</td></tr> <tr><td>1.8 Diesel (C64A)</td><td>04.88 - 05.92</td></tr> </table>	1.3 12V (C61A)	06.92 - 05.94	1.5 12V (C62A)	05.89 - 05.92	1.6 GLi 16V (C66A)	06.92 - 05.94	1.8 GLXi 4x4 (C77A)	09.89 - 06.92	1.8 GTi 16V (C68A)	11.89 - 05.92	1.8 GTi 16V (C69A)	06.92 - 12.93	1.8 Diesel (C64A)	04.88 - 05.92		<p>11851 MB 303375</p> 
1.3 12V (C61A)	06.92 - 05.94															
1.5 12V (C62A)	05.89 - 05.92															
1.6 GLi 16V (C66A)	06.92 - 05.94															
1.8 GLXi 4x4 (C77A)	09.89 - 06.92															
1.8 GTi 16V (C68A)	11.89 - 05.92															
1.8 GTi 16V (C69A)	06.92 - 12.93															
1.8 Diesel (C64A)	04.88 - 05.92															
<p>Stange/Strebe, Stabilisator / Rod/Strut, stabiliser Pendelstange / Suspension Rod</p> <table border="1"> <tr><td>1.5</td><td>06.88 - 05.92</td></tr> <tr><td>1.5 12V (C62A)</td><td>05.89 - 05.92</td></tr> <tr><td>1.8 GLXi 4x4 (C77A)</td><td>09.89 - 06.92</td></tr> <tr><td>1.8 GTi 16V (C68A)</td><td>11.89 - 05.92</td></tr> <tr><td>1.8 Diesel (C64A)</td><td>04.88 - 05.92</td></tr> </table>	1.5	06.88 - 05.92	1.5 12V (C62A)	05.89 - 05.92	1.8 GLXi 4x4 (C77A)	09.89 - 06.92	1.8 GTi 16V (C68A)	11.89 - 05.92	1.8 Diesel (C64A)	04.88 - 05.92		<p>29663 MB 892 982</p>				
1.5	06.88 - 05.92															
1.5 12V (C62A)	05.89 - 05.92															
1.8 GLXi 4x4 (C77A)	09.89 - 06.92															
1.8 GTi 16V (C68A)	11.89 - 05.92															
1.8 Diesel (C64A)	04.88 - 05.92															
<p>Faltenbalgsatz, Lenkung / Bellow Kit, steering system</p> <table border="1"> <tr><td colspan="2">ALL TYPES ausser/except for :</td></tr> <tr><td>1.2 (C65A)</td><td>07.88 - 08.90</td></tr> <tr><td>1.6 GTi 16V (C63A)</td><td>07.88 - 05.90</td></tr> </table>	ALL TYPES ausser/except for :		1.2 (C65A)	07.88 - 08.90	1.6 GTi 16V (C63A)	07.88 - 05.90		<p>30143 MB 347365</p> 								
ALL TYPES ausser/except for :																
1.2 (C65A)	07.88 - 08.90															
1.6 GTi 16V (C63A)	07.88 - 05.90															



OE







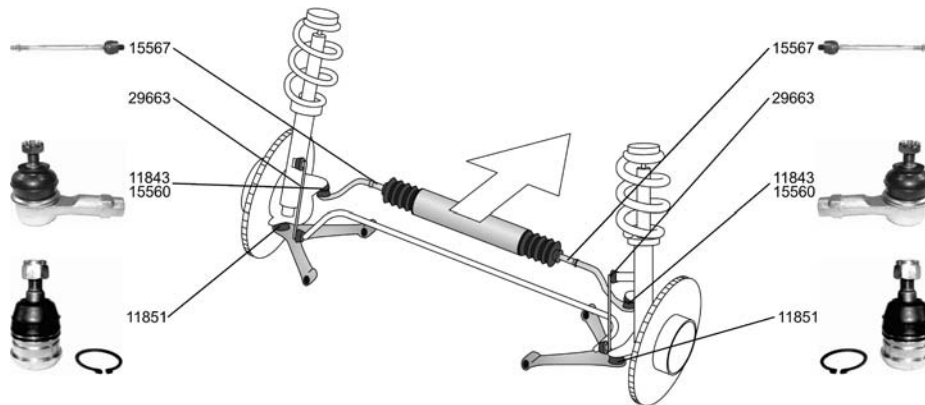

MITSUBISHI

LANCER IV (C6_A, C7_A) 04.88 - 05.94

<p> Faltenbalgsatz, Lenkung / Bellow Kit, steering system</p> <p>ALL TYPES ausser/except for :</p> <table border="1"> <tr> <td>1.2 (C65A)</td> <td>07.88 - 08.90</td> </tr> <tr> <td>1.6 GTi 16V (C63A)</td> <td>07.88 - 05.90</td> </tr> </table>	1.2 (C65A)	07.88 - 08.90	1.6 GTi 16V (C63A)	07.88 - 05.90		<p>30144 MB 501711</p> 
1.2 (C65A)	07.88 - 08.90					
1.6 GTi 16V (C63A)	07.88 - 05.90					
<p>Faltenbalgsatz, Lenkung / Bellow Kit, steering system</p> <p>ALL TYPES ausser/except for :</p> <table border="1"> <tr> <td>1.2 (C65A)</td> <td>07.88 - 08.90</td> </tr> <tr> <td>1.6 GTi 16V (C63A)</td> <td>07.88 - 05.90</td> </tr> </table>	1.2 (C65A)	07.88 - 08.90	1.6 GTi 16V (C63A)	07.88 - 05.90		<p>30173 MB 347364</p> 
1.2 (C65A)	07.88 - 08.90					
1.6 GTi 16V (C63A)	07.88 - 05.90					

LANCER IV Stufenheck/Saloon/avec coffre (C6_A) 04.88 - 06.92









<p>Spurstangenkopf / Tie-rod End</p> <p>Gewindeart: mit Rechtsgewinde / Thread Type: with right-hand thread Innengewinde [mm] / Inner Thread [mm]:M12x1,25</p> <p>ALL TYPES ausser/except for :</p> <table border="1"> <tr> <td>1.6 GTi 16V (C63A)</td> <td>07.88 - 12.92</td> </tr> <tr> <td>1.8 GTi 16V (C68A)</td> <td>11.89 - 05.92</td> </tr> </table>	1.6 GTi 16V (C63A)	07.88 - 12.92	1.8 GTi 16V (C68A)	11.89 - 05.92		<p>11843 MB 912076</p> 
1.6 GTi 16V (C63A)	07.88 - 12.92					
1.8 GTi 16V (C68A)	11.89 - 05.92					
<p>Spurstangenkopf / Tie-rod End</p> <p>Gewindeart: mit Rechtsgewinde / Thread Type: with right-hand thread Innengewinde [mm] / Inner Thread [mm]:M12x1,25</p> <p>ALL TYPES ausser/except for :</p> <table border="1"> <tr> <td>1.6 GTi 16V (C63A)</td> <td>07.88 - 12.92</td> </tr> <tr> <td>1.8 GTi 16V (C68A)</td> <td>11.89 - 05.92</td> </tr> </table>	1.6 GTi 16V (C63A)	07.88 - 12.92	1.8 GTi 16V (C68A)	11.89 - 05.92		<p>15560 MB 241982</p> 
1.6 GTi 16V (C63A)	07.88 - 12.92					
1.8 GTi 16V (C68A)	11.89 - 05.92					
<p>Axialgelenk, Spurstange / Axial Rod, tie rod</p> <p>Gewindeart: mit Rechtsgewinde / Thread Type: with right-hand thread Gewindemaß / Thread Size:M12x1,25</p> <p>ALL TYPES ausser/except for :</p> <table border="1"> <tr> <td>1.6 GTi 16V (C63A)</td> <td>07.88 - 12.92</td> </tr> <tr> <td>1.8 GTi 16V (C68A)</td> <td>11.89 - 05.92</td> </tr> </table>	1.6 GTi 16V (C63A)	07.88 - 12.92	1.8 GTi 16V (C68A)	11.89 - 05.92		<p>15567 MB 553249</p> 
1.6 GTi 16V (C63A)	07.88 - 12.92					
1.8 GTi 16V (C68A)	11.89 - 05.92					
<p>Trag-/Führungsgelenk / Support-/ Steering Link</p> <p>ALL TYPES ausser/except for :</p> <table border="1"> <tr> <td>1.6 GTi 16V (C63A)</td> <td>07.88 - 12.92</td> </tr> <tr> <td>1.8 GTi 16V (C68A)</td> <td>11.89 - 05.92</td> </tr> </table>	1.6 GTi 16V (C63A)	07.88 - 12.92	1.8 GTi 16V (C68A)	11.89 - 05.92		<p>11851 MB 303375</p> 
1.6 GTi 16V (C63A)	07.88 - 12.92					
1.8 GTi 16V (C68A)	11.89 - 05.92					
<p>Stange/Strebe, Stabilisator / Rod/Strut, stabiliser</p> <p>Pendelstange / Suspension Rod</p> <p>ALL TYPES ausser/except for :</p> <table border="1"> <tr> <td>1.6 GTi 16V (C63A)</td> <td>07.88 - 12.92</td> </tr> <tr> <td>1.8 GTi 16V (C68A)</td> <td>11.89 - 05.92</td> </tr> </table>	1.6 GTi 16V (C63A)	07.88 - 12.92	1.8 GTi 16V (C68A)	11.89 - 05.92		<p>29663 MB 892 982</p>
1.6 GTi 16V (C63A)	07.88 - 12.92					
1.8 GTi 16V (C68A)	11.89 - 05.92					



MITSUBISHI

LANCER IV Stufenheck/Saloon/avec coffre (C6_A)







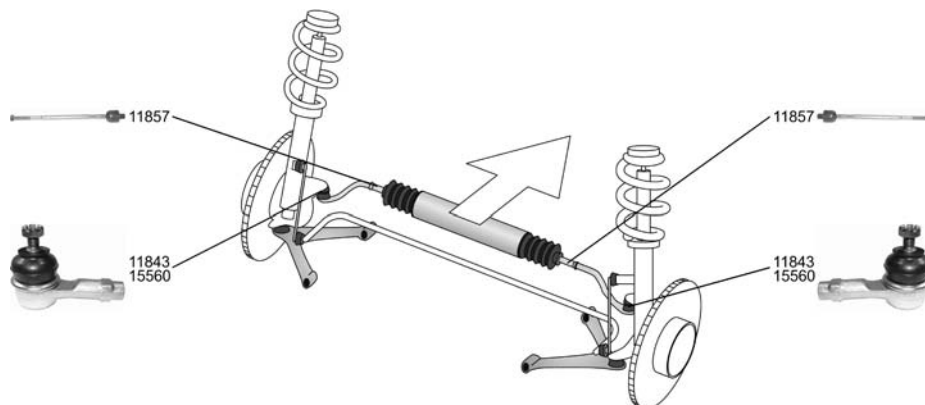

04.88 - 06.92

<p> Faltenbalgsatz, Lenkung / Bellow Kit, steering system</p> <p>ALL TYPES ausser/except for :</p> <table border="1"> <tr> <td>1.6 GTi 16V (C63A)</td> <td>07.88 - 12.92</td> </tr> <tr> <td>1.8 GTi 16V (C68A)</td> <td>11.89 - 05.92</td> </tr> </table>	1.6 GTi 16V (C63A)	07.88 - 12.92	1.8 GTi 16V (C68A)	11.89 - 05.92		<p>30143 MB 347365</p> 
1.6 GTi 16V (C63A)	07.88 - 12.92					
1.8 GTi 16V (C68A)	11.89 - 05.92					
<p>Faltenbalgsatz, Lenkung / Bellow Kit, steering system</p> <p>ALL TYPES ausser/except for :</p> <table border="1"> <tr> <td>1.6 GTi 16V (C63A)</td> <td>07.88 - 12.92</td> </tr> <tr> <td>1.8 GTi 16V (C68A)</td> <td>11.89 - 05.92</td> </tr> </table>	1.6 GTi 16V (C63A)	07.88 - 12.92	1.8 GTi 16V (C68A)	11.89 - 05.92		<p>30144 MB 501711</p> 
1.6 GTi 16V (C63A)	07.88 - 12.92					
1.8 GTi 16V (C68A)	11.89 - 05.92					
<p>Faltenbalgsatz, Lenkung / Bellow Kit, steering system</p> <p>ALL TYPES ausser/except for :</p> <table border="1"> <tr> <td>1.6 GTi 16V (C63A)</td> <td>07.88 - 12.92</td> </tr> <tr> <td>1.8 GTi 16V (C68A)</td> <td>11.89 - 05.92</td> </tr> </table>	1.6 GTi 16V (C63A)	07.88 - 12.92	1.8 GTi 16V (C68A)	11.89 - 05.92		<p>30173 MB 347364</p> 
1.6 GTi 16V (C63A)	07.88 - 12.92					
1.8 GTi 16V (C68A)	11.89 - 05.92					

LANCER V (CB/D_A)

06.92 - 11.95











<p>Spurstangenkopf / Tie-rod End</p> <p>Gewindeart: mit Rechtsgewinde / Thread Type: with right-hand thread Innengewinde [mm] / Inner Thread [mm]:M12x1,25</p> <p>ALL TYPES ausser/except for :</p> <table border="1"> <tr> <td>1.6 16V 4WD (CB4A)</td> <td>05.92 - 12.93</td> </tr> <tr> <td>1.8 16V (CB5A)</td> <td>06.92 - 12.93</td> </tr> <tr> <td>1.8 GTi (CB5A)</td> <td>06.92 -</td> </tr> </table>	1.6 16V 4WD (CB4A)	05.92 - 12.93	1.8 16V (CB5A)	06.92 - 12.93	1.8 GTi (CB5A)	06.92 -		<p>11843 MB 912076</p> 
1.6 16V 4WD (CB4A)	05.92 - 12.93							
1.8 16V (CB5A)	06.92 - 12.93							
1.8 GTi (CB5A)	06.92 -							
<p>Spurstangenkopf / Tie-rod End</p> <p>Gewindeart: mit Rechtsgewinde / Thread Type: with right-hand thread Innengewinde [mm] / Inner Thread [mm]:M12x1,25</p> <p>ALL TYPES ausser/except for :</p> <table border="1"> <tr> <td>1.6 16V 4WD (CB4A)</td> <td>05.92 - 12.93</td> </tr> <tr> <td>1.8 16V (CB5A)</td> <td>06.92 - 12.93</td> </tr> <tr> <td>1.8 GTi (CB5A)</td> <td>06.92 -</td> </tr> </table>	1.6 16V 4WD (CB4A)	05.92 - 12.93	1.8 16V (CB5A)	06.92 - 12.93	1.8 GTi (CB5A)	06.92 -		<p>15560 MB 241982</p> 
1.6 16V 4WD (CB4A)	05.92 - 12.93							
1.8 16V (CB5A)	06.92 - 12.93							
1.8 GTi (CB5A)	06.92 -							
<p>Axialgelenk, Spurstange / Axial Rod, tie rod</p> <p>ALL TYPES ausser/except for :</p> <table border="1"> <tr> <td>1.6 16V 4WD (CB4A)</td> <td>05.92 - 12.93</td> </tr> <tr> <td>1.8 16V (CB5A)</td> <td>06.92 - 12.93</td> </tr> <tr> <td>1.8 GTi (CB5A)</td> <td>06.92 -</td> </tr> </table>	1.6 16V 4WD (CB4A)	05.92 - 12.93	1.8 16V (CB5A)	06.92 - 12.93	1.8 GTi (CB5A)	06.92 -		<p>11857 MR 297969</p> 
1.6 16V 4WD (CB4A)	05.92 - 12.93							
1.8 16V (CB5A)	06.92 - 12.93							
1.8 GTi (CB5A)	06.92 -							
<p>Faltenbalgsatz, Lenkung / Bellow Kit, steering system</p> <p>ALL TYPES ausser/except for :</p> <table border="1"> <tr> <td>1.6 16V 4WD (CB4A)</td> <td>05.92 - 12.93</td> </tr> <tr> <td>1.8 16V (CB5A)</td> <td>06.92 - 12.93</td> </tr> <tr> <td>1.8 GTi (CB5A)</td> <td>06.92 -</td> </tr> </table>	1.6 16V 4WD (CB4A)	05.92 - 12.93	1.8 16V (CB5A)	06.92 - 12.93	1.8 GTi (CB5A)	06.92 -		<p>30143 MB 347365</p> 
1.6 16V 4WD (CB4A)	05.92 - 12.93							
1.8 16V (CB5A)	06.92 - 12.93							
1.8 GTi (CB5A)	06.92 -							



OE







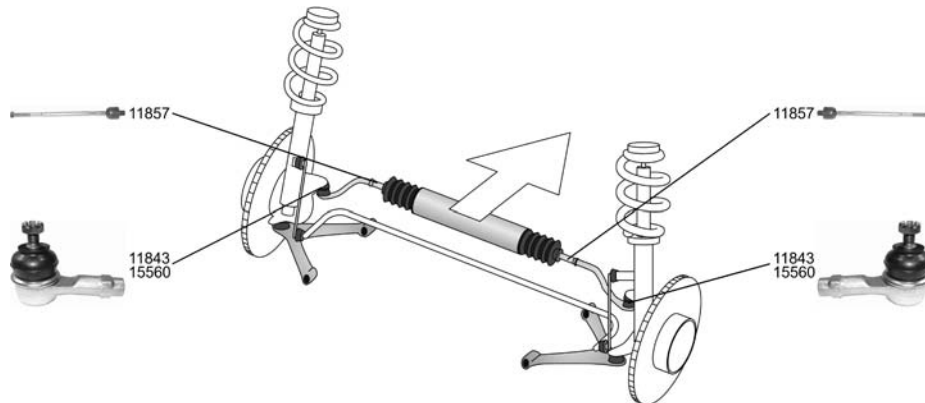

MITSUBISHI

LANCER V (CB/D_A) 06.92 - 11.95

	Faltenbaldsatz, Lenkung / Bellow Kit, steering system ALL TYPES ausser/except for : 1.6 16V 4WD (CB4A) 05.92 - 12.93 1.8 16V (CB5A) 06.92 - 12.93 1.8 GTi (CB5A) 06.92 -		30144 MB 501711	
	Faltenbaldsatz, Lenkung / Bellow Kit, steering system ALL TYPES ausser/except for : 1.6 16V 4WD (CB4A) 05.92 - 12.93 1.8 16V (CB5A) 06.92 - 12.93 1.8 GTi (CB5A) 06.92 -		30173 MB 347364	
	Stange/Strebe, Stabilisator / Rod/Strut, stabiliser Pendelstange / Suspension Rod ALL TYPES ausser/except for : 1.6 16V 4WD (CB4A) 05.92 - 12.93 1.8 16V (CB5A) 06.92 - 12.93 1.8 GTi (CB5A) 06.92 -	 ->11.1995	11859 MB 809354	

LANCER V Station Wagon/Estate/Break (CB_W, CD_W) 12.92 -







Spurstangenkopf / Tie-rod End Gewindeart: mit Rechtsgewinde / Thread Type: with right-hand thread Innengewinde [mm] / Inner Thread [mm]:M12x1,25 ALL TYPES		11843 MB 912076	
Spurstangenkopf / Tie-rod End Gewindeart: mit Rechtsgewinde / Thread Type: with right-hand thread Innengewinde [mm] / Inner Thread [mm]:M12x1,25 ALL TYPES		15560 MB 241982	
Axialgelenk, Spurstange / Axial Rod, tie rod ALL TYPES		11857 MR 297969	
Faltenbaldsatz, Lenkung / Bellow Kit, steering system ALL TYPES		30143 MB 347365	







MITSUBISHI

LANCER V Station Wagon/Estate/Break (CB_W, CD_W) 12.92 -

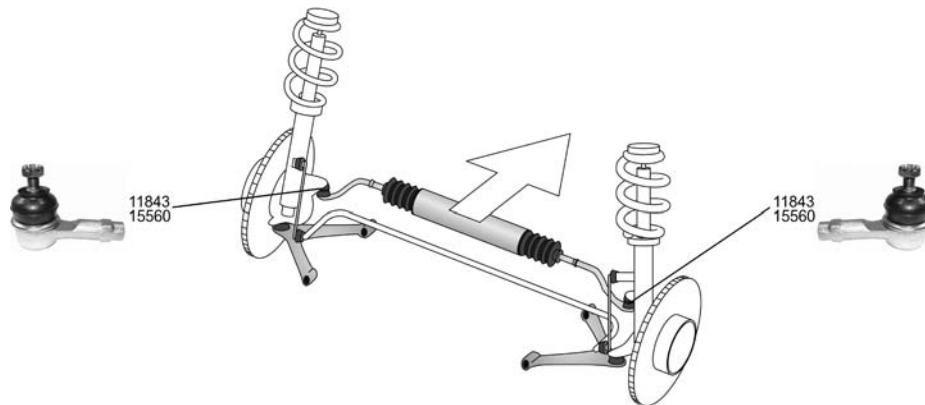
 Faltenbalgsatz, Lenkung / Bellow Kit, steering system ALL TYPES		30144 MB 501711 
Faltenbalgsatz, Lenkung / Bellow Kit, steering system ALL TYPES		30173 MB 347364 

LANCER VI (CK/P_A) 12.95 -



Spurstangenkopf / Tie-rod End Gewindeart: mit Rechtsgewinde / Thread Type: with right-hand thread Innengewinde [mm] / Inner Thread [mm]:M12x1,25 1.3 12V GL, GLX (CK1A) 12.95 - 1.5 16V (CK2A) 12.95 - 1.6 16V (CK4A) 12.95 - 2.0 16V EVO VI / VII (CP9A) 01.99 -		11843 MB 912076 
Spurstangenkopf / Tie-rod End Gewindeart: mit Rechtsgewinde / Thread Type: with right-hand thread Innengewinde [mm] / Inner Thread [mm]:M12x1,25 1.3 12V GL, GLX (CK1A) 12.95 - 1.5 16V (CK2A) 12.95 - 1.6 16V (CK4A) 12.95 - 2.0 16V EVO VI / VII (CP9A) 01.99 -		15560 MB 241982 









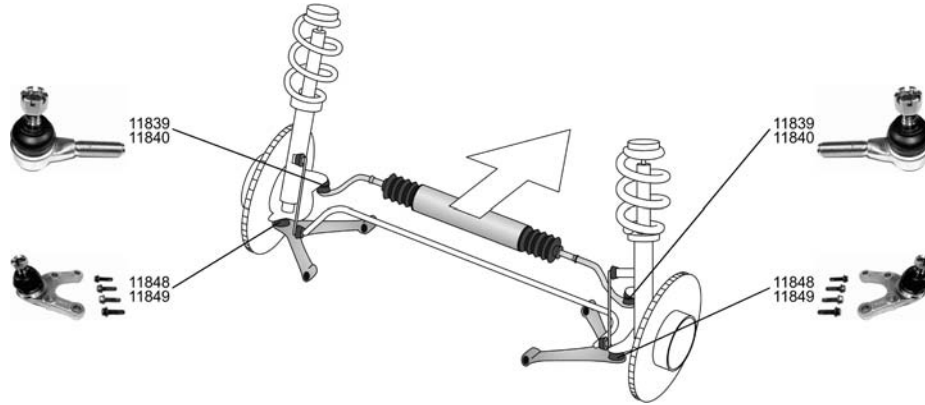

OE

MITSUBISHI

**PAJERO I / MONTERO I (L04_G,
L14_G)**

12.82 - 12.91



<p>Spurstangenkopf / Tie-rod End Gewindeart: mit Linksgewinde / Thread Type: With left-hand thread Aussengewinde [mm] / Outer Thread [mm]:M16x1,5 3.0 V6 (L141G, L146G) 11.88 - 11.90 2.5 TD (L044G, L049G) 11.89 - 12.91</p>		<p>11839 MB 315775</p> 
<p>Spurstangenkopf / Tie-rod End Gewindeart: mit Rechtsgewinde / Thread Type: with right-hand thread Aussengewinde [mm] / Outer Thread [mm]:M16x1,5 3.0 V6 (L141G, L146G) 11.88 - 11.90 2.5 TD (L044G, L049G) 11.89 - 12.91</p>		<p>11840 MB 315776</p> 
<p>Trag-/Führungsgelenk / Support-/ Steering Link Konusmaß [mm] / Cone Size [mm]:19,4 3.0 V6 (L141G, L146G) 11.88 - 11.90 2.5 TD (L044G, L049G) 11.89 - 12.91</p>		<p>11848 MB 176308</p> 
<p>Trag-/Führungsgelenk / Support-/ Steering Link Konusmaß [mm] / Cone Size [mm]:15,9 3.0 V6 (L141G, L146G) 11.88 - 11.90 2.5 TD (L044G, L049G) 11.89 - 12.91</p>		<p>11849</p> 









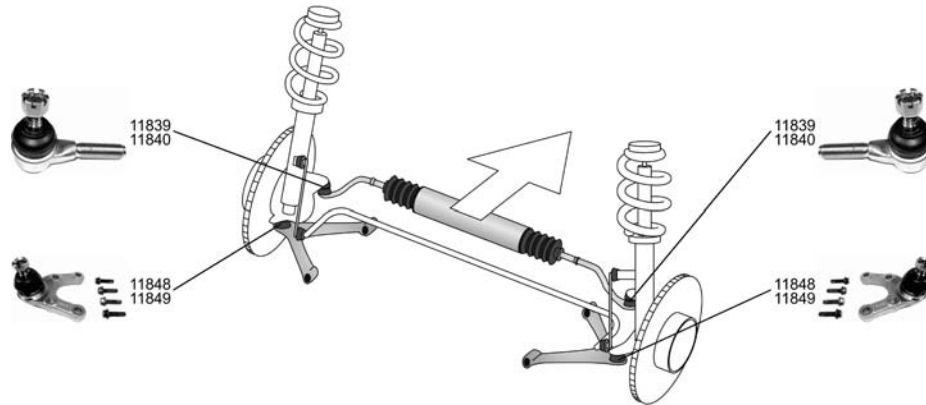

MITSUBISHI

PAJERO I / MONTERO I (L04_G)
Canvas Top/open off-road
vehicle/carrosserie ouverte

12.82 - 11.90



<p>Spurstangenkopf / Tie-rod End Gewindeart: mit Linksgewinde / Thread Type: With left-hand thread Aussengewinde [mm] / Outer Thread [mm]:M16x1,5</p>		<p>11839 MB 315775</p> 
<p>ALL TYPES</p>		
<p>Spurstangenkopf / Tie-rod End Gewindeart: mit Rechtsgewinde / Thread Type: with right-hand thread Aussengewinde [mm] / Outer Thread [mm]:M16x1,5</p>		<p>11840 MB 315776</p> 
<p>ALL TYPES</p>		
<p>Trag-/Führungsgelenk / Support-/ Steering Link Konusmaß [mm] / Cone Size [mm]:19,4</p>		<p>11848 MB 176308</p> 
<p>ALL TYPES</p>		
<p>Trag-/Führungsgelenk / Support-/ Steering Link Konusmaß [mm] / Cone Size [mm]:15,9</p>		<p>11849</p> 
<p>ALL TYPES</p>		











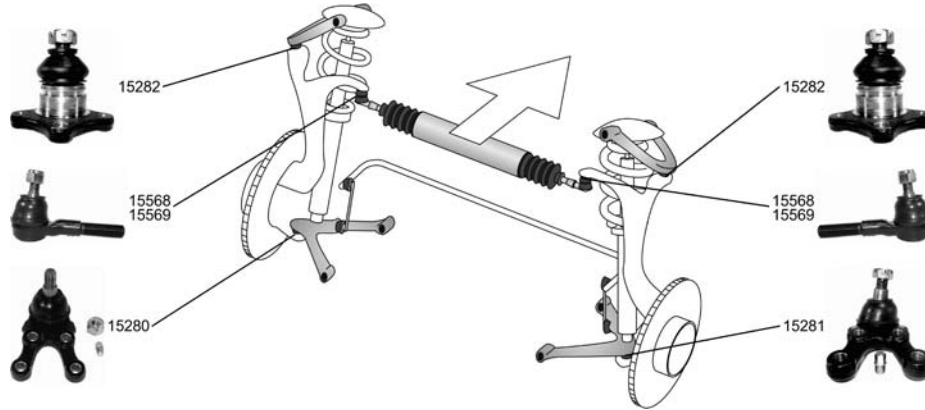



OE

MITSUBISHI

PAJERO II / MONTERO II (V2_W, V4_W)

12.90 - 04.00







<p>Spurstangenkopf / Tie-rod End</p> <p>2.4 3.0 V6 (V23W, V43W, V23C) 3.0 V6 24V, 133 kW 3.5 V6 24V 3.5 V6 24V (V25W, V45W) 2.5 TD (V24C, V24W) 2.8 TD (V46W)</p>	<p></p>	<p>15568 MB 831043</p> 
<p>Spurstangenkopf / Tie-rod End</p> <p>2.4 3.0 V6 (V23W, V43W, V23C) 3.0 V6 24V, 133 kW 3.5 V6 24V 3.5 V6 24V (V25W, V45W) 2.5 TD (V24C, V24W) 2.8 TD (V46W)</p>	<p></p>	<p>15569 MB 831044</p> 
<p>Trag-/Führungsgelenk / Support-/ Steering Link</p> <p>2.4 3.0 V6 (V23W, V43W, V23C) 3.0 V6 24V, 133 kW 3.5 V6 24V 3.5 V6 24V (V25W, V45W) 2.5 TD (V24C, V24W) 2.8 TD (V46W)</p>	<p></p>	<p>15280 MB 831037</p> 
<p>Trag-/Führungsgelenk / Support-/ Steering Link</p> <p>2.4 3.0 V6 (V23W, V43W, V23C) 3.0 V6 24V, 133 kW 3.5 V6 24V 3.5 V6 24V (V25W, V45W) 2.5 TD (V24C, V24W) 2.8 TD (V46W)</p>	<p></p>	<p>15281 MB 831038</p> 
<p>Trag-/Führungsgelenk / Support-/ Steering Link</p> <p>2.4 3.0 V6 (V23W, V43W, V23C) 3.0 V6 24V, 133 kW 3.5 V6 24V 3.5 V6 24V (V25W, V45W) 2.5 TD (V24C, V24W) 2.8 TD (V46W)</p>	<p></p>	<p>15282 MB 860830</p> 
<p>Lenkzwischenhebel / Idler Arm</p> <p>2.4 3.0 V6 (V23W, V43W, V23C) 3.0 V6 24V 3.5 V6 24V 3.5 V6 24V (V25W, V45W) 2.5 TD (V24C, V24W) 2.8 TD (V46W)</p>	<p></p>	<p>29664 MB 831 042</p> 



mitsubishi

PAJERO II / MONTERO II (V2_W,
V4_W)







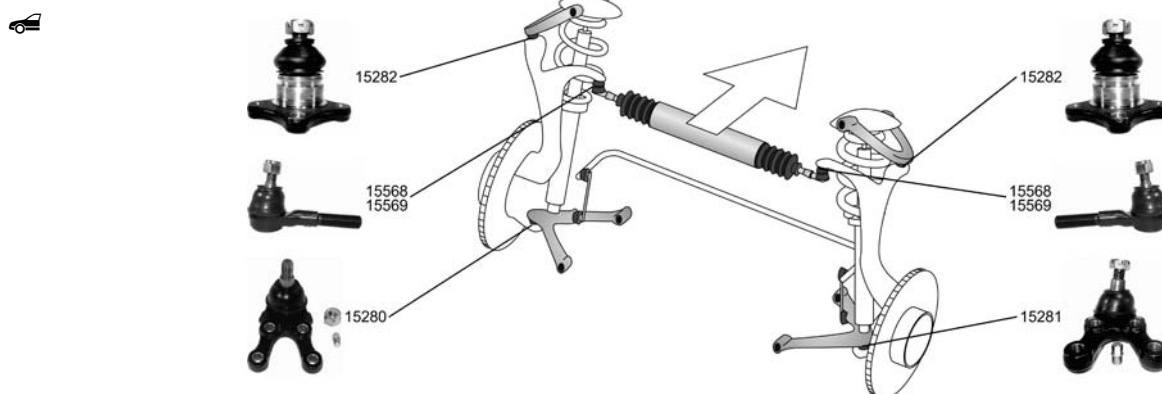

12.90 - 04.00

 Faltenbalgsatz, Lenkung / Bellow Kit, steering system 2.4 3.0 V6 (V23W, V43W, V23C) 3.0 V6 24V 3.5 V6 24V 3.5 V6 24V (V25W, V45W) 2.5 TD (V24C, V24W) 2.8 TD (V46W)	04.91 - 04.00		30204  MR 510272
	12.90 - 12.95		
	06.94 - 04.00		
	07.97 - 04.00		
	06.94 - 04.00		
	12.90 - 04.00		
	06.94 - 04.00		
Faltenbalgsatz, Lenkung / Bellow Kit, steering system 2.4 3.0 V6 (V23W, V43W, V23C) 3.0 V6 24V 3.5 V6 24V 3.5 V6 24V (V25W, V45W) 2.5 TD (V24C, V24W) 2.8 TD (V46W)	04.91 - 04.00		30222  MR 510271
	12.90 - 12.95		
	06.94 - 04.00		
	07.97 - 04.00		
	06.94 - 04.00		
	12.90 - 04.00		
	06.94 - 04.00		

PAJERO II / MONTERO II (V2_W,
V4_W) Canvas Top/open off-road
vehicle/carrosserie ouverte

12.90 - 04.00









Spurstangenkopf / Tie-rod End ALL TYPES		15568  MB 831043
	Spurstangenkopf / Tie-rod End ALL TYPES	
Trag-/Führungsgelenk / Support-/ Steering Link ALL TYPES		15280  MB 831037
	Trag-/Führungsgelenk / Support-/ Steering Link ALL TYPES	
Trag-/Führungsgelenk / Support-/ Steering Link ALL TYPES		15282  MB 860830
	ALL TYPES	





OE

MITSUBISHI







PAJERO II / MONTERO II (V2_W, V4_W) Canvas Top/open off-road vehicle/carrosserie ouverte **12.90 - 04.00**

	Lenkzwischenhebel / Idler Arm ALL TYPES		29664 MB 831 042
			
	Faltenbalgsatz, Lenkung / Bellow Kit, steering system ALL TYPES		30204 MR 510272
			
	Faltenbalgsatz, Lenkung / Bellow Kit, steering system ALL TYPES		30222 MR 510271
			

PAJERO / MONTERO PININ (H6_W, H7_W) **10.99 -**

	Stange/Strebe, Stabilisator / Rod/Strut, stabiliser Pendelstange / Suspension Rod ALL TYPES	 	29663 MB 892 982
---	--	---	-------------------------

SAPPORO III (E16A) **06.87 - 08.90**

	Spurstangenkopf / Tie-rod End Gewindeart: mit Rechtsgewinde / Thread Type: with right-hand thread Innengewinde [mm] / Inner Thread [mm]:M14x1,5 ALL TYPES	 	11841 MB 912519
			
	Trag-/Führungsgelenk / Support-/ Steering Link ALL TYPES	 	11851 MB 303375
			





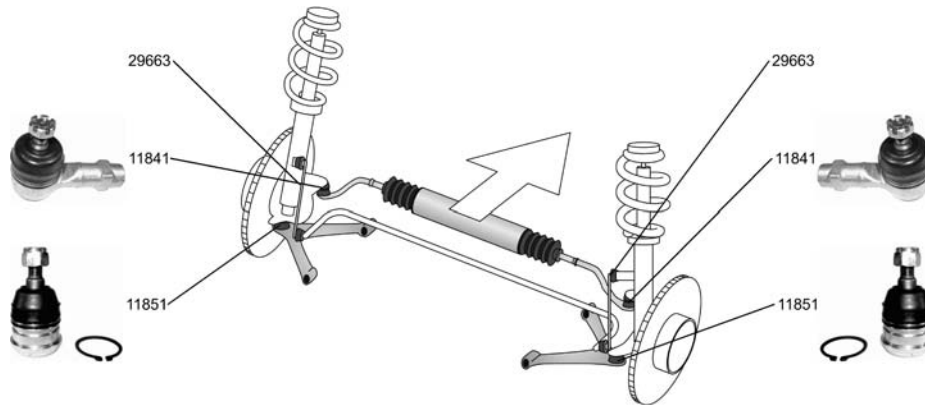

MITSUBISHI

SIGMA (F16A)

12.90 - 07.96





<p>Spurstangenkopf / Tie-rod End Gewindeart: mit Rechtsgewinde / Thread Type: with right-hand thread Innengewinde [mm] / Inner Thread [mm]:M14x1,5</p>		<p>11841 MB 912519</p>
<p>ALL TYPES</p>		
<p>Trag-/Führungsgelenk / Support-/ Steering Link</p>		<p>11851 MB 303375</p>
<p>ALL TYPES</p>		
<p>Stange/Strebe, Stabilisator / Rod/Strut, stabiliser Pendelstange / Suspension Rod</p>		<p>29663 MB 892 982</p>
<p>ALL TYPES</p>		

SIGMA Station Wagon/Estate/Break (F07W)

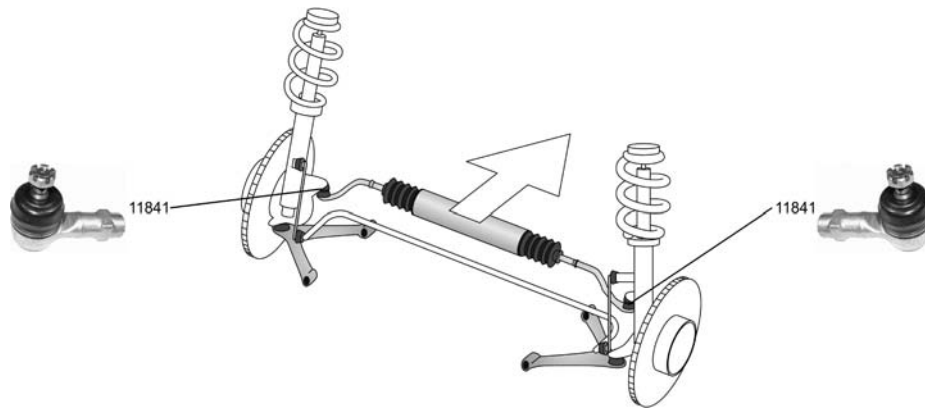
01.93 - 07.96



<p>Spurstangenkopf / Tie-rod End Gewindeart: mit Rechtsgewinde / Thread Type: with right-hand thread Innengewinde [mm] / Inner Thread [mm]:M14x1,5</p>		<p>11841 MB 912519</p>
<p>ALL TYPES</p>		







OE

MITSUBISHI

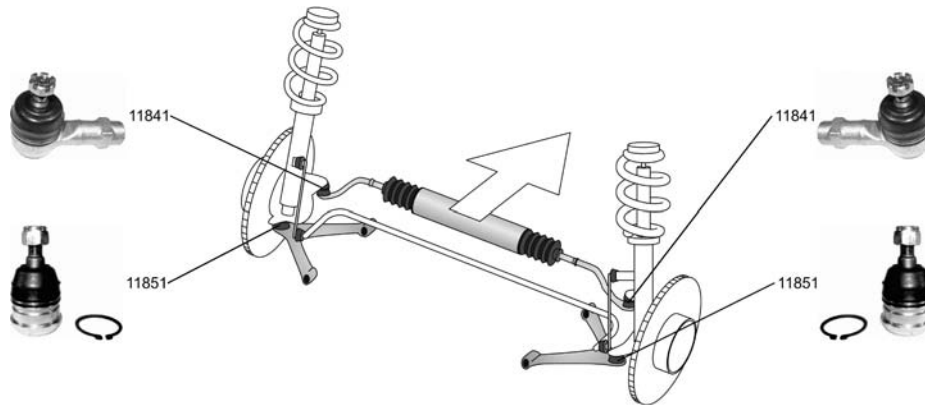
SPACE RUNNER (N1_W, N2_W)

10.91 - 08.99







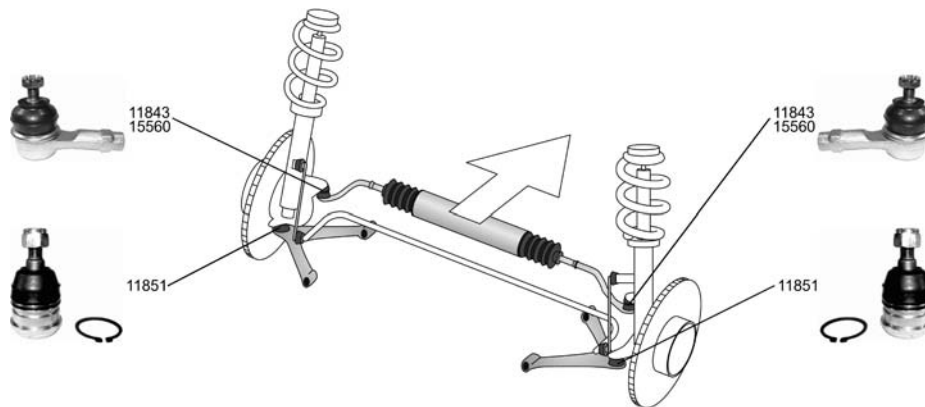

<p>Spurstangenkopf / Tie-rod End Gewindeart: mit Rechtsgewinde / Thread Type: with right-hand thread Innengewinde [mm] / Inner Thread [mm]:M14x1,5 ALL TYPES</p>		<p>11841 MB 912519</p> 
<p>Trag-/Führungsgelenk / Support-/ Steering Link 2.0 TD GLX (N18W) 10.92 - 08.99</p>		<p>11851 MB 303375</p> 

SPACE STAR (DG0)

06.98 -











<p>Spurstangenkopf / Tie-rod End Gewindeart: mit Rechtsgewinde / Thread Type: with right-hand thread Innengewinde [mm] / Inner Thread [mm]:M12x1,25 1.3 16V, 61 kW 12.98 - 1.3 16V, 63 kW 06.98 - 1.8 GDI, 90 kW 06.98 -</p>		<p>11843 MB 912076</p> 
<p>Spurstangenkopf / Tie-rod End Gewindeart: mit Rechtsgewinde / Thread Type: with right-hand thread Innengewinde [mm] / Inner Thread [mm]:M12x1,25 1.3 16V, 61 kW 12.98 - 1.3 16V, 63 kW 06.98 - 1.8 GDI, 90 kW 06.98 -</p>		<p>15560 MB 241982</p> 
<p>Trag-/Führungsgelenk / Support-/ Steering Link 1.3 16V, 61 kW 12.98 - 1.3 16V, 63 kW 06.98 - 1.8 GDI, 90 kW 06.98 -</p>		<p>11851 MB 303375</p> 



MITSUBISHI

SPACE WAGON (D0_V/W)



01.84 - 04.91

 Spurstangenkopf / Tie-rod End Gewindeart: mit Rechtsgewinde / Thread Type: with right-hand thread Innengewinde [mm] / Inner Thread [mm]:M14x1,5 ALL TYPES		11841 MB 912519 
Axialgelenk, Spurstange / Axial Rod, tie rod Gewindeart: mit Rechtsgewinde / Thread Type: with right-hand thread Gewindemaß / Thread Size:M14x1,5 ALL TYPES	 	15561 MB 243329 
Trag-/Führungsgelenk / Support-/ Steering Link ALL TYPES		11851 MB 303375 
Stange/Strebe, Stabilisator / Rod/Strut, stabiliser Pendelstange / Suspension Rod 2.0 GLXi (D04W)		29659 MB 672 370
06.88 - 04.91		

SPACE WAGON (N3_W, N4_W)

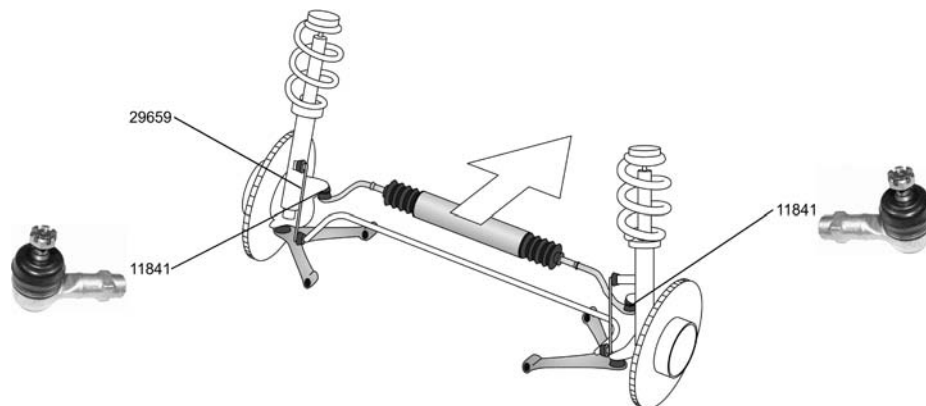
10.91 - 10.98



Spurstangenkopf / Tie-rod End Gewindeart: mit Rechtsgewinde / Thread Type: with right-hand thread Innengewinde [mm] / Inner Thread [mm]:M14x1,5 ALL TYPES ausser/except for : 2.4 i 10.92 - 10.98		11841 MB 912519 
Stange/Strebe, Stabilisator / Rod/Strut, stabiliser Pendelstange / Suspension Rod ALL TYPES ausser/except for : 2.4 i AWD (N34W) 10.91 - 05.96		29659 MB 672 370





OE

MITSUBISHI

SPACE WAGON (N5_W)

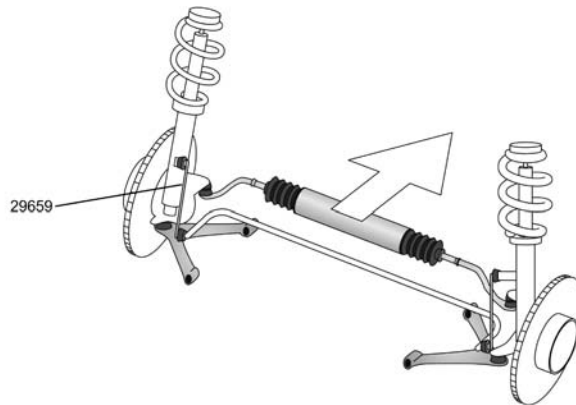
10.98 -





Stange/Strebe, Stabilisator / Rod/Strut, stabiliser Pendelstange / Suspension Rod ALL TYPES		29659	MB 672 370
--	---	--------------	-------------------

STARION (A18_A)

05.82 - 06.90













Trag-/Führungsgelenk / Support-/ Steering Link Konusmaß [mm] / Cone Size [mm]:15,9		11849	
2.0 Turbo ECI (A183A)	06.82 - 08.87		
2.6 Turbo ECI (A187A)	09.87 - 06.90		

TREDIA (A21_)

















09.82 - 07.86



Spurstangenkopf / Tie-rod End Gewindeart: mit Rechtsgewinde / Thread Type: with right-hand thread Innengewinde [mm] / Inner Thread [mm]:M14x1,5		11841	MB 912519
1.4 GLX (A211)	10.82 - 08.85		
GLS 1.6 (A212)	09.82 - 10.87		
1.6 Turbo (A212)	09.82 - 05.85		
1.8 GLS (A215)	08.84 - 07.86		
1.8 Turbo	08.84 - 07.86		
Axialgelenk, Spurstange / Axial Rod, tie rod Gewindeart: mit Rechtsgewinde / Thread Type: with right-hand thread Gewindemaß / Thread Size:M14x1,5		15561	MB 243329
1.4 GLX (A211)	10.82 - 08.85		
GLS 1.6 (A212)	09.82 - 10.87		
1.6 Turbo (A212)	09.82 - 05.85		
1.8 GLS (A215)	08.84 - 07.86		
1.8 Turbo	08.84 - 07.86		
Trag-/Führungsgelenk / Support-/ Steering Link		11851	MB 303375
1.4 GLX (A211)	10.82 - 08.85		
GLS 1.6 (A212)	09.82 - 10.87		
1.6 Turbo (A212)	09.82 - 05.85		
1.8 GLS (A215)	08.84 - 07.86		
1.8 Turbo	08.84 - 07.86		
Faltenbalgsatz, Lenkung / Bellow Kit, steering system		30142	MB 266166
1.4 GLX (A211)	10.82 - 08.85		
GLS 1.6 (A212)	09.82 - 10.87		
1.6 Turbo (A212)	09.82 - 05.85		
1.8 GLS (A215)	08.84 - 07.86		
1.8 Turbo	08.84 - 07.86		
Faltenbalgsatz, Lenkung / Bellow Kit, steering system		30144	MB 501711
1.4 GLX (A211)	10.82 - 08.85		
GLS 1.6 (A212)	09.82 - 10.87		
1.6 Turbo (A212)	09.82 - 05.85		
1.8 GLS (A215)	08.84 - 07.86		
1.8 Turbo	08.84 - 07.86		

Arithmetische Liste / Part number list

Artikelnummer Article No.	Seite Page	Hersteller Manufacturer	Artikelnummer Article No.	Seite Page	Hersteller Manufacturer
11826 ♂	14	MITSUBISHI	15280 ▽	29 30	MITSUBISHI
Spurstangenkopf / Tie-rod End			Trag-/Führungsgelenk / Support-/ Steering Link		
11838 ▲♂	14 17	MITSUBISHI	15281 ▽	29 30	MITSUBISHI
Spurstangenkopf / Tie-rod End			Trag-/Führungsgelenk / Support-/ Steering Link		
11839 ♂	14 27 28	MITSUBISHI	15282 ▲	29 30	MITSUBISHI
Spurstangenkopf / Tie-rod End			Trag-/Führungsgelenk / Support-/ Steering Link		
11840 ♂	14 27 28	MITSUBISHI	15283 ▽	16	MITSUBISHI
Spurstangenkopf / Tie-rod End			Trag-/Führungsgelenk / Support-/ Steering Link		
11841 ♂	7 8 9 10 11 12 14 17 19 31 32 33 34 35	MITSUBISHI	15284 ♂	4	MITSUBISHI
Spurstangenkopf / Tie-rod End			Stange/Strebe, Stabilisator / Rod/Strut, stabiliser		
11842 ♂	14 16 18 19	MITSUBISHI	15450 ♂	14 17	MITSUBISHI
Spurstangenkopf / Tie-rod End			Spurstangenkopf / Tie-rod End		
11843 ▲♂	1 2 4 5 6 20 21 22 23 24 25 26 33	MITSUBISHI	15560 ♂	1 2 3 4 5 6 20 21 22 23 24 25 26 33	MITSUBISHI
Spurstangenkopf / Tie-rod End			Spurstangenkopf / Tie-rod End		
11847 ▽♂	15 17	MITSUBISHI	15561 ♂	7 34 35	MITSUBISHI
Trag-/Führungsgelenk / Support-/ Steering Link			Axialgelenk, Spurstange / Axial Rod, tie rod		
11848 ▽♂	15 27 28	MITSUBISHI	15562 ♂	15 17 19	MITSUBISHI
Trag-/Führungsgelenk / Support-/ Steering Link			Spurstangenkopf / Tie-rod End		
11849 ▲	15 17 19 27 28 35	MITSUBISHI	15564 LHD	3 20 21	MITSUBISHI
Trag-/Führungsgelenk / Support-/ Steering Link			Axialgelenk, Spurstange / Axial Rod, tie rod		
11851 ▽	1 2 3 4 7 8 9 10 22 23 31 32 33 34 35	MITSUBISHI	15565 ♂	9 10	MITSUBISHI
Trag-/Führungsgelenk / Support-/ Steering Link			Axialgelenk, Spurstange / Axial Rod, tie rod		
11852 ▲♂	15 16 18	MITSUBISHI	15566 ♂	15 16 18 19	MITSUBISHI
Trag-/Führungsgelenk / Support-/ Steering Link			Axialgelenk, Spurstange / Axial Rod, tie rod		
11853 ▽♂	15 16 18	MITSUBISHI	15567 ♂	4 22 23	MITSUBISHI
Trag-/Führungsgelenk / Support-/ Steering Link			Axialgelenk, Spurstange / Axial Rod, tie rod		
11855 ♂	8	MITSUBISHI	15568 ♂	29 30	MITSUBISHI
Axialgelenk, Spurstange / Axial Rod, tie rod			Spurstangenkopf / Tie-rod End		
11856 ♂	3 20 21	MITSUBISHI	15569 ♂	29 30	MITSUBISHI
Axialgelenk, Spurstange / Axial Rod, tie rod			Spurstangenkopf / Tie-rod End		
11857 ♂	5 24 25	MITSUBISHI	22700 ♂	9 10	MITSUBISHI
Axialgelenk, Spurstange / Axial Rod, tie rod			Axialgelenk, Spurstange / Axial Rod, tie rod		
11859 ♂	25	MITSUBISHI	25487 ♂	1 2	MITSUBISHI
Stange/Strebe, Stabilisator / Rod/Strut, stabiliser			Axialgelenk, Spurstange / Axial Rod, tie rod		
			29640 ♂	1 2	MITSUBISHI
			Stange/Strebe, Stabilisator / Rod/Strut, stabiliser		

Artikelnummer Article No.	Seite Page	Hersteller Manufacturer	Artikelnummer Article No.	Seite Page	Hersteller Manufacturer
29642 	6	MITSUBISHI			
Stange/Strebe, Stabilisator / Rod/Strut, stabiliser					
29659 	34 35	MITSUBISHI			
Stange/Strebe, Stabilisator / Rod/Strut, stabiliser					
29660 	7 8 11 12 13	MITSUBISHI			
Stange/Strebe, Stabilisator / Rod/Strut, stabiliser					
29663  	1 4 9 10 11 12 22 23 31 32	MITSUBISHI			
Stange/Strebe, Stabilisator / Rod/Strut, stabiliser					
29664 	29 31	MITSUBISHI			
Lenkzwischenhebel / Idler Arm					
30142  	7 8 9 10 11 12 13 35	MITSUBISHI			
Faltenbalgsatz, Lenkung / Bellow Kit, steering system					
30143  	3 4 5 6 20 21 22 24 25	MITSUBISHI			
Faltenbalgsatz, Lenkung / Bellow Kit, steering system					
30144  	3 7 8 9 10 11 12 13 20 21 23 24 25 26 35	MITSUBISHI			
Faltenbalgsatz, Lenkung / Bellow Kit, steering system					
30173  	3 5 6 20 21 23 24 25 26	MITSUBISHI			
Faltenbalgsatz, Lenkung / Bellow Kit, steering system					
30204 	30 31	MITSUBISHI			
Faltenbalgsatz, Lenkung / Bellow Kit, steering system					
30220 	1 2	MITSUBISHI			
Faltenbalgsatz, Lenkung / Bellow Kit, steering system					
30222 	30 31	MITSUBISHI			
Faltenbalgsatz, Lenkung / Bellow Kit, steering system					

Vergleichsliste / Cross reference list

Vergleichs-Nr. Compare No.	Artikelnummer Article No.	Vergleichs-Nr. Compare No.	Artikelnummer Article No.	Vergleichs-Nr. Compare No.	Artikelnummer Article No.
MITSUBISHI					
	MB 175544		11847		
	MB 176308		11848		
	MB 241982		15560		
	MB 243329		15561		
	MB 266166		30142		
	MB 288119		15562		
	MB 303375		11851		
	MB 315629		15450		
	MB 315775		11839		
	MB 315776		11840		
	MB 347364		30173		
	MB 347365		30143		
	MB 350577		11855		
	MB 378704		11826		
	MB 501530		15564		
	MB 501711		30144		
	MB 518780		15284		
	MB 527350		11852		
	MB 527352		15283		
	MB 532046		11856		
	MB 532281		15565		
	MB 532971		15566		
	MB 553249		15567		
	MB 672 370		29659		
	MB 809354		11859		
	MB 831 042		29664		
	MB 831037		15280		
	MB 831038		15281		
	MB 831043		15568		
	MB 831044		15569		
	MB 860830		15282		
	MB 864164		11842		
	MB 892 981		29660		
	MB 892 982		29663		
	MB 912076		11843		
	MB 912519		11841		
	MB 949343		22700		
	MR 297969		11857		
	MR 510271		30222		
	MR 510272		30204		
	MR-272116		29640		
	MR-961477		29642		

Neuaufnahmen / New to range

Artikelnummer Article No.	Seite Page	Hersteller Manufacturer	Artikelnummer Article No.	Seite Page	Hersteller Manufacturer
11826	14	MITSUBISHI	29640	1 2	MITSUBISHI
11847	15 17	MITSUBISHI	29642	6	MITSUBISHI
11855	8	MITSUBISHI	29659	34 35	MITSUBISHI
11857	5 24 25	MITSUBISHI	29660	7 8 11	MITSUBISHI
11859	25	MITSUBISHI		12 13	
15280	29 30	MITSUBISHI	29663	1 4 9	MITSUBISHI
15281	29 30	MITSUBISHI		10 11 12	
15282	29 30	MITSUBISHI		22 23 31	
15283	16	MITSUBISHI		32	
15284	4	MITSUBISHI	29664	29 31	MITSUBISHI
15562	15 17 19	MITSUBISHI	30142	7 8 9	MITSUBISHI
15568	29 30	MITSUBISHI		10 11 12	
15569	29 30	MITSUBISHI		13 35	
22700	9 10	MITSUBISHI			

Neuaufnahmen / New to range

Artikelnummer Article No.	Seite Page	Hersteller Manufacturer
30143 ☒Ⓢ	3 4 5	MITSUBISHI
	6 20 21	
	22 24 25	
30144 ☒Ⓢ	3 7 8	MITSUBISHI
	9 10 11	
	12 13 20	
	21 23 24	
	25 26 35	
30173 ☒Ⓢ	3 5 6	MITSUBISHI
	20 21 23	
	24 25 26	
30204 Ⓢ	30 31	MITSUBISHI
30220 Ⓢ	1 2	MITSUBISHI
30222 Ⓢ	30 31	MITSUBISHI

Artikelnummer Article No.	Seite Page	Hersteller Manufacturer
------------------------------	---------------	----------------------------

Geänderte Bestellnummer / Amended part numbers

Artikelnummer alt Article No. old	Artikelnummer neu Article No. new	Artikelnummer alt Article No. old	Artikelnummer neu Article No. new	Artikelnummer alt Article No. old	Artikelnummer neu Article No. new
11838	15450				
11843	15560				
14951	11843				
15535	30142				
15538	30143				
15540	30144				
20215	30173				
28274	29640				

Geänderte Bestellnummer / Amended part numbers

Artikelnummer neu Article No. new	Artikelnummer alt Article No. old	Artikelnummer neu Article No. new	Artikelnummer alt Article No. old	Artikelnummer neu Article No. new	Artikelnummer alt Article No. old
11843	14951				
15450	11838				
15560	11843				
29640	28274				
30142	15535				
30143	15538				
30144	15540				
30173	20215				