

2004 HONDA

Element

BUZZERS, RELAYS & TIMERS**BUZZERS, RELAYS & TIMERS LOCATION**

Component	Location
A/C Compressor Clutch Relay	In underhood fuse/relay box. See Fig. 104 .
A/F Sensor Relay	Behind glove box. See Fig. 54 .
A/T Reverse Relay	Behind glove box. See Fig. 54 .
Blower Motor Relay	In underhood fuse/relay box. See Fig. 104 .
Condenser Fan Relay	In underhood fuse/relay box. See Fig. 104 .
Fog Light Relay	Under left side of dash. See Fig. 98 .
Headlight Relay 1	In underhood fuse/relay box. See Fig. 104 .
Headlight Relay 2	In underhood fuse/relay box. See Fig. 104 .
Horn Relay	In underhood fuse/relay box. See Fig. 104 .
PGM-FI Main Relay No. 1	Behind glove box. See Fig. 55 .
PGM-FI Main Relay No. 2	Behind glove box. See Fig. 55 .
Power Window Relay	In underdash fuse/relay box. See Fig. 103 .
Radiator Fan Relay	In underhood fuse/relay box. See Fig. 104 .
Rear Accessory Power Socket Relay	Behind glove box. See Fig. 54 .
Rear Window Defogger Relay	In underhood fuse/relay box. See Fig. 104 .
Starter Cut Relay	On underdash fuse/relay box. See Fig. 103 .
Taillight Relay	In underdash fuse/relay box. See Fig. 103 .
Turn Signal/Hazard Relay	In underdash fuse/relay box. See Fig. 103 .

CIRCUIT PROTECTION DEVICES**CIRCUIT PROTECTION DEVICES LOCATION**

Component	Location
Fog Light In-Line Fuse	Under left side of dash. See Fig. 98 .
Trailer Lighting In-Line Fuse	On right quarter panel. See Fig. 101 .
Underdash Fuse/Relay Box	Behind left side of dash, right of steering column. See Fig. 33 .
Underhood Fuse/Relay Box	At left rear of engine compartment. See Fig. 6 .

CONTROL UNITS**CONTROL UNITS LOCATION**

2004 Honda Element DX

2004 HONDA Element

Component	Location
ABS Modulator Control Unit	At right rear of engine compartment. See Fig. 1 .
ECM/PCM	Behind glove box. See Fig. 57 .
ELD Unit	In underhood fuse/relay box. See Fig. 104 .
Immobilizer Control Unit Receiver	In steering wheel cover. See Fig. 30 .
Keyless Receiver Unit	Under left side of dash. See Fig. 36 .
Rear Window Wiper Intermittent Control Unit	Behind left quarterpanel. See Fig. 73 .
Security Control Unit	Behind left side of dash. See Fig. 36 .
SRS Unit	Below center of dash. See Fig. 43 .
Trailer Unit	Right quarter panel. See Fig. 101 .

MOTORS**MOTORS LOCATION**

Component	Location
A/C Condenser Fan Motor	At front of engine compartment. See Fig. 4 .
Air Mix Control Motor	Below left side of dash, on HVAC unit. See Fig. 38 .
Blower Motor	Below right side of dash, on blower unit. See Fig. 59 .
Fuel Tank Unit	In top of fuel tank. See Fig. 71 .
Mode Control Motor	Behind right side of dash, on HVAC unit. See Fig. 56 .
Power Window Motor (Driver's)	In driver's door. See Fig. 61 .
Power Window Motor (Front Passenger's)	In right front door. See Fig. 62 .
Radiator Fan Motor	Behind left side of radiator. See Fig. 5 .
Rear Window Washer Motor	Behind right front inner fender, on washer fluid reservoir. See Fig. 83 .
Rear Window Wiper Motor	Below middle of rear window. See Fig. 77 .
Recirculation Control Motor	Behind right side of dash, on blower unit. See Fig. 56 .
Starter	Left side of engine. See Fig. 14 .
Windshield Washer Motor	Behind right side of front bumper, on washer fluid reservoir. See Fig. 81 .
Windshield Wiper Motor	Under left side of cowl cover. See Fig. 28 .

SENDING UNITS & SENSORS

2004 Honda Element DX

2004 HONDA Element

SENDING UNITS & SENSORS LOCATION

Component	Location
A/F Sensor	On front of three-way catalytic converter. See Fig. 90 .
CKP Sensor	On lower right front of engine, near crankshaft pulley. See Fig. 84 .
CMP Sensor A	On rear of cylinder head. See Fig. 20 .
CMP Sensor B	On rear of cylinder head. See Fig. 20 .
Countershaft Speed Sensor	On front right side of transaxle. See Fig. 23 .
ECT Sensor	On rear of cylinder head. See Fig. 19 .
Evaporator Temperature Sensor	Behind left side of dash, on HVAC unit. See Fig. 37 .
FTP Sensor	Under left rear of vehicle. See Fig. 92 .
IAT Sensor	On left side of intake manifold. See Fig. 16 .
Knock Sensor	On left side of engine. See Fig. 14 .
Left Front Impact Sensor	Behind left side of front bumper. See Fig. 80 .
Mainshaft Speed Sensor	On rear right side of transaxle. See Fig. 23 .
MAP Sensor	On left side of intake manifold. See Fig. 18 .
Right Front Impact Sensor	Behind right side of front bumper. See Fig. 82 .
Secondary HO2S	Under middle of vehicle. See Fig. 90 .
TP Sensor	On left side of intake manifold. See Fig. 18 .
VSS	On top left of transaxle. See Fig. 96 .
Wheel Speed Sensor (Left Front)	On left front wheel. See Fig. 87 .
Wheel Speed Sensor (Left Rear)	On left rear wheel. See Fig. 91 .
Wheel Speed Sensor (Right Front)	On right front wheel. See Fig. 84 .
Wheel Speed Sensor (Right Rear)	On right rear wheel. See Fig. 94 .

SOLENOIDS & SOLENOID VALVES**SOLENOIDS & SOLENOID VALVES LOCATION**

Component	Location
A/C Compressor Clutch	Right side of engine compartment. See Fig. 102 .
A/T Clutch Pressure Control Solenoid Valve A	On top of transaxle. See Fig. 22 .
A/T Clutch Pressure Control Solenoid Valve B	On left side of transaxle. See Fig. 89 .

2004 Honda Element DX

2004 HONDA Element

A/T Clutch Pressure Control Solenoid Valve C	On left side of transaxle. See Fig. 89 .
Cruise Control Actuator	On right side of engine compartment. See Fig. 25 .
EVAP Canister Purge Valve	At right rear of engine. See Fig. 19 .
EVAP Canister Vent Shut Valve	Under left rear of vehicle. See Fig. 93 .
Fuel Injector No. 1	Left side of engine. See Fig. 12 .
Fuel Injector No. 2	Left side of engine. See Fig. 12 .
Fuel Injector No. 3	Left side of engine. See Fig. 12 .
Fuel Injector No. 4	Left side of engine. See Fig. 12 .
Hatch Lock Actuator	In middle of hatch. See Fig. 77 .
IAC Valve	On rear of engine. See Fig. 17 .
Starter Solenoid	Left side of engine. See Fig. 14 .
VTC Oil Control Solenoid Valve	On front of cylinder head. See Fig. 9 .
VTEC Solenoid Valve	On right front of cylinder head. See Fig. 10 .

SWITCHES**SWITCHES LOCATION**

Component	Location
A/C Pressure Switch	At right front of engine compartment. See Fig. 3 .
Back-Up Light Switch	On top of transaxle. See Fig. 95 .
Brake Fluid Level Switch	On brake fluid reservoir. See Fig. 27 .
Brake Pedal Position Switch	On brake pedal support. See Fig. 36 .
Clutch Interlock Switch	On clutch pedal support. See Fig. 97 .
Clutch Pedal Position Switch	On clutch pedal support. See Fig. 97 .
Driver's Seat Belt Switch	In driver's seat belt buckle. See Fig. 67 .
Front Passenger's Seat Belt Switch	In front passenger's seat belt buckle. See Fig. 68 .
Left Tailgate Switch	Left side of tailgate. See Fig. 78 .
Oil Pressure Switch	On right front of engine. See Fig. 85 .
Parking Brake Switch	Under center console. See Fig. 70 .
PSP Switch	On lower center rear of engine compartment. See Fig. 26 .
Radiator Fan Switch	At bottom rear of radiator. See Fig. 86 .
Right Tailgate Switch	Right side of tailgate. See Fig. 79 .
Transmission Range Switch	On lower rear of transaxle. See Fig. 87 .
VTEC Oil Pressure Switch	On right front of cylinder head. See Fig. 10 .
2nd Clutch Pressure Switch	At top of transaxle. See Fig. 24 .

2004 Honda Element DX

2004 HONDA Element

3rd Clutch Pressure Switch

At rear of transaxle. See **Fig. 88** .**MISCELLANEOUS****MISCELLANEOUS LOCATION**

Component	Location
Alternator	On front of engine. See Fig. 15 .
Blower Power Transistor	Behind right side of dash, on HVAC unit. See Fig. 59 .
CD Changer	Under front passenger's seat. See Fig. 100 .
DLC	Under left side of dash. See Fig. 37 .
Driver's Airbag	Center of steering wheel. See Fig. 29 .
Driver's Seat Belt Buckle Tensioner	Under driver's seat. See Fig. 67 .
Driver's Seat Belt Tensioner	In left rear door. See Fig. 64 .
Front Passenger's Airbag	Right side of dash. See Fig. 53 .
Front Passenger's Seat Belt Buckle Tensioner	Under front passenger's seat. See Fig. 68 .
Front Passenger's Seat Belt Tensioner	In right rear door. See Fig. 64 .
Horn	Behind left side of front bumper. See Fig. 80 .
Ignition Coil No. 1	On top of engine. See Fig. 11 .
Ignition Coil No. 2	On top of engine. See Fig. 11 .
Ignition Coil No. 3	On top of engine. See Fig. 11 .
Ignition Coil No. 4	On top of engine. See Fig. 11 .
Junction Connector C105	At left rear of engine. See Fig. 21 .
Junction Connector C106	At left rear of engine. See Fig. 21 .
Junction Connector C107	Behind glove box. See Fig. 54 .
Junction Connector C456	Under middle of dash. See Fig. 47 .
Junction Connector C559	Under middle of dash. See Fig. 44 .
MES Connector	Under left side of dash. See Fig. 33 .
Microphone Jack	Under left side of dash. See Fig. 99 .
Rear Ceiling Light Diode	Under left side of dash. See Fig. 32 .
Stereo Amplifier	Right kick panel. See Fig. 60 .
Test Tachometer Connector	On left side of engine compartment, near battery. See Fig. 8 .

CONNECTORS**CONNECTORS LOCATION**

Component	Location
------------------	-----------------

2004 Honda Element DX

2004 HONDA Element

C101 (Gray, 20 Pin)	Behind glove box. See Fig. 55 .
C102 (Gray, 6 Pin)	At left rear side of engine. See Fig. 13 .
C103 (Gray, 1 Pin)	At left rear side of engine. See Fig. 13 .
C104 (Gray, 10 Pin)	On transaxle housing. See Fig. 23 .
C108 (Black, 8 Pin)	On transaxle housing. See Fig. 88 .
C320 (Brown, 1 Pin)	Behind left side of front bumper. See Fig. 80 .
C401 (Yellow, 4 Pin)	Under left middle of dash. See Fig. 42 .
C402 (Gray, 14 Pin)	Under middle of dash. See Fig. 46 .
C403 (Light Blue, 6 Pin)	Under right middle of dash. See Fig. 50 .
C404 (Yellow, 4 Pin)	Under right middle of dash. See Fig. 50 .
C451 (White, 10 Pin)	Under middle of dash. See Fig. 41 .
C452 (White, 8 Pin)	Under middle of dash. See Fig. 41 .
C453 (White, 17 Pin)	Under middle of dash. See Fig. 46 .
C454 (White, 17 Pin)	Under right middle of dash. See Fig. 50 .
C455 (Gray, 10 Pin)	Under right middle of dash. See Fig. 50 .
C459 (Brown, 1 Pin)	Under left side of dash. See Fig. 37 .
C501 (Gray, 8 Pin)	Under middle of dash. See Fig. 42 .
C502 (White, 13 Pin)	Under middle of dash. See Fig. 42 .
C504 (Gray, 3 Pin)	Under left side of dash. See Fig. 35 .
C551 (White, 4 Pin)	Under middle of dash. See Fig. 51 .
C552 (White, 4 Pin)	Under middle of dash. See Fig. 51 .
C553 (Gray, 10 Pin)	Under middle of dash. See Fig. 52 .
C554 (White, 6 Pin)	Behind left quarterpanel. See Fig. 72 .
C555 (Yellow, 4 Pin)	Behind left quarterpanel. See Fig. 72 .
C556 (White, 6 Pin)	Behind right quarterpanel. See Fig. 74 .
C557 (Yellow, 4 Pin)	Behind right quarterpanel. See Fig. 74 .
C558 (Except EX) (Gray, 10 Pin)	Under center console. See Fig. 70 .
C558 (EX) (Gray, 14 Pin)	Under center console. See Fig. 70 .
C571 (Gray, 4 Pin)	Behind right quarterpanel. See Fig. 101 .
C601 (Gray, 10 Pin)	At left "D" pillar. See Fig. 75 .
C651 (Light Blue, 6 Pin)	Under right side of dash. See Fig. 58 .
C681 (Gray, 3 Pin)	Behind left quarterpanel. See Fig. 73 .
C751 (Gray, 20 Pin)	Under left side of dash. See Fig. 35 .
C752 (Light Blue, 6 Pin)	Under left side of dash. See Fig. 35 .
C761 (Yellow, 4 Pin)	In right rear door. See Fig. 66 .
C762 (White, 6 Pin)	In right rear door. See Fig. 66 .
C771 (Yellow, 4 Pin)	In left rear door. See Fig. 63 .
C772 (White, 6 Pin)	In left rear door. See Fig. 63 .
C781 (EX & Canada DX) (Gray, 12	

2004 Honda Element DX

2004 HONDA Element

Pin)	Under right side of dash. See Fig. 58 .
C781 (USA DX) (Gray, 8 Pin)	Under right side of dash. See Fig. 58 .
C851 (Brown, 21 Pin)	Behind glove box. See Fig. 53 .
C852 (Brown, 1 Pin)	Behind glove box. See Fig. 53 .
C853 (Brown, 1 Pin)	Under middle of dash. See Fig. 52 .
C997 (Gray, 1 Pin)	At center front of engine compartment. See Fig. 86 .
C998 (Brown, 4 Pin)	Under right middle of dash. See Fig. 45 .
C999 (A/T) (Blue, 4 Pin)	Under middle of dash. See Fig. 47 .

GROUNDS**GROUNDS LOCATION**

Component	Location
G1	At left side of engine compartment. See Fig. 7 .
G2	At right side of engine compartment. See Fig. 2 .
G101	At left rear of engine. See Fig. 12 .
G102	At rear of engine. See Fig. 20 .
G201	Behind right side of front bumper. See Fig. 82 .
G202	Behind right side of front bumper. See Fig. 82 .
G301	Behind left side of front bumper. See Fig. 80 .
G401	Under right middle side of dash. See Fig. 48 .
G402	Under left middle side of dash. See Fig. 39 .
G451	Behind left center of dash. See Fig. 40 .
G501	Under left side of dash. See Fig. 31 .
G502	Under right side of dash. See Fig. 34 .
G503	Under middle of dash. See Fig. 49 .
G551	At right "D" pillar. See Fig. 76 .
G552	Under front passenger's seat. See Fig. 69 .
G553	At left "D" pillar. See Fig. 75 .
G711	At middle of tailgate, near rear wiper motor. See Fig. 77 .
G751	In right rear door. See Fig. 105 .
G771	In left rear door. See Fig. 65 .

COMPONENT LOCATION GRAPHICS

NOTE: Figures may show multiple component locations. Refer to appropriate table for proper figure references.

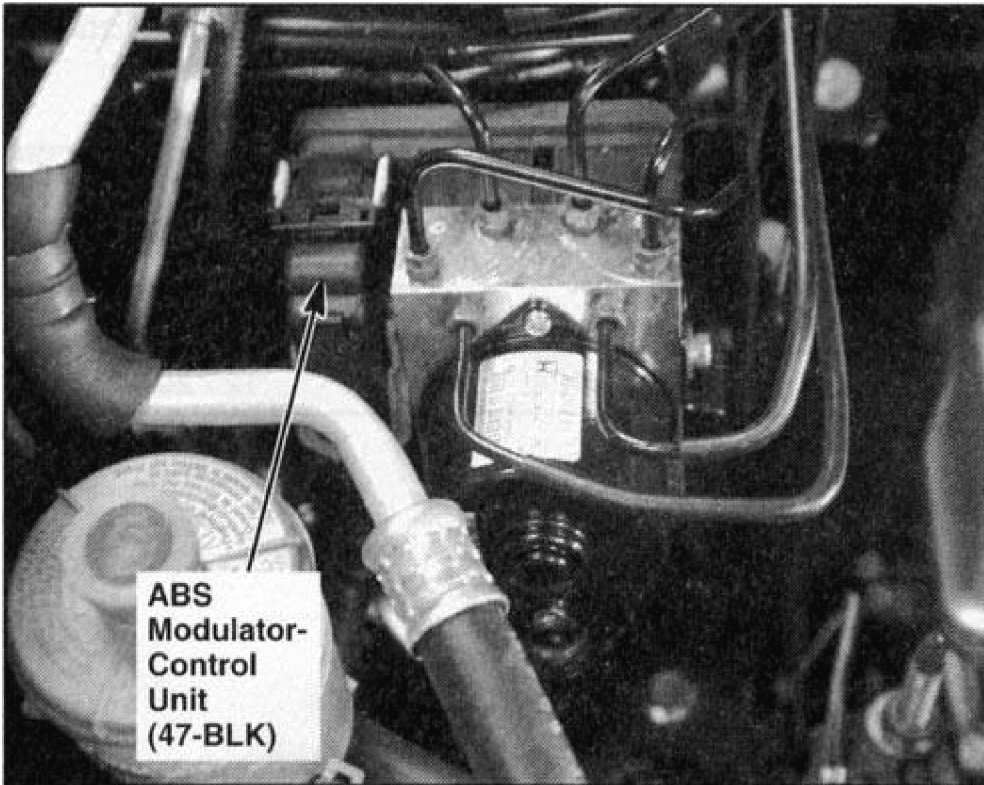

G00268410

Fig. 1: Right Side Of Engine Compartment (EX)
Courtesy of AMERICAN HONDA MOTOR CO., INC.

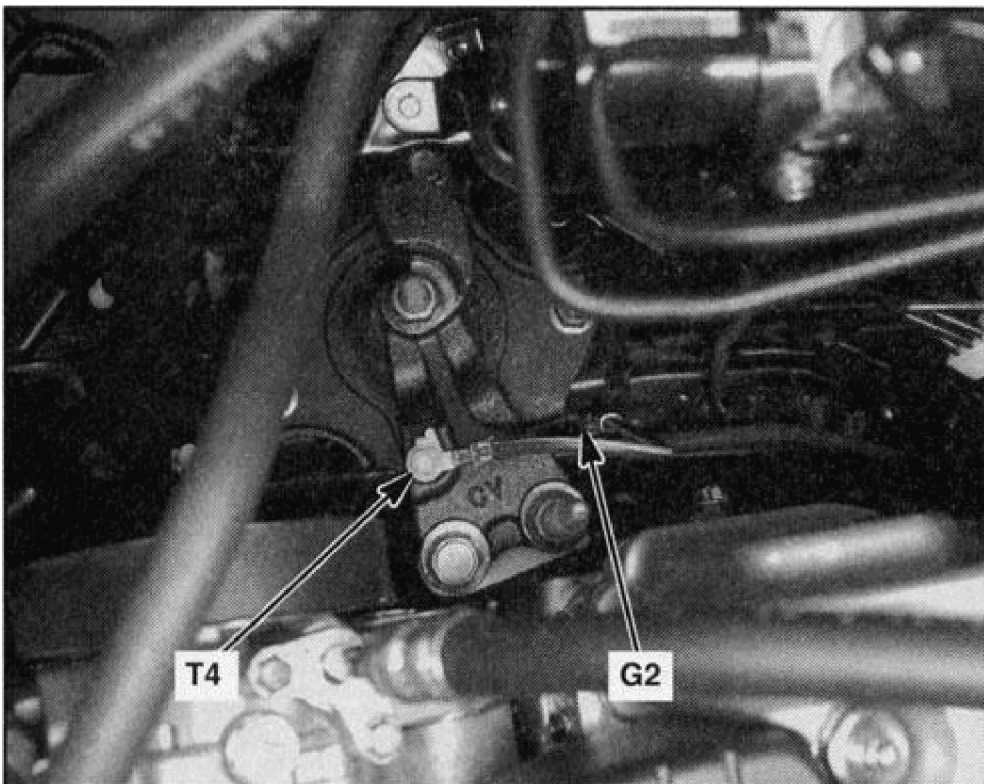

G00268411

Fig. 2: Right Side Of Engine Compartment

Courtesy of AMERICAN HONDA MOTOR CO., INC.

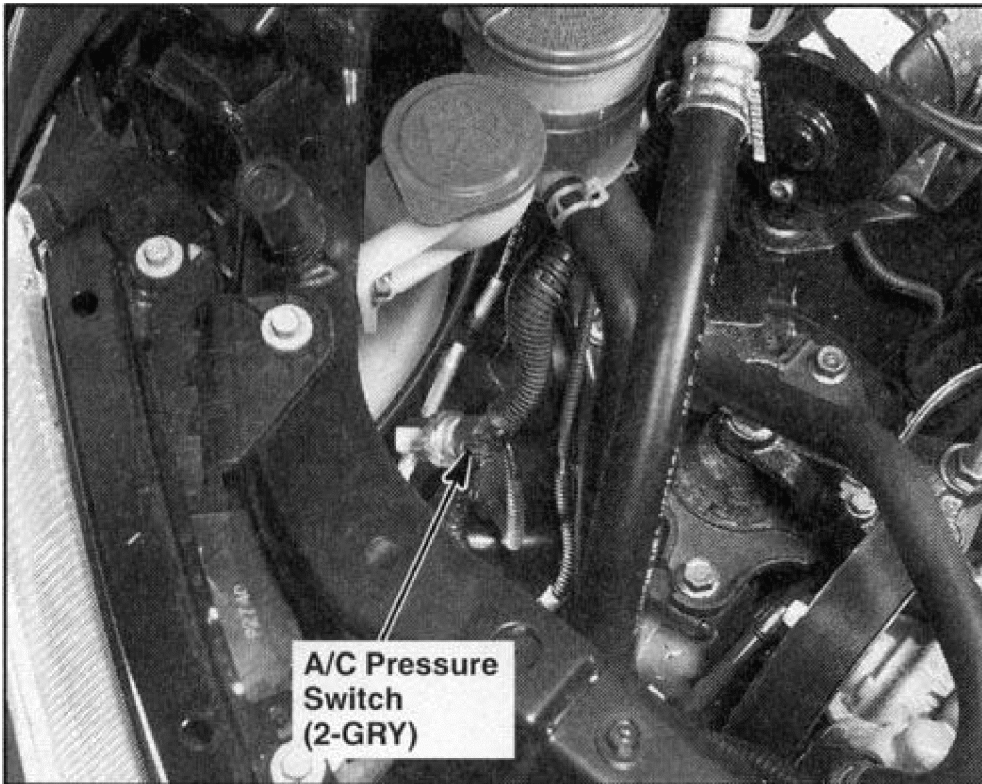

G00268412

Fig. 3: Right Side Of Engine Compartment
Courtesy of AMERICAN HONDA MOTOR CO., INC.

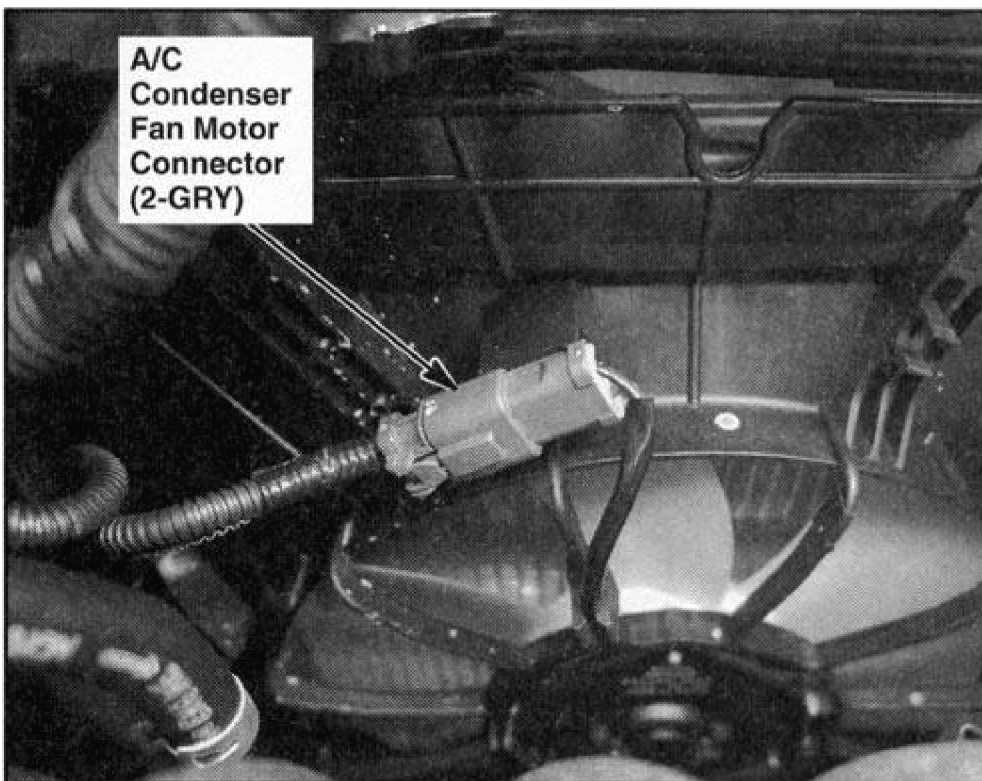

G00268413

Fig. 4: Front Of Engine Compartment
Courtesy of AMERICAN HONDA MOTOR CO., INC.

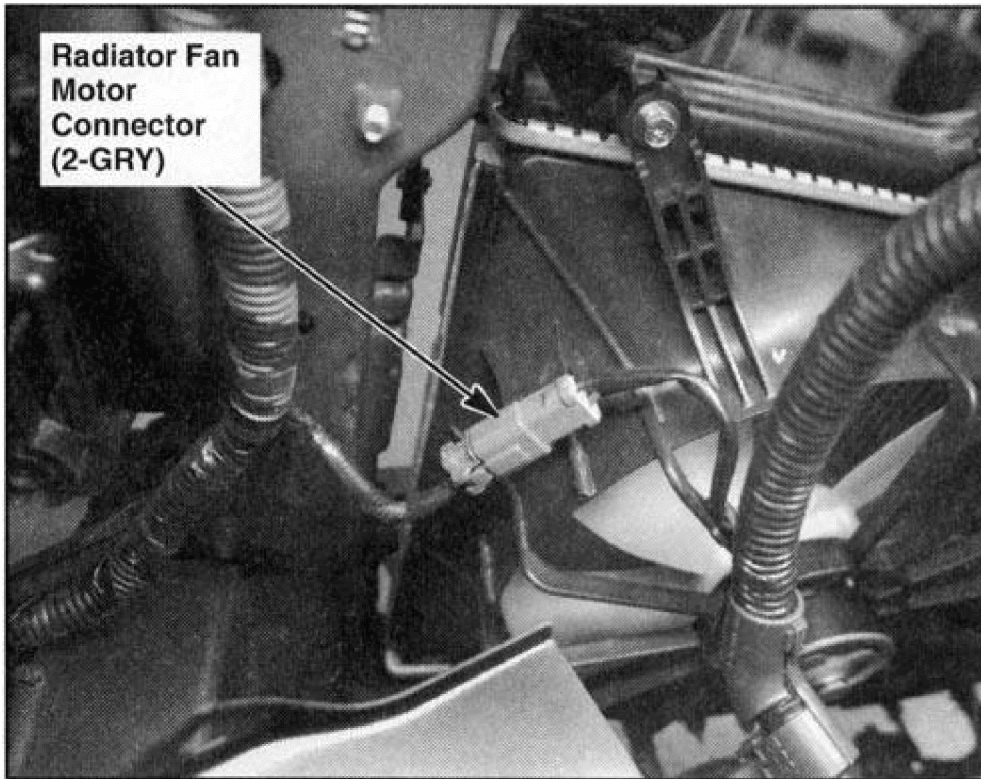

G00268414

Fig. 5: Front Of Engine Compartment
Courtesy of AMERICAN HONDA MOTOR CO., INC.

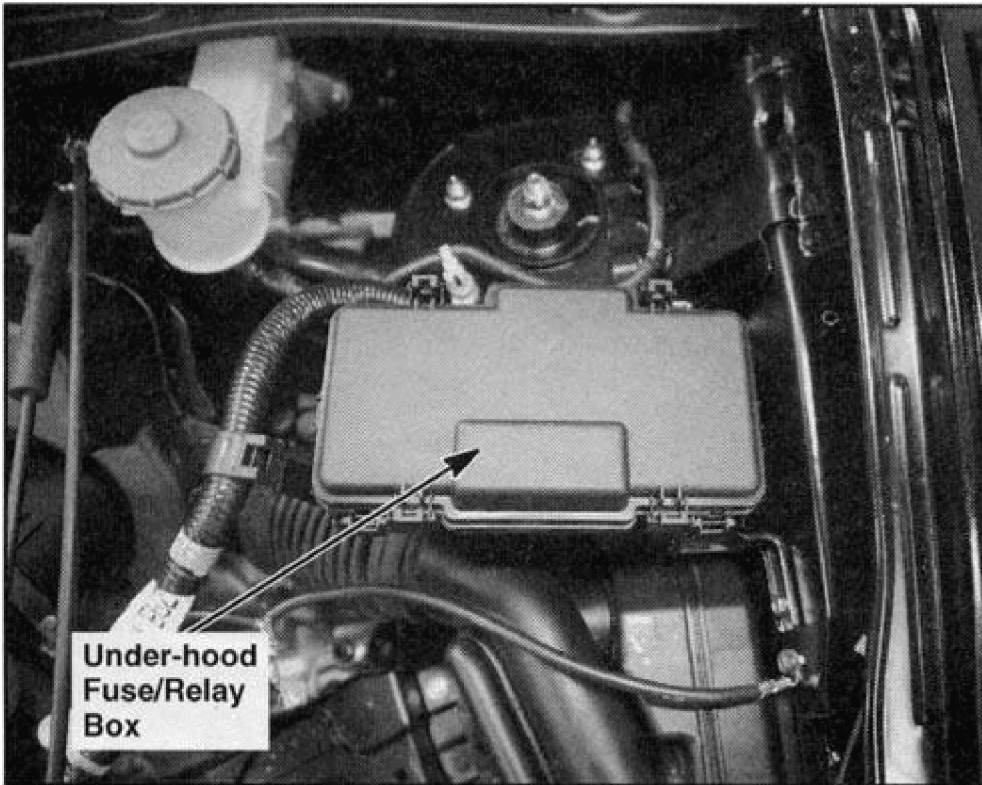

Under-hood
Fuse/Relay
Box

G00268415

Fig. 6: Left Side Of Engine Compartment
Courtesy of AMERICAN HONDA MOTOR CO., INC.

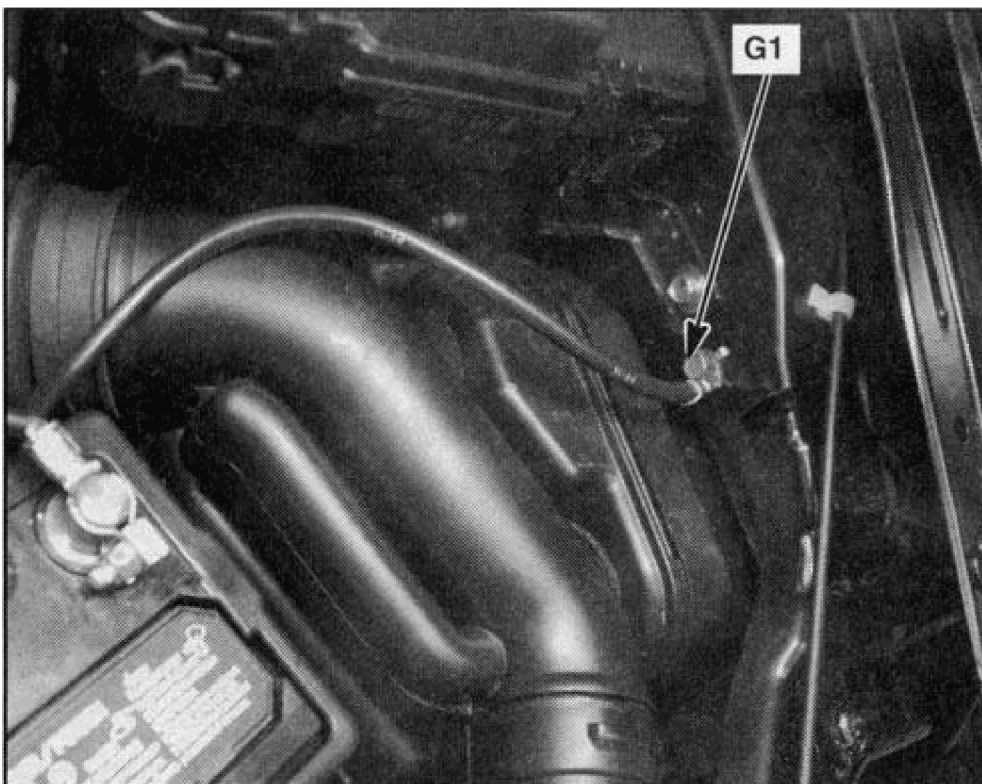

G1

G00268416

Fig. 7: Left Side Of Engine Compartment

Courtesy of AMERICAN HONDA MOTOR CO., INC.

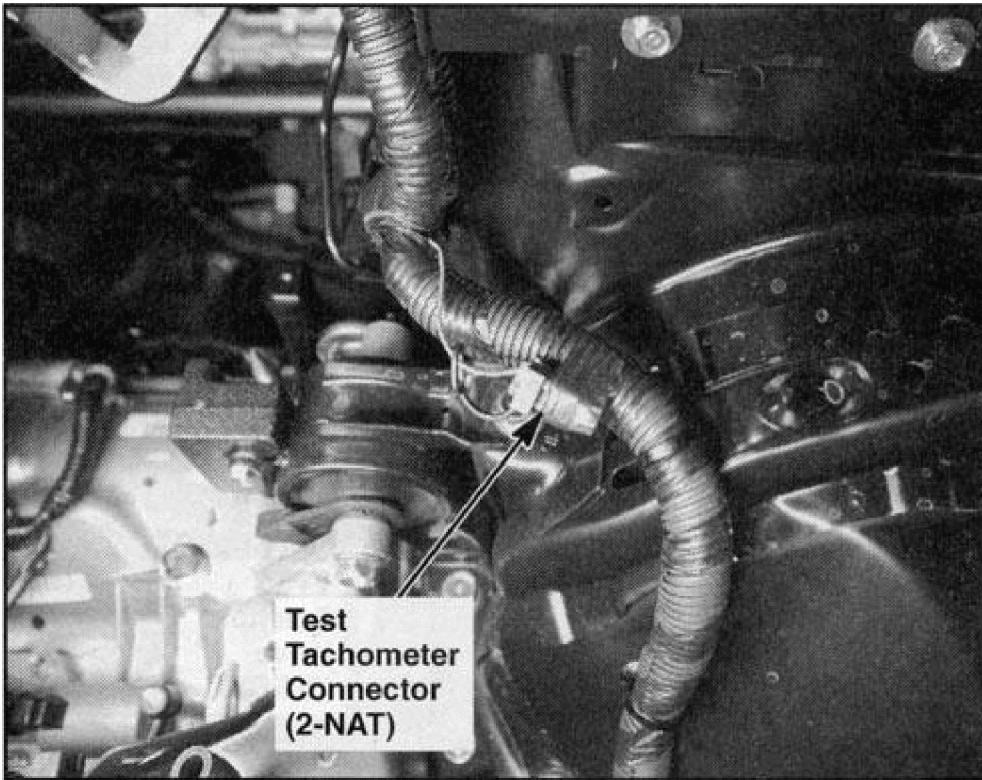

G00268417

Fig. 8: Left Side Of Engine Compartment
Courtesy of AMERICAN HONDA MOTOR CO., INC.

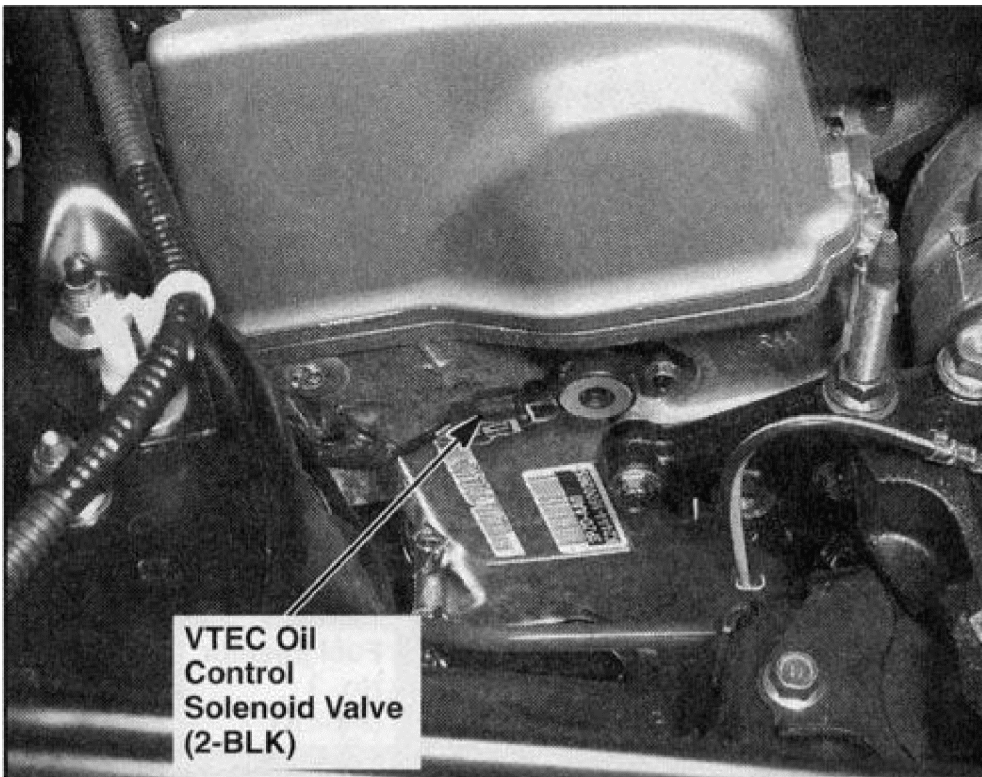

G00268418

Fig. 9: Right Side Of Engine

Courtesy of AMERICAN HONDA MOTOR CO., INC.

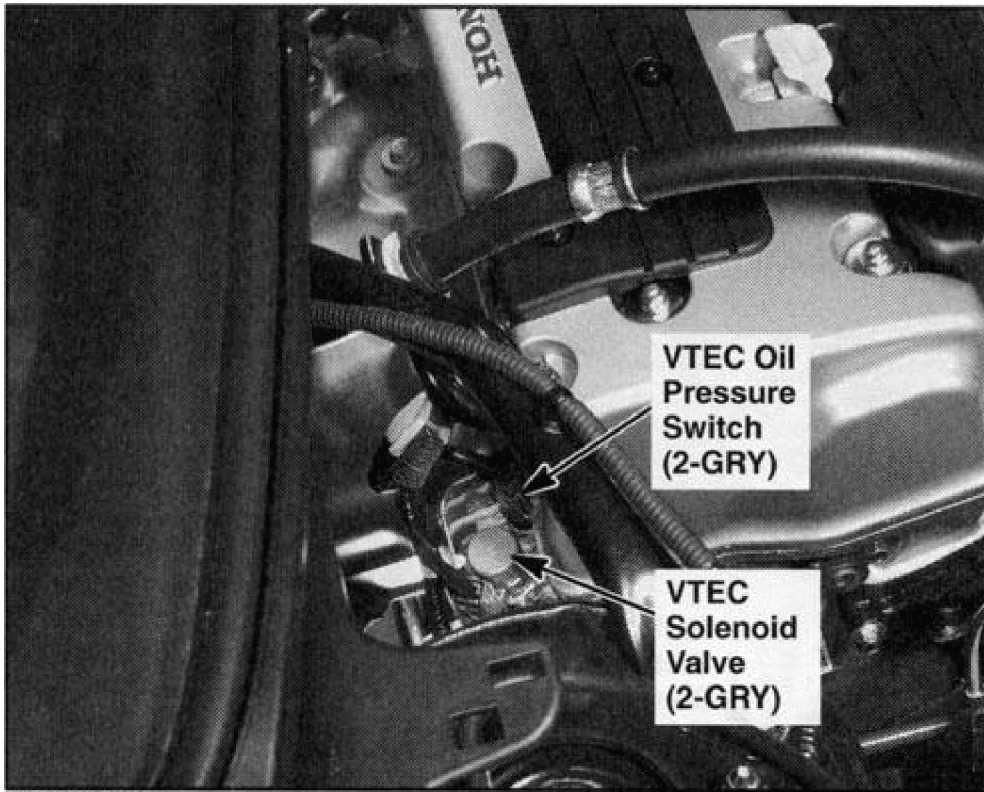

G00268419

Fig. 10: Right Side Of Engine

Courtesy of AMERICAN HONDA MOTOR CO., INC.

2004 Honda Element DX

2004 HONDA Element

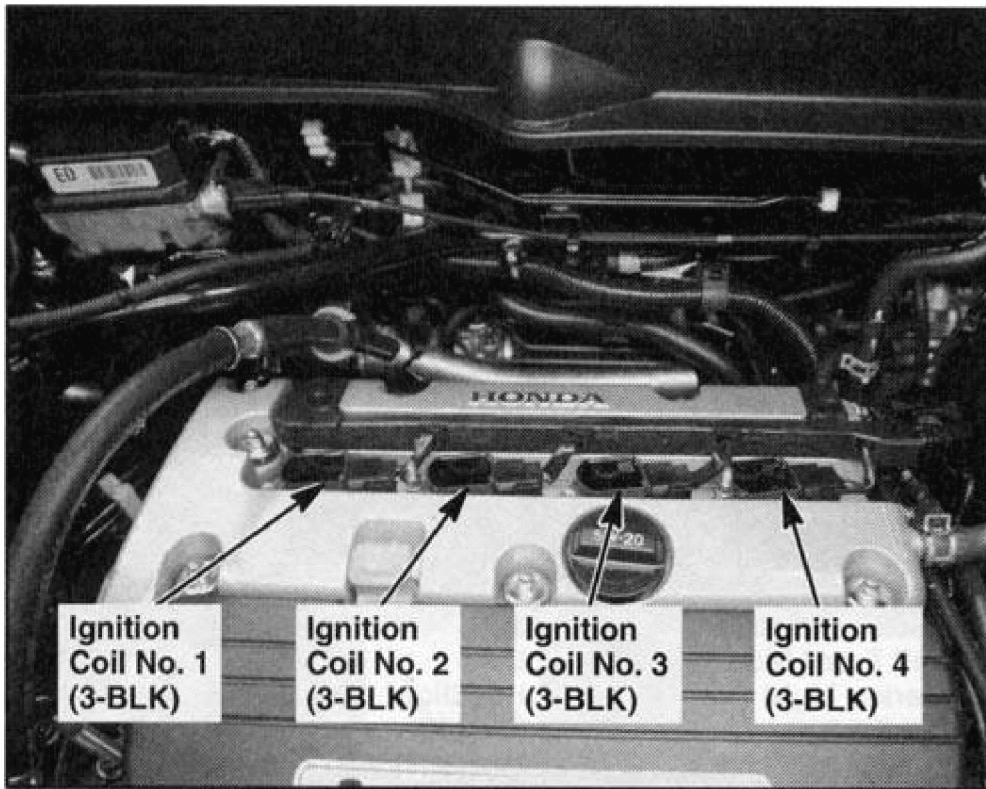

G00268420

Fig. 11: Middle Of Engine

Courtesy of AMERICAN HONDA MOTOR CO., INC.

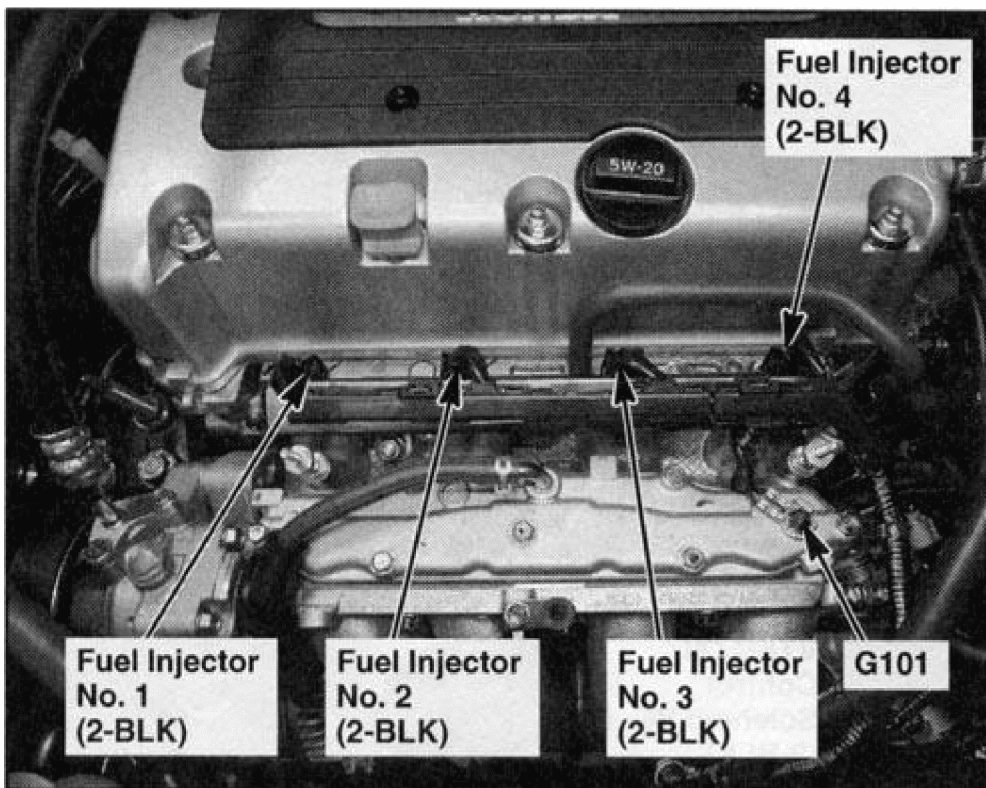

G00268421

Fig. 12: Middle Of Engine

Courtesy of AMERICAN HONDA MOTOR CO., INC.

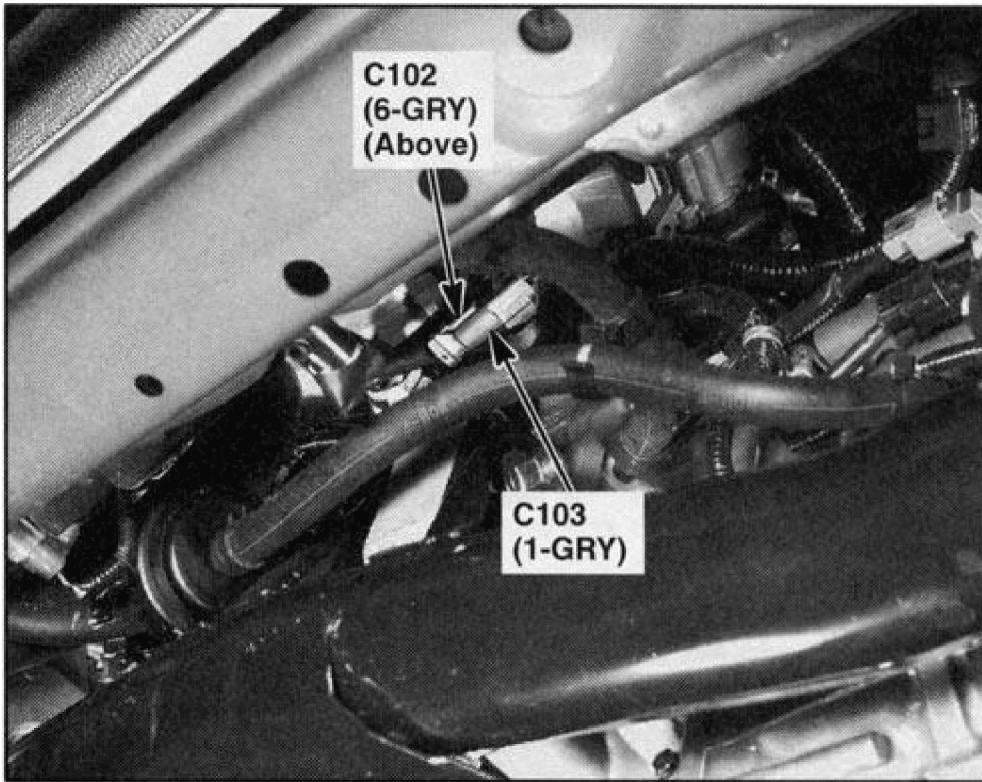

G00268422

Fig. 13: Middle Of Engine Compartment
Courtesy of AMERICAN HONDA MOTOR CO., INC.

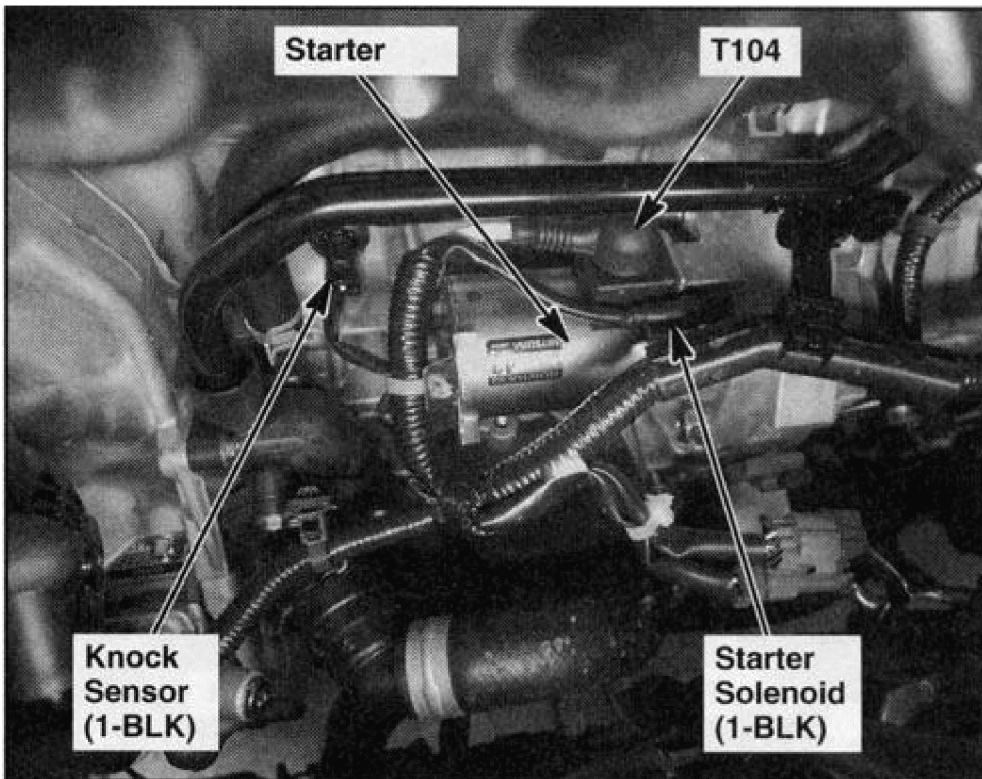

G00268423

Fig. 14: Front Of Engine (Intake Removed)
Courtesy of AMERICAN HONDA MOTOR CO., INC.

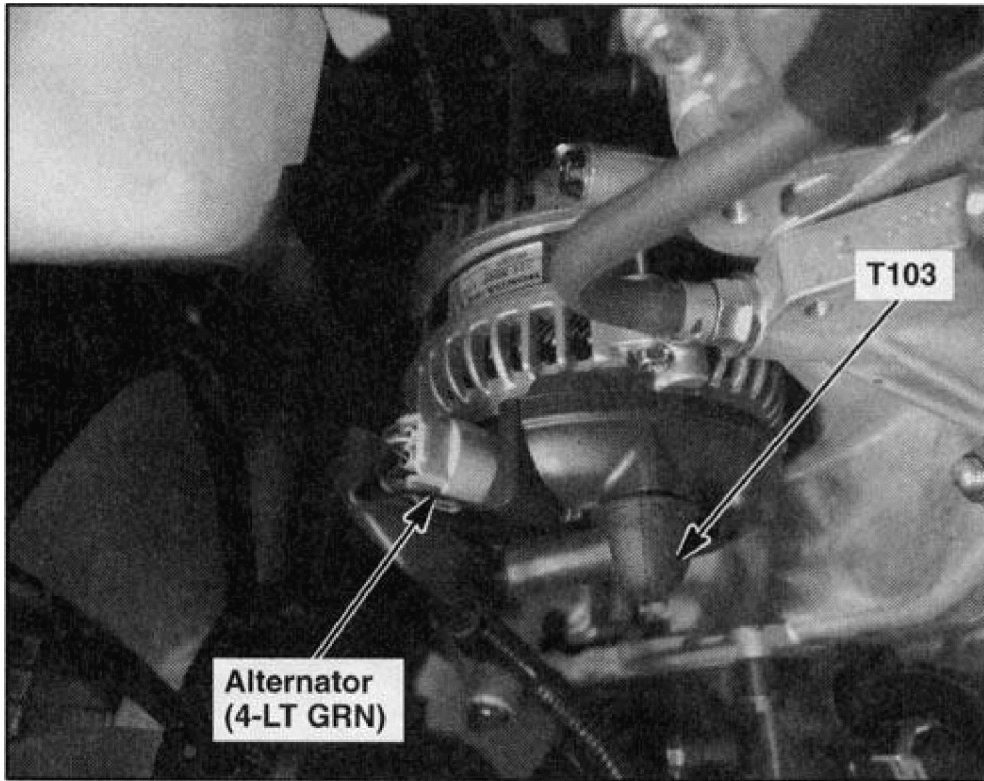

G00268424

Fig. 15: Right Side Of Engine Compartment (Intake Removed)
Courtesy of AMERICAN HONDA MOTOR CO., INC.

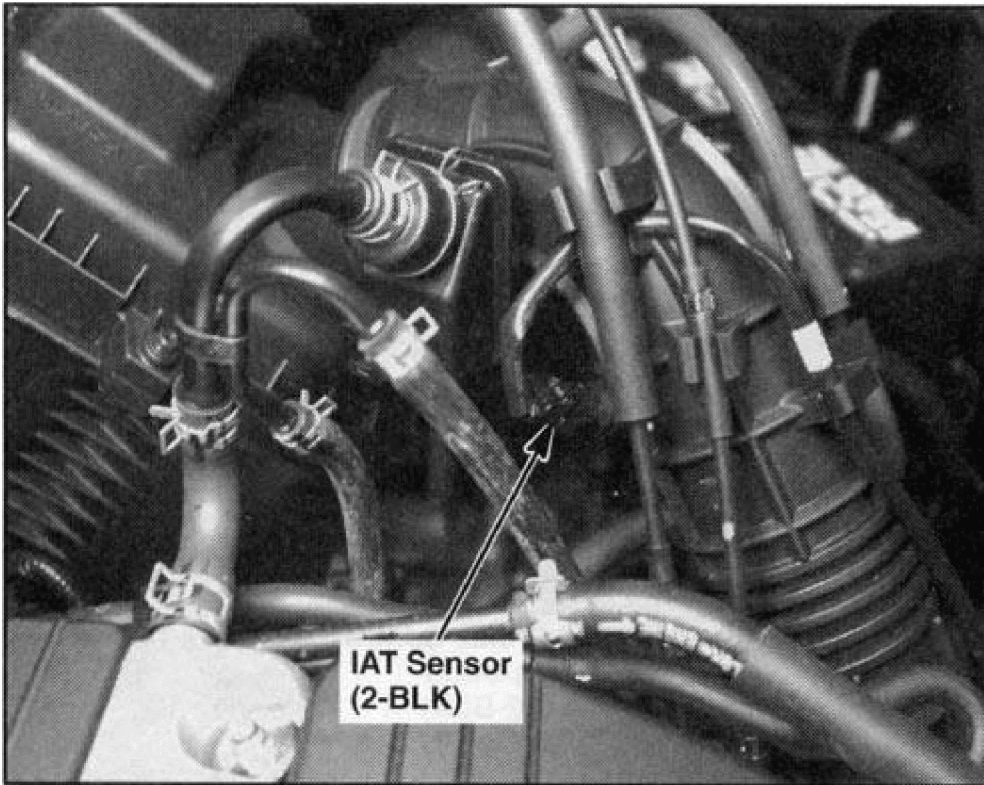

G00268425

Fig. 16: Left Side Of Intake Manifold
Courtesy of AMERICAN HONDA MOTOR CO., INC.

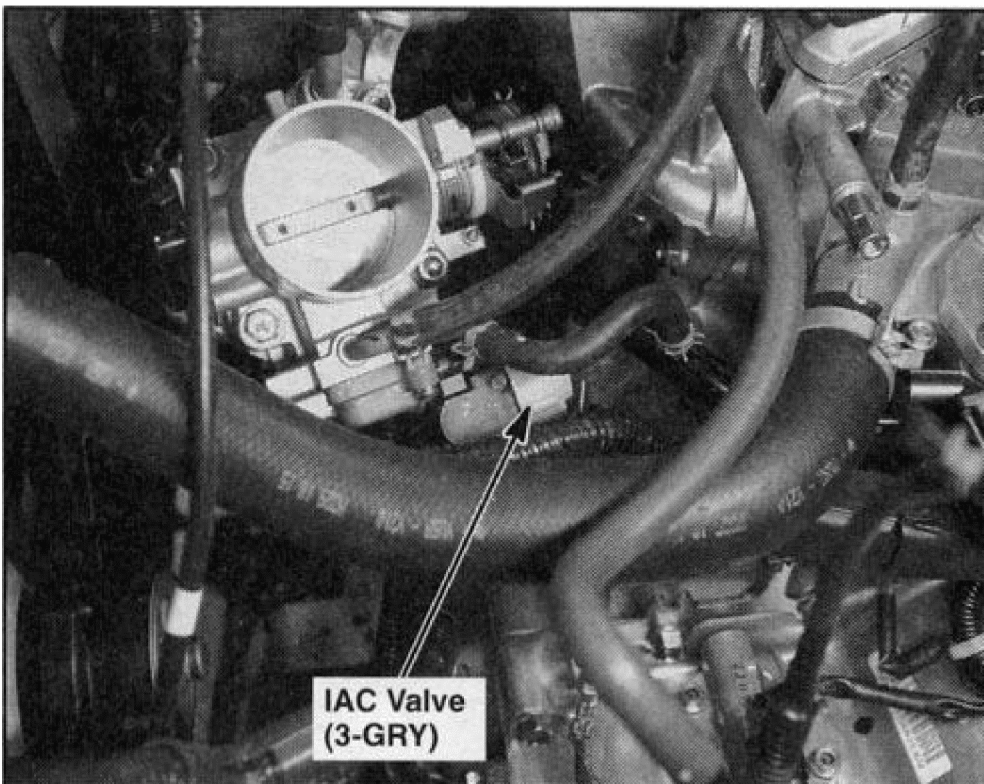

G00268426

Fig. 17: Left Side Of Intake Manifold

Courtesy of AMERICAN HONDA MOTOR CO., INC.

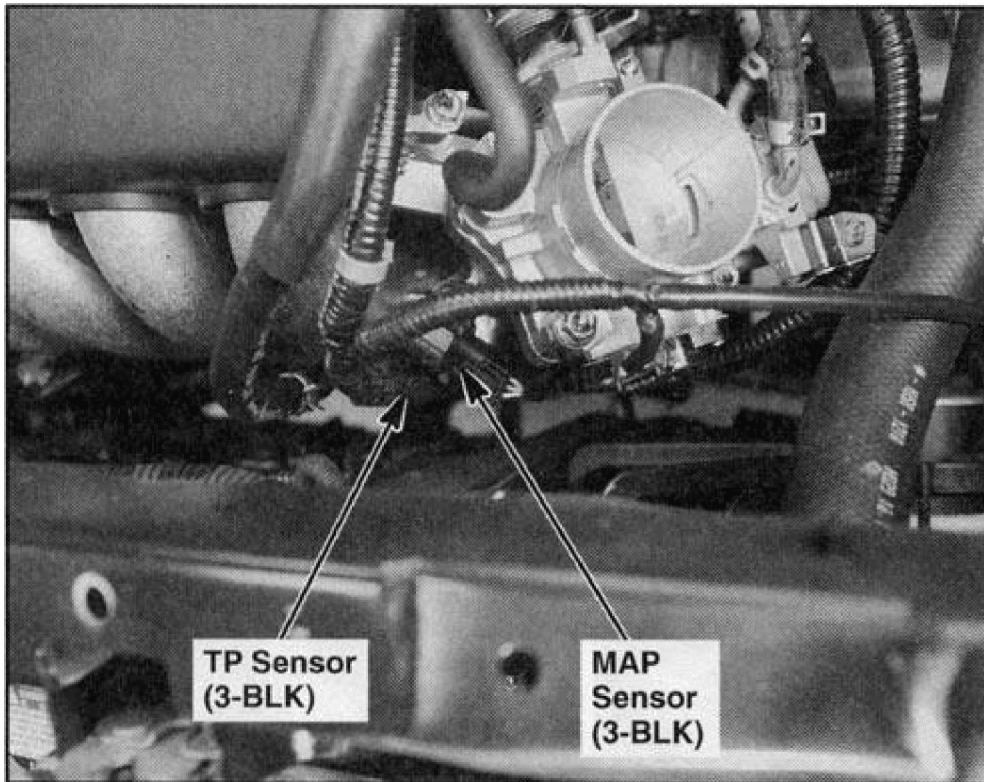

G00268427

Fig. 18: Left Side Of Intake Manifold
Courtesy of AMERICAN HONDA MOTOR CO., INC.

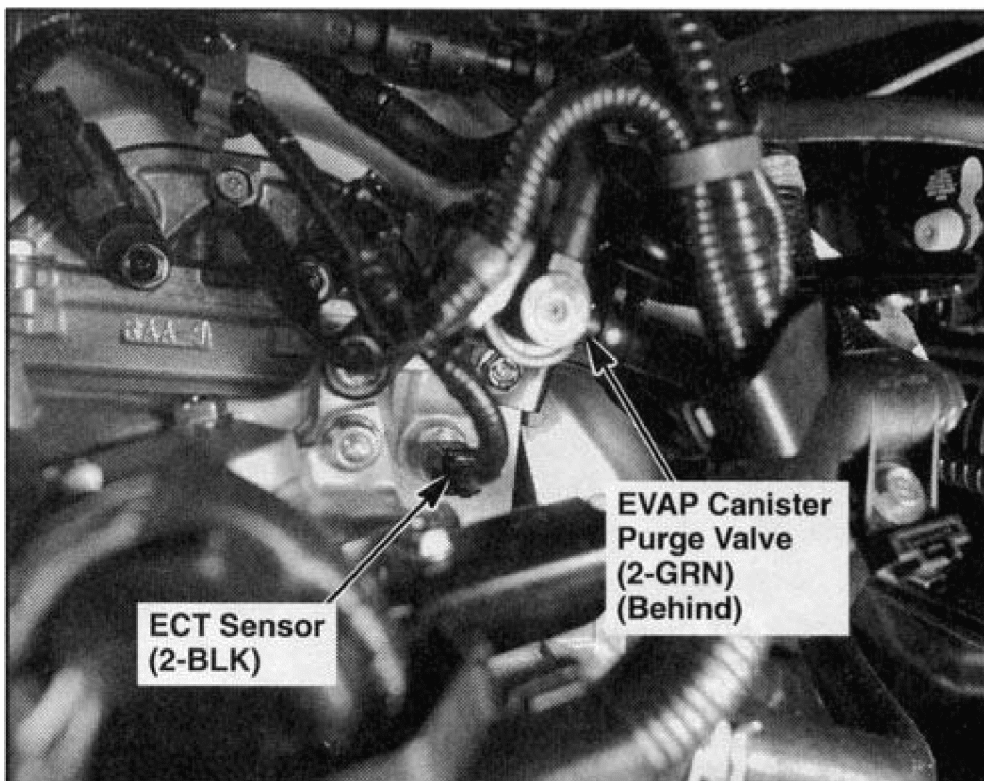

G00268428

Fig. 19: Left Side Of Engine

Courtesy of AMERICAN HONDA MOTOR CO., INC.

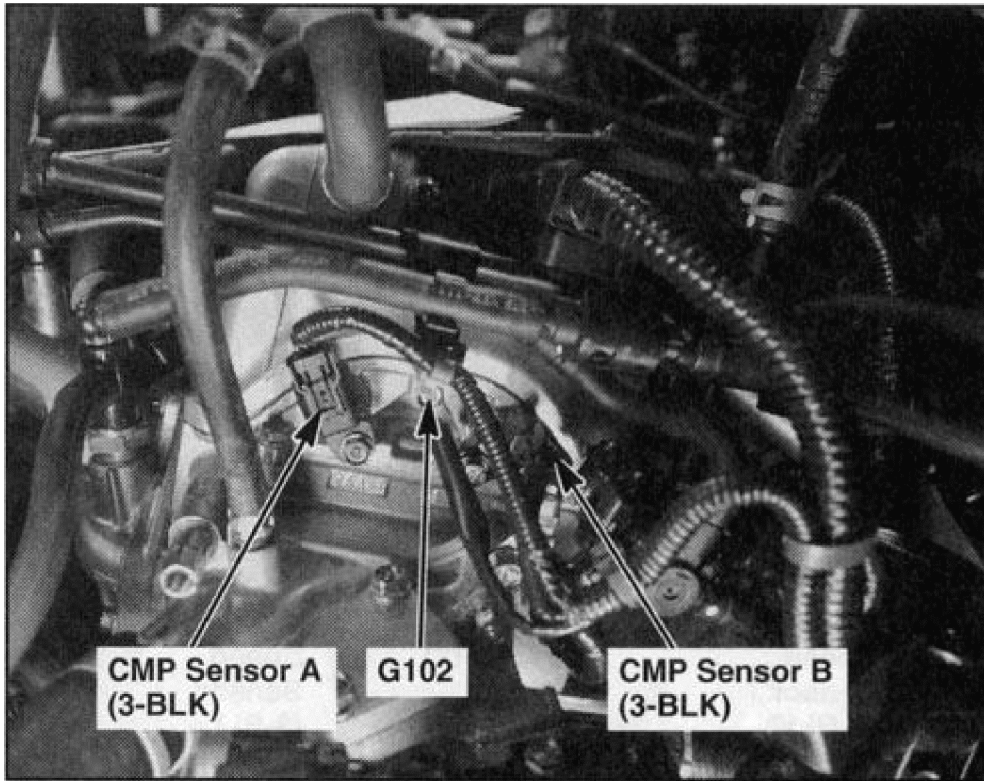

G00268429

Fig. 20: Left Side Of Engine

Courtesy of AMERICAN HONDA MOTOR CO., INC.

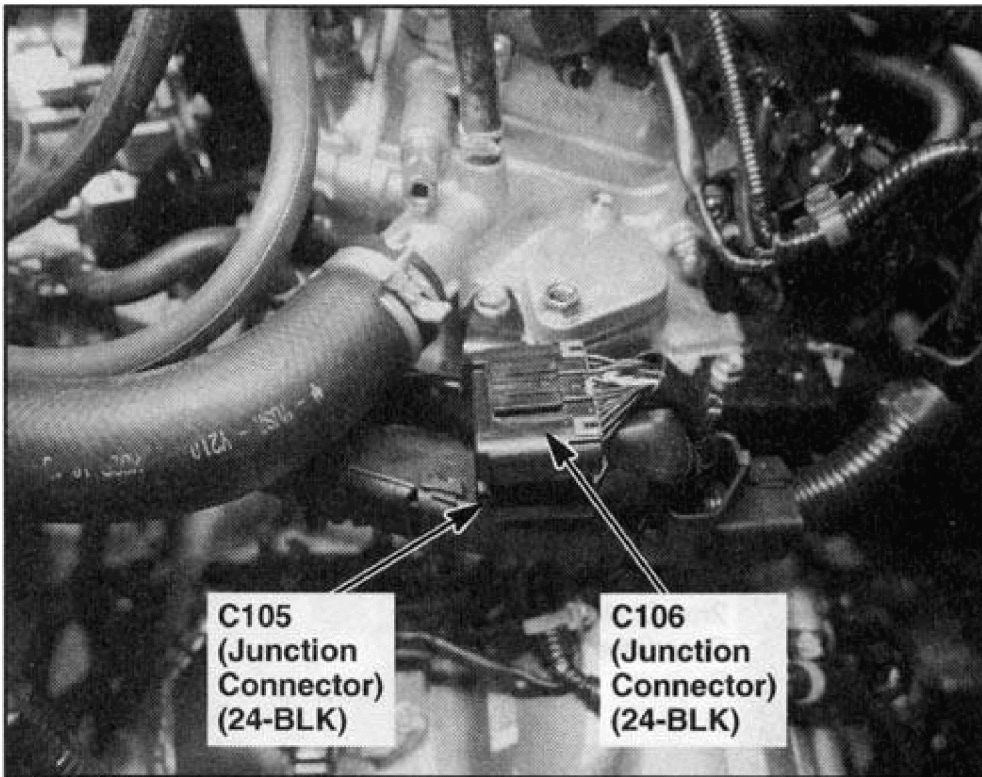

G00268430

Fig. 21: Left Side Of Engine

Courtesy of AMERICAN HONDA MOTOR CO., INC.

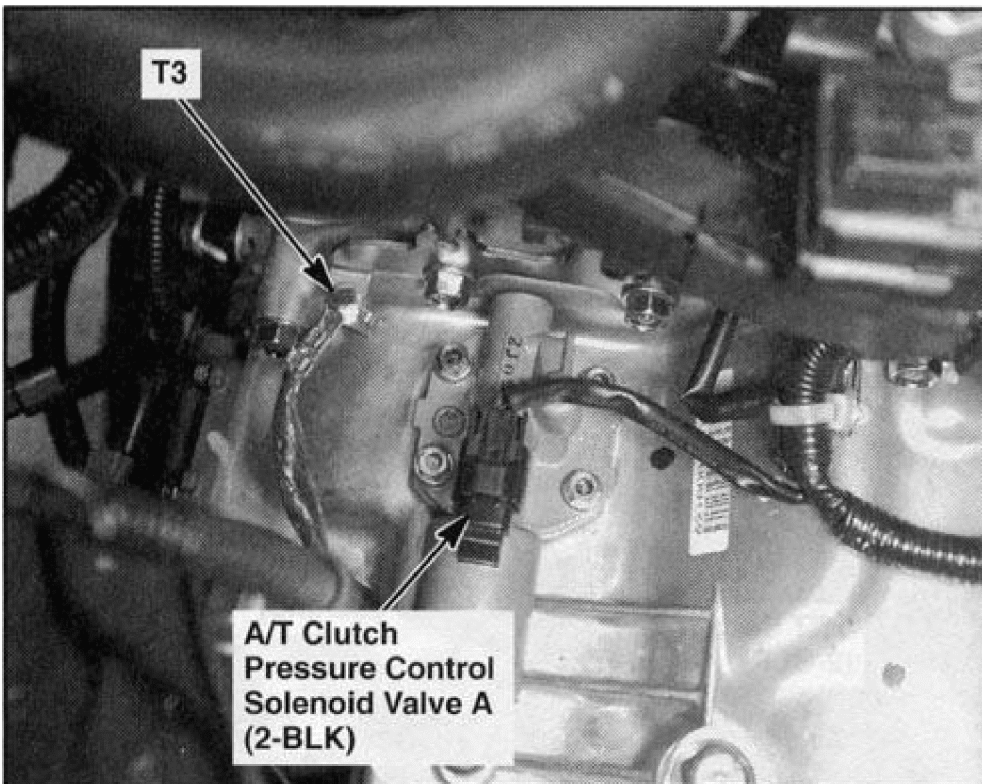

G00268431

Fig. 22: Transmission Housing

Courtesy of AMERICAN HONDA MOTOR CO., INC.

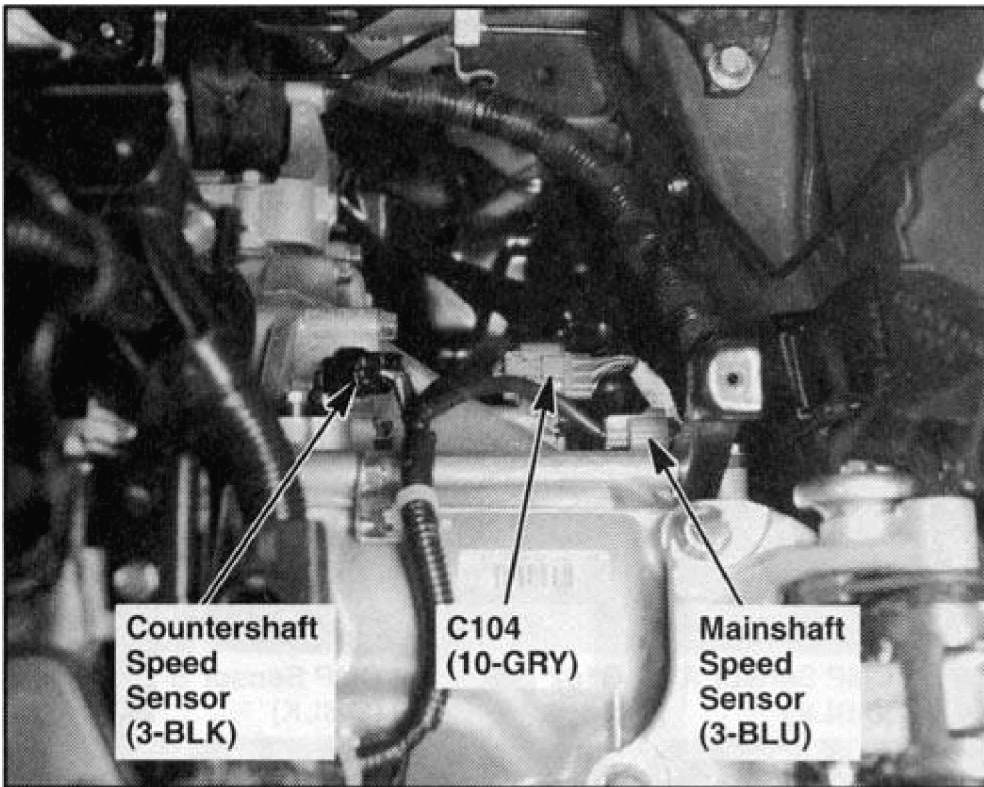

G00268432

Fig. 23: Transmission Housing (A/T)

Courtesy of AMERICAN HONDA MOTOR CO., INC.

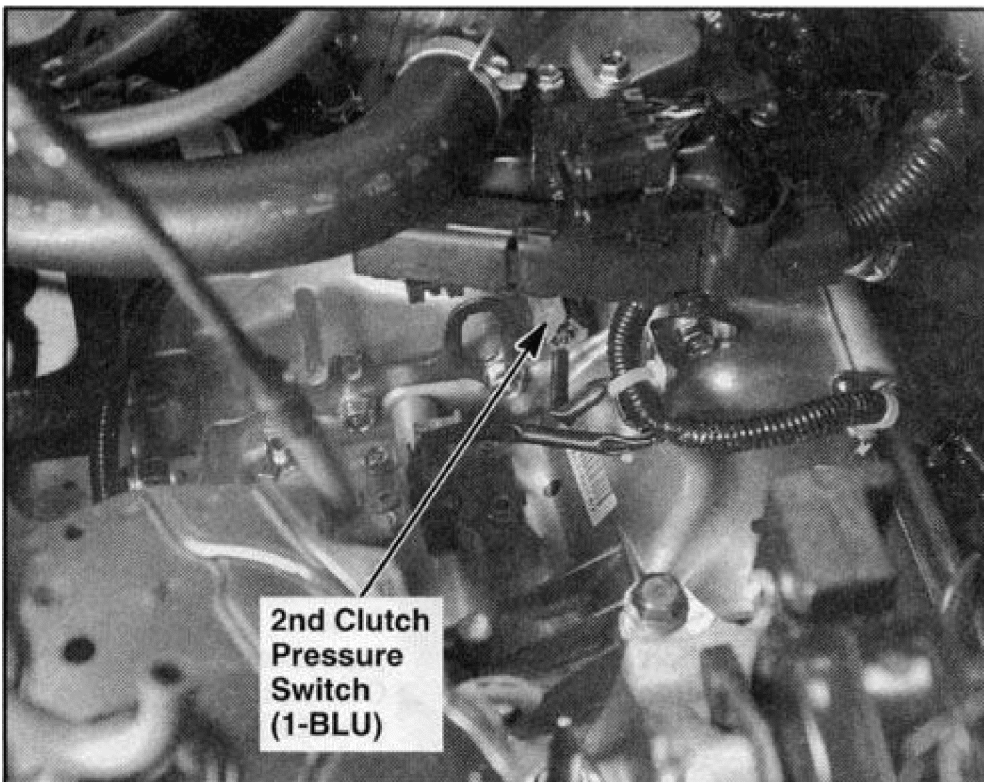

G00268433

Fig. 24: Transmission Housing (A/T)

Courtesy of AMERICAN HONDA MOTOR CO., INC.

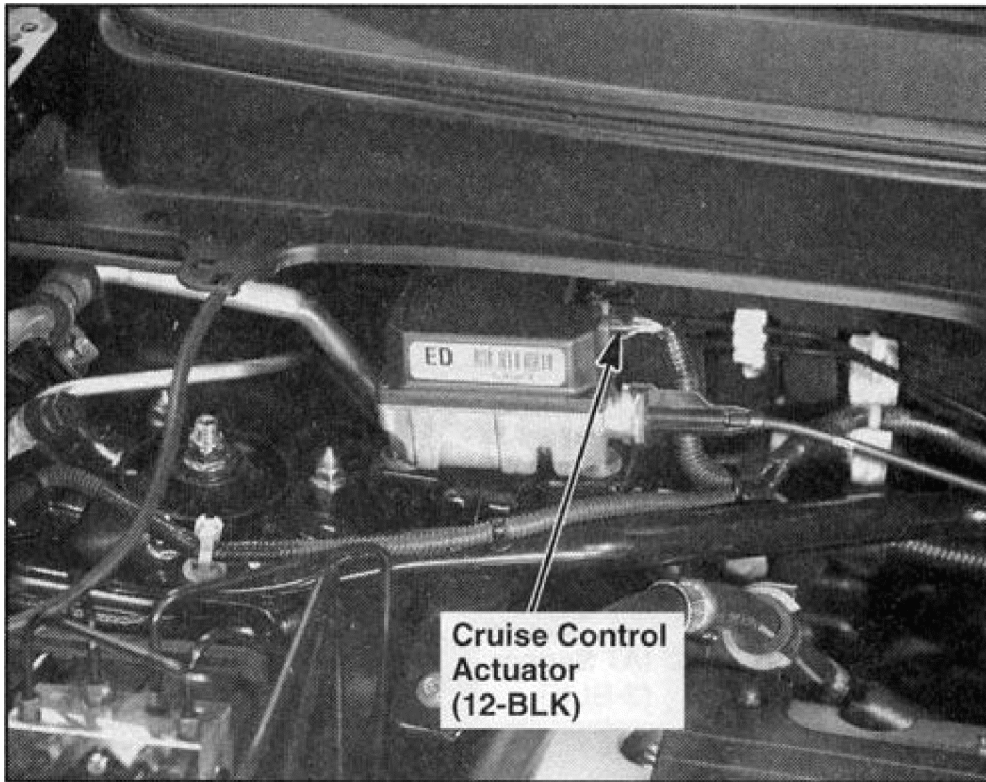

G00268434

Fig. 25: Right Side Of Engine Compartment (EX)
Courtesy of AMERICAN HONDA MOTOR CO., INC.

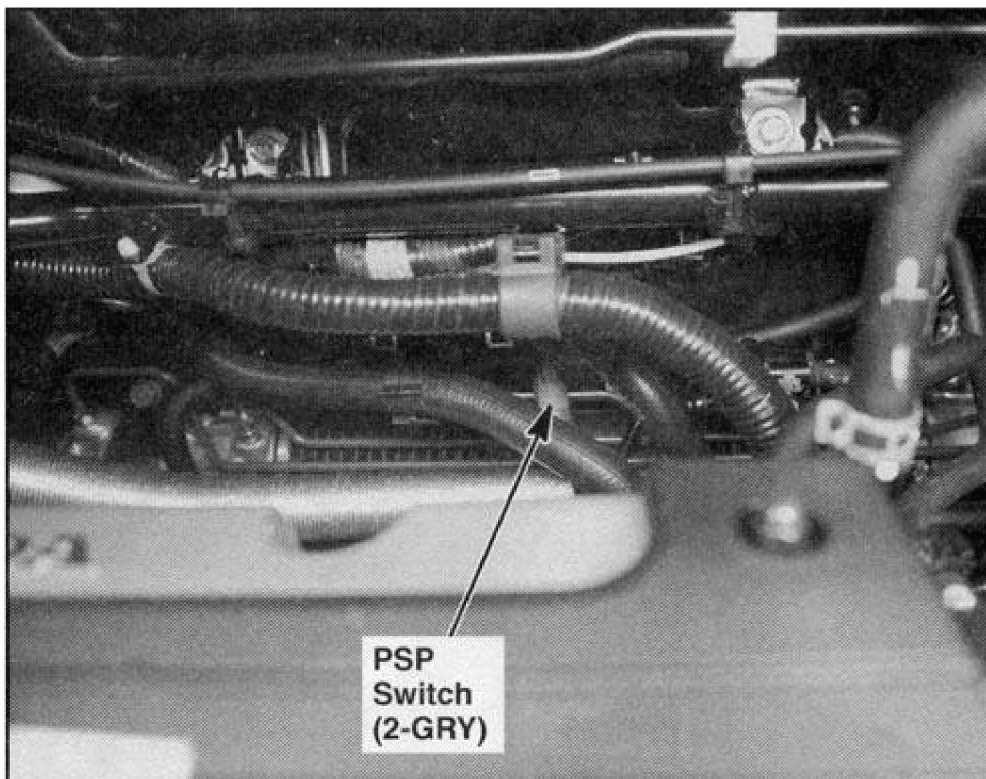

G00268435

Fig. 26: Rear Of Engine Compartment
Courtesy of AMERICAN HONDA MOTOR CO., INC.

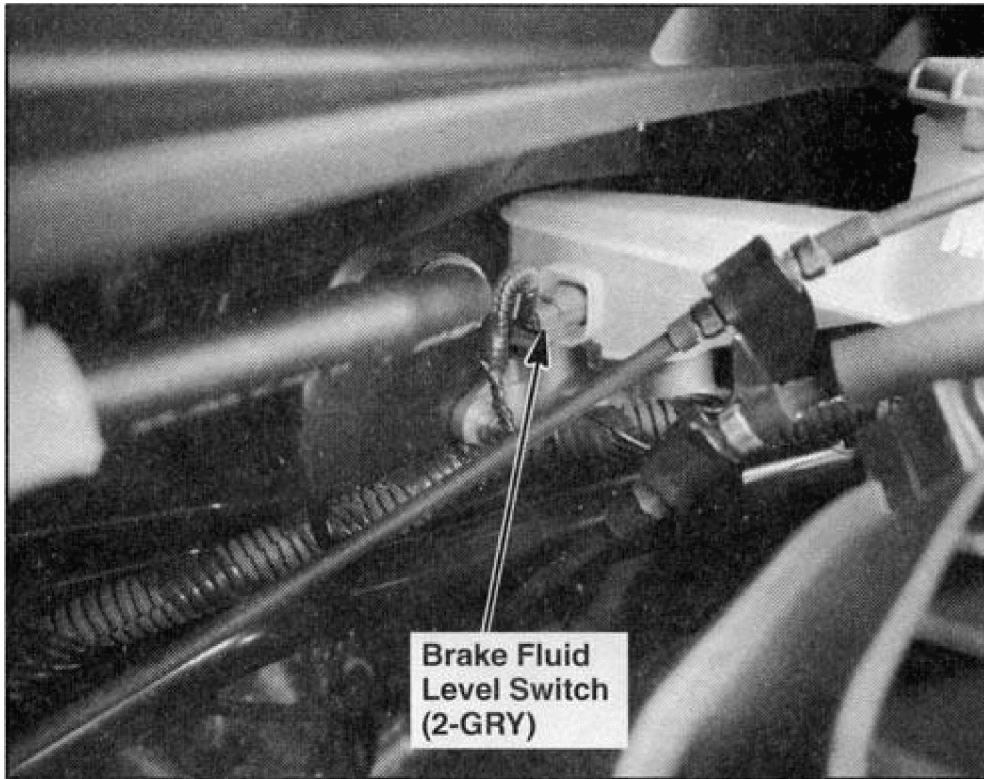

G00268436

Fig. 27: Left Side Of Engine Compartment
Courtesy of AMERICAN HONDA MOTOR CO., INC.

2004 Honda Element DX

2004 HONDA Element

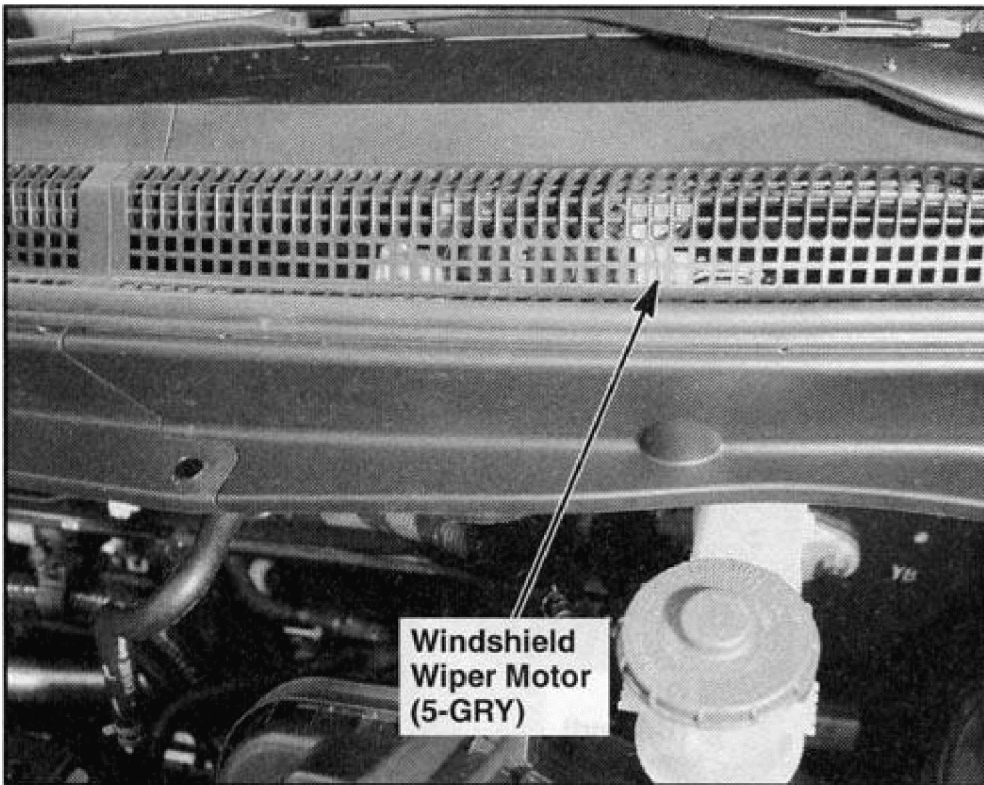

Windshield
Wiper Motor
(5-GRY)

G00268437

Fig. 28: Under Left Side Of Cowl Cover
Courtesy of AMERICAN HONDA MOTOR CO., INC.

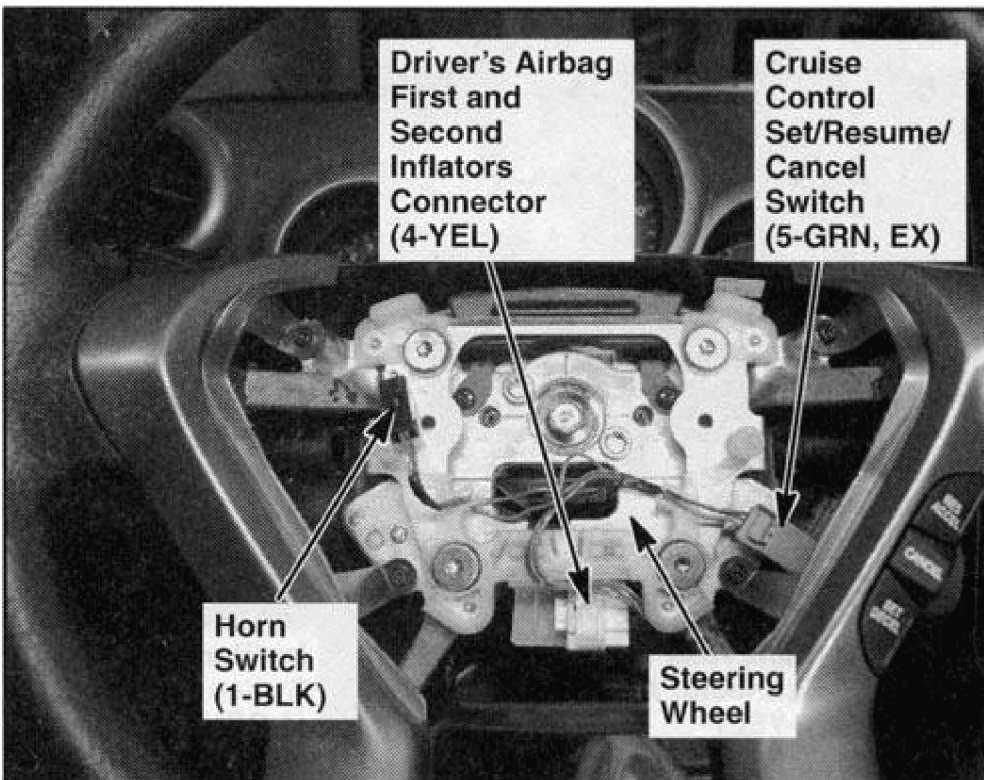

Driver's Airbag
First and
Second
Inflators
Connector
(4-YEL)

Cruise
Control
Set/Resume/
Cancel
Switch
(5-GRN, EX)

Horn
Switch
(1-BLK)

Steering
Wheel

G00268439

Fig. 29: Inside Steering Wheel

Courtesy of AMERICAN HONDA MOTOR CO., INC.

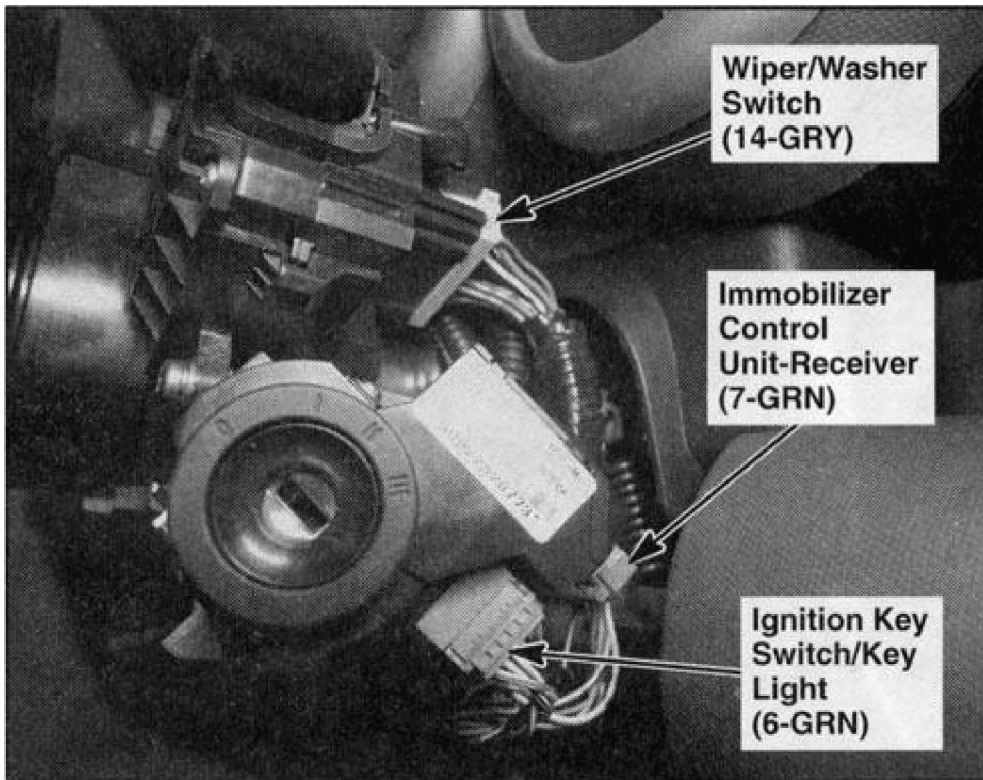

G00268440

Fig. 30: In Steering Column Cover
Courtesy of AMERICAN HONDA MOTOR CO., INC.

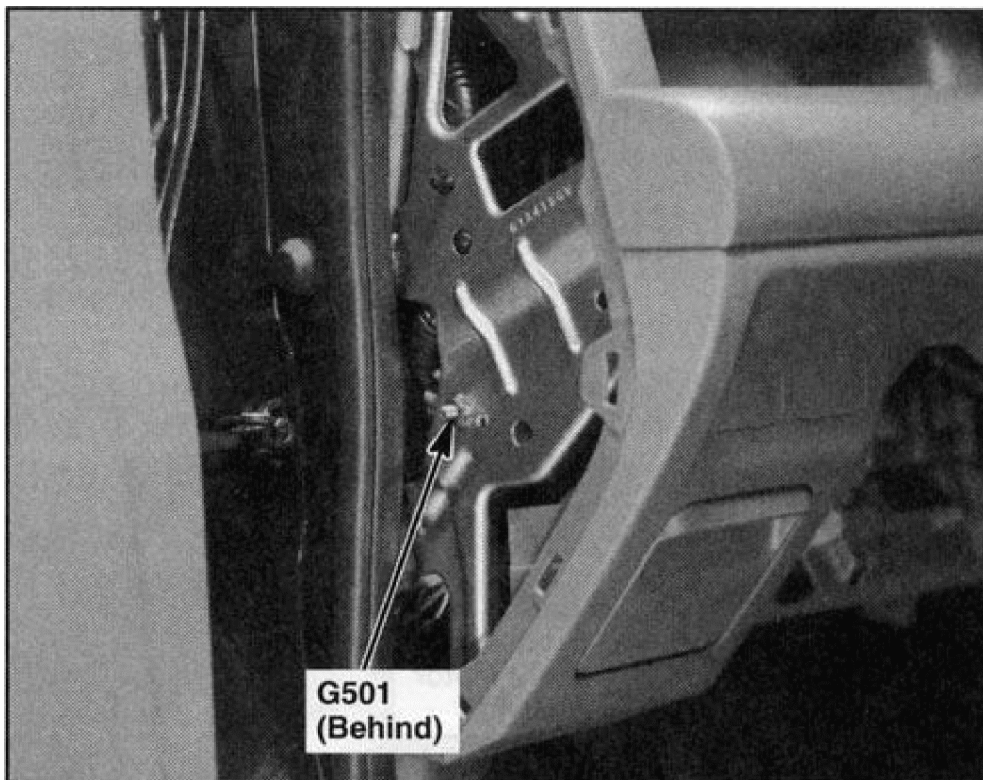

G00268441

Fig. 31: Behind Left Side Of Dash
Courtesy of AMERICAN HONDA MOTOR CO., INC.

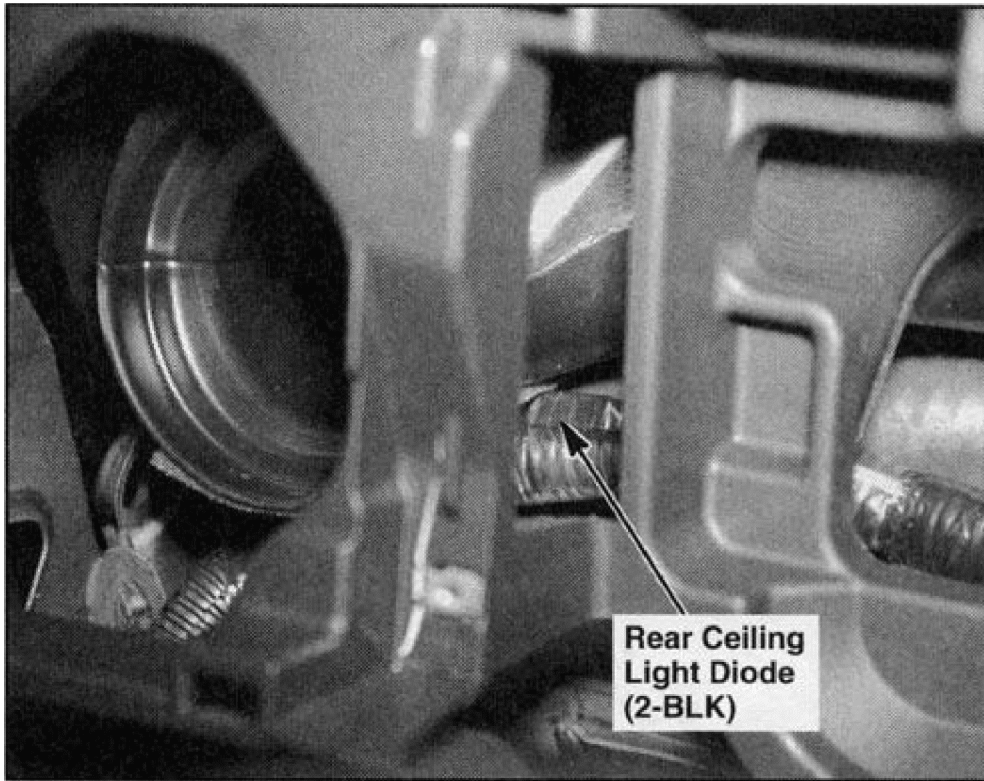

G00268442

Fig. 32: Behind Left Side Of Dash
Courtesy of AMERICAN HONDA MOTOR CO., INC.

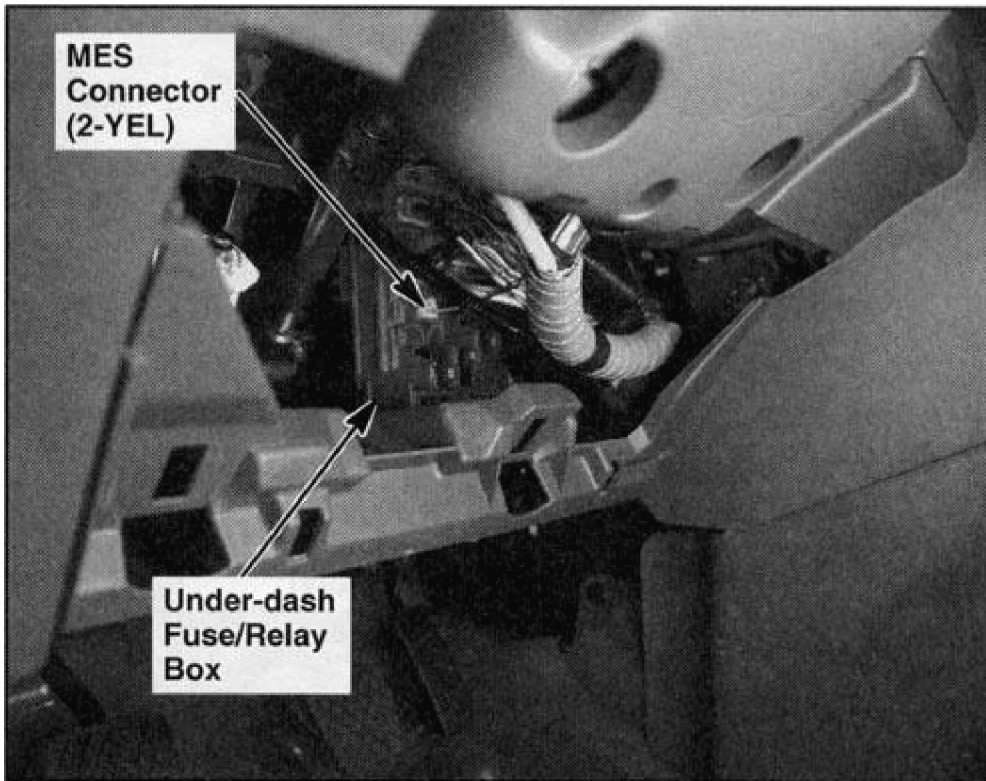

G00268443

Fig. 33: Under Left Side Of Dash
Courtesy of AMERICAN HONDA MOTOR CO., INC.



G00268444

Fig. 34: Behind Right Side Of Dash

Courtesy of AMERICAN HONDA MOTOR CO., INC.

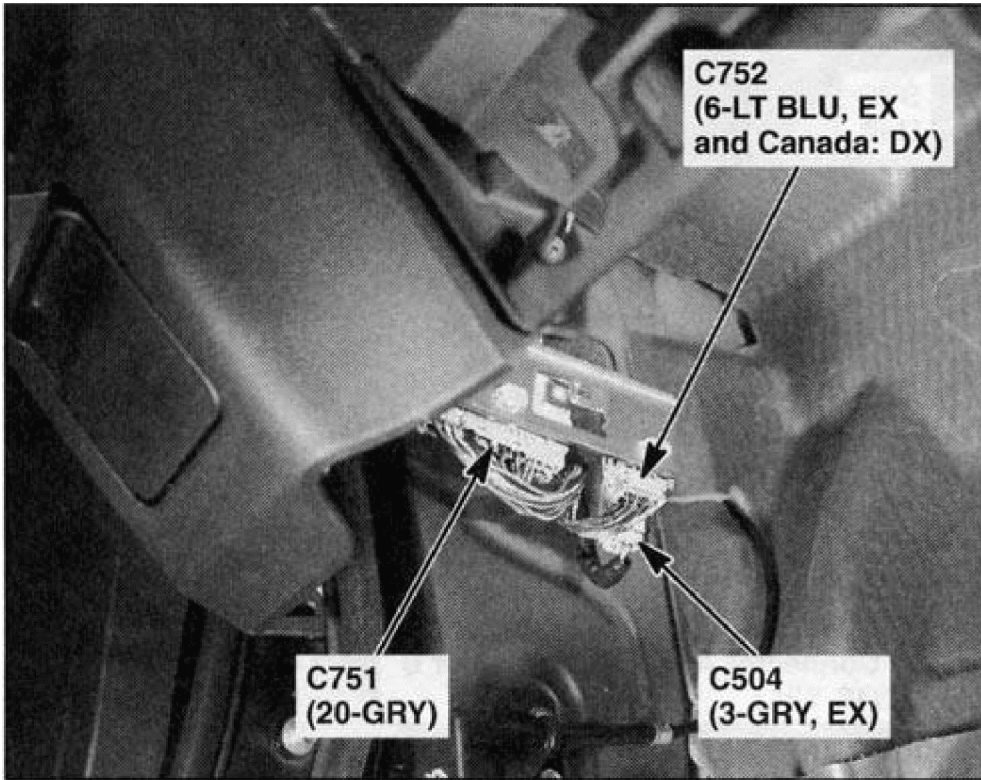

G00268445

Fig. 35: Under Left Side Of Dash

Courtesy of AMERICAN HONDA MOTOR CO., INC.

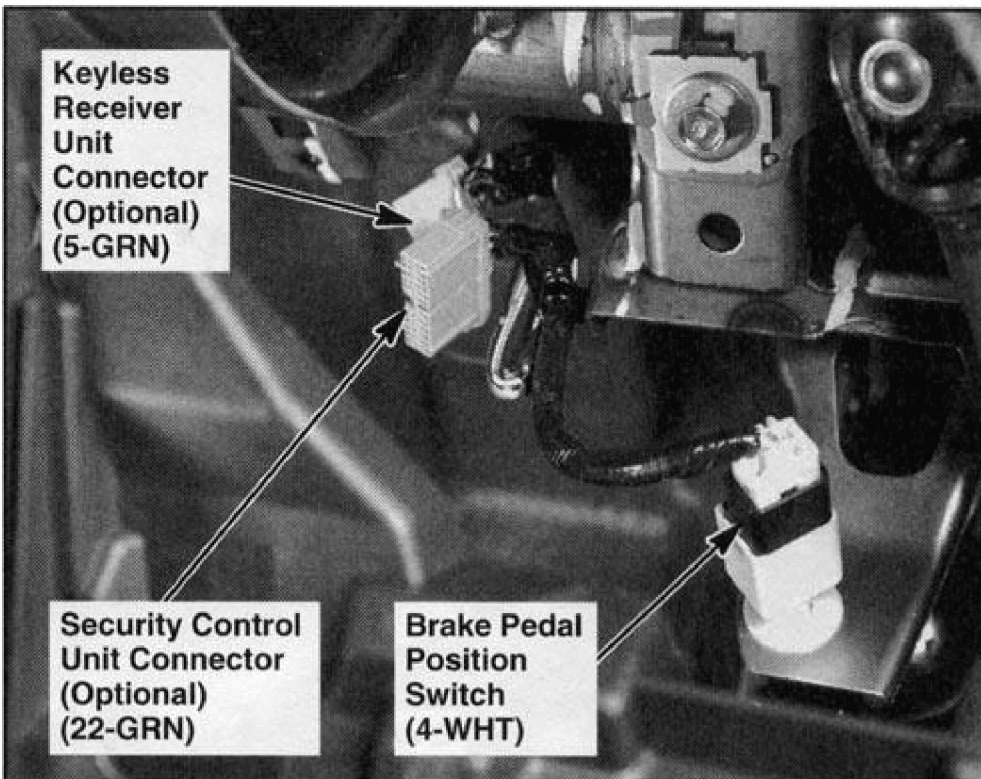

G00268446

Fig. 36: Under Left Side Of Dash
Courtesy of AMERICAN HONDA MOTOR CO., INC.

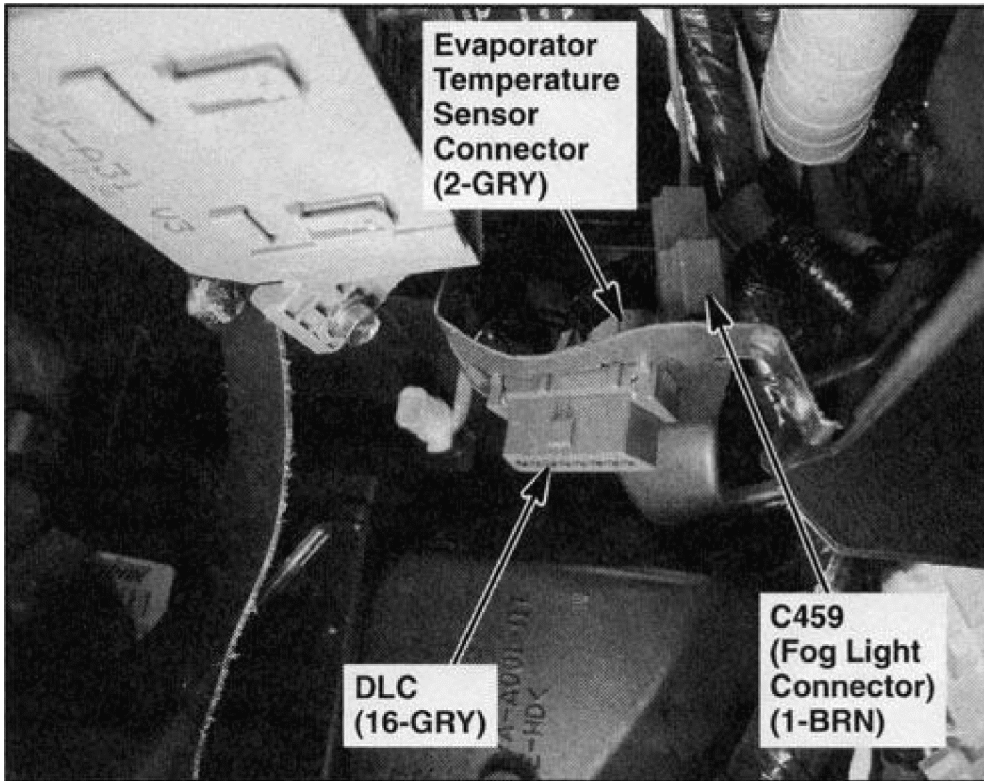

G00268447

Fig. 37: Under Left Side Of Dash
Courtesy of AMERICAN HONDA MOTOR CO., INC.

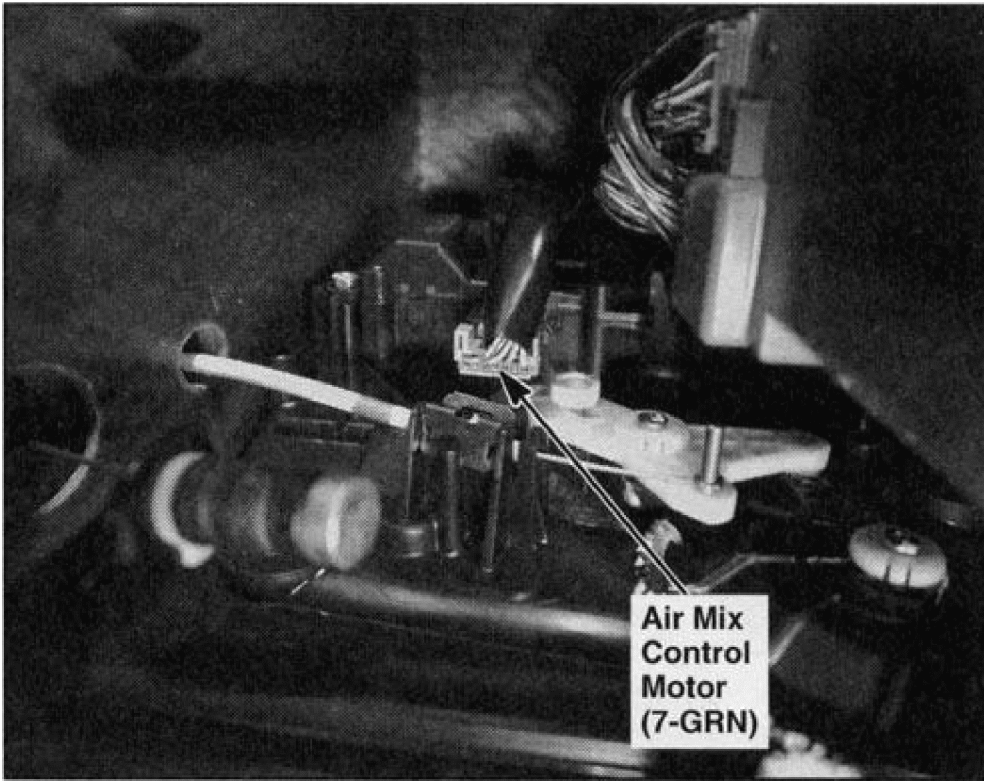

G00268448

Fig. 38: Under Left Side Of Dash
Courtesy of AMERICAN HONDA MOTOR CO., INC.

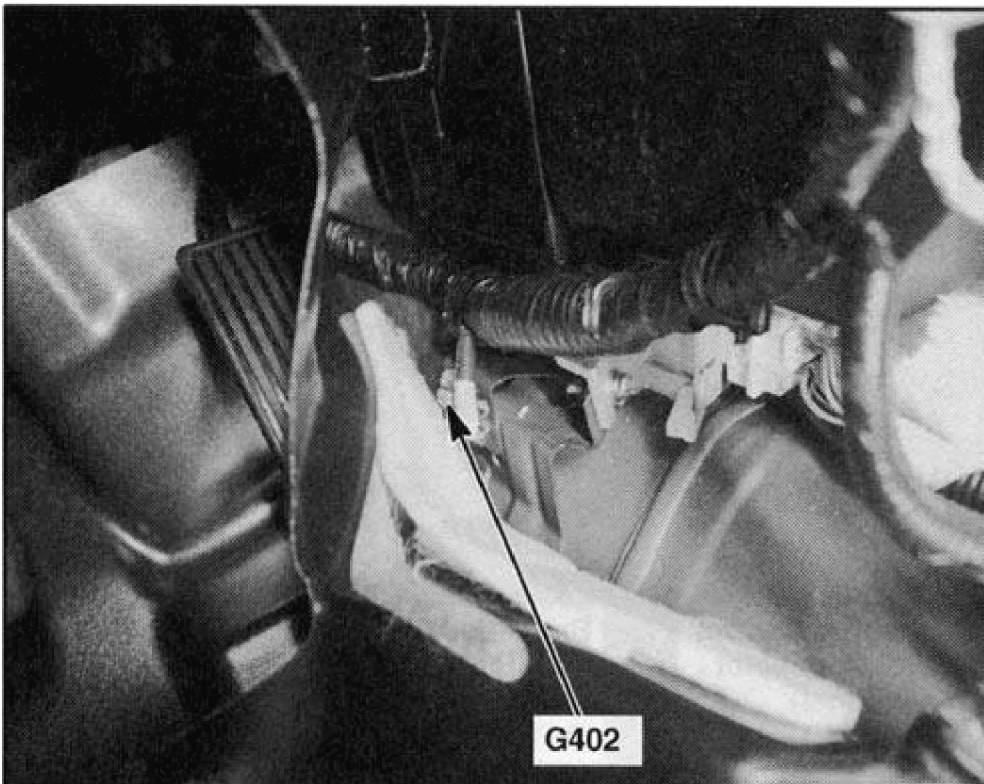

G00268449

Fig. 39: Under Middle Of Dash

Courtesy of AMERICAN HONDA MOTOR CO., INC.

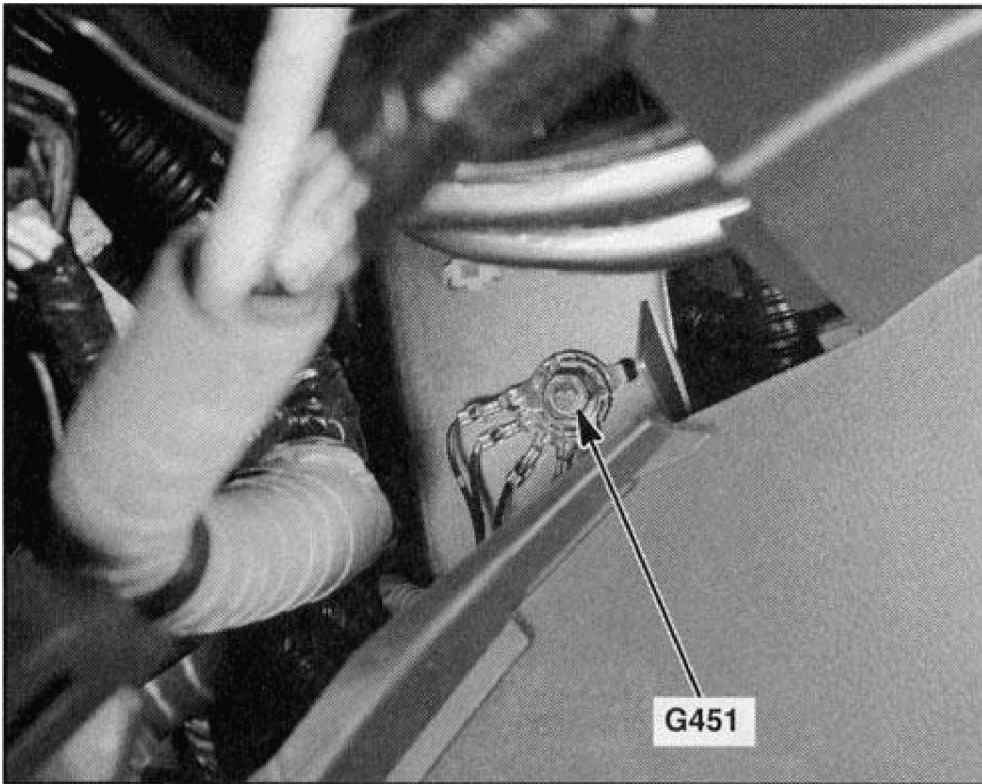

G00268450

Fig. 40: Under Middle Of Dash
Courtesy of AMERICAN HONDA MOTOR CO., INC.

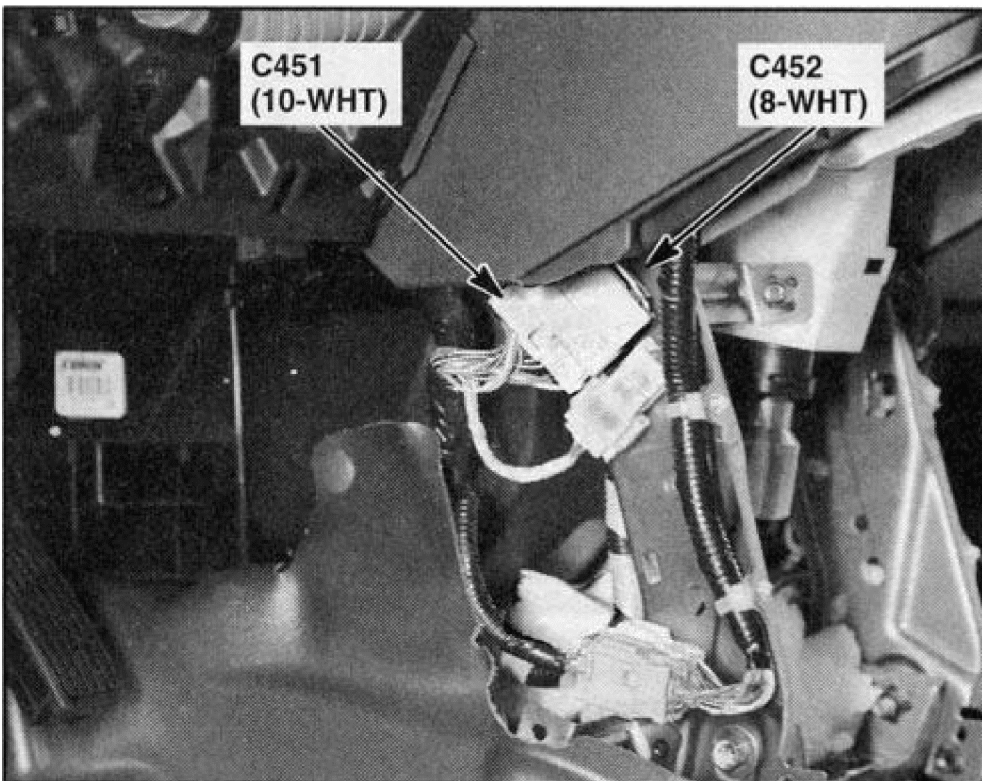

G00268451

Fig. 41: Under Middle Of Dash
Courtesy of AMERICAN HONDA MOTOR CO., INC.

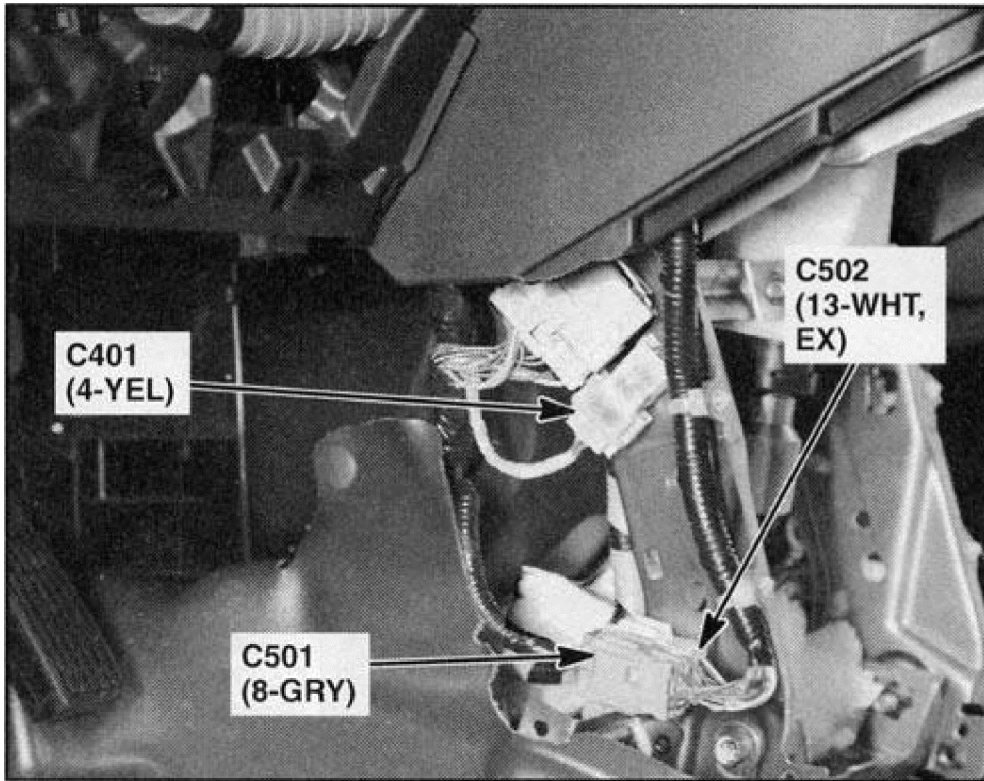

G00268452

Fig. 42: Under Middle Of Dash
Courtesy of AMERICAN HONDA MOTOR CO., INC.

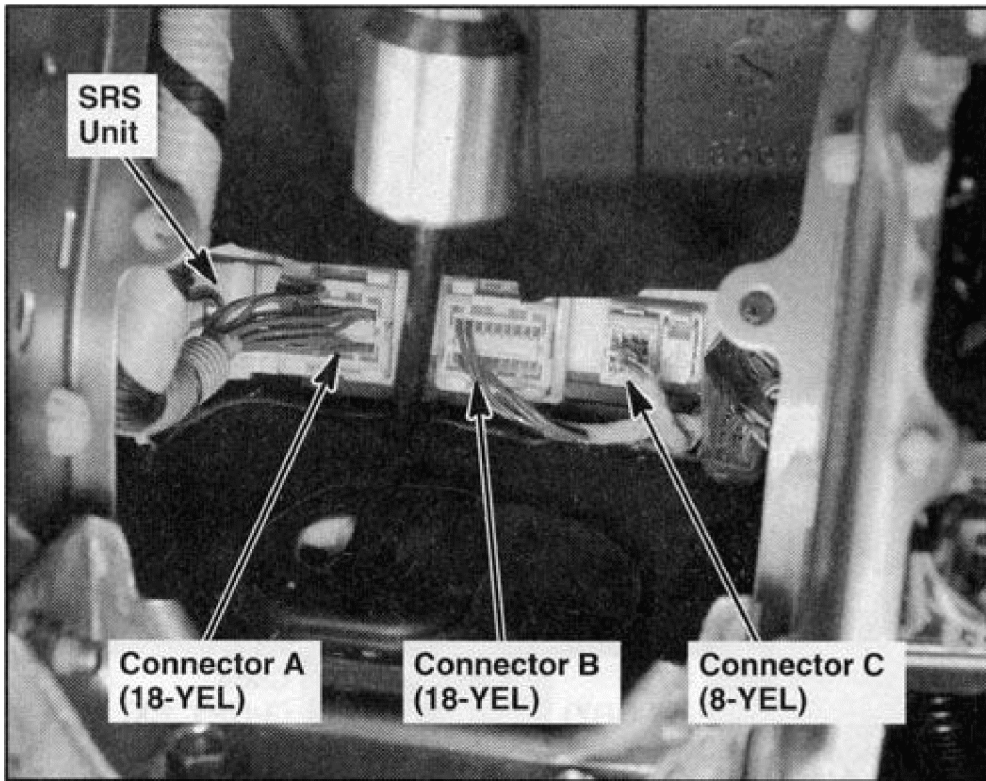

G00268453

Fig. 43: Under Middle Of Dash
Courtesy of AMERICAN HONDA MOTOR CO., INC.



G00268454

Fig. 44: Under Middle Of Dash

Courtesy of AMERICAN HONDA MOTOR CO., INC.

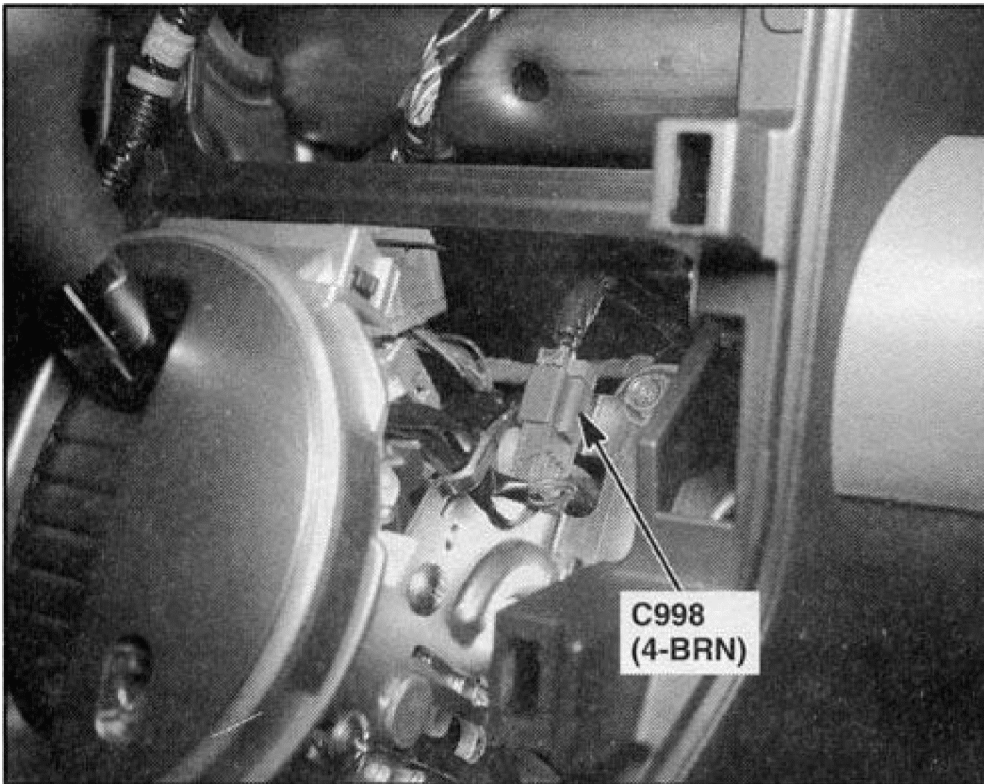

G00268455

Fig. 45: Under Middle Of Dash (A/T)

Courtesy of AMERICAN HONDA MOTOR CO., INC.

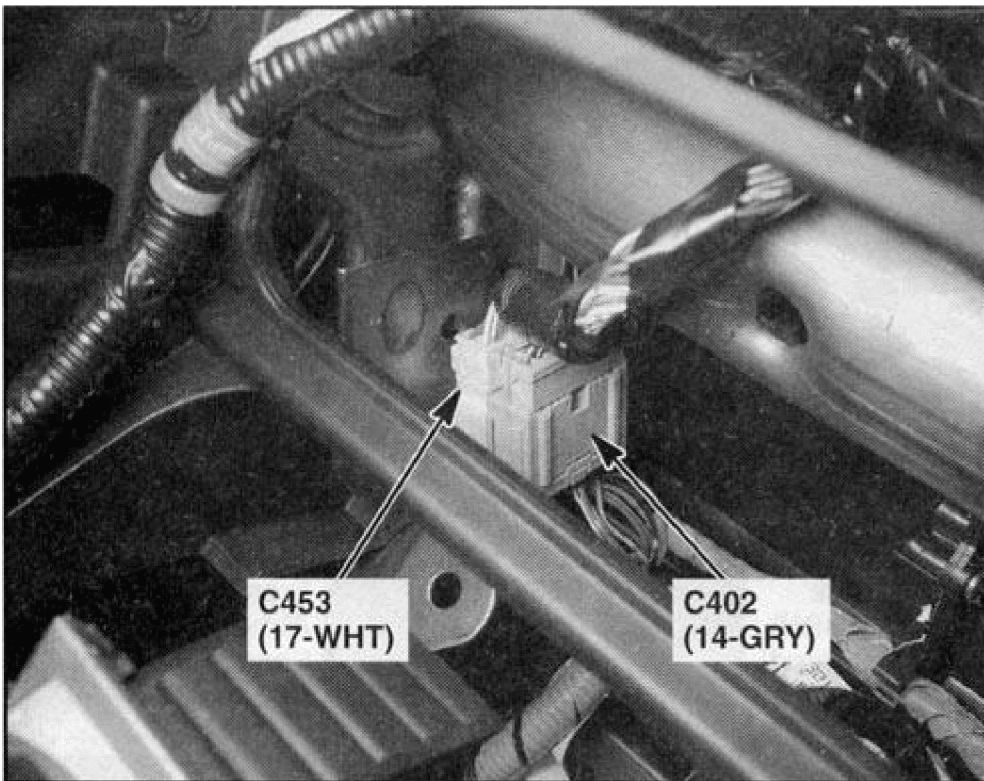

G00268456

Fig. 46: Under Middle Of Dash
Courtesy of AMERICAN HONDA MOTOR CO., INC.

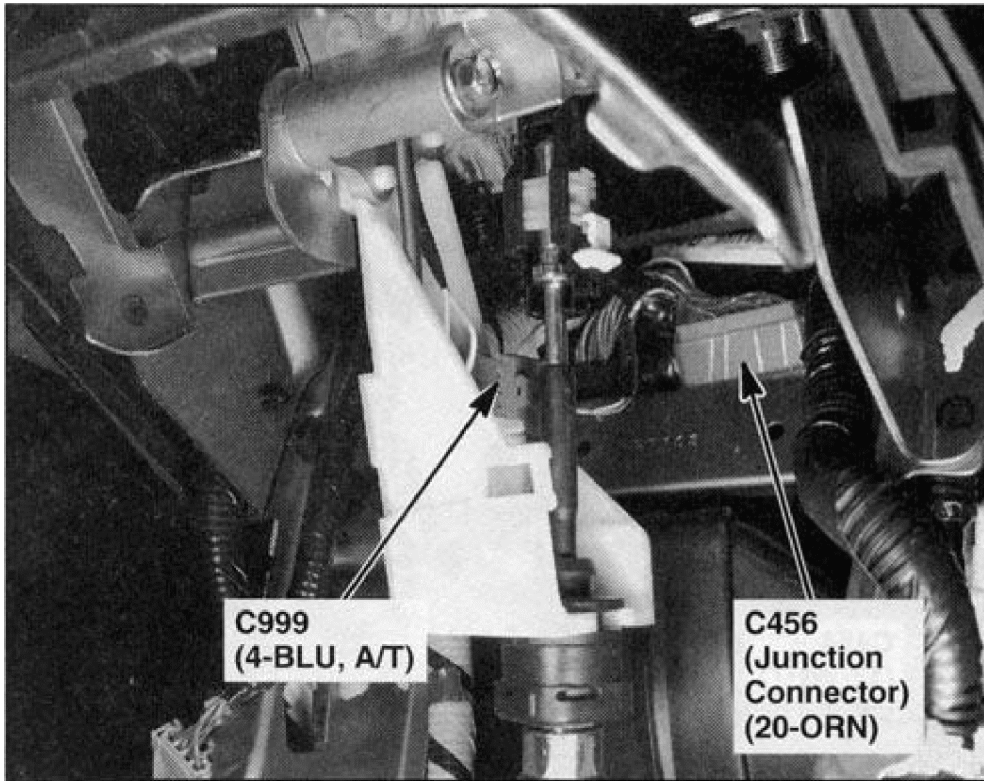

G00268457

Fig. 47: Under Middle Of Dash
Courtesy of AMERICAN HONDA MOTOR CO., INC.

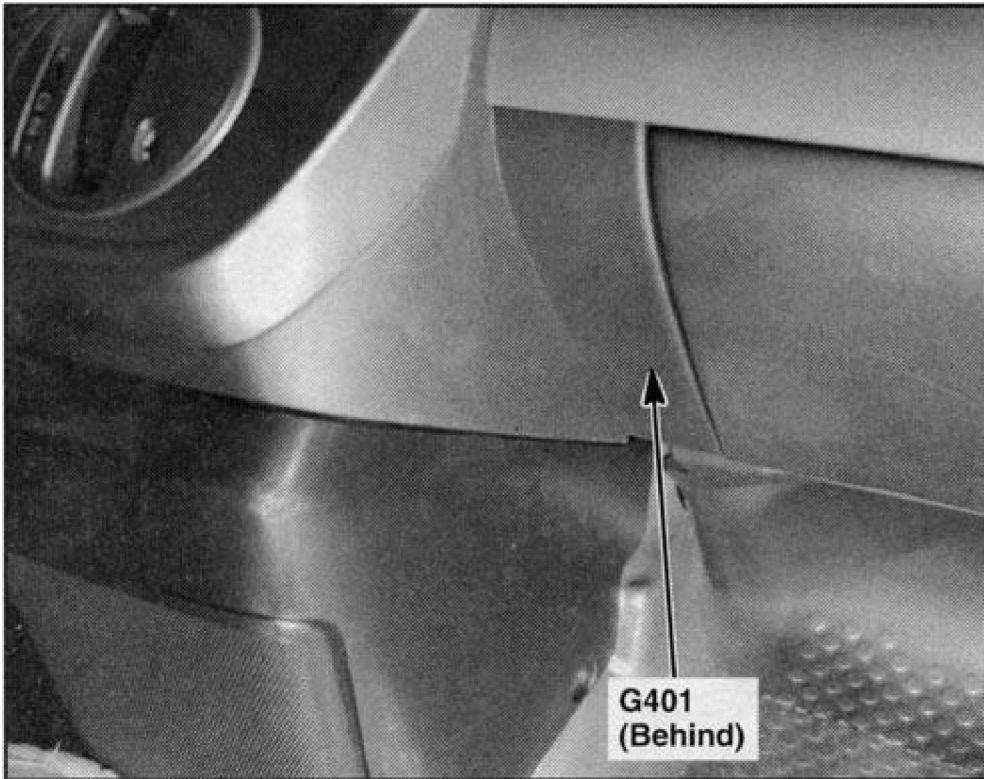

G00268458

Fig. 48: Under Middle Of Dash

Courtesy of AMERICAN HONDA MOTOR CO., INC.

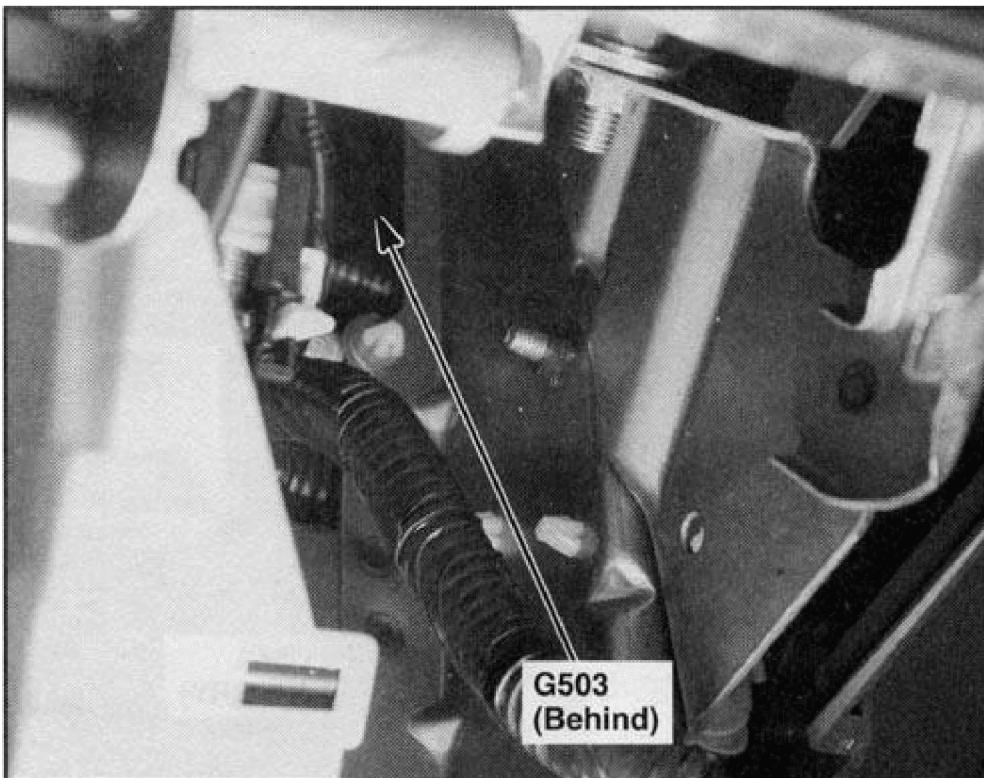

G00268459

Fig. 49: Under Middle Of Dash

Courtesy of AMERICAN HONDA MOTOR CO., INC.

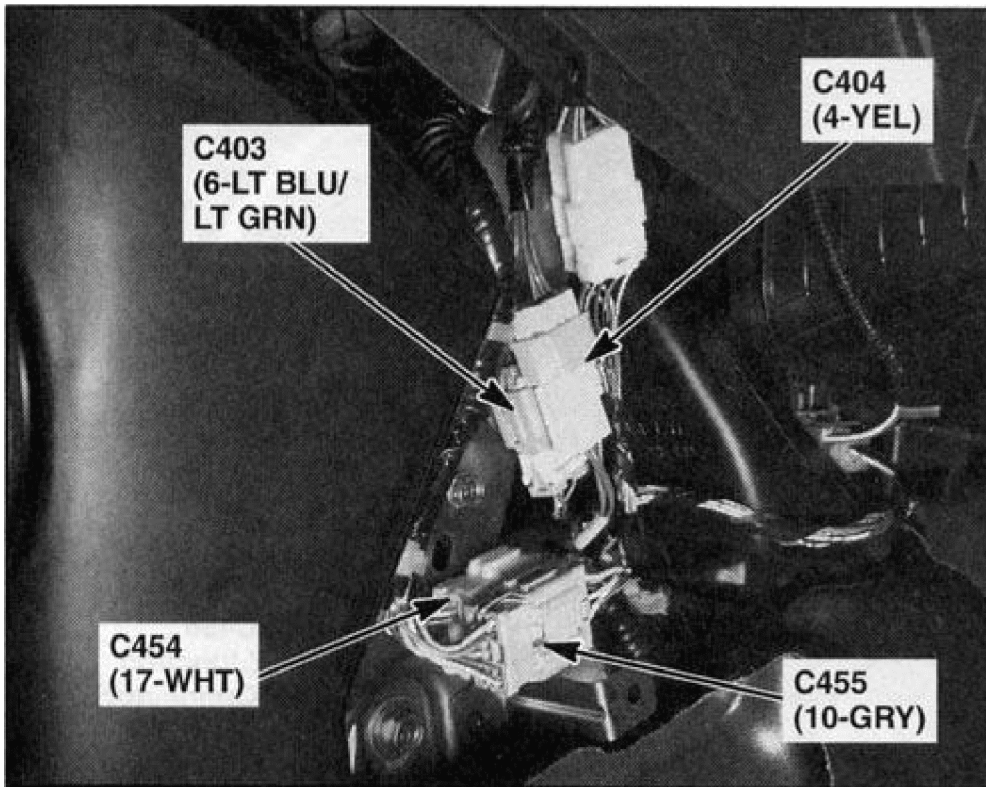

G00268460

Fig. 50: Under Middle Of Dash

Courtesy of AMERICAN HONDA MOTOR CO., INC.

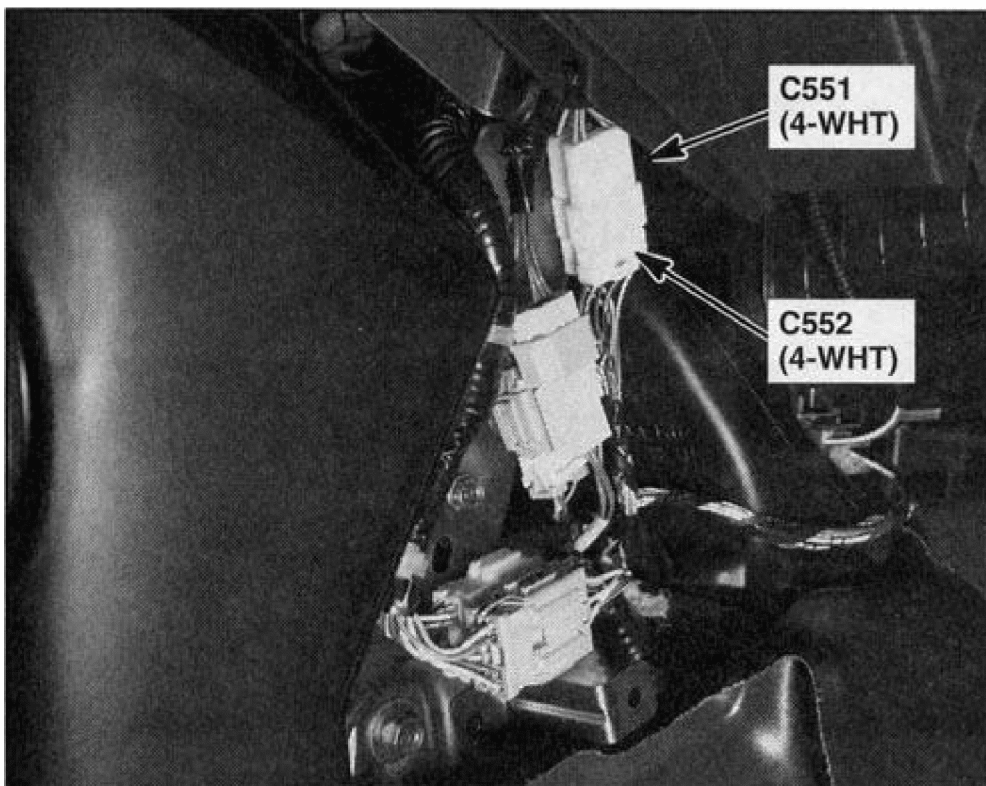

G00268461

Fig. 51: Under Middle Of Dash

Courtesy of AMERICAN HONDA MOTOR CO., INC.

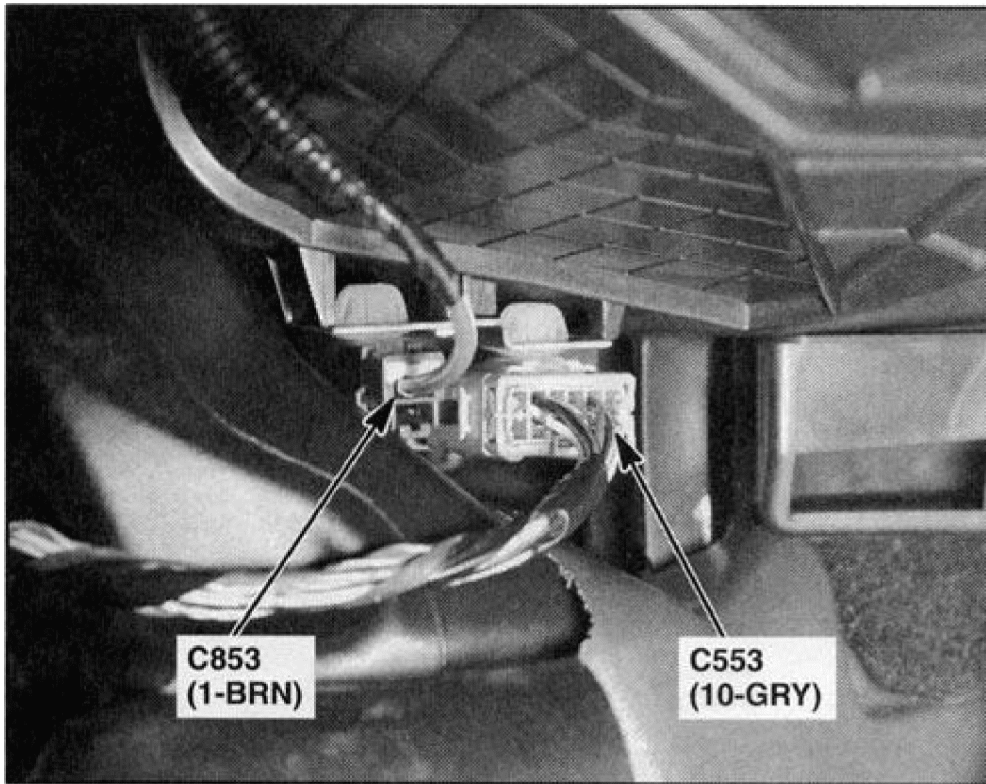

G00268462

Fig. 52: Under Middle Of Dash

Courtesy of AMERICAN HONDA MOTOR CO., INC.

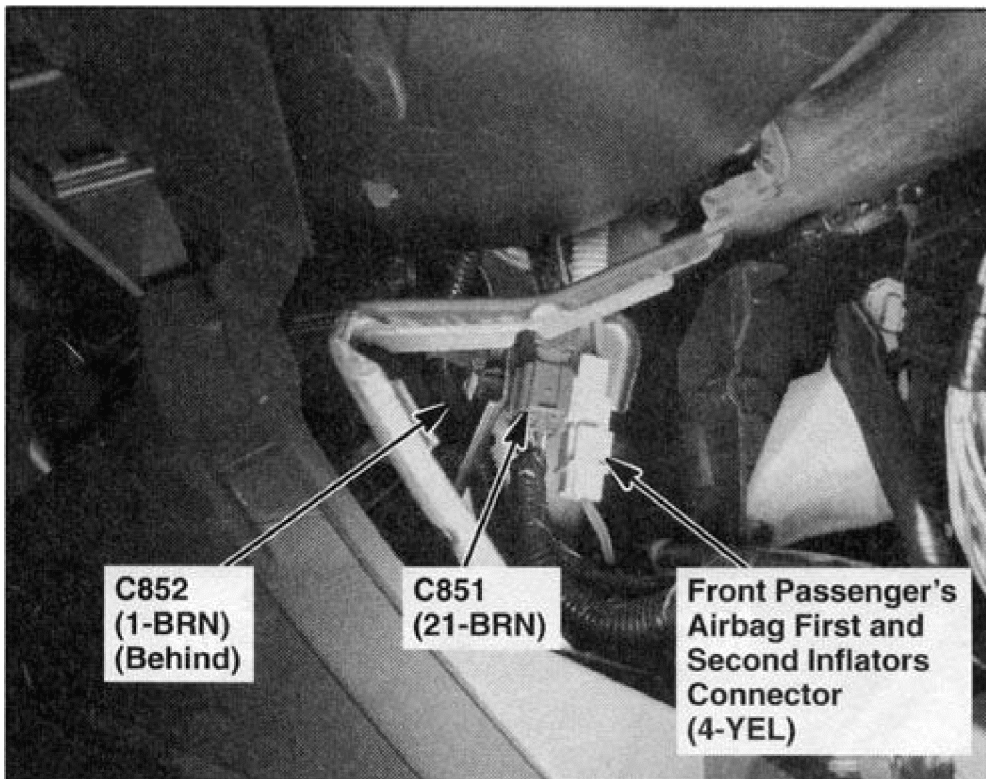

G00268463

Fig. 53: Behind Glove Box

Courtesy of AMERICAN HONDA MOTOR CO., INC.

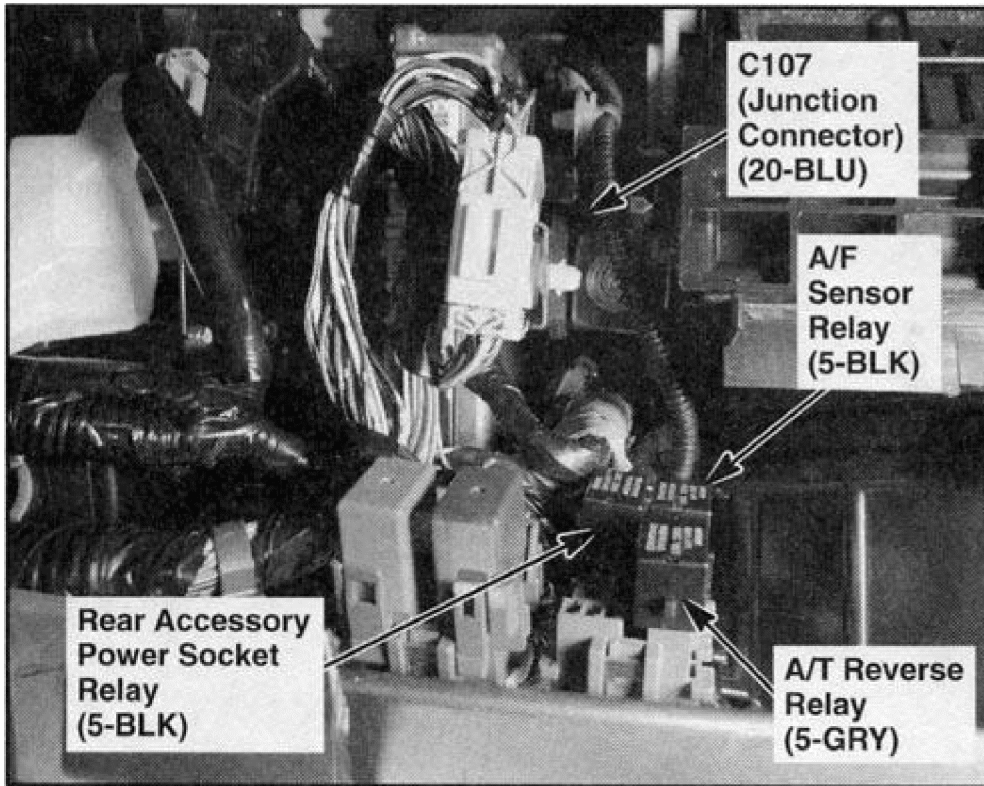

G00268464

Fig. 54: Behind Glove Box

Courtesy of AMERICAN HONDA MOTOR CO., INC.

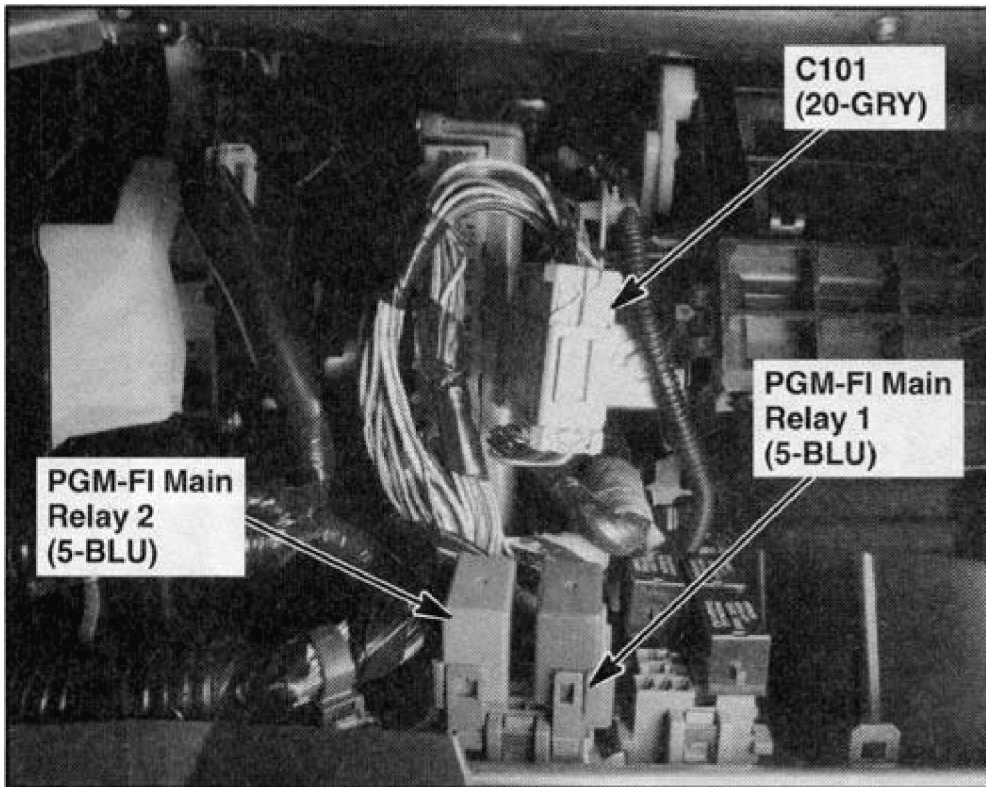

G00268465

Fig. 55: Behind Glove Box

Courtesy of AMERICAN HONDA MOTOR CO., INC.

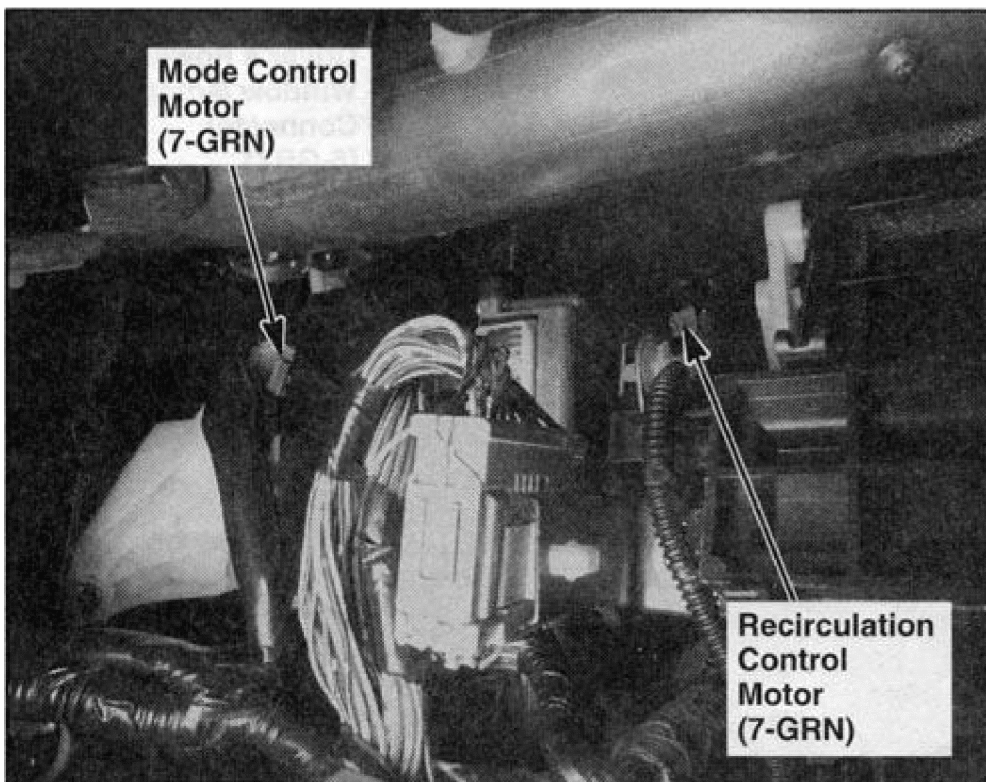

G00268466

Fig. 56: Behind Glove Box

Courtesy of AMERICAN HONDA MOTOR CO., INC.

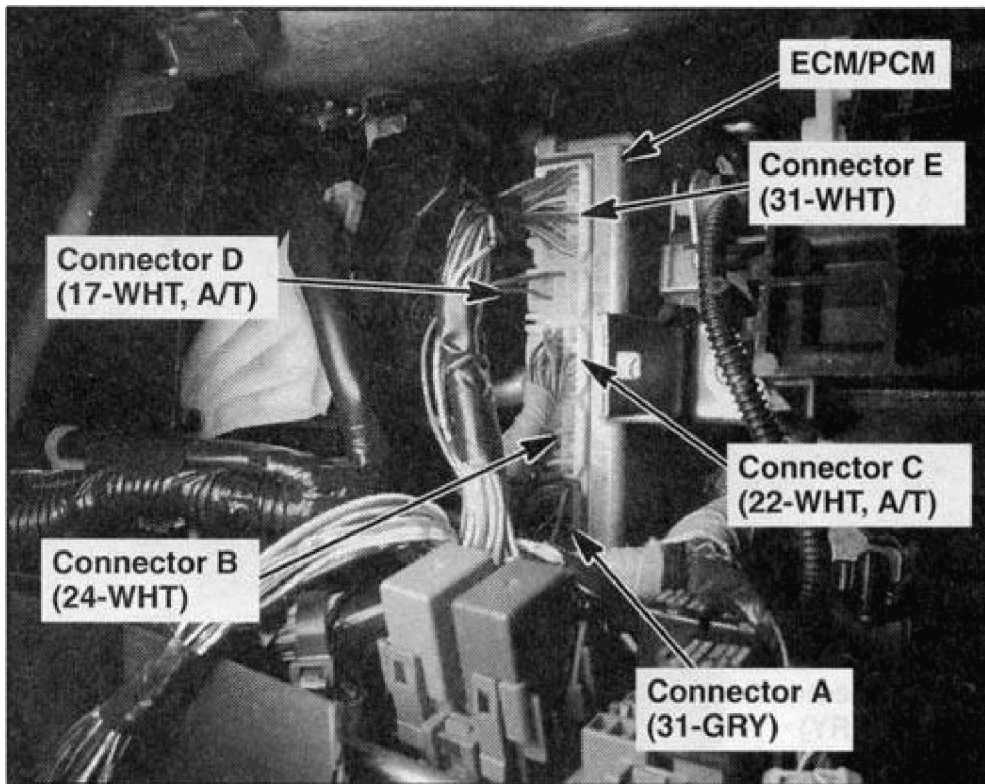

G00268467

Fig. 57: Behind Glove Box

Courtesy of AMERICAN HONDA MOTOR CO., INC.



G00268468

Fig. 58: Under Right Side Of Dash
Courtesy of AMERICAN HONDA MOTOR CO., INC.

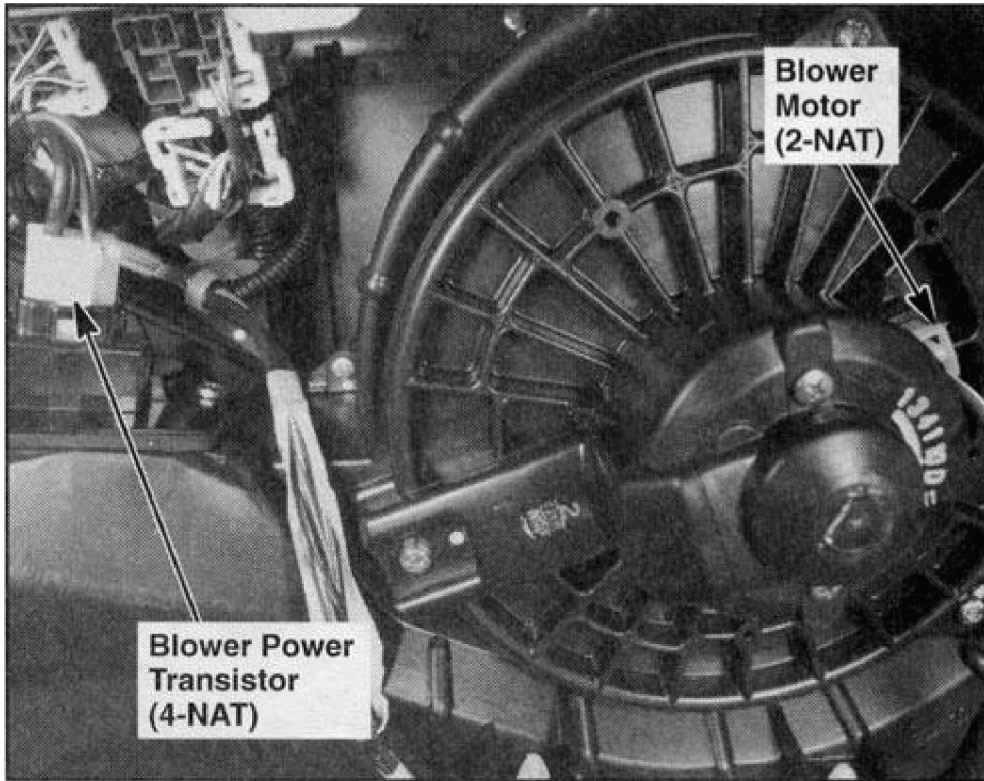

G00268469

Fig. 59: Under Right Side Of Dash
Courtesy of AMERICAN HONDA MOTOR CO., INC.

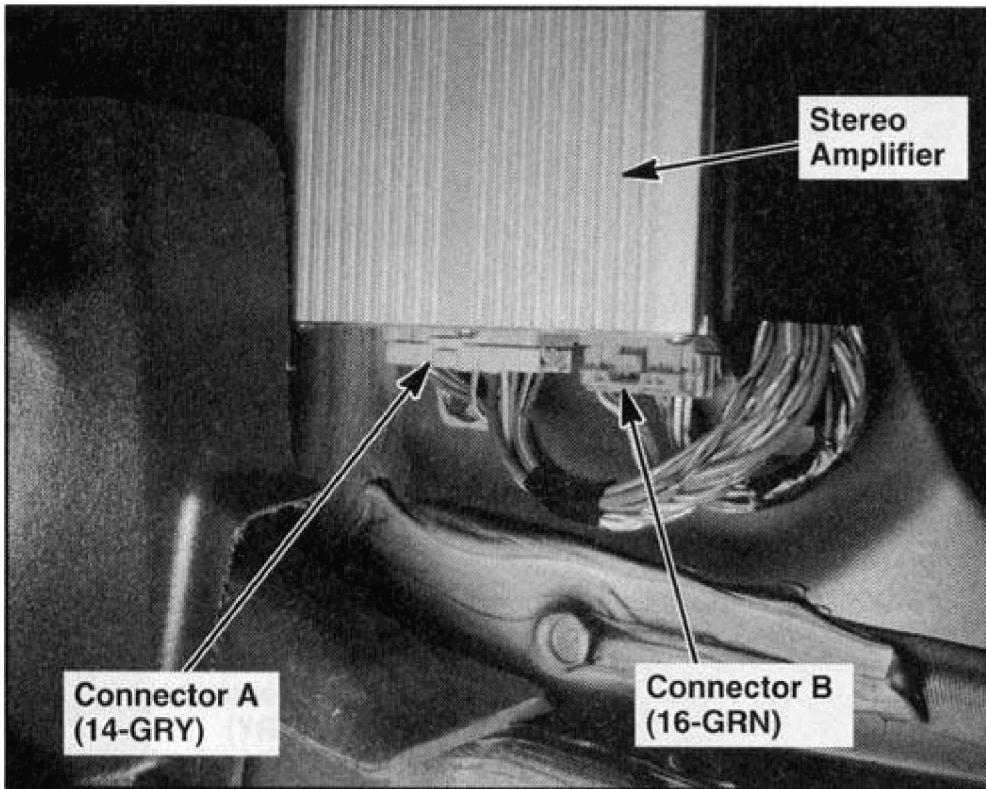

G00268470

Fig. 60: Behind Right Kick Panel (EX)

Courtesy of AMERICAN HONDA MOTOR CO., INC.

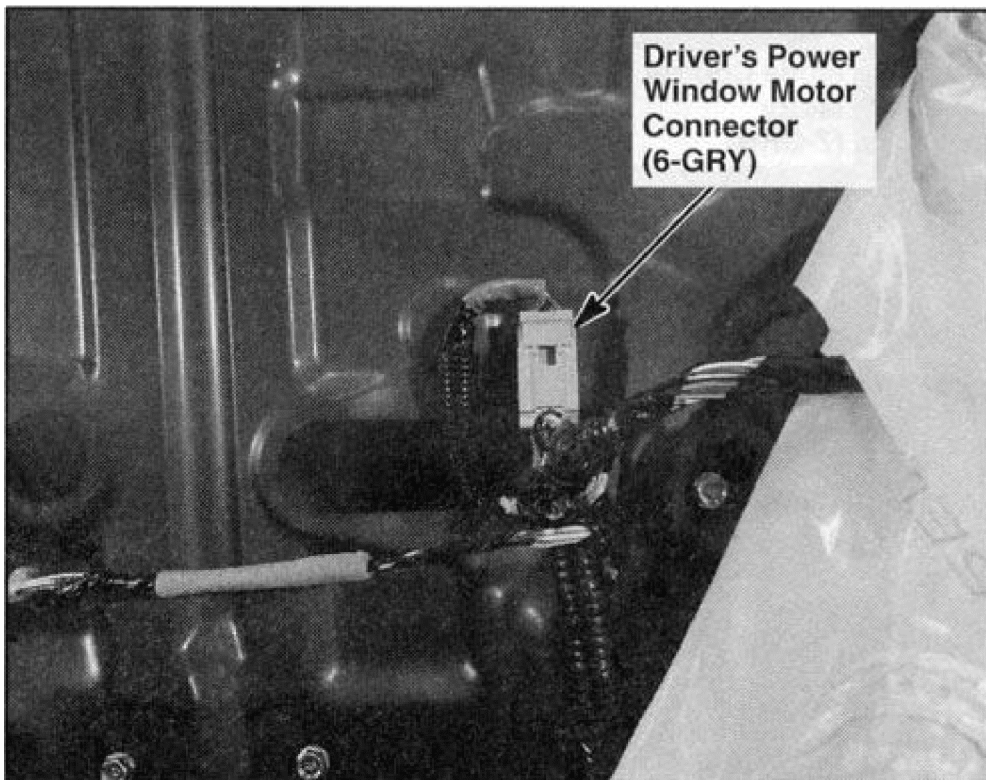

G00268471

Fig. 61: Driver's Door

Courtesy of AMERICAN HONDA MOTOR CO., INC.

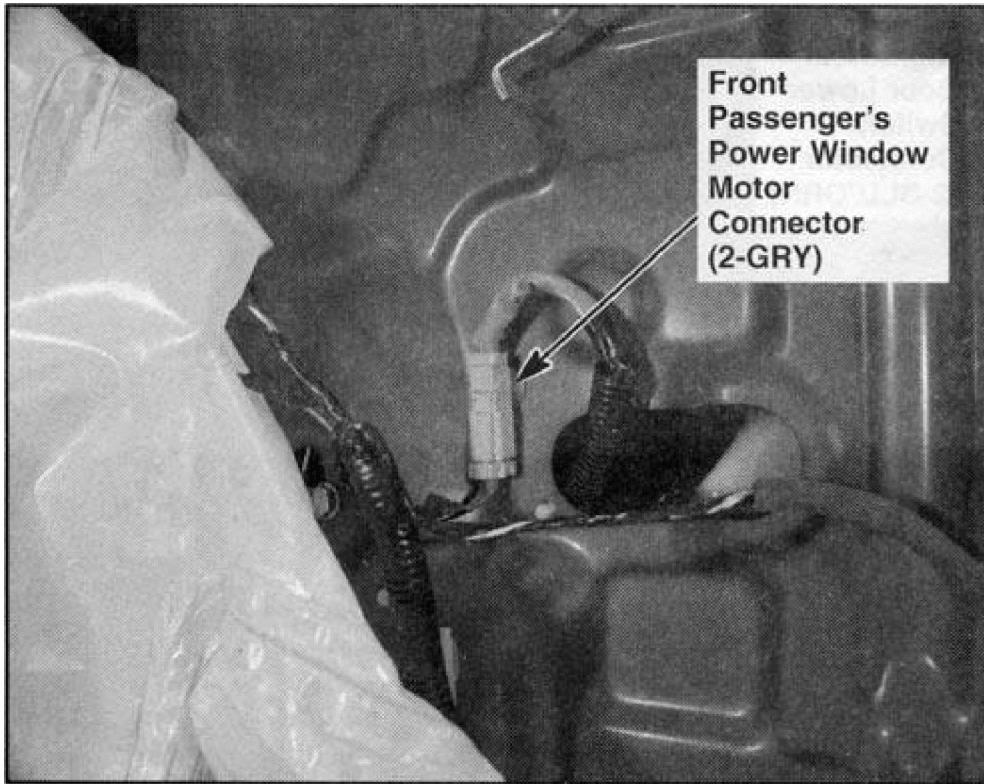

G00268472

Fig. 62: Front Passenger's Door
Courtesy of AMERICAN HONDA MOTOR CO., INC.

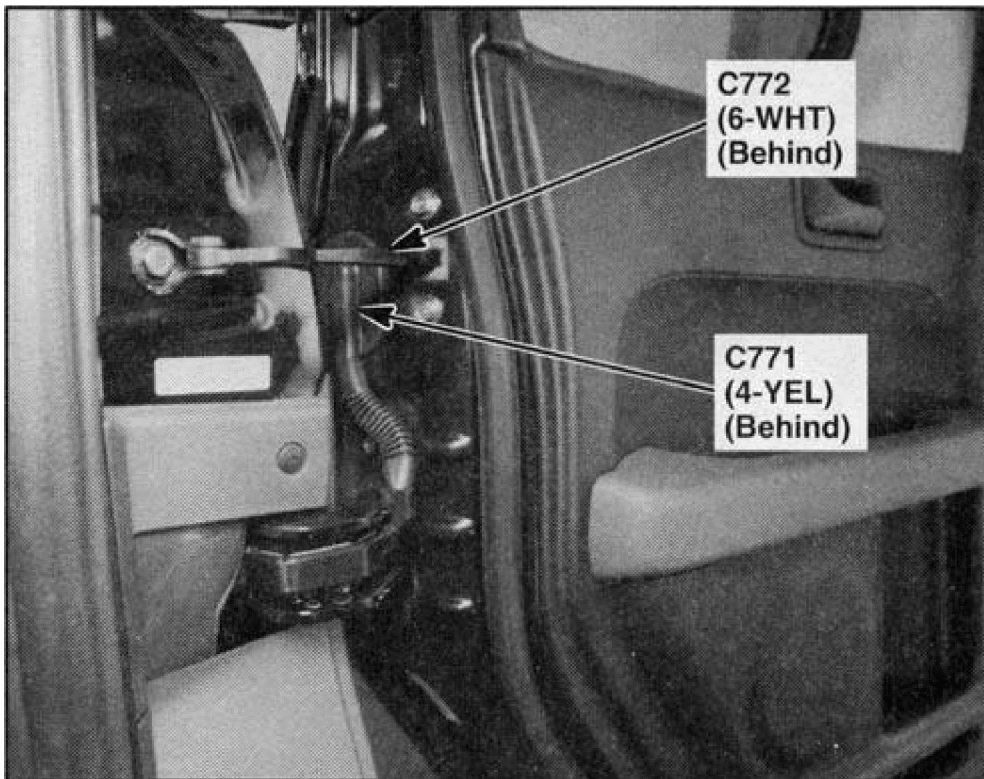

G00268473

Fig. 63: Left Rear Door

Courtesy of AMERICAN HONDA MOTOR CO., INC.

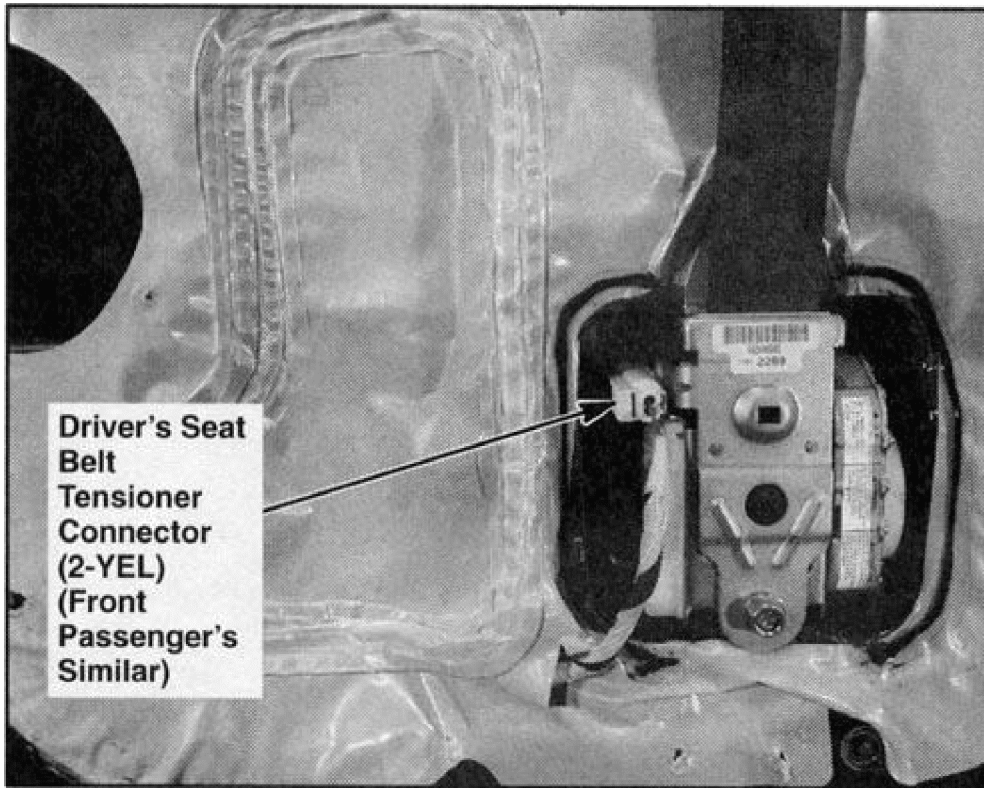

G00268474

Fig. 64: Left Rear Door (Right Similar)

Courtesy of AMERICAN HONDA MOTOR CO., INC.

2004 Honda Element DX

2004 HONDA Element

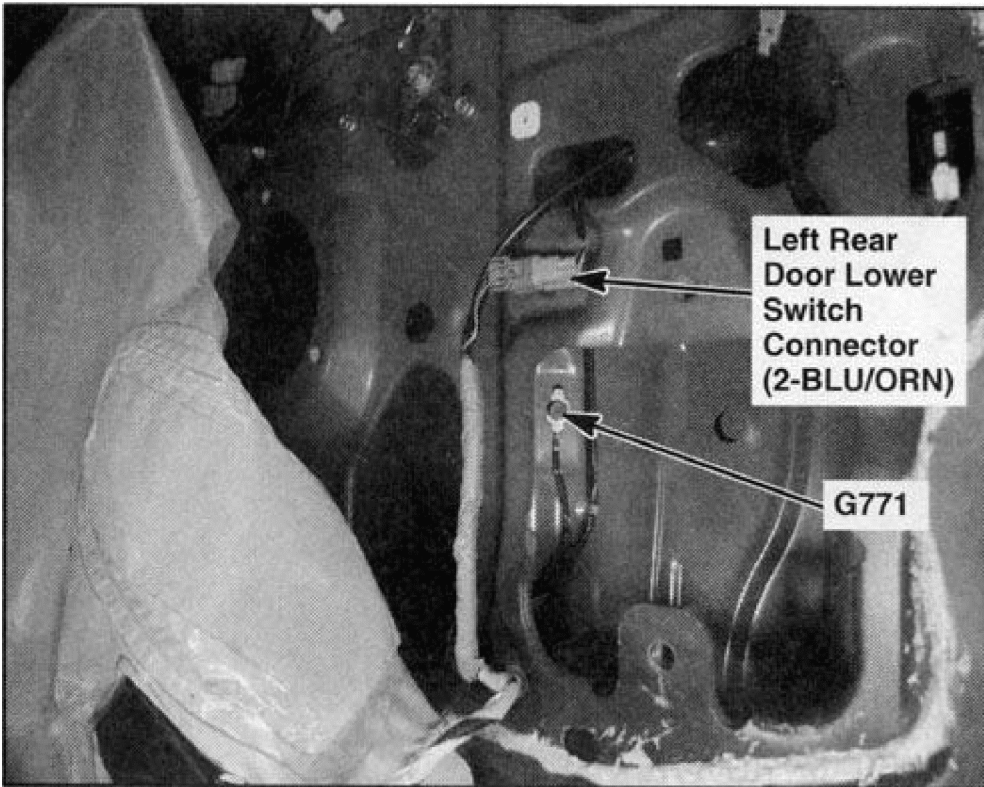

G00268475

Fig. 65: Left Rear Door

Courtesy of AMERICAN HONDA MOTOR CO., INC.

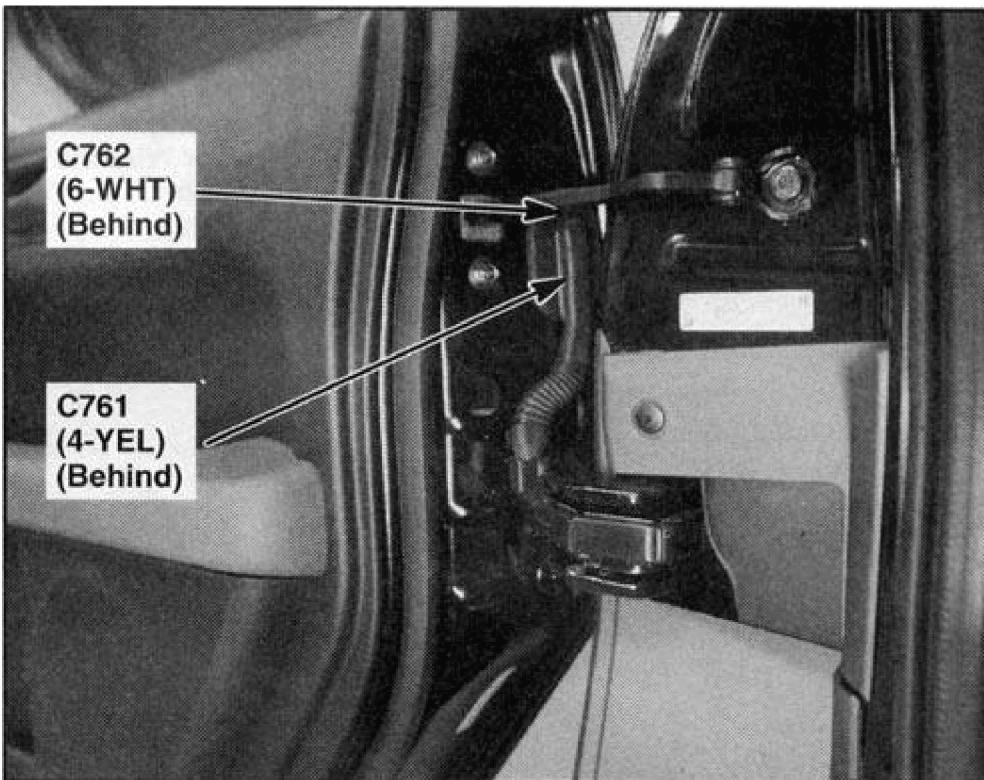

G00268476

Fig. 66: Right Rear Door

Courtesy of AMERICAN HONDA MOTOR CO., INC.

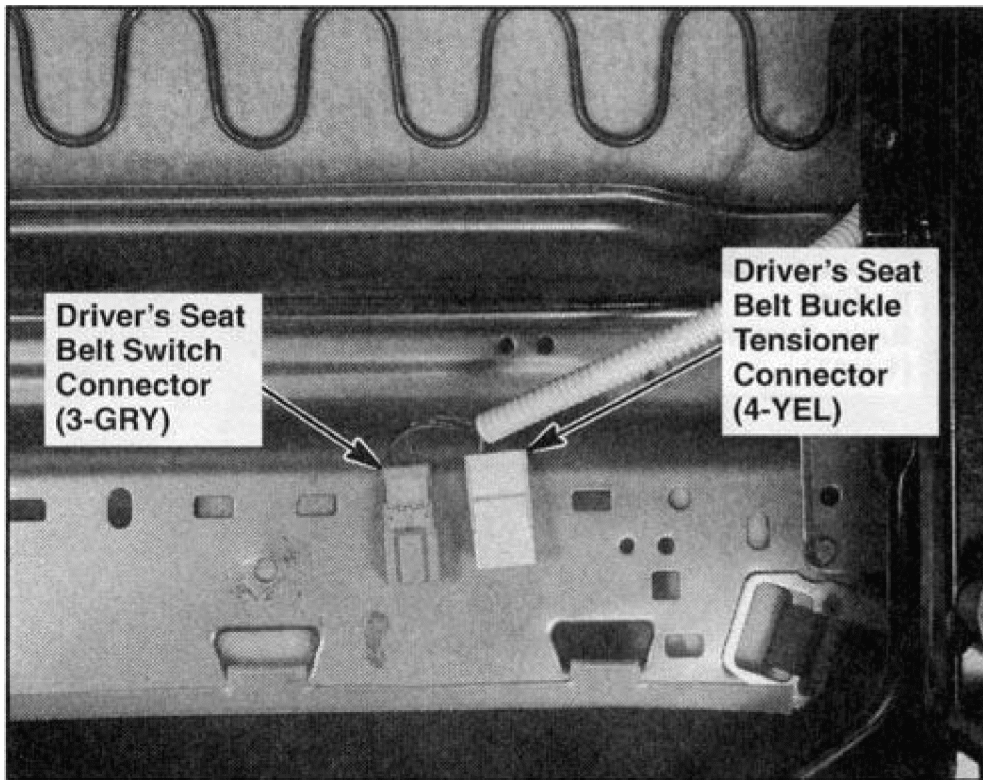

G00268477

Fig. 67: Under Driver's Seat

Courtesy of AMERICAN HONDA MOTOR CO., INC.

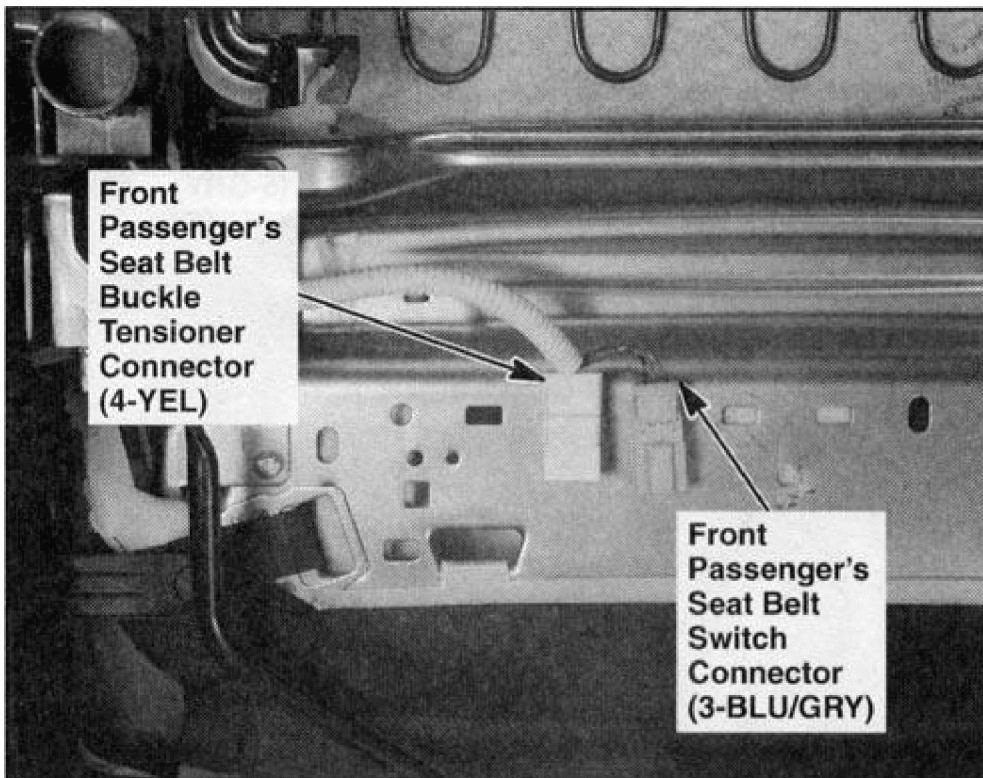

G00268478

Fig. 68: Under Front Passenger's Seat
Courtesy of AMERICAN HONDA MOTOR CO., INC.

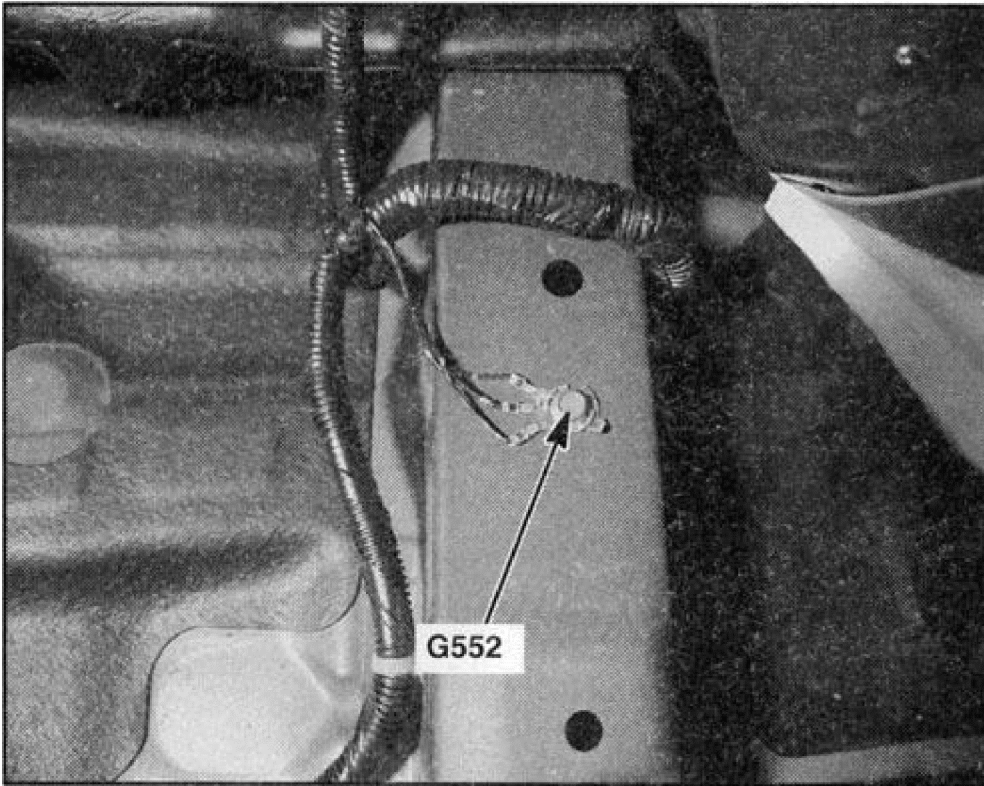

G00268479

Fig. 69: Under Front Passenger's Seat
Courtesy of AMERICAN HONDA MOTOR CO., INC.

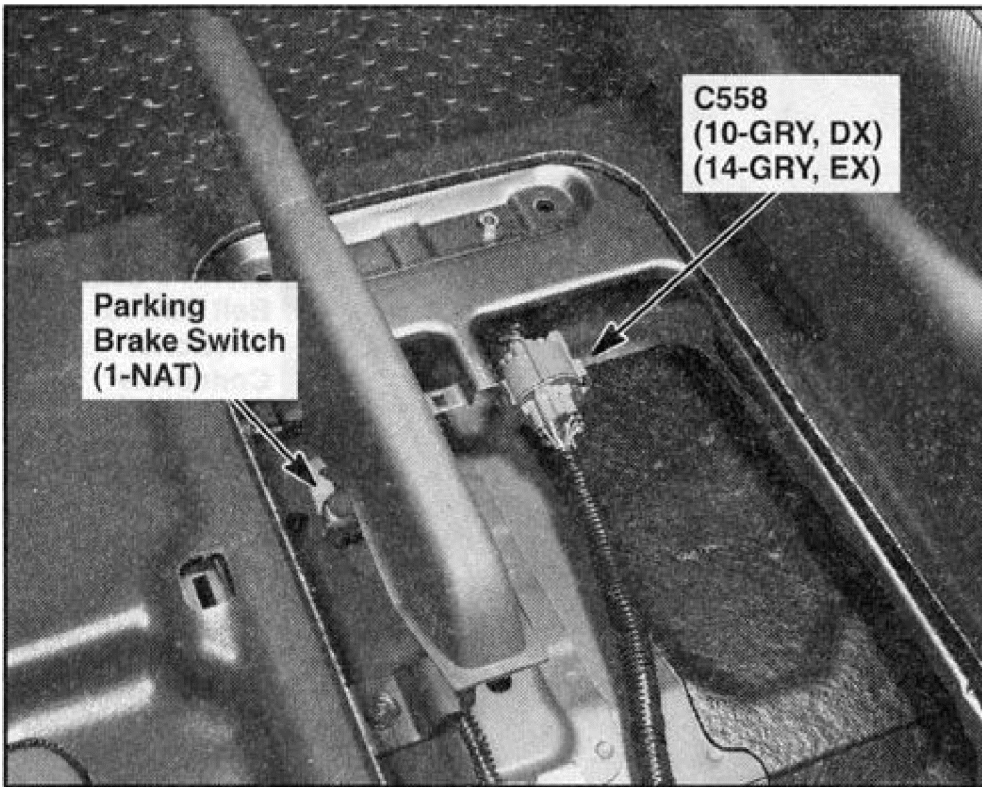

G00268480

Fig. 70: Under Center Console

Courtesy of AMERICAN HONDA MOTOR CO., INC.

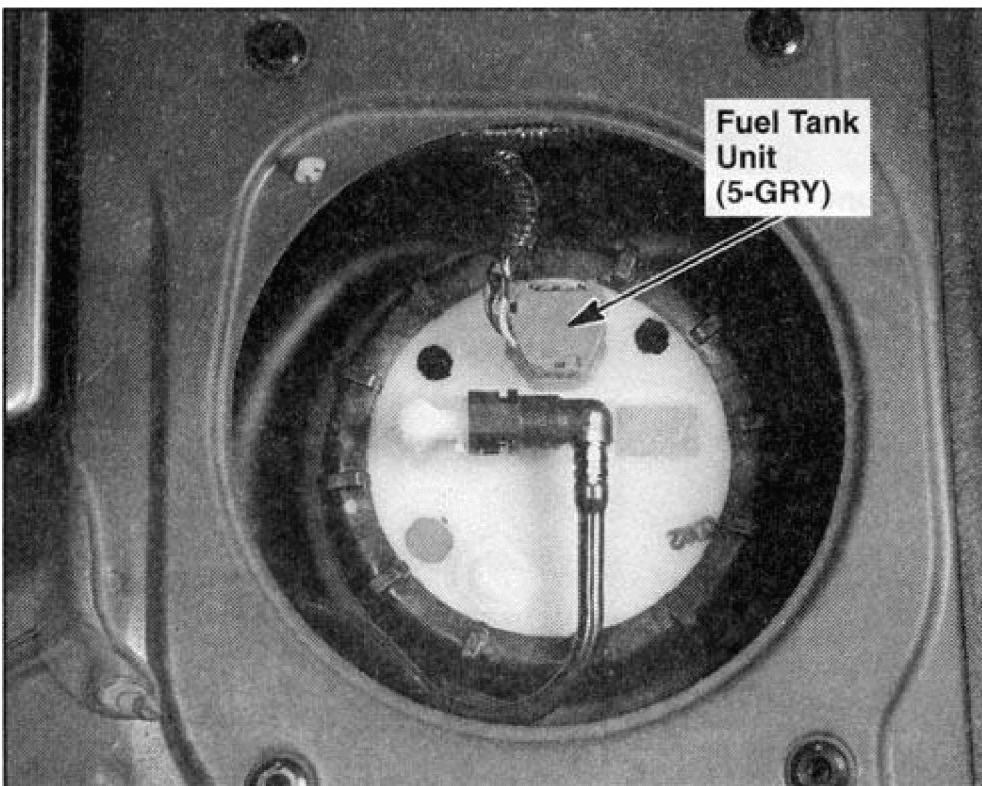

G00268481

Fig. 71: Middle Of Floor (Carpet Removed)

Courtesy of AMERICAN HONDA MOTOR CO., INC.

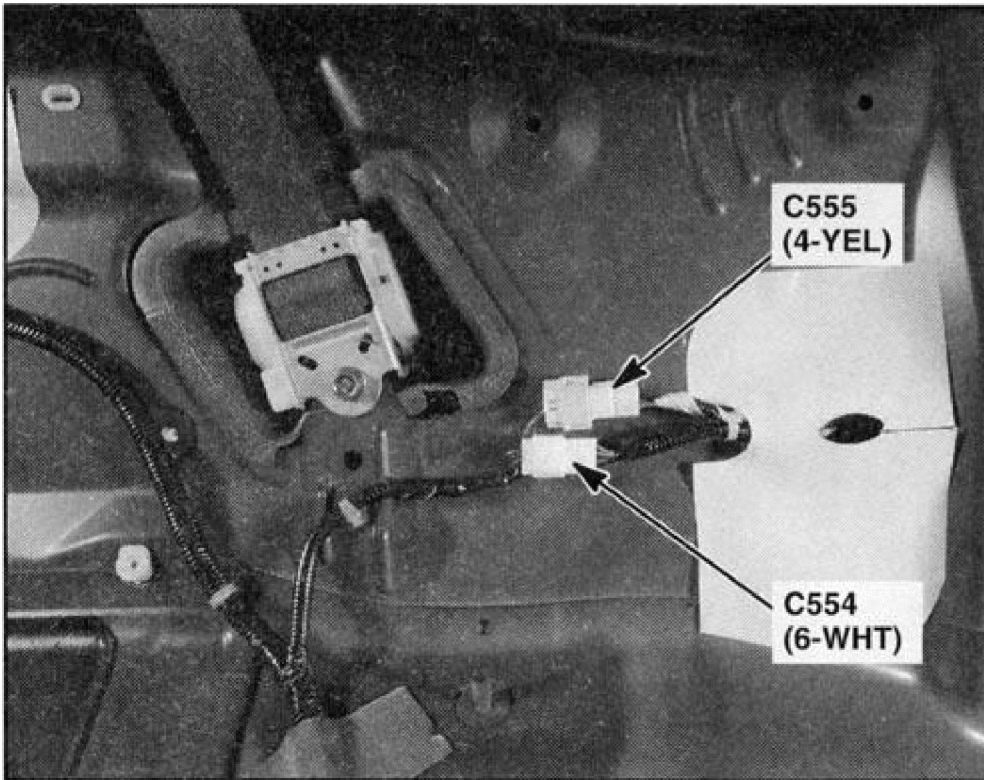

G00268482

Fig. 72: Left Quarter Panel

Courtesy of AMERICAN HONDA MOTOR CO., INC.

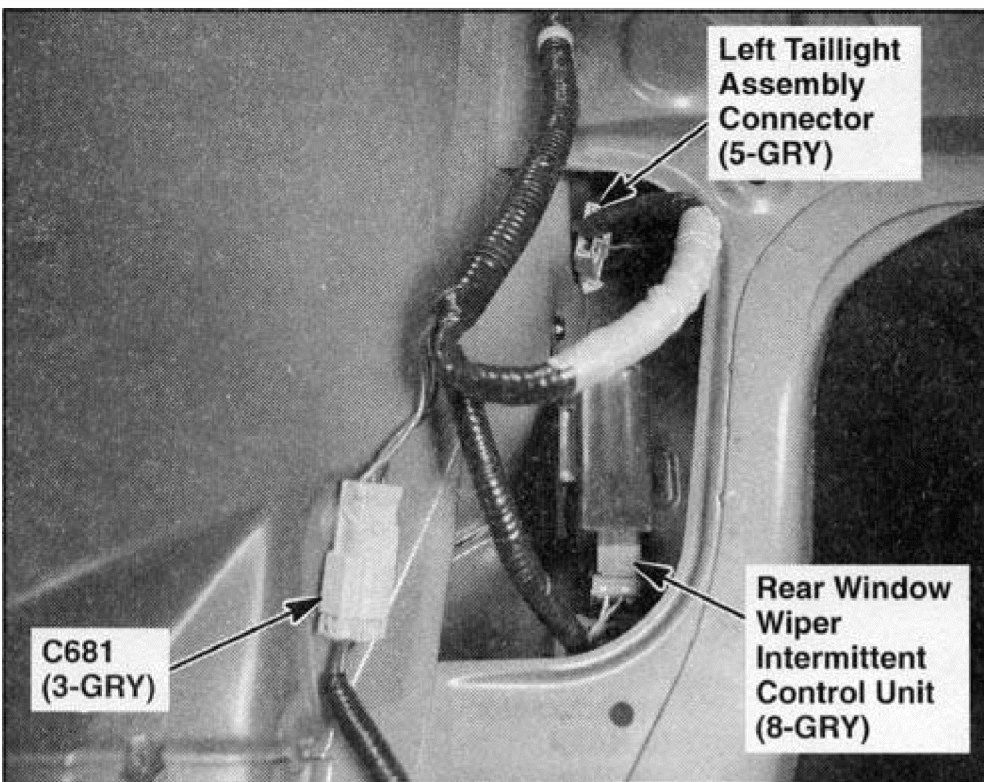

G00268483

Fig. 73: Left Quarter Panel

Courtesy of AMERICAN HONDA MOTOR CO., INC.

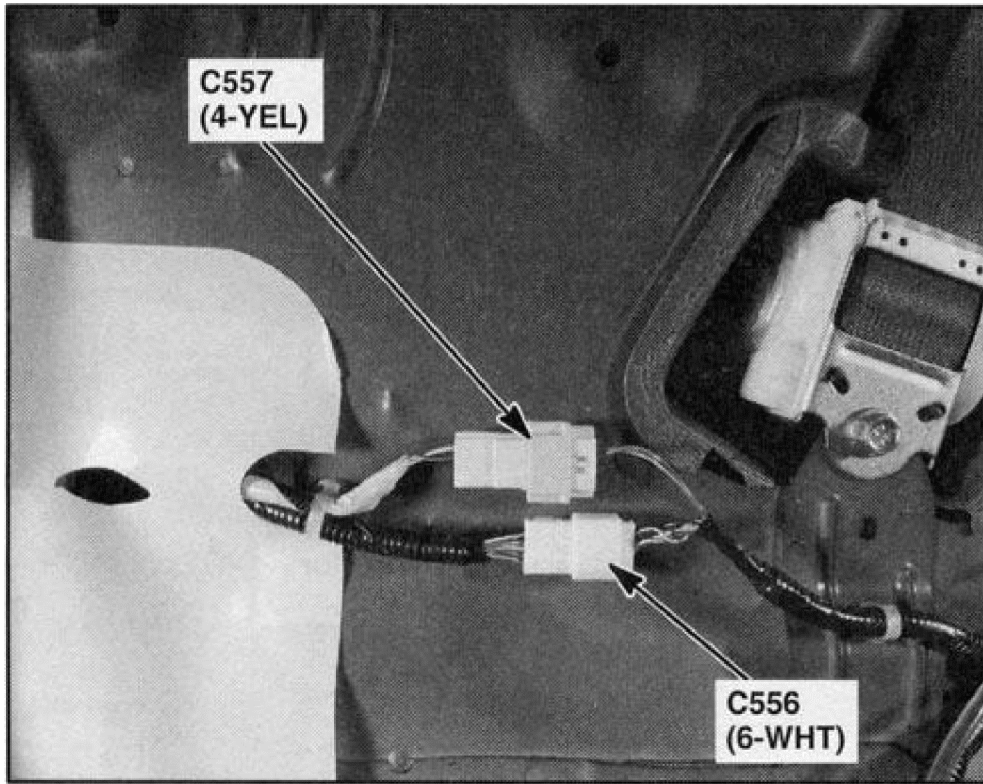

G00268484

Fig. 74: Right Quarter Panel

Courtesy of AMERICAN HONDA MOTOR CO., INC.

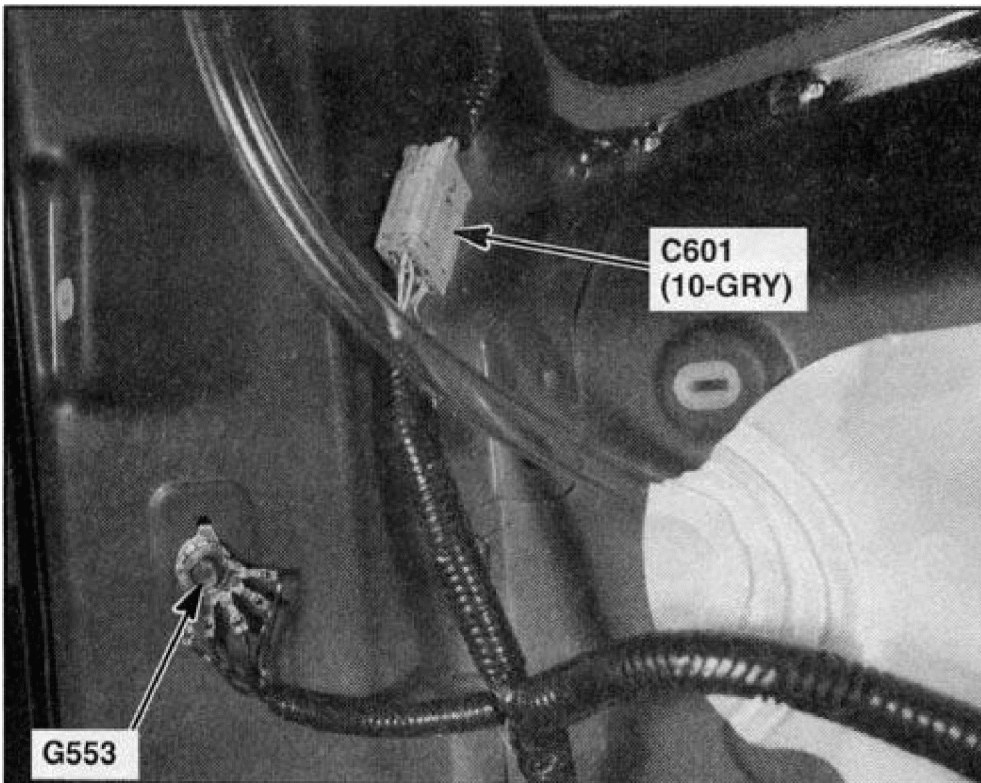

G00268485

Fig. 75: Left "D" Pillar
Courtesy of AMERICAN HONDA MOTOR CO., INC.

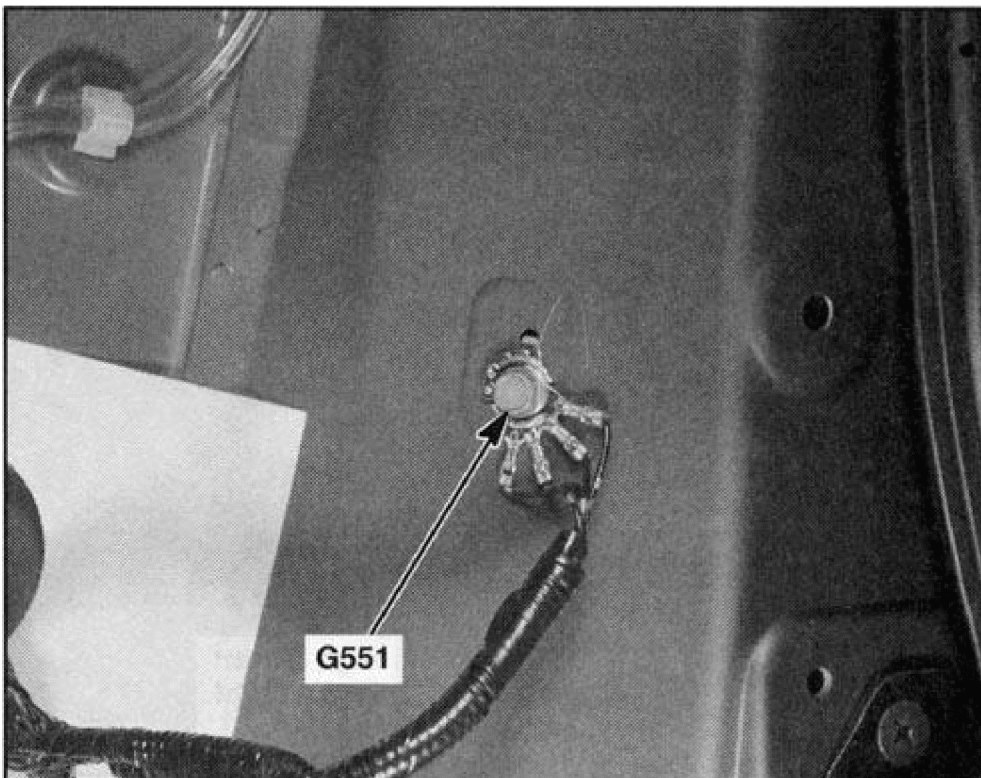

G00268486

Fig. 76: Right "D" Pillar

Courtesy of AMERICAN HONDA MOTOR CO., INC.

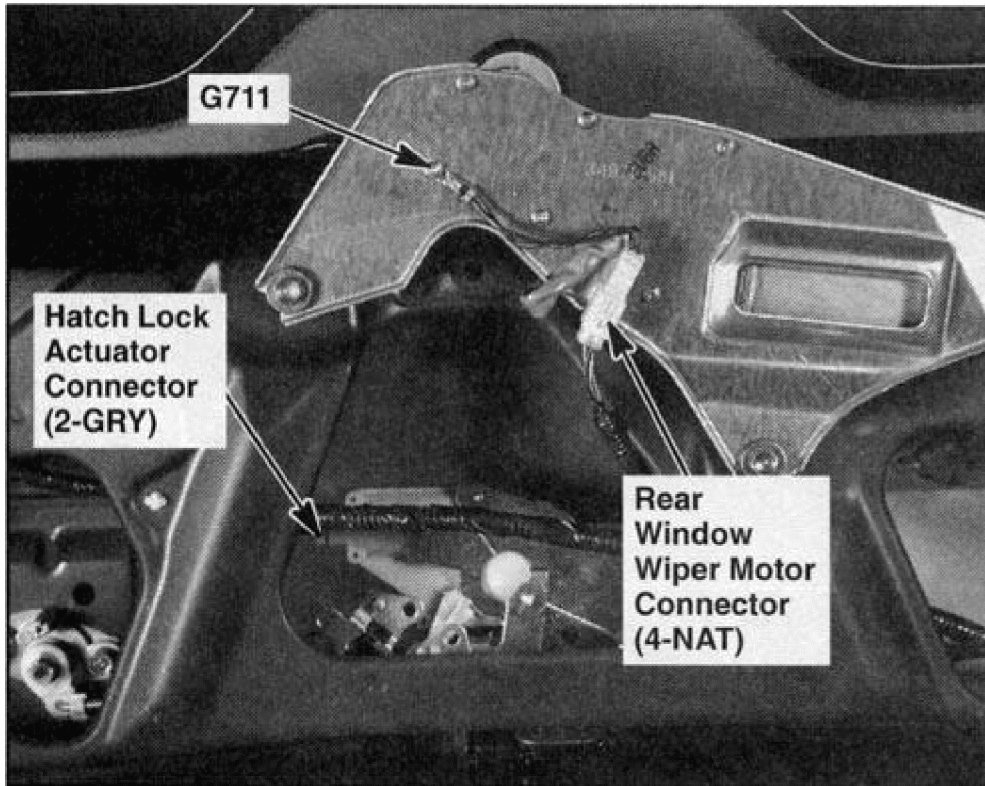

G00268487

Fig. 77: Middle Of Hatch

Courtesy of AMERICAN HONDA MOTOR CO., INC.

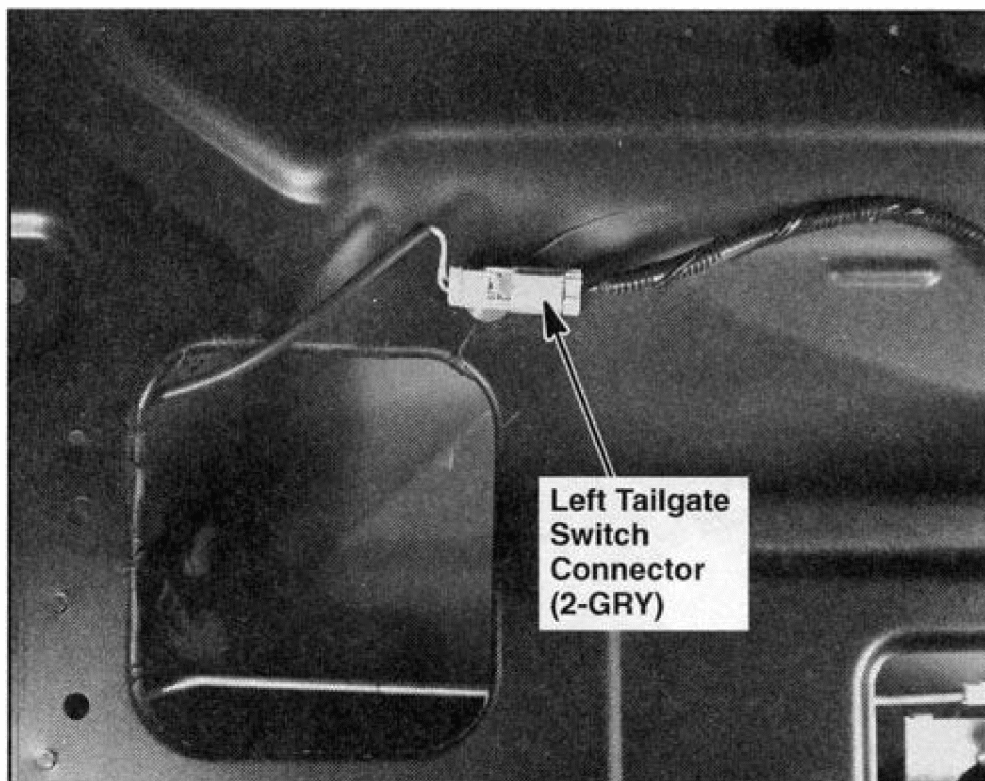

G00268488

Fig. 78: Left Side Of Tailgate

Courtesy of AMERICAN HONDA MOTOR CO., INC.

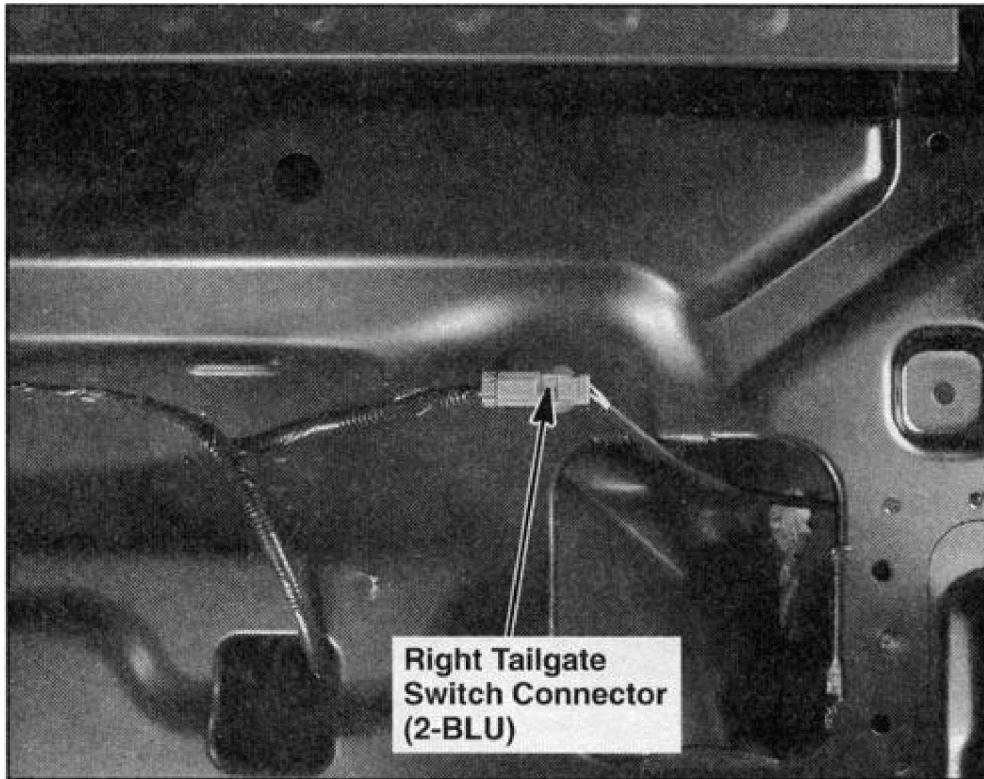

G00263919

Fig. 79: Right Side Of Tailgate

Courtesy of AMERICAN HONDA MOTOR CO., INC.

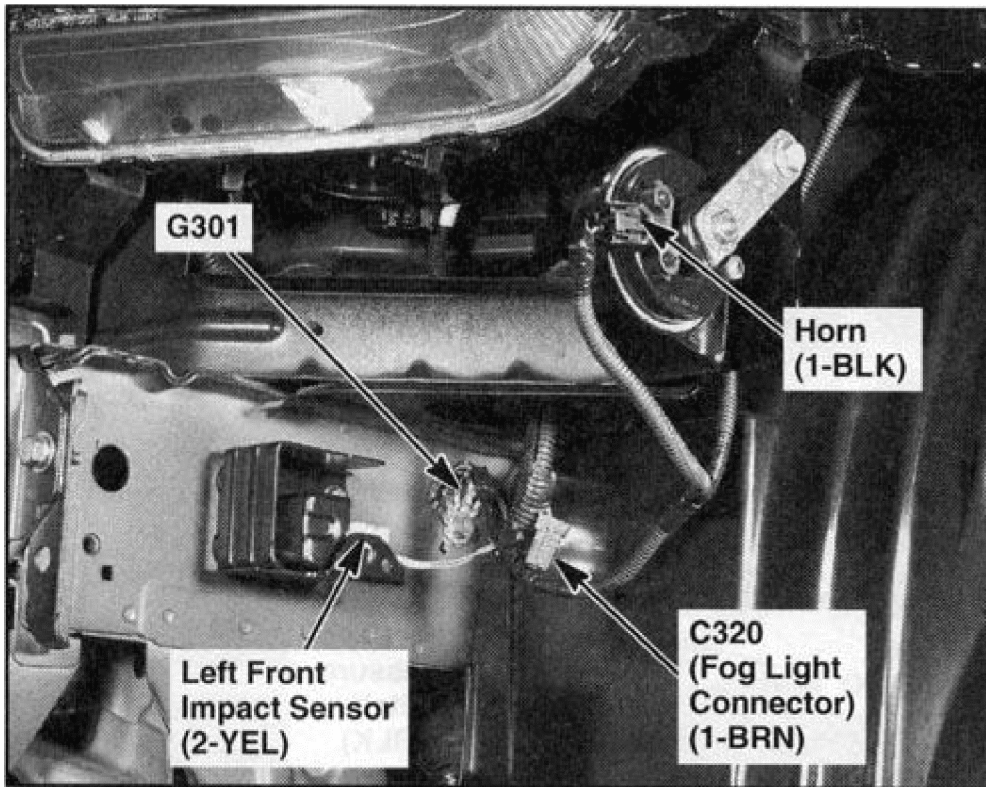

G00263920

Fig. 80: Behind Left Side Of Front Bumper
Courtesy of AMERICAN HONDA MOTOR CO., INC.

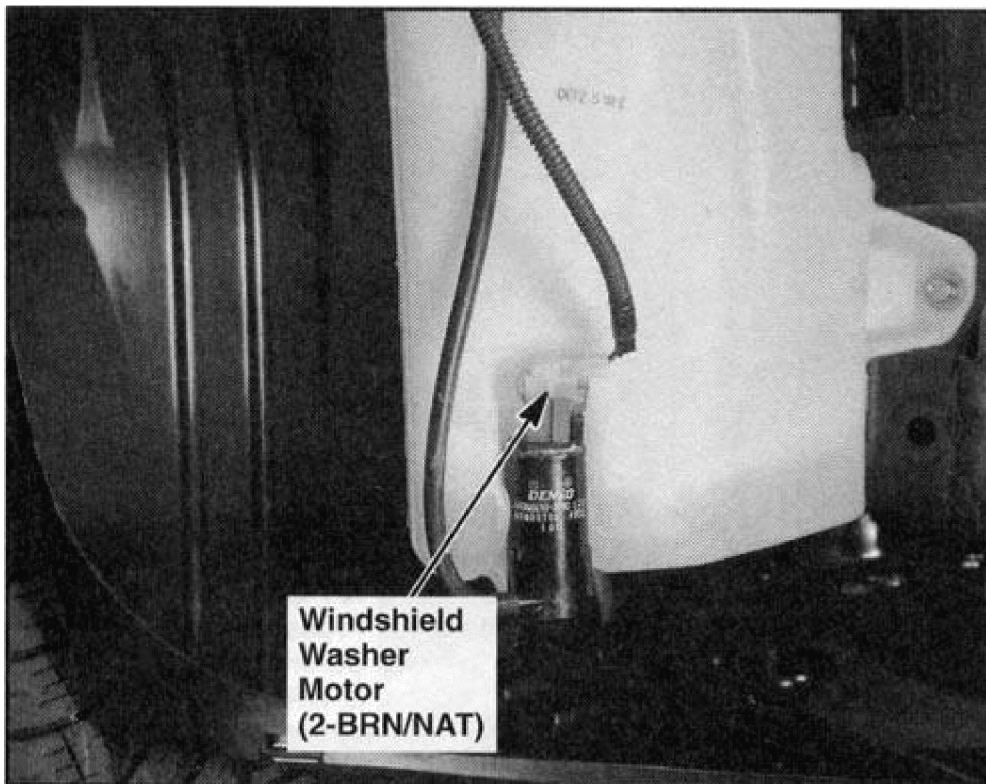

G00263921

Fig. 81: Behind Right Side Of Front Bumper

Courtesy of AMERICAN HONDA MOTOR CO., INC.

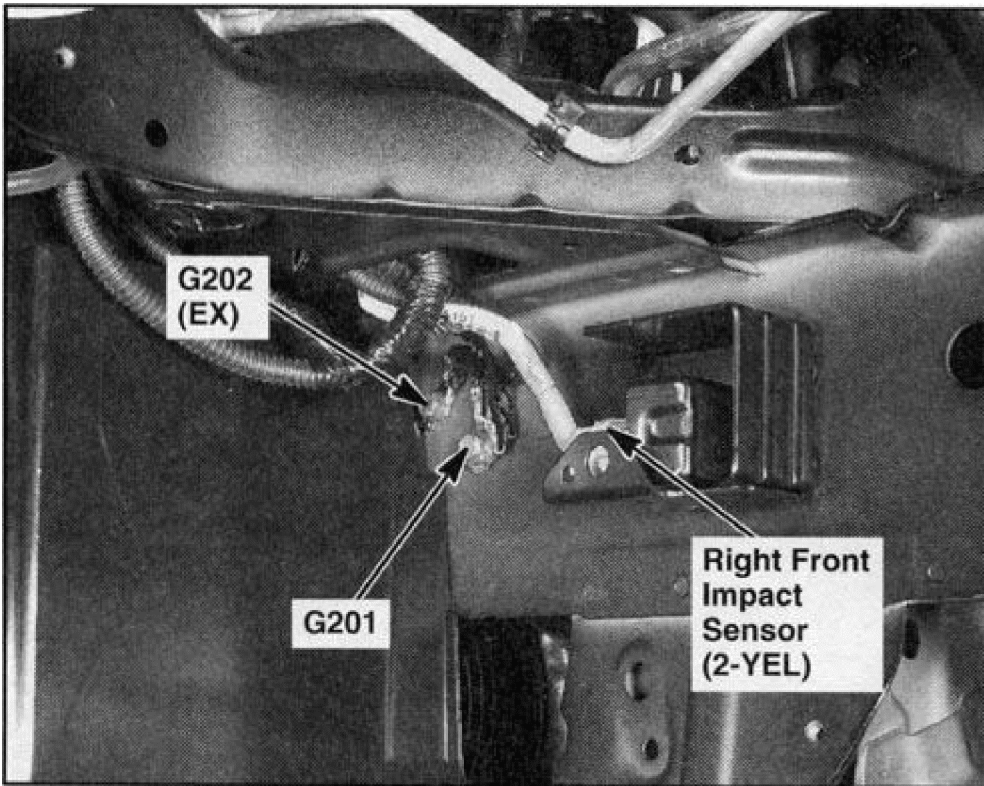

G00263922

Fig. 82: Behind Right Side Of Front Bumper
Courtesy of AMERICAN HONDA MOTOR CO., INC.

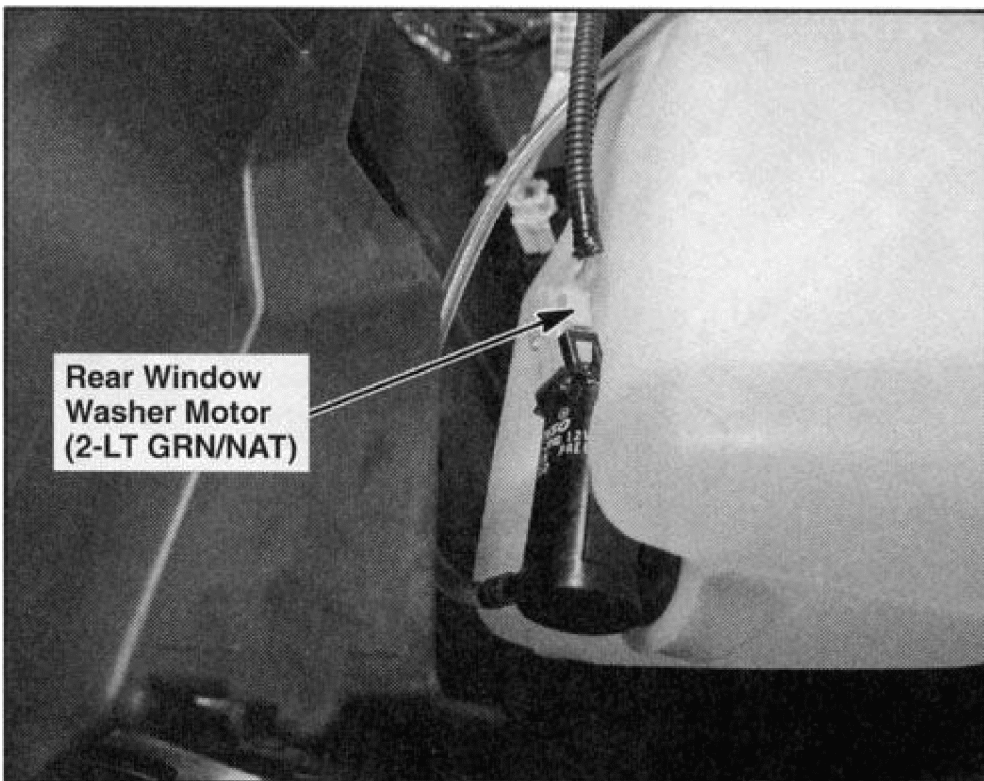

G00263923

Fig. 83: Behind Right Side Of Front Bumper
Courtesy of AMERICAN HONDA MOTOR CO., INC.

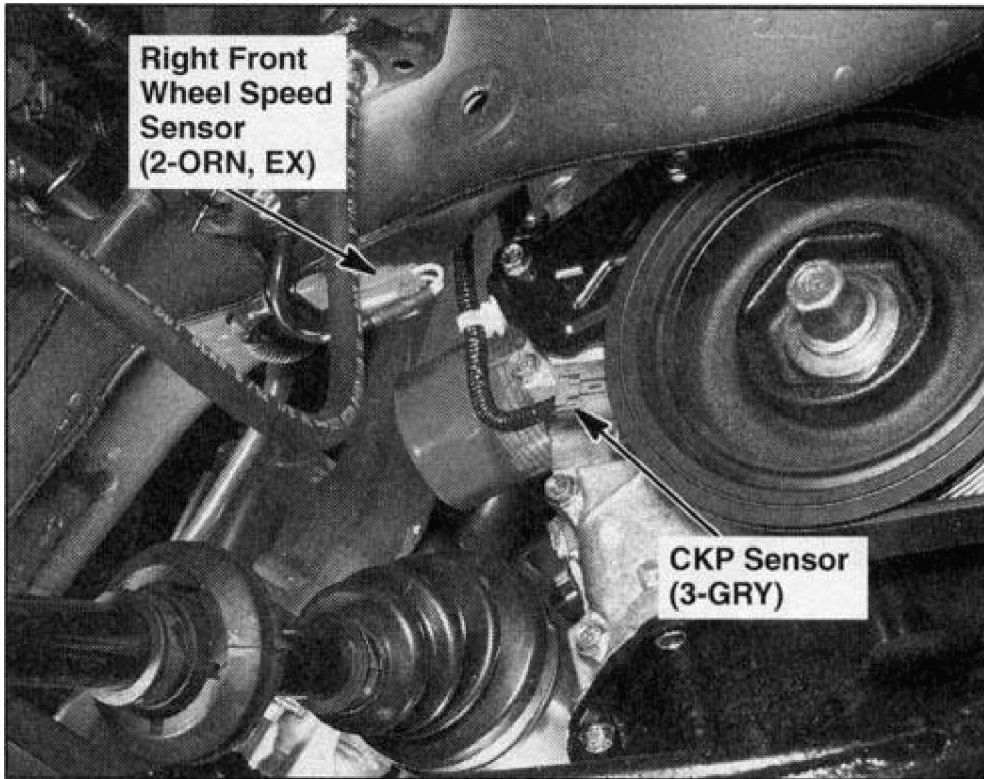

G00263924

Fig. 84: Right Side Of Engine Compartment
Courtesy of AMERICAN HONDA MOTOR CO., INC.

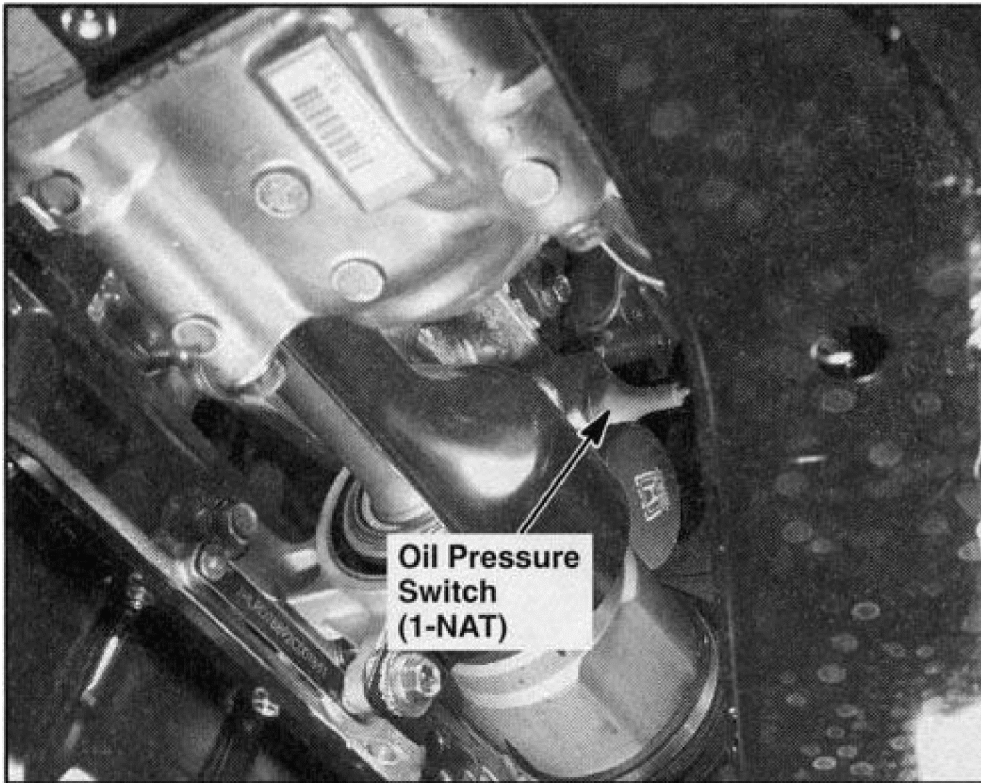

G00263925

Fig. 85: Right Side Of Engine

Courtesy of AMERICAN HONDA MOTOR CO., INC.

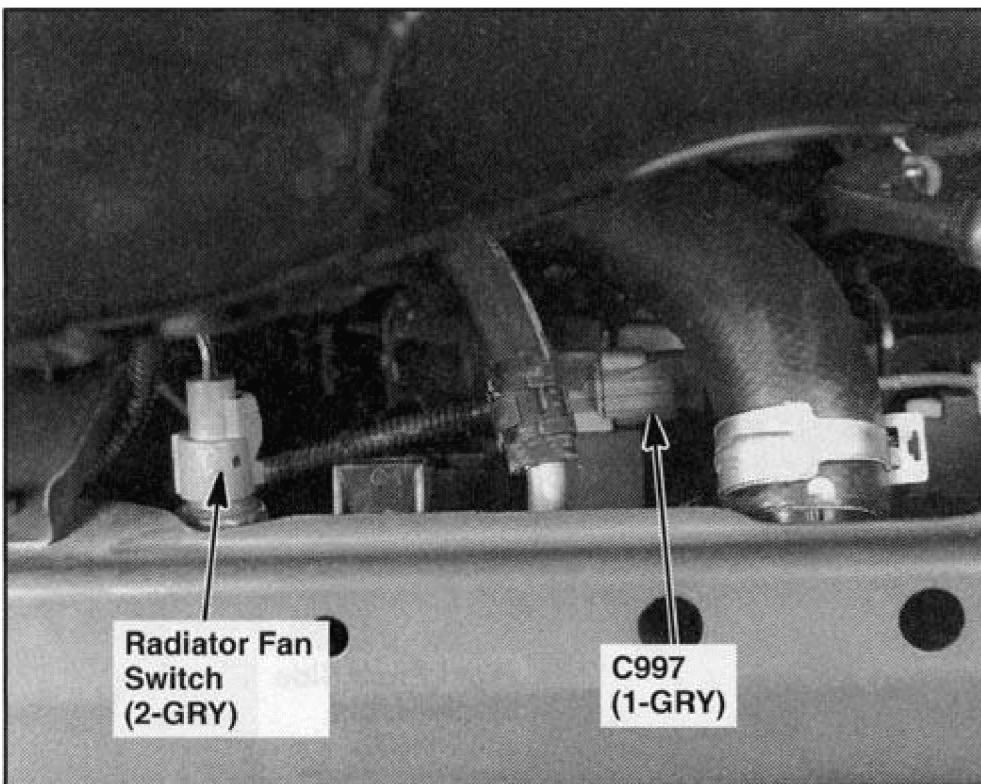

G00263926

Fig. 86: Front Of Engine Compartment

Courtesy of AMERICAN HONDA MOTOR CO., INC.

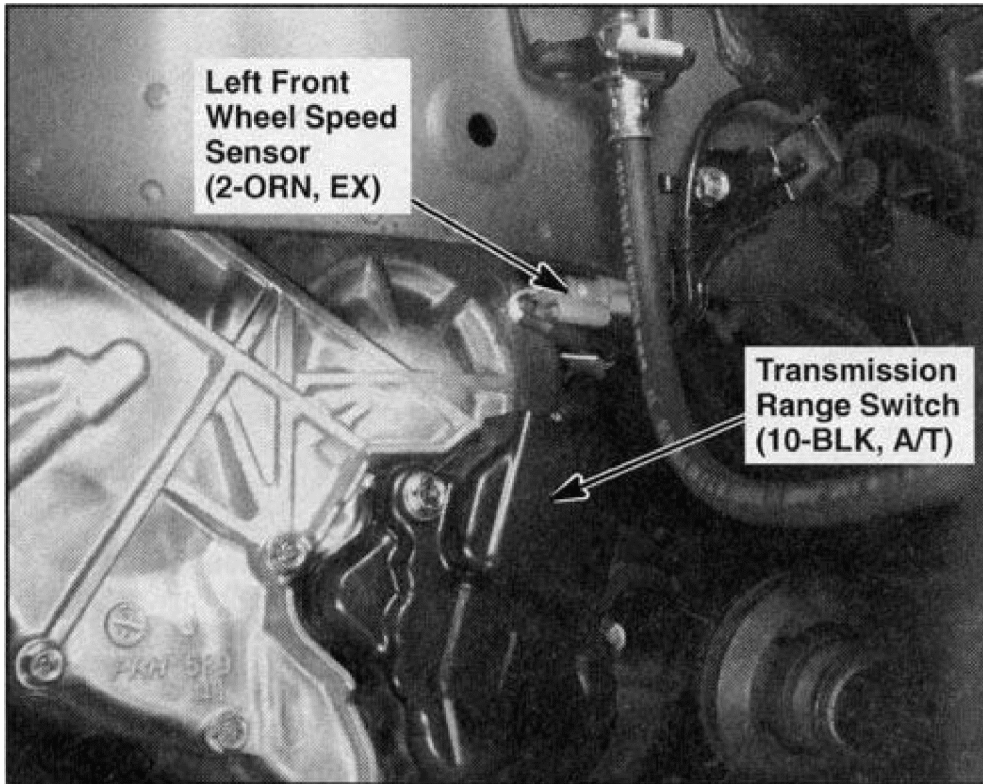

G00263927

Fig. 87: Left Side Of Engine Compartment
Courtesy of AMERICAN HONDA MOTOR CO., INC.

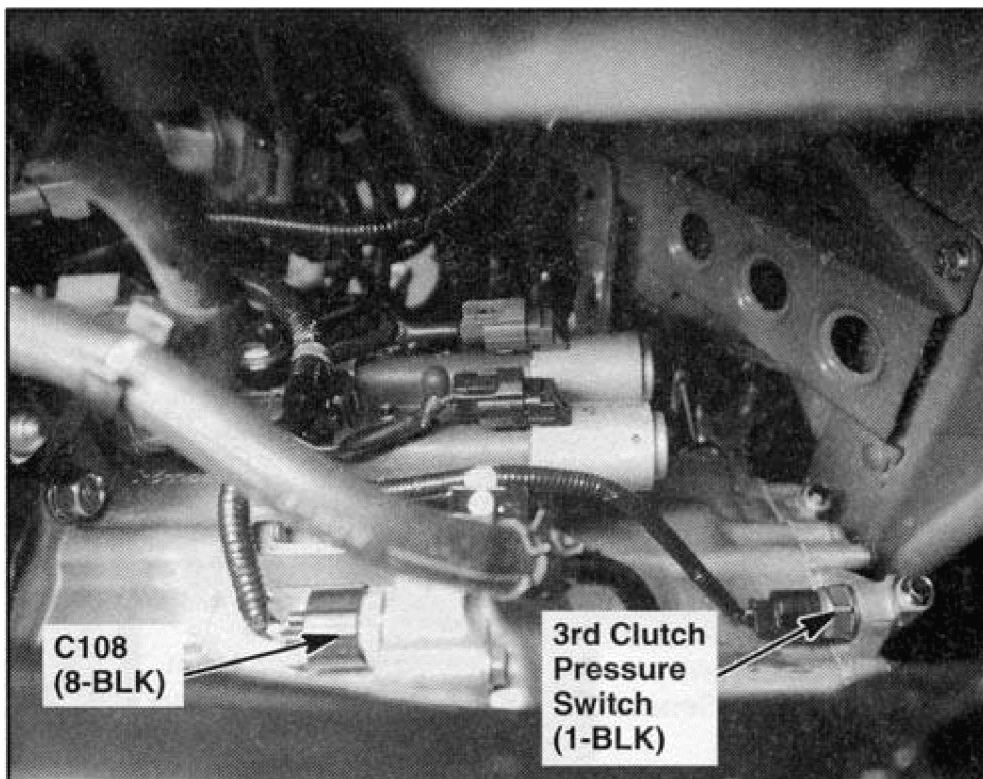

G00263928

Fig. 88: Transmission Housing (A/T)
Courtesy of AMERICAN HONDA MOTOR CO., INC.

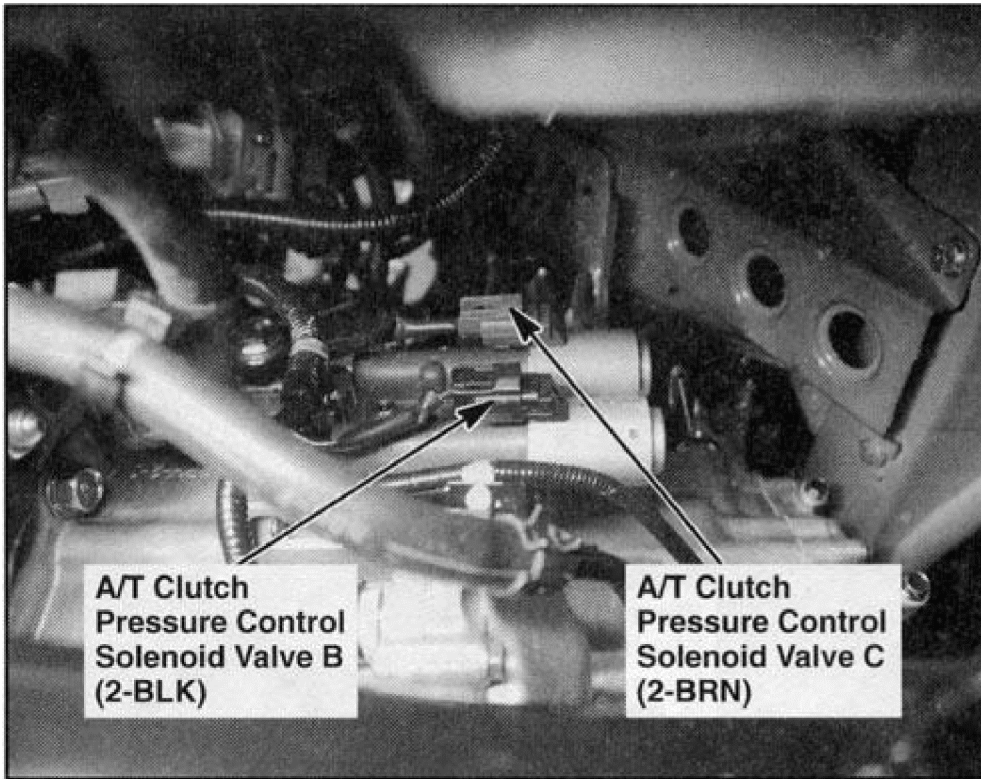

G00263929

Fig. 89: Transmission Housing (A/T)
Courtesy of AMERICAN HONDA MOTOR CO., INC.

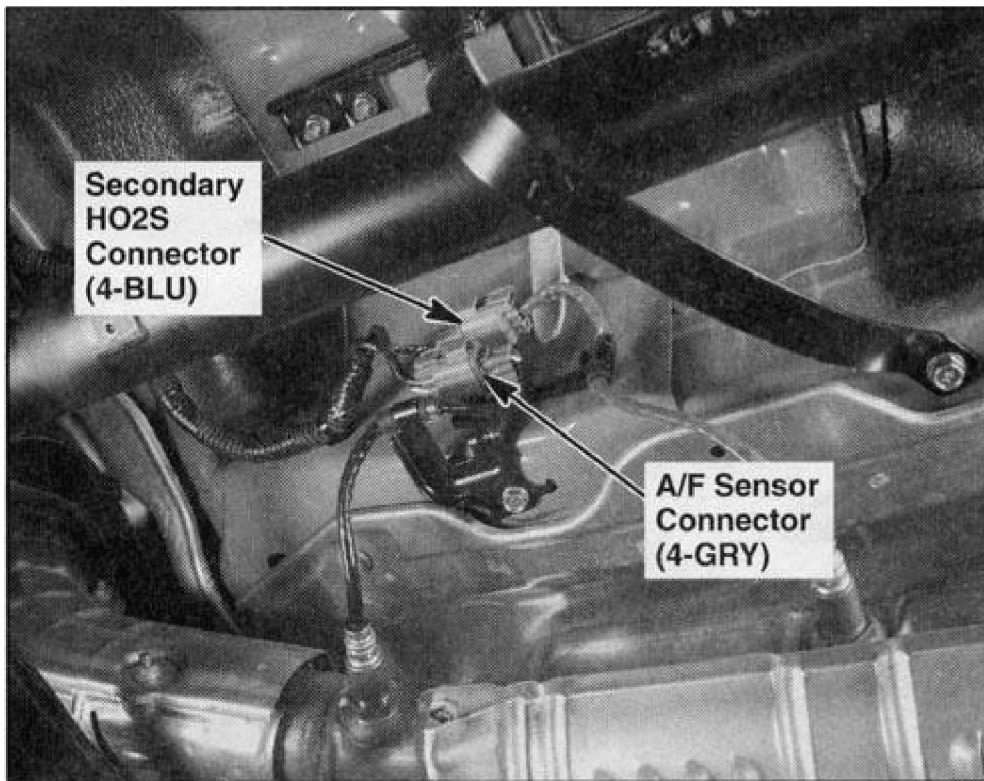

G00263930

Fig. 90: Under Middle Of Vehicle
Courtesy of AMERICAN HONDA MOTOR CO., INC.

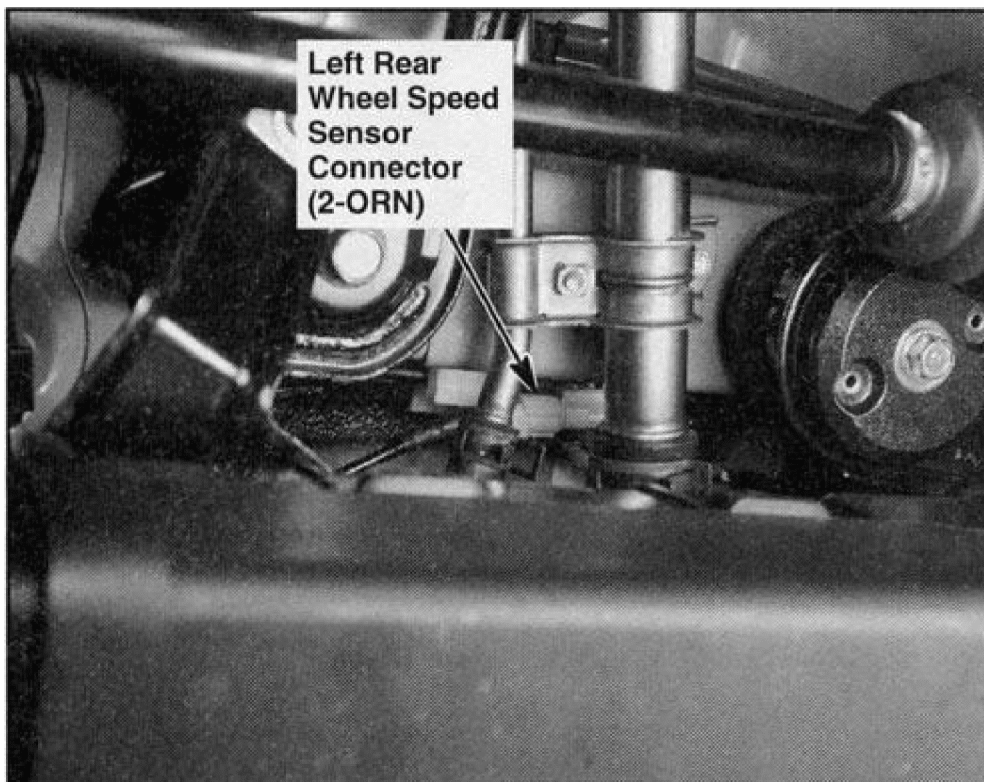

G00263931

Fig. 91: Under Left Rear Of Vehicle (EX)
Courtesy of AMERICAN HONDA MOTOR CO., INC.

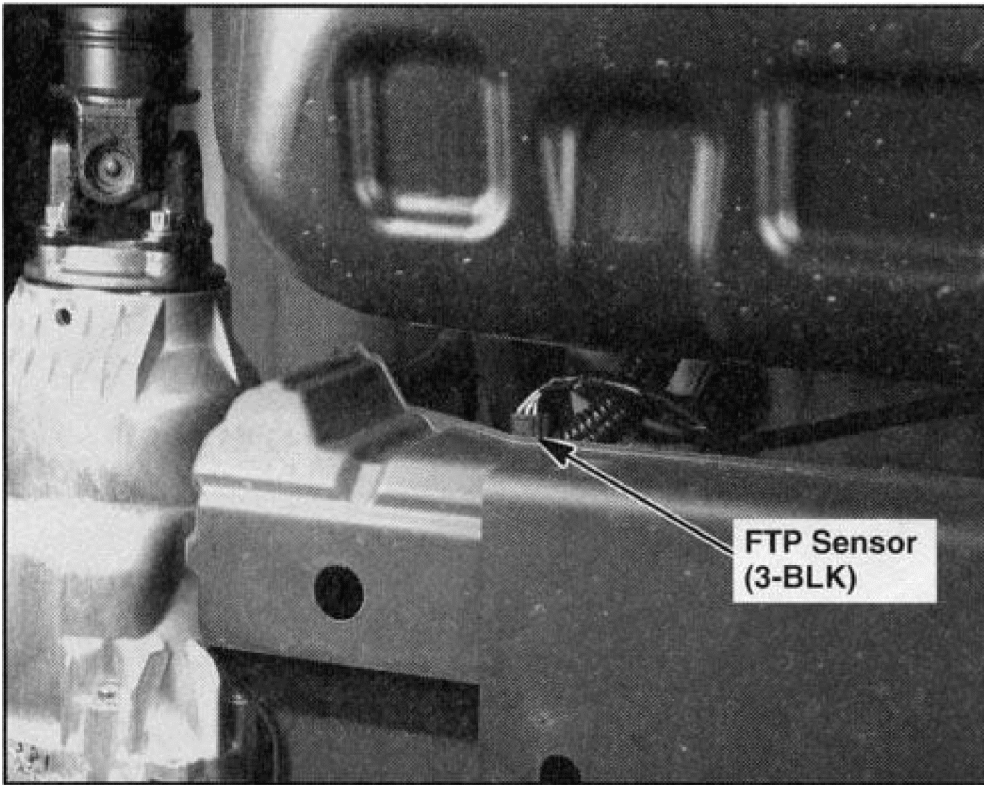

G00263932

Fig. 92: Under Left Rear Of Vehicle
Courtesy of AMERICAN HONDA MOTOR CO., INC.

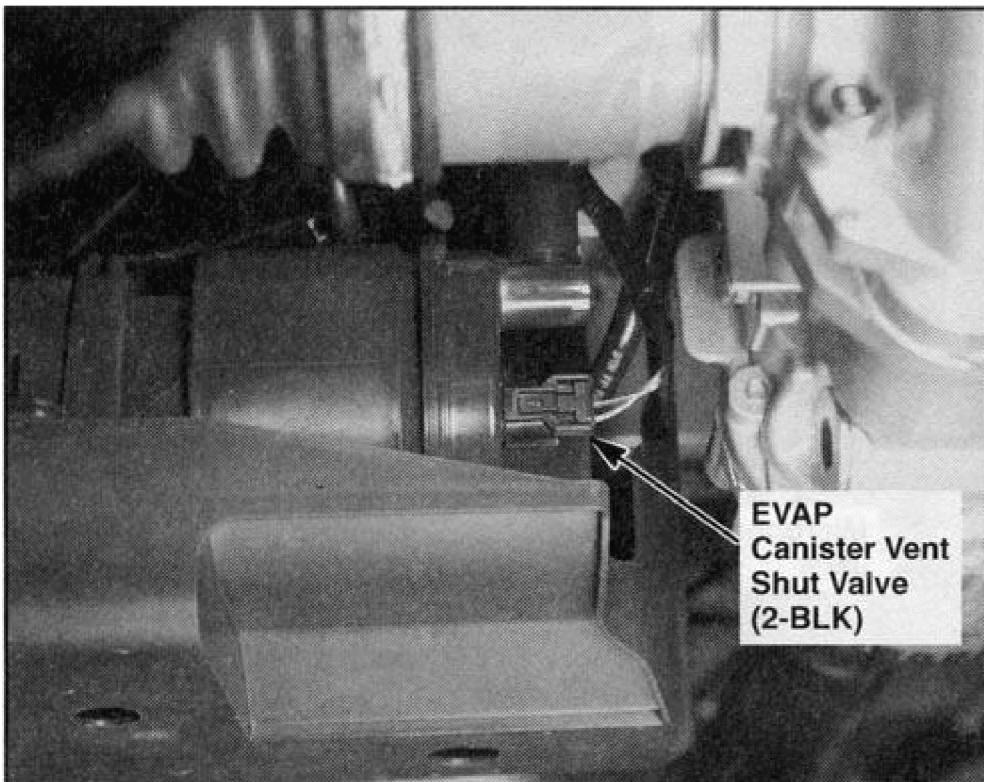

G00263933

Fig. 93: Under Left Rear Of Vehicle

Courtesy of AMERICAN HONDA MOTOR CO., INC.



G00263934

Fig. 94: Under Right Rear Of Vehicle (EX)

Courtesy of AMERICAN HONDA MOTOR CO., INC.

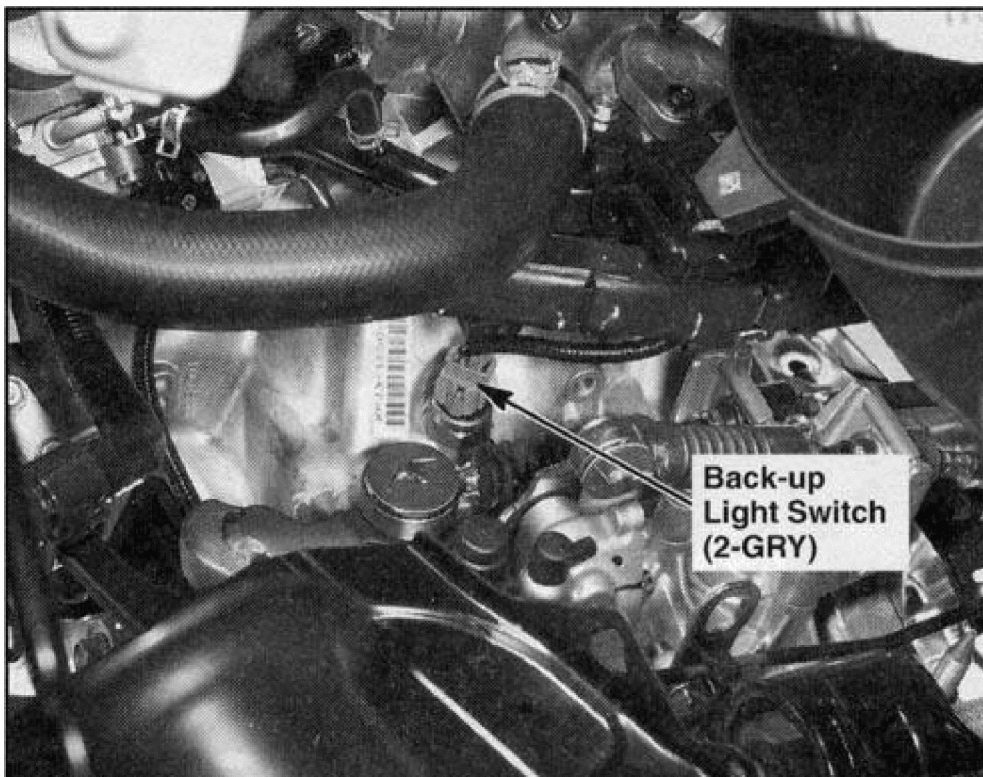

G00263935

Fig. 95: Transmission Housing (M/T)
Courtesy of AMERICAN HONDA MOTOR CO., INC.

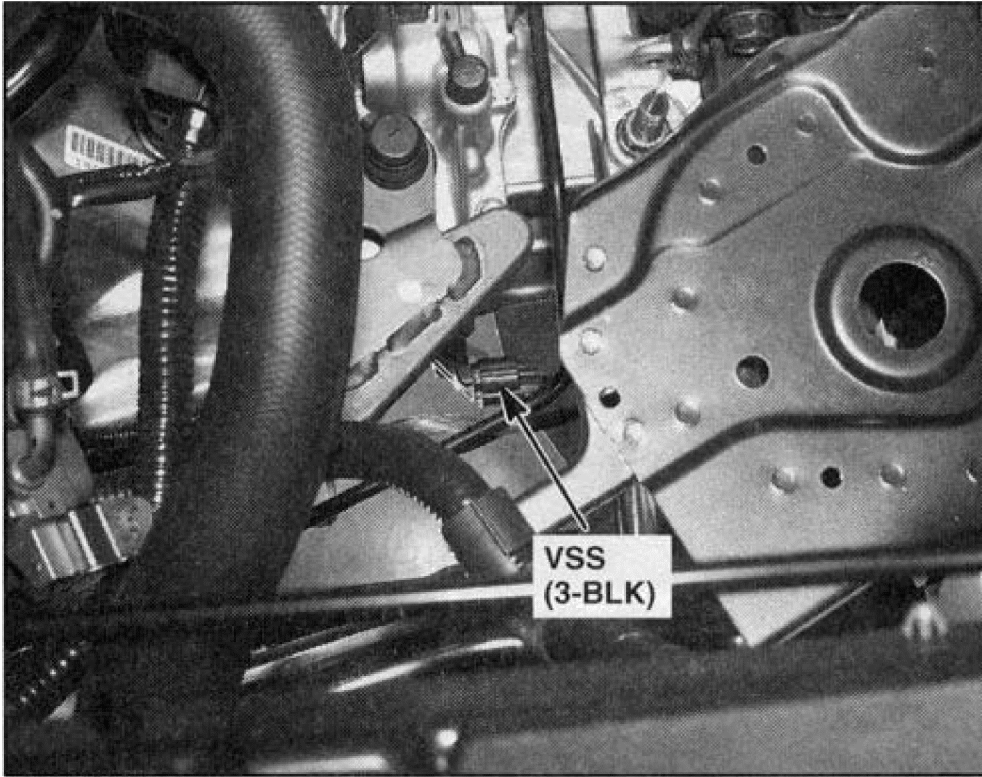

G00263936

Fig. 96: Transmission Housing (M/T)
Courtesy of AMERICAN HONDA MOTOR CO., INC.

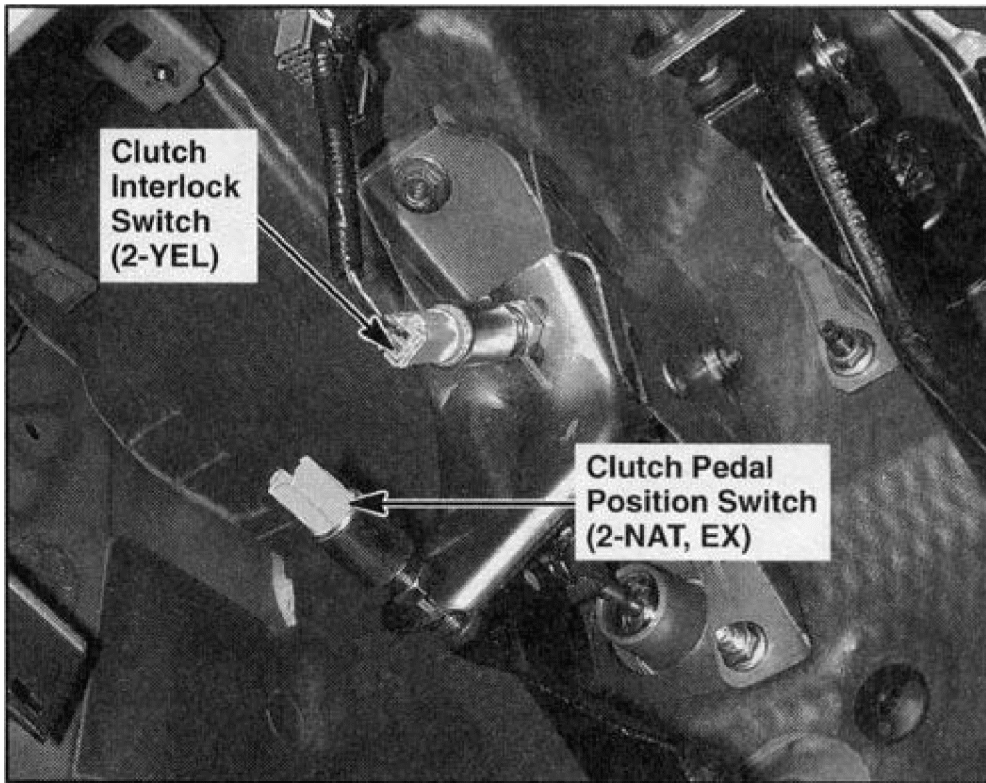

G00263937

Fig. 97: Under Left Side Of Dash (M/T)

Courtesy of AMERICAN HONDA MOTOR CO., INC.

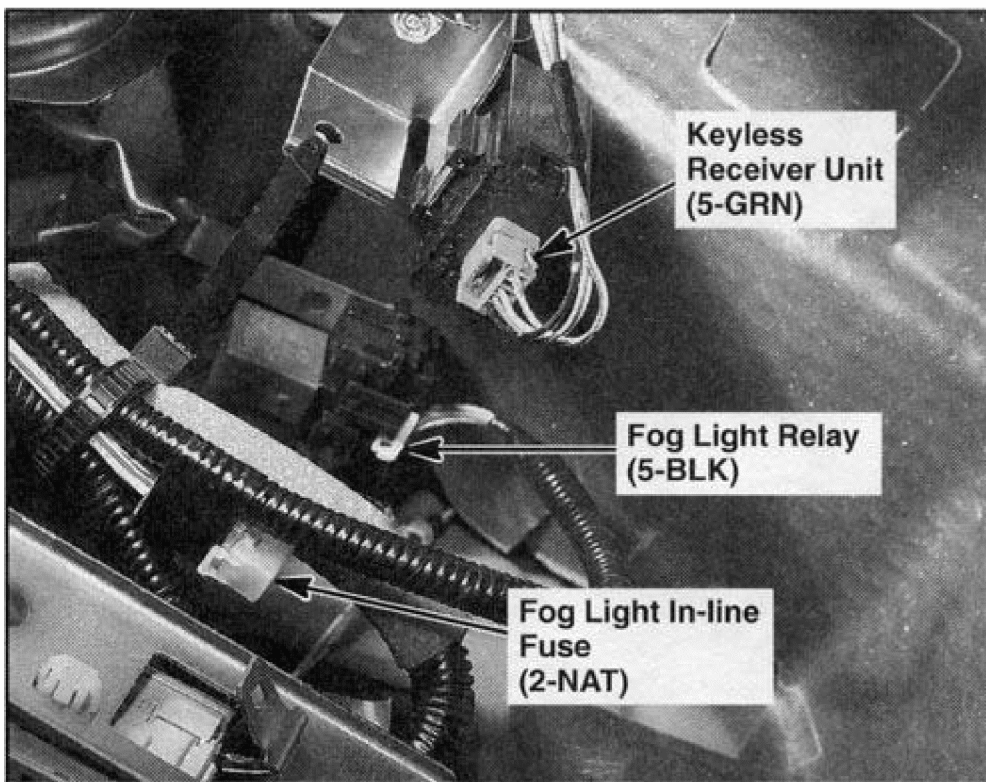

G00263938

Fig. 98: Under Left Side Of Dash (Honda Accessory)

Courtesy of AMERICAN HONDA MOTOR CO., INC.

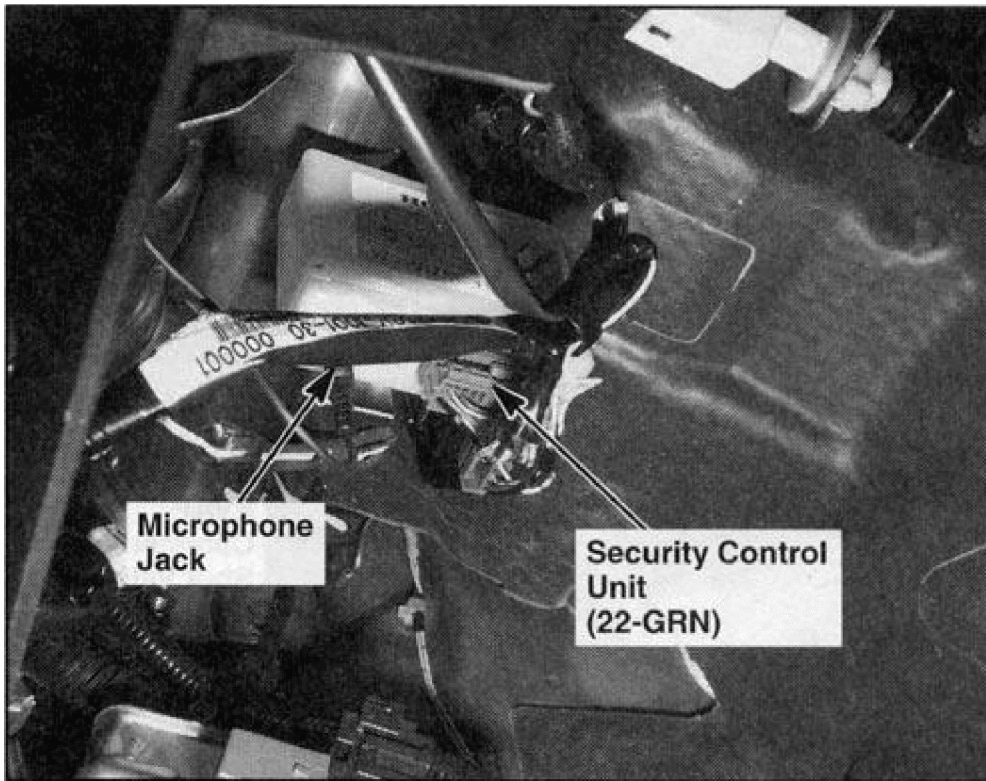

G00263939

Fig. 99: Under Left Side Of Dash (Honda Accessory)
Courtesy of AMERICAN HONDA MOTOR CO., INC.

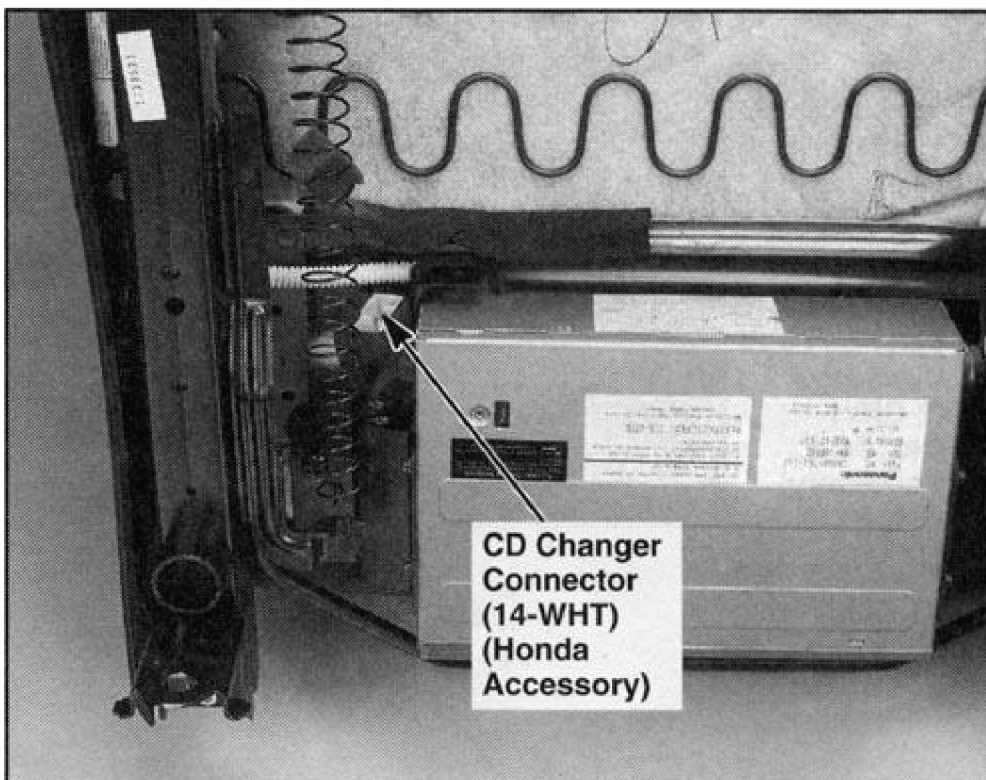

G00263941

Fig. 100: Under Front Passenger's Seat
Courtesy of AMERICAN HONDA MOTOR CO., INC.

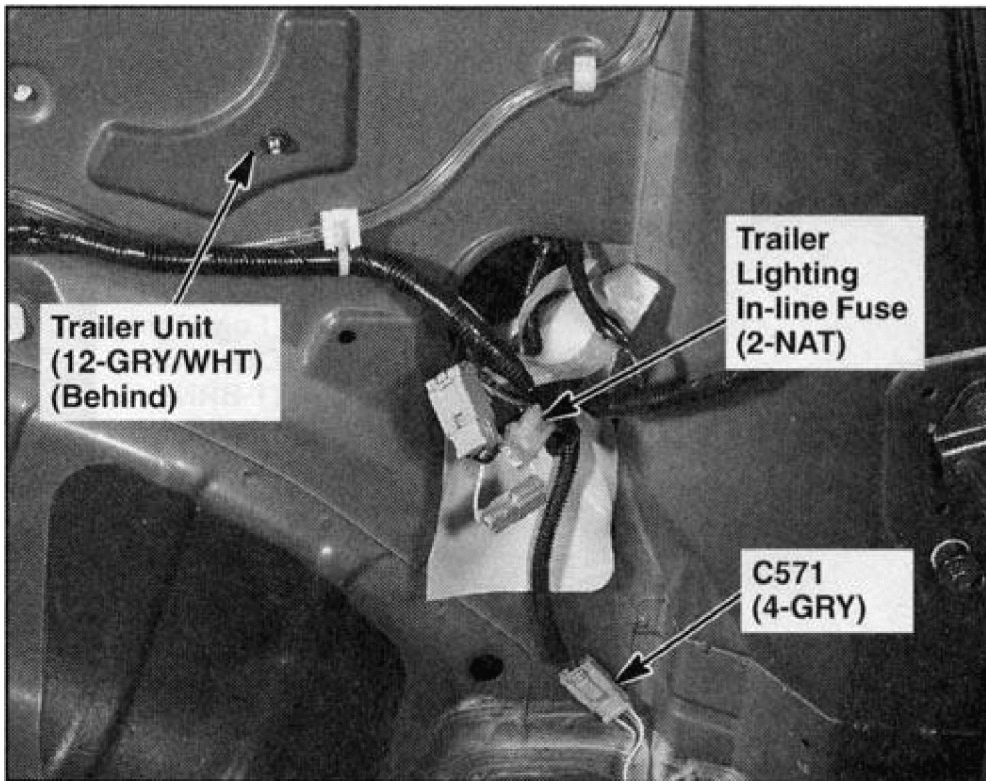

G00263942

Fig. 101: Right Quarter Panel (Honda Accessory)
Courtesy of AMERICAN HONDA MOTOR CO., INC.

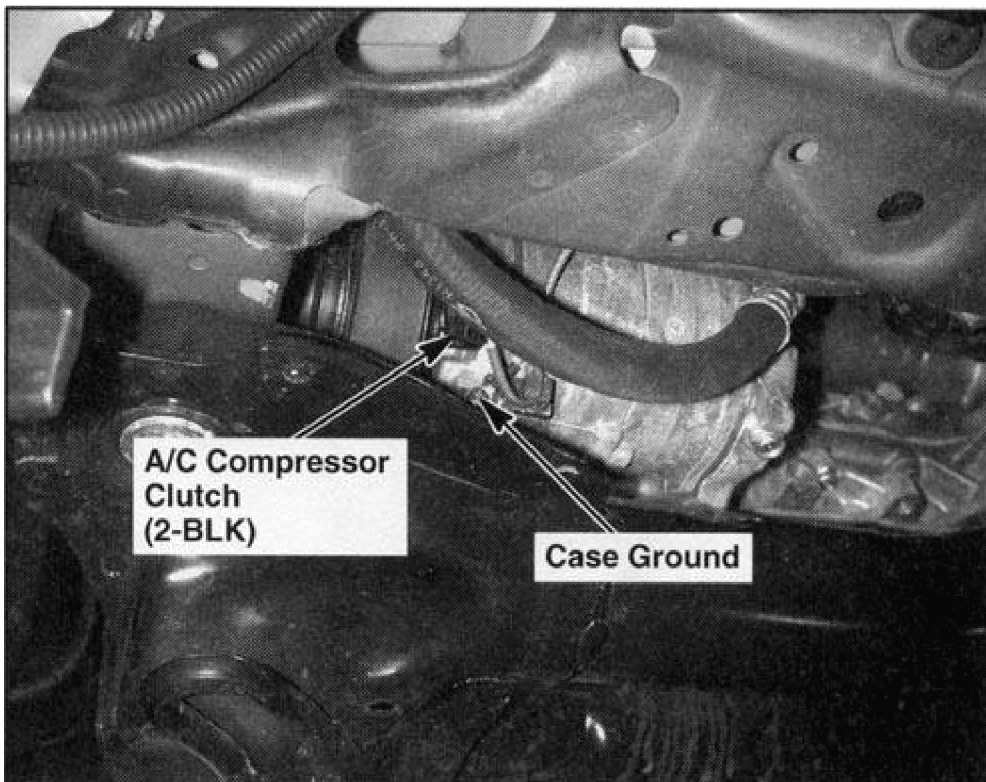

G00263943

Fig. 102: Front Of Engine Compartment (EX)

2004 Honda Element DX

2004 HONDA Element

Courtesy of AMERICAN HONDA MOTOR CO., INC.

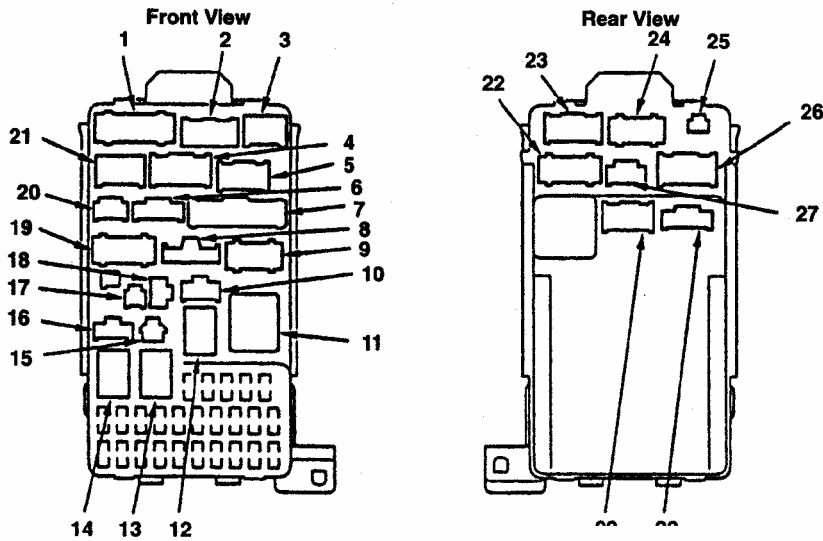

Ref	Socket
1	C
2	A
3	B
4	D
5	E
6	Q
7	P
8	H
9	G
10	R
11	Turn signal/hazard relay
12	Power window relay
13	Taillight relay
14	Starter cut relay
15	U
16	V
17	W (MES connector)
18	T
19	F
20	I (EX)
21	J
22	M
23	K
24	L
25	S
26	O
27	N
28	X
29	Y

G00292073

Fig. 103: Underdash Fuse/Relay Box
 Courtesy of AMERICAN HONDA MOTOR CO., INC.

2004 Honda Element DX

2004 HONDA Element

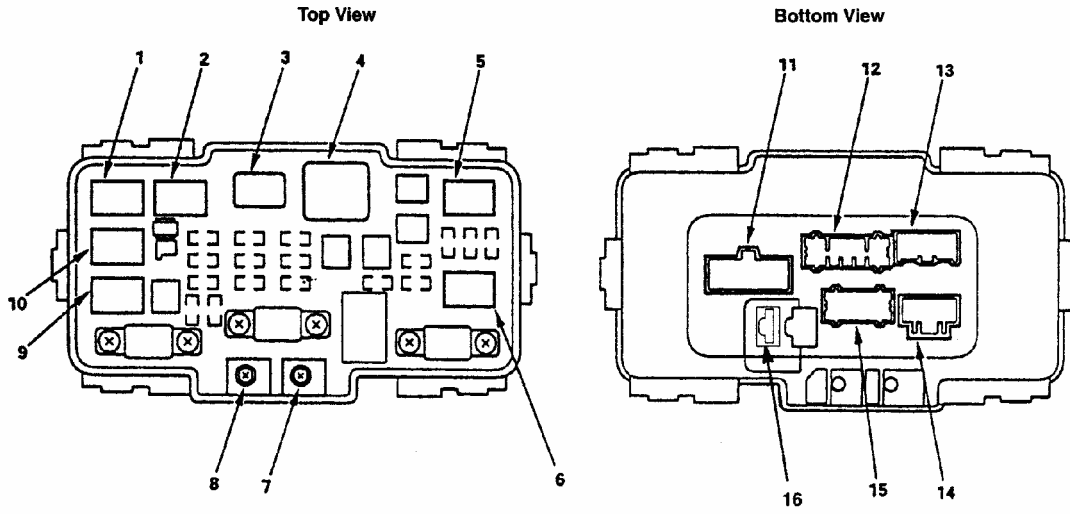

Ref	Socket
1	Radiator fan relay
2	A/C compressor clutch relay
3	Rear window defogger relay
4	Blower motor relay
5	Headlight relay 1
6	Headlight relay 2
7	T102
8	T101
9	Condenser Fan Relay
10	Horn relay
11	E
12	D
13	B
14	A
15	C
16	ELD unit

000292074

Fig. 104: Underhood Fuse/Relay Box
 Courtesy of AMERICAN HONDA MOTOR CO., INC.

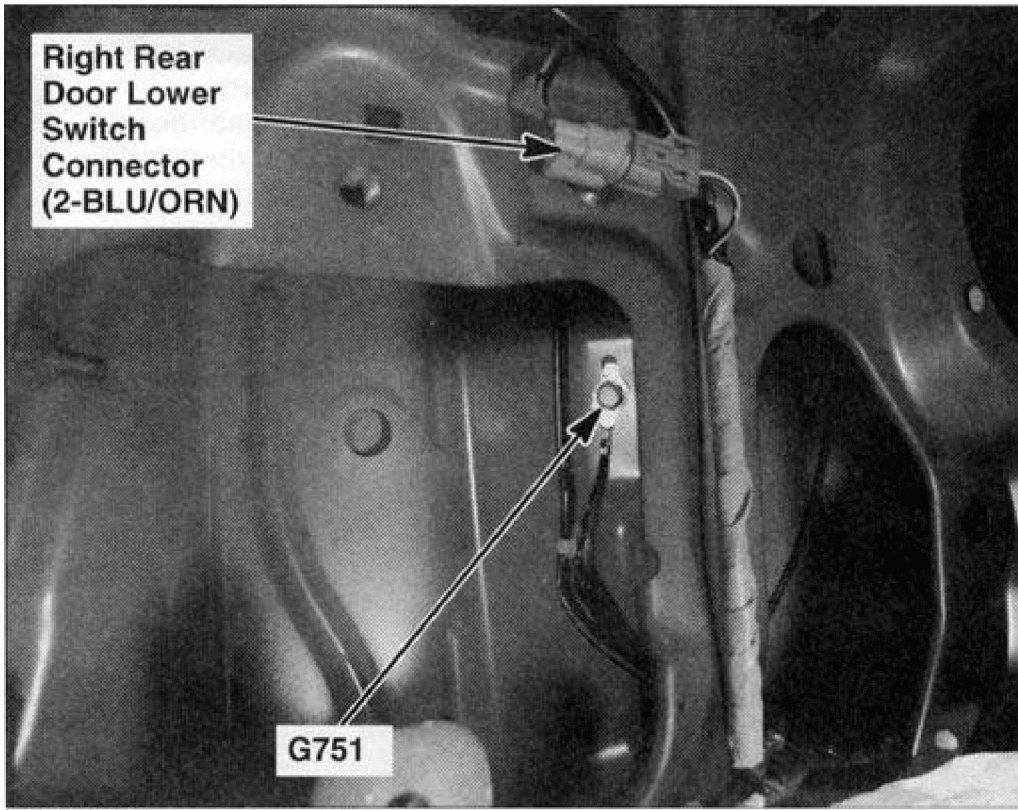

G00291682

Fig. 105: Right Rear Door
Courtesy of AMERICAN HONDA MOTOR CO., INC.