

LEXUS GS 450h (EM02D0U)

709

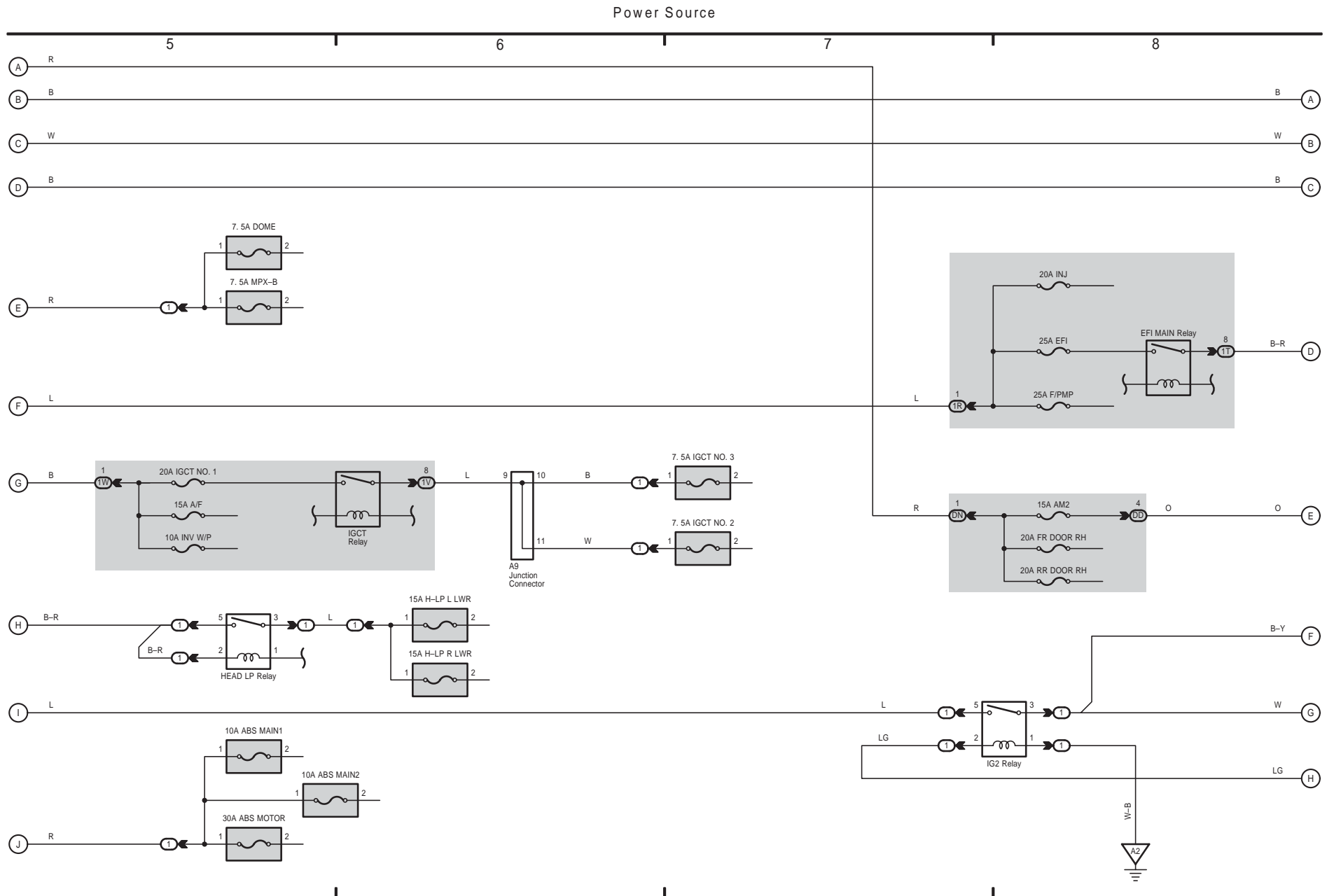

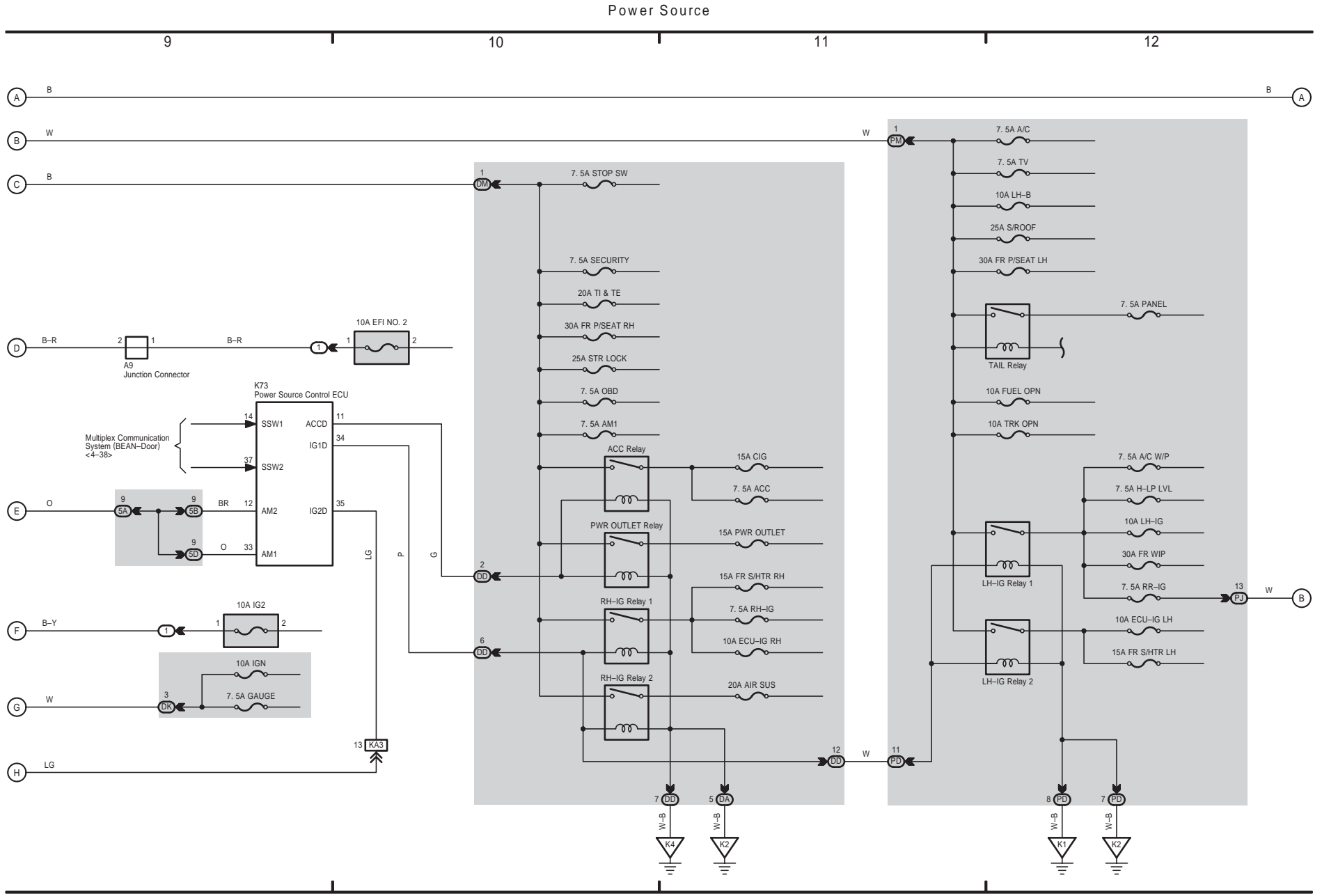

1 GS 450h (Cont' d)

Power Source

13

14

15

16

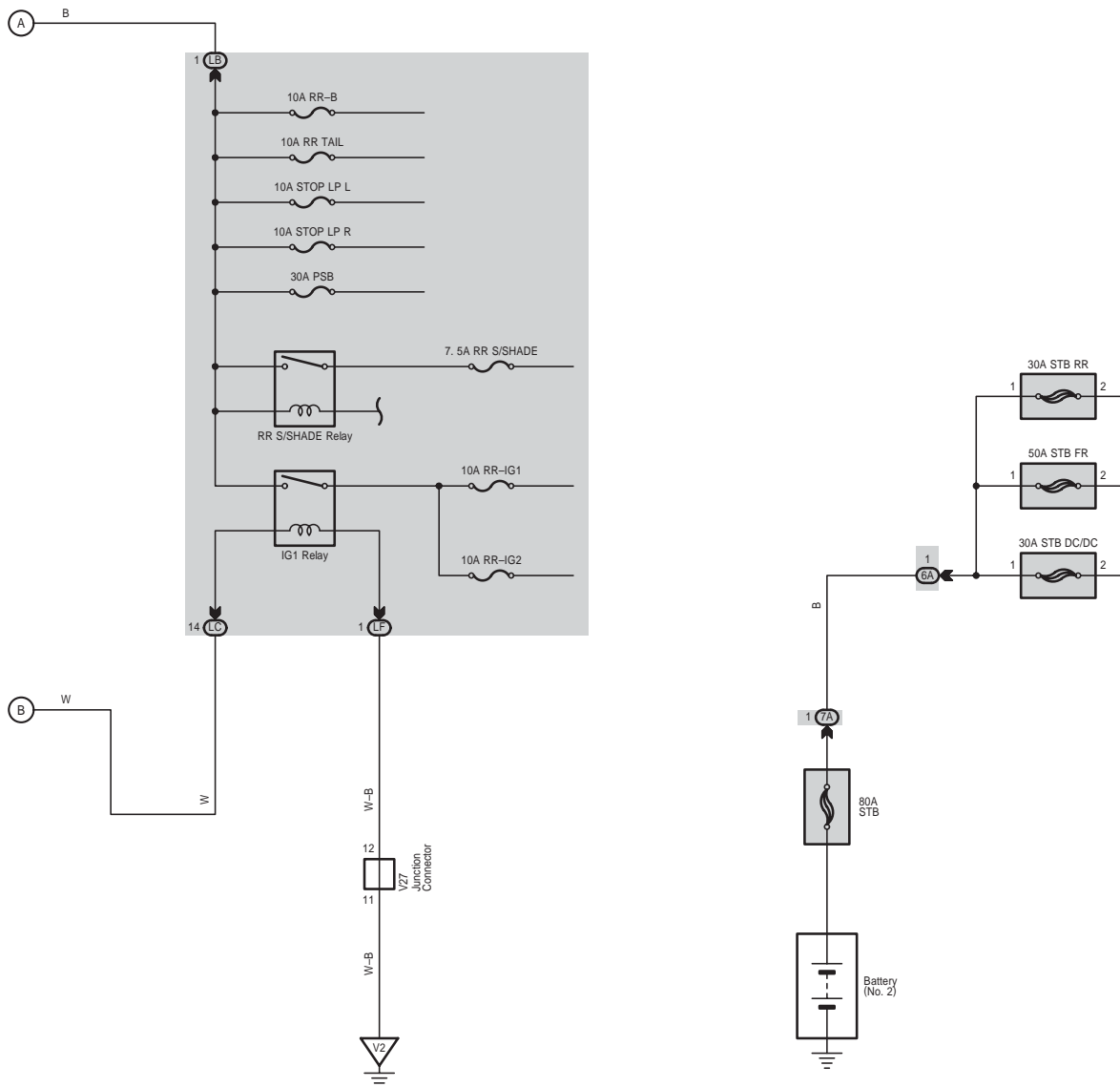

LEXUS GS 450h (EM02D0U)

711

M

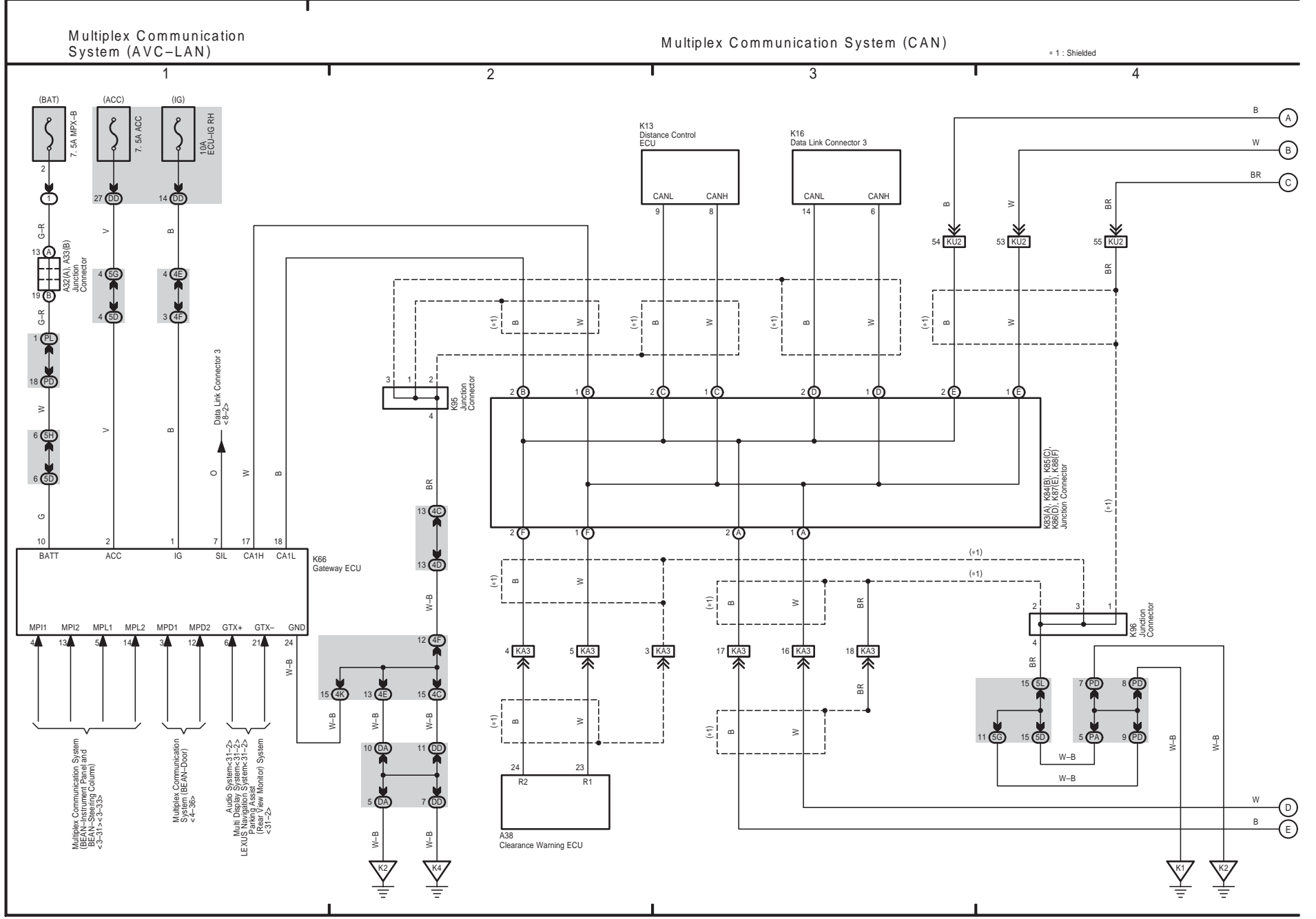

Multiplex Communication System (CAN)

* 1 : Shielded
* 2 : w/ Active Stabilizer Suspension System

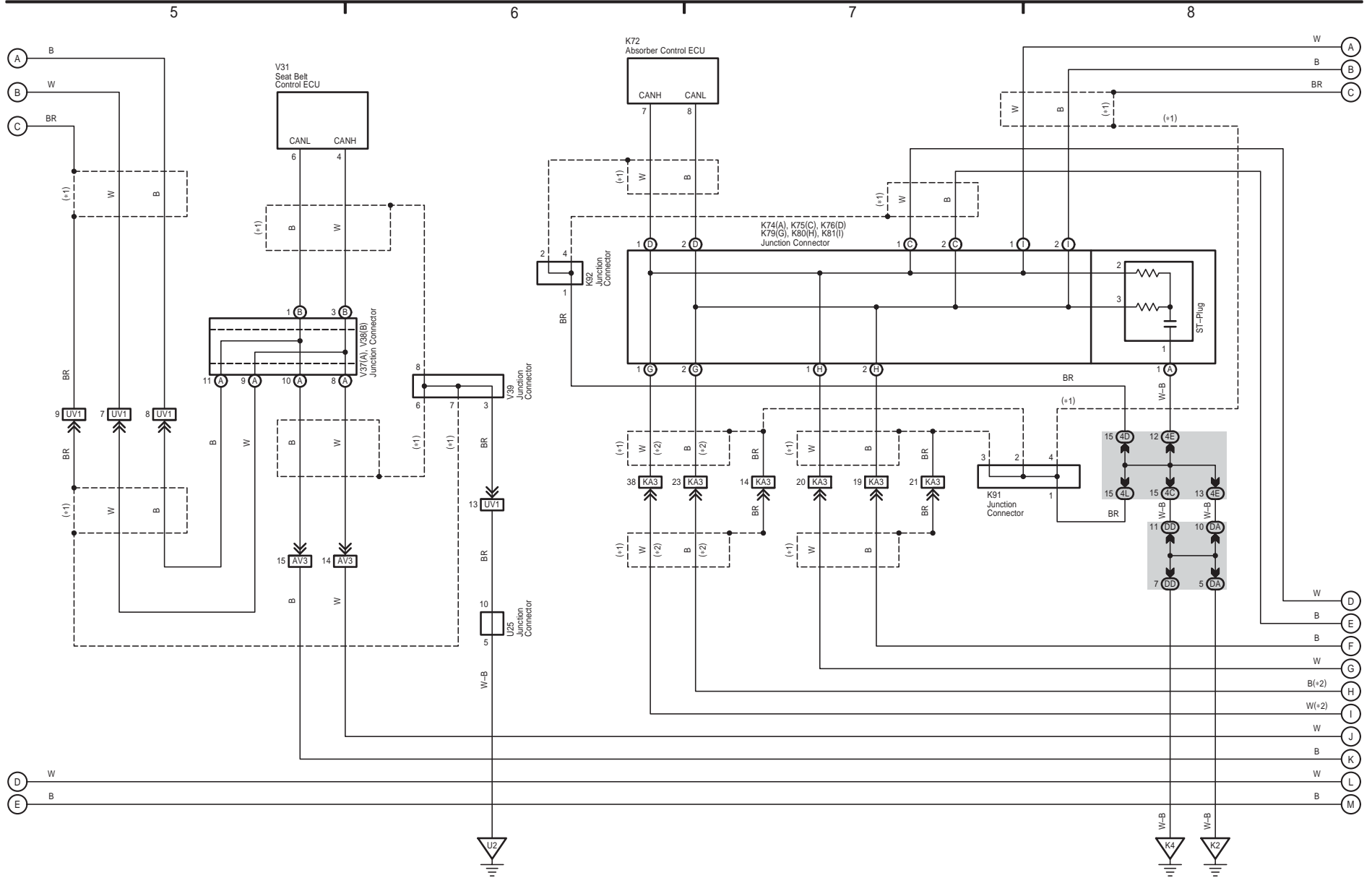

LEXUS GS 450h (EM02D0U)



Multiplex Communication System (CAN)

- * 1 : Shielded
- * 2 : w/ Active Stabilizer Suspension System
- * 3 : w/o Active Stabilizer Suspension System

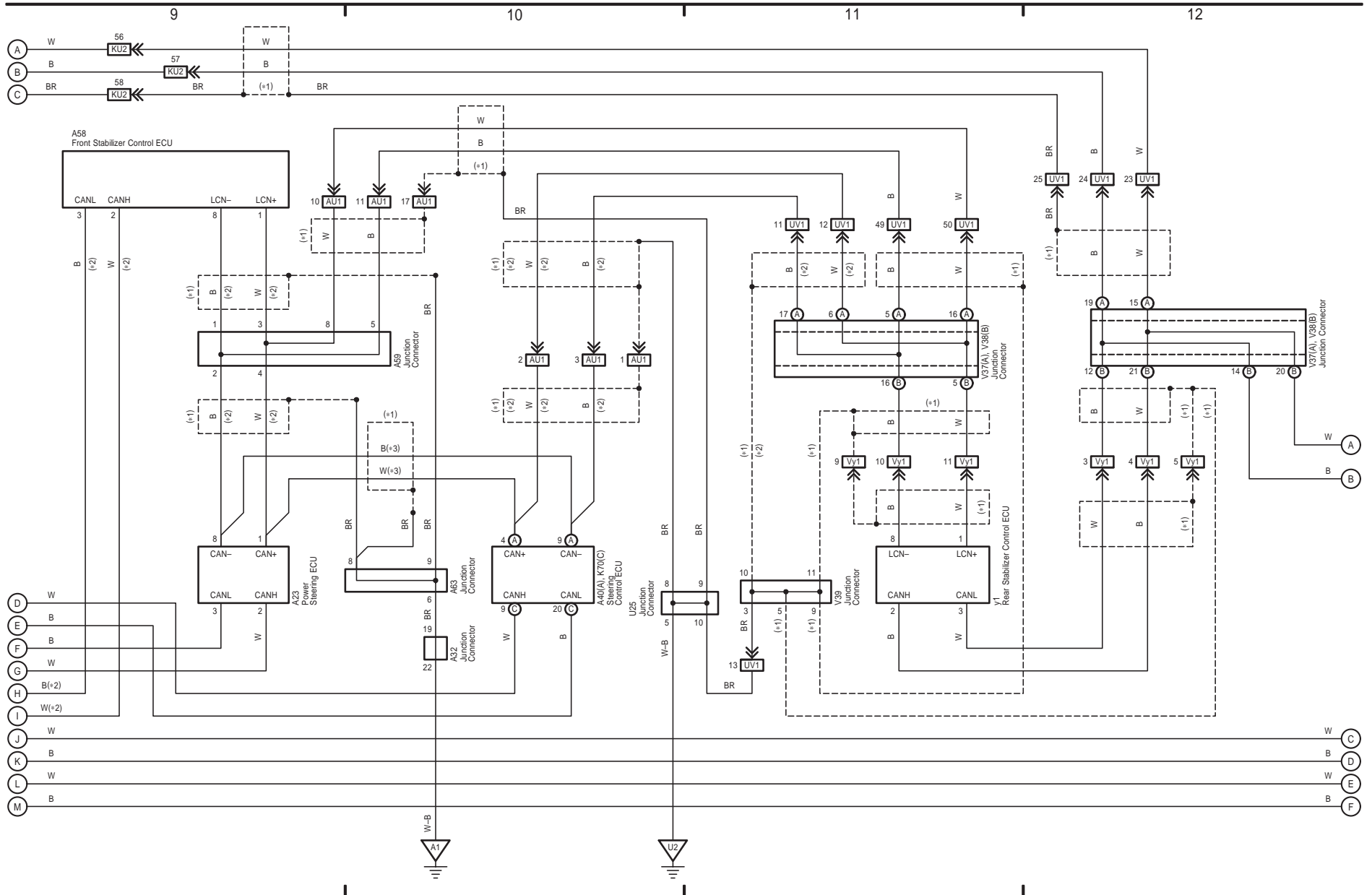

LEXUS GS 450h (EM02D0U)

Multiplex Communication System (CAN)

* 1 : Shielded

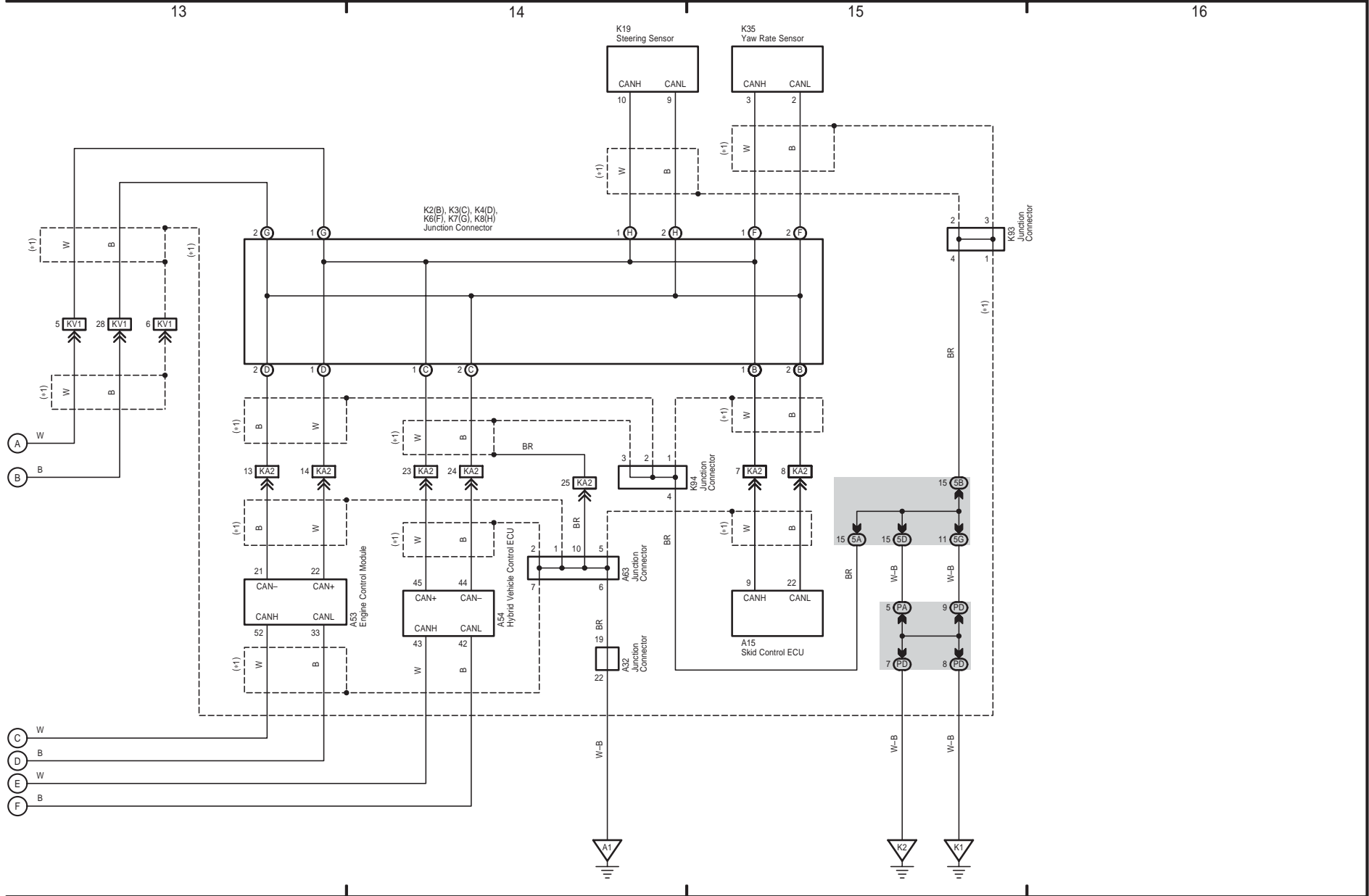

LEXUS GS 450h (EM02D0U)



Multiplex Communication System (BEAN-Instrument Panel and BEAN-Steering Column)

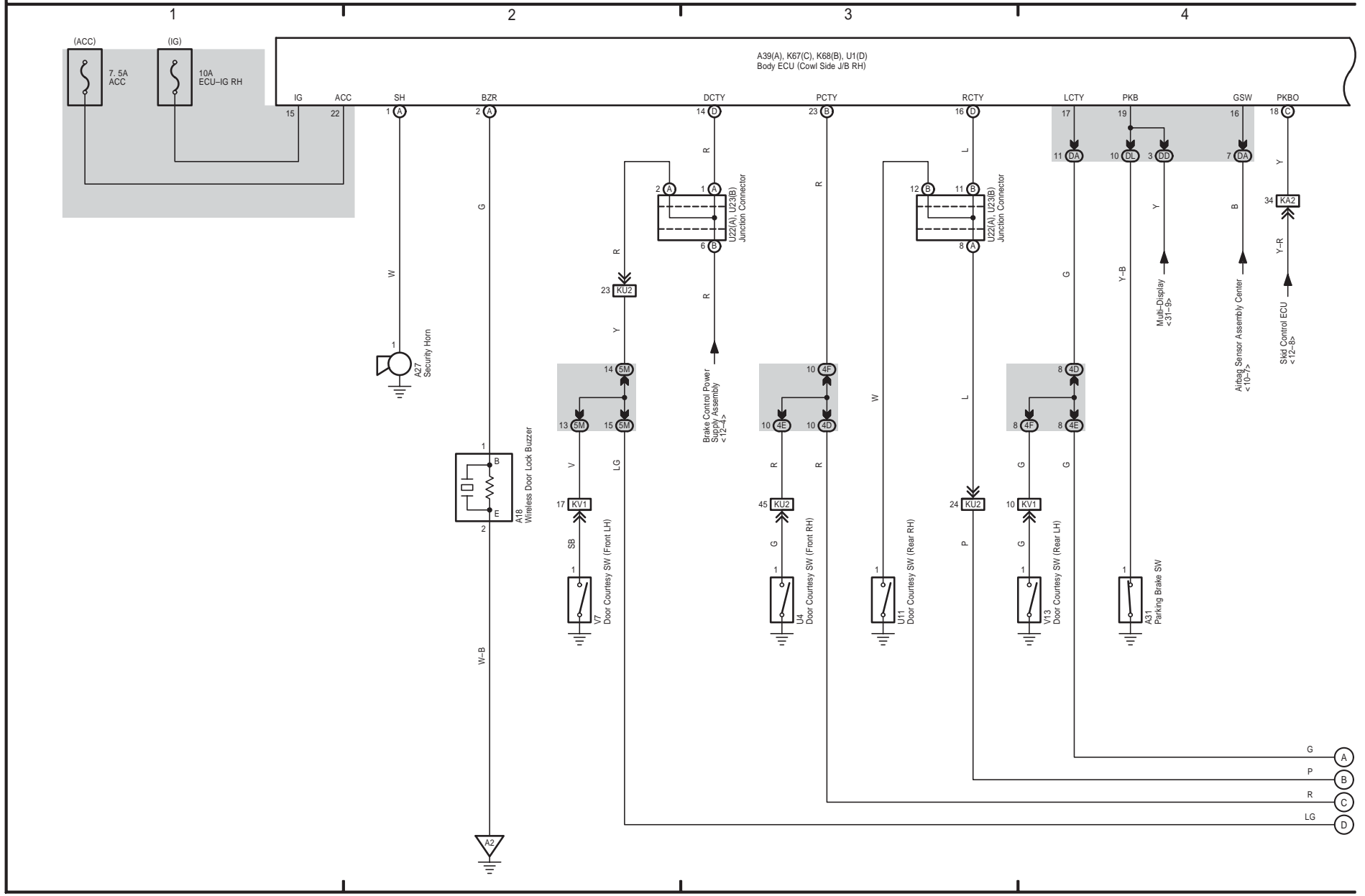

Multiplex Communication System (BEAN-Instrument Panel and BEAN-Steering Column)

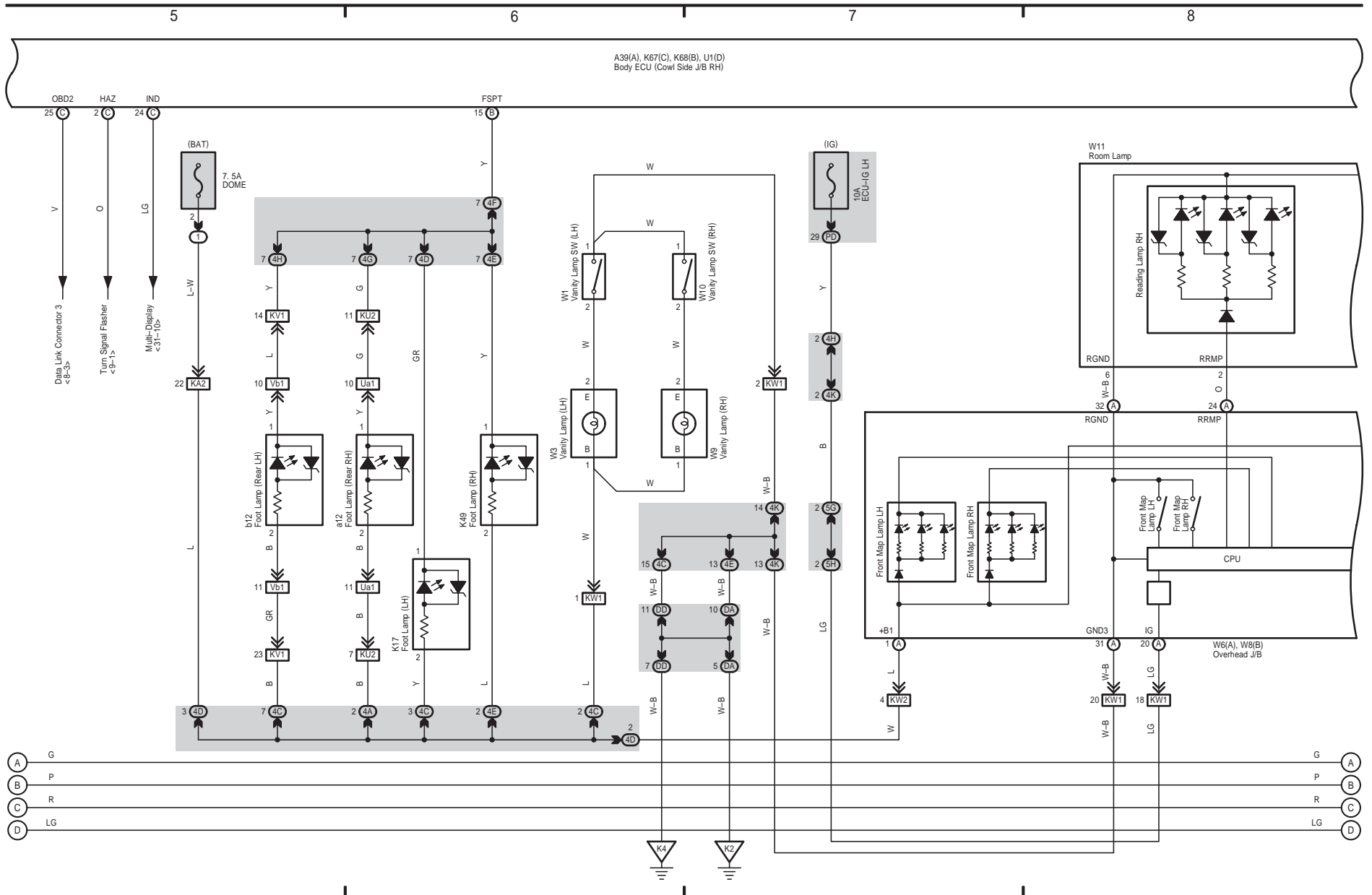

LEXUS GS 450h (EM02D0U)



Multiplex Communication System (BEAN-Instrument Panel and BEAN-Steering Column)

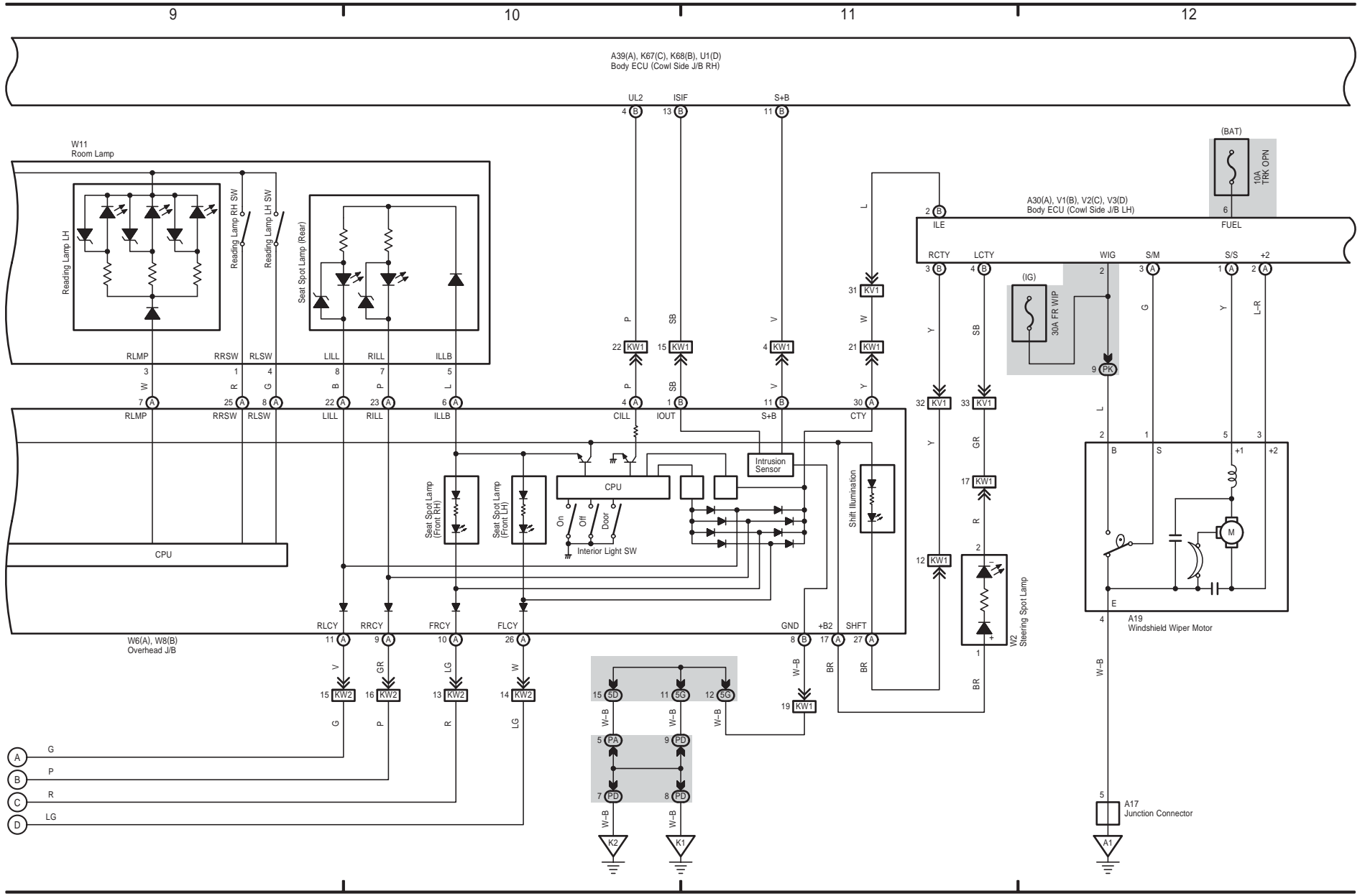

Multiplex Communication System (BEAN-Instrument Panel and BEAN-Steering Column)

13

14

15

16

A39(A), K67(C), K68(B), U1(D)
Body ECU (Cowl Side J/B RH)

A30(A), V1(B), V2(C), V3(D)
Body ECU (Cowl Side J/B LH)

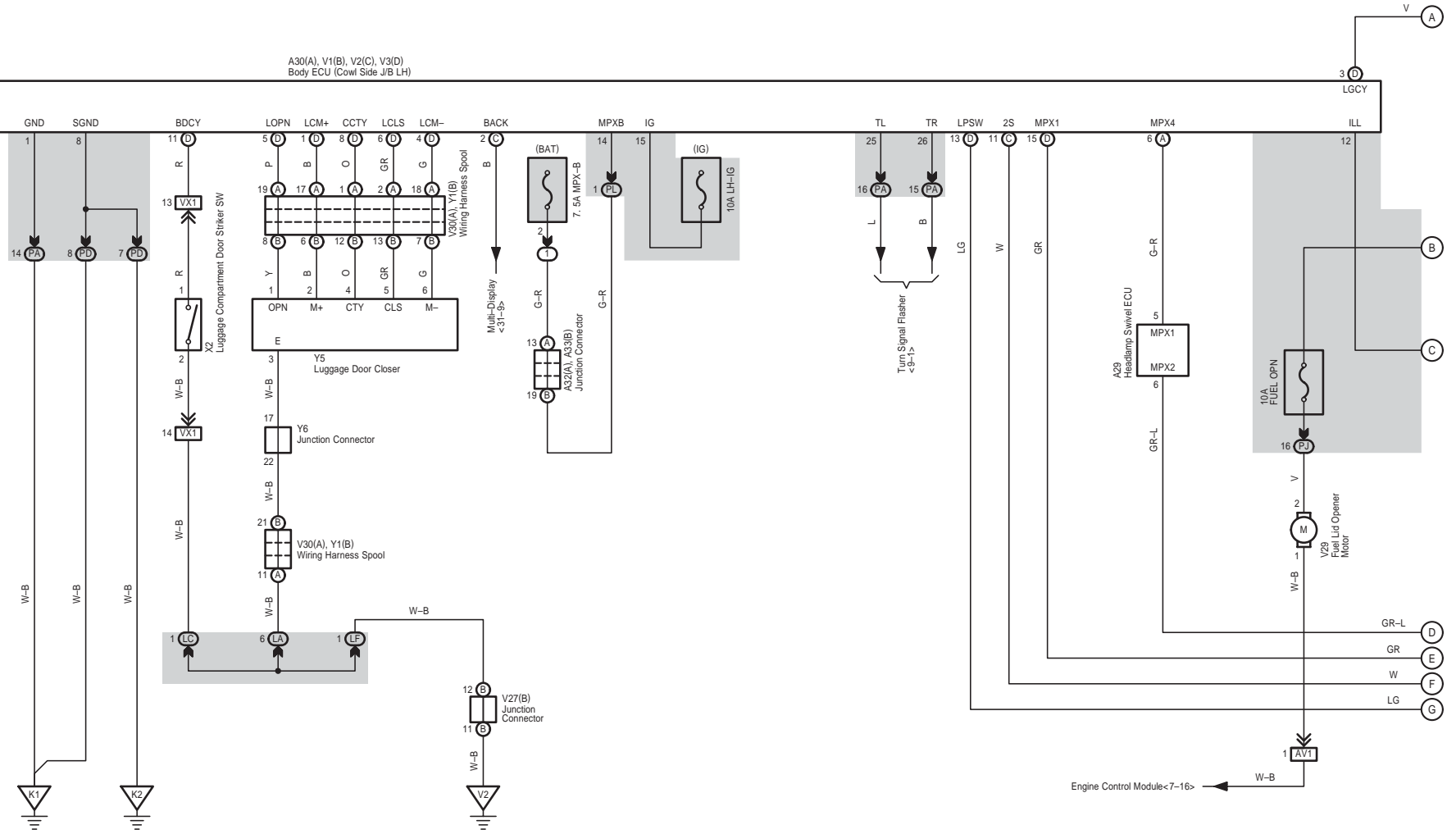

LEXUS GS 450h (EM02D0U)



Multiplex Communication System (BEAN-Instrument Panel and BEAN-Steering Column)

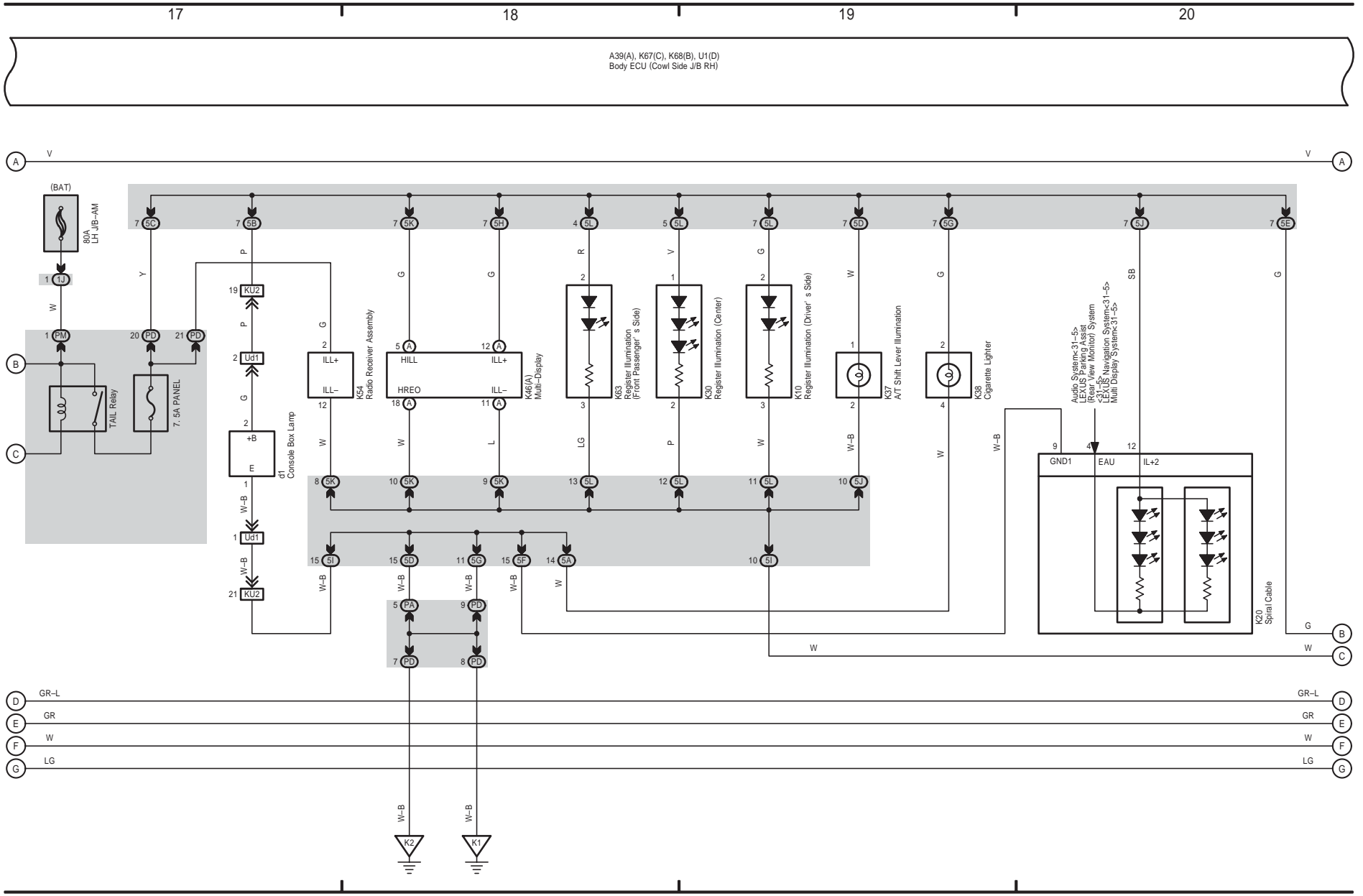

LEXUS GS 450h (EM02D0U)

Multiplex Communication System (BEAN-Instrument Panel and BEAN-Steering Column)

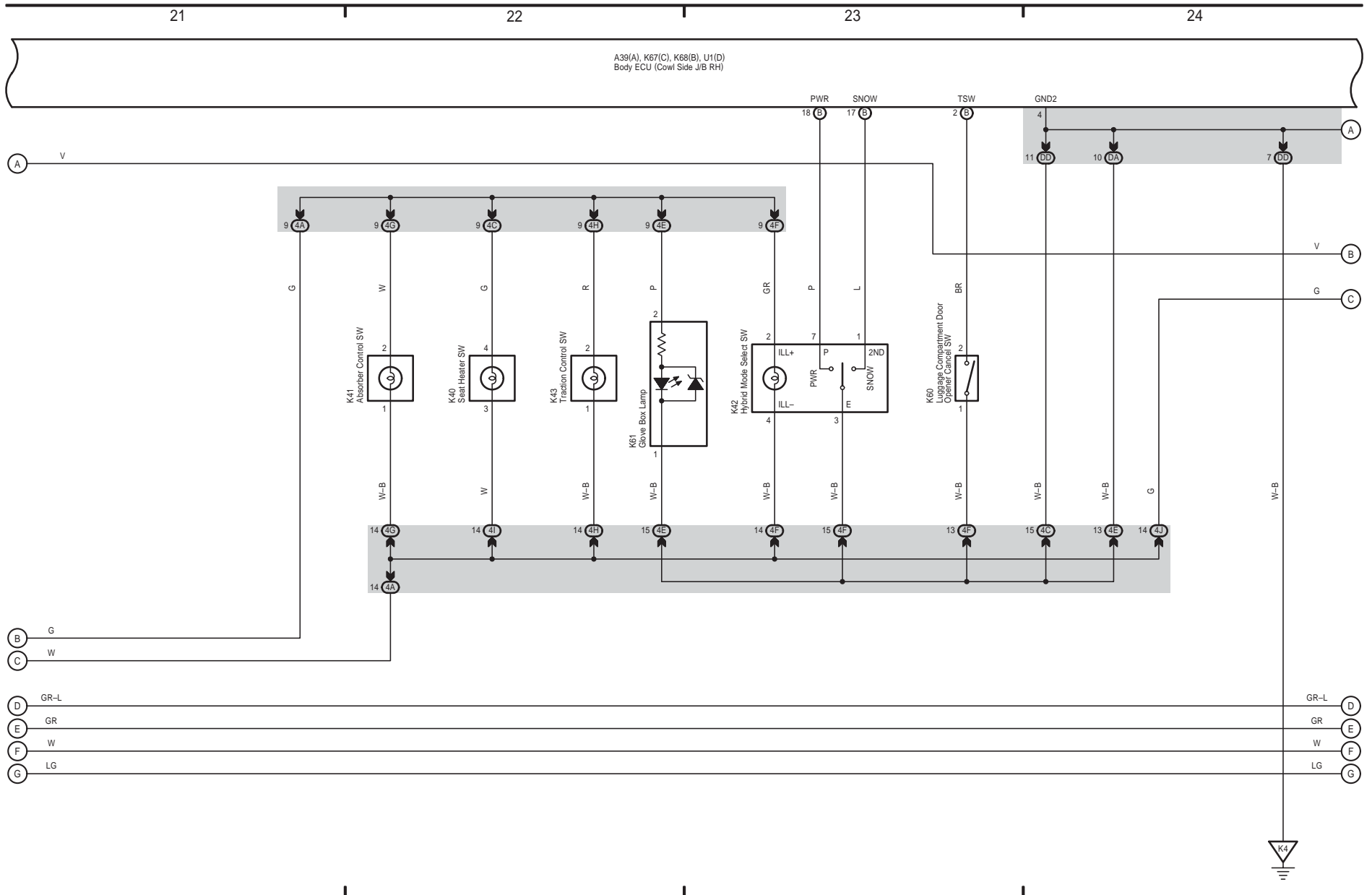

LEXUS GS 450h (EM02D0U)



Multiplex Communication System (BEAN-Instrument Panel and BEAN-Steering Column)

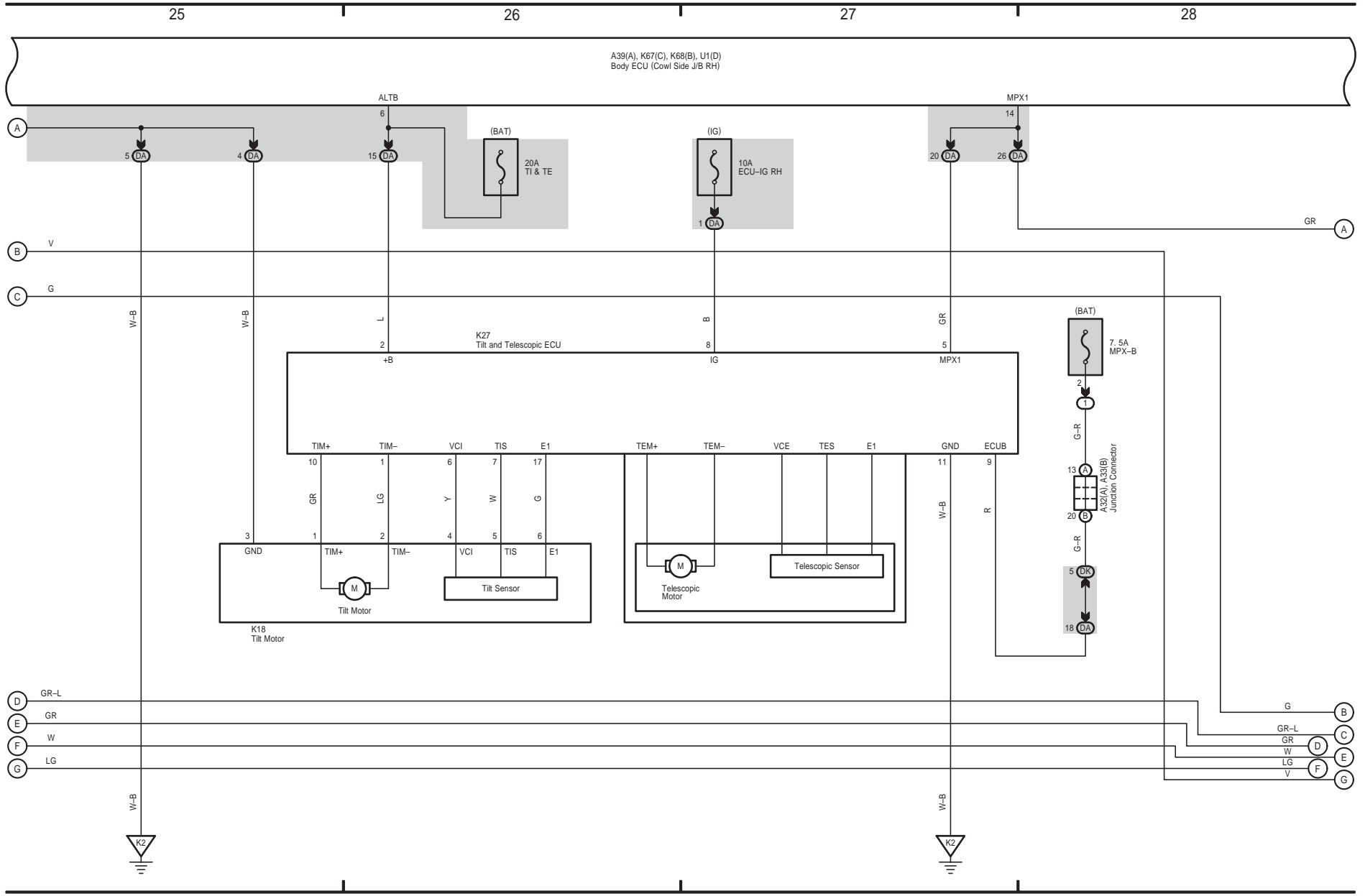

LEXUS GS 450h (EM02D0U)

Multiplex Communication System (BEAN-Instrument Panel and BEAN-Steering Column)

29 30 31 32

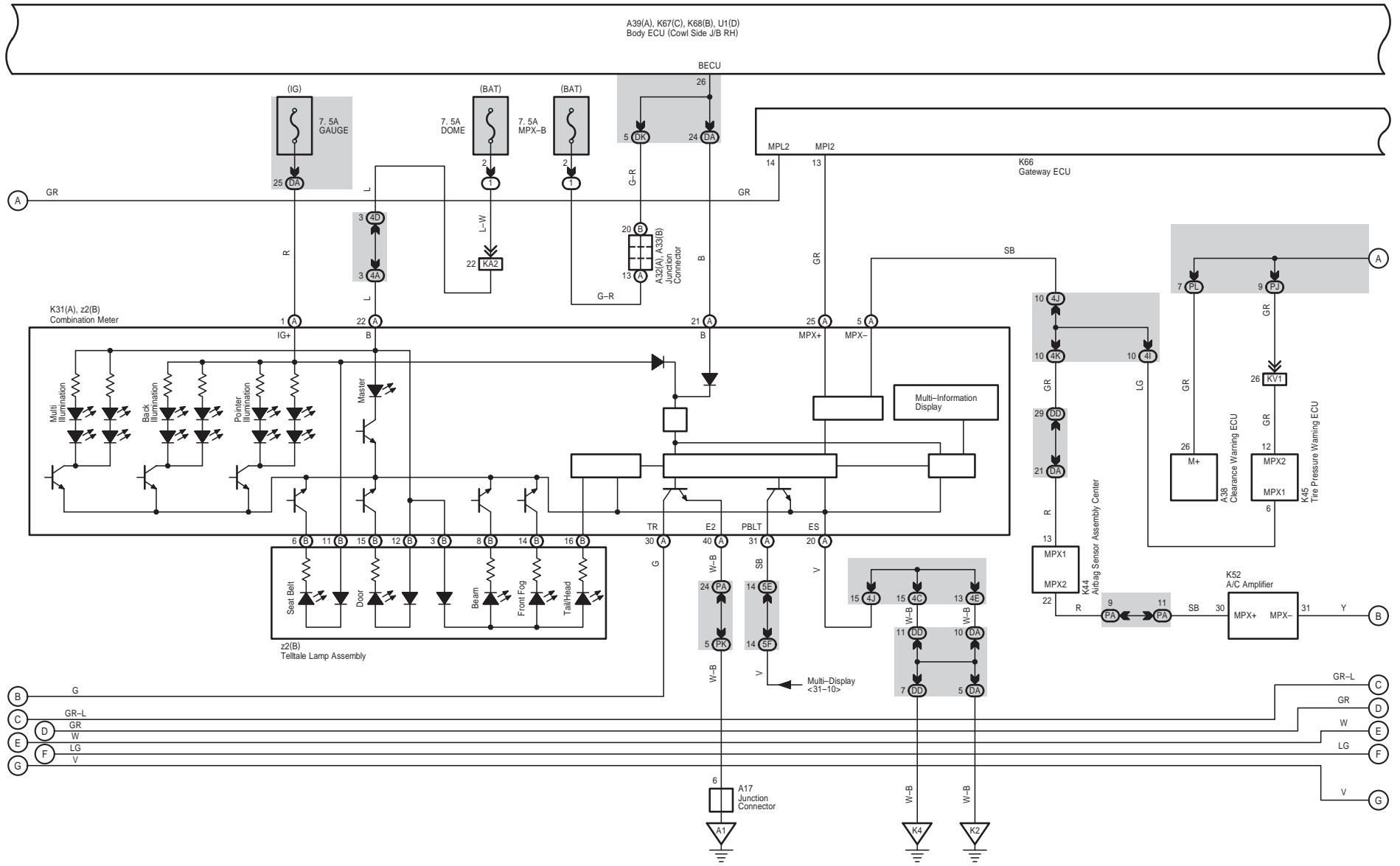

LEXUS GS 450h (EM02D0U)



Multiplex Communication System (BEAN-Instrument Panel and BEAN-Steering Column)

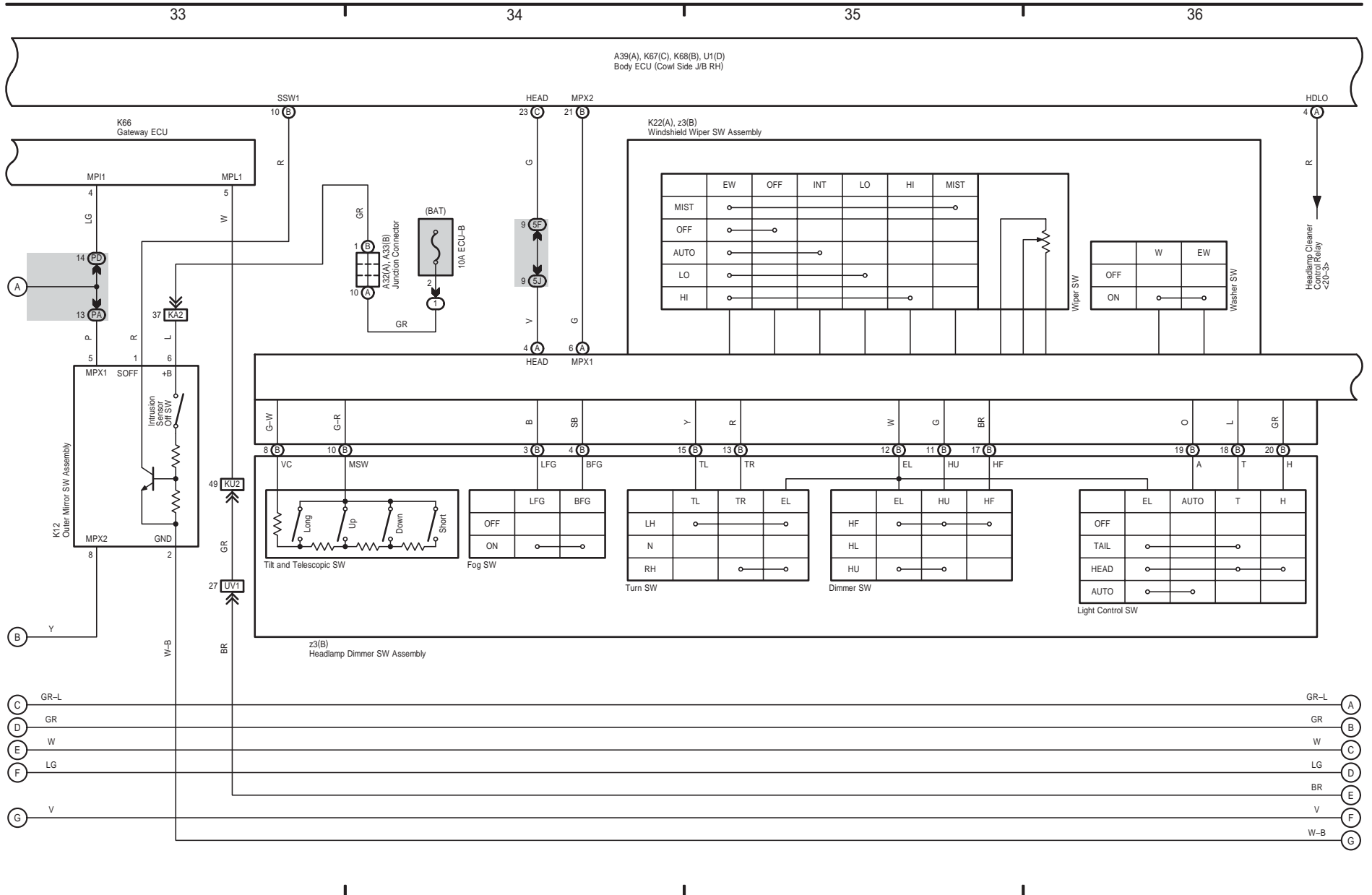

LEXUS GS 450h (EM02D0U)

Multiplex Communication System (BEAN-Instrument Panel and BEAN-Steering Column)

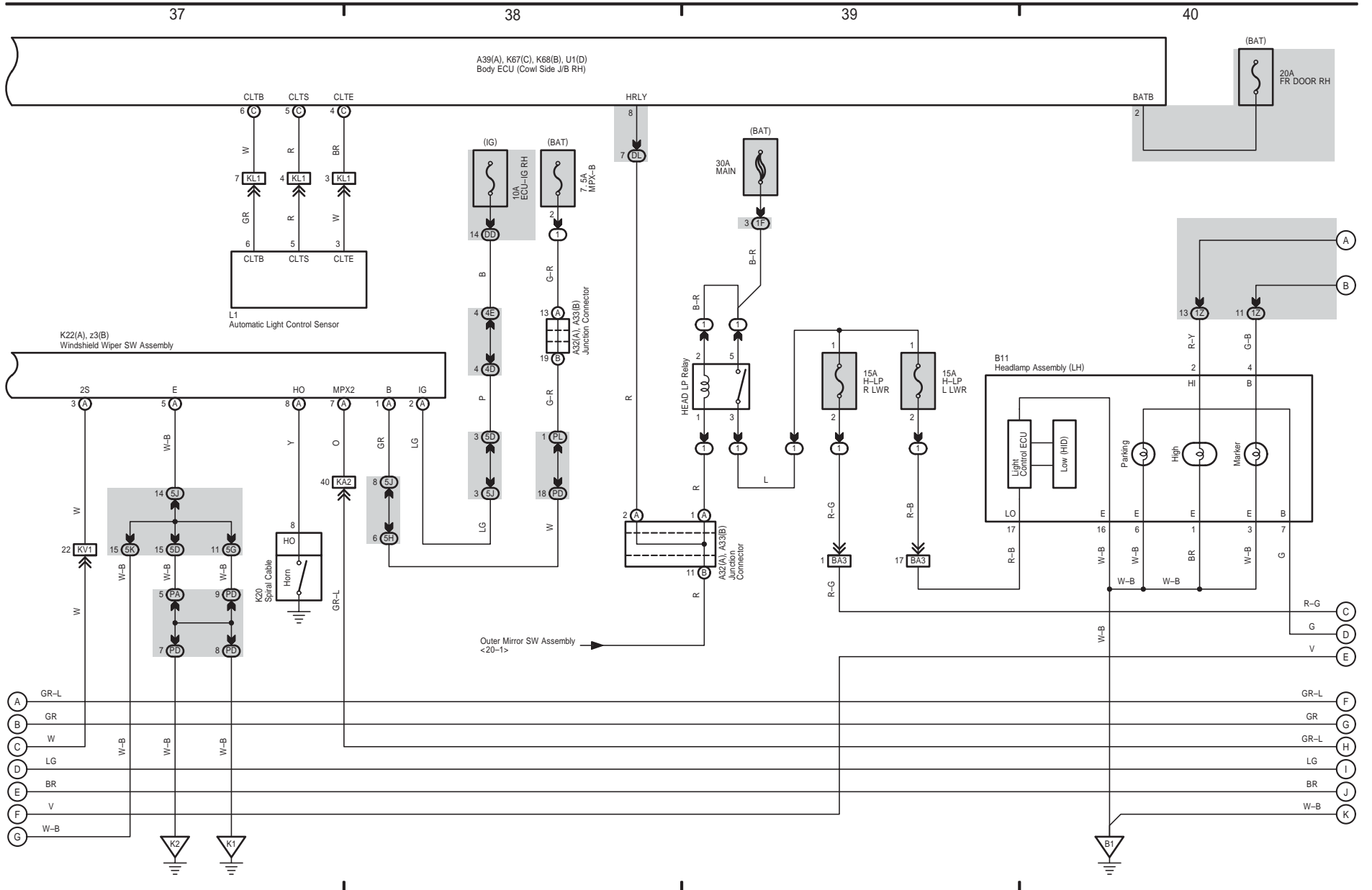

LEXUS GS 450h (EM02D0U)



Multiplex Communication System (BEAN-Instrument Panel and BEAN-Steering Column)

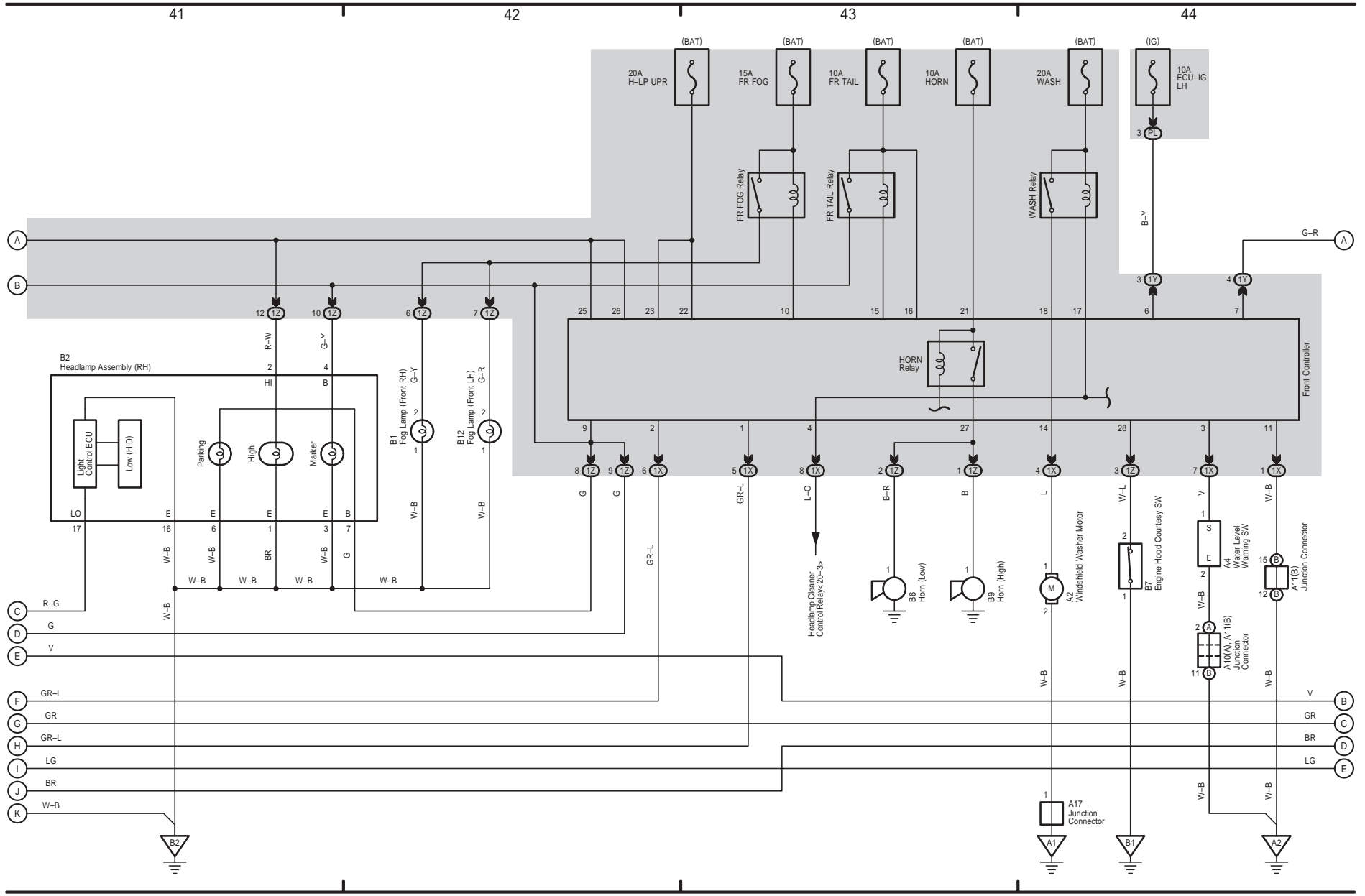

LEXUS GS 450h (EM02D0U)

Multiplex Communication System (BEAN-Instrument Panel and BEAN-Steering Column)

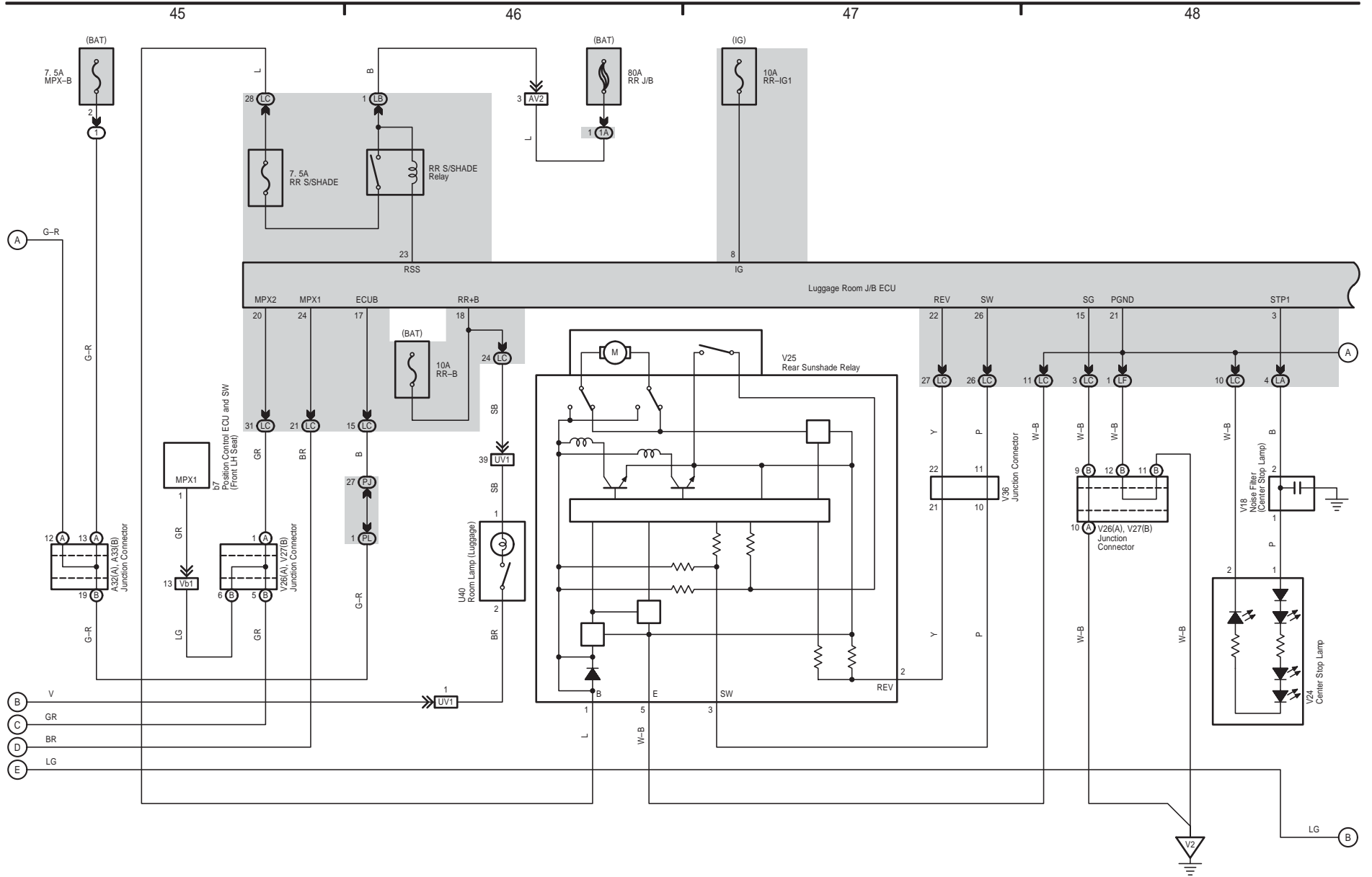

LEXUS GS 450h (EM02D0U)



3 GS 450h (Cont' d)

Multiplex Communication System (BEAN-Instrument Panel and BEAN-Steering Column)

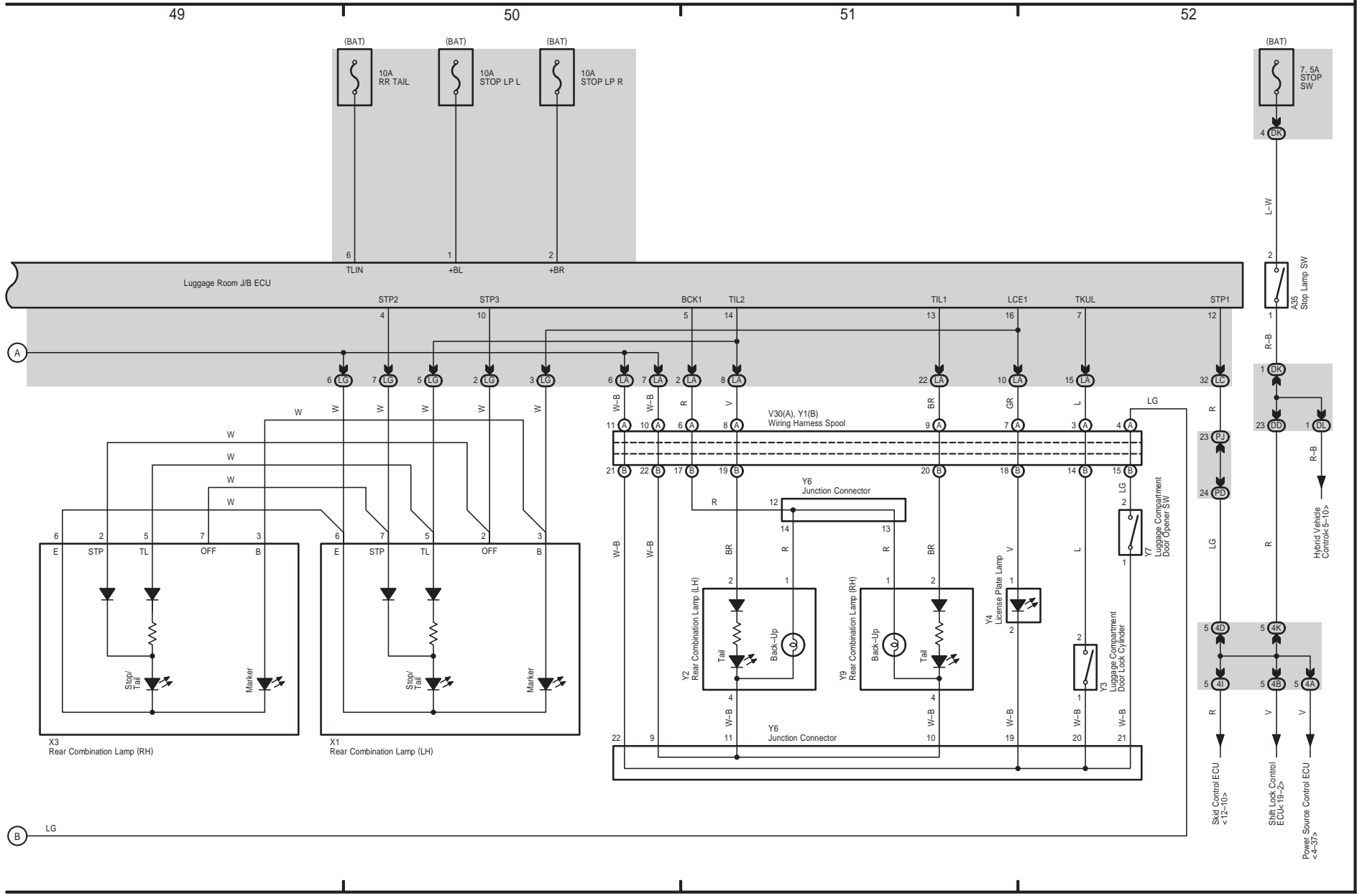

Multiplex Communication System (BEAN-Door)

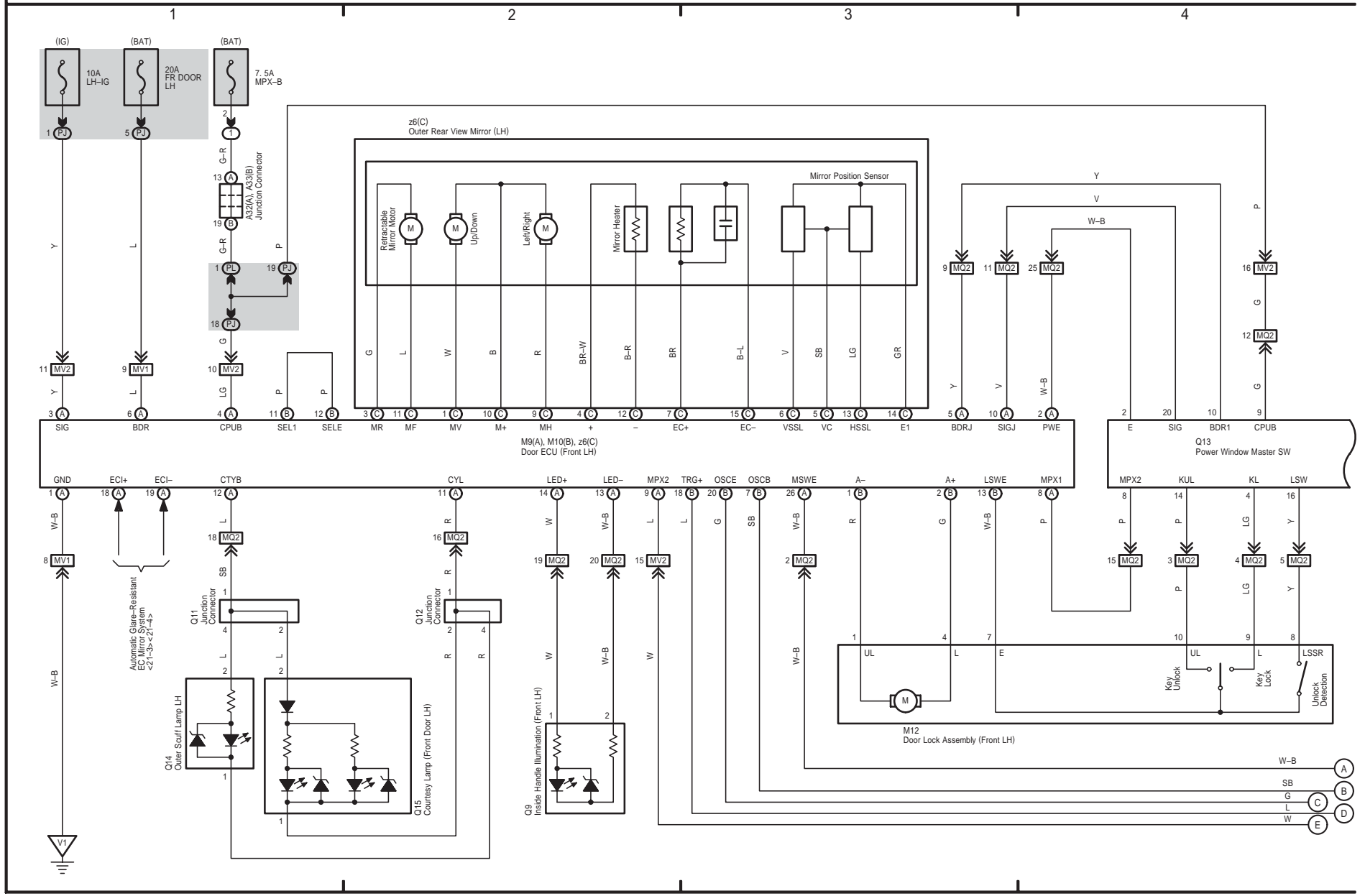

Multiplex Communication System (BEAN-Door)

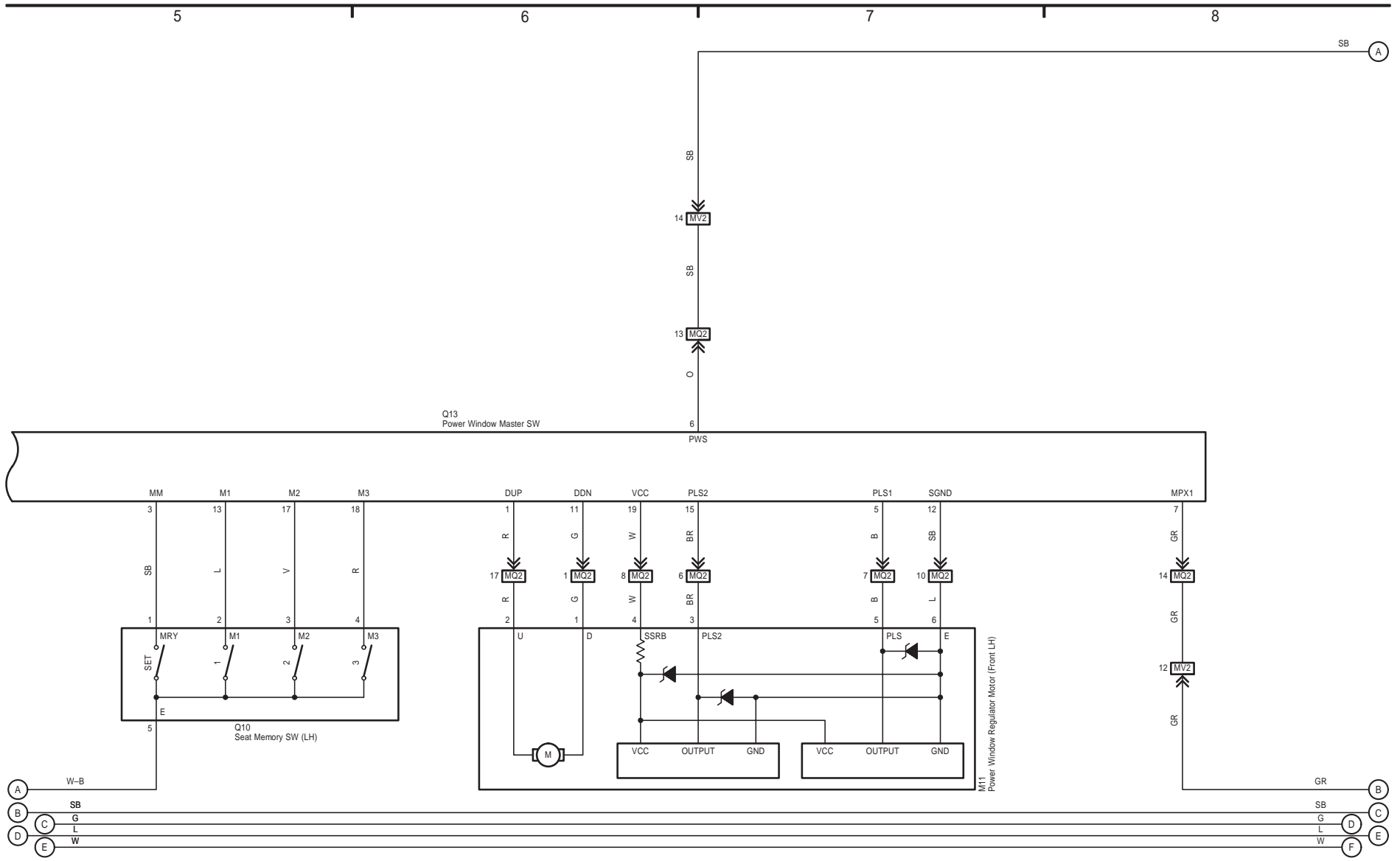

LEXUS GS 450h (EM02D0U)



Multiplex Communication System (BEAN-Door)

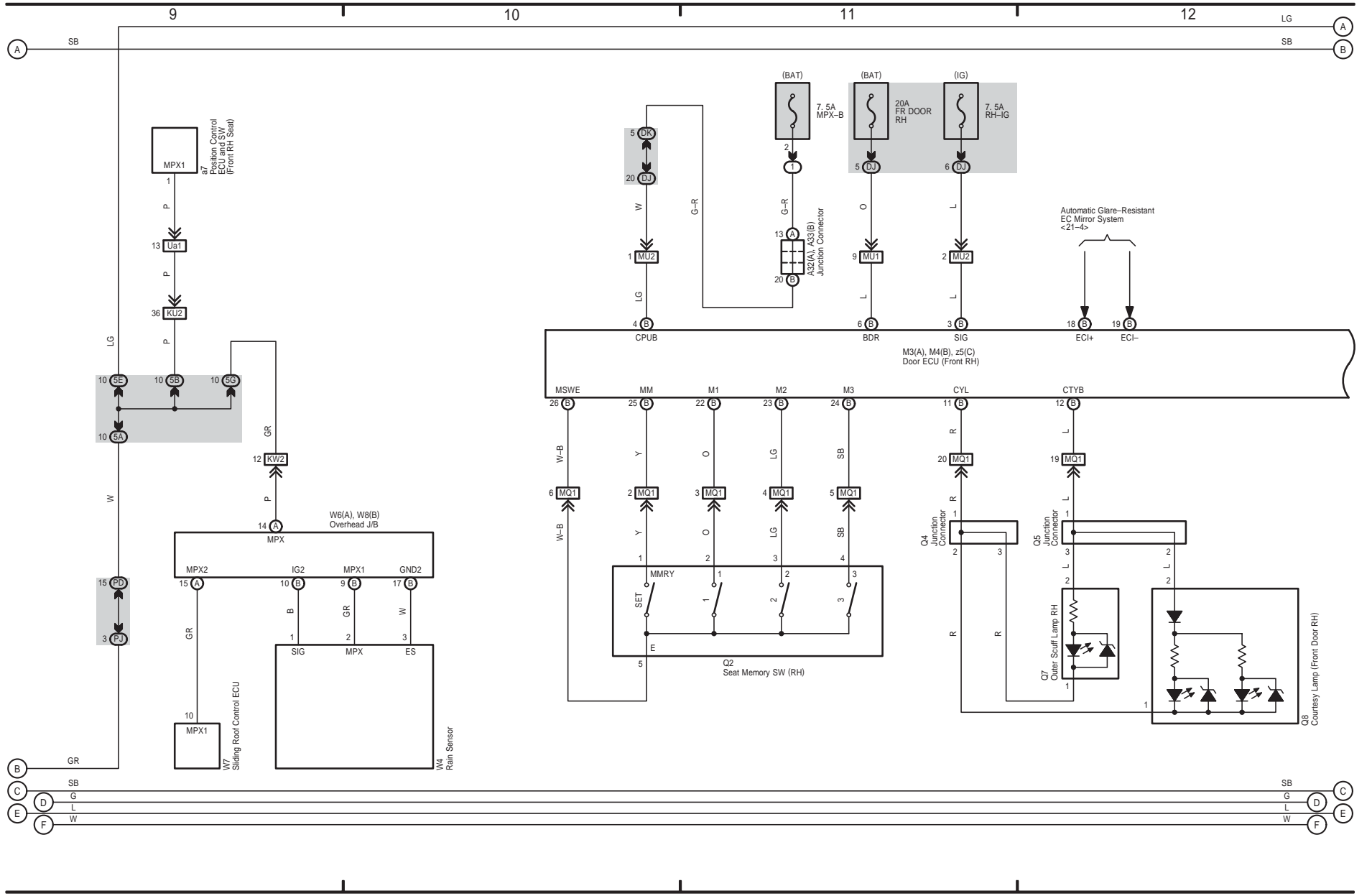

Multiplex Communication System (BEAN-Door)

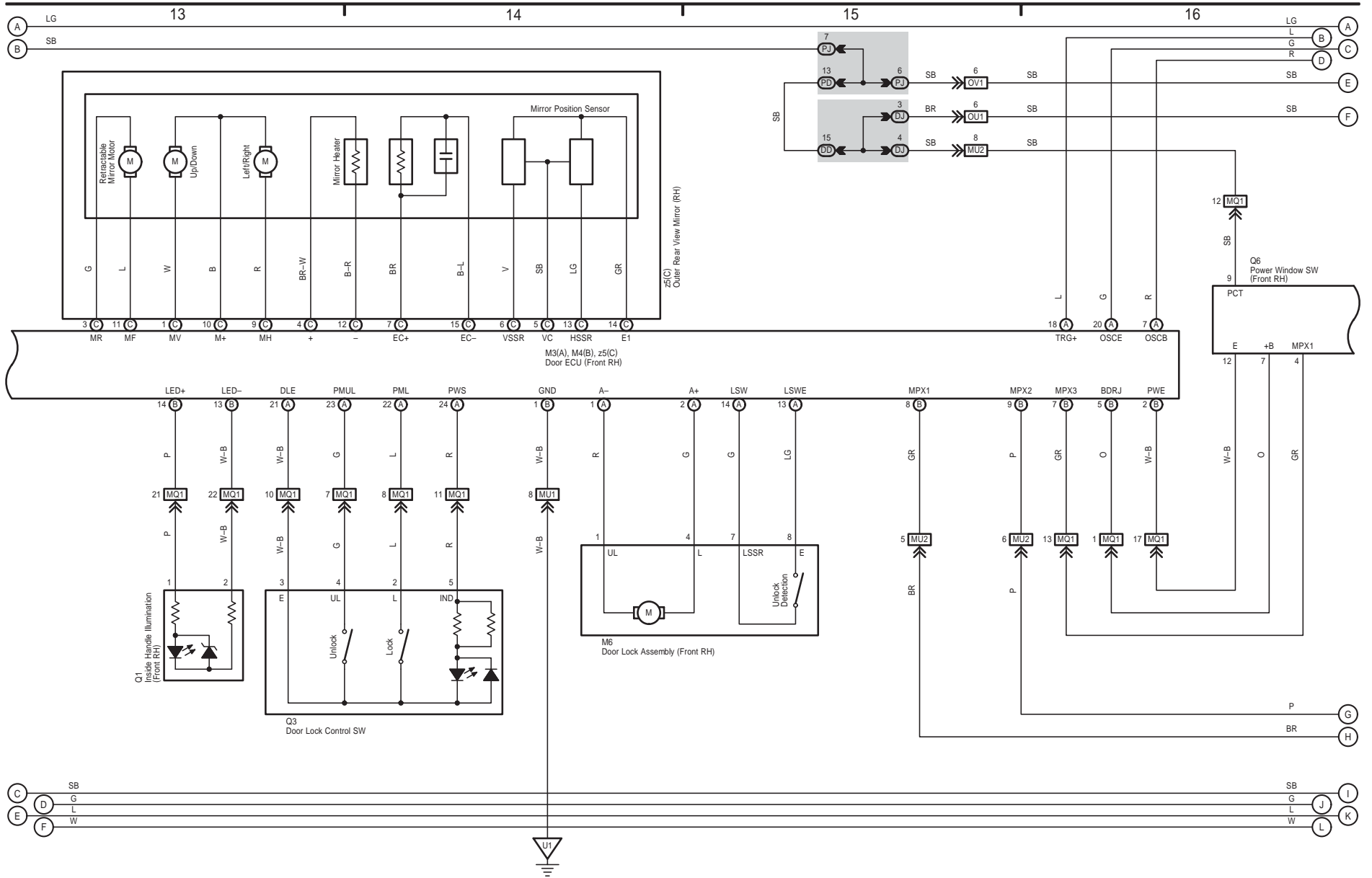

LEXUS GS 450h (EM02D0U)



Multiplex Communication System (BEAN-Door)

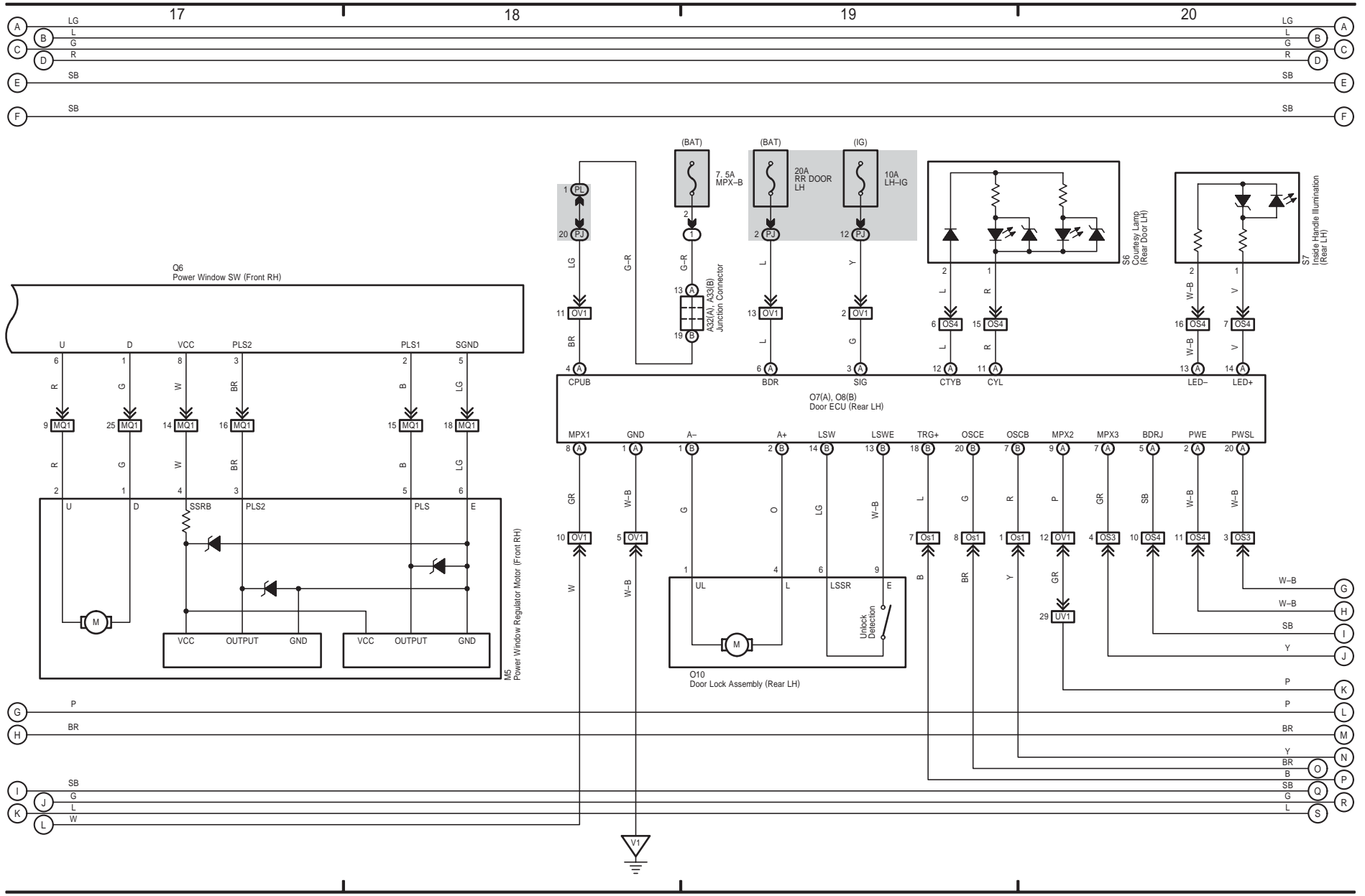

Multiplex Communication System (BEAN-Door)

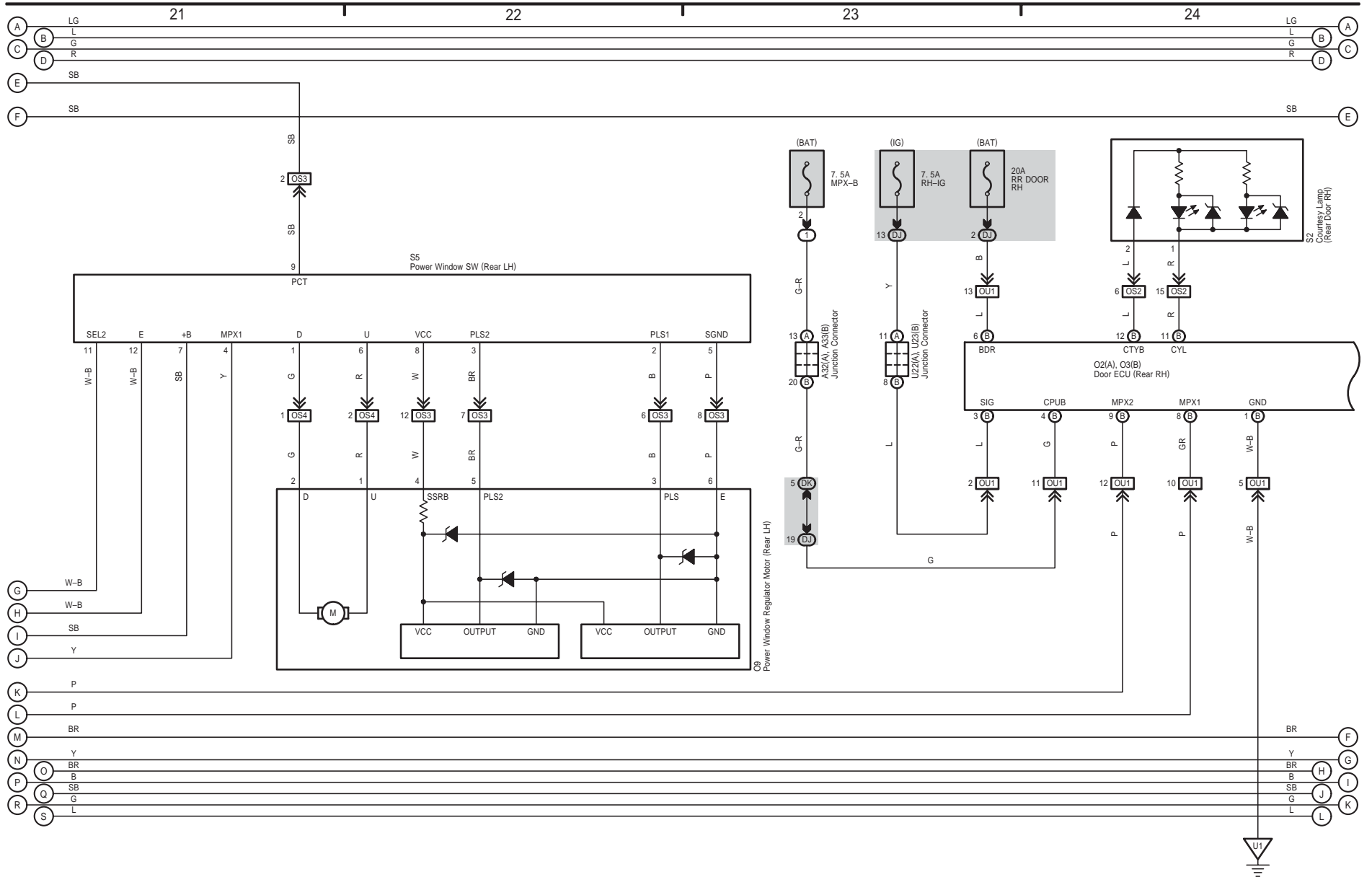

LEXUS GS 450h (EM02D0U)



Multiplex Communication System (BEAN-Door)

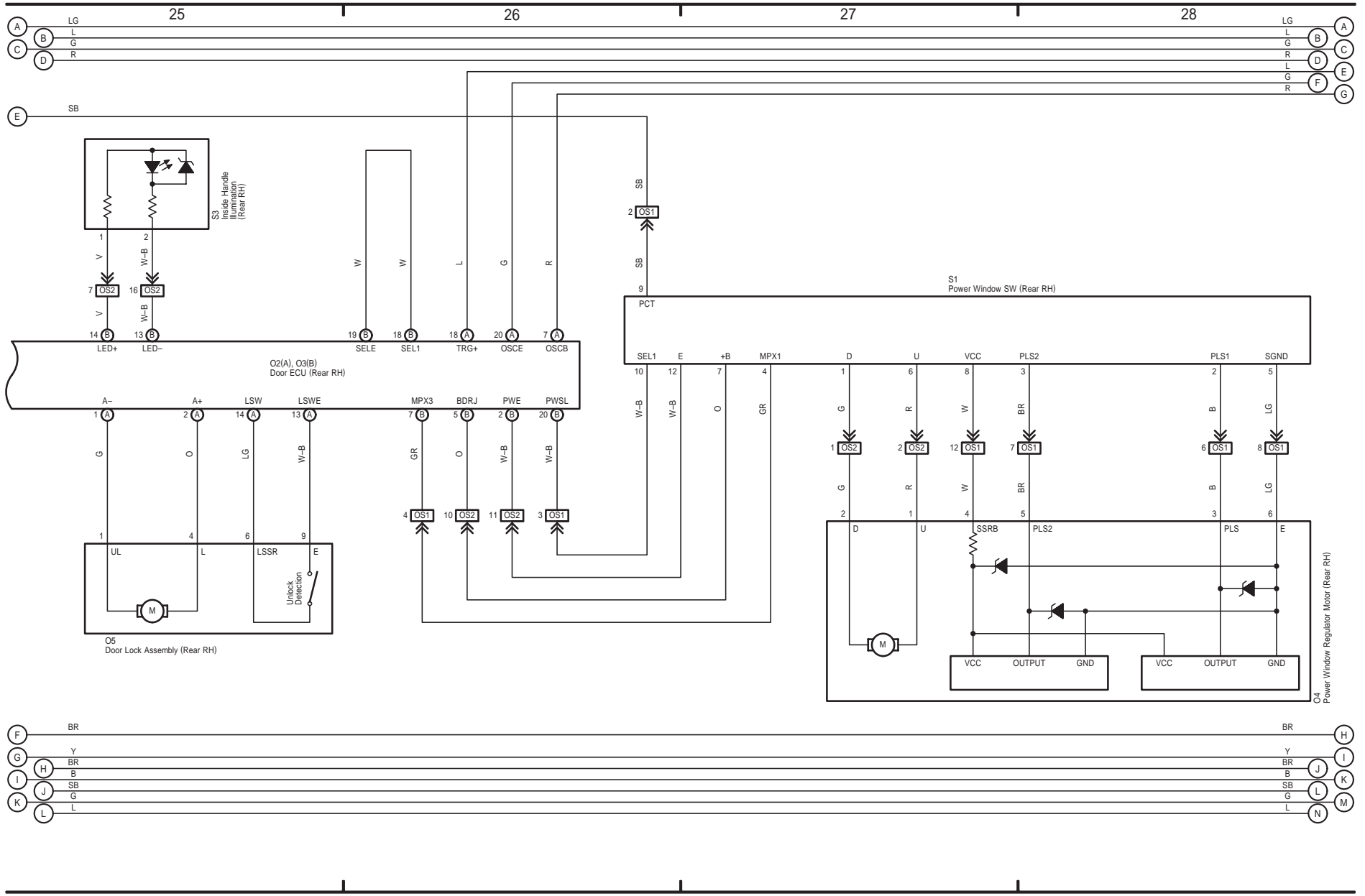

Multiplex Communication System (BEAN-Door)

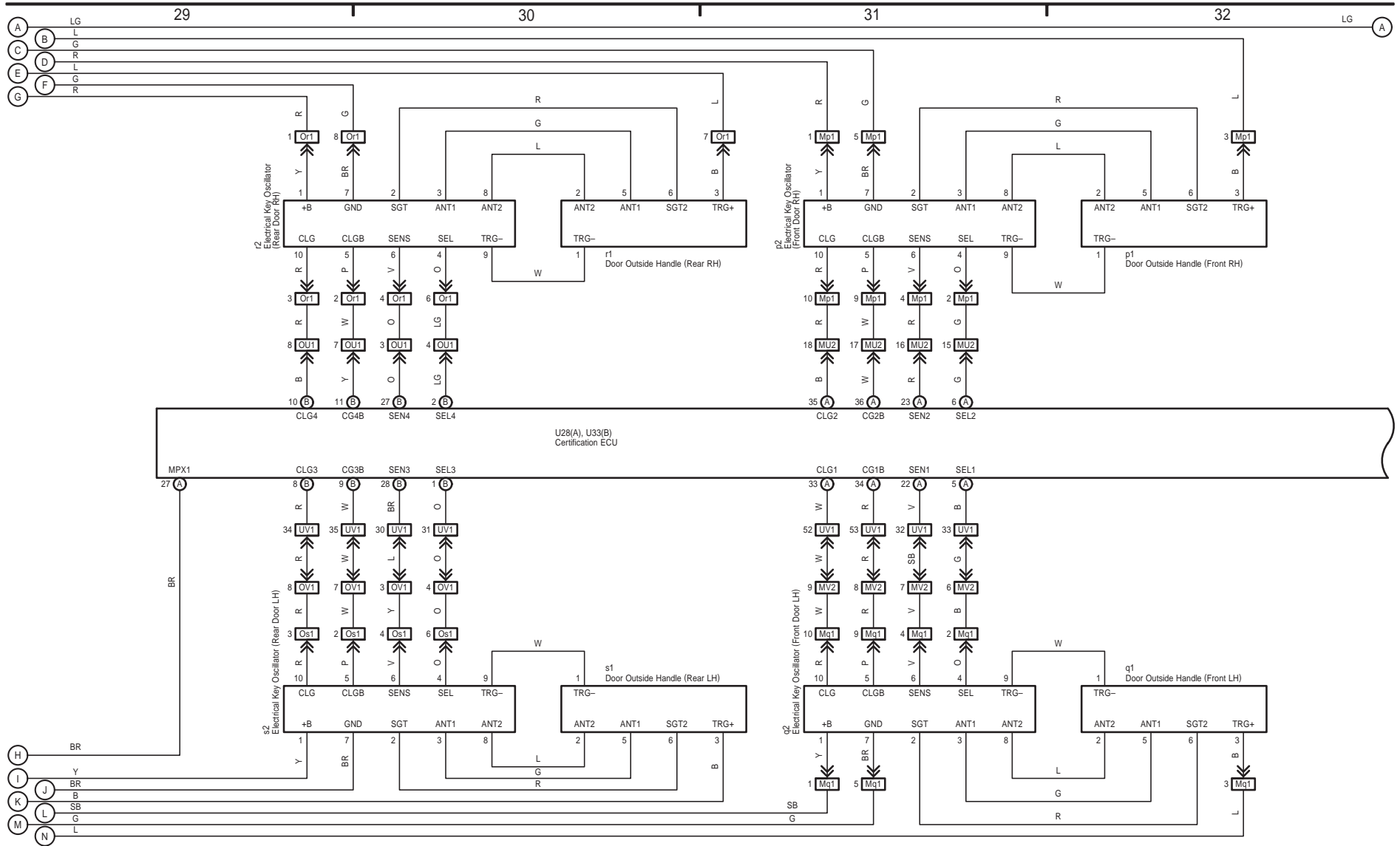

LEXUS GS 450h (EM02D0U)



Multiplex Communication System (BEAN-Door)

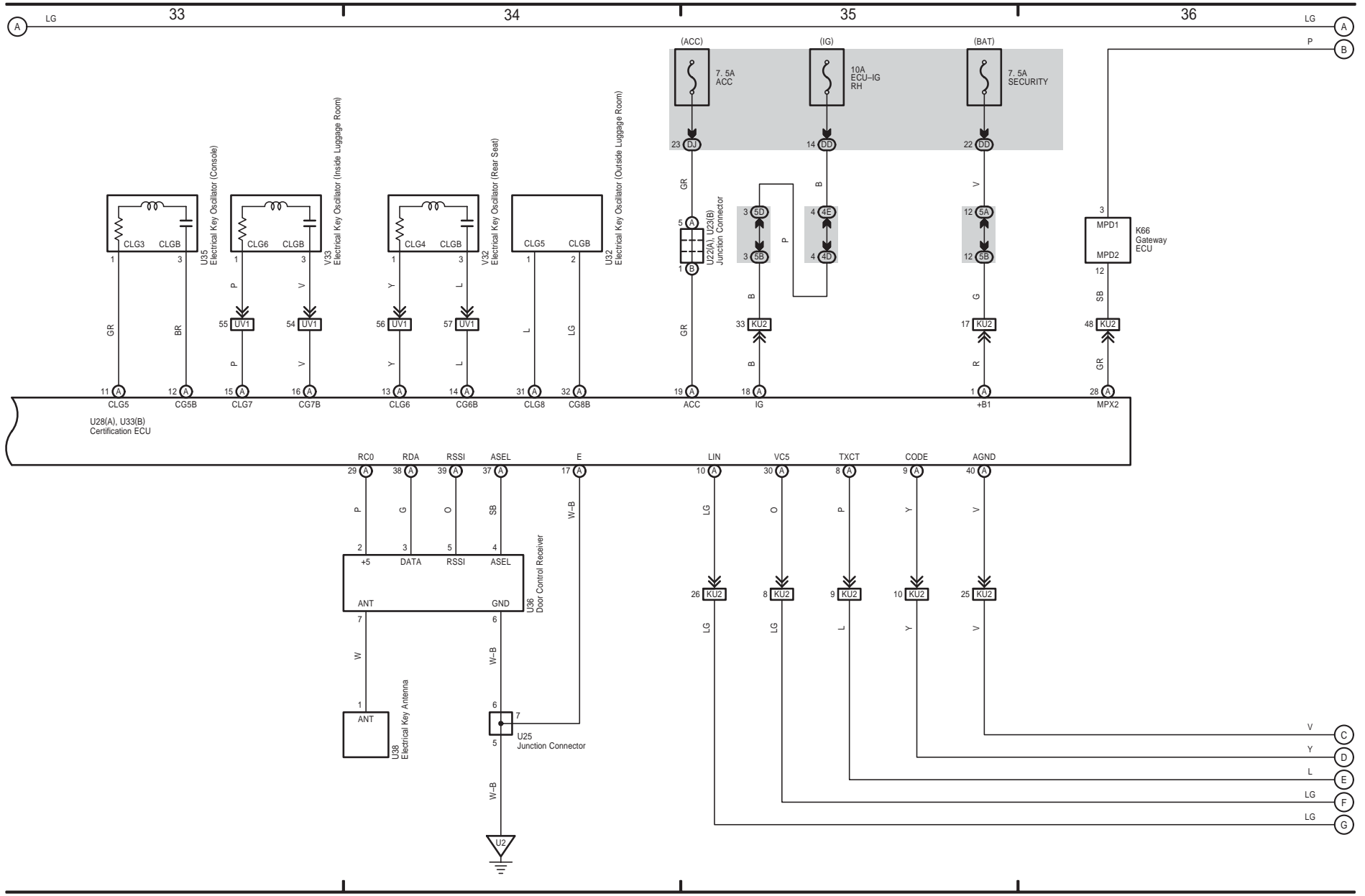

Multiplex Communication System (BEAN-Door)

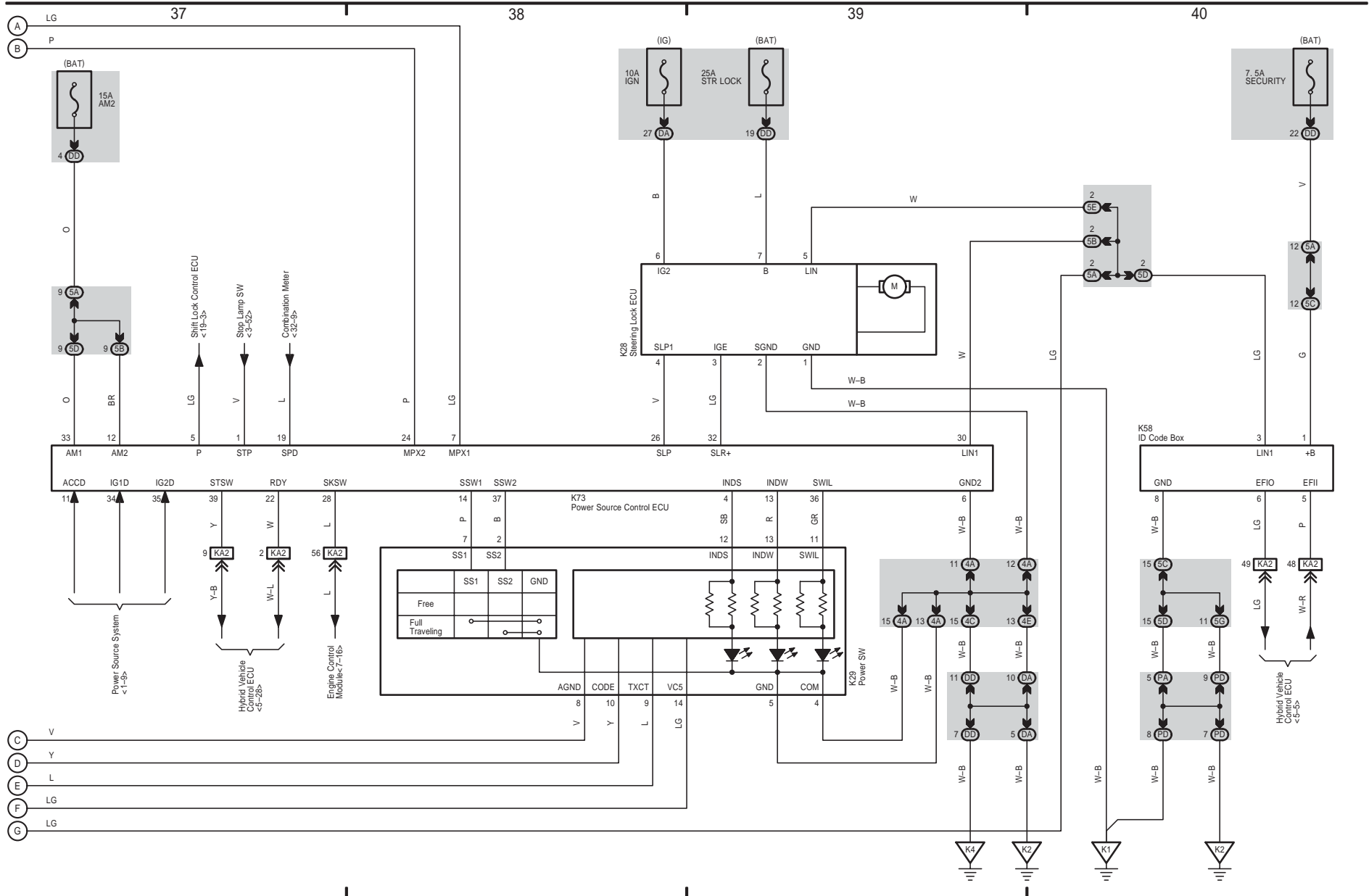

LEXUS GS 450h (EM02D0U)



Multiplex Communication System (BEAN-Door)

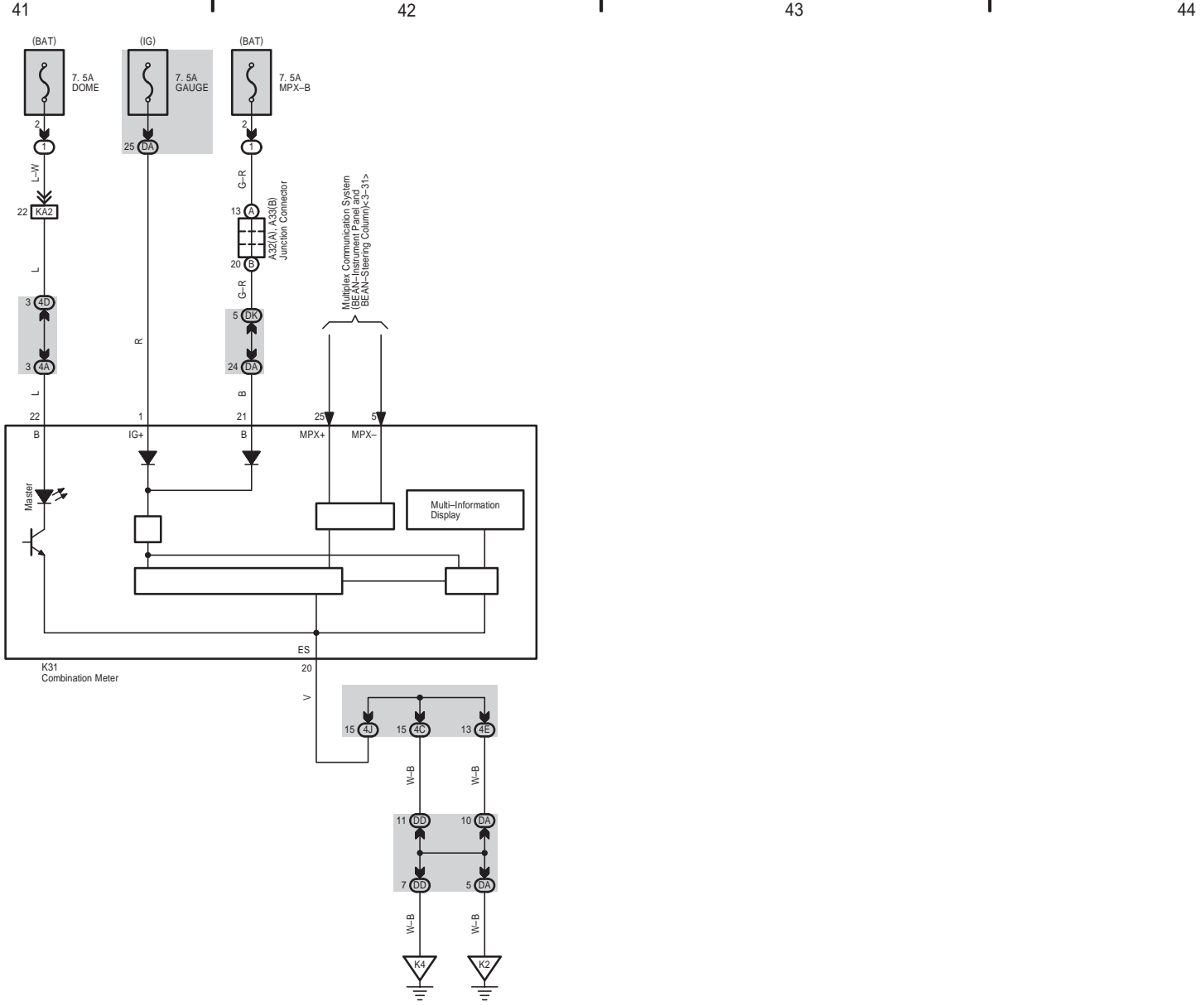

Multiplex Communication System (Power Train Control)

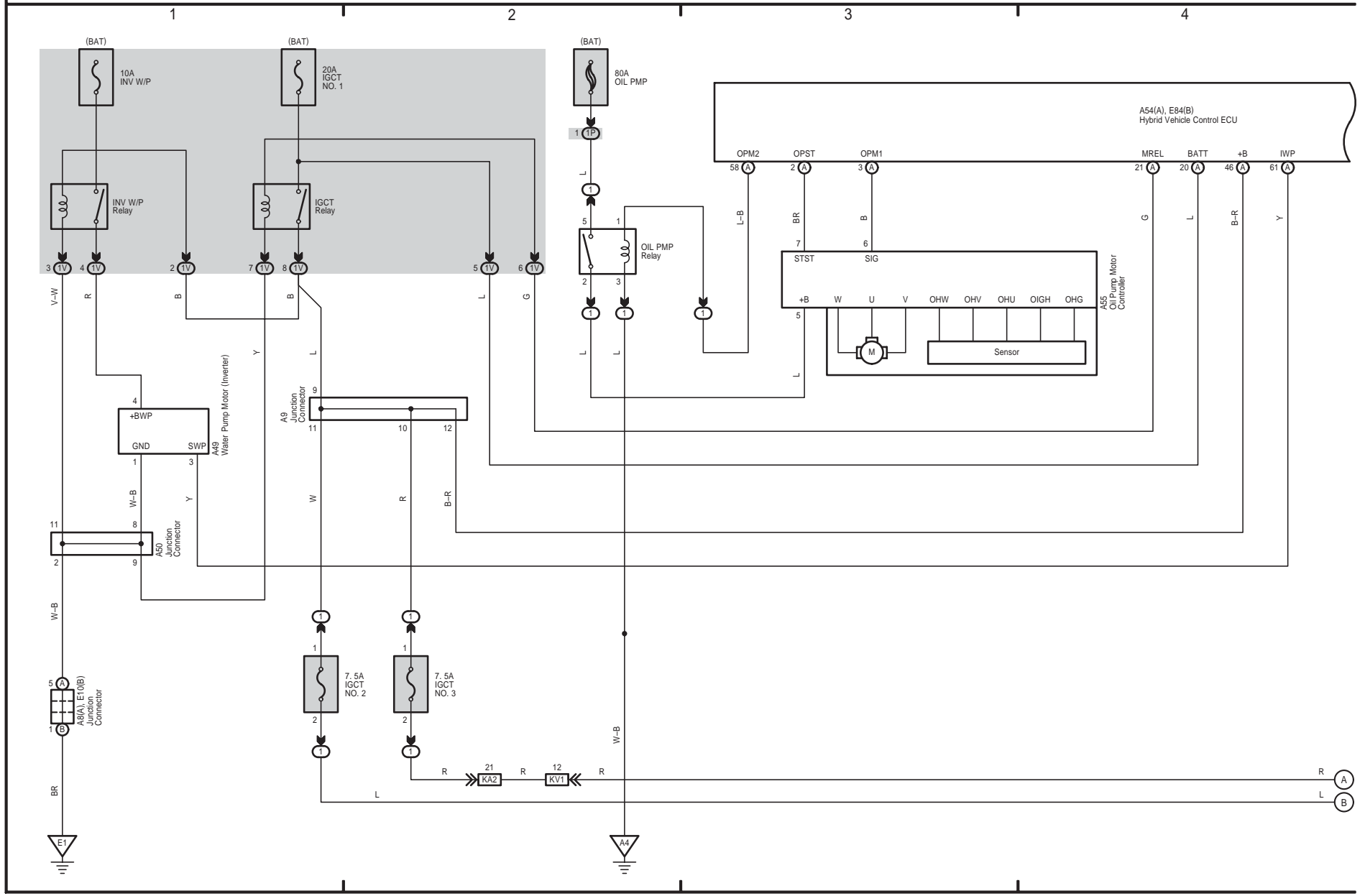

Multiplex Communication System (Power Train Control)

5 6 7 8

* 1 : Shielded

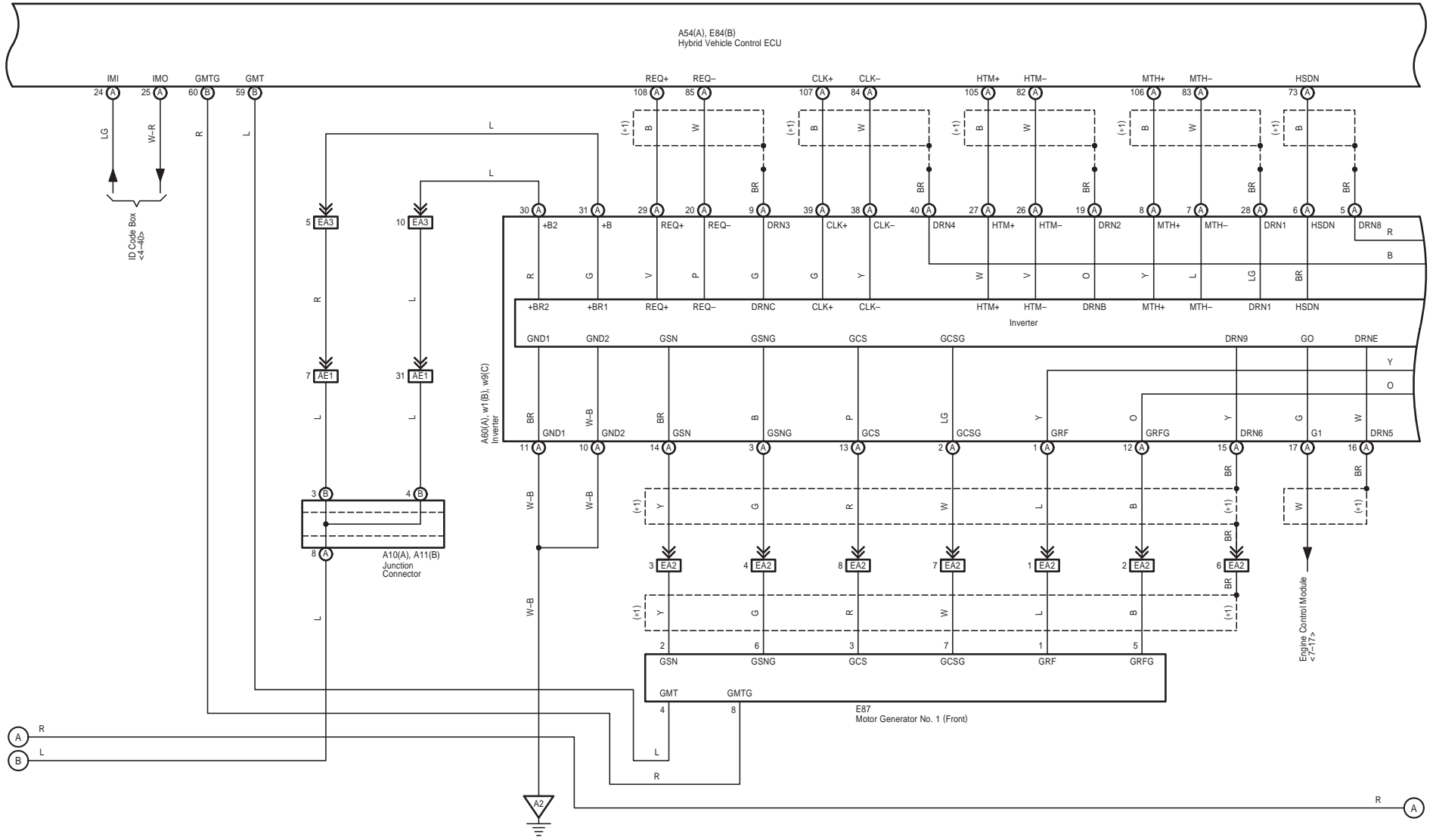

LEXUS GS 450h (EM02D0U)



Multiplex Communication System (Power Train Control)

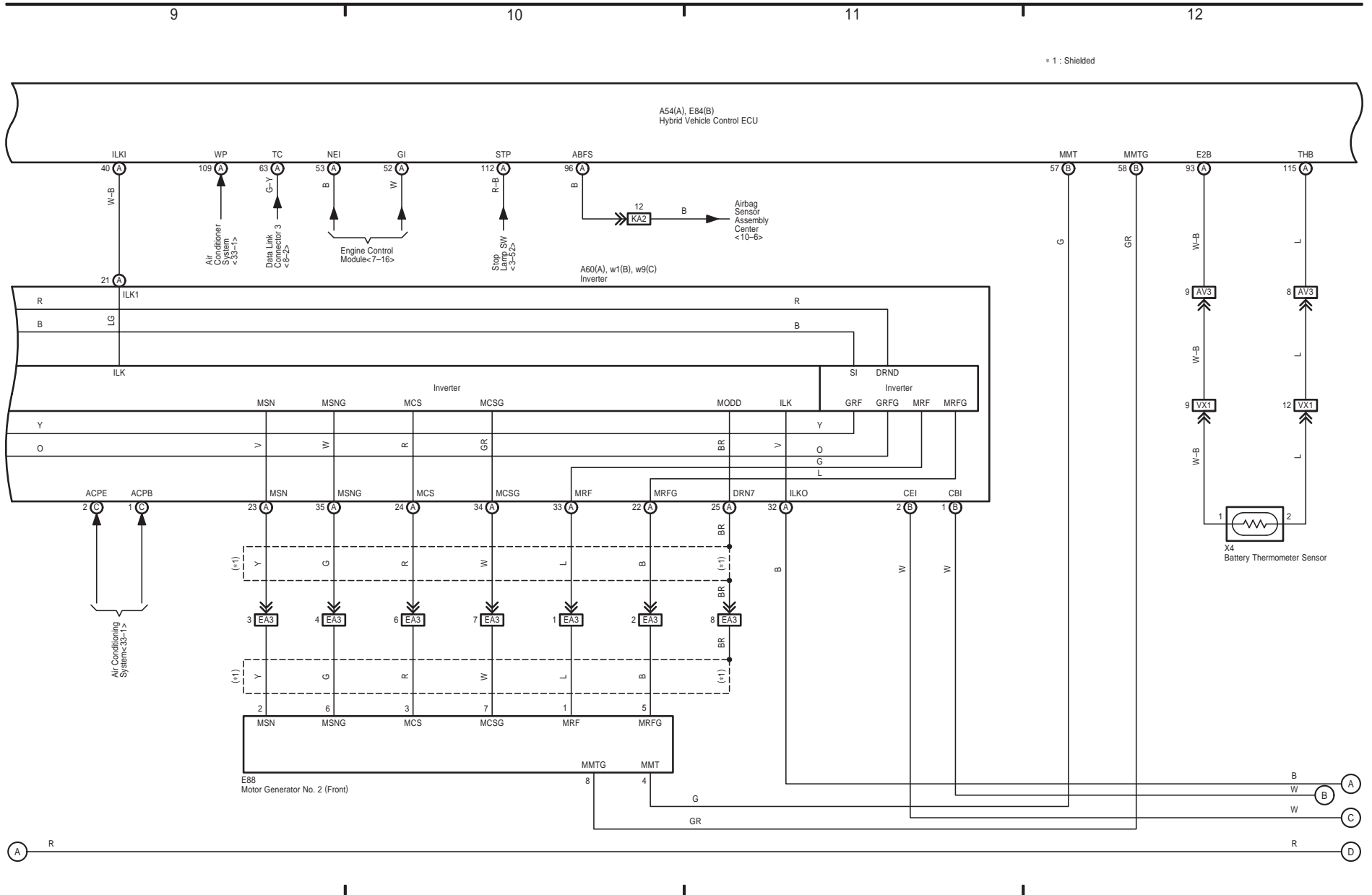

Multiplex Communication System (Power Train Control)

13

14

15

16

* 1: Shielded

LEXUS GS 450h (EM02D0U)

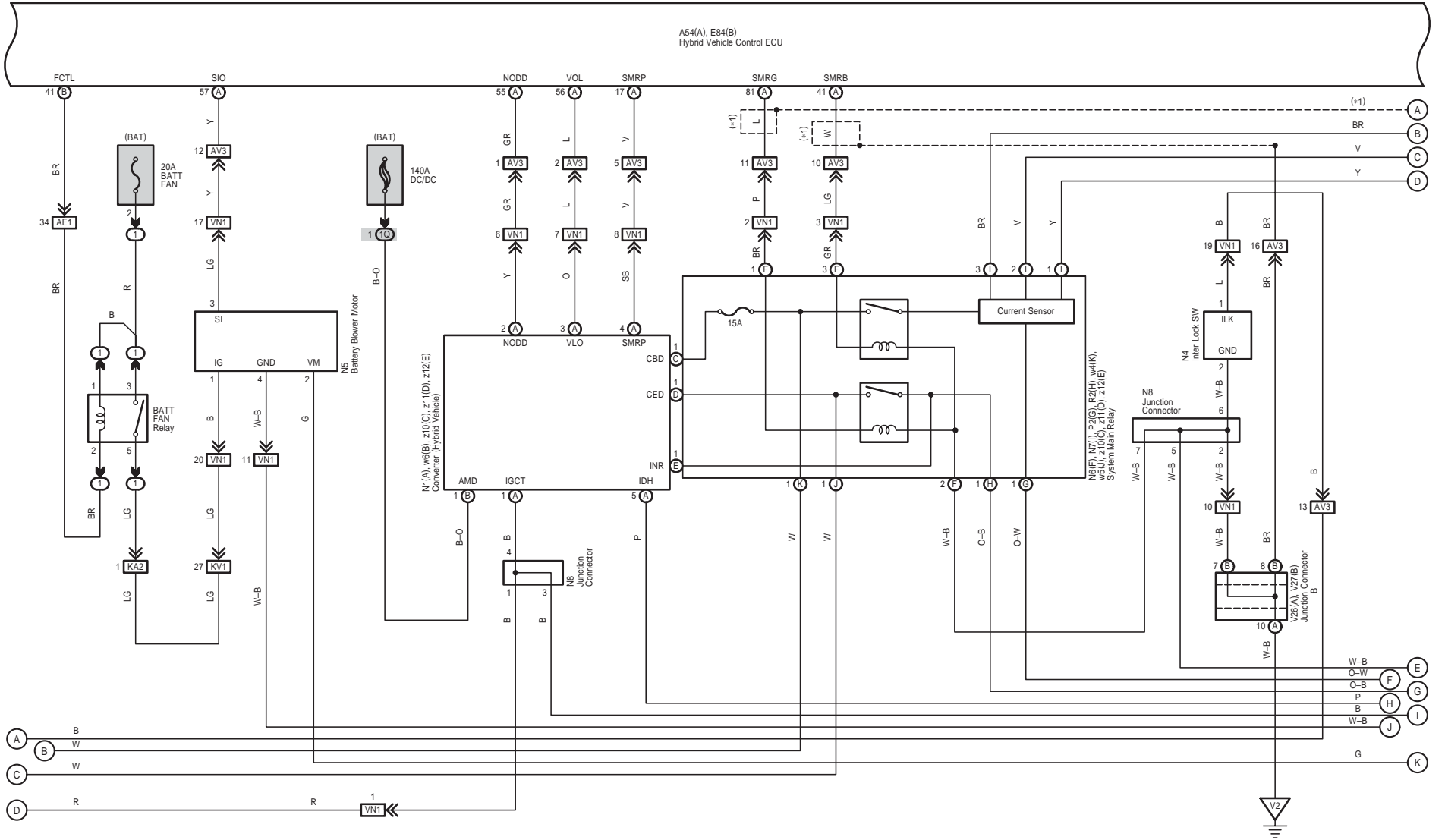

Multiplex Communication System (Power Train Control)

* 1 : Shielded

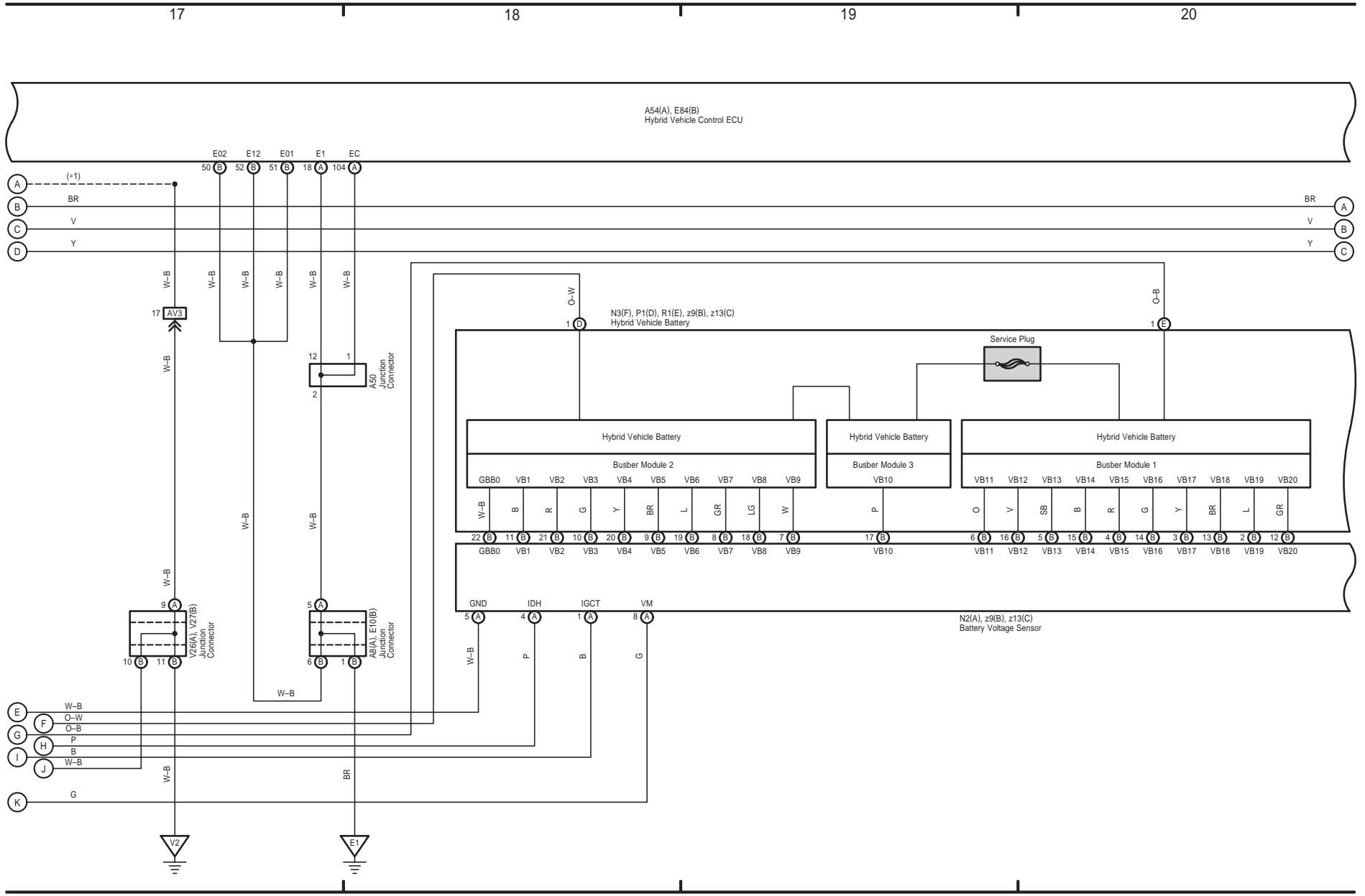

Multiplex Communication System (Power Train Control)

21

22

23

24

LEXUS GS 450h (EM02D0U)

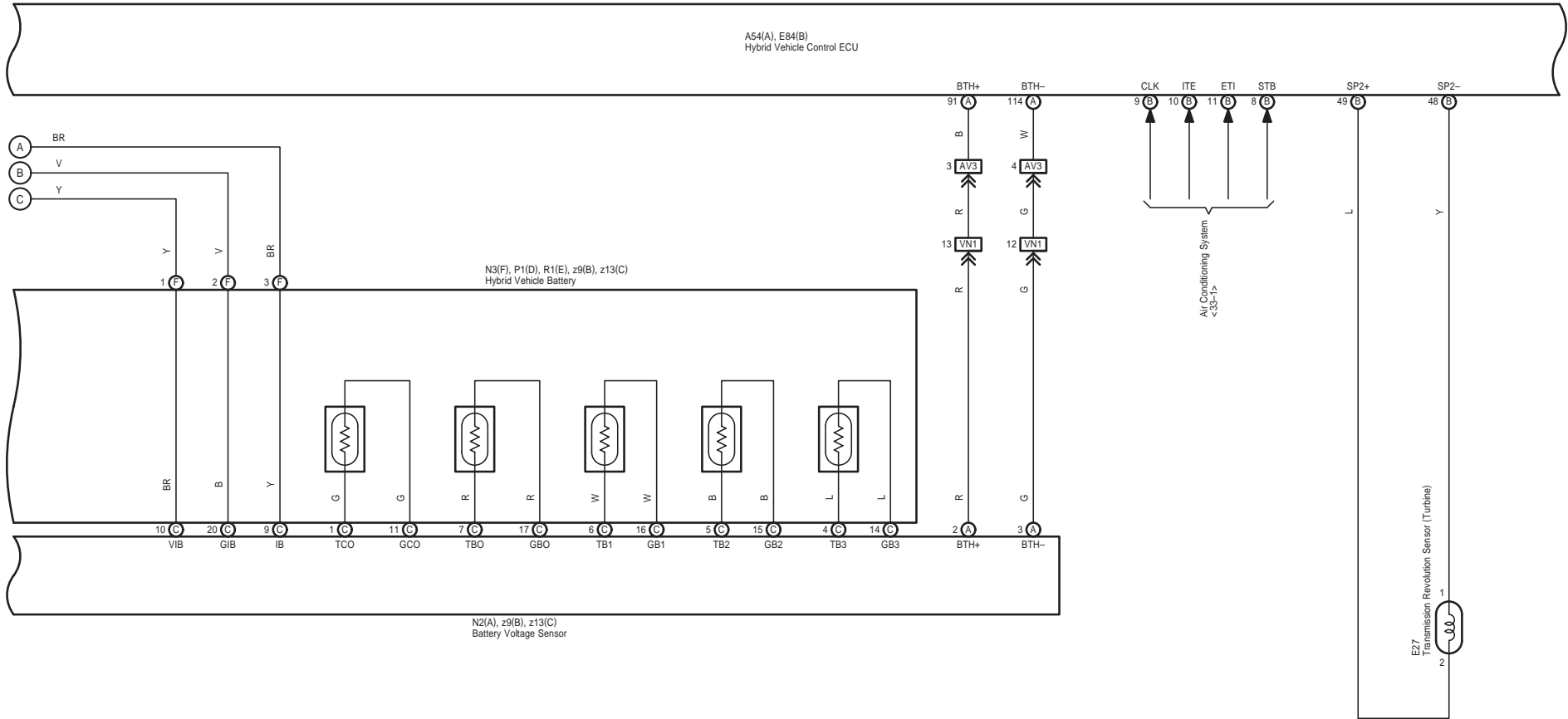

Multiplex Communication System (Power Train Control)

25

26

27

28

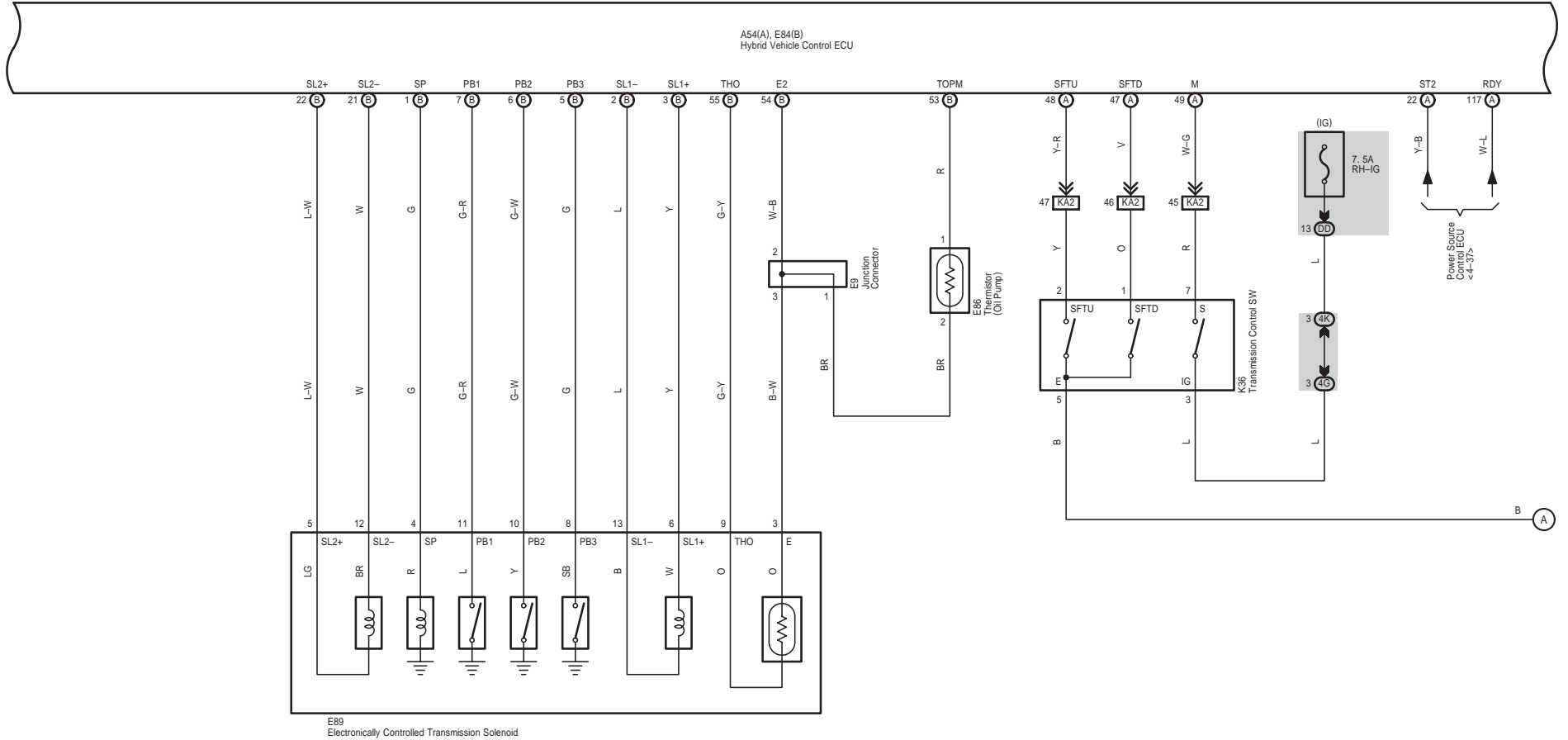

Multiplex Communication System (Power Train Control)

29

30

31

32

* 2 : w/ Dynamic Radar Cruise Control

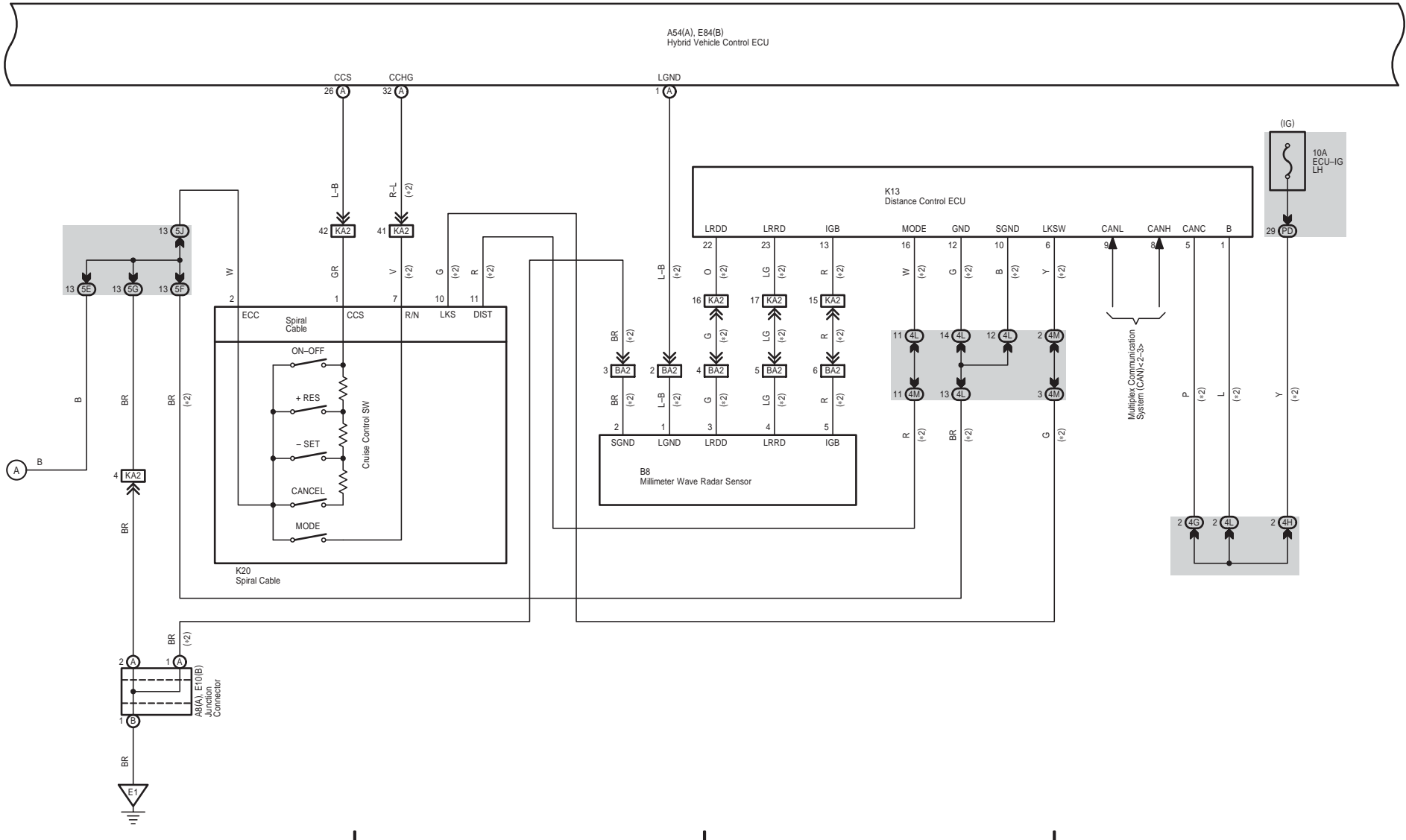

LEXUS GS 450h (EM02D0U)



Multiplex Communication System (Power Train Control)

* 1 : Shielded

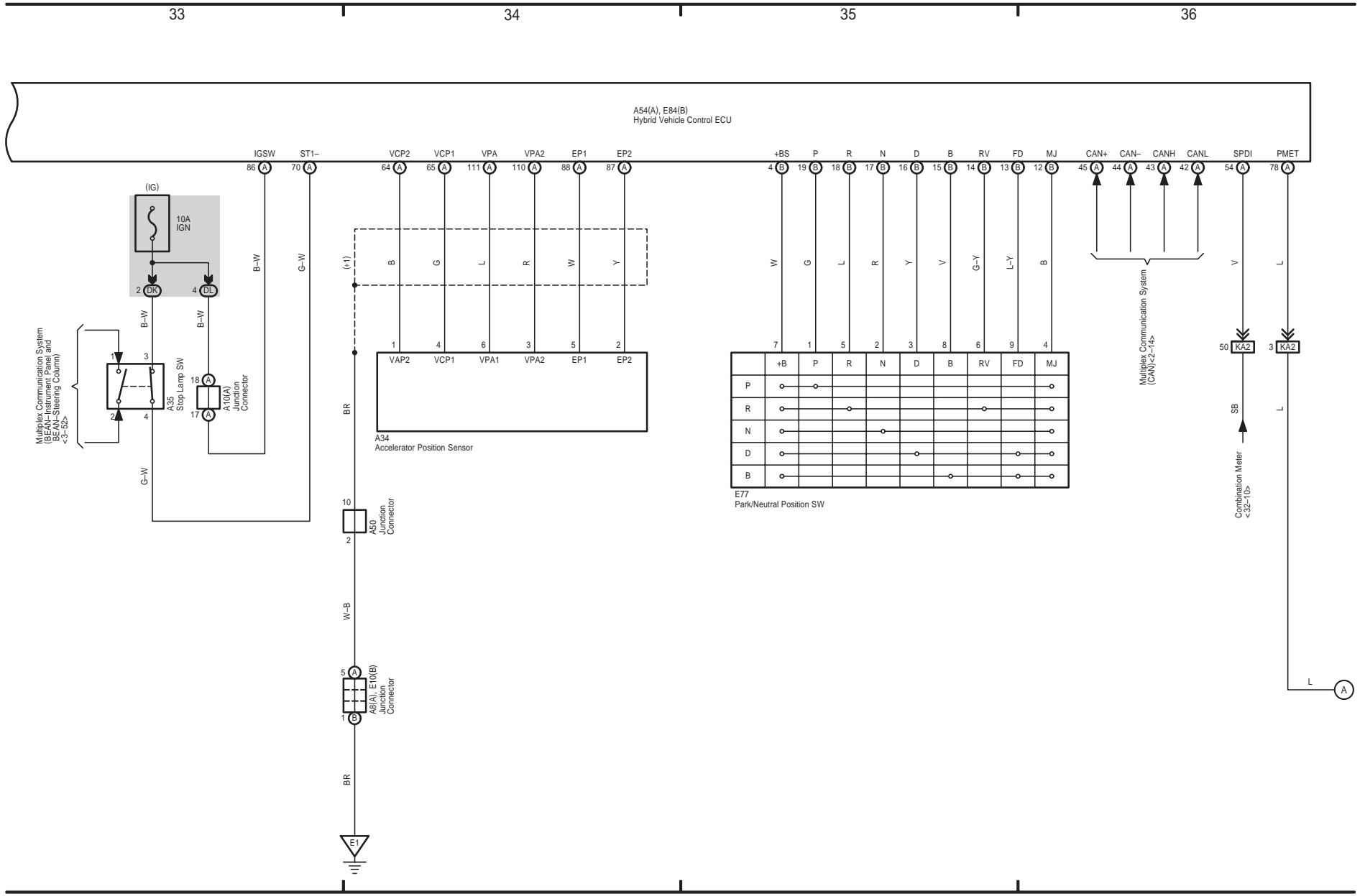

Multiplex Communication System (Power Train Control)

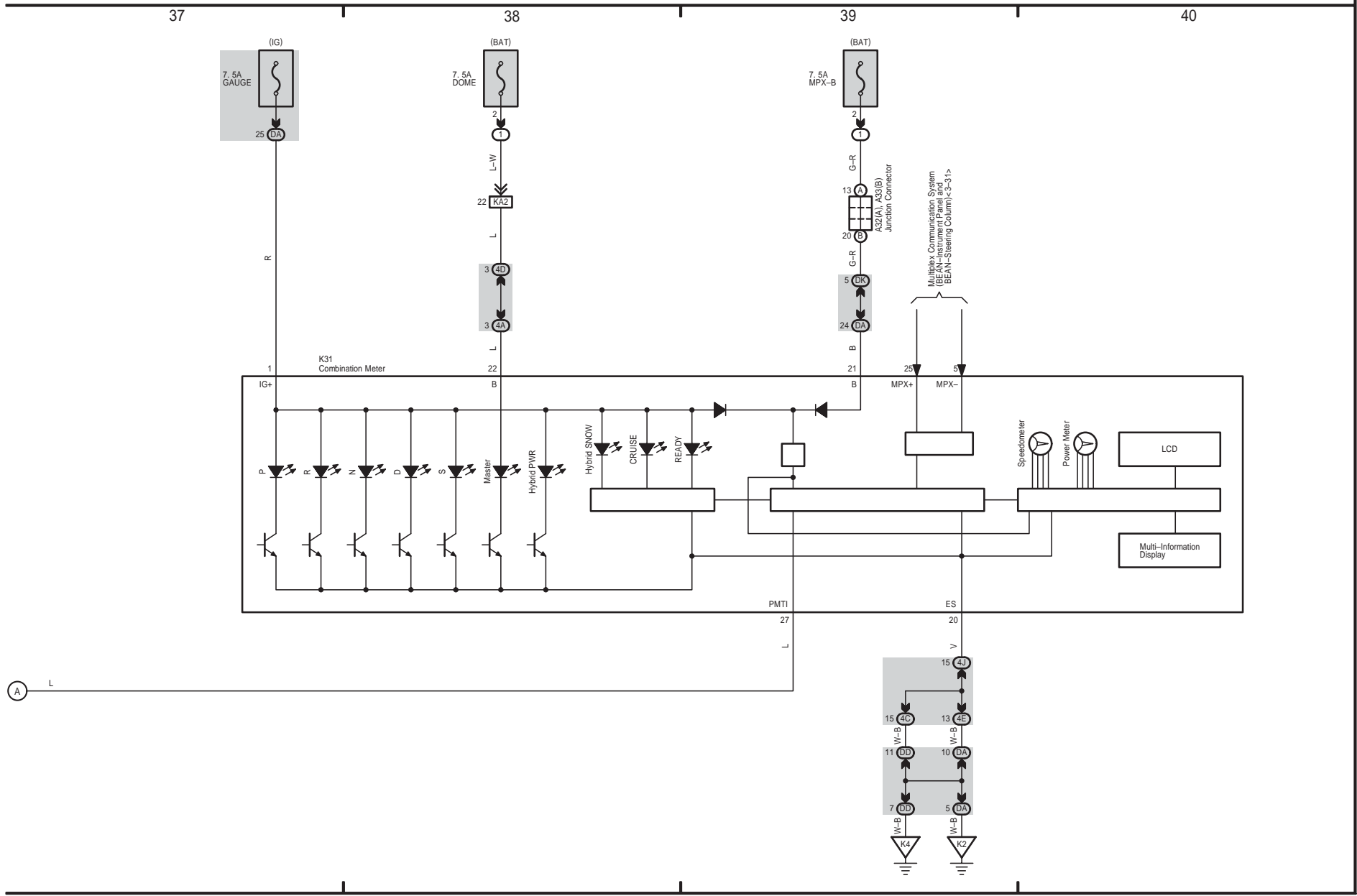

LEXUS GS 450h (EM02D0U)

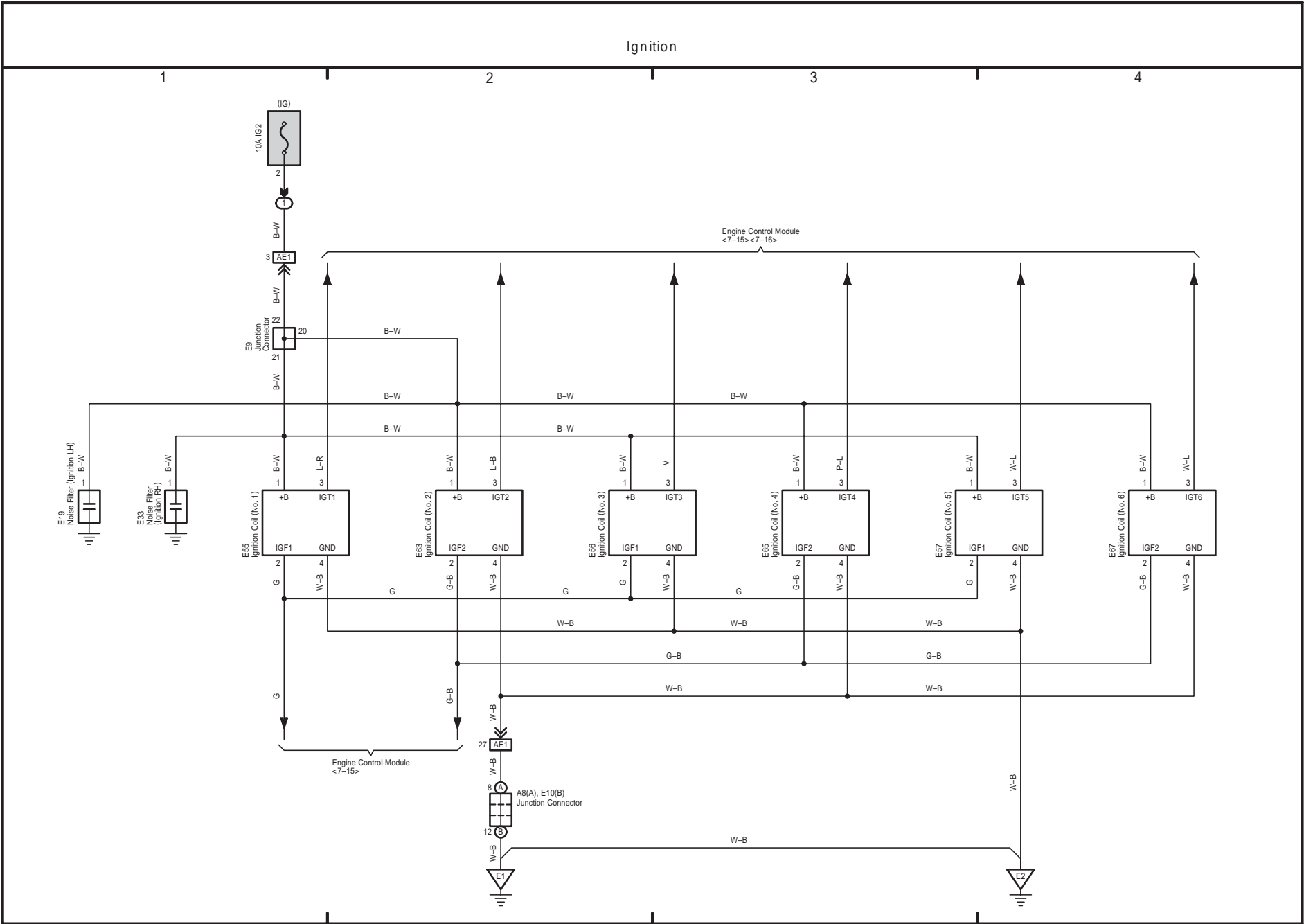

Engine Control

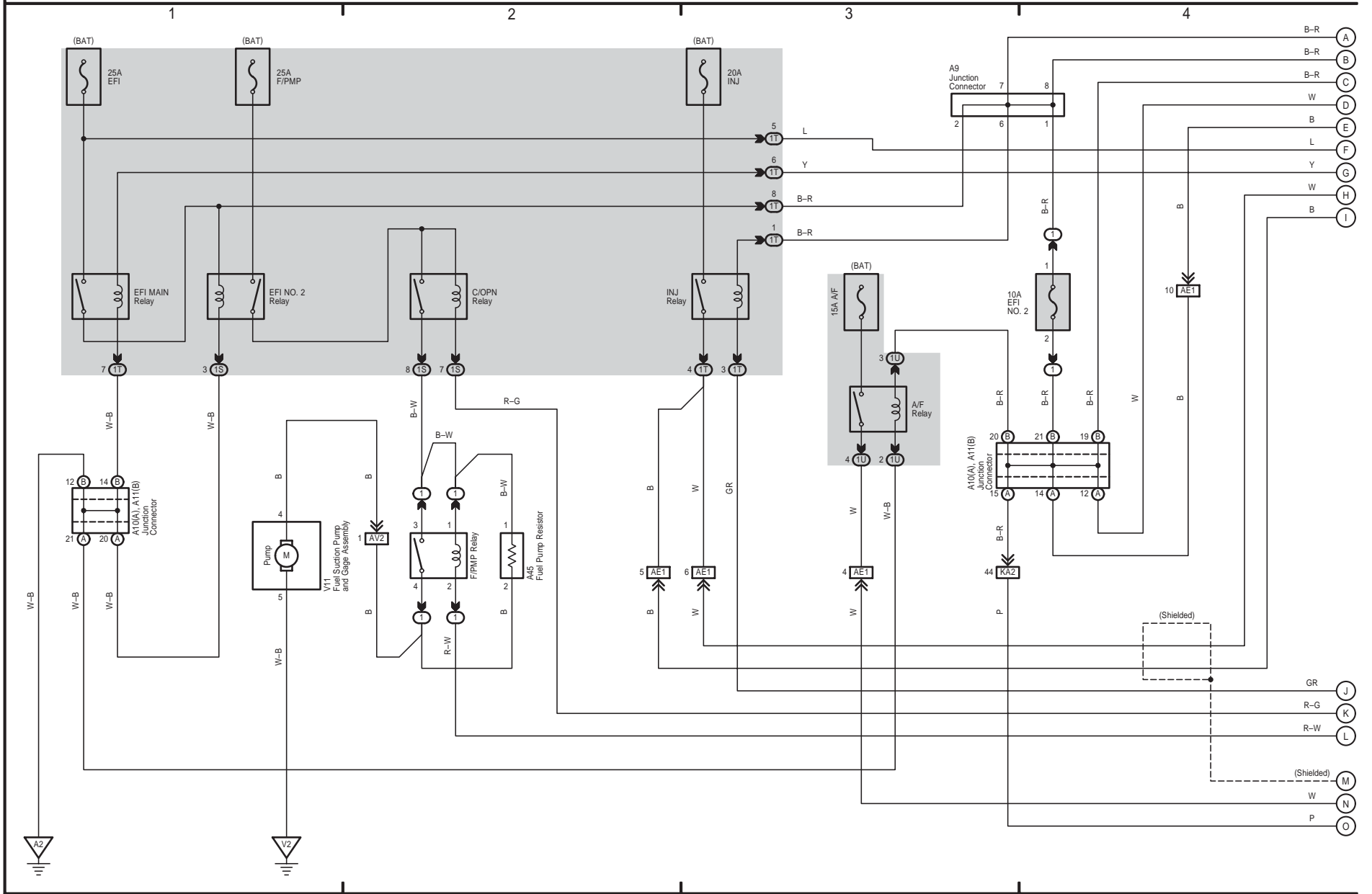

Engine Control

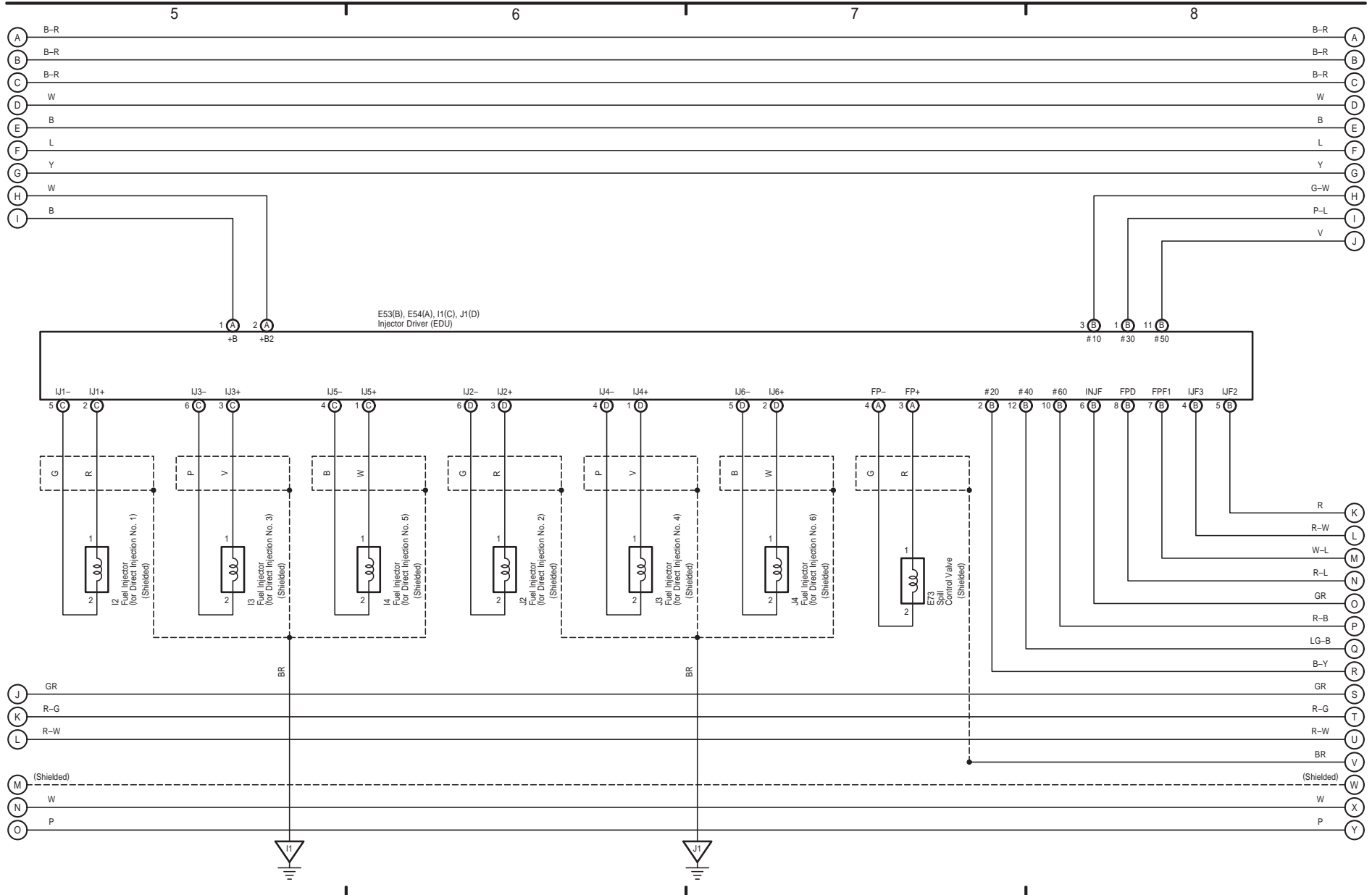

LEXUS GS 450h (EM02D0U)



Engine Control

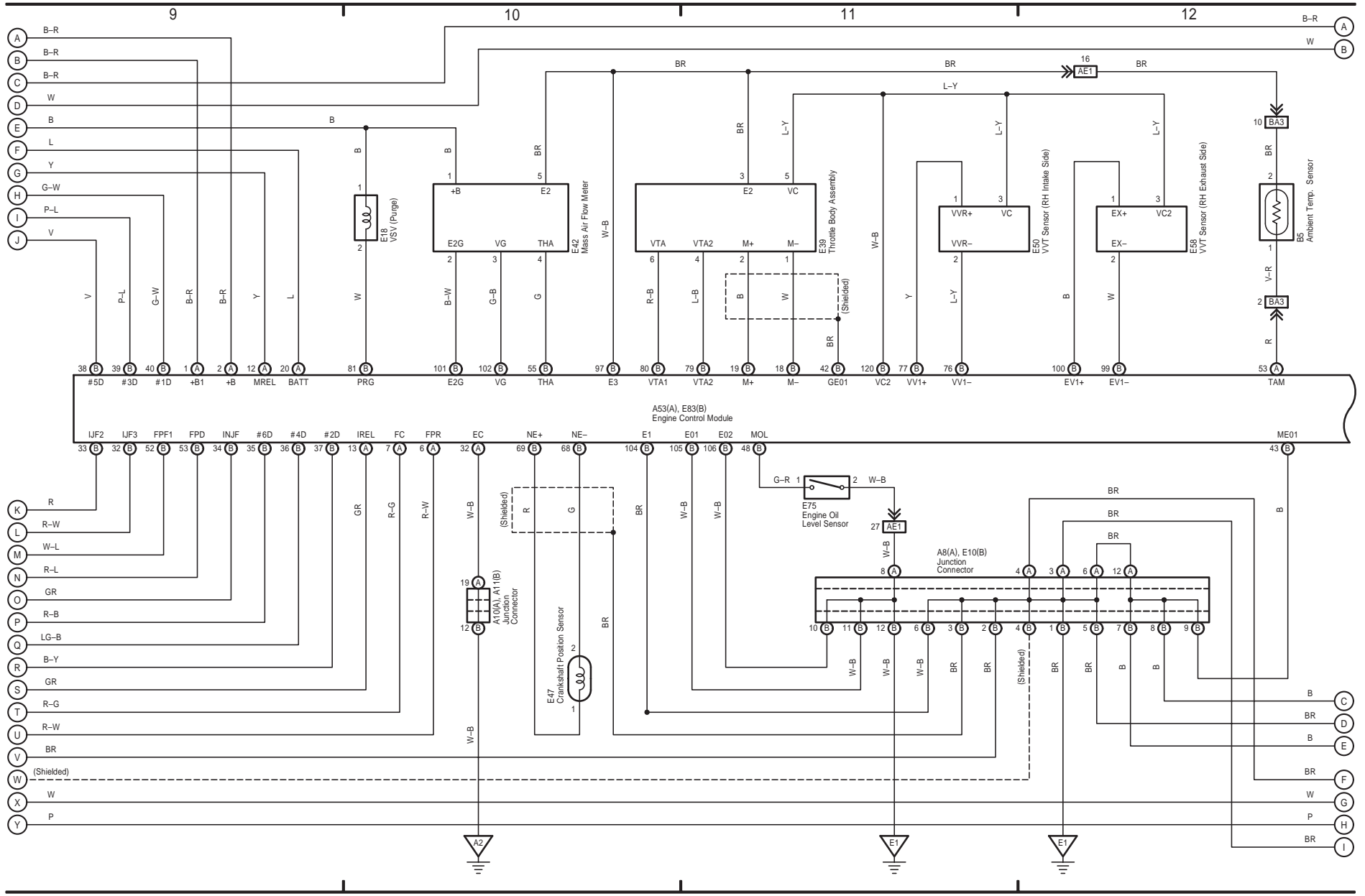

Engine Control

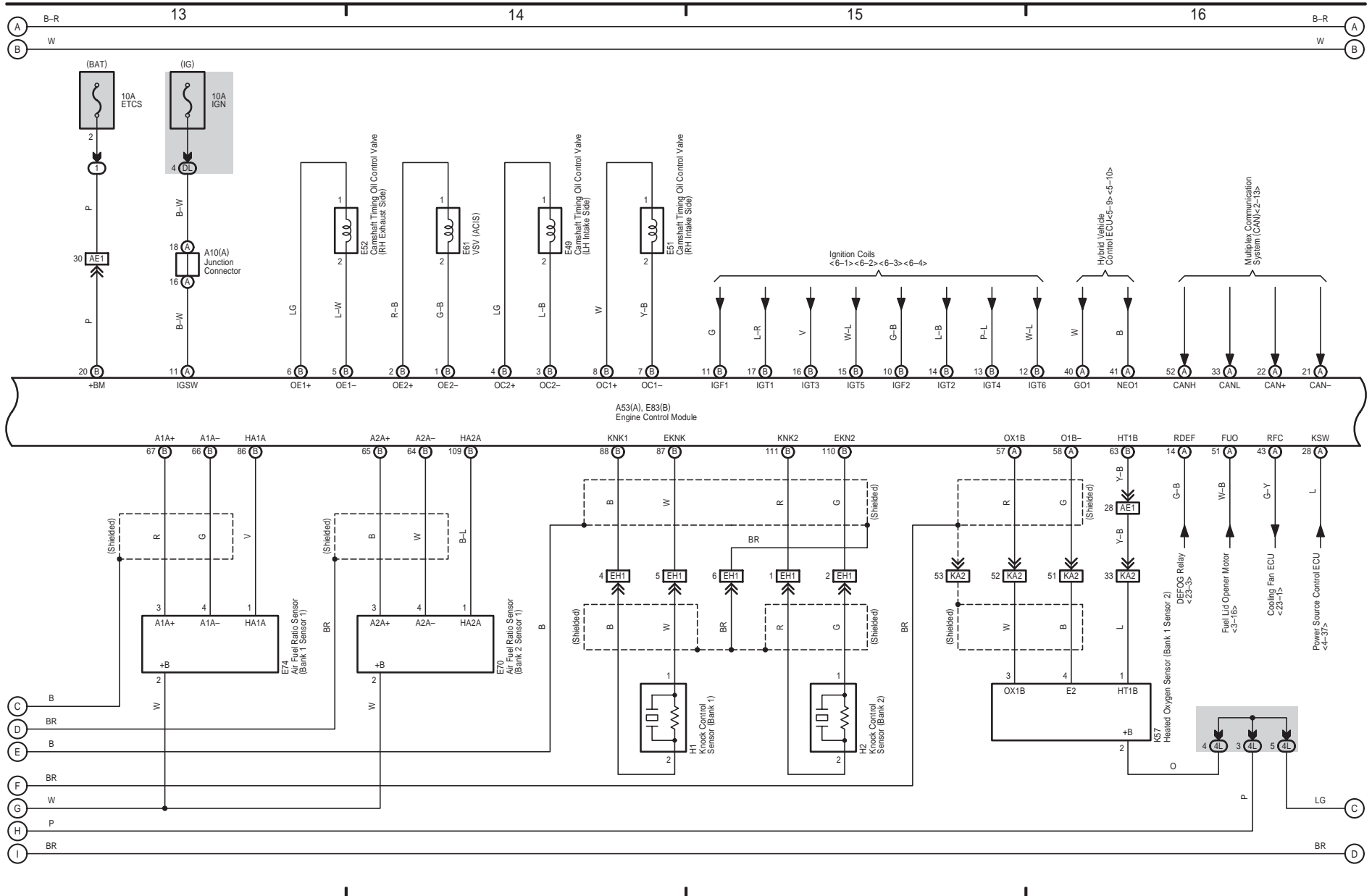

LEXUS GS 450h (EM02D0U)



Engine Control

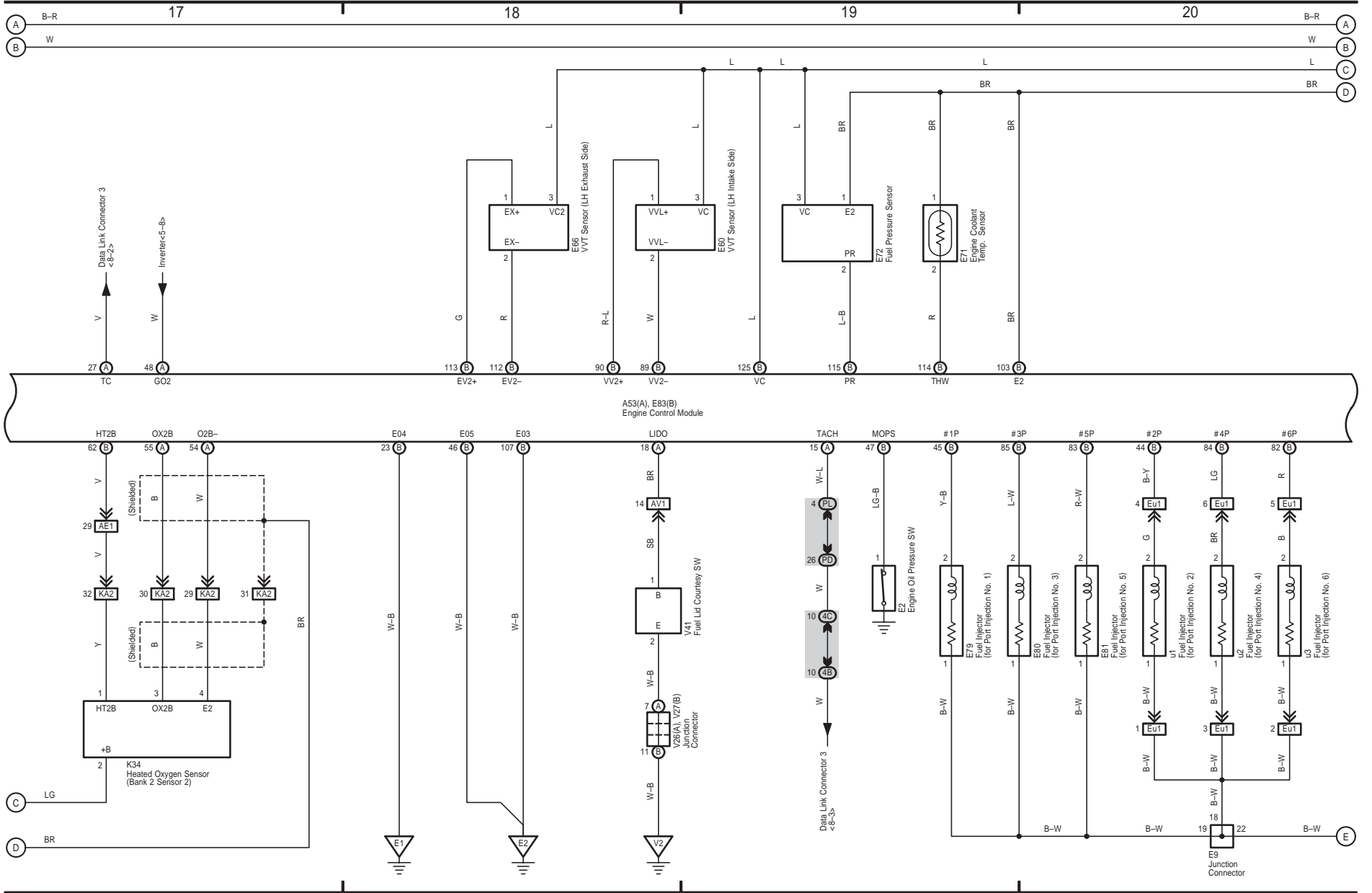

Engine Control

* 1 : w/ Active Stabilizer Suspension System
* 2 : w/o Active Stabilizer Suspension System

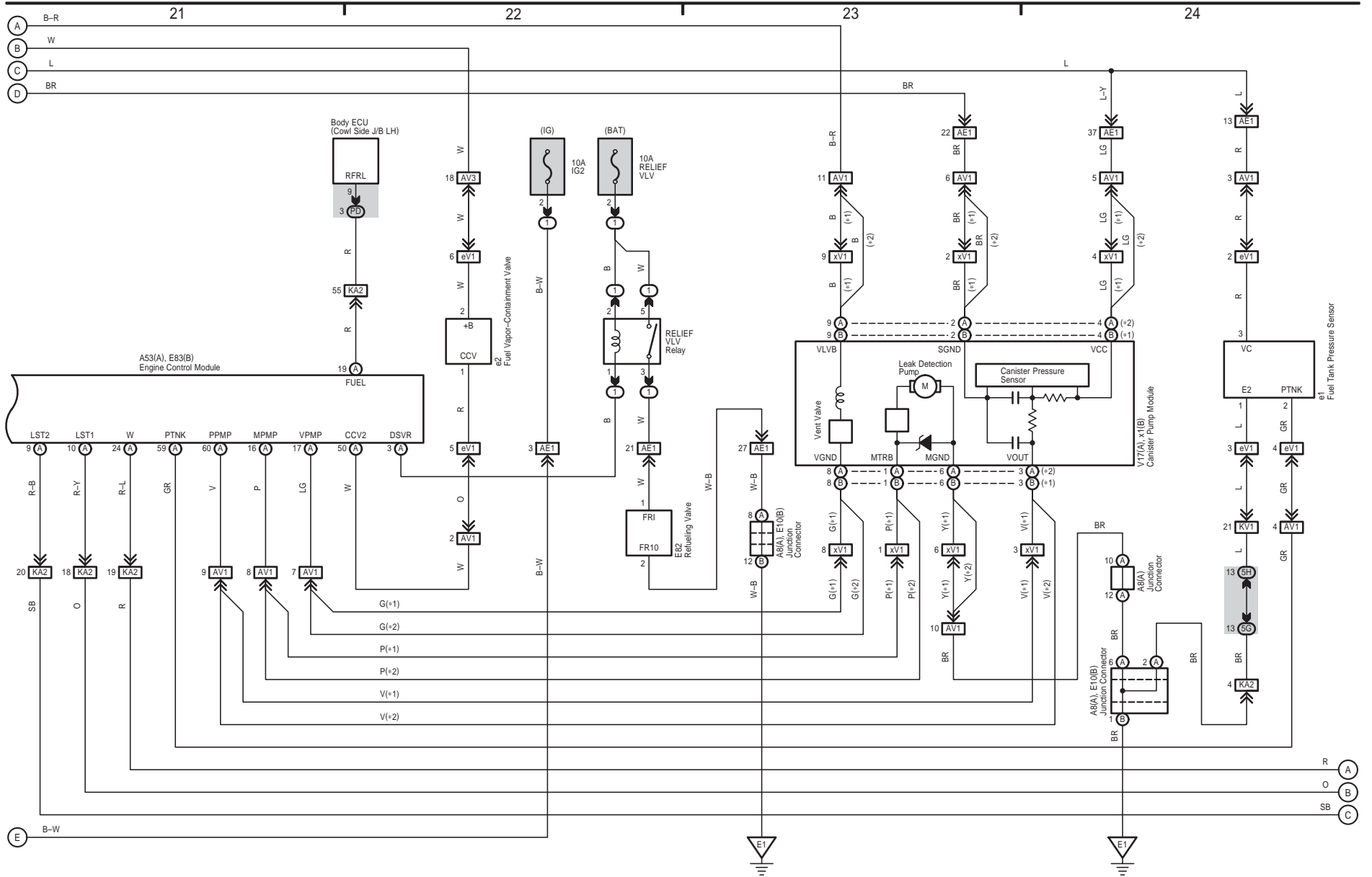

LEXUS GS 450h (EM02D0U)



7 GS 450h (Cont' d)

Engine Control

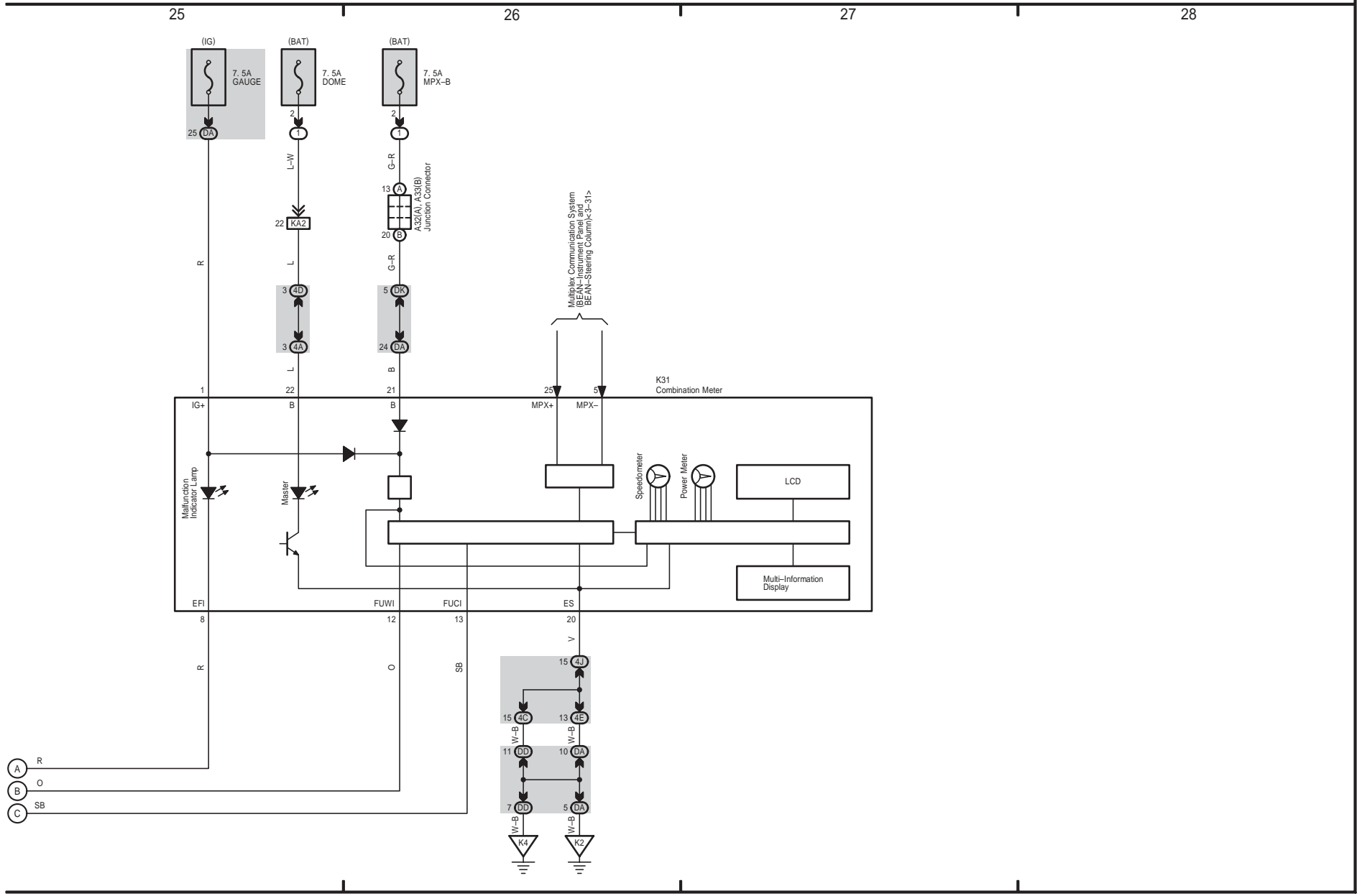

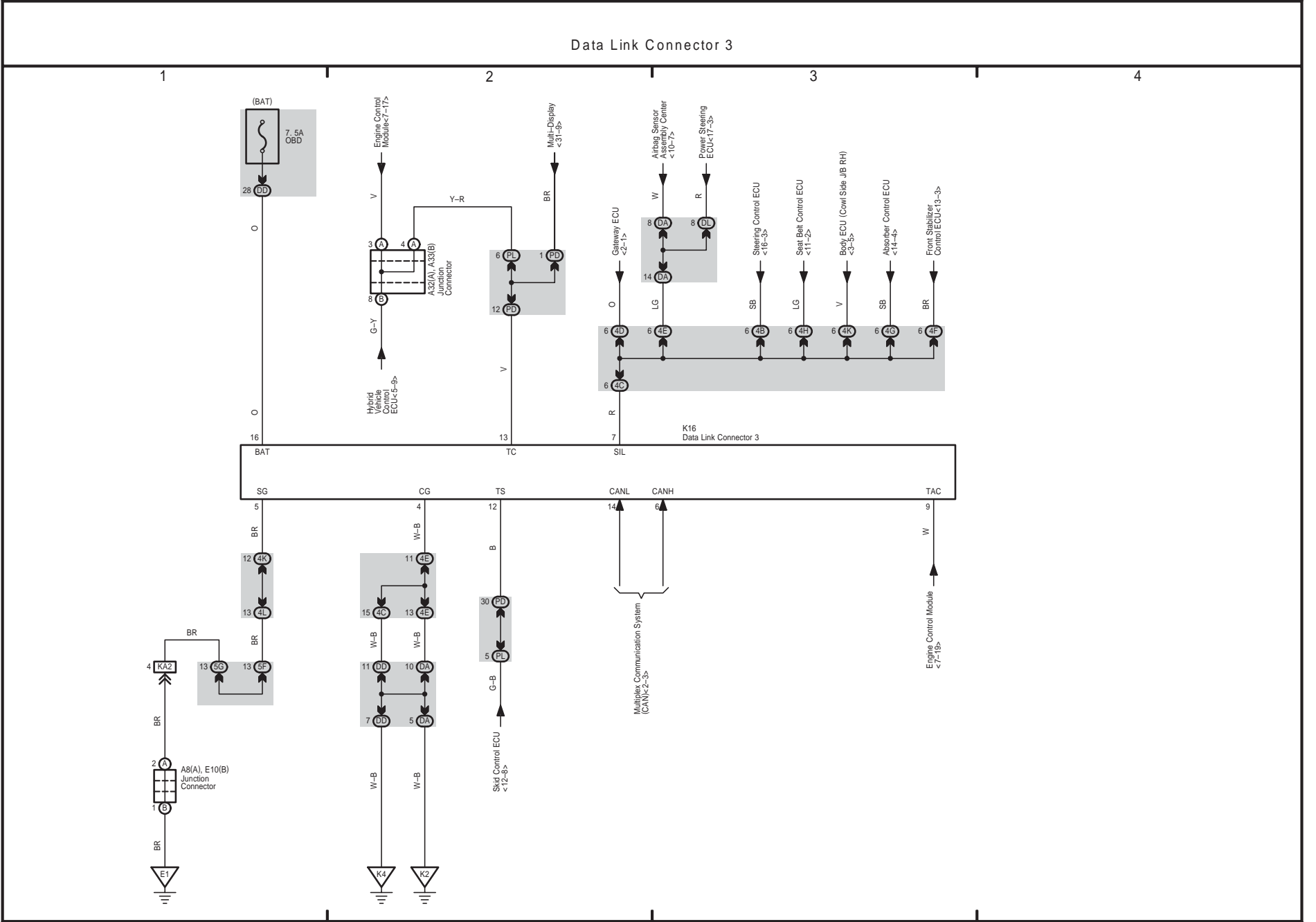

Turn Signal and Hazard Warning Light

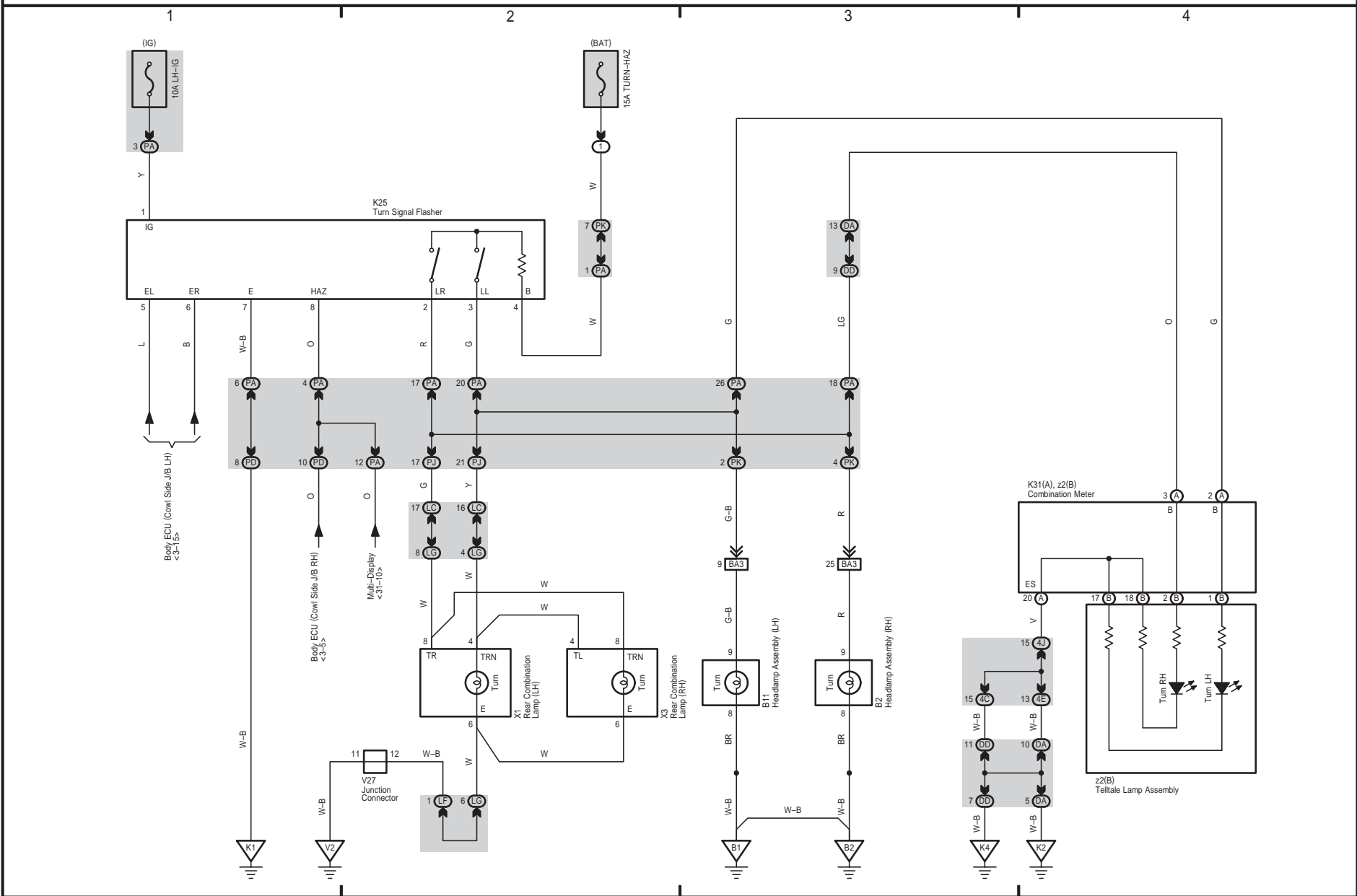

SRS

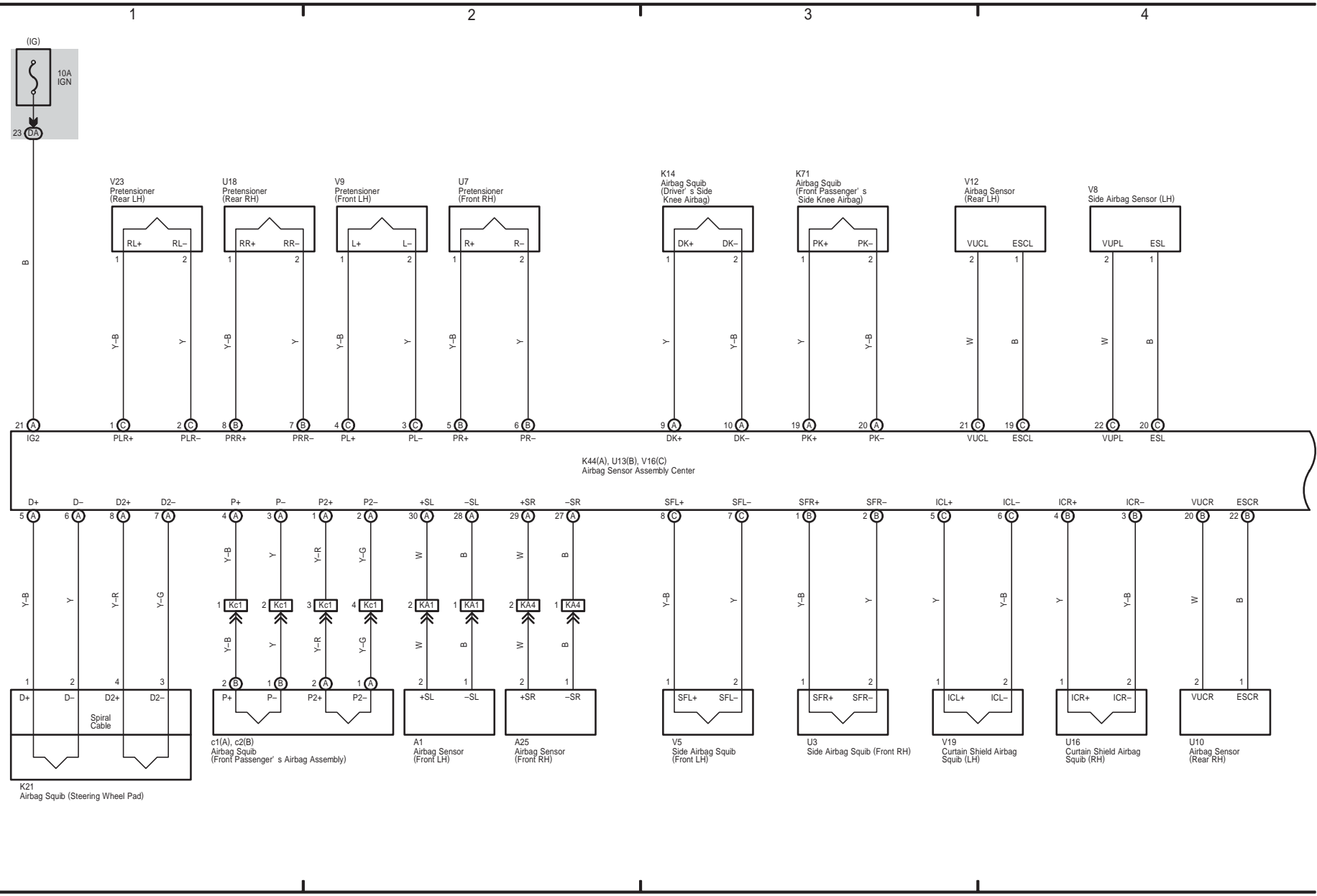

SRS

* 1 : Option Connector (Airbag Cut Off SW)

5 6 7 8

LEXUS GS 450h (EM02D0U)

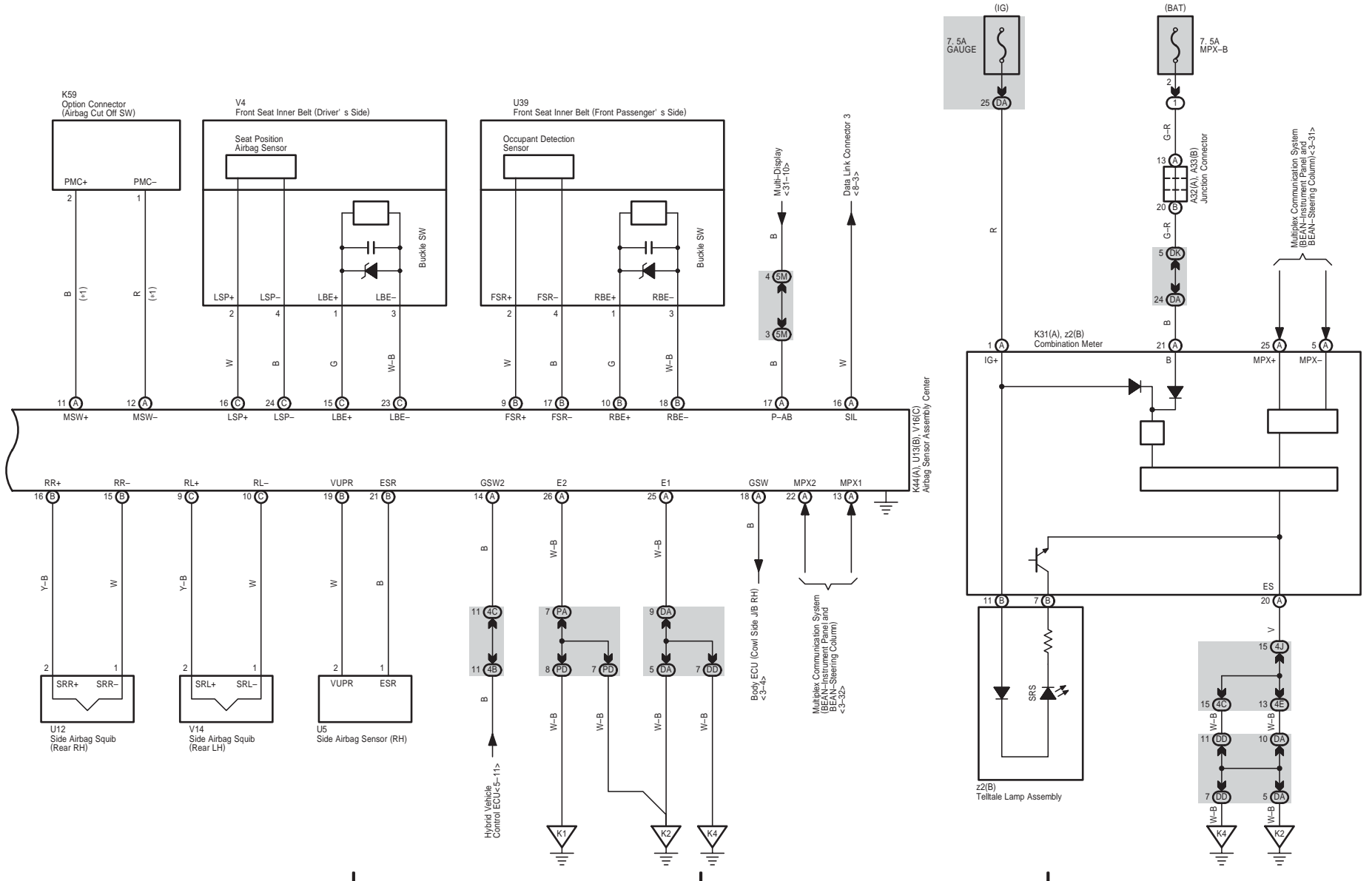

11 GS 450h

Pre-Collision System

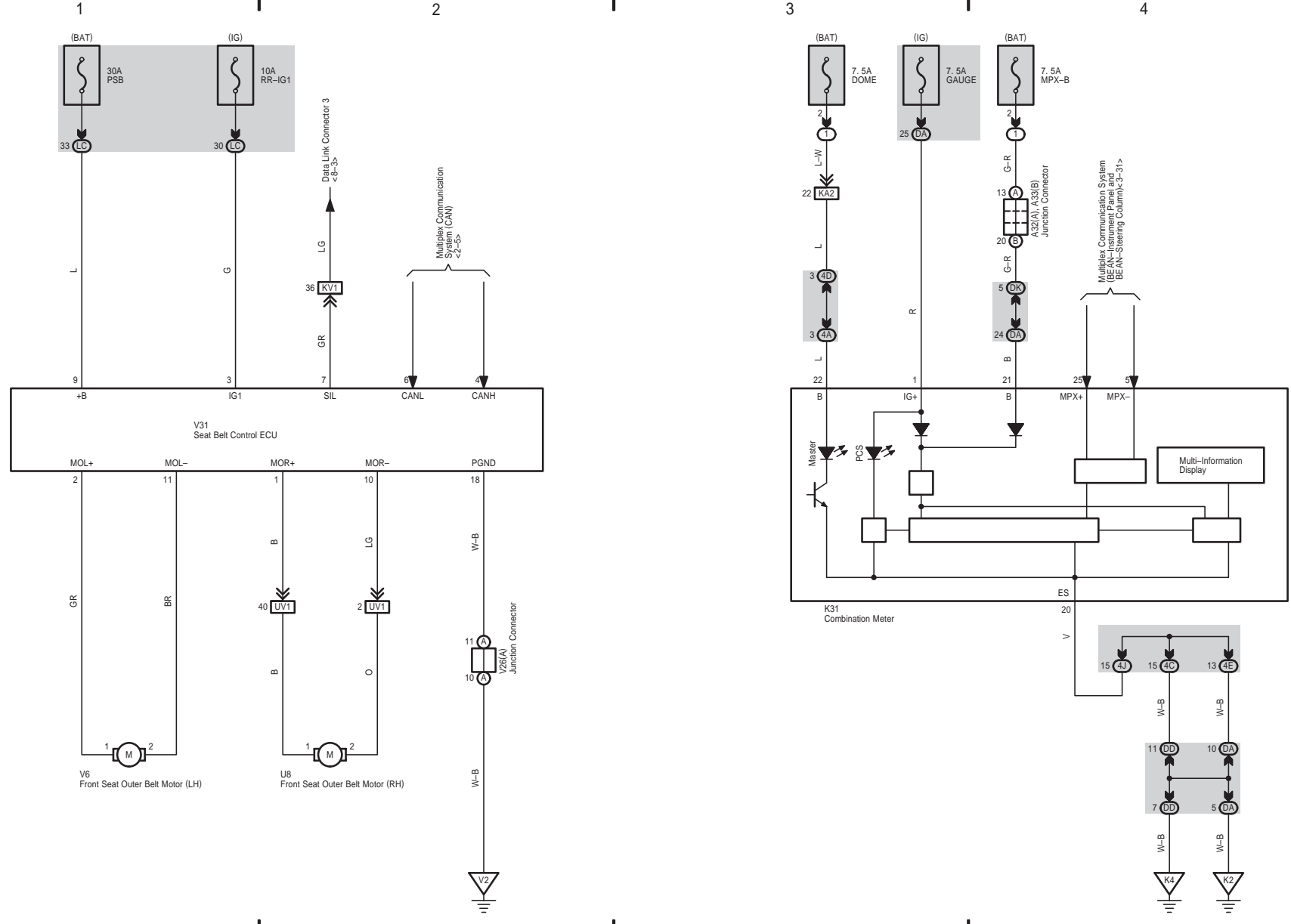

Vehicle Dynamics Integrated Management (for Hybrid Vehicle)

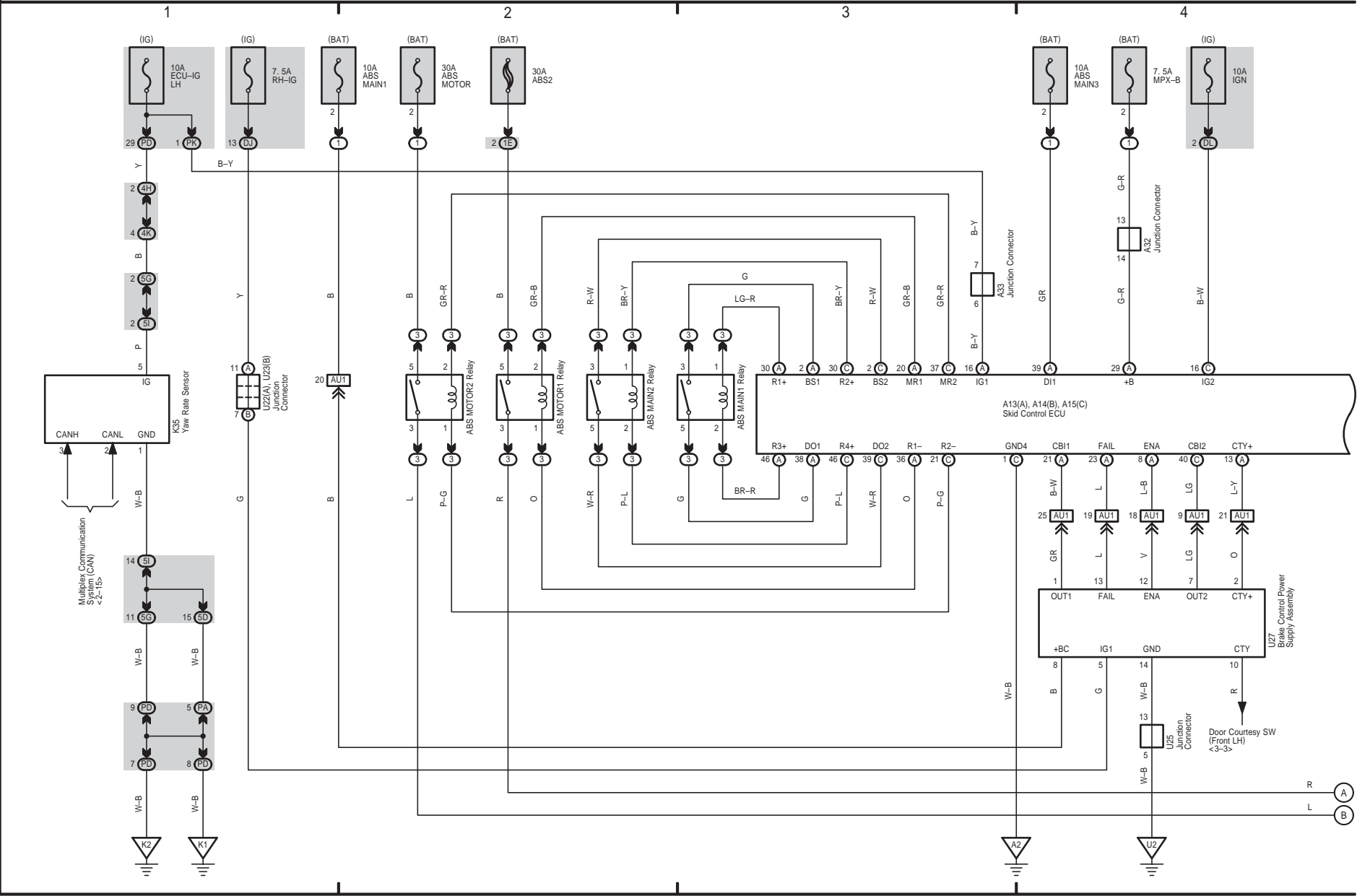

Vehicle Dynamics Integrated Management (for Hybrid Vehicle)

* 1 : Shielded

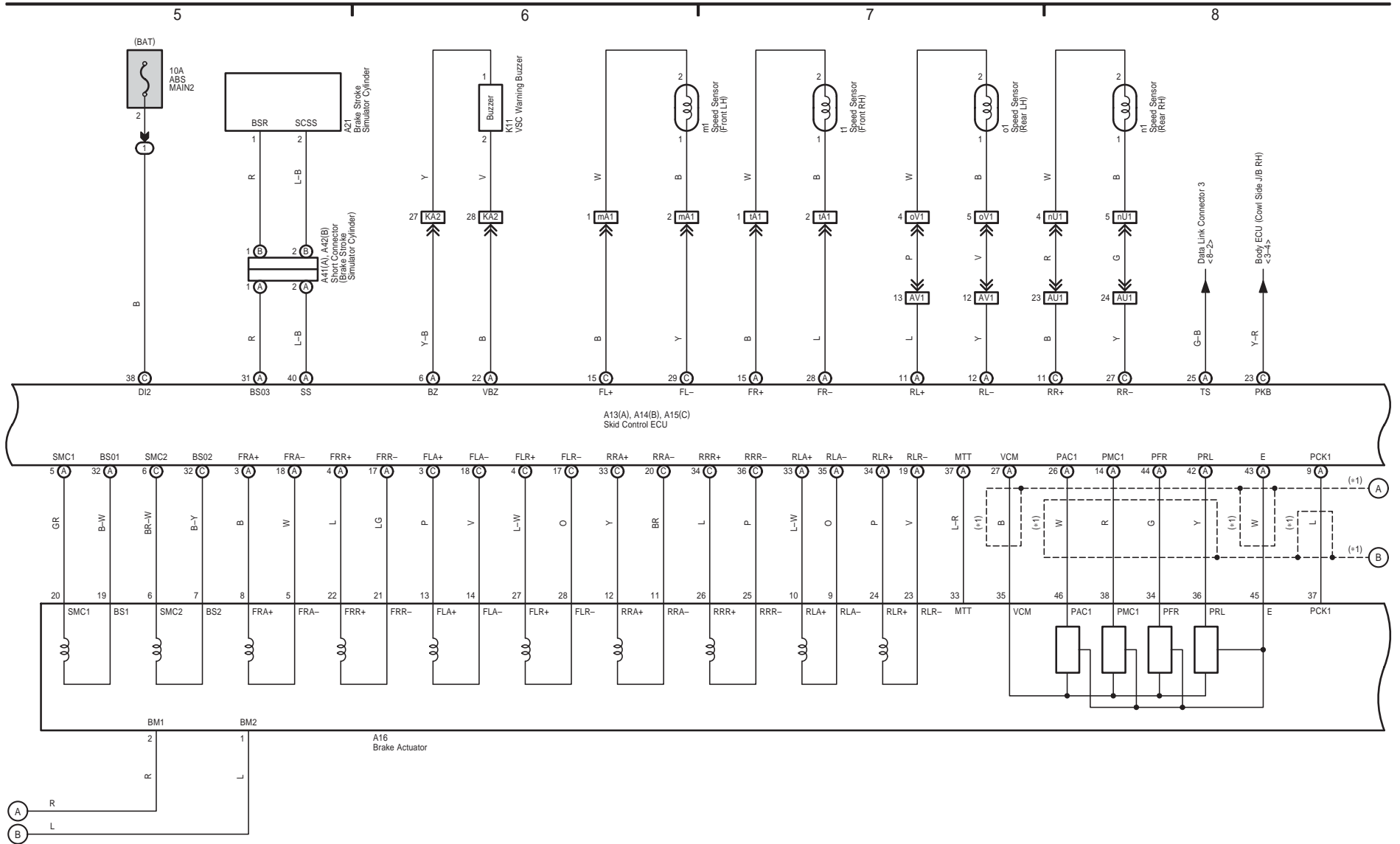

LEXUS GS 450h (EM02D0U)



Vehicle Dynamics Integrated Management (for Hybrid Vehicle)

* 1 : Shielded
* 2 : Electronically Controlled Brake System

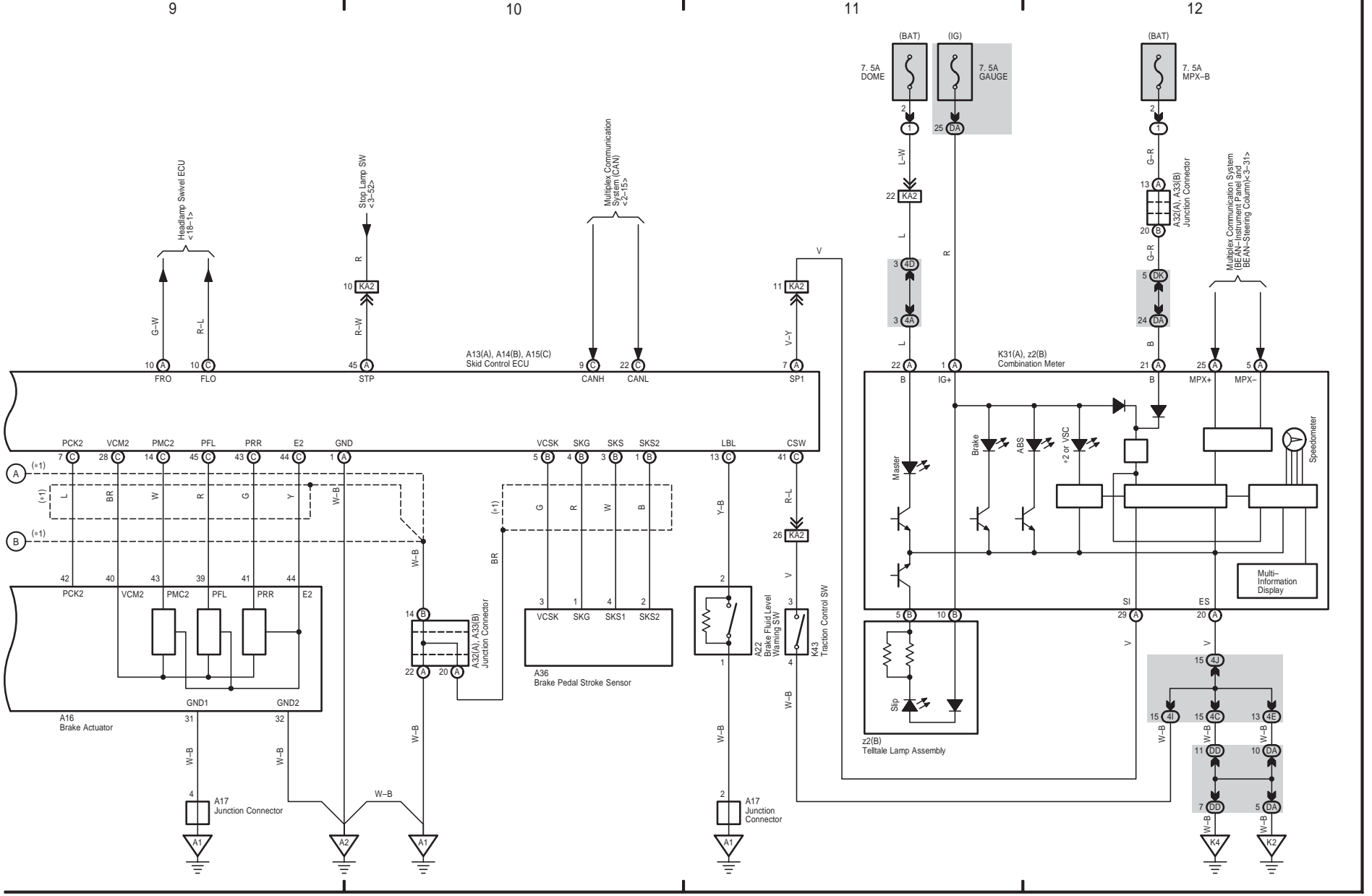

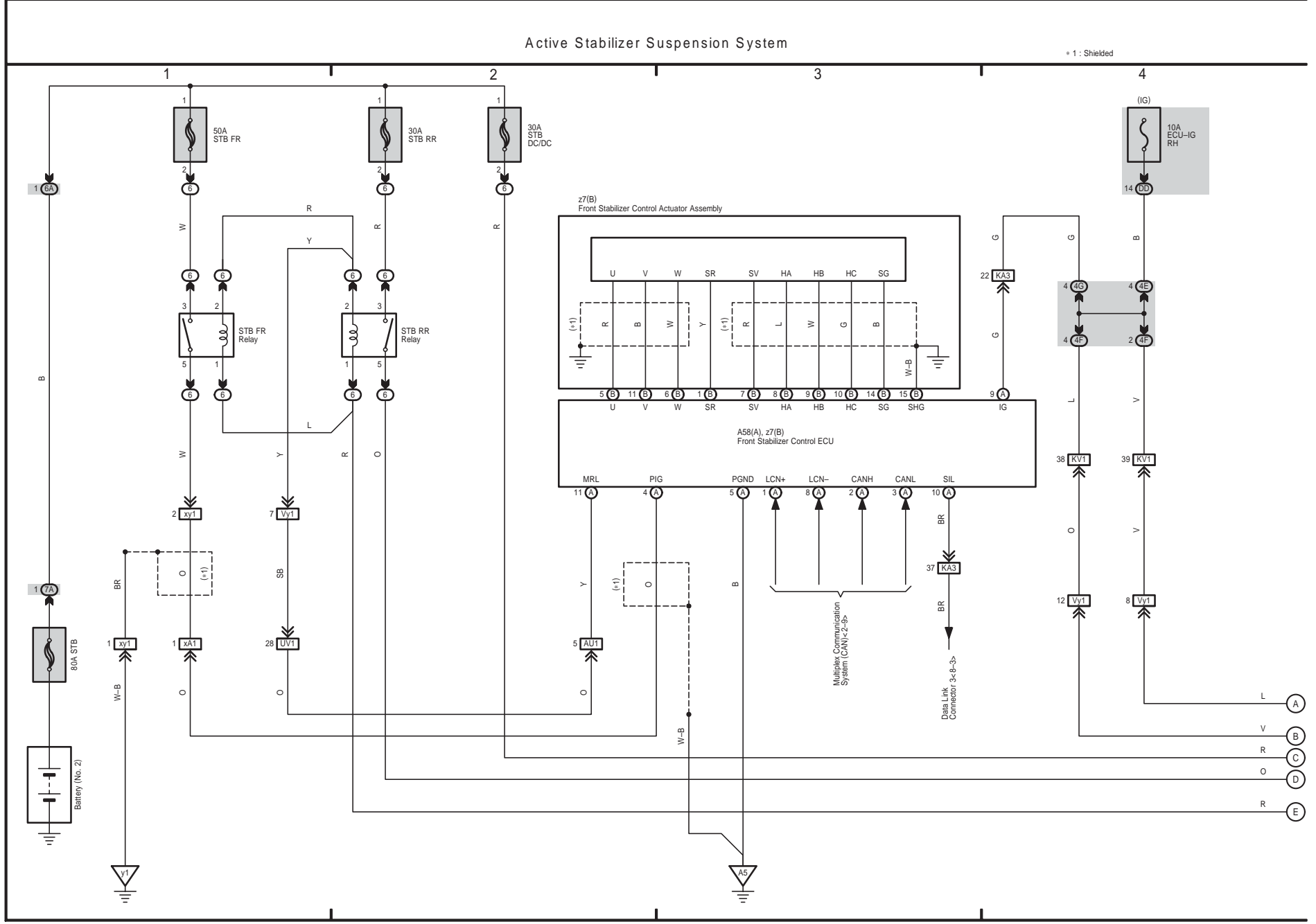

Active Stabilizer Suspension System

* 1 : Shielded

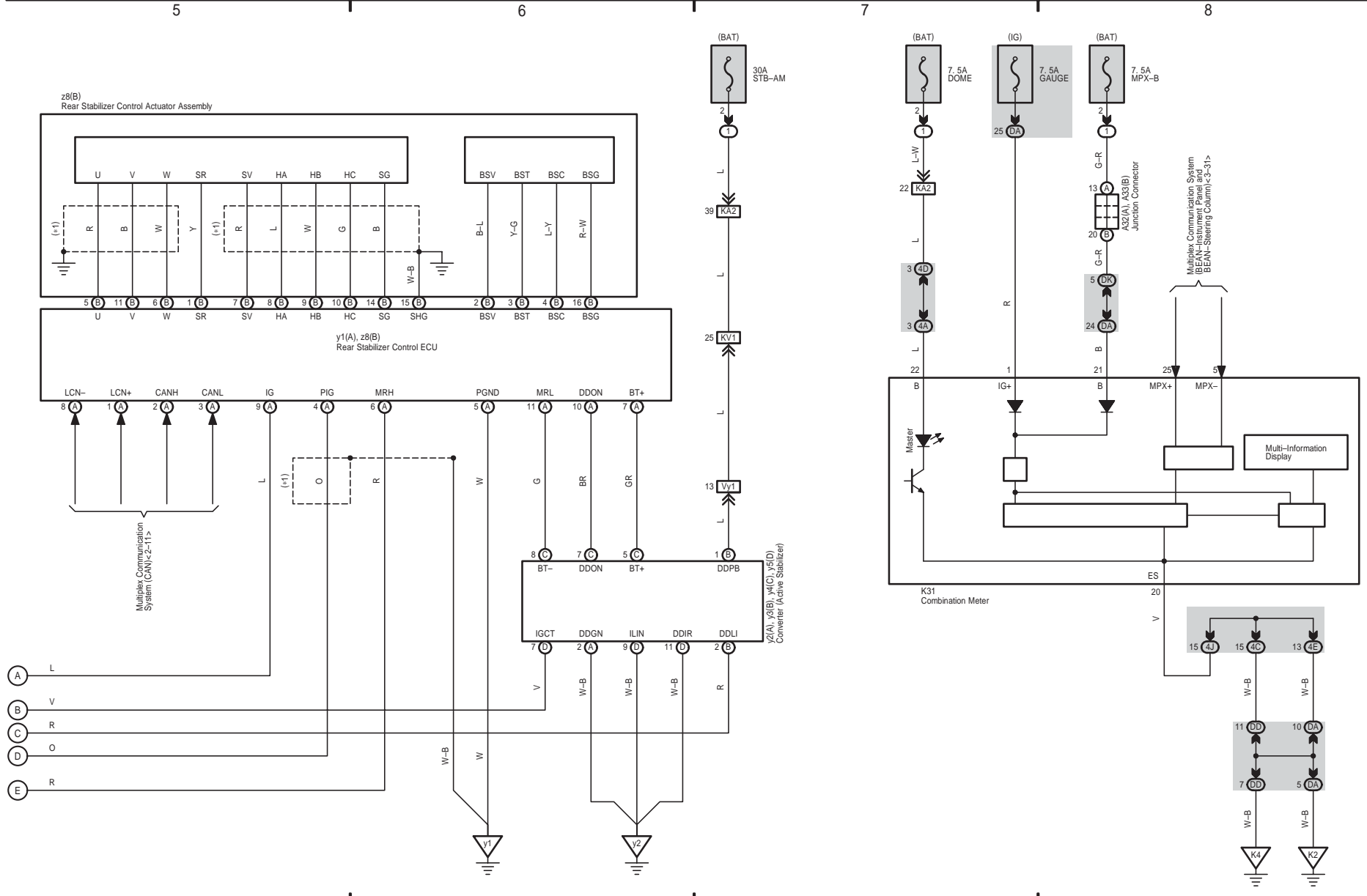

LEXUS GS 450h (EM02D0U)



Electronic Modulated Suspension

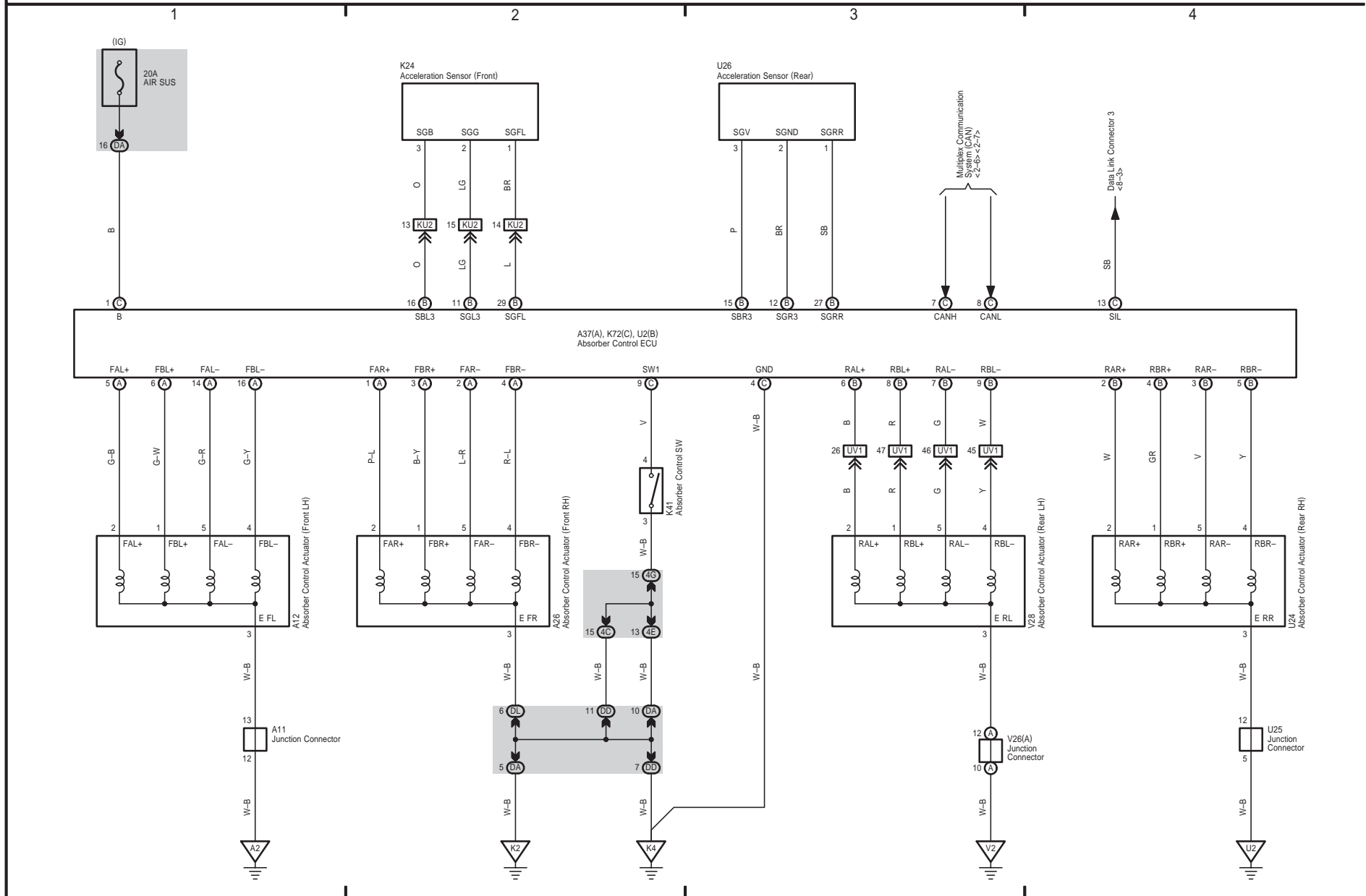

Electronic Modulated Suspension

5 6 7 8

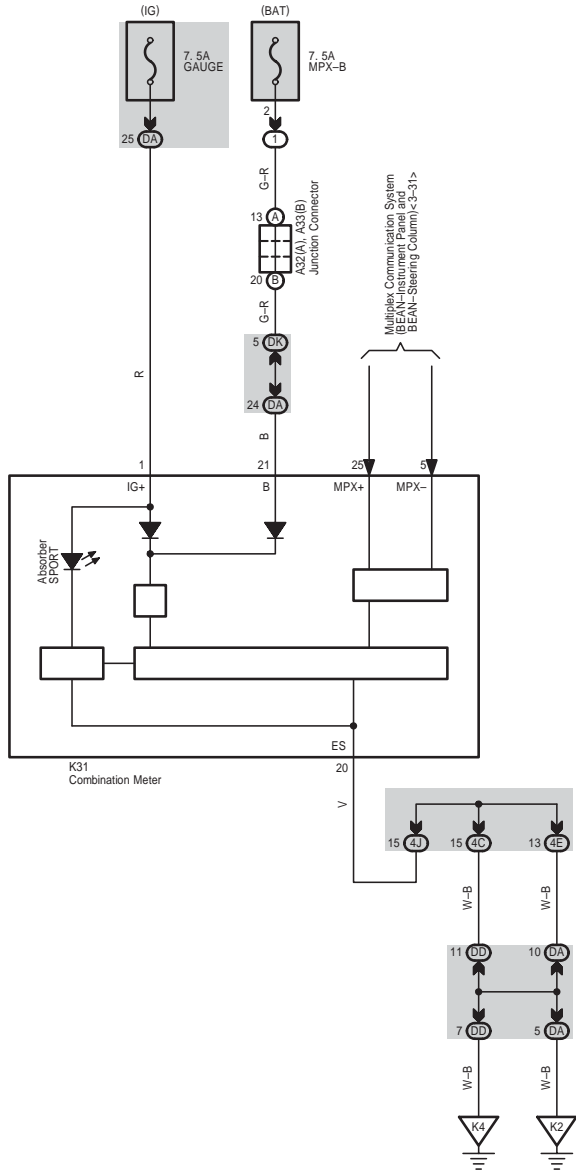

LEXUS GS 450h (EM02D0U)

Tire Pressure Warning System

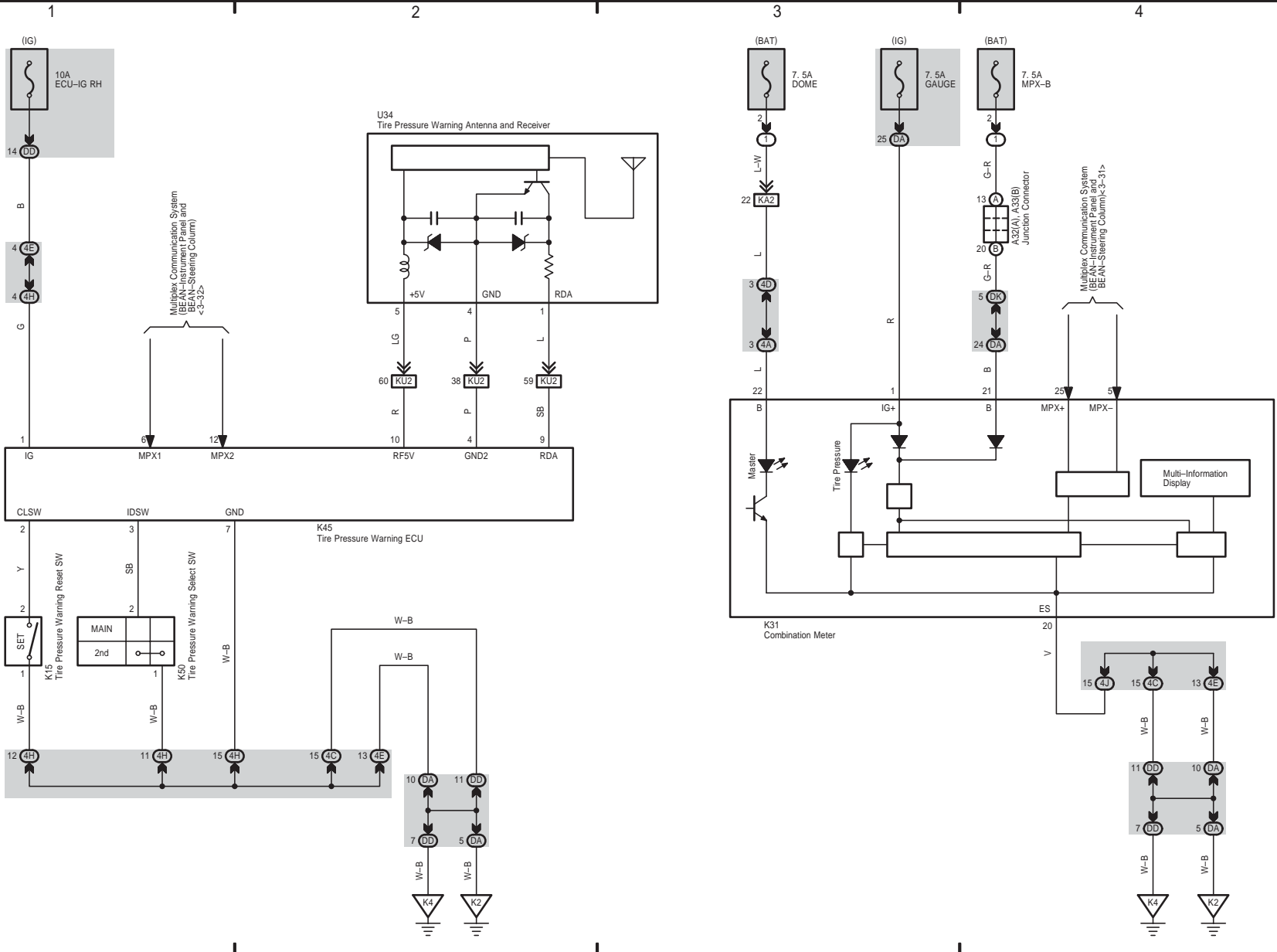

VGRS System

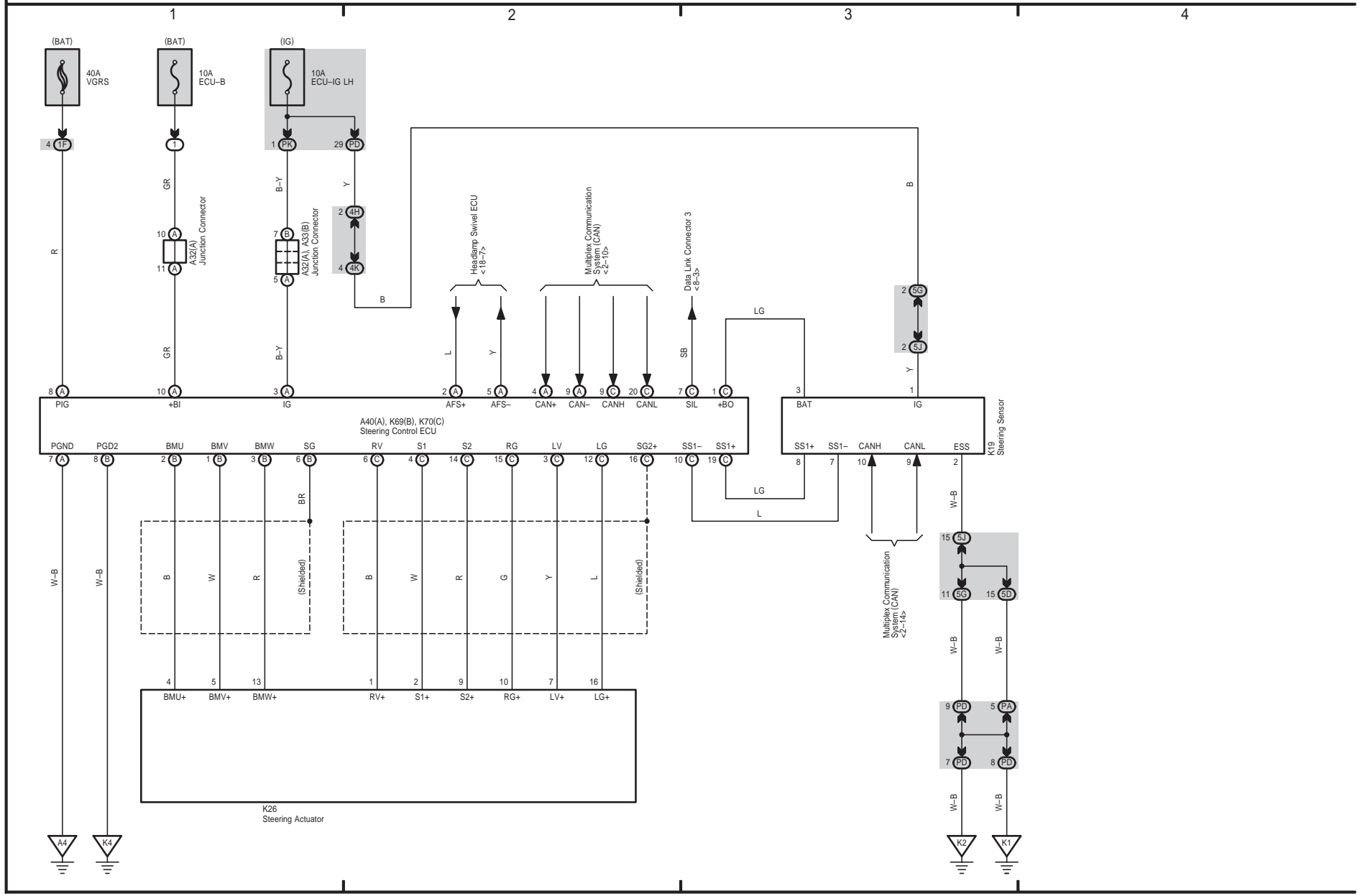

VGRS System

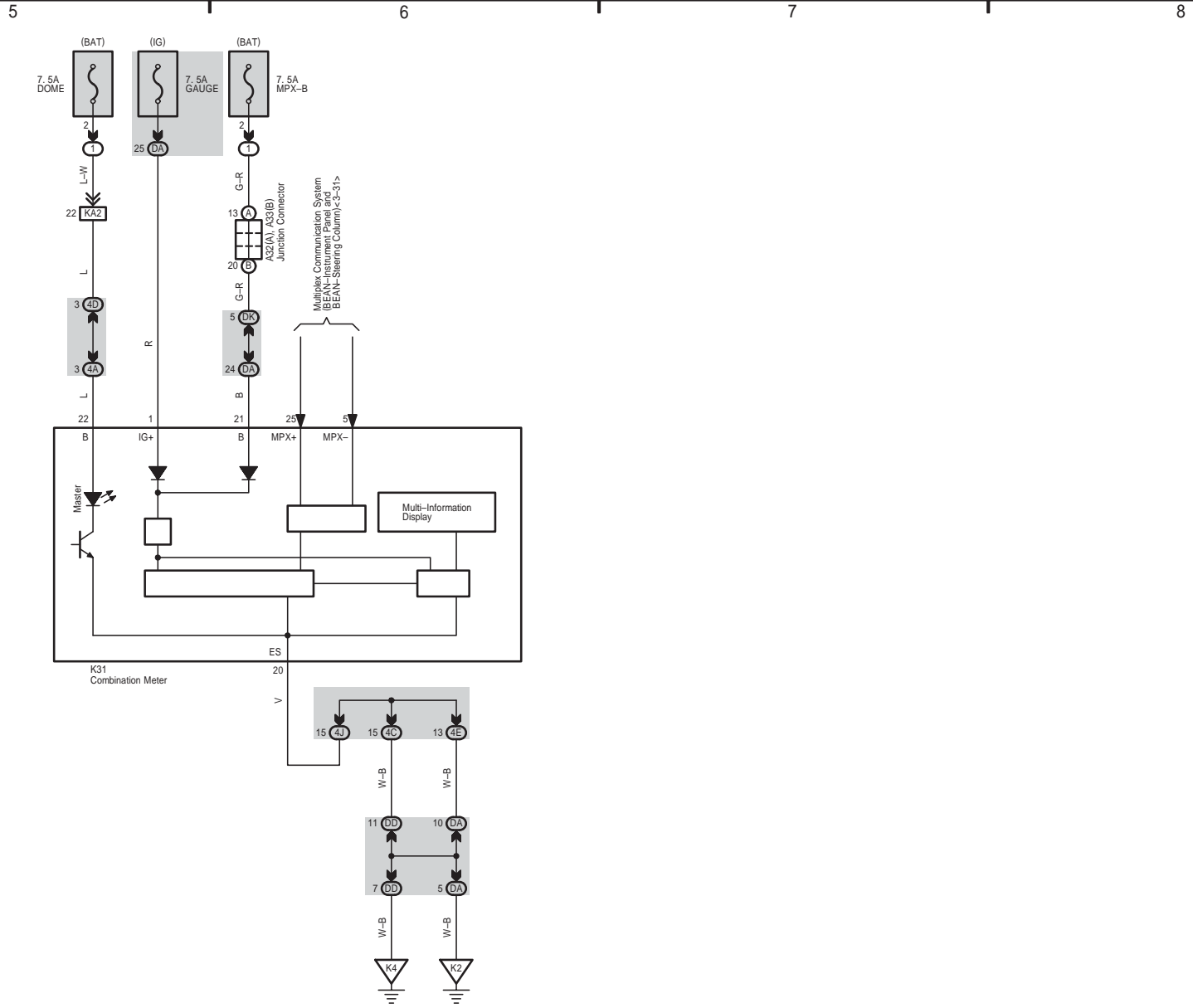

LEXUS GS 450h (EM02D0U)

17 GS 450h

EPS

OVERALL ELECTRICAL WIRING DIAGRAM

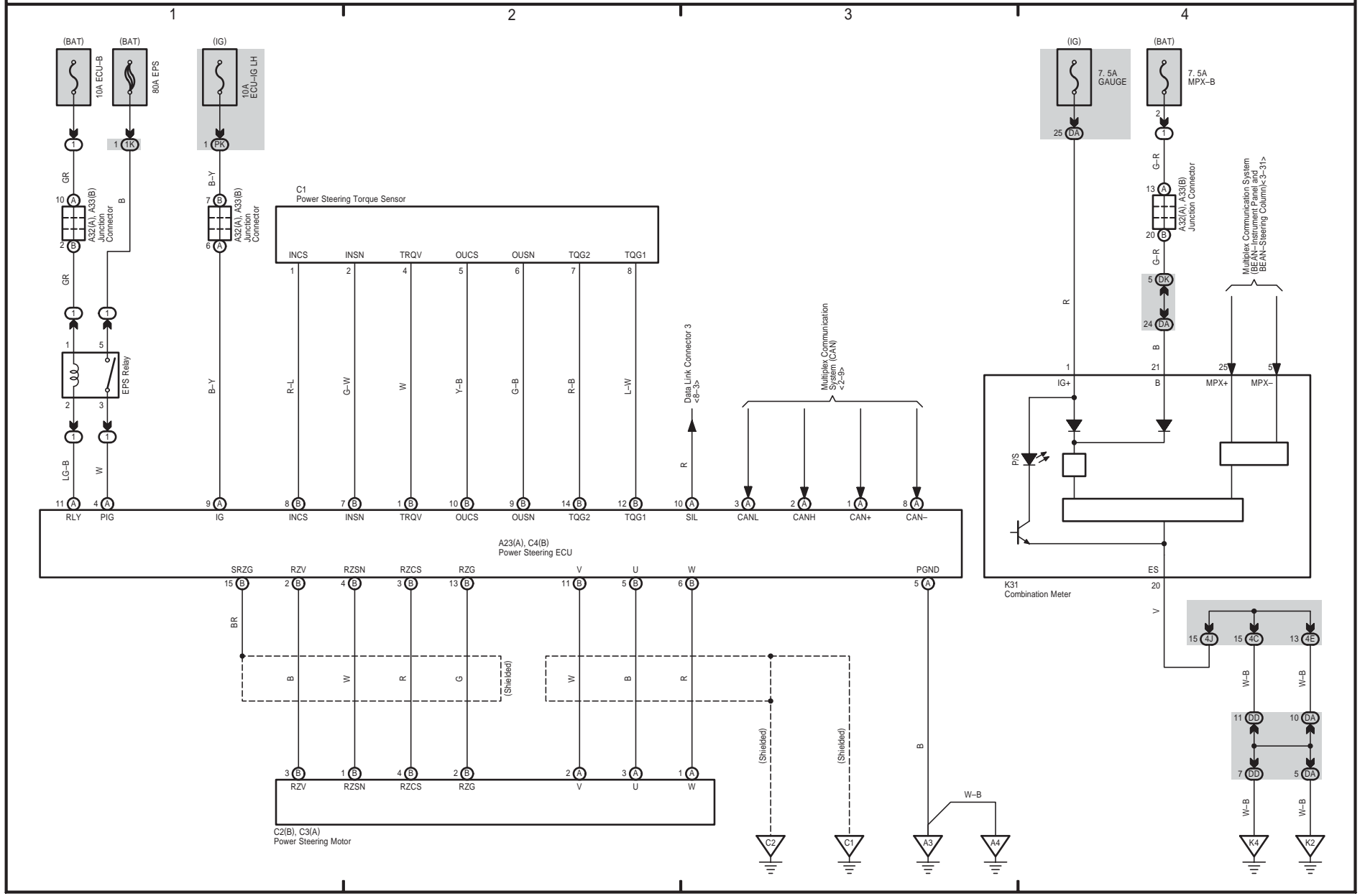

Adaptive Front-Lighting System

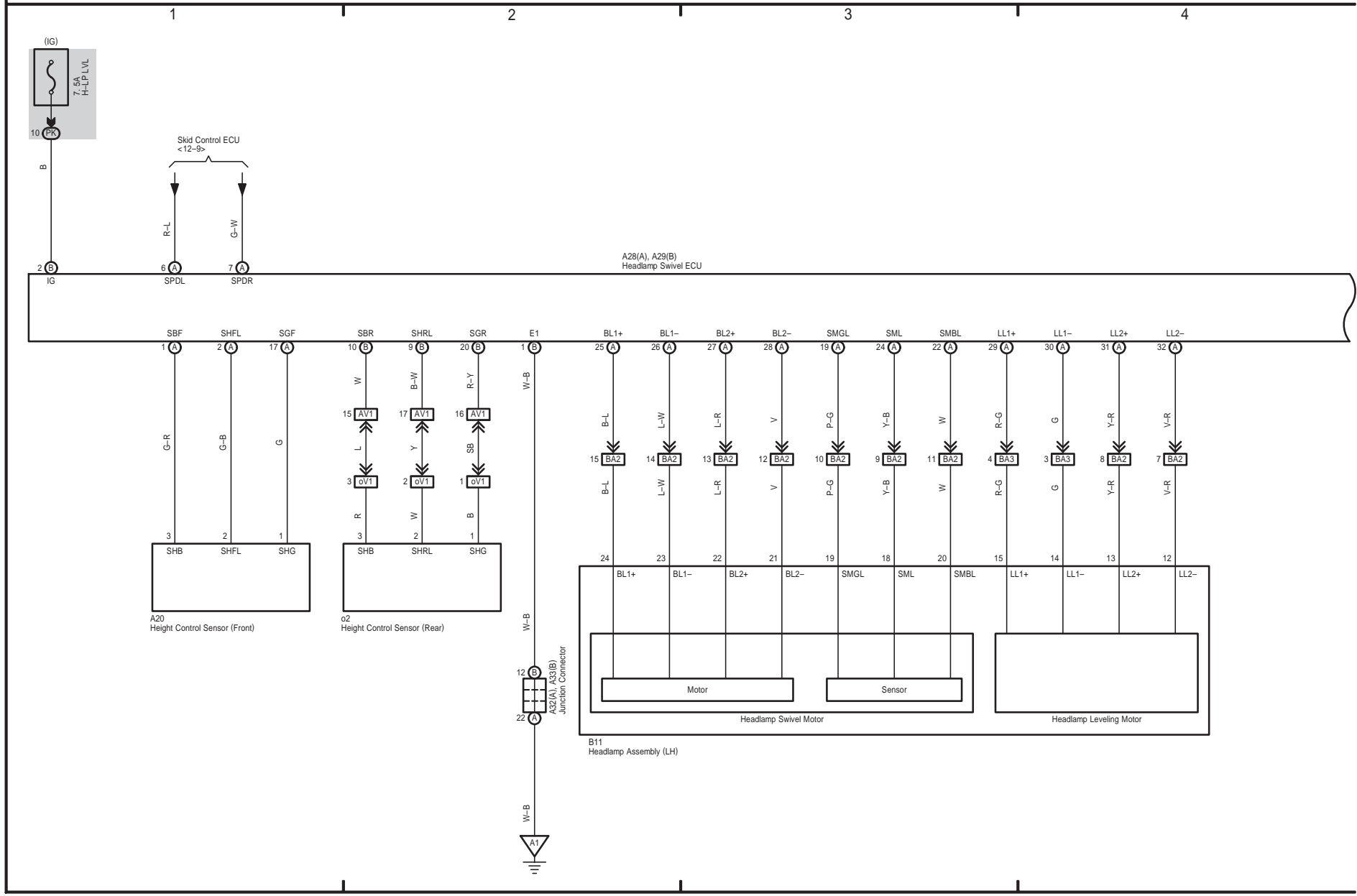

Adaptive Front-Lighting System

5 6 7 8

LEXUS GS 450h (EM02D0U)

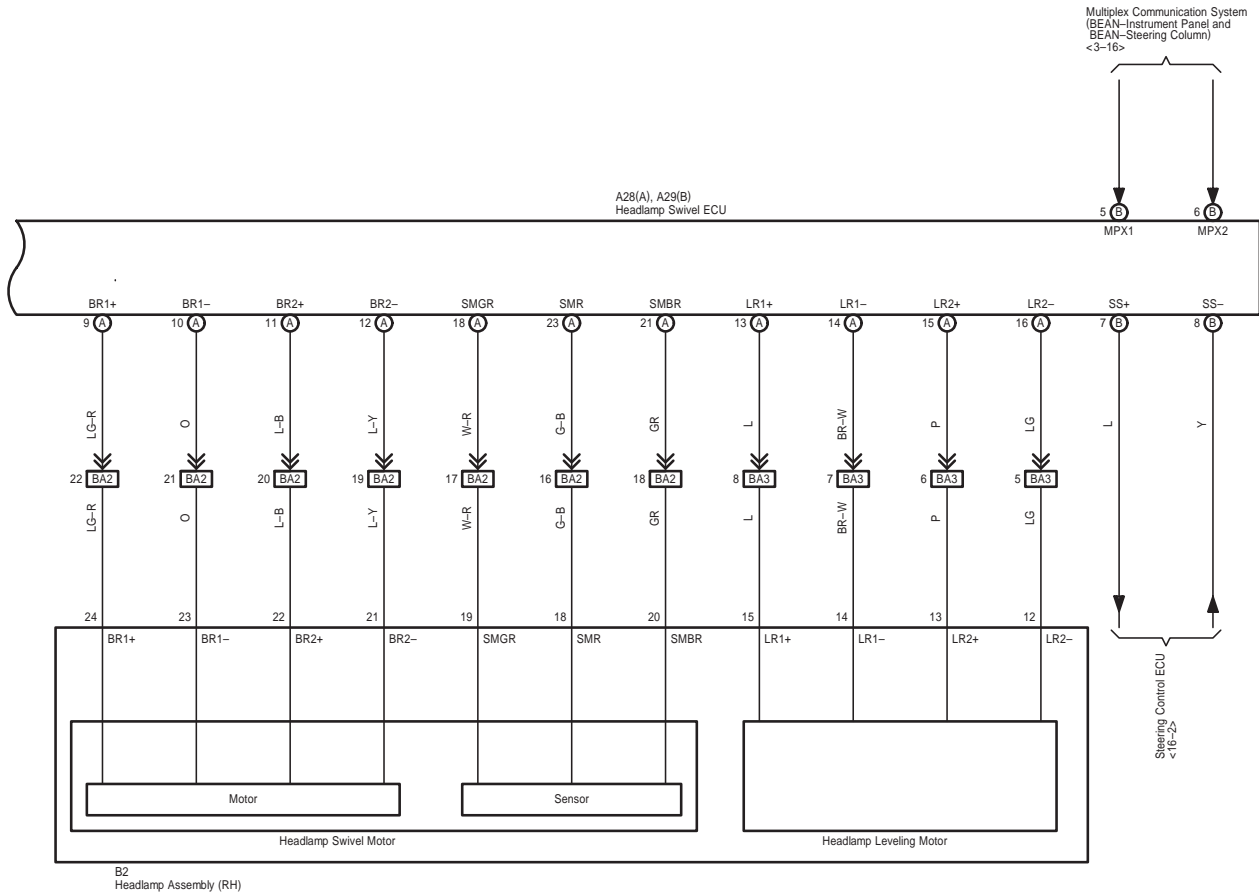

Adaptive Front-Lighting System

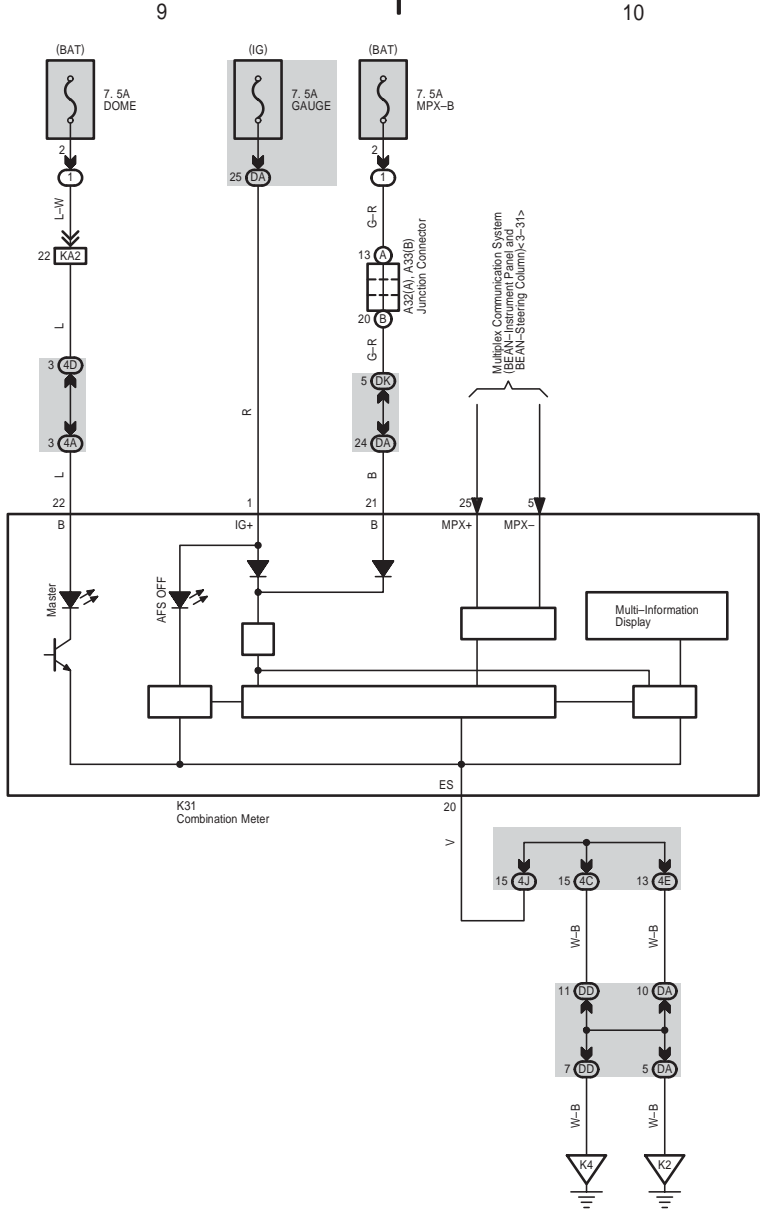

Shift Lock

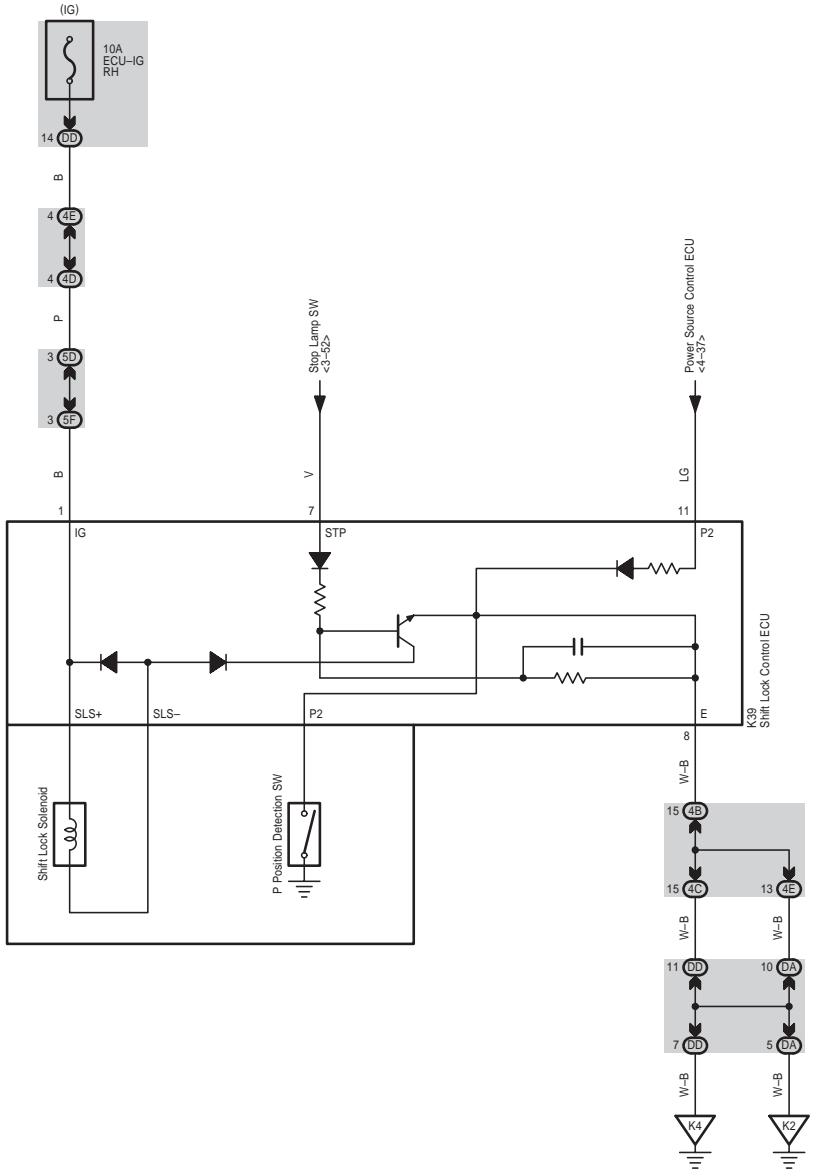

LEXUS GS 450h (EM02D0U)



20 GS 450h

Headlight Cleaner

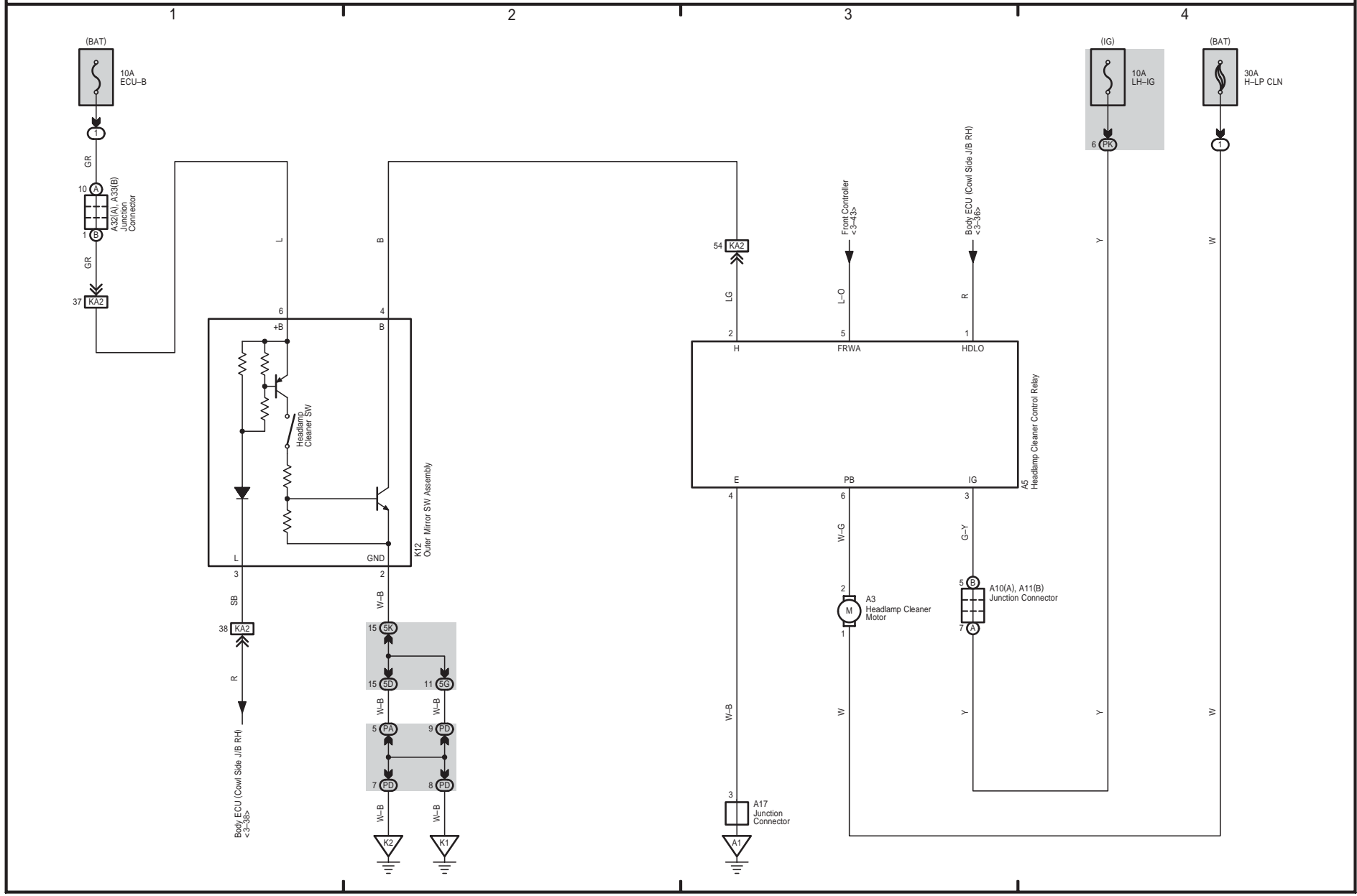

Garage Door Opener

Automatic Glare-Resistant EC Mirror

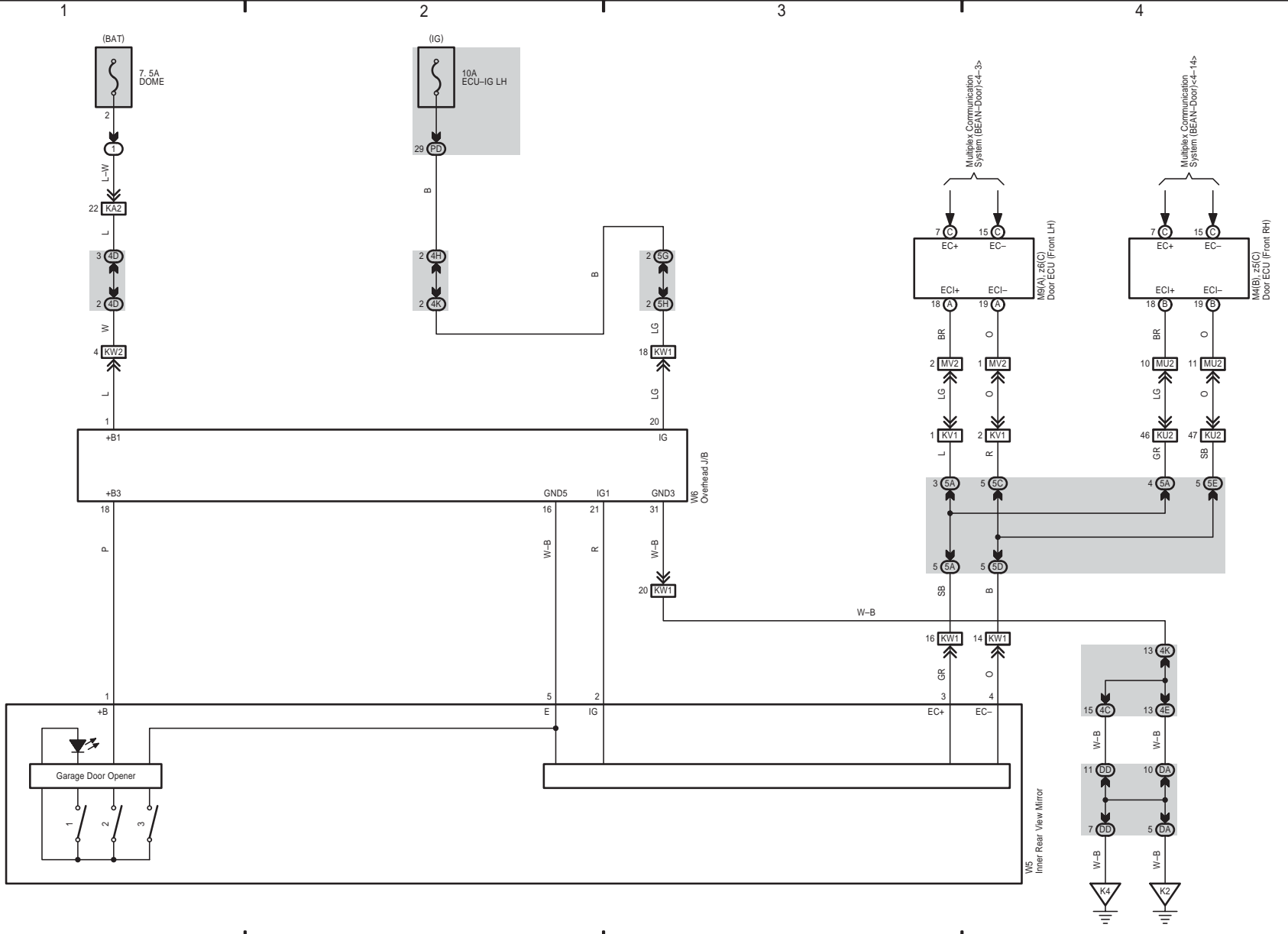

LEXUS GS 450h (EM02D0U)



Cooling Fan

Rear Window Defogger

1 2 3 4

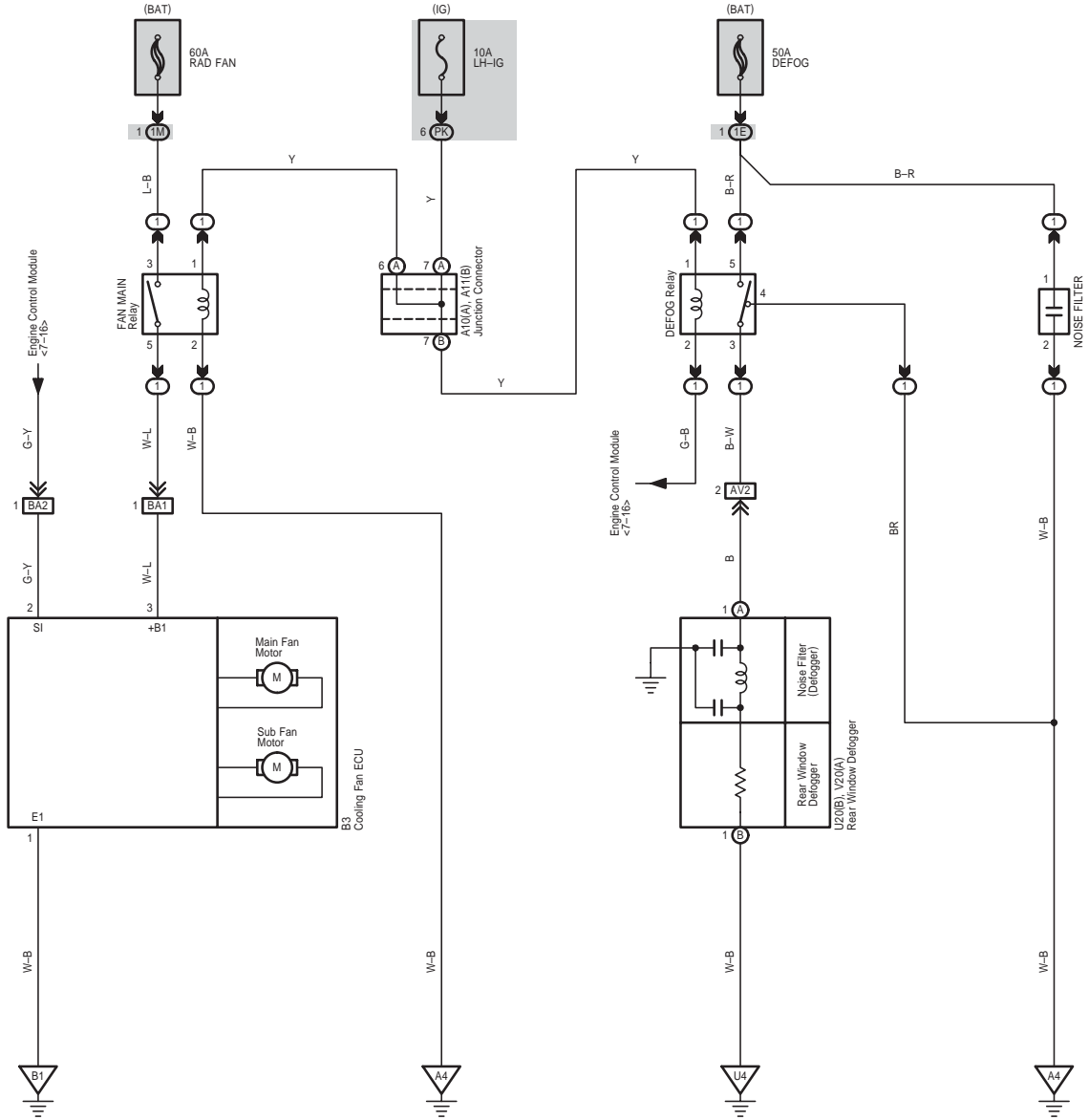

LEXUS GS 450h (EM02D0U)



24 GS 450h

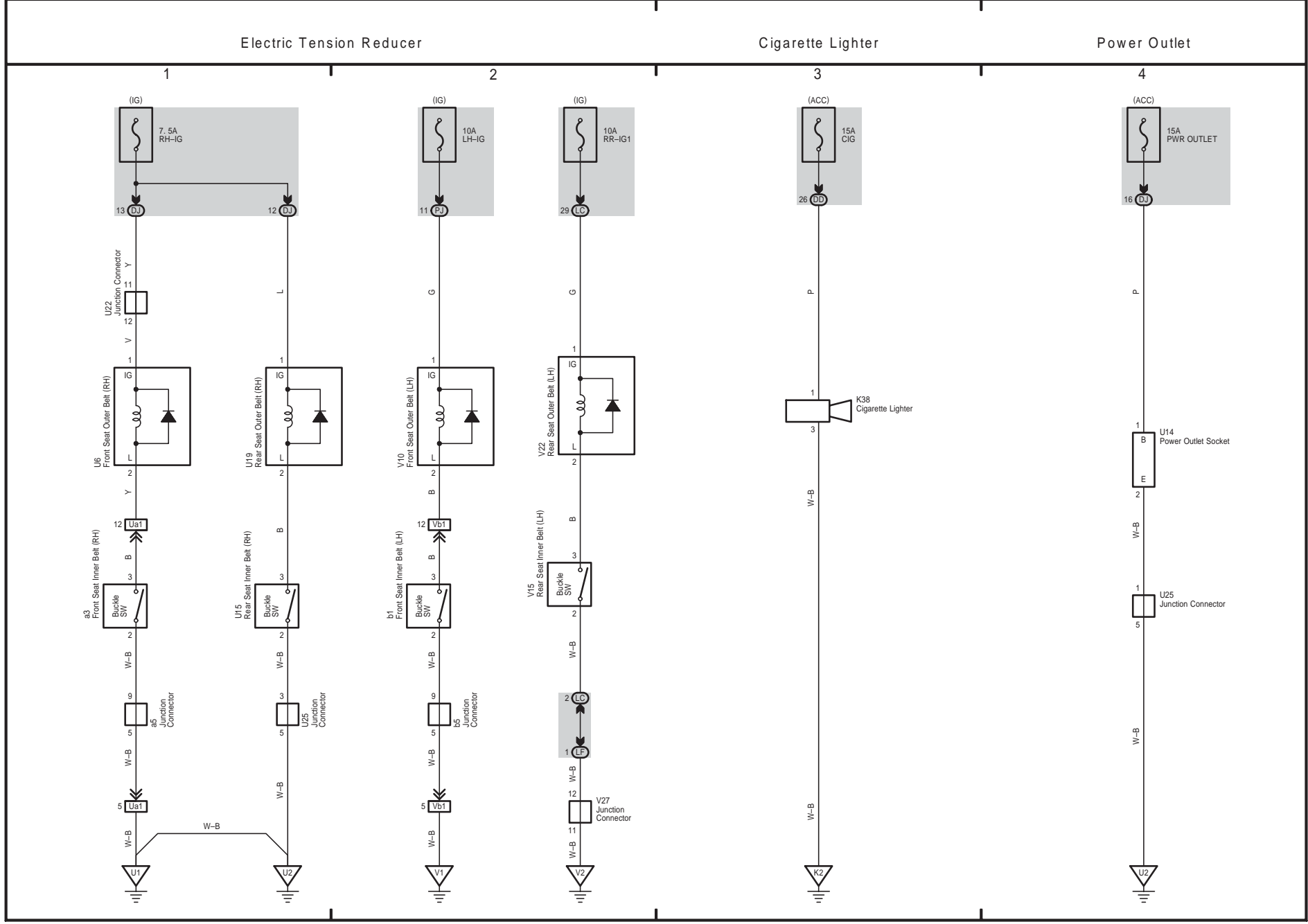

Power Seat
(Driver's Seat w/ Seat Position Memory)

Power Seat
(Front Passenger's Seat w/ Seat Position Memory)

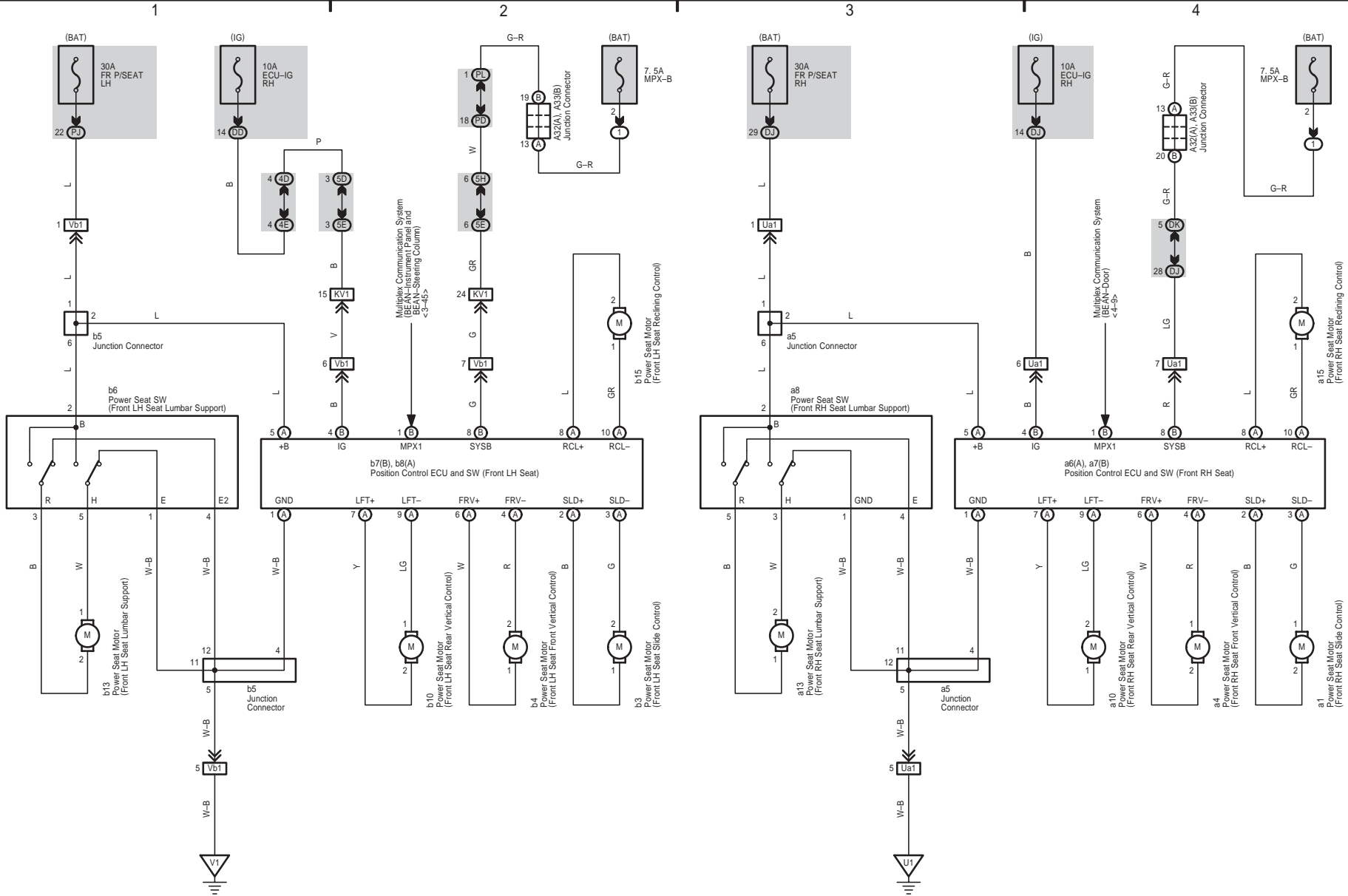

LEXUS GS 450h (EM02D0U)



Power Seat (Driver's Seat w/o Seat Position Memory)

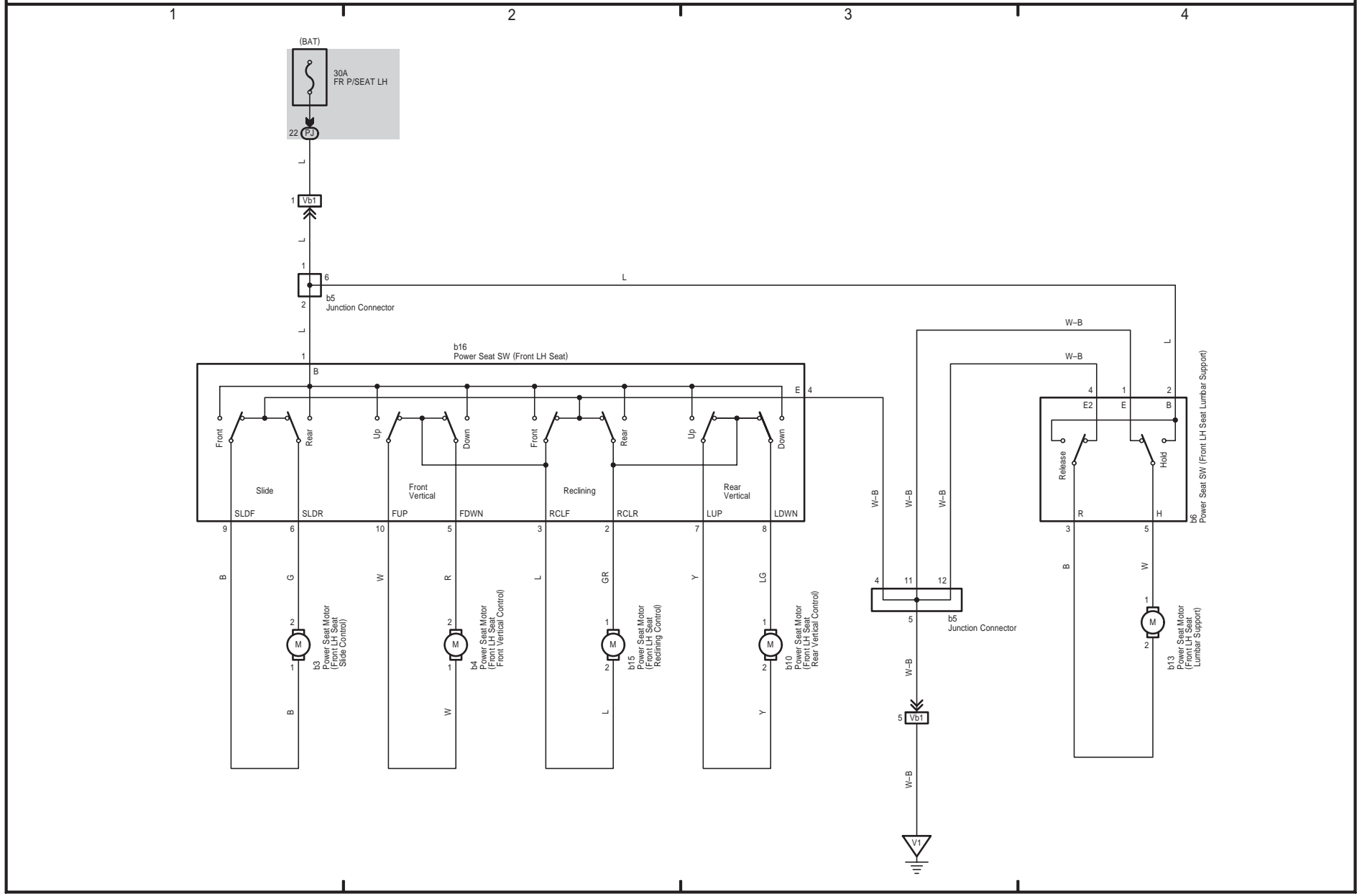

Power Seat (Front Passenger' s Seat w/o Seat Position Memory)

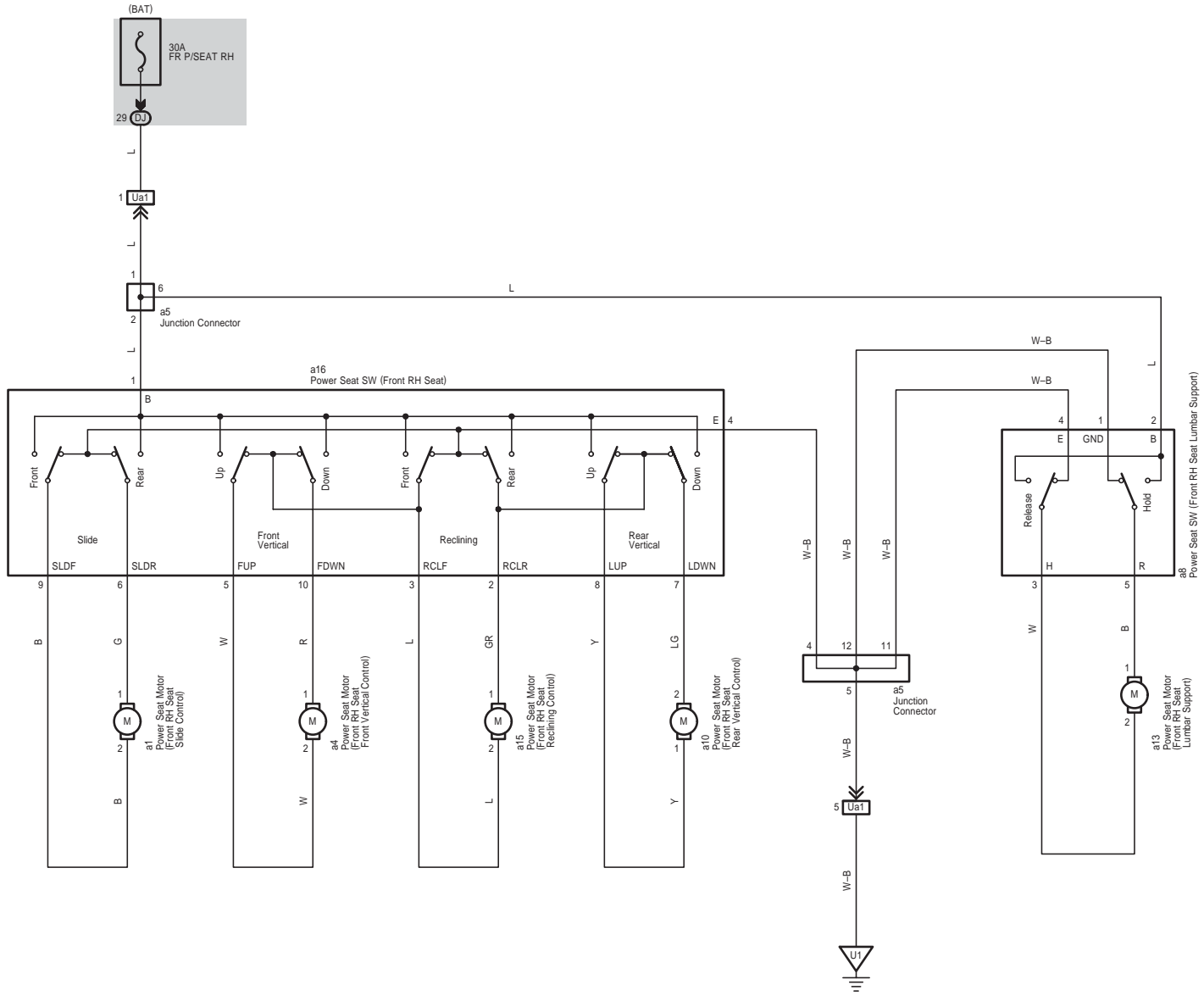

LEXUS GS 450h (EM02D0U)



Climate Control Seat

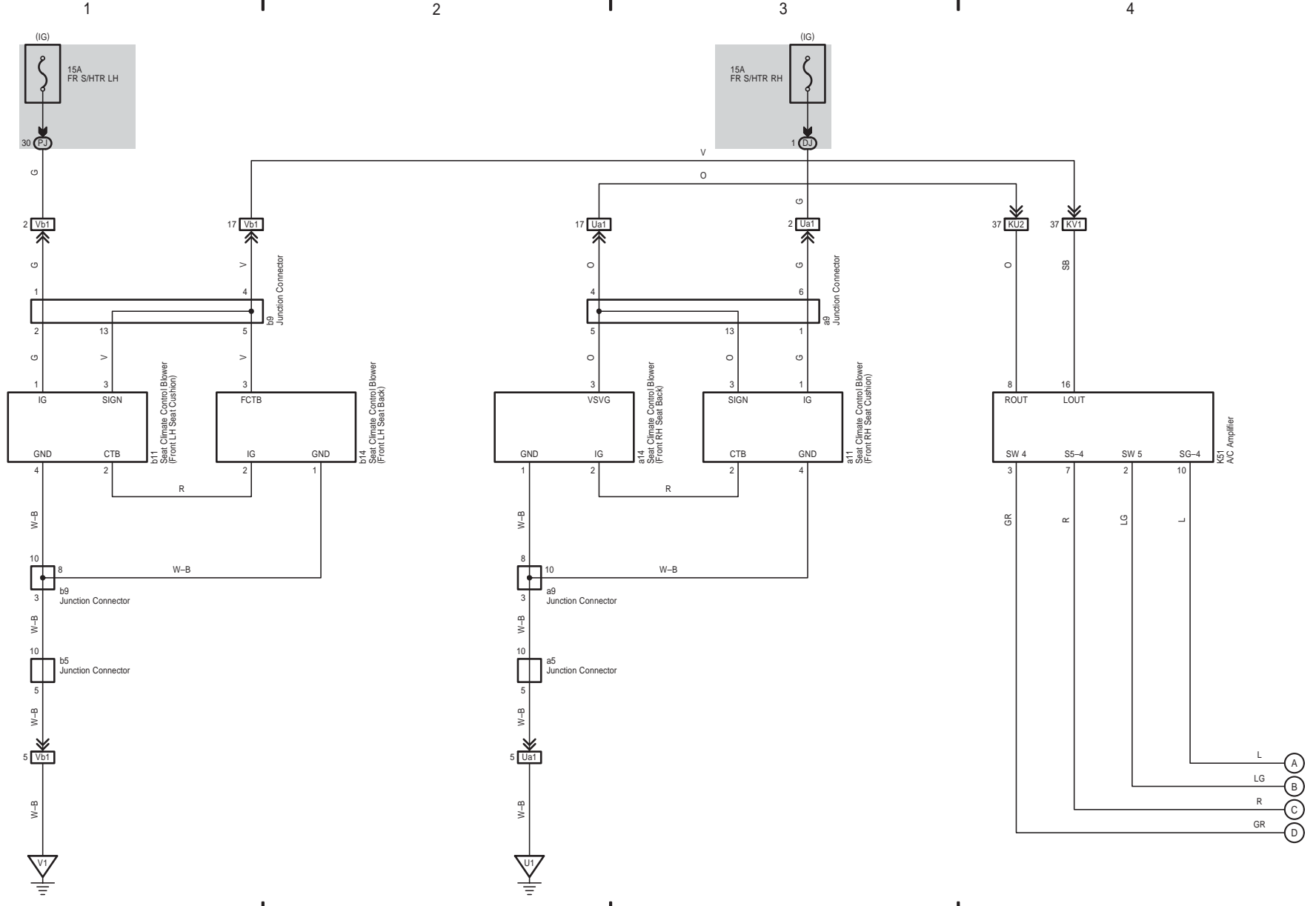

Climate Control Seat

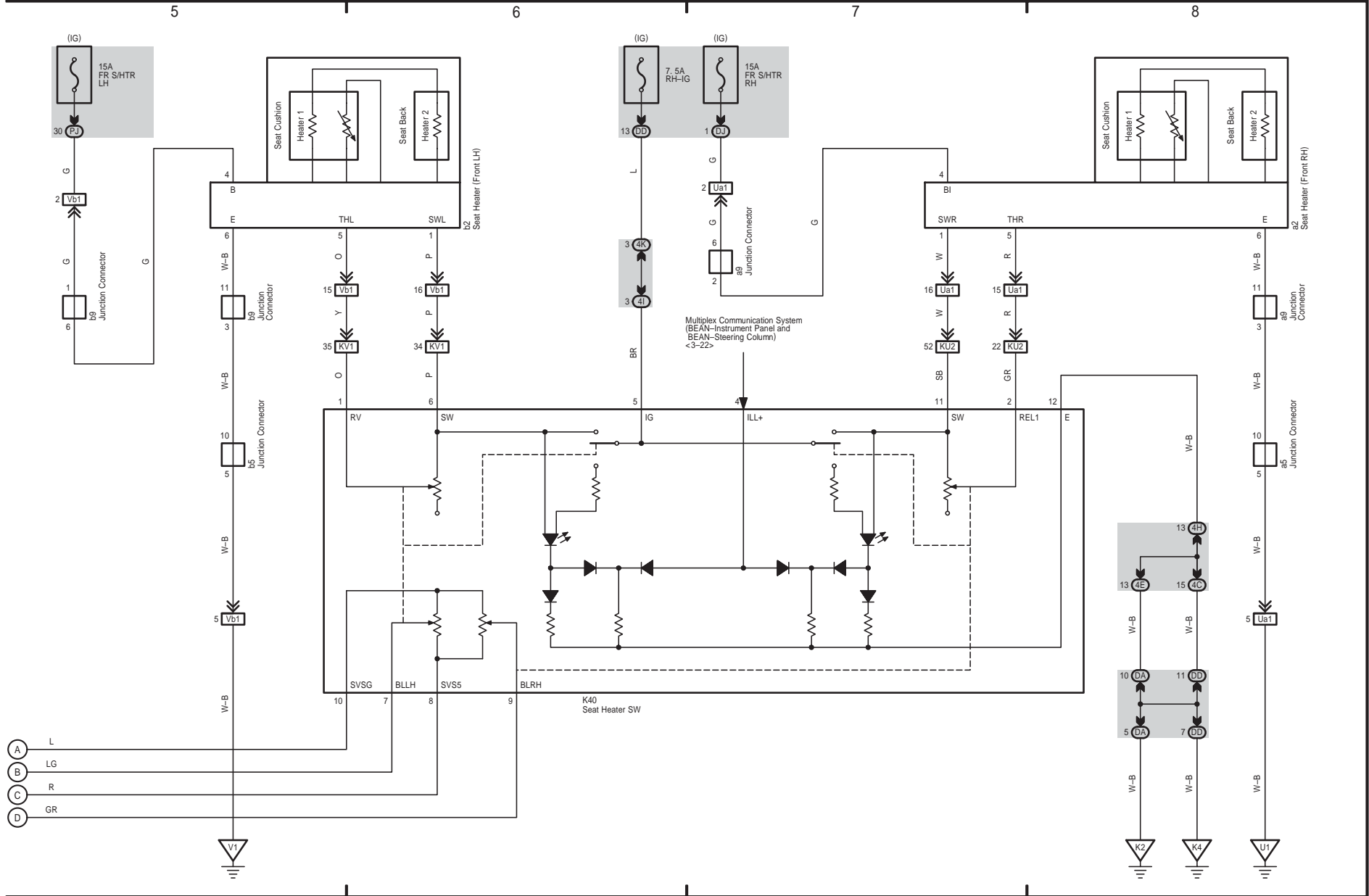

LEXUS GS 450h (EM02D0U)



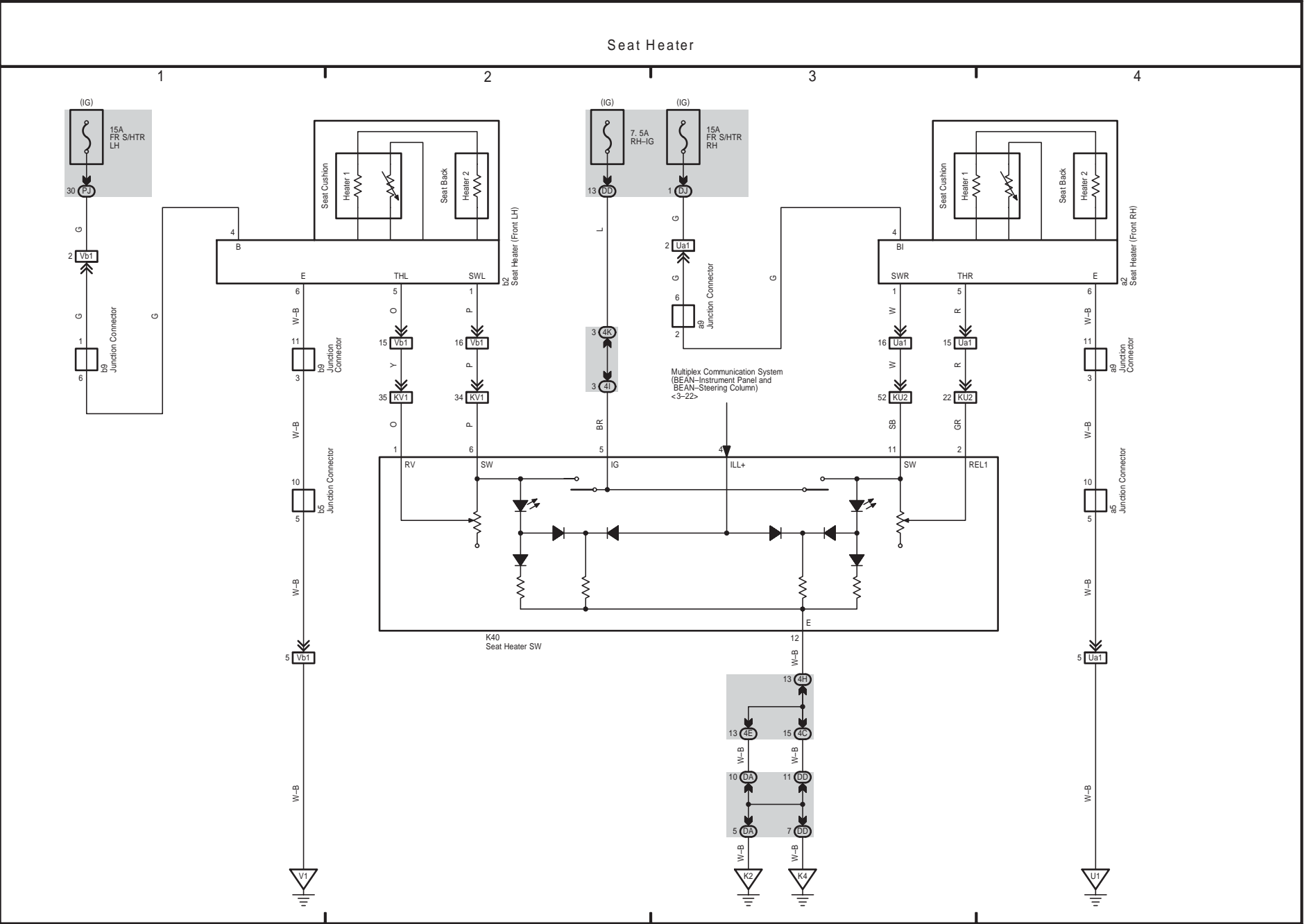

Parking Assist (Intuitive Parking Assist)

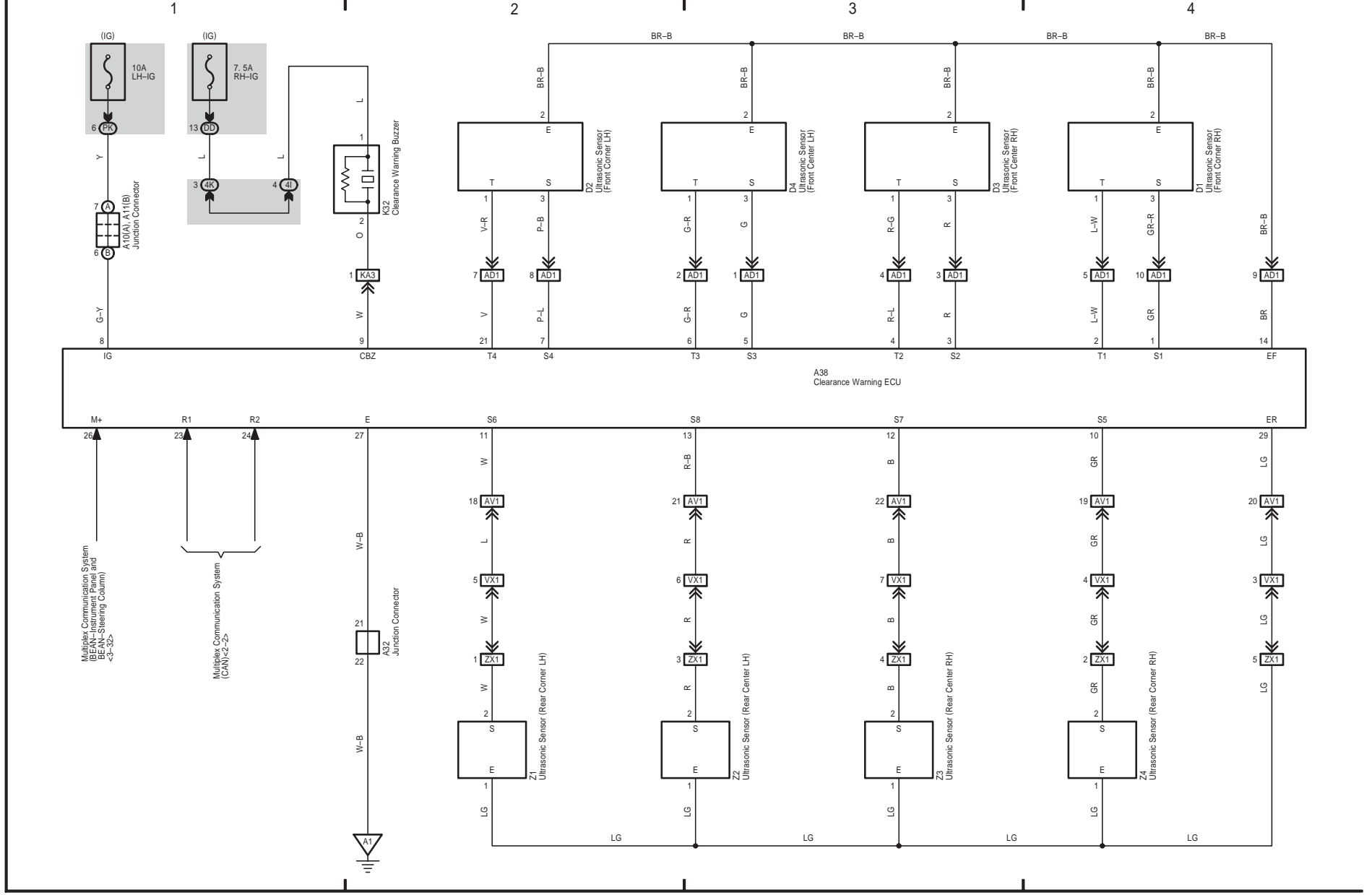

Parking Assist (Intuitive Parking Assist)

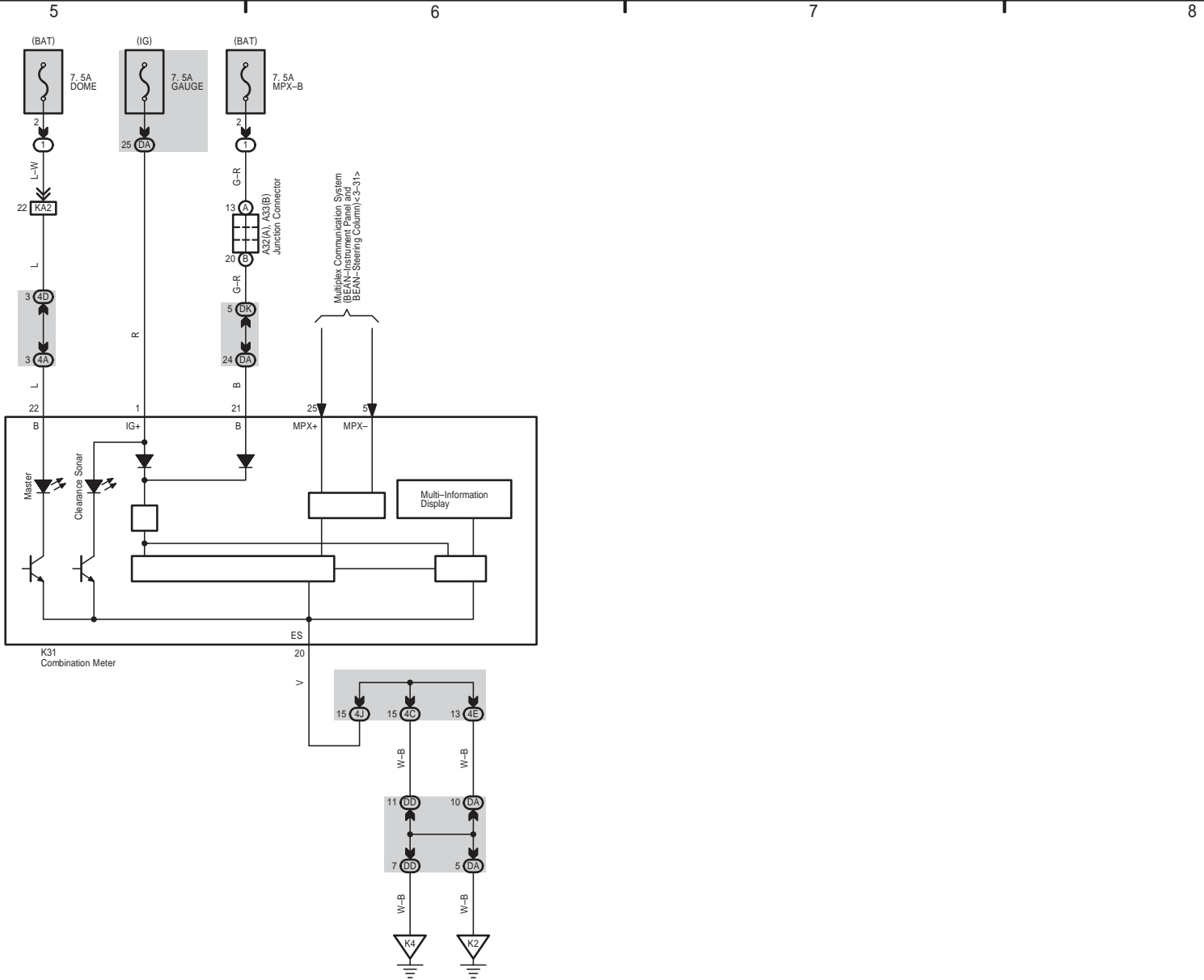

LEXUS GS 450h (EM02D0U)

Audio System, LEXUS Navigation System, Multi Display and Parking Assist (Rear View Monitor)

* 1 : Except MARK LEVINSON
* 2 : MARK LEVINSON

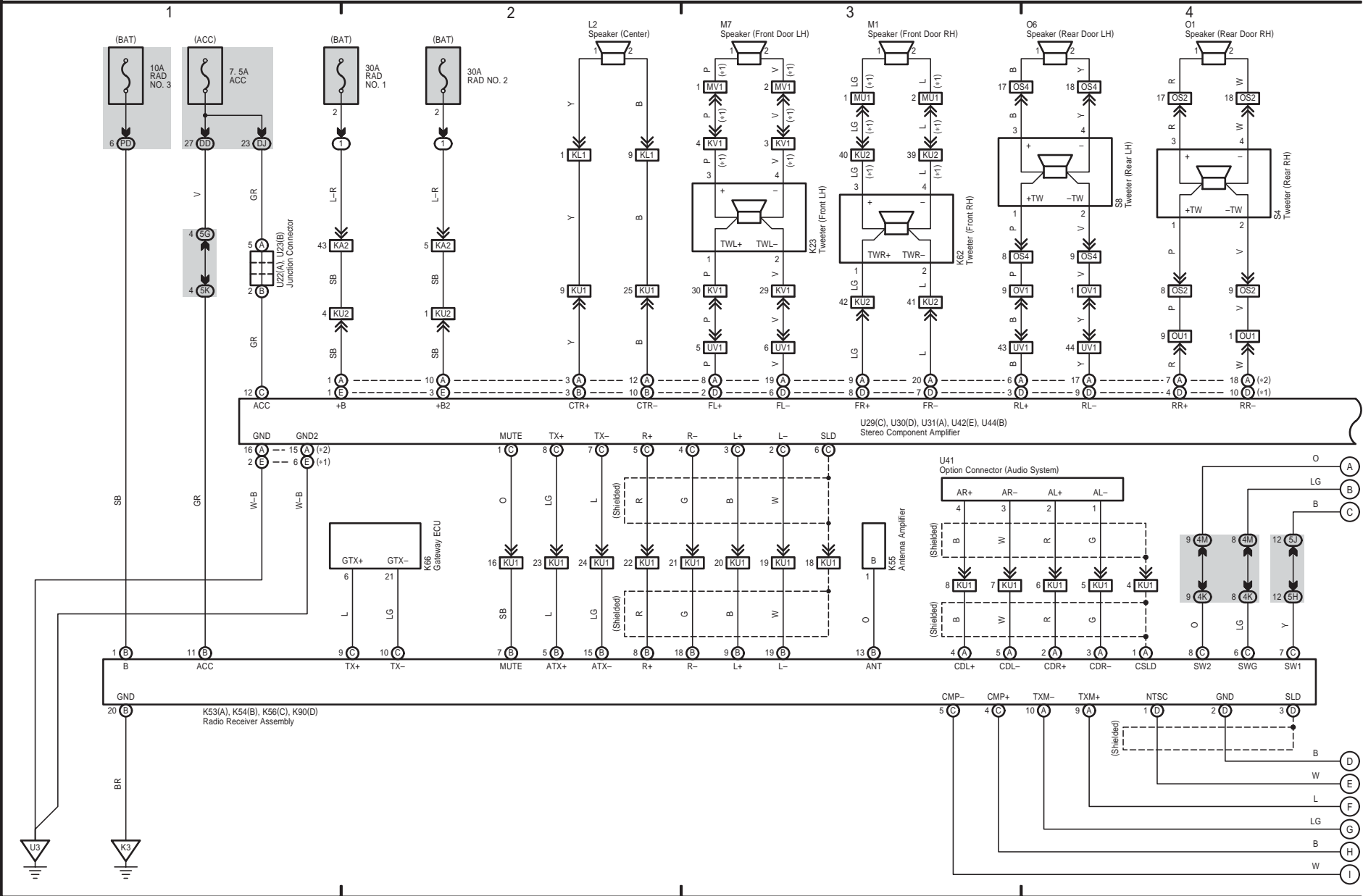

Audio System, LEXUS Navigation System, Multi Display and Parking Assist (Rear View Monitor)

* 1 : Except MARK LEVINSON
 * 2 : MARK LEVINSON

LEXUS GS 450h (EM02D0U)

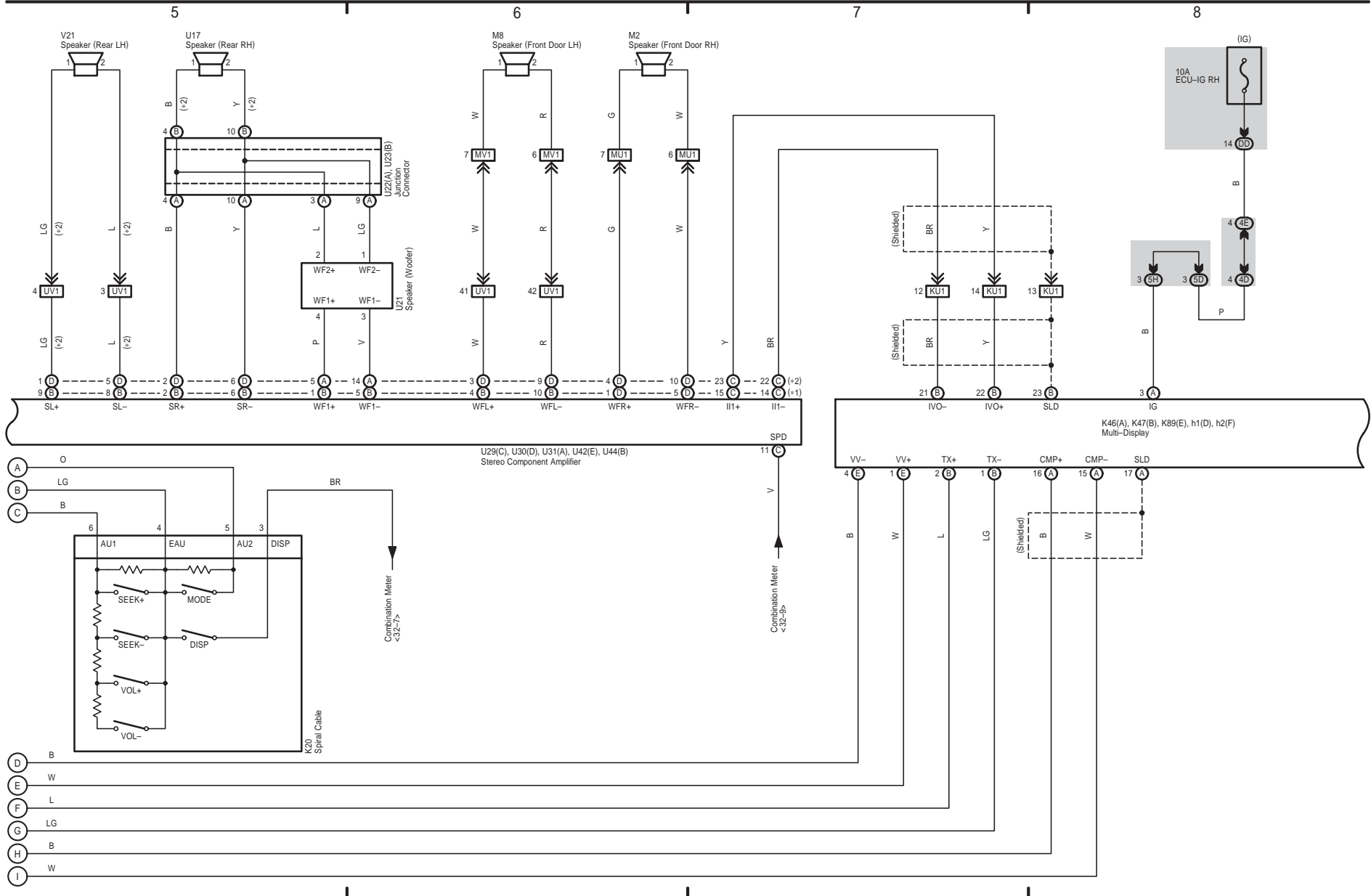

Audio System, LEXUS Navigation System, Multi Display and Parking Assist (Rear View Monitor)

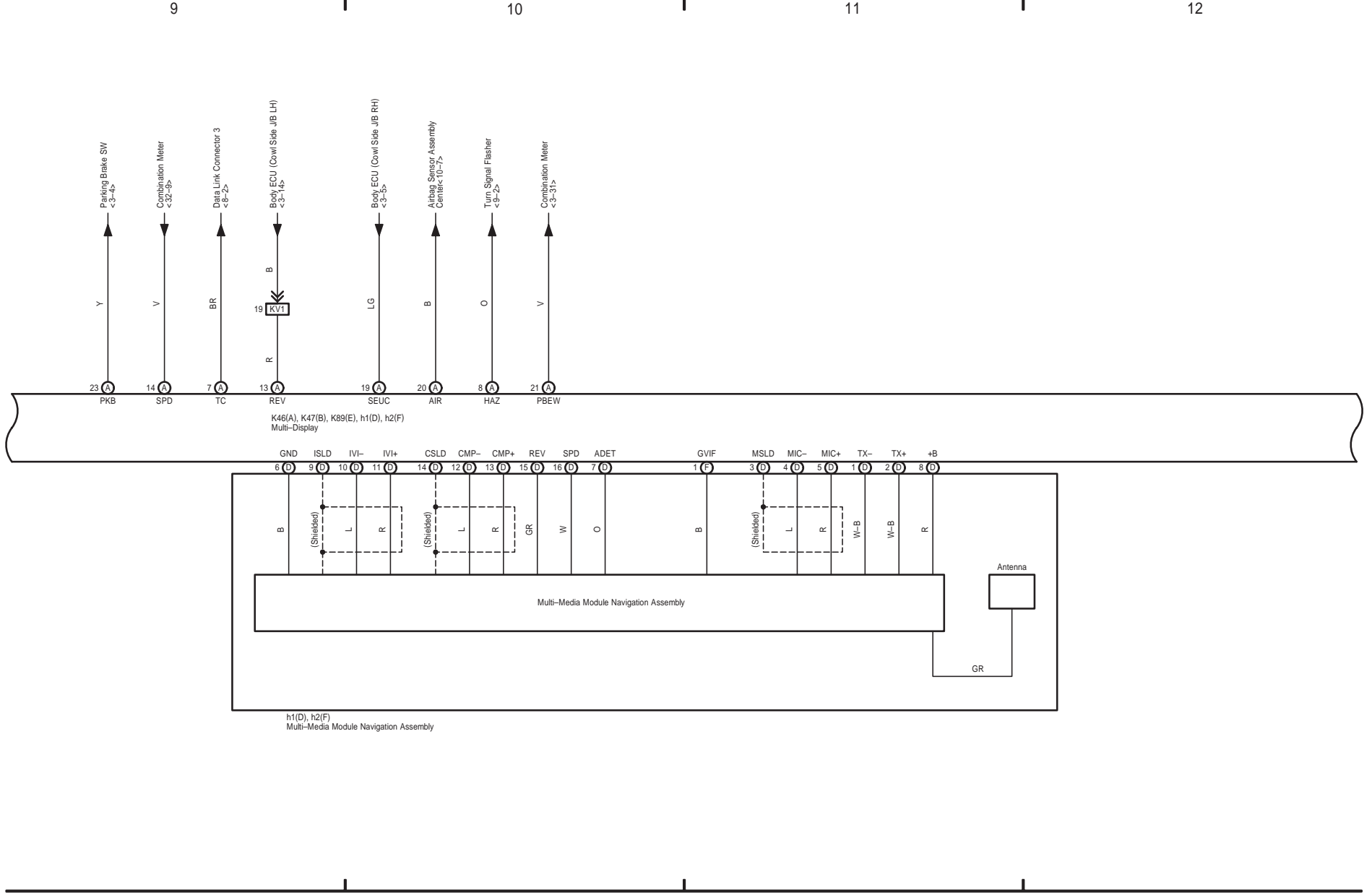

Audio System, LEXUS Navigation System, Multi Display and Parking Assist (Rear View Monitor)

13 14 15 16

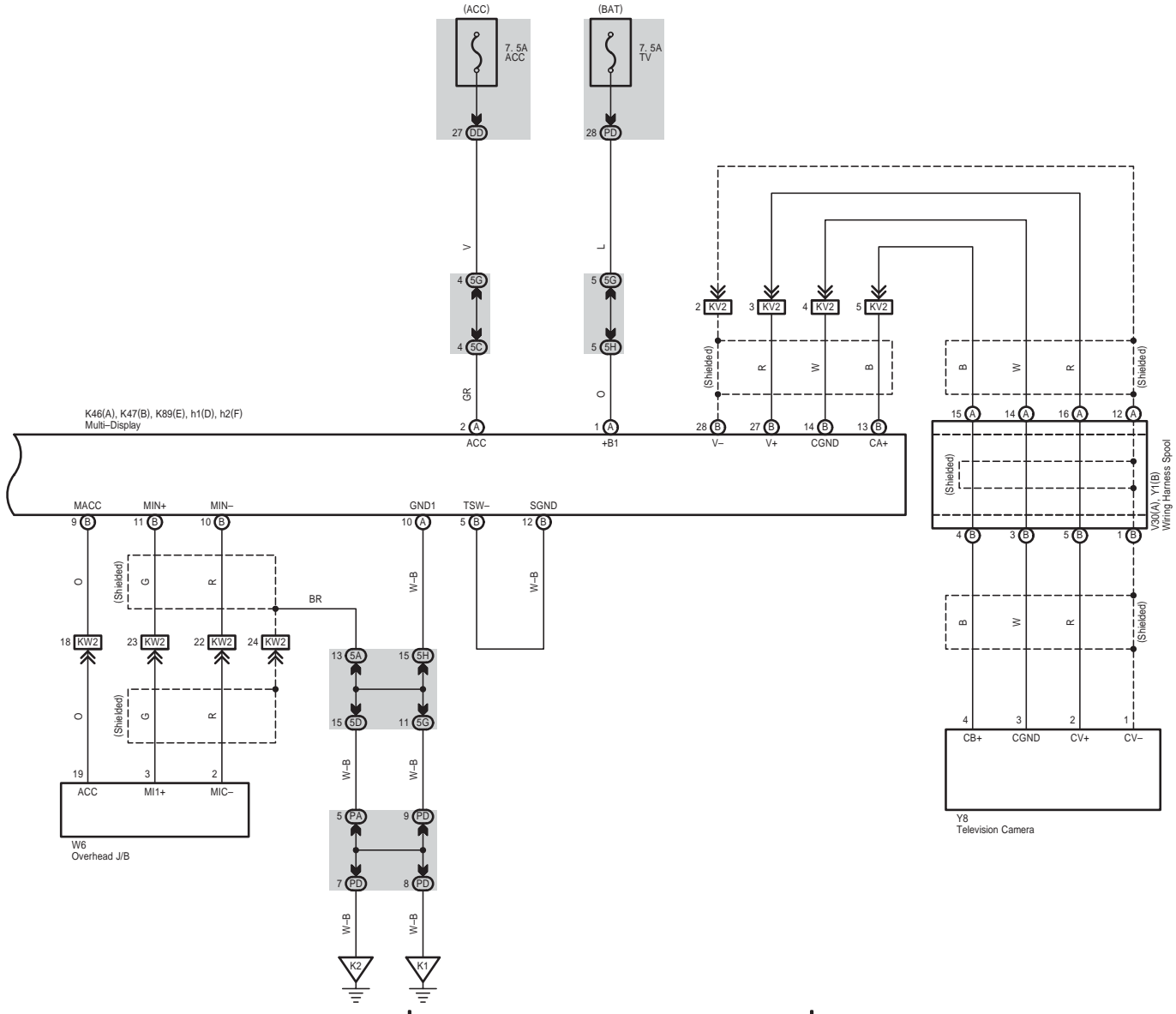

LEXUS GS 450h (EM02D0U)



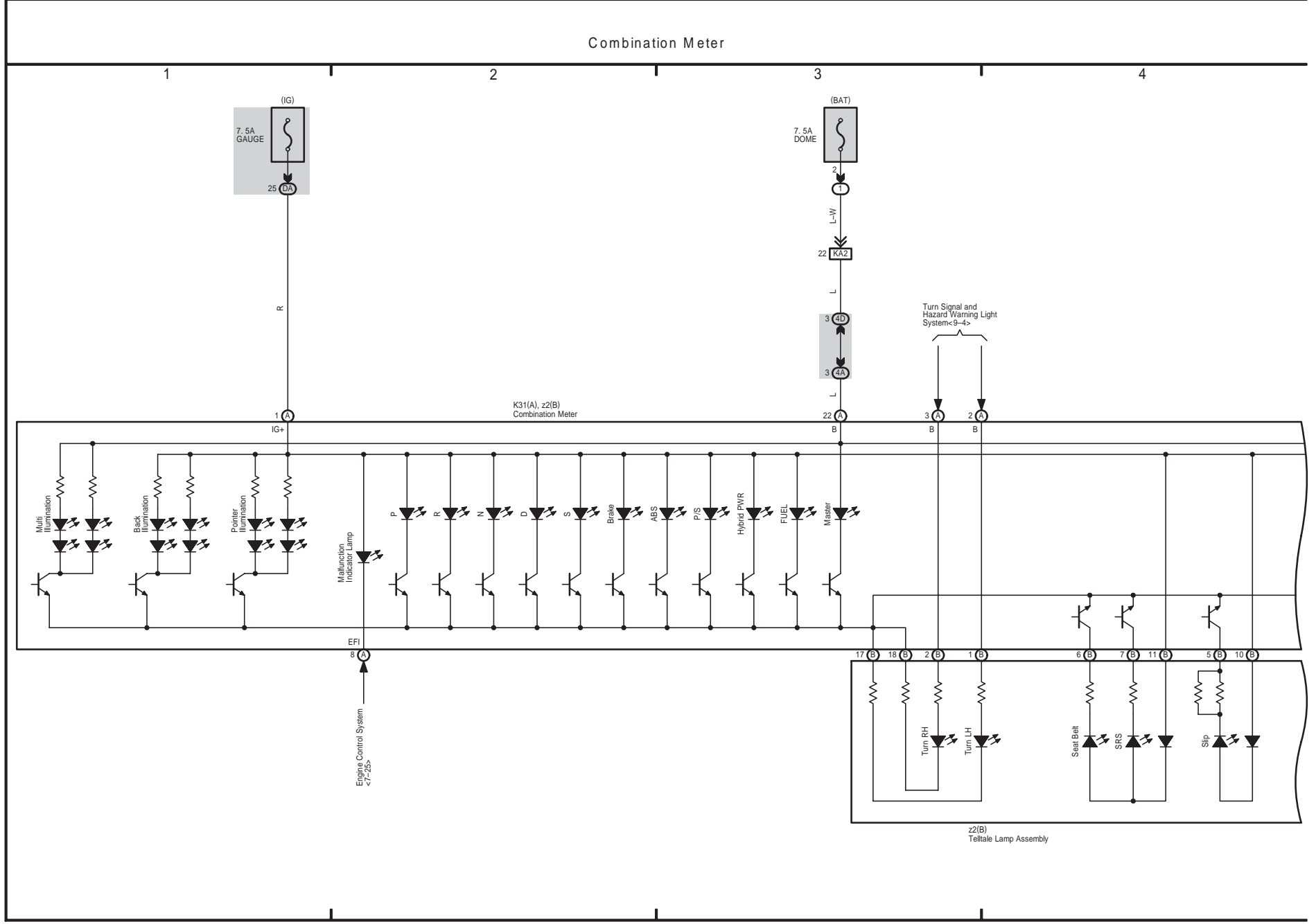

Combination Meter

* 1 : Electronically Controlled Brake System

5

6

7

8

LEXUS GS 450h (EM02D0U)

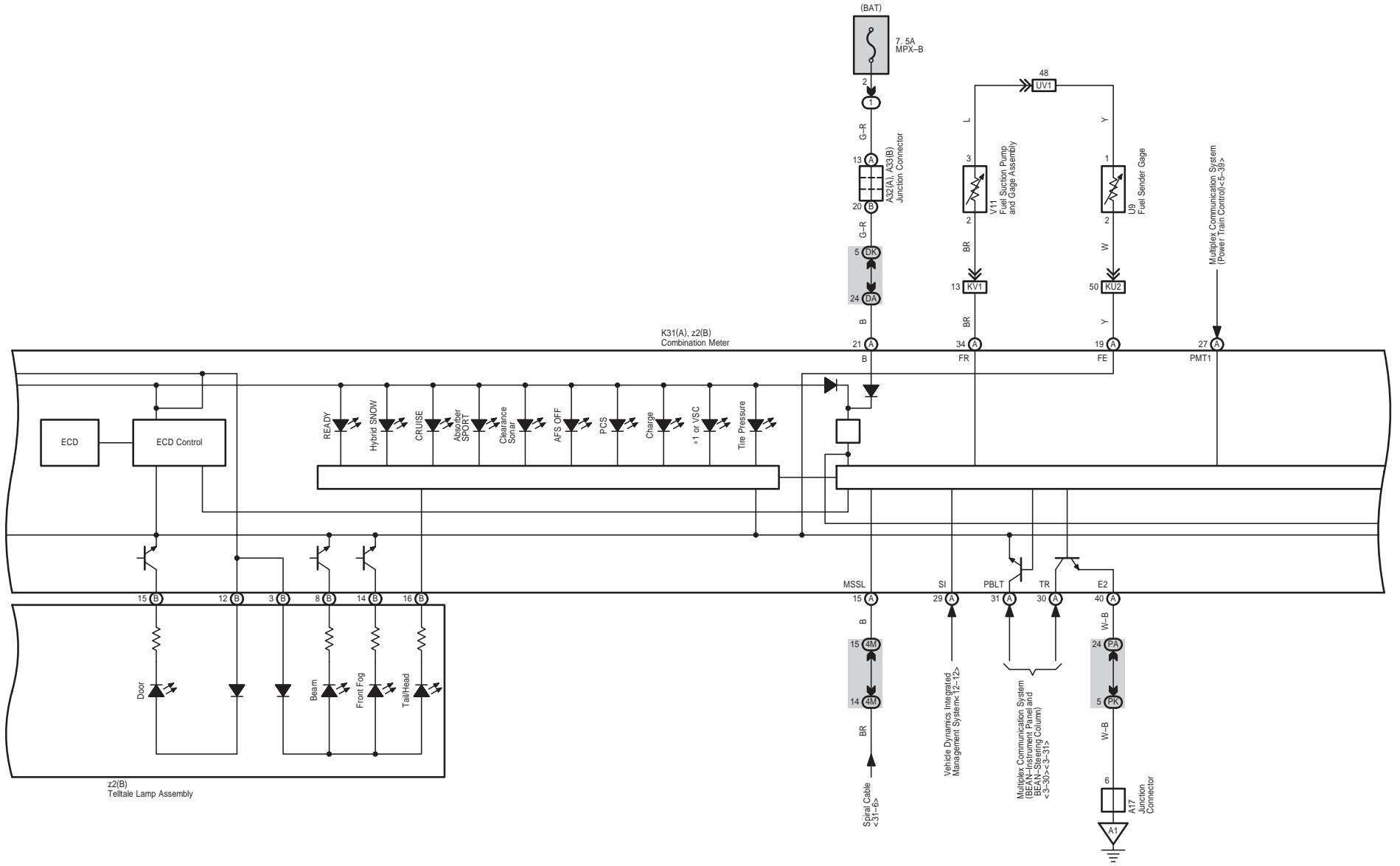

32 GS 450h (Cont' d)

Combination Meter

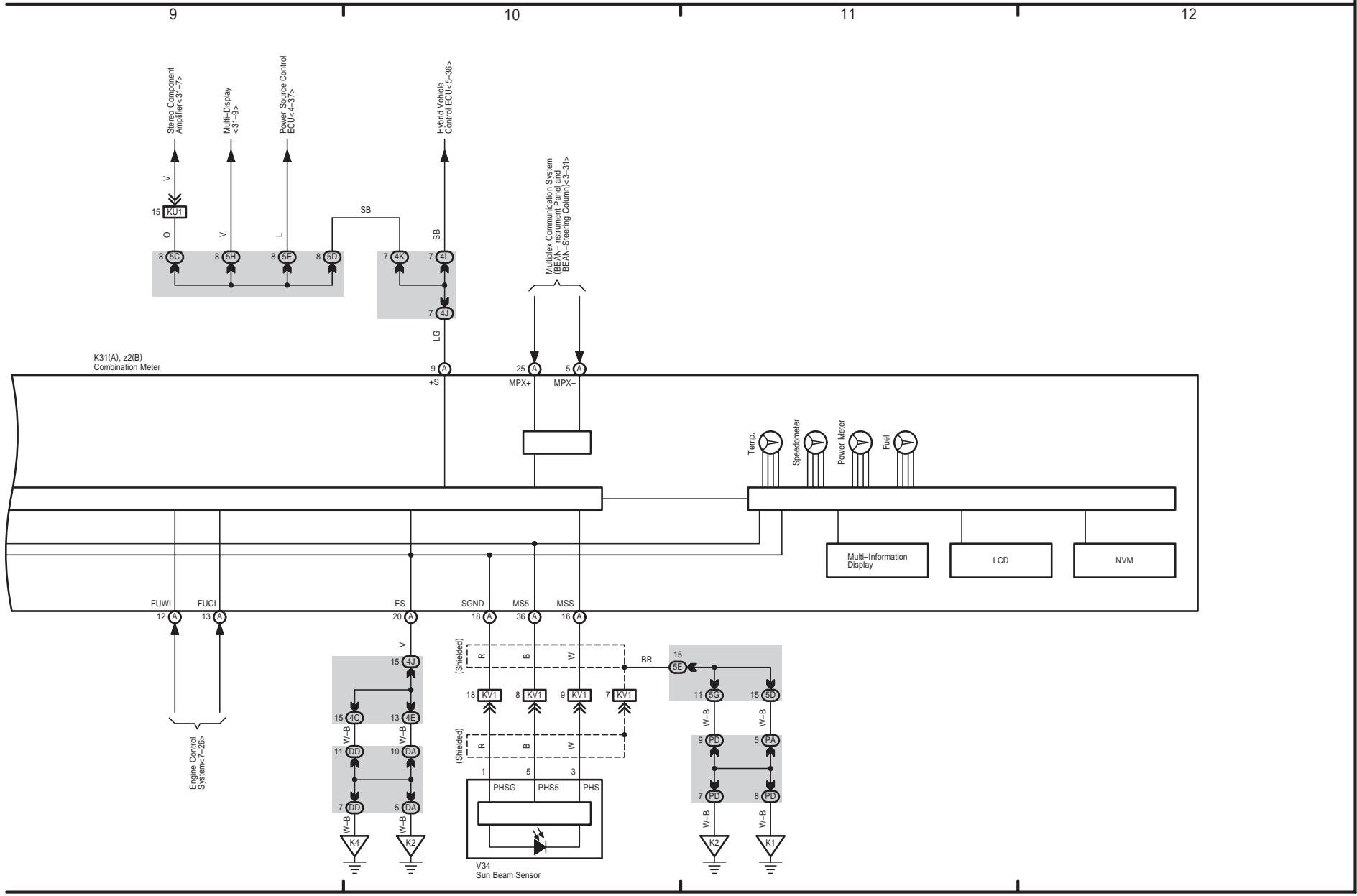

Air Conditioning

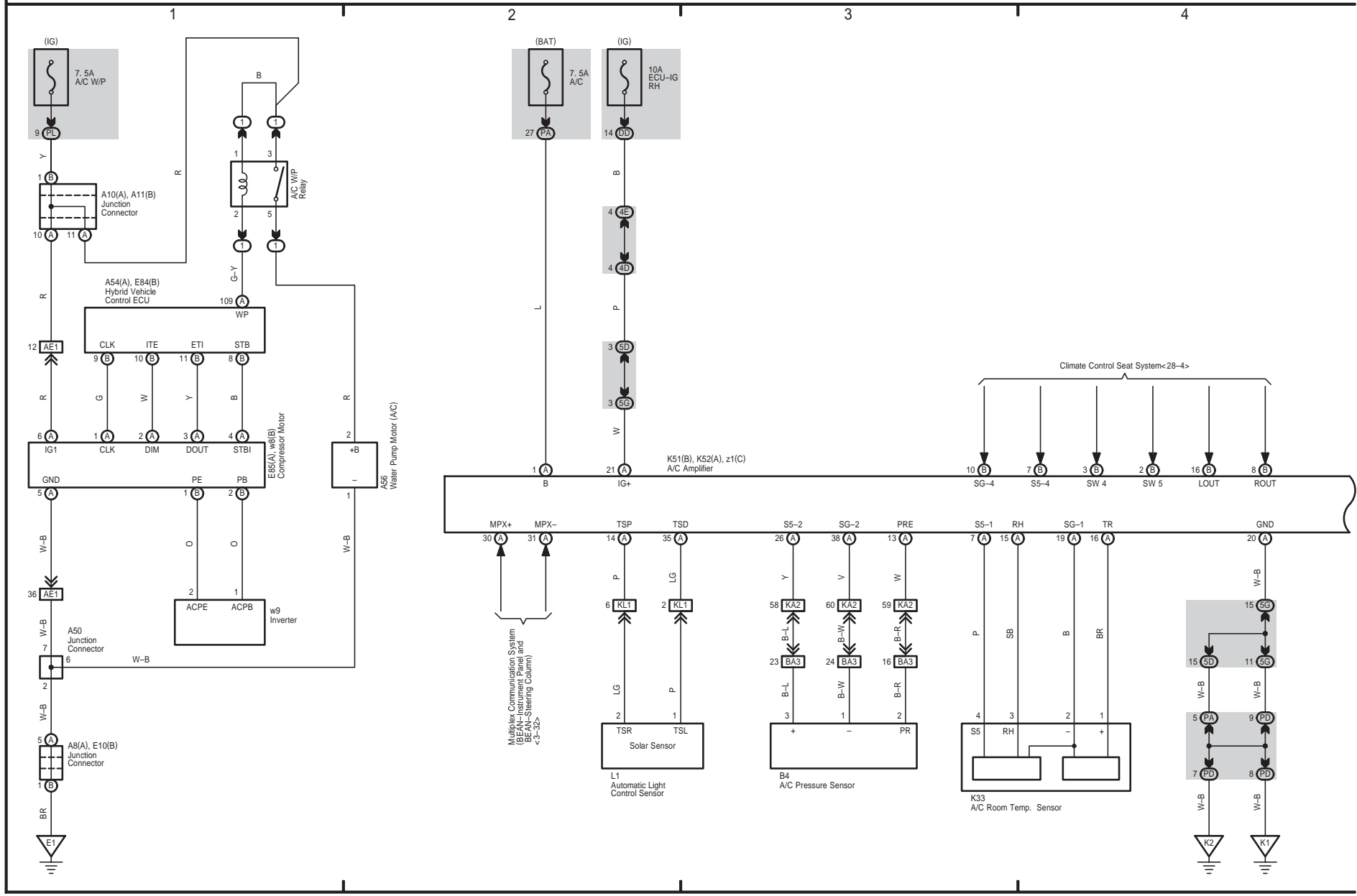

Air Conditioning

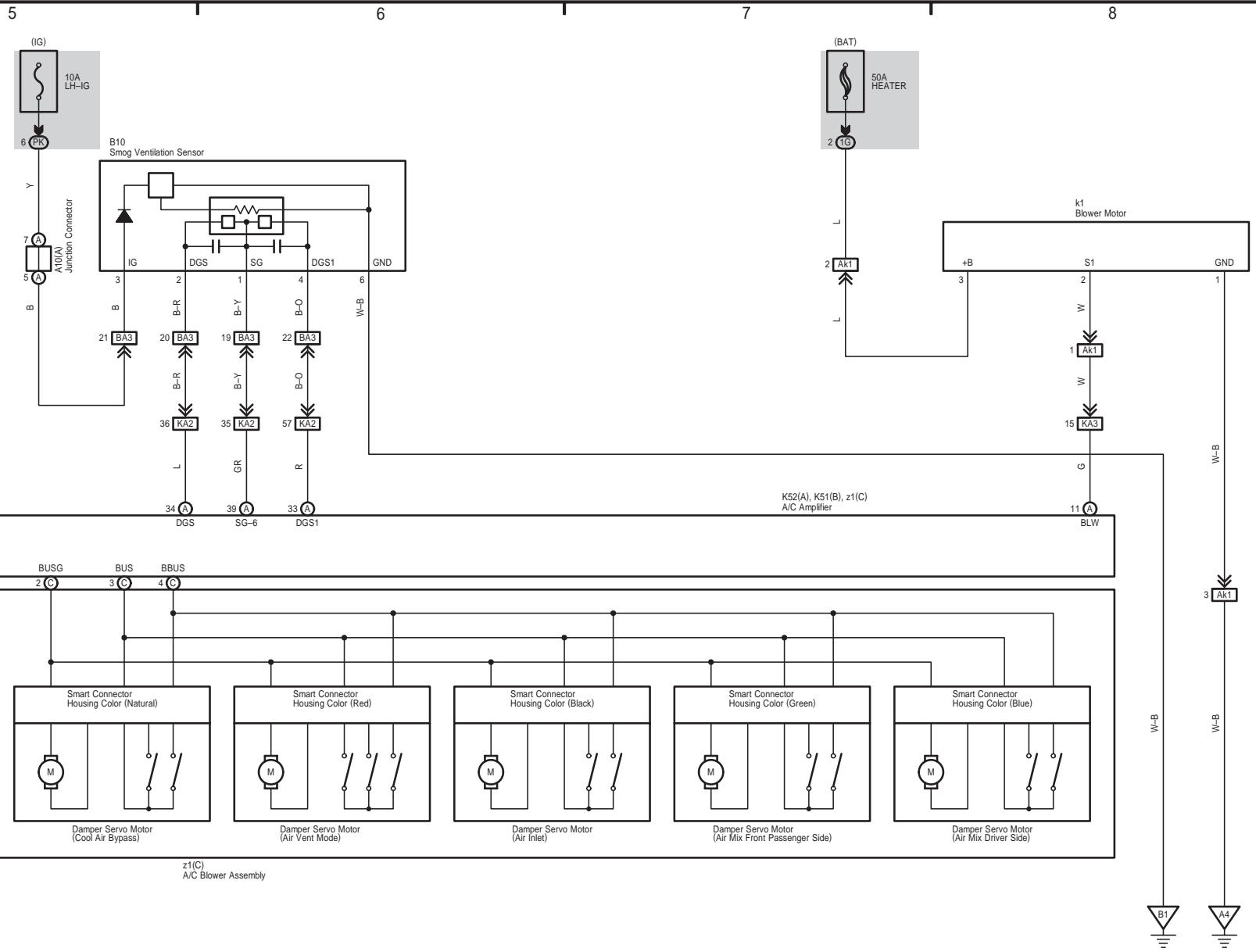

LEXUS GS 450h (EM02D0U)

