

ON-VEHICLE INSPECTION

1. INSPECT REFRIGERANT VOLUME

Observe the sight glass on the liquid tube.

Test conditions:

- Running engine at 1,500 rpm
- Blower speed control switch at "HI" position
- A/C switch ON
- Temperature control dial at "COOL" position
- Fully open the doors

Item	Symptom	Amount of refrigerant	Remedy
1	Bubbles present in sight glass	Insufficient*	(1) Check for gas leakage with gas leak detector and repair if necessary (2) Add refrigerant until bubbles disappear
2	No bubbles present in sight glass	None, sufficient or too much	Refer item 3 and 4
3	No temperature difference between compressor inlet and outlet	Empty or nearly empty	(1) Check for gas leakage with gas leak detector and repair if necessary (2) Add refrigerant until bubbles disappear
4	Temperature between compressor inlet and outlet is noticeably different	Correct or too much	Refer to items 5 and 6
5	Immediately after air conditioner is turned off, refrigerant in sight glass stays clear	Too much	(1) Discharge refrigerant (2) Evacuate air and charge proper amount of purified refrigerant
6	When air conditioner is turned off, refrigerant foams and then stays clear	Correct	-

*: Bubbles in the sight glass with ambient temperatures higher than usual can be considered normal if cooling is sufficient.

2. INSPECT REFRIGERANT PRESSURE WITH MANIFOLD GAUGE SET

This is a method in which the trouble is located by using a manifold gauge set. Read the manifold gauge pressure when these conditions are established.

Test conditions:

- Temperature at the air inlet with the switch set at RECIRC is 30 – 35 °C (86 – 95 °F)
- Engine running at 2,000 rpm
- Blower speed control switch at "HI" position
- Temperature control dial on "COOL" position

HINT:

It should be noted that the gauge indications may vary slightly due to ambient temperature conditions.

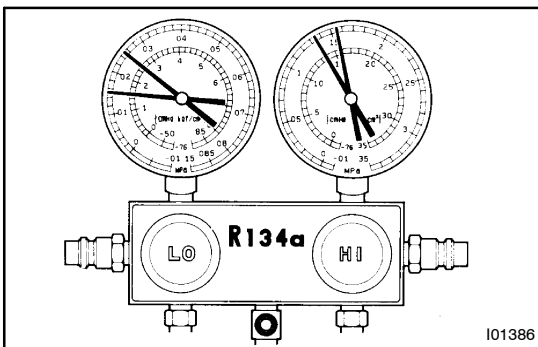

(1) Normally functioning refrigeration system.

Gauge reading:

Low pressure side:

0.15 – 0.25 MPa (1.5 – 2.5 kgf/cm²)

High pressure side:

1.37 – 1.57 MPa (14 – 15 kgf/cm²)

(2) Moisture present in refrigeration system.

Condition : Periodically cools and then fails to cool

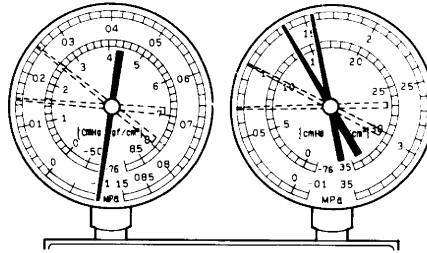

I01387

Symptom seen in refrigeration system	Probable cause	Diagnosis	Remedy
During operation, pressure on low pressure side sometimes become a vacuum and sometime normal	Moisture entered in refrigeration system freezes at expansion valve orifice and temporarily stops cycle, but normal state is restored after a time when the ice melts	<ul style="list-style-type: none"> • Drier in oversaturated state • Moisture in refrigeration system freezes at expansion valve orifice and blocks circulation of refrigerant 	<ol style="list-style-type: none"> (1) Replace dryer (2) Remove moisture in cycle through repeatedly evacuating air (3) Charge proper amount of new refrigerant

(3) Insufficient cooling

Condition: Insufficient cooling

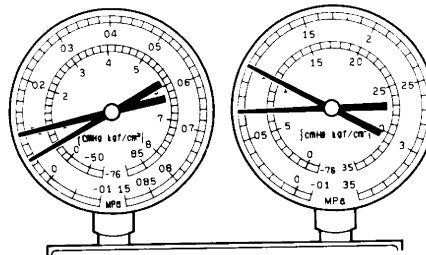

I01388

Symptom seen in refrigeration system	Probable cause	Diagnosis	Remedy
<ul style="list-style-type: none"> • Pressure low on both low and high pressure sides • Bubbles seen in sight glass continuously • Insufficient cooling performance 	Gas leakage at some place in refrigeration system	<ul style="list-style-type: none"> • Insufficient refrigerant in system • Refrigerant leaking 	<ol style="list-style-type: none"> (1) Check for gas leakage with gas leak detector and repair if necessary (2) Charge proper amount of refrigerant (3) If indicated pressure value is near 0 when connected to gauge, create the vacuum after inspecting and repairing the location of the leak

(4) Poor circulation of refrigerant

Condition: Insufficient cooling

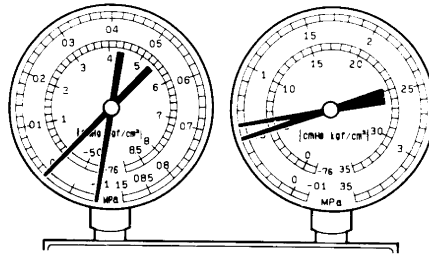

I01389

Symptom seen in refrigeration system	Probable cause	Diagnosis	Remedy
<ul style="list-style-type: none"> • Pressure low in both low and high pressure sides • Frost on tube from condenser to unit 	Refrigerant flow obstructed by dirt in condenser	condenser clogged	Replace dryer

(5) Refrigerant does not circulate

Condition: Does not cool (Cools from time to time in some cases)

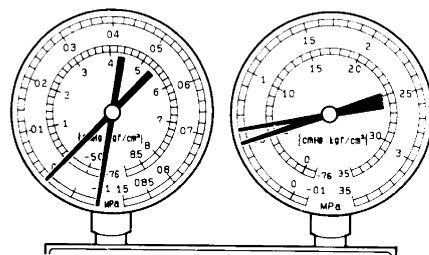

I01449

Symptom seen in refrigeration system	Probable cause	Diagnosis	Remedy
<ul style="list-style-type: none"> • Vacuum indicated on low pressure side, very low pressure indicated on high pressure side • Frost or dew seen on piping before and after condenser/ drier or expansion valve 	<ul style="list-style-type: none"> • Refrigerant flow obstructed by moisture or dirt in refrigeration system • Refrigerant flow obstructed by gas leakage from expansion valve 	Refrigerant does not circulate	<ol style="list-style-type: none"> (1) Check expansion valve (2) Clean out dirt in expansion valve by blowing with air (3) Replace dryer (4) Evacuate air and charge new refrigerant to proper amount (5) For gas leakage from expansion valve, replace expansion valve

(6) Refrigerant overcharged or insufficient cooling of condenser

Condition: Insufficient cooling

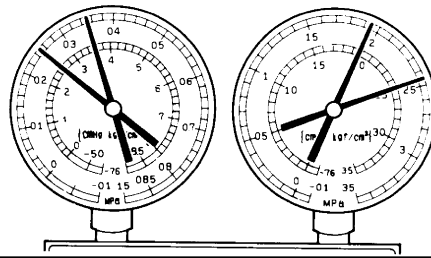

I01390

Symptom seen in refrigeration system	Probable cause	Diagnosis	Remedy
<ul style="list-style-type: none"> • Pressure too high on both low and high pressure sides • No air bubbles seen through the sight glass even when the engine rpm is lowered 	<ul style="list-style-type: none"> • Unable to develop sufficient performance due to excessive refrigeration system • Insufficient cooling of condenser 	<ul style="list-style-type: none"> • Excessive refrigerant in cycle → refrigerant over charged • Condenser cooling → condenser fins clogged or condenser fan faulty 	<ol style="list-style-type: none"> (1) Clean condenser (2) Check condenser fan motor operation (3) If (1) and (2) are in normal state, check amount of refrigerant. Charge proper amount of refrigerant

(7) Air present in refrigeration system

Condition: Insufficient cooling

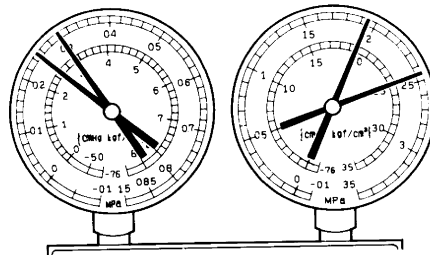

NOTE : These gauge indications are shown when the refrigeration system has been opened and the refrigerant charged without vacuum purging.

I01392

Symptom seen in refrigeration system	Probable cause	Diagnosis	Remedy
<ul style="list-style-type: none"> • Pressure too high on both low and high pressure sides • The low pressure piping hot to touch • Bubbles seen in sight glass 	Air entered in refrigeration system	<ul style="list-style-type: none"> • Air present in refrigeration system • Insufficient vacuum purging 	<ol style="list-style-type: none"> (1) Check compressor oil to see if it is dirty or insufficient (2) Evacuate air and charge new refrigerant

(8) Expansion valve improperly

Condition: Insufficient cooling

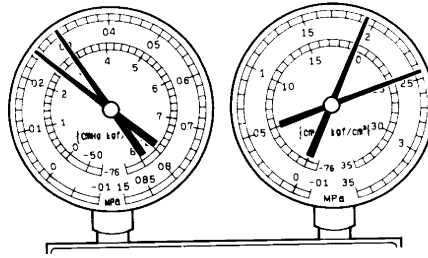

I01450

Symptom seen in refrigeration system	Probable cause	Diagnosis	Remedy
<ul style="list-style-type: none"> • Pressure too high on both low and high pressure sides • Frost or large amount of dew on piping on low pressure side 	Trouble in expansion valve	<ul style="list-style-type: none"> • Excessive refrigerant in low pressure piping • Expansion valve opened too wide 	Check expansion valve Replace if defective

(9) Defective compression compressor

Condition : Does not cool

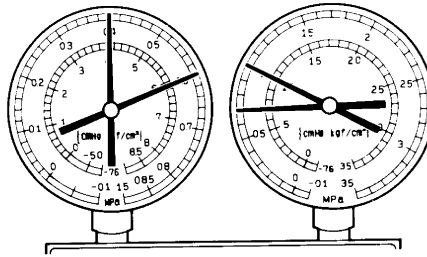

I01393

Symptom seen in refrigeration system	Probable cause	Diagnosis	Remedy
<ul style="list-style-type: none"> • Pressure too high on low and high pressure sides • Pressure too low on high pressure side 	Internal leak in compressor	<ul style="list-style-type: none"> • Compression defective • Valve leaking or broken sliding parts 	Repair or replace compressor

3. INSPECT IDLE-UP SPEED

- (a) Warm up engine
- (b) Inspect idle-up speed when the these conditions are established.

Test conditions:

- Blower speed control switch at "HI" position
- Temperature control dial at "COOL" position
- A/C switch ON
- Put gear shift in neutral

Magnetic clutch condition	Idle speed
Magnetic clutch not engaged	650 ± 50 rpm
Magnetic clutch engaged	650 ± 50 rpm

If idle speed is not as specified, check the idle control system.

4. INSPECT FOR LEAKAGE OF REFRIGERANT

- (a) Perform in these conditions.
 - Stop engine
 - Secure good ventilation (If the gas leak detector may not react volatile gases which are not refrigerant, such as evaporated gasoline and exhaust gas)
 - Repeat the test 2 or 3 times
 - Make sure that there is some refrigerant remaining in the refrigeration system.
When compressor is OFF: approx. 392 – 588 kPa (4 – 6 kgf·cm², 57 – 85 psi)
- (b) Bring the gas leak detector close to the drain hose before performing the test.

HINT:

- After the blower motor has stopped, leave the cooling for more than 15 minutes.
- Expose the gas leak detector sensor under the drain hose.
- When bring the gas leak detector close to the drain hose, make sure that the gas leak detector does not react to the volatile gases.

If such reaction is unavoidable, the vehicle must be lifted up.

- (c) If gas leak is not detected on the drain hose, remove the blower resistor from the cooling unit. Then insert the gas leak detector sensor into the unit and perform the test.
- (d) Disconnect the connector and leave the pressure switch for approx. 20 minutes. Then bring the gas leak detector close to the pressure switch and perform the test.
- (e) Bring the gas leak detector close to the refrigerant lines.