

REMOVAL

1. REMOVE REAR SEAT CUSHION (See page BO-142)
2. REMOVE REAR SEATBACK (See page BO-142)

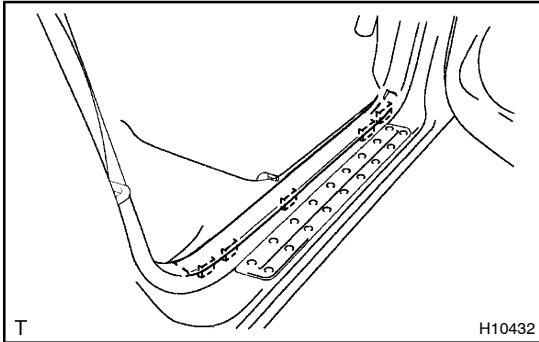

3. REMOVE FRONT DOOR INSIDE SCUFF PLATE

- (a) Using a screwdriver, remove the front door inside scuff plate as shown in the illustration.

HINT:

Tape the screwdriver tip before use.

- (b) Employ the same manner described above to the other side.

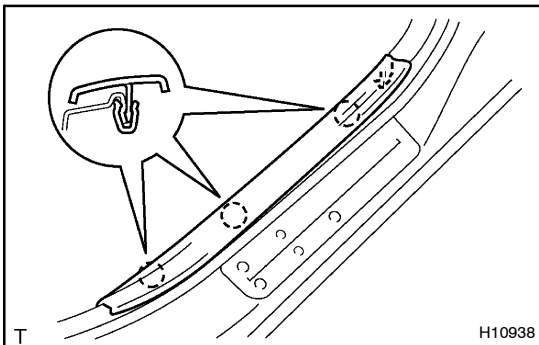

4. REMOVE REAR DOOR INSIDE SCUFF PLATE

- (a) Using a screwdriver, remove the rear door inside scuff plate as shown in the illustration.

HINT:

Tape the screwdriver tip before use.

- (b) Employ the same manner described above to the other side.

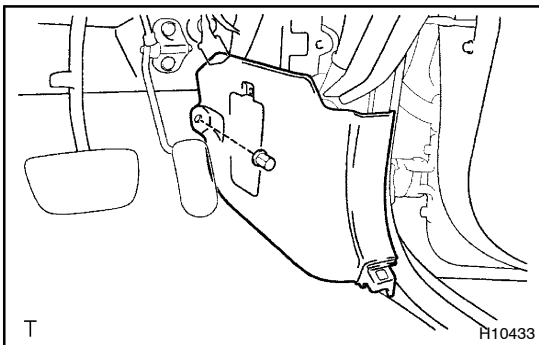

5. REMOVE COWL SIDE TRIM BOARD

- (a) Remove the clip and cowl side trim board.
- (b) Employ the same manner described above to the other side.

6. REMOVE FRONT DOOR OPENING TRIMS

7. REMOVE REAR DOOR OPENING TRIMS

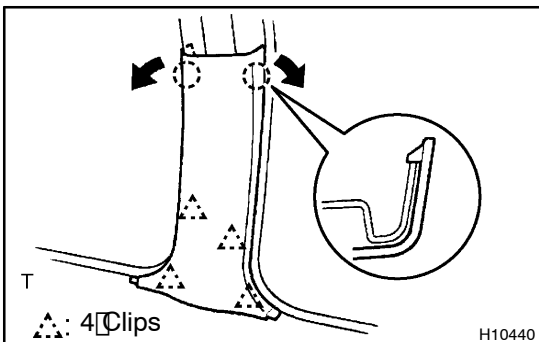

8. REMOVE CENTER PILLAR LOWER GARNISH

- (a) Using a screwdriver, remove the center pillar lower garnish.

HINT:

Tape the screwdriver tip before use.

- (b) Employ the same manner described above to the other side.

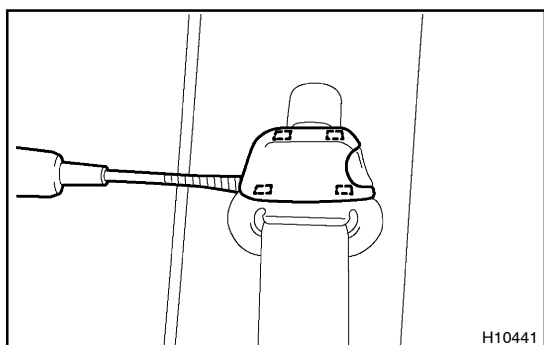

H10441

9. REMOVE FRONT SEAT OUTER BELT SHOULDER ANCHOR

- (a) Using a screwdriver, remove the anchor cap.

HINT:

Tape the screwdriver tip before use.

- (b) Remove the bolt and front seat outer belt shoulder anchor.

Torque: 41 N·m (420 kgf·cm, 30 ft·lbf)

- (c) Employ the same manner described above to the other side.

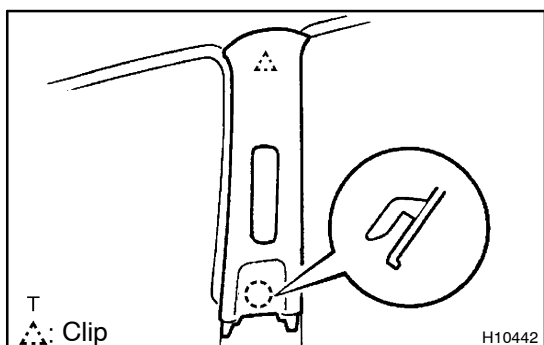

H10442

10. REMOVE CENTER PILLAR GARNISH

- (a) Using a screwdriver, remove the center pillar garnish.

HINT:

Tape the screwdriver tip before use.

- (b) Employ the same manner described above to the other side.

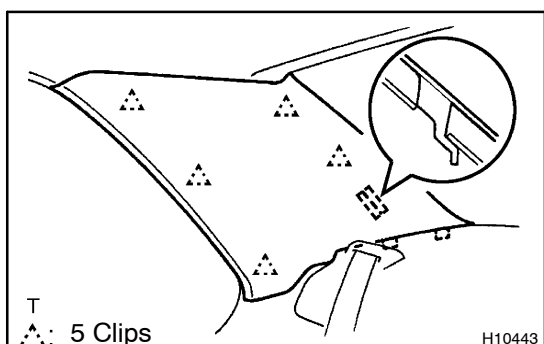

H10443

11. REMOVE ROOF SIDE INNER GARNISH

- (a) Using a screwdriver, remove the roof side inner garnish.

HINT:

Tape the screwdriver tip before use.

- (b) Employ the same manner described above to the other side.

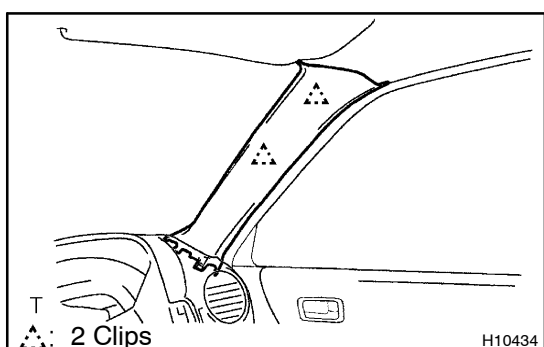

H10434

12. REMOVE FRONT PILLAR GARNISH

- (a) Using a screwdriver, remove the front pillar garnish.

HINT:

Tape the screwdriver tip before use.

- (b) Employ the same manner described above to the other side.

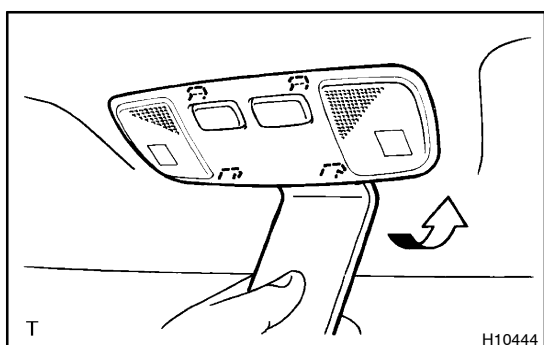

H10444

13. w/o Sliding roof: REMOVE MAP LIGHT ASSEMBLY

- (a) Using a moulding remover, remove the lens.
 (b) Remove the 2 screws and map light assembly.
 (c) Disconnect the connector.

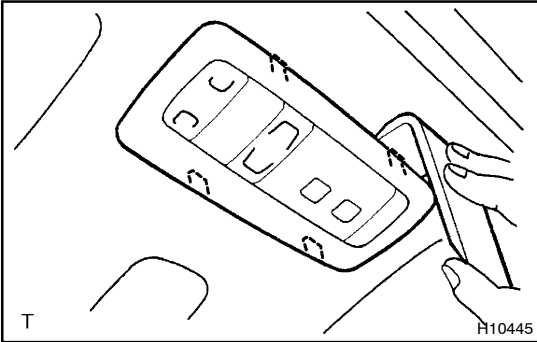

**14. w/ Sliding roof:
REMOVE MAP LIGHT ASSEMBLY**

- (a) Using a moulding remover, remove the cover.
- (b) Remove the 2 screws and map light assembly.
- (c) Disconnect the connector.

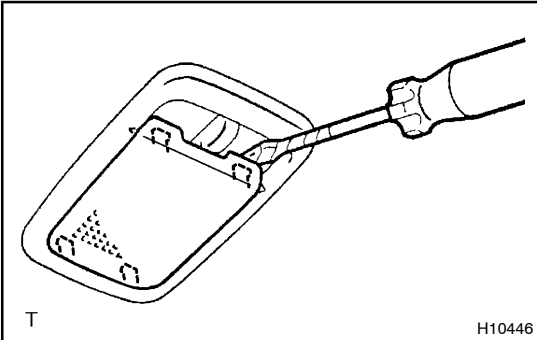

15. REMOVE ROOM LIGHT ASSEMBLY

- (a) Using a screwdriver, remove the lens.

HINT:

Tape the screwdriver tip before use.

- (b) Remove the 2 screws and room light assembly.
- (c) Disconnect the connector.

**16. w/ Sliding roof:
REMOVE ROOF OPENING TRIM**

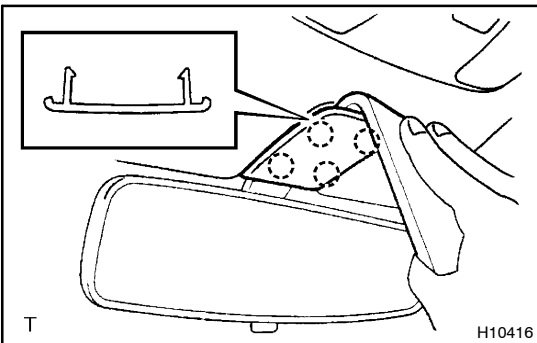

17. REMOVE INNER REAR VIEW MIRROR

- (a) Using a moulding remover, remove the cover as shown in the illustration.

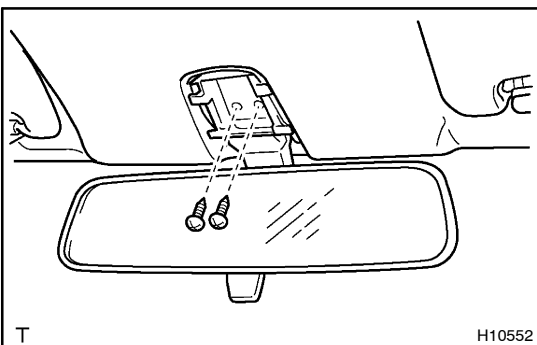

- (b) Remove the 2 screws and inner rear view mirror.

Torque: 5.5 N·m (56 kgf·cm, 49 in·lbf)

18. REMOVE ASSIST GRIPS

- (a) Using a screwdriver, remove the caps.

HINT:

Tape the screwdriver tip before use.

- (b) Remove the 6 bolts and 3 assist grips.

19. REMOVE SUN VISORS

- (a) Remove the 4 screws and pull the sun visors downward.
- (b) Disconnect the connectors.

20. REMOVE SUN VISOR HOLDERS

Remove the 2 screws and 2 holders.

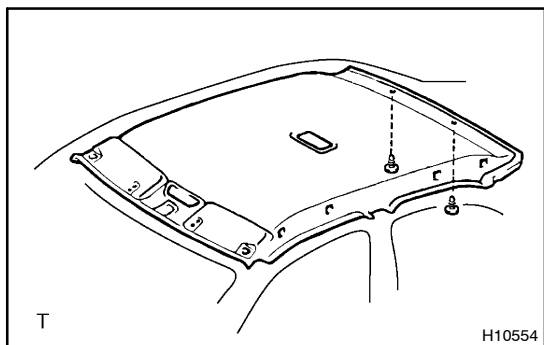
**21. REMOVE ROOF HEADLINING**

- (a) Remove the 2 clips.
- (b) Pull the roof headlining downward to remove it.