

AIRBAG SENSOR ASSEMBLY COMPONENTS

RS01G-15

w/ LEXUS navigation system:

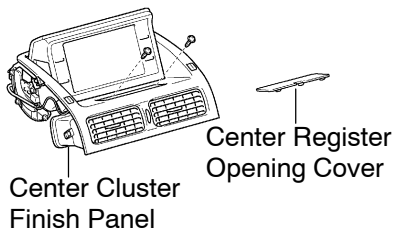

A/T:

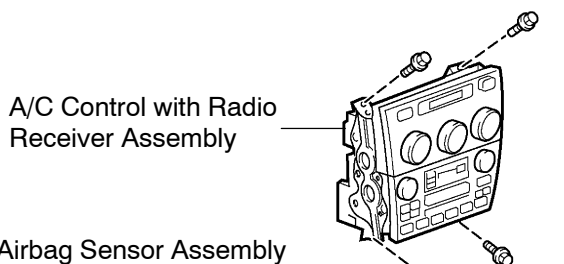
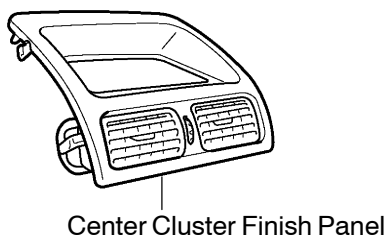
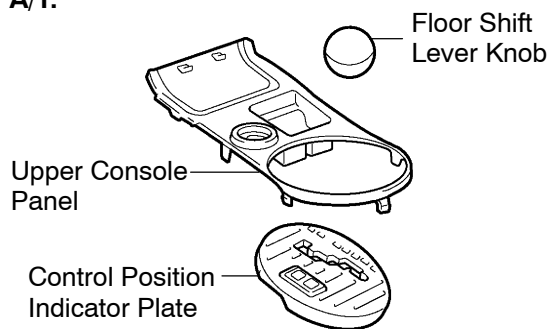

20 (205, 15)

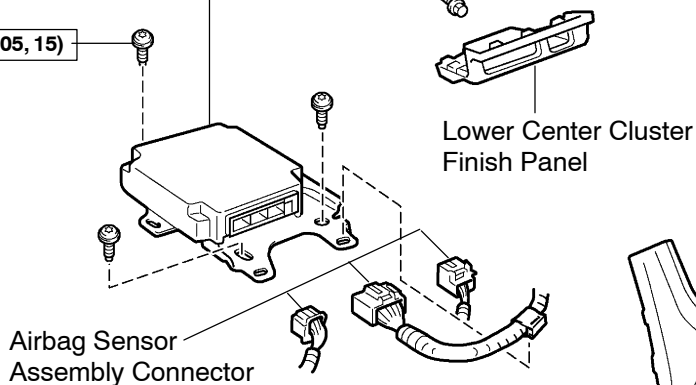

Floor Shift Lever Knob

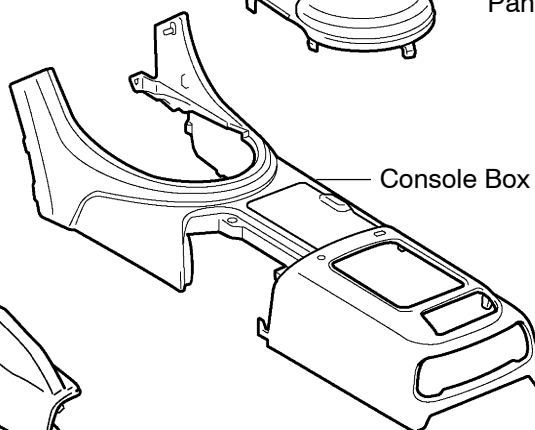
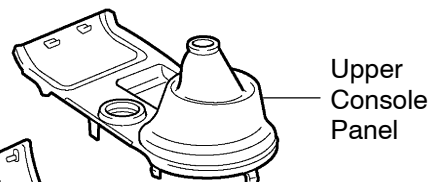

N·m (kgf·cm, ft·lbf) : Specified torque

H08432