

REPLACEMENT

NOTICE:

When using a vise, do not overtighten it.

IF NECESSARY, REPLACE OIL SEAL

- (a) Using a screwdriver with vinyl tape wound around its tip, remove the oil seal.

NOTICE:

Be careful not to damage the bushing of the front housing.

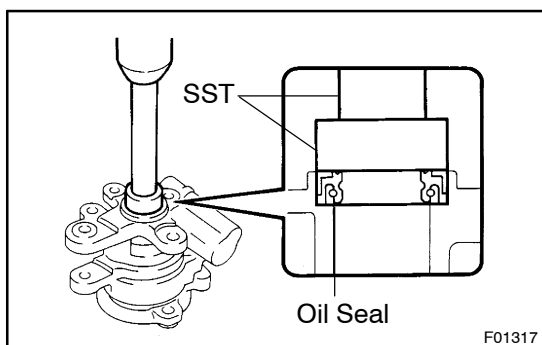

- (b) Coat a new oil seal lip with power steering fluid.

- (c) Using SST, press in the oil seal.

SST 09950-60010 (09951-00320),
09950-70010 (09951-07100)

NOTICE:

Make sure that the oil seal is installed facing in the correct direction.