

DTC	P0120/41	Throttle Position Sensor Circuit Malfunction
------------	-----------------	---

CIRCUIT DESCRIPTION

Throttle position sensor is mounted on the throttle body and it have the 2 sensors to detect the throttle opening angle and the malfunction of the throttle position sensor's own.

The voltage applied to the terminals VTA and VTA2 of the engine ECU changes between 0 V and 5 V in proportion to the opening angle of the throttle valve.

The engine ECU judges the current opening angle of the throttle valve from these signals input from terminals VTA and VTA2, and the engine ECU controls the throttle motor to make the throttle valve angle properly in response to driving condition.

If this DTC is stored, the engine ECU shuts down the power for the throttle motor and the electromagnetic clutch, and the throttle valve is fully closed by the return spring.

However, the opening angle of the throttle valve can be controlled by the accelerator pedal through the throttle cable.

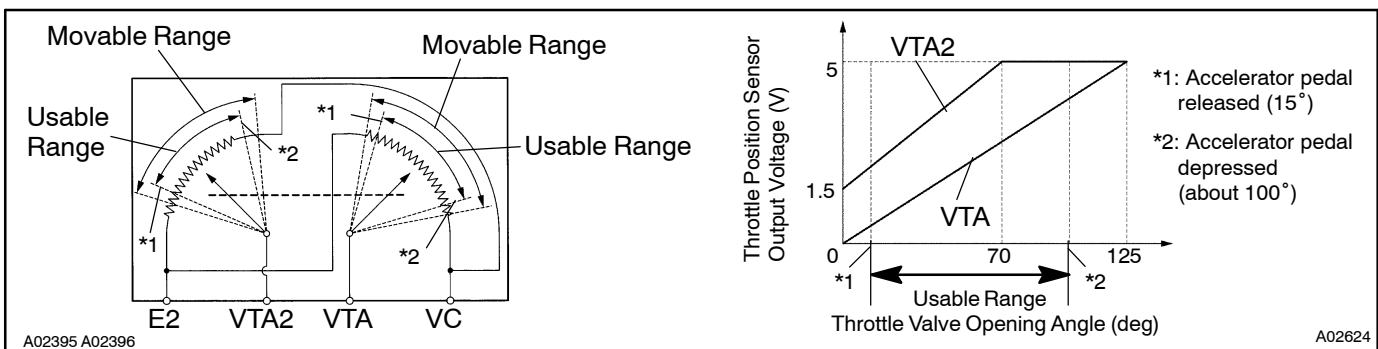

DTC No.	DTC Detecting Condition	Trouble Area
P0120/41	Condition (a), (b), (c) or (d) continues for 2.0 seconds: (a) $VTA \leq 0.2 \text{ V}$ (b) $VTA2 \leq 0.5 \text{ V}$ (c) $VTA \geq 4.8 \text{ V}$ (d) When $VTA \geq 0.2 \text{ V}$ and $\leq 2.0 \text{ V}$, and $VTA2 \geq 4.97 \text{ V}$ (b) $VTA - VTA2 \leq 0.02 \text{ V}$	<ul style="list-style-type: none"> • Open or short in throttle position sensor circuit • Throttle position sensor • Engine ECU
	Condition (a) or (b) continues for 0.4 seconds: (a) $VTA \leq 0.2 \text{ V}$ and $VTA2 \leq 0.5 \text{ V}$	

HINT:

After confirming DTC P0120/41 use the hand-held tester to confirm the throttle valve opening percentage and closed throttle position switch condition.

Accelerator pedal position expressed as percentage and voltage				Trouble area
Accelerator pedal released		Accelerator pedal depressed		
THROTTLEPOS	THROTTLEPOS#2	THROTTLEPOS	THROTTLEPOS#2	
0%	0V	0%	0V	VC line open
0%	2.0~2.9V	0%	4.6~5.1V	VTA line open or grand short
8~20%	0V	64~96%	0V	VTA2 line open or grand short
100%	5V	100%	5V	E2 line open

WIRING DIAGRAM

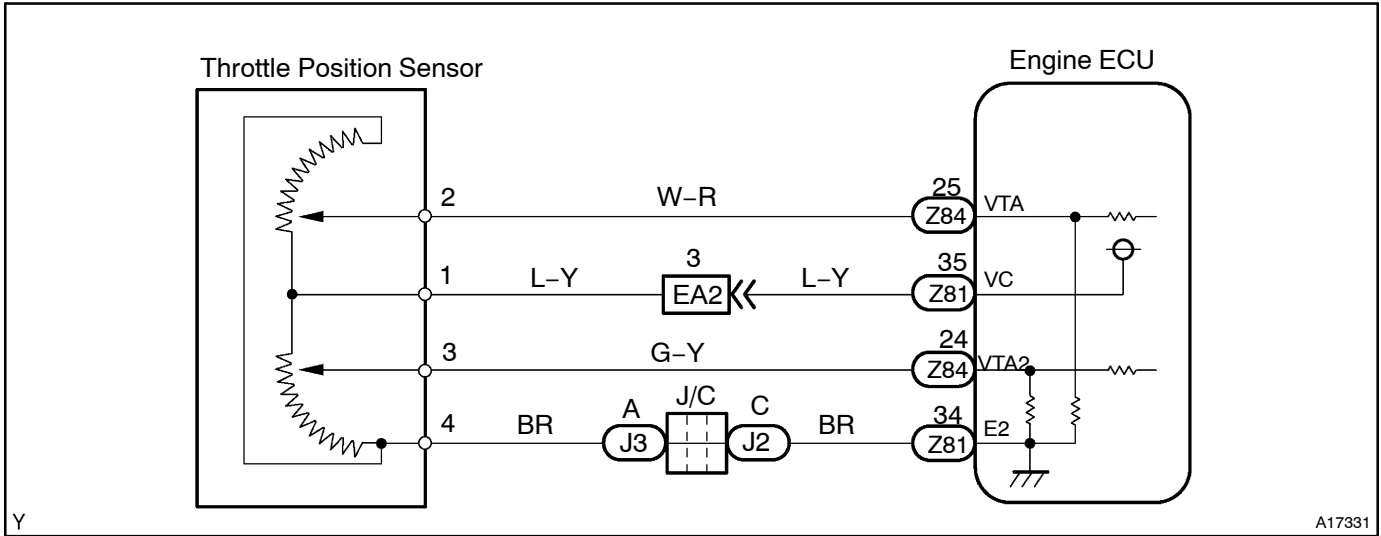

INSPECTION PROCEDURE

HINT:

- If DTC P0110/24 (Intake Air Temp. Circuit Malfunction), P0115/22 (Water Temp. Circuit Malfunction), P0120/41 (Throttle Position Sensor Circuit Malfunction), P1120/19 (Accelerator Pedal Position Sensor Circuit Malfunction) are output simultaneously, E2 (Sensor Ground) may be open.
- Read freeze frame data using hand-held tester. Because freeze frame records the engine conditions when the malfunction is detected, when troubleshooting it is useful for determining whether the vehicle was running or stopped, the engine warmed up or not, the air-fuel ratio lean or rich, etc. at the time of the malfunction.

When using hand-held tester

1 Connect hand-held tester, read throttle valve opening percentage.

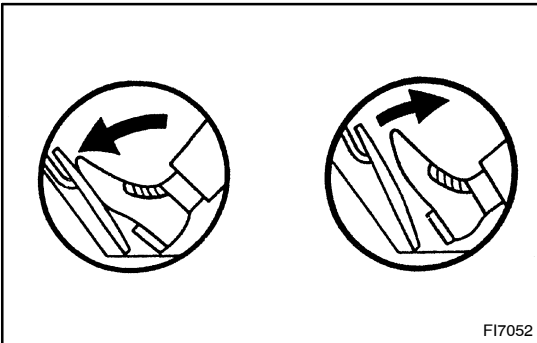

PREPARATION:

- Connect the hand-held tester to DLC3.
- Turn the ignition switch ON and switch the hand-held tester main switch ON.

CHECK:

Read the throttle valve opening percentage for VTA circuit and read the voltage for VTA2 circuit.

OK:

Accelerator pedal	Throttle valve opening position (expressed as percentage (VTA))	Voltage (VTA2)
Released	8 ~ 20%	2.0 ~ 2.9 V
Depressed	64 ~ 96%	4.6 ~ 5.1 V

OK

Check and replace engine ECU (See page IN-34).

NG

2 Check voltage between terminals VC and E2 of engine ECU connector.

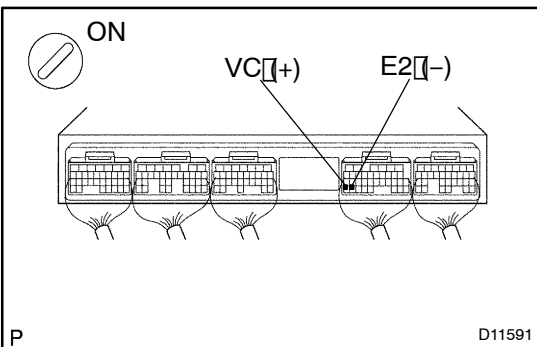

PREPARATION:

- Remove the engine room engine ECU hood and cover.
- Turn the ignition switch ON.

CHECK:

Measure voltage between terminals VC and E2 of the engine ECU connector.

OK:

Voltage: 4.5 ~ 5.5 V

NG

Check and replace engine ECU (See page IN-34).

OK

3 Check voltage between terminals VTA, VTA2 and E2 of engine ECU connector.

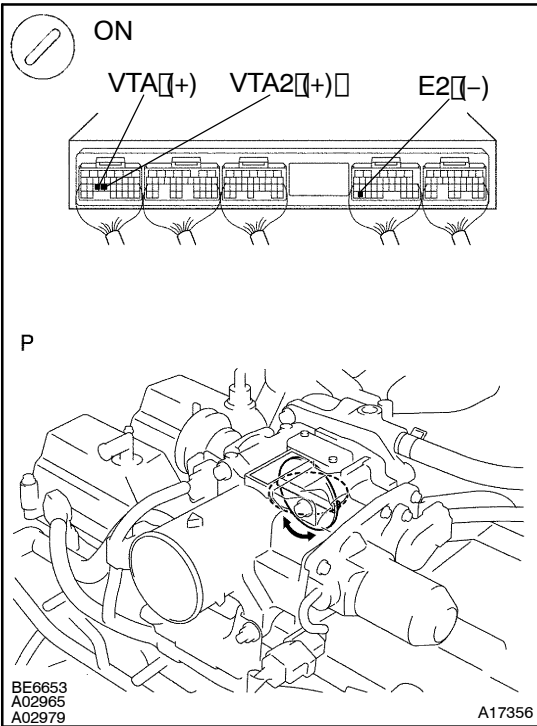

PREPARATION:

- Remove the engine room engine ECU hood and cover.
- Turn the ignition switch ON.

CHECK:

Measure voltage between terminals VTA, VTA2 and E2 of the engine ECU connector.

OK:

Accelerator pedal	Voltage	
	VTA	VTA2
Released	0.4 [~] .0 V	2.0 [~] 2.9 V
Depressed	3.2 [~] 4.8 V	4.6 [~] 5.1 V

OK

Check and replace engine ECU (See page IN-34).

NG

4 Check throttle position sensor (See page FI-32).

NG

Replace throttle position sensor (See page FI-37).

OK

Check for open and short in harness and connector between engine ECU and throttle position sensor (VC, VTA, VTA2, E2 line) (See page IN-34).

When not using hand-held tester

1 Check voltage between terminals VC and E2 of engine ECU connector.

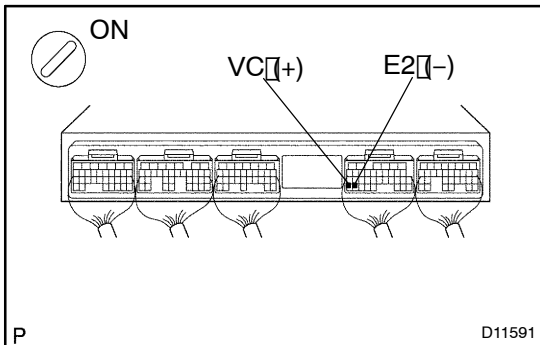

PREPARATION:

- Remove the engine room engine ECU hood and cover.
- Turn the ignition switch ON.

CHECK:

Measure voltage between terminals VC and E2 of the engine ECU connector.

OK:

Voltage: 4.5 ~ 5.5 V

NG

Check and replace engine ECU (See page IN-34).

OK

2 Check voltage between terminals VTA, VTA2 and E2 of engine ECU connector.

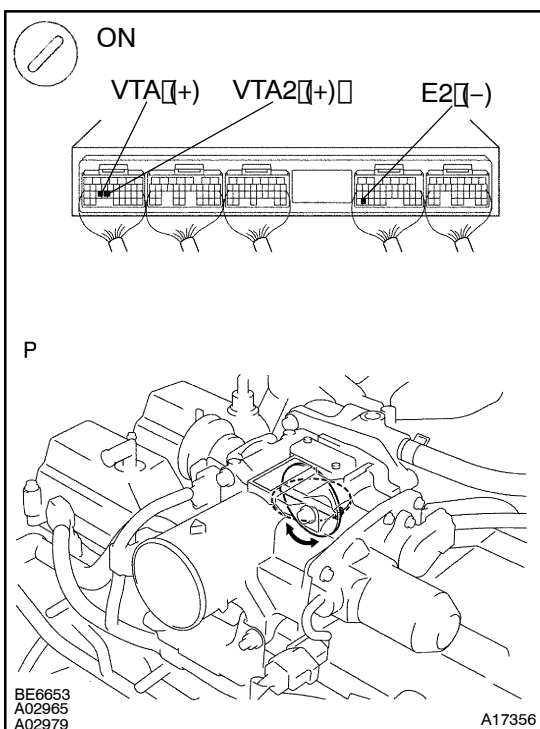

PREPARATION:

- Remove the engine room engine ECU hood and cover.
- Turn the ignition switch ON.

CHECK:

Measure voltage between terminals VTA, VTA2 and E2 of the engine ECU connector.

OK:

Accelerator pedal	Voltage	
	VTA	VTA2
Released	0.4 ~ 1.0 V	2.0 ~ 2.9 V
Depressed	3.2 ~ 4.8 V	4.6 ~ 5.1 V

OK

Check and replace engine ECU (See page IN-34).

NG

3 □ Check throttle position sensor (See page FI-32).

NG

Replace throttle position sensor
(See page FI-37).

OK

Check for open and short in harness and connector between engine ECU and throttle position sensor (VC, VTA, VTA2, E2 line) (See page IN-34).