

DTC	P1120/19	Accelerator Pedal Position Sensor Circuit Malfunction
------------	-----------------	--

CIRCUIT DESCRIPTION

Accelerator pedal position sensor is mounted on the throttle body and it has the 2 sensors to detect the accelerator position and a malfunction of the accelerator position's own.

The accelerator pedal position sensor is connected with the accelerator pedal by the accelerator wire and the voltage applied to the terminals VPA and VPA2 of the ECU changes between 0 V and 5 V in proportion to the opening angle of the accelerator pedal.

The engine ECU judges the current opening angle of the accelerator pedal from these signals input from terminals VPA and VPA2 and the engine ECU controls the throttle motor based on these signals.

If this DTC is stored, the engine ECU shuts down the power for the throttle motor and the magnetic clutch, and the throttle valve is fully closed by the return spring.

However, the opening angle of the throttle valve can be controlled by the accelerator pedal through the throttle cable.

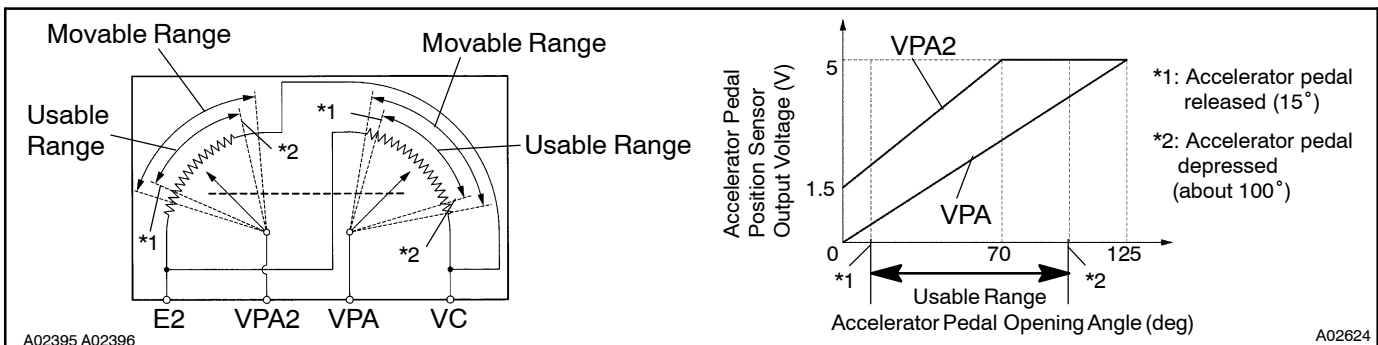

DTC No.	DTC Detecting Condition	Trouble Area
P1120/19	Condition (a), (b), (c) or (d) continues for 2.0 seconds: (a) $VPA \leq 0.2 \text{ V}$ and $VPAR20K \geq 0.97 \text{ deg}$ (b) $VPA2 \leq 0.5 \text{ V}$ and $VPAR10K \geq 0.97 \text{ deg}$ (c) $VPA \geq 4.7 \text{ V}$ (d) When $VPA \geq 0.2 \text{ V}$ and $\leq 1.8 \text{ V}$, and $VPA2 \geq 4.97 \text{ V}$ (e) $VPA - VPA2 \leq 0.02 \text{ V}$	<ul style="list-style-type: none"> • Open or short in accelerator pedal position sensor circuit • Accelerator pedal position sensor • Engine ECU
	Condition (a) or (b) continues for 2.0 seconds: (a) $VPA \leq 0.2 \text{ V}$ and $VPA2 \leq 0.5 \text{ V}$	

HINT:

After confirming DTC P1120/19 use the hand-held tester to confirm the accelerator pedal opening percentage.

Throttle valve position expressed as voltage				Trouble area
Accelerator pedal released		Accelerator pedal depressed		
ACCEL POS #1	ACCEL POS #2	ACCEL POS #1	ACCEL POS #2	
0V	0V	0V	0V	VC line open
0V	1.8~2.7V	0V	4.7~5.1V	VPA line open or grand short
0.3~0.9V	0V	3.2~4.8V	0V	VPA2 line open or grand short
5V	5V	5V	5V	E2 line open

WIRING DIAGRAM

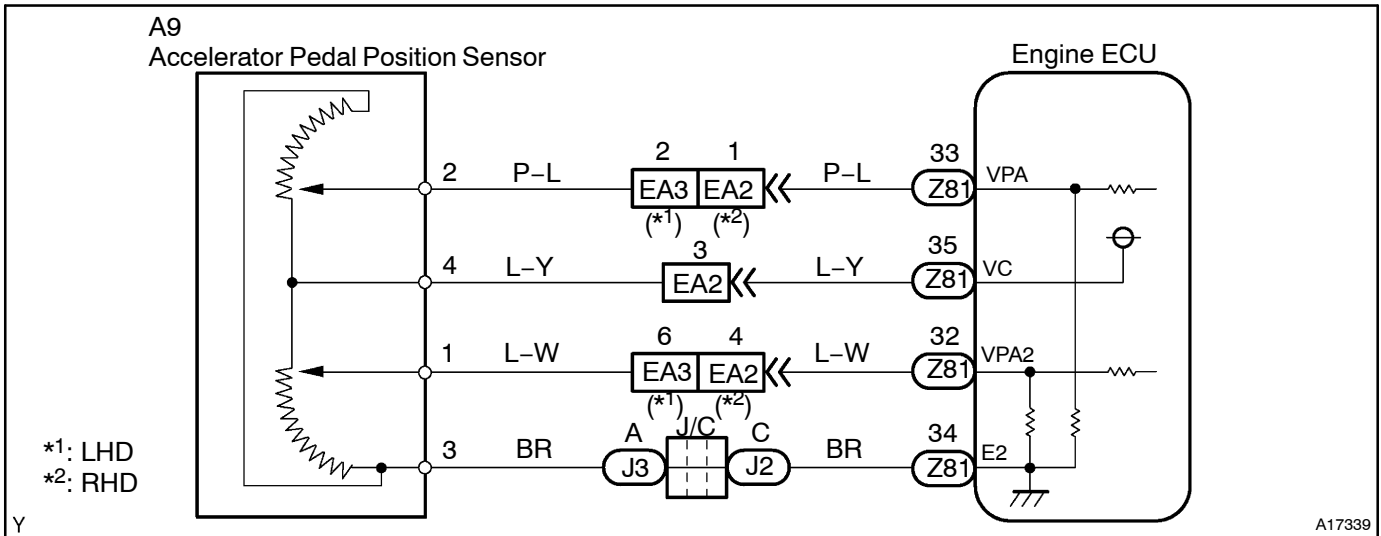

INSPECTION PROCEDURE

HINT:

- If DTC P0110/31 (Intake Air Temp. Circuit Malfunction), P0115/122 (Water Temp. Circuit Malfunction), P0120/41 (Throttle Position Sensor Circuit Malfunction), P1120/19 (Accelerator Pedal Position Sensor Circuit Malfunction) are output simultaneously, E2 (Sensor Ground) may be open.
- Read freeze frame data using hand-held tester. Because freeze frame records the engine conditions when the malfunction is detected, when troubleshooting it is useful for determining whether the vehicle was running or stopped, the engine warmed up or not, the air-fuel ratio lean or rich, etc. at the time of the malfunction.

When using hand-held tester

- 1** Connect hand-held tester, read the voltage for accelerator pedal position sensor data.

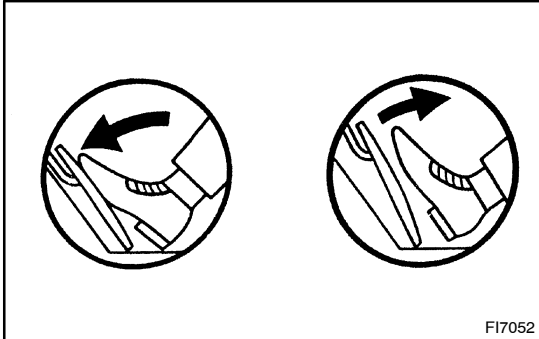

PREPARATION:

- Connect the hand-held tester to DLC3.
- Turn the ignition switch ON and switch the hand-held tester main switch ON.

CHECK:

Read the voltage for the accelerator pedal position sensor data.

OK:

Accelerator pedal	VPA	VPA2
Released	0.3 ~ 0.9 V	1.8 ~ 2.7 V
Depressed	3.2 ~ 4.8 V	4.7 ~ 5.1 V

OK

Check and replace engine ECU (See page IN-34).

NG

- 2** Check voltage between terminals VC and E2 of engine ECU connector.

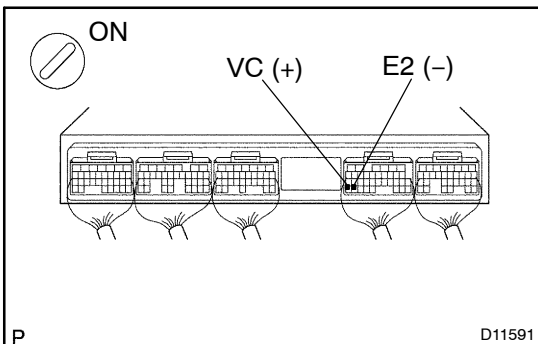

PREPARATION:

- Remove the engine room engine ECU hood and cover.
- Turn the ignition switch ON.

CHECK:

Measure voltage between terminals VC and E2 of the engine ECU connector.

OK:

Voltage: 4.5 ~ 5.5 V

NG

Check and replace engine ECU (See page IN-34).

OK

3 Check voltage between terminals VPA, VPA2 and E2 of engine ECU connector.

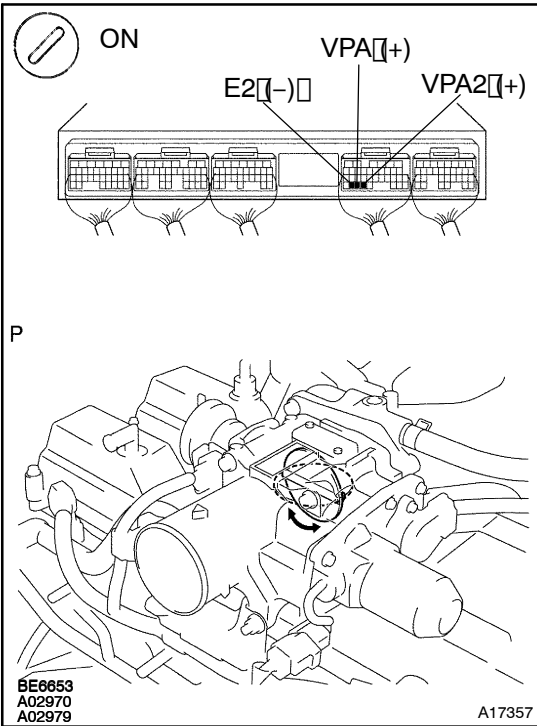

PREPARATION:

- Remove the engine room engine ECU hood and cover.
- Turn the ignition switch ON.

CHECK:

Measure voltage between terminals VPA, VPA2 and E2 of the engine ECU connector.

OK:

Accelerator pedal	Voltage	
	VPA	VPA2
Released	0.3-0.9V	1.8-2.7V
Depressed	3.2-4.8V	4.7-5.1V

OK

Check and replace engine ECU (See page IN-34).

NG

4 Check accelerator pedal position sensor (See page FI-32).

NG

Replace accelerator pedal position sensor (See page FI-37).

OK

Check for open and short in harness and connector between engine ECU and accelerator pedal position sensor (VC, VPA, VPA2, E2 line) (See page IN-34).

When not using hand-held tester

1 Check voltage between terminals VC and E2 of engine ECU connector.

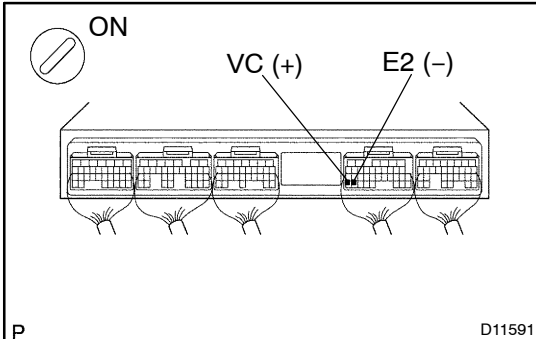

PREPARATION:

- Remove the engine room engine ECU hood and cover.
- Turn the ignition switch ON.

CHECK:

Measure voltage between terminals VC and E2 of the engine ECU connector.

OK:

Voltage: 4.5 ~ 5.5 V

NG

Check and replace engine ECU (See page IN-34).

OK

2 Check voltage between terminals VPA, VPA2 and E2 of engine ECU connector.

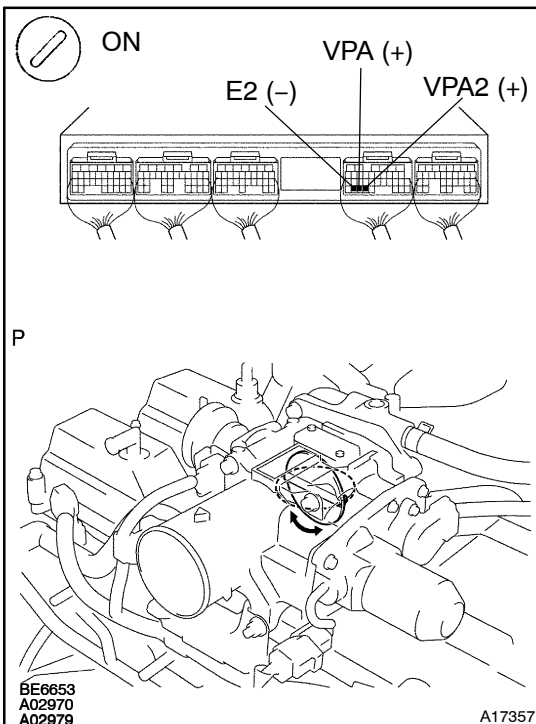

PREPARATION:

- Remove the engine room engine ECU hood and cover.
- Turn the ignition switch ON.

CHECK:

Measure voltage between terminals VPA, VPA2 and E2 of the engine ECU connector.

OK:

Accelerator pedal	Voltage	
	VPA	VPA2
Released	0.3 ~ 0.9 V	1.8 ~ 2.7 V
Depressed	3.2 ~ 4.8 V	4.7 ~ 5.1 V

OK

Check and replace engine ECU (See page IN-34).

NG

3 □ Check accelerator pedal position sensor (See page FI-32).

NG

Replace accelerator pedal position sensor (See page FI-37).

OK

Check for open and short in harness and connector between engine ECU and accelerator pedal position sensor (VC, VPA, VPA2, E2 line) (See page IN-34).