

---

# CHASSIS ELECTRICAL

## CONTENTS

GENERAL .....	2	MULTI CENTER DISPLAY .....	4
OUTLINE CHANGES .....	2	TROUBLESHOOTING <VEHICLES WITH NAVIGATION SYSTEM> .....	4
HEADLAMP .....	2	TROUBLESHOOTING <VEHICLES WITHOUT NAVIGATION SYSTEM> .....	31
REAR COMBINATION LAMP .....	3	MULTI CENTER DISPLAY .....	43
REAR WINDOW DEFOGGER SWITCH .....	3		

---

## GENERAL

### OUTLINE CHANGES

- The service procedure has been revised as the headlamp and the front turn-signal lamp have been unified.
- The service procedure has been revised due to the change in the rear combination lamp.
- The service procedure has been revised due to the change in the rear window defogger switch <Vehicles with manual air conditioner>.
- The service procedure has been added as the multi center display has been introduced. Furthermore, the multi center display is the same as for SPACE STAR and SPACE WAGON.
- The SRS warning lamp bulb inside the combination meter has been changed from 1.4 W to 0.84 W.

## HEADLAMP

### REMOVAL AND INSTALLATION

**Pre-removal and Post-Installation Operation**

- Removal and installation of radiator reserve tank and battery (When replacing only left side headlamp).

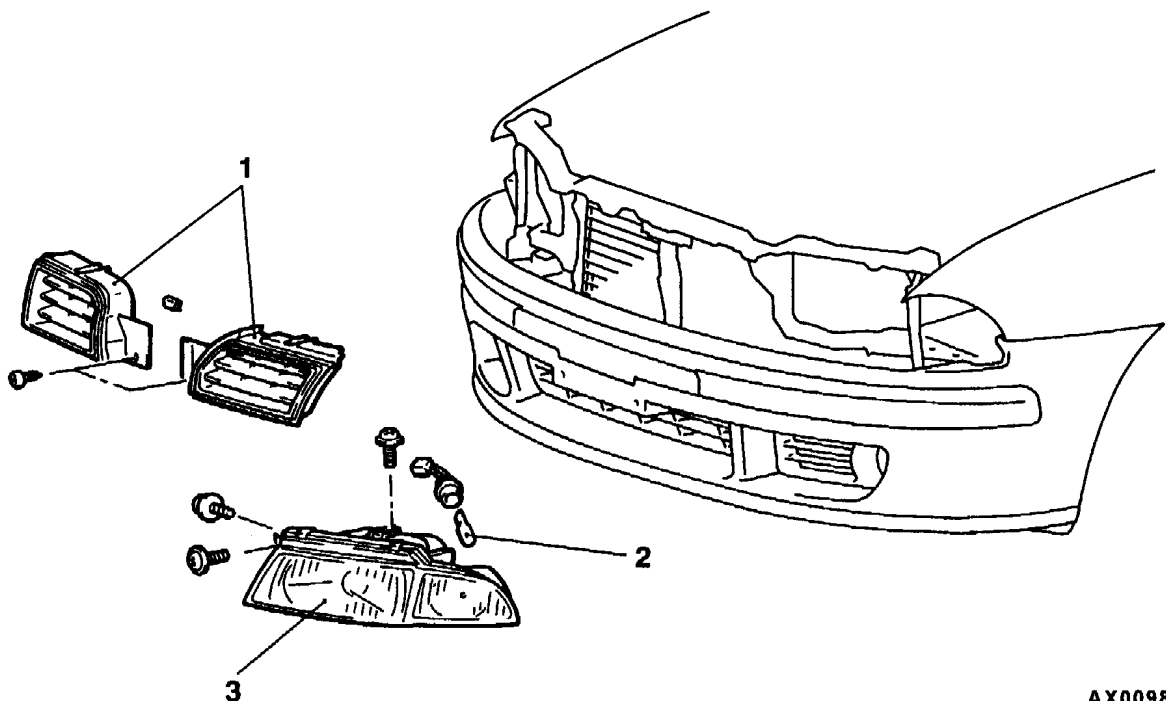

AX0098BN

**Removal steps**

1. Radiator grille  
(Refer to GROUP 51)
2. Front turn-signal lamp bulb
3. Headlamp assembly

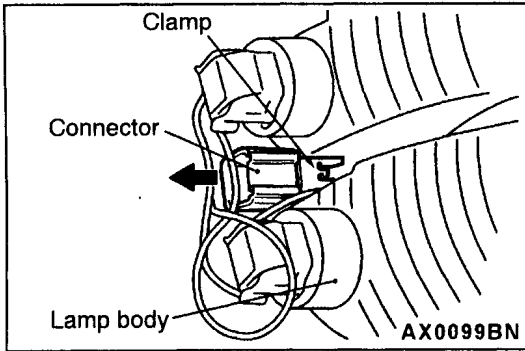

## REAR COMBINATION LAMP

### REMOVAL SERVICE POINTS

#### REAR LID LAMP ASSEMBLY

- (1) Remove the lamp lid.
- (2) Disconnect the wiring harness connector.
- (3) Unclamp the rear lid lamp assembly connector from the lamp body.
- (4) Remove the rear lid lamp assembly.

## REAR WINDOW DEFOGGER SWITCH

### REMOVAL AND INSTALLATION

Refer to GROUP 55 – Heater Control.

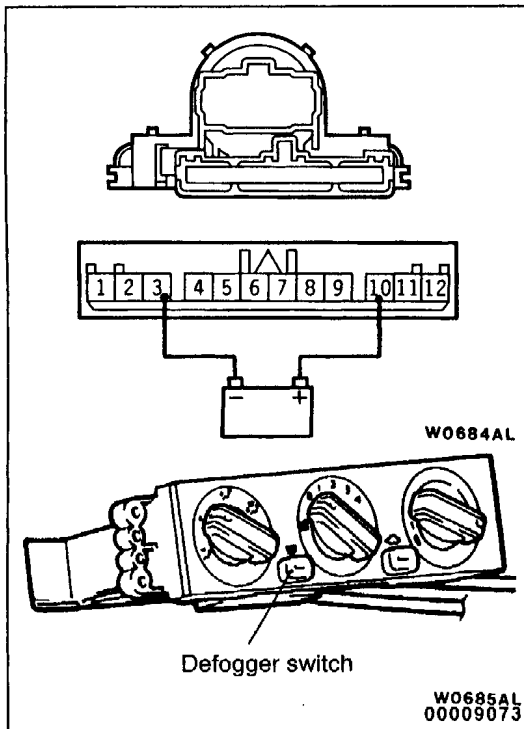

### INSPECTION

#### DEFOGGER SWITCH CONTINUITY CHECK

Switch position	Terminal No.				
	3	10	-	11	12
OFF	○		IND	○	
	⊖	⊕	⊕		
ON	○		IND	○	
	⊖	⊕	⊕		
	○				○

#### NOTE

Turn on the defogger switch, and then check that there is continuity between the terminals 3 and 12 for 9 to 13 minutes and after it, the defogger switch is turned off.

## MULTI CENTER DISPLAY

### TROUBLESHOOTING <Vehicles with navigation system>

#### NOTES WITH REGARD TO SERVICE PROCEDURES

##### 1. Before removing the battery

The multi center display has a large amount of data stored in memory which the user enters over time. When the terminals are disconnected from the battery, the memory which stores this data is affected as shown in the table below. Accordingly, it is necessary to make sure that you take notes of important information before disconnecting the battery.

Function	Input function	When battery is disconnected
Radio function	Channels which are selected during a search	Disappear after a few seconds
	Preset channels	Do not disappear
Navigation function	Current location	Do not disappear
	Recommended route	
	Destination	
	Route search conditions	
	Sensor initialization data	
	Language selection setting	
	Guidance volume setting	
Data search function, data display and input functions	Registered location names	Do not disappear
	Past destinations	
	Average fuel consumption, average speed, cruising range	
Clock display function	Current time	
Vehicle model settings for travel data	Setting details for vehicle model	
Monitor backlight luminance setting	Luminance setting value	

##### 2. Notes on trouble diagnosis relating to the overall system

- (1) If a problem occurs which seems like all of the functions have developed an abnormality simultaneously, the cause is most likely a communication abnormality between the various systems. Thus you should use the communication checking service function in the trouble diagnosis service functions in order to verify the cause.

- (2) If the above is not the problem, check the connections of the related harness connectors. If a malfunctioning location is discovered, repair it and then re-check the trouble symptoms.
- (3) If there are no abnormalities in the harness connections, check the harnesses themselves. If there are no abnormalities in the harnesses, replace the relevant unit. Make a note of any error codes and service function data generated at this time.

**NOTE**

If the cause of the problem seems to be related to system communication, carry out troubleshooting.

**3. Notes on trouble diagnosis when only specific functions are abnormal**

- (1) If only certain functions are showing an abnormality, use the audio checking function of the service functions to check the hardware switches.
- (2) If the switch functions are normal, check the connections of the related harness connectors. If a malfunctioning location is discovered, repair it and then re-check the trouble symptoms.
- (3) If there are no abnormalities in the harness connections, check the harnesses themselves. If there are no abnormalities in the harnesses, replace the unit which controls that function.

**4. Notes on trouble diagnosis of the navigation function**

- (1) The vehicle positioning accuracy of the navigation function is limited because of the principle of operation which it uses. Because of this, the system may be operating normally even though customers might be reporting a problem.

Before carrying out troubleshooting, get as much information as possible from the customer regarding things such as usage conditions and driving locations. If it is possible to judge from this that the problem is not caused by a system abnormality, explain the principle of operation used by the navigation function and how to utilize it effectively.

- (2) If you find that there is a system abnormality, check according to the Inspection Chart Classified by Trouble Symptoms in the Troubleshooting section.

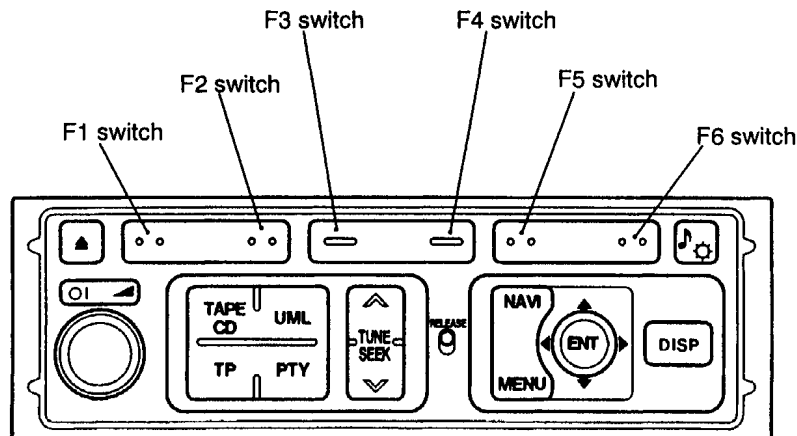
**MULTI CENTER DISPLAY**

AV0273AJ

**TROUBLE DIAGNOSIS SERVICE FUNCTIONS**

The Multi Center Display is equipped with the following trouble diagnosis service functions.

Function	Contents
Diagnosis function	During normal use, this function constantly monitors the system communication lines, and displays an error if it finds any abnormalities.
CD-ROM checking function	This function displays a message if it cannot read the CD-ROM or if no CD-ROM is inserted.
Service functions  1. Monitor checking 2. Audio checking  3. Automatic diagnosis by mode 4. Self-diagnosis <ul style="list-style-type: none"> <li>● Wiring and communication checking</li> <li>● Sensor checking</li> <li>● Vehicle signals</li> <li>● Version data</li> </ul> 5. Diagnosis recording	There are five checking modes available: monitor checking, audio checking, automatic checking by mode, self-diagnosis and diagnosis recording.  This mode checks that the image display function is operating normally. This mode checks that the speakers and operating switches of the audio system are all working normally. In this mode, wiring and communication checking, audio checking, sensor checking and vehicle signal checking are carried out continuously. This mode includes functions such as wiring and communication checking, sensor checking, vehicle signals and version data checking. This checks system communication between all units.  This checks all of the sensors that are necessary to the navigation system. This displays the current vehicle signal condition. This displays the version numbers for each unit in the Multi Center Display. This mode displays error codes from communication checking. (Error codes are erased when the ignition switch is turned to LOCK (OFF) position.)

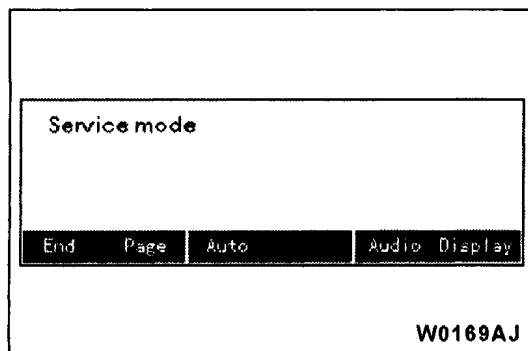

**1. ACTIVATING AND ENDING SERVICE MODE**

- (1) Activating service mode can be carried out by turning the ignition switch to the ON position while pressing the DISP switch on the audio unit and the F6 switch. (Continue pressing each switch for at least 5 seconds after turning the ignition switch to ON.)
- (2) If the special CD-ROM has been inserted into the navigation unit but the program has not been set up, the program will then be loaded from the CD-ROM. Service mode can be used once this process is completed.

**NOTE**

The special CD-ROM is a map CD-ROM which a distributor vends.

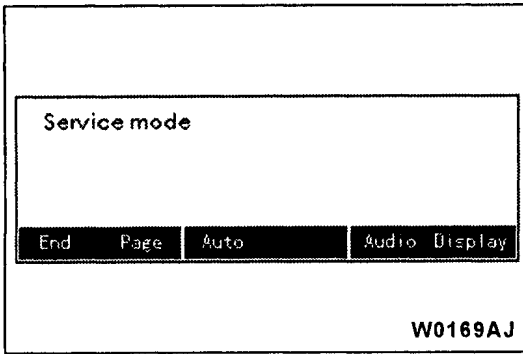

- (3) If the F1 switch is pressed at the service mode initial screen, service mode will be ended and the screen will change to navigation mode.

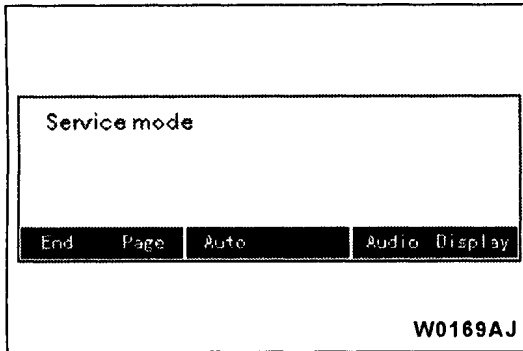

**2. MONITOR CHECKING**

- (1) If the F6 switch is pressed at the service mode initial screen, monitor checking will start.

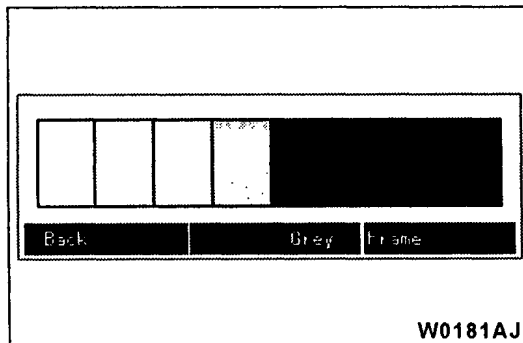

- (2) A colored bar will appear on the screen. Press a function switch to change to another screen. The screen will return to the service mode initial screen if the F1 switch is pressed.

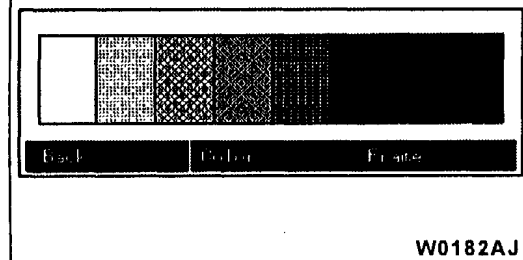

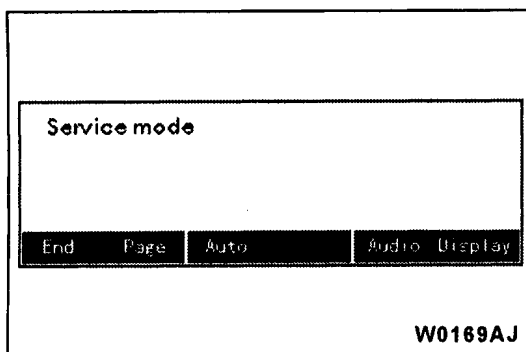

### 3. AUDIO CHECKING

- (1) If the F5 switch is pressed at the service mode initial screen, the audio checking menu screen will appear.

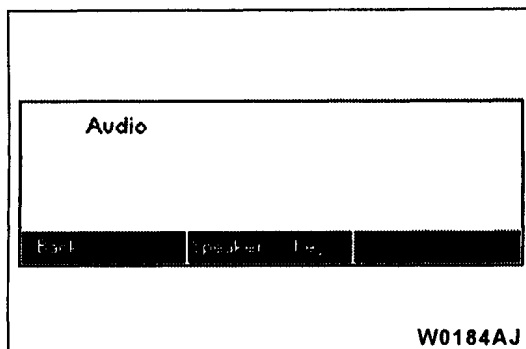

- (2) Next, press the function switches to carry out audio checking.

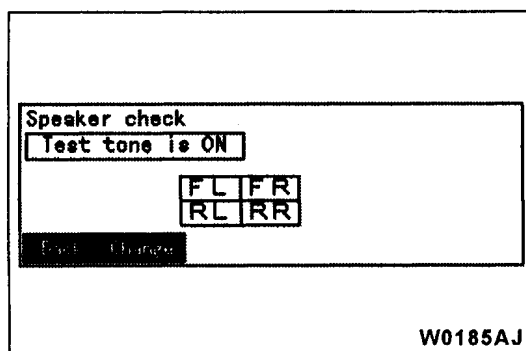

- (3) Press the F3 switch to display the speaker checking screen.

The test sound will be output alternately from each speaker each time the F2 switch is pressed.

Press the F1 switch to end speaker checking and return to the audio checking menu screen.

At the early mass production, sometimes radio sound will be output. This is not a sign of abnormality.

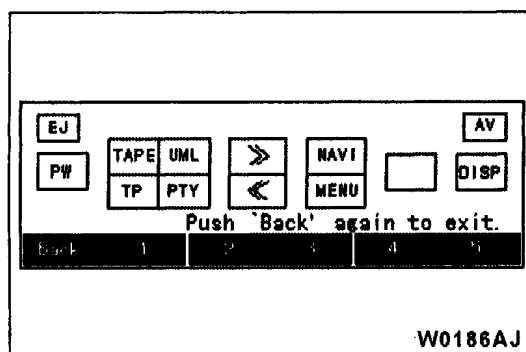

- (4) Press F4 to display the audio key checking screen. When one of the audio switches is pressed, the screen display color for that switch should change. This indicates that this particular switch system is working normally. Press the F1 switch to check the operation of the F1 switch. Press the F1 switch once more to return to the audio checking menu screen.

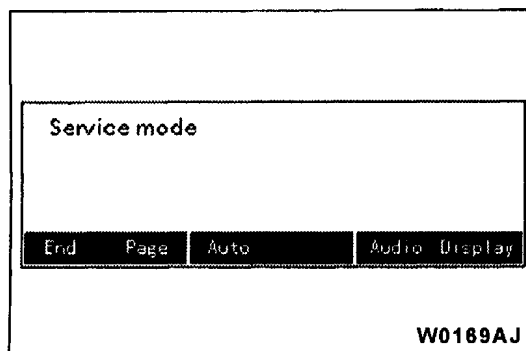

### 4. AUTOMATIC DIAGNOSIS BY MODE

- (1) If the F3 switch is pressed at the service mode screen, automatic diagnosis by mode will start.



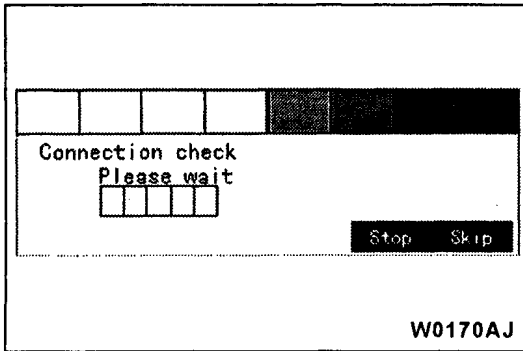

- (2) A colored bar will appear on the screen of the Multi Center Display unit, and all units which are connected to the navigation unit will be checked during this time.

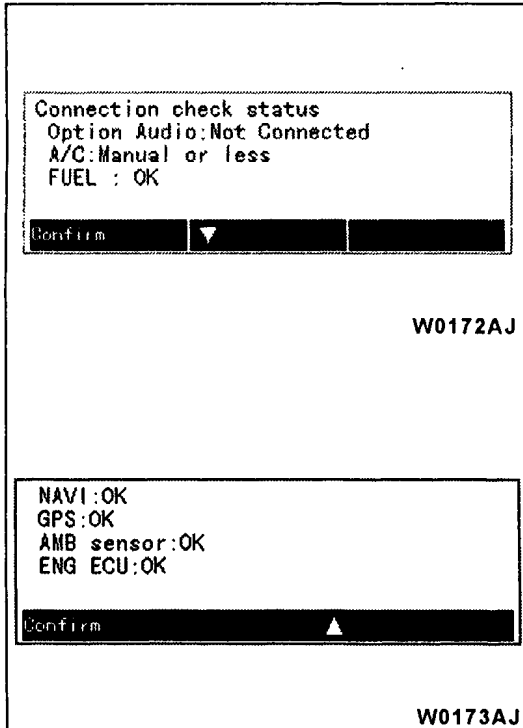

- (3) Once the transmission checking is completed, the results of the wiring and transmission checking will appear on the screen. After checking the results, press the F1 switch to proceed to the next check. The next check will start when the switch is pressed.

NOTE

- 1) If the fuel gauge and the engine-ECU are checked while the ignition switch is at ACC, an error will be generated, but this is not a sign of an abnormality.
- 2) If checking is carried out while the fuel tank is full or the while ignition switch is at ACC, the fuel gauge may be shown to be not connected, but this is not a sign of an abnormality.

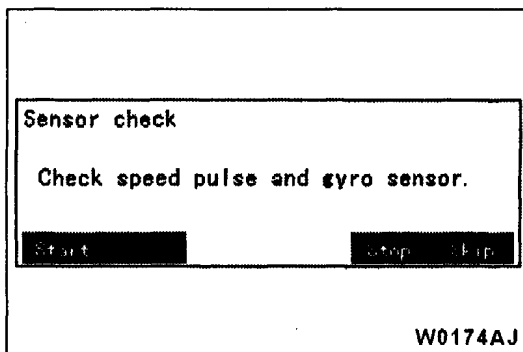

- (4) The next mode is the sensor checking mode. Press the F1 switch to start sensor checking. If you would like to proceed to the next checking operation without carrying out sensor checking, press the F6 switch.

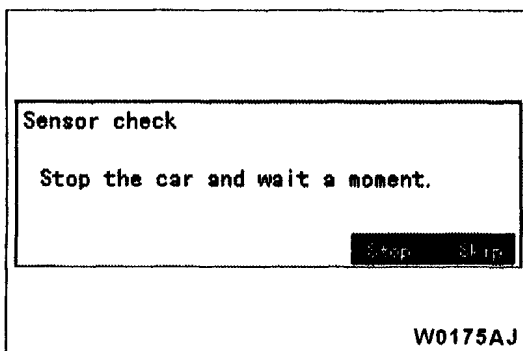

- (5) When sensor checking starts, the gyro output will be checked first while the vehicle is stopped, so make sure that the vehicle is stopped for this check. If the vehicle is moving when the sensor checking starts, the vehicle speed sensor will be shown as defective. Follow the guidance message on the multi center display.

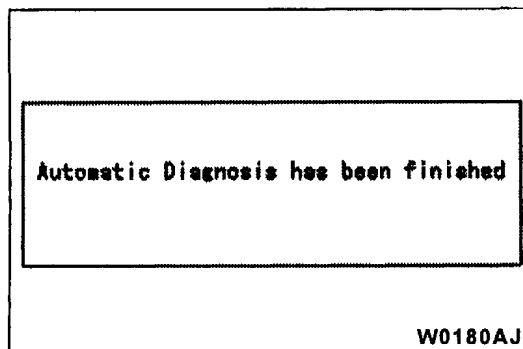
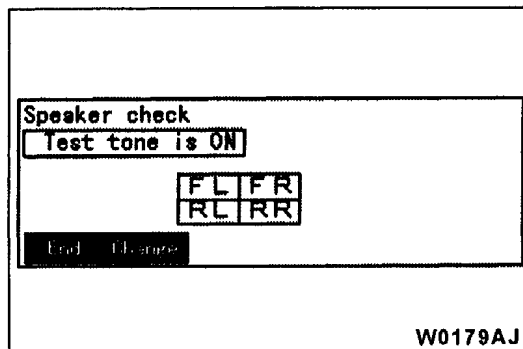
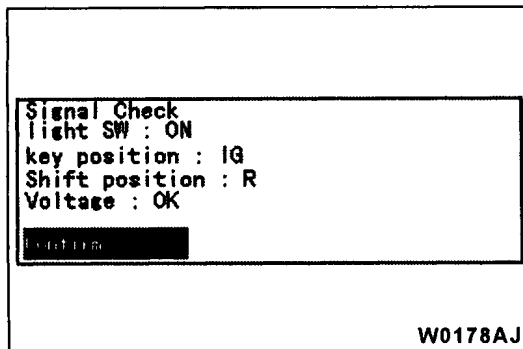
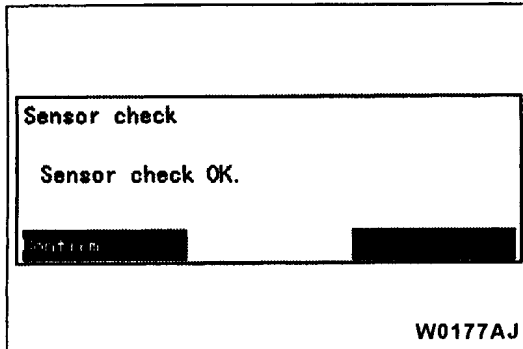
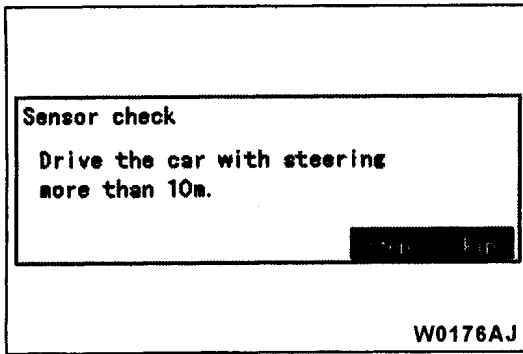

- (6) Next, drive the vehicle for approximately 10 meters while changing the running direction in order to check the vehicle speed pulse and the gyro sensor output. The sensor checking will then be completed. If there is an open circuit in the vehicle speed sensor, sensor checking will not complete even after the vehicle has travelled more than 10 meters. In this case, press the F5 switch to stop checking.  
If the vehicle does not move or there is an open circuit in vehicle speed sensor, the vehicle speed sensor will be shown as defective.
- (7) When sensor checking is completed, the check results will appear on the screen. After checking the results, press the F1 switch to proceed to the next check.
- (8) The next mode is the vehicle signal checking mode. The lighting switch condition, ignition key position, shift lever selection (R or a position other than R) and the power supply voltage drop will be appear on the screen. Check that the details displayed match the actual vehicle signals, and then press the F1 switch.  
If the vehicles does not move or there is an open circuit in vehicle speed sensor, the vehicle speed sensor will be shown as defective.
- (9) The next mode is speaker checking mode. The test sound will be output alternately from each speaker each time the F2 switch is pressed.  
At the early mass production, sometimes radio sound will be output. This is not a sign of abnormality.
- (10) Press the F1 switch to end service mode. The screen will change to navigation mode.

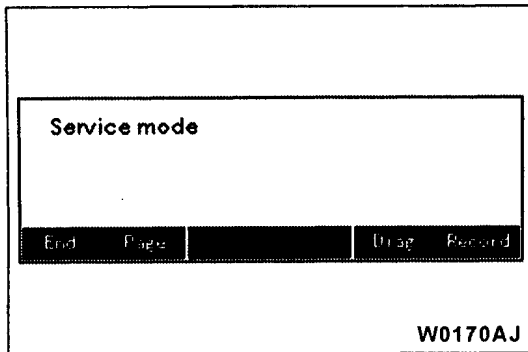

**5. SELF-DIAGNOSIS**

(1) If the F5 switch is pressed at the service mode initial screen, the self-diagnosis menu screen will appear.

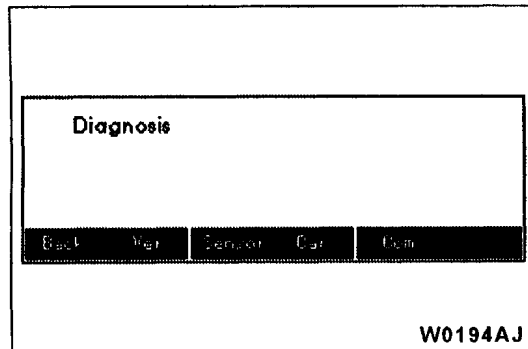

(2) Next, use the function switches to carry out self-diagnosis.

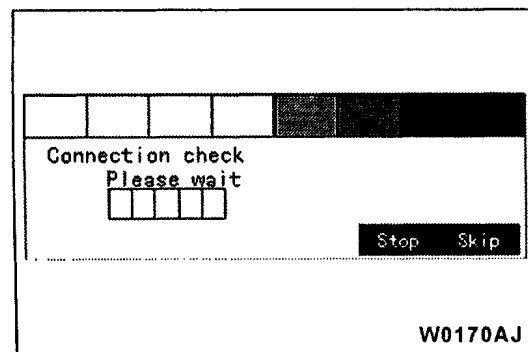

(3) When the F5 switch is pressed, self-diagnosis for the wiring is carried out. A colored bar will appear on the screen of the Multi Center Display unit, and all units which are connected to the navigation unit will be checked during this time.

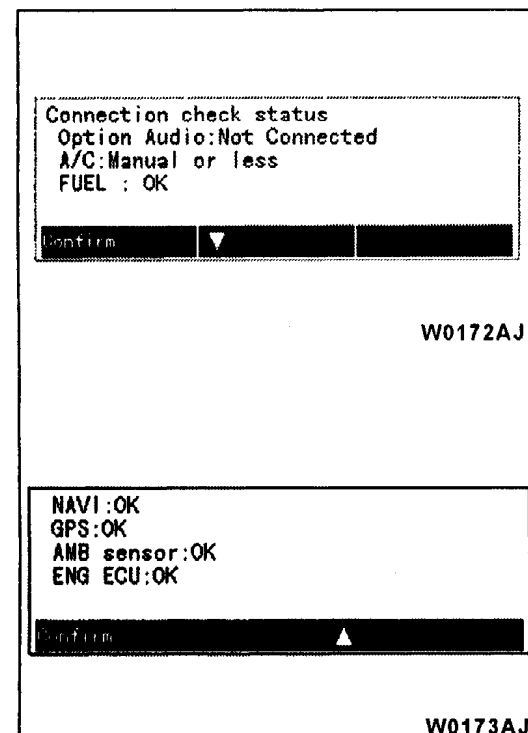

(4) Once the transmission checking is completed, the results of checking will appear on the screen. After checking the results, press the F1 switch to return to the self-diagnosis menu screen.

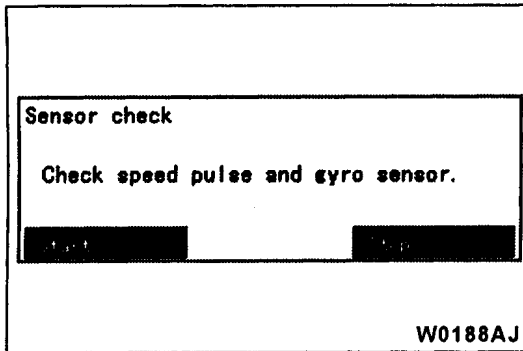

- (5) If the F6 switch is pressed at the self-diagnosis menu screen, sensor checking will start. Press the F1 switch to start sensor checking. If you would like to return to the self-diagnosis menu screen without carrying out sensor checking, press the F5 switch.

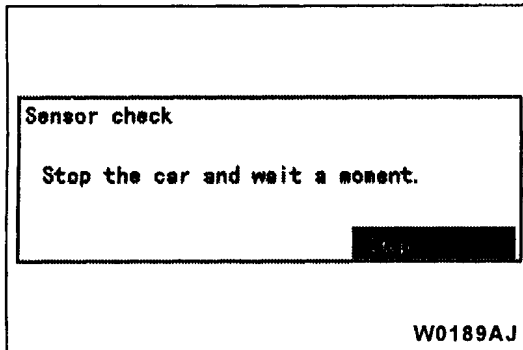

- (6) When sensor checking starts, the gyro output will be checked first while the vehicle is stopped, so make sure that the vehicle is stopped for this check. If the vehicle is moving when the sensor checking starts, the vehicle speed sensor will be shown as defective. Follow the guidance message on the multi center display.

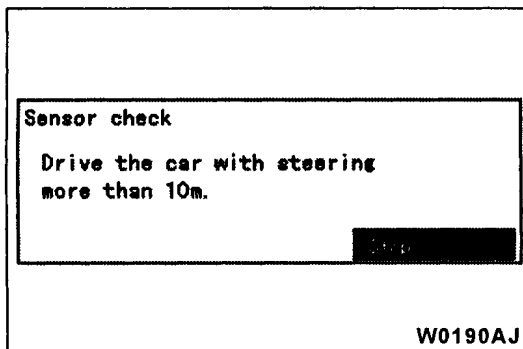

- (7) Next, drive the vehicle for approximately 10 meters while changing the running direction in order to check the vehicle speed pulse and the gyro sensor output. The sensor checking will then be completed. If there is an open circuit in the vehicle speed sensor, sensor checking will not complete even after the vehicle has travelled more than 10 meters. In this case, press the F5 switch to stop checking. If the vehicle does not move or there is an open circuit in vehicle speed sensor, the vehicle speed sensor will be shown as defective.

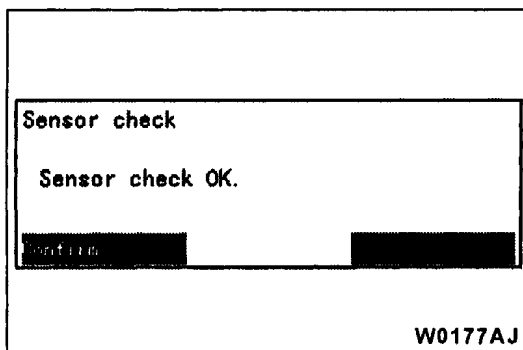

- (8) When sensor checking is completed, the check results will appear on the screen. After checking the results, press the F1 switch to return to the self-diagnosis menu screen.

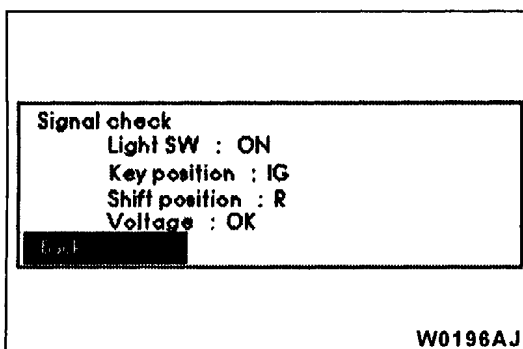

- (9) If the F6 switch is pressed at the self-diagnosis menu screen, vehicle signal checking will start. The lighting switch condition, ignition key position, shift lever selection (R or a position other than R) and the power supply voltage drop will be appear on the screen. Press the F1 switch to return to the self-diagnosis menu screen.

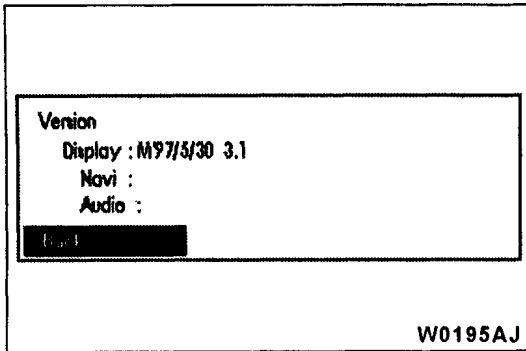

If the F2 switch is pressed at the self-diagnosis menu screen, version data self-diagnosis will be carried out, and the check results will appear on the screen. Press the F1 switch to return to the self-diagnosis menu screen.

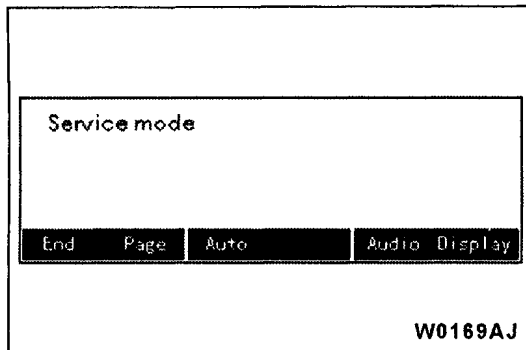

**6. DIAGNOSIS RECORDING**

- (1) If the F6 switch is pressed at the service mode initial screen, the diagnosis recording screen will appear.
- (2) Press the F1 switch to return to the service mode initial screen.

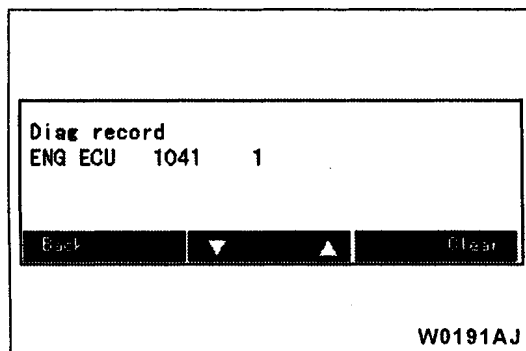

- (3) Press the F6 switch to clear any error codes which may still be remaining from diagnosis recording. When this is done, the clearing confirmation screen will appear. If it is okay to continue with the clear, press the F5 switch. To cancel clearing, press the F6 switch. If the F6 switch is pressed, the screen will return to the diagnosis recording screen.

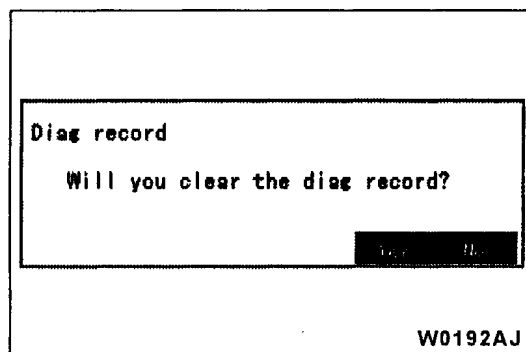

- (4) If the F5 switch is pressed, all past error codes will be cleared, and the screen will return to the diagnosis recording screen. The Clear button will not be displayed at this time.

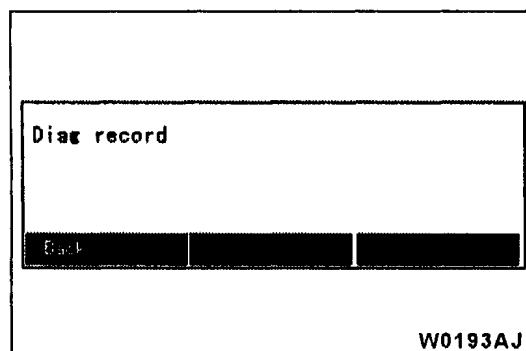

- (5) Press the F1 switch to return to the service mode initial screen.

## 7. ERROR CODE TABLE

Error Code No.	Error Details	Detection Method (Reference)	Reference Page
1011	Ambient temperature sensor not connected during diagnosis	Connection checking	54-28
1021	Fuel gauge not connected during diagnosis	Connection checking	54-29
1031	GPS abnormality during diagnosis	Connection checking	54-29
1041	Engine-ECU not connected during diagnosis	Connection checking	54-29
1051	SWS not connected during diagnosis (This error does not occur when correct car type is set)	Connection checking	54-29
1091	CD drive too hot during diagnosis	Connection checking	54-29
1092 – 1096	CD drive abnormality during diagnosis	Connection checking	54-30
10A1, 10B1	Memory of navigation unit abnormality during diagnosis	Connection checking	54-30
20D1, 30D1	Vehicle speed pulse abnormality during diagnosis	Sensor checking	54-30
20E1, 20E2, 30E1, 30E2	Gyro level abnormality during diagnosis	Sensor checking	54-30

MAIN UNIT TERMINAL VOLTAGES

1. MULTI CENTER DISPLAY UNIT

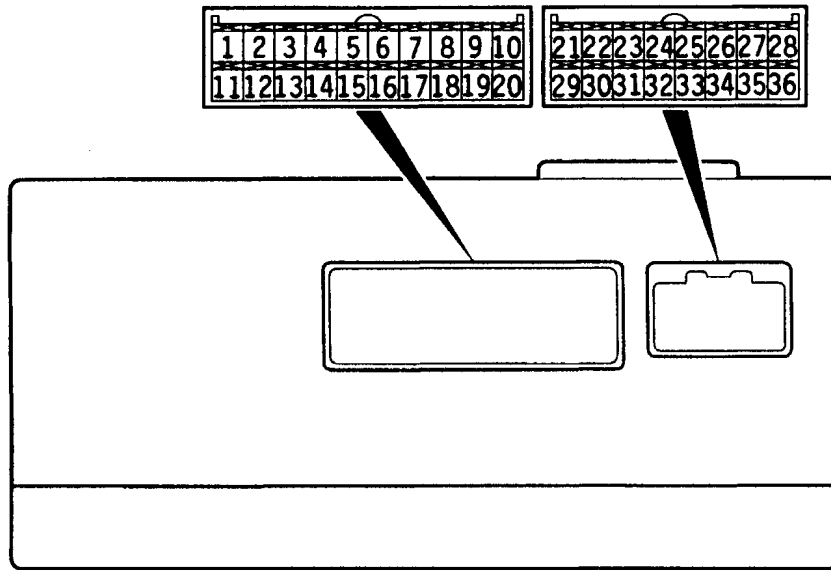

W0278AJ

Terminal No.	Input/Output	Signal Symbol	Terminal Voltage (V)	Harness Problem		Trouble Symptom Resulting from Harness Problem
				Open Circuit	Short-circuit	
1	Input	G+SYTNC (AUDIO)	-	○	○	Noise display (random dot pattern)
2	Input	B+SYNC (AUDIO)	-	○	○	Blue, white, cyan and magenta do not appear in RGB screen.
3, 4	-	-	-	-	-	-
5	Input	ISOK	Hi: System voltage Lo: 0 - 1	○	○	MUT-II cannot be used to check engine-ECU.
6	-	-	-	-	-	-
7	Input/Output	M-DATA (AUDIO)	Hi: 4 - 5 Lo: 0 - 1	○	○	Buzzer sounds 30 seconds after the power turned to on. Nighttime illumination does not appear for any navigation system.
8	Input/Output	M-CLOCK (AUDIO)	Hi: 4 - 5 Lo: 0 - 1	○	○	Buzzer sounds 30 seconds after the power turned to on. Nighttime illumination does not appear for any navigation system.
9, 10	-	-	-	-	-	-
11	-	SHIELD-GND	-	-	-	-
12	-	-	-	-	-	-
13	Input	R+SYNC (AUDIO)	-	○	○	Red, white, yellow and magenta do not appear in RGB screen.

Terminal No.	Input/Output	Signal Symbol	Terminal Voltage (V)	Harness Problem		Trouble Symptom Resulting from Harness Problem
				Open Circuit	Short-circuit	
14	-	-	-	-	-	-
15	Input/Output	K	Hi: System voltage Lo: 0 - 1	○	○	Values on Trip information screen (average speed, fuel consumption and cruising distance) are abnormal. Wiring and communication error. Communication is not possible between the engine-ECU and the MUT-II.
16	-	-	-	-	-	-
17	Input/Output	M-BUSY (AUDIO)	Hi: 4 - 5 Lo: 0 - 1	○	-	Screen display does not appear.
				-	○	Buzzer sounds 30 seconds after the power turned to on. Nighttime illumination does not appear for any navigation system.
18	-	SHIELD-GND	-	-	-	-
19 - 21	-	-	-	-	-	-
22	Input	PS-R	Hi: System voltage Lo: 0 - 1	○	○	Current location is not correct when reversing.
23	Input	EX-TEMP	0 - 5	○	○	Outside air temperature does not appear.
24	Input	ILL+	Hi: System voltage Lo: 0 - 1	○	-	Nighttime illumination does not appear for any navigation system units.
				-	○	Blown multipurpose fuse.
25	Input	ACC (ACC power supply)	System voltage	○	-	Screen display does not appear.
				-	○	Blown multipurpose fuse.
26	Input	+B	System voltage	○	-	Screen display does not appear.
				-	○	Blown multipurpose fuse.
27	Input	VSS	Hi: 4 - 5 Lo: 0 - 1	○	-	No effect.
28	-	GND (Ground)	-	○	-	Screen display does not appear.
29, 30	-	-	-	-	-	-
31	-	GND-TEMP	-	○	○	Outside air temperature does not appear.
32	-	-	-	-	-	-
33	Input	FUEL GAUGE	0 - 3	○	○	Abnormal cruising distance display.
34, 35	-	-	-	-	-	-



Terminal No.	Input/Output	Signal Symbol	Terminal Voltage (V)	Harness Problem		Trouble Symptom Resulting from Harness Problem
				Open Circuit	Short-circuit	
36	Input	IG1	System voltage	○	–	Communication with engine-ECU is not possible. Driving data values displayed are abnormal.
				–	○	Communication with engine-ECU is not possible. Driving data values displayed are abnormal. Blown multipurpose fuse.

2. NAVIGATION UNIT

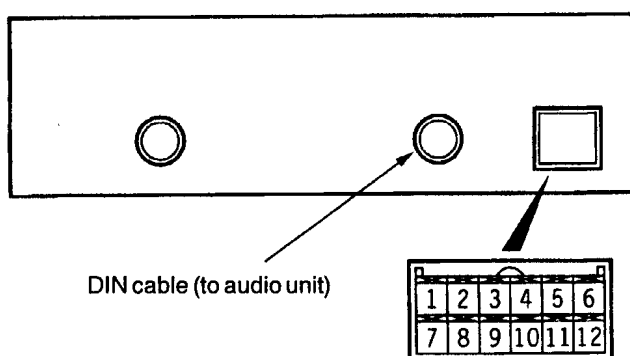

AV0845AE

Terminal No.	Input/Output	Signal Symbol	Terminal Voltage (V)	Harness Problem		Trouble Symptom Resulting from Harness Problem
				Open Circuit	Short-circuit	
1 – 3	–	–	–	–	–	–
4	Input	VEHICLE SPEED PULSE	Voltage should change when wheels are turning. Hi: 4 – 5 Lo: 0 – 1	○	○	Compass display does not change when not following a route. Guide does not appear when following a route.
5	Input	+BATTERY	System voltage	○	–	Navigation does not operate.
				–	○	Blown fuse in +B system.
6	Input	ACCESSORY	System voltage	○	–	Navigation does not operate.
				–	○	Blown fuse in ACC system.
7 – 11	–	–	–	–	–	–
12	–	GND	–	○	–	Navigation sometimes does not operate.

3. AUDIO UNIT

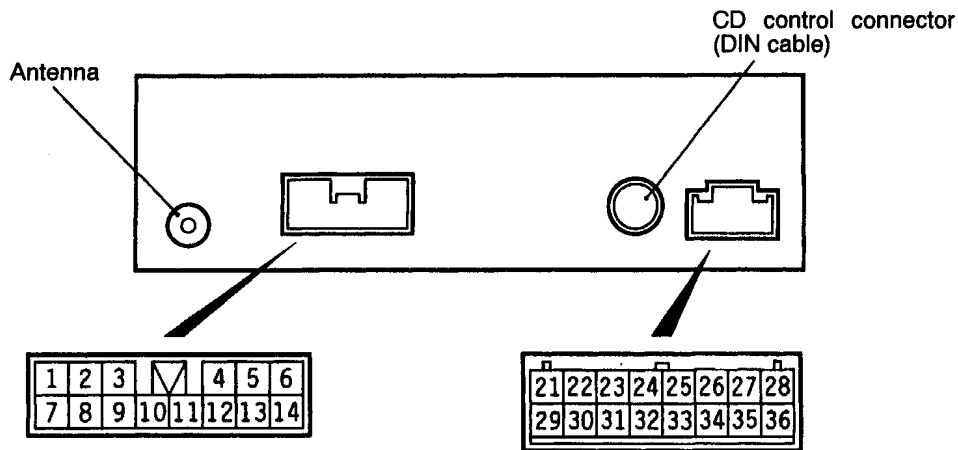

BV0846AE

Terminal No.	Input/Output	Signal Symbol	Terminal Voltage (V)	Harness Problem		Trouble Symptom Resulting from Harness Problem
				Open Circuit	Short-circuit	
1	Output	SPEAKER RR (+)	0 - System voltage (AC)	○	-	No sound is output from rear right speaker.
				-	○	No sound is output from rear left and right speakers.
2	Output	SPEAKER RL (+)	0 - System voltage (AC)	○	-	No sound is output from rear left speaker.
				-	○	No sound is output from rear left and right speakers.
3	Output	ANTENNA +B (Radio antenna amplifier power supply)	Hi: 10 or more Lo: 0 - 1	○	○	Low radio sensitivity.
4	-	-	-	-	-	-
5	Output	SPEAKER FL (+)	0 - System voltage (AC)	○	-	No sound is output from front left speaker.
				-	○	No sound is output from front left and right speakers.
6	Output	SPEAKER FR (+)	0 - System voltage (AC)	○	-	No sound is output from front right speaker.
				-	○	No sound is output from front left and right speakers.
7	Output	SPEAKER RR (-)	0 - System voltage (AC)	○	-	No sound is output from rear right speaker.
				-	○	No sound is output from rear left and right speakers.

Terminal No.	Input/Output	Signal Symbol	Terminal Voltage (V)	Harness Problem		Trouble Symptom Resulting from Harness Problem
				Open Circuit	Short-circuit	
8	Output	SPEAKER RL (-)	0 – System voltage (AC)	○	-	No sound is output from rear left speaker.
				-	○	No sound is output from rear left and right speakers.
9	-	-	-	-	-	-
10	Input	ACC (ACC power supply) (System voltage)	System voltage	○	-	Audio power supply does not turn on.
				-	○	Blown multipurpose fuse.
11	Input	+B (System voltage)	System voltage	○	-	Cassette is not ejected when ACC power turned off. Contents of memory are cleared.
				-	○	Blown multipurpose fuse.
12	Input	ILL (-)	-	-	-	-
13	Output	SPEAKER FL (-)	0 – System voltage (AC)	○	-	No sound is output from front left speaker.
				-	○	No sound is output from front left and right speakers.
14	Output	SPEAKER FR (-)	0 – System voltage (AC)	○	-	No sound is output from front right speaker.
				-	○	No sound is output from front left and right speakers.
21	Input/Output	M-DATA	Hi: 4 or more Lo: 1 or less	○	○	Panel switches cannot be operated.
22	Input/Output	M-SCK	Hi: 4 or more Lo: 1 or less	○	○	Panel switches cannot be operated.
23	Input	TELEPHONE MUTE	Hi: 4 or more Lo: 1 or less	-	-	-
24	Output	G+SYNC	0 – 5	○	○	Abnormal navigation screen color.
25	Output	B+SYNC	0 – 5	○	○	Abnormal navigation screen color.
26 – 28	-	-	-	-	-	-
29	Input/Output	M-BUSY	Hi: 4 or more Lo: 1 or less	○	○	Panel switches cannot be operated.
30	-	SHIELD EARTH (M-BUS)	-	-	-	-

Terminal No.	Input/Output	Signal Symbol	Terminal Voltage (V)	Harness Problem		Trouble Symptom Resulting from Harness Problem
				Open Circuit	Short-circuit	
31	-	-	-	-	-	-
32	-	SHIELD EARTH	-	-	-	-
33	-	-	-	-	-	-
34	Output	R+SYNC	0 – 5	○	○	Abnormal navigation screen color.
35, 36	-	-	-	-	-	-

## INSPECTION CHART CLASSIFIED BY TROUBLE SYMPTOMS

Related Unit	Trouble Symptom	Inspection Procedure No.	Reference Page
Malfunction of navigation unit, multi center display, audio unit and related sensor, harness	TAPE/CD, UML switches do not work. No display appears after the ignition key is turned to ACC.	1	54-21
	TAPE/CD, UML switches do not work. (Display appears.)	2	54-22
	No display appears after the ignition key is turned to ACC, but TAPE/CD, UML switches can be operative.	3	54-23
	CD changer screen display does not appear when TAPE/CD switch is operated.	4	54-24
	GPS reception is not possible.	5	54-24
	Outside air temperature data is not displayed.	6	54-24
	Abnormal driving data display <ul style="list-style-type: none"> <li>● Abnormal average fuel consumption (momentary fuel consumption) and average speed displays.</li> <li>● Abnormal cruising distance displays</li> </ul>	7	54-25
	Daytime/nighttime display mode does not change in conjunction with lighting switch operations.	8	54-26
	Display moves about. Screen colours do not match correctly.	9	54-26
	Compass display does not rotate , or guidance does not appear when following a route.	10	54-27
	One of the following messages appears during navigation mode. <ul style="list-style-type: none"> <li>● The CD drive has failure condition. Check and reload the disc, please.</li> <li>● Wrong disc is in the CD drive. Insert a map disc, please.</li> <li>● No disc is in the CD drive. Insert a map disc please.</li> <li>● A music disc is in the CD drive.</li> </ul>	11	54-27

INSPECTION PROCEDURES FOR EACH TROUBLE SYMPTOM

INSPECTION PROCEDURE 1

**TAPE/CD, UML switches do not work. No display appears after the Ignition key is turned to ACC.**

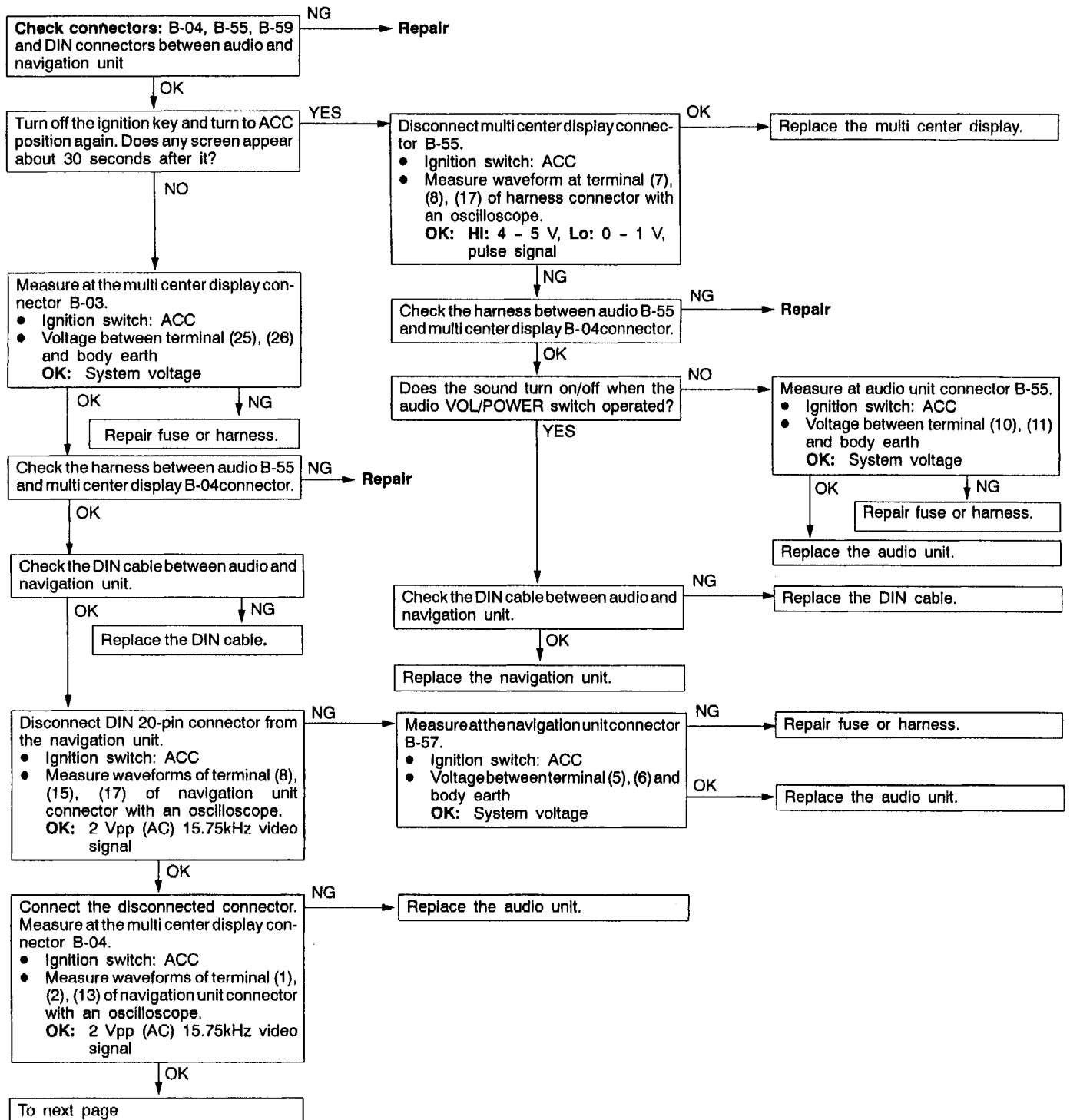

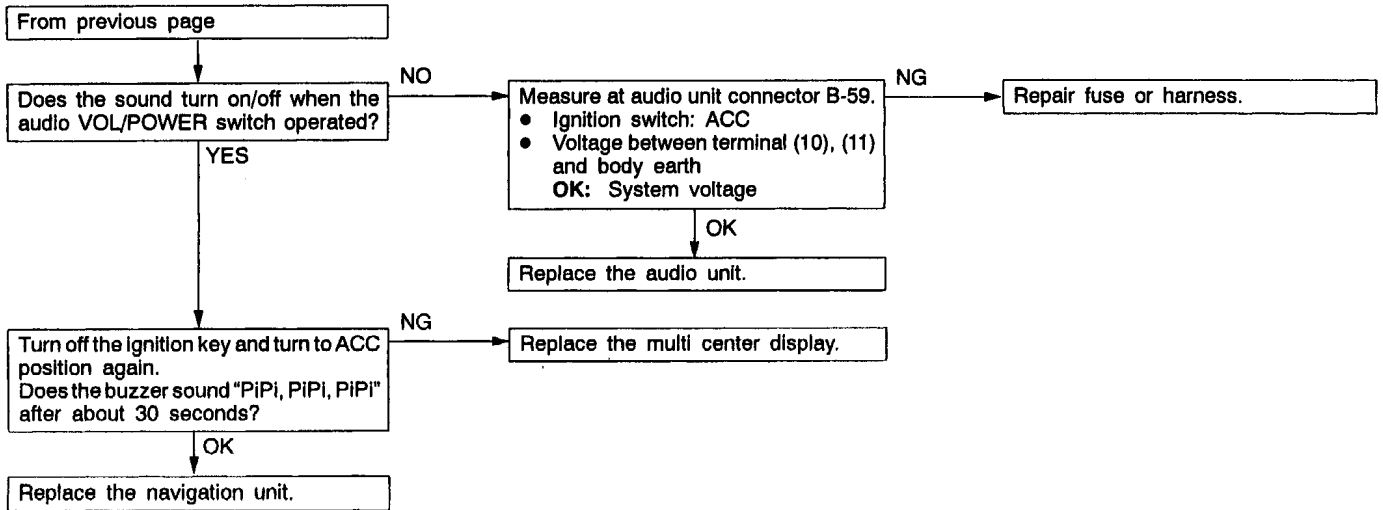

**INSPECTION PROCEDURE 2**

**TAPE/CD, UML switches do not work. (Display appears.)**

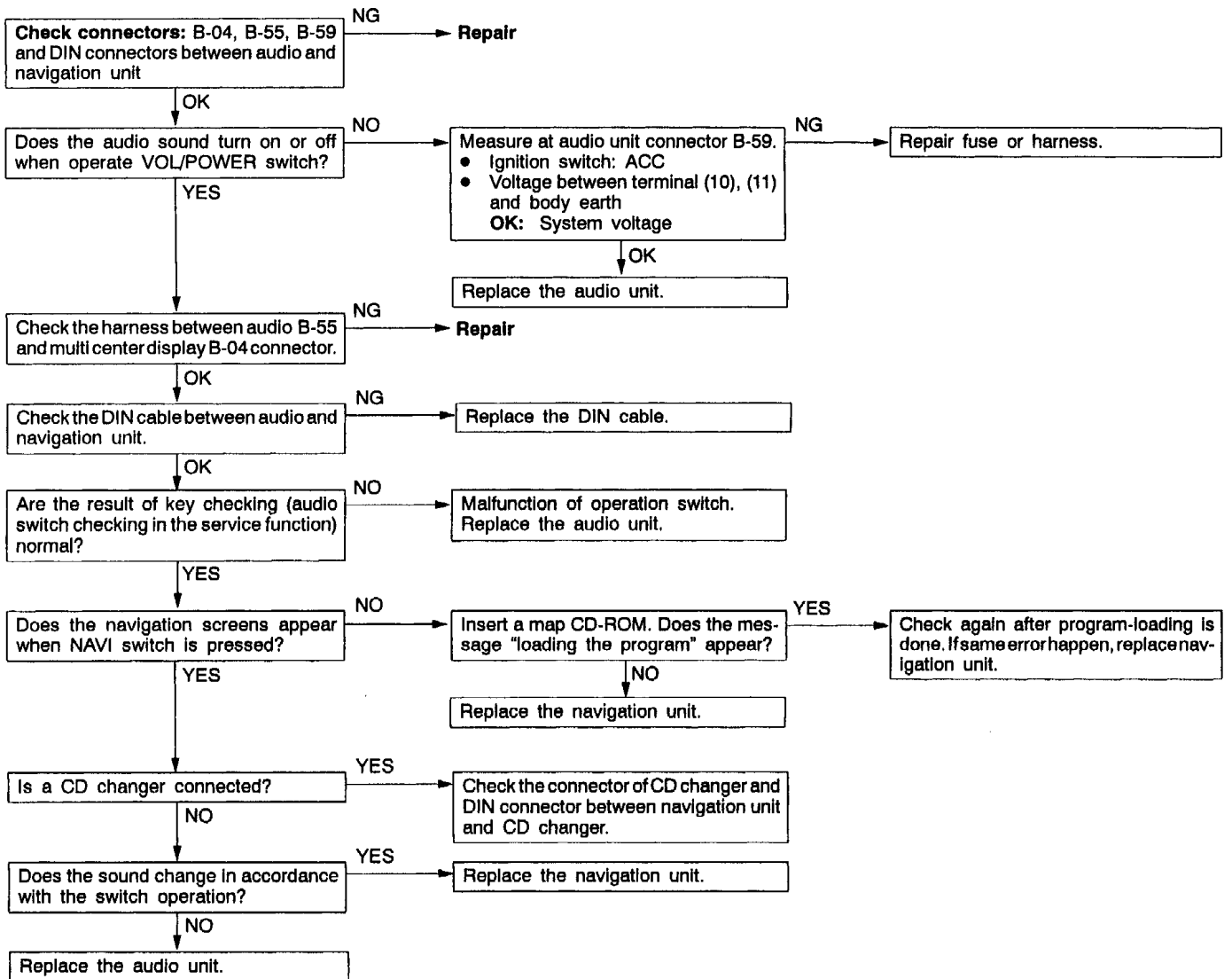

**INSPECTION PROCEDURE 3**

**No display appears after the ignition key is turned to ACC, but TAPE/CD, UML switches can be operative.**

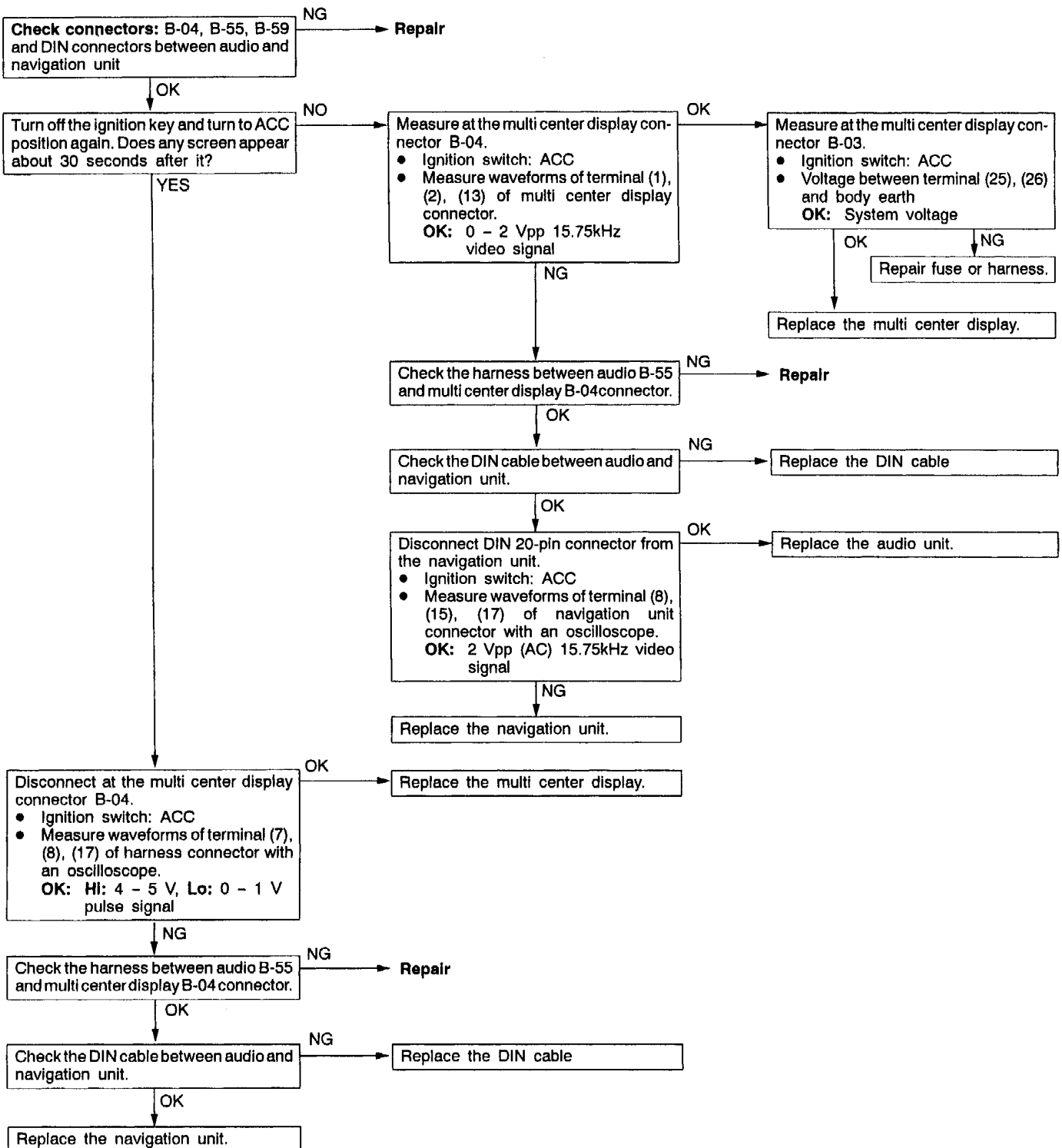

**INSPECTION PROCEDURE 4**

**CD changer screen displays do not appear when TAPE/CD switches are operated.**

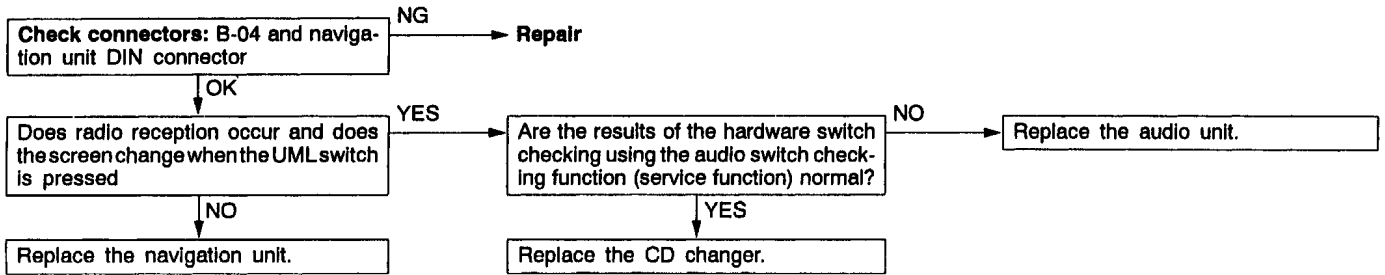

**INSPECTION PROCEDURE 5**

**GPS reception is not possible.**

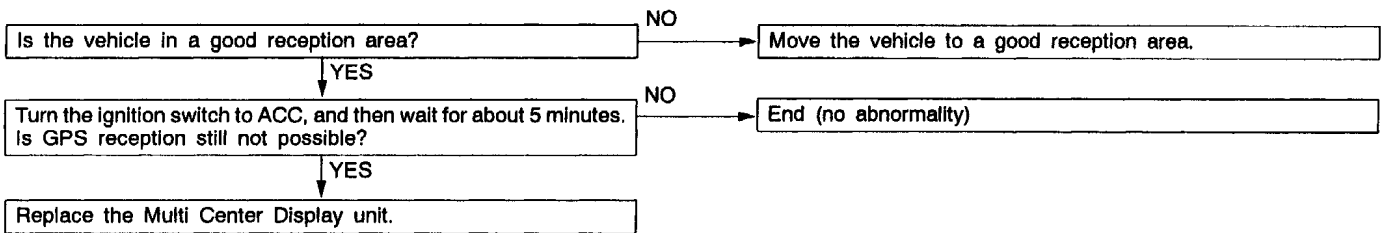

**INSPECTION PROCEDURE 6**

**Outside air temperature data is not displayed.**

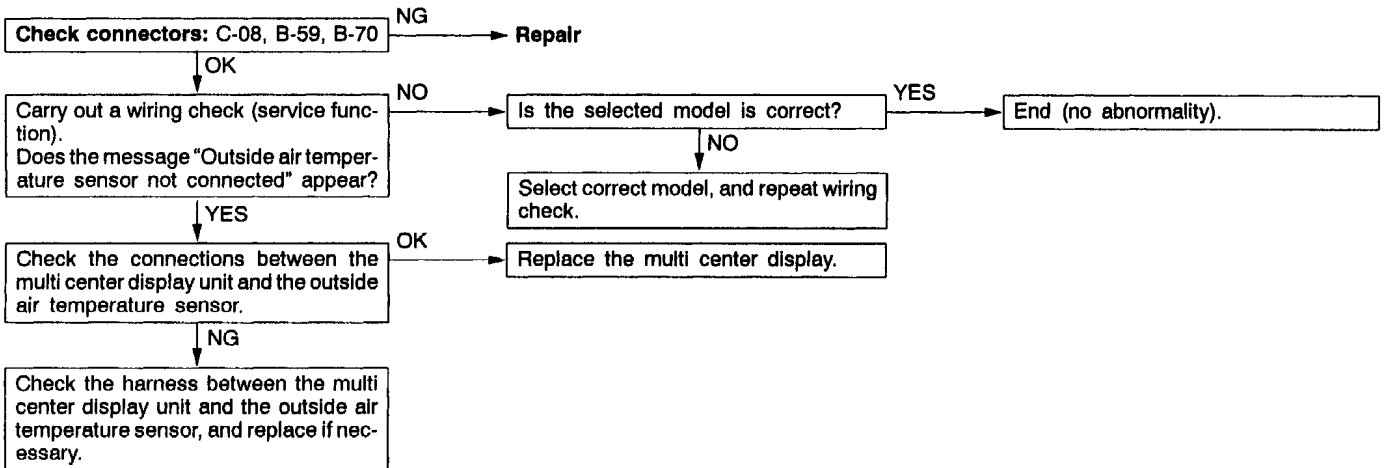



**INSPECTION PROCEDURE 7**

**Abnormal driving data displays.**

- Abnormal average fuel consumption (momentary fuel consumption) and average speed displays.
- Abnormal cruising distance displays.

**1. When average fuel consumption (momentary fuel consumption) and average speed displays are abnormal.**

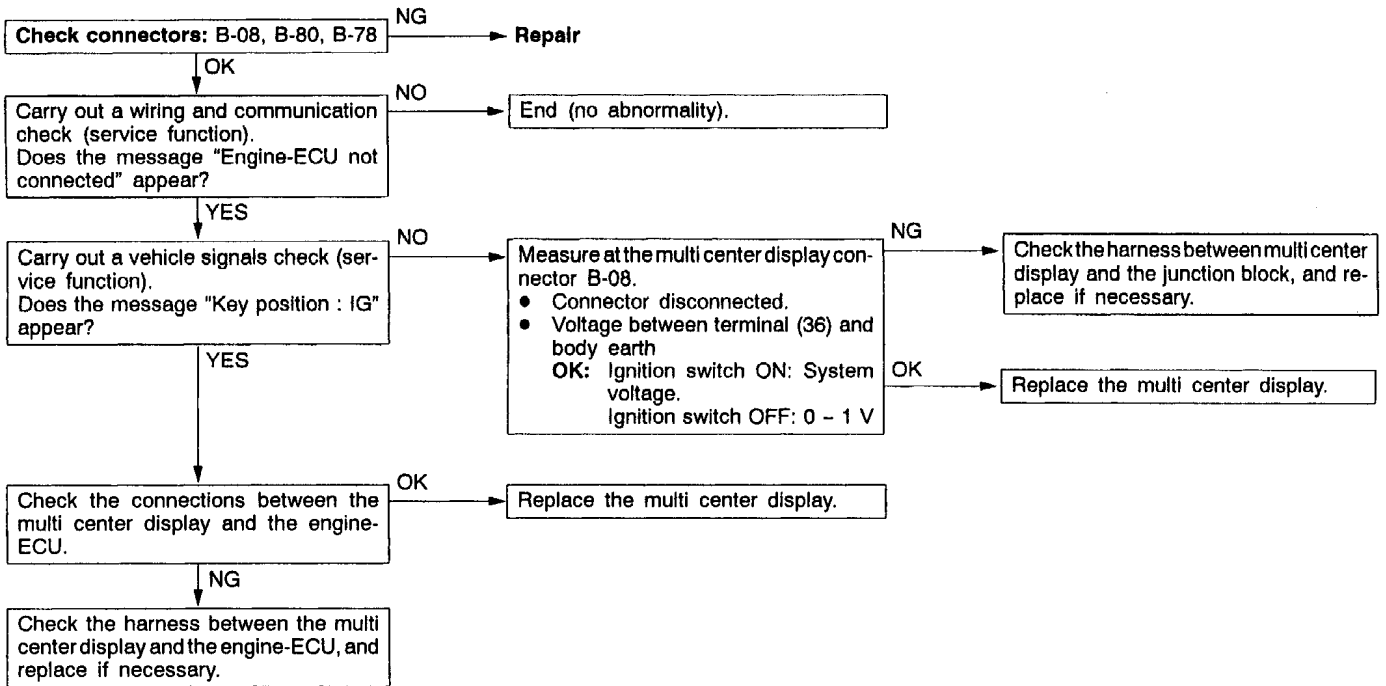

**2. When cruising distance display is abnormal.**

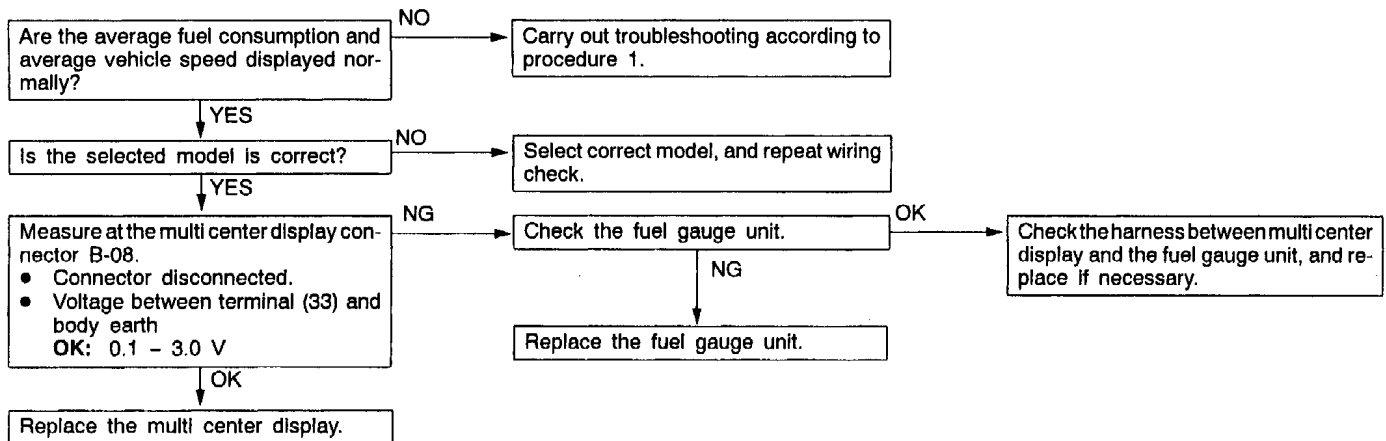

## INSPECTION PROCEDURE 8

**Display moves about.  
Screen colors do not match correctly.**

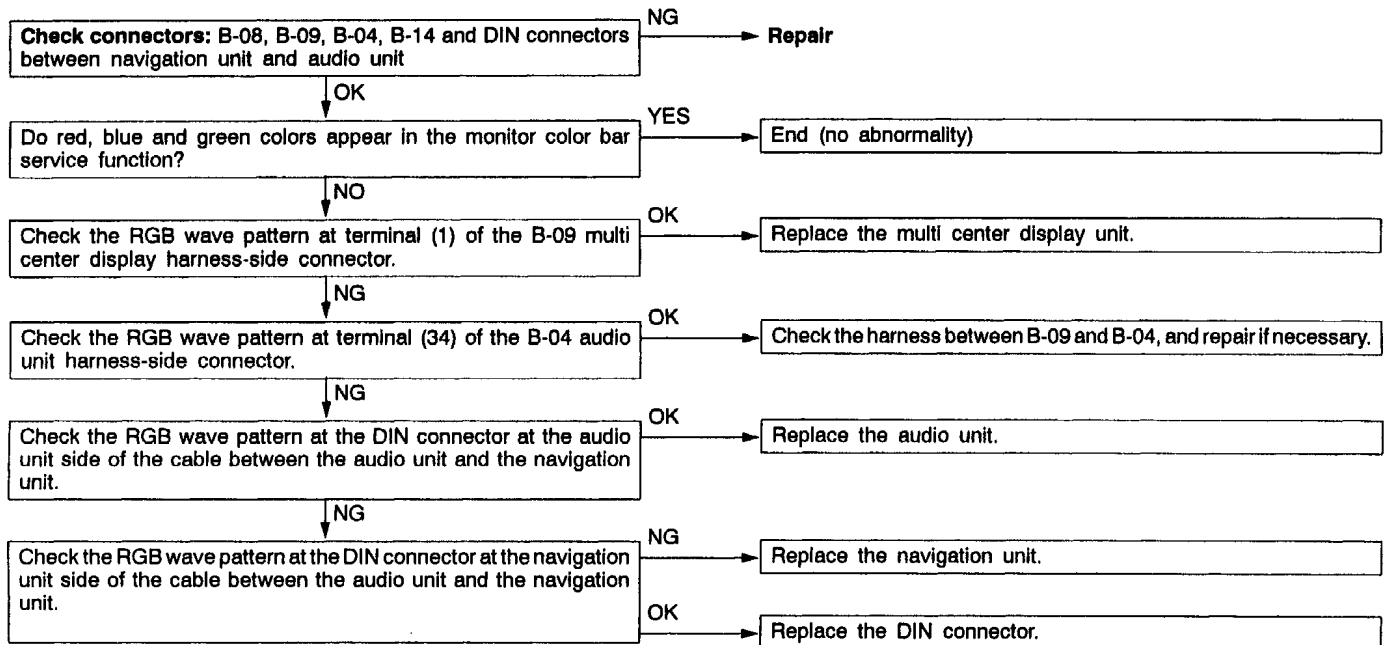

## INSPECTION PROCEDURE 9

**Daytime/nighttime display mode does not change in conjunction with lighting switch operations.**

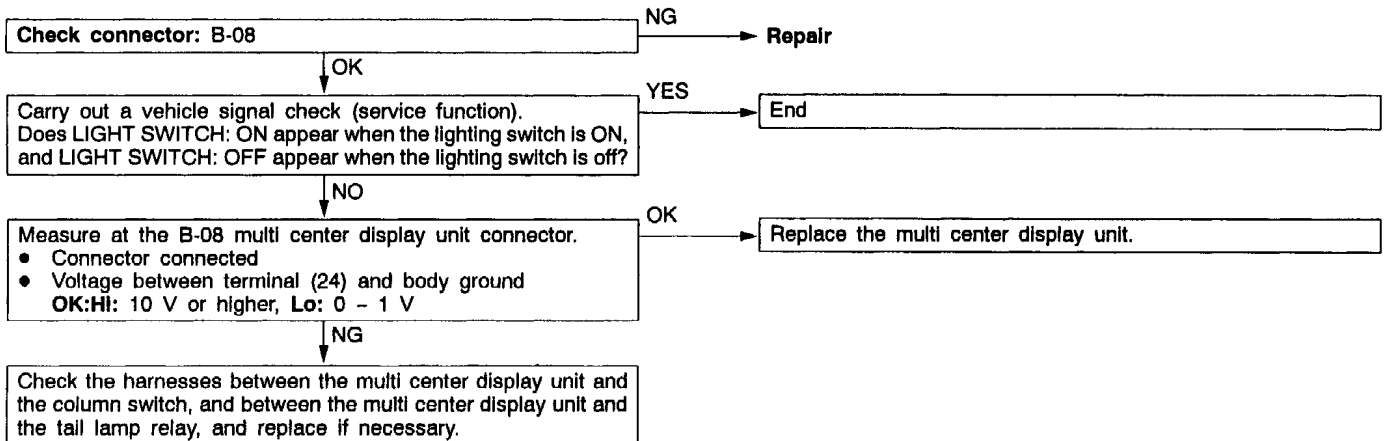

**INSPECTION PROCEDURE 10**

**Compass display does not change when not following a route, or guide does not appear when searching for and following a route.**

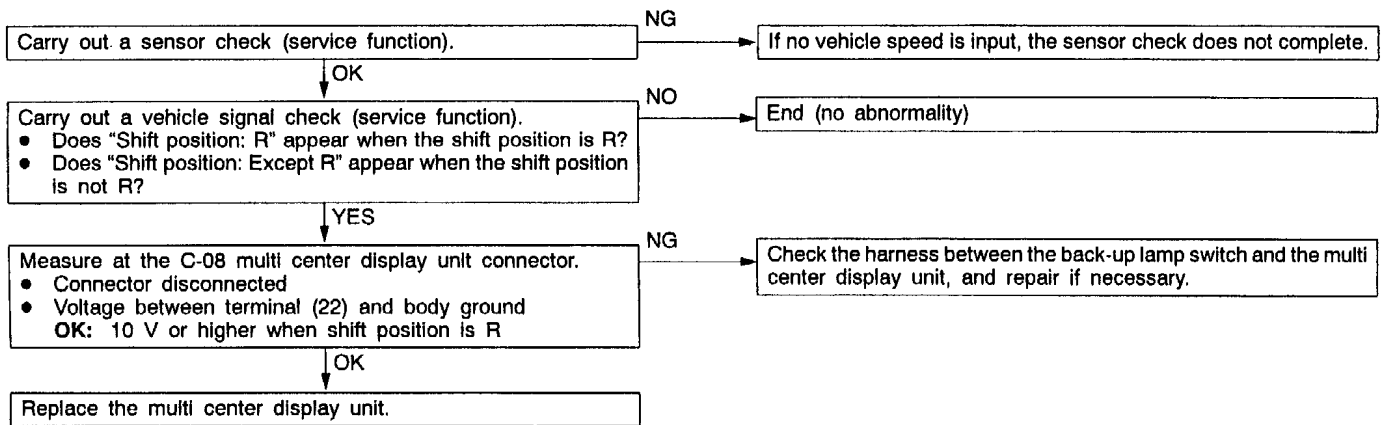

**INSPECTION PROCEDURE 11**

**One of the following messages appears during navigation mode.**

- The CD-drive has failure condition. Confirm and reload the disc, please.
- Wrong disc is in the CD-drive. Insert a map disc, please.
- No disc is in the CD-drive. Insert a map disc, please.
- A music disc is in the CD-drive.

**1. "The CD-drive has failure condition. Confirm and reload the disc, please." or "Wrong disc is in the CD-drive. Insert a map disc, please." appears.**

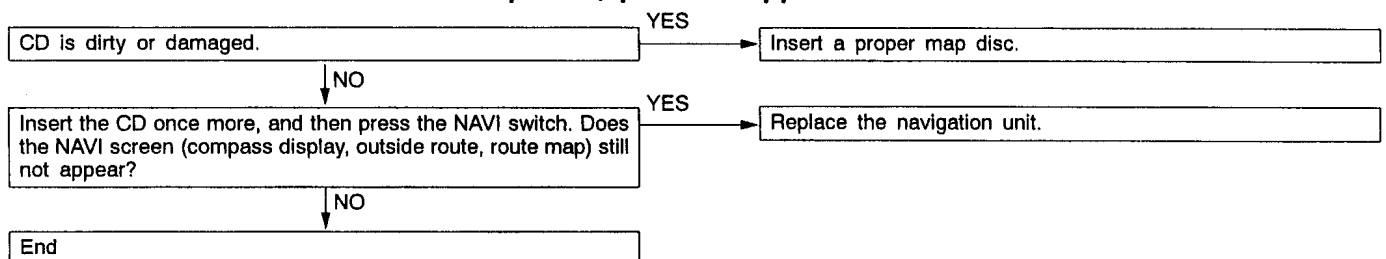

**2. "No disc is in the CD-drive. Insert a map disc, please." or "A music disc is in the CD-drive" appears.**

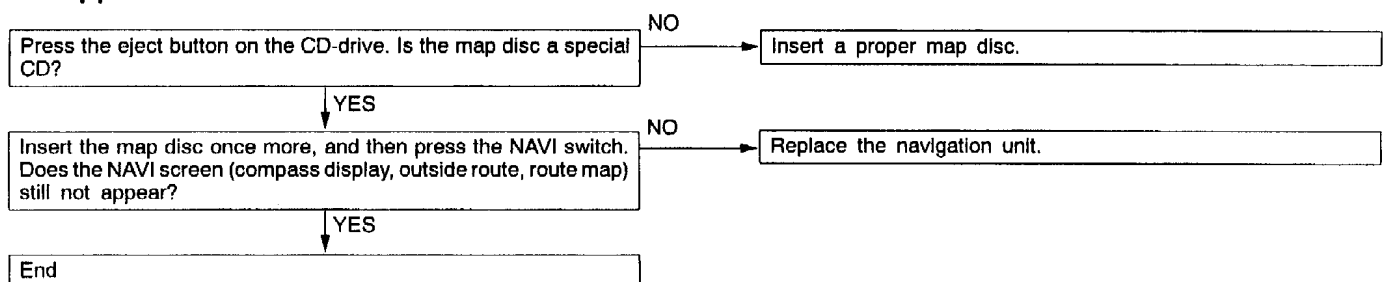

**ERROR CODE TABLE**

Error Code No.	Error Details	Detection Method (Reference)	Reference Page
1011	Ambient temperature sensor not connected during diagnosis	Connection checking	54-28
1021	Fuel gauge not connected during diagnosis	Connection checking	54-29
1031	GPS abnormality during diagnosis	Connection checking	54-29
1041	Engine-ECU not connected during diagnosis	Connection checking	54-29
1051	SWS not connected during diagnosis (This error does not occur when correct car type is set)	Connection checking	54-29
1091	CD drive too hot during diagnosis	Connection checking	54-29
1092 – 1096	CD drive abnormality during diagnosis	Connection checking	54-30
10A1, 10B1	Memory of navigation unit abnormality during diagnosis	Connection checking	54-30
20D1, 30D1	Vehicle speed pulse abnormality during diagnosis	Sensor checking	54-30
20E1, 20E2, 30E1, 30E2	Gyro level abnormality during diagnosis	Sensor checking	54-30

**INSPECTION PROCEDURES FOR EACH ERROR CODE**

**Error Code No. 1011**

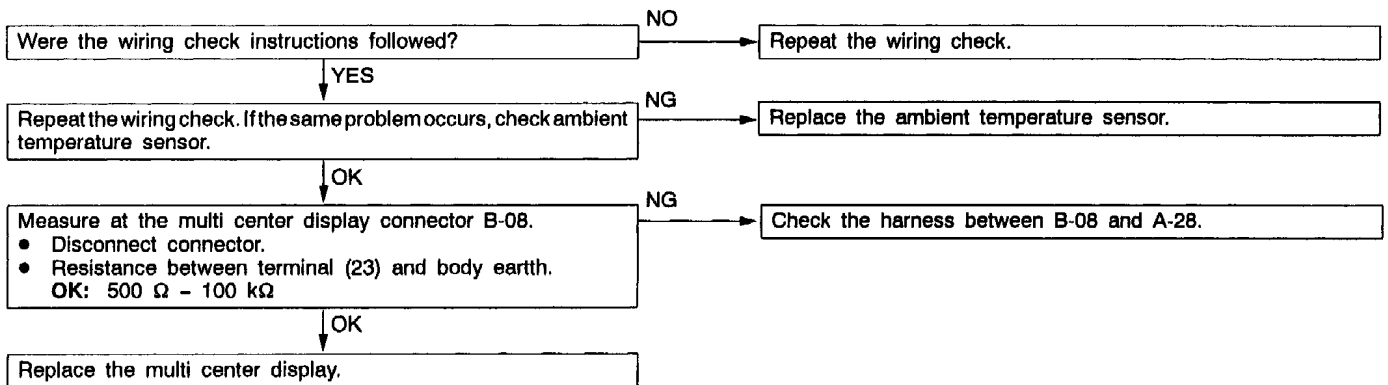

**Error Code No. 1021**

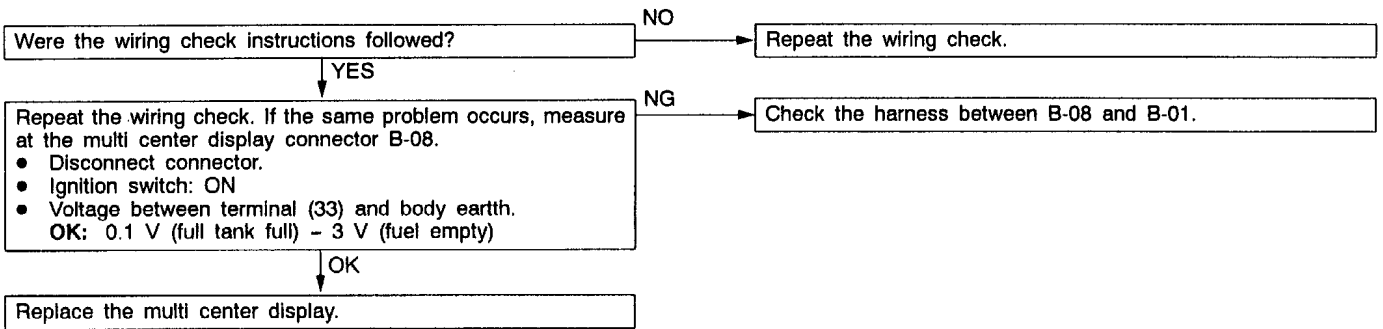

**Error Code No. 1031**

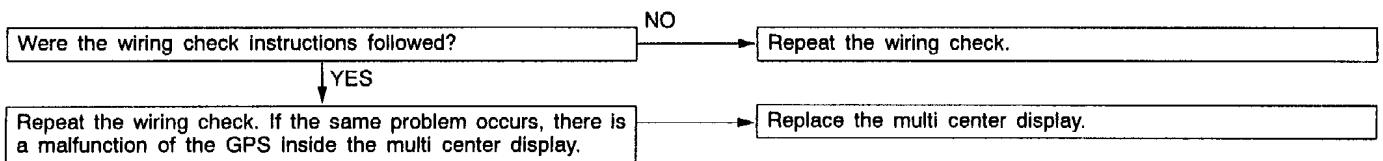

**Error Code No. 1041**

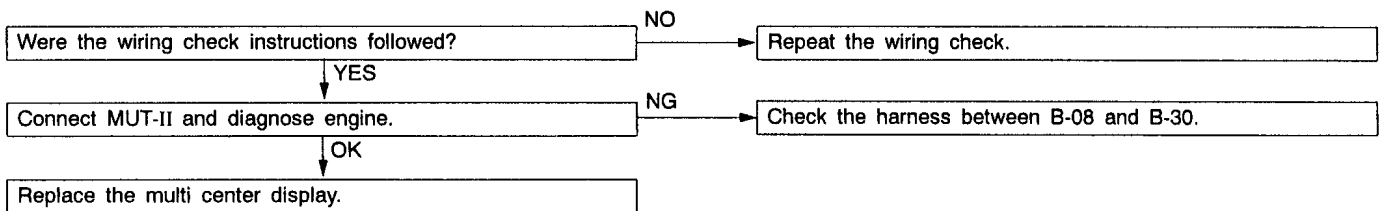

**Error Code No. 1051**

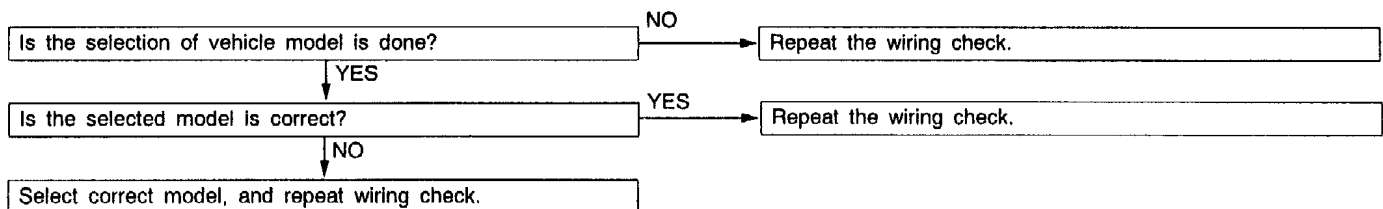

**How to confirm model selection is correctly done.**

- (1) Press "DISP" switch to get trip information display.
- (2) If "Please set your car type" message appears, the vehicle model is not set. Select the correct vehicle model from the list.
- (3) If trip information display appears normally, the vehicle model is set already. Press RESET (F1) switch and keep until the vehicle setting display appears. Current setting of vehicle model will appear on the display.

**Error Code No. 1091**

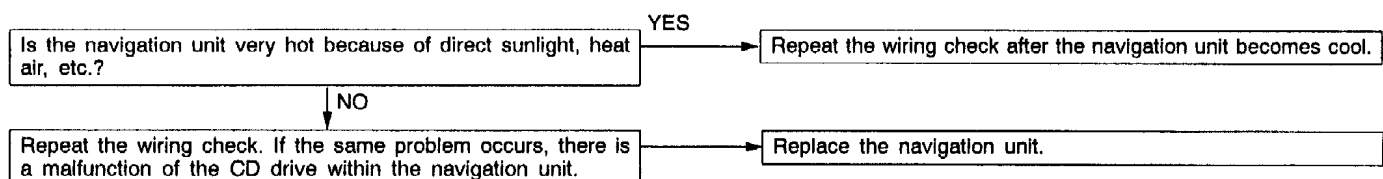

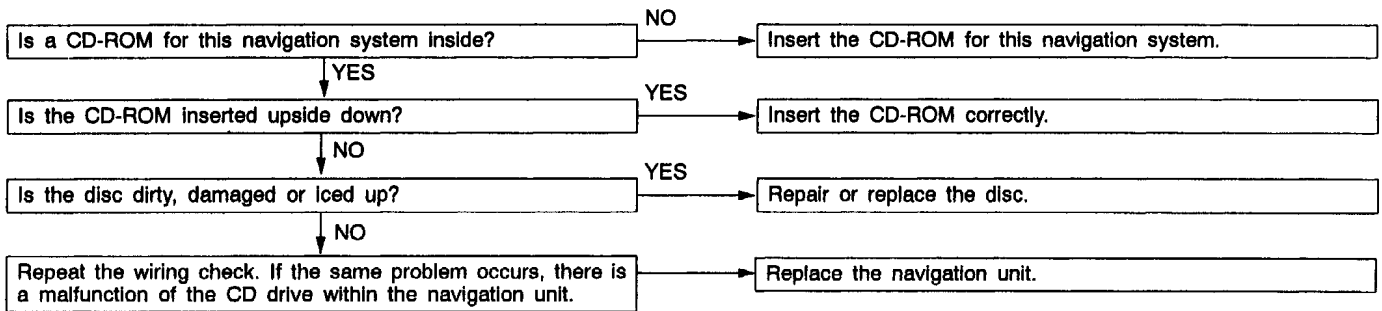
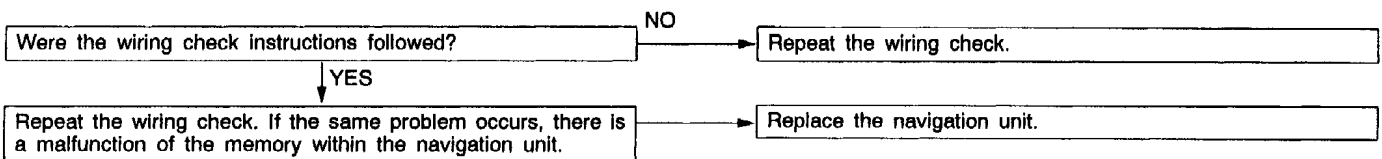
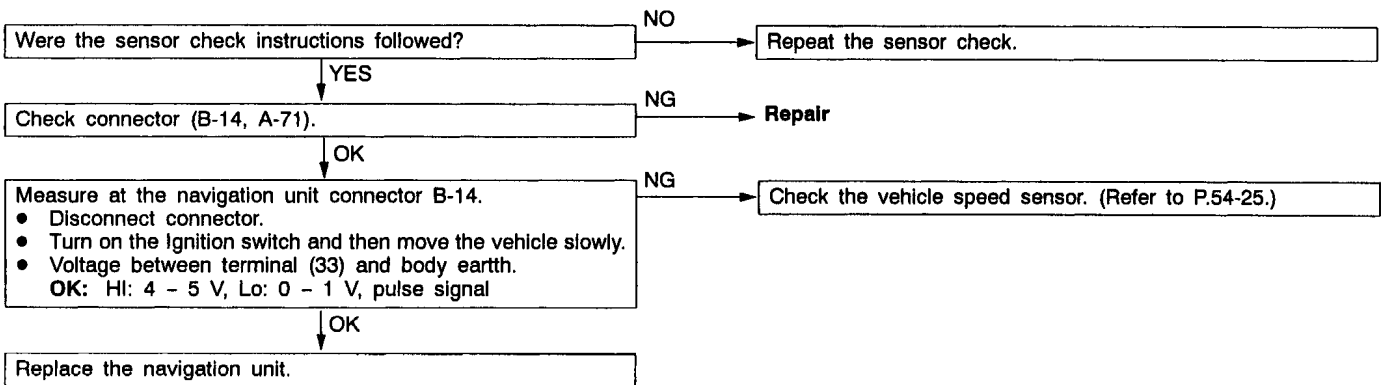
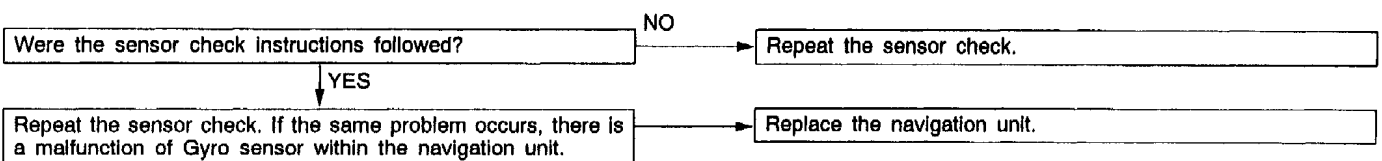
**Error Code No. 1092, 1093, 1094, 1095, 1096****Error Code No. 10A1, 10B1****Error Code No. 20D1, 30D1****Error Code No. 20E1, 20E2, 30E1, 30E2**

**TROUBLESHOOTING <Vehicles without navigation system>****NOTES WITH REGARD TO SERVICE PROCEDURES****1. Before removing the battery**

The audio system has a large amount of data stored in memory which the user enters over time. When the terminals are disconnected from the battery, the memory which stores this data is affected as shown in the table below. Accordingly, it is necessary to make sure that you take notes of important information before disconnecting the battery.

Function	Input function/memory	When battery is disconnected
Radio	Channels which are selected during a search	Disappear after a few seconds
	Preset channels	
Tone/Balance	Position set on Bass, Treble, Balance and Fader	
Clock set on display	Current time	Keep a data for approx. one hour
Brightness set for display	Position set on display	
Unit set for trip computer	km or mile, L/100km or mpg or km/L	
Average speed on display	Average speed after reset	
Average fuel consumption on display	Average fuel consumption after reset	
Cruising range on display	Cruising range, fuel economy	
Outside temperature on display	A temperature after the ignition switch is turned to OFF (LOCK).	Keep a data for approx. one hour If the engine is hot, the multi center display might show high temperature when the display unit is reconnected after one hour.

**2. Diagnosis Function for Audio System**

Audio system has the following diagnosis function.

Function	Contents
Speaker diagnosis function	This function checks if the speakers are all working normally on the audio system or not.
Service functions (1) Check the LCD segments (2) Check the sensors (3) Check units connected into audio system	There are the following 3 diagnosis modes available. The LCD segments for display available to light on or not. Outside temperature, voltage of fuel gauge unit and battery, remaining fuel level, fuel economy calculated after refuelling. Units connected on display Voltage on terminal for MUT-II Engine speed signal, which is sent by ECU Oscillation of internal clock

### 3. Speaker Connection Diagnosis

#### Outline

- This diagnosis function checks whether the more than one wired speakers are normally connected to the audio unit and the speaker wiring is pinched in the vehicle.
- The test tone sounds from an applicable speaker according to the display (FL, FR, RL, RR).

#### Function explanation

To diagnose speaker connections, follow the procedure below to enter the test mode.

##### 1. Entry to test mode

- (1) Turn the ignition switch to ACC.
- (2) Turn off the power supply switch of the audio unit.
- (3) Press the "CH1" button.
- (4) Press the "Automatic tuning in down button."
- (5) Press the "Automatic tuning in up button."
- (6) Press the "CH6" button. Then the audio unit will enter the test mode.

#### NOTE

The above operation must be finished within 60 seconds after the power supply switch is turned off (If 60 seconds have passed, the operation is invalid).

If you fail in the operation, you must push the power supply switch twice to reset the unit. Then repeat the steps above from step (1).

- (7) The test tone will sound at a constant interval. If you want to change an applicable speaker, you should press the "CH6" button.

##### 2. Cancelling the test mode

The test mode will be canceled by one of the operations below.

- Press any button (except the "CH6" button). In addition, if a mode button (LW/MW/LW, CD, TAPE) is pressed, the audio unit will enter an applicable function after cancelling the test mode.
- Turn the ignition switch to OFF(LOCK).



#### 4. Service Mode For Multi Center Display

##### 1. Enter and terminate the service mode

- (1) To enter the service mode, turn the ignition switch to ACC.
- (2) Press the "H" button twice.
- (3) Press the "SET" button and (A) button at the same time.
- (4) Then the audio unit will enter the service mode.

First of all, the service mode will show model identification for the multi center display and the vehicle identification. Then the service mode proceeds to three checks; LCD segment check, Sensor check and Unit check. To switch over these checks, press the "SET" button.

- (5) To terminate the service mode, press any button other than the "SET" button.

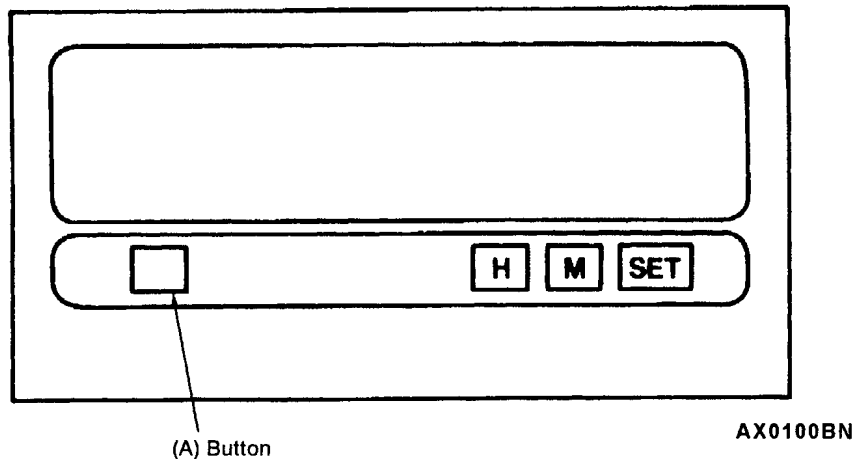

##### 2. Details of the service mode

The service mode checks the following in that order:

###### (1) LCD segment check

This screen is divided into four areas. Each area will be active sequentially whenever the "SET" button is pressed.

When the "SET" button is pressed four times in this screen, the service mode will proceed to the Sensor check.

###### (2) Sensor check

This screen shows voltage signals from the outside temperature sensor, the fuel gauge unit, and the ignition switch as well as fuel economy.

When the "SET" button is pressed once in this screen, the service mode will proceed to the Unit check.

###### (3) Unit check connected into audio system

This screen shows an audio equipment, air conditioner or MUT-II connected in the system, percentage of system voltage, engine speed sent by the engine-ECU, and oscillation of internal clock.

When the "SET" button is pressed once in this screen, the service mode will return to the first screen (model identification screen).

## MAIN UNIT TERMINAL VOLTAGES

## 1. MULTI CENTER DISPLAY UNIT

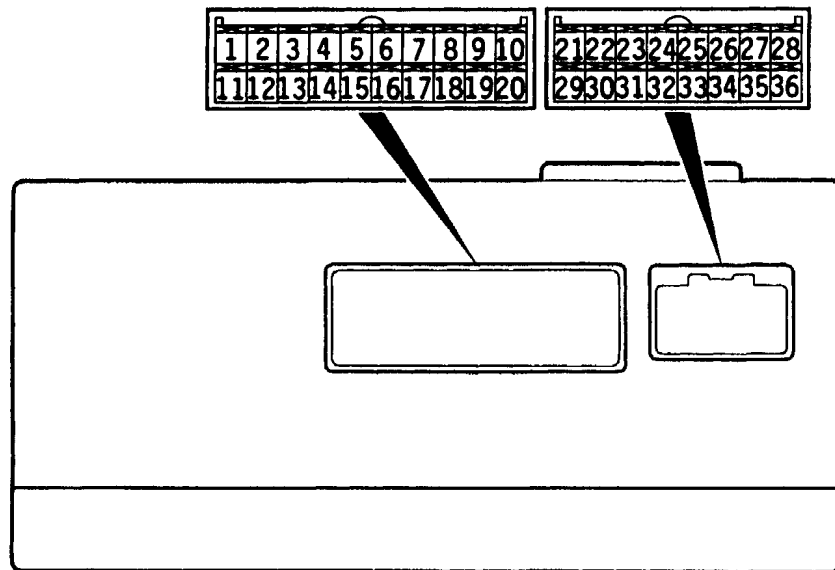

W0278AJ

Terminal No.	Input/Output	Signal Symbol	Terminal Voltage (V)	Harness Problem		Trouble Symptom Resulting from Harness Problem
				Open Circuit	Short-circuit	
1-4	-	-	-	-	-	-
5	Input	ISOK	Hi: System voltage Lo: 0 - 1	○	○	MUT-II cannot be used to check engine-ECU.
6	-	-	-	-	-	-
7	Input/Output	M-DATA (AUDIO)	Hi: 4 - 5 Lo: 0 - 1	○	○	Audio display dose not appear. Panel switch cannot be operated for audio unit. Nighttime illumination dose not appear for audio unit.
8	Input/Output	M-CLOCK (AUDIO)	Hi: 4 - 5 Lo: 0 - 1	○	○	Audio display dose not appear. Panel switch cannot be operated for audio unit. Nighttime illumination dose not appear for audio unit.
9-14	-	-	-	-	-	-
15	Input/Output	K	Hi: System voltage Lo: 0 - 1	○	○	Values on Trip information screen (average speed, fuel consumption and cruising distance) are abnormal. Communication is not possible between the engine-ECU and the MUT-II.
16	-	-	-	-	-	-

Terminal No.	Input/Output	Signal Symbol	Terminal Voltage (V)	Harness Problem		Trouble Symptom Resulting from Harness Problem
				Open Circuit	Short-circuit	
17	Input/Output	M-BUSY (AUDIO)	Hi: 4 – 5 Lo: 0 – 1	○	○	Audio display dose not appear. Panel switch cannot be operated for audio unit. Nighttime illumination dose not appear for audio unit.
18	-	SHIELD-GND	-	-	-	-
19 – 22	-	-	-	-	-	-
23	Input	EX-TEMP		○	○	Outside air temperature does not appear.
24	Input	ILL+	Hi: System voltage Lo: 0 – 1	○	-	Nighttime illumination does not appear for any navigation system units.
				-	○	Blown multipurpose fuse.
25	Input	ACC (ACC power supply)	System voltage	○	-	Screen display does not appear.
				-	○	Blown multipurpose fuse.
26	Input	+B	System voltage	○	-	Screen display does not appear.
				-	○	Blown multipurpose fuse.
27	Input	VSS		○	-	No effect.
28	-	GND (Ground)	-	○	-	Screen display does not appear.
29, 30	-	-	-	-	-	-
31	-	GND-TEMP	-	○	○	Outside air temperature does not appear.
32	Input	ILL-	-	-	-	-
33	Input	FUEL GAUGE	-	○	○	Abnormal cruising distance display.
34, 35	-	-	-	-	-	-
36	Input	IG1	System voltage	○	-	Communication with engine-ECU is not possible. Driving data values displayed are abnormal.
				-	○	Communication with engine-ECU is not possible. Driving data values displayed are abnormal. Blown multipurpose fuse.

2. AUDIO UNIT

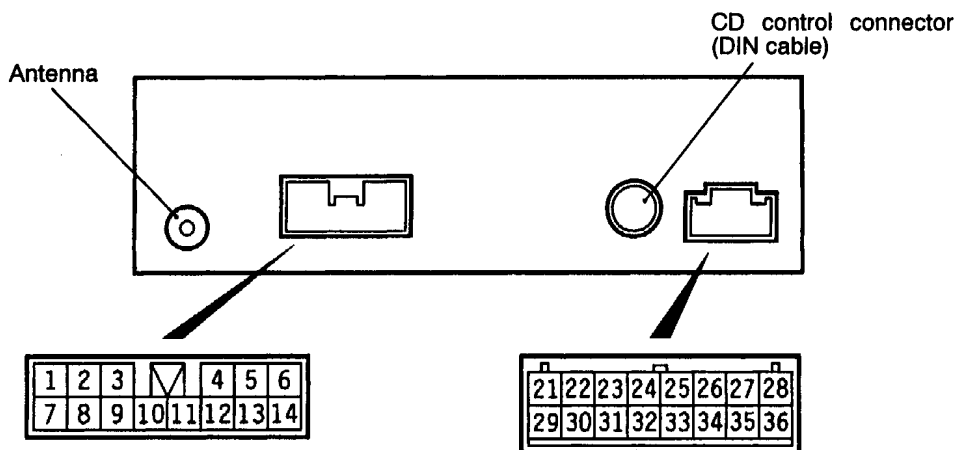

BV0846AE

Terminal No.	Input/Output	Signal Symbol	Terminal Voltage (V)	Harness Problem		Trouble Symptom Resulting from Harness Problem
				Open Circuit	Short-circuit	
1	Output	SPEAKER RR (+)	0 – System voltage (AC)	○	–	No sound is output from rear right speaker.
				–	○	No sound is output from rear left and right speakers.
2	Output	SPEAKER RL (+)	0 – System voltage (AC)	○	–	No sound is output from rear left speaker.
				–	○	No sound is output from rear left and right speakers.
3	Output	ANTENNA +B (Radio antenna amplifier power supply)	Hi: 10 or more Lo: 0 – 1	○	○	Low radio sensitivity.
4	–	–	–	–	–	–
5	Output	SPEAKER FL (+)	0 – System voltage (AC)	○	–	No sound is output from front left speaker.
				–	○	No sound is output from front left and right speakers.
6	Output	SPEAKER FR (+)	0 – System voltage (AC)	○	–	No sound is output from front right speaker.
				–	○	No sound is output from front left and right speakers.
7	Output	SPEAKER RR (–)	0 – System voltage (AC)	○	–	No sound is output from rear right speaker.
				–	○	No sound is output from rear left and right speakers.

Terminal No.	Input/Output	Signal Symbol	Terminal Voltage (V)	Harness Problem		Trouble Symptom Resulting from Harness Problem
				Open Circuit	Short-circuit	
8	Output	SPEAKER RL (-)	0 – System voltage (AC)	○	-	The rear left speaker does not sound.
				-	○	The rear left and right speakers do not sound.
9	-	-	-	-	-	-
10	Input	ACC (ACC power supply) (System voltage)	System voltage	○	-	The audio unit power supply does not turn on.
				-	○	Blown multipurpose fuse.
11	Input	+B (System voltage)	System voltage	○	-	Cassette is not ejected when the ignition switch is at ACCf. The memory are cleared.
				-	○	Blown multipurpose fuse.
12	Input	ILL (-)	-	-	-	-
13	Output	SPEAKER FL (-)	0 – System voltage (AC)	○	-	The front left speaker does not sound.
				-	○	The front left and right speakers do not sound.
14	Output	SPEAKER FR (-)	0 – System voltage (AC)	○	-	The front right speaker does not sound.
				-	○	The front left and right speakers do not sound.
21	Input/Output	M-DATA	Hi: 4 or more Lo: 1 or less	○	○	Panel switches cannot be operated.
22	Input/Output	M-SCK	Hi: 4 or more Lo: 1 or less	○	○	Panel switches cannot be operated.
23	Input	TELEPHONE MUTE	Hi: 4 or more Lo: 1 or less	-	○	Audio volume does not drop.
24 – 28	-	-	-	-	-	-
29	Input/Output	M-BUSY	Hi: 4 or more Lo: 1 or less	○	○	Panel switches cannot be operated.
30	-	SHIELD EARTH (M-BUS)	-	-	-	-
31 – 36	-	-	-	-	-	-

**INSPECTION CHART CLASSIFIED BY TROUBLE SYMPTOMS**

Related Unit	Trouble Symptom	Inspection Procedure No.	Reference Page
Malfunction of multi center display	No display appears after the ignition key is turned to ACC.	1	54-38
	TAPE/CD, UML switches do not work.	2	54-39
	CD switches do not work.	3	54-40
	Outside temperature data is not displayed. /Outside temperature data is abnormal.	4	54-40
	Abnormal driving data display <ul style="list-style-type: none"> <li>● Abnormal average fuel consumption (momentary fuel consumption) and average speed displays.</li> <li>● Abnormal cruising distance displays</li> </ul>	5	54-41
	No illumination of audio button	6	54-42
	Dim display	7	54-42
	Clock runs fast or slow	8	54-42

**INSPECTION PROCEDURES FOR EACH TROUBLE SYMPTOM**

**INSPECTION PROCEDURE 1**

**No display appears after the ignition key is turned to ACC.**

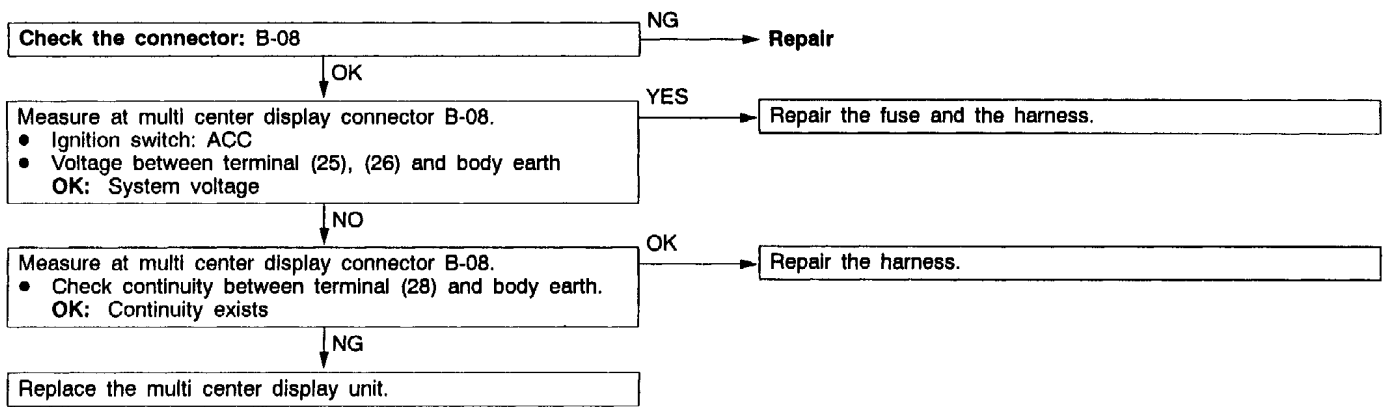

INSPECTION PROCEDURE 2

TAPE/CD, UML switches do not work.

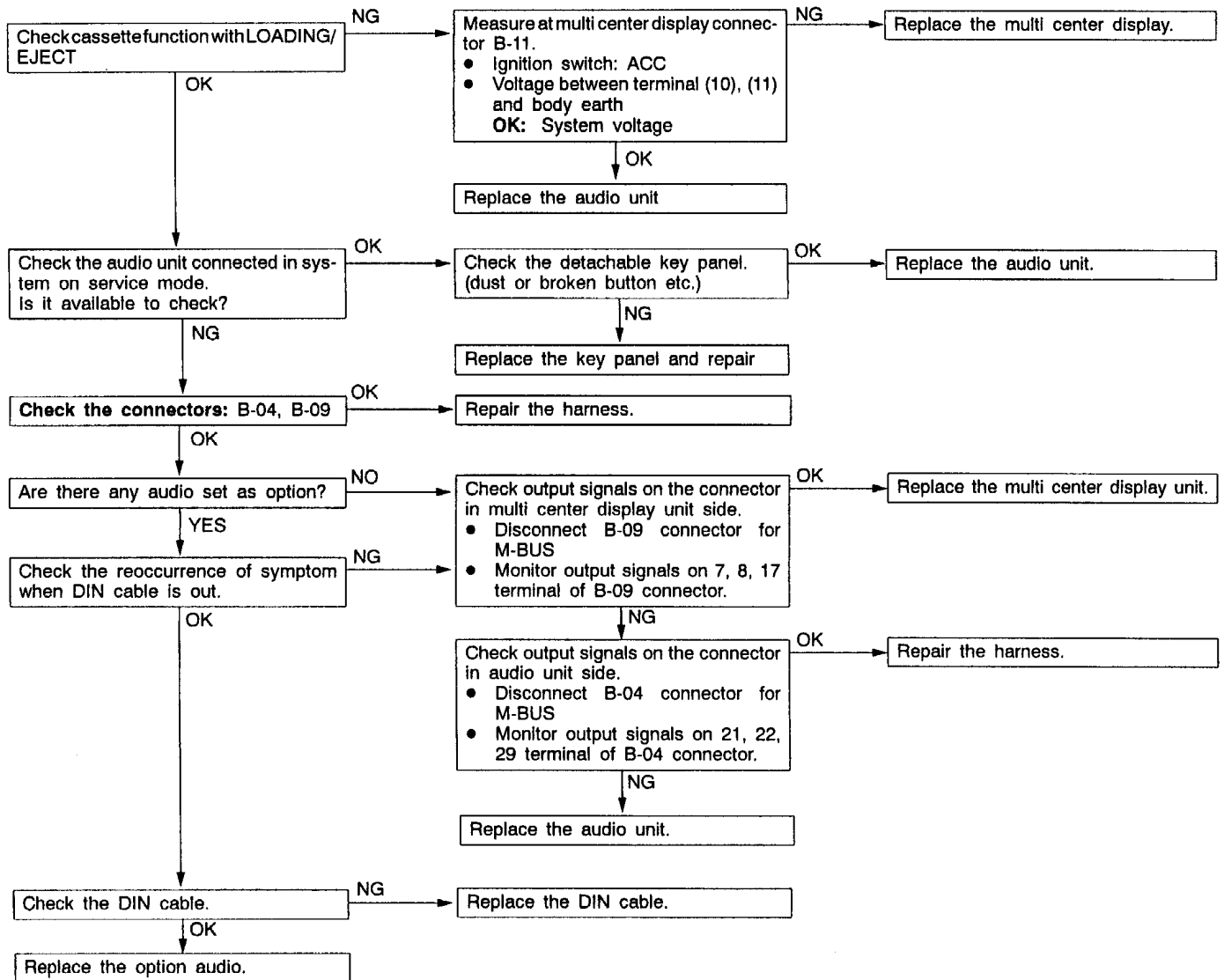

**INSPECTION PROCEDURE 3**

**CD switch do not work.**

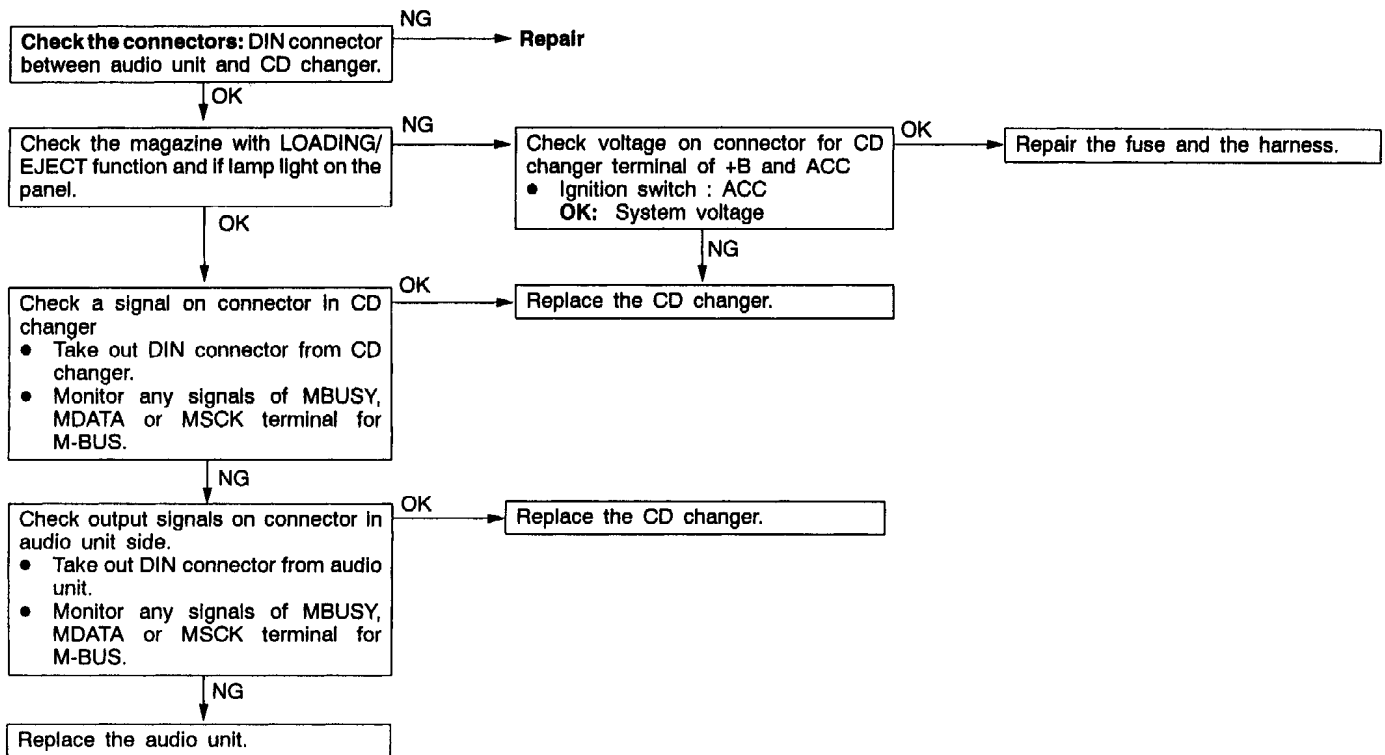

**INSPECTION PROCEDURE 4**

**Outside air temperature data is not displayed. /Outside air temperature data is abnormal.**

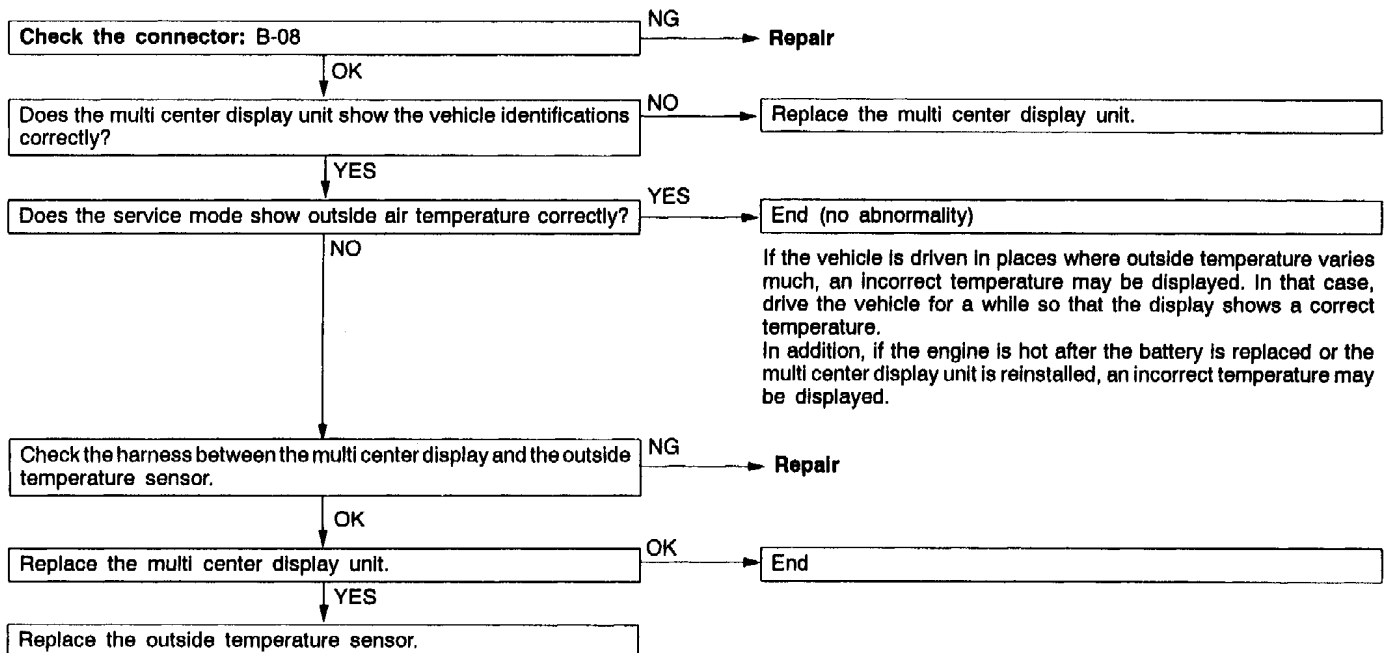



**INSPECTION PROCEDURE 5**

**Abnormal driving data displays.**

- Abnormal average fuel consumption (momentary fuel consumption) and average speed displays.
- Abnormal cruising distance displays.

**1. When average fuel consumption (momentary fuel consumption) and average speed displays are abnormal.**

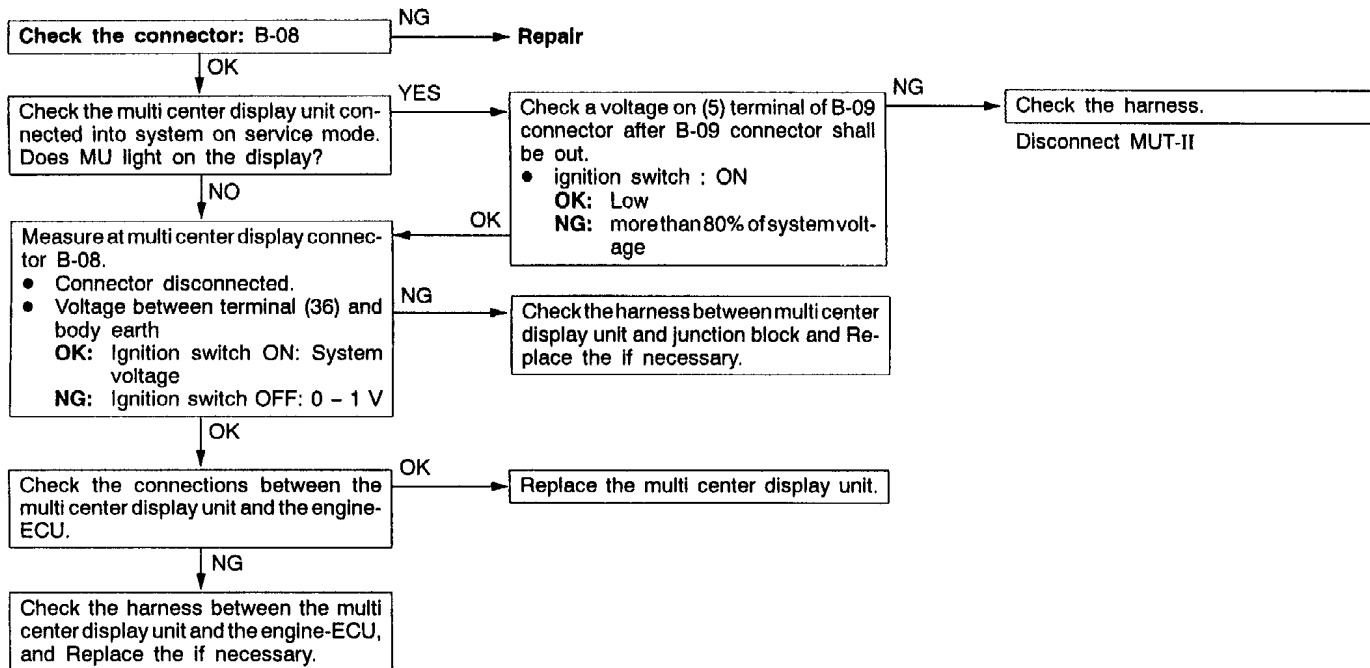

**2. When cruising distance display is abnormal.**

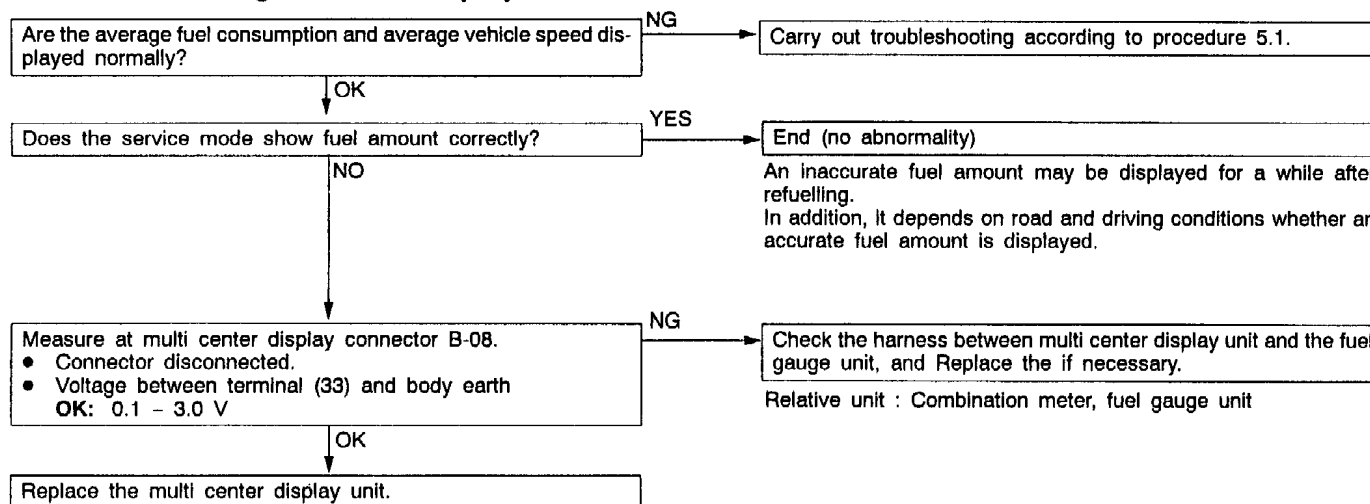

**INSPECTION PROCEDURE 6**

**No illumination for audio buttons light on.**

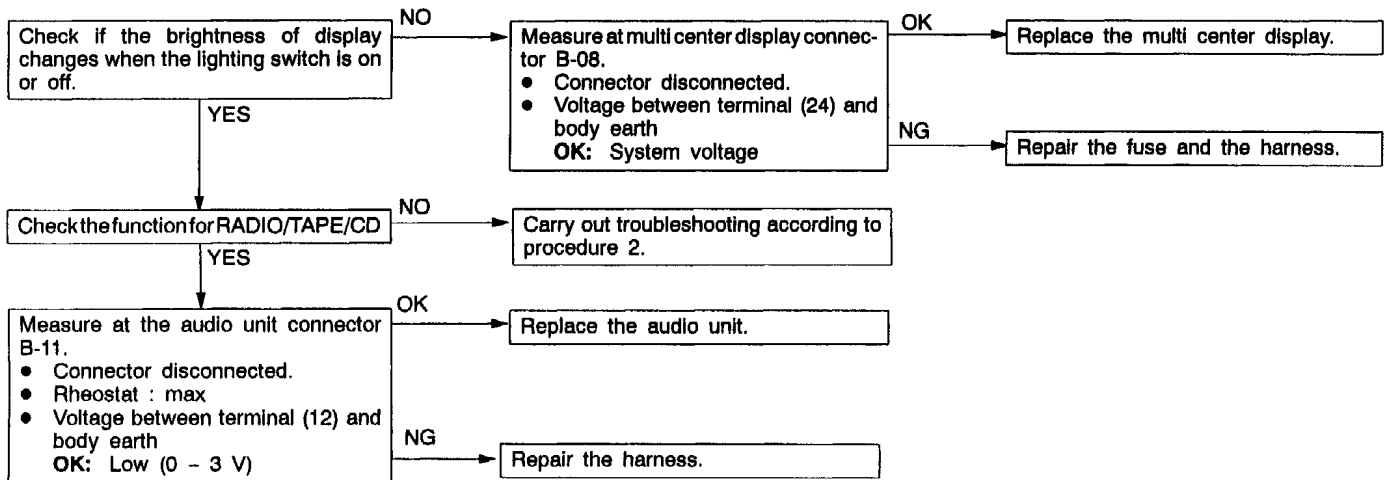

**INSPECTION PROCEDURE 7**

**Dim display**

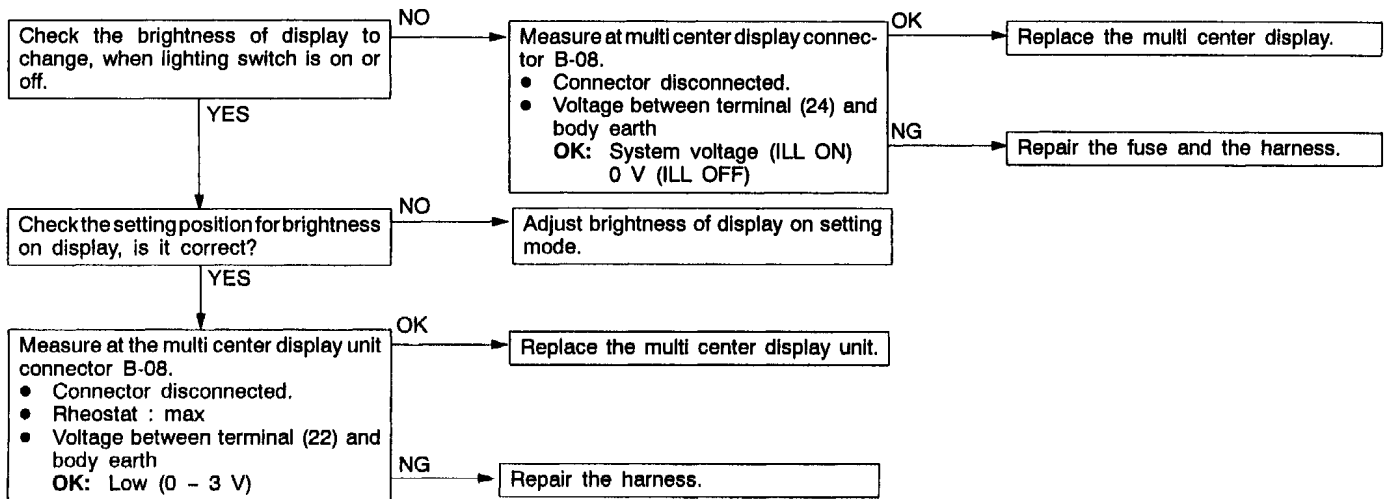

**INSPECTION PROCEDURE 8**

**Clock runs fast or slow/Indicate different time**

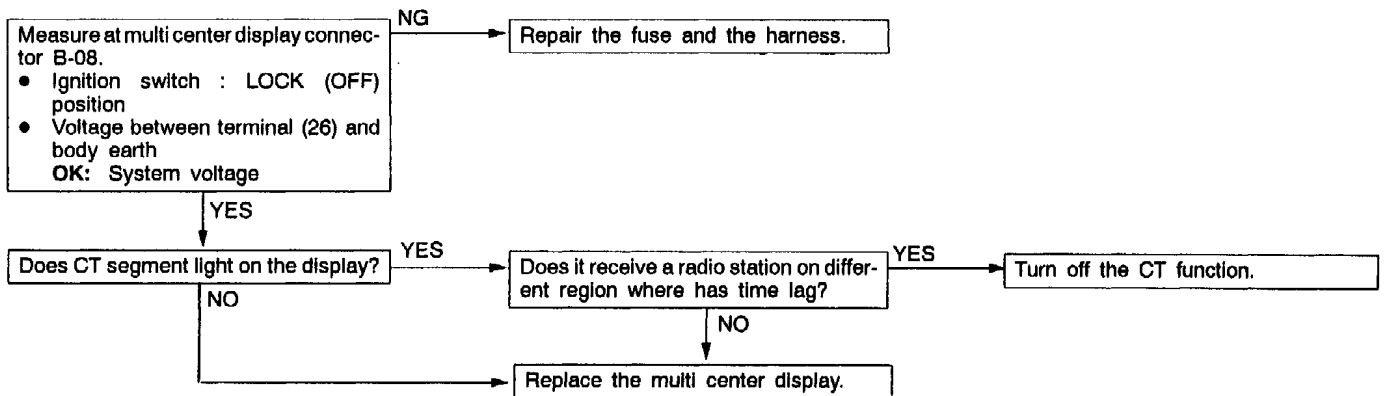

## MULTI CENTER DISPLAY REMOVAL AND INSTALLATION

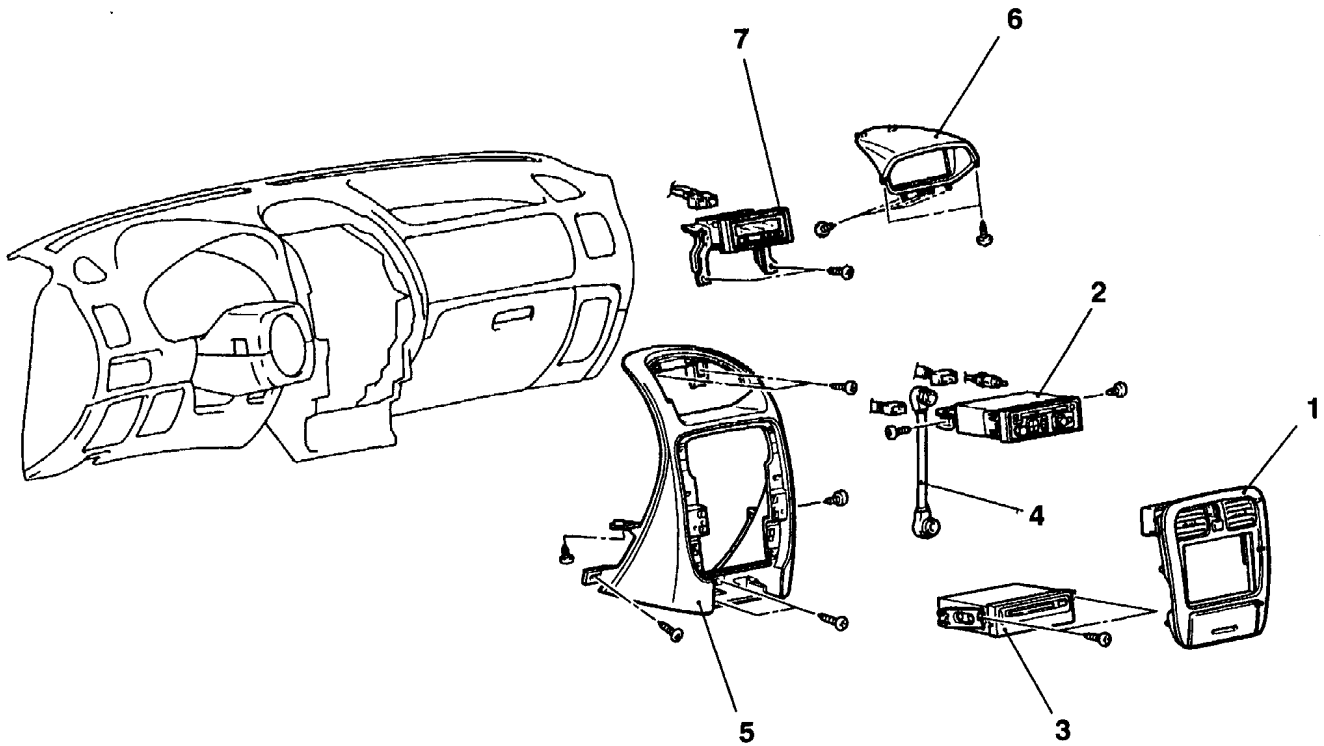

AX0101BN

### Removal steps

1. Center panel assembly  
(Refer to GROUP 52A – Floor Console.)
2. Radio and tape player
3. Navigation unit <Vehicles with navigation system>
4. DIN cable
5. Center console assembly  
(Refer to GROUP 52A – Floor Console.)
6. Multi center display hood
7. Multi center display