

GROUP 90

CIRCUIT DIAGRAMS

CONTENTS

HOW TO READ CIRCUIT DIAGRAMS	90-4	TAILLIGHT, POSITION LIGHT, REAR SIDE MAKER LIGHT, LICENSE PLATE LIGHT AND LIGHTING MONITOR TONE ALARM.....	90-74
ETACS-ECU.....	90-10	FOG LIGHT.....	90-78
JOINT CONNECTOR.....	90-14	DAYTIME RUNNING LIGHT.....	90-80
CENTRALIZED JUNCTION.....	90-19	DOME LIGHT, LUGGAGE COMPARTMENT LIGHT AND IGNITION KEY HOLE ILLMINATION LIGHT <VEHICLES WITHOUT KEYLESS ENTRY SYSTEM>	90-84
POWER DISTRIBUTION SYSTEM ..	90-26	DOME LIGHT, LUGGAGE COMPARTMENT LIGHT AND IGNITION KEY HOLE ILLMINATION LIGHT <VEHICLES WITH KEYLESS ENTRY SYSTEM>	90-88
STARTING SYSTEM <M/T>	90-34	TURN-SIGNAL LIGHT AND HAZARD WARNING LIGHT.....	90-94
STARTING SYSTEM <CVT>.....	90-35	STOPLIGHT	90-98
IGNITION SYSTEM	90-36	HORN	90-99
CHARGING SYSTEM	90-40		
MFI SYSTEM	90-44		
COOLING SYSTEM.....	90-56		
SHIFT LOCK MECHANISM.....	90-59		
INVECS-III CVT	90-60		
HEADLIGHT.....	90-70		

Continued on next page

BACKUP LIGHT.....	90-100	CLOCK	90-184
METER AND GAUGE	90-102	MITSUBISHI MULTI COMMUNICATION SYSTEM (MMCS)	90-186
BRAKE WARNING LIGHT, OIL PRESSURE WARNING LIGHT, FUEL WARNING LIGHT	90-106	ACCESSORY SOCKET AND CIGARETTE LIGHTER.....	90-202
POWER WINDOWS <VEHICLES WITHOUT CENTRAL DOOR LOCKING SYSTEM>.....	90-110	ANTI-LOCK BRAKING SYSTEM (ABS).....	90-204
POWER WINDOWS <VEHICLES WITH CENTRAL DOOR LOCKING SYSTEM>.....	90-116	SUPPLEMENTAL RESTRAINT SYSTEM (SRS).....	90-212
CENTRAL DOOR LOCKING SYSTEM <VEHICLES WITHOUT KEYLESS ENTRY SYSTEM>	90-122	IMMOBILIZER SYSTEM.....	90-222
CENTRAL DOOR LOCKING SYSTEM <VEHICLES WITH KEYLESS ENTRY SYSTEM>.....	90-128	AUTO-CRUISE CONTROL SYSTEM.	90-226
KEYLESS OPERATING SYSTEM (KOS)	90-138	SUNROOF.....	90-232
AUTOMATIC AIR CONDITIONING SYSTEM.....	90-146	HEATED SEAT	90-234
WINDSHIELD WIPER AND WASHER	90-158	IGNITION KEY REMINDER TONE ALARM <VEHICLES WITHOUT KOS>	90-238
REAR WINDOW DEFOGGER.....	90-160	IGNITION KEY REMINDER TONE ALARM <VEHICLES WITH KOS> ...	90-240
HEATED DOOR MIRROR	90-164	DOOR AJAR WARNING TONE ALARM	90-244
REMOTE CONTROLLED MIRROR..	90-166	SEAT BELT WARNING TONE ALARM	90-248
AUDIO SYSTEM <VEHICLES WITHOUT AUDIO AMPLIFIER>	90-168	HANDS FREE SYSTEM	90-252
AUDIO SYSTEM <VEHICLES WITH AUDIO AMPLIFIER>	90-174	CONTROLLER AREA NETWORK (CAN)	90-264
		TIRE PRESSURE MONITORING SYSTEM (TPMS)	90-274
		THEFT-ALARM SYSTEM.....	90-278

NOTES

HOW TO READ CIRCUIT DIAGRAMS

The circuit of each system from the fuse (or fusible link) to ground is shown. The power supply is shown at the top and the ground at the bottom to facilitate understanding of how the current flows. Some variations are included in one circuit diagram. Accordingly, some diagrams may not be applicable for individual vehicles. The circuit diagrams show the state when switches are operated.

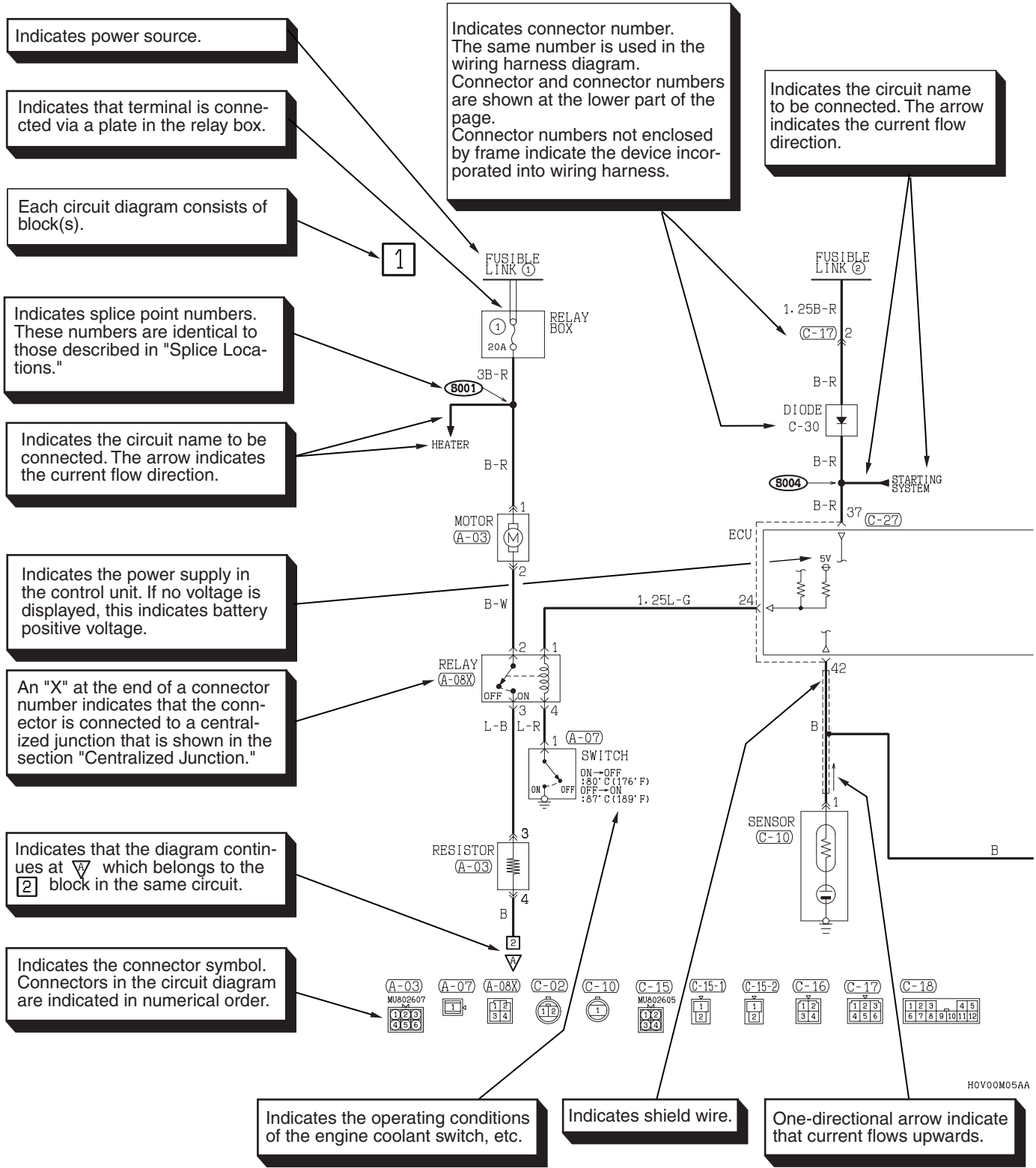

H0V00M05AA

AC106603AG

Indicates input/output to/from control unit (current flow direction).

Input Output Input/output

Indicates a wiring connector which is inside the equipment and which is not shown in the wiring harness configuration diagram.

Example C-15-2

Indicates a connector which is inside the equipment, numbered in order starting from 1.

Indicates the connector number shown in the wiring harness configuration diagram.

Indicates that the diagram comes from ▽ which belongs to the 1 block in the same circuit.

Indicates terminal number.

In case two or more connectors are connected to the same device, markings indicating the same connector is connected by a broken line.

Bi-directional arrow indicates that current flows in both directions due to control by an ECU.

Indicates harness junction where wire diameter or color changes.

Indicates intersections at which the lead wires are not connected.

Indicates intersections at which the lead wires are connected.

Indicates representative vehicle body ground point. (Same number as that of ground point in GROUNDING LOCATION).

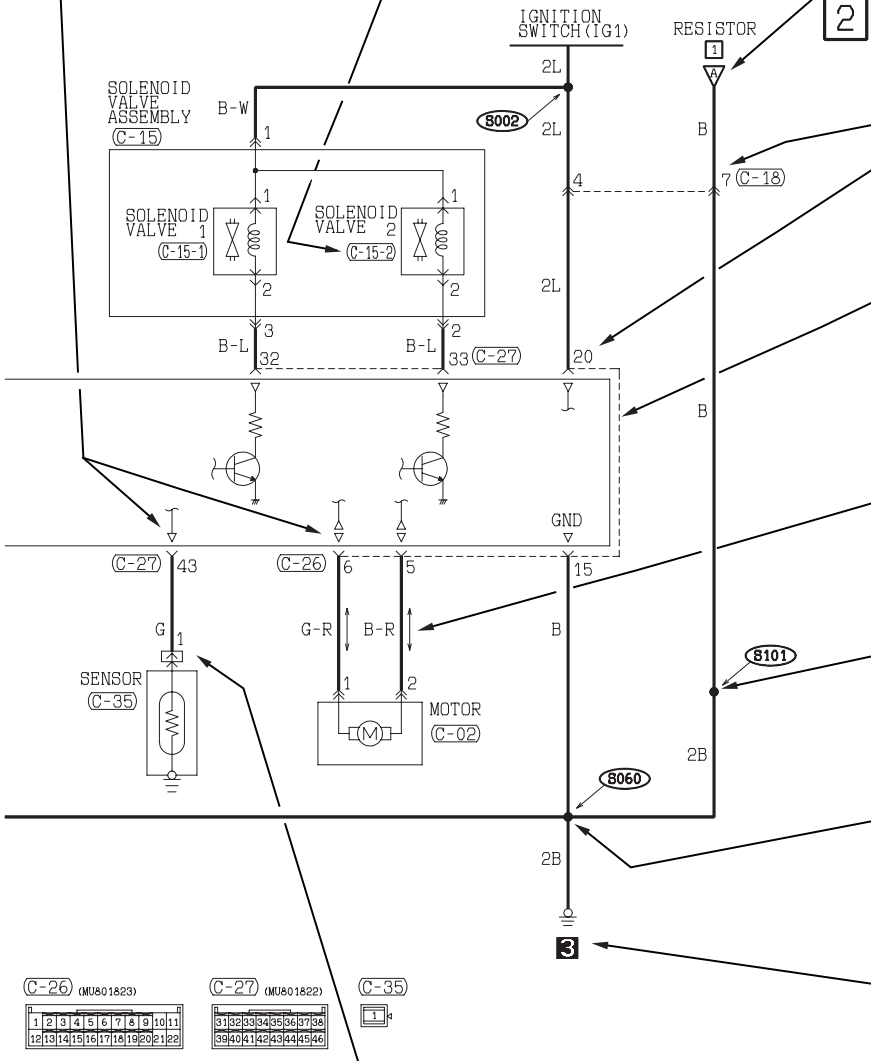

C-26 (MU801823)	C-27 (MU801822)	C-35
1 2 3 4 5 6 7 8 9 10 11 12 13 14 15 16 17 18 19 20 21 22	31 32 33 34 35 36 37 38 39 40 41 42 43 44 45 46	1





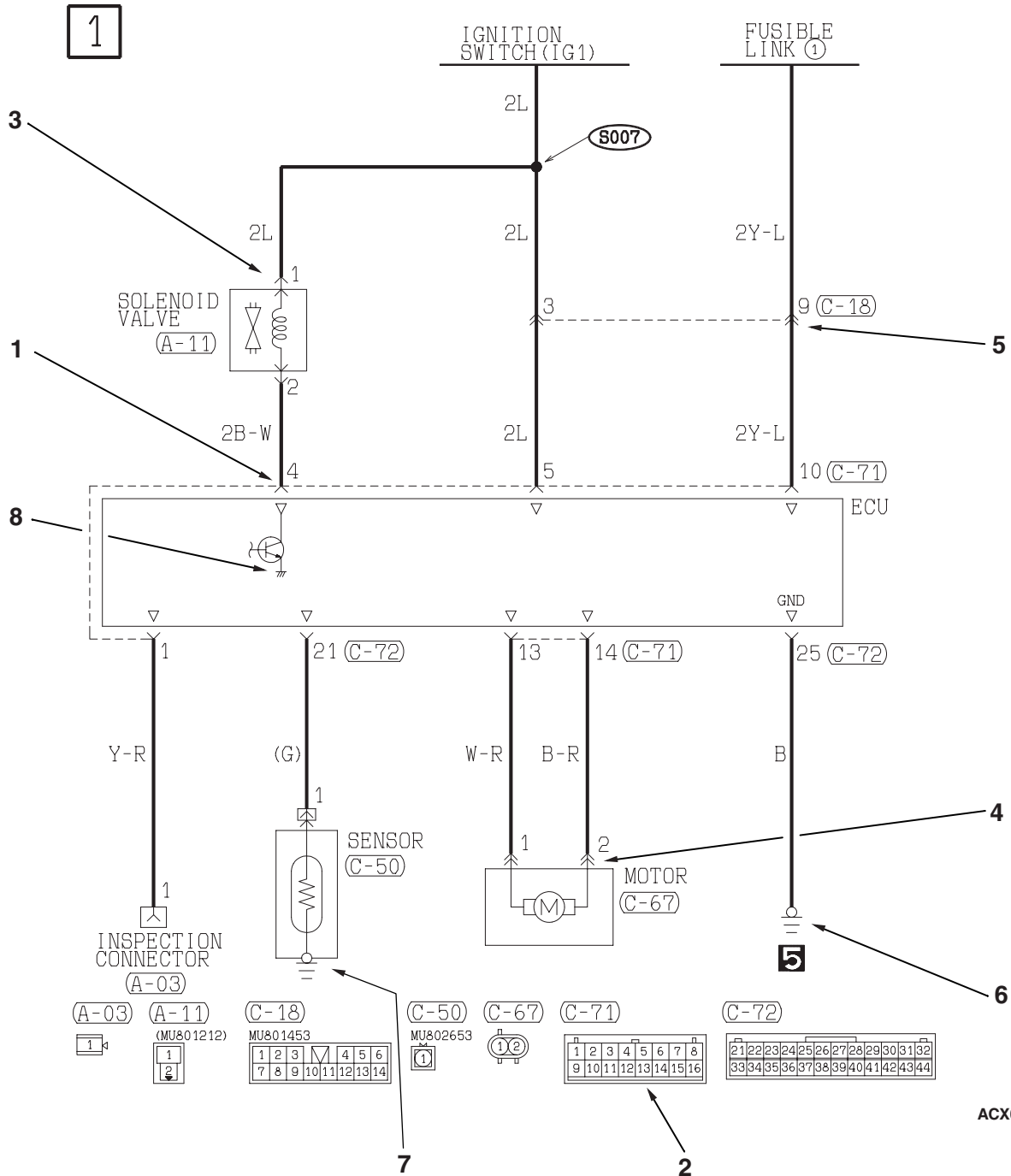

Indicates that the terminal is a spare one if the device (sensor in this case) is not provided.



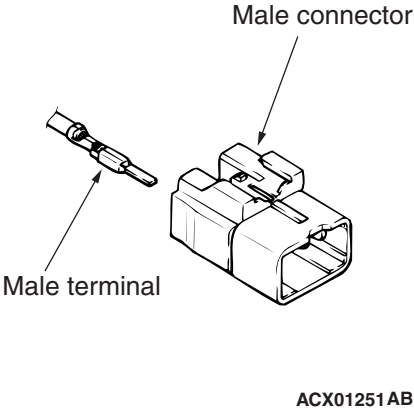

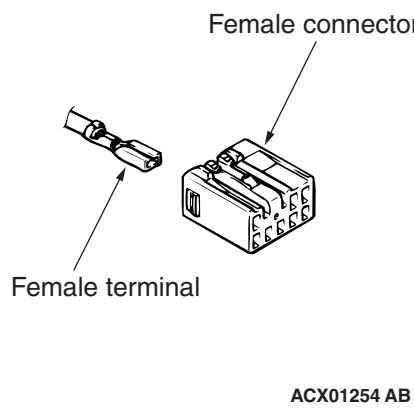
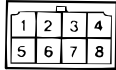
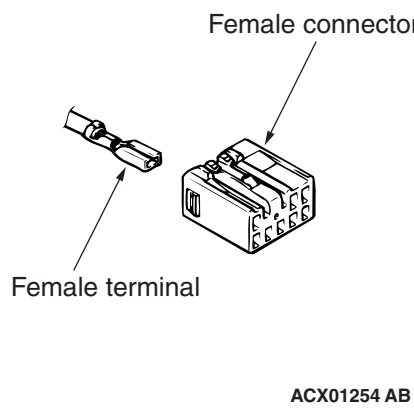

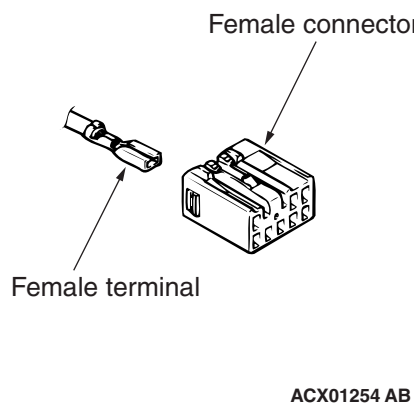
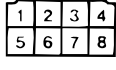
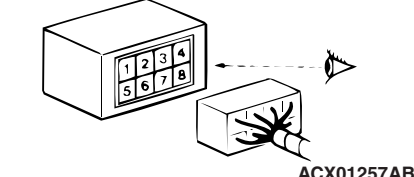
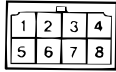
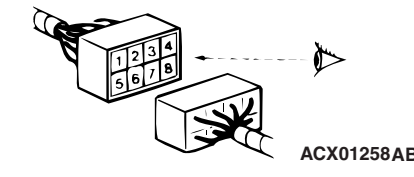

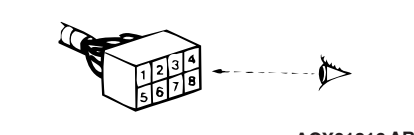
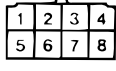
H0V00M05AB

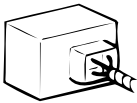
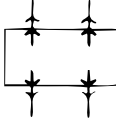
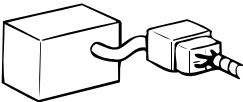
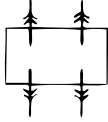
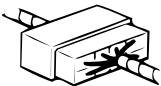
CONNECTOR/GROUNDING INDICATIONS

























ACX02364 AC

ITEM	NO.	CONNECTOR/ GROUNDING	SYMBOL	CONTENTS
Connector and terminal marking	1		<p>Male terminal</p>  <p>ACX01252AB</p>	The male and female terminals are indicated as shown. The connector with male terminal(s) is called as male connector and indicated by two connector contour lines, while the connector with female terminal(s) is called as female connector and indicated by single connector contour line.
			<p>Male connector</p>  <p>ACX01253 AB</p>	
			<p>Female terminal</p>  <p>ACX01255AB</p>	
			<p>Female connector</p>  <p>ACX01256 AB</p>	
Connector symbol marking	2	<p>Device</p> 	 <p>ACX01253</p>	The symbol indicates the connector is viewed as shown. At a device connection, the connector symbol on the device side is shown. For an intermediate connector, the male connector symbol is shown. For spare connectors and check connectors, no device is connected, and so the harness-side connector symbol is shown for these connectors. However, a data link connector is exceptional.
		<p>Intermediate connector</p> 		
		<p>Spare connector, check connector</p> 	 <p>ACX01256</p>	

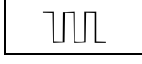
ITEM	NO.	CONNECTOR/ GROUNDING	SYMBOL	CONTENTS
Connector connection marking	3	Direct connection type  ACX01260 AB	 ACX01261	Connection between a device and the harness is either by direct insertion in the device (direct connection type) or by connection with a harness connector furnished on the device side (harness connection type). The two types are indicated as illustrated.
	4	Harness connection type  ACX01262 AB	 ACX01263	
	5	Intermediate connector  ACX01264 AB	 ACX01265	
Ground marking	6	Body ground  ACX01273 AB	 ACX01274	Grounding is either by body ground, device ground or control unit interior ground. These are indicated as illustrated.
	7	Device ground  ACX01275 AB	 ACX01276	
	8	Ground in control unit  ACX01277 AB	 ACX01278	

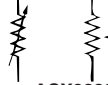
SYMBOLS (EXCEPT CONNECTOR AND GROUNDING)

Devices appearing in circuit diagrams are indicated by the following symbols.

<p align="center">Battery</p>  <p align="center">ACX02377 AB</p>	<p align="center">Buzzer</p>  <p align="center">ACX02378 AB</p>	<p align="center">Capacitor</p>  <p align="center">ACX02379 AB</p>	<p align="center">Electrolytic capacitor</p>  <p align="center">ACX02380 AB</p>	<p align="center">Variable capacitor</p>  <p align="center">ACX02381 AB</p>	<p align="center">Coil</p>  <p align="center">ACX02382 AB</p>
<p align="center">Diode</p>  <p align="center">ACX02383 AB</p>	<p align="center">Light emitting diode</p>  <p align="center">ACX02384 AB</p>	<p align="center">Photo diode</p>  <p align="center">ACX02385 AB</p>	<p align="center">Zener diode</p>  <p align="center">ACX02386 AB</p>	<p align="center">Dual filament bulb</p>  <p align="center">ACX02387 AC</p>	<p align="center">Single filament bulb</p>  <p align="center">ACX02388 AC</p>
<p align="center">Fuse</p>  <p align="center">ACX02389 AB</p>	<p align="center">Fusible link</p>  <p align="center">ACX02390 AB</p>	<p align="center">Horn</p>  <p align="center">ACX02391 AB</p>	<p align="center">Motor</p>  <p align="center">ACX02392 AB</p>	<p align="center">Pulse generator</p>  <p align="center">ACX02393 AB</p>	<p align="center">Piezoelectric device</p>  <p align="center">ACX02394 AB</p>
<p align="center">Resistor</p>  <p align="center">ACX02395 AB</p>	<p align="center">Variable resistor</p>  <p align="center">ACX02396 AB</p>	<p align="center">Speaker</p>  <p align="center">ACX02397 AB</p>	<p align="center">Thermistor</p>  <p align="center">ACX02398 AB</p>	<p align="center">Transistor</p>  <p align="center">ACX02399 AB</p>	<p align="center">Photo transistor</p>  <p align="center">ACX02400 AB</p>

WIRE COLOR CODES

Wire colors are identified by the following color codes.

CODE	WIRE COLOR	CODE	WIRE COLOR	CODE	WIRE COLOR	CODE	WIRE COLOR
B	Black	L	Blue	PU	Purple	V	Violet
BR	Brown	LG	Light green	R	Red	W	White
G	Green	O	Orange	SB	Sky blue	Y	Yellow
GR	Gray	P	Pink	SI	Silver	-	-

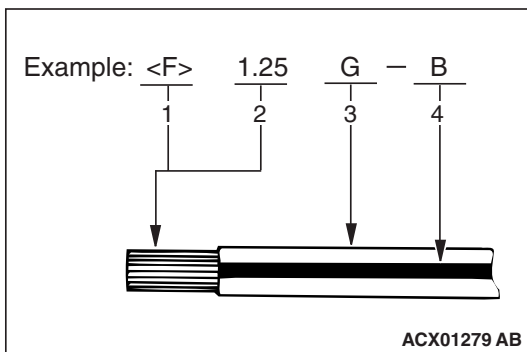

If a cable has two colors, the first of the two color code characters indicates the basic color (color of the cable coating) and the second indicates the marking (tracer) color.

NO.	MEANING
1	<F>: Flexible wire
	<T>: Twisted wire
2	Wire size (mm ²)*
3	Basic color (color of the cable coating)
4	Marking color

NOTE:

*: No code indicates 0.5 mm² (0.0008 in²). Cable color code in parentheses indicates 0.3 mm² (0.0005 in²).

ETACS-ECU

M1901026300106

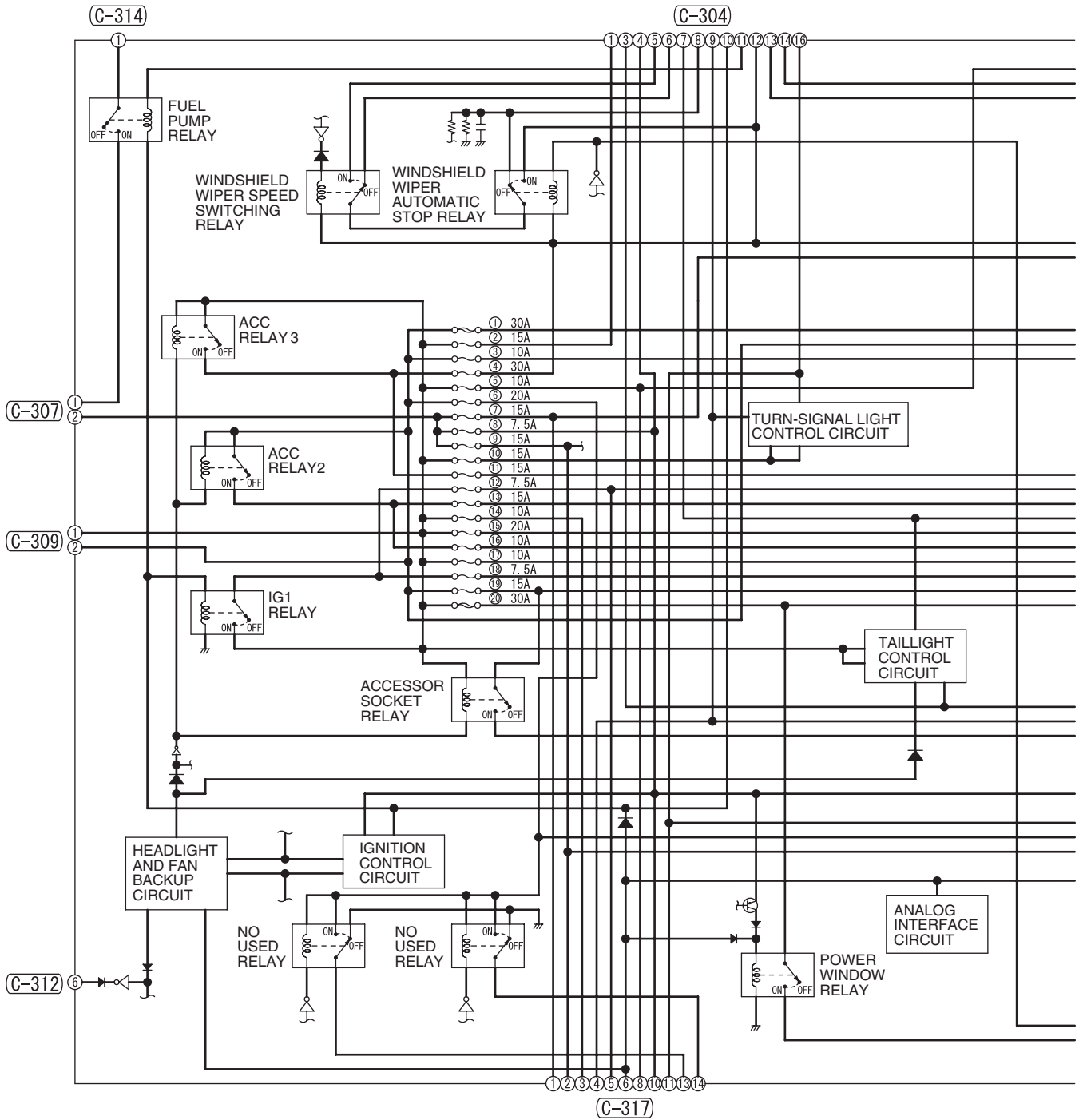

C-301



C-302



C-303



C-304



C-307



C-309



C-310



C-311

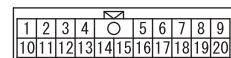

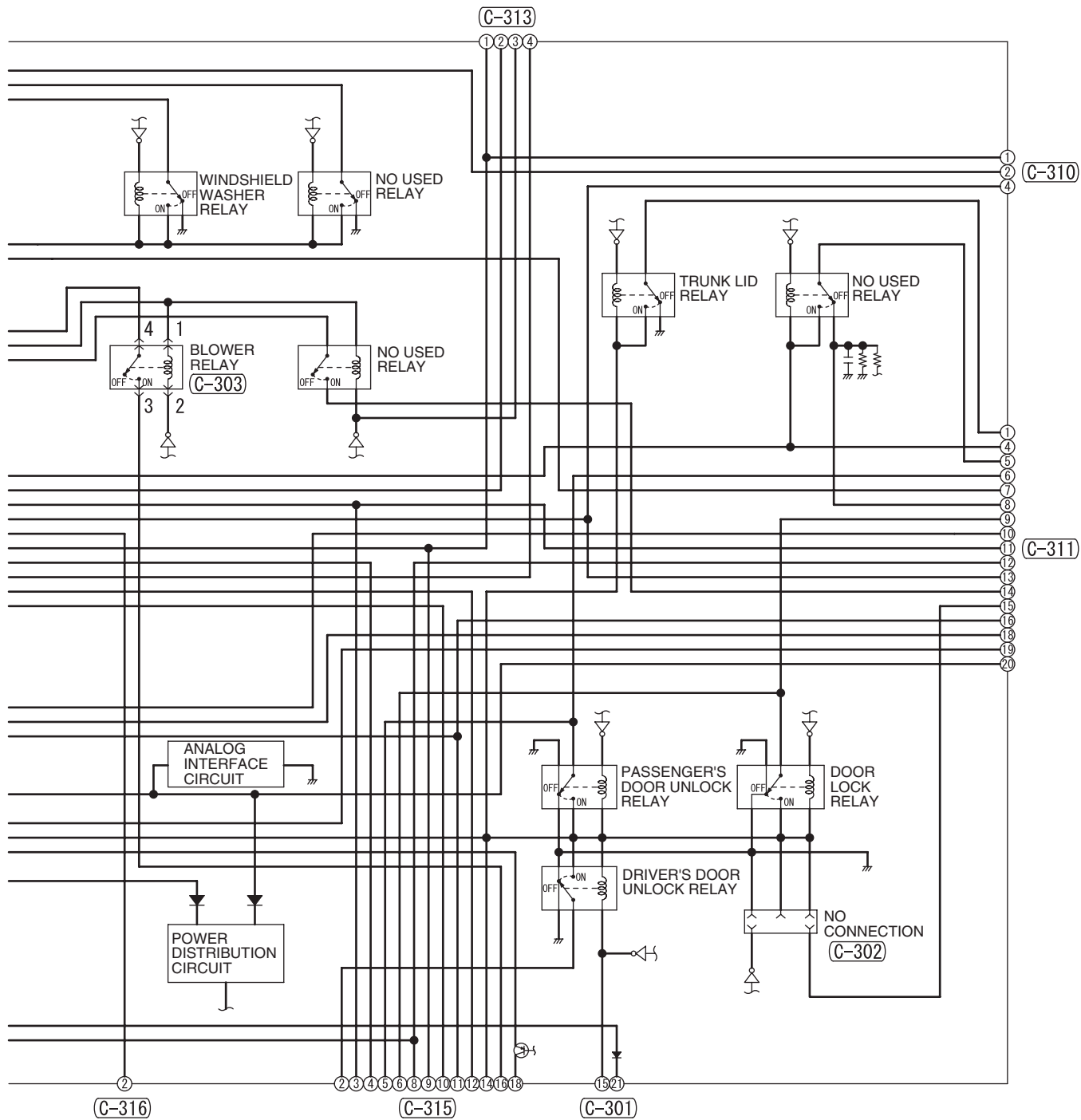

C-312



C-313



C-314

MU801323



C-315

MU801890

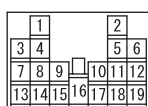

C-316



C-317

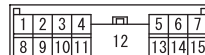

ETACS-ECU (CONTINUED)

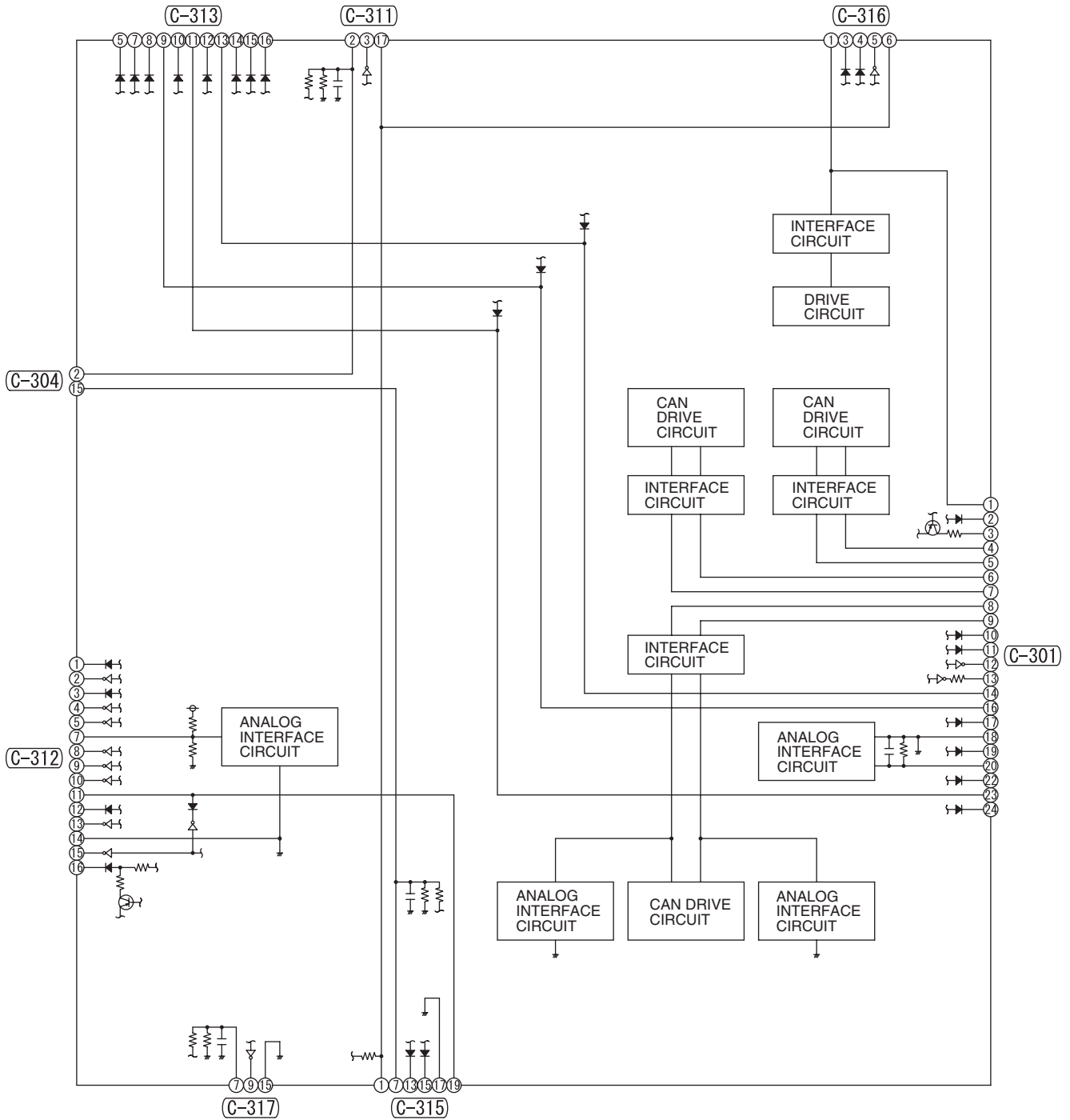

C-301

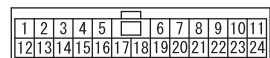

C-304

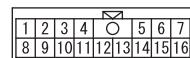

C-311

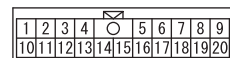

C-312



C-313



C-315

MU801890

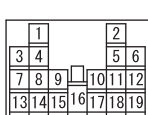

C-316



C-317



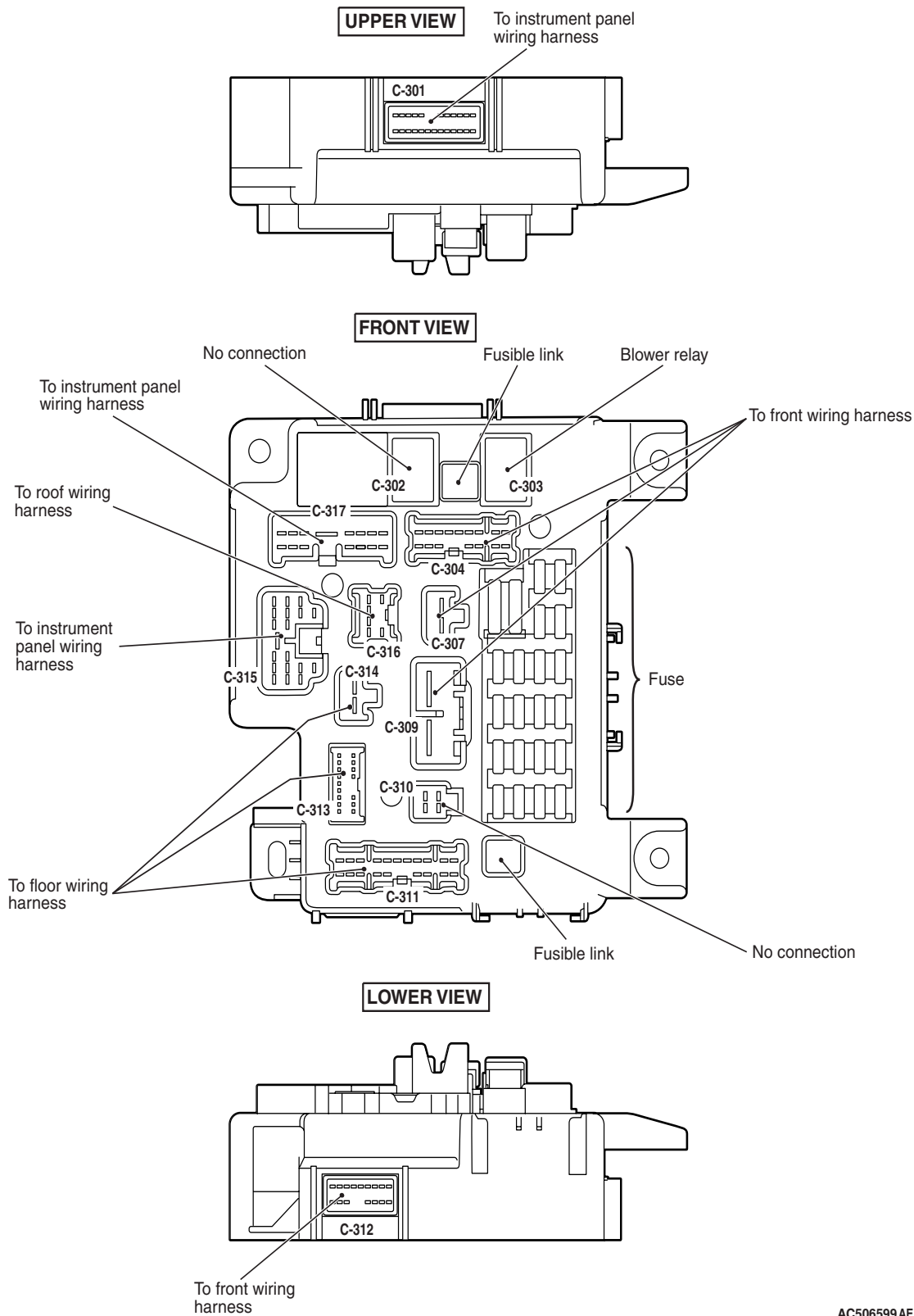

AC506599AE

JOINT CONNECTOR

M1901014202573

NOTE: IN THE ACTUAL VEHICLES, SOME OF THE JOINT CONNECTOR TERMINALS IN THE SAME BUS ARE USED, SO IN SOME CASES, THE TERMINAL ARRANGEMENT INDICATED ON THE CIRCUIT DIAGRAMS DO NOT COINCIDE WITH THE ONES IN THE ACTUAL VEHICLES.

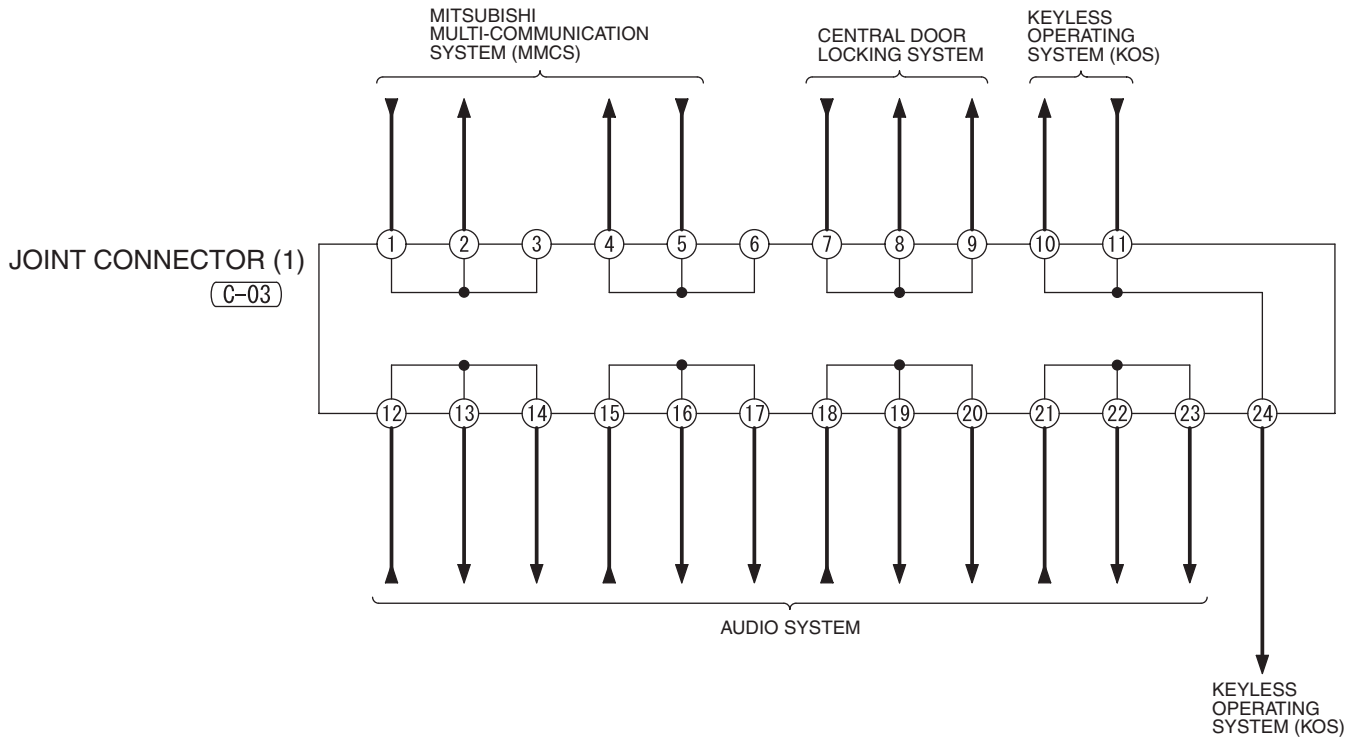

(C-02)

(C-03)

1	2	3	4	5		
6	7	8	9	10	11	12

1	2	3	4	5	6	7	8	9	10	11		
12	13	14	15	16	17	18	19	20	21	22	23	24

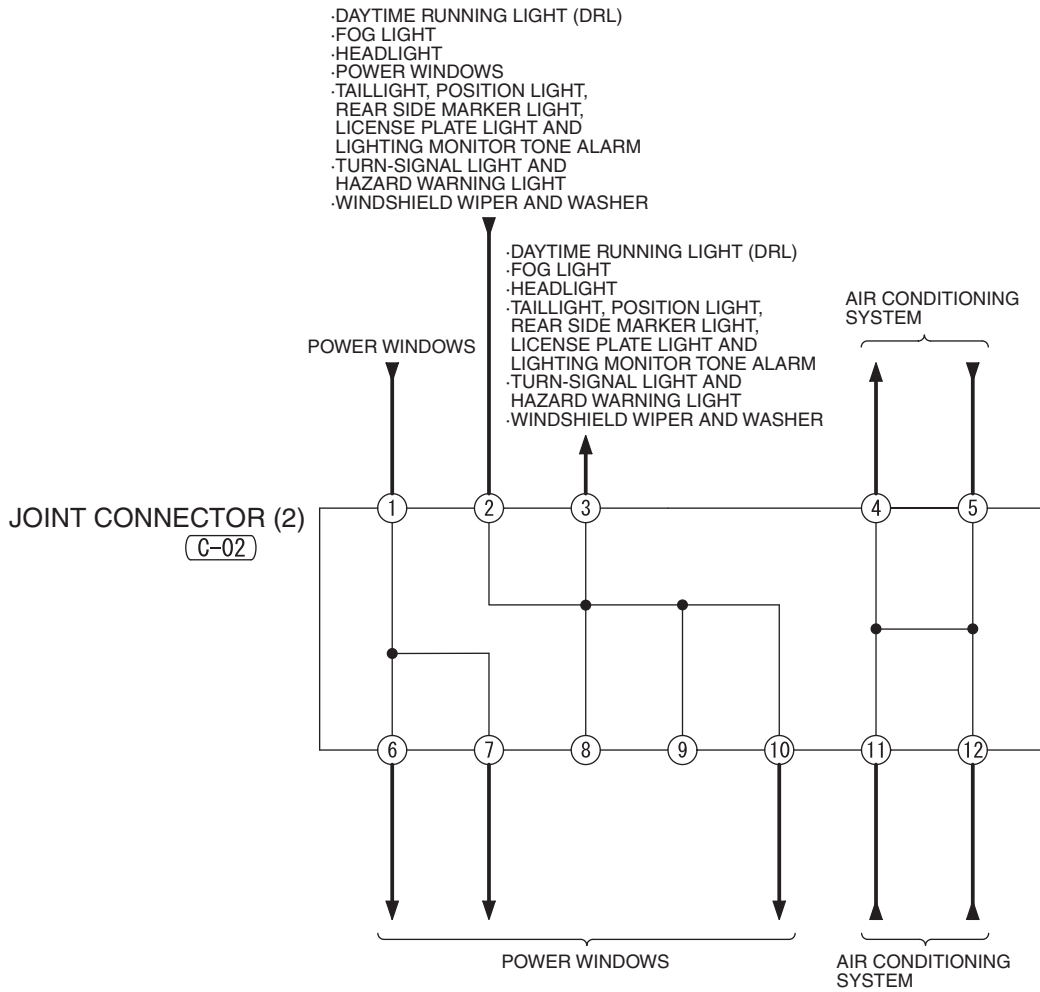

JOINT CONNECTOR (CONTINUED)

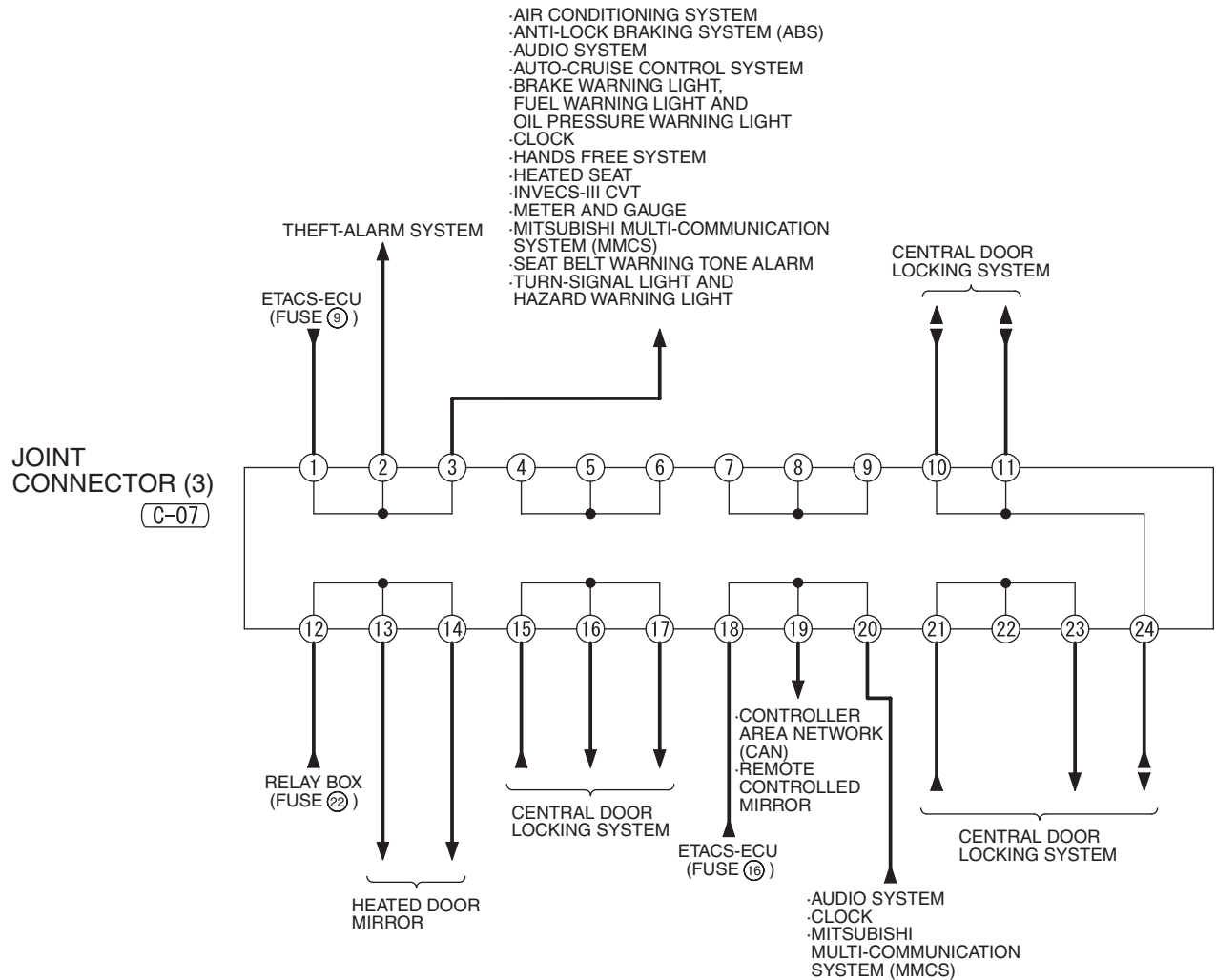

C-07

1	2	3	4	5	6	7	8	9	10	11		
12	13	14	15	16	17	18	19	20	21	22	23	24

C-38

1	2	3	4	5	6	7	8	9	10	11		
12	13	14	15	16	17	18	19	20	21	22	23	24

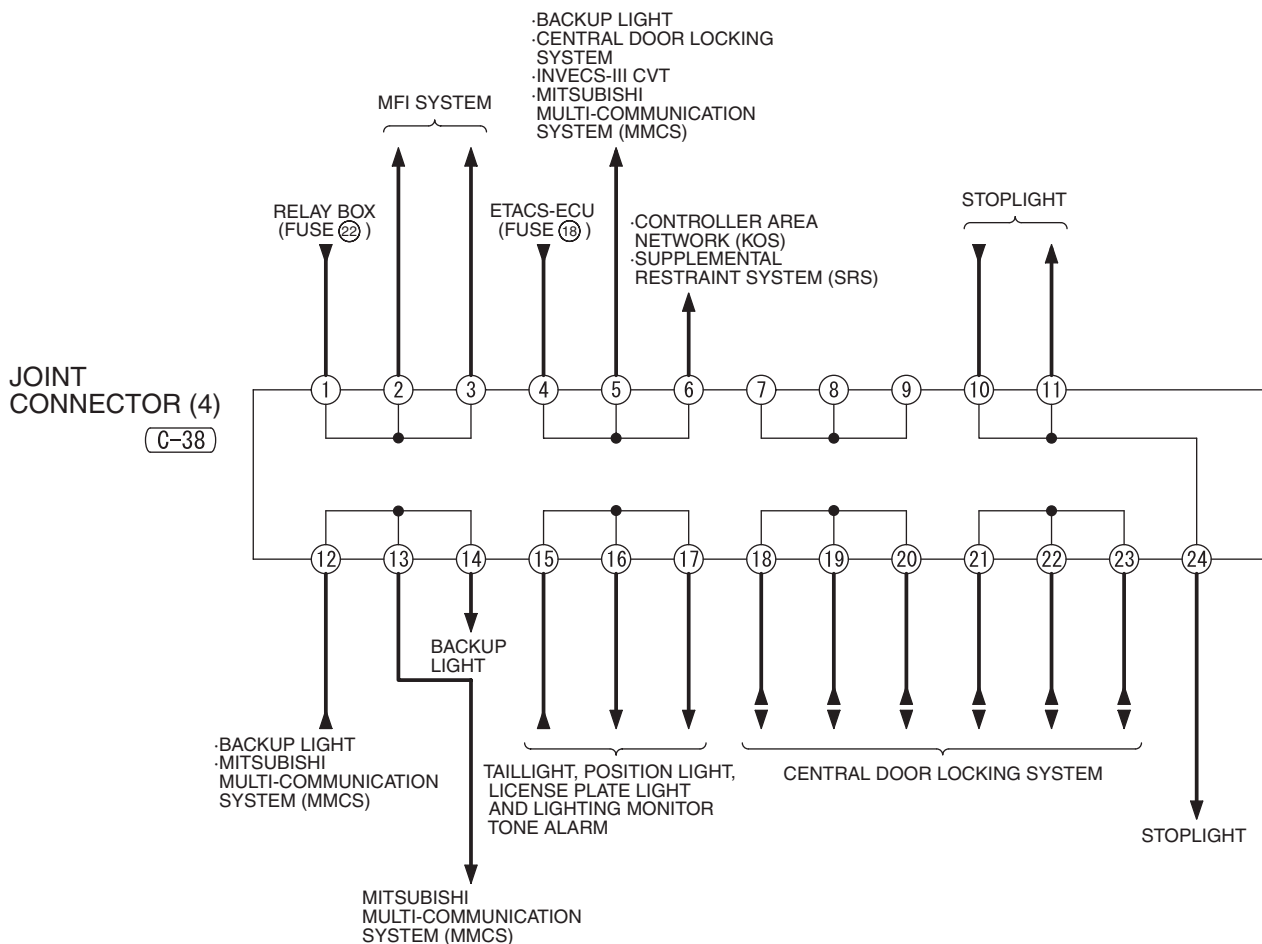

JOINT CONNECTOR (CONTINUED)

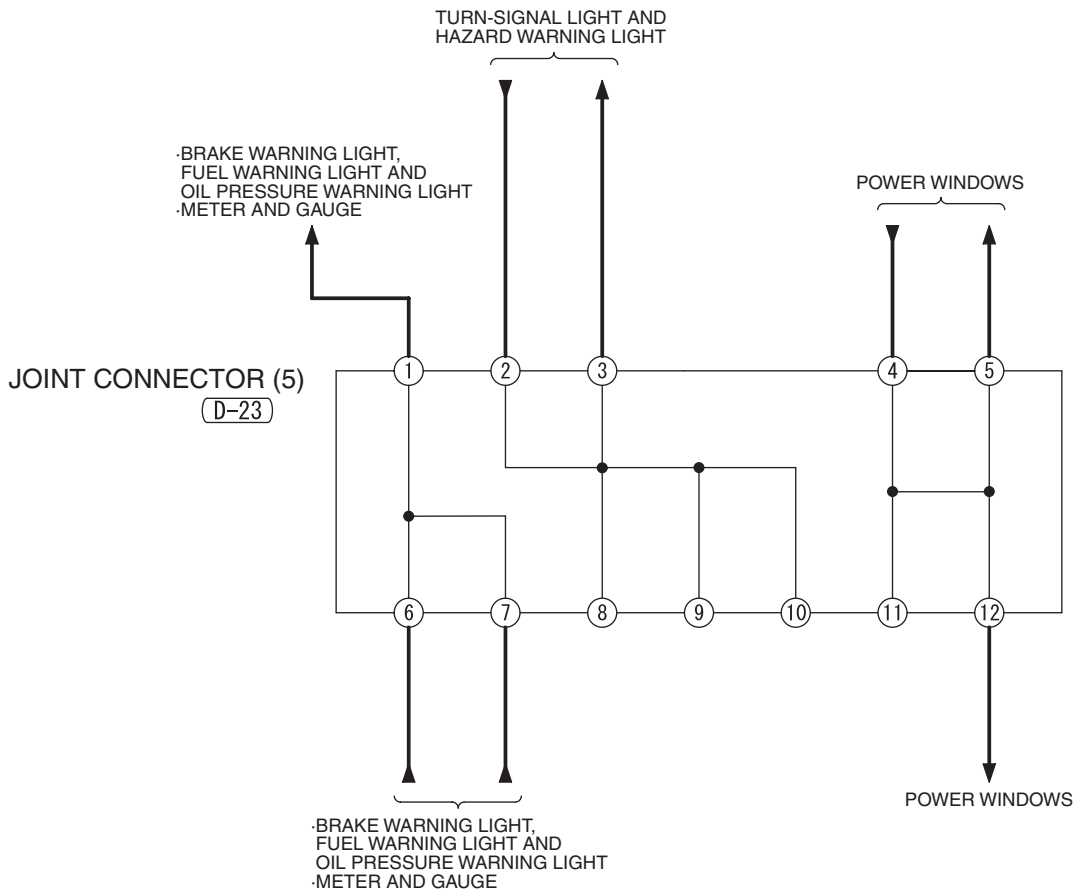

(D-23)

1	2	3	4	5
6	7	8	9	10
11	12			

CENTRALIZED JUNCTION

M1901000301950

FUSIBLE LINK AND FUSE ENGINE COMPARTMENT

No.	Power supply circuit	Name	Rated capacity (A)	Housing color	Load circuit
1	Fusible link No.36	Fuse	15	Blue	Fog light and fog light relay
2			7.5	Brown	Engine control module
3			20	Yellow	Primary pulley speed sensor <CVT>, secondary pulley speed sensor <CVT> and transaxle control module <CVT>
4			10	Red	Horn and horn relay
5			7.5	Brown	Generator
6			–	–	–
7			10	Red	A/C compressor assembly and A/C compressor clutch relay
8			15	Blue	Engine control module
9			–	–	–
10			–	–	–
11			–	–	–
12			–	–	–
13			10	Red	Daytime running light and daytime running light relay
14	Headlight relay (High)		10	Red	Headlight assembly (High: LH)
15			10	Red	Headlight assembly (High: RH)
16	Headlight relay (Low)		20	Yellow	–
17			20	Yellow	–
18			10	Red	Headlight assembly (Low: LH)
19			10	Red	Headlight assembly (Low: RH)
20	MFI relay		–	–	–
21			10	Red	Ignition coil No.1 to 4
22			20	Yellow	Center exhaust pipe heated oxygen sensor, engine control module, engine oil control valve, evaporative emission purge solenoid, evaporative emission ventilation solenoid, injector No.1 to 4, mass airflow sensor, heated oxygen sensor and vehicle speed sensor <M/T>
23			15	Blue	Fuel pump module

No.	Power supply circuit	Name	Rated capacity (A)	Housing color	Load circuit
24	Fusible link No.36	Fusible link	30	Pink	Starter
25			–	–	–
26			40	Green	ABS-ECU
27			30	Pink	ABS-ECU
28			30	Pink	Condenser fan motor, condenser fan relay and fan control relay
29			40	Green	Radiator fan motor and radiator fan relay
30		Fuse	30	Green	Fuse No.7 to 9 in passenger compartment
31			30	Green	Audio amplifier
32			–	–	–
33	Battery/Generator	Fusible link	120	–	Fusible link No.37/ Fusible link No.34 to 36
34	Battery/Fusible link No.33		80	–	Fuse Nos.2, 4, 5, 10, 11, 12, 14, 15, 17, 18, 20 and No.25 in passenger compartment
35			80	–	–
36			120	–	Fuse No.1 to 32 in engine compartment, headlight relay (High), headlight relay (Low) and MFI relay
37	Fusible link No.33/ Generator		80	–	Fusible link No.1 and 21, Fuse No. 3, 6, 13, 16, 19, and 22 in passenger compartment and ETACS-ECU(ACC relay 2 and blower relay)

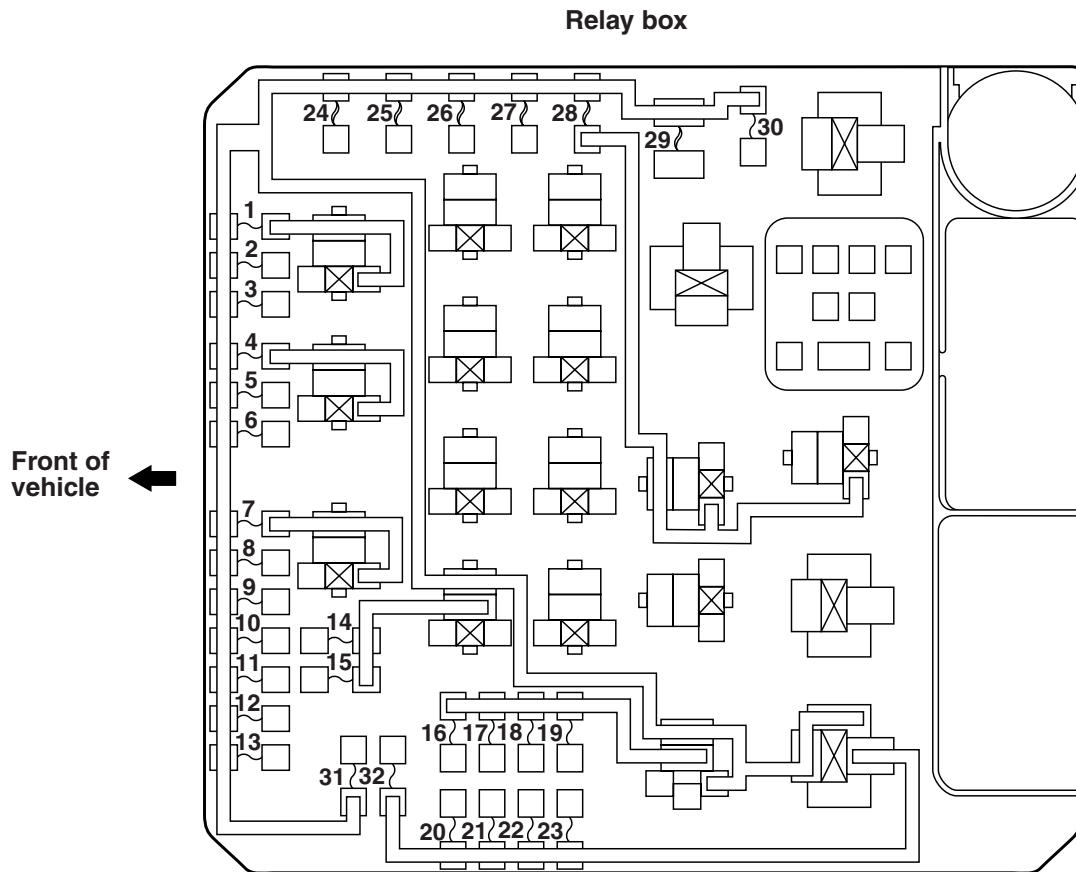

AC506808AI

Fusible link box connected directly to battery positive terminal

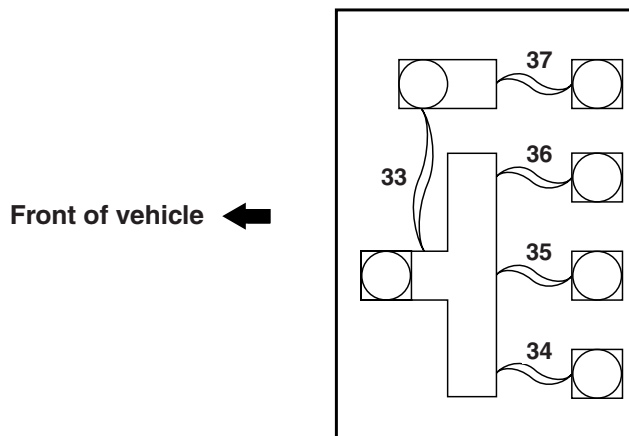

AC506810AD

PASSENGER COMPARTMENT

No.	Power supply circuit	Name	Rated capacity (A)	Housing color	Load circuit	
1	Fusible link No.37	Fusible link	30	Pink	Blower motor	
2	Fusible link No.34	Fuse	15	Blue	ETACS-ECU, high-mounted stoplight, rear combination light and shift switch assembly	
3	Fusible link No.37		10	Red	–	
4	ETACS-ECU (ACC relay 3)		30	Green	ETACS-ECU, washer motor and windshield wiper motor	
5	Fusible link No.34		10	Red	Data link connector	
6	Fusible link No.37		20	Yellow	ETACS-ECU, front door lock actuator, trunk lid actuator and switch and rear door lock actuator	
7	Fusible link No.30		15	Blue	Audio visual navigation unit, CAN box unit, center panel unit, hands free module, radio and CD player or CD changer, rear display unit and satellite radio tuner	
8			7.5	Brown	A/C-ECU, column switch, combination meter, ETACS-ECU, key reminder switch, KOS-ECU, power window relay, wireless control module <vehicles with KOS> and receiver antenna module <vehicles without KOS>	
9			15	Blue	Audio visual navigation unit, center panel unit, combination meter and key reminder switch	
10	Fusible link No.34			15	Blue	ETACS-ECU

No.	Power supply circuit	Name	Rated capacity (A)	Housing color	Load circuit
11	ETACS-ECU (ACC relay 3)	Fuse	–	–	–
12	ETACS-ECU (IG1 relay)		7.5	Brown	A/C control panel, A/C-ECU, CVT control relay, ABS-ECU, center panel unit, column switch, combination meter, heated seat relay, KOS-ECU, rear window defogger relay, shift switch assembly, SRS-ECU, sunroof motor assembly, wireless control module <vehicles without KOS> and receiver antenna module <vehicles with KOS>
13	ETACS-ECU (ACC relay 2)		15	Blue	Accessory socket (front floor console) and cigarette lighter
14	Fusible link No.34		10	Red	Ignition switch circuit
15			20	Yellow	Sunroof motor assembly
16	ETACS-ECU (ACC relay 2)		10	Red	Audio visual navigation unit, CAN box unit, door mirror assembly, radio and CD player or CD changer, rear display unit and remote controlled mirror switch
17	Fusible link No.34		10	Red	Occupant classification-ECU
18	ETACS-ECU (IG1 relay)		7.5	Brown	Audio visual navigation unit, backup light switch <M/T>, transaxle control module <CVT>, SRS-ECU and transmission range switch <CVT>
19	Fusible link No.37		15	Blue	Accessory socket (rear floor console)
20	Fusible link No.34		Fusible link	30	Pink
21	Fusible link No.37	30		Pink	Rear window defogger
22	Rear window defogger relay	Fuse	7.5	Brown	Door mirror assembly
23	Fusible link No.34		–	–	–
24			–	–	–
25			30	Green	Heated seat

Fuse box in ETACS-ECU

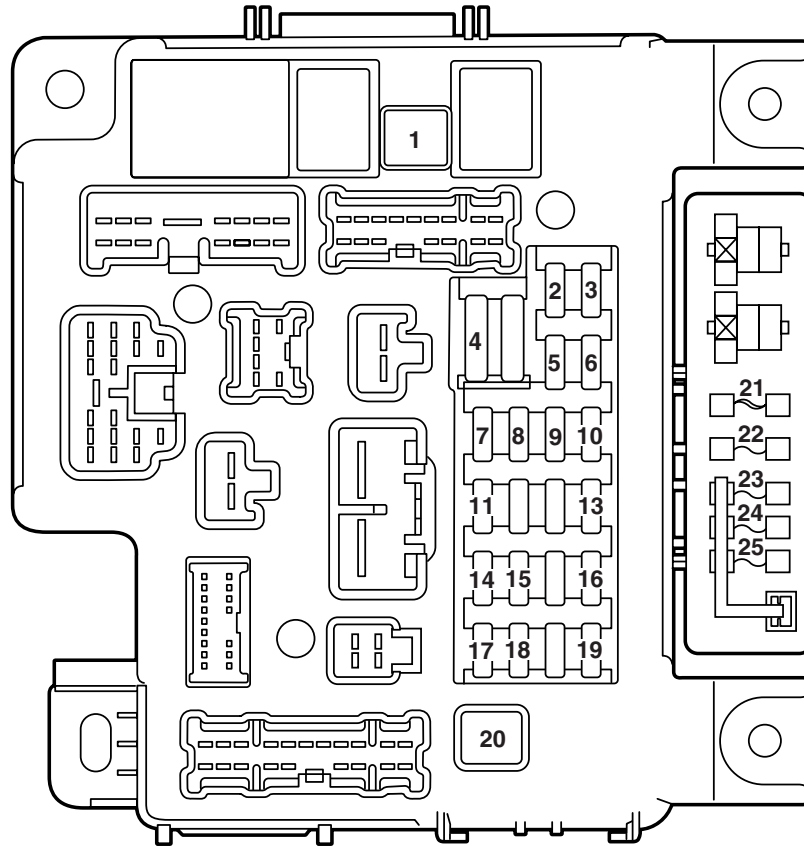

AC607380AB

CENTRALIZED RELAY

Connector No.	Name	Connector No.	Name
A-11X	Fog light relay	A-21X	Injector relay
A-12X	Horn relay	A-22X	–
A-13X	A/C compressor clutch relay	A-23X	Condenser fan relay
A-14X	–	A-24X	Stater relay
A-15X	CVT control relay	A-25X	Headlight relay (Low)
A-16X	–	A-26X	Radiator fan relay
A-17X	Headlight relay (High)	A-27X	–
A-18X	Throttle actuator control motor relay	A-28X	Fan control relay
A-19X	–	A-29X	–
A-20X	Daytime running light relay	A-30X	MFI relay

Relay box in engine room

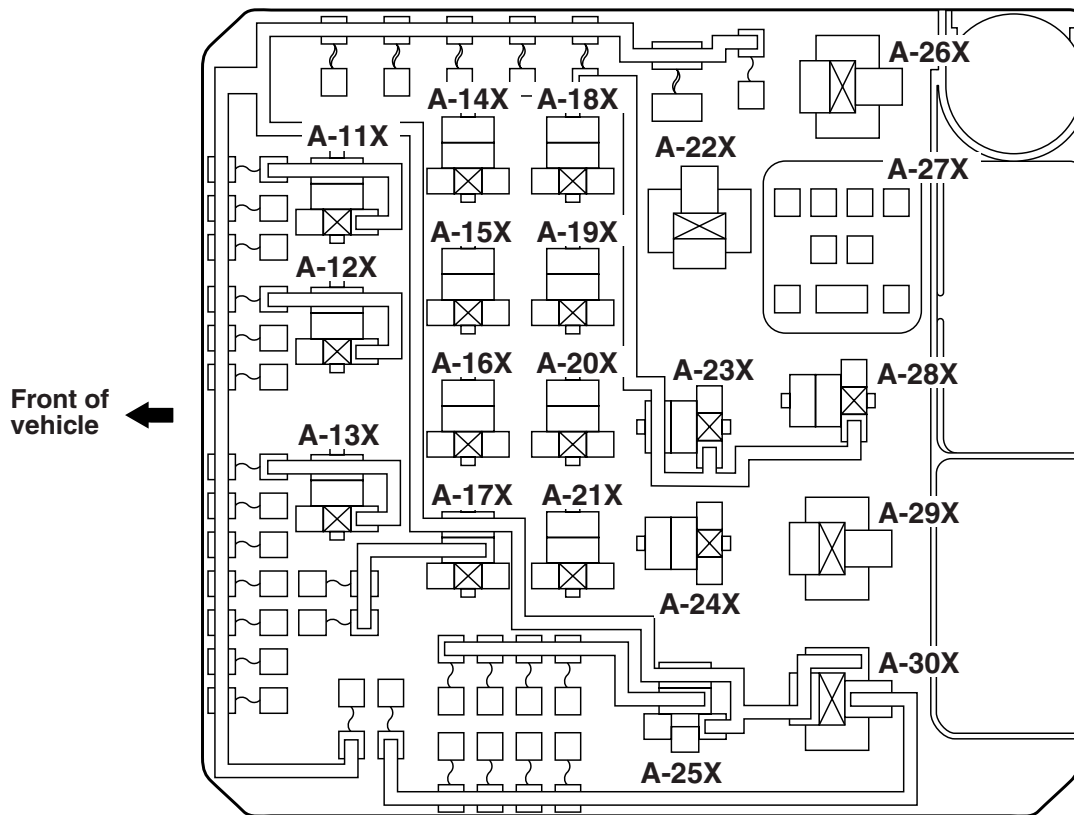

AC506808AH

POWER DISTRIBUTION SYSTEM

M1901000402723

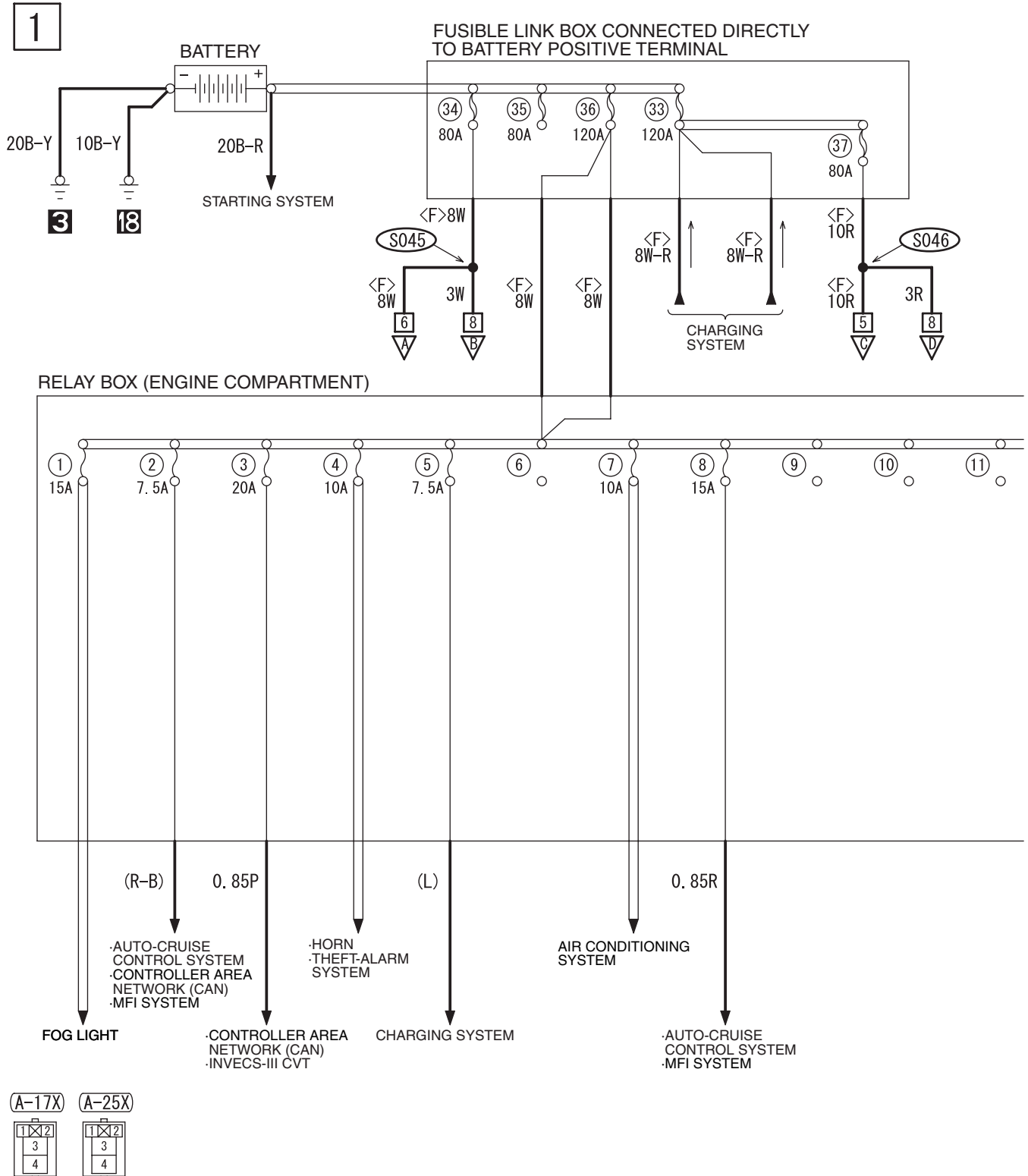

2

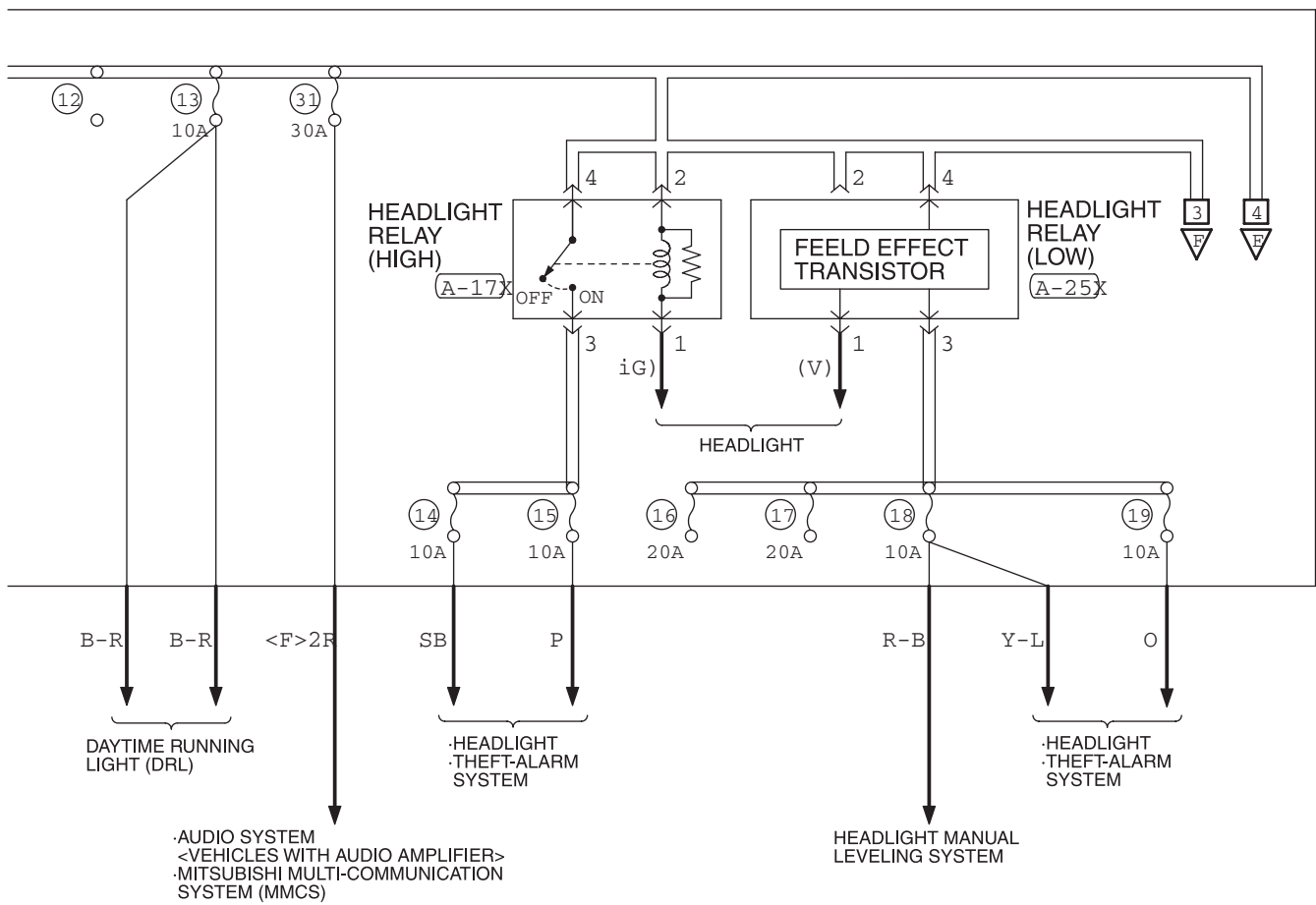

WIRE COLOR CODE

B: BLACK LG: LIGHT GREEN G: GREEN L: BLUE W: WHITE Y: YELLOW SB: SKY BLUE
BR: BROWN O: ORANGE GR: GRAY R: RED P: PINK V: VIOLET PU: PURPLE

H8G01M00AB

TSB Revision

POWER DISTRIBUTION SYSTEM (CONTINUED)

3 RELAY BOX (ENGINE COMPARTMENT)

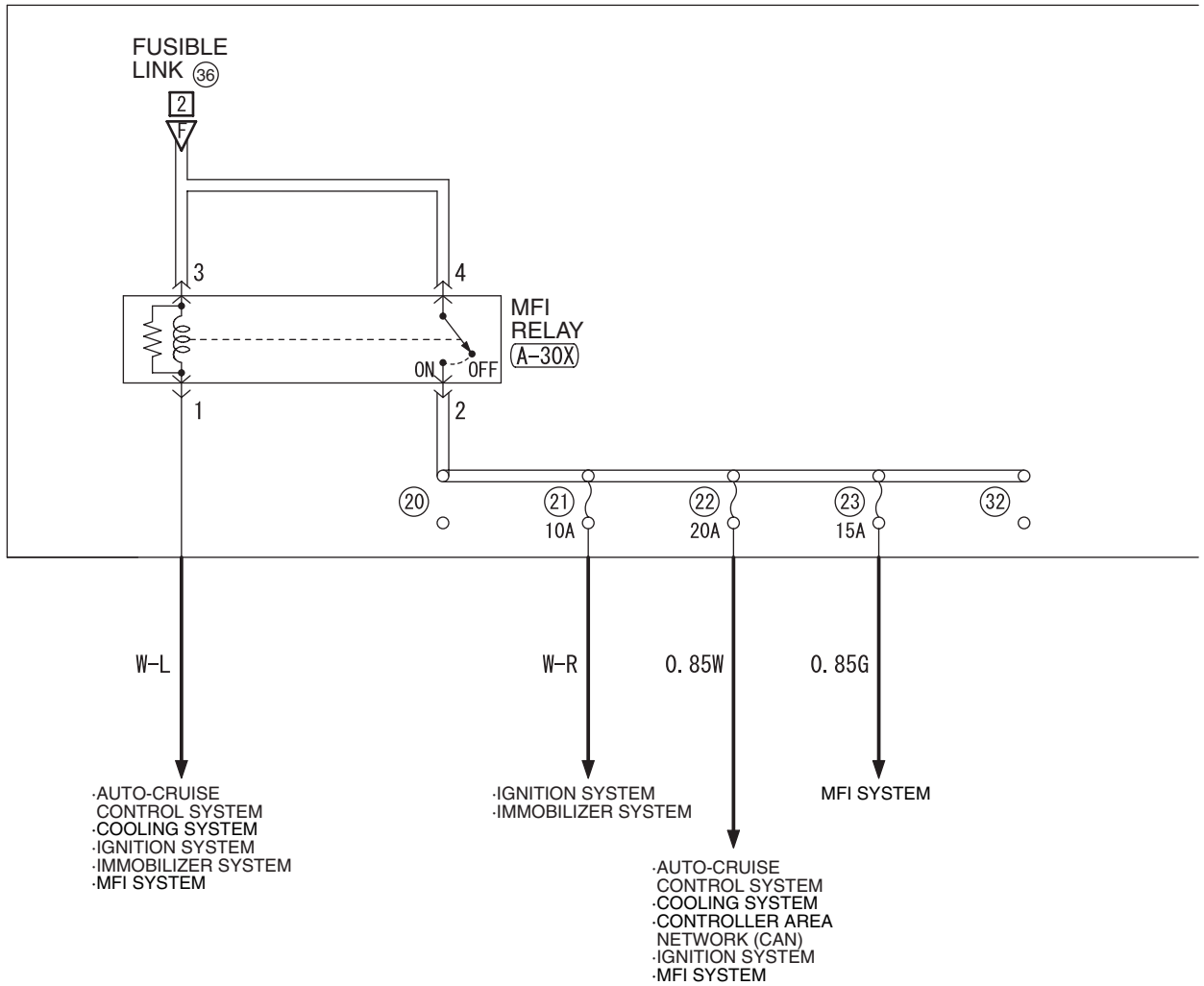

(A-30X)



4

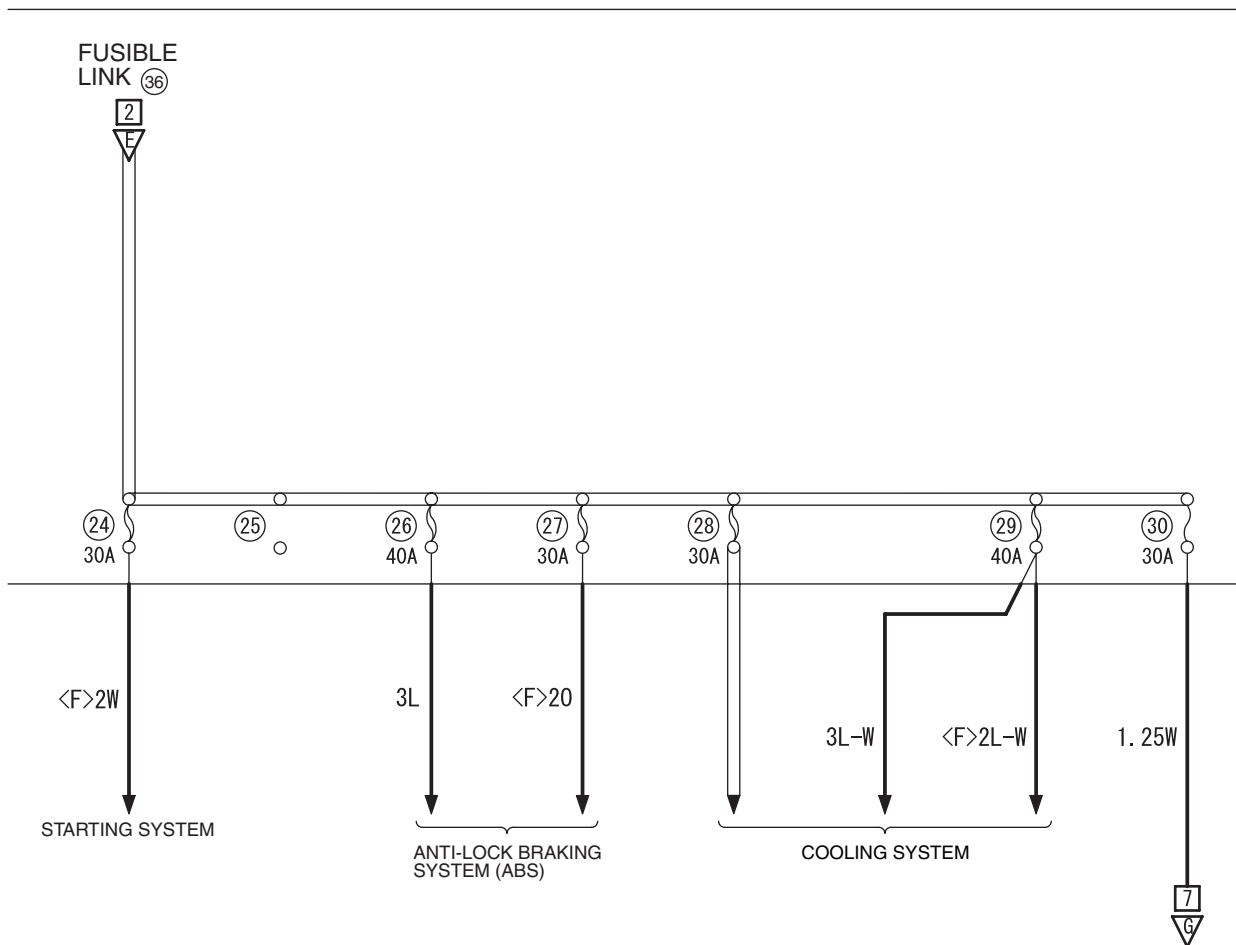

WIRE COLOR CODE

B: BLACK LG: LIGHT GREEN G: GREEN L: BLUE W: WHITE Y: YELLOW SB: SKY BLUE
BR: BROWN O: ORANGE GR: GRAY R: RED P: PINK V: VIOLET PU: PURPLE

H8G01M00BB

TSB Revision

POWER DISTRIBUTION SYSTEM (CONTINUED)

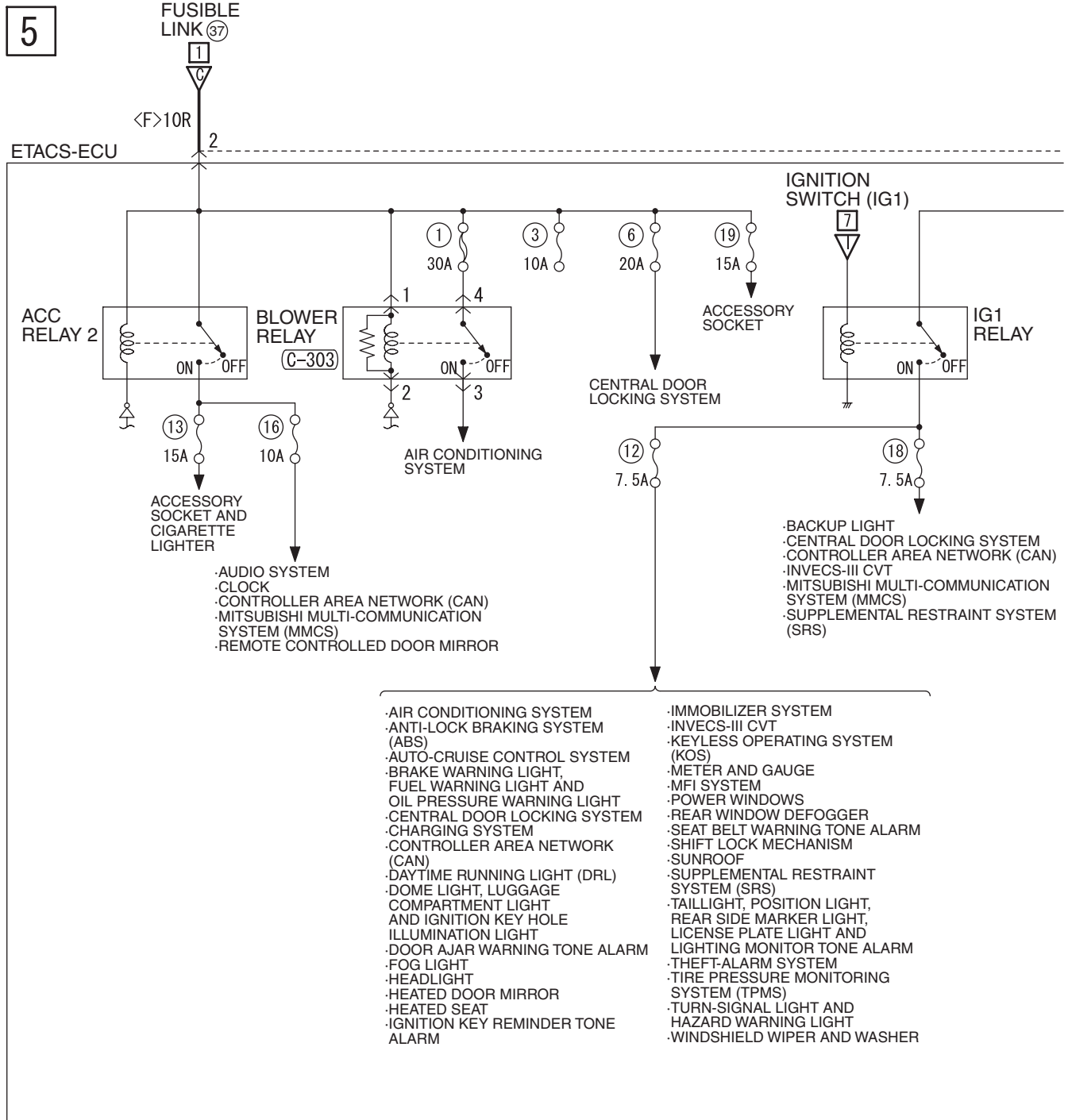

C-303

C-309

C-315

MU801890

C-317

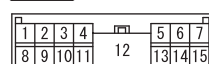
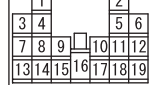

6

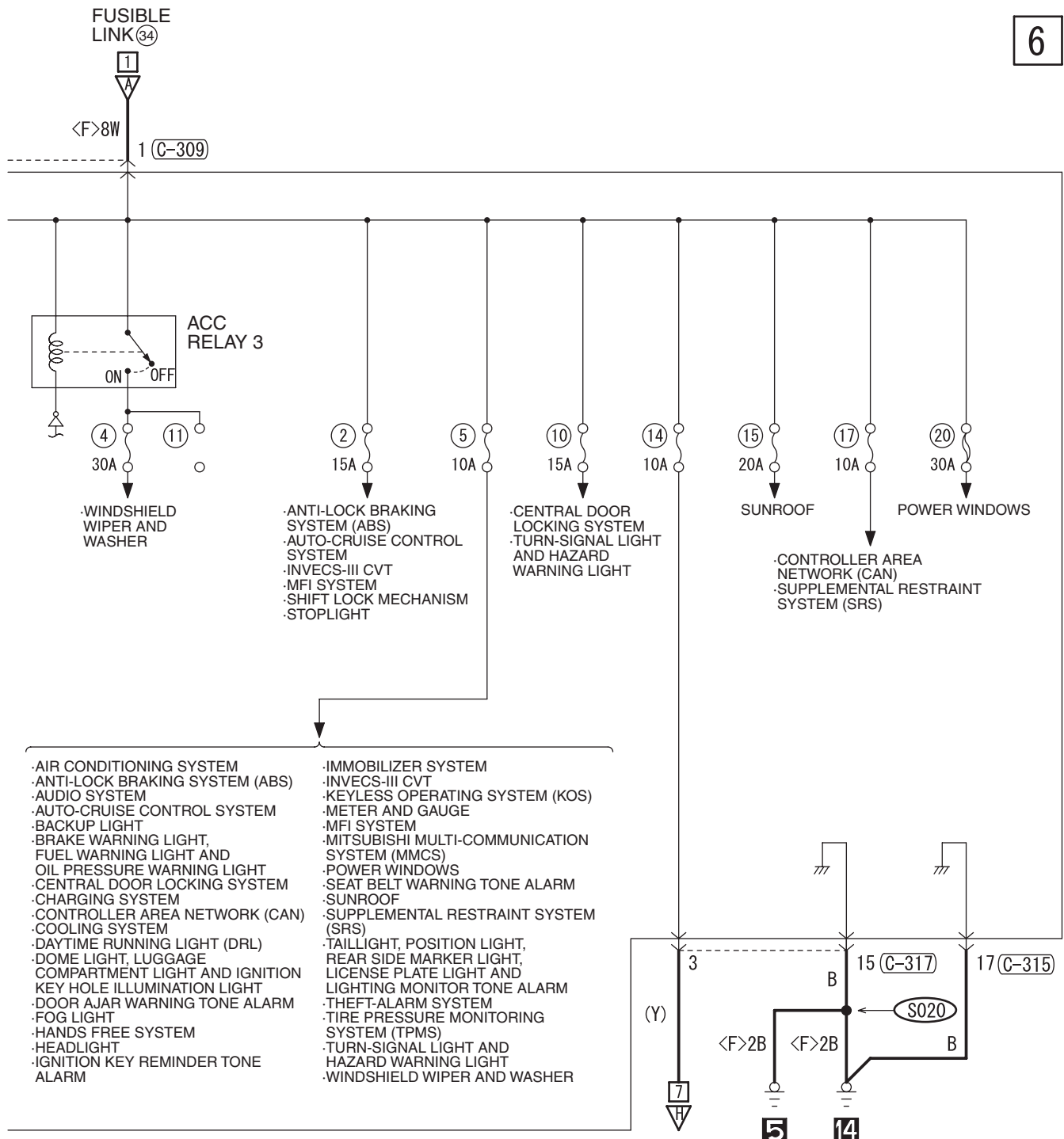

WIRE COLOR CODE
B: BLACK LG: LIGHT GREEN G: GREEN L: BLUE W: WHITE Y: YELLOW SB: SKY BLUE
BR: BROWN O: ORANGE GR: GRAY R: RED P: PINK V: VIOLET PU: PURPLE

TSB Revision

POWER DISTRIBUTION SYSTEM (CONTINUED)

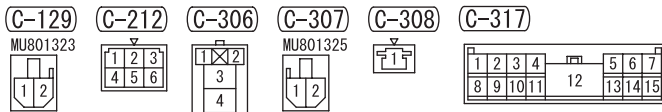
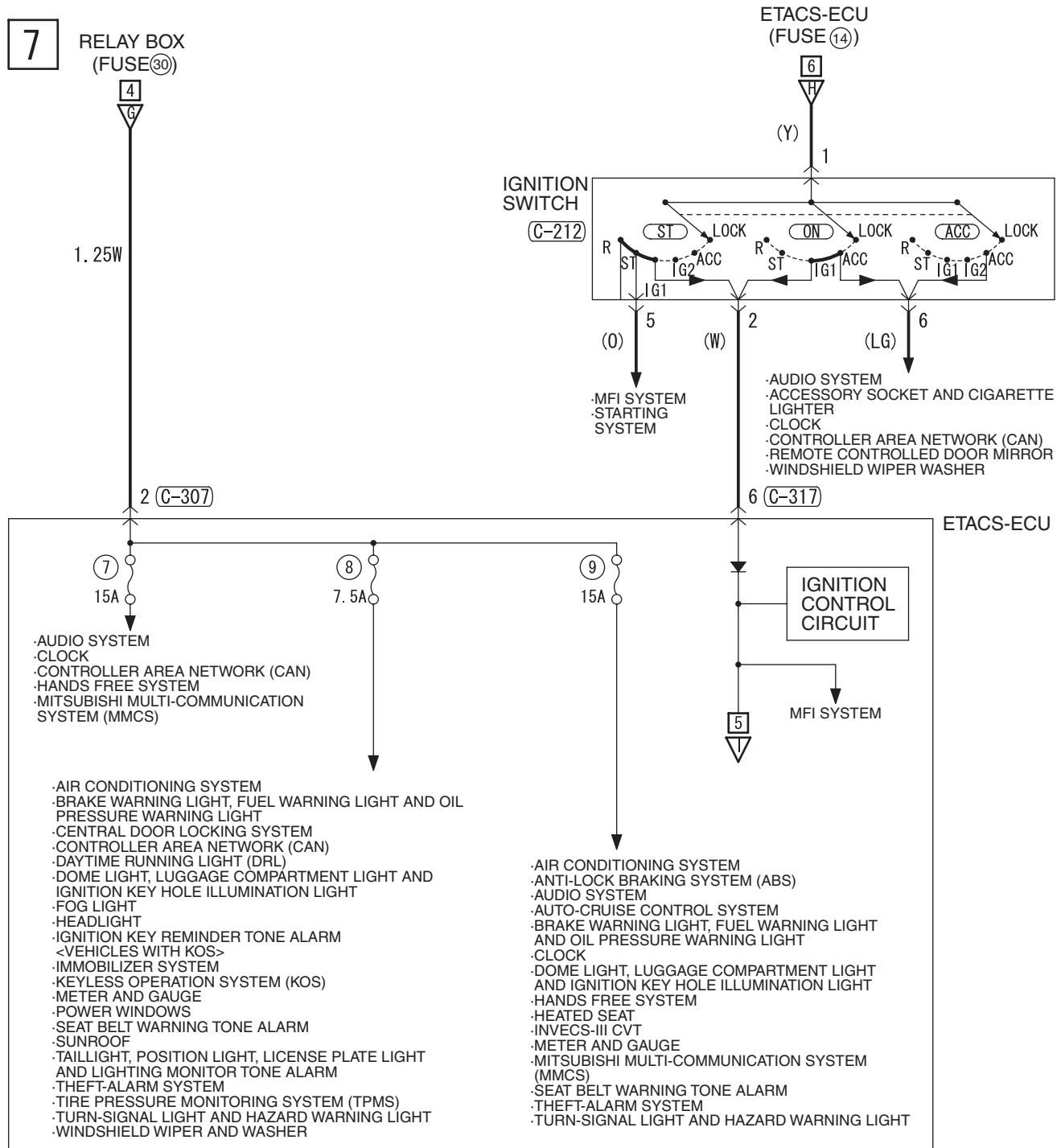

8

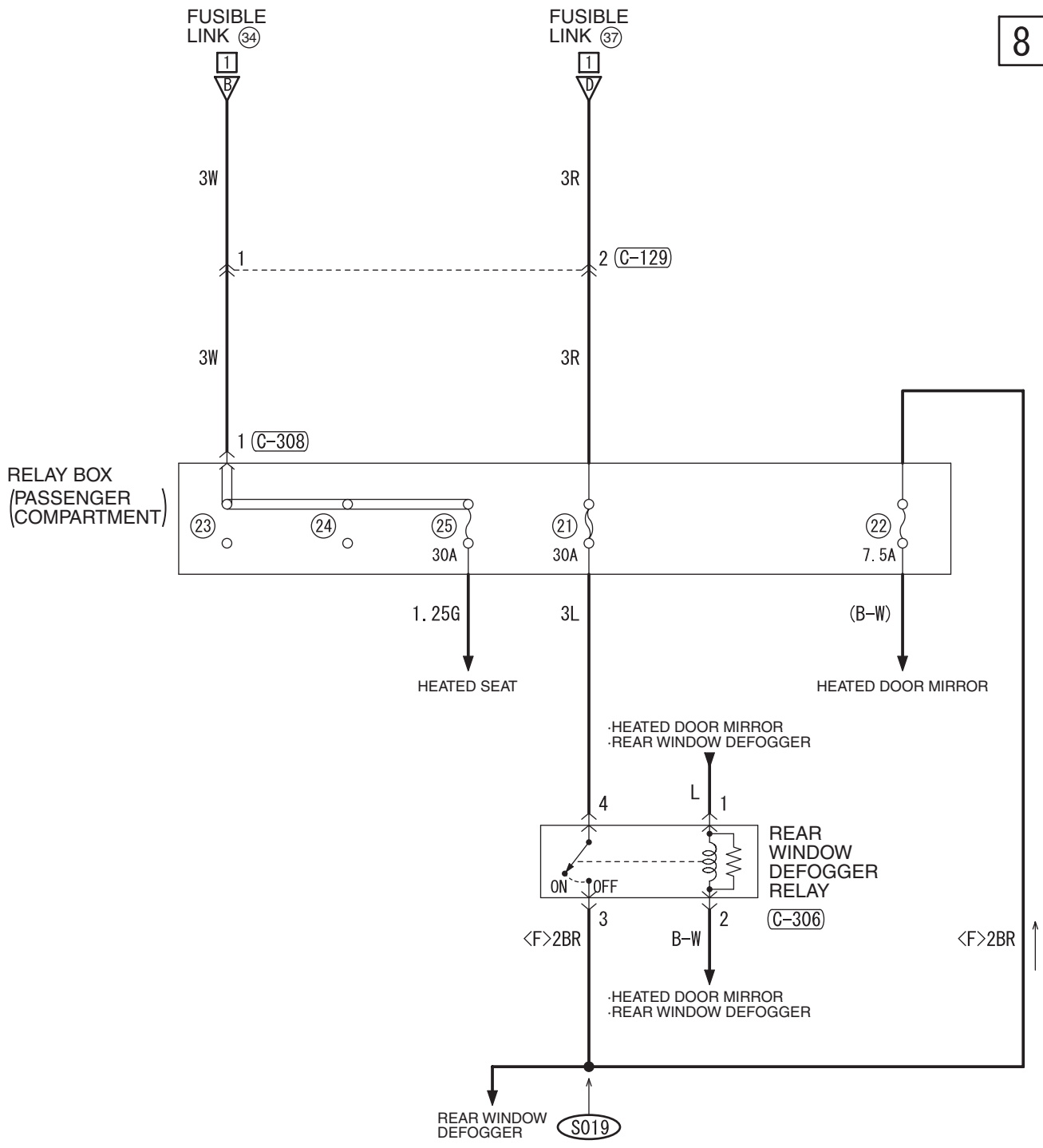

WIRE COLOR CODE
 B : BLACK LG : LIGHT GREEN G : GREEN L : BLUE W : WHITE Y : YELLOW SB : SKY BLUE
 BR : BROWN O : ORANGE GR : GRAY R : RED P : PINK V : VIOLET PU : PURPLE

TSB Revision

STARTING SYSTEM <M/T>

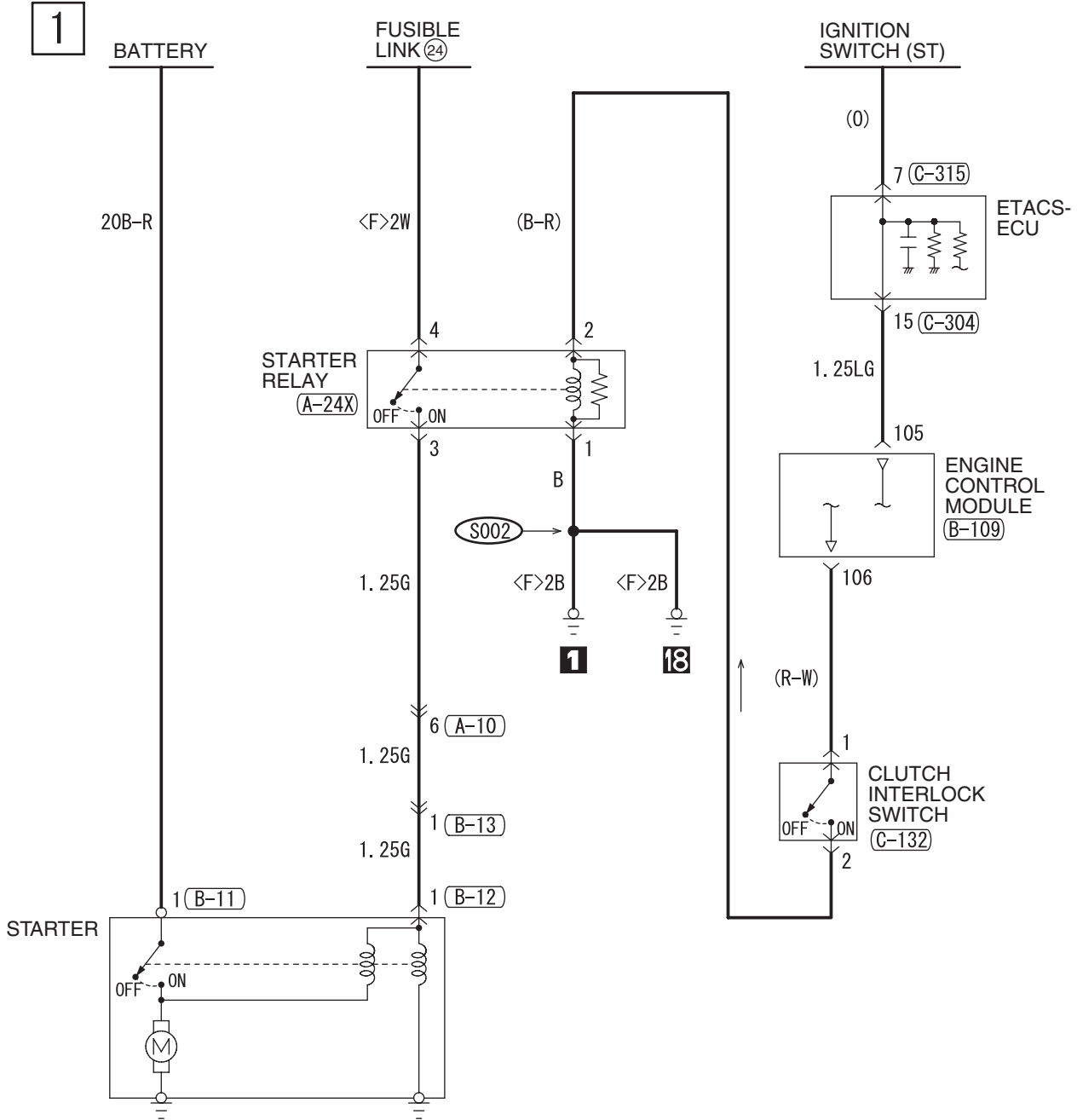

(A-10)

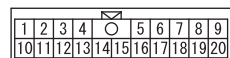

(A-24X)



(B-11)



(B-12)



(B-13)



(B-109)

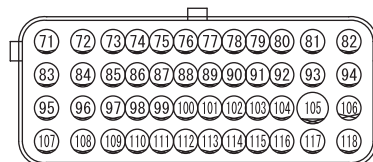

(C-132)



(C-304)

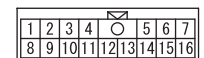

(C-315)

MU801890

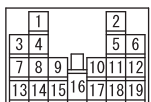

STARTING SYSTEM <CVT>

M1901000502957

1

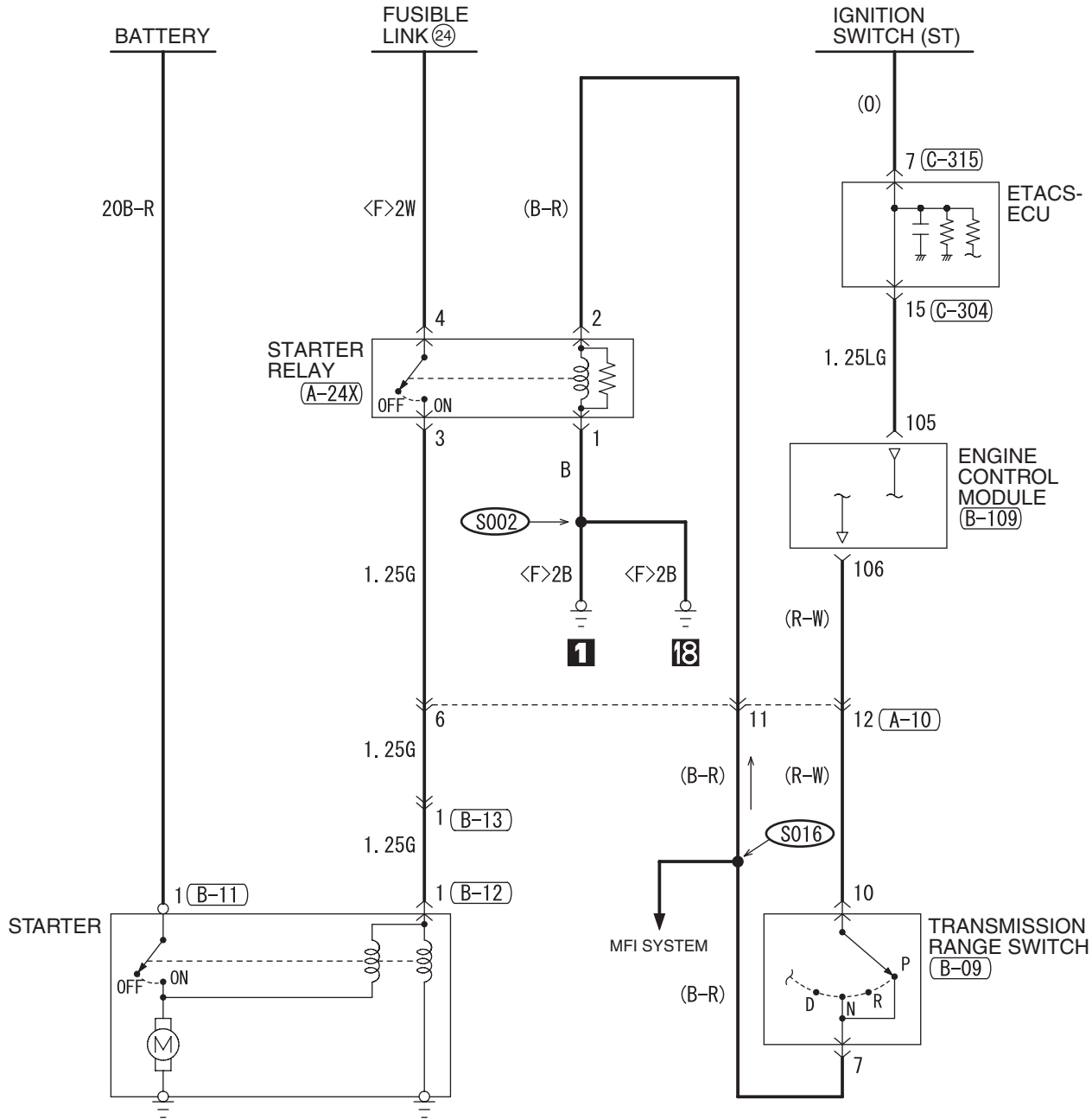

(A-10)

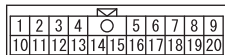

(A-24X)



(B-09)



(B-11)



(B-12)



(B-13)



(B-109)

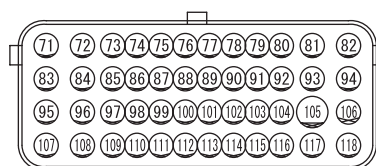

(C-304)

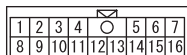

(C-315)



H8G02M01AA

IGNITION SYSTEM

M190100603849

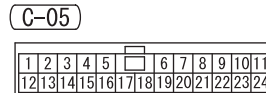
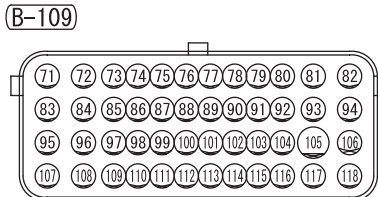
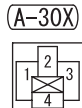
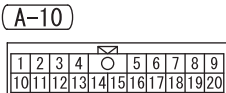
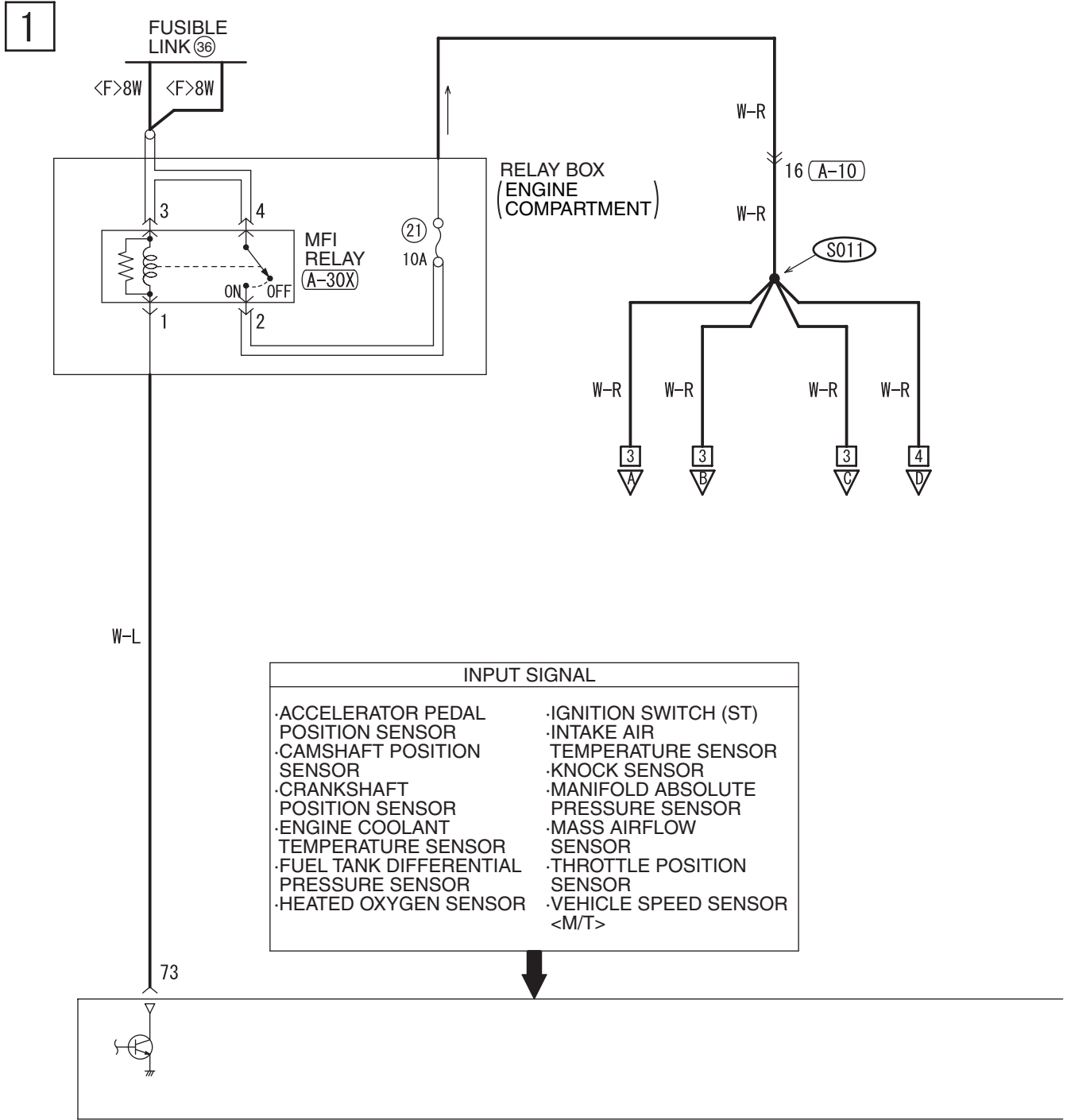

TSB Revision

2

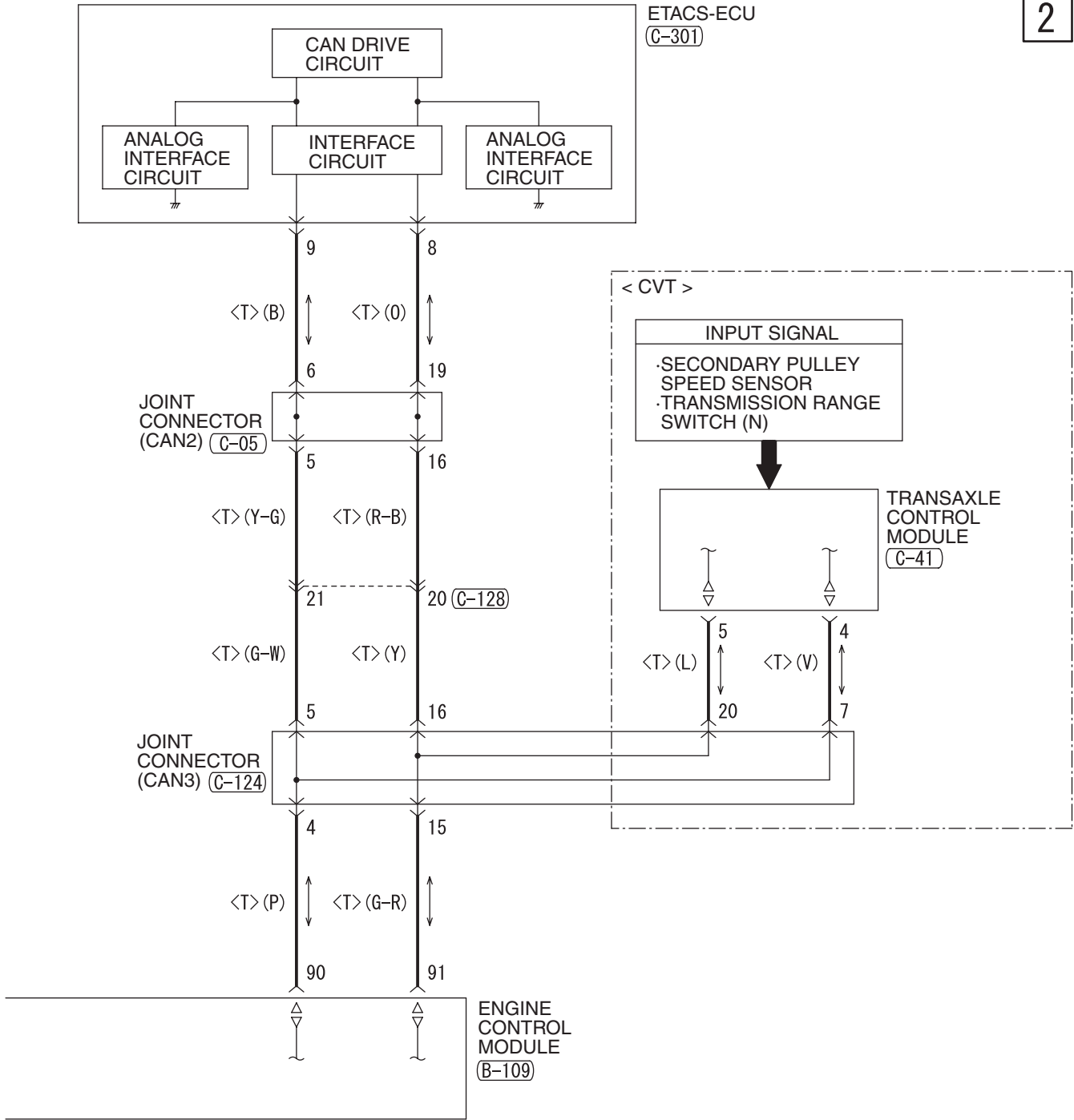

(C-124)

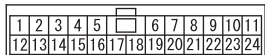

(C-128)

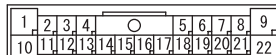

(C-301)



WIRE COLOR CODE

B : BLACK LG : LIGHT GREEN G : GREEN L : BLUE W : WHITE Y : YELLOW SB : SKY BLUE
BR : BROWN O : ORANGE GR : GRAY R : RED P : PINK V : VIOLET PU : PURPLE

IGNITION SYSTEM (CONTINUED)

3

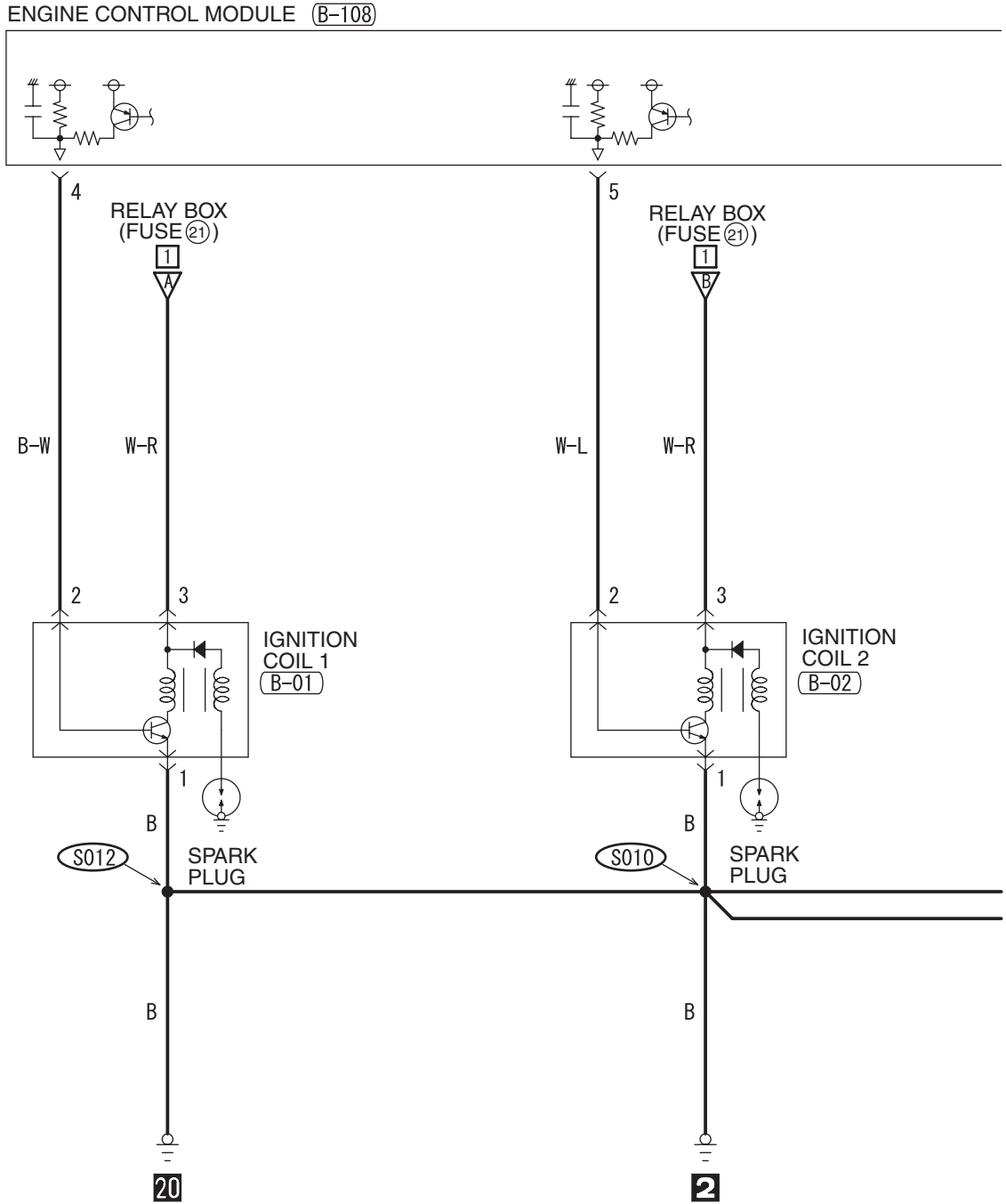

B-108

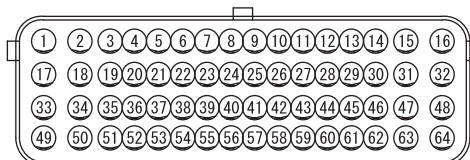

TSB Revision

4

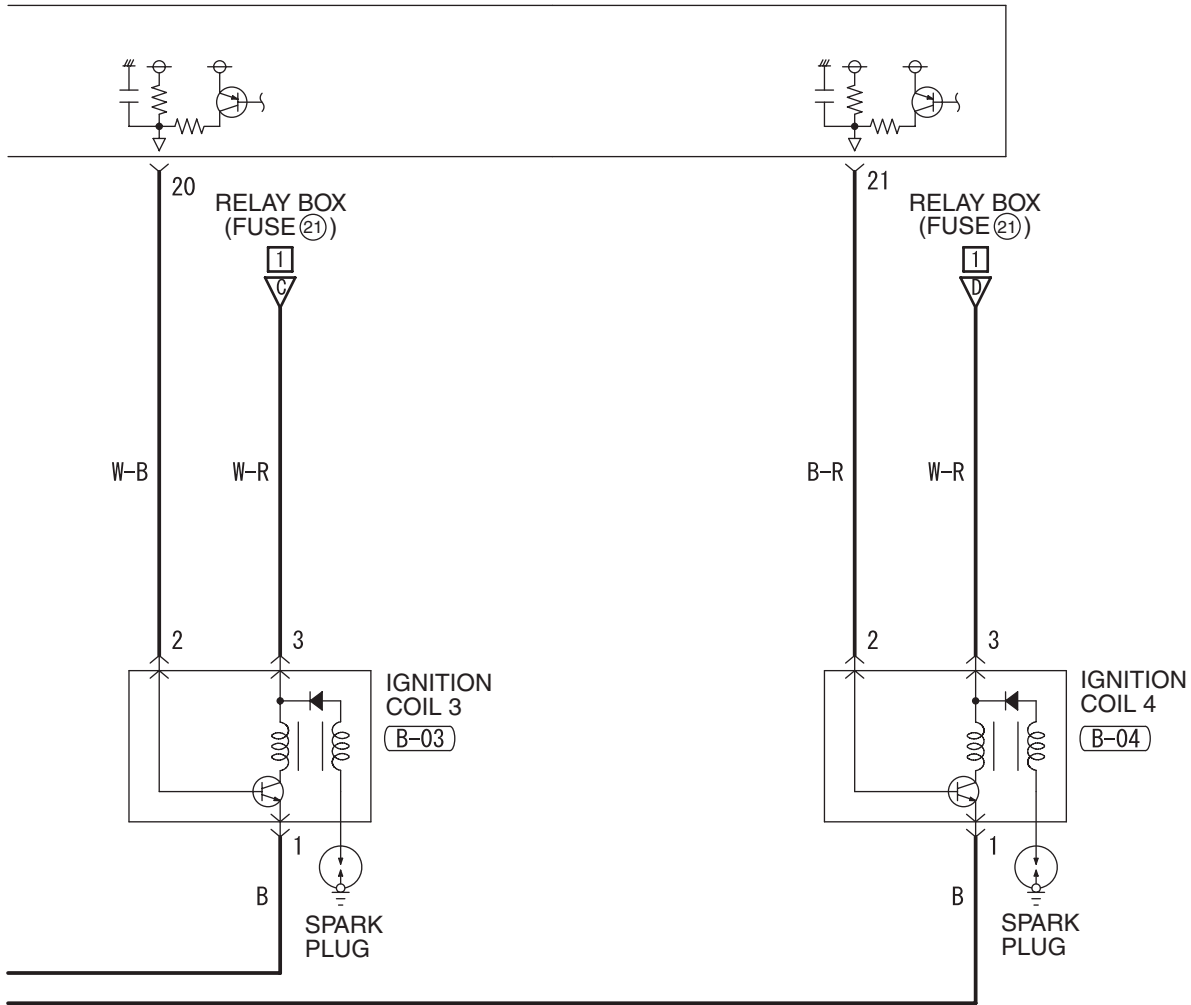

WIRE COLOR CODE
 B: BLACK LG: LIGHT GREEN G: GREEN L: BLUE W: WHITE Y: YELLOW SB: SKY BLUE
 BR: BROWN O: ORANGE GR: GRAY R: RED P: PINK V: VIOLET PU: PURPLE

H8G03M00BB

TSB Revision

CHARGING SYSTEM

M1901000703006

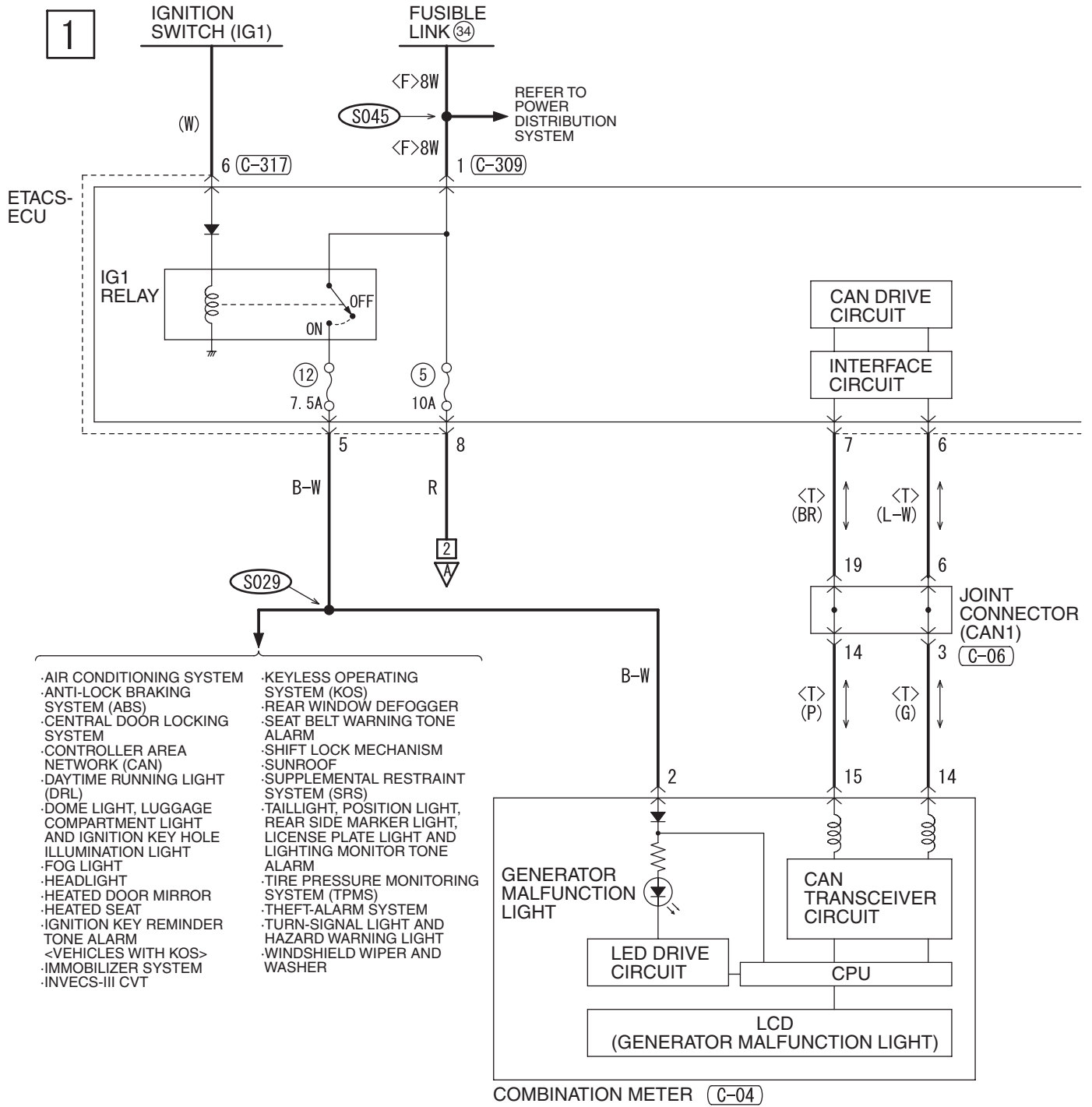

B-109

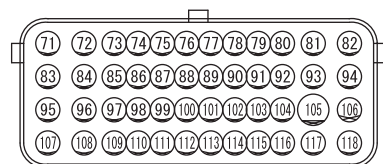

C-04

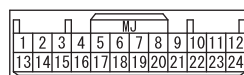

C-317

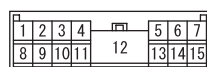

C-05

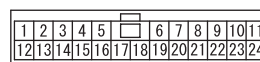

C-06

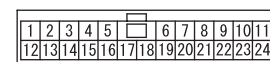

H8G04M00AA

2

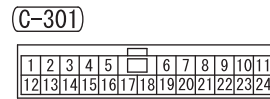
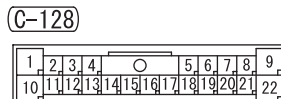
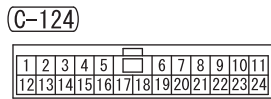
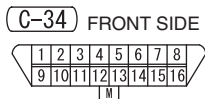
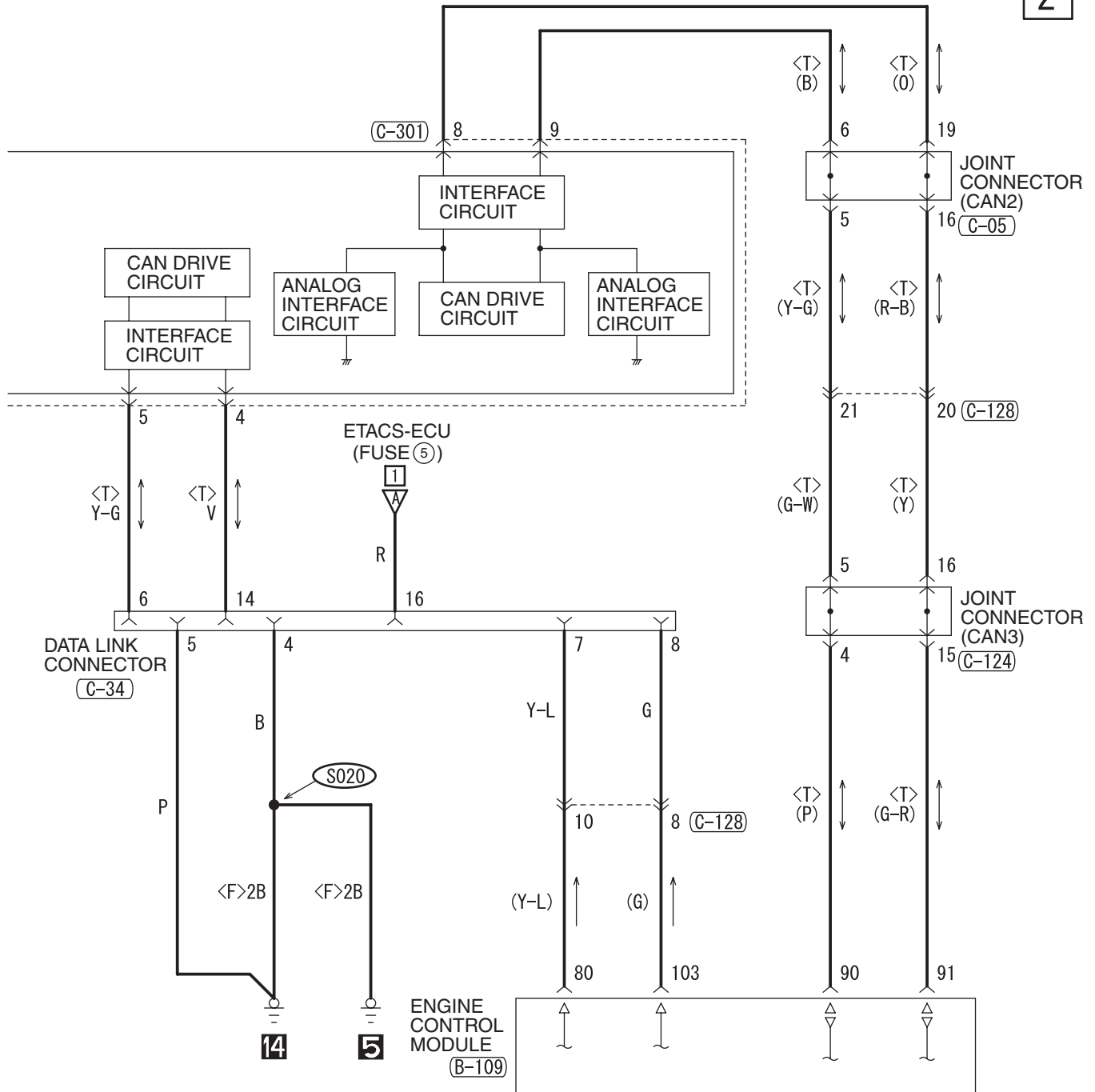

WIRE COLOR CODE
 B : BLACK LG : LIGHT GREEN G : GREEN L : BLUE W : WHITE Y : YELLOW SB : SKY BLUE
 BR : BROWN O : ORANGE GR : GRAY R : RED P : PINK V : VIOLET PU : PURPLE

H8G04M00AB

TSB Revision

CHARGING SYSTEM (CONTINUED)

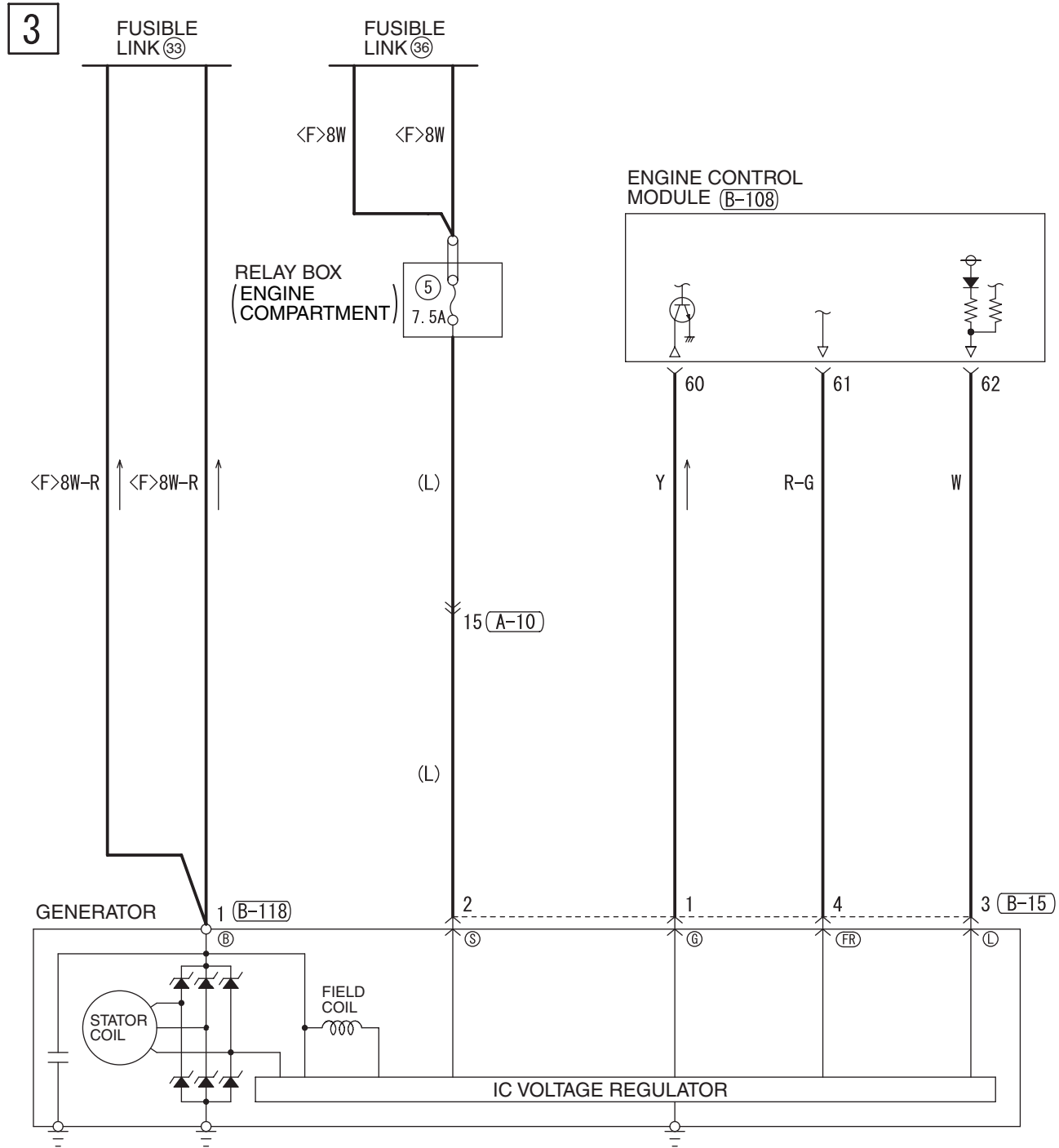

A-10

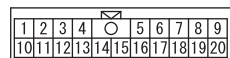

B-15



B-108

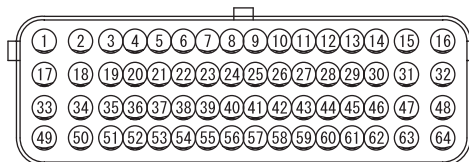

B-118



NOTES

MFI SYSTEM

M1901000805645

1

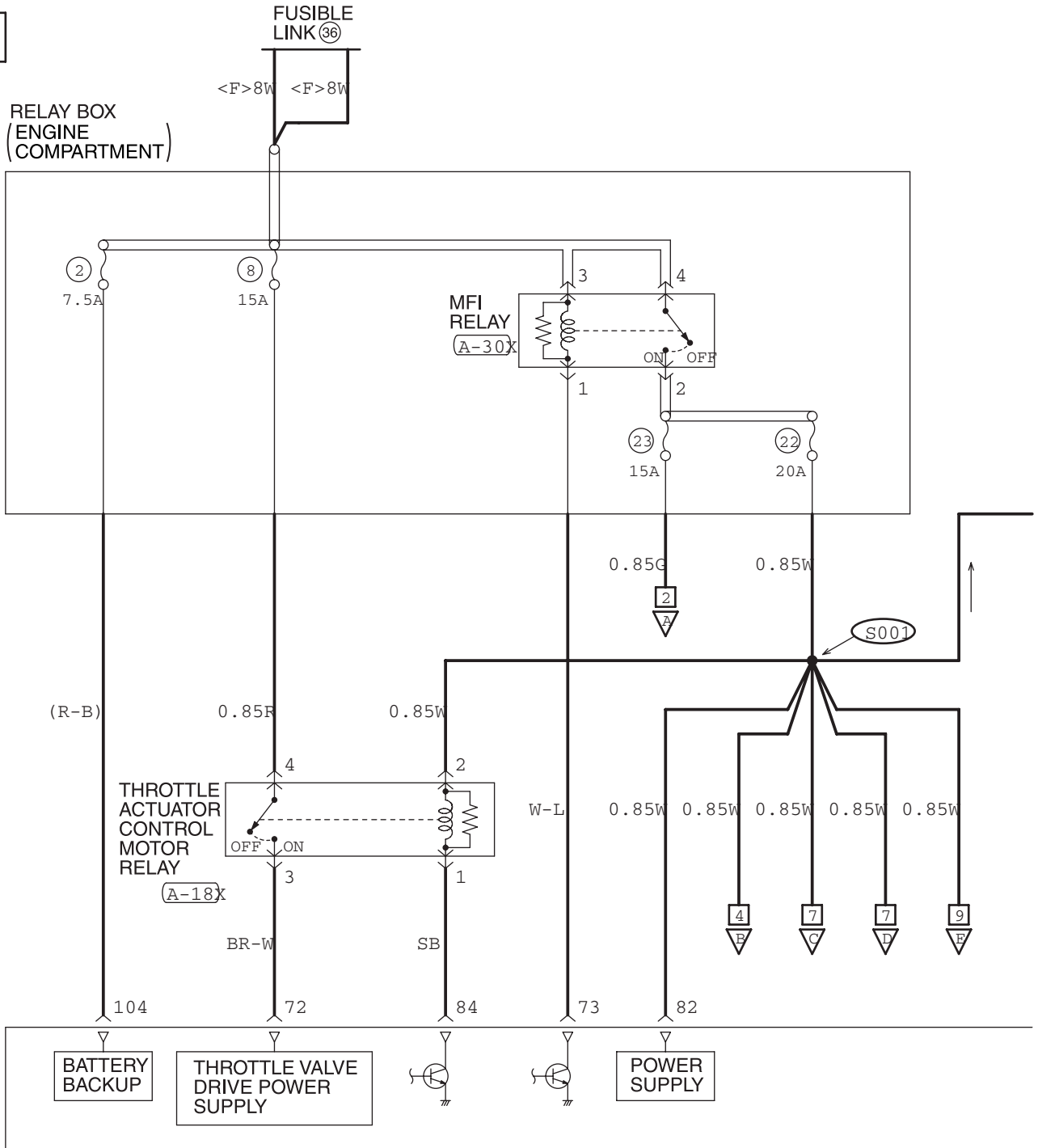

(A-10)

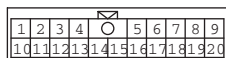

(A-18x)



(A-21x)



(A-30x)



(B-10)

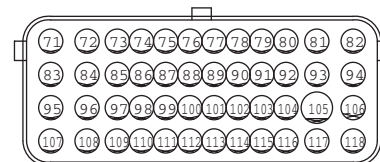

(C-30)

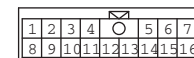

(C-30)



(C-31)



H8G05M00AA

TSB Revision

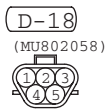
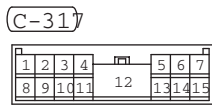
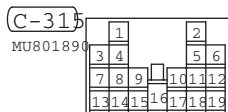
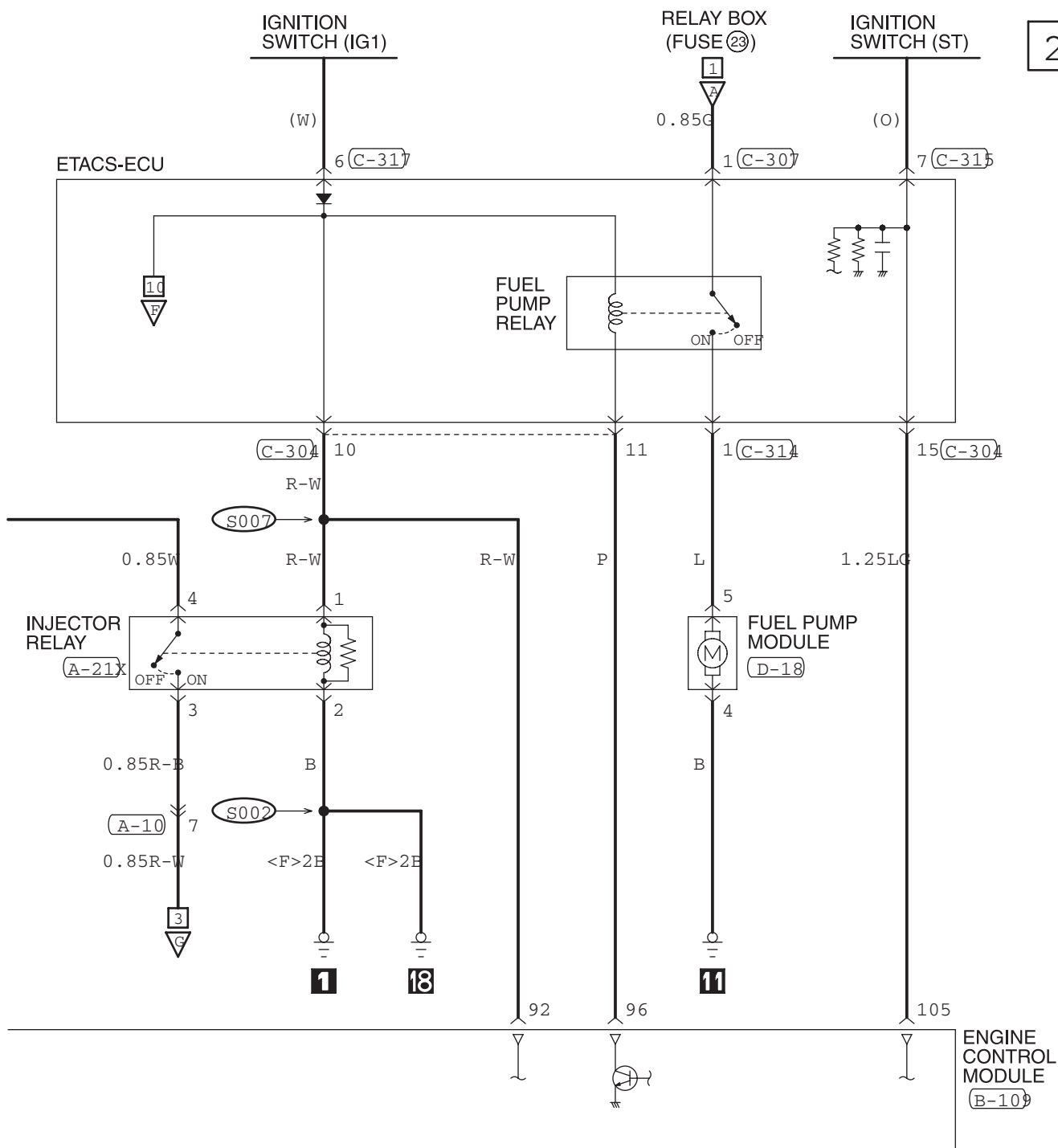

WIRE COLOR CODE
 B: BLACK LG: LIGHT GREEN G: GREEN L: BLUE W: WHITE Y: YELLOW SB: SKY BLUE
 BR: BROWN O: ORANGE GR: GRAY R: RED P: PINK V: VIOLET PU: PURPLE

MFI SYSTEM (CONTINUED)

3

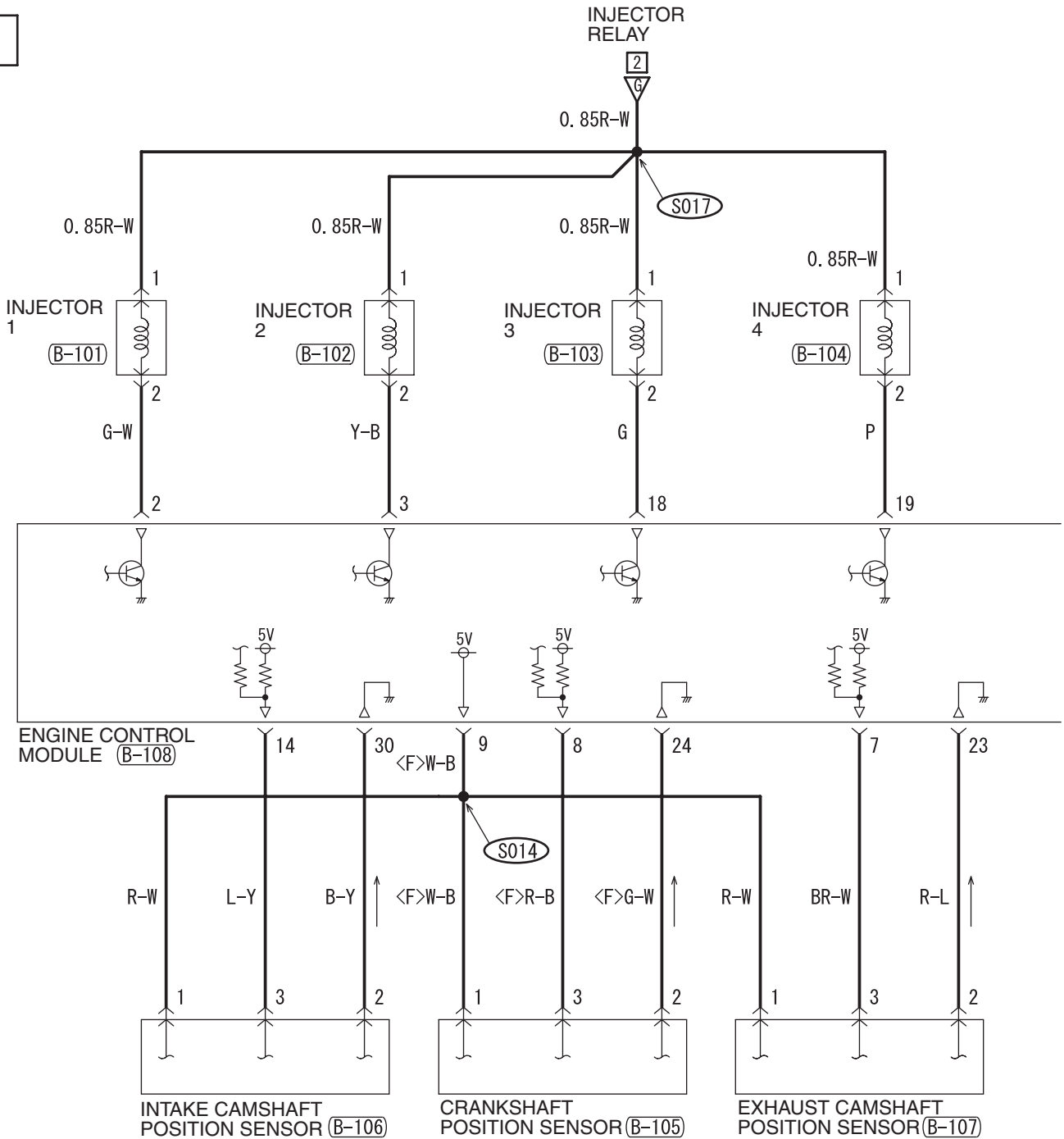

(A-10)

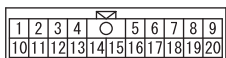

(B-16)



(B-18)



(B-19)



(B-101)



(B-102)



(B-103)



(B-104)



(B-105)



(B-106)



(B-107)



4

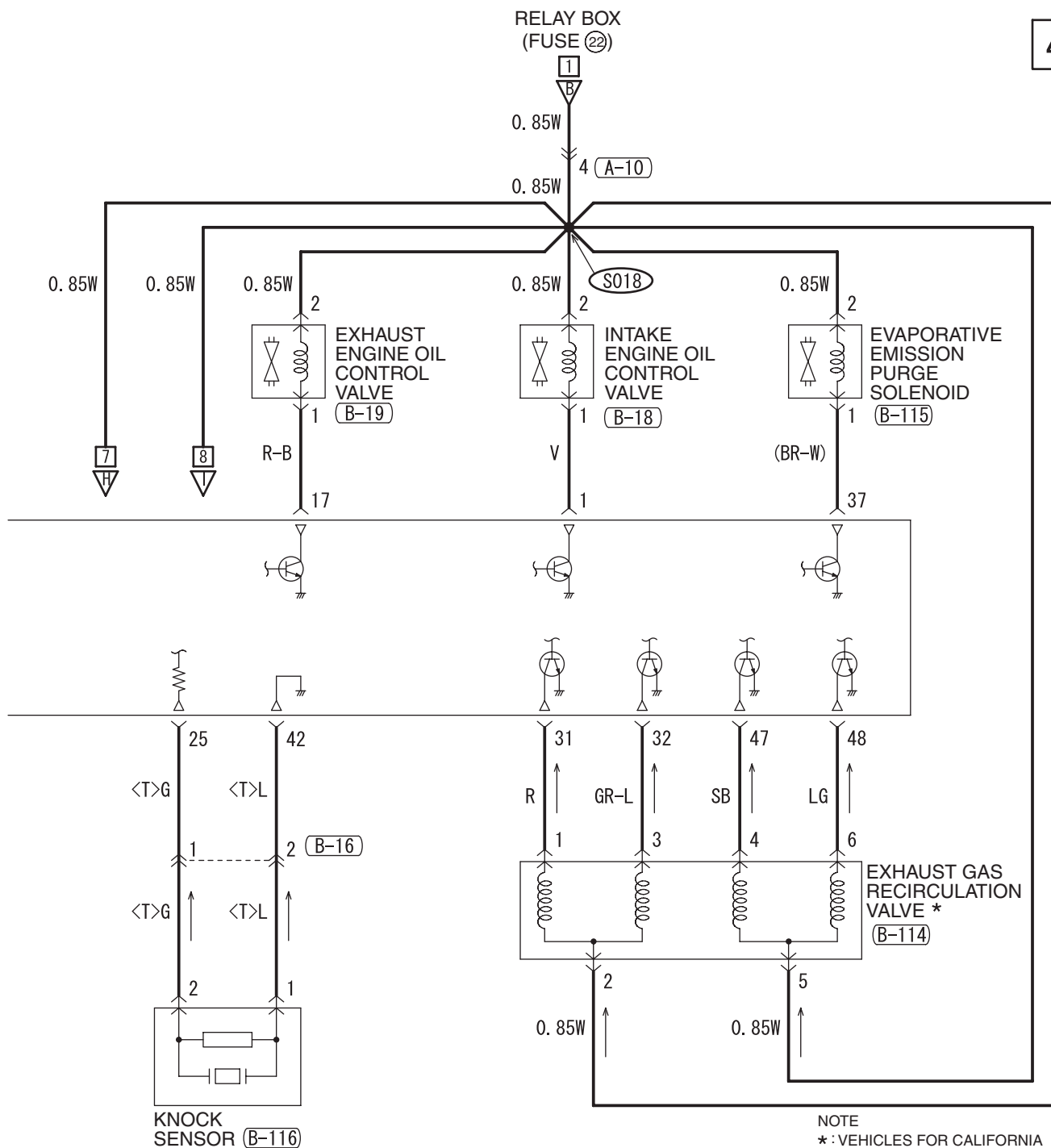

(B-108)

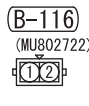
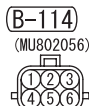
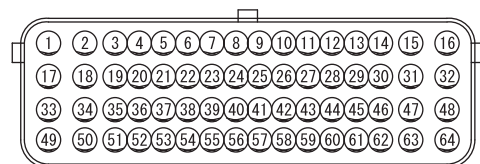

WIRE COLOR CODE
 B : BLACK SB : SKY BLUE
 BR : BROWN LG : LIGHT GREEN
 G : GREEN P : PINK GR : GRAY
 R : RED L : BLUE Y : YELLOW
 V : VIOLET W : WHITE O : ORANGE
 PU : PURPLE

H8G05M00BB

MFI SYSTEM (CONTINUED)

5

THROTTLE BODY ASSEMBLY (B-10)

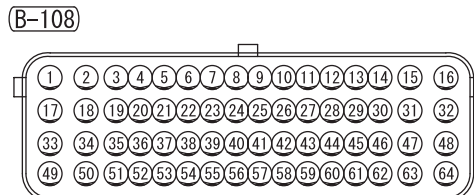
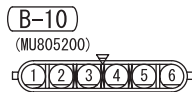
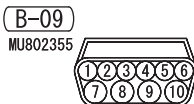
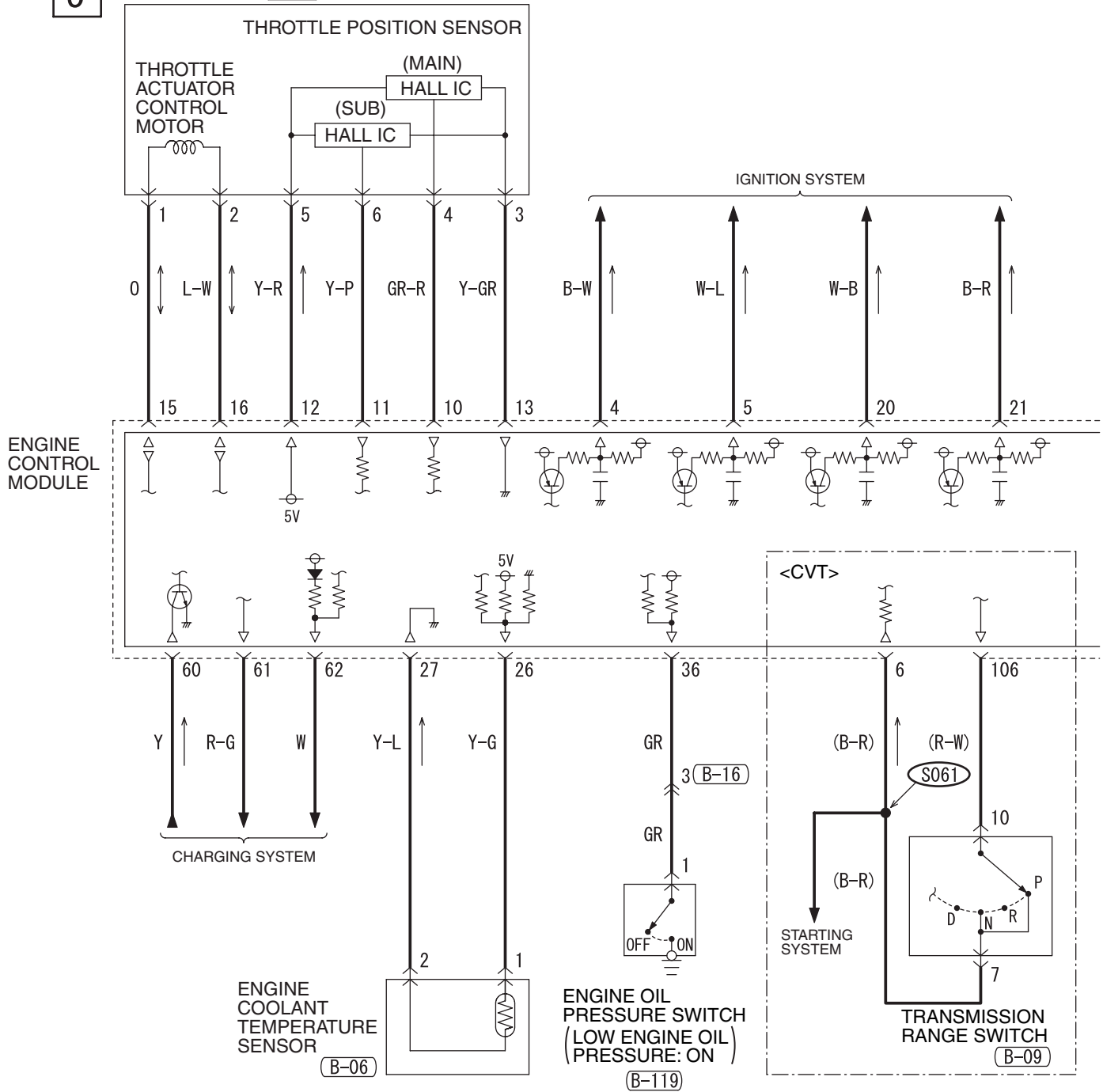

6

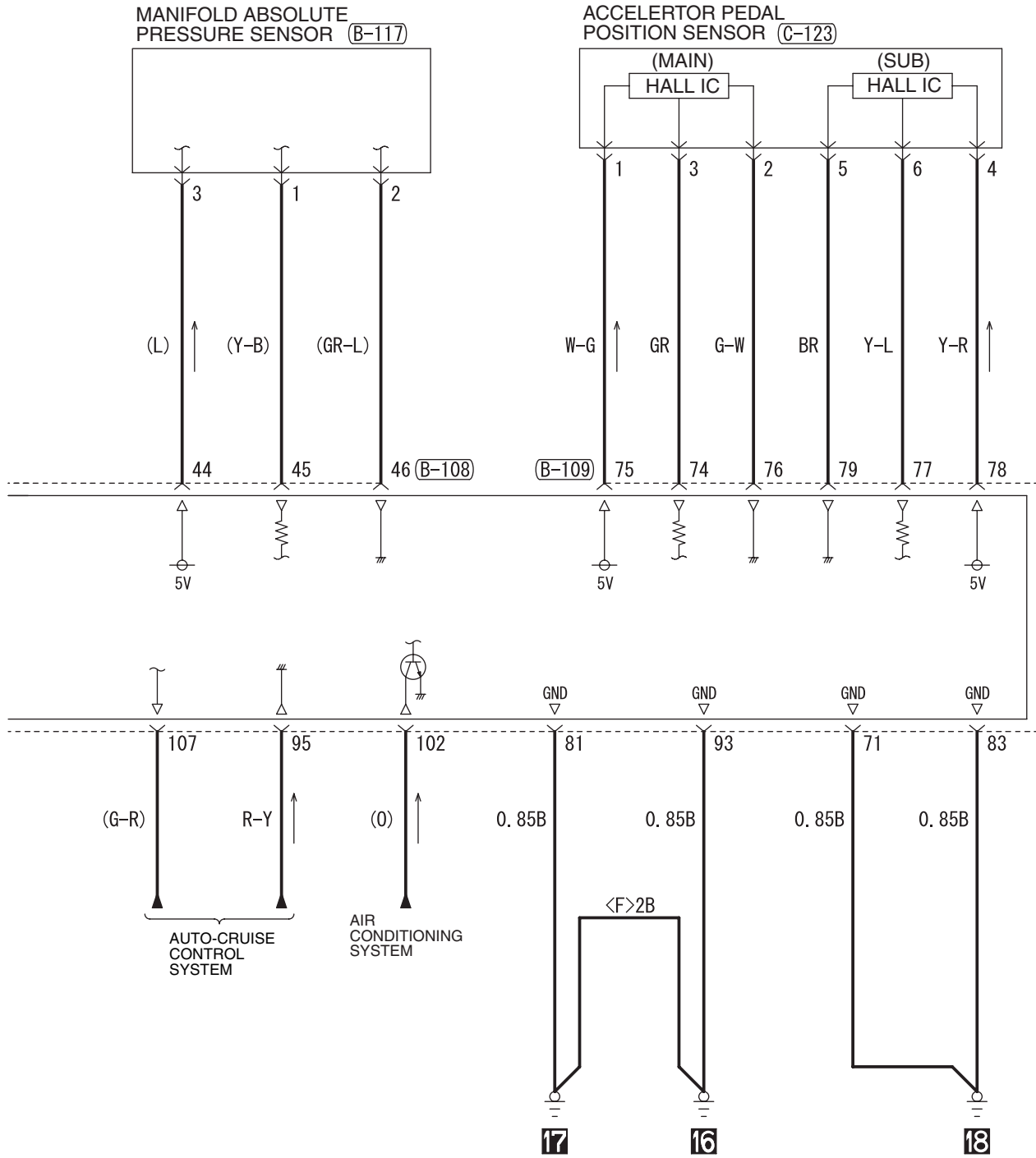

(B-109)

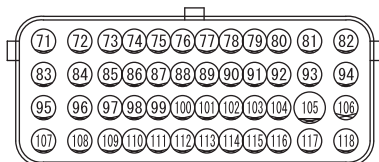

(B-117)



(B-119)



(C-123)

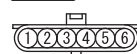

WIRE COLOR CODE
 B : BLACK SB : SKY BLUE
 BR : BROWN LG : LIGHT GREEN
 G : GREEN P : PINK GR : GRAY
 R : RED L : BLUE Y : YELLOW
 V : VIOLET W : WHITE O : ORANGE
 PU : PURPLE

H8G05M00CB

MFI SYSTEM (CONTINUED)

7

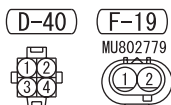
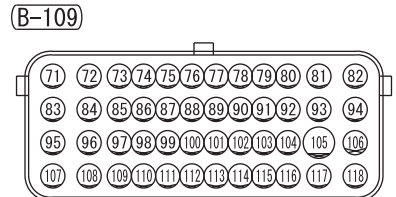
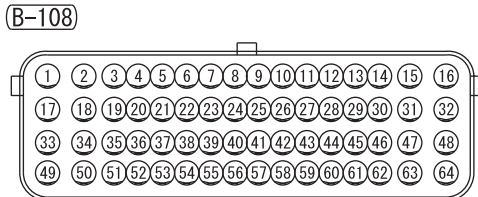
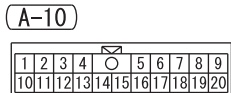
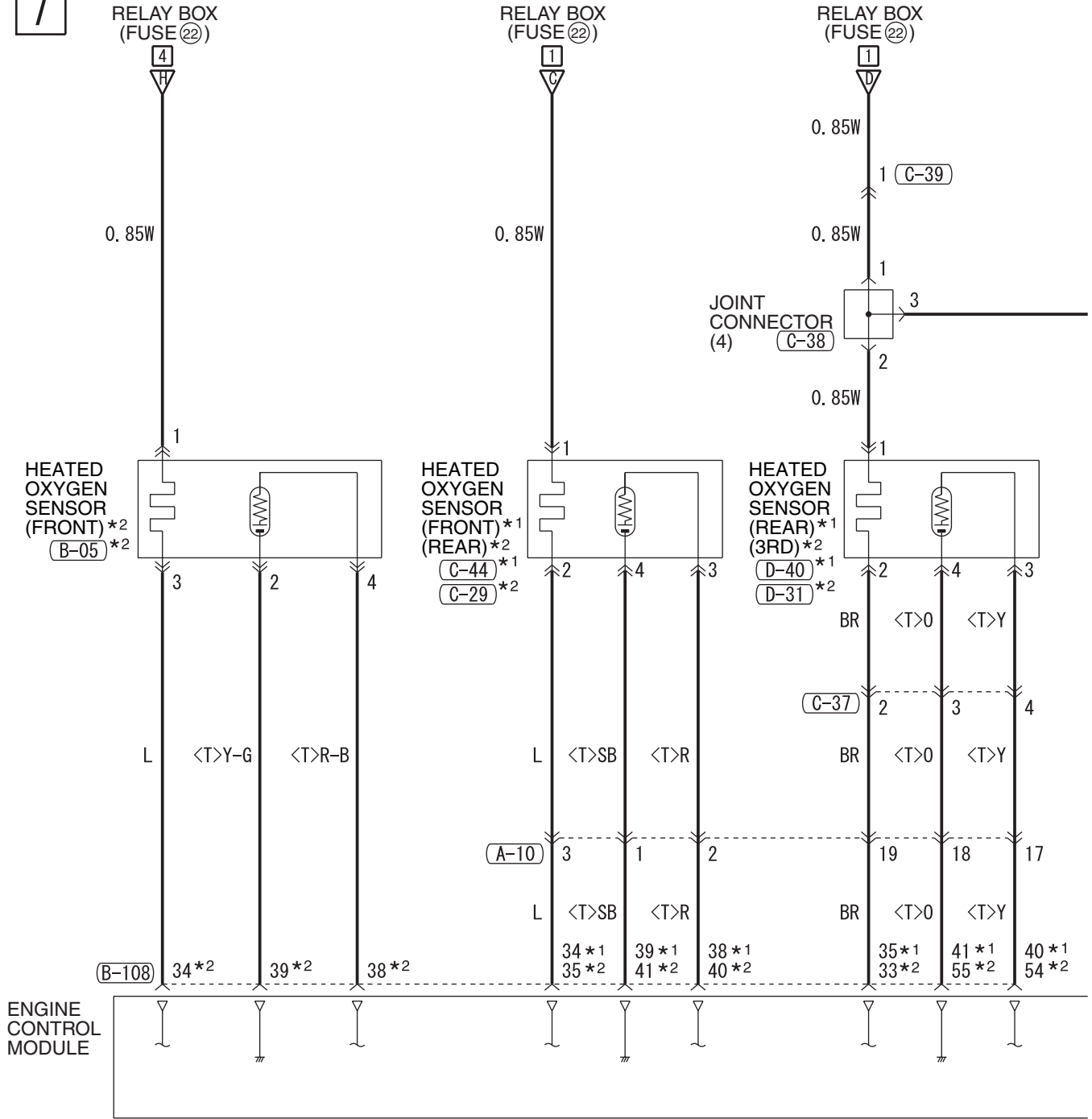

H8G05M00DA

TSB Revision

8

NOTE
*1 : VEHICLES FOR FEDERAL AND CANADA
*2 : VEHICLES FOR CALIFORNIA

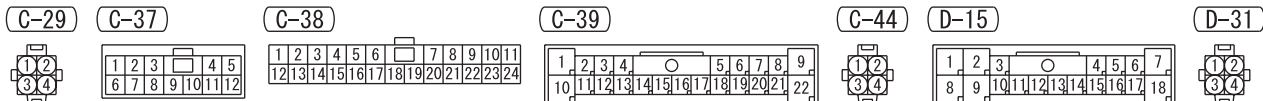
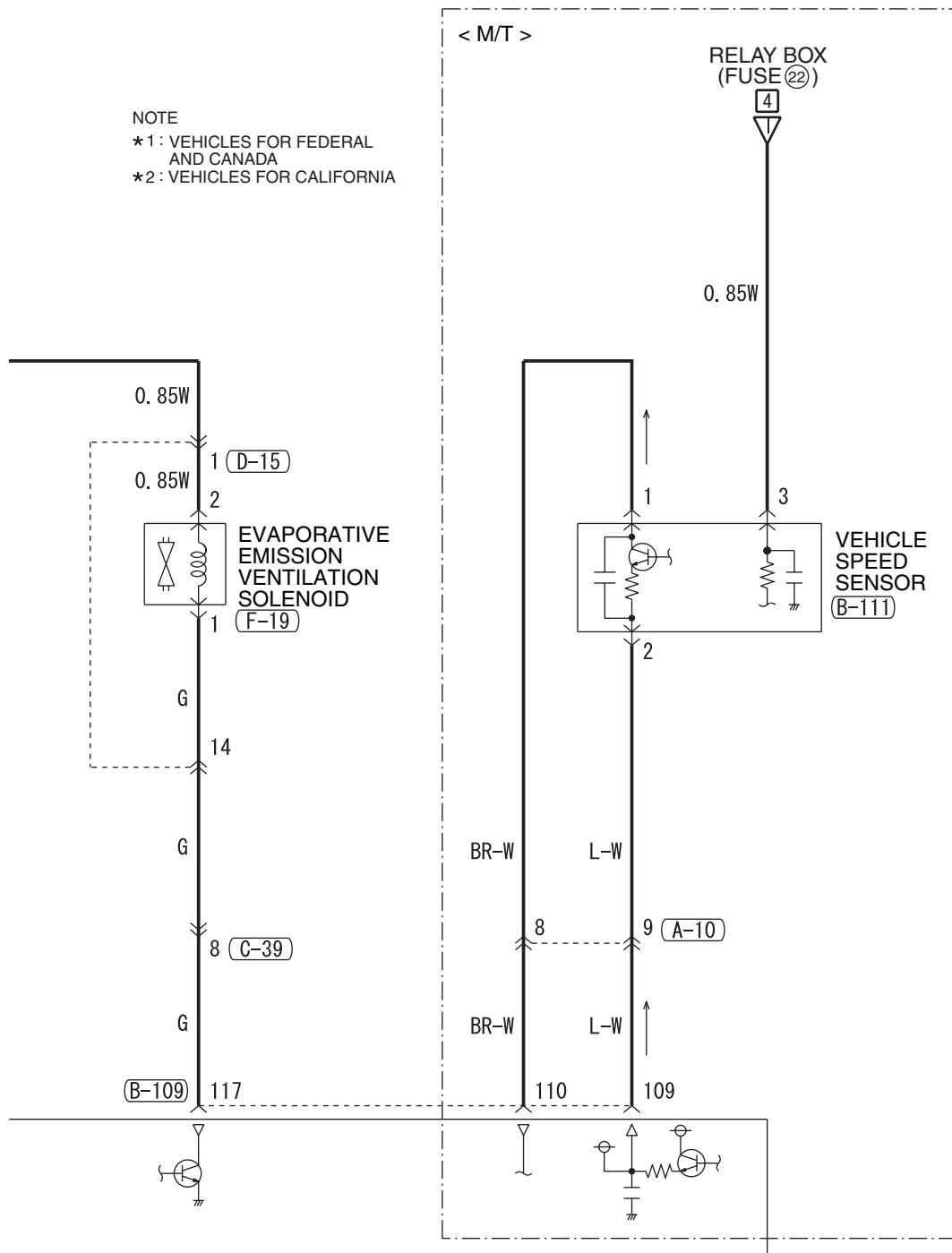

WIRE COLOR CODE

B : BLACK LG : LIGHT GREEN G : GREEN L : BLUE W : WHITE Y : YELLOW SB : SKY BLUE
BR : BROWN O : ORANGE GR : GRAY R : RED P : PINK V : VIOLET PU : PURPLE

H8G05M00DB

MFI SYSTEM (CONTINUED)

9

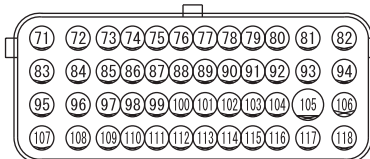
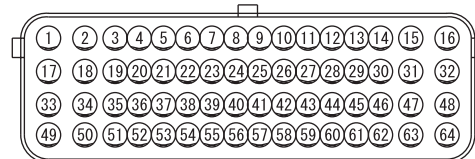
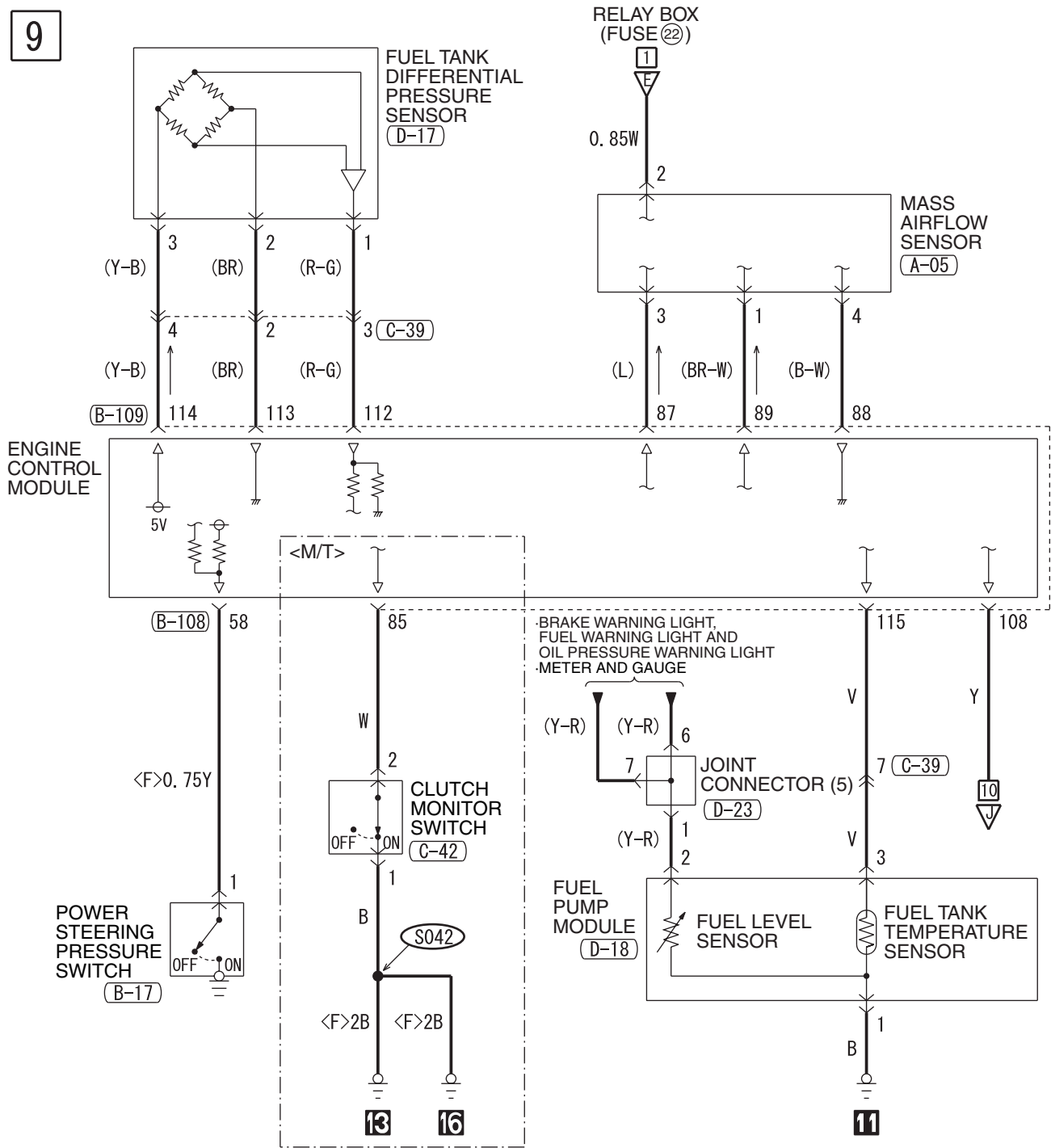

10

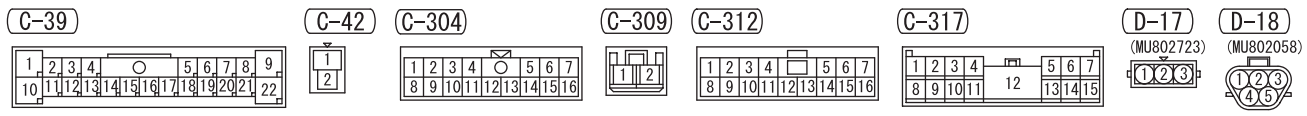
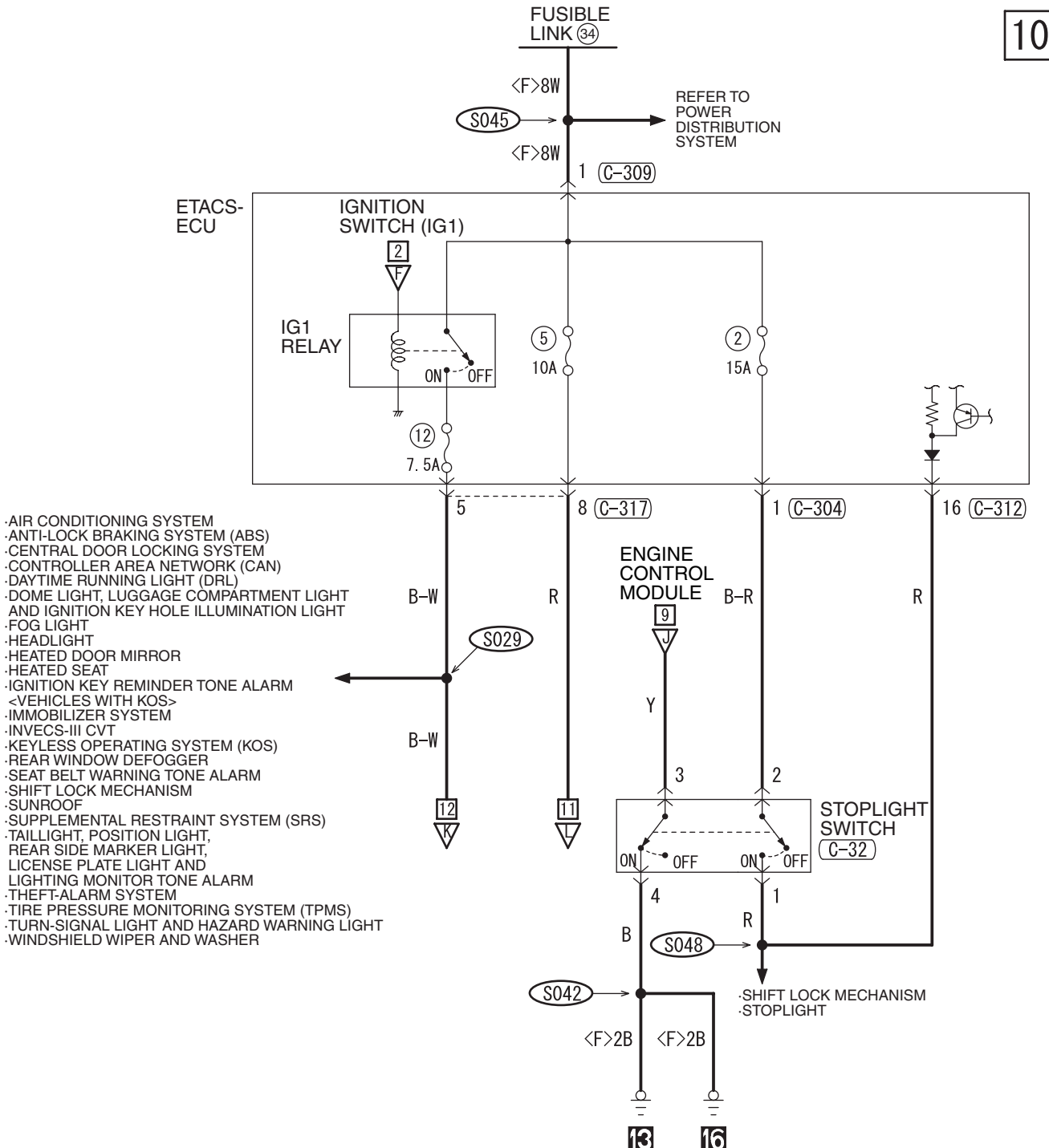

WIRE COLOR CODE
 B : BLACK LG : LIGHT GREEN G : GREEN L : BLUE W : WHITE Y : YELLOW SB : SKY BLUE
 BR : BROWN O : ORANGE GR : GRAY R : RED P : PINK V : VIOLET PU : PURPLE

H8G05M00EB

TSB Revision

MFI SYSTEM (CONTINUED)

11

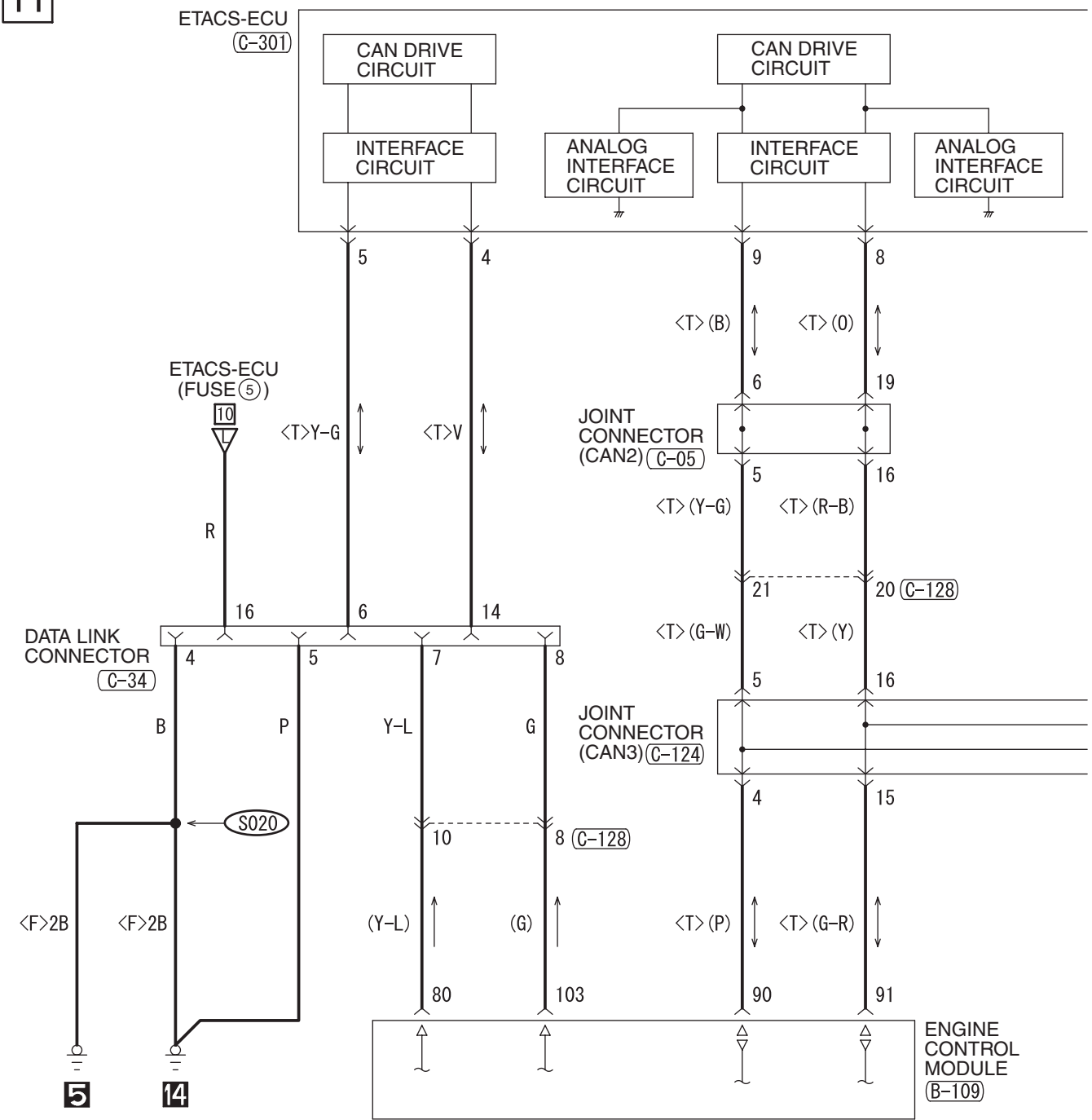

B-109

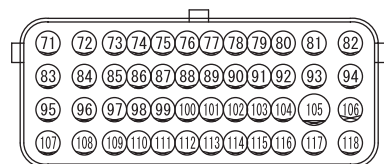

C-04

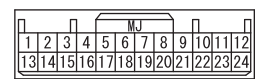

C-05

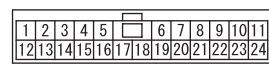

C-06

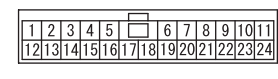

C-301

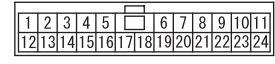

12

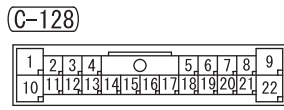
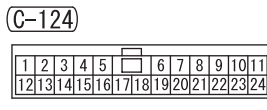
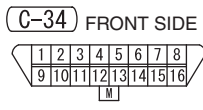
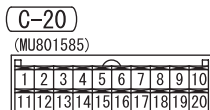
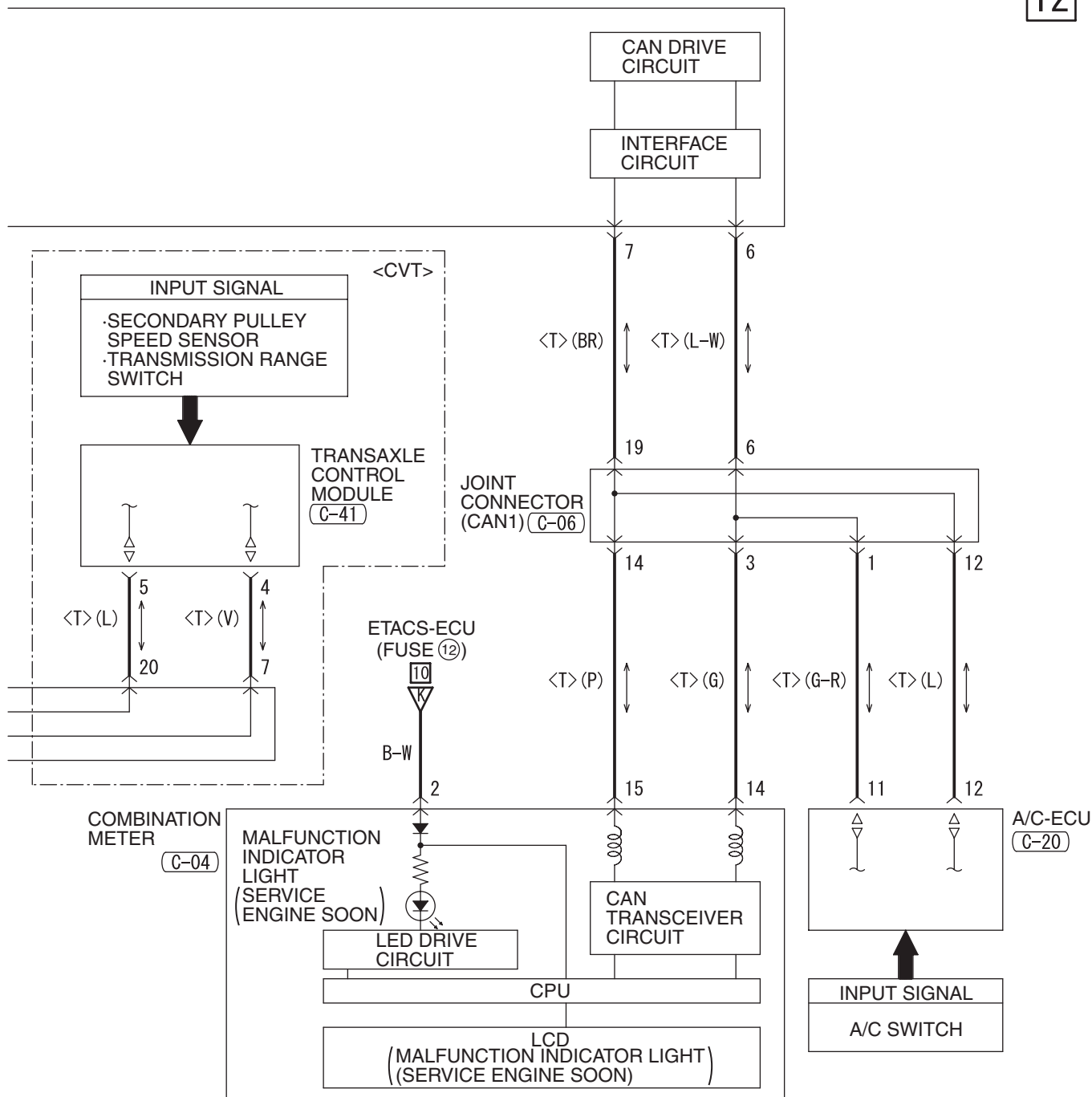

WIRE COLOR CODE
 B : BLACK LG : LIGHT GREEN G : GREEN L : BLUE W : WHITE Y : YELLOW SB : SKY BLUE
 BR : BROWN O : ORANGE GR : GRAY R : RED P : PINK V : VIOLET PU : PURPLE

H8G05M00FB

TSB Revision

COOLING SYSTEM

M1901001002308

1

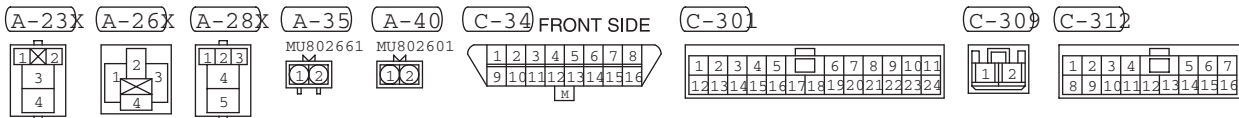
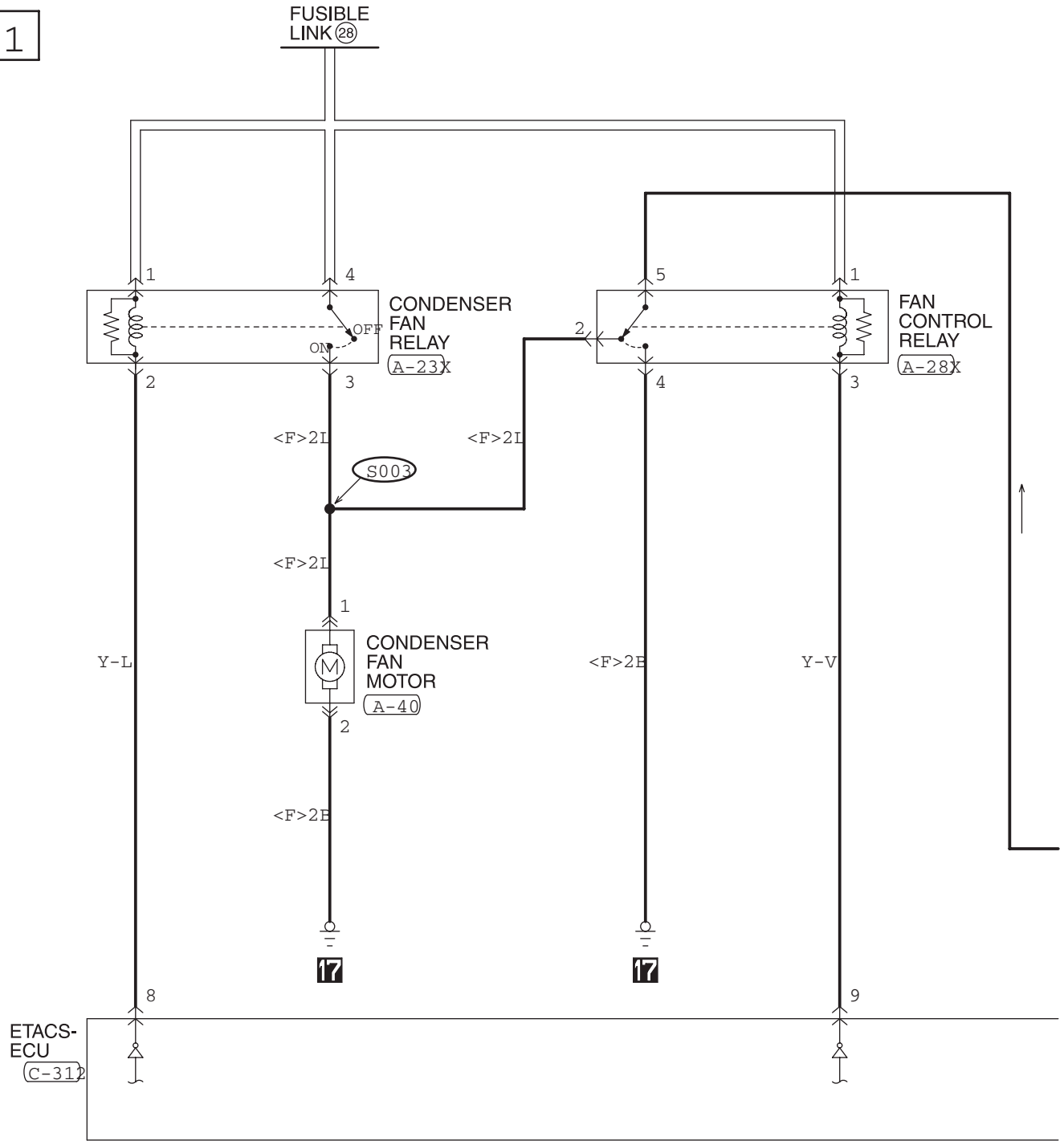

2

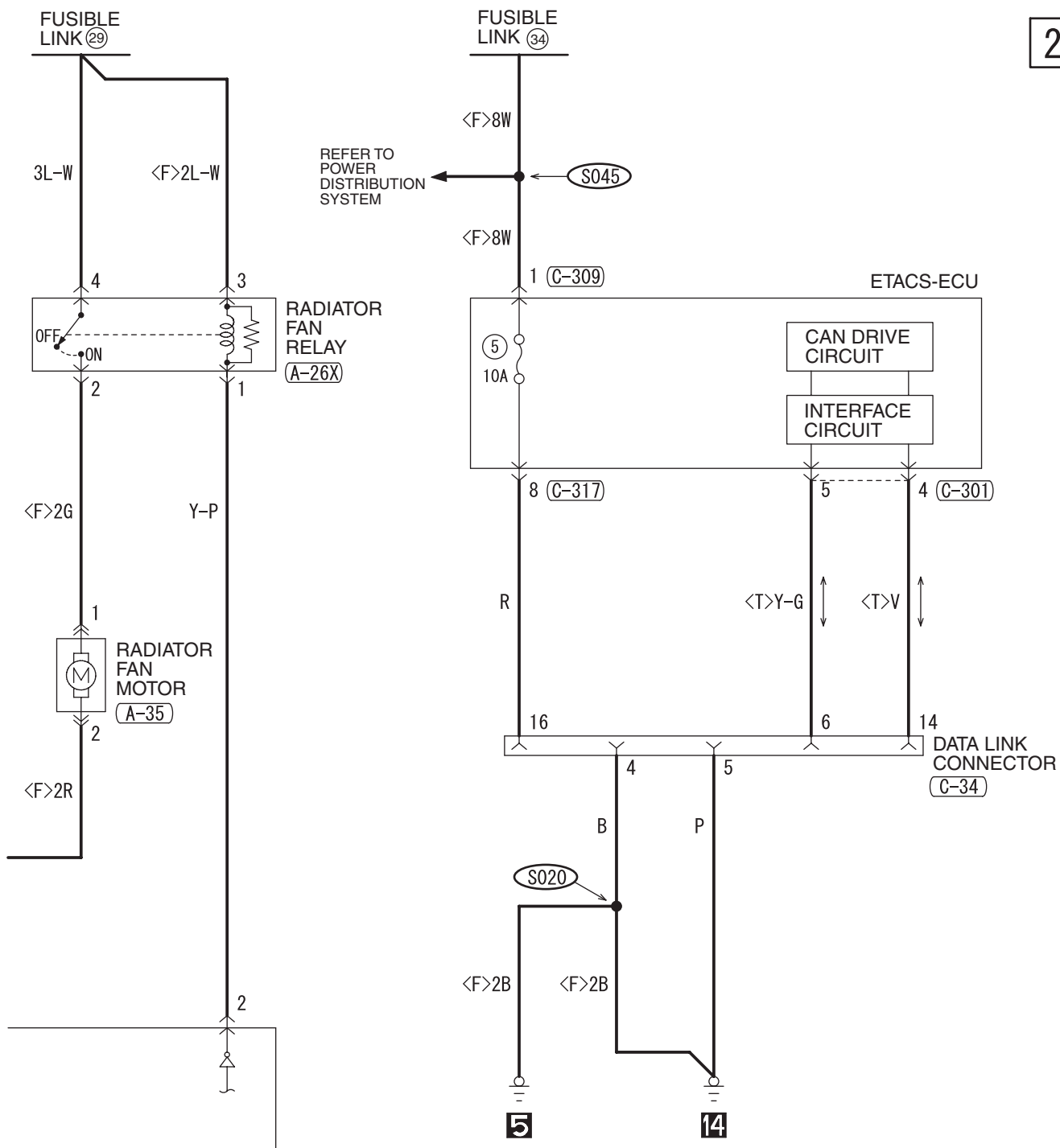

(C-317)

1	2	3	4	5	6	7
8	9	10	11	12	13	14
15						

WIRE COLOR CODE
 B: BLACK LG: LIGHT GREEN G: GREEN L: BLUE W: WHITE Y: YELLOW SB: SKY BLUE
 BR: BROWN O: ORANGE GR: GRAY R: RED P: PINK V: VIOLET PU: PURPLE

H8G06M00AB

TSB Revision

COOLING SYSTEM (CONTINUED)

3

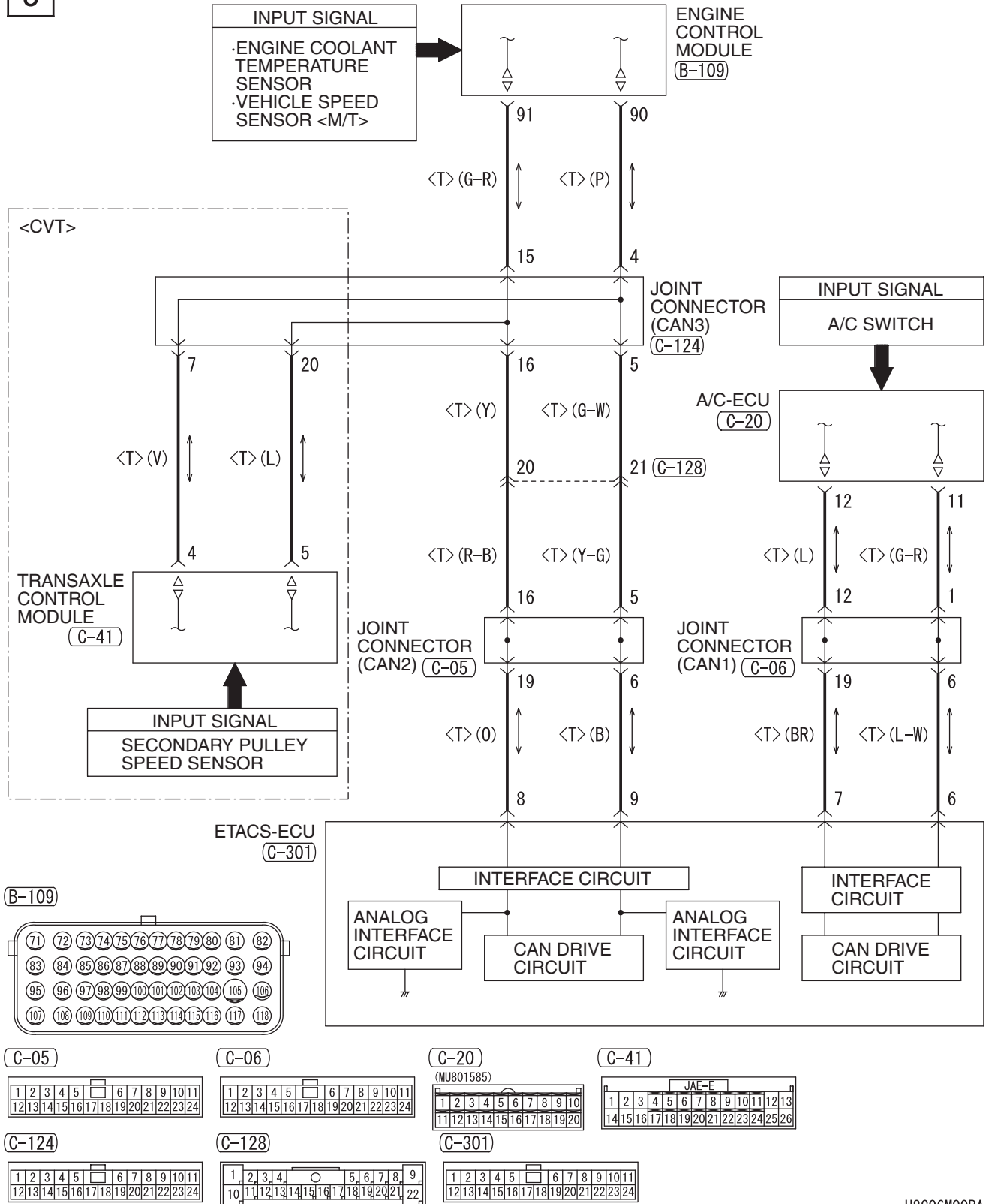

SHIFT LOCK MECHANISM

1

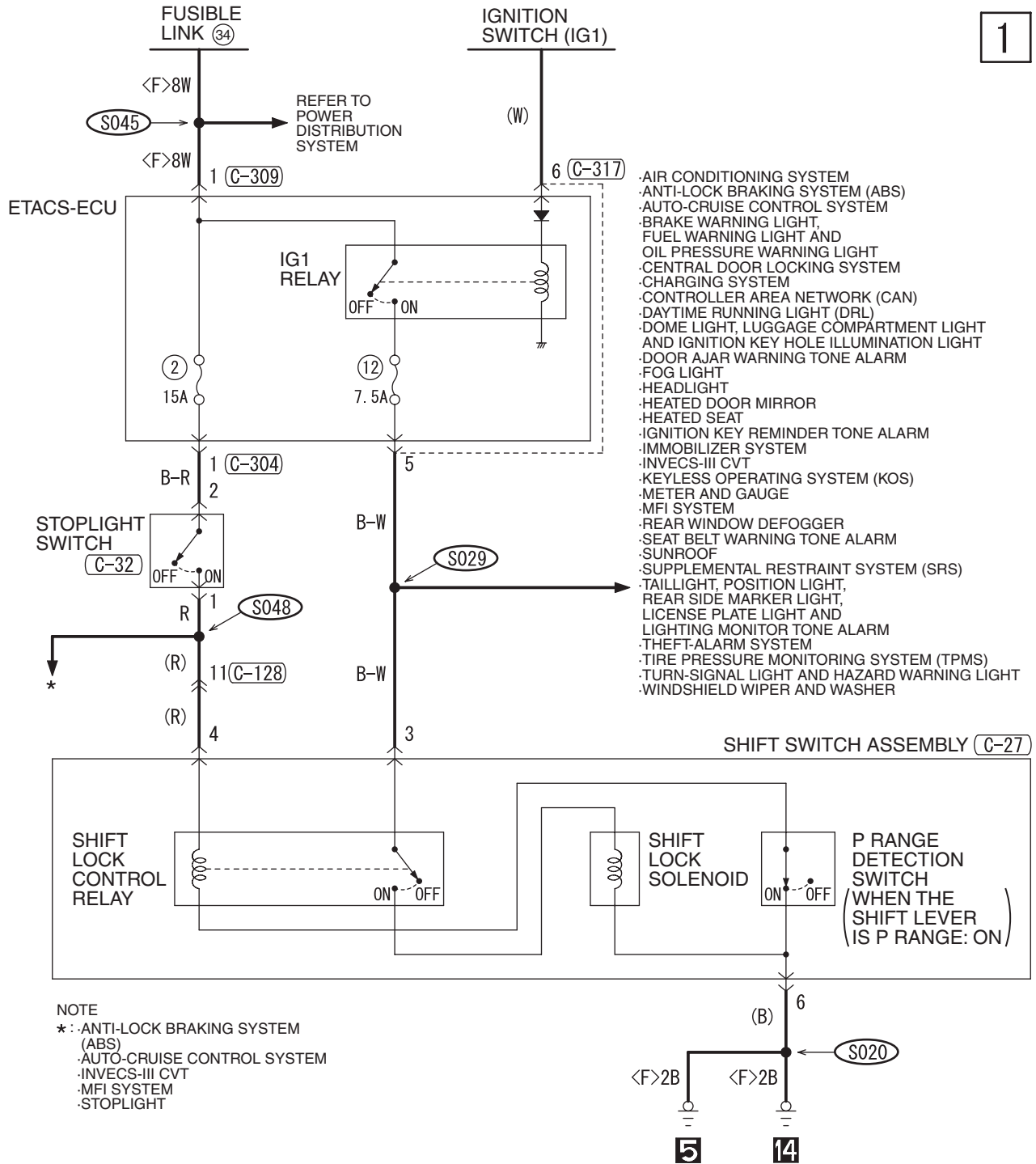

(C-27)

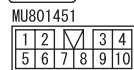

(C-32)



(C-128)

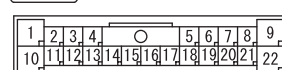

(C-304)

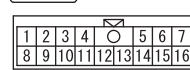

(C-309)



(C-317)

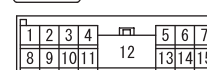

WIRE COLOR CODE

B : BLACK LG : LIGHT GREEN G : GREEN L : BLUE W : WHITE Y : YELLOW SB : SKY BLUE
 BR : BROWN O : ORANGE GR : GRAY R : RED P : PINK V : VIOLET PU : PURPLE

INVECS-III CVT

M1901023100211

1

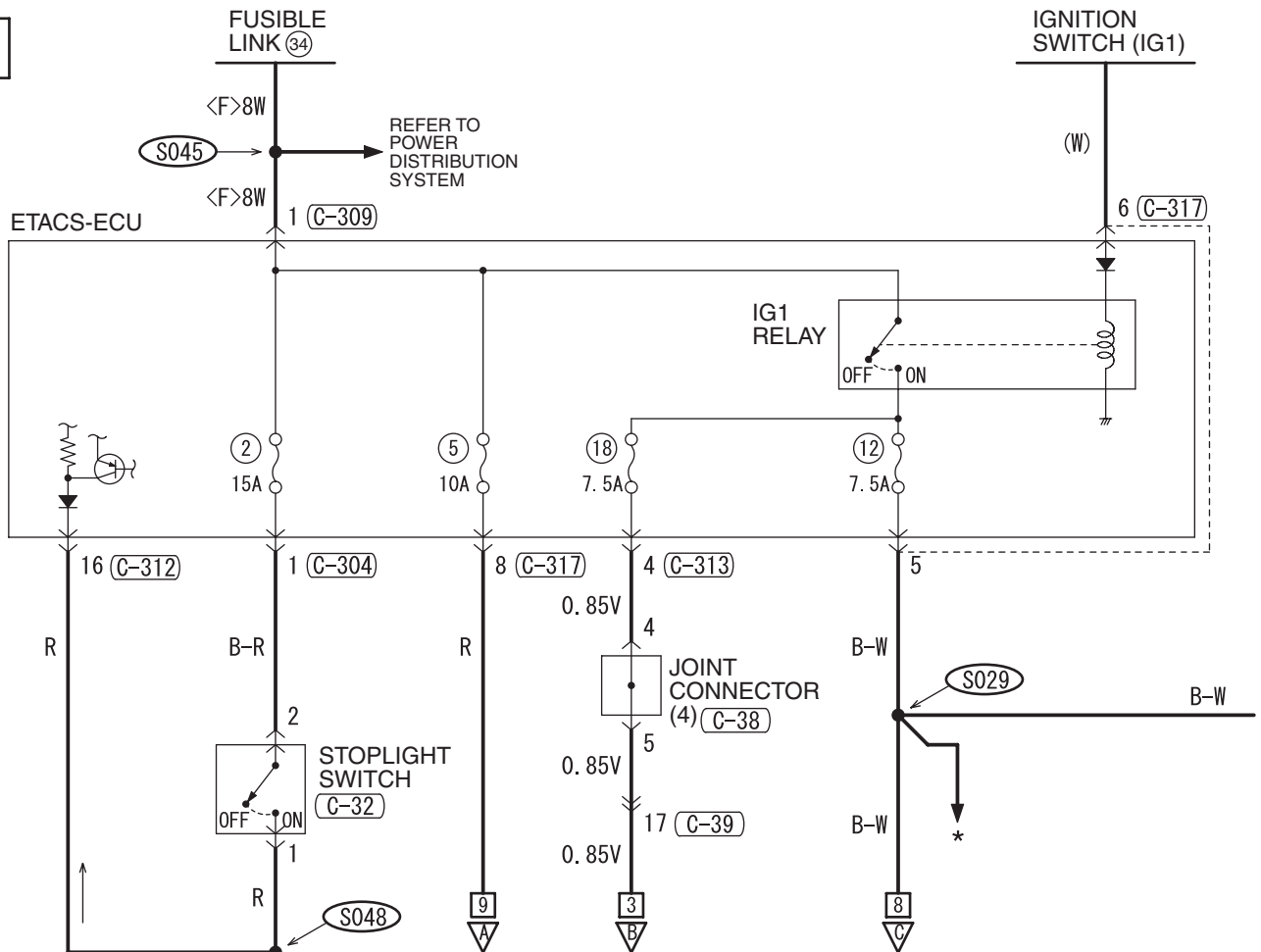

NOTE

- * : AIR CONDITIONING SYSTEM
- ANTI-LOCK BRAKING SYSTEM (ABS)
- CENTRAL DOOR LOCKING SYSTEM
- CONTROLLER AREA NETWORK (CAN)
- DAYTIME RUNNING LIGHT (DRL)
- DOME LIGHT, LUGGAGE COMPARTMENT LIGHT AND IGNITION KEY HOLE ILLUMINATION LIGHT
- FOG LIGHT
- HEADLIGHT
- HEATED DOOR MIRROR
- HEATED SEAT
- IGNITION KEY REMINDER TONE ALARM <VEHICLES WITH KOS>
- IMMOBILIZER SYSTEM
- KEYLESS OPERATING SYSTEM (KOS)
- REAR WINDOW DEFOGGER
- SEAT BELT WARNING TONE ALARM
- SHIFT LOCK MECHANISM
- SUNROOF
- SUPPLEMENTAL RESTRAINT SYSTEM (SRS)
- TAILLIGHT, POSITION LIGHT, REAR SIDE MARKER LIGHT, LICENSE PLATE LIGHT AND LIGHTING MONITOR TONE ALARM
- THEFT-ALARM SYSTEM
- TIRE PRESSURE MONITORING SYSTEM (TPMS)
- TURN-SIGNAL LIGHT AND HAZARD WARNING LIGHT
- WINDSHIELD WIPER AND WASHER

(A-15X)



(C-32)



(C-38)

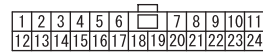

(C-39)

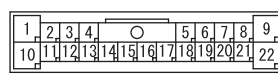

(C-40)

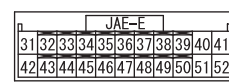

(C-41)

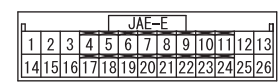

2

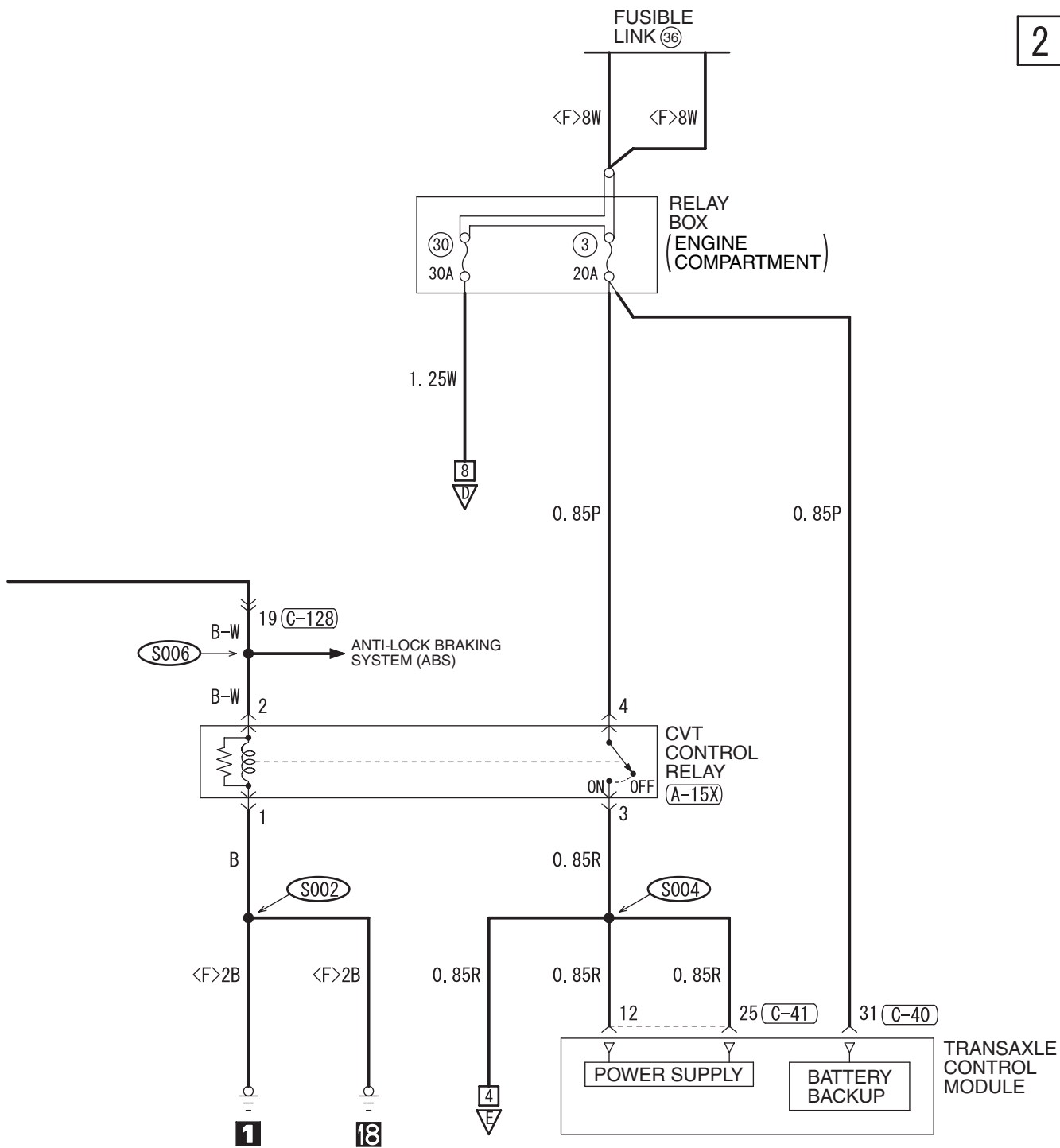

(C-128)

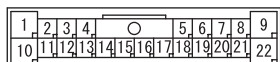

(C-304)

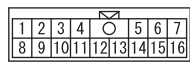

(C-309)



(C-312)

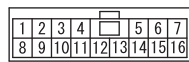

(C-313)

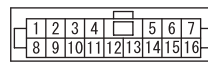

(C-317)



WIRE COLOR CODE

B: BLACK LG: LIGHT GREEN G: GREEN L: BLUE W: WHITE Y: YELLOW SB: SKY BLUE
BR: BROWN O: ORANGE GR: GRAY R: RED P: PINK V: VIOLET PU: PURPLE

H8G07M01AB

TSB Revision

INVECS-III CVT (CONTINUED)

3

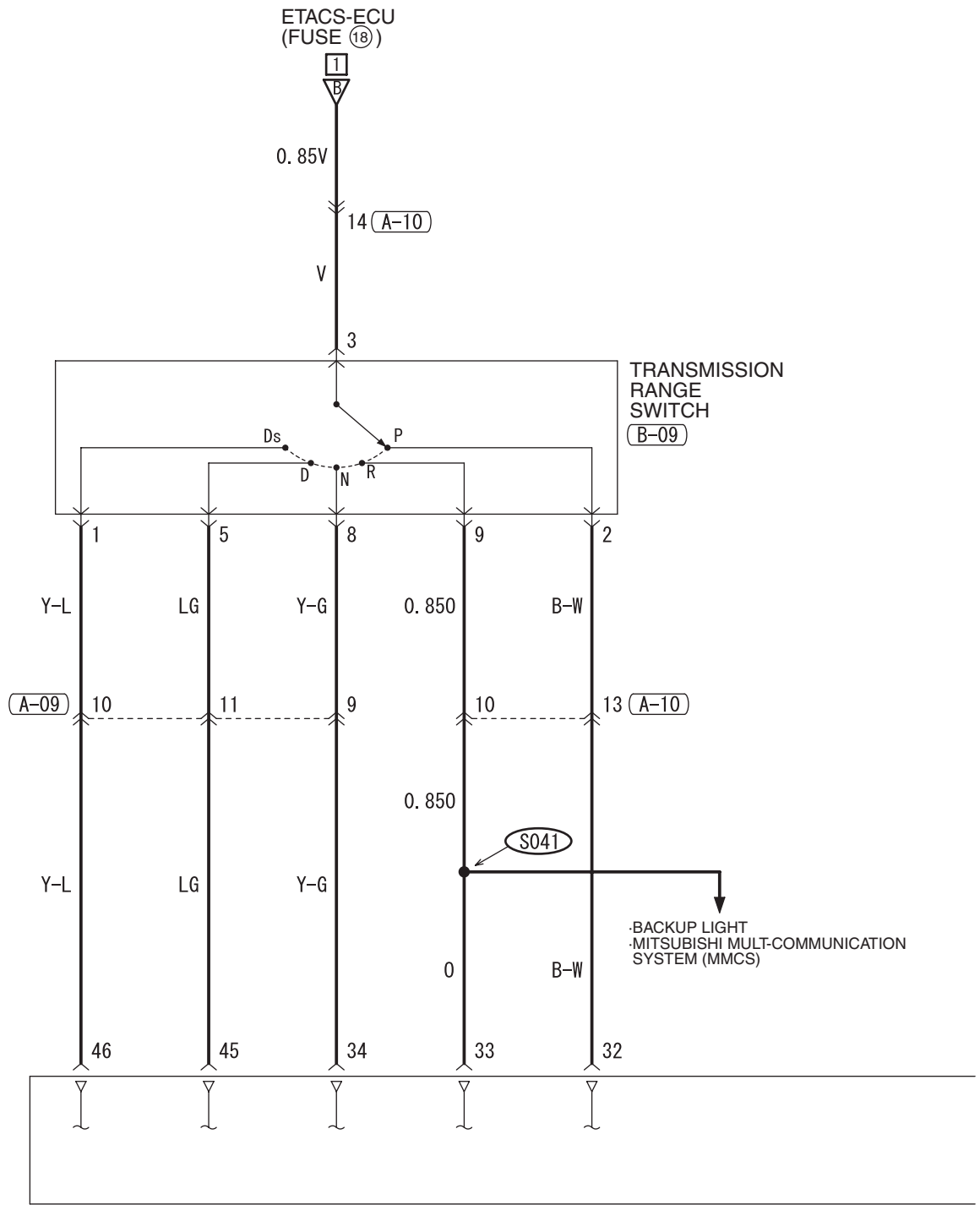

A-09



A-10

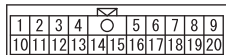

B-07



B-09

(MU802355)

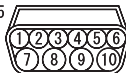

B-113



C-40

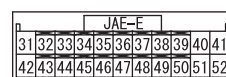

4

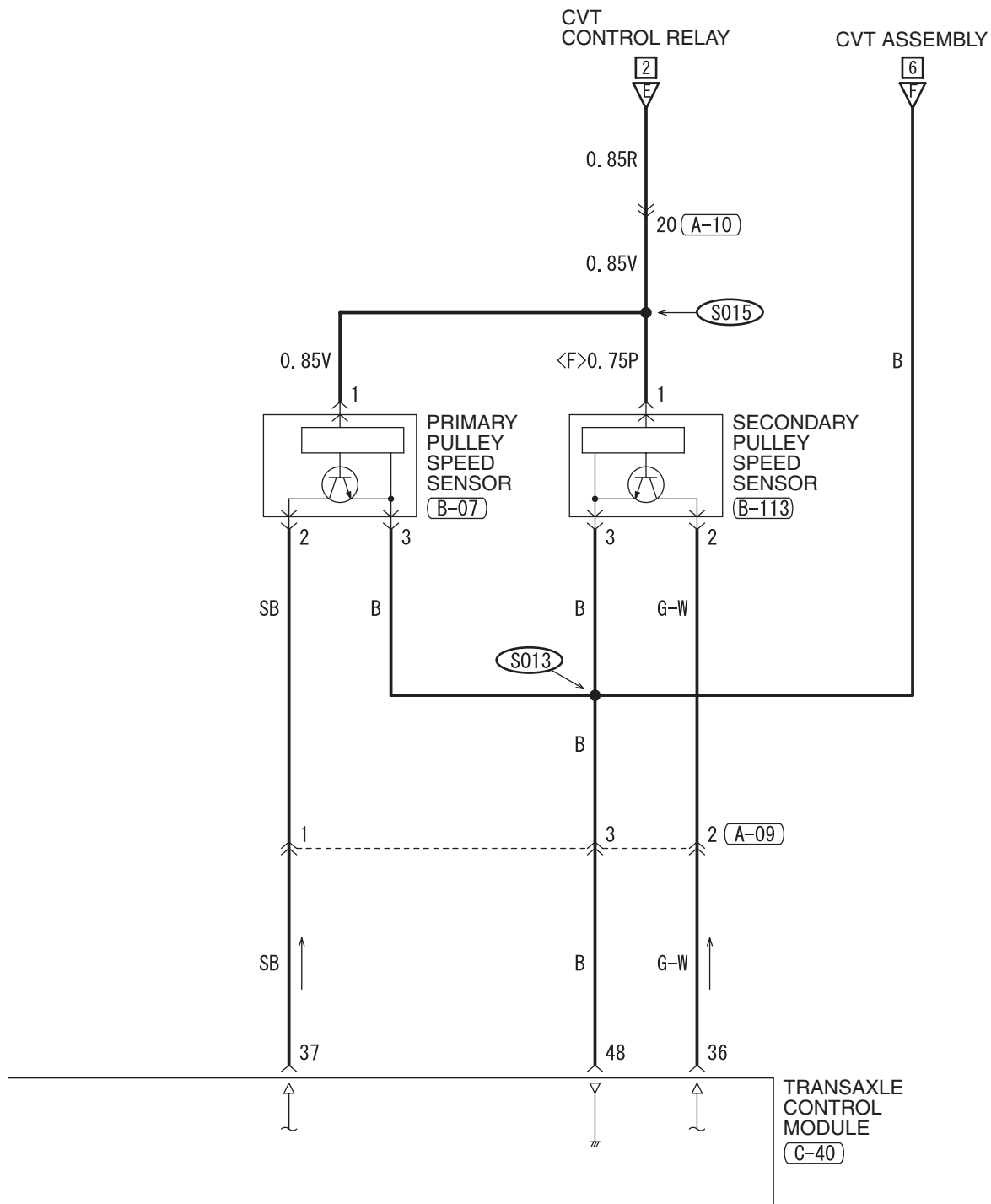

WIRE COLOR CODE

B : BLACK LG : LIGHT GREEN G : GREEN L : BLUE W : WHITE Y : YELLOW SB : SKY BLUE
 BR : BROWN O : ORANGE GR : GRAY R : RED P : PINK V : VIOLET PU : PURPLE

H8G07M01BB

TSB Revision

INVECS-III CVT (CONTINUED)

5

TRANSAXLE CONTROL MODULE

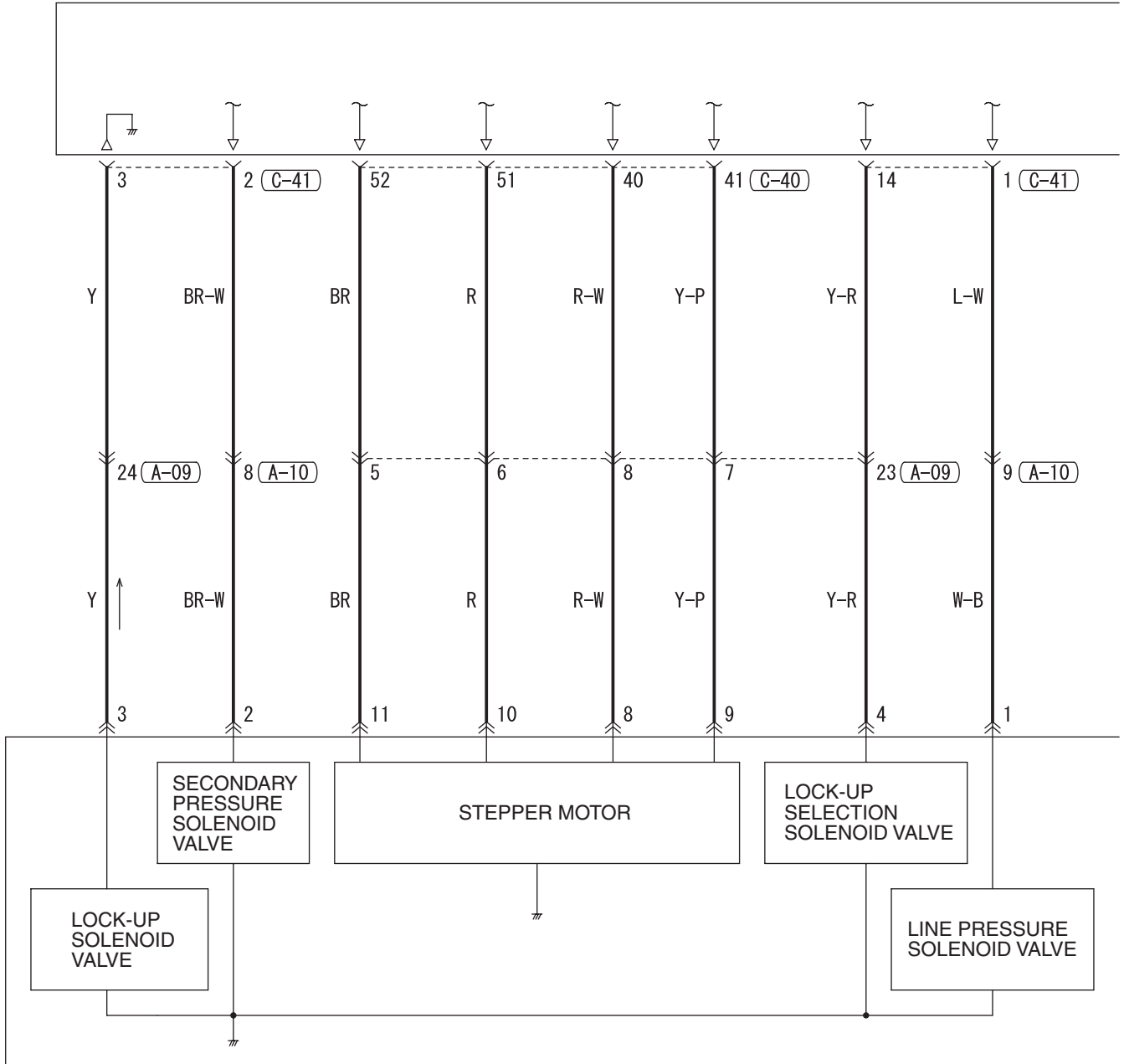

(A-09)

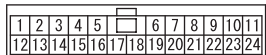

(A-10)

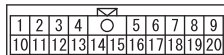

(B-08)



(C-40)

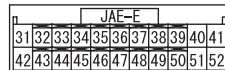

(C-41)



6

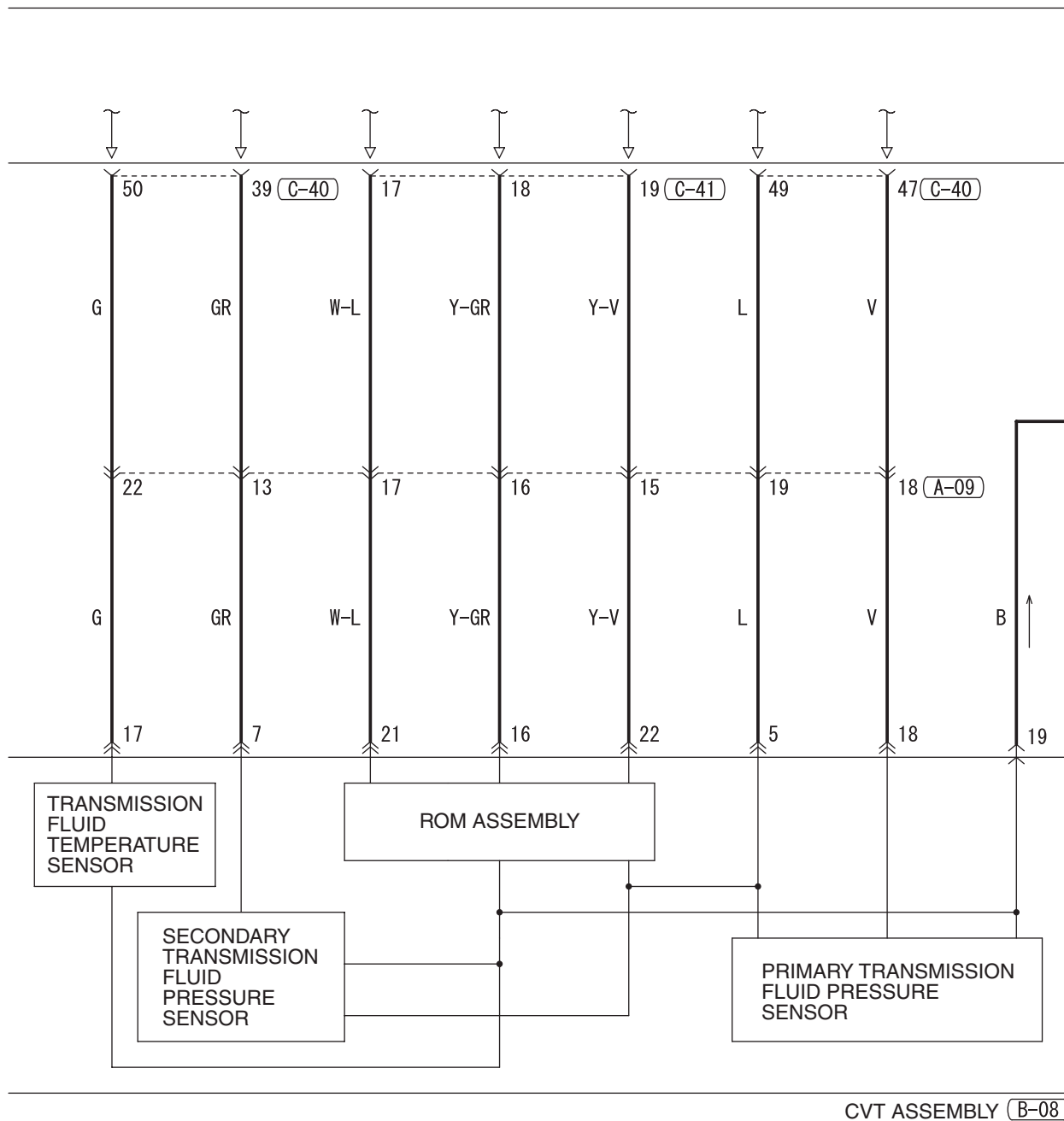

WIRE COLOR CODE
 B: BLACK LG: LIGHT GREEN G: GREEN L: BLUE W: WHITE Y: YELLOW SB: SKY BLUE
 BR: BROWN O: ORANGE GR: GRAY R: RED P: PINK V: VIOLET PU: PURPLE

H8G07M01CB

TSB Revision

INVECS-III CVT (CONTINUED)

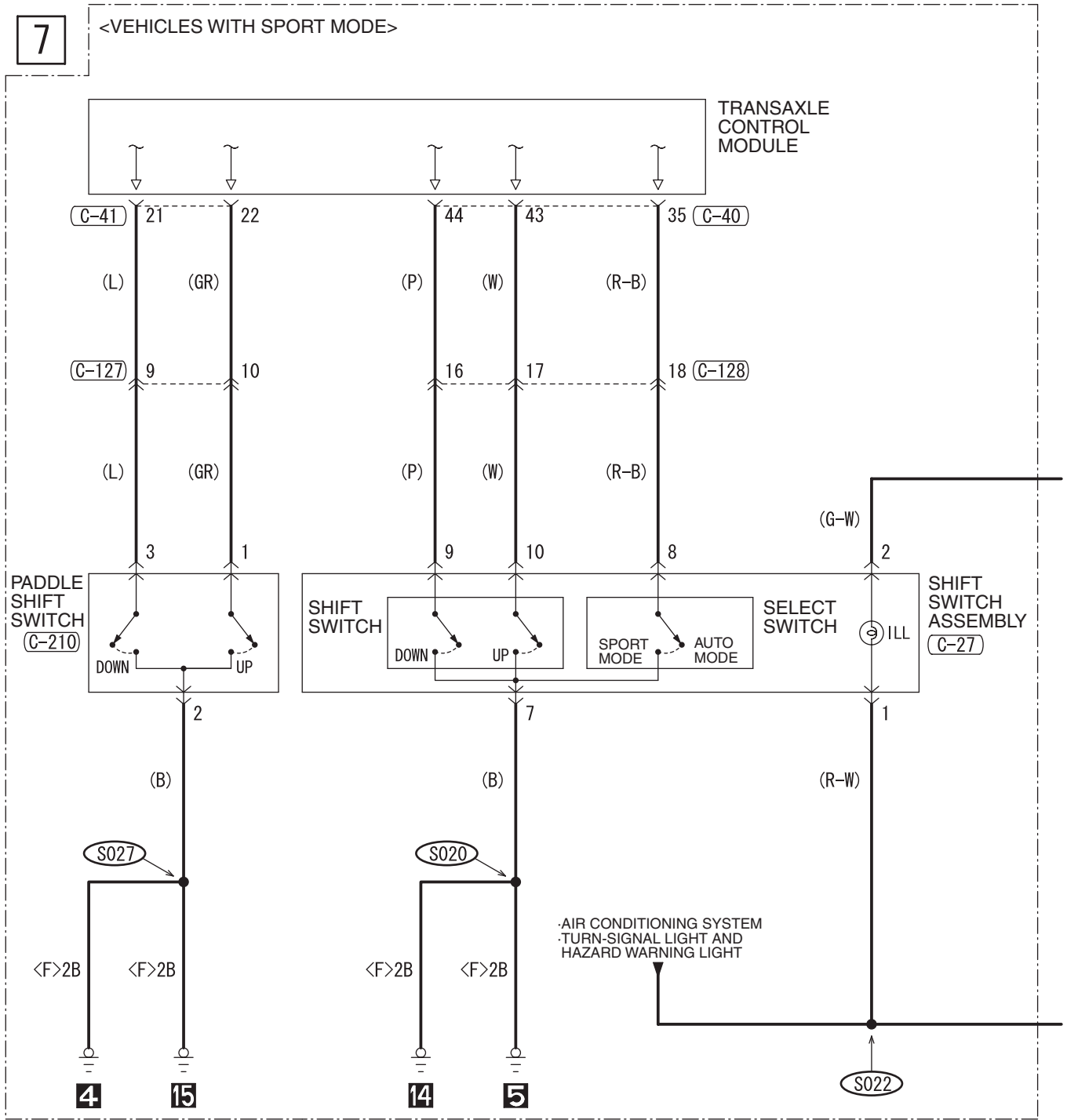

C-04

1	2	3	4	5	6	7	8	9	10	11	12
13	14	15	16	17	18	19	20	21	22	23	24

C-06

1	2	3	4	5	6	7	8	9	10	11		
12	13	14	15	16	17	18	19	20	21	22	23	24

C-07

1	2	3	4	5	6	7	8	9	10	11		
12	13	14	15	16	17	18	19	20	21	22	23	24

C-27

1	2	3	4		
5	6	7	8	9	10

C-40

31	32	33	34	35	36	37	38	39	40	41
42	43	44	45	46	47	48	49	50	51	52

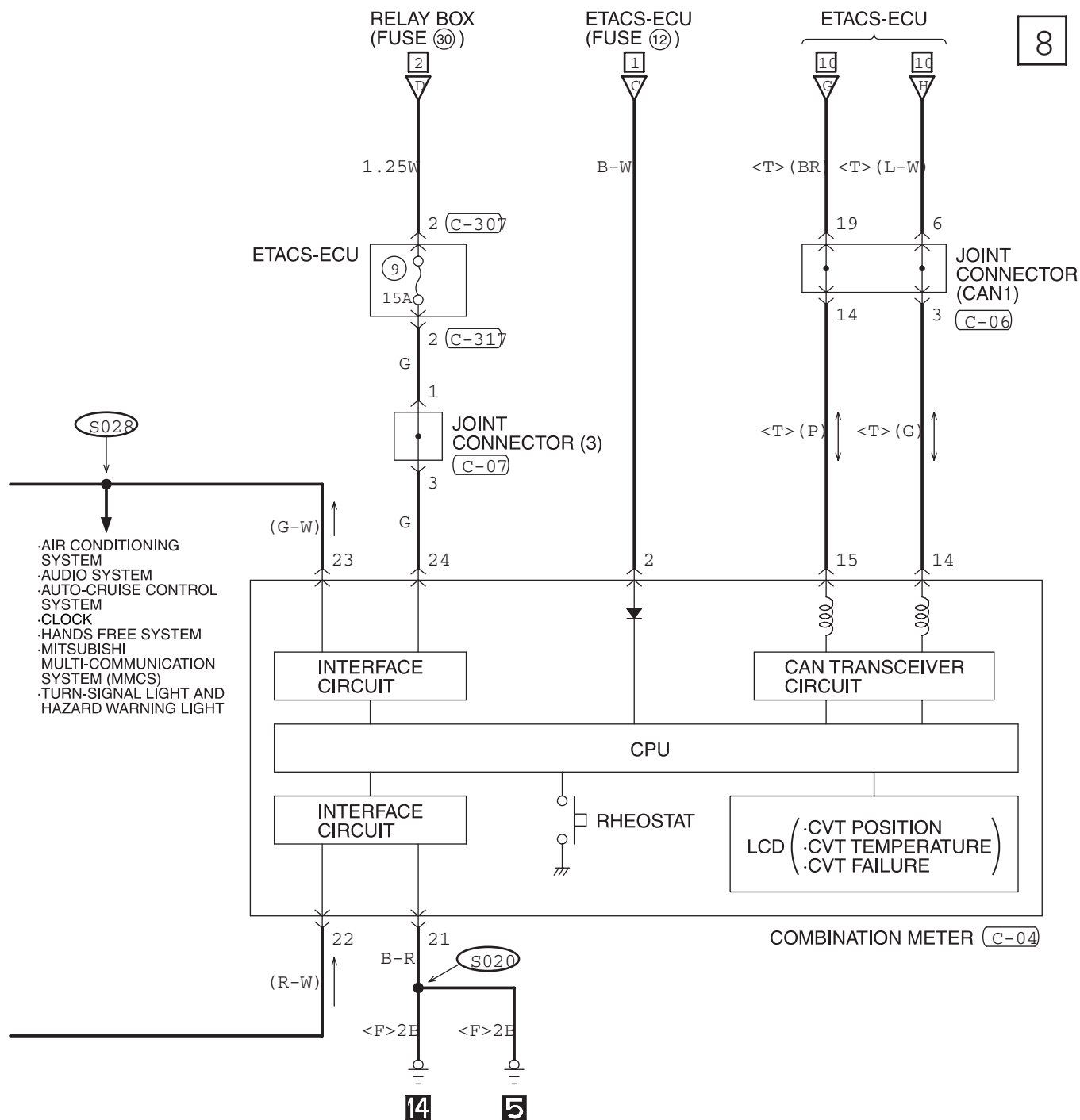

(C-41)

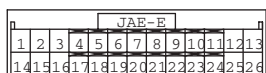

(C-12)

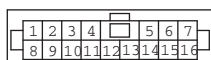

(C-12)

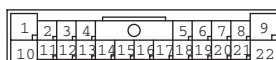

(C-21)



(C-30)



(C-31)

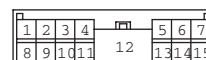

WIRE COLOR CODE

B: BLACK LG: LIGHT GREEN G: GREEN L: BLUE W: WHITE Y: YELLOW SB: SKY BLUE
BR: BROWN O: ORANGE GR: GRAY R: RED P: PINK V: VIOLET PU: PURPLE

INVECS-III CVT (CONTINUED)

9

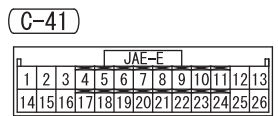
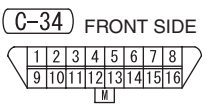
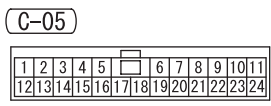
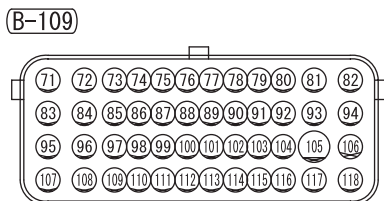
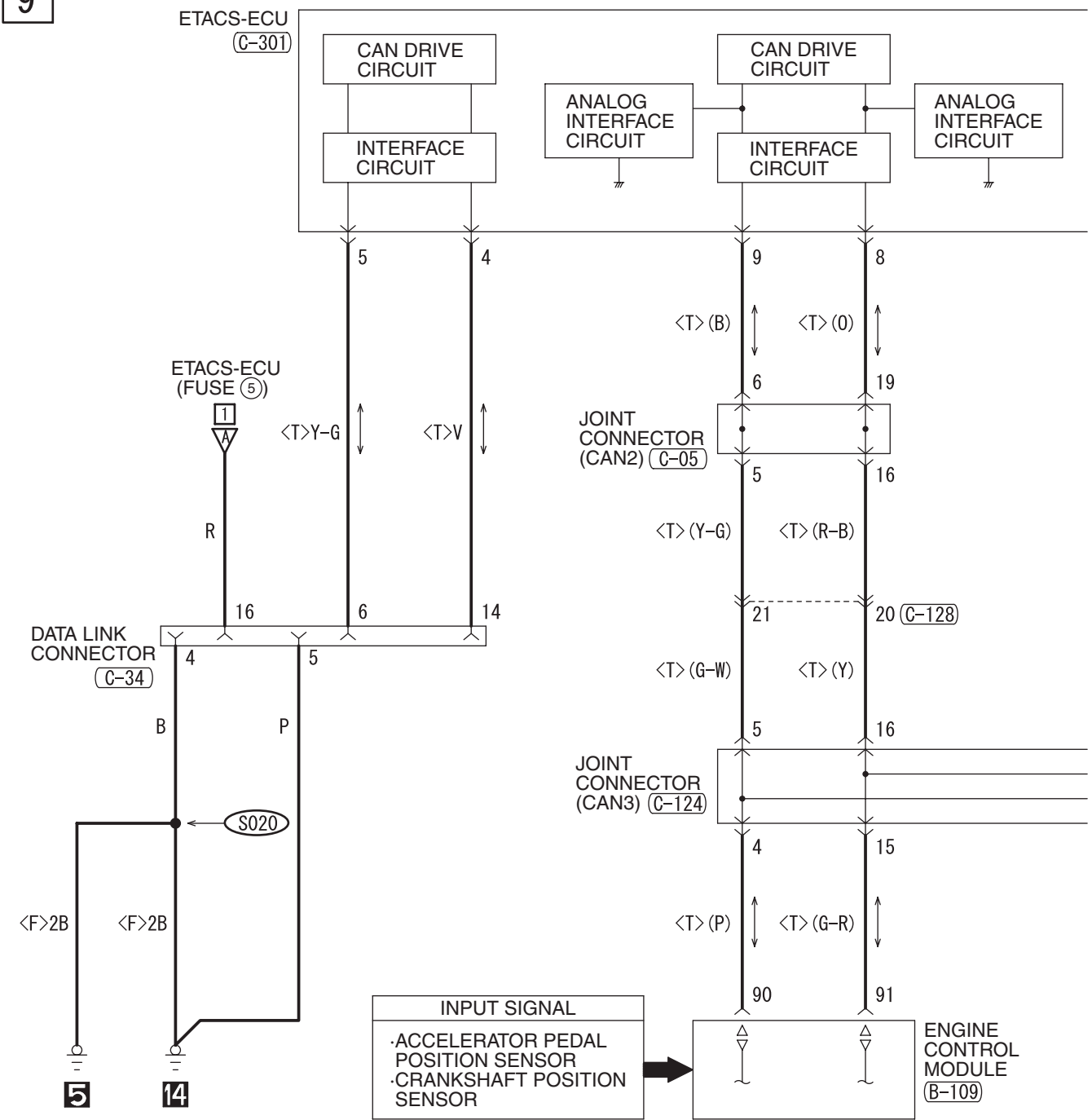

10

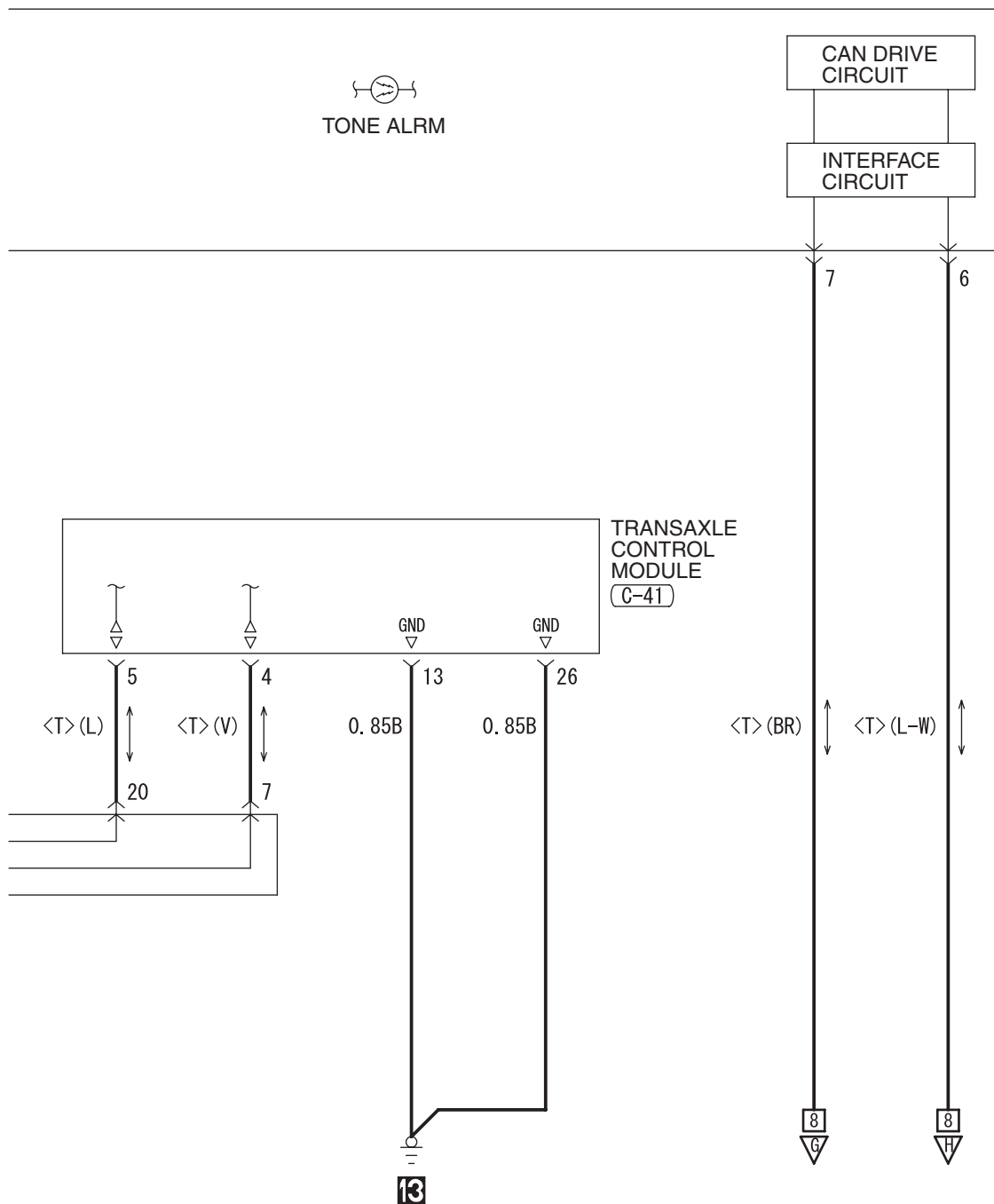

C-124

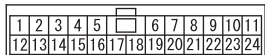

C-128

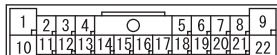

C-301



WIRE COLOR CODE

B : BLACK LG : LIGHT GREEN G : GREEN L : BLUE W : WHITE Y : YELLOW SB : SKY BLUE
BR : BROWN O : ORANGE GR : GRAY R : RED P : PINK V : VIOLET PU : PURPLE

H8G07M01EB

TSB Revision

HEADLIGHT

1

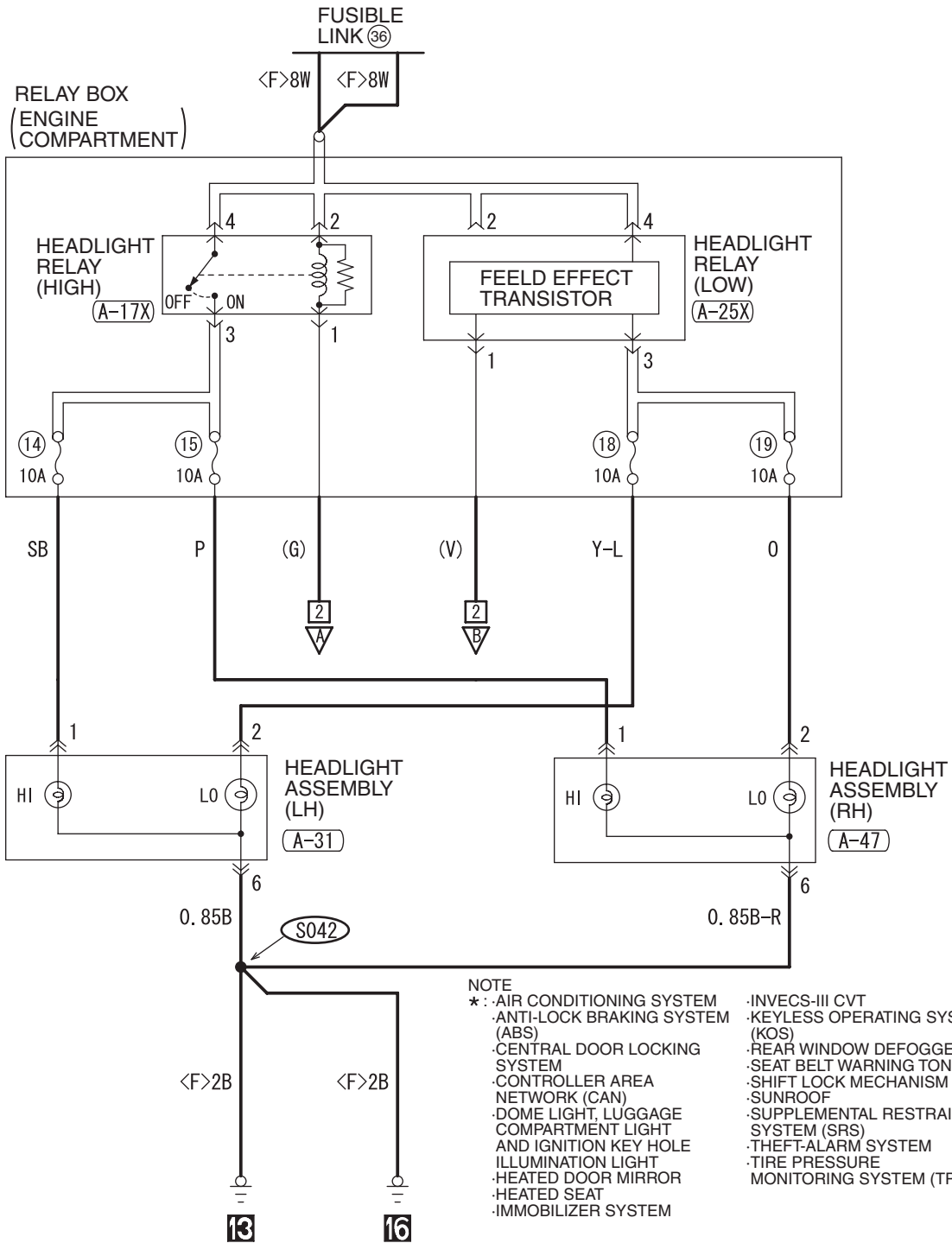

NOTE
* : -AIR CONDITIONING SYSTEM
-ANTI-LOCK BRAKING SYSTEM (ABS)
-CENTRAL DOOR LOCKING SYSTEM
-CONTROLLER AREA NETWORK (CAN)
-DOME LIGHT, LUGGAGE COMPARTMENT LIGHT AND IGNITION KEY HOLE ILLUMINATION LIGHT
-HEATED DOOR MIRROR
-HEATED SEAT
-IMMOBILIZER SYSTEM
-INVECS-III CVT
-KEYLESS OPERATING SYSTEM (KOS)
-REAR WINDOW DEFOGGER
-SEAT BELT WARNING TONE ALARM
-SHIFT LOCK MECHANISM
-SUNROOF
-SUPPLEMENTAL RESTRAINT SYSTEM (SRS)
-THEFT-ALARM SYSTEM
-TIRE PRESSURE MONITORING SYSTEM (TPMS)

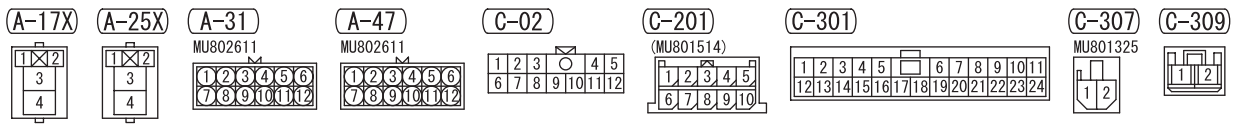

2

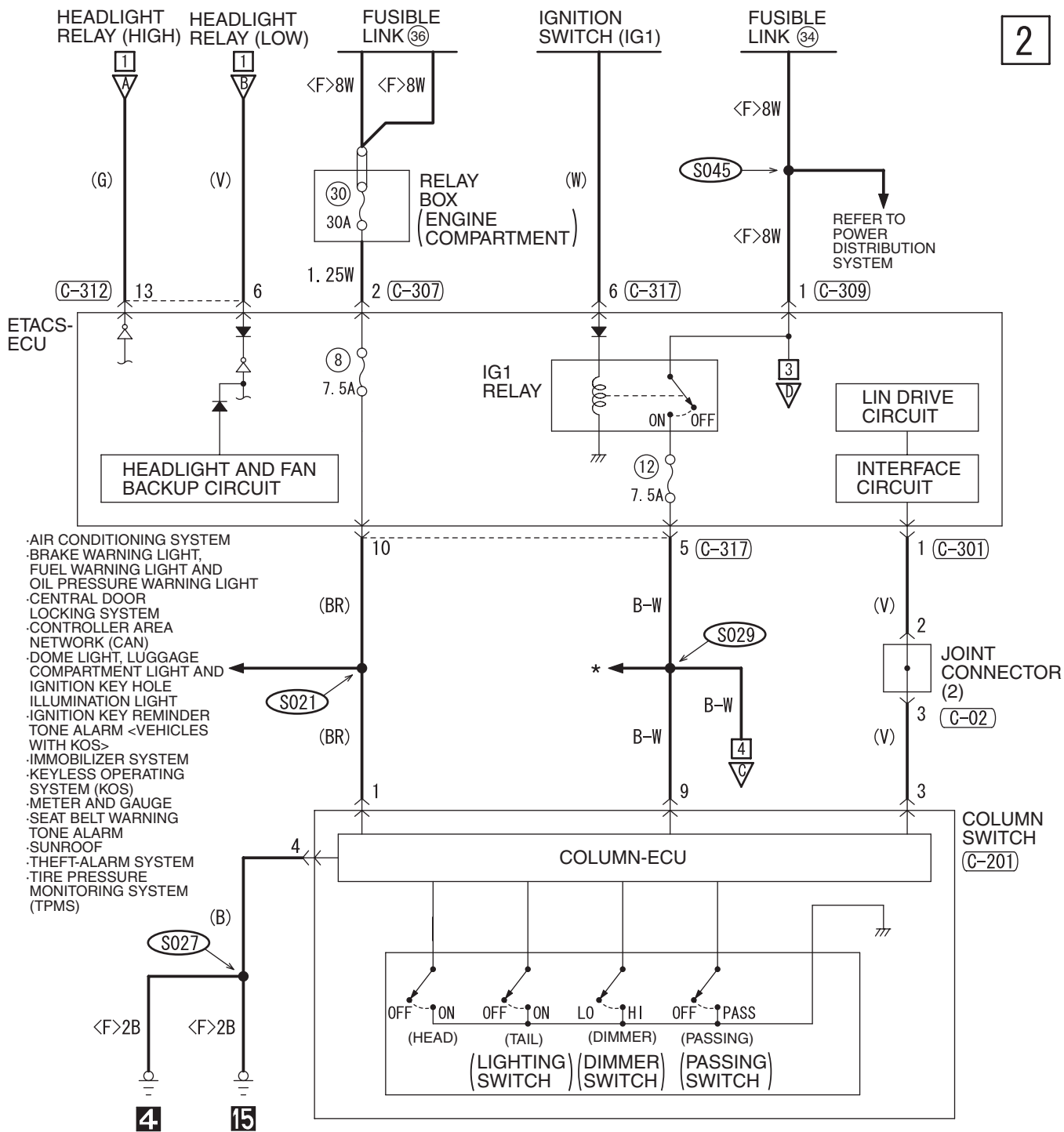

(C-312)

(C-317)

1	2	3	4	5	6	7
8	9	10	11	12	13	14
15	16					

1	2	3	4	5	6	7
8	9	10	11	12	13	14
15						

WIRE COLOR CODE

B: BLACK LG: LIGHT GREEN G: GREEN L: BLUE W: WHITE Y: YELLOW SB: SKY BLUE
 BR: BROWN O: ORANGE GR: GRAY R: RED P: PINK V: VIOLET PU: PURPLE

H8G08M00AB

HEADLIGHT (CONTINUED)

3

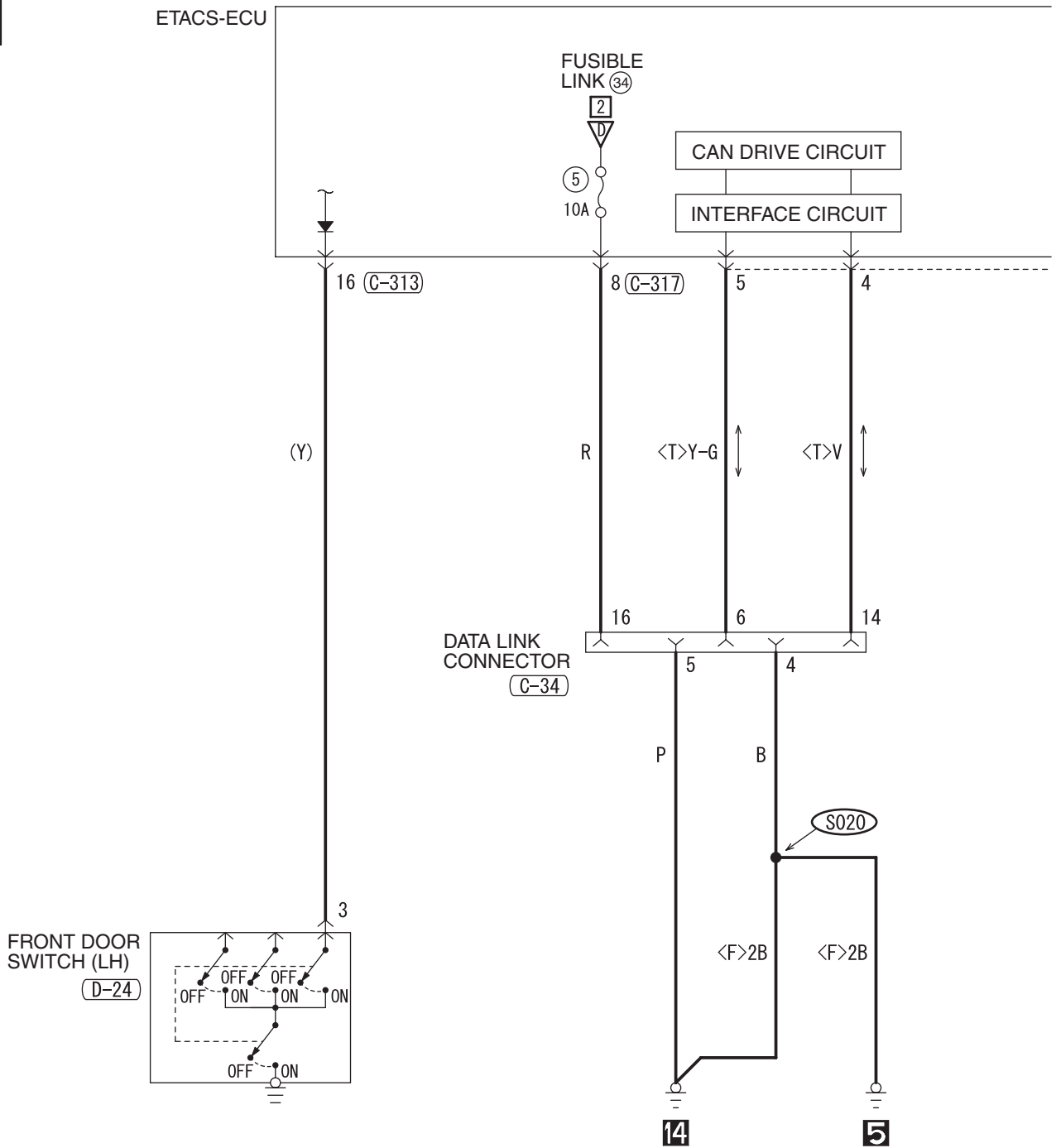

C-04

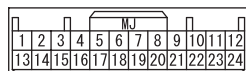

C-06

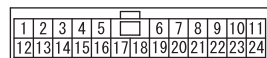

C-34 FRONT SIDE



C-301

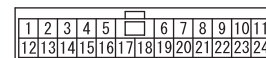

C-313



4

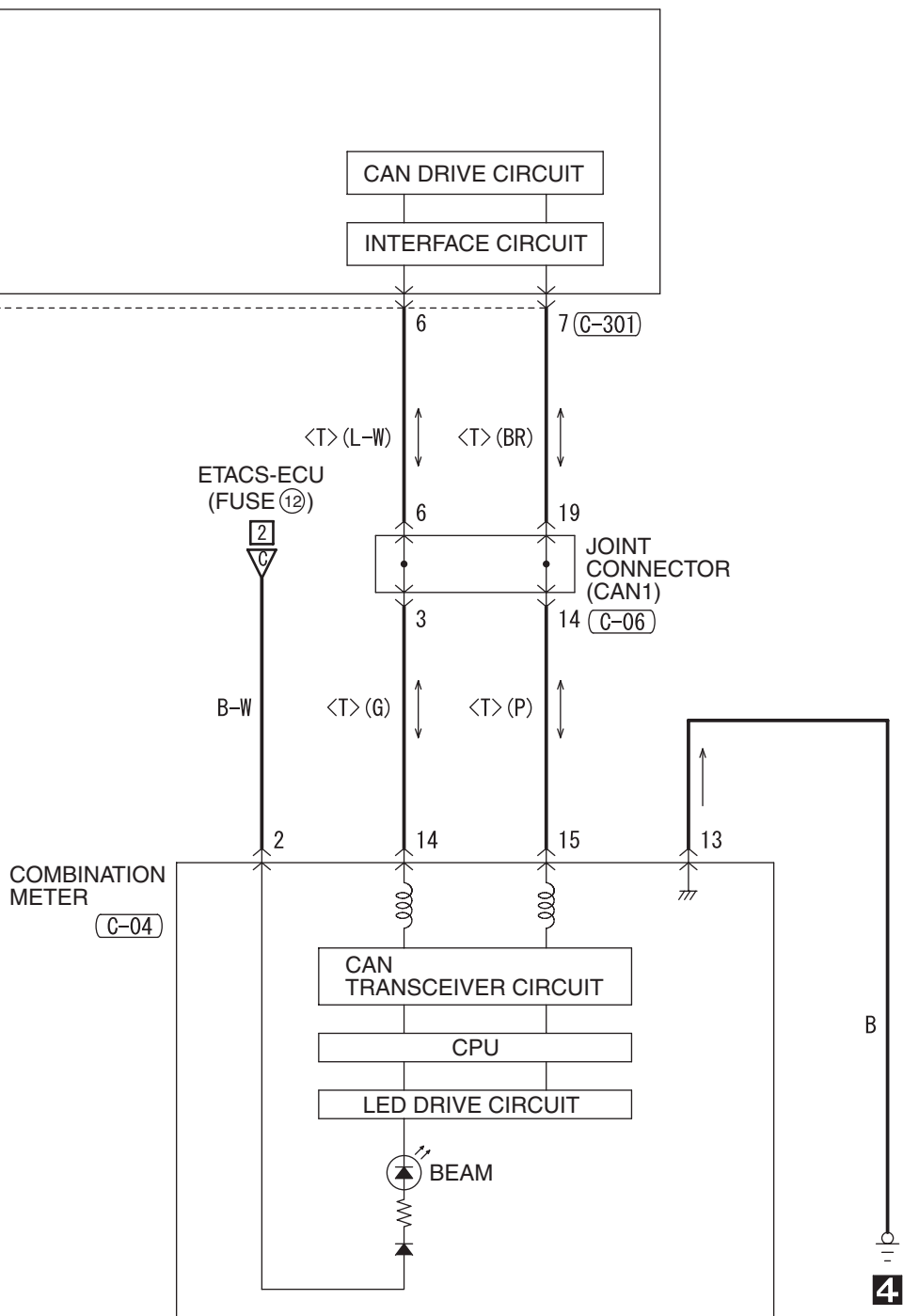

(C-317)



(D-24)



WIRE COLOR CODE

B: BLACK LG: LIGHT GREEN G: GREEN L: BLUE W: WHITE Y: YELLOW SB: SKY BLUE
BR: BROWN O: ORANGE GR: GRAY R: RED P: PINK V: VIOLET PU: PURPLE

H8G08M00BB

TSB Revision

TAILLIGHT, POSITION LIGHT, REAR SIDE MARKER LIGHT, LICENSE PLATE LIGHT AND LIGHTING MONITOR TONE ALARM

M1901030600025

1

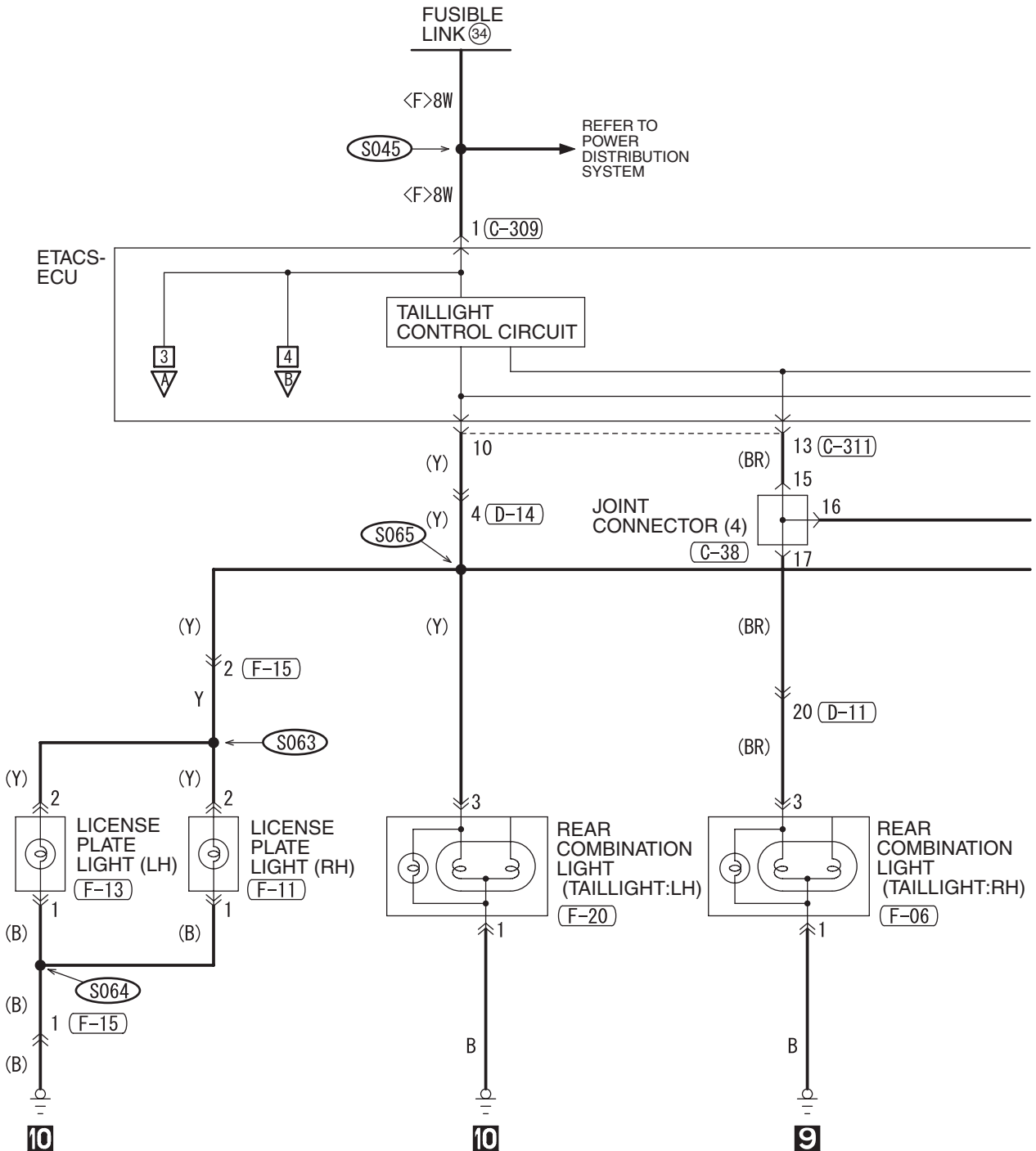

(A-31)



(A-47)

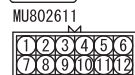

(C-38)



(C-304)

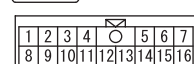

(C-309)



(C-311)

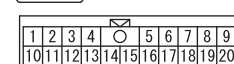

(F-23)

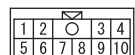

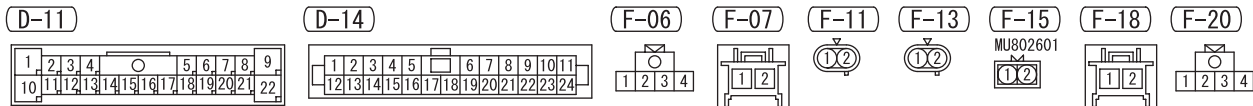
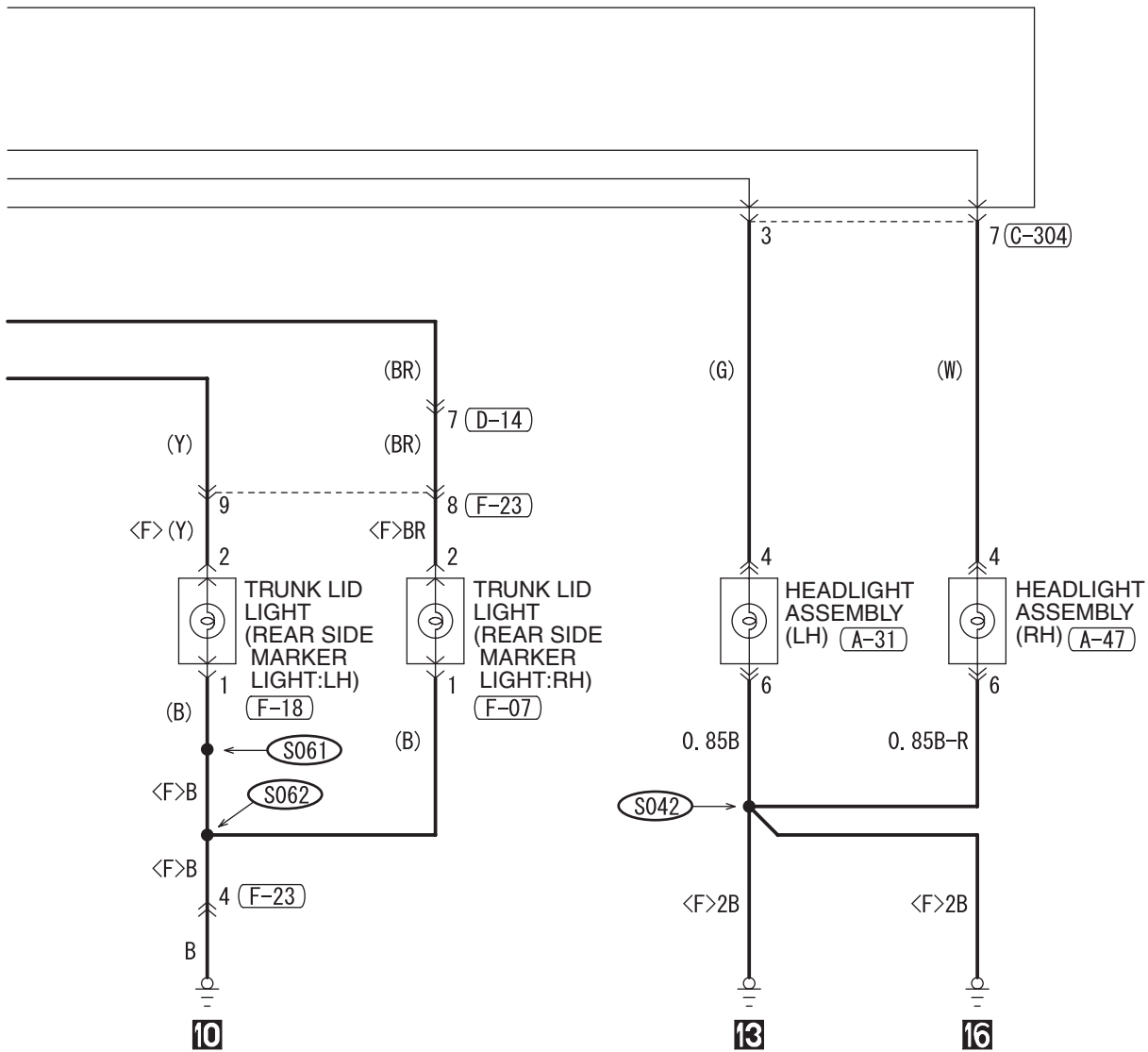

WIRE COLOR CODE

B: BLACK LG: LIGHT GREEN G: GREEN L: BLUE W: WHITE Y: YELLOW SB: SKY BLUE
 BR: BROWN O: ORANGE GR: GRAY R: RED P: PINK V: VIOLET PU: PURPLE

H8G08M02AB

TAILLIGHT, POSITION LIGHT, REAR SIDE MARKER LIGHT, LICENSE PLATE LIGHT AND LIGHTING MONITOR TONE ALARM (CONTINUED)

3

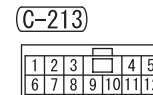
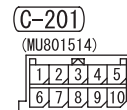
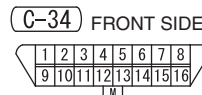
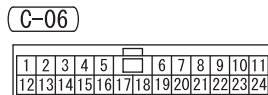
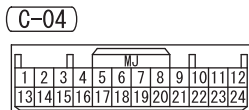
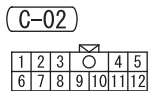
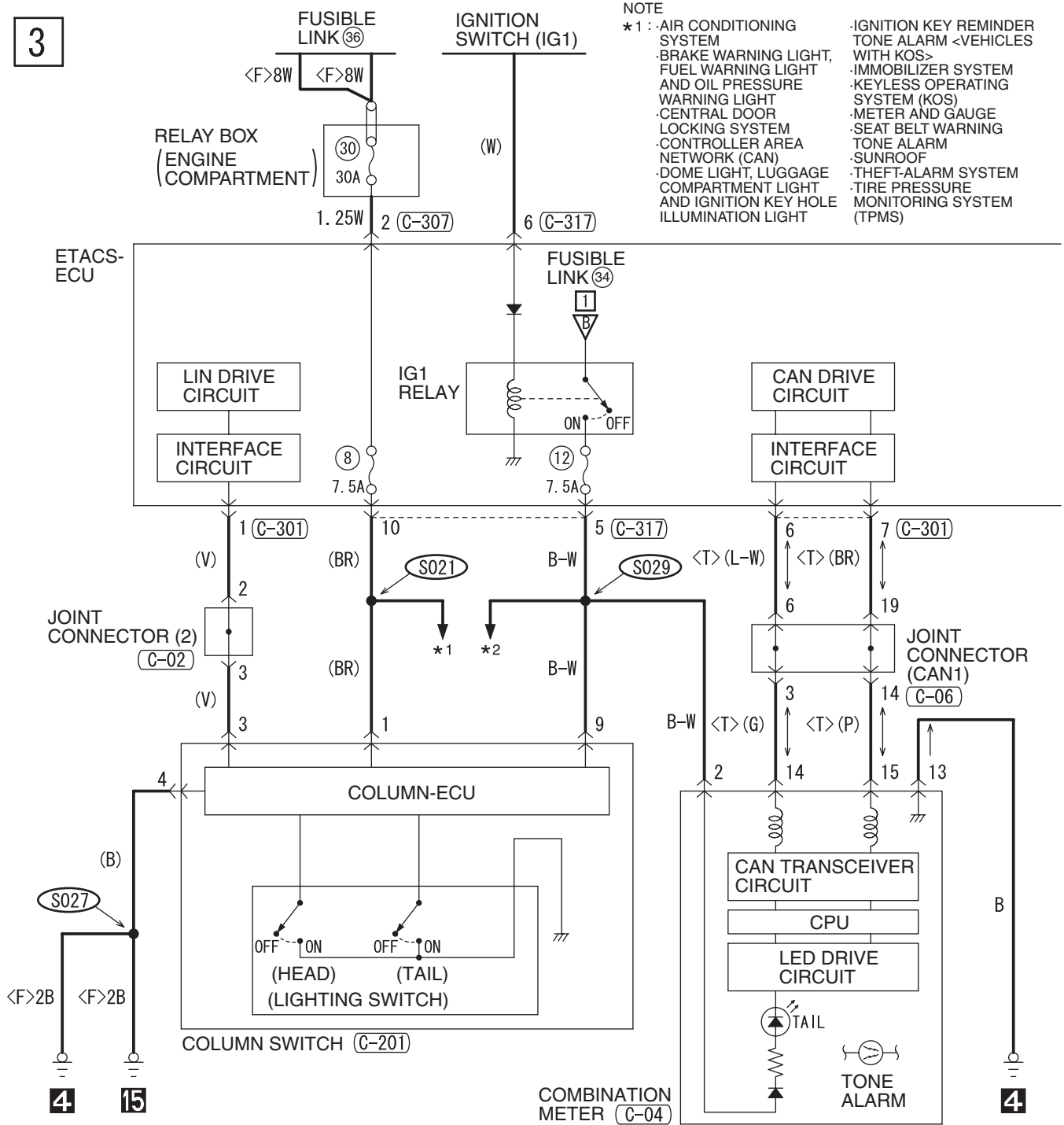

- *2 : ·AIR CONDITIONING SYSTEM
- ANTI-LOCK BRAKING SYSTEM (ABS)
- CENTRAL DOOR LOCKING SYSTEM
- CONTROLLER AREA NETWORK (CAN)
- DOME LIGHT, LUGGAGE COMPARTMENT LIGHT AND IGNITION KEY HOLE ILLUMINATION LIGHT
- HEATED DOOR MIRROR
- HEATED SEAT
- IMMOBILIZER SYSTEM
- INVECS-III CVT
- KEYLESS OPERATING SYSTEM (KOS)
- REAR WINDOW DEFOGGER
- SEAT BELT WARNING TONE ALARM
- SHIFT LOCK MECHANISM
- SUNROOF
- SUPPLEMENTAL RESTRAINT SYSTEM (SRS)
- THEFT-ALARM SYSTEM
- TIRE PRESSURE MONITORING SYSTEM (TPMS)

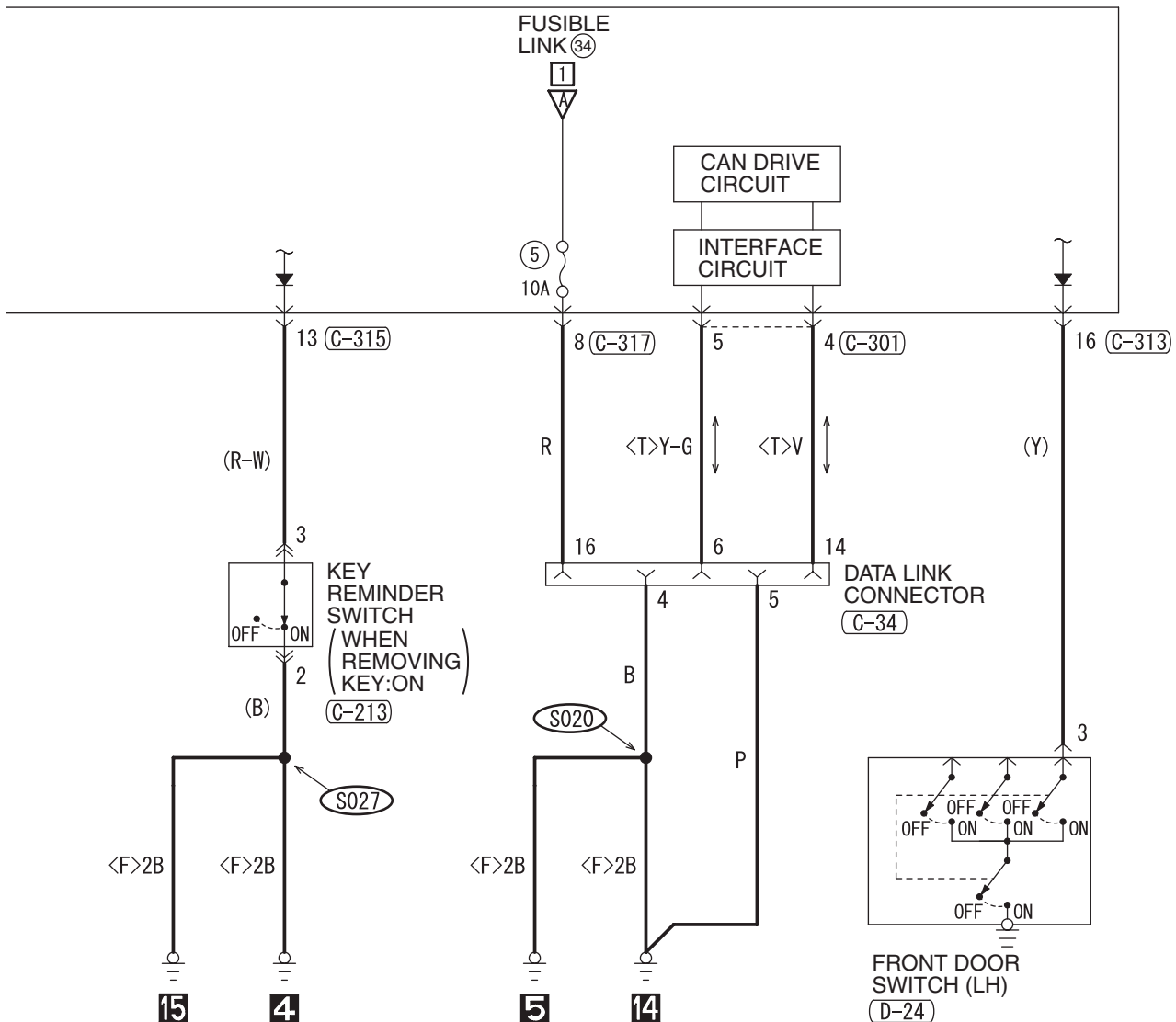

(C-301)



(C-307)



(C-313)



(C-315)



(C-317)

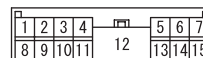

(D-24)



WIRE COLOR CODE

B : BLACK LG : LIGHT GREEN G : GREEN L : BLUE W : WHITE Y : YELLOW SB : SKY BLUE
 BR : BROWN O : ORANGE GR : GRAY R : RED P : PINK V : VIOLET PU : PURPLE

FOG LIGHT

M1901001801118

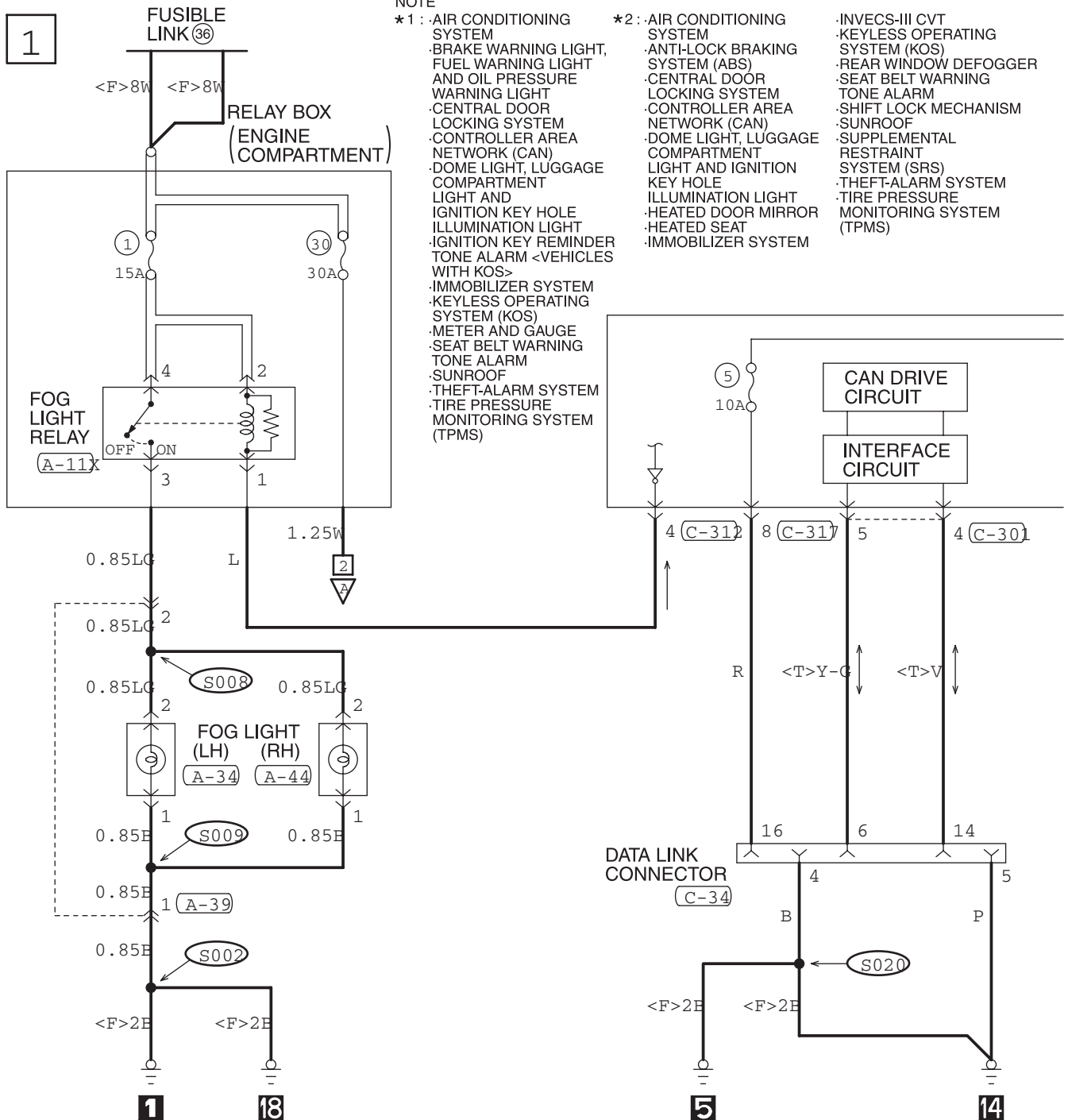

NOTE

- *1: ·AIR CONDITIONING SYSTEM
 - BRAKE WARNING LIGHT, FUEL WARNING LIGHT AND OIL PRESSURE WARNING LIGHT
 - CENTRAL DOOR LOCKING SYSTEM
 - CONTROLLER AREA NETWORK (CAN)
 - DOME LIGHT, LUGGAGE COMPARTMENT LIGHT AND IGNITION KEY HOLE ILLUMINATION LIGHT
 - IGNITION KEY REMINDER TONE ALARM <VEHICLES WITH KOS>
 - IMMOBILIZER SYSTEM
 - KEYLESS OPERATING SYSTEM (KOS)
 - METER AND GAUGE
 - SEAT BELT WARNING TONE ALARM
 - SUNROOF
 - THEFT-ALARM SYSTEM
 - TIRE PRESSURE MONITORING SYSTEM (TPMS)
- *2: ·AIR CONDITIONING SYSTEM
 - ANTI-LOCK BRAKING SYSTEM (ABS)
 - CENTRAL DOOR LOCKING SYSTEM
 - CONTROLLER AREA NETWORK (CAN)
 - DOME LIGHT, LUGGAGE COMPARTMENT LIGHT AND IGNITION KEY HOLE ILLUMINATION LIGHT
 - HEATED DOOR MIRROR
 - HEATED SEAT
 - IMMOBILIZER SYSTEM
 - INVECS-III CVT
 - KEYLESS OPERATING SYSTEM (KOS)
 - REAR WINDOW DEFOGGER
 - SEAT BELT WARNING TONE ALARM
 - SHIFT LOCK MECHANISM
 - SUNROOF
 - SUPPLEMENTAL RESTRAINT SYSTEM (SRS)
 - THEFT-ALARM SYSTEM
 - TIRE PRESSURE MONITORING SYSTEM (TPMS)

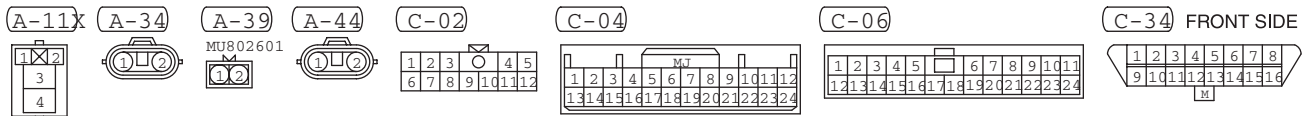

2

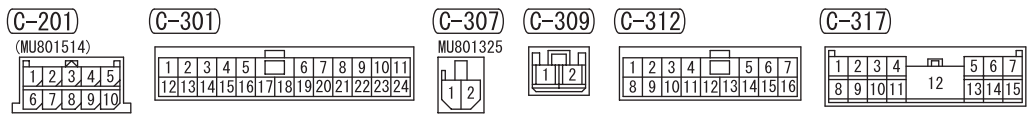
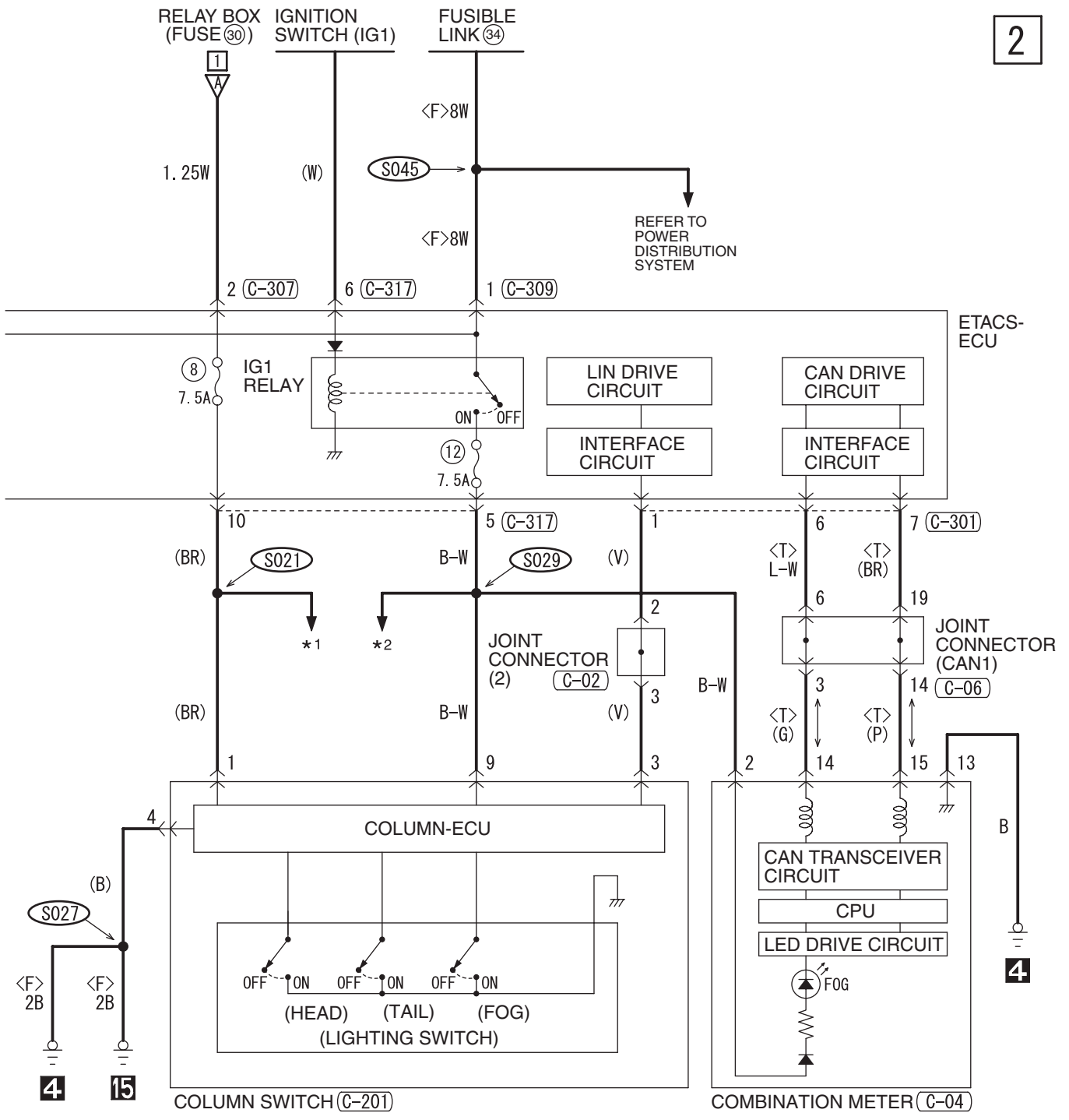

WIRE COLOR CODE
 B: BLACK LG: LIGHT GREEN G: GREEN L: BLUE W: WHITE Y: YELLOW SB: SKY BLUE
 BR: BROWN O: ORANGE GR: GRAY R: RED P: PINK V: VIOLET PU: PURPLE

H8G08M04AB

TSB Revision

DAYTIME RUNNING LIGHT (DRL)

M1901030700033

1

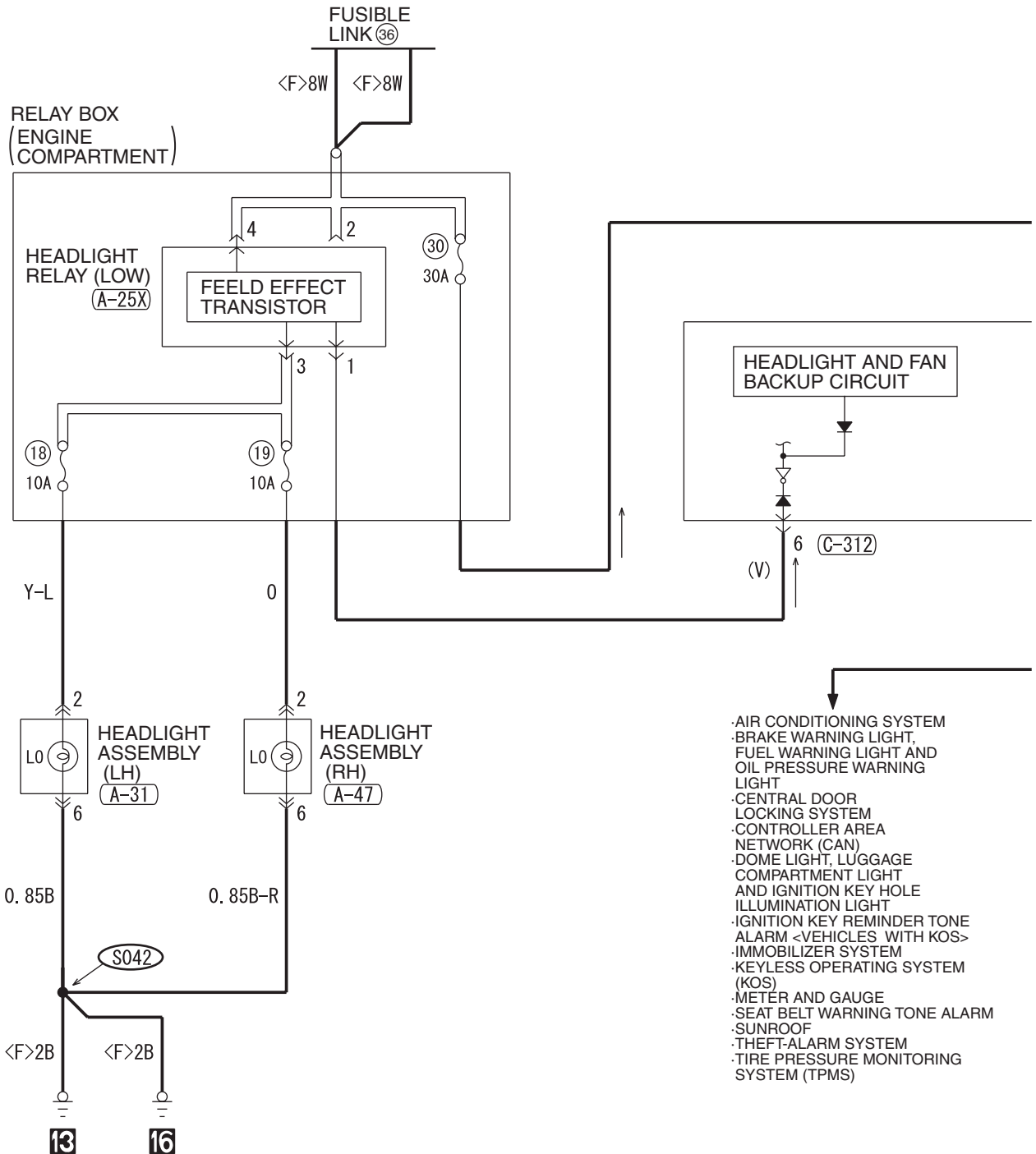

- AIR CONDITIONING SYSTEM
- BRAKE WARNING LIGHT, FUEL WARNING LIGHT AND OIL PRESSURE WARNING LIGHT
- CENTRAL DOOR LOCKING SYSTEM
- CONTROLLER AREA NETWORK (CAN)
- DOME LIGHT, LUGGAGE COMPARTMENT LIGHT AND IGNITION KEY HOLE ILLUMINATION LIGHT
- IGNITION KEY REMINDER TONE ALARM <VEHICLES WITH KOS>
- IMMOBILIZER SYSTEM
- KEYLESS OPERATING SYSTEM (KOS)
- METER AND GAUGE
- SEAT BELT WARNING TONE ALARM
- SUNROOF
- THEFT-ALARM SYSTEM
- TIRE PRESSURE MONITORING SYSTEM (TPMS)

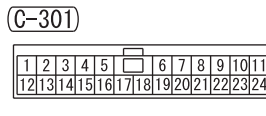
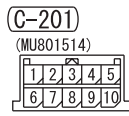
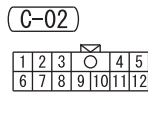
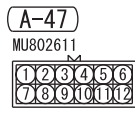
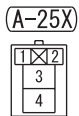

2

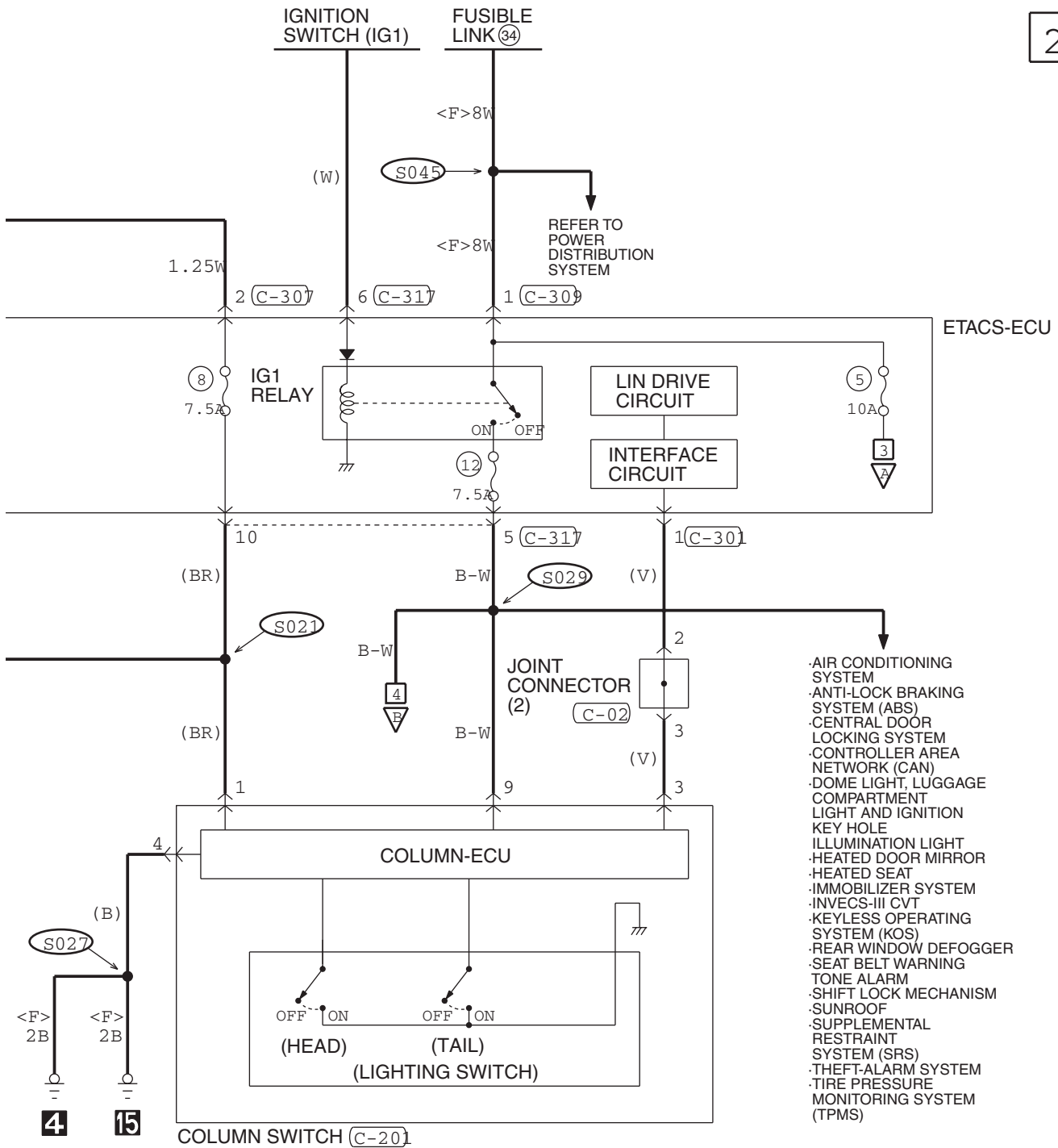

(C-31)

(C-31)

1	2	3	4	5	6	7
8	9	10	11	12	13	14
15	16					

1	2	3	4	5	6	7
8	9	10	11	12	13	14
15						

WIRE COLOR CODE

B: BLACK LG: LIGHT GREEN G: GREEN L: BLUE W: WHITE Y: YELLOW SB: SKY BLUE
BR: BROWN O: ORANGE GR: GRAY R: RED P: PINK V: VIOLET PU: PURPLE

H8G08M10AB

DAYTIME LUNNING LIGHT (DRL) (CONTINUED)

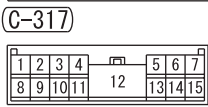
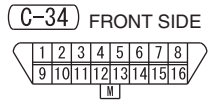
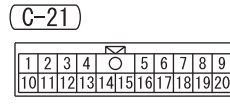
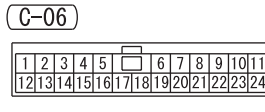
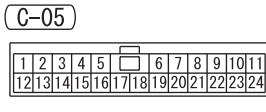
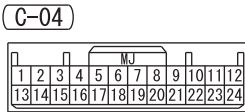
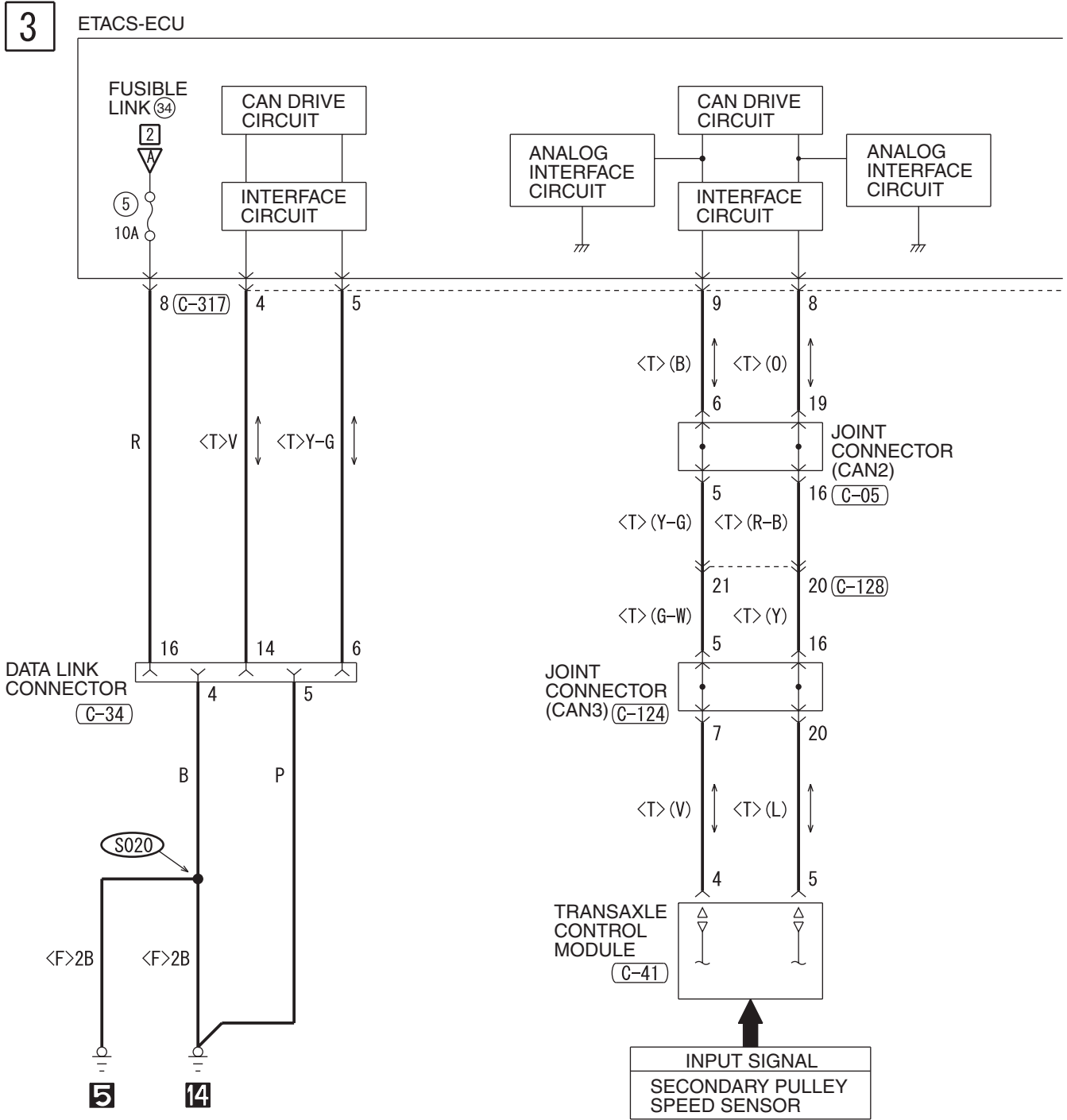

4

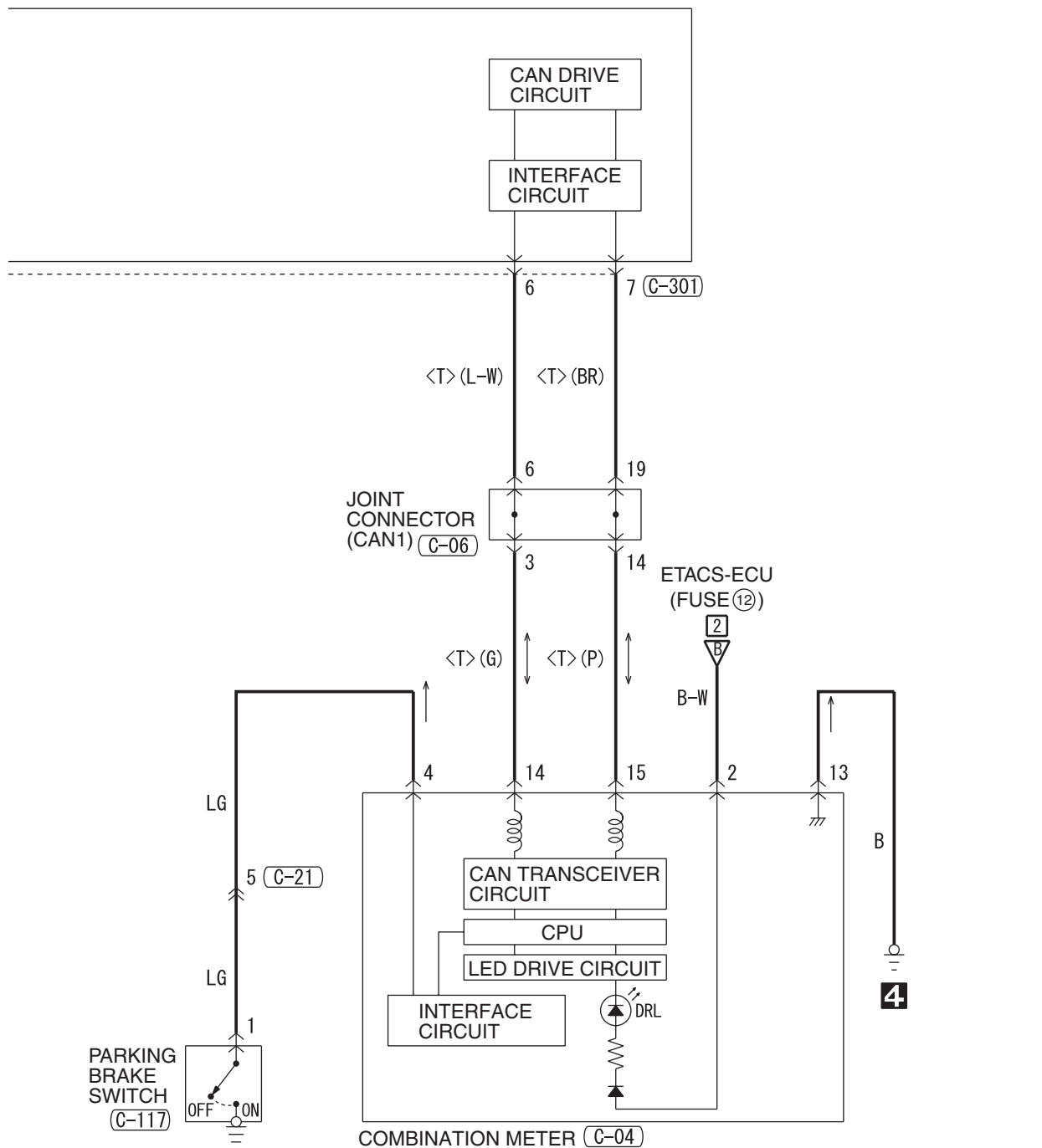

(C-41)

JAE-E												
1	2	3	4	5	6	7	8	9	10	11	12	13
14	15	16	17	18	19	20	21	22	23	24	25	26

(C-117)
(MU801211)



(C-124)

1	2	3	4	5	6	7	8	9	10	11		
12	13	14	15	16	17	18	19	20	21	22	23	24

(C-128)

1	2	3	4	5	6	7	8	9				
10	11	12	13	14	15	16	17	18	19	20	21	22

(C-301)

1	2	3	4	5	6	7	8	9	10	11		
12	13	14	15	16	17	18	19	20	21	22	23	24

WIRE COLOR CODE
 B: BLACK LG: LIGHT GREEN G: GREEN L: BLUE W: WHITE Y: YELLOW SB: SKY BLUE
 BR: BROWN O: ORANGE GR: GRAY R: RED P: PINK V: VIOLET PU: PURPLE

H8G08M10BB

TSB Revision

DOME LIGHT, LUGGAGE COMPARTMENT LIGHT AND IGNITION KEY HOLE ILLUMINATION LIGHT

<VEHICLES WITHOUT KEYLESS ENTRY SYSTEM>

M1901030800030

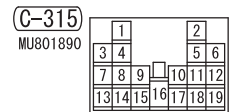
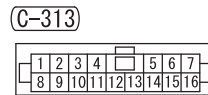
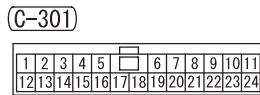
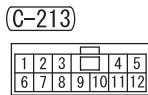
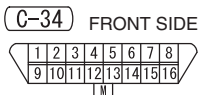
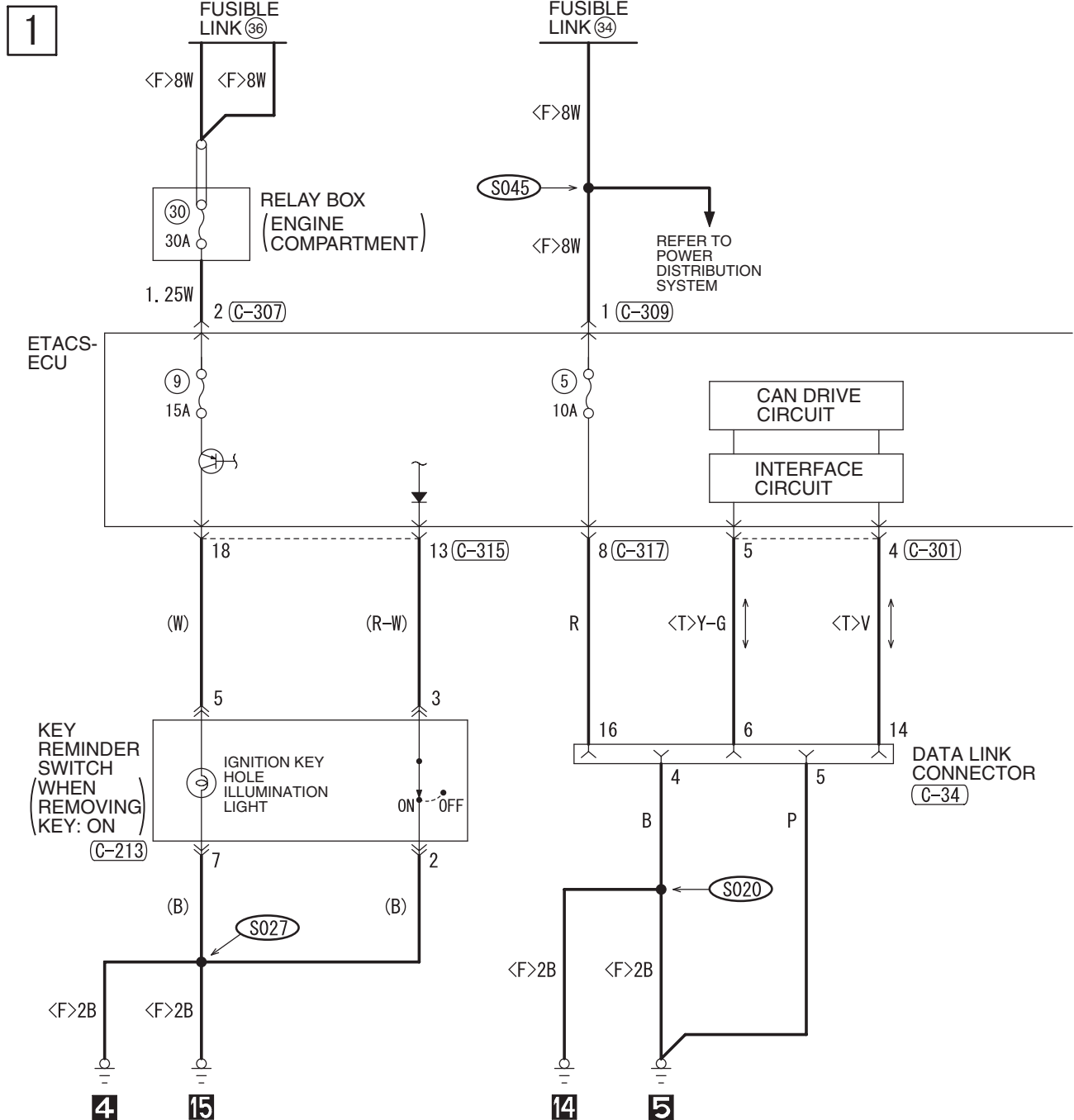

H8G08M09AA

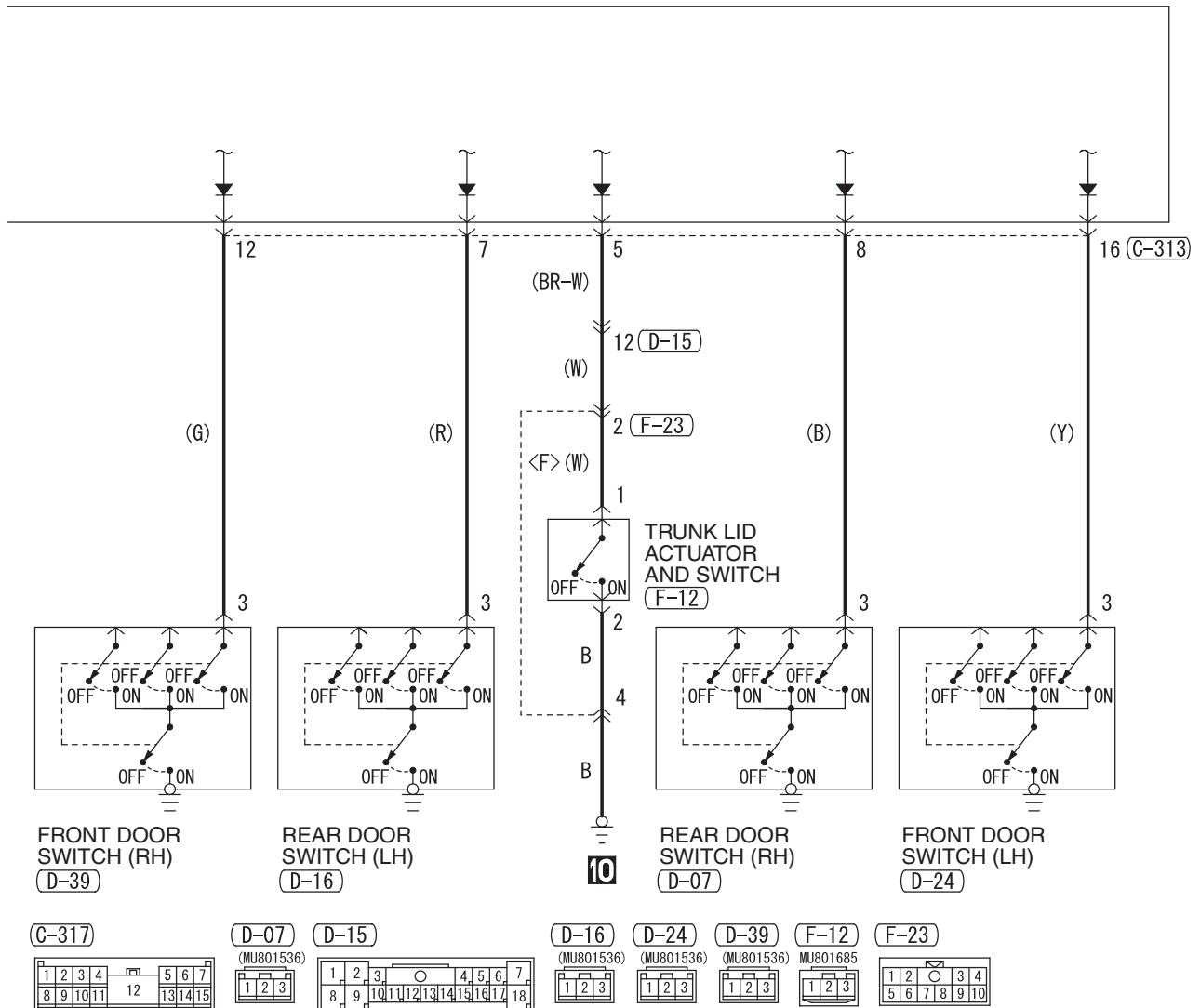

WIRE COLOR CODE

B: BLACK LG: LIGHT GREEN G: GREEN L: BLUE W: WHITE Y: YELLOW SB: SKY BLUE
 BR: BROWN O: ORANGE GR: GRAY R: RED P: PINK V: VIOLET PU: PURPLE

H8G08M09AB

DOME LIGHT, LUGGAGE COMPARTMENT LIGHT AND IGNITION KEY HOLE ILLUMINATION LIGHT
 <VEHICLES WITHOUT KEYLESS ENTRY SYSTEM> (CONTINUED)

3

ETACS-ECU

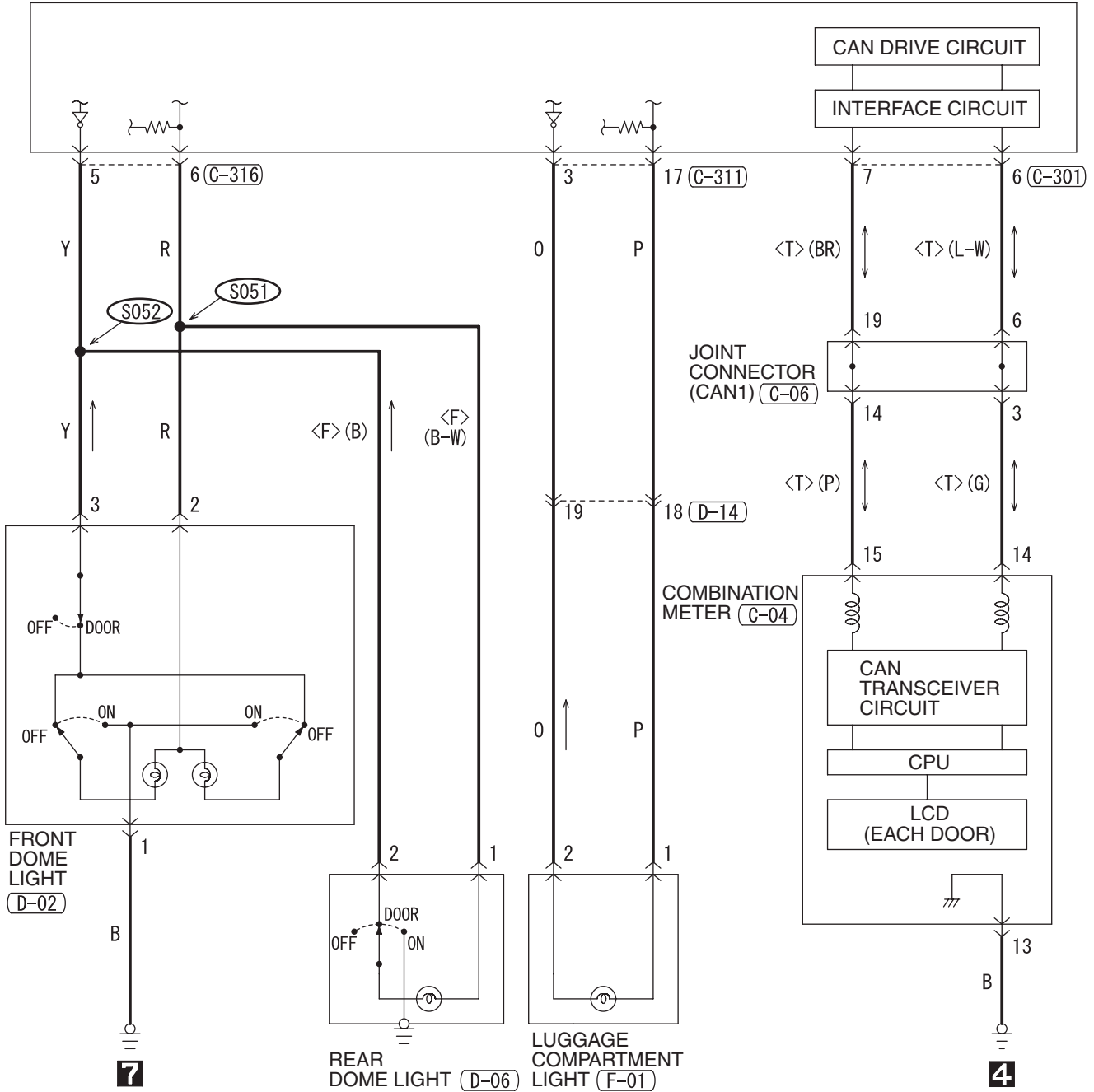

(C-04)

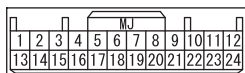

(C-06)

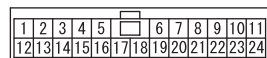

(C-301)

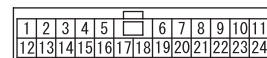

(C-311)

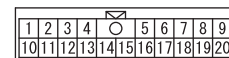

(C-316)



(D-02)



(D-06)



(D-14)



(F-01)



NOTES

DOME LIGHT, LUGGAGE COMPARTMENT LIGHT AND IGNITION KEY HOLE ILLMINATION LIGHT

<VEHICLES WITH KEYLESS ENTRY SYSTEM>

M1901030800041

1

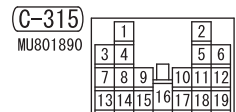
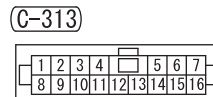
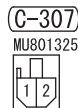
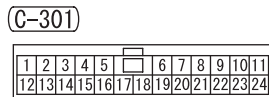
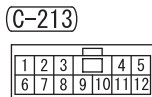
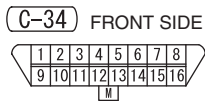
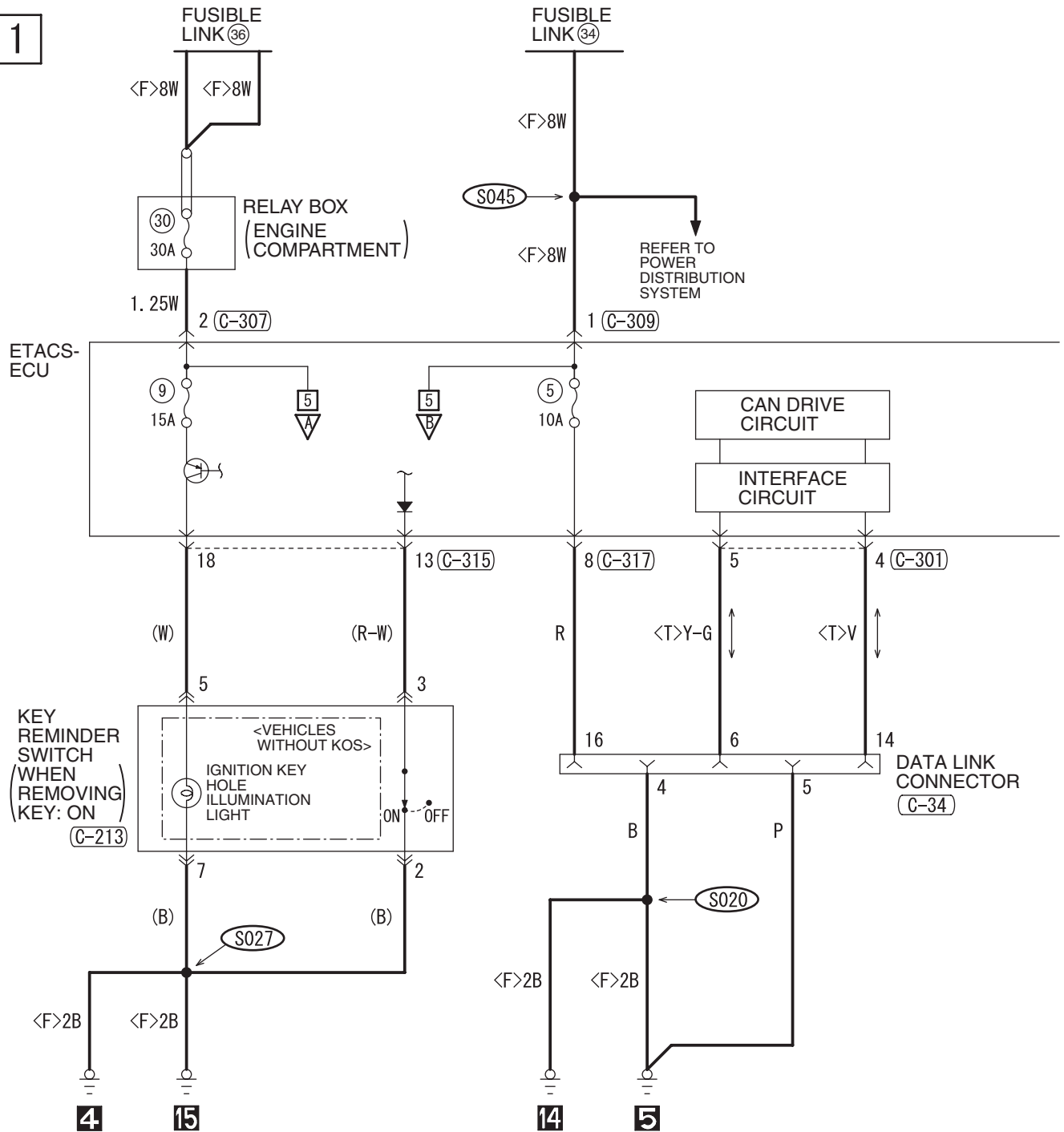

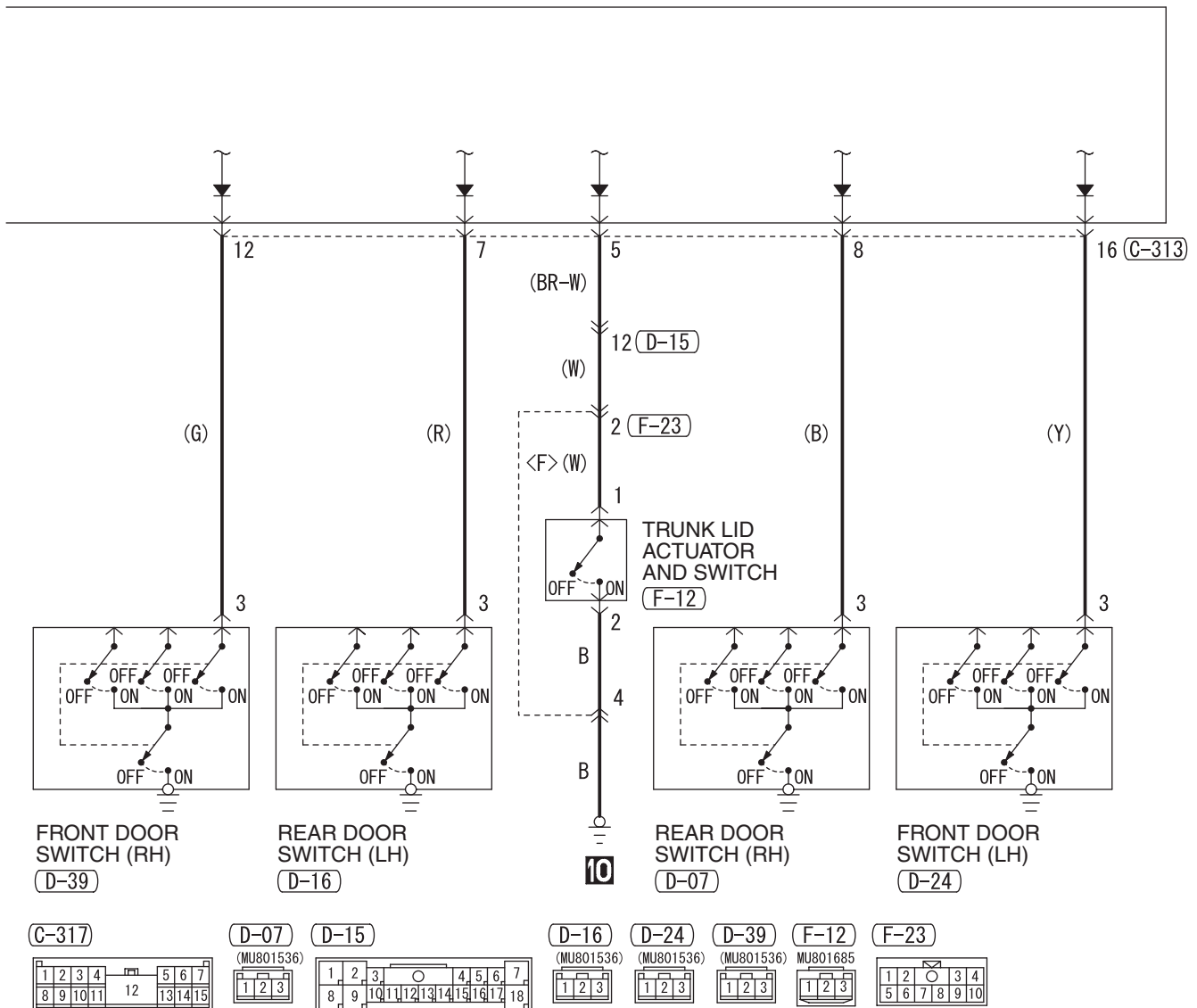

WIRE COLOR CODE

B: BLACK LG: LIGHT GREEN G: GREEN L: BLUE W: WHITE Y: YELLOW SB: SKY BLUE
 BR: BROWN O: ORANGE GR: GRAY R: RED P: PINK V: VIOLET PU: PURPLE

H8G08M06AB

DOME LIGHT, LUGGAGE COMPARTMENT LIGHT AND IGNITION KEY HOLE ILLUMINATION LIGHT
 <VEHICLES WITH KEYLESS ENTRY SYSTEM> (CONTINUED)

3

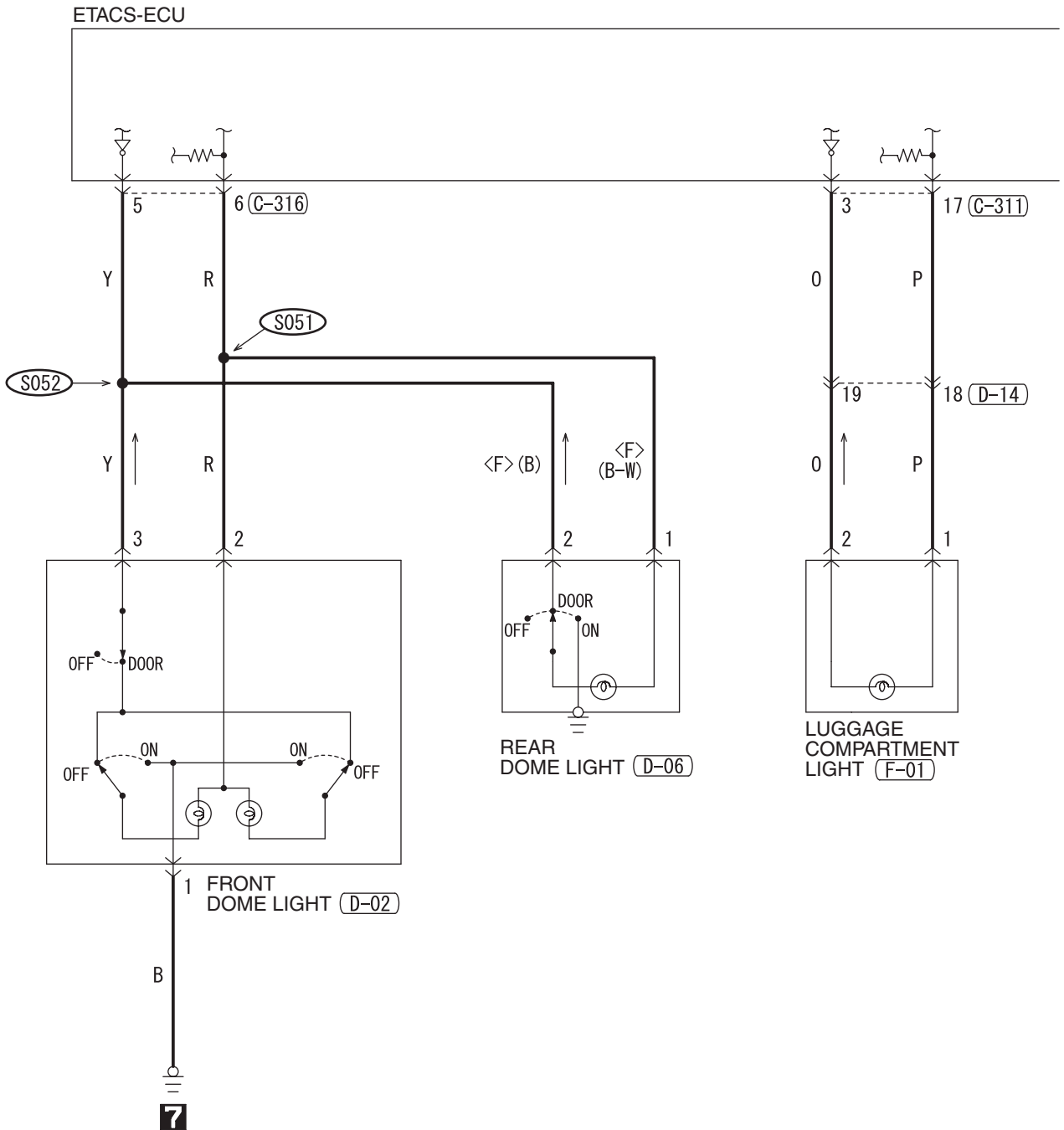

C-04

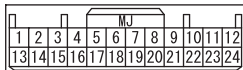

C-06



C-301



C-311

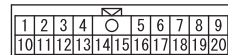

C-316



D-02



MU801685

4

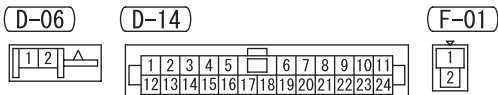
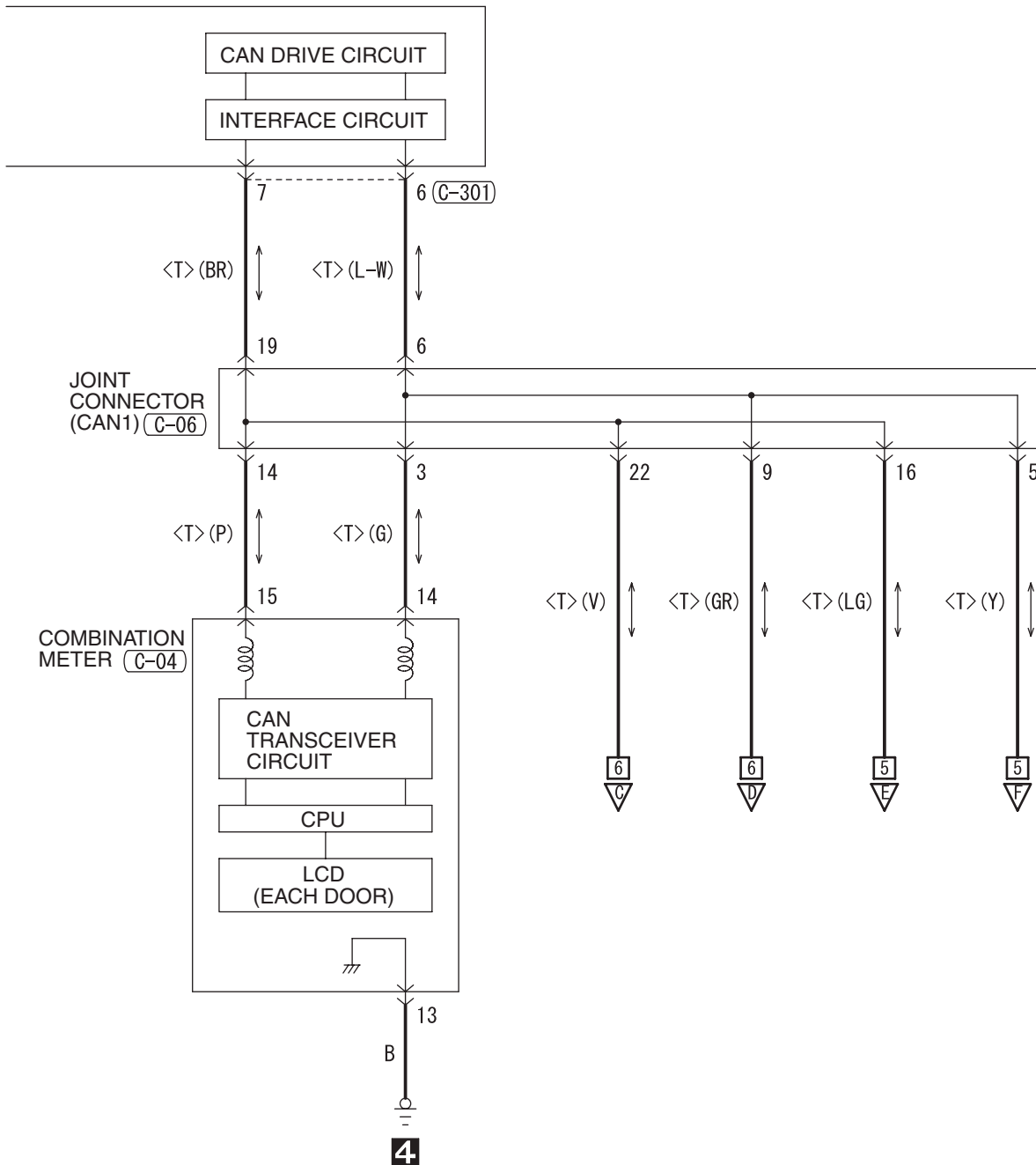

WIRE COLOR CODE
 B: BLACK LG: LIGHT GREEN G: GREEN L: BLUE W: WHITE Y: YELLOW SB: SKY BLUE
 BR: BROWN O: ORANGE GR: GRAY R: RED P: PINK V: VIOLET PU: PURPLE

H8G08M06BB

TSB Revision

DOME LIGHT, LUGGAGE COMPARTMENT LIGHT AND IGNITION KEY HOLE ILLUMINATION LIGHT
 <VEHICLES WITH KEYLESS ENTRY SYSTEM> (CONTINUED)

5

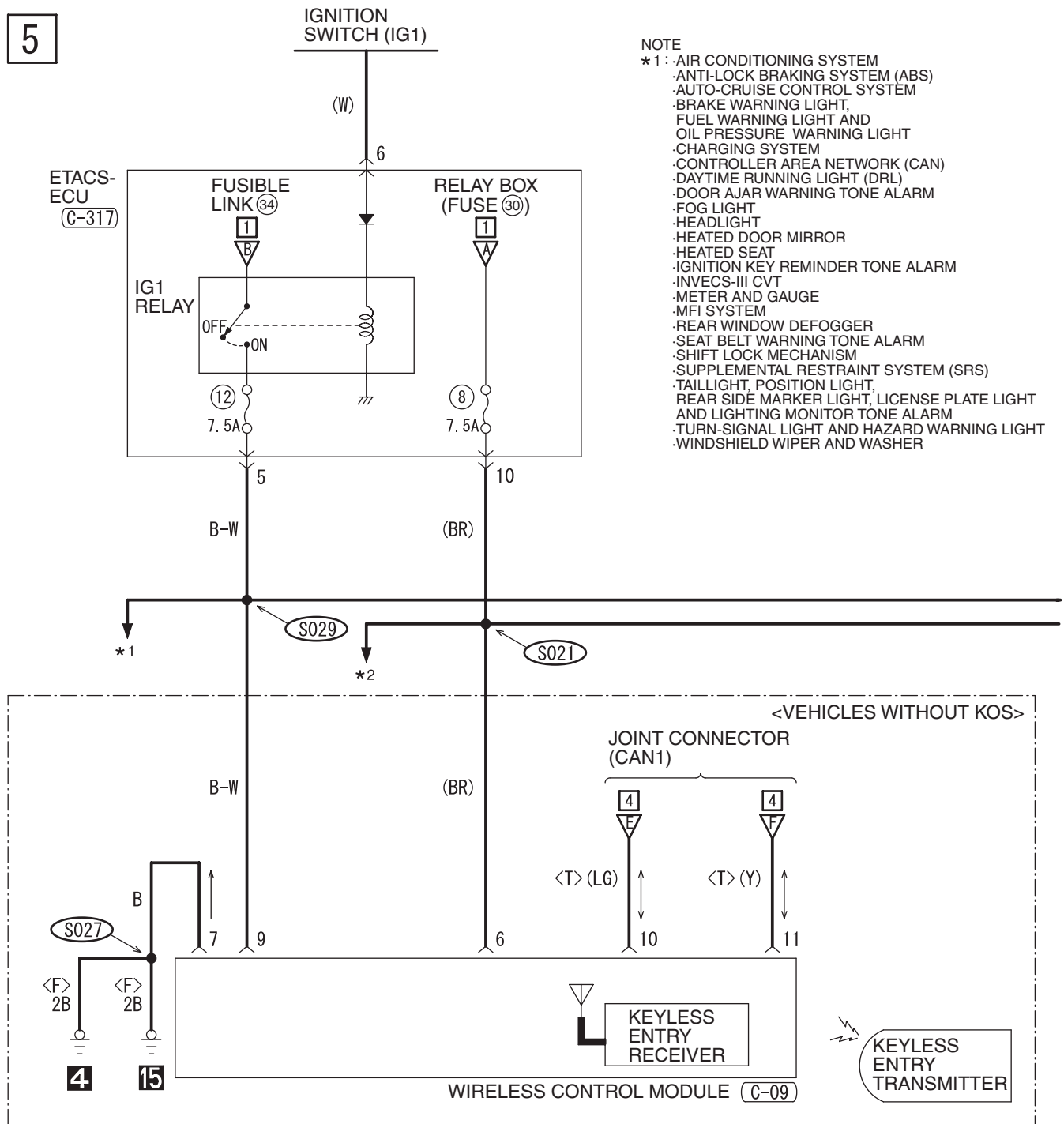

C-09

C-10

C-31

C-317

1	2	3	4	5	6
7	8	9	10	11	12

1	2	3	4	5	6
7	8	9	10	11	12

1	2	3	4	5	6	7	8	9	10	11	12	13	14	15	16	17	18	19	20
21	22	23	24	25	26	27	28	29	30	31	32	33	34	35	36	37	38	39	40

1	2	3	4	5	6	7	
8	9	10	11	12	13	14	15

6

- *2: ·AIR CONDITIONING SYSTEM
- BRAKE WARNING LIGHT,
- FUEL WARNING LIGHT AND
- OIL PRESSURE WARNING LIGHT
- CONTROLLER AREA NETWORK (CAN)
- DAYTIME RUNNING LIGHT (DRL)
- FOG LIGHT
- HEADLIGHT
- IGNITION KEY REMINDER TONE ALARM
- <VEHICLES WITH KOS>
- METER AND GAUGE
- SEAT BELT WARNING TONE ALARM
- TAILLIGHT, POSITION LIGHT,
- REAR SIDE MARKER LIGHT, LICENSE PLATE LIGHT
- AND LIGHTING MONITOR TONE ALARM
- TURN-SIGNAL LIGHT AND HAZARD WARNING LIGHT
- WINDSHIELD WIPER AND WASHER

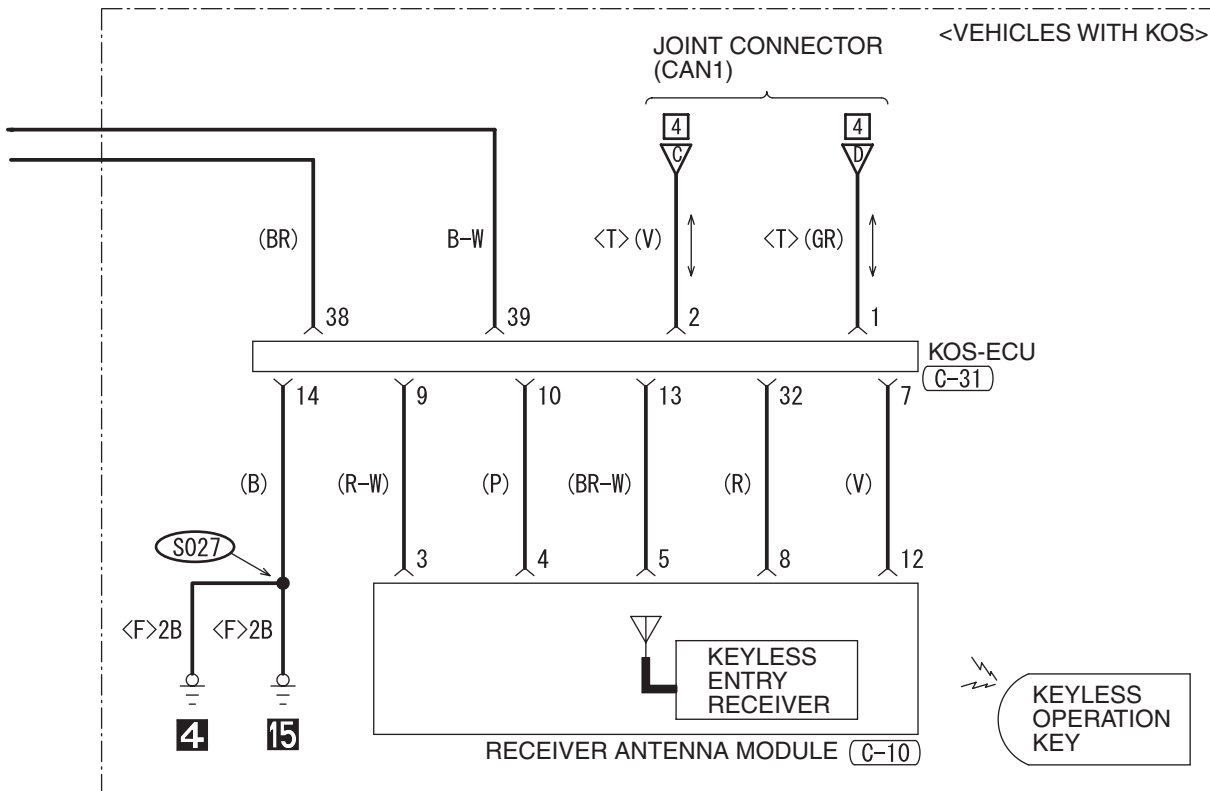

WIRE COLOR CODE

B: BLACK LG: LIGHT GREEN G: GREEN L: BLUE W: WHITE Y: YELLOW SB: SKY BLUE
 BR: BROWN O: ORANGE GR: GRAY R: RED P: PINK V: VIOLET PU: PURPLE

H8G08M06CB

TSB Revision

TURN-SIGNAL LIGHT AND HAZARD WARNING LIGHT

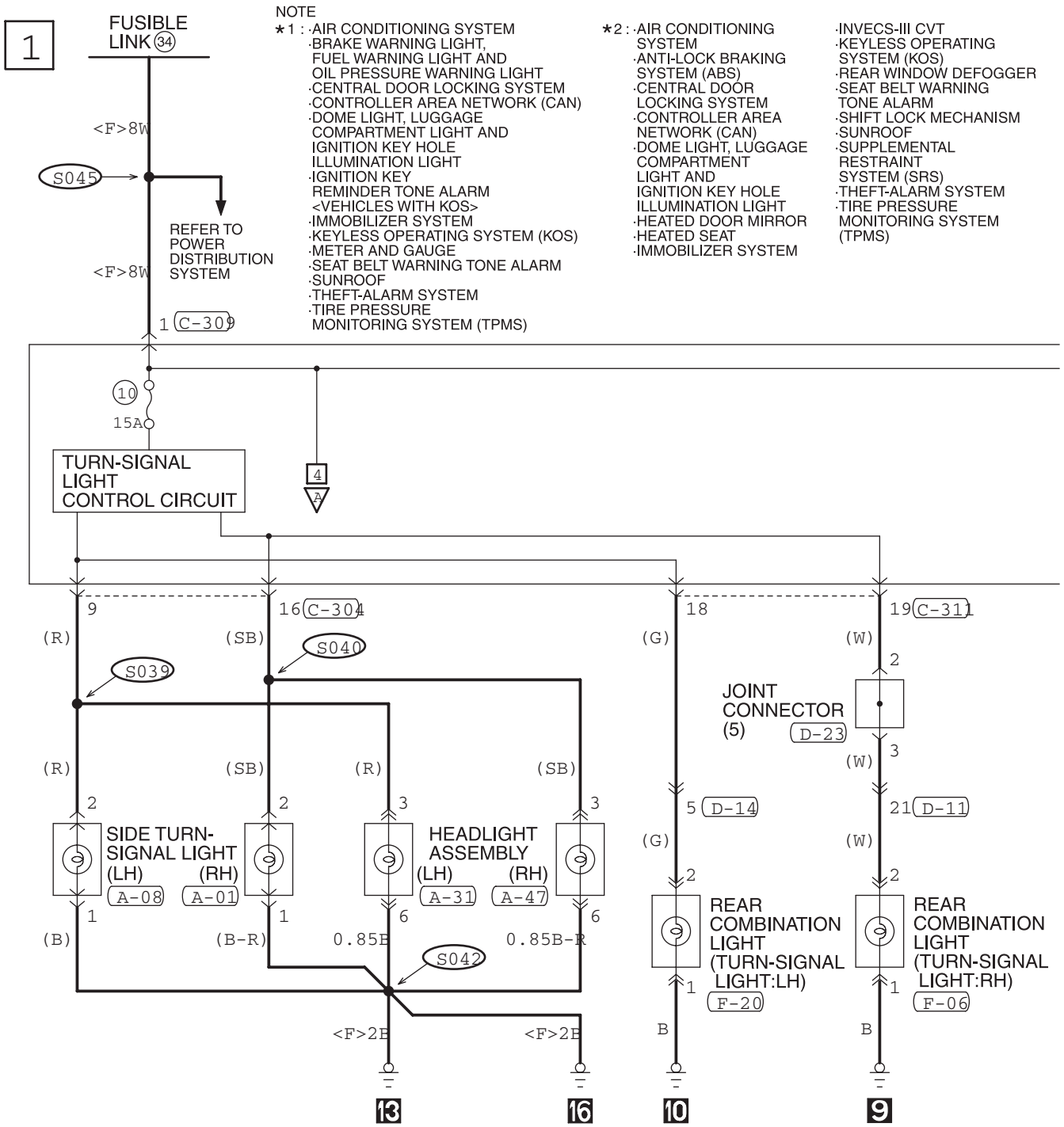

NOTE

- * 1 : -AIR CONDITIONING SYSTEM
 -BRAKE WARNING LIGHT,
 FUEL WARNING LIGHT AND
 OIL PRESSURE WARNING LIGHT
 -CENTRAL DOOR LOCKING SYSTEM
 -CONTROLLER AREA NETWORK (CAN)
 -DOME LIGHT, LUGGAGE
 COMPARTMENT LIGHT AND
 IGNITION KEY HOLE
 ILLUMINATION LIGHT
 -IGNITION KEY
 REMINDER TONE ALARM
 <VEHICLES WITH KOS>
 -IMMOBILIZER SYSTEM
 -KEYLESS OPERATING SYSTEM (KOS)
 -METER AND GAUGE
 -SEAT BELT WARNING TONE ALARM
 -SUNROOF
 -THEFT-ALARM SYSTEM
 -TIRE PRESSURE
 MONITORING SYSTEM (TPMS)

- * 2 : -AIR CONDITIONING
 SYSTEM
 -ANTI-LOCK BRAKING
 SYSTEM (ABS)
 -CENTRAL DOOR
 LOCKING SYSTEM
 -CONTROLLER AREA
 NETWORK (CAN)
 -DOME LIGHT, LUGGAGE
 COMPARTMENT
 LIGHT AND
 IGNITION KEY HOLE
 ILLUMINATION LIGHT
 -HEATED DOOR MIRROR
 -HEATED SEAT
 -IMMOBILIZER SYSTEM

- INVECS-III CVT
 -KEYLESS OPERATING
 SYSTEM (KOS)
 -REAR WINDOW DEFOGGER
 -SEAT BELT WARNING
 TONE ALARM
 -SHIFT LOCK MECHANISM
 -SUNROOF
 -SUPPLEMENTAL
 RESTRAINT
 SYSTEM (SRS)
 -THEFT-ALARM SYSTEM
 -TIRE PRESSURE
 MONITORING SYSTEM
 (TPMS)

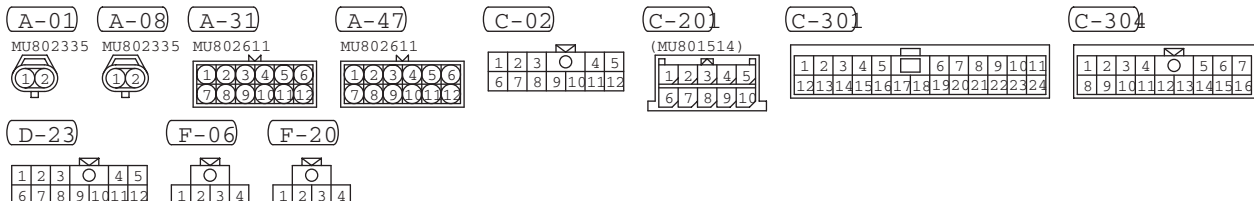

2

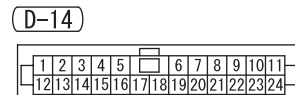
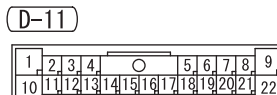
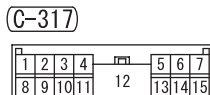
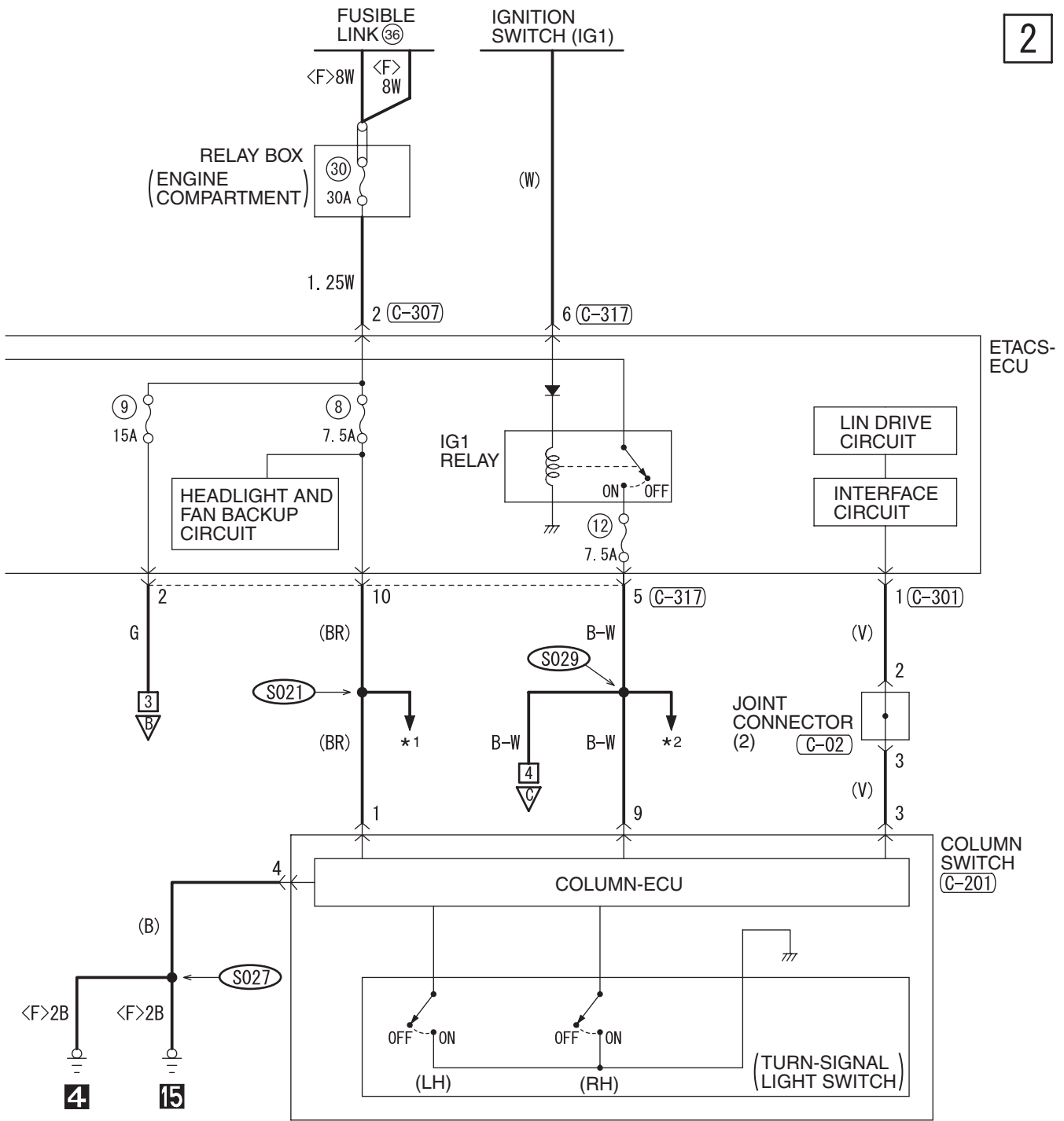

WIRE COLOR CODE

B: BLACK LG: LIGHT GREEN G: GREEN L: BLUE W: WHITE Y: YELLOW SB: SKY BLUE
BR: BROWN O: ORANGE GR: GRAY R: RED P: PINK V: VIOLET PU: PURPLE

H8G09M00AB

TSB Revision

TURN-SIGNAL LIGHT AND HAZARD WARNING LIGHT (CONTINUED)

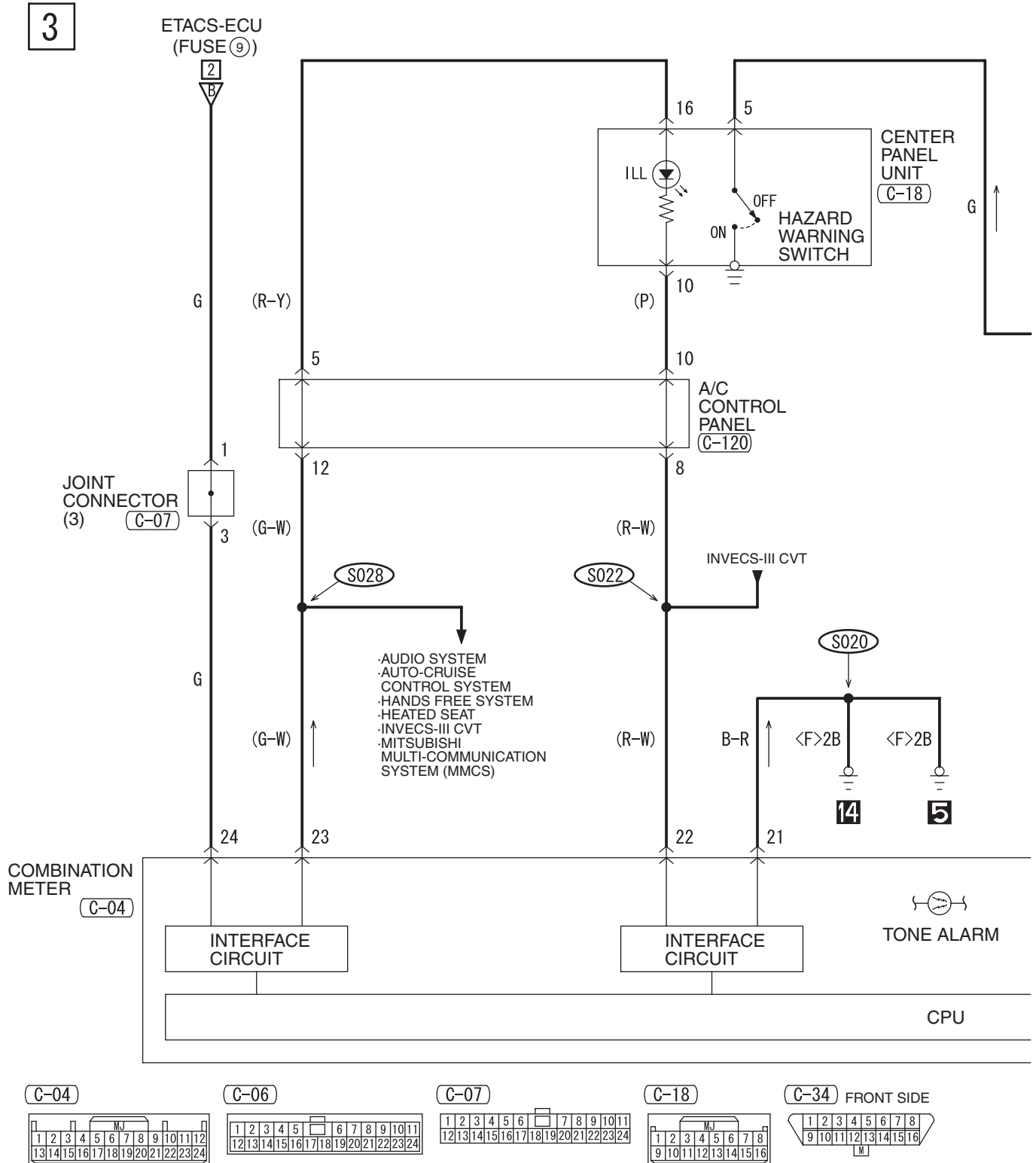

4

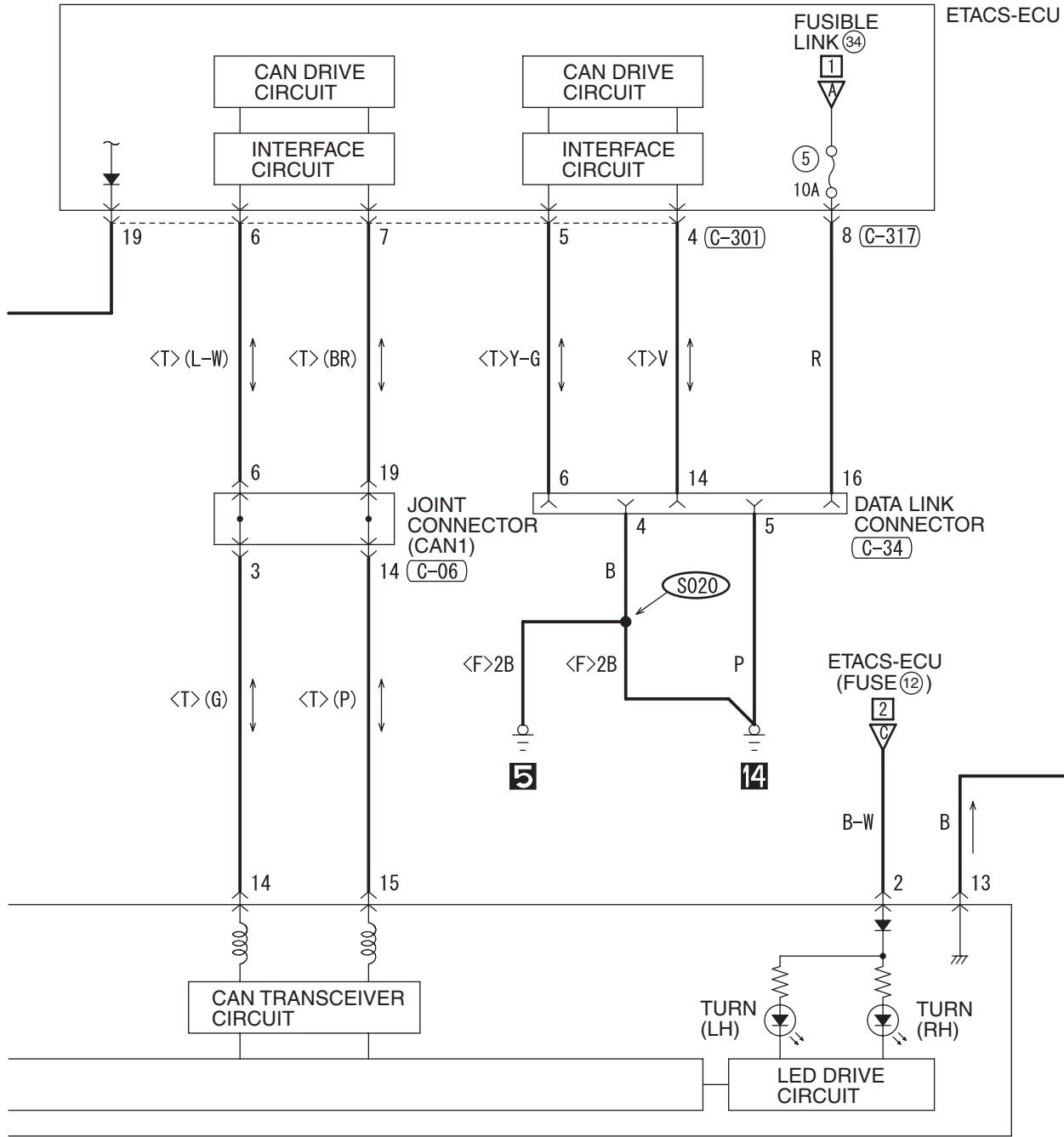

(C-120)

(C-301)

(C-317)

1	2	3	4	5	6
7	8	9	10	11	12

1	2	3	4	5	6	7	8	9	10	11		
12	13	14	15	16	17	18	19	20	21	22	23	24

1	2	3	4	5	6	7	
8	9	10	11	12	13	14	15

WIRE COLOR CODE

B: BLACK LG: LIGHT GREEN G: GREEN L: BLUE W: WHITE Y: YELLOW SB: SKY BLUE
BR: BROWN O: ORANGE GR: GRAY R: RED P: PINK V: VIOLET PU: PURPLE

H8G09M00BB

TSB Revision

STOPLIGHT

1

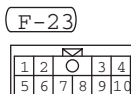
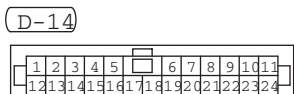
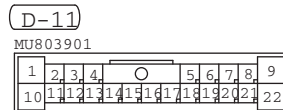
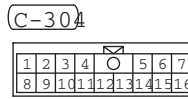
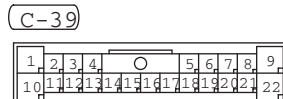
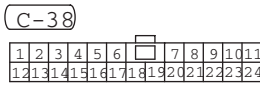
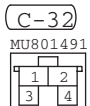
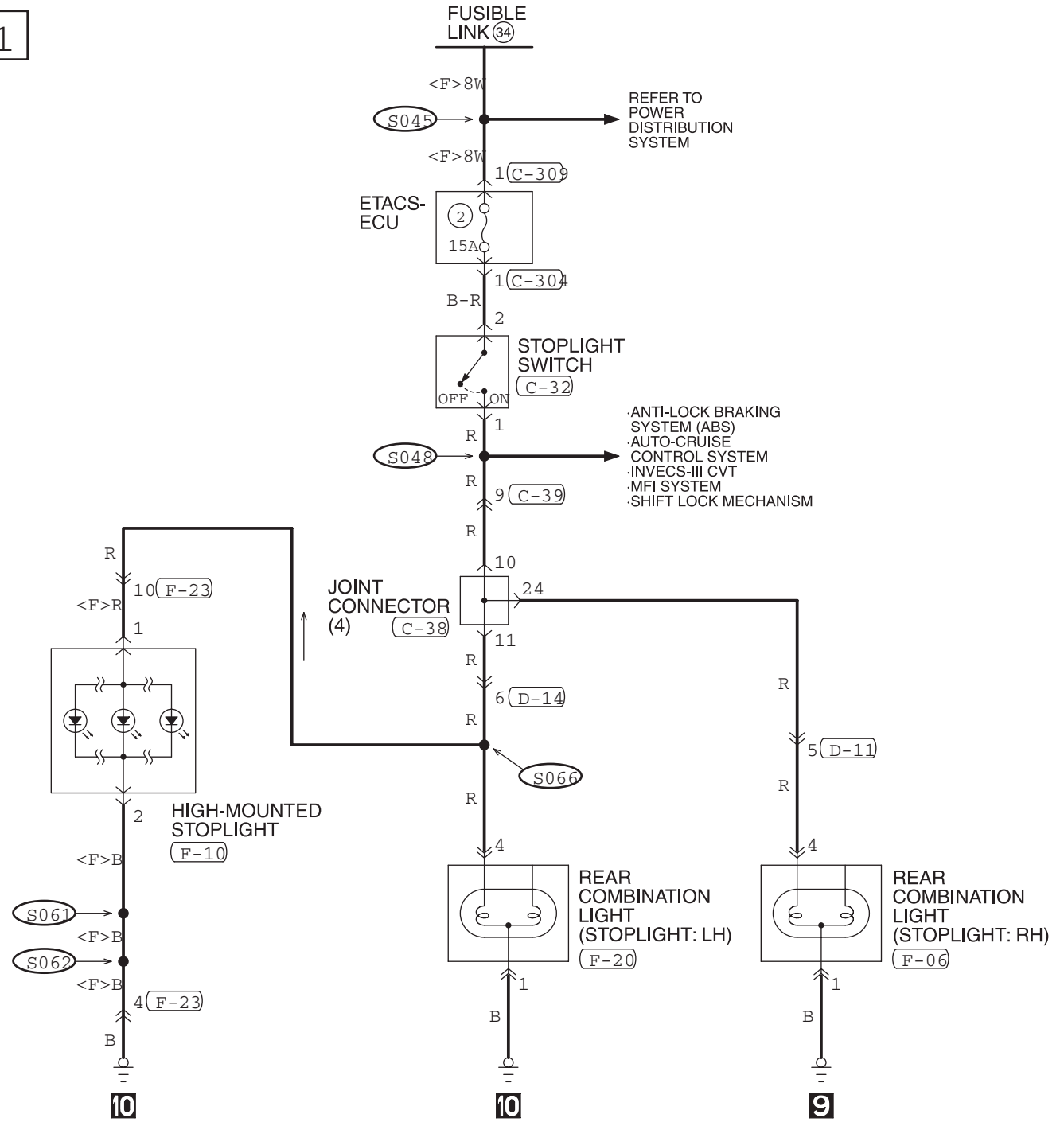

HORN

1

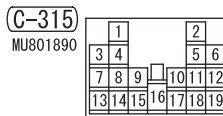
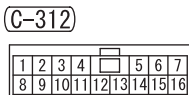
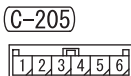
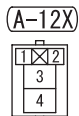
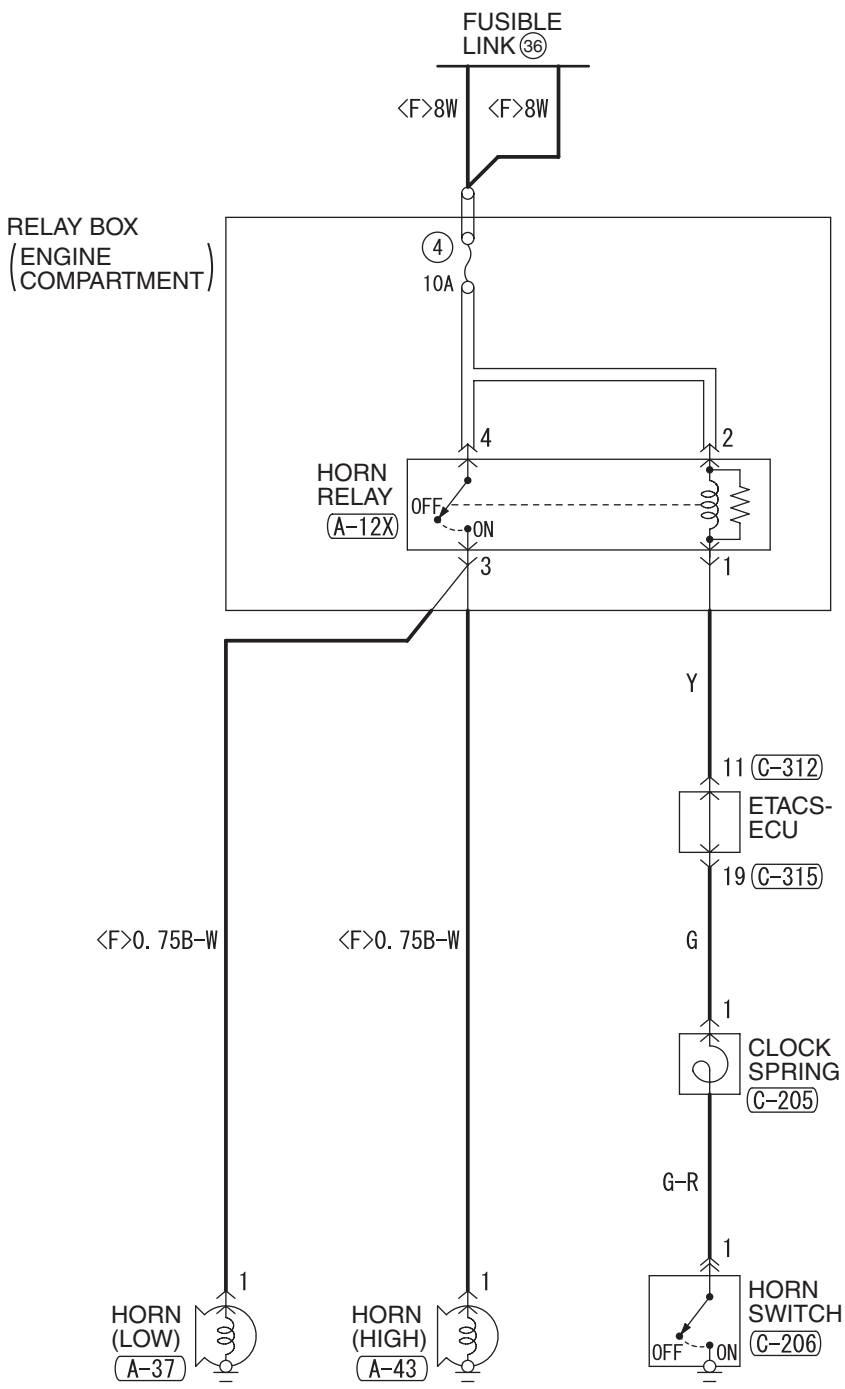

WIRE COLOR CODE

B: BLACK LG: LIGHT GREEN G: GREEN L: BLUE W: WHITE Y: YELLOW SB: SKY BLUE
BR: BROWN O: ORANGE GR: GRAY R: RED P: PINK V: VIOLET PU: PURPLE

BACKUP LIGHT

1

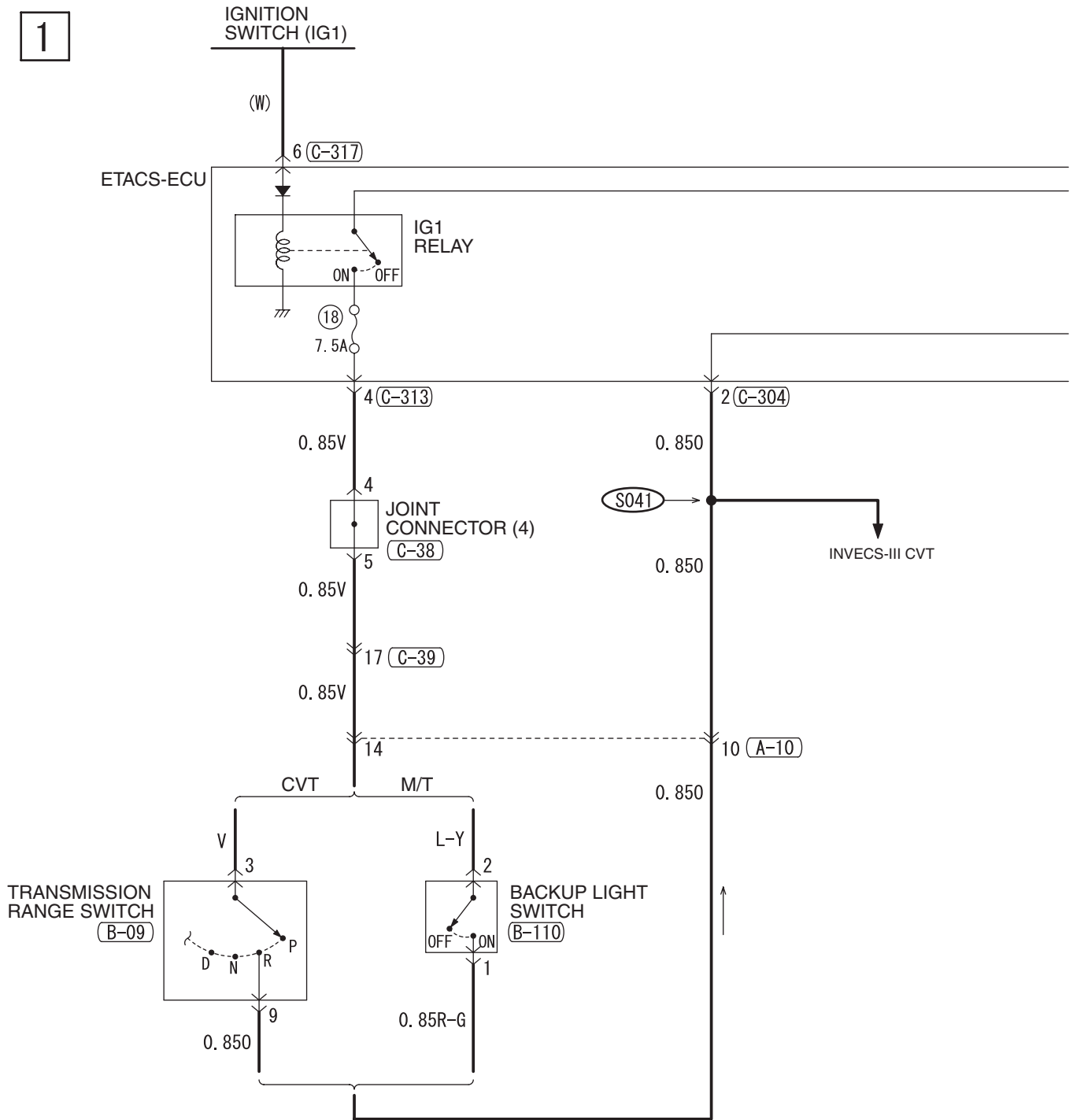

A-10

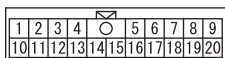

B-09

MU802355

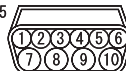

B-110

MU802601



C-34 FRONT SIDE



C-38

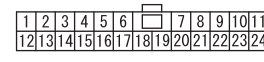

C-39

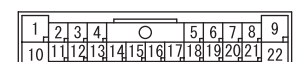

D-14

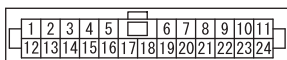

F-08

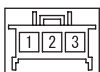

F-17

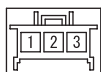

F-23

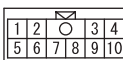

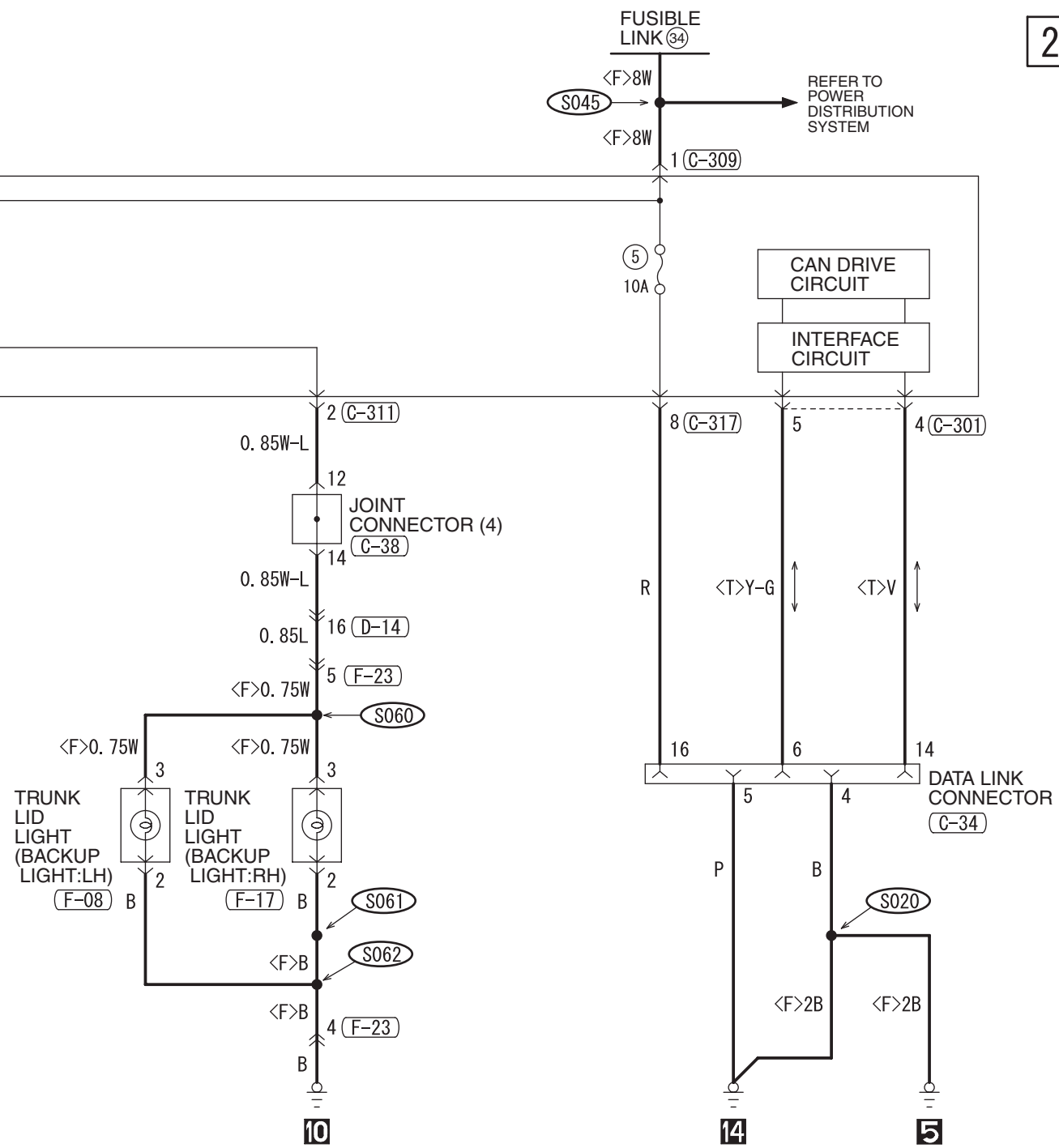

2

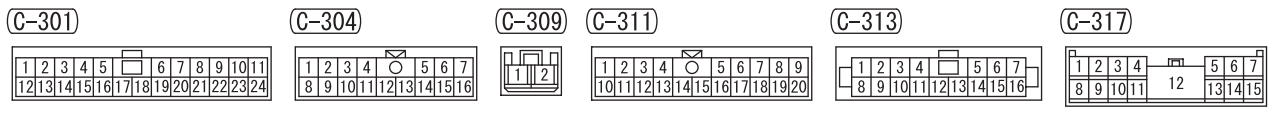

WIRE COLOR CODE
 B: BLACK LG: LIGHT GREEN G: GREEN L: BLUE W: WHITE Y: YELLOW SB: SKY BLUE
 BR: BROWN O: ORANGE GR: GRAY R: RED P: PINK V: VIOLET PU: PURPLE

H8G09M03AB

TSB Revision

METER AND GAUGE

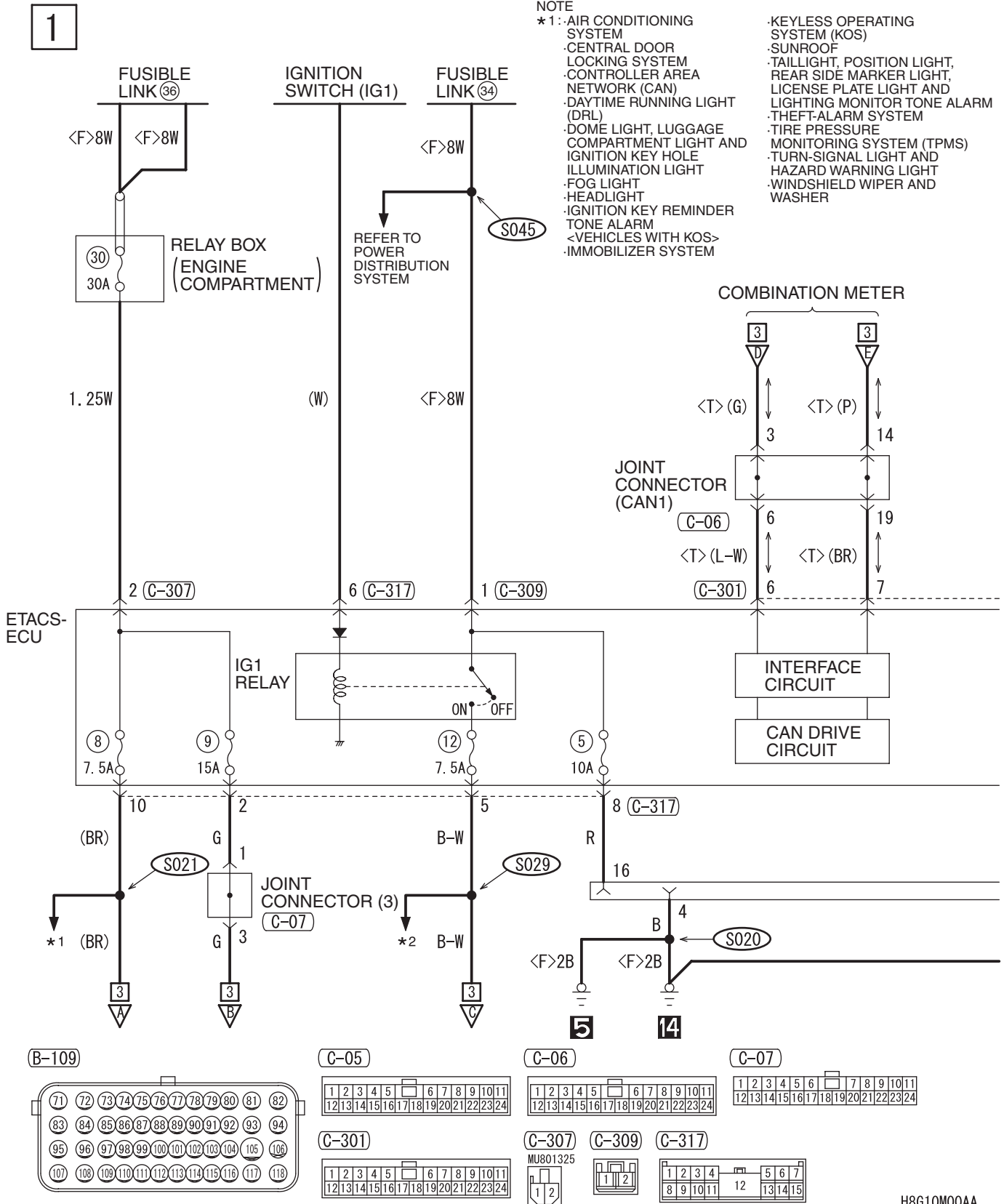

2

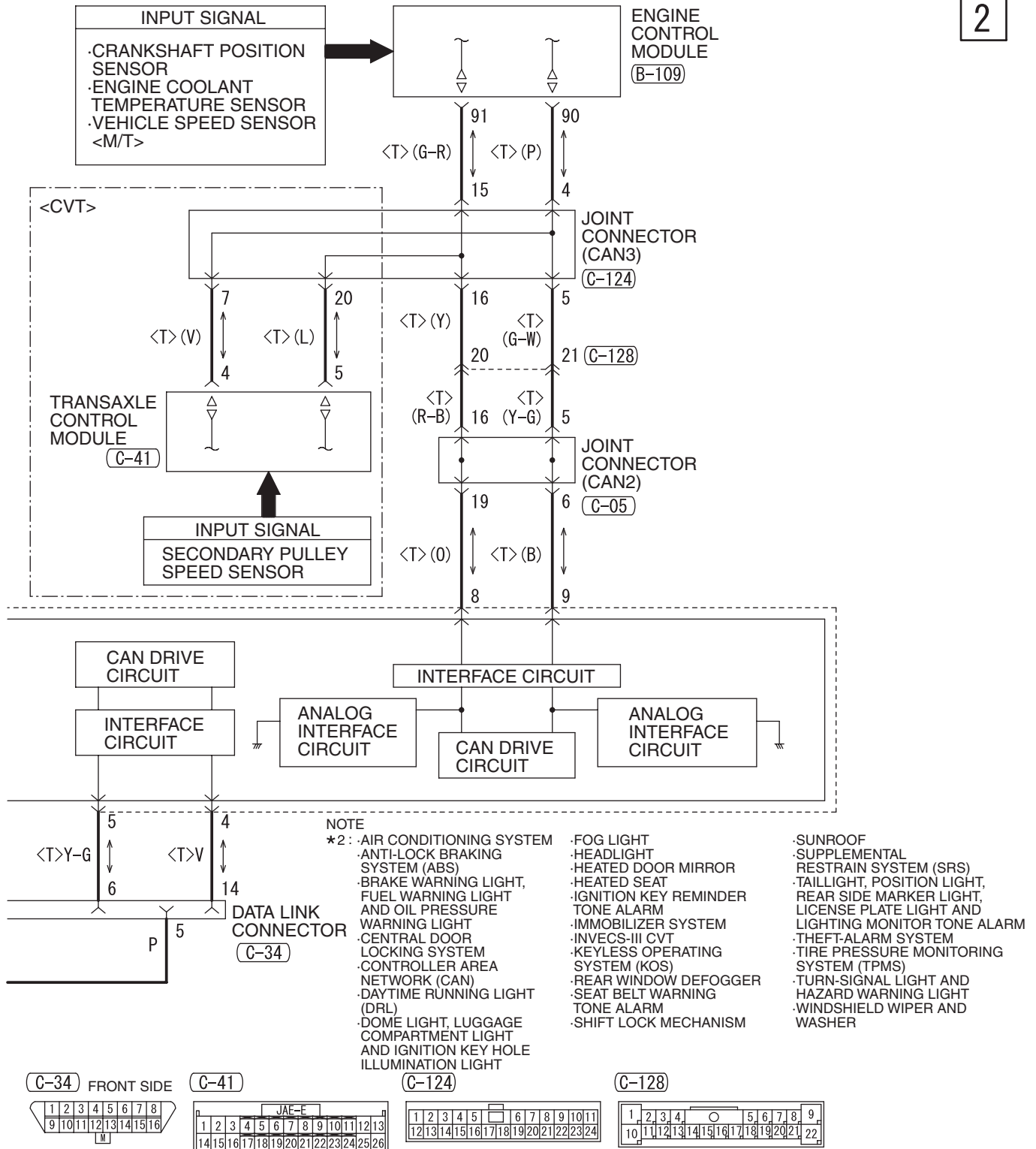

METER AND GAUGE (CONTINUED)

3

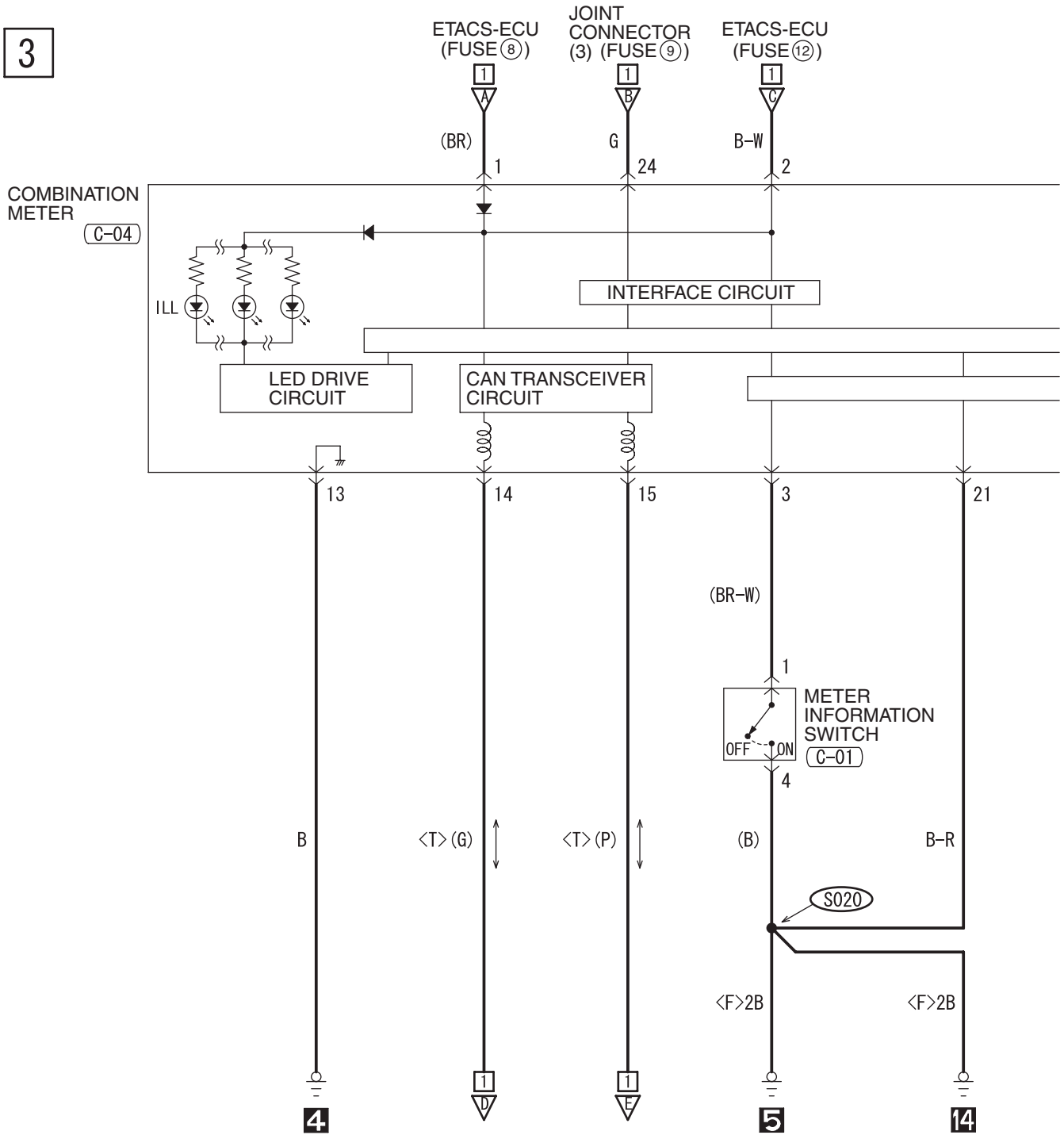

C-01

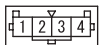

C-04

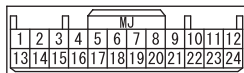

C-35



D-08



D-18



D-23

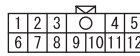

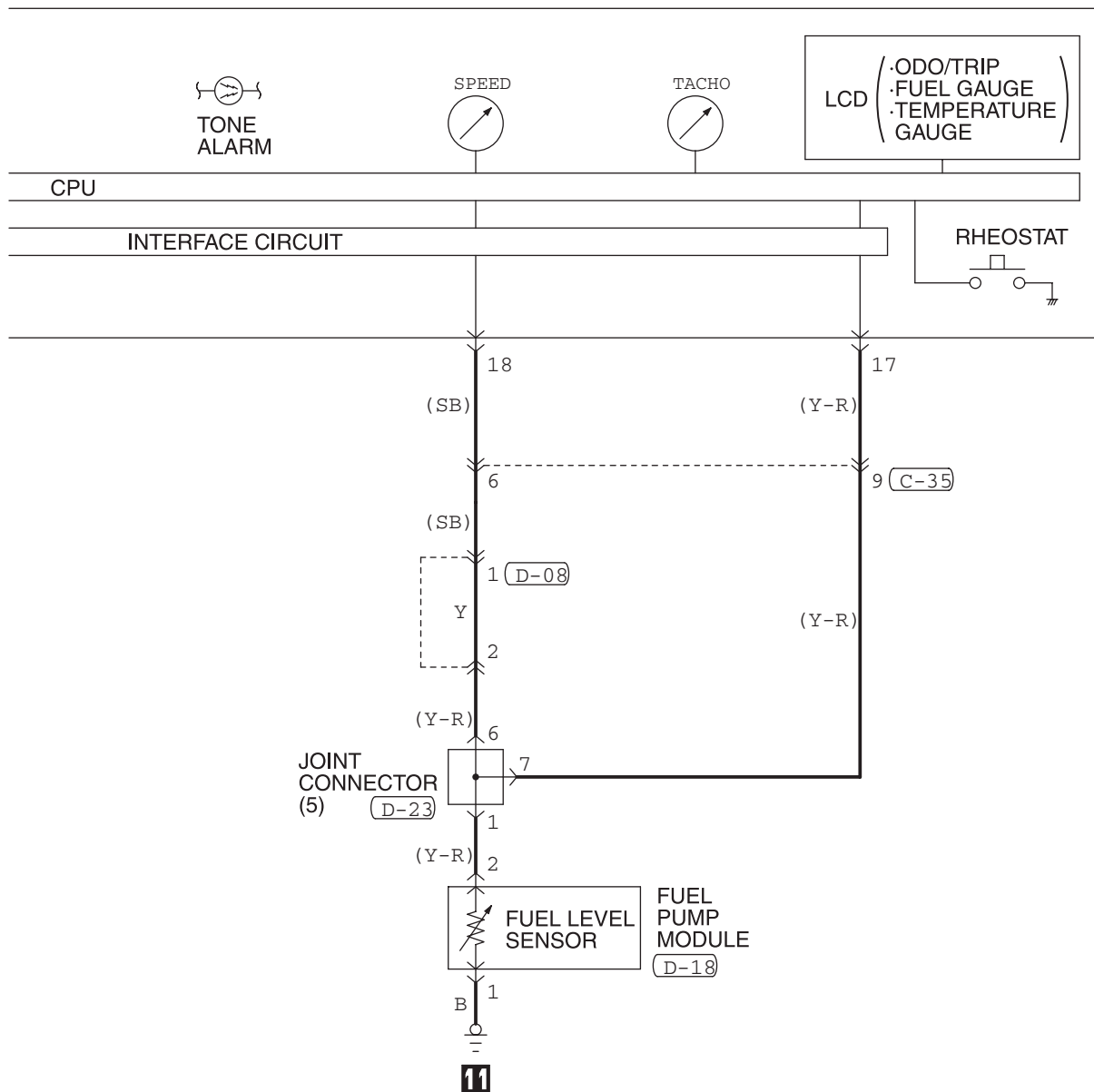

WIRE COLOR CODE
 B: BLACK LG: LIGHT GREEN G: GREEN L: BLUE W: WHITE Y: YELLOW SB: SKY BLUE
 BR: BROWN O: ORANGE GR: GRAY R: RED P: PINK V: VIOLET PU: PURPLE

H8G10M00BB

BRAKE WARNING LIGHT, FUEL WARNING LIGHT AND OIL PRESSURE WARNING LIGHT

M190102000088

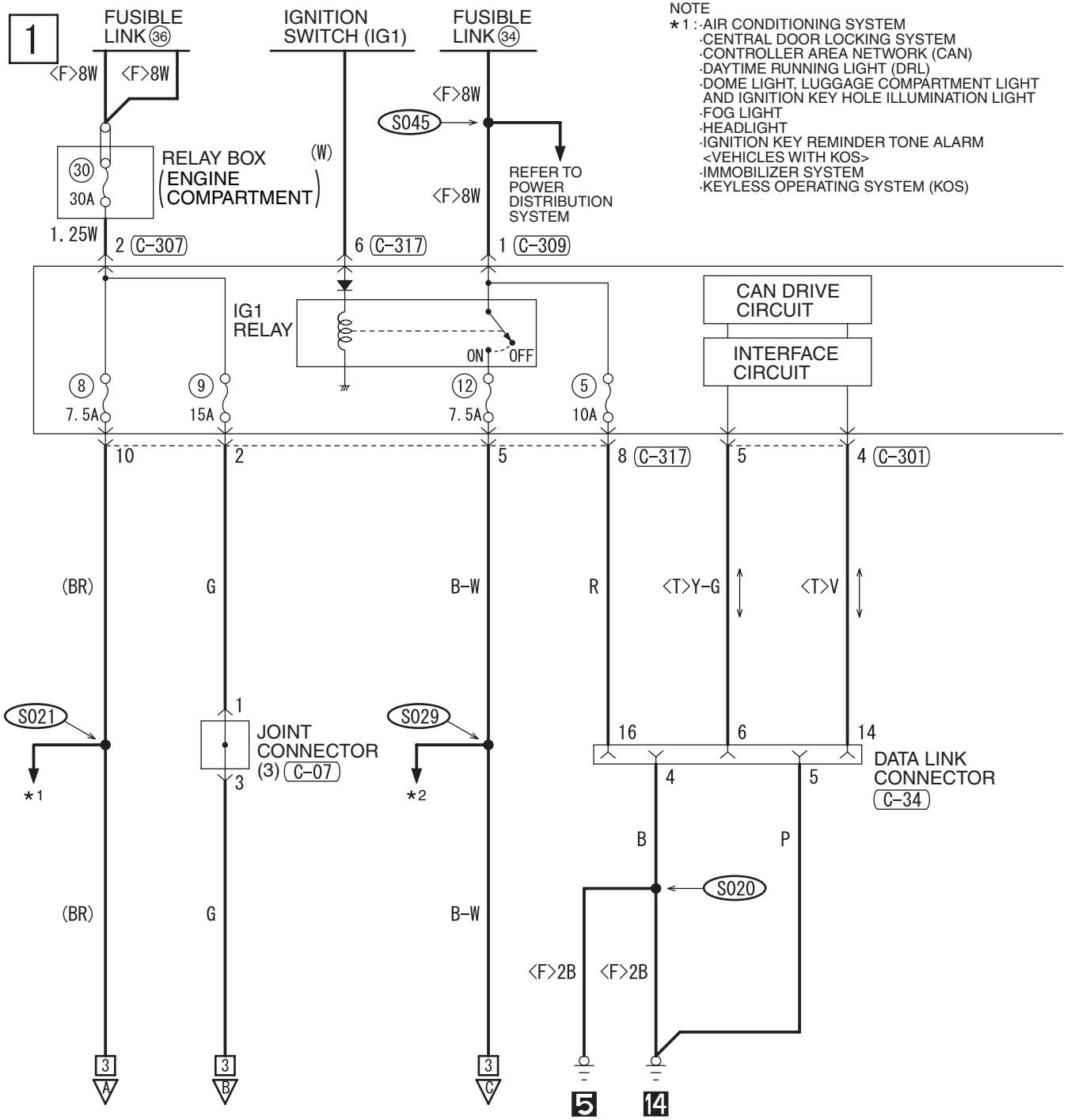

- NOTE
- * 1 : -AIR CONDITIONING SYSTEM
 - CENTRAL DOOR LOCKING SYSTEM
 - CONTROLLER AREA NETWORK (CAN)
 - DAYTIME RUNNING LIGHT (DRL)
 - DOME LIGHT, LUGGAGE COMPARTMENT LIGHT AND IGNITION KEY HOLE ILLUMINATION LIGHT
 - FOG LIGHT
 - HEADLIGHT
 - IGNITION KEY REMINDER TONE ALARM
 - VEHICLES WITH KOS->
 - IMMOBILIZER SYSTEM
 - KEYLESS OPERATING SYSTEM (KOS)

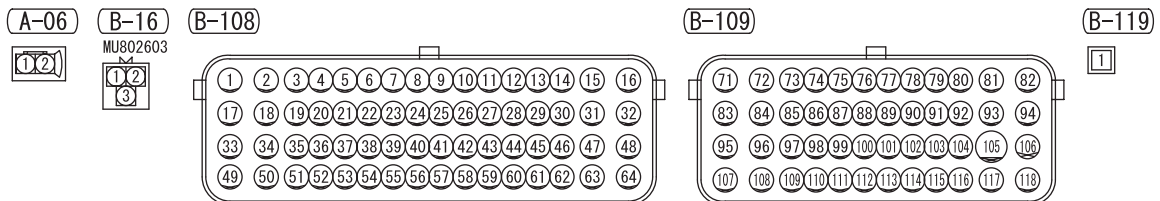

- SUNROOF
- TAILLIGHT, POSITION LIGHT, REAR SIDE MARKER LIGHT, LICENSE PLATE LIGHT AND LIGHTING MONITOR TONE ALARM
- THEFT-ALARM SYSTEM
- TIRE PRESSURE MONITORING SYSTEM (TPMS)
- TURN-SIGNAL LIGHT AND HAZARD WARNING LIGHT
- WINDSHIELD WIPER AND WASHER

- *2:
- AIR CONDITIONING SYSTEM
 - ANTI-LOCK BRAKING SYSTEM (ABS)
 - CENTRAL DOOR LOCKING SYSTEM
 - CHARGING SYSTEM
 - CONTROLLER AREA NETWORK (CAN)
 - DAYTIME RUNNING LIGHT (DRL)
 - DOME LIGHT, LUGGAGE COMPARTMENT LIGHT AND IGNITION KEY HOLE ILLUMINATION LIGHT
 - FOG LIGHT
 - HEADLIGHT
 - HEATED DOOR MIRROR
 - HEATED SEAT
 - IGNITION KEY REMINDER TONE ALARM
 - <VEHICLES WITH KOS>
 - IMMOBILIZER SYSTEM
 - INVECS-III CVT

- KEYLESS OPERATING SYSTEM (KOS)
- REAR WINDOW DEFOGGER
- SEAT BELT WARNING TONE ALARM
- SHIFT LOCK MECHANISM
- SUNROOF
- SUPPLEMENTAL RESTRAINT SYSTEM (SRS)
- TAILLIGHT, POSITION LIGHT, REAR SIDE MARKER LIGHT, LICENSE PLATE LIGHT AND LIGHTING MONITOR TONE ALARM
- THEFT-ALARM SYSTEM
- TIRE PRESSURE MONITORING SYSTEM (TPMS)
- TURN-SIGNAL LIGHT AND HAZARD WARNING LIGHT
- WINDSHIELD WIPER AND WASHER

2

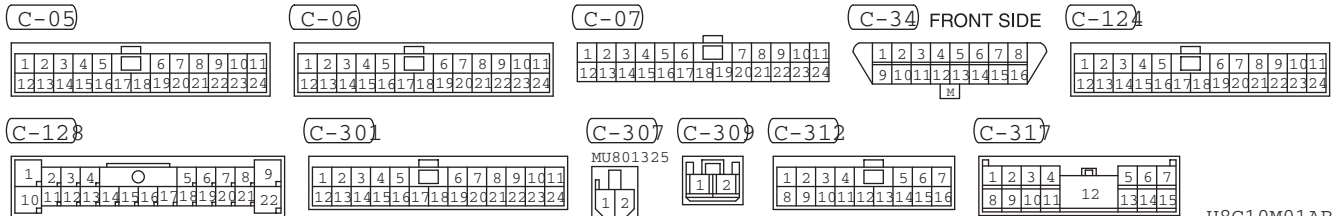
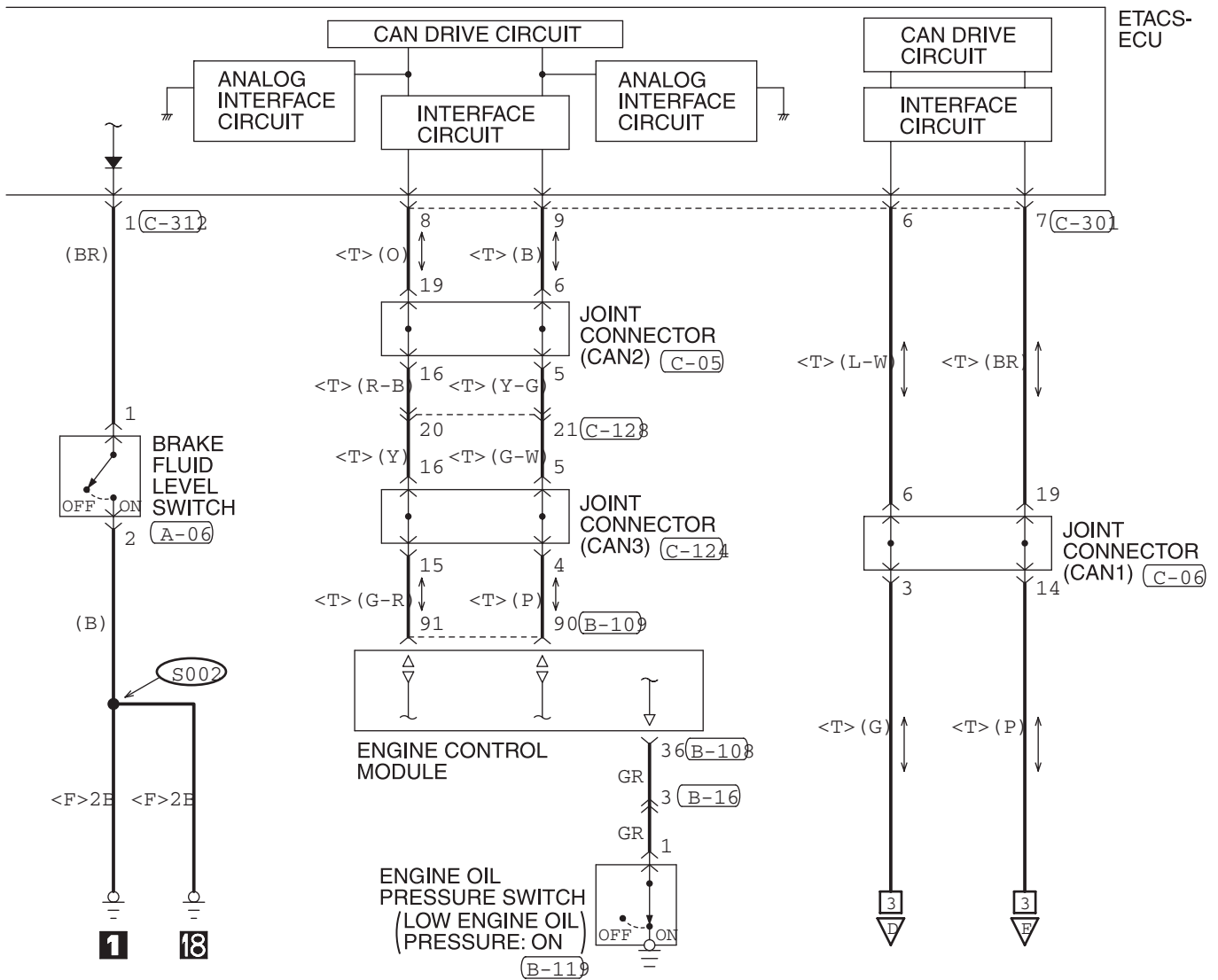

BRAKE WARNING LIGHT, FUEL WARNING LIGHT AND OIL PRESSURE WARNING LIGHT (CONTINUED)

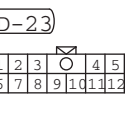
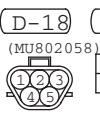
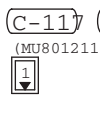
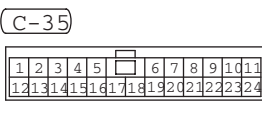
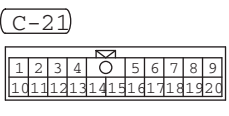
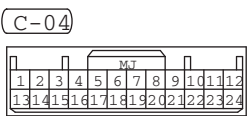
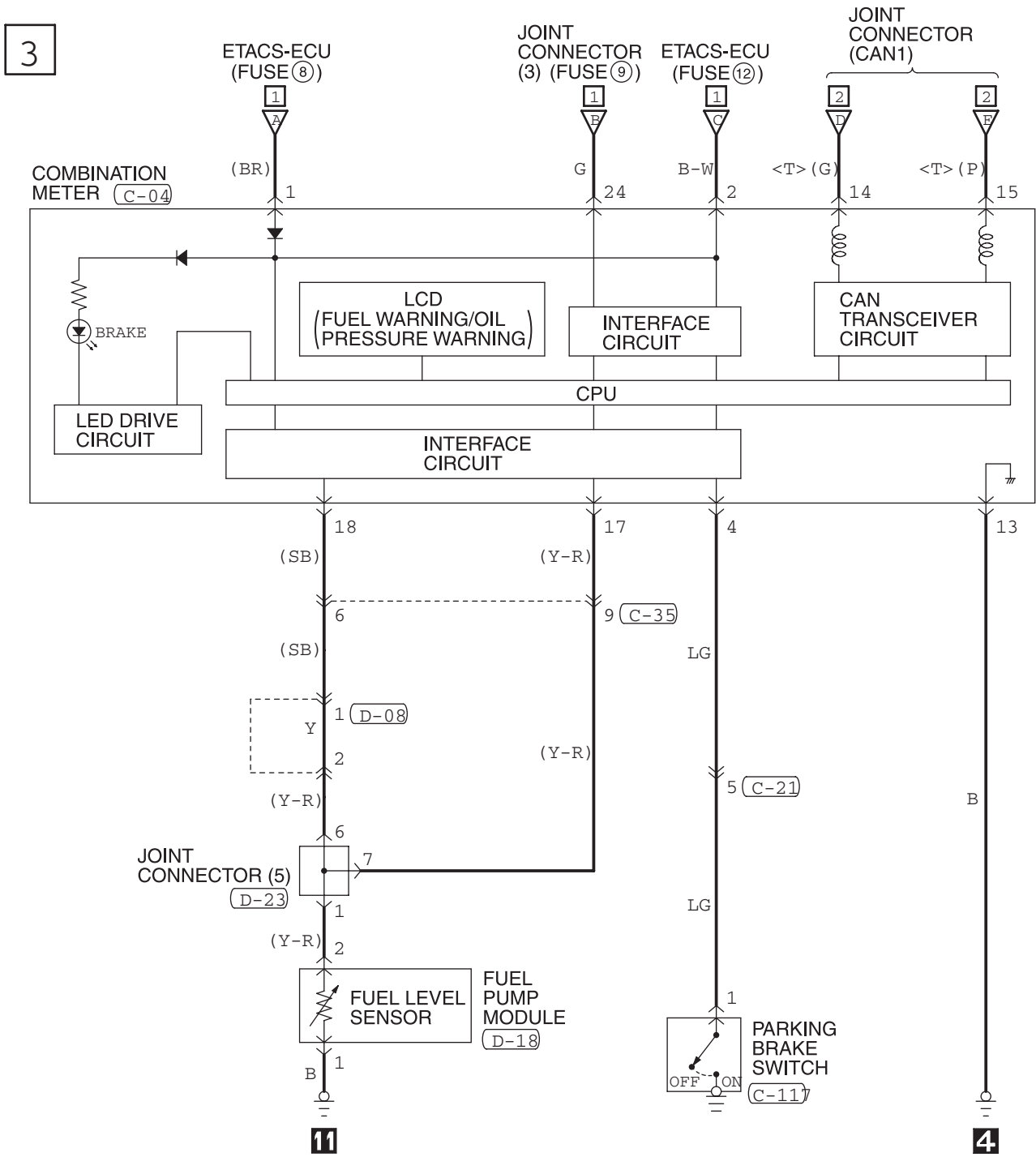

WIRE COLOR CODE
 B: BLACK LG: LIGHT GREEN G: GREEN L: BLUE W: WHITE Y: YELLOW SB: SKY BLUE
 BR: BROWN O: ORANGE GR: GRAY R: RED P: PINK V: VIOLET PU: PURPLE

NOTES

POWER WINDOWS <VEHICLES WITHOUT CENTRAL DOOR LOCKING SYSTEM>

M1901004602912

1

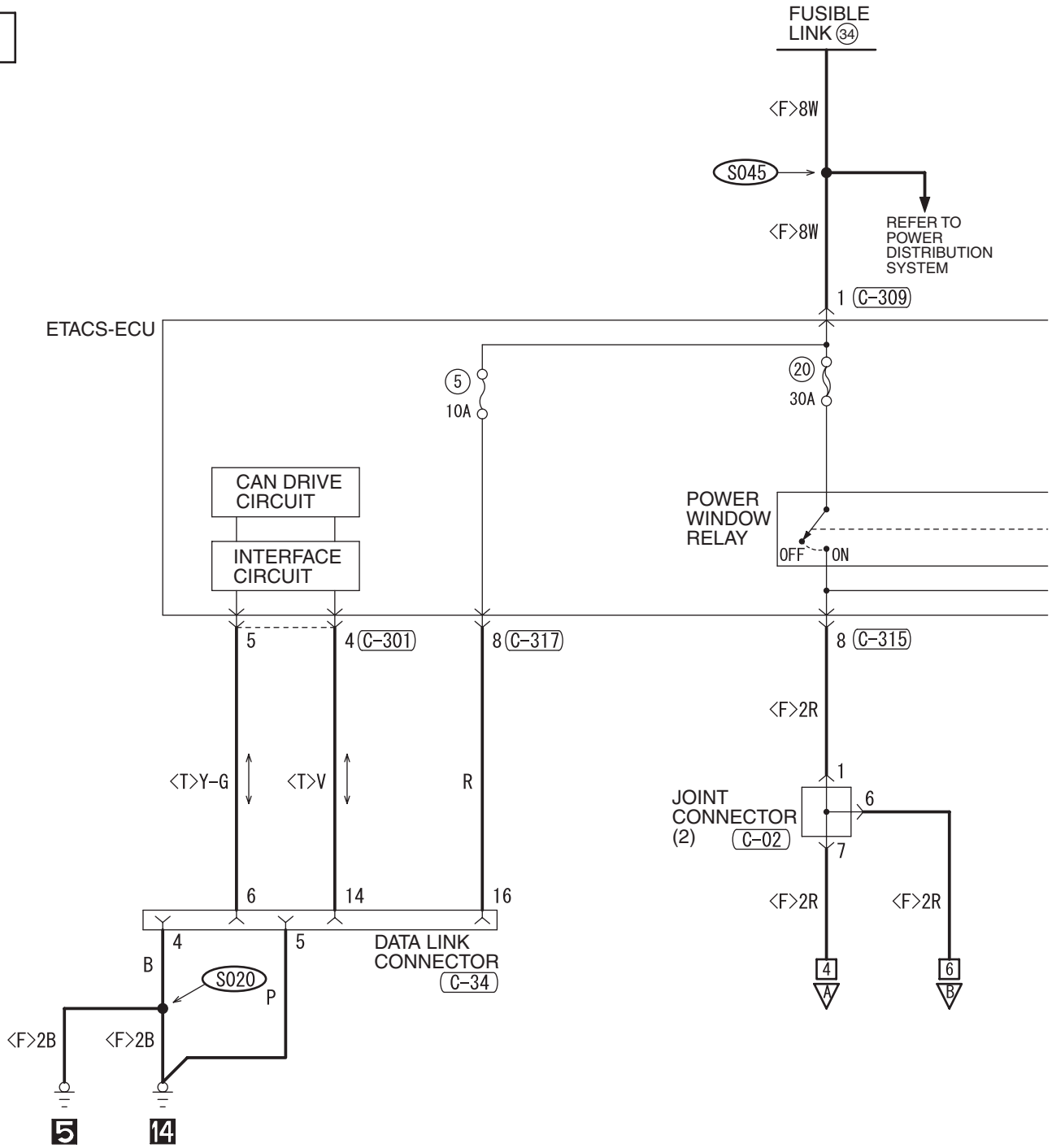

(C-02)

(C-34) FRONT SIDE

(C-301)

(C-307)

(C-309)

(C-311)

(C-313)

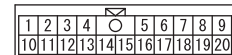
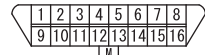
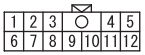

2

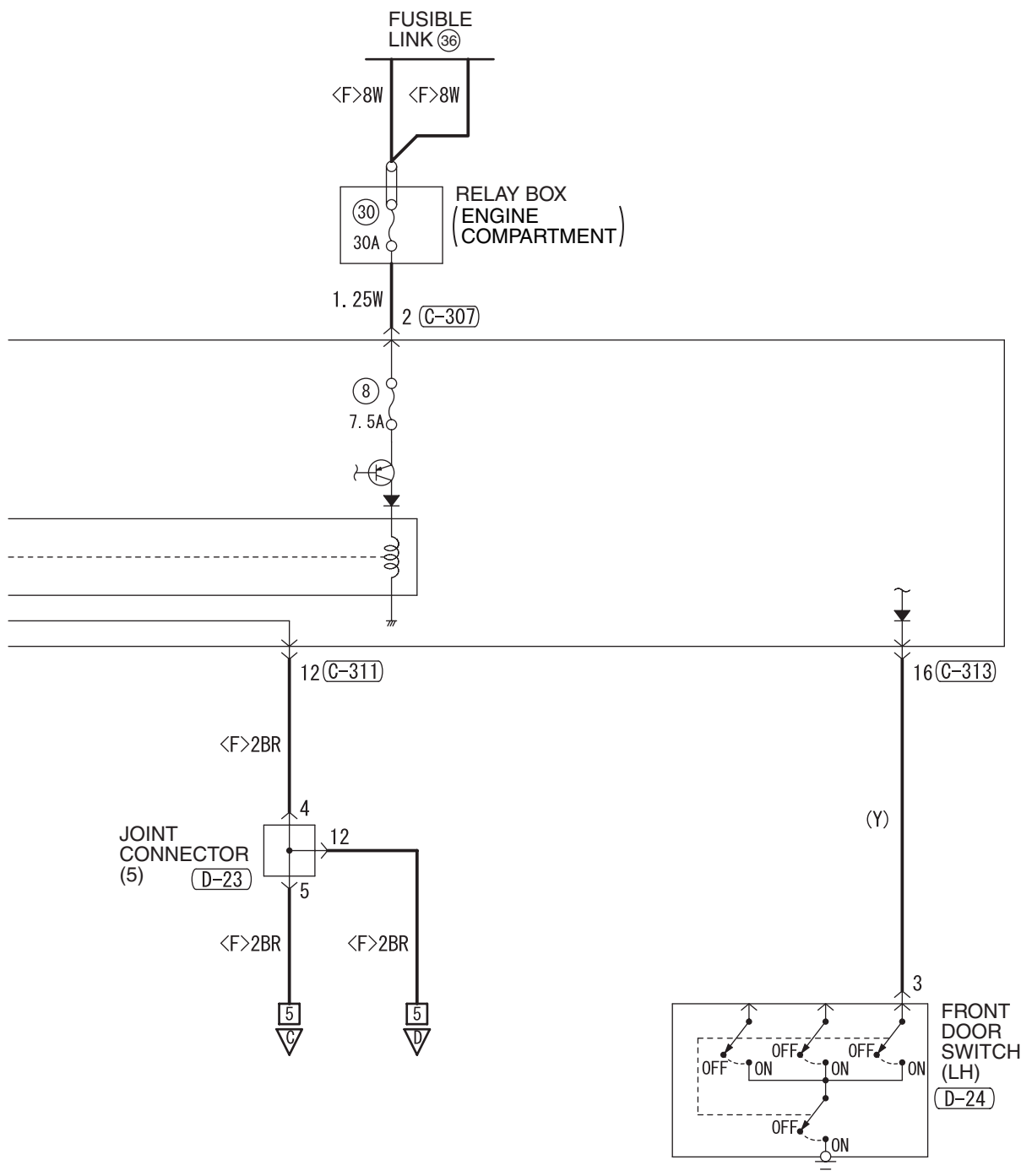

(C-315)
MU801890

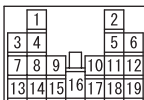

(C-317)



(D-23)

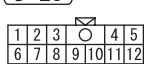

(D-24)



WIRE COLOR CODE

B : BLACK LG : LIGHT GREEN G : GREEN L : BLUE W : WHITE Y : YELLOW SB : SKY BLUE
BR : BROWN O : ORANGE GR : GRAY R : RED P : PINK V : VIOLET PU : PURPLE

H8G11M04AB

POWER WINDOWS <VEHICLES WITHOUT CENTRAL DOOR LOCKING SYSTEM> (CONTINUED)

3

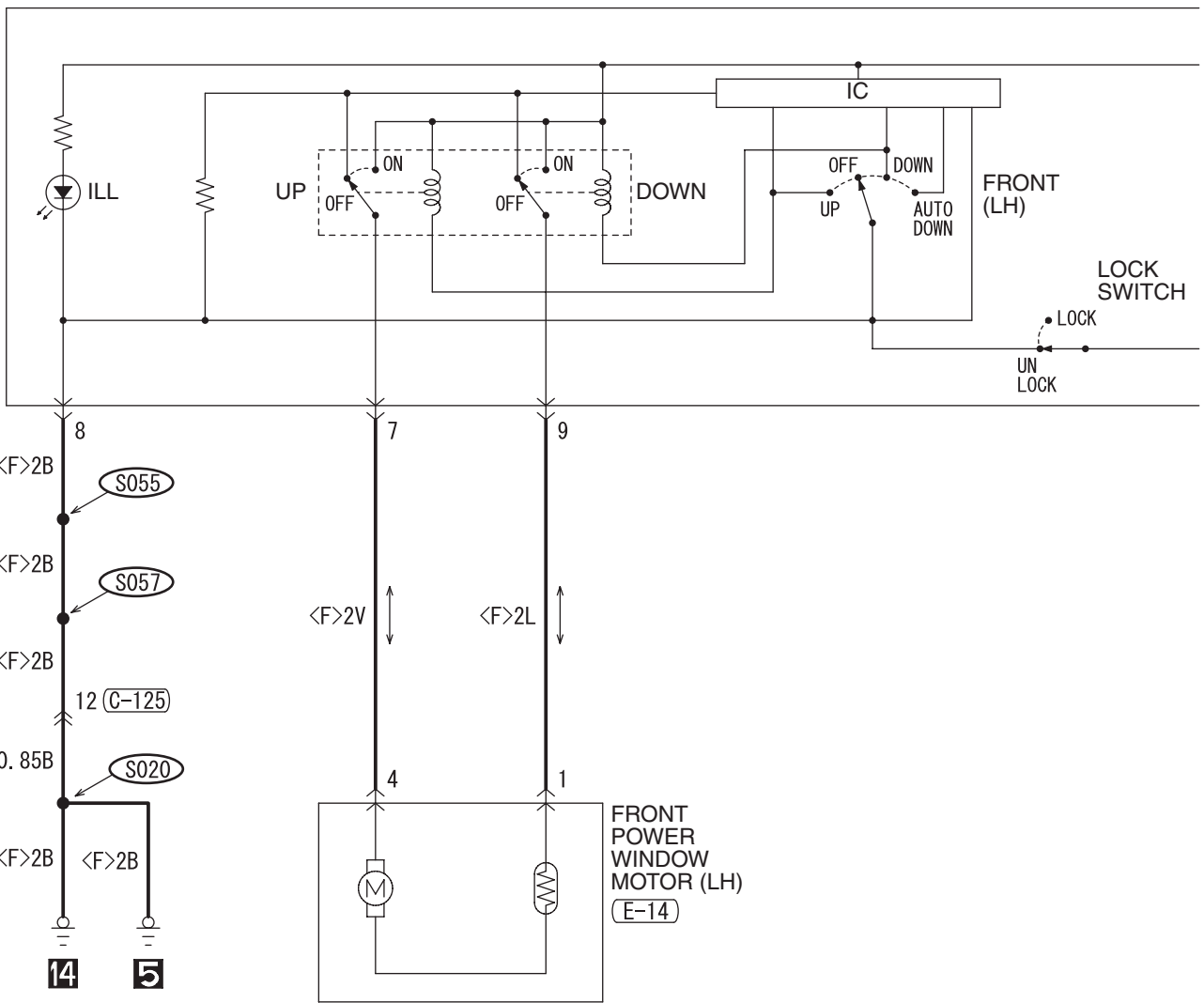

C-125

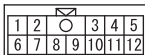

E-14

(MU802758)



E-15

MU801857

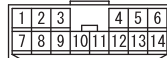

4

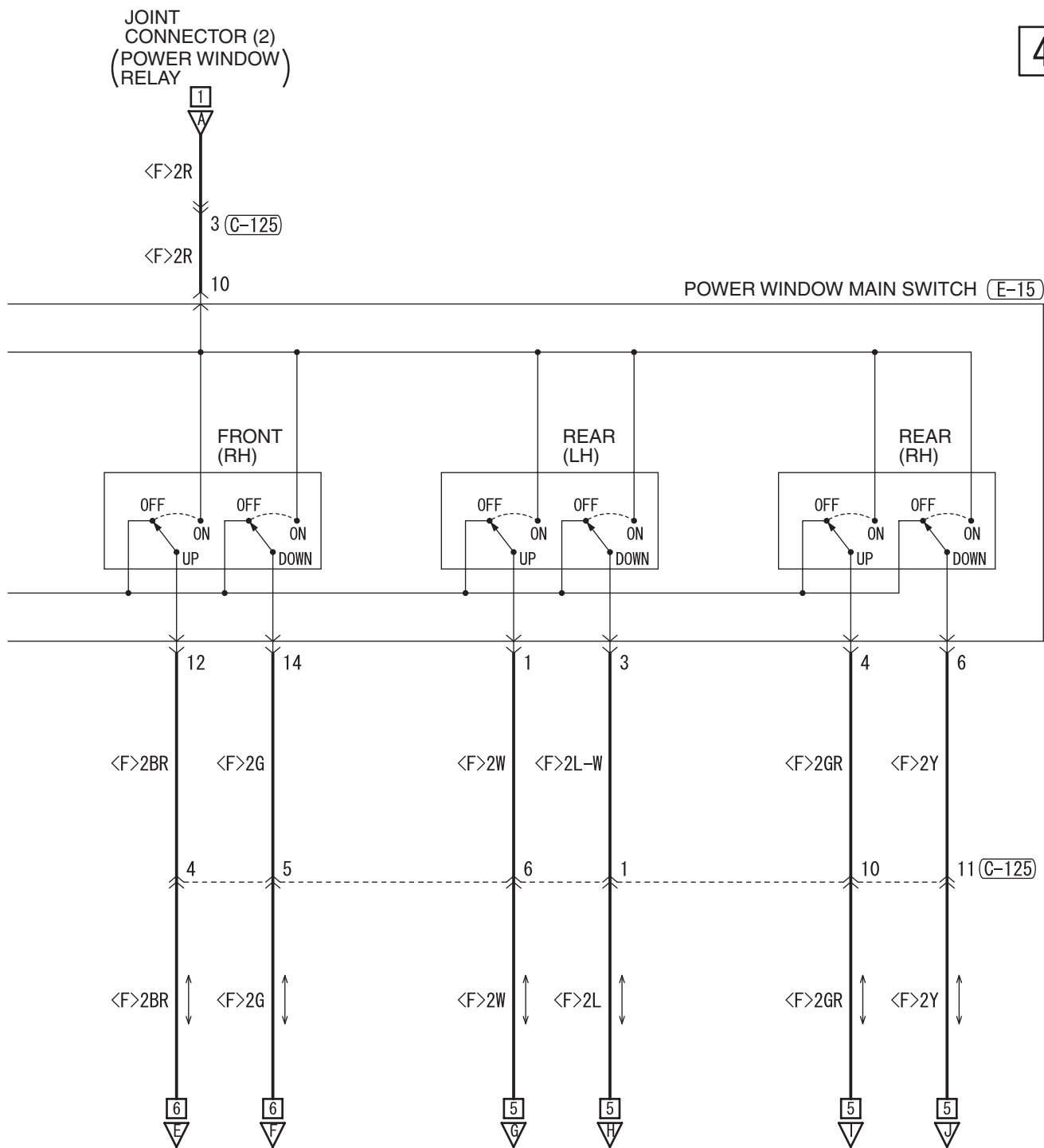

WIRE COLOR CODE

B : BLACK LG : LIGHT GREEN G : GREEN L : BLUE W : WHITE Y : YELLOW SB : SKY BLUE
 BR : BROWN O : ORANGE GR : GRAY R : RED P : PINK V : VIOLET PU : PURPLE

H8G11M04BB

TSB Revision

POWER WINDOWS <VEHICLES WITHOUT CENTRAL DOOR LOCKING SYSTEM> (CONTINUED)

5

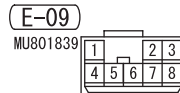
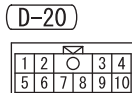
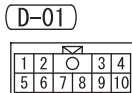
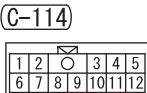
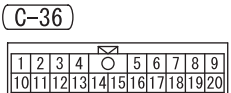
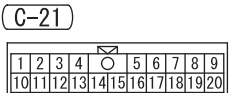
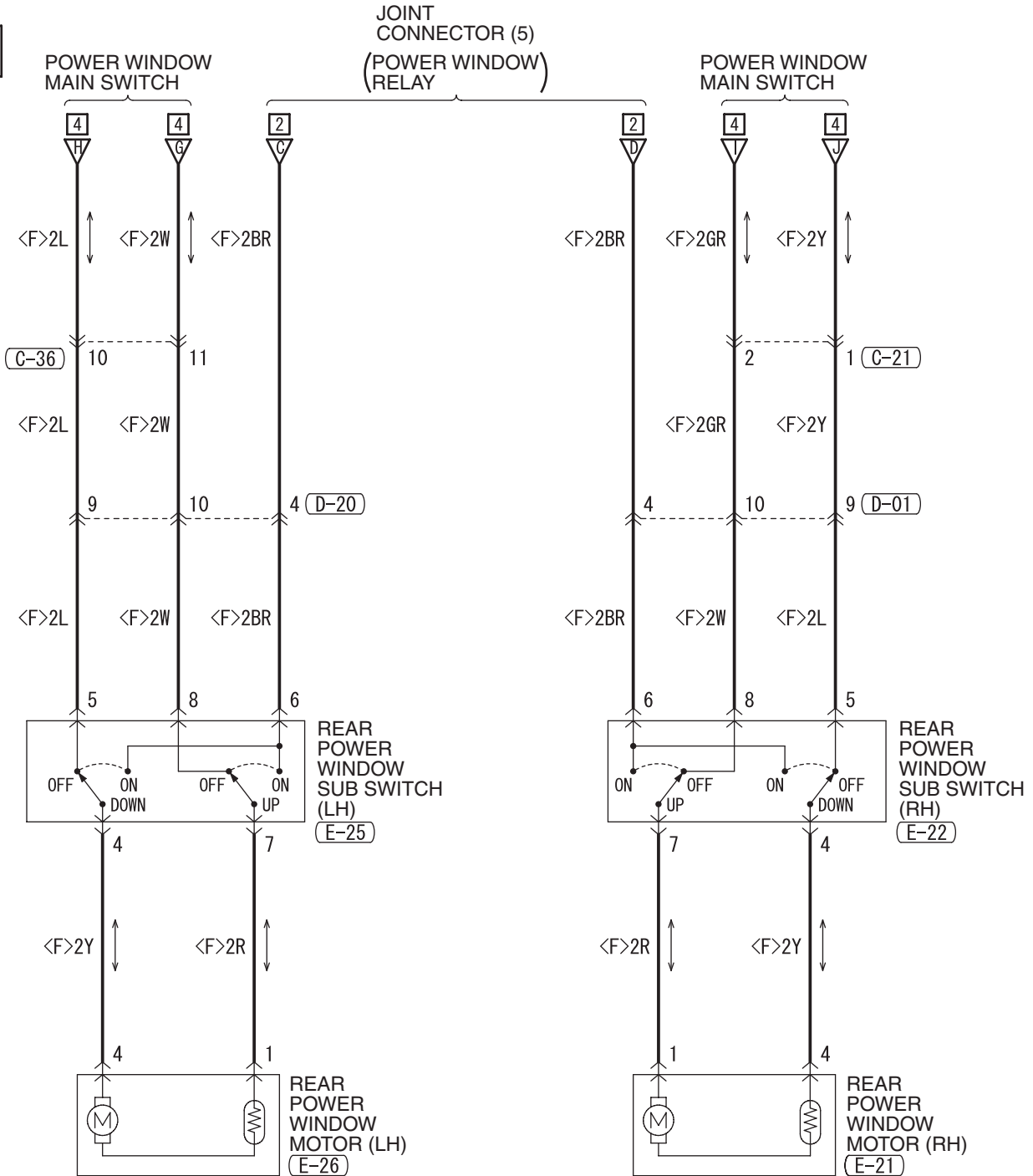

6

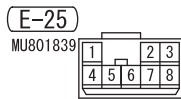
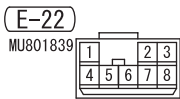
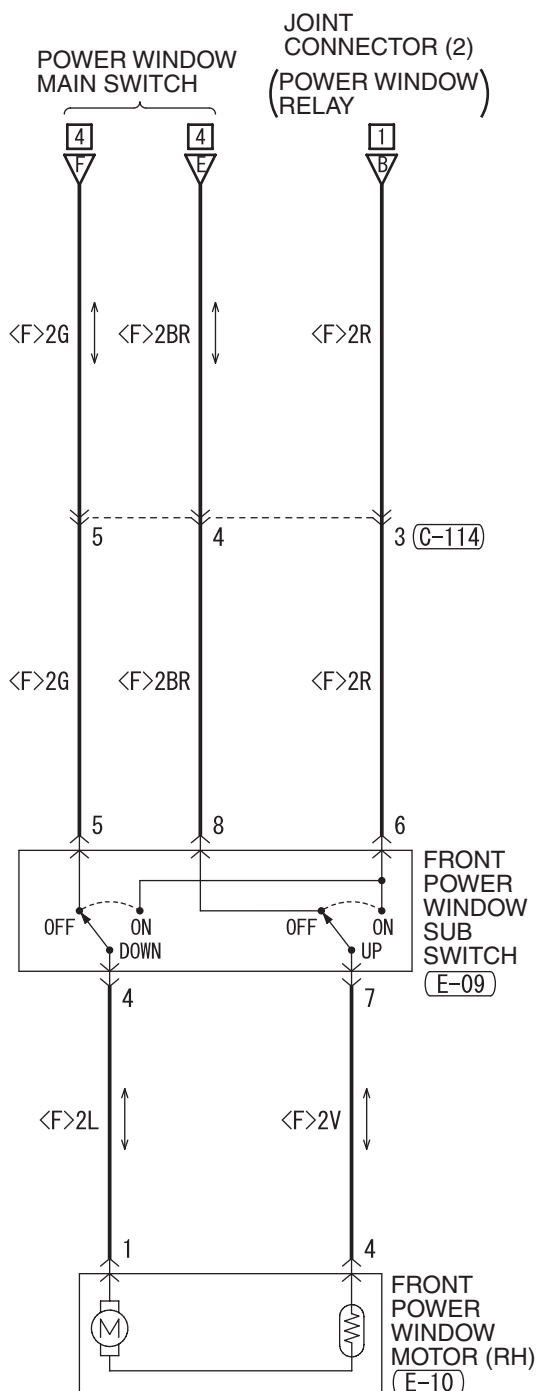

WIRE COLOR CODE

B : BLACK LG : LIGHT GREEN G : GREEN L : BLUE W : WHITE Y : YELLOW SB : SKY BLUE
BR : BROWN O : ORANGE GR : GRAY R : RED P : PINK V : VIOLET PU : PURPLE

H8G11M04CB

TSB Revision

2

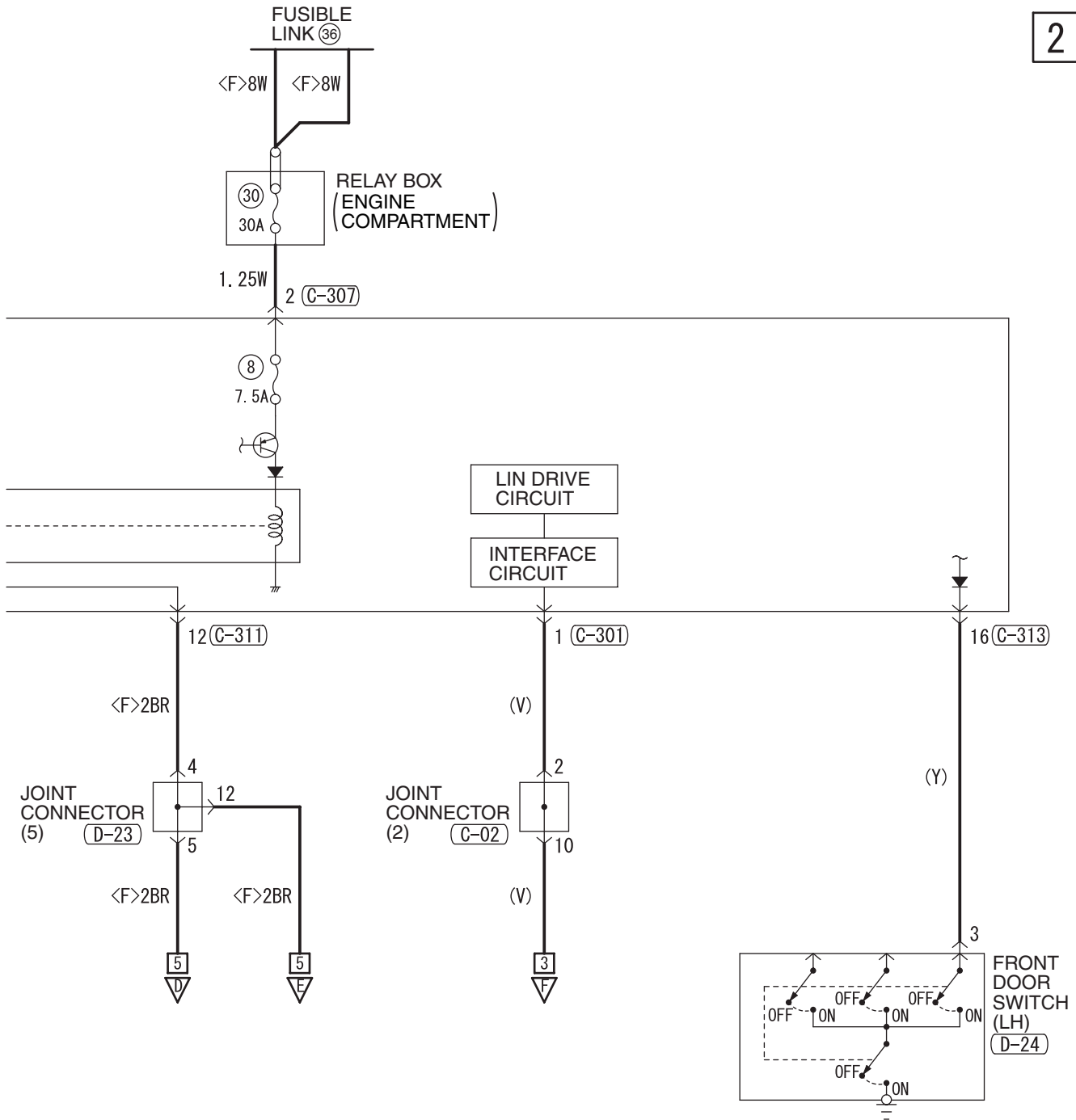

WIRE COLOR CODE

B : BLACK LG : LIGHT GREEN G : GREEN L : BLUE W : WHITE Y : YELLOW SB : SKY BLUE
BR : BROWN O : ORANGE GR : GRAY R : RED P : PINK V : VIOLET PU : PURPLE

H8G11M00AB

TSB Revision

POWER WINDOWS <VEHICLES WITH CENTRAL DOOR LOCKING SYSTEM> (CONTINUED)

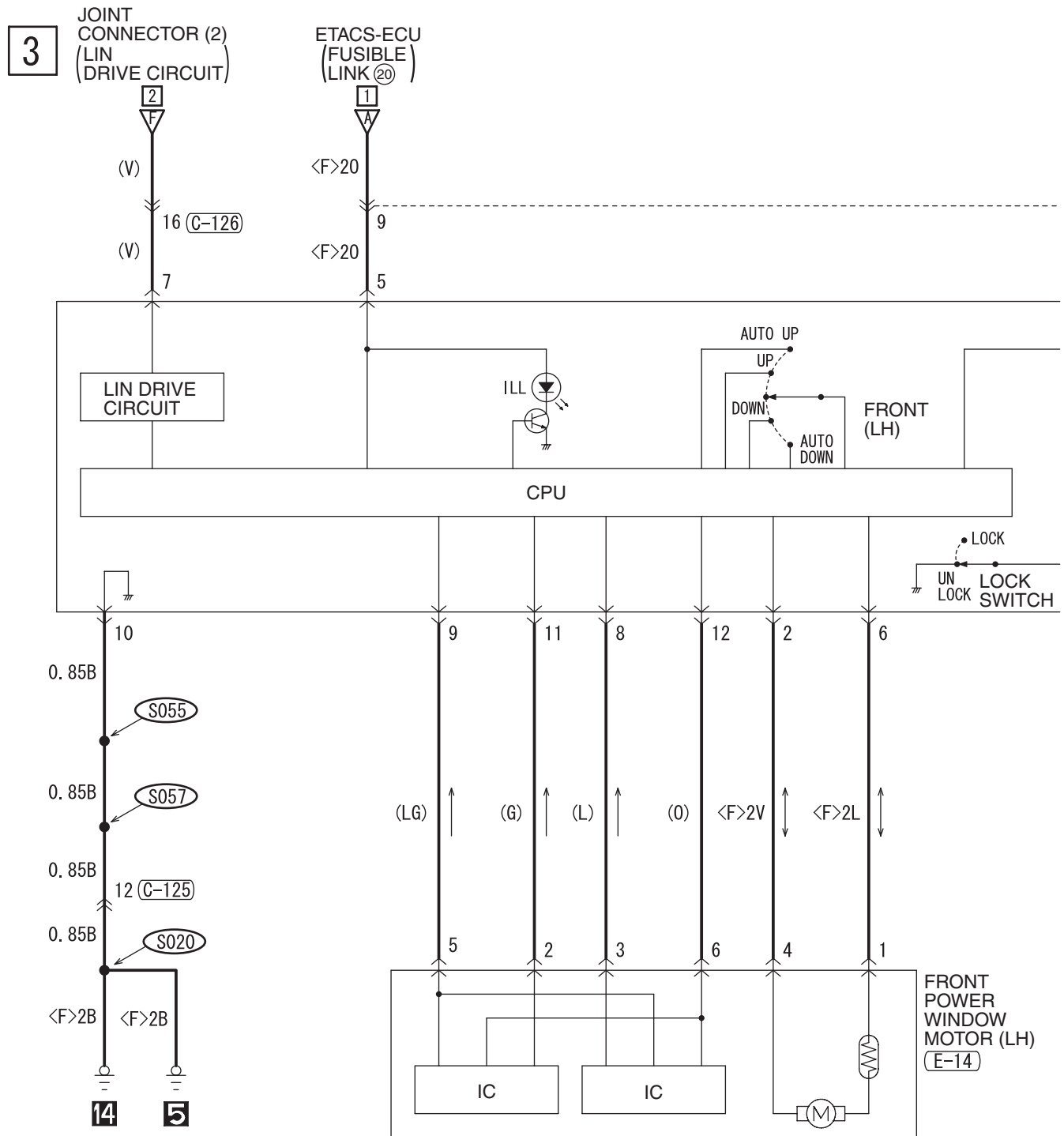

C-125

C-126

E-14

E-28

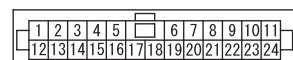
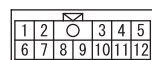

4

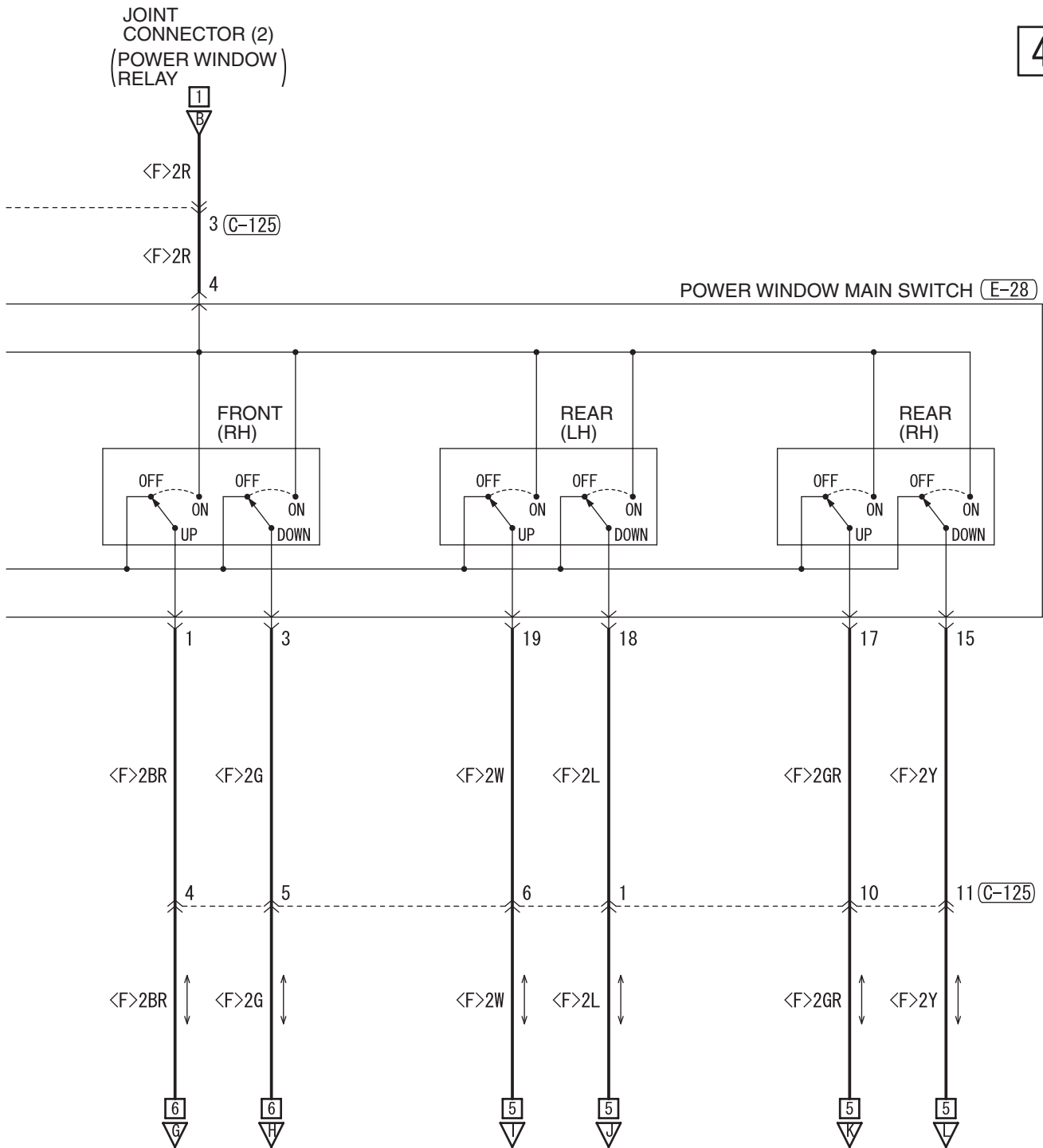

WIRE COLOR CODE

B : BLACK LG : LIGHT GREEN G : GREEN L : BLUE W : WHITE Y : YELLOW SB : SKY BLUE
BR : BROWN O : ORANGE GR : GRAY R : RED P : PINK V : VIOLET PU : PURPLE

H8G11M00BB

TSB Revision

POWER WINDOWS <VEHICLES WITH CENTRAL DOOR LOCKING SYSTEM> (CONTINUED)

5

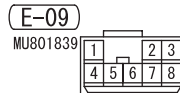
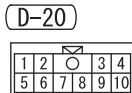
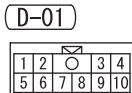
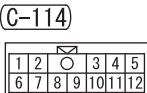
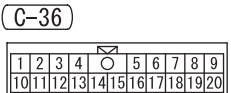
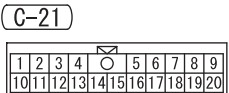
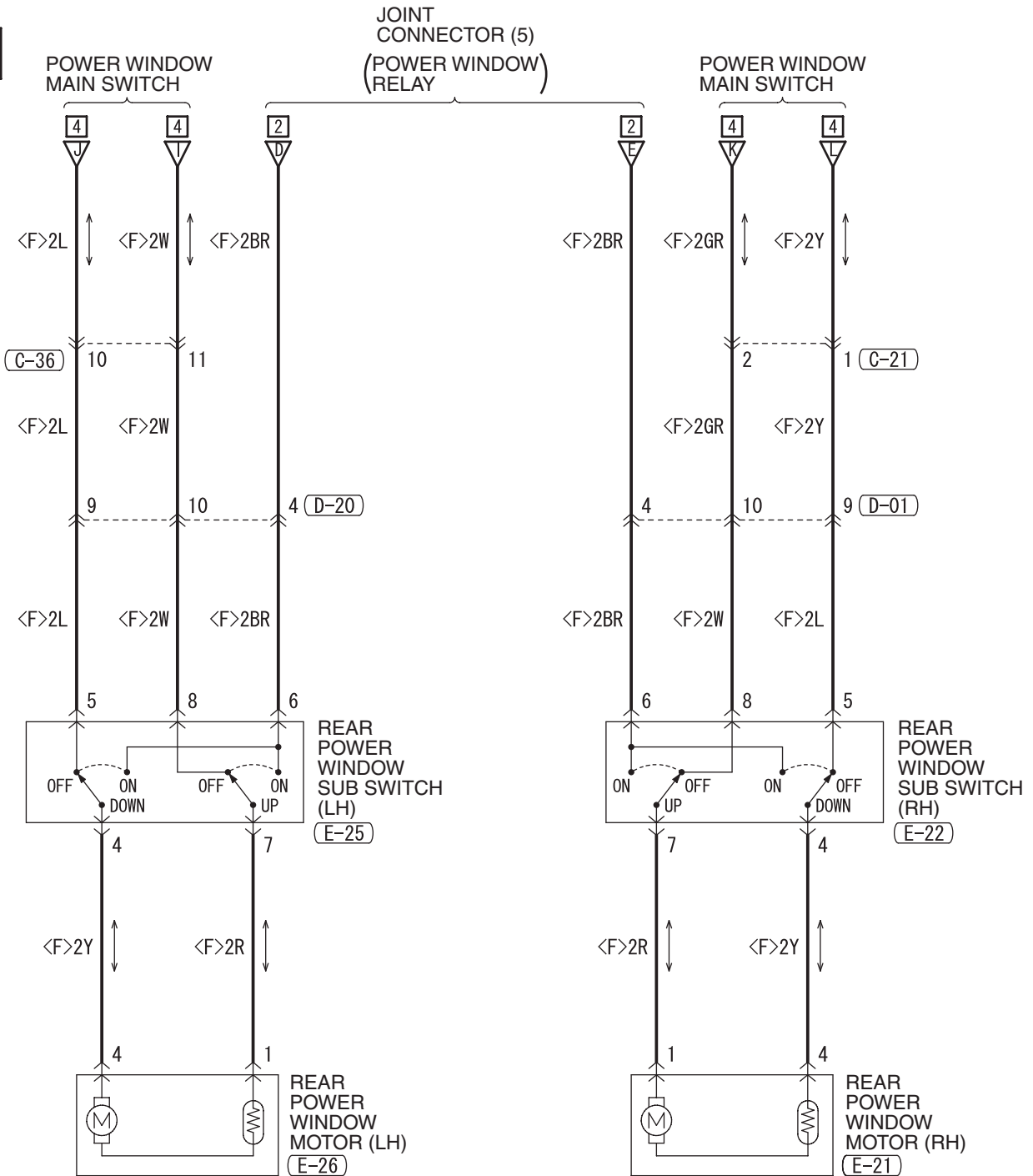

6

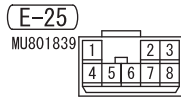
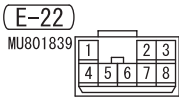
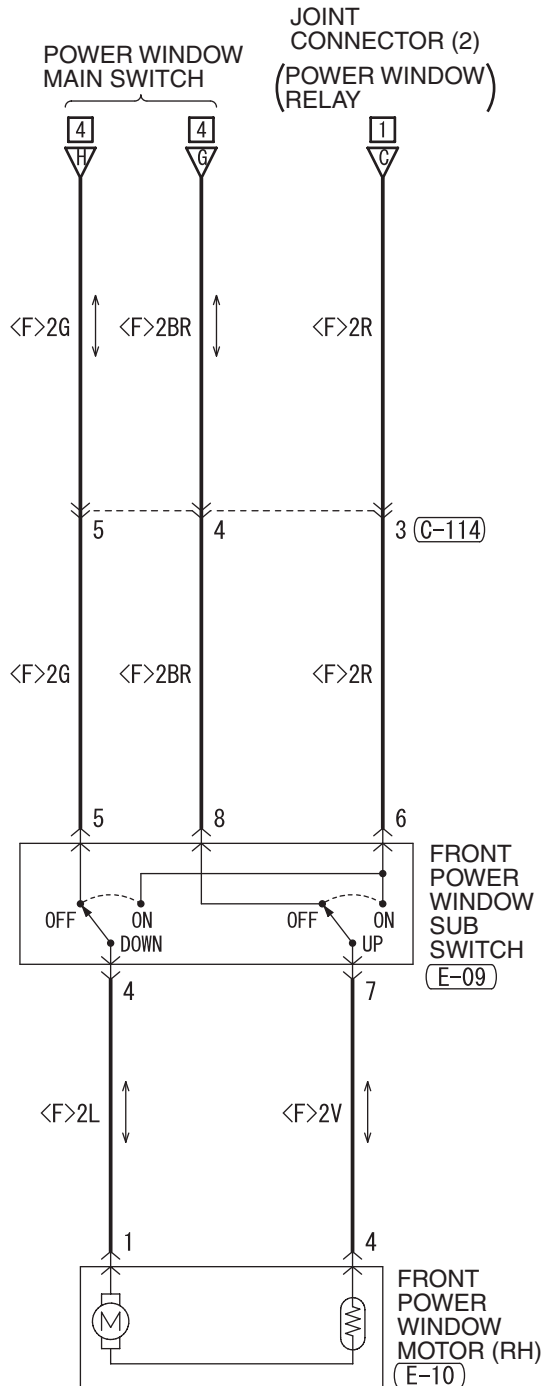

WIRE COLOR CODE

B : BLACK LG : LIGHT GREEN G : GREEN L : BLUE W : WHITE Y : YELLOW SB : SKY BLUE
BR : BROWN O : ORANGE GR : GRAY R : RED P : PINK V : VIOLET PU : PURPLE

H8G11M00CB

TSB Revision

CENTRAL DOOR LOCKING SYSTEM <VEHICLES WITHOUT KEYLESS ENTRY SYSTEM>

M1901004704487

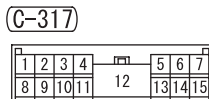
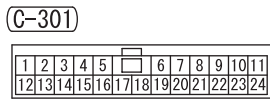
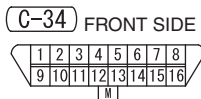
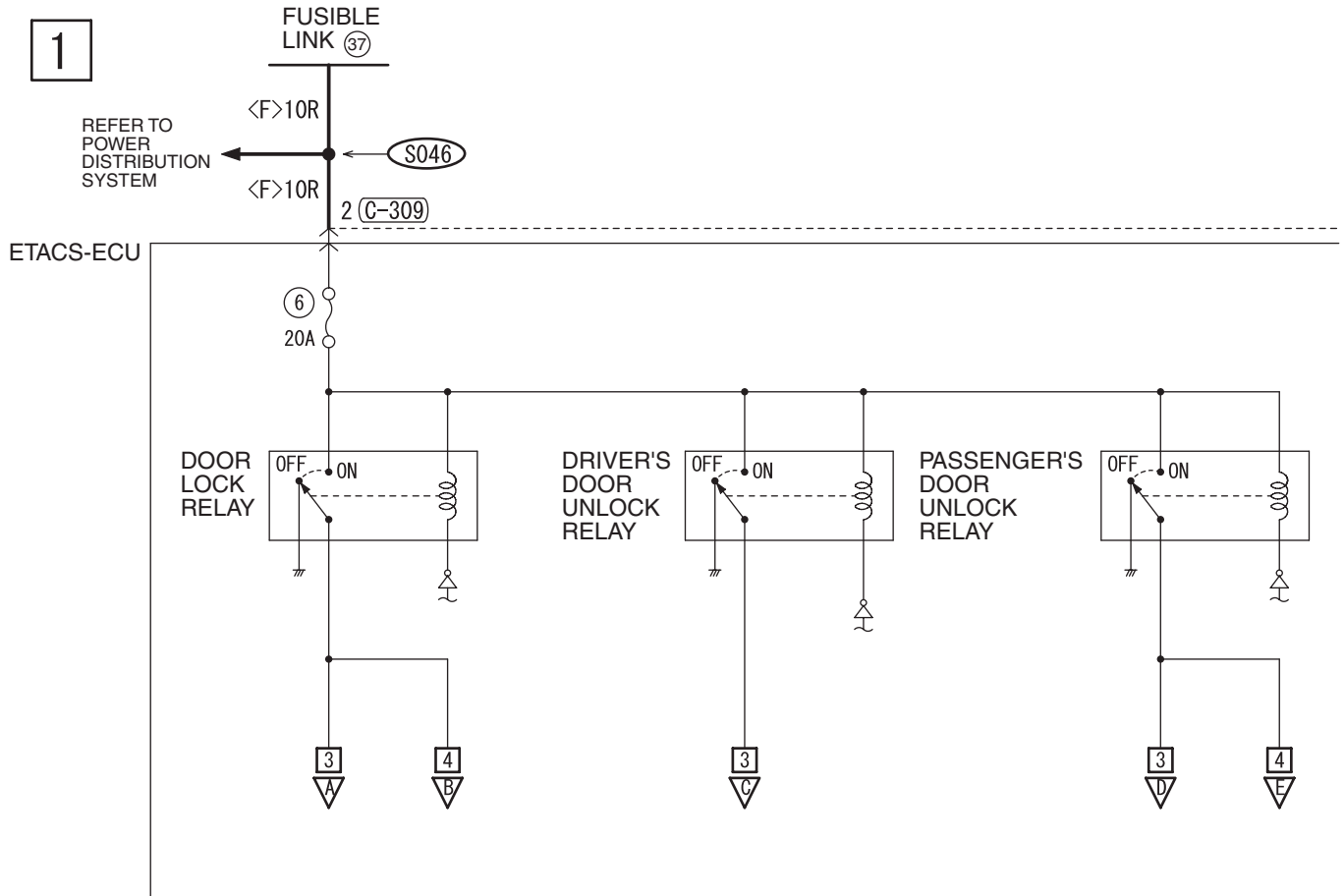

2

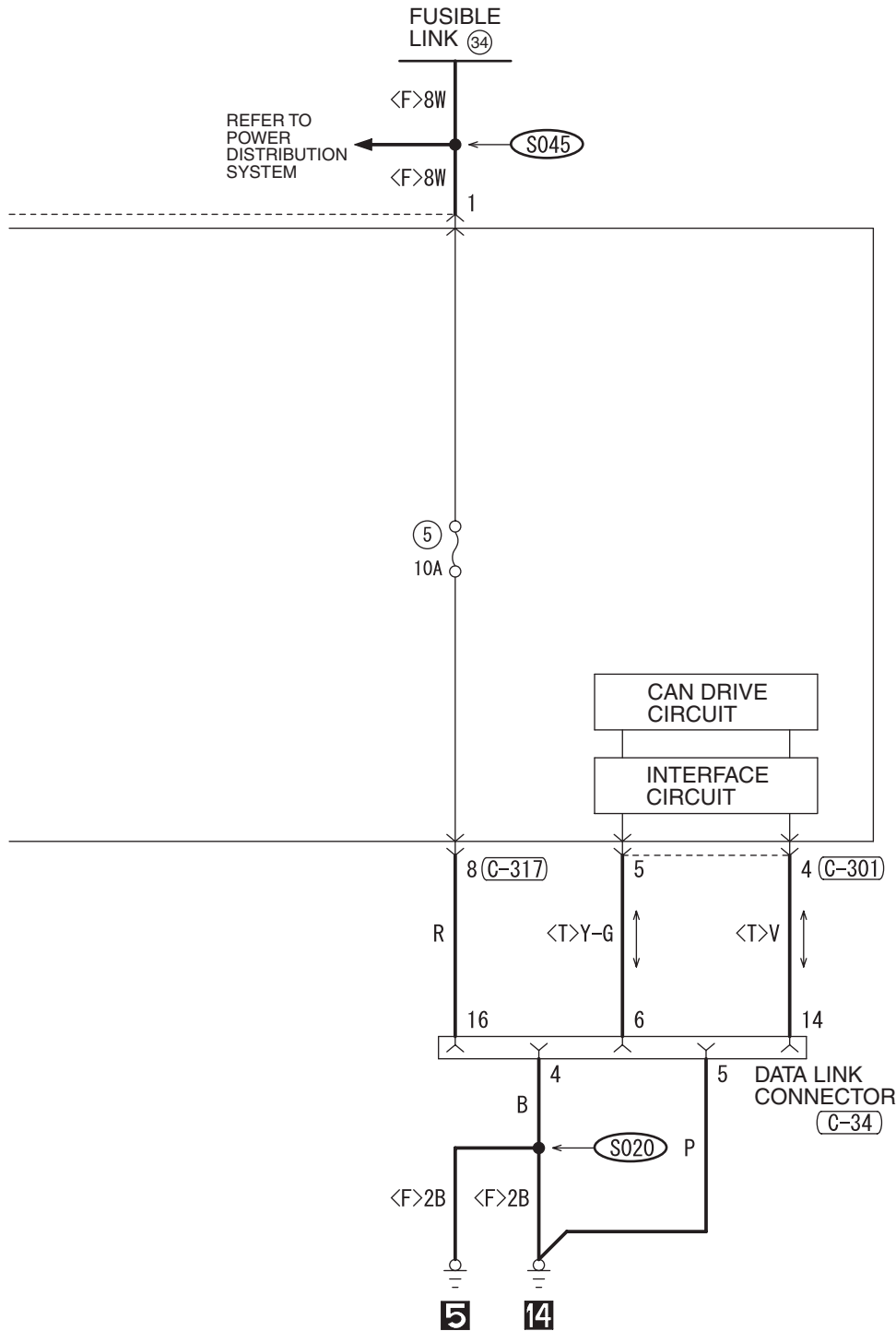

WIRE COLOR CODE
 B: BLACK LG: LIGHT GREEN G: GREEN L: BLUE W: WHITE Y: YELLOW SB: SKY BLUE
 BR: BROWN O: ORANGE GR: GRAY R: RED P: PINK V: VIOLET PU: PURPLE

H8G11M03AB

TSB Revision

CENTRAL DOOR LOCKING SYSTEM <VEHICLES WITHOUT KEYLESS ENTRY SYSTEM> (CONTINUED)

3

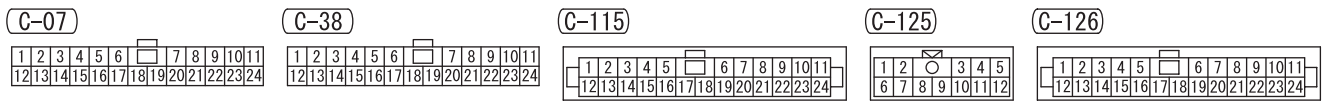
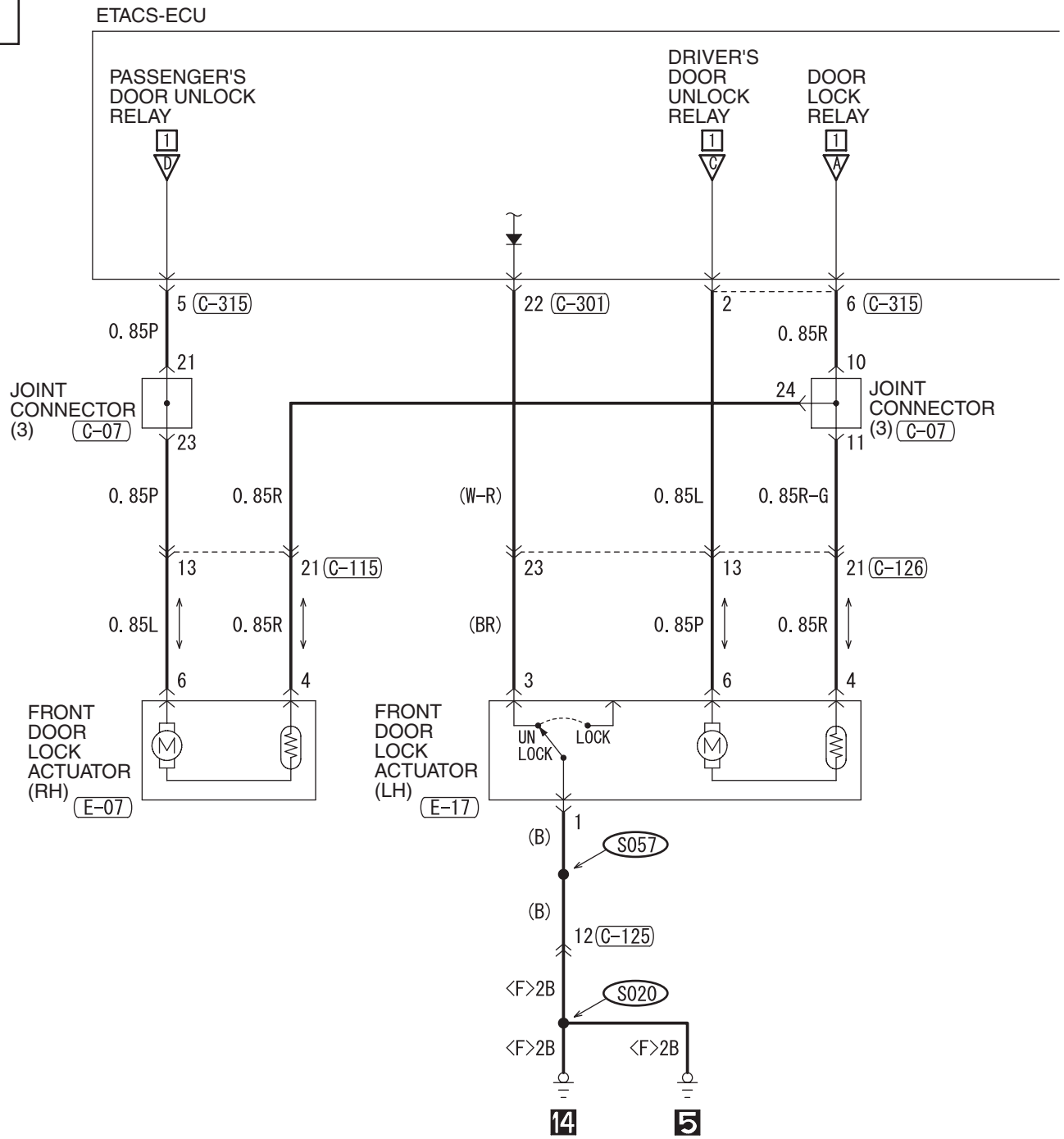

4

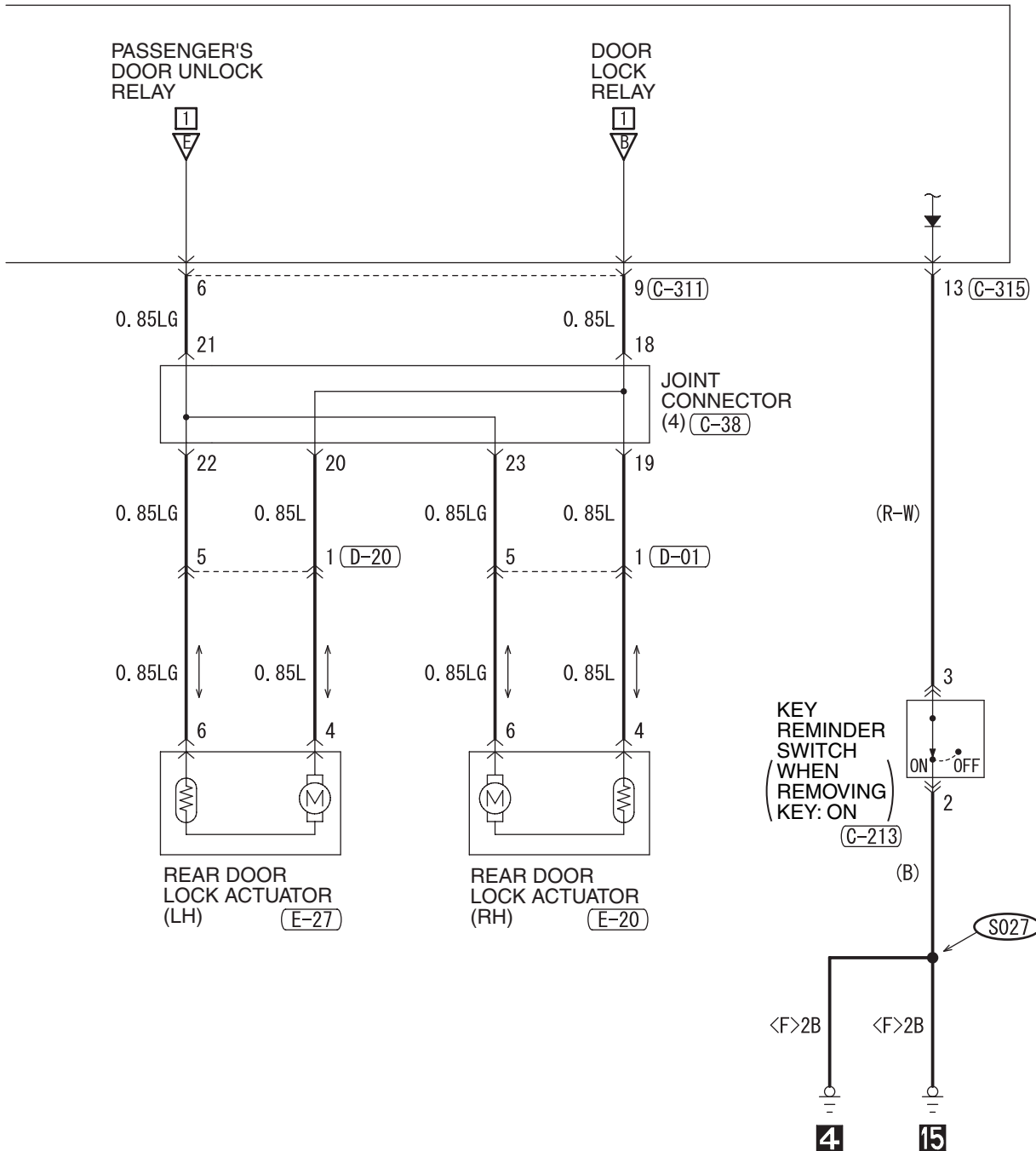

(C-213)



(C-301)



(C-311)

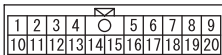

(C-315)

MU801890

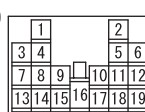

(D-01)

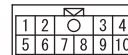

(D-20)



(E-07)

MU802341



WIRE COLOR CODE

B : BLACK LG : LIGHT GREEN G : GREEN L : BLUE W : WHITE Y : YELLOW SB : SKY BLUE
BR : BROWN O : ORANGE GR : GRAY R : RED P : PINK V : VIOLET PU : PURPLE

H8G11M03BB

CENTRAL DOOR LOCKING SYSTEM <VEHICLES WITHOUT KEYLESS ENTRY SYSTEM> (CONTINUED)

5

ETACS-ECU

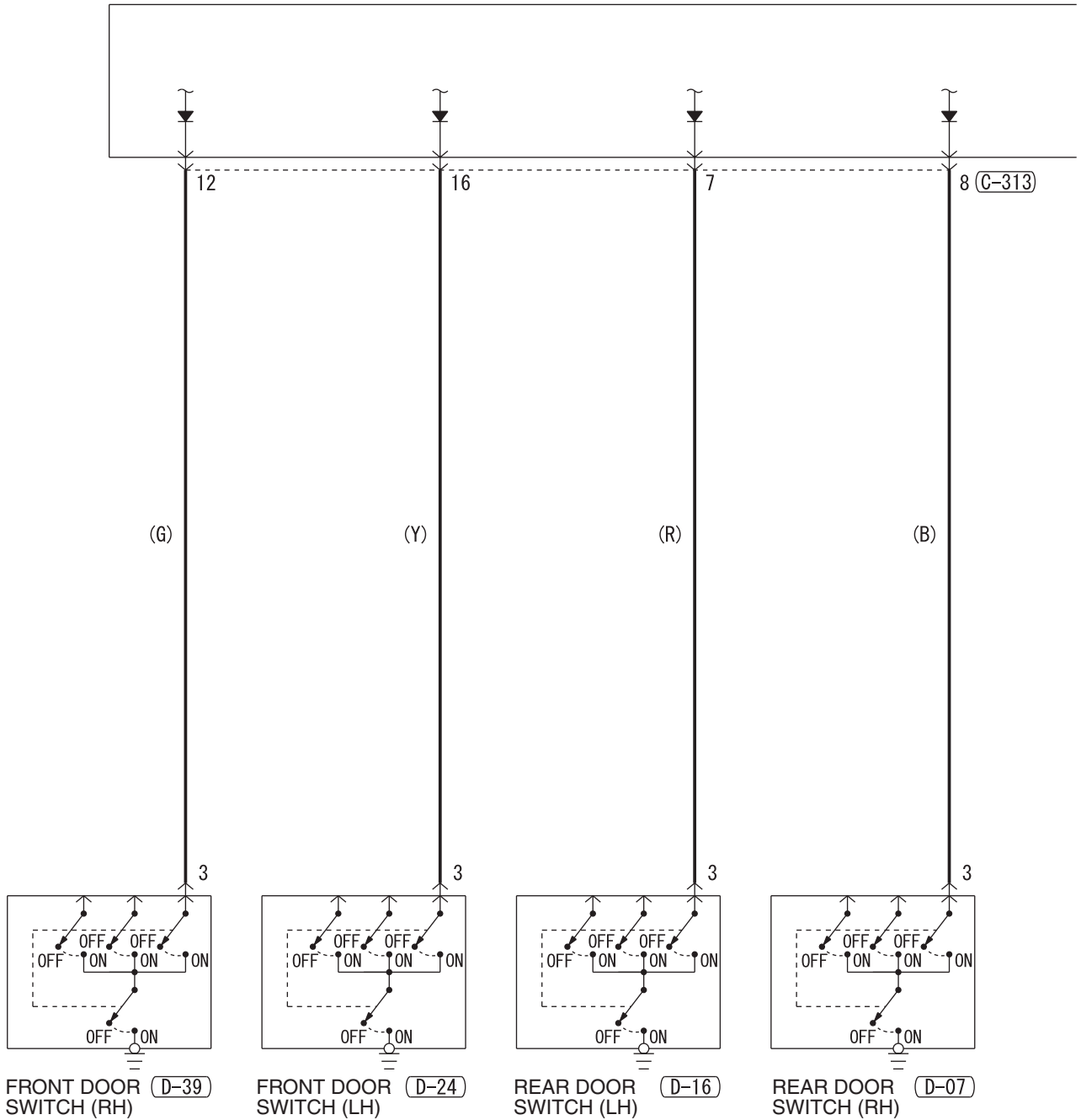

(C-03)

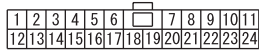

(C-07)

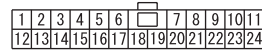

(C-126)

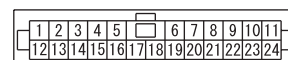

(C-301)

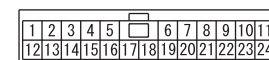

6

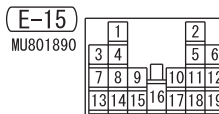
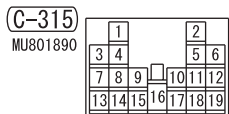
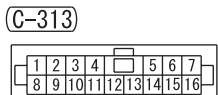
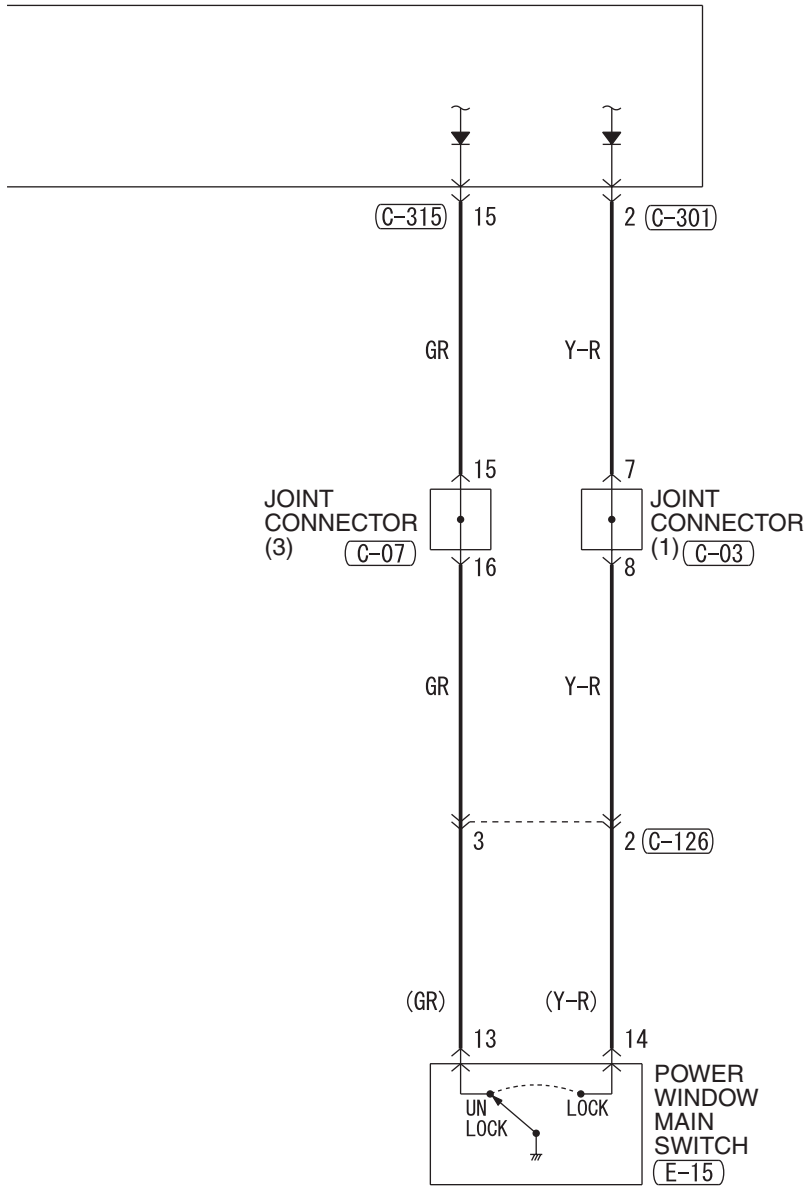

WIRE COLOR CODE

B : BLACK LG : LIGHT GREEN G : GREEN L : BLUE W : WHITE Y : YELLOW SB : SKY BLUE
BR : BROWN O : ORANGE GR : GRAY R : RED P : PINK V : VIOLET PU : PURPLE

H8G11M03CB

TSB Revision

CENTRAL DOOR LOCKING SYSTEM <VEHICLES WITH KEYLESS ENTRY SYSTEM>

M1901004704476

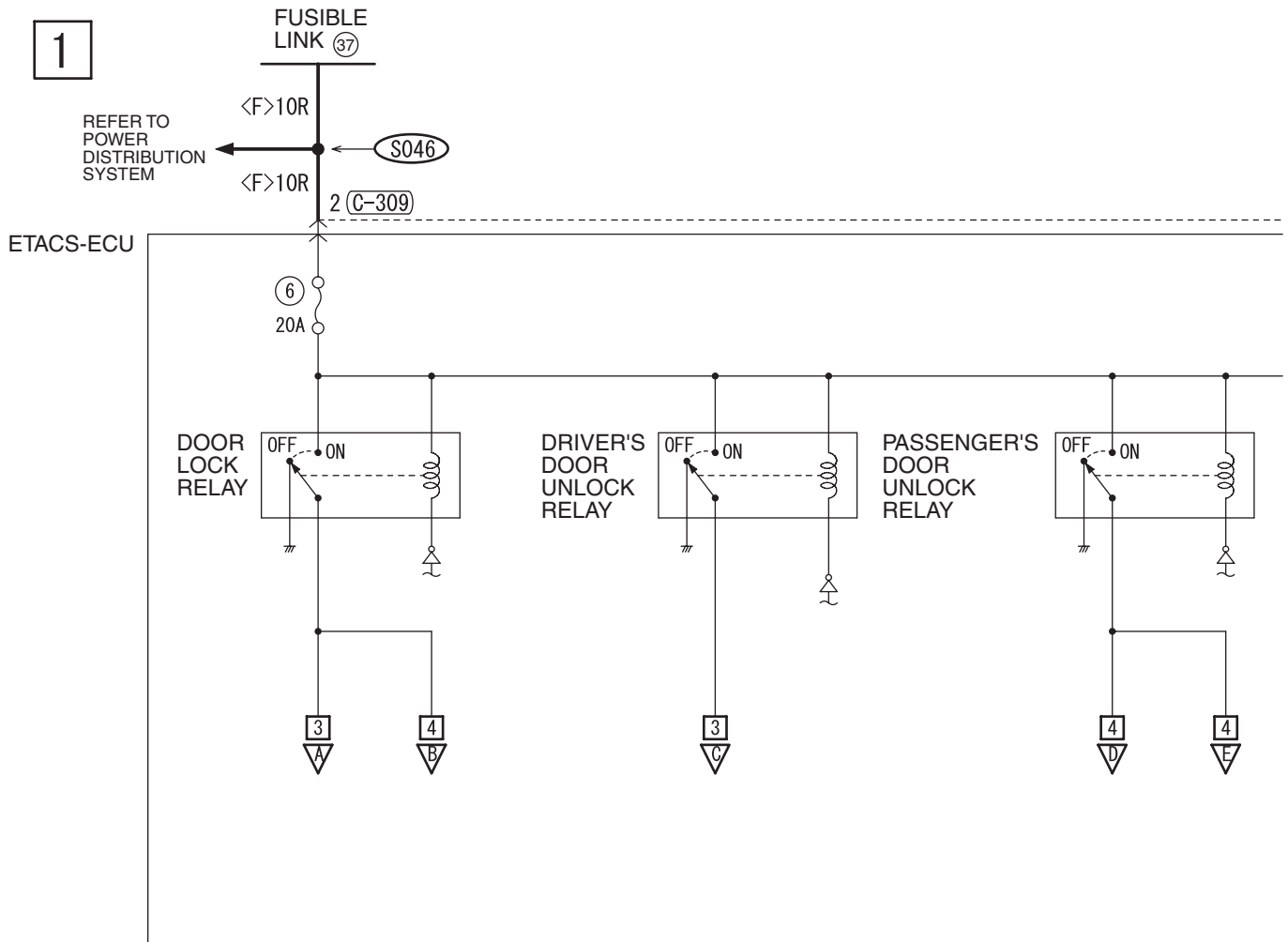

(C-34) FRONT SIDE

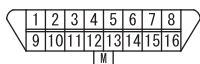

(C-301)

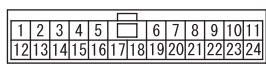

(C-304)

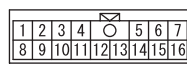

(C-309)



(C-311)

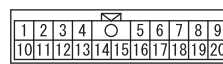

(C-317)

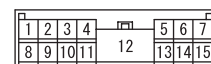

2

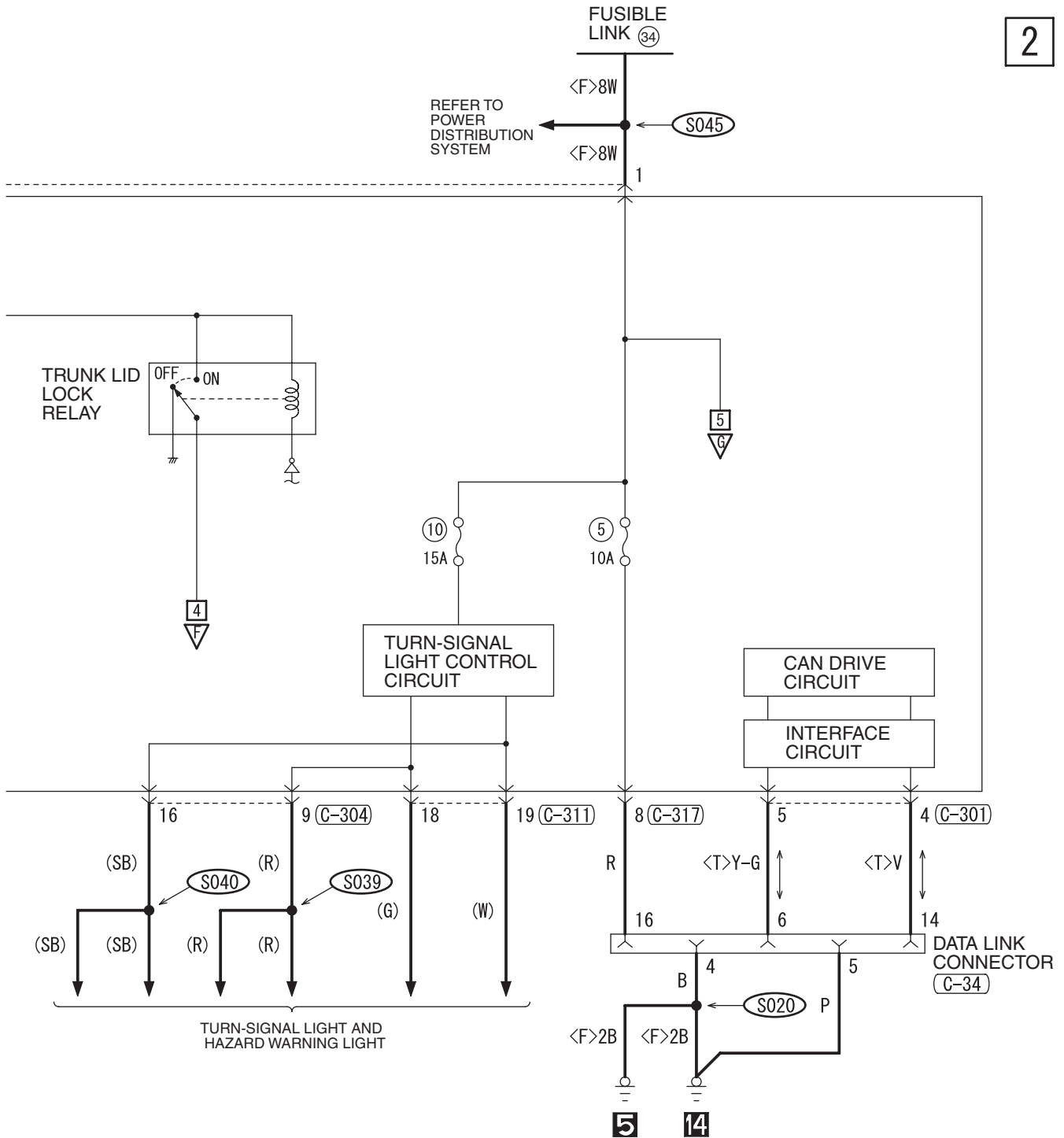

WIRE COLOR CODE

B: BLACK LG: LIGHT GREEN G: GREEN L: BLUE W: WHITE Y: YELLOW SB: SKY BLUE
BR: BROWN O: ORANGE GR: GRAY R: RED P: PINK V: VIOLET PU: PURPLE

H8G11M01AB

TSB Revision

CENTRAL DOOR LOCKING SYSTEM <VEHICLES WITH KEYLESS ENTRY SYSTEM> (CONTINUED)

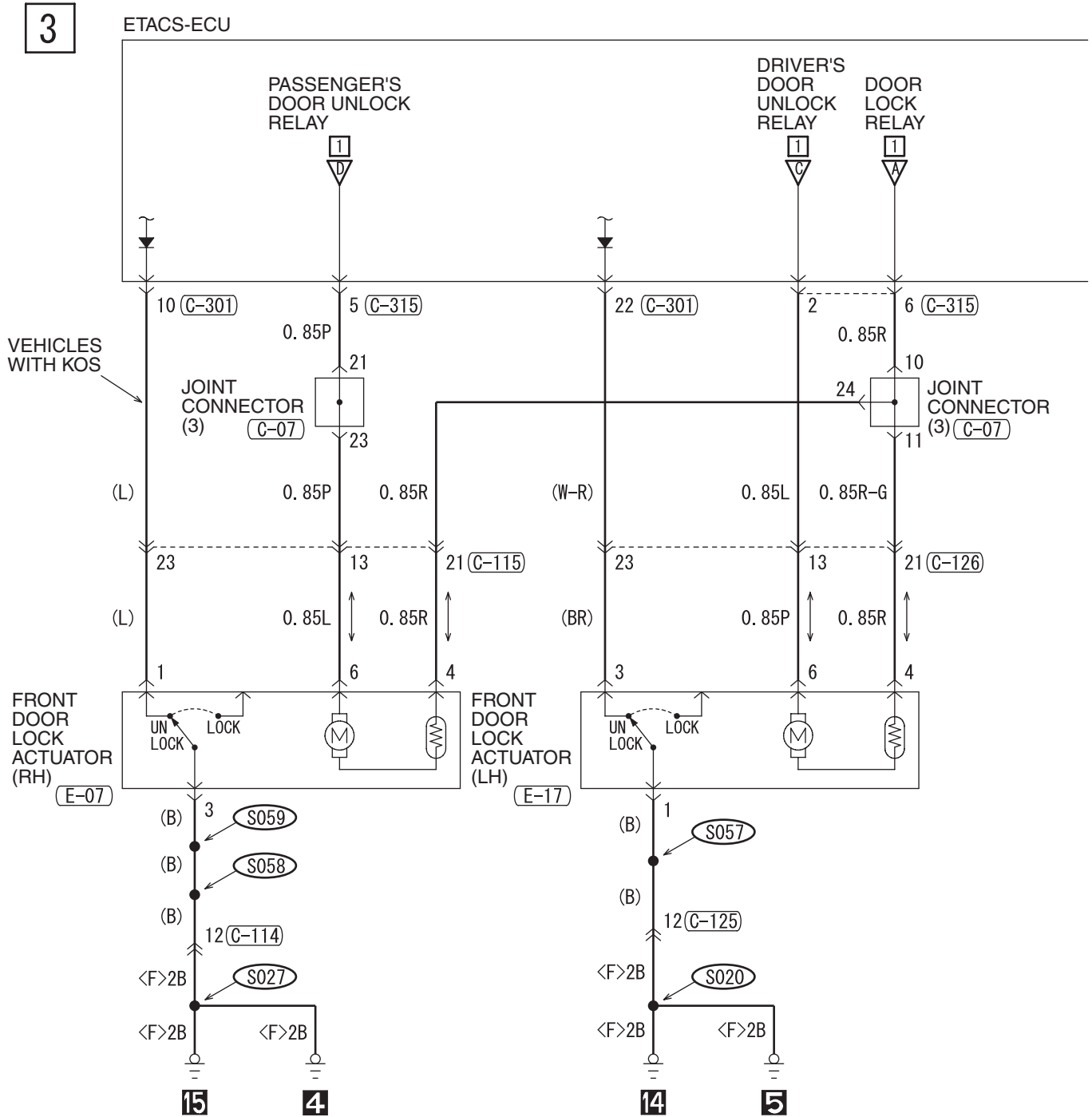

C-07

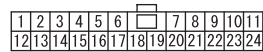

C-38

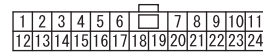

C-114

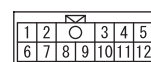

C-115

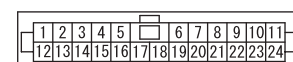

C-125

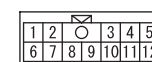

D-01



D-14



D-15

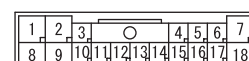

D-20



E-07



E-17



E-20



4

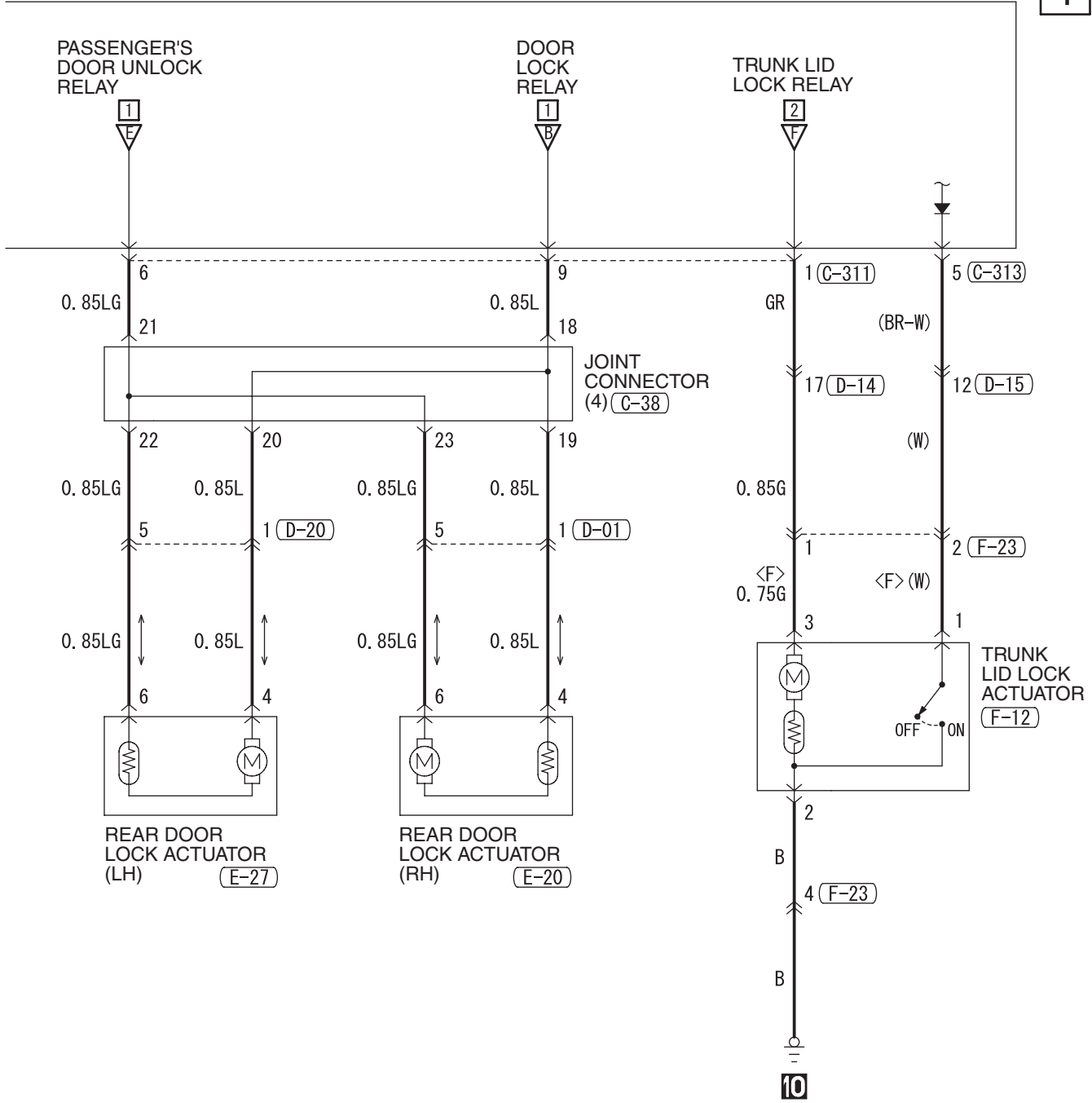

C-126

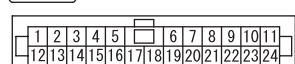

C-301



C-311

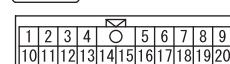

C-313

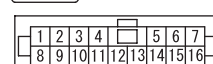

C-315



E-27



F-12



F-23



WIRE COLOR CODE

B : BLACK LG : LIGHT GREEN G : GREEN L : BLUE
BR : BROWN O : ORANGE GR : GRAY R : RED W : WHITE
SB : SKY BLUE P : PINK Y : YELLOW V : VIOLET P : PURPLE

H8G11M01BB

TSB Revision

CENTRAL DOOR LOCKING SYSTEM <VEHICLES WITH KEYLESS ENTRY SYSTEM> (CONTINUED)

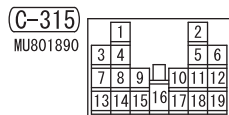
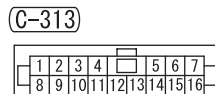
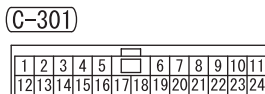
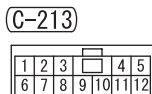
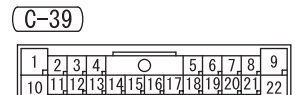
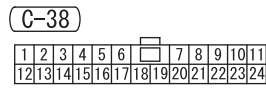
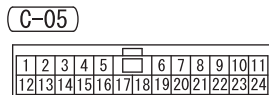
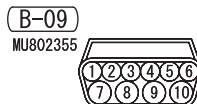
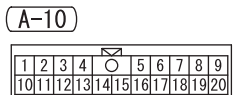
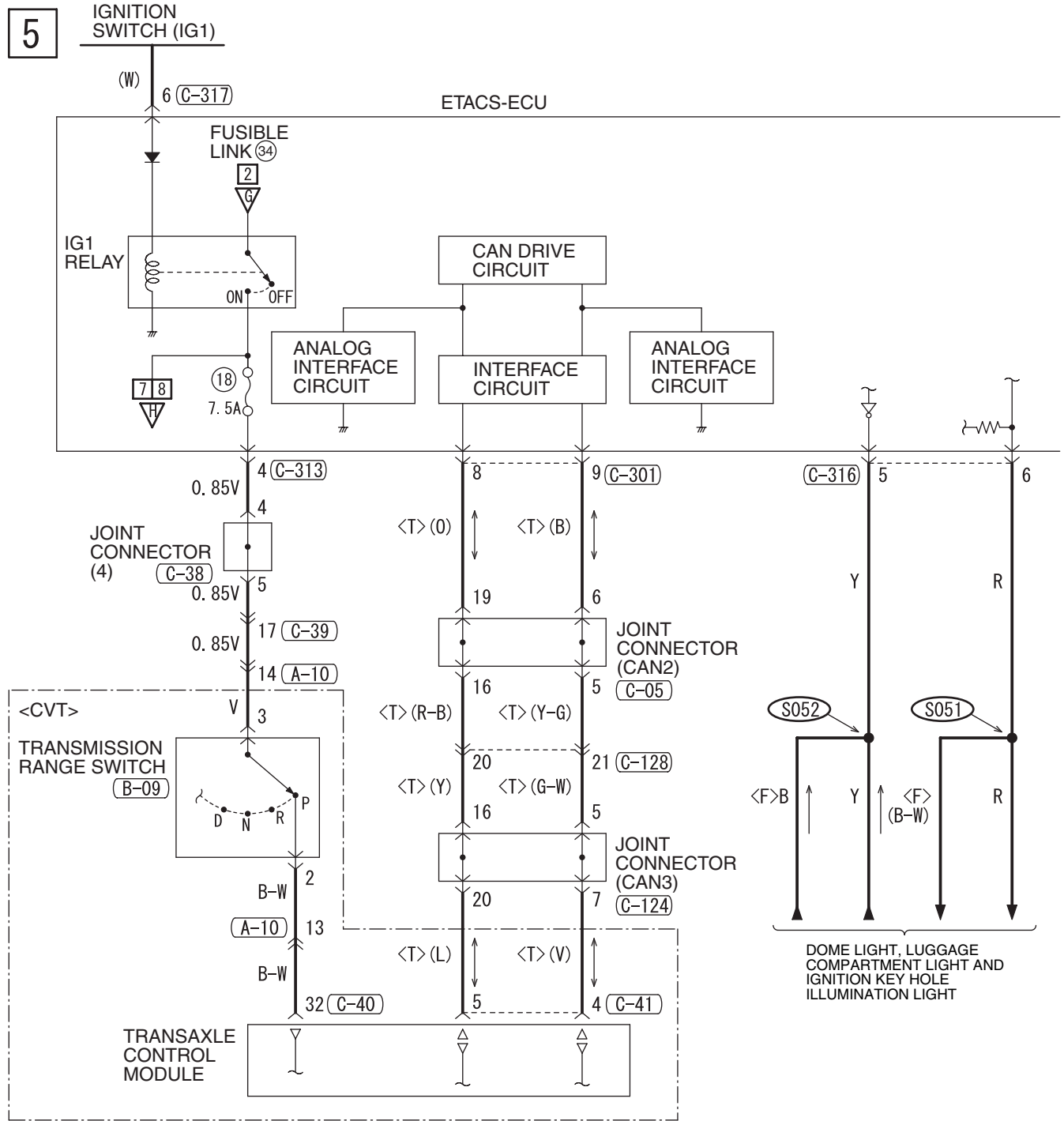

6

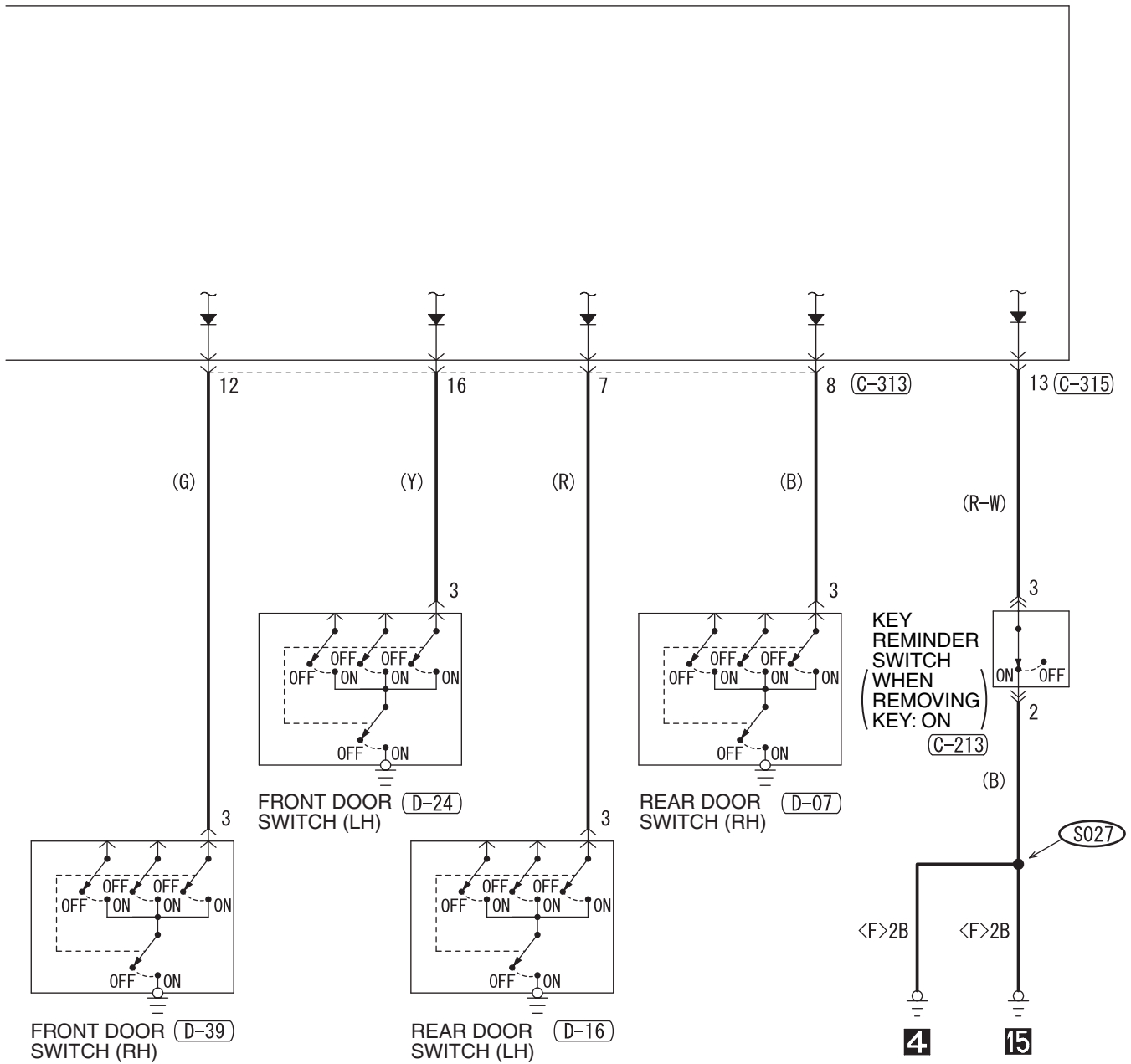

C-40 (MU801823)

31	32	33	34	35	36	37	38	39	40	41
42	43	44	45	46	47	48	49	50	51	52

C-41

JAE-E												
1	2	3	4	5	6	7	8	9	10	11	12	13
14	15	16	17	18	19	20	21	22	23	24	25	26

C-124

1	2	3	4	5	6	7	8	9	10	11		
12	13	14	15	16	17	18	19	20	21	22	23	24

C-128

1	2	3	4	5	6	7	8	9				
10	11	12	13	14	15	16	17	18	19	20	21	22

C-317

1	2	3	4	5	6	7	
8	9	10	11	12	13	14	15

D-07 (MU801536)

1	2	3
---	---	---

D-16 (MU801536)

1	2	3
---	---	---

D-24 (MU801536)

1	2	3
---	---	---

D-39 (MU801536)

1	2	3
---	---	---

F-23

1	2	3	4		
5	6	7	8	9	10

CENTRAL DOOR LOCKING SYSTEM <VEHICLES WITH KEYLESS ENTRY SYSTEM> (CONTINUED)

7

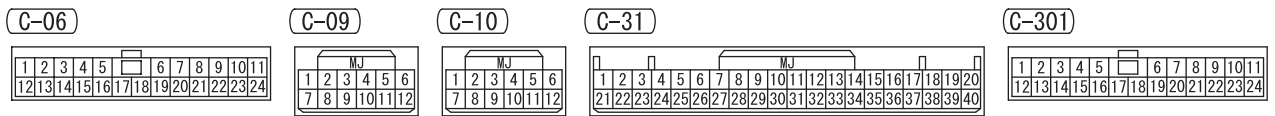
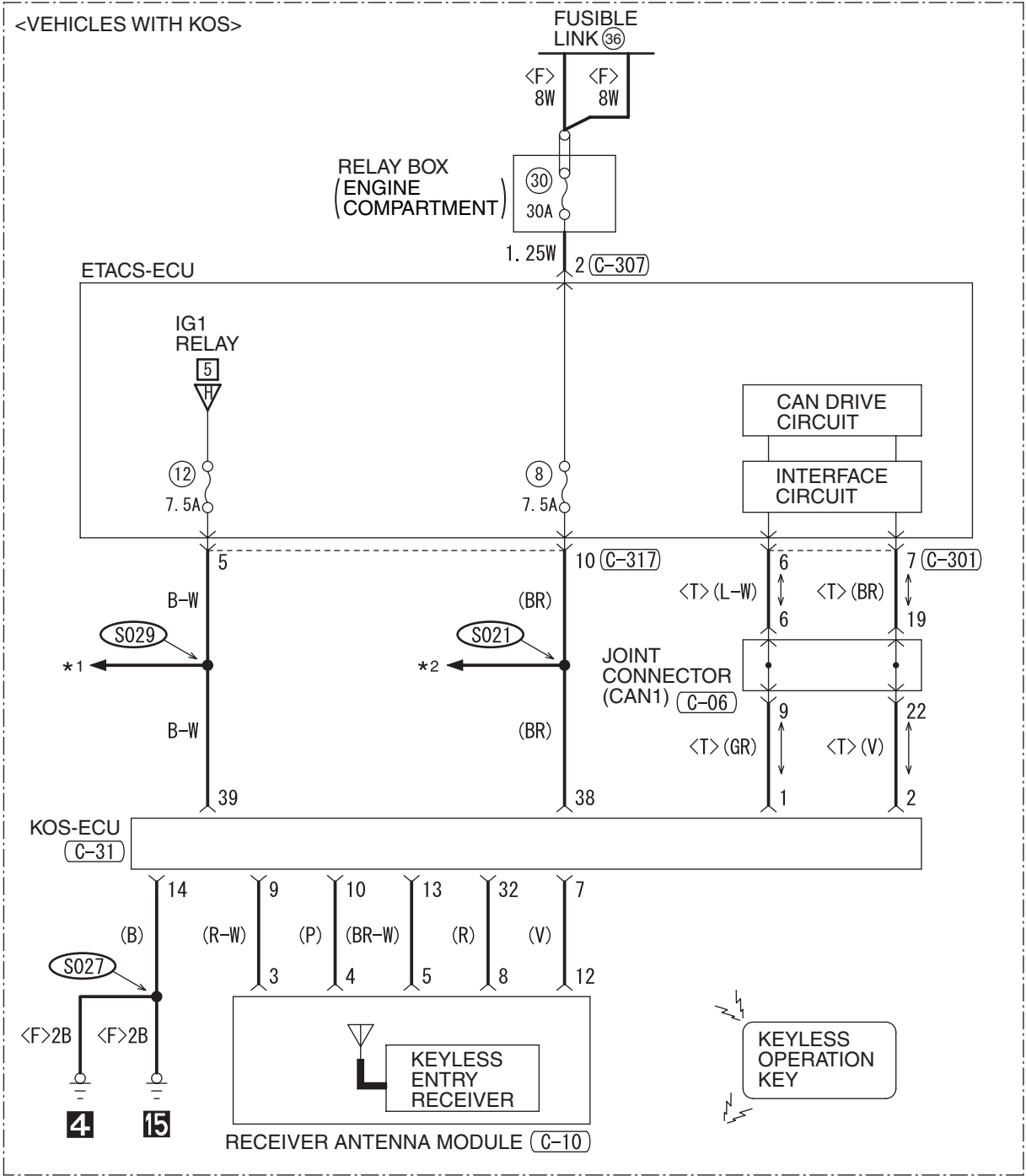

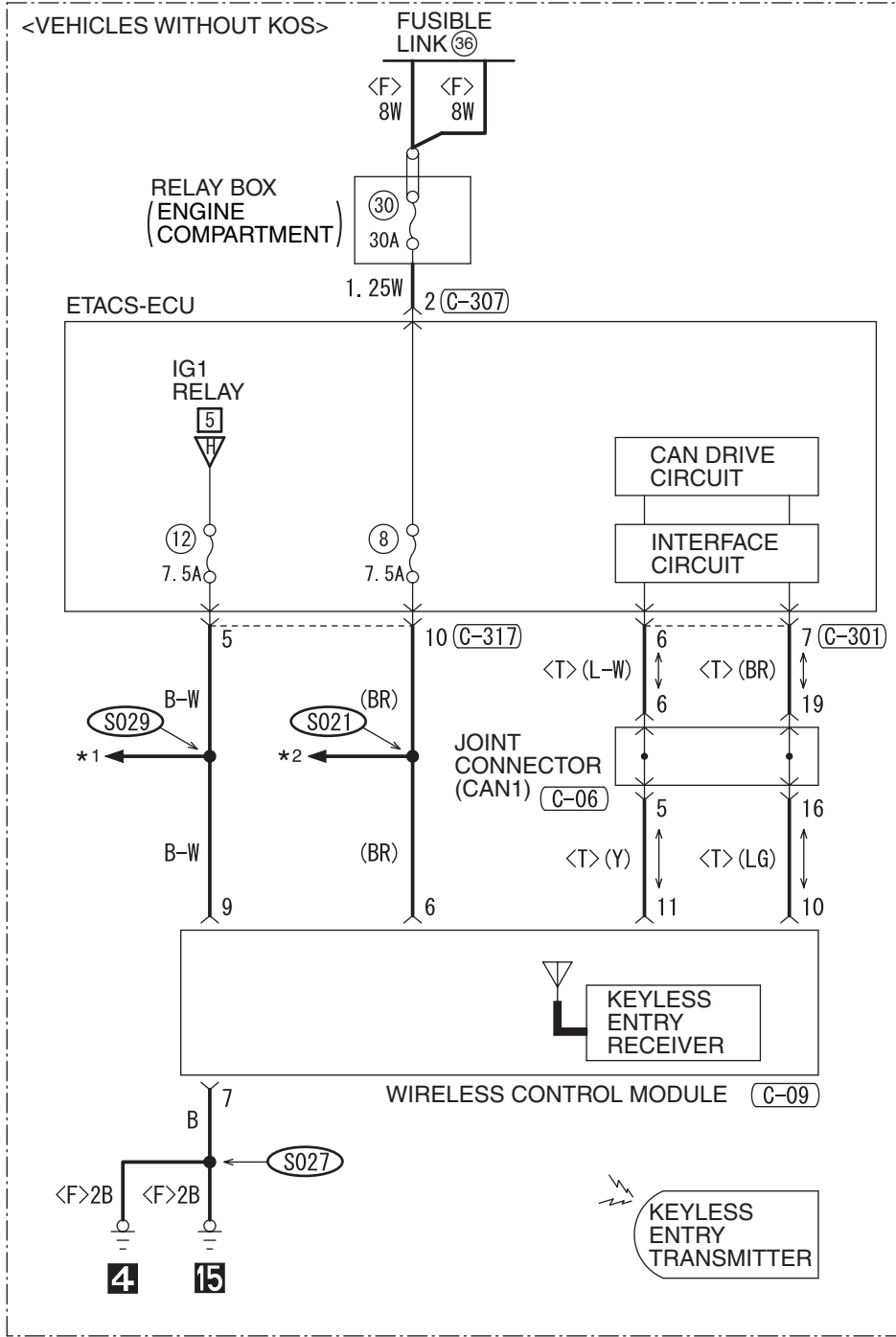

- NOTE**
- *1:
 - AIR CONDITIONING SYSTEM
 - ANTI-LOCK BRAKING SYSTEM (ABS)
 - AUTO-CRUISE CONTROL SYSTEM
 - BRAKE WARNING LIGHT,
 - FUEL WARNING LIGHT AND
 - OIL PRESSURE WARNING LIGHT
 - CHARGING SYSTEM
 - CONTROLLER AREA NETWORK (CAN)
 - DAYTIME RUNNING LIGHT (DRL)
 - DOOR AJAR WARNING TONE ALARM
 - FOG LIGHT
 - HEADLIGHT
 - HEATED DOOR MIRROR
 - HEATED SEAT
 - IGNITION KEY REMINDER TONE ALARM
 - INVECS-III CVT
 - METER AND GAUGE
 - MFI SYSTEM
 - REAR WINDOW DEFOGGER
 - SEAT BELT WARNING TONE ALARM
 - SHIFT LOCK MECHANISM
 - SUNROOF
 - SUPPLEMENTAL RESTRAINT SYSTEM (SRS)
 - TAILLIGHT, POSITION LIGHT, REAR SIDE MARKER LIGHT, LICENSE PLATE LIGHT AND LIGHTING MONITOR TONE ALARM
 - THEFT-ALARM SYSTEM
 - TIRE PRESSURE MONITORING SYSTEM (TPMS)
 - TURN-SIGNAL LIGHT AND HAZARD WARNING LIGHT
 - WINDSHIELD WIPER AND WASHER
 - *2:
 - AIR CONDITIONING SYSTEM
 - BRAKE WARNING LIGHT,
 - FUEL WARNING LIGHT AND
 - OIL PRESSURE WARNING LIGHT
 - CONTROLLER AREA NETWORK (CAN)
 - DAYTIME RUNNING LIGHT (DRL)
 - FOG LIGHT
 - HEADLIGHT
 - IGNITION KEY REMINDER TONE ALARM <VEHICLES WITH KOS>
 - METER AND GAUGE
 - SEAT BELT WARNING TONE ALARM
 - TAILLIGHT, POSITION LIGHT, REAR SIDE MARKER LIGHT, LICENSE PLATE LIGHT AND LIGHTING MONITOR TONE ALARM
 - TURN-SIGNAL LIGHT AND HAZARD WARNING LIGHT
 - WINDSHIELD WIPER AND WASHER

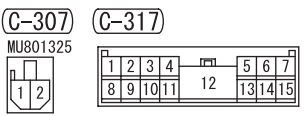

WIRE COLOR CODE
 B: BLACK LG: LIGHT GREEN G: GREEN L: BLUE W: WHITE Y: YELLOW SB: SKY BLUE
 BR: BROWN O: ORANGE GR: GRAY R: RED P: PINK V: VIOLET PU: PURPLE

CENTRAL DOOR LOCKING SYSTEM <VEHICLES WITH KEYLESS ENTRY SYSTEM> (CONTINUED)

9

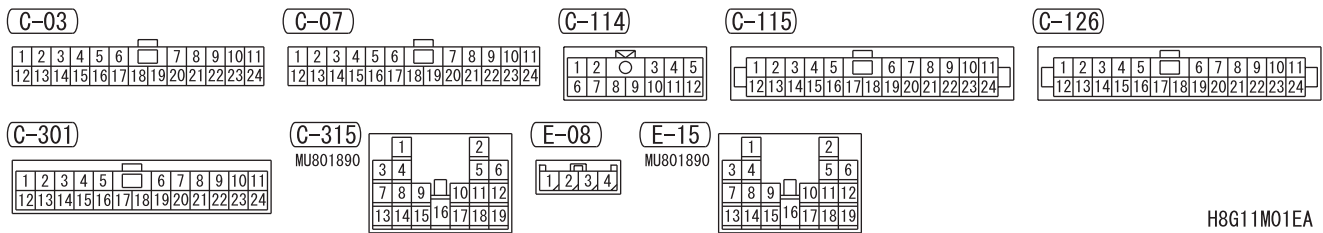
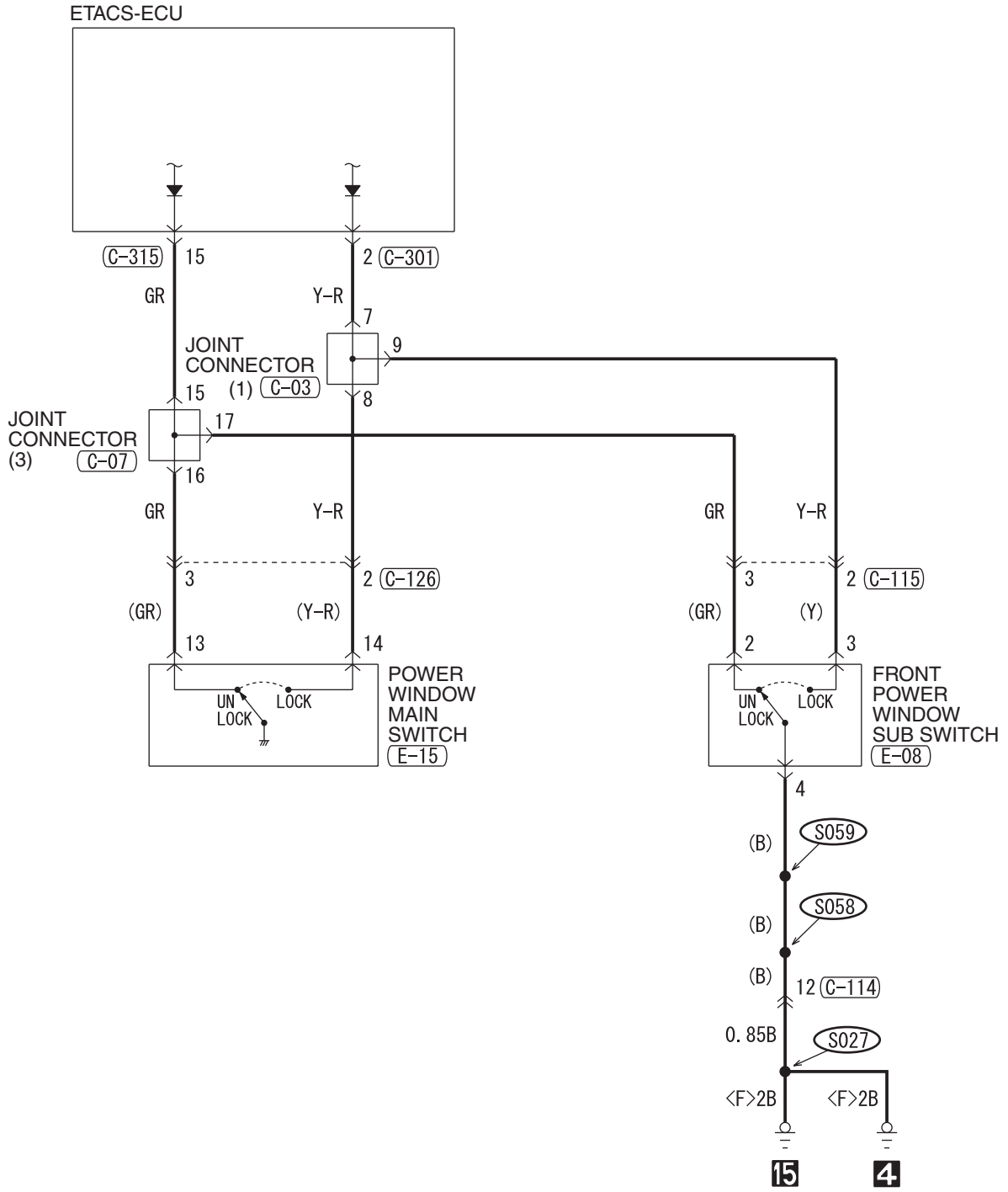

NOTES

KEYLESS OPERATING SYSTEM (KOS)

M1901025500107

1

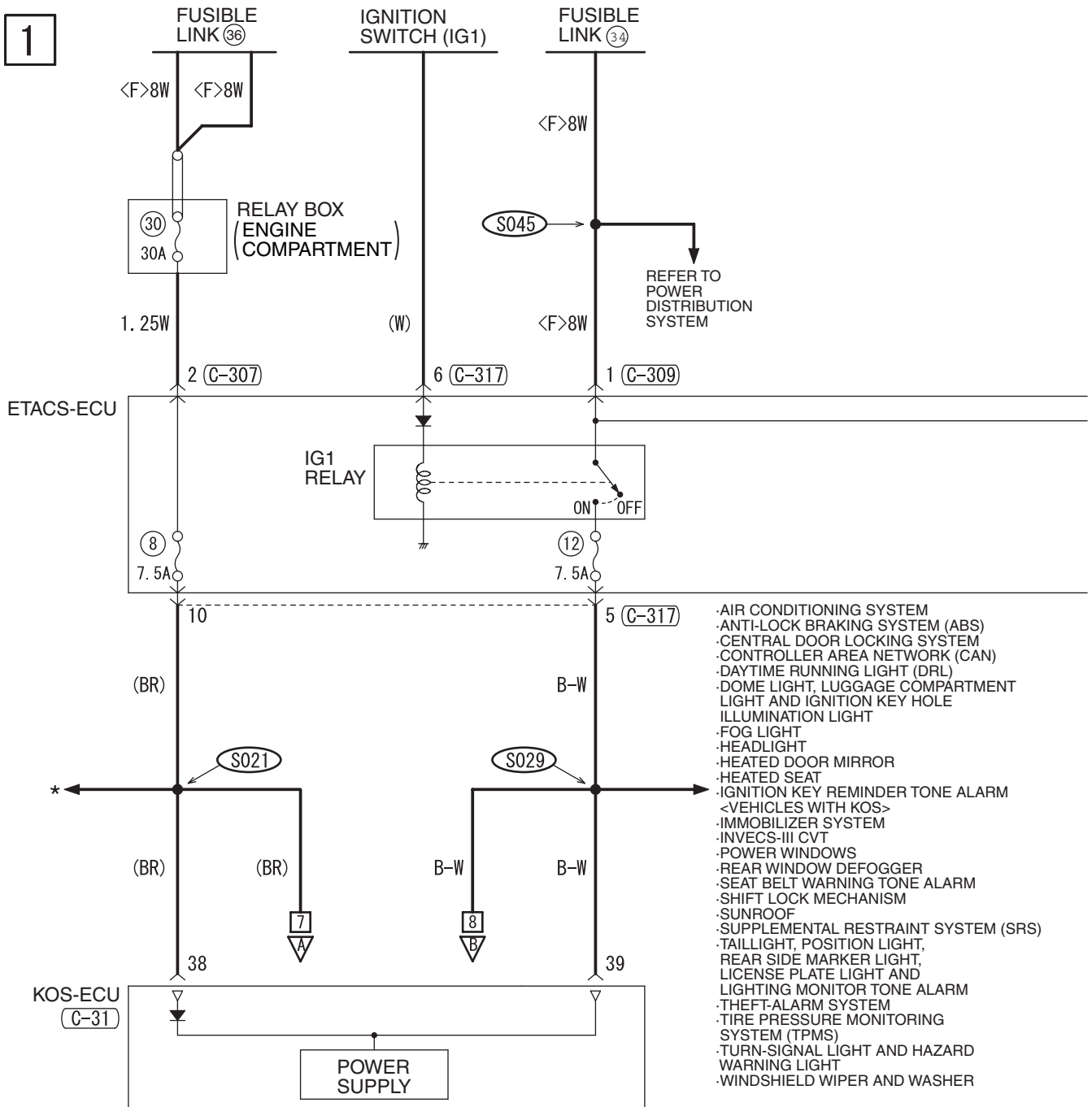

C-05



C-31

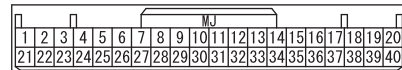

C-34 FRONT SIDE

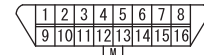

C-41



NOTE

- * : AIR CONDITIONING SYSTEM
- .BRAKE WARNING LIGHT,
- FUEL WARNING LIGHT AND
- OIL PRESSURE WARNING LIGHT
- .CONTROLLER AREA NETWORK (CAN)
- .DAYTIME RUNNING LIGHT (DRL)
- .FOG LIGHT
- .HEADLIGHT
- .METER AND GAUGE
- .SEAT BELT WARNING TONE ALARM
- .TAILLIGHT, POSITION LIGHT,
- REAR SIDE MARKER LIGHT, LICENSE PLATE LIGHT
- AND LIGHTING MONITOR TONE ALARM
- .TURN-SIGNAL LIGHT AND HAZARD WARNING LIGHT
- .WINDSHIELD WIPER AND WASHER

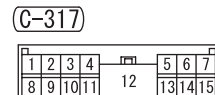
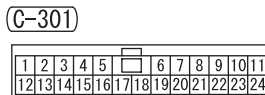
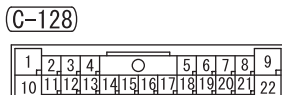
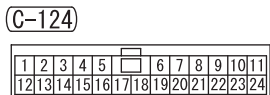
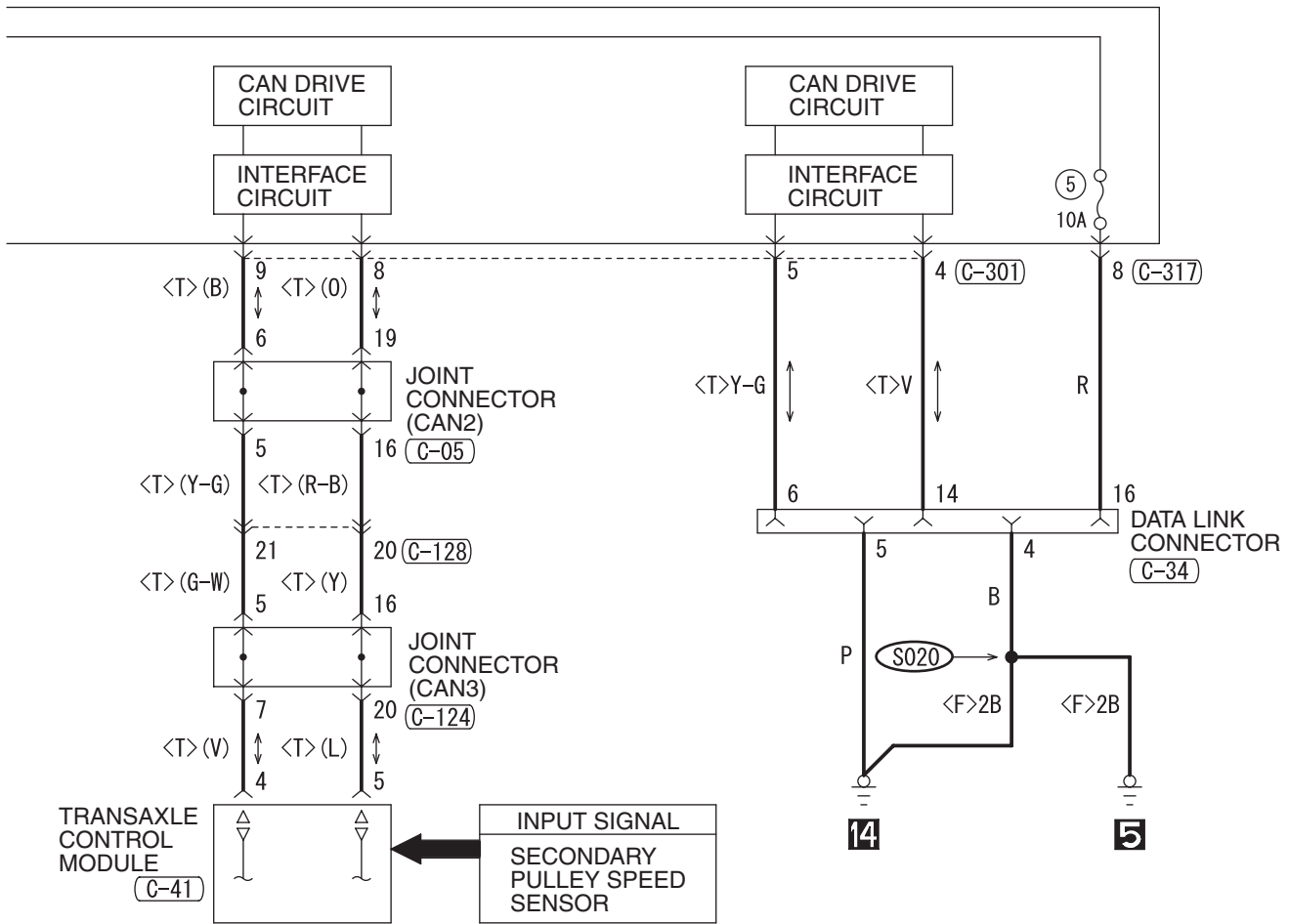

WIRE COLOR CODE

B : BLACK LG : LIGHT GREEN G : GREEN L : BLUE W : WHITE Y : YELLOW SB : SKY BLUE
BR : BROWN O : ORANGE GR : GRAY R : RED P : PINK V : VIOLET PU : PURPLE

H8G11M02AB

KEYLESS OPERATING SYSTEM (KOS) (CONTINUED)

3

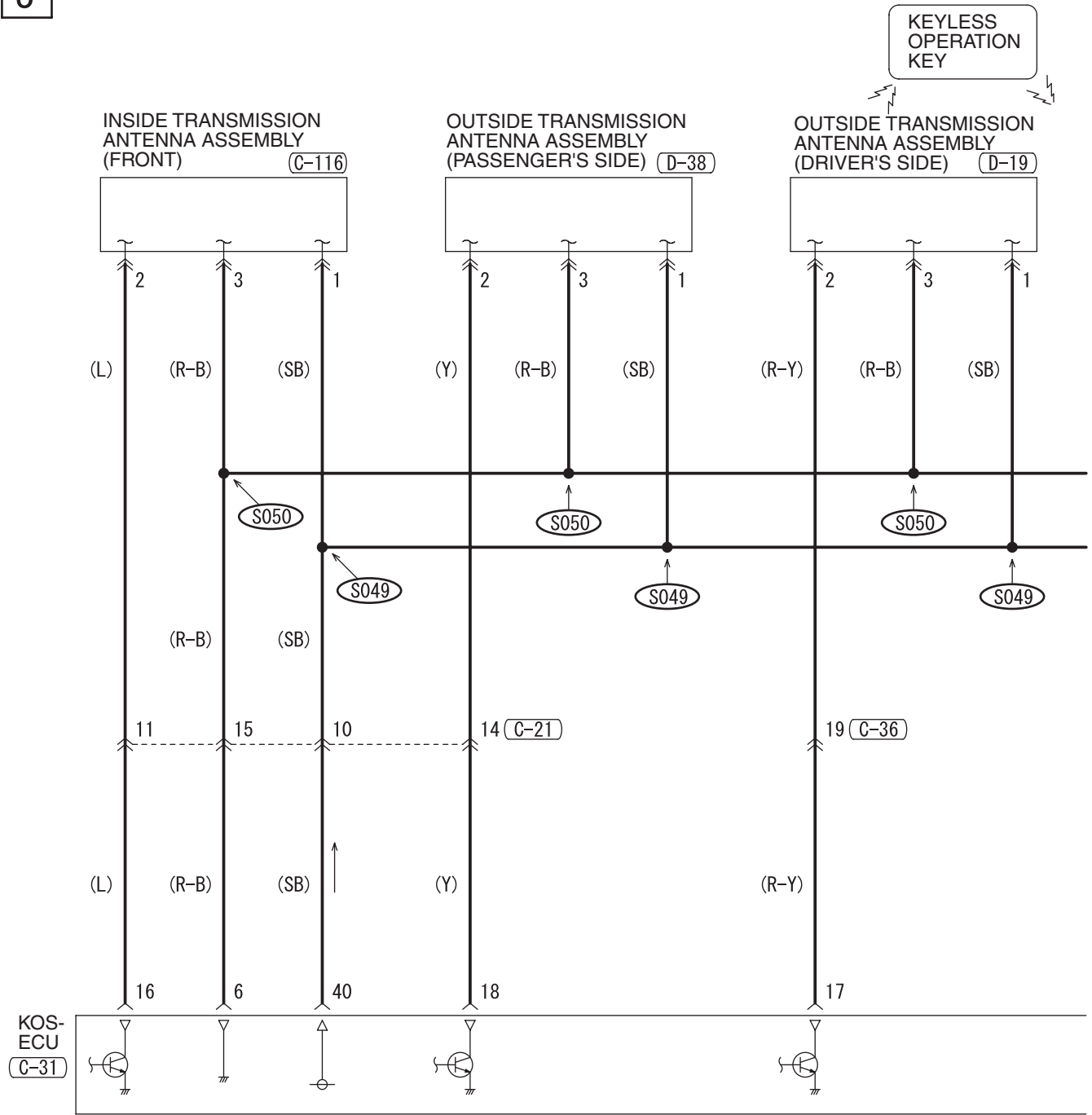

C-21

1	2	3	4	5	6	7	8	9		
10	11	12	13	14	15	16	17	18	19	20

C-31

1	2	3	4	5	6	7	8	9	10	11	12	13	14	15	16	17	18	19	20
21	22	23	24	25	26	27	28	29	30	31	32	33	34	35	36	37	38	39	40

C-36

1	2	3	4	5	6	7	8	9		
10	11	12	13	14	15	16	17	18	19	20

C-116

1	2	3
---	---	---

D-11

1	2	3	4	5	6	7	8	9				
10	11	12	13	14	15	16	17	18	19	20	21	22

4

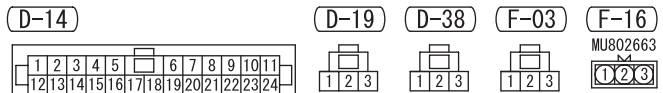
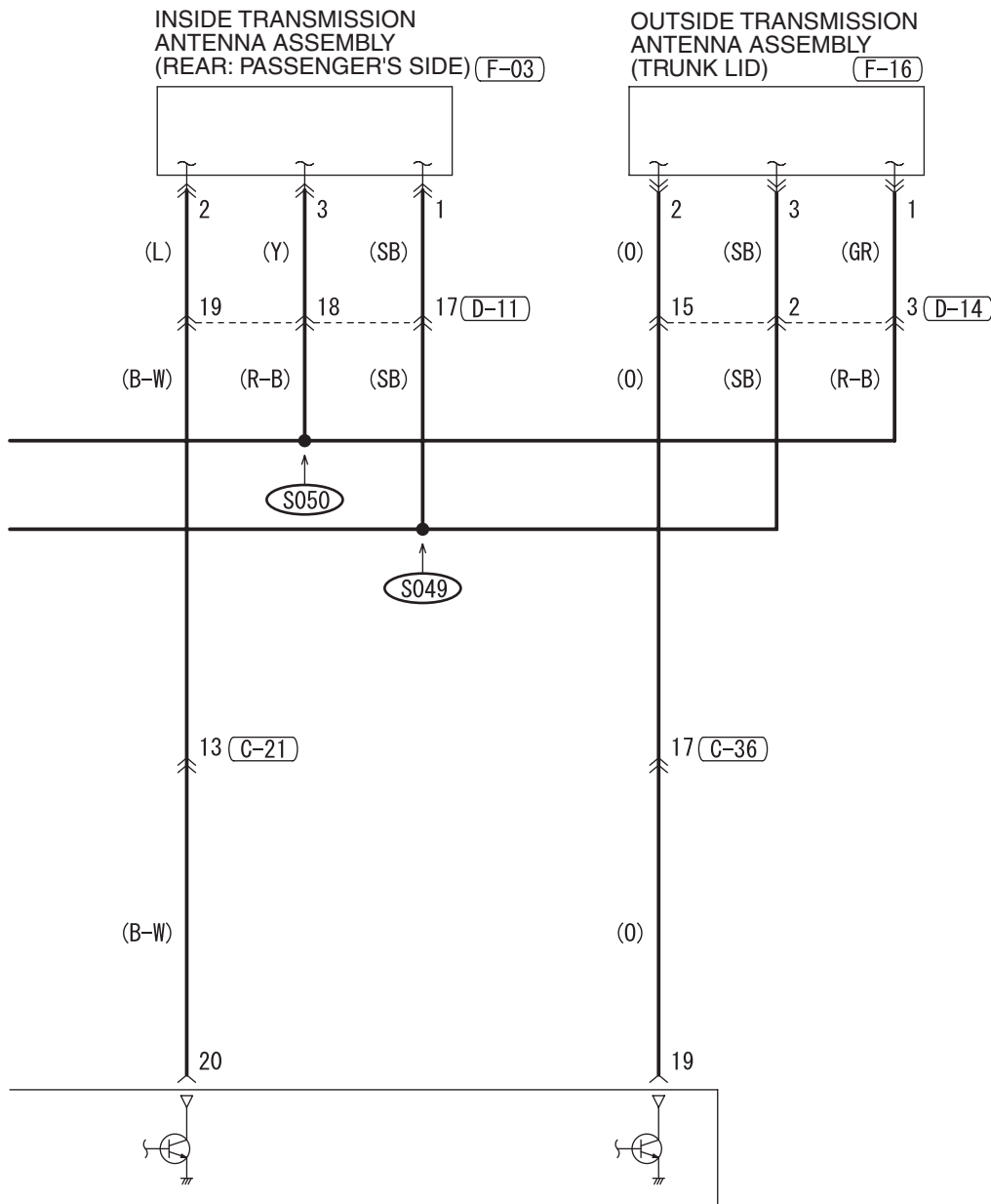

WIRE COLOR CODE
 B : BLACK LG : LIGHT GREEN G : GREEN L : BLUE W : WHITE Y : YELLOW SB : SKY BLUE
 BR : BROWN O : ORANGE GR : GRAY R : RED P : PINK V : VIOLET PU : PURPLE

H8G11M02BB

TSB Revision

KEYLESS OPERATING SYSTEM (KOS) (CONTINUED)

5

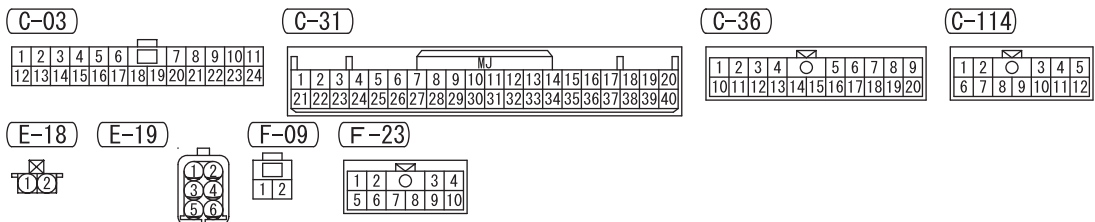
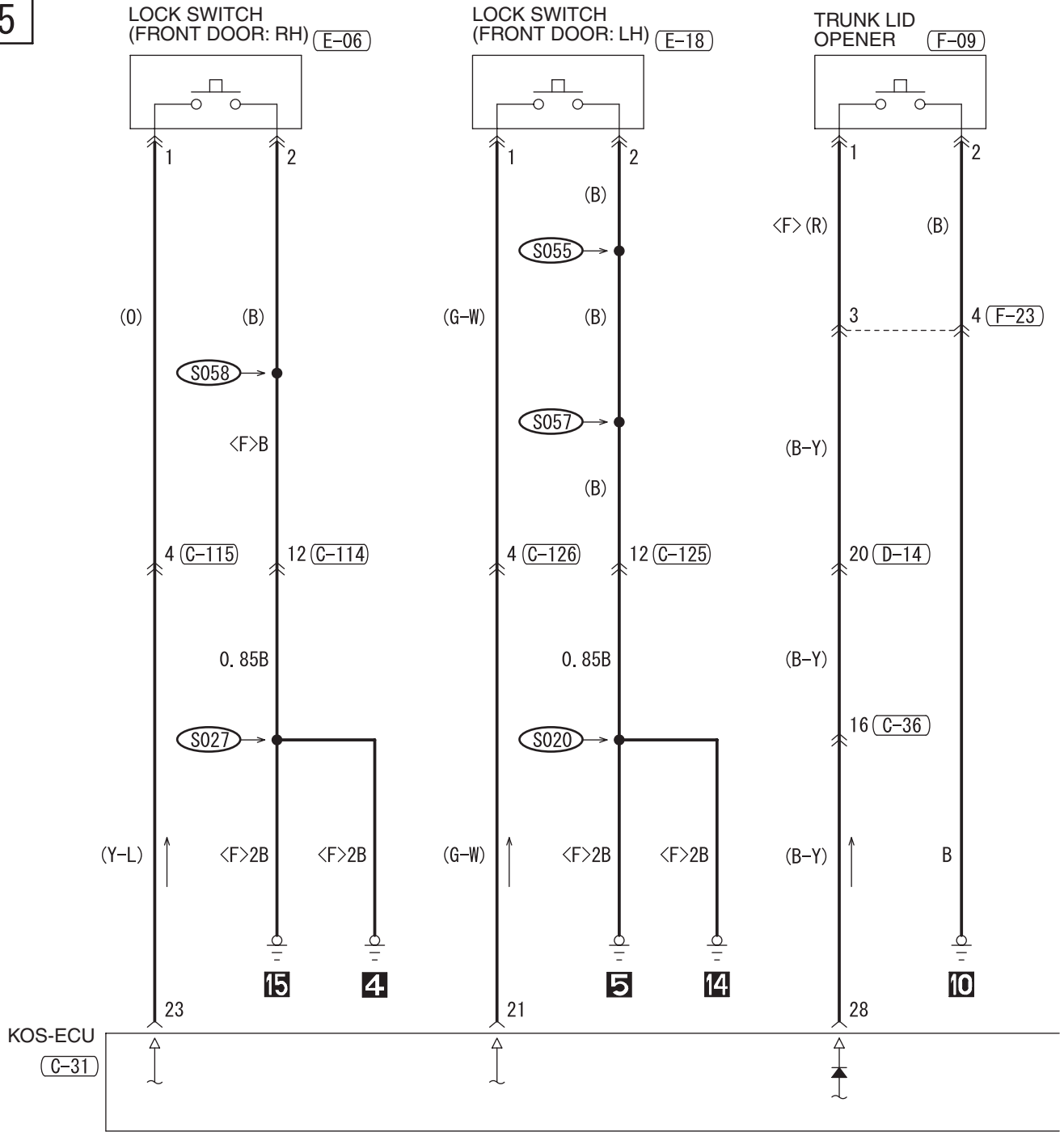

6

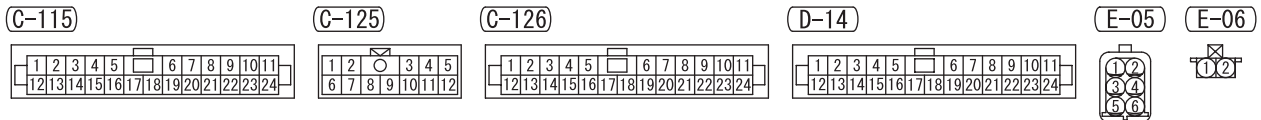
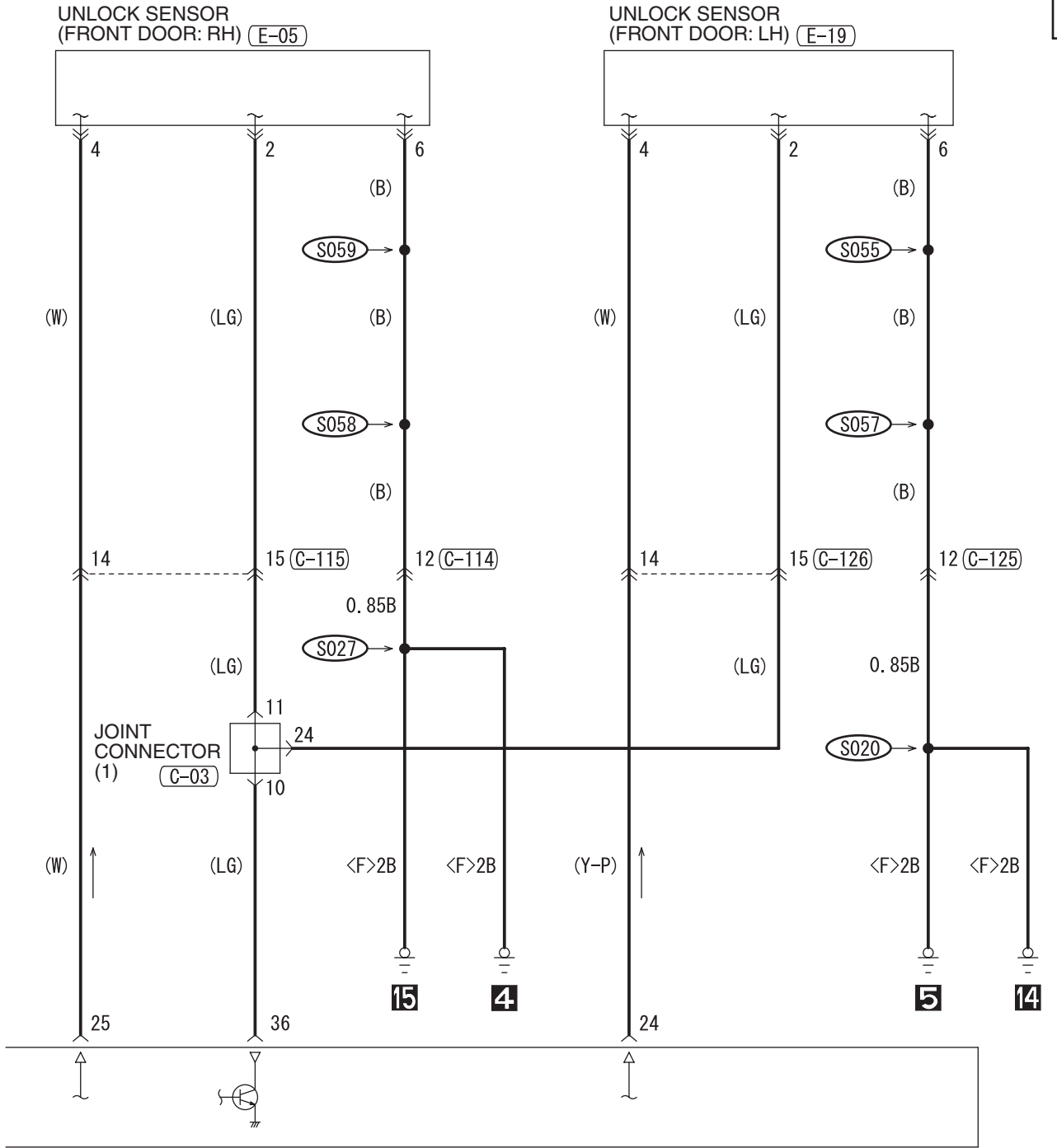

WIRE COLOR CODE
 B : BLACK LG : LIGHT GREEN G : GREEN L : BLUE W : WHITE Y : YELLOW SB : SKY BLUE
 BR : BROWN O : ORANGE GR : GRAY R : RED P : PINK V : VIOLET PU : PURPLE

H8G11M02CB

TSB Revision

8

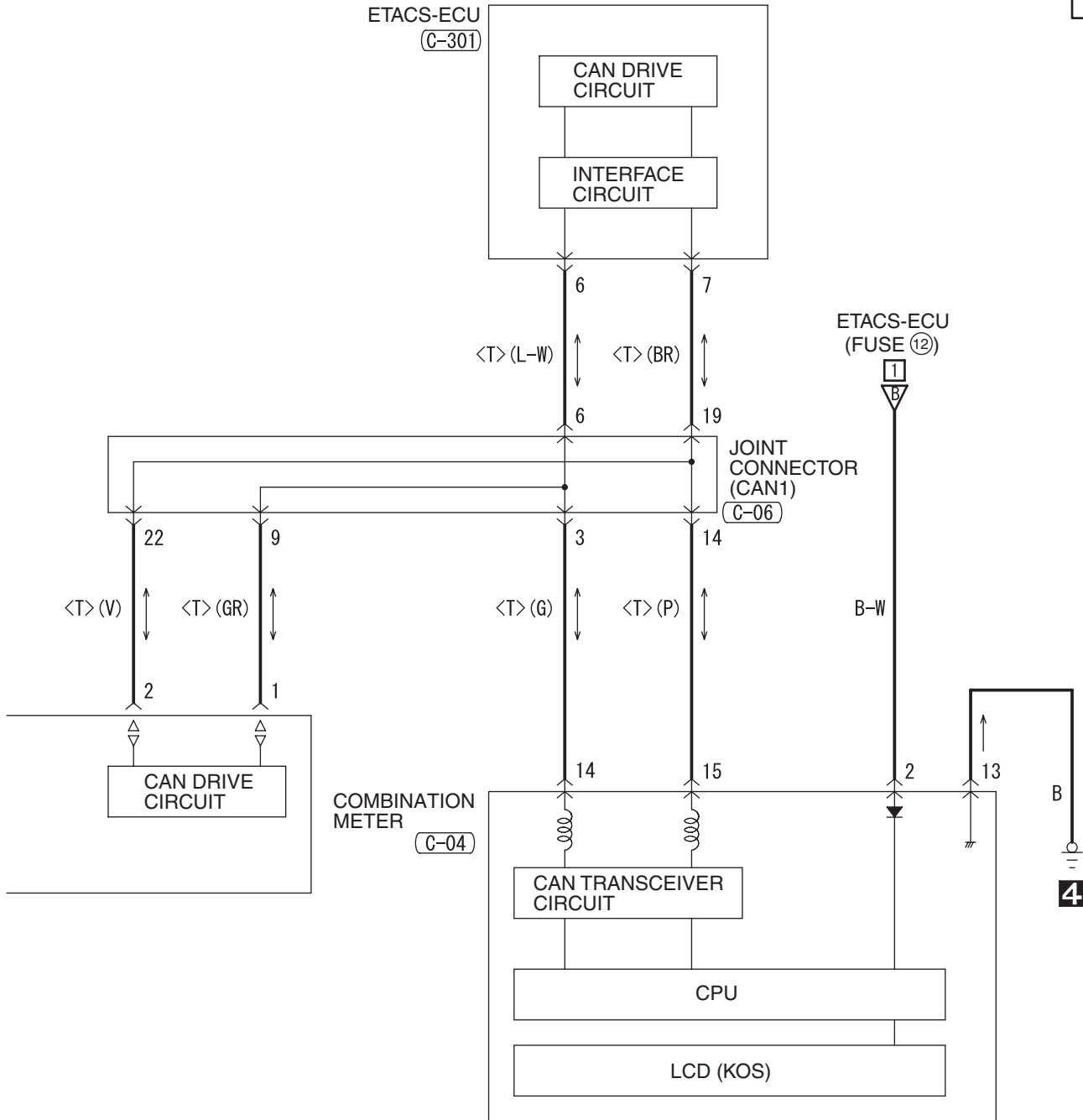

(C-213)



(C-301)



(C-315)



(D-14)



(F-14)



WIRE COLOR CODE

B: BLACK LG: LIGHT GREEN G: GREEN L: BLUE W: WHITE Y: YELLOW SB: SKY BLUE
BR: BROWN O: ORANGE GR: GRAY R: RED P: PINK V: VIOLET PU: PURPLE

H8G11M02DB

AIR CONDITIONING SYSTEM

M1901005601570

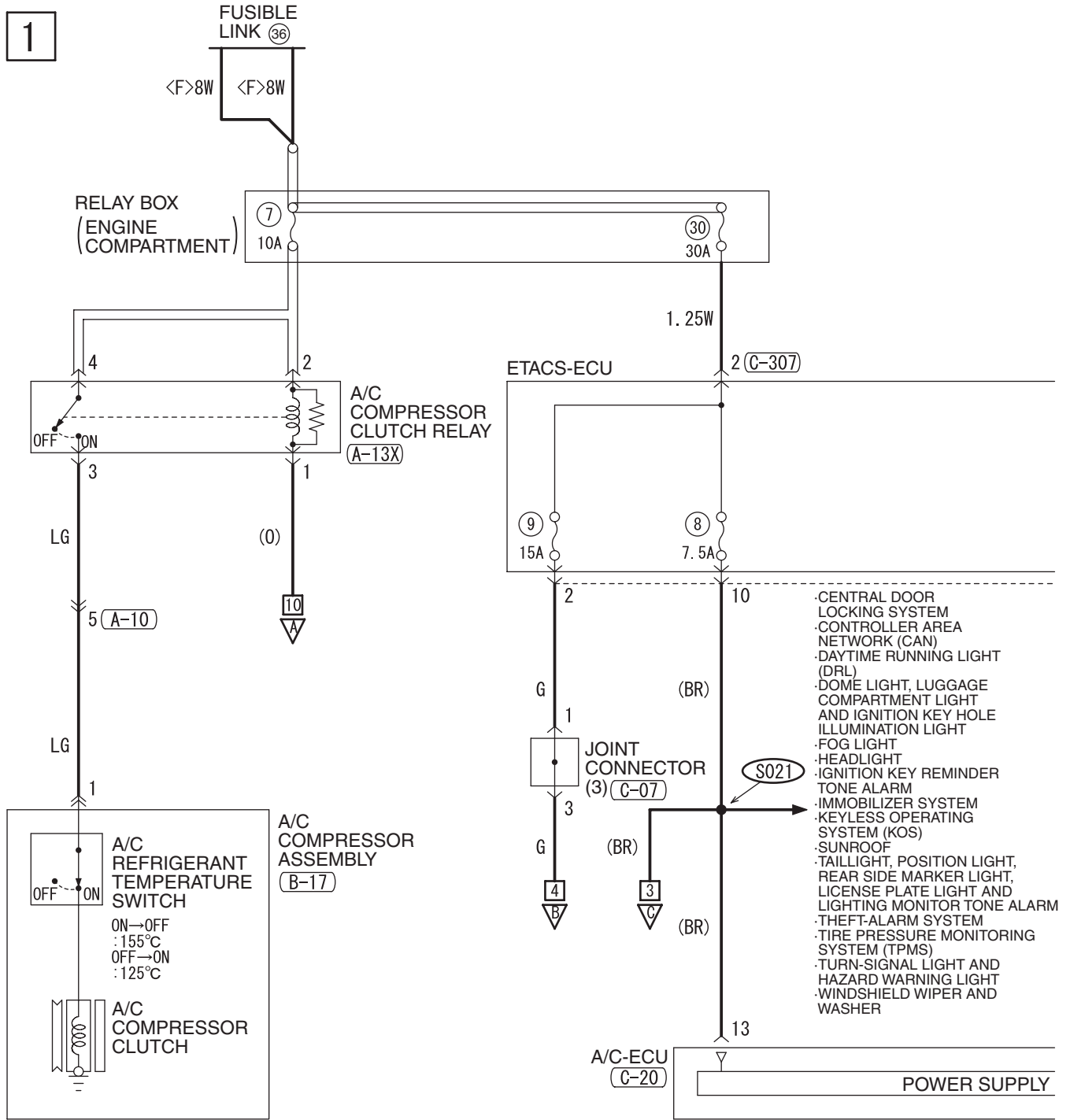

(A-10)

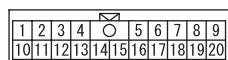

(A-13X)



(B-17)



(C-07)

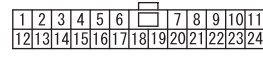

(C-20)

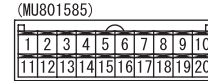

(C-34) FRONT SIDE

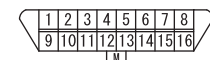

2

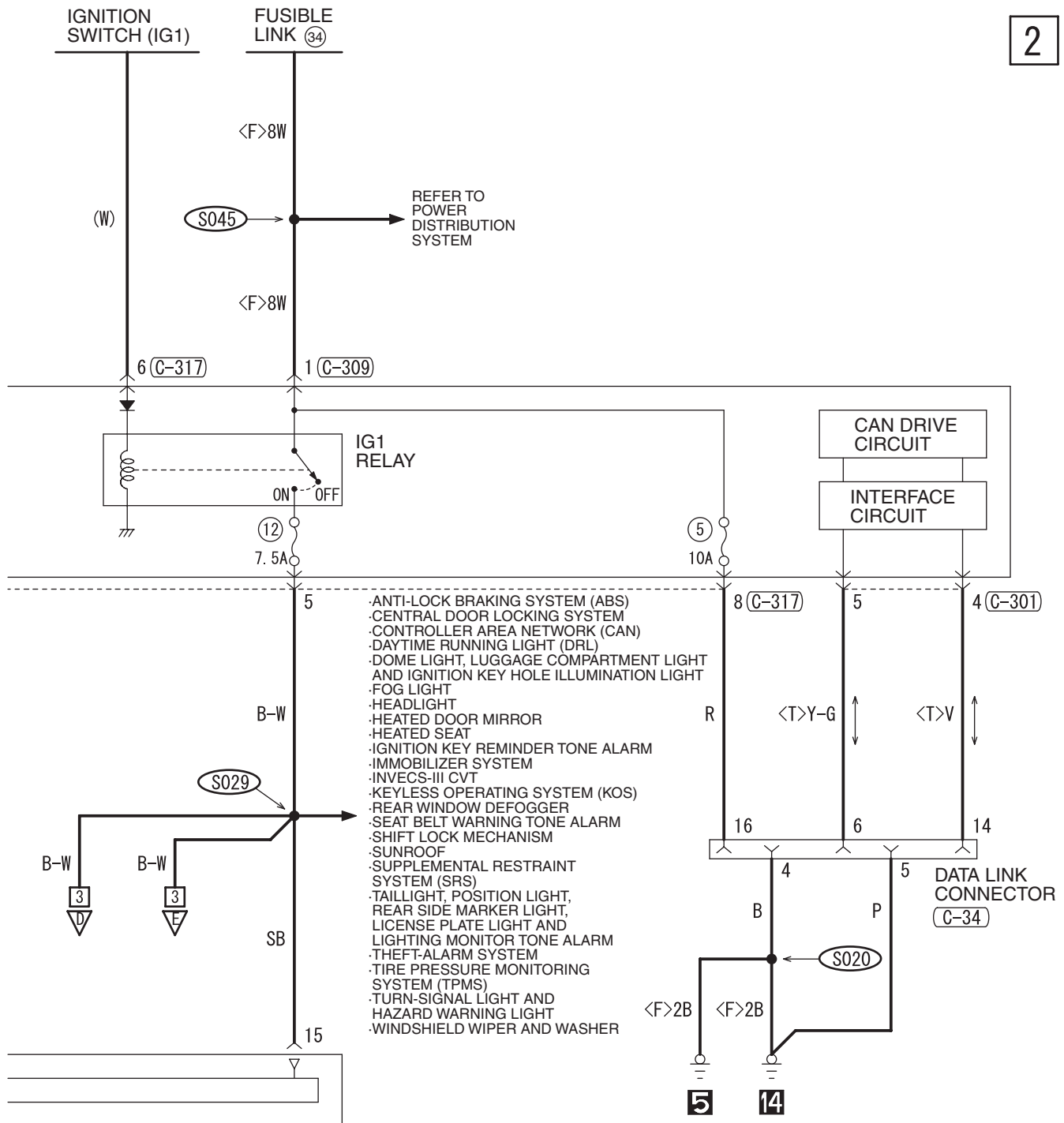

(C-301)

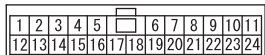

(C-307)



(C-309)



(C-317)

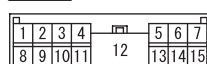

WIRE COLOR CODE

B : BLACK LG : LIGHT GREEN G : GREEN L : BLUE W : WHITE Y : YELLOW SB : SKY BLUE
BR : BROWN O : ORANGE GR : GRAY R : RED P : PINK V : VIOLET PU : PURPLE

AIR CONDITION SYSTEM (CONTINUED)

3

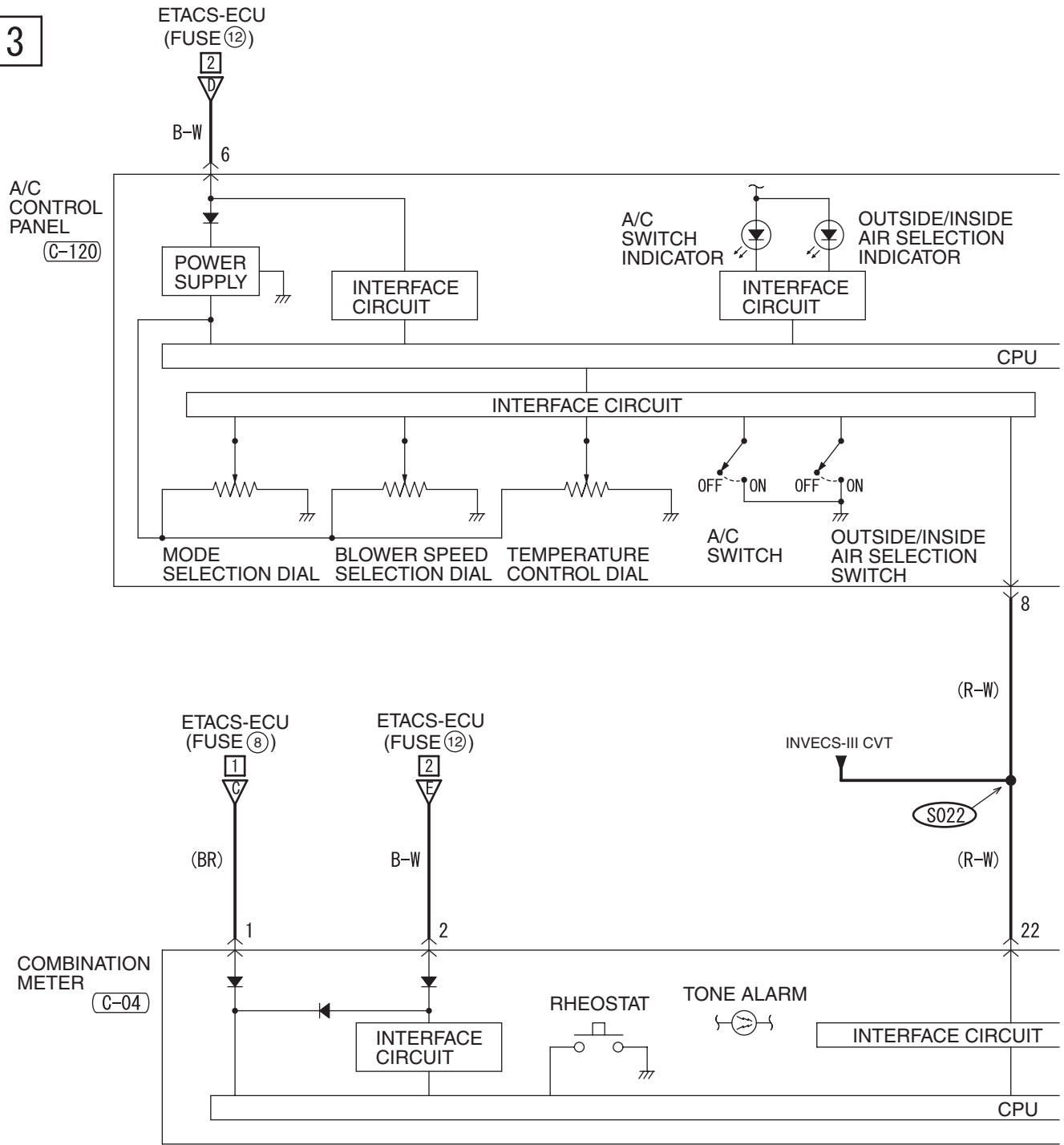

C-04

1	2	3	4	5	6	7	8	9	10	11	12
13	14	15	16	17	18	19	20	21	22	23	24

C-120

1	2	3	4	5	6
7	8	9	10	11	12

4

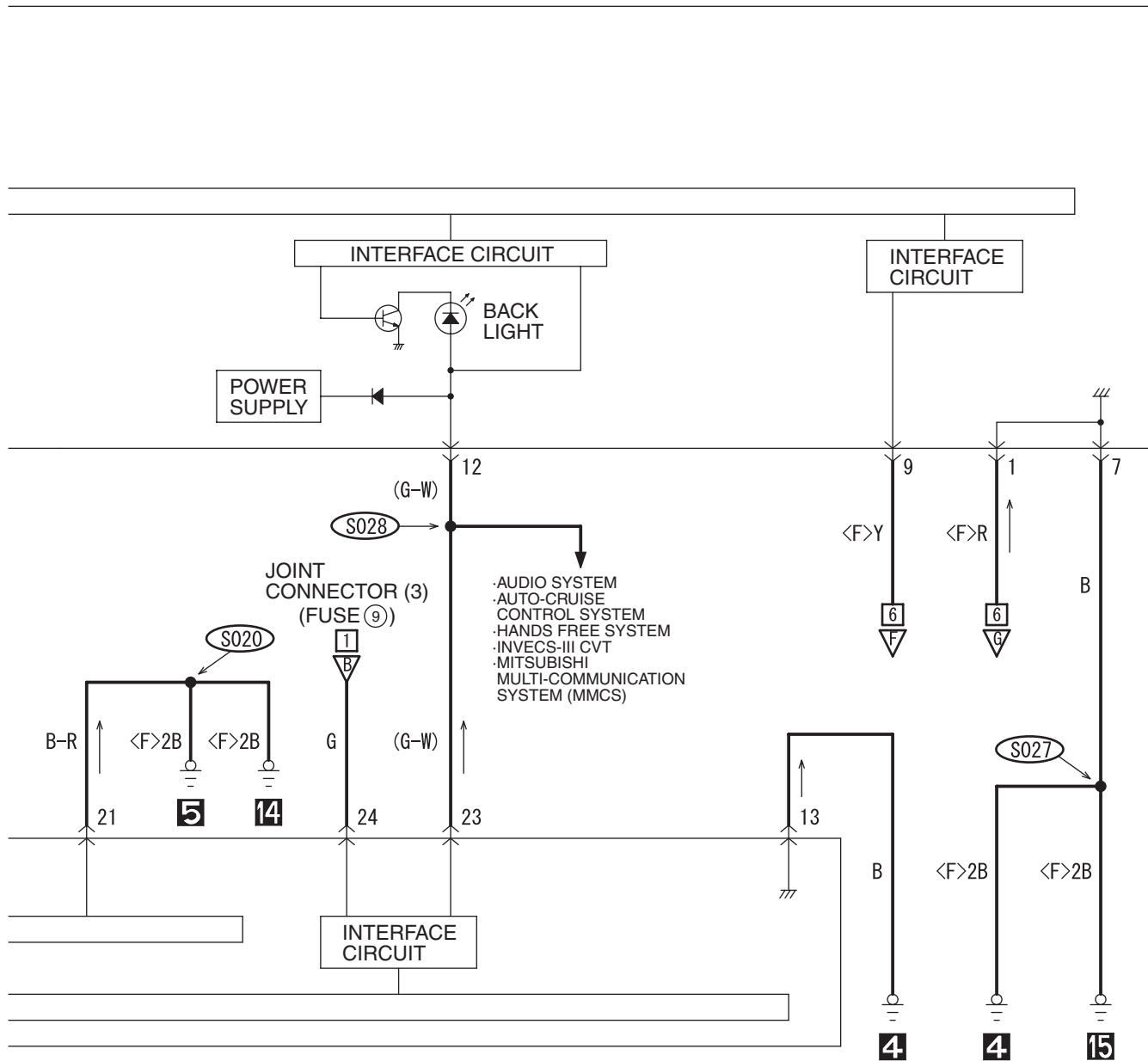

WIRE COLOR CODE
 B: BLACK LG: LIGHT GREEN G: GREEN L: BLUE W: WHITE Y: YELLOW SB: SKY BLUE
 BR: BROWN O: ORANGE GR: GRAY R: RED P: PINK V: VIOLET PU: PURPLE

H8G12M00BB

TSB Revision

AIR CONDITION SYSTEM (CONTINUED)

5

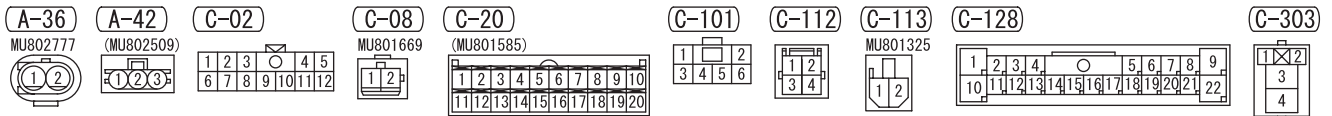
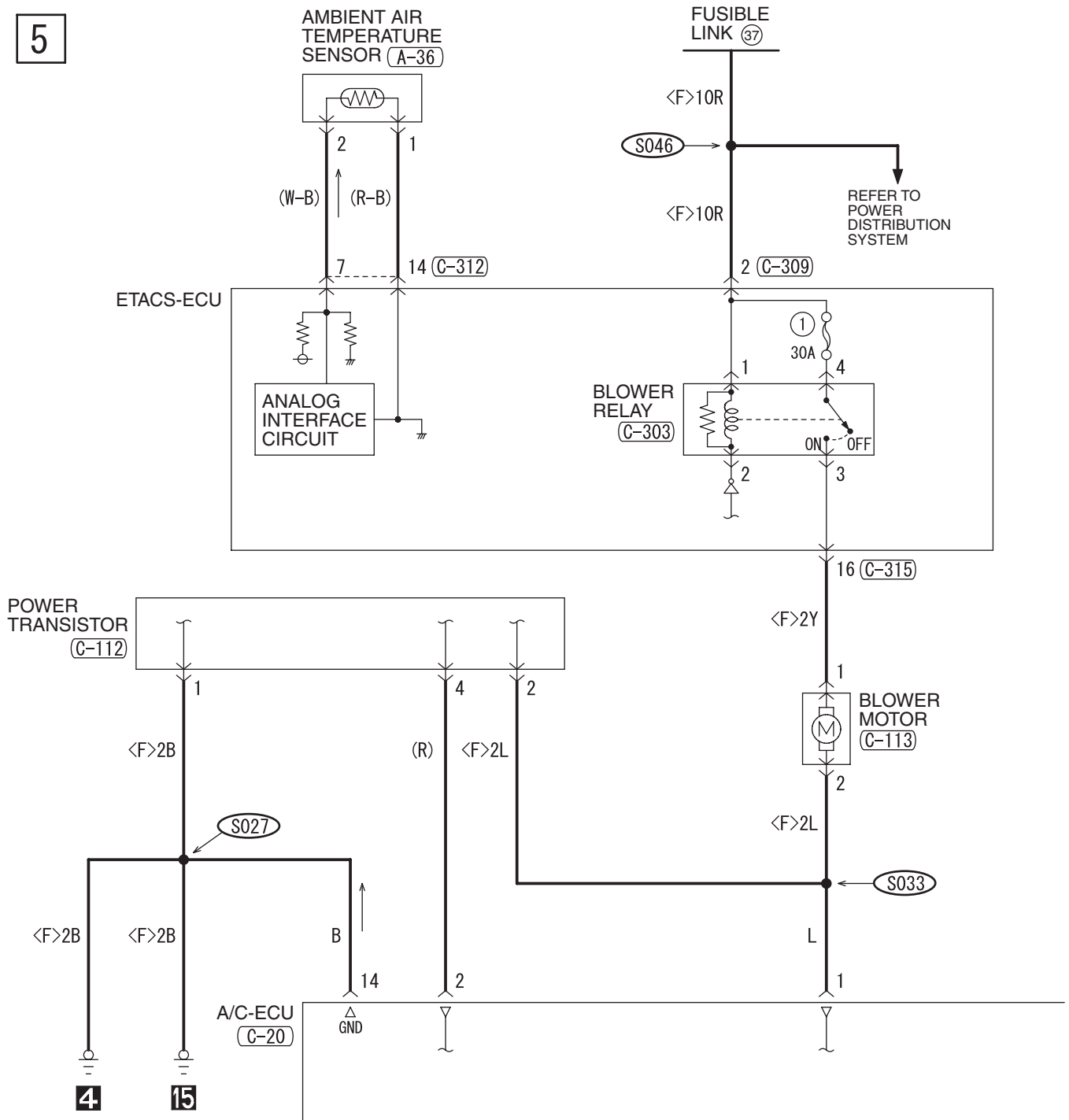

6

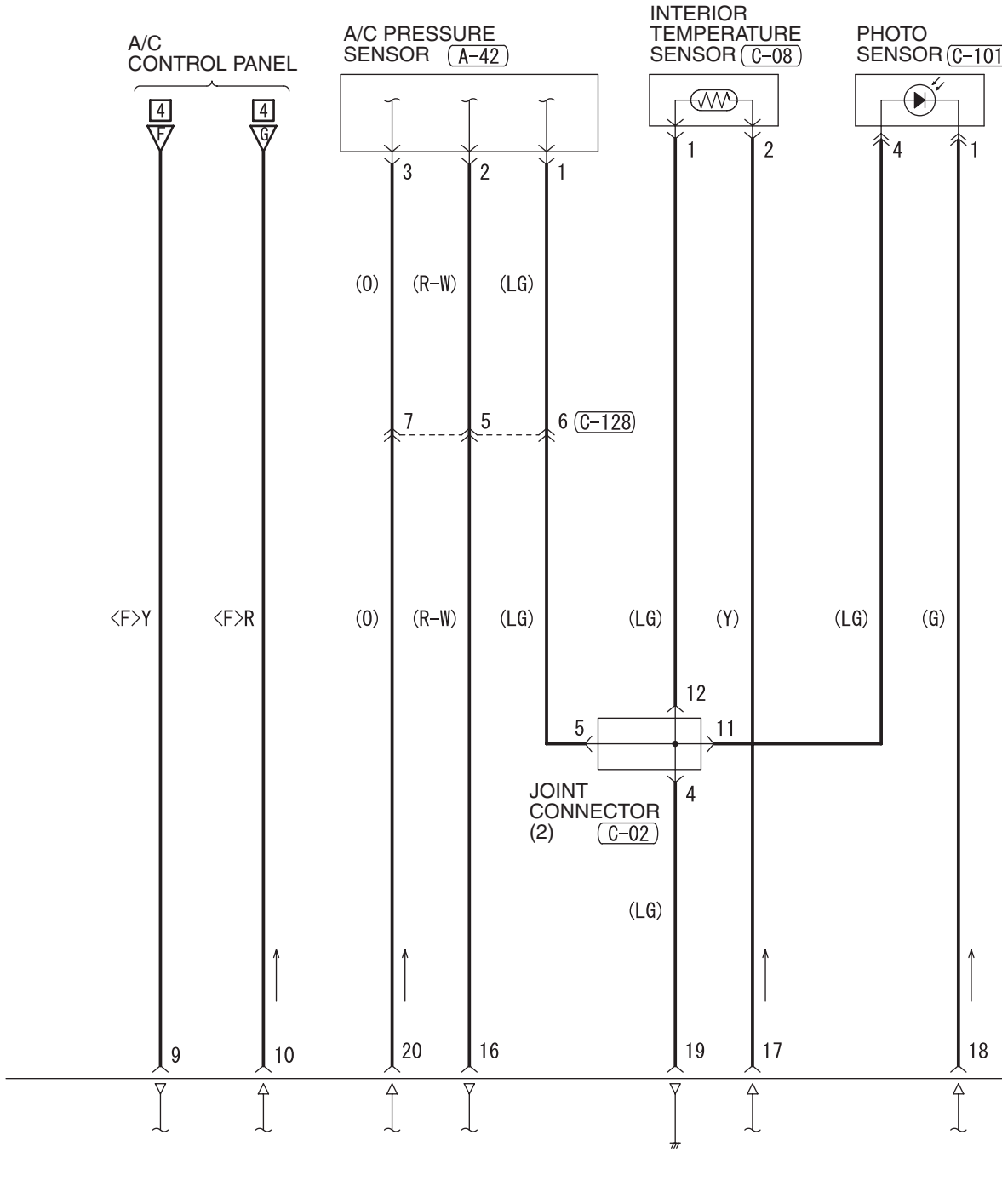

(C-309)

(C-312)

(C-315)

MU801890

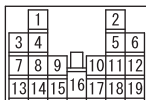

WIRE COLOR CODE

B: BLACK LG: LIGHT GREEN G: GREEN L: BLUE W: WHITE Y: YELLOW SB: SKY BLUE
BR: BROWN O: ORANGE GR: GRAY R: RED P: PINK V: VIOLET PU: PURPLE

H8G12M00CB

TSB Revision

AIR CONDITION SYSTEM (CONTINUED)

7

A/C-ECU
(C-19)

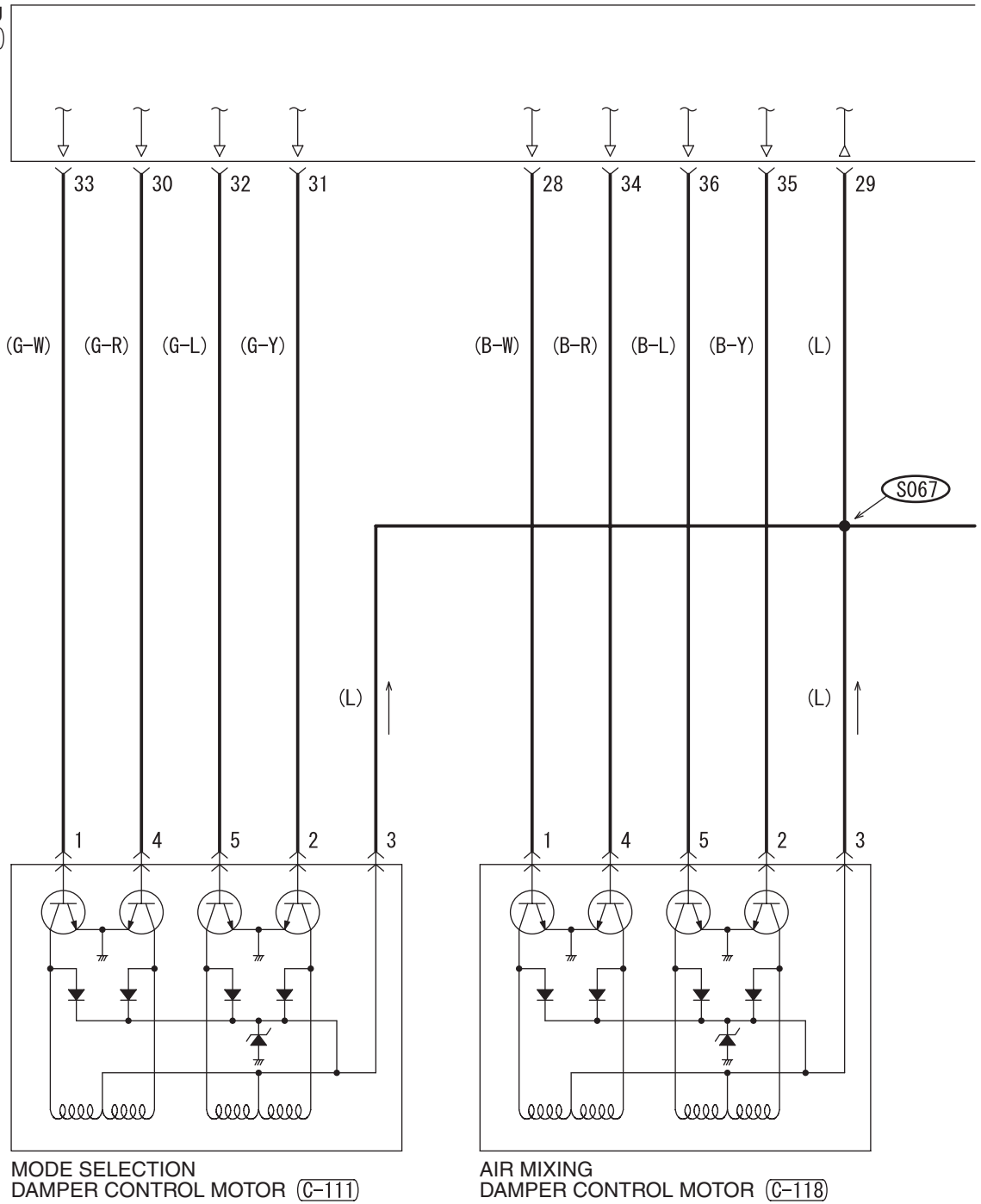

(C-19)
(MU801584)

21	22	23	24	25	26	27	28
29	30	31	32	33	34	35	36

(C-109)

1	2	3	4	5
---	---	---	---	---

(C-111)

1	2	3	4	5
---	---	---	---	---

(C-118)

1	2	3	4	5
---	---	---	---	---

(C-119)

1
2

8

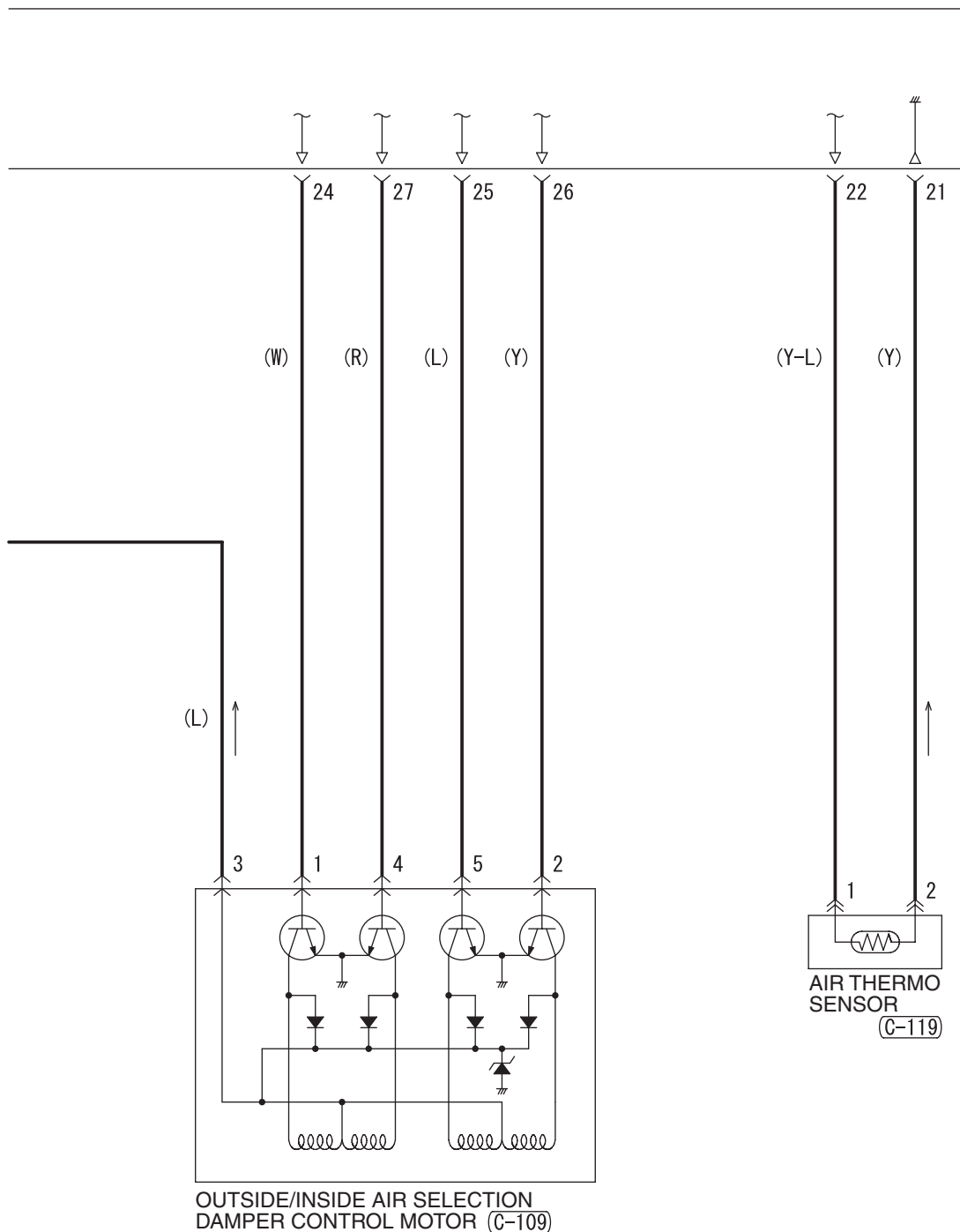

WIRE COLOR CODE
 B: BLACK LG: LIGHT GREEN G: GREEN L: BLUE W: WHITE Y: YELLOW SB: SKY BLUE
 BR: BROWN O: ORANGE GR: GRAY R: RED P: PINK V: VIOLET PU: PURPLE

H8G12M00DB

TSB Revision

AIR CONDITION SYSTEM (CONTINUED)

9

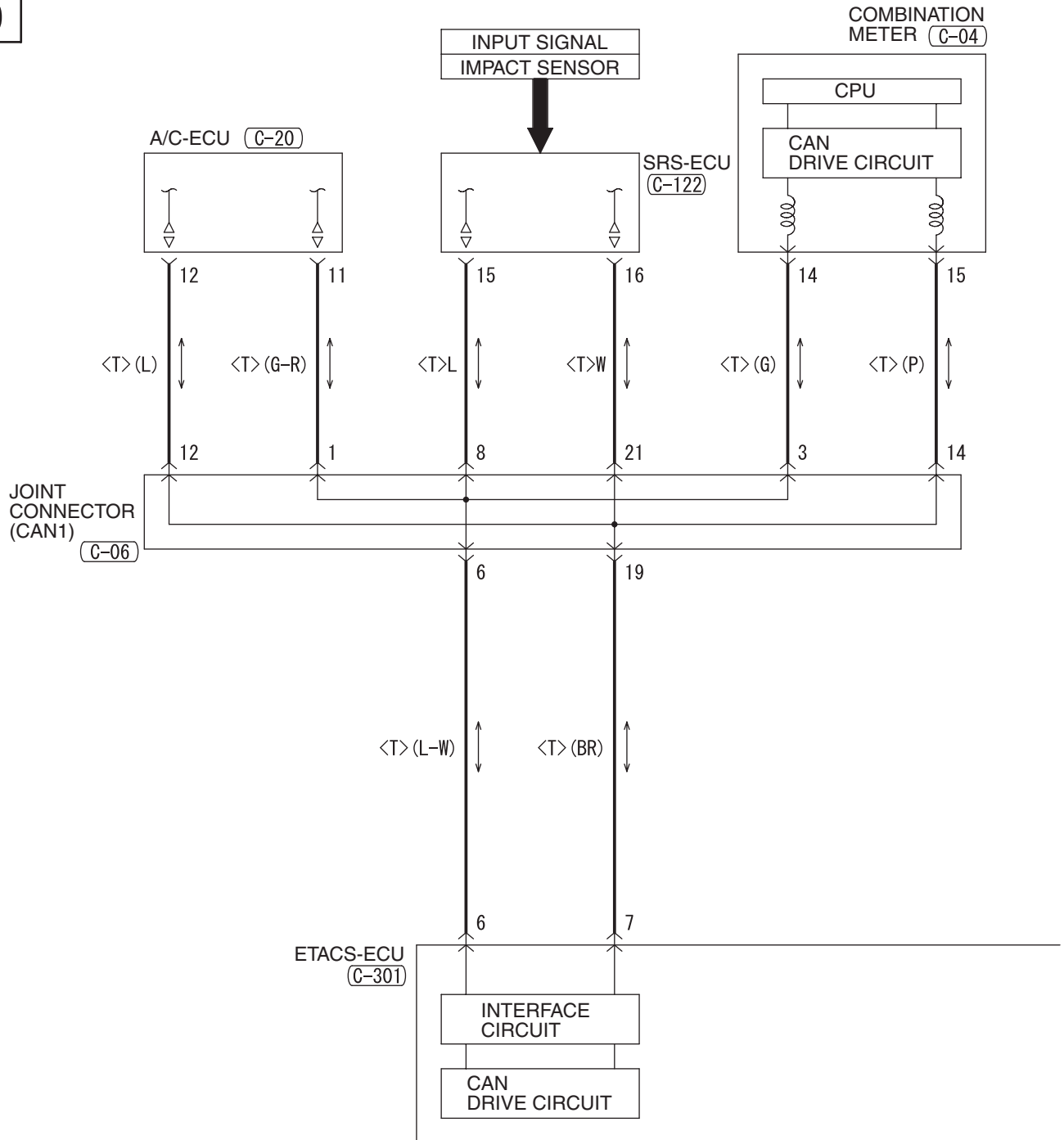

B-109

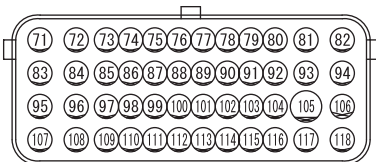

C-04

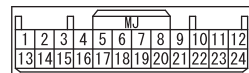

C-05

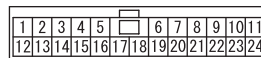

C-06

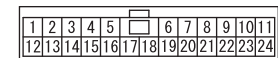

C-128

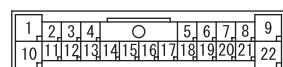

C-301

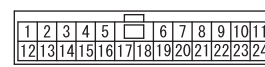

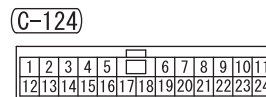
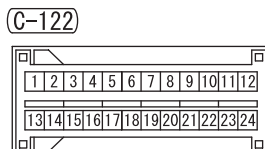
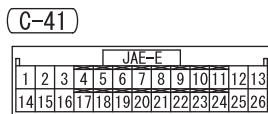
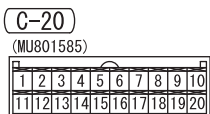
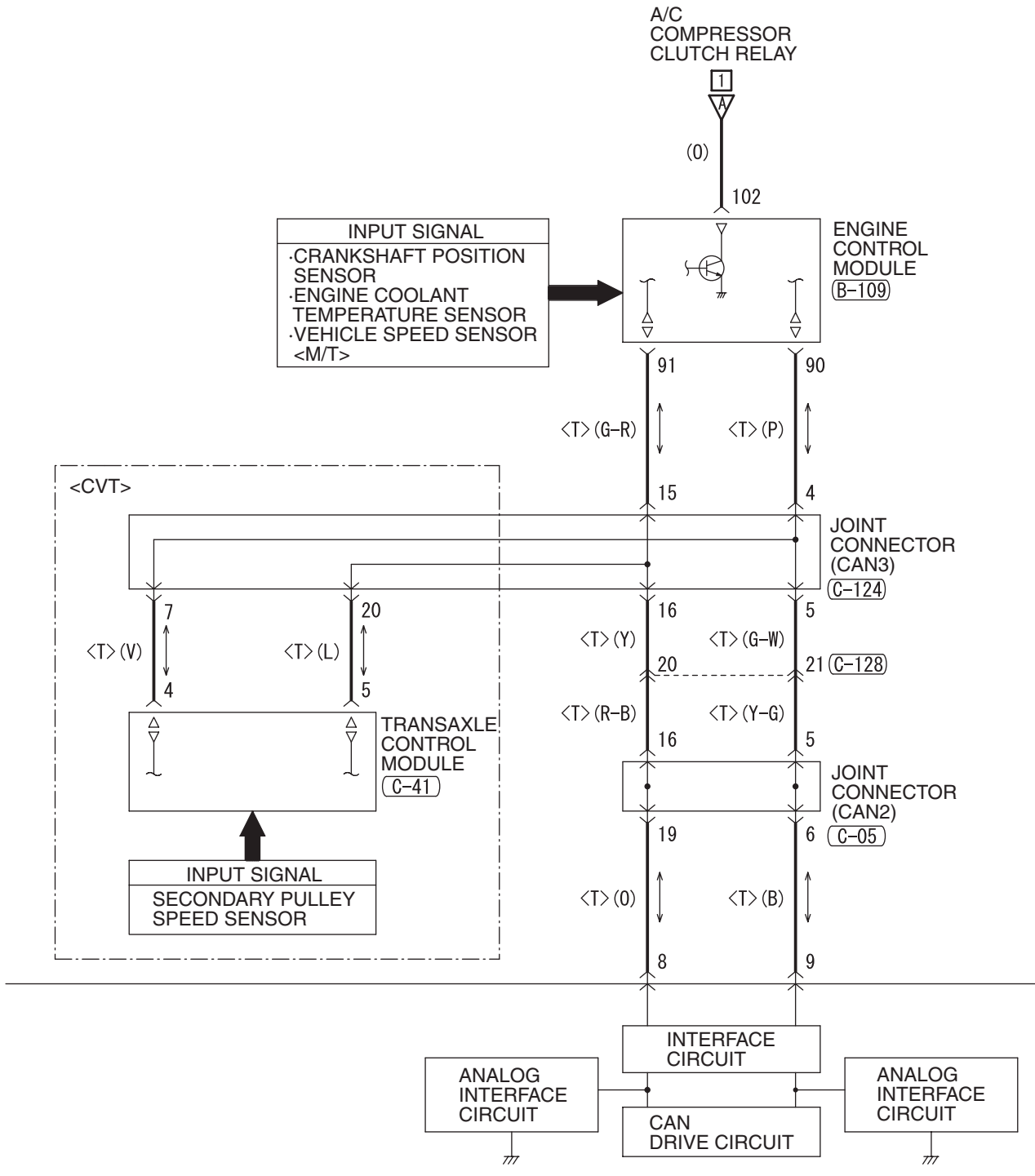

WIRE COLOR CODE

B: BLACK LG: LIGHT GREEN G: GREEN L: BLUE W: WHITE Y: YELLOW SB: SKY BLUE
BR: BROWN O: ORANGE GR: GRAY R: RED P: PINK V: VIOLET PU: PURPLE

H8G12M00EB

AIR CONDITION SYSTEM (CONTINUED)

11

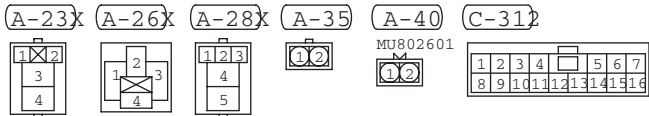
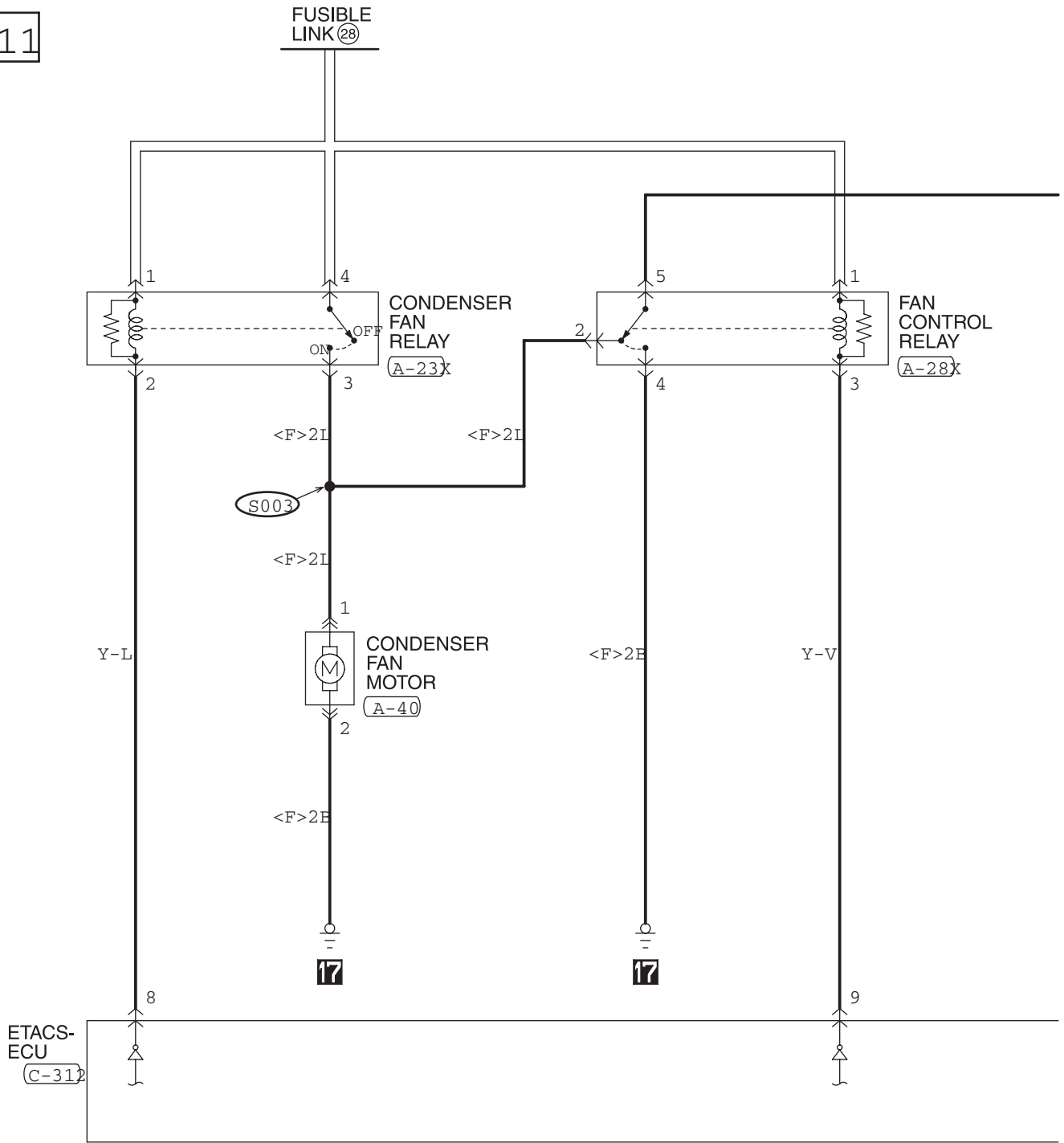

12

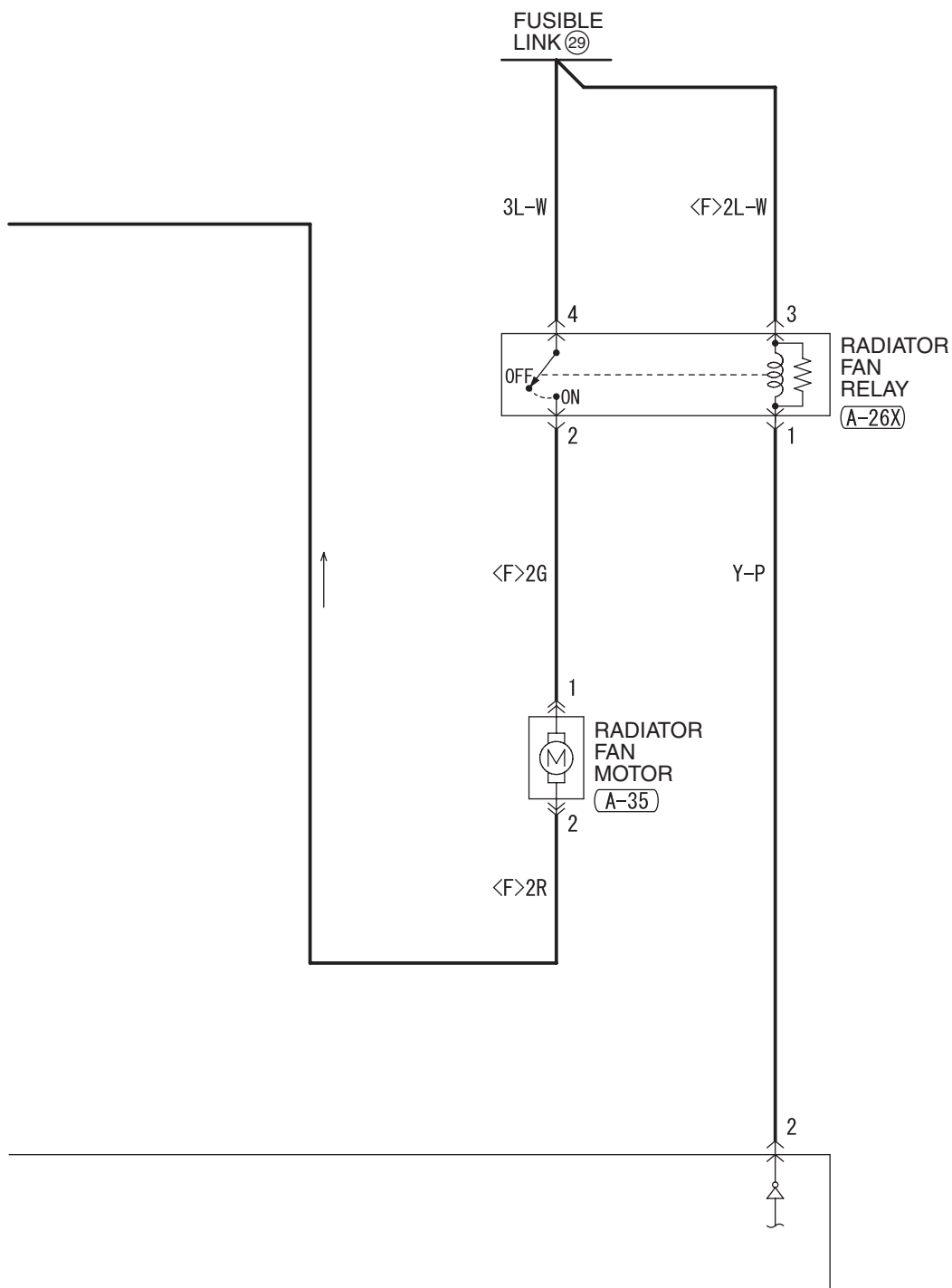

WIRE COLOR CODE
 B : BLACK LG : LIGHT GREEN G : GREEN L : BLUE W : WHITE Y : YELLOW SB : SKY BLUE
 BR : BROWN O : ORANGE GR : GRAY R : RED P : PINK V : VIOLET PU : PURPLE

H8G12M00FB

TSB Revision

WINDSHIELD WIPER AND WASHER

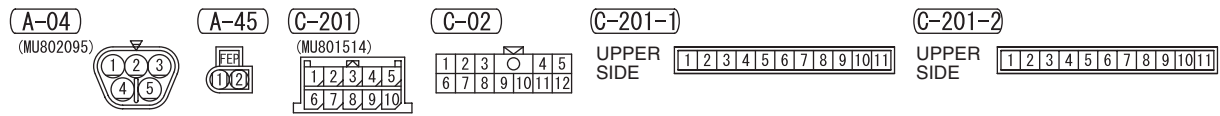
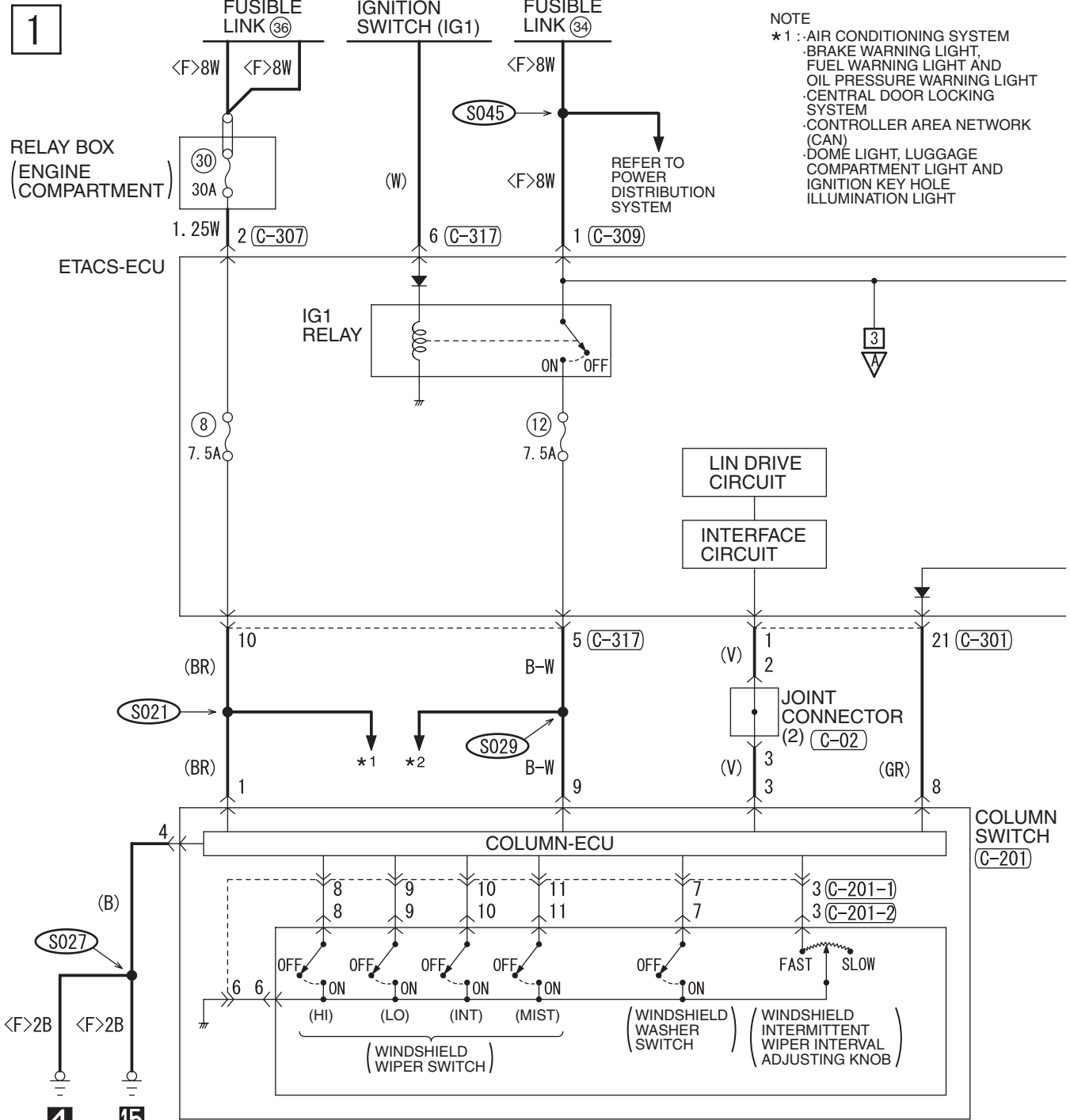

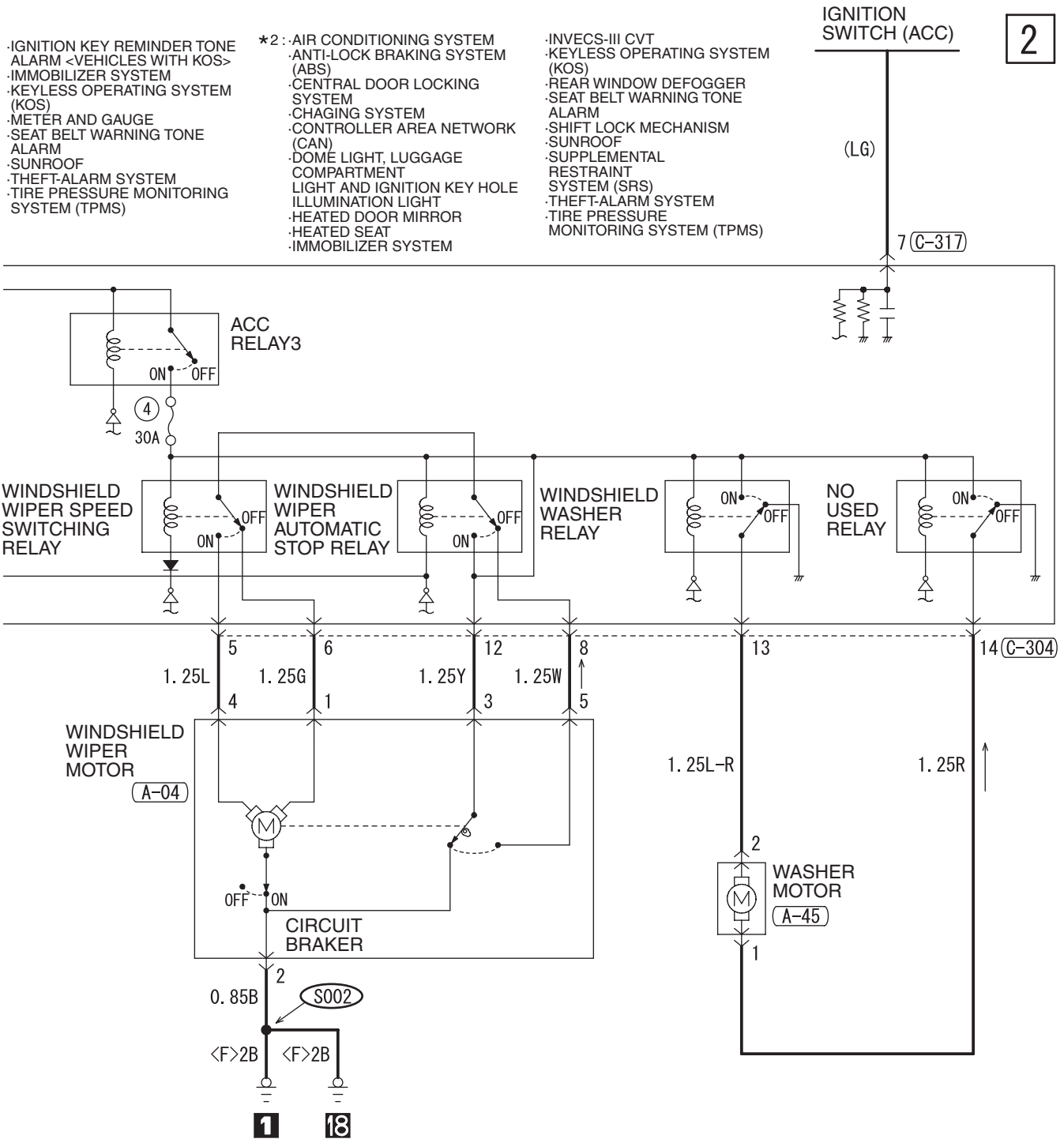

- IGNITION KEY REMINDER TONE ALARM <VEHICLES WITH KOS>
- IMMOBILIZER SYSTEM
- KEYLESS OPERATING SYSTEM (KOS)
- METER AND GAUGE
- SEAT BELT WARNING TONE ALARM
- SUNROOF
- THEFT-ALARM SYSTEM
- TIRE PRESSURE MONITORING SYSTEM (TPMS)

- *2 :
- AIR CONDITIONING SYSTEM
 - ANTI-LOCK BRAKING SYSTEM (ABS)
 - CENTRAL DOOR LOCKING SYSTEM
 - CHAGING SYSTEM
 - CONTROLLER AREA NETWORK (CAN)
 - DOME LIGHT, LUGGAGE COMPARTMENT LIGHT AND IGNITION KEY HOLE ILLUMINATION LIGHT
 - HEATED DOOR MIRROR
 - HEATED SEAT
 - IMMOBILIZER SYSTEM

- INVECS-III CVT
- KEYLESS OPERATING SYSTEM (KOS)
- REAR WINDOW DEFOGGER
- SEAT BELT WARNING TONE ALARM
- SHIFT LOCK MECHANISM
- SUNROOF
- SUPPLEMENTAL RESTRAINT SYSTEM (SRS)
- THEFT-ALARM SYSTEM
- TIRE PRESSURE MONITORING SYSTEM (TPMS)

IGNITION SWITCH (ACC)

2

(LG)

7 (C-317)

ACC RELAY3

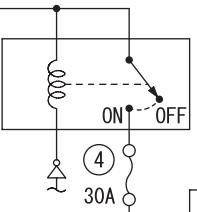

WINDSHIELD WIPER SPEED SWITCHING RELAY

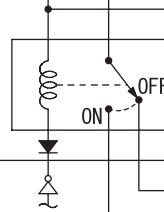

WINDSHIELD WIPER AUTOMATIC STOP RELAY

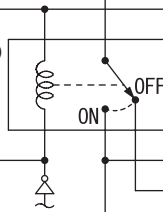

WINDSHIELD WASHER RELAY

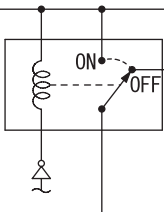

NO USED RELAY

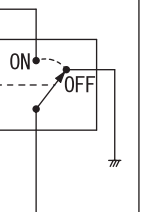

WINDSHIELD WIPER MOTOR (A-04)

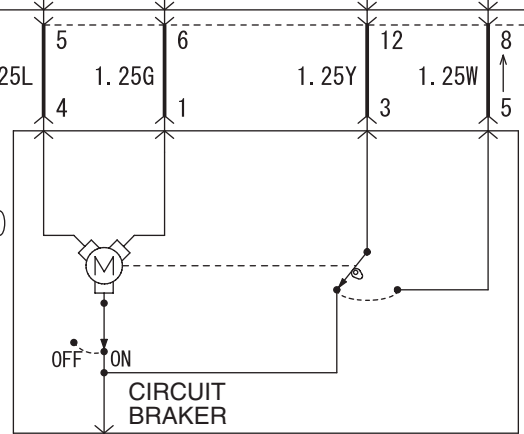

WASHER MOTOR (A-45)

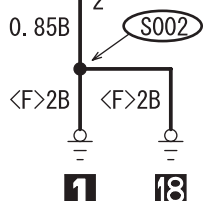
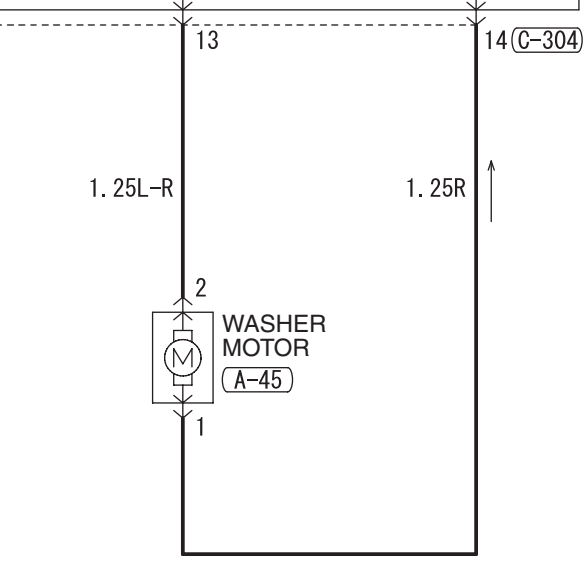

(C-301)

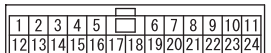

(C-304)



(C-307)



(C-309)



(C-317)



WIRE COLOR CODE

B: BLACK LG: LIGHT GREEN G: GREEN L: BLUE W: WHITE Y: YELLOW SB: SKY BLUE
BR: BROWN O: ORANGE GR: GRAY R: RED P: PINK V: VIOLET PU: PURPLE

H8G13M00AB

TSB Revision

REAR WINDOW DEFOGGER

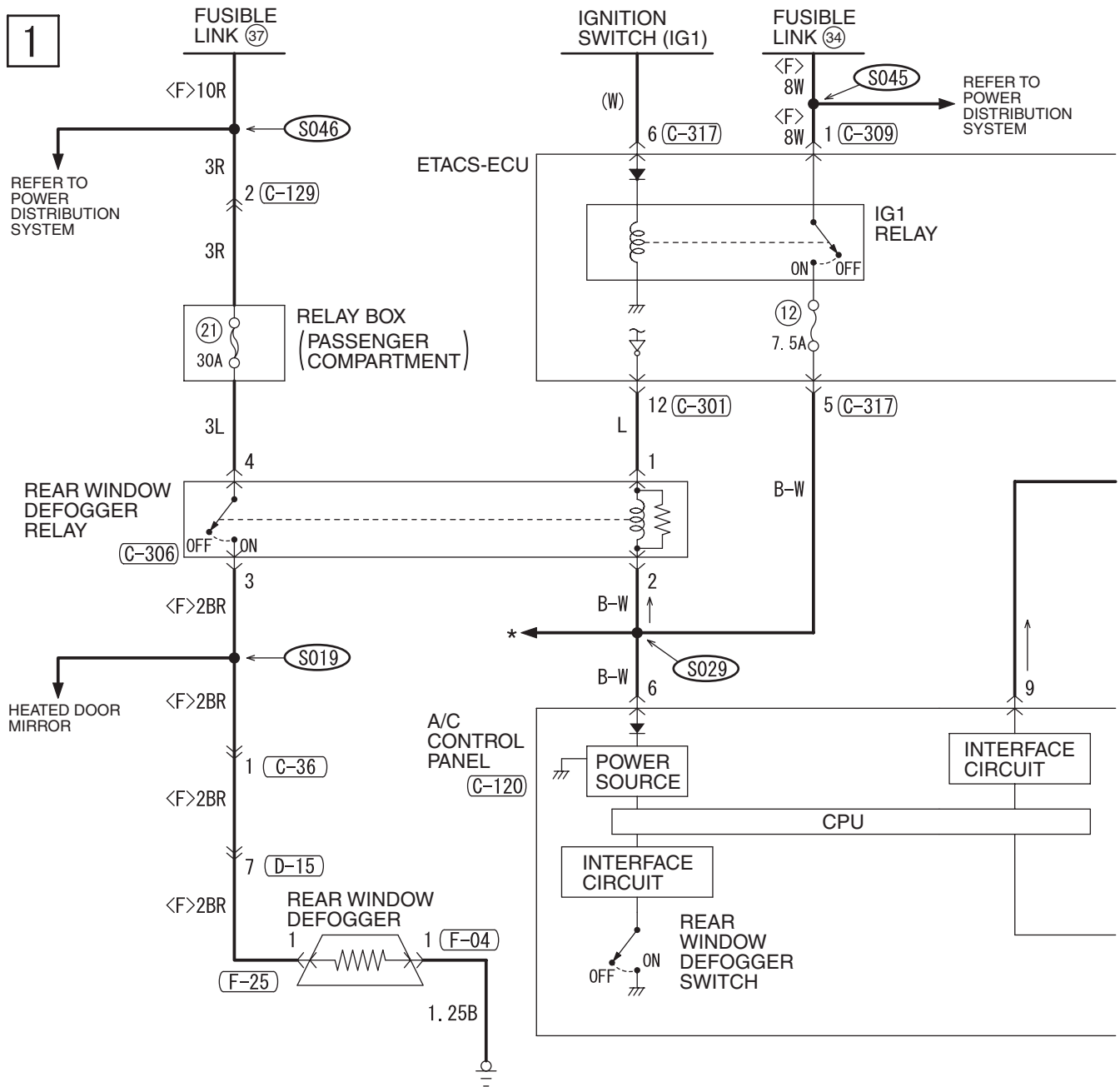

C-06



C-20

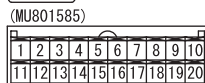

C-36

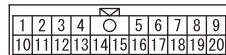

C-120

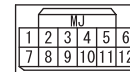

C-129



C-301



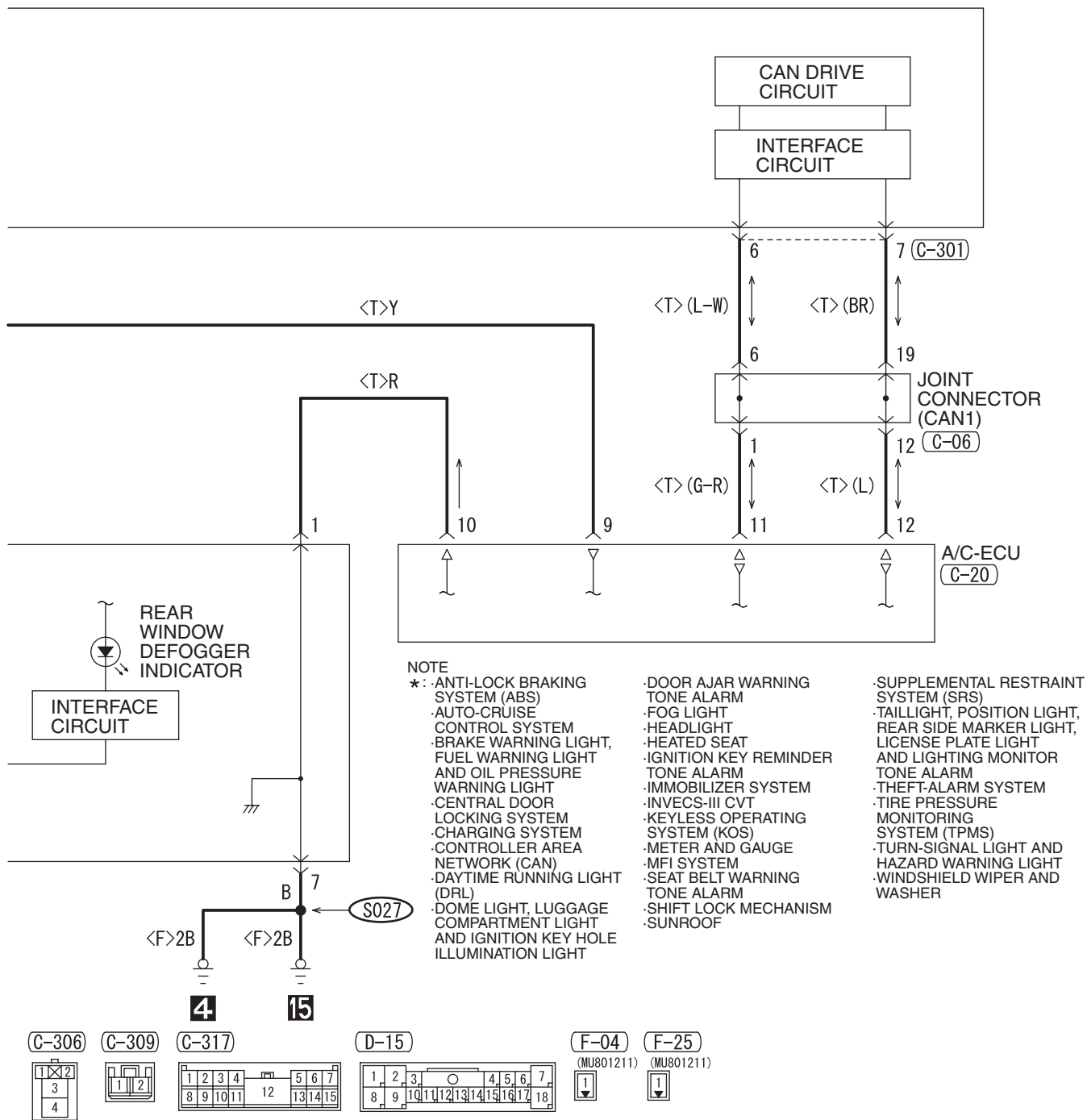

REAR WINDOW DEFOGGER (CONTINUED)

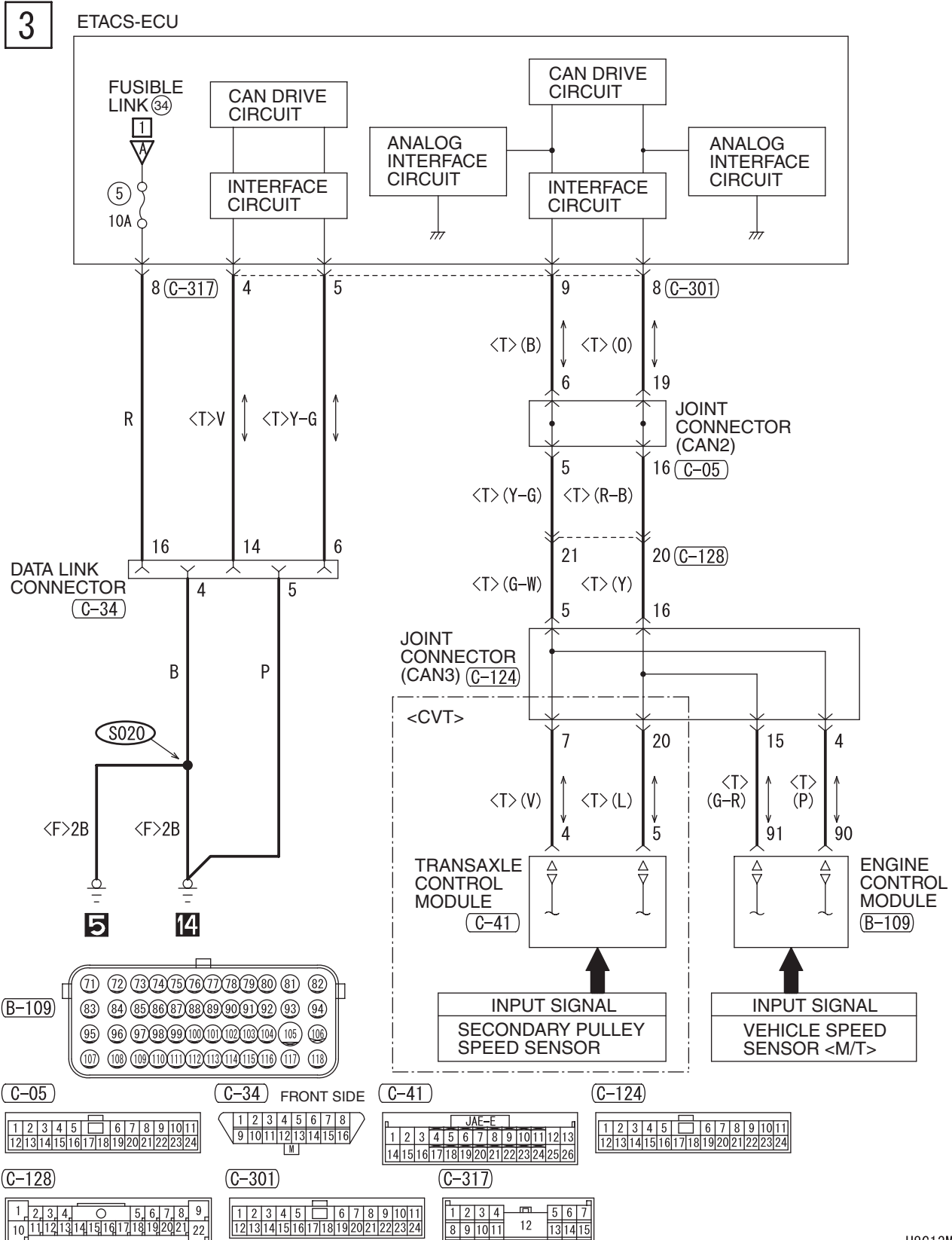

NOTES

HEATED DOOR MIRROR

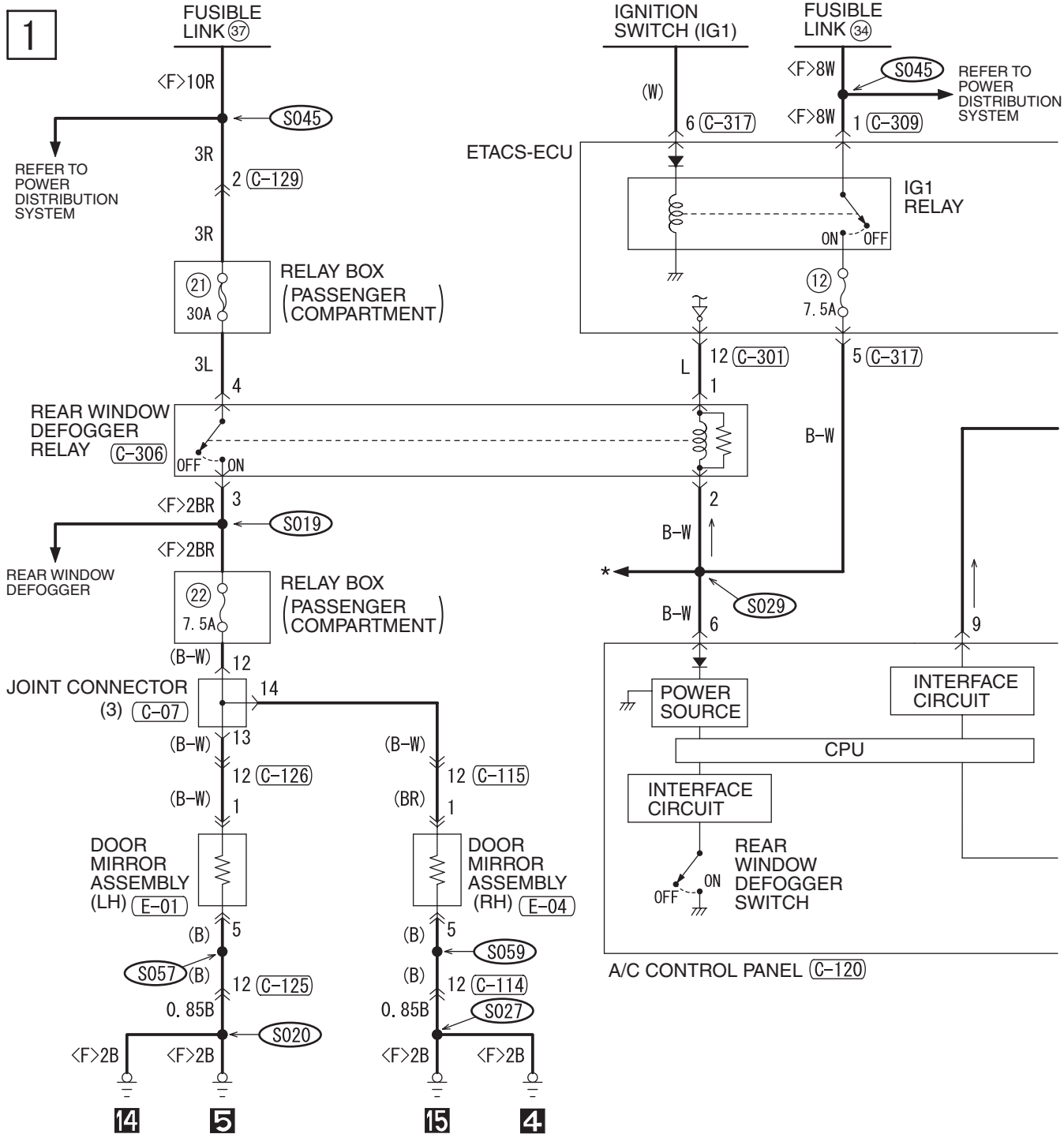

C-06

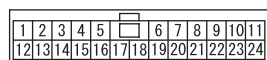

C-07

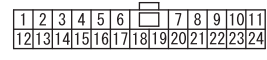

C-20

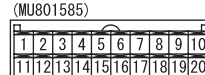

C-114

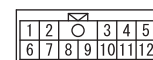

C-115

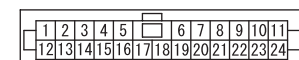

C-317

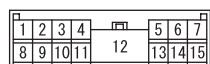

E-01



E-04

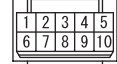

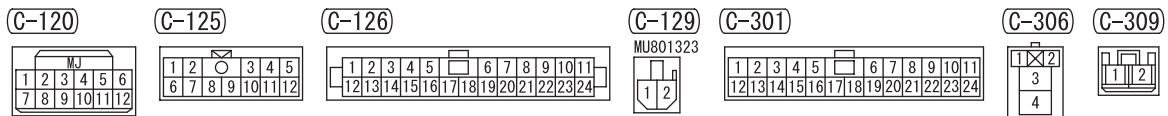
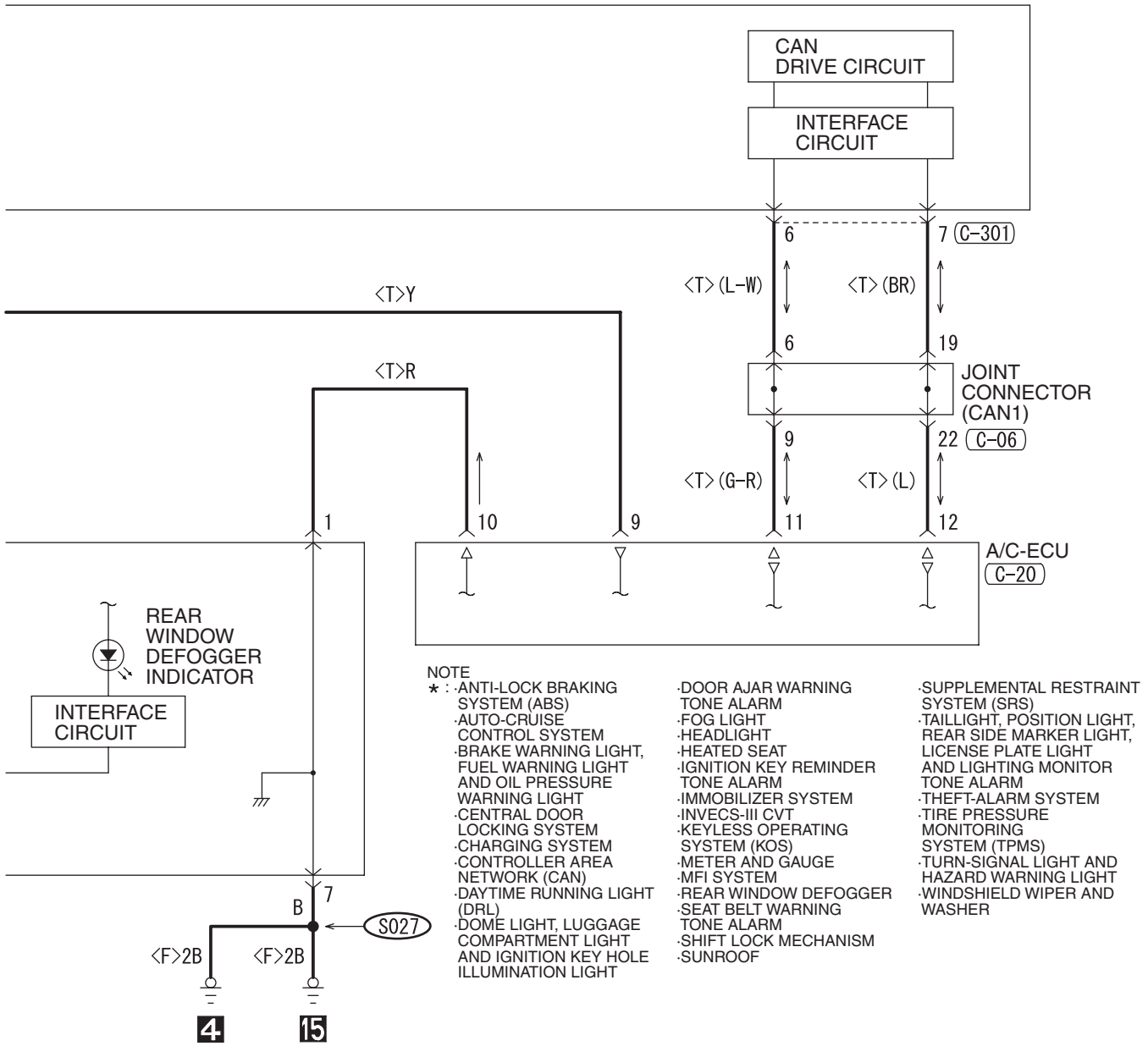

WIRE COLOR CODE
 B : BLACK LG : LIGHT GREEN G : GREEN L : BLUE W : WHITE Y : YELLOW SB : SKY BLUE
 BR : BROWN O : ORANGE GR : GRAY R : RED P : PINK V : VIOLET PU : PURPLE

H8G13M02AB

REMOTE CONTROLLED DOOR MIRROR

M1901006502137

1

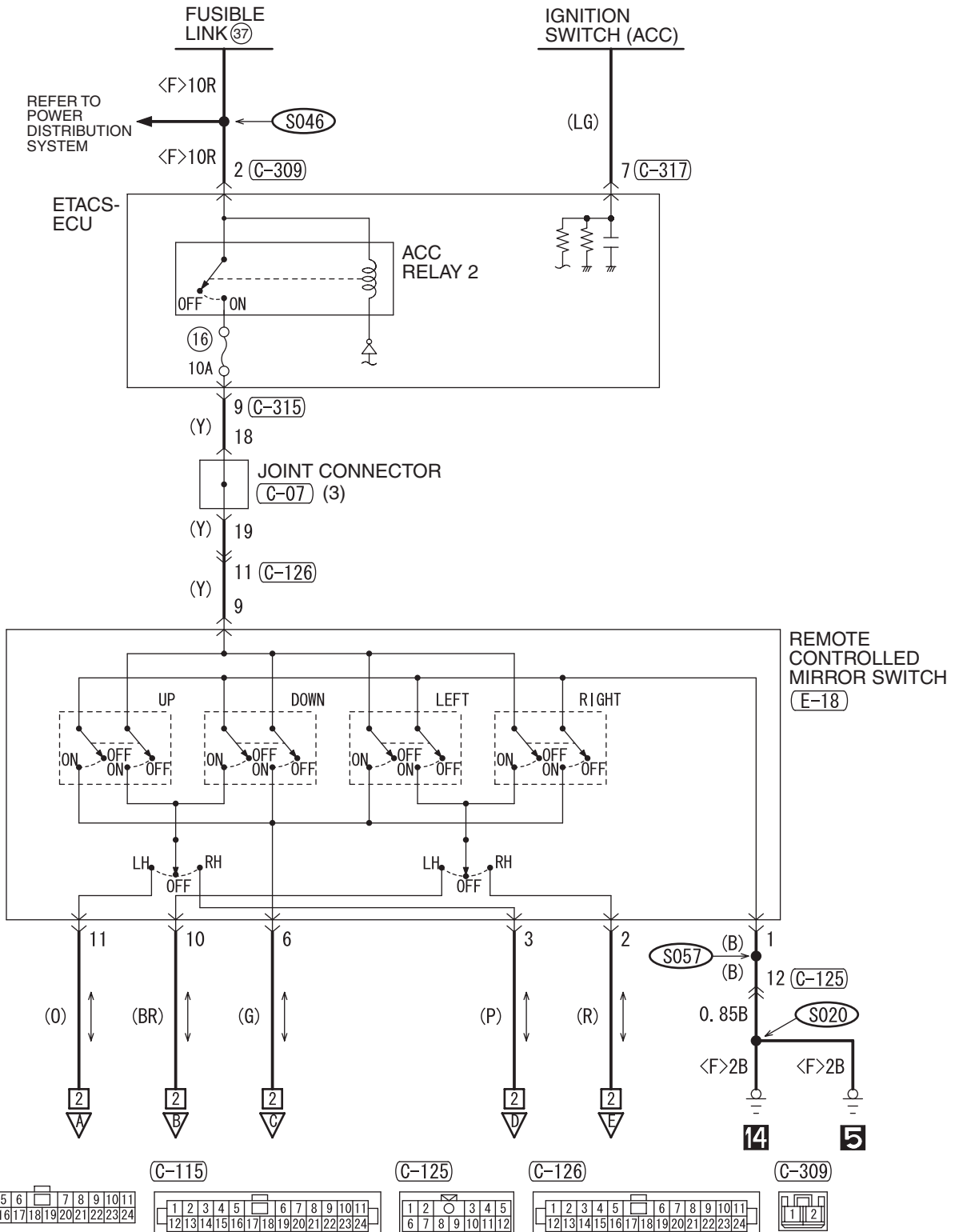

2

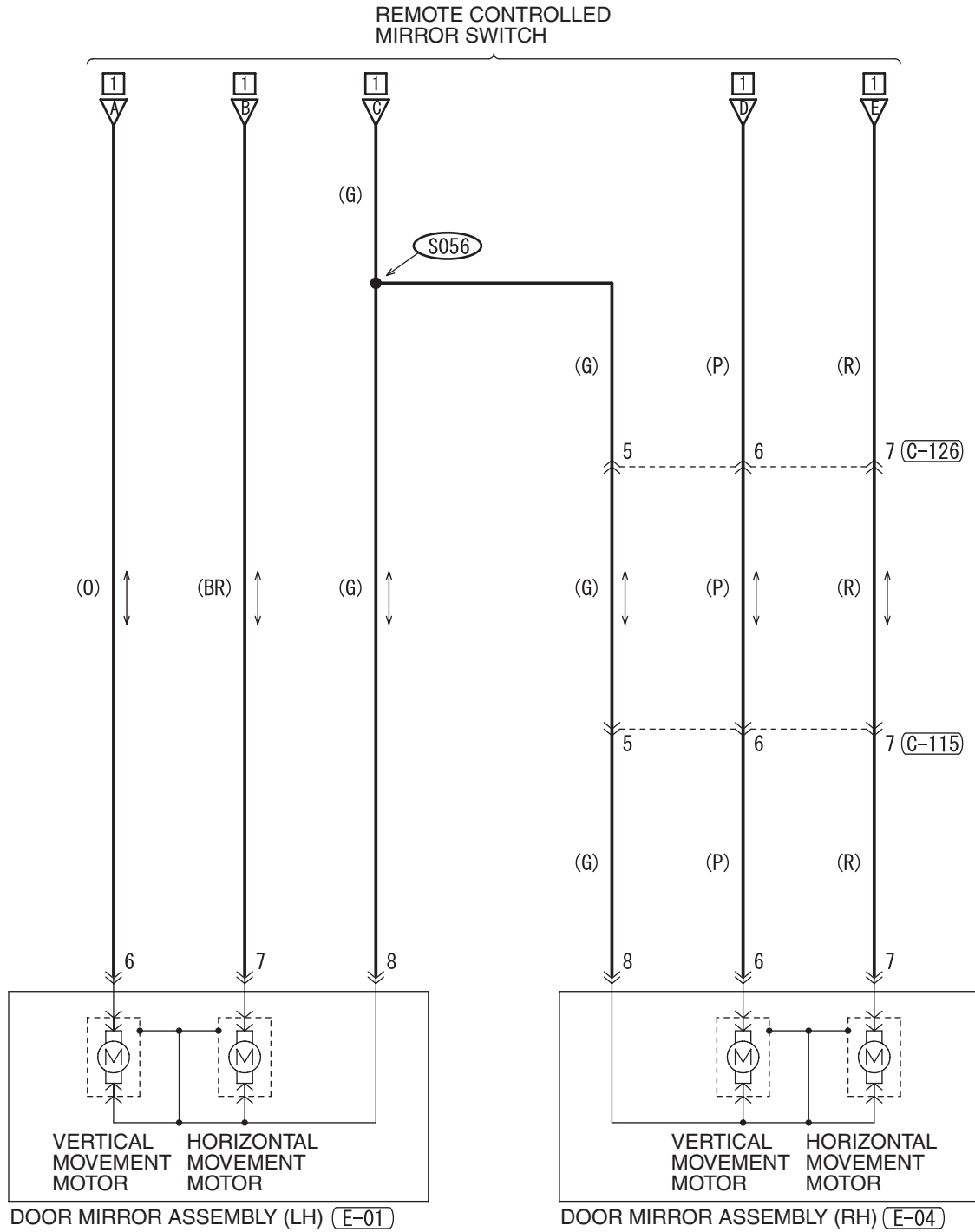

(C-315)
MU801890

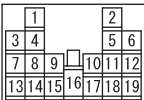

(C-317)

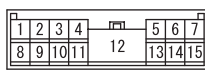

(E-01)

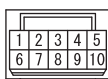

(E-04)

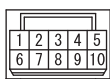

(E-18)



MU801847

WIRE COLOR CODE

B: BLACK LG: LIGHT GREEN G: GREEN L: BLUE W: WHITE Y: YELLOW SB: SKY BLUE
BR: BROWN O: ORANGE GR: GRAY R: RED P: PINK V: VIOLET PU: PURPLE

H8G13M03AB

TSB Revision

AUDIO SYSTEM <VEHICLES WITHOUT AUDIO AMPLIFIER>

M1901015602949

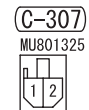
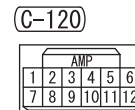
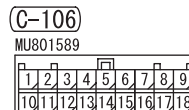
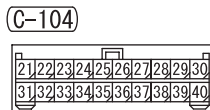
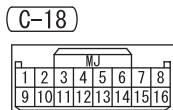
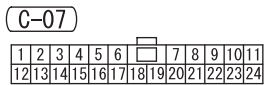
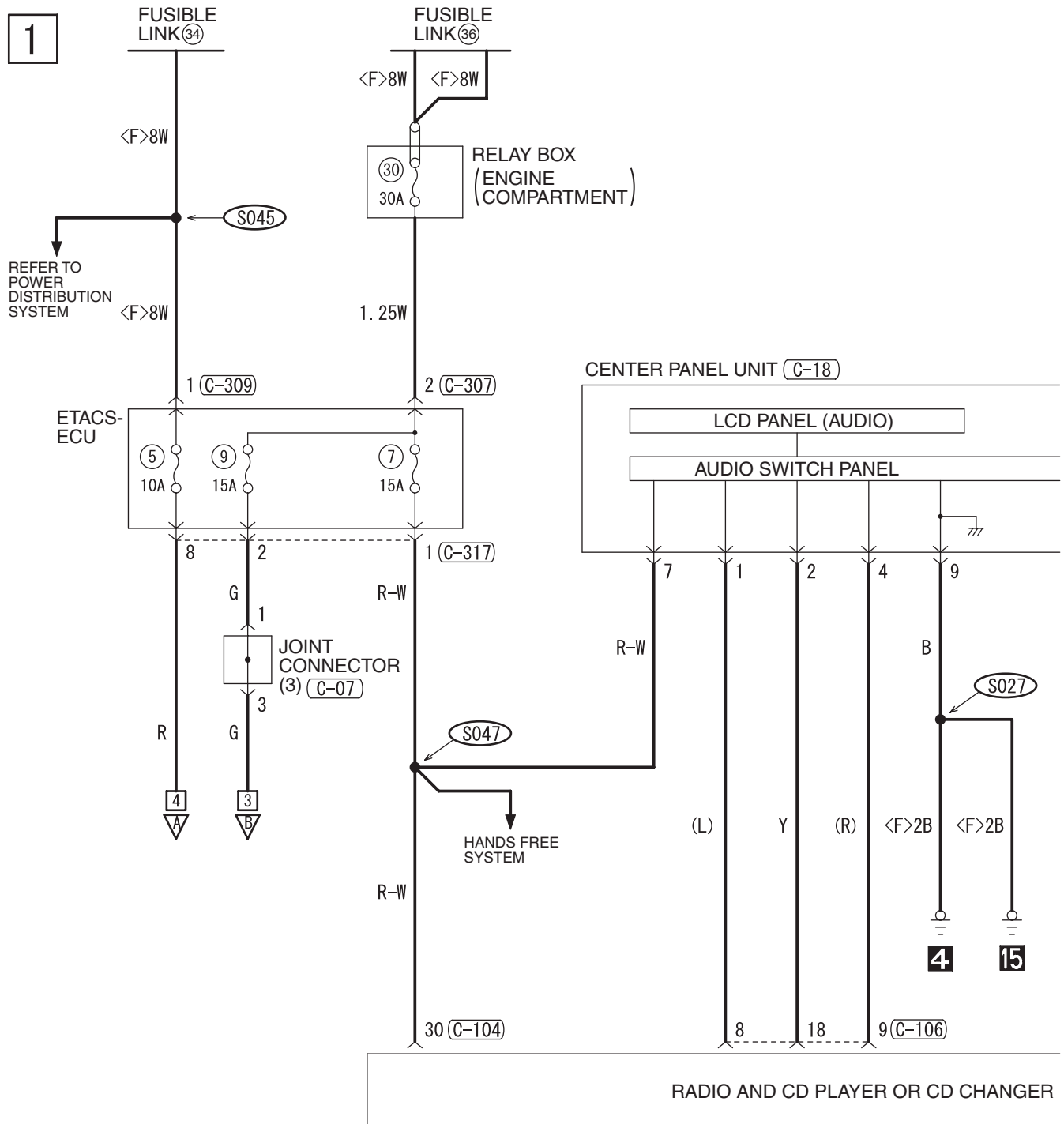

2

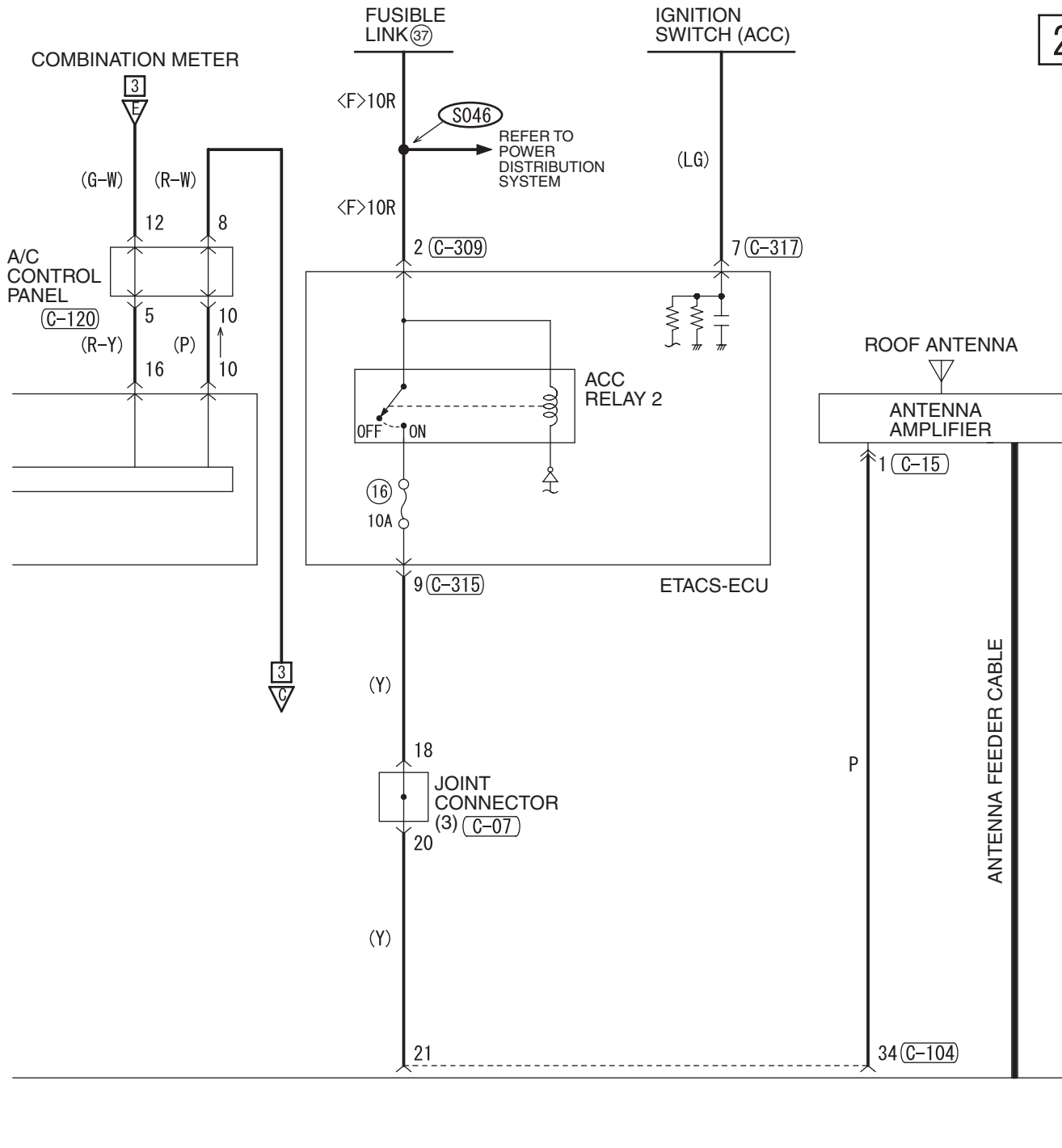

(C-315)
MU801890

1	2
3	4
5	6
7	8
9	10
11	12
13	14
15	16
17	18
19	

(C-317)

1	2	3	4	5	6	7
8	9	10	11	12	13	14
15						

WIRE COLOR CODE

B: BLACK LG: LIGHT GREEN G: GREEN L: BLUE W: WHITE Y: YELLOW SB: SKY BLUE
BR: BROWN O: ORANGE GR: GRAY R: RED P: PINK V: VIOLET PU: PURPLE

H8G14M00AB

AUDIO SYSTEM <VEHICLES WITHOUT AUDIO AMPLIFIER> (CONTINUED)

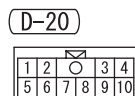
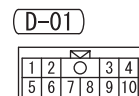
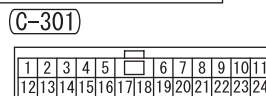
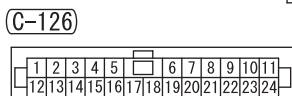
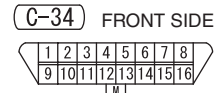
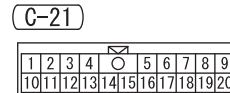
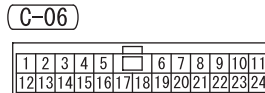
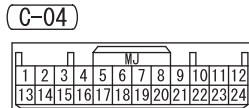
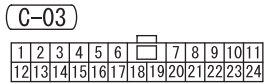
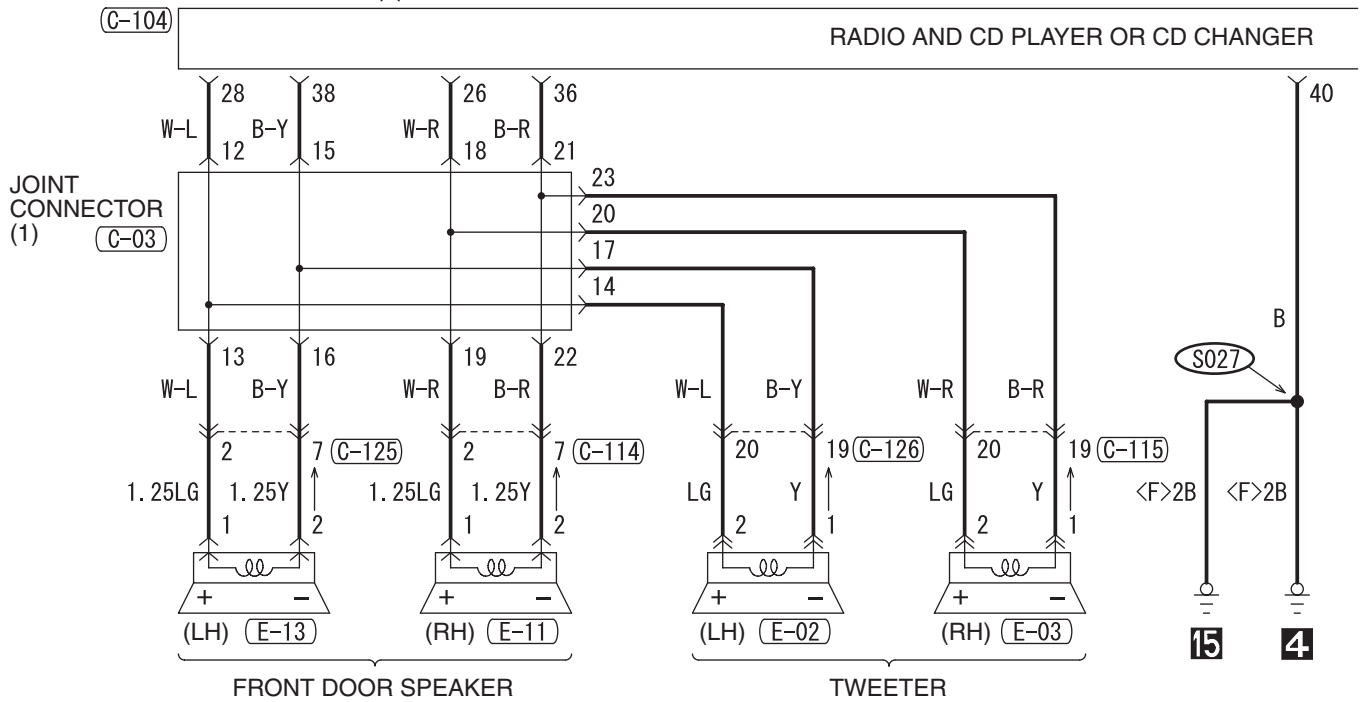
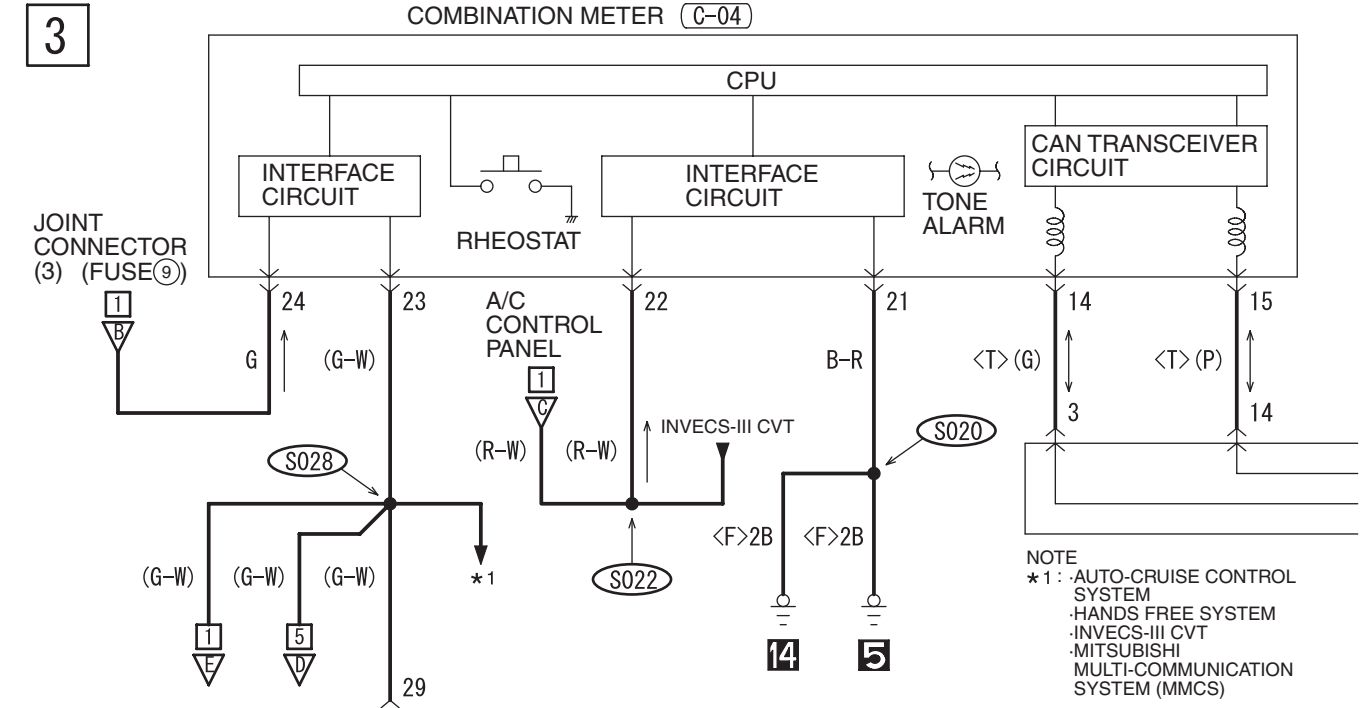

H8G14M00BA

4

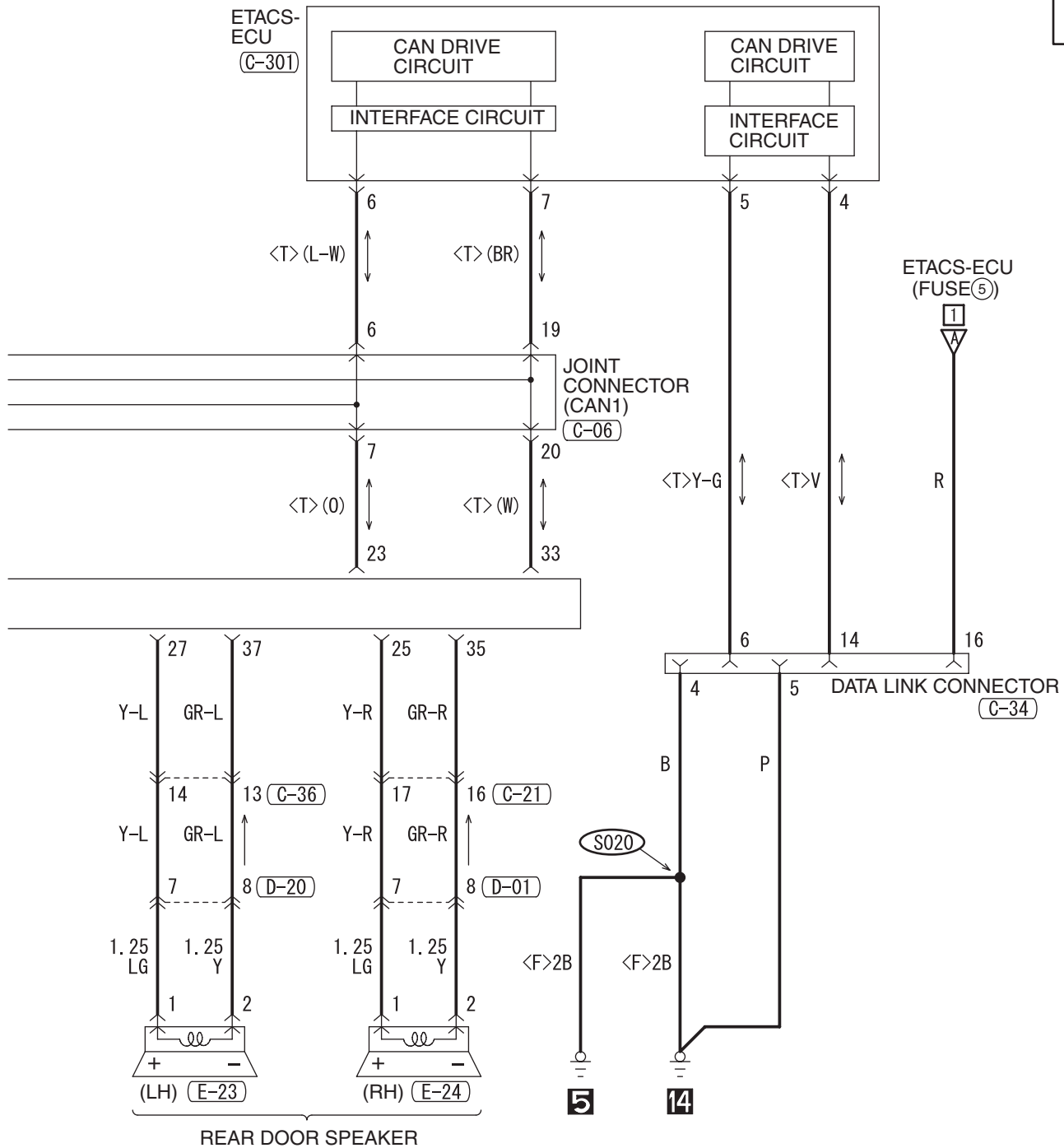

C-36

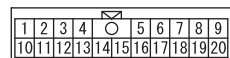

C-104

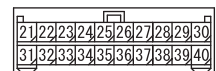

C-114

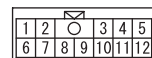

C-115

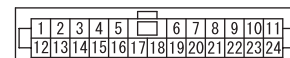

C-125

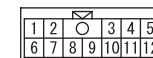

E-13



E-23



E-24



WIRE COLOR CODE
 B : BLACK LG : LIGHT GREEN G : GREEN L : BLUE
 BR : BROWN O : ORANGE GR : GRAY R : RED W : WHITE
 SB : SKY BLUE P : PINK Y : YELLOW V : VIOLET P : PURPLE

H8G14M00BB

TSB Revision

AUDIO SYSTEM <VEHICLES WITHOUT AUDIO AMPLIFIER> (CONTINUED)

5

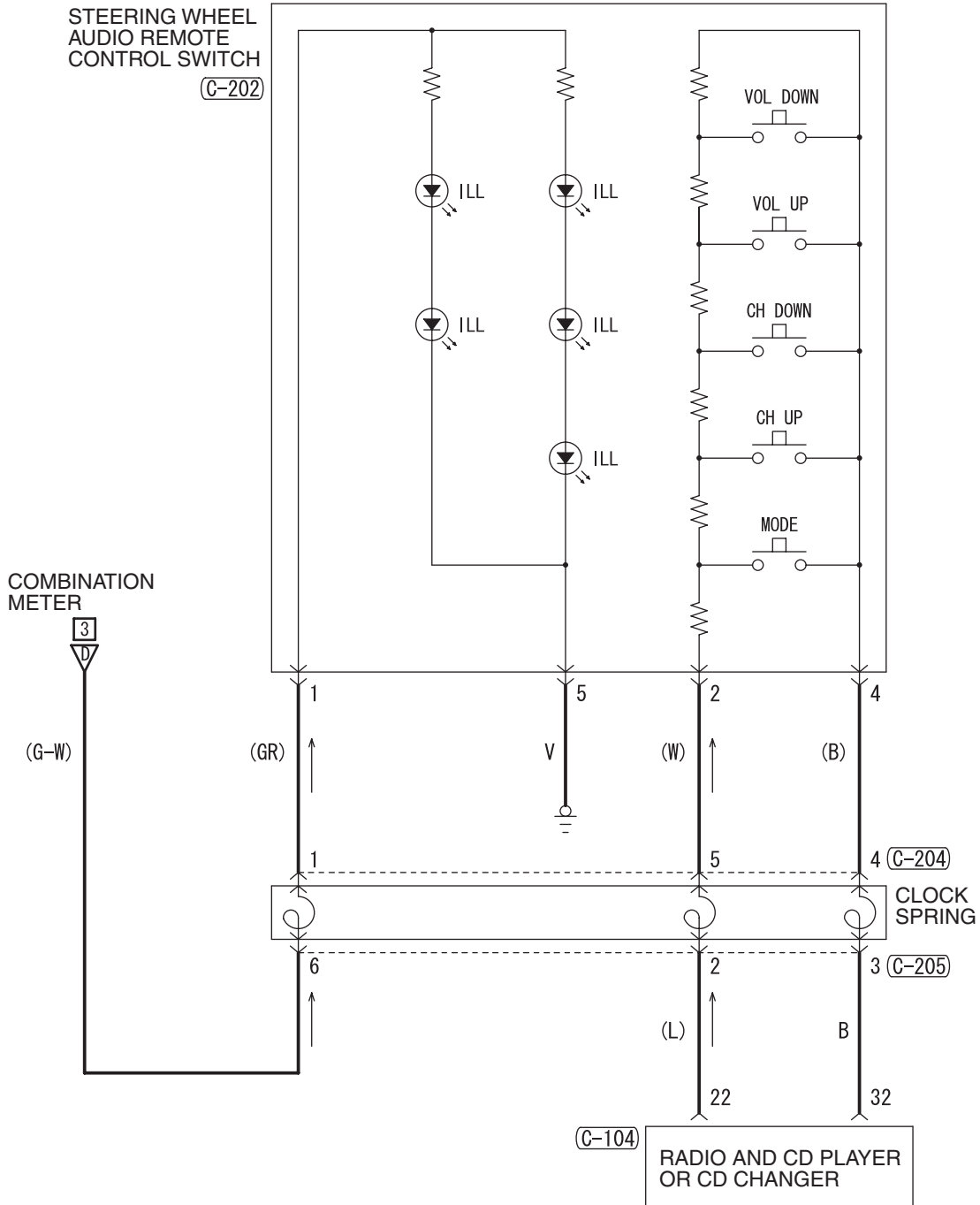

(C-104)

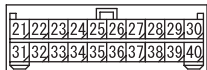

(C-202)

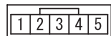

(C-204)

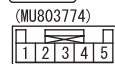

(C-205)

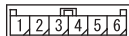

WIRE COLOR CODE

B : BLACK LG : LIGHT GREEN G : GREEN L : BLUE W : WHITE Y : YELLOW SB : SKY BLUE
BR : BROWN O : ORANGE GR : GRAY R : RED P : PINK V : VIOLET PU : PURPLE

H8G14M00CA

NOTES

AUDIO SYSTEM <VEHICLES WITH AUDIO AMPLIFIER>

M1901015602950

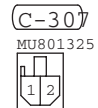
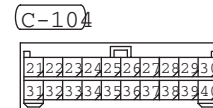
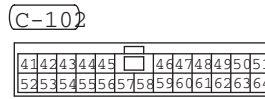
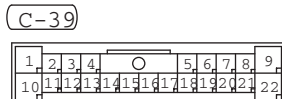
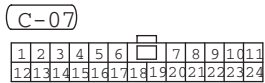
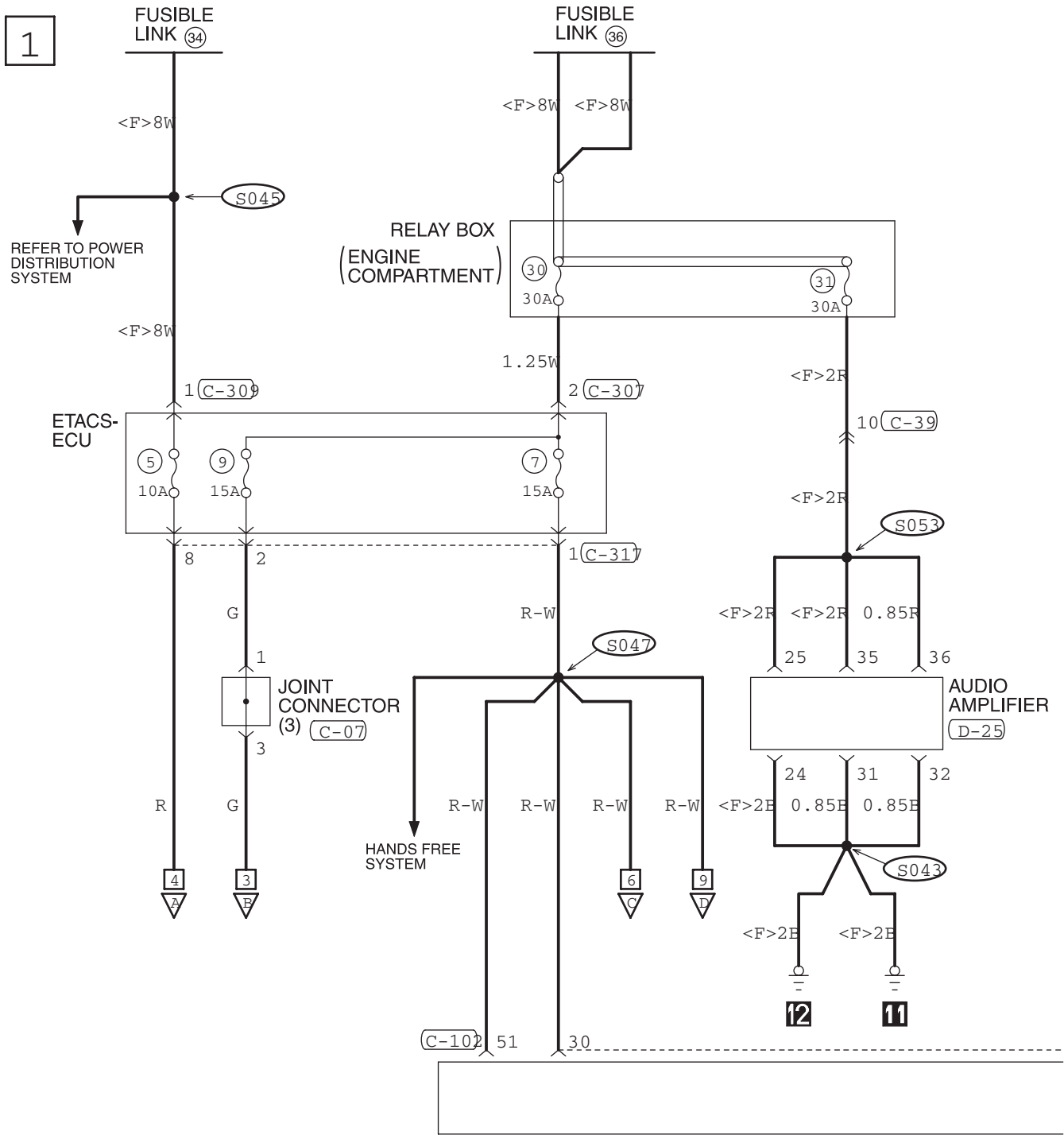

2

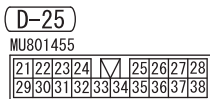
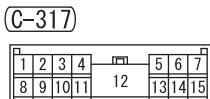
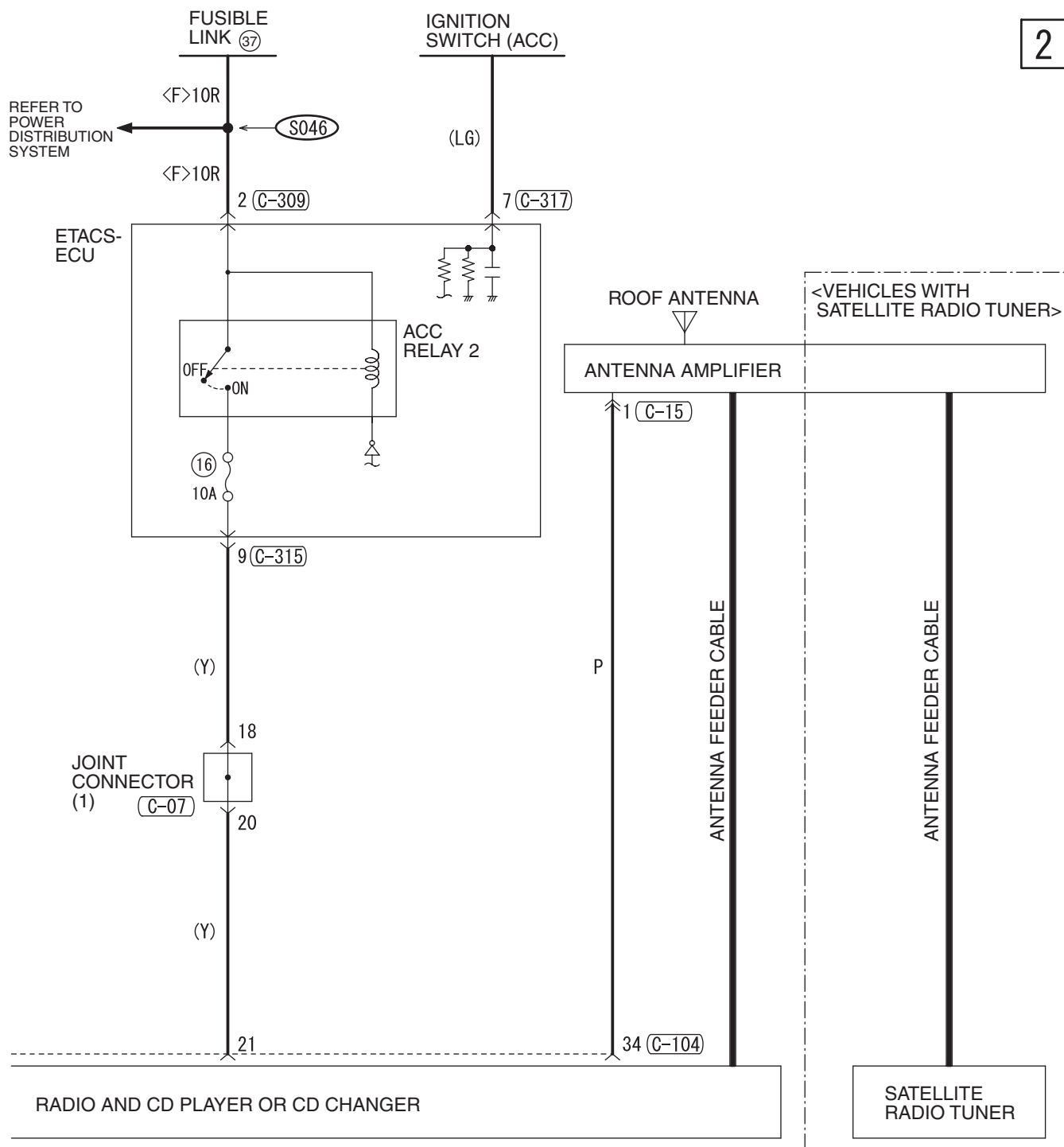

WIRE COLOR CODE

B: BLACK LG: LIGHT GREEN G: GREEN L: BLUE W: WHITE Y: YELLOW SB: SKY BLUE
BR: BROWN O: ORANGE GR: GRAY R: RED P: PINK V: VIOLET PU: PURPLE

H8G14M01AB

AUDIO SYSTEM <VEHICLES WITH AUDIO AMPLIFIER> (CONTINUED)

3

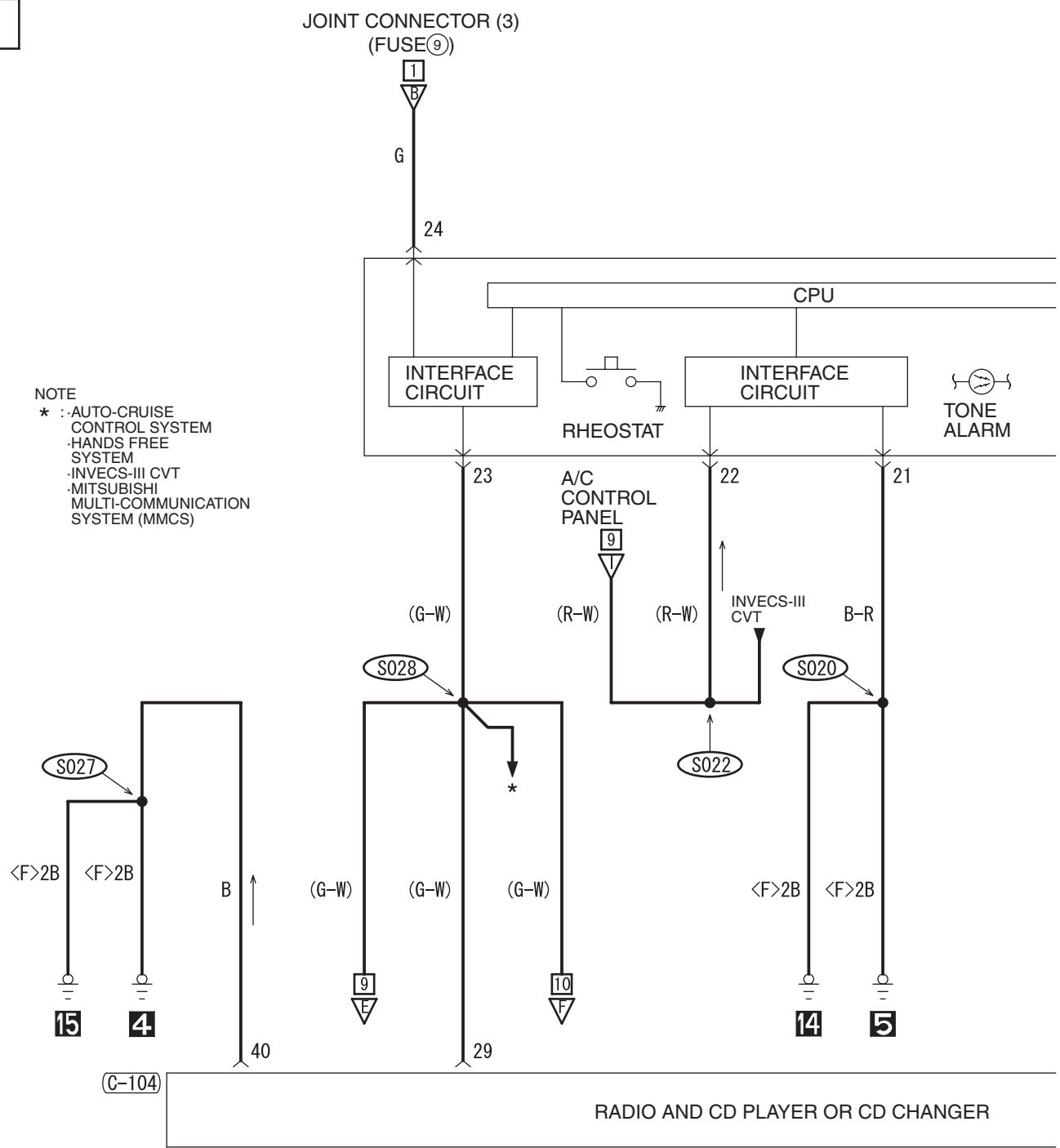

NOTE
* : -AUTO-CRUISE CONTROL SYSTEM
-HANDS FREE SYSTEM
-INVECS-III CVT
-MITSUBISHI MULTI-COMMUNICATION SYSTEM (MMCS)

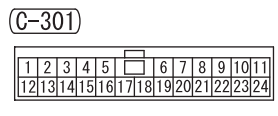
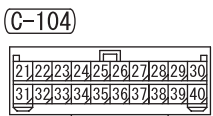
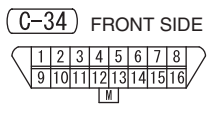
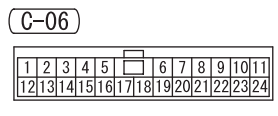
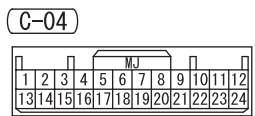

4

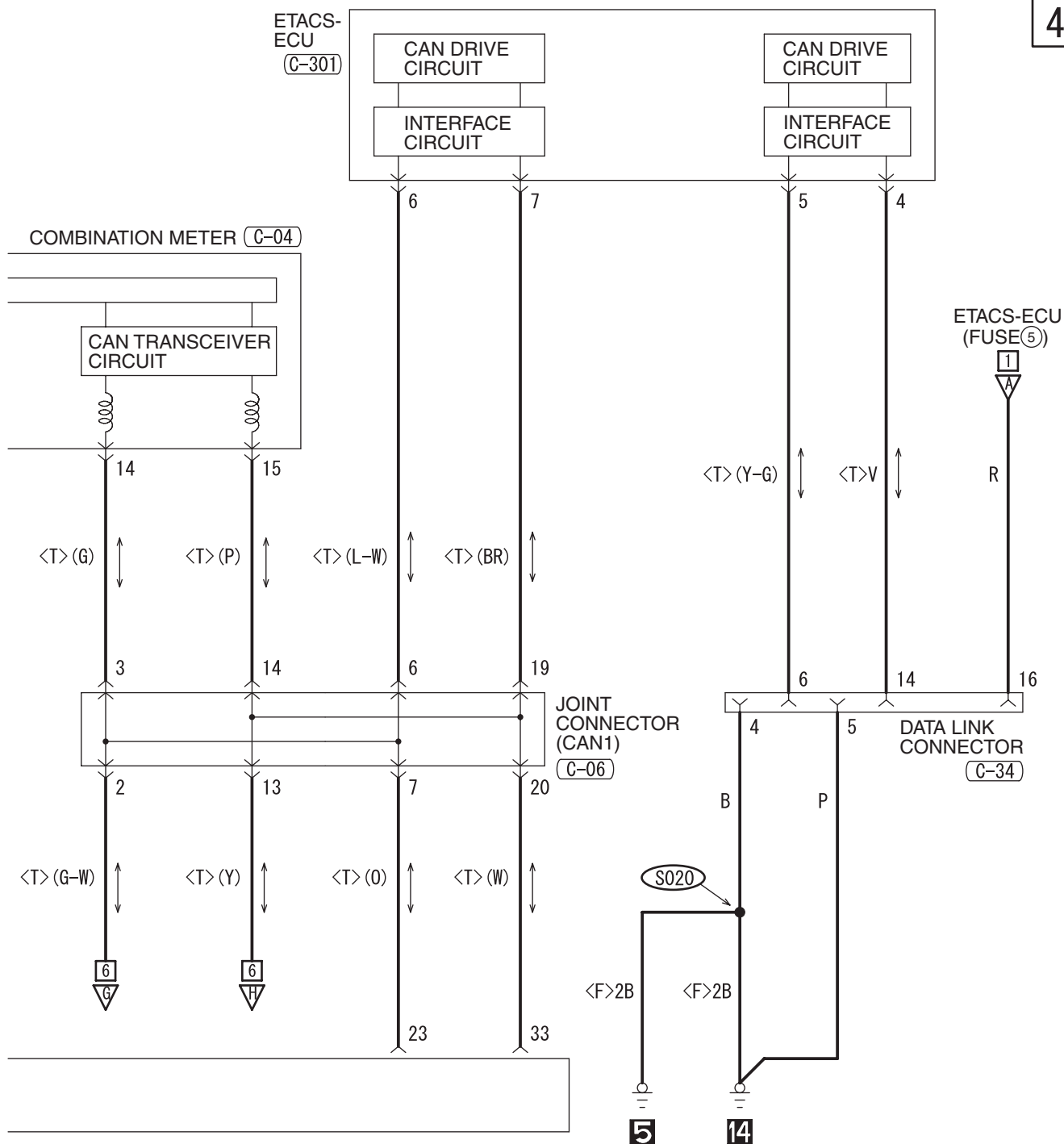

WIRE COLOR CODE

B: BLACK LG: LIGHT GREEN G: GREEN L: BLUE W: WHITE Y: YELLOW SB: SKY BLUE
BR: BROWN O: ORANGE GR: GRAY R: RED P: PINK V: VIOLET PU: PURPLE

H8G14M01BB

TSB Revision

AUDIO SYSTEM <VEHICLES WITH AUDIO AMPLIFIER> (CONTINUED)

5

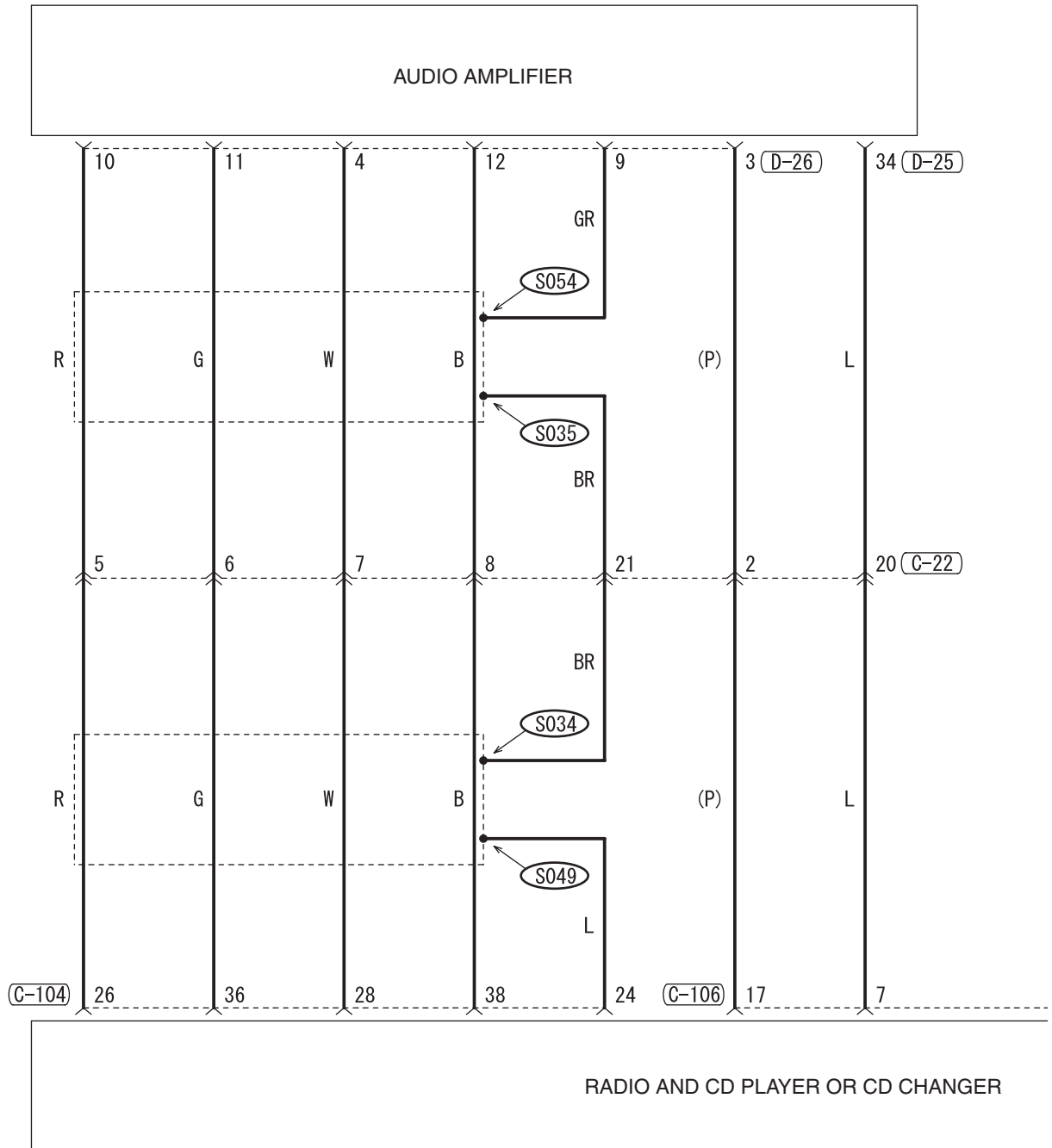

C-17

MU801586

1	2	3	4	5	6	7
8	9	10	11	12	13	14

C-22

1	2	3	4	5	6	7	8	9
10	11	12	13	14	15	16	17	18
19	20	21	22					

C-104

21	22	23	24	25	26	27	28	29	30
31	32	33	34	35	36	37	38	39	40

C-106

MU801589

1	2	3	4	5	6	7	8	9
10	11	12	13	14	15	16	17	18

D-25

MU801455

21	22	23	24	25	26	27	28
29	30	31	32	33	34	35	36
37	38						

D-26

MU801453

1	2	3	4	5	6
7	8	9	10	11	12
13	14				

6

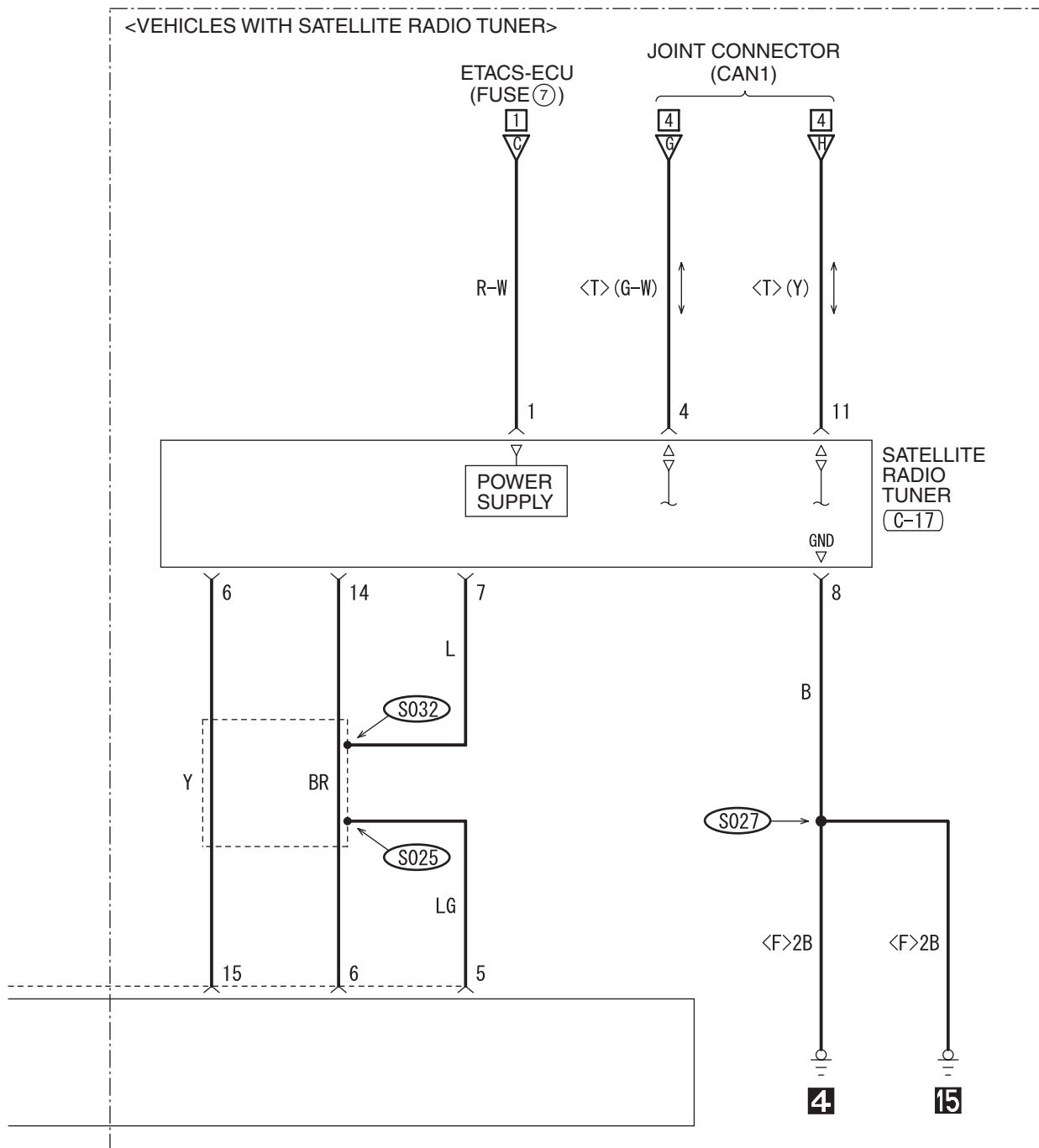

WIRE COLOR CODE

B: BLACK LG: LIGHT GREEN G: GREEN L: BLUE W: WHITE Y: YELLOW SB: SKY BLUE
BR: BROWN O: ORANGE GR: GRAY R: RED P: PINK V: VIOLET PU: PURPLE

H8G14M01CB

TSB Revision

AUDIO SYSTEM <VEHICLES WITH AUDIO AMPLIFIER> (CONTINUED)

7

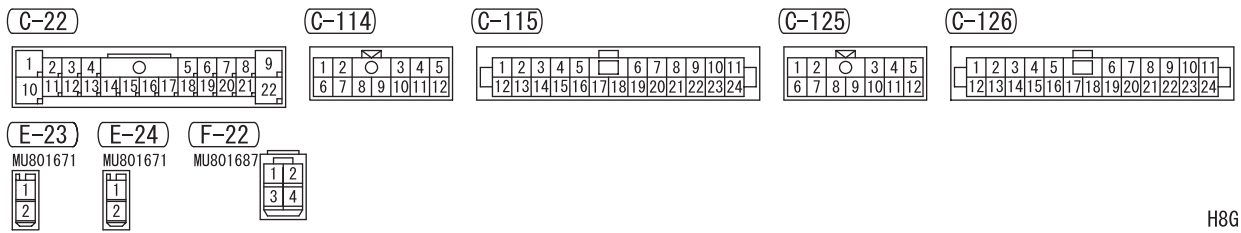
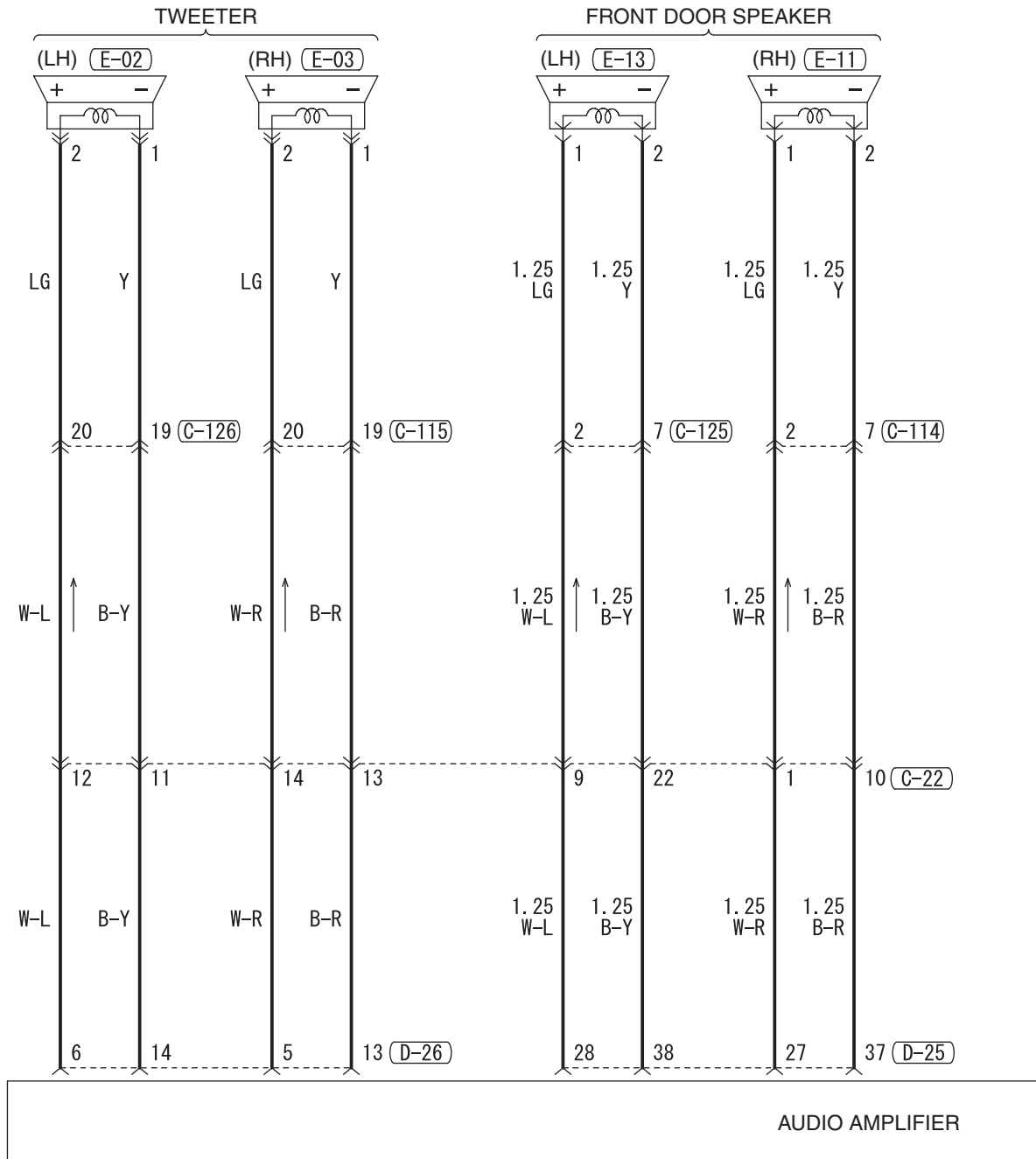

8

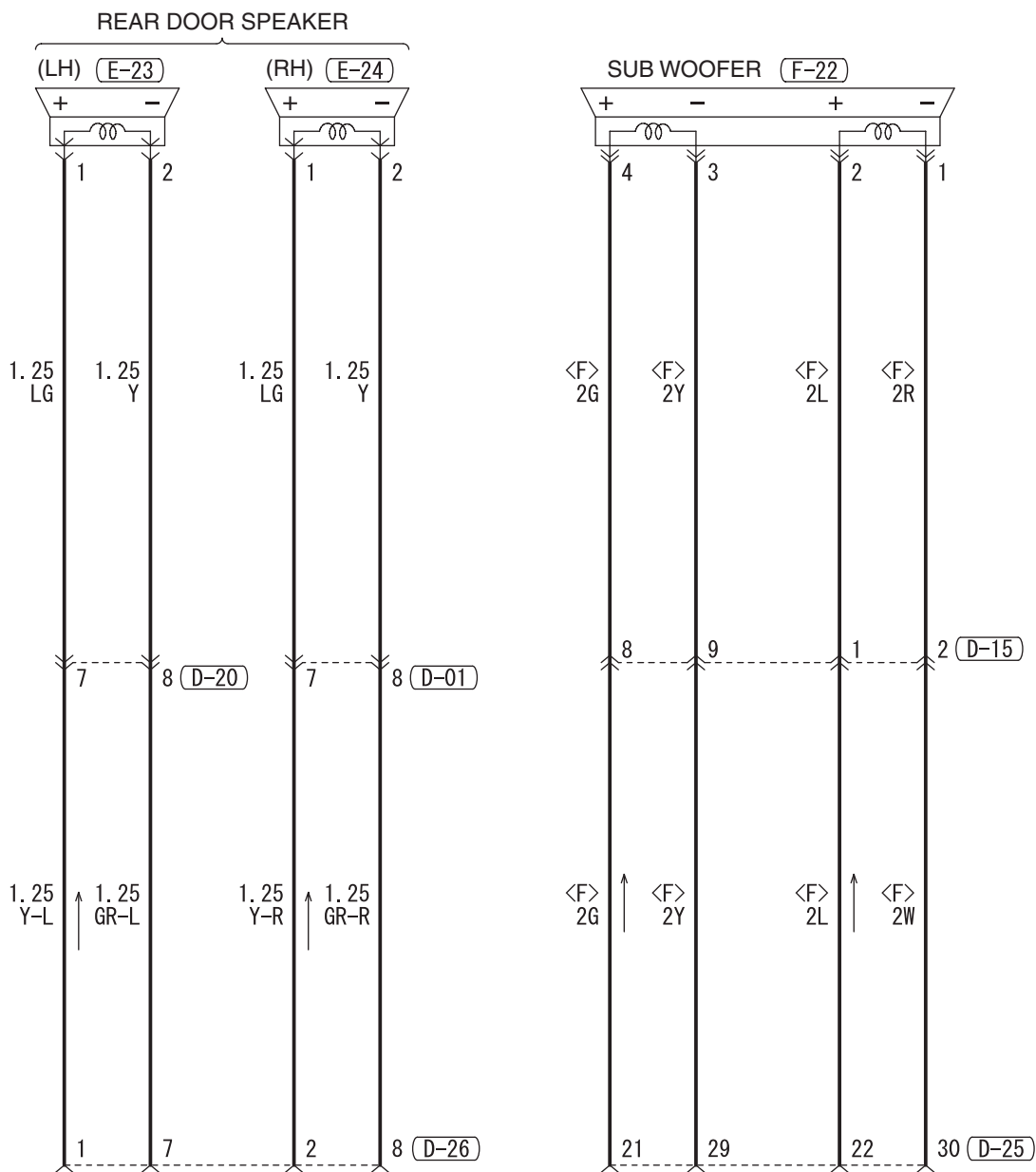

(D-01)

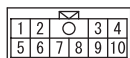

(D-15)

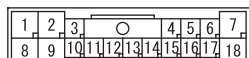

(D-20)

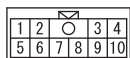

(D-25)

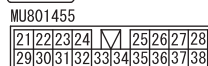

(D-26)

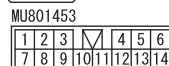

(E-02)



(E-03)



(E-11)



(E-13)



WIRE COLOR CODE

B: BLACK LG: LIGHT GREEN G: GREEN L: BLUE W: WHITE Y: YELLOW SB: SKY BLUE
BR: BROWN O: ORANGE GR: GRAY R: RED P: PINK V: VIOLET PU: PURPLE

H8G14M01DB

TSB Revision

AUDIO SYSTEM <VEHICLES WITH AUDIO AMPLIFIER> (CONTINUED)

9

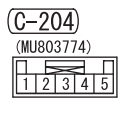
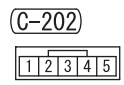
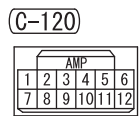
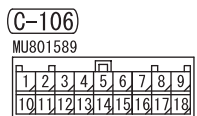
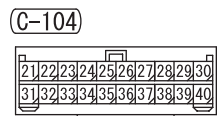
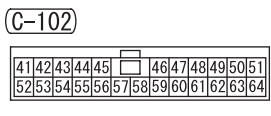
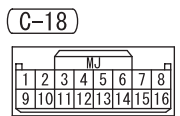
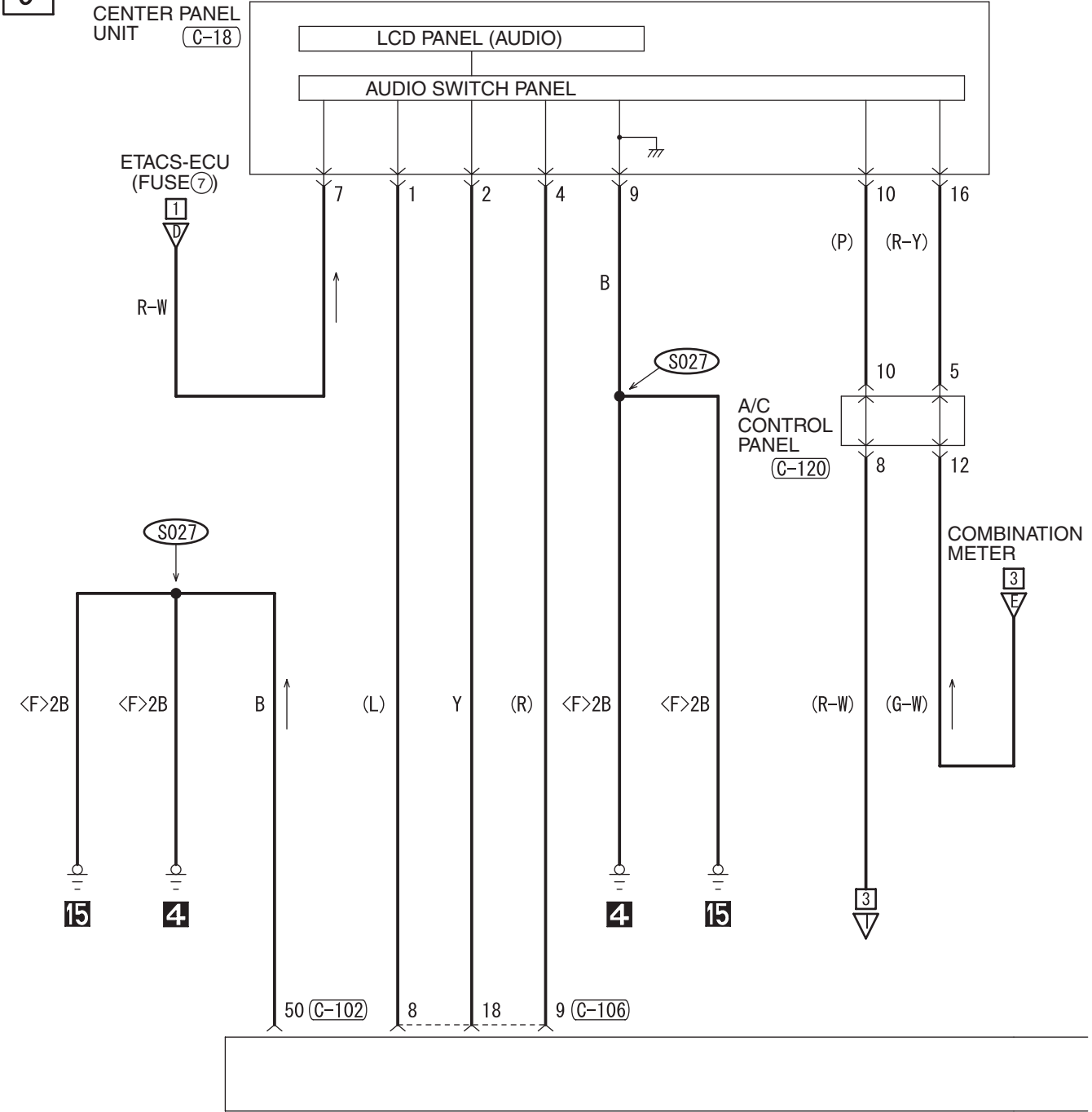

CLOCK

M1901007701669

1

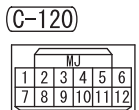
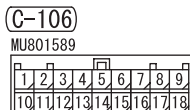
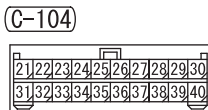
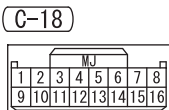
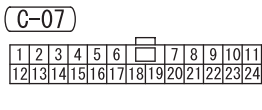
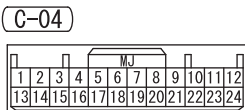
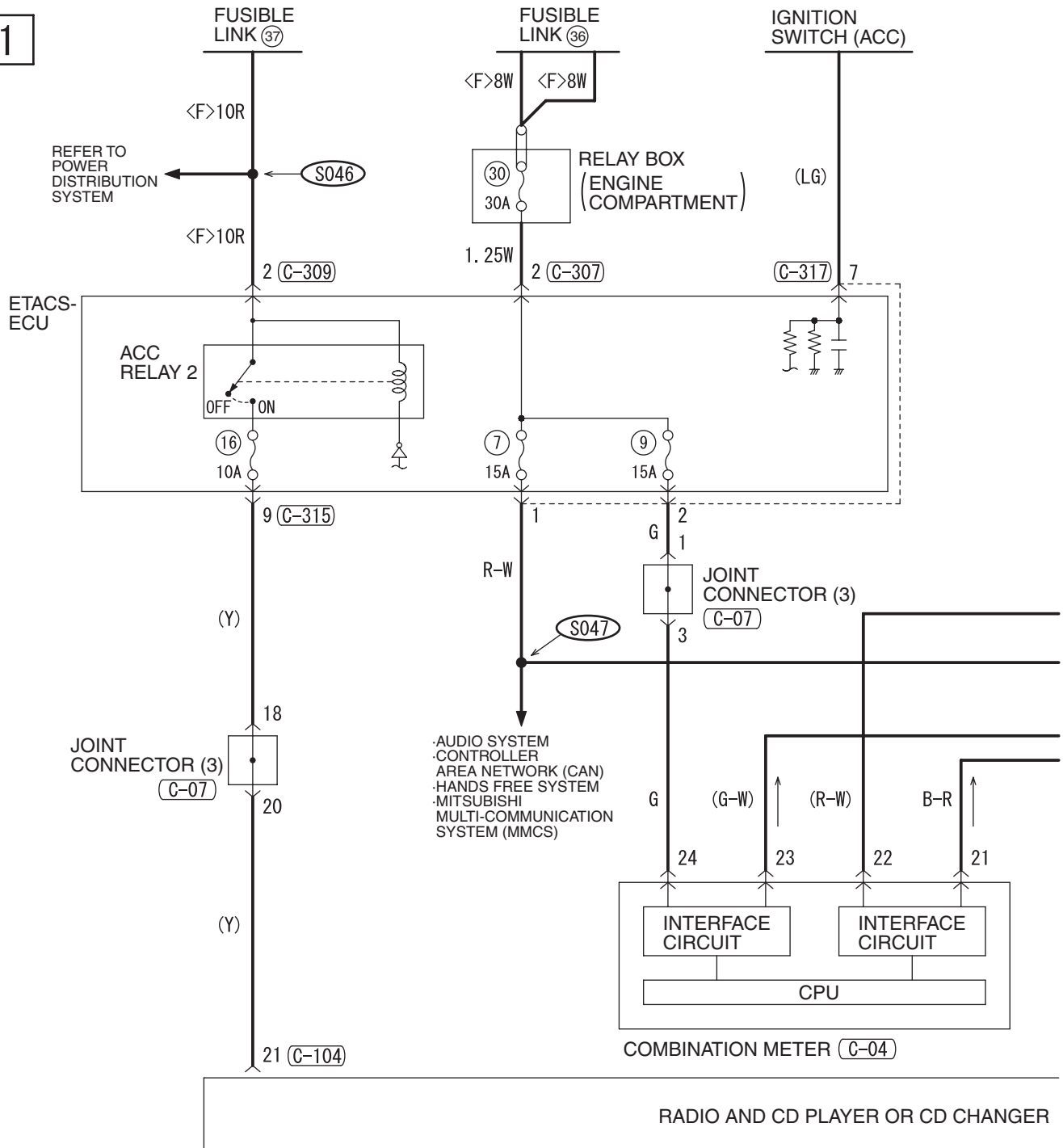

2

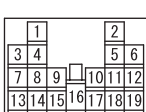
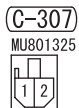
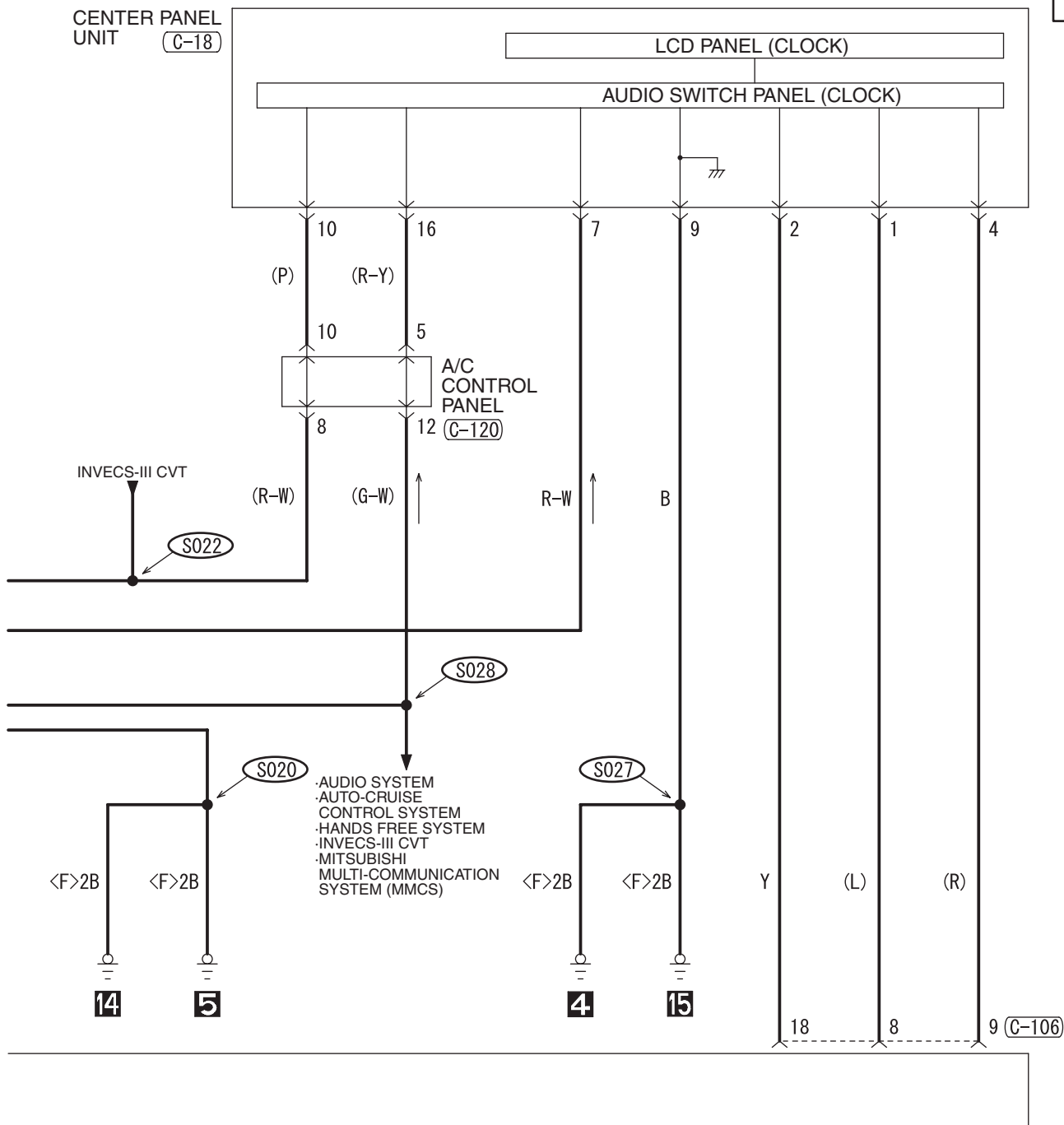

WIRE COLOR CODE
 B : BLACK LG : LIGHT GREEN G : GREEN L : BLUE W : WHITE Y : YELLOW SB : SKY BLUE
 BR : BROWN O : ORANGE GR : GRAY R : RED P : PINK V : VIOLET PU : PURPLE

H8G14M02AB

TSB Revision

MITSUBISHI MULTI COMMUNICATION SYSTEM (MMCS)

M1901007500123

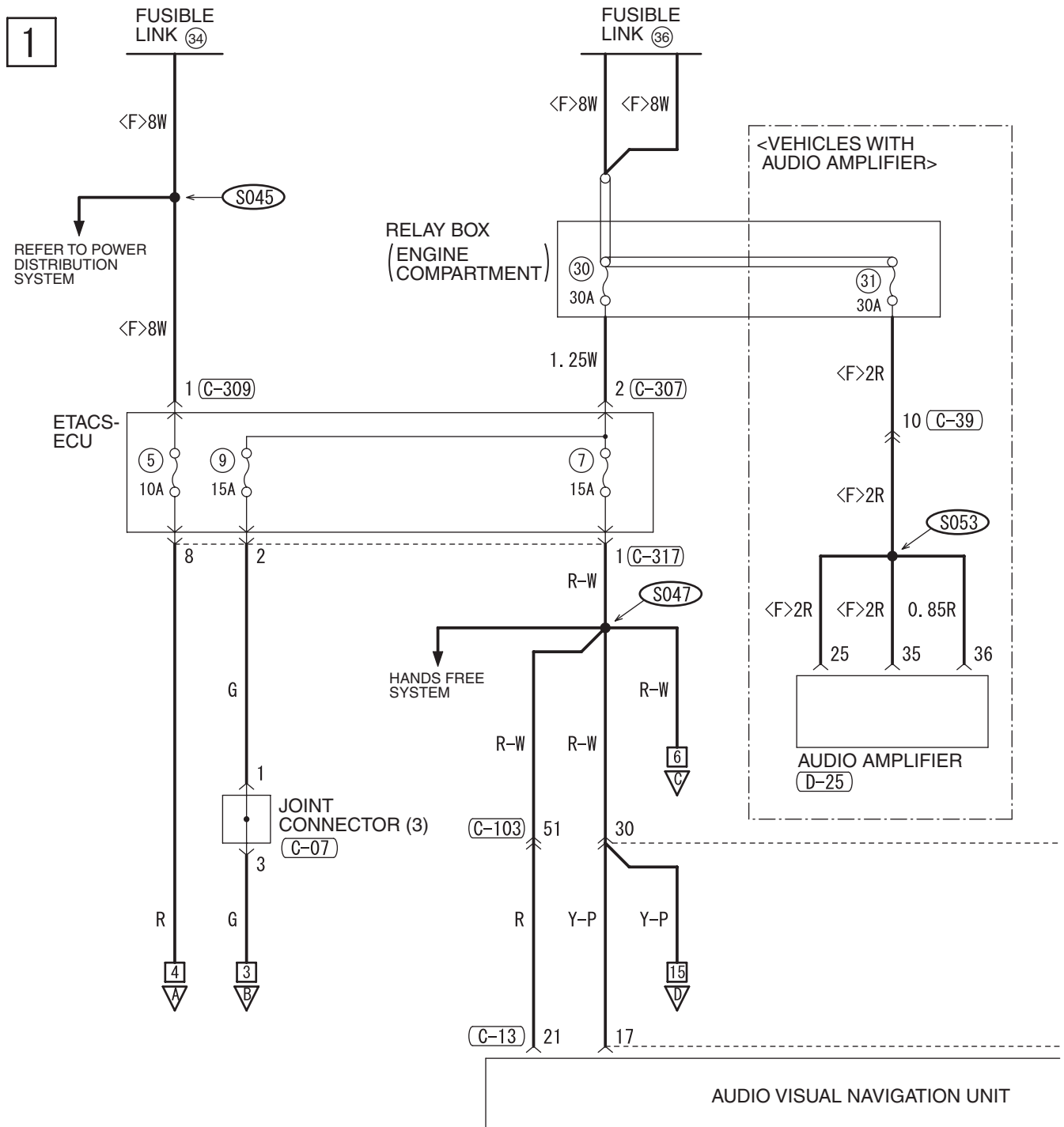

C-07

1	2	3	4	5	6	7	8	9	10	11		
12	13	14	15	16	17	18	19	20	21	22	23	24

C-11

81	82	83	84	85	86	87
----	----	----	----	----	----	----

C-13

21	22	23	24	25
----	----	----	----	----

C-14

1	2	3	4	5	6	7	8	9			
X	10	11	12	X	13	14	X	15	16	17	X

C-15

1	2
---	---

C-39

1	2	3	4	5	6	7	8	9				
10	11	12	13	14	15	16	17	18	19	20	21	22

D-25

MU801455

21	22	23	24	25	26	27	28		
29	30	31	32	33	34	35	36	37	38

H8G14M04AA

2

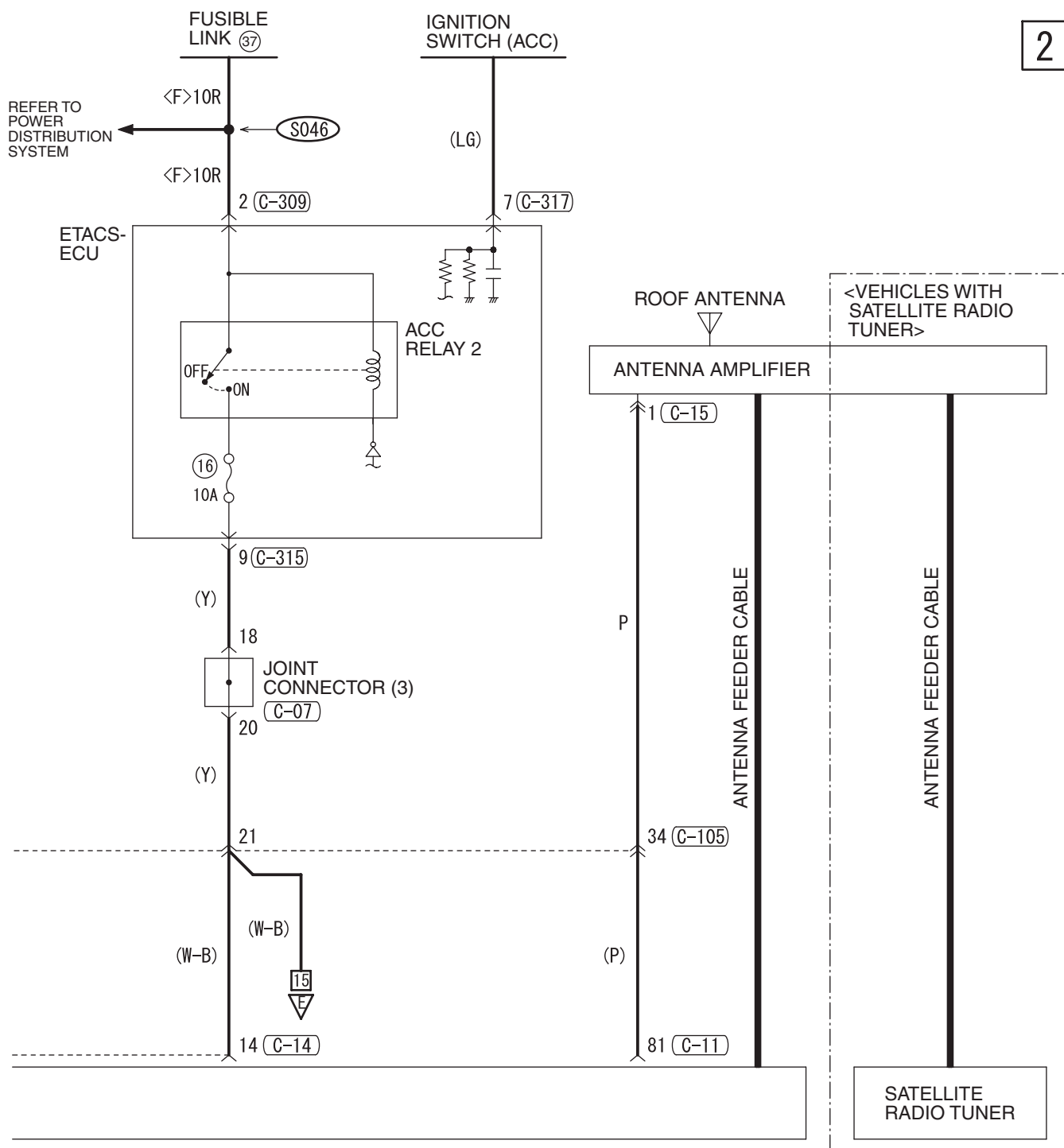

C-103

41	42	43	44	45	46	47	48	49	50	51		
52	53	54	55	56	57	58	59	60	61	62	63	64

C-105

21	22	23	24	25	26	27	28	29	30
31	32	33	34	35	36	37	38	39	40

C-307

1	2
---	---

C-309

1	2
---	---

C-315

1	2					
3	4	5	6			
7	8	9	10	11	12	
13	14	15	16	17	18	19

C-317

1	2	3	4	5	6	7	
8	9	10	11	12	13	14	15

WIRE COLOR CODE

B: BLACK LG: LIGHT GREEN G: GREEN L: BLUE W: WHITE Y: YELLOW SB: SKY BLUE
 BR: BROWN O: ORANGE GR: GRAY R: RED P: PINK V: VIOLET PU: PURPLE

H8G14M04AB

MITSUBISHI MULTI-COMMUNICATION SYSTEM (MMCS) (CONTINUED)

3

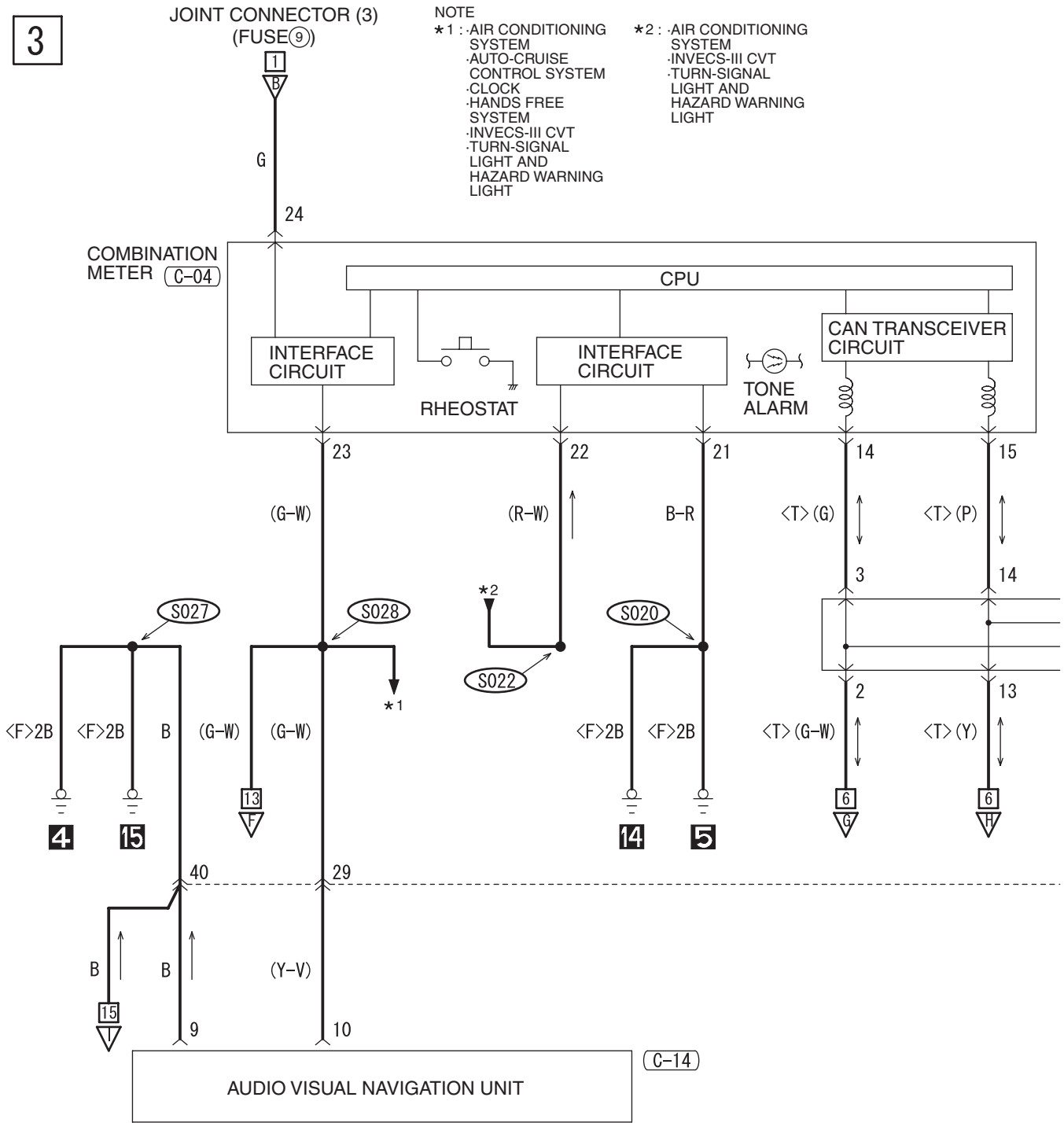

A-10

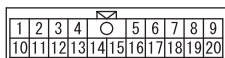

B-111



C-04

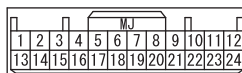

C-06

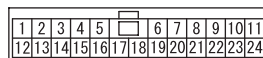

C-14

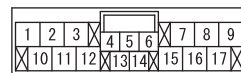

C-313



C-317

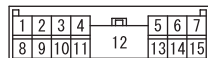

4

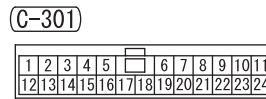
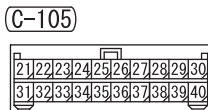
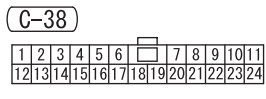
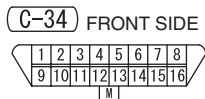
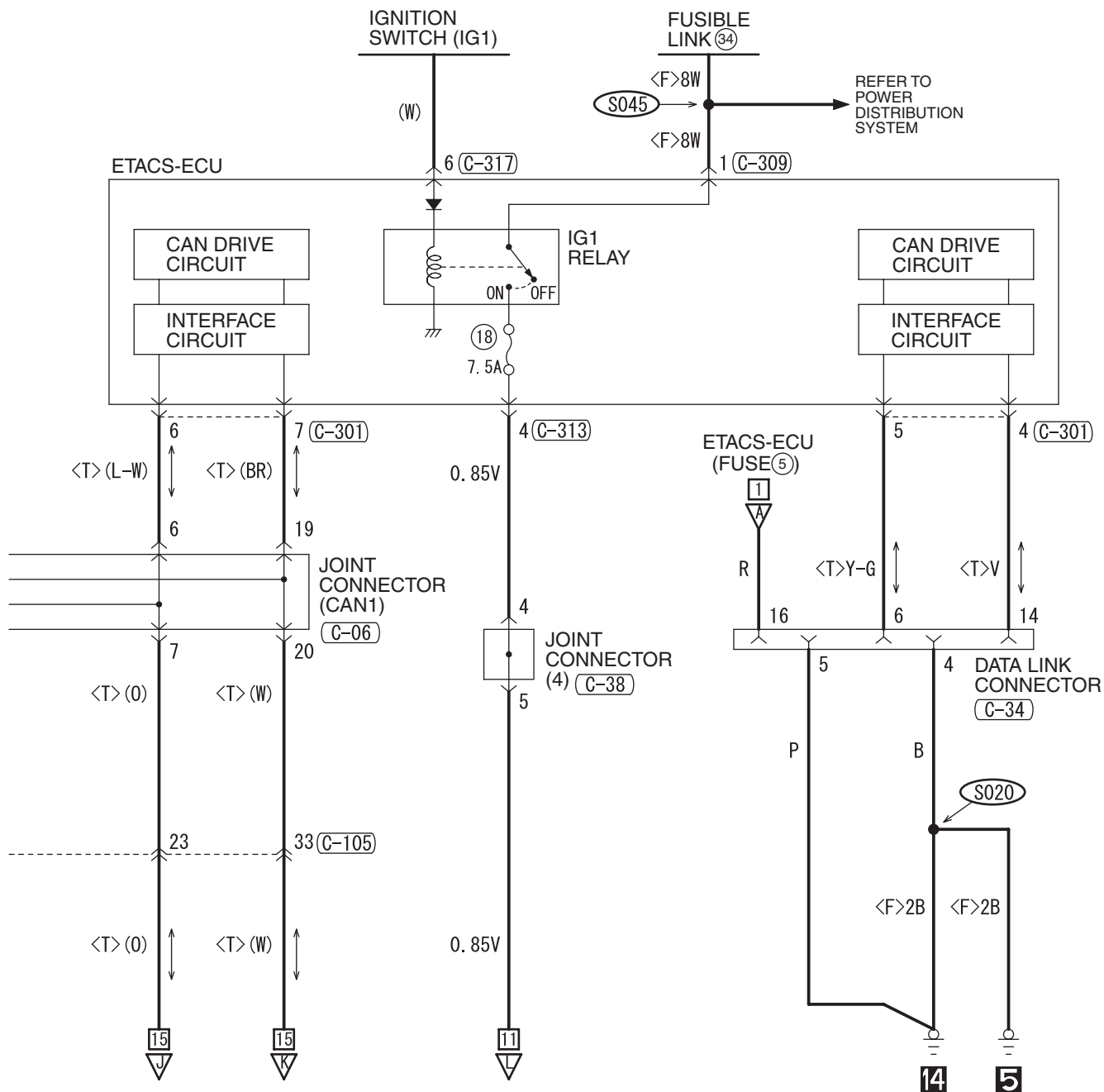

WIRE COLOR CODE
 B: BLACK LG: LIGHT GREEN G: GREEN L: BLUE W: WHITE Y: YELLOW SB: SKY BLUE
 BR: BROWN O: ORANGE GR: GRAY R: RED P: PINK V: VIOLET PU: PURPLE

H8G14M04BB

TSB Revision

MITSUBISHI MULTI-COMMUNICATION SYSTEM (MMCS) (CONTINUED)

5

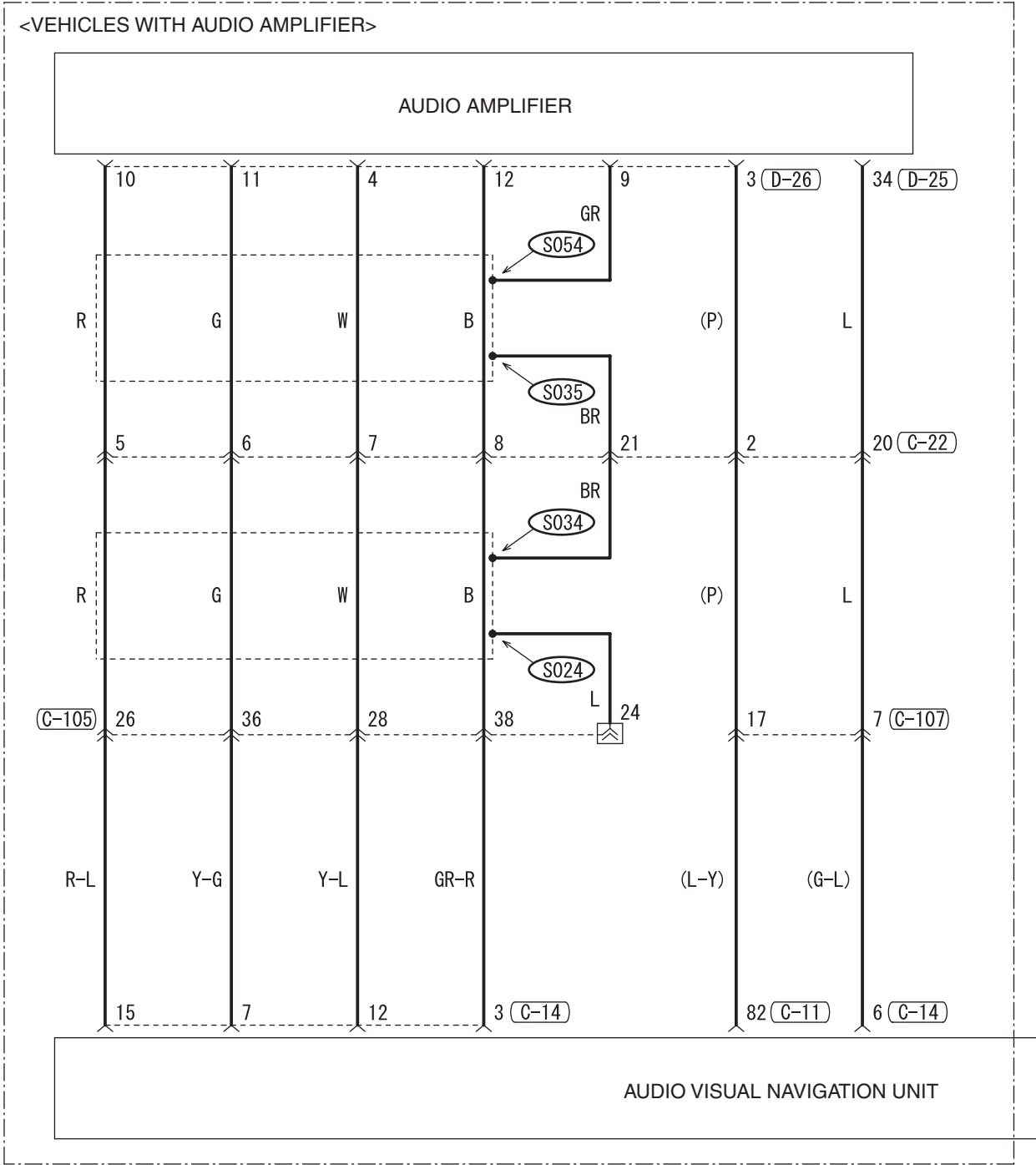

6

<VEHICLES WITH SATELLITE RADIO TUNER>

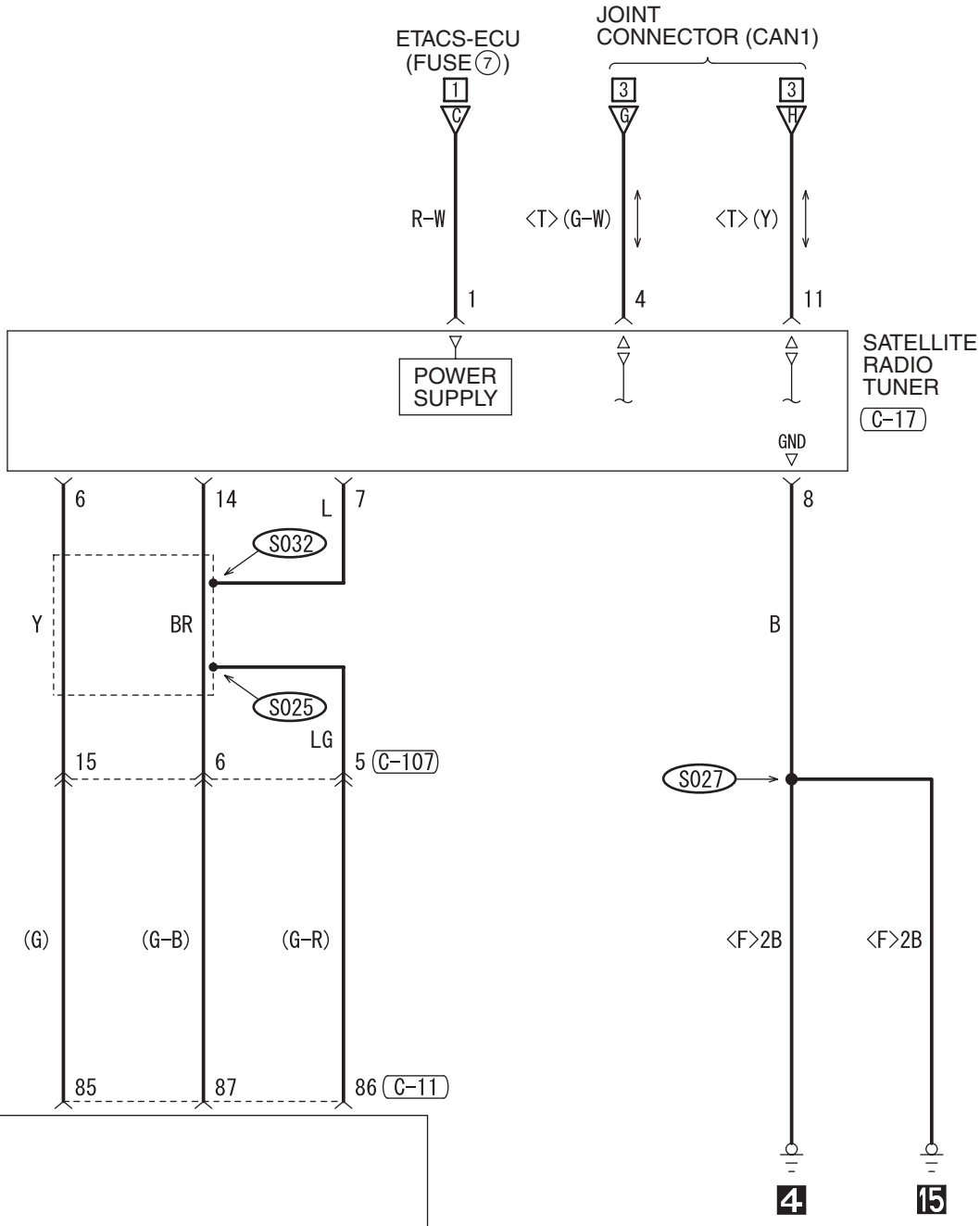

D-25

MU801455

21	22	23	24	25	26	27	28		
29	30	31	32	33	34	35	36	37	38

D-26

MU801453

1	2	3	4	5	6		
7	8	9	10	11	12	13	14

WIRE COLOR CODE

B: BLACK LG: LIGHT GREEN G: GREEN L: BLUE W: WHITE Y: YELLOW SB: SKY BLUE
BR: BROWN O: ORANGE GR: GRAY R: RED P: PINK V: VIOLET PU: PURPLE

H8G14M04CB

TSB Revision

MITSUBISHI MULTI-COMMUNICATION SYSTEM (MMCS) (CONTINUED)

7

<VEHICLES WITHOUT AUDIO AMPLIFIER>

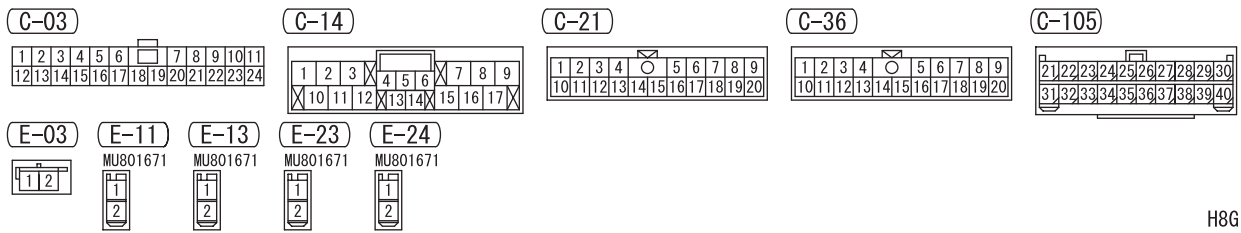
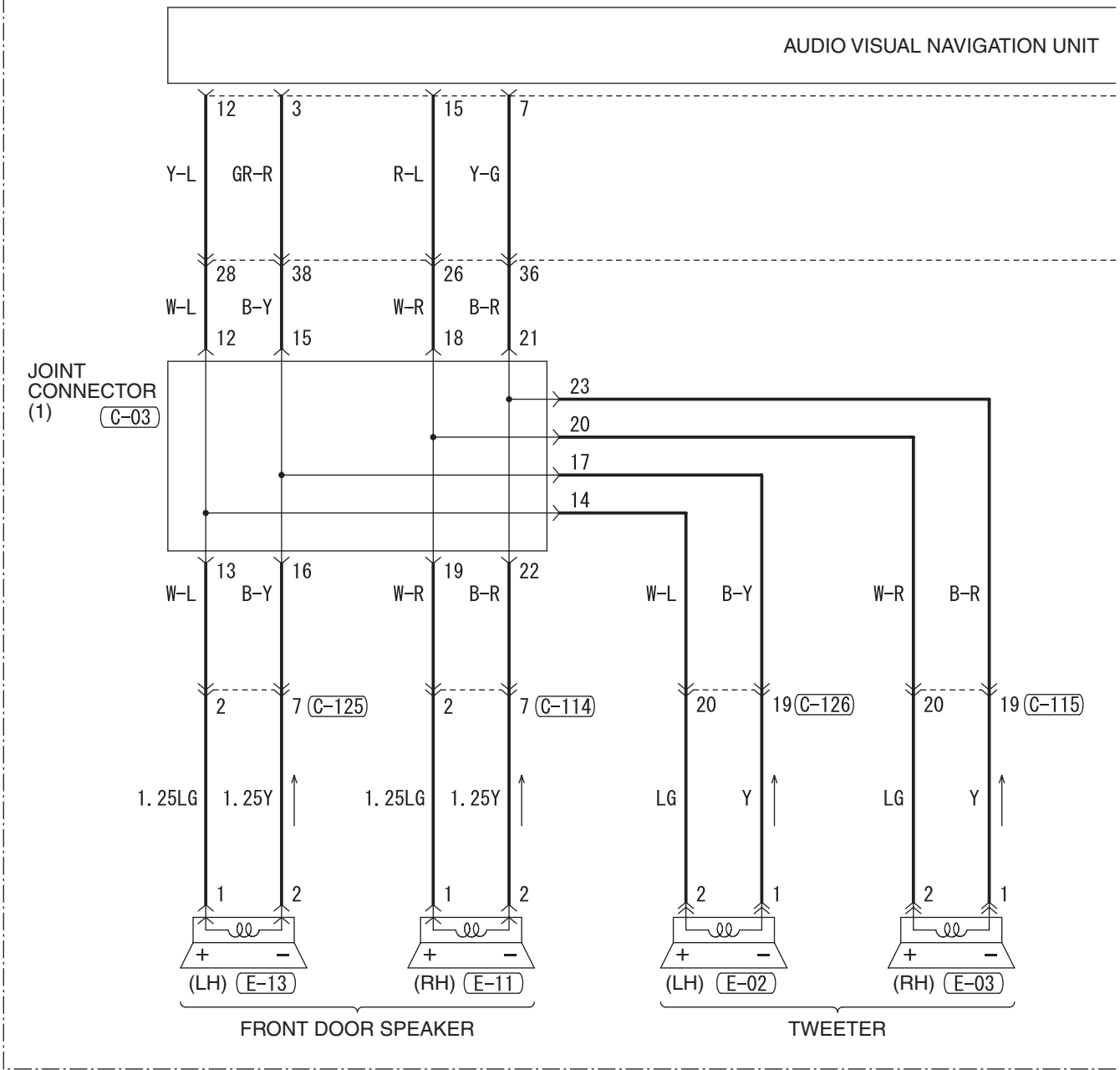

8

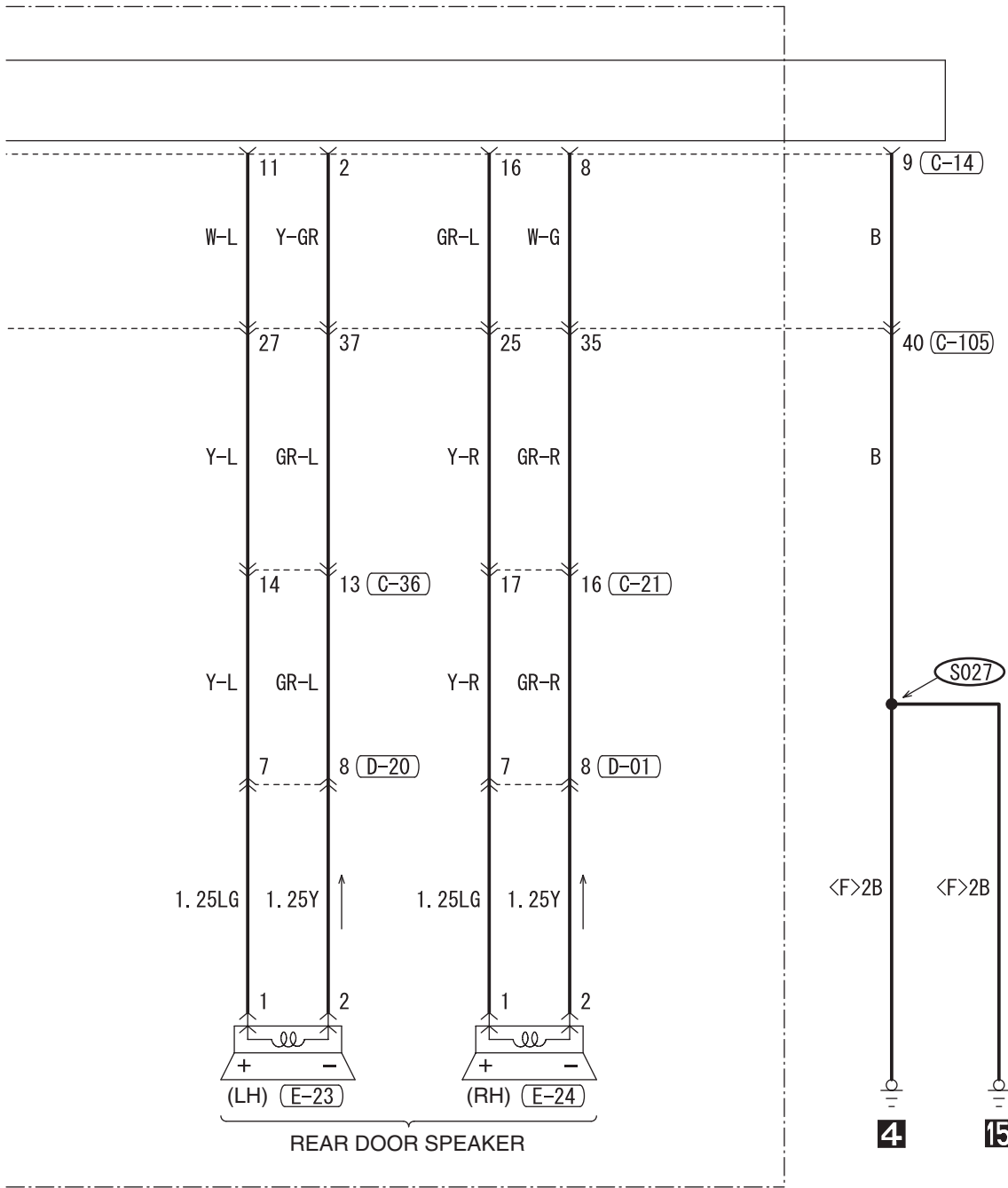

(C-114)

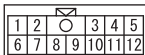

(C-115)



(C-125)

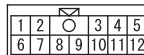

(C-126)



(D-01)



(D-20)

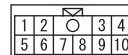

(E-02)



WIRE COLOR CODE

B: BLACK LG: LIGHT GREEN G: GREEN L: BLUE W: WHITE Y: YELLOW SB: SKY BLUE
 BR: BROWN O: ORANGE GR: GRAY R: RED P: PINK V: VIOLET PU: PURPLE

H8G14M04DB

TSB Revision

MITSUBISHI MULTI-COMMUNICATION SYSTEM (MMCS) (CONTINUED)

9

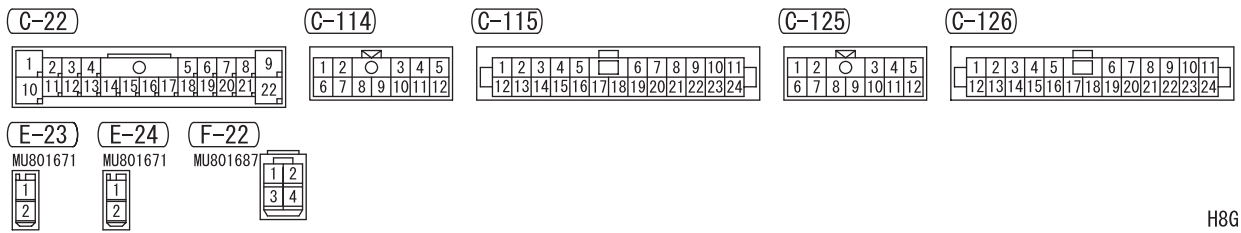
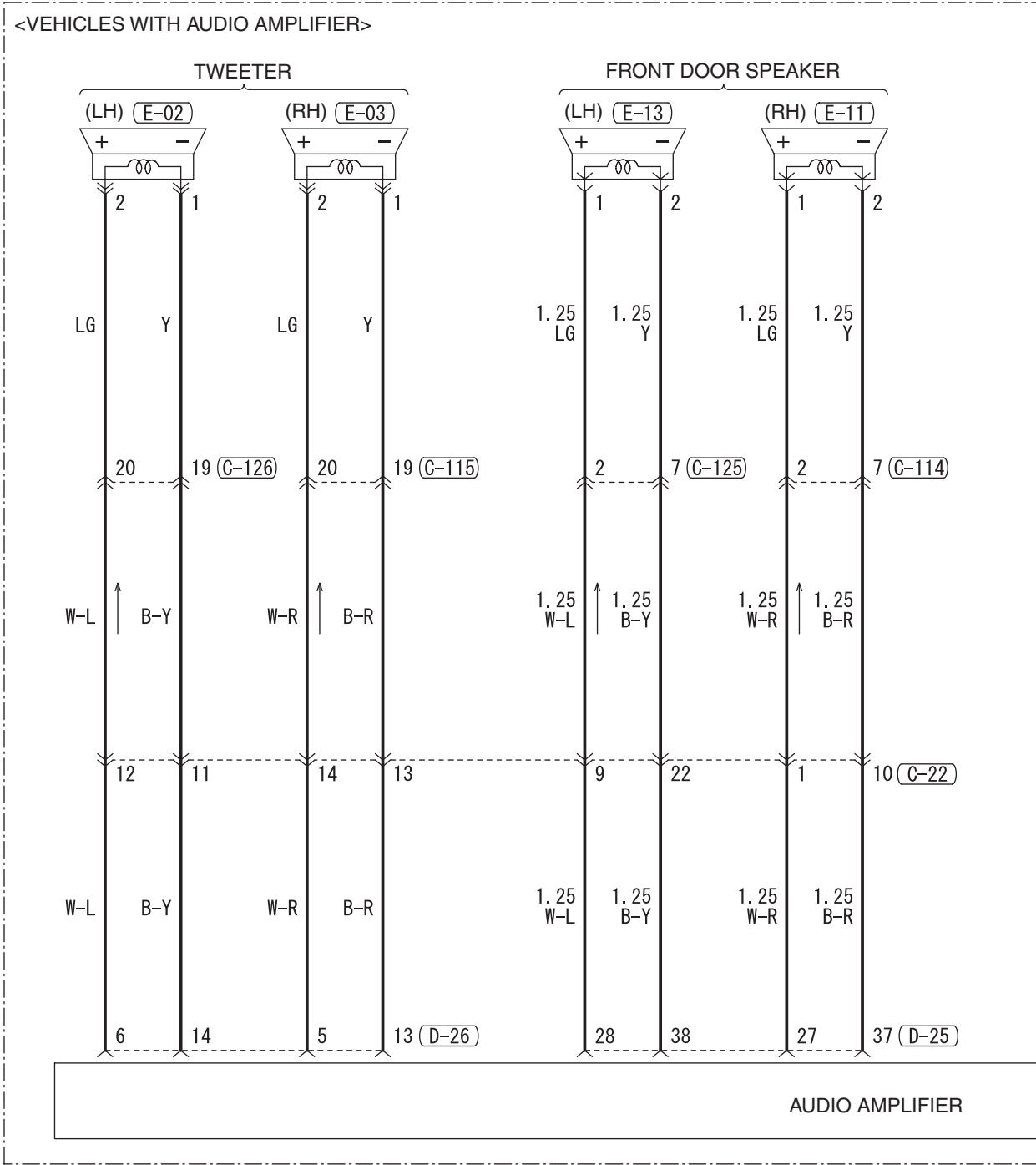

10

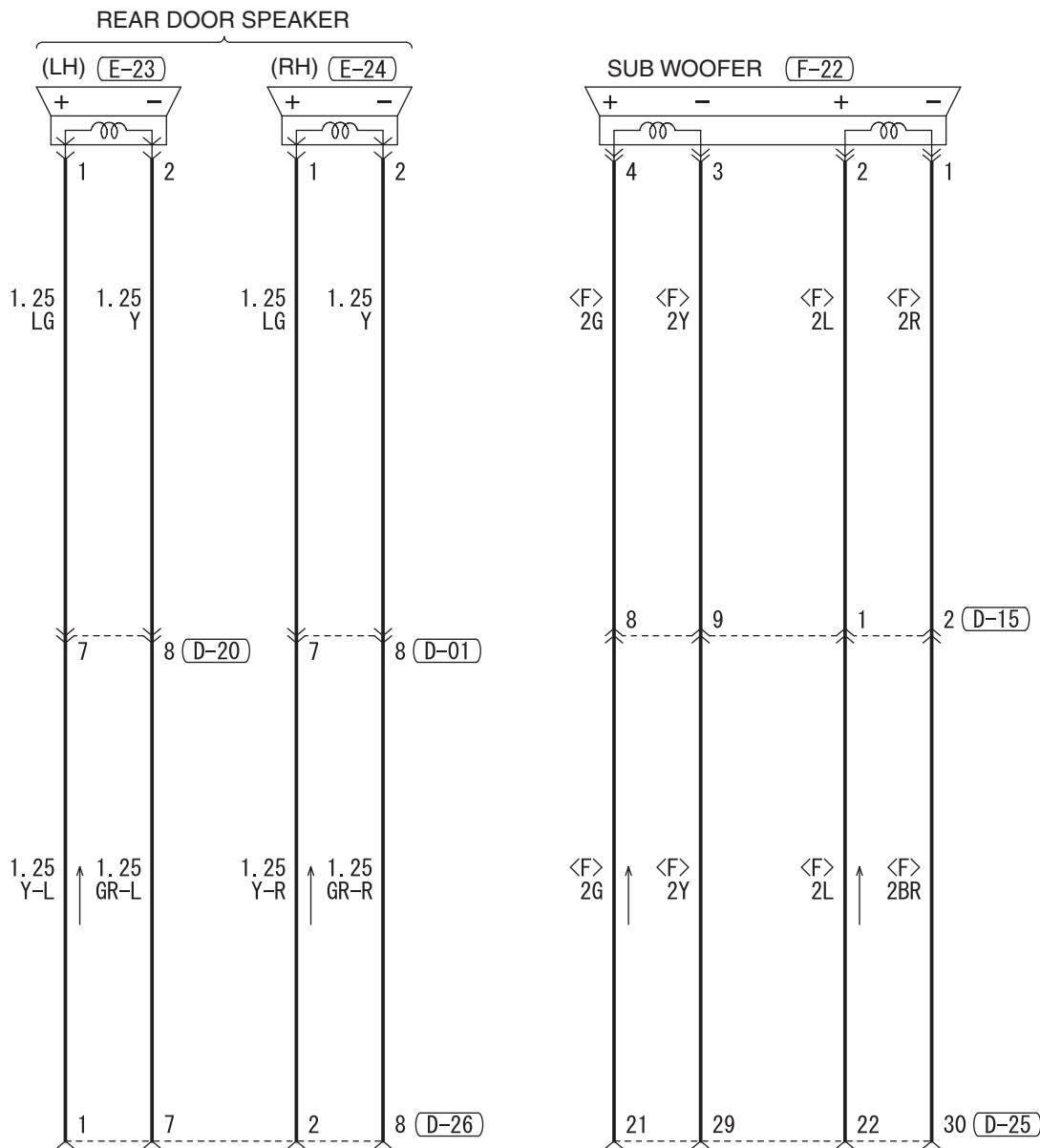

(D-01)

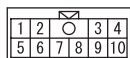

(D-15)

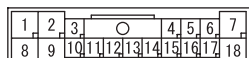

(D-20)

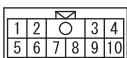

(D-25)

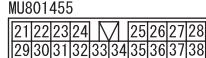

(D-26)

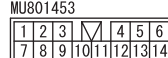

(E-02)



(E-03)



(E-11)



(E-13)



WIRE COLOR CODE

B: BLACK LG: LIGHT GREEN G: GREEN L: BLUE W: WHITE Y: YELLOW SB: SKY BLUE
BR: BROWN O: ORANGE GR: GRAY R: RED P: PINK V: VIOLET PU: PURPLE

H8G14M04EB

TSB Revision

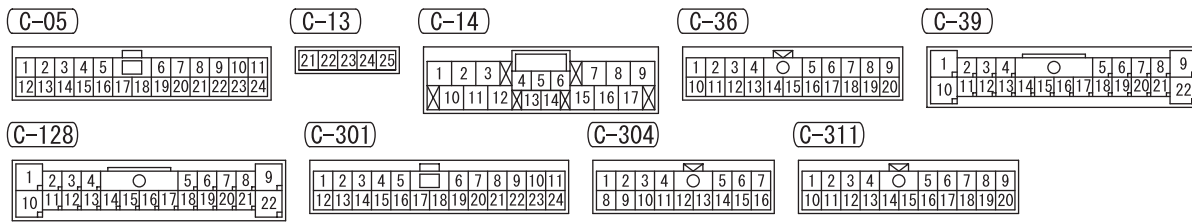
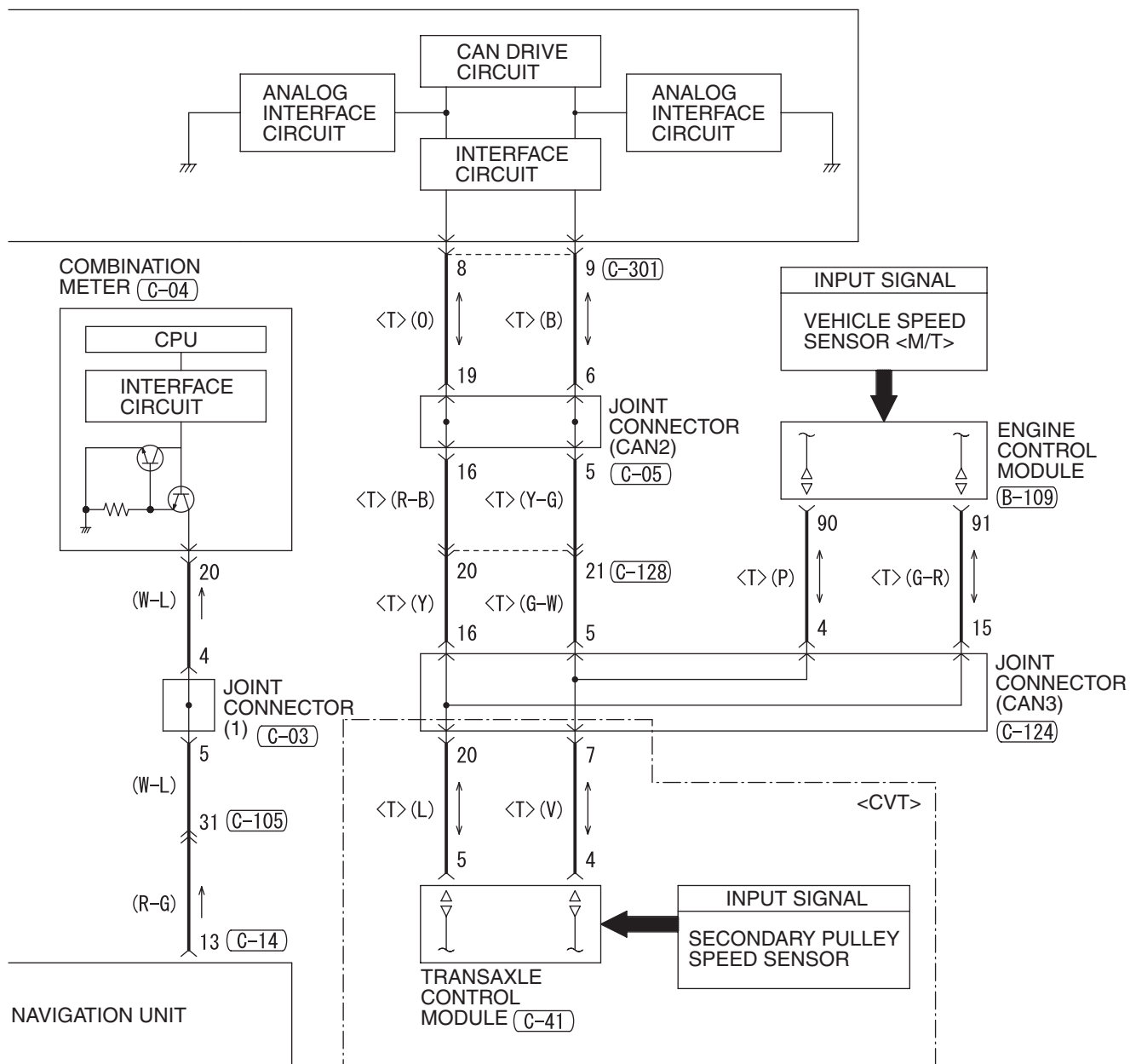

MITSUBISHI MULTI-COMMUNICATION SYSTEM (MMCS) (CONTINUED)

13

STEERING WHEEL
 AUDIO REMOTE
 CONTROL SWITCH
 (C-202)

COMBINATION
 METER



(G-W)

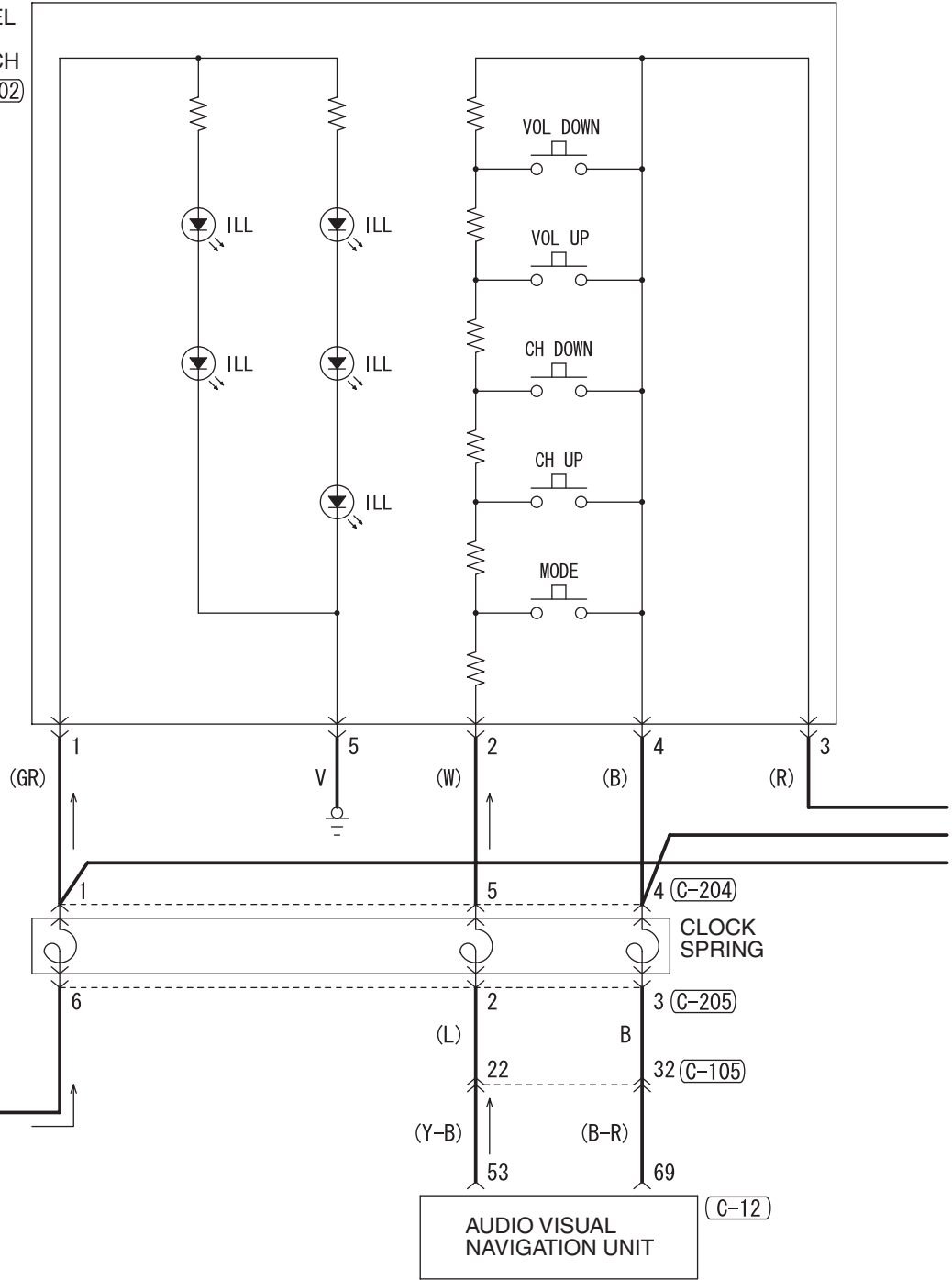

(C-12)

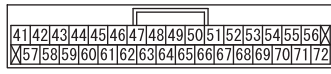

(C-105)

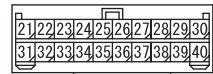

(C-202)

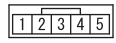

(C-204)

(MU803774)

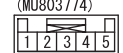

(C-205)

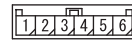

(C-209)

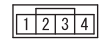

14

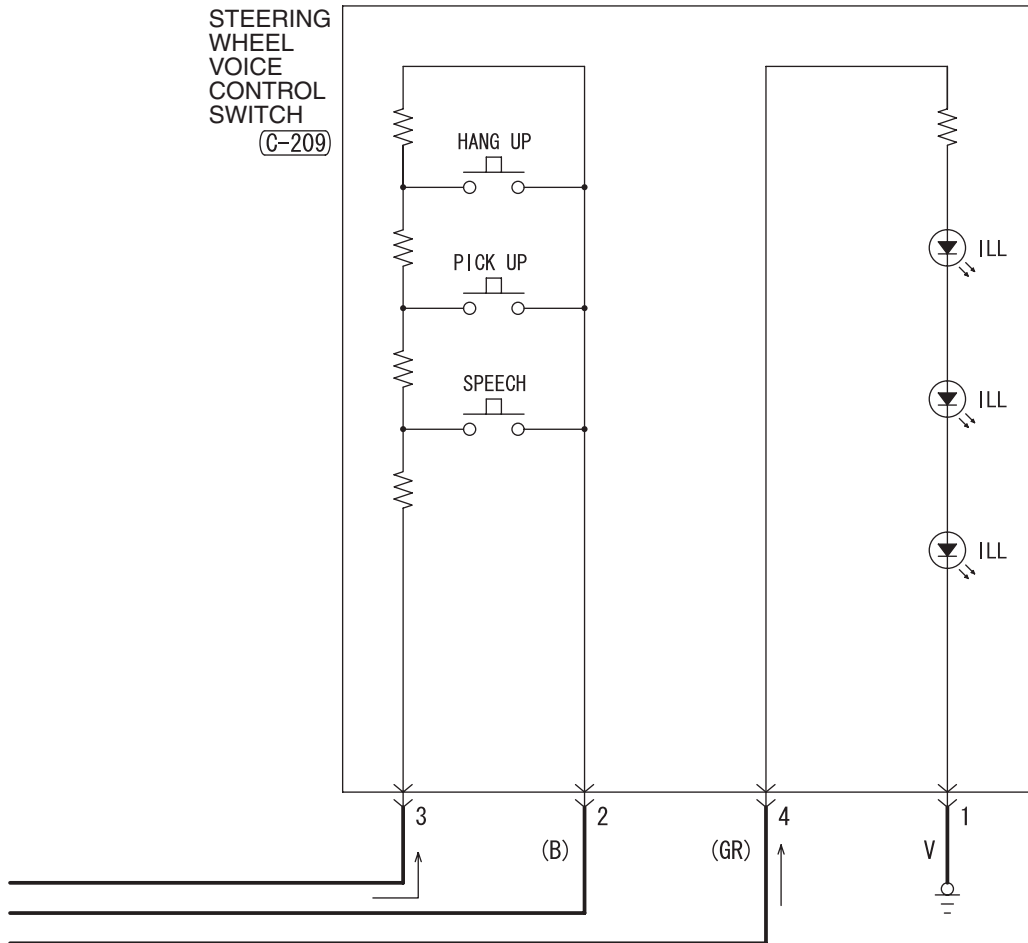

WIRE COLOR CODE

B : BLACK LG : LIGHT GREEN G : GREEN L : BLUE W : WHITE Y : YELLOW SB : SKY BLUE
 BR : BROWN O : ORANGE GR : GRAY R : RED P : PINK V : VIOLET PU : PURPLE

H8G14M04GB

TSB Revision

MITSUBISHI MULTI-COMMUNICATION SYSTEM (MMCS) (CONTINUED)

15

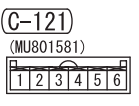
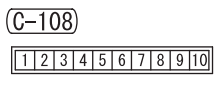
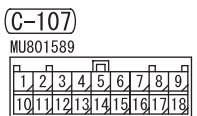
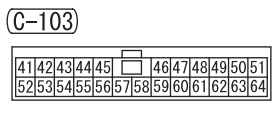
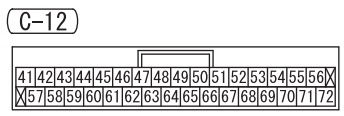
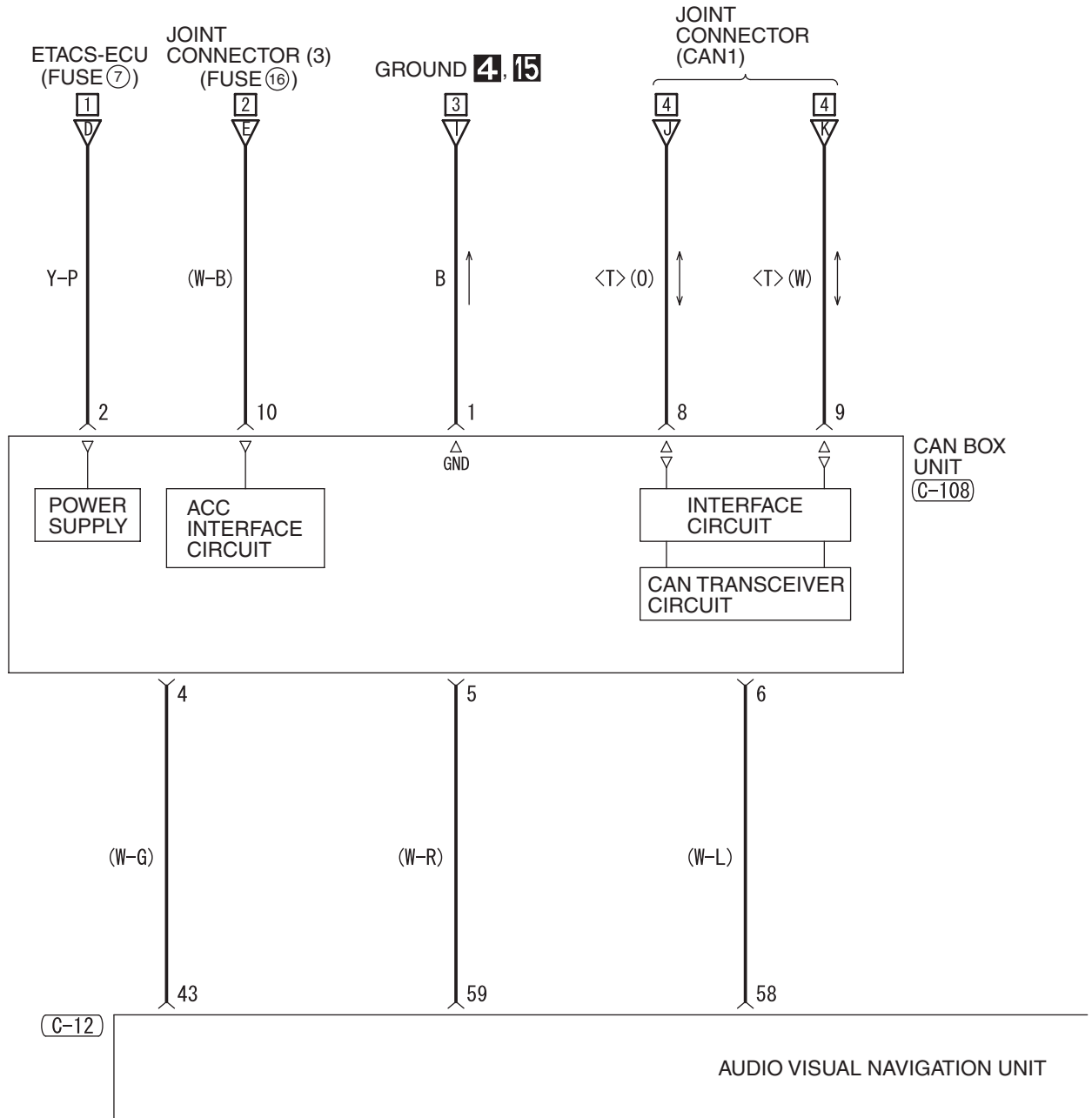

16

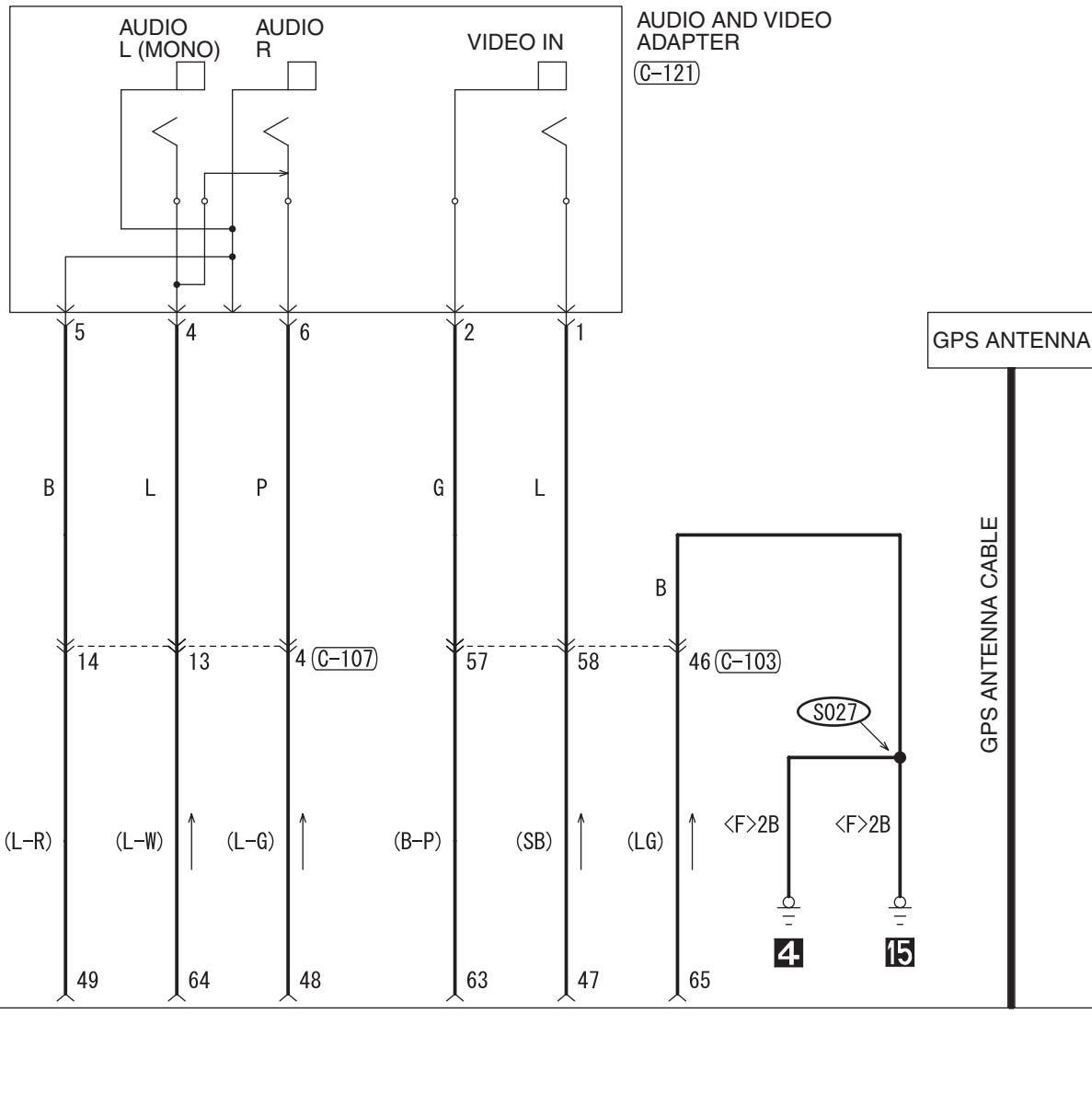

WIRE COLOR CODE
 B: BLACK LG: LIGHT GREEN G: GREEN L: BLUE W: WHITE Y: YELLOW SB: SKY BLUE
 BR: BROWN O: ORANGE GR: GRAY R: RED P: PINK V: VIOLET PU: PURPLE

H8G14M04HB

TSB Revision

ACCESSORY SOCKET AND CIGARETTE LIGHTER

M1901030900026

1

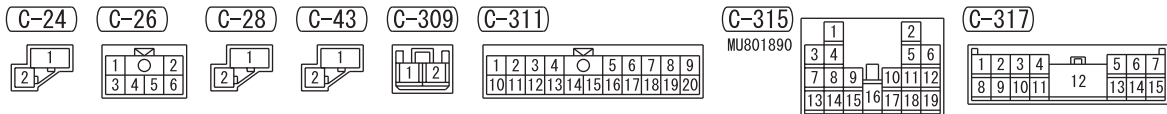
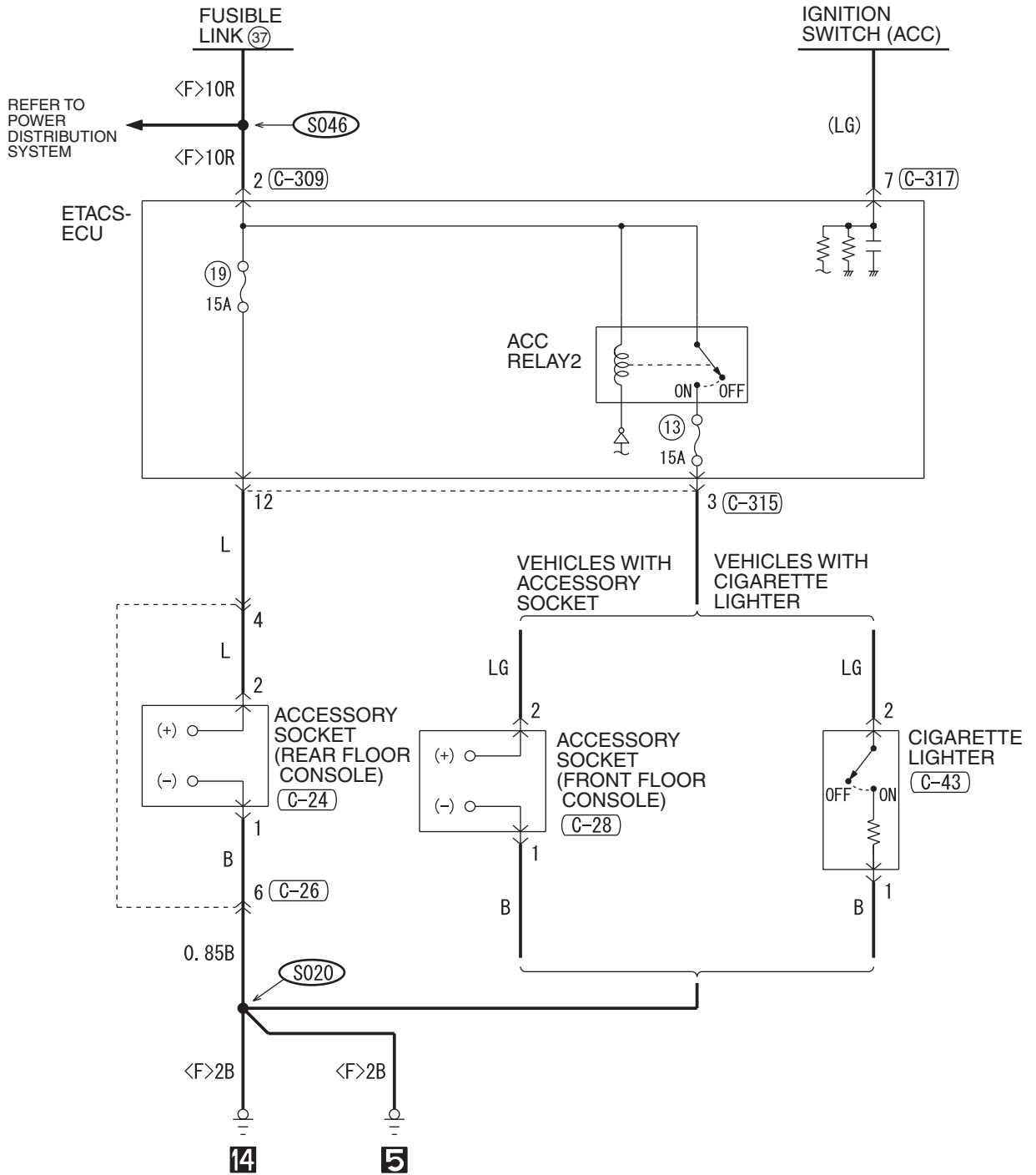

WIRE COLOR CODE

B: BLACK LG: LIGHT GREEN G: GREEN L: BLUE W: WHITE Y: YELLOW SB: SKY BLUE
BR: BROWN O: ORANGE GR: GRAY R: RED P: PINK V: VIOLET PU: PURPLE

H8G14M03AA

TSB Revision

NOTES

ANTI-LOCK BRAKING SYSTEM (ABS)

M1901008401564

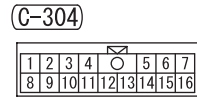
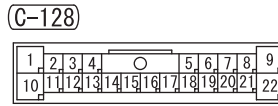
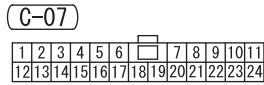
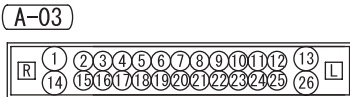
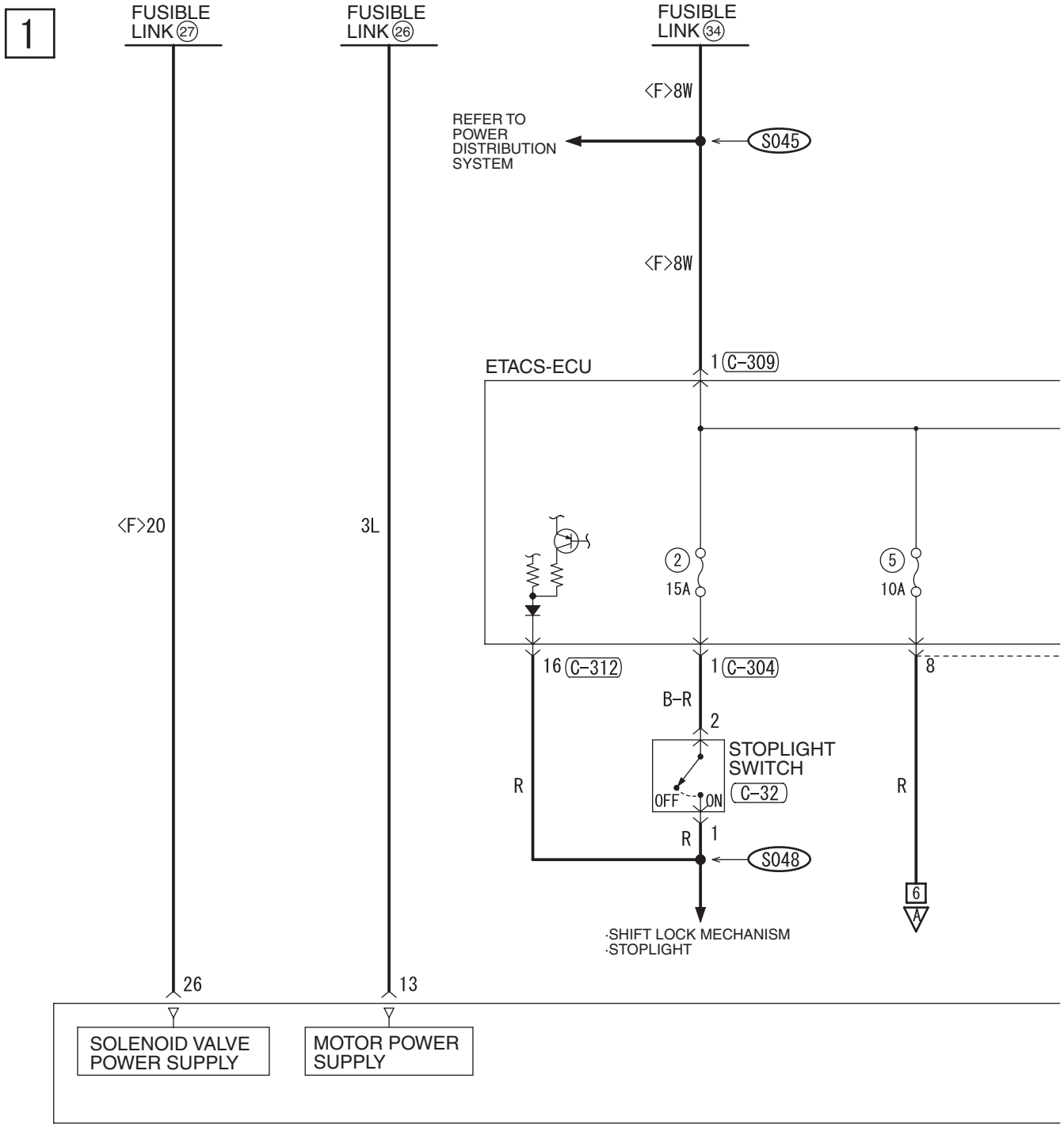

2

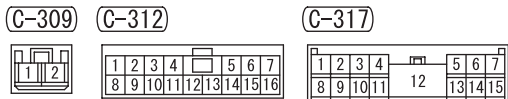
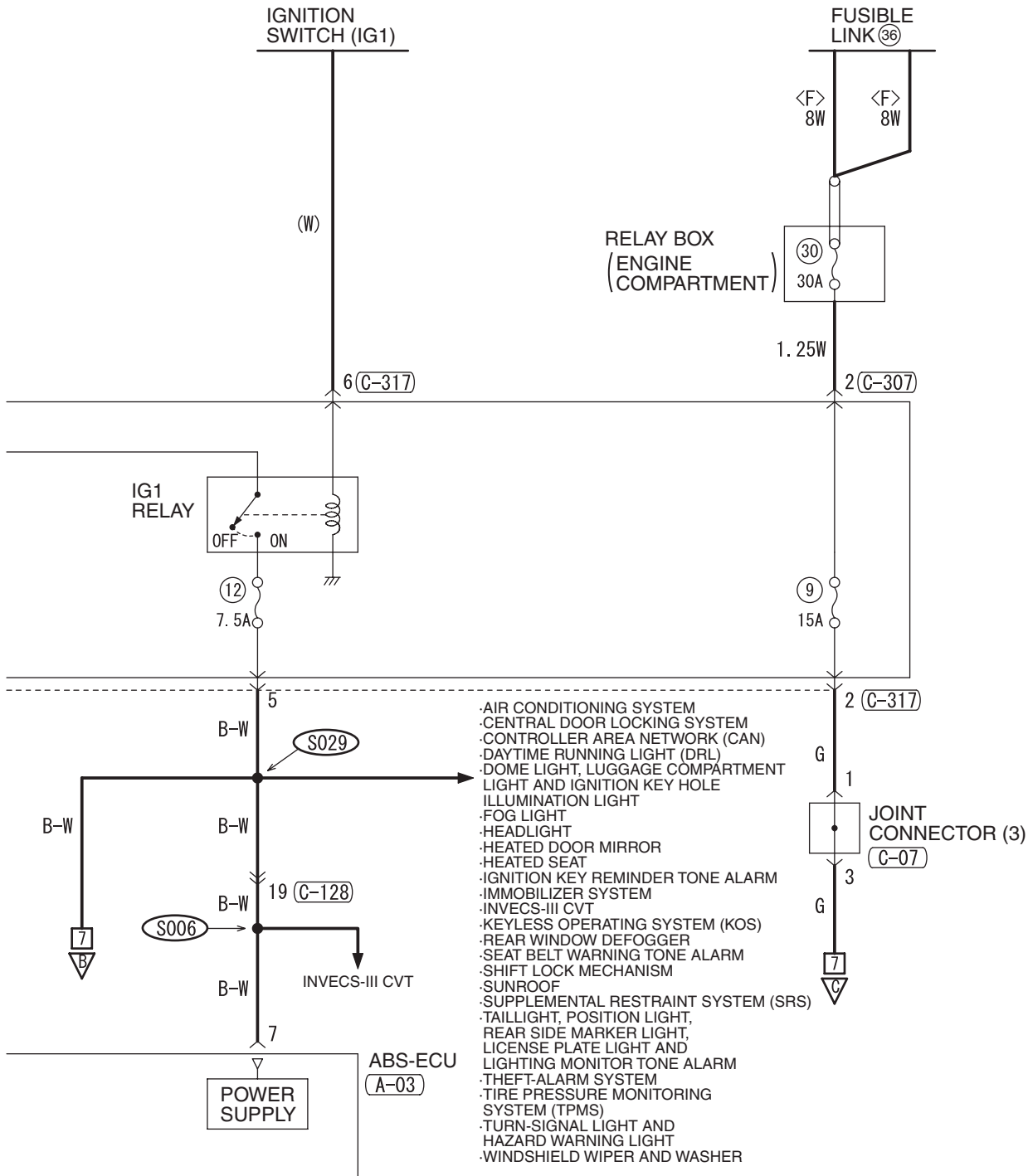

WIRE COLOR CODE
 B : BLACK LG : LIGHT GREEN G : GREEN L : BLUE W : WHITE Y : YELLOW SB : SKY BLUE
 BR : BROWN O : ORANGE GR : GRAY R : RED P : PINK V : VIOLET PU : PURPLE

H8G15M00AB

TSB Revision

ANTI-LOCK BRAKING SYSTEM (ABS) (CONTINUED)

3

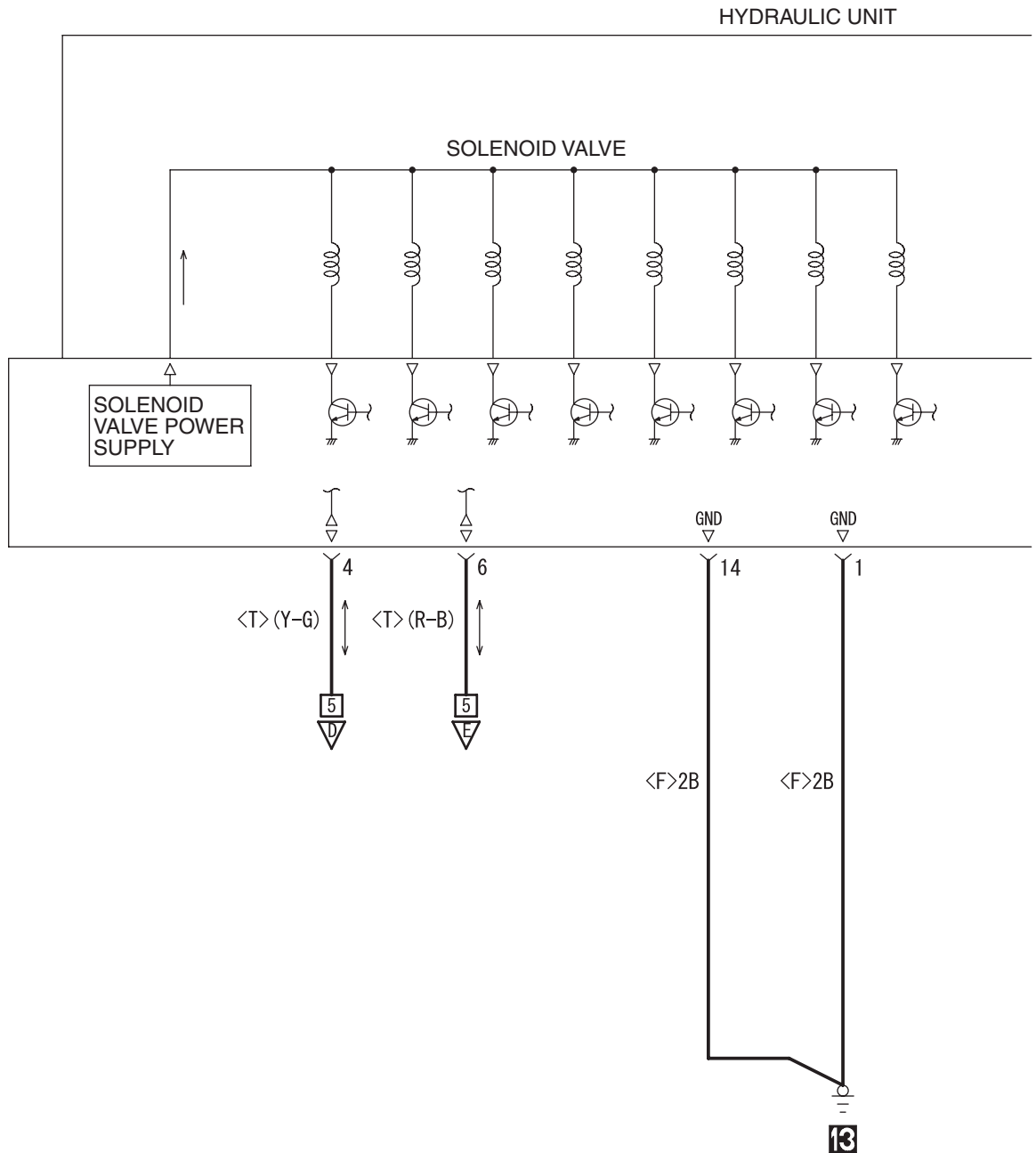

A-02

A-03

A-07

C-39

D-11

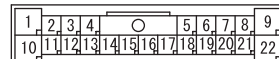
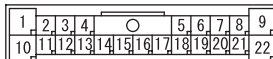

4

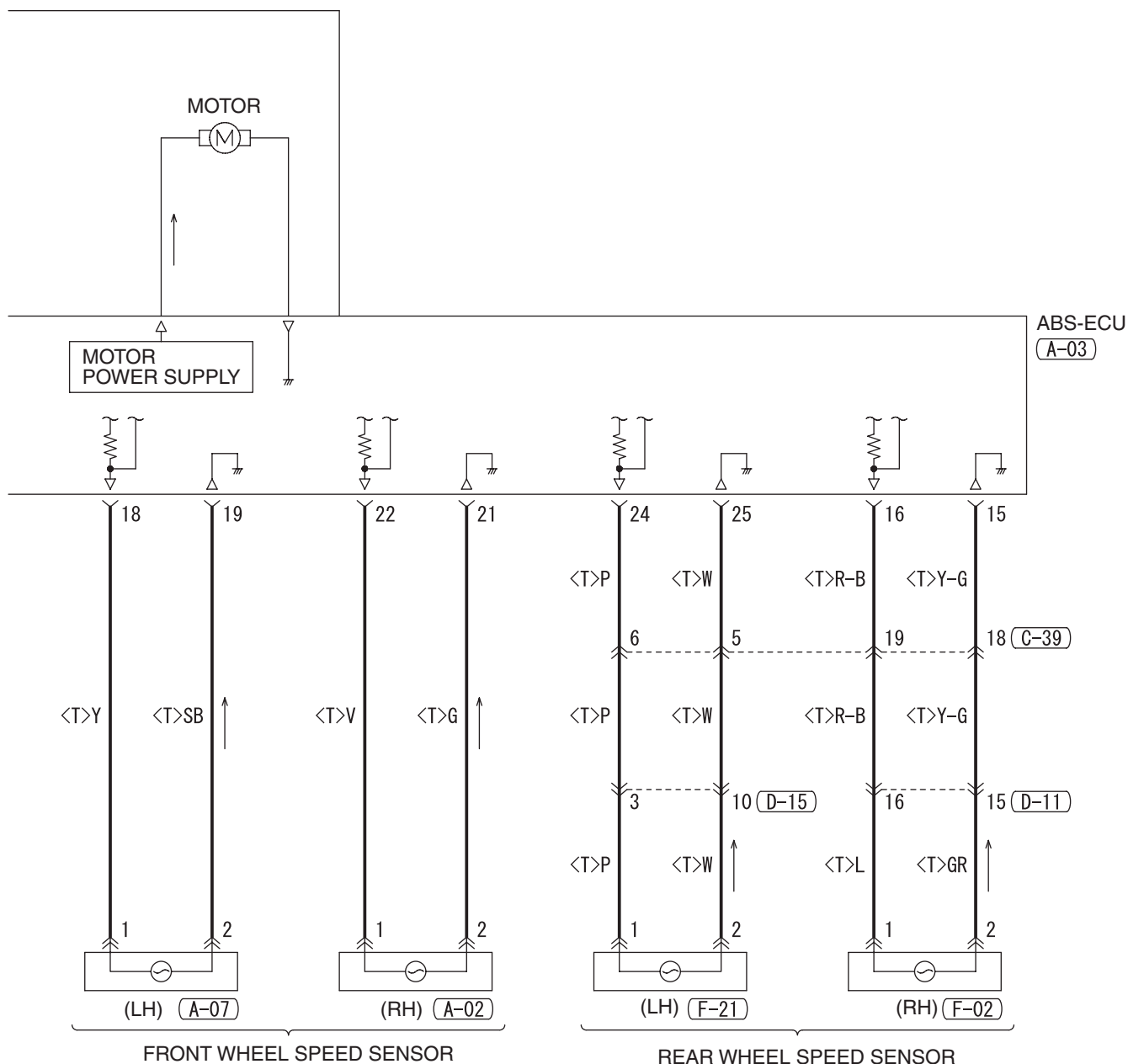

(D-15)

(F-02) (F-21)

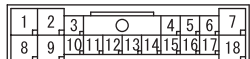

WIRE COLOR CODE

B : BLACK LG : LIGHT GREEN G : GREEN L : BLUE W : WHITE Y : YELLOW SB : SKY BLUE
BR : BROWN O : ORANGE GR : GRAY R : RED P : PINK V : VIOLET PU : PURPLE

H8G15M00BB

TSB Revision

ANTI-LOCK BRAKING SYSTEM (ABS) (CONTINUED)

5

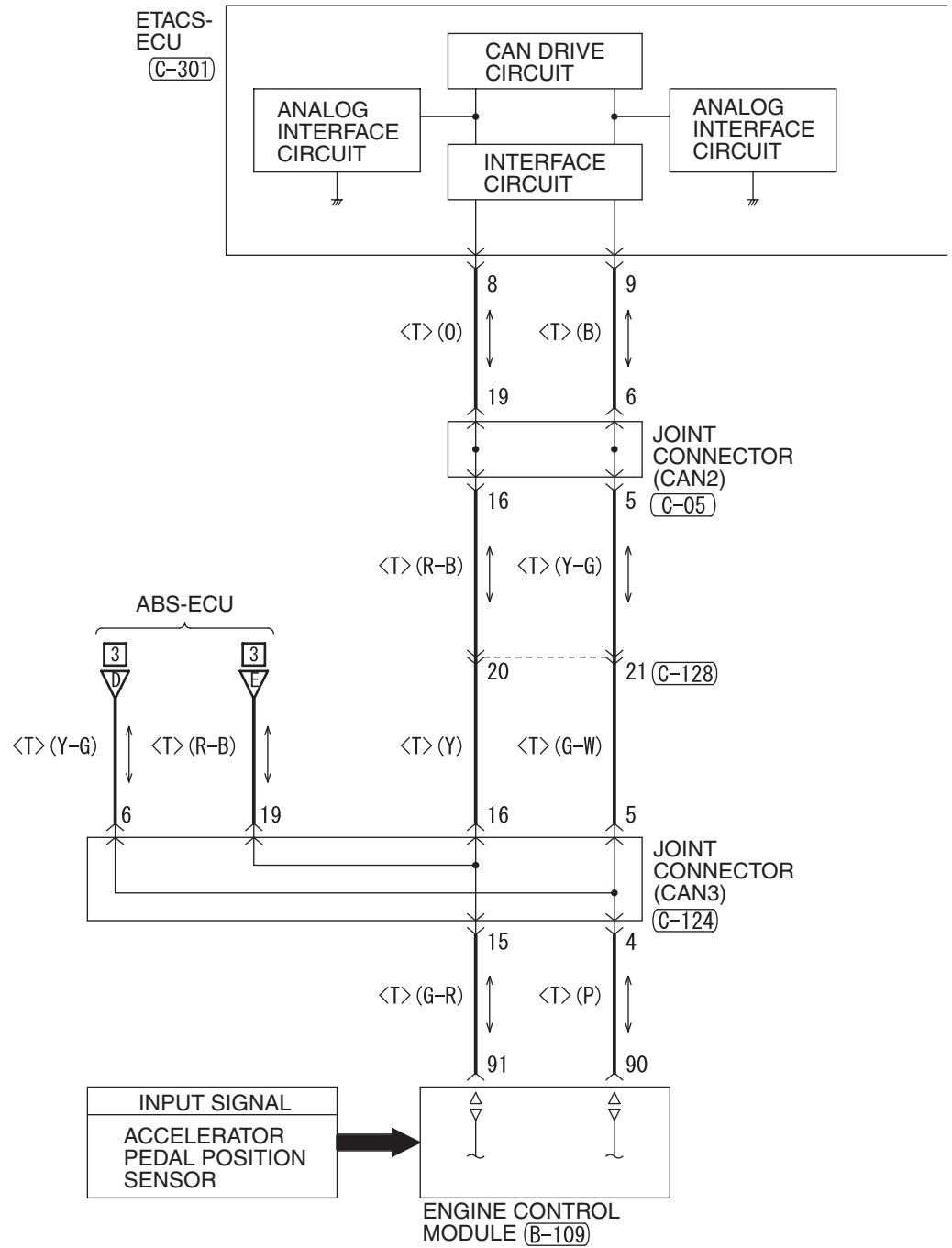

(B-109)

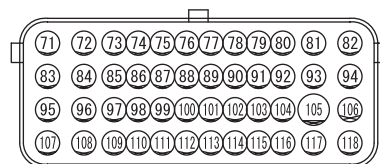

(C-05)

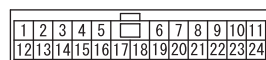

(C-06)

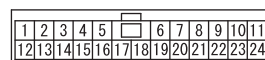

(C-34) FRONT SIDE



TSB Revision

6

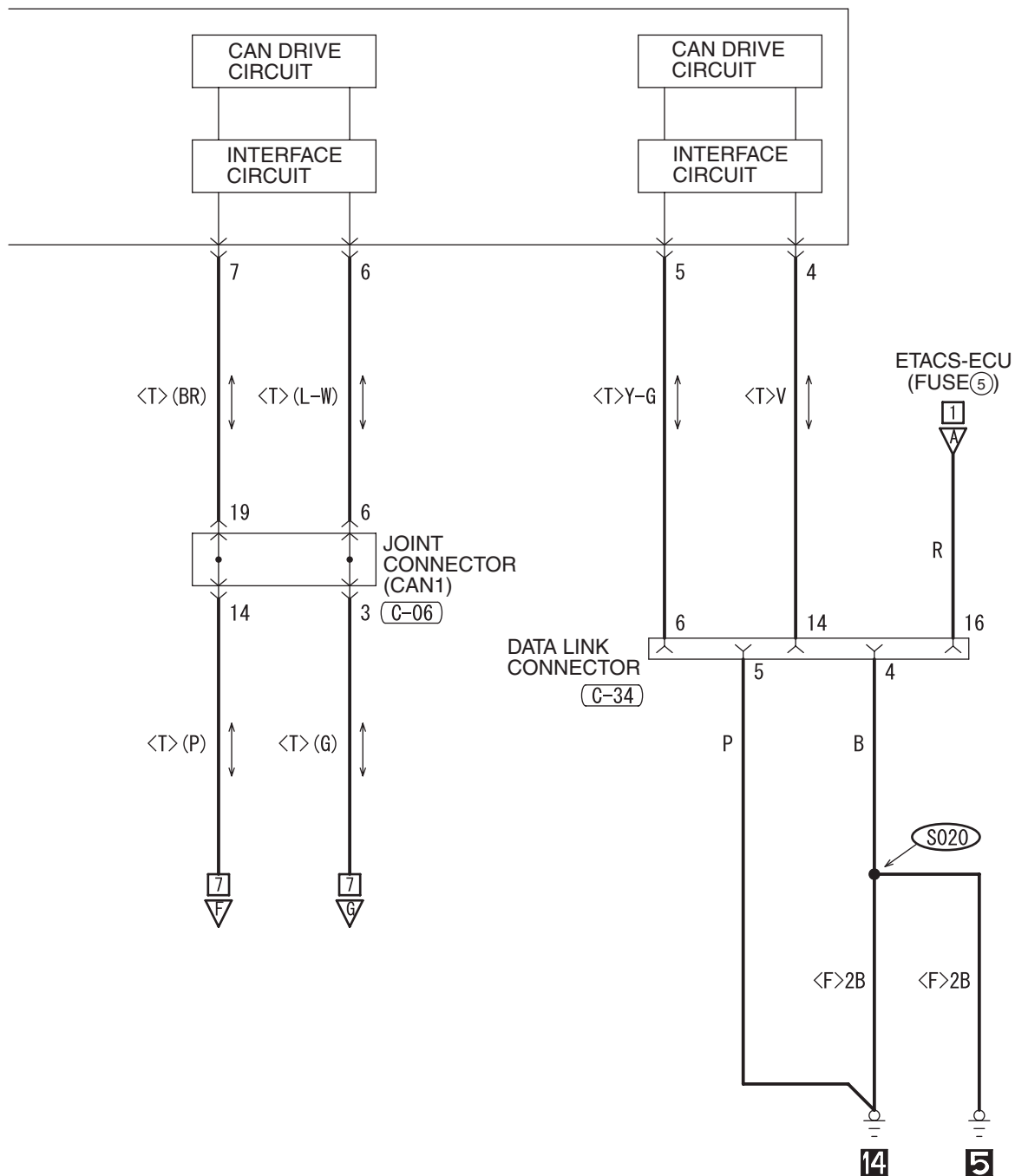

C-124



C-128

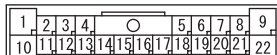

C-301



WIRE COLOR CODE

B: BLACK LG: LIGHT GREEN G: GREEN L: BLUE W: WHITE Y: YELLOW SB: SKY BLUE
BR: BROWN O: ORANGE GR: GRAY R: RED P: PINK V: VIOLET PU: PURPLE

H8G15M00CB

TSB Revision

ANTI-LOCK BRAKING SYSTEM (ABS) (CONTINUED)

7

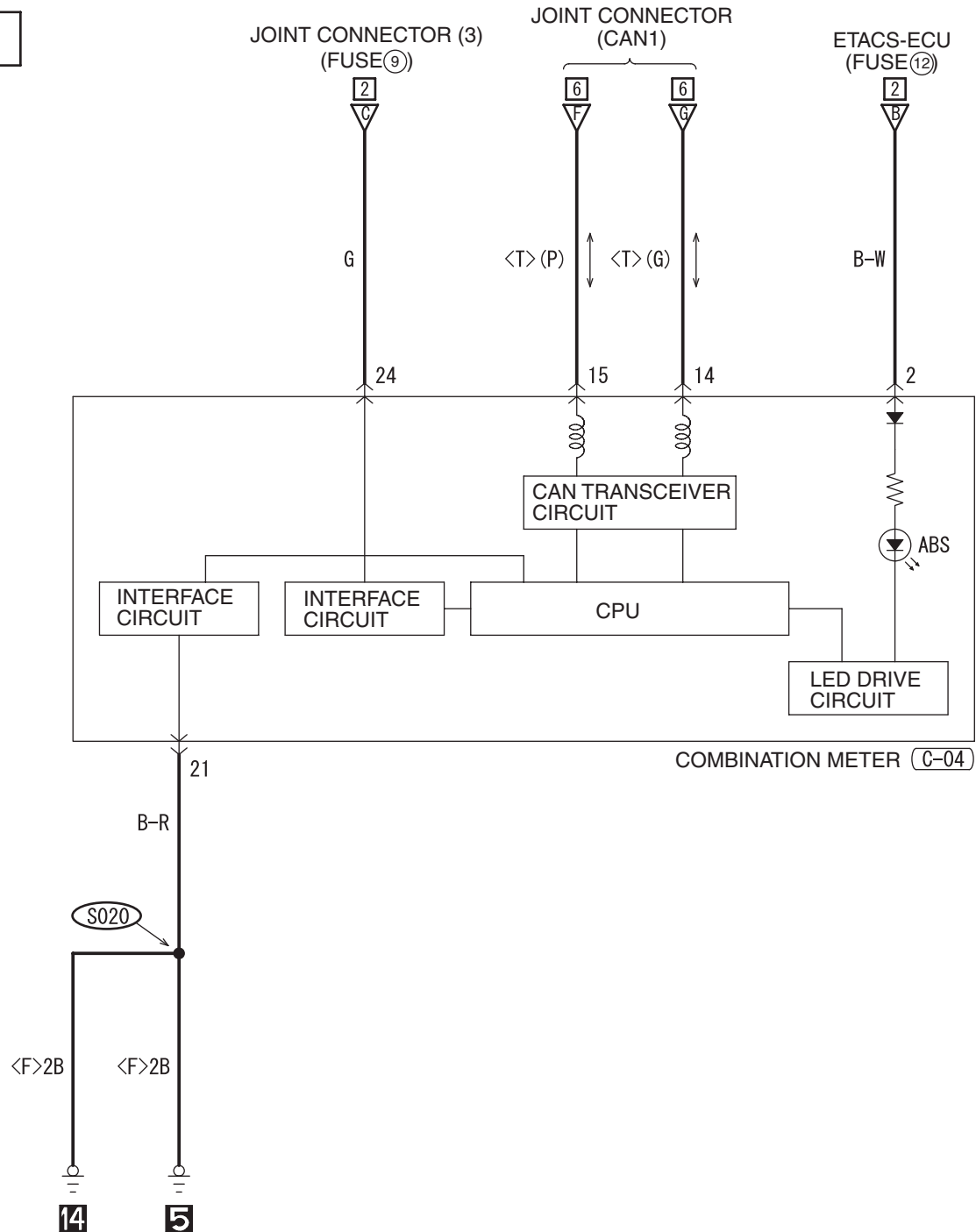

C-04

1	2	3	4	5	6	7	8	9	10	11	12
13	14	15	16	17	18	19	20	21	22	23	24

WIRE COLOR CODE

B: BLACK LG: LIGHT GREEN G: GREEN L: BLUE W: WHITE Y: YELLOW SB: SKY BLUE
BR: BROWN O: ORANGE GR: GRAY R: RED P: PINK V: VIOLET PU: PURPLE

H8G15M00DA

TSB Revision

NOTES

SUPPLEMENTAL RESTRAINT SYSTEM (SRS)

M1901009702334

1

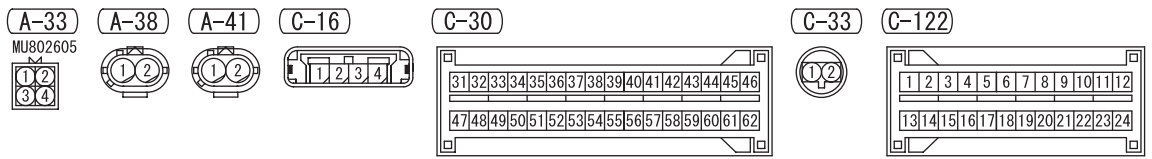
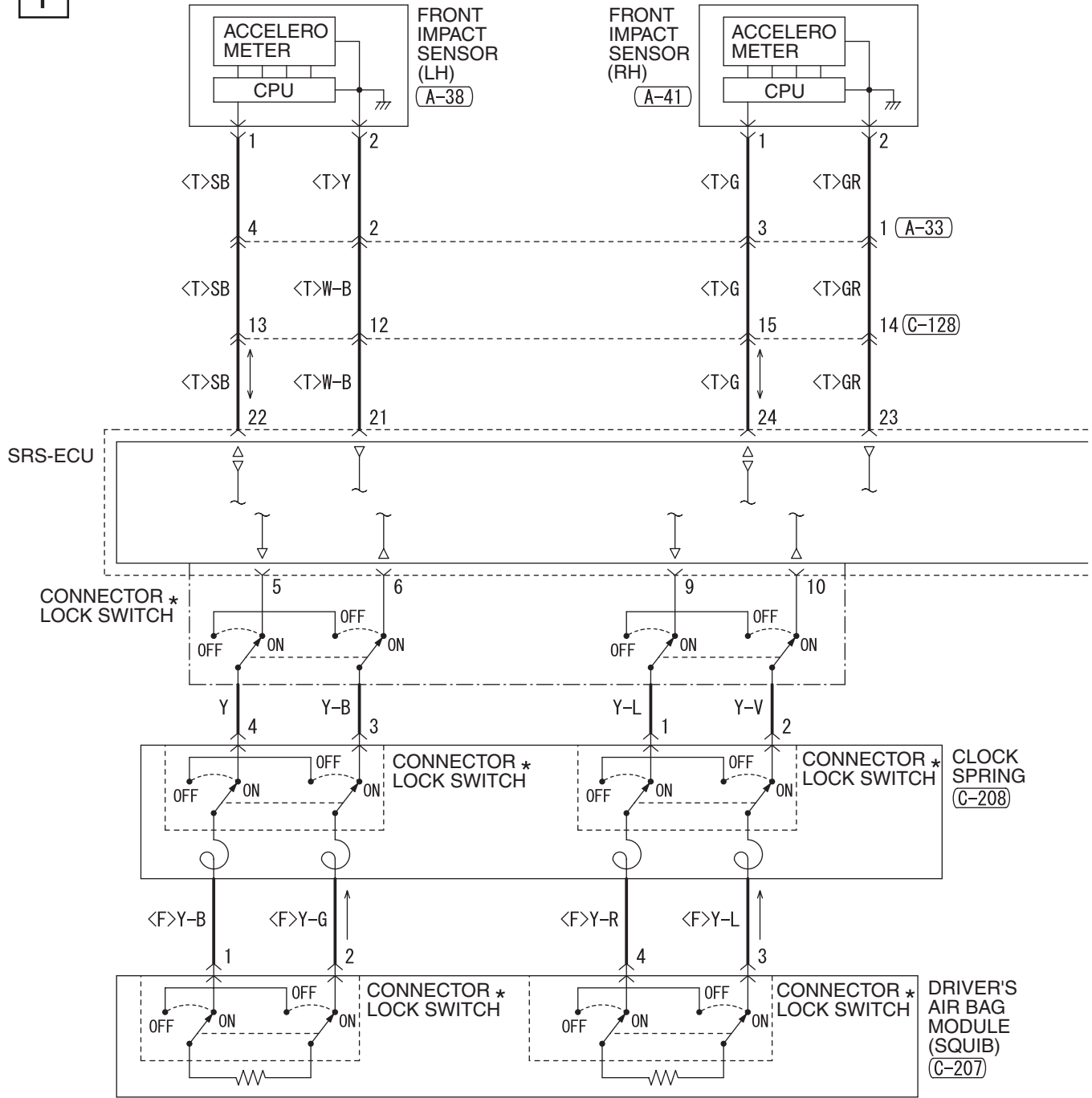

2

NOTE
* : CONNECTOR COUPLED : ON
CONNECTOR UNCOUPLED : OFF

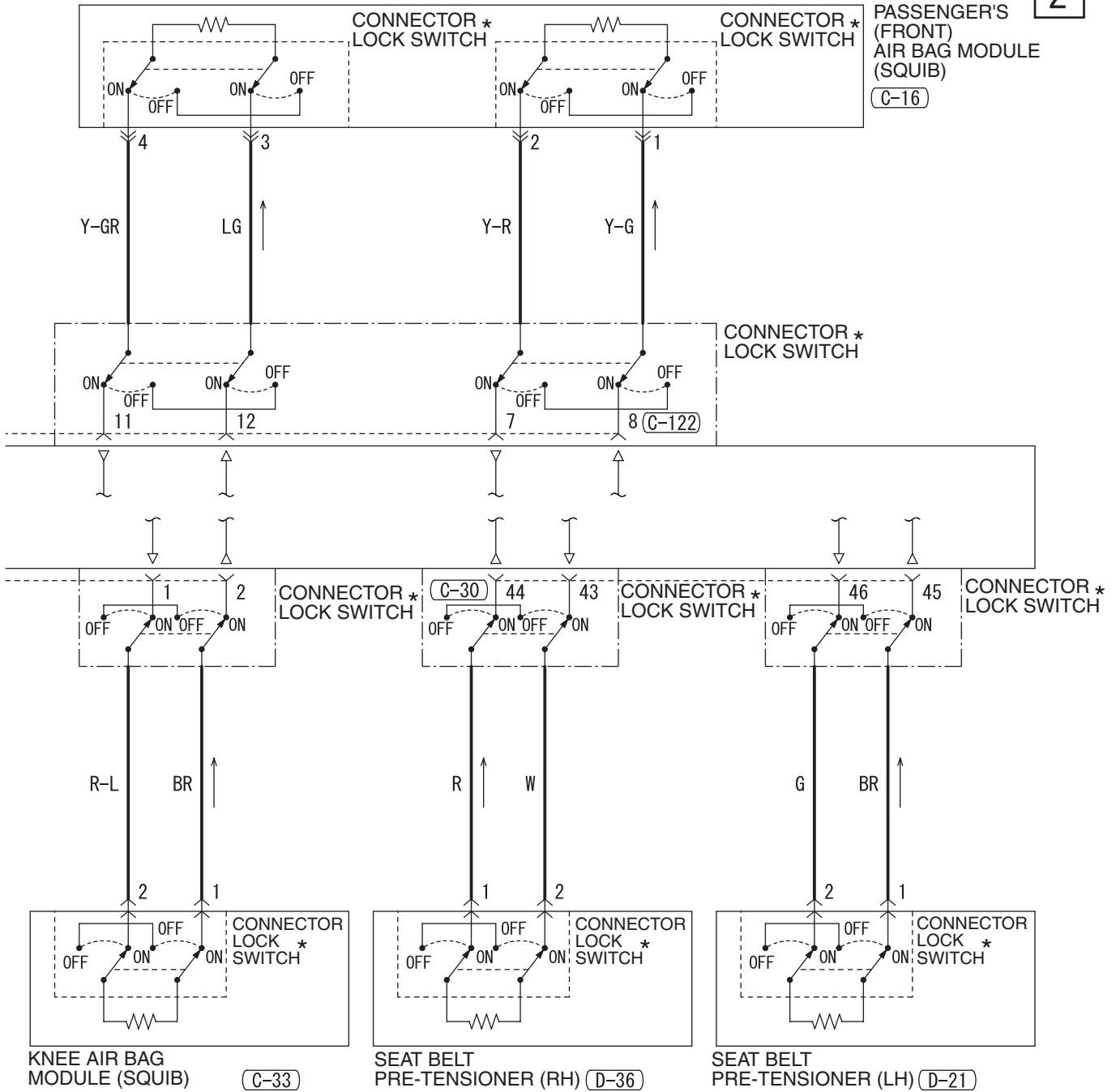

(C-128)

(C-207)

(C-208)

(D-21)

(D-36)

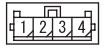
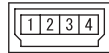
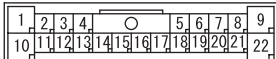

WIRE COLOR CODE

B : BLACK LG : LIGHT GREEN G : GREEN L : BLUE W : WHITE Y : YELLOW SB : SKY BLUE
BR : BROWN O : ORANGE GR : GRAY R : RED P : PINK V : VIOLET PU : PURPLE

H8G15M01AB

SUPPLEMENTAL RESTRAINT SYSTEM (SRS) (CONTINUED)

3

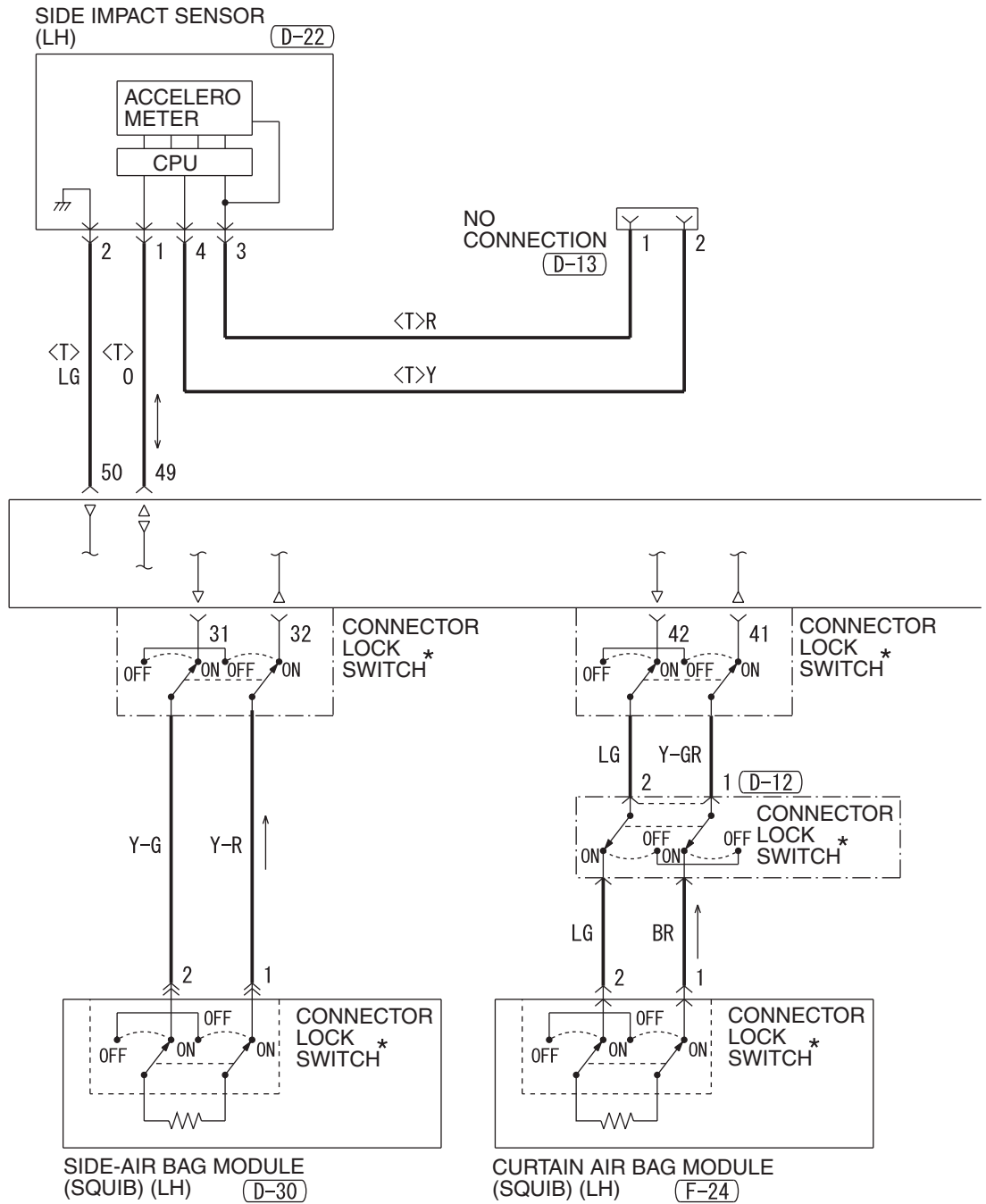

C-30

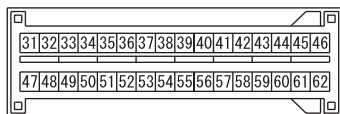

D-09

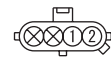

D-10



D-12



D-13

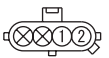

D-22



D-30



D-32



D-37



F-05



SIDE IMPACT SENSOR (RH) (D-37)

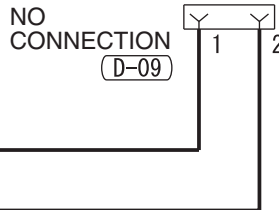
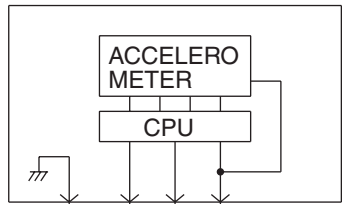

NOTE
* : CONNECTOR COUPLED : ON
CONNECTOR UNCOUPLED : OFF

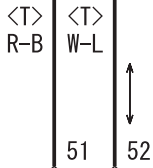

SRS-ECU (C-30)

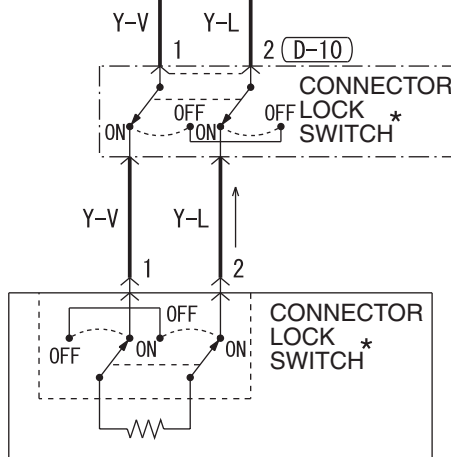
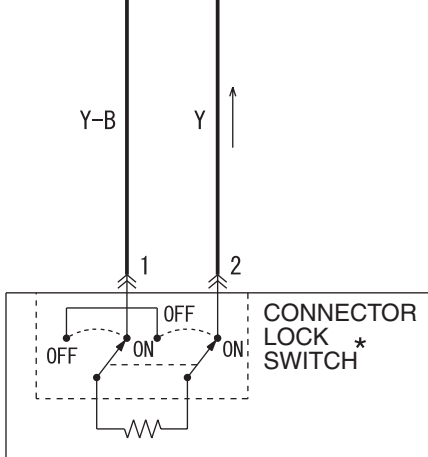
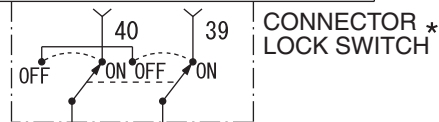
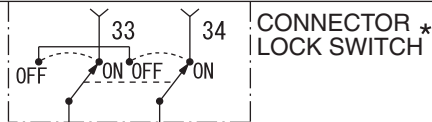

SIDE-AIR BAG MODULE (SQUIB) (RH) (D-32)

CURTAIN AIR BAG MODULE (SQUIB) (RH) (F-05)

(F-24)



WIRE COLOR CODE
B : BLACK LG : LIGHT GREEN G : GREEN L : BLUE W : WHITE Y : YELLOW SB : SKY BLUE
BR : BROWN O : ORANGE GR : GRAY R : RED P : PINK V : VIOLET PU : PURPLE

H8G15M01BB

SUPPLEMENTAL RESTRAINT SYSTEM (SRS) (CONTINUED)

5

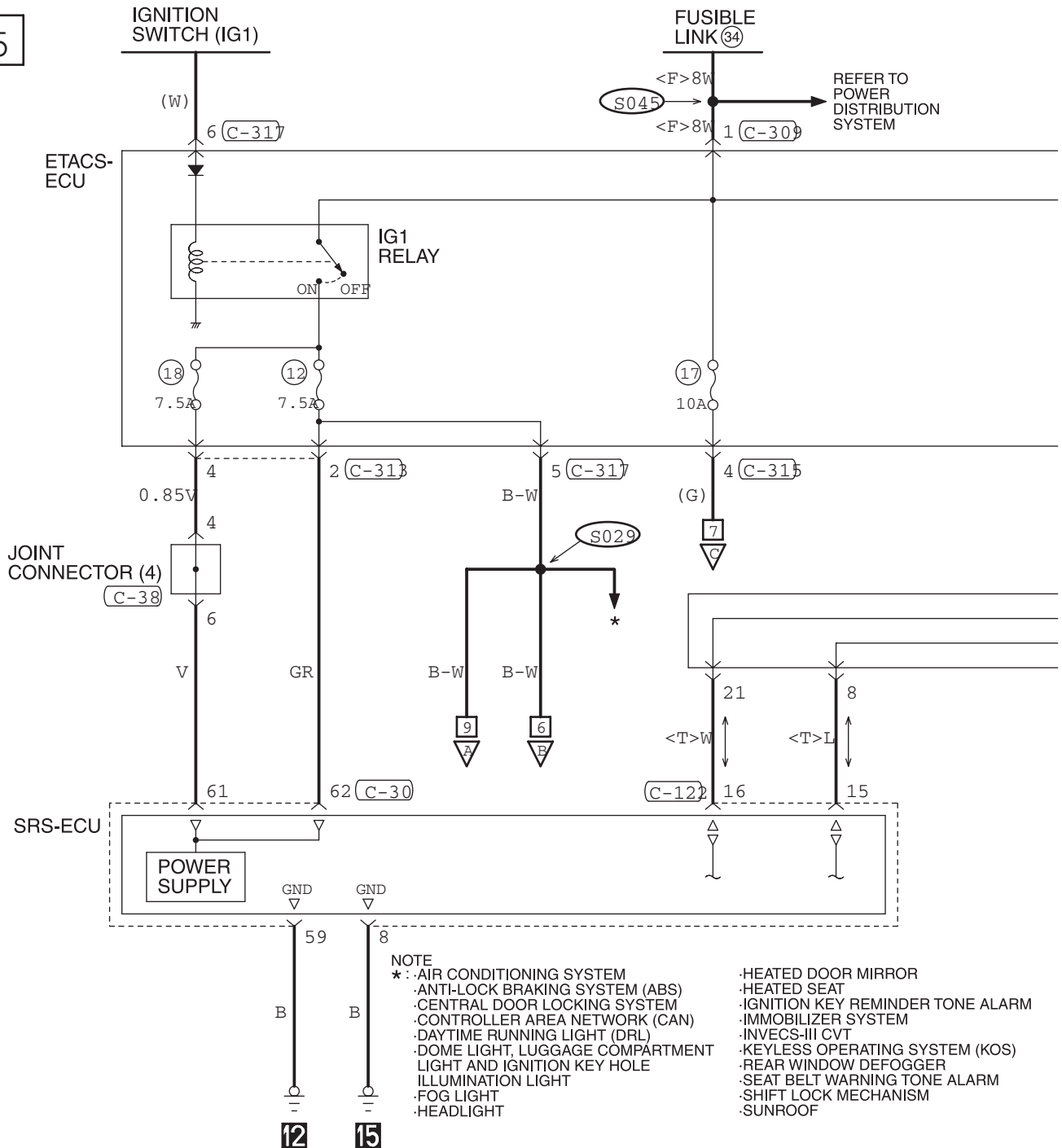

C-04

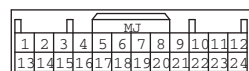

C-06

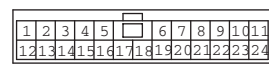

C-30

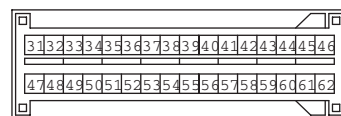

C-34 FRONT SIDE

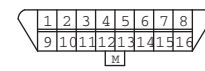

C-31



C-31

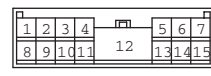

6

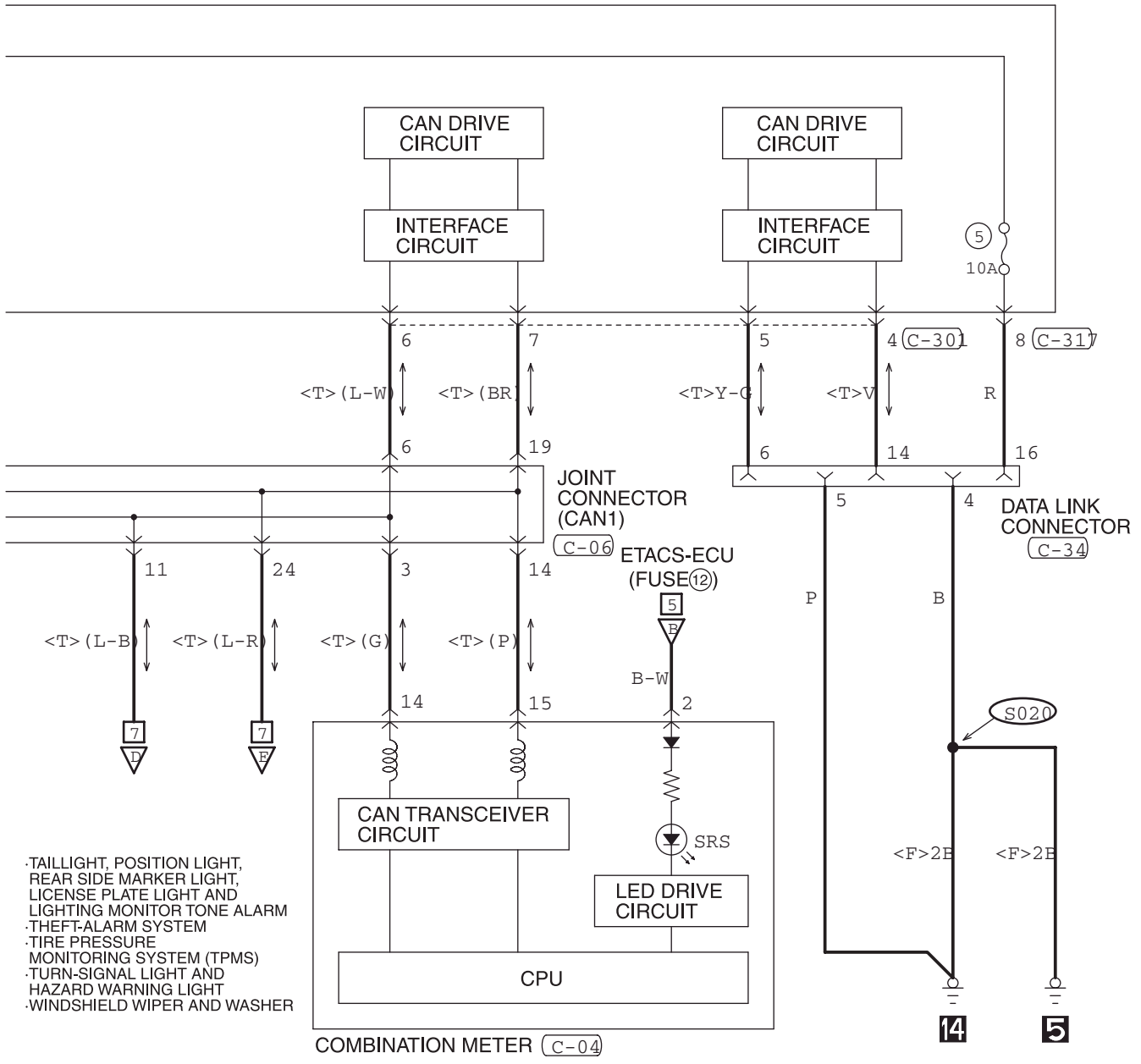

- TAILLIGHT, POSITION LIGHT, REAR SIDE MARKER LIGHT, LICENSE PLATE LIGHT AND LIGHTING MONITOR TONE ALARM
- THEFT-ALARM SYSTEM
- TIRE PRESSURE MONITORING SYSTEM (TPMS)
- TURN-SIGNAL LIGHT AND HAZARD WARNING LIGHT
- WINDSHIELD WIPER AND WASHER

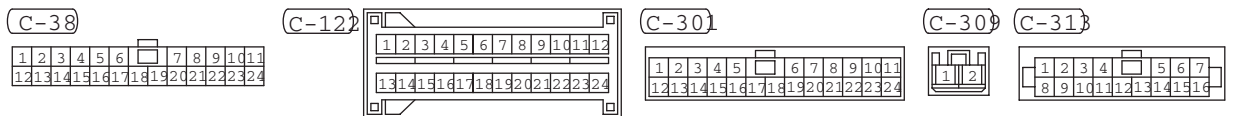

WIRE COLOR CODE
 B: BLACK LG: LIGHT GREEN G: GREEN L: BLUE W: WHITE Y: YELLOW SB: SKY BLUE
 BR: BROWN O: ORANGE GR: GRAY R: RED P: PINK V: VIOLET PU: PURPLE

H8G15M01CB

TSB Revision

SUPPLEMENTAL RESTRAINT SYSTEM (SRS) (CONTINUED)

7

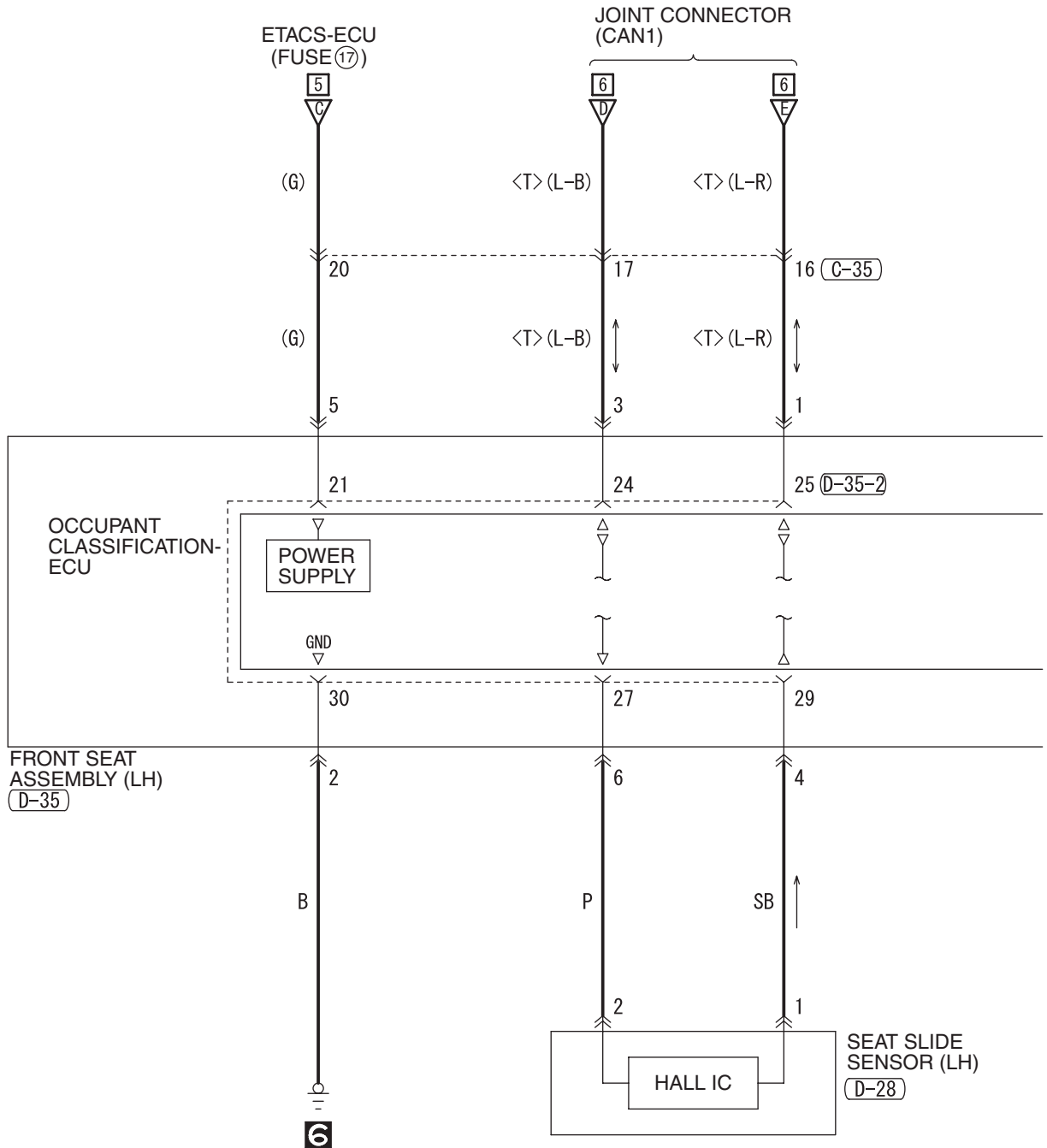

C-35



D-28



D-35



D-35-1

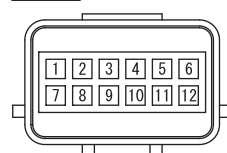

D-35-2

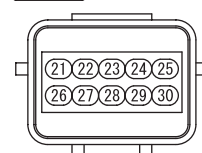

D-35-3



D-35-4



D-35-5



D-35-6

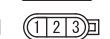

8

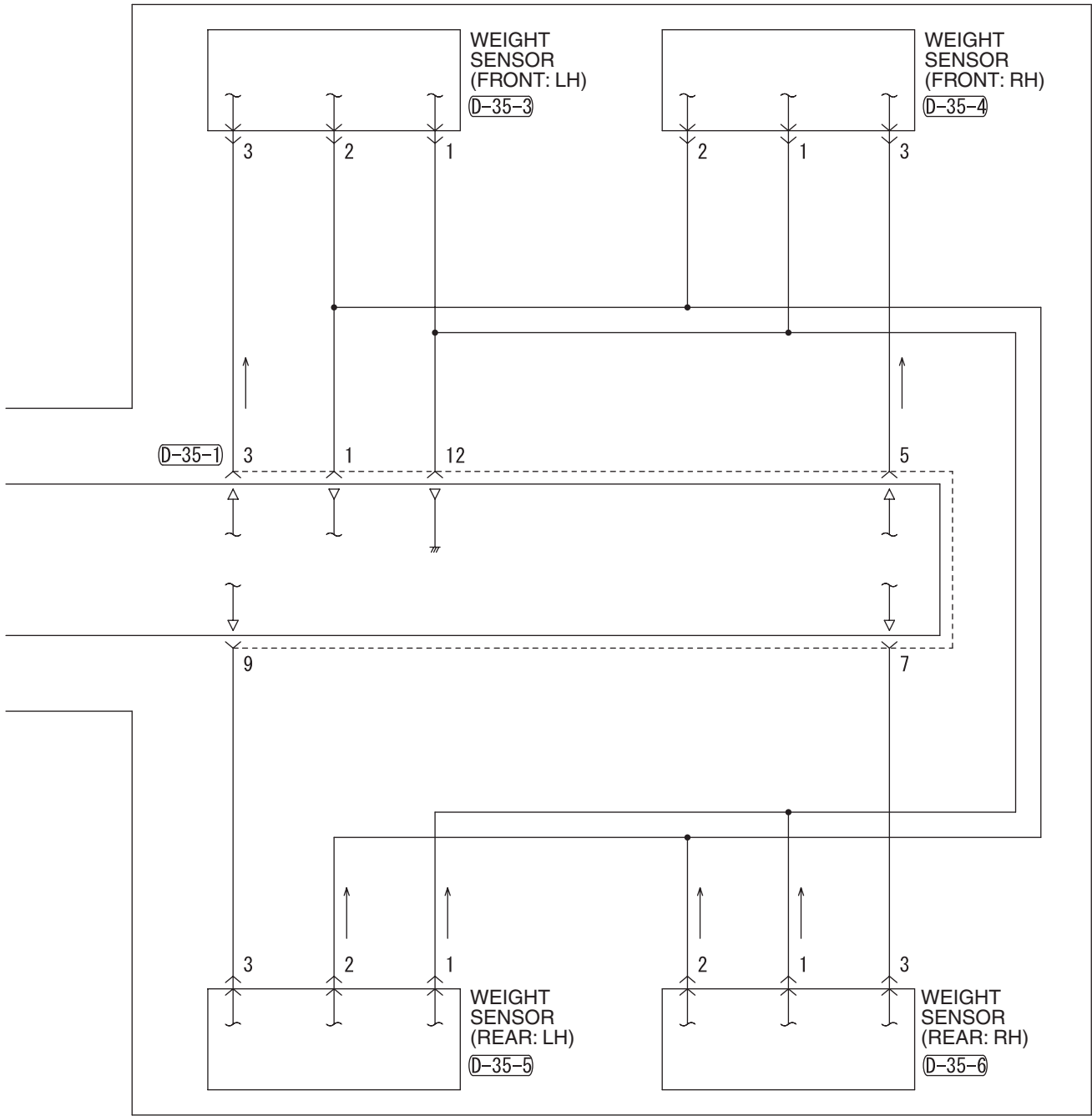

WIRE COLOR CODE

B: BLACK LG: LIGHT GREEN G: GREEN L: BLUE W: WHITE Y: YELLOW SB: SKY BLUE
BR: BROWN O: ORANGE GR: GRAY R: RED P: PINK V: VIOLET PU: PURPLE

H8G15M01DB

TSB Revision

SUPPLEMENTAL RESTRAINT SYSTEM (SRS) (CONTINUED)

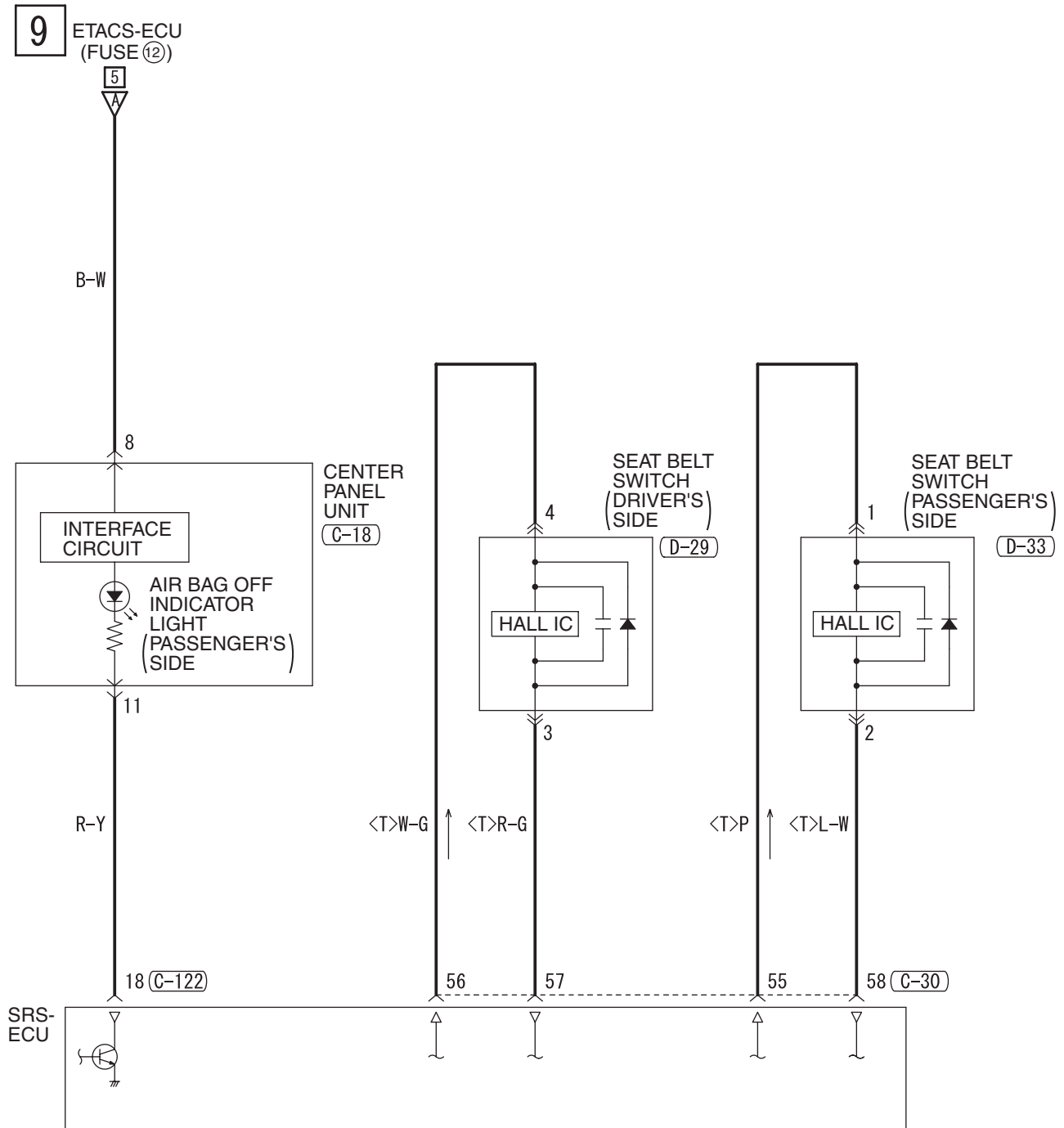

(C-18)

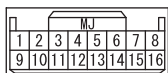

(C-30)

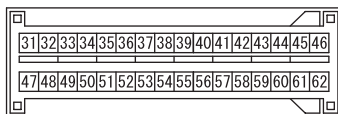

(C-122)

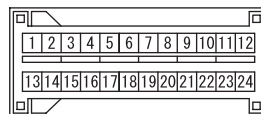

(D-29)



(D-33)



NOTES

IMMOBILIZER SYSTEM

M1901013602910

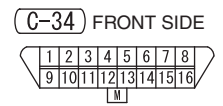
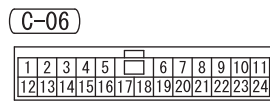
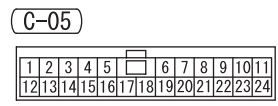
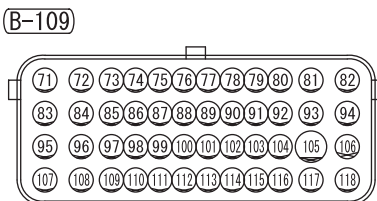
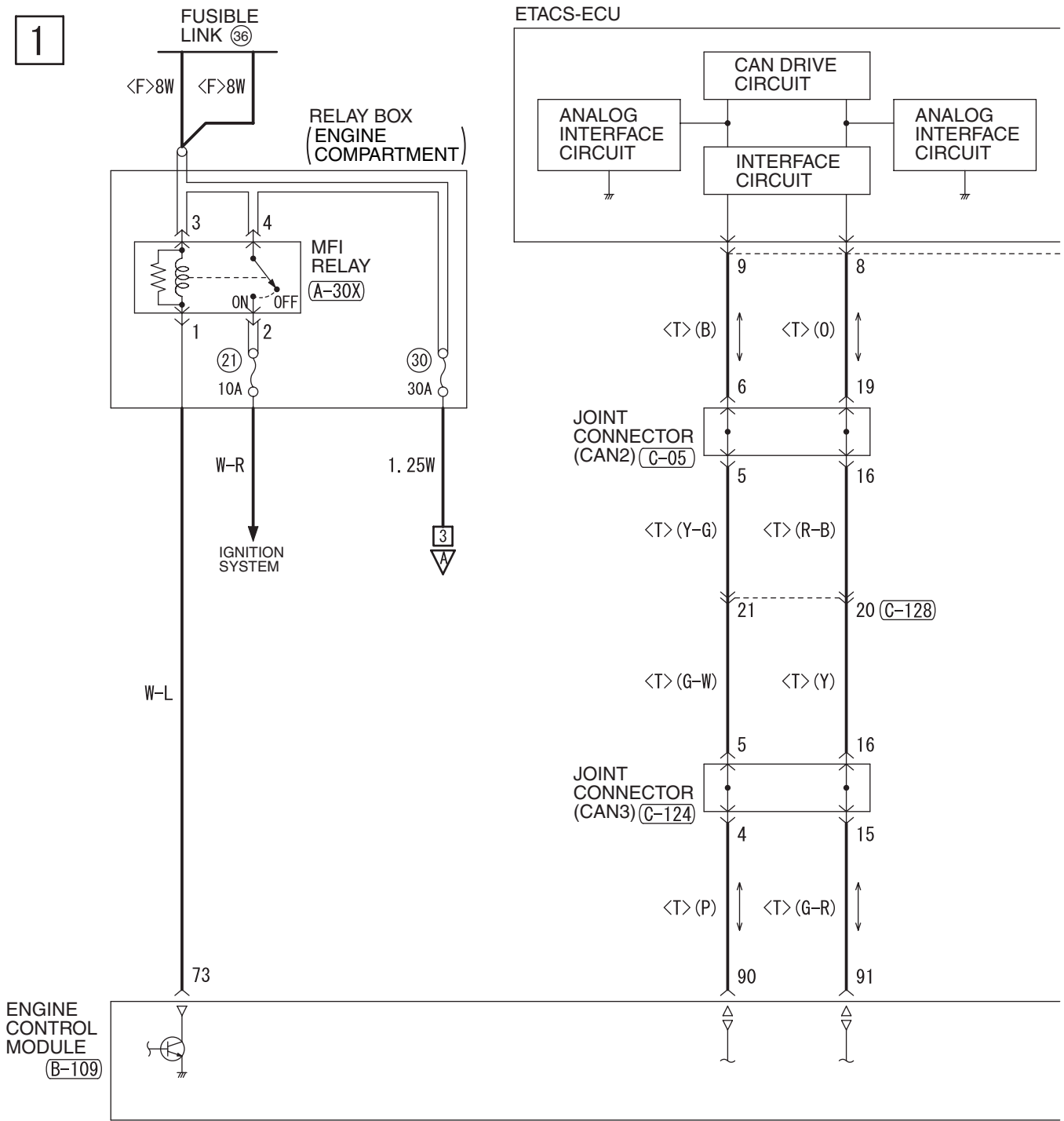

H8G15M02AA

TSB Revision

2

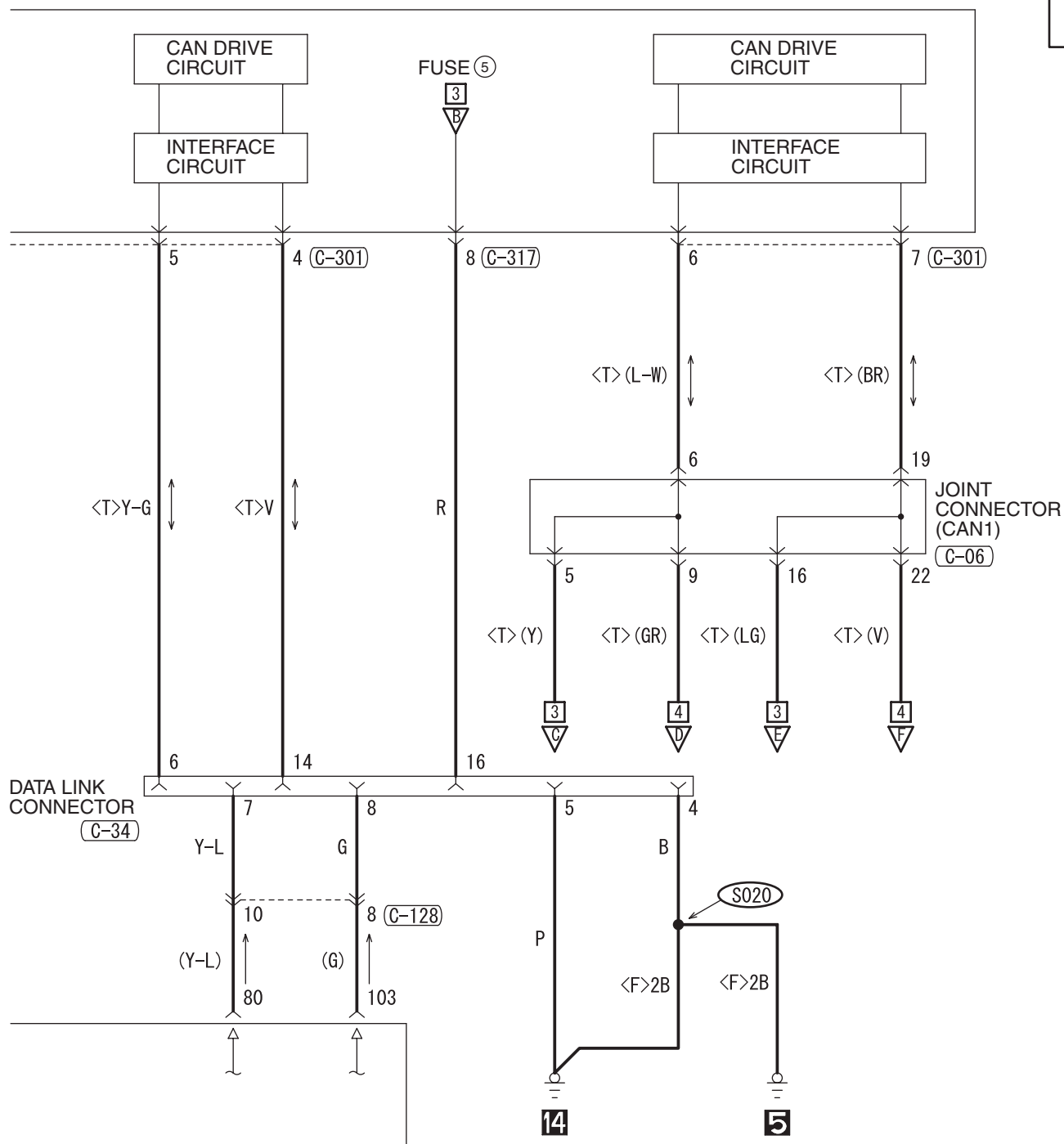

(C-124)

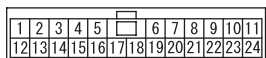

(C-128)

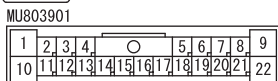

(C-301)

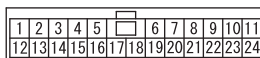

(C-317)

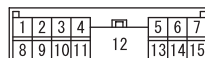

WIRE COLOR CODE

B : BLACK LG : LIGHT GREEN G : GREEN L : BLUE W : WHITE Y : YELLOW SB : SKY BLUE
BR : BROWN O : ORANGE GR : GRAY R : RED P : PINK V : VIOLET PU : PURPLE

H8G15M02AB

IMMOBILIZER SYSTEM (CONTINUED)

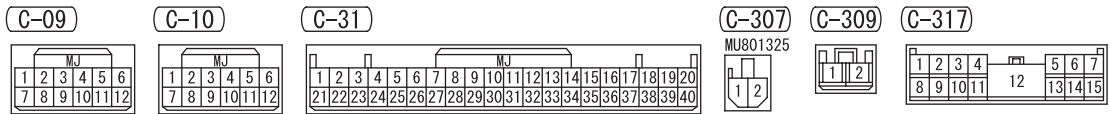
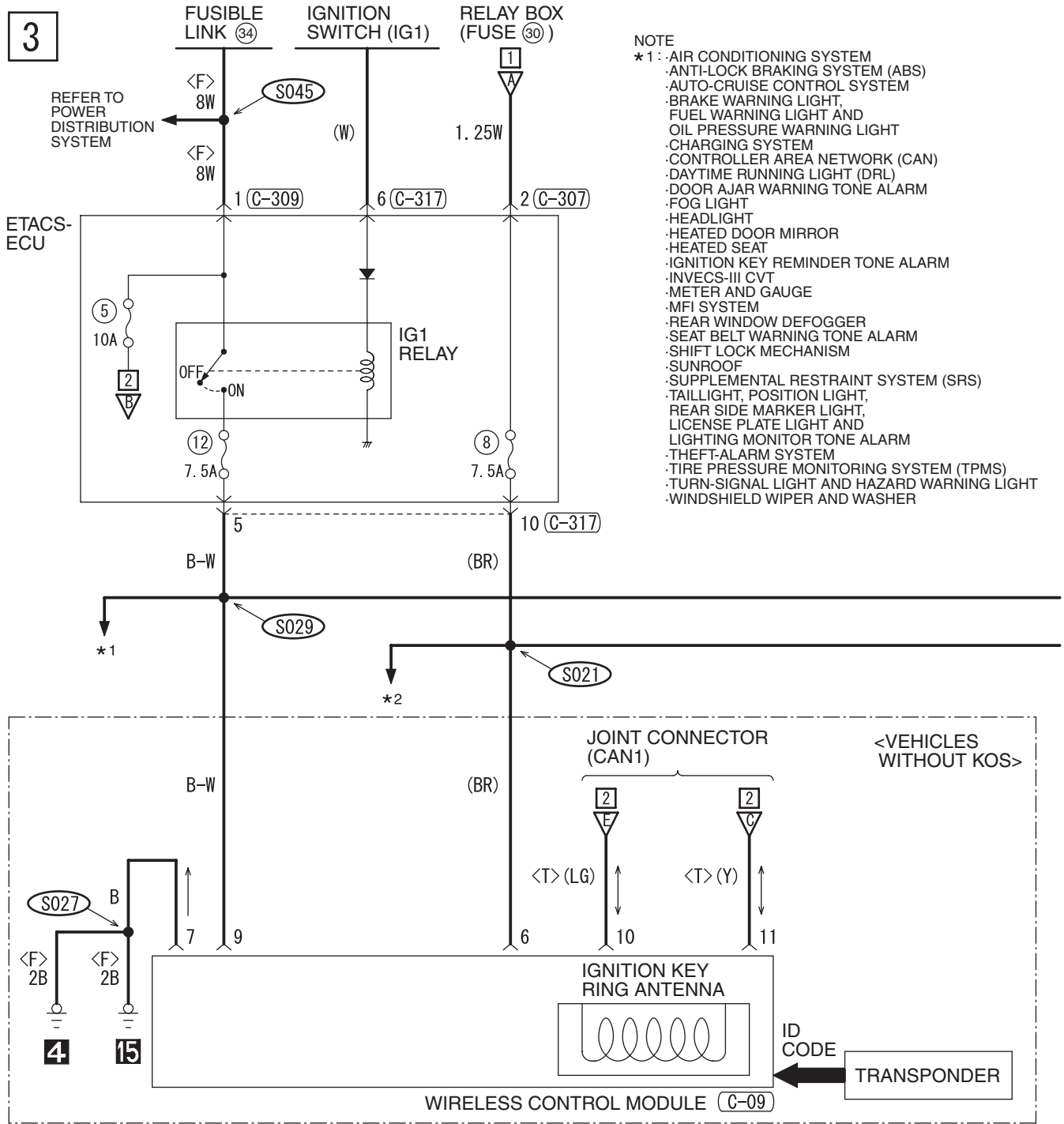

- *2 : ·AIR CONDITIONING SYSTEM
·BRAKE WARNING LIGHT,
FUEL WARNING LIGHT AND
OIL PRESSURE WARNING LIGHT
·CONTROLLER AREA NETWORK (CAN)
·DAYTIME RUNNING LIGHT (DRL)
·FOG LIGHT
·HEADLIGHT
·IGNITION KEY REMINDER TONE ALARM
<VEHICLES WITH KOS>
·METER AND GAUGE
·SEAT BELT WARNING TONE ALARM
·TAILLIGHT, POSITION LIGHT,
REAR SIDE MARKER LIGHT,
LICENSE PLATE LIGHT AND
LIGHTING MONITOR TONE ALARM
·TURN-SIGNAL LIGHT AND HAZARD WARNING LIGHT
·WINDSHIELD WIPER AND WASHER

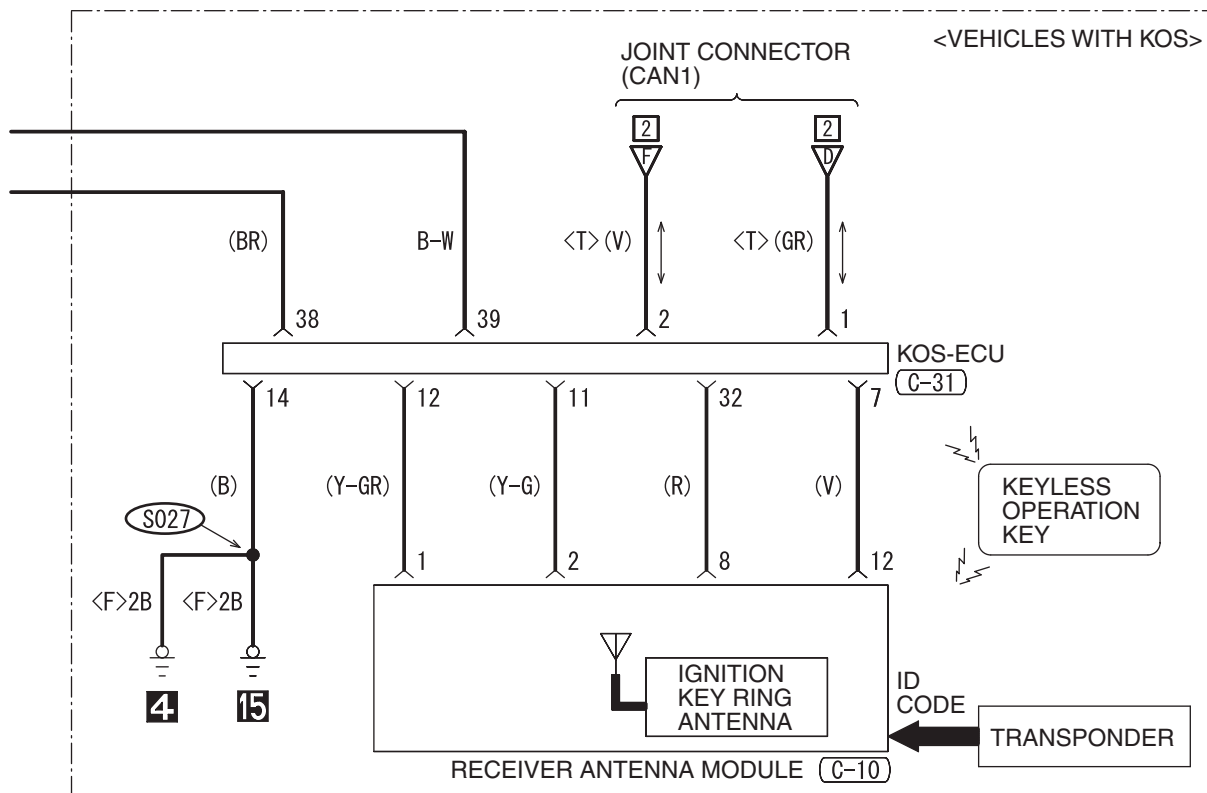

WIRE COLOR CODE

B: BLACK LG: LIGHT GREEN G: GREEN L: BLUE W: WHITE Y: YELLOW SB: SKY BLUE
BR: BROWN O: ORANGE GR: GRAY R: RED P: PINK V: VIOLET PU: PURPLE

H8G15M02BB

AUTO-CRUISE CONTROL SYSTEM

M1901009302433

1

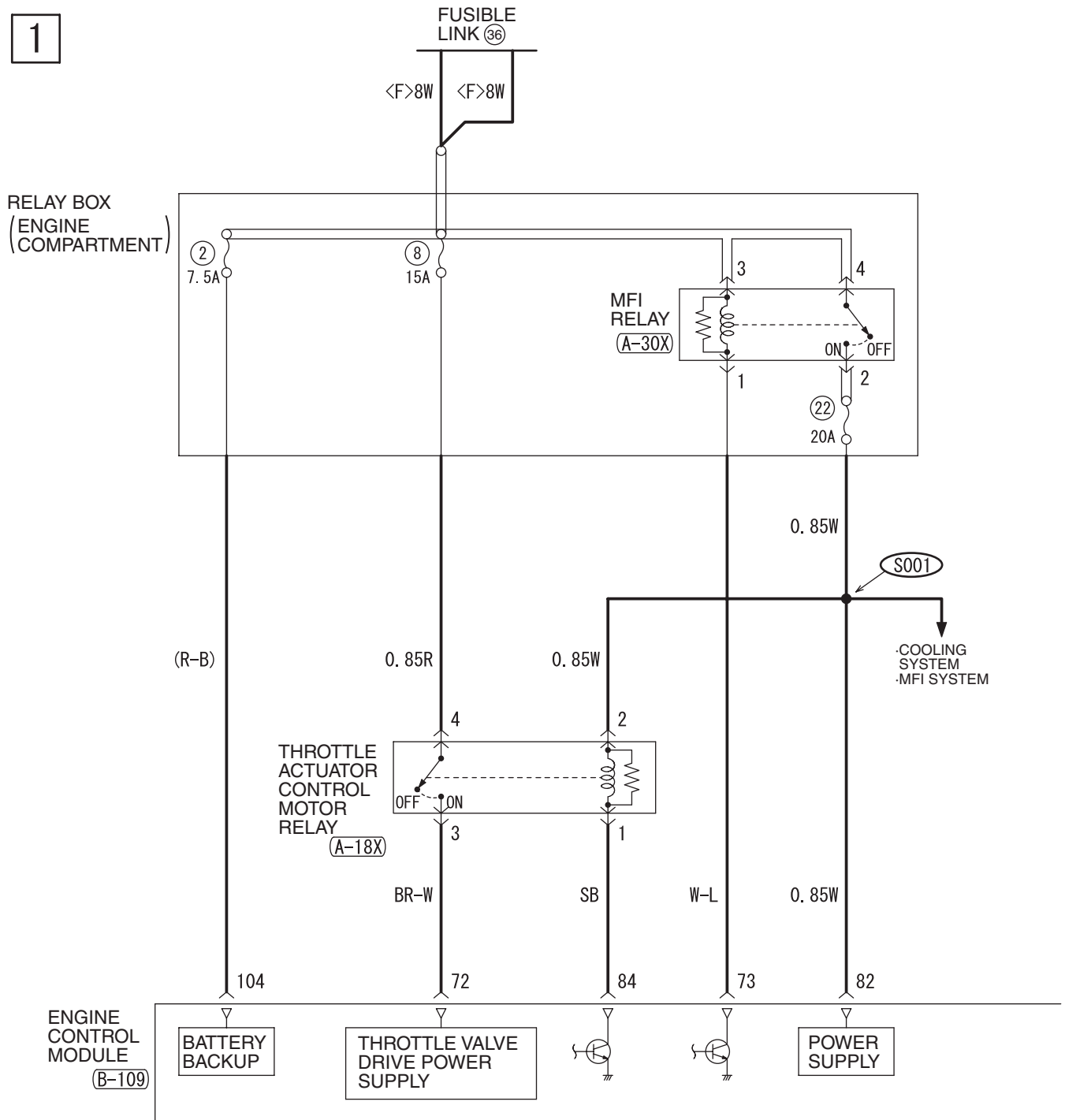

(A-10)

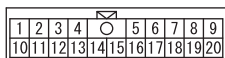

(A-18X)



(A-30X)



(B-109)

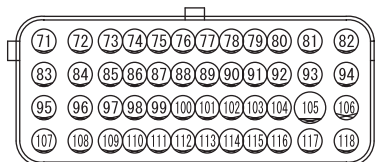

(B-111)



(C-32)



(C-304)

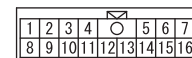

(C-309)



TSB Revision

2

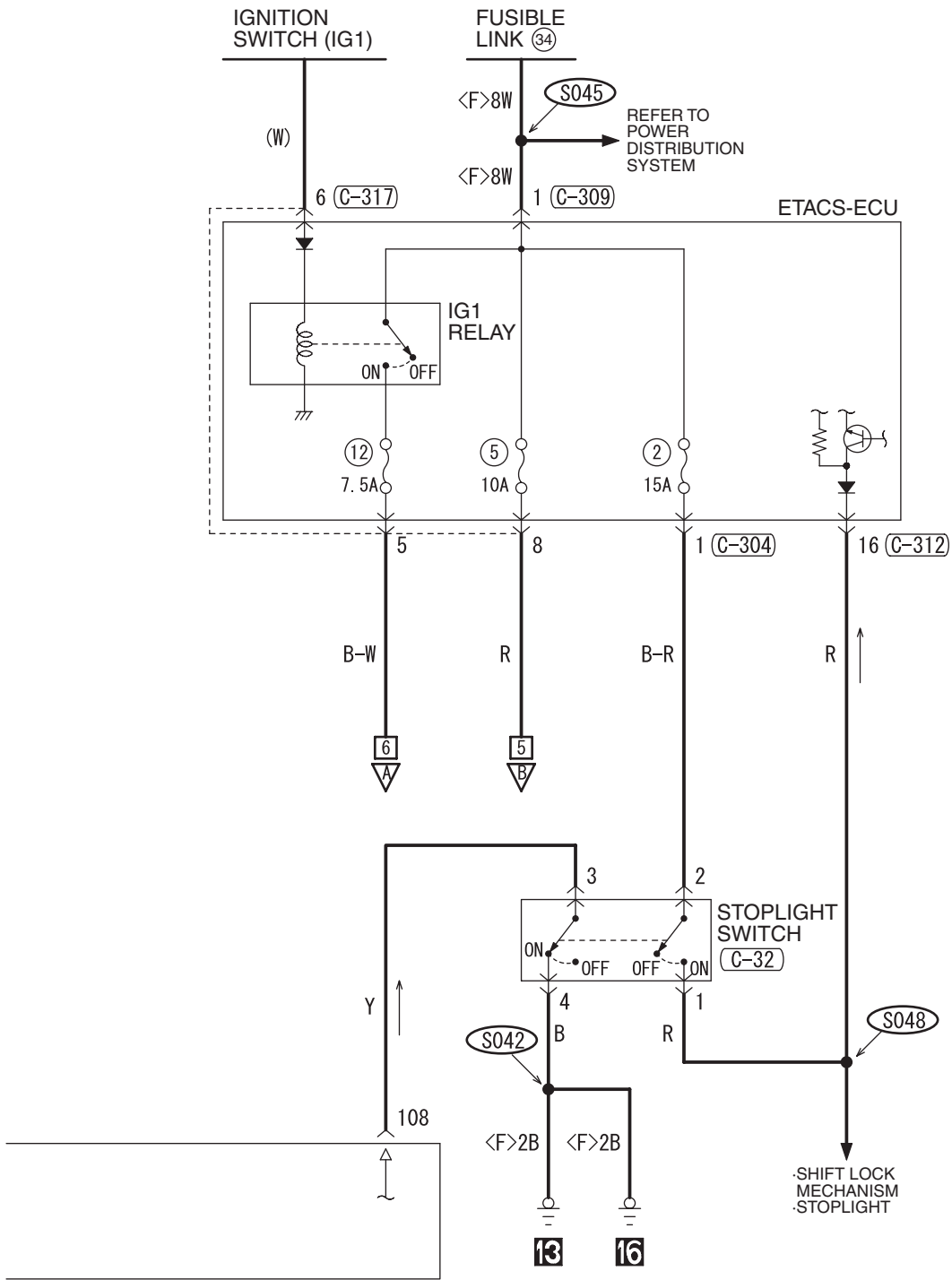

(C-312)

(C-317)

1	2	3	4	5	6	7		
8	9	10	11	12	13	14	15	16

1	2	3	4	5	6	7	
8	9	10	11	12	13	14	15

WIRE COLOR CODE

B: BLACK LG: LIGHT GREEN G: GREEN L: BLUE W: WHITE Y: YELLOW SB: SKY BLUE
BR: BROWN O: ORANGE GR: GRAY R: RED P: PINK V: VIOLET PU: PURPLE

H8G15M03AB

AUTO-CRUISE CONTROL SYSTEM (CONTINUED)

3

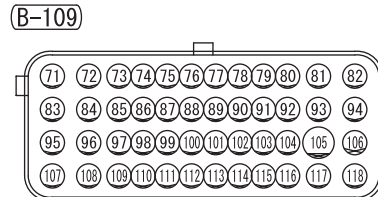
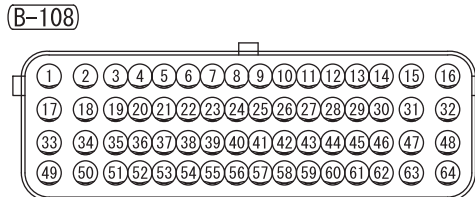
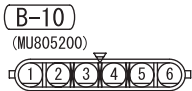
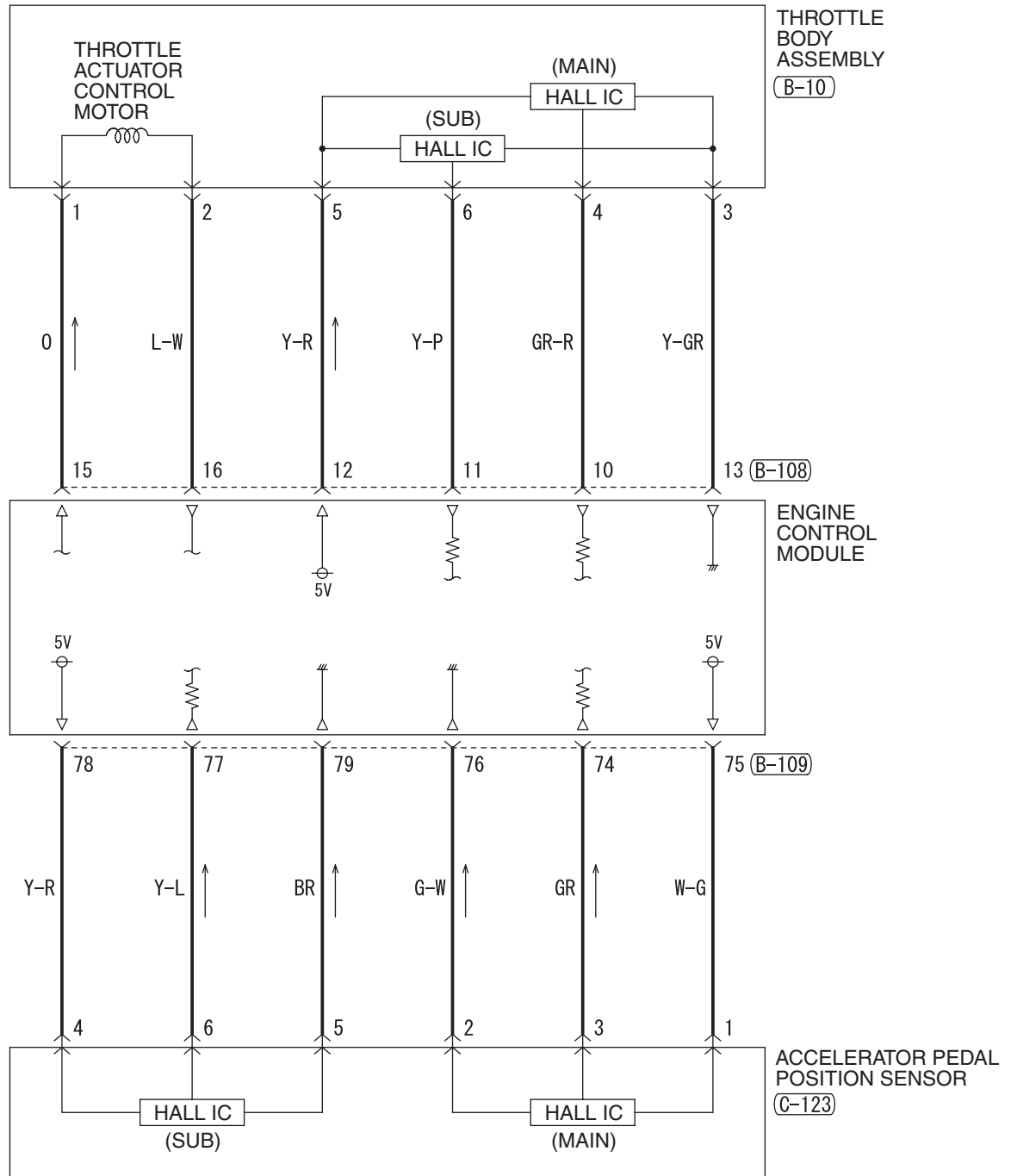

AUTO-CRUISE CONTROL SYSTEM (CONTINUED)

5

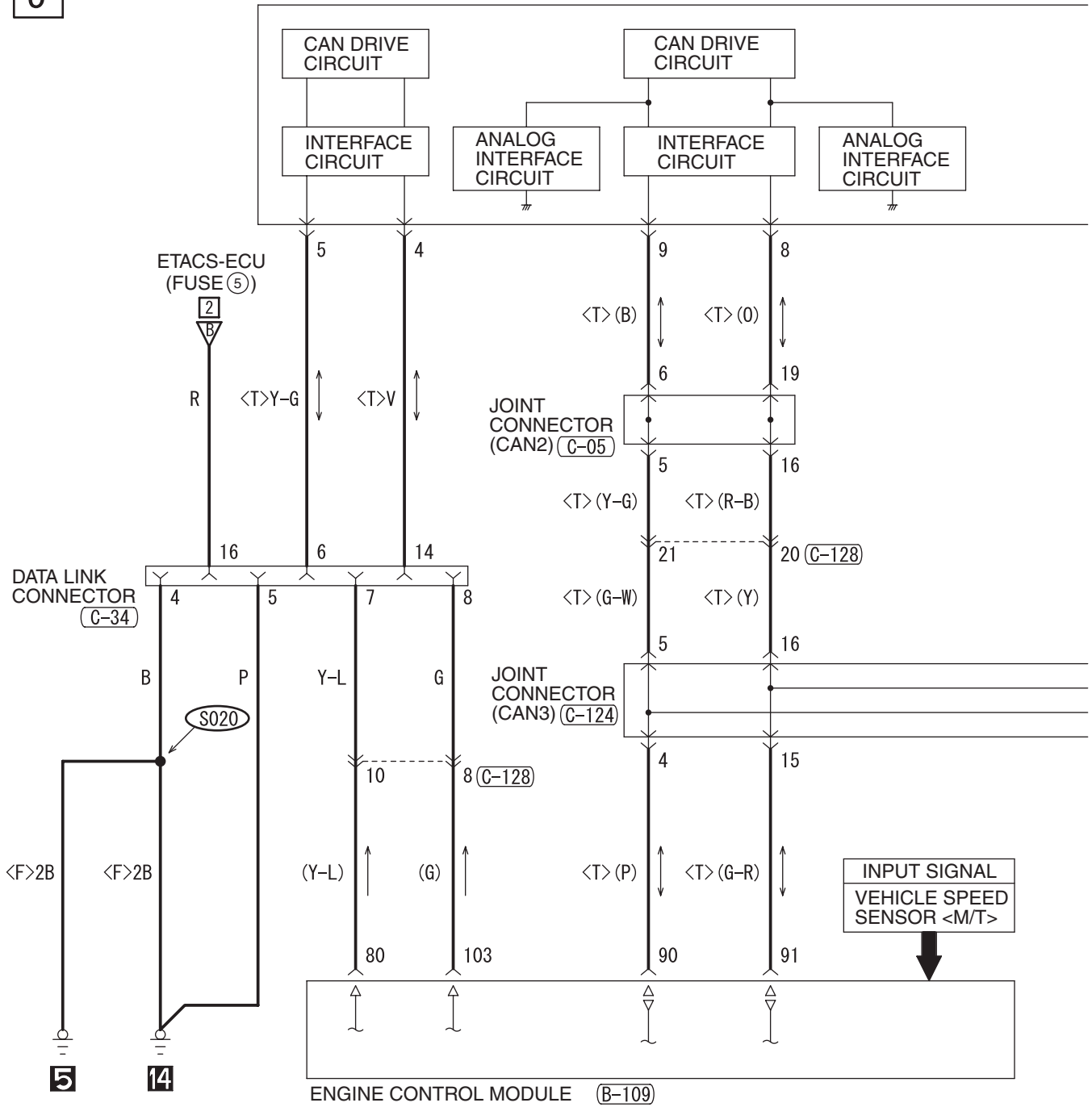

(B-109)

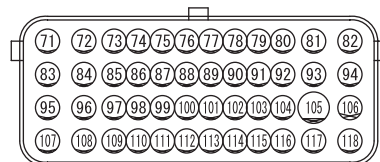

(C-04)

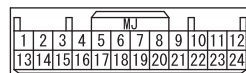

(C-05)

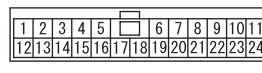

(C-06)

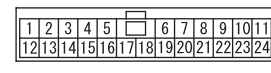

(C-301)

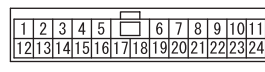

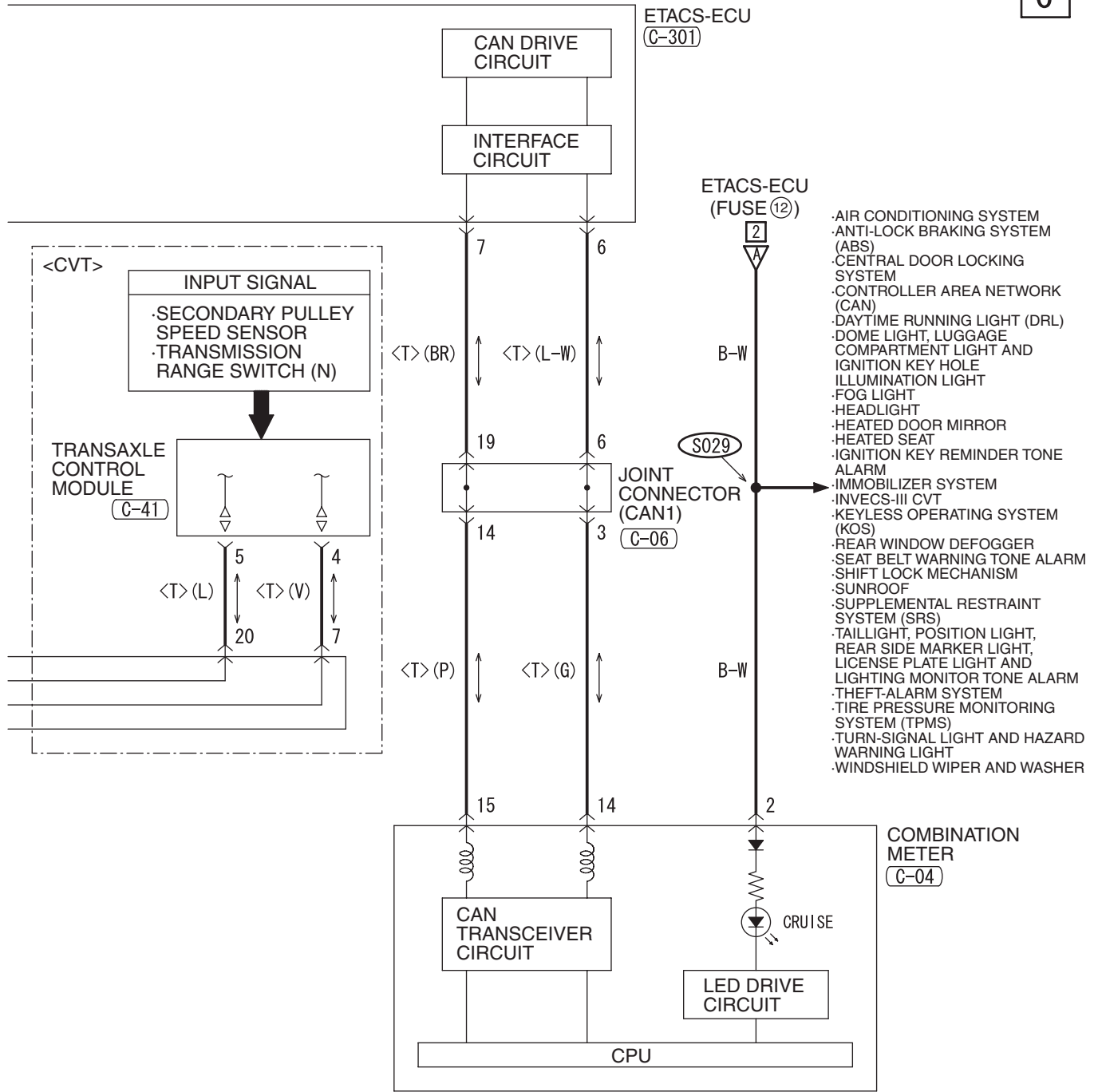

C-34 FRONT SIDE



C-41

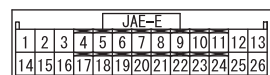

C-124

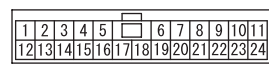

C-128

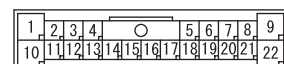

WIRE COLOR CODE

B : BLACK LG : LIGHT GREEN G : GREEN L : BLUE W : WHITE Y : YELLOW SB : SKY BLUE
 BR : BROWN O : ORANGE GR : GRAY R : RED P : PINK V : VIOLET PU : PURPLE

H8G15M03CB

SUNROOF

1

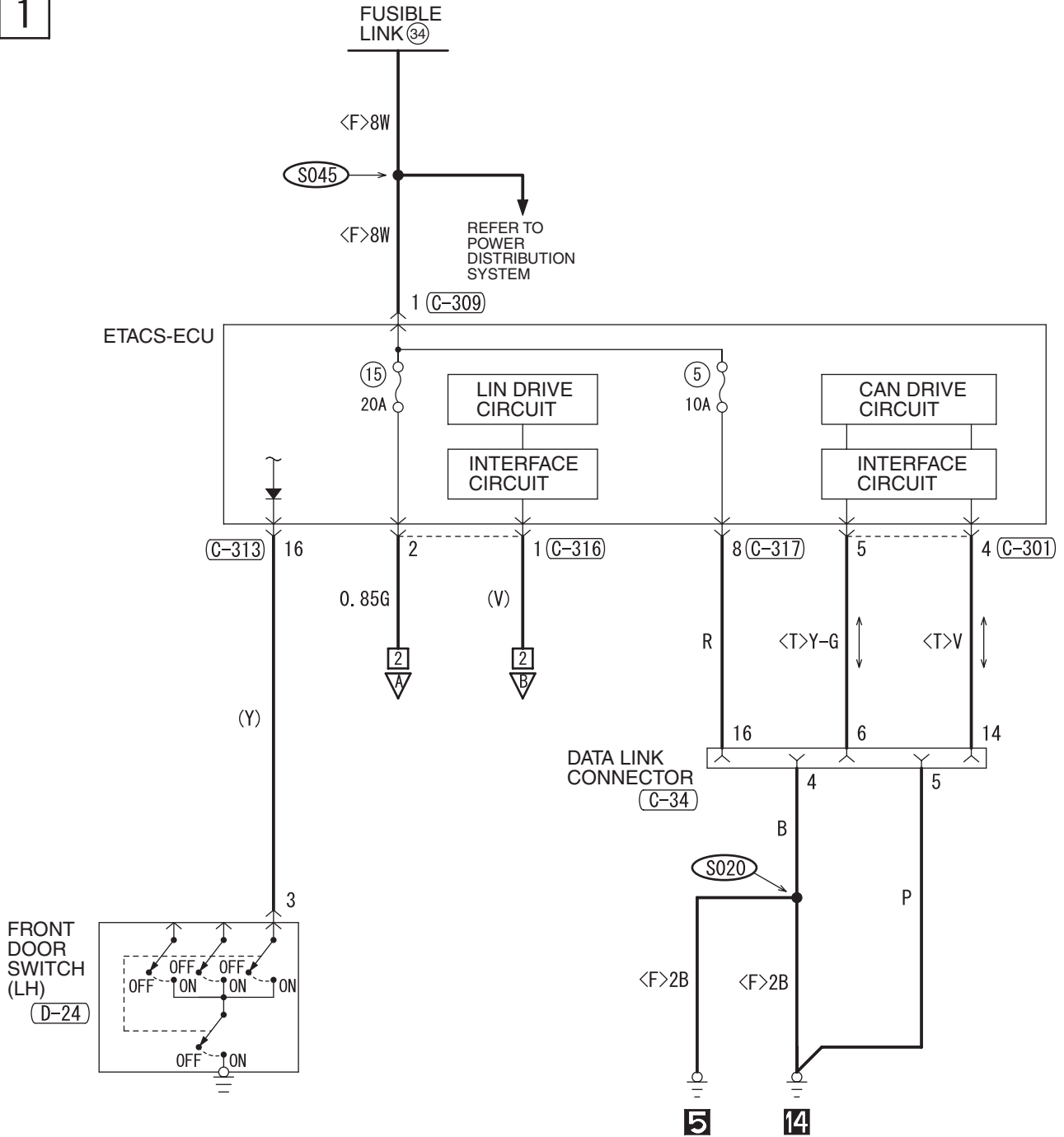

C-34 FRONT SIDE



C-301

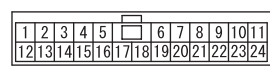

C-309



C-313

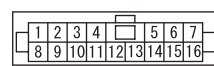

C-316



C-317

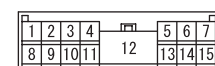

D-04

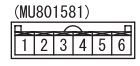

2

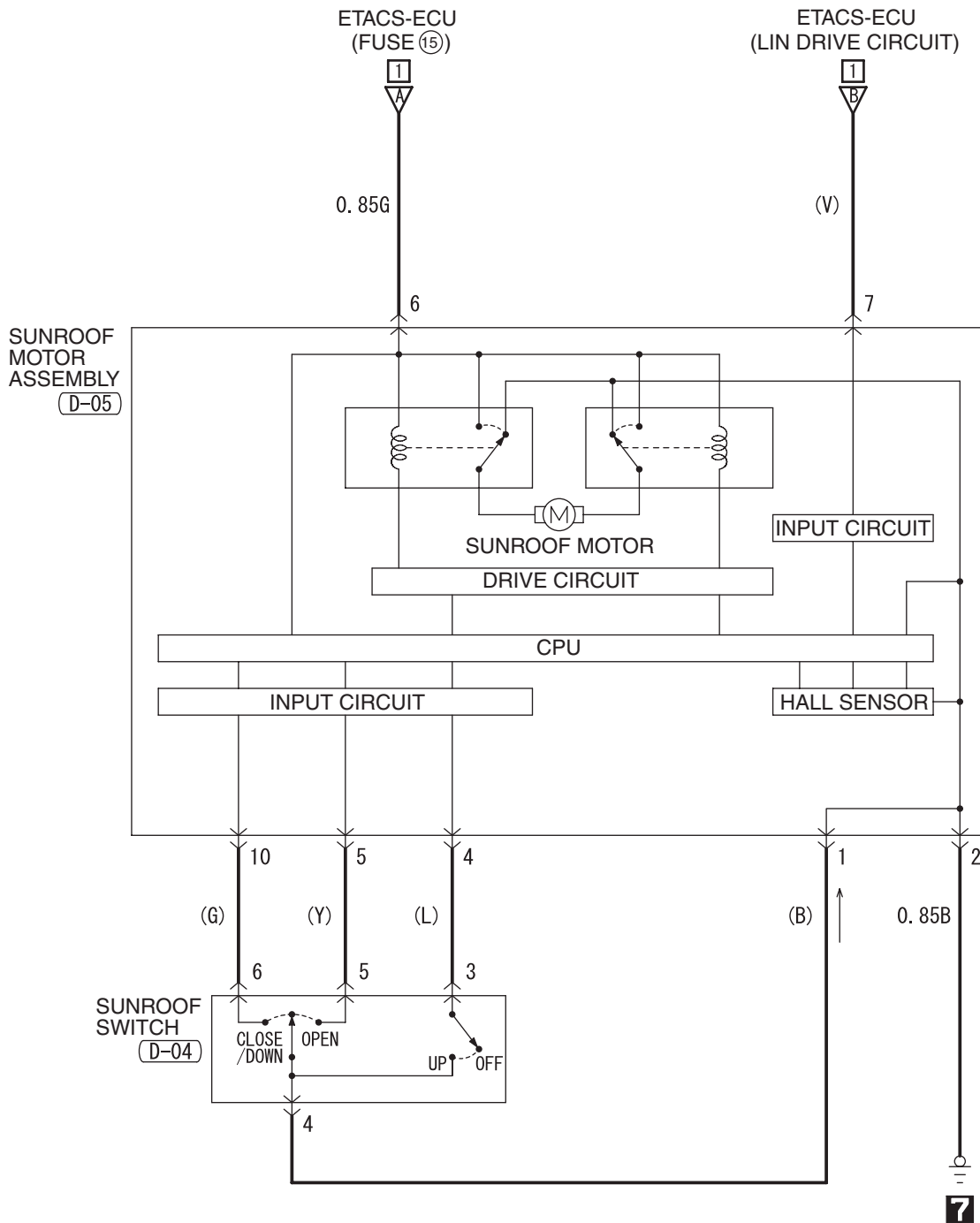

D-05

D-24

(MU801536)



WIRE COLOR CODE

B: BLACK LG: LIGHT GREEN G: GREEN L: BLUE W: WHITE Y: YELLOW SB: SKY BLUE
BR: BROWN O: ORANGE GR: GRAY R: RED P: PINK V: VIOLET PU: PURPLE

H8G15M04AB

TSB Revision

HEATED SEAT

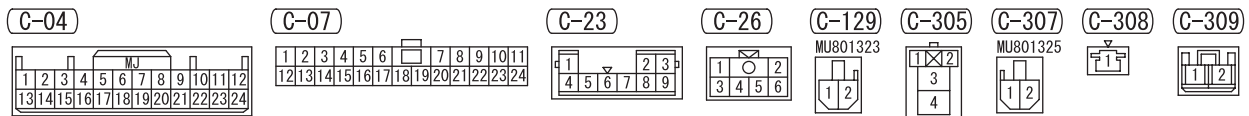
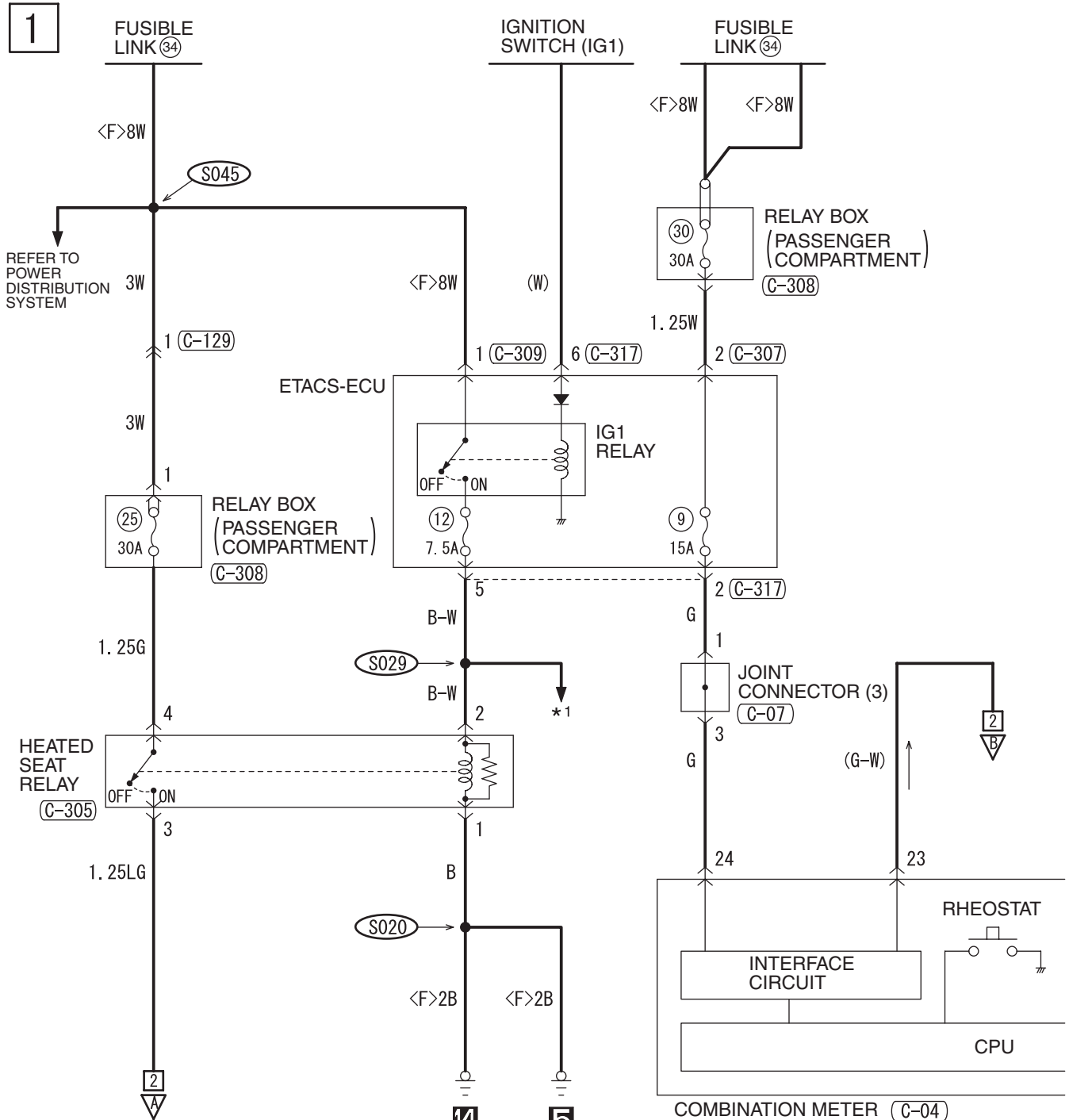

2

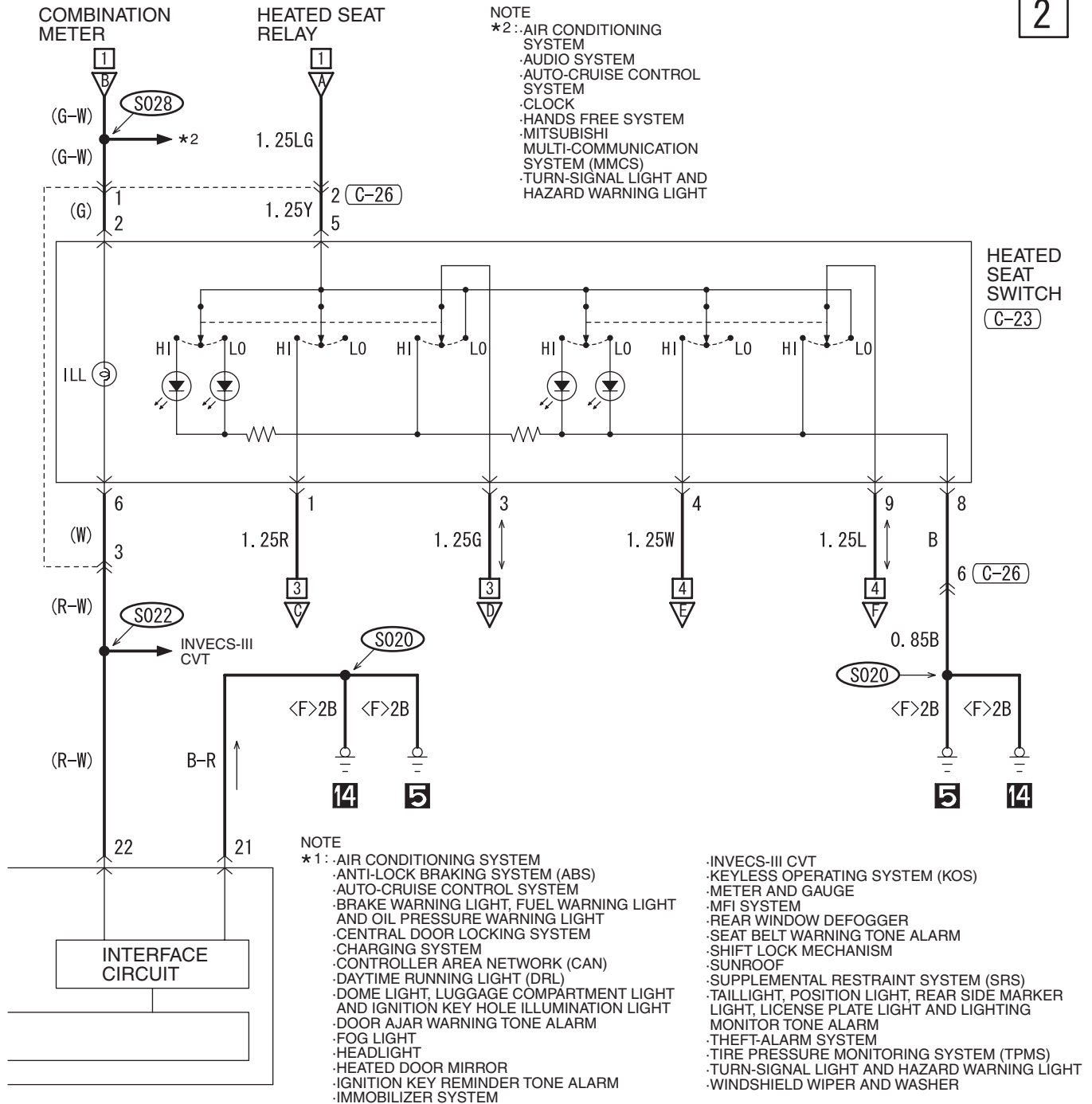

C-317

1	2	3	4	5	6	7	
8	9	10	11	12	13	14	15

WIRE COLOR CODE

B: BLACK LG: LIGHT GREEN G: GREEN L: BLUE W: WHITE Y: YELLOW SB: SKY BLUE
 BR: BROWN O: ORANGE GR: GRAY R: RED P: PINK V: VIOLET PU: PURPLE

H8G15M05AB

HEATED SEAT (CONTINUED)

3

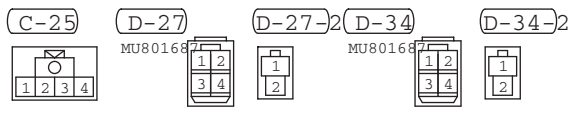
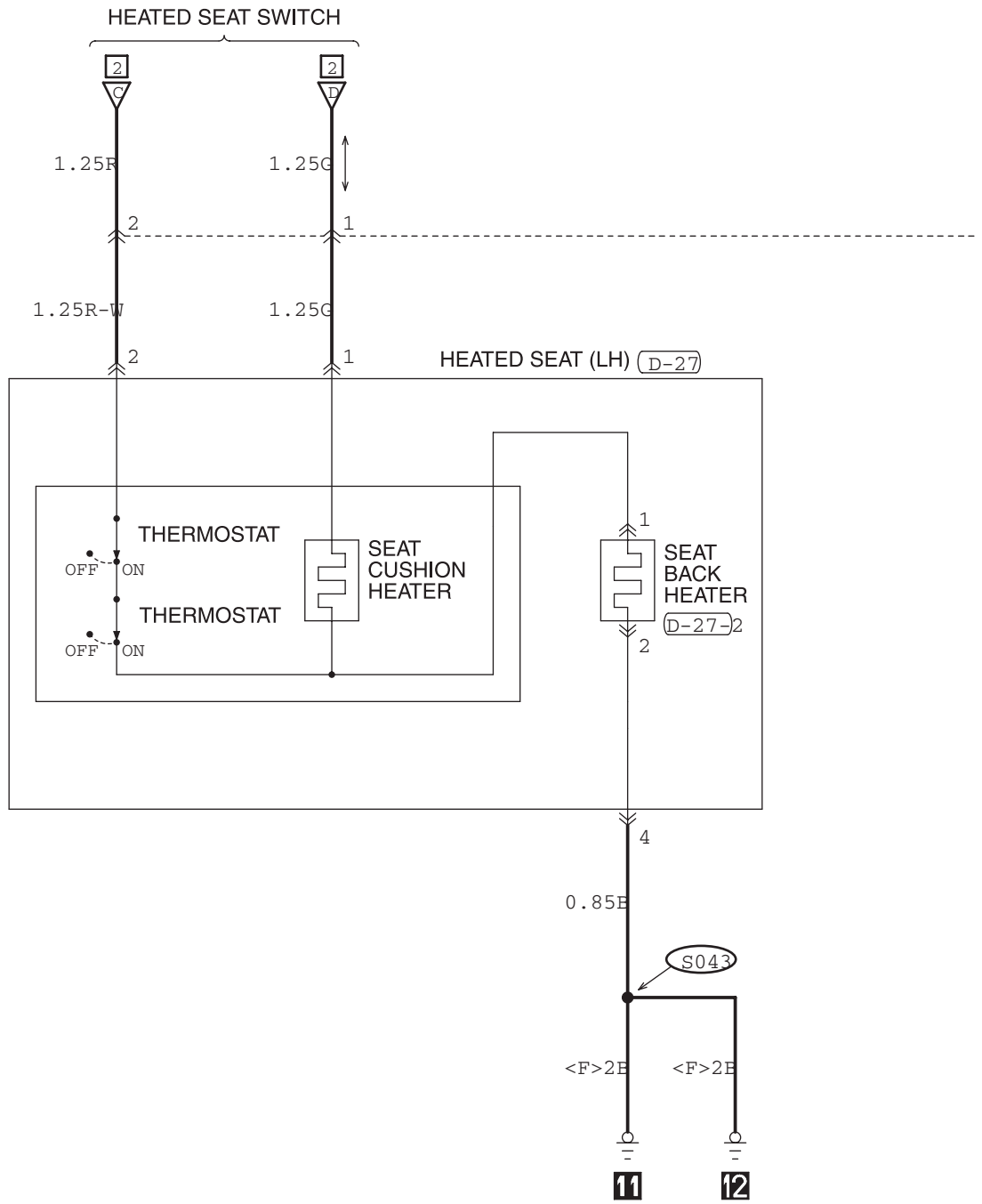

4

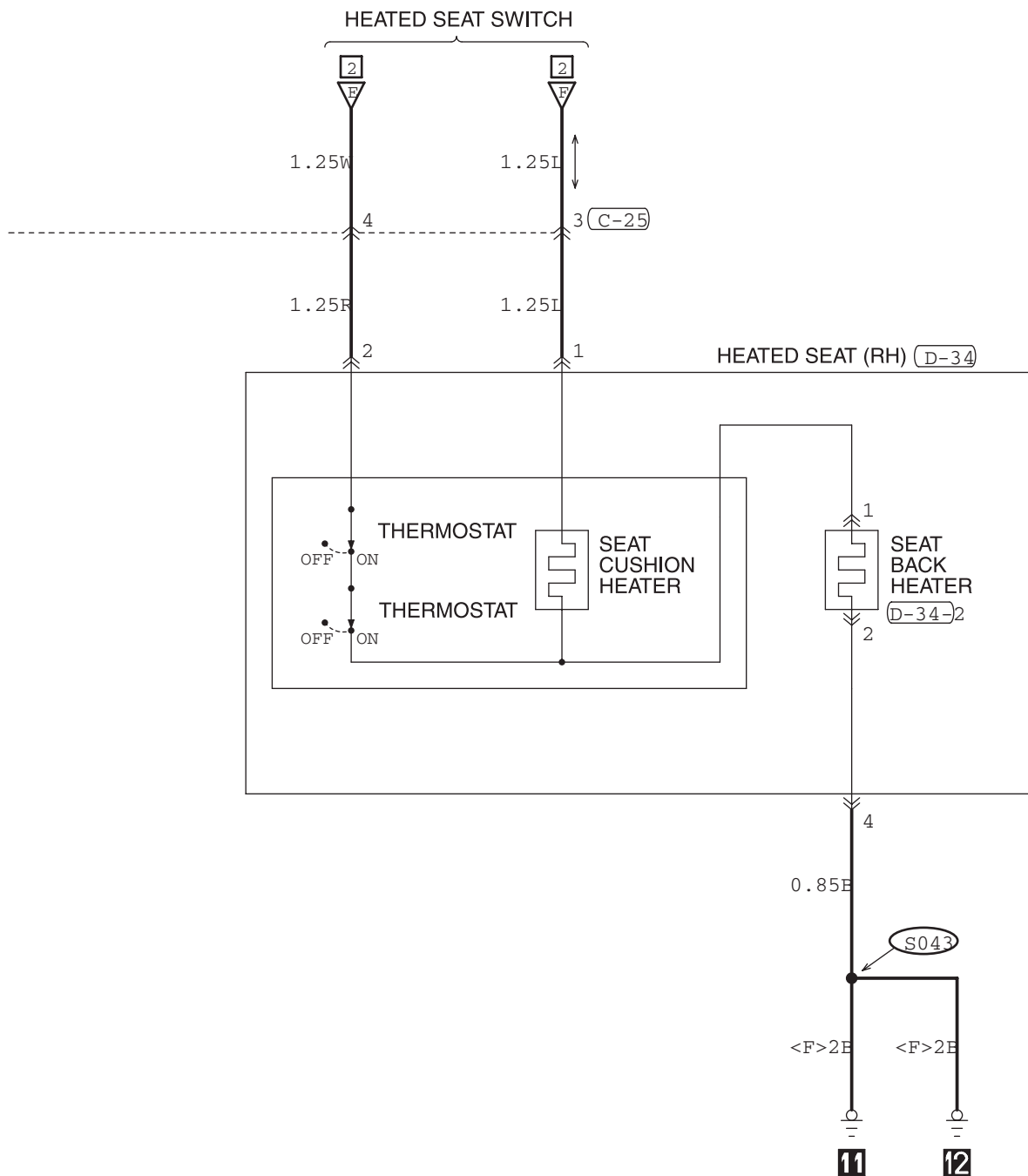

WIRE COLOR CODE

B: BLACK LG: LIGHT GREEN G: GREEN L: BLUE W: WHITE Y: YELLOW SB: SKY BLUE
BR: BROWN O: ORANGE GR: GRAY R: RED P: PINK V: VIOLET PU: PURPLE

H8G15M05BB

TSB Revision

IGNITION KEY REMINDER TONE ALARM <VEHICLES WITHOUT KOS>

M1901011301374

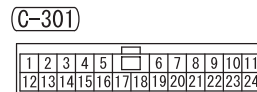
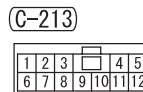
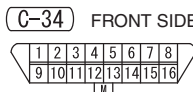
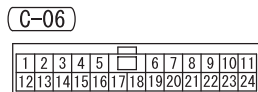
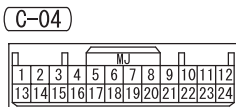
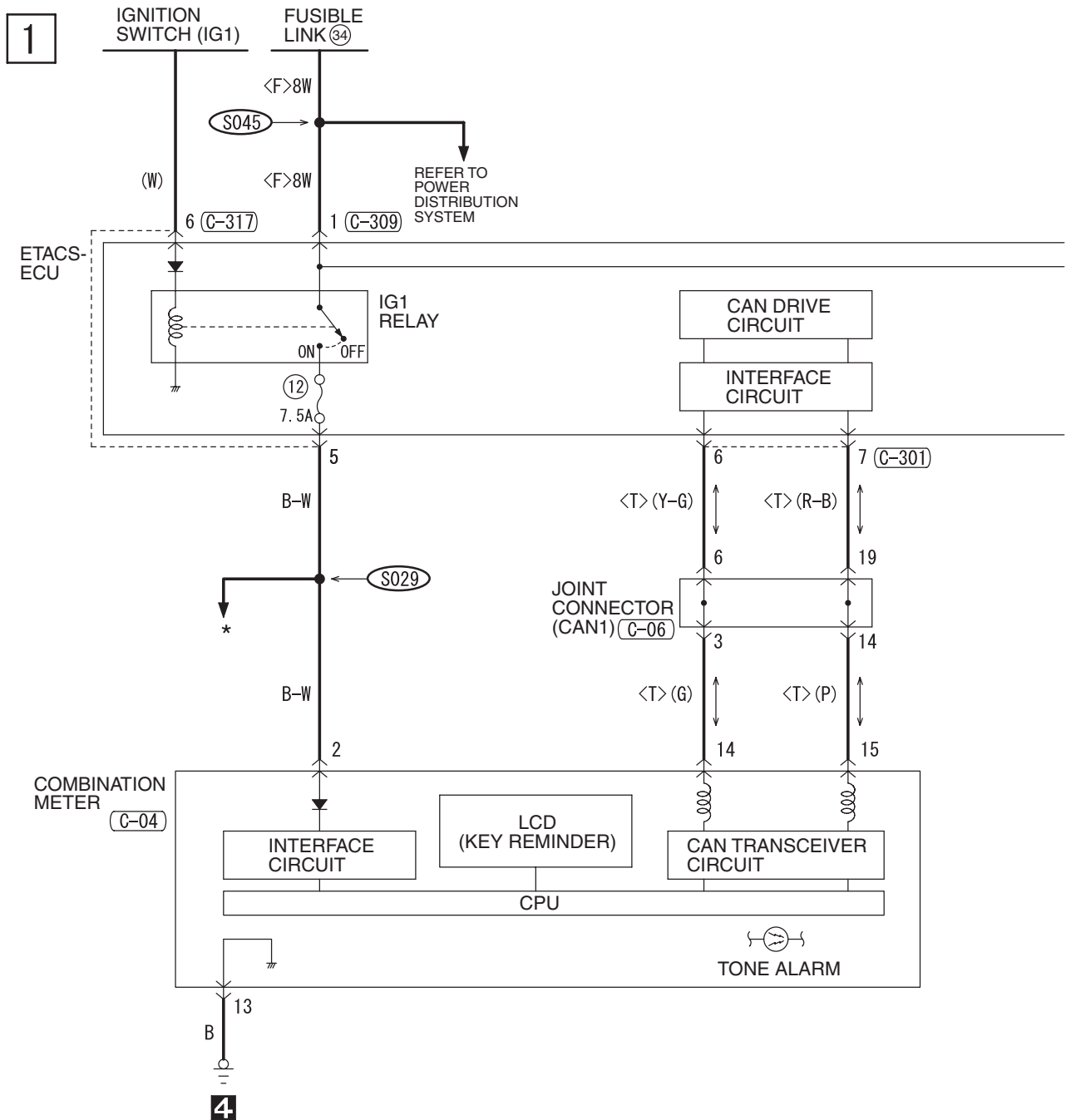

H8G15M06AA

IGNITION KEY REMINDER TONE ALARM <VEHICLES WITH KOS>

M1901011301363

1

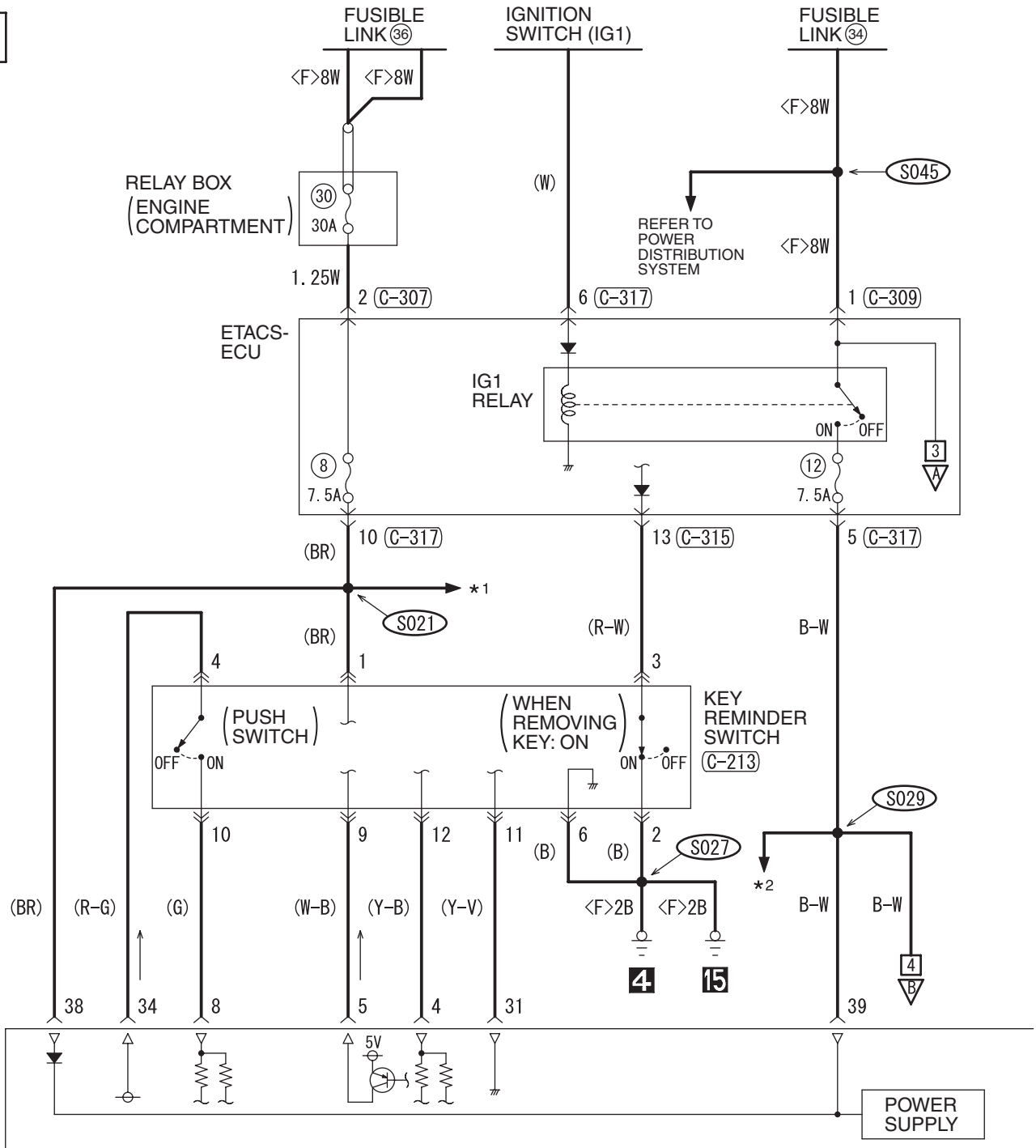

C-21

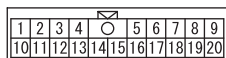

C-31

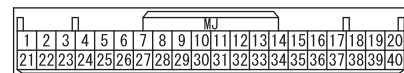

C-213



C-307



C-309



C-315



2

NOTE

- *1 :** -AIR CONDITIONING SYSTEM
 -BRAKE WARNING LIGHT,
 FUEL WARNING LIGHT AND
 OIL PRESSURE WARNING LIGHT
 -CENTRAL DOOR LOCKING SYSTEM
 -CONTROLLER AREA NETWORK (CAN)
 -DAYTIME RUNNING LIGHT (DRL)
 -FOG LIGHT
 -HEADLIGHT
 -METER AND GAUGE
 -SEAT BELT WARNING TONE ALARM
 -TAILLIGHT, POSITION LIGHT,
 REAR SIDE MARKER LIGHT,
 LICENSE PLATE LIGHT AND
 LIGHTING MONITOR TONE ALARM
 -TURN-SIGNAL LIGHT AND
 HAZARD WARNING LIGHT
 -WINDSHIELD WIPER AND WASHER

- *2 :** -AIR CONDITIONING SYSTEM
 -BRAKE WARNING LIGHT,
 FUEL WARNING LIGHT AND
 OIL PRESSURE WARNING LIGHT
 -CENTRAL DOOR LOCKING SYSTEM
 -CHARGING SYSTEM
 -CONTROLLER AREA NETWORK (CAN)
 -DAYTIME RUNNING LIGHT (DRL)
 -DOME LIGHT, LUGGAGE
 COMPARTMENT LIGHT AND IGNITION
 KEY HOLE ILLUMINATION LIGHT
 -FOG LIGHT
 -HEADLIGHT
 -HEATED DOOR MIRROR
 -HEATED SEAT
 -IMMOBILIZER SYSTEM
 -INVECS-III CVT
 -KEYLESS OPERATING SYSTEM (KOS)
 -REAR WINDOW DEFOGGER
 -SEAT BELT WARNING TONE ALARM
 -SHIFT LOCK MECHANISM
 -SUNROOF
 -SUPPLEMENTAL RESTRAINT
 SYSTEM (SRS)
 -TAILLIGHT, POSITION LIGHT,
 REAR SIDE MARKER LIGHT,
 LICENSE PLATE LIGHT AND
 LIGHTING MONITOR TONE ALARM
 -THEFT-ALARM SYSTEM
 -TIRE PRESSURE
 MONITORING SYSTEM (TPMS)
 -TURN-SIGNAL LIGHT AND
 HAZARD WARNING LIGHT
 -WINDSHIELD WIPER AND WASHER

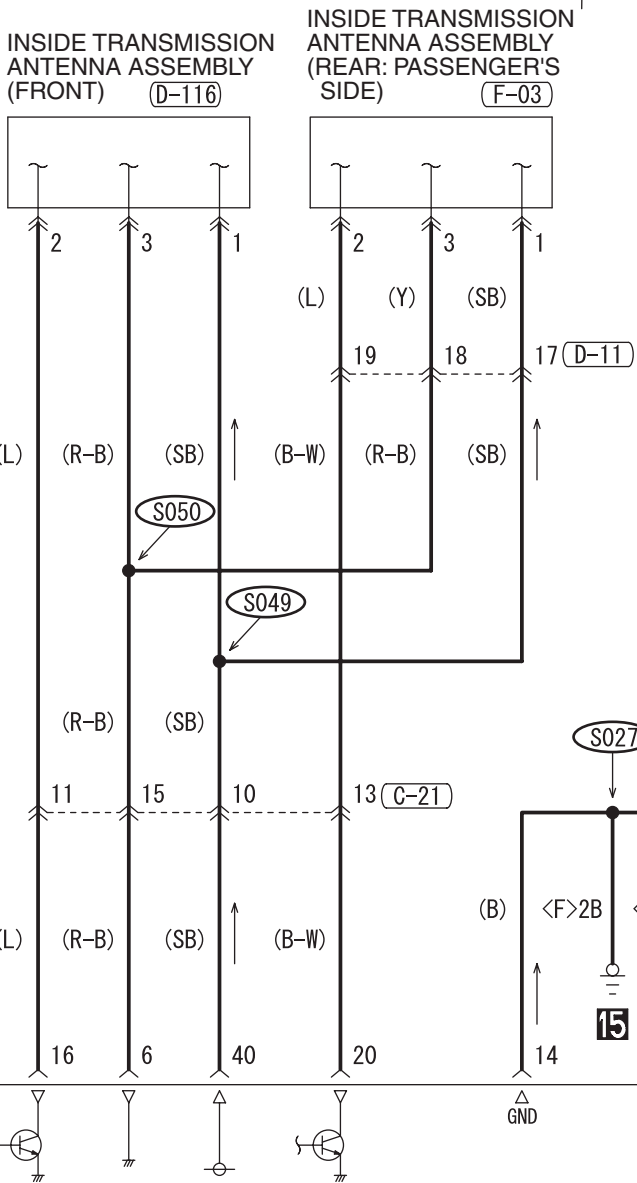

JOINT CONNECTOR (CAN1)

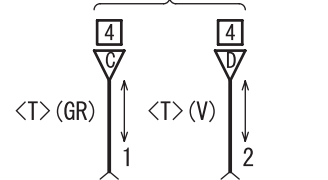

KOS-ECU
(C-31)

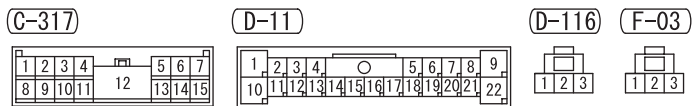

WIRE COLOR CODE
 B : BLACK LG : LIGHT GREEN G : GREEN L : BLUE W : WHITE Y : YELLOW SB : SKY BLUE
 BR : BROWN O : ORANGE GR : GRAY R : RED P : PINK V : VIOLET PU : PURPLE

IGNITION KEY REMINDER TONE ALARM <VEHICLES WITH KOS> (CONTINUED)

3

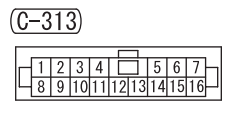
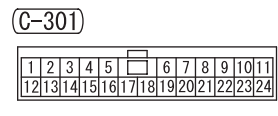
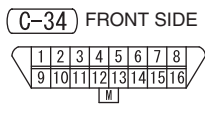
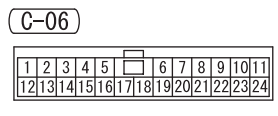
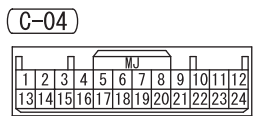
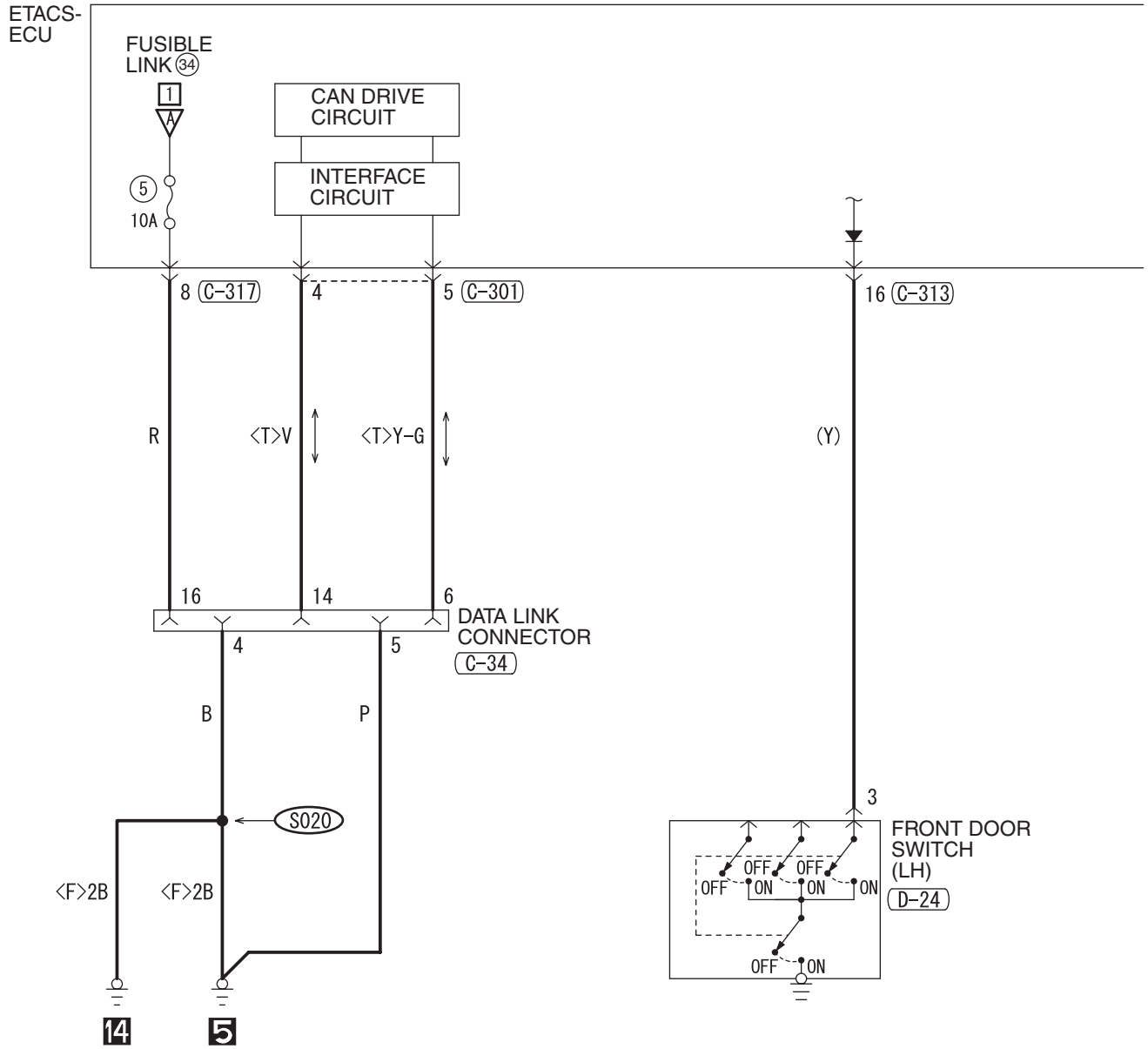

4

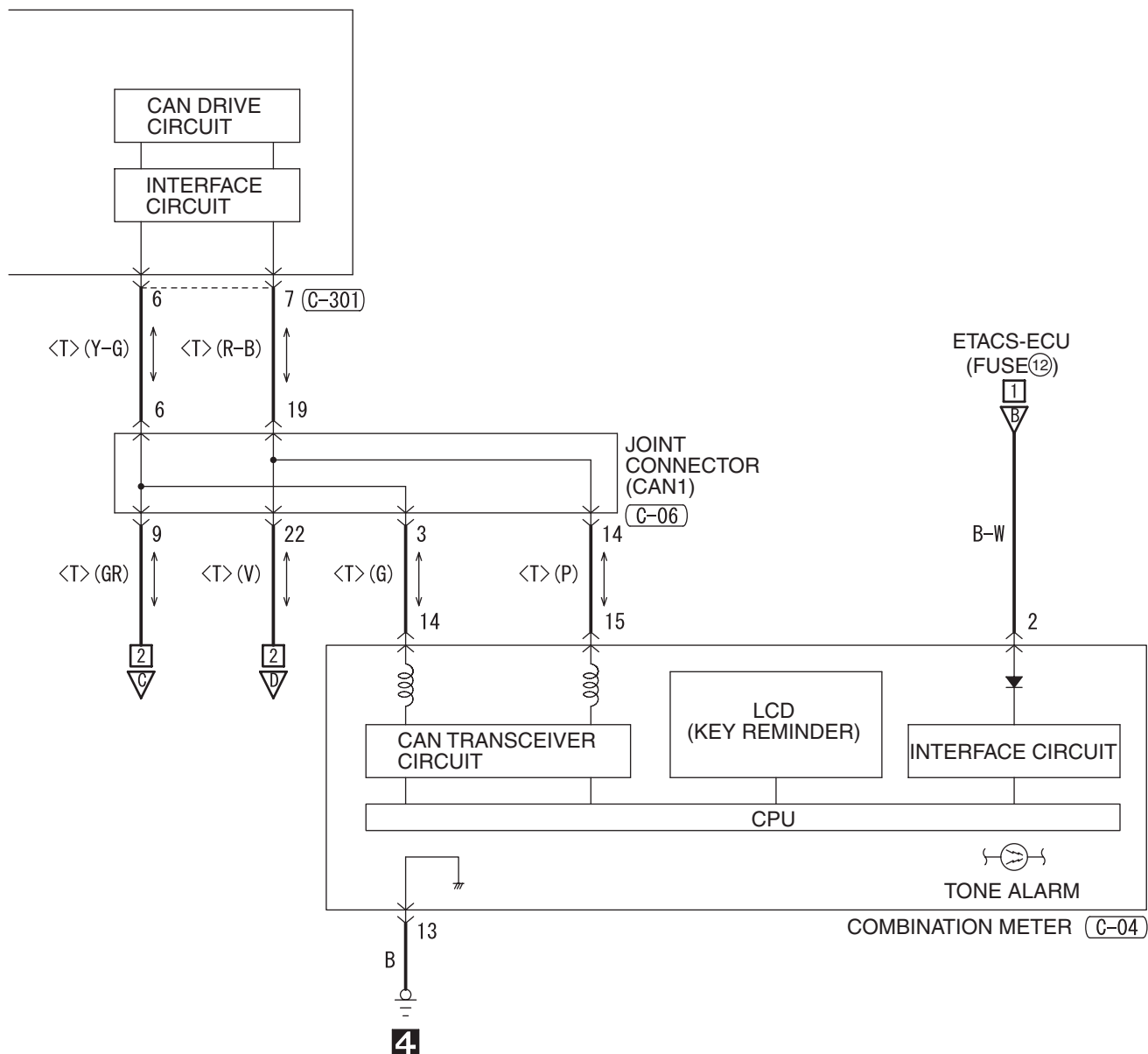

C-317

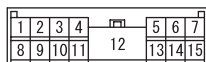

D-24



WIRE COLOR CODE

B: BLACK LG: LIGHT GREEN G: GREEN L: BLUE W: WHITE Y: YELLOW SB: SKY BLUE
BR: BROWN O: ORANGE GR: GRAY R: RED P: PINK V: VIOLET PU: PURPLE

H8G15M07BB

DOOR AJAR WARNING TONE ALARM

M1901016601121

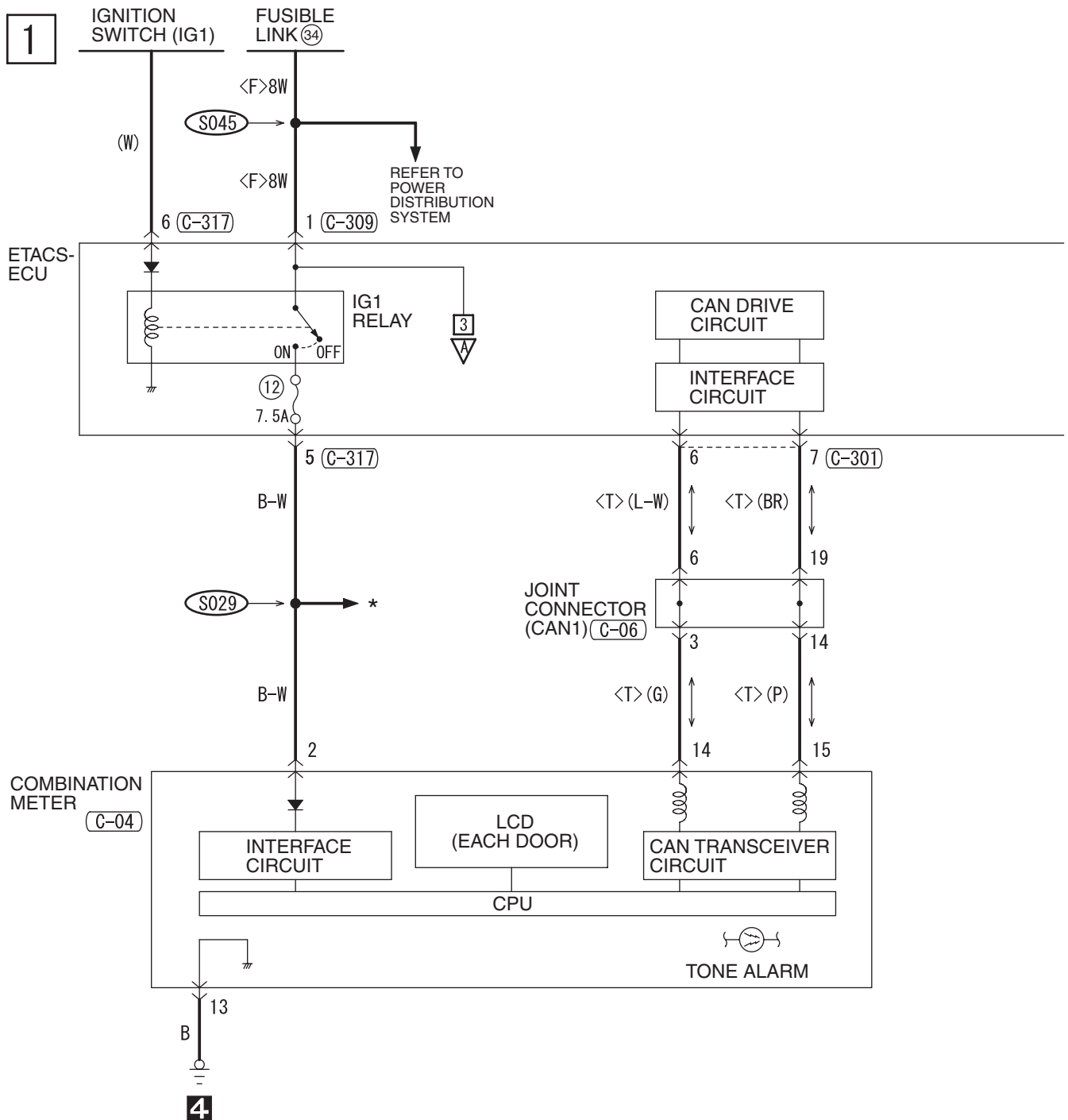

C-04

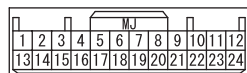

C-06

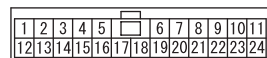

C-301

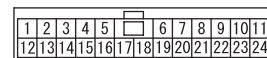

C-309



C-313

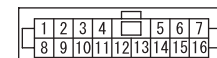

NOTE

- * : AIR CONDITIONING SYSTEM
- BRAKE WARNING LIGHT
- FUEL WARNING LIGHT AND OIL PRESSURE WARNING LIGHT
- CENTRAL DOOR LOCKING SYSTEM
- CONTROLLER AREA NETWORK (CAN)
- DAYTIME RUNNING LIGHT (DRL)
- DOME LIGHT, LUGGAGE COMPARTMENT LIGHT AND IGNITION KEY HOLE ILLUMINATION LIGHT
- FOG LIGHT
- HEADLIGHT
- HEATED DOOR MIRROR
- HEATED SEAT
- IGNITION KEY REMINDER TONE ALARM
- IMMOBILIZER SYSTEM
- INVECS-III CVT
- KEYLESS OPERATING SYSTEM (KOS)
- REAR WINDOW DEFOGGER
- SEAT BELT WARNING TONE ALARM
- SHIFT LOCK MECHANISM
- SUNROOF
- SUPPLEMENTAL RESTRAINT SYSTEM (SRS)
- TAILLIGHT, POSITION LIGHT, REAR SIDE MARKER LIGHT, LICENSE PLATE LIGHT AND LIGHTING MONITOR TONE ALARM
- THEFT-ALARM SYSTEM
- TIRE PRESSURE MONITORING SYSTEM (TPMS)
- TURN-SIGNAL LIGHT AND HAZARD WARNING LIGHT
- WINDSHIELD WIPER AND WASHER

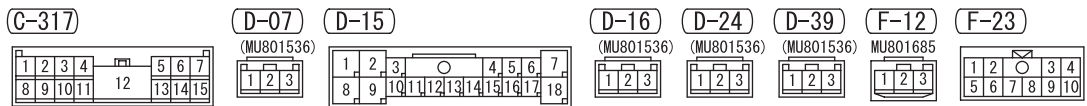
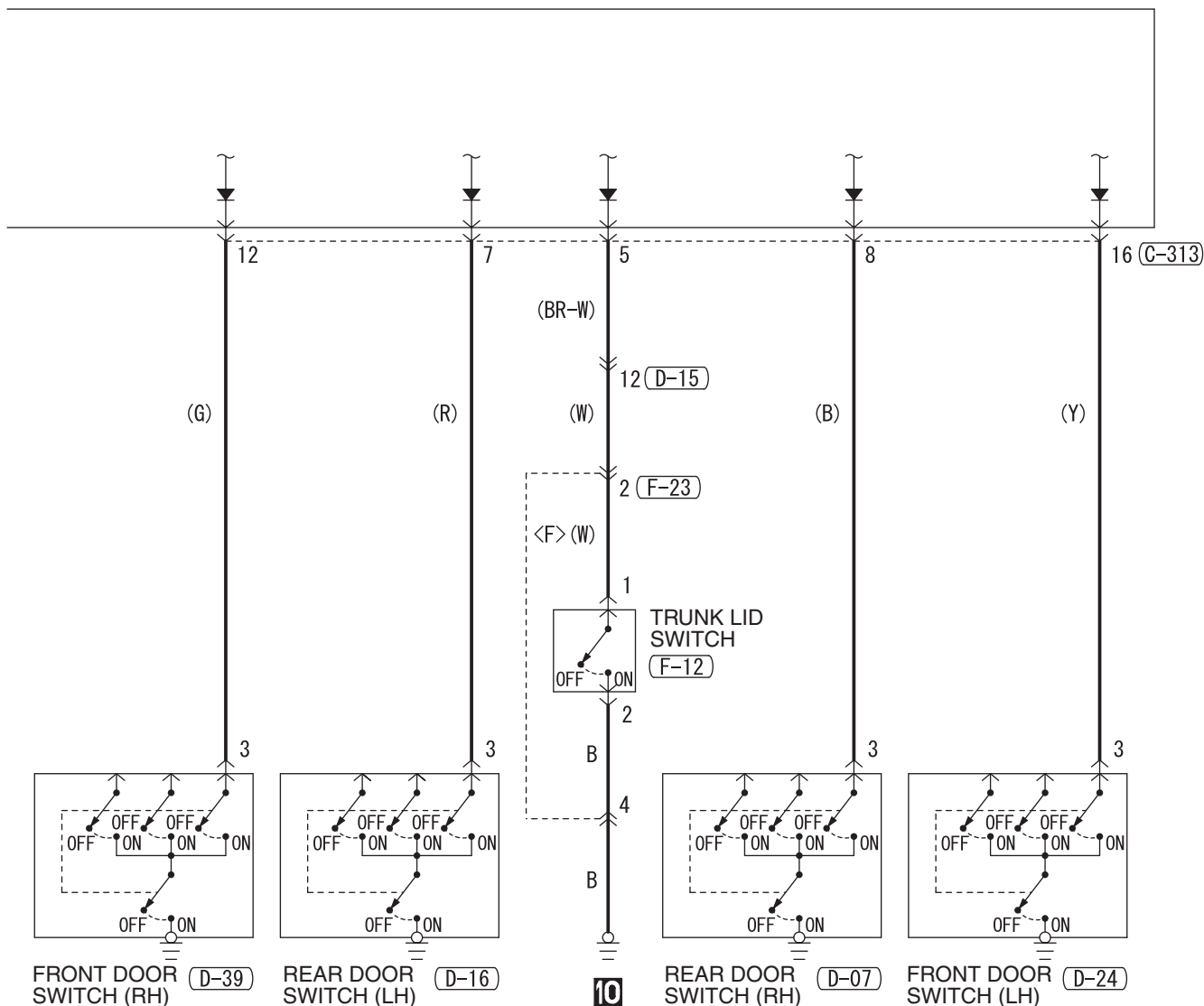

WIRE COLOR CODE
 B : BLACK LG : LIGHT GREEN G : GREEN L : BLUE W : WHITE Y : YELLOW SB : SKY BLUE
 BR : BROWN O : ORANGE GR : GRAY R : RED P : PINK V : VIOLET PU : PURPLE

H8G15M08AB

DOOR AJAR WARNING TONE ALARM (CONTINUED)

3

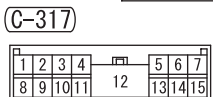
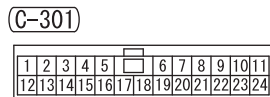
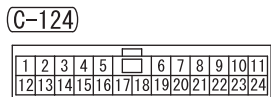
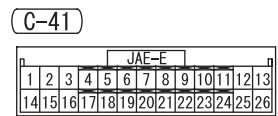
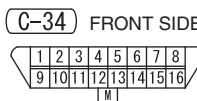
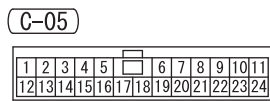
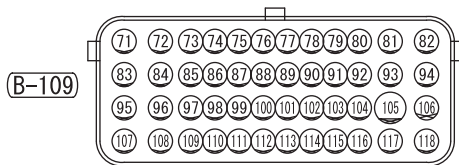
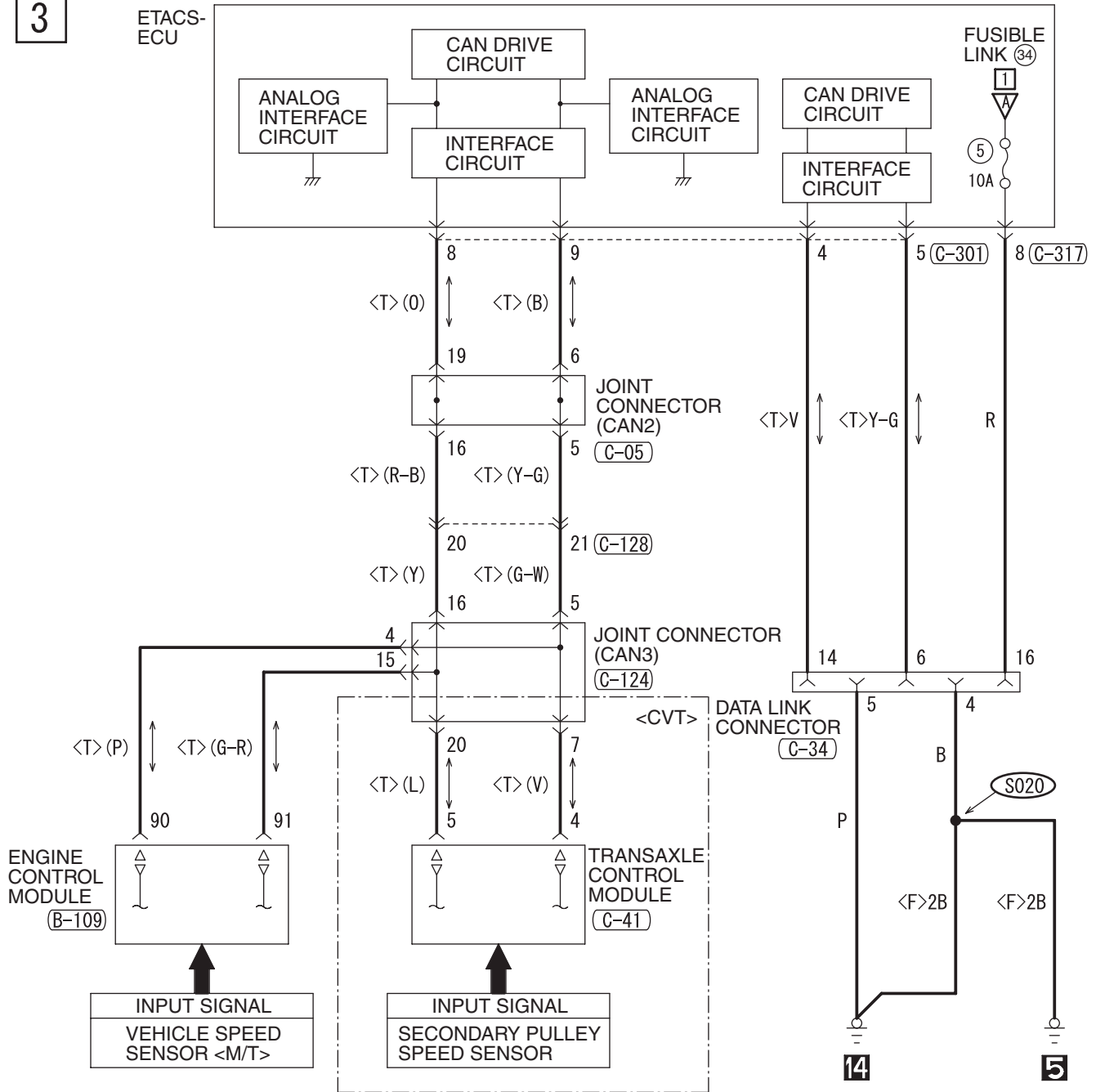

NOTES

SEAT BELT WARNING TONE ALARM

1

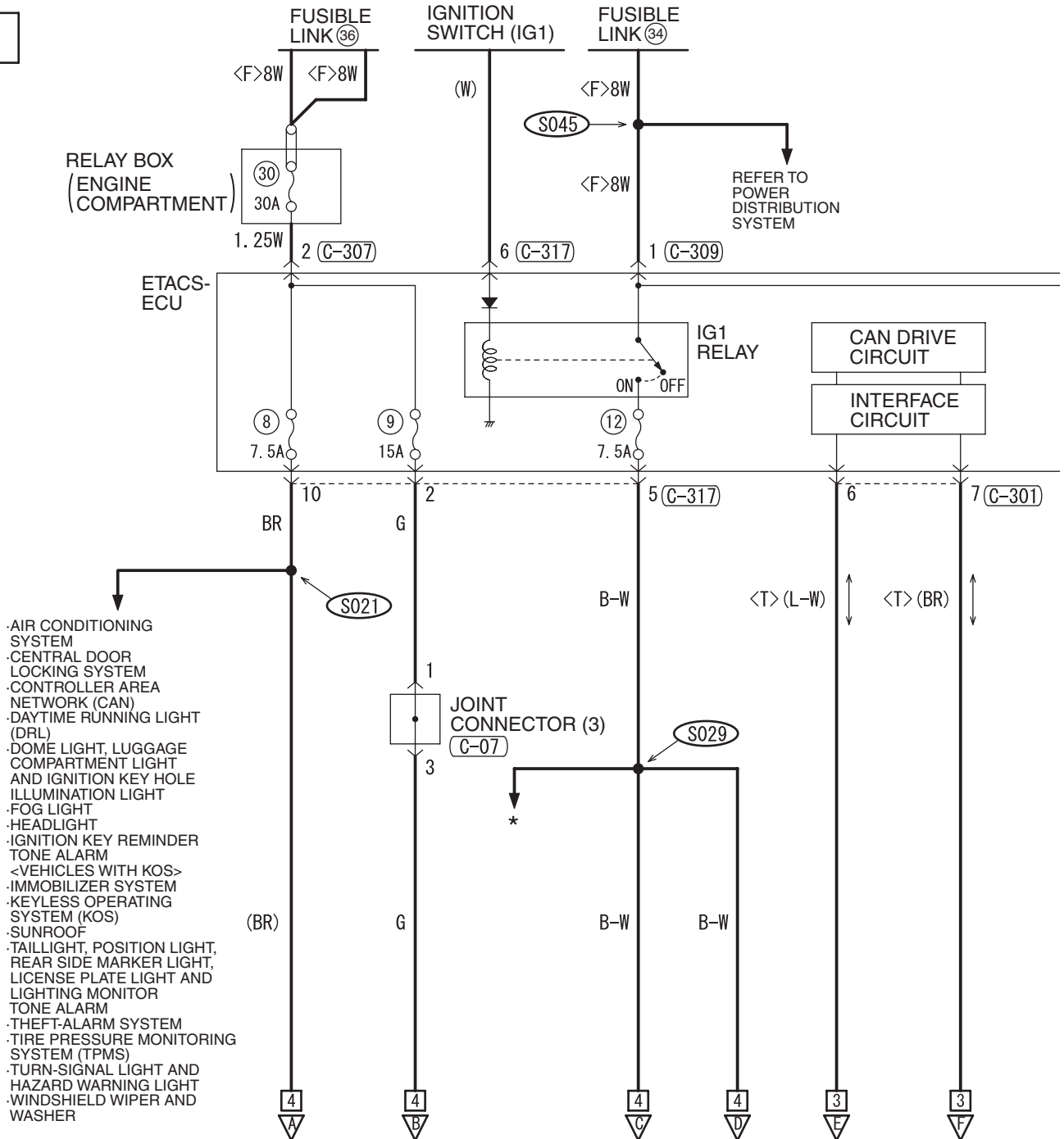

- AIR CONDITIONING SYSTEM
- CENTRAL DOOR LOCKING SYSTEM
- CONTROLLER AREA NETWORK (CAN)
- DAYTIME RUNNING LIGHT (DRL)
- DOME LIGHT, LUGGAGE COMPARTMENT LIGHT AND IGNITION KEY HOLE ILLUMINATION LIGHT
- FOG LIGHT
- HEADLIGHT
- IGNITION KEY REMINDER TONE ALARM
- <VEHICLES WITH KOS>
- IMMOBILIZER SYSTEM
- KEYLESS OPERATING SYSTEM (KOS)
- SUNROOF
- TAILLIGHT, POSITION LIGHT, REAR SIDE MARKER LIGHT, LICENSE PLATE LIGHT AND LIGHTING MONITOR TONE ALARM
- THEFT-ALARM SYSTEM
- TIRE PRESSURE MONITORING SYSTEM (TPMS)
- TURN-SIGNAL LIGHT AND HAZARD WARNING LIGHT
- WINDSHIELD WIPER AND WASHER

B-109

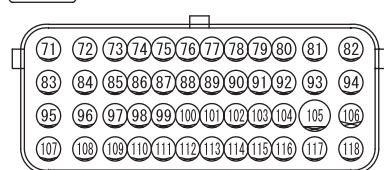

C-05

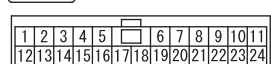

C-07

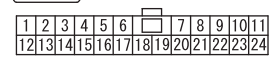

C-34 FRONT SIDE

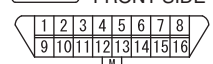

C-317

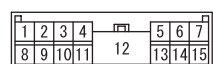

TSB Revision

2

NOTE

- * : AIR CONDITIONING SYSTEM
- BRAKE WARNING LIGHT,
- FUEL WARNING LIGHT
- AND OIL PRESSURE
- WARNING LIGHT
- CENTRAL DOOR
- LOCKING SYSTEM
- CONTROLLER AREA
- NETWORK (CAN)
- DAYTIME RUNNING LIGHT
- (DRL)
- DOME LIGHT, LUGGAGE
- COMPARTMENT LIGHT AND
- IGNITION KEY HOLE
- ILLUMINATION LIGHT
- FOG LIGHT
- HEADLIGHT
- HEATED DOOR MIRROR
- HEATED SEAT
- IGNITION KEY REMINDER
- TONE ALARM
- IMMOBILIZER SYSTEM
- INVECS-III CVT
- KEYLESS OPERATING
- SYSTEM (KOS)
- REAR WINDOW DEFOGGER
- SHIFT LOCK MECHANISM
- SUNROOF
- SUPPLEMENTAL RESTRAINT
- SYSTEM (SRS)
- TAILLIGHT, POSITION LIGHT,
- REAR SIDE MARKER LIGHT,
- LICENSE PLATE LIGHT AND
- LIGHTING MONITOR TONE ALARM
- THEFT-ALARM SYSTEM
- TIRE PRESSURE
- MONITORING SYSTEM (TPMS)
- TURN-SIGNAL LIGHT AND
- HAZARD WARNING LIGHT
- WINDSHIELD WIPER AND
- WASHER

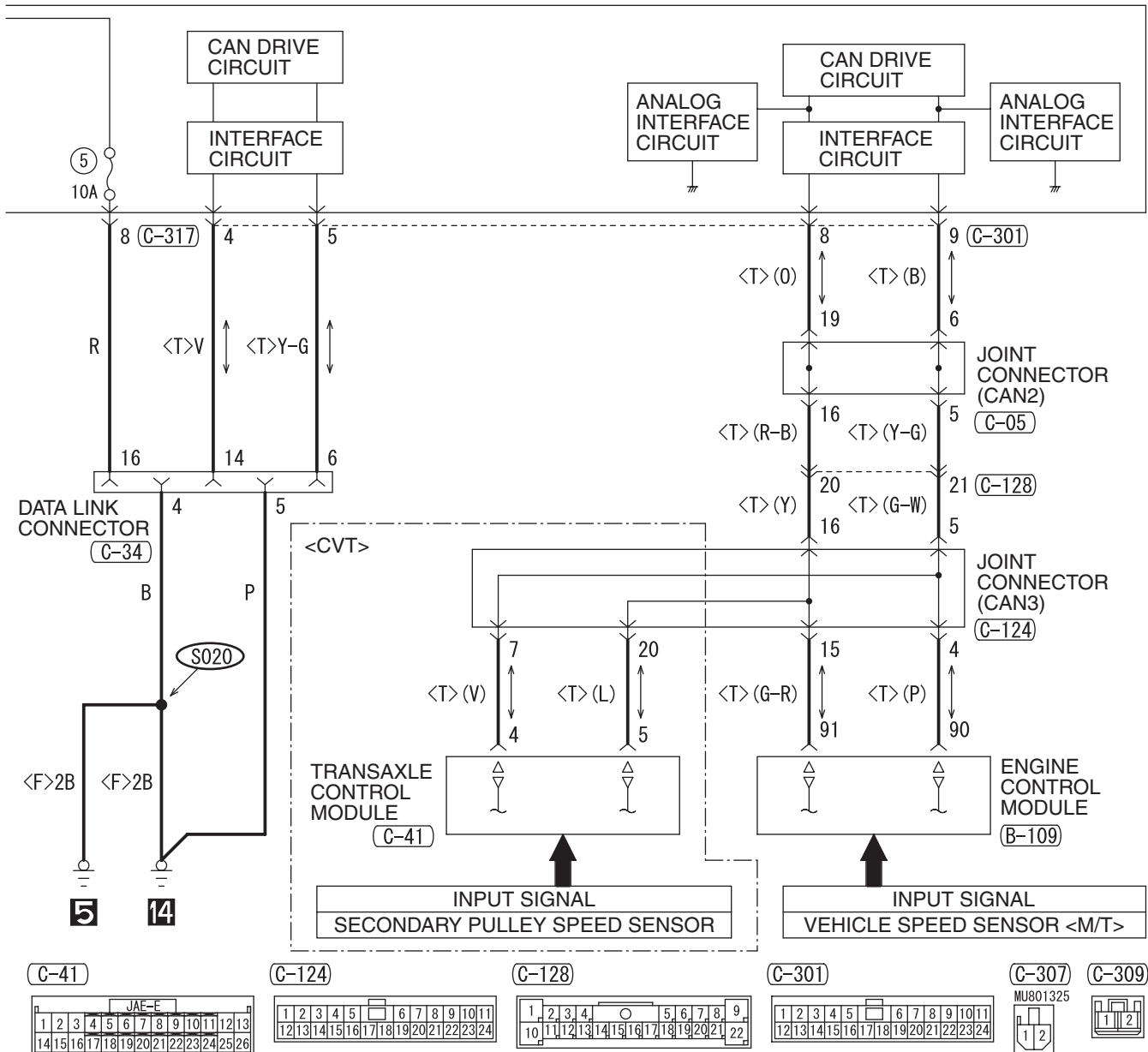

WIRE COLOR CODE

B : BLACK LG : LIGHT GREEN G : GREEN L : BLUE W : WHITE Y : YELLOW SB : SKY BLUE
BR : BROWN O : ORANGE GR : GRAY R : RED P : PINK V : VIOLET PU : PURPLE

H8G15M09AB

SEAT BELT WARNING TONE ALARM (CONTINUED)

3

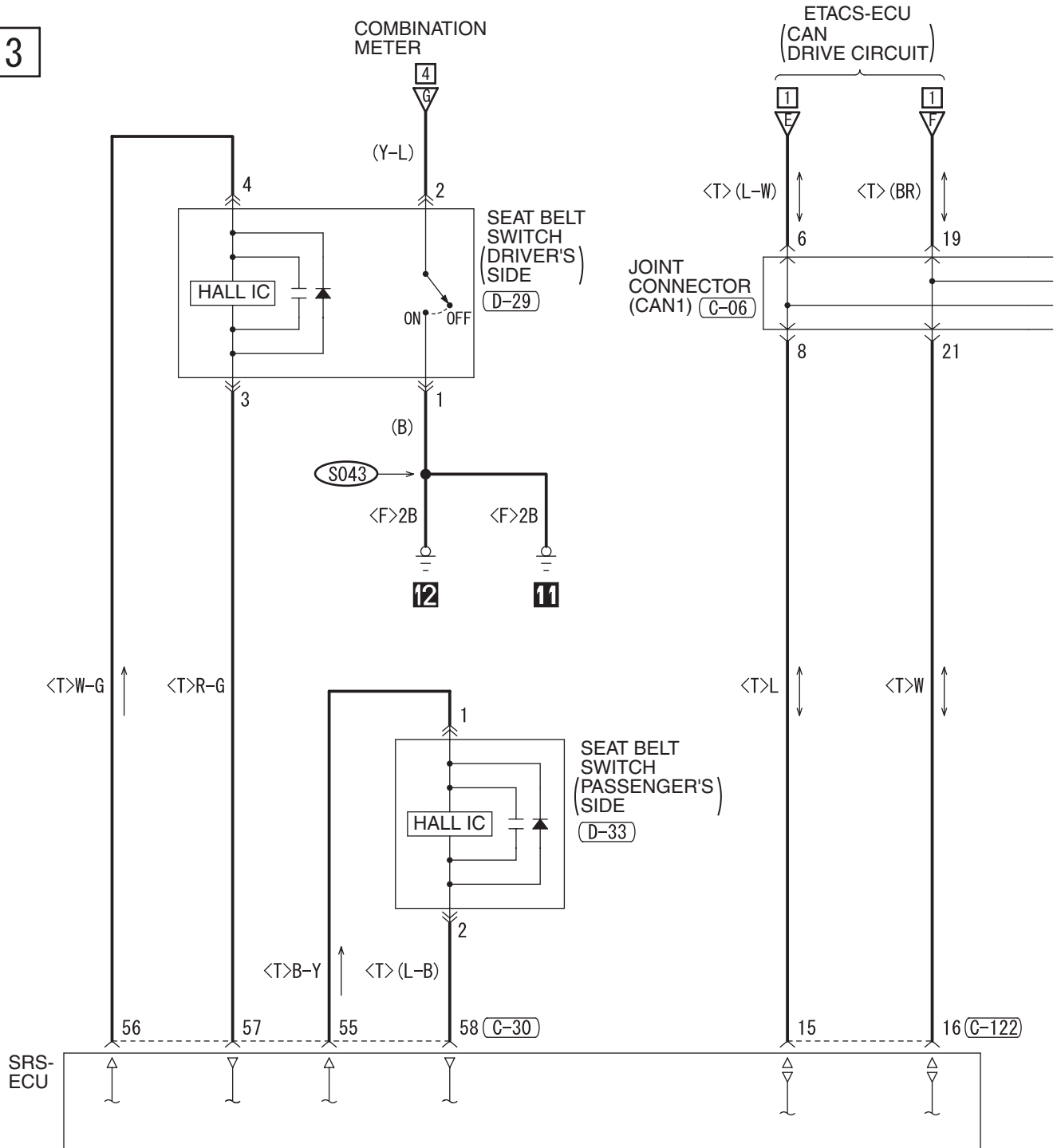

(C-04)

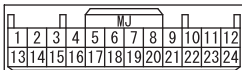

(C-06)

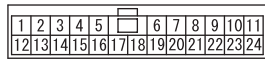

(C-18)

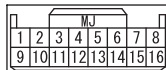

(C-30)

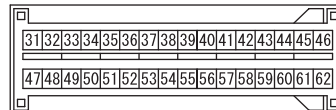

4

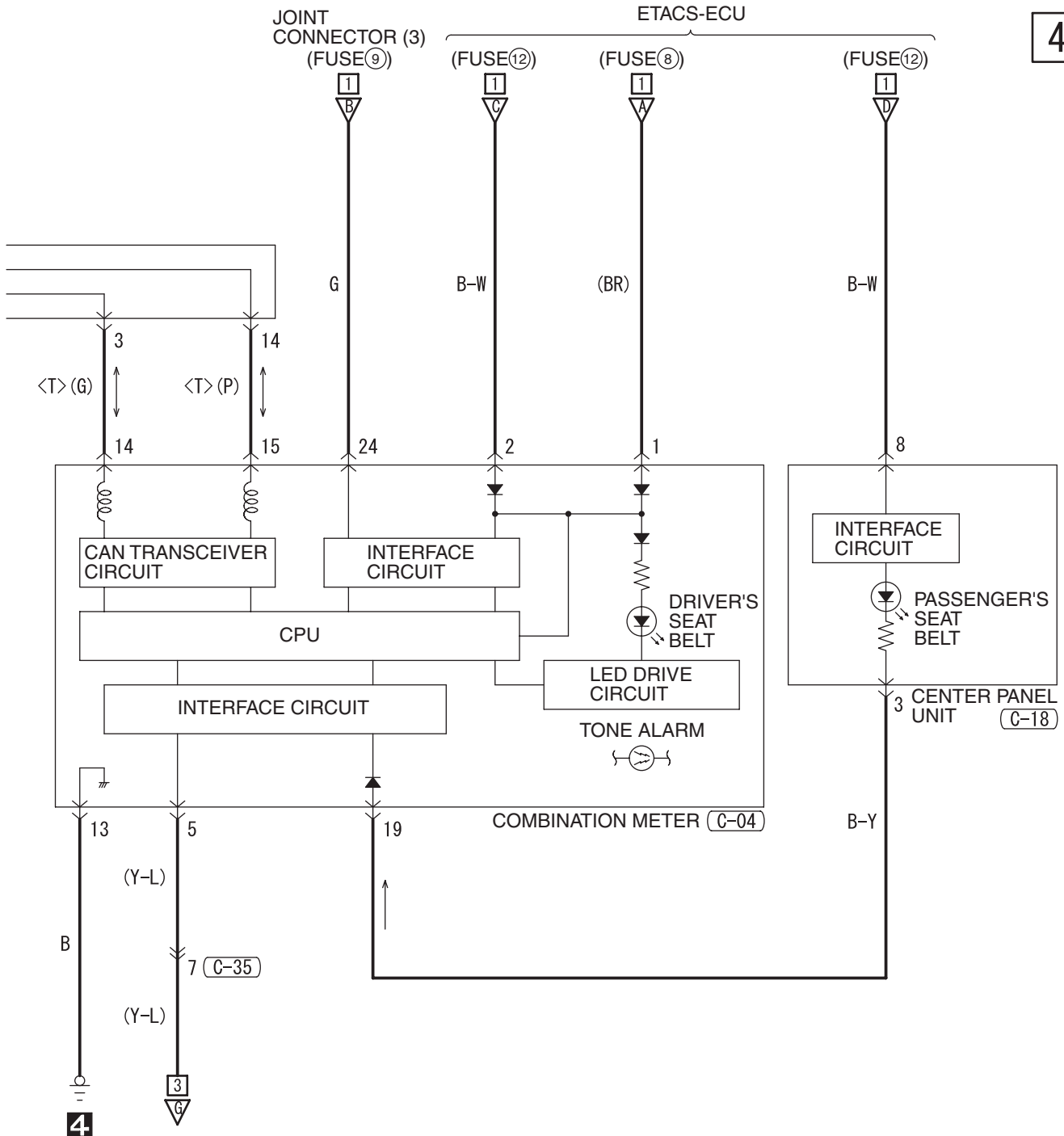

(C-35)

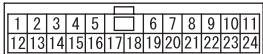

(C-122)

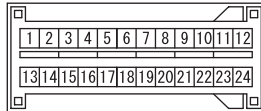

(D-29)



(D-33)



WIRE COLOR CODE

B: BLACK LG: LIGHT GREEN G: GREEN L: BLUE W: WHITE Y: YELLOW SB: SKY BLUE
BR: BROWN O: ORANGE GR: GRAY R: RED P: PINK V: VIOLET PU: PURPLE

H8G15M09BB

HANDS FREE SYSTEM

1

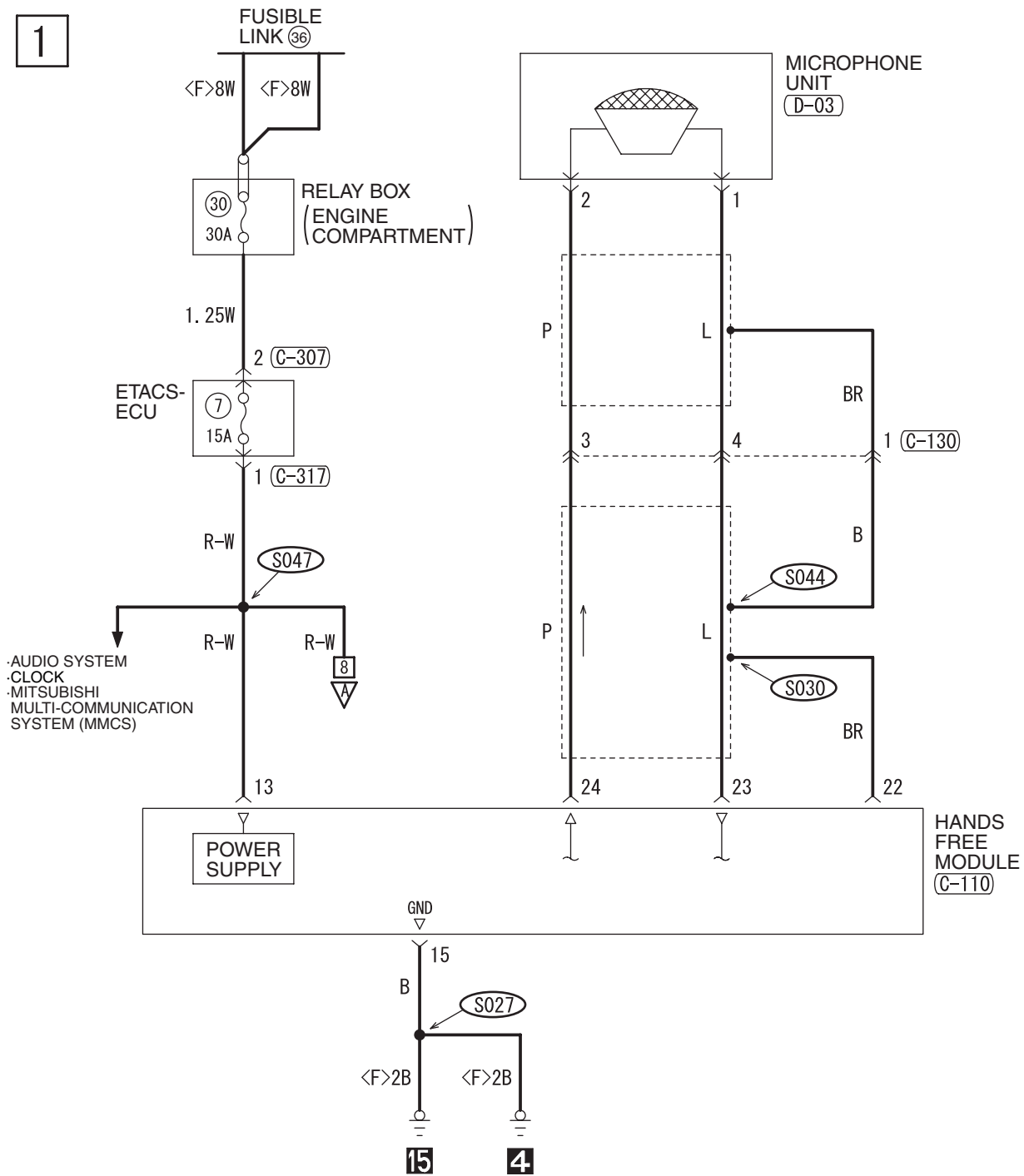

(B-109)

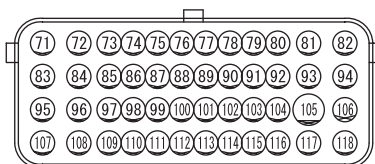

(C-05)

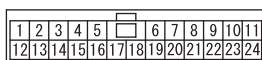

(C-41)

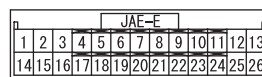

(C-110)

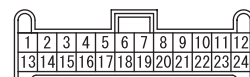

(C-317)

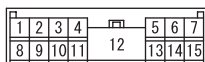

(D-03)



2

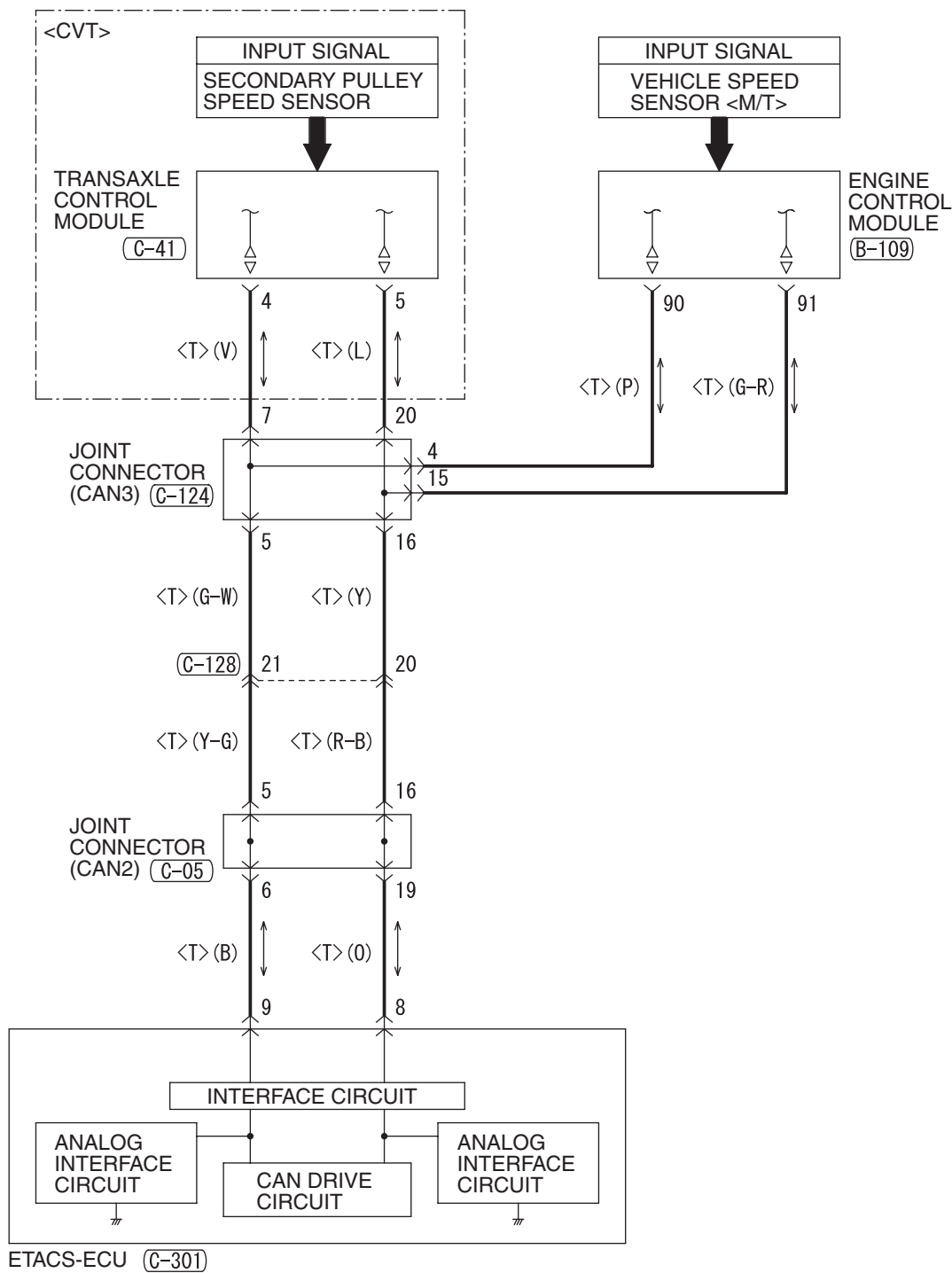

C-124

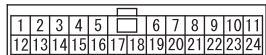

C-128

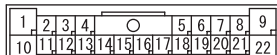

C-130

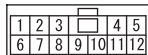

C-301



C-307



WIRE COLOR CODE

B: BLACK LG: LIGHT GREEN G: GREEN L: BLUE W: WHITE Y: YELLOW SB: SKY BLUE
BR: BROWN O: ORANGE GR: GRAY R: RED P: PINK V: VIOLET PU: PURPLE

H8G15M10AB

TSB Revision

HANDS FREE SYSTEM (CONTINUED)

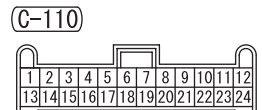
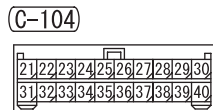
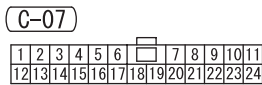
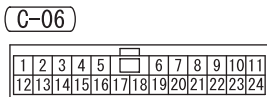
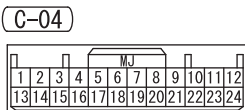
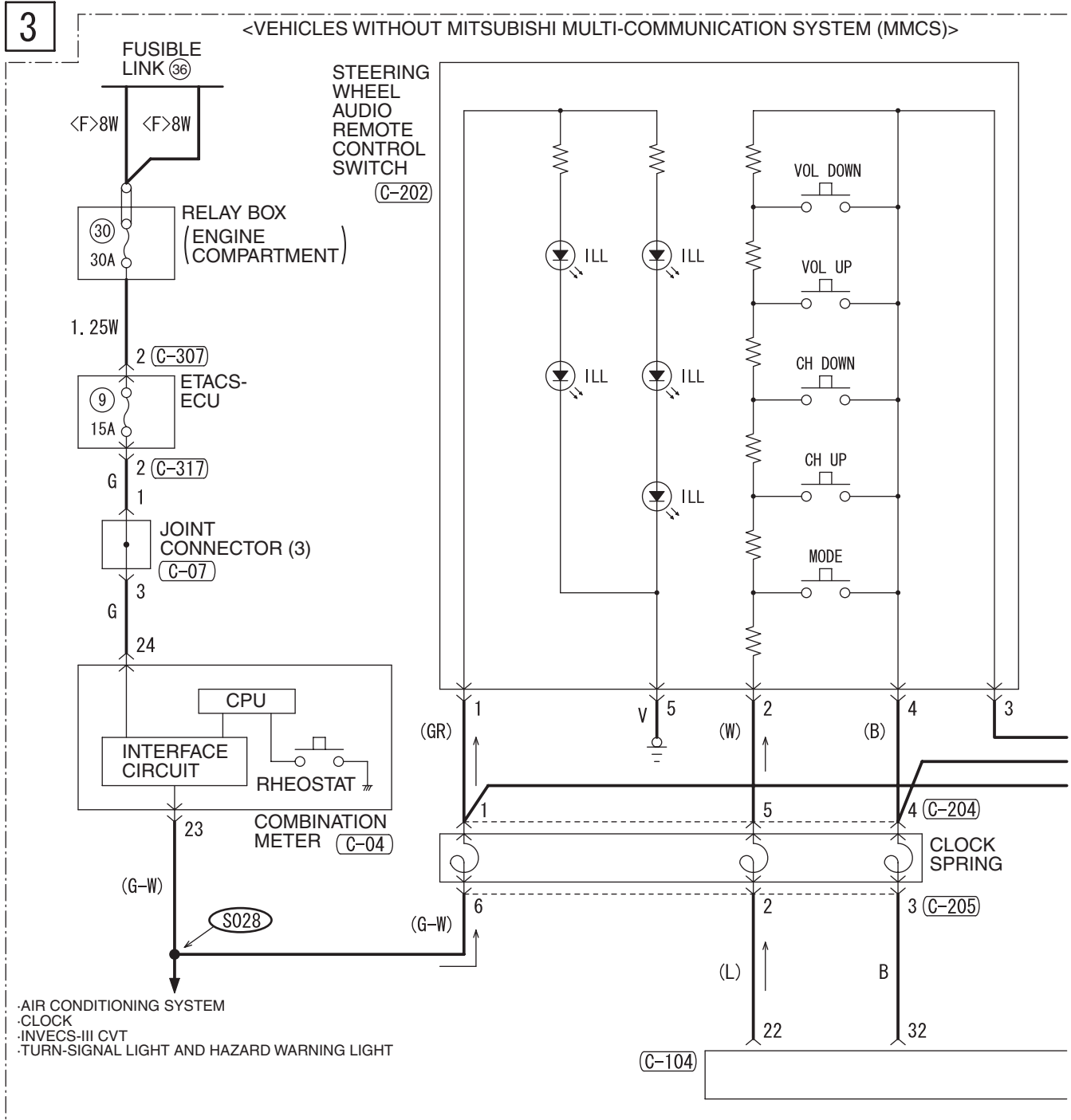

4

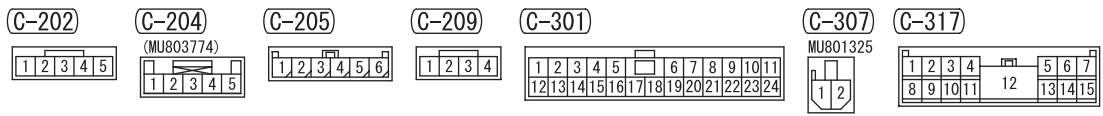
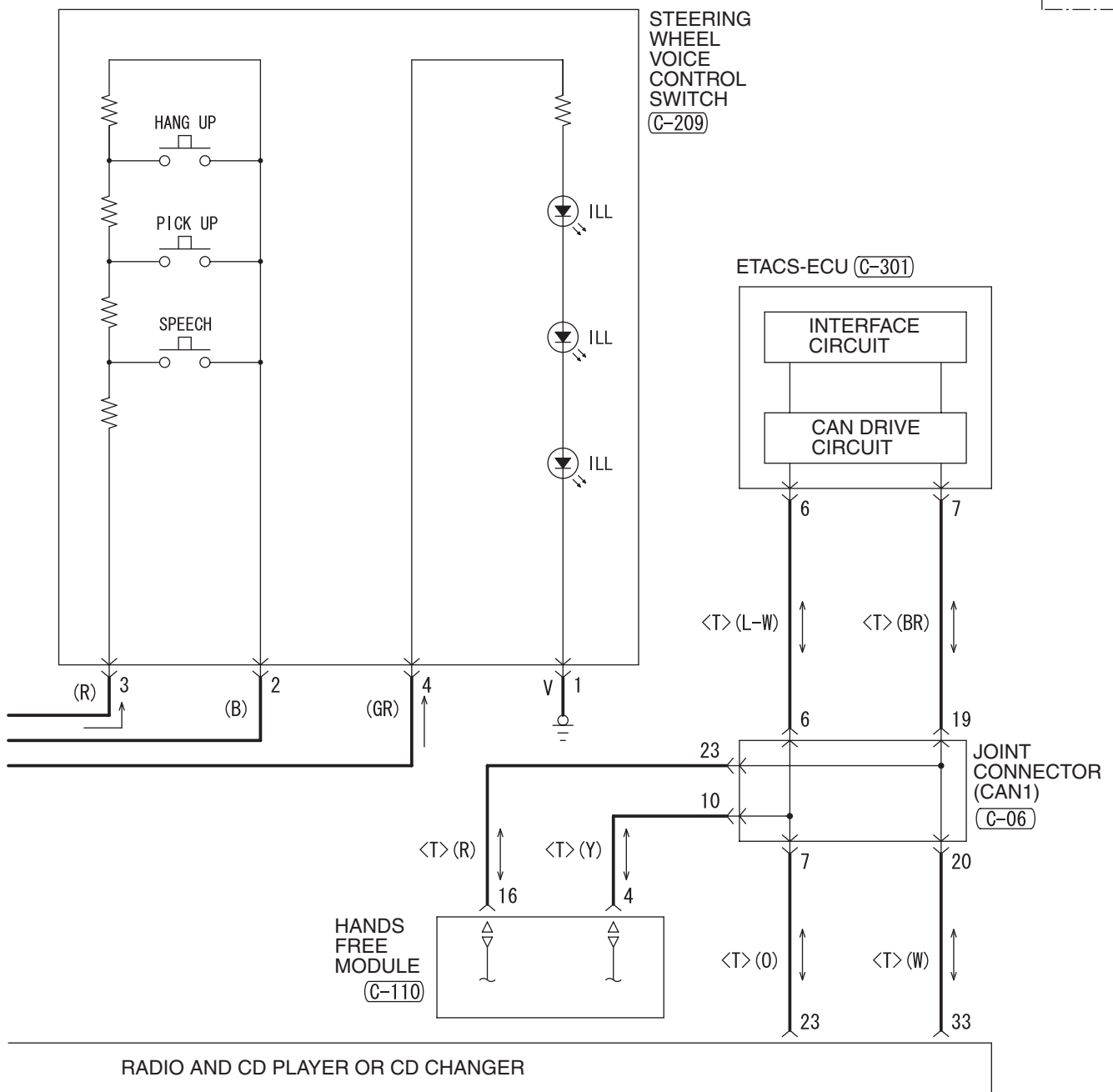

WIRE COLOR CODE
 B: BLACK LG: LIGHT GREEN G: GREEN L: BLUE W: WHITE Y: YELLOW SB: SKY BLUE
 BR: BROWN O: ORANGE GR: GRAY R: RED P: PINK V: VIOLET PU: PURPLE

H8G15M10BB

TSB Revision

HANDS FREE SYSTEM (CONTINUED)

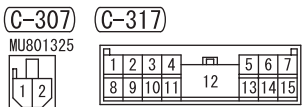
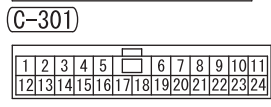
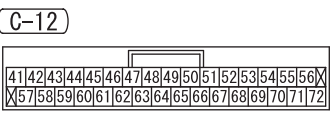
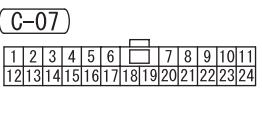
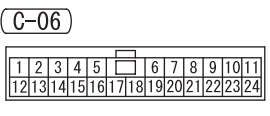
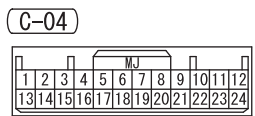
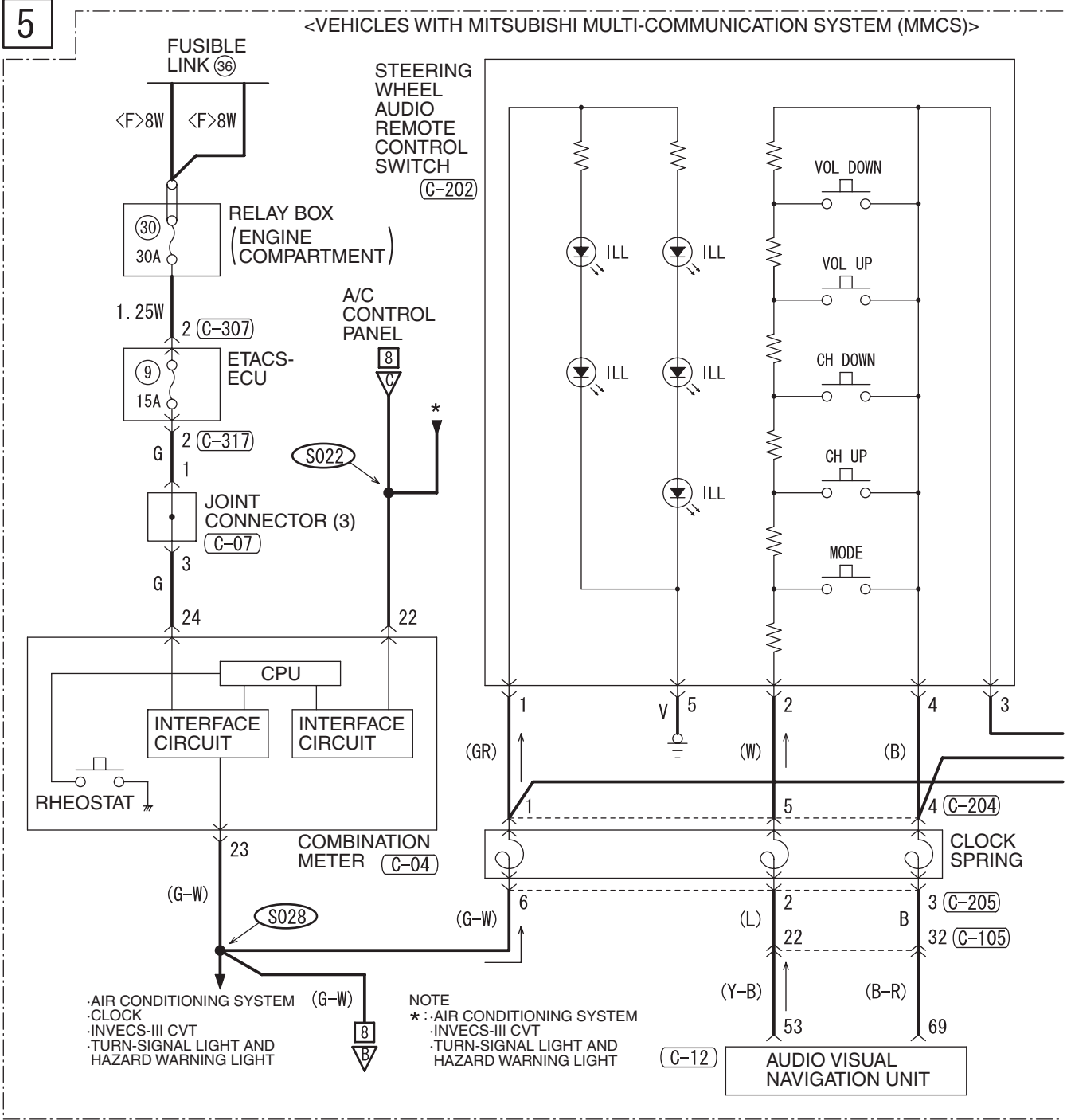

6

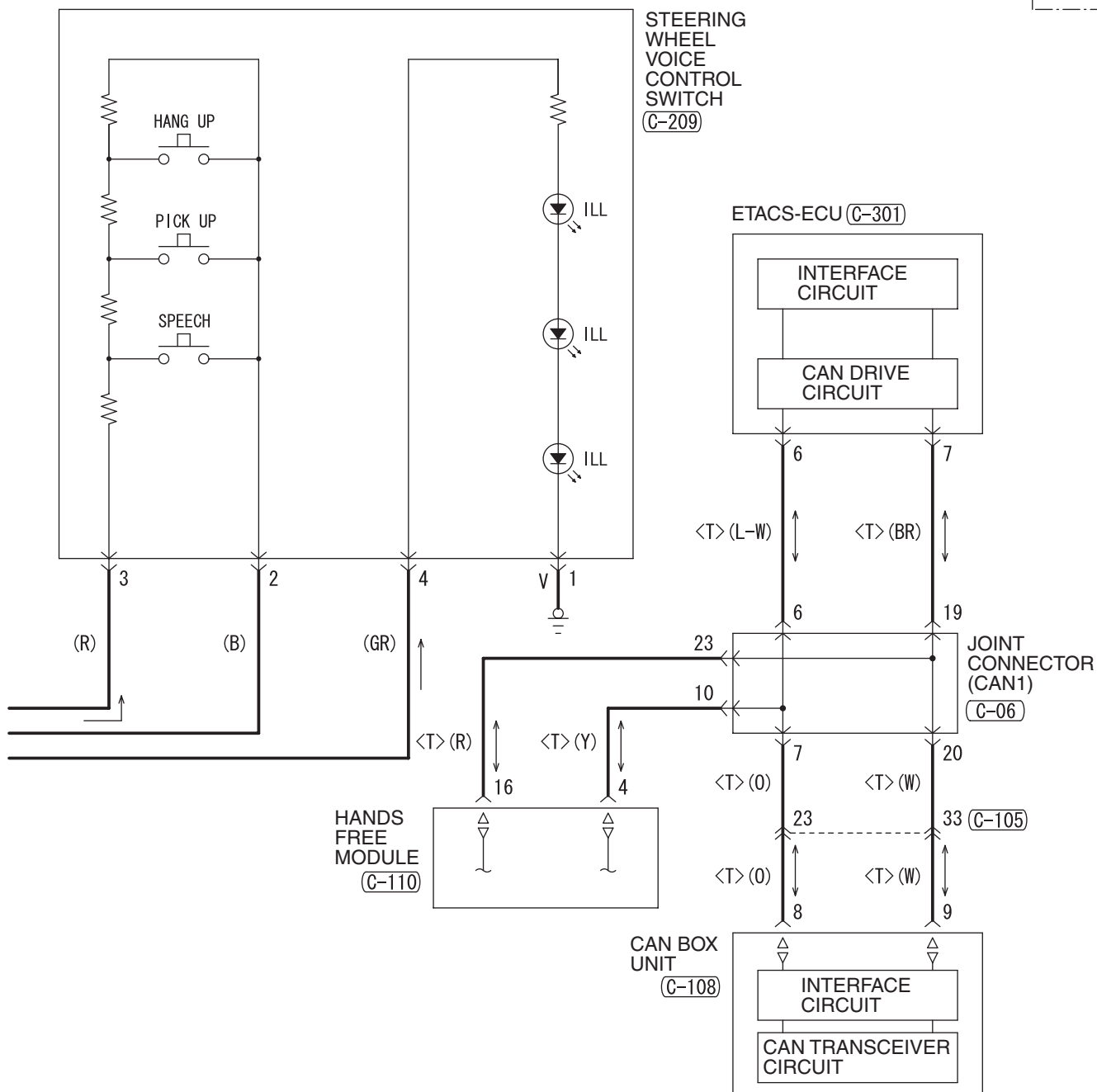

C-105

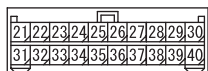

C-108

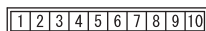

C-110

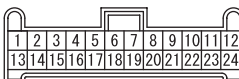

C-202

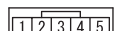

C-204



C-205

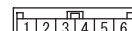

C-209



WIRE COLOR CODE

B: BLACK LG: LIGHT GREEN G: GREEN L: BLUE W: WHITE Y: YELLOW SB: SKY BLUE
BR: BROWN O: ORANGE GR: GRAY R: RED P: PINK V: VIOLET PU: PURPLE

H8G15M10CB

HANDS FREE SYSTEM (CONTINUED)

7

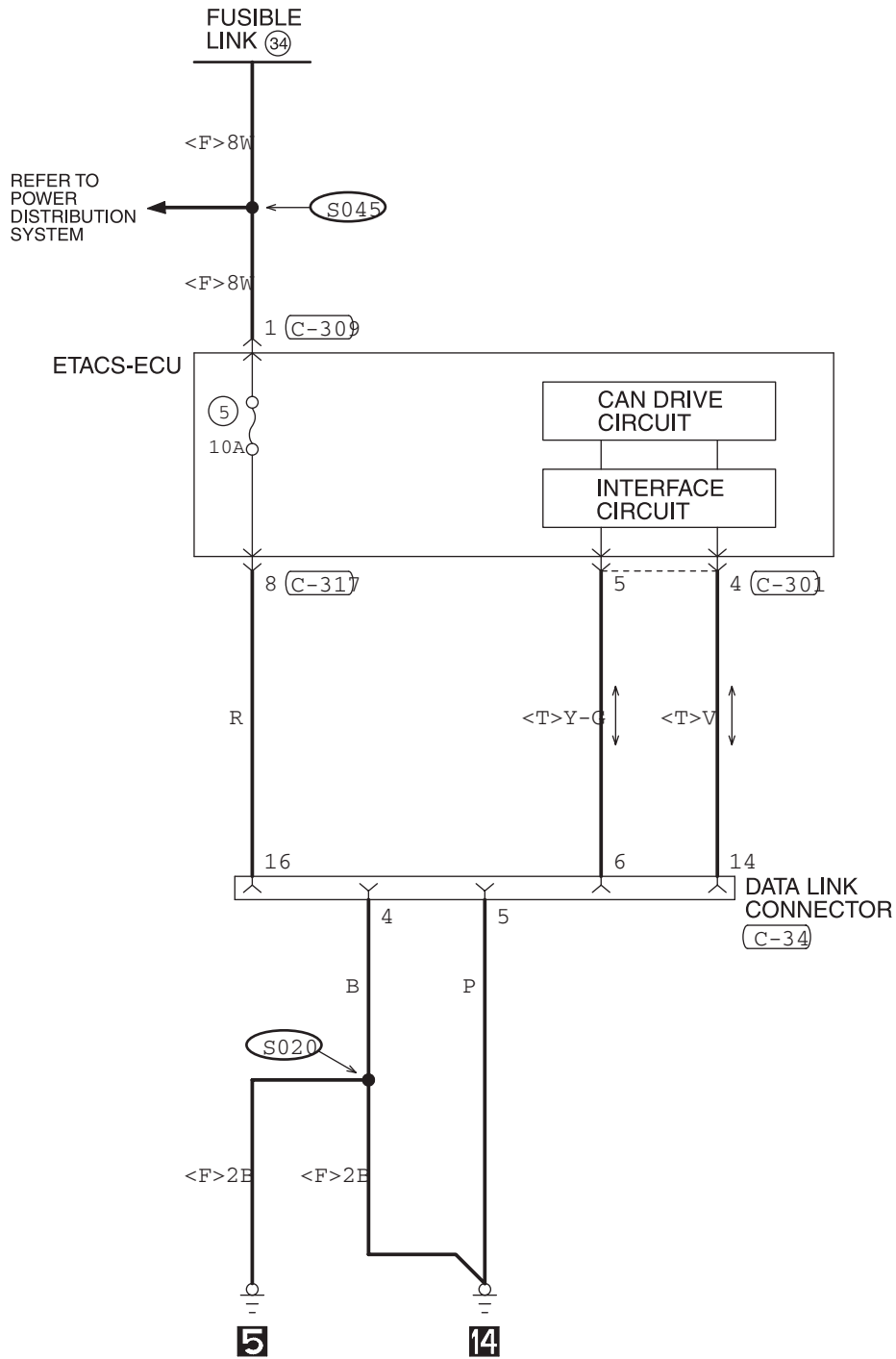

C-18

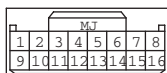

C-34 FRONT SIDE

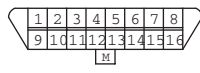

C-104

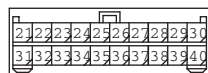

C-106

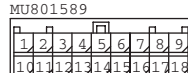

C-120

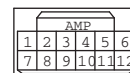

C-30

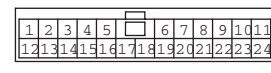

HANDS FREE SYSTEM (CONTINUED)

9

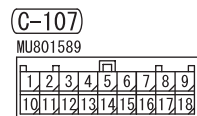
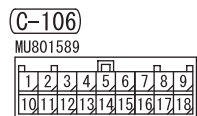
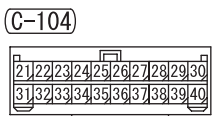
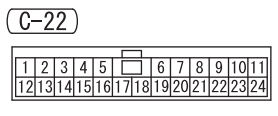
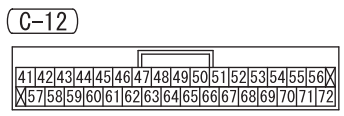
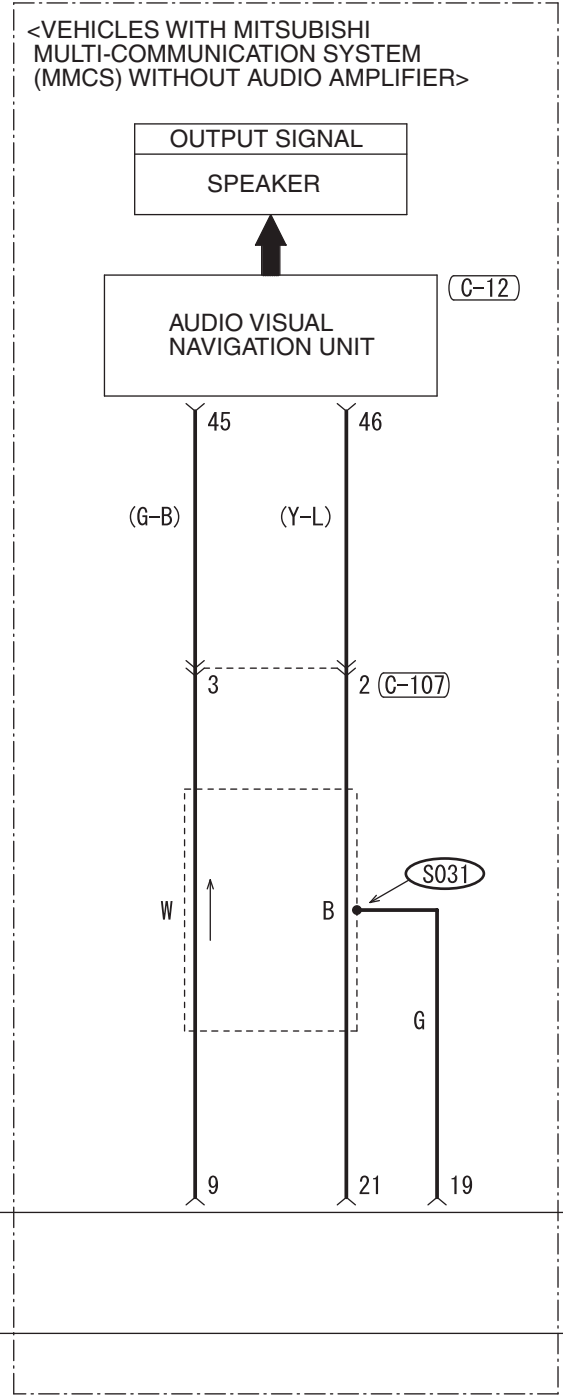
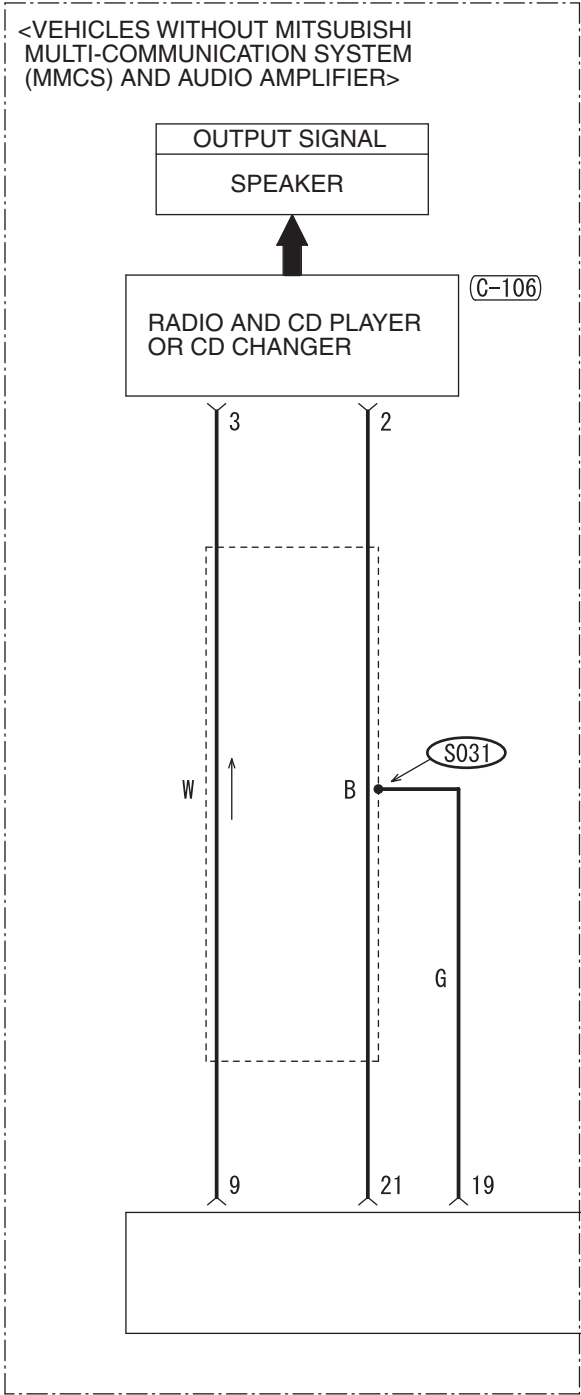

10

<VEHICLES WITHOUT MITSUBISHI MULTI-COMMUNICATION SYSTEM (MMCS) WITH AUDIO AMPLIFIER>

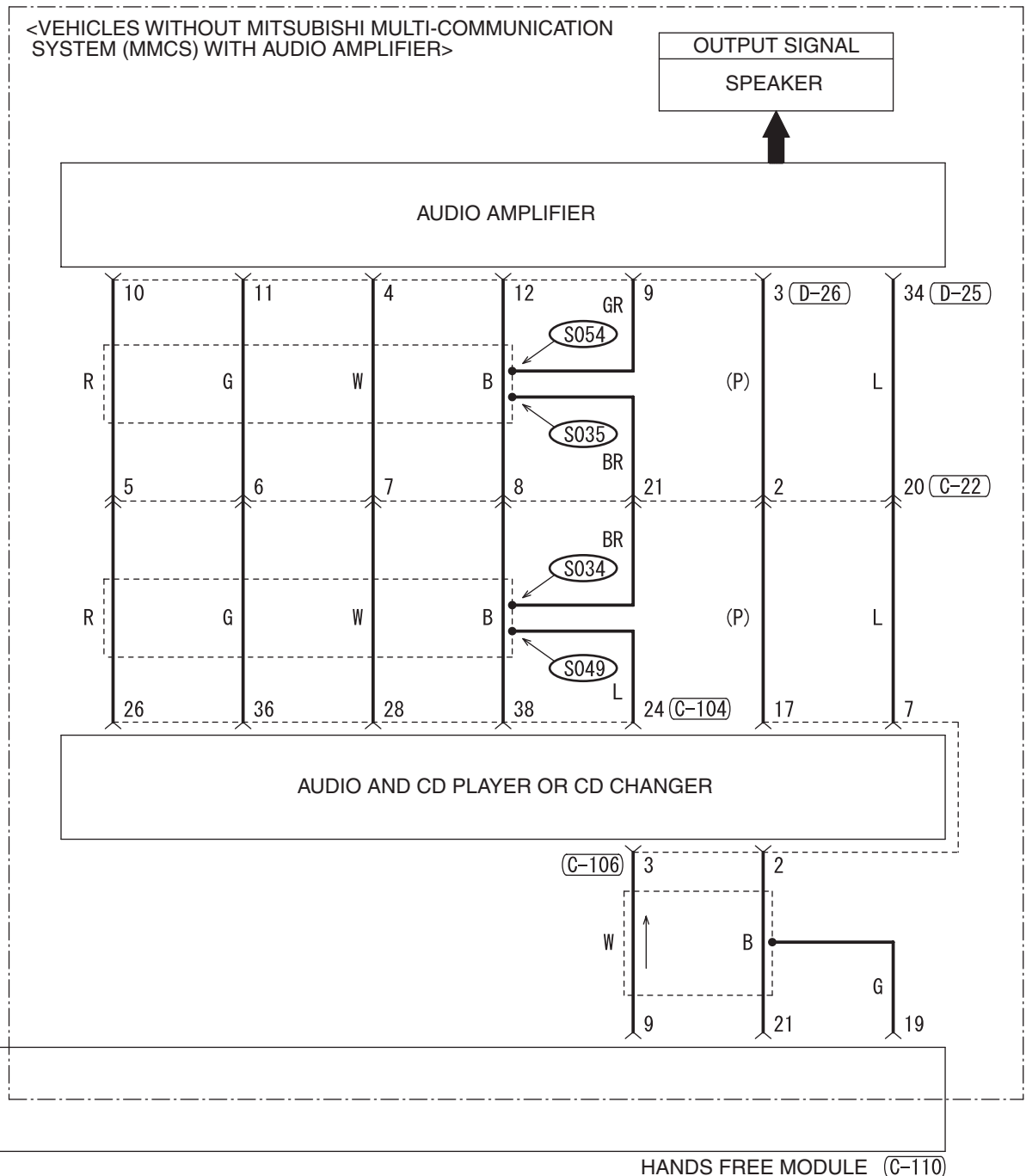

(C-110)

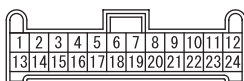

(D-25)

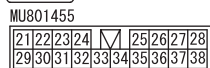

(D-26)

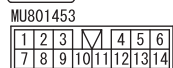

WIRE COLOR CODE

B: BLACK LG: LIGHT GREEN G: GREEN L: BLUE W: WHITE Y: YELLOW SB: SKY BLUE
BR: BROWN O: ORANGE GR: GRAY R: RED P: PINK V: VIOLET PU: PURPLE

H8G15M10EB

TSB Revision

NOTES

CONTROLLER AREA NETWORK (CAN)

M1901004000390

1

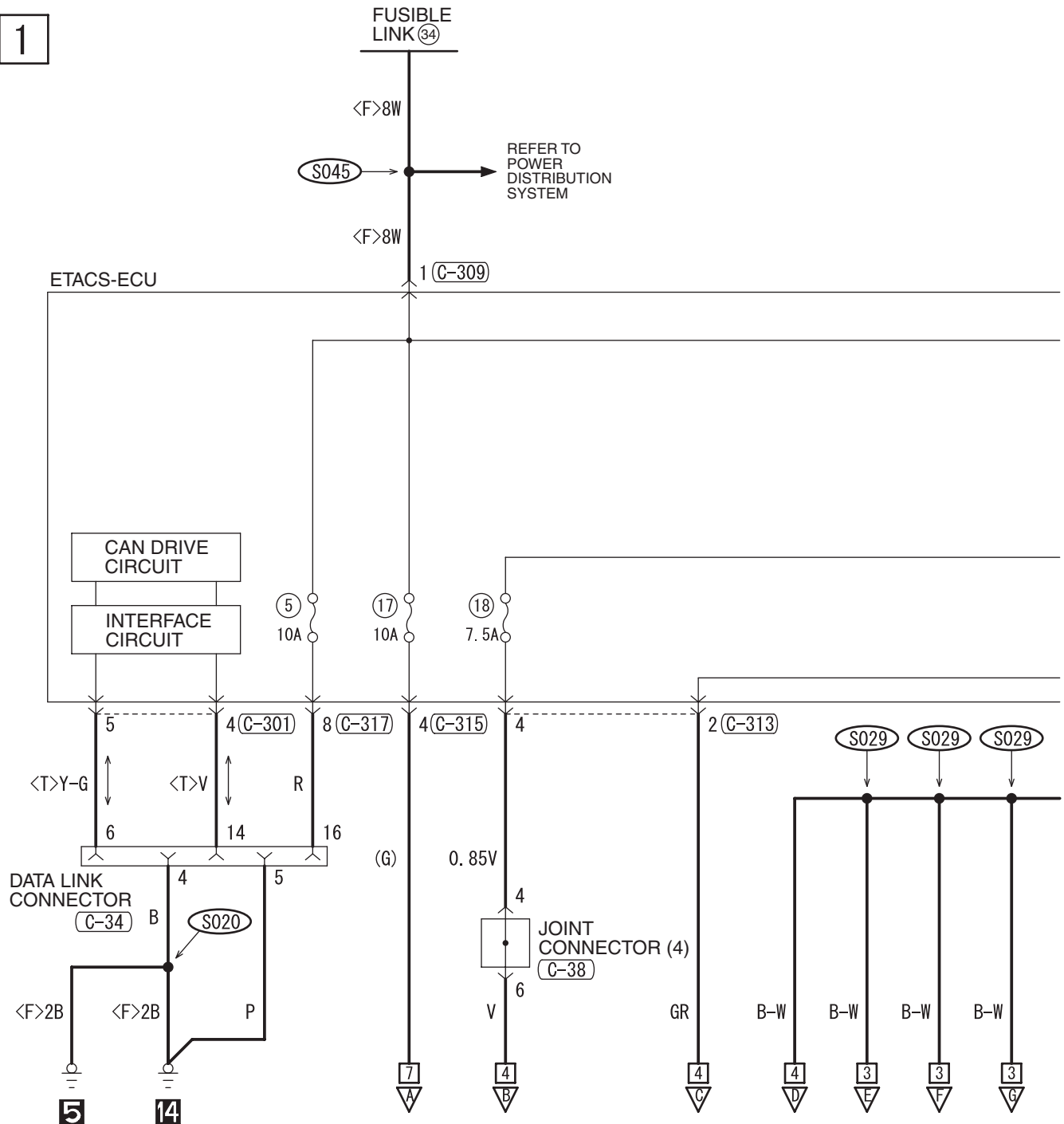

(C-07)

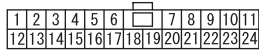

(C-34) FRONT SIDE



(C-38)

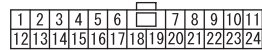

(C-128)

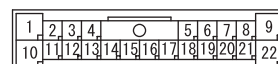

2

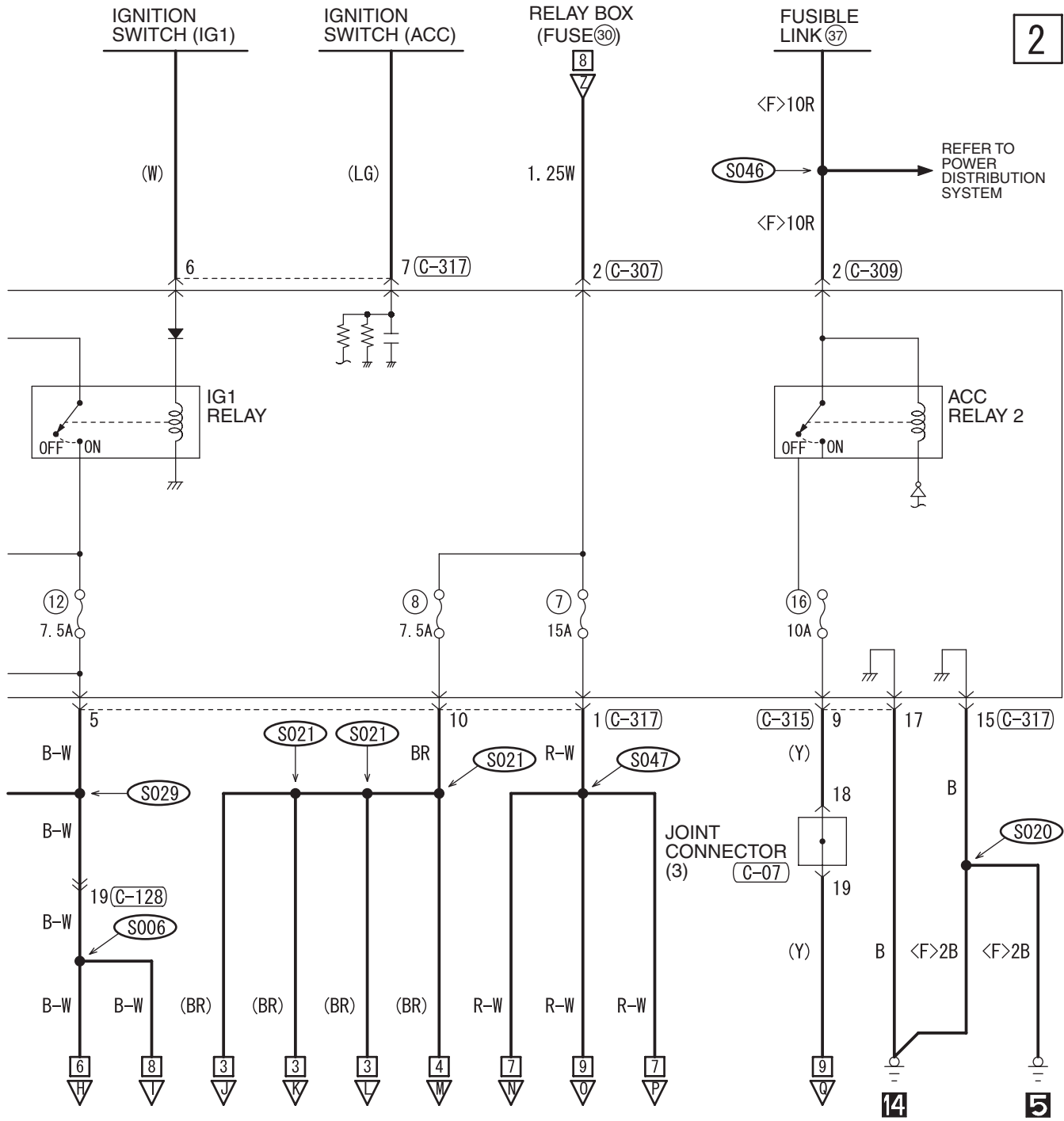

(C-301)



(C-307)



(C-309)



(C-313)

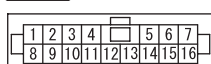

(C-315)

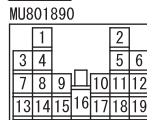

(C-317)

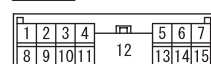

WIRE COLOR CODE

B: BLACK LG: LIGHT GREEN G: GREEN L: BLUE W: WHITE Y: YELLOW SB: SKY BLUE
BR: BROWN O: ORANGE GR: GRAY R: RED P: PINK V: VIOLET PU: PURPLE

H8G15M11AB

CONTROLLER AREA NETWORK (CAN) (CONTINUED)

3

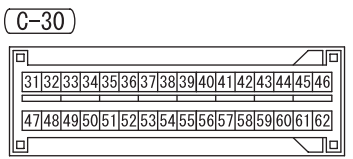
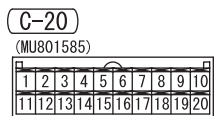
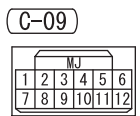
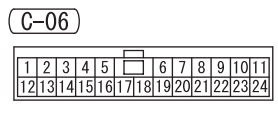
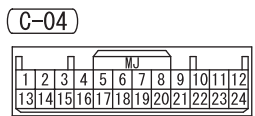
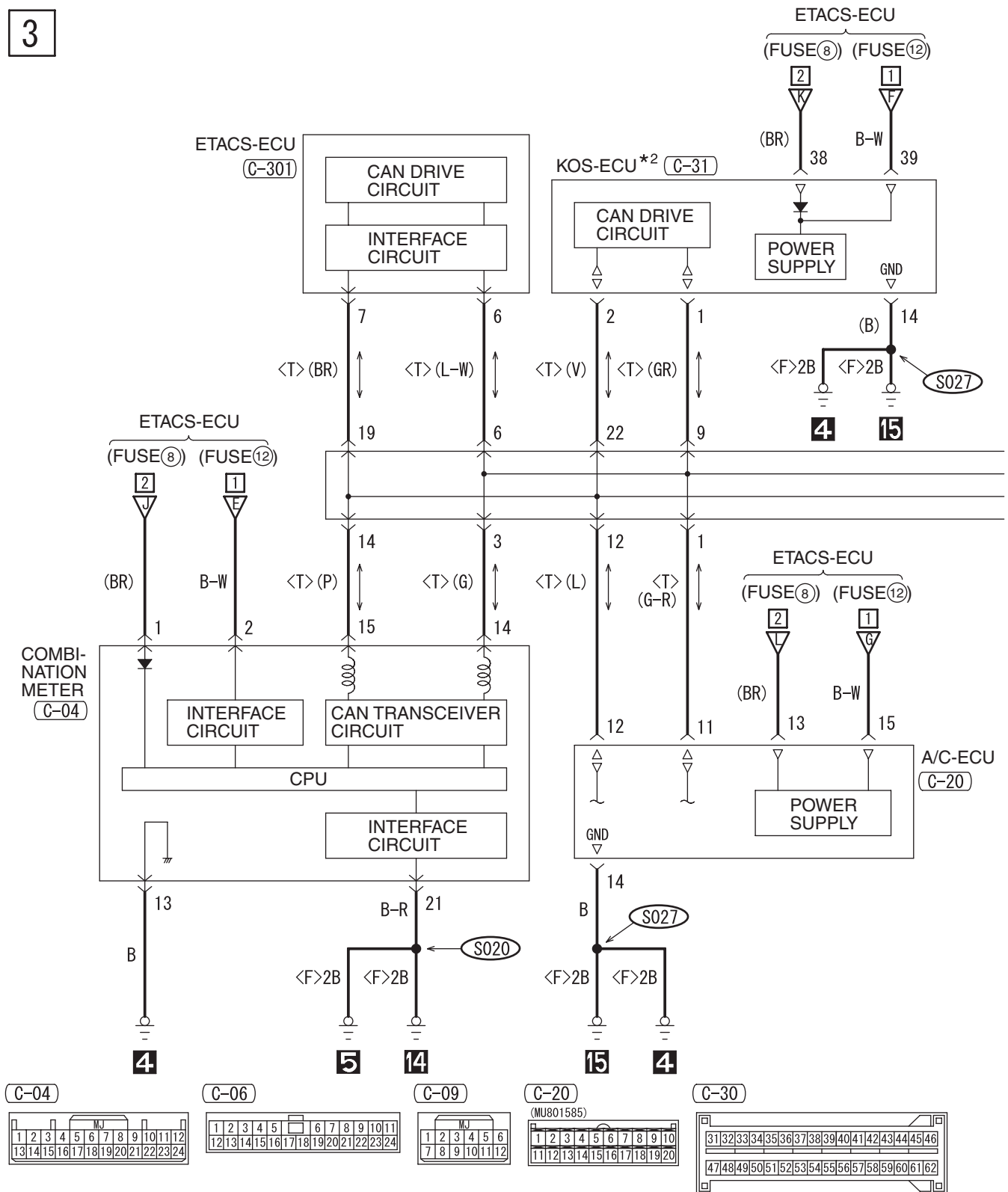

4

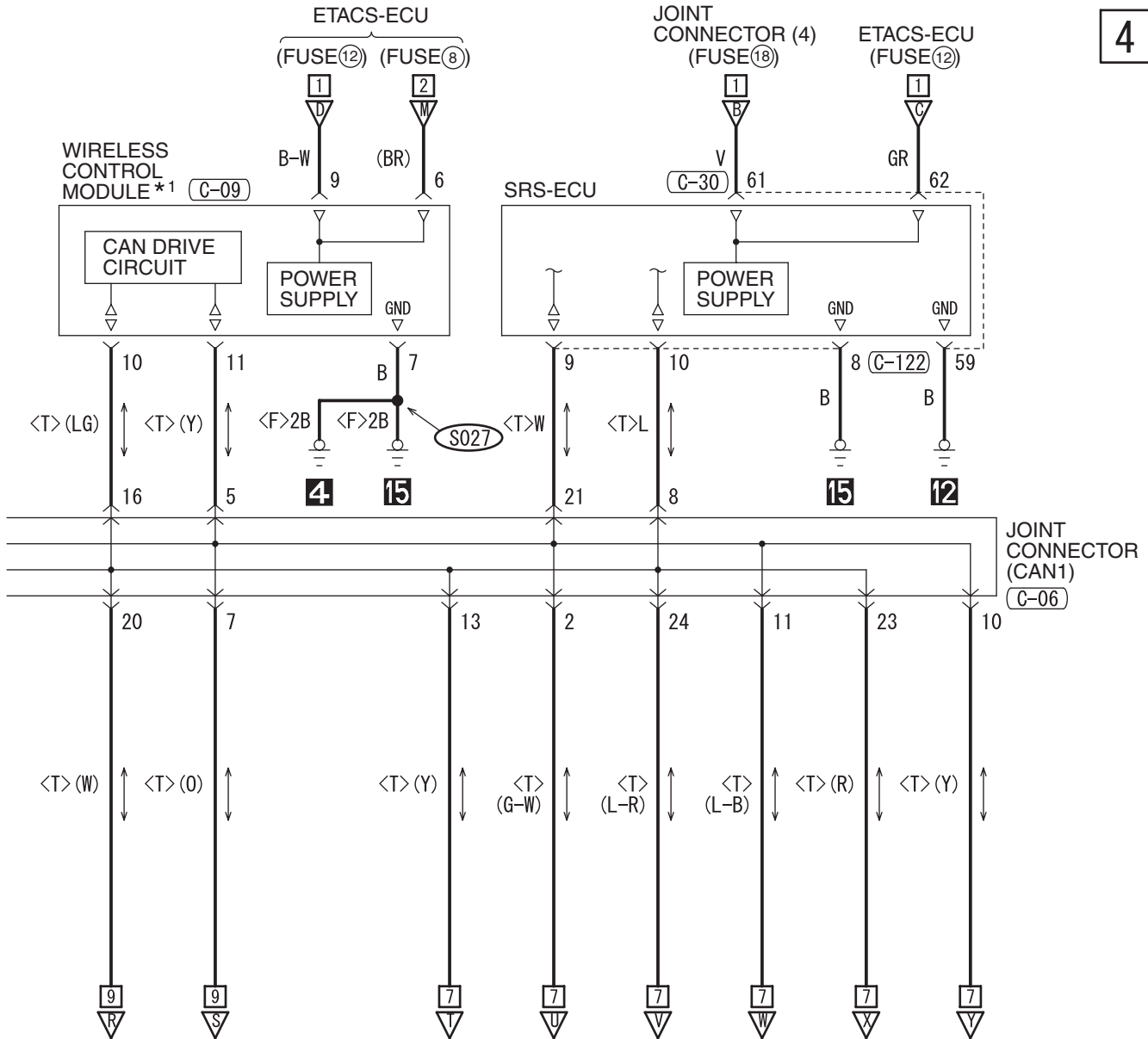

NOTE
* 1 : VEHICLES WITHOUT KOS
* 2 : VEHICLES WITH KOS

(C-31)

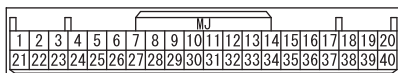

(C-122)

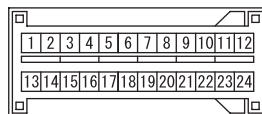

(C-301)

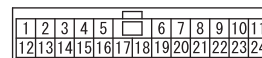

WIRE COLOR CODE

B : BLACK LG : LIGHT GREEN G : GREEN L : BLUE W : WHITE Y : YELLOW SB : SKY BLUE
BR : BROWN O : ORANGE GR : GRAY R : RED P : PINK V : VIOLET PU : PURPLE

H8G15M11BB

CONTROLLER AREA NETWORK (CAN) (CONTINUED)

5

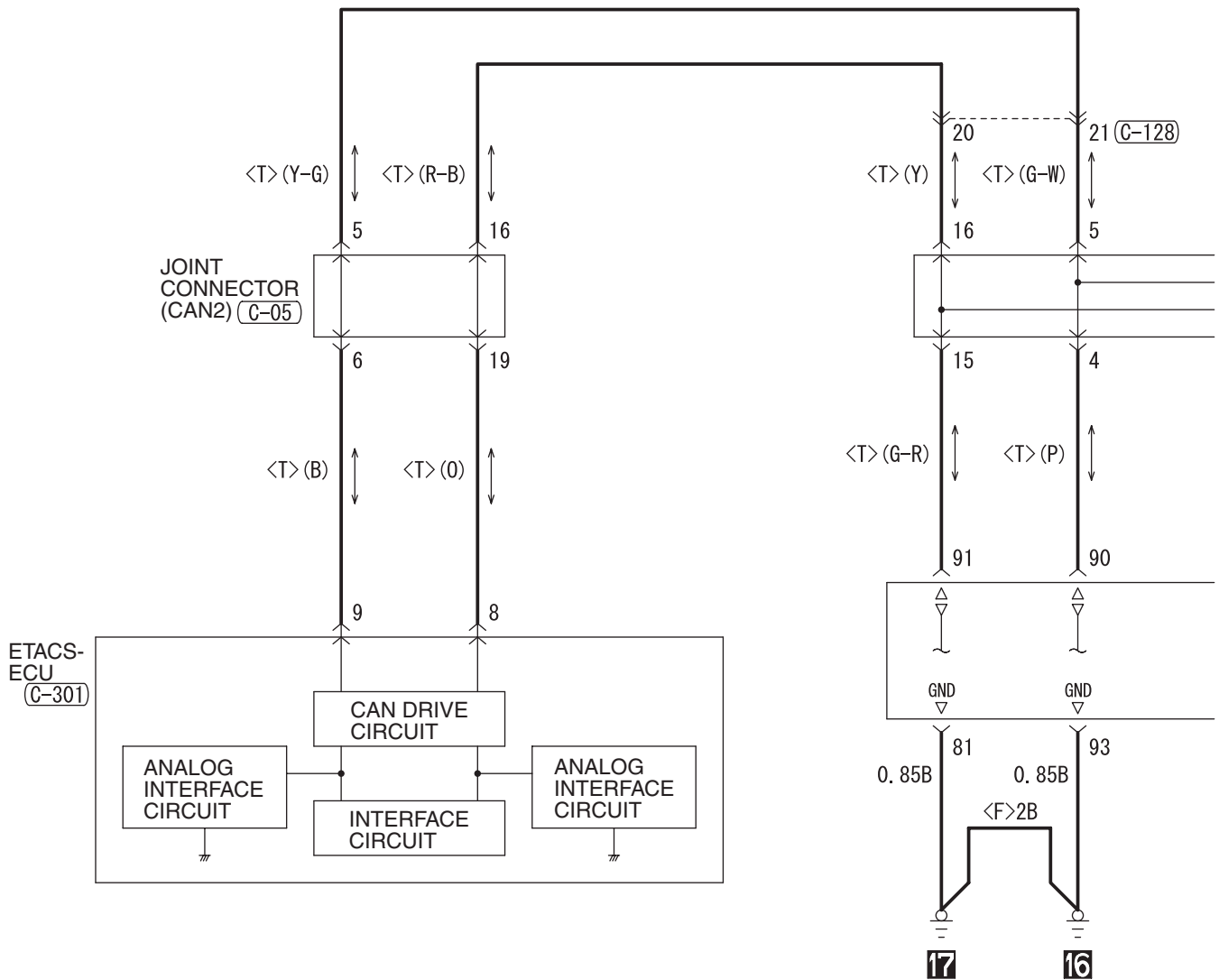

A-03

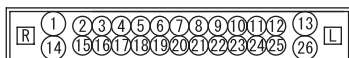

B-109

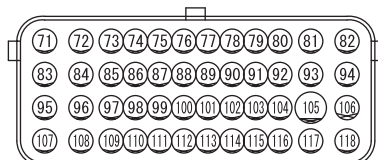

C-05

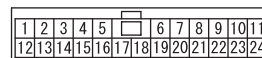

C-40



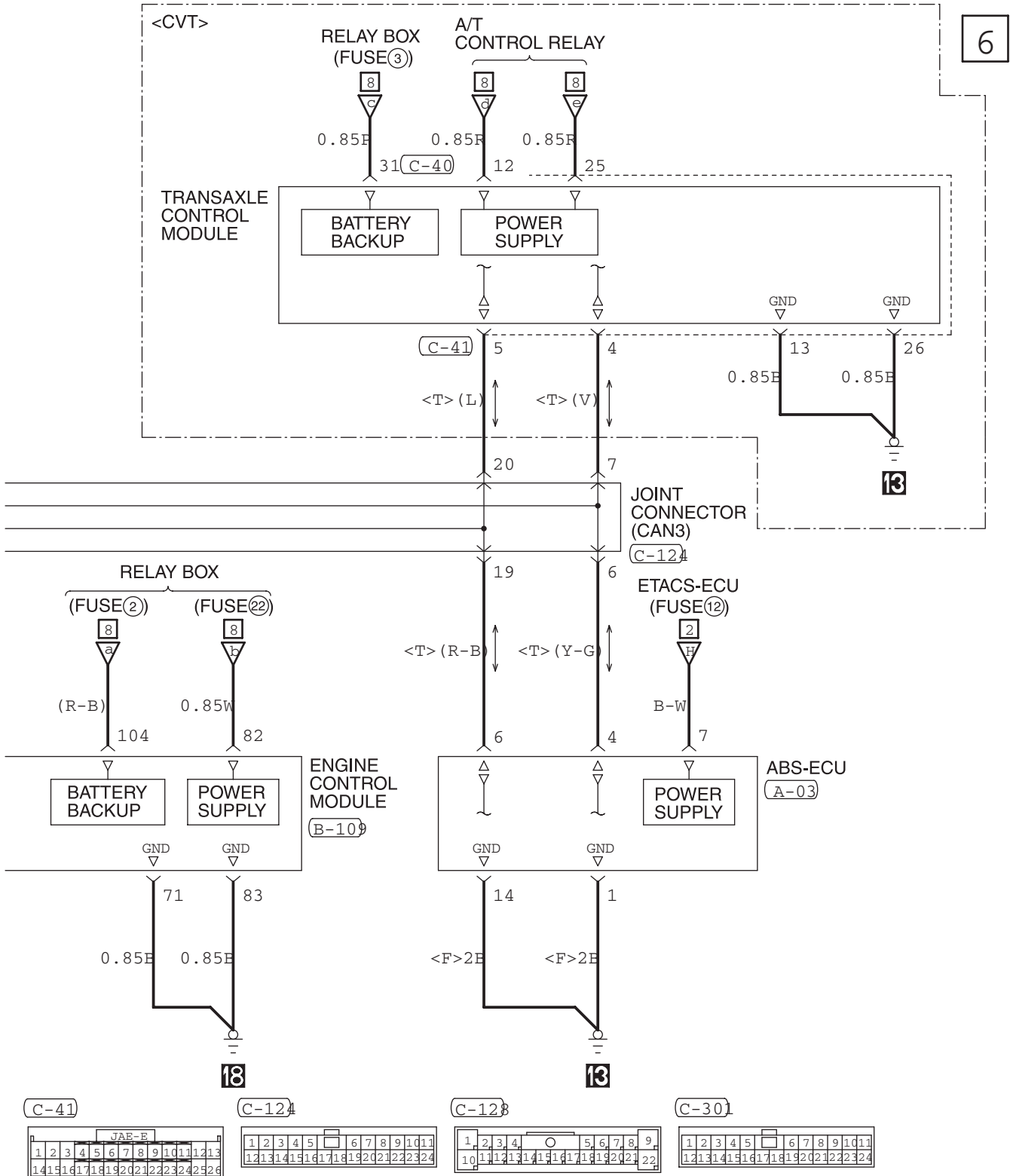

WIRE COLOR CODE

B: BLACK LG: LIGHT GREEN G: GREEN L: BLUE W: WHITE Y: YELLOW SB: SKY BLUE
BR: BROWN O: ORANGE GR: GRAY R: RED P: PINK V: VIOLET PU: PURPLE

H8G15M11CB

CONTROLLER AREA NETWORK (CAN) (CONTINUED)

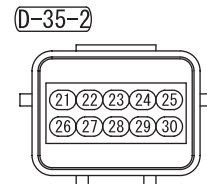
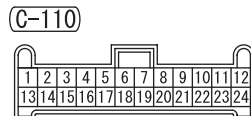
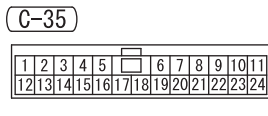
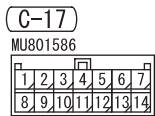
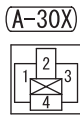
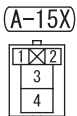
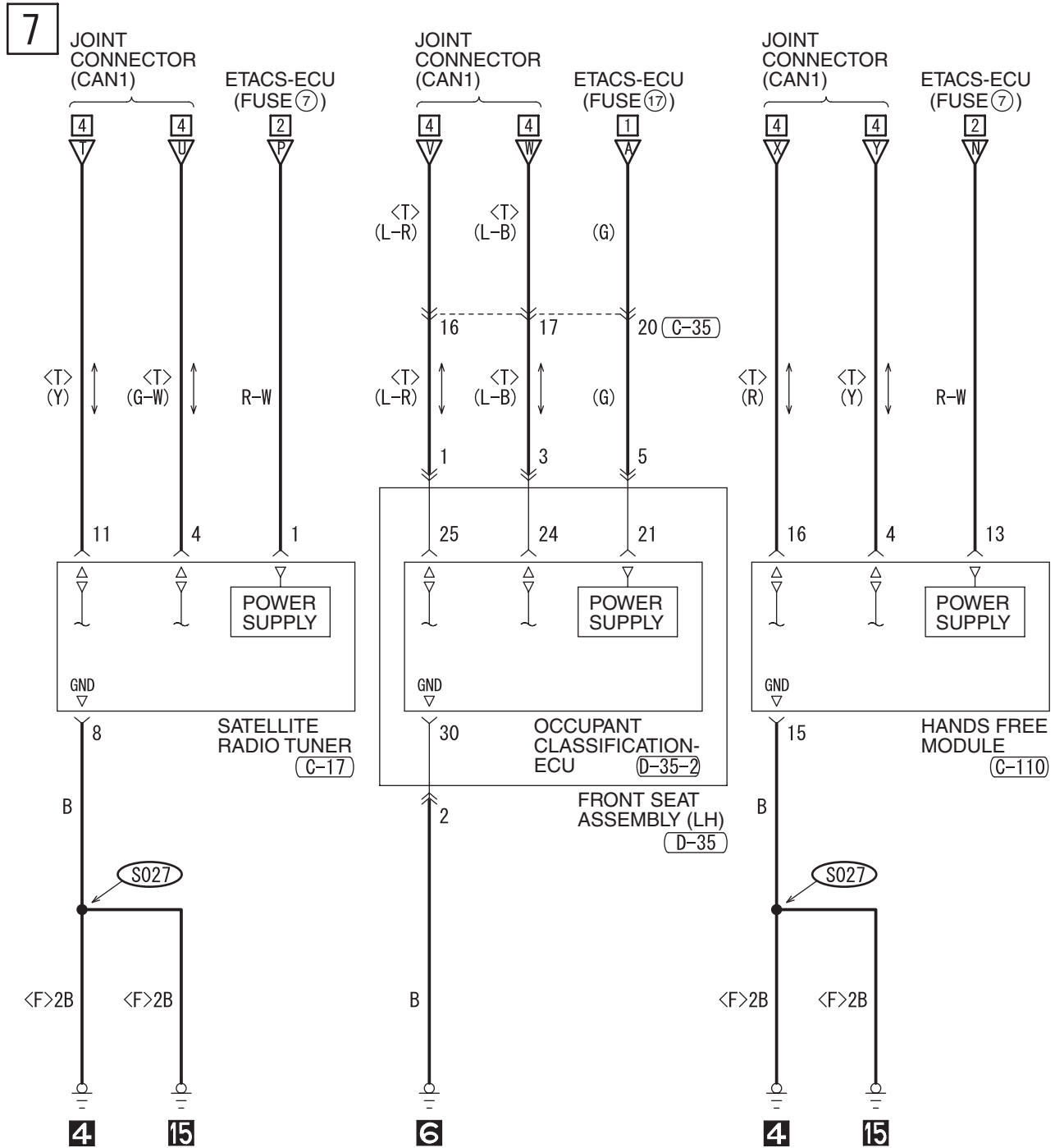

8

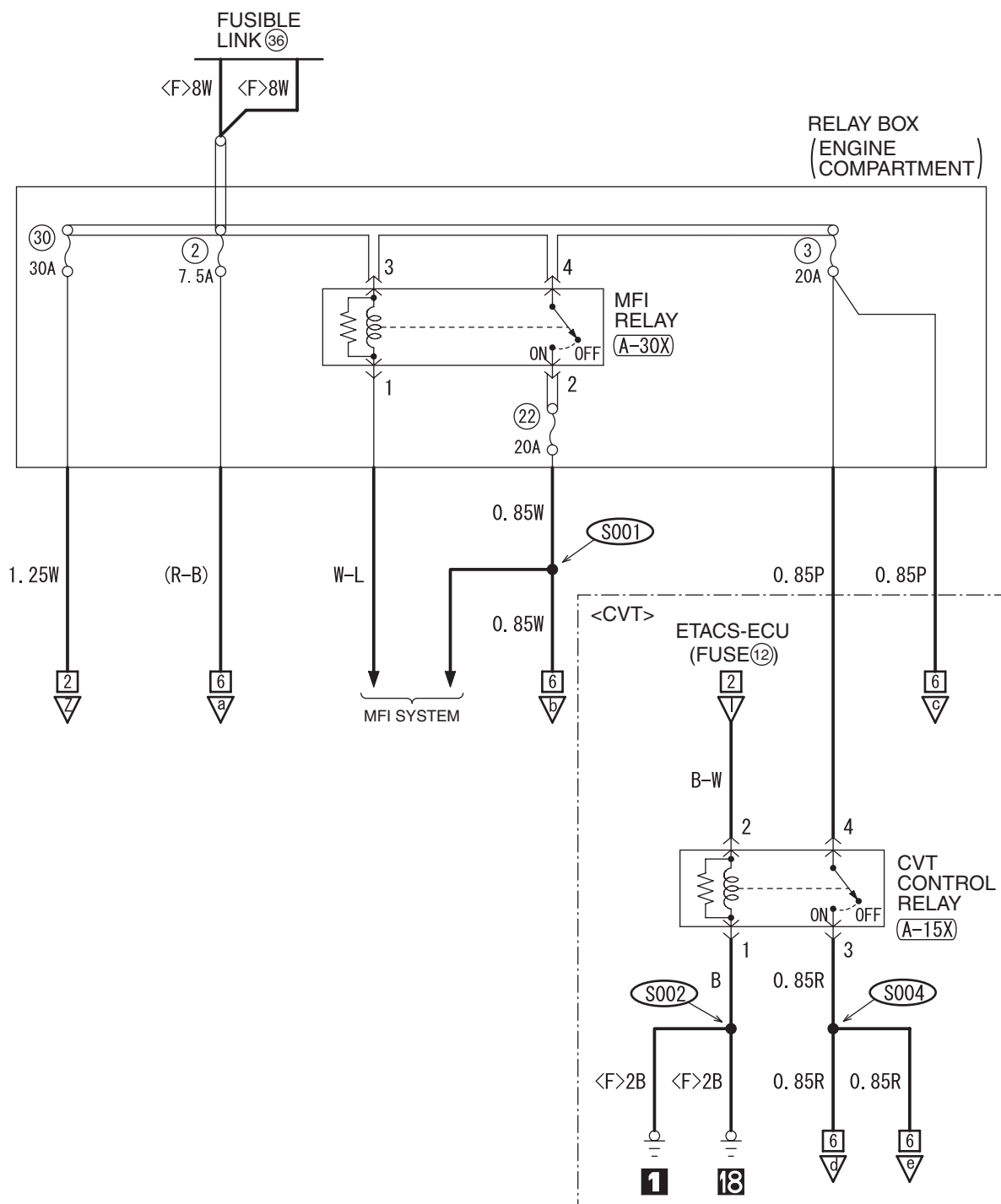

WIRE COLOR CODE

B: BLACK LG: LIGHT GREEN G: GREEN L: BLUE W: WHITE Y: YELLOW SB: SKY BLUE
BR: BROWN O: ORANGE GR: GRAY R: RED P: PINK V: VIOLET PU: PURPLE

H8G15M11DB

TSB Revision

CONTROLLER AREA NETWORK (CAN) (CONTINUED)

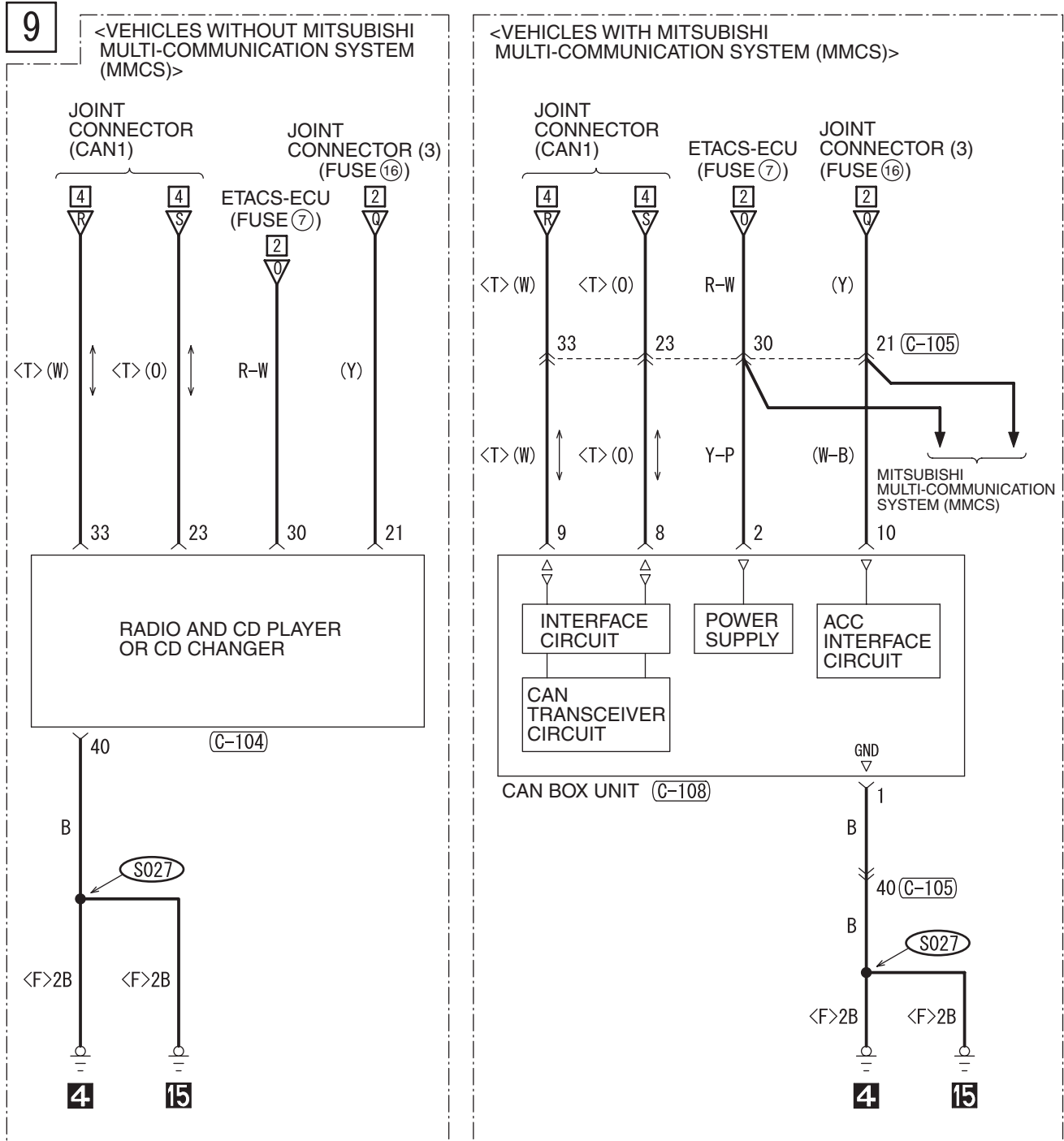

(C-104)

(C-105)

(C-108)

21	22	23	24	25	26	27	28	29	30
31	32	33	34	35	36	37	38	39	40

21	22	23	24	25	26	27	28	29	30
31	32	33	34	35	36	37	38	39	40

1	2	3	4	5	6	7	8	9	10
---	---	---	---	---	---	---	---	---	----

WIRE COLOR CODE

B: BLACK LG: LIGHT GREEN G: GREEN L: BLUE W: WHITE Y: YELLOW SB: SKY BLUE
BR: BROWN O: ORANGE GR: GRAY R: RED P: PINK V: VIOLET PU: PURPLE

H8G15M11EA

NOTES

TIRE PRESSURE MONITORING SYSTEM (TPMS)

M1901003900271

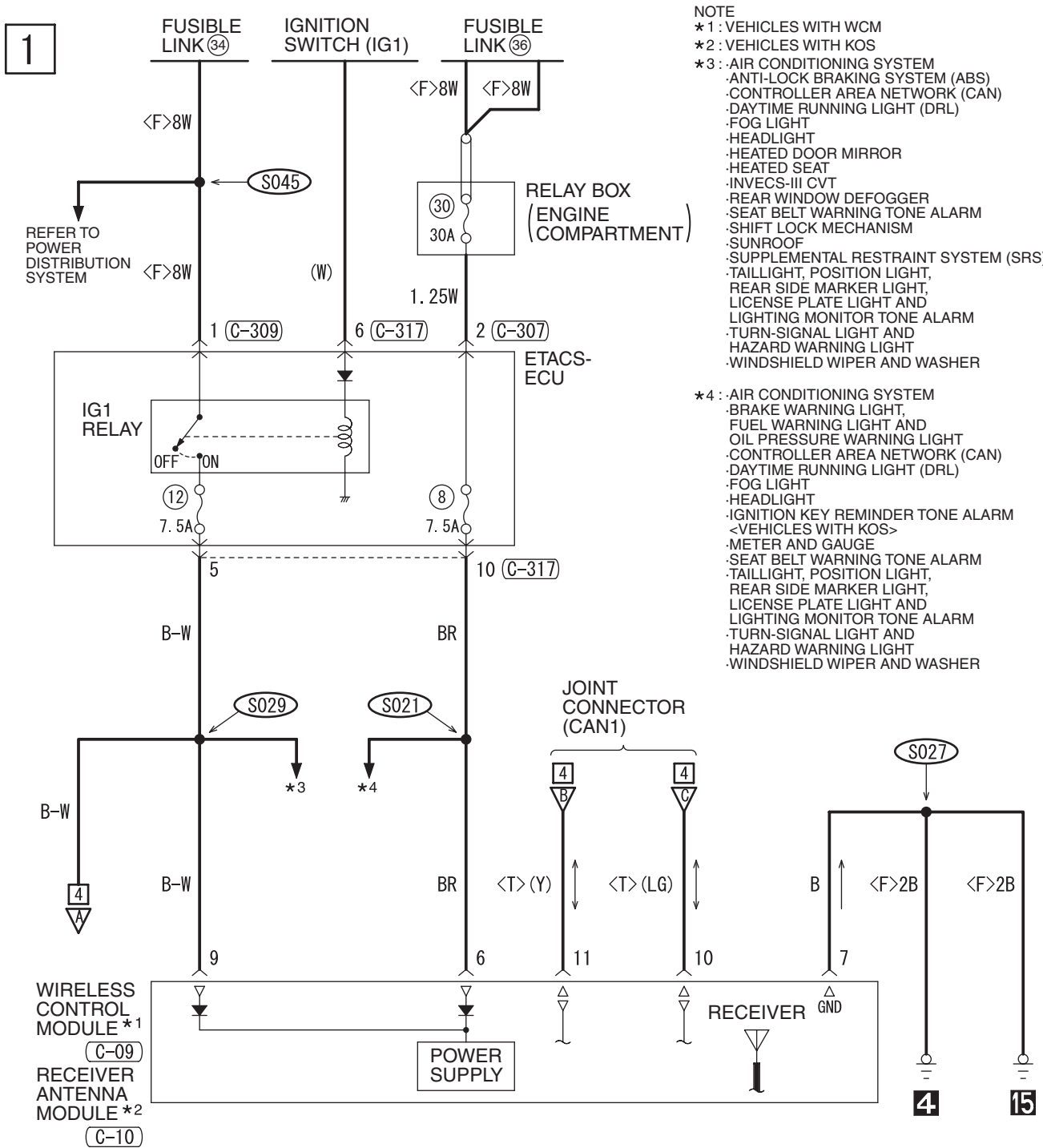

- NOTE
- *1 : VEHICLES WITH WCM
 - *2 : VEHICLES WITH KOS
 - *3 : AIR CONDITIONING SYSTEM
 - ANTI-LOCK BRAKING SYSTEM (ABS)
 - CONTROLLER AREA NETWORK (CAN)
 - DAYTIME RUNNING LIGHT (DRL)
 - FOG LIGHT
 - HEADLIGHT
 - HEATED DOOR MIRROR
 - HEATED SEAT
 - INVECS-III CVT
 - REAR WINDOW DEFOGGER
 - SEAT BELT WARNING TONE ALARM
 - SHIFT LOCK MECHANISM
 - SUNROOF
 - SUPPLEMENTAL RESTRAINT SYSTEM (SRS)
 - TAILLIGHT, POSITION LIGHT, REAR SIDE MARKER LIGHT, LICENSE PLATE LIGHT AND LIGHTING MONITOR TONE ALARM
 - TURN-SIGNAL LIGHT AND HAZARD WARNING LIGHT
 - WINDSHIELD WIPER AND WASHER
 - *4 : AIR CONDITIONING SYSTEM
 - BRAKE WARNING LIGHT, FUEL WARNING LIGHT AND OIL PRESSURE WARNING LIGHT
 - CONTROLLER AREA NETWORK (CAN)
 - DAYTIME RUNNING LIGHT (DRL)
 - FOG LIGHT
 - HEADLIGHT
 - IGNITION KEY REMINDER TONE ALARM
 - METER AND GAUGE
 - SEAT BELT WARNING TONE ALARM
 - TAILLIGHT, POSITION LIGHT, REAR SIDE MARKER LIGHT, LICENSE PLATE LIGHT AND LIGHTING MONITOR TONE ALARM
 - TURN-SIGNAL LIGHT AND HAZARD WARNING LIGHT
 - WINDSHIELD WIPER AND WASHER

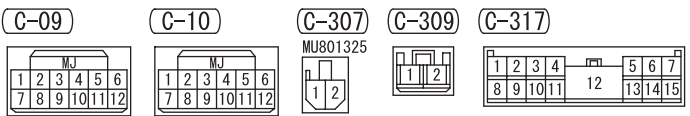

2

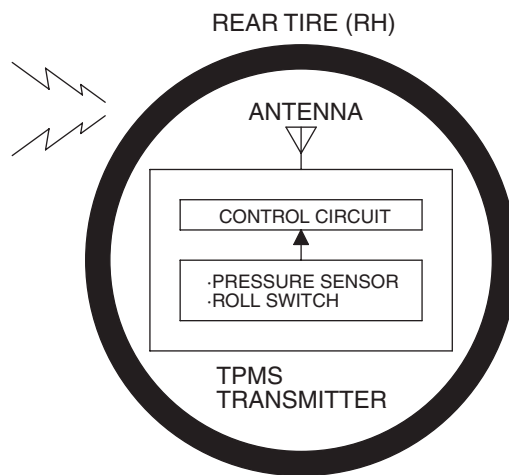
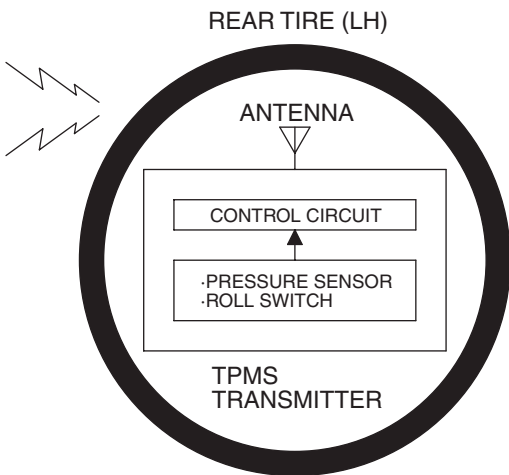
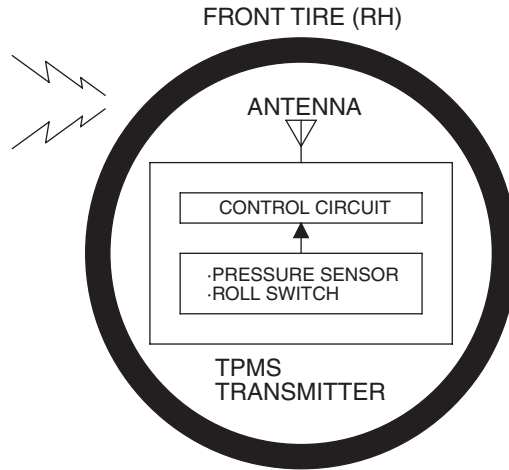
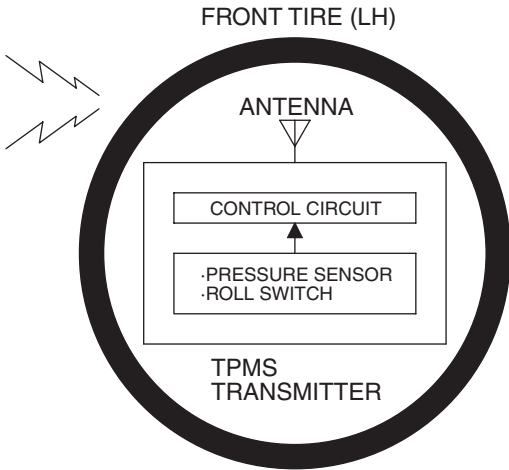

WIRE COLOR CODE

B: BLACK LG: LIGHT GREEN G: GREEN L: BLUE W: WHITE Y: YELLOW SB: SKY BLUE
BR: BROWN O: ORANGE GR: GRAY R: RED P: PINK V: VIOLET PU: PURPLE

H8G15M12AB

TSB Revision

TIRE PRESSURE MONITORING SYSTEM (CONTINUED)

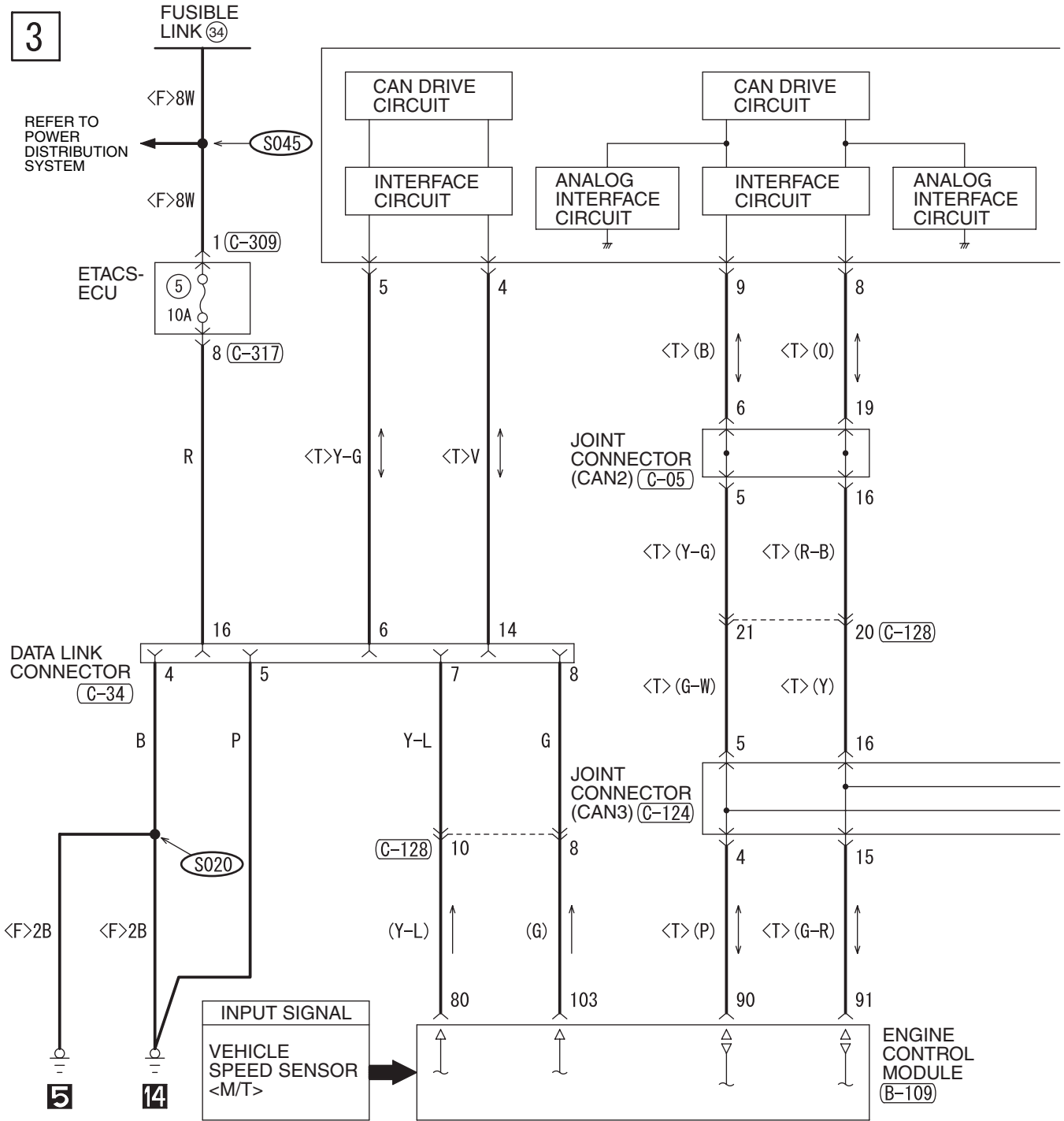

(B-109)

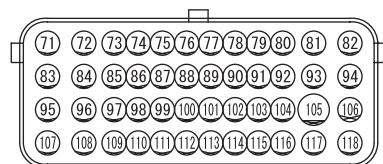

(C-04)

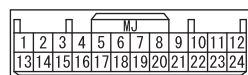

(C-05)

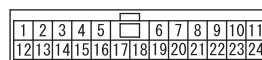

(C-06)



(C-301)

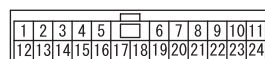

(C-309)



(C-317)



4

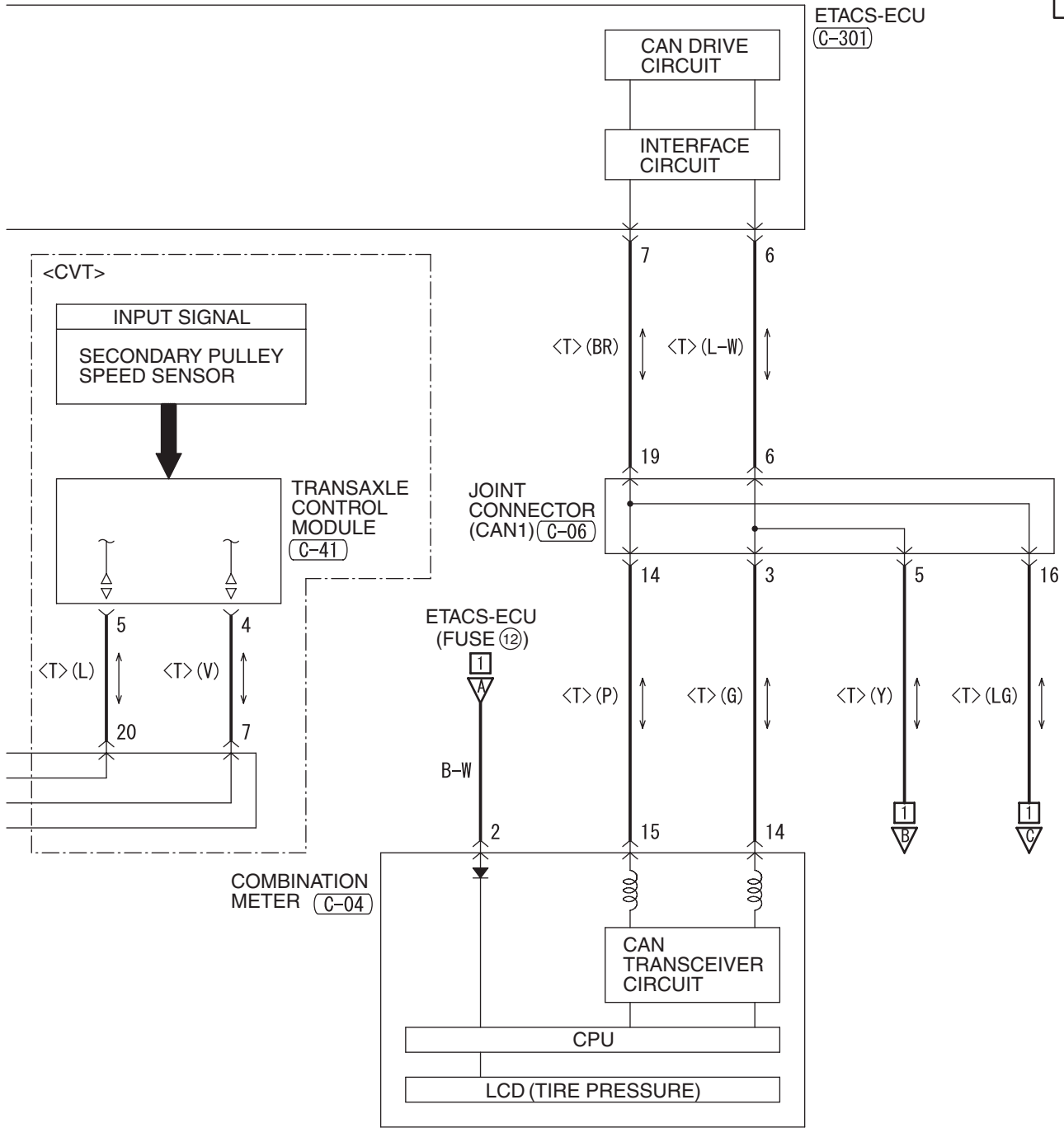

(C-34) FRONT SIDE

(C-41)

(C-124)

(C-128)

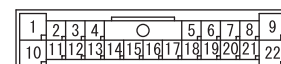
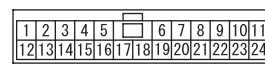
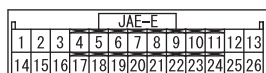

WIRE COLOR CODE

B: BLACK LG: LIGHT GREEN G: GREEN L: BLUE W: WHITE Y: YELLOW SB: SKY BLUE
BR: BROWN O: ORANGE GR: GRAY R: RED P: PINK V: VIOLET PU: PURPLE

H8G15M12BB

TSB Revision

THEFT-ALARM SYSTEM

M1901012400768

1

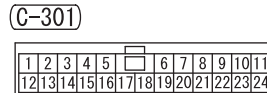
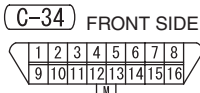
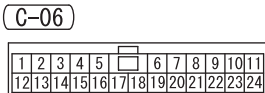
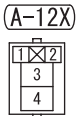
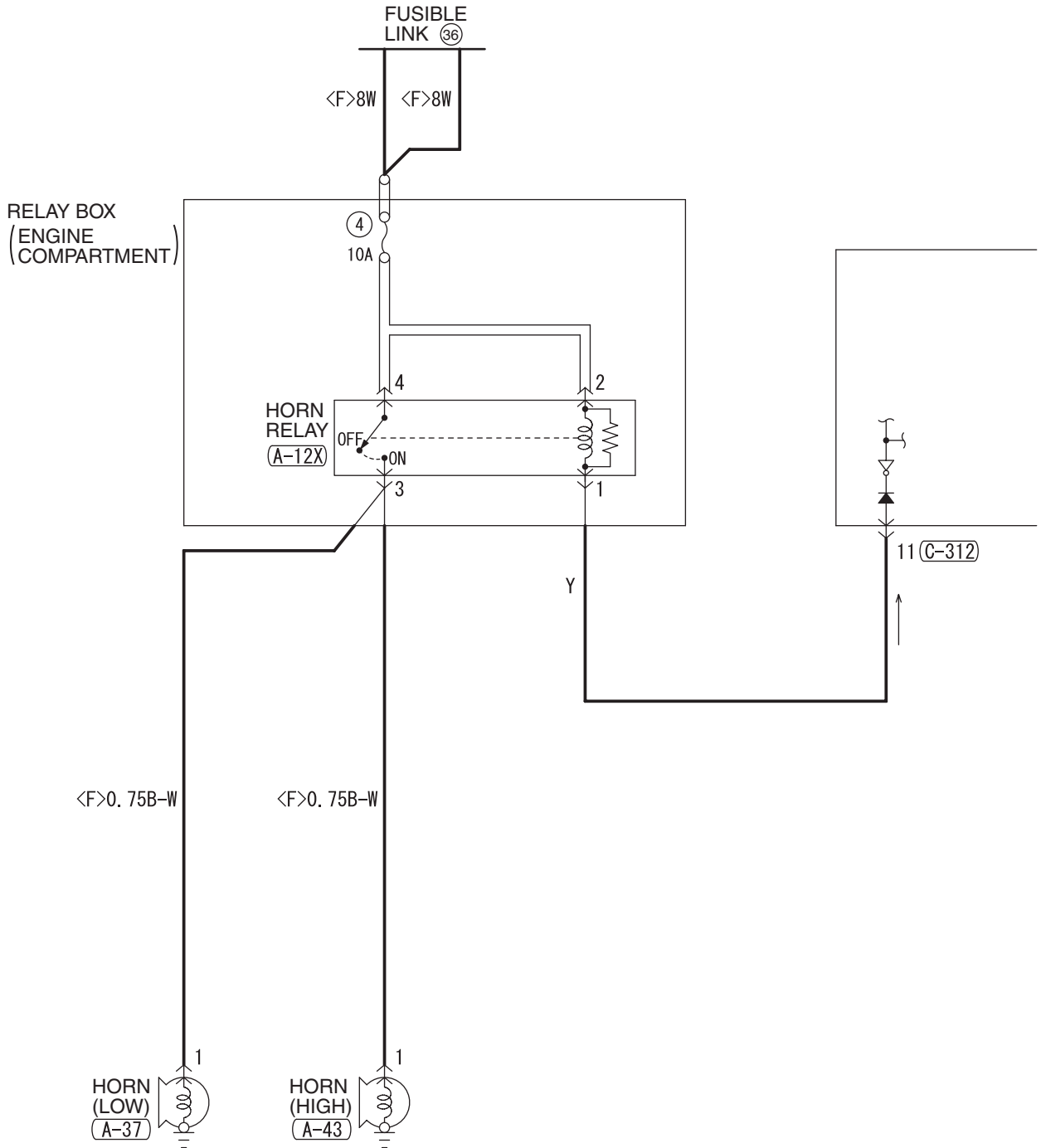

THEFT-ALARM SYSTEM (CONTINUED)

3

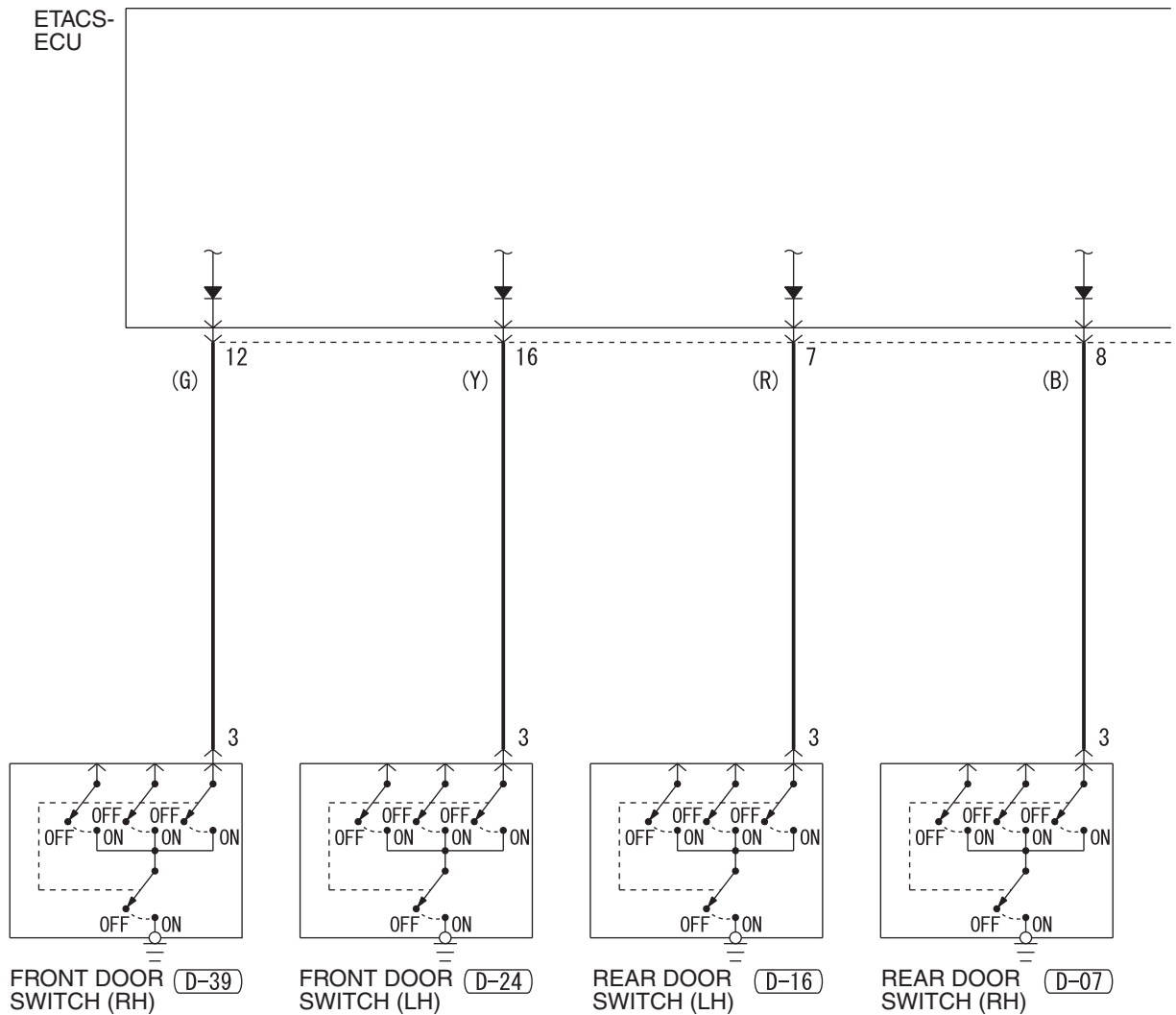

(C-07)

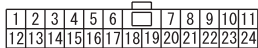

(C-18)

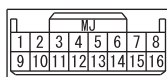

(C-307)



(C-312)

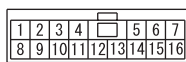

(C-313)

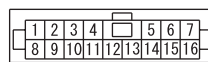

(C-315)



4

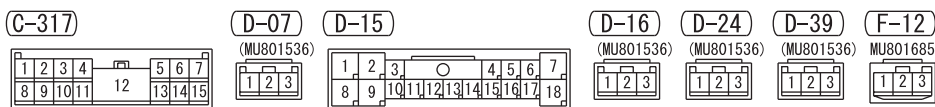
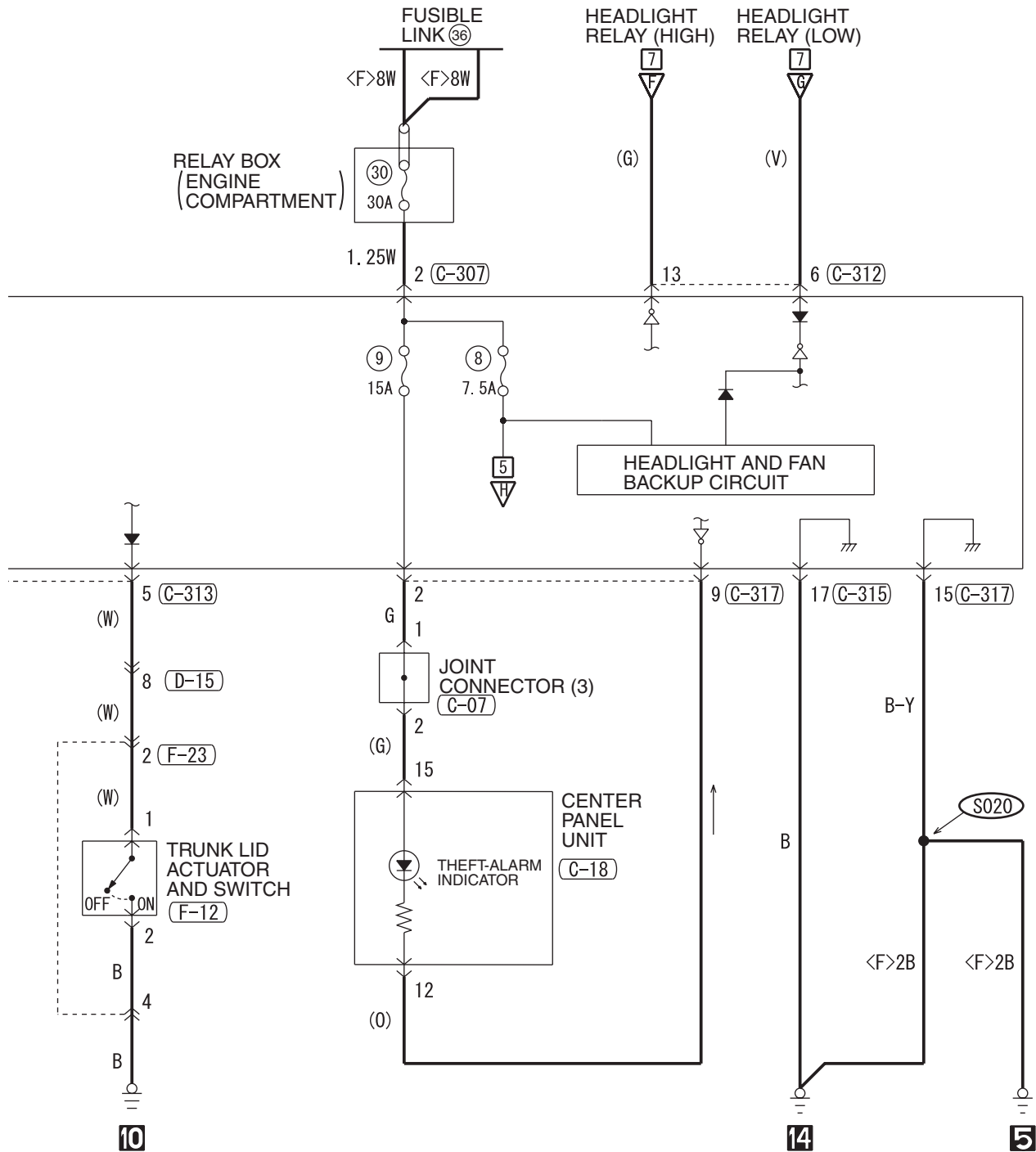

WIRE COLOR CODE

B: BLACK LG: LIGHT GREEN G: GREEN L: BLUE W: WHITE Y: YELLOW SB: SKY BLUE
BR: BROWN O: ORANGE GR: GRAY R: RED P: PINK V: VIOLET PU: PURPLE

H8G15M13BB

THEFT-ALARM SYSTEM (CONTINUED)

5

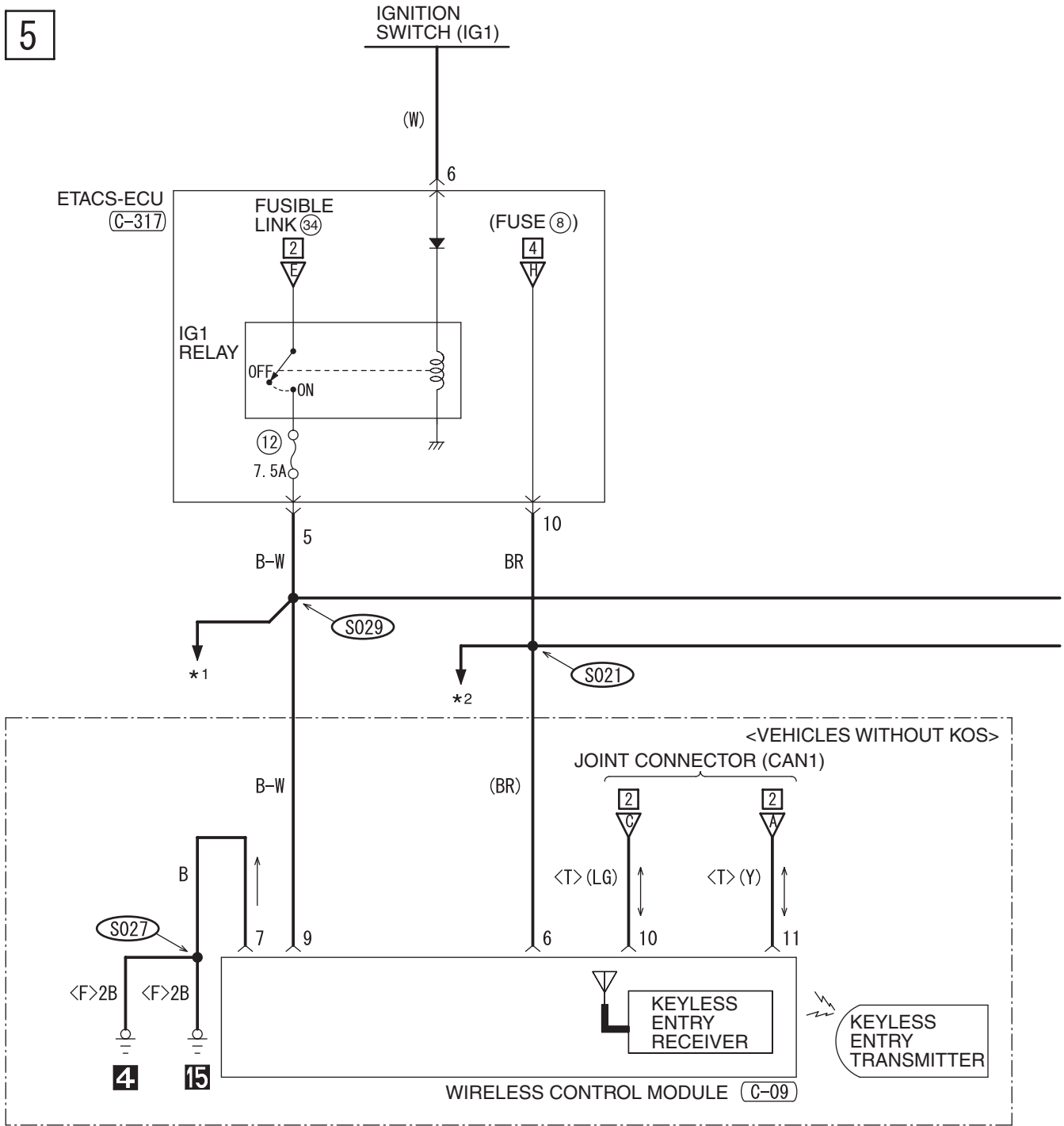

C-09

C-10

C-31

C-317

1	2	3	4	5	6
7	8	9	10	11	12

1	2	3	4	5	6
7	8	9	10	11	12

1	2	3	4	5	6	7	8	9	10	11	12	13	14	15	16	17	18	19	20
21	22	23	24	25	26	27	28	29	30	31	32	33	34	35	36	37	38	39	40

1	2	3	4	5	6	7	
8	9	10	11	12	13	14	15

NOTE

*1: -AIR CONDITIONING SYSTEM

- ANTI-LOCK BRAKING SYSTEM (ABS)
- AUTO-CRUISE CONTROL SYSTEM
- BRAKE WARNING LIGHT, FUEL WARNING LIGHT AND OIL PRESSURE WARNING LIGHT
- CENTRAL DOOR LOCKING SYSTEM
- CHARGING SYSTEM
- CONTROLLER AREA NETWORK (CAN)
- DAYTIME RUNNING LIGHT (DRL)
- DOME LIGHT,LUGGAGE COMPARTMENT LIGHT AND IGNITION KEY HOLE ILLUMINATION LIGHT
- DOOR AJAR WARNING TONE ALARM
- FOG LIGHT
- HEADLIGHT
- HEATED DOOR MIRROR
- HEATED SEAT
- INVECS-III CVT
- IGNITION KEY REMINDER TONE ALARM
- IMMOBILIZER SYSTEM
- METER AND GAUGE
- MFI SYSTEM
- REAR WINDOW DEFOGGER
- SEAT BELT WARNING TONE ALARM
- SHIFT LOCK MECHANISM
- SUNROOF
- SUPPLEMENTAL RESTRAINT SYSTEM (SRS)
- TAILLIGHT, POSITION LIGHT, REAR SIDE MARKER LIGHT, LICENSE PLATE LIGHT AND LIGHTING MONITOR TONE ALARM
- TIRE PRESSURE MONITORING SYSTEM (TPMS)
- TURN-SIGNAL LIGHT AND HAZARD WARNING LIGHT
- WINDSHIELD WIPER AND WASHER

*2: -AIR CONDITIONING SYSTEM

- AUDIO SYSTEM
- BRAKE WARNING LIGHT, FUEL WARNING LIGHT AND OIL PRESSURE WARNING LIGHT
- CENTRAL DOOR LOCKING SYSTEM
- DAYTIME RUNNING LIGHT (DRL)
- DOME LIGHT,LUGGAGE COMPARTMENT LIGHT AND IGNITION KEY HOLE ILLUMINATION LIGHT
- FOG LIGHT
- HEADLIGHT
- IGNITION KEY REMINDER TONE ALARM <VEHICLES WITH KOS>
- METER AND GAUGE
- SEAT BELT WARNING TONE ALARM
- SUNROOF
- TAILLIGHT, POSITION LIGHT, REAR SIDE MARKER LIGHT, LICENSE PLATE LIGHT AND LIGHTING MONITOR TONE ALARM
- TIRE PRESSURE MONITORING SYSTEM (TPMS)
- TURN-SIGNAL LIGHT AND HAZARD WARNING LIGHT
- WINDSHIELD WIPER AND WASHER

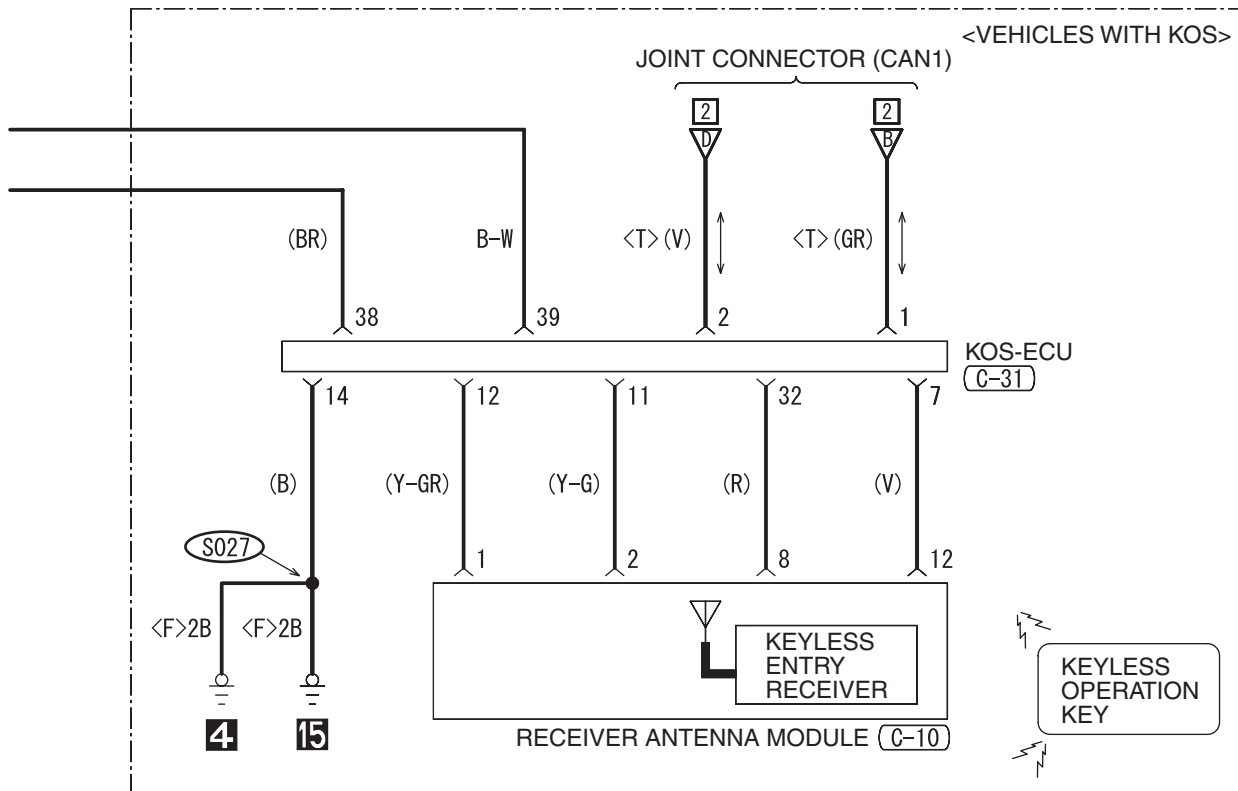

WIRE COLOR CODE

B: BLACK LG: LIGHT GREEN G: GREEN L: BLUE W: WHITE Y: YELLOW SB: SKY BLUE
 BR: BROWN O: ORANGE GR: GRAY R: RED P: PINK V: VIOLET PU: PURPLE

H8G15M13CB

THEFT-ALARM SYSTEM (CONTINUED)

7

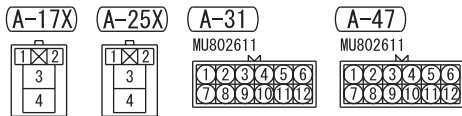
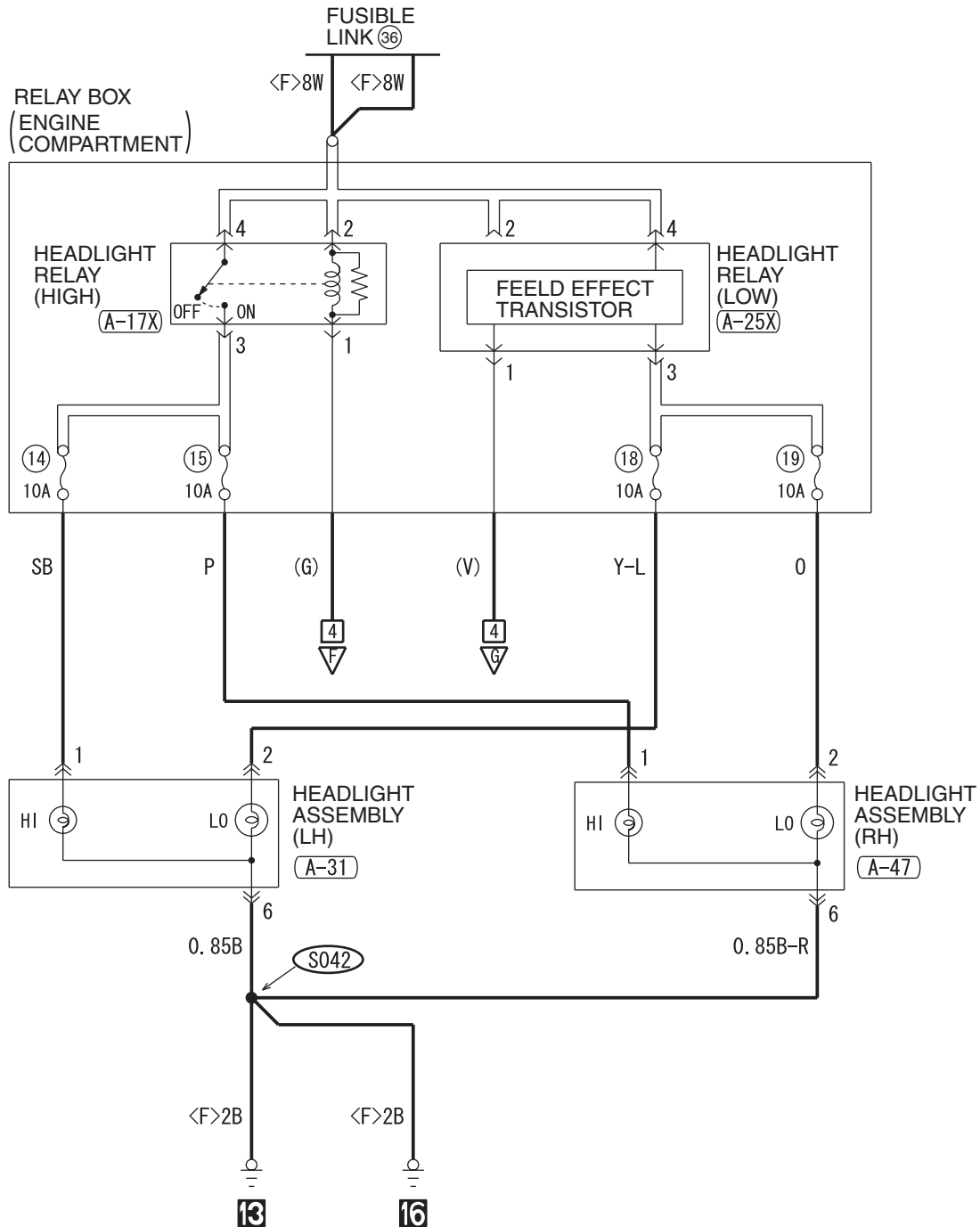

WIRE COLOR CODE
 B : BLACK LG : LIGHT GREEN G : GREEN L : BLUE W : WHITE Y : YELLOW SB : SKY BLUE
 BR : BROWN O : ORANGE GR : GRAY R : RED P : PINK V : VIOLET PU : PURPLE

H8G15M13DA

TSB Revision