

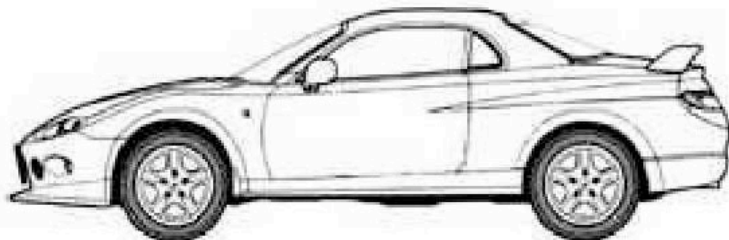

Mitsubishi FTO handbook

FTO



www.modifiedfto.com

OUTSIDE OVERVIEW

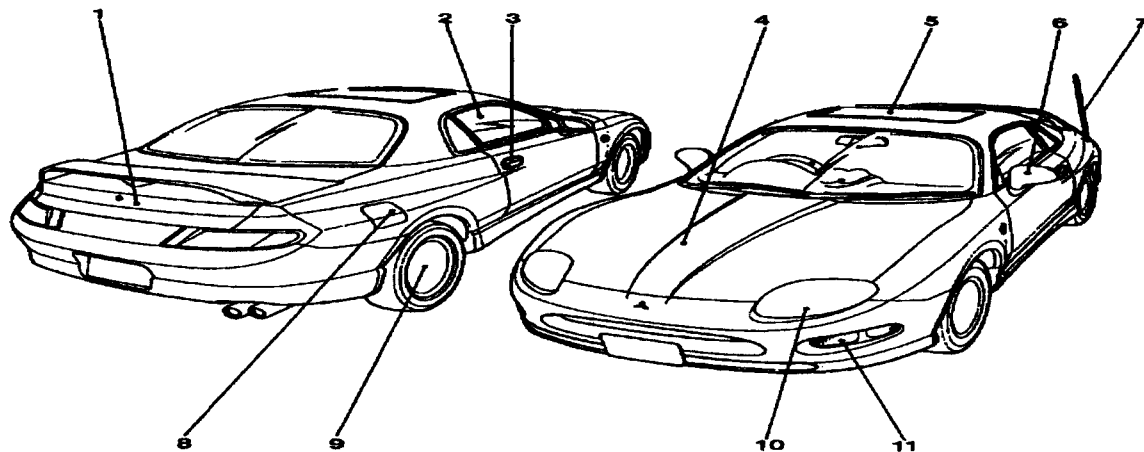

- 1. Trunk Lid
- 2. Power Window
- 3. Door Lock (Keyless Entry)
- 4. Engine Bonnet
- 5. Sunroof
- 6. Door Mirror

- 7. Motor Antenna
- 8. Fuel Lid
- 9. Tyre
- 10. Head Lamp
- 11. Fog Lamp

ENGINE OVERVIEW

1. Brake Fluid Reservoir
2. Engine Oil Cap
3. Clutch Fluid reservoir (M/ Transmission)
4. Radiator Cap
5. Battery
6. Condenser Tank
7. Power Steering Tank
8. Engine Oil Level Gauge
9. Automatic Transmission Oil Level Gauge
10. Air Cleaner
11. Front / Rear Washer Tank

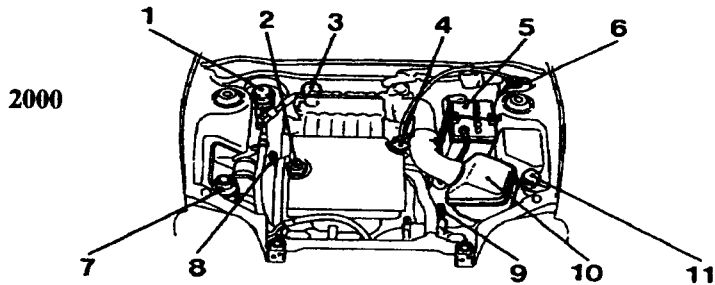
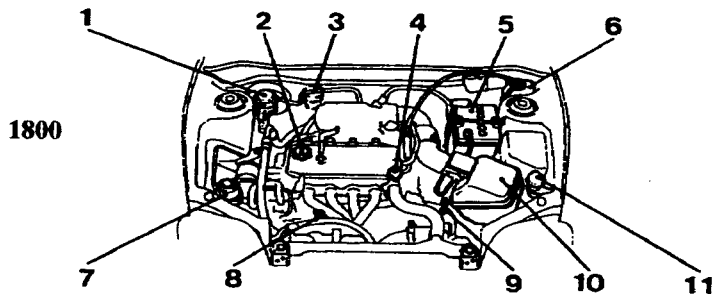

INTERIOR OVERVIEW

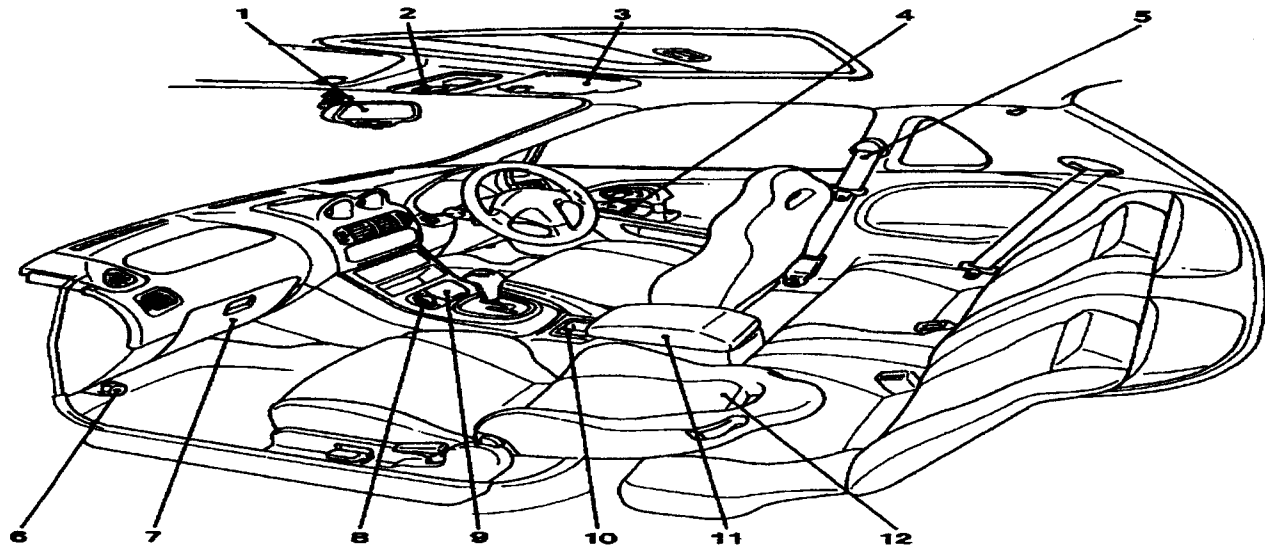

1. Room Mirror / Room Lamp

2. Sunroof Switch

3. Sun Visor

4. Power Window Switch

5. Seat Belt

6. Flare

7. Glove Box

8. Cigarette Lighter

9. ash tray

10. Cup Tray

11. Console Box

12. Seat

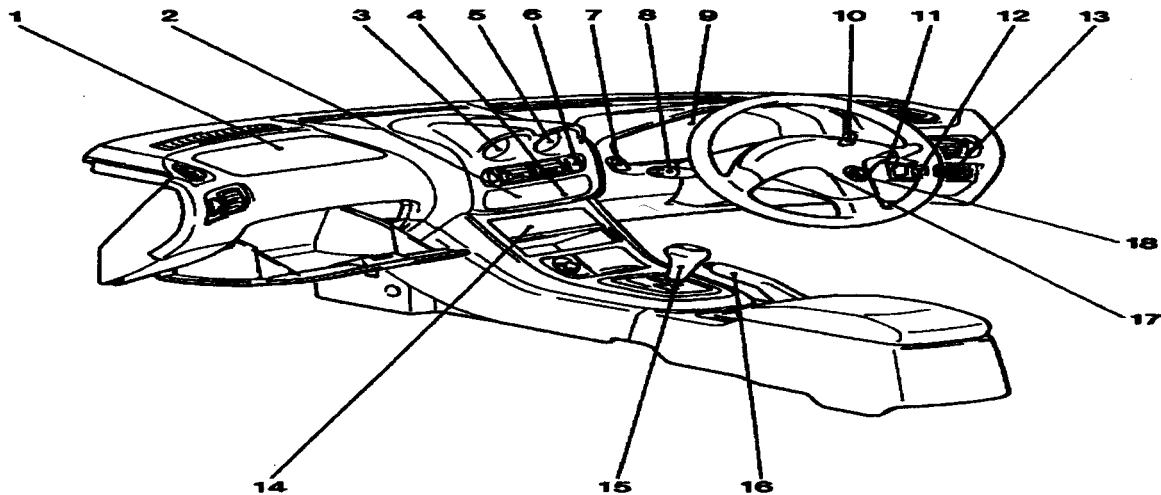

- 1. Passenger Air Bag
- 2. Air Conditioner
- 3. Clock
- 4. Rear Window Defogger Control
- 5. Battery Level Gauge
- 6. Hazard Light Switch
- 7. Motor Antenna Switch

- 8. Front / Rear Wiper / Washer
- 9. Meter, Indicators, Warning Lights
- 10. Fog Lamp Switch
- 11. Light, Indicator
- 12. Traction Control
- 13. Power Mirror Switch
- 14. Audio

- 15. Shift / Automatic Shift Lever
- 16. Hand Brake
- 17. Driver Air bag
- 18. Ignition

CHAPTER 1

VEHICLE INTRODUCTION AND SAFETY

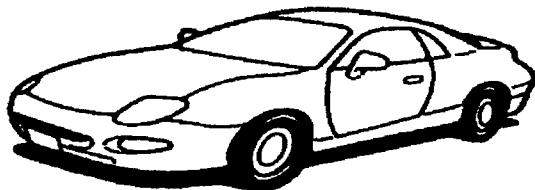

PLEASE READ THIS CHAPTER

Even if you cant read the entire manual, this chapter should be studied before operation of vehicle.

For your safety and understanding of vehicle we suggest you read this chapter only, then follow up by reading rest of the manual at a later date.

VEHICLE OPERATION

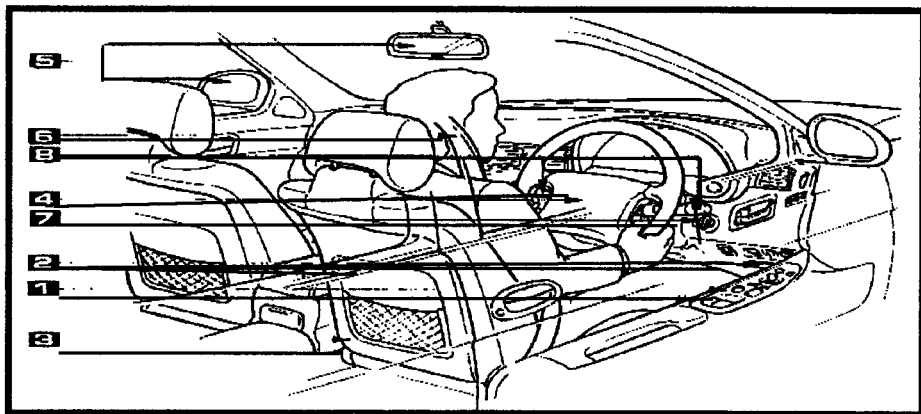

1. DOORS & WINDOWS

All windows and doors are fully powered electronically.
Each door is fitted with a locking tab just to the inside of the door handle.

2. BONNET RELEASE LEVER

Bonnet release lever is situated under steering wheel to the right.
Lift lever under bonnet to release hook from bonnet then open bonnet..

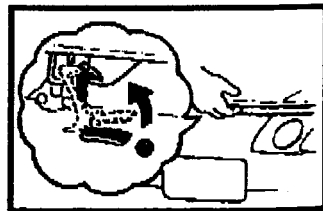

3. SEAT POSITION

Adjust seat so steering wheel can be reached properly. Arms should be slightly bent with hands at 10 & 2 o'clock. Be sure brake and accelerator pedal can be reached and pushed with ease. And head rest is comfortable.

4. STEERING WHEEL

Before driving steering wheel should be adjusted to give you full view of dash meters and make driving more comfortable.

5. MIRRORS

Side mirrors are all electrical with rear view mirror fitted with day/ night adjustment tab. All mirrors should be adjusted accordingly to suit before driving.

6. SEAT BELTS

Vehicle is fitted with lap shoulder seat belts designed for adults, to prevent injury in an emergency stop or accident situation. Belts are also designed for your comfort.

7. STARTING ENGINE

Have shift lever in park. Then place foot on brake and turn ignition key to the right to start engine, once engine has turned over and started, release key immediately, it should flip back to on position.

8. LIGHTS & WIPERS

Take time to make yourself familiar with all indicators and lights for safety on roads.

SAFETY POINTS

FLAMMABLE PRODUCTS

Don't carry flammable products in your vehicle, in case of accident which may cause fire or an explosion.



SAFETY BELTS

Be sure to fit safety belts to all your passengers as well as yourself. For extra information see seat belts later in the book.



DRIVING POSTURE

Position yourself for comfort and safety while seated.

CORRECT FUEL

Be sure to only use specified fuel in your vehicle.

Use unleaded fuel in your vehicle for leaded fuel may cause blockages and may cause damage to the catalytic converter.

Don't use a fuel that hasn't come from a specified supplier.

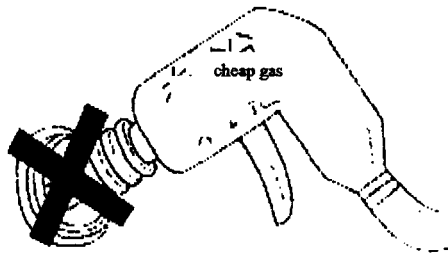

SAFETY POINTS

HAVE YOU CHECKED ?

Be sure there are no materials that may catch fire such as dead plant material wrapped around exhaust pipe.

OBSTRUCTIONS

Take care to only have correct fitting mats that will not obstruct brake or accelerator pedals. Also take care to put no rubbish on floor such as cans etc may also obstruct pedals.

SET HEATER AT A COMFORTABLE TEMPERATURE

Set heater at a comfortable temperature for driving which will not make you sleepy. Don't leave heater running for a long period of time for this may cause damage and use excess fuel. Don't leave heater running when you leave your vehicle even for a short time.

CARBON MONOXIDE HAZARD

Don't have vehicle running in a concealed area for a long period of time for this will fill area with carbon monoxide which is dangerous. If your compelled to do so make sure there is adequate ventilation.

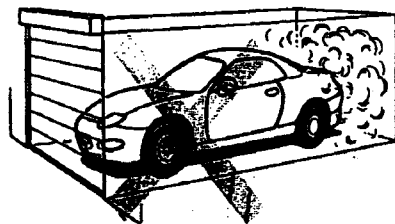
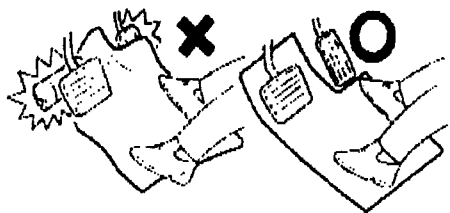

SAFETY POINTS

WARNING LIGHTS

Don't ignore warning lights for this may cause damage to your vehicle and may be dangerous. Stop vehicle and check vehicle.

If a warning light shown to the right appears stop vehicle immediately for this light means one of two things, it could mean a charging problem or unusually high temperatures in the system.

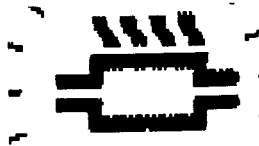

FUEL GAUGE

Always add fuel when needle reaches empty. Don't continue to drive for too much more distance. To prevent any solids in the tank going into the engine system.

FIRE HAZARD

Don't drive on material that may catch fire, such as long dry grass.

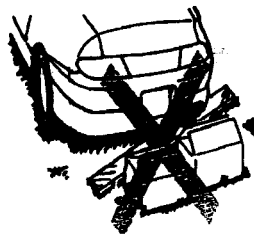

WARM VEHICLE FIRST

Don't drive vehicle at high revs when cold, for engine parts wear more when engine is cold also this may also cause unburned fuel to enter exhaust system causing damage.

IGNITION

Don't switch ignition off while driving, for this may cause damage to engine. If you place key into ACC or LOCK position while driving you will lose the use of power brakes and power steering, also steering lock will engage and any warning lights won't show. All of the above are very dangerous.

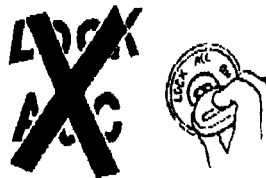

OPERATION FOR AUTOMATIC TYPE VEHICLE

Vehicles fitted with automatic transmission are easier to drive for there is no need for gear changes or clutch operation. But you must still learn the technique for using automatic transmission vehicles.

AUTOMATIC TRANSMISSION CHARACTERISTICS

When shift lever is in any other position than P or N vehicle may creep forward even when accelerator isn't pressed, take care not to cause a collision with another vehicle. When stationary, even when on level ground, apply foot brake, for vehicle may creep forward. If air conditioning is operating engine will be idling faster causing this creeping movement to become stronger. On the other hand this creeping motion can be used to your advantage when parking or travelling slowly, for vehicle can be controlled by just applying brake.



KICK DOWN

When accelerator is pressed to a certain position the transmission will kick down to a lower gear giving vehicle instant power which is useful when overtaking or pulling onto a motorway.

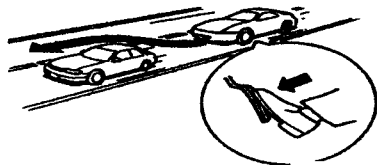

DRIVING TIPS FOR AUTOMATIC VEHICLES

BEFORE STARTING ENGINE:

1. Position your seat in a comfortable position but where brake and accelerator can be operated correctly.
2. Apply foot brake (only use right foot to operate brake and accelerator pedals in automatic vehicles to stop confusion).
3. Check shift lever is in park and hand brake is on.

START ENGINE:

4. Place shift lever into drive or reverse .(Take care not to have any pressure at all on accelerator pedal for vehicle will jump forward).
5. Let off hand brake while slightly accelerating, (this is more important when performing a hill start) .

DRIVING:

6. When driving operate brake and accelerator with right foot, only apply one at a time.
7. When shift lever is positioned in **D** transmission will change automatically to suit revs of the engine.
8. When accelerator pedal is pressed to a certain point transmission will kick down to a lower gear.
- 9 When driving don't place shift lever into **N**, for the engine brake will become dysfunctional and may also cause damage to the transmission, and will not save fuel expenses.
10. When travelling down a hill it is good practice to place shift lever in a lower gear to use the engine brake.

STOPPING:

11. After slowing down and stopping apply park brake.
12. If you will be stopped for some time place shift lever into N.

PARKING:

13. Place foot on brake then place shift lever into P.
14. Always place shift lever into P, for this mechanically locks wheels.
15. Turn engine off.
16. While away from vehicle don't leave vehicle running and be sure shift lever is in P and park brake is on.

PARKING NOTES: When parking in reverse be sure to position yourself so you can turn and see out the back window. After reversing place shift lever into N immediately so not to forget vehicle is in reverse, which could cause an accident. When shifting between gears be sure vehicle is stationary before shifting to the next gear.

WARNING: Don't operate brake and accelerator together.

Don't abruptly accelerate and decelerate while travelling up long hills for this may cause transmission to over heat.

Don't place shift lever into P while vehicle is still moving, this will damage transmission.

DRIVING HAZARDS

DRIVING DOWN STEEP HILLS

Take care when driving down hills not to use brakes too much for this will cause excessive wear and if brake fluid becomes too hot and boils, bubbles will form in the brake fluid causing weak brakes.

If possible use the engine brake to keep vehicle at a steady speed.

PUNCTURES WHILE DRIVING

When travelling at speed, if a puncture occurs, hold steering wheel tight and let vehicle slow down without applying brake, for this could pull vehicle off the road.

WET BRAKES

When driving in wet conditions take care brakes don't become weak, occasionally test brakes by lightly applying the brakes on and off.

If brakes are weak keep lightly applying brakes until brakes dry out.

And take extra care with following distances.

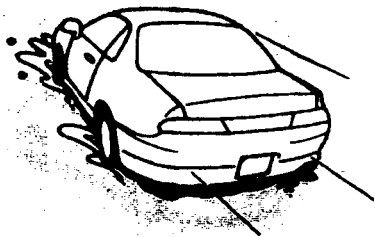
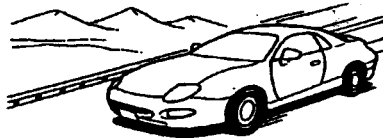

SAFETY WHEN TRAVELLING WITH A CHILD ON BOARD

CHILD RESTRAINT

Never hold a baby or child on your lap when travelling in a vehicle. Even if you are wearing a seat belt the child will be pulled from your arms in an accident situation. Never wear a seat belt over yourself and a child for this will cause great dangers to the child if the vehicle has a collision. Installation should be followed by information supplied by the producer. If at all possible a parent should be seated next to child.

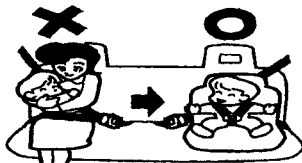

WARNINGS:

1. Always help child from vehicle and never leave child in vehicle alone there are many dangers such as vehicle rolling if child tampers with vehicles controls also a hot day could cause great distress to a child.
2. Always operate windows, sun roof and doors for child to prevent limbs being jammed.
3. Don't let child hang out windows and always make sure all doors are securely locked.
4. Apply the power window child safety lock switch which is situated next to the power window controls.
5. When children are getting out of the vehicle on busy roads always make sure they can get out safely.

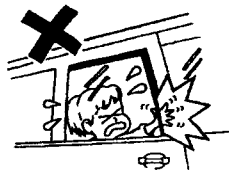

WARNING NOTES

MODIFYING VEHICLE

Do not modify vehicle and only use parts specified by MITSUBISHI.

or vehicle may become dangerous or damage other vehicle parts.

Do not change steering wheel for this will stop air bags from working.

ACCESSORIES

Do not have too many accessories hanging from rear view mirror for this could obstruct your view making driving hazardous. Don't stick anything on the steering wheel or the passengers side air bag terminal for this may stop the air bags from working.

TYRES

Only use specified tyre sizes stated by MITSUBISHI.

ELECTRIC

Don't modify or add electrical products for this may cause a fire. Contact your nearest MITSUBISHI dealer for advice.

OIL

Only add specified top grade oils and always check for oil leaks.

POWER STEERING

Don't hold steering wheel hard to the left or right for any length of time for this may cause damage to the power steering pump.

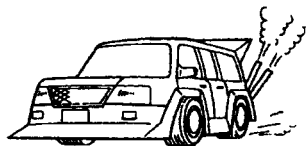

WARNING NOTES

1. Only use right foot to operate automatic vehicles, don't operate left and right foot together for this will also cause excessive wear on brake pads.
2. Don't push or tow car to try and start vehicle.
3. Don't use cruise control on icy or roads with snow or any of the conditions stated below:
Busy roads, roads with tight down hill corners Any other conditions where roads are slippery.
4. Only position jack on specified jacking points, always apply hand brake and use tyre blocks.
5. Always close ashtray after use to prevent a fire inside vehicle. Also follow rules stated below:
Put out match before you place into ashtray.
Empty ashtray regularly, for when ash tray is to full a fire may start.
Don't insert material that can burn easily, such as tissue or paper.
The cigarette butt is a filter used for collecting toxic waste so don't through butts out of window, for this is bad for the environment.
6. Don't remove radiator cap when engine is hot for steam and boiling water is very dangerous. Wait for engine to cool or slowly remove cap bit by bit, but this is very dangerous and not good safety practice.

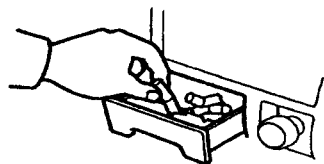

NOTES

CHAPTER: 2

OPERATING DOORS AND WINDOWS

Keys for vehicle are made to only fit your lock and are extremely difficult to copy, with locks being made from very strong material and makes it very hard to get into vehicle once it has been locked, making it difficult for someone to steal. Care must be taken not to loose or lock keys in the vehicle making entering vehicle near impossible even for the AA.

Master key

If you loose your key contact MITSUBISHI with your key number to get another made, this should take two weeks (in Japan).

Write your key number here:

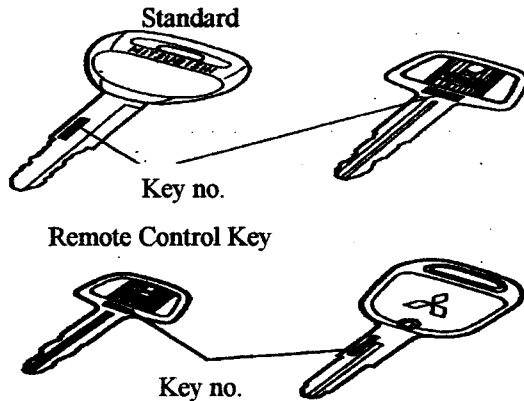

DOORS

To open and lock doors from the outside with the key: Once key is inserted turn clockwise to lock and anti-clockwise to unlock.

This will also automatically lock or unlock all the doors.

To lock without key:(1) Push the locking tab which is situated near the door handle inside, forward, then (2) hold the outside door handle up while (3) closing the door.

Lock and unlock is written on the locking tab and door will automatically unlock if the handle on the drivers door is pulled.

Warning bell for forgetting keys in ignition

If keys are left in ignition and door is opened a warning bell will sound.

Always turn engine off and lock doors when leaving vehicle.

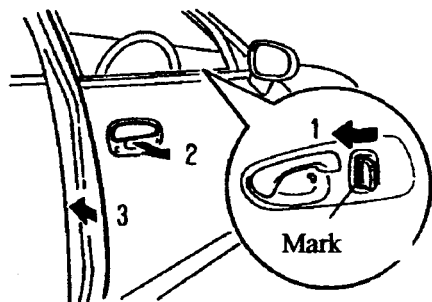
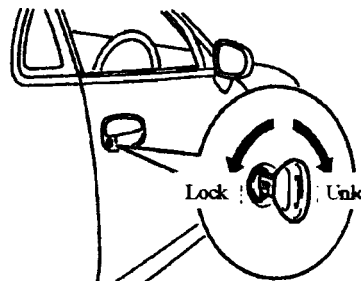

REMOTE CONTROL

Remote control unlocking & locking

Button situated on master key will lock and unlock all doors.

On locking if the interior light is in the (.) position the light will flash twice. On unlocking the interior light will come on and stay on for a few seconds.

Remote control

Each push of the remote button will either lock or unlock door in sequence.

If doors aren't opened within 30 seconds after unlocking with remote doors will automatically lock again.

The range of the remote is approximately 1 m.

While keys are still in ignition remote won't operate doors.

The inside of the remote is very delicate, take care not to open drop or hit remote.

If remote isn't working contact your nearest MITSUBISHI dealer.

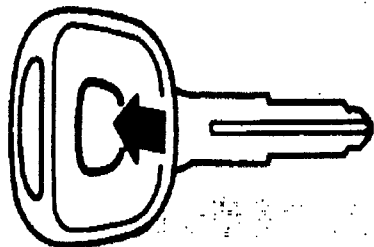

POWER WINDOWS

To protect battery try to only operate windows when engine is running.

The drivers seat power window switches can operate all windows.

Take care not to operate two switches for the same window at the same time.

When operating windows from the drivers door, take care not to jam a passengers hand in a window. When the system is activated the drivers control AUTO switch will light.

Open and closing operation from drivers seat:

For auto open operation push button fully then release.

The window should automatically open. To stop the window at a certain point pull switch up then quickly release. For auto close operation pull the button fully up and release. To stop window mid way, push the switch then quickly release. Just lightly pulling or pushing button gives you full control of window operation.

Passenger Window Operation: The passengers power window operation is manually operated, the switch must be held down or up through the entire operation. Releasing your finger from the control will stop the window in the position that it is in.

Window lock switch: Lock should be applied when a child is riding in vehicle.

When the window lock is applied only drivers door window is operational.

To operate the switch push to lock then again to unlock.

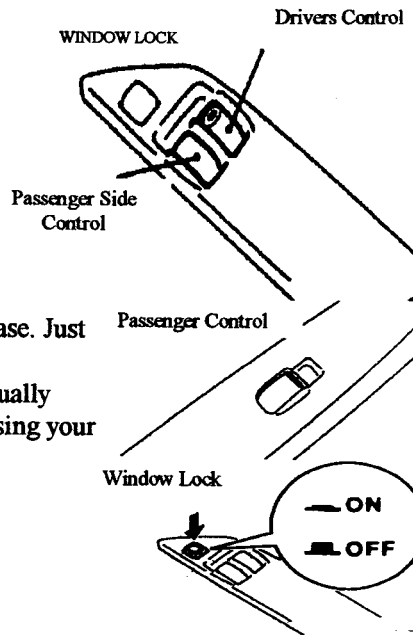

FUEL LID / CAP

Warnings...

- Do not smoke or strike matches around the area of the fuel tank.
- When opening the fuel tank cap open it slowly as fuel can be under pressure, especially on hot days.
- When replacing the fuel tank cap make sure it is sealed properly before closing the outer fuel lid.

The fuel lid opener is placed on the right side under the drivers seat.

The fuel cap is retrieved and replaced by screwing it clockwise or anti-clockwise, however when replacing the cap screw the cap on until you hear 2 clicks this will seal the cap.

While you are re-fueling there is a cap holder on the inside of the fuel lid.

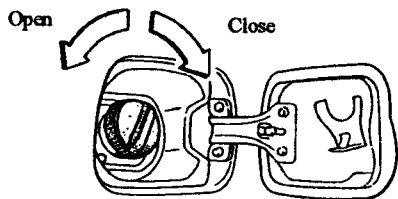
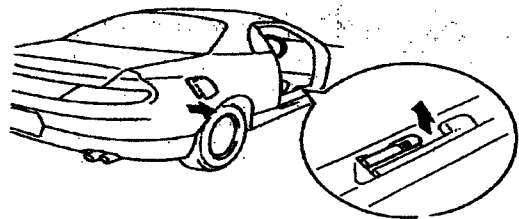

BONNET OPERATION

Opening...

The lever to open the bonnet is situated to the below right of the steering wheel. First pull the lever which will make an opening noise as the bonnet opens to the first stage. Then get out of the vehicle and move around to the front of the bonnet. Place your hand under the front of the bonnet and find the release catch, pull this catch to release and raise the bonnet. Hold the bonnet in place with the stay positioned on top of the radiator.

Closing...

Lift the bonnet slightly to let the stay down and fold it away. Then let the bonnet down until it is resting on the front of the vehicle, then firmly push down on the bonnet until you hear a 'catch' noise as the bonnet locks into place. Always make sure the bonnet is securely closed and locked into place after opening. The vehicle should not be driven with the bonnet in the unlocked state under any circumstances.

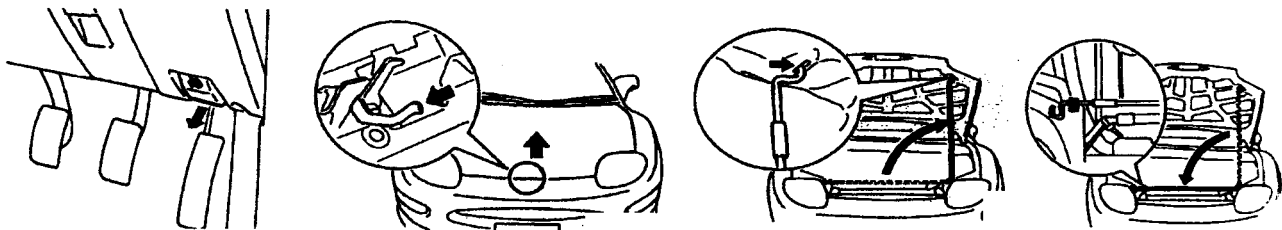

TRUNK OPERATION

To minimize the chance of theft from the vehicle do not leave valuables in the vehicle or in the trunk...

Opening from the inside...

Pull the trunk opener lever situated by the fuel lid opener on the below right side of the drivers seat.

Opening from the outside...

Insert the key and turn clockwise.

When the trunk is opened the trunk light will come on.

Warnings...

- Do not let anyone ride in the trunk under any circumstances. There is no way of opening the trunk from the inside of it.
- Take care not to lock the key inside of the trunk.
- Make sure the trunk is closed properly before driving.
- Care should taken not jam hands fingers etc in the trunk when closing it.

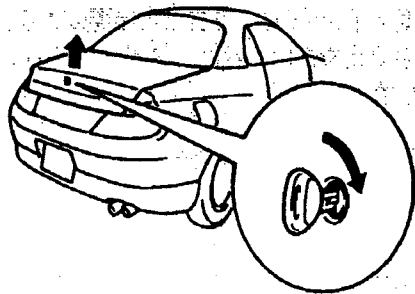
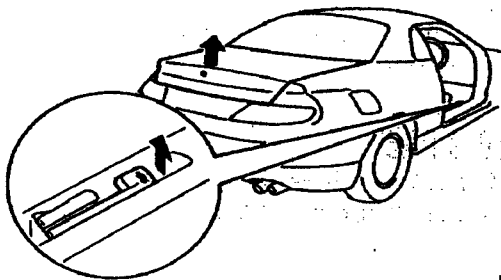

SUNROOF OPERATION

Sunroof:

Tilt Up Operation:

- 1) When the glass roof is closed press the `1` side of the UP / DOWN switch.
- 2) The glass roof will raise slightly. Then it will stop.
- 3). Push the `2` side of the UP / DOWN and the roof will lower slightly then stop.

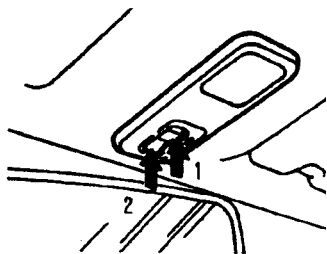

Open / Close Operation:

Open: Simply press the `1` side of the OPEN / CLOSE switch and the sunroof will open. Taking your finger off the switch will stop the sunroof in that position.

Close: Pressing the CLOSE `2` side of the OPEN / CLOSE switch will close the sunroof to a few cm before complete close. Here you must release your finger from the control and then push the switch again to close the sunroof completely. This is for safety purposes.

Sun Shade:

This is operated manually by hand.

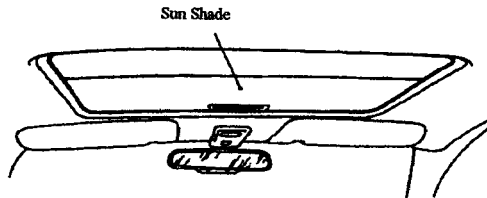

SUNROOF MANUAL OPERATION

Should the sunroof become non-operational follow the next steps...

1. Go to the boot and out of the tool bag retrieve the sunroof wrench & the jack bar.
2. Remove the room lamp cover. With the screwdriver end of the of the jack bar. (Use a cloth over the end of the bar).
3. Remove the revealed screw with the sun roof wrench.
4. Then place the sunroof wrench and turn it clock-wise to close the sunroof. Should the sunroof tilt up while closing the sunroof rewind the sunroof anti-clockwise then turn the sunroof wrench again clock wise to close the sunroof.
5. Once the sunroof has been closed it is advised to have the sunroof checked by your dealer.

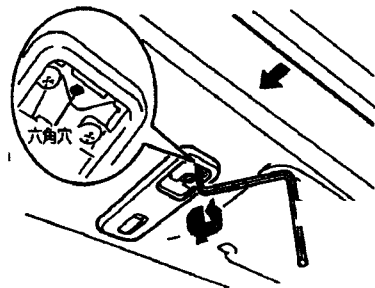
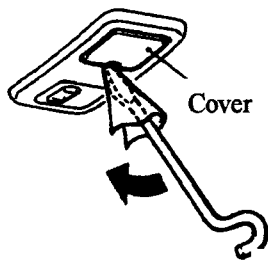
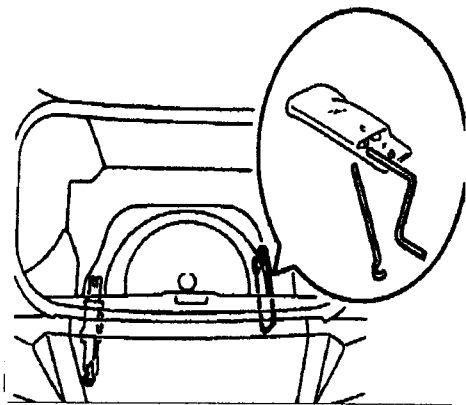

NOTES

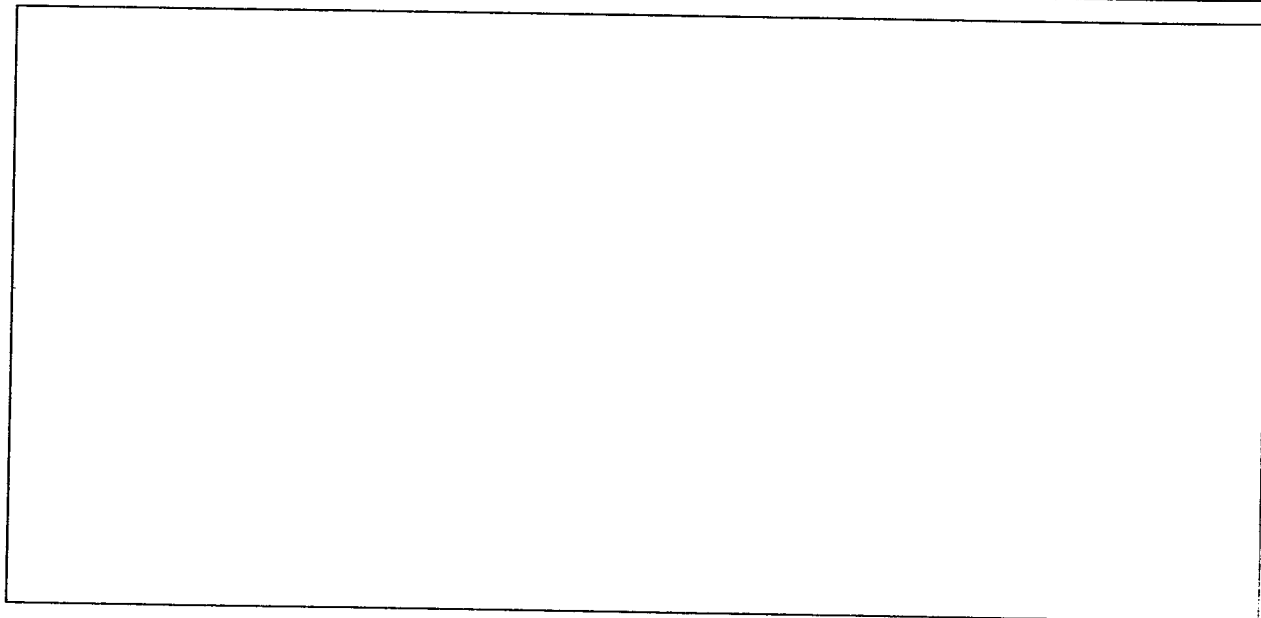
A large, empty rectangular box with a black border, intended for writing notes. It occupies the majority of the page below the 'NOTES' header.

CHAPTER: 3 FRONT SEATS & SEAT BELTS

Front Seat:

Always adjust the seat to suit you before driving.

You can reach the steering wheel with ease

Able to operate pedals

Make sure the seat belt is on properly with no twists.

You are seated in the seat fully.

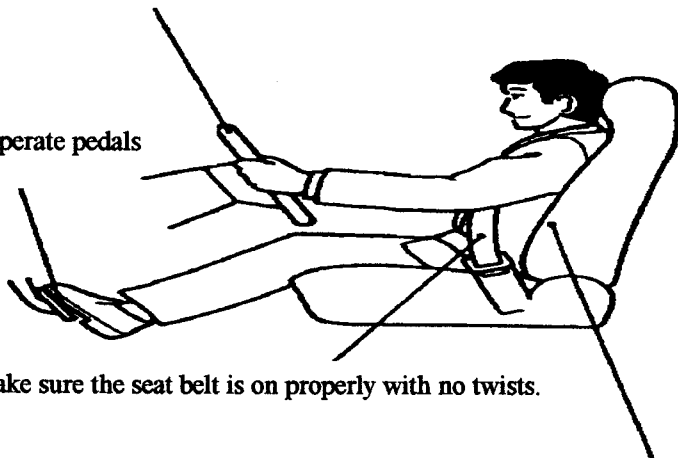

Front Seat Adjustment:

Do not try to adjust the front drivers seat while driving, there is a risk of you loosing hold of the steering wheel creating an extremely dangerous situation.

Forward & Backward motion:

This is achieved simply by pulling the lever on the left hand side of the seat.

Reclining Adjustment:

Pulling the recliner adjust lever on the right hand side of the seat and then pushing with your back or letting the seat come forward to come to the desired position.

Adjusting the Front Seat Cushion (Front, Rear):

By turning the two dials on the left hand side of the front seat, the front & rear cushions height can be adjusted to suit.

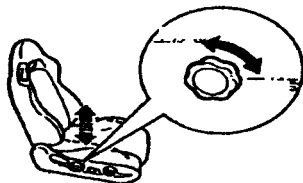
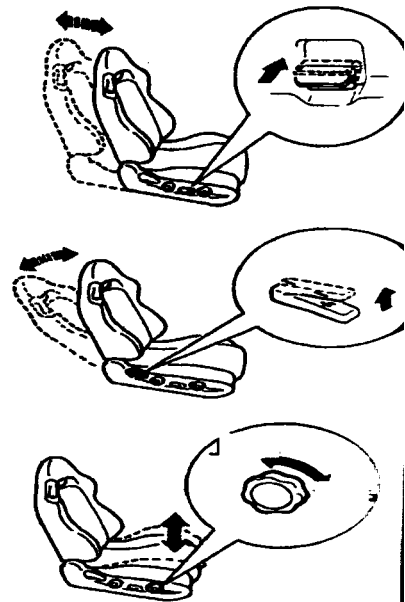

FRONT PASSENGERS SEAT: Passengers riding in the rear. Embarking & Disembarking:

Passengers in the rear can pull lever no.1 or lever no. 2 may pulled to drop the front passengers seat forward, to allow ease of entry and exit for passengers sitting in the rear seat.

Care should be taken with passengers sitting in the rear when returning the front passengers seat to the normal position.

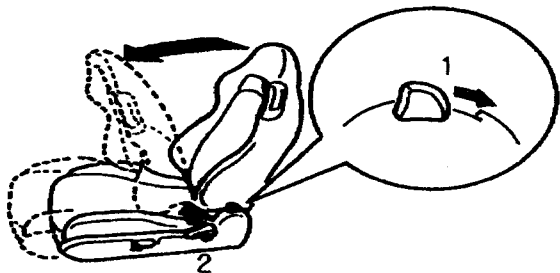

Removing the Rear Seat:

Pull the Rear Stoppers towards you to remove the lock. Then by lifting up the seat and pulling it towards you to remove the seat.

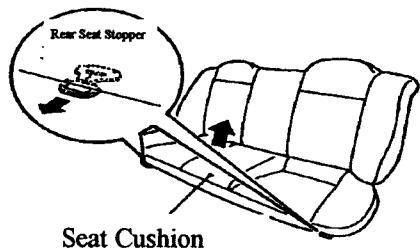

Replacing the Rear Seat:

1. Make sure the Rear seat belt buckles are placed on top of the rear seat.
2. Push the seat into the rear of the vehicle and then clip the two Stoppers back in.

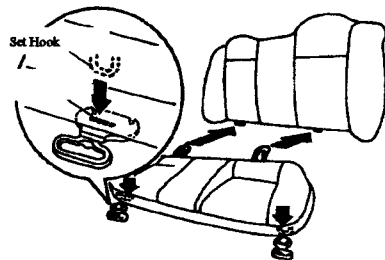

SEAT BELTS:

AT TIMES VEHICLES FROM JAPAN ARE REQUIRED TO HAVE NEW ZEALAND AND SPECIFIED SEAT BELT FITTED.

Make sure you are sitting in the seat properly

Make sure the seatbelt is high
across the shoulders

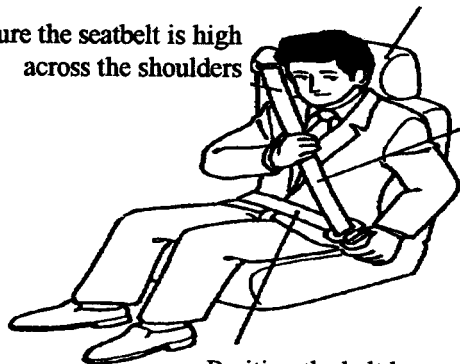

Check for twists
in the belt

Position the belt low across the hips.

Seat Belts...

Front Seat Belts: Adjust the seat as needed and sit well back in the seat and straight up. Should your vehicle be equipped with an adjustable shoulder anchor, adjust it to your size by pushing the knob and sliding it up or down to suit, then releasing the knob. Always be sure that the belt is positioned well across the shoulder. Failure to do so could reduce the amount of protection in an accident and increase the chance of injury.

To fasten the seat belt, pull it out of the retractor and insert the tab into the buckle. You will hear a click when the tab locks into place. Make sure that the connection is secure and the belt is not twisted.

The seat belt automatically adjusts to your size and the seat position.

Position the belt as low possible on your hips not on your waist. For your safety do not place the shoulder belt under your arm.

The retractor will lock on sudden stop or impact. It may also lock if you lean forward too quickly. A slow easy motion will allow the belt to extend.

To release the belt press the button and allow the belt to retract. Make sure there are no twists in the belt.

Seat Belt Reminder: When the ignition has been switched to ON the seat belt reminder will show until the drivers seat belt has been placed and locked in the buckle holder.

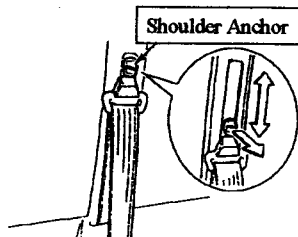
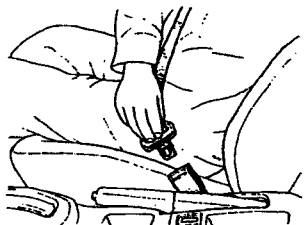
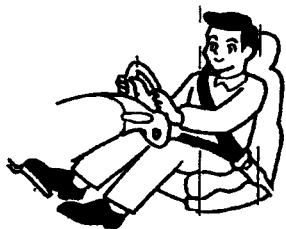

Seat Belts...

Rear Seat Belts: (Lap Belts): To fasten your seat belt pull it out of the retractor and insert into the tab until you hear a 'click'. To release push the button on the buckle and the seat belt will automatically retract. Make sure there are no twists in the belt.

Should the vehicle be equipped with shoulder belts the same operation as in page 33 is applied. While the rear seat belts are not in use it is recommended that the buckles be folded away in their storage holders.

Care should be taken to avoid contamination of the webbing with polish, oils, chemicals and in particular battery acid. Cleaning should be carried out by using mild soap and water. The belt should be replaced if the webbing becomes frayed, contaminated or damaged.

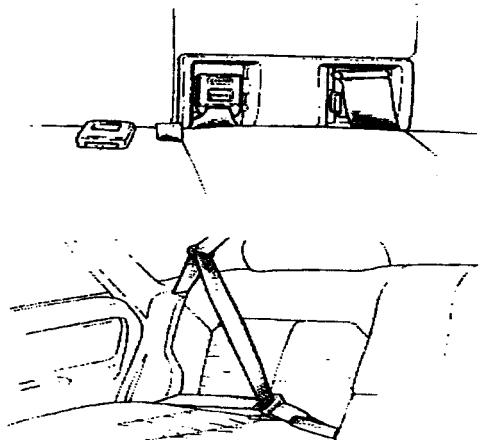
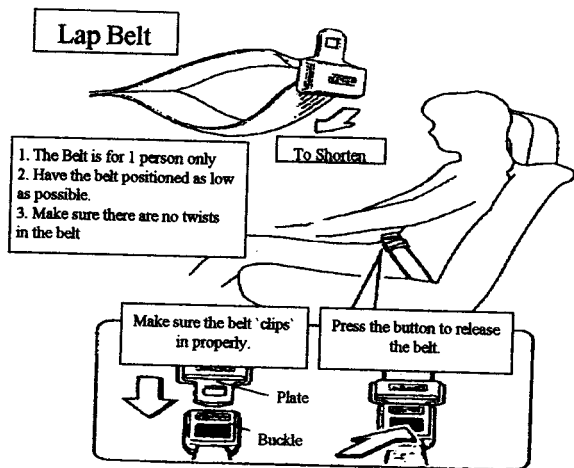

SRS AIR BAGS (Supplemental Restraint System)

Air bags are used to soften the blow in an accident situation where there is a hard impact to the front and the side of the vehicle. Even with air bags you must wear seat belts. The air bags can not be turned off.

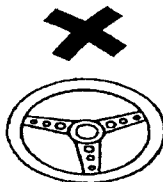
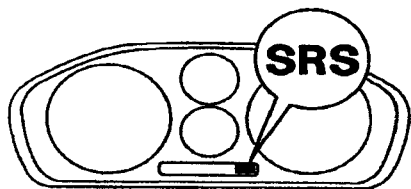

No Stickers

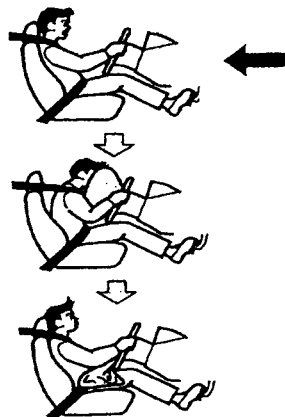

WARNING

The air bag light should show on the dash and go out after 7 seconds once the ignition is turned on. If the warning light comes on and stays on or doesn't show at all contact your nearest dealer for there may be a fault in the system. The air bag won't operate if there is an impact to the rear or side of vehicle. Air bag can't be reused. Contact your dealer to replace air bag. Don't place anything around or on steering wheel, or the passengers air bag side such as stickers that may obstruct the air bag operation. Don't replace steering wheel with another type. Take care when installing other optional material to your vehicle such as a radio transmitter etc, always have your dealer fit other material to your vehicle.

SRS Air Bags cont...

Driver / Passenger Air Bag: In an accident where the airbags are activated on a frontal impact both the drivers and the passengers air bag will activate even if there is no passenger in the passengers seat.

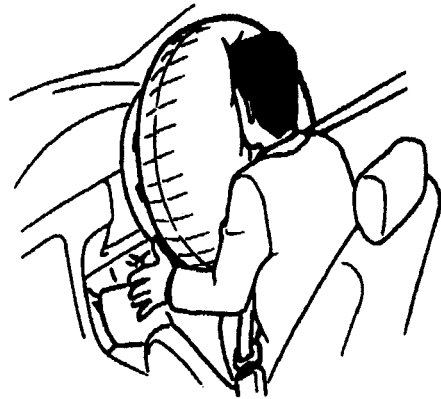
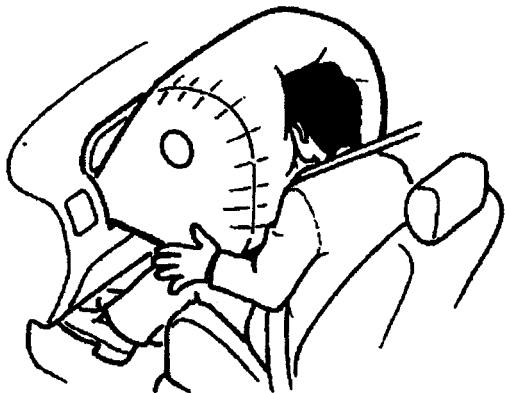

CHAPTER: 4 METERS & SWITCHES

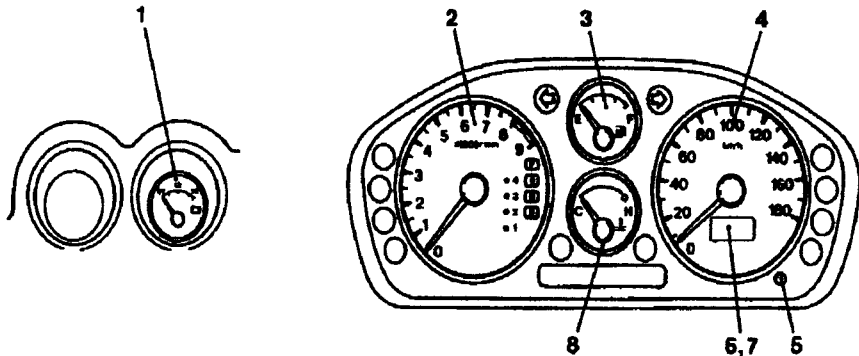

1. Battery Power Level
2. Tachometer (Engine Revolution Counter)
3. Fuel Gauge
4. Speedometer
5. Reset Button

6. Odometer
7. Trip Meter
8. Engine Temperature Gauge

Vehicle water temperature:

If the needle on the temperature gauge goes into the red zone the engine has overheated. Stop immediately and check later on in the booklet on overheating.

Fuel meter:

Turn on the ignition and the fuel gauge will show how much fuel is remaining in the tank.

Speedometer:

Meter readout of the vehicles speed. Should you wish to place a radar detector on this vehicle, your dealer has a range that is best suited for this purpose.

Tachometer:

Meter readout of engine revolutions per minute. To protect your engine never drive in the red zone area.

Odometer:

Shows how many kilometers your vehicle has traveled.

Trip meter:

Shows total kilometers since last reset. **Reset button:** To reset a new reading of kilometers traveled.

Battery Power Level Gauge:

This meter shows the power of the battery while the engine is running. It should read between 12~16V under normal conditions. On ignition the needle may drop below 11V however should come back to normal once the engine is running.

Should the needle go above 16V or stay below 11V have the battery checked.

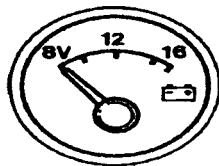
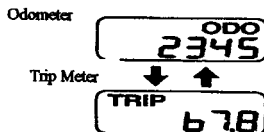

WARNING LIGHTS & INDICATORS

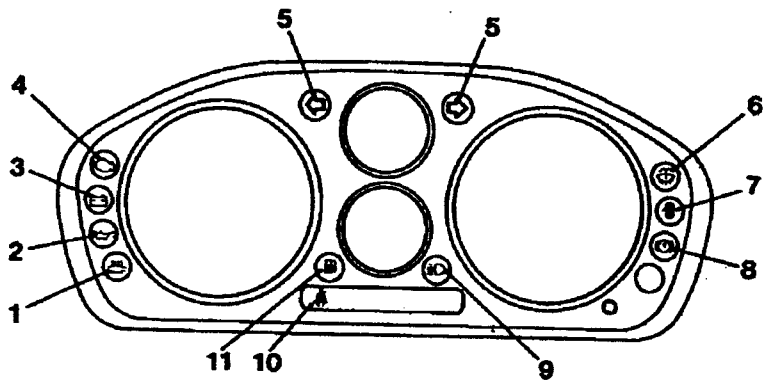

- | | |
|--------------------------|-------------------------------|
| 1. Exhaust Warning | 7. Door Ajar Warning |
| 2. Oil pressure Warning | 8. Brake / Hand Brake Warning |
| 3. Battery Warning | 9. High Beam Indicator |
| 4. Engine System Warning | 10. Seat Belt Reminder |
| 5. Indicator Meter | 11. Low Fuel Warning |
| 6. Washer Reservoir Tank | |

INDICATION & WARNING LIGHTS

Turn signal and hazard indicators:

When the indicator lever is operated for a left or a right turn the appropriate indicator light on the instrument panel will flash along with the outside indicators. Pushing the hazard warning switch will make all indicators flash simultaneously along with both arrows on the instrument panel.

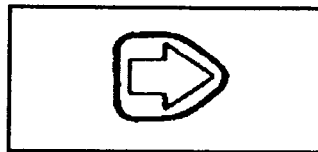

High beam indicator:

This light will show when the high beam option is used along with the headlights.

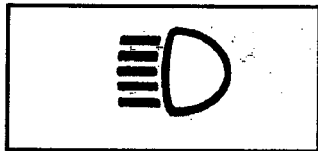

Low Washer Reservoir Indicator:

When the Washer Reservoir becomes low this indicator will show to remind you top up the reservoir. Check later in this booklet on refilling the Washer.



Indication & Warning Lights cont...

Warning Lights:

Battery Charge: This light will normally come on when the ignition is first turned on however will soon go out. Should it stay on, or come on when driving your battery may be low on power. Stop the vehicle in a safe place and call a mechanic.



Oil Pressure: Should this light show (except on start), your oil pressure is low. Pull over to a safe place and contact your nearest dealer. This indicator does not indicate low oil level. To check your oil level see later on in this booklet.



Exhaust System Overheat Warning Indicator: This indicator shows an overheat problem within the exhaust system. Should this light show stop the vehicle for 10 minutes where there is no dry flammable material such as dry grass etc. Then re-start the vehicle, if the light stays out it is safe to drive, should the light stay on contact a mechanic as soon as possible.



Engine Warning Light: Should this light appear there is something wrong with the vehicle's electrical system or the engine itself. Take the vehicle to your nearest dealer as soon as possible.

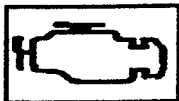

Warning Light cont...

Parking brake and brake system indicator:

This light has two functions:

1. Lights up when the park brake is on. This light also appears on ignition, the parking brake may be damaged if left on while driving.
2. This light can also appear when the brake fluid is low, and on diesel models this light can also appear when there is something wrong with the booster braking system.

This light will also show when the brake pads need changing.



Air Bag Warning:

Should this indicator come on while driving or stay on 8 seconds after ignition there is something wrong with the air bag system, in this case have your dealer look at the as soon as possible.

Open door warning light:

This light will show when any of the doors are open or not shut properly.



Seat belt reminder:

On ignition should the seat belt not be used this indicator will show.



Low Fuel Warning:

Should this light show there is only around 8 ltr of fuel left in the fuel tank.

Re-fuel as soon as possible.



Light Switch Operation:

Light Switch Operation:

Make sure that all the lights have been turned off before leaving the vehicle, failure to do so may place a strain on the battery.

It is therefore advised if you are turning the lights on that the engine be running.

Lights	1 Click	2 Click
Head Lights	-	0
Tail Lights	0	0
Plate Lights	0	0
Meters	0	0

High / Low Beam Operation: Push the lever forward for high beam and pull back for low beam, full further back for passing options.

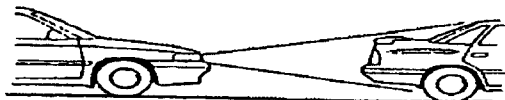
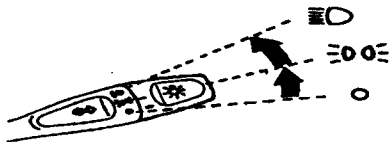

Light Switch Operation cont...

Indicators: Operated conventionally, push the indicator lever down or push up for turns. This lever should automatically turn off after most normal turns are completed.

1. To indicate,
2. To change lanes.

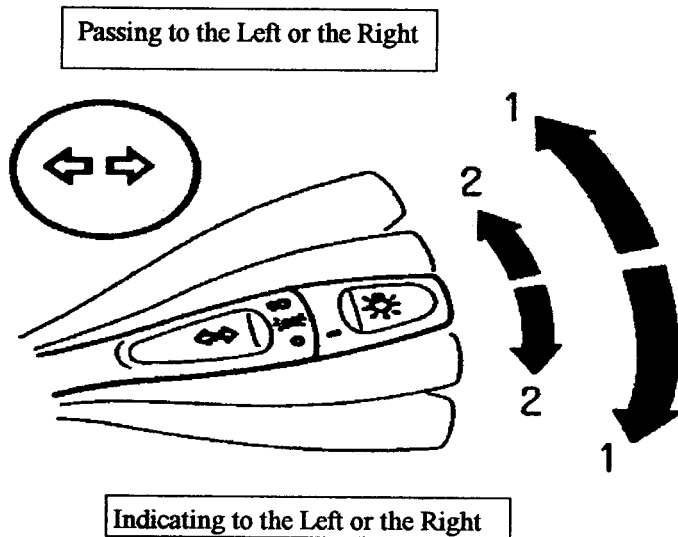

FRONT WIPERS & WASHERS

There are three types of wiper control:

The ignition must be in ACC or ON for wiper operation:

The wiper has 3 stages:

1. Interval (INT): This will make the wiper wipe to where the middle dial is set from 2~12 seconds. (On the Normal Type there is a set 4 second interval).
2. Low Speed (LO): The wiper will operate continuously slow
3. The wiper will operate continuously fast.

By pressing the end of the switch the washer can be operated.

By pulling the switch towards you the wiper will activate once to clear any drops of rain etc on the front glass. On the Normal Type pull the lever towards you to operate the washer.

Normal Type:

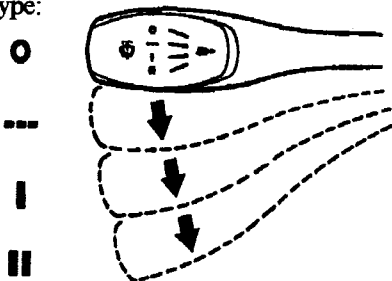

A Type

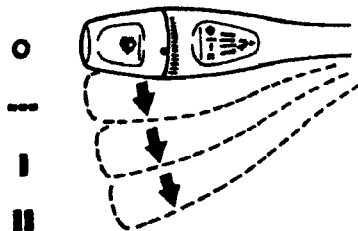

B Type

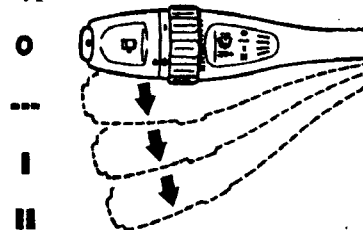

REAR WIPER & WASHER

The switch will operate when the ignition is ON or in ACC.

The switch has 3 options:

1. Interval (INT): The wiper will activate every 8 seconds
2. ON the wiper will continuously operate
3. Washer: The washer can be activated by twisting the end control either way at the end of the scale, pulling it towards you or pushing the Washer button at the end of the lever depending on the type.

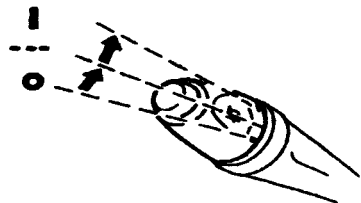

Washer Reserve Tank:

Always check the level of washer in the reserve tank before driving. The front and the rear washer use the same source.

Do not use the wipers when the windows are dry always use the washer system when it is not raining to avoid any scratches on the glass. In freezing situations wait for the glass to heat a little first from the inside before using the washers.

Rear Wiper / Washer cont...

Should the washer be non-operational in icy conditions do not force the switch as this could overload the system. Check the washer level first then check the spray nozzles for ice or dirt trapped inside them.

Should the wiper start leaving lines on the windscreen change the blade as soon as possible. The blades should be changed once a year. Replacement details are stated later in this booklet.

In extreme cold conditions: When leaving the vehicle, 'stand' the wipers up so they do not freeze to the windscreen. Should the wiper not work efficiently over a semi iced windscreen use the de-froster to help.

Should the windscreen be covered with snow. When turning the wiper on, should it stop because of the snow build up, clear the snow first. Do not try to force the wiper to do something it can not.

Rear Window De-Fogger:

This option is operational with the ignition switch in the ON position.

Push this button and inside the switch operational light will show.

There are two types of De-Fogger, one with a timer & one without. The timer fitted option will turn itself off automatically after 20 min approx.

This option uses a large volume of power. When the rear window has cleared turn the option OFF as soon as possible.

Care should be taken when cleaning the inside of the rear window not to damage the heating wires etc. Do not lean luggage etc up against the inside of the rear window.

Normal Type:

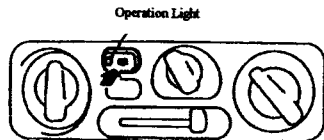

Timer Fitted Type:

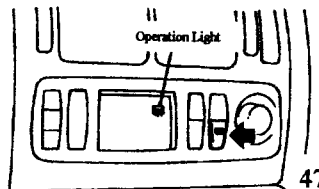

HAZARD LIGHTS, FOG LAMP SWITCH

Hazard Lights:

One press of this button will start the hazard lights (all four indicators turning on and off simultaneously).

This system should only be used in an emergency.

Using this system for a long time without the engine will place a strain on the battery.

Fog Lamp Switch: (Maker Option)

The fog lamp switch is operational when the ignition is in the ON position.

Push the switch once for ON and once more for OFF. When on the operation switch will light. Also the meters, heater control light, dash board, side lights and license plate lights will show.

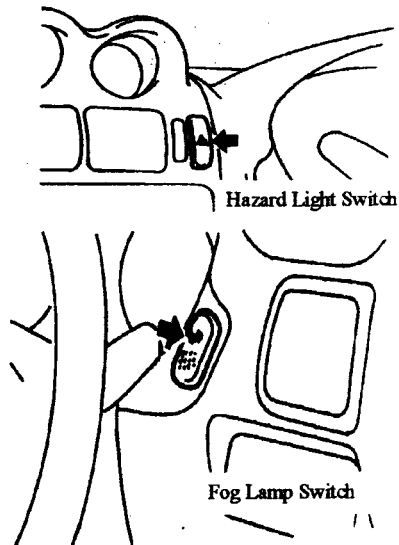

NOTES

CHAPTER: 5 STANDARD & OPTIONAL DRIVING EQUIPMENT

TRANSMISSION, IGNITION & HAND BRAKE USE

Ignition:

LOCK: In this position ignition will be locked and the key may be removed.

ACC: In this position the engine will not run however accessories will be able to be operated.

ON: After starting the engine the key will flip back to the ON position, this is the position where the engine is running.

START: This position is only to turn over the engine. Once the engine has started the key will flip back to the ON position.

1. Turning the key from ACC to LOCK , the key must be pushed in.

2. Should the key become hard to move from LOCK to ACC gently turn the steering wheel left and right.

3. Removing the key from the ignition, turn the key to the ACC position and then push and turn the key to the LOCK position. With automatic types the select lever must be in P (Park) to remove the key.

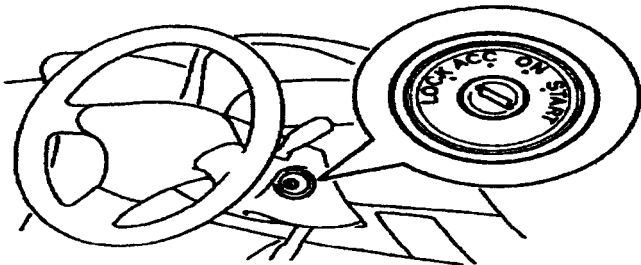

TRANSMISSION, IGNITION & HAND BRAKE USE

Hand Brake:

When applying the handbrake lever, pull the lever up without pushing the release button in. When releasing the hand brake lift the lever up slightly, push the release button in and slowly let the lever down.

When the hand brake is on the brake warning light will also show.

When leaving the vehicle make sure the hand brake is on. Before driving make sure the hand brake light is OFF.

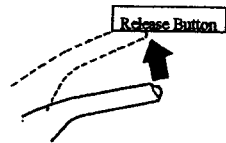

Engine Start / Stop:

1. Make sure the hand brake is on.
2. Be sure the automatic transmission is in 'P' (Park) or the manual transmission is in 'N' (Neutral) position.
3. Place the key in the ignition and switch the key through to the start position, hold there until the engine has started then the key should flip back to the ON position.

Should the engine not start after 10 seconds of starting, let the engine have a 10 second brake then try again.

Should the engine already be hot it may be a little hard to start.

4. Do not push the accelerator when starting. Let the vehicle warm up a little before driving. When the engine is cold the idle speed will be slightly higher than normal until the engine reaches the optimum operating temperature.

To Stop the Engine:

Make sure the engines idle speed is normal and then turn the key to the LOCK position. Should your engine be fitted with turbo capabilities and you have been driving fast (over 80km/hr), up / down hills or over sand hills etc. It is advised to let the engine cool down the turbos a little in idling speed before turning the engine off. (around 1 minute)

MIVEC ENGINE:

The MIVEC system is simply an engine designed to change the optimum output of the engine to suit the speed of the vehicle from slow speeds to high speeds. This all achieved automatically through the 'Breathing' Exhaust Valve.

When the engine is cold this system may not function as well as when the engine is at its optimum operating temperature.

MANUAL TRANSMISSION:

Shift Lever:

When shifting make sure you have pressed the clutch in as far as possible.

When driving do not rest your foot on the clutch.

Should the lever not move into gear from neutral release the clutch, and then re-press the clutch in again.

The Manual Transmission is designed so you must place the lever into N (Neutral) before placing the vehicle into reverse mode.

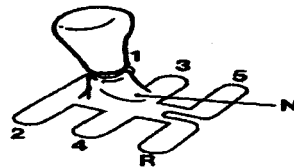

Maximum Speeds in each Gear: Manual Transmission

Engine Type	1	2	3	4
1800cc	45	85	120	165
2000cc	55	105	145	180

AUTOMATIC TRANSMISSION: (INVECS-II SPORTS MODE 4 A/T)

INVECS: Intelligent & Innovative Vehicle Electronic Control System

This highly advanced system automatically adjusts the vehicles gearing for all types of surfaces and terrain's, up & downs the vehicle has to travel over. Selecting the optimum gear for the speed required.

Traveling Uphill:

Even when the accelerator has been let up traveling uphill the vehicle will not change up to a faster gear when not needed creating a much smoother ride uphill.

Traveling Downhill:

As the vehicle travels downhill the system will automatically select the most appropriate gear an engine brake lessening the amount of times the driver must press the brake pedal.

Should the Transmission oil become overheated, this system will be non-operational. However the transmission can be manually shifted down or the brake may be used to slow the vehicle down when traveling downhill.

Sport Driving:

When fast acceleration de-celeration is required the system will change to sport mode making the vehicle not change up to higher gear so quickly, giving a higher output of power in each gear.

Sporty Transmission:

This system can be operated in a similar way to a vehicle with a manual mission.

Should the Engines Battery be dis-connected, the next time you drive the vehicles mission may not change as smooth until the system has re-programmed itself to suit driving conditions again.

AUTOMATIC TRANSMISSION: SELECT LEVER

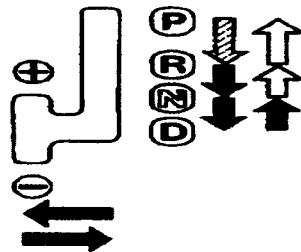
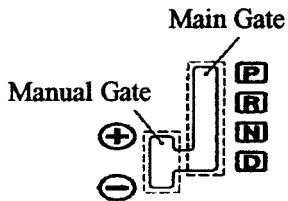
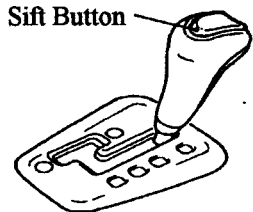

= The Brake Pedal must be pushed in and the shift Button pressed to operate the control.

Shifting from P without pressing the Brake Pedal will cause the Shift Lock to activate. Also when the ignition is in the LOCK position even with the Brake pedal pushed the Lever will not be able to be moved from P. The Shift LOCK will activate.



= Do not press the Brake Pedal or the Shift Button for operation.

Make sure the vehicle is completely stopped before shifting from D>R, R>D, R>P. To move to R or P particularly, while the vehicle is moving may damage the transmission.



= Press the Shift Button for Operation.

Always press the Brake Pedal when shifting from: N>D, N>R, R>P

SELECT LEVER DISPLAY:

When the Select Lever is 'D' the Transmission will automatically change from 1~4 gearing:

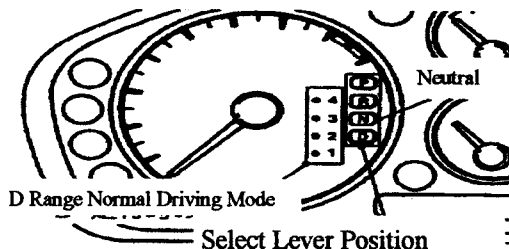

Caution: Should the ~N~ (Neutral) Light start to flash, there is a problem with the unit. Follow the next steps to correct:

While driving in 'D' mode should the 'N' light flash quickly (2 times per second). This means the Automatic Transmission Oil has overheated. Pull over to the side of the road, place the lever in 'P' and leave the engine running, then go around to the front of the vehicle and open the bonnet. Wait a while (5~10 minutes) then place the mission in 'D' should the 'N' not flash anymore it is ok to drive. Should the 'N' light still flash quickly or slowly have the vehicle checked by a mechanic.

Should the 'N' light flash slowly while driving (1 time per second) have the vehicle checked by your dealer as soon as possible.

Make sure you place the mission in 'D' to check if the 'N' light has stooped flashing before driving.

SELECT LEVER POSITIONING:

P= `Park` The Mission should be placed in this position when starting, stopping the engine.

R= `Reverse` For reversing. A buzzer will sound while the mission in this gear.

N= `Neutral` The vehicle may be started in this mode, however its main use is for when the vehicle is stationary with the engine in idle mode.

D= `Drive` In this position, pressing the accelerator will move the vehicle forward and the mission will automatically change through the vehicles gearing 1~4 as the speed increases.

Sports Mode:

To change to this mode is simple: It can done while driving or while the vehicle is stationary. The Sports Mode is different from a manual vehicle where as there is no clutch and you do not have to take your foot off the accelerator when changing gears. Place the lever upwards (+) to change up, or down (-) to move down a gear. This is an extremely fast way of changing gears.

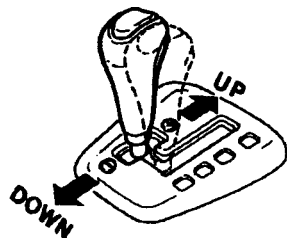

Sports Mode Cont...

In the Sports Mode the gearing will not automatically change up. The vehicle can therefore be driven at higher revolutions in lower gears however do not let the vehicle go into the 'Red Zone'.

The gearing can be shifted down 2 gears at one time if required by simply tapping the control down twice effectively moving the mission down from 4~2 or 3~1 gearing as needed.

The Sports Mode is only able to be applied to the 4 main forward gearing. R & P have no function in this mode. To protect the system changing down to a gear that is much too fast for the system to function in, the unit will not change.

In Sports Mode when the vehicle's speed drops the system will automatically change down until the vehicle has stopped in which case the mission will be in 1st gear.

In Sports Mode the display will automatically show which gear you are in:

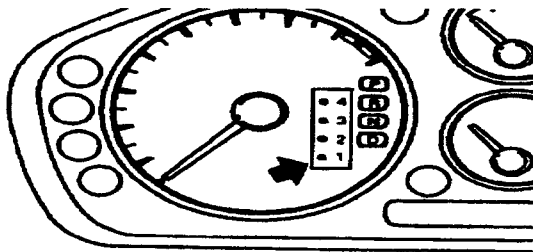

MANUAL TILT STEERING:

Pull the lever under the steering wheel to set the angle on the steering wheel.

ADVICE: You should always set the steering wheel after someone else has driven the vehicle. Always make sure that the steering wheel is locked in place before driving.

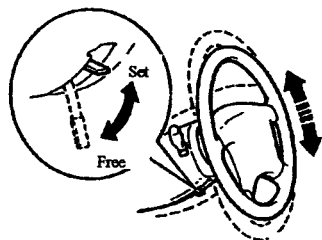

DAY & NIGHT MIRROR:

- 1). Have the mirror placed in position 1 through daylight hours.
- 2) Through sunset and hours of darkness should a vehicle come up behind you turning the mirror to position 2 will cut down any bright light from the vehicle behind.

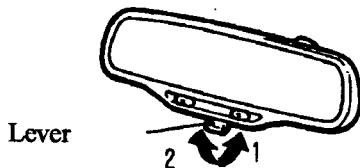

REAR VIEW MIRRORS

Outer Mirror:

There are two kinds of control, one with collapsible mirrors and one without this function:

Auto Mirror Operation: Ignition must be ON, or in ACC.

Always adjust before driving. Place main switch into left or right (R,L) depending on which side needs to be adjusted.

Then use the control switch to adjust the mirror angle. Once mirrors have been adjusted, place the main switch back in the middle (off) position. The mirrors can stick out when moving into tight spaces.

The mirrors can be closed to help give you extra room in tight areas.

Closing Mirrors: Ignition must be ON or in ACC.

Always close mirrors when washing vehicle in a car wash or parking in a narrow place. This operation is engaged by the mirror open/close button beside the main switch for the mirrors or by doing this manually. Do not drive with the mirrors closed.

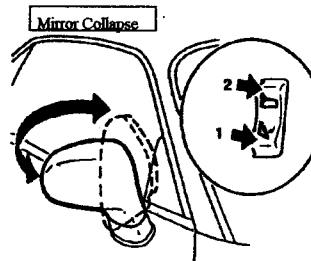
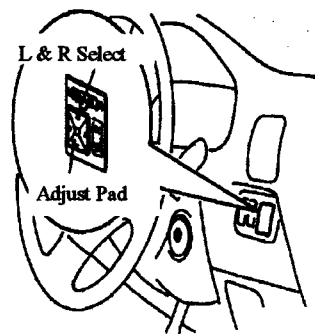
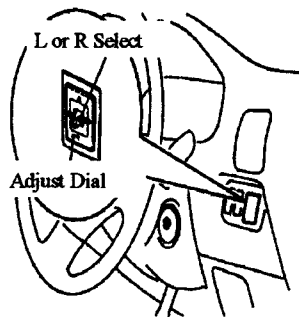

ABS BRAKING SYSTEM (ANTI-LOCK BRAKING)

This system prevents the wheels from locking or sliding during heavy braking, shortening the distance required to stop the vehicle. Once the ignition has been switched on the ABS light will show for a few seconds on the dash however will soon go out as the system checks itself. Should the light come on while driving, this means something is wrong with the system. Take the vehicle to a mechanic as soon as possible.

When the brakes are applied there may be a slight pulse feeling come through the brakes and / or the steering, this is normal.

There may sometimes be a sound come from the engine bay when the brakes are applied, this is also normal.

Should the ABS system malfunction this system will shut down however normal braking will resume.

The ABS will not engage when the vehicles speed is less than 10km/hr.

The system will not always guarantee shorter braking distances.

On sand hills, gravel and snow covered roads the ABS braking may be longer than in normal vehicles. Caution is advised.

Should the following situations happen have the ABS system checked by your Mitsubishi dealer:

On ignition the ABS light does not show.

Should the ABS light not go out even when the vehicle is traveling over 12km/hr.

Should the ABS light show while driving.

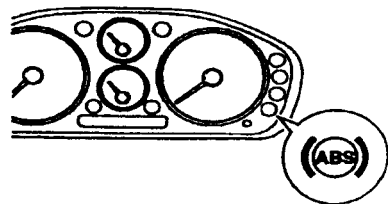

TCL: TRACTION CONTROL SYSTEM (Maker Option)

TCL is a function designed to help prevent the wheels slipping on slippery surfaces helping the steering and the drive power of the vehicle.

By the operation switch you can turn off the system in this situation the TCL OFF light will show on the dashboard. In this mode the vehicle will be the same as a normal vehicle not fitted with the TCL system.

On ignition the TCL system will automatically come on.

The TCL system although very useful in giving the vehicle more 'stickability' especially on start has limitations. All normal precautions should always be taken when driving. Should tyre chains be required it is advised to use them and always drive with caution especially in slippery areas.

Using the TCL system:

Just after ignition sometimes a small noise can be heard coming from the engine room, this is the TCL system checking itself. When the system is in operation you may hear the TCL engaging and the system may send a slight vibration through the vehicle. This is normal. When the TCL is in operation the TCL operation light will flash.

Care should be taken when driving around corners even with vehicles fitted with the TCL system.

When the TCL system is in operation you may feel a slightly different sensation through the steering system of the vehicle

The system helps the vehicle take corners.

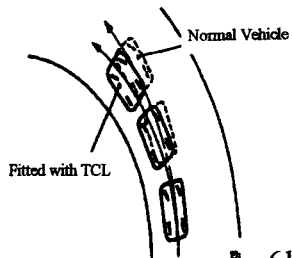
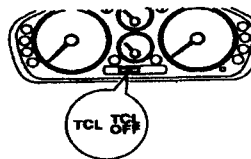

NOTES

CHAPTER: 6 STANDARD FEATURES

CIGARETTE LIGHTER

Push the cigarette lighter in and release the lighter will stay inserted until it is ready . When ready the lighter will slightly pop out .

Remove the lighter from the socket and light your cigarette.

Once cigarette has been lit place the lighter back into the socket immediately.

Don't use other electronic goods in the cigarette lighter unless specified by Subaru.

Don't use a lighter from another vehicle. And don't place your finger into the lighter socket at any stage.

ASH TRAY

For opening up the front ash tray pull the lever shown in the picture, this will flip up the ash tray lid. To empty, hold the left and right sides and pull it straight out.

For opening and emptying the back ash tray pull the ash tray door .

To empty : while pushing the centre plate used for putting out cigarettes pull the ash tray out.

WARNINGS

Don't let the ash tray get too full or put any burnable material inside such as tissue paper etc. And always keep the ash tray closed.

Don't throw cigarette butts out the car window for this is dangerous and

bad for the environment. The filter in the butt is a filter for toxic material, which none of us want in our streams, oceans, on our streets or in our drinking water so keep your rubbish inside your vehicle and throw away later.



Ignition must be in ACC or ON.

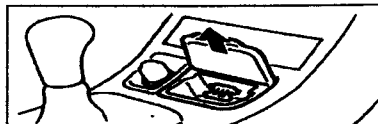
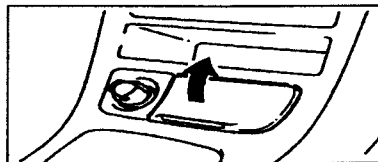
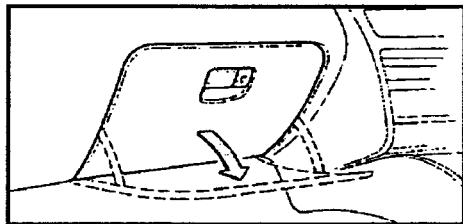

Plate for putting out cigarettes

STANDARD FEATURES Cont...

Glove Box:

The glove box is designed for small items, however it is advised not to leave valuables in the glove box. When the interior lighting switch is ON and the glove box is opened the the glove box inside light will come on. Always have the glove box closed while driving.



Console Box, Trunk Side Box & Cup Tray:

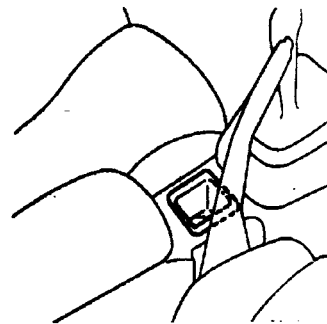
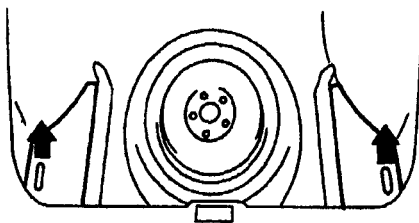
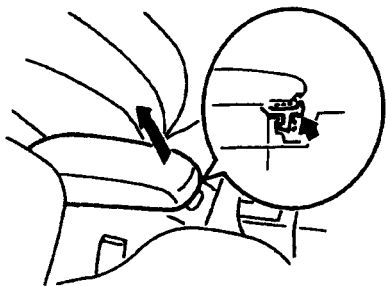

STANDARD FEATURES Cont...

Sun Visor / Vanity Mirror:

Flip the sun visor when traveling into sunny bright conditions. The sun visor may also be twisted around from the hook to stop direct sunlight coming in from the side.

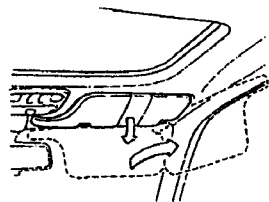

Ticket Holder:

Behind the Drivers Sun Visor is a strap for holding Cards & Tickets etc

Clock:

To adjust the clock pull the knob and turn it either way to adjust the clock hands.

Illuminated Entry System:

On opening the Drivers Door the ring around the ignition switch will glow for 10 sec. approx.

Room Lamp: (Drivers & Passengers):

Switch either side of the lights on by no. 1 or 2 buttons. The light will also show when the door is opened.

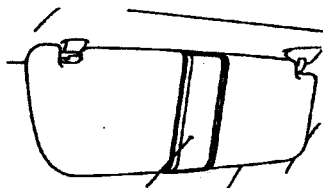

Ticket Holder

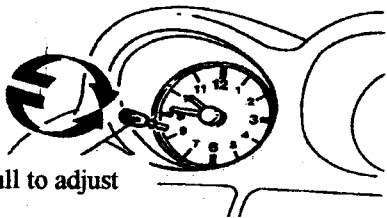

Pull to adjust

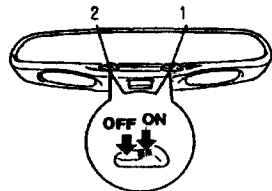

NOTES

CHAPTER: 7

MANUAL AIR CONDITIONING & FULL AUTO AIR CONDITIONING

Manual Air Conditioner:

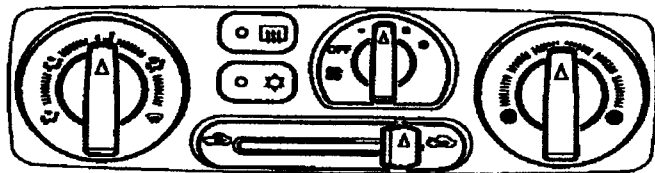

Full Auto Air Conditioner:

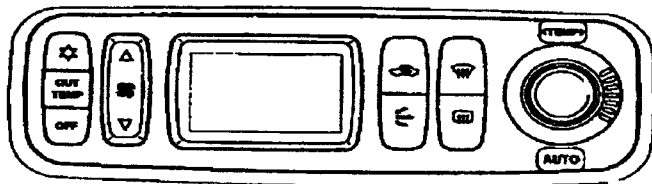

AIR CONDITIONER: THE VENTILATION SYSTEM

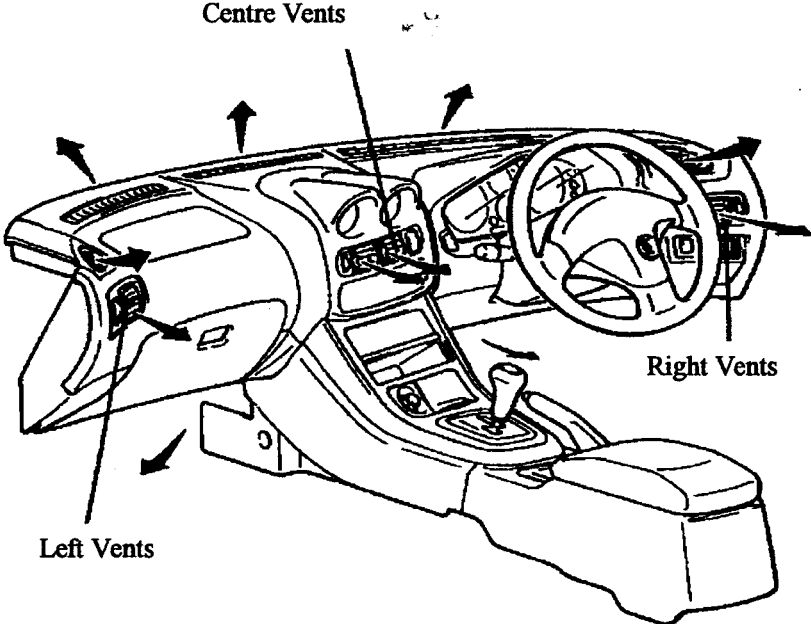

MANUAL AIR CONDITIONING:

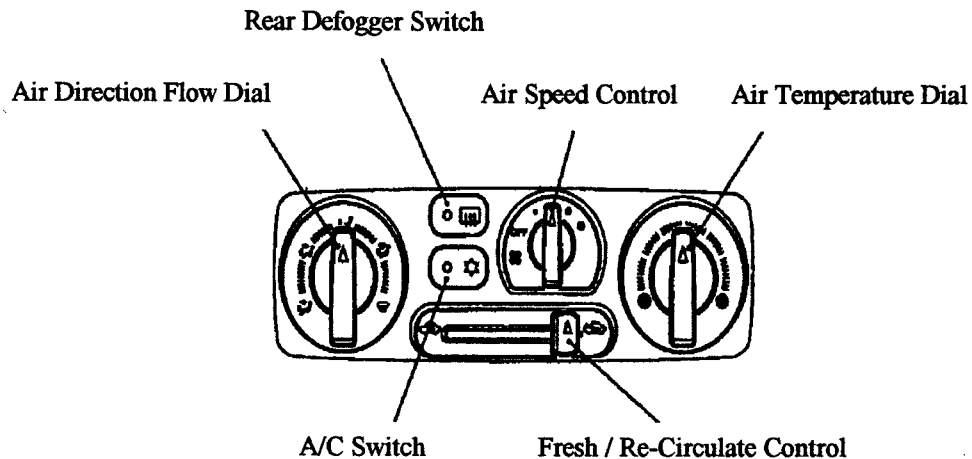

Manual Air Conditioner:

Operation of the Controls is simply:

1. Air Direction Dial:

Is used to select the air flow outlet desired i.e. to the floor, dashboard vents or to the wind shield.

2. Temperature Control Dial:

Is used to adjust the air temperature from warm to cool as desired. (This may not work at optimum when the vehicles engine is cold).

3. Fan Speed Dial:

Control Air Speed. 4 Speeds are able.

4. Re-Circulating / Fresh Air:

Re-Circulating air is mainly used for the A/C option to keep cool air in & keep bad air out, however temporarily change the air with the fresh function when possible.

5. Air Conditioner:

Is used to turn the A/C unit off and on

6. Rear Defogger:

Push this button to clear any condensation on the back window.

Air Conditioner Use:

Fast Cooling: Push the A/C button to ON, Place the air intake control lever to Fresh, Turn the air temperature to cool, set the air speed to full & the air direction control to the face option. When the interior cools down switch the air intake on to re-circulate and turn down the air speed control to low.

FULL AUTO AIR CONDITIONER:

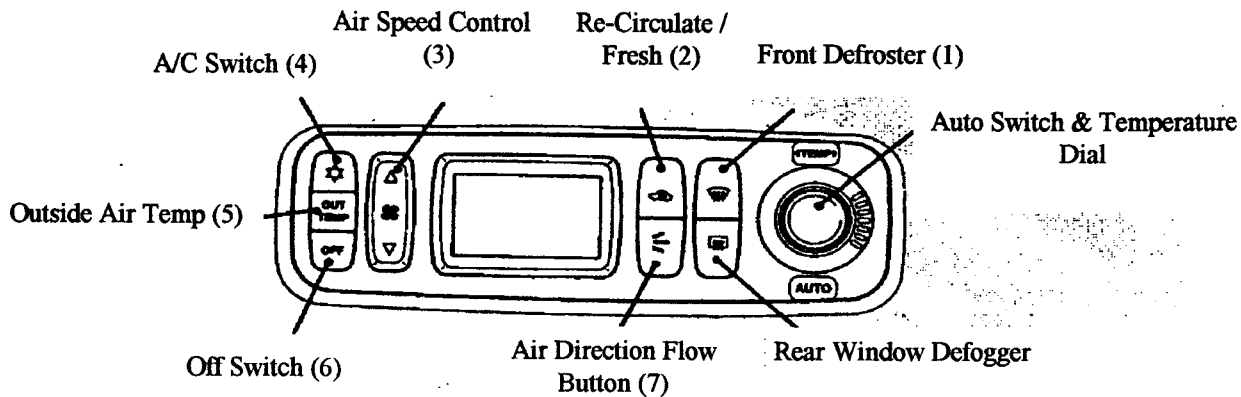
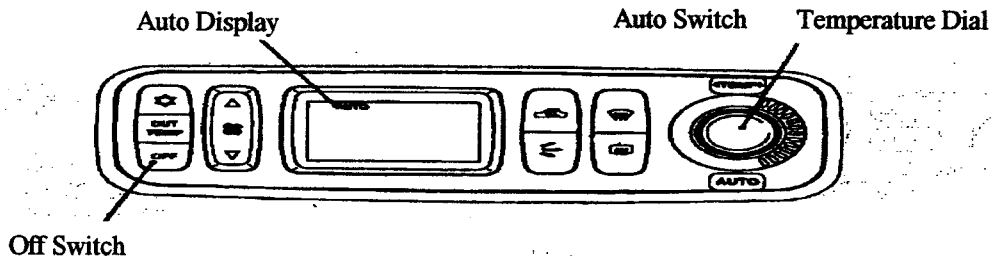

FULL AUTO AIR CONDITIONER: Cont...

Display:

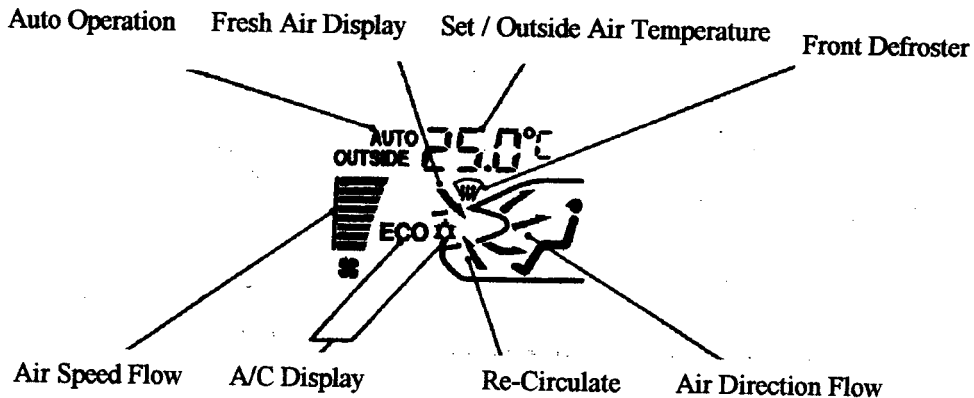

Sensors:



Interior Sensor

Outside Air Temperature & Light Sensor

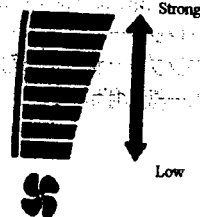

Air Speed Display

Full Auto Air Conditioner cont...

The Auto Air Conditioner is fully automatic high class air conditioning system. Pushing the AUTO switch will automatically start the unit working on a set rate of 25.0 degrees centigrade. The temperature range can be set by the temperature adjusting control buttons from 17.0 ~ 32.0 degrees centigrade. Then the unit will adjust fan speed etc according to temperature in the vehicle to give all year round comfort driving. You can also adjust the unit in the AUTO mode further by using the other manual control switches to fine tune the system or to turn off the air conditioner unit etc

Air Conditioner Operation...

- Only operate the air conditioner when the engine is running.
- Over the winter months when the engine has just been started it is recommended that you have the system in defrost mode while the engine is warming up. Once the engine has reached normal operating temperature, normal operation of the unit is ok.
- In AUTO mode when the air conditioner is in cooling mode, when the A/C is not needed it will automatically turn off, however should condensation form on the inside of the windows in low temperatures press the A/C button.
- When the unit is in AUTO mode and the desired temperature is lowered. The A/C will automatically come on.

Setting the Temperature in AUTO Mode:

Pressing the temperature button either side will lower or raise the temperature from 17~32 degrees. This will go up in 0.1 degrees or holding the button in will make the system automatically run through the temperature range. After turning off the system the unit will record the temperature set at the time of turn off, and will start at that set temperature when the unit is turned on again. (Unless the vehicles battery has been disconnected).

Full Auto Air Conditioner cont...

Manual Operation:

While the system is in AUTO mode simply pressing any of the controls, except temperature control, OFF switch & the outside temperature switch, will automatically change the system into manual mode and on the display screen AUTO will go out. To change back to automatic mode simply press the AUTO switch.

Turning OFF the System:

With the system in manual or auto mode simply pressing the OFF button will turn off the system. In this state the system will be on re-circulating air and air from the outside will not come in.

Using the System in Manual Mode:

1. Simply pressing the defroster switch and / or the fan switch will automatically turn on the A/C system In this state push the control buttons to set the desired situation. The other controls will set automatically. In this state pressing the AUTO button will automatically turn on the A/C system.
2. Pushing the MODE button will automatically show Outside / Inside Temperature (Automatically Change), and fan speed. The A/C will automatically turn off. With the MODE button control you can choose only the air direction flow. Pressing the AUTO button will change the system back to auto mode.

Using the system without the A/C:

In this situation it is not possible to make the temperature in the vehicle cooler than the outside temperature.

3. Pushing the Fresh / Re-Circulate button will show the Manual display on the screen. Also by pushing this button the unit will show the outside air temperature and for fresh air option will show inside air temperature for re-circulating options.

Full Auto Air Conditioner System cont...





Defroster Switch:

Pushing this switch will automatically place the air flow direction into the windscreen and the side glass areas. It will also show the outside air temperature and the A/C will come on. The unit will automatically set the speed of the fan depending of the temperature desired.

Care should be taken not to set the temperature at lower than the outside as this air could cause condensation to form on the inside of the windscreen.

Re-Circulate / Fresh Air Select Switch:

Use this control to temporarily change the air inside the vehicle when you are using the A/C continuously. Pushing the fresh air option will show outside temperature readings and selecting the re-circulate option will show the inside vehicle temperature.

	Vent (A): This option will select the air direction to Head & Chest
	Bi-Level (A+B): This option will blow air to your Head, Chest & Lower Legs.
	Heat (B+C): This option is mainly for the legs however a small amount of air is blown onto the windscreen.
	Defroster / Heat (B+C): For the Windscreen & Lower Legs.

Fan Switch:

Pushing the fan speed select switch will show the fan mode on the display screen and pushing the button from here will set the fan speed from OFF to 1~4 speed options.

Mode Button:

Pushing this button will give you selections for air direction controls from Vent, Bi-Level, Heat & Defroster / Heat:

Full Auto Air Conditioner cont...

Air Conditioner Switch:

To turn on and off the A/C unit use this switch. Use this option when removing condensation from the windscreen glass. However if the temperature is below 0 degrees centigrade the A/C compressor will be non-operational. Should you have the fan speed in the OFF mode the compressor will not work.

Outside Temperature Display:

Should you wish to check the outside temperature push the OUT. TEMP button and the display will show the outside temperature for around 5 seconds. However should you push the OUT. TEMP button for more than 1 second the display will show the outside temperature until you wish to change back to the inside temperature display.

The outside temperature will be displayed even if the A/C unit is off when the ignition is ON.

The outside temperature reading will sometimes show a higher reading than actual outside temperature in the following situations:

1. When the vehicle has been parked in direct sunlight.
2. When the engine is in idle mode for a long period of time.
3. In traffic jams.

Full Auto Air Conditioner cont...

A/C Unit Sensor:

Do not spill any water, place any items over the sensors or allow them to be damaged. As this may cause a strange reading to come from the A/C unit.

Sensors:

Light Meter / Heat Sensor: Placed on the right hand side of the drivers meters.

Interior Temperature Sensor: Placed on the right side of the unit operation panel.

Outside Temperature Sensor: Placed on the outer front grill.

Should you not wish to use the A/C Unit for a long period of time temporarily start the A/C system for 1~2 minutes once a month to keep the working parts of the unit in working order.

AIR CONDITIONER SYSTEM Cont...

Checking the Gas Cylinder:

To check the A/C Gas cylinder open the bonnet and check the 'Check Window' shown in the diagram.

If the system shows a few bubbles in the system, the system is ok.

Lots of bubbles in the system, the gas is low.

Nothing, there is no gas.

When the Gas is running out, the cooling ability of the A/C unit will become faint until the unit is not able to produce cool air at all.

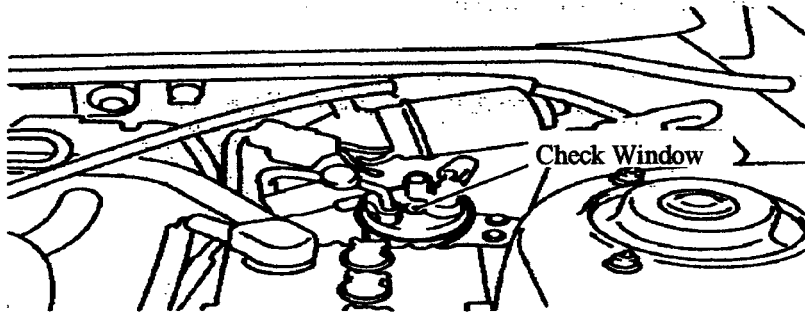

- Normal Gas Level
- Gas is Running Out
- No Gas

NOTES

CHAPTER: 8 AUDIO

FM / AM Electronic
Radio & Cassette
Stereo A Type

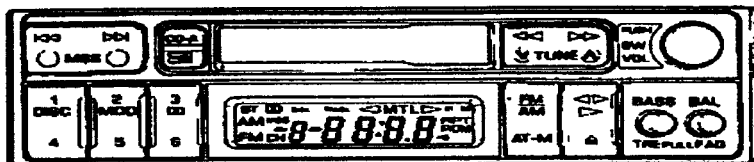

FM / AM Electronic Radio
& Cassette Stereo B Type

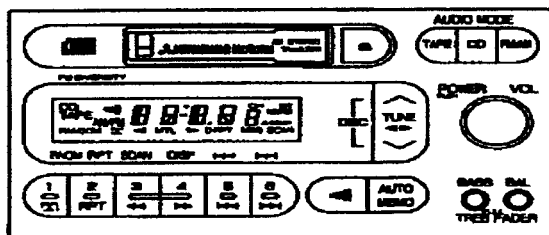

FM /AM ELECTRONIC RADIO & CASSETTE STEREO (A TYPE)

Radio Operation:

1. Traffic Station (Japan)

Radio Frequency

2. Tuning Buttons

3. Power & Volume Button

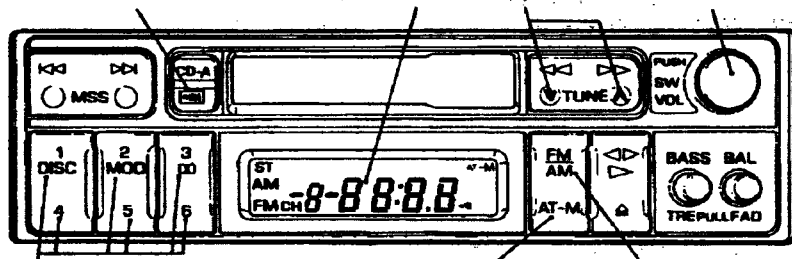

4. Manual Memory Select Button

5. A-TM (Auto Memory) Select

FM / AM Select Button

Listening to the Radio:

1. The Unit may be operated when the ignition is in ACC or ON. By pressing the Power / Volume button (3)
2. Select the AM or FM option by pressing button number (6).
3. Press the tuning buttons (2) to find the local station desired. Holding one side of button (2) for over 1/2 a second will cause the unit to automatically search for the nearest station up or down the frequency scale.
4. To place a station into one of the memory buttons simply push buttons 1~6 for over 2 seconds, a beep will sound to indicate the station is in memory. Am & FM functions can both be saved on one memory channel.
5. To set the Automatic Memory System simply press button number (5) after selecting AM or FM options for over 2 seconds. Here the unit will automatically select the 6 most strongest stations in the area.
6. Press button number (1) to tune into the local Traffic Report (1620kHz). This system is only available in Japan.

Tape Operation:

1. MSS Tape Skip Control Button

2. Tape

3. Tape Fast Forward & Rewind Control

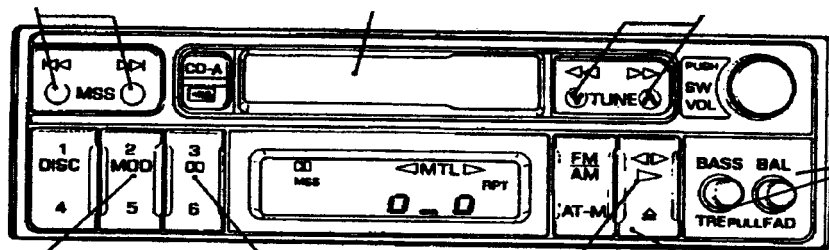

4. Repeat Play Mode

5. Dolby Option Mode

6. Play & Reverse Play Mode

7. Tape Eject Button

Listening to a Tape:

1. Place a tape into the unit and it will automatically start playing. When the tape has reached the end of one side the unit will begin playing the next side.
2. Should you wish to switch to Tape function from CD or Radio options simply press button (6). For METAL type tapes the display will show MTL automatically.
3. To use the DOLBY Sound System mode simply press button (5) once for On once again for Off.
4. To FF or REW the tape simply press either side of button (3).
5. To listen to the reverse side of the tape press button (6).
6. To FF or REW the Tape automatically to the next or previous piece or pieces press either side of button (1).
7. To listen to the same piece repeatedly press button (2). Press again to cancel this option.
8. Press button number (7) to eject the Tape.

CD Changer Operation:

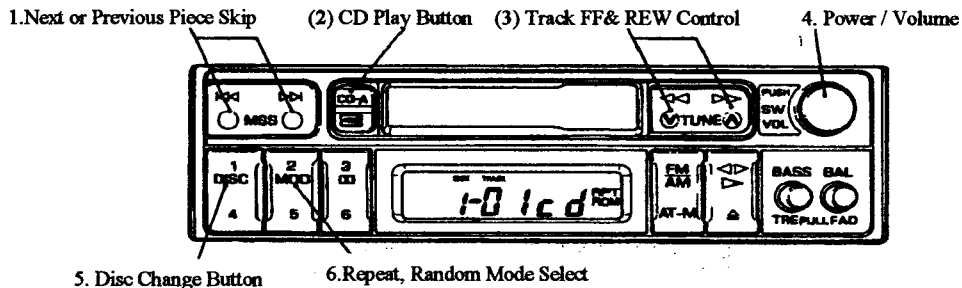

CD Changer Operation:

This Booklet does not detail how to use a CD Changer on this unit. Check with your dealer on having a CD Changer installed in your vehicle.

- 1). Press button number (2) to start a CD playing.
- 2). Choose which CD you would like to listen to by pressing button number (5).
- 3). To skip through the tracks of the CD press either side of button number (1).
- 4). Press button number (3) for FF and REW options in one piece.
- 5). Press button number (6) for Repeat & Random options on each CD. Press again to cancel this option.

FM/AM ELECTRONIC RADIO & STEREO CASSETTE (B TYPE)

Radio Operation:

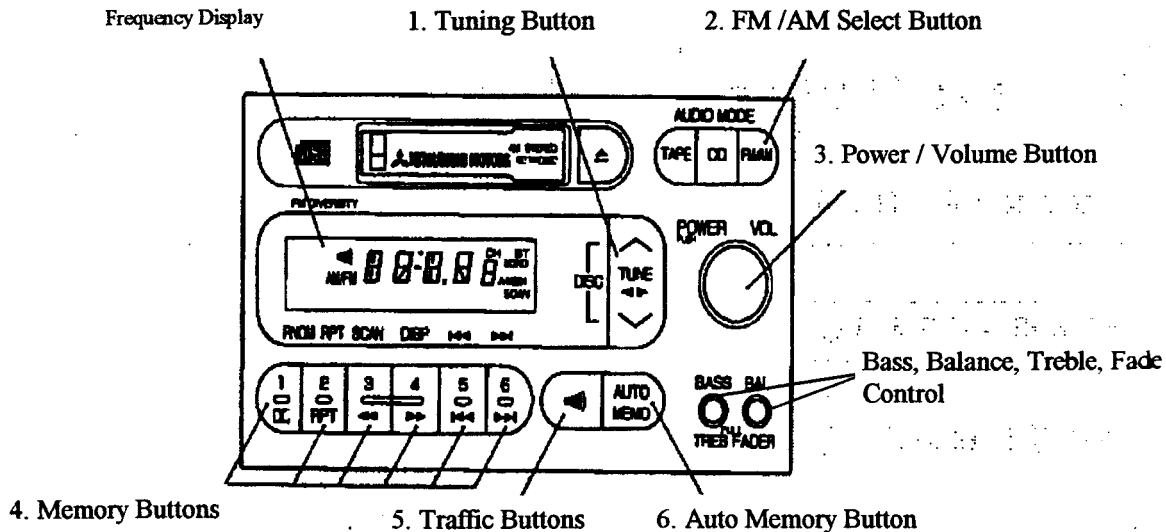

FM / AM ELECTRONIC RADIO & STEREO CASSETTE (B TYPE):

Radio Operation:

1. The Unit can be operated when the ignition is in ACC or ON. Press the power button for Off /On functions.
2. Select either FM or AM functions by pressing button number (2).
3. Press either side of the tuning buttons, up or down, (no. 1) to find the radio frequency desired.
4. To make the unit automatically search for the next station, simply press either side of the tuning button for over 1/2 of a second.

Placing a station into Memory:

When you have found a station you would like to place into memory, simply press one of the 6 memory buttons (4) for over 1 and 1/2 seconds to place the current station into memory. Each Memory button can have both a AM and a FM station on 1 memory button creating 12 possible stations to be recorded.

Using the Auto Memory Tuner:

When you are in an area that you do not know what Radio stations are in use, simply press the AUTO MEMO button (6) for over 1 and 1/2 seconds, after selecting AM or FM options. This will cause the unit to find the strongest 9 stations in the area.

When this has finished press the AUTO MEMO button each time to recall the stations from 1~9.

Traffic Stations:

Set at 1620 kHz, pressing button (5) will tune into the local traffic report> (Only in Japan)

To switch between Stereo (ST) function and Mono Radio functions press the AM/FM button for over 1.5 seconds.

When using the Automatic Searcher or the Auto Memo function a station with weak frequency will not be picked up by the unit.

FM / AM ELECTRONIC RADIO & STEREO CASSETTE (B TYPE):

Cassette Operation:

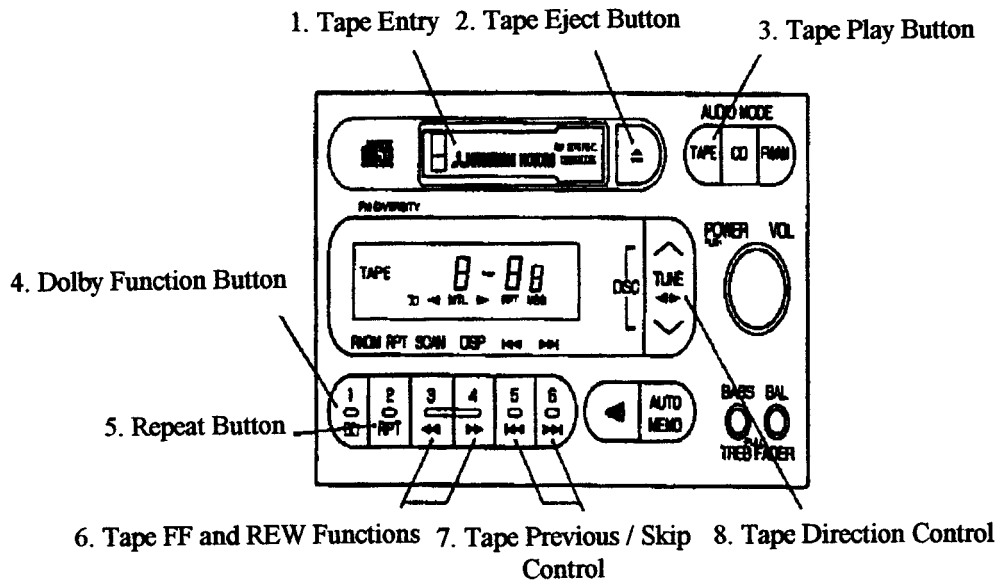

FM / AM ELECTRONIC RADIO & STEREO CASSETTE (B TYPE):

Cassette Operation Cont:

1. The unit will function with a tape when the ignition is in ACC or ON. Placing a tape in the unit will automatically start the tape playing. When the tape reaches the end of one side the unit will automatically start the the next side playing.
2. To place the Dolby Sound System function ON simply press button number (4). To turn it OFF again press the same button again.
3. To retrieve a tape simply press the Eject Button number (2).
4. Fast Forward & Rewind Functions are controlled by buttons (6). (Memory Button 3 & 4).
5. To change the Tape Direction of Play simply press button number (8).
6. To listen to the same song again press the Repeat button number (5).
7. To skip to previous or the next piece on the tape press the MSS Skip Button (7) (Memory Buttons 5 & 6). The unit can skip a number of pieces on the tape, e.g. by pushing the button 4 times the unit will show MSS-4 on the screen and the unit will FF or REW 4 pieces on the tape depending on which direction you have selected.

However should the distance on the tape between a piece be under 4 seconds or if the dubbing is of poor quality the unit may not read it very well..

FM / AM ELECTRONIC RADIO & STEREO CASSETTE (B TYPE):

Compact Disc Operation:

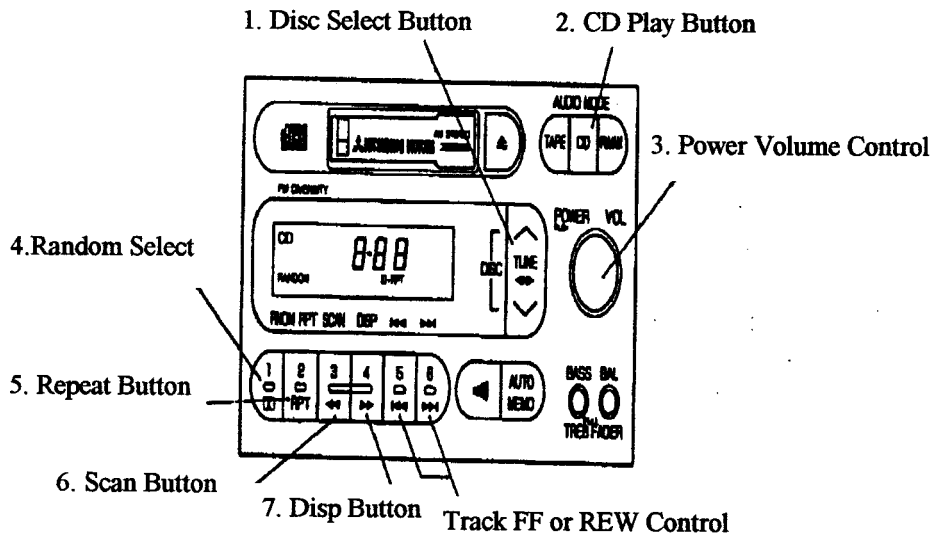

FM / AM ELECTRONIC RADIO & STEREO CASSETTE (B TYPE):

Compact Disc Operation: Cont...

1. The unit will work with the ignition in ACC or ON when pressing button number (3).
2. Press button number (2) to start a CD playing or to stop it playing press the Power button or the AM / FM select or press the Tape Mode button.
3. To Fast Forward or Rewind during a piece simply press button number (8) (memory buttons number 5 or 6).
4. To select another CD press the CD select button number (1).
5. To listen to same piece again press the Repeat button number (5). To cancel this function press the same button again twice.
6. To listen to the same CD press the Repeat button (5) twice, the display screen will show 'D-RPT', to cancel press the same button once.
7. Press the button number (4) to select a range of of CD's from the Auto Changer to be played in Random order. The Display will show 'RANDOM'. To cancel the option press the button again.
8. Scan through the first 10 seconds of each piece on the CD by pressing button number (6) until you get to the piece you want to listen to. The function is stopped by pressing the button again.
9. To find out what track & CD you are listening to press button number (7) (Display), By pressing the button again the Display will show how long the piece has been playing.
10. To skip to previous or next pieces press and hold in button number (8) (memory buttons 5 & 6).

SETTING THE AUTO CHANGER:

The CD Auto Changer is placed in the Floor Console and can take up to 6 12cm CD's. Even with adapters, 8cm CD's should not be used in this magazine.

Retrieving the Magazine:

1. Slide the Cover Left to completely open the cover.
2. Press the eject button to retrieve the magazine.

Retrieve each CD holder by hand:

Place CD upright in the holder and then place the holder back in the magazine. Make sure each holder is placed back in the magazine straight.

Place the magazine back in the the unit and then close the cover.

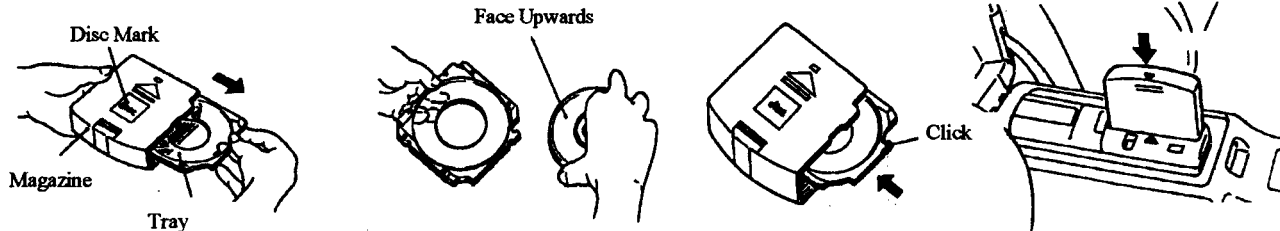
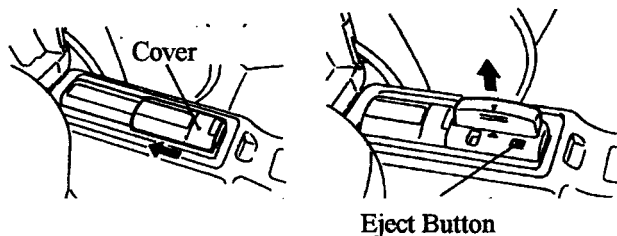

AUDIO CARE

Take care not to operate your audio system while driving and always keep your eyes on the road. Your antenna will occasionally have problems receiving because of buildings and other electrical interference. Such as cell phone sites and over head wires. But as you move away from these places the reception will soon improve.

CASSETTE

A cleaning tape should be used at least once a month to keep the heads clean.

Always keep the tapes in there case and out of sunshine.

Don't use 120 minute tapes for these tapes are too thin and will jam up your cassette deck.

Also don't use tapes that are dirty or have loose labels or tape stuck on for if they get jammed tape will be very difficult to remove.

Placing tapes into the unit take care that you can see the tape part of the cassette to the right side of it.

Try not to 'over wind' tapes as this can place a strain on the stereo unit and the tapes themselves. To fully wind the tape use a pencil or something that will wind the tape manually.

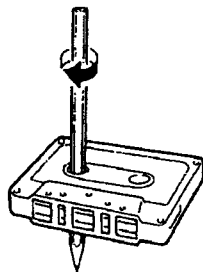
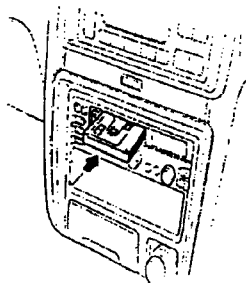
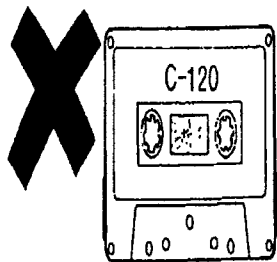

Audio Care cont...

Compact Disc:

When retrieving discs from their holders, firstly take the disc your finger in the middle of the disc then when out of the holder hold the disc on each end.

Do not touch the face or the rear of the disc as this may cause dirt and especially may scratch the surface. Should this happen the stereo unit may not read the disc as well as it should.

Do not place any stickers etc on the disc itself.

Make sure the discs are clean with a soft cleaning towel. When cleaning do not use detergents or alcohol based products.

Should you disc have a scratch, be out of shape or be partly broken do not use that disc in the unit.

Do not place discs in hot places such as near a heater or in direct sunlight.

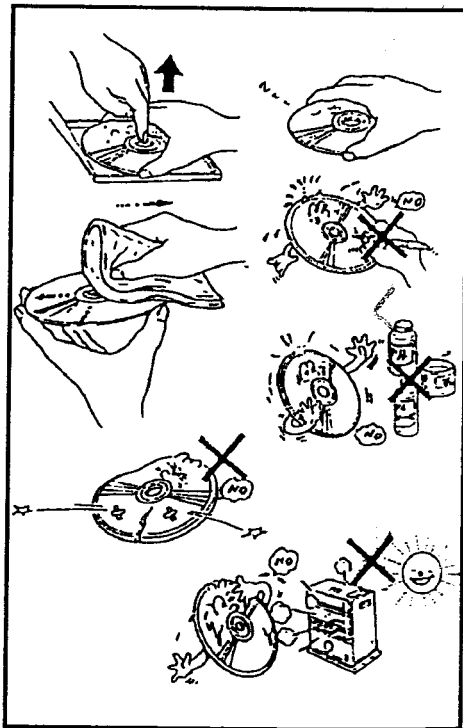

RADIO & AUDIO SYSTEM

CAUTION: Never have the stereo volume inside the vehicle so loud that you can not hear what is happening outside the vehicle.

It is advised that as much as possible adjustments to the stereo should be made while the vehicle is stationary

Power Antenna: (Maker Option)

Turn the radio power switch on and the antenna will automatically extend from its casing. Turning the radio off or turning the ignition off will automatically cause the antenna to fold away again.

Diversity Antenna + Power Antenna:(Maker Option)

This antenna is placed as a wire on the inside of the rear window.

Care should be taken when cleaning the back window as to not damage the wires of the diversity antenna.

Power Antenna: When the power switch is pushed the antenna will raise up out of its casing. Check that no one or nothing is around that area.

When driving into low roofed building or car washers make sure the antenna has folded away. Do not try to manually fold away the power antenna or if your vehicle is fitted with...

Press the Motor Antenna Switch to have the Antenna at 1/2 its normal height when driving into low carparks, garages etc.

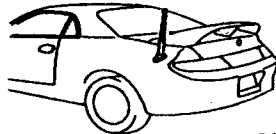
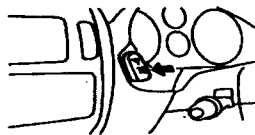
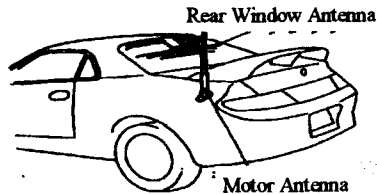

NOTES

CHAPTER: 9 WINTER PREPARATION

BEFORE WINTER SETS IT IS ADVISED TO HAVE THE VEHICLE SERVICED.

Having the vehicle serviced will help insure a trouble free winter for your vehicle. However there are some checks on your vehicle which should be done by yourself every time before your vehicle is used and regular monthly checks.

Some of these checks include:

Checking that you know how to start your vehicle in cold times.

Checking the wiper/washer system has sufficient cleaner.

Radiator anti-freeze has been added to your radiator.

Check the battery fluid levels.

Winter Oil has been added to your engine.(Depending on your area).

Snow Chains (depending on your area) are prepared.

Checking your vehicle for any frozen doors, brake hoses, hand brake, wind wipers etc.

Check your speed when traveling on the roads.

Knowing how to drive on snowy icy roads.

Pre-Drive preparation

Correct parking.

Correct Tyres



Should the doors or windows freeze use hot water (not boiling) to melt the ice.

WINTER PREPARATION (CONT)

Fuel:

Once you have reached a particularly cold area it is also advised that you fill your fuel tank up with fuel from that area as this has been stored at cold temperatures for some period of time. And is fuel designed for that area.

Always clean off ice around the vehicle before usage. And should you be leaving your vehicle for long periods of time in extremely cold areas do not use the hand brake, place the vehicle in gear or in park (auto type), then put something under the rear wheel to stop the vehicle moving. This is to stop the hand brake from freezing. Also stand the wipers up so they do not freeze do the windscreen.

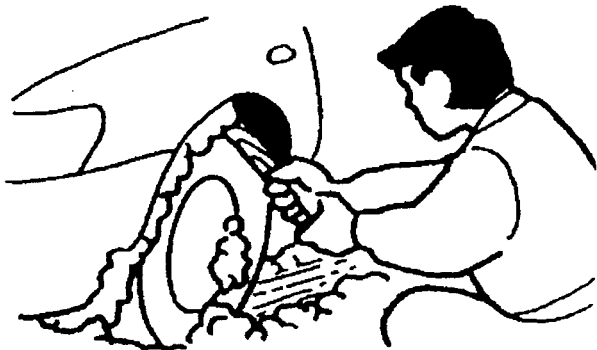
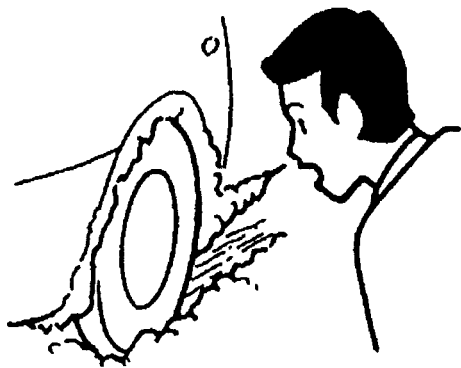

CHAINS

Chains that will best suit your vehicle are available from your dealer. Only use on the front wheels on your vehicle. Make sure that the chains are not too loose before driving. Do not drive over 50 km/hr with snow chains. Follow the instructions that are with the snow chains on installation. Make sure the chains are properly installed before driving. However follow the diagrams below to help with the installation.

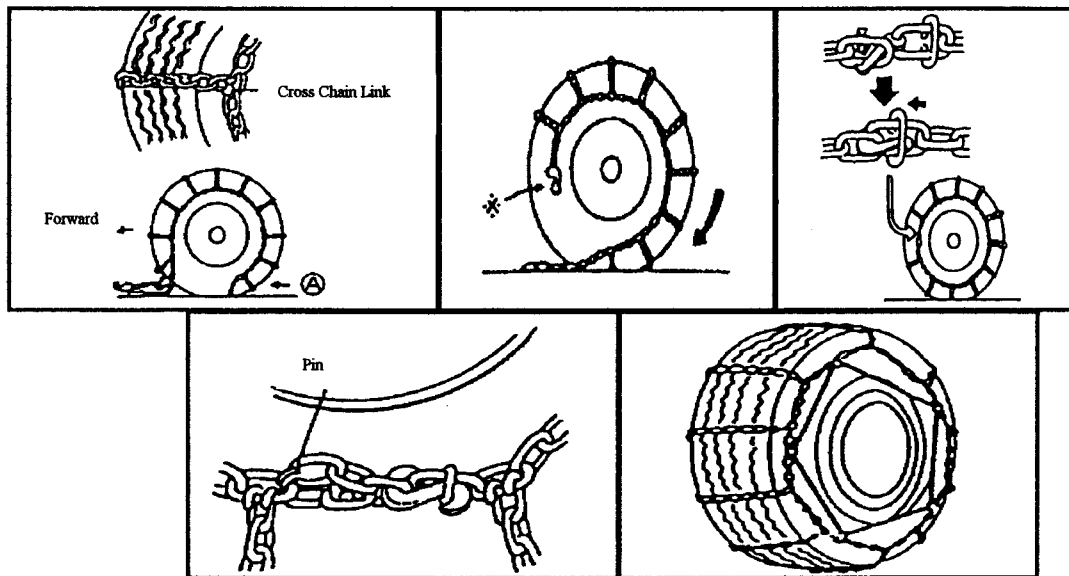

NOTES

A large, empty rectangular box with a black border, intended for handwritten notes.

CHAPTER: 10 WHEN THINGS GO WRONG

FLARES

Flares are not required in New Zealand under normal circumstances. However should your vehicle still have the factory fitted flare use is simple:

1. Remove the flare from its holder under the glove compartment.
2. Remove the flare casing.
3. Then remove the end tape across the `strike zone` and strike the end of the flare with end of the case to start the flare.

***CAUTION:** Do not use the flare near any gasoline or any easily combustible materials.

Do not hold the flare near one's head etc.

Do not let children play with the flare.

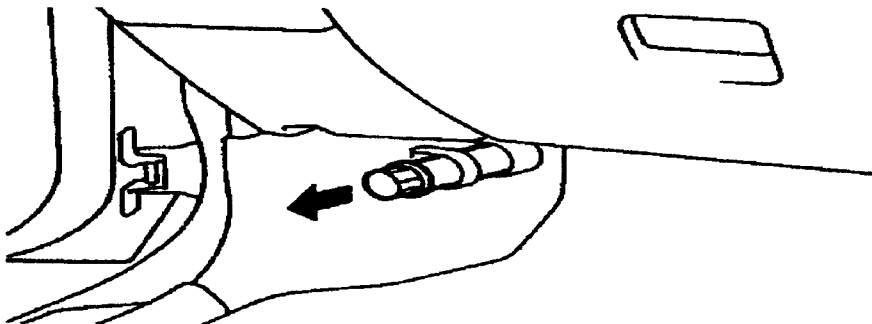

JACK, SPARE TYRE & TOOLS:

Jack:

You must detract the jack slightly to remove from its holder. Check the Jacks grease level periodically the winding part of the Jack should be greased for ease of use.

Spare Tyre:

Placed in the subtrunk. Twist the to loosen the tyre, when replacing make sure the holding bolts are in place to hold the tyre when traveling.

Tool Bag:

Positioned to the right of the spare tyre.

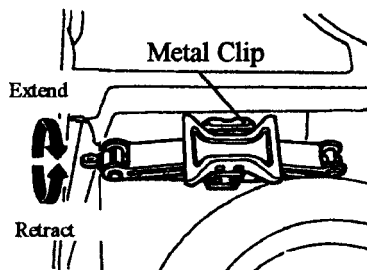
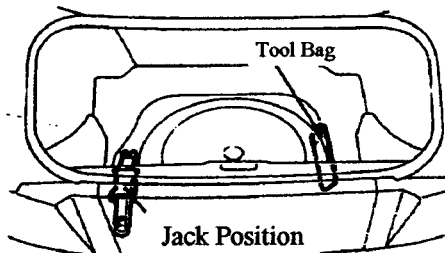

Jack Handle

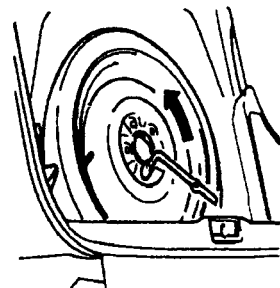

Spare Tyre Position

JACK, TOOLS & SPARE TYRE Cont...

Tools:

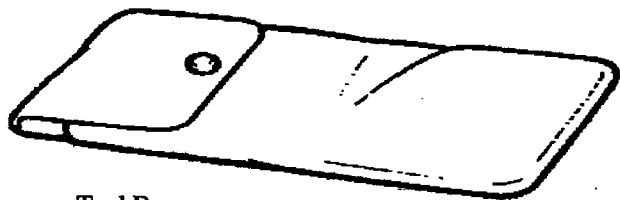

Tool Bag



Sunroof Wrench

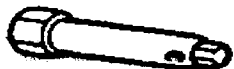

Plug Wrench (MIVEC)

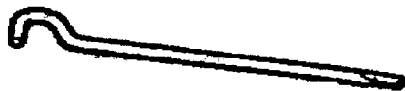

Jack Bar

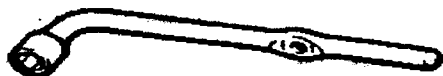

Wheel Nut Wrench

CHANGING A FLAT TYRE

1. Remove wheel cap.
 2. Loosen wheel nuts slightly first.
 3. Jack up vehicle on the proper jacking points.
 4. Loosen wheel nuts fully, and remove wheel.
 4. Get spare wheel from boot (under cover in boot).
 5. Place spare wheel on and tighten wheel nuts loosely by hand.
 6. Then tighten wheel nuts with the wheel brace, all nuts must be done up evenly therefore tighten every nut bit by bit moving amongst the nuts in criss crosses.
 7. Then lower vehicle until tyre has just come in contact with the ground, at this stage, wheel nuts should be fully tightened.
 8. Let vehicle down from jack and put the flat in the boot.
- Tyre should be repaired as soon as possible.

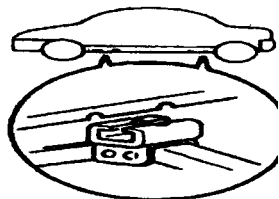

Normal tyre

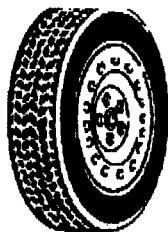

Spare tyre

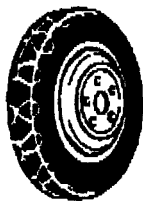

When driving with the spare tyre installed

- Don't drive on snow or iced roads.
- Don't drive over 50 Km/h.
- Don't install snow chains

While tyre is off this is a good chance to wipe around the brake disc and wheel rim.

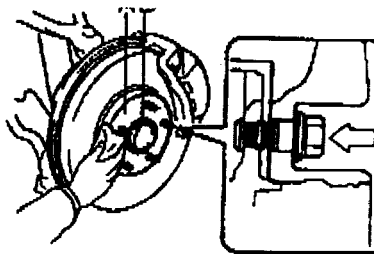

JUMP STARTING

Push / Pull Starting is not recommended for this vehicle as backfiring can damage the catalytic converter.

Jump Starting: To avoid serious personal injury and damage to your vehicle which might result from battery explosion, acid burns, electrical burns or damaged electrical components, these instructions must be followed precisely. If you are unsure of about how to follow this procedure, it is advised that you seek the advice of a competent mechanic or towing service.

If the booster battery is in another vehicle make sure the two vehicles are not touching. Make sure the engine of the booster vehicle is running. About 2000 RPM is suggested. Connect the jumper leads in the exact order shown in the diagram. **NOTE** that you first connect the positive cable to the discharged battery and then to the booster battery. Next connect the negative cable to the booster battery and then to your vehicles chassis.

Start the engine in the normal way, then disconnect the cables. Then run the vehicle at around 2000 RPM for a few minutes before driving.

1. Connect your battery positive charge to the new battery positive charge
(1/2)
2. Connect the negative charge from the charged battery (4) to a metal part of your engine.
The suggested places to clip the cable to are shown on the far right diagram.

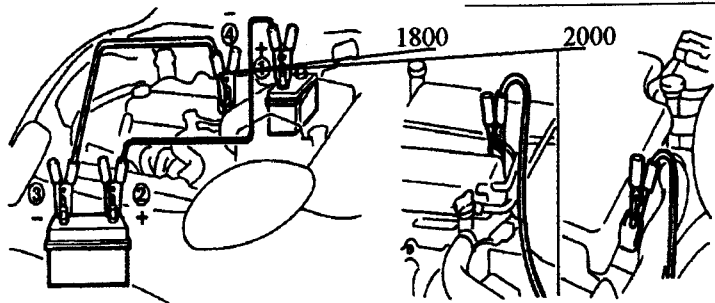

TOWING:

This Vehicle can not and is not designed to tow other vehicles, the rear tie down tabs are designed to pull the vehicle out of a situation from the rear only.

Should you need to have your vehicle towed it is advised to ring your Mitsubishi dealer and have the vehicle taken directly there if possible.

Use the Tie Down Tab in the front of the vehicle when having your vehicle towed.

If possible when towing have the engine running, if this is not possible have the ignition in the ACC or the ON position.

For Manual types have the transmission in Neutral, and the Automatic types have the Select Lever in N- Do not tow an automatic vehicle over 30km and do not tow over 30km/hr.

Seek professional advice from your dealer or a competent mechanic if you are not sure on these towing procedures.

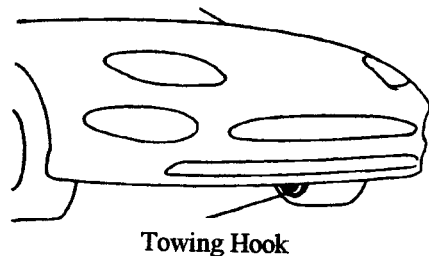
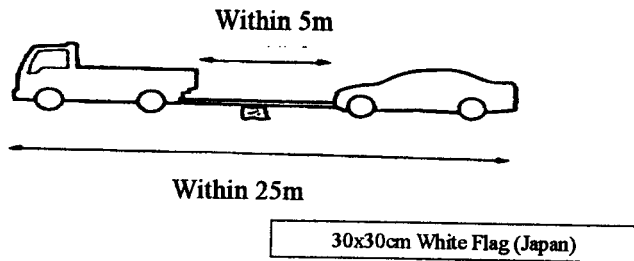

FUSE AND CIRCUIT BREAKER LOCATIONS...

The fuse box is located on the right hand side underneath the steering column and one in the engine bay. Once the cover has been removed you will find different circuit breakers for each of the different electrical components. To help remove a suspected blown fuse there is a fuse remover located on the right hand side of the fuse box.

Blown fuses are easily recognizable:

When replacing fuses only use the same amperage fuse. If this is not available use a lesser amperage. Should you need more fuses than supplied contact your Mitsubishi dealer.

Before replacement: It is advised to find out the reason why the fuse shorted before replacing with a new fuse.

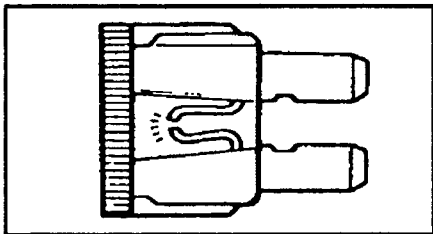

Engine Room & Interior Fuse Box:

When replacing fuse make sure the ignition is in the LOCK position.

Interior Fuse Box

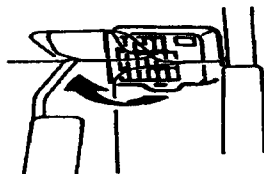

Engine Room Fuse Box

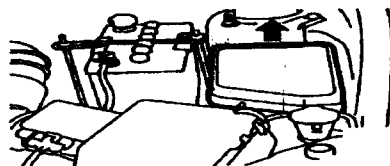

FUSE & CIRCUIT BREAKERS Cont...

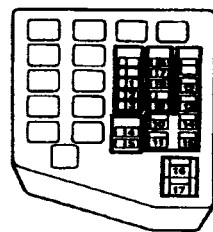
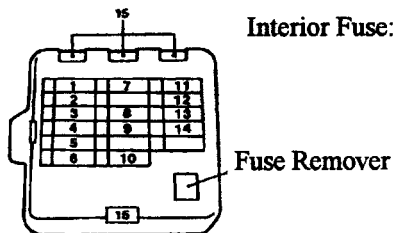

Interior Fuse Box:

1. 10A Horn
2. 10A Heater Relay
3. 15A Cigarette Lighter
4. 10A Automatic Transmission
5. 10A Collapsible Mirror
6. 20A Sunroof
7. 30A Defogger
8. 10A Meter
9. 15A Wiper
10. 30A Heater
11. 15A Door Lock
12. 10A Traction Control
13. 10A Back Door Lamp

14. 10A Turn Signal Lamp
15. Spare Fuse

Engine Room Fuse Box:

1. 10A Tail Lamp
2. 10A High Beam
3. 10A AirCon
4. 10A Room Lamp
5. 15A Radio
6. 15A Stop Lamp
7. 10A Hazard
8. 15A Fog Lamp
9. 30A Condenser Fan

Fusible Link:

10. 30A Power Window
11. 50A ABS
- 12.. 40A Ignition
13. 30A Radiator Fan
14. 40A Lamp
15. 20A MPI
16. 100A Alternator
17. 60A J/B

OVERHEAT

Should the needle on the temperature gauge go into the red zone, your vehicles engine has overheated. Pull to the side of the road as quickly and as safely as possible, leave the engine running and then go around to the front of the vehicle. If steam and radiator coolant is coming out of the front of the vehicle, turn off the engine immediately. If there is no steam or coolant coming from the front of the vehicle leave the engine running and open the bonnet. With the engine running the engine will cool down faster than with the engine off.

Wait while the engine returns to normal temperature, when this has happened you may drive but with caution. However check for any radiator leaks in the system and check the radiator level before driving. If you have lost some coolant this must be replaced before driving again. However do not remove the radiator cap until the engine temperature is at normal even then remove the cap slowly as coolant can be under pressure.

Taking preventative measures before driving is advised. i.e. checking coolant levels before driving, periodically turning off the air conditioner on hot days. Refer to the back of the book on checking coolant levels.

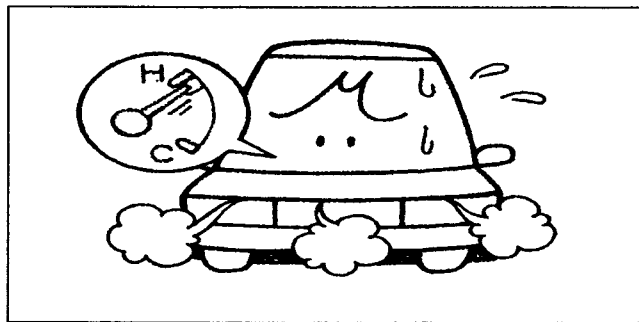

NOTES

[Empty rectangular box for notes]

CHAPTER: 11 SERVICE DATA

Fuel Tank Capacity: 60ltr

Engine Oil Capacity: 1800cc Type: 3.8ltr / 2000cc Type: 4.1ltr (Add 0.3 ltr for Oil Filter on both models)

Manual Transmission Oil Capacity: 2.2ltr

Auto Transmission Oil Capacity: 7.8ltr

Washer Reservoir Capacity: 2.8ltr

Brake / Clutch Fluid: As Needed

Power Steering Oil: 0.9ltr

Radiator Capacity: 6.5ltr (Condenser Tank incl.)

Spark Plugs: 1800cc NGK: BK5E-11 or ND: K16P-U11

Spark Clearance: 1.0~1.1mm

2000cc Non-MIVEC Type Engine: Front Side: NGK: BKR6E-11

or ND: K20PR-U11

Rear Side: NGK: PFR6G-11 or ND: PK20PR-11

Spark Clearance Front & Rear: 1.0~1.1mm

2000cc MIVEC Type Engine: Front Side: NGK: BKR7EKC-N

Rear Side: NGK: PFR7M

Spark Clearance: 0.7~0.8mm

Should these Spark Plugs not be available in the country you are in, check with your dealer or a reputable car parts dealer.

2000cc Type

Rear Side: White/
Gold Plug

White / Gold Plug

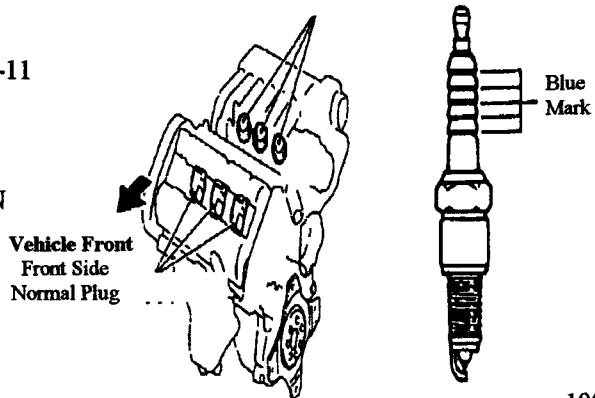

SERVICE DATA

Brake Pedal: Play 3~8mm

Depressed Brake Pedal Distance to the floor: Over 80mm

Clutch Pedal: Play 6~13mm

Engaged Clutch: Distance to the Floor Over 70mm

Hand Brake: 4~6 notch

Lamp Bulb Wattage:

Headlamp:High Beam: 60W / Low Beam:51W

Side Lights: 5W

Fog Lamp: 55W

Rear Lights: 21/5W

Reverse Lights: 21W

Indicators: Front:21W, Side: 5W, Rear:21W

License Plate Light: 5W

High Mount Stop Lamp: 5W

Interior: Room Lamp 8W

Trunk Room Lamp: 5W

SERVICE DATA

Belt Deflection: 1800cc

A & B: 10 kg pressure

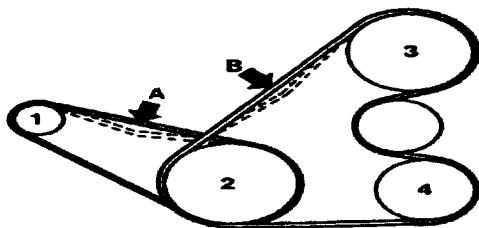

2000cc

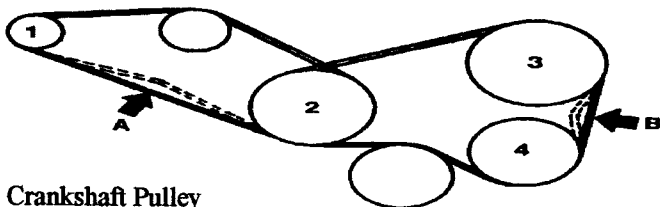

1. Alternator Pulley 2. Crankshaft Pulley
3. Power Steering Pulley 4. Air Con Compressor

A : ALTERNATOR : 1800cc: New Belt: 7.0~8.0mm, Used Belt: 8.5~10.0mm /

2000cc: New Belt: 8.0~12.0mm, Used Belt: 11.0~15.0mm

B: Air Compressor & Power Steering Pump: 1800cc: New Belt: 7.0~9.0mm, Used Belt: 10.0~11.0mm

2000cc: New Belt: 3.4~4.0mm, Used Belt: 4.4~5.2mm

SERVICE DATA

Tyre Sizes & Pressure:

FTO 1800cc Type:

Tyre Size: Factory Fitted: 185/70R14 88S

Other Size Options: 185/70R14 88H, 195/60R15 88H, 205/5016 87V, 205/50ZR16

Wheel Size: Factory Fitted: Steel 14x 5.5JJ (46mm)

Other Size Options: Steel 15x6JJ (46mm), Aluminum 15x6JJ (38mm), Aluminum 16x6.5JJ (38mm)

FTO 2000cc GR, GP Type:

Tyre Size: Factory Fitted: 195/60R15 88H

Other Size Options: 205/50R 87V, 205/50ZR16

Wheel Size: Factory Fitted: Steel 15x6JJ (38mm)

Other Size Options: 15x6JJ (38mm), 16x6.5JJ (38mm)

FTO 2000cc GR Sports Package, GPX:

Tyre Size: Factory Fitted: 205/50R16 87V

Other Size Options: 195/60R15 88H, 205/50ZR16

Wheel Size: Factory Fitted: Aluminum: 16x6.5JJ (38mm)

Other Size Options: Aluminum 15x6JJ (38mm), Steel 15X6JJ (46mm)

Should these sizes not be available in the country you reside check with your Mitsubishi dealer.

SERVICE DATA

Tyre Sizes & Pressure Cont...

Tyre Pressure:

TYRE PRESSURE CHART UNIT:kgf/cm²		
TYRE SIZE	FRONT	REAR
185/70R14 88S	2.2	1.9
185/70R14 88H		
195/60R15 88H		
205/50R16 87V		
205/50ZR16		
TEMPORARY SPARE WHEEL	4.2	

NOTES

CHAPTER: 12 SERVICE & MAINTENANCE

WASHING AND WAXING YOUR VEHICLE...

Wash your vehicle in the shade with a mild car wash soap, and rinse well . Dirt can cause small scratches in the paint and the chemicals in some dirt and air pollutants can cause deterioration of the paint work. Therefore frequent washing is recommended. If you park or drive your vehicle near ocean roads or salted / lime stoned roads it is especially important to prevent corrosion.

Your vehicle may be washed in an automatic car wash, however the paint surface may be scratched by the brushes of the automatic washer.

Bugs and insects will come off with warm soapy water. Road tar will come off with some turpentine.

When washing always make sure to wash under your vehicle as well especially mud guards etc.

Polishing and waxing is recommended to maintain the original beauty of your vehicle. Always dry your vehicle before you begin waxing.

Cleaning the interior:

The upholstery may be easily cleaned with a mild soap or detergent and water after vacuuming. Commercial foaming type cleaners are also available which work well.

Carpets: Use a good foam-type shampoo to clean the carpets. Begin by vacuuming thoroughly to remove loose dirt. Then follow the manufactures instructions carefully.

SERVICE FOR YOUR VEHICLE

Please read this part of the booklet and follow its instructions carefully. It should be kept in your vehicle at all times along with the original Service Booklet to allow verification of the warranty, and as a record of the servicing which has been done. Your dealer will endorse each of the services as they are completed to give you peace of mind knowing that your vehicle is safe and reliable. When it comes to service remember that your dealer knows your vehicle and the best parts for your vehicle.

He is also interested in your complete satisfaction and he will provide quality maintenance and any other assistance you may require.

Please leave this booklet in the vehicle at the time of resale as the next owner will need this information.

Note: Some of the information in this booklet applies to a range of models and explains about a range of equipment including options. Therefore there may be some explanations for equipment not installed in your vehicle.

Please also note that this is a translated version of the original handbook for this vehicle when it was produced in Japan, therefore information that is irrelevant to other countries has been left out, in particular the addresses of the many Service centers in Japan near the back of the original booklet and some of the warranties which are exclusively made for when the vehicle was new in Japan.

JPNZ also offers a range of services available to its customers, for example translated letters to the original owner in Japan to verify odometer readings and other information at the time of sale of the vehicle in Japan.

Owner Maintenance Items...

Although the following simple checks are included in the recommended service schedule for your vehicle, in the interest of safety and reliability it is suggested that they be done by the owner on a weekly basis:

- Check engine oil level
- Check water level in the radiator expansion tank (when cold) and also check the windscreen washer bottle
- Check tyre pressures- including the spare
- Check brake and clutch fluid levels

Car Care...

Just as mechanical maintenance is important, proper care of the vehicle bodywork is also, to insure long term corrosion protection and to preserve the paint work to keep your vehicle in showroom condition.

It is recommended that your vehicle be washed on a regular basis.

- When washing the vehicle, remember to hose the inside wheel arches to remove mud, and if you live by the sea hose under the vehicle.
- Check the condition of the paint. If you find any stone chips or scratches, touch them up as soon as possible.

Check with your local dealer on paint.

- Check the interior. Water and dirt can accumulate under floor and boot mats and, if left may cause corrosion.

Be extra careful when transporting chemicals, fertilizers etc Should there be any spillage, make sure you clean up as soon as possible.

- Polish your vehicle often enough to maintain a wax film on the paint work. When the wax is sufficient any water on the body of the vehicle will bead like water droplets on the paint rather than spreading over the whole surface.
- Keep your garage well ventilated. This will allow a wet vehicle to dry out, minimizing the chance of dampness in the vehicle.
- Headlight protectors and mudflaps are recommended to be installed if the vehicle is to be used on unsealed roads.

Service Recommendations...

To maintain your vehicle in peak condition, the manufacturers have carefully designed a comprehensive service schedule which will provide worry free motoring to its customers. Research shows that for the majority of vehicles, a time based service schedule is more beneficial to the vehicle than one based on kilometers traveled.

Inspection Service:

(In Japan)

The Manufacturer provides a free service check over the vehicle 1 month (or the first 1000km) after purchase, and then a second free service after 6 months (or after the first 10000km).

Inspection Recommendations....

These are recommended preventative maintenance services which will keep your vehicle in top running order, it is strongly recommended that these schedules are carried out as they represent an insurance on your vehicle in terms of life, economy, and performance of the vehicle.

If you travel over 10000km in less than 6 months it is suggested that the services are carried out on kilometers traveled (@10000km).

Severe Driving Conditions: Commercial vehicles, or others operating in harsh conditions should be serviced more frequently. It is suggested that these vehicles are serviced every 3 months or every 5000km.

Severe driving conditions include:

- Unsealed roads
- Frequent short distance driving
- Towing a caravan or trailer
- Operation in extreme cold

Service Schedule....

It is strongly recommended that you service your vehicle according to the schedule. The first two services (1 month and 6 month) show the free of charge services that were performed in Japan, and then a list of the check points around your vehicle which would be performed in Japan. O=Check Needed, X =No Check Needed, XO= Optional

1 month	X,O	15 month	O	30 month	X,O	45 month	O
3	O	18	X,O	33	O	48	X,O
6	X,O	21	O	36	X,O	51	O
9	O	24	X,O	39	O	54	X,O
12	X,O	27	O	42	X,O	57	O
						60	X,O

Most checks are advised to be done by a professional mechanic or technician with specified tools etc. However there are some items around your vehicle which are relatively easy to check and perform yourself. **CAUTION:** You should be aware that improper or incomplete servicing can result in operating problems. If you do not understand any of the procedures detailed in the next part of this section see your dealer.

Before Driving...

1. Raise the bonnet or the engine room latch:

Check the brake / clutch fluid, engine oil, radiator, air conditioner coolant level

2. Check the outside of the vehicle:

Check all of the lights and indicators etc. Check that the number plate is clean.

Check tyre pressure, tread, nails and other abnormalities.

3. When seated in the vehicle:

To make sure your seat is in the correct position, make sure you can reach all of the pedals and the control panel and the hand brake with ease.

Check that you can see out of all the windows and then all the mirrors (rear vision out and in).

Check you have enough fuel for your destination.

After starting check for any warning lights etc on the dash board.

Every 6 months...

1. Raise the bonnet or the engine room latch:

Check the brake / clutch levels and the hose pipes for any fraying or splits . Check the engine oil level and if it is dirty.

Check the radiator, air conditioner coolant level. Check all engine belts (fan, air conditioner, power steering). Check the battery level

2. Check the outside of the vehicle:

Walk around the whole vehicle checking all of the lights etc Then check the tyres for pressure, tread, nails, stones, frayed or any split tyres. Then check under the vehicle for any oil leaks and or radiator coolant leaks etc.

3. Inside the vehicle: Check the brake and clutch pedal play. (how long the pedals take to engage), Check the hand-brake play (how many clicks the hand brake takes to engage). Drive the vehicle and see how long the brakes take to stop the vehicle.

Engine / Vehicle Check...

When the engine just been running care should be taken around certain areas of the engine as it can be extremely hot. Should you inspect the engine when it is running do not put your hands, tools etc near any of the moving parts. Do not leave the vehicle by any flammable items such as fuel, oily rags, chemicals etc. And do not park the vehicle over combustible materials such as dry leaves, cloth, newspaper etc.

Checking brake pedal freeplay:

1. With the engine running, have someone press the brake pedal several times, and then press the brake pedal down hard. (approx 50kg) The distance from the back wall of the vehicle should be over 80mm. If the clearance is any less than specified have your dealer adjust the brake.



2. With the engine stopped, first reduce the vacuum in the booster by depressing the brake pedal several times. Then with your fingers lightly depress the pedal until slight resistance is felt.

Around 3~8mm is normal.

Should the pedal be outside this figure have your dealer adjust the brake pedal to correct.

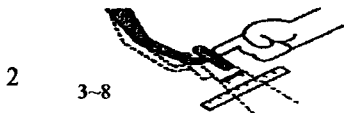

Checking the parking brake:

Count the number of clicks as you slowly pull on the parking brake as far as it will go. The hand parking lever should be about half full to stop the vehicle. If the parking lever is on full, the adjustment is wrong. Have your dealer adjust it. The hand brake may also be operated by the foot pedal on some vehicle. To push in 1 click means 1 notch on the hand brake Specifications on the hand brake are stated earlier on in this booklet.

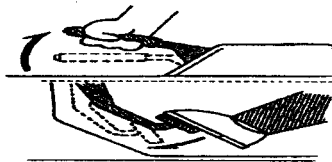

Checking the clutch pedal freeplay:

1. Press down lightly on the clutch pedal and measure the distance it moves freely before the clutch resistance is felt. The freeplay should be within 6~13mm.
2. Press the clutch all the way in and then slowly bring your foot up until the engine engages. This should be over 70mm.

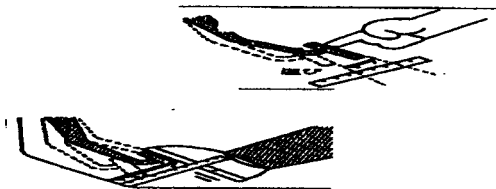

Checking brake / clutch fluid levels:

To check these levels simply look at the see through reservoirs. The fluid should be between the min and the max levels stated on the side of the reservoirs.

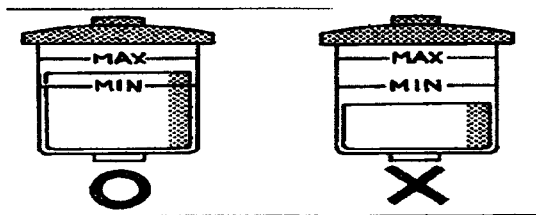

Checking the oil level:

With the engine turned off and at operating temperature, check the oil level on the oil 'dipstick'.

1. To get a true reading the vehicle should be parked on level ground. After turning the engine off wait a few minutes to let the oil settle on the bottom of the engine. Pull out the dipstick and wipe it with a rag.
2. Re-insert the dipstick and push it in as far as it will go.
3. Pull out the dipstick again and look at the level, if it is between 'F' and 'L' it is ok if not it should be topped up to

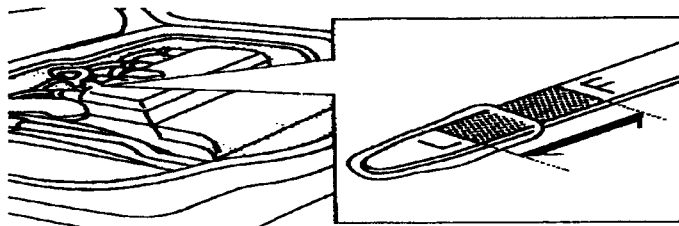

Checking the engine drive belts...

Visually inspect the condition of the belts. Check their tension by applying thumb pressure midway between the pulleys. Press hard on the middle section of each belt. Each belt should deflect no more than the amount stated later on in the book.

With the engine turned off check the engine drive belts for signs of wear and tear ie cracking, splitting, oil stains etc. Any slack, worn or damaged engine drive belts should adjusted and or replaced by your dealer as soon as possible.

Checking the electrolyte level of the battery:

When checking the electrolyte level check all 6 cells not just 1 or 2. Use only distilled water when refilling the battery terminals and do not overfill or the battery may squirt out of the terminals during periods of heavy charging causing corrosive damage to the surrounding areas of the battery and to the battery itself.

Frayed, Cracked
Engine Belts

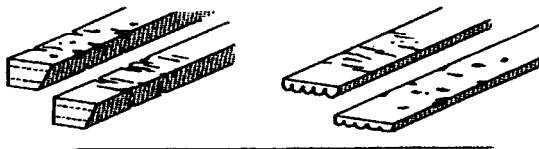

The Electrolyte
level should be
between the two
lines.

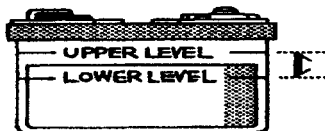

Checking the engine coolant level...

Look at the see through coolant reservoir tank. The coolant level is satisfactory if the level is between the 'Full' and the 'Low' lines on the tank.

The coolant level in the reservoir tank will vary with the engine temperature. However if the level is on or below the 'Low' line add coolant until the line is on the 'Full' line.

Always replace with the same kind of coolant already in the radiator. If the coolant level drops within a short time after refilling. There may be a leak in the system. Visually check the radiator cap, plug, hoses, and the water pump for any leaks. If no leaks can be found have the radiator cap pressure tested by your dealer.

To prevent burning yourself, do not remove the cap when the engine is hot.

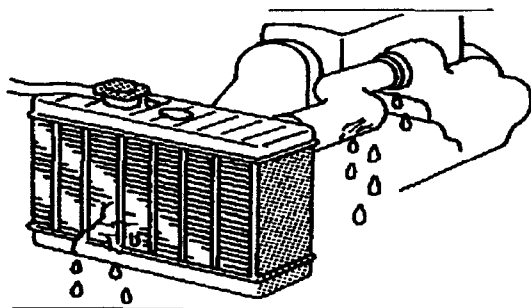
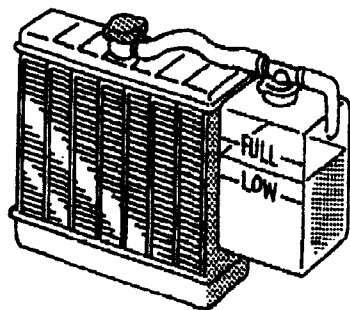

Checking the lights around your vehicle...

Turn the ignition switch on to ACC or start the engine before checking the lights around the vehicle.

Lights to check are:

- Indicators
- Main headlights: Check for brightness cracks, level and make sure the lights are clean.
- Hazard
- Number Plate: Check for blown bulbs etc and make sure they are clean.

Check that all the reflectors are clean and that there are no cracks, broken lenses etc. Also check for any fading of the colours in the lights. ie stop, indicator, reflectors

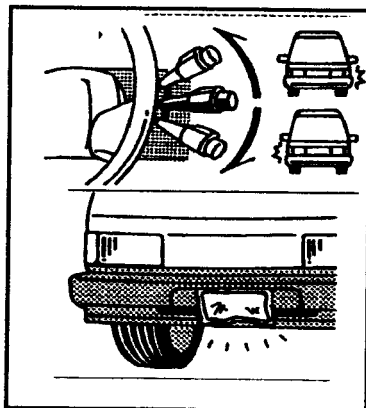
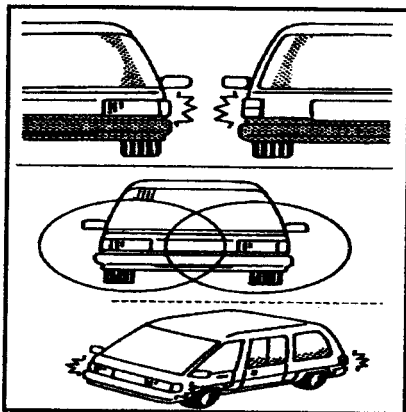

TYRE INFORMATION...

Replacement: When replacing tyre and Rims use only the same size and construction as originally installed. Should you wish to replace with another brand, it is advised to check with your dealer first. As some makes and sizes can seriously affect the handling of the vehicle.

When replacing tyres it is recommended to replace all four at the same time to create even wear, or at least the same on each axle and the tyres should be of the same load capacity, diameter, rim width, and offset.

Tyre pressure: You should check the tyre pressure at least once a month, including the spare. Tyre pressure levels are stated earlier in the book.

Low tyre pressure: Results in excessive wear poor handling, reduced fuel economy and the possibility of blowouts from overheated tyres. There is also the possibility of wheel deformation and/or tyre separation. Should your tyre need constant refilling have it checked by your dealer.

High tyre pressure: Produces a harsh ride, handling problems, excessive wear on the center of the tyre tread, and a greater possibility of tyre damage from road hazards.

Parking: When parking check that your tyres are not pressed against the kerb or other objects.

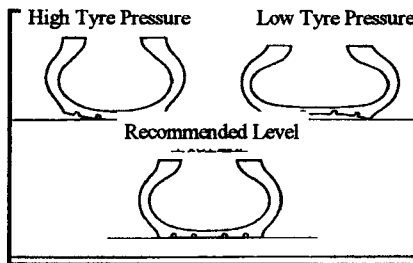

Tyre Check...

The tyres on your vehicle have built in tread wear indicators to help you know when the tyres need replacement. When the tread depth wears to 1.6mm or less the indicators will appear. If you can see the indicators in two or more adjacent grooves the tyres should be replaced.



Tyre Rotation: To equalize the wear of your tyres, we recommend rotating them every 5000 km. Including the spare tyre in your rotation will cause the tyres to last longer. When rotating tyres check for uneven wear, abnormal wear is usually caused by incorrect tire pressure.

Tyre Chains: Chains that will best suit your vehicle are available from your dealer. Only use on the rear wheels of the vehicle. Make sure that the chains are not too slack before driving. Do not drive over 50 km/hr with snow chains.

Brake line check...

To check the brake line, firstly turn the wheels to the right fully to expose the the inside of the right wheel. Check the brake hose pipe for any cracks or any leakage in the joint of the line. For best results feel the brake line hose pipe for any brake fluid that may be leaking out. If any brake fluid is leaking, take the vehicle to your dealer.

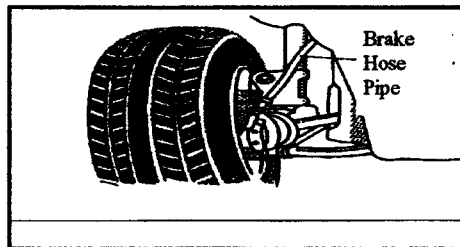

Testing the brakes for even application...

Drive the vehicle on an even surface at a reasonably slow speed (around 40km), Then apply the brake and see if the vehicle stops in a straight line, or pulls to the left or right. Should the vehicle pull either way take the vehicle to your dealer.

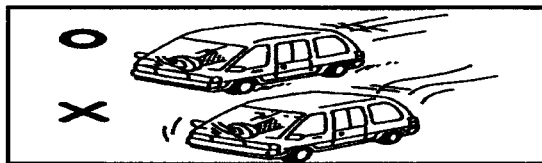

Battery Maintenance / Recharge...

The factory installed battery placed in this vehicle by the manufacturer is a non-maintenance battery and there is no need to check the fluid levels of the battery. However all batteries should be checked on a regular basis for loose cables or cracked cables and loose hold down clamps.

Should you have a normal battery installed in your vehicle. Check for corrosion and if any, wash off with a solution of baking soda and water. Care should be taken to prevent the solution from getting into the battery. Then coat the outside of the terminals with grease to prevent further corrosion.

If loose tighten the cables and /or the hold down clamps- but do not overtighten as this can place a strain on the battery casing and make the cables hard to take off again.

Check the electrolyte level of the battery and, if low add distilled water. When checking the electrolyte level check all 6 cells not just 1 or 2. Do not overfill as the electrolyte can squirt from the battery during periods of heavy charging, causing corrosion and damage to areas surrounding the battery. After topping up the battery make sure the covers are replaced securely.

Battery Recharging:

During recharging, the battery is producing hydrogen gas. Therefore before recharging remove the battery from the vehicle and disconnect the filler/ vent caps.

Be sure the power switch on the recharger is off before connecting the cables and again removing the cables when recharged.

If recharging the battery installed in the vehicle, be sure to disconnect the ground cable

Checking and replacing the air cleaner element / air cleaner dust cup...

To inspect the air cleaner element: Unscrew the wingnut and release the clips. Then remove the cover and take out the element. The wingnut may be unscrewed by hand and the wire clips will release by pulling their tabs. Inspect the upper surface of the element. If it is dirty replace it, if it is only moderately dirty it may be cleaned by a compressed air gun. Do not try to clean the element by washing or rinsing the element.

To clean the pre-air cleaner dust cup: Lift the wire tab to remove each clip, remove the dust cup and clean it thoroughly.

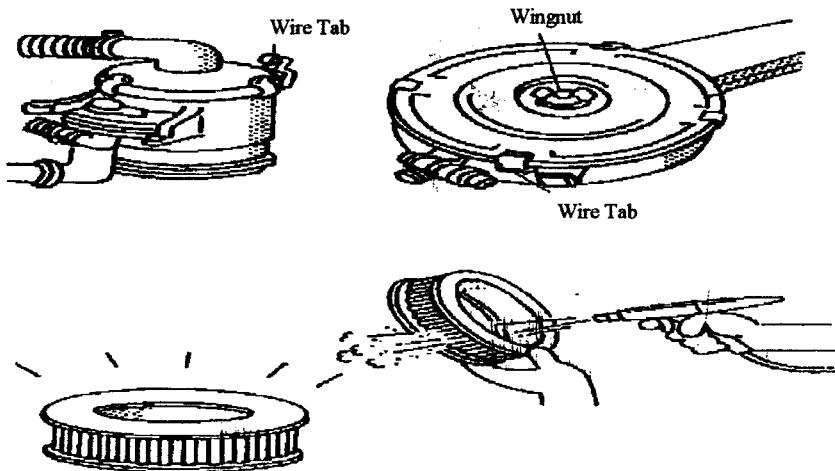

Changing the engine coolant...

Drain the the cooling system and flush it out with water: Park the vehicle on an even surface and place a suitable container to drain the old coolant into. Remove the the radiator cap (but do not do this if the engine is hot). Then loosen the 2 radiator drain plugs.

Re-filling the system: Close the two drain plugs and fill the system again with anti-freeze and water. Then replace the radiator cap and secure tightly.

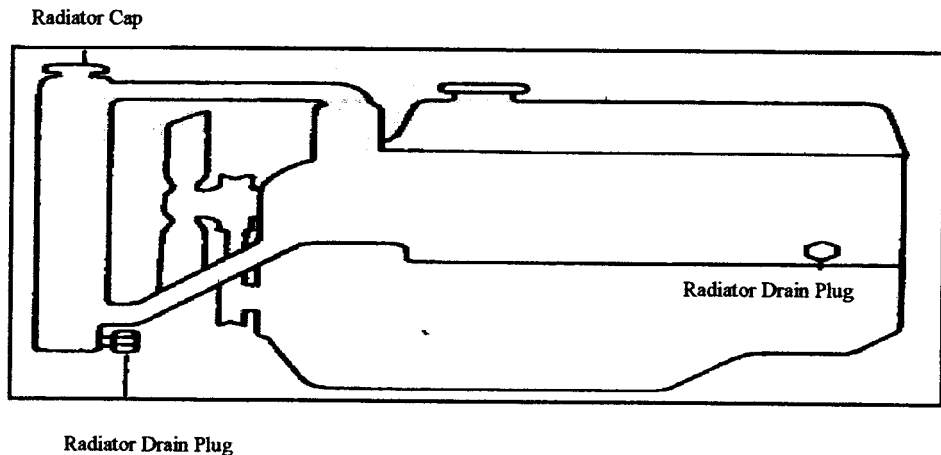

Automatic Transmission Oil Level...

Checking levels of the automatic transmission is strongly advised.

Check the fluid level only when the transmission is hot (normal operating temperature) . With the vehicle level, first set the parking brake and then start the engine. While the engine is idling, depress the brake pedal and shift the selector into each range through to the lowest gearing and back again (this is to help give a true reading) .

If the vehicle has been driven over 15 km the transmission is hot (it should be around 70~80 degrees.

You may check the level when the vehicle is cold. If the vehicle has not been driven for 5 hours or more and the transmission oil is around 20~30 degrees. However checking the levels when the vehicle is cold will not give a true indicator of the oil levels of your vehicle.

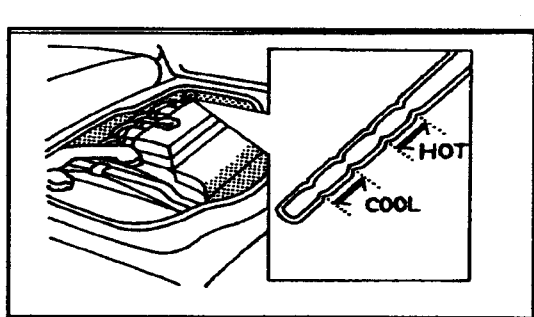

MIN MAX MIN MAX

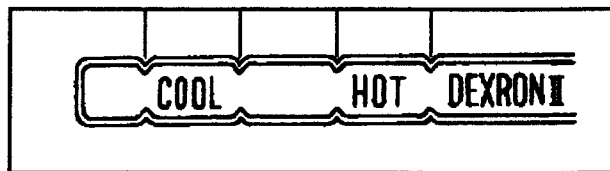

Replacing the windshield / headlight wiper blades...

After the a harsh winter especially where salt is used to melt the snow on the roads or a particularly hot summer the wiper blades can deteriorate substantially.

To remove: Pull the top end of the rubber blade inward until the rubber blade is free and you can see the end slot. Then pull the rubber blade out of the replacement hole.

To Replace: Insert the end with small protrusions into the replacement hole and work the rubber along the slot into the blade frame.

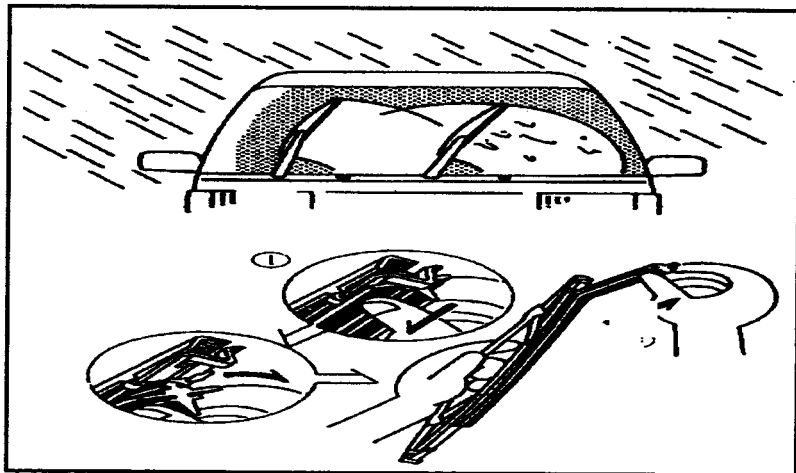

Adding washer fluid...

If any washer does not work, the washer tank may be empty.

You may use plain water as washer fluid. However, in cold areas where the temperature reaches below freezing point, you will need to use fluid containing anti-freeze. This product is available from your dealer or most auto part stores. Follow the manufactures instructions on directions for how much water to add, however the following can be used as a basic guide:

Temperature degrees:

- 10 1 part anti freeze washer / 2 parts water**
- 20 1 part anti freeze washer / 1 part water**
- 20 and below only anti freeze**

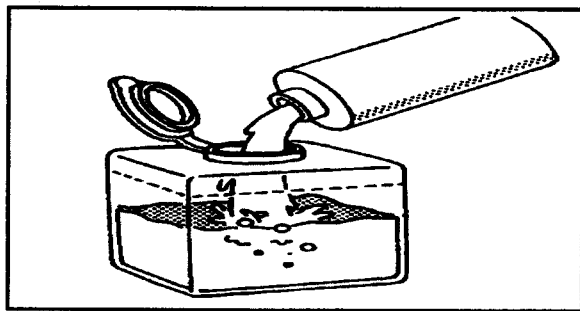

NOTES

A large empty rectangular box intended for taking notes.

A

ABS.....	60
Air bags.....	35, 36
Air cleaner.....	131
Air conditioning.....	67~78
Air Vents.....	68
Antenna.....	93
Ash Tray.....	63
Audio.....	80~93
Auto Transmission.....	11~14, 53, 57

B

Battery.....	38, 130
Bonnet.....	24
Boot.....	25
Brakes.....	123
Brake pedal.....	122

C

CD changer.....	83
-----------------	----

Child restraint.....	15
Clock.....	65
Clutch pedal.....	52, 122
Clutch/ Brake fluid.....	123
Console.....	64
Coolant level.....	132

D

Defogger.....	47
Door Mirrors.....	37,38
Doors.....	19, 20
Drive belts.....	111

E

Emergencies.....	99~107
Engine starting.....	51
Exterior care.....	115

INDEX

F

Flat tyre.....	102
Fog lamp.....	48
Fuel cap.....	23
Fuel meter.....	38
Fuses.....	105, 106

G

Gas Air Con.....	78
Glove box.....	64

H

Hazards.....	48
Head lights.....	43, 44

I

Ignition.....	50
Illuminated entry.....	65
Indicators.....	44

Indication lights.....	39~42
Invecs-II.....	53

J

Jack.....	100
Jump starting.....	103

K

Keys.....	19, 21
-----------	--------

L

Lighter.....	63
Light bulbs.....	110
Lights.....	43, 44

M

Maintenance.....	115~135
Manual Transmission.....	52
Meters.....	37~39
Mirrors.....	59
MIVEC engine.....	52

O

Odometer.....	107
Oil/ fluid levels.....	123
Oil pressure.....	41
Over heat.....	38

P

Park brake.....	51
Power windows.....	22

R

Rear veiw mirrors.....	59
Rear wiper & washer.....	46
Rear deffoger.....	47
Remote control.....	21

S

Safety.....	5~10
Seats.....	29~31
Seat belts.....	32~34
Service data.....	109~114
Snow chains.....	96
Spare tyre.....	100
Speedometer.....	48
SRS.....	35, 36
Sun roof.....	26, 27
Sun roof (power).....	26
Sun roof (manual).....	27
Sun shade.....	26
Sun visor.....	65
Steering.....	58

INDEX

T

Tachometer.....	38
TCL.....	61
Temperature gauge.....	38
Tilt steering wheel.....	58
Tools.....	100
Towing.....	104
Transmission fluid.....	133
Trip meter.....	38
Tyres.....	113
Tyre rotation.....	128

V

Vanity mirror.....	65
Vents.....	68
Vehicle service.....	115~135

W

Warnings.....	16~17
Warning lights.....	39~42
Washer reserve.....	46
Washer fluid.....	135
Wiper blade.....	134
Winter preparation.....	95