

M - VACUUM DIAGRAMS

1998 Mitsubishi Galant

1998 ENGINE PERFORMANCE
Mitsubishi - Vacuum Diagrams

Diamante, Eclipse, Galant, Mirage, Montero, Montero Sport,
3000GT

INTRODUCTION

This article contains underhood views or schematics of vacuum hose routing. Use these vacuum diagrams during the visual inspection in F - BASIC TESTING article. This will assist in identifying improperly routed vacuum hoses, which cause driveability and/or computer-indicated malfunctions.

NOTE: California and Federal applies to installed emission equipment, which may be verified by underhood Emission Control label. California emissions may be available in other states.

NOTE: Always refer to Emission Control label in engine compartment before attempting service. If manual and label differ, always use emission label specifications.

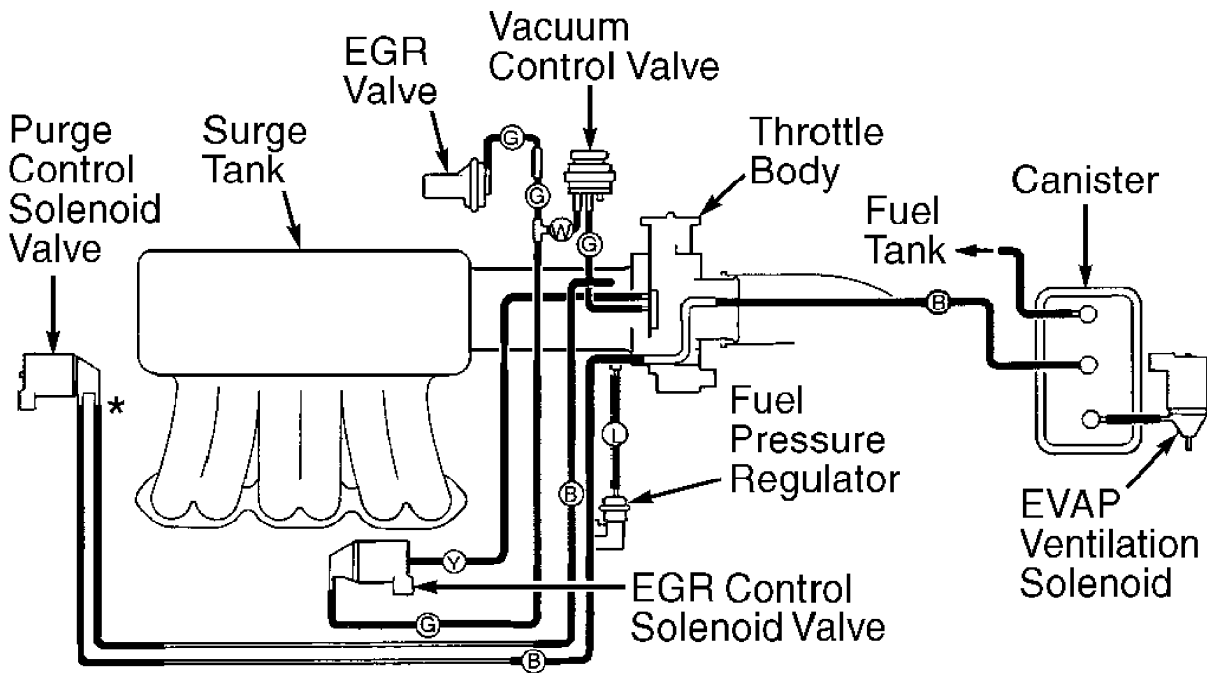

B: Black L: Light Blue W: White *: Red Paint Mark
G: Green R: Red Y: Yellow

98J12566

Fig. 1: Vacuum Diagram (Diamante)
Courtesy of Mitsubishi Motor Sales of America

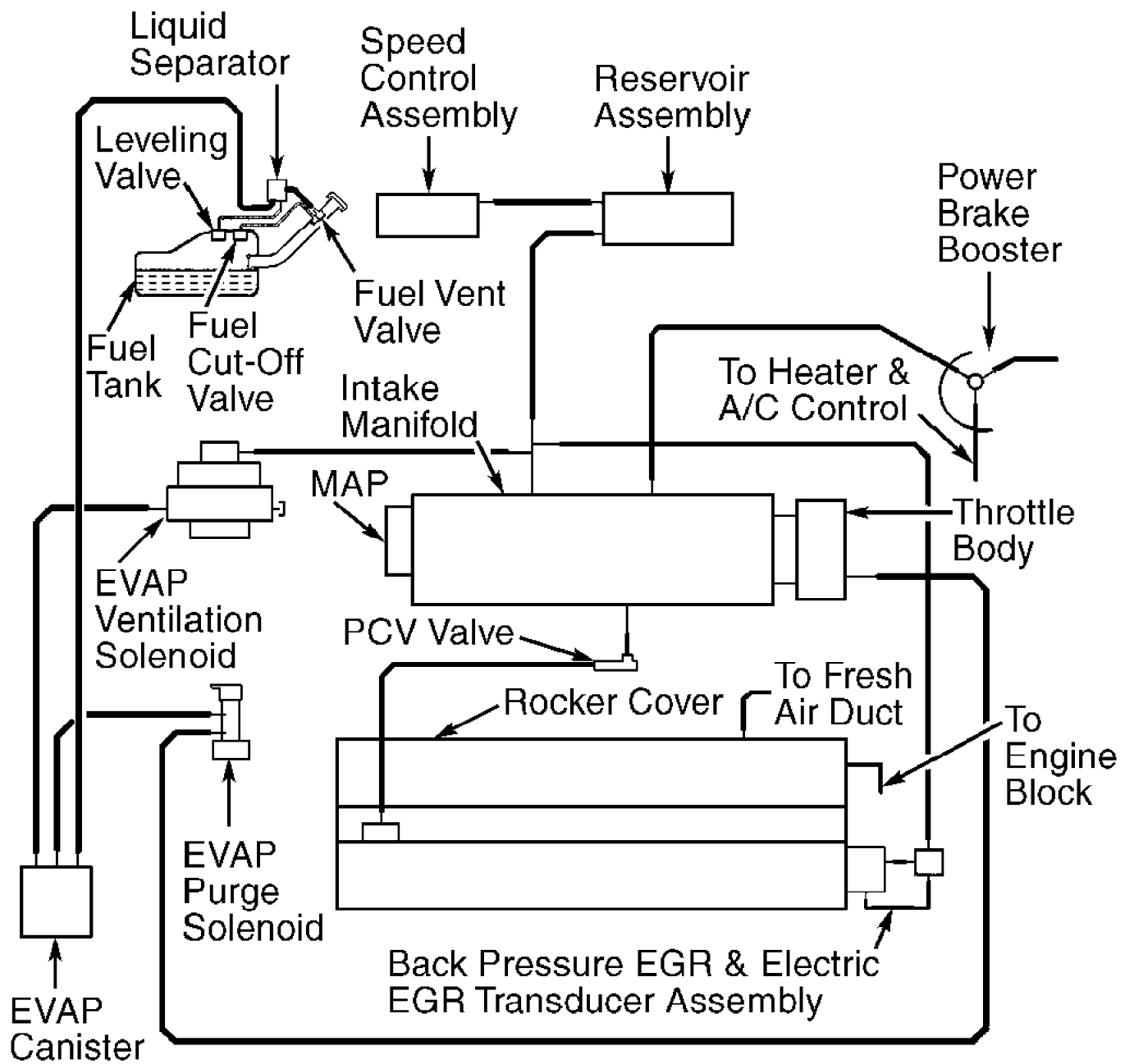

98A12567

Fig. 2: Vacuum Diagram (Eclipse 2.0L Non-Turbo)
 Courtesy of Mitsubishi Motor Sales of America

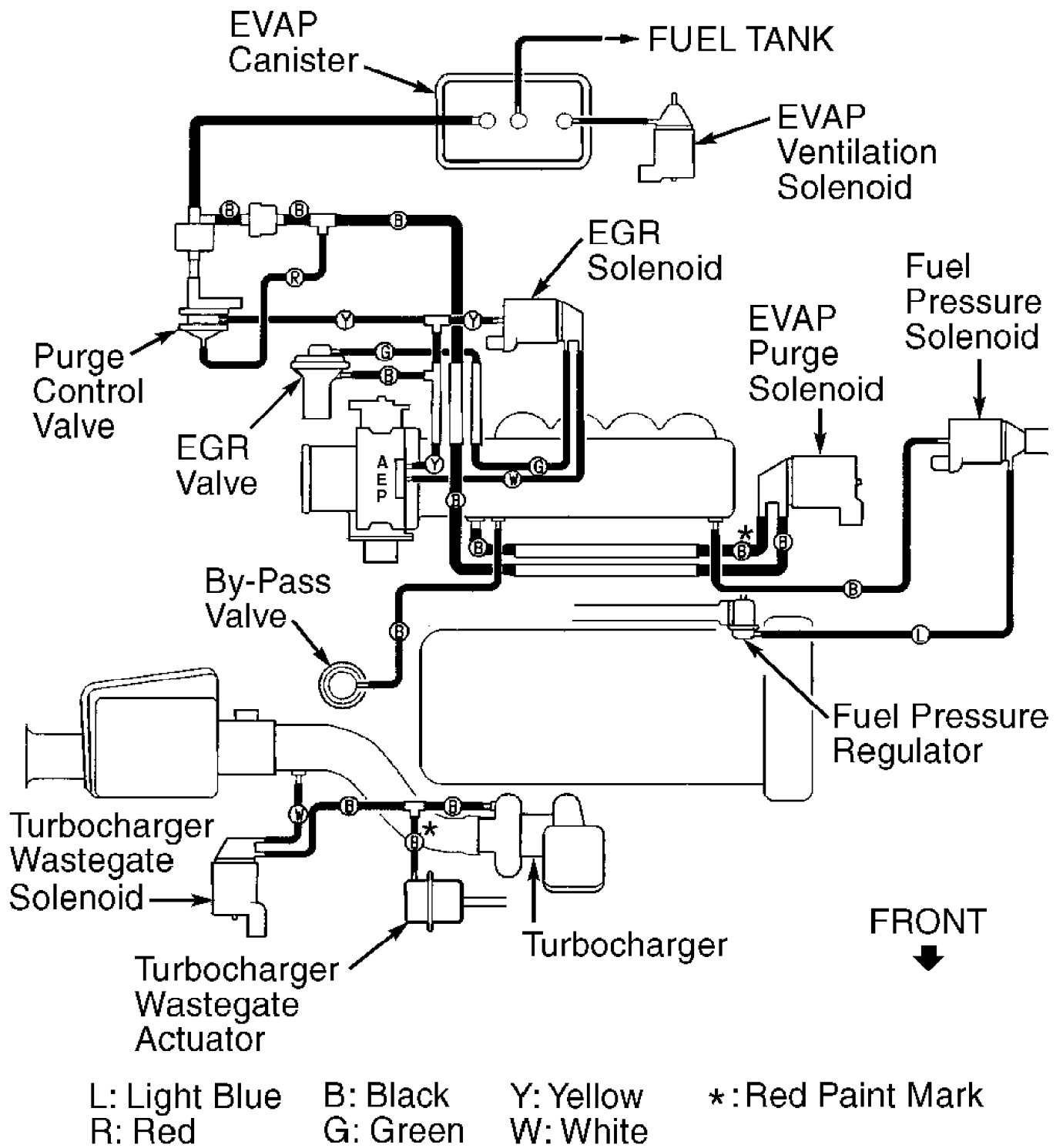

98B12568

Fig. 3: Vacuum Diagram (Eclipse 2.0L Turbo)
 Courtesy of Mitsubishi Motor Sales of America

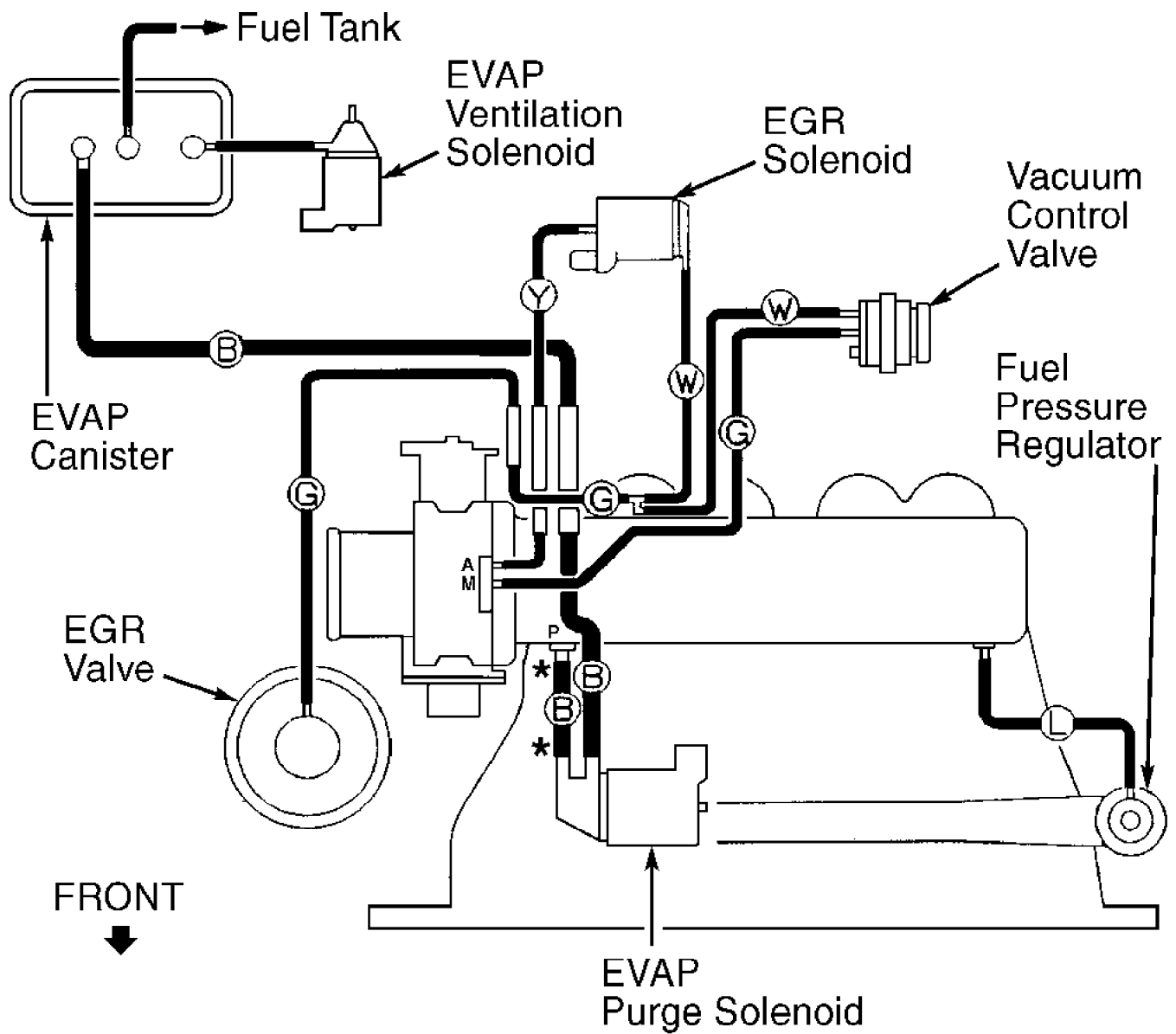

L: Light Blue B: Black Y: Yellow *: Red Paint Mark
 R: Red G: Green W: White

98C12569

Fig. 4: Vacuum Diagram (Eclipse 2.4L)
 Courtesy of Mitsubishi Motor Sales of America

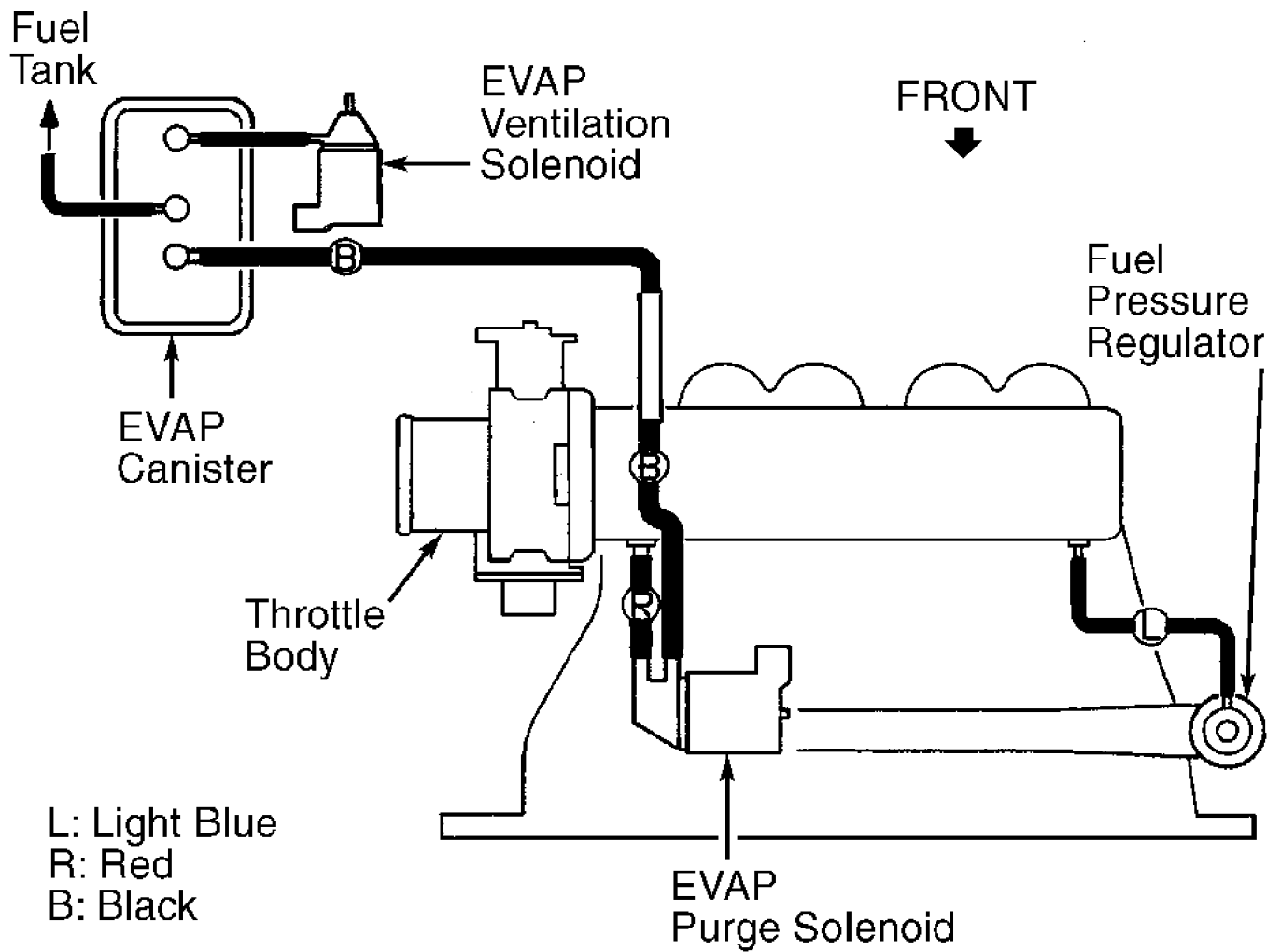

98F12570

Fig. 5: Vacuum Diagram (Galant - California)
Courtesy of Mitsubishi Motor Sales of America

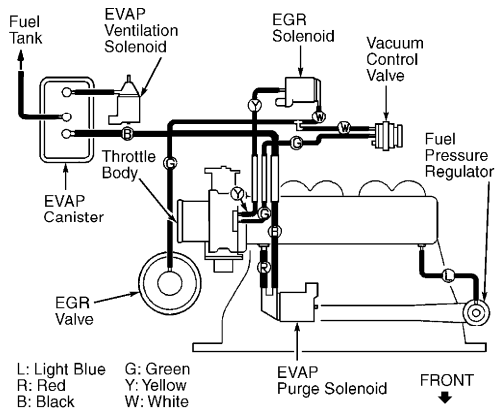

98G12571

Fig. 6: Vacuum Diagram (Galant - Federal)
Courtesy of Mitsubishi Motor Sales of America

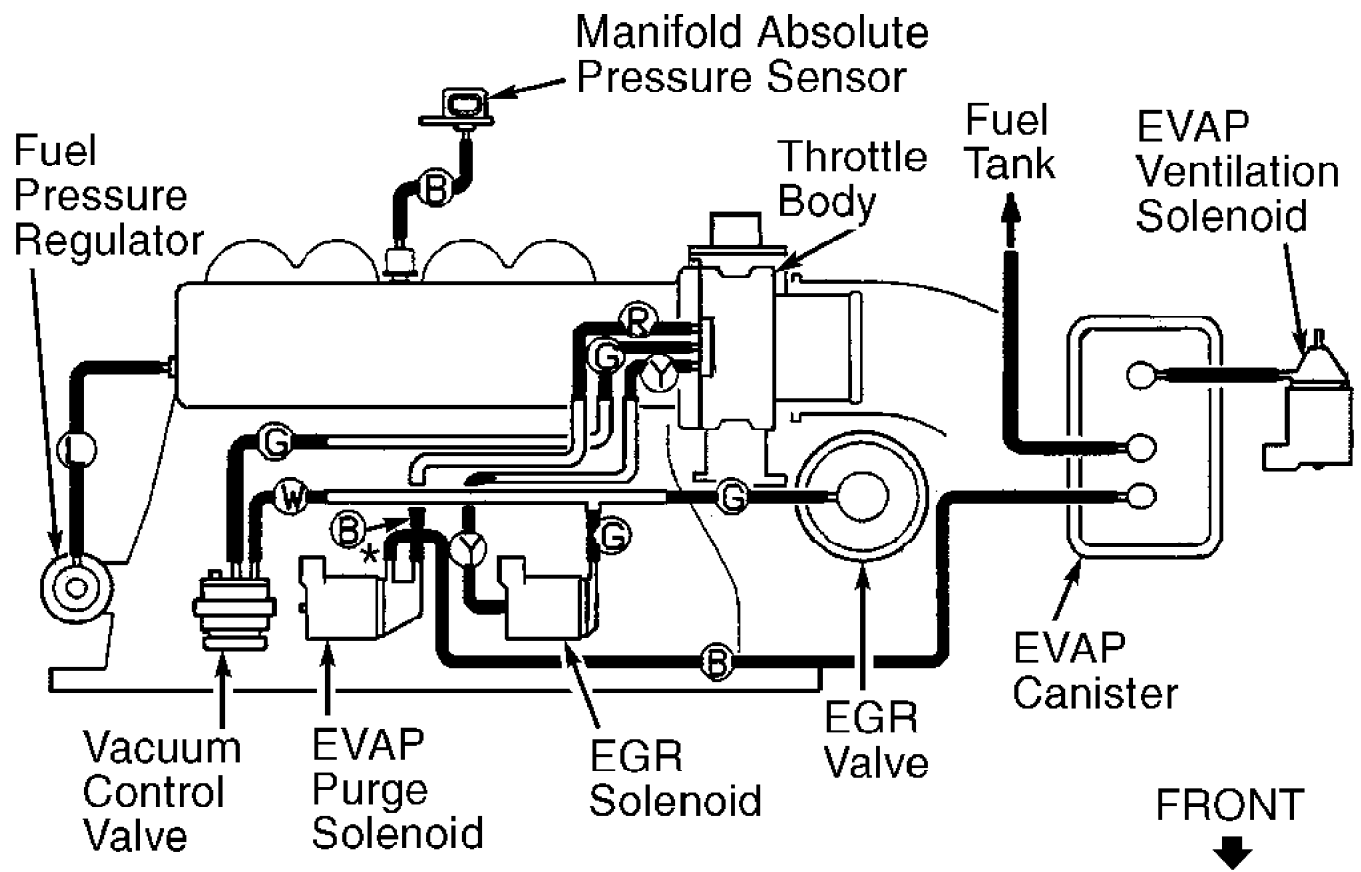

L: Light Blue B: Black Y: Yellow * : Red Paint Mark
 R: Red G: Green W: White

98H12572

Fig. 7: Vacuum Diagram (Mirage 1.5L)
 Courtesy of Mitsubishi Motor Sales of America

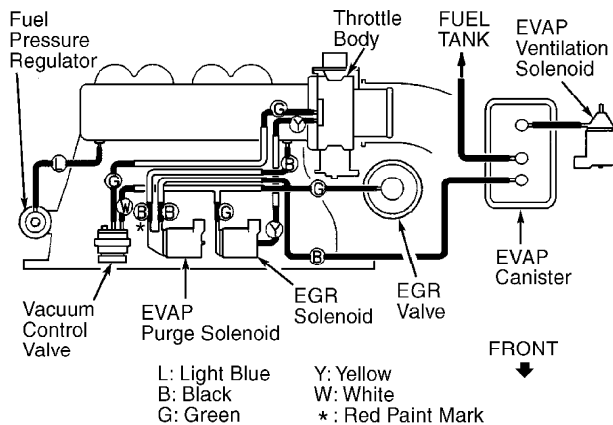

L: Light Blue Y: Yellow
 B: Black W: White
 G: Green * : Red Paint Mark

98H12573

Fig. 8: Vacuum Diagram (Mirage 1.8L)
 Courtesy of Mitsubishi Motor Sales of America

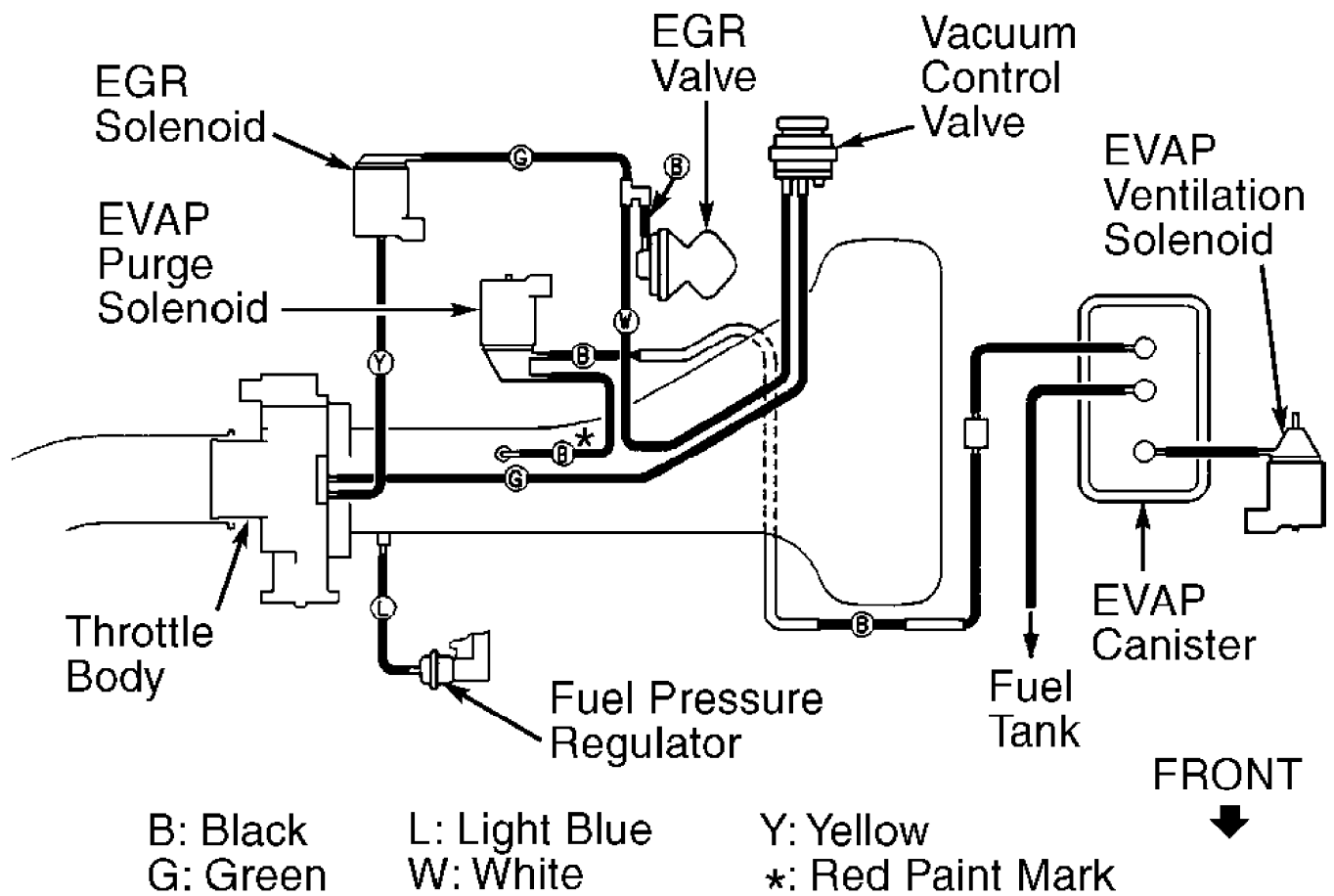

98J12574

Fig. 9: Vacuum Diagram (Montero)
 Courtesy of Mitsubishi Motor Sales of America

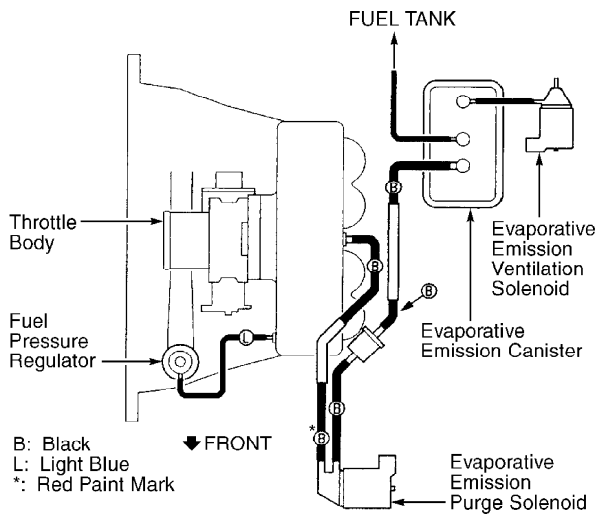

97J07058

Fig. 10: Vacuum Diagram (Montero Sport 2.4L - California)
 Courtesy of Mitsubishi Motor Sales of America

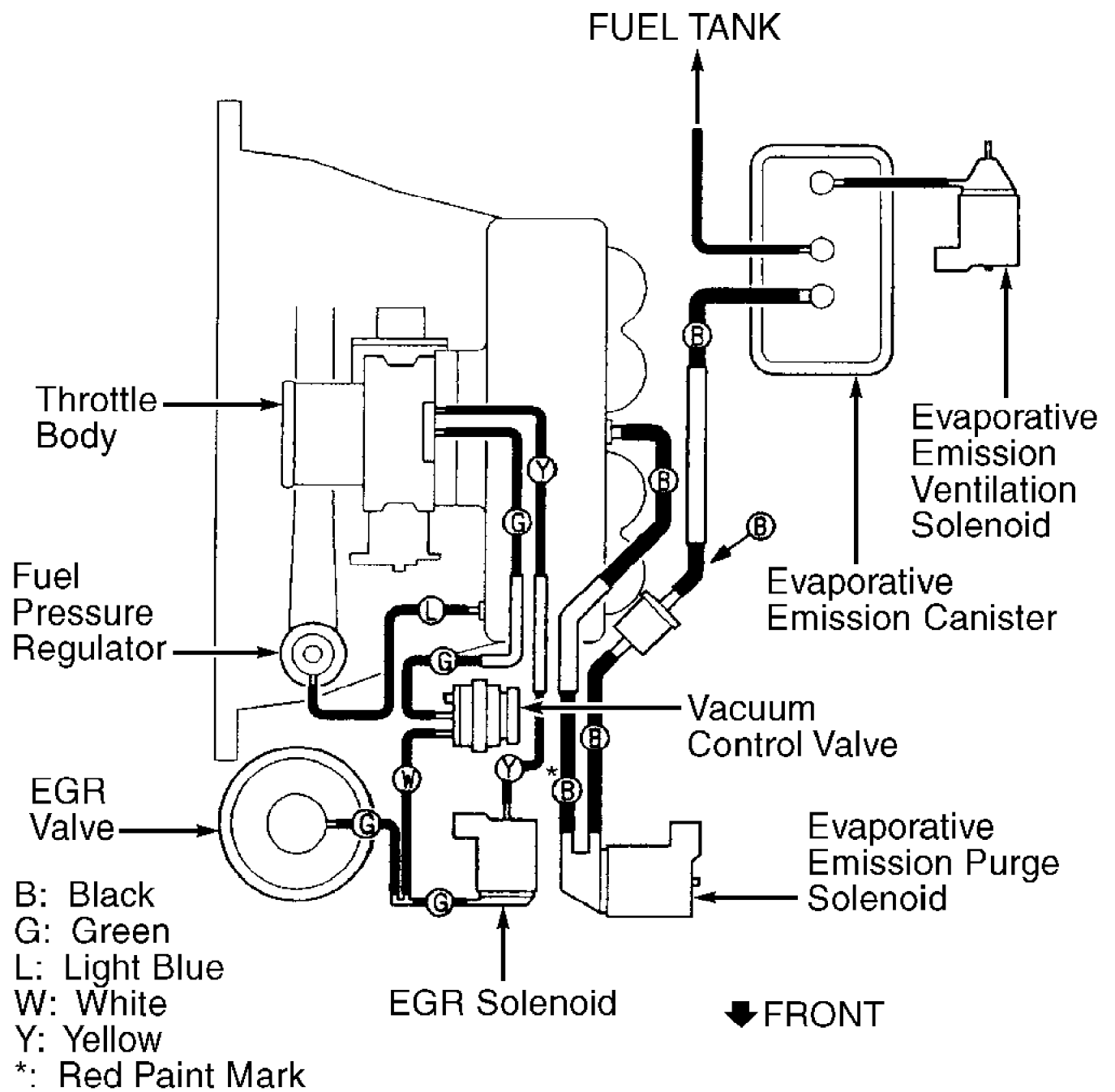

97B07059

Fig. 11: Vacuum Diagram (Montero 2.4L - Federal)
 Courtesy of Mitsubishi Motor Sales of America

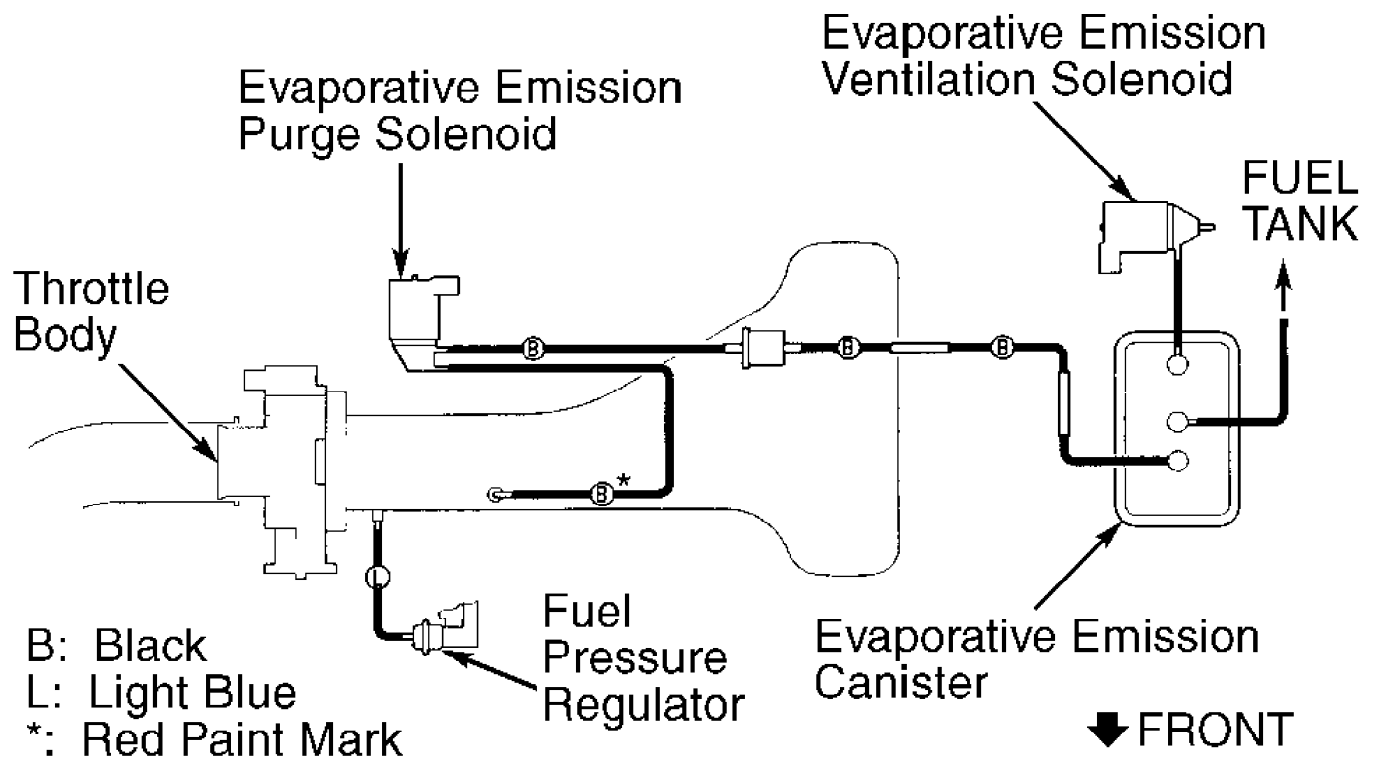

97D07060

Fig. 12: Vacuum Diagram (Montero Sport 3.0L - California)
Courtesy of Mitsubishi Motor Sales of America

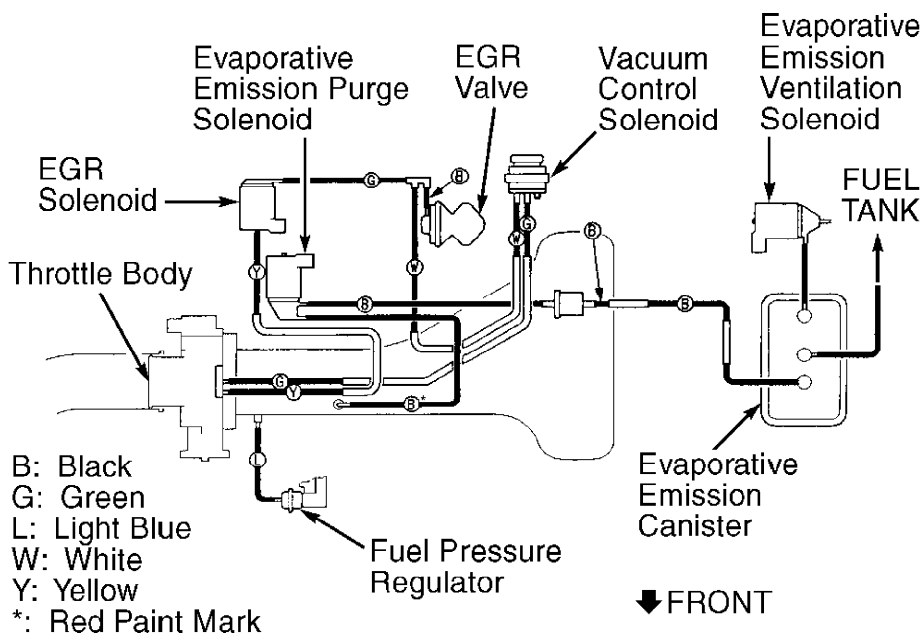

97F07061

Fig. 13: Vacuum Diagram (Montero Sport 3.0L - Federal)
Courtesy of Mitsubishi Motor Sales of America

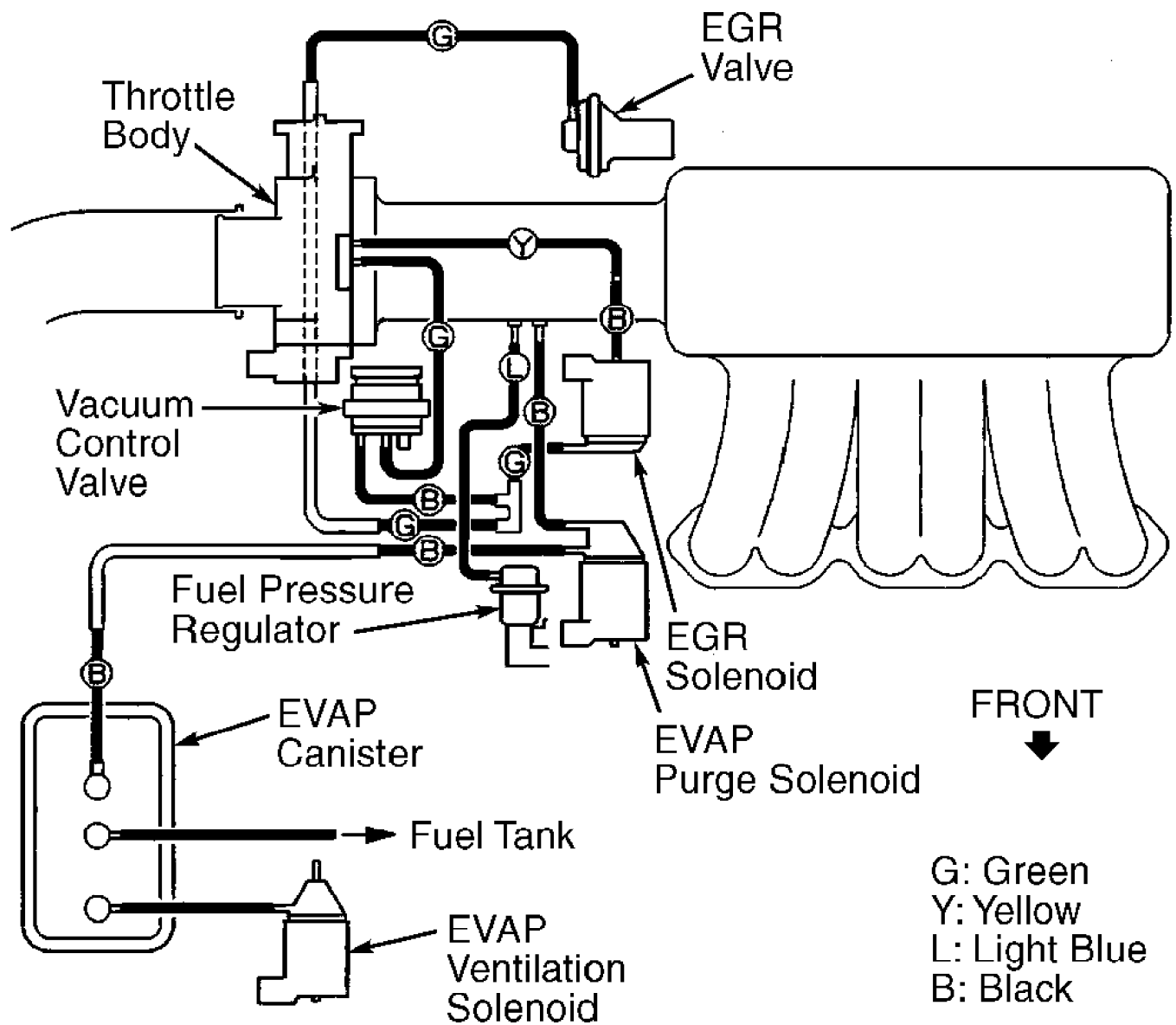

98A12575

Fig. 14: Vacuum Diagram (3000GT SOHC)
 Courtesy of Mitsubishi Motor Sales of America

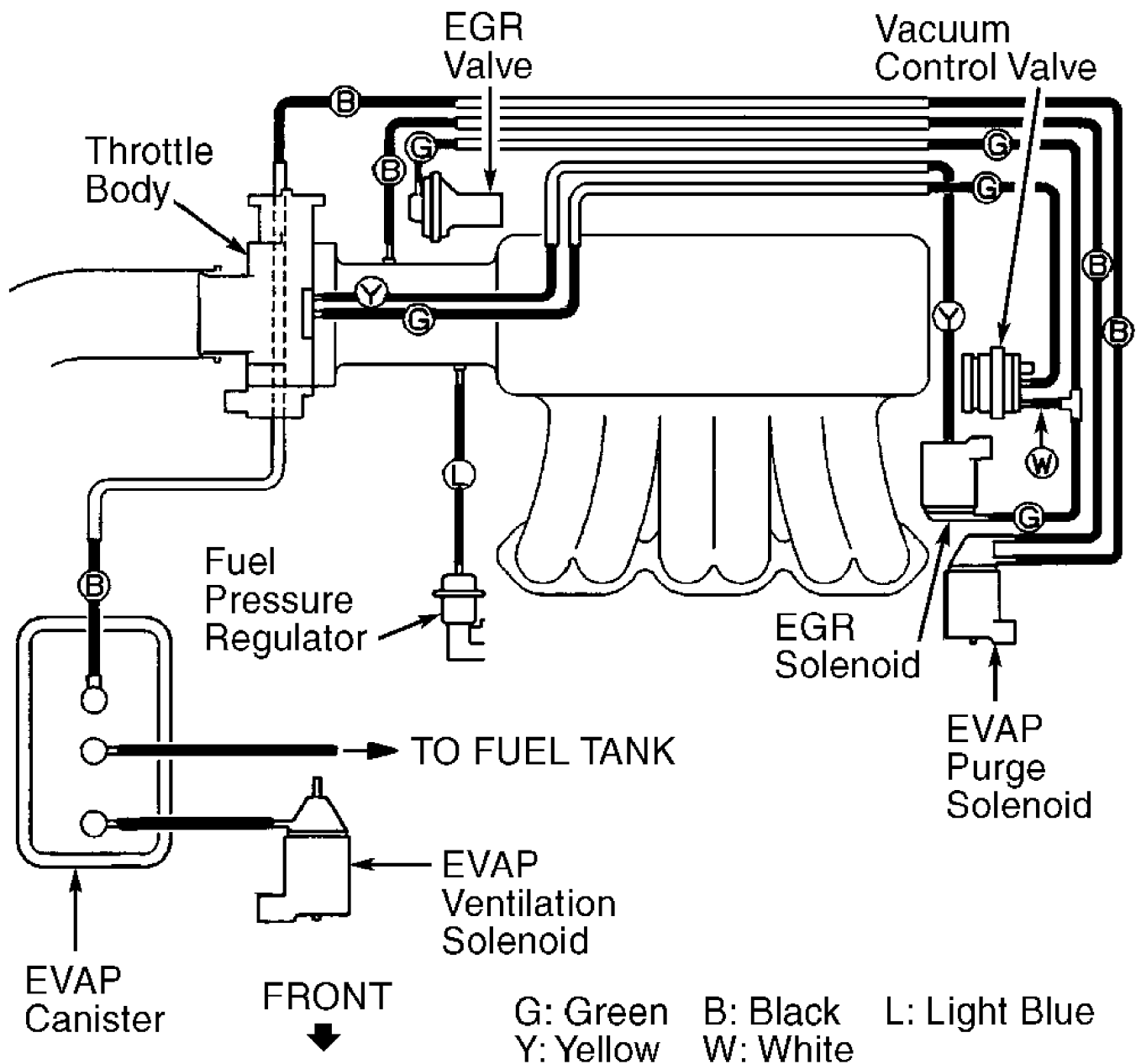

98B12576

Fig. 15: Vacuum Diagram (3000GT DOHC Non-Turbo)
 Courtesy of Mitsubishi Motor Sales of America

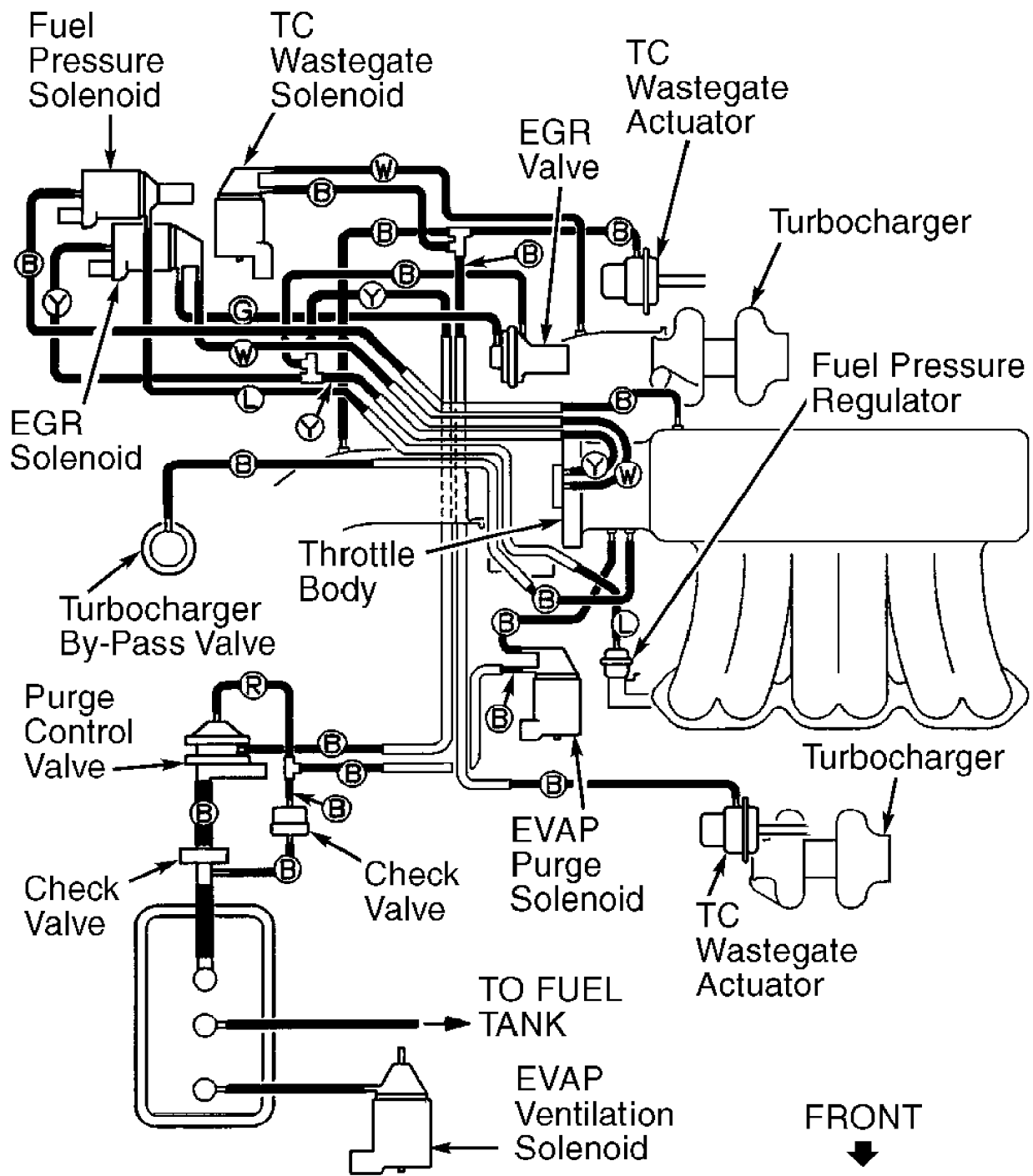

98C12577

Fig. 16: Vacuum Diagram (3000GT DOHC Turbo)
 Courtesy of Mitsubishi Motor Sales of America