

---

# CIRCUIT DIAGRAMS

## CONTENTS

<b>INVECS-II 4A/T</b>	
4G1 engine .....	4-2
<b>TAIL LAMP, POSITION LAMP, LICENCE PLATE LAMP AND LIGHTING MONITOR BUZZER</b>	
Vehicles without daytime running lamp .....	4-10
Vehicles with daytime running lamp .....	4-14
<b>FRONT FOG LAMP</b>	
Vehicles without daytime running lamp .....	4-18
Vehicles with daytime running lamp .....	4-20
<b>REAR FOG LAMP</b>	
Vehicles without daytime running lamp .....	4-22
Vehicles with daytime running lamp .....	4-26
<b>ROOM LAMP, MAP LAMP AND LUGGAGE COMPARTMENT LAMP</b>	
Vehicles without keyless entry system .....	4-30
Vehicles with keyless entry system .....	4-32
<b>TURN-SIGNAL LAMP AND HAZARD WARNING LAMP .....</b>	<b>4-34</b>
<b>STOP LAMP .....</b>	<b>4-37</b>
<b>BACK-UP LAMP</b>	
Petrol-powered vehicles .....	4-38
Diesel-powered vehicles .....	4-39
<b>METER AND GAUGE</b>	
Petrol-powered vehicles .....	4-40
Diesel-powered vehicles .....	4-44
<b>CENTRAL DOOR LOCKING SYSTEM</b>	
Vehicles without keyless entry system .....	4-46
Vehicles with keyless entry system .....	4-48
<b>HEATER .....</b>	<b>4-54</b>
<b>MANUAL AIR CONDITIONER</b>	
4G1 engine .....	4-56
F9Q1 engine .....	4-60
<b>REAR WIPER AND WASHER .....</b>	<b>4-64</b>
<b>DEFOGGER AND DOOR MIRROR HEATER</b>	
L.H. drive vehicles .....	4-66
R.H. drive vehicles .....	4-68
<b>REMOTE CONTROLLED MIRROR .....</b>	<b>4-70</b>
<b>CIGARETTE LIGHTER .....</b>	<b>4-71</b>
<b>MULTI CENTER DISPLAY</b>	
Vehicles without navigation system .....	4-72
Vehicles with navigation system .....	4-78
<b>SUNROOF .....</b>	<b>4-86</b>
<b>HEATED SEAT .....</b>	<b>4-88</b>
<b>SUPPLEMENTAL RESTRAINT SYSTEM ..</b>	<b>4-90</b>

---

INVECS-II 4A/T

4G1 engine

1

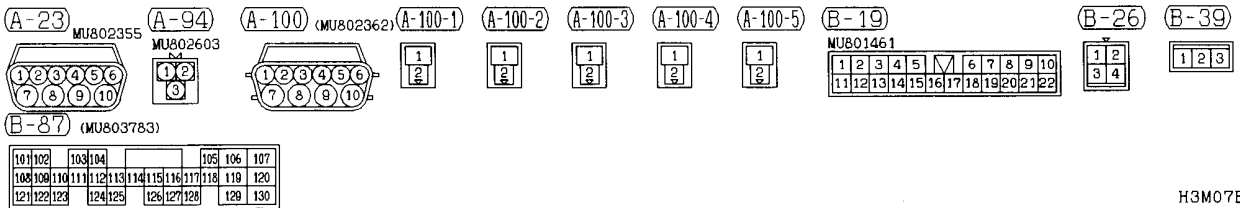
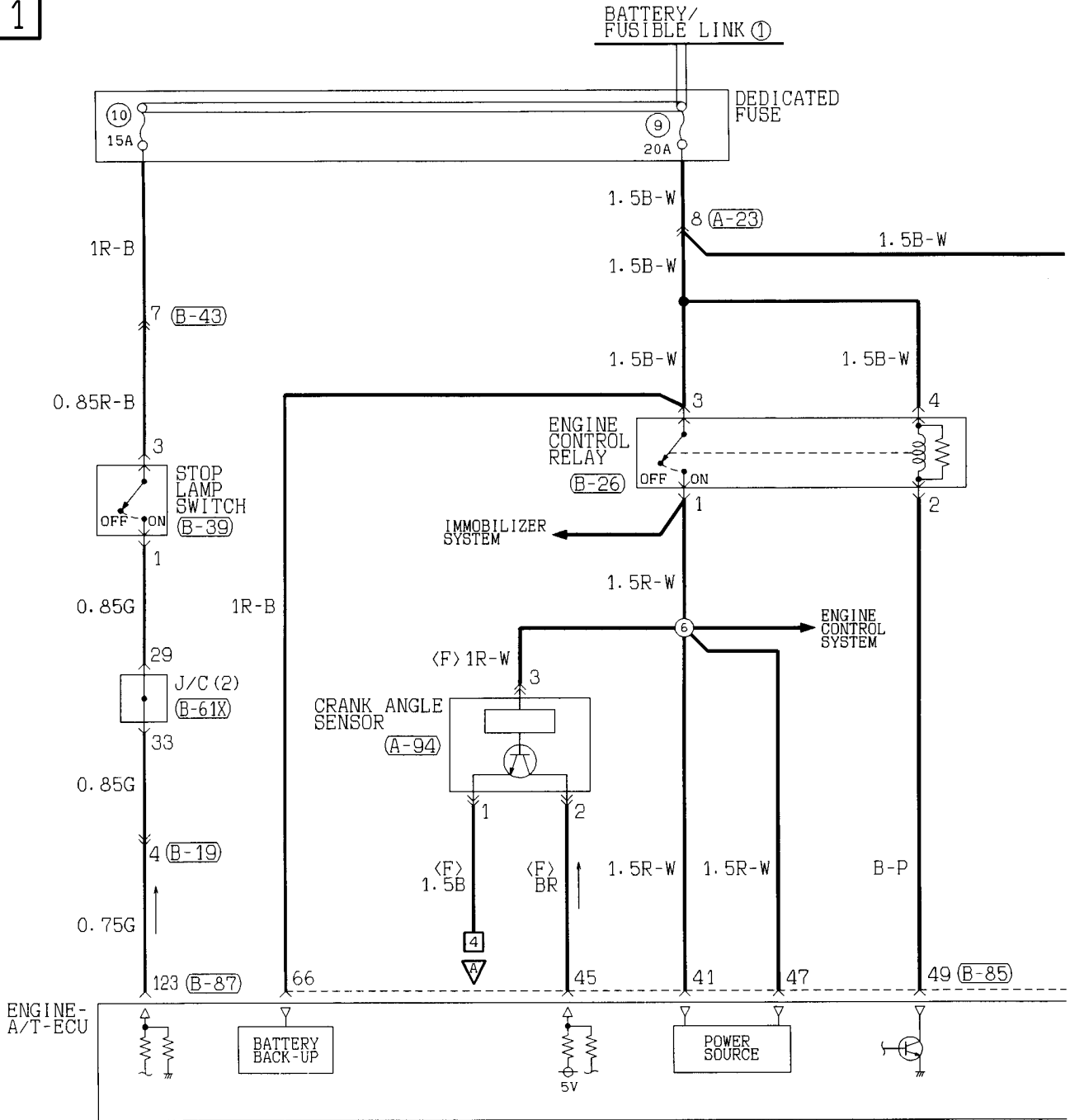

2

NOTE  
 \*1: UNDERDRIVE SOLENOID VALVE  
 \*2: SECOND SOLENOID VALVE  
 \*3: OVERDRIVE SOLENOID VALVE  
 \*4: DAMPER CLUTCH CONTROL SOLENOID VALVE  
 \*5: LOW AND REVERSE SOLENOID VALVE

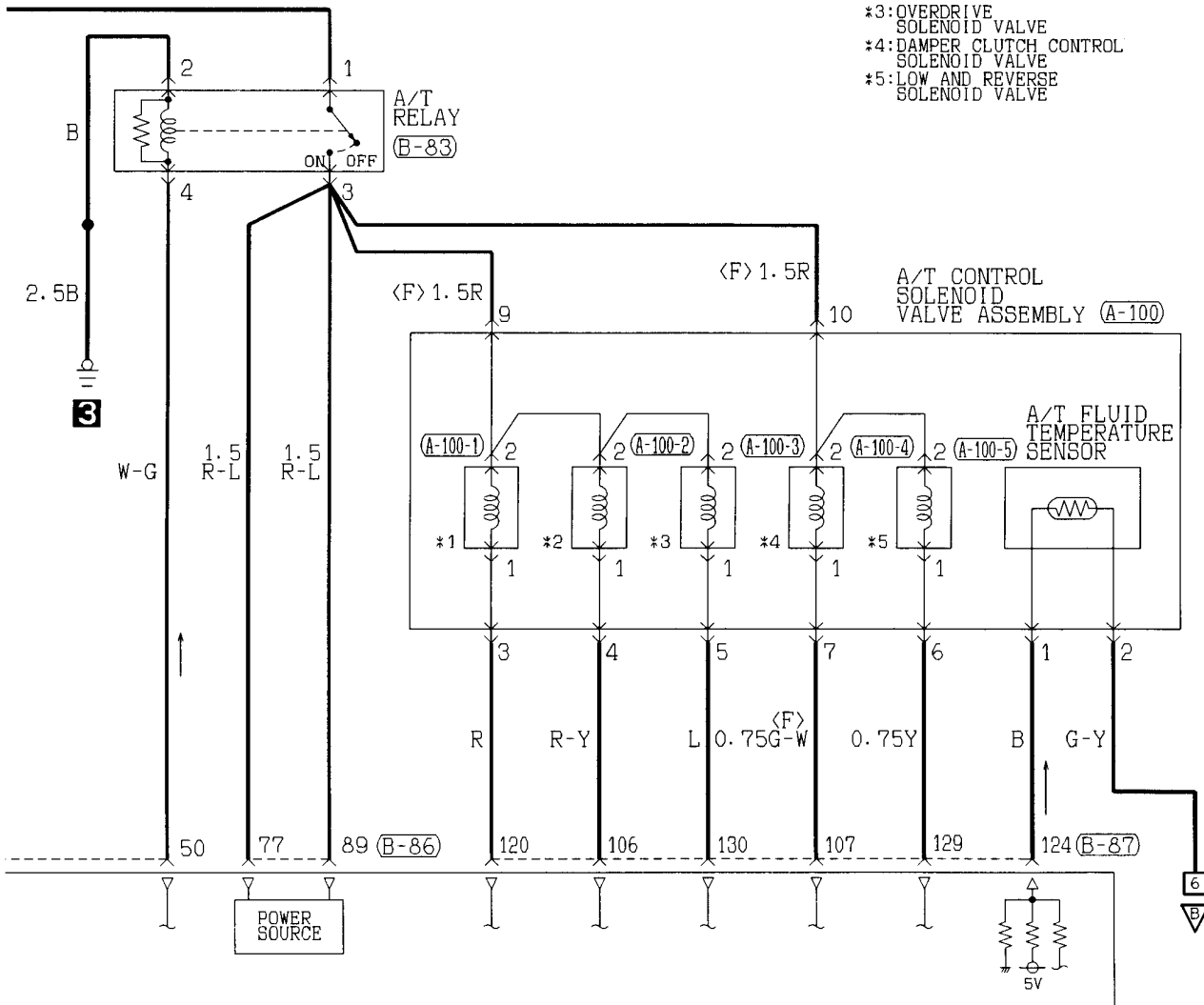

(B-43)

1	2	3	4	5	6	7	8	9	10
11	12	13	14	15	16	17	18	19	20
21	22								

(B-61X)

1	2	3	4	5	6	7	8	9	10	11
12	13	14	15	16	17	18	19	20	21	22
23	24	25	26	27	28	29	30	31	32	33

(B-83)

1	2
3	4

(B-85) (MU803781)

41	42	43		44	45	46
47	48	49	50	51	52	53
54	55	56	57			
58	59	60	61	62	63	64
65	66					

(B-86) (MU803782)

71	72	73	74		75	76	77
78	79	80	81	82	83	84	85
86	87	88	89				
90	91	92	93	94	95	96	97
98							

Wire colour code

B : Black LG: Light green G : Green L : Blue W : White Y : Yellow SB: Sky blue  
 BR: Brown O : Orange GR: Gray R : Red P : Pink V : Violet

INVECS-II 4A/T <4G1 engine> (CONTINUED)

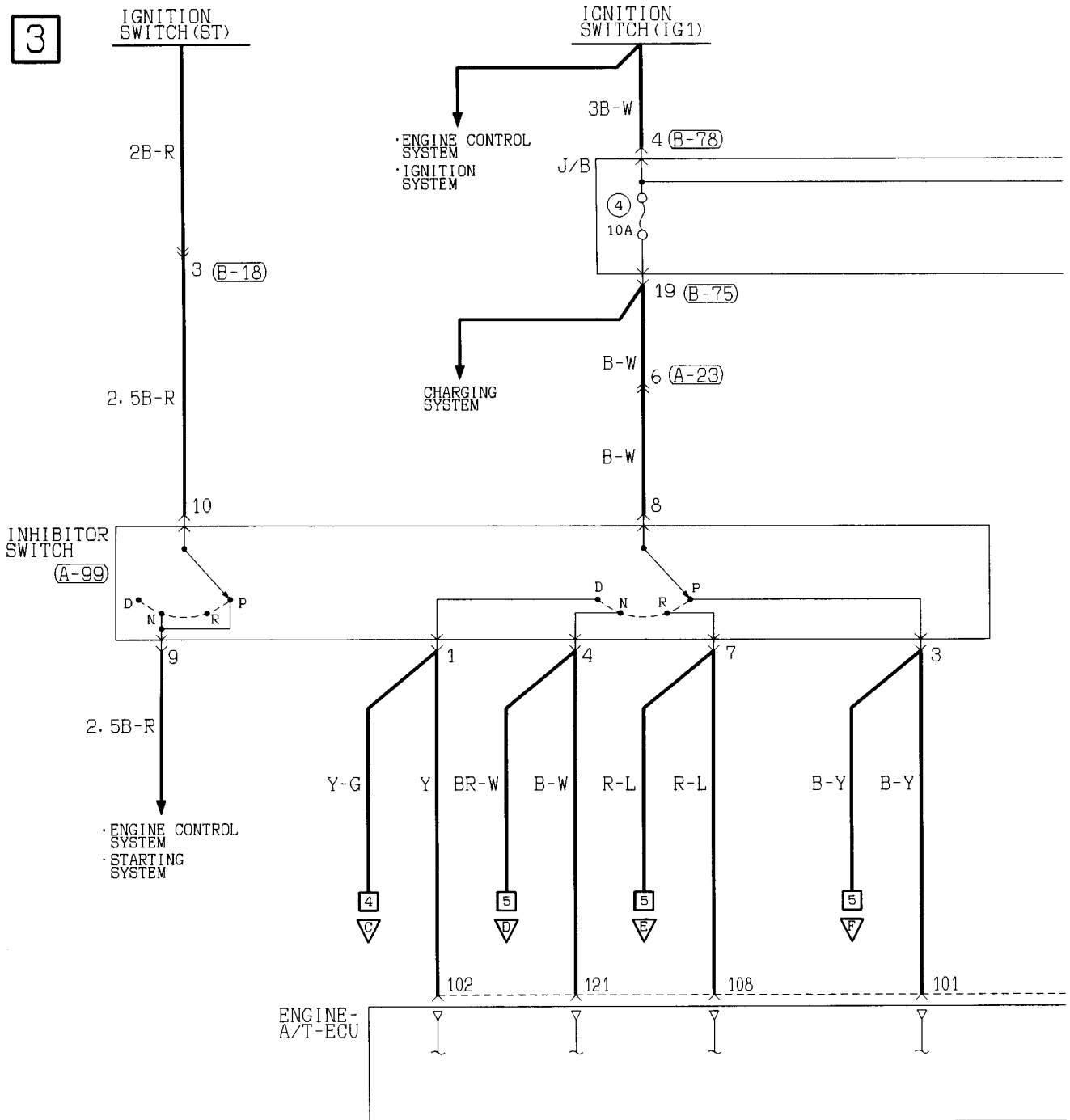

(A-23)  
MU802355

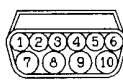

(A-97)  
(MU802348)



(A-98)  
MU802337



(A-99)  
MU802355

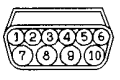

(B-18)  
MU801329



(B-75)  
MU801457

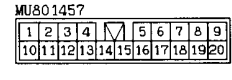

(B-78)

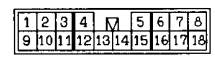

4

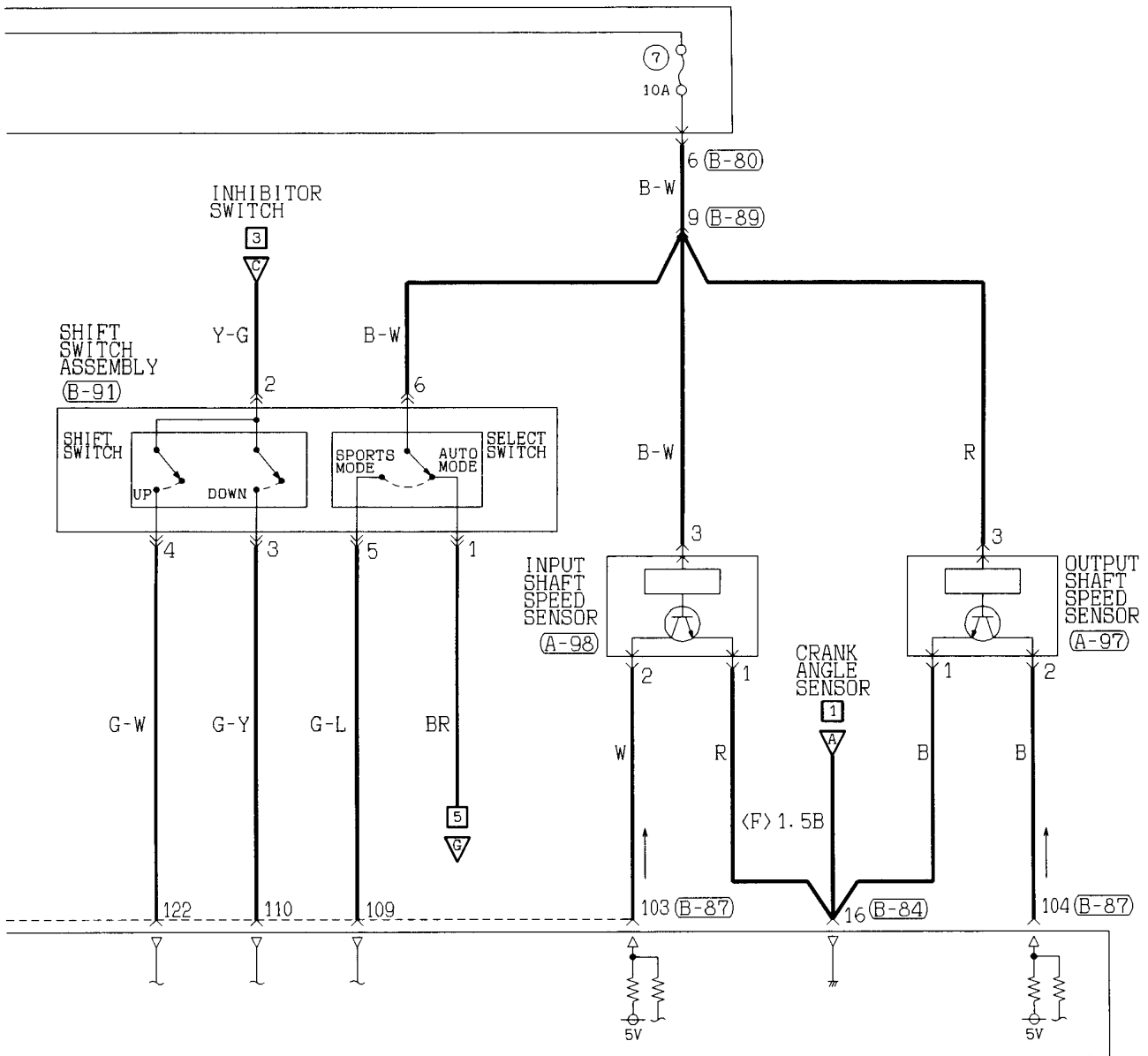

(B-80)

1	2	3	4	5	6	7	8	9	10
11	12	13	14	15	16	17	18	19	20
21	22								

(B-84) (MU803784)

1	2	3	4	5	6	7	8
9	10	11	12	13	14	15	16
17	18	19	20	21	22	23	24
25	26	27	28	29	30	31	32
33	34	35					

(B-87) (MU803783)

101	102	103	104	105	106	107
108	109	110	111	112	113	114
115	116	117	118	119	120	121
122	123	124	125	126	127	128
129	130					

(B-89) MU801461

1	2	3	4	5	6	7	8	9	10
11	12	13	14	15	16	17	18	19	20
21	22								

(B-91) MU801447

1	2
3	4
5	6

Wire colour code  
 B : Black    LG: Light green    G : Green    L : Blue    W : White    Y : Yellow    SB: Sky blue  
 BR: Brown    O : Orange    GR: Gray    R : Red    P : Pink    V : Violet

INVECS-II 4A/T <4G1 engine> (CONTINUED)

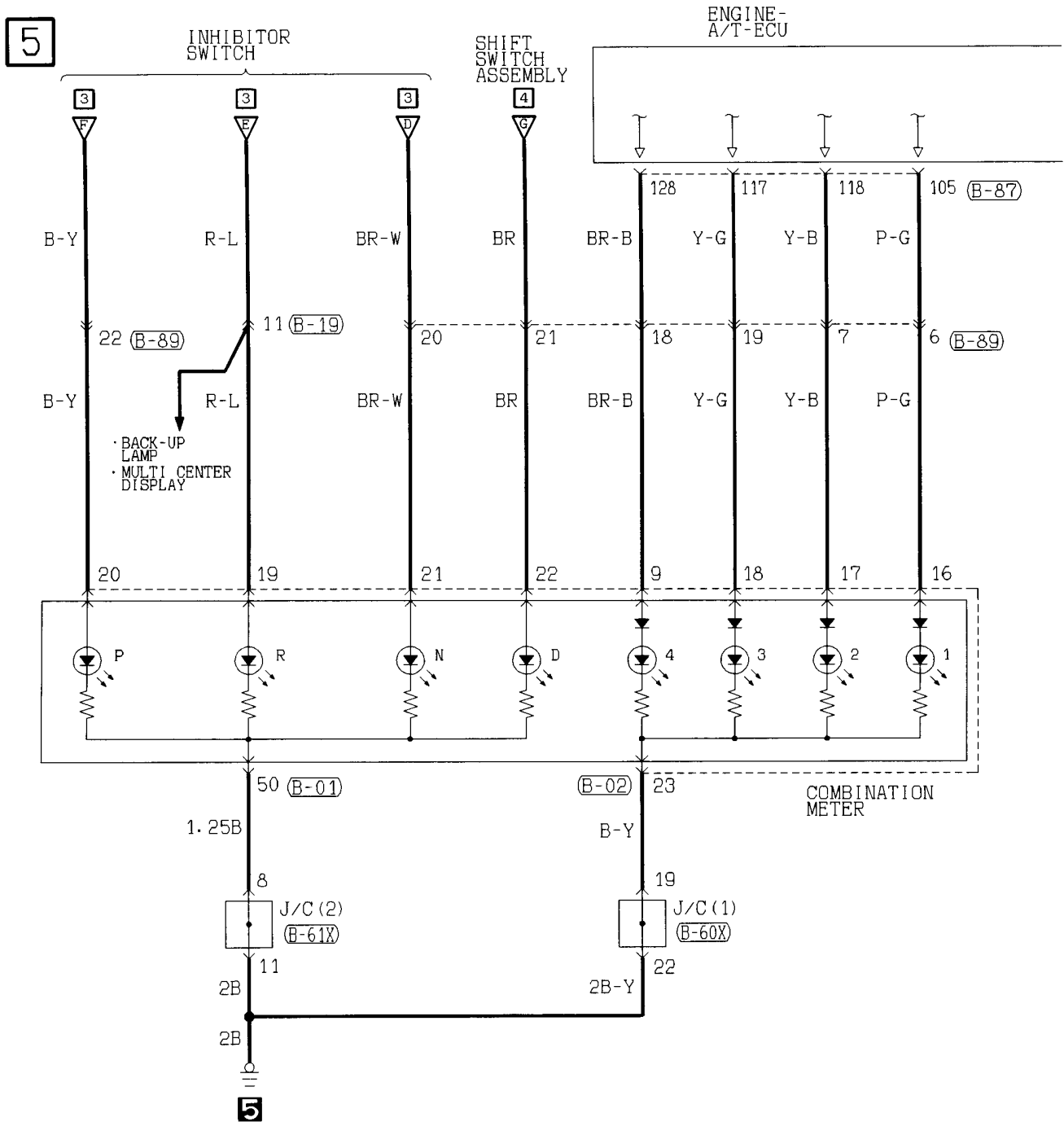

(A-66)

1	2	3	4
---	---	---	---

(B-01)

31	32	33	34	35	36	37	38	39	40	41	42	
43	44	45	46	47	48	49	50	51	52	53	54	55

(B-02)

1	2	3	4	5	6	7	8	9	10	11	12	
13	14	15	16	17	18	19	20	21	22	23	24	25

(B-19)

1	2	3	4	5	6	7	8	9	10		
11	12	13	14	15	16	17	18	19	20	21	22

(B-60X)

1	2	3	4	5	6	7	8	9	10	11
12	13	14	15	16	17	18	19	20	21	22
23	24	25	26	27	28	29	30	31	32	33

(B-89)

1	2	3	4	5	6	7	8	9	10		
11	12	13	14	15	16	17	18	19	20	21	22

6

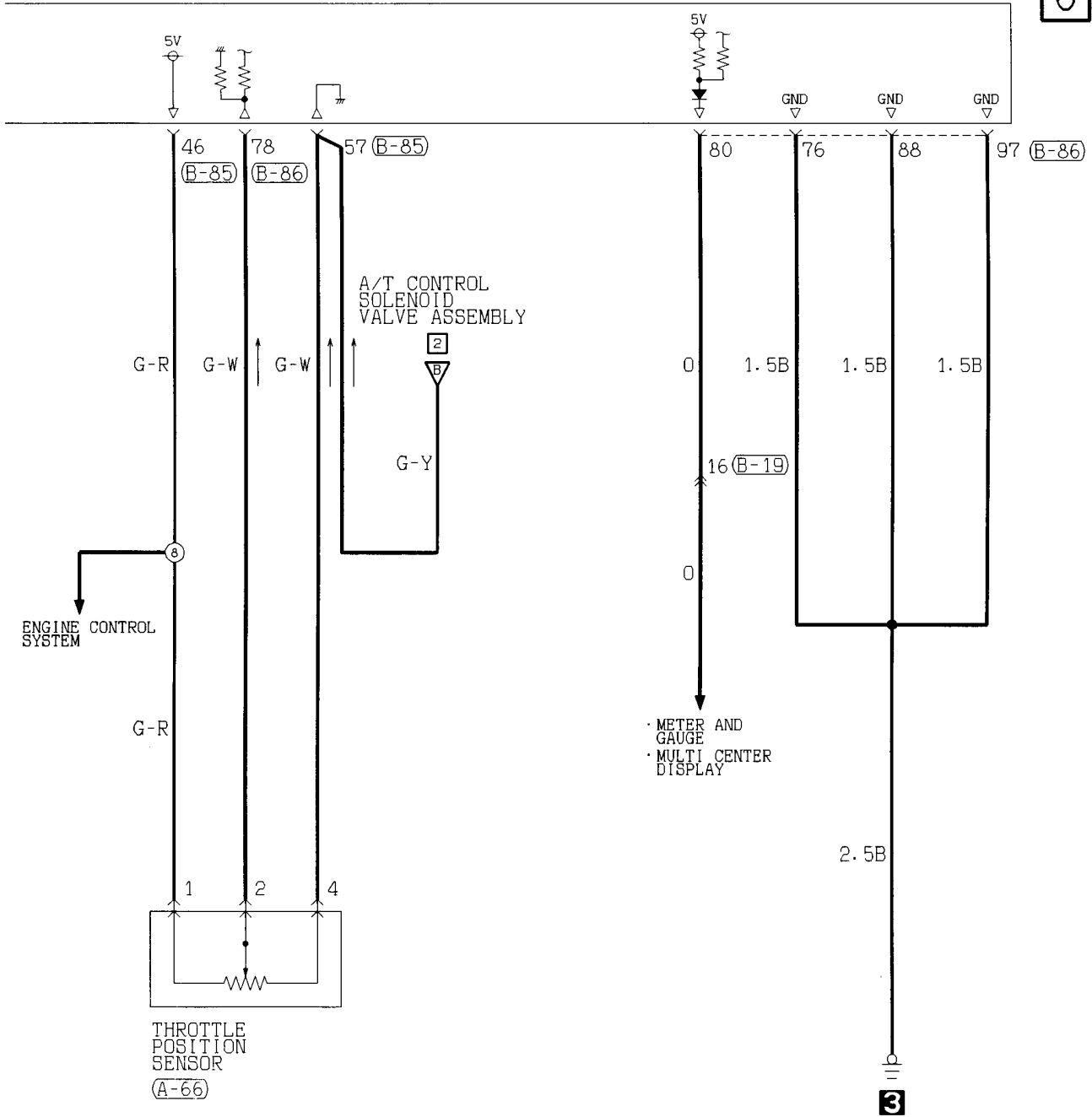

(B-61X)

1	2	3	4	5	6	7	8	9	10	11
12	13	14	15	16	17	18	19	20	21	22
23	24	25	26	27	28	29	30	31	32	33

(B-85) (MU803781)

41	42	43		44	45	46
47	48	49	50	51	52	53
54	55	56	57	58	59	60
61	62	63	64	65	66	

(B-86) (MU803782)

71	72	73	74		75	76	77
78	79	80	81	82	83	84	85
86	87	88	89	90	91	92	93
94	95	96	97	98			

(B-87) (MU803783)

101	102	103	104		105	106	107
108	109	110	111	112	113	114	115
116	117	118	119	120	121	122	123
124	125	126	127	128	129	130	

Wire colour code  
 B : Black    LG: Light green    G : Green    L : Blue    W : White    Y : Yellow    SB: Sky blue  
 BR: Brown    O : Orange    GR: Gray    R : Red    P : Pink    V : Violet

INVECS-II 4A/T <4G1 engine> (CONTINUED)

7

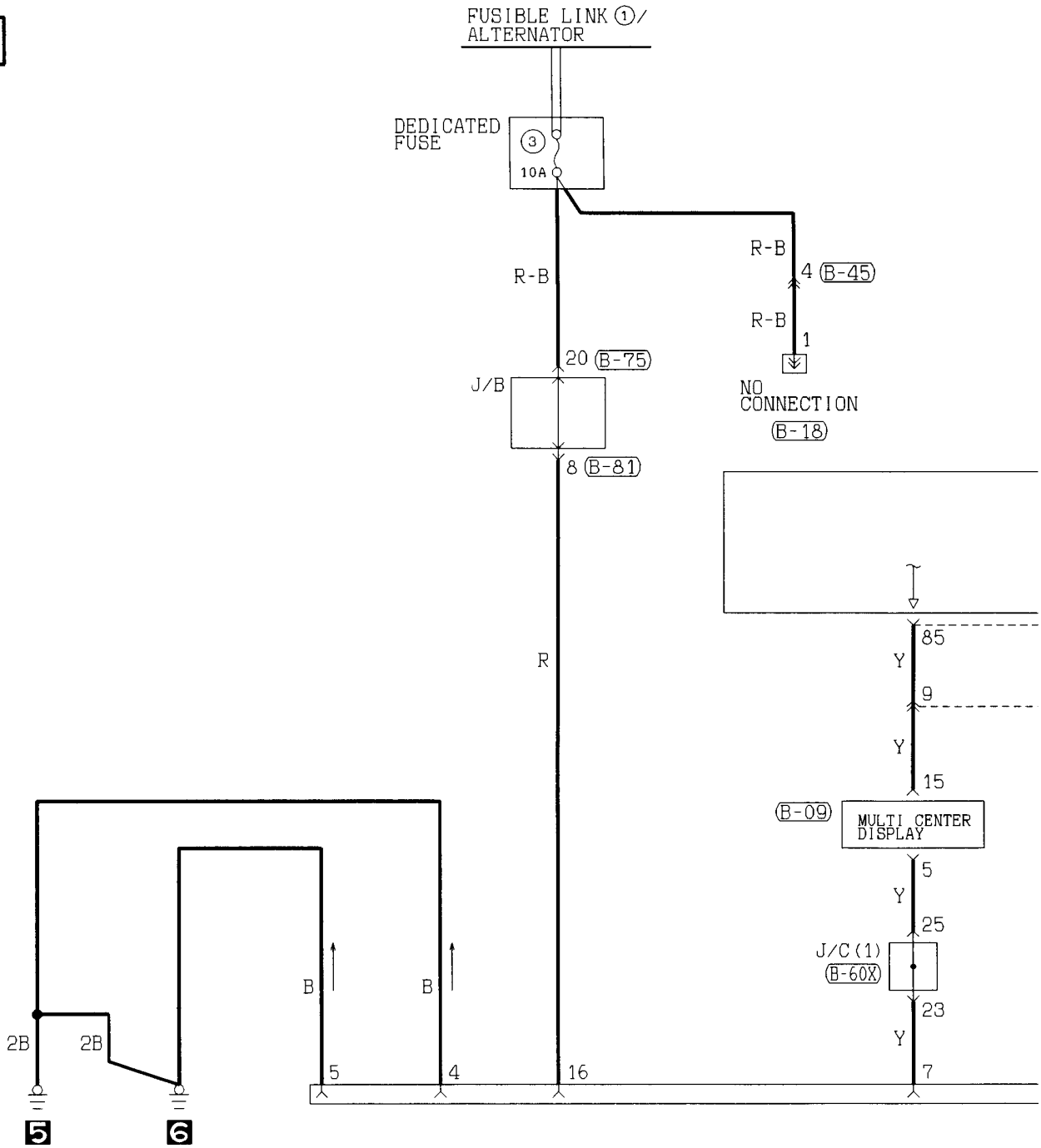

**B-09** (MU801585)

1	2	3	4	5	6	7	8	9	10
11	12	13	14	15	16	17	18	19	20

**B-18** (MU801329)

1	2
3	4

**B-19** (MU801461)

1	2	3	4	5	6	7	8	9	10
11	12	13	14	15	16	17	18	19	20
21	22								

**B-33 FRONT SIDE**

25	24	23	22	21
32	31	30	29	28
27	26			

**B-35 FRONT SIDE**

1	2	3	4	5	6	7	8
9	10	11	12	13	14	15	16

**B-45** (MU801335)

1	2	3	4
5	6	7	8
9	10		

**B-86** (MU803782)

71	72	73	74			75	76	77
78	79	80	81	82	83	84	85	86
87	88	89						
90	91	92	93	94	95	96	97	98

**B-87** (MU803783)

101	102	103	104			105	106	107
108	109	110	111	112	113	114	115	116
117	118	119	120					
121	122	123	124	125	126	127	128	129
130								

**D-29** (MU801441)

1	2
---	---



8

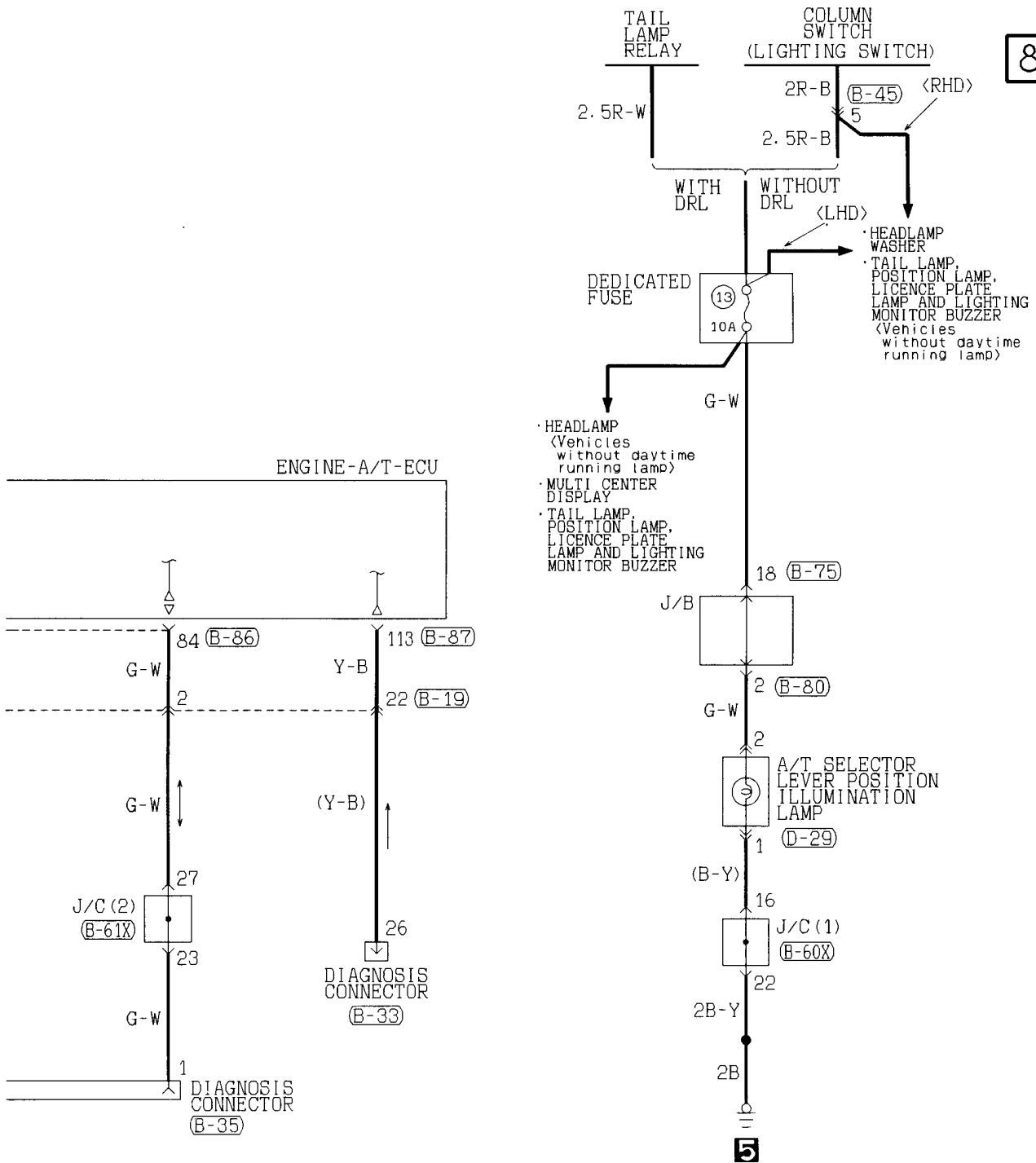

(B-60X)	(B-61X)	(B-75)	(B-80)	(B-81)																																																																																																																																		
<table border="1"> <tr><td>1</td><td>2</td><td>3</td><td>4</td><td>5</td><td>6</td><td>7</td><td>8</td><td>9</td><td>10</td><td>11</td></tr> <tr><td>12</td><td>13</td><td>14</td><td>15</td><td>16</td><td>17</td><td>18</td><td>19</td><td>20</td><td>21</td><td>22</td></tr> <tr><td>23</td><td>24</td><td>25</td><td>26</td><td>27</td><td>28</td><td>29</td><td>30</td><td>31</td><td>32</td><td>33</td></tr> </table>	1	2	3	4	5	6	7	8	9	10	11	12	13	14	15	16	17	18	19	20	21	22	23	24	25	26	27	28	29	30	31	32	33	<table border="1"> <tr><td>1</td><td>2</td><td>3</td><td>4</td><td>5</td><td>6</td><td>7</td><td>8</td><td>9</td><td>10</td><td>11</td></tr> <tr><td>12</td><td>13</td><td>14</td><td>15</td><td>16</td><td>17</td><td>18</td><td>19</td><td>20</td><td>21</td><td>22</td></tr> <tr><td>23</td><td>24</td><td>25</td><td>26</td><td>27</td><td>28</td><td>29</td><td>30</td><td>31</td><td>32</td><td>33</td></tr> </table>	1	2	3	4	5	6	7	8	9	10	11	12	13	14	15	16	17	18	19	20	21	22	23	24	25	26	27	28	29	30	31	32	33	<table border="1"> <tr><td>1</td><td>2</td><td>3</td><td>4</td><td>5</td><td>6</td><td>7</td><td>8</td><td>9</td></tr> <tr><td>10</td><td>11</td><td>12</td><td>13</td><td>14</td><td>15</td><td>16</td><td>17</td><td>18</td><td>19</td><td>20</td></tr> </table>	1	2	3	4	5	6	7	8	9	10	11	12	13	14	15	16	17	18	19	20	<table border="1"> <tr><td>1</td><td>2</td><td>3</td><td>4</td><td>5</td><td>6</td><td>7</td><td>8</td><td>9</td><td>10</td></tr> <tr><td>11</td><td>12</td><td>13</td><td>14</td><td>15</td><td>16</td><td>17</td><td>18</td><td>19</td><td>20</td><td>21</td><td>22</td></tr> </table>	1	2	3	4	5	6	7	8	9	10	11	12	13	14	15	16	17	18	19	20	21	22	<table border="1"> <tr><td>1</td><td>2</td><td>3</td><td>4</td><td>5</td><td>6</td><td>7</td><td>8</td><td>9</td><td>10</td></tr> <tr><td>11</td><td>12</td><td>13</td><td>14</td><td>15</td><td>16</td><td>17</td><td>18</td><td>19</td><td>20</td><td>21</td><td>22</td></tr> </table>	1	2	3	4	5	6	7	8	9	10	11	12	13	14	15	16	17	18	19	20	21	22
1	2	3	4	5	6	7	8	9	10	11																																																																																																																												
12	13	14	15	16	17	18	19	20	21	22																																																																																																																												
23	24	25	26	27	28	29	30	31	32	33																																																																																																																												
1	2	3	4	5	6	7	8	9	10	11																																																																																																																												
12	13	14	15	16	17	18	19	20	21	22																																																																																																																												
23	24	25	26	27	28	29	30	31	32	33																																																																																																																												
1	2	3	4	5	6	7	8	9																																																																																																																														
10	11	12	13	14	15	16	17	18	19	20																																																																																																																												
1	2	3	4	5	6	7	8	9	10																																																																																																																													
11	12	13	14	15	16	17	18	19	20	21	22																																																																																																																											
1	2	3	4	5	6	7	8	9	10																																																																																																																													
11	12	13	14	15	16	17	18	19	20	21	22																																																																																																																											

Wire colour code  
 B : Black    LG : Light green    G : Green    L : Blue    W : White    Y : Yellow    SB : Sky blue  
 BR : Brown    O : Orange    GR : Gray    R : Red    P : Pink    V : Violet

# TAIL LAMP, POSITION LAMP, LICENCE PLATE LAMP AND LIGHTING MONITOR BUZZER

Vehicles without daytime running lamp

1

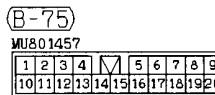
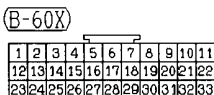
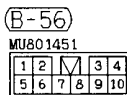
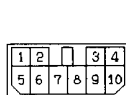
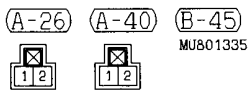
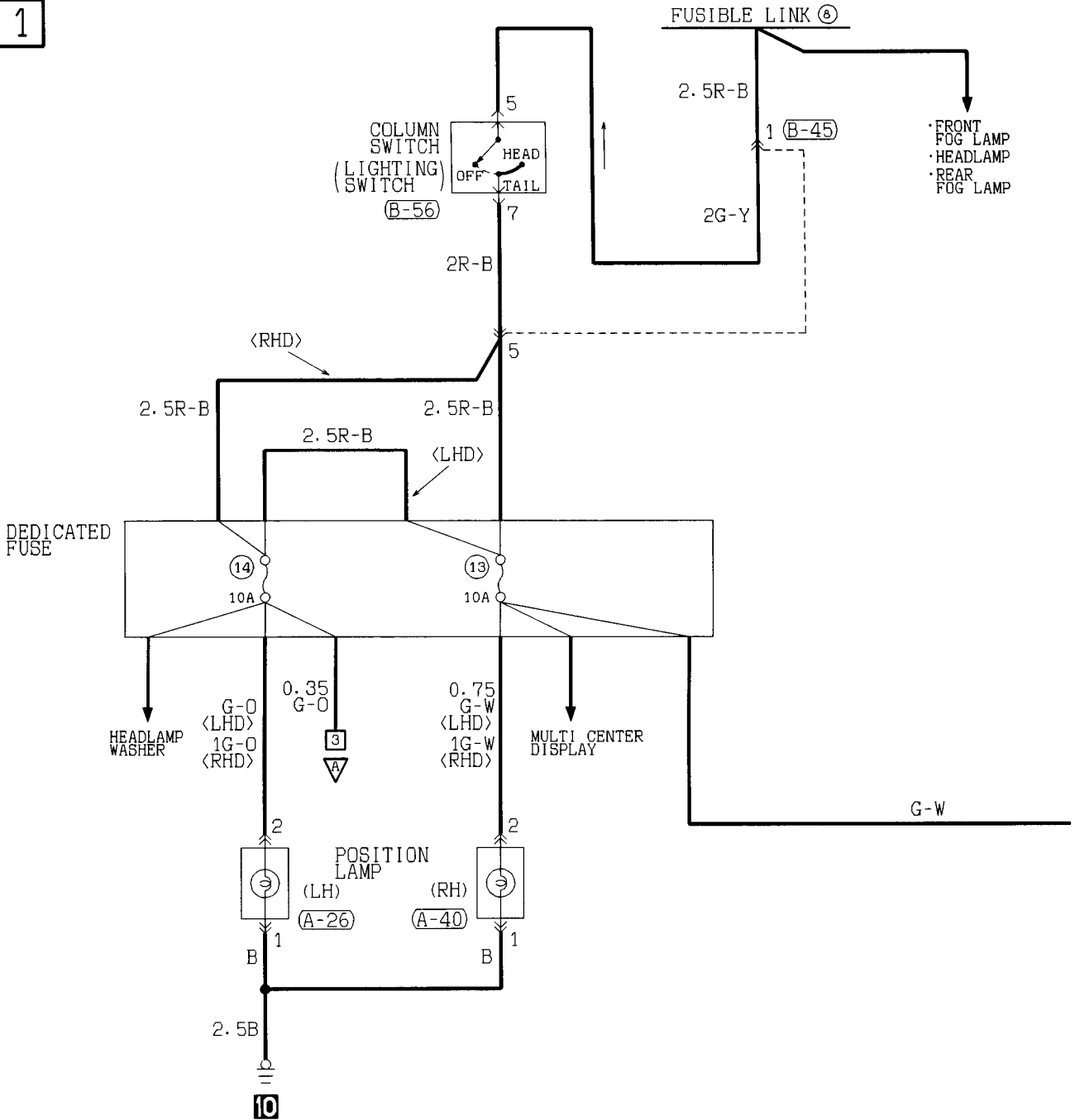

2

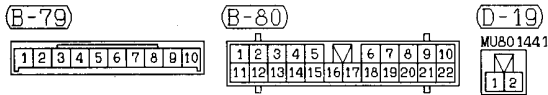
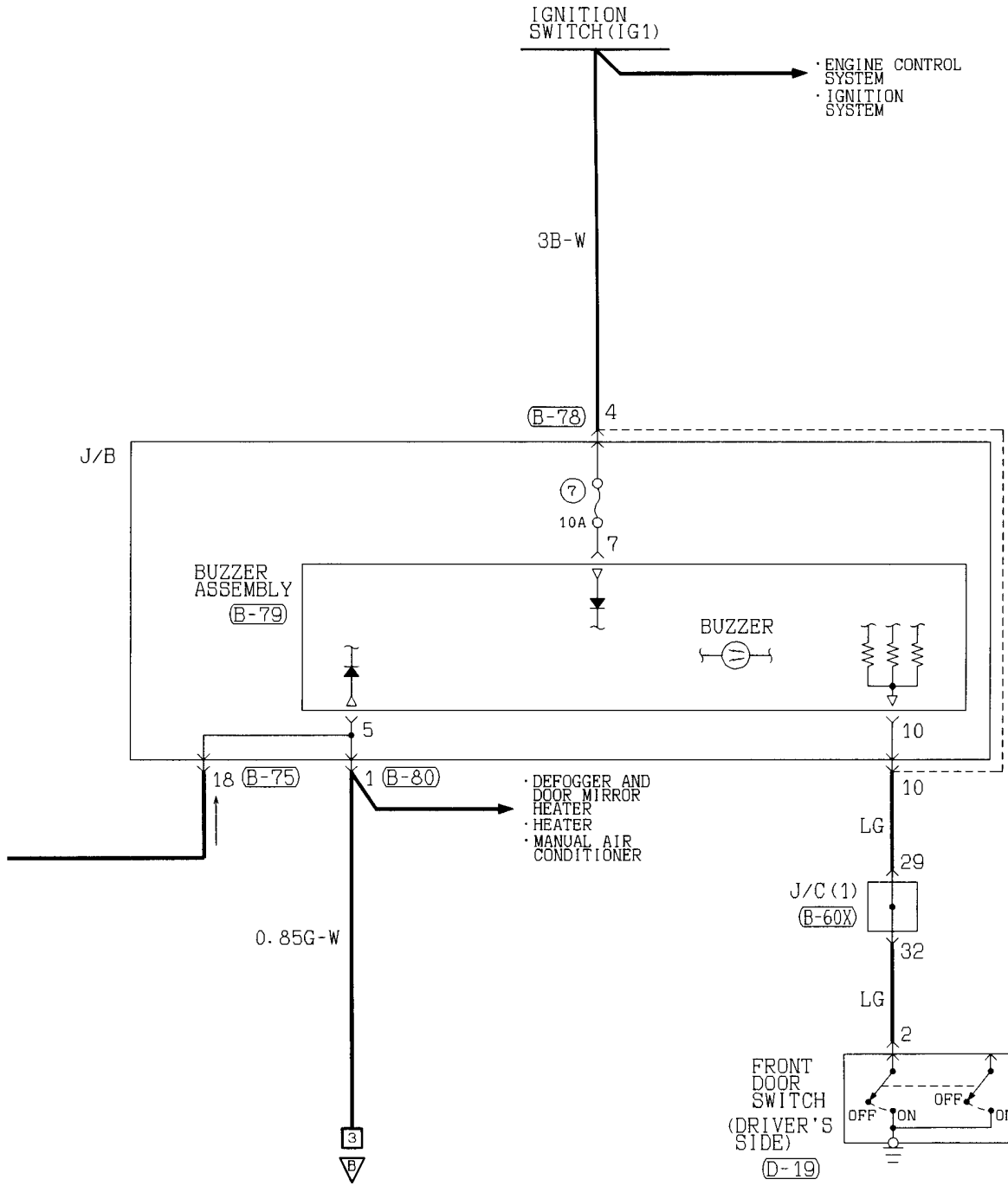

Wire colour code  
 B :Black LG:Light green G :Green L :Blue W :White Y :Yellow SB:Sky blue  
 BR:Brown O :Orange GR:Gray R :Red P :Pink V :Violet

TAIL LAMP, POSITION LAMP, LICENCE PLATE LAMP AND LIGHTING MONITOR BUZZER <Vehicles without daytime running lamp> (CONTINUED)

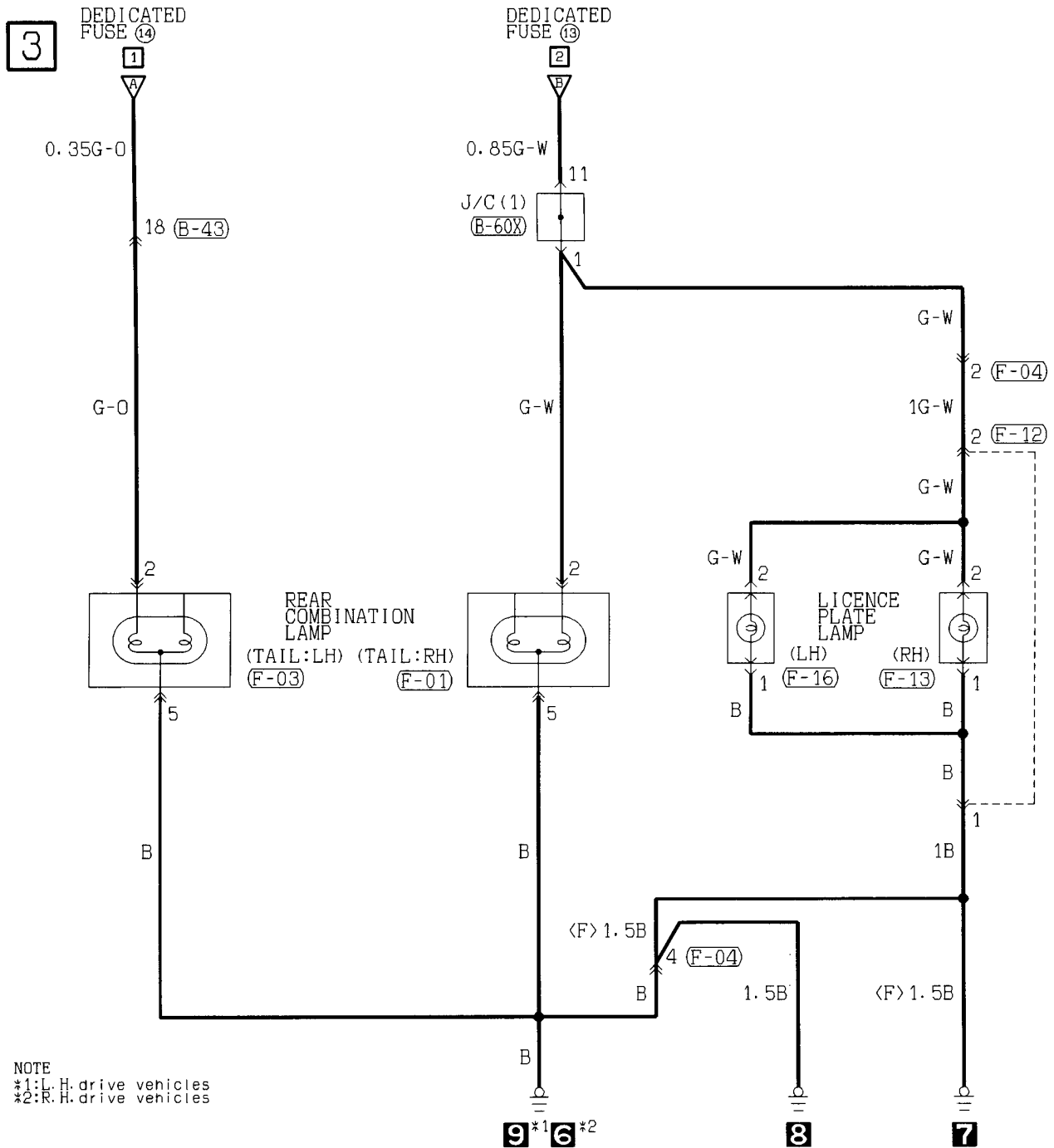

NOTE  
 \*1:L.H. drive vehicles  
 \*2:R.H. drive vehicles

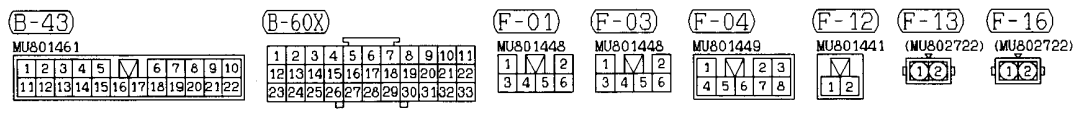

---

NOTES

# TAIL LAMP, POSITION LAMP, LICENCE PLATE LAMP AND LIGHTING MONITOR BUZZER

Vehicles with daytime running lamp

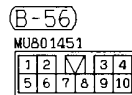
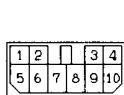
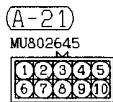
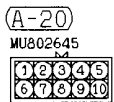
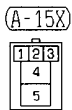
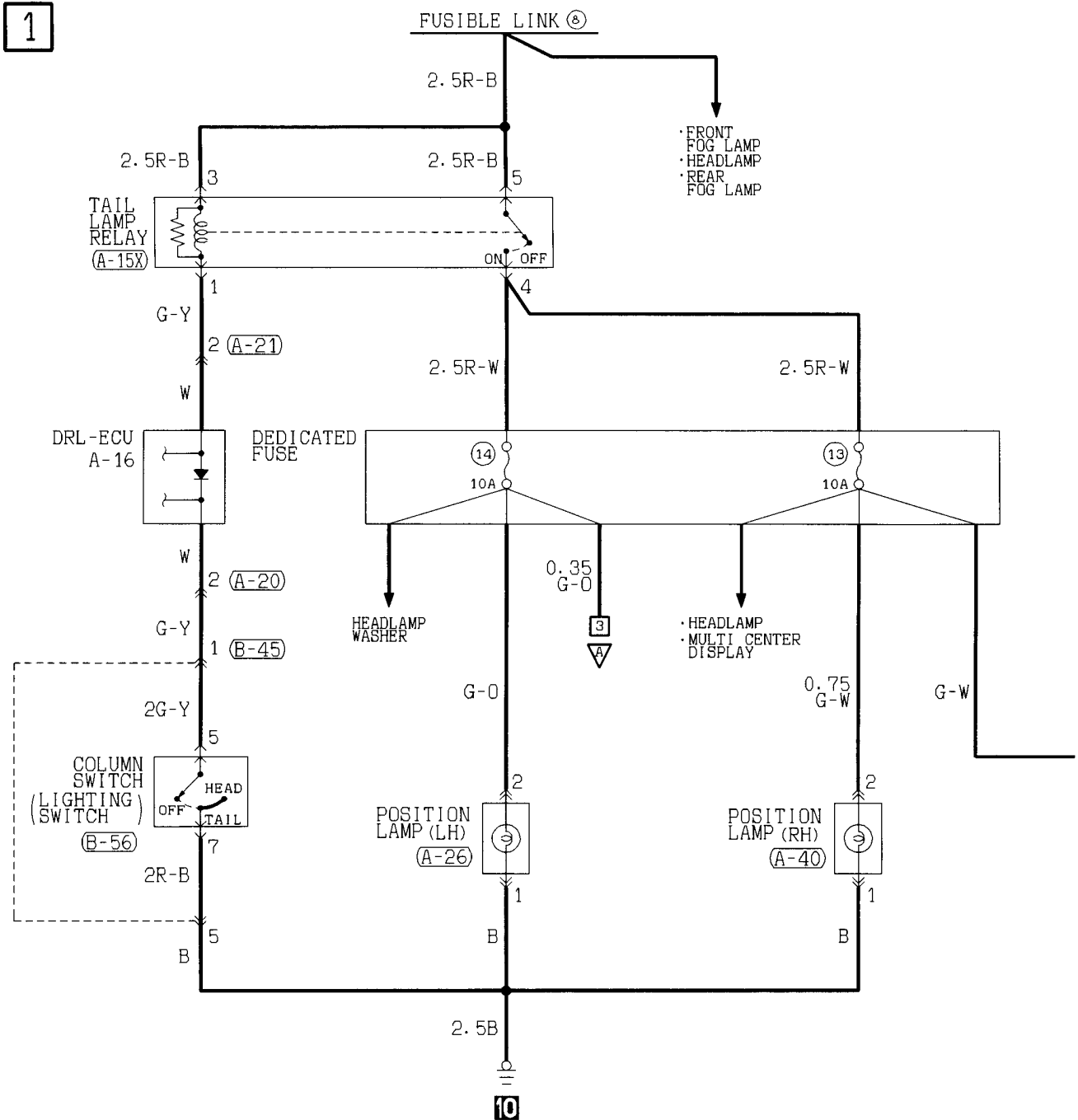

2

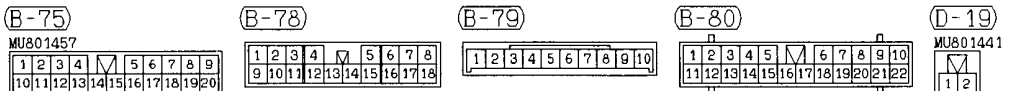
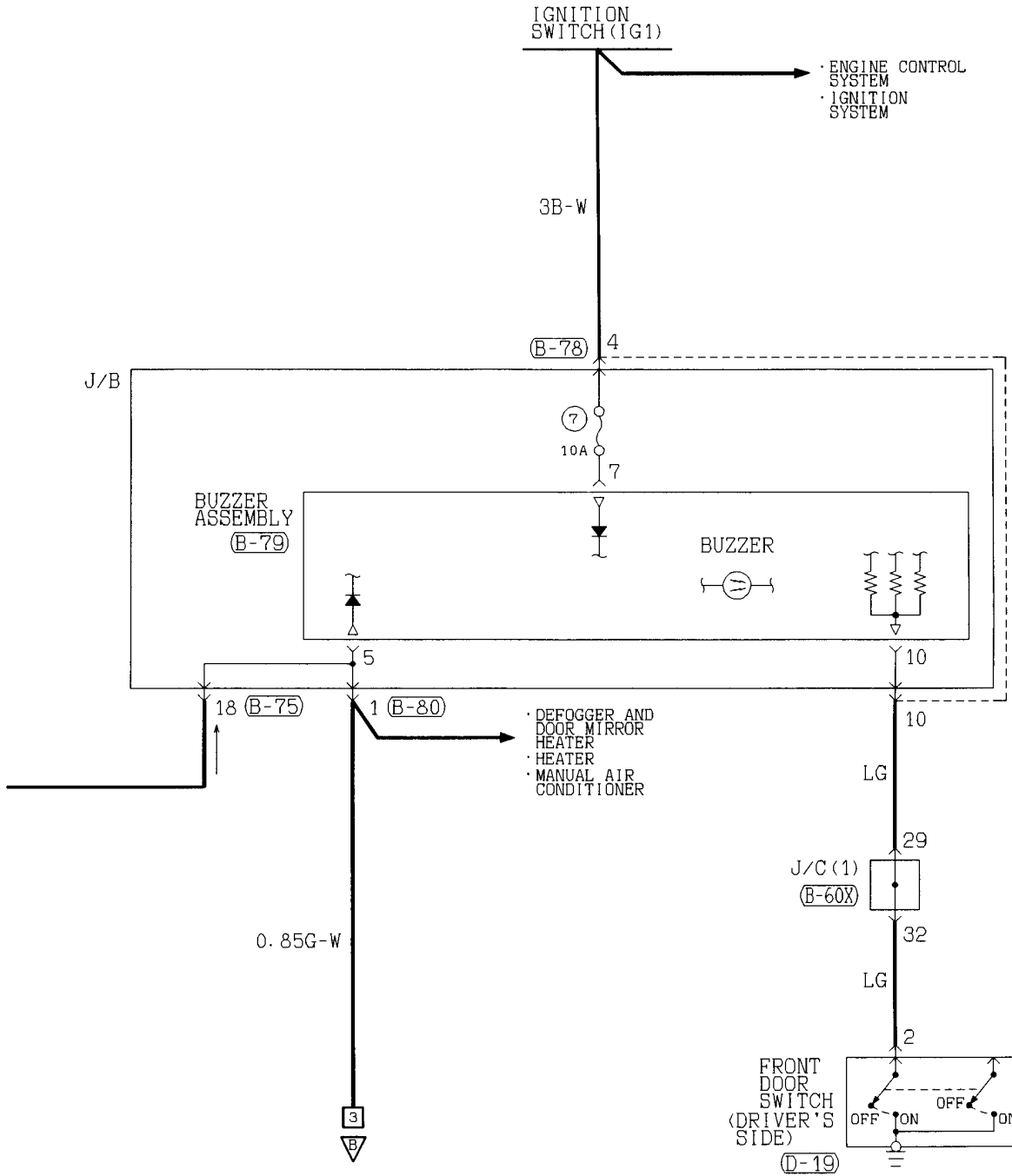

Wire colour code  
 B : Black LG: Light green G : Green L : Blue W : White Y : Yellow SB: Sky blue  
 BR: Brown O : Orange GR: Gray R : Red P : Pink V : Violet

TAIL LAMP, POSITION LAMP, LICENCE PLATE LAMP AND LIGHTING MONITOR BUZZER <Vehicles with daytime running lamp> (CONTINUED)

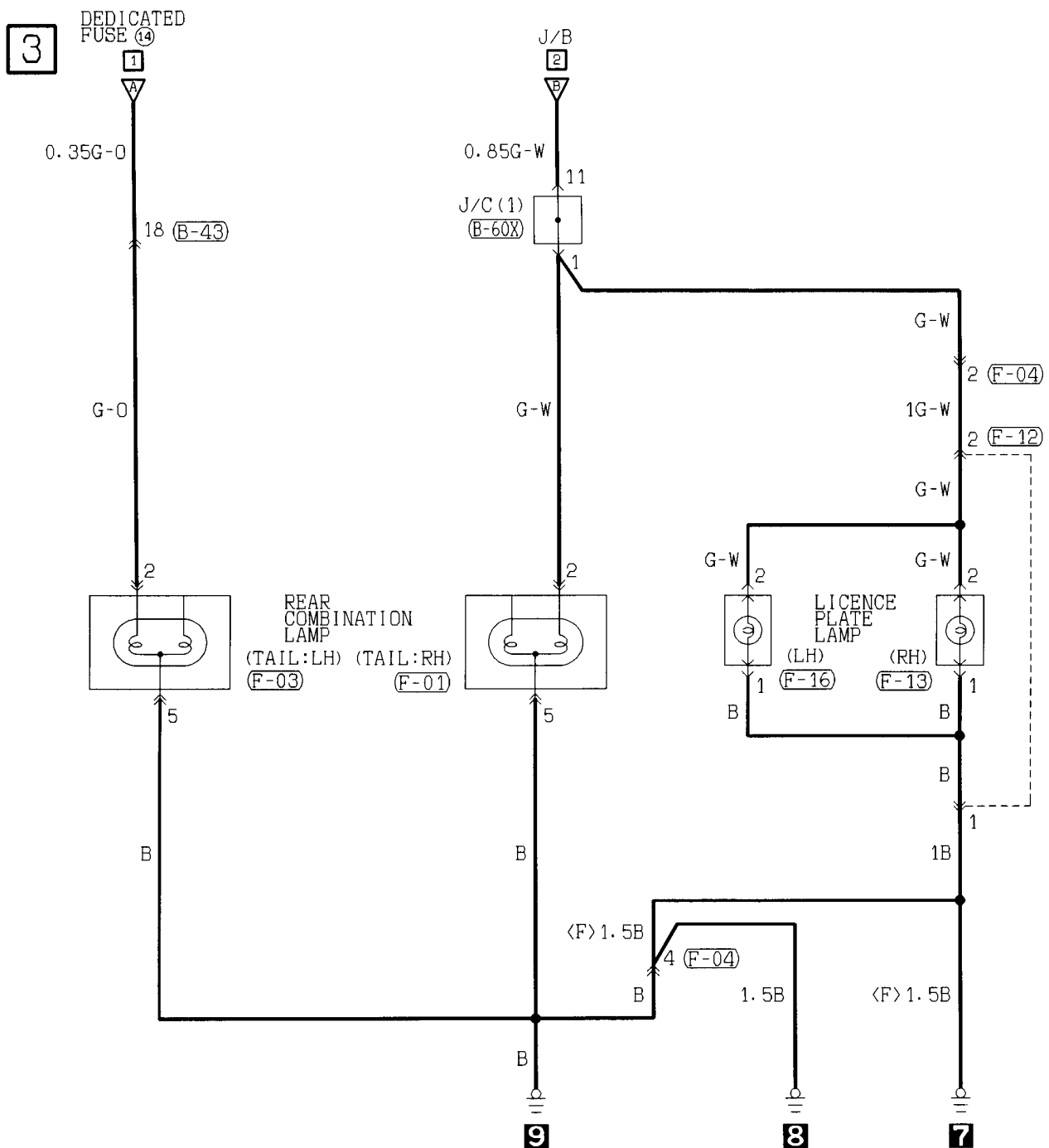

<b>(B-43)</b> MU801461	<b>(B-60X)</b> 1 2 3 4 5 6 7 8 9 10 11 12 13 14 15 16 17 18 19 20 21 22 23 24 25 26 27 28 29 30 31 32 33	<b>(F-01)</b> MU801448	<b>(F-03)</b> MU801448	<b>(F-04)</b> MU801449	<b>(F-12)</b> MU801441	<b>(F-13)</b> (MU802722)	<b>(F-16)</b> (MU802722)
---------------------------	---	---------------------------	---------------------------	---------------------------	---------------------------	-----------------------------	-----------------------------

Wire colour code  
 B : Black    LG : Light green    G : Green    L : Blue    W : White    Y : Yellow    SB : Sky blue  
 BR : Brown    O : Orange    GR : Gray    R : Red    P : Pink    V : Violet



---

NOTES

# FRONT FOG LAMP

Vehicles without daytime running lamp

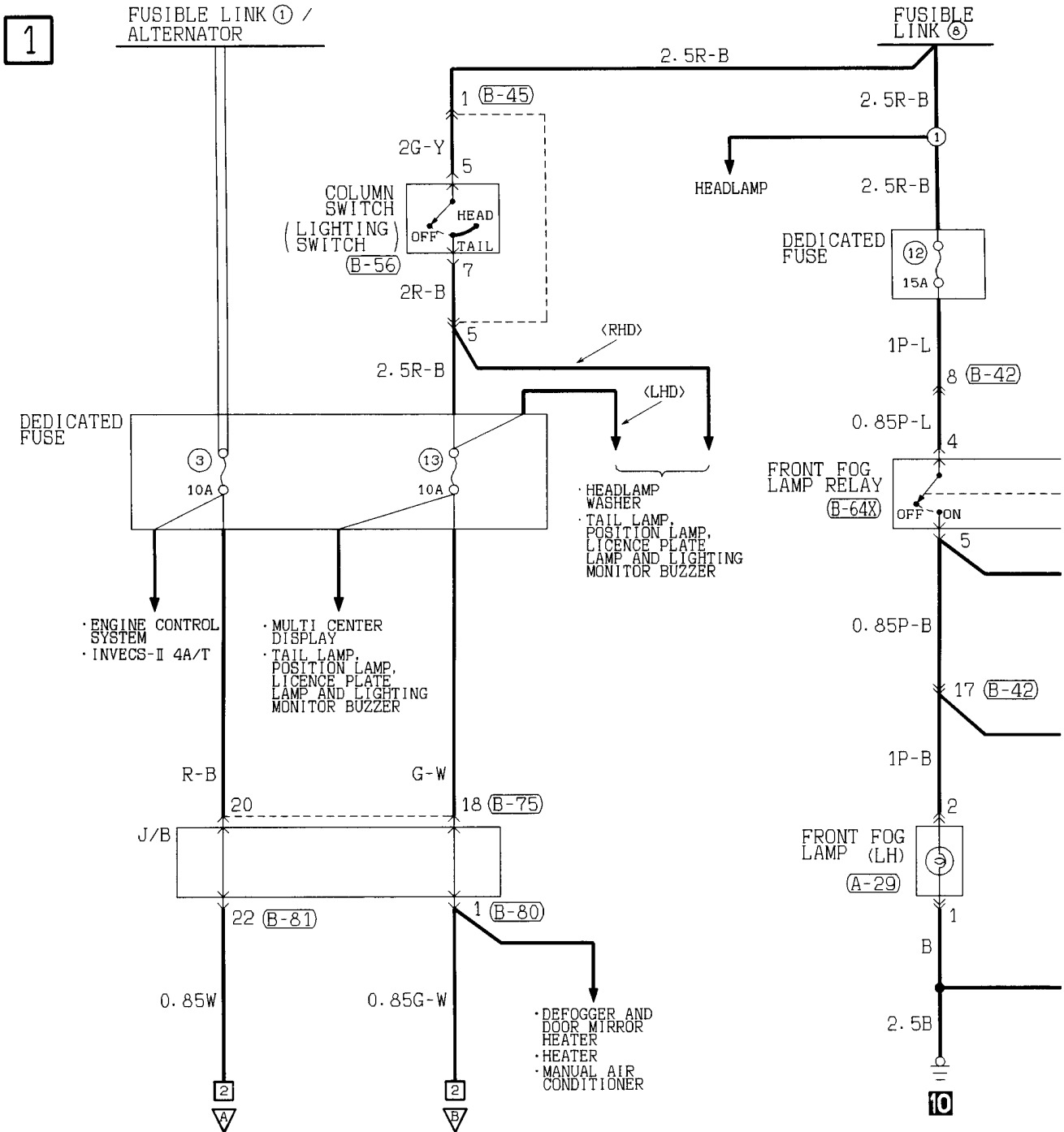

<b>(A-29)</b> MU802661 1 2	<b>(A-36)</b> MU802661 1 2	<b>(B-01)</b> 31 32 33 34 35 36 37 38 39 40 41 42 43 44 45 46 47 48 49 50 51 52 53 54 55	<b>(B-42)</b> MU801455 1 2 3 4 M 5 6 7 8 9 10 11 12 13 14 15 16 17 18	<b>(B-45)</b> MU801335 1 2 M 3 4 5 6 7 8 9 10	<b>(B-47)</b> MU801451 1 2 M 3 4 5 6 7 8 9 10	<b>(B-56)</b> MU801451 1 2 M 3 4 5 6 7 8 9 10	<b>(B-60X)</b> 1 2 3 4 5 6 7 8 9 10 11 12 13 14 15 16 17 18 19 20 21 22 23 24 25 26 27 28 29 30 31 32 33
----------------------------------	----------------------------------	---	--	--	--	--	---

2

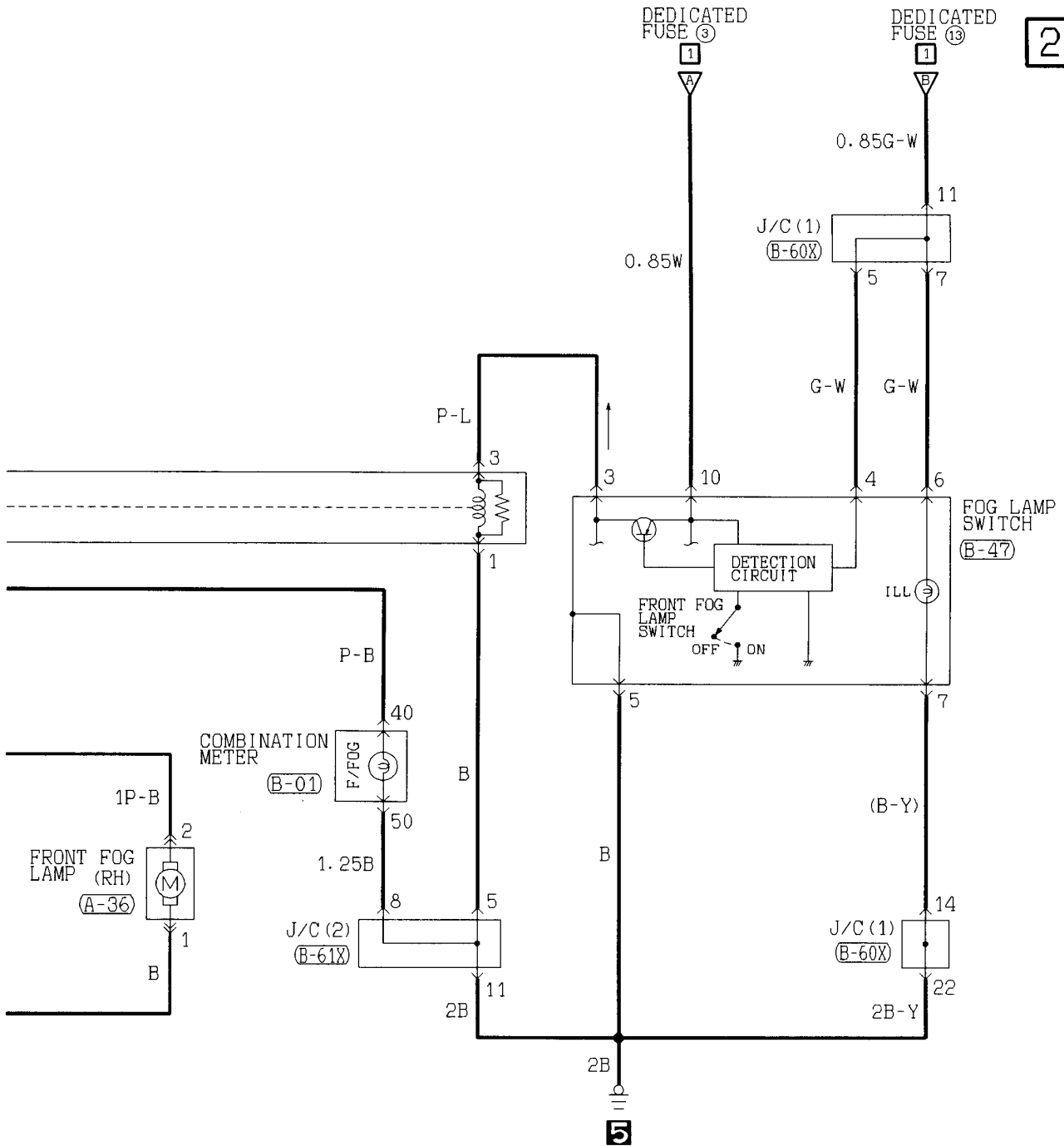

(B-61X)

1	2	3	4	5	6	7	8	9	10	11
12	13	14	15	16	17	18	19	20	21	22
23	24	25	26	27	28	29	30	31	32	33

(B-64X)

1	2	3
4		
5		

(B-75)

MU801457

1	2	3	4	M	5	6	7	8	9	
10	11	12	13	14	15	16	17	18	19	20

(B-80)

1	2	3	4	5	M	6	7	8	9	10	
11	12	13	14	15	16	17	18	19	20	21	22

(B-81)

MU801461

1	2	3	4	5	M	6	7	8	9	10	
11	12	13	14	15	16	17	18	19	20	21	22

Wire colour code

B : Black    LG: Light green    G : Green    L : Blue    W : White    Y : Yellow    SB: Sky blue  
 BR: Brown    O : Orange    GR: Gray    R : Red    P : Pink    V : Violet

# FRONT FOG LAMP

Vehicles with daytime running lamp

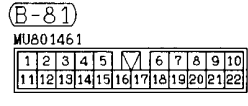
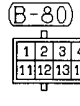
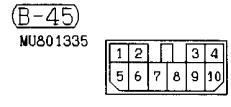
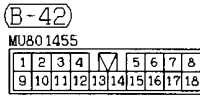
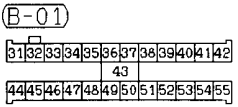
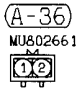
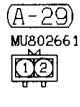
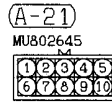
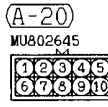
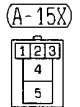
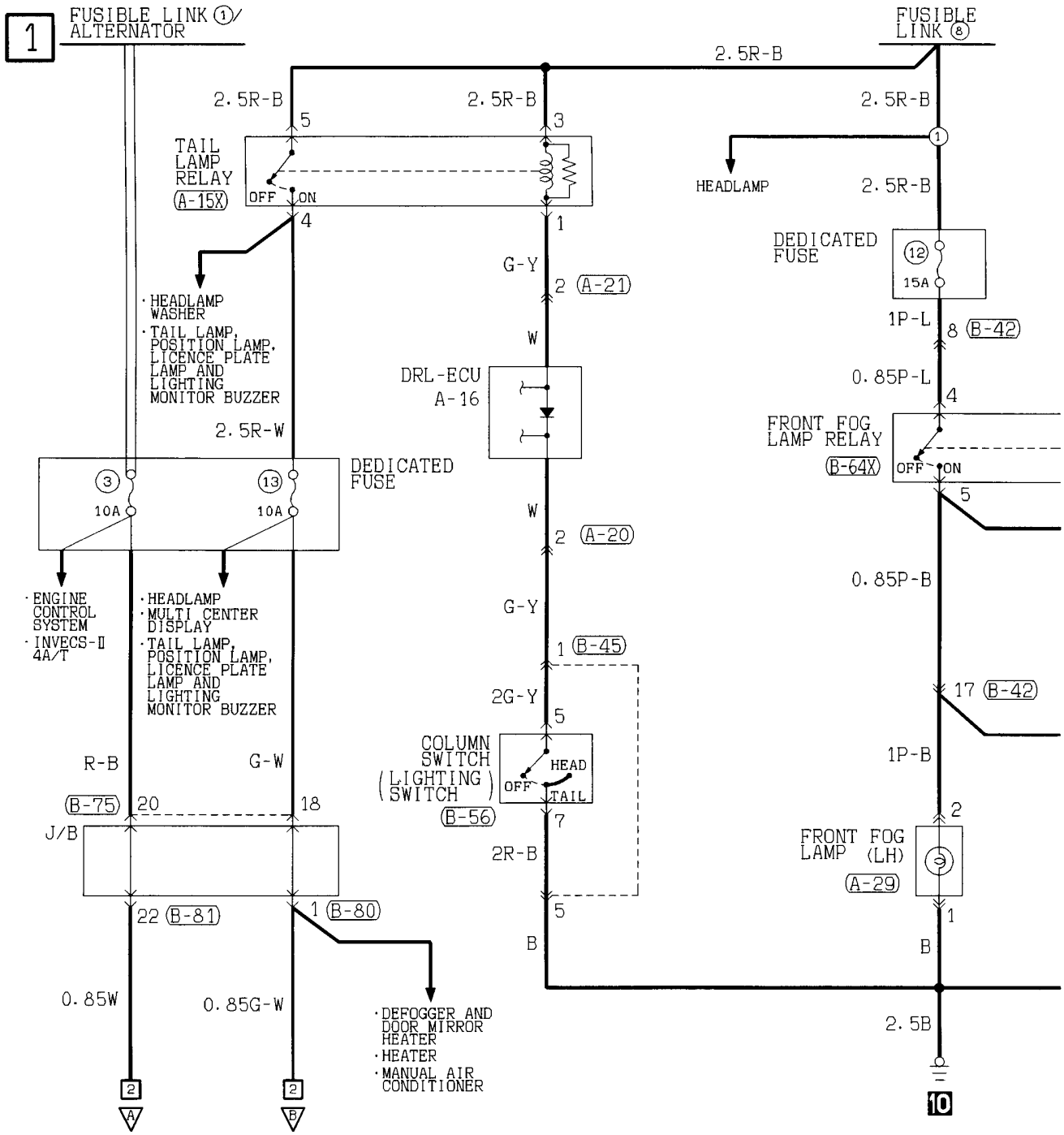

2

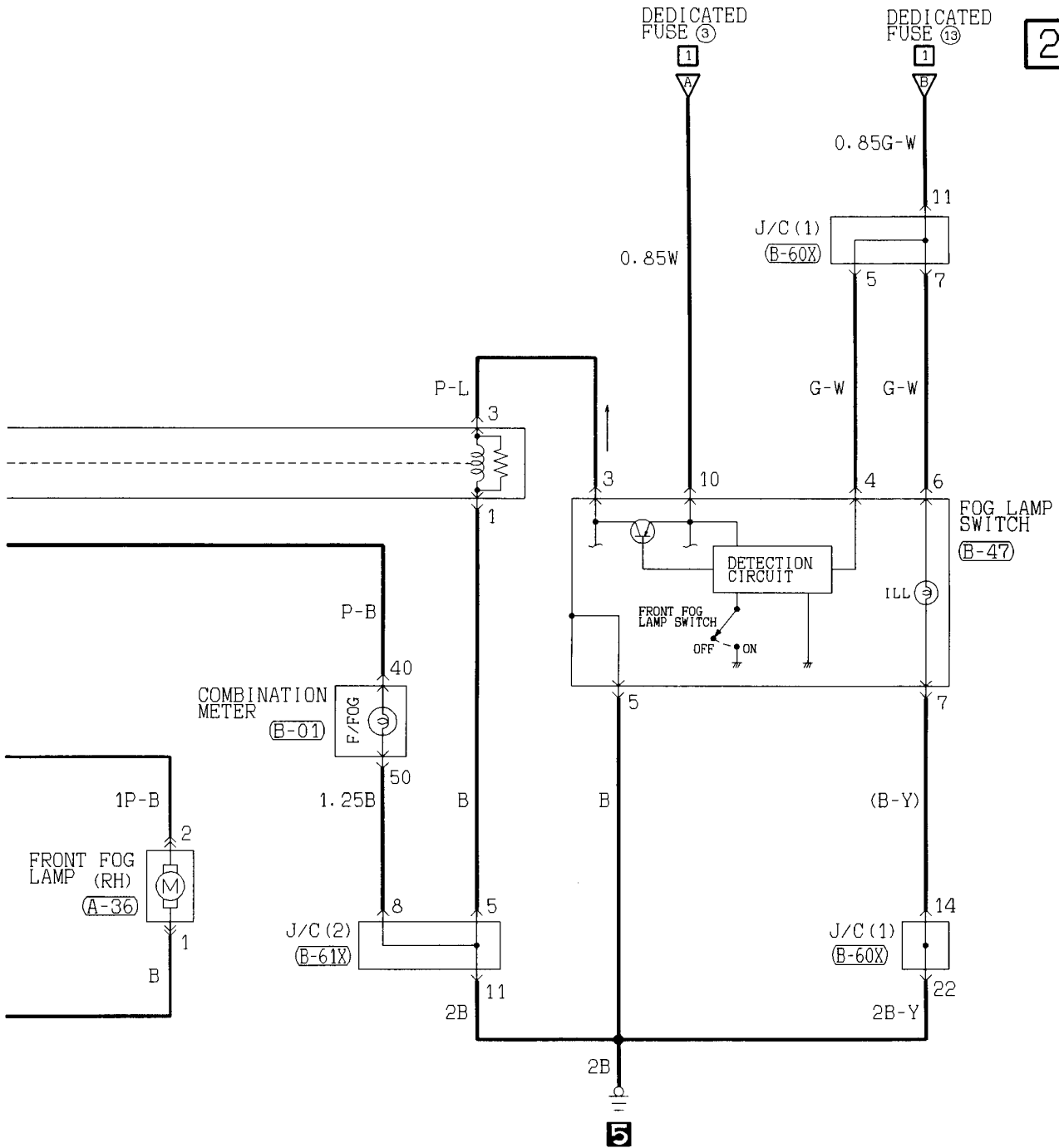

5

(B-47)	(B-56)	(B-60X)	(B-61X)	(B-64X)	(B-75)
MU801451	MU801451	MU801451	MU801451	MU801451	MU801457
1 2 3 4 5 6 7 8 9 10	1 2 3 4 5 6 7 8 9 10	1 2 3 4 5 6 7 8 9 10 11 12 13 14 15 16 17 18 19 20 21 22 23 24 25 26 27 28 29 30 31 32 33	1 2 3 4 5 6 7 8 9 10 11 12 13 14 15 16 17 18 19 20 21 22 23 24 25 26 27 28 29 30 31 32 33	1 2 3 4 5	1 2 3 4 M 5 6 7 8 9 10 11 12 13 14 15 16 17 18 19 20

Wire colour code  
 B : Black LG:Light green G :Green L :Blue W :White Y :Yellow SB:Sky blue  
 BR:Brown O :Orange GR:Gray R :Red P :Pink V :Violet

REAR FOG LAMP

Vehicles without daytime running lamp

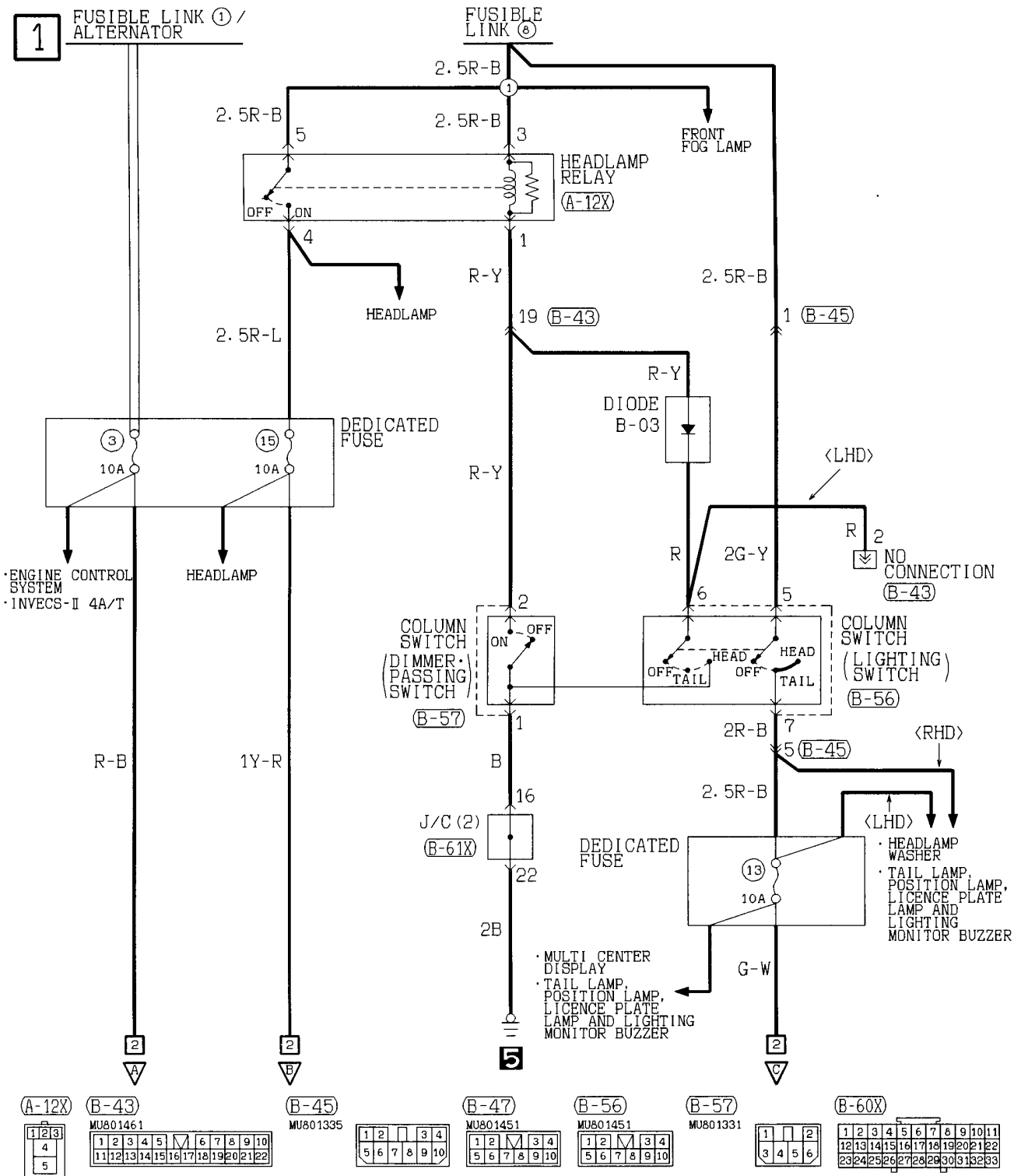

2

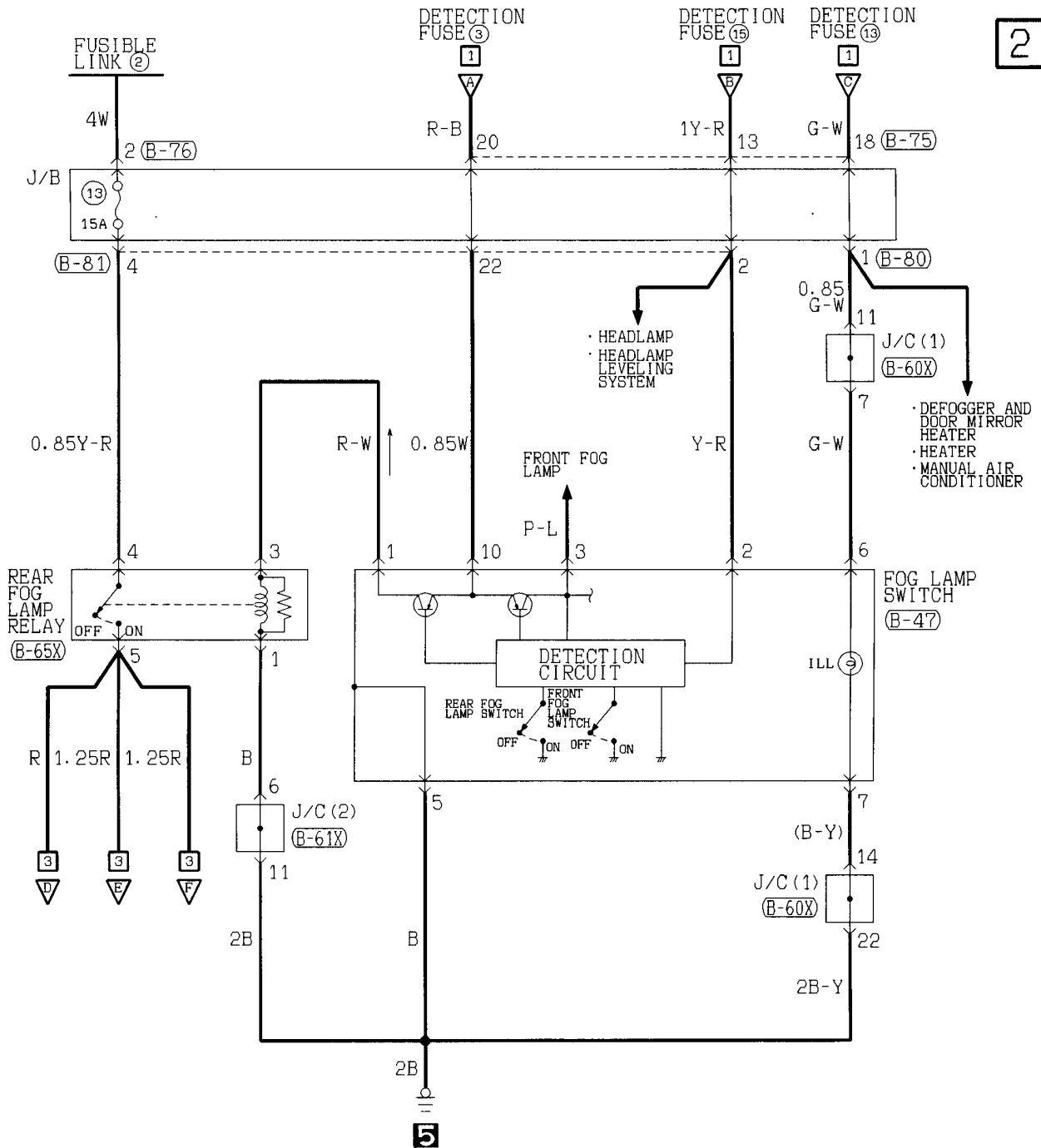

(B-61X)

1	2	3	4	5	6	7	8	9	10	11
12	13	14	15	16	17	18	19	20	21	22
23	24	25	26	27	28	29	30	31	32	33

(B-65X)

1	2	3
4		
5		

(B-75)

MU801457

1	2	3	4	5	6	7	8	9		
10	11	12	13	14	15	16	17	18	19	20

(B-76)

1	2
---	---

(B-80)

1	2	3	4	5	6	7	8	9	10		
11	12	13	14	15	16	17	18	19	20	21	22

(B-81)

MU801461

1	2	3	4	5	6	7	8	9	10		
11	12	13	14	15	16	17	18	19	20	21	22

Wire colour code  
 B : Black    LG : Light green    G : Green    L : Blue    W : White    Y : Yellow    SB : Sky blue  
 BR : Brown    O : Orange    GR : Gray    R : Red    P : Pink    V : Violet

REAR FOG LAMP <Vehicles without daytime running lamp> (CONTINUED)

3

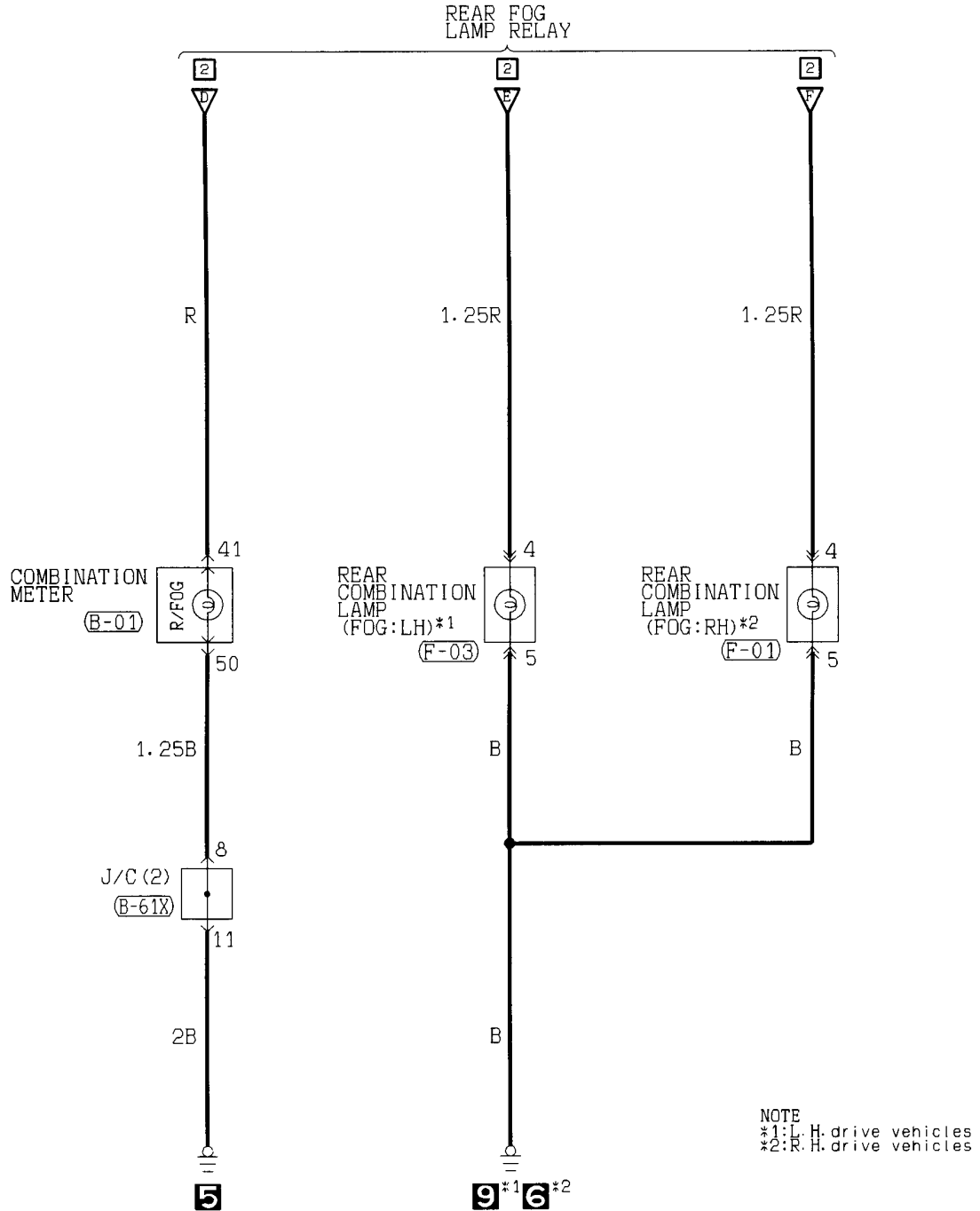

NOTE  
 \*1: L. H. drive vehicles  
 \*2: R. H. drive vehicles

(B-01)	(B-61X)	(F-01)	(F-03)																																																																																																																																																													
<table border="1"> <tr><td>3</td><td>1</td><td>3</td><td>2</td><td>3</td><td>3</td><td>3</td><td>4</td><td>3</td><td>5</td><td>3</td><td>6</td><td>3</td><td>7</td><td>3</td><td>8</td><td>3</td><td>9</td><td>4</td><td>0</td><td>4</td><td>1</td><td>4</td><td>2</td></tr> <tr><td colspan="11"></td><td>4</td><td>3</td><td colspan="5"></td></tr> <tr><td>4</td><td>4</td><td>5</td><td>4</td><td>6</td><td>4</td><td>7</td><td>4</td><td>8</td><td>4</td><td>9</td><td>5</td><td>0</td><td>5</td><td>1</td><td>5</td><td>2</td><td>5</td><td>3</td><td>5</td><td>4</td><td>5</td><td>5</td></tr> </table>	3	1	3	2	3	3	3	4	3	5	3	6	3	7	3	8	3	9	4	0	4	1	4	2												4	3						4	4	5	4	6	4	7	4	8	4	9	5	0	5	1	5	2	5	3	5	4	5	5	<table border="1"> <tr><td>1</td><td>2</td><td>3</td><td>4</td><td>5</td><td>6</td><td>7</td><td>8</td><td>9</td><td>10</td><td>11</td></tr> <tr><td>1</td><td>2</td><td>3</td><td>4</td><td>5</td><td>6</td><td>7</td><td>8</td><td>9</td><td>10</td><td>11</td></tr> <tr><td>1</td><td>2</td><td>3</td><td>4</td><td>5</td><td>6</td><td>7</td><td>8</td><td>9</td><td>10</td><td>11</td></tr> <tr><td>1</td><td>2</td><td>3</td><td>4</td><td>5</td><td>6</td><td>7</td><td>8</td><td>9</td><td>10</td><td>11</td></tr> </table>	1	2	3	4	5	6	7	8	9	10	11	1	2	3	4	5	6	7	8	9	10	11	1	2	3	4	5	6	7	8	9	10	11	1	2	3	4	5	6	7	8	9	10	11	<table border="1"> <tr><td>1</td><td>2</td><td>3</td><td>4</td><td>5</td><td>6</td></tr> <tr><td>1</td><td>2</td><td>3</td><td>4</td><td>5</td><td>6</td></tr> <tr><td>1</td><td>2</td><td>3</td><td>4</td><td>5</td><td>6</td></tr> <tr><td>1</td><td>2</td><td>3</td><td>4</td><td>5</td><td>6</td></tr> </table>	1	2	3	4	5	6	1	2	3	4	5	6	1	2	3	4	5	6	1	2	3	4	5	6	<table border="1"> <tr><td>1</td><td>2</td><td>3</td><td>4</td><td>5</td><td>6</td></tr> <tr><td>1</td><td>2</td><td>3</td><td>4</td><td>5</td><td>6</td></tr> <tr><td>1</td><td>2</td><td>3</td><td>4</td><td>5</td><td>6</td></tr> <tr><td>1</td><td>2</td><td>3</td><td>4</td><td>5</td><td>6</td></tr> </table>	1	2	3	4	5	6	1	2	3	4	5	6	1	2	3	4	5	6	1	2	3	4	5	6
3	1	3	2	3	3	3	4	3	5	3	6	3	7	3	8	3	9	4	0	4	1	4	2																																																																																																																																									
											4	3																																																																																																																																																				
4	4	5	4	6	4	7	4	8	4	9	5	0	5	1	5	2	5	3	5	4	5	5																																																																																																																																										
1	2	3	4	5	6	7	8	9	10	11																																																																																																																																																						
1	2	3	4	5	6	7	8	9	10	11																																																																																																																																																						
1	2	3	4	5	6	7	8	9	10	11																																																																																																																																																						
1	2	3	4	5	6	7	8	9	10	11																																																																																																																																																						
1	2	3	4	5	6																																																																																																																																																											
1	2	3	4	5	6																																																																																																																																																											
1	2	3	4	5	6																																																																																																																																																											
1	2	3	4	5	6																																																																																																																																																											
1	2	3	4	5	6																																																																																																																																																											
1	2	3	4	5	6																																																																																																																																																											
1	2	3	4	5	6																																																																																																																																																											
1	2	3	4	5	6																																																																																																																																																											

Wire colour code  
 B : Black    LG : Light green    G : Green    L : Blue    W : White    Y : Yellow    SB : Sky blue  
 BR : Brown    O : Orange    GR : Gray    R : Red    P : Pink    V : Violet



NOTES

# REAR FOG LAMP

Vehicles with daytime running lamp

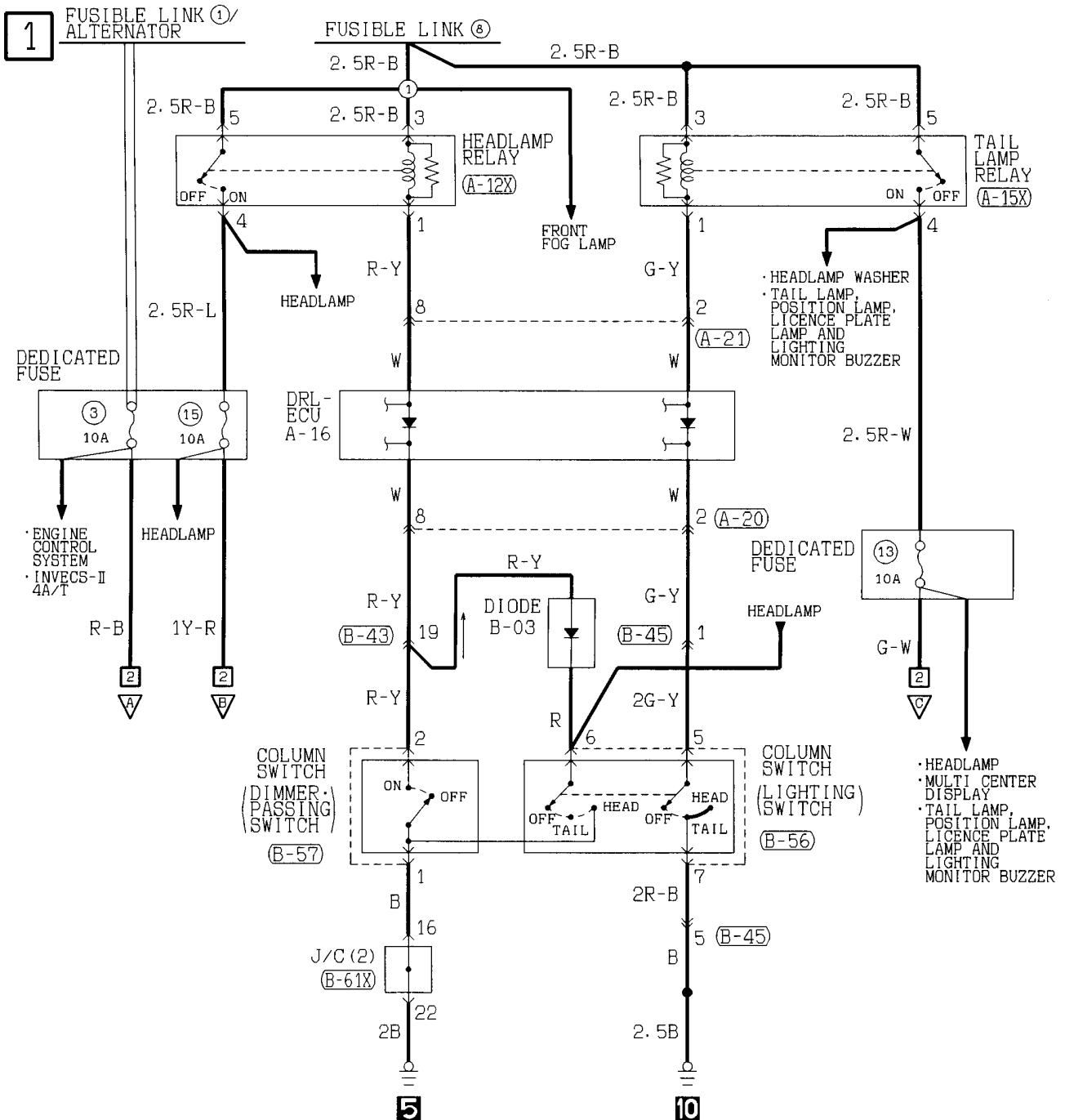

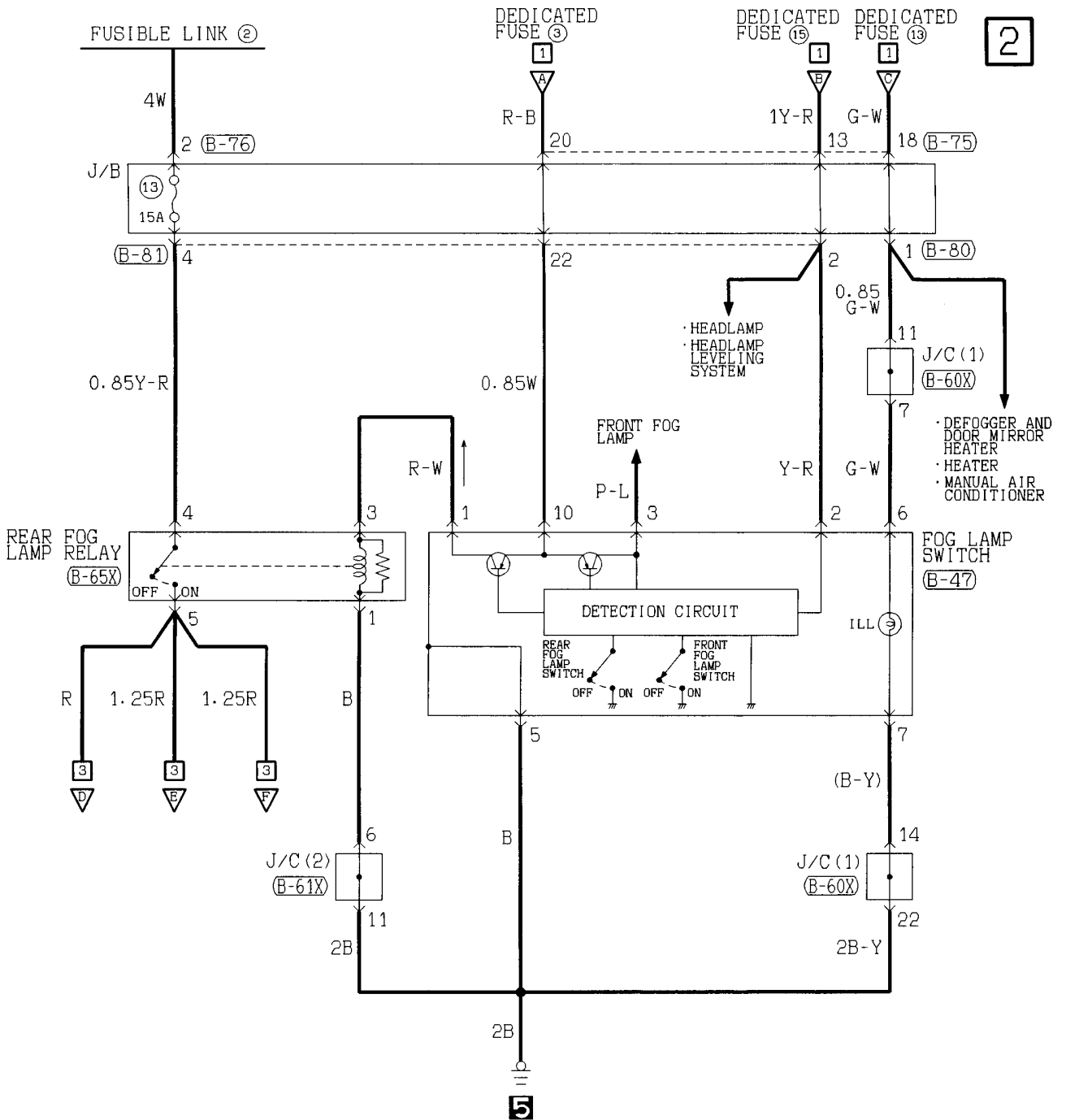

(B-57)  
MU801331

1	2
3	4

(B-60X)

1	2	3	4	5	6	7	8	9	10	11
12	13	14	15	16	17	18	19	20	21	22
23	24	25	26	27	28	29	30	31	32	33

(B-61X)

1	2	3	4	5	6	7	8	9	10	11
12	13	14	15	16	17	18	19	20	21	22
23	24	25	26	27	28	29	30	31	32	33

(B-65X)

1	2	3
4		
5		

(B-75)  
MU801457

1	2	3	4	5	6	7	8	9		
10	11	12	13	14	15	16	17	18	19	20

(B-76)

1	2
---	---

(B-80)

1	2	3	4	5	6	7	8	9	10		
11	12	13	14	15	16	17	18	19	20	21	22

Wire colour code  
 B : Black    LG:Light green    G : Green    L : Blue    W : White    Y : Yellow    SB:Sky blue  
 BR:Brown    O : Orange    GR:Gray    R : Red    P : Pink    V : Violet

REAR FOG LAMP <Vehicles with daytime running lamp> (CONTINUED)

3

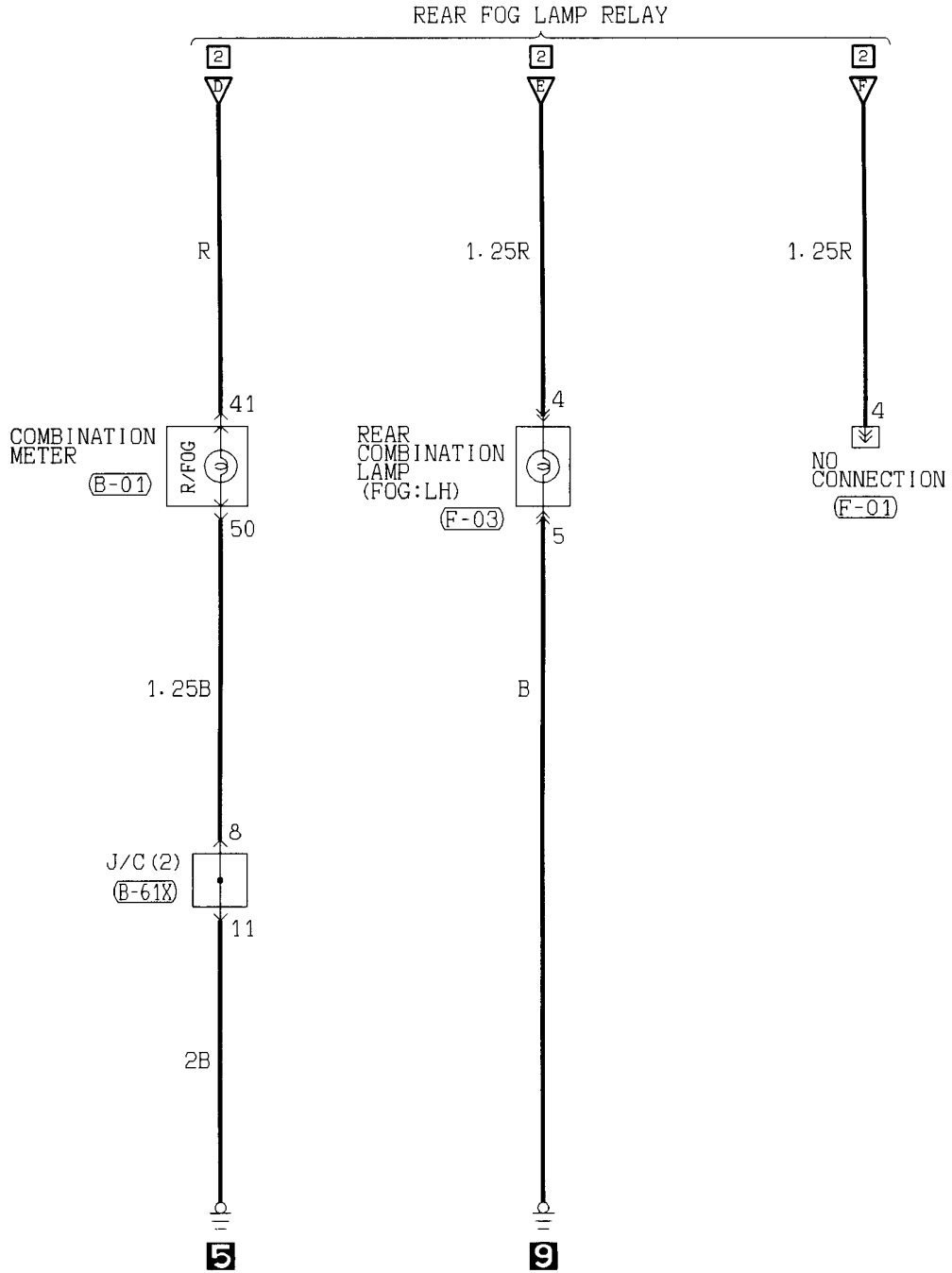

(B-01)

31	32	33	34	35	36	37	38	39	40	41	42
				43							
44	45	46	47	48	49	50	51	52	53	54	55

(B-61X)

1	2	3	4	5	6	7	8	9	10	11
12	13	14	15	16	17	18	19	20	21	22
23	24	25	26	27	28	29	30	31	32	33

(F-01)

MU801448					
1	2				
3	4	5	6		

(F-03)

MU801448					
1	2				
3	4	5	6		

Wire colour code  
 B :Black    LG:Light green    G :Green    L :Blue    W :White    Y :Yellow    SB:Sky blue  
 BR:Brown    O :Orange    GR:Gray    R :Red    P :Pink    V :Violet

---

NOTES

ROOM LAMP, MAP LAMP AND LUGGAGE COMPARTMENT LAMP

Vehicles without keyless entry system

1

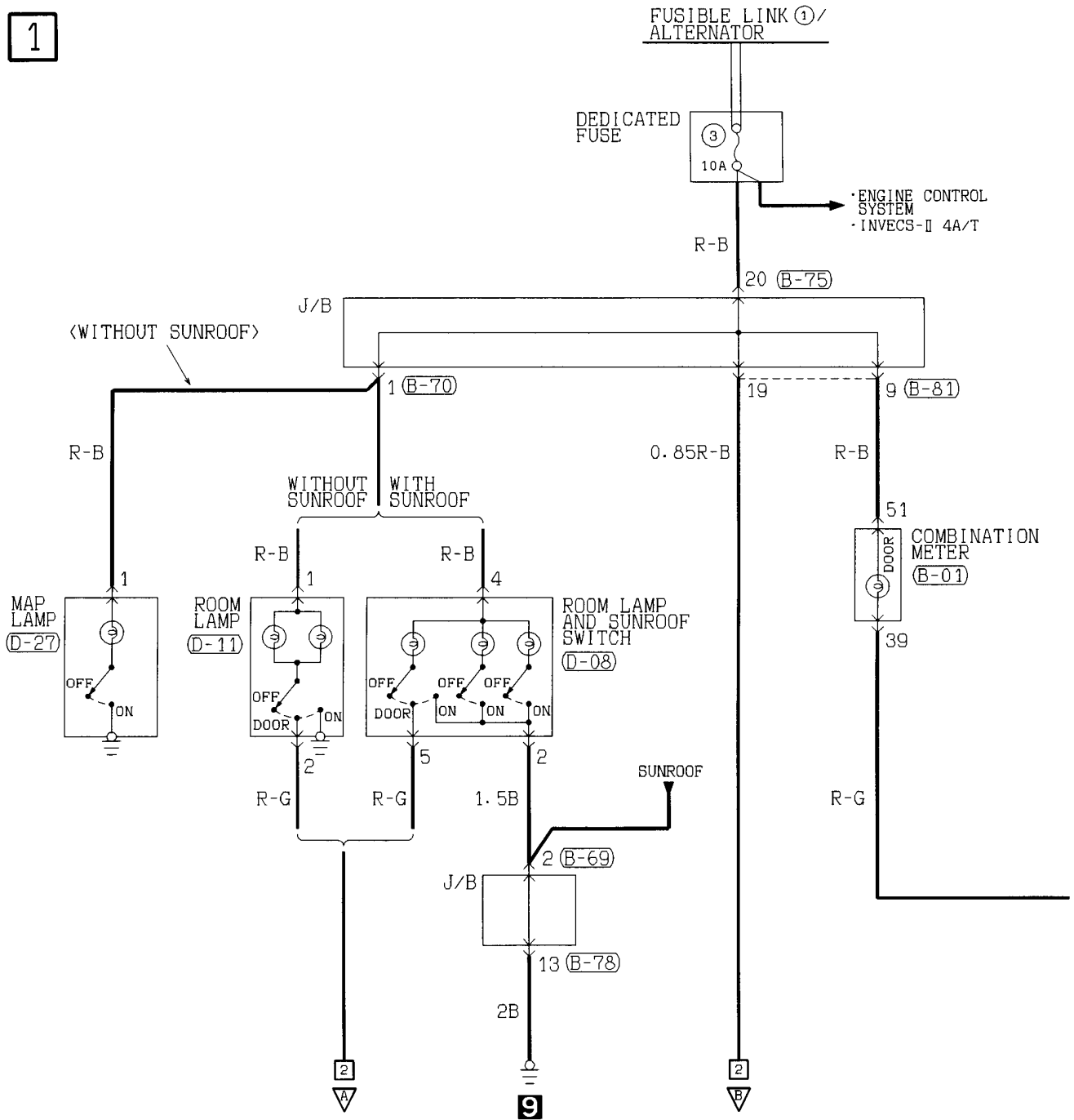

(B-01)

3	1	2	3	3	3	4	3	5	3	6	3	7	3	8	3	9	4	0	4	1	4	2
											43											
4	4	5	4	6	4	7	4	8	4	9	5	1	5	2	5	3	5	4	5	5		

(B-69)

MU801441

1	2
---	---

(B-70)

MU801447

1	2
3	4
5	6

(B-75)

MU801457

1	2	3	4	5	6	7	8	9			
10	11	12	13	14	15	16	17	18			
19	20										

(B-78)

1	2	3	4	5	6	7	8
9	10	11	12	13	14	15	16
17	18						

(B-81)

MU801461

1	2	3	4	5	6	7	8	9	10
11	12	13	14	15	16	17	18	19	20
21	22								

(D-01)

(MU801211)

1
---

2

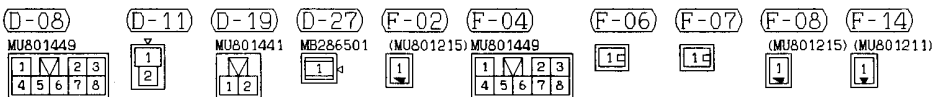
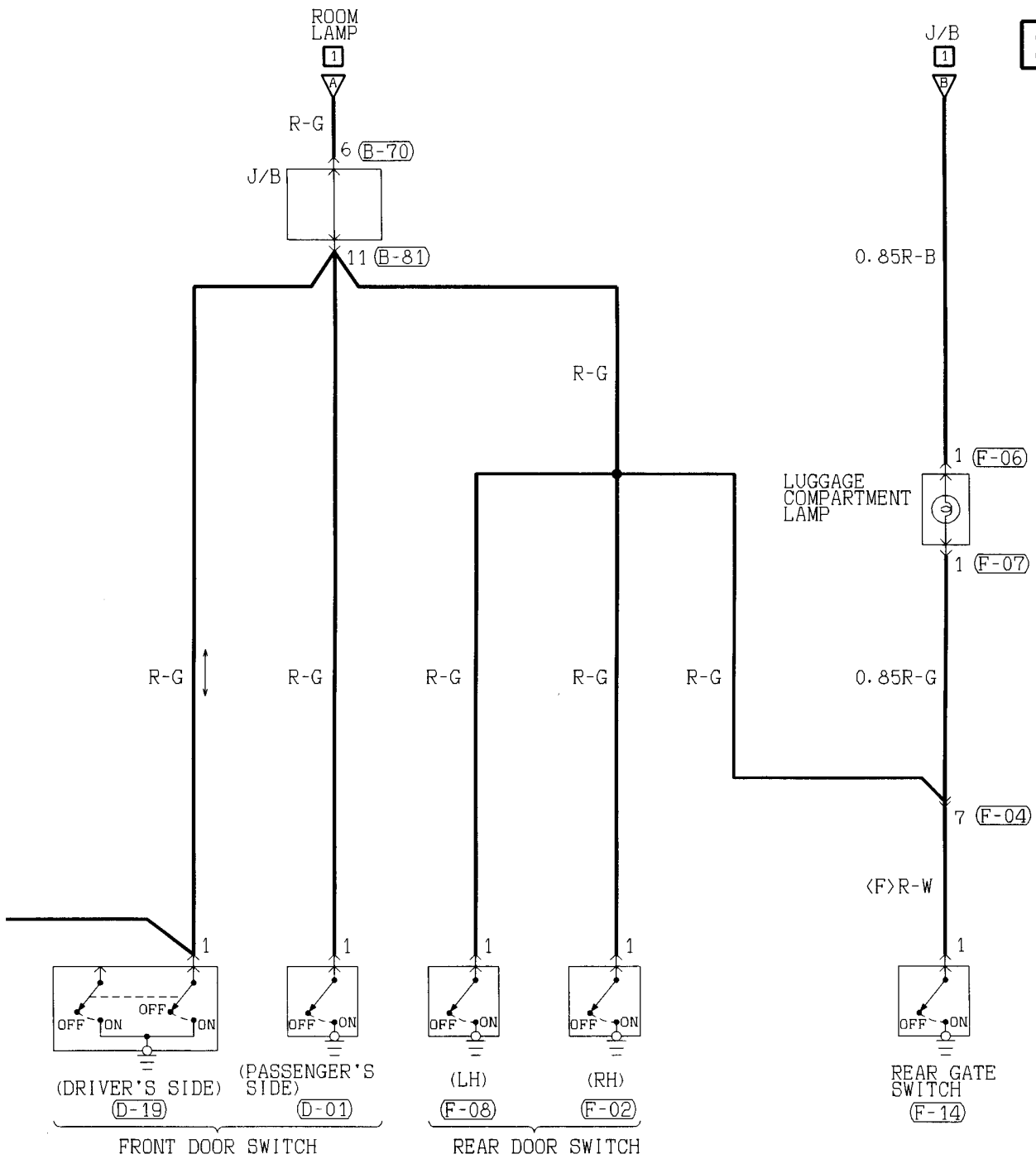

Wire colour code  
 B : Black    LG: Light green    G : Green    L : Blue    W : White    Y : Yellow    SB: Sky blue  
 BR: Brown    O : Orange    GR: Gray    R : Red    P : Pink    V : Violet

ROOM LAMP, MAP LAMP AND LUGGAGE COMPARTMENT LAMP

Vehicles with keyless entry system

1

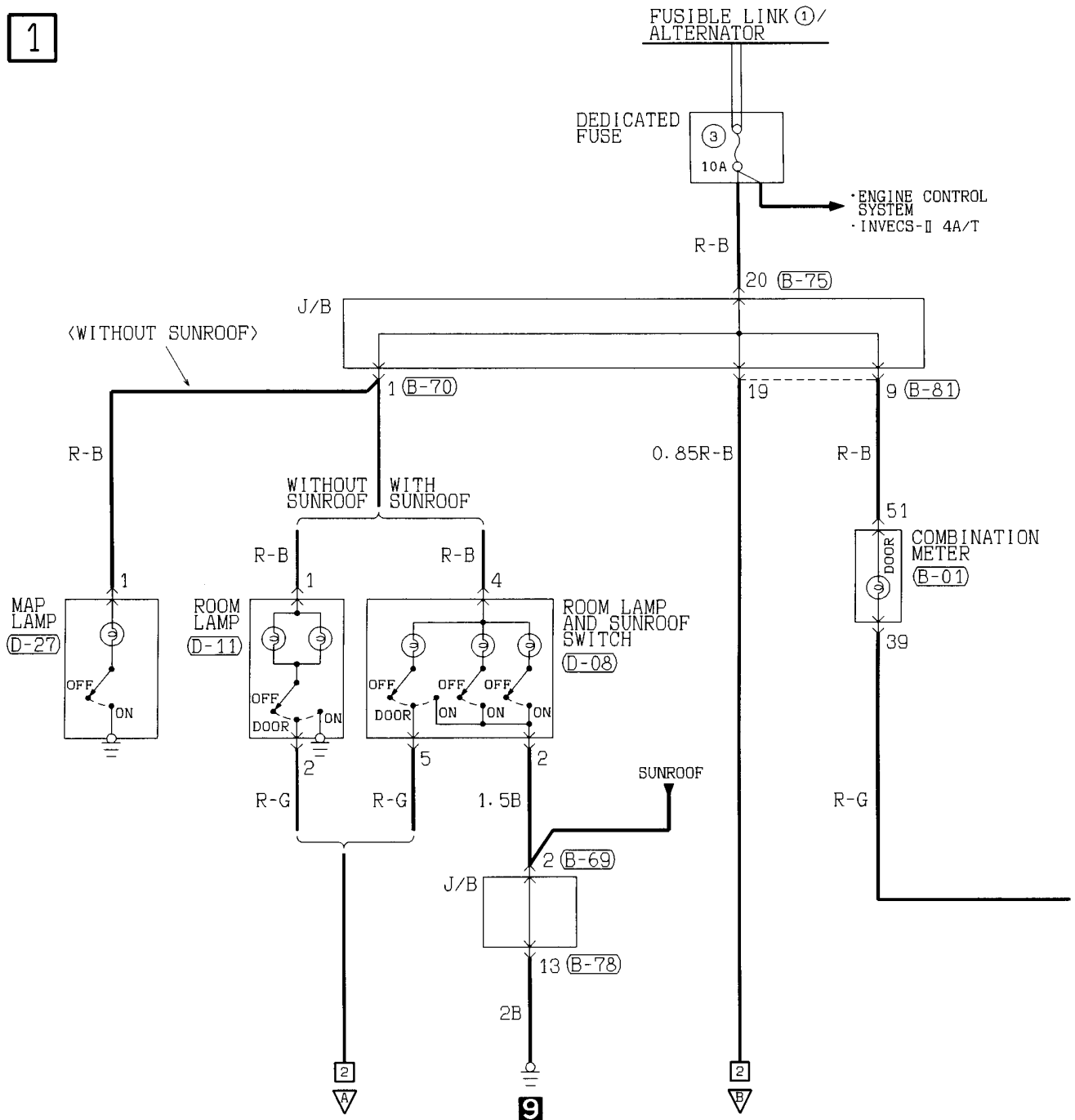

(B-01)

31	32	33	34	35	36	37	38	39	40	41	42
						43					
44	45	46	47	48	49	50	51	52	53	54	55

(B-69)

MU801441
1 2

(B-70)

MU801447
1 2
3 4 5 6

(B-75)

MU801457
1 2 3 4
5 6 7 8 9
10 11 12 13 14 15 16 17 18 19 20

(B-78)

1	2	3	4	M	5	6	7	8	
9	10	11	12	13	14	15	16	17	18

(B-81)

MU801461
1 2 3 4 5
6 7 8 9 10
11 12 13 14 15 16 17 18 19 20 21 22

(D-01)

(MU801211)
1



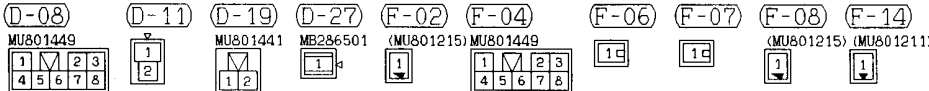
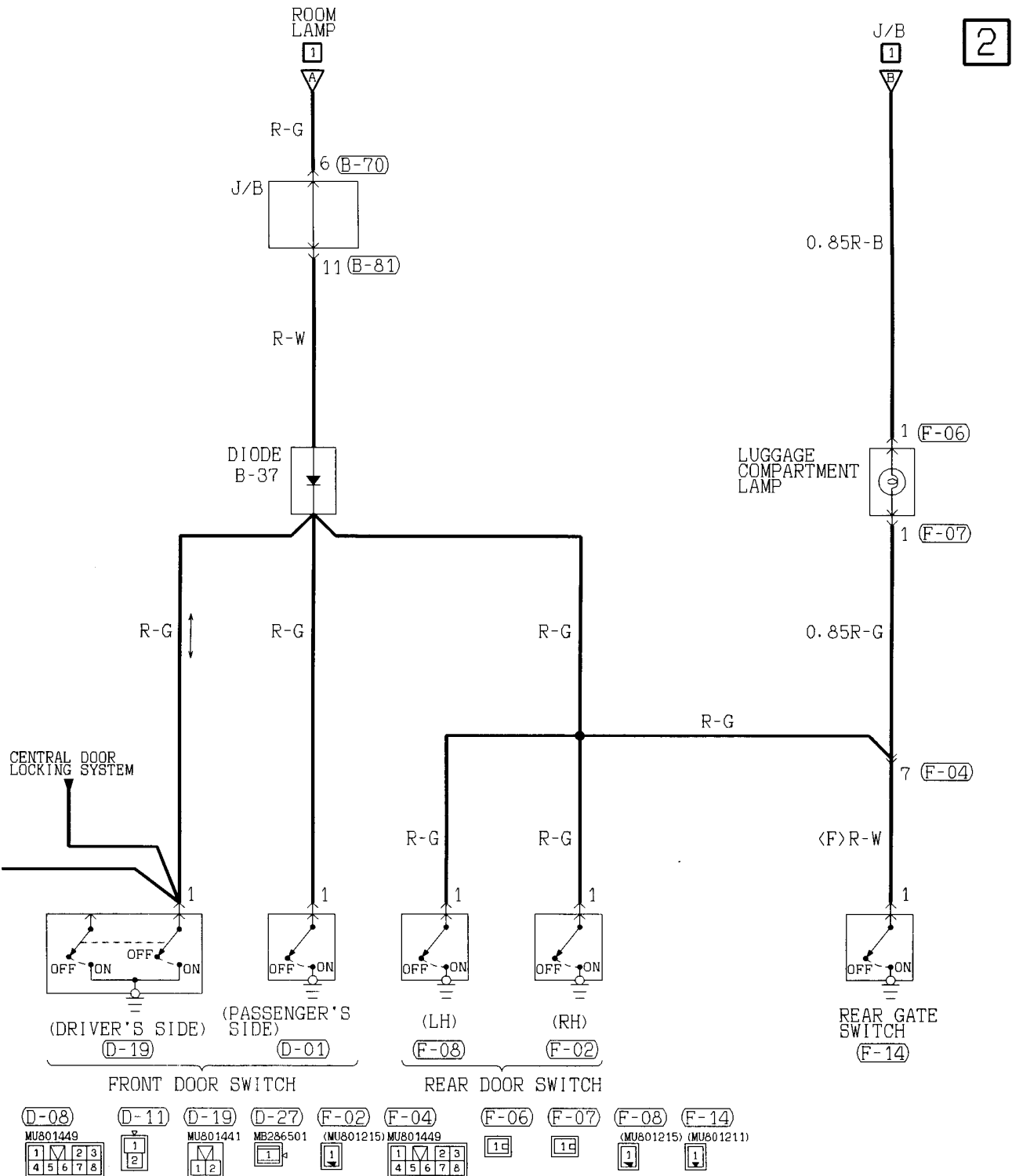

Wire colour code  
 B:Black LG:Light green G:Green L:Blue W:White Y:Yellow SB:Sky blue  
 BR:Brown O:Orange GR:Gray R:Red P:Pink V:Violet

TURN-SIGNAL LAMP AND HAZARD WARNING LAMP

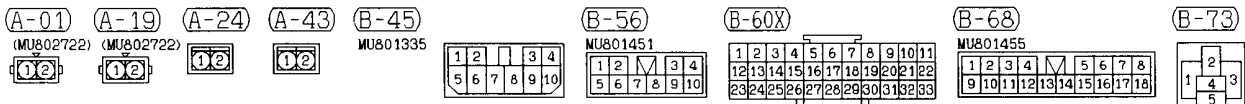
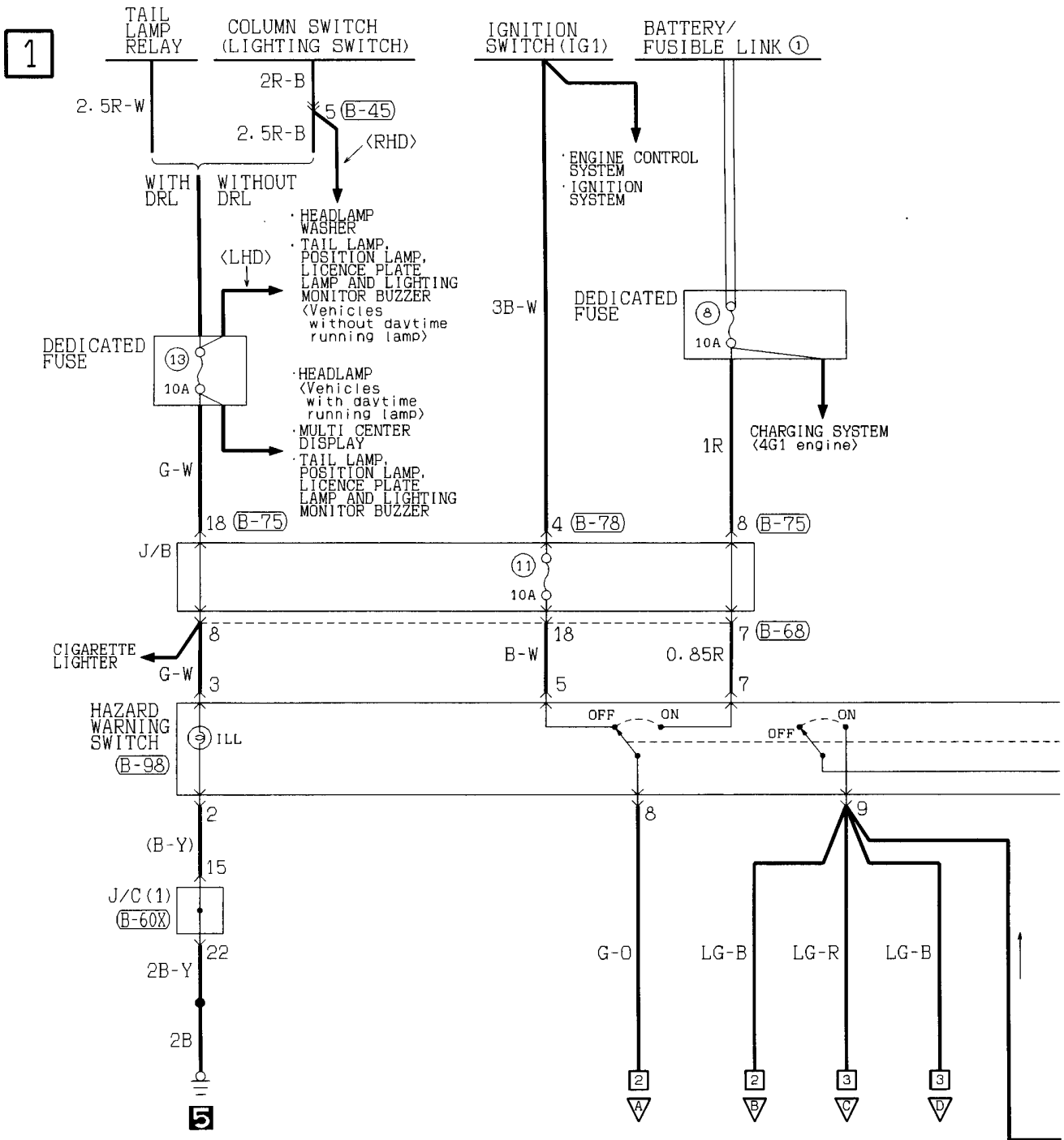

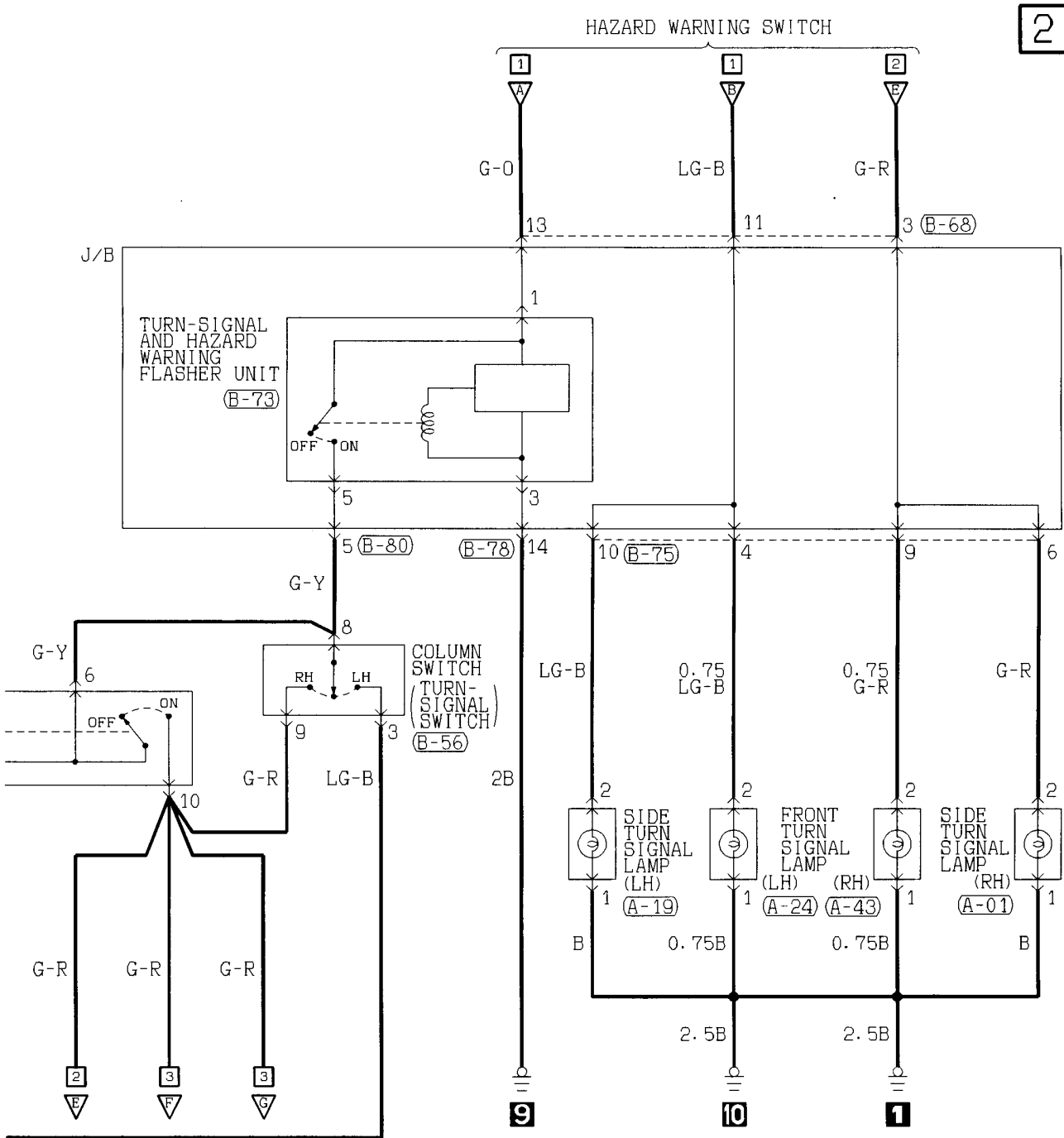

<b>(B-75)</b> MU801457	<b>(B-78)</b>	<b>(B-80)</b>	<b>(B-98)</b> MU801451																																																																																													
<table border="1"> <tr><td>1</td><td>2</td><td>3</td><td>4</td><td>5</td><td>6</td><td>7</td><td>8</td><td>9</td></tr> <tr><td>10</td><td>11</td><td>12</td><td>13</td><td>14</td><td>15</td><td>16</td><td>17</td><td>18</td></tr> <tr><td>19</td><td>20</td><td></td><td></td><td></td><td></td><td></td><td></td><td></td></tr> </table>	1	2	3	4	5	6	7	8	9	10	11	12	13	14	15	16	17	18	19	20								<table border="1"> <tr><td>1</td><td>2</td><td>3</td><td>4</td><td>5</td><td>6</td><td>7</td><td>8</td></tr> <tr><td>9</td><td>10</td><td>11</td><td>12</td><td>13</td><td>14</td><td>15</td><td>16</td></tr> <tr><td>17</td><td>18</td><td></td><td></td><td></td><td></td><td></td><td></td></tr> </table>	1	2	3	4	5	6	7	8	9	10	11	12	13	14	15	16	17	18							<table border="1"> <tr><td>1</td><td>2</td><td>3</td><td>4</td><td>5</td><td>6</td><td>7</td><td>8</td><td>9</td><td>10</td></tr> <tr><td>11</td><td>12</td><td>13</td><td>14</td><td>15</td><td>16</td><td>17</td><td>18</td><td>19</td><td>20</td></tr> <tr><td>21</td><td>22</td><td></td><td></td><td></td><td></td><td></td><td></td><td></td><td></td></tr> </table>	1	2	3	4	5	6	7	8	9	10	11	12	13	14	15	16	17	18	19	20	21	22									<table border="1"> <tr><td>1</td><td>2</td><td>3</td><td>4</td></tr> <tr><td>5</td><td>6</td><td>7</td><td>8</td></tr> <tr><td>9</td><td>10</td><td></td><td></td></tr> </table>	1	2	3	4	5	6	7	8	9	10		
1	2	3	4	5	6	7	8	9																																																																																								
10	11	12	13	14	15	16	17	18																																																																																								
19	20																																																																																															
1	2	3	4	5	6	7	8																																																																																									
9	10	11	12	13	14	15	16																																																																																									
17	18																																																																																															
1	2	3	4	5	6	7	8	9	10																																																																																							
11	12	13	14	15	16	17	18	19	20																																																																																							
21	22																																																																																															
1	2	3	4																																																																																													
5	6	7	8																																																																																													
9	10																																																																																															

Wire colour code  
 B :Black    LG:Light green    G :Green    L :Blue    W :White    Y :Yellow    SB:Sky blue  
 BR:Brown    O :Orange    GR:Gray    R :Red    P :Pink    V :Violet

TURN-SIGNAL LAMP AND HAZARD WARNING LAMP (CONTINUED)

3

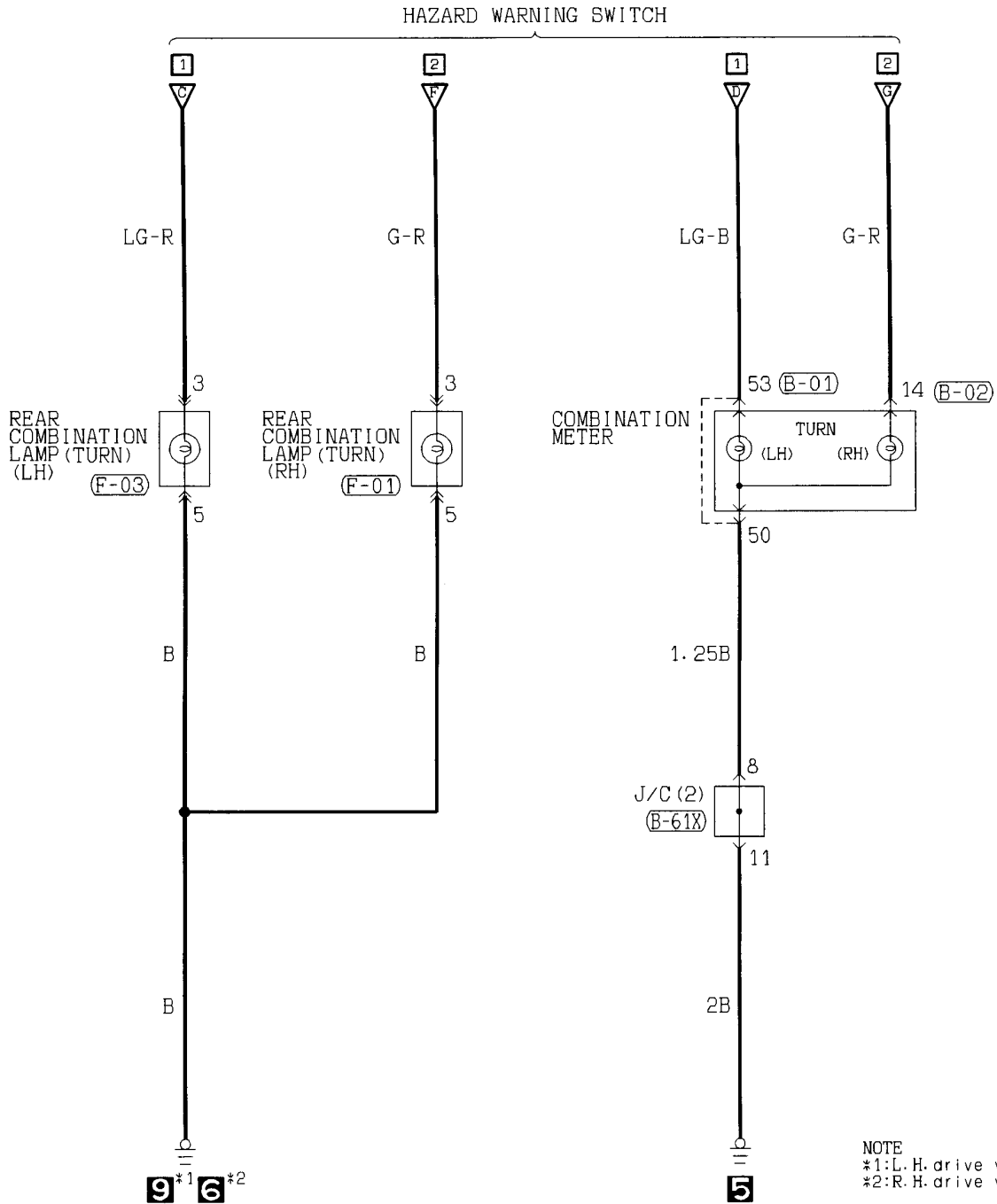

NOTE  
 \*1: L.H. drive vehicles  
 \*2: R.H. drive vehicles

(B-01)

3	1	2	3	3	3	4	3	5	3	6	3	7	3	8	3	9	4	0	4	1	4	2
4	4	4	5	4	7	4	8	4	0	5	1	5	2	5	3	5	4	5	5			

(B-02)

1	2	3	4	5	6	7	8	9	10	11	12
14	15	16	17	18	19	20	21	22	23	24	25

(B-61X)

1	2	3	4	5	6	7	8	9	10	11
12	13	14	15	16	17	18	19	20	21	22
23	24	25	26	27	28	29	30	31	32	33

(F-01)

1	2
3	4
5	6

(F-03)

1	2
3	4
5	6

Wire colour code  
 B : Black    LG: Light green    G : Green    L : Blue    W : White    Y : Yellow    SB: Sky blue  
 BR: Brown    O : Orange    GR: Gray    R : Red    P : Pink    V : Violet

STOP LAMP

1

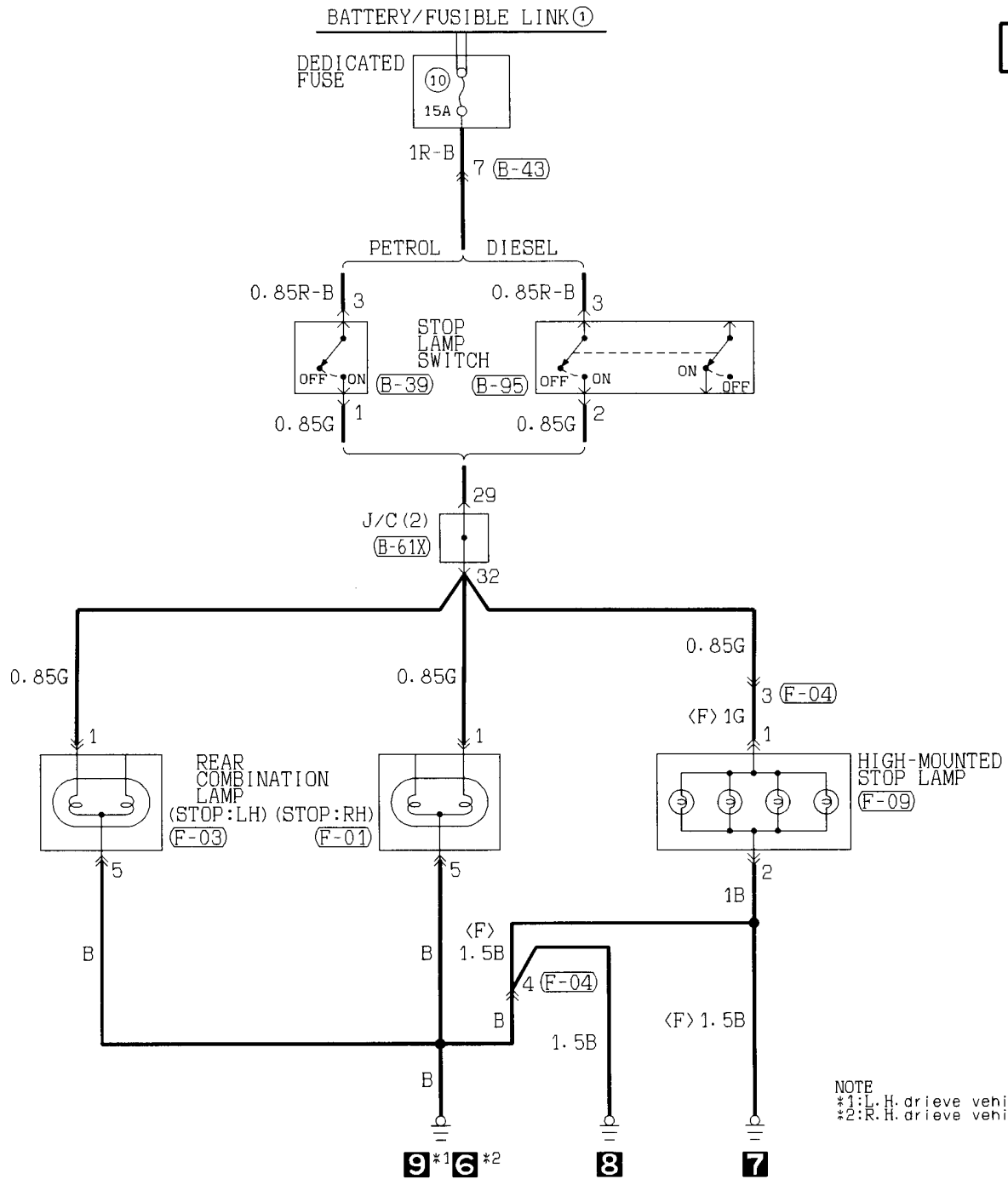

NOTE  
 \*1:L.H. drive vehicles  
 \*2:R.H. drive vehicles

<b>(B-39)</b> 1 2 3	<b>(B-43)</b> MU801461 1 2 3 4 5 6 7 8 9 10 11 12 13 14 15 16 17 18 19 20 21 22	<b>(B-61X)</b> 1 2 3 4 5 6 7 8 9 10 11 12 13 14 15 16 17 18 19 20 21 22 23 24 25 26 27 28 29 30 31 32 33	<b>(B-95)</b> 1 2 3 4	<b>(F-01)</b> MU801448 1 1 2 3 4 5 6	<b>(F-03)</b> MU801448 1 2 3 4 5 6	<b>(F-04)</b> MU801449 1 2 3 4 5 6 7 8	<b>(F-09)</b> MU801441 1 2
------------------------	--	---	--------------------------	---	---	---	----------------------------------

Wire colour code  
 B :Black LG:Light green G :Green L :Blue W :White Y :Yellow SB:Sky blue  
 BR:Brown O :Orange GR:Gray R :Red P :Pink V :Violet

# BACK-UP LAMP

## Petrol-powered vehicles

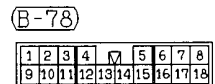
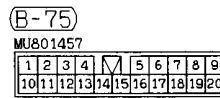
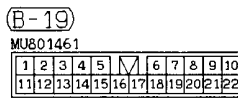
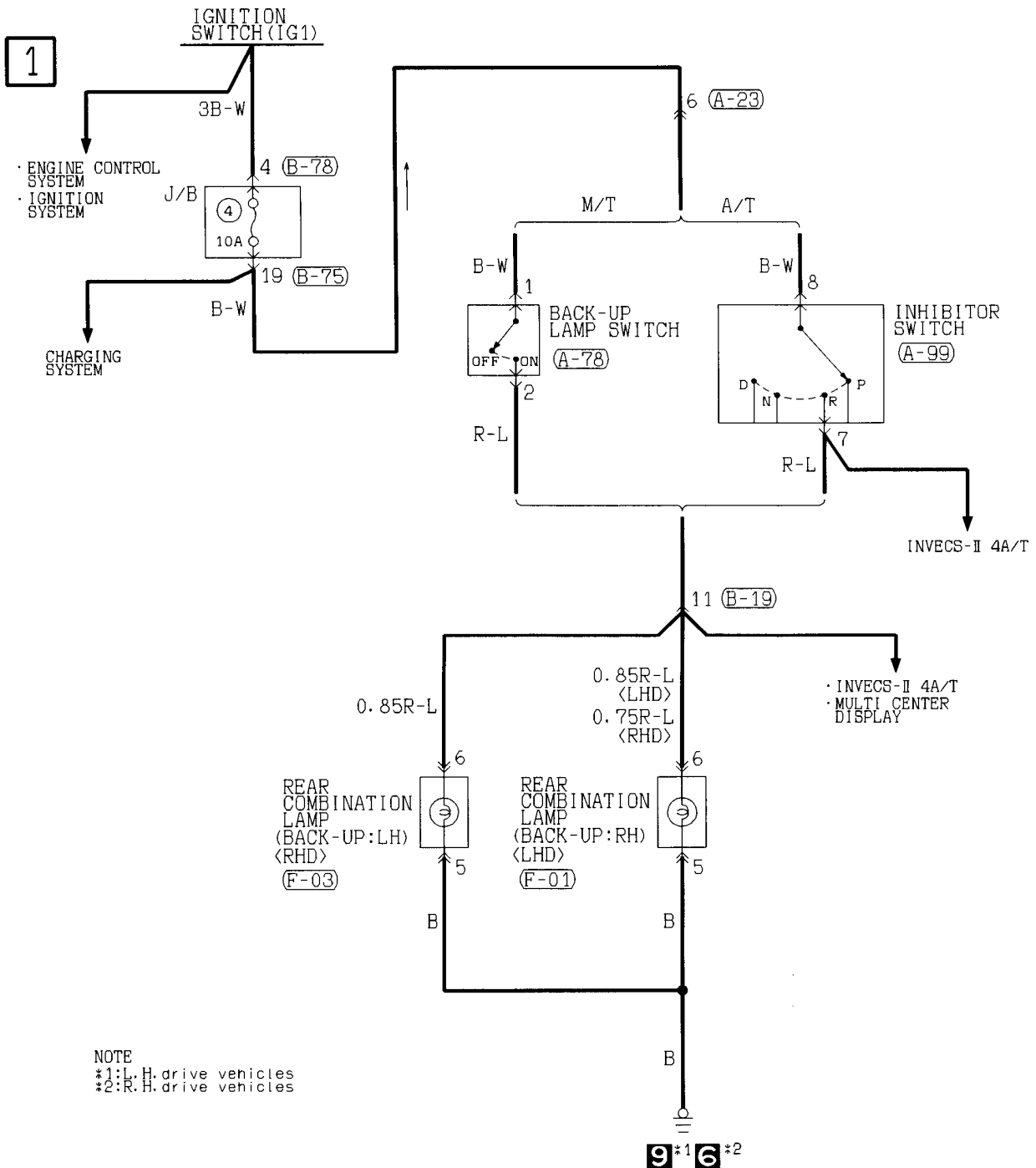

Wire colour code

B : Black LG: Light green G : Green L : Blue W : White Y : Yellow SB: Sky blue  
 BR: Brown O : Orange GR: Gray R : Red P : Pink V : Violet

# BACK-UP LAMP

Diesel-powered vehicles

1

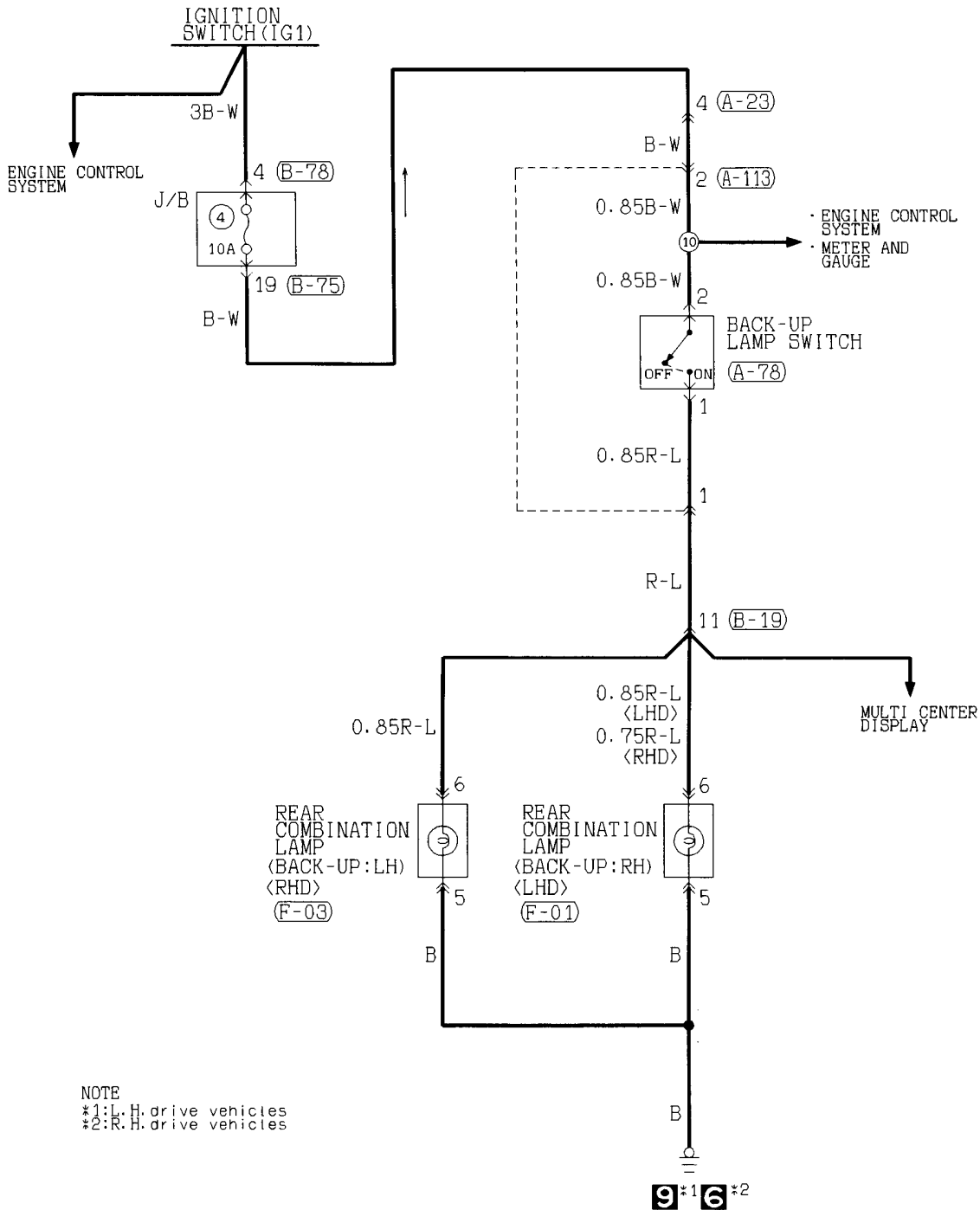

NOTE  
 \*1:L.H. drive vehicles  
 \*2:R.H. drive vehicles

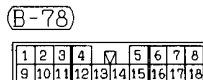
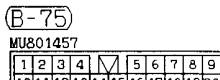
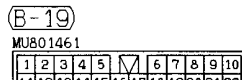

Wire colour code  
 B : Black    LG: Light green    G : Green    L : Blue  
 BR: Brown    O : Orange    GR: Gray    R : Red  
 W : White    SB: Sky blue    P : Pink    Y : Yellow  
 V : Violet

METER AND GAUGE

Petrol-powered vehicles

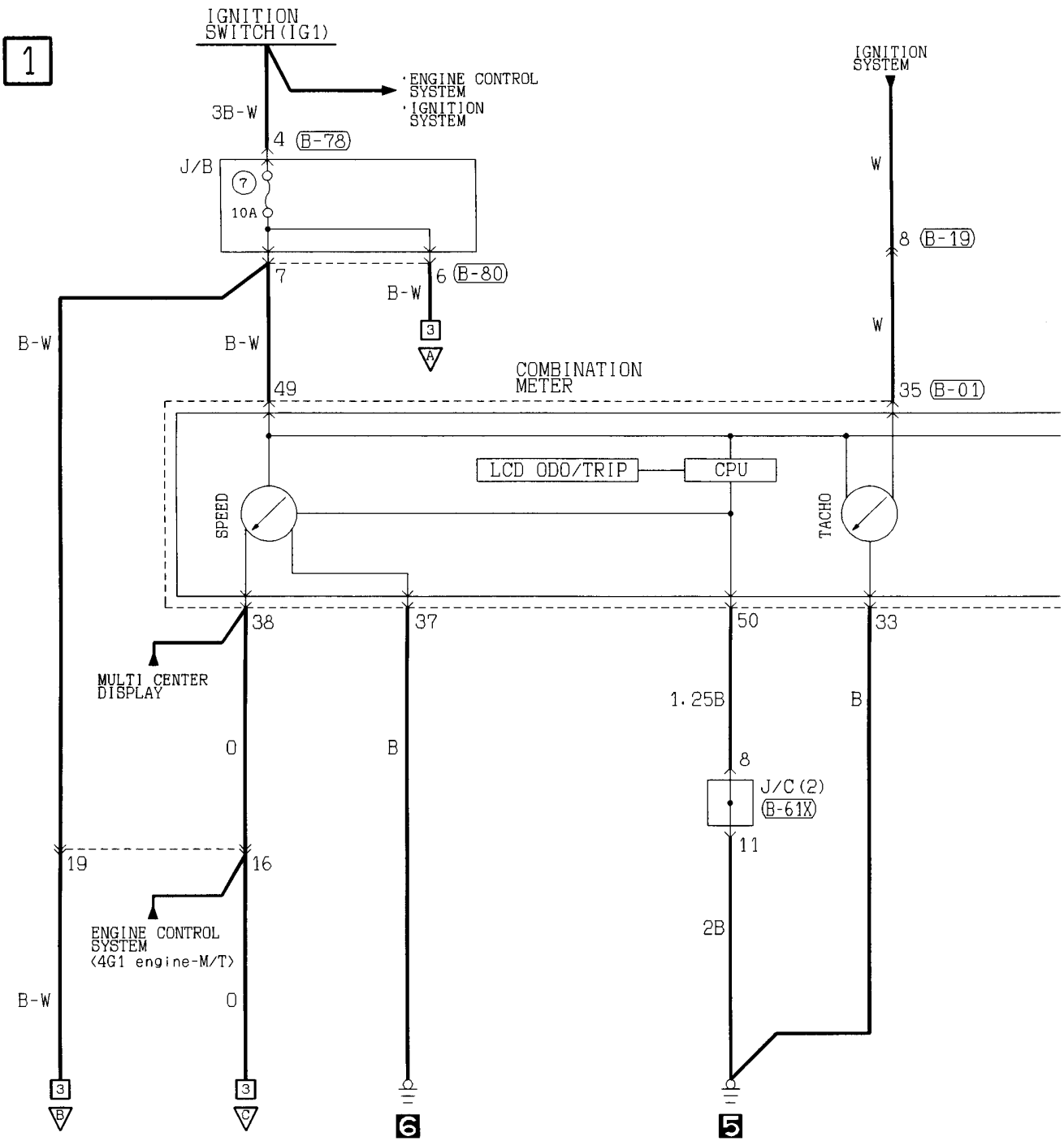

(A-77) MU801211	(B-01)	(B-02)	(B-19) MU801461	(B-45) MU801335	(B-60X)
1	31 32 33 34 35 36 37 38 39 40 41 42	1 2 3 4 5 6 7 8 9 10 11 12	1 2 3 4 5 6 7 8 9 10 11 12 13 14 15 16 17 18 19 20 21 22	1 2 3 4 5 6 7 8 9 10	1 2 3 4 5 6 7 8 9 10 11 12 13 14 15 16 17 18 19 20 21 22 23 24 25 26 27 28 29 30 31 32 33
	43 44 45 46 47 48 49 50 51 52 53 54 55	13 14 15 16 17 18 19 20 21 22 23 24 25			



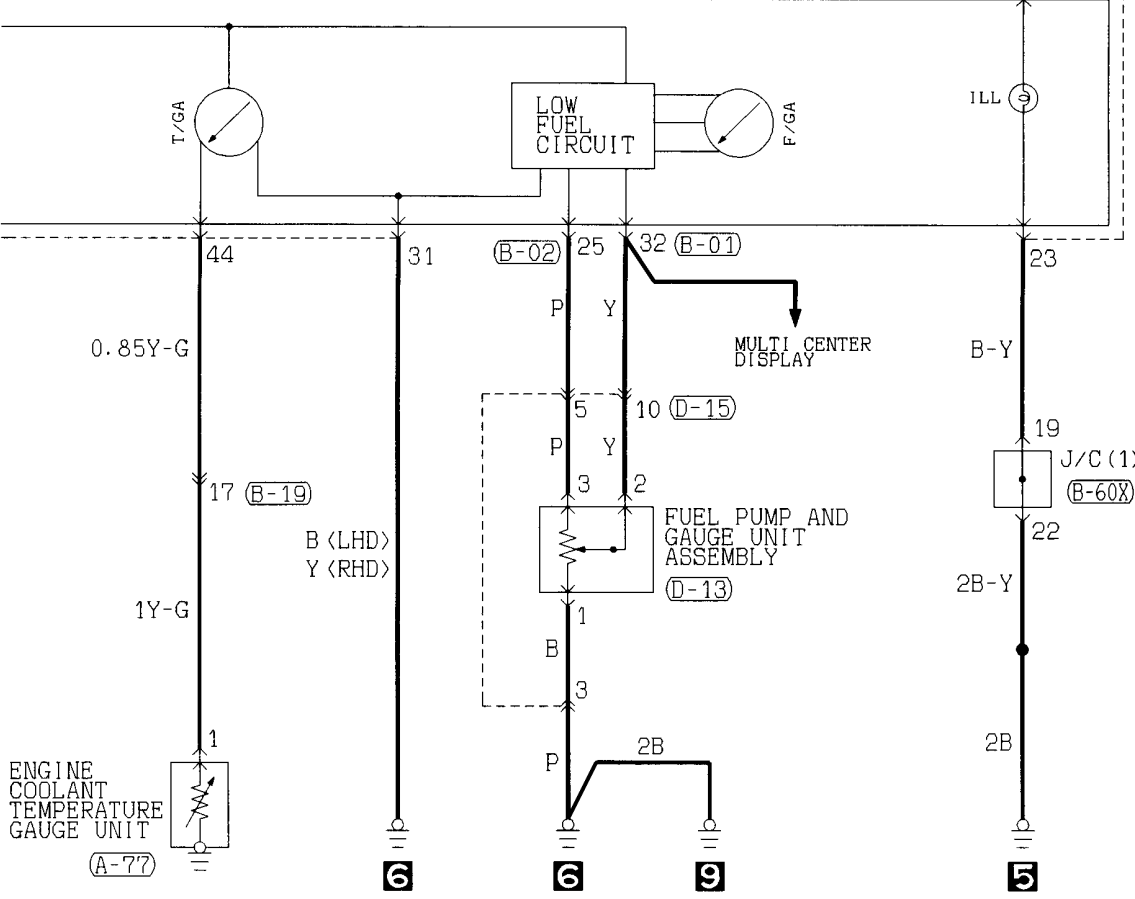
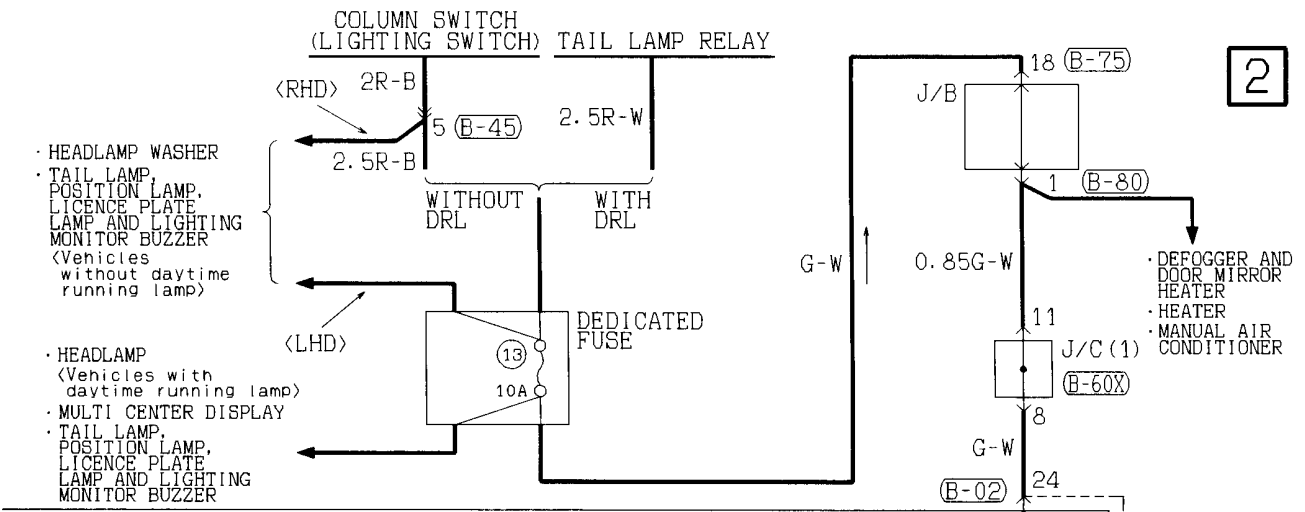

(B-61X)

1	2	3	4	5	6	7	8	9	10	11
12	13	14	15	16	17	18	19	20	21	22
23	24	25	26	27	28	29	30	31	32	33

(B-75)

1	2	3	4	5	6	7	8	9
10	11	12	13	14	15	16	17	18
19	20							

(B-78)

1	2	3	4	5	6	7	8
9	10	11	12	13	14	15	16
17	18						

(B-80)

1	2	3	4	5	6	7	8	9	10
11	12	13	14	15	16	17	18	19	20
21	22								

(D-13)

1	2	3
4	5	

(D-15)

1	2	3	4
5	6	7	8
9	10		

Wire colour code  
 B : Black    LG: Light green    G : Green    L : Blue    W : White    Y : Yellow    SB: Sky blue  
 BR: Brown    O : Orange    GR: Gray    R : Red    P : Pink    V : Violet

METER AND GAUGE <Petrol-powered vehicles> (CONTINUED)

3

<M/T>

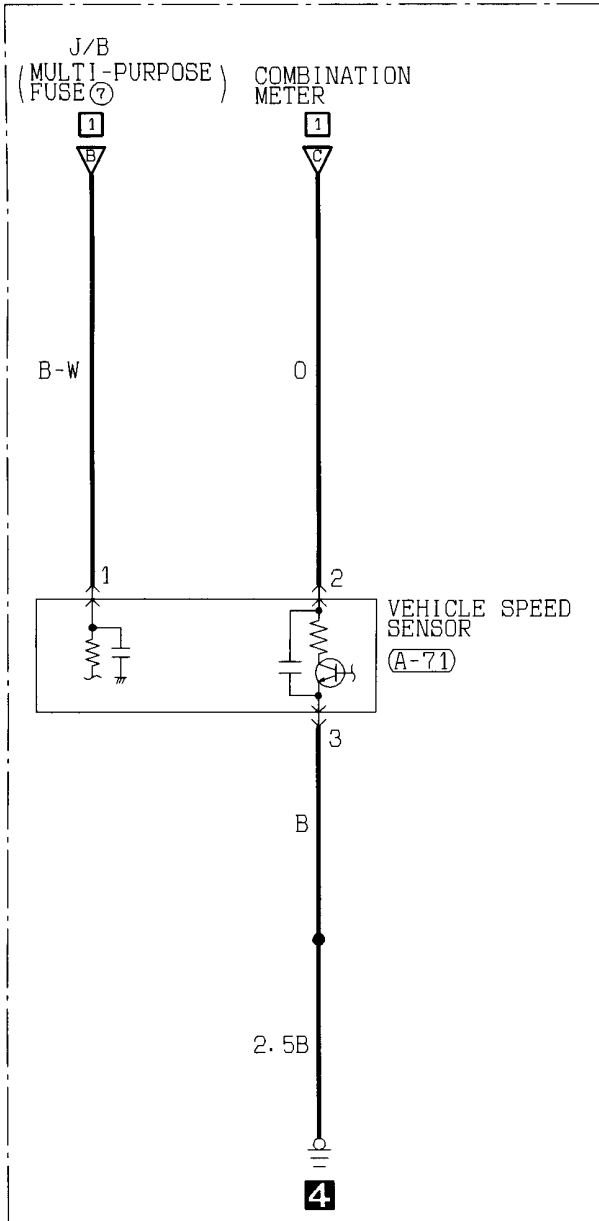

<A/T>

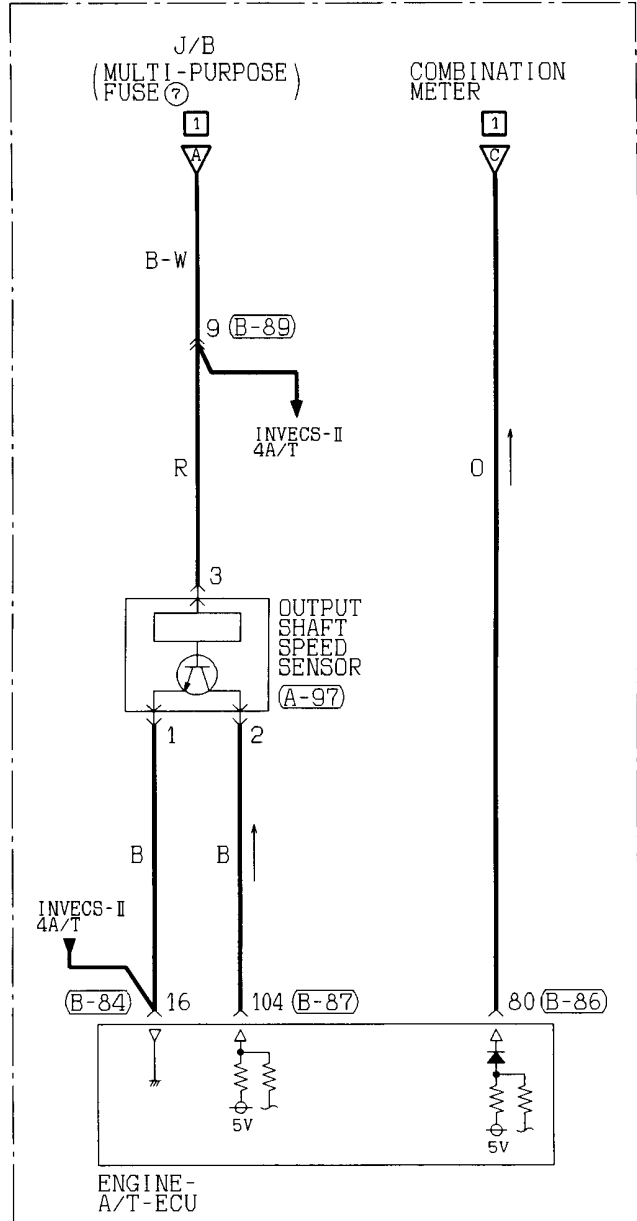

(A-71)

1	2	3
---	---	---

(A-97)

1	2	3
---	---	---

(B-84)

1	2	3	4	5	6	7	8
9	10	11	12	13	14	15	16
17	18	19	20	21	22	23	24
25	26	27	28	29	30	31	32
33	34	35					

(MU803784)

(B-86)

71	72	73	74	75	76	77
78	79	80	81	82	83	84
85	86	87	88	89	90	91
92	93	94	95	96	97	98

(MU803782)

(B-87)

101	102	103	104	105	106	107
108	109	110	111	112	113	114
115	116	117	118	119	120	121
122	123	124	125	126	127	128
129	130					

(MU803783)

(B-89)

1	2	3	4	5	6	7	8	9	10
11	12	13	14	15	16	17	18	19	20
21	22								

M	6	7	8	9	10
11	12	13	14	15	16
17	18	19	20	21	22

Wire colour code  
 B : Black  
 BR : Brown  
 W : White  
 V : Violet

LG : Light green  
 O : Orange  
 SB : Sky blue

G : Green  
 GR : Gray  
 P : Pink

L : Blue  
 R : Red  
 Y : Yellow

---

NOTES

METER AND GAUGE

Diesel-powered vehicles

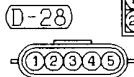
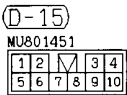
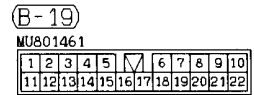
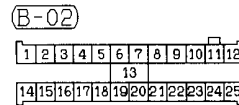
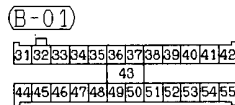
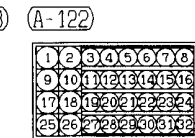
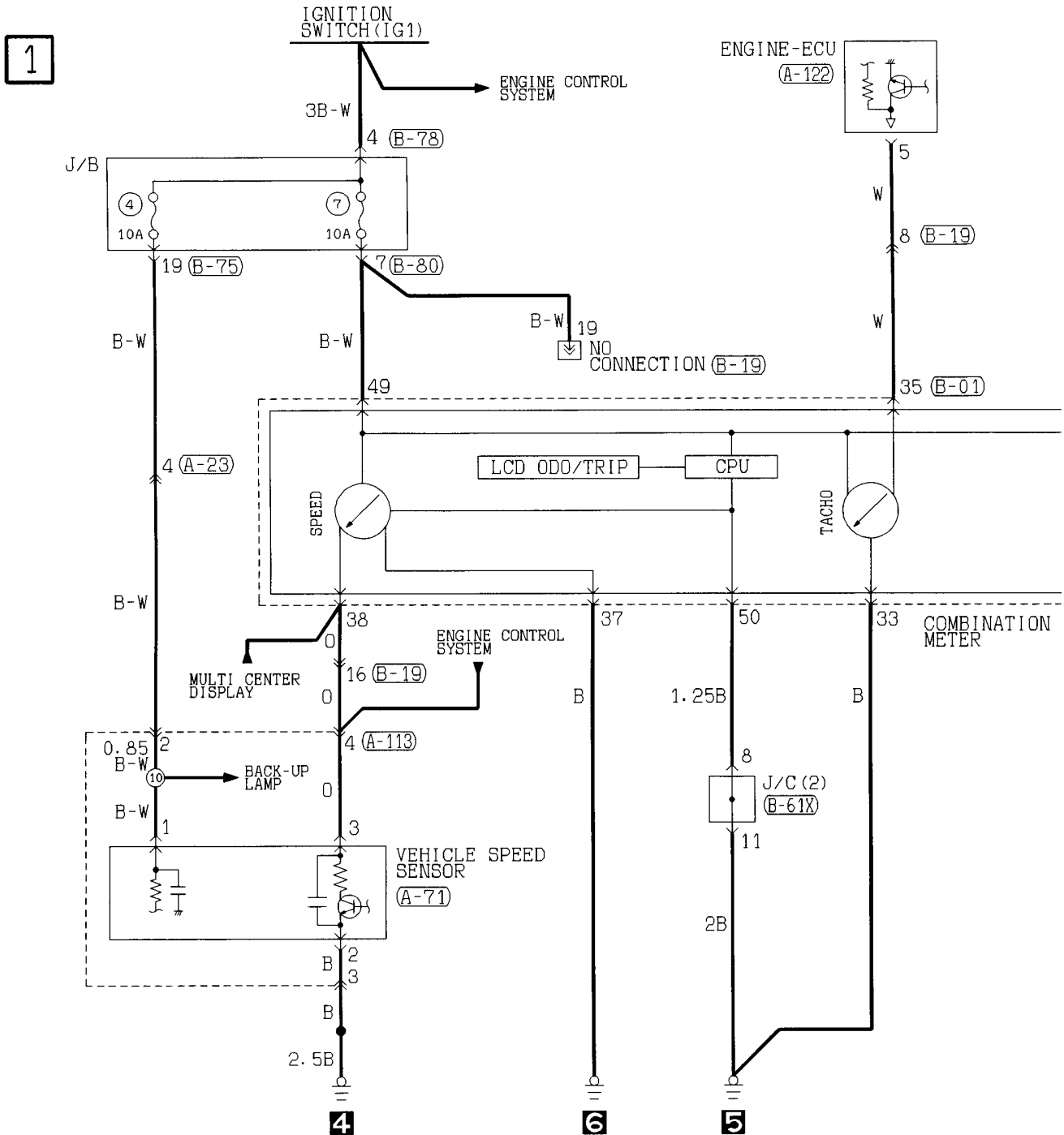

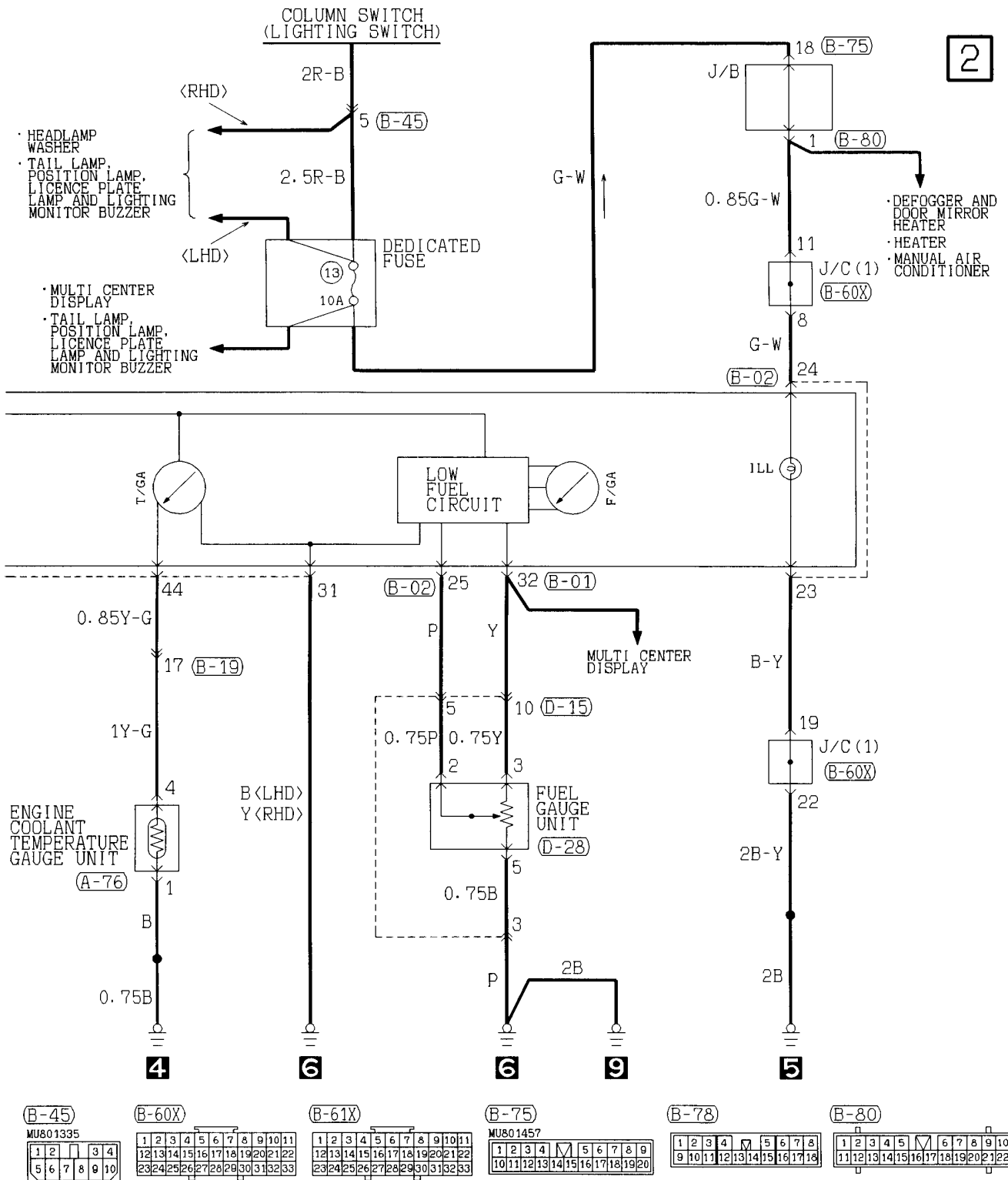

(B-45) MU801335	(B-60X) MU801335	(B-61X) MU801335	(B-75) MU801457	(B-78) MU801457	(B-80) MU801457
1 2 3 4 5 6 7 8 9 10	1 2 3 4 5 6 7 8 9 10 11 12 13 14 15 16 17 18 19 20 21 22 23 24 25 26 27 28 29 30 31 32 33	1 2 3 4 5 6 7 8 9 10 11 12 13 14 15 16 17 18 19 20 21 22 23 24 25 26 27 28 29 30 31 32 33	1 2 3 4 M 5 6 7 8 9 10 11 12 13 14 15 16 17 18 19 20	1 2 3 4 M 5 6 7 8 9 10 11 12 13 14 15 16 17 18	1 2 3 4 5 6 7 8 9 10 11 12 13 14 15 16 17 18 19 20 21 22

Wire colour code  
 B : Black LG : Light green G : Green L : Blue W : White Y : Yellow SB : Sky blue  
 BR : Brown O : Orange GR : Gray R : Red P : Pink V : Violet

**CENTRAL DOOR LOCKING SYSTEM**

Vehicles without keyless entry system

1

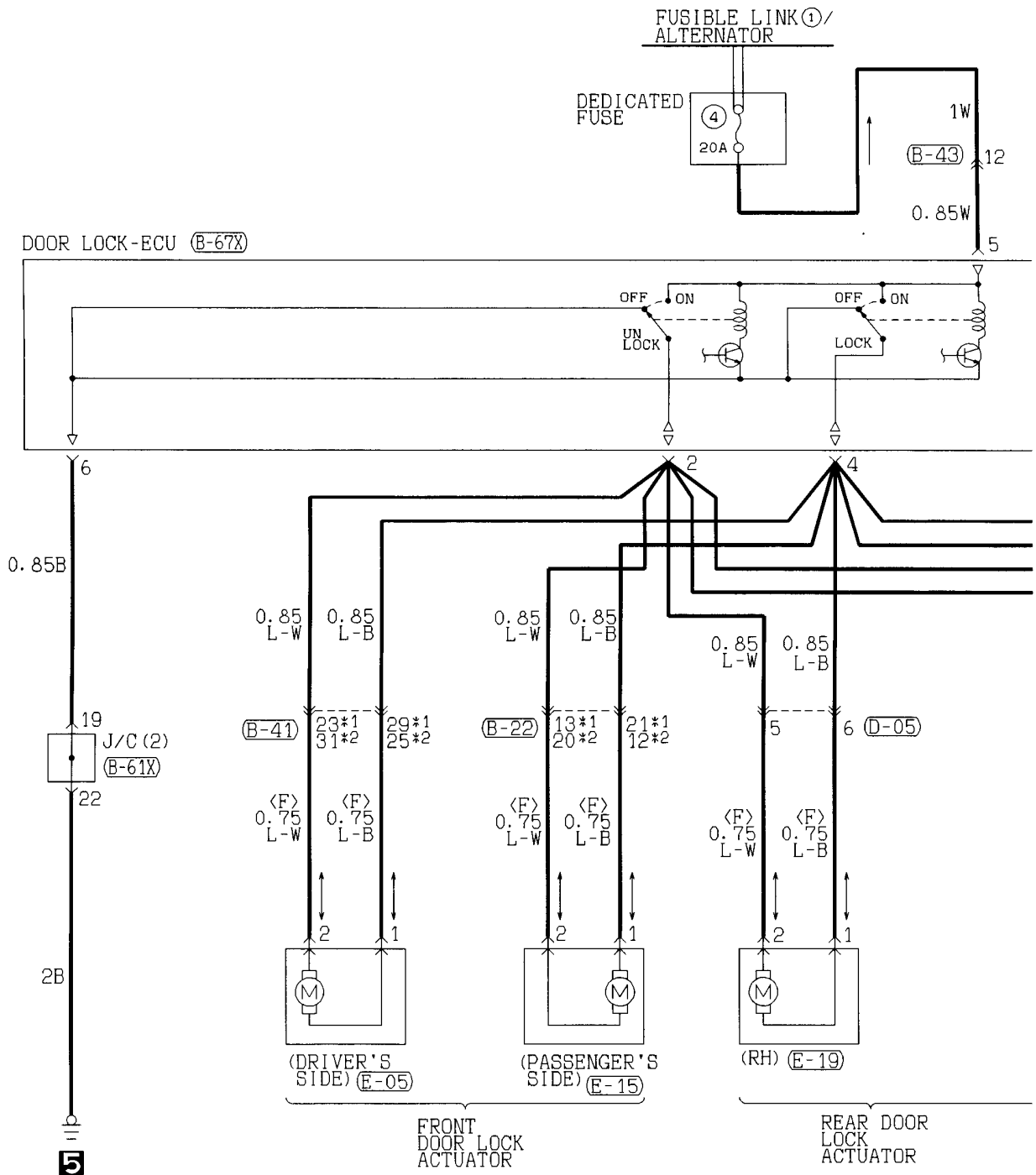

B-22

1	2	3	4	5	6	7	8	9	10
11	12	13	14	15	16	17	18	19	20
21	22	23	24	25	26	27	28	29	30
31	32								

B-41

1	2	3	4	5	6	7	8	9	
10	11	12	13	14	15	16	17	18	19
20	21	22	23	24	25	26	27	28	29
30	31	32							

B-43

1	2	3	4	5	6	7	8	9	10
11	12	13	14	15	16	17	18	19	20
21	22	23	24	25	26	27	28	29	30
31	32	33							

B-61X

1	2	3	4	5	6	7	8	9	10
11	12	13	14	15	16	17	18	19	20
21	22	23	24	25	26	27	28	29	30
31	32	33							

B-67X

1	2	3
4	5	6
7	8	9

D-05

1	2	3	4
5	6	7	8
9	10		

2

NOTE  
 \*1:L.H. drive vehicles  
 \*2:R.H. drive vehicles

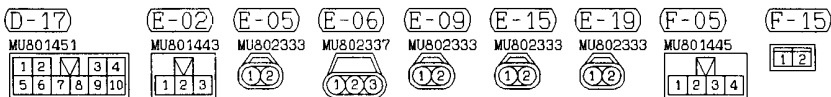
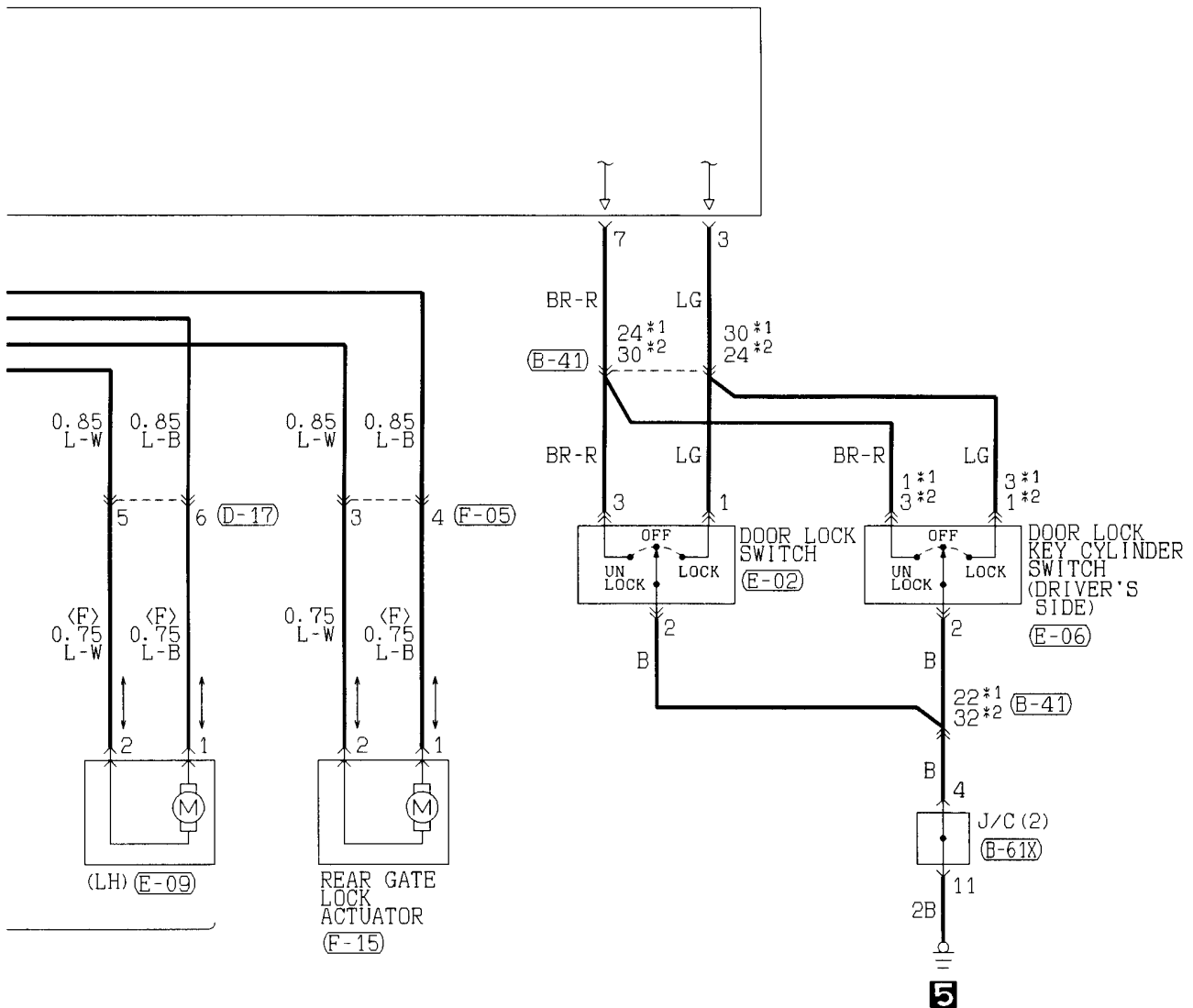

Wire colour code  
 B :Black LG:Light green G :Green L :Blue W :White Y :Yellow SB:Sky blue  
 BR:Brown O :Orange GR:Gray R :Red P :Pink V :Violet

# CENTRAL DOOR LOCKING SYSTEM

Vehicles with keyless entry system

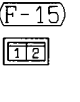
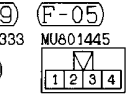
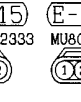
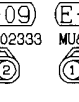
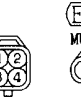
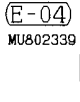
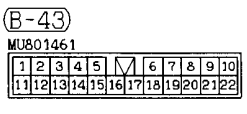
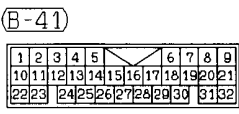
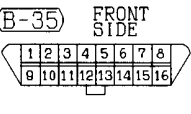
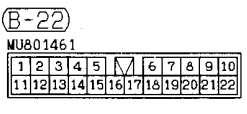
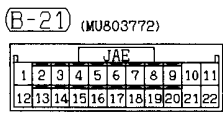
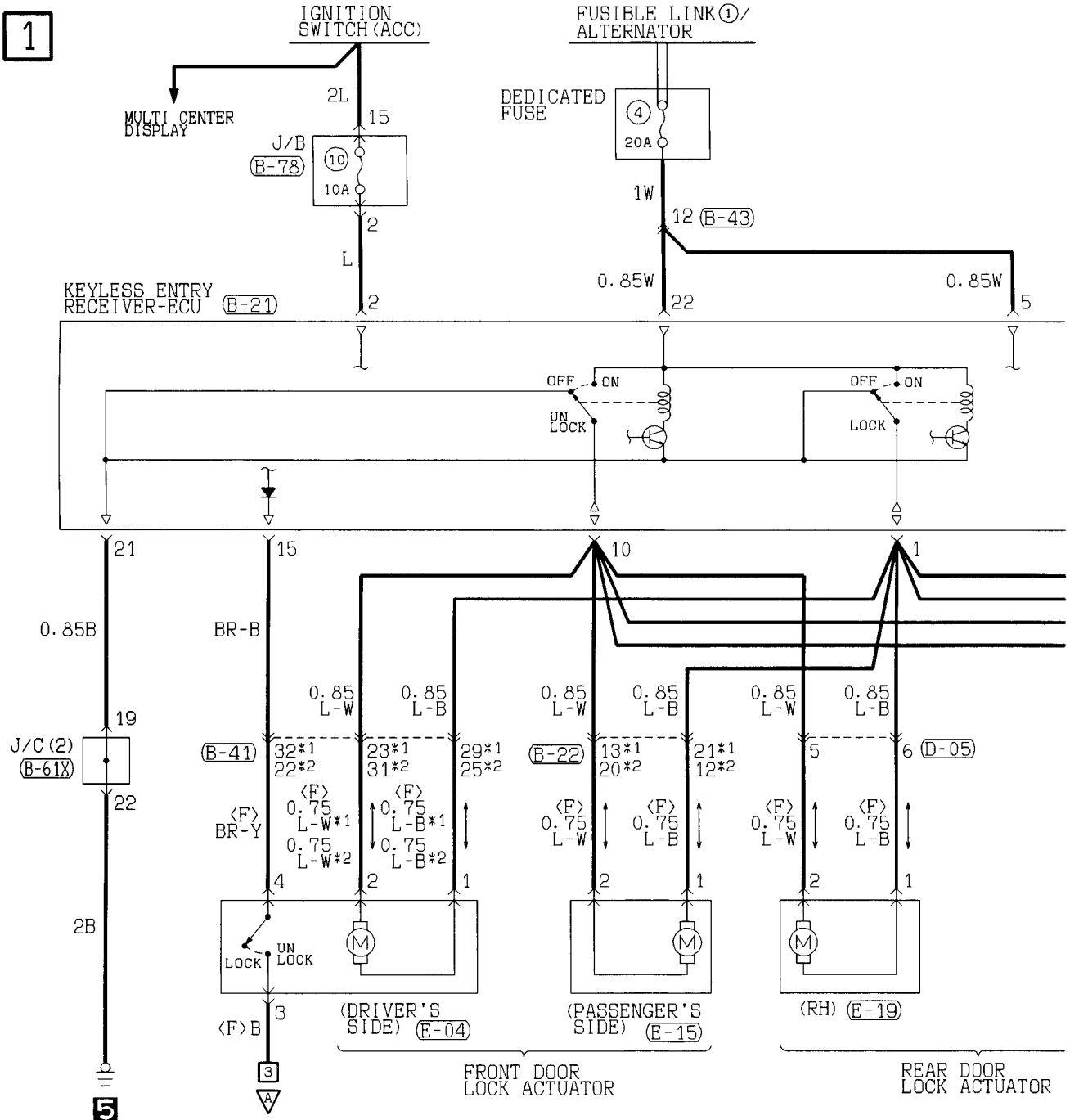



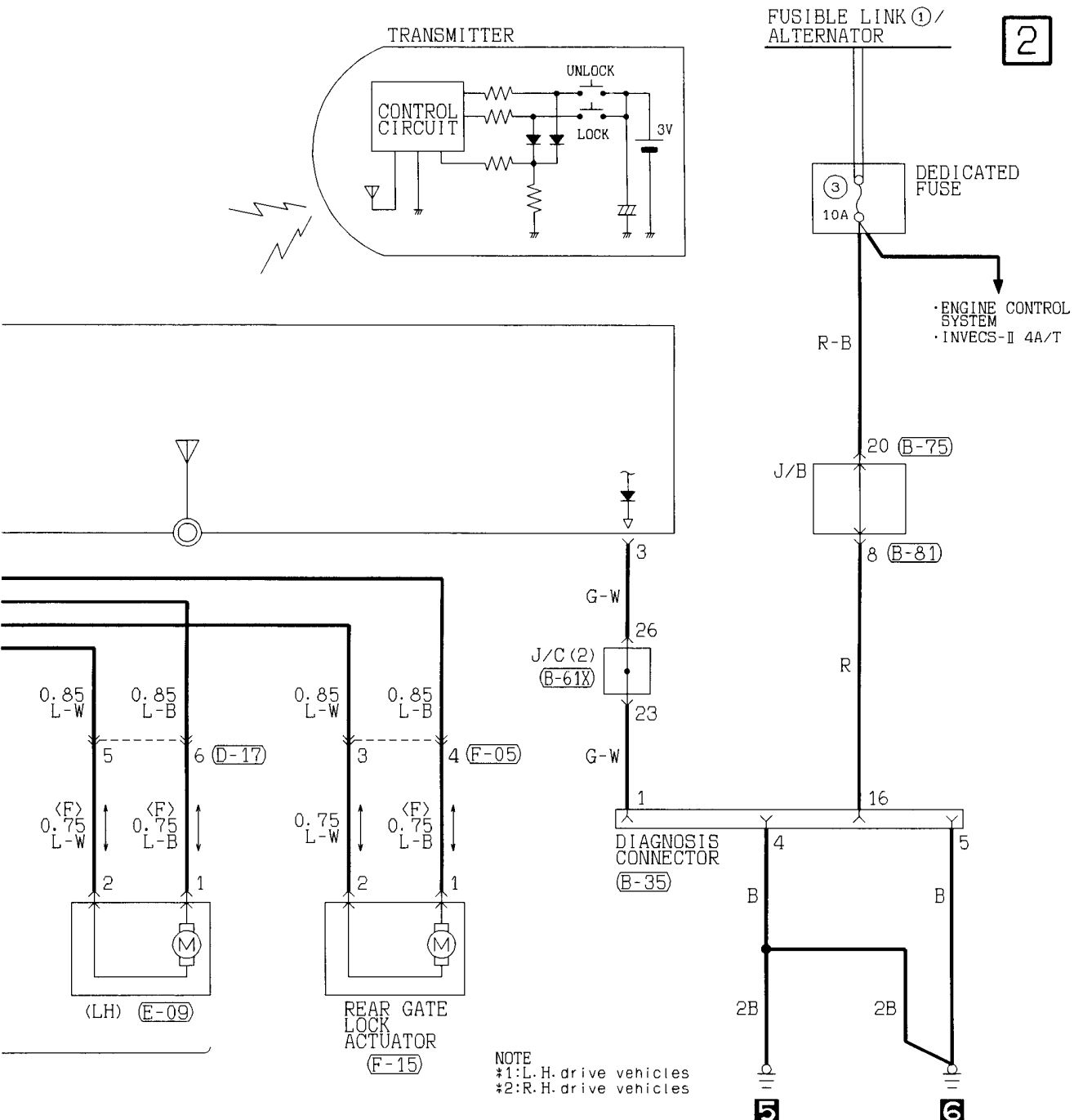

NOTE  
 \*1:L.H. drive vehicles  
 \*2:R.H. drive vehicles

(B-61X)	(B-75)	(B-78)	(B-81)	(D-05)	(D-17)
1 2 3 4 5 6 7 8 9 10 11 12 13 14 15 16 17 18 19 20 21 22 23 24 25 26 27 28 29 30 31 32 33	MU801457 1 2 3 4 M 5 6 7 8 9 10 11 12 13 14 15 16 17 18 19 20	1 2 3 4 M 5 6 7 8 9 10 11 12 13 14 15 16 17 18	MU801461 1 2 3 4 5 M 6 7 8 9 10 11 12 13 14 15 16 17 18 19 20 21 22	MU801451 1 2 M 3 4 5 6 7 8 9 10	MU801451 1 2 M 3 4 5 6 7 8 9 10

Wire colour code  
 B :Black L G :Light green G :Green L :Blue W :White Y :Yellow SB:Sky blue  
 BR:Brown O :Orange GR:Gray R :Red P :Pink V :Violet

**CENTRAL DOOR LOCKING SYSTEM <Vehicles with keyless entry system>  
(CONTINUED)**

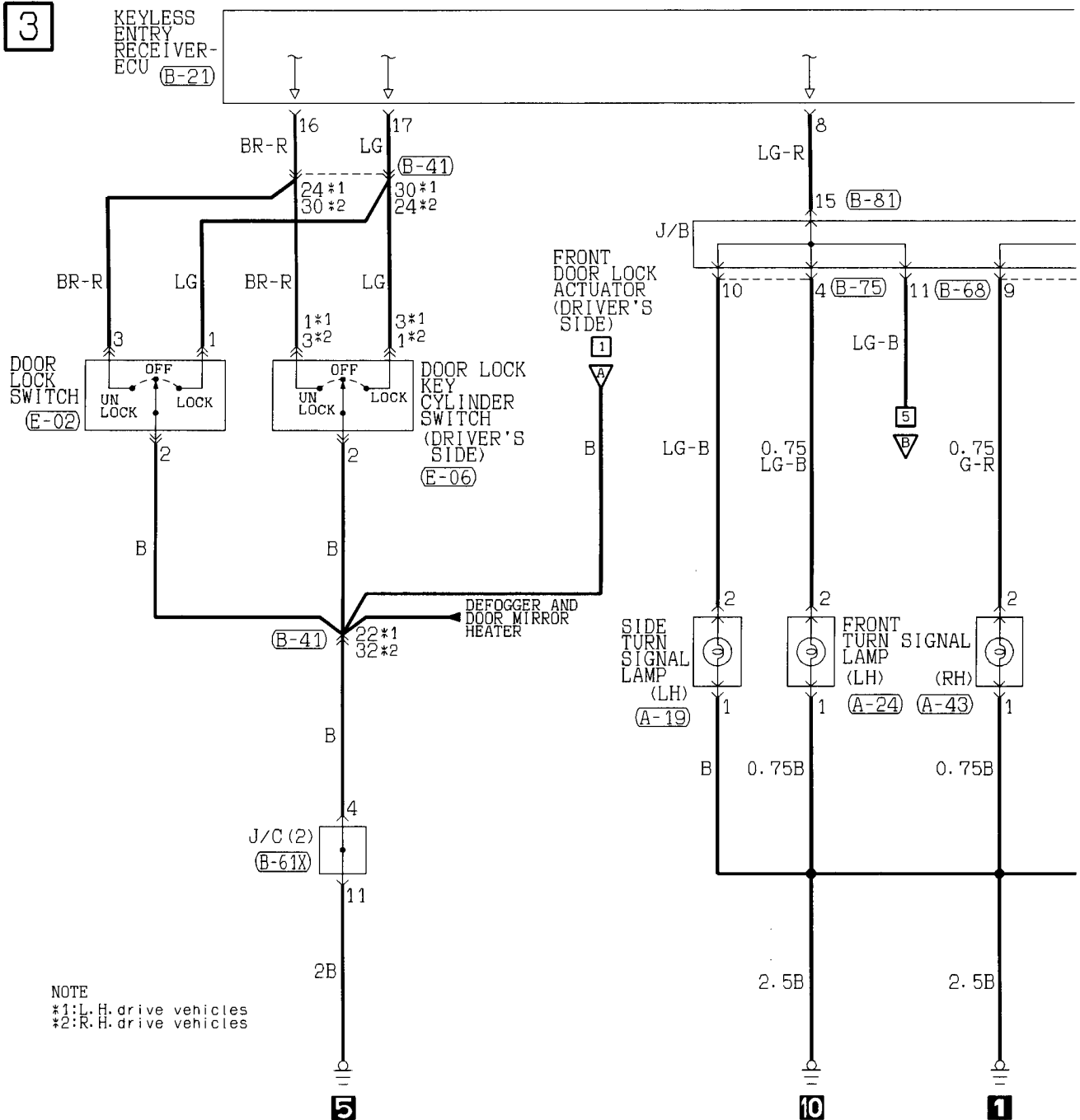

A-01 (MU802722)	A-19 (MU802722)

A-24	A-43

B-21 (MU803772)											
JAE											
1	2	3	4	5	6	7	8	9	10	11	12
12	13	14	15	16	17	18	19	20	21	22	23
24	25	26	27	28	29	30	31	32			

B-41											
1	2	3	4	5	6	7	8	9	10	11	12
13	14	15	16	17	18	19	20	21	22	23	24
25	26	27	28	29	30	31	32				

B-61X											
1	2	3	4	5	6	7	8	9	10	11	12
13	14	15	16	17	18	19	20	21	22	23	24
25	26	27	28	29	30	31	32	33			

B-68 (MU801455)											
1	2	3	4	5	6	7	8	9	10	11	12
13	14	15	16	17	18	19	20	21	22	23	24
25	26	27	28	29	30	31	32	33			

F-08 (MU801215)	F-14 (MU801211)

4

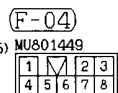
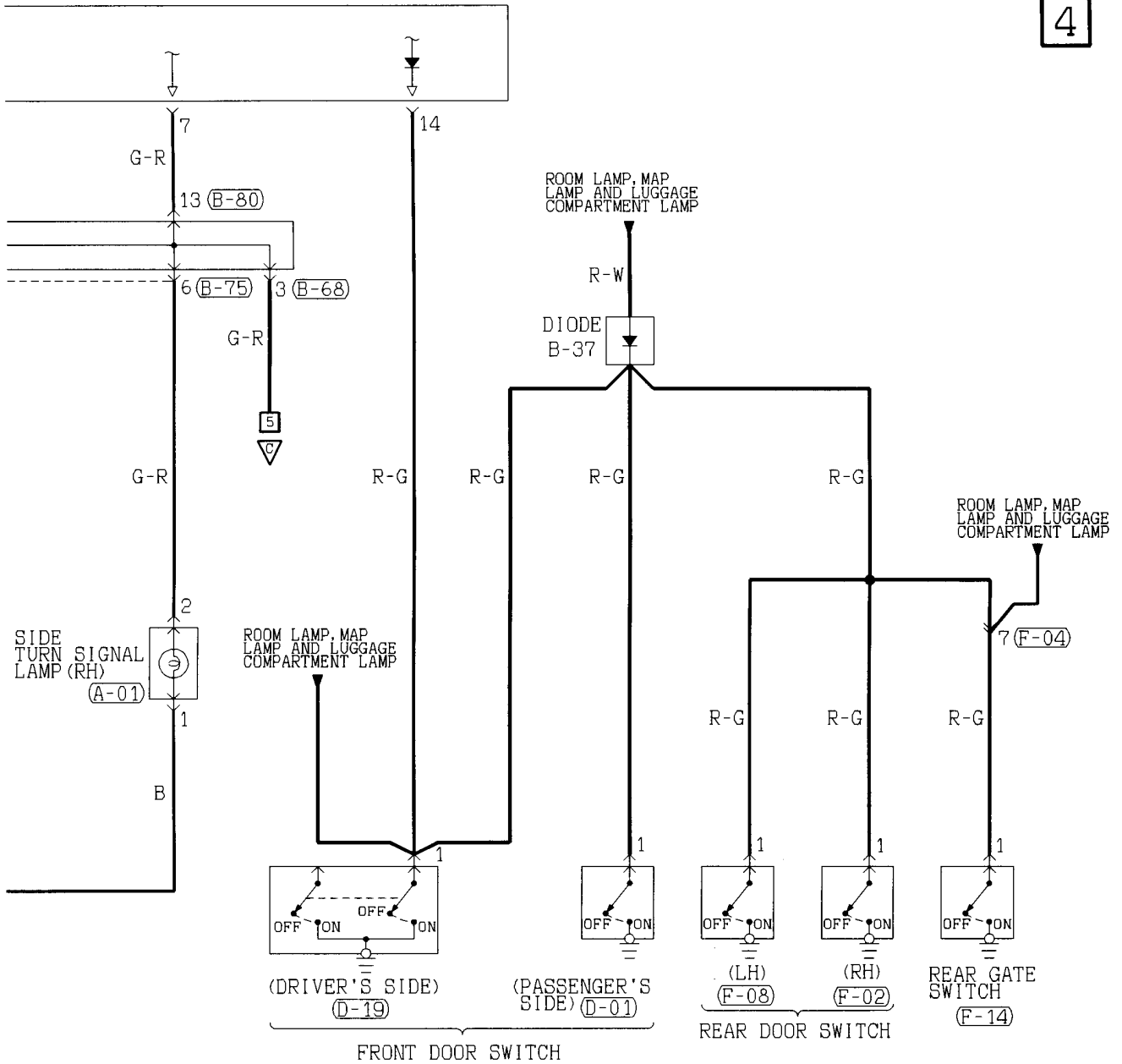

Wire colour code  
 B :Black LG:Light green G :Green L :Blue W :White Y :Yellow SB:Sky blue  
 BR:Brown O :Orange GR:Gray R :Red P :Pink V :Violet

**CENTRAL DOOR LOCKING SYSTEM <Vehicles with keyless entry system>  
(CONTINUED)**

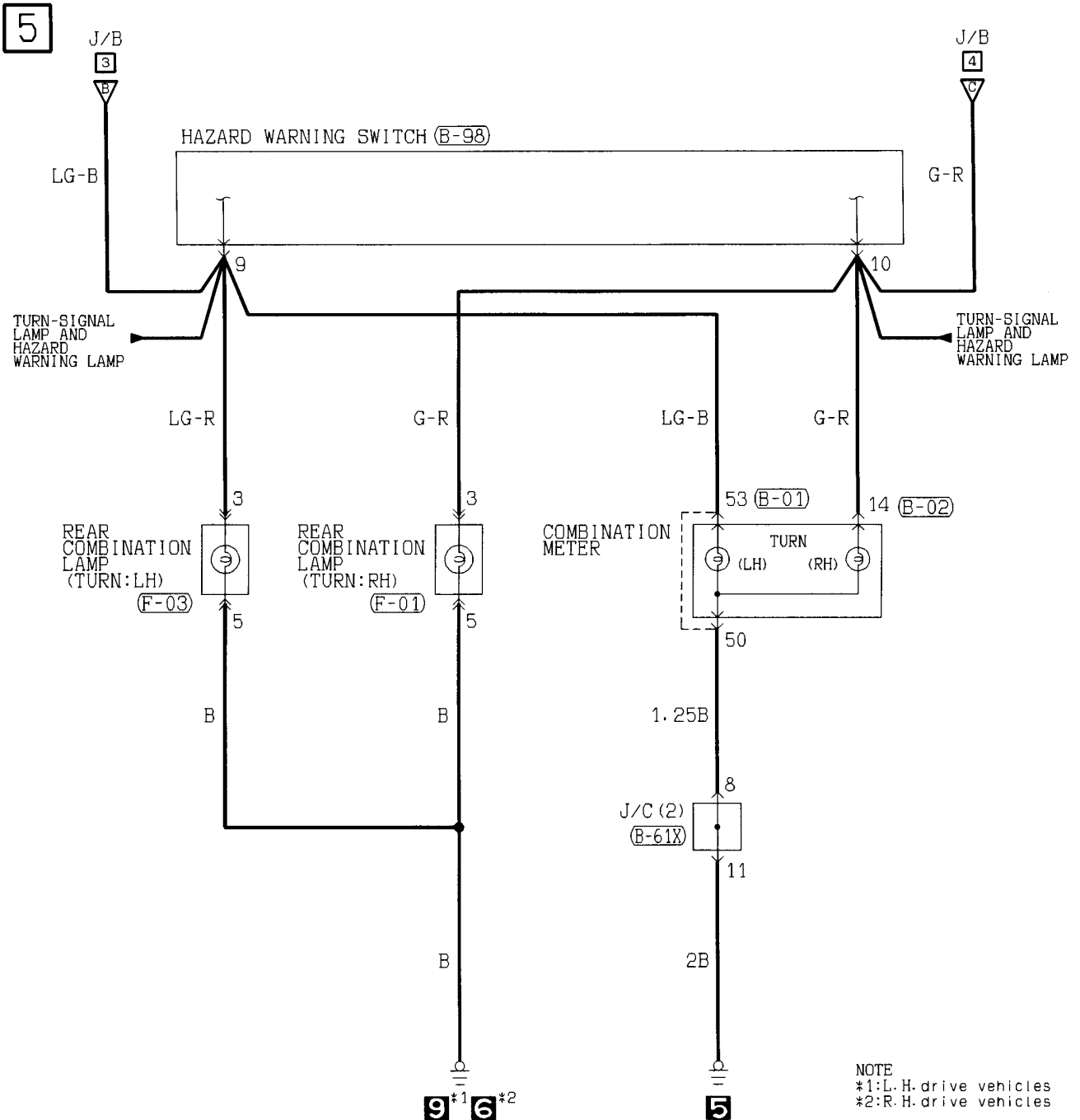

(B-01)

3	1	2	3	3	4	3	5	3	6	3	7	3	8	3	9	4	0	4	1	4	2	
							43															
4	4	4	5	4	6	4	7	4	8	4	9	5	0	5	1	5	2	5	3	5	4	5

(B-02)

1	2	3	4	5	6	7	8	9	10	11	12												
											13												
1	4	1	5	1	6	1	7	1	8	1	9	2	0	2	1	2	2	2	3	2	4	2	5

(B-61X)

1	2	3	4	5	6	7	8	9	10	11											
1	2	13	14	15	16	17	18	19	20	21	22										
2	3	2	4	2	5	2	6	2	7	2	8	2	9	3	0	3	1	3	2	3	3

(B-98)

1	2	3	4		
5	6	7	8	9	10

(F-01)

1	1	2	
3	4	5	6

(F-03)

1	1	2	
3	4	5	6

Wire colour code  
B : Black LG: Light green G : Green L : Blue W : White Y : Yellow SB: Sky blue  
BR: Brown O : Orange GR: Gray R : Red P : Pink V : Violet

NOTES

HEATER

1

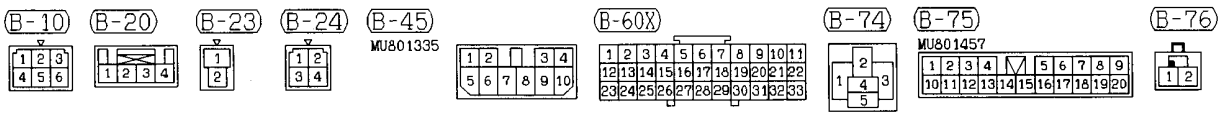
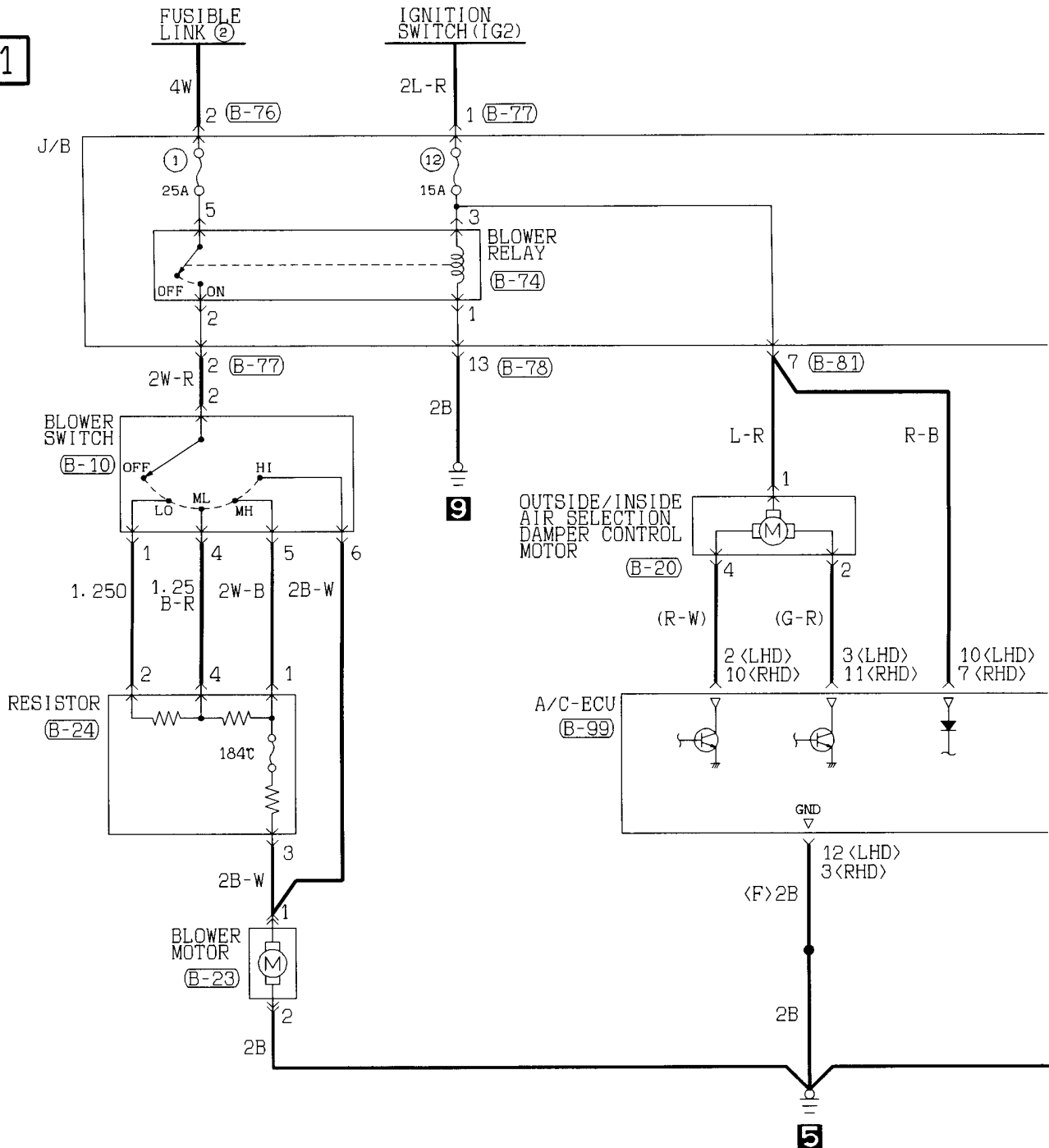

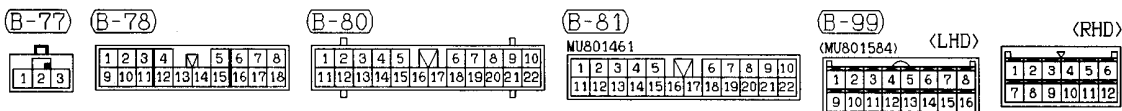
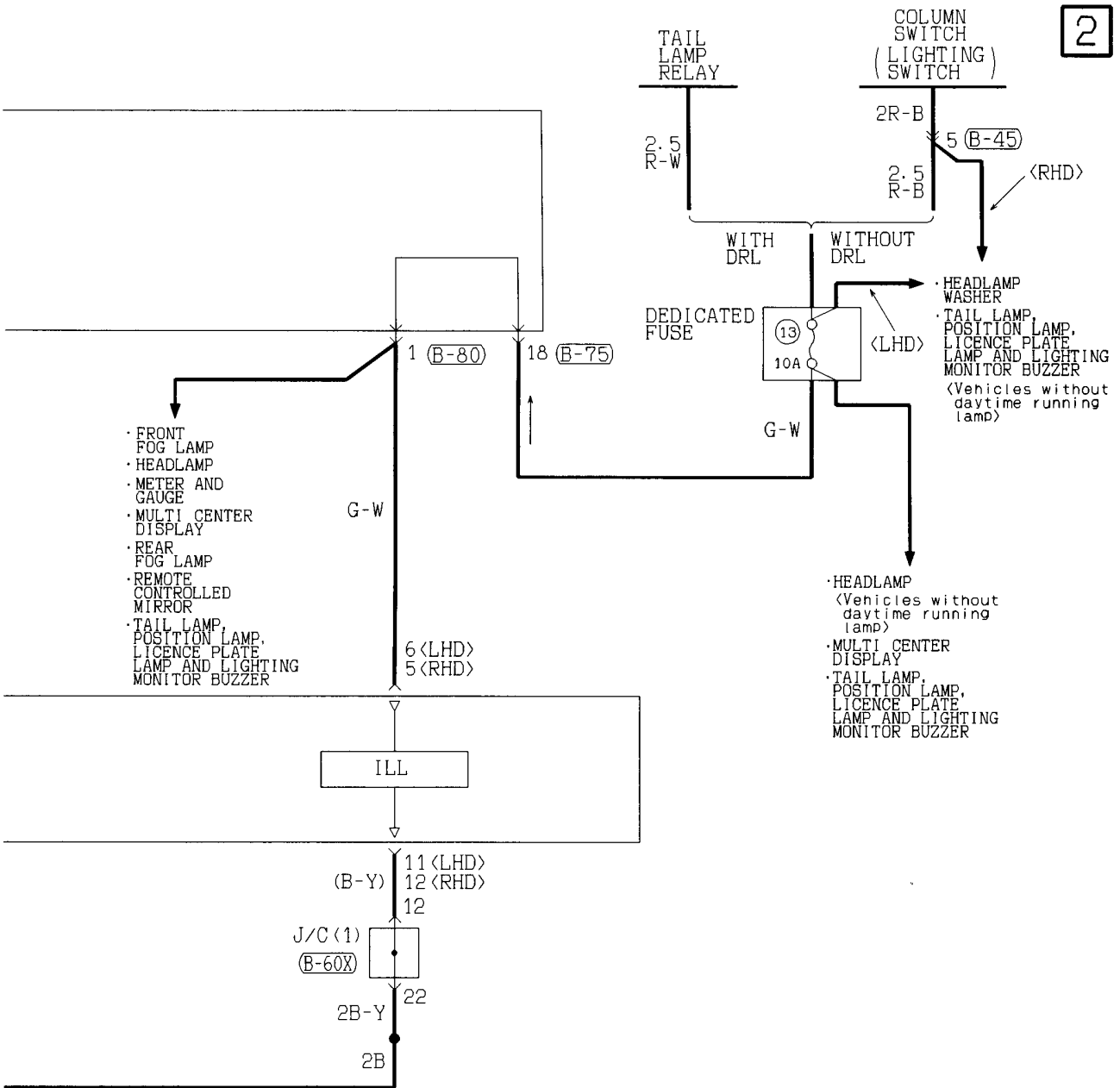

Wire colour code  
 B :Black LG:Light green G :Green L :Blue W :White Y :Yellow SB:Sky blue  
 BR:Brown O :Orange GR:Gray R :Red P :Pink V :Violet

MANUAL AIR CONDITIONER

4G1 engine

1

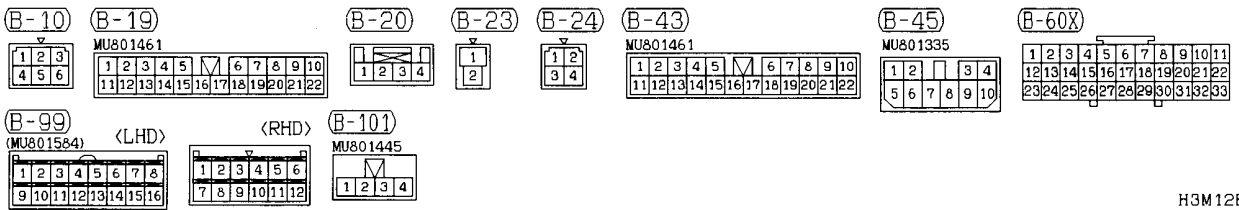
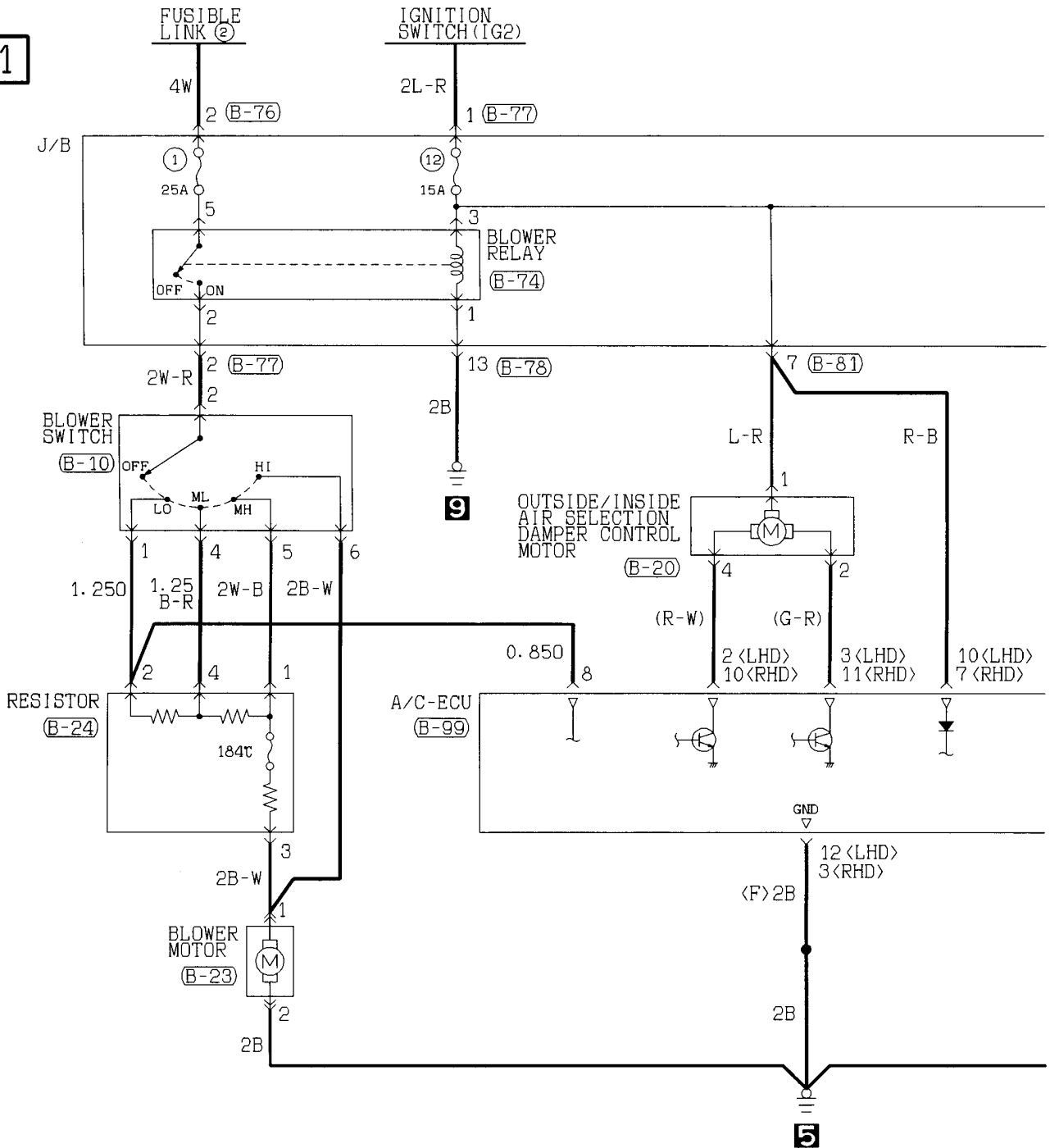



2

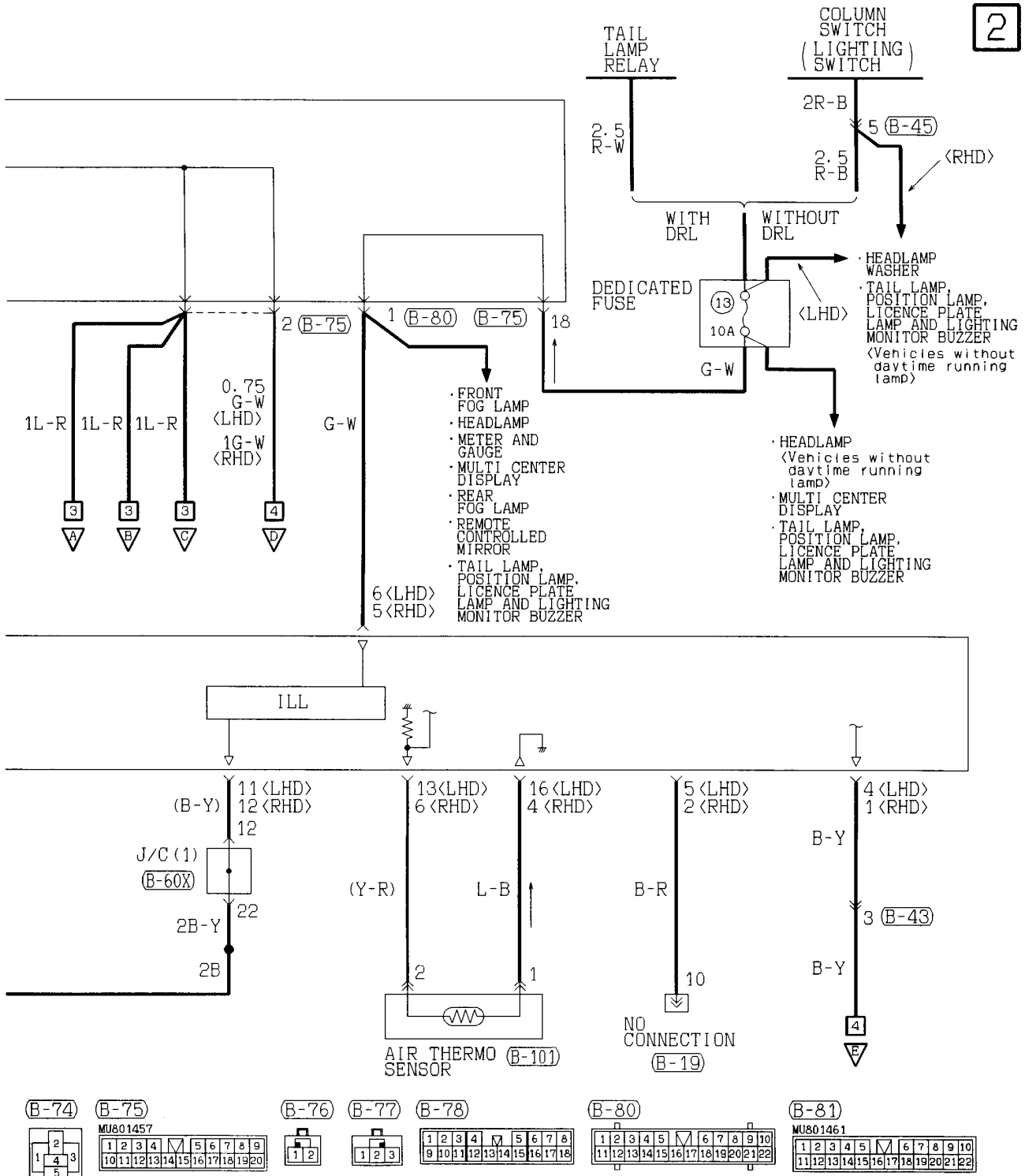

Wire colour code  
 B:Black LG:Light green G:Green L:Blue W:White Y:Yellow SB:Sky blue  
 BR:Brown O:Orange GR:Gray R:Red P:Pink V:Violet

MANUAL AIR CONDITIONER <4G1 engine> (CONTINUED)

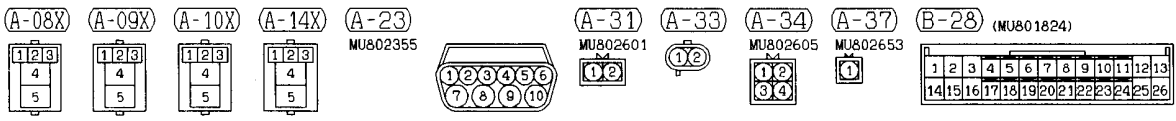
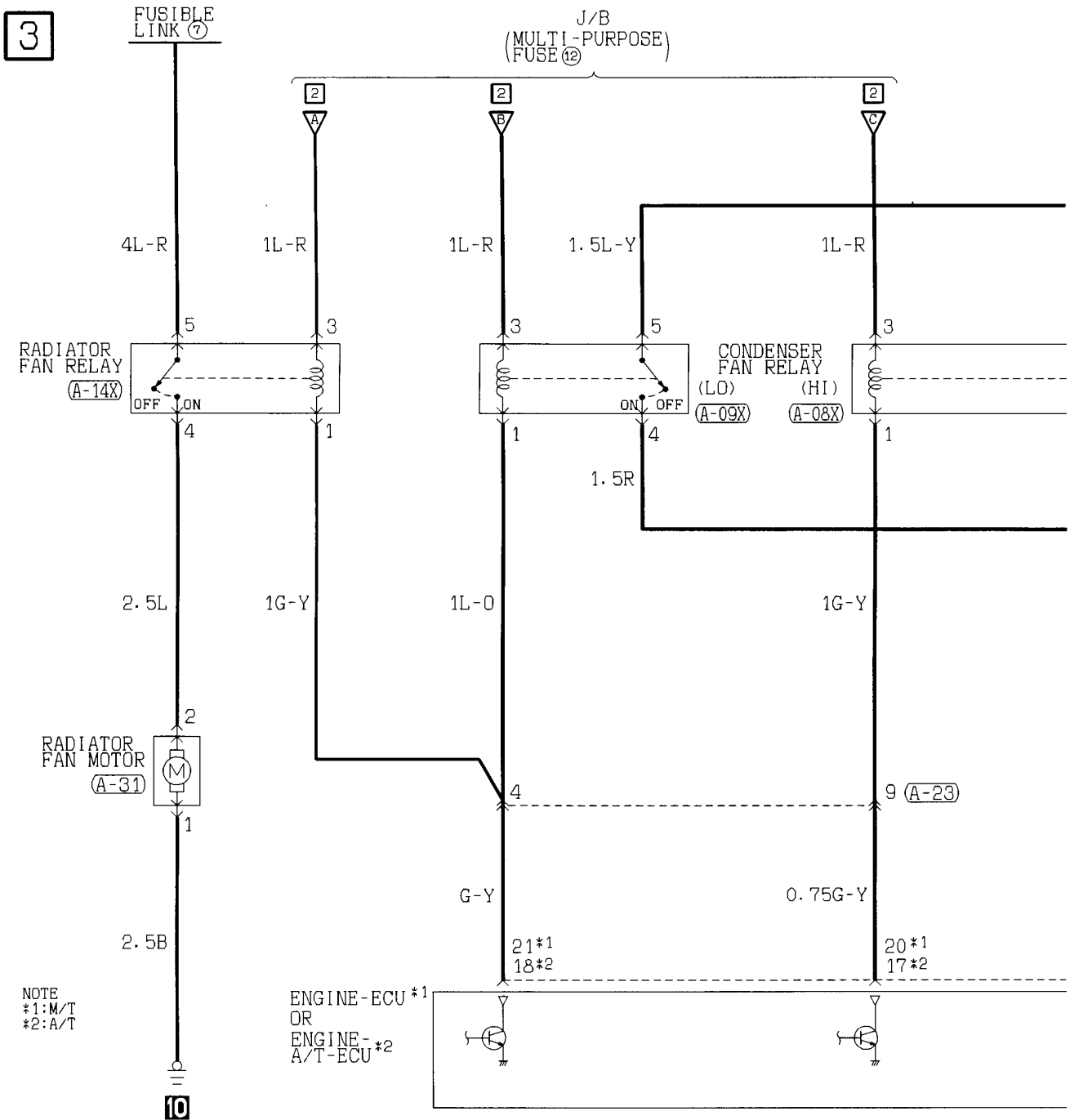

4

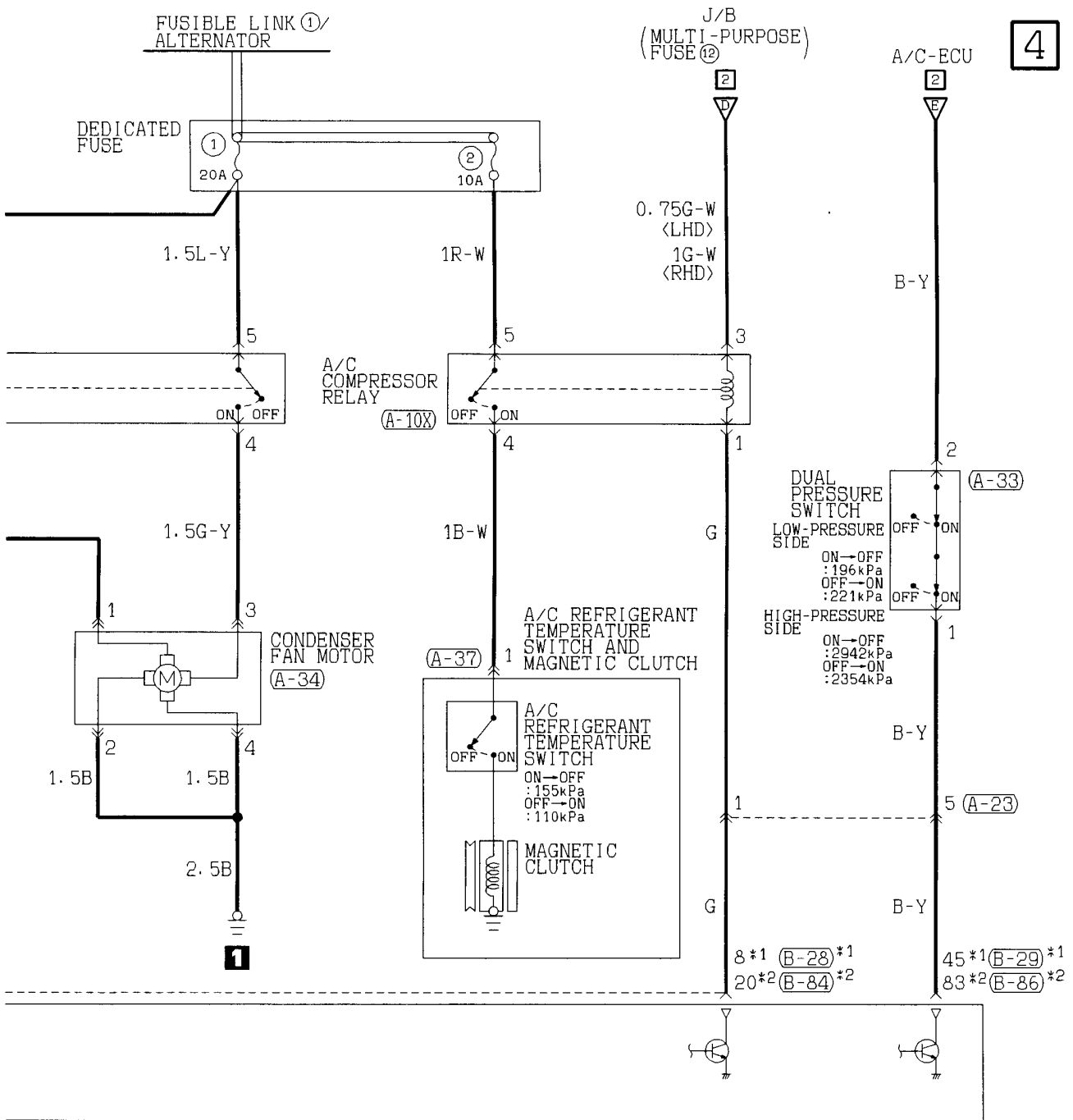

(B-29) (MU801822)

(B-84) (MU803784)

(B-86) (MU803782)

31	32	33	34	35	36	37	38
39	40	41	42	43	44	45	46

1	2	3	4	5	6	7	8
9	10	11	12	13	14	15	16
17	18	19	20	21	22	23	24
25	26	27	28	29	30	31	32
33	34	35					

71	72	73	74	75	76	77
78	79	80	81	82	83	84
85	86	87	88	89	90	91
92	93	94	95	96	97	98

Wire colour code  
 B : Black    LG : Light green    G : Green    L : Blue    W : White    Y : Yellow    SB : Sky blue  
 BR : Brown    O : Orange    GR : Gray    R : Red    P : Pink    V : Violet

MANUAL AIR CONDITIONER

F9Q1 engine

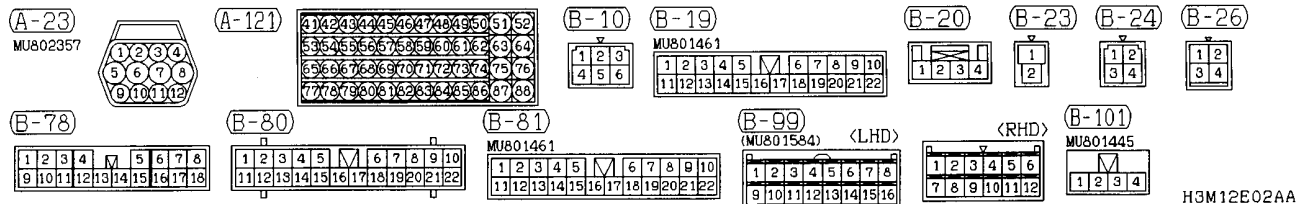
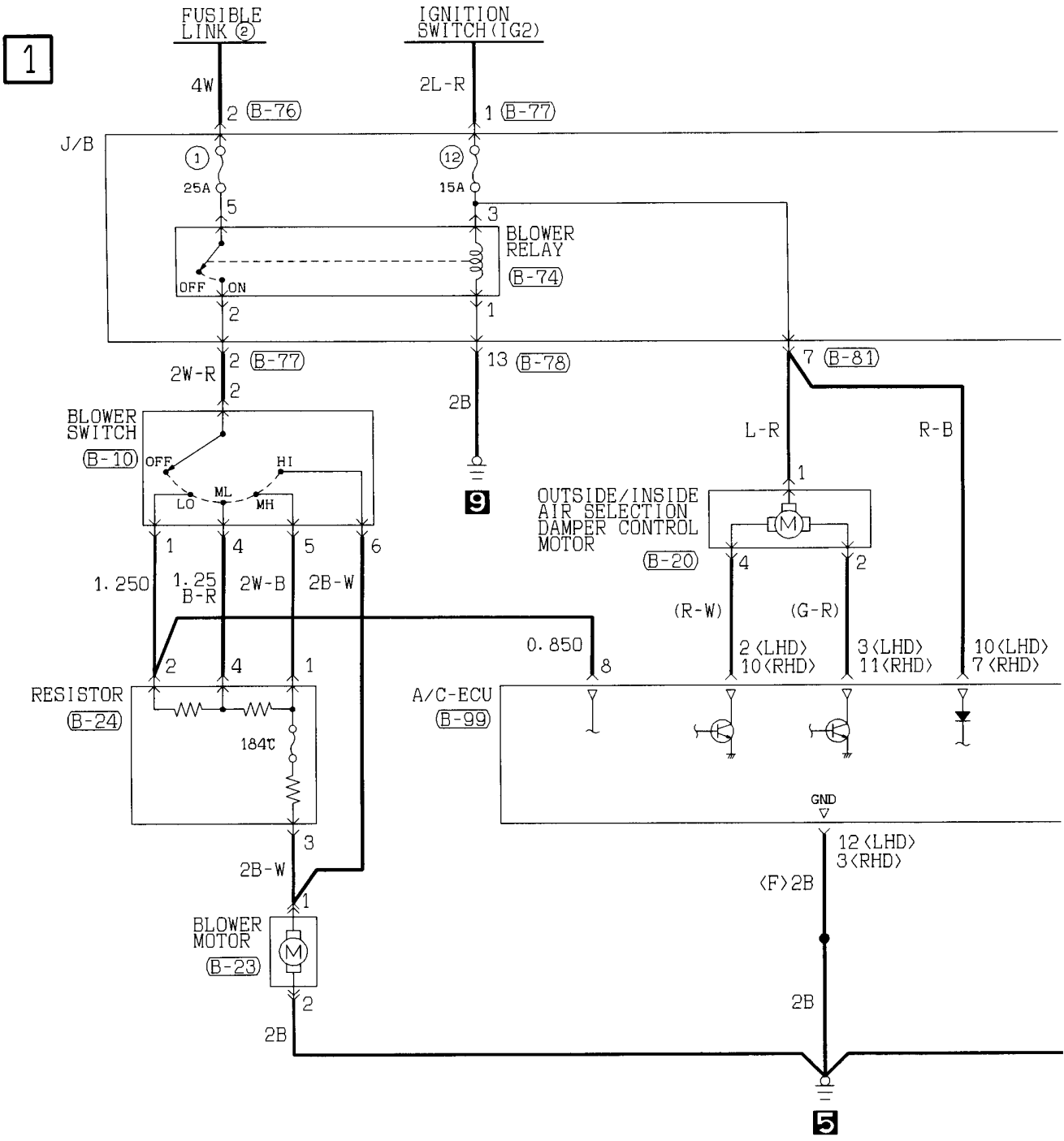

2

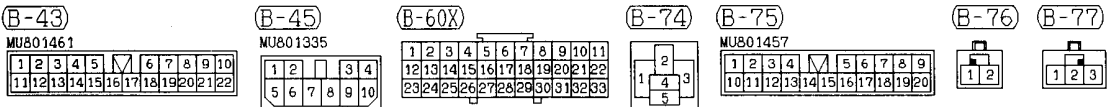
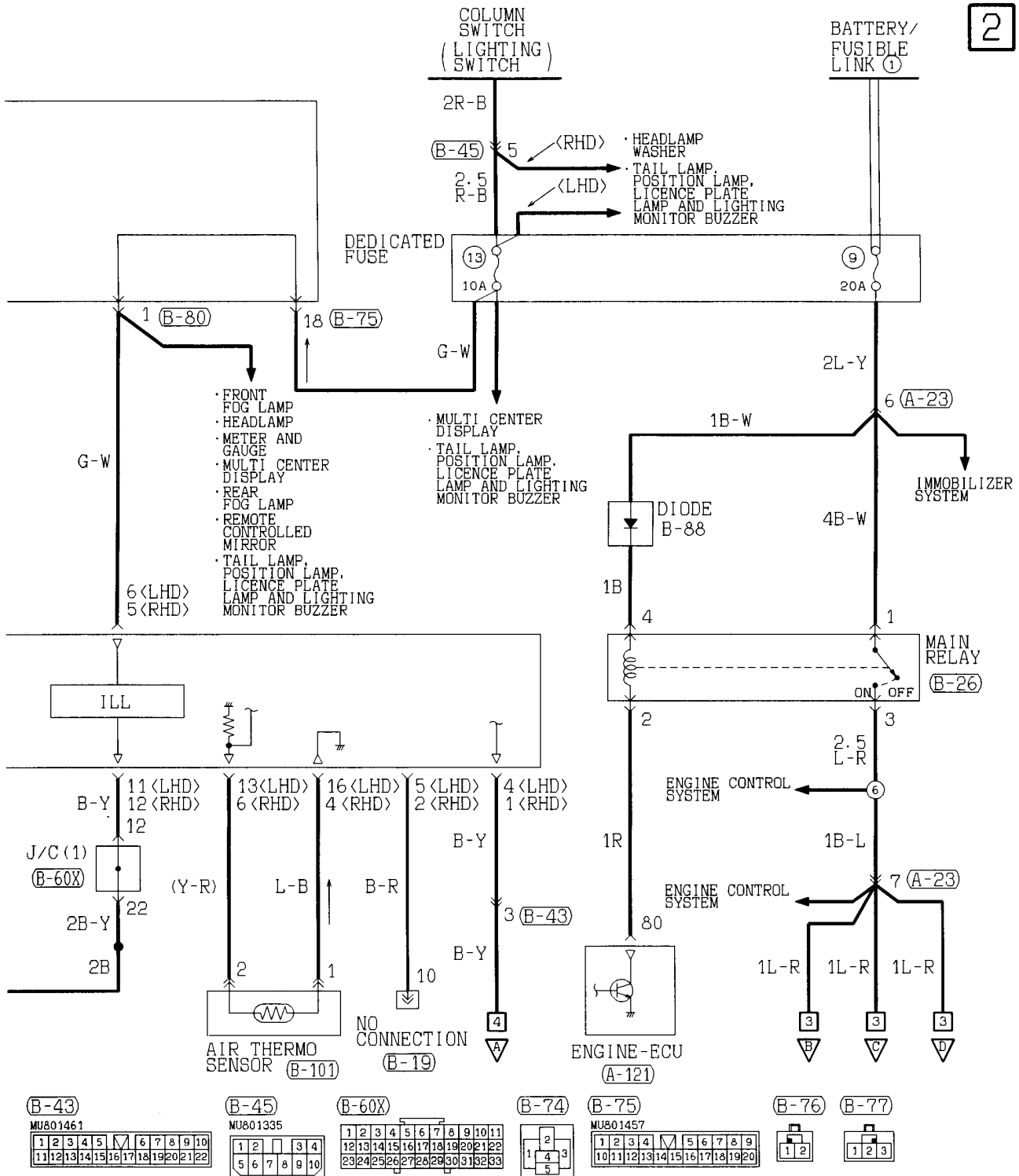

Wire colour code  
 B :Black LG:Light green G:Green L :Blue W :White Y :Yellow SB:Sky blue  
 BR:Brown O :Orange GR:Gray R :Red P :Pink V :Violet

MANUAL AIR CONDITIONER <F9Q1 engine> (CONTINUED)

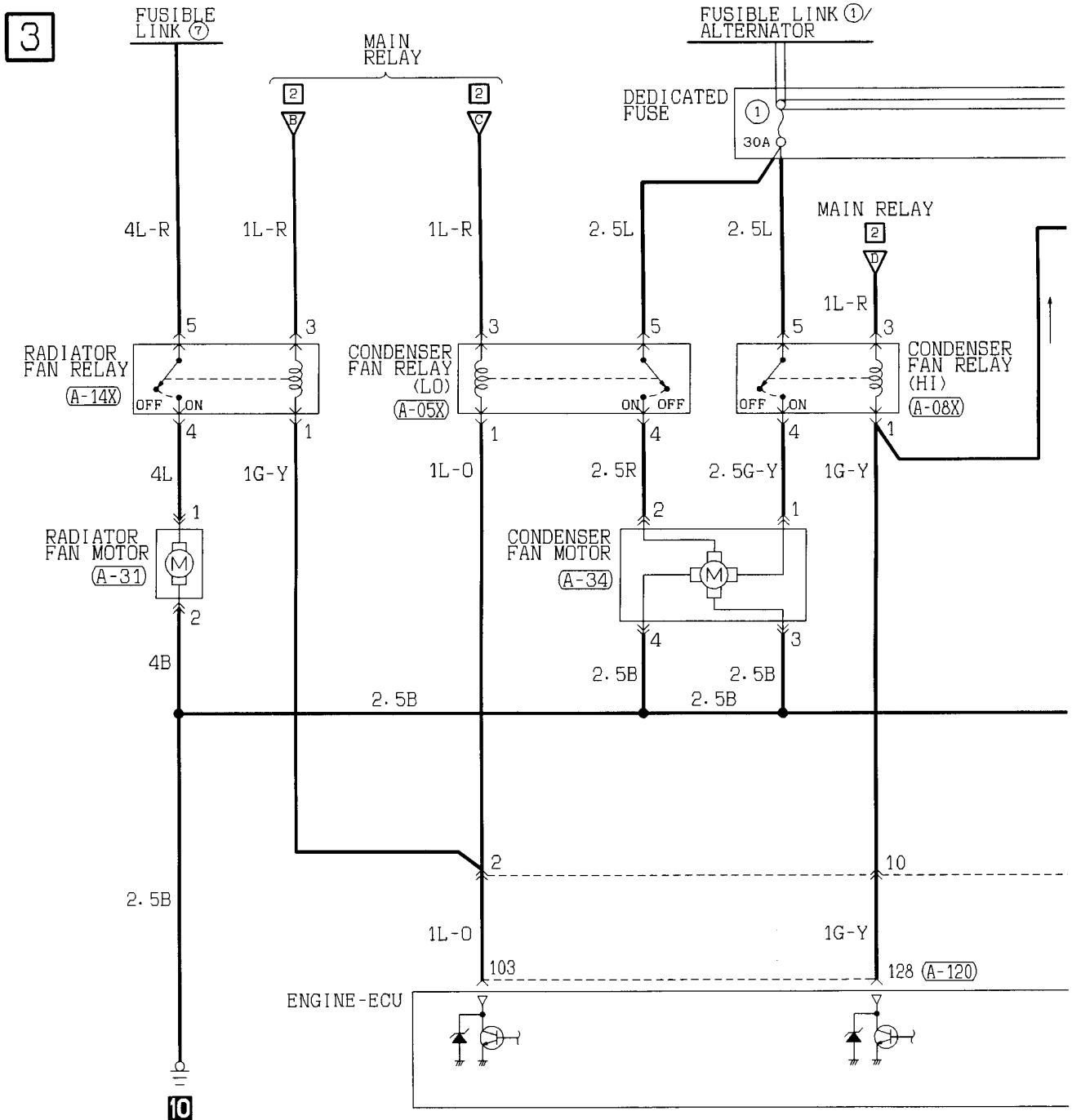

- (A-05X)

1	2	3
4		
5		
- (A-08X)

1	2	3
4		
5		
- (A-10X)

1	2	3
4		
5		
- (A-14X)

1	2	3
4		
5		
- (A-23)

MU802357

1	2	3	4
5	6	7	8
9	10	11	12
- (A-31)

1	2
3	4
- (A-34)

1	2
3	4
- (A-37)

MU802653

1
---
- (A-103)

1	2	3
---	---	---
- (A-120)

9	10	11	12	13	14	15	16	17	18	19	20	21	22	23	24	25	26	27	28	29	30	31	32	33	34	35	36	37	38
---	----	----	----	----	----	----	----	----	----	----	----	----	----	----	----	----	----	----	----	----	----	----	----	----	----	----	----	----	----

4

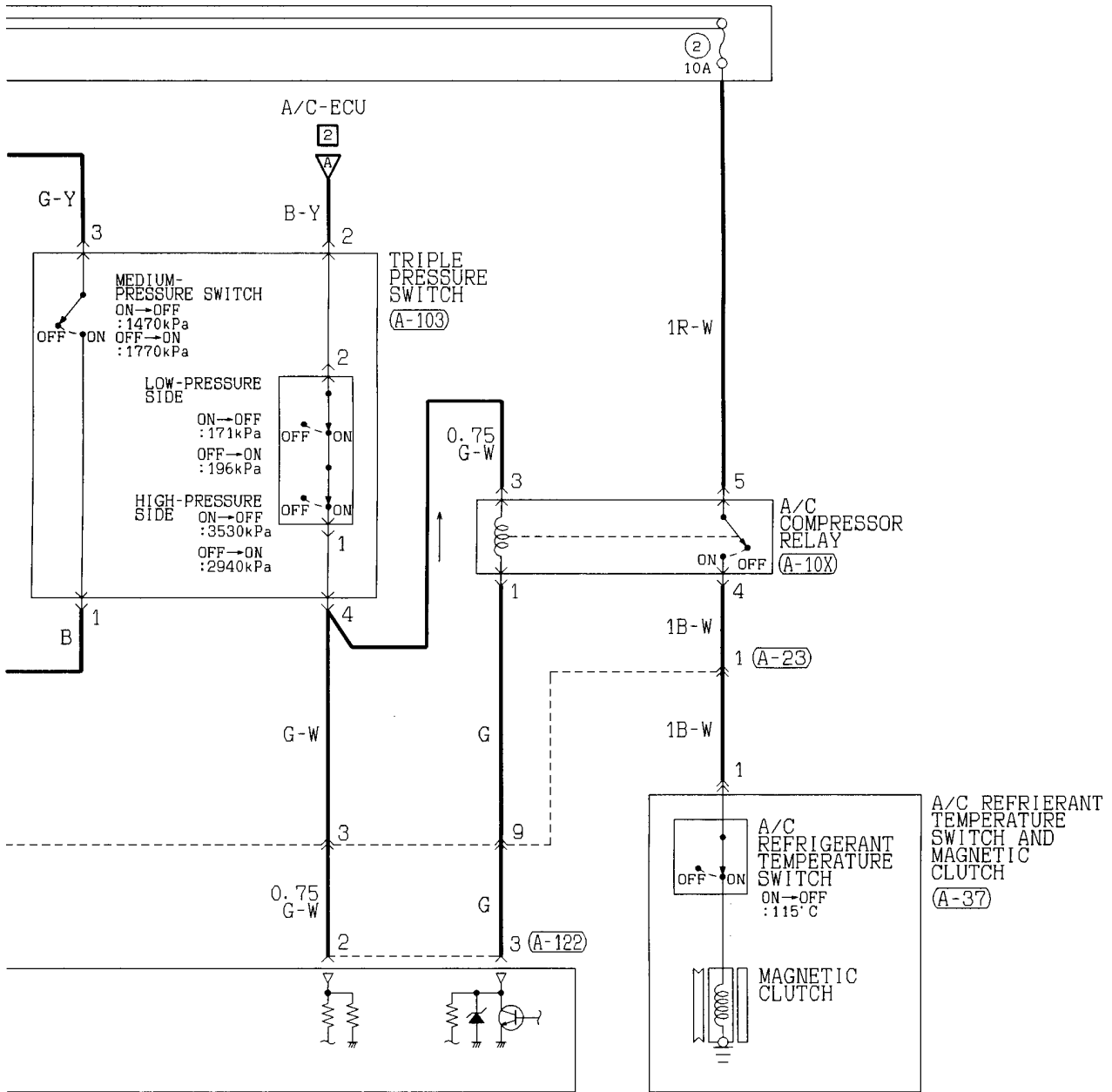

(A-122)

1	2	3	4	5	6	7	8
9	10	11	12	13	14	15	16
17	18	19	20	21	22	23	24
25	26	27	28	29	30	31	32

Wire colour code  
 B : Black    LG: Light green    G : Green    L : Blue    W : White    Y : Yellow    SB: Sky blue  
 BR: Brown    O : Orange    GR: Gray    R : Red    P : Pink    V : Violet

REAR WIPER AND WASHER

1

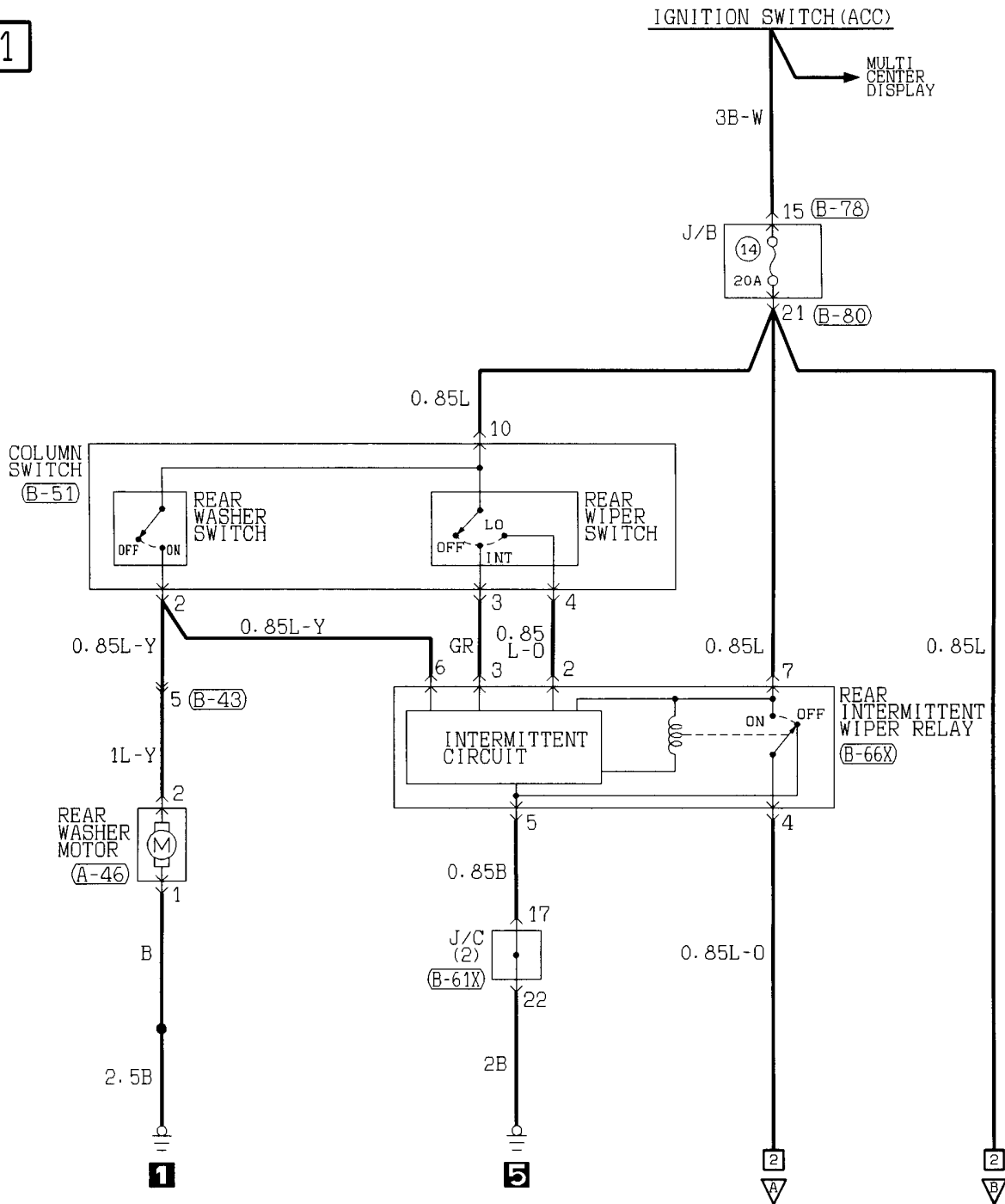

(A-46)

1
2

(B-43)

MU801461

1	2	3	4	5	6	7	8	9	10		
11	12	13	14	15	16	17	18	19	20	21	22

(B-51)

(MU803723)

1	2	3	4	5		
6	7	8	9	10	11	12

(B-61X)

1	2	3	4	5	6	7	8	9	10	11
12	13	14	15	16	17	18	19	20	21	22
23	24	25	26	27	28	29	30	31	32	33

(B-66X)

1	2	3
4	5	6
7		

(B-78)

1	2	3	4	5	6	7	8		
9	10	11	12	13	14	15	16	17	18



2

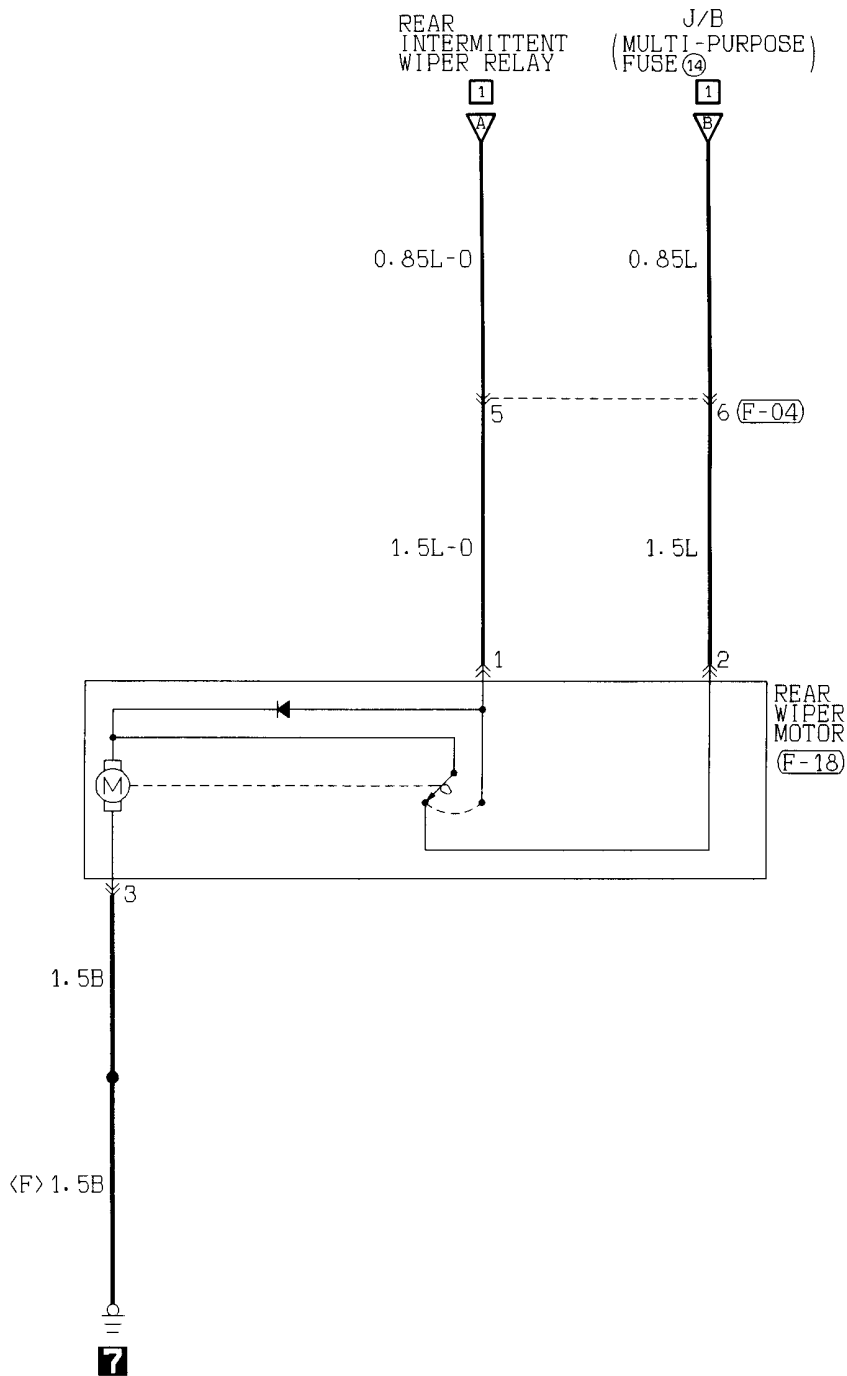

(B-80)

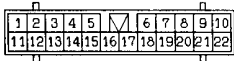

(F-04)

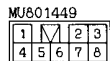

(F-18)



Wire colour code  
 B :Black LG:Light green G :Green L :Blue W :White Y :Yellow SB:Sky blue  
 BR:Brown O :Orange GR:Gray R :Red P :Pink V :Violet

DEFOGGER AND DOOR MIRROR HEATER

L.H. drive vehicles

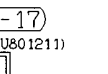
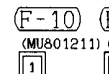
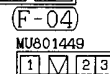
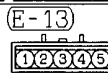
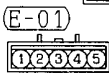
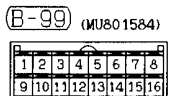
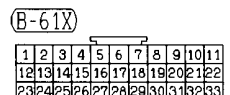
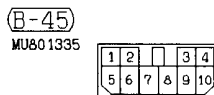
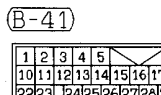
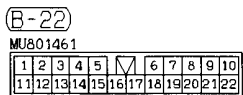
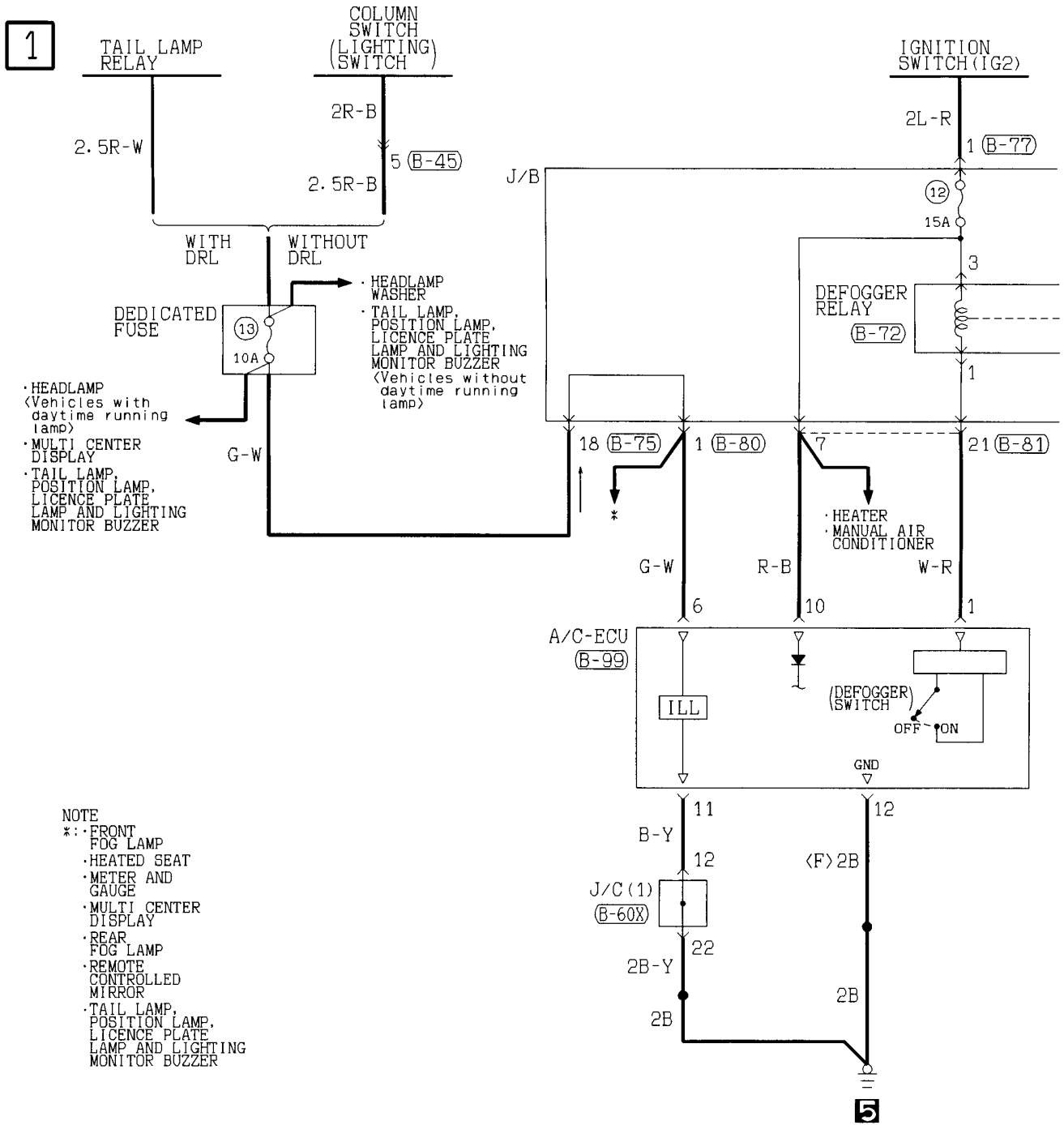

2

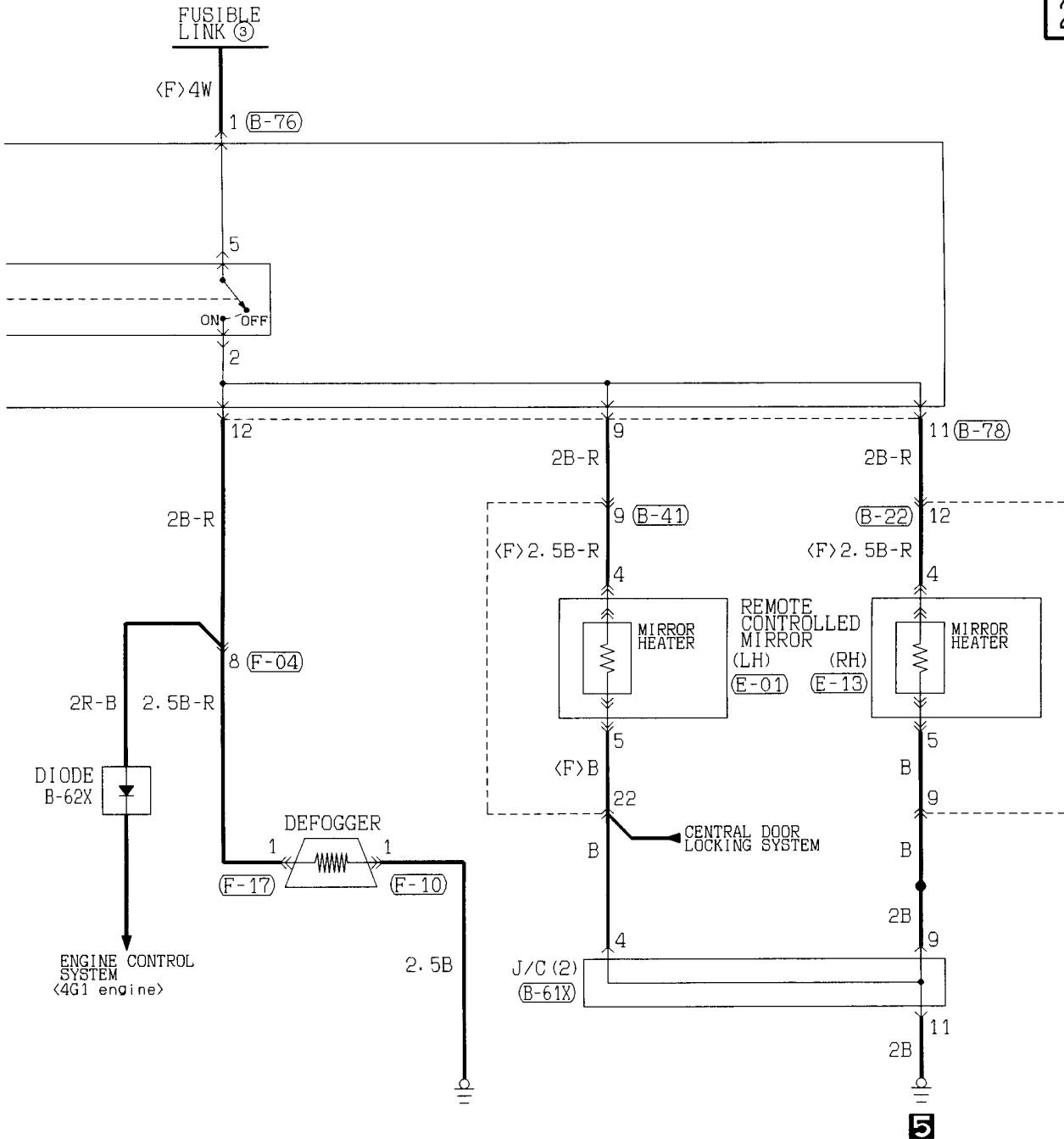

(B-75)

MU801457

1	2	3	4	5	6	7	8	9		
10	11	12	13	14	15	16	17	18	19	20

(B-76)

1	2
---	---

(B-77)

1	2	3
---	---	---

(B-78)

1	2	3	4	5	6	7	8		
9	10	11	12	13	14	15	16	17	18

(B-80)

1	2	3	4	5	6	7	8	9	10		
11	12	13	14	15	16	17	18	19	20	21	22

(B-81)

MU801461

1	2	3	4	5	6	7	8	9	10		
11	12	13	14	15	16	17	18	19	20	21	22

Wire colour code  
 B :Black    LG:Light green    G :Green    L :Blue    W :White    Y :Yellow    SB:Sky blue  
 BR:Brown    O :Orange    GR:Gray    R :Red    P :Pink    V :Violet

DEFOGGER AND DOOR MIRROR HEATER

R.H. drive vehicles

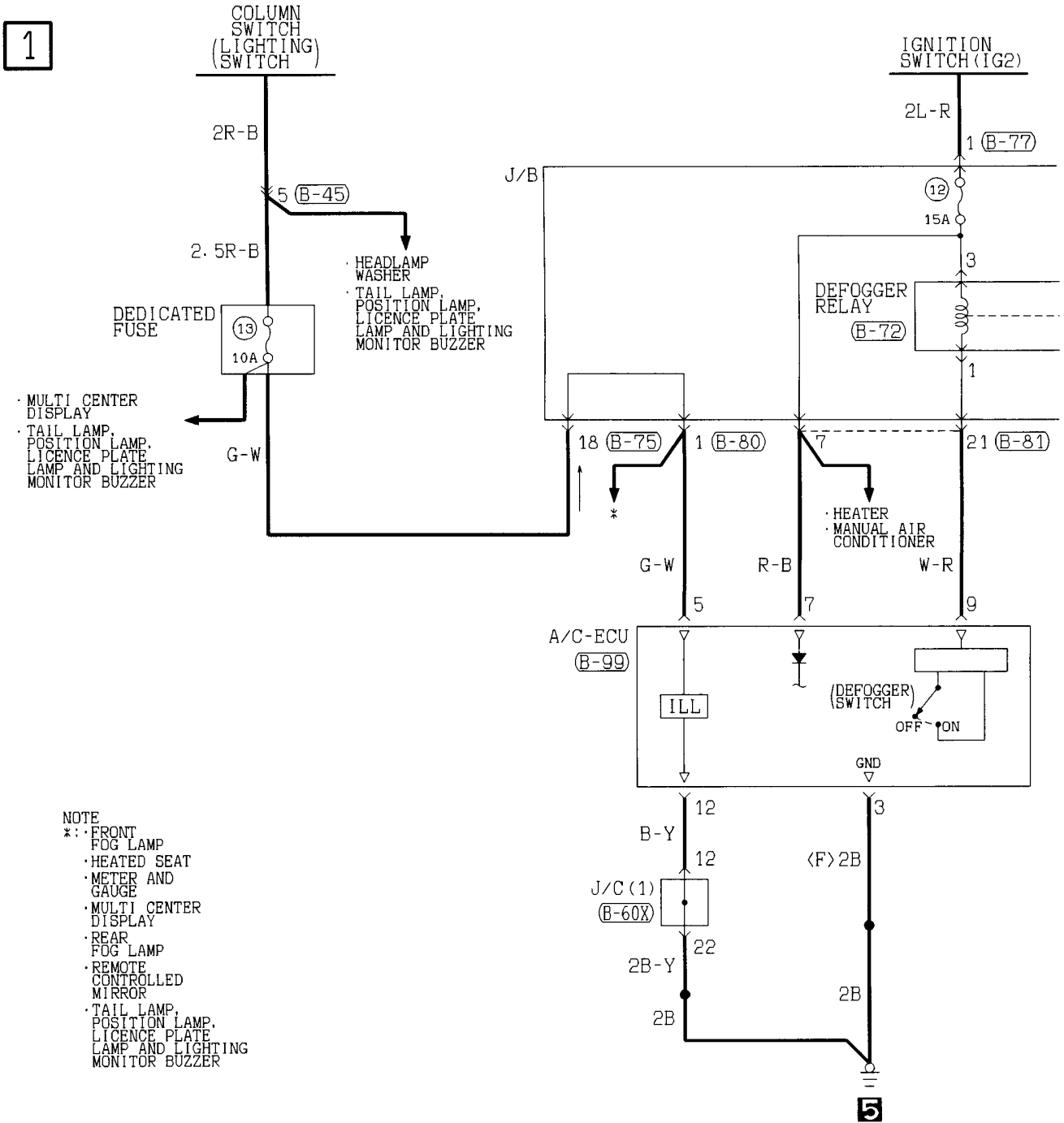

- NOTE
- \*: FRONT FOG LAMP
  - HEATED SEAT
  - METER AND GAUGE
  - MULTI CENTER DISPLAY
  - REAR FOG LAMP
  - REMOTE CONTROLLED MIRROR
  - TAIL LAMP, POSITION LAMP, LICENCE PLATE LAMP AND LIGHTING MONITOR BUZZER

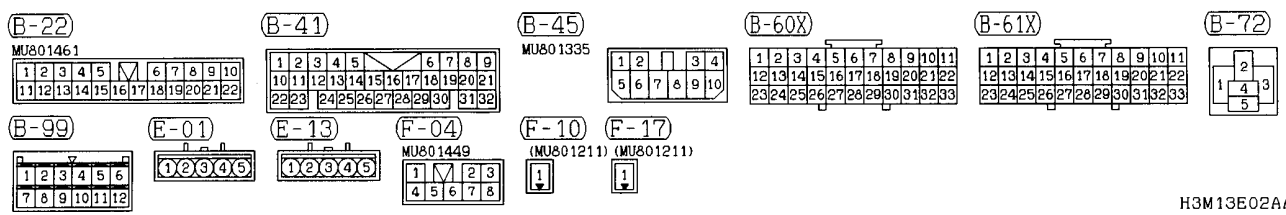

2

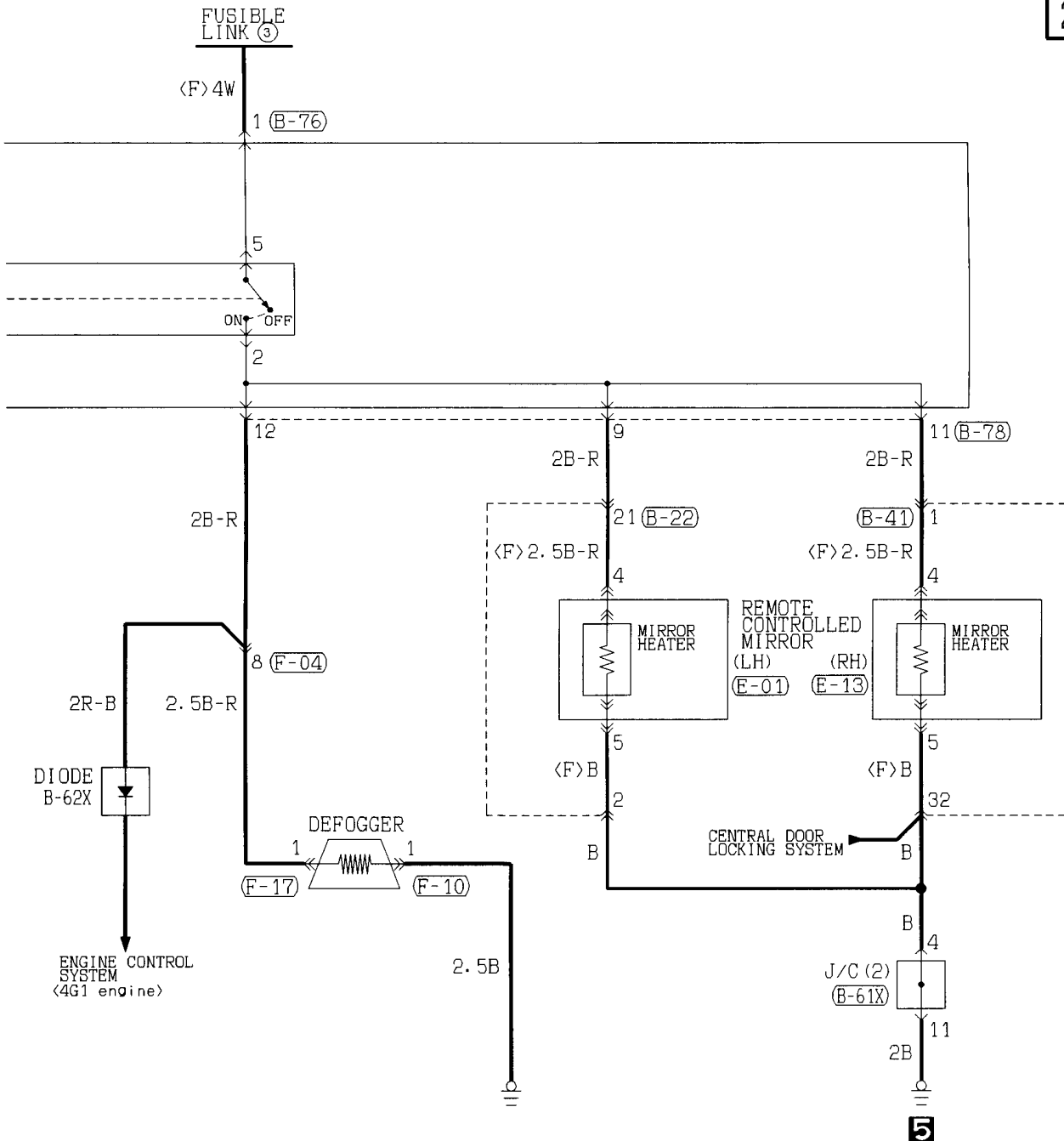

5

(B-75)

1	2	3	4	5	6	7	8	9		
10	11	12	13	14	15	16	17	18	19	20

(B-76)

1	2
---	---

(B-77)

1	2	3
---	---	---

(B-78)

1	2	3	4	5	6	7	8		
9	10	11	12	13	14	15	16	17	18

(B-80)

1	2	3	4	5	6	7	8	9	10		
11	12	13	14	15	16	17	18	19	20	21	22

(B-81)

1	2	3	4	5	6	7	8	9	10		
11	12	13	14	15	16	17	18	19	20	21	22

Wire colour code  
 B :Black LG:Light green G :Green L :Blue W :White Y :Yellow SB:Sky blue  
 BR:Brown O :Orange GR:Gray R :Red P :Pink V :Violet

REMOTE CONTROLLED MIRROR

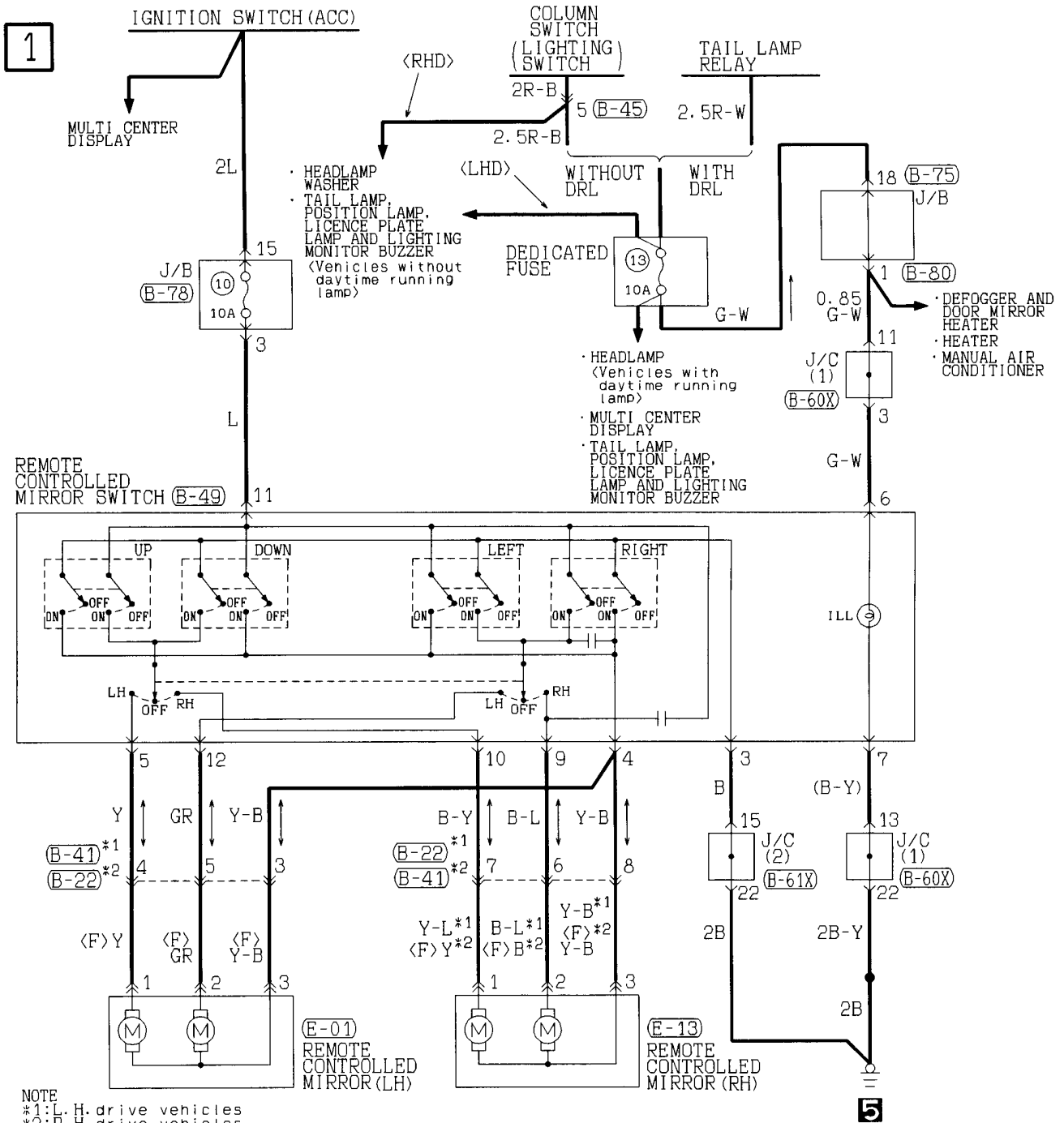

NOTE

\*1: L. H. drive vehicles

\*2: R. H. drive vehicles

(B-22) MU801461	(B-41) MU801457	(B-45) MU801335	(B-49) (MU803723)	(B-60X)	(B-61X)	(B-75)	(B-78)	(B-80)	(E-01)	(E-13)
1 2 3 4 5 6 7 8 9 10 11 12 13 14 15 16 17 18 19 20 21 22	1 2 3 4 5 6 7 8 9 10 11 12 13 14 15 16 17 18 19 20 21 22 23 24 25 26 27 28 29 30 31 32	1 2 3 4 5 6 7 8 9 10	1 2 3 4 5 6 7 8 9 10 11 12	1 2 3 4 5 6 7 8 9 10 11 12 13 14 15 16 17 18 19 20 21 22 23 24 25 26 27 28 29 30 31 32 33	1 2 3 4 5 6 7 8 9 10 11 12	1 2 3 4 5 6 7 8 9 10 11 12 13 14 15 16 17 18 19 20	1 2 3 4 5 6 7 8 9 10 11 12 13 14 15 16 17 18	1 2 3 4 5 6 7 8 9 10 11 12 13 14 15 16 17 18 19 20 21 22	1 2 3 4 5	1 2 3 4 5

CIGARETTE LIGHTER

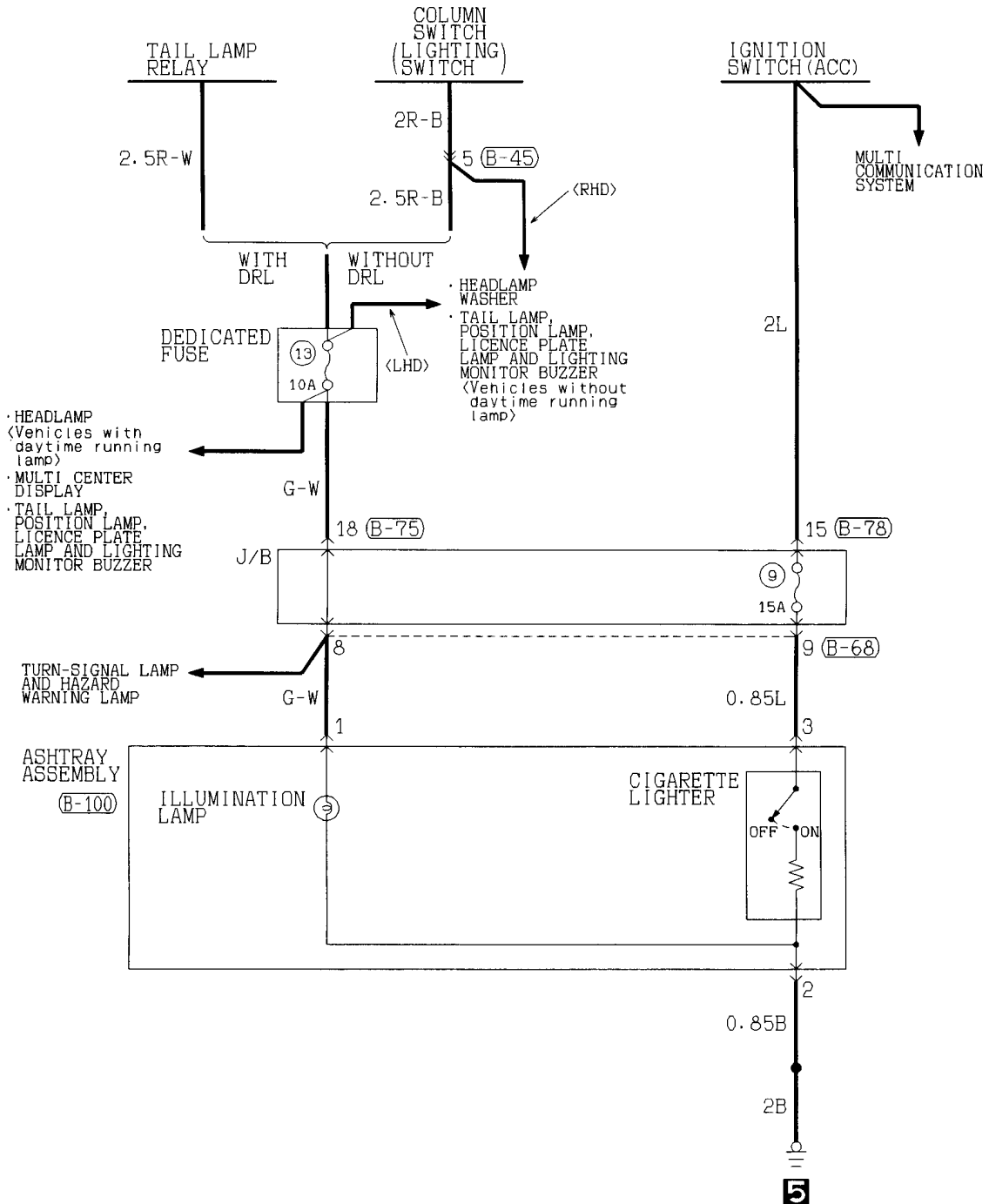

1

(B-45)  
MU801335

1	2	3	4
5	6	7	8
9	10		

(B-68)  
MU801455

1	2	3	4	5	6	7	8
9	10	11	12	13	14	15	16
17	18						

(B-75)  
MU801457

1	2	3	4	5	6	7	8	9
10	11	12	13	14	15	16	17	18
19	20							

(B-78)  
MU801685

1	2	3	4	5	6	7	8
9	10	11	12	13	14	15	16
17	18						

(B-100)  
MU801685

1	2	3
---	---	---

MULTI CENTER DISPLAY

Vehicles without navigation system

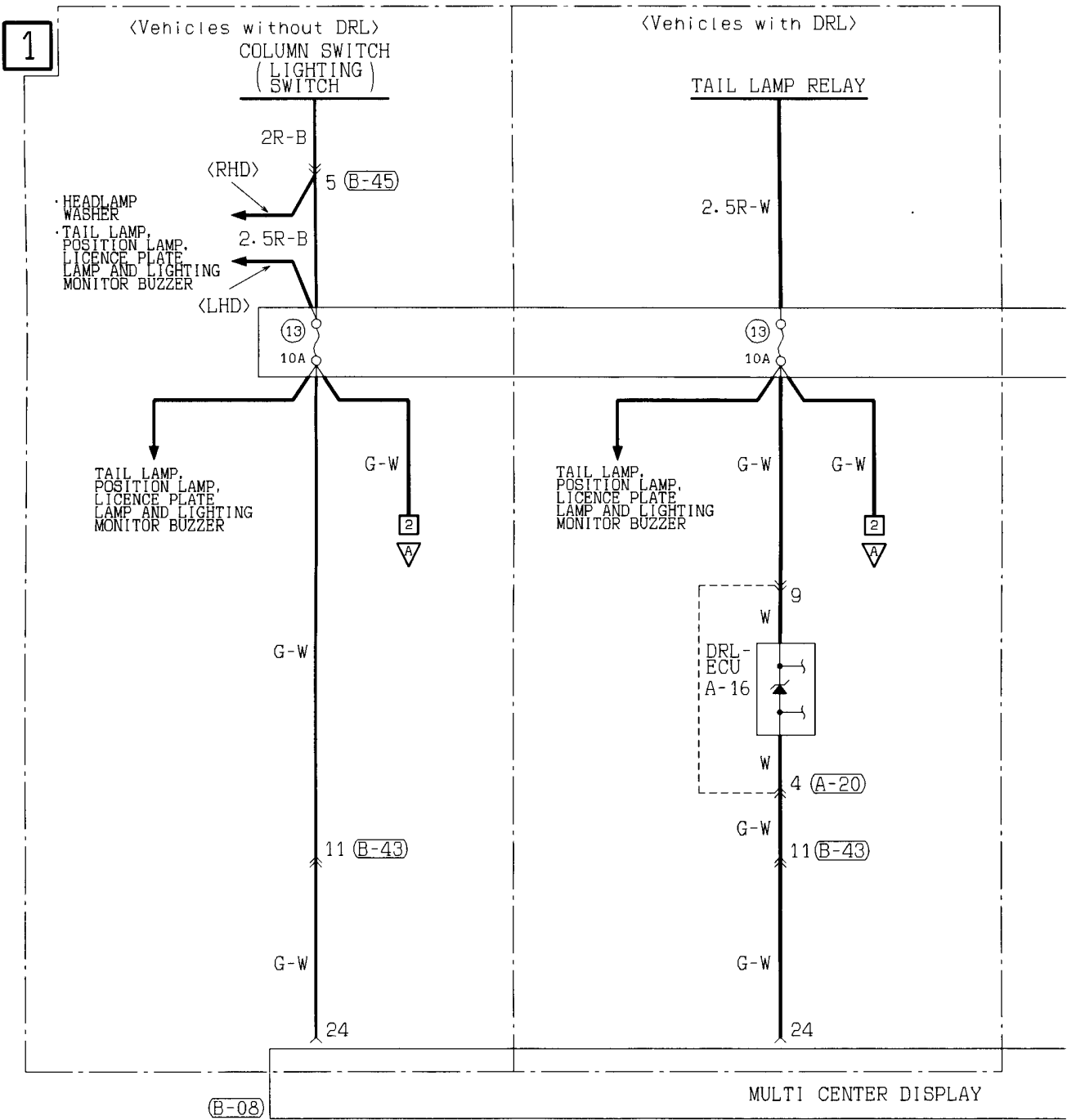

(A-20) MU802645

1	2	3	4	5
6	7	8	9	10

(B-05) NU801453

31	32	33	34	35	36		
37	38	39	40	41	42	43	44

(B-08) (MU801584)

21	22	23	24	25	26	27	28
29	30	31	32	33	34	35	36

(B-43) MU801461

1	2	3	4	5	6	7	8	9	10		
11	12	13	14	15	16	17	18	19	20	21	22

(B-45) MU801335

1	2	3	4		
5	6	7	8	9	10

(B-60X)

1	2	3	4	5	6	7	8	9	10	11
12	13	14	15	16	17	18	19	20	21	22
23	24	25	26	27	28	29	30	31	32	33



2

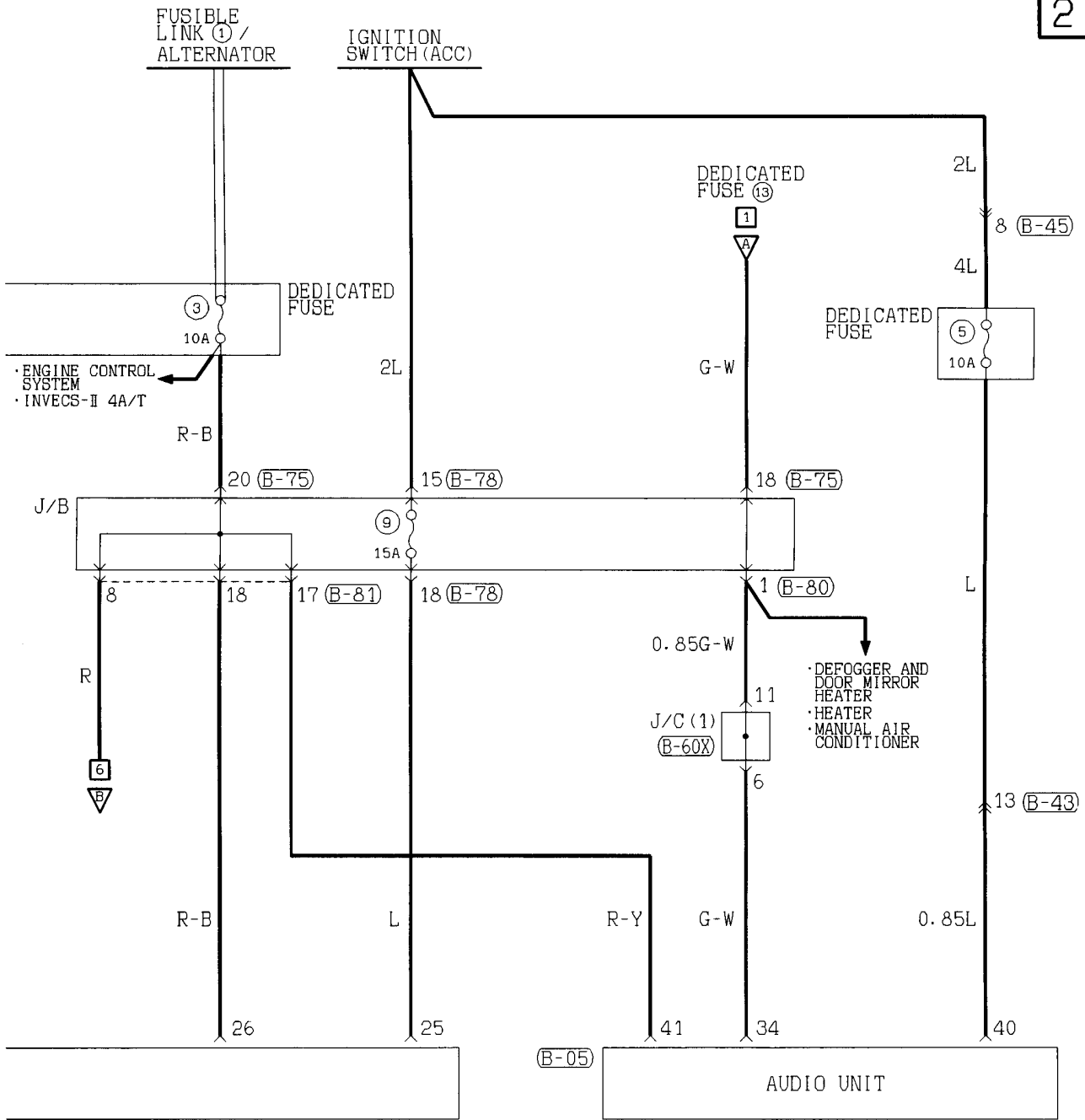

(B-75)

MU801457

1	2	3	4	5	6	7	8	9		
10	11	12	13	14	15	16	17	18	19	20

(B-78)

1	2	3	4	5	6	7	8		
9	10	11	12	13	14	15	16	17	18

(B-80)

1	2	3	4	5	6	7	8	9	10		
11	12	13	14	15	16	17	18	19	20	21	22

(B-81)

MU801461

1	2	3	4	5	6	7	8	9	10		
11	12	13	14	15	16	17	18	19	20	21	22

Wire colour code

B : Black LG: Light green G : Green L : Blue W : White Y : Yellow SB: Sky blue  
 BR: Brown O : Orange GR: Gray R : Red P : Pink V : Violet

MULTI CENTER DISPLAY <Vehicles without navigation system> (CONTINUED)

3

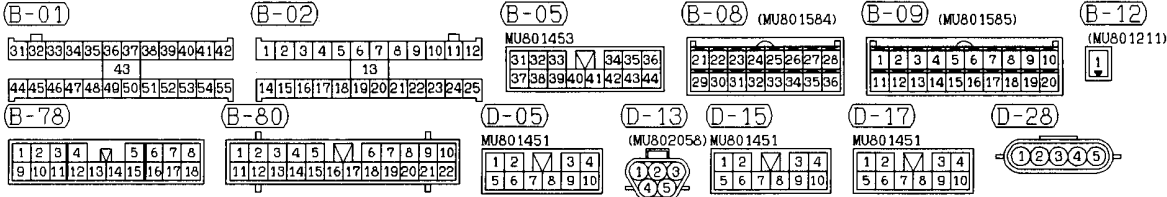
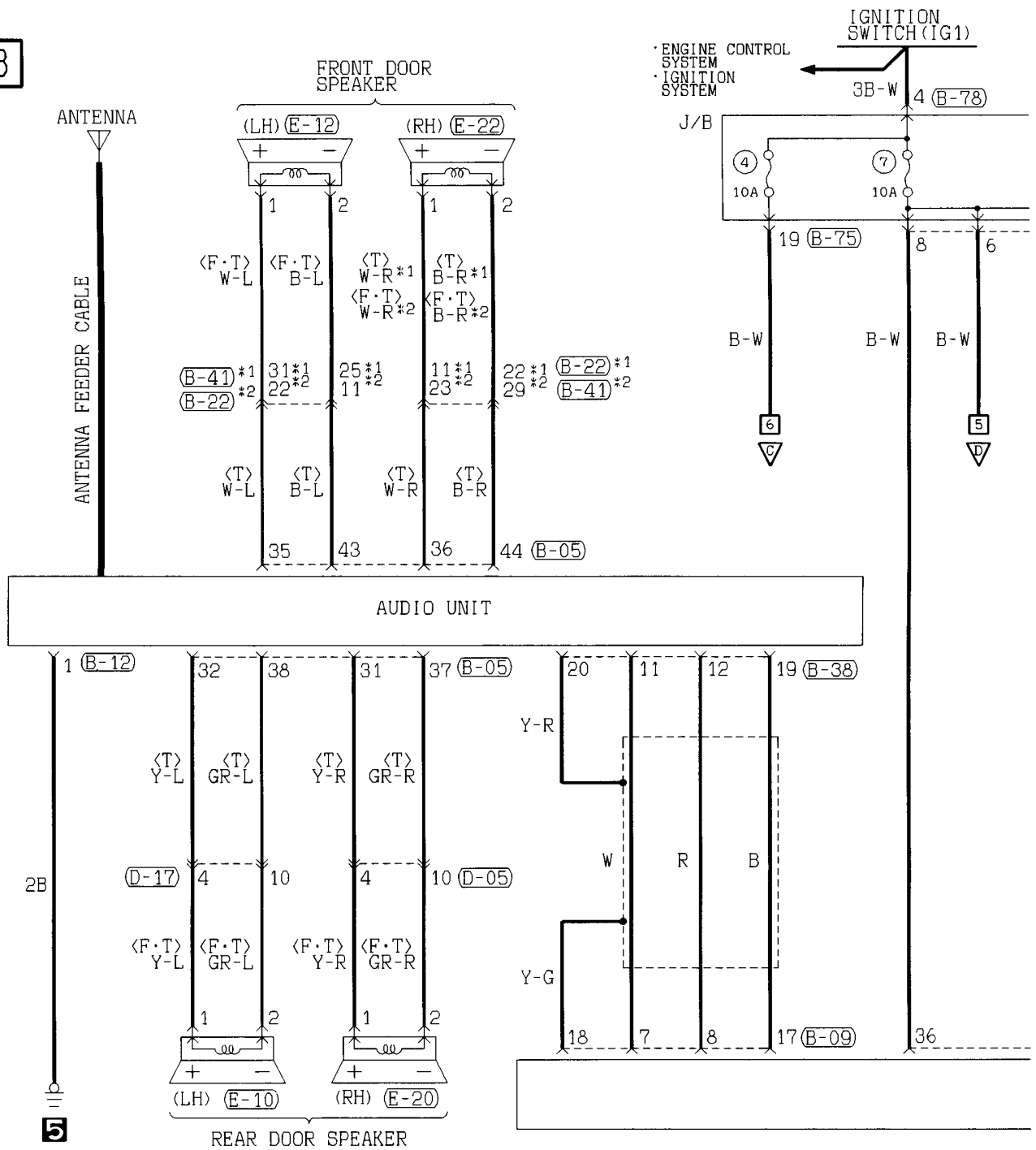

4

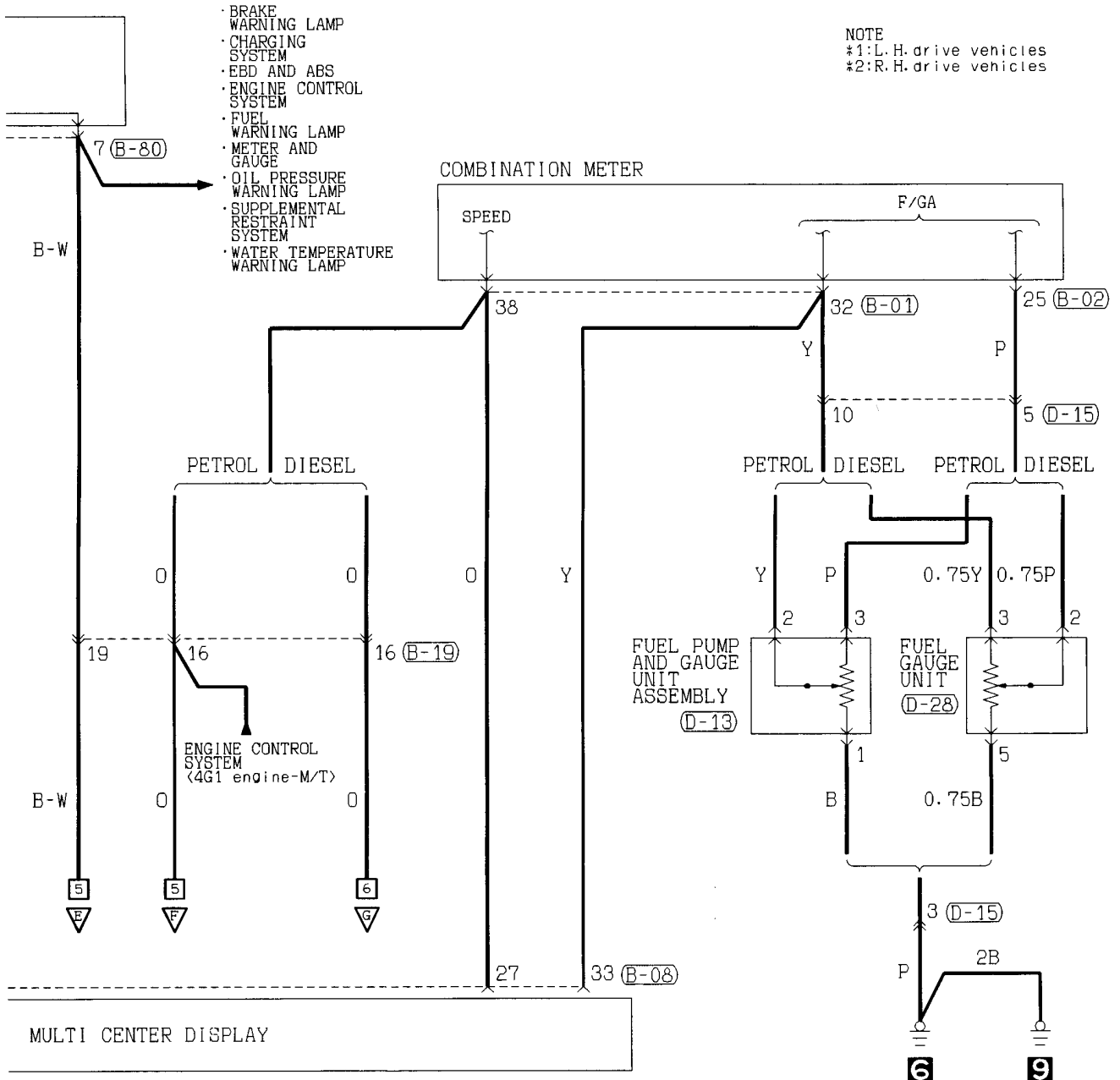

(B-19)

MU801461									
1	2	3	4	5	6	7	8	9	10
11	12	13	14	15	16	17	18	19	20
21	22								

(B-22)

MU801461									
1	2	3	4	5	6	7	8	9	10
11	12	13	14	15	16	17	18	19	20
21	22								

(B-38)

MU801461									
1	2	3	4	5	6	7	8	9	10
11	12	13	14	15	16	17	18	19	20
21	22	23	24	25	26				

(B-41)

MU801457									
1	2	3	4	5	6	7	8	9	
10	11	12	13	14	15	16	17	18	19
20	21	22	23	24	25	26	27	28	29
30	31	32							

(B-75)

MU801457									
1	2	3	4	5	6	7	8	9	
10	11	12	13	14	15	16	17	18	19
20	21	22	23	24	25	26	27	28	29
30	31	32							

(E-10)

MU801212	
1	2

(E-12)

MU801212	
1	2

(E-20)

MU801212	
1	2

(E-22)

MU801212	
1	2

Wire colour code  
 B : Black    LG: Light green    G : Green    L : Blue  
 BR: Brown    O : Orange    GR: Gray    R : Red  
 W : White    SB: Sky blue    P : Pink    Y : Yellow  
 V : Violet

MULTI CENTER DISPLAY <Vehicles without navigation system> (CONTINUED)

5

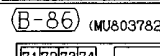
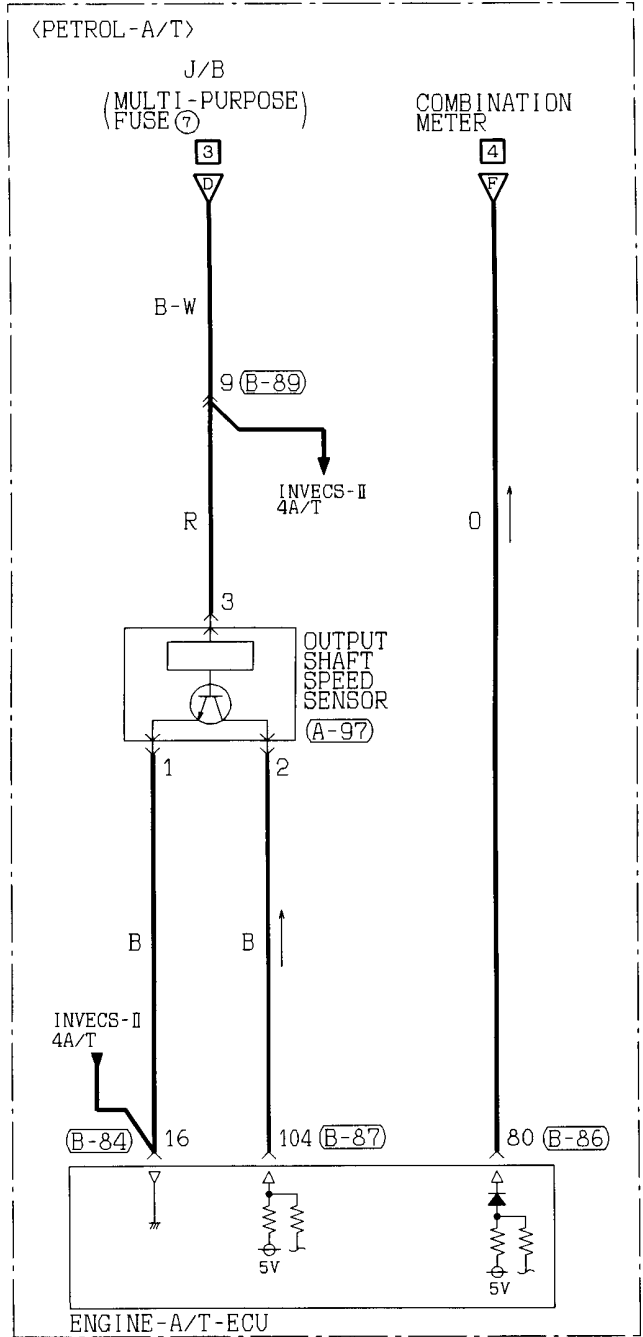
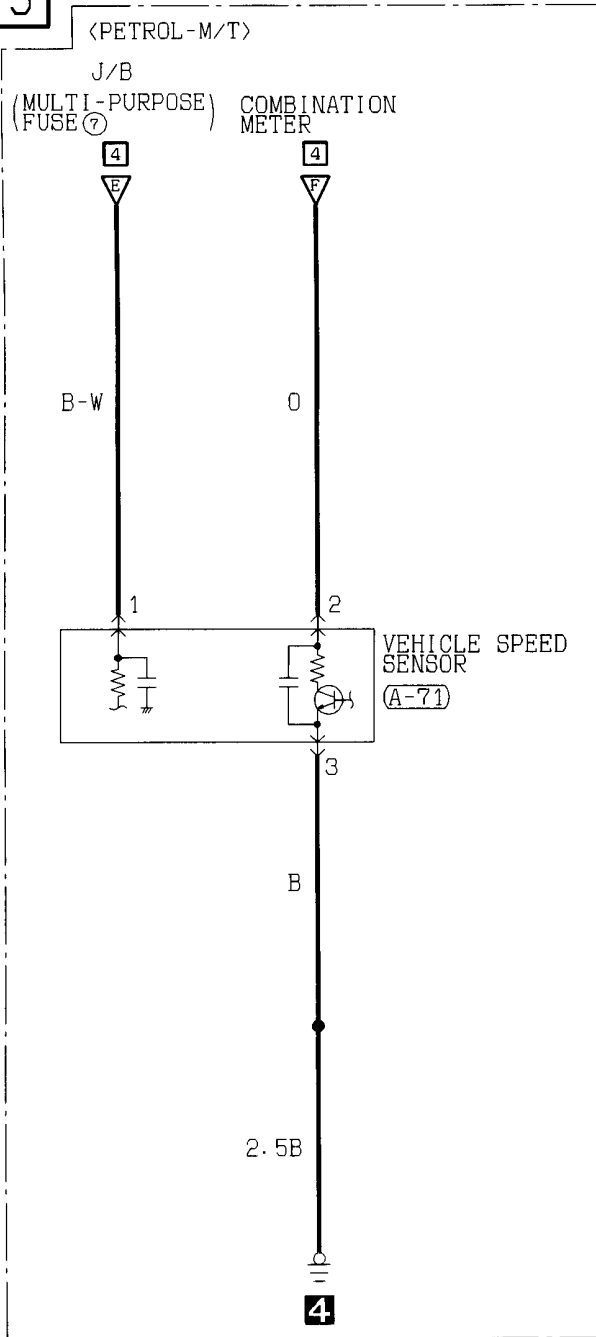

6

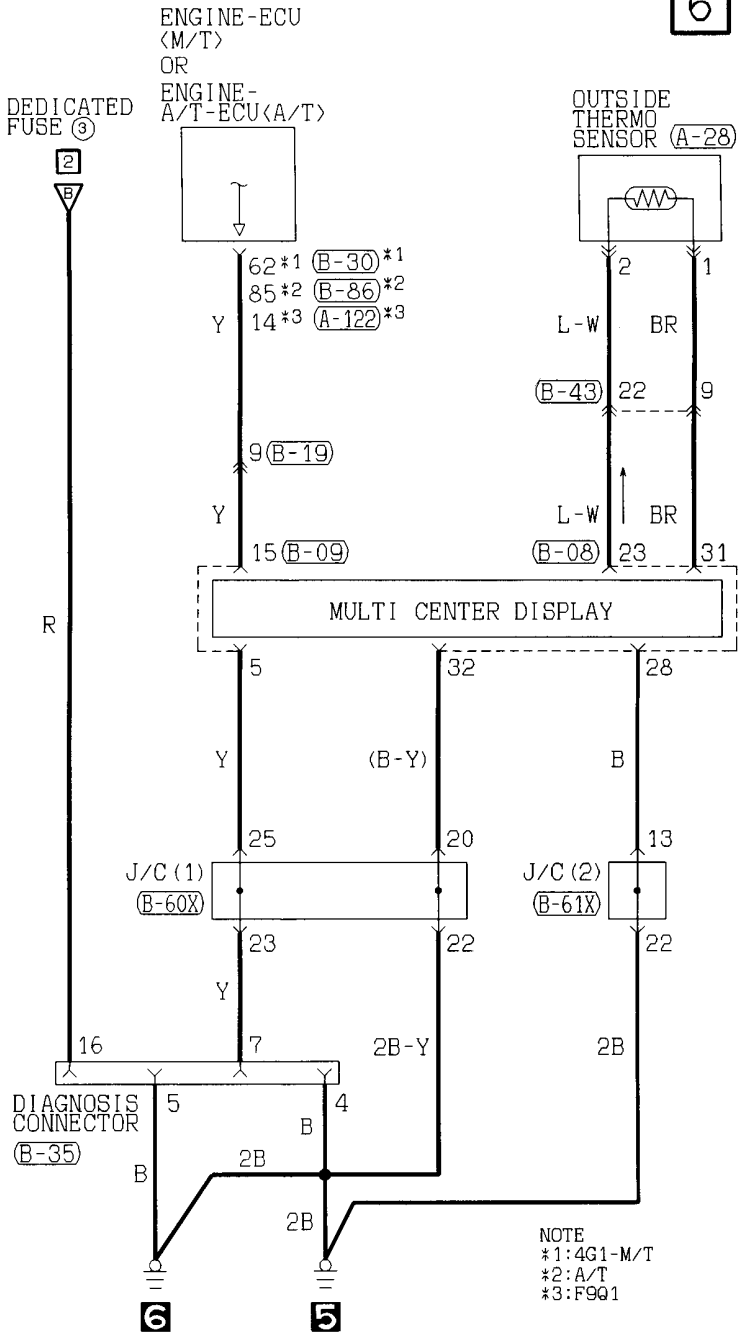
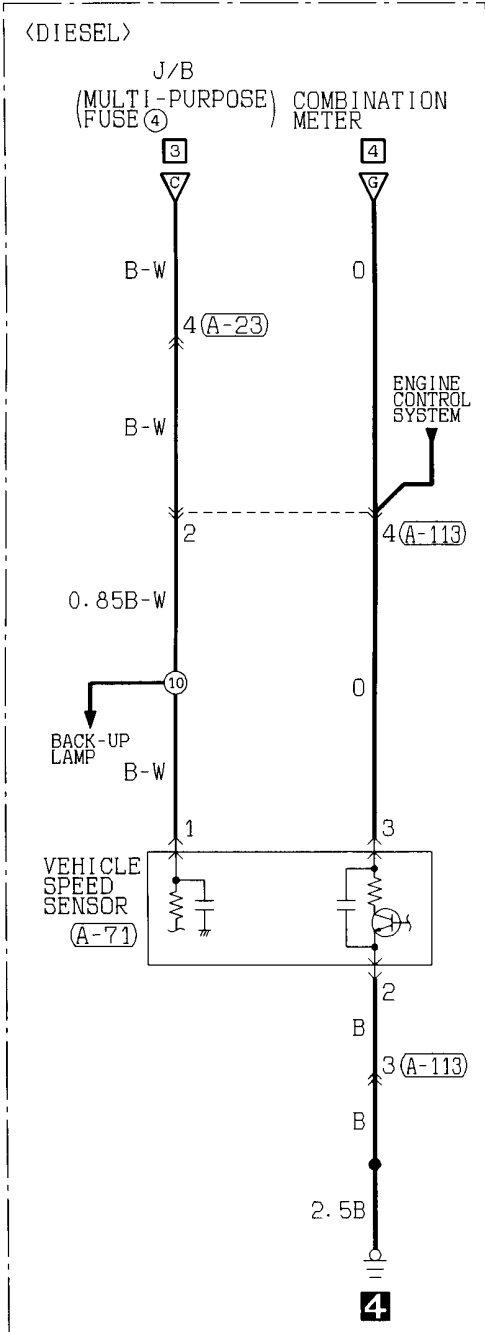

NOTE  
 \*1: 4G1-M/T  
 \*2: A/T  
 \*3: F9Q1

(B-09) (MU801585)

1	2	3	4	5	6	7	8	9	10
11	12	13	14	15	16	17	18	19	20

(B-19) MU801461

1	2	3	4	5	6	7	8	9	10		
11	12	13	14	15	16	17	18	19	20	21	22

(B-30) (MU801820)

51	52	53	54	55	56
57	58	59	60	61	62

(B-35) FRONT SIDE

1	2	3	4	5	6	7	8
9	10	11	12	13	14	15	16

(B-43) MU801461

1	2	3	4	5	6	7	8	9	10		
11	12	13	14	15	16	17	18	19	20	21	22

(B-87) (A/T) (MU803783)

101	102	103	104	105	106	107						
108	109	110	111	112	113	114	115	116	117	118	119	120
121	122	123	124	125	126	127	128	129	130			

(B-89) MU801461

1	2	3	4	5	6	7	8	9	10		
11	12	13	14	15	16	17	18	19	20	21	22

Wire colour code  
 B : Black      LG: Light green      G : Green      L : Blue  
 BR: Brown      O : Orange              GR: Gray          R : Red  
 W : White      SB: Sky blue              P : Pink            Y : Yellow  
 V : Violet

**MULTI CENTER DISPLAY**

Vehicles with navigation system

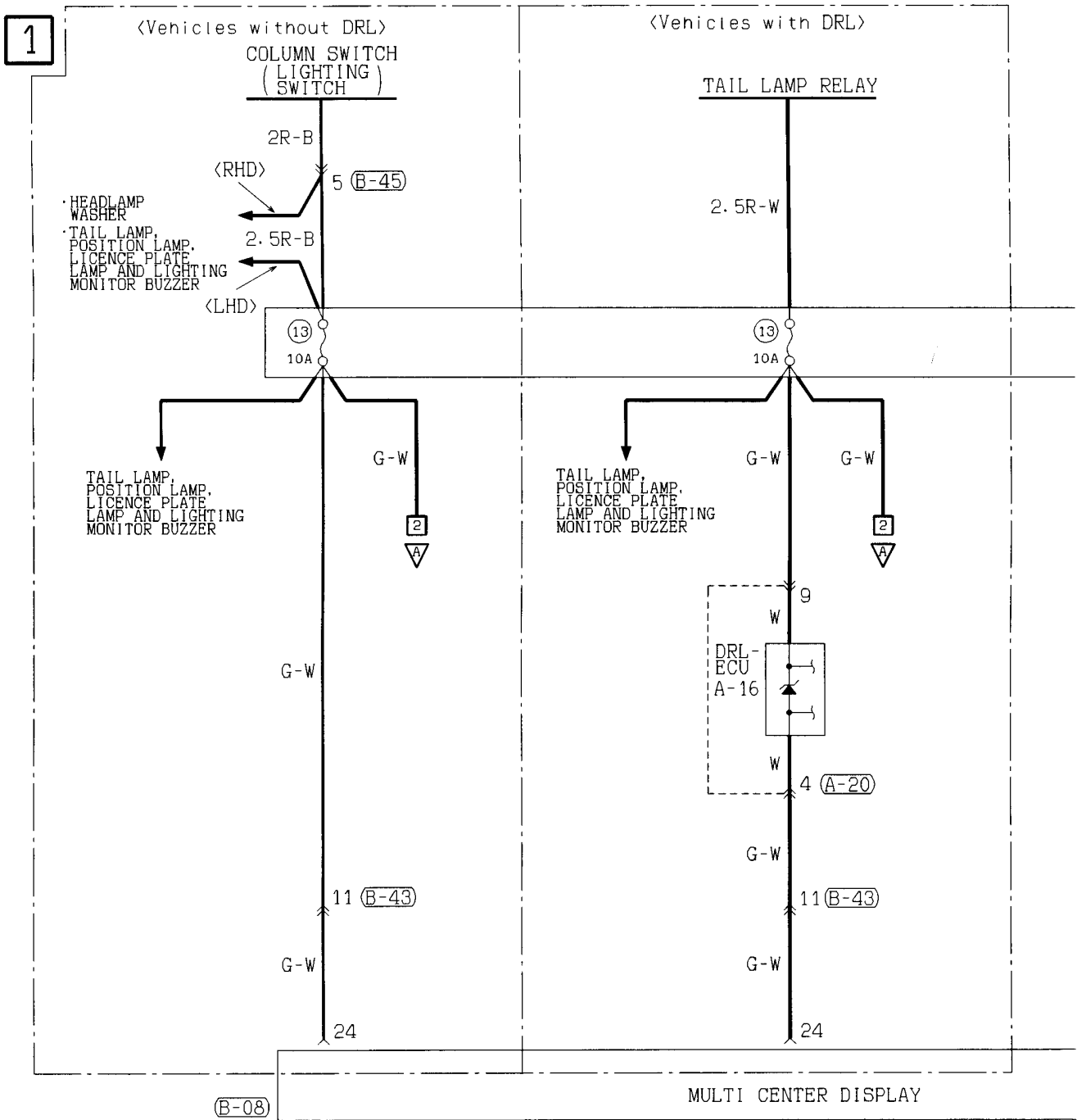

(A-20) MU802645

1	2	3	4	5
6	7	8	9	10

(B-08) (MU801584)

21	22	23	24	25	26	27	28
29	30	31	32	33	34	35	36

(B-11) MU801453

1	2	3	4	5	6		
7	8	9	10	11	12	13	14

(B-43) MU801461

1	2	3	4	5	6	7	8	9	10		
11	12	13	14	15	16	17	18	19	20	21	22

(B-45) MU801335

1	2	3	4		
5	6	7	8	9	10

1	2	3	4		
5	6	7	8	9	10

(B-60X)

1	2	3	4	5	6	7	8	9	10	11
12	13	14	15	16	17	18	19	20	21	22
23	24	25	26	27	28	29	30	31	32	33

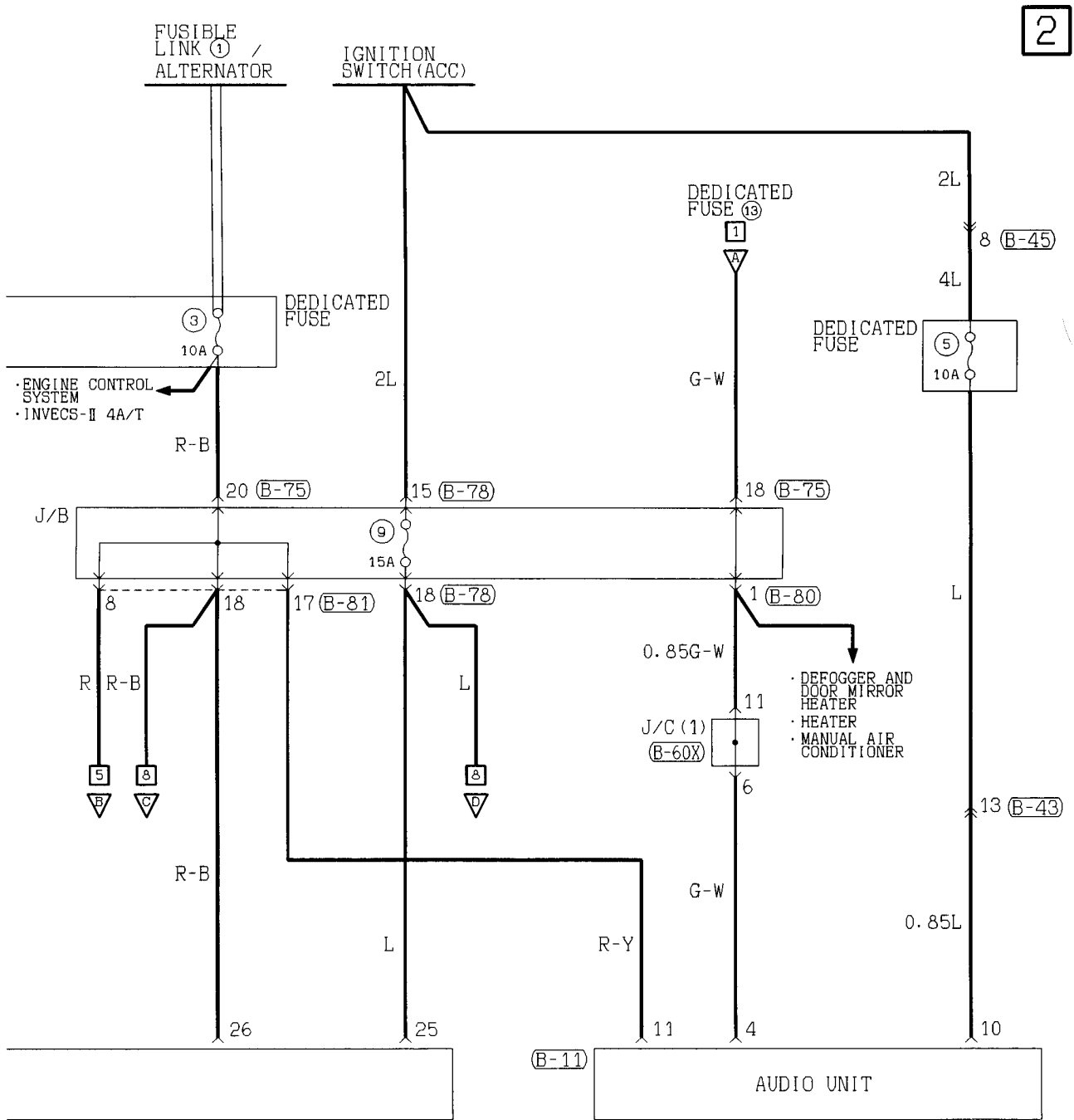

(B-75)	(B-78)	(B-80)	(B-81)
MU801457			MU801461
1 2 3 4 M 5 6 7 8 9	1 2 3 4 5 6 7 8	1 2 3 4 5 6 7 8 9 10	1 2 3 4 5 M 6 7 8 9 10
10 11 12 13 14 15 16 17 18 19 20	9 10 11 12 13 14 15 16 17 18	11 12 13 14 15 16 17 18 19 20 21 22	11 12 13 14 15 16 17 18 19 20 21 22

Wire colour code  
 B : Black LG: Light green G : Green L : Blue W : White Y : Yellow SB: Sky blue  
 BR: Brown O : Orange GR: Gray R : Red P : Pink V : Violet

MULTI CENTER DISPLAY <Vehicles with navigation system> (CONTINUED)

3

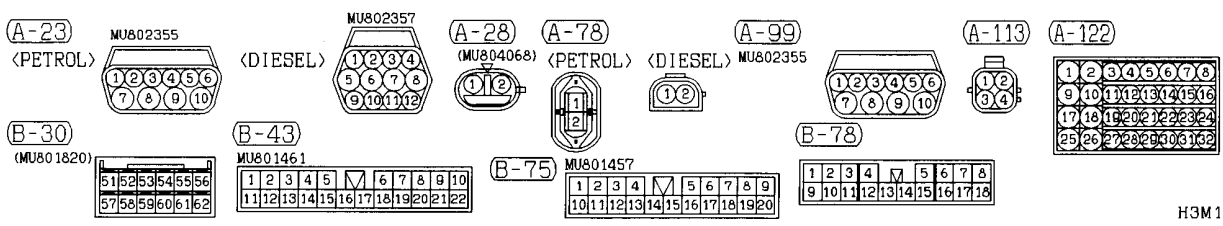
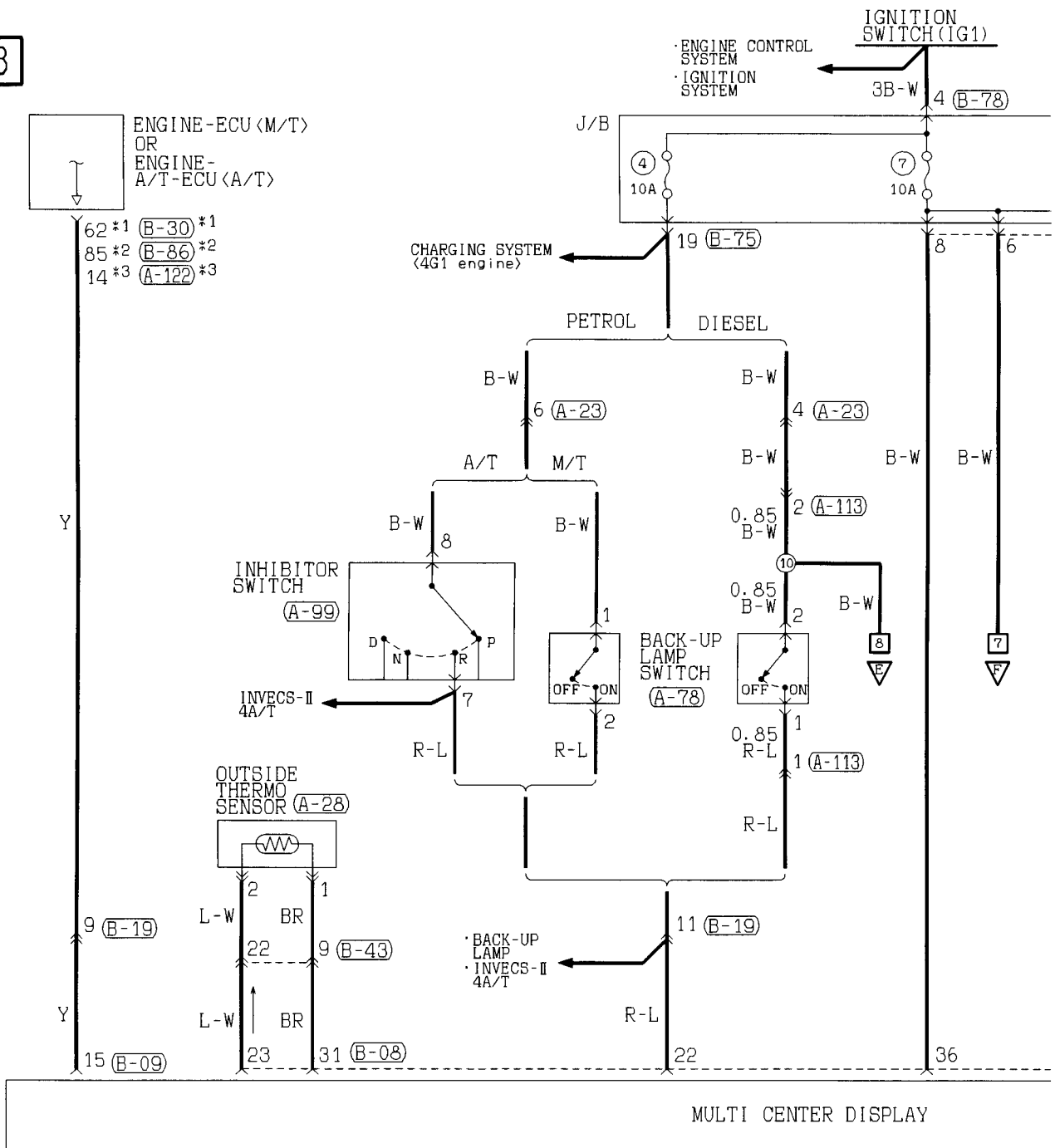



4

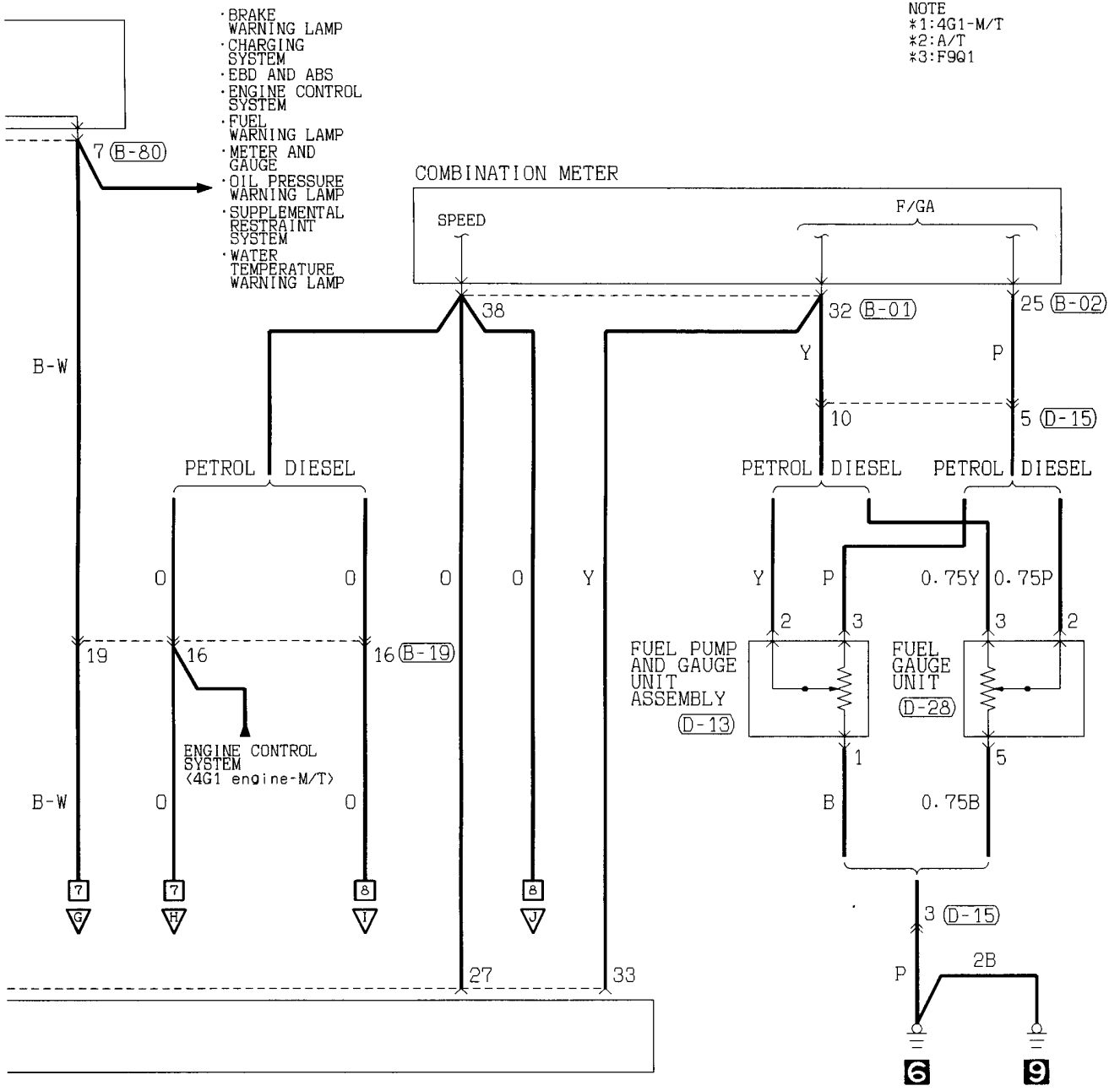

<b>(B-01)</b> 31 32 33 34 35 36 37 38 39 40 41 42 43 44 45 46 47 48 49 50 51 52 53 54 55	<b>(B-02)</b> 1 2 3 4 5 6 7 8 9 10 11 12 13 14 15 16 17 18 19 20 21 22 23 24 25	<b>(B-08)</b> (MU801584) 21 22 23 24 25 26 27 28 29 30 31 32 33 34 35 36	<b>(B-09)</b> (MU801585) 1 2 3 4 5 6 7 8 9 10 11 12 13 14 15 16 17 18 19 20	<b>(B-19)</b> MU801461 1 2 3 4 5 6 7 8 9 10 11 12 13 14 15 16 17 18 19 20 21 22
<b>(B-80)</b> 1 2 3 4 5 6 7 8 9 10 11 12 13 14 15 16 17 18 19 20 21 22	<b>(B-86)</b> (MU803782) 71 72 73 74 75 76 77 78 79 80 81 82 83 84 85 86 87 88 89 90 91 92 93 94 95 96 97 98	<b>(D-13)</b> (MU802058) MU801451 1 2 3 4 5	<b>(D-15)</b> 1 2 3 4 5 6 7 8 9 10	<b>(D-28)</b> 1 2 3 4 5

MULTI CENTER DISPLAY <Vehicles with navigation system> (CONTINUED)

5

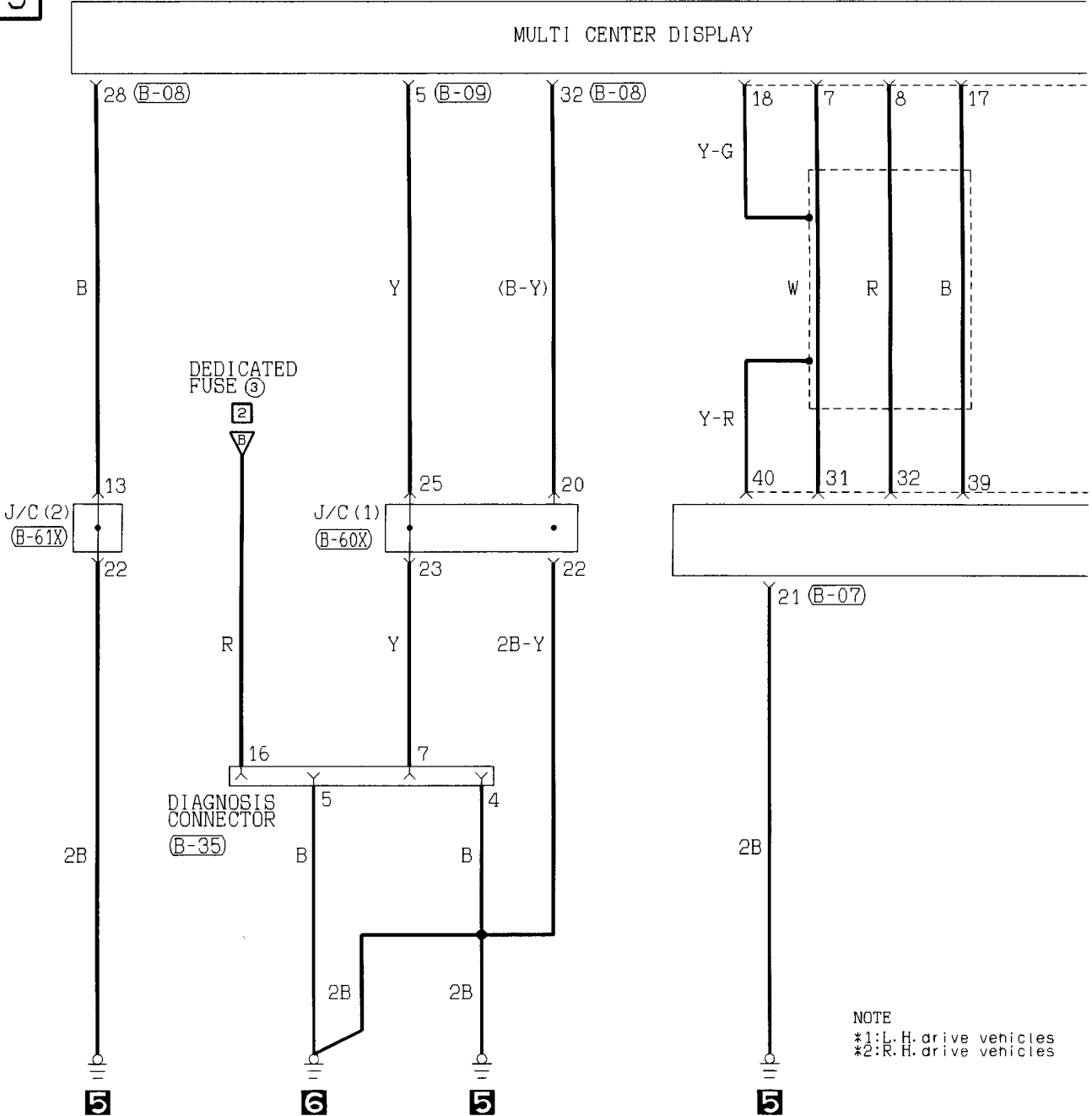

B-04

1	2	3	4	5	6	7	8
9	10	11	12	13	14	15	16
17	18	19	20	21	22	23	24
25	26	27	28	29	30	31	32
33	34	35	36	37	38	39	40
41	42	43	44	45	46		

B-07 (MU801211)

1	2
3	4

B-08 (MU801584)

1	2	3	4	5	6	7	8
9	10	11	12	13	14	15	16
17	18	19	20	21	22	23	24
25	26	27	28	29	30	31	32
33	34	35	36				

B-09 (MU801585)

1	2	3	4	5	6	7	8	9	10
11	12	13	14	15	16	17	18	19	20

B-11 (MU801453)

1	2	3	4	5	6
7	8	9	10	11	12
13	14	15	16	17	18

B-22 (MU801461)

1	2	3	4	5	6	7	8	9	10
11	12	13	14	15	16	17	18	19	20
21	22								

B-35 FRONT SIDE

1	2	3	4	5	6	7	8
9	10	11	12	13	14	15	16

E-22 (MU801212)

1
2

6

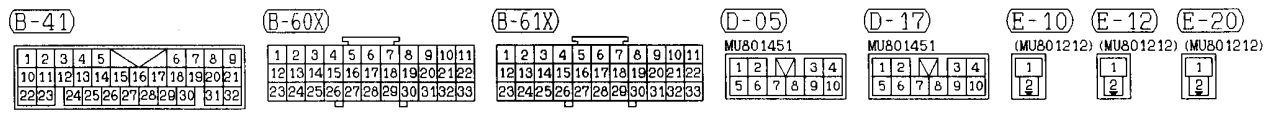
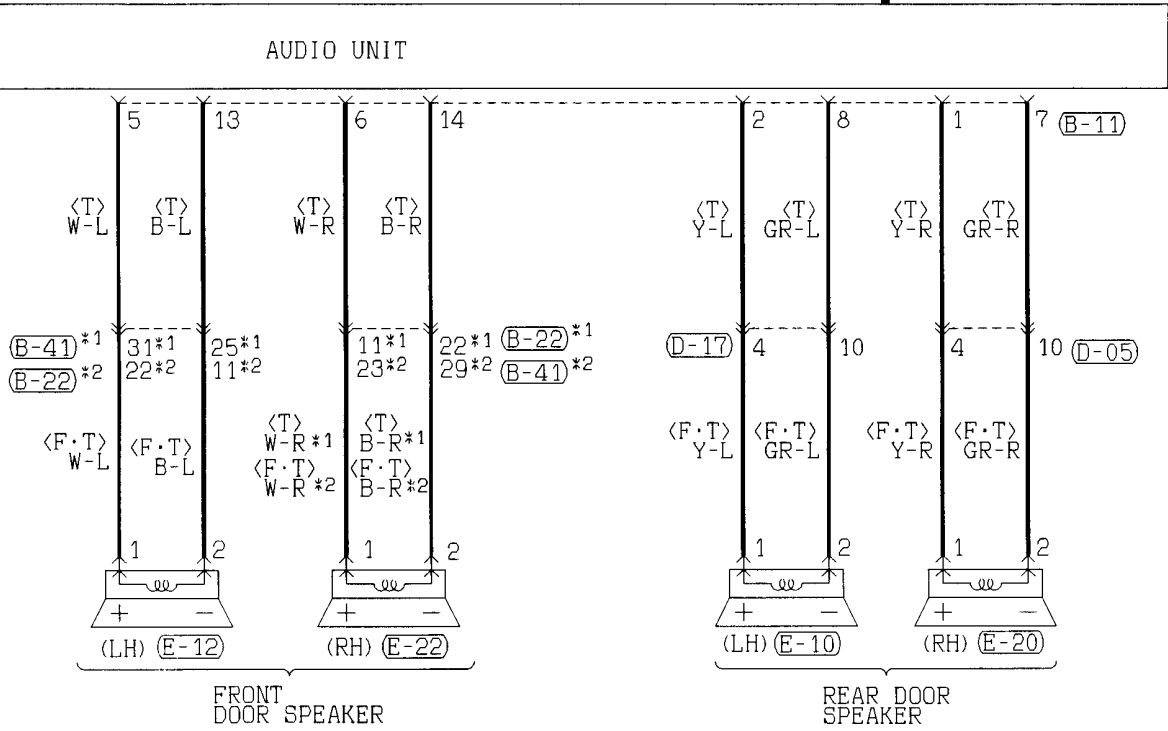
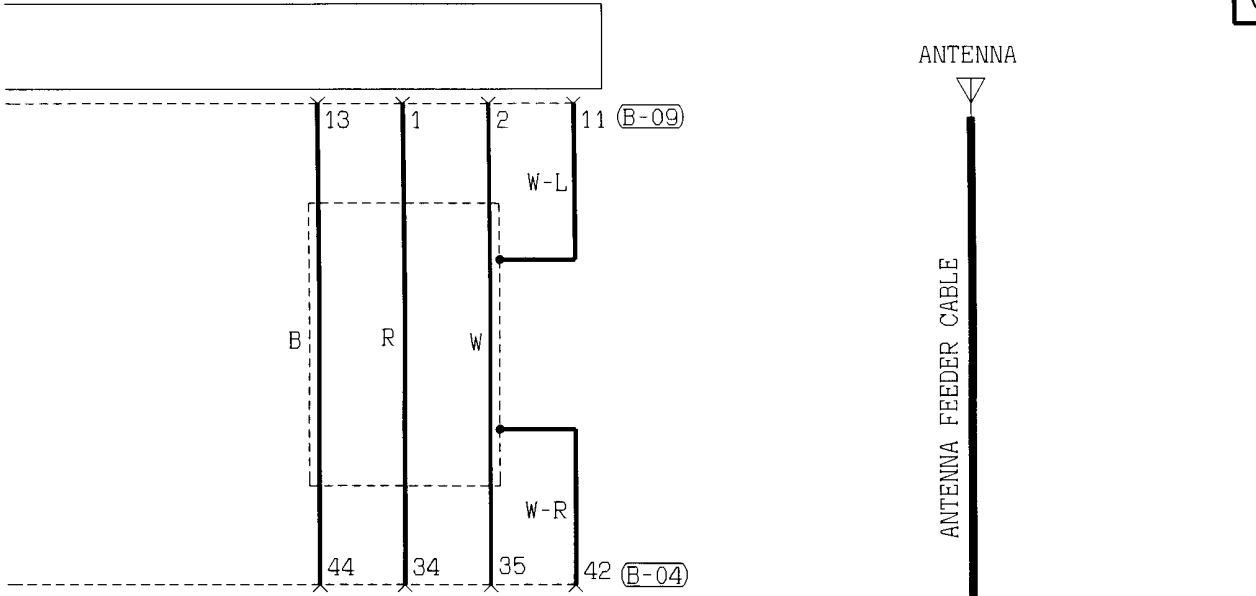

Wire colour code  
 B : Black    LG : Light green    G : Green    L : Blue    W : White    Y : Yellow    SB : Sky blue  
 BR : Brown    O : Orange    GR : Gray    R : Red    P : Pink    V : Violet

MULTI CENTER DISPLAY <Vehicles with navigation system> (CONTINUED)

7

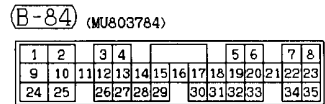
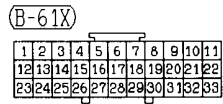
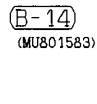
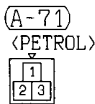
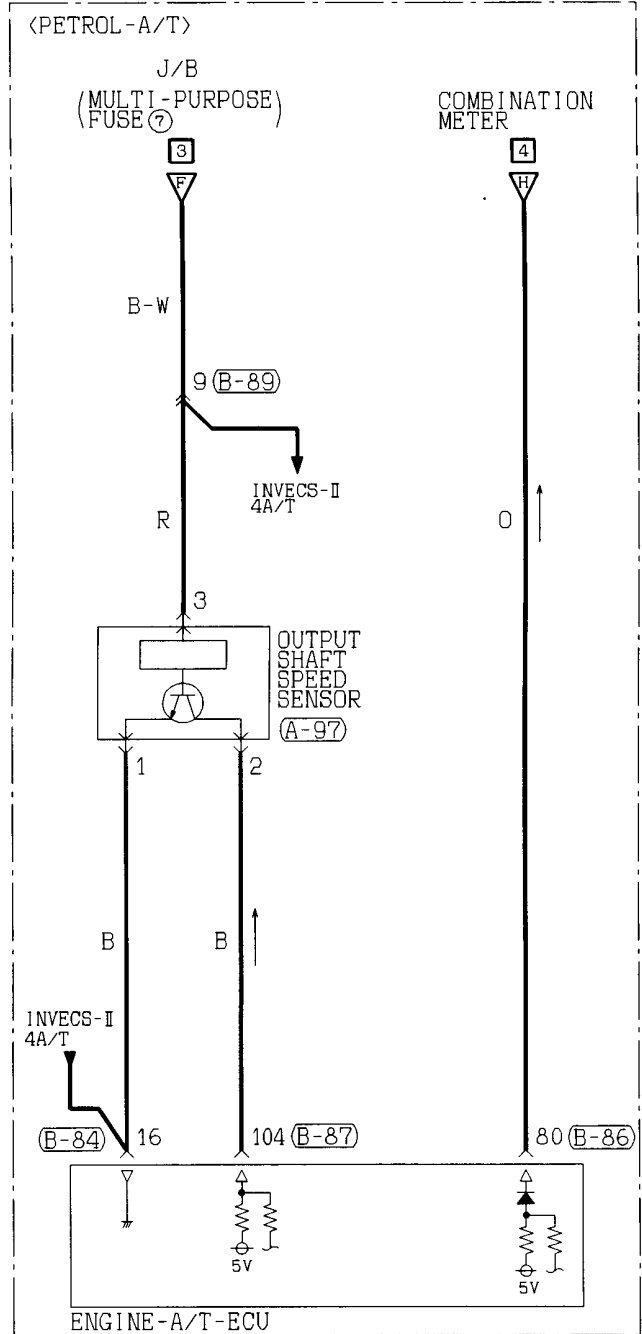
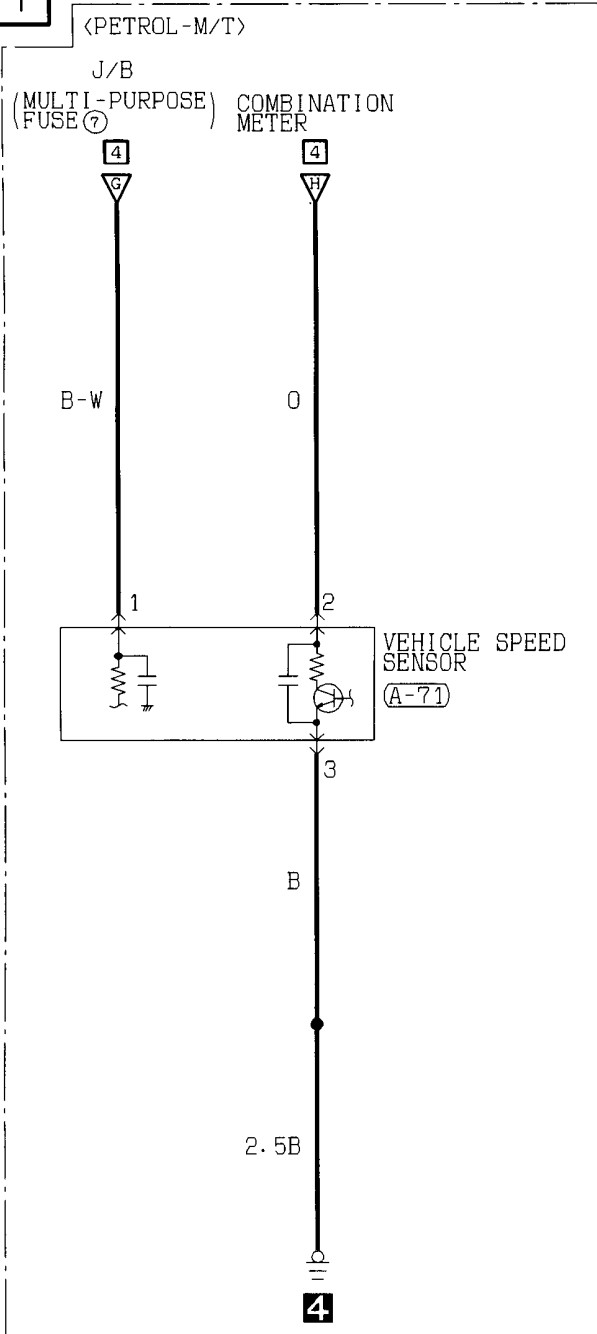

8

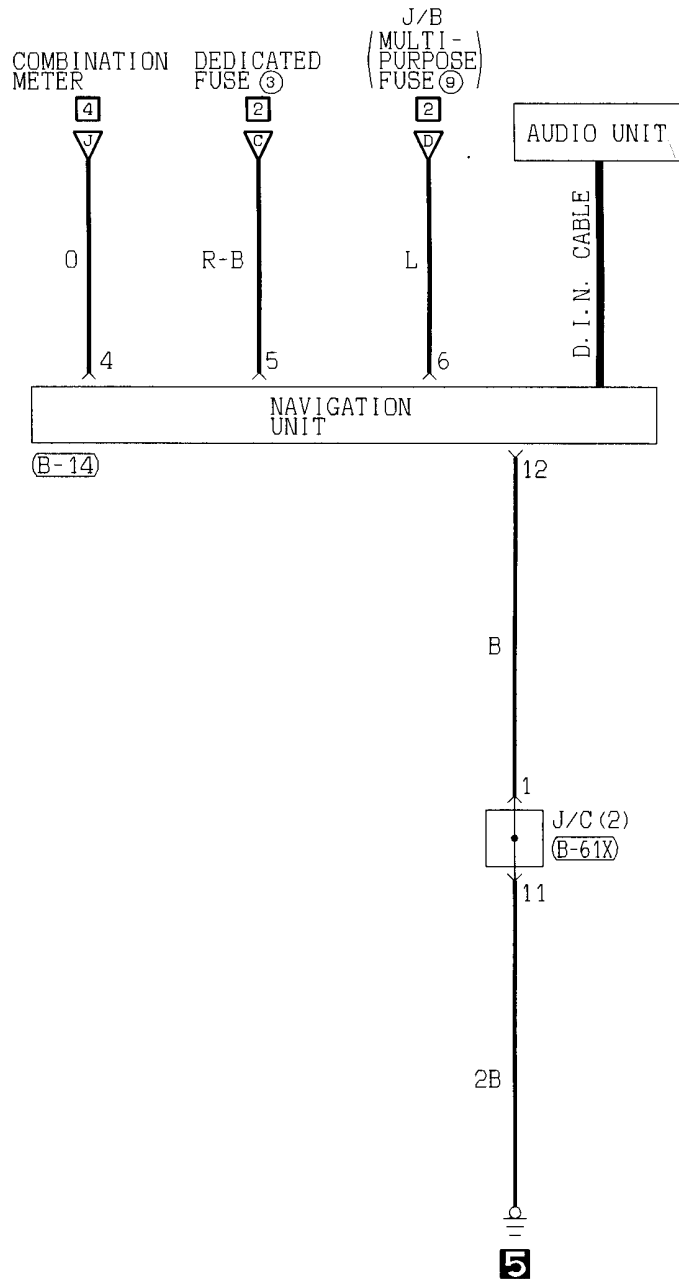
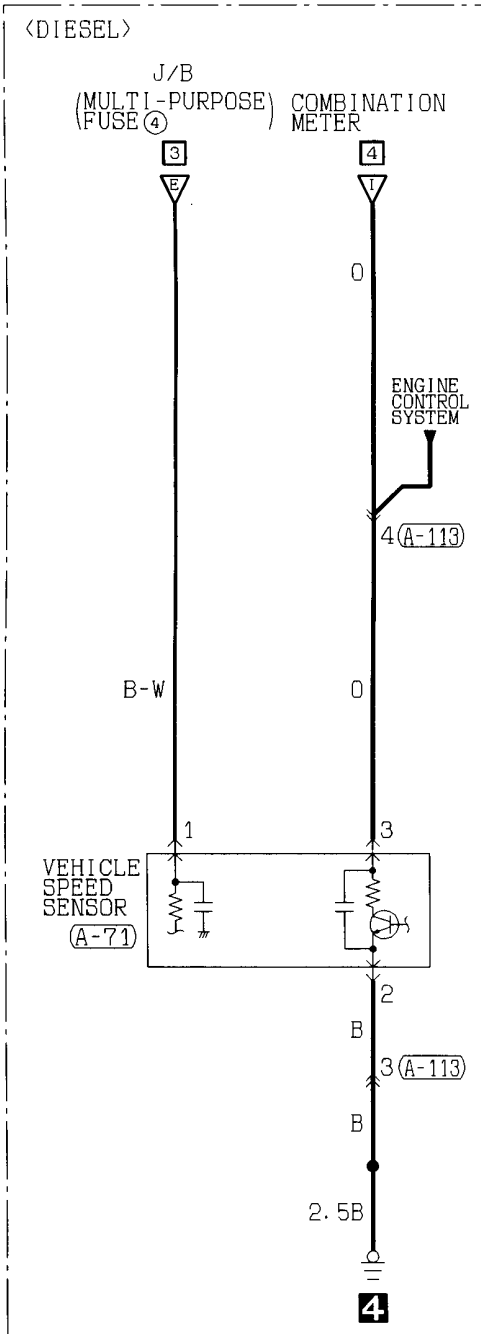

B-86 (MU803782)

71	72	73	74	75	76	77					
78	79	80	81	82	83	84	85	86	87	88	89
90	91	92	93	94	95	96	97	98			

B-87 (MU803783)

101	102	103	104	105	106	107						
108	109	110	111	112	113	114	115	116	117	118	119	120
121	122	123	124	125	126	127	128	129	130			

B-89

MU801461

1	2	3	4	5	6	7	8	9	10		
11	12	13	14	15	16	17	18	19	20	21	22

Wire colour code  
 B : Black    LG: Light green    G : Green    L : Blue    W : White    Y : Yellow    SB: Sky blue  
 BR: Brown    O : Orange    GR: Gray    R : Red    P : Pink    V : Violet

SUNROOF

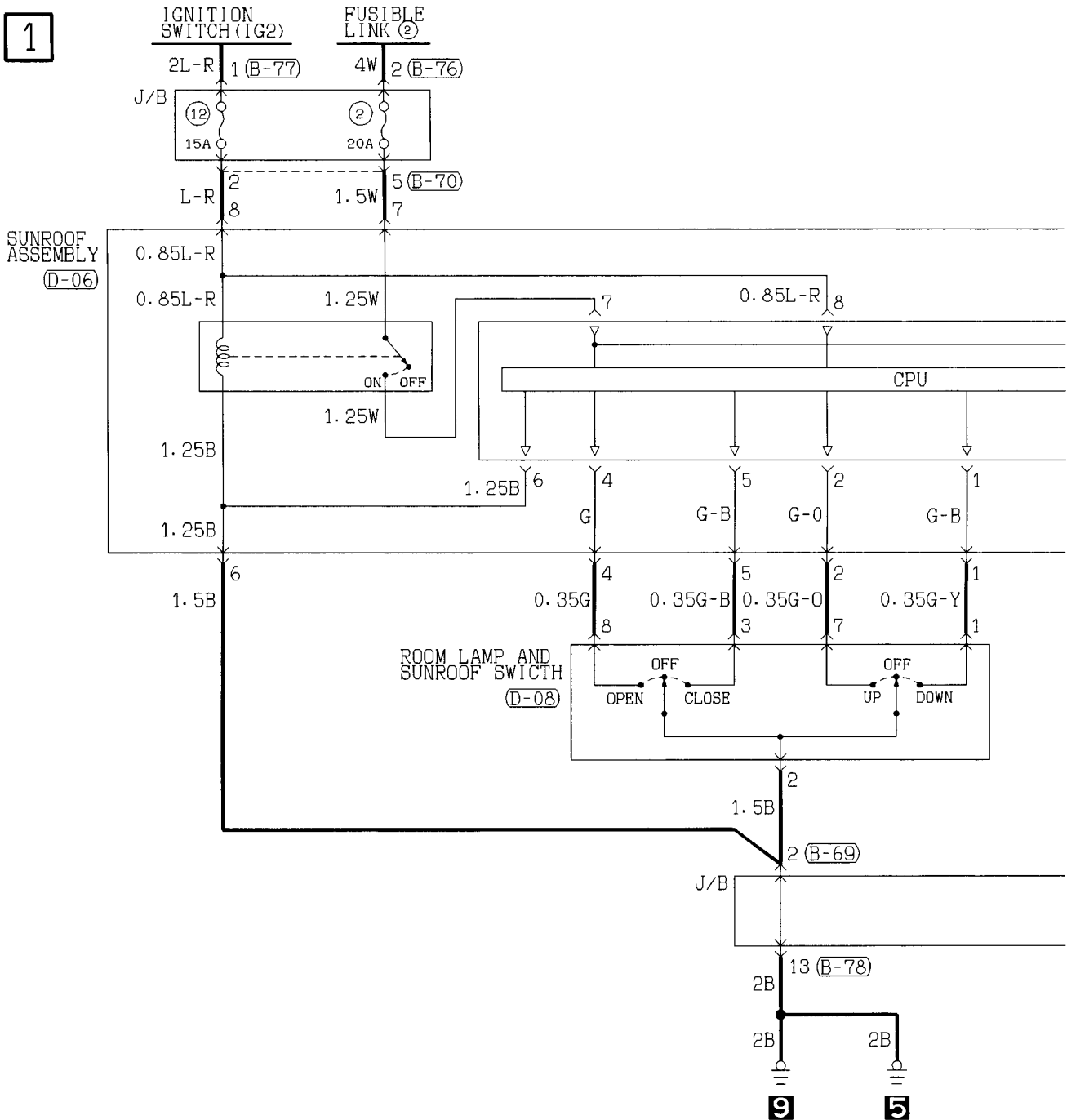

(B-60X)

1	2	3	4	5	6	7	8	9	10	11
12	13	14	15	16	17	18	19	20	21	22
23	24	25	26	27	28	29	30	31	32	33

(B-69)

1	2
---	---

(B-70)

1	2
3	4
5	6

(B-76)

1	2
---	---

(B-77)

1	2	3
---	---	---

(B-78)

1	2	3	4	M	5	6	7	8	
9	10	11	12	13	14	15	16	17	18

(B-81)

1	2	3	4	5	6	7	8	9	10		
11	12	13	14	15	16	17	18	19	20	21	22

(D-06)

1	2	3	4	5	6	7	8	9	10	
					A					

2

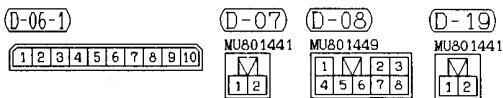
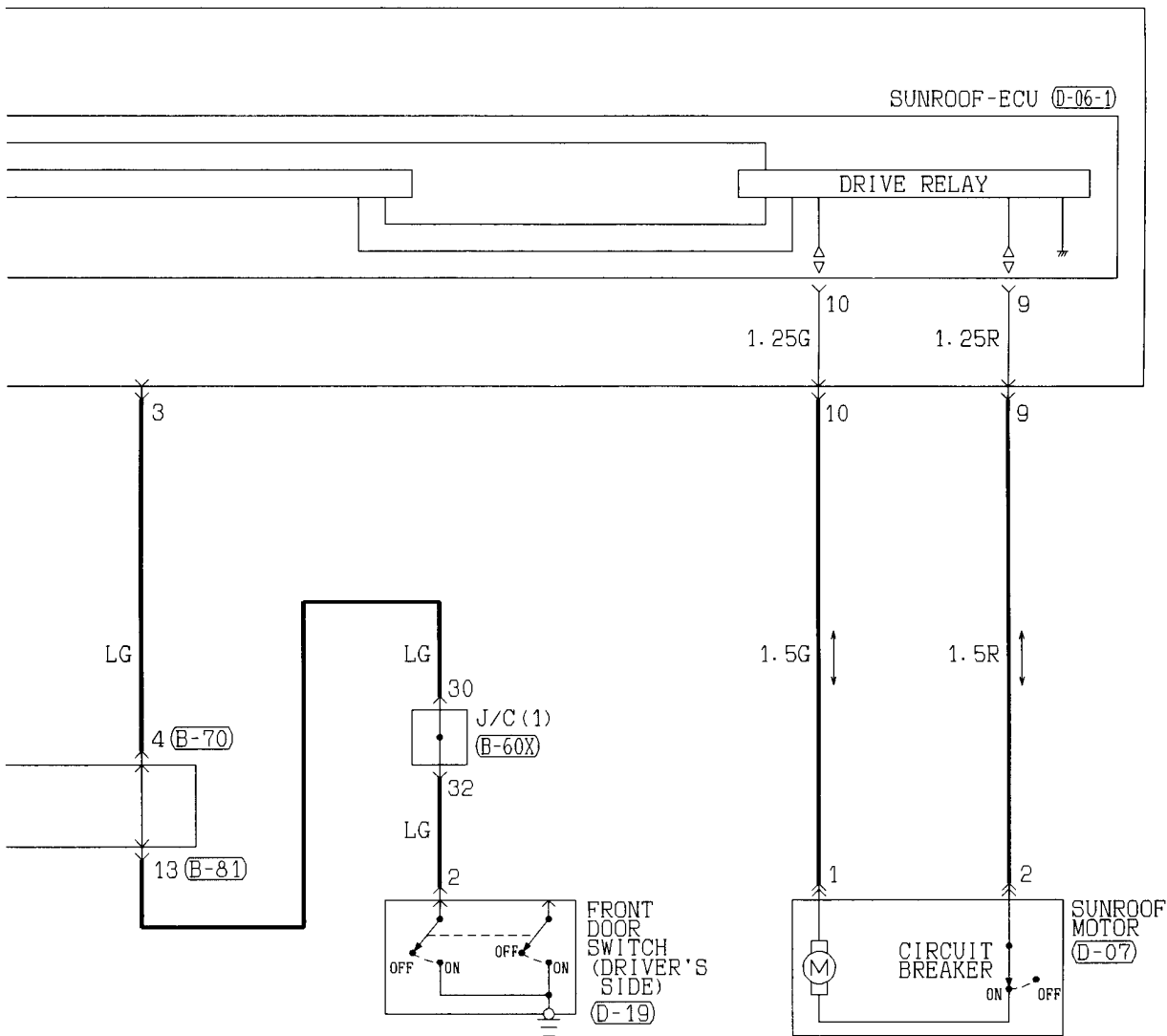

Wire colour code  
 B :Black LG:Light green G :Green L :Blue W :White Y :Yellow SB:Sky blue  
 BR:Brown O :Orange GR:Gray R :Red P :Pink V :Violet

HEATED SEAT

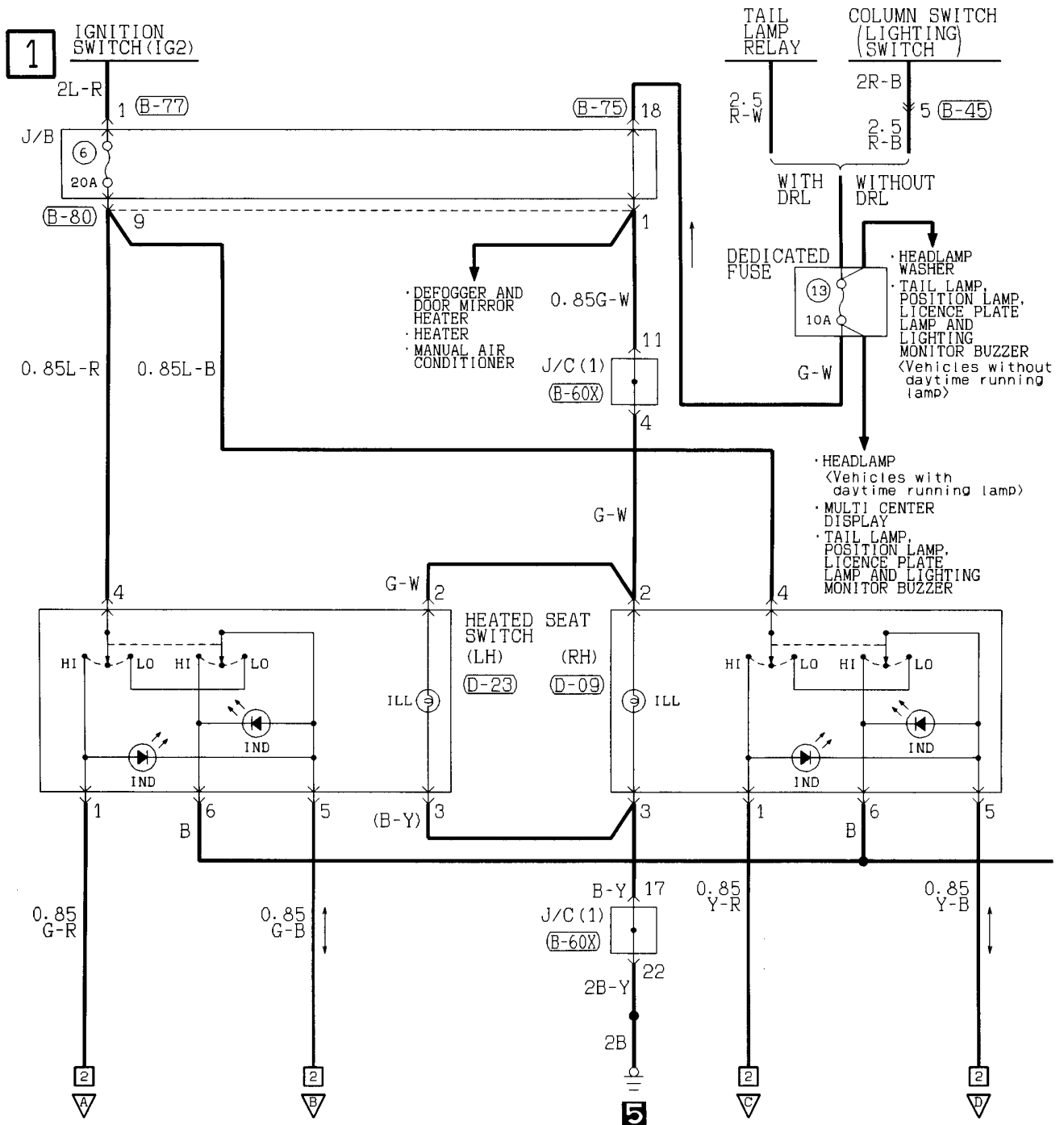

(B-45) MU801335

1	2	3	4
5	6	7	8
9	10		

(B-60X)

1	2	3	4	5	6	7	8	9	10	11
12	13	14	15	16	17	18	19	20	21	22
23	24	25	26	27	28	29	30	31	32	33

(B-61X)

1	2	3	4	5	6	7	8	9	10	11
12	13	14	15	16	17	18	19	20	21	22
23	24	25	26	27	28	29	30	31	32	33

(B-75) MU801457

1	2	3	4	5	6	7	8	9
10	11	12	13	14	15	16	17	18
19	20							

(B-77)

1	2	3
---	---	---

(B-80)

1	2	3	4	5	6	7	8	9	10
11	12	13	14	15	16	17	18	19	20
21	22								



2

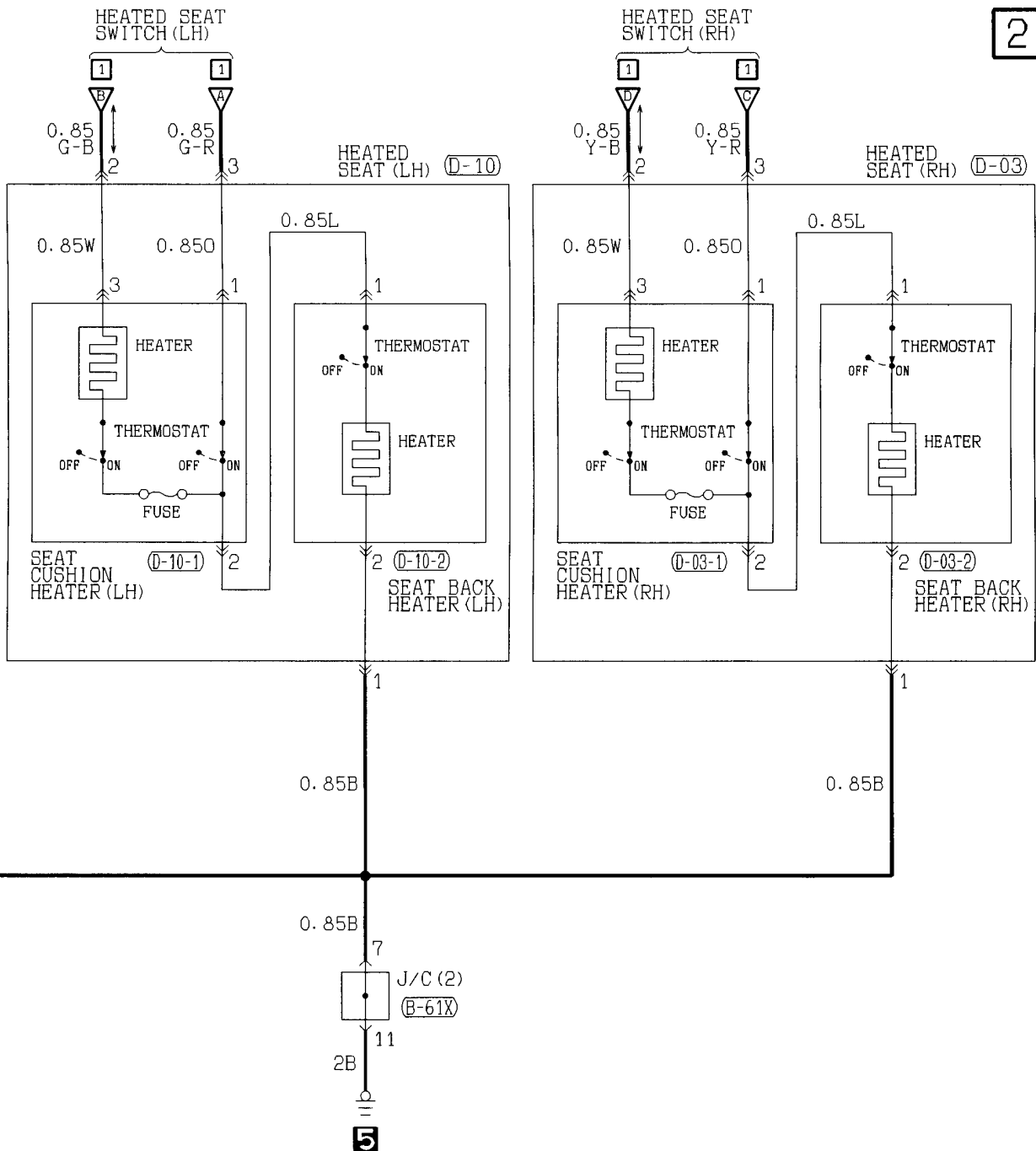

5

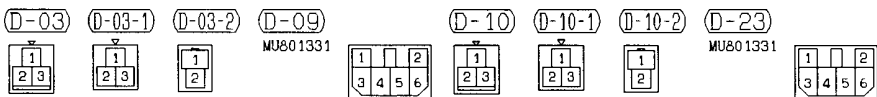

Wire colour code  
 B :Black LG:Light green G :Green L :Blue W :White Y :Yellow SB:Sky blue  
 BR:Brown O :Orange GR:Gray R :Red P :Pink V :Violet

SUPPLEMENTAL RESTRAINT SYSTEM

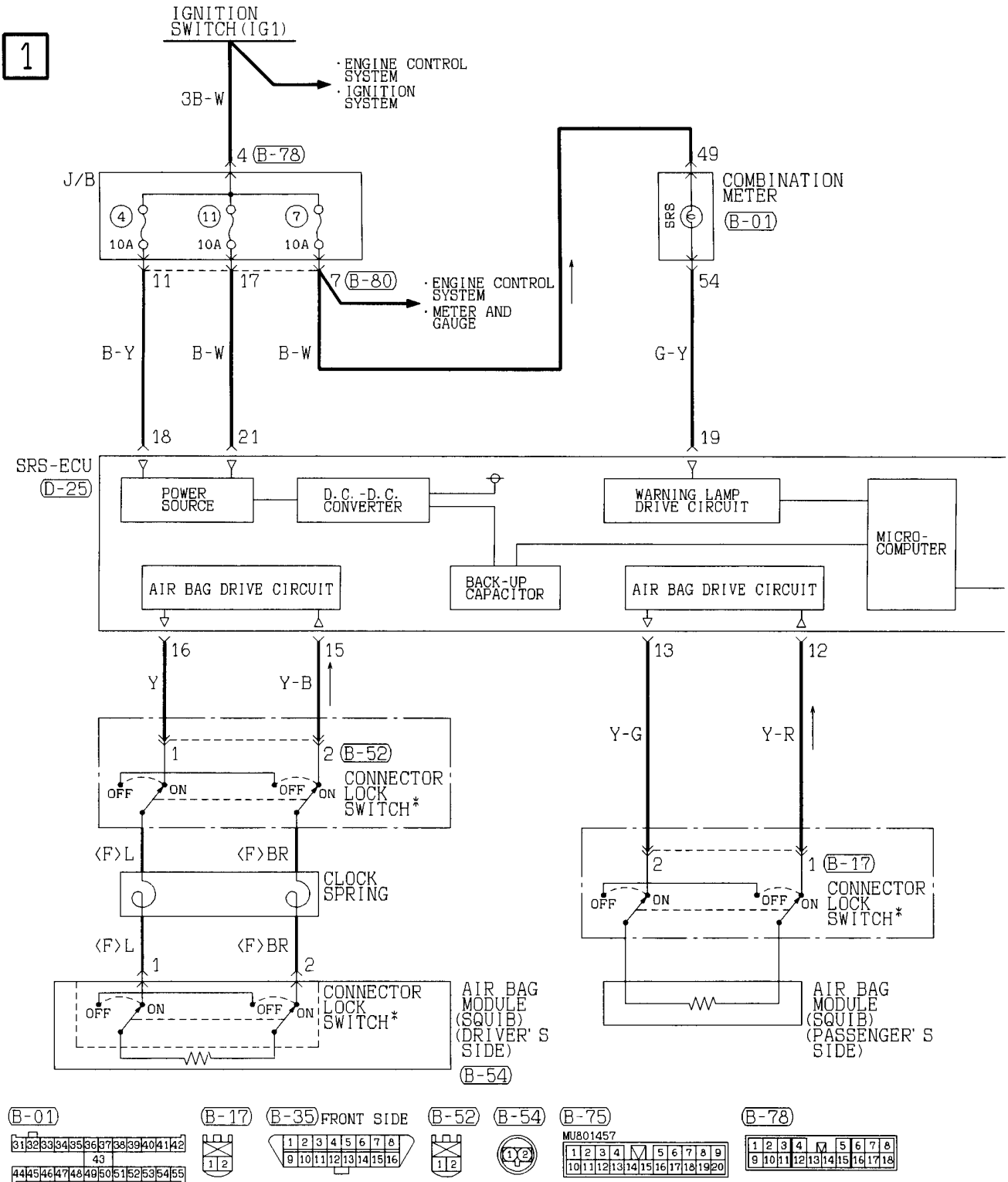

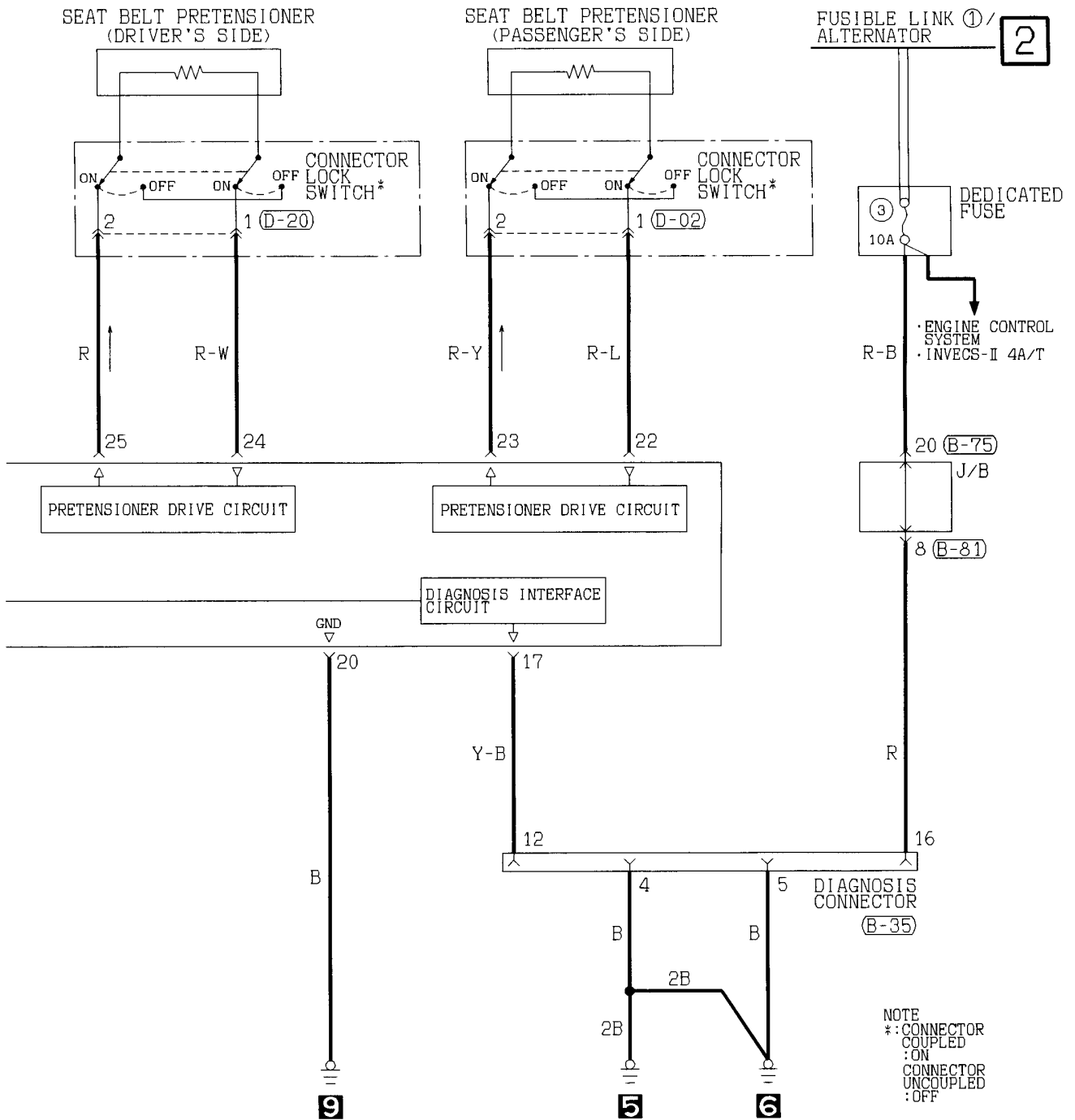

(B-80)

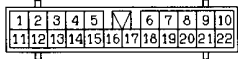

(B-81)

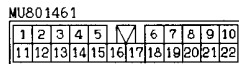

(D-02)



(D-20)



(D-25)

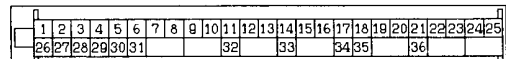

Wire colour code

B : Black    LG: Light green    G : Green    L : Blue    W : White    Y : Yellow    SB: Sky blue  
BR: Brown    O : Orange    GR: Gray    R : Red    P : Pink    V : Violet

SUPPLEMENTAL RESTRAINT SYSTEM (CONTINUED)

3

