

FOREWORD

Thank you for purchasing a NISSAN vehicle.

This user's manual is for the navigation system only. This manual contains operating instructions for the NISSAN Navigation System offered in your NISSAN vehicle.

Please read this manual carefully to ensure safe operation of the navigation system.

- Because of possible specification changes and optional equipment, sections of this manual may not apply to your vehicle.
- All information, specifications and illustrations in this manual are those in effect at the time of printing. NISSAN reserves the right to change specifications or design at any time without notice.
- Do not remove this manual from the vehicle when selling this vehicle. The next user of this navigation system may need the manual.

Table of Contents

Introduction	1
Getting started	2
Map settings	3
Setting a destination	4
Route guidance	5
Storing a location/route	6
Viewing technical information	7
Other settings	8
General system information	9
Troubleshooting guide	10
Index	11

1 Introduction

How to use this manual	1-2
For safe operation	1-2
Reference symbols	1-2

Safety information	1-3
Laser product.....	1-4



HOW TO USE THIS MANUAL

This manual uses special words, symbols and icons, organized by function.

Please refer to the following items and familiarize yourself with them.

Basic operations of the navigation system can be performed in a similar manner for all vehicle models. However, the map screen and setting screen may be different for each model. Set the navigation system as appropriate for your vehicle.

FOR SAFE OPERATION



WARNING

This is used to indicate the presence of a hazard that could cause death or serious personal injury. To avoid or reduce the risk, the procedures must be followed precisely.



CAUTION

This is used to indicate the presence of a hazard that could cause minor or moderate personal injury or damage to your vehicle. To avoid or reduce the risk, the procedures must be followed carefully.



NOTE:

This indicates an item to help you understand and maximize the performance of your vehicle. If ignored, it may lead to a malfunction or poor performance.

REFERENCE SYMBOLS



INFO:

This indicates information that is necessary for efficient use of your vehicle or accessories.



Reference page:

This indicates the title and page that you should refer to.

<>:

This indicates a button on the control panel.

[]:

This indicates a key/item displayed on the screen.

SAFETY INFORMATION

This system is primarily designed to help you reach your destination, and it also performs other functions as outlined in this manual. However, you, the driver, must use the system safely and properly. Information concerning road conditions, traffic signs and the availability of services may not always be up-to-date. The system is not a substitute for safe, proper and legal driving.

Before using the navigation system, please read the following safety information. Always use the system as outlined in this manual.



WARNING

- **When the driver wants to operate the navigation system, first park the vehicle in a safe location and set the parking brake. Operating the system while driving can distract the driver and may result in a serious accident.**
- **Do not rely on route guidance alone. Always be sure that all driving maneuvers are legal and safe in order to avoid accidents.**
- **Do not disassemble or modify this system. If you do, it may result in accidents, fire or electrical shock.**

- **Do not use this system if you notice any malfunctions such as a frozen screen or the lack of sound. Continued use of the system may result in accidents, fire or electrical shock.**
- **If you notice any foreign objects in the system hardware, spill liquid on the system or notice smoke or a smell coming from it, stop using the system immediately and contact a NISSAN dealer. Ignoring such conditions may lead to accidents, fire or electrical shock.**



CAUTION

- **Do not keep the navigation system running with the engine stopped. Doing so may discharge the vehicle battery. When you use the navigation system, always keep the engine running.**
- **Some states/provinces may have laws limiting the use of video screens while driving. Use this system only where it is legal to do so.**

LASER PRODUCT

This navigation system is certified as a Class 1 laser product.

The navigation system complies with DHHS Rules 21 CFR Chapter 1, Subchapter J.



WARNING

- **Do not disassemble or modify this system. There are no user serviceable parts in this navigation system.**
- **If maintenance, adjustments and operations other than those specified in this manual are attempted, injury due to laser radiation and exposure could occur.**

2 Getting started

Control buttons and functions	2-2	Moving around within a map	2-19
Control panel	2-3	Changing the scale of a map	2-20
Opening/closing the cover of the Liquid Crystal		Storing your home location/address.....	2-21
Display (LCD) (350Z only).....	2-5	How to store your home	2-21
How to open the cover of the LCD	2-5	Character (letter and number) input screen	2-24
How to close the cover of the LCD	2-6	Phone number input screen.....	2-26
Start-up screen	2-7	List screen	2-28
Menu screen types and how to operate.....	2-8	Setting a destination.....	2-29
Menu screens and their purposes	2-8	Searching for a destination.....	2-29
Using controls to adjust values, levels, etc.....	2-10	Starting route guidance	2-32
Map menu screen	2-11	Deleting a route.....	2-34
Functions disabled while driving	2-14	Setting the voice guidance	2-36
Operating maps.....	2-15	Turning voice guidance on/off	2-36
How to view map screen	2-15	Adjusting voice guidance volume	2-38
Map screen types	2-16		
Switching map view.....	2-17		

CONTROL BUTTONS AND FUNCTIONS

ARMADA, TITAN

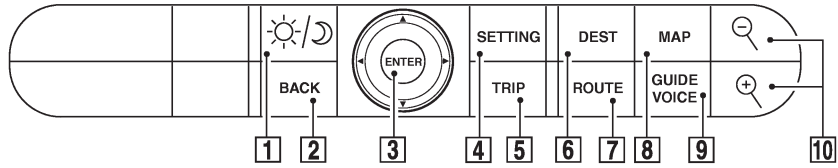

MAXIMA

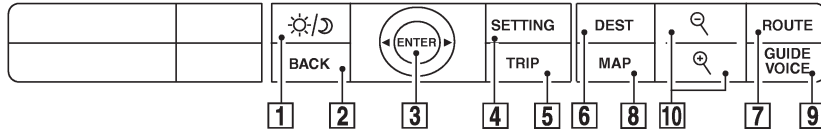

QUEST

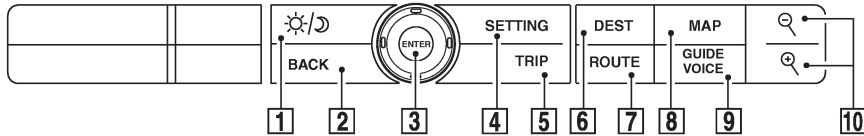

PATHFINDER

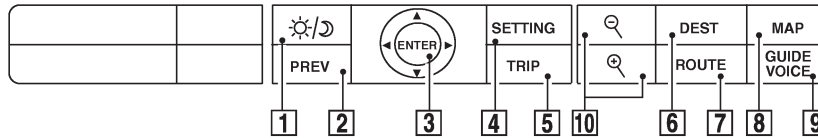

NAI0401

MURANO

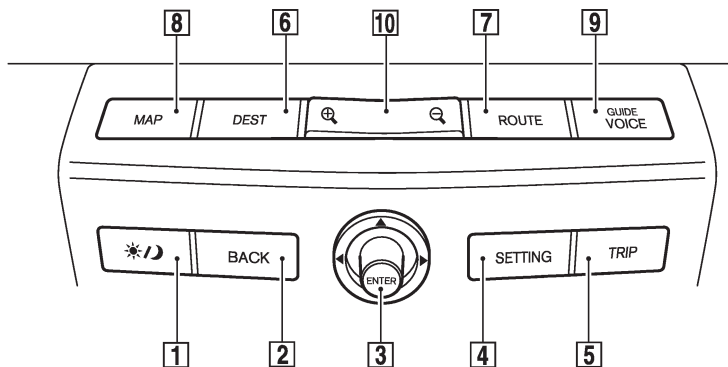

CONTROL PANEL

Armada, Maxima, Murano, Pathfinder, Quest, Titan

1 <DAY/NIGHT>:

Push to switch between the day screen and the night screen.

2 <BACK>/<PREV>:

Push to return to the previous screen. In a settings screen, this button can also be

used to apply the setting.

3 JOYSTICK and <ENTER>:

Push to highlight an item on the screen, select the highlighted item, move on the map, etc.

4 <SETTING>:

Push to access the system settings.

NAI0402

5 <TRIP>:

Push to display the vehicle information. Refer to the Owner's Manual of your vehicle.

6 <DEST>:

Push to enter a destination. Various methods for entering a destination are available.

"4. Setting a destination".

7 <ROUTE>:

Push to access guidance control functions (guidance cancellation, route priority, way-point setting on the route, etc.).

8 <MAP>:

Push to display the current location map screen.

9 <GUIDE VOICE>:

Push to repeat voice guidance for a guide point.

10 <ZOOM IN/ZOOM OUT>:

Push to switch to the zoom mode to change the map scale.

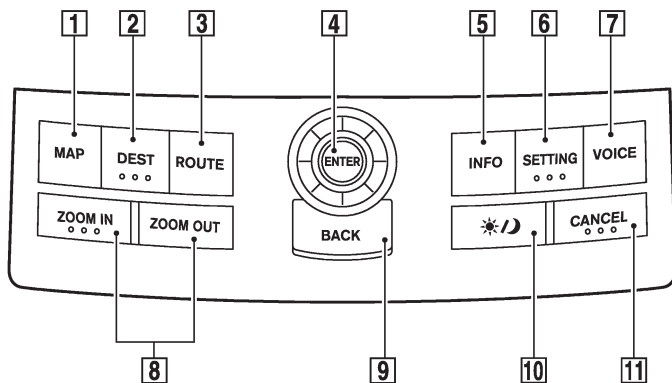

NAI0403

350Z

1 <MAP>:

Push to display the current location map screen.

2 <DEST>:

Push to enter a destination. Various methods for entering a destination are available.

"4. Setting a destination".

3 <ROUTE>:

Push to access guidance control functions (guidance cancellation, route priority, way-point setting on the route, etc.).

4 JOYSTICK and <ENTER>:

Push to highlight an item on the screen, select the highlighted item, move on the map, etc.

5 <INFO>:

Push to display the navigation information, such as GPS and version information, etc.

6 <SETTING>:

Push to access the system settings.

7 <VOICE>:

Push to repeat voice guidance for a guide point.

8 <ZOOM IN>/<ZOOM OUT>:

Push to switch to the zoom mode to change the map scale.

9 <BACK>:

Push to return to the previous screen. In a settings screen, this button can also be used to apply the setting.

10 <☀/☾> (DAY/NIGHT):

Push to switch between the day screen and the night screen. Push and hold to toggle the display on and off.

11 <CANCEL>:

Push to return to the map screen or cancel the route that has already been set.

OPENING/CLOSING THE COVER OF THE LIQUID CRYSTAL DISPLAY (LCD) (350Z only)

When you use this system, make sure the engine is running.

! NOTE:

If you use the system with the engine not running (ignition in the ON or ACC position) for long periods of time, this may drain the battery, making it difficult to start the engine.

HOW TO OPEN THE COVER OF THE LCD

! CAUTION

- **Do not place any objects on the instrument panel. If you drop any objects onto the instrument panel or spill liquid on it, it may result in a system malfunction.**
- **To protect the liquid crystal display, close it when it is not being used.**

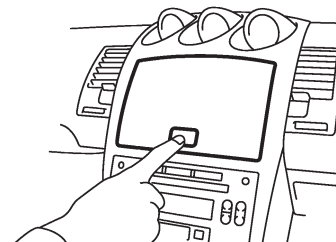

NAI0404

The cover of the liquid crystal display closes when:

- the ignition key is turned to the OFF position. (It will open when the ignition key is turned to the ON or ACC position.)
- the button on the cover of the liquid crystal display is pressed with the ignition key in the ON or ACC position.

i INFO:

The cover of the liquid crystal display may not open if the power supply had been interrupted due to disconnecting the vehicle battery etc.

HOW TO CLOSE THE COVER OF THE LCD

CAUTION

- Be careful not to pinch your hands or fingers when the liquid crystal display is closed.
- Do not open/close the liquid crystal display manually. It may damage the equipment.

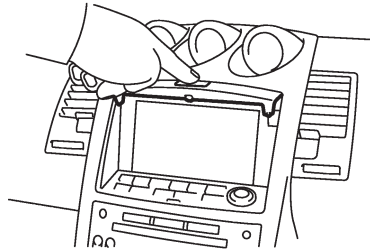

NAI0405

contact a NISSAN dealer.

The cover of the liquid crystal display closes when:

- the ignition key is turned to the OFF position.
- the button on the cover of the liquid crystal display is pressed with the ignition key in the ON or ACC position.

The voice guidance cannot be heard when the cover is closed.

NOTE:

If the liquid crystal display stays opened/closed (or partly opened) and does not move when the button on the cover of the liquid crystal display is pressed, turn the ignition key off and turn it on again. Then try the open/close operation again. If the liquid crystal display still does not move,

START-UP SCREEN



NAV2701

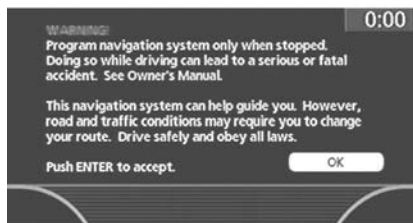

NAV2702



NAV3022

1. The navigation system starts when the ignition switch is turned to the ACC or ON position.

Armada, Maxima, Murano, Pathfinder, Quest, Titan

2. As the start-up screen is displayed, read the precautions carefully, highlight [OK] and push **<ENTER>**.

350Z

INFO:

If you do not push **<ENTER>** for more than 30 seconds, the status screen will be displayed. Push **<DEST>**, **<MAP>**, **<ROUTE>**, **<INFO>**, **<SETTING>** or **<TRIP>** to return to the start-up screen.

MENU SCREEN TYPES AND HOW TO OPERATE

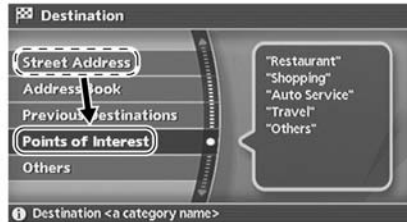
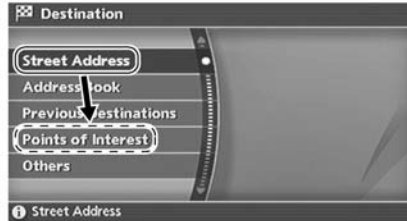

MENU SCREENS AND THEIR PURPOSES

Push **<DEST>**, **<ROUTE>**, **<TRIP>**, **<INFO>** or **<SETTING>** to display the corresponding menu screen.

How to select a menu item

Example: **<DEST>** screen

1. Tilt the joystick up and down. An item is highlighted accordingly.
2. To select the preferred menu item, highlight the item and push **<ENTER>**.

INFO:

Some items in the menu contain further details, which are displayed on the right side of the screen when the menu item is highlighted. This allows you to preview details of the item. These details appear only on the menu screen displayed by pushing **<DEST>**.

NAI0406

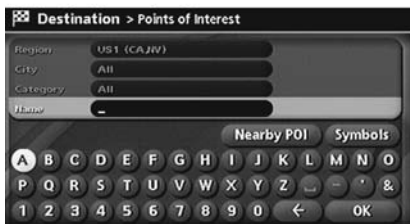

NAV2703



NAV2704

3. Depending on the item you selected, a detailed menu screen, a character input screen or a setting screen, etc. is displayed. On the screen displayed, make adjustments, input information, etc. accordingly.
4. Push **<BACK>/<PREV>** to return to the previous screen without applying any changes.
Push **<MAP>** to return to the current location map screen without applying any changes.

 **INFO:**

Depending on the menu selected, pushing **<MAP>** may not return you to the current location map screen.

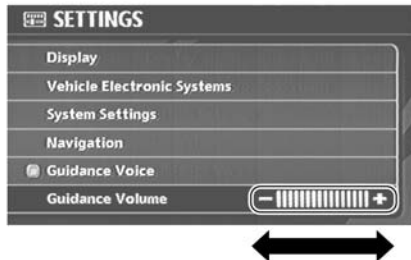

USING CONTROLS TO ADJUST VALUES, LEVELS, ETC.

Use the joystick to adjust the volume of the voice guidance and the display brightness.

How to adjust

1. Highlight the preferred setting item and push **<ENTER>**. The color of the corresponding adjustment item changes.
2. Use the joystick, and the value or bar indicating levels increases or decreases accordingly.
3. Push **<ENTER>** or **<BACK>/<PREV>** to apply the setting.

NAI0407

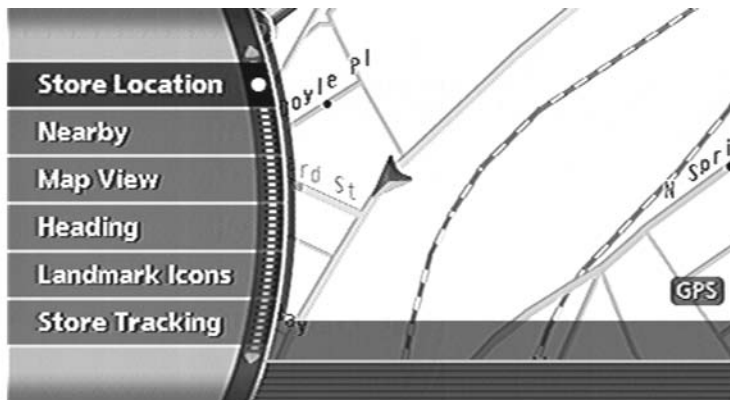

NAV2705

MAP MENU SCREEN

Push **<ENTER>** while the current location map screen or a scrolled map screen is displayed to display the menu corresponding to that screen.

This menu allows you to quickly use helpful functions, such as setting a destination easily and searching for facilities nearby.

To select a menu item, use the method described in "Menu screen types and how to operate".

Current location map screen

If **<ENTER>** is pushed while the current location map screen is displayed, the following options are available.

- **Store Location:**
Allows you to store the current vehicle location in the Address Book. The stored location can be retrieved as necessary to set it as a destination (waypoint).
☞ "STORING A LOCATION" (page 6-2)

- **Nearby:**
Allows you to search for facilities near the current vehicle location, such as restaurants and gas stations, etc.
☞ "SETTING A NEARBY PLACE" (page 4-47)
- **Map View:**
Switches the map type. It is used to switch between Plan View and Birdview™ and set the left screen display.
☞ "SWITCHING THE MAP VIEW" (page 3-4)
- **Heading:**
Switches the orientation of the map. "North Up" or "Heading Up" are the available options.
☞ "SETTINGS OF HEADING/LONG RANGE MAP VIEW" (page 3-15)
- **Landmark Icons:**
Allows you to display facilities near the current vehicle location on the map, such as restaurants and gas stations, etc.
☞ "DISPLAYING LANDMARK ICONS" (page 3-22)

- Store Tracking:
Allows you to store in the Address Book the route that you have travelled from the starting point to the current location.
 "STORING A TRACKED ROUTE"
(page 6-14)

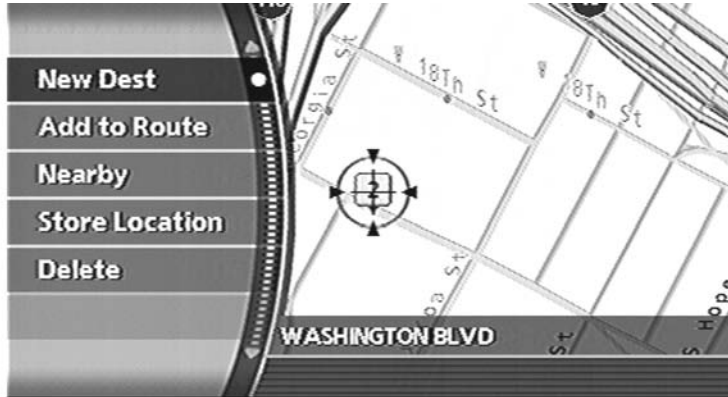



NAV2706

Scrolled location map screen

If **<ENTER>** is pushed while a scrolled map screen is displayed, the following options are available.

- **New Dest:**
Allows you to set the destination to the location where you pushed **<ENTER>**. If a destination is already set, the location will be set as the new destination.
 "SETTING FROM MAP" (page 4-20)

- **Add to Route:**
Allows you to set the location where you pushed **<ENTER>** as the destination or a waypoint.
This is available only when the suggested route is already set.
 "Setting a destination or waypoint" (page 5-20)

- **Nearby:**
Allows you to search for a facility near the location where you pushed **<ENTER>** and set it as a destination or waypoint.
Use the same search method as the one for POI.
 "SETTING A NEARBY PLACE" (page 4-47)
- **Store Location:**
Allows you to store the location where you pushed **<ENTER>** in the Address Book. The stored location can be retrieved to set it as a destination or waypoint.
 "STORING A LOCATION" (page 6-2)
- **Delete:**
Allows you to delete a stored location, destination or waypoint. To delete it, place the cross pointer over the corresponding icon.

FUNCTIONS DISABLED WHILE DRIVING

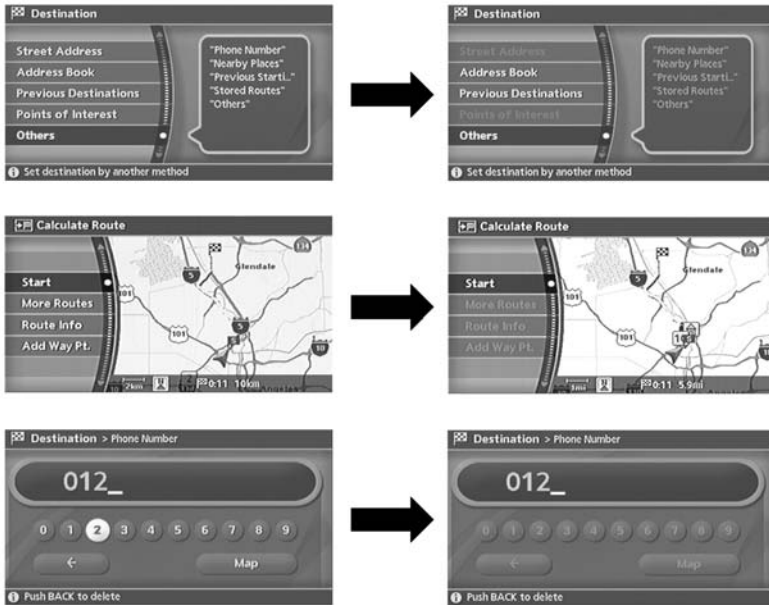

To ensure safe driving, some functions cannot be operated while driving.

The on-screen functions that are not available while driving will be "grayed-out" or muted.

Park the vehicle in a safe location and then operate the navigation system.

NAV2707

OPERATING MAPS

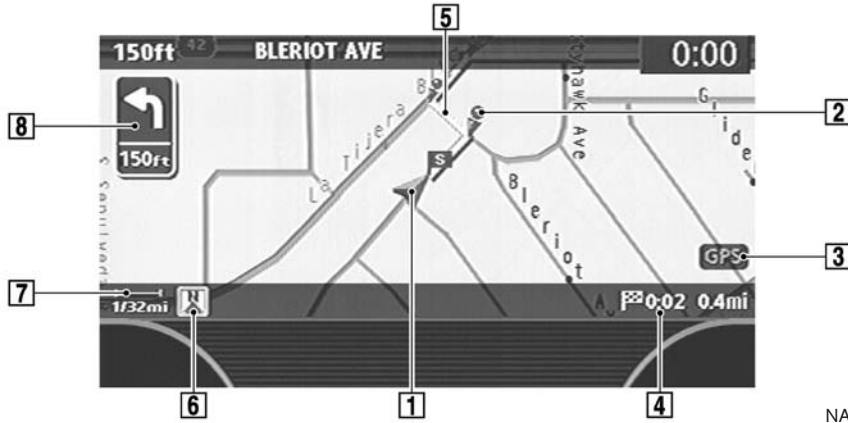





NAV2708





HOW TO VIEW MAP SCREEN

The navigation system displays various information on the map screen.

Screen information

- 1  Vehicle icon:
Indicates the current vehicle location and the direction that you are traveling.
- 2  Guide point:
Indicates a guide point on the route.

- 3  GPS indicator:
Indicates the GPS reception condition of signals from the satellites.
 - Green: positioning is possible
 - Gray: positioning is not possible
- 4  Remaining time and distance to the destination:
Indicates the remaining time and distance to the destination.

- 5 Suggested route:
Appears in bold yellow during route guidance.
- 6  /  Direction indicator:
Indicates the direction of the map.
- 7  Scale indicator:
Indicates the scale of the map.
- 8  Arrow and distance:
Appears on the upper left corner of the screen when the suggested route is set.
Indicates the distance to the next guide point and the turning direction at that guide point. This function can be turned on or off.

INFO:

- Roads with a width of 10 ft (3 m) or less may not be displayed on the map.
- The system may require a long time for positioning. The GPS indicator may remain gray for 3 to 4 minutes after the system is started. This is not a malfunction.

MAP SCREEN TYPES

Two types of map views are available: Plan View and Birdview™.



NAV2709

Plan View

Plan View displays the map in a 2-dimensional environment similar to a road map.



NAV2710

Birdview™

Birdview™ displays the view from an elevated perspective. In Birdview™, it is easy to recognize an image of the route because it provides a panoramic view over a long distance.



NAV2711

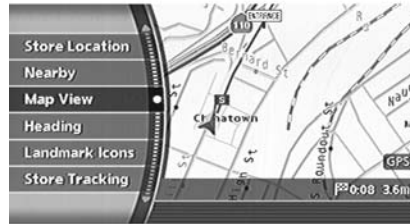

NAV2712



NAV2713

SWITCHING MAP VIEW

1. Push **<ENTER>** while the current location map screen is displayed.

2. Highlight [Map View] and push **<ENTER>**.

3. Highlight the preferred map view and push **<ENTER>**. The indicator of the selected map view illuminates.

 "SWITCHING THE MAP VIEW"
(page 3-4)

4. Push **<MAP>** to return to the current location map screen.



INFO:

- When you select a map view, a preview of that view is displayed on the right side of the screen.
- You can also switch the map view using the following procedure.
 - 1) Push **<SETTING>**.
 - 2) Highlight [Navigation] and push **<ENTER>**.
 - 3) Highlight [Map View] and push **<ENTER>**.

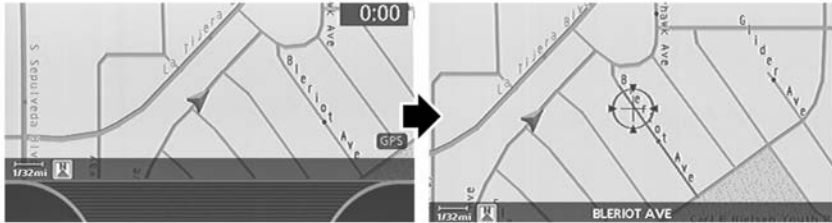

MOVING AROUND WITHIN A MAP

You can manually move across the map to view the surrounding areas or a preferred location.

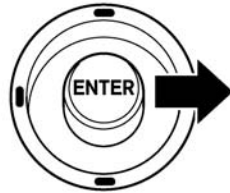

1. Tilt the joystick corresponding to the direction that you want to move across the map. Keep tilting the joystick to continuously move across the map in that direction. Once you start moving on the map, the cross pointer appears.
2. Returning to the current location map screen
Push **<MAP>** or **<BACK>/<PREV>** to return to the current location map screen, and the cross pointer disappears.





NAI0408





CHANGING THE SCALE OF A MAP

Push **<ZOOM IN>** () or **<ZOOM OUT>** (). A scale appears on the left side of the screen.





To view the map in detail, push **<ZOOM IN>** ().

To view a wider area, push **<ZOOM OUT>** ().

The scale will automatically disappear when neither **<ZOOM IN>** () nor **<ZOOM OUT>** () has been pushed for several seconds.

INFO:

Free zoom

Push and hold **<ZOOM IN>** () or **<ZOOM OUT>** () to change the map scale in smaller steps (free zoom). Once the free zoom has been utilized, push **<ZOOM IN>** () or **<ZOOM OUT>** () to change the map scale in smaller steps.

NAI0409

STORING YOUR HOME LOCATION/ ADDRESS

HOW TO STORE YOUR HOME

If your home location is already stored in the Address Book, it can be easily retrieved to set the route to your home.

The procedure to store your home location is the same as for storing any other location.

"4. Setting a destination"

As an example, the procedure for storing your home location by searching for a destination by address is described here.



1. Push **<DEST>**.

NAI0410

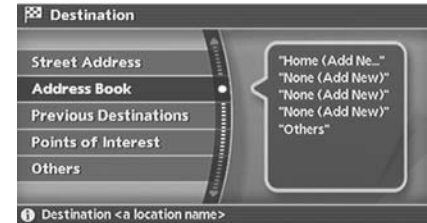

NAV2714

2. Highlight [Address Book] and push **<ENTER>**.

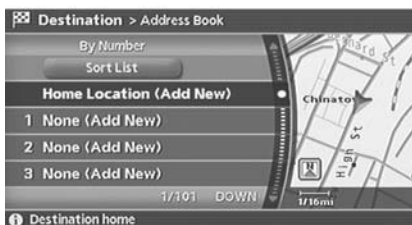

NAV2715



NAV3023



NAV3048

3. Highlight [Home Location (Add New)] and push **<ENTER>**.
4. A confirmation message is displayed. Confirm the contents of the message, highlight [Yes] and push **<ENTER>**.
5. Highlight [Street Address] and push **<ENTER>**. A character input screen is displayed.



NAV3049



NAV3050



NAV3051

6. Enter the address of your home, highlight [OK] and push **<ENTER>**.
The map screen is displayed.
☞ "SETTING A STREET ADDRESS"
(page 4-5)

7. Using the joystick, adjust your home location.
8. After adjusting the location, push **<ENTER>**.

9. A message is displayed and your home location is stored.
10. Push **<MAP>** to return to the current location map screen.
The home icon is displayed on the map.

i **INFO:**

You can also perform the same setting by pushing **<SETTING>** and selecting [Navigation].

- ☞ "STORING A LOCATION BY SEARCHING" (page 6-2)

CHARACTER (letter and number) INPUT SCREEN

You will have to enter alphanumeric characters when setting a destination, searching for a facility or editing the stored locations, etc.



NAV2719



NAV2720

1. Use the joystick to highlight a character on the displayed keyboard.
2. Push **<ENTER>**. The highlighted character is entered.

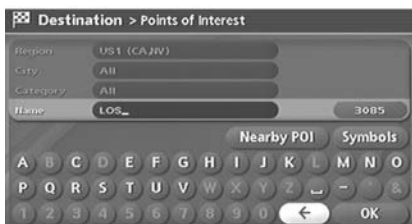

NAV2721

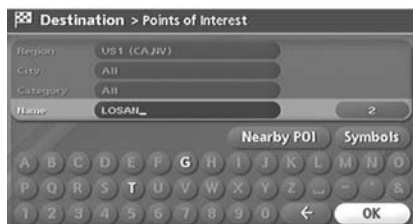

NAV2722

3. Push **<BACK>/<PREV>**, or highlight [] and push **<ENTER>** to delete the last character entered.

Push and hold **<BACK>/<PREV>** to delete all the characters entered.

Push [] to enter a space.

4. After finishing the entry, highlight [OK] and push **<ENTER>**.

INFO:

You can push **<BACK>/<PREV>** to return to the previous screen, but only after deleting all the characters entered.

PHONE NUMBER INPUT SCREEN

You can enter a phone number as a search method to look for a business or facility.



INFO:

Only the locations included in the database in the map DVD-ROM can be searched by the phone number.



NAV2723



NAV2724

1. Use the joystick to highlight a number on the displayed keyboard.
2. Push **<ENTER>**. The highlighted number is entered.



NAV2725



NAV2726

3. Push **<BACK>/<PREV>**, or highlight [↩] and push **<ENTER>** to delete the last number entered.
Push and hold **<BACK>/<PREV>** to delete all the numbers entered.

4. After finishing the entry, highlight [Map] and push **<ENTER>**.

 **INFO:**

You can push **<BACK>/<PREV>** to return to the previous screen, but only after deleting all the numbers entered.

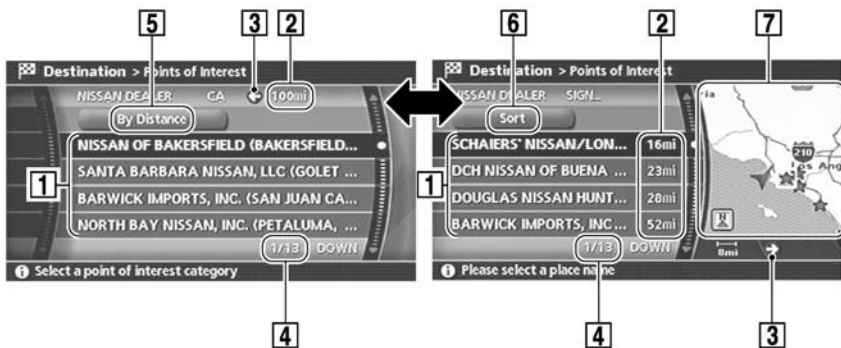

NAV2727

LIST SCREEN

After searching for locations or facilities, a list screen is displayed.

Depending on the list displayed, it can be sorted.

Items displayed in a list

- 1 Highlight the preferred item from the list and push **<ENTER>** to select it.
If a location or facility name is not completely displayed (due to length), highlight the item to show the hidden part of the name.
- 2 Distance from the current location
- 3 Direction to the location or facility

- 4 If the entire list cannot be displayed on the screen, the system displays the total number of items in the list and the entry number of the selected item. Tilt the joystick upward or downward to scroll the list.
- 5 Highlight and push **<ENTER>** to sort the list by shortest distance.
- 6 Highlight and push **<ENTER>** to sort the list in the original order.
- 7 When the list is sorted by the shortest distance, you can confirm the selected location in the preview on the right side of the screen.

SETTING A DESTINATION

SEARCHING FOR A DESTINATION

As an example, the method for setting an airport as the destination using [Points of Interest] is described here.



1. Push **<DEST>**.

NAI0410

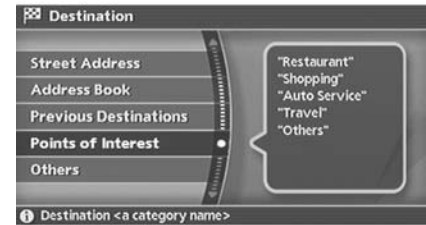

NAV2728

2. Highlight [Points of Interest] and push **<ENTER>**.

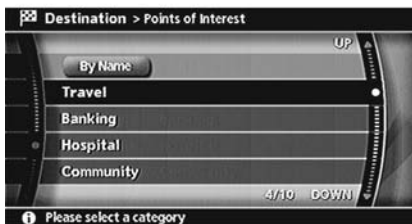

NAV2729

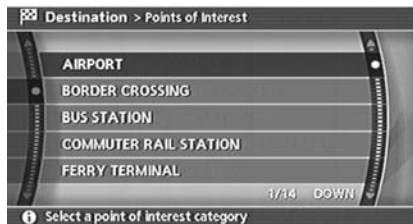

NAV2730



NAV2731

3. Highlight [Travel] and push **<ENTER>**.
4. From the category list, highlight [AIRPORT] and push **<ENTER>**.
The character input screen is displayed.
5. Highlight [OK] and push **<ENTER>**.
A list screen is displayed.

INFO:

You can enter the city name and facility name to narrow down your search.



NAV2732



NAV2733

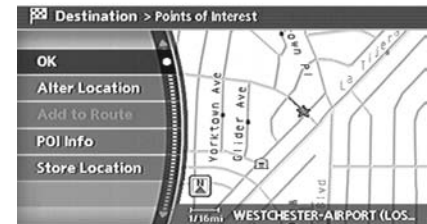

NAV2734

6. Highlight the preferred airport from the list and push **<ENTER>**.

i INFO:

By selecting [By Distance], you can sort the list by the shortest distance.

The position of the selected location is displayed in the preview on the right side of the screen.

7. The selected destination is displayed at the center of the map. Highlight [OK] after confirming the location of the displayed destination, and push **<ENTER>**.

i INFO:

The system sets the destination to the selected location and starts calculating a route.

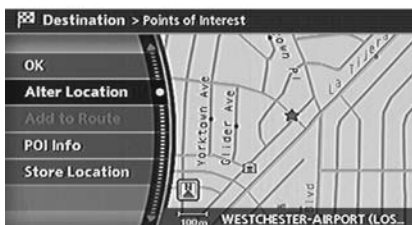

NAV2735

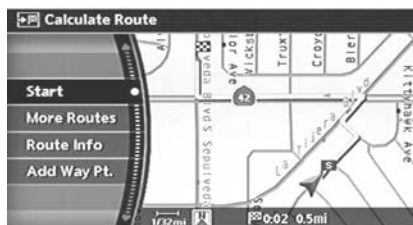

NAV2736



NAV2737

INFO:

Even after setting a destination, you can adjust the location of the destination, store the route, etc.

 "OPERATIONS AFTER SETTING A DESTINATION" (page 4-50)

STARTING ROUTE GUIDANCE

After setting the destination and performing route calculation, the suggested route is displayed.

1. Highlight [Start] and push **<ENTER>**.

2. Once route guidance is started, the system navigates you through the guide points using visual and voice guidance.



NAV2738



NAV2739

3. When approaching a guide point, the system automatically changes to the split screen and shows an enlarged view of the intersection in the left screen.
4. When arriving at the destination, route guidance automatically ends.

DELETING A ROUTE

To delete a route already set, use the following procedure. If you delete a route, the destination is also deleted.



1. Push **<ROUTE>**.

NAI0411

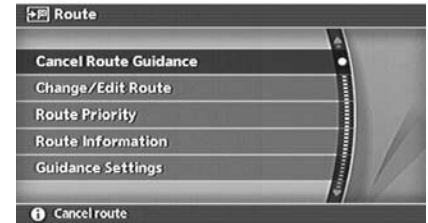

NAV2740

2. Highlight [Cancel Route Guidance] and push **<ENTER>**.



NAV2741



NAI0412



NAV3024

3. A confirmation message is displayed. Highlight [Yes] and push **<ENTER>**.

INFO:

If a route is cancelled, [Cancel Route Guidance] changes to [Resume Route Guidance]. Highlight [Resume Route Guidance] and push **<ENTER>** to reactivate the cancelled route. This is available only until a new route is set.

Delete the route using **<CANCEL>** (only for 350Z)

1. Push **<CANCEL>**.

2. A confirmation message is displayed. Highlight [Yes] and push **<ENTER>**.

SETTING THE VOICE GUIDANCE

TURNING VOICE GUIDANCE ON/OFF

You can activate or deactivate voice guidance and adjust the volume.



NAI0413

For Armada, Maxima, Murano, Pathfinder, Quest, Titan

1. Push **<SETTING>**.

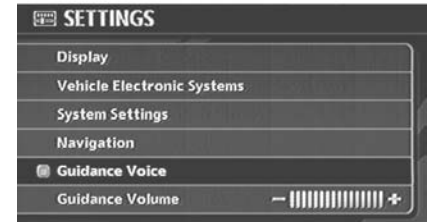

NAV3052

2. Highlight [Guidance Voice] and push **<ENTER>**. The indicator illuminates if voice guidance is activated.



NAI0411

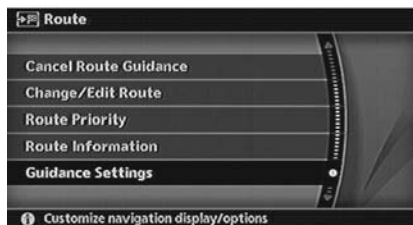

NAV3047



NAV2743

For 350Z

1. Push **<ROUTE>**.

2. Highlight [Guidance Settings] and push **<ENTER>**.
3. Highlight [Guidance Voice] and push **<ENTER>**. The indicator illuminates if voice guidance is activated.



NAV3026

INFO:

You can also activate or deactivate voice guidance using the following procedure.

- 1) Push **<SETTING>**.
- 2) Highlight [Volume and Beeps] and push **<ENTER>**.
- 3) Highlight [Guidance Voice] and push **<ENTER>**.

ADJUSTING VOICE GUIDANCE VOLUME

You can adjust the volume of voice guidance.



NAI0413

For Armada, Maxima, Murano, Pathfinder, Quest, Titan

1. Push **<SETTING>**.

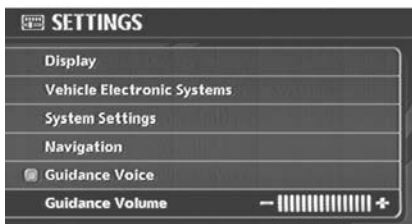

NAV3053

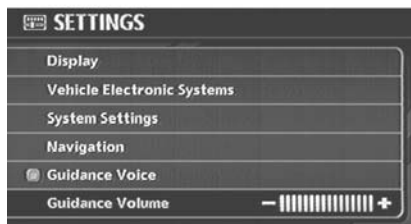

NAV3054



NAI0413

2. Highlight [Guidance Volume] and push **<ENTER>**.

3. Adjust the voice guidance volume using the joystick.

For 350Z

1. Push **<SETTING>**.

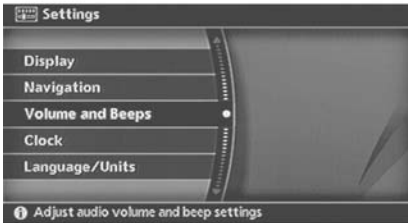

NAV2742

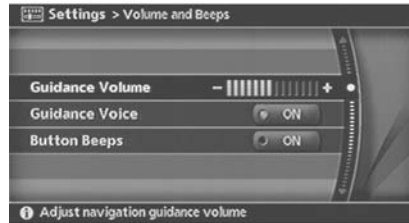

NAV2744

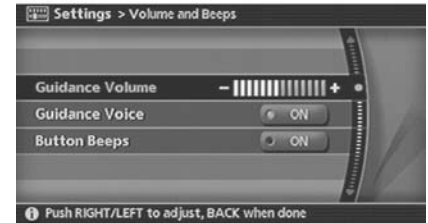





NAV2745

2. Highlight [Volume and Beeps] and push **<ENTER>**.
3. Highlight [Guidance Volume] and push **<ENTER>**.
4. Adjust the voice guidance volume using the joystick.

3 Map settings

Map types	3-2	Changing the scale of a map	3-12
Plan view	3-2	Map scale	3-13
Birdview™	3-3	Other settings for the map screen.....	3-15
Switching the map view.....	3-4	Settings of heading/long range map view.....	3-15
Available views	3-5	Changing the Birdview™ angle	3-17
Moving a map	3-7	Changing the scale of the left screen.....	3-20
Plan view	3-7	Map icons	3-22
Birdview™	3-8	Displaying landmark icons	3-22
Returning to the current vehicle location	3-9	Map symbols.....	3-24
Map scrolling information	3-10		

tion and start route guidance.

- 5 Suggested route:
Appears in bold yellow during route guidance.
- 6  /  Direction indicator:
Indicates the direction of the map.
- 7  Scale indicator:
Indicates the scale of the map.
- 8  Arrow:
Indicates the distance to the next guide point and the turning direction at that guide point.

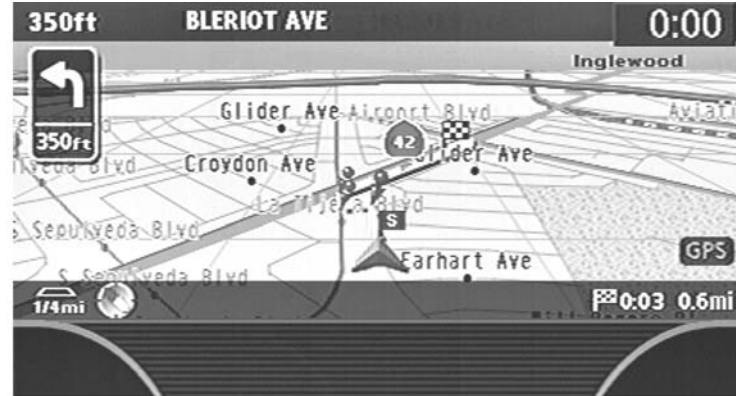

NAV2746

BIRDVIEW™

Birdview™ displays the map from an elevated perspective. In Birdview™, it is easy to recognize an image of the route because it provides a panoramic view over a long distance.

INFO:

About the Birdview™ display

- “Birdview™” is a registered trademark of Xanavi Informatics Corporation.
- The map in Birdview™ always appears with the current forward direction facing up.

SWITCHING THE MAP VIEW

The map view can be changed between Plan View and Birdview™. The map can also be displayed in the split screen mode.



NAV2711



NAV2712

1. Push **<ENTER>** while the current location map screen is displayed.
2. Highlight [Map View] and push **<ENTER>**.

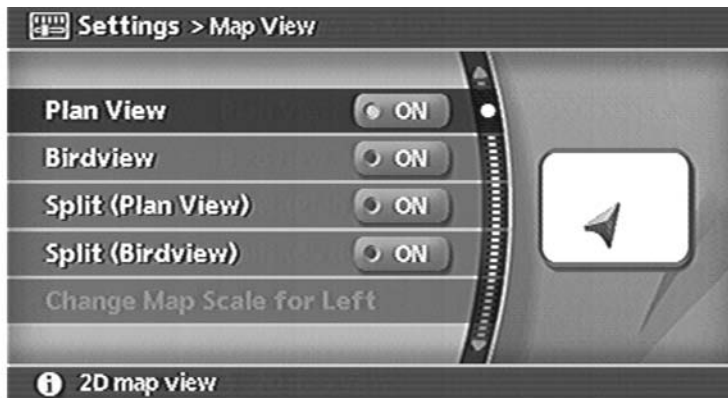

3. Highlight the preferred map view and push **<ENTER>**. The indicator of the selected map view illuminates.
4. Push **<MAP>** to return to the current location map screen.

AVAILABLE VIEWS

- Plan View:
Switches to Plan View.
- Birdview™:
Switches to Birdview™.
- Split (Plan View):
Changes to the split screen mode and both halves display maps in Plan View.
- Split (Birdview™):
Changes to the split screen mode and the left half displays the map in Plan View and the right half displays the map in Birdview™.

INFO:

- When you select a map view, a preview of that view is displayed on the right side of the screen.
- When you select [Split (Plan View)] or [Split (Birdview™)], [Change Map Scale for Left] becomes available. This is used to change the scale of the map in the left screen.
 "CHANGING THE SCALE OF THE LEFT SCREEN" (page 3-20)

NAV2747



NAV2748

Split (Plan View)



NAV2750

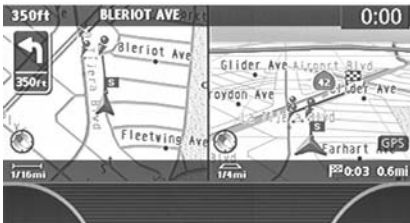

NAV2749

Split (Birdview™)

INFO:

You can also set the map view using the following procedure.

- 1) Push **<SETTING>**.
- 2) Highlight [Navigation] and push **<ENTER>**.
- 3) Highlight [Map View] and push **<ENTER>**.

MOVING A MAP

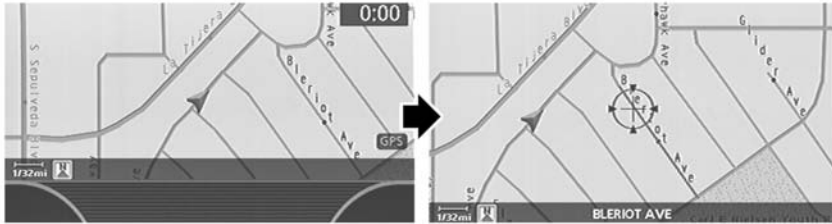

The operations for moving across the map are different between Plan View and Birdview™.

PLAN VIEW

Tilt the joystick corresponding to the direction that you want to move across the map. Keep tilting the joystick to continuously move across the map in that direction.

Once you start moving across the map, the cross pointer appears.

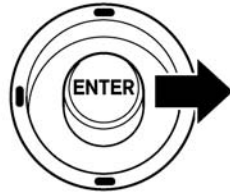

NAI0408

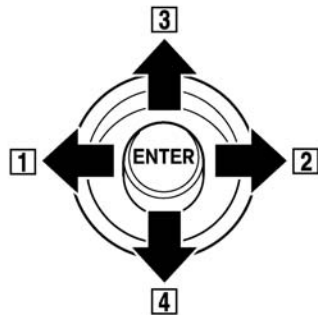
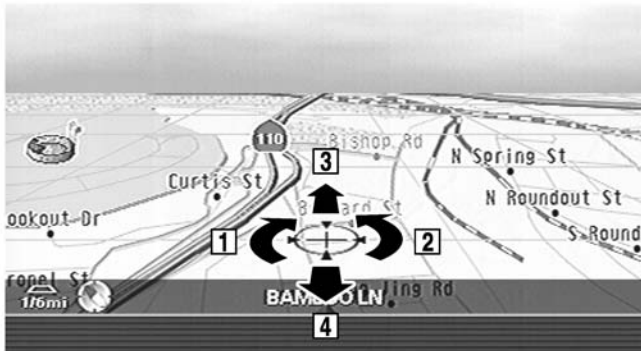

BIRDVIEW™

The joystick allows movement in the following ways.

Keep tilting the joystick to continuously move across the map in that direction.

- 1 Rotates the map clockwise.
- 2 Rotates the map counterclockwise.
- 3 Moves the cross pointer on the map upward.
- 4 Moves the cross pointer on the map downward.

Once you start moving on the map, the cross pointer appears.

NAI0414

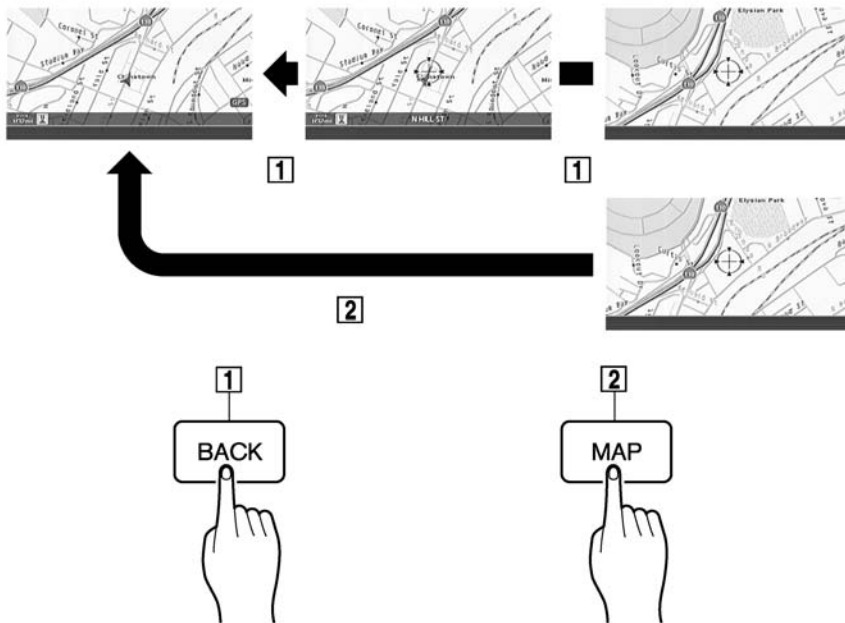

RETURNING TO THE CURRENT VEHICLE LOCATION

Push **<MAP>**.

The current location map screen is displayed.

INFO:

- The previous screen can be displayed by pushing **<BACK>/<PREV>**. You can also return to the current location map screen by repeatedly pushing **<BACK>/<PREV>**.
- Depending on the menu selected, pushing **<MAP>** may not return you to the current location map screen.

NAI0415

MAP SCROLLING INFORMATION

Information about the location, on which the center of the cross pointer is placed by scrolling on the map, can be set to be displayed.

1. Push **<SETTING>**.

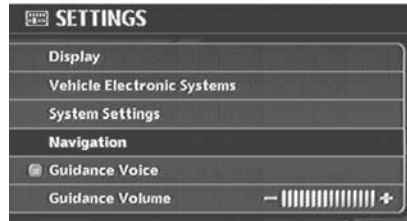

NAV3055

Armada, Maxima, Murano, Pathfinder, Quest, Titan

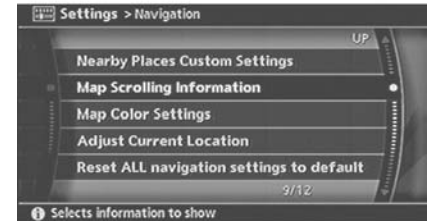

NAV2752

3. Highlight [Map Scrolling Information] and push **<ENTER>**.



NAV3029

350Z

2. Highlight [Navigation] and push **<ENTER>**.



NAV2753



NAV2754

4. Highlight the preferred information item and push **<ENTER>**. The indicator of the selected information item illuminates.

Available information items:

- Address Book Icons
- Destination/Waypoint Icons
- Latitude/Longitude Info

5. Push **<MAP>** to return to the current location map screen.
Move the cross pointer to the set location to display the information.

CHANGING THE SCALE OF A MAP

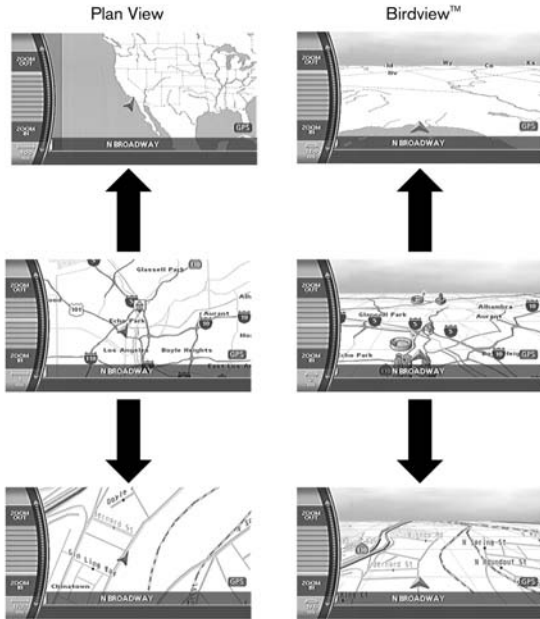

Push **<ZOOM IN>** (⊕) or **<ZOOM OUT>** (⊖). A scale appears on the left side of the screen.

To view the map in detail, push **<ZOOM IN>** (⊕).

To view a wider area, push **<ZOOM OUT>** (⊖).

The scale will automatically disappear when neither **<ZOOM IN>** (⊕) nor **<ZOOM OUT>** (⊖) has been pushed for several seconds.

INFO:

Free zoom

Push and hold **<ZOOM IN>** (⊕) or **<ZOOM OUT>** (⊖) to change the map scale in smaller steps (free zoom). Once the free zoom has been utilized, push **<ZOOM IN>** (⊕) or **<ZOOM OUT>** (⊖) to change the map scale in smaller steps.

NAI0409

MAP SCALE

The following scales are available depending on the map view.

- In Plan View:
Widest (1/51,200,000) to the most detailed (1/5,000)
- In Birdview™:
Widest (1/20,480,000) to the most detailed (viewpoint height at 1/25,000)

Scale level of the Plan View display

Map scale	Actual distance
1:51.2 million	400 miles (640 km)
1:5.12 million	32 miles (64 km)
1:1.28 million	8 miles (16 km)
1:320,000	2 miles (4 km)
1:160,000	1 mile (2 km)
1:80,000	1/2 mile (1 km)
1:40,000	1/4 mile (500 m)
1:20,000	1/8 mile (200 m)
1:10,000	1/16 mile (100 m)
1:5,000	1/32 mile (50 m)



NAV2755

Example: The most detailed level



NAV2756

Example: The widest level

Scale level of the Birdview™ display

Map scale	Distance between grids
1:20.48 million	160 miles (256 km)
1:5.12 million	32 miles (64 km)
1:2.56 million	16 miles (32 km)
1:1.28 million	8 miles (16 km)
1:640,000	4 miles (8 km)
1:320,000	2 miles (4 km)
1:160,000	1 mile (2 km)
1:80,000	1/2 mile (1 km)
1:40,000	1/4 mile (500 m)
1:25,000	1/6 mile (250 m)



NAV2757

Example: The most detailed level



NAV2758

Example: The widest level

OTHER SETTINGS FOR THE MAP SCREEN

Other settings are also available for the map screen, such as changing the map direction, splitting the screen, etc.

SETTINGS OF HEADING/LONG RANGE MAP VIEW

You can change the map direction (orientation) in Plan View or change the position of the vehicle icon to view a wider area in the traveling direction.

These settings are available only in the Plan View or Split (Plan View) mode.



NAV2711



NAV2759

1. Push **<ENTER>** while the current location map screen is displayed.
2. Highlight [Heading] and push **<ENTER>**.



NAV2760

Available map orientations

- **North Up:**
North is set at the top of the map.
- **Heading Up:**
The traveling direction is set at the top of the map.
- **Long Range Map View:**
The vehicle icon is located slightly lower than the center of the screen. This offers a wider view in the traveling direction.
- **Birdview™ Angle:**
This changes the Birdview™ angle.

3. Highlight the preferred map orientation and push **<ENTER>**. The indicator of the selected map orientation illuminates.

INFO:

[Long Range Map View] is displayed only when you select [Heading Up].

4. Push **<MAP>** to return to the current location map screen.



NAV2761

North Up



NAV2762

Heading Up



NAV2763

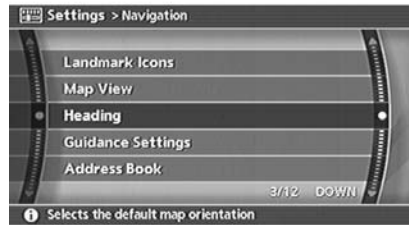

NAV2764

CHANGING THE BIRDVIEW™ ANGLE

This changes the Birdview™ angle. This setting is available only in the Birdview™ or Split (Birdview™) mode.

Long Range Map View

INFO:

If the map orientation is switched, the icon displayed in the lower left corner is also switched.

 : North Up

 : Heading Up

INFO:

You can also set the orientation of the map using the following procedure.

- 1) Push **<SETTING>**.
- 2) Highlight [Navigation] and push **<ENTER>**.
- 3) Highlight [Heading] and push **<ENTER>**.



NAV2711



NAV2759



NAV2765



1. Push **<ENTER>** while the current location map screen is displayed.
2. Highlight [Heading] and push **<ENTER>**.
3. Highlight [Birdview™ Angle] and push **<ENTER>**.

i INFO:

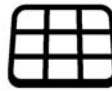
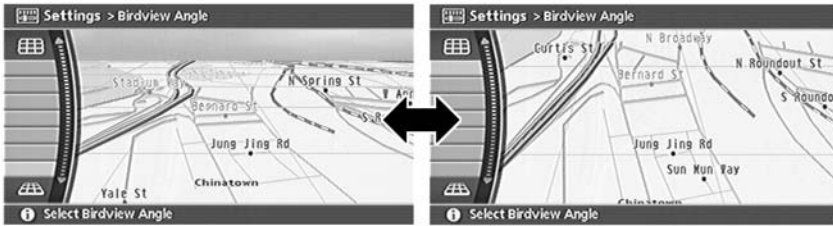
This setting is available only when the map view is set to the Birdview™ or Split (Birdview™) mode.



NAV2766

4. Adjust the Birdview™ angle by moving the cursor in the direction of [] or [].
5. Push **<MAP>** to return to the current location map screen.

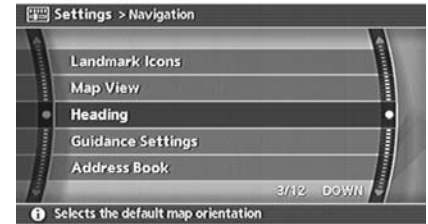

NAV2764

INFO:

You can also set the Birdview™ angle using the following procedure.

- 1) Push **<SETTING>**.
- 2) Highlight [Navigation] and push **<ENTER>**.
- 3) Highlight [Heading] and push **<ENTER>**.
- 4) Highlight [Birdview™ Angle] and push **<ENTER>**.

CHANGING THE SCALE OF THE LEFT SCREEN

When the split screen is displayed, you can change the scale of the left screen.



NAV2711



NAV2712

1. Push **<ENTER>** while the current location map screen is displayed.
2. Highlight [Map View] and push **<ENTER>**.



NAV2767

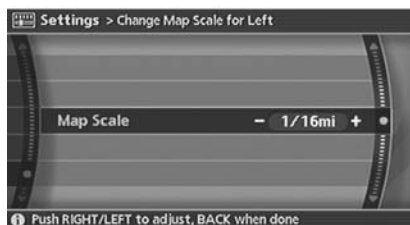

NAV2768

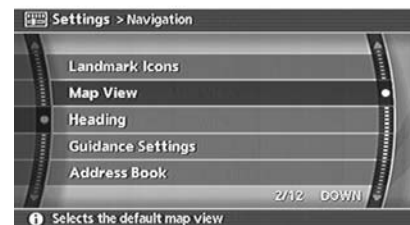

NAV2750

- Highlight [Change Map Scale for Left] and push **<ENTER>**.

INFO:

[Change Map Scale for Left] is displayed only when the map view is in the Split (Plan View) or Split (Birdview™) mode.

- Highlight [Map Scale] and push **<ENTER>**. Adjust the map scale by moving the cursor in the direction of [+] or [-]. Use the joystick to adjust the scale of the map. After finishing the setup, push **<ENTER>** or **<BACK>/<PREV>** to apply the scale setting.
- Push **<MAP>** to return to the current location map screen.

INFO:

You can also change the scale of the left screen using the following procedure.

- Push **<SETTING>**.
- Highlight [Navigation] and push **<ENTER>**.
- Highlight [Map View] and push **<ENTER>**.
- Highlight [Change Map Scale for Left] and push **<ENTER>**.





MAP ICONS

Some landmarks in the surrounding area can be displayed as icons on the screen.

DISPLAYING LANDMARK ICONS

This allows you to display or hide the landmark icons by type.

Landmark icons that can be displayed

-  Restaurant
-  Gas Station
-  Hotel
-  ATM
-  Rest Area



NAV2711

1. Push **<ENTER>** while the current location map screen is displayed.



NAV2769

2. Highlight [Landmark Icons] and push **<ENTER>**.



NAV2770



NAV2771

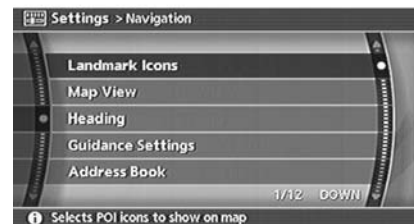

NAV2772

3. Highlight the preferred icon and push **<ENTER>**.
The icon display setting toggles on and off each time you push **<ENTER>**.
The indicator of the selected icon illuminates.

4. Push **<MAP>** to return to the current location map screen.
The activated landmark icons are displayed on the map.

INFO:

You can also set the landmark icons using the following procedure.

- 1) Push **<SETTING>**.
- 2) Highlight [Navigation] and push **<ENTER>**.
- 3) Highlight [Landmark Icons] and push **<ENTER>**.

MAP SYMBOLS

This navigation system uses symbols to display facilities.

2-D icons (Plan View)



Airport



Ferry Terminal



Military Base



Restaurant



Amusement Park



Golf Course



Museum



Shopping Center



Bank



Gas Station



Open Parking Area



Sports Complex



Car Rental



Historical Monument



Park & Ride



Station



City Hall



Hotel or Motel



Parking Garage



Super Market



Commuter Rail Station



Library



Police Station



Tourist Office



Courthouse



Marina



Rest Area



University or College

3-D icons (Birdview™)

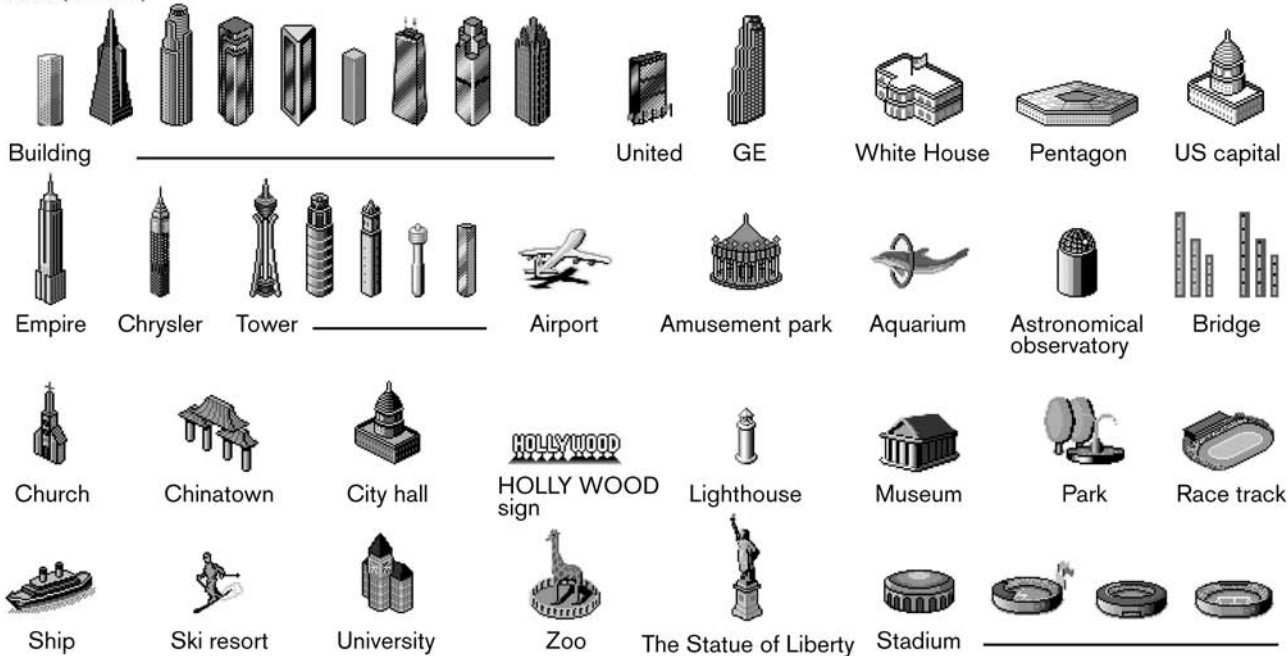

NAI0417

Road color

The road types are differentiated by colors.

Freeway: Pink with red border

Main road: Amber

Narrow street: Gray

Road with incomplete map data: Dark green

4 Setting a destination

Destination screen.....	4-2	Setting from stored routes.....	4-32
Basic operation	4-2	Setting a facility as the destination	4-33
Setting a street address/residence as the destination.....	4-4	Setting a point of interest.....	4-34
Setting a Street Address	4-5	Setting a freeway entrance/exit.....	4-43
Setting a City Center	4-10	Setting by phone number.....	4-46
Setting an Intersection	4-14	Setting a nearby place	4-47
Setting from map	4-20	Operations after setting a destination.....	4-50
Setting a stored location as the destination	4-22	Available setting items.....	4-50
Setting your home.....	4-23	Adjusting the location of the destination	4-51
Setting from Address Book	4-25	Adding additional destinations to a route	4-52
Setting a previous destination	4-28	Viewing information about the searched location.....	4-53
Setting the previous starting point.....	4-30	Storing a location.....	4-54

DESTINATION SCREEN

There are several methods you can use to set your destination. Understand the advantages of each method and select the best method for finding and setting your destination.

BASIC OPERATION

1. Push **<DEST>**.
2. Highlight the preferred destination setting method and push **<ENTER>**.

NOTE:

There may be a case that you cannot search by pointing at “Street Address”, “Intersection” and “Point of Interest (POI)”. This is because the map DVD-ROM data of Nunavut in Canada is undeveloped.

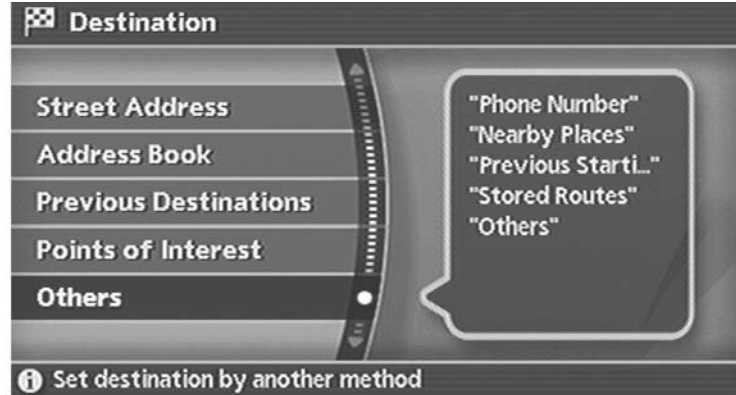

NAV2773

Available setting items

- **Street Address:**
Searches for a destination by address.
- **Address Book:**
Searches for a destination from the list of stored home and the stored locations.
- **Previous Destinations:**
Searches for a destination from the previous destinations.
- **Points of Interest:**
Searches for a destination from various categories of businesses or locations.

- Others
 - Phone Number:
Searches for a destination by the telephone number.
 - Nearby Places:
Searches for a business/location near your vehicle.
 - Previous Starting Point:
Sets the previous starting point as the destination.
 - Stored Route:
Selects a stored route.
 - Freeway Entrance/Exit:
Searches for a destination from a freeway entrance/exit.
 - Intersection:
Searches for a destination from intersections.
 - City Center:
Sets the center of a city as the destination.

SETTING A STREET ADDRESS/ RESIDENCE AS THE DESTINATION

If you know the address of a friend or business or you are going to a central location (tourist spot, etc.) in a city, the following setting methods are available.

- **Setting a Street Address**
If you know the address of your destination, use this method to enter the address and then have the system calculate a route. You can also search for a location near the preferred destination by entering the house number if the map DVD-ROM contains the relevant data.
- **Setting a City Center**
This allows you to have the system calculate a route to the center of a city, without setting a specific location.
- **Setting an Intersection**
This allows you to set the destination to an intersection of any two streets, and then have the system calculate a route.



NAV2825



NAV2826

SETTING A STREET ADDRESS

1. Highlight [Street Address] and push **<ENTER>**.
A character input screen is displayed.

INFO:

Character input screen for Street Address

- 1 Region:
The region previously entered is automatically displayed. It can be changed.
- 2 City:
"All" is displayed, and all cities in the region are available. Route calculation conditions can be narrowed down by entering the name of the city.

- 3 Street:
Enter the name of a street.
- 4 House No.:
A house number can be entered.
- 5 Symbols/A-Z:
Symbol keys are displayed by highlighting [Symbols] and pushing **<ENTER>**. Alphabet keys are displayed by highlighting [A-Z] and pushing **<ENTER>**.



NAV2827



NAV2828



NAV2829

2. Enter the house number, highlight [OK] and push **<ENTER>**.
If you do not know the house number, highlight [OK] or [Skip] and push **<ENTER>**.
3. Enter the name of the street. After finishing the entry, highlight [OK] and push **<ENTER>**. A list of cities is displayed.
4. Highlight the correct city of the destination from the list and push **<ENTER>**.

4-6 Setting a destination

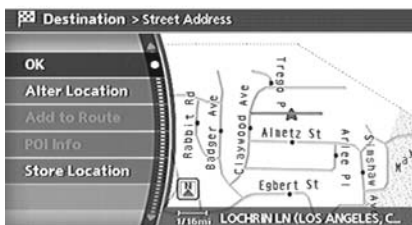

NAV2830

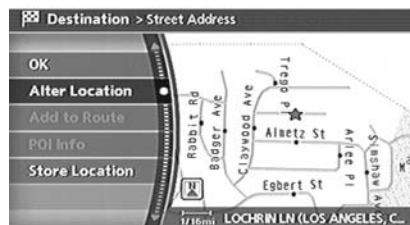

NAV2831



NAV2832

- The selected destination is displayed at the center of the map. Highlight [OK] after confirming the location of the displayed destination, and push **<ENTER>**. The system sets the destination to the selected location and starts calculating a route.

INFO:

Even after setting a destination, you can adjust the location of the destination, store the route, etc.

-  "OPERATIONS AFTER SETTING A DESTINATION" (page 4-50)

Changing the region

- Highlight [Region] and push **<ENTER>** to change the region.



NAV2833



NAV2834



NAV2835

Specifying a city

2. Highlight the preferred region and push **<ENTER>**.
A character input screen is displayed.

1. Highlight [City] and push **<ENTER>** to narrow down the route calculation conditions by entering the name of the city.

2. Enter the name of the city, highlight [OK] and push **<ENTER>**.
A list screen is displayed.

INFO:

- Highlight [All Cities] and push **<ENTER>** to include all cities in the region as the route calculation condition.
- Highlight [Last 5 Cities] and push **<ENTER>** to display 5 cities recently set as destinations.



NAV2836

3. Highlight the city of the destination from the list and push **<ENTER>**.

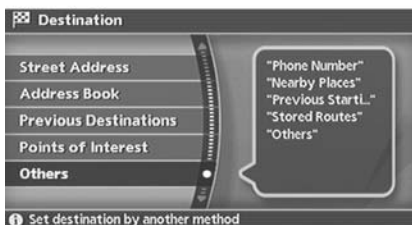

NAV2787



NAV2837



NAV2838

SETTING A CITY CENTER

1. Highlight [Others] and push **<ENTER>**.

2. Highlight [City Center] and push **<ENTER>**.
A character input screen is displayed.

INFO:

Character input screen for City Center

- 1 Region:

The region previously entered is automatically displayed. It can be changed.

- 2 City:

"All" is displayed, and all cities in the region are available. Route calculation conditions can be narrowed down by entering the name of the city.

3 Symbols/A-Z:

Symbol keys are displayed by highlighting [Symbols] and pushing **<ENTER>**. Alphabet keys are displayed by highlighting [A-Z] and pushing **<ENTER>**.



NAV2839



NAV2840

3. Highlight [City] and push **<ENTER>** to narrow down the route calculation conditions by entering the name of the city. Enter the name of the city, highlight [OK] and push **<ENTER>**. A list screen is displayed.

i **INFO:**

Highlight [Last 5 Cities] and push **<ENTER>** to display 5 cities recently set as destinations.

4. Highlight the preferred destination from the list and push **<ENTER>**. The position of the selected location is displayed in the preview on the right side of the screen.



NAV2841



NAV2842



NAV2843

INFO:

By selecting [By Distance], you can sort the list by the nearest distance.

- The selected destination is displayed at the center of the map. Highlight [OK] after confirming the location of the displayed destination, and push **<ENTER>**. The system sets the destination to the selected location and starts calculating a route.

INFO:

Even after setting a destination, you can adjust the location of the destination, store the route, etc.

 "OPERATIONS AFTER SETTING A DESTINATION" (page 4-50)



NAV2844



NAV2845

Changing the region

1. Highlight [Region] and push **<ENTER>** to change the region.
2. Highlight the preferred region and push **<ENTER>**.
A character input screen is displayed.

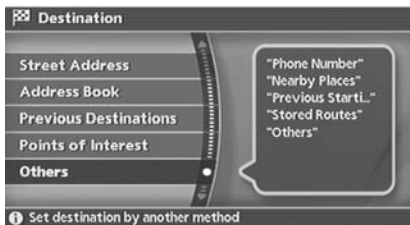

NAV2787



NAV2846

SETTING AN INTERSECTION

1. Highlight [Others] and push **<ENTER>**.
2. Highlight [Intersection] and push **<ENTER>**.
A character input screen is displayed.



5 Symbols/A-Z:

Symbol keys are displayed by highlighting [Symbols] and pushing **<ENTER>**. Alphabet keys are displayed by highlighting [A-Z] and pushing **<ENTER>**.

NAV2847

i **INFO:**

Character input screen for Intersection

1 Region:

The region previously entered is automatically displayed. It can be changed.

2 City:

"All" is displayed, and all cities in the region are available. Route calculation conditions can be narrowed down by entering the name of the city.

3 1st Street:

Enter the name of the 1st street of the destination intersection.

4 2nd Street:

Enter the name of the 2nd street of the destination intersection.



NAV2848



NAV2849



NAV2850

3. Enter the name of the 1st street.
After finishing the entry, highlight [OK] and push **<ENTER>**.
A list screen is displayed.
4. Highlight a street as the 1st street from the list and push **<ENTER>**.
5. Enter the name of the 2nd street.
After finishing the entry, highlight [OK] and push **<ENTER>**.
A list screen is displayed.

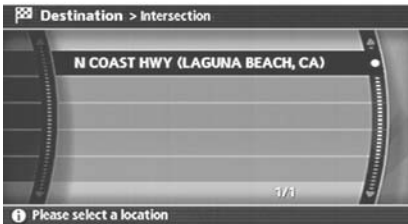

NAV2851

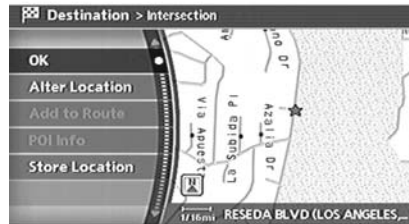

NAV2852

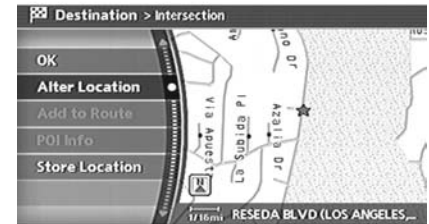

NAV2853

6. Highlight a street as the 2nd street from the list and push **<ENTER>**.
7. The selected destination is displayed at the center of the map. Highlight [OK] after confirming the location of the displayed destination, and push **<ENTER>**.
The system sets the destination to the selected location and starts calculating a route.

INFO:

Even after setting a destination, you can adjust the location of the destination, store the route, etc.

 "OPERATIONS AFTER SETTING A DESTINATION" (page 4-50)



NAV2854



NAV2855



NAV2856

Changing the region

1. Highlight [Region] and push **<ENTER>** to change the region.

2. Highlight the preferred region and push **<ENTER>**.
A character input screen is displayed.

Specifying a city

1. Highlight [City] and push **<ENTER>** to narrow down the route calculation conditions by entering the name of the city.



NAV2857



NAV2858

2. Enter the name of the city, highlight [OK] and push **<ENTER>**.
A list screen is displayed.
3. Highlight the city of the destination from the list and push **<ENTER>**.
A character input screen is displayed.

INFO:

- Highlight [All Cities] and push **<ENTER>** to include all cities in the region as the route calculation condition.
- Highlight [Last 5 Cities] and push **<ENTER>** to display 5 cities recently set as destinations.

SETTING FROM MAP

This allows you to search for a destination by scrolling the map, and then have the system calculate a route to the destination.

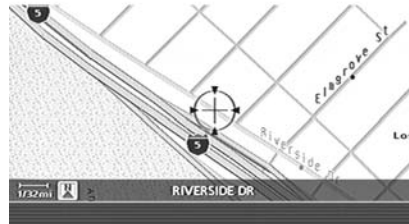

NAV2859

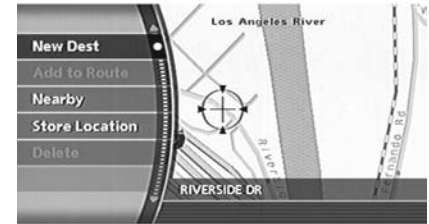

NAV2860

1. Scroll the map, place the cross pointer over the preferred location, and push **<ENTER>**.

INFO:

- Adjust the map scale to search for a location more effectively.
- The point on the blinking road where the center of the cross pointer is located can be set as a destination.

2. Highlight [New Dest] and push **<ENTER>**.

INFO:

For the items except for [New Dest], refer to “Map menu screen”.

 “Scrolled location map screen” (page 2-13)

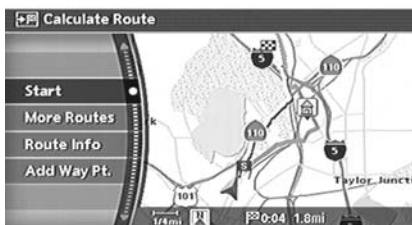

NAV2861

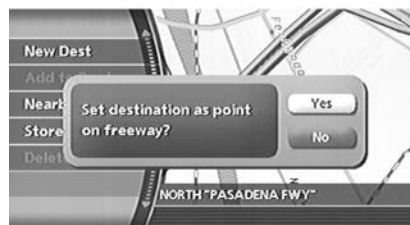

NAV2862

3. The system sets the destination to the selected location and starts calculating a route.

 **INFO:**

If you set the destination on a freeway, a confirmation message is displayed.

SETTING A STORED LOCATION AS THE DESTINATION

The following setting methods are available when setting the destination to your home or any location stored in the Address Book.

- Setting your home

This allows you to set your home as the destination and have the system calculate a route. It is useful especially when you are searching for a route to return to your home.

 "STORING A LOCATION" (page 6-2)

- Setting from Address Book

This allows you to set the destination to a location stored in the Address Book and have the system calculate a route. To utilize this function more effectively, destinations that you often travel to should be stored in advance.

 "STORING A LOCATION" (page 6-2)

- Setting a Previous Destination

This allows you to set the destination to a location that you have previously set as the destination and have the system calculate a route. Up to 100 previous destinations will be automatically stored.

If the number of previous destinations exceeds 100, the oldest one will be replaced by the new one.

- Setting the Previous Starting Point

This allows you to set the destination to the starting point of the previous route guidance and have the system calculate a route.

- Setting from Stored Routes

You can select a preferred route from the stored routes.

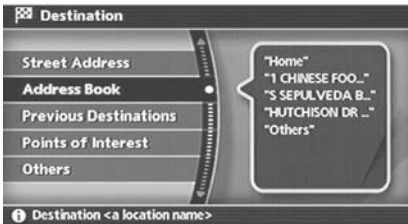

NAV2774

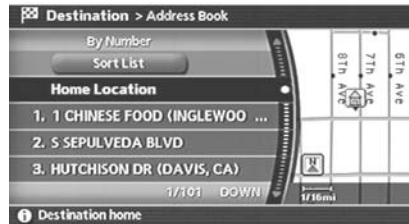

NAV2775



NAV2776

SETTING YOUR HOME

1. Highlight [Address Book] and push **<ENTER>**.

2. Highlight [Home Location] and push **<ENTER>**.

INFO:

If you have not stored your home yet, the system will automatically display a screen for storing it.

 "STORING A LOCATION" (page 6-2)

3. A confirmation message is displayed, and the system sets your home as the destination.



NAV2777

4. Your home is displayed at the center of the map, and the system starts calculating a route.

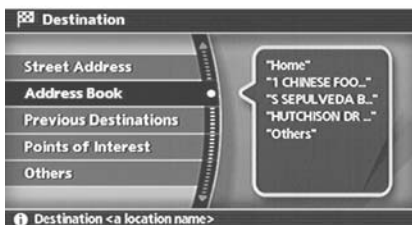

NAV2774

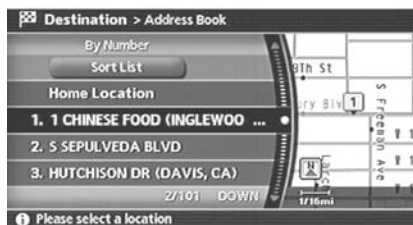

NAV2778

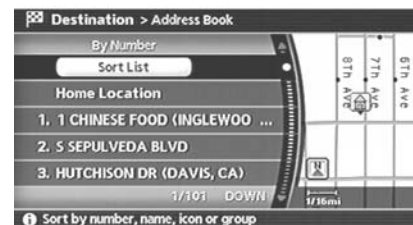

NAV2779

SETTING FROM ADDRESS BOOK

1. Highlight [Address Book] and push **<ENTER>**.
A list screen is displayed.

2. Highlight the preferred location from the list and push **<ENTER>**.

INFO:

Selecting [Sort List] displays a list of various sort functions.
To use the sort functions, stored locations must be set in advance.

-  "EDITING THE STORED HOME AND LOCATION" (page 6-16)

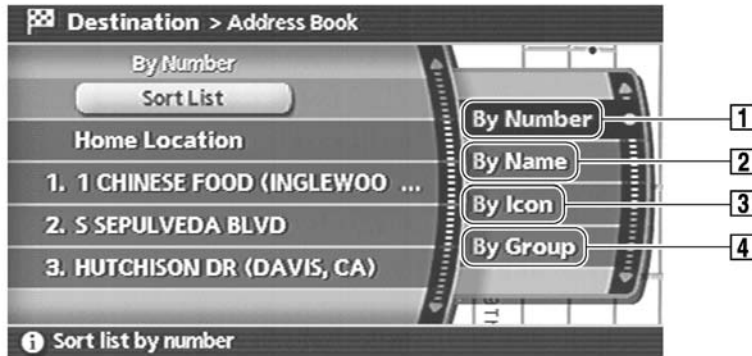

NAV2780

- 1 Sort by number:
The Address Book entries are displayed in ascending numerical order.
- 2 Sort by name:
The Address Book entries are displayed in alphabetic order.

- 3 Sort by icon:
By selecting a particular icon, a list that contains only the Address Book entries associated with that icon is displayed.
- 4 Sort by group:
By selecting a particular group (family, friends, leisure, etc.), the selected group is displayed at the top of the list.

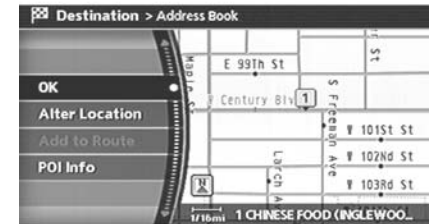

NAV2781

- 3. The selected destination is displayed at the center of the map. Highlight [OK] after confirming the location of the displayed destination, and push **<ENTER>**.
The system sets the destination to the selected location and starts calculating a route.

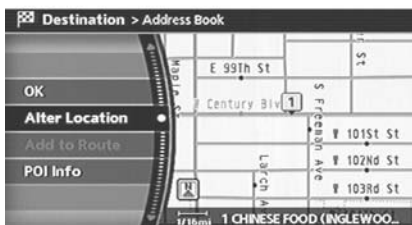

NAV2782

INFO:

Even after setting a destination, you can adjust the location of the destination, store the route, etc.

 "OPERATIONS AFTER SETTING A DESTINATION" (page 4-50)

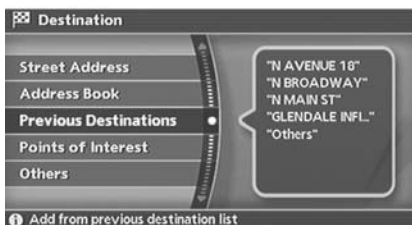

NAV2783



NAV2784



NAV2785

SETTING A PREVIOUS DESTINATION

1. Highlight [Previous Destinations] and push **<ENTER>**.
2. Highlight the preferred destination from the list and push **<ENTER>**.
3. The selected destination is displayed at the center of the map. Highlight [OK] after confirming the location of the displayed destination, and push **<ENTER>**. The system sets the destination to the selected location and starts calculating a route.

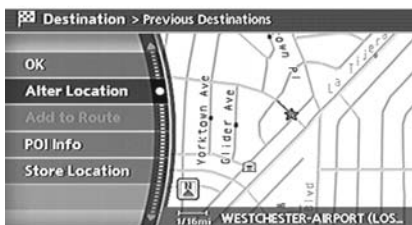

NAV2786

 **INFO:**

Even after setting a destination, you can adjust the location of the destination, store the route, etc.

 "OPERATIONS AFTER SETTING A DESTINATION" (page 4-50)

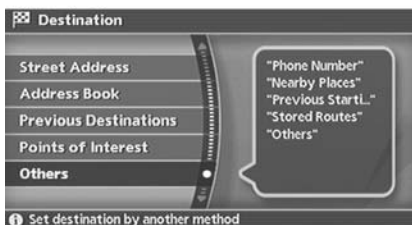

NAV2787



NAV2788



NAV2789

SETTING THE PREVIOUS STARTING POINT

1. Highlight [Others] and push **<ENTER>**.
2. Highlight [Previous Starting Point] and push **<ENTER>**.
3. The starting point of the route of the previous route guidance is displayed at the center of the map. Highlight [OK] after confirming the location of the displayed destination, and push **<ENTER>**.
The system sets the destination to the selected location and starts calculating a route.



NAV2790

 **INFO:**

Even after setting a destination, you can adjust the location of the destination, store the route, etc.

 "OPERATIONS AFTER SETTING A DESTINATION" (page 4-50)

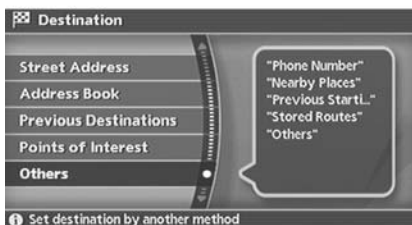

NAV2787



NAV2791



NAV2792

SETTING FROM STORED ROUTES

1. Highlight [Others] and push **<ENTER>**.
2. Highlight [Stored Routes] and push **<ENTER>**.
A list screen is displayed.
3. Highlight the preferred route from the list and push **<ENTER>**.
The route to the destination is set.

INFO:

The stored route includes only locations (destination and waypoints) and route calculation conditions, not the route itself. Therefore, when the destination is set using a stored route, a different route may be suggested if the current vehicle location is different from the one when the route was stored.

SETTING A FACILITY AS THE DESTINATION

When you are setting the destination to a facility, the following methods are available.

- **Setting a Point of Interest**
This allows you to find a facility by type, and then have the system calculate a route to that destination. Specify the region and city of the destination to find it more quickly.
- **Setting a Freeway Entrance/Exit**
This allows you to set the destination to an entrance or exit of a freeway, and then have the system calculate a route.
- **Setting by Phone Number**
If you know the telephone number of the facility, use this to find the facility by entering the number, and then have the system calculate a route.
- **Setting a Nearby Place**
This allows you to set the destination to a facility located near the current vehicle location or another location that you move to by scrolling the map, and then have the system calculate a route.
If there is any particular facility type that you intend to use frequently, you can store it in the list of nearby facilities.
 **"CUSTOMIZING NEARBY PLACES"**
(page 6-33)



NAV2728



NAV2793



NAV2794

SETTING A POINT OF INTEREST

1. Highlight [Points of Interest] and push **<ENTER>**.
2. Highlight the main category and push **<ENTER>**.
3. Highlight the subcategory and push **<ENTER>**.

A character input screen is displayed.

INFO:

Highlight [By Name] and push **<ENTER>** to include all categories in the route calculation conditions.

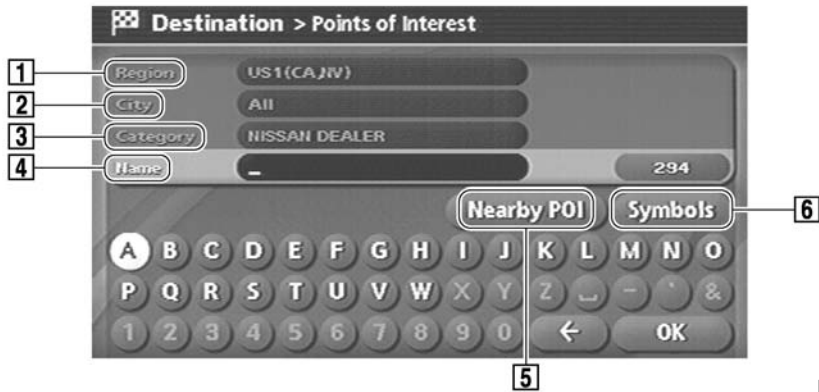

6 Symbols/A-Z:

Symbol keys are displayed by highlighting [Symbols] and pushing **<ENTER>**. Alphabet keys are displayed by highlighting [A-Z] and pushing **<ENTER>**.

i **INFO:**

Character input screen for Points of Interest

1 Region:

The region previously entered is automatically displayed. It can be changed.

2 City:

"All" is displayed, and all cities in the region are available. Route calculation conditions can be narrowed down by entering the name of the city.

3 Category:

The preferred facility type can be selected.

4 Name:

The name of the destination facility can be selected.

5 Nearby POI:

The system will search for the facility, based on the type selected, near the current vehicle location.

NAV2795



NAV2796



NAV2797



NAV2798

4. Highlight [Name] and push **<ENTER>**.
Enter the name of the destination facility.
5. After finishing the entry, highlight [OK] and push **<ENTER>**.
A list screen is displayed.
6. Highlight the preferred destination facility from the list and push **<ENTER>**.

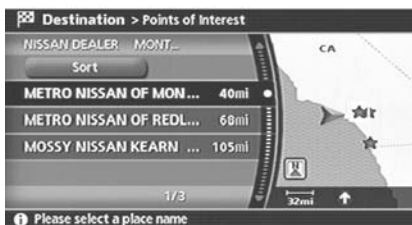

NAV2799

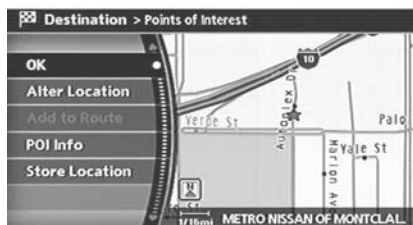

NAV2800

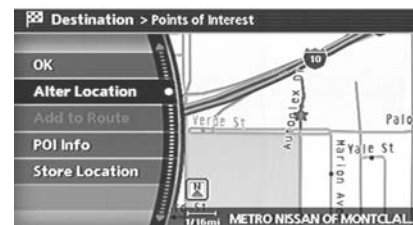

NAV2801

INFO:

By selecting [By Distance], you can sort the list by the nearest distance. The position of the selected location is displayed in the preview on the right side of the screen.

7. The selected destination is displayed at the center of the map. Highlight [OK] after confirming the location of the displayed destination, and push **<ENTER>**. The system sets the destination to the selected location and starts calculating a route.

INFO:

Even after setting a destination, you can adjust the location of the destination, store the location, etc.

"OPERATIONS AFTER SETTING A DESTINATION" (page 4-50)



NAV2802



NAV2803



NAV2804

Changing the region

1. Highlight [Region] and push **<ENTER>** to change the region.

2. Highlight the preferred region and push **<ENTER>**.
A character input screen is displayed.

Specifying a city

1. Highlight [City] and push **<ENTER>** to narrow down the route calculation conditions by entering the name of the city.

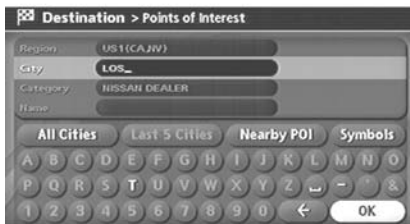

NAV2805



NAV2806

2. Enter the name of the city, highlight [OK] and push **<ENTER>**.

i **INFO:**

- Highlight [All Cities] and push **<ENTER>** to include all cities in the region as the route calculation condition.
- Highlight [Last 5 Cities] and push **<ENTER>** to display 5 cities recently set as destinations.

3. Highlight the city of the destination facility from the list, and push **<ENTER>**.
A character input screen is displayed.

Category list

Restaurant	Restaurant all African, American, Austrian, Balkan, Barbecue/Southern, Belgian, Bistro, Bohemian, Brewpub, British isles, Cajun/Caribbean, Californian, Canadian, Chinese, Continental, Dutch, East European, Fast food, Filipino, French, German, Greek, Grill, Hawaiian/Polynesian, Hungarian, Indian, Indonesian/Malaysian, International, Italian, Japanese, Jewish/Kosher, Korean, Latin American, Maltese, Mexican, Middle Eastern, Oriental, Other, Pizza, Polish, Portuguese, Russian, Sandwich, Scandinavian, Seafood, Soul food, South American, South-western, Southeast Asian, Spanish, Steak house, Swiss, Thai, Turkish, Unknown, Vegetarian, Vietnamese	
Shopping	Grocery store	Grocery store all 7-Eleven, AM PM, Casey's General Store, Circle K, Convenient Food Stores, Cumberland Farms, Dairy Mart, Holiday Station Store, Kash-N-Karry, Loblaw, Others, Pantry, Stop-N-Go, Uni Mart Inc., White Hen Pantry
	Shopping	
Auto service	Auto dealerships	
	Automobile club	
	Gas station	Gas station all Amoco, Arco, Beacon (Valero), Chevron, Citgo, Conoco, Esso, Exxon, Getty, Gulf, Husky, Marathon, Mobil, Mohawk, Others, Petro-Canada, Phillips 66, Pioneer, Shell, Sinclair, Sunoco, Texaco, Ultramar (Valero), Ultramar USA, Unocal 76, Valero
	Rental car agency	
	Auto service & maintenance	
	NISSAN dealer	
	INFINITI dealer	

Travel	Airport	
	Border crossing	
	Bus station	
	Commuter rail station	
	Ferry terminal	
	Hotel	Hotel all America Inn & Suites, Amerihost (Cendant), Amerisuites, Best Western, Clarion, Country Hearth Inn, Country Inn Suites (Carlson Group), Courtyard by Marriott, Crowne Plaza, Days Inn, Double Tree (Hilton Group), Drury Inn/ Pear Tree by Drury, Econo Lodge, Embassy Suites, Fairfield Inn, Four Seasons, Hampton Inn, Hawthorn Suites, Hilton, Hilton Garden Inn, Holiday Inn, Homestead, Homewood, Howard Johnson, Hyatt, Intercontinental, Jameson Inns/Signature Inns, Knights Inn (Cendant), La Quinta Inn, Microtel Inn & Suites, Motel 6/Studio 6, Others, Park Inn (Carlson Group), Quality, Radisson, Ramada Inn, Red Roof Inn, Renaissance (Marriott), Residence Inns, Ritz Carlton, Rodeway Inn (Choice), Scottish Inn, Sheraton, Shilo Inn, Shoney's Inn, Sleep Inn (Choice), Super 8, Travelodge, Venture Inns, Village (Cendant), Westin, Wyndham
	Automobile club	
	Rental car agency	
	Rest area	
	Ski resort	
	Tourist attraction	
	Tourist information	
	Train station	
	Auto service & maintenance	
Banking	ATM	
	Bank	
Hospital		

Community	City hall, Community center, Convention/Exhibition center, Court house, Historical monument, Hospital, Library, Marina, Museum, Police station, Park/Recreation area, School, Sports center, Sports complex, Performing arts, Higher education
Leisure	Amusement park, Bowling center, Casino, Movie theater, Convention/Exhibition center, Golf course, Historical monument, Ice skating park, Marina, Museum, Nightlife, Park/Recreation area, Ski resort, Sports center, Sports complex, Performing arts, Tourist attraction, Tourist information, Winery
Parking	Parking lot
	Park & Ride
	Parking garage
Others	Border crossing, Business facility, Court house, Historical monument, Police station, School, Higher education

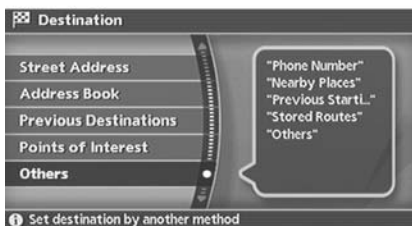

NAV2787



NAV2807



NAV2808

SETTING A FREEWAY ENTRANCE/EXIT

1. Highlight [Others] and push **<ENTER>**.
2. Highlight [Freeway Entrance/Exit] and push **<ENTER>**.
A character input screen is displayed.
3. Select a region and enter the name of the freeway.
4. After finishing the entry, highlight [OK] and push **<ENTER>**.

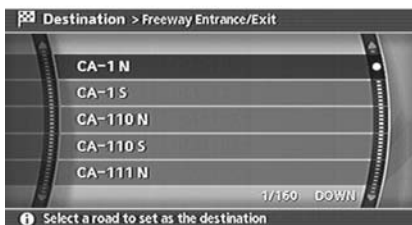

NAV2809

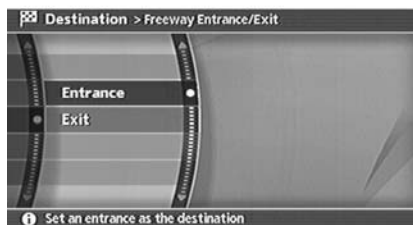

NAV2810

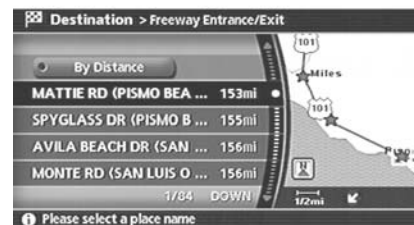

NAV2811

5. Highlight the freeway of the destination from the list, and push **<ENTER>**.
6. Highlight [Entrance] or [Exit] and push **<ENTER>**.
A list screen is displayed.
7. Select the preferred destination from the list. The position of the selected location is displayed in the preview on the right side of the screen. Then, push **<ENTER>**.

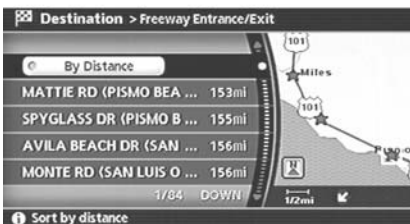

NAV2812

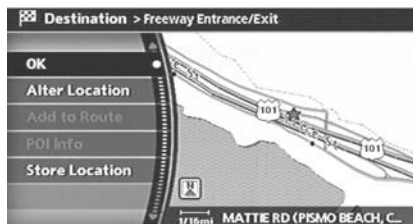

NAV2813



NAV2814

INFO:

By selecting [By Distance], you can sort the list by the nearest distance.

8. The selected destination is displayed at the center of the map. Highlight [OK] after confirming the location of the displayed destination, and push **<ENTER>**. The system sets the destination to the selected location and starts calculating a route.

INFO:

Even after setting a destination, you can adjust the location of the destination, store the route, etc.

 "OPERATIONS AFTER SETTING A DESTINATION" (page 4-50)

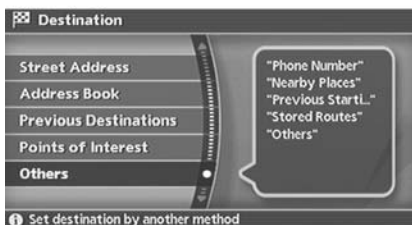

NAV2787



NAV2815



NAV2816

SETTING BY PHONE NUMBER

INFO:

- If the area code of the specified telephone number does not exist in the map data, the system will not search for the location.
 - Only the locations included in the database in the map DVD-ROM can be searched by the phone number. Personal phone numbers cannot be used to search for a location.
1. Highlight [Others] and push **<ENTER>**.

2. Highlight [Phone Number] and push **<ENTER>**.
The telephone number input screen is displayed.

3. Enter the telephone number including the area code.
4. After finishing the entry, highlight [Map] and push **<ENTER>**.
 "PHONE NUMBER INPUT SCREEN" (page 2-26)

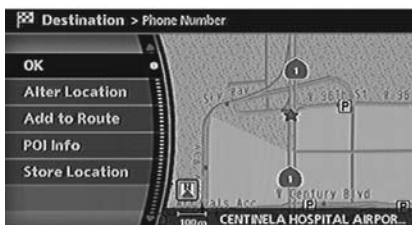

NAV2817

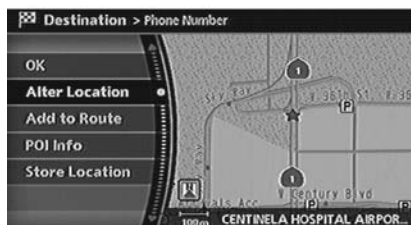

NAV2818

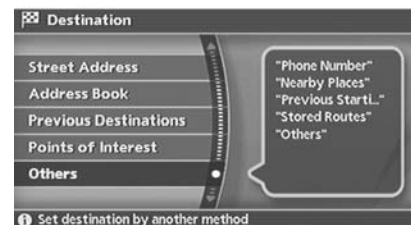

NAV2787

5. The selected destination is displayed at the center of the map. Highlight [OK] after confirming the location of the displayed destination, and push **<ENTER>**. The system sets the destination to the selected location and starts calculating a route.

INFO:

Even after setting a destination, you can adjust the location of the destination, store the route, etc.

 "OPERATIONS AFTER SETTING A DESTINATION" (page 4-50)

SETTING A NEARBY PLACE

1. Highlight [Others] and push **<ENTER>**.



NAV2819



NAV2820



NAV2821

2. Highlight [Nearby Places] and push **<ENTER>**.
3. Highlight the preferred destination facility and push **<ENTER>**.
A list screen is displayed.
4. Highlight the preferred destination from the list, and push **<ENTER>**.
The position of the selected location is displayed in the preview on the right side of the screen.

INFO:

If there is any particular facility type that you intend to use frequently, you can store it in the list of nearby facilities.

 "CUSTOMIZING NEARBY PLACES"
(page 6-33)



NAV2822

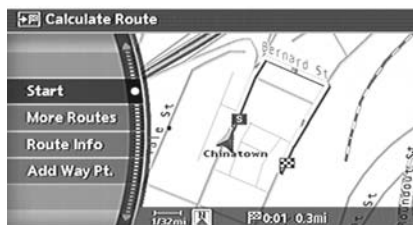

NAV2823



NAV2824

INFO:

If the suggested route is already set, by highlighting [Show Along Route] and pushing **<ENTER>**, the system displays only the facilities located along the route.

- The system sets the destination to the selected location and starts calculating a route.

INFO:

If the route is already set, the selected location becomes a waypoint.

INFO:

You can also set the destination by pushing **<ENTER>** in the current location map screen and selecting [Nearby].

OPERATIONS AFTER SETTING A DESTINATION

The following operations are available after you set a destination.

INFO:

The menu will not be displayed if you select, [Stored Route] or [Nearby Places] from the Destination menu.

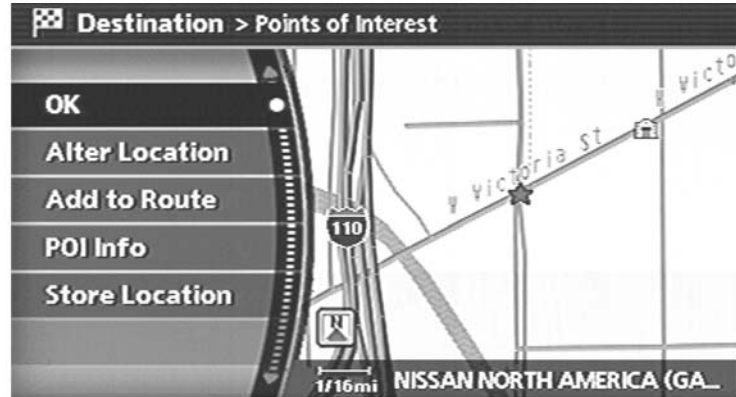

NAV2863

AVAILABLE SETTING ITEMS

- **OK:**
Sets the destination. If the route is already set, the location becomes the new destination, and the route is recalculated.
- **Alter Location:**
Displays a map screen where you can adjust the location of the destination.
- **Add to Route:**
Allows you to add a waypoint to the route already set.
- **POI Info:**
Allows you to view information about the facility that you have set as the destination if it is included in the map DVD-ROM data.
- **Store Location:**
Allows you to store the location in the Address Book.

ADJUSTING THE LOCATION OF THE DESTINATION

You can adjust the location of the destination by moving the cross pointer across the map.

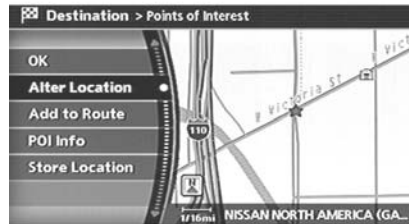

NAV2864



NAV2865

1. Set the destination using an appropriate method.
2. Highlight [Alter Location] and push **<ENTER>**.
3. Adjust the location by moving the cross pointer across the map and push **<ENTER>**.
The location of the destination is modified.

ADDING ADDITIONAL DESTINATIONS TO A ROUTE

Even after the route is already set, you can add a searched location as a new destination or waypoint to that route.

If the route has not been set, [Add to Route] cannot be selected.

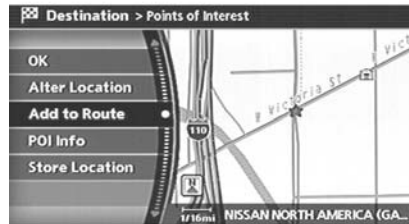

NAV2866

1. Set the destination using an appropriate method.
2. Highlight [Add to Route] and push **<ENTER>**.

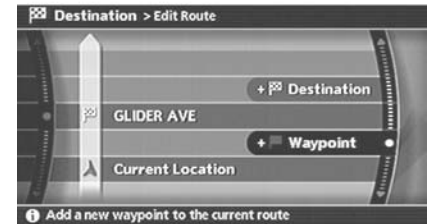

NAV2867

3. Highlight [Destination] or [Waypoint] and push **<ENTER>**.

VIEWING INFORMATION ABOUT THE SEARCHED LOCATION

Information (street address and phone number) about facilities stored in the map DVD-ROM data can be displayed.

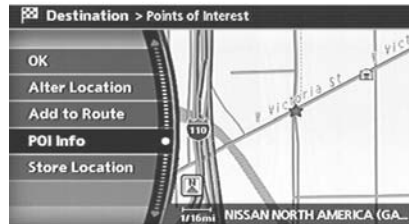

NAV2868

1. Set the destination using an appropriate method.
2. Highlight [POI Info] and push **<ENTER>**.



NAV2869

3. Information about the location is displayed.
4. Push **<ENTER>**, or highlight [Back] and push **<ENTER>** to return to the previous screen.

STORING A LOCATION

A searched location can be stored in the Address Book. Then it can be easily retrieved and set as a destination (or waypoint).

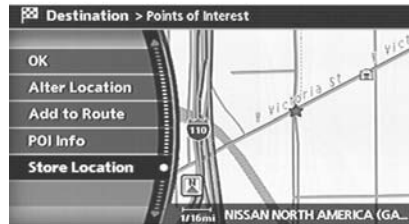

NAV2870

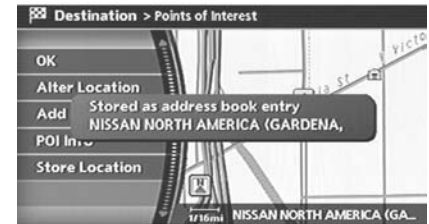

NAV2871

1. Set the destination using an appropriate method.
2. Highlight [Store Location] and push **<ENTER>**.
3. The location is stored in the Address Book. The corresponding icon is displayed at the set location on the map.

5 Route guidance

Procedures after setting a destination	5-2	Setting a detour route	5-17
Available items after setting a destination	5-2	Recalculate route	5-18
Starting route guidance	5-3	Editing a route	5-19
Selecting a route	5-3	Confirming a route	5-26
Confirming a route	5-4	Basic operation	5-26
Adding a destination or waypoint	5-5	Using turn list	5-27
About route guidance	5-7	Using route preview	5-27
Voice guidance during route guidance	5-7	Confirming by simulation	5-28
Guidance screens and preview mode	5-8	Route guidance settings	5-29
Route setting	5-10	Basic operation	5-29
Basic operation	5-10	Visual guidance settings	5-31
Setting conditions for the route calculation	5-12	Voice guidance settings	5-32
Route priority settings	5-12	Set average speeds	5-33
Detailed route priorities	5-13	Deleting/reactivating a route	5-35
Change/edit route	5-15	Deleting a route	5-35
Basic operation	5-15	Reactivating a route	5-36

PROCEDURES AFTER SETTING A DESTINATION

After you set a destination using an appropriate method and select [OK], the system starts calculating a route to the destination.

Select the preferred setting item and push <ENTER>.



INFO:

If you have not performed any operations on the system for several seconds, [Start] is automatically selected, and the system starts route guidance.



NAV2872

AVAILABLE ITEMS AFTER SETTING A DESTINATION

- **Start:**
Starts route guidance to the selected destination.
 "STARTING ROUTE GUIDANCE" (page 5-3)
- **More Routes:**
Displays 3 alternative routes.
 "SELECTING A ROUTE" (page 5-3)

- **Route Info:**
Displays the route information.
 "CONFIRMING A ROUTE" (page 5-4)
- **Add Way Pt.:**
Allows you to edit the route by adding a destination or waypoint.
 "ADDING A DESTINATION OR WAYPOINT" (page 5-5)



NAV2873



NAV2874



NAV2875

STARTING ROUTE GUIDANCE

1. Highlight [Start] and push **<ENTER>**.
Route guidance starts.

SELECTING A ROUTE

1. Highlight [More Routes] and push **<ENTER>**.
2. Highlight the preferred route condition and push **<ENTER>**.
3. Push **<BACK>/<PREV>** to return to the previous screen.

Available route conditions

- 1 Short. Time (Blue):
Prioritizes by the shortest time.
- 2 Min. FWY (Red):
Minimizes the use of freeways.
- 3 Short. Dist. (Green):
Prioritizes by the shortest distance.

INFO:

- After you select a route, a preview is displayed on the right side of the screen.
- The 3 routes may not always be different.



NAV2876





NAV2877

CONFIRMING A ROUTE

1. Highlight [Route Info] and push **<ENTER>**.
2. Highlight the preferred information item and push **<ENTER>**.
3. Push **<BACK>/<PREV>** to return to the previous screen.

Available information

- Preview:
Allows you to confirm the route by scrolling on the map manually.
 "USING ROUTE PREVIEW"
(page 5-27)
- Simulation:
Allows you to view a simulation of the route.
 "CONFIRMING BY SIMULATION"
(page 5-28)

ADDING A DESTINATION OR WAY-POINT

Before starting route guidance, you can add destinations and/or waypoints.

A total of 6 destinations or waypoints can be set.



NAV2878

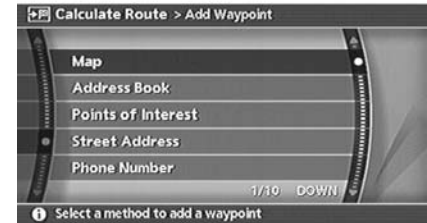

NAV2879

1. Highlight [Add Way Pt.] and push **<ENTER>**.
2. Set additional destinations or waypoints and push **<ENTER>**.

INFO:

The method of searching for a location is the same as the one for a destination.

 "4. Setting a destination"

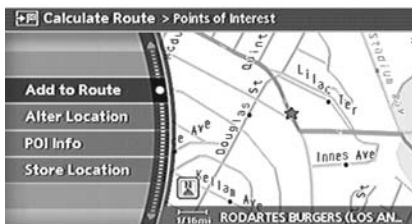

NAV2880

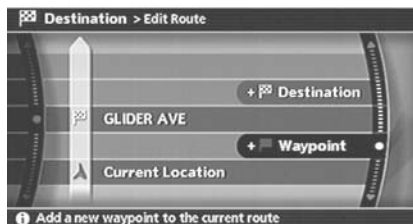

NAV2881

- The selected location is displayed at the center of the map. Highlight [Add to Route] after confirming the location and push **<ENTER>**.

INFO:

You can modify the location by selecting [Alter Location]. The method of adjusting a location is the same as the one for a destination.

"ADJUSTING THE LOCATION OF THE DESTINATION" (page 4-51)

- Highlight [Destination] or [Waypoint] and push **<ENTER>**.

The system starts calculating a route that includes the added destination or waypoint. When the calculation is finished, the route is displayed.

INFO:

- If a waypoint was added, [More Routes] cannot be selected.
- If a destination was added, the prior destination becomes a waypoint.

ABOUT ROUTE GUIDANCE

After setting the route, select [Start] to begin route guidance.

Throughout route guidance, the system navigates you through the guide points using visual and voice guidance.

CAUTION

The navigation system's visual and voice guidance is for reference purposes only. The contents of the guidance may be inappropriate depending on the situation.

When driving along the suggested route, follow all traffic regulations (e.g., one-way traffic).

 "ROUTE GUIDANCE" (page 9-11)

VOICE GUIDANCE DURING ROUTE GUIDANCE

When approaching a guide point (intersection or corner), destination, etc. during route guidance, voice guidance announces the remaining distance and/or turning direction.

Push **<VOICE>/<GUIDE VOICE>** to repeat voice guidance.

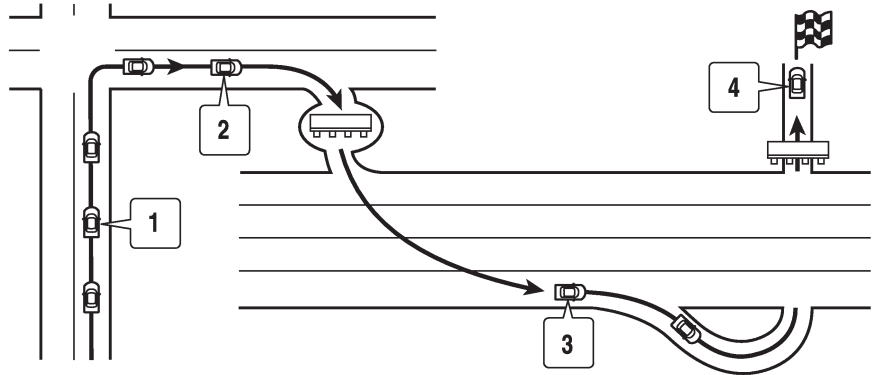

NAI0418

Example of voice guidance

- 1** "In about one quarter mile (400 meters), right (left) turn."
"Right (left) turn ahead."
- 2** "In about one quarter mile (400 meters) freeway entrance on your right onto (road number and direction)."
"Freeway entrance on your right onto (road number and direction)."
- 3** "In about one mile (1.6 kilometers), exit on your right."
"Take the second exit on your right."
- 4** "You have arrived at your destination. Ending route guidance."

GUIDANCE SCREENS AND PREVIEW MODE

Route guidance displays map screens and various information according to the situation.



NAV2882

When route guidance starts, the Small Turn Arrow on Map is displayed in the upper left corner of the map screen. This arrow indicates the turning direction at the next guide point (corner or intersection). The distance is also displayed. At the top of the screen, the distance to the next guide point and the name of the next street to turn on to are displayed. Also, there may be cases that next street names are announced.

The Small Turn Arrow on Map can be enabled or disabled by the user.

 "ROUTE GUIDANCE SETTINGS"
(page 5-29)



NAV2883

Enlarged intersection view

When approaching a guide point, the system automatically changes to the split screen and shows an enlarged view of the intersection in the left screen. After passing through the intersection, the system automatically returns to the full screen mode.

To switch to the full screen mode while the enlarged intersection view is displayed, push **<MAP>**.



NAV2884

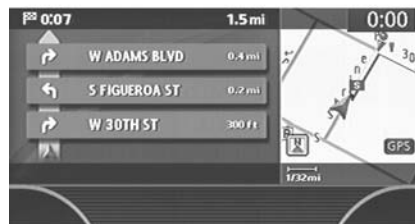

NAV2885

Junction guidance

While driving on a freeway, when the vehicle is approximately 1 mile (approximately 2 km) from a junction, the system automatically switches to the split screen and displays an enlarged view of the junction (3D) in the left screen.

After passing the junction, the system automatically returns to the full screen mode.

To switch to the full screen mode while the enlarged junction view is displayed, push **<MAP>**.

Turn list

Depending on the setting, the system can constantly display the split screen and show the turn list in the left screen. When approaching a guide point, the left screen automatically switches to an enlarged view of the intersection.

To switch to the full screen mode, push **<MAP>**.

 "ROUTE GUIDANCE SETTINGS"
(page 5-29)

ROUTE SETTING

During route guidance, you can modify the route conditions or confirm the route information. Set the appropriate route condition according to your purpose.

BASIC OPERATION

1. Push **<ROUTE>**.
2. Highlight the preferred setting item and push **<ENTER>**.
3. Push **<MAP>** to return to the current location map screen.



WARNING

Always stop the vehicle in a safe location before modifying the route conditions.

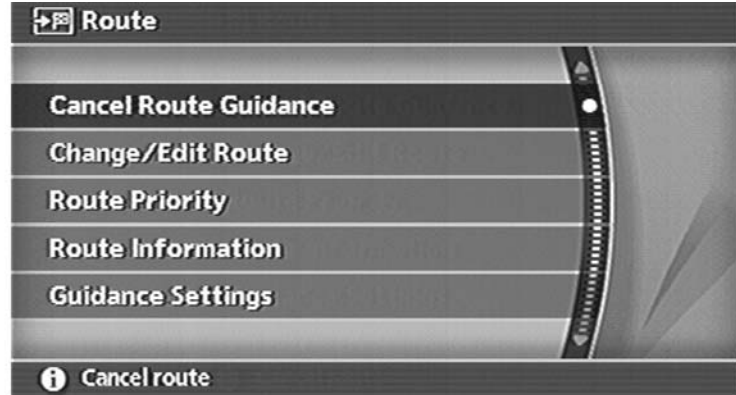

Modifying the route conditions while driving may cause an accident.



NAV2886

Available setting items

- **Cancel Route Guidance/Resume Route Guidance:**
Allows you to cancel the current route guidance. A cancelled route can also be reactivated. If the suggested route is cancelled, [Cancel Route Guidance] changes to [Resume Route Guidance].
☞ "DELETING/REACTIVATING A ROUTE" (page 5-35)
- **Change/Edit Route:**
Allows you to change or edit the route already set.
☞ "CHANGE/EDIT ROUTE" (page 5-15)
- **Route Priority:**
Allows you to change the route calculation conditions anywhere along the route.
☞ "SETTING CONDITIONS FOR THE ROUTE CALCULATION" (page 5-12)

- **Route Information:**
Allows you to confirm the route by the route information or simulation.
 "CONFIRMING A ROUTE"
(page 5-26)
- **Guidance Settings:**
You can set various guidance information to be displayed during route guidance and activate or deactivate route and/or voice guidance.
 "ROUTE GUIDANCE SETTINGS"
(page 5-29)

SETTING CONDITIONS FOR THE ROUTE CALCULATION

- Route Priority Settings
Allows you to set the priority for the route calculation.
- Detailed Route Priorities
Allows you to set detailed route conditions.
 "DETAILED ROUTE PRIORITIES"
(page 5-13)

ROUTE PRIORITY SETTINGS

The route can be recalculated after changing the route calculation conditions anywhere along the route.

Basic operation

1. Push **<ROUTE>**.
2. Highlight [Route Priority] and push **<ENTER>**.
3. Highlight the preferred condition and push **<ENTER>**. The indicator for the selected condition illuminates.
4. When the current location map screen or route setting screen is displayed, the system recalculates a route with the set conditions.



NAV2887

Available conditions

- Fastest Route:
Prioritizes by the fastest time.
- Minimize Freeway:
Minimizes the use of freeways.

- Shortest Route:
Prioritizes by the shortest route.

INFO:

Only one of these conditions can be utilized at a time.

DETAILED ROUTE PRIORITIES

Detailed conditions can be set for the route calculation.

Basic operation

1. Push **<ROUTE>**.
2. Highlight [Route Priority] and push **<ENTER>**.
3. Highlight [Detailed Route Priorities] and push **<ENTER>**.
4. Highlight the preferred condition and push **<ENTER>**. The indicator for the selected condition illuminates.
5. When the current location map screen or route setting screen is displayed, the system recalculates a route with the set conditions.



NAV2888

Available setting items

- Minimize Toll Roads:
Minimizes the use of toll roads.
- Use Time Restricted Roads:
Uses any roads subject to time restrictions.
- Use Avoid Area Settings:
Enables the avoid area setting.
- Use Ferries:
Includes the use of ferries.
- Auto Reroute:
If the vehicle deviates from the suggested route, the system automatically recalculates a route that leads the vehicle to the suggested route.



INFO:

- The recalculated route may not be the shortest route because the system prioritizes easy-to-drive roads for safety reasons.
- If you set the route conditions from [Route Priority], all sections in the route are subject to the same route conditions even though you have set different route conditions for different sections in [Edit Route].
- If [Use Time Restricted Roads] is deactivated, the system calculates a route without any consideration of the regulations concerning the time or day of the week. Therefore, the suggested route may include a road subject to traffic regulations concerning the time or day of the week. When driving along the route, always follow all regulations.
- If the system cannot calculate any alternative routes, it displays the previous route.
- If the vehicle overly deviates from the suggested route, the system calculates a new route.

CHANGE/EDIT ROUTE

You can calculate a detour for a section of the route, edit the route or store the route.

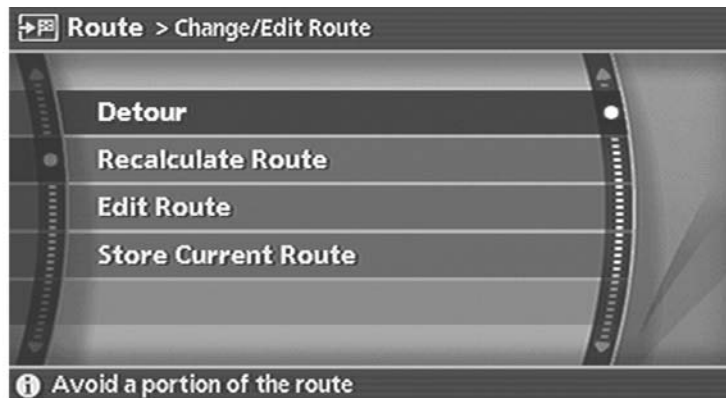

BASIC OPERATION

1. Push **<ROUTE>**.
2. Highlight [Change/Edit Route] and push **<ENTER>**.
3. Highlight the preferred setting item and push **<ENTER>**.
4. Push **<MAP>** to return to the current location map screen.



NAV2889

Available setting items

- **Detour:**
If you want to detour from the suggested route, you can calculate a route detouring for a specified distance.
 "SETTING A DETOUR ROUTE"
(page 5-17)
- **Recalculate Route:**
When you have deviated from the suggested route, you can recalculate a route from the current location to the destination manually or automatically.
 "RECALCULATE ROUTE"
(page 5-18)
- **Edit Route:**
You can edit the route and adjust the settings for route calculation.
 "EDITING A ROUTE" (page 5-19)

- Store Current Route:
A calculated route can be stored. A maximum of 5 routes can be stored. Stored routes can be easily retrieved and set as the suggested route.
 "STORING A ROUTE" (page 6-12)

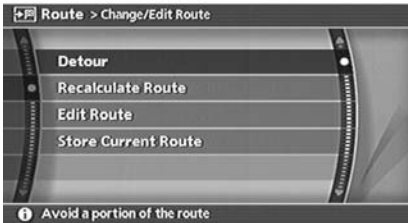

NAV2890

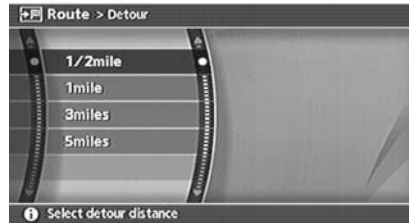

NAV2891

SETTING A DETOUR ROUTE

1. Highlight [Detour] and push **<ENTER>**.

2. Highlight a detour distance and push **<ENTER>**.

After calculating the detour, the system displays the detour route on the map.

INFO:

- When the vehicle has deviated from the suggested route, [Detour] cannot be selected.
- If the system cannot calculate a detour with the specified conditions, it displays the previous suggested route.
- If the vehicle is traveling very fast, the detour route may start from a location that the vehicle has already passed.

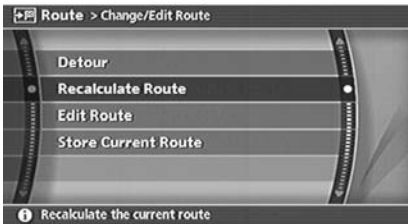

NAV2892

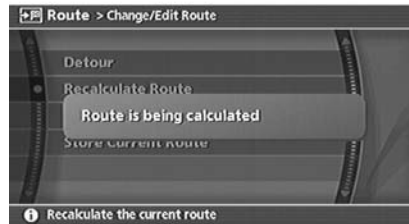

NAV2893



NAV2894

RECALCULATE ROUTE

1. Highlight [Recalculate Route] and push **<ENTER>**.
2. A message is displayed, and the route is recalculated.
3. Set the route conditions. After finishing the setting, highlight [Start] and push **<ENTER>**.
 ⓘ "PROCEDURES AFTER SETTING A DESTINATION" (page 5-2)

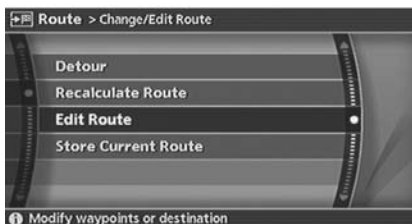

NAV2895



EDITING A ROUTE

1. Highlight [Edit Route] and push **<ENTER>**.
2. Highlight the preferred condition and push **<ENTER>**.
3. Push **<BACK>/<PREV>** to return to the previous screen. Push **<MAP>** to return to the current location map screen.





NAV2896

Available setting items

- 1 Current destination:
Allows you to change or delete the destination.
 "Editing/deleting a destination or waypoint" (page 5-22)
- 2 Current waypoint:
Allows you to change or delete the waypoint.
 "Editing/deleting a destination or way-

point" (page 5-22)

- 3 Condition for calculating a route to the destination:
Allows you to change the conditions for calculating a route to the destination.
 "Changing route calculation conditions" (page 5-24)
- 4 Condition for calculating a route to a waypoint:
Allows you to change the conditions for calculating a route to a waypoint.

 “Changing route calculation conditions”
(page 5-24)

5 Allows you to add a destination.

 “Setting a destination or waypoint”
(page 5-20)

6 Allows you to add a waypoint.

 “Setting a destination or waypoint”
(page 5-20)

Setting a destination or waypoint

You can add a destination or waypoint to the route already set.

A total of 6 destinations or waypoints can be set.

Adding a destination or waypoint

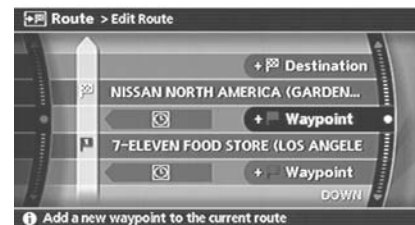

NAV2897

1. Highlight [Destination] or [Waypoint] and push **<ENTER>**.

INFO:

If you select [Destination], the current destination is changed to a waypoint.

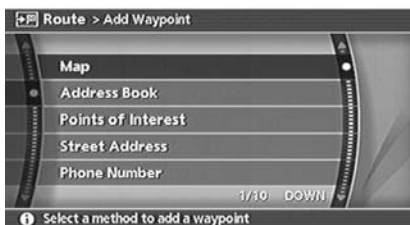

NAV2898

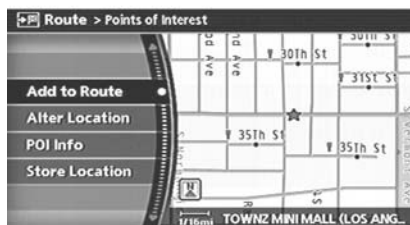

NAV2899

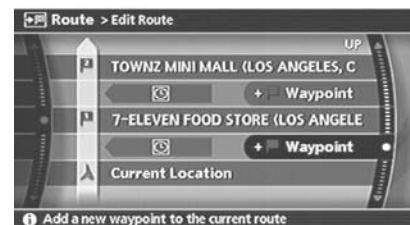

NAV2900

2. Set a destination or waypoint. The method of searching for a destination or waypoint is the same as the one for a destination.
 "4. Setting a destination"

3. The selected location is displayed at the center of the map. Highlight [Add to Route] after confirming the location and push **<ENTER>**.

INFO:

Even after setting a destination/waypoint, you can adjust the destination/waypoint location, store the route, etc.

- "OPERATIONS AFTER SETTING A DESTINATION" (page 4-50)

4. Return to the Edit Route screen.
Set the route conditions as necessary.
5. Push **<MAP>** to return to the current location map screen. The route you have set is automatically displayed.

INFO:

The prior route is automatically deleted.

Editing/deleting a destination or waypoint

You can modify or delete the destination or waypoint already set.

INFO:

If you modify or delete a location when a suggested route is already set, the prior suggested route will be recalculated accordingly.

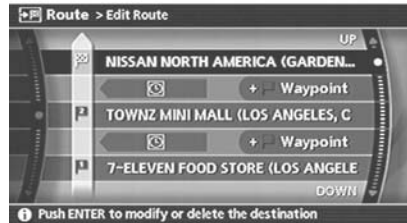

NAV2901



NAV2902

1. Highlight a destination or waypoint that is already set and push **<ENTER>**.
2. Highlight [Alter Locn.] to modify the location and push **<ENTER>**.
 "ADJUSTING THE LOCATION OF THE DESTINATION" (page 4-51)



NAV2903

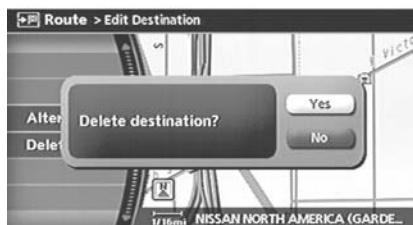

NAV2904

3. Highlight [Delete] and push **<ENTER>** to delete the location.
4. A confirmation message is displayed. Confirm the contents of the message, highlight [Yes] and push **<ENTER>**.
The destination or waypoint is deleted from the route.

 **INFO:**

If the destination is deleted, the final waypoint of the route becomes the destination.

Changing route calculation conditions

Each section of the route between waypoints can have different route calculation conditions. After setting these conditions, you can recalculate the entire route.

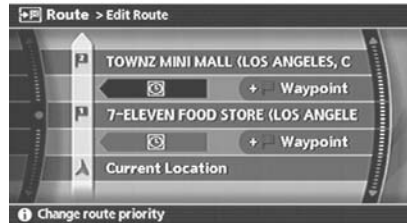



NAV2905



NAV2906

1. Highlight the preferred section of the route to the destination or waypoint and push **<ENTER>**.
2. Highlight the preferred condition and push **<ENTER>**.

Available conditions:

-  : Fastest Route
-  : Minimize Freeway
-  : Shortest Route



NAV2907



NAV2908

3. The system automatically recalculates a route according to the conditions set. The screen will automatically return to the [Edit Route] screen after route calculation.
4. The icon corresponding to the set route condition is displayed. Push **<MAP>** to return to the current location map screen.

INFO:

- The recalculated route may not be the shortest route because the system prioritizes easy-to-drive roads for safety reasons.
- If you set the route conditions from [Route Priority], all sections in the route are subject to the same route conditions even though you have set different route conditions for different sections in [Edit Route].

CONFIRMING A ROUTE

When the suggested route is displayed after calculation, you can confirm the route information or simulate the suggested route.

BASIC OPERATION

1. Highlight [Route Information] and push **<ENTER>**.
2. Highlight the preferred item and push **<ENTER>**.



NAV2909

Available items

- Turn list:
Displays the details of the suggested route.
☞ "USING TURN LIST" (page 5-27)
- Where am I? (Armada, Maxima, Murano, Pathfinder, Quest, Titan):
Allows you to display the information about the vehicle location on the route when driving according to route guidance.
☞ "VIEWING INFORMATION ABOUT CURRENT VEHICLE LOCATION" (page 7-3)
- Preview:
Allows you to confirm the suggested route by scrolling the map.
☞ "USING ROUTE PREVIEW" (page 5-27)
- Simulation:
Allows you to simulate the suggested route. This function provides a detailed image of the route with voice guidance.
☞ "CONFIRMING BY SIMULATION" (page 5-28)



NAV2910

USING TURN LIST

1. You can confirm the information (e.g., intersections) on the route to the destination by scrolling the screen using the joystick.
2. Push **<MAP>** to return to the current location map screen.

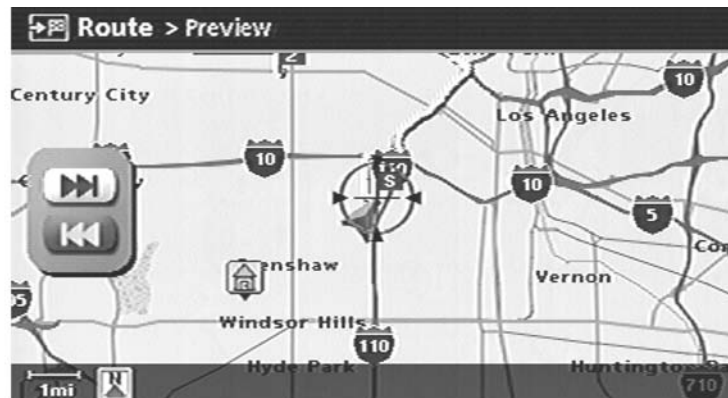

NAV2911

USING ROUTE PREVIEW

1. Highlight the preferred key and push **<ENTER>**.

: Goes forward in the direction of the destination.

: Goes backward in the direction of the starting point.

: Pauses the route preview.

2. Push **<BACK>/<PREV>** to cancel the preview and return to the current location map screen.

INFO:

During route preview, you can change the map scale by pushing **<ZOOM IN>** () or **<ZOOM OUT>** ()

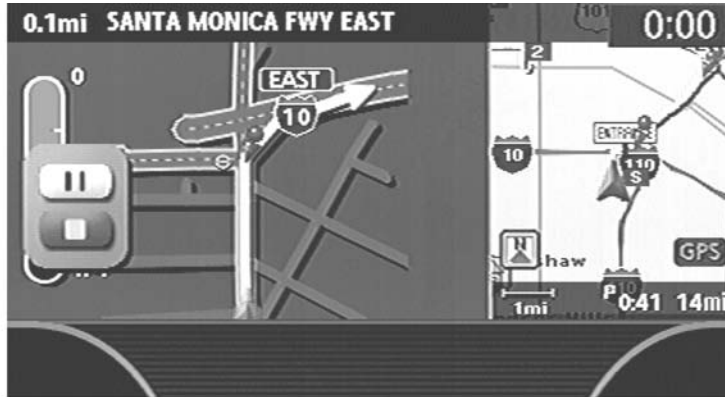

NAV2912

CONFIRMING BY SIMULATION

1. Highlight the preferred key and push **<ENTER>**.

|| : Pauses the simulation.

▶ : Resumes the simulation.

■ : Ends the simulation.

2. Push **<BACK>/<PREV>** to cancel the simulation and return to the current location map screen.



INFO:

During simulation, you can change the map scale by pushing **<ZOOM IN>** (⊕) or **<ZOOM OUT>** (⊖).

ROUTE GUIDANCE SETTINGS

You can set various guidance information to be displayed during route guidance and activate or deactivate route and/or voice guidance.

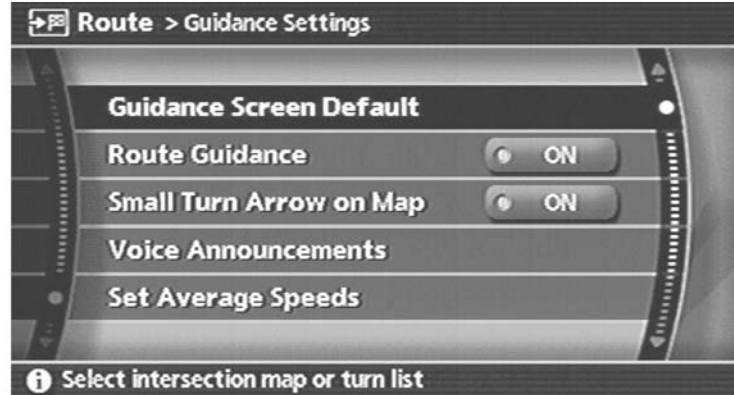

BASIC OPERATION

1. Highlight [Guidance Settings] and push **<ENTER>**.
2. Highlight the preferred item and push **<ENTER>**.
3. Push **<BACK>/<PREV>** to return to the previous screen. Push **<MAP>** to return to the current location map screen.





NAV2913

Available setting items

- **Guidance Screen Default:**
Sets the default display screen for route guidance.
 "VISUAL GUIDANCE SETTINGS"
(page 5-31)
- **Route Guidance:**
Activates or deactivates route guidance. Route guidance is activated when the indicator illuminates. Route information is not available when route guidance is set to OFF.
- **Guidance Voice (350Z):**
Activates or deactivates voice guidance. The indicator illuminates if voice guidance is activated.
 "SETTING THE VOICE GUIDANCE"
(page 2-36)
- **Small Turn Arrow on Map:**
Activates or deactivates the Small Turn Arrow on Map (simplified turn indicator) displayed in the upper left corner of the map screen. The indicator illuminates if the Small

Route guidance 5-29

Turn Arrow on Map is displayed.

- Voice Announcements:
Sets how many times voice guidance is repeated for guide points.
 "VOICE GUIDANCE SETTINGS"
(page 5-32)
- Set Average Speeds:
Allows you to set an average vehicle speed for each type of road, which is reflected in the calculation of the required time to the destination.
 "SET AVERAGE SPEEDS"
(page 5-33)



NAV2914



NAV2915



NAV2916

VISUAL GUIDANCE SETTINGS

1. Highlight [Guidance Screen Default] and push **<ENTER>**.
2. The indicator of the selected type of guidance illuminates.

Intersection Map: Enlarged intersection view



INFO:

Push **<MAP>** to switch to the full map screen.

Turn list: Right/Left turn list



INFO:

- Turn list can be scrolled using the joystick.
- Pushing **<MAP>** toggles between the full map screen and enlarged intersection view.

VOICE GUIDANCE SETTINGS

You can set how many times voice guidance is repeated.



NAV2917



NAV2918

1. Highlight [Voice Announcements] and push **<ENTER>**.
2. Highlight [Twice] or [Three Times] and push **<ENTER>**.
The indicator for the selected number of repetitions illuminates.
3. Push **<MAP>** to return to the current location map screen.

SET AVERAGE SPEEDS

You can calculate the required time to the destination based on the set vehicle speeds.

Basic operation

1. Highlight [Set Average Speeds] and push **<ENTER>**.
2. Highlight the preferred item and push **<ENTER>**.
3. Use the joystick to make an adjustment. The speed can be increased/decreased by 5 MPH (5 km/h).
4. After finishing the setting, push **<ENTER>** or **<BACK>/<PREV>** to activate the setting.
5. Push **<BACK>/<PREV>** to return to the previous screen. Push **<MAP>** to return to the current location map screen.



NAV2919

Available setting items

- Auto:
If set to ON, the system automatically calculates the required time to the destination, the indicator illuminates and the speed settings cannot be changed.
- Freeway:
Allows you to adjust the average vehicle speed on a freeway by moving the joystick in the direction of [+] or [-].
- Main Road:
Allows you to adjust the average vehicle speed on a main road by moving the joystick in the direction of [+] or [-].
- Town Road:
Allows you to adjust the average vehicle speed on a town road by moving the joystick in the direction of [+] or [-].
- Residential:
Allows you to adjust the average vehicle speed in a residential area by moving the joystick in the direction of [+] or [-].

- Reset:
Sets the average vehicle speeds to the default values.

DELETING/REACTIVATING A ROUTE

You can delete a route already set at any time. If you delete a route, the destination and waypoints are also deleted.

It is also possible to reactivate the route that you deleted.

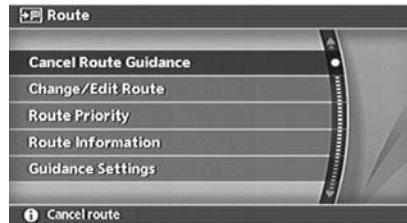

NAV2920



NAV2921

DELETING A ROUTE

1. Highlight [Cancel Route Guidance] and push **<ENTER>**.
2. A confirmation message is displayed. Highlight [Yes] and push **<ENTER>**.
The route is deleted along with the destination and waypoints.

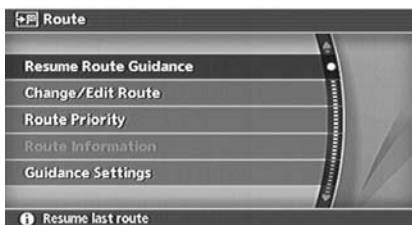

NAV2922



NAV2923

REACTIVATING A ROUTE

1. Highlight [Resume Route Guidance] and push **<ENTER>**.

2. A confirmation message is displayed. Highlight [Yes] and push **<ENTER>**.
The route you have deleted is reactivated.

INFO:

If you set a new route, the deleted route cannot be reactivated.

6 Storing a location/route

Storing a location.....	6-2	Minor adjustment of the stored home and locations	6-17
Storing a location by searching	6-2	Editing the stored route	6-25
Storing the current vehicle location.....	6-5	Editing the stored tracking.....	6-26
Storing a location by moving the map	6-6	Editing the avoid area	6-27
Avoid area settings.....	6-7	Deleting a stored item.....	6-28
Storing a route	6-12	Deleting a stored item individually	6-28
Storing a tracked route.....	6-14	Deleting an individual item on the map.....	6-30
Editing the address book	6-15	Deleting all stored items	6-31
Basic operation	6-15	Customizing nearby places.....	6-33
Editing the stored home and location.....	6-16		

STORING A LOCATION

Locations that you often visit can be stored in the Address Book. The stored locations can be easily retrieved to set them as a destination or waypoint.

INFO:

- The Address Book can store up to 100 locations.
- New information placed in the same storage position will overwrite the old data.

STORING A LOCATION BY SEARCHING

After you have searched for a location as previously described, you can store the location for future use.

1. Push **<SETTING>**.

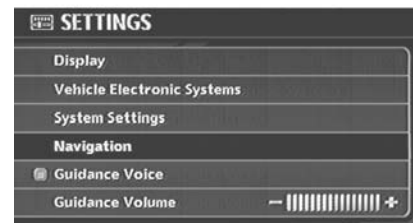

NAV3055

Armada, Maxima, Murano, Pathfinder, Quest, Titan



NAV3029

350Z

2. Highlight [Navigation] and push **<ENTER>**.



NAV2930



NAV2931

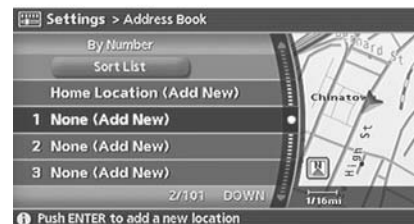

NAV2932

3. Highlight [Address Book] and push **<ENTER>**.
4. Highlight [Stored Location] and push **<ENTER>**.
5. Highlight [Home Location (Add New)] or [None (Add New)] and push **<ENTER>**.

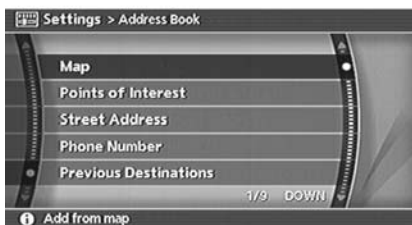

NAV2933



NAV2934

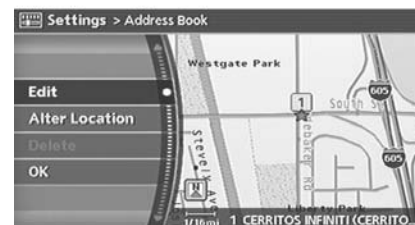

NAV2935

6. Highlight the appropriate method to search for a location and push **<ENTER>**.
 "4. Setting a destination"

7. When your preferred location is displayed at the center of the map, confirm the location and push **<ENTER>**.
 A message is displayed, and the location is stored in the Address Book.

8. Adjust the location of the stored item and edit the contents of the stored item as necessary.
 After finishing the setting, highlight [OK] and push **<ENTER>**.

 **INFO:**

You can adjust a location by selecting [Alter Location] using the same method as the one for a destination.

-  "ADJUSTING THE LOCATION OF THE DESTINATION" (page 4-51)



NAV2924



NAV2925



NAV2926

STORING THE CURRENT VEHICLE LOCATION

1. Push **<ENTER>** at the current vehicle location.

2. Highlight [Store Location] and push **<ENTER>**.
A message is displayed, and the current vehicle location is stored in the Address Book.

INFO:

The location is stored in the first available position number in the Address Book list.

3. Push **<MAP>** or **<BACK>/<PREV>** to return to the current location map screen. The icon representing the stored location is displayed on the map.



NAV2927

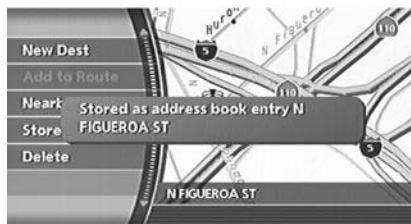

NAV2928



NAV2929

STORING A LOCATION BY MOVING THE MAP

1. Move to the preferred location on the map and push **<ENTER>**.

2. Highlight [Store Location] and push **<ENTER>**.
A message is displayed, and the location is stored in the Address Book.

INFO:

The location is stored in the first available position number in the Address Book list.

3. Push **<MAP>** to return to the current location map screen.
The icon representing the stored location is displayed on the map.

AVOID AREA SETTINGS

An Avoid Area can be stored.

The Avoid Area is an area that you want to exclude from a route, such as a road that is always congested.

Once you store Avoid Areas, the system avoids those areas when calculating a route.

Up to 5 Avoid Areas can be stored.

1. Push **<SETTING>**.

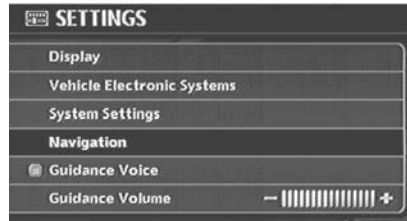

NAV3055

Armada, Maxima, Murano, Pathfinder, Quest, Titan

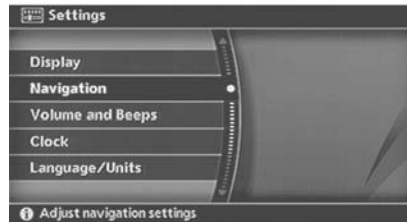

NAV3029

350Z

2. Highlight [Navigation] and push **<ENTER>**.



NAV2936

3. Highlight [Avoid Area Settings] and push **<ENTER>**.

INFO:

You can also access and store an Avoid Area from the Address Book.



NAV2937

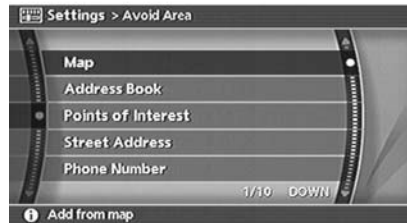

NAV2938



NAV2939

4. Highlight [None (Add New)] and push **<ENTER>**.

INFO:

A maximum of 5 Avoid Areas can be stored.
 "DELETING A STORED ITEM"
 (page 6-28)

5. Highlight the appropriate method to search for a location and push **<ENTER>**.
 "4. Setting a destination"

6. Set the following items for the searched location.

Available setting items

- Rename
- Alter Location
- Resize Area
- FWY
- Delete

7. After finishing the setting, highlight [OK] and push **<ENTER>**.



NAV2940

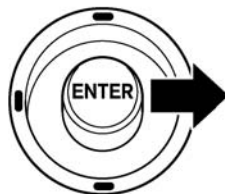

Rename

1. A character input screen is displayed.
2. Enter the preferred name.
3. Highlight [OK] and push **<ENTER>**.

NAI0419

Alter Location

1. Using the joystick, adjust the location of the Avoid Area.
2. After adjusting the location, push **<ENTER>**.

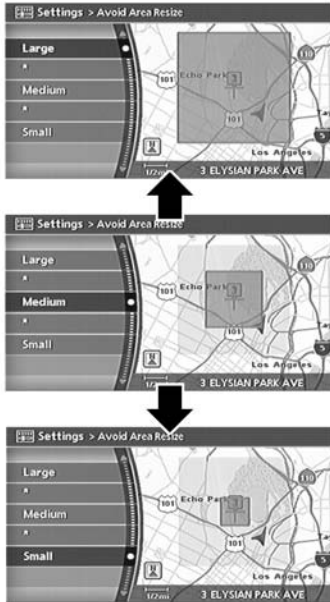

NAV2941

Resize Area

Select the range from 5 available levels.

After selecting the range, push **<ENTER>**.



INFO:

Push **<ZOOM IN>** (⊕) or **<ZOOM OUT>** (⊖) to change the scale of the map.



NAV2942



NAV2943

FWY

If you want to include freeways in the Avoid Area, push **<ENTER>** to illuminate this indicator.

The Avoid Area is displayed in green if it includes a freeway or in blue if it does not include freeways.

INFO:

If you set an Avoid Area at the current vehicle location, the system will not provide route guidance.

STORING A ROUTE

A calculated route can be stored.

A maximum of 5 routes can be stored.

Stored routes can be easily retrieved and set as the suggested route.



INFO:

Stored route includes only locations (destination and waypoints) and route calculation conditions, not the route itself.

1. Push **<ROUTE>**.

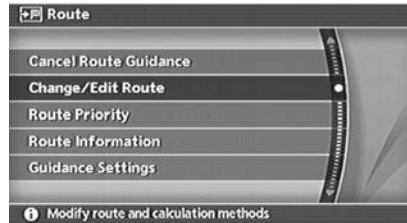

NAV2944

2. Highlight [Change/Edit Route] and push **<ENTER>**.

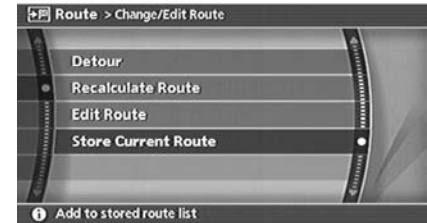

NAV2945

3. Highlight [Store Current Route] and push **<ENTER>**.

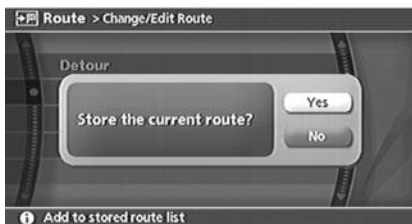

NAV2946

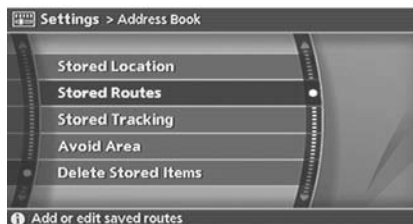

NAV2947

4. A confirmation message is displayed. Confirm the contents of the message, highlight [Yes] and push **<ENTER>**. The current route is stored.

INFO:

You can also store a route using the following procedure.

- 1) Push **<SETTING>**.
- 2) Highlight [Navigation] and push **<ENTER>**.
- 3) Highlight [Address Book] and push **<ENTER>**.
- 4) Highlight [Stored Routes] and push **<ENTER>**.
- 5) Highlight [None (Add New)] and push **<ENTER>**.

INFO:

- The route is stored in the first available position number in the store current route list.
- A maximum of 5 routes can be stored.
 - ☞ “DELETING A STORED ITEM” (page 6-28)
- If you have not set any waypoints on the route, the route cannot be stored.

STORING A TRACKED ROUTE

You can store the route you have traveled up to the current location. A maximum of 5 tracked routes can be stored.

A tracked route must not exceed 12 miles (20 km) in distance.

The stored tracked route can be displayed on the map as necessary.

1. Push **<ENTER>**.

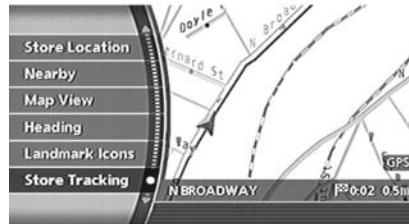

NAV2948

2. Highlight [Store Tracking] and push **<ENTER>**.

INFO:

A maximum of 5 tracked routes can be stored.

 "DELETING A STORED ITEM"
(page 6-28)

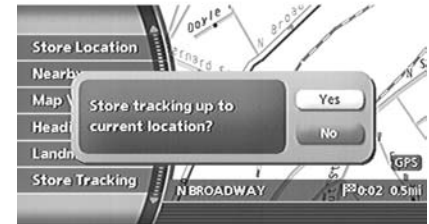

NAV2949

3. A confirmation message is displayed. Confirm the contents of the message, highlight [Yes] and push **<ENTER>**. The tracked route you have traveled is stored.
4. Push **<MAP>** or **<BACK>/<PREV>** to return to the current location map screen.

INFO:

The tracked route is stored in the first available position number in the store tracking list.

EDITING THE ADDRESS BOOK

Items stored in the Address Book can be modified. You can edit these settings to make the navigation system more useful.

BASIC OPERATION

1. Push **<SETTING>**.
2. Highlight [Navigation] and push **<ENTER>**.
3. Highlight [Address Book] and push **<ENTER>**.
4. Highlight the preferred item and push **<ENTER>**.
5. Push **<BACK>/<PREV>** to return to the previous screen. Push **<MAP>** to return to the current location map screen.

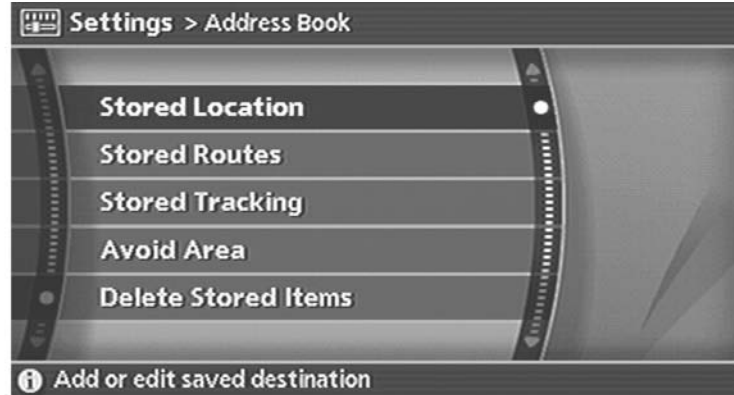

NAV2950

Available items

- **Stored Location:**
Edits the information of a stored home and location.
👉 "EDITING THE STORED HOME AND LOCATION" (page 6-16)
- **Stored Routes:**
Edits the information of a stored route.
👉 "EDITING THE STORED ROUTE" (page 6-25)
- **Stored Tracking:**
Edits the information of a stored tracked route.
👉 "EDITING THE STORED TRACKING" (page 6-26)
- **Avoid Area:**
Edits the information of a stored Avoid Area.
👉 "EDITING THE AVOID AREA" (page 6-27)

- Delete Stored Items:
Deletes a stored location or route.
☞ “DELETING ALL STORED ITEMS”
(page 6-31)

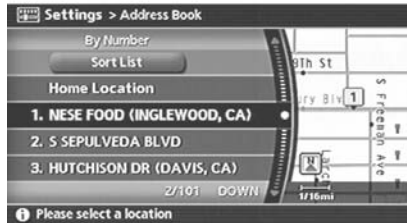

NAV2951

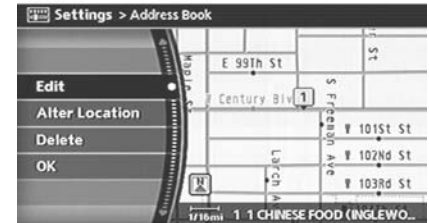

NAV2952

EDITING THE STORED HOME AND LOCATION

1. Highlight the preferred stored home location or stored location and push **<ENTER>**.

INFO:

Selecting [Sort List] displays a list of various sort functions.

To use the sort functions, stored locations must be set in advance.

- ☞ “MINOR ADJUSTMENT OF THE STORED HOME AND LOCATIONS”
(page 6-17)

2. Highlight the preferred item and push **<ENTER>**.

Available setting items

- Edit:
Edits the stored location information.
- Alter Location:
Adjusts the location of the stored location.
- Delete:
Deletes the stored location.
- OK:
Applies the settings.

MINOR ADJUSTMENT OF THE STORED HOME AND LOCATIONS

When you select [Edit], you can edit the following items of the home or stored location.

- Show Icon on Map
- Name (only for stored locations)
- Icon
- Sound
- Direction
- Distance
- Phone No.
- Group (only for stored locations)
- Entry Number (only for stored locations)



NAV2953

Show Icon on Map

Displays the home icon or the stored location icon on the map.

1. Highlight [Show Icon on Map] and push **<ENTER>**.
2. The indicator illuminates when the item is set. Then the system displays the icon on the map.



NAV2954

Name (only for stored locations)

Changes the name of a stored location.

1. Highlight [Name] and push **<ENTER>**.
A character input screen is displayed.



NAV2955



NAV2956



NAV2957

2. Enter the preferred name for the stored location.
 ☞ "CHARACTER (letter and number) INPUT SCREEN" (page 2-24)
3. Highlight [OK] and push **<ENTER>**.
 The name is stored.

Icon

Changes the icon of the home or stored location to the preferred one. By changing the icons, you can utilize the [By Icon] option of the sort function more effectively.

1. Highlight [Icon] and push **<ENTER>**.
 A list of icons is displayed.

2. Highlight the preferred icon by scrolling the list using the joystick. Then push **<ENTER>**.

Icon List:



NAI0420



NAV2958



NAV2959

Sound

Sets the tone of the arrival alarm that sounds when the vehicle approaches the home or a stored location.

1. Highlight [Sound] and push **<ENTER>**.
A sound list is displayed.

2. Highlight the preferred alarm tone by scrolling the list using the joystick. Then push **<ENTER>**.
The indicator of the selected alarm tone illuminates.

Sound list:

None
Chime
Melody
Sound
Dog
Cat
Wave
Church bell
Music box 1
Music box 2
Marimba
Trumpet
Horn
Scratch



NAV2960

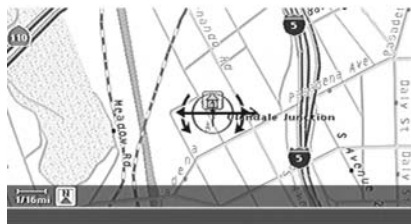

NAV2961



NAV2962

Direction

Sets the alarm to sound when approaching from a specific direction.

1. Highlight [Direction] and push **<ENTER>**.
The home or stored location is displayed at the center of the map.

2. Set the direction that sounds the alarm using the joystick. Then push **<ENTER>**.
The selected direction is set.

INFO:

After the direction is set, if you highlight [Direction] and push **<ENTER>** once again, a confirmation message is displayed. Confirm the contents of the message, highlight [Yes] and push **<ENTER>**.
The set direction is cancelled.

Distance

Sets the alarm to sound when reaching a specific distance to the home or stored location.

1. Highlight [Distance] and push **<ENTER>**.

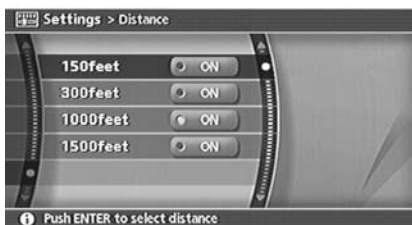

NAV2963

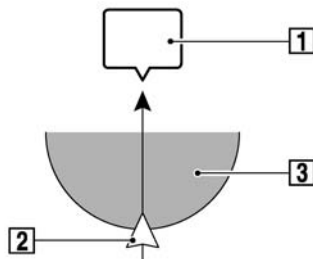

NAI0421

INFO:

Once you set the direction and distance to sound an alarm, the system will sound the alarm when the vehicle icon passes a half circle outline on the map, as shown in the figure.
 Example: Set to 300 feet (100 m) distance, upward direction

- 1 Stored location icon
- 2 Vehicle icon
- 3 Setting range

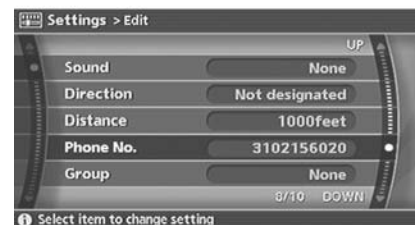

NAV2964

Phone No.

Stores the telephone number of the home or a stored location.

1. Highlight [Phone No.] and push **<ENTER>**. The telephone number entry screen is displayed.



NAV2965

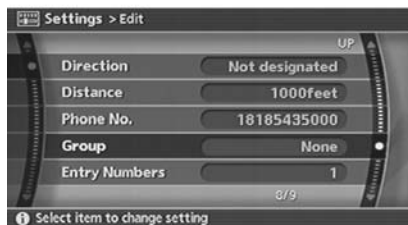

NAV2966



NAV2967

2. Enter the telephone number of the home or stored location.
 "PHONE NUMBER INPUT SCREEN" (page 2-26)
3. Highlight [OK] and push **<ENTER>**.
 The telephone number is stored.

 **INFO:**

If the phone number of your home or a location is stored, the phone number can be used to search for the destination even if it is not included in the map DVD-ROM data.

Group (only for stored locations)

This allows you to group the stored locations. By grouping the stored locations, you can utilize the [By Group] option of the sort function more effectively.

1. Highlight [Group] and push **<ENTER>**.

2. Highlight the preferred group and push **<ENTER>**.
 When the indicator of the selected group illuminates, the stored location is classified into the applicable group.



NAV2968



NAV2969

Entry Number (only for stored locations)

Swaps the position numbers of any two stored locations in the list.

1. Highlight [Entry Number] and push **<ENTER>**.

A list of stored locations is displayed.

2. Highlight the stored locations you want to swap and push **<ENTER>**.
The position numbers of the selected stored locations are swapped.



NAV2970

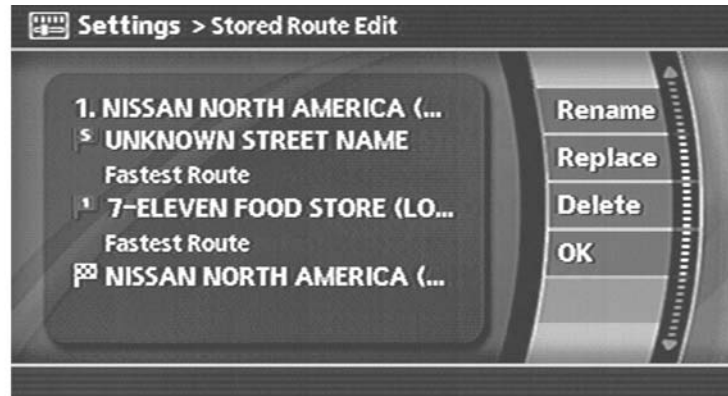

NAV2971

EDITING THE STORED ROUTE

1. Highlight the preferred stored route and push **<ENTER>**.
2. Tilt the joystick to the right to select the Edit screen. The setting items are highlighted.
3. Highlight the preferred item and push **<ENTER>**.
4. After finishing the setting, highlight [OK] and push **<ENTER>**.

INFO:

If you select [None (Add New)], the system stores the current route.

Available setting items

- Rename:
Changes the name.
 "CHARACTER (letter and number) INPUT SCREEN" (page 2-24)
- Replace:
Overwrites the stored route to the current route.
- Delete:
Deletes the stored route.
- OK:
Applies the settings.



NAV2972

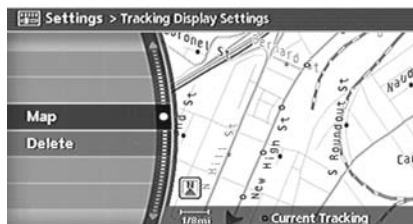

NAV2973

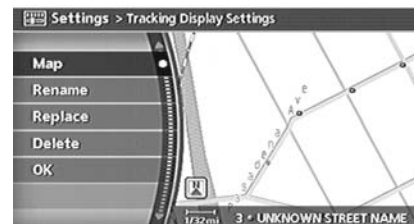

NAV2974

EDITING THE STORED TRACKING

1. Highlight the preferred stored tracked route and push **<ENTER>**. The [Show] indicator for the stored tracked route illuminates, and the route is displayed on the map. Tilt the joystick to the right to highlight [Edit].

INFO:

- Current tracking is displayed up to 62 miles (100 km).
- Stored tracking is displayed up to 12 miles (20 km).

2. Highlight the preferred item and push **<ENTER>**.

Available setting items (Current tracking)

- Map:
Displays the tracked route up to the current location.
- Delete:
Deletes the tracked route up to the current location.

Available setting items (Stored tracked routes)

- Map:
Displays a stored tracked route on the map.
- Rename:
Changes the name.
 "CHARACTER (letter and number) INPUT SCREEN" (page 2-24)
- Replace:
Overwrites the stored tracked route to the current tracked route.
- Delete:
Deletes the stored tracked route.
- OK:
Applies the settings.

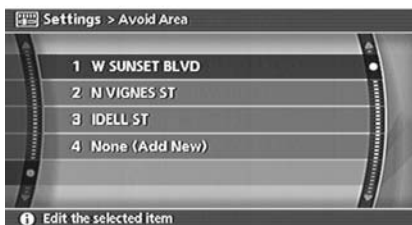

NAV2975

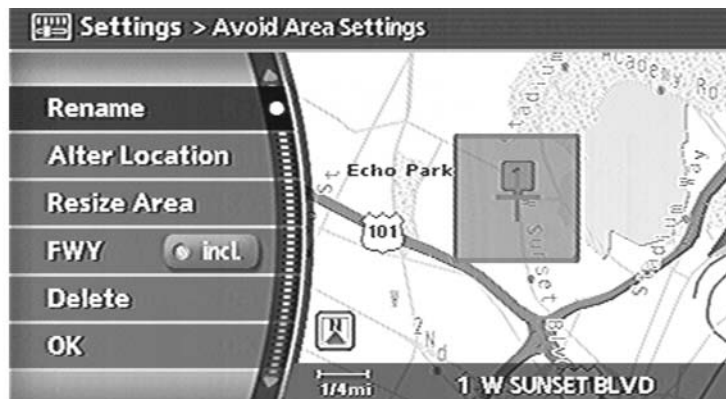

NAV2976

EDITING THE AVOID AREA

1. Highlight the preferred Avoid Area and push **<ENTER>**.
2. Highlight the preferred item and push **<ENTER>**.
The setting method is the same as the one for the Avoid Area setting.
 "AVOID AREA SETTINGS"
(page 6-7)

INFO:

If you select [None (Add New)], you can add an Avoid Area.

 "AVOID AREA SETTINGS" (page 6-7)

Available setting items

- **Rename:**
Changes the name.
- **Alter Location:**
Adjusts the location of the Avoid Area.
- **Resize Area:**
Adjusts the range of the Avoid Area.
- **FWY:**
Avoids freeways.
- **Delete:**
Deletes the stored Avoid Area.
- **OK:**
Applies the settings.

DELETING A STORED ITEM

You can delete locations and routes stored in the Address Book.

Two deletion methods are available, deleting an individual item and deleting all stored items.



NOTE:

Deleted items cannot be restored. Before deleting an item, always make sure that the item is truly not necessary.

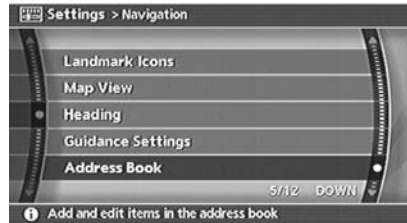

NAV2977

DELETING A STORED ITEM INDIVIDUALLY

1. Highlight [Address Book] and push **<ENTER>**.

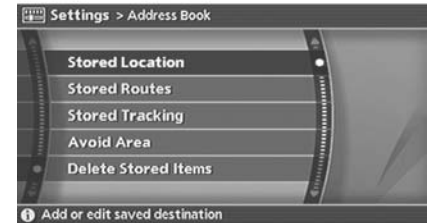

NAV2978

- Example: [Stored Location] is selected
2. Highlight the preferred item for deletion and push **<ENTER>**.

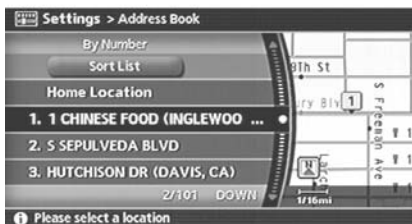

NAV2979

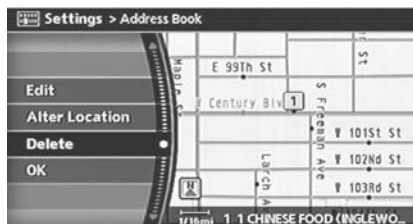

NAV2980



NAV2981

3. Highlight the preferred location/route for deletion and push **<ENTER>**.
4. Highlight [Delete] and push **<ENTER>**.
5. A confirmation message is displayed. Confirm the contents of the message, highlight [Yes] and push **<ENTER>**. The stored item is deleted from the Address Book.

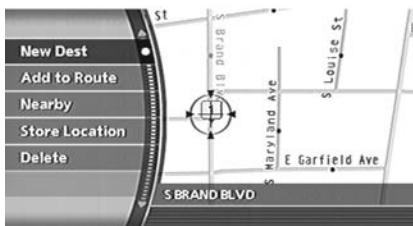

NAV2982

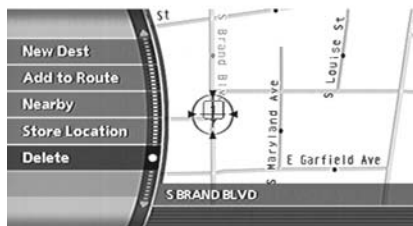

NAV2983



NAV2984

DELETING AN INDIVIDUAL ITEM ON THE MAP

1. Align the cross pointer over the preferred stored location for deletion by moving on the map. Then push **<ENTER>**.

2. Highlight [Delete] and push **<ENTER>**.

3. A confirmation message is displayed. Confirm the contents of the message, highlight [Yes] and push **<ENTER>**. The stored item is deleted from the Address Book.

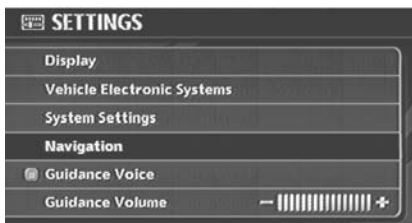

NAV3055



NAV2930



NAV2985

Armada, Maxima, Murano, Pathfinder, Quest, Titan

2. Highlight [Address Book] and push **<ENTER>**.
3. Highlight [Delete Stored Items] and push **<ENTER>**.



NAV3029

350Z

DELETING ALL STORED ITEMS

1. Highlight [Navigation] and push **<ENTER>**.



NAV2986

4. Highlight the preferred item for deletion and push **<ENTER>**.

Items that can be deleted

- Delete Home Location:
Deletes the home location.
- Delete Stored Locations:
Deletes all stored locations.
- Delete Stored Routes:
Deletes all stored routes.
- Delete Current Tracking:
Deletes the current tracked route.
- Delete Stored Tracking:
Deletes all stored tracked routes.
- Delete Avoid Areas:
Deletes all stored Avoid Areas.
- Delete Previous Destinations:
Deletes all previous destinations.
- Delete Previous Starting Point:
Deletes the previous starting point.



NAV2987

5. A confirmation message is displayed. Confirm the contents of the message, highlight [Yes] and push **<ENTER>**. The stored items are deleted from the Address Book.

CUSTOMIZING NEARBY PLACES

You can change the categories used for searching facilities nearby.

The modified list of facilities can be used for searching for a location using [Nearby Places].

 "SETTING A NEARBY PLACE"
(page 4-47)

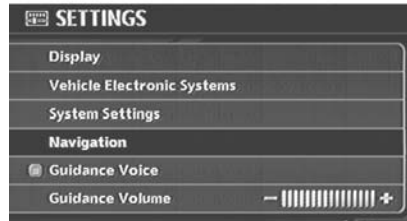

NAV3055

Armada, Maxima, Murano, Pathfinder, Quest, Titan



NAV3029

350Z

1. Highlight [Navigation] and push **<ENTER>**.



NAV2988

2. Highlight [Nearby Places Custom Settings] and push **<ENTER>**.



NAV2989



NAV2990



NAV2991

3. Highlight the preferred item and push **<ENTER>**.
The main category list is displayed.
4. Highlight a main category and push **<ENTER>**.
The sub category list is displayed.
5. Highlight a sub category and push **<ENTER>**.
The category setting is modified.
6. Push **<MAP>** to return to the current location map screen.

7 Viewing technical information

Information screen (350Z only).....	7-2	Viewing GPS current location information	7-4
Basic operation	7-2	Basic operation	7-4
Viewing information about current vehicle location.....	7-3	Viewing navigation system version information.....	7-5
Basic operation	7-3	Basic operation	7-5



INFORMATION SCREEN (350Z only)

This screen allows you to set or view various information that is helpful for using the vehicle safely and comfortably, such as maintenance information, current location information, GPS information and map DVD version.



BASIC OPERATION

1. Push **<INFO>**.
2. Highlight the preferred item and push **<ENTER>**.



NAV2992

Available items

- Maintenance:
Refer to the Owner's Manual of your vehicle.
- Where am I?:
 "VIEWING INFORMATION ABOUT CURRENT VEHICLE LOCATION"
(page 7-3)
- GPS Satellite Info:
 "VIEWING GPS CURRENT LOCATION INFORMATION" (page 7-4)
- Navigation Versions:
 "VIEWING NAVIGATION SYSTEM VERSION INFORMATION"
(page 7-5)

VIEWING INFORMATION ABOUT CURRENT VEHICLE LOCATION

This allows you to display the information about the vehicle location on the route when driving according to route guidance.

BASIC OPERATION

Armada, Maxima, Murano, Pathfinder, Quest, Titan:

1. Push **<ROUTE>**.
2. Highlight [Route Information] and push **<ENTER>**.
3. Highlight [Where am I?] and push **<ENTER>**.
4. Push **<BACK>/<PREV>** to return to the previous screen.
Push **<MAP>** to return to the current location map screen.

350Z:

1. Push **<INFO>**.
2. Highlight [Where am I?] and push **<ENTER>**.
3. Push **<BACK>** to return to the previous screen.
Push **<MAP>** to return to the current location map screen.



NAV2993

Contents of vehicle location information

- 1** Next Street:
Displays the next street on the route.
- 2** Current Street:
Displays the current street on the route.
- 3** Previous Street:
Displays the previous street on the route.

- 4** Displays the distance to the next intersection on the route.
- 5** Displays the distance traveled from the previous intersection on the route.

VIEWING GPS CURRENT LOCATION INFORMATION

This allows you to display GPS information, such as the positioning status, latitude/longitude, altitude and satellite locations.

BASIC OPERATION

Armada, Maxima, Murano, Pathfinder, Quest, Titan:

1. Push **<SETTING>**.
2. Highlight [Navigation] and push **<ENTER>**.
3. Highlight [GPS Satellite Info] and push **<ENTER>**.
4. Push **<BACK>/<PREV>** to return to the previous screen.
Push **<MAP>** to return to the current location map screen.

350Z:

1. Push **<INFO>**.
2. Highlight [GPS Satellite Info] and push **<ENTER>**.
3. Push **<BACK>** to return to the previous screen.
Push **<MAP>** to return to the current location map screen.

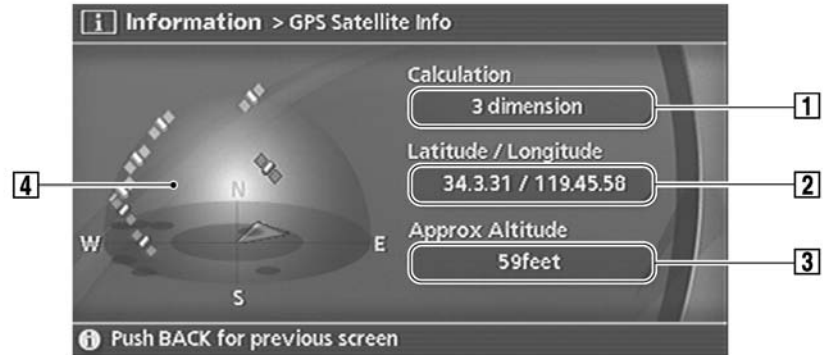

NAV2994



Contents of GPS information

- 1 Calculation:
Displays the GPS positioning method.

3-dimension	Calculating the latitude, longitude and altitude by four or more satellites.
2-dimension	Calculating the latitude, longitude and altitude by three or more satellites.
Out of range	Cannot calculate because no GPS satellites can be located.

VIEWING NAVIGATION SYSTEM VERSION INFORMATION

- 2 Latitude/Longitude:
Displays the latitude/longitude.
- 3 Approx Altitude:
Displays the approximate altitude.
- 4 Positioning status:

	It indicates that satellites are available.
	It indicates that satellites are being searched for.



NAV2995

This allows you to display the map DVD-ROM version information.

BASIC OPERATION

Armada, Maxima, Murano, Pathfinder, Quest, Titan:

1. Push **<SETTING>**.
2. Highlight [Navigation] and push **<ENTER>**.
3. Highlight [Navigation Versions] and push **<ENTER>**.
4. Push **<BACK>/<PREV>** to return to the previous screen.
Push **<MAP>** to return to the current location map screen.

350Z:

1. Push **<INFO>**.
2. Highlight [Navigation Versions] and push **<ENTER>**.
3. Push **<BACK>** to return to the previous screen.
Push **<MAP>** to return to the current location map screen.

MEMO

8 Other settings

Settings screen (Armada, Maxima, Murano, Pathfinder, Quest, Titan)	8-2	Display settings	8-13
Basic operation	8-2	Volume adjustment	8-16
Display settings	8-3	Clock settings	8-17
System settings screen	8-6	Language and unit settings.....	8-19
Language and unit settings.....	8-7	Map color settings.....	8-22
Clock settings	8-10	Adjusting the current vehicle location.....	8-23
Setting screen (350Z).....	8-12	Reset all navigation settings to default	8-25
Basic operation	8-12		



SETTINGS SCREEN (Armada, Maxima, Murano, Pathfinder, Quest, Titan)

The navigation system can be customized to make it easier for you to use.

BASIC OPERATION

1. Push **<SETTING>**.
2. Highlight the preferred setting item and push **<ENTER>**.

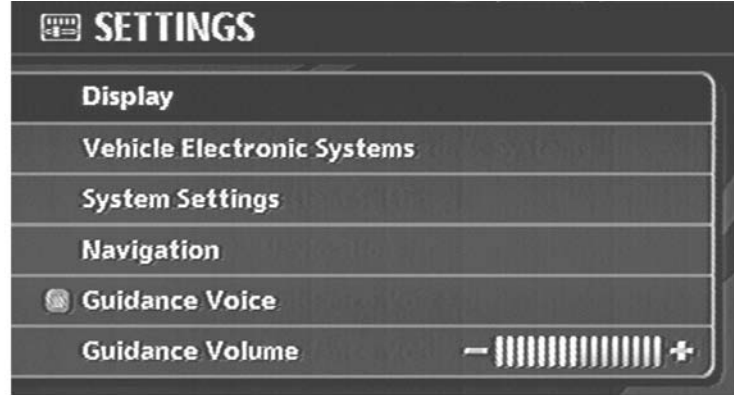

NAV3056

Available setting items

- Display:
👉 "DISPLAY SETTINGS" (page 8-3)
- Vehicle Electronic Systems:
Refer to the Owner's Manual of your vehicle.
- System Settings:
Allows you to adjust the time setting, language/measurement unit setting and ON/OFF setting of beeps used in the system.
- Navigation:
Allows you to adjust various settings of the navigation system. Refer to the instructions in the relevant sections.
- Guidance Voice:
Select to toggle the voice guidance function between on and off. The indicator light illuminates when the voice guidance function is set to on.

- Guidance Volume:
Adjust the volume level of voice guidance by tilting the joystick in the direction of [+] or [-].

DISPLAY SETTINGS

This menu allows you to turn on and off the display and adjust the image quality.

Basic operation

1. Highlight [Display] and push **<ENTER>**.
2. Highlight the preferred adjustment item and push **<ENTER>**.
3. Use the joystick to adjust to the preferred setting.
4. After setting, push **<ENTER>** or **<BACK>**/**<PREV>** to apply the setting.
5. Push **<BACK>**/**<PREV>** to return to the previous screen. Push **<MAP>** to return to the current location map screen.

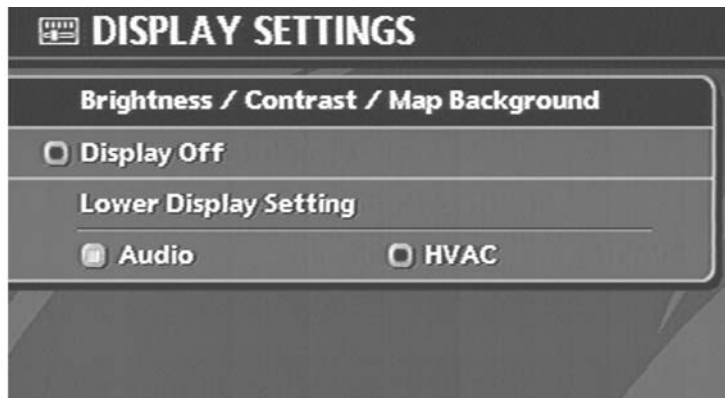

NAV2997

Available setting items

- Brightness/Contrast/Map Background:
Allows you to adjust the screen brightness and contrast, and set the background color.
- Display off:
Allows you to turn on/off the screen.
👉 "Display off" (page 8-4)
- Lower Display Setting:
Refer to the Owner's Manual of your vehicle.

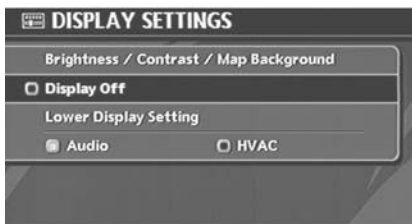

NAV2998



NAV2999

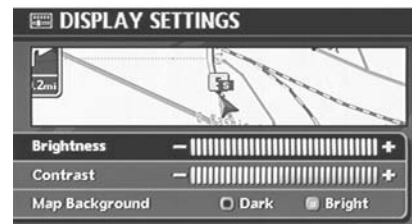

NAV3000

Display off

To turn off the display, push **<ENTER>** and turn the [Display off] indicator on.

When any button is pushed with the display off, the display turns on. The display will automatically turn off 5 seconds after the operation is finished.

To return to the previous screen, push **<SETTING>**, highlight [Display] and push **<ENTER>** to turn off the indicator.

Brightness

Adjust the display brightness by tilting the joystick in the direction of [+] or [-].



INFO:

The preview of the map screen is displayed on the upper portion of the screen, if the previous screen showed a map.

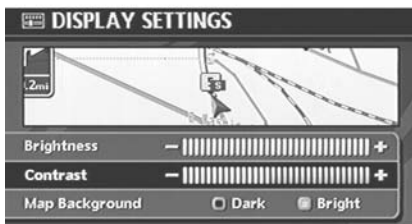

NAV3001

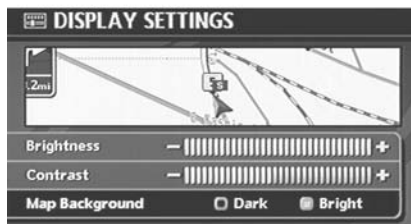

NAV3002

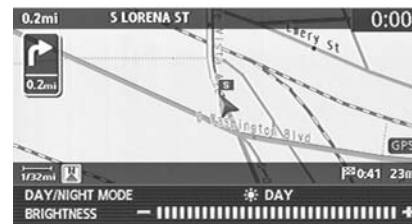

NAV3003

Bright background color

Contrast

Adjust the display contrast by tilting the joystick in the direction of [+] or [-].

INFO:

The preview of the map screen is displayed on the upper portion of the screen, if the previous screen showed a map.

Map Background

Select the background color from bright color or dark color.

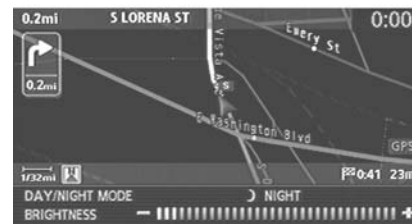

NAV3004

Dark background color

SYSTEM SETTINGS SCREEN

Allows you to set system settings such as language/measurement unit setting.

Basic operation

1. Highlight [System Settings] and push **<ENTER>**.
2. Highlight the preferred adjustment item and push **<ENTER>**.
3. Push **<BACK>/<PREV>** to return to the previous screen. Push **<MAP>** to return to the current location map screen.

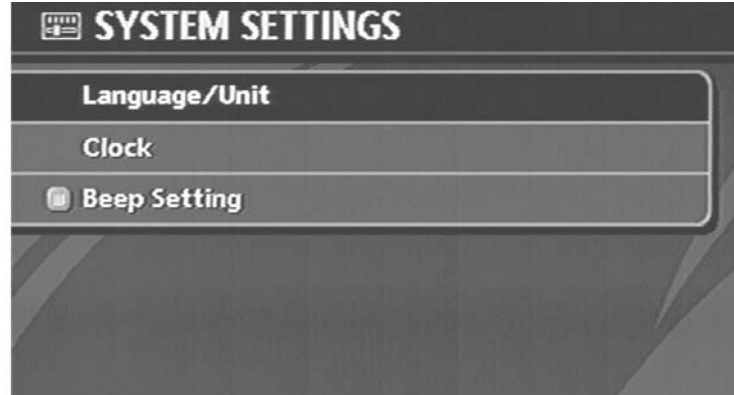

NAV3030

Available setting items

- Language/Unit:
👉 "LANGUAGE AND UNIT SETTINGS" (page 8-7)
- Clock:
👉 "CLOCK SETTINGS" (page 8-10)
- Beep Setting:
Select to toggle the beep function between on and off. The indicator light illuminates when the beep function is set to on. The beep that sounds when pushing and holding a button or when a prohibited operation is performed cannot be set to off.

LANGUAGE AND UNIT SETTINGS

This allows you to change the language and measurement unit used in the system.

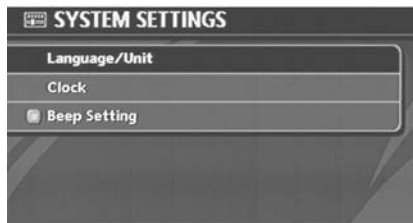

NAV3031



NAV3032

Language settings

1. Highlight [Language/Units] and push **<ENTER>**.
2. Highlight the preferred setting item and push **<ENTER>**. The indicator light of the selected item illuminates.
Available languages
 - English
 - Français

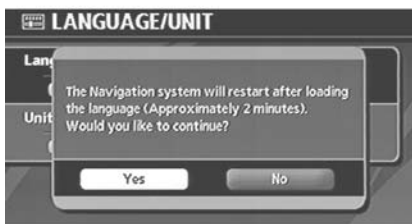

NAV3033

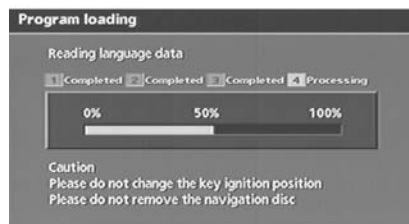

NAV3034

3. A message is displayed. Confirm the contents of the message. After confirming the message, highlight [Yes] and push **<ENTER>**.
4. The program loading screen is displayed, and the system initiates language setting. Upon completion, the start-up screen is automatically displayed.



CAUTION

Do not change the ignition switch position while changing the language. Doing so may cause a system malfunction.

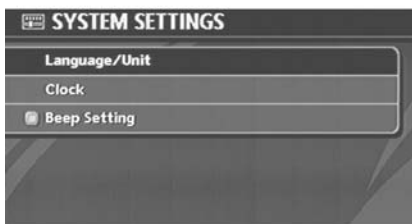

NAV3031



NAV3035

Unit settings

1. Highlight [Language/Units] and push **<ENTER>**.
2. Highlight [Unit] and tilt the joystick to the right or left or push **<ENTER>** to highlight the preferred unit.
The indicator of the selected unit illuminates.
Available units
 - US:
mile, MPH, °F, MPG
 - Metric:
km, km/h, °C, L/100 km
3. Push **<BACK>/<PREV>** to return to the previous screen.
Push **<MAP>** to return to the current location map screen.

CLOCK SETTINGS

This allows you to change the clock settings.

Basic operation

1. Highlight [Clock] and push **<ENTER>**.
2. Highlight the preferred adjustment item.
3. Use the joystick to adjust to the preferred setting.
4. After setting, push **<ENTER>** or **<BACK>/<PREV>** to apply the setting.
5. Push **<BACK>/<PREV>** to return to the previous screen. Push **<MAP>** to return to the current location map screen.

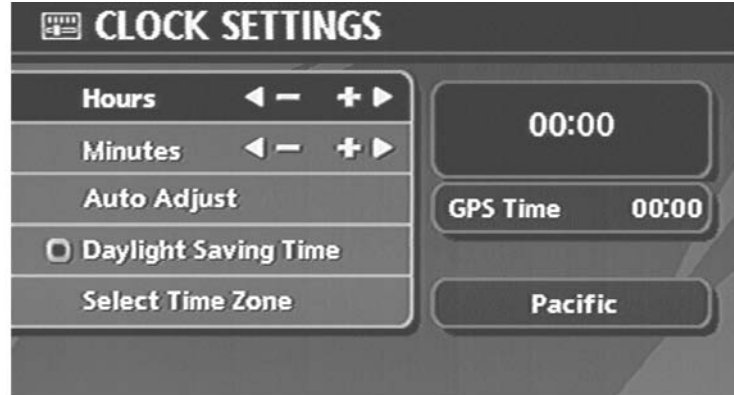

NAV3036

Setting items

- Hour:
Set the hour.
Adjust the hour by tilting the joystick in the direction of [+] or [-].
- Minutes:
Set the minutes.
Adjust the minutes by tilting the joystick in the direction of [+] or [-].
- Auto Adjust:
The time currently set is reset to the GPS time.
- Daylight Saving Time:
Select to toggle the daylight saving time setting between on and off. The indicator light illuminates when the daylight saving time setting is set on.

- Select Time Zone:
Select an appropriate time zone from the list that appears when you select this item.
 - Pacific
 - Mountain
 - Central
 - Eastern
 - Atlantic
 - Newfoundland

SETTING SCREEN (350Z)

The navigation system can be customized to make it easier for you to use.

BASIC OPERATION

1. Push **<SETTING>**.
2. Highlight the preferred setting item and push **<ENTER>**.

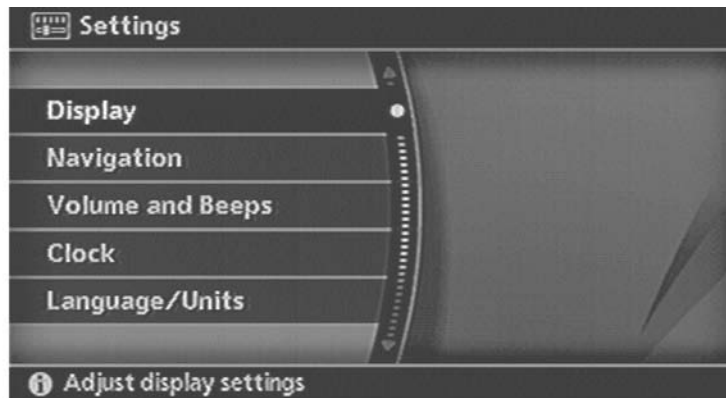

NAV3037

Available setting items

- Display:
👉 "DISPLAY SETTINGS" (page 8-13)
- Navigation:
Allows you to adjust various settings of the navigation system. Refer to the instructions in the relevant sections.
- Volume and Beeps:
👉 "VOLUME ADJUSTMENT" (page 8-16)
- Clock:
👉 "CLOCK SETTINGS" (page 8-17)
- Language/Unit:
👉 "LANGUAGE AND UNIT SETTINGS" (page 8-19)

DISPLAY SETTINGS

This menu allows you to turn on and off the display and adjust the image quality.

Basic operation

1. Highlight [Display] and push **<ENTER>**.
2. Highlight the preferred adjustment item and push **<ENTER>**.
3. Use the main directional buttons or the center dial to adjust to the preferred setting.
4. After setting, push **<ENTER>** or **<BACK>** to apply the setting.
5. Push **<BACK>** to return to the previous screen. Push **<MAP>** to return to the current location map screen.

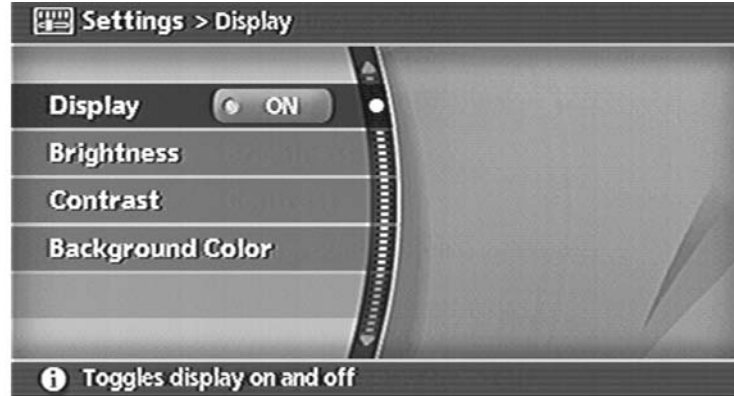

NAV3038

Available setting items

- Display
Allows you to turn on/off the screen.
☞ "Display" (page 8-14)
- Brightness
Allows you to adjust the screen brightness.
☞ "Brightness" (page 8-14)
- Contrast
Allows you to adjust the screen contrast.
☞ "Contrast" (page 8-15)
- Background Color
Allows you to set the background color.
☞ "Background Color" (page 8-15)



NAV3039

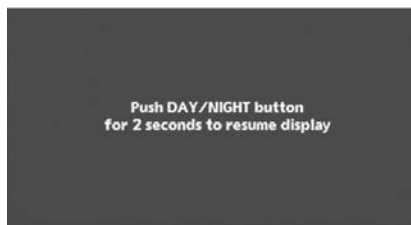

NAV3040

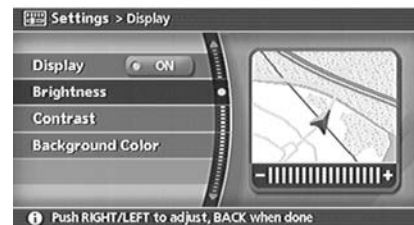

NAV3041

Display

To turn off the display, push **<ENTER>**.

The display can also be turned off by pushing and holding **<☀/🌙>** (Day/Night) for more than 2 seconds.

When any button is pushed with the display off, the display turns on. The display will automatically turn off 5 seconds after the operation is finished.

To turn on the display, push **<☀/🌙>** (Day/Night) for more than 2 seconds.

Brightness

Adjust the display brightness by tilting the joystick in the direction of **[+]** or **[-]**.

INFO:

The preview of the map screen is displayed on the right side of the screen.

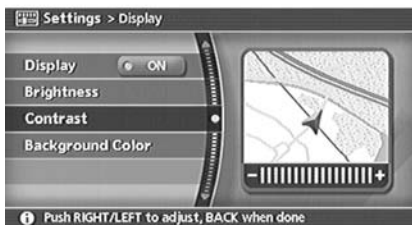

NAV3042

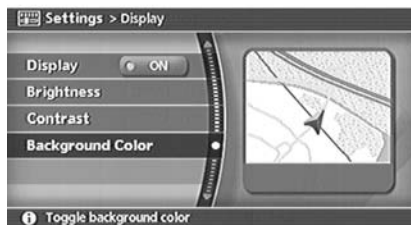

NAV3043

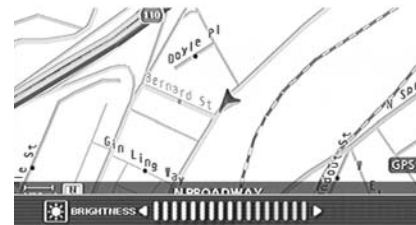

NAV3044

Bright background color

Contrast

Adjust the display contrast by tilting the joystick in the direction of [+] or [-].

INFO:

The preview of the map screen is displayed on the right side of the screen.

Background Color

Select the background color from bright color or dark color.



NAV3045

Dark background color

VOLUME ADJUSTMENT

This allows you to turn on and off, as well as adjust, the voice guide function and the beep function.

Basic operation

1. Highlight [Volume and Beeps] and push **<ENTER>**.
2. Highlight the preferred adjustment item and push **<ENTER>**.
3. Use the joystick to adjust the volume. Push **<ENTER>** to set ON/OFF.
4. After setting, push **<ENTER>** or **<BACK>** to apply the setting.
5. Push **<BACK>** to return to the previous screen. Push **<MAP>** to return to the current location map screen.

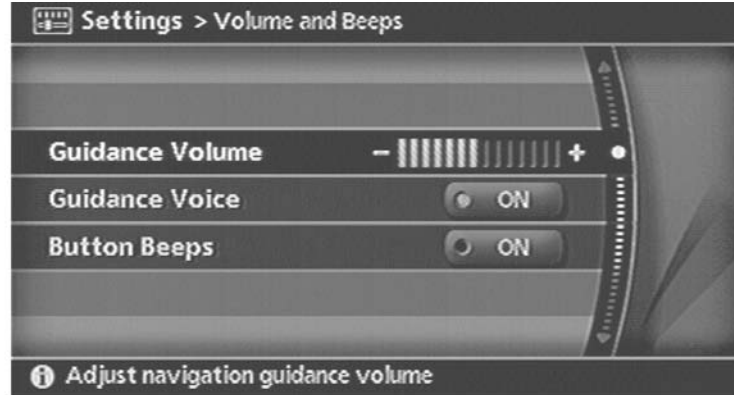

NAV3007

Setting items

- **Guidance Volume:**
Adjust the volume level of voice guidance by tilting the joystick in the direction of [+] or [-].
- **Guidance Voice:**
Select to toggle the voice guidance function between on and off. The indicator light illuminates when the voice guidance function is set to on.
- **Button Beeps:**
Select to toggle the beep function between on and off. The indicator light illuminates when the beep function is set to on. The beep that sounds when pushing and holding a button or when a prohibited operation is performed cannot be set to off.

CLOCK SETTINGS

This allows you to change the clock settings.

Basic operation

1. Highlight [Clock] and push **<ENTER>**.
2. Highlight the preferred adjustment item and push **<ENTER>**.
3. Use the joystick to adjust to the preferred setting.
Push **<ENTER>** to set ON/OFF.
4. After setting, push **<ENTER>** or **<BACK>** to apply the setting.
5. Push **<BACK>** to return to the previous screen. Push **<MAP>** to return to the current location map screen.

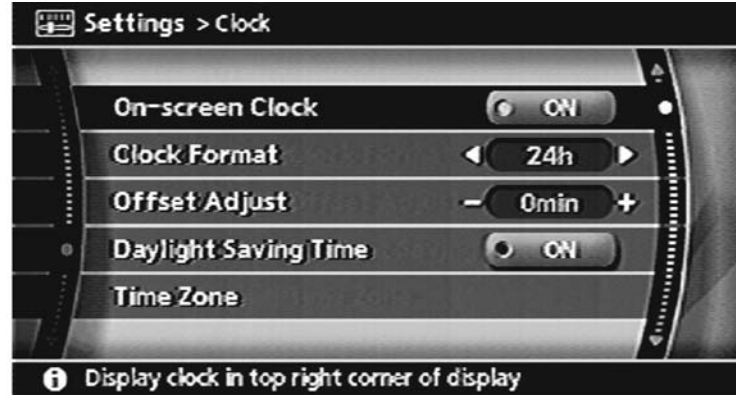

NAV3008

Setting items

- On-screen Clock:
Select to toggle the clock display located in the top right corner of the display between on and off. The indicator light illuminates when the clock display is set to on.
- Clock Format:
Use the joystick to change the clock format between 12-hour and 24-hour.
- Offset Adjust:
Use the joystick to adjust the offset value (between -59 and +59).
- Daylight Saving Time:
Select to toggle the daylight saving time setting between on and off. The indicator light illuminates when the daylight saving time setting is set to on.

- Time Zone:
Select an appropriate time zone from the list that appears when you select this item.
 - Pacific
 - Mountain
 - Central
 - Eastern
 - Atlantic
 - Newfoundland

LANGUAGE AND UNIT SETTINGS

This allows you to change the language and measurement unit used in the system.

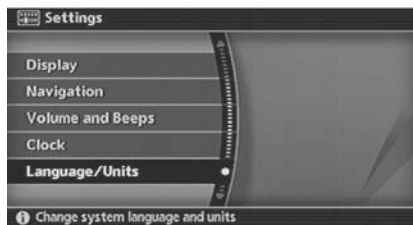

NAV3009

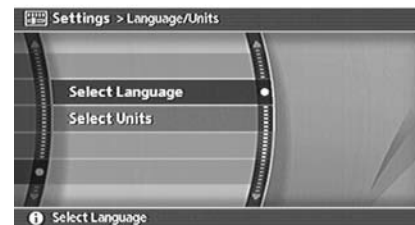

NAV3010

Language settings

1. Highlight [Language/Units] and push **<ENTER>**.
2. Highlight [Select Language] and push **<ENTER>**.



NAV3011

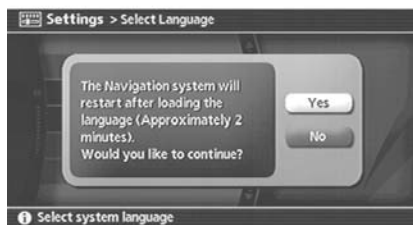

NAV3012



NAV3013

3. Highlight the preferred setting item and push **<ENTER>**. The indicator light of the selected item illuminates.
Available languages
 - English
 - Français
4. A message is displayed. Confirm the contents of the message.
After confirming the message, highlight [Yes] and push **<ENTER>**.
5. The program loading screen is displayed, and the system initiates language setting. Upon completion, the start-up screen is automatically displayed.



CAUTION

Do not change the ignition switch position while changing the language. Doing so may cause a system malfunction.

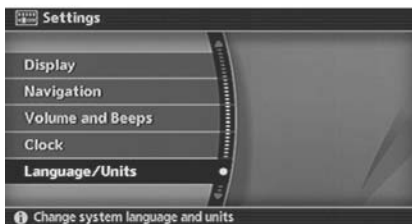

NAV3009

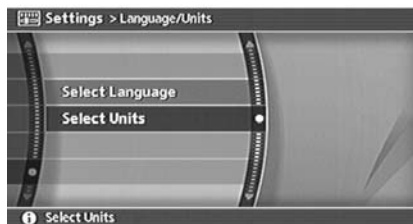

NAV3014



NAV3015

Unit settings

1. Highlight [Language/Units] and push **<ENTER>**.
2. Highlight [Select Units] and push **<ENTER>**.
3. Highlight the preferred unit and push **<ENTER>**.
The indicator of the selected unit illuminates.
Available units
 - US:
mile, MPH, °F, MPG
 - Metric:
km, km/h, °C, L/100 km
4. Push **<BACK>** to return to the previous screen.
Push **<MAP>** to return to the current location map screen.

MAP COLOR SETTINGS

This allows you to change the map color.



NAV3005



NAV3006

1. Highlight [Navigation] and push **<ENTER>**.
2. Highlight [Map Color Settings] and push **<ENTER>**.
3. Highlight the preferred map color and push **<ENTER>**. The indicator light of the selected color illuminates.

Available map colors

Warm: Sets warm colors for the map coloring.

Cool: Sets cool colors for the map coloring.

INFO:

You can confirm the effect of your setting on the preview displayed on the right side of the screen.

ADJUSTING THE CURRENT VEHICLE LOCATION

If the vehicle icon indicating the current vehicle location is not located in the correct position, you can correct the position of the vehicle icon on the map screen.

INFO:

- Regardless of the map view setting, the map is displayed in Plan View when adjusting the position of the vehicle icon.
- When you correct the position of the vehicle icon, the map is automatically displayed in the North Up mode. After finishing the correction, the map restores the current orientation setting.
- The position and direction of the vehicle icon may be misaligned depending on the external conditions and environment.
- If the vehicle icon is misaligned, drive for a while in a location where the GPS signals can be received. This may correct the position of the vehicle icon.
 "CURRENT VEHICLE LOCATION"
(page 9-3)



NAV3016

1. Highlight [Navigation] and push **<ENTER>**.
2. Highlight [Adjust Current Location] and push **<ENTER>**.
The current location map screen is displayed.



NAV3017

3. Adjust the position of the vehicle icon using the joystick.
After adjusting the position of the vehicle icon, push **<ENTER>**.



NAV3018



NAV3019

4. Adjust the direction of the vehicle icon using the joystick.
After adjusting the direction of the vehicle icon, push **<ENTER>**.
5. A message is displayed, and the adjusted vehicle location is stored.

RESET ALL NAVIGATION SETTINGS TO DEFAULT

This allows you to restore various settings (display, volume level, etc.) to the default settings.



INFO:

The memory contents, such as the stored locations, will not be deleted.

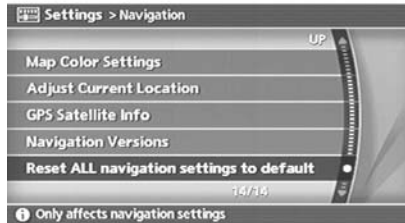

NAV3020

1. Highlight [Navigation] and push **<ENTER>**.
2. Highlight [Reset ALL navigation settings to default] and push **<ENTER>**.



NAV3021

3. A confirmation message is displayed. Confirm the contents of the message, highlight [Yes] and push **<ENTER>**.

MEMO

9 General system information

Features of this navigation system.....	9-2	Route calculation	9-9
Route guidance	9-2	Route guidance	9-11
Points of interest (POI) directory.....	9-2	Basics of voice guidance	9-11
Address book.....	9-2	Directions provided and the distances to guide points.....	9-11
Avoid area.....	9-2	Repeating voice guidance	9-14
Automatic reroute.....	9-2	Notes on voice guidance	9-14
Detour.....	9-2	Map DVD-ROM.....	9-15
Birdview™	9-3	How to order map DVD-ROM updates.....	9-15
Voice guidance.....	9-3	About the map DVD-ROM	9-15
Current vehicle location	9-3	Map DVD-ROM drive location.....	9-16
Display of current vehicle location	9-3	Disc replacement	9-18
What is GPS (Global Positioning System)?.....	9-3	How to handle the DVD-ROM.....	9-19
Accuracy of positioning	9-4	How to handle the display.....	9-20
Incorrect display of vehicle position	9-6	Characteristics of a liquid crystal display.....	9-20
Detailed Map Coverage Areas (MCA) for the navigation system.....	9-8	Maintenance of the display.....	9-20
When a gray road is displayed on the map	9-9		

FEATURES OF THIS NAVIGATION SYSTEM

ROUTE GUIDANCE

The main features of the NISSAN Navigation System are visual guidance and voice guidance in selected map coverage areas. Utilizing a network of GPS (Global Positioning System) satellites, the NISSAN Navigation System tracks your location on the map and navigates you to a preferred location.

Once you set the destination in a map coverage area, the NISSAN Navigation System will calculate a route from your current location to your destination. The real-time map display and turn-by-turn voice guidance leads the driver along the route.

These features can be especially helpful when driving to unfamiliar locations.

The system may be unable to set a destination and/or calculate a route when the destination is outside the map coverage area. Additionally, voice guidance may not be available if the destination is outside the map coverage area. For more information on how to set a destination, refer to section 4.

POINTS OF INTEREST (POI) DIRECTORY

The NISSAN Navigation System offers an extensive Points of Interest (POI) directory in map coverage areas. This directory includes a

wide variety of destinations ranging from gas stations, ATMs, and restaurants to casinos, ski resorts, shopping centers and businesses. By accessing the Points of Interest directory, you can search for addresses and phone numbers for a destination, and just by pushing a button, the NISSAN Navigation System will calculate a route to the destination.

The POI directory has many uses. For example, the directory can be sorted by the various types of restaurants near your current location. If you need an ATM or gas station, the NISSAN Navigation System can navigate you to the closest preferred location.

For more information on how to use the Points of Interest directory, refer to section 4.

ADDRESS BOOK

The Address Book can store up to 100 locations from map coverage areas into a personal directory. This is especially useful for frequently visited locations, such as clients, relatives and friends. The Address Book function allows easy access to frequently visited locations when setting them as your destination.

For more information on how to use the Address Book, refer to section 6.

AVOID AREA

The Avoid Area function allows you to identify areas or freeways that you would like the NISSAN Navigation System to avoid when calculating routes. For example, if a freeway or area is always congested with traffic, you can set the NISSAN Navigation System to calculate routes that exclude that freeway or area.

For more information on the Avoid Area function, refer to section 6.

AUTOMATIC REROUTE

If you deviate from the suggested route, the NISSAN Navigation System will automatically recalculate a new route to your destination.

For more information on the Automatic reroute function, refer to section 5.

DETOUR

If you want to make a detour due to traffic conditions, you can use the Detour function to calculate an alternative route. The NISSAN Navigation System can calculate a route using secondary roads that will return you to primary roads after a specified number of miles.

For more information on the Detour function, refer to section 5.

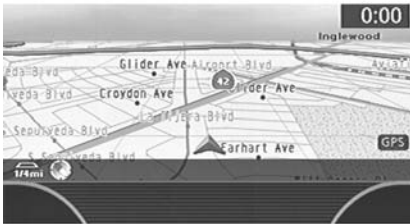

NAV2710

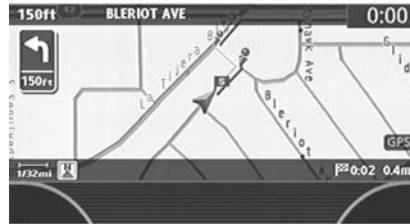

NAV2704

BIRDVIEW™

Two map types, 2-dimensional Plan View and 3-dimensional Birdview™, are available in the NISSAN Navigation System. Birdview™ displays the map from an elevated perspective. In Birdview™, it is easy to recognize an image of the route because it provides a panoramic view over a long distance.

For more information on Birdview™, refer to section 3.

VOICE GUIDANCE

Route guidance is provided through voice and visual instructions. Voice guidance announces the appropriate directions when approaching an intersection at which you need to turn.

For more information on voice guidance, refer to section 5.

CURRENT VEHICLE LOCATION

DISPLAY OF CURRENT VEHICLE LOCATION

This navigation system combines the data obtained from the vehicle (by gyro sensor) and from GPS (Global Positioning System) satellites to calculate the current location of the vehicle. This position is then displayed throughout route guidance to a destination.

WHAT IS GPS (Global Positioning System)?

GPS is a position detecting system that uses satellites deployed by the U.S. government. This navigation system receives radio signals from three or more different satellites that orbit 13,049 miles (21,000 km) above the earth in space, and detects the position of the vehicle by utilizing the principle of triangulation.



NAV3046

ACCURACY OF POSITIONING

The color of the GPS indicator in the lower right corner of the screen indicates the accuracy of positioning as follows:

- Green: positioning is possible
- Gray: positioning is not possible

INFO:

For approximately 3 or 4 minutes after starting the system, the GPS indicator remains gray, even if accurate positioning is possible.

Positioning adjustment

When the system judges that the vehicle position information is not accurate based on vehicle speed and gyro sensor data calculations,

9-4 General system information

the system will automatically adjust the position of the vehicle icon using GPS signals.

Receiving signals from GPS satellites

The reception of GPS signals can be weak, depending on the environment. Vehicles in the following areas/environments may not receive GPS signals (indicator color: gray).

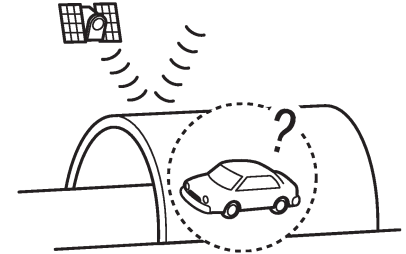

NAI0422

- Inside tunnels or parking garages



NAI0423

- Areas with numerous tall buildings

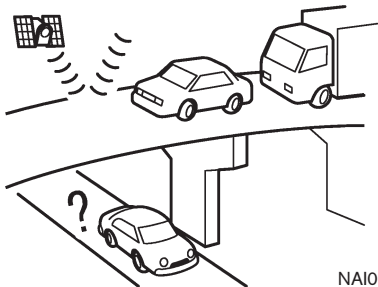

NAI0424

- Under multi-layered highways

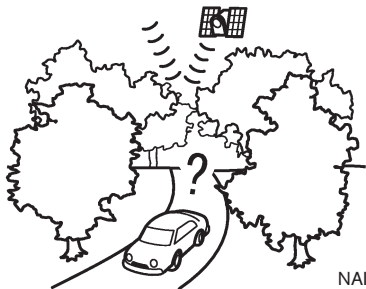

NAI0425

- Under many big trees

INFO:

The GPS antenna is located on the instrument panel inside the vehicle. Do not place any objects, especially mobile phones or transceivers, on the instrument panel. Because the strength of the GPS signal is approximately one billionth of that of TV waves, phones and transceivers will affect or may totally disrupt the signal.

Display of GPS information

GPS information can be displayed.

 "VIEWING GPS CURRENT LOCATION INFORMATION" (page 7-4)

NOTE:

Route guidance provided by the navigation system does not take carpool lane driving into consideration, especially when carpool lanes are separated from other road lanes.

INCORRECT DISPLAY OF VEHICLE POSITION

The following cases may affect the display accuracy of the vehicle's position or traveling direction. The accuracy will return to normal if the driving conditions return to normal.

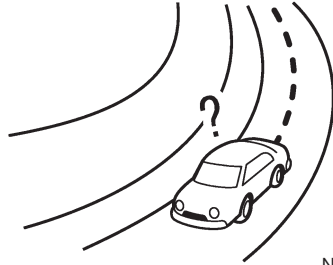

NAI0426

- When there is a similar road nearby.

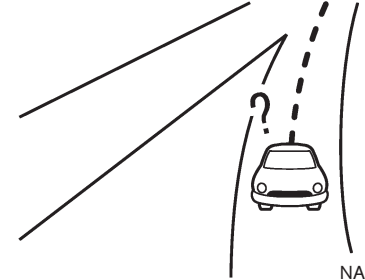

NAI0428

- When the vehicle is passing through a large Y-shaped intersection/junction.

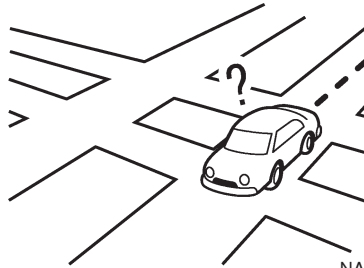

NAI0427

- When the vehicle is traveling in an area with a grid pattern road system.

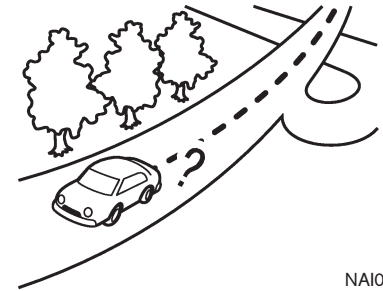

NAI0429

- When the vehicle is traveling on a continuous, slowly curving road.

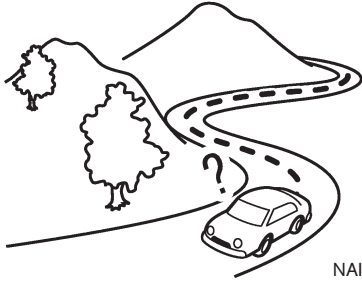

NAI0430

- When the vehicle is traveling on a road with repeating S-shaped curves.



NAI0432

- When the vehicle is on a snow-covered or unpaved road.

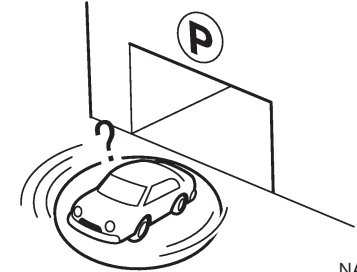

NAI0434

- When the vehicle is rotated on a parking lot turntable while the ignition switch is off.

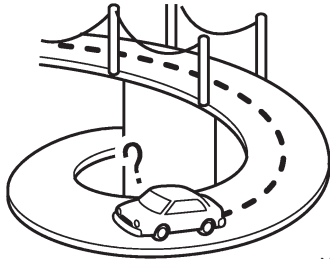

NAI0431

- When the vehicle is on a loop bridge.

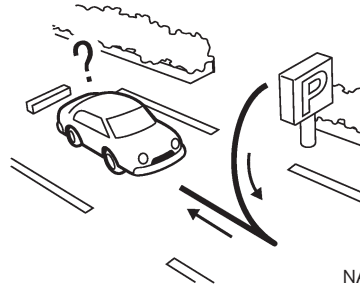

NAI0433

- When repeatedly turning left or right, or driving in zigzags.

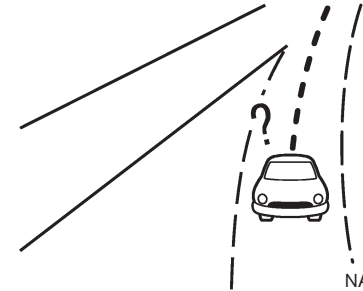

NAI0435

- When driving on a road not displayed on the map screen or a road that has been changed due to additional construction or other reasons.

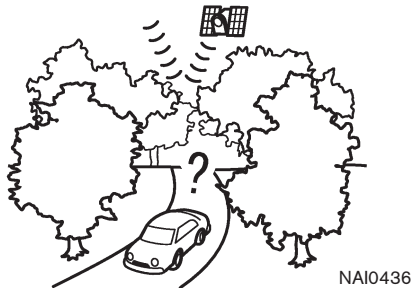

- When the GPS positioning accuracy is low.

INFO:

- The vehicle icon may be misaligned when starting the vehicle just after starting the engine.
- The vehicle icon may also be misaligned if different sized tires or tire chains are installed.
- The system has a function that automatically corrects the vehicle icon position when it is misaligned from the actual position.
- Vehicle position correction by GPS may not function when the vehicle is stopped.

- If the vehicle icon position does not return to normal even after driving for a while, correct the vehicle icon position manually.
 "ADJUSTING THE CURRENT VEHICLE LOCATION" (page 8-23)

DETAILED MAP COVERAGE AREAS (MCA) FOR THE NAVIGATION SYSTEM

This system is designed to help you reach your destination, and it also performs other functions as outlined in this manual. However, you, the driver, must use the system safely and properly. Information concerning road conditions, traffic signs and the availability of services may not always be up-to-date. The system is not a substitute for safe, proper and legal driving. Map data covers select metropolitan areas in the United States.

Map data is available on map DVD-ROMs. For information about map DVD-ROMs, contact a NISSAN dealer or call the NISSAN NAVIGATION SYSTEM HELPDESK at 1-888-661-9995.

Map data includes two types of areas: "Detailed coverage areas" providing all detailed road data and other areas showing "Main roads only".

NOTE:

Detailed map data is not available in many areas and is generally limited to select major metropolitan areas.

For information on which metropolitan areas are in detailed coverage areas, please refer to the NISSAN Navigation System Software Booklet (included). When you purchase an updated map DVD-ROM, a new software booklet will be included.

ROUTE CALCULATION

WHEN A GRAY ROAD IS DISPLAYED ON THE MAP

- When you are driving on a road displayed in gray after the vehicle has deviated from the suggested route during route guidance, automatic rerouting may not start immediately.
- The navigation system does not provide route guidance for roads displayed in dark green. Therefore, if the destination is set on a road displayed in dark green, the enlarged map display will return to the ordinary map screen at some point on a suggested route that is near the destination. Also, voice guidance will stop at some point on a suggested route that is near the destination.
- POI information and street names near roads displayed in gray may not be contained in the map data.

- There may be cases that carpool lanes are included on a suggested route when the automatic rerouting function is activated, even if the "Use Time Restricted Roads" is turned off.



"SETTING CONDITIONS FOR THE ROUTE CALCULATION"
(page 5-12)

- The navigation system does not provide route guidance for roads displayed in dark green.
- If the destination is set on a dark green road, the enlarged map display will switch to the ordinary map screen at some point and suggest a route that is near the destination. The distance and direction to the endpoint of the suggested route will be displayed in the lower right corner of the screen. Also, at this time, voice guidance will announce, "En route to your destination, some roads contain incomplete map data. Turn guidance will not be provided in this area".

When approaching the endpoint of the suggested route, voice guidance will announce, "Entering the road with incomplete map data. Please use the direction arrow and distance information to proceed to your destination."

To reach your destination, refer to the map

screen. Always follow actual roads and regulations and drive safely.

- The suggested route may not be the shortest, nor are other circumstances such as traffic jams considered.
- Because of the inevitable difference in road conditions and circumstances between the time you use this system and the time the information was produced for the DVD, there may be discrepancies in roads and regulations. In such cases, follow the actual information available.
- During route calculation, the map will not scroll, however the vehicle icon will move with the actual vehicle's movement.
- During route calculation, buttons such as **<MAP>** , **<DEST>** , **<ZOOM OUT>** (🔍) and **<ZOOM IN>** (🔍) will be disabled.
- In some cases, after the calculation is complete, the calculated route may not be immediately displayed.
- Waypoints that have been passed will be disregarded by rerouting calculation.
- If you scroll the map while the suggested route is being drawn, it may take more time to finish drawing.

- If waypoints are set, the system calculates multiple routes between waypoints simultaneously, and the following may result.
 - If one section between waypoints cannot be calculated, none of the route will be displayed.
 - The route may not connect completely at some waypoints.
 - The route may require a U-turn close to some waypoints.
- Route calculation may not be completed in the following cases.
 - If there is no main road within a range of 1.5 miles (2.5 km) from the vehicle, a message saying so will appear on the screen. Try recalculating when the vehicle is closer to a main road.
 - If there is no main road within a range of 1.5 miles (2.5 km) from the destination or waypoint, a message saying so will appear on the screen. Try setting the location closer to a main road.
 - If the vehicle is too close to the destination or if there are no roads to the destination, a message saying so will appear on the screen.
- If it is impossible to reach the destination or waypoints because of traffic regulations, etc.
- If the only route to reach the destination or waypoints is extremely complicated.
- If the destination, current vehicle position or waypoint is within the "Avoid Area".
- If a part of the route is included in the "Avoid Area".
- The following may occur when the route is displayed.
 - If you calculate a route on a main road, the starting point of the route may not exactly match the current vehicle location.
 - The endpoint of the route may not exactly match the destination.
 - If you calculate a route on a main road, the system may display a route from another main road. This may be because the position of the vehicle icon is not accurate. In this case, park the vehicle in a safe location and reset the vehicle icon, or continue driving to see if the position of the vehicle icon is automatically adjusted before recalculating the route.
- There are cases in which the system shows an indirect route to reach the destination or waypoints, if you set them from stored or facility information. In order to correct this, you must be careful about the traffic direction, especially when lanes with different travel directions are shown separately, such as interchanges and service areas.
- This system makes no distinction between limited traffic control and total control (blockage). It may show an indirect route even if the road is usable.
- Even if the freeway preference is set to OFF, a route that uses the freeway may be suggested.
- Even if the preference is set to OFF, a route that uses a ferry line may be suggested.
- Ferry lines, excluding those that are only for pedestrians, bicycles and motorcycles, are stored in this system. Take into consideration the travel time required and operational condition before deciding whether to use them or not.

ROUTE GUIDANCE



INFO:

The announcement of the street name during route guidance is available only when English is set as the language for the system. Street names are not announced if French is set for the system.

BASICS OF VOICE GUIDANCE

Voice guidance announces which direction to turn when approaching an intersection in which a turn is necessary.



NOTE:

- **There may be some cases in which voice guidance and actual road conditions do not correspond. This may occur because of discrepancies between the actual road and the information on the DVD-ROM, or it is due to the vehicle's speed.**
- **In case voice guidance does not correspond to the actual road conditions, follow the information obtained from traffic signs or notices on the road.**

- **Route guidance provided by the navigation system does not take carpool lane driving into consideration, especially when carpool lanes are separated from other road lanes.**

DIRECTIONS PROVIDED AND THE DISTANCES TO GUIDE POINTS

Directions will differ, depending on the road type.



INFO:

Distances may vary, depending on the vehicle speed.

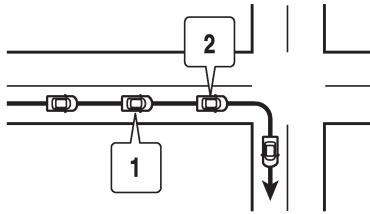

NAI0437

Notification of an intersection on an ordinary road

1. "In about one quarter mile (400 meters), right (left) turn."
2. "Right (left) turn ahead."

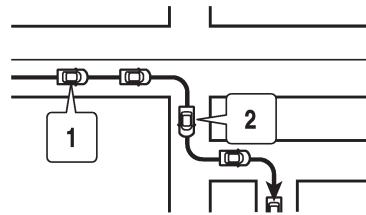

NAI0438

Notification of consecutive intersections on an ordinary road

When the road has three or more consecutive intersections ahead, voice guidance will announce the following.

1. "In about one quarter mile (400 meters), right (left) turn, then left (right) turn."
2. "Right (left) turn ahead, then left (right) turn."

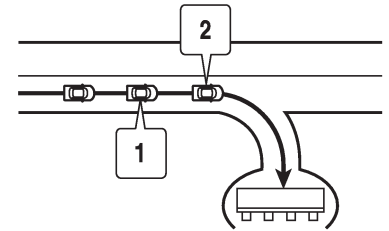

NAI0439

Notification of a freeway entrance

1. "In about one quarter mile (400 meters) freeway entrance on your right onto (road number and direction)."
2. "Freeway entrance on your right onto (road number and direction)."

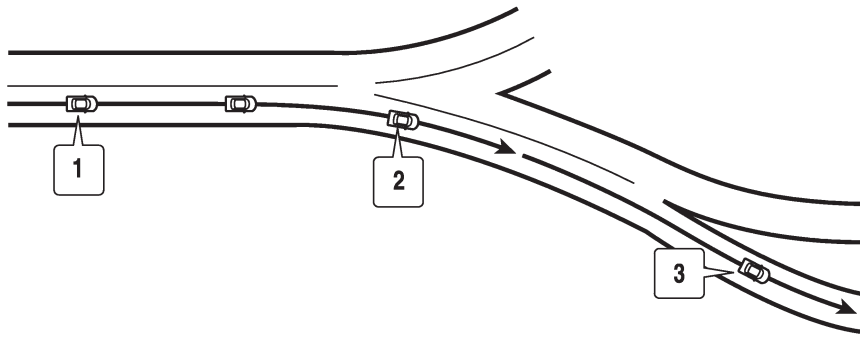

NAI0440

Notification of a freeway junction

1. "In about one mile (1.6 kilometers), keep to the right (left) onto (road number and direction), then in about one quarter mile (400 meters) keep to the left (right)."
2. "Keep to the right (left) onto (road number and direction), then in about one quarter mile (400 meters) keep to the left (right) onto (road number and direction)."

3. "Keep to the left (right) onto (road number and direction)."

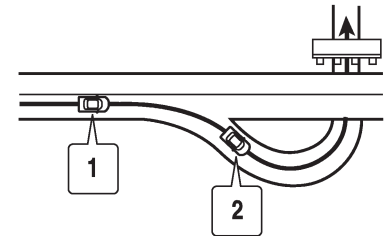

NAI0441

Notification of a freeway exit

1. "In about one mile (1.6 kilometers), exit on your right."
2. "Take the second exit on your right."

Notification when approaching the destination

Ordinary road:

When approaching the destination, voice guidance will announce, "You have arrived at your destination. Ending route guidance." To finally reach your destination, refer to the map screen.

Dark green road:

After passing the last turning point on a suggested route, voice guidance will announce, "En route to your destination, some roads contain incomplete map data. Turn guidance will not be provided in this area." When approaching the endpoint of the suggested road, voice guidance will announce, "Entering the road with incomplete map data. Please use the direction arrow and distance information to proceed to your destination."

REPEATING VOICE GUIDANCE

This function is available throughout route guidance, from the time after the route calculation is completed until the vehicle arrives at the destination.

Push **<VOICE>/<GUIDE VOICE>**.

Voice guidance will be repeated.



INFO:

- If you push **<VOICE>/<GUIDE VOICE>** when you have deviated from the suggested route and when the automatic reroute function is off, voice guidance will announce, "Proceed to the highlighted route."
- If you push **<VOICE>/<GUIDE VOICE>** when you are going in the wrong direction, voice guidance will announce: "Please make a legal U-turn if possible."

NOTES ON VOICE GUIDANCE

- Voice guidance in this system should be regarded as a supplementary function. When driving your vehicle, check the route on the map and follow the actual roads and traffic regulations.
- Voice guidance is activated only for intersections with certain conditions. There may be cases that the vehicle has to turn, but voice guidance is not provided.
- Voice guidance contents may vary, depending on the direction of the turn and the type of intersection.
- The voice guidance timing will vary depending on the situation.
- When the vehicle has deviated from the suggested route, voice guidance is not available. The system will not announce this to you. Refer to the map and recalculate the route.
 "RECALCULATE ROUTE"
(page 5-18)
- Voice guidance may not accurately correspond with road numbers and directions at freeway junctions.
- Voice guidance may not accurately correspond to street names at freeway exits.

MAP DVD-ROM

- The displayed street names may sometimes differ from the actual names, or "UNKNOWN STREET NAME" may be displayed.
- Voice guidance is not available when the [Guidance Voice] indicator is not illuminated.
- Voice guidance will start when the vehicle enters the suggested route. Refer to the map for directions to the starting point of the route.
- When approaching a waypoint, voice guidance will announce, "You have arrived at waypoint 1 (2, 3, 4,...)." Voice guidance will switch to the next section of the route. When voice guidance is not available, refer to the map for directions.
- In some cases, voice guidance ends before arrival at the destination. Refer to the destination icon on the map to reach the destination.
- If the system recognizes on which side the destination (waypoint) is located, voice guidance will announce "on the right/left" after announcing the arrival at the destination.
- Voice guidance may be partially operational or inoperative due to the angle of roads at an intersection.

HOW TO ORDER MAP DVD-ROM UPDATES

To order updated map DVD-ROMs or additional map DVD-ROMs, contact the NISSAN NAVIGATION SYSTEM HELPDESK at:

- ADDRESS: P.O. Box 2082, Burlingame, CA 94011
- E-MAIL: customersupport@zenrin.com
- WEB SITE: www.zenrin.com
- PHONE: 1-888-661-9995
- HOURS: 6:00 AM to 5:00 PM (Pacific Time)

ABOUT THE MAP DVD-ROM

1. This map DVD-ROM has been prepared by ZENRIN CO., LTD. under license from Navigation Technologies Corporation. ZENRIN CO., LTD. has added, processed and digitized data based on the digital road map data of Navigation Technologies Corporation. Due to the production timing of the map data, some new roads may not be included in this map data or some of the names or roads may be different from those at the time you use this map DVD-ROM.
2. Traffic control and regulation data used in this map DVD-ROM may be different from those at the time you use this map DVD-ROM due to the data production timing. When driving your vehicle, follow the actual traffic control signs and notices on the roads.
3. Reproducing or copying this map software is strictly prohibited by law.

Published by NISSAN North America, Inc.

©2002 Navigation Technologies. All rights reserved. "Certain business data provided by infoUSA.com, Inc. Copyright 2002. All rights reserved".

MAP DVD-ROM DRIVE LOCATION

Maxima map DVD-ROM drive location

INFO:

The DVD-ROM drive is located behind the cover plate located inside the covered storage box in front of the gearshift selector lever.

When you purchase this system, a map DVD-ROM is provided.

NOTE:

Please be very careful when handling the disc.

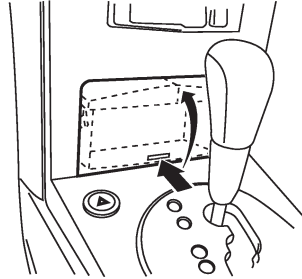

NAI0442

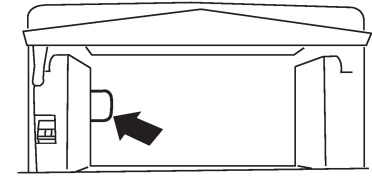

NAI0443

1. Open the covered storage box.

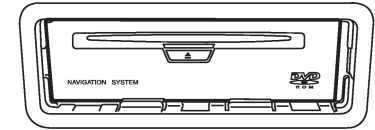

NAI0444

2. Remove the cover plate by placing your finger in the hole on the cover plate and pulling gently.

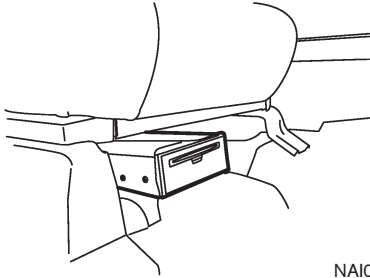

NAI0445

Armada, Pathfinder, Quest and Titan map DVD-ROM drive location

INFO:

The DVD-ROM drive is located under the front passenger seat. When you purchase this system, a map DVD-ROM is provided.

NOTE:

Please be very careful when handling the disc.

Slide the front passenger seat back for easier access to the DVD-ROM drive.

The DVD-ROM drive is mounted under the front passenger seat with the slot facing the front of the vehicle.

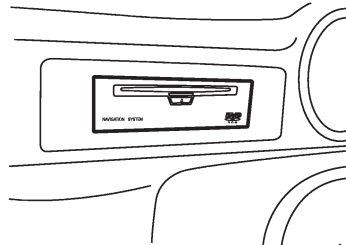

NAI0446

350Z map DVD-ROM drive location

INFO:

The DVD-ROM drive is located on the rear parcel shelf. When you purchase this system, a map DVD-ROM is provided.

NOTE:

Please be very careful when handling the disc.

Murano map DVD-ROM drive location

INFO:

The DVD-ROM drive is located behind a cover located on the right side of the center console, next to the passenger legroom area. When you purchase this system, a map DVD-ROM is provided.

NOTE:

Please be very careful when handling the disc.

DISC REPLACEMENT

CAUTION

- **The included map DVD-ROM is designed specifically for your navigation system. Do not use it in another system as it could cause a malfunction.**
- **Do not allow the system to get wet. Excessive moisture, such as spilled liquids, may cause the system to malfunction.**



NAI0447

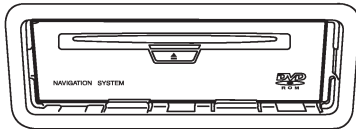

NAI0448

Use a suitable tool wrapped with a protective cloth to open the cover: remove the cover.

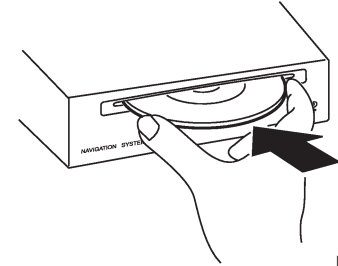

NAI0449

1. To insert a disc:
Place the disc in the slot. It will be drawn in automatically. You do not have to push it in all the way.

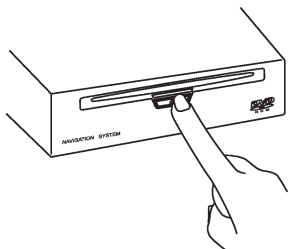

NAI0450

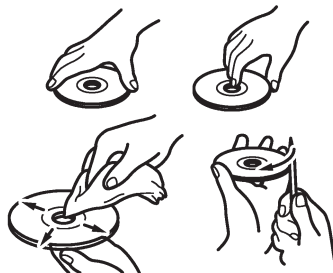

NAI0451

HOW TO HANDLE THE DVD-ROM

CAUTION

- Handle a DVD-ROM by its edges. Never touch the surface of the disc.
- To clean a disc, wipe the surface from the center to the outer edge using a clean, soft cloth. Do not wipe the disc using a circular motion. Do not use a conventional record cleaner, benzine, thinner or alcohol intended for industrial use.
- A new disc may be rough on its inner and outer edges. Remove the rough edges using the side of a pen or pencil

as illustrated.

- Never attempt to use a DVD-ROM that has been cracked, deformed or repaired using adhesive. Doing so may damage the equipment.
- Handle the DVD-ROM carefully to avoid contamination or flaws. Otherwise, the data may not be read properly.
- Do not write, draw or attach anything on either side of the DVD-ROM.
- Do not store the DVD-ROM in locations exposed to direct sunlight or in high temperatures or humidity.
- Do not apply any stickers or write anything on either side of the DVD-ROM.

2. To eject the disc:
Press the  button, and remove the disc.

HOW TO HANDLE THE DISPLAY

The display is a liquid crystal display and should be handled with care.



WARNING

Never disassemble the display. Some parts utilize extremely high voltage. Touching them may result in serious personal injury.

CHARACTERISTICS OF A LIQUID CRYSTAL DISPLAY

- If the temperature inside the vehicle is especially low, the display will stay relatively dim or the movement of the images may be slow. These conditions are normal. The display will function normally when the interior of the vehicle has warmed up.
- Some pixels in the display are darker or brighter than others. This condition is an inherent characteristic of liquid crystal displays, and it is not a malfunction.
- You may also notice a remnant of the previous display image on the screen. This screen burn is inherent in displays, and it is not a malfunction.



INFO:

The screen may become distorted by strong magnetic fields.

MAINTENANCE OF THE DISPLAY



CAUTION

- **To clean the display, never use a rough cloth, alcohol, benzine, thinner and any kind of solvent or paper towel with a chemical cleaning agent. They will scratch or deteriorate the panel.**
- **Do not splash any liquid such as water or car fragrance on the display. Contact with liquid will cause the system to malfunction.**

If you need to clean the display screen, use a dry, soft cloth. If additional cleaning is necessary, use a small amount of neutral detergent with a soft cloth. Never spray the screen with water or detergent. Dampen the cloth first, then wipe the screen.

10 Troubleshooting guide

Customer assistance.....	10-2	Map DVD-ROM.....	10-6
Basic operations.....	10-3	Route calculation and visual guidance.....	10-7
Vehicle icon.....	10-4	Voice guidance.....	10-9



CUSTOMER ASSISTANCE

For assistance or inquiries about the NISSAN Navigation System, please contact:
The NISSAN NAVIGATION HELPDESK at 1-800-NISSAN-1 (1-800-647-7261) for U.S., and at 1-800-777-0325 for CANADA or visit the NISSAN web site at www.nissan-usa.com.

BASIC OPERATIONS

Symptom	Possible cause	Possible solution
No image is displayed.	The brightness is at the lowest setting.	Adjust the brightness of the display.
	The display is turned off.	Push and hold <  > (Day/Night) to turn on the display.
No voice guidance is available. or The volume is too high or too low.	The volume is not set correctly, or it is turned off.	Adjust the volume of voice guidance.
	Voice guidance is not provided for certain streets (roads displayed in gray).	This is not a malfunction.
No map is displayed on the screen.	The map DVD-ROM is not inserted, or it is inserted upside down.	Insert the map DVD-ROM correctly.
	A screen other than map screen is displayed.	Push <MAP>.
	The pickup lens of the DVD unit is dirty.	The pickup lens can become dirty depending on how you use the vehicle. Contact a NISSAN dealer for cleaning of the pickup lens.
The screen is too dim. The movement is slow.	The temperature in the interior of the vehicle is low.	Wait until the interior of the vehicle has warmed up.
Some pixels in the display are darker or brighter than others.	This condition is an inherent characteristic of liquid crystal displays.	This is not a malfunction.
Some menu items cannot be selected.	Some menu items become unavailable while the vehicle is driven.	Park the vehicle in a safe location, and then operate the navigation system.





NOTE:

Locations stored in the Address Book and other memory functions may be lost if the vehicle's battery is disconnected or becomes discharged.

If this occurs, service the vehicle's battery as necessary and re-enter the information in the Address Book.

VEHICLE ICON

Symptom	Possible cause	Possible solution
Names of roads and locations differ between Plan view and Birdview™.	This is because the quantity of the displayed information is reduced so that the screen does not become too crowded. There is also a chance that names of the roads or locations may be displayed multiple times, and the names appearing on the screen may be different because of a processing procedure.	This is not a malfunction.
The vehicle icon is not displayed in the correct position.	The vehicle was transported after the ignition switch was pushed off, for example, by a ferry or car transporter.	Drive the vehicle for a while on a road where GPS signals can be received.
	The position and direction of the vehicle icon may be incorrect depending on the driving environments and the levels of positioning accuracy of the navigation system.	This is not a malfunction. Drive the vehicle for a while to automatically correct the position and direction of the vehicle icon.  "CURRENT VEHICLE LOCATION" (page 9-3)
When the vehicle is traveling on a new road, the vehicle icon is located on another road nearby.	Because the new road is not stored in the map data, the system automatically places the vehicle icon on the nearest road available.	Updated road information will be included in the next version of the map DVD-ROM.
The screen does not switch to the night screen even after turning on the headlights.	The daytime screen was set the last time the headlights were turned on.	Set the screen to the night screen mode using  (Day/Night) when you turn on the headlights.  "DISPLAY SETTINGS" (page 8-3)
The map does not scroll even when the vehicle is moving.	The current location map screen is not displayed.	Push <MAP> .
The vehicle icon is not displayed.	The current location map screen is not displayed.	Push <MAP> .
The GPS indicator on the screen remains gray.	GPS signals cannot be received under certain conditions, such as in a parking garage, on a road with many tall buildings, etc.	Drive on an open, straight road for a while.
	GPS signals cannot be received because objects are placed on the instrument panel.	Remove the objects from the instrument panel.
	A sufficient number of GPS satellites is not available.	Please wait for the satellites to move to locations available for your navigation system.

Symptom	Possible cause	Possible solution
The location of the vehicle icon is misaligned from the actual position.	When using tire chains or replacing the tires, speed calculations based on the speed sensor may be incorrect.	Drive the vehicle for a while (at approximately 19 MPH for about 30 minutes) to automatically correct the vehicle icon position. If this does not correct the vehicle icon position, contact a NISSAN dealer.
	The map data has a mistake or is incomplete (the vehicle icon position is always misaligned in the same area).	Updated road information will be included in the next version of the map DVD-ROM.

MAP DVD-ROM

Symptom	Possible cause	Possible solution
The message "Error" appears.	The map DVD-ROM is dirty or damaged.	Check the map DVD-ROM and wipe it clean with a soft cloth, following the cautions and instructions on page 9-19.
		If you see any damage, replace the map DVD-ROM.

ROUTE CALCULATION AND VISUAL GUIDANCE

Symptom	Possible cause	Possible solution
Waypoints are not included in the auto reroute calculation.	Waypoints that you have already passed are not included in the auto reroute calculation.	If you want to go to that waypoint again, you need to edit the route.
Route information is not displayed.	Route calculation has not yet been performed.	Set the destination and perform route calculation.
	You are not driving on the suggested route.	Drive on the suggested route.
	Route guidance is set to off.	Turn on route guidance.
	Route information is not provided for certain types of roads (roads displayed in gray).	This is not a malfunction.
The auto reroute calculation (or detour calculation) suggests the same route as the one previously suggested.	Route calculations took priority conditions into consideration, but the same route was calculated.	This is not a malfunction.
A waypoint cannot be added.	Five waypoints are already set on the route, including ones that you have already passed.	A maximum of 5 waypoints can be set on the route. If you want to go to 6 or more waypoints, perform route calculations multiple times as necessary.
The suggested route is not displayed.	Roads near the destination cannot be calculated.	Reset the destination to a main or ordinary road, and recalculate the route.
	The starting point and destination are too close.	Set a more distant destination.
	The starting point and destination are too far away.	Divide your trip by selecting one or two intermediate destinations, and perform route calculations multiple times.
	There are time restricted roads (by the day of the week, by time) near the current vehicle location or destination.	Set [Use Time Restricted Roads] to off.  "SETTING CONDITIONS FOR THE ROUTE CALCULATION" (page 5-12)
A part of the route is not displayed.	The suggested route includes narrow streets (roads displayed in gray).	This is not a malfunction.
The part of the route that you have already passed is deleted.	A route is managed by sections between waypoints. If you passed the first waypoint, the section between the starting point and the waypoint is deleted. (It may not be deleted depending on the area.)	This is not a malfunction.

Symptom	Possible cause	Possible solution
An indirect route is suggested.	If there are restrictions (such as one-way streets) on roads close to the starting point or destination, the system may suggest an indirect route.	Adjust the location of the starting point or destination.
	The system may suggest an indirect route because route calculation does not take into consideration some areas such as narrow streets (gray roads).	Reset the destination to a main or ordinary road, and recalculate the route.
The landmark information does not correspond to the actual information.	This may be caused by insufficient or incorrect data on the DVD-ROM.	Updated information will be included in the next version of the map DVD-ROM.
The suggested route does not exactly connect to the starting point, waypoints, or destination.	There is no data for route calculation closer to these locations.	Set the starting point, waypoints and destination on a main road, and perform route calculation.

VOICE GUIDANCE

Symptom	Possible cause	Possible solution
Voice guidance is not available.	Voice guidance is only available at certain intersections marked with  . In some cases, voice guidance is not available even when the vehicle should make a turn.	This is not a malfunction.
	The vehicle has deviated from the suggested route.	Go back to the suggested route or request route calculation again.
	Voice guidance is set to off.	Turn on voice guidance.
	Route guidance is set to off.	Turn on route guidance.
The guidance content does not correspond to the actual condition.	The content of voice guidance may vary, depending on the types of intersections at which turns are made.	Follow all traffic rules and regulations.

MEMO

11 Index

CURRENT LOCATION MAP SCREEN

<ENTER>

Store Location		page 6-2
Nearby		page 4-47
Map View	Plan View	page 3-4
	Birdview™	page 3-4
	Split (Plan View)	page 3-4
	Split (Birdview™)	page 3-4
	Change Map Scale for left	page 3-20
Heading	North Up	page 3-15
	Heading Up	page 3-15
	Long Range Map View	page 3-15
	Birdview Angle	page 3-17
Landmark Icons		page 3-22
Store Tracking		page 6-14

SCROLL LOCATION MAP SCREEN

<ENTER>

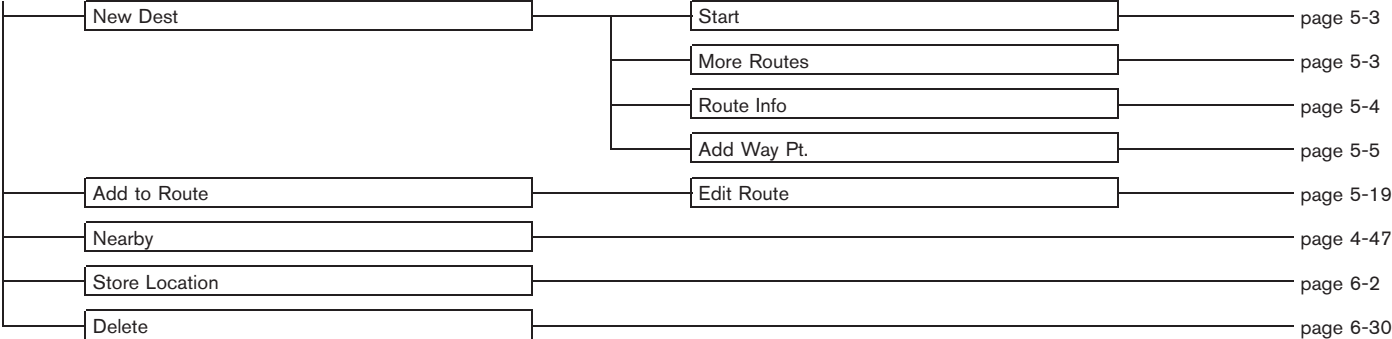

DESTINATION SCREEN

<DEST>

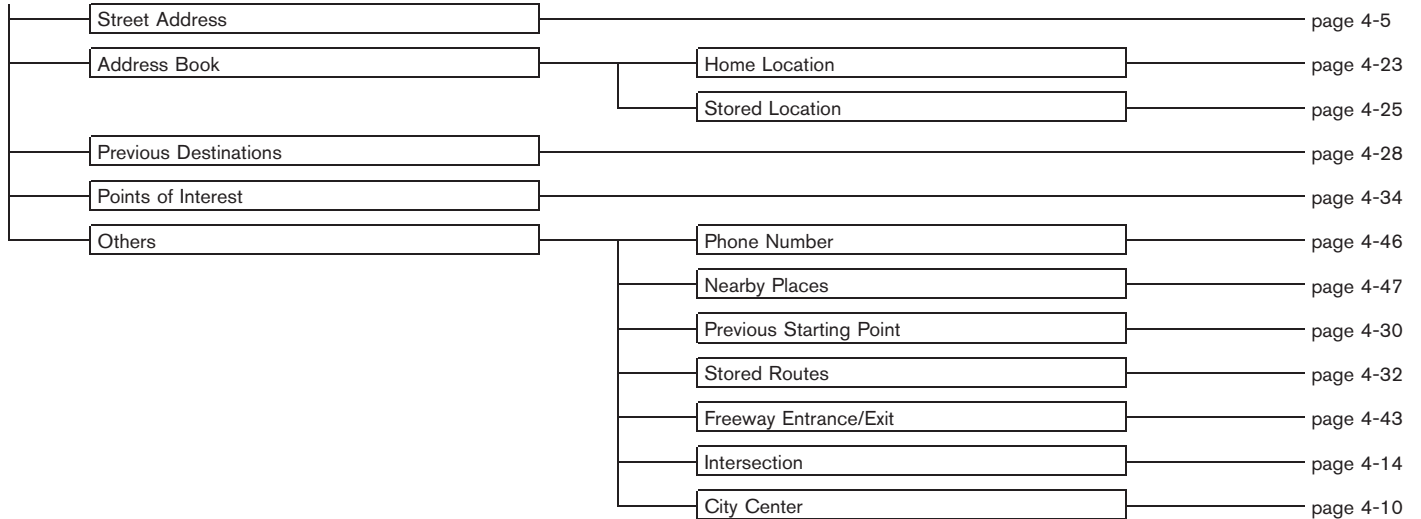

ROUTE SCREEN

<ROUTE>

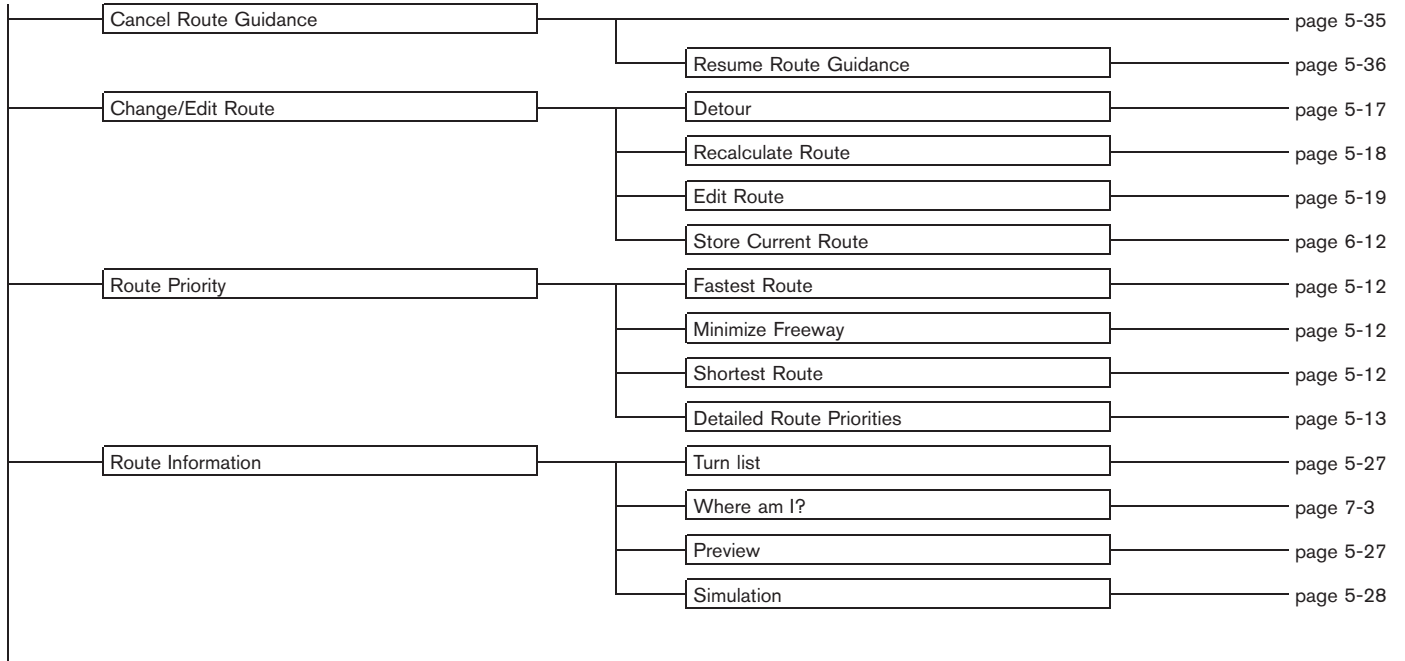

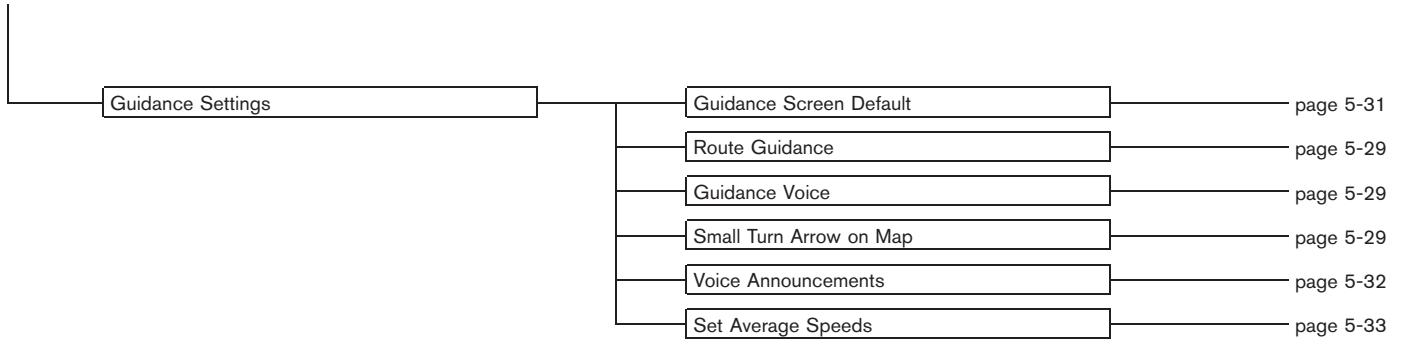

SETTING SCREEN (ARMADA, MAXIMA, MURANO, PATHFINDER, QUEST, TITAN)

<SETTING>

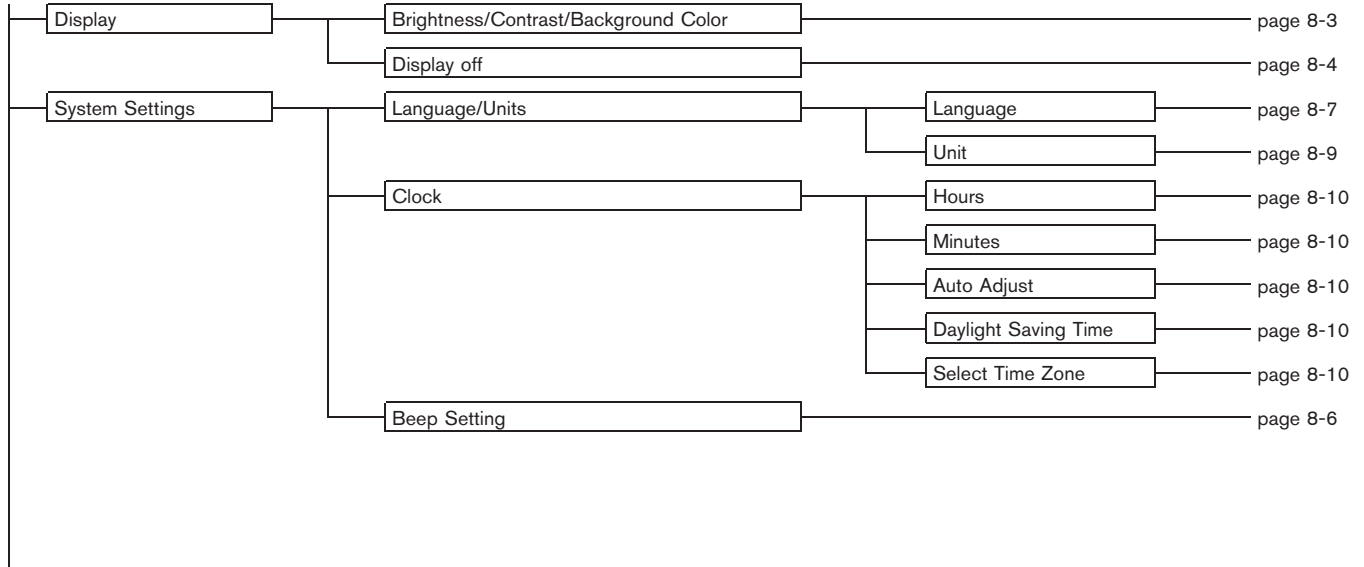

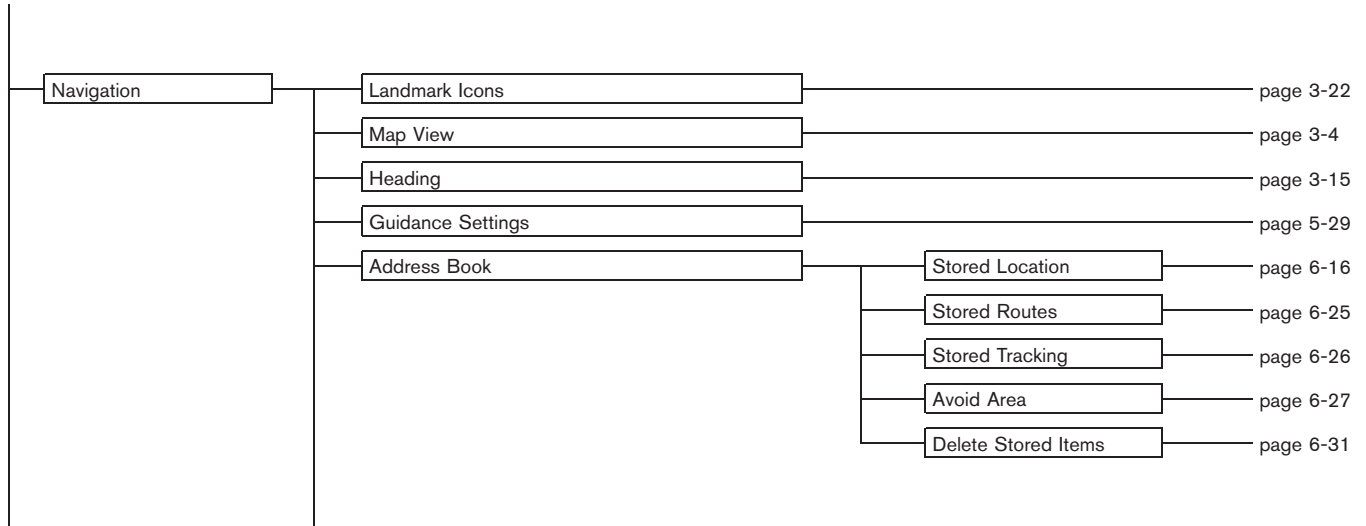

	Avoid Area Settings	page 6-7
	Tracking Display Settings	page 6-26
	Nearby Places Custom Settings	page 6-33
	Map Scrolling Information	page 3-10
	Map Color Settings	page 8-22
	Adjust Current Location	page 8-23
	GPS Satellite Info	page 7-4
	Navigation Versions	page 7-5
	Reset ALL navigation settings to default	page 8-25
Guidance Voice		page 8-2
Guidance Volume		page 8-2

SETTING SCREEN (350Z)

<SETTING>

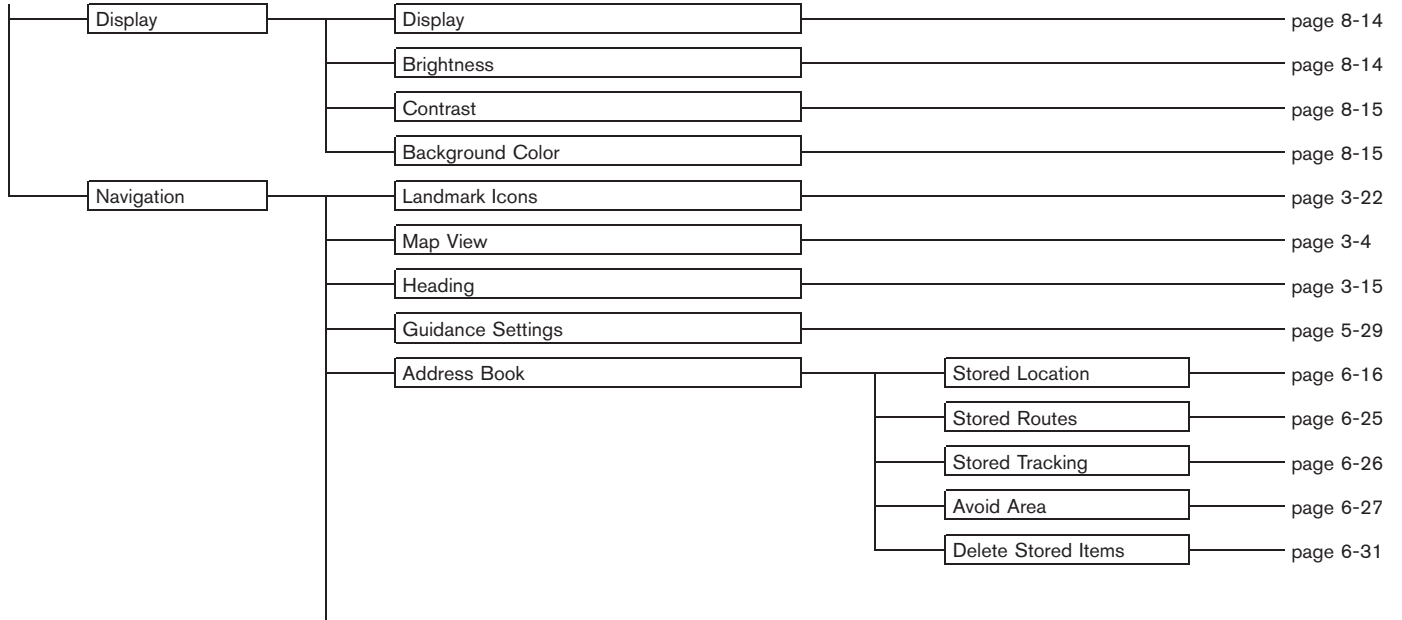

Avoid Area Settings	page 6-7
Tracking Display Settings	page 6-26
Nearby Places Custom Settings	page 6-33
Map Scrolling Information	page 3-10
Map Color Settings	page 8-22
Adjust Current Location	page 8-23
Reset ALL navigation settings to default	page 8-25

Volume and Beeps	Guidance Volume	page 8-16
	Guidance Voice	page 8-16
	Button Beeps	page 8-16
Clock	On-screen Clock	page 8-17
	Clock Format	page 8-17
	Offset Adjust	page 8-17
	Daylight Saving Time	page 8-17
	Time Zone	page 8-17
Language/Units	Select Language	page 8-19
	Select Units	page 8-21

INFORMATION SCREEN (350Z)

<INFO>

Where am I?	page 7-3
GPS Satellite Info	page 7-4
Navigation Versions	page 7-5

A

About route guidance	5-7
About the map DVD-ROM	9-15
Adding a destination or waypoint	5-5
Adding additional destinations to a route	4-52
Address book	9-2
Adjusting the current vehicle location	8-23
Adjusting the location of the destination	4-51
Adjusting voice guidance volume	2-38
Automatic reroute	9-2
Avoid area settings	6-7, 9-2

B

Background Color	8-15
Basics of voice guidance	9-11
Birdview™	3-3, 3-8, 9-3
Brightness	8-4, 8-14

C

Change/edit route	5-15
Changing the Birdview™ angle	3-17
Changing the scale of a map	2-20, 3-12
Changing the scale of the left screen	3-20
Character (letter and number) input screen	2-24
Characteristics of a liquid crystal display	9-20
Clock settings	8-10, 8-17
Confirming a route	5-4, 5-26
Confirming by simulation	5-28
Control panel	2-3
Current vehicle location	9-3
Customer assistance	10-2
Customizing nearby places	6-33

D

Deleting a route	2-34, 5-35
Deleting a stored item	6-28
Deleting a stored item individually	6-28
Deleting all stored items	6-31
Deleting an individual item on the map	6-30
Destination screen	4-2
Detailed route priorities	5-13
Detour	9-2
Directions provided and the distances to guide points	9-11
Disc replacement	9-18
Display of current vehicle location	9-3
Display settings	8-3, 8-13
Displaying landmark icons	3-22

E

Editing a route	5-19
Editing the address book	6-15
Editing the avoid area	6-27
Editing the stored home and location	6-16
Editing the stored route	6-25
Editing the stored tracking	6-26

F

For safe operation	1-2
Free zoom	2-20, 3-12
Functions disabled while driving	2-14

G

Guidance screens and preview mode	5-8
---	-----

H

Heading up	3-16
How to close the cover of the LCD	2-6
How to handle the display	9-20
How to handle the DVD-ROM	9-19
How to open the cover of the LCD	2-5
How to order map DVD-ROM updates	9-15
How to store your home	2-21
How to use this manual	1-2
How to view map screen	2-15

I

Incorrect display of vehicle position	9-6
Information screen (350Z only)	7-2

L

Language setting	8-7, 8-17
Laser product	1-4
List screen	2-28
Long Range Map View	3-16

M

Maintenance of the display	9-20
Map color settings	8-22
Map DVD-ROM	9-15, 10-6
Map DVD-ROM drive location	9-16
Map icons	3-22
Map menu screen	2-11
Map scale	3-13
Map screen types	2-16
Map scrolling information	3-10
Map symbols	3-24

Map types	3-2
Menu screen types and how to operate	2-8
Menu screens and their purposes.....	2-8
Minor adjustment of the stored home and locations	6-17
Moving a map.....	3-7
Moving around within a map.....	2-19

N

North Up.....	3-16
Notes on voice guidance.....	9-14

O

Operating maps.....	2-15
Operations after setting a destination.....	4-50
Other settings for the map screen	3-15

P

Phone number input screen.....	2-26
Plan view	3-2, 3-7
Points of interest (POI) directory	9-2
Procedures after setting a destination	5-2

R

Reactivating a route	5-36
Recalculate route	5-18
Reference symbols	1-2
Repeating voice guidance.....	9-14
Reset all navigation settings to default.....	8-25
Returning to the current vehicle location.....	3-9
Route calculation	9-9
Route calculation and visual guidance	10-7

Road color.....	3-26
Route guidance	9-2, 9-11
Route guidance settings	5-29
Route priority settings.....	5-12
Route setting.....	5-10

S

Safety information.....	1-3
Searching for a destination	2-29
Selecting a route.....	5-3
Set average speeds	5-33
Setting a City Center.....	4-10
Setting a destination.....	2-29
Setting a detour route.....	5-17
Setting a freeway entrance/exit.....	4-43
Setting a nearby place	4-47
Setting a point of interest.....	4-34
Setting a previous destination	4-28
Setting a Street Address.....	4-5
Setting an Intersection	4-14
Setting by phone number	4-46
Setting conditions for the route calculation.....	5-12
Setting from Address Book	4-25
Setting from map	4-20
Setting from stored routes	4-32
Setting screen	8-2, 8-12
Setting the previous starting point	4-30
Setting the voice guidance.....	2-36
Setting your home	4-23
Settings of heading/long range map view	3-15
Start-up screen	2-7
Starting route guidance	2-32, 5-3
Storing a location.....	6-2, 6-5 6-6
Storing a route.....	6-12

Storing a tracked route.....	6-14
Storing the current vehicle location	6-5
Storing your home location/address	2-21
Switching map view	2-17
Switching the map view.....	3-4
System settings screen	8-6

T

Turn list	5-9
Turning voice guidance on/off	2-36

U

Unit setting	8-9, 8-17
Using controls to adjust values, levels, etc.....	2-10
Using route preview	5-27
Using turn list	5-27

V

Vehicle icon	10-4
Viewing GPS current location information	7-4
Viewing information about current vehicle location.....	7-3
Viewing information about the searched location	4-53
Viewing navigation system version information.....	7-5
Visual guidance settings	5-31
Voice guidance.....	9-3, 10-9
Voice guidance during route guidance.....	5-7
Voice guidance settings.....	5-32
Volume adjustment.....	8-16