

SUPER MULTIPLE JUNCTION (SMJ)

Installation

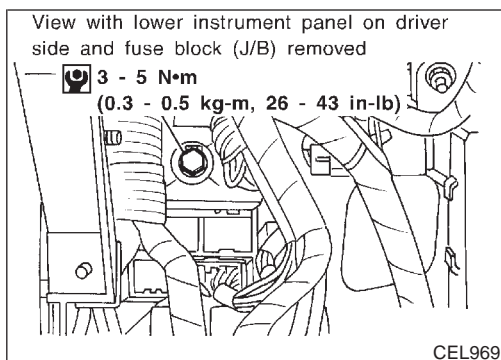

Installation

To install SMJ, tighten bolts until orange “fulltight” mark appears and then retighten to specified torque as required.

NHEL0146

 : 3 - 5 N•m (0.3 - 0.5 kg-m, 26 - 43 in-lb)

CAUTION:

Do not overtighten bolts, otherwise, they may be damaged.

SUPER MULTIPLE JUNCTION (SMJ)

Terminal Arrangement

Terminal Arrangement

NHEL0147

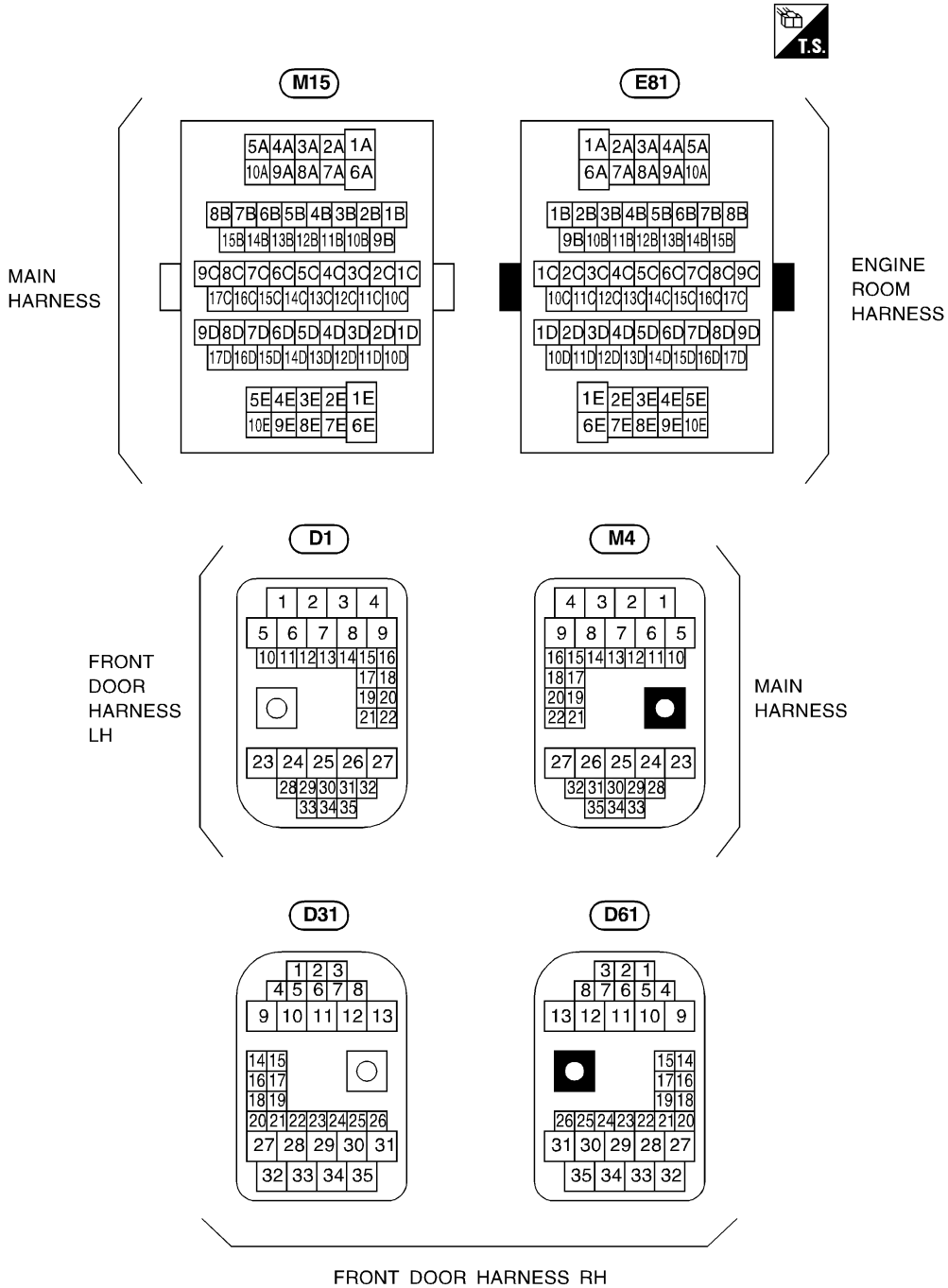

FUSE BLOCK — JUNCTION BOX (J/B)

Terminal Arrangement

Terminal Arrangement

NHEL0148

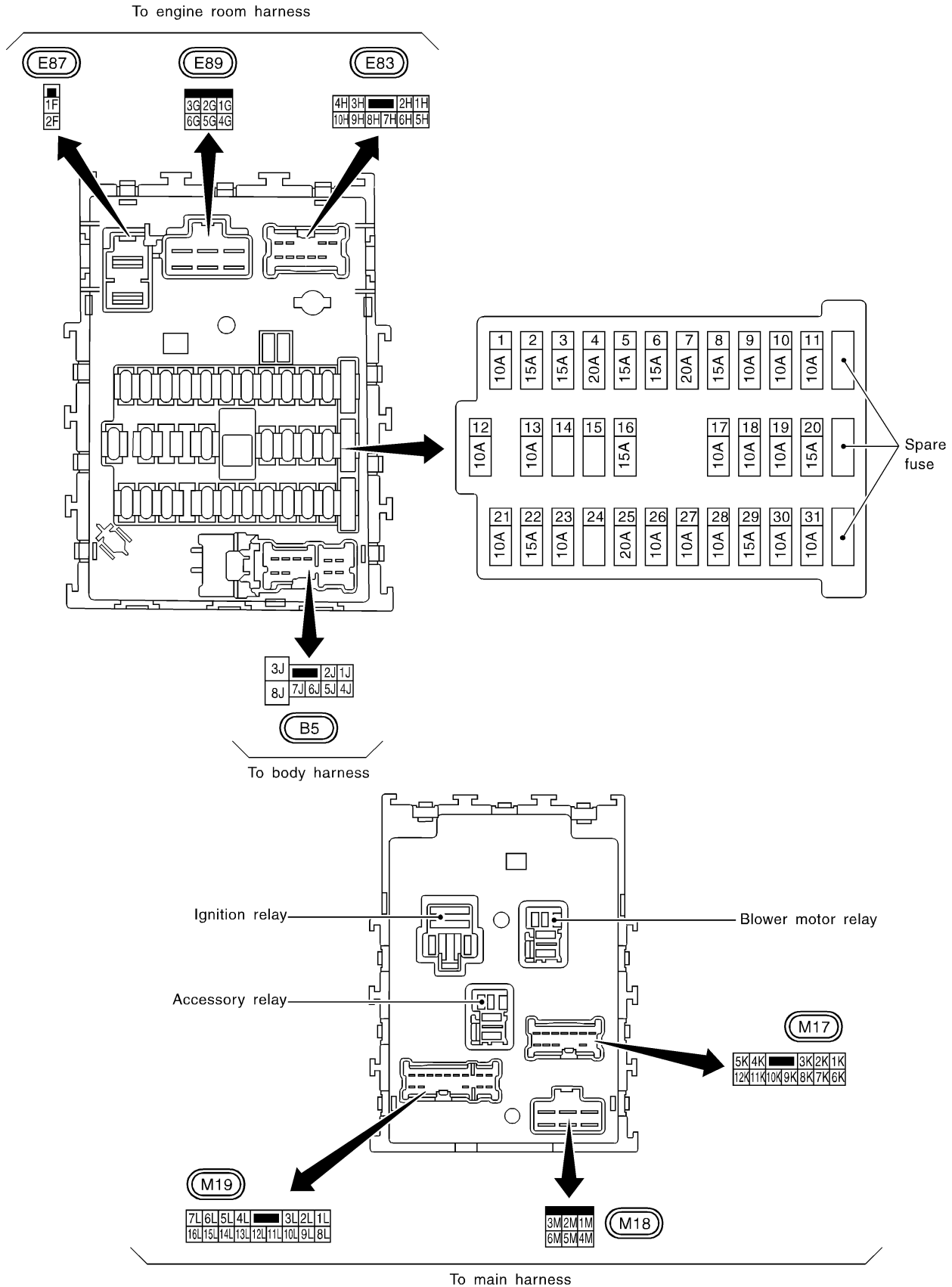

FUSE AND FUSIBLE LINK BOX

Terminal Arrangement

Terminal Arrangement

NHEL0149

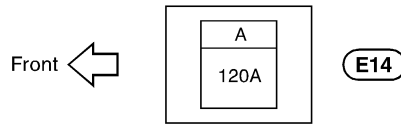

*1 40A: **TS**

50A: **VD**

*2 40A: **TS**

30A: **VD**

TS : With TCS

VD : With VDC

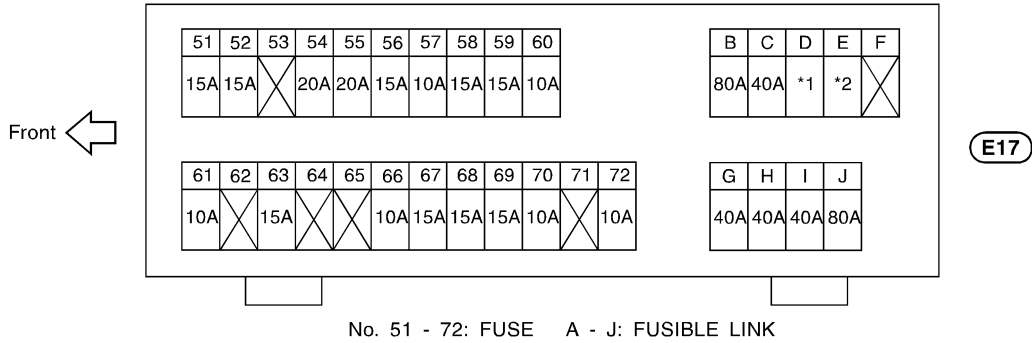

MEL2490

Terminal Arrangement

NHEL0150

ECM (F48)

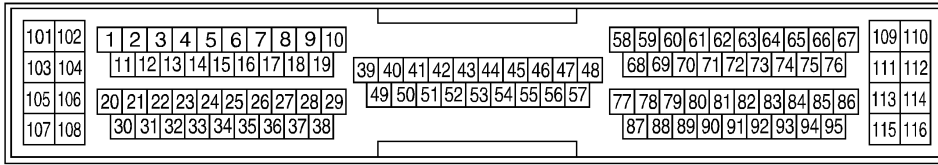

(Gray)



TCM (TRANSMISSION CONTROL MODULE)

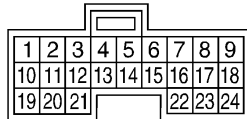

(White)

(F51)

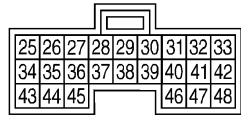

(Gray)

(F50)



ABS/TCS CONTROL UNIT (E162) : TS

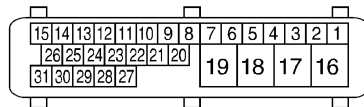

(Black)



VDC/TCS/ABS CONTROL UNIT (B57) : VD

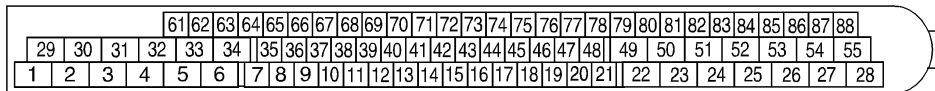

(Black)



A/C AUTO AMP.

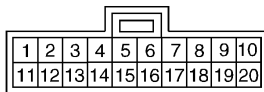

(Gray)

(M59)

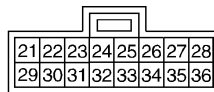

(Gray)

(M60)



SMART ENTRANCE CONTROL UNIT

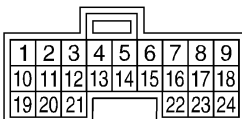

(White)

(M143)

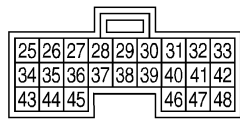

(Gray)

(M144)

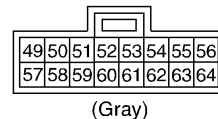

(Gray)

(M145)



TS : With TCS

VD : With VDC

JOINT CONNECTOR (J/C)

Terminal Arrangement

Terminal Arrangement

NHEL0160



(White)

J/C-9 **E20**

J/C-10 **E21**

J/C-12 **E73**

J/C-13 **E74**

J/C-14 **E75**



(Gray)

J/C-7 **E18**

J/C-8 **E19**



J/C-3 **M29**

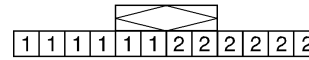
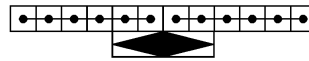

(Blue)

J/C-18 **F46**

J/C-17 **F54**

ENGINE TUNE-UP DATA

Engine model	VQ35DE		
Firing order	1-2-3-4-5-6		
Idle speed	rpm	A/T (in "N" position)	675±50
Ignition timing (degree BTDC at idle speed)	A/T: 15°±5°		
CO% at idle	Idle mixture screw is preset and sealed at factory.		
Drive belt deflection adjustment (Cold)	Used belt		Deflection of new belt
	mm (in)	Limit	
Alternator and air conditioner compressor	7 (0.28)	4.2 - 4.6 (0.165 - 0.181)	3.7 - 4.1 (0.146 - 0.161)
Power steering oil pump	11 (0.43)	7.3 - 8 (0.287 - 0.315)	6.5 - 7.2 (0.256 - 0.283)
Applied pushing force	N (kg, lb)	98 (10, 22)	
Drive belt tension adjustment (Cold)	Used belt		New belt
	N (kg, lb)	Limit	
Alternator and air conditioner compressor	294 (30, 66)	730 - 818 (74.5 - 83.5, 164 - 184)	838 - 926 (85.5 - 94.5, 188 - 208)
Power steering oil pump	196 (20, 44)	495 - 583 (50.5 - 59.5, 111 - 131)	603 - 691 (61.5 - 70.5, 136 - 155)
Applied pushing force	—		
Radiator cap relief pressure	kPa (kg/cm ² , psi)	78 - 98 (0.8 - 1.0, 11 - 14)	
Cooling system leakage testing pressure	kPa (kg/cm ² , psi)	157 (1.6, 23)	
Compression pressure	Standard	1,275 (13.0, 185)/300	
	kPa (kg/cm ² , psi)/rpm	Minimum	981 (10.0, 142)/300
High tension cable resistance	kΩ	—	
Spark plug	Type		
	Standard	PLFR5A-11	
	Hot	PLFR4A-11	
	Cold	PLFR6A-11	
Gap (Nominal)	mm (in)	1.1 (0.043)	

FRONT WHEEL ALIGNMENT (Unladen*)

Tire size	P225/50R17, P215/55R17		
Camber	Minimum	-1°00' (-1.00°)	
	Nominal	-0°15' (-0.25°)	
	Maximum	0°30' (0.50°)	
	Degree minute (Decimal degree)	Left and right difference	45' (0.75°) or less
Caster	Minimum	2°00' (2.00°)	
	Nominal	2°45' (2.75°)	
	Maximum	3°30' (3.50°)	
	Degree minute (Decimal degree)	Left and right difference	45' (0.75°) or less
Total toe-in	Minimum	0 (0)	
	Nominal	1 (0.04)	
	Maximum	2 (0.08)	
Distance (A - B)	mm (in)		
	Angle (left plus right)	Minimum	0' (0)
Degree minute (Decimal degree)	Nominal	6' (0.10°)	
	Maximum	12' (0.20°)	
	Wheel turning angle (Full turn)	Minimum	29°30' (29.50°)
Inside	Degree minute (Decimal degree)	Nominal	33°00' (33.00°)
	Maximum	34°00' (34.00°)	
	Outside	Degree minute (Decimal degree)	Nominal

* Fuel, radiator coolant and engine oil full.
Spare tire, jack, hand tools and mats in designated positions.

REAR WHEEL ALIGNMENT (Unladen*)

Camber	Degree minute (Decimal degree)	Minimum	-1°45' (-1.75°)
		Nominal	-1°00' (-1.00°)
		Maximum	-0°15' (-0.25°)
Total toe-in	Distance (A - B)	Minimum	-3 (-0.12)
		Nominal	1 (0.04)
		Maximum	5 (0.20)
Angle (left plus right)	Degree minute (Decimal degree)	Minimum	-16' (-0.27°)
		Nominal	5°30' (0.09°)
		Maximum	26' (0.43°)

* Fuel, radiator coolant and engine oil full.
Spare tire, jack, hand tools and mats in designated positions.

BRAKE

		Unit: mm (in)
Front brake	Pad wear limit	2.0 (0.079)
	Rotor repair limit	24.0 (0.945)
Rear brake	Pad wear limit	1.5 (0.059)
	Rotor repair limit	8.0 (0.315)
Pedal free height	167 - 174 (6.57 - 6.85)	
Pedal depressed height*1	82.5 (3.248)	
Parking brake		
	Number of notches*2	3 - 4

*1 Under force of 490 N (50 kg, 110 lb) with engine running

*2 At pulling force: 196 N (20 kg, 44 lb)

REFILL CAPACITIES

		Unit	Liter	US measure
Coolant with reservoir			7.7	8-1/8 qt
Engine*	Drain and refill			
	With oil filter		4.0	4-1/4 qt
	Without oil filter		3.7	3-7/8 qt
	Dry engine (engine overhaul)		5.0	5-1/4 qt
Transaxle	A/T	RE4F04B	8.5	9 qt
Power steering system			1.1	1-1/8 qt
Air conditioning system	Refrigerant		0.50 kg	1.10 lb
	Compressor oil		0.18	6.1 fl oz

* For further details, see "Changing Engine Oil" in MA section.