

GENERAL INFORMATION

SECTION **GI**

GI

MA

EM

LC

EF &
EC

FE

CL

MT

AT

FA

RA

BR

ST

BF

HA

EL

IDX

PRECAUTIONS	2	Checking Equipment.....	14
Precautions for Supplemental Restraint System "AIR BAG".....	2	IDENTIFICATION INFORMATION	15
General Precautions.....	2	Model Variation.....	15
Precautions for Multiport Fuel Injection System or ECCS Engine.....	4	Identification Number.....	16
Precautions for Three Way Catalyst.....	4	Dimensions.....	18
Engine Oils.....	4	Wheels and Tires.....	18
Precautions for Fuel.....	5	LIFTING POINTS AND TOW TRUCK TOWING	19
HOW TO USE THIS MANUAL	6	Garage Jack and Safety Stand.....	19
HOW TO READ WIRING DIAGRAMS	8	2-pole Lift.....	19
HOW TO FOLLOW FLOW CHART IN TROUBLE		Tow Truck Towing.....	20
DIAGNOSES	11	TIGHTENING TORQUE OF STANDARD BOLTS	21
CONSULT CHECKING SYSTEM	14	SAE J1930 TERMINOLOGY LIST	22
System Application and Function.....	14	SAE J1930 Terminology List.....	22
Lithium Battery Replacement.....	14		

PRECAUTIONS

Observe the following precautions to ensure safe and proper servicing. These precautions are not described in each individual section.

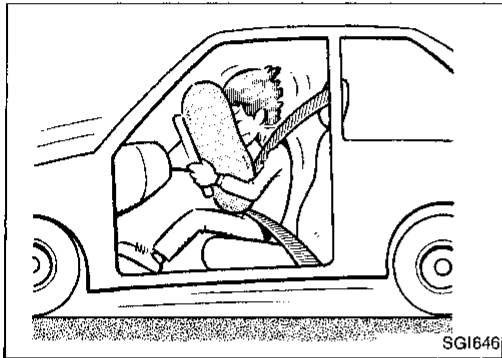

Precautions for Supplemental Restraint System "AIR BAG"

The Supplemental Restraint System "Air Bag" helps to reduce the risk or severity of injury to the driver in a frontal collision. The Supplemental Restraint System consists of an air bag (located in the center of the steering wheel), sensors, a diagnosis unit, warning lamp, wiring harness and spiral cable. Information necessary to service the system safely is included in the **BF** section of this Service Manual.

WARNING:

- To avoid rendering the SRS inoperative, which could lead to personal injury or death in the event of a severe frontal collision, all maintenance must be performed by an authorized NISSAN dealer.
- Improper maintenance, including incorrect removal and installation of the SRS, can lead to personal injury caused by unintentional activation of the system.
- All SRS electrical wiring harnesses and connectors are covered with yellow outer insulation. Do not use electrical test equipment on any circuit related to the SRS "Air Bag".

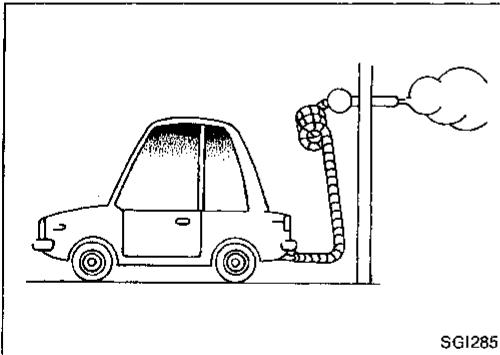

General Precautions

1. Do not operate the engine for an extended period of time without proper exhaust ventilation. Keep the work area well ventilated and free of any inflammable materials. Special care should be taken when handling any inflammable or poisonous materials, such as gasoline, refrigerant gas, etc. When working in a pit or other enclosed area, be sure to properly ventilate the area before working with hazardous materials. Do not smoke while working on the vehicle.
2. Before jacking up the vehicle, apply wheel chocks or other tire blocks to the wheels to prevent the vehicle from moving. After jacking up the vehicle, support the vehicle weight with safety stands at the points designated for proper lifting before working on the vehicle. These operations should be done on a level surface.
3. When removing a heavy component such as the engine or transaxle/transmission, be careful not to lose your balance and drop them. Also, do not allow them to strike adjacent parts, especially the brake tubes and master cylinder.

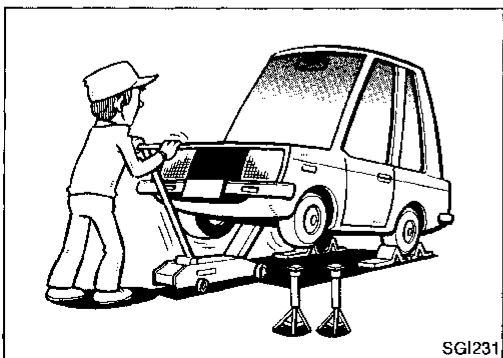

PRECAUTIONS

General Precautions (Cont'd)

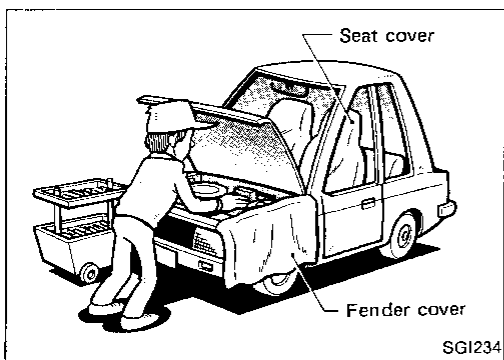
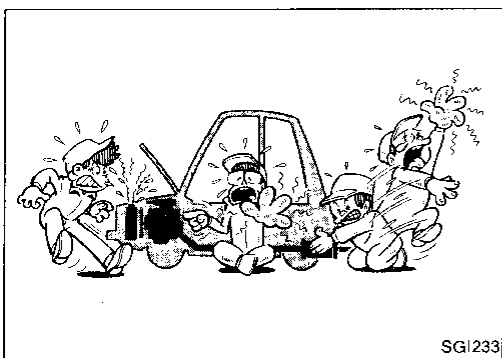
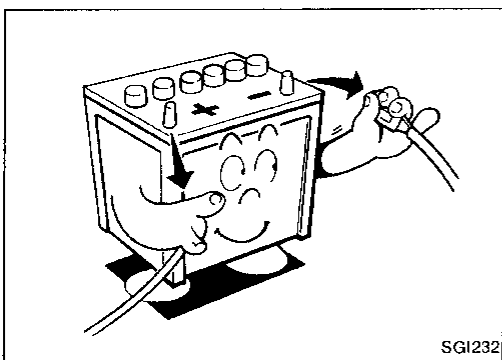

4. Before starting repairs which do not require battery power, always turn off the ignition switch, then disconnect the ground cable from the battery to prevent accidental short circuit.
5. To prevent serious burns, avoid contact with hot metal parts such as the radiator, exhaust manifold, tail pipe and muffler. Do not remove the radiator cap when the engine is hot.
6. Before servicing the vehicle, protect fenders, upholstery and carpeting with appropriate covers. Take caution that keys, buckles or buttons on your person do not scratch the paint.
7. Clean all disassembled parts in the designated liquid or solvent prior to inspection or assembly.
8. Replace oil seals, gaskets, packings, O-rings, locking washers, cotter pins, self-locking nuts, etc. with new ones.
9. Replace inner and outer races of tapered roller bearings and needle bearings as a set.
10. Arrange the disassembled parts in accordance with their assembled locations and sequence.
11. Do not touch the terminals of electrical components which use microcomputers (such as ECMs). Static electricity may damage internal electronic components.
12. After disconnecting vacuum or air hoses, attach a tag to indicate the proper connection.
13. Use only the fluids and the lubricants specified in MA section or their equivalents.
14. Use approved bonding agent, sealants or their equivalents when required.
15. Use tools and recommended special tools where specified for safe and efficient service repairs.
16. When repairing the fuel, oil, water, vacuum or exhaust systems, check all affected lines for leaks.
17. Dispose of drained oil or the solvent used for cleaning parts in an appropriate manner.

GI

MA

EM

LC

EF &
EC

FE

CL

MT

AT

FA

RA

BR

ST

BF

HA

EL

IDX

PRECAUTIONS

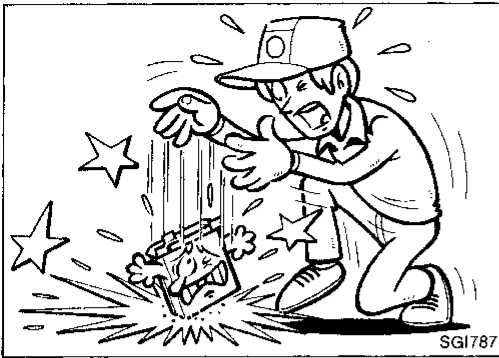

Precautions for Multiport Fuel Injection System or ECCS Engine

1. Before connecting or disconnecting multiport fuel injection system or ECCS harness connector to or from any multiport fuel injection system or ECM (ECCS control module), be sure to turn the ignition switch to the "OFF" position and disconnect the negative battery terminal. Otherwise, there may be damage to ECM.
2. Before disconnecting pressurized fuel line from fuel pump to injectors, be sure to release fuel pressure to eliminate danger.
3. Be careful not to jar components such as ECM and mass air flow sensor.

Precautions for Three Way Catalyst

If a large amount of unburned fuel flows into the converter, the converter temperature will be excessively high. To prevent this, follow the procedure below:

1. Use unleaded gasoline only. Leaded gasoline will seriously damage the three way catalyst.
2. When checking for ignition spark or measuring engine compression, make tests quickly and only when necessary.
3. Do not run engine when the fuel tank level is low, otherwise the engine may misfire causing damage to the converter.
4. Do not place the vehicle on inflammable material. Keep inflammable material off the exhaust pipe.

Engine Oils

Prolonged and repeated contact with used engine oil may cause skin cancer. Try to avoid direct skin contact with used oil. If skin contact is made, wash thoroughly with soap or hand cleaner as soon as possible.

HEALTH PROTECTION PRECAUTIONS

1. Avoid prolonged and repeated contact with oils, particularly used engine oils.
2. Wear protective clothing, including impervious gloves where practicable.
3. Do not put oily rags in pockets.
4. Avoid contaminating clothes, particularly underpants, with oil.
5. Heavily soiled clothing and oil-impregnated footwear should not be worn. Overalls must be cleaned regularly.
6. First Aid treatment should be obtained immediately for open cuts and wounds.
7. Use barrier creams, applying them before each work period, to help the removal of oil from the skin.
8. Wash with soap and water to ensure all oil is removed (skin cleansers and nail brushes will help). Preparations containing lanolin replace the natural skin oils which have been removed.
9. Do not use gasoline, kerosine, diesel fuel, gas oil, thinners or solvents for cleaning skin.
10. If skin disorders develop, obtain medical advice without delay.
11. Where practicable, degrease components prior to handling.

PRECAUTIONS

Engine Oils (Cont'd)

12. Where there is a risk of eye contact, eye protection should be worn, for example, chemical goggles or face shields; in addition an eye wash facility should be provided.

ENVIRONMENTAL PROTECTION PRECAUTIONS

Burning used engine oil in small space heaters or boilers can be recommended only for units of approved design. The heating system must meet the requirements of HM Inspectorate of Pollution for small burners of less than 0.4 MW. If in doubt check with the appropriate local authority and/or manufacturer of the approved appliance.

Dispose of used oil and used oil filters through authorized waste disposal contractors to licensed waste disposal sites, or to the waste oil reclamation trade. If in doubt, contact the local authority for advice on disposal facilities.

It is illegal to pour used oil on to the ground, down sewers or drains, or into water courses.

The regulations concerning the pollution of the environment will vary from country to country.

Precautions for Fuel

VG30E engine models

Unleaded gasoline with an octane rating of at least 87 AKI (Anti-Knock Index) number (Research octane number 91).

For improved vehicle performance, the use of premium unleaded gasoline with an octane rating of at least 91 AKI number (Research octane number 96) is recommended.

VE30DE engine models

Unleaded premium gasoline with an octane rating of at least 91 AKI (Anti-Knock Index) number (Research octane number 96). If unleaded premium gasoline is not available, unleaded regular gasoline with an octane rating of at least 87 AKI (Research octane number 91) can be used.

However, for maximum vehicle performance, the use of unleaded premium gasoline is recommended.

CAUTION:

Using a fuel other than that specified could adversely affect the emission control devices and systems, and could also affect the warranty coverage validity.

Under no circumstances should a leaded gasoline be used, since this will damage the three way catalyst.

GI

MA

EM

LC

EF &
EC

FE

CL

MT

AT

FA

RA

BR

ST

BF

HA

EL

IDX

HOW TO USE THIS MANUAL



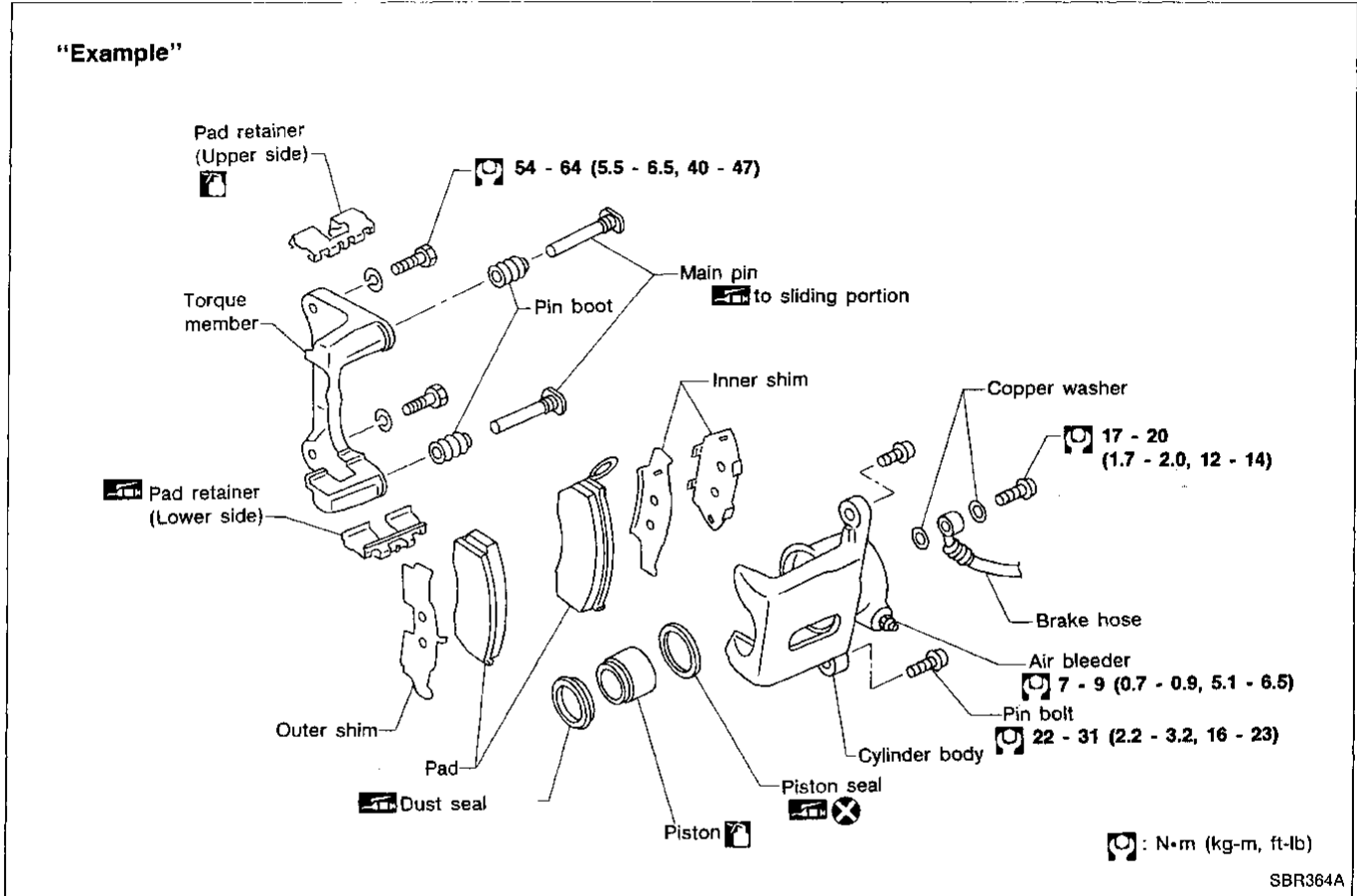





1. **ALPHABETICAL INDEX** is provided at the end of this manual so that you can rapidly find the item and page you are searching for.
2. **A QUICK REFERENCE INDEX**, a black tab (e.g. **BR**) is provided on the first page. You can quickly find the first page of each section by mating it to the section's black tab.
3. **THE CONTENTS** are listed on the first page of each section.
4. **THE TITLE** is indicated on the upper portion of each page and shows the part or system.
5. **THE PAGE NUMBER** of each section consists of two letters which designate the particular section and a number (e.g. "BR-5").
6. **THE LARGE ILLUSTRATIONS** are exploded views (See below) and contain tightening torques, lubrication points and other information necessary to perform repairs. The illustrations should be used in reference to service matters only. When ordering parts, refer to the appropriate **PARTS CATALOG**.



7. **THE SMALL ILLUSTRATIONS** show the important steps such as inspection, use of special tools, knacks of work and hidden or tricky steps which are not shown in the previous large illustrations. Assembly, inspection and adjustment procedures for the complicated units such as the automatic transaxle or transmission, etc. are presented in a step-by-step format where necessary.

HOW TO USE THIS MANUAL

8. The following **SYMBOLS AND ABBREVIATIONS** are used:

	: Tightening torque	M/T	: Manual Transaxle/Transmission
	: Should be lubricated with grease. Unless otherwise indicated, use recommended multi-purpose grease.	A/T	: Automatic Transaxle/Transmission
	: Should be lubricated with oil.	Tool	: Special Service Tools
	: Sealing point	LHD	: Left-Hand Drive
	: Checking point	RHD	: Right-Hand Drive
	: Always replace after every disassembly.	ATF	: Automatic Transmission Fluid
	: Apply petroleum jelly.	D ₁	: Drive range 1st gear
	: Apply ATF	D ₂	: Drive range 2nd gear
★	: Select with proper thickness.	D ₃	: Drive range 3rd gear
☆	: Adjustment is required.	D ₄	: Drive range 4th gear
SDS	: Service Data and Specifications	OD	: Overdrive
LH, RH	: Left-Hand, Right-Hand	2 ₂	: 2nd range 2nd gear
		2 ₁	: 2nd range 1st gear
		1 ₂	: 1st range 2nd gear
		1 ₁	: 1st range 1st gear

9. The **UNITS** given in this manual are primarily expressed as the SI UNIT (International System of Unit), and alternatively expressed in the metric system and in the yard/pound system.

“Example”

Tightening torque:

59 - 78 N·m (6.0 - 8.0 kg-m, 43 - 58 ft-lb)

- TROUBLE DIAGNOSES** are included in sections dealing with complicated components.
- SERVICE DATA AND SPECIFICATIONS** are contained at the end of each section for quick reference of data.
- The captions **WARNING** and **CAUTION** warn you of steps that must be followed to prevent personal injury and/or damage to some part of the vehicle.
 - **WARNING** indicates the possibility of personal injury if instructions are not followed.
 - **CAUTION** indicates the possibility of component damage if instructions are not followed.
 - **BOLD TYPED STATEMENTS** except **WARNING** and **CAUTION** give you helpful information.

GI

MA

EM

LC

EF &
EC

FE

CL

MT

AT

FA

RA

BR

ST

BF

HA

EL

IDX

HOW TO READ WIRING DIAGRAMS

WIRING DIAGRAM

Symbols used in WIRING DIAGRAM are shown below:

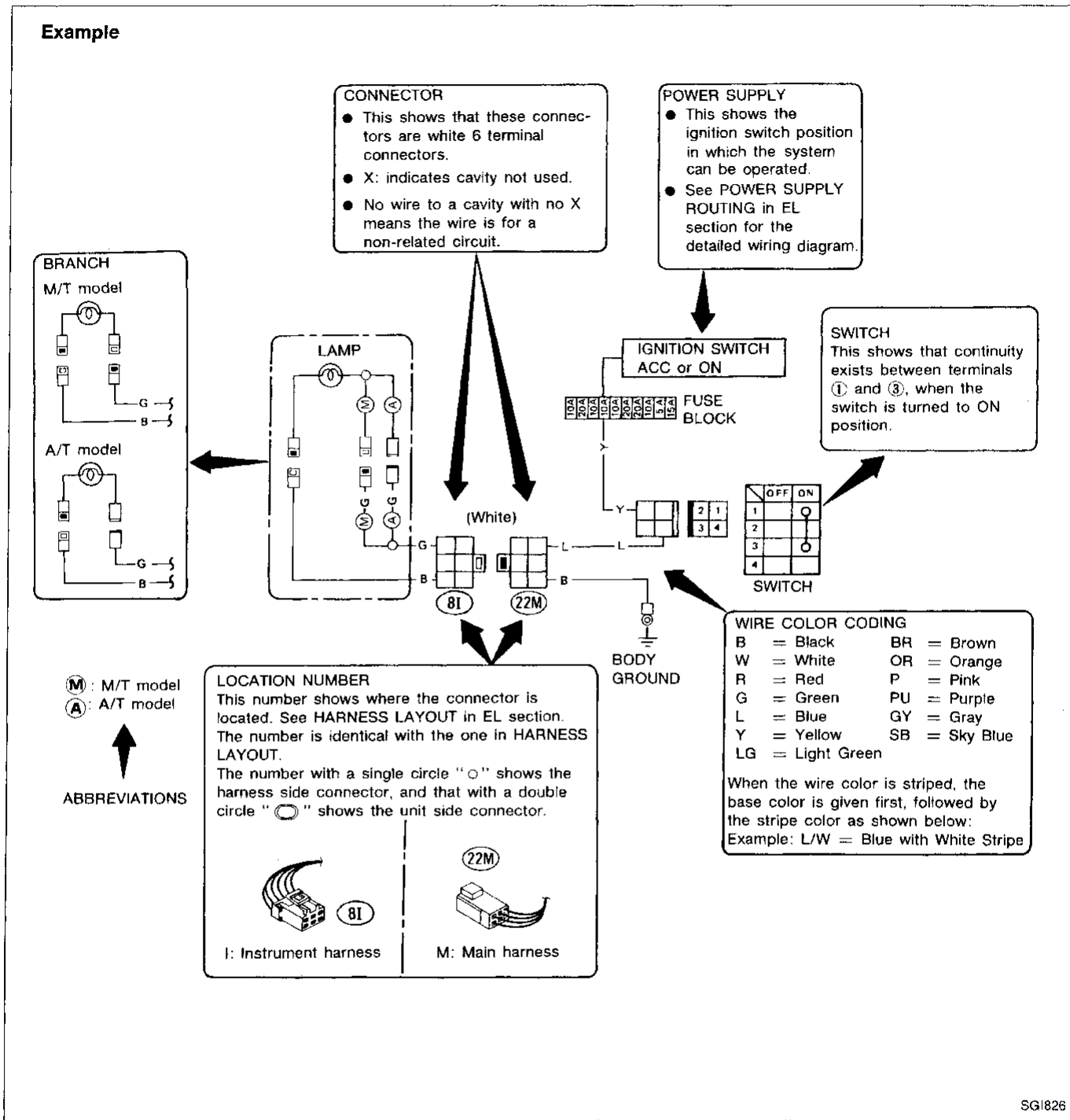

SGI826

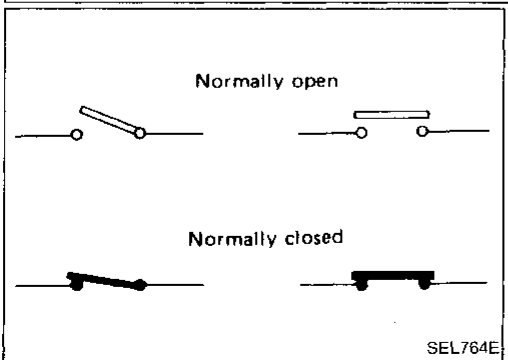

HOW TO READ WIRING DIAGRAMS

Example

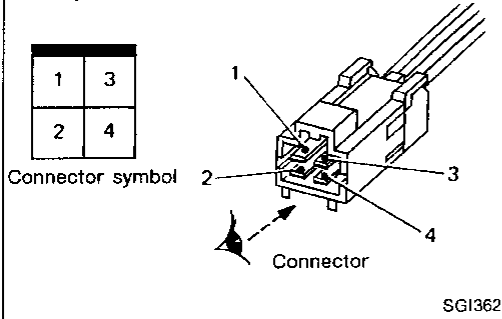

CONNECTOR SYMBOLS

- All connector symbols in wiring diagrams are shown from the terminal side.

Example

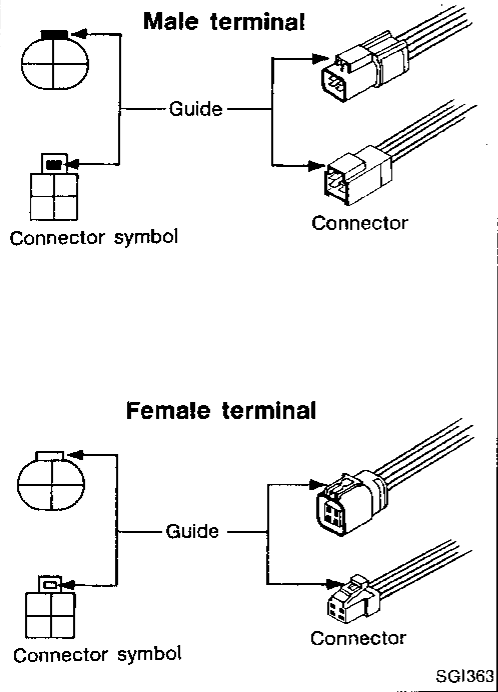

- Male and female terminals
Connector guides for male terminals are shown in black and female terminals in white in wiring diagrams.

MULTIPLE SWITCH

The continuity of the multiple switch is identified in the switch chart in wiring diagrams.

Example

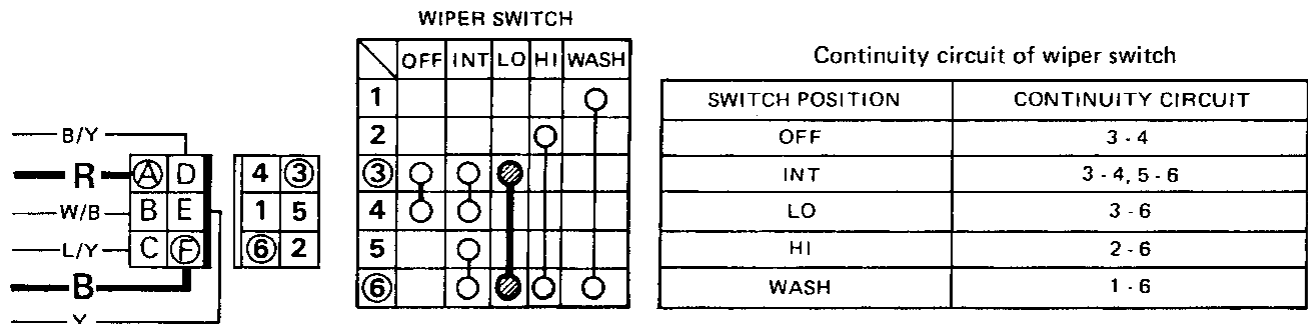

Example: Wiper switch in LO position

Continuity circuit: Red wire - (A) terminal - (3) terminal - Wiper switch (● - ●: LO) - (6) terminal - (F) terminal - Black wire

SGI365

HOW TO READ WIRING DIAGRAMS

SUPER MULTIPLE JUNCTION (SMJ)

- The "SMJ" indicated in wiring diagrams is shown in a simplified form. The terminal arrangement should therefore be referred to in the foldout at the end of the Service Manual.
- The foldout should be spread to read the entire wiring diagram.

Example

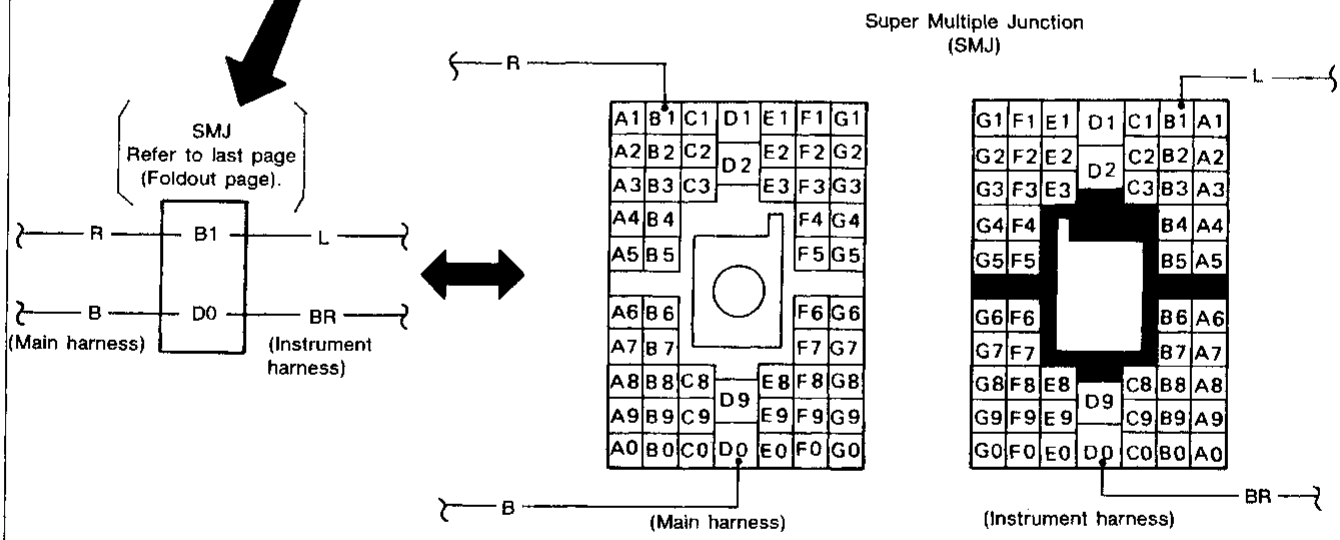
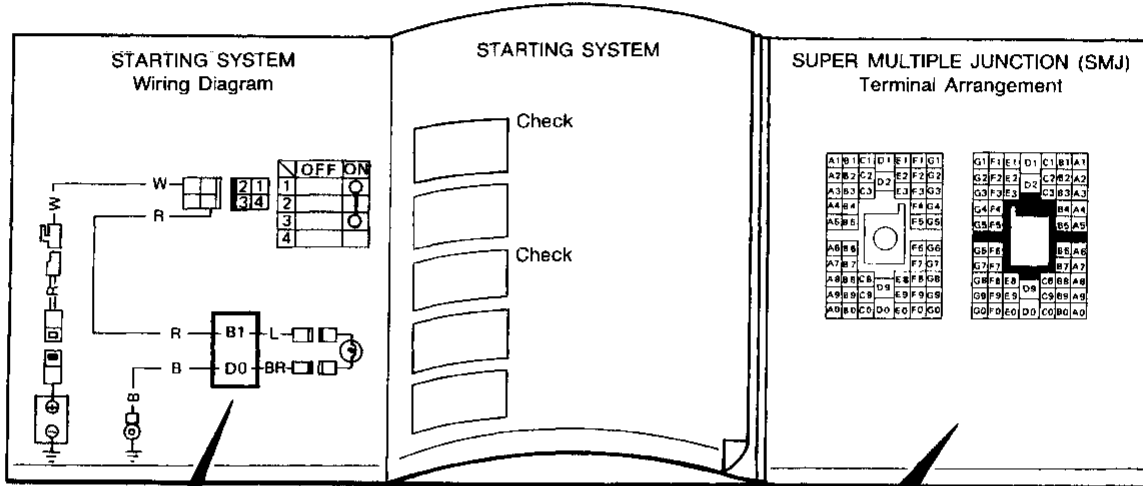

SG1618

HOW TO FOLLOW FLOW CHART IN TROUBLE DIAGNOSES

Example

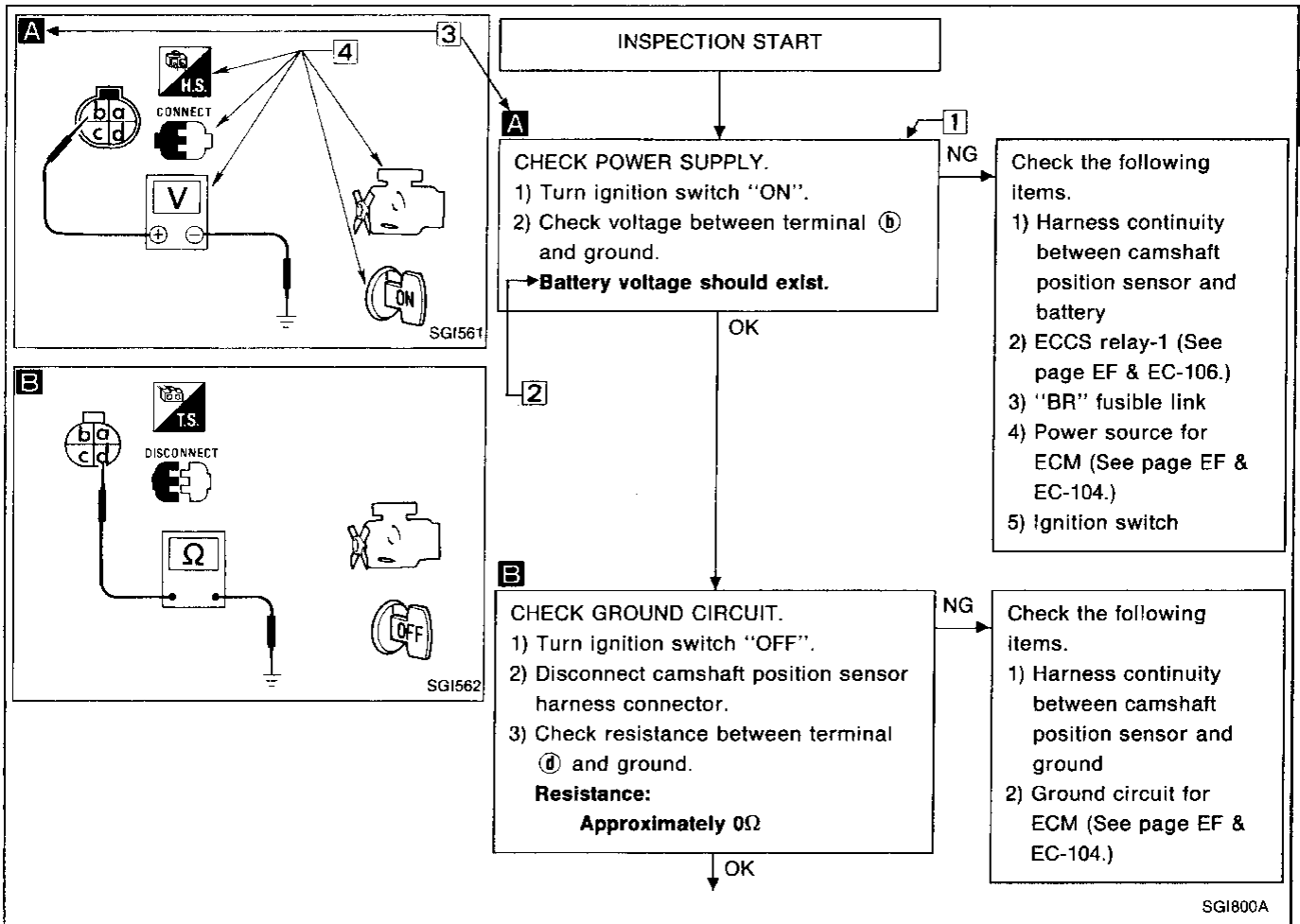

NOTICE

The flow chart indicates work procedures required to diagnose problems effectively. Observe the following instructions before diagnosing.

- 1) Use the flow chart after locating probable causes of a problem following the "Preliminary Check" or the "Symptom Chart".
- 2) After repairs, re-check that the problem has been completely eliminated.
- 3) Refer to Component Parts Location and Harness Layout for the Systems described in each section for identification/location of components and harness connectors.
- 4) Refer to the Circuit Diagram for Quick Pinpoint Check. If you must check circuit continuity between harness connectors in more detail, such as when a sub-harness is used, refer to Wiring Diagram and Harness Layout in EL section for identification of harness connectors.
- 5) When checking circuit continuity, ignition switch should be "OFF".
- 6) Before checking voltage at connectors, check battery voltage.
- 7) After accomplishing the Diagnostic Procedures and Electrical Components Inspection, make sure that all harness connectors are reconnected as they were.

HOW TO FOLLOW FLOW CHART IN TROUBLE DIAGNOSES

HOW TO FOLLOW THIS FLOW CHART

1 Work and diagnostic procedure

Start to diagnose a problem using procedures indicated in enclosed blocks, as shown in the following example.

A

CHECK POWER SUPPLY.
 1) Turn ignition switch "ON".
 2) Check voltage between terminal **(B)** and ground.
Battery voltage should exist.

← Check item being performed.
 Procedure, steps or measurement results

2 Measurement results

Required results are indicated in bold type in the corresponding block, as shown below:

These have the following meanings:

Battery voltage → 11 - 14V or approximately 12V

Voltage: Approximately 0V → **Less than 1V**

3 Cross reference of work symbols in the text and illustrations

Illustrations are provided as visual aids for work procedures. For example, symbol **A** indicated in the left upper portion of each illustration corresponds with the symbol in the flow chart for easy identification. More precisely, the procedure under the "CHECK POWER SUPPLY" outlined previously is indicated by an illustration **A**.

4 Symbols used in illustrations

Symbols included in illustrations refer to measurements or procedures. Before diagnosing a problem, familiarize yourself with each symbol.

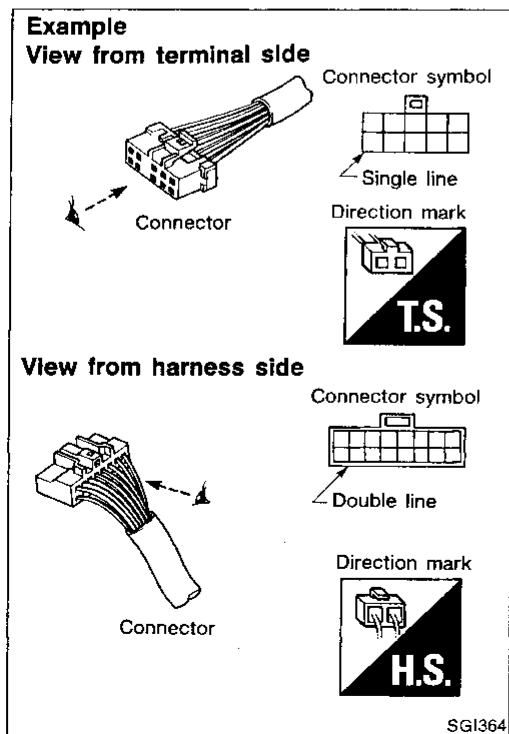

Direction mark

A direction mark is shown to clarify the side of connector (terminal side or harness side).

Direction marks are mainly used in the illustrations indicating terminal inspection.



: View from terminal side ... TS

- All connector symbols shown from the terminal side are enclosed by a single line.























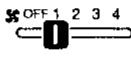

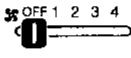











: View from harness side ... HS

- All connector symbols shown from the harness side are enclosed by a double line.

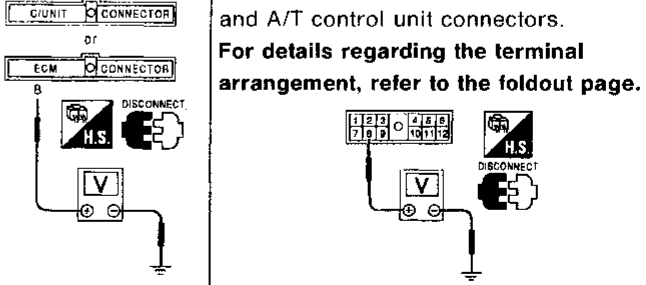
HOW TO FOLLOW FLOW CHART IN TROUBLE DIAGNOSES

Key to symbols signifying measurements or procedures

Symbol	Symbol explanation	Symbol	Symbol explanation
	Check after disconnecting the connector to be measured.		A/C switch is "OFF".
	Check after connecting the connector to be measured.		A/C switch is "ON".
	Insert key into ignition switch.		REC switch is "ON".
	Turn ignition switch to "OFF" position.		REC switch is "OFF".
	Turn ignition switch to "ON" position.		DEF switch is "ON".
	Turn ignition switch to "START" position.		VENT switch is "ON".
	Turn ignition switch from "OFF" to "ACC" position.		Fan switch is "ON". (At any position except for "OFF" position)
	Turn ignition switch from "ACC" to "OFF" position.		Fan switch is "OFF".
	Turn ignition switch from "OFF" to "ON" position.		Apply fused battery positive voltage directly to components.
	Turn ignition switch from "ON" to "OFF" position.		Drive vehicle.
	Do not start engine, or check with engine stopped.		Disconnect battery negative cable.
	Start engine, or check with engine running.		Depress brake pedal.
	Apply parking brake.		Release brake pedal.
	Release parking brake.		Depress accelerator pedal.
	Check after engine is warmed up sufficiently.		Release accelerator pedal.
	Voltage should be measured with a voltmeter.		
	Circuit resistance should be measured with an ohmmeter.		
	Current should be measured with an ammeter.		
	Procedure with CONSULT		
	Procedure without CONSULT		

GI

MA

EM

LC

EF & EC

FE

CL

MT

AT

FA

RA

BR

ST

BF

HA

EL

IDX

CONSULT CHECKING SYSTEM

System Application and Function

Diagnostic test mode	Function	ECCS (VE30DE engine)	A/T	Air bag
Work support	This mode enables a technician to adjust some devices faster and more accurately by following the indications on CONSULT.	X	—	—
Self-diagnostic results	Self-diagnostic results can be read and erased quickly.	X	X	X
Data monitor	Input/Output data in the ECM can be read.	X	X	—
Active test	Diagnostic Test Mode in which CONSULT drives some actuators apart from the ECMs and also shifts some parameters in a specified range.	X	—	—
ECM part number	ECM part number can be read.	X	X	—
Function test	ECCS faults can be isolated to a general area, semi-automatically and in a short time, by following the directions on the screen.	X	—	—

X: Applicable

Lithium Battery Replacement

CONSULT contains a lithium battery. When replacing the battery obey the following:

WARNING:

Replace the lithium battery with SANYO Electric Co., Ltd., CR2032 only. Use of another battery may present a risk of fire or explosion. The battery may present a fire or chemical burn hazard if mistreated. Do not recharge, disassemble or dispose of in fire.

Keep the battery out of reach of children and discard used battery conforming to the local regulations.

Checking Equipment

When ordering the below equipment, contact your NISSAN distributor.

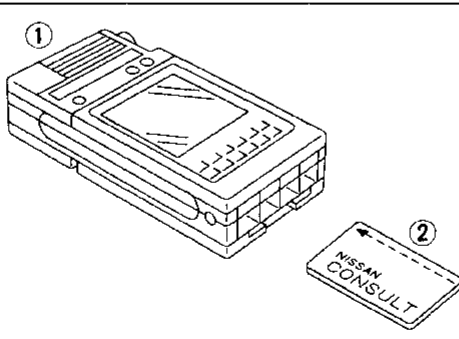
Tool name	Description
NISSAN CONSULT ① CONSULT unit and accessories ② Program card (UE 920)	 <p style="text-align: left; margin-left: 20px;">NT004</p>

IDENTIFICATION INFORMATION

Model Variation

Destination	Body	Grade	Engine		
			VG30E	VE30DE	
			Transaxle		
			RE4F02A	RS5F50V	RE4F04V
Non-California, U.S.A.	Sedan	GXE	HLJ30DAEU	—	—
		GXE (bose)	HLJ30HAEU	—	—
		SE (bose)	—	ELJ30GFEU	ELJ30GAEU
California, U.S.A.		GXE	HLJ30DAEV	—	—
		GXE (bose)	HLJ30HAEV	—	—
		SE (bose)	—	ELJ30GFEV	ELJ30GAEV
Canada		GXE	HLJ30DAEN	—	—
		GXE (brougham)	HLJ30HAEN	—	—
		SE	—	ELJ30GFEN	ELJ30GAEN

Prefix and suffix designations:

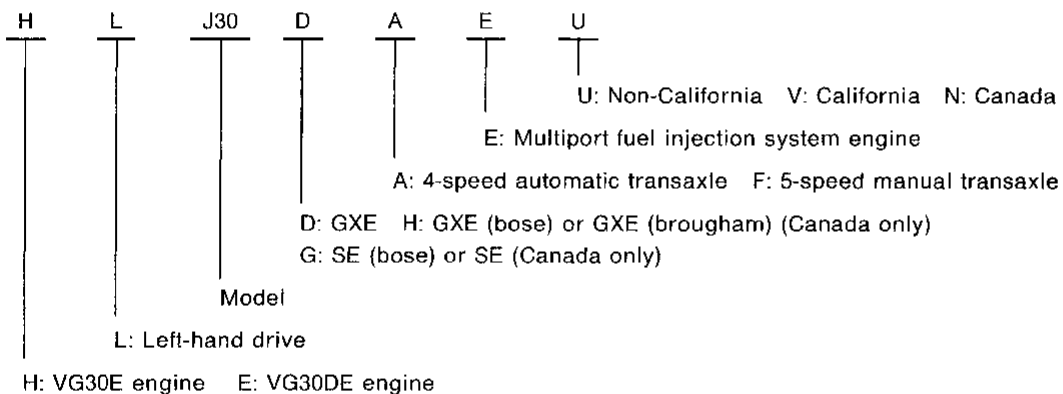

IDENTIFICATION INFORMATION

Identification Number (Cont'd)

IDENTIFICATION PLATE

NISSAN MOTOR CO., LTD. JAPAN		
型式	TYPE TIPO	△
CHASSIS NO NO DE CHASSIS		△
MODEL MODELO		△
○ カラー-COLOR TRIM トリム-COLOR GUARNICION		○
エンジン シリンダー MOTOR		△ △ CC
ミッション TRANS. AXLE アクスル TRANS. EJE		△ △
	工場 PLANT PLANTA	
日産自動車株式会社		MADE IN JAPAN

- 1 Type
- 2 Vehicle identification number (Chassis number)
- 3 Model
- 4 Body color code
- 5 Trim color code
- 6 Engine model
- 7 Engine displacement
- 8 Transmission model
- 9 Axle model

SGI315

ENGINE SERIAL NUMBER

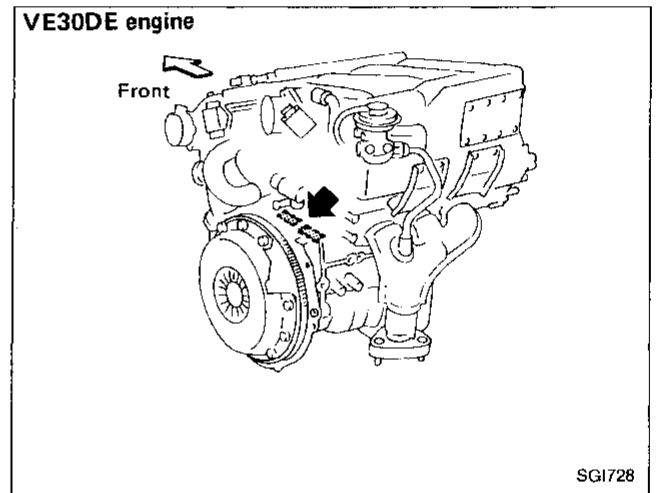
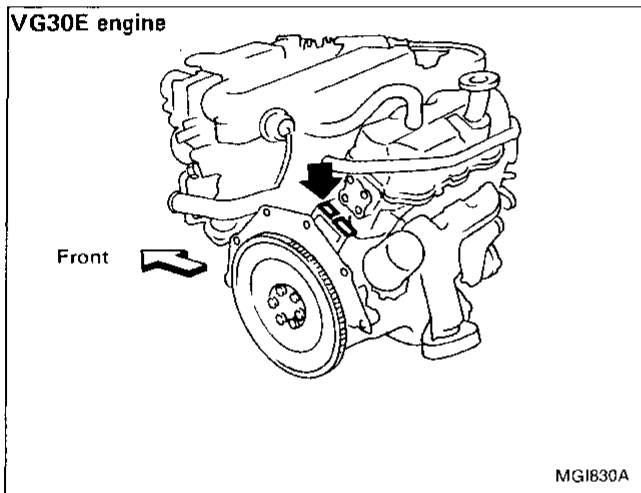

MANUAL TRANSAXLE NUMBER

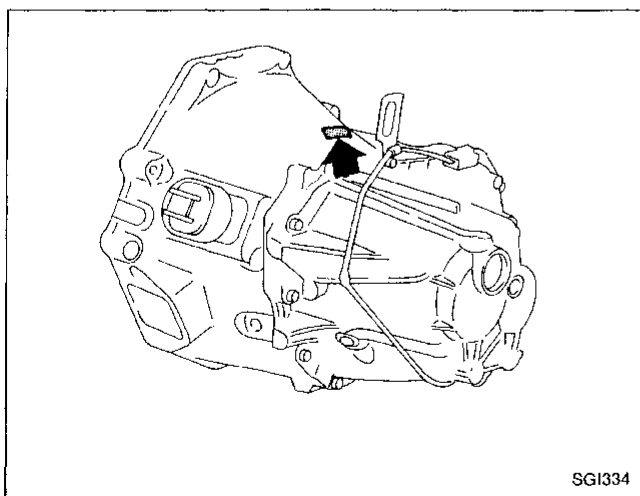

GI

MA

EM

LC

EF &
EC

FE

CL

MT

AT

FA

RA

BR

ST

BF

HA

EL

IDX

IDENTIFICATION INFORMATION

Identification Number (Cont'd)

AUTOMATIC TRANSAXLE NUMBER

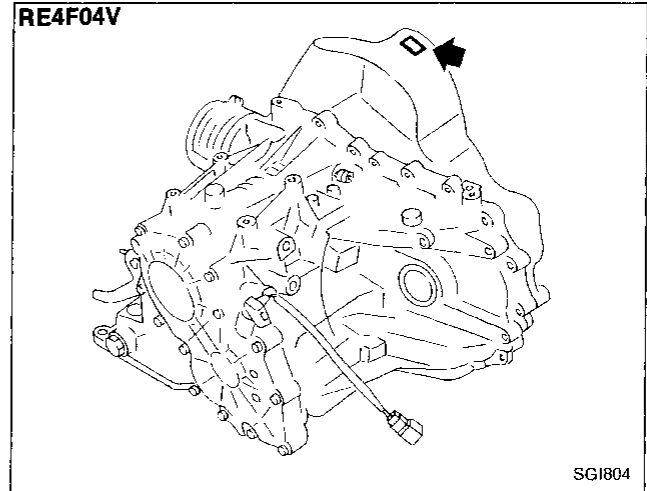
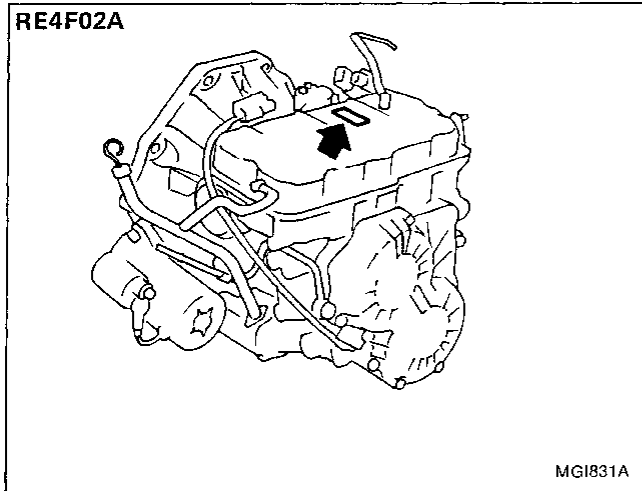

Dimensions

Unit: mm (in)

	Sedan
Overall length	4,765 (187.6)
Overall width	1,760 (69.3)
Overall height	1,400 (55.1)
Front tread	1,510 (59.4)
Rear tread	1,490 (58.7)
Wheelbase	2,650 (104.3)

Wheels and Tires

Road wheel	Aluminum	15 x 6JJ, 6.5JJ x 15
	Offset mm (in)	35 (1.38)
Tire size	Conventional	P205/65R15 P205/65VR15*
	Spare	T125/70D16

*: VE30DE engine with manual transaxle for U.S.A.

Garage Jack and Safety Stand

WARNING:

- Never get under the vehicle while it is supported only by the jack. Always use safety stands to support the frame when you have to get under the vehicle.
- Place wheel chocks at both front and back of the wheels on the ground.

CAUTION:

Place a wooden or rubber block between safety stand and vehicle body when the supporting body is flat.

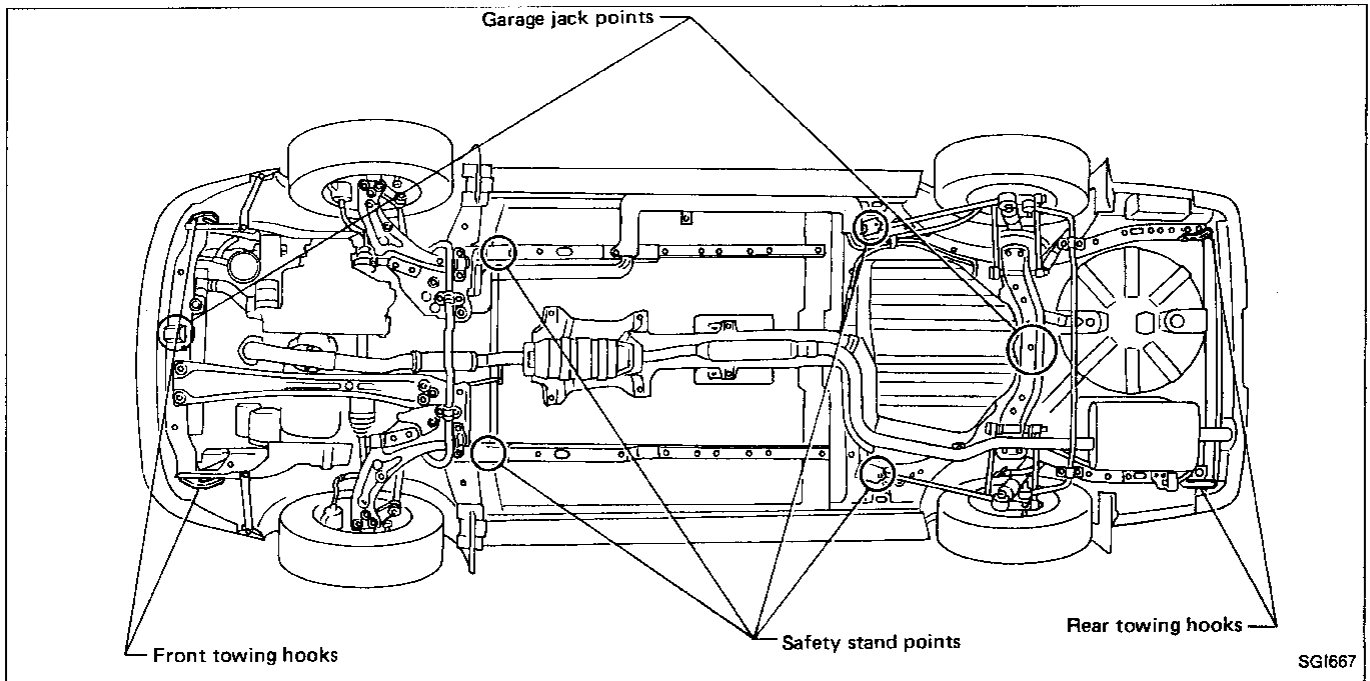

2-pole Lift

WARNING:

When lifting the vehicle, open the lift arms as wide as possible and ensure that the front and rear of the vehicle are well balanced.

When setting the lift arm, do not allow the arm to contact the brake tubes and fuel lines.

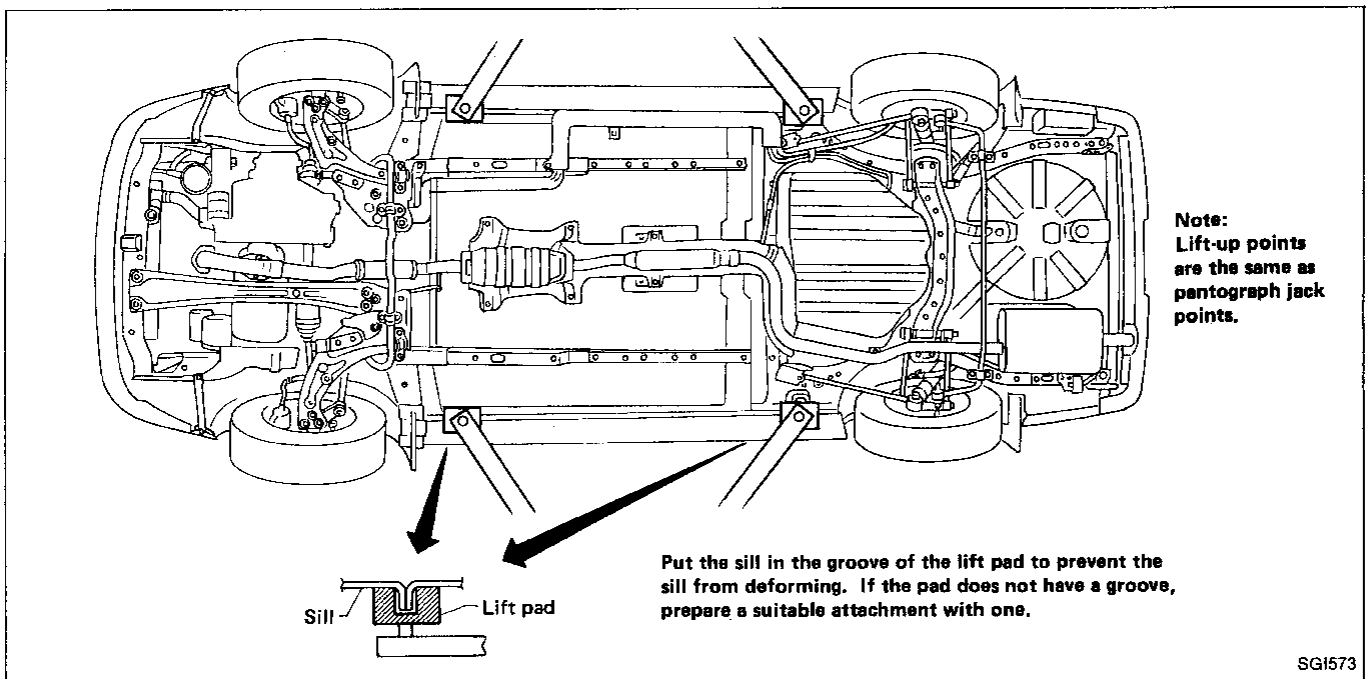

GI

MA

EM

LC

EF &
EC

FE

CL

MT

AT

FA

RA

BR

ST

BF

HA

EL

IDX

Tow Truck Towing

CAUTION:

- All applicable state or Provincial (in Canada) laws and local laws regarding the towing operation must be obeyed.
- It is necessary to use proper towing equipment to avoid possible damage to the vehicle during towing operation. Towing is in accordance with Towing Procedure Manual at dealer.
- When towing with the rear wheels on the ground, release the parking brake and move the gearshift lever to neutral position.

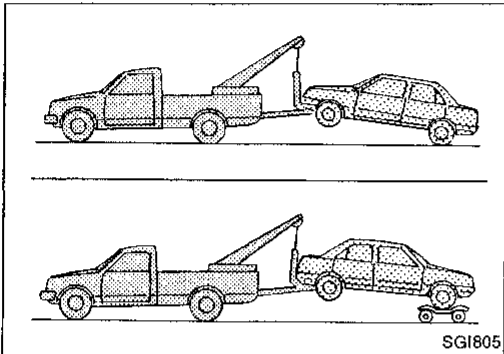

NISSAN recommends that vehicle be towed with the driving (front) wheels off the ground as illustrated.

TOWING AN AUTOMATIC TRANSAXLE MODEL WITH FOUR WHEELS ON GROUND

Observe the following restricted towing speeds and distances.

Speed:

Below 50 km/h (30 MPH)

Distance:

Less than 65 km (40 miles)

CAUTION:

Never tow an automatic transaxle model from the rear (i.e., backward) with four wheels on the ground as this may cause serious and expensive damage to the transaxle.

TOWING AN AUTOMATIC TRANSAXLE MODEL WITH REAR WHEELS RAISED (With front wheels on ground)

Never tow an automatic transaxle model with rear wheels raised (with front wheels on ground) as this may cause serious and expensive damage to the transaxle. If it is necessary to tow it with rear wheels raised, always use a towing dolly under the front wheels.

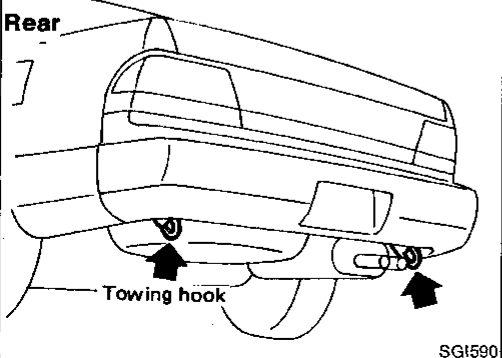
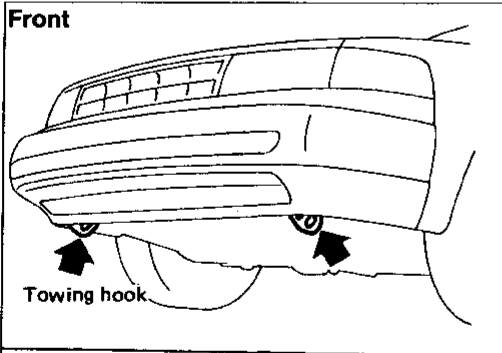
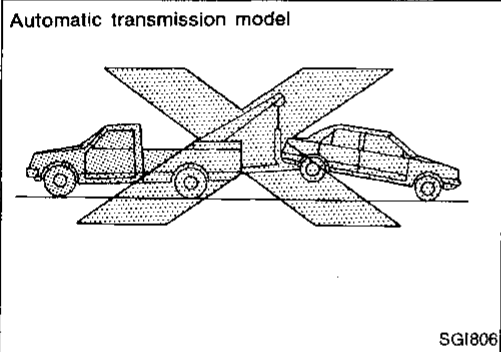

TOWING POINT

Always pull the cable straight out from the vehicle. Never pull on the hook at a sideways angle.

TIGHTENING TORQUE OF STANDARD BOLTS

Grade	Bolt size	Bolt diameter* mm	Pitch mm	Tightening torque (Without lubricant)					
				Hexagon head bolt			Hexagon flange bolt		
				N·m	kg·m	ft·lb	N·m	kg·m	ft·lb
4T	M6	6.0	1.0	5.1	0.52	3.8	6.1	0.62	4.5
	M8	8.0	1.25	13	1.3	9	15	1.5	11
			1.0	13	1.3	9	16	1.6	12
	M10	10.0	1.5	25	2.5	18	29	3.0	22
			1.25	25	2.6	19	30	3.1	22
	M12	12.0	1.75	42	4.3	31	51	5.2	38
1.25			46	4.7	34	56	5.7	41	
M14	14.0	1.5	74	7.5	54	88	9.0	65	
7T	M6	6.0	1.0	8.4	0.86	6.2	10	1.0	7
	M8	8.0	1.25	21	2.1	15	25	2.5	18
			1.0	22	2.2	16	26	2.7	20
	M10	10.0	1.5	41	4.2	30	48	4.9	35
			1.25	43	4.4	32	51	5.2	38
	M12	12.0	1.75	71	7.2	52	84	8.6	62
1.25			77	7.9	57	92	9.4	68	
M14	14.0	1.5	127	13.0	94	147	15.0	108	
9T	M6	6.0	1.0	12	1.2	9	15	1.5	11
	M8	8.0	1.25	29	3.0	22	35	3.6	26
			1.0	31	3.2	23	37	3.8	27
	M10	10.0	1.5	59	6.0	43	70	7.1	51
			1.25	62	6.3	46	74	7.5	54
	M12	12.0	1.75	98	10.0	72	118	12.0	87
1.25			108	11.0	80	137	14.0	101	
M14	14.0	1.5	177	18.0	130	206	21.0	152	

- Special parts are excluded.
- This standard is applicable to bolts having the following marks embossed on the bolt head.

*: Nominal diameter

Grade	Mark
4T 4
7T 7
9T 9

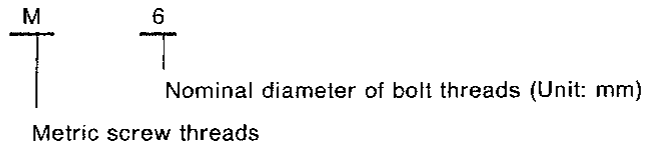

SAE J1930 TERMINOLOGY LIST

SAE J1930 Terminology List

All emission related terms used in this publication are listed in accordance with SAE J1930. Accordingly, new terms, new acronyms/abbreviations and old terms are listed in the following chart.

***: Not applicable

NEW TERM	NEW ACRONYM / ABBREVIATION	OLD TERM
Air cleaner	ACL	Air cleaner
Barometric pressure	BARO	***
Barometric pressure sensor-BCDD	BAROS-BCDD	BCDD
Camshaft position	CMP	***
Camshaft position sensor	CMPS	Crank angle sensor
Carburetor	CARB	Carburetor
Charge air cooler	CAC	Intercooler
Closed loop	CL	Closed loop
Closed throttle position switch	CTP switch	Idle switch
Clutch pedal position switch	CPP switch	Clutch switch
Continuous fuel injection system	CFI system	***
Continuous trap oxidizer system	CTOX system	***
Crankshaft position	CKP	***
Crankshaft position sensor	CKPS	***
Data link connector	DLC	***
Data link connector for CONSULT	DLC for CONSULT	Diagnostic connector for CONSULT
Diagnostic test mode	DTM	Diagnostic mode
Diagnostic test mode selector	DTM selector	Diagnostic mode selector
Diagnostic test mode I	DTM I	Mode I
Diagnostic test mode II	DTM II	Mode II
Diagnostic trouble code	DTC	Malfunction code
Direct fuel injection system	DFI system	***
Distributor ignition system	DI system	Ignition timing control
Early fuel evaporation-mixture heater	EFE-mixture heater	Mixture heater
Early fuel evaporation system	EFE system	Mixture heater control
Electrically erasable programmable read only memory	EEPROM	***
Electronic ignition system	EI system	Ignition timing control
Engine control module	ECM	ECCS control unit
Engine coolant temperature	ECT	Engine temperature
Engine coolant temperature sensor	ECTS	Engine temperature sensor
Engine modification	EM	***
Engine speed	RPM	Engine speed
Erasable programmable read only memory	EPROM	***
Evaporative emission system	EVAP system	Evaporative emission control system
Exhaust gas recirculation valve	EGR valve	EGR valve

SAE J1930 TERMINOLOGY LIST

SAE J1930 Terminology List (Cont'd)

***: Not applicable

NEW TERM	NEW ACRONYM / ABBREVIATION	OLD TERM
Exhaust gas recirculation control -BPT valve	EGRC-BPT valve	BPT valve
Exhaust gas recirculation control -solenoid valve	EGRC-solenoid valve	EGR control solenoid valve
Exhaust gas recirculation temperature sensor	EGR temperature sensor	Exhaust gas temperature sensor
Flash electrically erasable programmable read only memory	FEEPROM	***
Flash erasable programmable read only memory	FEPRM	***
Flexible fuel sensor	FFS	***
Flexible fuel system	FF system	***
Heated Oxygen sensor	HO2S	Exhaust gas sensor
Idle air control system	IAC system	Idle speed control
Idle air control valve-air regulator	IACV-air regulator	Air regulator
Idle air control valve-auxiliary air control valve	IACV-AAC valve	Auxiliary air control(AAC) valve
Idle air control valve-FICD solenoid valve	IACV-FICD solenoid valve	FICD solenoid valve
Idle air control valve-idle up control solenoid valve	IACV-idle up control solenoid valve	Idle up control solenoid valve
Idle speed control-FI pot	ISC-FI pot	FI pot
Idle speed control system	ISC system	***
Ignition control module	ICM	***
Indirect fuel injection system	IFI system	***
Intake air temperature sensor	IATS	Air temperature sensor
Knock	***	Detonation
Knock sensor	KS	Detonation sensor
Malfunction indicator lamp	MIL	Check engine light
Manifold absolute pressure	MAP	***
Manifold absolute pressure sensor	MAPS	***
Manifold differential pressure	MDP	***
Manifold differential pressure sensor	MDPS	***
Manifold surface temperature	MST	***
Manifold surface temperature sensor	MSTS	***
Manifold vacuum zone	MVZ	***
Manifold vacuum zone sensor	MVZS	***
Mass air flow sensor	MAFS	Air flow meter
Mixture control solenoid valve	MC solenoid valve	Air-fuel ratio control solenoid valve
Multiport fuel injection System	MFI system	Fuel injection control
Neutral position switch	***	Neutral switch
Non-volatile random access memory	NVRAM	***
On-board diagnostic system	OBD system	Self-diagnosis
Open loop	OL	Open loop
Oxidation catalyst	OC	Catalyst

GI
 MA
 EM
 LC
 EF & EC
 FE
 CL
 MT
 AT
 FA
 RA
 BR
 ST
 BF
 HA
 EL
 IX

SAE J1930 TERMINOLOGY LIST

SAE J1930 Terminology List (Cont'd)

***: Not applicable

NEW TERM	NEW ACRONYM / ABBREVIATION	OLD TERM
Oxidation catalytic converter system	OC system	***
Oxygen sensor	O2S	Exhaust gas sensor
Park position switch	***	Park switch
Park/neutral position switch	PNP switch	Park/neutral switch
Periodic trap oxidizer system	PTOX system	***
Powertrain control module	PCM	***
Programmable read only memory	PROM	***
Pulsed secondary air injection control solenoid valve	PAIRC solenoid valve	AIV control solenoid valve
Pulsed secondary air injection system	PAIR system	Air induction valve(AIV) control
Pulsed secondary air injection valve	PAIR valve	Air induction valve
Random access memory	RAM	***
Read only memory	ROM	***
Scan tool	ST	***
Secondary air injection pump	AIR pump	***
Secondary air injection system	AIR system	***
Sequential multiport fuel injection system	SFI system	Sequential fuel injection
Service reminder indicator	SRI	***
Simultaneous multiport fuel injection system	***	Simultaneous fuel injection
Smoke puff limiter system	SPL system	***
Supercharger	SC	***
Supercharger bypass	SCB	***
System readiness test	SRT	***
Thermal vacuum valve	TVV	Thermal vacuum valve
Three way catalyst	TWC	Catalyst
Three way catalytic converter system	TWC system	***
Three way + oxidation catalyst	TWC + OC	Catalyst
Three way + oxidation catalytic converter system	TWC + OC system	***
Throttle body	TB	Throttle chamber SPI body
Throttle body fuel injection system	TBI system	Fuel injection control
Throttle position	TP	Throttle position
Throttle position sensor	TPS	Throttle sensor
Throttle position switch	TP switch	Throttle switch
Torque converter clutch solenoid valve	TCC solenoid valve	Lock-up cancel solenoid Lock-up solenoid
Turbocharger	TC	Turbocharger
Vehicle speed sensor	VSS	Vehicle speed sensor
Volume air flow sensor	VAFS	Air flow meter

SAE J1930 TERMINOLOGY LIST

SAE J1930 Terminology List (Cont'd)

***: Not applicable

NEW TERM	NEW ACRONYM / ABBREVIATION	OLD TERM
Warm up oxidation catalyst	WU-OC	Catalyst
Warm up oxidation catalytic converter system	WU-OC system	***
Warm up three-way catalyst	WU-TWC	Catalyst
Warm up three-way catalytic converter system	WU-TWC system	***
Wide open throttle position switch	WOTP switch	Full switch

GI

MA

EM

LC

EF &
EC

FE

CL

MT

AT

FA

RA

BR

ST

BF

HA

EL

IDX