

SUPER MULTIPLE JUNCTION (SMJ)

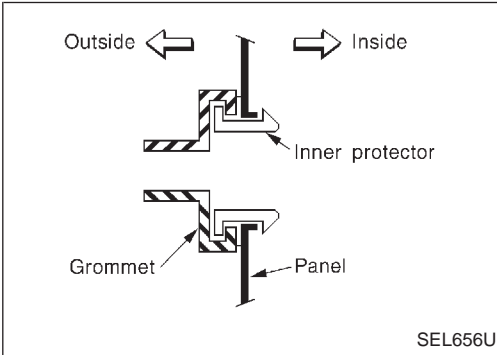
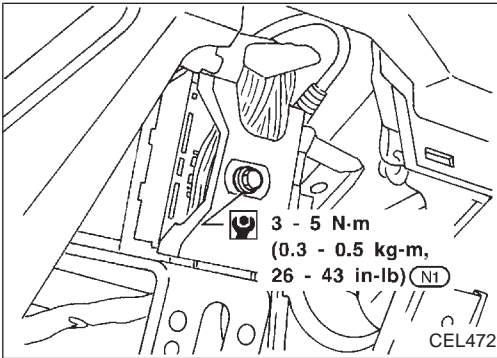
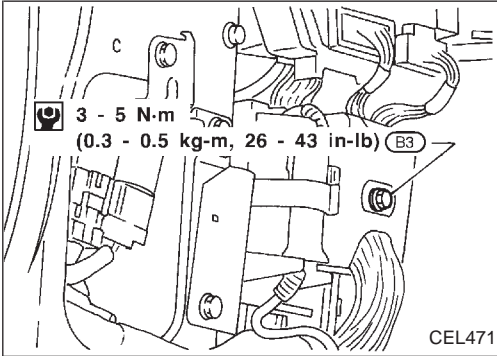
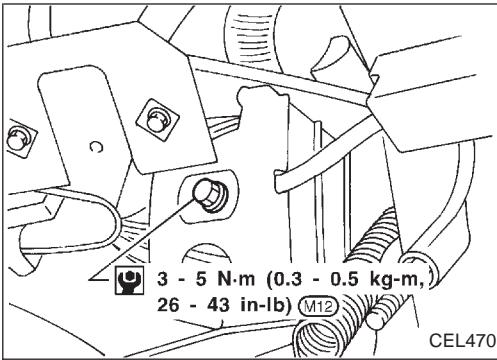

INSTALLATION

To install SMJ, tighten bolts until orange “fulltight” mark appears and then retighten to specified torque as required.

 : 3 - 5 N·m
(0.3 - 0.5 kg-m, 26 - 43 in-lb)

CAUTION:

Do not overtighten bolts, otherwise, they may be damaged.

Grommet

A grommet of the shape shown on left is used for engine room harness through hole and engine control harness.

CAUTION:

Do not use old inner protector after removal; replace with new one.

SUPER MULTIPLE JUNCTION (SMJ)

Terminal Arrangement



MAIN HARNESS

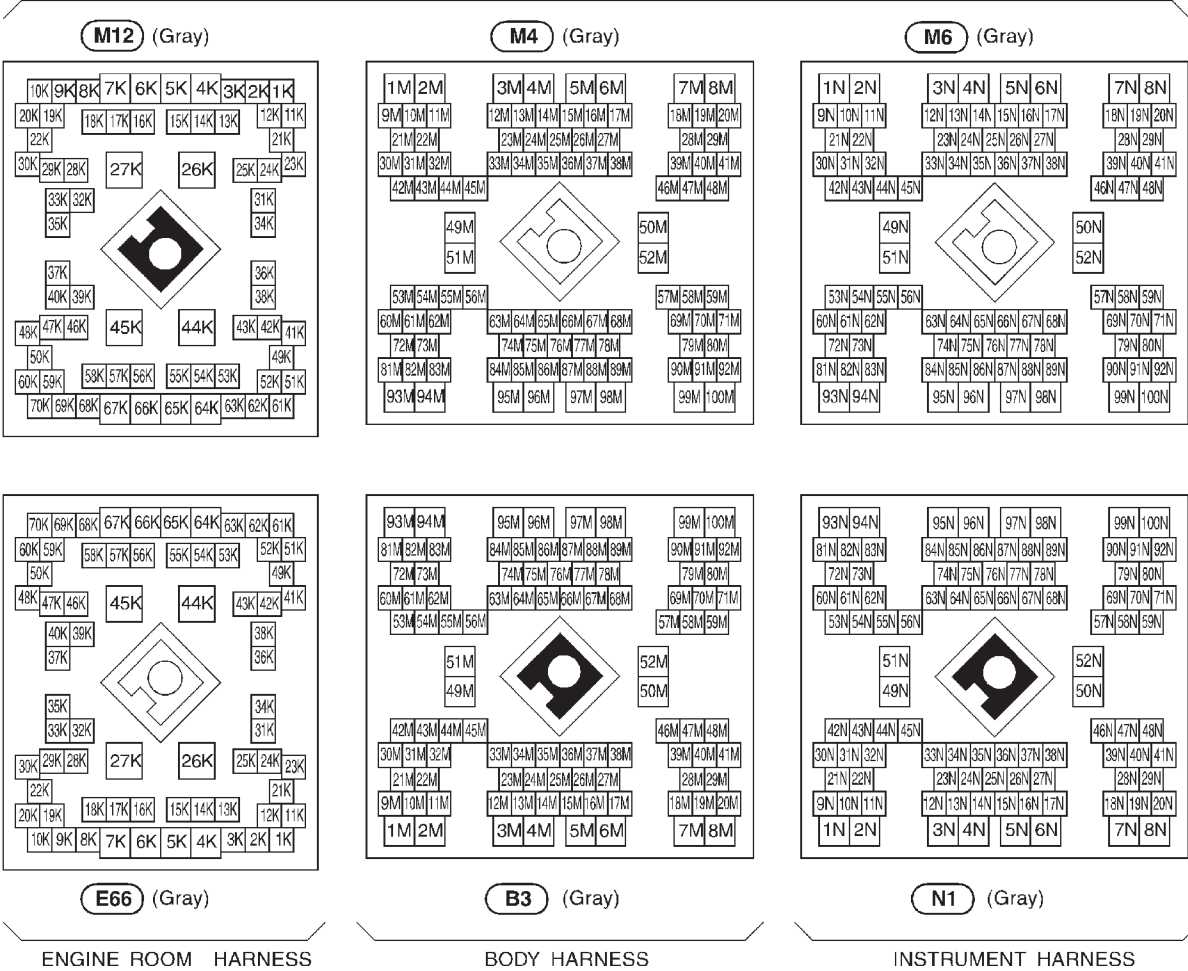

MAIN HARNESS

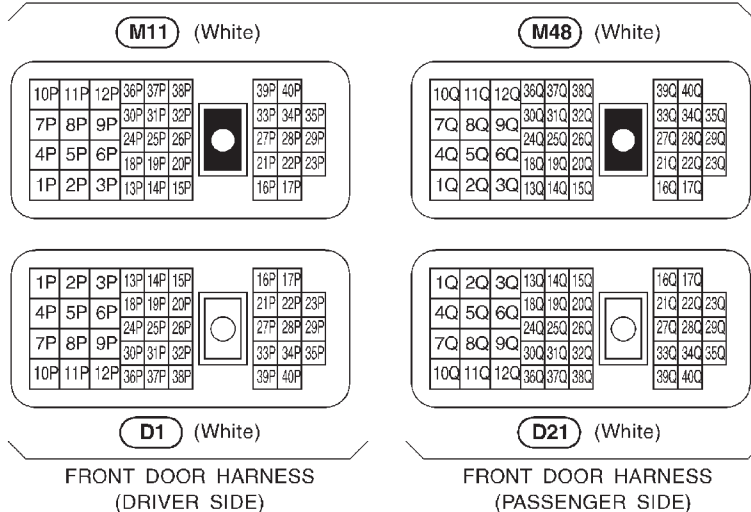

SUPER MULTIPLE JUNCTION (SMJ)

Terminal Arrangement (Cont'd)

MAIN HARNESS



M3 (White)

9V	10V	11V	12V	13V	14V	15V	16V	33V	34V	35V	36V	37V	38V	39V	40V	41V	42V	43V	44V	45V	46V	47V	48V
1V	2V	3V	4V	5V	6V	7V	8V	17V	18V	19V	20V	21V	22V	23V	24V	25V	26V	27V	28V	29V	30V	31V	32V

1V	2V	3V	4V	5V	6V	7V	8V	17V	18V	19V	20V	21V	22V	23V	24V	25V	26V	27V	28V	29V	30V	31V	32V
9V	10V	11V	12V	13V	14V	15V	16V	33V	34V	35V	36V	37V	38V	39V	40V	41V	42V	43V	44V	45V	46V	47V	48V

B4 (White)

BODY HARNESS

MAIN HARNESS



M50 (White)

1R	2R	3R	4R	5R	6R	7R	8R	17R	18R	19R	20R	21R	22R	23R	24R	25R	26R	27R	28R	29R	30R	31R	32R
9R	10R	11R	12R	13R	14R	15R	16R	33R	34R	35R	36R	37R	38R	39R	40R	41R	42R	43R	44R	45R	46R	47R	48R

9R	10R	11R	12R	13R	14R	15R	16R	33R	34R	35R	36R	37R	38R	39R	40R	41R	42R	43R	44R	45R	46R	47R	48R
1R	2R	3R	4R	5R	6R	7R	8R	17R	18R	19R	20R	21R	22R	23R	24R	25R	26R	27R	28R	29R	30R	31R	32R

B101 (White)

BODY NO.2 HARNESS

MAIN HARNESS



M49 (White)

9S	10S	11S	12S	13S	14S	15S	16S	33S	34S	35S	36S	37S	38S	39S	40S	41S	42S	43S	44S	45S	46S	47S	48S
1S	2S	3S	4S	5S	6S	7S	8S	17S	18S	19S	20S	21S	22S	23S	24S	25S	26S	27S	28S	29S	30S	31S	32S

1S	2S	3S	4S	5S	6S	7S	8S	17S	18S	19S	20S	21S	22S	23S	24S	25S	26S	27S	28S	29S	30S	31S	32S
9S	10S	11S	12S	13S	14S	15S	16S	33S	34S	35S	36S	37S	38S	39S	40S	41S	42S	43S	44S	45S	46S	47S	48S

F63 (White)

ENGINE CONTROL HARNESS

ENGINE ROOM HARNESS



E70 (White)

9T	10T	11T	12T	13T	14T	15T	16T	33T	34T	35T	36T	37T	38T	39T	40T	41T	42T	43T	44T	45T	46T	47T	48T
1T	2T	3T	4T	5T	6T	7T	8T	17T	18T	19T	20T	21T	22T	23T	24T	25T	26T	27T	28T	29T	30T	31T	32T

1T	2T	3T	4T	5T	6T	7T	8T	17T	18T	19T	20T	21T	22T	23T	24T	25T	26T	27T	28T	29T	30T	31T	32T
9T	10T	11T	12T	13T	14T	15T	16T	33T	34T	35T	36T	37T	38T	39T	40T	41T	42T	43T	44T	45T	46T	47T	48T

E81 (White)

COMBINATION SUB-HARNESS

SUPER MULTIPLE JUNCTION (SMJ)

Terminal Arrangement (Cont'd)

ENGINE CONTROL HARNESS



F64 (White)

1U	2U	3U	4U	5U	6U	7U	8U	↗	17U	18U	9U	20U	21U	22U	23U
9U	10U	11U	12U	13U	14U	15U	16U	↘	24U	25U	26U	27U	28U	29U	30U

9U	10U	11U	12U	13U	14U	15U	16U	◆	24U	25U	26U	27U	28U	29U	30U
1U	2U	3U	4U	5U	6U	7U	8U	◆	17U	18U	9U	20U	21U	22U	23U

B102 (White)

BODY NO.2 HARNESS

FUSE BLOCK — Junction Box (J/B)

Terminal Arrangement

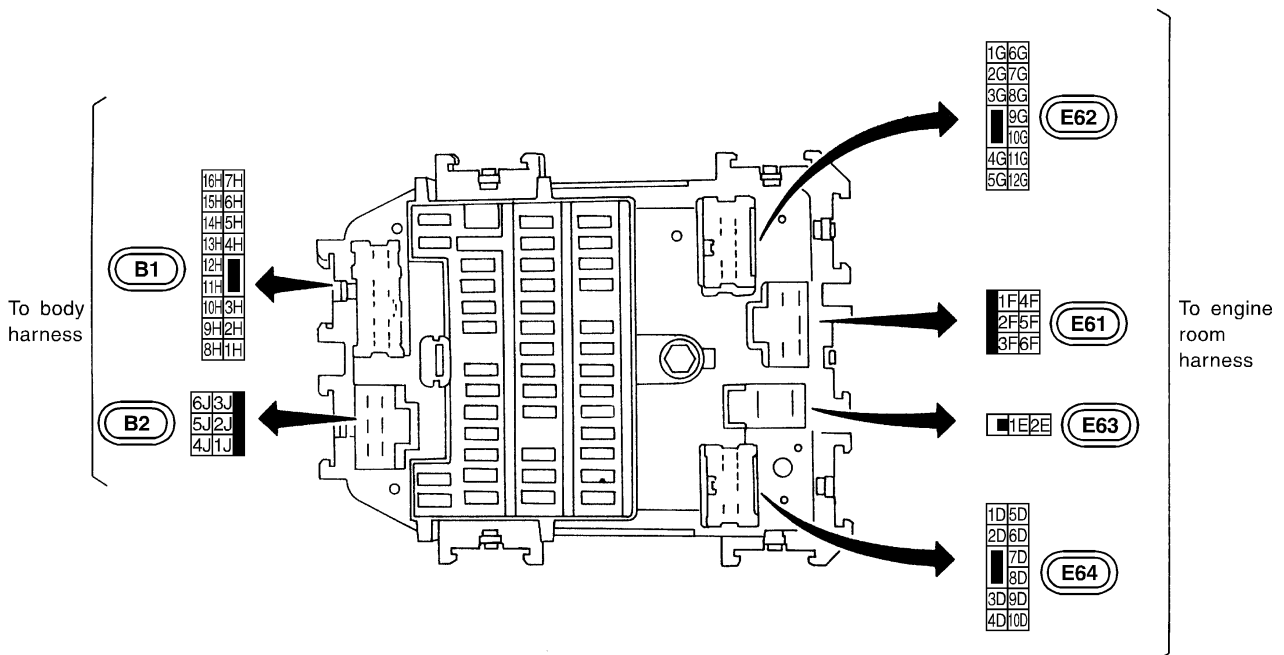
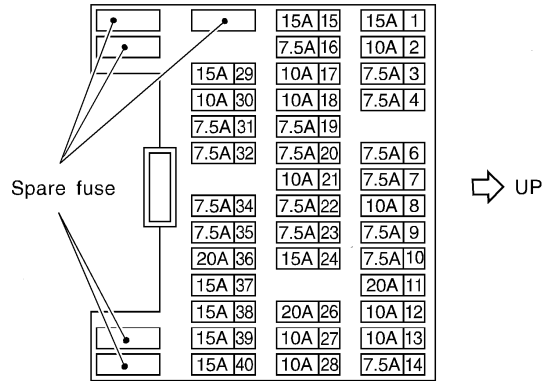
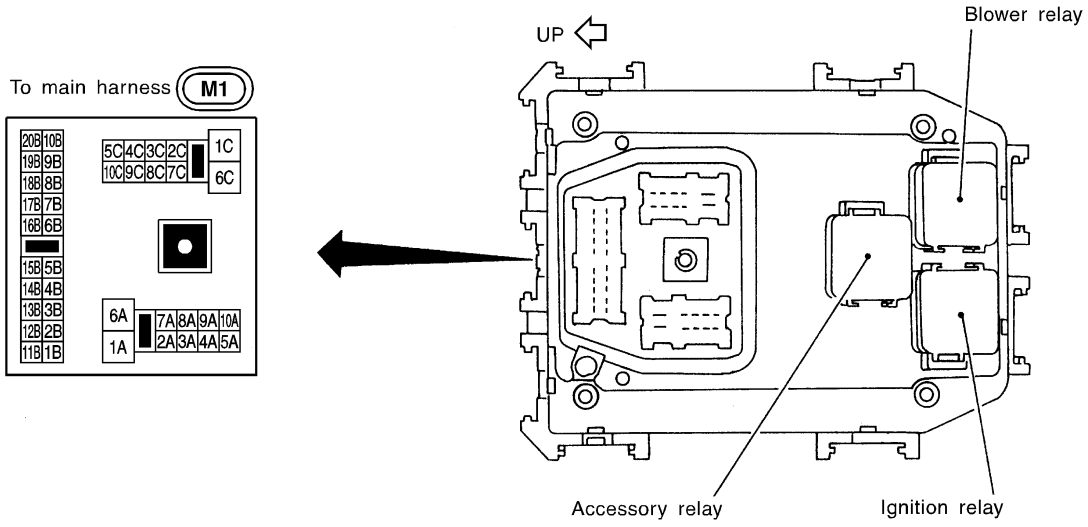

FUSE AND FUSIBLE LINK BOX

Terminal Arrangement

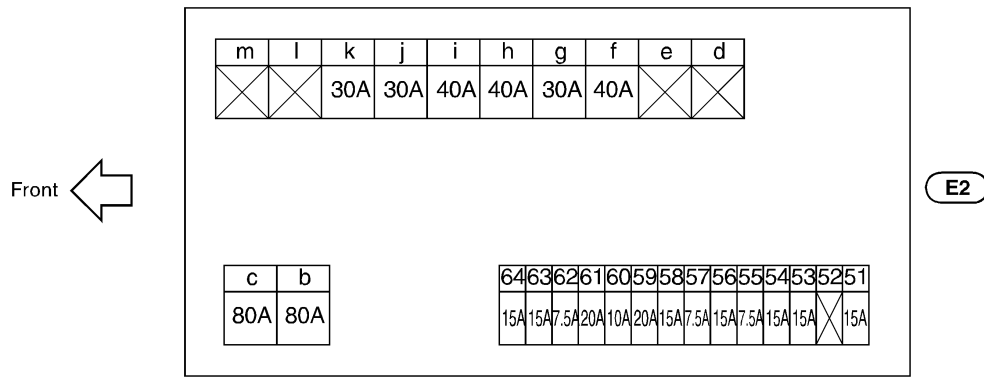

a-m FUSIBLE LINK

NO. 51-64 FUSE

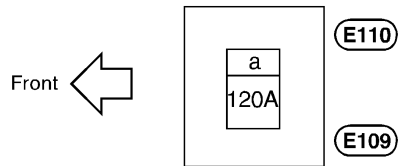

ELECTRICAL UNITS

Terminal Arrangement

ECM (F69)

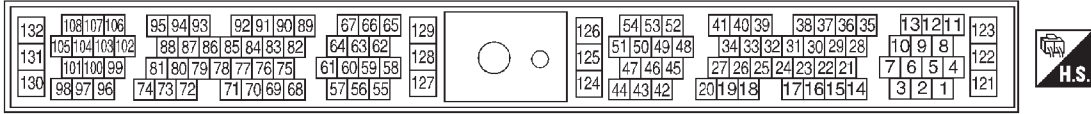

(White)

TCM (TRANSMISSION CONTROL MODULE) (B9)

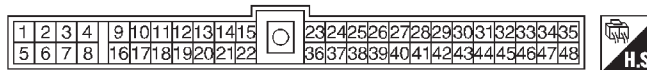

(White)

ABS/TCS CONTROL UNIT (B103)

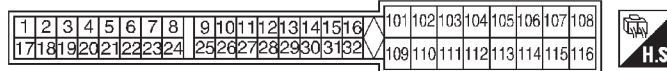

(White)

BCM (BODY CONTROL MODULE) (M22)

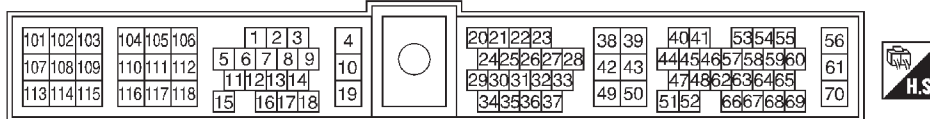

(White)

A/C AUTO AMP.

(M44)

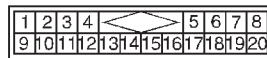

(White)

(M45)

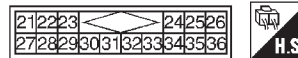

(White)

JOINT CONNECTOR (J/C)

Terminal Arrangement

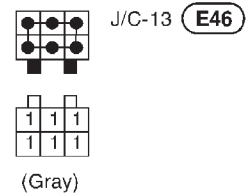
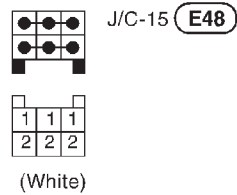
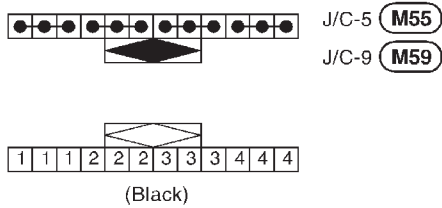
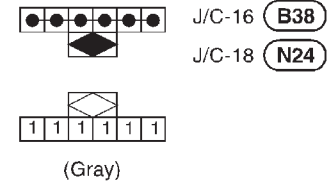
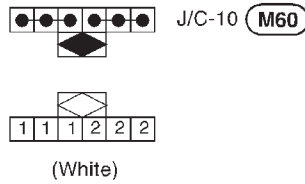
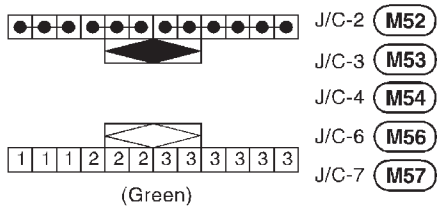
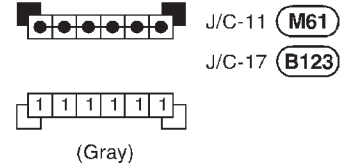
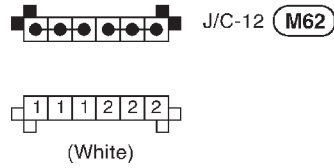
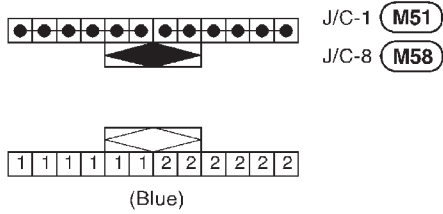

QUICK REFERENCE CHART: Q45

2001

ENGINE TUNE-UP DATA

Engine model	VH41DE		
Firing order	1-8-7-3-6-5-4-2		
Idle speed A/T (in "N" position)	rpm	650±50	
Ignition timing (BTDC at idle speed)	15°±2°		
CO% at idle	Idle mixture screw is preset and sealed at factory.		
Drive belt deflection (Cold)	mm (in)	Used belt deflection	
		Limit	Deflection after adjustment
Alternator	8 (0.31)	4 - 5 (0.16 - 0.20)	3.5 - 4.5 (0.138 - 0.177)
Air conditioner compressor	13 (0.51)	9 - 10 (0.35 - 0.39)	8 - 9 (0.31 - 0.35)
Power steering oil pump	14 (0.55)	9 - 10 (0.35 - 0.39)	8 - 9 (0.31 - 0.35)
Water pump	9 (0.35)	6 - 7 (0.24 - 0.28)	5 - 6 (0.20 - 0.24)
Applied pushing force	N (kg, lb)	98 (10, 22)	
Drive belt tension (Cold)*	N (kg, lb)	Used belt tension	
		Limit	Tension after adjustment
Alternator	196 (20, 44)	736 - 814 (75 - 83, 165 - 183)	843 - 922 (86 - 94, 190 - 207)
Air conditioner compressor	196 (20, 44)	500 - 579 (51 - 59, 112 - 130)	608 - 686 (62 - 70, 137 - 154)
Power steering oil pump	137 (14, 31)	353 - 432 (36 - 44, 79 - 97)	451 - 530 (46 - 54, 101 - 119)
Water pump	196 (20, 44)	539 - 618 (55 - 63, 121 - 139)	657 - 736 (67 - 75, 148 - 165)
Radiator cap relief pressure	kPa (kg/cm ² , psi)	98 - 118 (1.0 - 1.2, 14 - 17)	
Cooling system leakage testing pressure	kPa (kg/cm ² , psi)	157 (1.6, 23)	
Compression pressure	kPa (kg/cm ² , psi)/rpm	1,285 (13.1, 186)/300	
		Minimum 991 (10.1, 144)/300	
Spark plug	Standard type	PFR5G-11	
	Hot type	PFR4G-11	
	Cold type	PFR6G-11	

* If the belt tension gauge cannot be installed at check points, check drive belt tension at a different location on the belt.

FRONT WHEEL ALIGNMENT (Unladen*)

Camber	Minimum	-1°25' (-1.42°)	
	Nominal	-0°40' (-0.67°)	
	Maximum	0°05' (0.08°)	
Degree minute (Decimal degree)	Left and right difference	1° (1.00°) or less	
Caster	Minimum	5°40' (5.67°)	
	Nominal	6°25' (6.42°)	
	Maximum	7°10' (7.17°)	
Degree minute (Decimal degree)	Left and right difference	1° (1.00°) or less	
Kingpin inclination	Minimum	12°25' (12.42°)	
	Nominal	13°10' (13.17°)	
	Maximum	13°55' (13.92°)	
Degree minute (Decimal degree)			
Total toe-in	Minimum	1 (0.04)	
	Nominal	2 (0.08)	
	Maximum	3 (0.12)	
Distance (A - B)	mm (in)	Minimum	4' (0.07°)
		Nominal	10' (0.17°)
Angle (left plus right)	Degree minute (Decimal degree)	Maximum	16' (0.27°)
Wheel turning angle (Full turn)	Minimum	36°50' (36.83°)	
	Nominal	39°50' (39.83°)	
	Maximum	40°50' (40.83°)	
Degree minute (Decimal degree)			
Wheel turning angle (Full turn)	Degree minute (Decimal degree)	Minimum	32°25' (32.42°)
		Nominal	

* Fuel, radiator coolant and engine oil full.
Spare tire, jack, hand tools and mats in designated positions.

REAR WHEEL ALIGNMENT (Unladen*)

Camber	Minimum	-0°15' (-0.25°)	
	Nominal	-0°45' (-0.75°)	
	Maximum	-1°15' (-1.25°)	
Degree minute (Decimal degree)			
Total toe-in	Minimum	0 (0)	
	Nominal	2.5 (0.098)	
	Maximum	5 (0.20)	
Distance (A - B)	mm (in)	Minimum	0' (0.00°)
		Nominal	14' (0.23°)
Angle (left plus right)	Degree minute (Decimal degree)	Maximum	28' (0.47°)

* Fuel, radiator coolant and engine oil full.
Spare tire, jack, hand tools and mats in designated positions.

BRAKE

Unit: mm (in)

Front brake		
Pad wear limit		2.0 (0.079)
Rotor repair limit		26.0 (1.024)
Rear brake		
Pad wear limit		2.0 (0.079)
Rotor repair limit		14.0 (0.551)
Pedal free height		183 - 193 (7.20 - 7.60)
Pedal depressed height*		More than 95 (3.74)

* Under force of 490 N (50 kg, 110 lb) with engine running

REFILL CAPACITIES

Unit	Liter	US measure	
Fuel tank	80	21-1/8 gal	
Coolant (With reservoir tank)	11.7	12-3/8 qt	
Engine*	Drain and refill		
	With oil filter change	5.3	5-5/8 qt
	Without oil filter change	5.0	5-1/4 qt
	Dry engine (overhaul)	6.2	6-1/2 qt
Transmission	A/T	10.5	11-1/8 qt
Differential carrier		1.3	2-3/4 pt
Power steering system		1.3	1-3/8 qt
Air conditioning system	Compressor oil	0.250	8.5 fl oz
	Refrigerant	0.675 - 0.725 kg	1.488 - 1.599 lb

* For further details, see "Changing Engine Oil" in MA section.