

SECTION **MIR**  
MIRRORS

A  
B  
C  
D  
E  
F  
G  
H  
I  
J  
K  
M  
N  
O  
P

CONTENTS

<b>FUNCTION DIAGNOSIS</b> .....	2	<b>PRECAUTION</b> .....	16
<b>DOOR MIRROR SYSTEM</b> .....	2	<b>PRECAUTIONS</b> .....	16
Component Description .....	2	Supplemental Restraint System (SRS) "AIR B AG" and "SEAT BELT PRE-TENSIONER" .....	16
<b>INSIDE MIRROR SYSTEM</b> .....	3	<b>PREPARATION</b> .....	17
System Description .....	3	<b>PREPARATION</b> .....	17
Component Description .....	3	Commercial Service Tools .....	17
<b>COMPONENT DIAGNOSIS</b> .....	4	<b>ON-VEHICLE REPAIR</b> .....	18
<b>DOOR MIRROR</b> .....	4	<b>INSIDE MIRROR</b> .....	18
Wiring Diagram - DOOR MIRROR SYSTEM (LHD MODELS) - .....	4	Exploded View .....	18
Wiring Diagram - DOOR MIRROR SYSTEM (RHD MODELS) - .....	6	Removal and Installation .....	18
<b>AUTO ANTI-DAZZLING INSIDE MIRROR SYSTEM</b> .....	8	<b>DOOR MIRROR</b> .....	19
Wiring Diagram - INSIDE MIRROR SYSTEM - .....	8	Exploded View .....	19
<b>SYMPTOM DIAGNOSIS</b> .....	10	Removal and Installation .....	20
<b>SQUEAK AND RATTLE TROUBLE DIAGNO- SIS</b> .....	10	Disassembly and Assembly .....	20
Work Flow .....	10	<b>DOOR MIRROR REMOTE CONTROL SWITCH</b> .....	22
Generic Squeak and Rattle Troubleshooting .....	12	Exploded View .....	22
Diagnostic Worksheet .....	14	Removal and Installation .....	22

MIR

# DOOR MIRROR SYSTEM

< FUNCTION DIAGNOSIS >

## FUNCTION DIAGNOSIS

### DOOR MIRROR SYSTEM

#### Component Description

INFOID:000000001188561

Component	Function
Door mirror remote control switch (mirror switch · change over switch)	It supplies power to mirror motor by operating mirror switch and change over switch.
Door mirror remote control switch (open/close switch)	It supplies power to folding motor by operating open/close switch.
Door mirror motor	It makes mirror face operate from side to side and up and down with the mirror control switch operation.
Folding motor	It makes mirror folding with the mirror control switch operation.

# INSIDE MIRROR SYSTEM

< FUNCTION DIAGNOSIS >

## INSIDE MIRROR SYSTEM

### System Description

INFOID:000000001188562

It senses the brightness of the headlight of the vehicle from the rear with the sensor integrated into the mirror. It automatically changes the light transmittance according to the sensed brightness of the light from the headlight.

### Component Description

INFOID:000000001188563

Component	Function
Auto anti-dazzling inside mirror	It automatically changes the light transmittance according to the brightness of the light at the headlight of the vehicle from the rear.

A

B

C

D

E

F

G

H

I

J

K

MIR

M

N

O

P

# DOOR MIRROR

< COMPONENT DIAGNOSIS >

## COMPONENT DIAGNOSIS

### DOOR MIRROR

#### Wiring Diagram - DOOR MIRROR SYSTEM (LHD MODELS) -

INFOID:000000001188583

#### DOOR MIRROR (LHD MODELS)

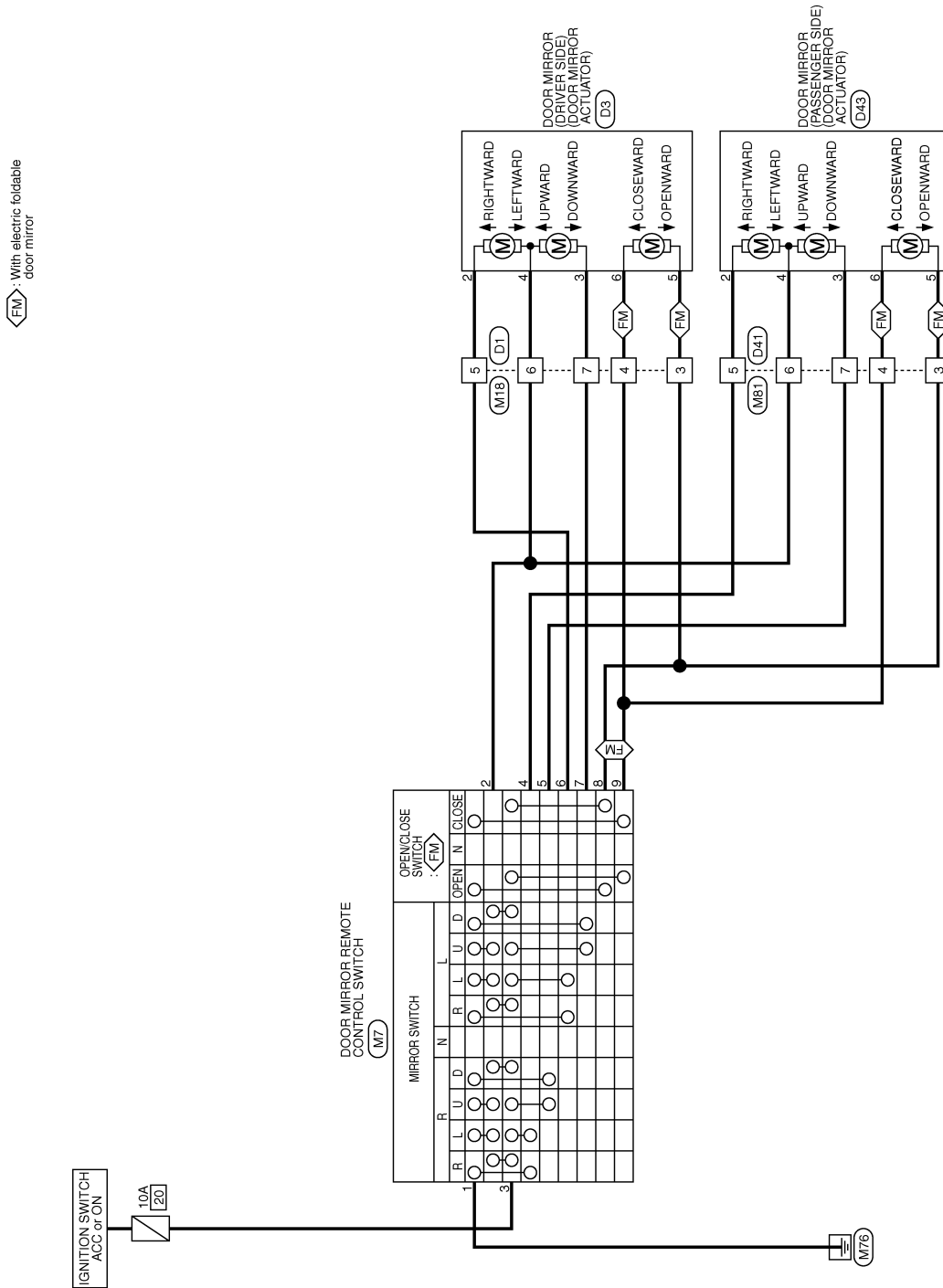

2006/12/06

JCLWA0327GB

# DOOR MIRROR

< COMPONENT DIAGNOSIS >

## DOOR MIRROR (LHD MODELS)

Connector No.	D1
Connector Name	WIRE TO WIRE
Connector Type	TK18FW



Terminal No.	Color of Wire	Signal Name [Specification]
1	O	-
2	SB	-
3	V	-
4	P	-
5	W	-
6	W	-
7	P	-

Connector No.	D3
Connector Name	DOOR MIRROR (DRIVER SIDE)
Connector Type	TK08MGY



Terminal No.	Color of Wire	Signal Name [Specification]
1	V	-
2	P	-
3	W	-
4	W	-
5	O	-
6	SB	-

Connector No.	D41
Connector Name	WIRE TO WIRE
Connector Type	TK18FW



Terminal No.	Color of Wire	Signal Name [Specification]
3	O	-
4	SB	-
5	L	-
6	W	-
7	LG	-

Connector No.	D43
Connector Name	DOOR MIRROR (PASSENGER SIDE)
Connector Type	TK08MGY



Terminal No.	Color of Wire	Signal Name [Specification]
2	L	-
3	LG	-
4	W	-
5	O	-
6	SB	-

Connector No.	M7
Connector Name	DOOR MIRROR REMOTE CONTROL SWITCH
Connector Type	MS0FW-CS



Terminal No.	Color of Wire	Signal Name [Specification]
1	B	-
2	W	-
3	R	-
4	L	-
5	LG	-
6	V	-
7	P	-
8	O	-
9	SB	-

Connector No.	M81
Connector Name	WIRE TO WIRE
Connector Type	TK18MW



Terminal No.	Color of Wire	Signal Name [Specification]
3	O	-
4	SB	-
5	L	-
6	W	-
7	LG	-

Connector No.	M18
Connector Name	WIRE TO WIRE
Connector Type	TK18MW



Terminal No.	Color of Wire	Signal Name [Specification]
3	O	-
4	SB	-
5	V	-
6	W	-
7	P	-

A  
B  
C  
D  
E  
F  
G  
H  
I  
J  
K  
L  
M  
N  
O  
P

MIR

# DOOR MIRROR

< COMPONENT DIAGNOSIS >

## Wiring Diagram - DOOR MIRROR SYSTEM (RHD MODELS) -

INFOID:000000001188584

### DOOR MIRROR (RHD MODELS)

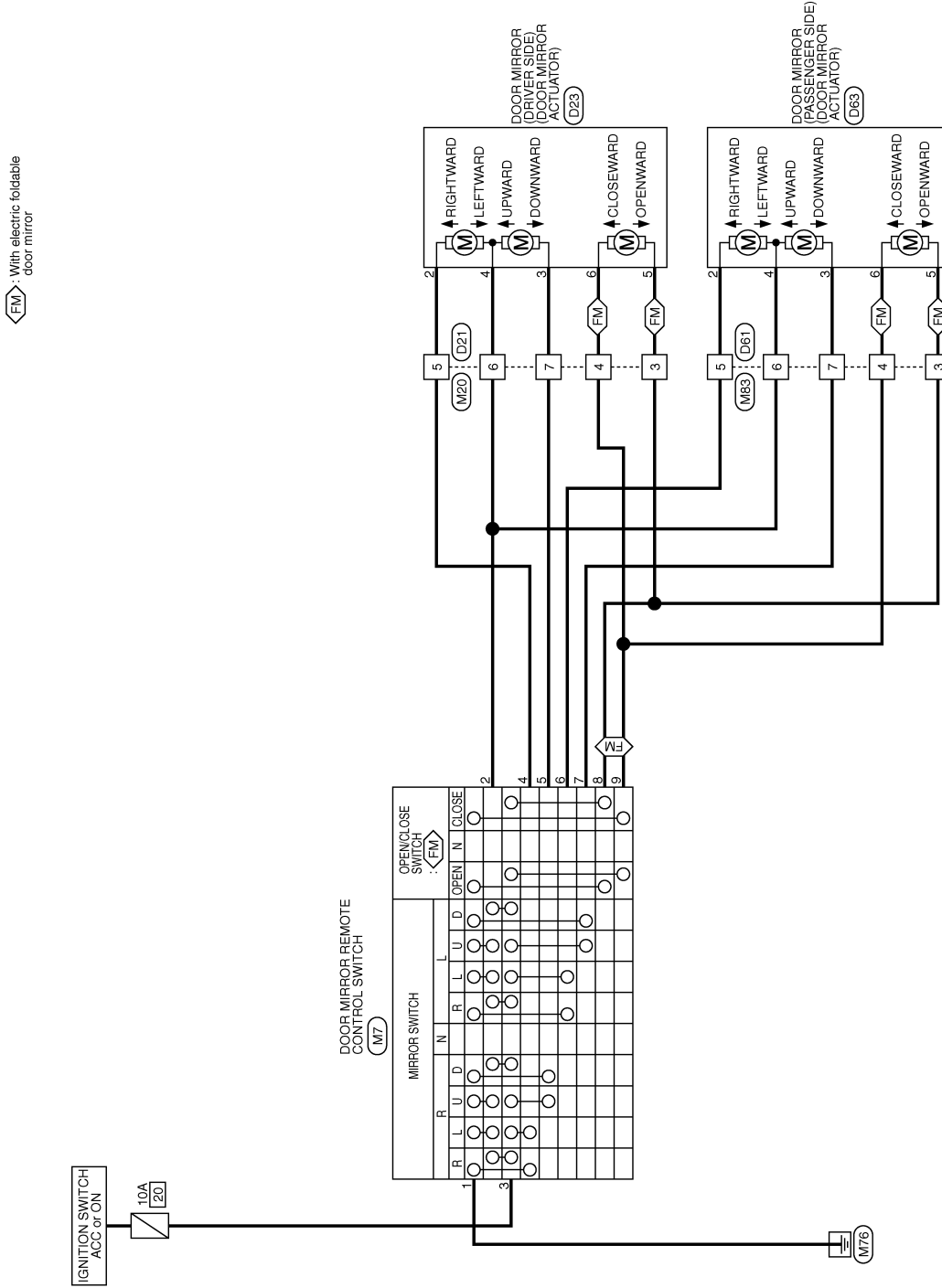

2006/12/06

JCLWA0329GB

# DOOR MIRROR

< COMPONENT DIAGNOSIS >

## DOOR MIRROR (RHD MODELS)

Connector No.	D21
Connector Name	WIRE TO WIRE
Connector Type	TK18FW



Terminal No.	Color of Wire	Signal Name [Specification]
1	O	-
2	L	-
3	SB	-
4	SB	-
5	L	-
6	W	-
7	LG	-

Connector No.	D23
Connector Name	DOOR MIRROR (DRIVER SIDE)
Connector Type	TK08MGY



Terminal No.	Color of Wire	Signal Name [Specification]
1	L	-
2	L	-
3	LG	-
4	W	-
5	O	-
6	SB	-

Connector No.	D61
Connector Name	WIRE TO WIRE
Connector Type	TK18FW



Terminal No.	Color of Wire	Signal Name [Specification]
3	O	-
4	SB	-
5	V	-
6	W	-
7	P	-

Connector No.	D63
Connector Name	DOOR MIRROR (PASSENGER SIDE)
Connector Type	TK08MGY



Terminal No.	Color of Wire	Signal Name [Specification]
2	V	-
3	P	-
4	W	-
5	O	-
6	SB	-

Connector No.	M7
Connector Name	DOOR MIRROR REMOTE CONTROL SWITCH
Connector Type	MS10FW-CS



Terminal No.	Color of Wire	Signal Name [Specification]
1	B	-
2	W	-
3	R	-
4	L	-
5	LG	-
6	V	-
7	P	-
8	O	-
9	SB	-

Connector No.	M83
Connector Name	WIRE TO WIRE
Connector Type	TK18MW



Terminal No.	Color of Wire	Signal Name [Specification]
3	O	-
4	SB	-
5	V	-
6	W	-
7	P	-

Connector No.	M20
Connector Name	WIRE TO WIRE
Connector Type	TK18MW



Terminal No.	Color of Wire	Signal Name [Specification]
3	O	-
4	SB	-
5	L	-
6	W	-
7	LG	-

A  
B  
C  
D  
E  
F  
G  
H  
I  
J  
K  
L  
M  
N  
O  
P

## MIR

# AUTO ANTI-DAZZLING INSIDE MIRROR SYSTEM

< COMPONENT DIAGNOSIS >

## AUTO ANTI-DAZZLING INSIDE MIRROR SYSTEM

Wiring Diagram - INSIDE MIRROR SYSTEM -

INFOID:000000001188585

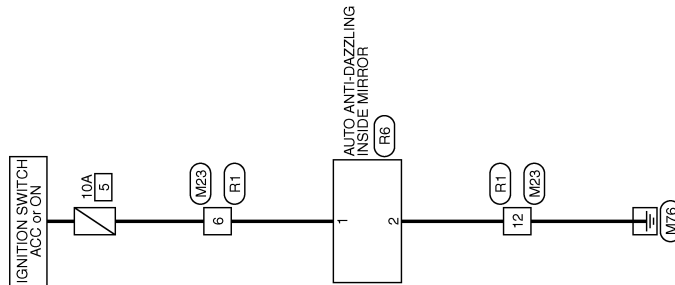

INSIDE MIRROR

2006/12/06

JCLWA0331GB



# AUTO ANTI-DAZZLING INSIDE MIRROR SYSTEM

## < COMPONENT DIAGNOSIS >

### INSIDE MIRROR

Connector No.	M23
Connector Name	WIRE TO WIRE
Connector Type	TK10PW-NSS



Terminal No.	6	12
Color of Wire	R	B
Signal Name [Specification]	-	-

Connector No.	R1
Connector Name	WIRE TO WIRE
Connector Type	TK10MW-NSS

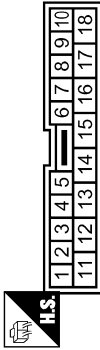

Terminal No.	6	12
Color of Wire	R	B
Signal Name [Specification]	-	-

Connector No.	R6
Connector Name	AUTO ANTI-DAZZLING INSIDE MIRROR
Connector Type	CINCH 6983223



Terminal No.	1	2
Color of Wire	R	B
Signal Name [Specification]	-	-

A  
B  
C  
D  
E  
F  
G  
H  
I  
J  
K  
M  
N  
O  
P

MIR

JCLWA0332GB

# SQUEAK AND RATTLE TROUBLE DIAGNOSIS

< SYMPTOM DIAGNOSIS >

## SYMPTOM DIAGNOSIS

### SQUEAK AND RATTLE TROUBLE DIAGNOSIS

#### Work Flow

INFOID:000000001188590

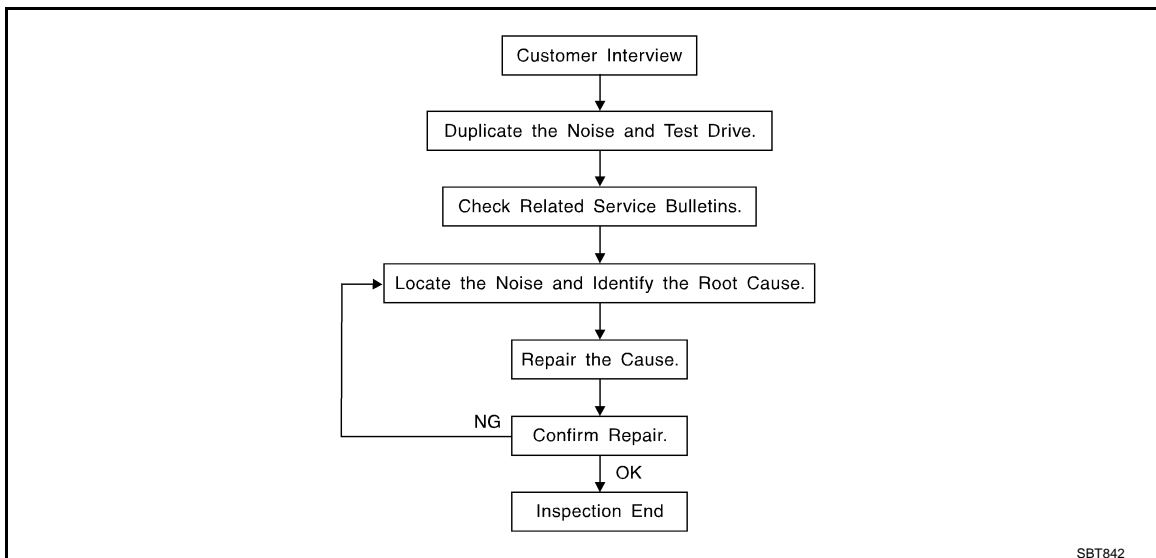

#### CUSTOMER INTERVIEW

Interview the customer if possible, to determine the conditions that exist when the noise occurs. Use the Diagnostic Worksheet during the interview to document the facts and conditions when the noise occurs and any of the customer's comments; refer to [INT-6. "Diagnostic Worksheet"](#). This information is necessary to duplicate the conditions that exist when the noise occurs.

- The customer may not be able to provide a detailed description or the location of the noise. Attempt to obtain all the facts and conditions that exist when the noise occurs (or does not occur).
- If there is more than one noise in the vehicle, be sure to diagnose and repair the noise that the customer is concerned about. This can be accomplished by a test drive with the customer.
- After identifying the type of noise, isolate the noise in terms of its characteristics. The noise characteristics are provided so the customer, service adviser and technician are all speaking the same language when defining the noise.
- Squeak – (Like tennis shoes on a clean floor)  
Squeak characteristics include the light contact/fast movement/brought on by road conditions/hard surfaces = higher pitch noise/softer surfaces = lower pitch noises/edge to surface = chirping
- Creak – (Like walking on an old wooden floor)  
Creak characteristics include firm contact/slow movement/twisting with a rotational movement/pitch dependent on materials/often brought on by activity.
- Rattle – (Like shaking a baby rattle)  
Rattle characteristics include the fast repeated contact/vibration or similar movement/loose parts/missing clip or fastener/incorrect clearance.
- Knock – (Like a knock on a door)  
Knock characteristics include hollow sounding/sometimes repeating/often brought on by driver action.
- Tick – (Like a clock second hand)  
Tick characteristics include gentle contacting of light materials/loose components/can be caused by driver action or road conditions.
- Thump – (Heavy, muffled knock noise)  
Thump characteristics include softer knock/dead sound often brought on by activity.
- Buzz – (Like a bumble bee)  
Buzz characteristics include high frequency rattle/firm contact.
- Often the degree of acceptable noise level will vary depending upon the person. A noise that you may judge as acceptable may be very irritating to the customer.
- Weather conditions, especially humidity and temperature, may have a great effect on noise level.

#### DUPLICATE THE NOISE AND TEST DRIVE

# SQUEAK AND RATTLE TROUBLE DIAGNOSIS

## < SYMPTOM DIAGNOSIS >

If possible, drive the vehicle with the customer until the noise is duplicated. Note any additional information on the Diagnostic Worksheet regarding the conditions or location of the noise. This information can be used to duplicate the same conditions when you confirm the repair.

If the noise can be duplicated easily during the test drive, to help identify the source of the noise, try to duplicate the noise with the vehicle stopped by doing one or all of the following:

- 1) Close a door.
  - 2) Tap or push/pull around the area where the noise appears to be coming from.
  - 3) Rev the engine.
  - 4) Use a floor jack to recreate vehicle "twist".
  - 5) At idle, apply engine load (electrical load, half-clutch on M/T model, drive position on A/T model).
  - 6) Raise the vehicle on a hoist and hit a tire with a rubber hammer.
- Drive the vehicle and attempt to duplicate the conditions the customer states exist when the noise occurs.
  - If it is difficult to duplicate the noise, drive the vehicle slowly on an undulating or rough road to stress the vehicle body.

## LOCATE THE NOISE AND IDENTIFY THE ROOT CAUSE

1. Narrow down the noise to a general area. To help pinpoint the source of the noise, use a listening tool (Engine Ear or mechanics stethoscope).
2. Narrow down the noise to a more specific area and identify the cause of the noise by:
  - removing the components in the area that you suspect the noise is coming from.  
Do not use too much force when removing clips and fasteners, otherwise clips and fastener can be broken or lost during the repair, resulting in the creation of new noise.
  - tapping or pushing/pulling the component that you suspect is causing the noise.  
Do not tap or push/pull the component with excessive force, otherwise the noise will be eliminated only temporarily.
  - feeling for a vibration with your hand by touching the component(s) that you suspect is (are) causing the noise.
  - placing a piece of paper between components that you suspect are causing the noise.
  - looking for loose components and contact marks.  
Refer to [MIR-12. "Generic Squeak and Rattle Troubleshooting"](#).

## REPAIR THE CAUSE

- If the cause is a loose component, tighten the component securely.
- If the cause is insufficient clearance between components:
  - separate components by repositioning or loosening and retightening the component, if possible.
  - insulate components with a suitable insulator such as urethane pads, foam blocks, felt cloth tape or urethane tape are available through your authorized Nissan Parts Department.

### **CAUTION:**

**Do not use excessive force as many components are constructed of plastic and may be damaged.**

### **NOTE:**

- URETHANE PADS  
Insulates connectors, harness, etc.
- INSULATOR (Foam blocks)  
Insulates components from contact. Can be used to fill space behind a panel.
- INSULATOR (Light foam block)
- FELT CLOTHTAPE  
Used to insulate where movement does not occur. Ideal for instrument panel applications.  
The following materials, not available through NISSAN Parts Department, can also be used to repair squeaks and rattles.
- UHMW(TEFLON) TAPE  
Insulates where slight movement is present. Ideal for instrument panel applications.
- SILICONE GREASE  
Used in place of UHMW tape that will be visible or not fit.  
Note: Will only last a few months.
- SILICONE SPRAY  
Use when grease cannot be applied.
- DUCT TAPE  
Use to eliminate movement.

## CONFIRM THE REPAIR

# SQUEAK AND RATTLE TROUBLE DIAGNOSIS

## < SYMPTOM DIAGNOSIS >

Confirm that the cause of a noise is repaired by test driving the vehicle. Operate the vehicle under the same conditions as when the noise originally occurred. Refer to the notes on the Diagnostic Worksheet.

### Generic Squeak and Rattle Troubleshooting

INFOID:000000001188591

Refer to Table of Contents for specific component removal and installation information.

#### INSTRUMENT PANEL

Most incidents are caused by contact and movement between:

1. Cluster lid A and instrument panel
2. Acrylic lens and combination meter housing
3. Instrument panel to front pillar garnish
4. Instrument panel to windshield
5. Instrument panel mounting pins
6. Wiring harnesses behind the combination meter
7. A/C defroster duct and duct joint

These incidents can usually be located by tapping or moving the components to duplicate the noise or by pressing on the components while driving to stop the noise. Most of these incidents can be repaired by applying felt cloth tape or silicon spray (in hard to reach areas). Urethane pads can be used to insulate wiring harness.

#### **CAUTION:**

**Do not use silicone spray to isolate a squeak or rattle. If you saturate the area with silicone, you will not be able to recheck the repair.**

#### CENTER CONSOLE

Components to pay attention to include:

1. Shifter assembly cover to finisher
2. A/C control unit and cluster lid C
3. Wiring harnesses behind audio and A/C control unit

The instrument panel repair and isolation procedures also apply to the center console.

#### DOORS

Pay attention to the:

1. Finisher and inner panel making a slapping noise
2. Inside handle escutcheon to door finisher
3. Wiring harnesses tapping
4. Door striker out of alignment causing a popping noise on starts and stops

Tapping or moving the components or pressing on them while driving to duplicate the conditions can isolate many of these incidents. You can usually insulate the areas with felt cloth tape or insulator foam blocks to repair the noise.

#### TRUNK

Trunk noises are often caused by a loose jack or loose items put into the trunk by the owner.

In addition look for:

1. Trunk lid dumpers out of adjustment
2. Trunk lid striker out of adjustment
3. Trunk lid torsion bars knocking together
4. A loose license plate or bracket

Most of these incidents can be repaired by adjusting, securing or insulating the item(s) or component(s) causing the noise.

#### SUNROOF/HEADLINING

Noises in the sunroof/headlining area can often be traced to one of the following:

1. Sunroof lid, rail, linkage or seals making a rattle or light knocking noise
2. Sunvisor shaft shaking in the holder
3. Front or rear windshield touching headlining and squeaking

# SQUEAK AND RATTLE TROUBLE DIAGNOSIS

## < SYMPTOM DIAGNOSIS >

Again, pressing on the components to stop the noise while duplicating the conditions can isolate most of these incidents. Repairs usually consist of insulating with felt cloth tape.

A

### SEATS

When isolating seat noise it is important to note the position the seat is in and the load placed on the seat when the noise is present. These conditions should be duplicated when verifying and isolating the cause of the noise.

B

Cause of seat noise include:

1. Headrest rods and holder
2. A squeak between the seat pad cushion and frame
3. Rear seatback lock and bracket

C

These noises can be isolated by moving or pressing on the suspected components while duplicating the conditions under which the noise occurs. Most of these incidents can be repaired by repositioning the component or applying urethane tape to the contact area.

D

### UNDERHOOD

Some interior noise may be caused by components under the hood or on the engine wall. The noise is then transmitted into the passenger compartment.

E

Causes of transmitted underhood noise include:

F

1. Any component mounted to the engine wall
2. Components that pass through the engine wall
3. Engine wall mounts and connectors
4. Loose radiator mounting pins
5. Hood bumpers out of adjustment
6. Hood striker out of adjustment

G

H

These noises can be difficult to isolate since they cannot be reached from the interior of the vehicle. The best method is to secure, move or insulate one component at a time and test drive the vehicle. Also, engine RPM or load can be changed to isolate the noise. Repairs can usually be made by moving, adjusting, securing, or insulating the component causing the noise.

I

J

K

MIR

M

N

O

P

# SQUEAK AND RATTLE TROUBLE DIAGNOSIS

< SYMPTOM DIAGNOSIS >

## Diagnostic Worksheet

INFOID:000000001188592



### SQUEAK & RATTLE DIAGNOSTIC WORKSHEET

Dear Nissan Customer:

We are concerned about your satisfaction with your Nissan vehicle. Repairing a squeak or rattle sometimes can be very difficult. To help us fix your Nissan right the first time, please take a moment to note the area of the vehicle where the squeak or rattle occurs and under what conditions. You may be asked to take a test drive with a service advisor or technician to ensure we confirm the noise you are hearing.

#### I. WHERE DOES THE NOISE COME FROM? (circle the area of the vehicle)

The illustrations are for reference only, and may not reflect the actual configuration of your vehicle.

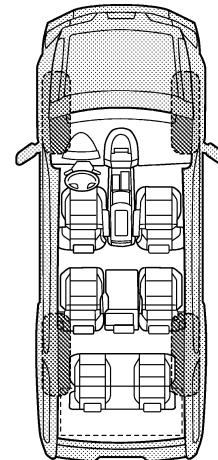
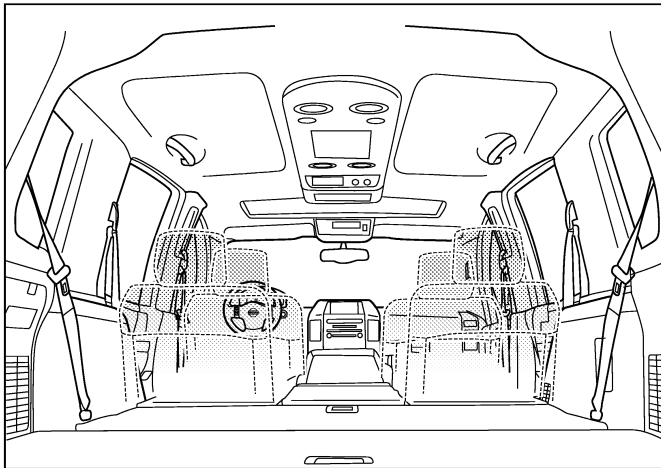
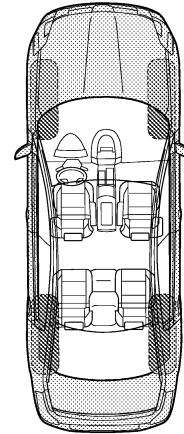
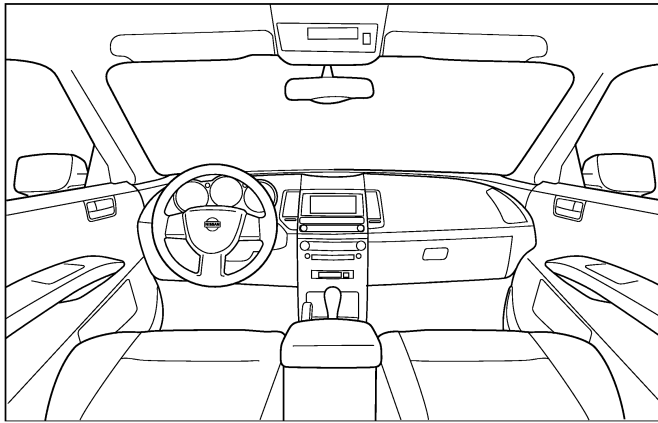

Continue to page 2 of the worksheet and briefly describe the location of the noise or rattle. In addition, please indicate the conditions which are present when the noise occurs.

PIIB8740E

# SQUEAK AND RATTLE TROUBLE DIAGNOSIS

< SYMPTOM DIAGNOSIS >

## SQUEAK & RATTLE DIAGNOSTIC WORKSHEET - page 2

Briefly describe the location where the noise occurs:

---

---

### II. WHEN DOES IT OCCUR? (please check the boxes that apply)

- |   |  |
|---|--|
| <input type="checkbox"/> anytime                      | <input type="checkbox"/> after sitting out in the rain |
| <input type="checkbox"/> 1st time in the morning      | <input type="checkbox"/> when it is raining or wet     |
| <input type="checkbox"/> only when it is cold outside | <input type="checkbox"/> dry or dusty conditions       |
| <input type="checkbox"/> only when it is hot outside  | <input type="checkbox"/> other:                        |

### III. WHEN DRIVING:

- through driveways
- over rough roads
- over speed bumps
- only about \_\_\_\_ mph
- on acceleration
- coming to a stop
- on turns: left, right or either (circle)
- with passengers or cargo
- other: \_\_\_\_\_
- after driving \_\_\_\_ miles or \_\_\_\_ minutes

### IV. WHAT TYPE OF NOISE

- squeak (like tennis shoes on a clean floor)
- creak (like walking on an old wooden floor)
- rattle (like shaking a baby rattle)
- knock (like a knock at the door)
- tick (like a clock second hand)
- thump (heavy, muffled knock noise)
- buzz (like a bumble bee)

### TO BE COMPLETED BY DEALERSHIP PERSONNEL

#### Test Drive Notes:

---

---

---

	YES	NO	Initials of person performing
Vehicle test driven with customer	<input type="checkbox"/>	<input type="checkbox"/>	_____
- Noise verified on test drive	<input type="checkbox"/>	<input type="checkbox"/>	_____
- Noise source located and repaired	<input type="checkbox"/>	<input type="checkbox"/>	_____
- Follow up test drive performed to confirm repair	<input type="checkbox"/>	<input type="checkbox"/>	_____

VIN: \_\_\_\_\_ Customer Name: \_\_\_\_\_  
W.O.# \_\_\_\_\_ Date: \_\_\_\_\_

This form must be attached to Work Order

PIIB8742E

A  
B  
C  
D  
E  
F  
G  
H  
I  
J  
K  
M  
N  
O  
P

MIR

# PRECAUTIONS

< PRECAUTION >

---

## PRECAUTION

### PRECAUTIONS

#### Supplemental Restraint System (SRS) "AIR BAG" and "SEAT BELT PRE-TENSIONER"

INFOID:000000001188593

The Supplemental Restraint System such as "AIR BAG" and "SEAT BELT PRE-TENSIONER", used along with a front seat belt, helps to reduce the risk or severity of injury to the driver and front passenger for certain types of collision. This system includes seat belt switch inputs and dual stage front air bag modules. The SRS system uses the seat belt switches to determine the front air bag deployment, and may only deploy one front air bag, depending on the severity of a collision and whether the front occupants are belted or unbelted. Information necessary to service the system safely is included in the SRS and SB section of this Service Manual.

**WARNING:**

- To avoid rendering the SRS inoperative, which could increase the risk of personal injury or death in the event of a collision which would result in air bag inflation, all maintenance must be performed by an authorized NISSAN/INFINITI dealer.
- Improper maintenance, including incorrect removal and installation of the SRS, can lead to personal injury caused by unintentional activation of the system. For removal of Spiral Cable and Air Bag Module, see the SRS section.
- Do not use electrical test equipment on any circuit related to the SRS unless instructed to in this Service Manual. SRS wiring harnesses can be identified by yellow and/or orange harnesses or harness connectors.



# PREPARATION

< PREPARATION >

## PREPARATION

### PREPARATION

#### Commercial Service Tools

INFOID:000000001188594

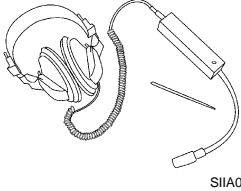
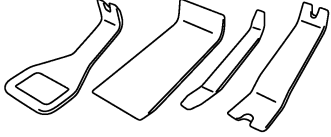
Tool name	Description
Engine ear  SIIA0995E	Locating the noise
Remover tool	 PIIB7923J

A

B

C

D

E

F

G

H

I

J

K

MIR

M

N

O

P

# INSIDE MIRROR

< ON-VEHICLE REPAIR >

## ON-VEHICLE REPAIR

### INSIDE MIRROR

Exploded View

INFOID:000000001188596

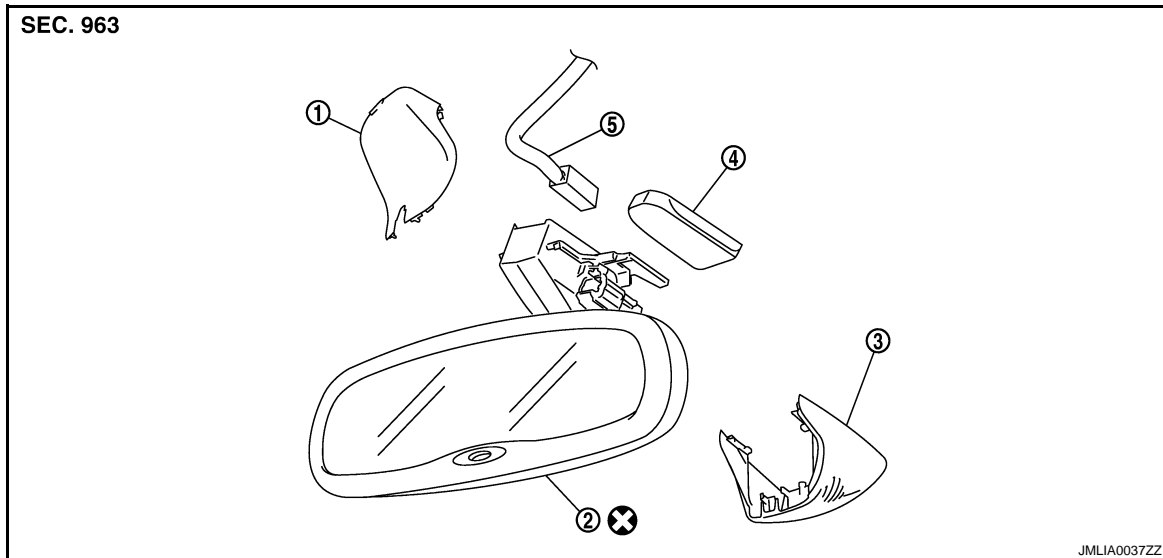

- |                                |   |                                |
|--------------------------------|---|--------------------------------|
| 1. Inside mirror cover (upper) | 2. Inside mirror  | 3. Inside mirror cover (lower) |
| 4. Mirror base                 | 5. Connector (with auto anti-dazzling inside mirror system) |                                |

Refer to [GI-4. "Components"](#) for symbols in the figure.

### Removal and Installation

INFOID:000000001188597

#### REMOVAL

1. Remove the inside mirror finisher (upper and lower).
2. Slide the mirror upward to remove.
3. Disconnect the connector. (with auto anti-dazzling inside mirror system)

#### INSTALLATION

Install in the reverse order of removal.

# DOOR MIRROR

< ON-VEHICLE REPAIR >

## DOOR MIRROR

Exploded View

INFOID:000000001188598

REMOVAL

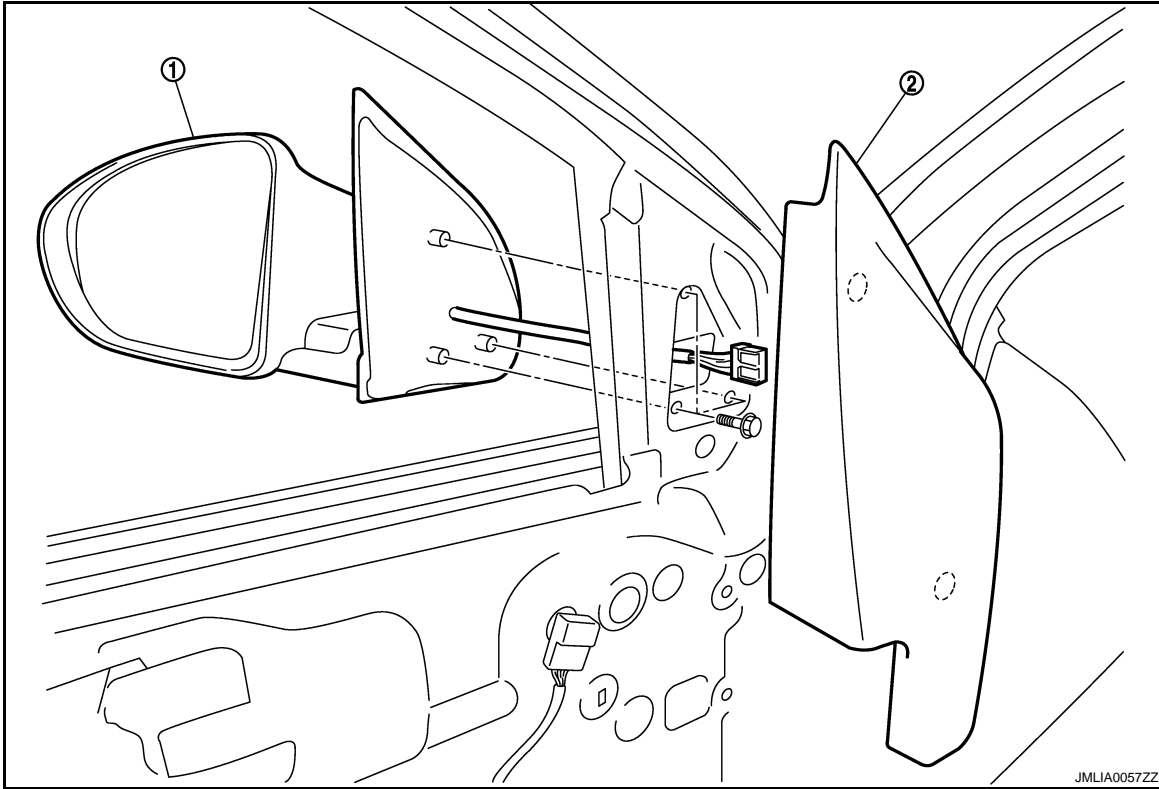

1. Door mirror assembly

2. Corner cover

○ :Clip

DISASSEMBLY

A  
B  
C  
D  
E  
F  
G  
H  
I  
J  
K  
M  
N  
O  
P

MIR

# DOOR MIRROR

< ON-VEHICLE REPAIR >

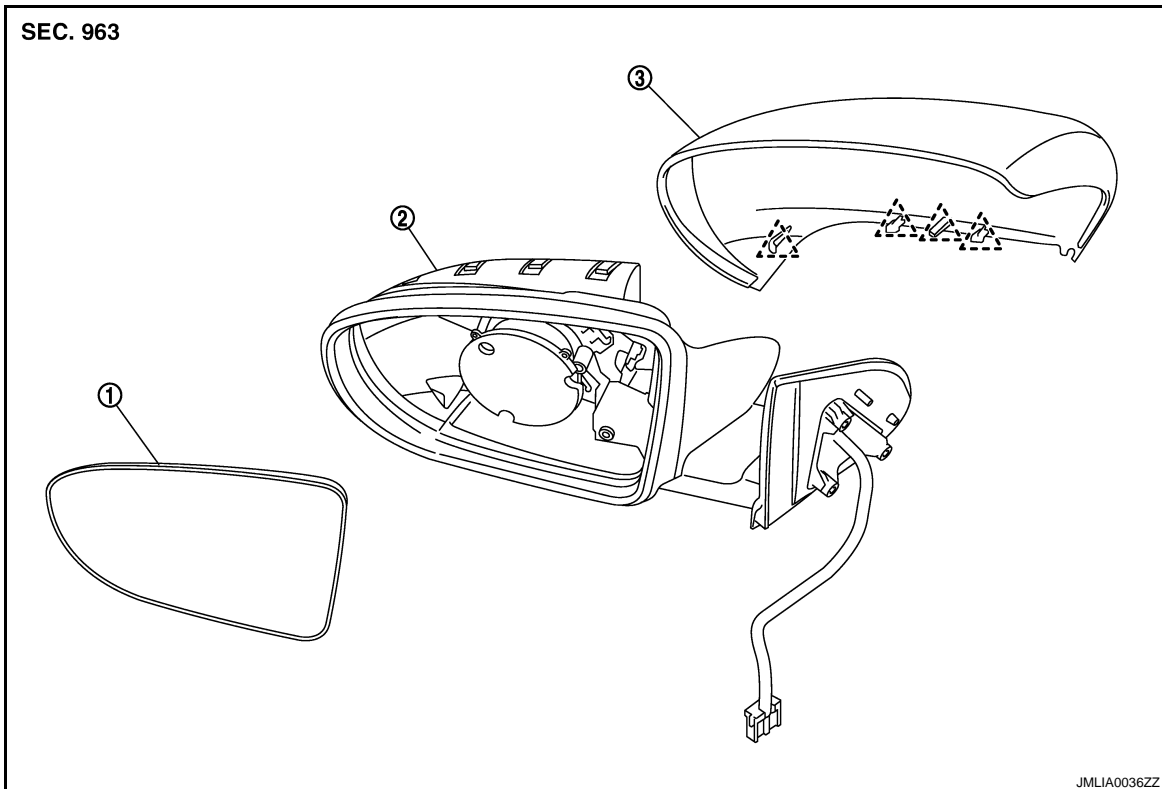

1. Mirror (mirror holder)

2. Mirror assembly

3. Mirror cover

 Pawl

## Removal and Installation

INFOID:000000001188599

### REMOVAL

1. Remove the front door finisher. Refer to [INT-10, "FRONT DOOR FINISHER : Removal and Installation"](#).
2. Remove the corner cover.
3. Disconnect the door mirror harness connector.
4. Remove the door mirror mounting bolts, and remove the door mirror assembly.

### CAUTION:

**Do not damage the mirror bodies.**

### INSTALLATION

Install in the reverse order of removal.

### CAUTION:

**Do not damage the mirror bodies.**

## Disassembly and Assembly

INFOID:000000001188600

### DISASSEMBLY

1. Remove the clips and mirror cover from the housing.
2. Place the mirror body with mirror glass upward.

# DOOR MIRROR

## < ON-VEHICLE REPAIR >

- Put a strip of protective tape (B) on mirror body.

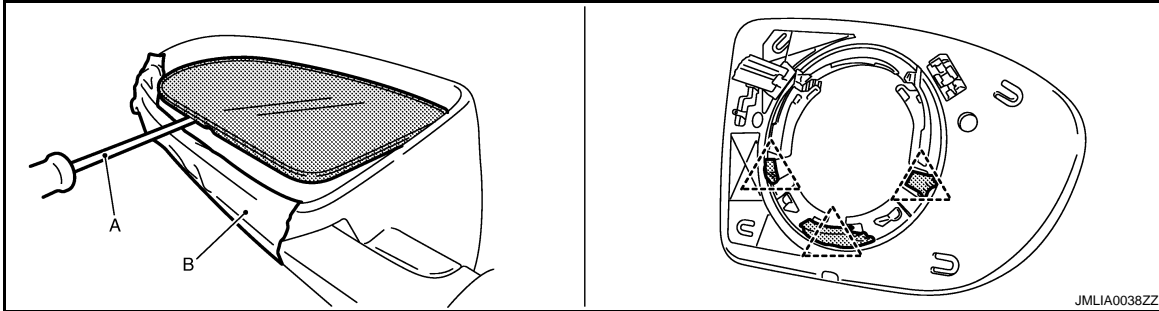

 :Pawl

- Insert a small flattened driver (A) between the mirror assembly and the mirror glass, and remove the pawl located under the mirror glass from mirror assembly.

### NOTE:

when removing the pawl under the mirror glass, the left and right side pawls are simultaneously removed.

- From the mirror assembly side, hold and push the mirror glass downward.

### CAUTION:

**Avoid dropping the mirror glass by holding it securely.**

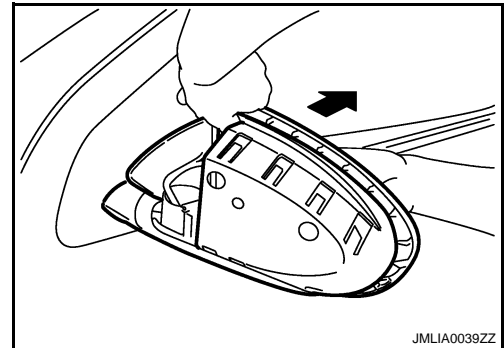

- Slide the mirror glass upward as shown by the arrow and remove it from the mirror assembly.

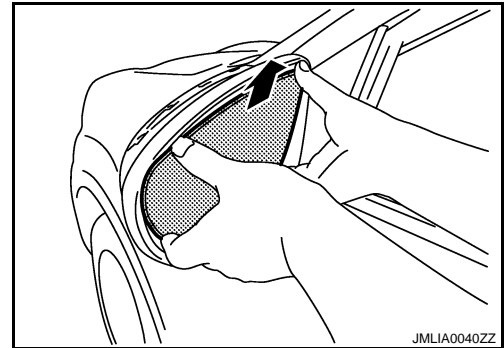

- Remove two terminals of mirror heater attachment.

## ASSEMBLY

Install in the reverse order of removal.

### NOTE:

After installation, visually check that pawls are securely engaged.

A  
B  
C  
D  
E  
F  
G  
H  
I  
J  
K  
M  
N  
O  
P

MIR

# DOOR MIRROR REMOTE CONTROL SWITCH

< ON-VEHICLE REPAIR >

## DOOR MIRROR REMOTE CONTROL SWITCH

Exploded View

INFOID:000000001188601

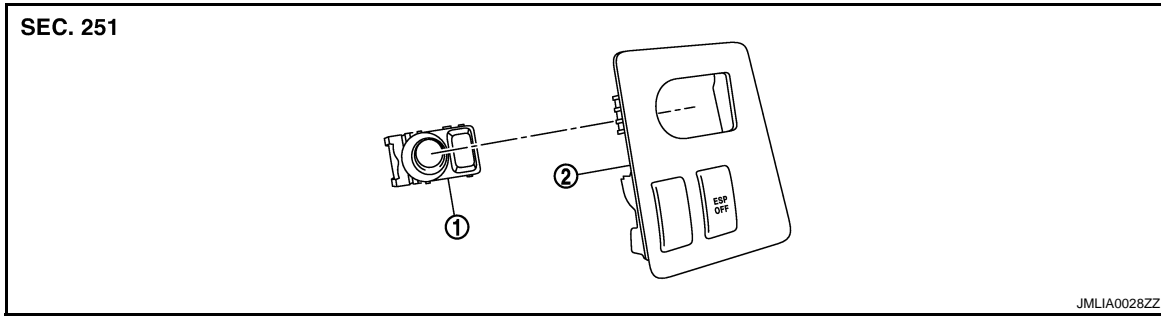

1. Door mirror remote control switch
2. Mirror switch finisher

## Removal and Installation

INFOID:000000001188602

### REMOVAL

1. Remove the mirror switch finisher (2).  
Refer to [IP-12, "Removal and Installation"](#)
2. Remove door mirror remote control switch (1) from mirror switch finisher (2) using screw driver (A).



: Pawl

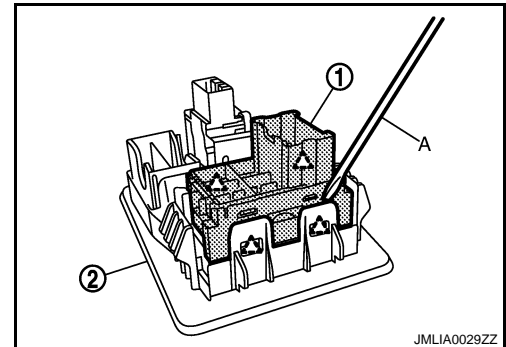

### INSTALLATION

Install in the reverse order of removal.