

SECTION **EXT**  
EXTERIOR

A  
B  
C  
D  
E  
F  
G  
H  
I  
J  
EXT  
L  
M  
N  
O  
P

CONTENTS

<b>PRECAUTION</b> .....	2	Removal and Installation .....	14
<b>PRECAUTIONS</b> .....	2	<b>FRONT GRILLE</b> .....	16
Precaution for Supplemental Restraint System (SRS) "AIR BAG" and "SEAT BELT PRE-TEN- SIONER" .....	2	Removal and Installation .....	16
Precaution for Procedure without Cowl Top Cover.....	2	<b>COWL TOP</b> .....	17
Precaution .....	2	Removal and Installation .....	17
<b>PREPARATION</b> .....	3	<b>FENDER PROTECTOR</b> .....	18
<b>PREPARATION</b> .....	3	Removal and Installation .....	18
Special Service Tool .....	3	<b>MUDGUARD</b> .....	19
Commercial Service Tool .....	3	Removal and Installation .....	19
<b>ON-VEHICLE MAINTENANCE</b> .....	4	<b>SIDE GUARD MOLDING</b> .....	20
<b>SQUEAK AND RATTLE TROUBLE DIAG- NOSES</b> .....	4	Removal and Installation .....	20
Work Flow .....	4	<b>DOOR OUTSIDE MOLDING</b> .....	21
Generic Squeak and Rattle Troubleshooting .....	6	Removal and Installation .....	21
Diagnostic Worksheet .....	8	<b>DRIP MOLDING</b> .....	22
Clip and Fastener .....	9	Removal and Installation .....	22
<b>ON-VEHICLE REPAIR</b> .....	12	<b>ROOF SIDE MOLDING</b> .....	23
<b>FRONT BUMPER</b> .....	12	Removal and Installation .....	23
Removal and Installation .....	12	<b>LICENSE LAMP FINISHER</b> .....	24
<b>REAR BUMPER</b> .....	14	Removal and Installation .....	24
		<b>REAR SPOILER</b> .....	25
		Removal and Installation .....	25

# PRECAUTIONS

< PRECAUTION >

## PRECAUTION

### PRECAUTIONS

#### Precaution for Supplemental Restraint System (SRS) "AIR BAG" and "SEAT BELT PRE-TENSIONER"

INFOID:000000004216191

The Supplemental Restraint System such as "AIR BAG" and "SEAT BELT PRE-TENSIONER", used along with a front seat belt, helps to reduce the risk or severity of injury to the driver and front passenger for certain types of collision. This system includes seat belt switch inputs and dual stage front air bag modules. The SRS system uses the seat belt switches to determine the front air bag deployment, and may only deploy one front air bag, depending on the severity of a collision and whether the front occupants are belted or unbelted. Information necessary to service the system safely is included in the SR and SB section of this Service Manual.

#### **WARNING:**

- To avoid rendering the SRS inoperative, which could increase the risk of personal injury or death in the event of a collision which would result in air bag inflation, all maintenance must be performed by an authorized NISSAN/INFINITI dealer.
- Improper maintenance, including incorrect removal and installation of the SRS, can lead to personal injury caused by unintentional activation of the system. For removal of Spiral Cable and Air Bag Module, see the SR section.
- Do not use electrical test equipment on any circuit related to the SRS unless instructed to in this Service Manual. SRS wiring harnesses can be identified by yellow and/or orange harnesses or harness connectors.

#### Precaution for Procedure without Cowl Top Cover

INFOID:000000004216192

When performing the procedure after removing cowl top cover, cover the lower end of windshield with urethane, etc.

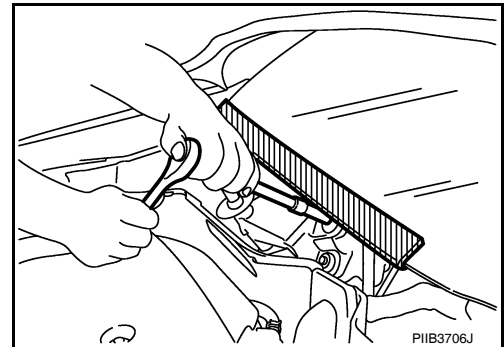

#### Precaution

INFOID:000000004216193

- When removing or disassembling any part, be careful not to damage or deform it. Protect parts which may get in the way with cloth.
- When removing parts with a screwdriver or other tool, protect parts by wrapping them with vinyl or tape.
- Keep removed parts protected with cloth.
- If a clip is deformed or damaged, replace it.
- If an un reusable part is removed, replace it with a new one.
- Tighten bolts and nuts firmly to the specified torque.
- After re-assembly has been completed, make sure each part functions correctly.
- Remove stains in the following way.
  - Water-soluble stains:  
Dip a cloth in warm water, and squeeze tightly. After wiping the stain, wipe with a soft dry cloth.
  - Oil stain:  
Dissolve a synthetic detergent in warm water (density of 2 to 3% or less), dip the cloth, then clean off the stain with the cloth. Next, dip the soft cloth in fresh water, and then squeeze it tightly. Then clean off the detergent completely. Then wipe the area with a soft dry cloth.
- Do not use any organic solvent, such as thinner or benzene.

# PREPARATION

< PREPARATION >

## PREPARATION

### PREPARATION

#### Special Service Tool

INFOID:000000004216194

The actual shapes of Kent-Moore tools may differ from those of special service tools illustrated here.

Tool number (Kent-Moore No.) Tool name	Description
— (J-39570) Chassis ear	Locating the noise
— (J-43980) NISSAN Squeak and Rattle kit	Repairing the cause of noise

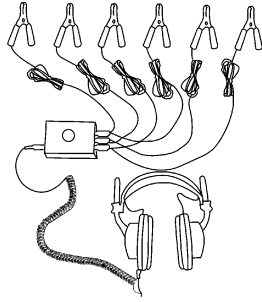

SBT839

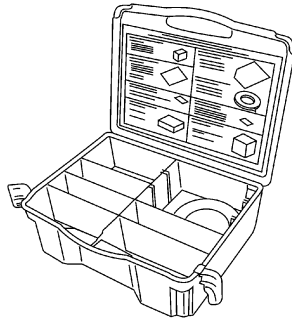

SBT840

#### Commercial Service Tool

INFOID:000000004216195

(Kent-Moore No.) Tool name	Description
(J-39565) Engine ear	Locating the noise

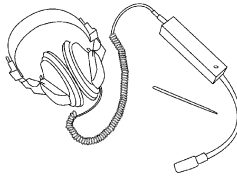

SIIA0995E

A  
B  
C  
D  
E  
F  
G  
H  
I  
J  
EXT  
L  
M  
N  
O  
P

# SQUEAK AND RATTLE TROUBLE DIAGNOSES

< ON-VEHICLE MAINTENANCE >

## ON-VEHICLE MAINTENANCE

### SQUEAK AND RATTLE TROUBLE DIAGNOSES

#### Work Flow

INFOID:000000004216196

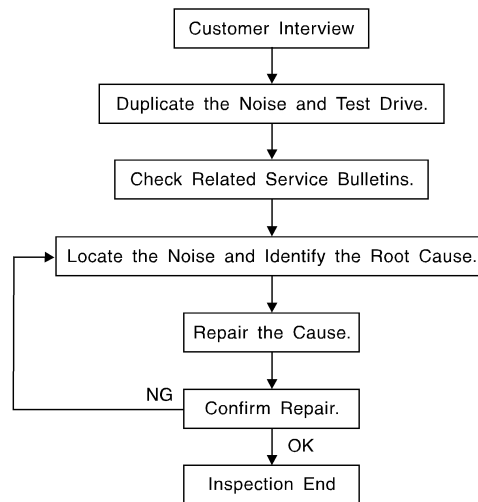

SBT842

#### CUSTOMER INTERVIEW

Interview the customer, if possible, to determine the conditions that exist when the noise occurs. Use the Diagnostic Worksheet during the interview to document the facts and conditions when the noise occurs and any customer's comments; refer to [EXT-8, "Diagnostic Worksheet"](#). This information is necessary to duplicate the conditions that exist when the noise occurs.

- The customer may not be able to provide a detailed description or the location of the noise. Attempt to obtain all the facts and conditions that exist when the noise occurs (or does not occur).
- If there is more than one noise in the vehicle, be sure to diagnose and repair the noise that the customer is concerned about. This can be accomplished by test driving the vehicle with the customer.
- After identifying the type of noise, isolate the noise in terms of its characteristics. The noise characteristics are provided so the customer, service adviser and technician are all speaking the same language when defining the noise.
- Squeak — (Like tennis shoes on a clean floor)  
Squeak characteristics include the light contact/fast movement/brought on by road conditions/hard surfaces = higher pitch noise/softer surfaces = lower pitch noises/edge to surface = chirping
- Creak — (Like walking on an old wooden floor)  
Creak characteristics include firm contact/slow movement/twisting with a rotational movement/pitch dependent on materials/often brought on by activity.
- Rattle — (Like shaking a baby rattle)  
Rattle characteristics include the fast repeated contact/vibration or similar movement/loose parts/missing clip or fastener/incorrect clearance.
- Knock — (Like a knock on a door)  
Knock characteristics include hollow sounding/sometimes repeating/often brought on by driver action.
- Tick — (Like a clock second hand)  
Tick characteristics include gentle contacting of light materials/loose components/can be caused by driver action or road conditions.
- Thump — (Heavy, muffled knock noise)  
Thump characteristics include softer knock/dead sound often brought on by activity.
- Buzz — (Like a bumblebee)  
Buzz characteristics include high frequency rattle/firm contact.
- Often the degree of acceptable noise level will vary depending upon the person. A noise that you may judge as acceptable may be very irritating to the customer.
- Weather conditions, especially humidity and temperature, may have a great effect on noise level.

#### DUPLICATE THE NOISE AND TEST DRIVE

# SQUEAK AND RATTLE TROUBLE DIAGNOSES

## < ON-VEHICLE MAINTENANCE >

If possible, drive the vehicle with the customer until the noise is duplicated. Note any additional information on the Diagnostic Worksheet regarding the conditions or location of the noise. This information can be used to duplicate the same conditions when you confirm the repair.

If the noise can be duplicated easily during the test drive, to help identify the source of the noise, try to duplicate the noise with the vehicle stopped by doing one or all of the following:

- Close a door.
- Tap or push/pull around the area where the noise appears to be coming from.
- Rev the engine.
- Use a floor jack to recreate vehicle "twist".
- At idle, apply engine load (electrical load, half-clutch on M/T model, drive position on A/T model).
- Raise the vehicle on a hoist and hit a tire with a rubber hammer.
- Drive the vehicle and attempt to duplicate the conditions the customer states exist when the noise occurs.
- If it is difficult to duplicate the noise, drive the vehicle slowly on an undulating or rough road to stress the vehicle body.

## CHECK RELATED SERVICE BULLETINS

After verifying the customer concern or symptom, check ASIST for Technical Service Bulletins (TSBs) related to that concern or symptom.

If a TSB relates to the symptom, follow the procedure to repair the noise.

## LOCATE THE NOISE AND IDENTIFY THE ROOT CAUSE

1. Narrow down the noise to a general area. To help pinpoint the source of the noise, use a listening tool (Chassis Ear: J-39570, Engine Ear: J-39565 and mechanics stethoscope).
2. Narrow down the noise to a more specific area and identify the cause of the noise by:
  - Removing the components in the area that you suspect the noise is coming from.  
**Do not use too much force when removing clips and fasteners, otherwise clips and fasteners can be broken or lost during the repair, resulting in the creation of new noise.**
  - Tapping or pushing/pulling the component that you suspect is causing the noise.  
**Do not tap or push/pull the component with excessive force, otherwise the noise will be eliminated only temporarily.**
  - Feeling for a vibration with your hand by touching the component(s) that you suspect is (are) causing the noise.
  - Placing a piece of paper between components that you suspect are causing the noise.
  - Looking for loose components and contact marks.

Refer to [EXT-6, "Generic Squeak and Rattle Troubleshooting"](#).

## REPAIR THE CAUSE

- If the cause is a loose component, tighten the component securely.
- If the cause is insufficient clearance between components:
  - Separate components by repositioning or loosening and retightening the component, if possible.
  - Insulate components with a suitable insulator such as urethane pads, foam blocks, felt cloth tape or urethane tape. A NISSAN Squeak and Rattle Kit (J-43980) is available through your authorized NISSAN Parts Department.

### CAUTION:

**Do not use excessive force as many components are constructed of plastic and may be damaged.**

**Always check with the Parts Department for the latest parts information.**

The following materials are contained in the NISSAN Squeak and Rattle Kit (J-43980). Each item can be ordered separately as needed.

URETHANE PADS [1.5 mm (0.059 in) thick]

Insulates connectors, harness, etc.

76268-9E005: 100 x 135 mm (3.94 x 5.31 in)/76884-71L01: 60 x 85 mm (2.36 x 3.35 in)/76884-71L02: 15 x 25 mm (0.59 x 0.98 in)

INSULATOR (Foam blocks)

Insulates components from contact. Can be used to fill space behind a panel.

73982-9E000: 45 mm (1.77 in) thick, 50 x 50 mm (1.97 x 1.97 in)/73982-50Y00: 10 mm (0.39 in) thick, 50 x 50 mm (1.97 x 1.97 in)

INSULATOR (Light foam block)

80845-71L00: 30 mm (1.18 in) thick, 30 x 50 mm (1.18 x 1.97 in)

FELT CLOTH TAPE

Used to insulate where movement does not occur. Ideal for instrument panel applications.

68370-4B000: 15 x 25 mm (0.59 x 0.98 in) pad/68239-13E00: 5 mm (0.20 in) wide tape roll

A  
B  
C  
D  
E  
F  
G  
H  
I  
J

L  
M  
N  
O  
P

# SQUEAK AND RATTLE TROUBLE DIAGNOSES

## < ON-VEHICLE MAINTENANCE >

---

The following materials, not found in the kit, can also be used to repair squeaks and rattles.

### UHMW (TEFLON) TAPE

Insulates where slight movement is present. Ideal for instrument panel applications.

### SILICONE GREASE

Used in place of UHMW tape that will be visible or not fit.

Note: Will only last a few months.

### SILICONE SPRAY

Use when grease cannot be applied.

### DUCT TAPE

Use to eliminate movement.

## CONFIRM THE REPAIR

Confirm that the cause of a noise is repaired by test driving the vehicle. Operate the vehicle under the same conditions as when the noise originally occurred. Refer to the notes on the Diagnostic Worksheet.

## Generic Squeak and Rattle Troubleshooting

INFOID:000000004216197

Refer to Table of Contents for specific component removal and installation information.

## INSTRUMENT PANEL

Most incidents are caused by contact and movement between:

1. The cluster lid A and instrument panel
2. Acrylic lens and combination meter housing
3. Instrument panel to front pillar garnish
4. Instrument panel to windshield
5. Instrument panel mounting pins
6. Wiring harnesses behind the combination meter
7. A/C defroster duct and duct joint

These incidents can usually be located by tapping or moving the components to duplicate the noise or by pressing on the components while driving to stop the noise. Most of these incidents can be repaired by applying felt cloth tape or silicone spray (in hard to reach areas). Urethane pads can be used to insulate wiring harness.

### **CAUTION:**

**Do not use silicone spray to isolate a squeak or rattle. If you saturate the area with silicone, you will not be able to recheck the repair.**

## CENTER CONSOLE

Components to pay attention to include:

1. Shifter assembly cover to finisher
2. A/C control unit and cluster lid C
3. Wiring harnesses behind audio and A/C control unit

The instrument panel repair and isolation procedures also apply to the center console.

## DOORS

Pay attention to the:

1. Finisher and inner panel making a slapping noise
2. Inside handle escutcheon to door finisher
3. Wiring harnesses tapping
4. Door striker out of alignment causing a popping noise on starts and stops

Tapping or moving the components or pressing on them while driving to duplicate the conditions can isolate many of these incidents. You can usually insulate the areas with felt cloth tape or insulator foam blocks from the NISSAN Squeak and Rattle Kit (J-43980) to repair the noise.

## TRUNK

Trunk noises are often caused by a loose jack or loose items put into the trunk by the owner.

In addition look for:

1. Trunk lid bumpers out of adjustment
2. Trunk lid striker out of adjustment

# SQUEAK AND RATTLE TROUBLE DIAGNOSES

## < ON-VEHICLE MAINTENANCE >

---

3. The trunk lid torsion bars knocking together

4. A loose license plate or bracket

Most of these incidents can be repaired by adjusting, securing or insulating the item(s) or component(s) causing the noise.

### SUNROOF/HEADLINING

Noises in the sunroof/headlining area can often be traced to one of the following:

1. Sunroof lid, rail, linkage or seals making a rattle or light knocking noise

2. Sun visor shaft shaking in the holder

3. Front or rear windshield touching headliner and squeaking

Again, pressing on the components to stop the noise while duplicating the conditions can isolate most of these incidents. Repairs usually consist of insulating with felt cloth tape.

### OVERHEAD CONSOLE (FRONT AND REAR)

Overhead console noises are often caused by the console panel clips not being engaged correctly. Most of these incidents are repaired by pushing up on the console at the clip locations until the clips engage.

In addition look for:

1. Loose harness or harness connectors.

2. Front console map/reading lamp lens loose.

3. Loose screws at console attachment points.

### SEATS

When isolating seat noise it's important to note the position the seat is in and the load placed on the seat when the noise is present. These conditions should be duplicated when verifying and isolating the cause of the noise.

Cause of seat noise include:

1. Headrest rods and holder

2. A squeak between the seat pad cushion and frame

3. The rear seatback lock and bracket

These noises can be isolated by moving or pressing on the suspected components while duplicating the conditions under which the noise occurs. Most of these incidents can be repaired by repositioning the component or applying urethane tape to the contact area.

### UNDERHOOD

Some interior noise may be caused by components under the hood or on the engine wall. The noise is then transmitted into the passenger compartment.

Causes of transmitted underhood noise include:

1. Any component mounted to the engine wall

2. Components that pass through the engine wall

3. Engine wall mounts and connectors

4. Loose radiator mounting pins

5. Hood bumpers out of adjustment

6. Hood striker out of adjustment

These noises can be difficult to isolate since they cannot be reached from the interior of the vehicle. The best method is to secure, move or insulate one component at a time and test drive the vehicle. Also, engine RPM or load can be changed to isolate the noise. Repairs can usually be made by moving, adjusting, securing, or insulating the component causing the noise.

A

B

C

D

E

F

G

H

I

J

EXT

L

M

N

O

P

# SQUEAK AND RATTLE TROUBLE DIAGNOSES

< ON-VEHICLE MAINTENANCE >

## Diagnostic Worksheet

INFOID:000000004216198

Dear Customer:

We are concerned about your satisfaction with your vehicle. Repairing a squeak or rattle sometimes can be very difficult. To help us fix your vehicle right the first time, please take a moment to note the area of the vehicle where the squeak or rattle occurs and under what conditions. You may be asked to take a test drive with a service advisor or technician to ensure we confirm the noise you are hearing.

### SQUEAK & RATTLE DIAGNOSTIC WORKSHEET

#### I. WHERE DOES THE NOISE COME FROM? (circle the area of the vehicle)

The illustrations are for reference only, and may not reflect the actual configuration of your vehicle.

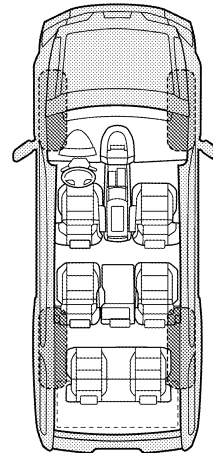
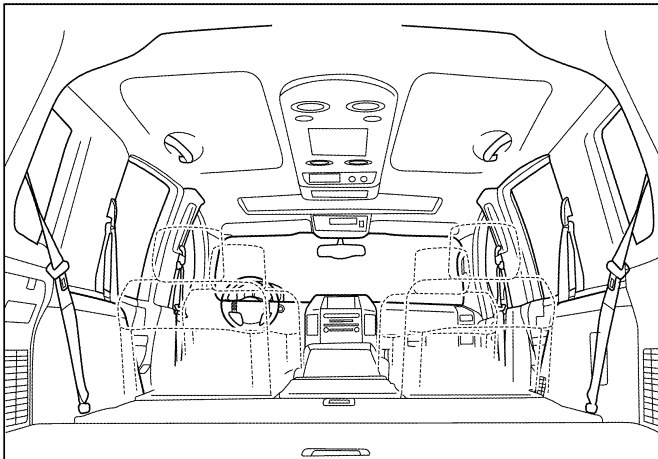
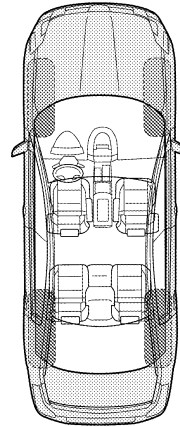
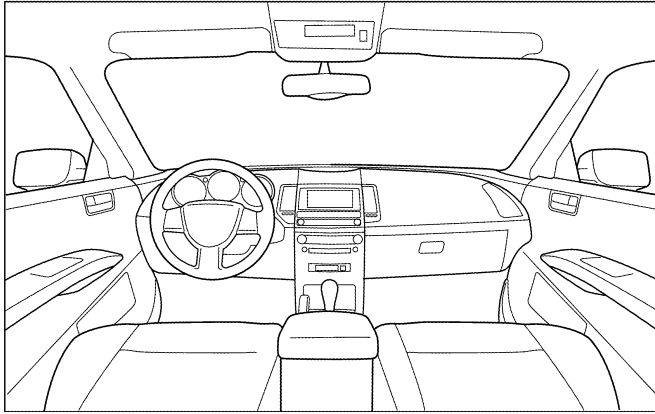

Continue to page 2 of the worksheet and briefly describe the location of the noise or rattle. In addition, please indicate the conditions which are present when the noise occurs.



# SQUEAK AND RATTLE TROUBLE DIAGNOSES

< ON-VEHICLE MAINTENANCE >

## SQUEAK & RATTLE DIAGNOSTIC WORKSHEET - page 2

Briefly describe the location where the noise occurs:

---

---

### II. WHEN DOES IT OCCUR? (please check the boxes that apply)

- |   |  |
|---|--|
| <input type="checkbox"/> Anytime                      | <input type="checkbox"/> After sitting out in the rain |
| <input type="checkbox"/> 1st time in the morning      | <input type="checkbox"/> When it is raining or wet     |
| <input type="checkbox"/> Only when it is cold outside | <input type="checkbox"/> Dry or dusty conditions       |
| <input type="checkbox"/> Only when it is hot outside  | <input type="checkbox"/> Other:                        |

### III. WHEN DRIVING:

- Through driveways
- Over rough roads
- Over speed bumps
- Only about \_\_\_\_ mph
- On acceleration
- Coming to a stop
- On turns: left, right or either (circle)
- With passengers or cargo
- Other: \_\_\_\_\_
- After driving \_\_\_\_ miles or \_\_\_\_ minutes

### IV. WHAT TYPE OF NOISE

- Squeak (like tennis shoes on a clean floor)
- Creak (like walking on an old wooden floor)
- Rattle (like shaking a baby rattle)
- Knock (like a knock at the door)
- Tick (like a clock second hand)
- Thump (heavy muffled knock noise)
- Buzz (like a bumble bee)

### TO BE COMPLETED BY DEALERSHIP PERSONNEL

#### Test Drive Notes:

---

---

---

	YES	NO	Initials of person performing
Vehicle test driven with customer	<input type="checkbox"/>	<input type="checkbox"/>	_____
- Noise verified on test drive	<input type="checkbox"/>	<input type="checkbox"/>	_____
- Noise source located and repaired	<input type="checkbox"/>	<input type="checkbox"/>	_____
- Follow up test drive performed to confirm repair	<input type="checkbox"/>	<input type="checkbox"/>	_____

VIN: \_\_\_\_\_ Customer Name \_\_\_\_\_

W.O.# \_\_\_\_\_ Date: \_\_\_\_\_

This form must be attached to Work Order

LAI0071E









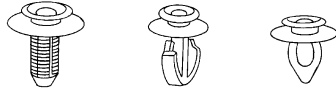

INFOID:000000004216199

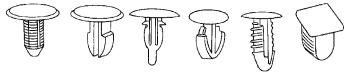
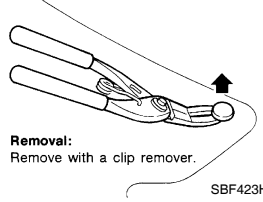
## Clip and Fastener

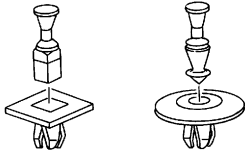
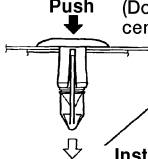
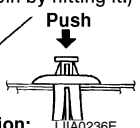
- Clips and fasteners in EXT section correspond to the following numbers and symbols.
- Replace any clips and/or fasteners which are damaged during removal or installation.

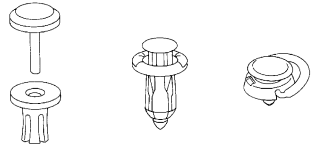
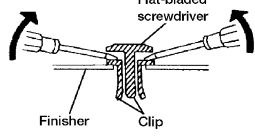

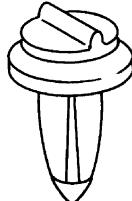
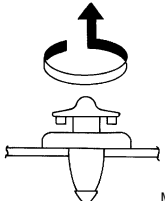

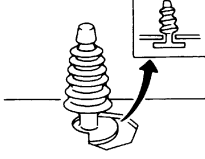
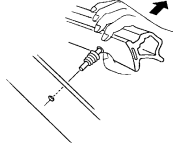
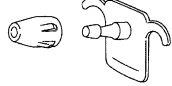
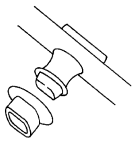
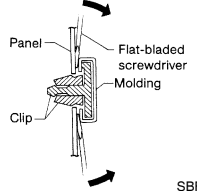





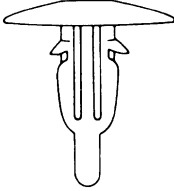
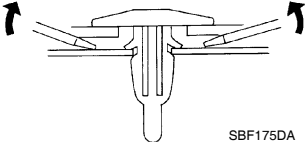

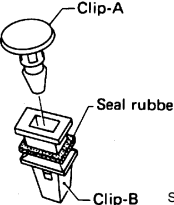
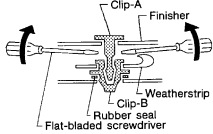

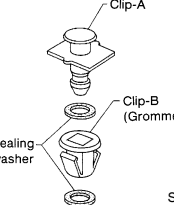
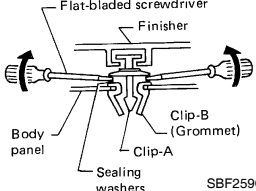
# SQUEAK AND RATTLE TROUBLE DIAGNOSES

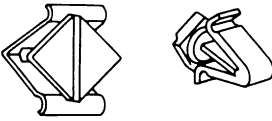
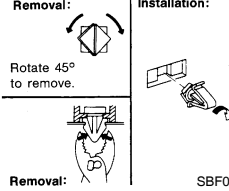
< ON-VEHICLE MAINTENANCE >

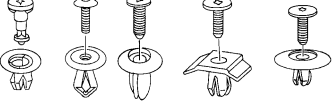
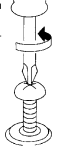
Symbol No.	Shapes	Removal & Installation
<p>C101</p> 	 <p>SBF302H</p>	<p><b>Removal:</b> Remove by bending up with flat-bladed screwdrivers or clip remover.</p>  <p>SBF367BA</p>
<p>C103</p> 	 <p>SBT095</p>	 <p><b>Removal:</b> Remove with a clip remover.</p> <p>SBF423H</p>
<p>C203</p> 	 <p>SBF258G</p>	<p>Push center pin to catching position. (Do not remove center pin by hitting it.)</p>  <p><b>Installation:</b></p>  <p>LTA0236E</p>
<p>C205</p> 	 <p>MBT080A</p>	<p><b>Removal:</b></p>  <p>Flat-bladed screwdriver Finisher Clip</p> <p>SBF638CA</p>
<p>C206</p> 	 <p>MBF519B</p>	 <p>MBF520B</p>
<p>CE103</p> 	 <p>SBF104B</p>	<p><b>Removal:</b></p>  <p>SBF147B</p>
<p>CE107</p> 	 <p>SBF411H</p>	<p>Panel Clip Flat-bladed screwdriver Molding</p>  <p>SBF767B</p>

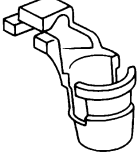
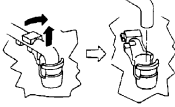
# SQUEAK AND RATTLE TROUBLE DIAGNOSES

< ON-VEHICLE MAINTENANCE >

Symbol No.	Shapes	Removal & Installation	
<p>CE117</p> 	 <p>SBF174D</p>	<p><b>Removal:</b> Remove by bending up with a flat-bladed screwdriver or pliers.</p>  <p>SBF175DA</p>	<p>A B C</p>
<p>CF110</p> 	 <p>SBF648B</p>	<p><b>Removal:</b></p>  <p>SBF649B</p>	<p>D E F</p>
<p>CF118</p> 	 <p>SBF151D</p>	<p><b>Removal:</b></p>  <p>SBF259G</p>	<p>G H</p>
<p>CG101</p> 	 <p>SBF145B</p>	<p><b>Removal:</b> Rotate 45° to remove.</p> <p><b>Installation:</b></p>  <p>SBF085B</p>	<p>I J</p>
<p>CS101</p> 	 <p>SBF078B</p>	<p><b>Removal:</b></p> <ol style="list-style-type: none"> <li>Screw out with a Phillips screwdriver.</li> <li>Remove female portion with flat-bladed screwdriver.</li> </ol>  <p>SBF992G</p>	<p>EXT L M</p>
<p>CR103</p> 	 <p>SBF768B</p>	<p><b>Removal:</b> Holder portion of clip must be spread out to remove rod.</p>  <p>SBF770B</p>	<p>N O</p>
<p>Metal Clip</p> 	 <p>WBT072</p>	<p><b>Removal:</b></p>  <p>WBT073</p>	<p>P</p>

# FRONT BUMPER

< ON-VEHICLE REPAIR >

## ON-VEHICLE REPAIR

### FRONT BUMPER

#### Removal and Installation

INFOID:000000004216200

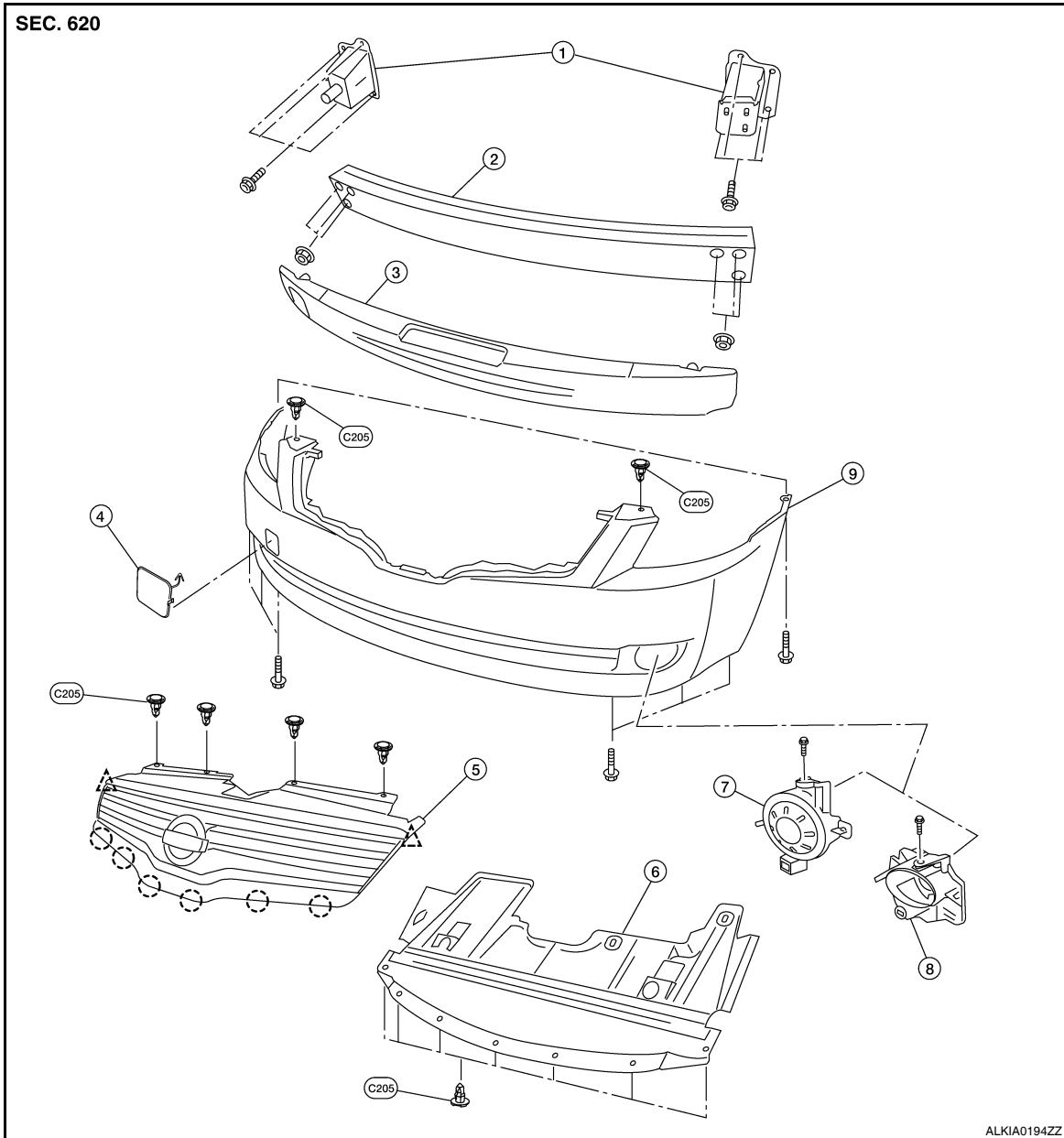

ALKIA0194ZZ

- |                          |                               |                          |
|--------------------------|-------------------------------|--------------------------|
| 1. Front bumper supports | 2. Front bumper reinforcement | 3. Energy absorbing foam |
| 4. Tow cover             | 5. Front grille               | 6. Engine under cover    |
| 7. Fog lamp finisher     | 8. Fog lamp (if equipped)     | 9. Front bumper fascia   |
- △ Clip      ○ Pawl

#### REMOVAL

1. Remove the front fender protectors RH and LH. Refer to [EXT-18, "Removal and Installation"](#).
2. Remove the engine under cover.
3. Remove the front grille. Refer to [EXT-16, "Removal and Installation"](#).
4. Remove the fog lamp if equipped. Refer to [EXL-162, "Removal and Installation"](#).

## FRONT BUMPER

### < ON-VEHICLE REPAIR >

---

5. Remove the front bumper fascia clips and screws, then remove the front bumper fascia.
6. Remove the front energy absorbing foam.
7. Remove the front bumper reinforcement.
8. Remove the front bumper supports.

### INSTALLATION

Installation is in the reverse order of removal.

A

B

C

D

E

F

G

H

I

J

EXT

L

M

N

O

P

# REAR BUMPER

< ON-VEHICLE REPAIR >

## REAR BUMPER

### Removal and Installation

INFOID:000000004216201

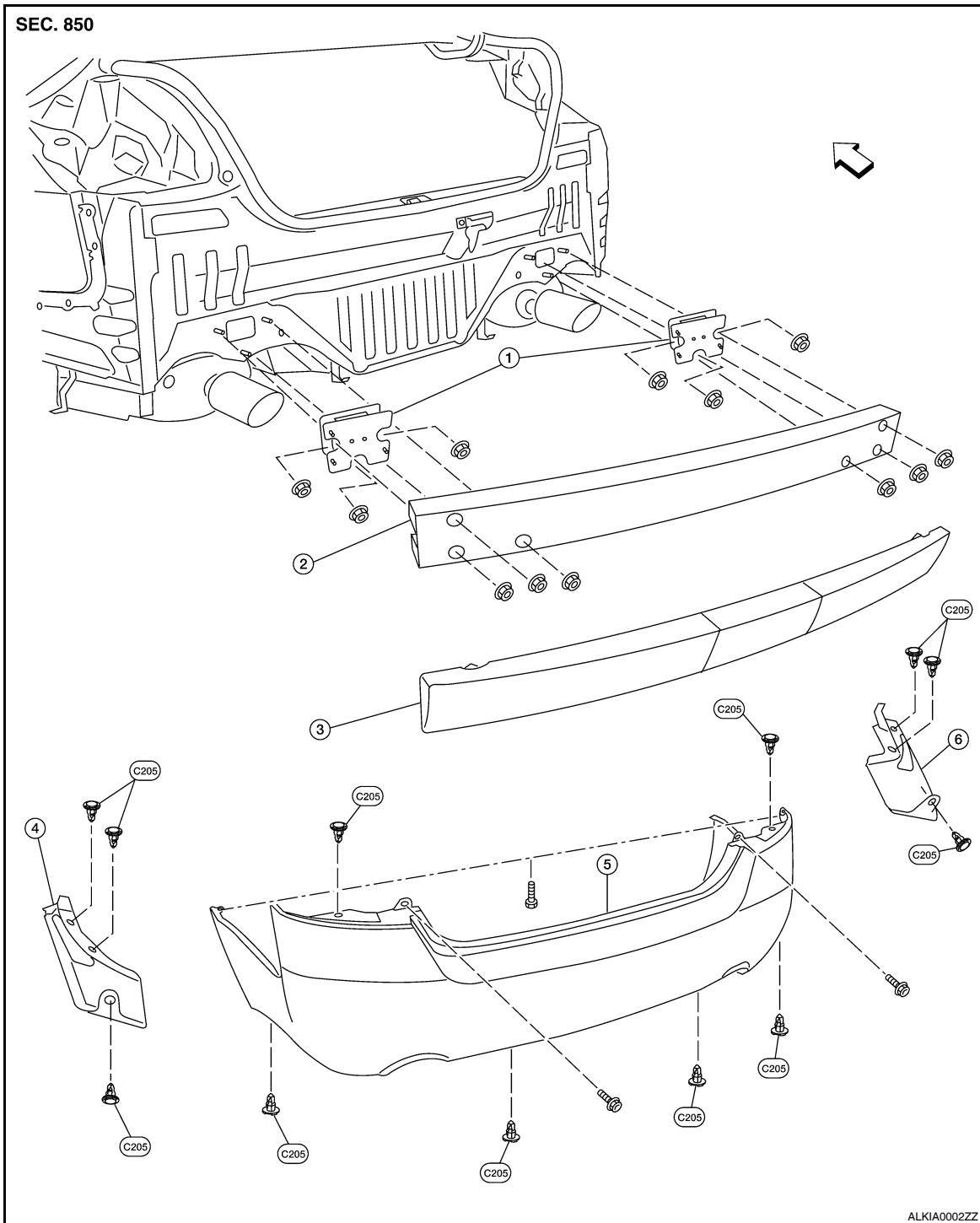

- |                         |                              |                          |
|-------------------------|------------------------------|--------------------------|
| 1. Rear bumper supports | 2. Rear bumper reinforcement | 3. Energy absorbing foam |
| 4. Splash shield LH     | 5. Rear bumper fascia        | 6. Splash shield RH      |
| ← Vehicle front         |                              |                          |

### REMOVAL

1. Remove the LH and RH rear combination lamps. Refer to [EXL-166, "Removal and Installation"](#).
2. Remove both the rear wheels and tires. Refer to [WT-62, "Adjustment"](#).

## REAR BUMPER

### < ON-VEHICLE REPAIR >

---

3. Remove the LH and RH splash shields.
4. Remove the rear bumper fascia clips and screws, then remove the rear bumper fascia. A
5. Remove the rear energy absorbing foam.
6. Remove the rear bumper reinforcement. B
7. Remove the rear bumper supports.

### INSTALLATION

Installation is in the reverse order of removal. C

D

E

F

G

H

I

J

EXT

L

M

N

O

P

# FRONT GRILLE

< ON-VEHICLE REPAIR >

## FRONT GRILLE

### Removal and Installation

INFOID:000000004216202

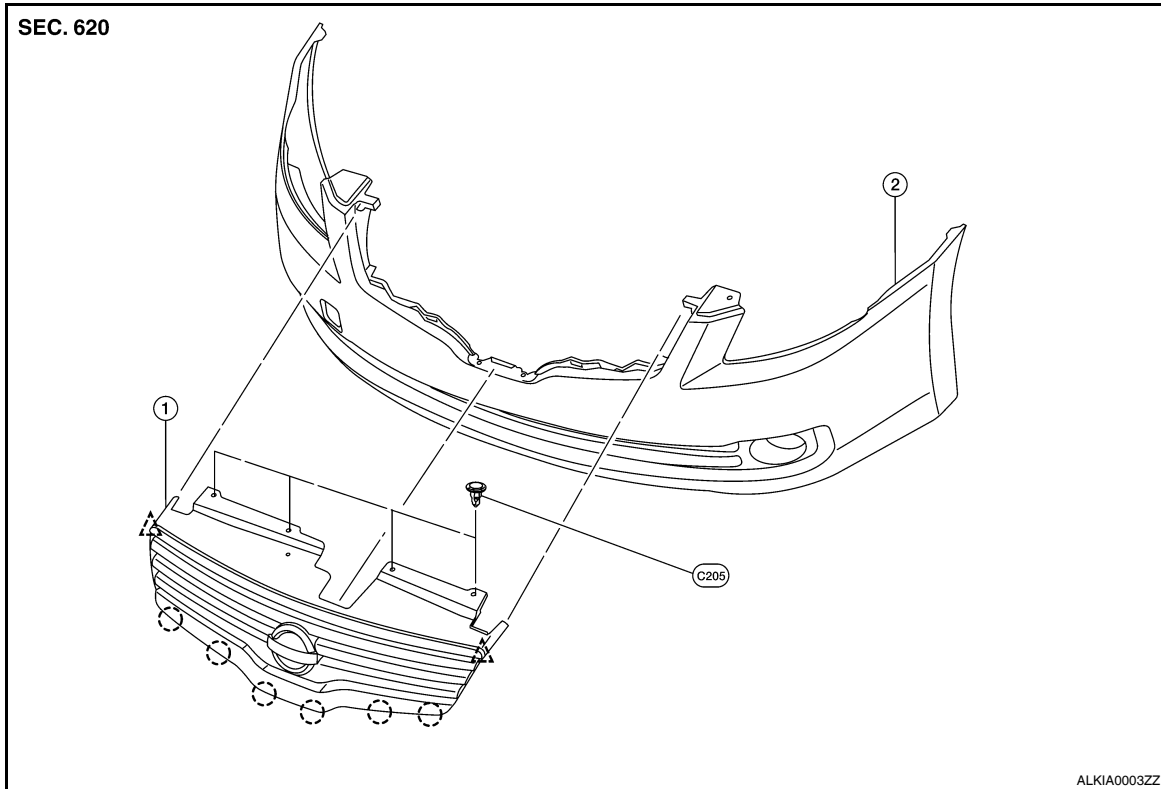

1. Front grille

2. Bumper fascia

△ Clip

○ Pawl

## FRONT GRILLE

### Removal

1. Remove the front grille clips.
2. Release the grille pawl from the front bumper fascia, then remove the front grille.

### Installation

Installation is in the reverse order of removal.



# COWL TOP

< ON-VEHICLE REPAIR >

## COWL TOP

### Removal and Installation

INFOID:000000004216203

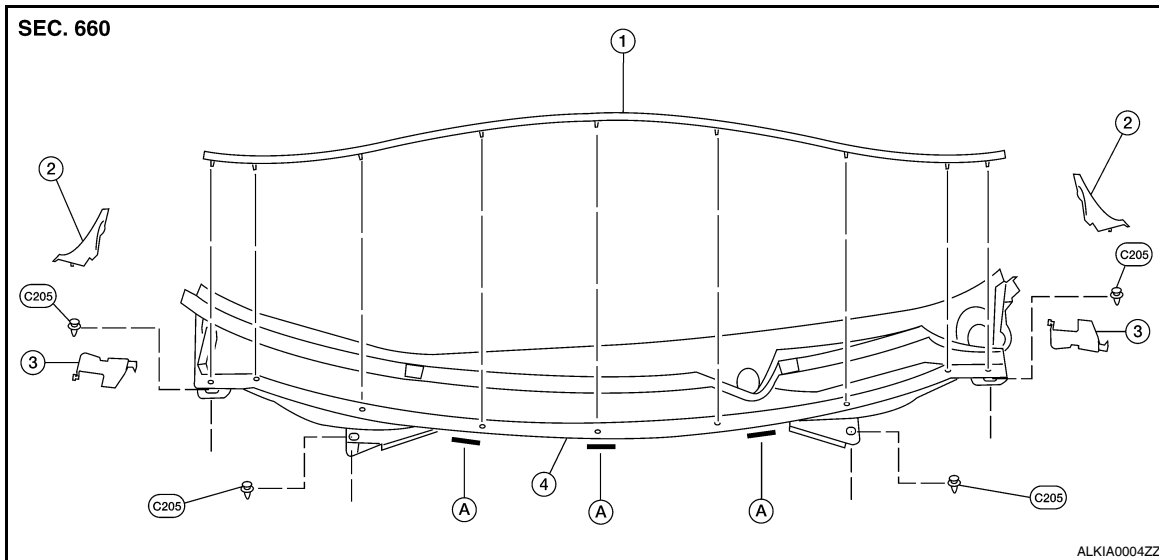

- |                  |                              |                         |
|------------------|------------------------------|-------------------------|
| 1. Cowl top seal | 2. Cowl top side trim covers | 3. Cowl top foam blocks |
| 4. Cowl top      | A Clips                      |                         |

#### REMOVAL

1. Remove both the RH and LH wiper arms. Refer to [WW-92, "FRONT WIPER ARMS : Removal and Installation"](#).
2. Remove the cowl top side trim covers.
3. Remove the cowl top foam blocks.
4. Remove the cowl top clips and remove the cowl top.

#### INSTALLATION

Installation is in the reverse order of removal.

A  
B  
C  
D  
E  
F  
G  
H  
I  
J  
L  
M  
N  
O  
P

EXT

# FENDER PROTECTOR

< ON-VEHICLE REPAIR >

## FENDER PROTECTOR

### Removal and Installation

INFOID:000000004216204

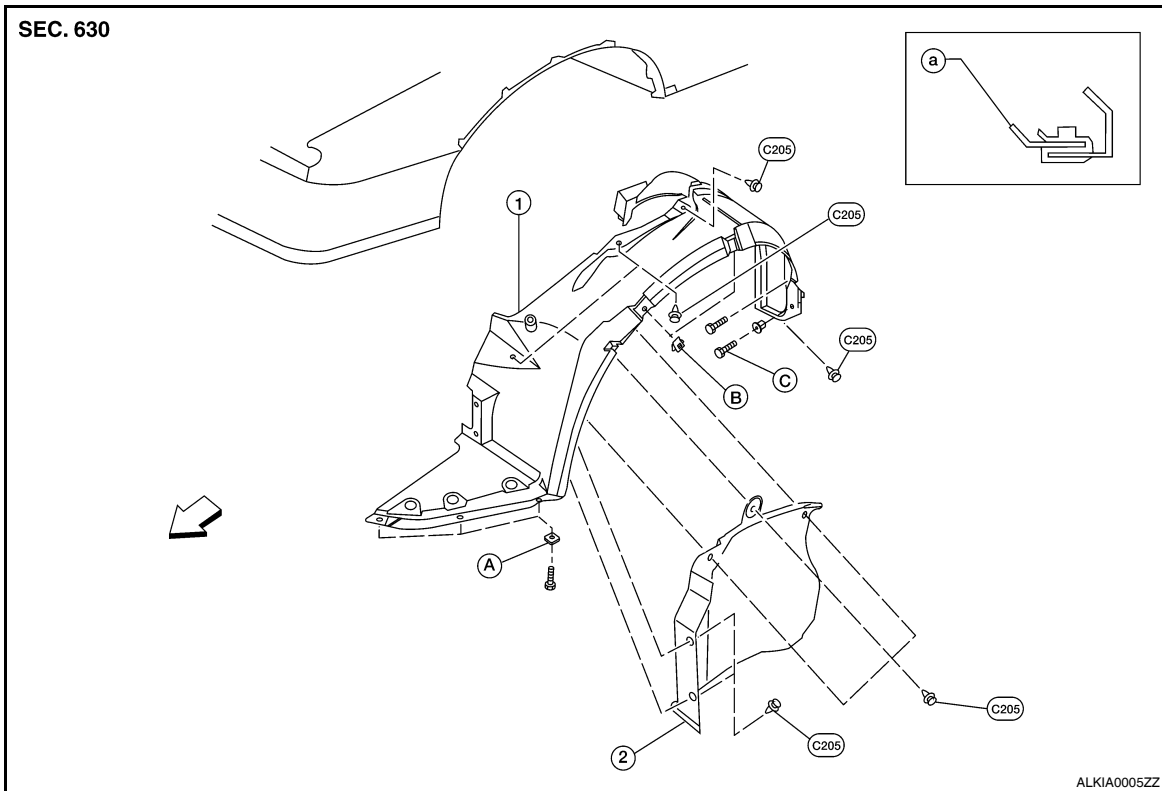

1. Fender protector

2. Fender protector side cover

A. J-clips

B. Clips

C. Center mudguard screw

a. Sheet metal

←: Vehicle front

### REMOVAL

1. Remove the engine under cover. Refer to [EXT-12. "Removal and Installation"](#).
2. Remove the screw from center mudguard.
3. Remove the fender protector screws and clips.
4. Remove the fender protector.

### INSTALLATION

Installation is in the reverse order of removal.

# MUDGUARD

< ON-VEHICLE REPAIR >

## MUDGUARD

### Removal and Installation

INFOID:000000004216205

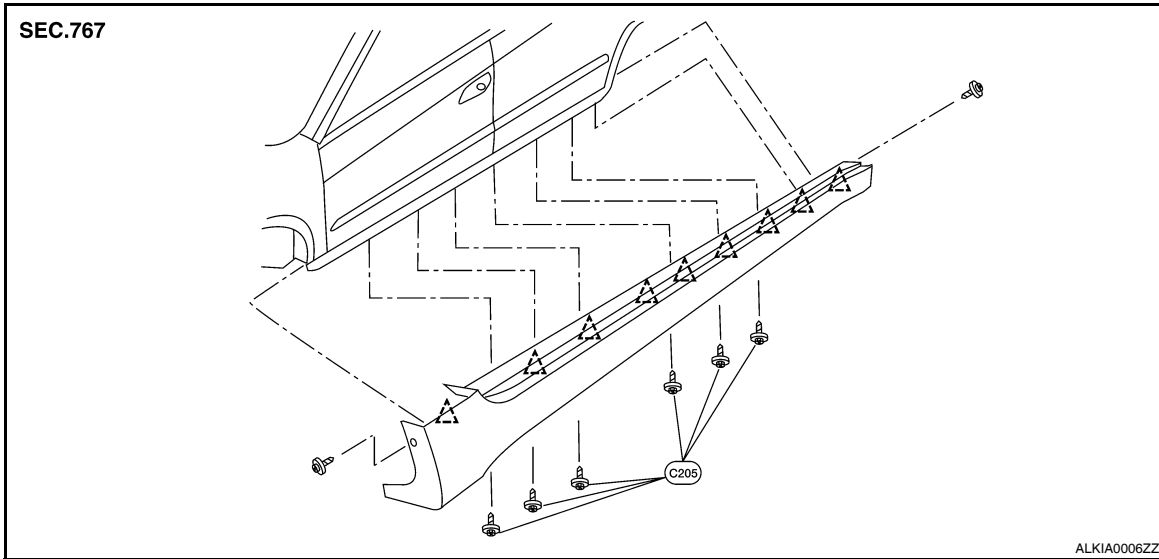

 Clips

#### REMOVAL

1. Remove the C205 push-pins located on the under body.
2. Remove the center mudguard screws and remove the center mudguard.

#### INSTALLATION

Installation is in the reverse order of removal.

A  
B  
C  
D  
E  
F  
G  
H  
I  
J  
L  
M  
N  
O  
P

EXT

# SIDE GUARD MOLDING

< ON-VEHICLE REPAIR >

## SIDE GUARD MOLDING

### Removal and Installation

INFOID:000000004216206

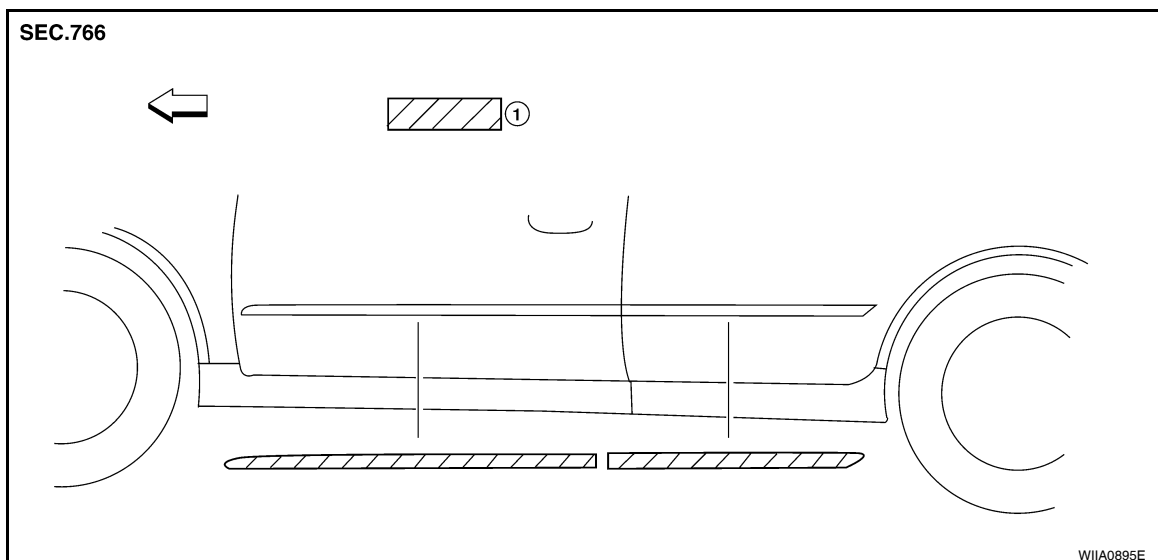

1. Double-faced adhesive tape      ← Vehicle front

#### Removal

#### **CAUTION:**

**Never apply tack-paper adhesive remover to body panel surface finished with lacquer-based paints.**

- Original side guard molding is affixed to body panel with double-faced adhesive tape.
1. Heat molding to between 30° and 40°C (86° to 104°F) with a heat gun.
  2. Using a trim stick, gently lift an end of the molding and cut away tape to remove molding.
  3. Remove all remaining traces of tape and adhesive.

#### Installation

- On vehicles coated with Hard Clear Coat, use double-faced 3M® adhesive tape Product No. 4210 or equivalent, after priming with 3M primer Product No. N200 or C-100 or equivalent.
  - The repair parts are also attached with double-faced adhesive tape.
  - To re-use existing molding, clean all traces of double sided tape from the molding and apply new double-faced tape to the molding.
1. Clean the panel surface with isopropyl alcohol or equivalent to degrease the surface.
  2. Using a heat gun, heat the panel and molding tape surface to 30° to 40°C (86° to 104°F).
  3. Remove the backing sheet from the tape surface.
  4. Press ends by hand and use a roller to apply 5 kg-f (11 lb-f) to press molding to door surface.

#### **NOTE:**

For maximum adhesion, allow vehicle to set without washing for 24 hours after installation.

# DOOR OUTSIDE MOLDING

< ON-VEHICLE REPAIR >

## DOOR OUTSIDE MOLDING

### Removal and Installation

INFOID:000000004216207

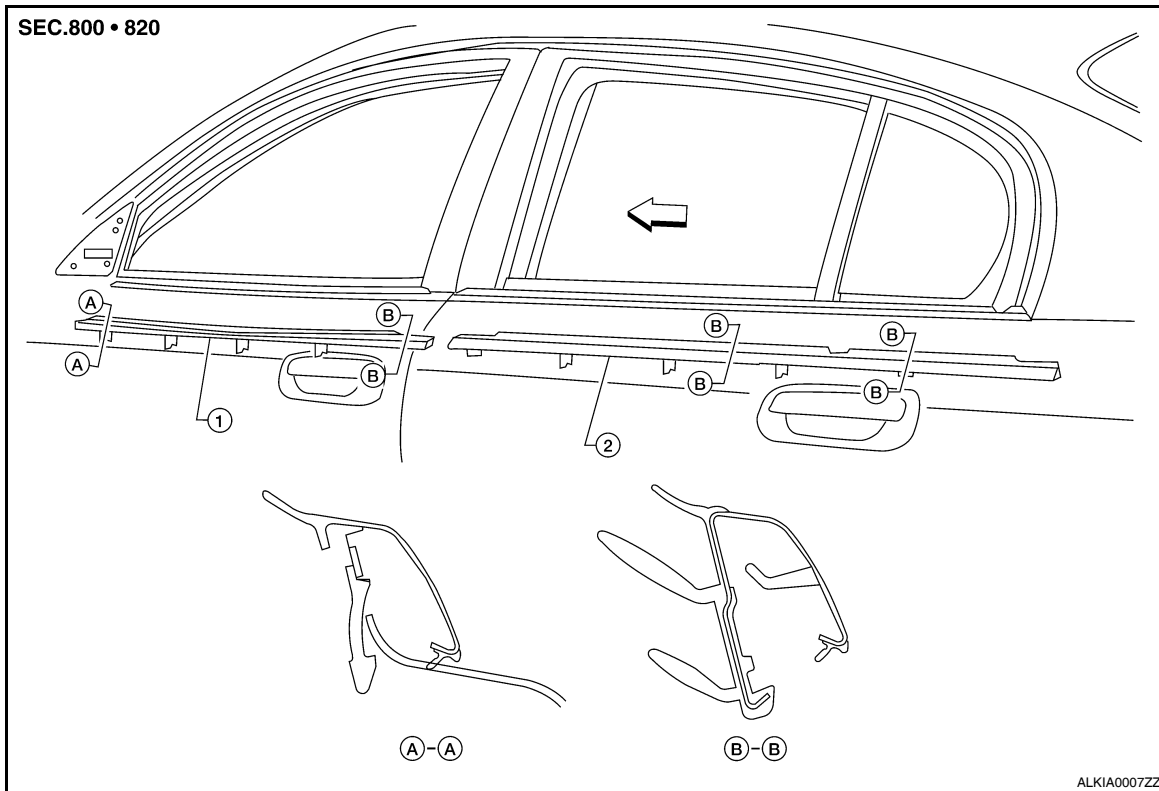

1. Front door outside molding      2. Rear door outside molding      ← Vehicle front

### Front Door Outside Molding

#### Removal

1. Open the front door window fully.
2. Remove the side view mirror. Refer to [MIR-16, "Removal and Installation"](#).
3. Lift and twist from rear side, disconnect clips from flange and pull the front door molding out backwards.

#### Installation

Installation is in the reverse order of removal.

### Rear Door Outside Molding

#### Removal

1. Open the rear door window fully.
2. Lift and twist from rear side, then disconnect clips from flange and pull the rear door molding out.

#### Installation

Installation is in the reverse order of removal.

A  
B  
C  
D  
E  
F  
G  
H  
I  
J  
L  
M  
N  
O  
P

EXT

# DRIP MOLDING

< ON-VEHICLE REPAIR >

## DRIP MOLDING

### Removal and Installation

INFOID:000000004216208

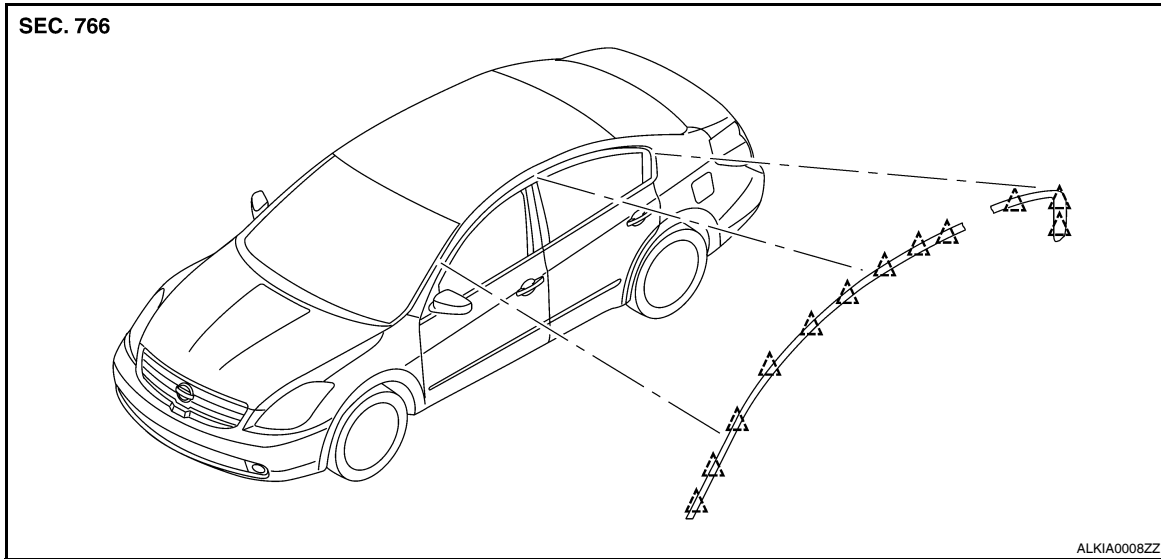

 Clips

#### REMOVAL

1. Using a trim stick or equivalent, disconnect the drip mouldings starting at the front, working rearward.
2. Remove the drip moldings.

#### INSTALLATION

Installation is in the reverse order of removal.

- Insert drip moldings onto vehicle starting at the rear, working forward.

# ROOF SIDE MOLDING

< ON-VEHICLE REPAIR >

## ROOF SIDE MOLDING

### Removal and Installation

INFOID:000000004216209

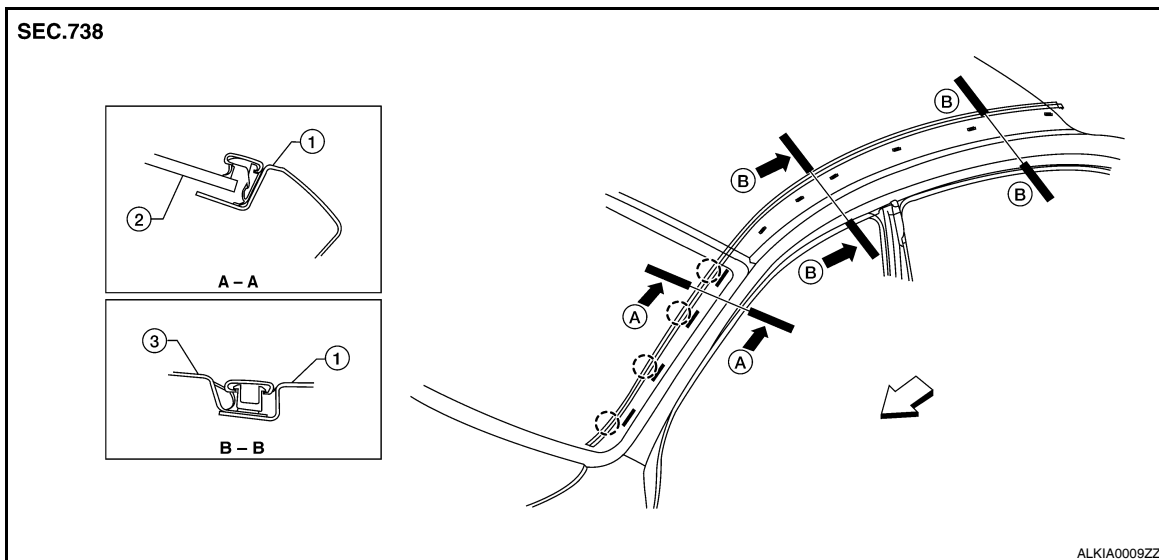

#### REMOVAL

1. Lift and twist the roof side molding up from the rear edge.
2. Disconnect the roof side molding from the pawls, and remove the roof side molding.

#### INSTALLATION

Installation is in the reverse order of removal.

- Engage the roof molding into the pawls starting at the rear.

A  
B  
C  
D  
E  
F  
G  
H  
I  
J  
EXT  
L  
M  
N  
O  
P

# LICENSE LAMP FINISHER

< ON-VEHICLE REPAIR >

## LICENSE LAMP FINISHER

### Removal and Installation

INFOID:000000004216210

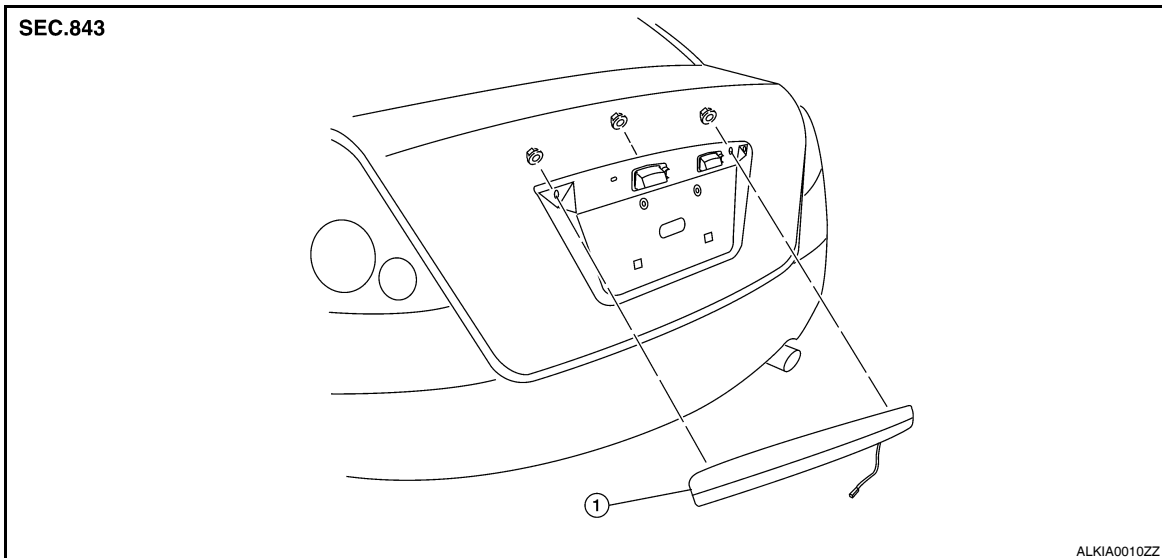

1. License lamp finisher

#### REMOVAL

1. Remove the trunk lid finisher (if equipped). Refer to [INT-27, "Removal and Installation"](#).
2. Remove the license lamp finisher nuts.
3. Remove license lamp finisher by pulling toward the rear, then disconnect the trunk request switch connector.

#### INSTALLATION

Installation is in the reverse order of removal.



# REAR SPOILER

< ON-VEHICLE REPAIR >

## REAR SPOILER

### Removal and Installation

INFOID:000000004216211

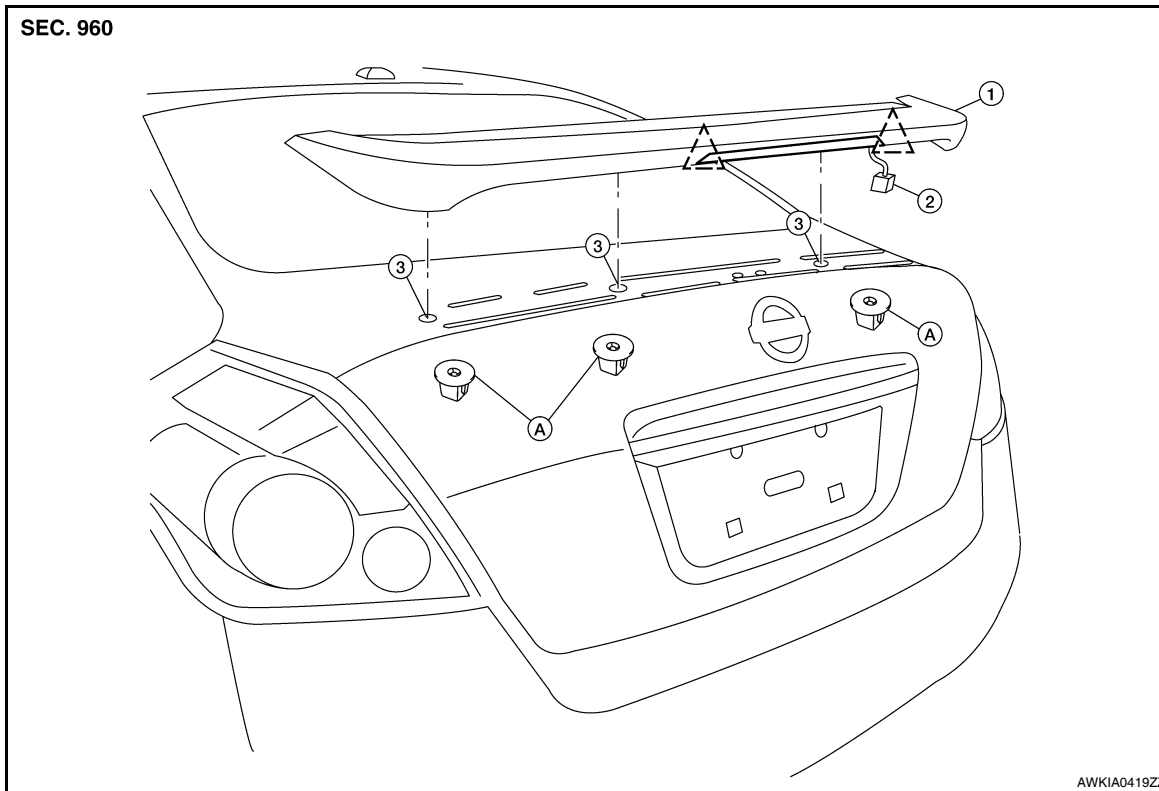

1. Rear spoiler assembly      2. High mounted stop lamp harness      3. Gasket  
A. Nuts       Clips

#### Removal

1. Remove trunk lid finisher (if equipped). Refer to [INT-27, "Removal and Installation"](#).
2. Disconnect high mounted stop lamp connector.
3. Using a trim stick, carefully release the clips and pry foam tape free from trunk lid surface.

#### CAUTION:

**Use care not to damage painted surfaces during removal of, or releasing adhesive backed foam tapes.**

4. Release the high mounted stop lamp harness grommet from trunk lid, then remove rear spoiler.

#### Installation

Installation is in the reverse order of removal.

#### NOTE:

- Before installing rear spoiler, clean the surface where it will be mounted with isopropyl alcohol or equivalent to degrease the surface.
- Before installing, be sure there are no gaps or waves in the foam tape where the surfaces meet.
- During installation, be sure grommet of high mounted stop lamp harness is fully seated into trunk lid opening prior to final rear air spoiler placement.

A  
B  
C  
D  
E  
F  
G  
H  
I  
J  
EXT  
L  
M  
N  
O  
P