

MWI

SECTION

METER, WARNING LAMP & INDICATOR

A
B
C
D
E
F
G
H
I
J
K
L
M
O
P

CONTENTS

BASIC INSPECTION	4	FUEL GAUGE : Component Description	22
DIAGNOSIS AND REPAIR WORKFLOW	4	ODO/TRIP METER	22
Work Flow	4	ODO/TRIP METER : System Diagram	22
FUNCTION DIAGNOSIS	5	ODO/TRIP METER : System Description	22
METER SYSTEM	5	ODO/TRIP METER : Component Parts Location	23
METER SYSTEM	5	ODO/TRIP METER : Component Description	25
METER SYSTEM : System Diagram	5	SHIFT POSITION INDICATOR	25
METER SYSTEM : System Description	5	SHIFT POSITION INDICATOR : System Diagram	25
METER SYSTEM : Arrangement of Combination		SHIFT POSITION INDICATOR : System Description	25
Meter	6	SHIFT POSITION INDICATOR : Component	
METER SYSTEM : Component Parts Location	7	Parts Location	26
METER SYSTEM : Component Description	9	SHIFT POSITION INDICATOR : Component Description	28
SPEEDOMETER	10	WARNING LAMPS/INDICATOR LAMPS	28
SPEEDOMETER : System Diagram	10	WARNING LAMPS/INDICATOR LAMPS : System	
SPEEDOMETER : System Description	10	Diagram	28
SPEEDOMETER : Component Parts Location	11	WARNING LAMPS/INDICATOR LAMPS : System	
SPEEDOMETER : Component Description	13	Description	28
TACHOMETER	13	WARNING LAMPS/INDICATOR LAMPS : Com-	
TACHOMETER : System Diagram	13	ponent Parts Location	29
TACHOMETER : System Description	13	WARNING LAMPS/INDICATOR LAMPS : Com-	
TACHOMETER : Component Parts Location	14	ponent Description	31
TACHOMETER : Component Description	16	INFORMATION DISPLAY	31
ENGINE COOLANT TEMPERATURE GAUGE	16	INFORMATION DISPLAY : System Diagram	31
ENGINE COOLANT TEMPERATURE GAUGE :		INFORMATION DISPLAY : System Description	32
System Diagram	16	INFORMATION DISPLAY : Component Parts Lo-	
ENGINE COOLANT TEMPERATURE GAUGE :		cation	33
System Description	16	INFORMATION DISPLAY : Component Descrip-	
ENGINE COOLANT TEMPERATURE GAUGE :		tion	35
Component Parts Location	17	COMPASS	36
ENGINE COOLANT TEMPERATURE GAUGE :		Description	36
Component Description	19	DIAGNOSIS SYSTEM (METER)	38
FUEL GAUGE	19	Diagnosis Description	38
FUEL GAUGE : System Diagram	19	CONSULT-III Function (METER/M&A)	38
FUEL GAUGE : System Description	19		
FUEL GAUGE : Component Parts Location	20		

MWI

COMPONENT DIAGNOSIS	41	ECU DIAGNOSIS	59
DTC U1000 CAN COMMUNICATION	41	COMBINATION METER	59
DTC Logic	41	Reference Value	59
Diagnosis Procedure	41	Wiring Diagram - Coupe	61
DTC B2205 VEHICLE SPEED CIRCUIT	42	Wiring Diagram - Sedan	78
Description	42	Fail Safe	94
DTC Logic	42	DTC Index	95
Diagnosis Procedure	42	BCM (BODY CONTROL MODULE)	96
POWER SUPPLY AND GROUND CIRCUIT	43	Reference Value	96
COMBINATION METER	43	Terminal Layout	101
COMBINATION METER : Diagnosis Procedure ...	43	Physical Values	101
BCM (BODY CONTROL MODULE)	43	Wiring Diagram-Coupe	120
BCM (BODY CONTROL MODULE) : Diagnosis		Wiring Diagram-Sedan	129
Procedure	44	Fail Safe	137
BCM (BODY CONTROL MODULE) : Special Re-		DTC Inspection Priority Chart	139
pair Requirement	44	DTC Index	140
IPDM E/R (INTELLIGENT POWER DISTRI-		IPDM E/R (INTELLIGENT POWER DISTRI-	
BUTION MODULE ENGINE ROOM)	44	BUTION MODULE ENGINE ROOM)	143
IPDM E/R (INTELLIGENT POWER DISTRI-		Reference Value	143
BUTION MODULE ENGINE ROOM) : Diagnosis Pro-		Wiring Diagram — Coupe	151
cedure	44	Wiring Diagram — Sedan	157
FUEL LEVEL SENSOR SIGNAL CIRCUIT	46	Fail Safe	162
Description	46	DTC Index	164
Component Function Check	46	SYMPTOM DIAGNOSIS	165
Diagnosis Procedure	46	THE FUEL GAUGE POINTER DOES NOT	
Component Inspection	47	MOVE	165
OIL PRESSURE SWITCH SIGNAL CIRCUIT ...	48	Description	165
Description	48	Diagnosis Procedure	165
Component Function Check	48	THE FUEL GAUGE POINTER DOES NOT	
Diagnosis Procedure	48	MOVE TO "F" WHEN REFUELING	166
Component Inspection	48	Description	166
PARKING BRAKE SWITCH SIGNAL CIR-		Diagnosis Procedure	166
CUIT	49	THE OIL PRESSURE WARNING LAMP	
Description	49	DOES NOT TURN ON	167
Component Function Check	49	Description	167
Diagnosis Procedure	49	Diagnosis Procedure	167
Component Inspection	50	THE OIL PRESSURE WARNING LAMP	
WASHER LEVEL SWITCH SIGNAL CIRCUIT...	51	DOES NOT TURN OFF	168
Description	51	Description	168
Component Function Check	51	Diagnosis Procedure	168
Diagnosis Procedure	51	THE PARKING BRAKE RELEASE WARNING	
Component Inspection	51	CONTINUES DISPLAYING, OR DOES NOT	
AMBIENT SENSOR SIGNAL CIRCUIT	53	DISPLAY	169
Description	53	Description	169
Component Function Check	53	Diagnosis Procedure	169
Diagnosis Procedure	53	THE LOW WASHER FLUID WARNING CON-	
Component Inspection	54	TINUES DISPLAYING, or DOES NOT DIS-	
COMPASS	55	PLAY	170
Wiring Diagram - Coupe	55	Description	170
Wiring Diagram - Sedan	57	Diagnosis Procedure	170

THE DOOR OPEN WARNING CONTINUES		
DISPLAYING, OR DOES NOT DISPLAY	171	
Description	171	
Diagnosis Procedure	171	
THE AMBIENT TEMPERATURE DISPLAY IS		
INCORRECT	173	
Description	173	
Diagnosis Procedure	173	
NORMAL OPERATING CONDITION	174	
COMPASS	174	
COMPASS : Description	174	
PRECAUTION	175	
PRECAUTIONS	175	
Supplemental Restraint System (SRS) "AIR BAG"		A
and "SEAT BELT PRE-TENSIONER"	175	
Necessary for Steering Wheel Rotation After Bat-		
tery Disconnect	175	B
ON-VEHICLE REPAIR	176	
COMBINATION METER	176	
Removal and Installation	176	C
DISASSEMBLY AND ASSEMBLY	177	
COMBINATION METER	177	
Disassembly and Assembly	177	D
		E
		F
		G
		H
		I
		J
		K
		L
		M
		MWI
		O
		P

DIAGNOSIS AND REPAIR WORKFLOW

< BASIC INSPECTION >

BASIC INSPECTION

DIAGNOSIS AND REPAIR WORKFLOW

Work Flow

INFOID:000000004204044

DETAILED FLOW

1.CONFIRM SYMPTOM

Confirm symptom or customer complaint.

>> GO TO 2

2.CHECK SELF-DIAGNOSIS OPERATION OF COMBINATION METER

Perform self-diagnosis of combination meter. Refer to [MWI-38. "Diagnosis Description"](#).

Does self-diagnosis mode operate?

YES >> GO TO 3

NO >> Check power supply and ground circuit of combination meter. Refer to [MWI-43. "COMBINATION METER : Diagnosis Procedure"](#). Then, GO TO 4

3.CHECK COMBINATION METER (CONSULT-III)

Select "METER/M&A" on CONSULT-III and perform "SELF-DIAGNOSIS" of combination meter. Refer to [MWI-38. "CONSULT-III Function \(METER/M&A\)"](#).

Self-diagnostic results content

No malfunction detected>>Repair or replace the cause of symptom. Then, GO TO 4

Malfunction detected>>Refer to [MWI-95. "DTC Index"](#). Then, GO TO 4

4.CONFIRM OPERATION

Does the combination meter operate normally?

YES or NO

YES >> Inspection End.

NO >> GO TO 1

METER SYSTEM

< FUNCTION DIAGNOSIS >

FUNCTION DIAGNOSIS

METER SYSTEM

METER SYSTEM

METER SYSTEM : System Diagram

INFOID:000000004204045

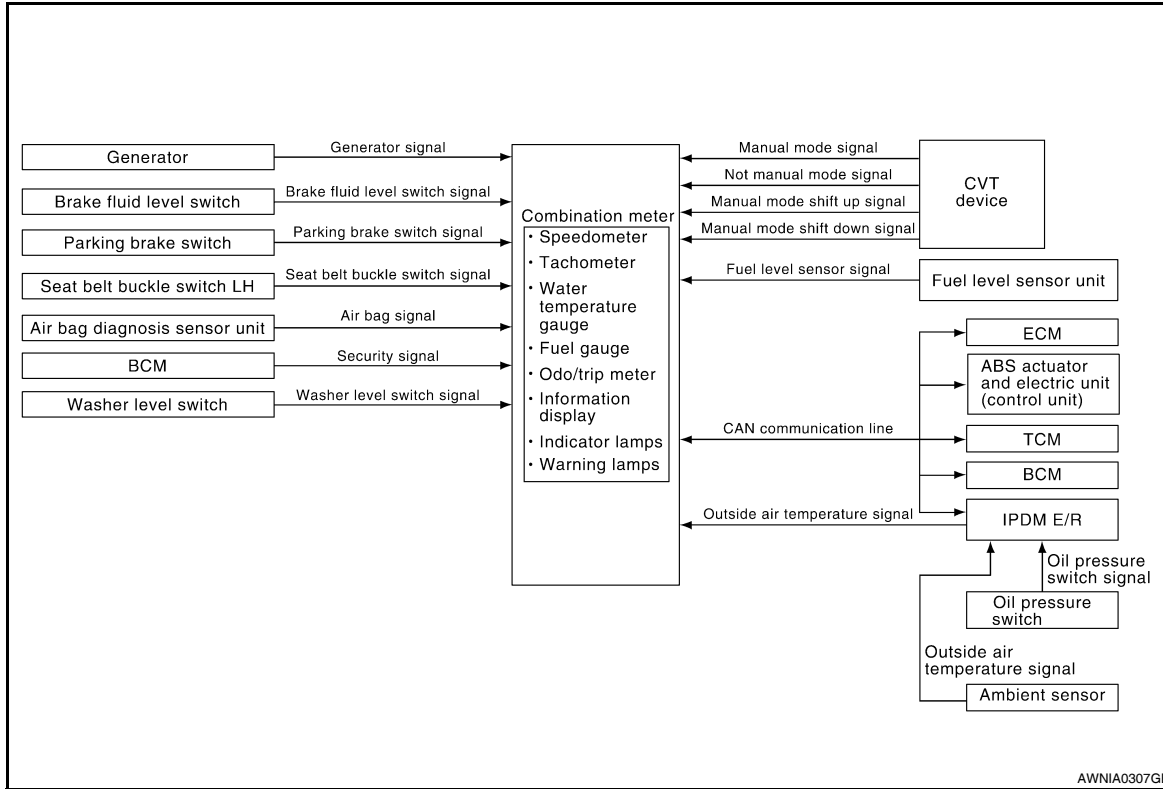

AWNIA0307GB

METER SYSTEM : System Description

INFOID:000000004204046

COMBINATION METER

- Speedometer, odo/trip meter, tachometer, fuel gauge, engine coolant temperature gauge and information display are controlled by the unified meter control unit, which is built into the combination meter.
- Warning and indicator lamps are controlled by the unified meter control unit and by components connected directly to the combination meter.
- Digital meter is adopted for odo/trip meter.*
*The record of the odometer is kept even if the battery cable is disconnected. The record of the trip meter is erased when the battery cable is disconnected.
- Odo/trip meter and information display segments can be checked in diagnosis mode.
- Meter/gauge can be checked in diagnosis mode.

A
B
C
D
E
F
G
H
I
J
K
L
M
N
O
P

MWI

METER SYSTEM

< FUNCTION DIAGNOSIS >

METER SYSTEM : Arrangement of Combination Meter

INFOID:000000004204047

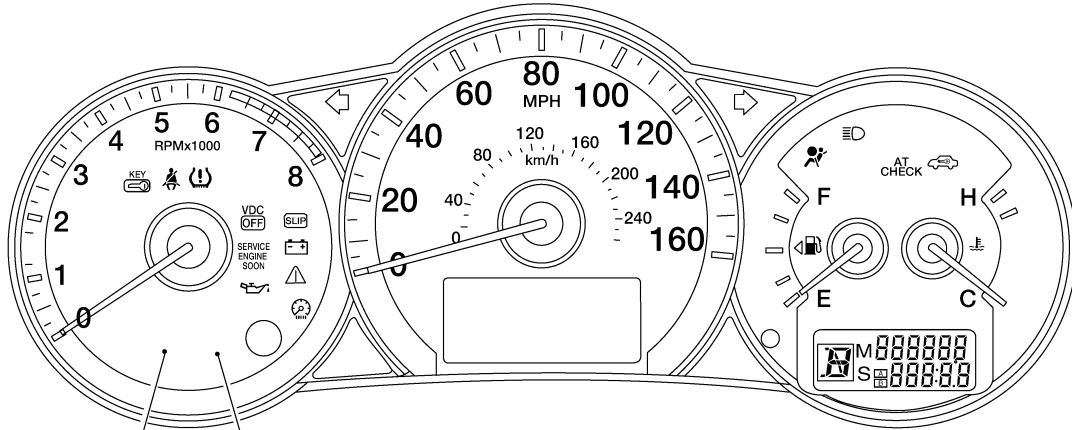

ABS : U
 (ABS) : N
 BRAKE : U
 (I) : N

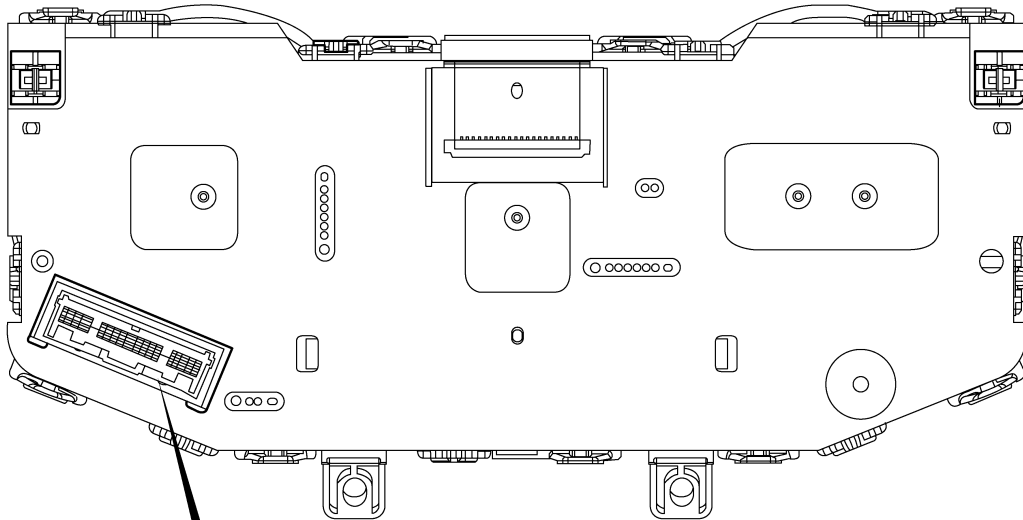

N : Canada
 U : USA

1	2	3	4	5	6	7	8	9	10	11	12	13	14	15	16	17	18	19	20	(M24)
21	22	23	24	25	26	27	28	29	30	31	32	33	34	35	36	37	38	39	40	

ALNIA0009GB

METER SYSTEM

< FUNCTION DIAGNOSIS >

METER SYSTEM : Component Parts Location

INFOID:000000004204048

A

B

C

D

E

F

G

H

I

J

K

L

M

MWI

O

P

METER SYSTEM

< FUNCTION DIAGNOSIS >

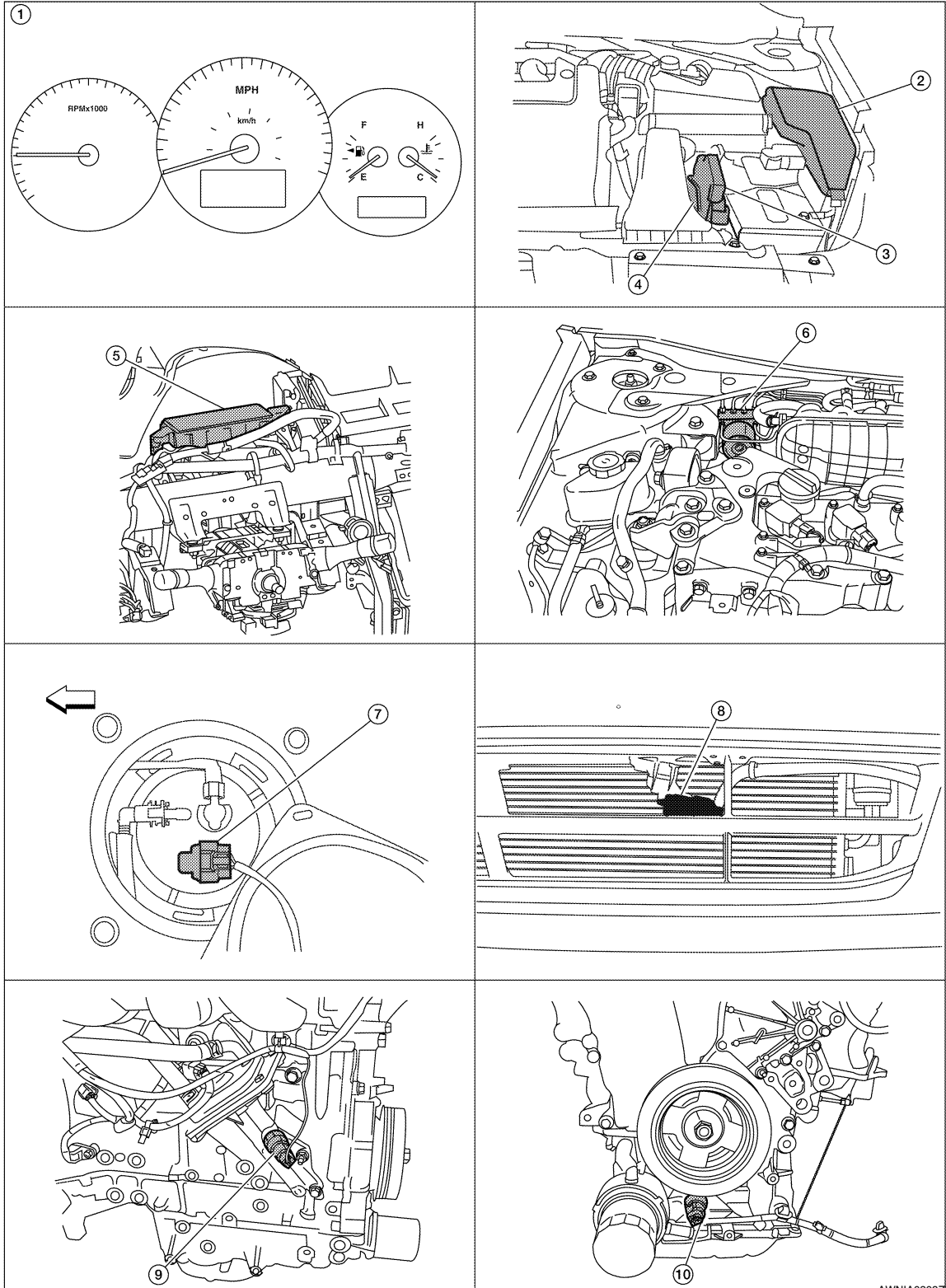

METER SYSTEM

< FUNCTION DIAGNOSIS >

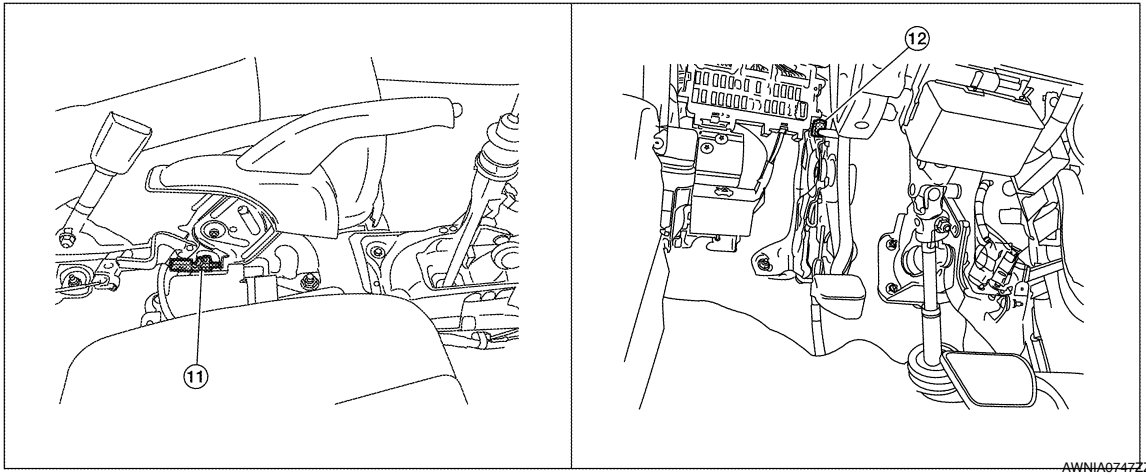

- | | | |
|---|--|---|
| 1. Combination meter M24 | 2. IPDM E/R E17, E18, E201, F10 | 3. ECM E10 |
| 4. TCM F16 | 5. BCM M17, M18, M19, M21 (view with instrument panel removed) | 6. ABS actuator and electric unit (control unit) E26 |
| 7. Fuel level sensor unit and fuel pump (fuel level sensor) B42 (view with rear seat and inspection hole cover removed) | 8. Ambient sensor E211 (view of front bumper fascia) | 9. Oil pressure switch F41 (QR25DE) (view with engine removed) |
| 10. Oil pressure switch F41 (VQ35DE) (view with engine removed) | 11. Parking brake switch M73 (Sedan with M/T and Coupe) (view with center console removed) | 12. Parking brake switch E35 (Sedan with CVT) (view with instrument lower cover LH removed) |

METER SYSTEM : Component Description

INFOID:000000004204049

Unit	Description
Combination meter	Controls the following with the signals received from each unit via CAN communication and the signals from switches and sensors. <ul style="list-style-type: none"> Speedometer Engine coolant temperature gauge Odo/trip meter Indicator lamps Information display Tachometer Fuel gauge Warning lamps Warning chime
IPDM E/R	IPDM E/R reads the ON/OFF signals of the oil pressure switch and transmits the oil pressure switch signal to the combination meter via BCM with CAN communication line.
Fuel level sensor unit	Refer to MWI-46. "Description" .
Oil pressure switch	Refer to MWI-48. "Description" .
ECM	Transmits the following signals to the combination meter with CAN communication line. <ul style="list-style-type: none"> Engine speed signal Fuel consumption monitor signal Engine coolant temperature signal
ABS actuator and electric unit (control unit)	Transmits the vehicle speed signal to the combination meter with CAN communication line.
BCM	<ul style="list-style-type: none"> Transmits signals provided by various units to the combination meter with CAN communication line. Transmits the security signal to the combination meter.
TCM	Transmits shift position signal to the combination meter with CAN communication line.
Washer level switch	Transmits the washer level signal to the combination meter.

METER SYSTEM

< FUNCTION DIAGNOSIS >

Unit	Description
Brake fluid level switch	Transmits the brake fluid level switch signal to the combination meter.
Parking brake switch	Refer to MWI-49. "Description" .

SPEEDOMETER

SPEEDOMETER : System Diagram

INFOID:000000004204050

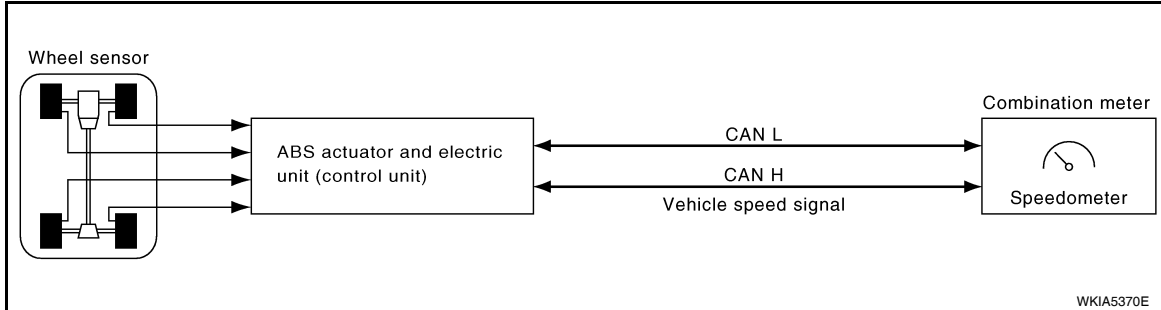

SPEEDOMETER : System Description

INFOID:000000004204051

The ABS actuator and electric unit (control unit) provides a vehicle speed signal to the combination meter via CAN communication lines.

METER SYSTEM

< FUNCTION DIAGNOSIS >

SPEEDOMETER : Component Parts Location

INFOID:000000004495941

A

B

C

D

E

F

G

H

I

J

K

L

M

MWI

O

P

METER SYSTEM

< FUNCTION DIAGNOSIS >

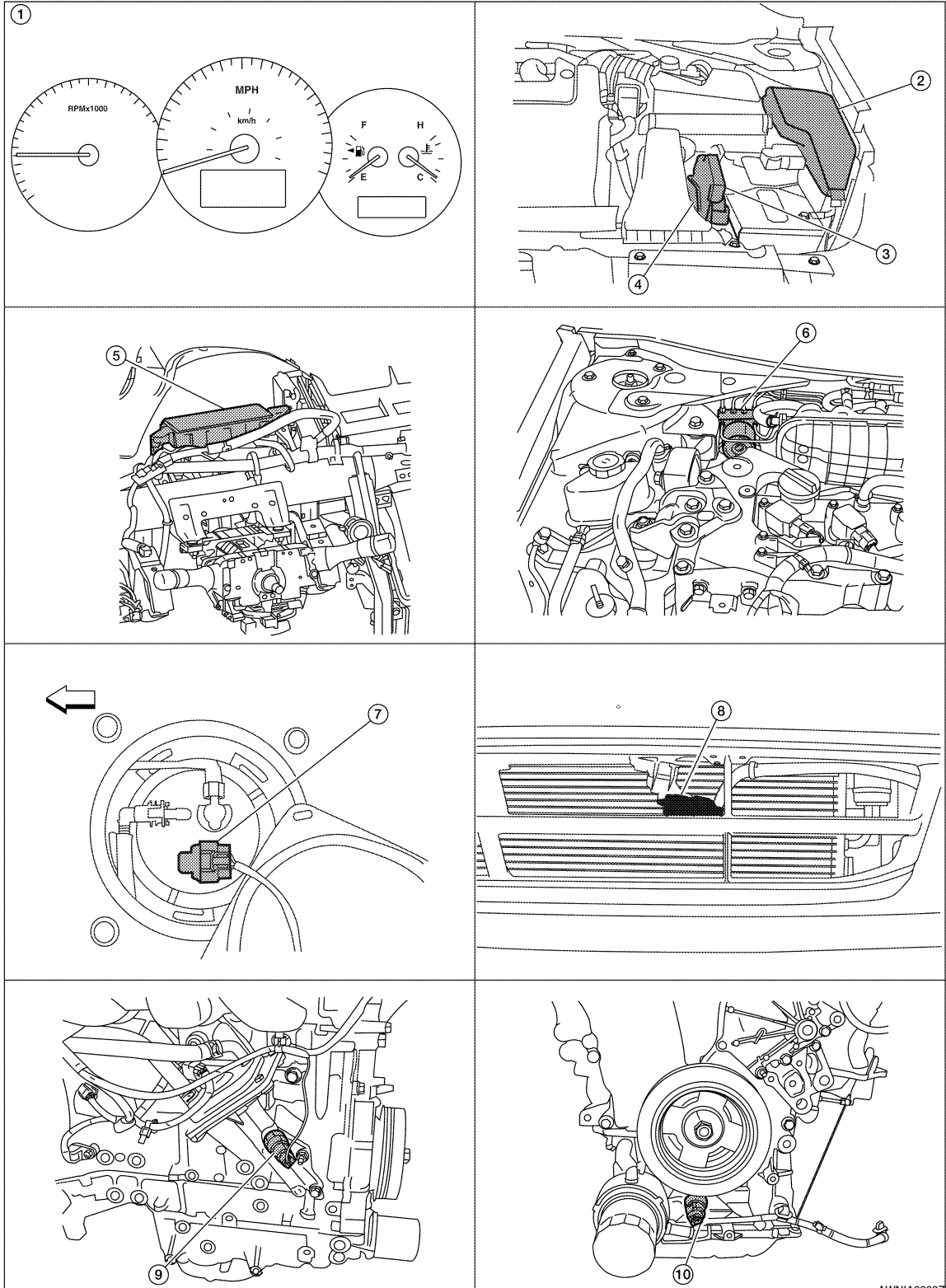

METER SYSTEM

< FUNCTION DIAGNOSIS >

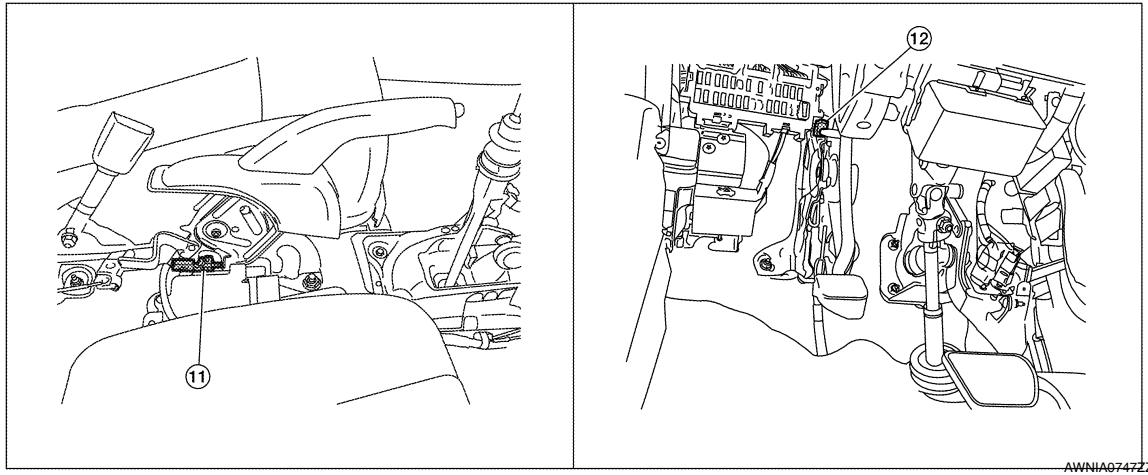

- | | | |
|---|--|---|
| 1. Combination meter M24 | 2. IPDM E/R E17, E18, E201, F10 | 3. ECM E10 |
| 4. TCM F16 | 5. BCM M17, M18, M19, M21 (view with instrument panel removed) | 6. ABS actuator and electric unit (control unit) E26 |
| 7. Fuel level sensor unit and fuel pump (fuel level sensor) B42 (view with rear seat and inspection hole cover removed) | 8. Ambient sensor E211 (view of front bumper fascia) | 9. Oil pressure switch F41 (QR25DE) (view with engine removed) |
| 10. Oil pressure switch F41 (VQ35DE) (view with engine removed) | 11. Parking brake switch M73 (Sedan with M/T and Coupe) (view with center console removed) | 12. Parking brake switch E35 (Sedan with CVT) (view with instrument lower cover LH removed) |

SPEEDOMETER : Component Description

INFOID:000000004204053

Unit	Description
Combination meter	Indicates the vehicle speed according to the vehicle speed signal received from ABS actuator and electric unit (control unit) via CAN communication.
ABS actuator and electric unit (control unit)	Transmits the vehicle speed signal to the combination meter with CAN communication line.

TACHOMETER

TACHOMETER : System Diagram

INFOID:000000004204054

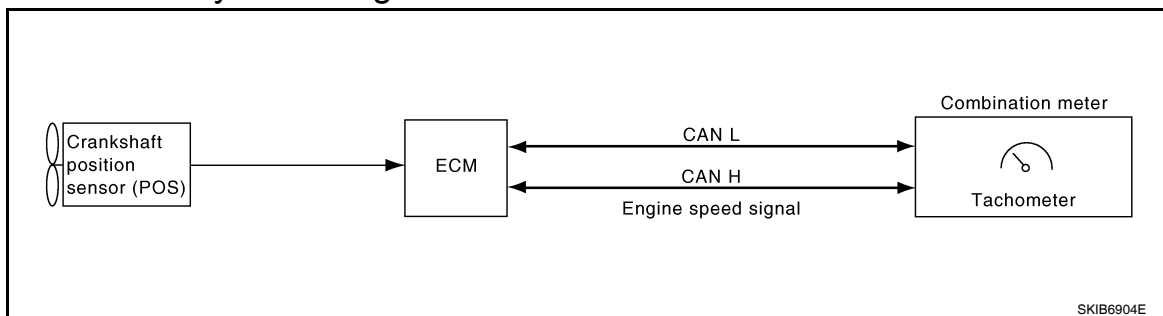

TACHOMETER : System Description

INFOID:000000004204055

The tachometer indicates engine speed in revolutions per minute (rpm).
The ECM provides an engine speed signal to the combination meter via CAN communication lines.

METER SYSTEM

< FUNCTION DIAGNOSIS >

TACHOMETER : Component Parts Location

INFOID:000000004495942

METER SYSTEM

< FUNCTION DIAGNOSIS >

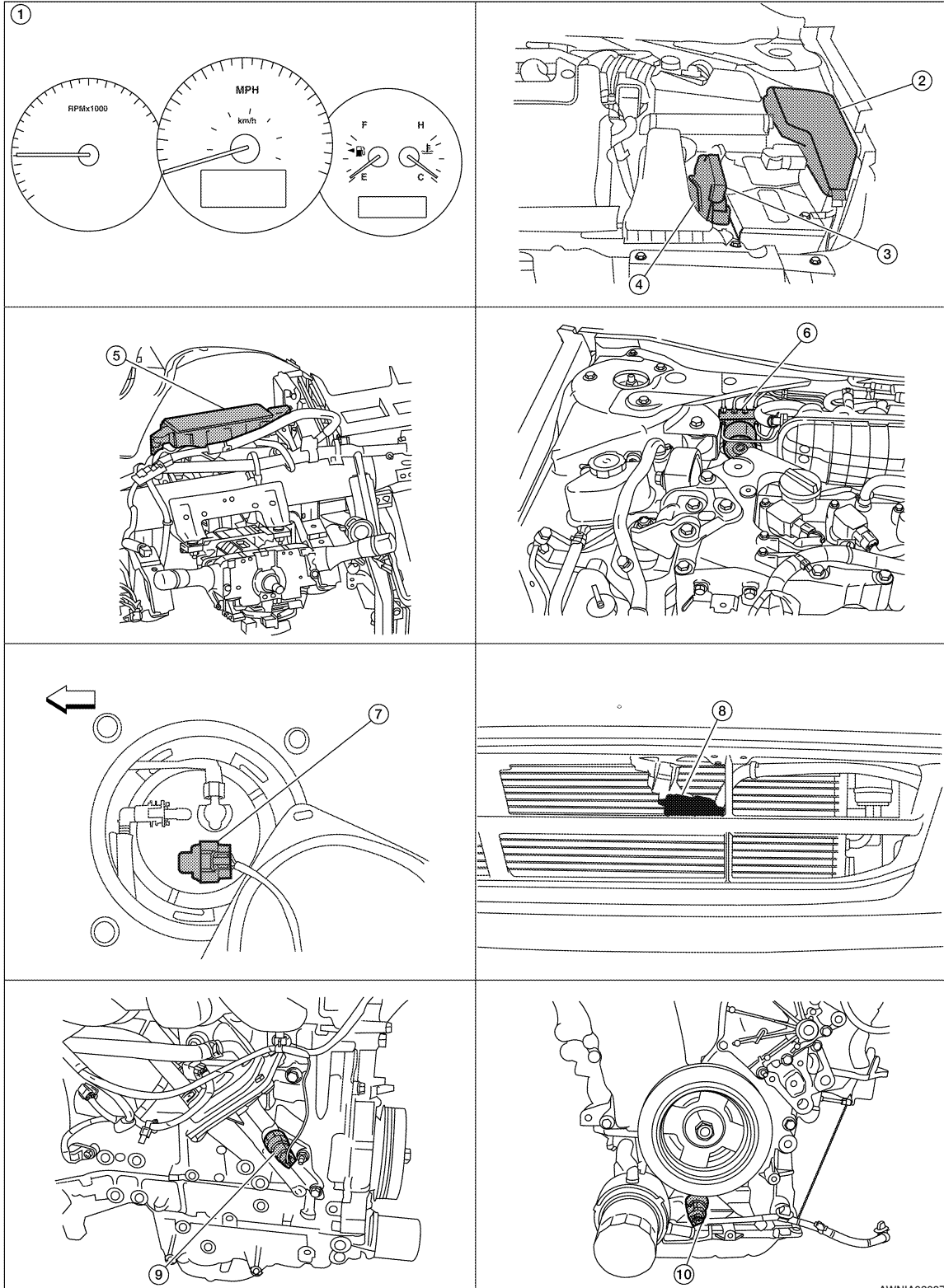

A
B
C
D
E
F
G
H
I
J
K
L
M
MWI
O
P

METER SYSTEM

< FUNCTION DIAGNOSIS >

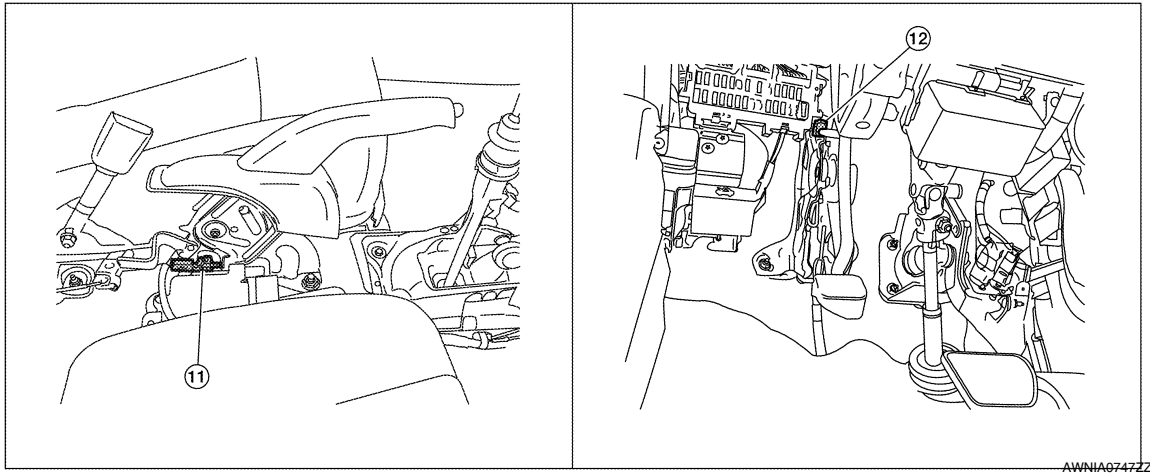

- | | | |
|---|--|---|
| 1. Combination meter M24 | 2. IPDM E/R E17, E18, E201, F10 | 3. ECM E10 |
| 4. TCM F16 | 5. BCM M17, M18, M19, M21 (view with instrument panel removed) | 6. ABS actuator and electric unit (control unit) E26 |
| 7. Fuel level sensor unit and fuel pump (fuel level sensor) B42 (view with rear seat and inspection hole cover removed) | 8. Ambient sensor E211 (view of front bumper fascia) | 9. Oil pressure switch F41 (QR25DE) (view with engine removed) |
| 10. Oil pressure switch F41 (VQ35DE) (view with engine removed) | 11. Parking brake switch M73 (Sedan with M/T and Coupe) (view with center console removed) | 12. Parking brake switch E35 (Sedan with CVT) (view with instrument lower cover LH removed) |

TACHOMETER : Component Description

INFOID:000000004204057

Unit	Description
Combination meter	Indicates the engine speed in RPM according to the engine speed signal received from ECM via CAN communication.
ECM	Transmits the engine speed signal to the combination meter with CAN communication line.

ENGINE COOLANT TEMPERATURE GAUGE

ENGINE COOLANT TEMPERATURE GAUGE : System Diagram

INFOID:000000004204058

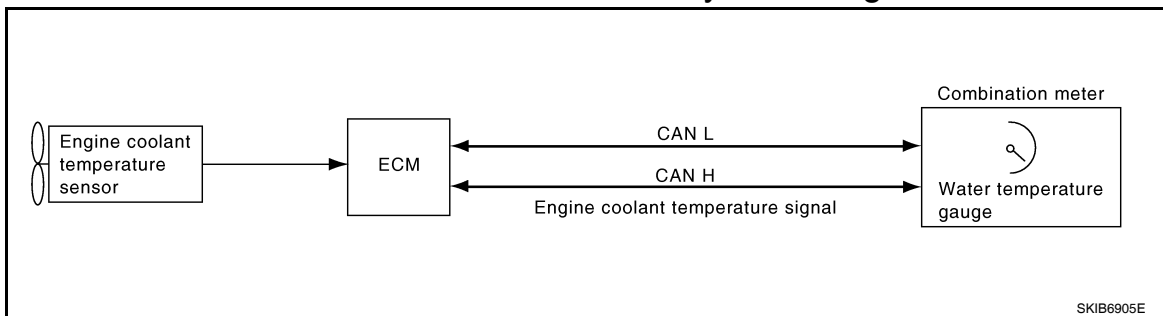

SKIB6905E

ENGINE COOLANT TEMPERATURE GAUGE : System Description

INFOID:000000004204059

The engine coolant temperature gauge indicates the engine coolant temperature. The ECM provides an engine coolant temperature signal to the combination meter via CAN communication lines.

METER SYSTEM

< FUNCTION DIAGNOSIS >

ENGINE COOLANT TEMPERATURE GAUGE : Component Parts Location

INFOID:000000004495943

A

B

C

D

E

F

G

H

I

J

K

L

M

MWI

O

P

METER SYSTEM

< FUNCTION DIAGNOSIS >

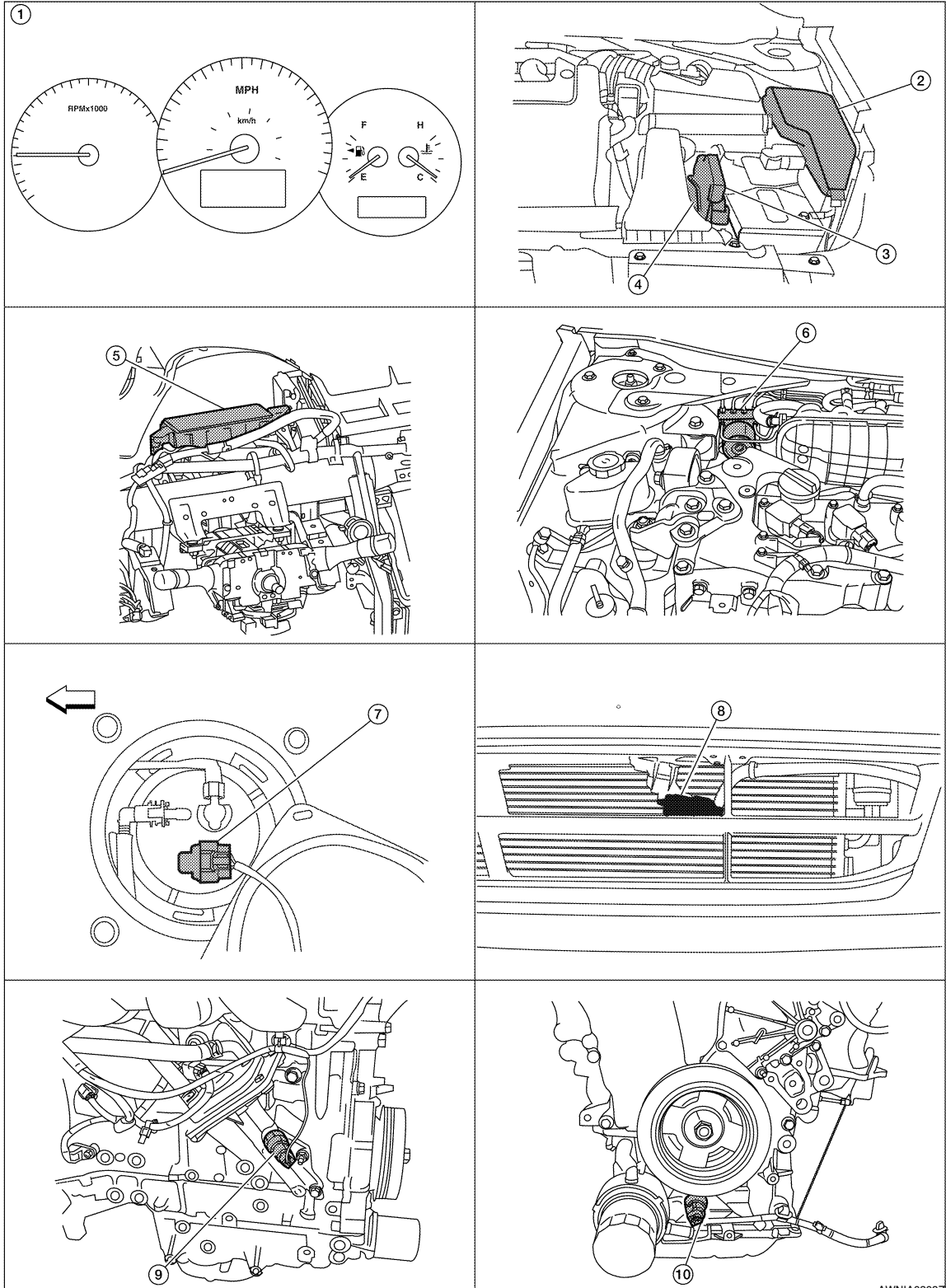

METER SYSTEM

< FUNCTION DIAGNOSIS >

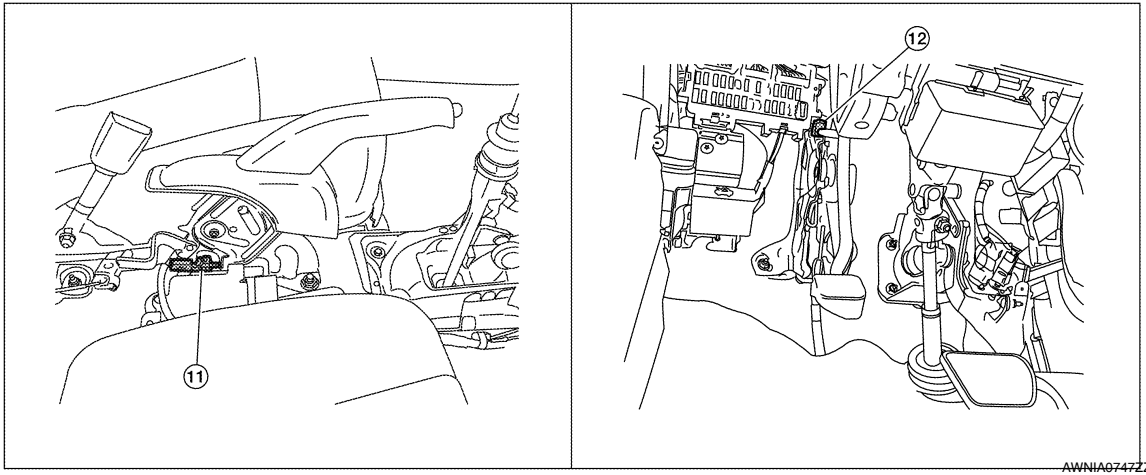

- | | | |
|---|--|---|
| 1. Combination meter M24 | 2. IPDM E/R E17, E18, E201, F10 | 3. ECM E10 |
| 4. TCM F16 | 5. BCM M17, M18, M19, M21 (view with instrument panel removed) | 6. ABS actuator and electric unit (control unit) E26 |
| 7. Fuel level sensor unit and fuel pump (fuel level sensor) B42 (view with rear seat and inspection hole cover removed) | 8. Ambient sensor E211 (view of front bumper fascia) | 9. Oil pressure switch F41 (QR25DE) (view with engine removed) |
| 10. Oil pressure switch F41 (VQ35DE) (view with engine removed) | 11. Parking brake switch M73 (Sedan with M/T and Coupe) (view with center console removed) | 12. Parking brake switch E35 (Sedan with CVT) (view with instrument lower cover LH removed) |

ENGINE COOLANT TEMPERATURE GAUGE : Component Description

INFOID:000000004204061

Unit	Description
Combination meter	Indicates the engine coolant temperature according to the engine coolant temperature signal received from ECM via CAN communication.
ECM	Transmits the engine coolant temperature signal to the combination meter via CAN communication.

FUEL GAUGE

FUEL GAUGE : System Diagram

INFOID:000000004204062

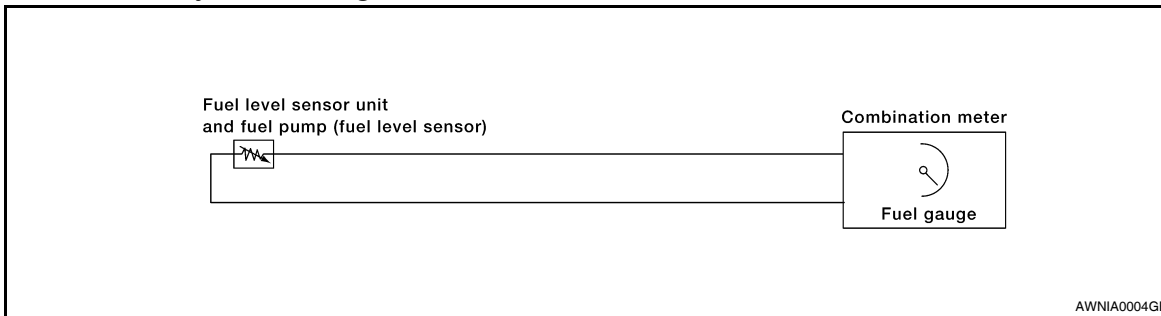

FUEL GAUGE : System Description

INFOID:000000004204063

The fuel gauge indicates the approximate fuel level in the fuel tank. The fuel gauge is regulated by the unified meter control unit and a variable resistor signal supplied by the fuel level sensor unit.

METER SYSTEM

< FUNCTION DIAGNOSIS >

FUEL GAUGE : Component Parts Location

INFOID:000000004495944

METER SYSTEM

< FUNCTION DIAGNOSIS >

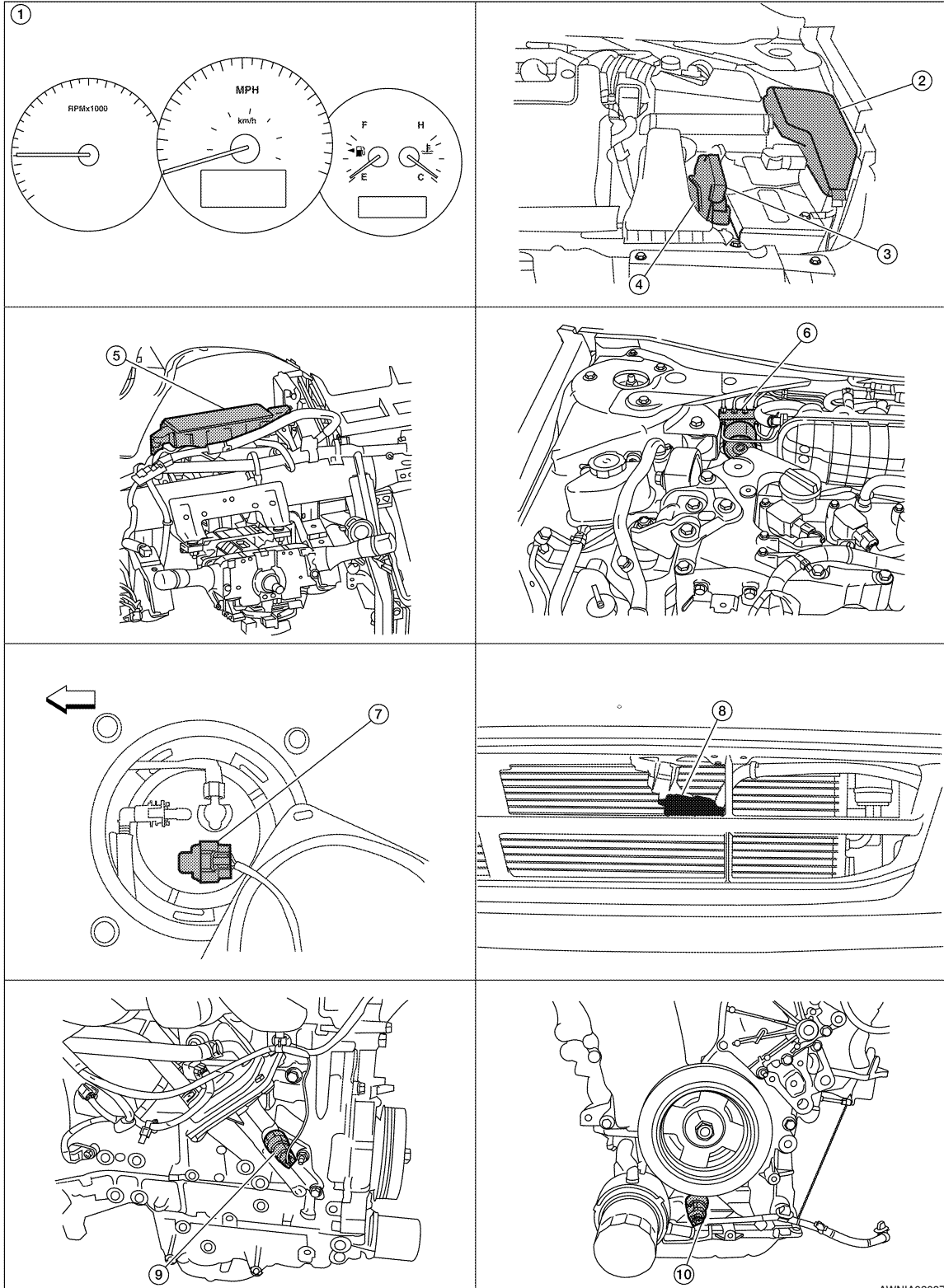

METER SYSTEM

< FUNCTION DIAGNOSIS >

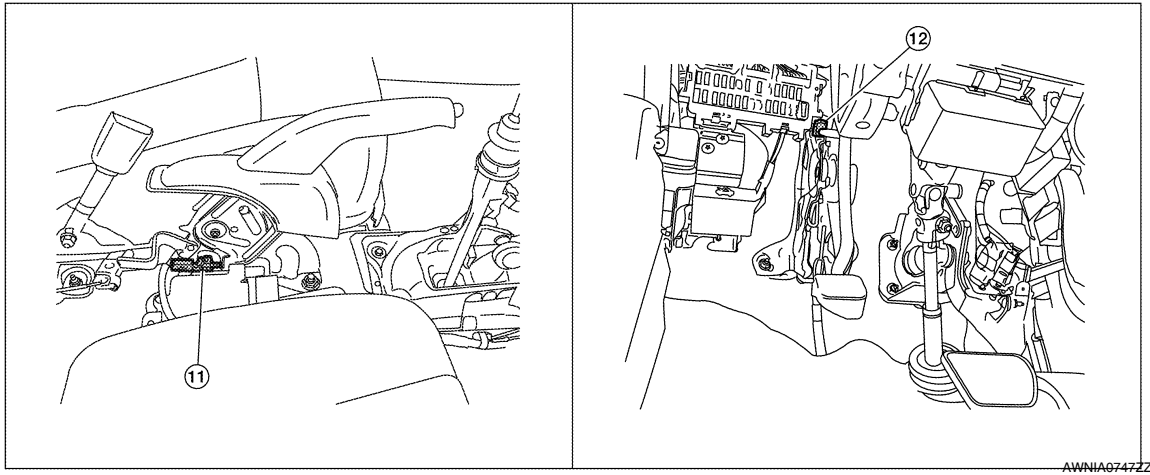

- | | | |
|---|--|---|
| 1. Combination meter M24 | 2. IPDM E/R E17, E18, E201, F10 | 3. ECM E10 |
| 4. TCM F16 | 5. BCM M17, M18, M19, M21 (view with instrument panel removed) | 6. ABS actuator and electric unit (control unit) E26 |
| 7. Fuel level sensor unit and fuel pump (fuel level sensor) B42 (view with rear seat and inspection hole cover removed) | 8. Ambient sensor E211 (view of front bumper fascia) | 9. Oil pressure switch F41 (QR25DE) (view with engine removed) |
| 10. Oil pressure switch F41 (VQ35DE) (view with engine removed) | 11. Parking brake switch M73 (Sedan with M/T and Coupe) (view with center console removed) | 12. Parking brake switch E35 (Sedan with CVT) (view with instrument lower cover LH removed) |

FUEL GAUGE : Component Description

INFOID:000000004204065

Unit	Description
Combination meter	Indicates the fuel level according to the fuel level sensor signal received from the fuel level sensor unit.
Fuel level sensor unit	Refer to MWI-46, "Description" .

ODO/TRIP METER

ODO/TRIP METER : System Diagram

INFOID:000000004204066

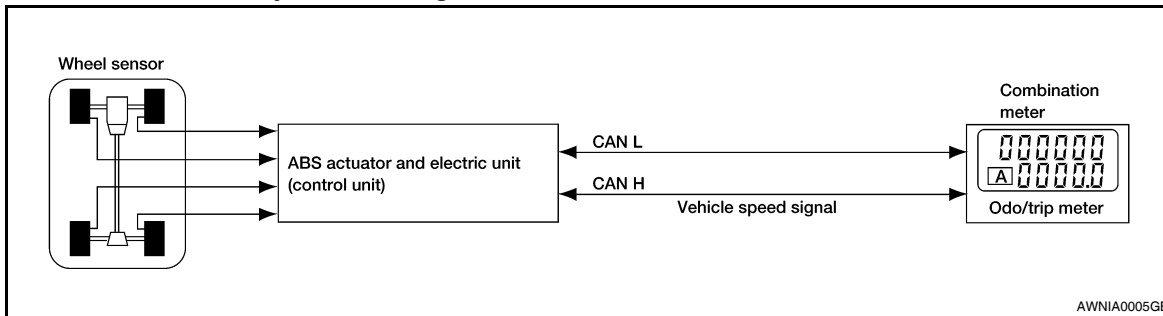

ODO/TRIP METER : System Description

INFOID:000000004204067

The vehicle speed signal and the memory signals from the meter memory circuit are processed by the combination meter and the mileage is displayed.

HOW TO CHANGE THE DISPLAY FOR ODO/TRIP METER

Refer to Owner's Manual for odo/trip meter operating instructions.

METER SYSTEM

< FUNCTION DIAGNOSIS >

ODO/TRIP METER : Component Parts Location

INFOID:000000004495945

A

B

C

D

E

F

G

H

I

J

K

L

M

MWI

O

P

METER SYSTEM

< FUNCTION DIAGNOSIS >

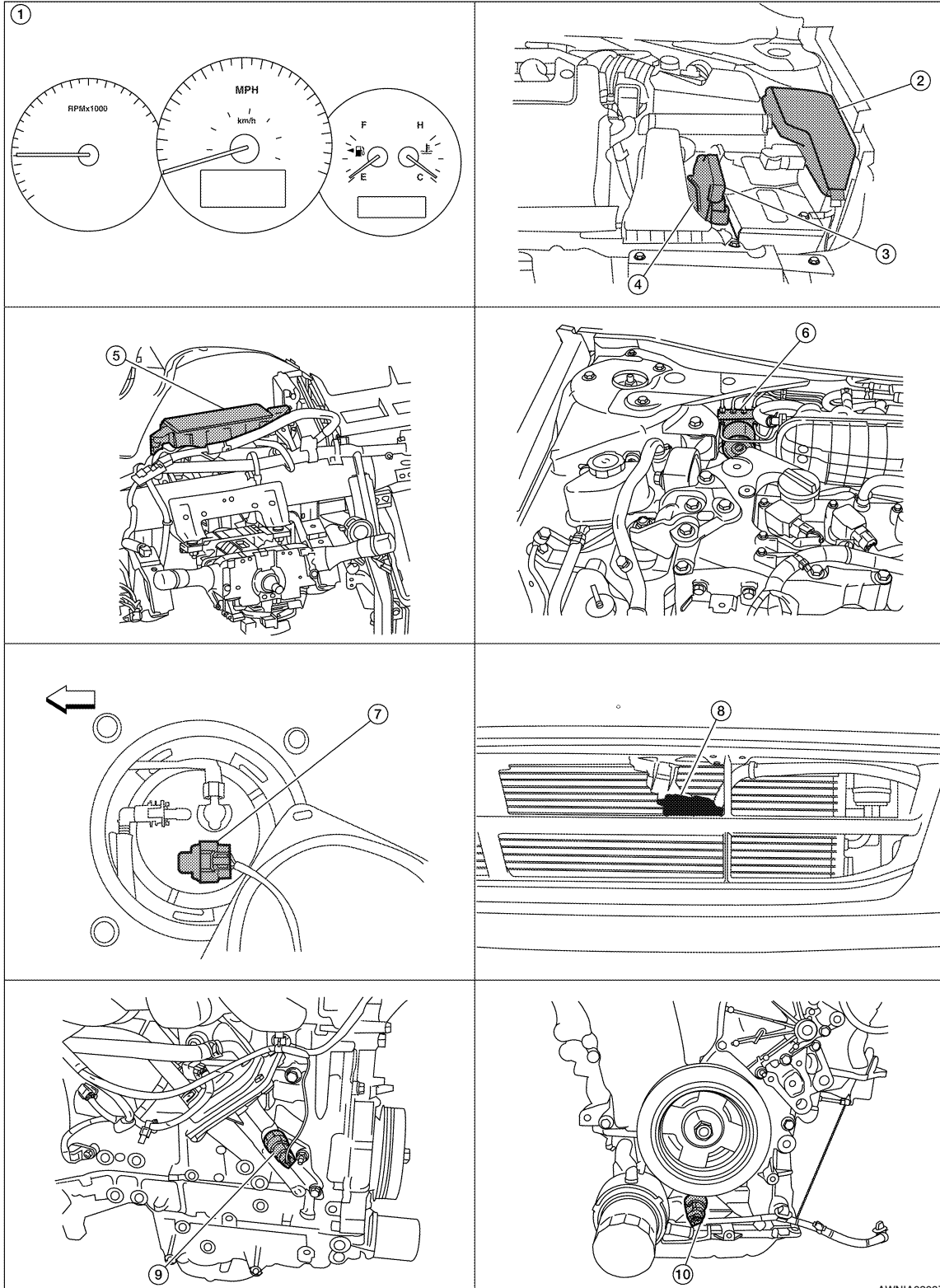

METER SYSTEM

< FUNCTION DIAGNOSIS >

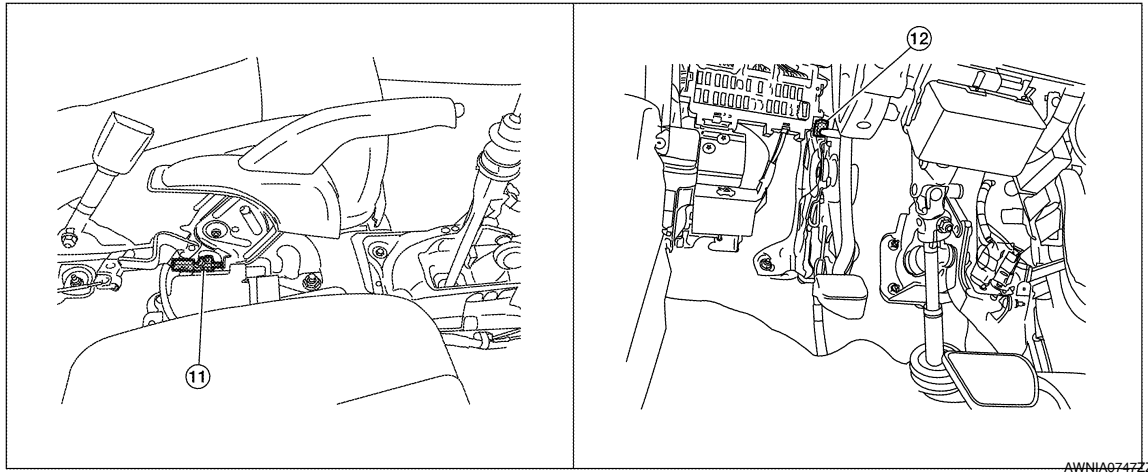

- | | | |
|---|--|---|
| 1. Combination meter M24 | 2. IPDM E/R E17, E18, E201, F10 | 3. ECM E10 |
| 4. TCM F16 | 5. BCM M17, M18, M19, M21 (view with instrument panel removed) | 6. ABS actuator and electric unit (control unit) E26 |
| 7. Fuel level sensor unit and fuel pump (fuel level sensor) B42 (view with rear seat and inspection hole cover removed) | 8. Ambient sensor E211 (view of front bumper fascia) | 9. Oil pressure switch F41 (QR25DE) (view with engine removed) |
| 10. Oil pressure switch F41 (VQ35DE) (view with engine removed) | 11. Parking brake switch M73 (Sedan with M/T and Coupe) (view with center console removed) | 12. Parking brake switch E35 (Sedan with CVT) (view with instrument lower cover LH removed) |

ODO/TRIP METER : Component Description

INFOID:000000004204069

Unit	Description
Combination meter	Indicates the vehicle speed according to the vehicle speed signal received from ABS actuator and electric unit (control unit) via CAN communication.
ABS actuator and electric unit (control unit)	Transmits the vehicle speed signal to the combination meter with CAN communication line.

SHIFT POSITION INDICATOR

SHIFT POSITION INDICATOR : System Diagram

INFOID:000000004204070

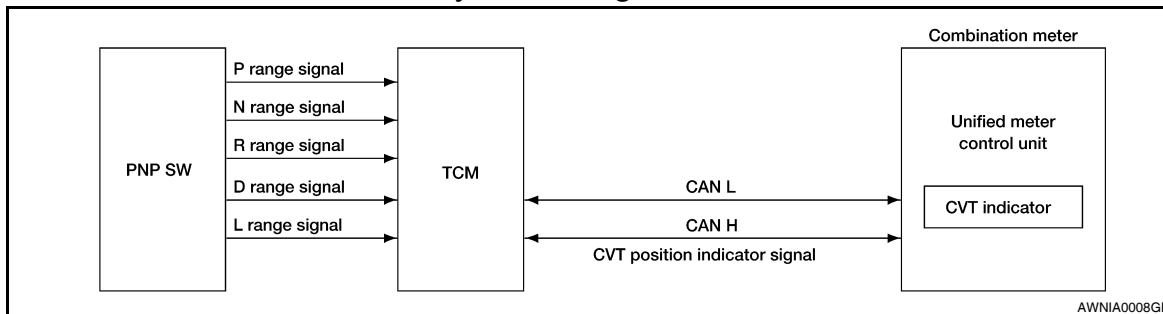

SHIFT POSITION INDICATOR : System Description

INFOID:000000004204071

The TCM receives CVT indicator signals from the park/neutral position (PNP) switch. The TCM then sends CVT position indicator signals to the combination meter via CAN communication lines. The combination meter indicates the received shift position.

A
B
C
D
E
F
G
H
I
J
K
L
M
O
P

MWI

METER SYSTEM

< FUNCTION DIAGNOSIS >

SHIFT POSITION INDICATOR : Component Parts Location

INFOID:000000004495946

METER SYSTEM

< FUNCTION DIAGNOSIS >

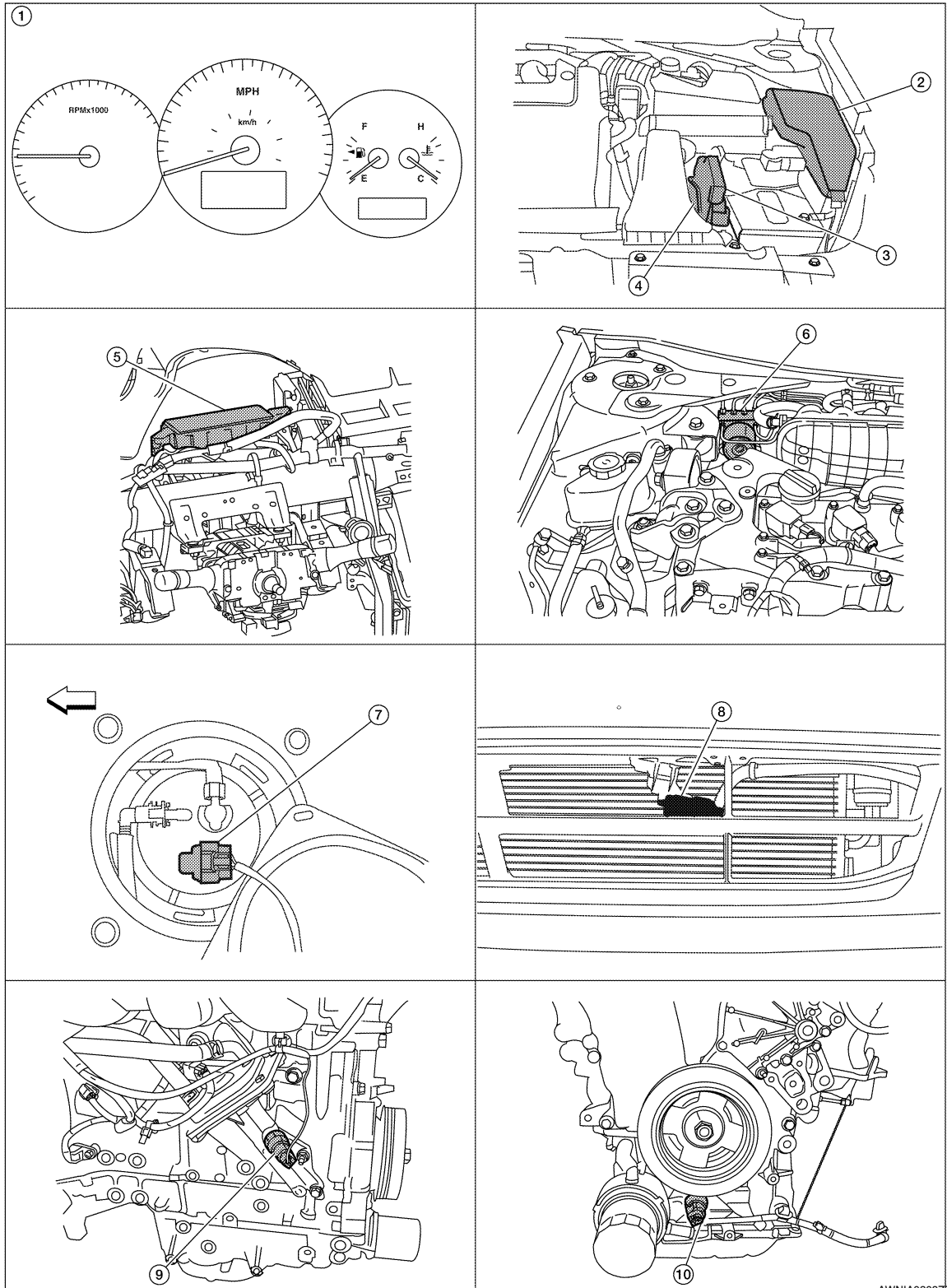

A
B
C
D
E
F
G
H
I
J
K
L
M
MWI
O
P

METER SYSTEM

< FUNCTION DIAGNOSIS >

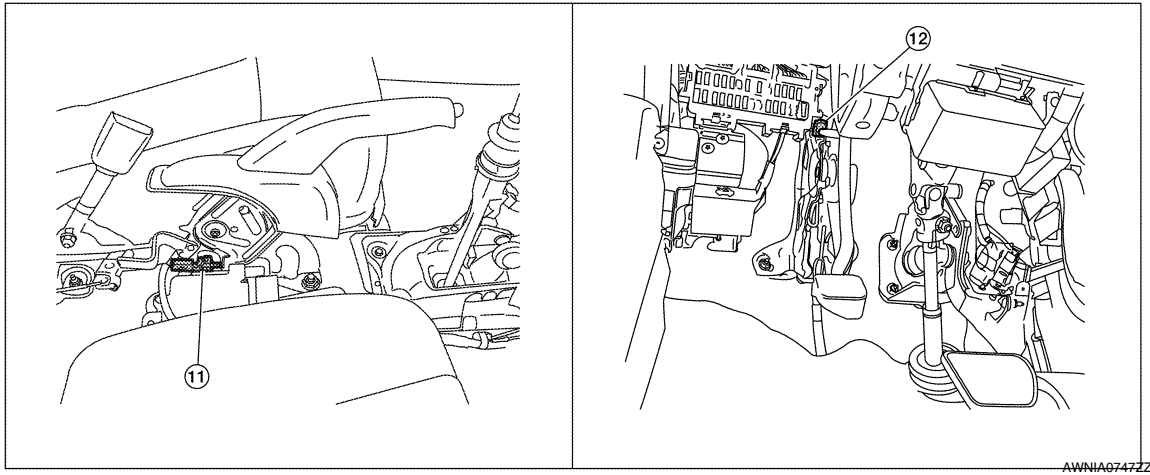

- | | | |
|---|--|---|
| 1. Combination meter M24 | 2. IPDM E/R E17, E18, E201, F10 | 3. ECM E10 |
| 4. TCM F16 | 5. BCM M17, M18, M19, M21 (view with instrument panel removed) | 6. ABS actuator and electric unit (control unit) E26 |
| 7. Fuel level sensor unit and fuel pump (fuel level sensor) B42 (view with rear seat and inspection hole cover removed) | 8. Ambient sensor E211 (view of front bumper fascia) | 9. Oil pressure switch F41 (QR25DE) (view with engine removed) |
| 10. Oil pressure switch F41 (VQ35DE) (view with engine removed) | 11. Parking brake switch M73 (Sedan with M/T and Coupe) (view with center console removed) | 12. Parking brake switch E35 (Sedan with CVT) (view with instrument lower cover LH removed) |

SHIFT POSITION INDICATOR : Component Description

INFOID:000000004204073

Unit	Description
Combination meter	Displays the shift position using shift position signal received from TCM.
TCM	Transmits the shift position signal to the combination meter via CAN communication.

WARNING LAMPS/INDICATOR LAMPS

WARNING LAMPS/INDICATOR LAMPS : System Diagram

INFOID:000000004204074

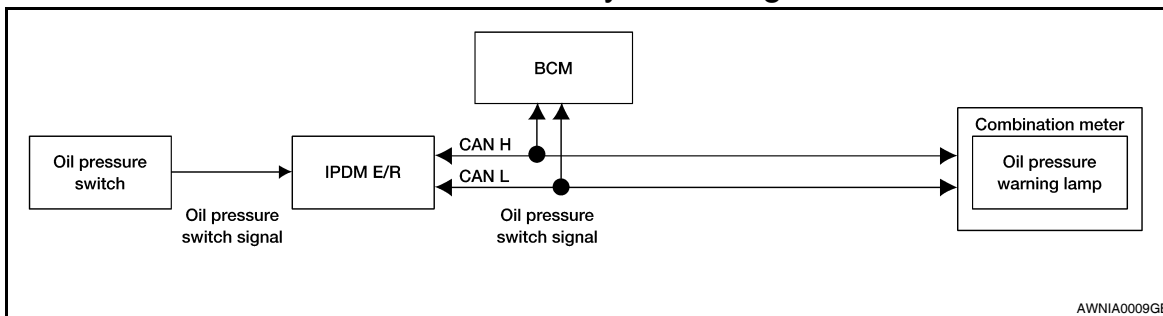

WARNING LAMPS/INDICATOR LAMPS : System Description

INFOID:000000004204075

OIL PRESSURE WARNING LAMP

The oil pressure warning lamp is controlled by the IPDM E/R (intelligent power distribution module engine room).

Low oil pressure causes the oil pressure switch to provide a ground signal to the IPDM E/R. The IPDM E/R then signals the combination meter (unified meter control unit) via the CAN communication lines and ground is provided to the oil pressure warning lamp.

When power and ground are supplied, the oil pressure warning lamp illuminates.

METER SYSTEM

< FUNCTION DIAGNOSIS >

WARNING LAMPS/INDICATOR LAMPS : Component Parts Location

INFOID:000000004495947

A

B

C

D

E

F

G

H

I

J

K

L

M

MWI

O

P

METER SYSTEM

< FUNCTION DIAGNOSIS >

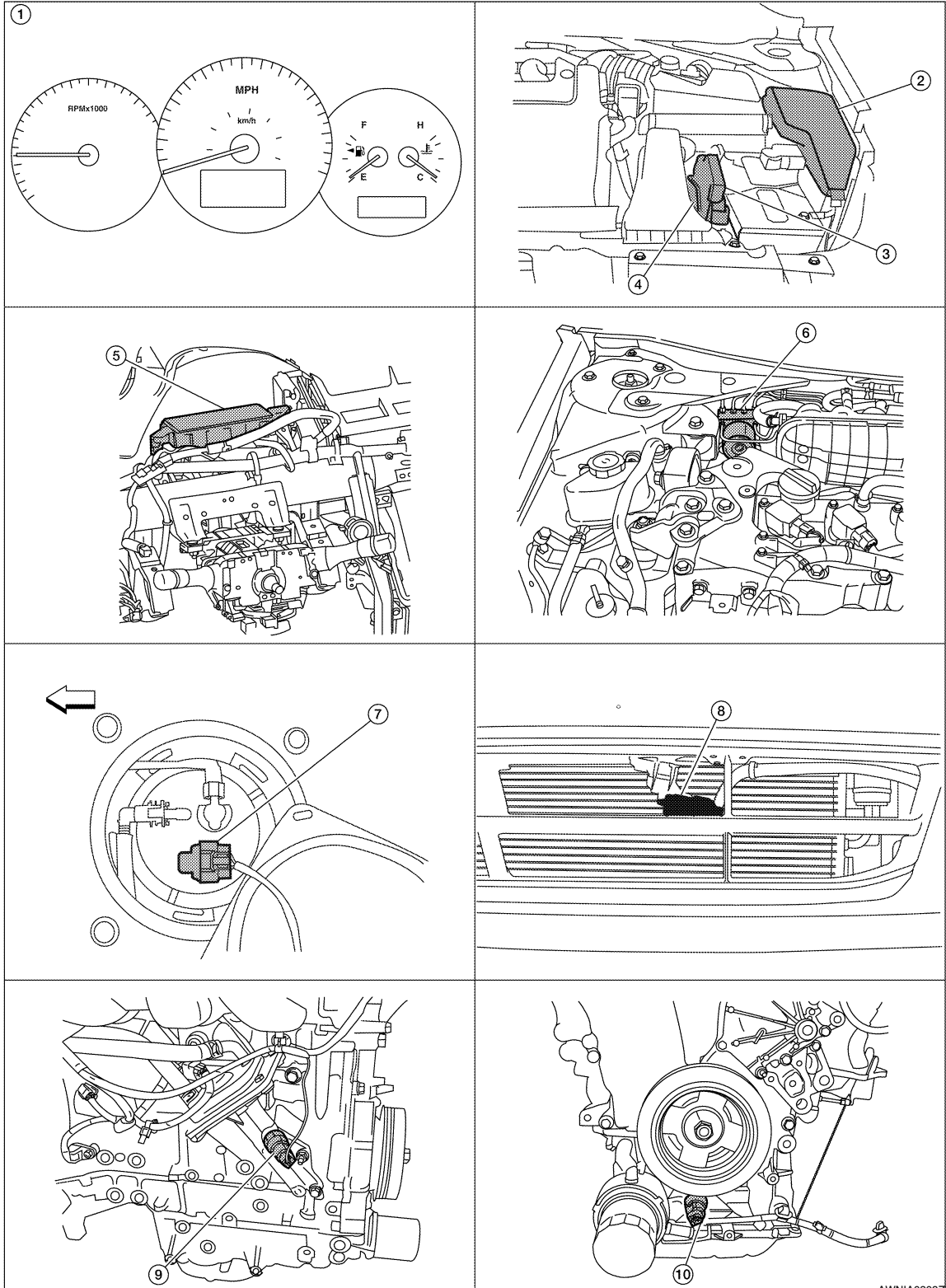

METER SYSTEM

< FUNCTION DIAGNOSIS >

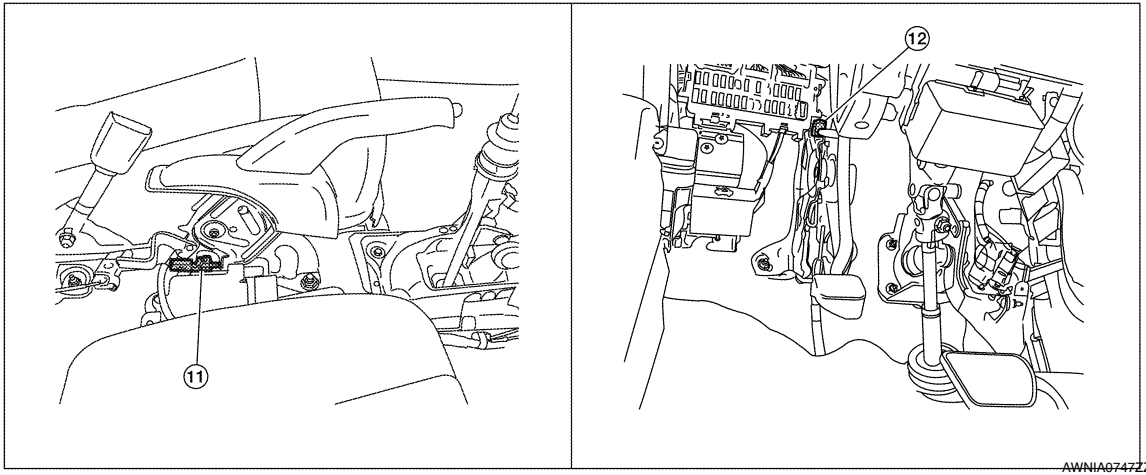

- | | | |
|---|--|---|
| 1. Combination meter M24 | 2. IPDM E/R E17, E18, E201, F10 | 3. ECM E10 |
| 4. TCM F16 | 5. BCM M17, M18, M19, M21 (view with instrument panel removed) | 6. ABS actuator and electric unit (control unit) E26 |
| 7. Fuel level sensor unit and fuel pump (fuel level sensor) B42 (view with rear seat and inspection hole cover removed) | 8. Ambient sensor E211 (view of front bumper fascia) | 9. Oil pressure switch F41 (QR25DE) (view with engine removed) |
| 10. Oil pressure switch F41 (VQ35DE) (view with engine removed) | 11. Parking brake switch M73 (Sedan with M/T and Coupe) (view with center console removed) | 12. Parking brake switch E35 (Sedan with CVT) (view with instrument lower cover LH removed) |

WARNING LAMPS/INDICATOR LAMPS : Component Description

INFOID:000000004204077

Unit	Description
Combination meter	Turns the oil pressure warning lamp ON/OFF according to the oil pressure switch signal received from BCM by means of communication.
IPDM E/R	Reads the ON/OFF signals from the oil pressure switch and transmits the oil pressure switch signal to the combination meter via BCM with the CAN communication line.
Oil pressure switch	Refer to MWI-48. "Description" .
BCM	Transmits the oil pressure switch signal received from IPDM E/R via CAN communication to the combination meter via CAN communication.

INFORMATION DISPLAY

INFORMATION DISPLAY : System Diagram

INFOID:000000004204078

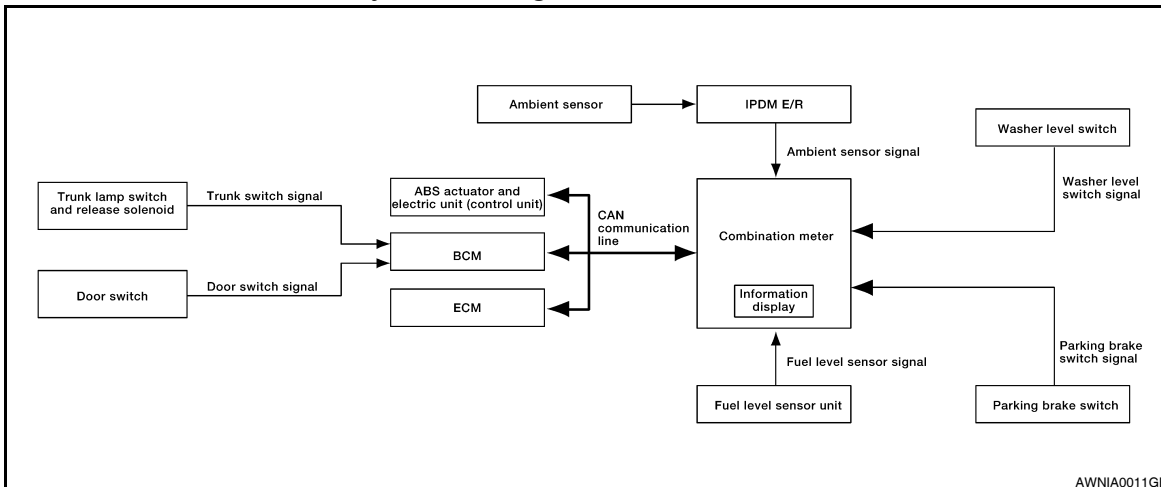

A
B
C
D
E
F
G
H
I
J
K
L
M
N
O
P

MWI

METER SYSTEM

< FUNCTION DIAGNOSIS >

INFORMATION DISPLAY : System Description

INFOID:000000004204079

FUNCTION

The information display can indicate the following items.

- Outside air temperature
- Trip/fuel consumption readings
- Intelligent Key operation information
- Maintenance information
- Warning/Indication messages (Door ajar, low fuel, low washer fluid, parking brake, cruise control)

OUTSIDE AIR TEMPERATURE INDICATION

The outside air temperature indication is displayed while the ignition switch is in the ON position.

Indication range is between -30 and 55°C (-22 and 131°F). When outside temperature is less than 3°C (37°F), display shows ICY. The indicated temperature is not affected by engine heat. It changes only when one of the following conditions exists.

- When vehicle speed is more than approximately 20 km/h (12 MPH).
- The ignition switch has been turned OFF for more than 3.5 hours.
- When outside air temperature is less than the indicated temperature.

MPG

Average fuel consumption indication is calculated using vehicle speed signals from the ABS actuator and electric unit (control unit) and fuel consumption information from the ECM.

MPG/MPH

The average speed mode can be selected to display the average fuel consumption and average speed since last reset. The indications are calculated using vehicle speed signals from the ABS actuator and electric unit (control unit) and fuel consumption information from the ECM.

RANGE

The range indication provides the driver with an estimation of the distance that can be driven before refueling. The range is calculated using signals from the fuel level sensor unit (fuel remaining), ECM (fuel consumption) and vehicle speed signals from the ABS actuator and electric unit (control unit).

DOOR AJAR WARNING

This warning appears when the Intelligent Key is in the vehicle and any door or the trunk is opened.

LOW FUEL WARNING

This warning appears when the fuel level in the fuel tank reaches approximately 12.3 ℓ (3 1/4 US gal, 2 3/4 Imp gal). A variable resistor signal is supplied to the combination meter from the fuel level sensor unit to determine the amount of fuel in the fuel tank.

LOW WINDSHIELD WASHER FLUID WARNING

This warning appears when the windshield washer fluid level is low. When the windshield washer fluid level is low, the washer level switch provides a ground signal to the combination meter (unified meter control unit). The message will be displayed after the ignition switch is turned on for 3 minutes. Once fluid is added, the message will stay on for 30 seconds and then turn off.

PARKING BRAKE INDICATOR

When the ignition switch is in the ON position and the parking brake is applied, the indicator will turn on. When the parking brake is applied, the parking brake switch provides a ground signal to the combination meter (unified meter control unit). Then, when the ignition switch is turned ON and vehicle speed is greater than 5 km/h (3 MPH), the message is displayed.

CRUISE INDICATOR

The cruise indicator message is displayed when the cruise control main switch is turned on. The ECM provides an ASCD ON signal to the combination meter (unified meter control unit) via CAN communication lines.

CRUISE SET INDICATOR

The cruise set indicator message is displayed when the vehicle speed is controlled by the ASCD system. The ECM provides an ASCD ON signal to the combination meter (unified meter control unit) via CAN communication lines.

METER SYSTEM

< FUNCTION DIAGNOSIS >

INFORMATION DISPLAY : Component Parts Location

INFOID:000000004495948

A

B

C

D

E

F

G

H

I

J

K

L

M

MWI

O

P

METER SYSTEM

< FUNCTION DIAGNOSIS >

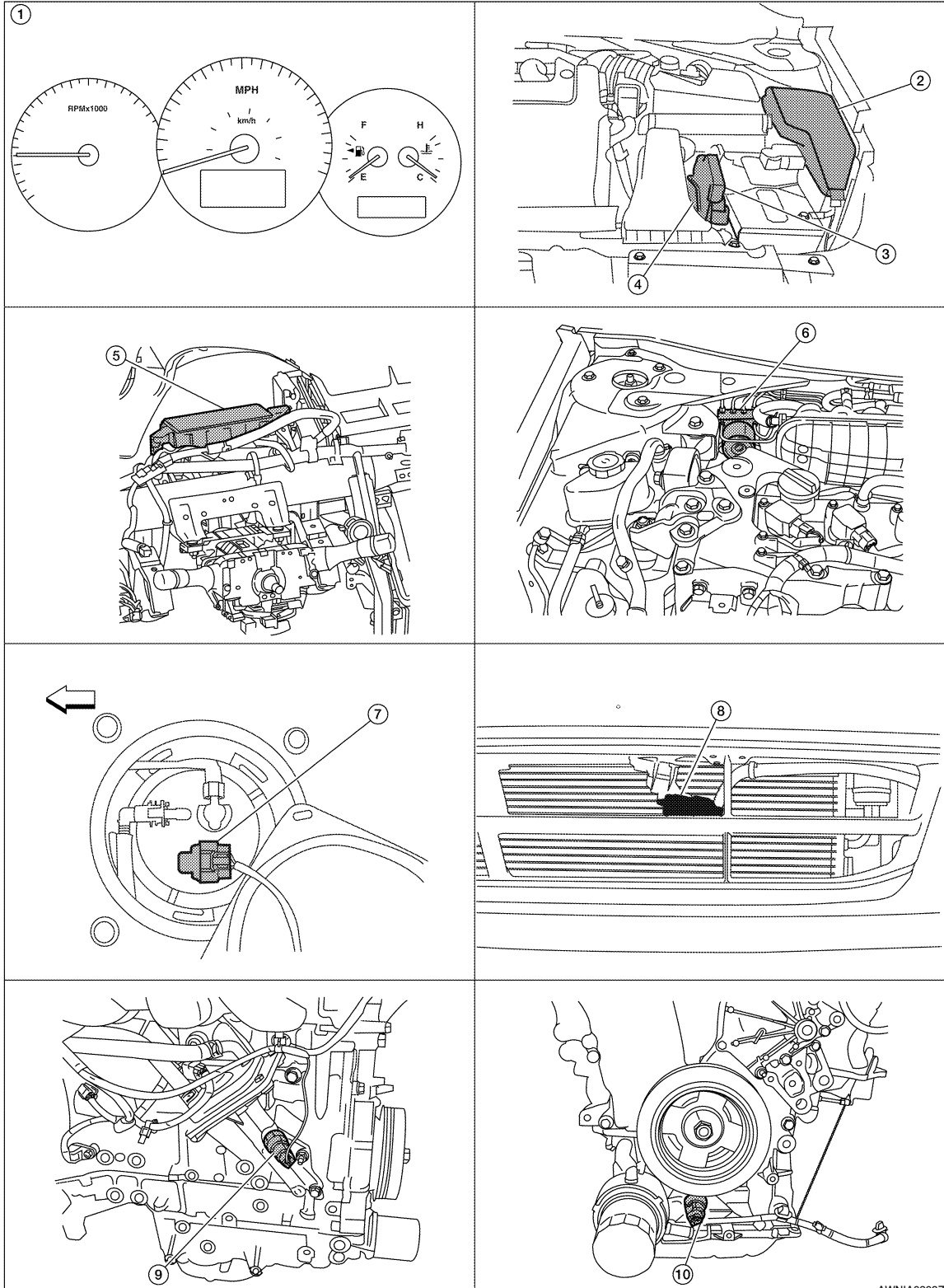

AWNIA0306ZZ

METER SYSTEM

< FUNCTION DIAGNOSIS >

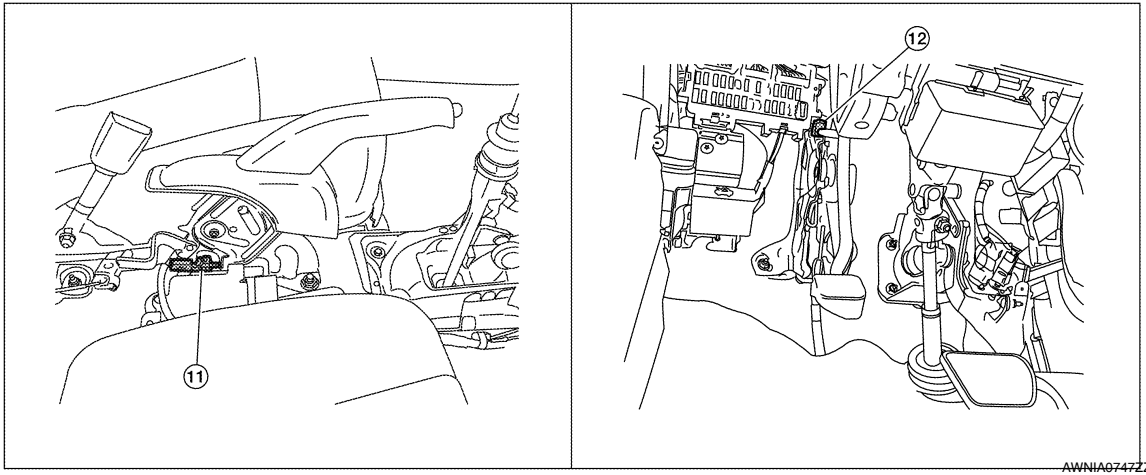

- | | | |
|---|--|---|
| 1. Combination meter M24 | 2. IPDM E/R E17, E18, E201, F10 | 3. ECM E10 |
| 4. TCM F16 | 5. BCM M17, M18, M19, M21 (view with instrument panel removed) | 6. ABS actuator and electric unit (control unit) E26 |
| 7. Fuel level sensor unit and fuel pump (fuel level sensor) B42 (view with rear seat and inspection hole cover removed) | 8. Ambient sensor E211 (view of front bumper fascia) | 9. Oil pressure switch F41 (QR25DE) (view with engine removed) |
| 10. Oil pressure switch F41 (VQ35DE) (view with engine removed) | 11. Parking brake switch M73 (Sedan with M/T and Coupe) (view with center console removed) | 12. Parking brake switch E35 (Sedan with CVT) (view with instrument lower cover LH removed) |

INFORMATION DISPLAY : Component Description

INFOID:000000004204081

Unit	Description
Combination meter	Controls the information display according to the signal received from each unit.
Fuel level sensor unit	Refer to MWI-46. "Description" .
ECM	Transmits the following signals to the combination meter via CAN communication line. <ul style="list-style-type: none"> • Engine speed signal • Fuel consumption monitor signal
ABS actuator and electric unit (control unit)	Transmits the vehicle speed signal to the combination meter via CAN communication line.
BCM	Transmits signals provided by various units to the combination meter via CAN communication line.
Washer level switch	Transmits the washer level signal to the combination meter.
Parking brake switch	Refer to MWI-49. "Description" .
Door switch	Transmits the door switch signals to BCM.
Trunk lamp switch and trunk release solenoid	Transmits the trunk switch signal to BCM.
IPDM E/R	Transmits the ambient sensor signal received from the ambient sensor to the combination meter.
Ambient sensor	Detects the ambient temperature and transmits the ambient sensor signal to the IPDM E/R.

COMPASS

< FUNCTION DIAGNOSIS >

COMPASS

Description

INFOID:000000004204082

DESCRIPTION

With the ignition switch in the ON position, and the mode (N) switch ON, the compass display will indicate the direction the vehicle is heading.

Vehicle direction is displayed as follows:

- N: north
- E: east
- S: south
- W: west

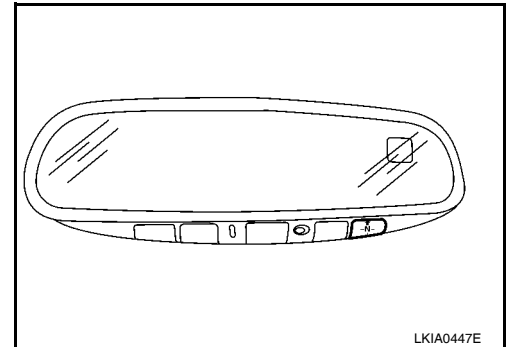

ZONE VARIATION SETTING PROCEDURE

The difference between magnetic north and geographical north can sometimes be great enough to cause false compass readings. This difference is known as variance. In order for the compass to operate properly (accurately) in a particular zone, the zone variation must be calibrated using the following procedure.

Zone Variation Chart

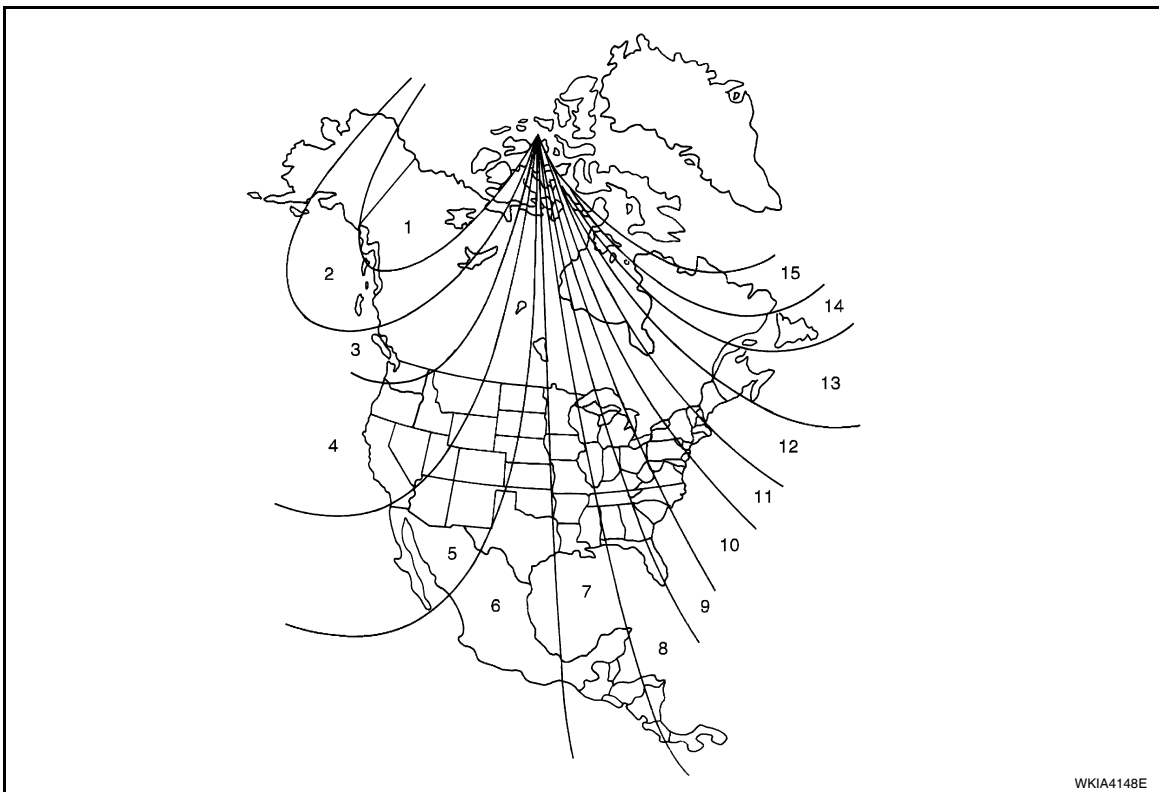

1. Determine your location on the zone map.
2. Turn the ignition switch to the ON position.
3. Press and hold the mode (N) switch for about 5 seconds. The current zone number will appear in the display.
4. Press the mode (N) switch repeatedly until the desired zone number appears in the display.

Once the desired zone number is displayed, stop pressing the mode (N) switch and the display will show a compass direction after a few seconds.

NOTE:

Use zone number 5 for Hawaii.

CALIBRATION PROCEDURE

COMPASS

< FUNCTION DIAGNOSIS >

The compass display is equipped with an automatic correction function. If the compass display reads "C" or the direction is not shown correctly, perform the correction procedure below.

1. Press and hold the mode (N) switch for about 9 seconds. The display will read "C".
2. Drive the vehicle slowly in a circle, in an open, safe place. The initial calibration is completed in about three turns.

NOTE:

In places where the terrestrial magnetism is extremely disturbed, the initial correction may start automatically.

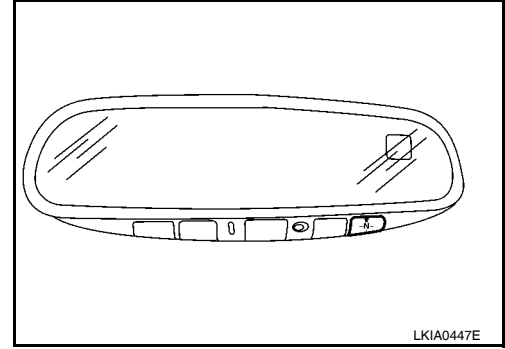

A
B
C
D
E
F
G
H
I
J
K
L
M
O
P

MWI

DIAGNOSIS SYSTEM (METER)

< FUNCTION DIAGNOSIS >

DIAGNOSIS SYSTEM (METER)

Diagnosis Description

INFOID:000000004204083

SELF-DIAGNOSIS MODE

- Odo/trip meter and information display segment operation can be checked in self-diagnosis mode.
- Meters/gauges can be checked in self-diagnosis mode.

OPERATION PROCEDURE

1. Turn the ignition switch OFF.
2. While pushing the odo/trip meter switch, turn the ignition switch ON again.
3. Push the odo/trip meter switch at least 3 times within 7 seconds after the ignition switch is turned ON.
4. The unified meter control unit is turned to self-diagnosis mode.
 - All the segments on the odo/trip meter illuminate.

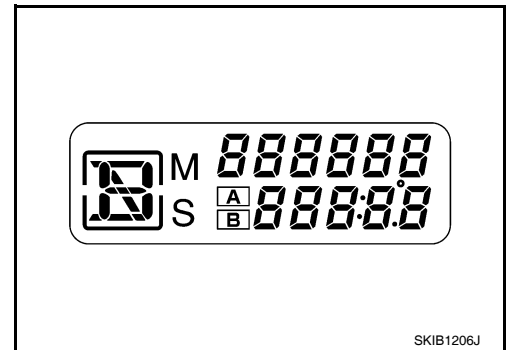

- Dots in all segments of information display LCD (1) flash alternately.

NOTE:

If any of the segments are not displayed, replace the combination meter. Refer to [MWI-176, "Removal and Installation"](#).

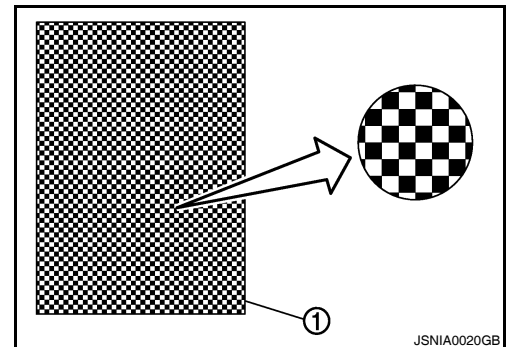

5. Push the odo/trip meter switch. Each meter/gauge should indicate as shown in the figure.

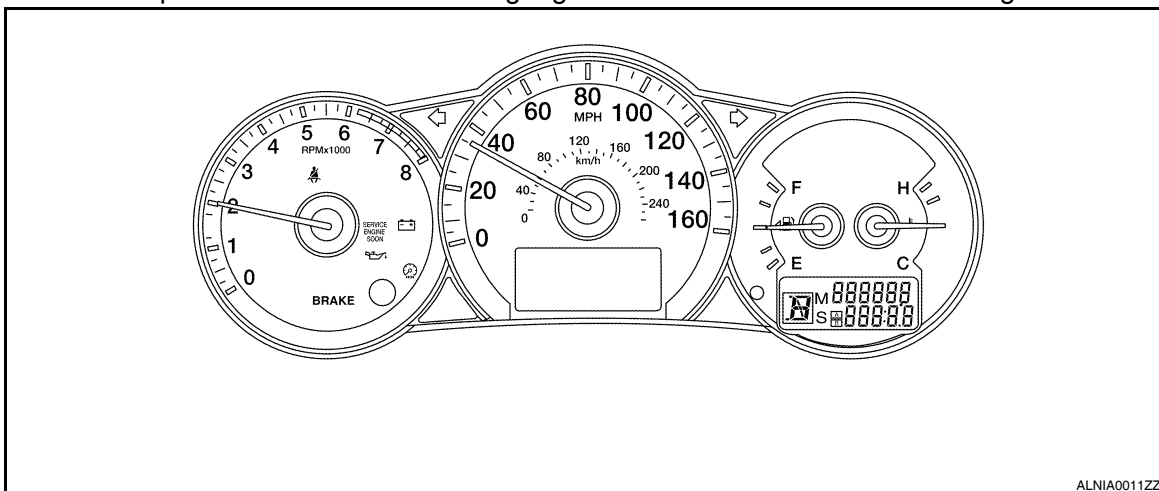

CONSULT-III Function (METER/M&A)

INFOID:000000004204084

CONSULT-III can display each diagnostic item using the diagnostic test modes shown following.

DIAGNOSIS SYSTEM (METER)

< FUNCTION DIAGNOSIS >

METER/M&A diagnosis mode	Description
SELF-DIAG RESULTS	Displays combination meter self-diagnosis results.
DATA MONITOR	Displays combination meter input/output data in real time.
CAN DIAG SUPPORT MNTR	The result of transmit/receive diagnosis of CAN communication can be read.

SELF-DIAG RESULTS

Display Item List

Refer to [MWI-95, "DTC Index"](#).

DATA MONITOR

Display Item List

X: Applicable

Display item [Unit]	MAIN SIGNALS	SELECTION FROM MENU	Description
SPEED METER [km/h] or [mph]	X	X	Displays the value of vehicle speed signal.
SPEED OUTPUT [km/h] or [mph]	X	X	Displays the value of vehicle speed signal, which is transmitted to each unit with CAN communication.
ODO OUTPUT		X	Displays the value, which is calculated by vehicle speed signal.
TACHO METER [rpm]	X	X	Displays the value of engine speed signal, which is input from ECM.
FUEL METER [lit.]	X	X	Displays the value, which processes a resistance signal from fuel gauge.
W TEMP METER [°C] or [°F]	X	X	Displays the value of engine coolant temperature signal, which is input from ECM.
ABS W/L [ON/OFF]		X	Displays [ON/OFF] condition of ABS warning lamp.
VDC/TCS IND [ON/OFF]		X	Displays [ON/OFF] condition of VDC/TCS OFF indicator lamp.
SLIP IND [ON/OFF]		X	Displays [ON/OFF] condition of SLIP indicator lamp.
BRAKE W/L [ON/OFF]		X	Displays [ON/OFF] condition of brake warning lamp.*
DOOR W/L [ON/OFF]		X	Displays [ON/OFF] condition of door warning lamp.
TRUNK/GLAS-H [ON/OFF]		X	Displays [ON/OFF] condition of trunk warning lamp.
HI-BEAM IND [ON/OFF]		X	Displays [ON/OFF] condition of high beam indicator.
TURN IND [ON/OFF]		X	Displays [ON/OFF] condition of turn indicator.
OIL W/L [ON/OFF]		X	Displays [ON/OFF] condition of oil pressure warning lamp.
MIL [ON/OFF]		X	Displays [ON/OFF] condition of malfunction indicator lamp.
CRUISE IND [ON/OFF]		X	Displays [ON/OFF] condition of CRUISE indicator.
SET IND [ON/OFF]		X	Displays [ON/OFF] condition of SET indicator.
ATC/T-AMT W/L [ON/OFF]		X	Displays [ON/OFF] condition of AT CHECK warning lamp.
FUEL W/L [ON/OFF]		X	Displays [ON/OFF] condition of low-fuel warning lamp.
WASHER W/L [ON/OFF]		X	Displays [ON/OFF] condition of low-washer fluid warning lamp.
AIR PRES W/L [ON/OFF]		X	Displays [ON/OFF] condition of tire pressure warning lamp.
KEY G W/L [ON/OFF]		X	Displays [ON/OFF] condition of key warning lamp.
LCD		X	Displays the value of Intelligent Key system message indication.
SHIFT IND [P, R, N, D, L]		X	Displays [P, R, N, D, L] range position of CVT.
M RANGE SW [ON/OFF]		X	Displays [ON/OFF] condition of manual mode range switch.
NM RANGE SW [ON/OFF]		X	Displays [ON/OFF] condition of except for manual mode range switch.
AT SFT UP SW [ON/OFF]		X	Displays [ON/OFF] condition of A/T shift-up switch.
AT SFT DWN SW [ON/OFF]		X	Displays [ON/OFF] condition of A/T shift-down switch.

DIAGNOSIS SYSTEM (METER)

< FUNCTION DIAGNOSIS >

Display item [Unit]	MAIN SIGNALS	SELECTION FROM MENU	Description
COMP F/B SIG [ON/OFF]		X	A/C compressor activation condition that ECM judges according to the water temperature and the acceleration degree.
PKB SW [ON/OFF]		X	Displays [ON/OFF] condition of parking brake switch.
BUCKLE SW [ON/OFF]		X	Displays [ON/OFF] condition of seat belt buckle switch LH.
BRAKE OIL SW [ON/OFF]		X	Displays [ON/OFF] condition of brake fluid level switch.
DISTANCE [km] or [mile]		X	Displays the value, which is calculated by vehicle speed signal, fuel gauge and fuel consumption from ECM.
OUTSIDE TEMP [°C]		X	Displays the ambient air temperature, which is input from ambient sensor.
FUEL LOW SIG [ON/FF]		X	Displays [ON/OFF] condition of low-fuel warning signal.
BUZZER [ON/OFF]	X	X	Displays [ON/OFF] condition of buzzer.

NOTE:

Some items are not available due to vehicle specification.

*: The monitor will indicate "OFF" even though the brake warning lamp is on if either of the following conditions exist.

- The parking brake is engaged
- The brake fluid level is low

DTC U1000 CAN COMMUNICATION

< COMPONENT DIAGNOSIS >

COMPONENT DIAGNOSIS

DTC U1000 CAN COMMUNICATION

DTC Logic

INFOID:000000004204085

DTC DETECTION LOGIC

DTC	CONSULT-III display	Detection condition
U1000	CAN COMM CIRC [U1000]	When combination meter is not transmitting or receiving CAN communication signals for 2 seconds or more.

Diagnosis Procedure

INFOID:000000004204086

Symptom: Displays "CAN COMM CIRC [U1000]" as a self-diagnosis result of combination meter.

1. CHECK CAN COMMUNICATION

Select "SELF-DIAG RESULTS" mode for "METER/M&A" with CONSULT-III.

>> Go to "LAN system". Refer to [LAN-10. "Condition of Error Detection"](#).

A
B
C
D
E
F
G
H
I
J
K
L
M
O
P

MWI

DTC B2205 VEHICLE SPEED CIRCUIT

< COMPONENT DIAGNOSIS >

DTC B2205 VEHICLE SPEED CIRCUIT

Description

INFOID:000000004204087

The ABS actuator and electric unit (control unit) provides a vehicle speed signal to the combination meter via CAN communication lines.

DTC Logic

INFOID:000000004204088

DTC	CONSULT-III display	Detection condition
B2205	VEHICLE SPEED CIRC [B2205]	Malfunction is detected when an erroneous speed signal is input for 2 seconds or more.

Diagnosis Procedure

INFOID:000000004204089

Symptom: Displays "VEHICLE SPEED CIRC [B2205]" as a self-diagnosis result of combination meter.

1. CHECK COMBINATION METER INPUT SIGNAL

1. Start engine and select "METER/M&A" on CONSULT-III.
2. Using "SPEED METER" on "DATA MONITOR", compare the value of DATA MONITOR with speedometer pointer of combination meter. Speedometer and DATA MONITOR indications should be close.

Is the inspection result normal?

- YES >> Perform ABS actuator and electric unit (control unit) self-diagnosis. Refer to [BRC-12, "CONSULT-III Function \(ABS\)"](#) (with ABS), [BRC-76, "CONSULT-III Function \(ABS\)"](#) (with TCS/ABS) or [BRC-149, "CONSULT-III Function \(ABS\)"](#) (with VDC/TCS/ABS).
- NO >> Replace combination meter. Refer to [MWI-176, "Removal and Installation"](#).

POWER SUPPLY AND GROUND CIRCUIT

< COMPONENT DIAGNOSIS >

POWER SUPPLY AND GROUND CIRCUIT COMBINATION METER

COMBINATION METER : Diagnosis Procedure

INFOID:000000004204090

1. CHECK FUSES

Check for blown combination meter fuses.

Unit	Power source	Fuse No.
Combination meter	Battery	11
	Ignition switch ON or START	4
	Ignition switch ACC or ON	19

Is the inspection result normal?

YES >> GO TO 2

NO >> If fuse is blown, be sure to eliminate cause of malfunction before installing new fuse.

2. POWER SUPPLY CIRCUIT CHECK

1. Disconnect combination meter connector.
2. Check voltage between combination meter harness connector M24 terminals 1, 2, 14 and ground.

Terminals		(-)	Ignition switch position			
(+)	Connector		Terminal	OFF	ACC	ON
M24	1	Ground	Battery voltage	Battery voltage	Battery voltage	Battery voltage
	2		0V	0V	Battery voltage	Battery voltage
	14		0V	Battery voltage	Battery voltage	Battery voltage

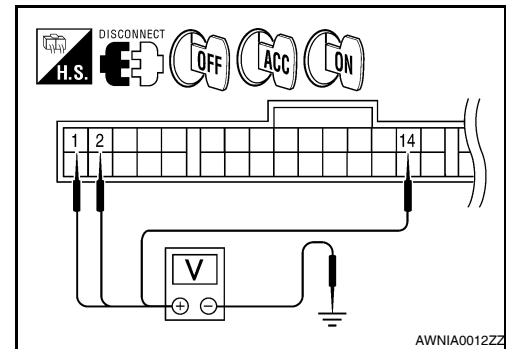

Is the inspection result normal?

YES >> GO TO 3

NO >> Check harness for open between combination meter and fuse.

3. GROUND CIRCUIT CHECK

1. Turn ignition switch OFF.
2. Check continuity between combination meter harness connector terminals 3, 4, 23 and ground.

Terminals		(-)	Continuity
(+)	Connector		
M24	3	Ground	Yes
	4		
	23		

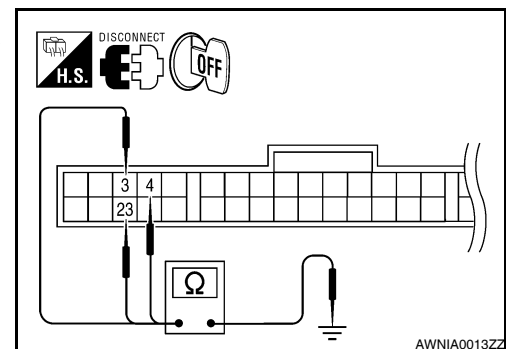

Is the inspection result normal?

YES >> Inspection End.

NO >> Check ground harness.

BCM (BODY CONTROL MODULE)

A
B
C
D
E
F
G
H
I
J
K
L
M
MWI
O
P

POWER SUPPLY AND GROUND CIRCUIT

< COMPONENT DIAGNOSIS >

BCM (BODY CONTROL MODULE) : Diagnosis Procedure

INFOID:000000004495949

1. CHECK FUSE AND FUSIBLE LINK

Check if the following BCM fuse or fusible link are blown.

Terminal No.	Signal name	Fuse and fusible link No.
1	Battery power supply	H
11		10

Is the fuse or fusible link blown?

- YES >> Replace the blown fuse or fusible link after repairing the affected circuit.
 NO >> GO TO 2

2. CHECK POWER SUPPLY CIRCUIT

- Turn ignition switch OFF.
- Disconnect BCM.
- Check voltage between BCM harness connector and ground.

Terminals		Voltage (Approx.)
(+)	(-)	
BCM		Ground
Connector	Terminal	
M16	1	
M17	11	
		Battery voltage

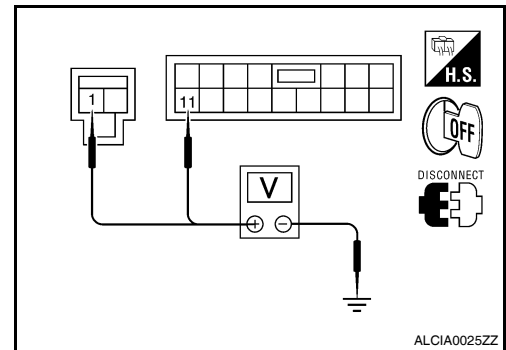

Is the measurement normal?

- YES >> GO TO 3
 NO >> Repair or replace harness.

3. CHECK GROUND CIRCUIT

Check continuity between BCM harness connector and ground.

BCM		Ground	Continuity
Connector	Terminal		
M17	13		Yes

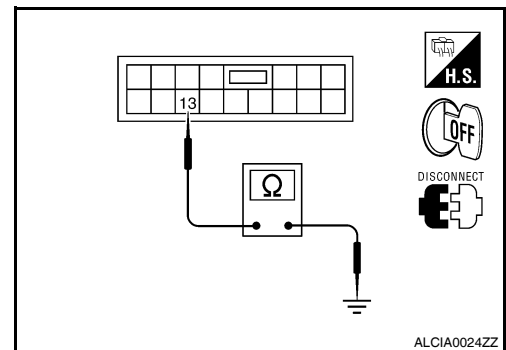

Does continuity exist?

- YES >> Inspection End.
 NO >> Repair or replace harness.

BCM (BODY CONTROL MODULE) : Special Repair Requirement

INFOID:000000004495950

1. REQUIRED WORK WHEN REPLACING BCM

Initialize control unit. Refer to [BCS-6, "CONFIGURATION \(BCM\) : Special Repair Requirement"](#).

>> Work End.

IPDM E/R (INTELLIGENT POWER DISTRIBUTION MODULE ENGINE ROOM)

IPDM E/R (INTELLIGENT POWER DISTRIBUTION MODULE ENGINE ROOM) : Diagnosis Procedure

INFOID:000000004495951

1. CHECK FUSES AND FUSIBLE LINK

Check that the following IPDM E/R fuses or fusible link are not blown.

POWER SUPPLY AND GROUND CIRCUIT

< COMPONENT DIAGNOSIS >

Terminal No.	Signal name	Fuses and fusible link No.
1, 2	Battery power supply	B, D
—		42
—		43

Is the fuse blown?

- YES >> Replace the blown fuse or fusible link after repairing the affected circuit.
 NO >> GO TO 2

2. CHECK POWER SUPPLY CIRCUIT

- Turn ignition switch OFF.
- Disconnect IPDM E/R connectors.
- Check voltage between IPDM E/R harness connector and ground.

Terminals		Voltage (V) (Approx.)
(+)		
IPDM E/R		(-)
Connector	Terminal	
E16	1	Ground
	2	
		Battery voltage

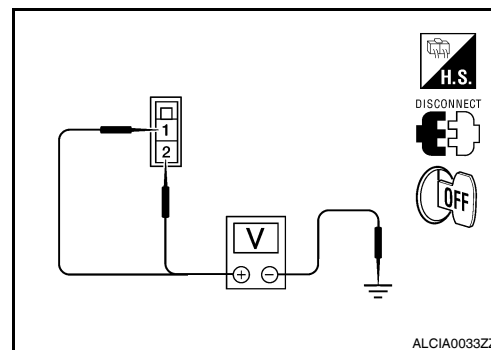

Is the measurement value normal?

- YES >> GO TO 3
 NO >> Repair harness or connector.

3. CHECK GROUND CIRCUIT

Check continuity between IPDM E/R harness connectors and ground.

IPDM E/R		Ground	Continuity
Connector	Terminal		
A: E18	12		Yes
B: E17	41		

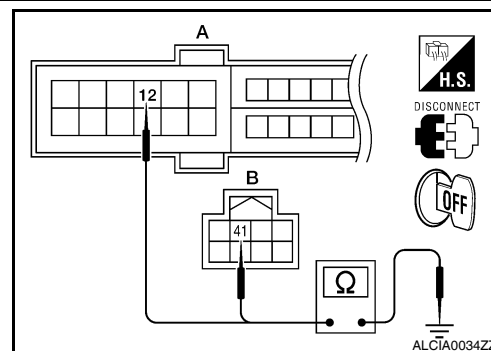

Does continuity exist?

- YES >> Inspection End.
 NO >> Repair harness or connector.

A
B
C
D
E
F
G
H
I
J
K
L
M
N
O
P



FUEL LEVEL SENSOR SIGNAL CIRCUIT

< COMPONENT DIAGNOSIS >

FUEL LEVEL SENSOR SIGNAL CIRCUIT

Description

INFOID:000000004204094

The fuel level sensor unit and fuel pump detects the approximate fuel level in the fuel tank and transmits the fuel level signal to the combination meter.

Component Function Check

INFOID:000000004204095

1.COMBINATION METER INPUT SIGNAL

1. Select "METER/M&A" on CONSULT-III.
2. Using "FUEL METER" of "DATA MONITOR", compare the value of DATA MONITOR with fuel gauge pointer of combination meter.

Fuel gauge pointer	Reference value of data monitor [lit.]
Full	Approx. 68
3/4	Approx. 56
1/2	Approx. 38
1/4	Approx. 22
Empty	Approx. 4

Does the data monitor value approximately match the fuel gauge indication?

YES >> Inspection End.

NO >> Replace combination meter. Refer to [MWI-176. "Removal and Installation"](#).

Diagnosis Procedure

INFOID:000000004204096

1.CHECK HARNESS CONNECTOR

1. Turn ignition switch OFF.
2. Check combination meter and fuel level sensor unit terminals (meter-side and harness-side) for poor connection.

Is the inspection result normal?

YES >> GO TO 2

NO >> Repair or replace terminals or connectors.

2.CHECK FUEL LEVEL SENSOR UNIT CIRCUIT

1. Disconnect combination meter connector and fuel level sensor unit connector.
2. Check continuity between combination meter harness connector (A) and fuel level sensor unit and fuel pump harness connector (B).

A		B		Continuity
Connector	Terminal	Connector	Terminal	
M24	34	B42	2	Yes

3. Check continuity between combination meter harness connector (A) and ground.

A		Ground	Continuity
Connector	Terminal		
M24	34		No

Is the inspection result normal?

YES >> GO TO 3

NO >> Repair harness or connector.

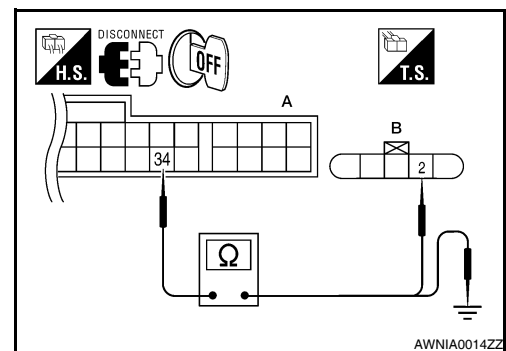

FUEL LEVEL SENSOR SIGNAL CIRCUIT

< COMPONENT DIAGNOSIS >

3. CHECK FUEL LEVEL SENSOR UNIT GROUND CIRCUIT

1. Check continuity between combination meter harness connector (A) and fuel level sensor unit and fuel pump harness connector (B).

A		B		Continuity
Connector	Terminal	Connector	Terminal	
M24	24	B42	5	Yes

2. Check continuity between combination meter harness connector (A) and ground.

A		Ground	Continuity
Connector	Terminal		
M24	24		No

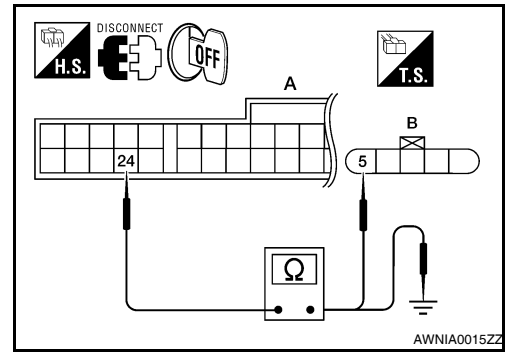

Is the inspection result normal?

- YES >> GO TO 4
- NO >> Repair harness or connector.

4. CHECK INSTALLATION CONDITION

Check fuel level sensor unit installation, and check whether the float arm interferes or binds with any of the internal components in the fuel tank.

Is the inspection result normal?

- YES >> Inspection End.
- NO >> Install the fuel level sensor unit properly.

Component Inspection

INFOID:000000004204097

1. REMOVE FUEL LEVEL SENSOR UNIT

Remove the fuel level sensor unit. Refer to [FL-6. "Removal and Installation"](#).

>> GO TO 2

2. CHECK FUEL LEVEL SENSOR UNIT AND FUEL PUMP

Check the resistance between terminals 2 and 5.

Terminal		Float position mm (in)		Resistance value (Approx.)
2	5	1*	Full (1)	155.4 (6.1)
		2*	Empty (2)	22.9 (0.9)

1* and 2*: When float arm is in contact with stopper.

Is inspection result normal?

- YES >> Inspection End.
- NO >> Replace fuel level sensor unit and fuel pump. Refer to [FL-6. "Removal and Installation"](#).

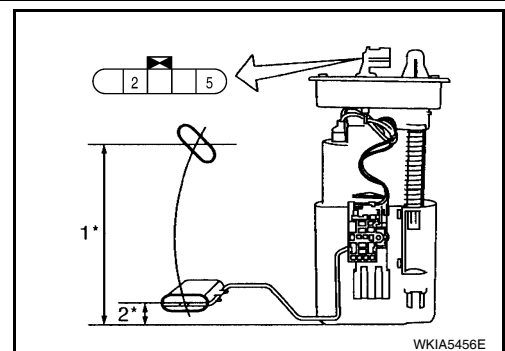

OIL PRESSURE SWITCH SIGNAL CIRCUIT

< COMPONENT DIAGNOSIS >

OIL PRESSURE SWITCH SIGNAL CIRCUIT

Description

INFOID:000000004204098

Detects the engine oil pressure and transmits the oil pressure switch signal to the IPDM E/R.

Component Function Check

INFOID:000000004204099

1.COMBINATION METER INPUT SIGNAL

1. Select "METER/M&A" on CONSULT-III.
2. Monitor "OIL W/L" of "DATA MONITOR" while operating ignition switch.

OIL W/L

When ignition switch is in ON : ON
position (Engine stopped)

When engine is running : OFF

>> Inspection End.

Diagnosis Procedure

INFOID:000000004204100

1.CHECK OIL PRESSURE SWITCH CIRCUIT

1. Turn ignition switch OFF.
2. Disconnect IPDM E/R connector F10 and oil pressure switch connector F41.
3. Check continuity between IPDM E/R harness connector F10 (A) terminal 75 and oil pressure switch harness connector F41 (B) terminal 1.

Continuity should exist.

Is the inspection result normal?

- YES >> Inspection End.
NO >> Repair harness or connector.

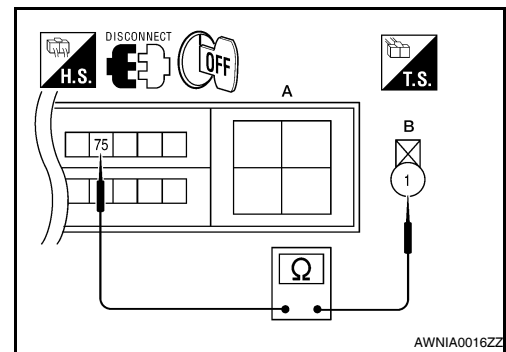

Component Inspection

INFOID:000000004204101

1.CHECK OIL PRESSURE SWITCH

Check continuity between oil pressure switch and ground.

Condition	Oil pressure [kPa (kg/cm ² , psi)]	Continuity
Engine stopped	Less than 29 (0.3, 4)	Yes
Engine running	More than 29 (0.3, 4)	No

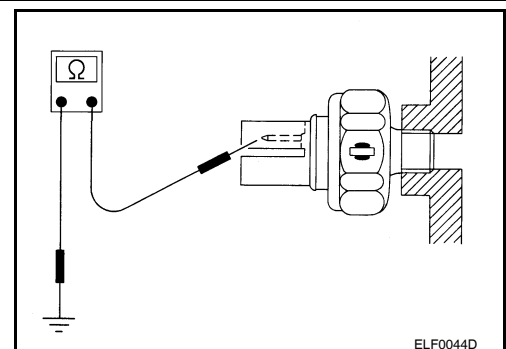

Is the inspection result normal?

- YES >> Inspection End.
NO >> Replace the oil pressure switch.

PARKING BRAKE SWITCH SIGNAL CIRCUIT

< COMPONENT DIAGNOSIS >

PARKING BRAKE SWITCH SIGNAL CIRCUIT

Description

INFOID:000000004204102

Transmits the parking brake switch signal to the combination meter.

Component Function Check

INFOID:000000004204103

1.COMBINATION METER INPUT SIGNAL

1. Select "METER/M&A" on CONSULT-III.
2. Monitor "PKB SW" of "DATA MONITOR" while applying and releasing the parking brake.

PKB SW

Parking brake applied : ON

Parking brake released : OFF

>> Inspection End.

Diagnosis Procedure

INFOID:000000004204104

COUPE

1.CHECK PARKING BRAKE SWITCH CIRCUIT

1. Disconnect combination meter connector and parking brake switch connector.
2. Check continuity between combination meter harness connector M24 (A) terminal 26 and parking brake switch harness connector M73 (B) terminal 1.

26 - 1 : Continuity should exist.

3. Check continuity between combination meter harness connector M24 (A) terminal 26 and ground.

26 - Ground : Continuity should not exist.

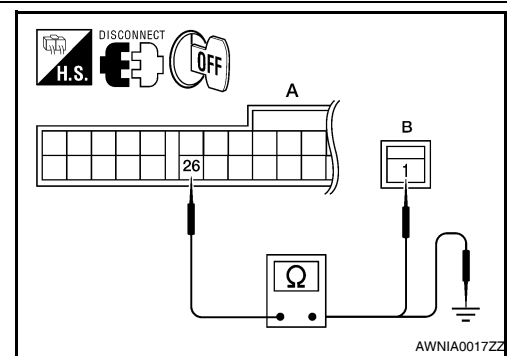

Is the inspection result normal?

- YES >> Inspection End.
NO >> Repair harness or connector.

SEDAN

1.CHECK PARKING BRAKE SWITCH CIRCUIT

1. Disconnect combination meter connector and parking brake switch connector.
2. Check continuity between combination meter harness connector M24 (A) terminal 26 and parking brake switch harness connector M73 (B) (with M/T) or E35 (B) (with CVT) terminal 1.

26 - 1 : Continuity should exist.

3. Check continuity between combination meter harness connector M24 (A) terminal 26 and ground.

26 - Ground : Continuity should not exist.

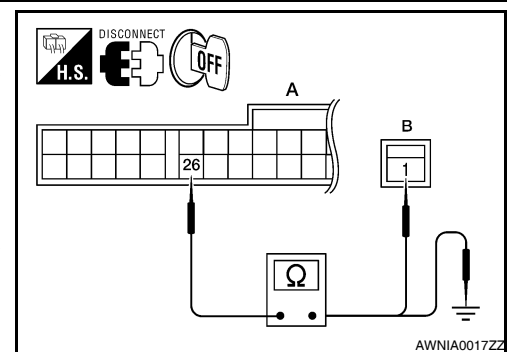

Is the inspection result normal?

- YES >> Inspection End.
NO >> Repair harness or connector.

A
B
C
D
E
F
G
H
I
J
K
L
M

MWI

O
P

PARKING BRAKE SWITCH SIGNAL CIRCUIT

< COMPONENT DIAGNOSIS >

Component Inspection

INFOID:000000004204105

1. CHECK PARKING BRAKE SWITCH

Check continuity between parking brake switch terminal 1 and switch case ground.

Component	Terminal	Condition	Continuity
Parking brake switch	1	Parking brake applied	Yes
		Parking brake released	No

Is the inspection result normal?

- YES >> Inspection End.
- NO >> Replace parking brake switch.

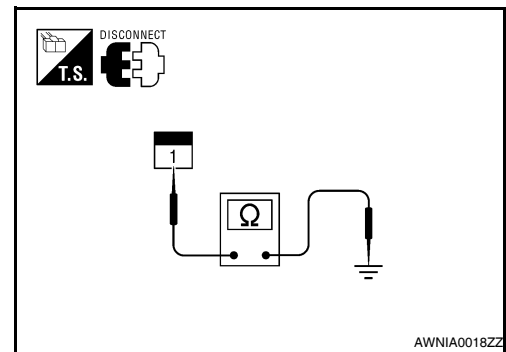

AWNIA0018ZZ

WASHER LEVEL SWITCH SIGNAL CIRCUIT

< COMPONENT DIAGNOSIS >

WASHER LEVEL SWITCH SIGNAL CIRCUIT

Description

INFOID:000000004204106

Transmits the washer level switch signal to the combination meter.

Component Function Check

INFOID:000000004204107

1.COMBINATION METER INPUT SIGNAL

1. Select "METER/M&A" on CONSULT-III.
2. Monitor "WASHER W/L" of "DATA MONITOR" under the following conditions.

WASHER W/L

Washer fluid level low : ON

Washer fluid level other : OFF

>> Inspection End.

Diagnosis Procedure

INFOID:000000004204108

1.CHECK WASHER LEVEL SWITCH SIGNAL CIRCUIT

1. Turn ignition switch OFF.
2. Disconnect combination meter connector and washer level switch connector.
3. Check continuity between combination meter harness connector M24 (A) terminal 29 and washer level switch harness connector E208 (B) terminal 1.

29 - 1 : Continuity should exist.

4. Check continuity between combination meter harness connector M24 (A) terminal 29 and ground.

29 - Ground : Continuity should not exist.

Is the inspection result normal?

YES >> GO TO 2

NO >> Repair harness or connector.

2.CHECK WASHER LEVEL SWITCH GROUND CIRCUIT

Check continuity between washer fluid level switch harness connector E208 terminal 2 and ground.

2 - Ground : Continuity should exist.

Is the inspection result normal?

YES >> Inspection End.

NO >> Repair harness or connector.

Component Inspection

INFOID:000000004204109

1.CHECK WASHER FLUID LEVEL SWITCH

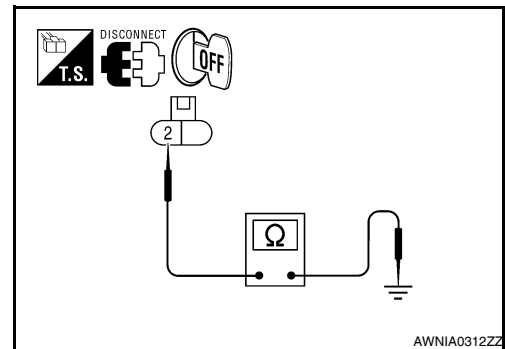
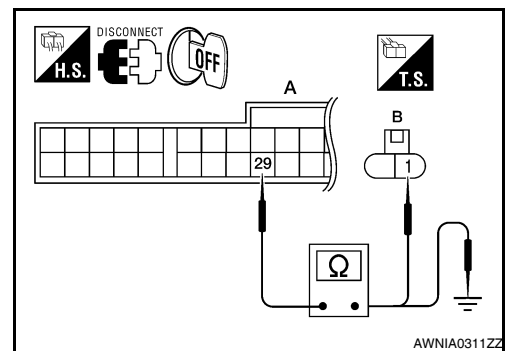

WASHER LEVEL SWITCH SIGNAL CIRCUIT

< COMPONENT DIAGNOSIS >

Check continuity between washer level switch terminals 1 and 2.

Terminal	Washer fluid level	Continuity
1 - 2	Low	Yes
	Other	No

Is the inspection result normal?

- YES >> Inspection End.
- NO >> Replace washer level switch.

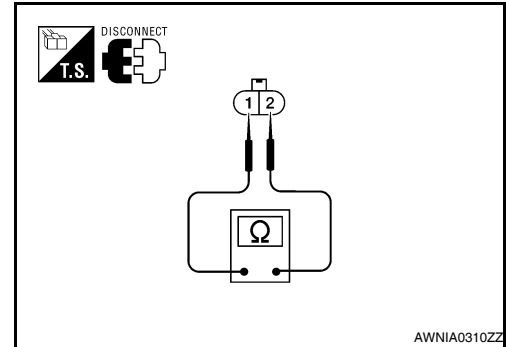

AMBIENT SENSOR SIGNAL CIRCUIT

< COMPONENT DIAGNOSIS >

AMBIENT SENSOR SIGNAL CIRCUIT

Description

INFOID:000000004204110

Transmits the ambient sensor signal to the combination meter.

Component Function Check

INFOID:000000004204111

1.COMBINATION METER INPUT SIGNAL

1. Select "METER/M&A" on CONSULT-III.
2. Using "OUTSIDE TEMP" on "DATA MONITOR", compare the value of DATA MONITOR with temperature display on combination meter. DATA MONITOR and combination meter indications should be close.

Does the data monitor value approximately match the display on the combination meter?

- YES >> Inspection End.
 NO >> Replace combination meter. Refer to [MWI-176. "Removal and Installation"](#).

Diagnosis Procedure

INFOID:000000004204112

1.CHECK AMBIENT SENSOR CIRCUITS BETWEEN COMBINATION METER AND IPDM E/R

1. Disconnect combination meter connector M24 and IPDM E/R connector E18.
2. Check continuity between combination meter harness connector M24 (A) terminals 18, 20 and IPDM E/R harness connector E18 (B) terminals 20 and 21.

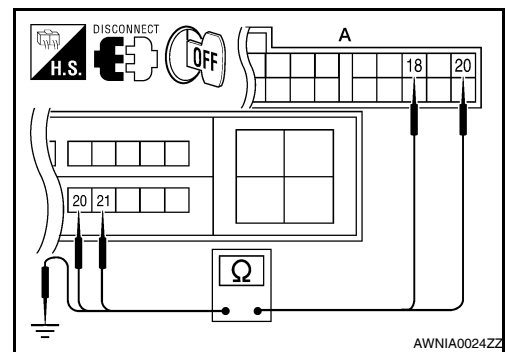

A		B		Continuity
Connector	Terminal	Connector	Terminal	
M24	18	E18	21	Yes
	20		20	

3. Check continuity between combination meter harness connector M24 (A) terminals 18, 20 and ground.

A		Ground	Continuity
Connector	Terminal		
M24	18		No
	20		

Is the inspection result normal?

- YES >> GO TO 2
 NO >> Repair harness or connector.

2.CHECK AMBIENT SENSOR CIRCUITS BETWEEN IPDM E/R AND AMBIENT SENSOR

1. Disconnect IPDM E/R connector E201 and ambient sensor connector E211.
2. Check continuity between IPDM E/R harness connector E201 (A) terminals 99, 100 and ambient sensor harness connector E211 terminals 1 and 2.

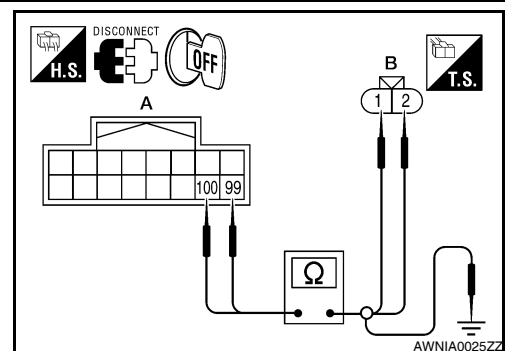

A		B		Continuity
Connector	Terminal	Connector	Terminal	
E201	99	E211	2	Yes
	100		1	

3. Check continuity between IPDM E/R harness connector E201 (A) terminals 99, 100 and ground.

A
B
C
D
E
F
G
H
I
J
K
L
M
O
P

AMBIENT SENSOR SIGNAL CIRCUIT

< COMPONENT DIAGNOSIS >

A		Ground	Continuity
Connector	Terminal		
E201	99		No
	100		

Is the inspection result normal?

YES >> Replace IPDM E/R. Refer to [PCS-48, "Removal and Installation"](#).

NO >> Repair harness or connector.

Component Inspection

INFOID:000000004204113

Refer to [HAC-51, "Component Inspection"](#).

COMPASS

< COMPONENT DIAGNOSIS >

COMPASS

Wiring Diagram - Coupe

INFOID:000000004204114

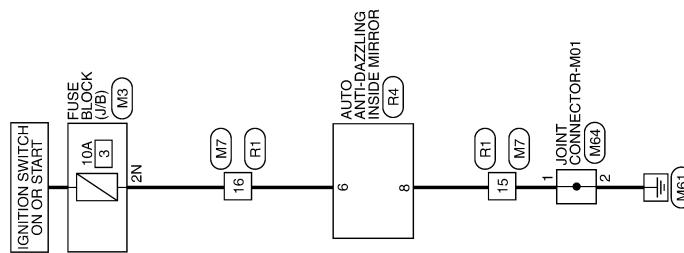

COMPASS

A
B
C
D
E
F
G
H
I
J
K
L
M
N
O
P

MWI

ABNWA0211Gf

COMPASS CONNECTORS

Connector No.	M3
Connector Name	FUSE BLOCK (J/B)
Connector Color	WHITE

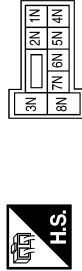

Terminal No.	Color of Wire	Signal Name
2N	G	-

Connector No.	M7
Connector Name	WIRE TO WIRE
Connector Color	WHITE

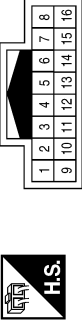

Terminal No.	Color of Wire	Signal Name
15	B	-
16	G	-

Connector No.	M64
Connector Name	JOINT CONNECTOR-M01
Connector Color	GRAY

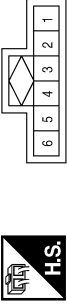

Terminal No.	Color of Wire	Signal Name
1	B	-
2	B	-

Connector No.	R1
Connector Name	WIRE TO WIRE
Connector Color	WHITE

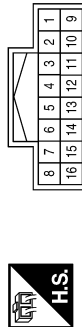

Terminal No.	Color of Wire	Signal Name
15	B	-
16	B/R	-

Connector No.	R4
Connector Name	AUTO ANTI-DAZZLING INSIDE MIRROR
Connector Color	BLACK

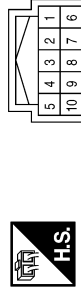

Terminal No.	Color of Wire	Signal Name
6	B/R	IGN
8	B	GND

COMPASS

< COMPONENT DIAGNOSIS >

Wiring Diagram - Sedan

INFOID:000000004204115

A
B
C
D
E
F
G
H
I
J
K
L
M
O
P

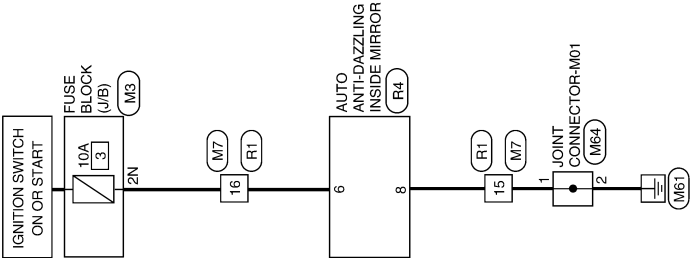

COMPASS

MWI

ABNWA0212Gf

COMPASS CONNECTORS

Connector No.	M3
Connector Name	FUSE BLOCK (J/B)
Connector Color	WHITE

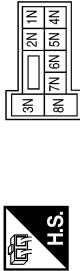

Terminal No.	Color of Wire	Signal Name
2N	G	-

Connector No.	M7
Connector Name	WIRE TO WIRE
Connector Color	WHITE

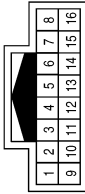

Terminal No.	Color of Wire	Signal Name
15	B	-
16	G	-

Connector No.	M64
Connector Name	JOINT CONNECTOR-M01
Connector Color	GRAY

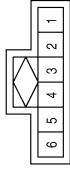

Terminal No.	Color of Wire	Signal Name
1	B	-
2	B	-

Connector No.	R1
Connector Name	WIRE TO WIRE
Connector Color	WHITE

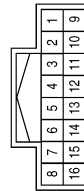

Terminal No.	Color of Wire	Signal Name
15	B	-
16	B/R	-

Connector No.	R4
Connector Name	AUTO ANTI-DAZZLING INSIDE MIRROR
Connector Color	BLACK

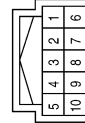

Terminal No.	Color of Wire	Signal Name
6	B/R	IGN
8	B	GND

COMBINATION METER

< ECU DIAGNOSIS >

ECU DIAGNOSIS

COMBINATION METER

Reference Value

INFOID:000000004204116

TERMINAL LAYOUT

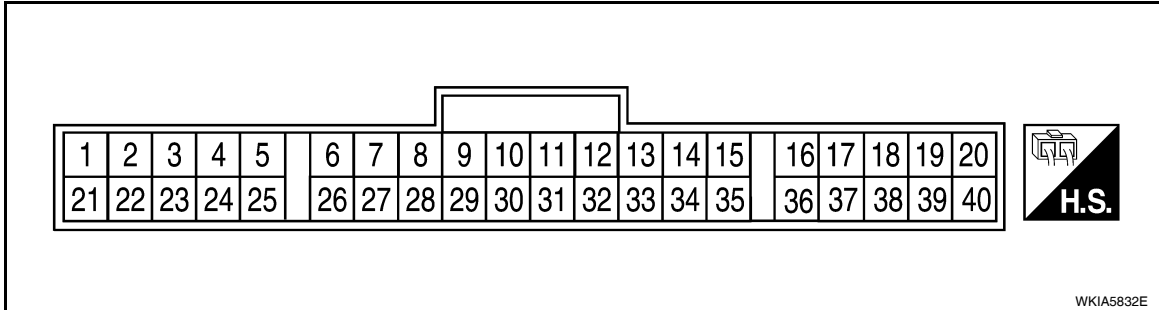

PHYSICAL VALUES

Terminal	Wire color	Item	Condition		Reference value (V) (Approx.)
			Ignition switch	Operation or condition	
1	W/L	Battery power supply	—	—	Battery voltage
2	O	Ignition switch ON or START	ON	—	Battery voltage
3	B	Ground (Power)	—	—	0
4	B	Ground (Illumination)			
5	R/Y	Illumination output	—	—	Refer to INL-10, "System Description" .
9	GR/W	Illumination switch power	—	—	
10	O/L	Mode switch ground	ON	—	0
11	L/R	Mode switch A	ON	Switch pressed	0
				Switch released	5
12	B/R	Mode switch B	ON	Switch pressed	0
				Switch released	5
14	V/Y	Ignition switch ACC or ON	ON	—	Battery voltage
15	BR/W	Air bag warning lamp input	ON	Air bag warning lamp ON	3
				Air bag warning lamp OFF	0
16	G/W	Water temperature output	ON	At idle [after warming up, approx. 80°C (176°F)] NOTE: The wave forms vary depending on coolant temperature.	
17	R/W	AC PD CUT	ON	Signal ON	0
				Signal OFF	5
18	O/B	Ambient sensor signal	ON	—	0 - 5 (Based on ambient temperature)
20	B/Y	Ambient sensor ground	ON	—	0
21	L	CAN-H	—	—	—

COMBINATION METER

< ECU DIAGNOSIS >

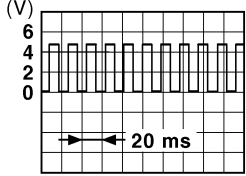
Terminal	Wire color	Item	Condition		Reference value (V) (Approx.)
			Ignition switch	Operation or condition	
22	P	CAN-L	—	—	—
23	B	Ground (Circuit)	—	—	0
24	B/W	Fuel level sensor ground	ON	—	0
25	BR	Generator	ON	Generator voltage low	0
				Generator voltage normal	Battery voltage
26	G/R	Parking brake switch	ON	Parking brake applied	0
				Parking brake released	Battery voltage
27	V	Brake fluid level switch	ON	Brake fluid level low	0
				Brake fluid level normal	Battery voltage
28	L/O	Security indicator input	OFF	Security indicator ON	0
				Security indicator OFF	Battery voltage
29	R	Washer fluid level switch	ON	Washer fluid level low	0
				Washer fluid level normal	Battery voltage
30	L/B	Vehicle speed signal output (2-pulse)	ON	Speedometer operated [When vehicle speed is approx. 20 km/h (12 MPH)]	240 Hz
31	V/W	Vehicle speed signal output (8-pulse)	ON	Speedometer operated [When vehicle speed is approx. 40 km/h (25 MPH)]	<p>NOTE: Maximum voltage may be 12V due to specifications (connected units).</p>  <p style="text-align: right; font-size: small;">PKIC0643E</p>
34	G/B	Fuel level sensor signal	—	—	Refer to MWI-19. "FUEL GAUGE : System Description" .
35	W/B	Seat belt buckle switch LH	ON	Unfastened (ON)	0
				Fastened (OFF)	Battery voltage
36	L/W	Seat belt buckle switch RH	ON	Unfastened (ON)	0
				Fastened (OFF)	Battery voltage
37	G	Not M range	ON	Manual mode switch OFF	0
				Manual mode switch ON	Battery voltage
38	BR	AT shift down	ON	<ul style="list-style-type: none"> • Manual mode switch ON • Shift down operation 	0
				Other than above	Battery voltage
39	W	AT shift up	ON	<ul style="list-style-type: none"> • Manual mode switch ON • Shift up operation 	0
				Other than above	Battery voltage
40	LG/R	M range	ON	Manual mode switch OFF	Battery voltage
				Manual mode switch ON	0

COMBINATION METER

< ECU DIAGNOSIS >

Wiring Diagram - Coupe

INFOID:000000004204117

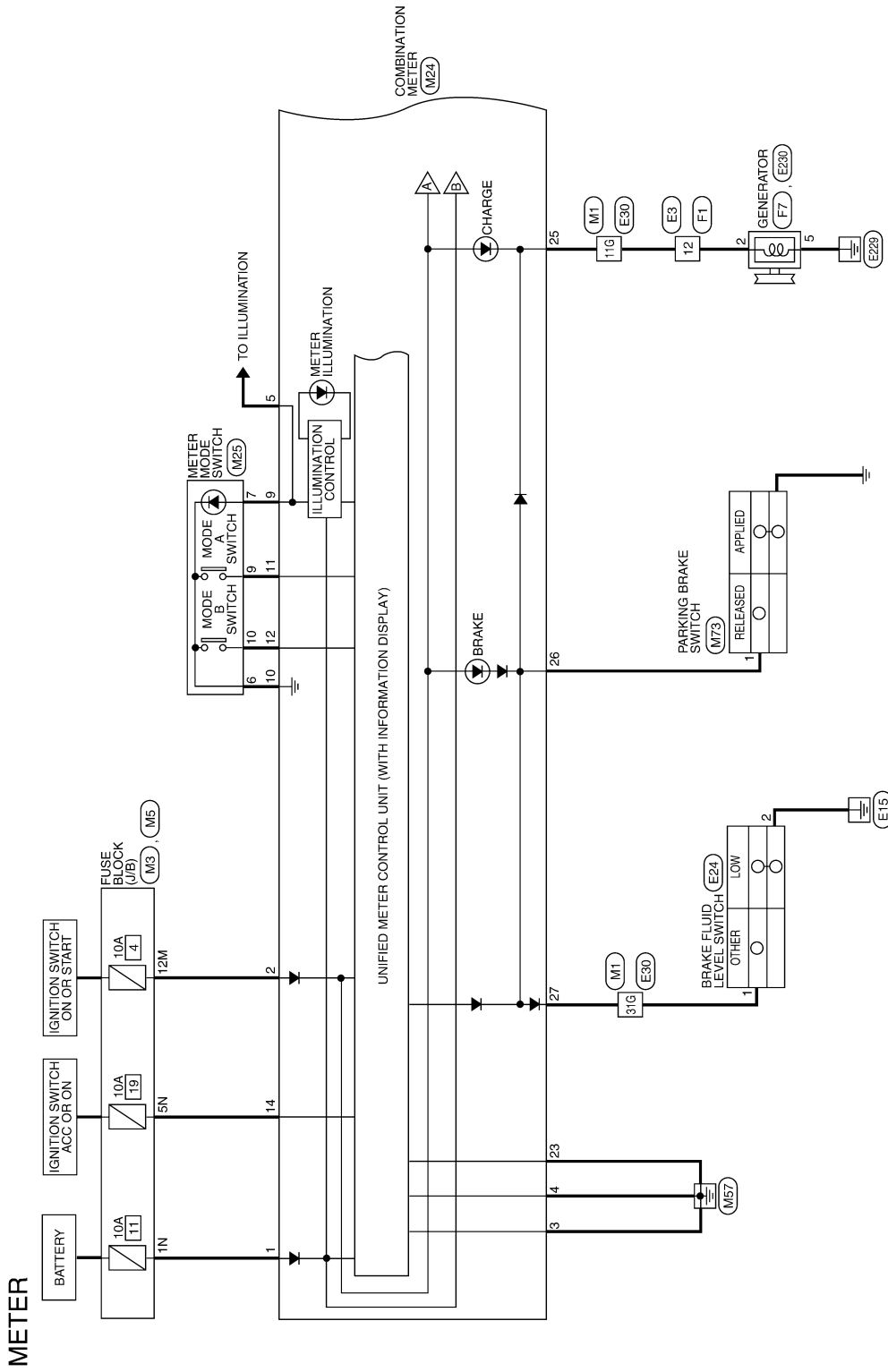

A
B
C
D
E
F
G
H
I
J
K
L
M
N
O
P

MWI

ABNWA0206GI

COMBINATION METER

< ECU DIAGNOSIS >

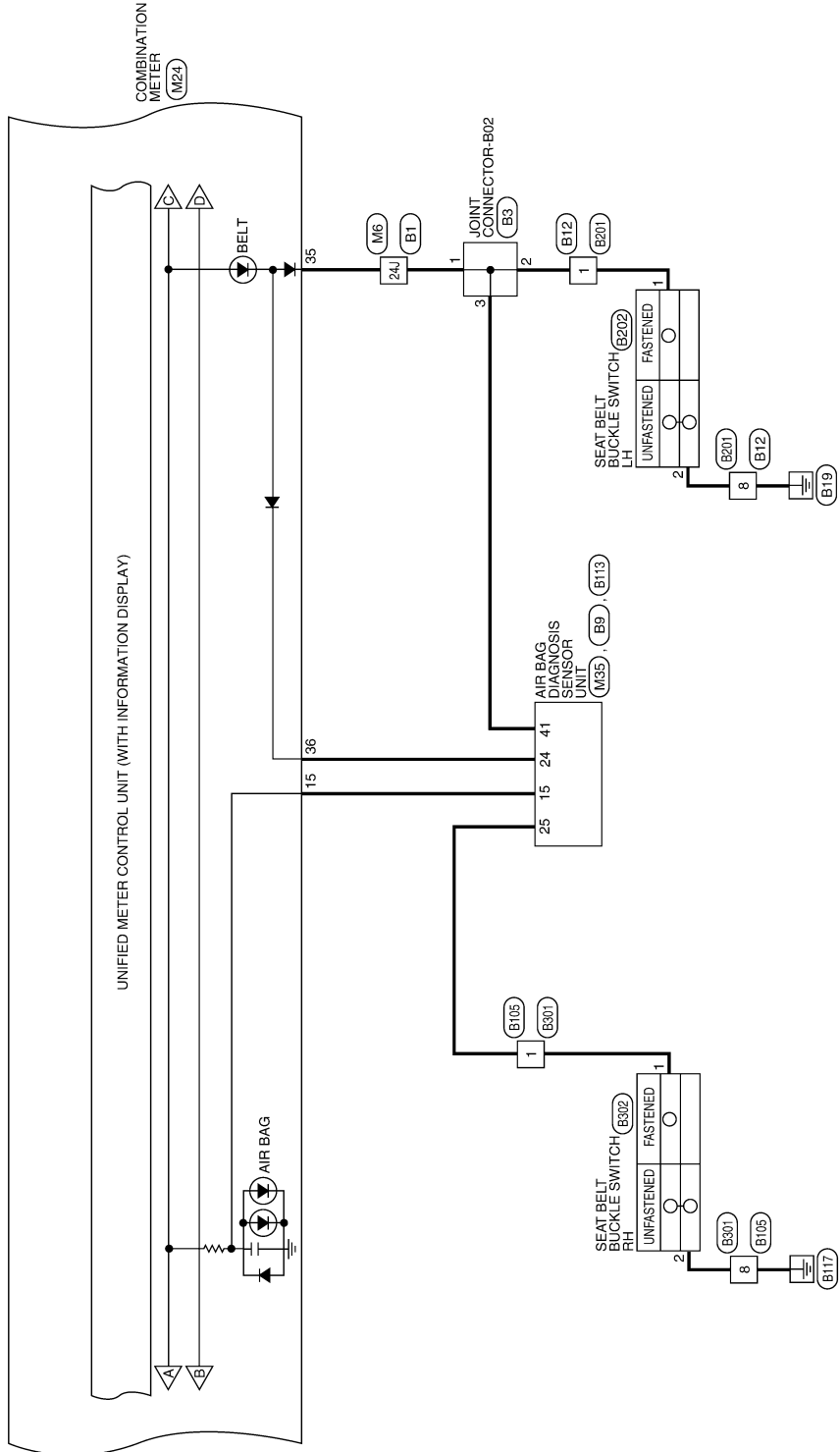

ABNWA0209Gf

COMBINATION METER

< ECU DIAGNOSIS >

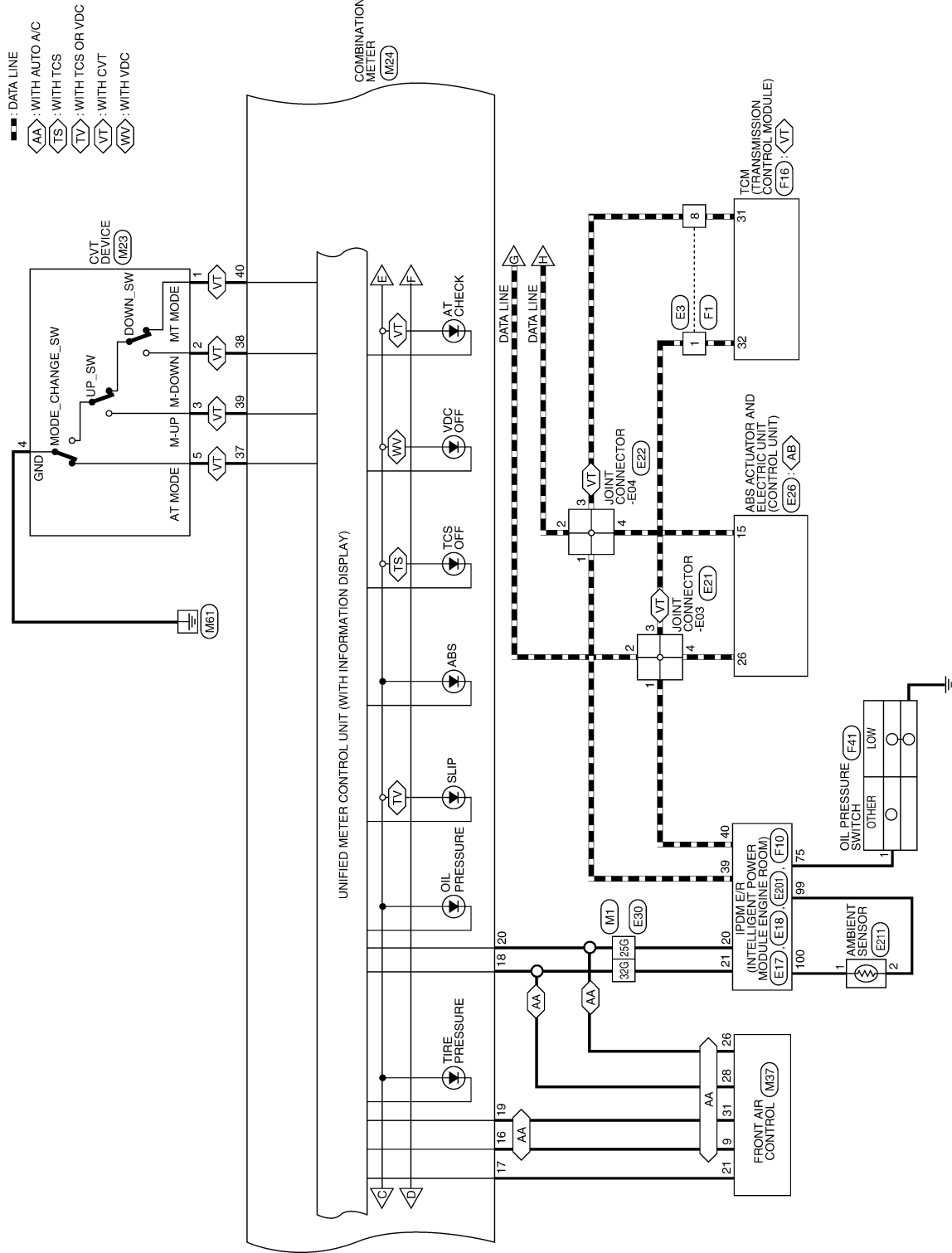

A
B
C
D
E
F
G
H
I
J
K
L
M
N
O
P

MWI

ABNWA0210GI

COMBINATION METER

< ECU DIAGNOSIS >

--- : DATA LINE

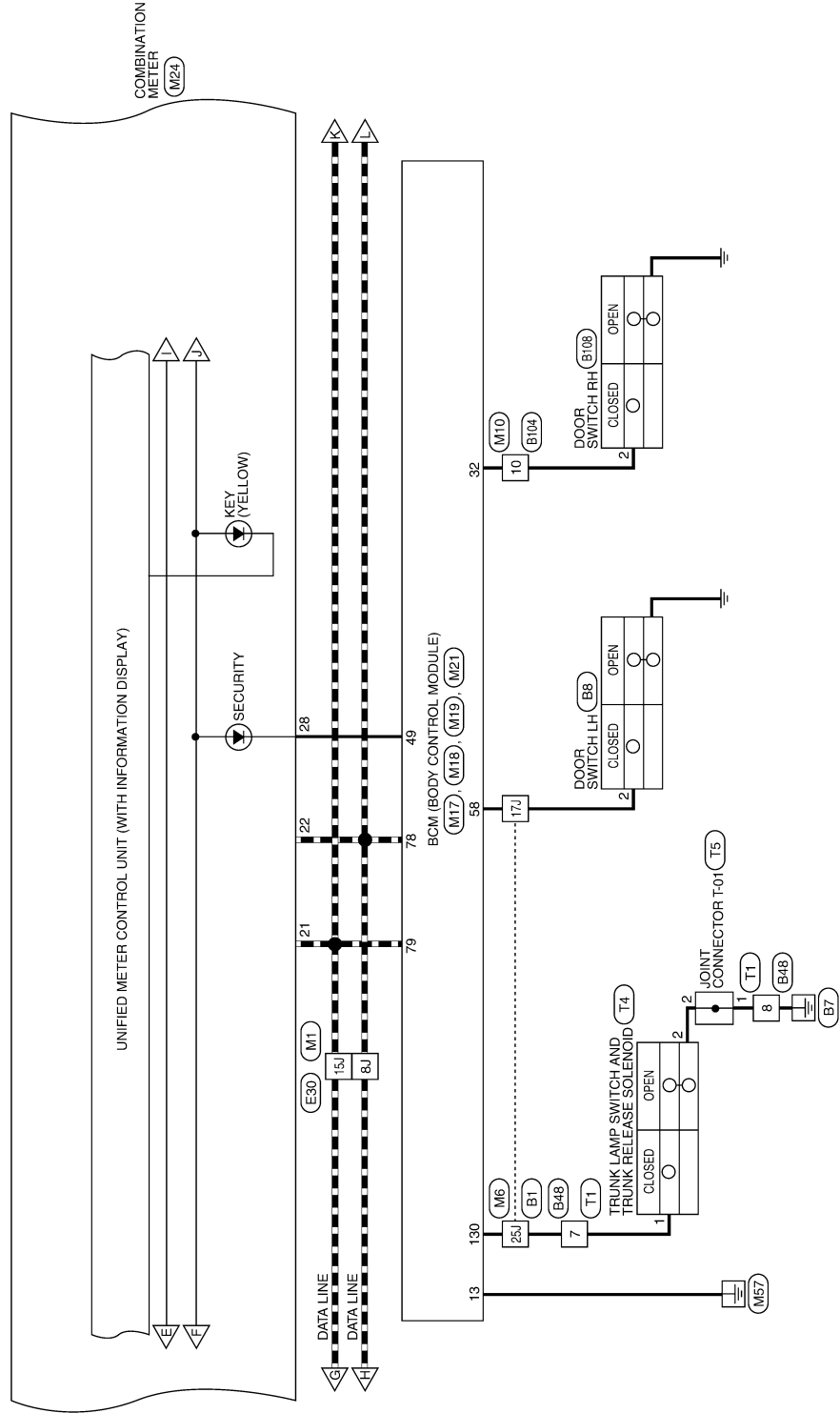

ABNWA0207G1

COMBINATION METER

< ECU DIAGNOSIS >

--- : DATA LINE

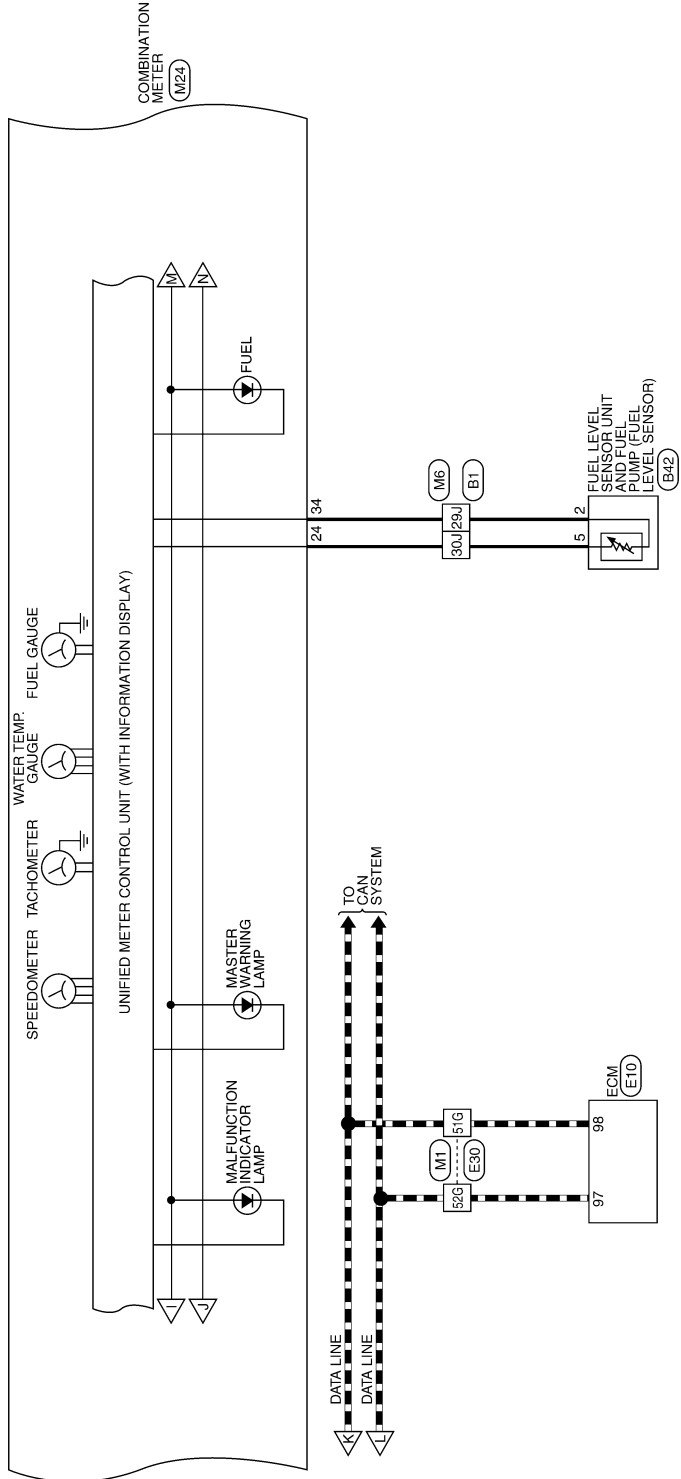

A
B
C
D
E
F
G
H
I
J
K
L
M
N
O
P

MWI

AWNWA0052G

COMBINATION METER

< ECU DIAGNOSIS >

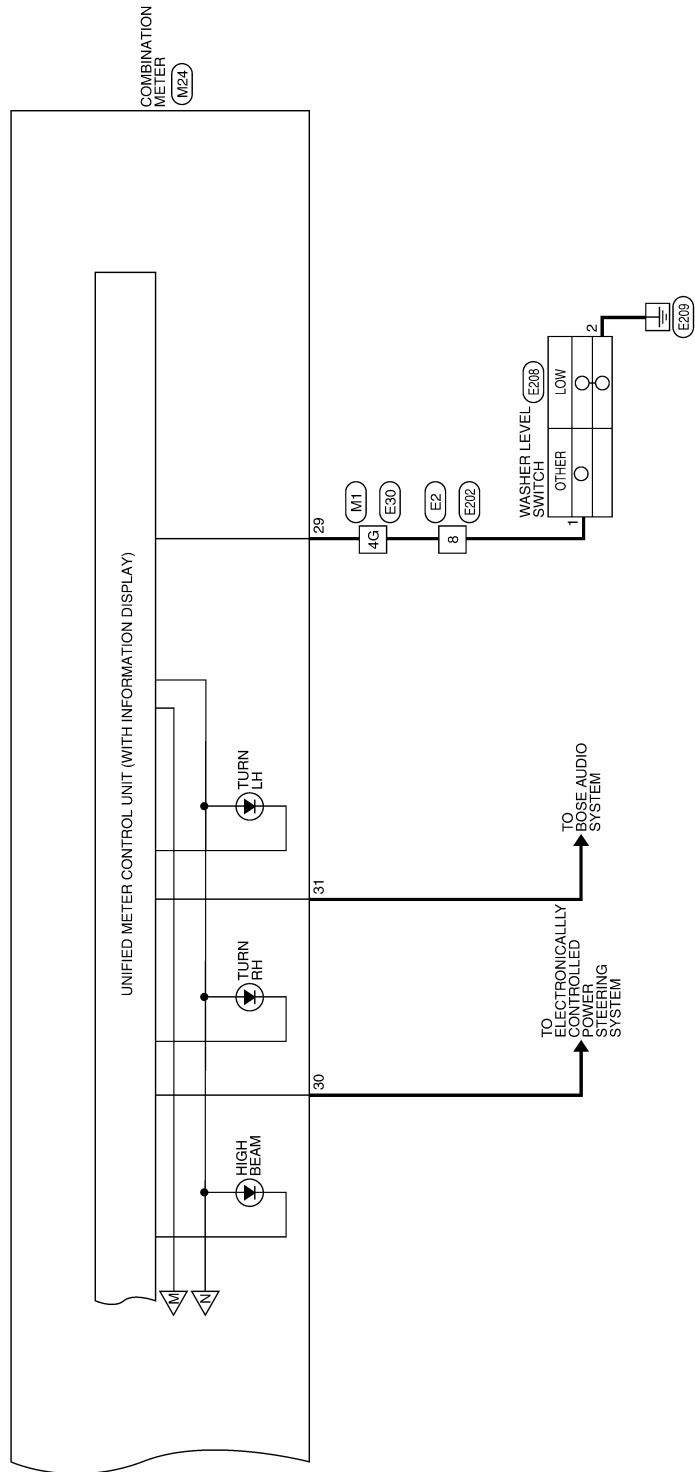

ABNWA0208Gf

COMBINATION METER

< ECU DIAGNOSIS >

METER CONNECTORS

Connector No.	M1
Connector Name	WIRE TO WIRE
Connector Color	WHITE

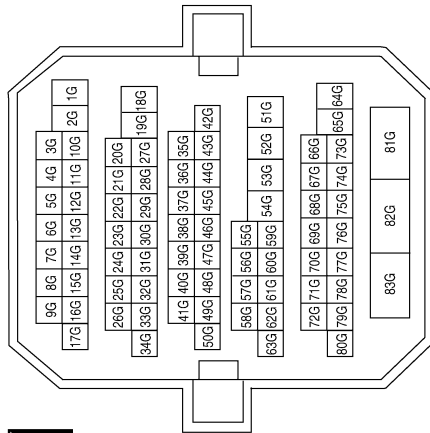

Terminal No.	Color of Wire	Signal Name
4G	R	-
8G	P	-
11G	BR	-
15G	L	-
25G	B/Y	-
31G	V	-
32G	O/B	-
51G	L	-
52G	P	-

Connector No.	M3
Connector Name	FUSE BLOCK (J/B)
Connector Color	WHITE

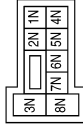

Terminal No.	Color of Wire	Signal Name
1N	W/L	-
5N	V/Y	-

Connector No.	M5
Connector Name	FUSE BLOCK (J/B)
Connector Color	WHITE

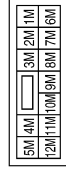

Terminal No.	Color of Wire	Signal Name
12M	P	-

A
B
C
D
E
F
G
H
I
J
K
L
M
MWI
O
P

ABNIA0667GB

COMBINATION METER

< ECU DIAGNOSIS >

Connector No.	M10
Connector Name	WIRE TO WIRE
Connector Color	BROWN

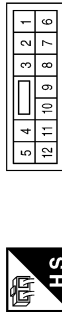

Terminal No.	Color of Wire	Signal Name
10	R/B	-

Connector No.	M17
Connector Name	BCM (BODY CONTROL MODULE)
Connector Color	WHITE

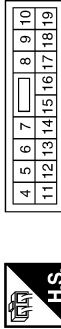

Terminal No.	Color of Wire	Signal Name
13	B	GND1

Connector No.	M18
Connector Name	BCM (BODY CONTROL MODULE)
Connector Color	GREEN

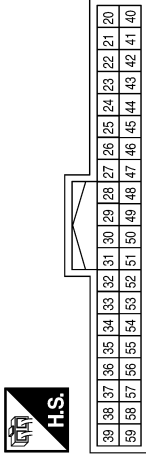

Terminal No.	Color of Wire	Signal Name
32	R/B	AS_DOOR_SW
49	L/O	IMMO_LED
58	SB	DR_DOOR_SW

Connector No.	M19
Connector Name	BCM (BODY CONTROL MODULE)
Connector Color	BLACK

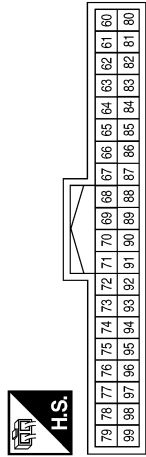

Terminal No.	Color of Wire	Signal Name
78	P	CAN-L
79	L	CAN-H

Connector No.	M21
Connector Name	BCM (BODY CONTROL MODULE)
Connector Color	GRAY

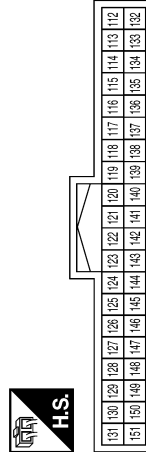

Terminal No.	Color of Wire	Signal Name
130	Y/G	TRUNK_SW

Connector No.	M23
Connector Name	CVT DEVICE
Connector Color	WHITE



Terminal No.	Color of Wire	Signal Name
1	LG/R	MT-MODE
2	BR	M-DOWN
3	W	M-UP
4	B	GND
5	G	AT-MODE

AWNIA0320GB

COMBINATION METER

< ECU DIAGNOSIS >

Connector No.	M24
Connector Name	COMBINATION METER
Connector Color	WHITE



1	2	3	4	5	6	7	8	9	10	11	12	13	14	15	16	17	18	19	20
21	22	23	24	25	26	27	28	29	30	31	32	33	34	35	36	37	38	39	40

Terminal No.	Color of Wire	Signal Name
1	W/L	BAT
2	O	IGN
3	B	GND
4	B	GND
5	R/Y	ILL OUTPUT
6	-	-
7	-	-
8	-	-

Terminal No.	Color of Wire	Signal Name
9	GR/W	SW ILL PWR
10	O/L	GND (SATELLITE SW)
11	L/R	MODE A SW
12	B/R	MODE B SW
13	-	-
14	V/Y	ACC
15	BR/W	AIR/BAG
16	GW	WATER_TEMP_OUT
17	R/W	A/C_PD_CUT
18	O/B	OAT
19	P	OAT POWER
20	B/Y	GND (OAT SENSOR)
21	L	CAN-H
22	P	CAN-L
23	B	GND
24	B/W	GND (FUEL SENSOR)

Terminal No.	Color of Wire	Signal Name
25	BR	CHG
26	G/R	PKB
27	V	BRAKE OIL IN
28	L/O	SECURITY
29	R	LOW WASHESR FLUID SW
30	L/B	2P/R OUT
31	V/W	8P/R OUT
32	-	-
33	-	-
34	G/B	FUEL SENSOR
35	W/B	DR_BELT
36	L/W	AS_BELT
37	G	NOT M RANGE
38	BR	AT SHIFT DOWN
39	W	AT SHIFT UP
40	LG/R	M RANGE

Connector No.	M25
Connector Name	METER MODE SWITCH
Connector Color	WHITE



1	2	3	4	5
6	7	8	9	10

Terminal No.	Color of Wire	Signal Name
6	O/L	GND (SATELLITE SW)
7	GR/W	SW ILL POWER
9	L/R	MODE A SW
10	B/R	MODE B SW

Connector No.	M35
Connector Name	AIR BAG DIAGNOSIS SENSOR UNIT
Connector Color	YELLOW



21	24	49	1		
22	11	46	48	47	45
16	12	15	18	1	2

Terminal No.	Color of Wire	Signal Name
15	BR/W	AIRBAG WL
24	L/W	SEAT BELT REMINDER

Connector No.	M37
Connector Name	FRONT AIR CONTROL
Connector Color	WHITE



1	2	3	4	5	6	7	8	9	10	11	12	13	14	15	16	17	18	19	20
21	22	23	24	25	26	27	28	29	30	31	32	33	34	35	36	37	38	39	40

Terminal No.	Color of Wire	Signal Name
9	GW	WATER TEMP
21	R/W	PD CUT
26	B/Y	SENS GND
28	O/B	AMB SENS
31	P	AMB VDD

AWNIA0321GB

A B C D E F G H I J K L M N O P

MWI

COMBINATION METER

< ECU DIAGNOSIS >

Connector No.	M6
Connector Name	WIRE TO WIRE
Connector Color	WHITE

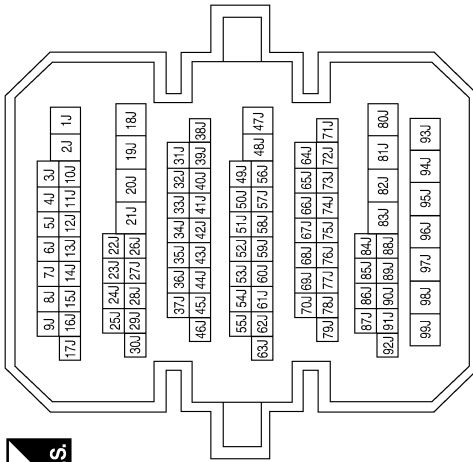

Terminal No.	Color of Wire	Signal Name
17J	SB	-
24J	W/B	-
25J	Y/G	-
29J	G/B	-
30J	B/W	-

Connector No.	M73
Connector Name	PARKING BRAKE SWITCH
Connector Color	BLACK



Terminal No.	Color of Wire	Signal Name
1	G/R	-

Connector No.	E2
Connector Name	WIRE TO WIRE
Connector Color	WHITE



Terminal No.	Color of Wire	Signal Name
8	V	-

Connector No.	E3
Connector Name	WIRE TO WIRE
Connector Color	WHITE

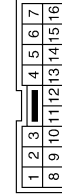

Terminal No.	Color of Wire	Signal Name
1	L	-
8	P	-
12	LG	-

Connector No.	E10
Connector Name	ECM
Connector Color	BLACK

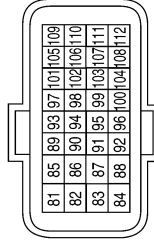

Terminal No.	Color of Wire	Signal Name
97	P	CAN-L
98	L	CAN-H

ABNIA0669GB

COMBINATION METER

< ECU DIAGNOSIS >

Terminal No.	Color of Wire	Signal Name
20	B/Y	AMB_SENS_GND
21	O/B	AMB_SENS_SIG

Connector No.	E18
Connector Name	IPDM E/R (INTELLIGENT POWER DISTRIBUTION MODULE ENGINE ROOM)
Connector Color	WHITE

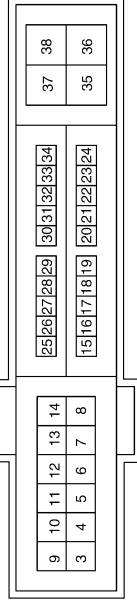

Connector No.	E17
Connector Name	IPDM E/R (INTELLIGENT POWER DISTRIBUTION MODULE ENGINE ROOM)
Connector Color	WHITE

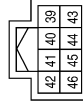

Terminal No.	Color of Wire	Signal Name
39	P	CAN-L
40	L	CAN-H

Connector No.	E24
Connector Name	BRAKE FLUID LEVEL SWITCH
Connector Color	GRAY



Connector No.	E22
Connector Name	JOINT CONNECTOR-E04
Connector Color	WHITE



Terminal No.	Color of Wire	Signal Name
1	P	-
2	P	-
3	P	-
4	P	-

Connector No.	E21
Connector Name	JOINT CONNECTOR-E03
Connector Color	WHITE

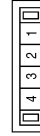

Terminal No.	Color of Wire	Signal Name
1	L	-
2	L	-
3	L	-
4	L	-

ABNIA0670GB

A
B
C
D
E
F
G
H
I
J
K
L
M
N
O
P

COMBINATION METER

< ECU DIAGNOSIS >

Terminal No.	Color of Wire	Signal Name
4G	V	-
8G	P	-
11G	LG	-
15G	L	-
25G	L	-
31G	V	-
32G	LG	-
51G	L	-
52G	P	-

Connector No.	E30
Connector Name	WIRE TO WIRE
Connector Color	WHITE

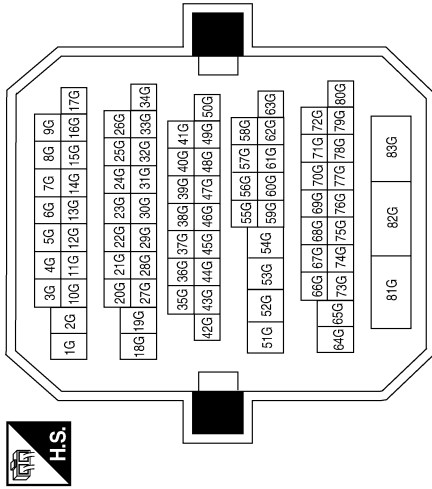

Connector No.	E26
Connector Name	ABS ACTUATOR AND ELECTRIC UNIT (CONTROL UNIT)
Connector Color	BLACK

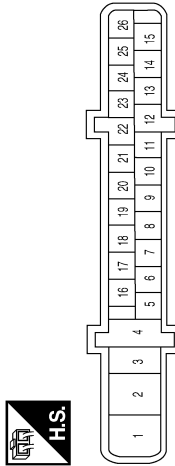

Terminal No.	Color of Wire	Signal Name
15	P	CAN-L
26	L	CAN-H

Connector No.	E202
Connector Name	WIRE TO WIRE
Connector Color	WHITE



Terminal No.	Color of Wire	Signal Name
8	R	-

Connector No.	E201
Connector Name	IPDM E/R (INTELLIGENT POWER DISTRIBUTION MODULE ENGINE ROOM)
Connector Color	WHITE

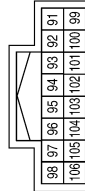

Terminal No.	Color of Wire	Signal Name
99	BR/W	AMB_SENS_GND-FEM
100	SB	AMB_SENS_SIG-FEM

ABNIA0671GB

COMBINATION METER

< ECU DIAGNOSIS >

Connector No.	E230
Connector Name	GENERATOR
Connector Color	-



Terminal No.	Color of Wire	Signal Name
5	B	-

Connector No.	E211
Connector Name	AMBIENT SENSOR
Connector Color	BLACK



Terminal No.	Color of Wire	Signal Name
1	SB	AMB_SENS_SIG
2	BRW	AMB_SENS_GND

Connector No.	E208
Connector Name	WASHER LEVEL SWITCH
Connector Color	WHITE



Terminal No.	Color of Wire	Signal Name
1	R	WASHER
2	B	GND

Connector No.	F10
Connector Name	IPDM E/R (INTELLIGENT POWER DISTRIBUTION MODULE ENGINE ROOM)
Connector Color	WHITE



Terminal No.	Color of Wire	Signal Name							
53	54	55	56	57	58				
47	48	49	50	51	52				
69	70	71	72	73	74	75	76	77	78
59	60	61	62	63	64	65	66	67	68
81	82	79	80						

Terminal No.	Color of Wire	Signal Name
75	P/L	OIL_PRESSURE_SW

Connector No.	F7
Connector Name	GENERATOR
Connector Color	BLACK



Terminal No.	Color of Wire	Signal Name
2	BR	CHG

Connector No.	F1
Connector Name	WIRE TO WIRE
Connector Color	WHITE

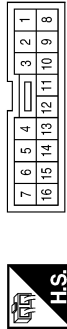

Terminal No.	Color of Wire	Signal Name
1	L	-
8	P	-
12	BR	-

ABNIA0672GB

COMBINATION METER

< ECU DIAGNOSIS >

Connector No.	F16
Connector Name	TCM (TRANSMISSION CONTROL MODULE)
Connector Color	BLACK

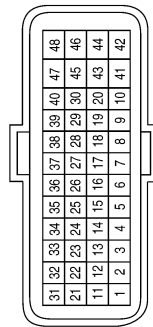

Terminal No.	Color of Wire	Signal Name
31	P	CAN-L
32	L	CAN-H

Connector No.	F41
Connector Name	OIL PRESSURE SWITCH
Connector Color	GRAY



Terminal No.	Color of Wire	Signal Name
1	P/L	-

Connector No.	B1
Connector Name	WIRE TO WIRE
Connector Color	WHITE

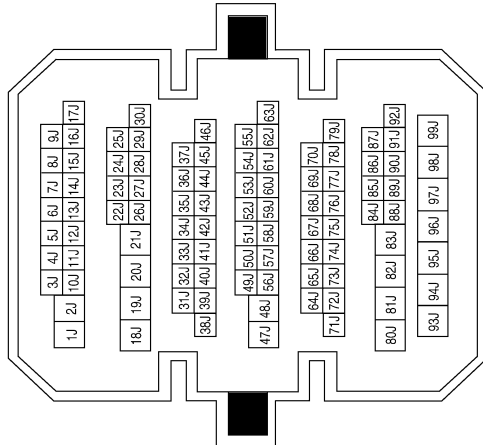

Terminal No.	Color of Wire	Signal Name
17J	SB	-
24J	W/B	-
25J	Y/G	-
29J	G/B	-
30J	B/W	-

Connector No.	B3
Connector Name	JOINT CONNECTOR-B02
Connector Color	WHITE



Terminal No.	Color of Wire	Signal Name
1	W/B	-
2	W/B	-
3	W/B	-

ABNIA0673GB

COMBINATION METER

< ECU DIAGNOSIS >

Connector No.	B8
Connector Name	DOOR SWITCH LH
Connector Color	WHITE

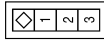

Terminal No.	SB	Signal Name	DOOR SW (DR)
Color of Wire	SB		

Connector No.	B9
Connector Name	AIR BAG DIAGNOSIS SENSOR UNIT
Connector Color	YELLOW

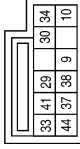

Terminal No.	41	Color of Wire	W/B	Signal Name	LH BUCKLE SW INPUT
--------------	----	---------------	-----	-------------	--------------------

Connector No.	B12
Connector Name	WIRE TO WIRE
Connector Color	WHITE

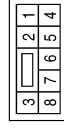

Terminal No.	1	Color of Wire	W/B	Signal Name	CAN-L
--------------	---	---------------	-----	-------------	-------

Connector No.	B42
Connector Name	FUEL LEVEL SENSOR UNIT AND FUEL PUMP
Connector Color	GRAY

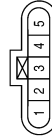

Terminal No.	Color of Wire	Signal Name
2	G/B	FUEL_GND
5	B/W	FUEL_SIGNAL

Connector No.	B48
Connector Name	WIRE TO WIRE
Connector Color	WHITE

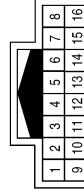

Terminal No.	Color of Wire	Signal Name
7	Y/G	FUEL_GND
8	B	FUEL_SIGNAL

Connector No.	B104
Connector Name	WIRE TO WIRE
Connector Color	BROWN

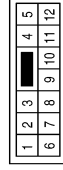

Terminal No.	Color of Wire	Signal Name
10	R/B	-

ABNIA0674GB

A
B
C
D
E
F
G
H
I
J
K
L
M
N
O
P

COMBINATION METER

< ECU DIAGNOSIS >

Connector No.	B105
Connector Name	WIRE TO WIRE
Connector Color	WHITE

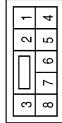

Terminal No.	Color of Wire	Signal Name
1	L	-
8	B	-

Connector No.	B108
Connector Name	DOOR SWITCH RH
Connector Color	WHITE

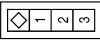

Terminal No.	Color of Wire	Signal Name
2	R/B	DOOR SW (AS)

Connector No.	B113
Connector Name	AIR BAG DIAGNOSIS SENSOR UNIT
Connector Color	YELLOW

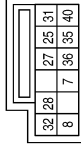

Terminal No.	Color of Wire	Signal Name
25	L	RH BUCKLE SW INPUT

Connector No.	B201
Connector Name	WIRE TO WIRE
Connector Color	WHITE

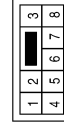

Terminal No.	Color of Wire	Signal Name
1	W/B	-
8	B/Y	-

Connector No.	B202
Connector Name	SEAT BELT BUCKLE SWITCH LH
Connector Color	WHITE

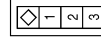

Terminal No.	Color of Wire	Signal Name
1	W/B	SIGNAL
2	B/Y	GND

Connector No.	B301
Connector Name	WIRE TO WIRE
Connector Color	WHITE

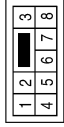

Terminal No.	Color of Wire	Signal Name
1	L	-
8	B	-

ABNIA0675GB

COMBINATION METER

< ECU DIAGNOSIS >

Connector No.	T4
Connector Name	TRUNK LAMP SWITCH AND TRUNK RELEASE SOLENOID
Connector Color	WHITE



2	1
4	3

Terminal No.	Color of Wire	Signal Name
1	Y/G	TRUNK_REQUEST_SW
2	B	GND

Connector No.	T1
Connector Name	WIRE TO WIRE
Connector Color	WHITE



8	7	6	5	4	3	2	1
16	15	14	13	12	11	10	9

Terminal No.	Color of Wire	Signal Name
7	Y/G	-
8	B	-

Connector No.	B302
Connector Name	SEAT BELT BUCKLE SWITCH RH
Connector Color	WHITE



1	2	3
---	---	---

Terminal No.	Color of Wire	Signal Name
1	L	SIGNAL
2	B	GND

Connector No.	T5
Connector Name	JOINT CONNECTOR-T01
Connector Color	WHITE



4	3	2	1
---	---	---	---

Terminal No.	Color of Wire	Signal Name
1	B	-
2	B	-

ABNIA0688GB

A
B
C
D
E
F
G
H
I
J
K
L
M
N
O
P

COMBINATION METER

< ECU DIAGNOSIS >

Wiring Diagram - Sedan

INFOID:000000004204118

M : WITH M/T
VT : WITH CVT

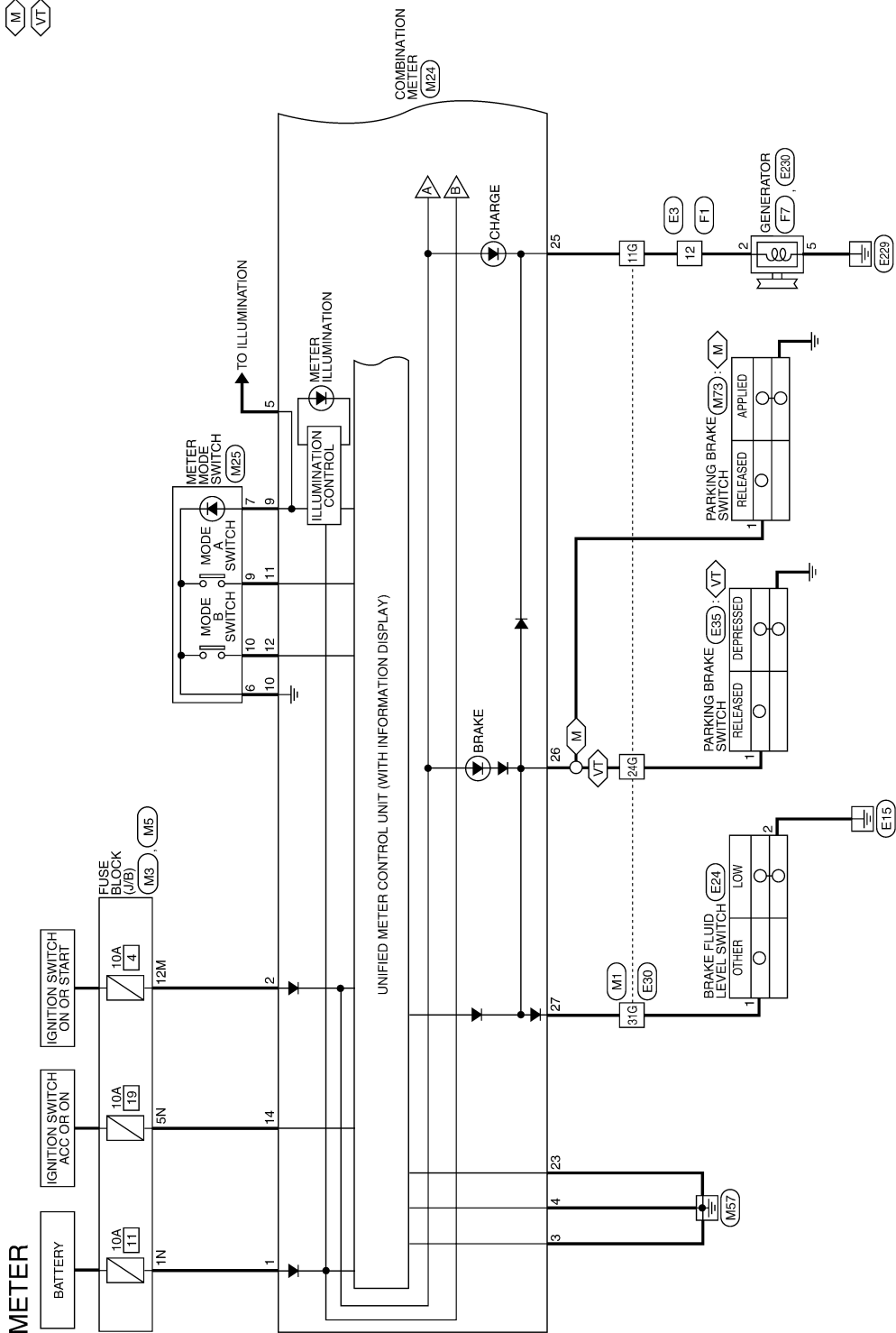

ABNWA0201Gf

COMBINATION METER

< ECU DIAGNOSIS >

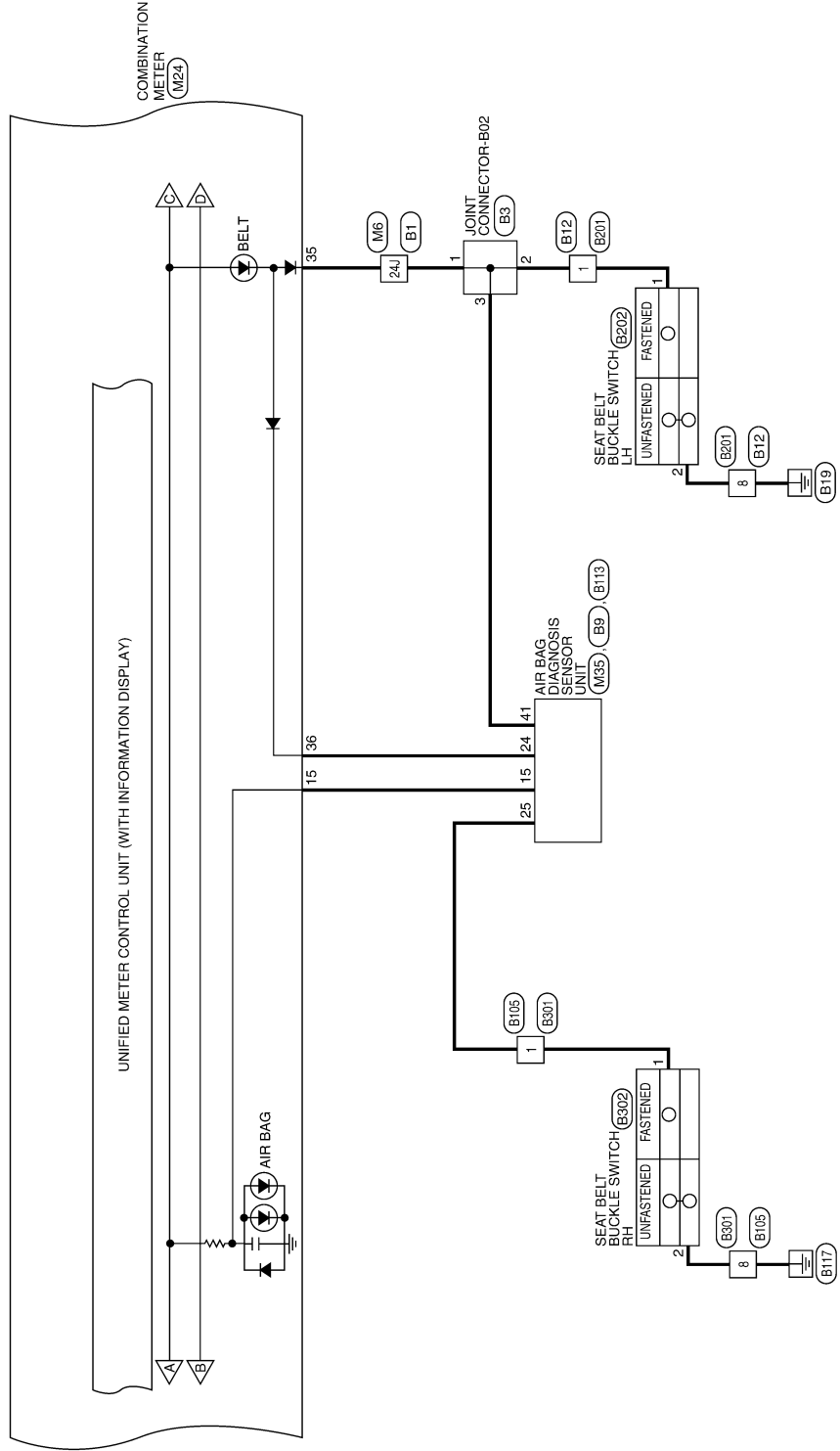

ABNWA0213GI

A
B
C
D
E
F
G
H
I
J
K
L
M
O
P

MWI

COMBINATION METER

< ECU DIAGNOSIS >

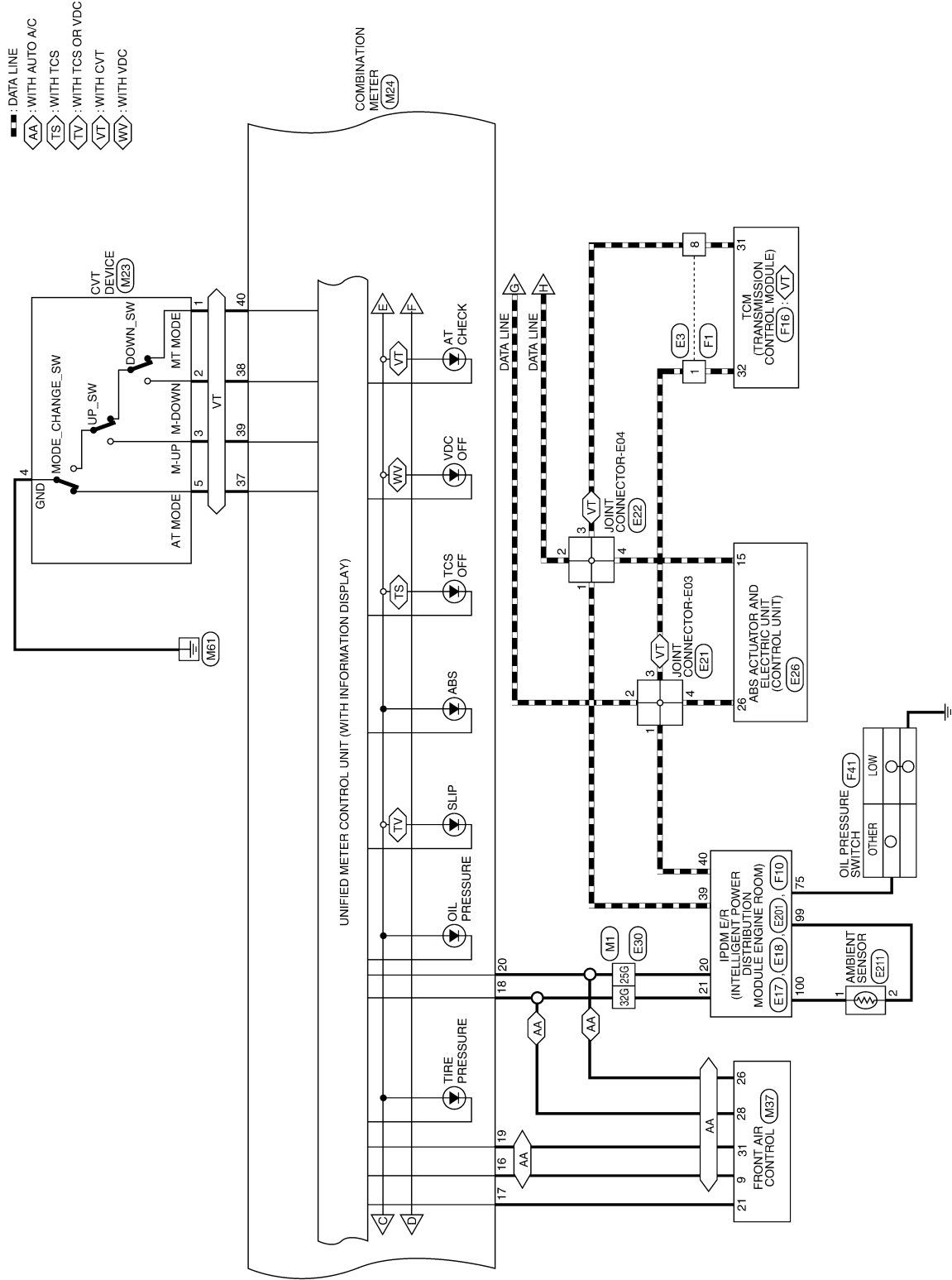

ABNWA0202GI

COMBINATION METER

< ECU DIAGNOSIS >

--- : DATA LINE

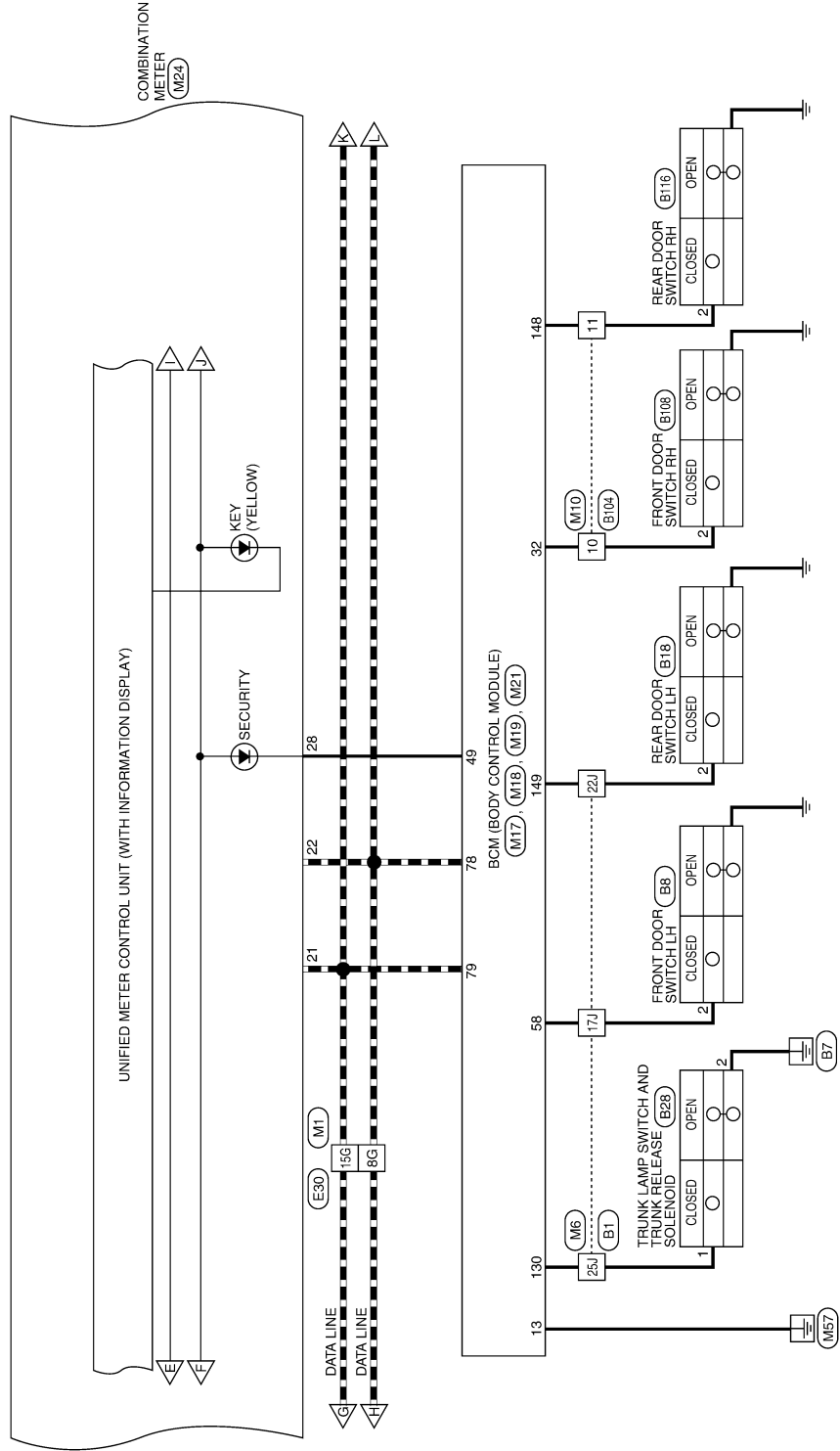

ABNWA0203GI

A
B
C
D
E
F
G
H
I
J
K
L
M
N
O
P

MWI

COMBINATION METER

< ECU DIAGNOSIS >

--- : DATA LINE

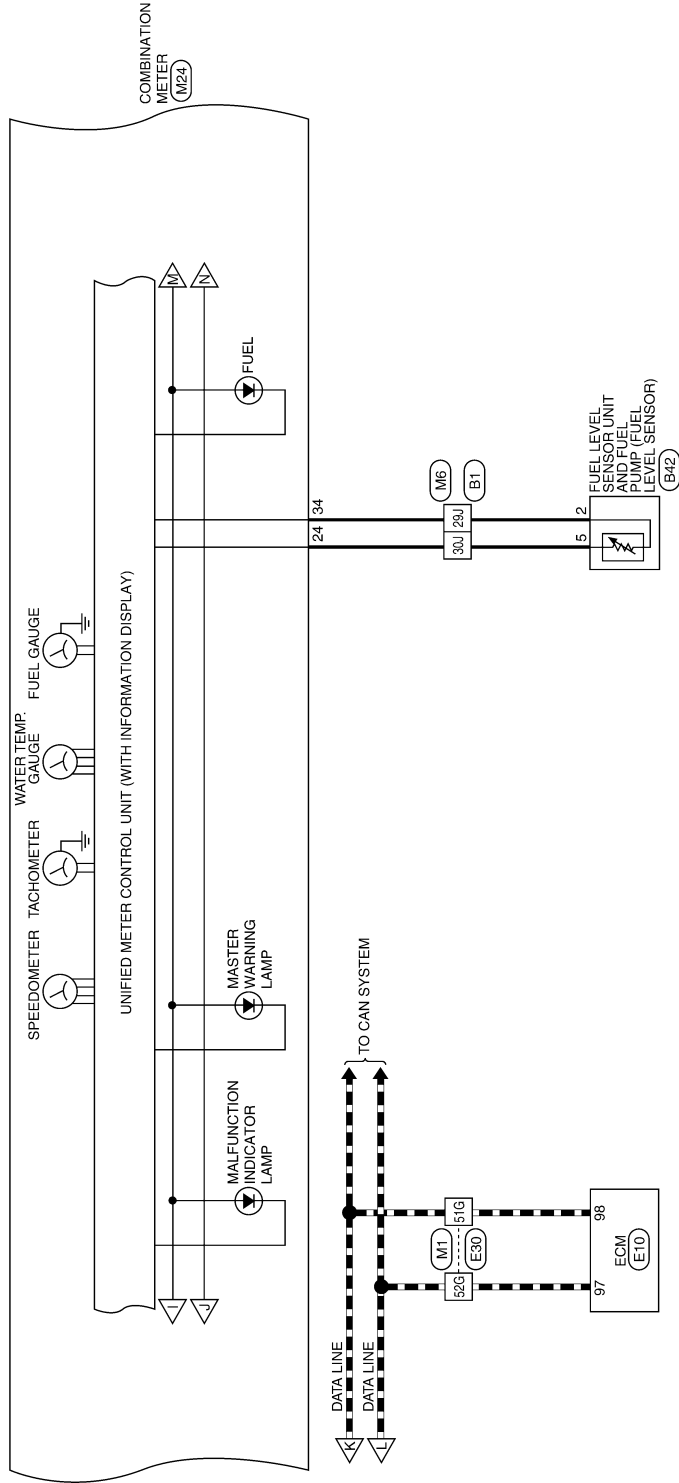

ABNWA0204Gf

COMBINATION METER

< ECU DIAGNOSIS >

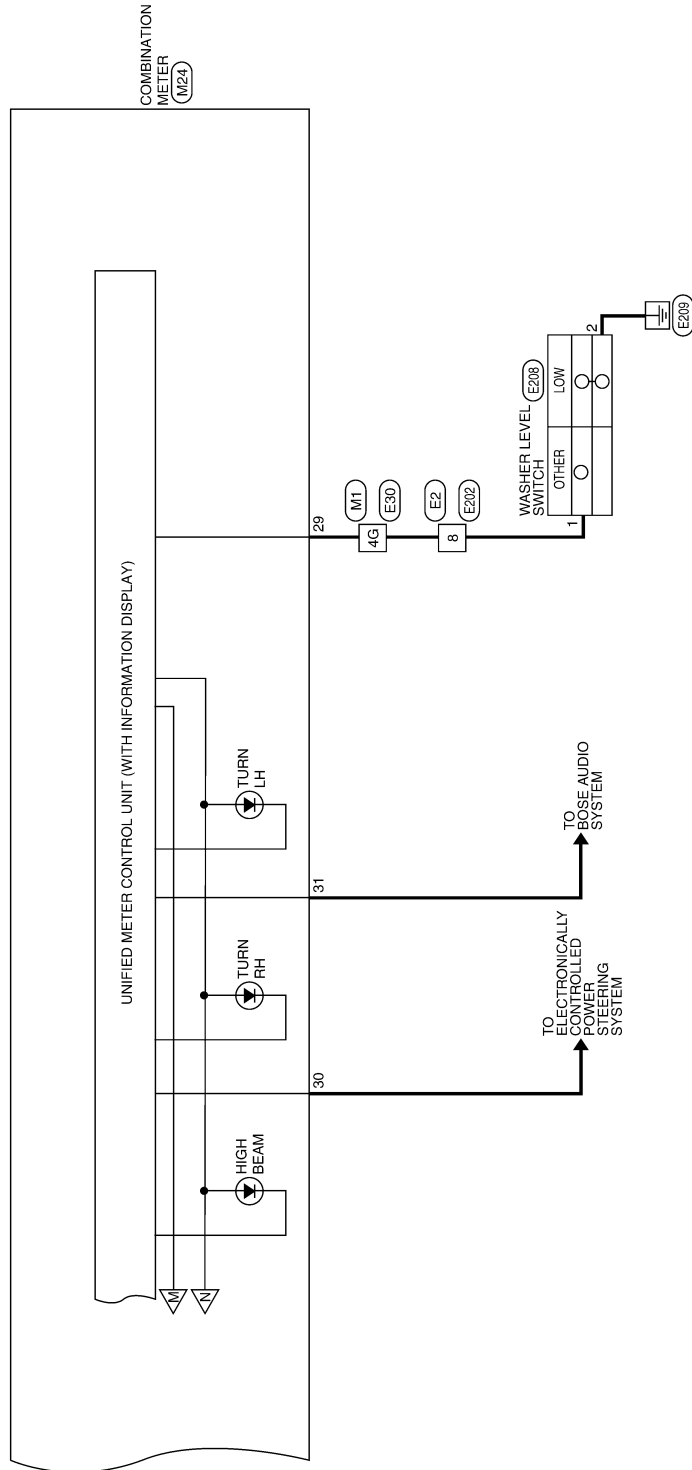

A
B
C
D
E
F
G
H
I
J
K
L
M
O
P

MWI

ABNWA0205Gf

COMBINATION METER

< ECU DIAGNOSIS >

METER CONNECTORS

Connector No.	M1
Connector Name	WIRE TO WIRE
Connector Color	WHITE

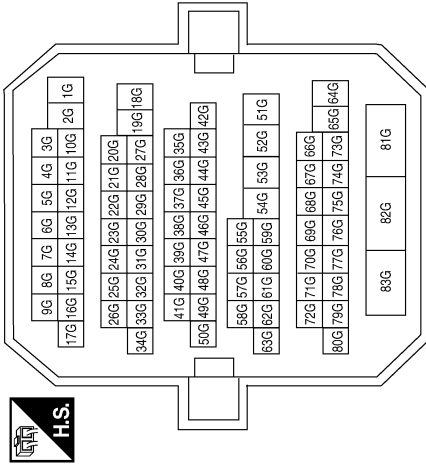

Terminal No.	Color of Wire	Signal Name
4G	R	-
8G	P	-
11G	BR	-
15G	L	-
24G	G/R	-
25G	B/Y	-
31G	V	-
32G	O/B	-
51G	L	-
52G	P	-

Connector No.	M3
Connector Name	FUSE BLOCK (J/B)
Connector Color	WHITE

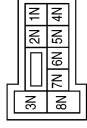

Terminal No.	Color of Wire	Signal Name
1N	W/L	-
5N	V/Y	-

Connector No.	M5
Connector Name	FUSE BLOCK (J/B)
Connector Color	WHITE

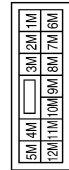

Terminal No.	Color of Wire	Signal Name
12M	P	-

ABNIA0660GB

COMBINATION METER

< ECU DIAGNOSIS >

Connector No.	M6
Connector Name	WIRE TO WIRE
Connector Color	WHITE

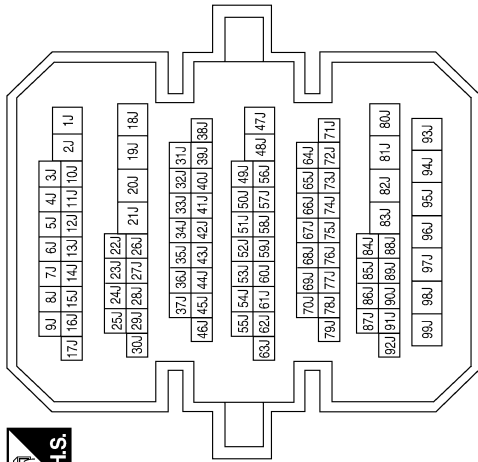

Terminal No.	Color of Wire	Signal Name
17J	SB	-
22J	R/B	-
24J	W/B	-
25J	Y/G	-
29J	G/B	-
30J	B/W	-

Connector No.	M10
Connector Name	WIRE TO WIRE
Connector Color	BROWN

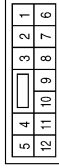

Terminal No.	Color of Wire	Signal Name
10	R/B	-
11	R/W	-

Connector No.	M17
Connector Name	BCM (BODY CONTROL MODULE)
Connector Color	WHITE



Terminal No.	Color of Wire	Signal Name
13	B	GND1

Connector No.	M18
Connector Name	BCM (BODY CONTROL MODULE)
Connector Color	GREEN

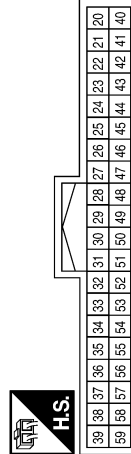

Terminal No.	Color of Wire	Signal Name
32	R/B	AS_DOOR_SW
49	L/O	IMMO_LED
58	SB	DR_DOOR_SW

Connector No.	M19
Connector Name	BCM (BODY CONTROL MODULE)
Connector Color	BLACK

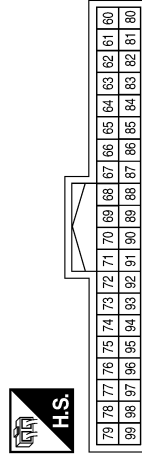

Terminal No.	Color of Wire	Signal Name
78	P	CAN-L
79	L	CAN-H

ABNIA0680GB

A B C D E F G H I J K L M N O P

COMBINATION METER

< ECU DIAGNOSIS >

Connector No.	M23
Connector Name	CVT DEVICE
Connector Color	WHITE

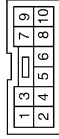

Terminal No.	Color of Wire	Signal Name
1	LG/R	MT-MODE
2	BR	M-DOWN
3	W	M-UP
4	B	GND
5	G	AT-MODE

Connector No.	M21
Connector Name	BCM (BODY CONTROL MODULE)
Connector Color	GRAY

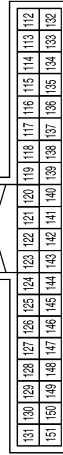

Terminal No.	Color of Wire	Signal Name
130	Y/G	TRUNK_SW
148	R/W	RR_DOOR_SW
149	R/B	RL_DOOR_SW

Terminal No.	Color of Wire	Signal Name
8	-	-
9	GR/W	SW ILL PWR
10	O/L	GND (SATELLITE SW)
11	L/R	MODE A SW
12	B/R	MODE B SW
13	-	-
14	V/Y	ACC
15	BR/W	AIR_BAG
16	G/W	WATER_TEMP_OUT
17	R/W	A/C_PD_CUT
18	O/B	OAT
19	P	OAT POWER
20	B/Y	GND (OAT SENSOR)
21	L	CAN-H
22	P	CAN-L
23	B	GND
24	B/W	GND (FUEL SENSOR)

Connector No.	M24
Connector Name	COMBINATION METER
Connector Color	WHITE

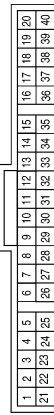

Terminal No.	Color of Wire	Signal Name
1	W/L	BAT
2	O	IGN
3	B	GND
4	B	GND
5	R/Y	ILL OUTPUT
6	-	-
7	-	-

Terminal No.	Color of Wire	Signal Name
25	BR	CHG
26	G/R	PKB
27	V	BRAKE OIL IN
28	L/O	SECURITY
29	R	LOW WASHER FLUID SW
30	L/B	2P/R OUT
31	V/W	8P/R OUT
32	-	-
33	-	-
34	G/B	FUEL SENSOR
35	W/B	DR_BELT
36	L/W	AS_BELT
37	G	NOT M RANGE
38	BR	AT SHIFT DOWN
39	W	AT SHIFT UP
40	LG/R	M RANGE

ABNIA0661GB

COMBINATION METER

< ECU DIAGNOSIS >

Connector No.	M37
Connector Name	FRONT AIR CONTROL
Connector Color	WHITE

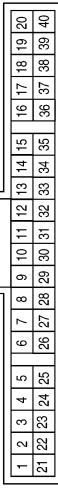
Terminal No.	Color of Wire	Signal Name
9	GW	WATER TEMP
21	R/W	PD CUT
26	B/Y	SENS GND
28	O/B	AMB SENS
31	P	AMB VDD

Connector No.	M35
Connector Name	AIR BAG DIAGNOSIS SENSOR UNIT
Connector Color	YELLOW

Terminal No.	Color of Wire	Signal Name
15	BRW	AIRBAG W/L
24	L/W	SEAT BELT REMINDER

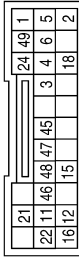
Connector No.	M25
Connector Name	METER MODE SWITCH
Connector Color	BLACK

Terminal No.	Color of Wire	Signal Name
6	O/L	GND (SATELLITE SW)
7	GRW	SW ILL POWER
9	L/R	MODE A SW
10	B/R	MODE B SW

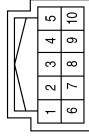
Connector No.	E3
Connector Name	WIRE TO WIRE
Connector Color	WHITE

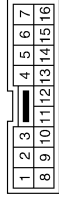

Terminal No.	Color of Wire	Signal Name
1	L	-
8	P	-
12	LG	-

Connector No.	E2
Connector Name	WIRE TO WIRE
Connector Color	WHITE

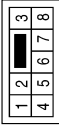
Terminal No.	Color of Wire	Signal Name
8	V	-

Connector No.	M73
Connector Name	PARKING BRAKE SWITCH (WITH M/T)
Connector Color	BLACK

Terminal No.	Color of Wire	Signal Name
1	G/R	-

ABNIA0662GB

A
B
C
D
E
F
G
H
I
J
K
L
M
MWI
O
P

COMBINATION METER

< ECU DIAGNOSIS >

Connector No.	E10
Connector Name	ECM
Connector Color	BLACK

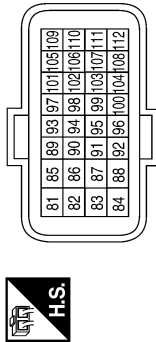

Terminal No.	Color of Wire	Signal Name
97	P	CAN-L
98	L	CAN-H

Connector No.	E17
Connector Name	IPDM E/R (INTELLIGENT POWER DISTRIBUTION MODULE ENGINE ROOM)
Connector Color	WHITE



Terminal No.	Color of Wire	Signal Name
39	P	CAN-L
40	L	CAN-H

Connector No.	E18
Connector Name	IPDM E/R (INTELLIGENT POWER DISTRIBUTION MODULE ENGINE ROOM)
Connector Color	WHITE

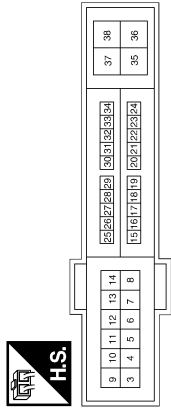

Terminal No.	Color of Wire	Signal Name
20	B/Y	AMB_SENS_GND-E/R
21	O/B	AMB_SENS_SIG-E/R

Connector No.	E21
Connector Name	JOINT CONNECTOR-E03
Connector Color	WHITE

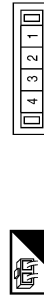

Terminal No.	Color of Wire	Signal Name
1	L	-
2	L	-
3	L	-
4	L	-

Connector No.	E22
Connector Name	JOINT CONNECTOR-E04
Connector Color	WHITE



Terminal No.	Color of Wire	Signal Name
1	P	-
2	P	-
3	P	-
4	P	-

Connector No.	E24
Connector Name	BRAKE FLUID LEVEL SWITCH
Connector Color	GRAY



Terminal No.	Color of Wire	Signal Name
1	V	-
2	B/Y	-

ABNIA0663GB

COMBINATION METER

< ECU DIAGNOSIS >

Connector No.	E26
Connector Name	ABS ACTUATOR AND ELECTRIC UNIT (CONTROL UNIT)
Connector Color	BLACK

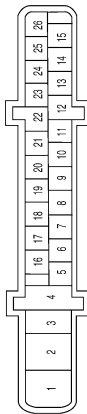

Terminal No.	Color of Wire	Signal Name
15	P	CAN-L
26	L	CAN-H

Connector No.	E30
Connector Name	WIRE TO WIRE
Connector Color	WHITE

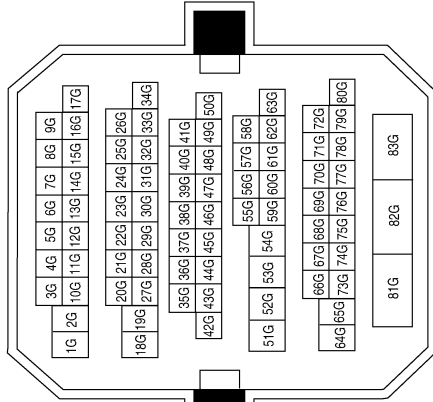

Terminal No.	Color of Wire	Signal Name
4G	V	-
8G	P	-
11G	LG	-
15G	L	-
24G	P	-
25G	L	-
31G	V	-
32G	LG	-
51G	L	-
52G	P	-

Connector No.	E35
Connector Name	PARKING BRAKE SWITCH (WITH CVT)
Connector Color	BLACK



Terminal No.	Color of Wire	Signal Name
1	P	-

Connector No.	E201
Connector Name	IPDM E/R (INTELLIGENT POWER DISTRIBUTION MODULE ENGINE ROOM)
Connector Color	WHITE

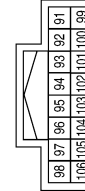

Terminal No.	Color of Wire	Signal Name
99	BR/W	AMB_SENS_GND-FEM
100	SB	AMB_SENS_SIG-FEM

Connector No.	E202
Connector Name	WIRE TO WIRE
Connector Color	WHITE

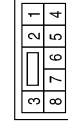

Terminal No.	Color of Wire	Signal Name
8	R	-

ABNIA0664GB

A
B
C
D
E
F
G
H
I
J
K
L
M
N
O
P

COMBINATION METER

< ECU DIAGNOSIS >

Connector No.	E230
Connector Name	GENERATOR
Connector Color	-



Terminal No.	Color of wire	Signal Name
5	B	-

Connector No.	E211
Connector Name	AMBIENT SENSOR
Connector Color	BLACK



Terminal No.	Color of wire	Signal Name
1	SB	AMB_SENS_SIG
2	BR/W	AMB_SENS_GND

Connector No.	E208
Connector Name	WASHER LEVEL SWITCH
Connector Color	WHITE



Terminal No.	Color of wire	Signal Name
1	R	WASHER
2	B	GND

Connector No.	F10
Connector Name	IPDM E/R (INTELLIGENT POWER DISTRIBUTION MODULE ENGINE ROOM)
Connector Color	WHITE



Terminal No.	Color of wire	Signal Name
75	P/L	OIL_PRESSURE_SW

Connector No.	F7
Connector Name	GENERATOR
Connector Color	BLACK



Terminal No.	Color of wire	Signal Name
2	BR	CHG

Connector No.	F1
Connector Name	WIRE TO WIRE
Connector Color	WHITE

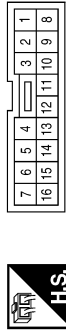

Terminal No.	Color of wire	Signal Name
1	L	-
8	P	-
12	BR	-

ABNIA0665GB

COMBINATION METER

< ECU DIAGNOSIS >

Connector No.	F16
Connector Name	TCM (TRANSMISSION CONTROL MODULE)
Connector Color	BLACK

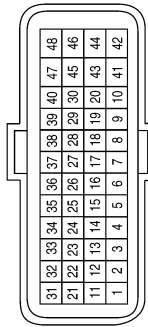

Terminal No.	Color of Wire	Signal Name
31	P	CAN-L
32	L	CAN-H

Connector No.	F41
Connector Name	OIL PRESSURE SWITCH
Connector Color	GRAY



Terminal No.	Color of Wire	Signal Name
1	P/L	-

Connector No.	B1
Connector Name	WIRE TO WIRE
Connector Color	WHITE

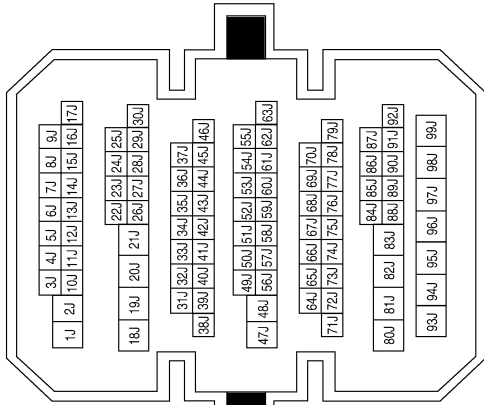

Terminal No.	Color of Wire	Signal Name
17J	SB	-
22J	R/B	-
24J	W/B	-
25J	Y/G	-
29J	G/B	-
30J	B/W	-

Connector No.	B3
Connector Name	JOINT CONNECTOR-B02
Connector Color	WHITE



Terminal No.	Color of Wire	Signal Name
1	W/B	-
2	W/B	-
3	W/B	-

ABNIA0678GB

A
B
C
D
E
F
G
H
I
J
K
L
M
MWI
O
P

COMBINATION METER

< ECU DIAGNOSIS >

Connector No.	B12
Connector Name	WIRE TO WIRE
Connector Color	WHITE

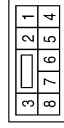

Terminal No.	Color of Wire	Signal Name
1	W/B	-
8	B/Y	-

Connector No.	B9
Connector Name	AIR BAG DIAGNOSIS SENSOR UNIT
Connector Color	YELLOW

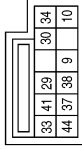

Terminal No.	Color of Wire	Signal Name
41	W/B	LH BUCKLE SW INPUT

Connector No.	B8
Connector Name	FRONT DOOR SWITCH LH
Connector Color	WHITE

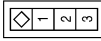

Terminal No.	Color of Wire	Signal Name
2	SB	DOOR SW (DR)

Connector No.	B42
Connector Name	FUEL LEVEL SENSOR UNIT AND FUEL PUMP
Connector Color	GRAY

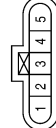

Terminal No.	Color of Wire	Signal Name
2	G/B	FUEL_GND
5	B/W	FUEL_SIGNAL

Connector No.	B28
Connector Name	TRUNK LAMP SWITCH AND TRUNK RELEASE SOLENOID
Connector Color	WHITE



Terminal No.	Color of Wire	Signal Name
1	Y/G	-
2	B	-

Connector No.	B18
Connector Name	REAR DOOR SWITCH LH
Connector Color	WHITE

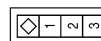

Terminal No.	Color of Wire	Signal Name
2	R/B	DOOR SW (RL)

ABNIA0666GB

COMBINATION METER

< ECU DIAGNOSIS >

Connector No.	B108
Connector Name	FRONT DOOR SWITCH RH
Connector Color	WHITE

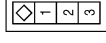

Terminal No.	Color of Wire	Signal Name
2	R/B	DOOR SW (AS)

Connector No.	B105
Connector Name	WIRE TO WIRE
Connector Color	WHITE

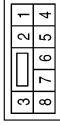

Terminal No.	Color of Wire	Signal Name
1	L	-
8	B	-

Connector No.	B104
Connector Name	WIRE TO WIRE
Connector Color	BROWN

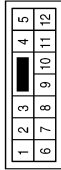

Terminal No.	Color of Wire	Signal Name
10	R/B	-
11	R/W	-

Connector No.	B201
Connector Name	WIRE TO WIRE
Connector Color	WHITE

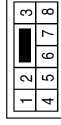

Terminal No.	Color of Wire	Signal Name
1	W/B	-
8	B/Y	-

Connector No.	B116
Connector Name	REAR DOOR SWITCH RH
Connector Color	WHITE

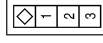

Terminal No.	Color of Wire	Signal Name
2	R/W	DOOR SW (RR)

Connector No.	B113
Connector Name	AIR BAG DIAGNOSIS SENSOR UNIT
Connector Color	YELLOW

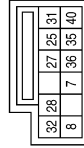

Terminal No.	Color of Wire	Signal Name
25	L	RH BUCKLE SW INPUT

A
B
C
D
E
F
G
H
I
J
K
L
M
MWI
O
P

ABNIA0679GB

COMBINATION METER

< ECU DIAGNOSIS >

Connector No.	B302
Connector Name	SEAT BELT BUCKLE SWITCH RH
Connector Color	WHITE

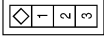
Terminal No.	Color of Wire	Signal Name
1	L	SIGNAL
2	B	GND

Connector No.	B301
Connector Name	WIRE TO WIRE
Connector Color	WHITE

Terminal No.	Color of Wire	Signal Name
1	L	-
8	B	-

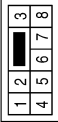
Connector No.	B202
Connector Name	SEAT BELT BUCKLE SWITCH LH
Connector Color	WHITE

Terminal No.	Color of Wire	Signal Name
1	W/B	SIGNAL
2	B/Y	GND

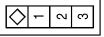
ABNIA0684GB

INFOID:000000004204119

Fail Safe

The combination meter performs a fail-safe operation for the functions listed below when communication is lost.

COMBINATION METER

< ECU DIAGNOSIS >

Function		Specifications	
Speedometer		Zero indication.	A
Tachometer			B
Fuel gauge			C
Engine coolant temperature gauge			D
Illumination control	Meter illumination	Change to nighttime mode when communication is lost.	E
Segment LCD	Odometer	Freeze current indication.	F
	CVT position	Display turns off.	G
Buzzer		Buzzer turns off.	H
Warning lamp/indicator lamp	ABS warning lamp	Lamp turns on when communication is lost.	I
	Brake warning lamp		J
	TCS/VDC OFF indicator lamp		K
	SLIP indicator lamp		L
	A/T CHECK warning lamp	Lamp turns off when communication is lost.	M
	Oil pressure warning lamp		N
	Malfunction indicator lamp		O
	Master warning lamp		P
	Air bag warning lamp		Q
	High beam indicator		R
	Turn signal indicator lamp		S
	Intelligent Key system warning lamp	Lamp turns off when disconnected.	T
	Driver and passenger seat belt warning lamp		U
	Charge warning lamp		V
Security indicator lamp	Lamp will flash every second for 1 minute and then stay on continuously thereafter.	W	
Low tire pressure warning lamp		X	

DTC Index

INFOID:000000004204120

CONSULT-III display	Malfunction	Reference page
CAN COMM CIRC [U1000]	Malfunction is detected in CAN communication. CAUTION: Even when there is no malfunction on CAN communication system, malfunction may be misinterpreted when battery has low voltage (when maintaining 7 - 8 V for about 2 seconds) or 10A fuse [No. 19, located in the fuse block (J/B)] is disconnected.	MWI-41
VEHICLE SPEED CIRC [B2205]	Malfunction is detected when an erroneous speed signal is input. CAUTION: Even when there is no malfunction on speed signal system, malfunction may be misinterpreted when battery has low voltage (when maintaining 7 - 8 V for about 2 seconds).	MWI-42

NOTE:

“TIME” indicates the following.

- 0: Indicates that a malfunction is detected at present.
- 1-63: Indicates that a malfunction was detected in the past. (Displays number of ignition switch OFF → ON cycles after malfunction is detected. Self-diagnosis result is erased when “63” is exceeded.)

BCM (BODY CONTROL MODULE)

< ECU DIAGNOSIS >

BCM (BODY CONTROL MODULE)

Reference Value

INFOID:000000004495952

VALUES ON THE DIAGNOSIS TOOL

Monitor Item	Condition	Value/Status
FR WIPER HI	Other than front wiper switch HI	OFF
	Front wiper switch HI	ON
FR WIPER LOW	Other than front wiper switch LO	OFF
	Front wiper switch LO	ON
FR WASHER SW	Front washer switch OFF	OFF
	Front washer switch ON	ON
FR WIPER INT	Other than front wiper switch INT	OFF
	Front wiper switch INT	ON
FR WIPER STOP	Front wiper is not in STOP position	OFF
	Front wiper is in STOP position	ON
INT VOLUME	Wiper intermittent dial is in a dial position 1 - 7	Wiper intermittent dial position
TURN SIGNAL R	Other than turn signal switch RH	OFF
	Turn signal switch RH	ON
TURN SIGNAL L	Other than turn signal switch LH	OFF
	Turn signal switch LH	ON
TAIL LAMP SW	Other than lighting switch 1ST and 2ND	OFF
	Lighting switch 1ST or 2ND	ON
HI BEAM SW	Other than lighting switch HI	OFF
	Lighting switch HI	ON
HEAD LAMP SW 1	Other than lighting switch 2ND	OFF
	Lighting switch 2ND	ON
HEAD LAMP SW 2	Other than lighting switch 2ND	OFF
	Lighting switch 2ND	ON
PASSING SW	Other than lighting switch PASS	OFF
	Lighting switch PASS	ON
AUTO LIGHT SW	Other than lighting switch AUTO	OFF
	Lighting switch AUTO	ON
FR FOG SW	Front fog lamp switch OFF	OFF
	Front fog lamp switch ON	ON
DOOR SW-DR	Driver door closed	OFF
	Driver door opened	ON
DOOR SW-AS	Passenger door closed	OFF
	Passenger door opened	ON
DOOR SW-RR	Rear door RH closed	OFF
	Rear door RH opened	ON
DOOR SW-RL	Rear door LH closed	OFF
	Rear door LH opened	ON
DOOR SW-BK	NOTE: This item is displayed, but cannot be monitored.	OFF

BCM (BODY CONTROL MODULE)

< ECU DIAGNOSIS >

Monitor Item	Condition	Value/Status	
CDL LOCK SW	Other than power door lock switch LOCK	OFF	A
	Power door lock switch LOCK	ON	
CDL UNLOCK SW	Other than power door lock switch UNLOCK	OFF	B
	Power door lock switch UNLOCK	ON	
KEY CYL LK-SW	Other than driver door key cylinder LOCK position	OFF	C
	Driver door key cylinder LOCK position	ON	
KEY CYL UN-SW	Other than driver door key cylinder UNLOCK position	OFF	D
	Driver door key cylinder UNLOCK position	ON	
KEY CYL SW-TR	NOTE: This item is displayed, but cannot be monitored.	OFF	
HAZARD SW	When hazard switch is not pressed	OFF	E
	When hazard switch is pressed	ON	
REAR DEF SW	When rear window defogger switch is pressed	ON	
TR CANCEL SW	Trunk lid opener cancel switch OFF	OFF	F
	Trunk lid opener cancel switch ON	ON	
TR/BD OPEN SW	Trunk lid opener switch OFF	OFF	G
	While the trunk lid opener switch is turned ON	ON	
TRNK/HAT MNTR	Trunk lid closed	OFF	H
	Trunk lid opened	ON	
RKE-LOCK	When LOCK button of Intelligent Key is not pressed	OFF	I
	When LOCK button of Intelligent Key is pressed	ON	
RKE-UNLOCK	When UNLOCK button of Intelligent Key is not pressed	OFF	J
	When UNLOCK button of Intelligent Key is pressed	ON	
RKE-TR/BD	When TRUNK OPEN button of Intelligent Key is not pressed	OFF	K
	When TRUNK OPEN button of Intelligent Key is pressed	ON	
RKE-PANIC	When PANIC button of Intelligent Key is not pressed	OFF	L
	When PANIC button of Intelligent Key is pressed	ON	
RKE-P/W OPEN	When UNLOCK button of Intelligent Key is not pressed and held	OFF	M
	When UNLOCK button of Intelligent Key is pressed and held	ON	
RKE-MODE CHG	When LOCK/UNLOCK button of Intelligent Key is not pressed and held simultaneously	OFF	
	When LOCK/UNLOCK button of Intelligent Key is pressed and held simultaneously	ON	
OPTICAL SENSOR	When outside of the vehicle is bright	Close to 5 V	MWI
	When outside of the vehicle is dark	Close to 0 V	
REQ SW-DR	When driver door request switch is not pressed	OFF	O
	When driver door request switch is pressed	ON	
REQ SW-AS	When passenger door request switch is not pressed	OFF	P
	When passenger door request switch is pressed	ON	
REQ SW-BD/TR	When trunk request switch is not pressed	OFF	
	When trunk request switch is pressed	ON	
PUSH SW	When engine switch (push switch) is not pressed	OFF	
	When engine switch (push switch) is pressed	ON	
IGN RLY2-F/B	Ignition switch OFF or ACC	OFF	
	Ignition switch ON	ON	

BCM (BODY CONTROL MODULE)

< ECU DIAGNOSIS >

Monitor Item	Condition	Value/Status
ACC RLY-F/B	Ignition switch OFF	OFF
	Ignition switch ACC or ON	ON
CLUTCH SW	When the clutch pedal is not depressed	OFF
	When the clutch pedal is depressed	ON
BRAKE SW 1	When the brake pedal is not depressed	ON
	When the brake pedal is depressed	OFF
DETE/CANCL SW	When selector lever is in P position	OFF
	When selector lever is in any position other than P	ON
SFT PN/N SW	When selector lever is in any position other than P or N	OFF
	When selector lever is in P or N position	ON
S/L-LOCK	Electronic steering column lock LOCK status	OFF
	Electronic steering column lock UNLOCK status	ON
S/L-UNLOCK	Electronic steering column lock UNLOCK status	OFF
	Electronic steering column lock LOCK status	ON
S/L RELAY-F/B	Ignition switch OFF or ACC	OFF
	Ignition switch ON	ON
UNLK SEN-DR	Driver door UNLOCK status	OFF
	Driver door LOCK status	ON
PUSH SW-IPDM	When engine switch (push switch) is not pressed	OFF
	When engine switch (push switch) is pressed	ON
IGN RLY1 F/B	Ignition switch OFF or ACC	OFF
	Ignition switch ON	ON
DETE SW -IPDM	When selector lever is in P position	OFF
	When selector lever is in any position other than P	ON
SFT PN -IPDM	When selector lever is in any position other than P or N	OFF
	When selector lever is in P or N position	ON
SFT P-MET	When selector lever is in any position other than P	OFF
	When selector lever is in P position	ON
SFT N-MET	When selector lever is in any position other than N	OFF
	When selector lever is in N position	ON
ENGINE STATE	Engine stopped	STOP
	While the engine stalls	STALL
	At engine cranking	CRANK
	Engine running	RUN
S/L LOCK-IPDM	Electronic steering column lock LOCK status	OFF
	Electronic steering column lock UNLOCK status	ON
S/L UNLCK-IPDM	Electronic steering column lock UNLOCK status	OFF
	Electronic steering column lock LOCK status	ON
S/L RELAY-REQ	Ignition switch OFF or ACC	OFF
	Ignition switch ON	ON
VEH SPEED 1	While driving	Equivalent to speedometer reading
VEH SPEED 2	While driving	Equivalent to speedometer reading

BCM (BODY CONTROL MODULE)

< ECU DIAGNOSIS >

Monitor Item	Condition	Value/Status	
DOOR STAT-DR	Driver door LOCK status	LOCK	A
	Wait with selective UNLOCK operation (5 seconds)	READY	
	Driver door UNLOCK status	UNLK	B
DOOR STAT-AS	Passenger door LOCK status	LOCK	
	Wait with selective UNLOCK operation (5 seconds)	READY	C
	Passenger door UNLOCK status	UNLK	
ID OK FLAG	Ignition switch ACC or ON	RESET	
	Ignition switch OFF	SET	D
PRMT ENG STAT	When the engine start is prohibited	RESET	
	When the engine start is permitted	SET	
PRMT RKE STAT	NOTE: This item is displayed, but cannot be monitored.	RESET	E
KEY SW -SLOT	When Intelligent Key is not inserted into key slot	OFF	
	When Intelligent Key is inserted into key slot	ON	F
RKE OPE COUN1	During the operation of Intelligent Key	Operation frequency of Intelligent Key	
RKE OPE COUN2	NOTE: This item is displayed, but cannot be monitored.	Operation frequency of Intelligent Key	G
CONFIRM ID ALL	The key ID that the key slot receives does not accord with any key ID registered to BCM.	YET	
	The key ID that the key slot receives accords with any key ID registered to BCM.	DONE	H
CONFIRM ID4	The key ID that the key slot receives does not accord with the fourth key ID registered to BCM.	YET	I
	The key ID that the key slot receives accords with the fourth key ID registered to BCM.	DONE	
CONFIRM ID3	The key ID that the key slot receives does not accord with the third key ID registered to BCM.	YET	J
	The key ID that the key slot receives accords with the third key ID registered to BCM.	DONE	K
CONFIRM ID2	The key ID that the key slot receives does not accord with the second key ID registered to BCM.	YET	
	The key ID that the key slot receives accords with the second key ID registered to BCM.	DONE	L
CONFIRM ID1	The key ID that the key slot receives does not accord with the first key ID registered to BCM.	YET	M
	The key ID that the key slot receives accords with the first key ID registered to BCM.	DONE	
TP 4	The ID of fourth key is not registered to BCM	YET	MWI
	The ID of fourth key is registered to BCM	DONE	
TP 3	The ID of third key is not registered to BCM	YET	O
	The ID of third key is registered to BCM	DONE	
TP 2	The ID of second key is not registered to BCM	YET	
	The ID of second key is registered to BCM	DONE	P
TP 1	The ID of first key is not registered to BCM	YET	
	The ID of first key is registered to BCM	DONE	
AIR PRESS FL	Ignition switch ON (only when the signal from the transmitter is received)	Air pressure of front LH tire	
AIR PRESS FR	Ignition switch ON (only when the signal from the transmitter is received)	Air pressure of front RH tire	

BCM (BODY CONTROL MODULE)

< ECU DIAGNOSIS >

Monitor Item	Condition	Value/Status
AIR PRESS RR	Ignition switch ON (only when the signal from the transmitter is received)	Air pressure of rear RH tire
AIR PRESS RL	Ignition switch ON (only when the signal from the transmitter is received)	Air pressure of rear LH tire
ID REGST FL1	When ID of front LH tire transmitter is registered	DONE
	When ID of front LH tire transmitter is not registered	YET
ID REGST FR1	When ID of front RH tire transmitter is registered	DONE
	When ID of front RH tire transmitter is not registered	YET
ID REGST RR1	When ID of rear RH tire transmitter is registered	DONE
	When ID of rear RH tire transmitter is not registered	YET
ID REGST RL1	When ID of rear LH tire transmitter is registered	DONE
	When ID of rear LH tire transmitter is not registered	YET
WARNING LAMP	Tire pressure indicator OFF	OFF
	Tire pressure indicator ON	ON
BUZZER	Tire pressure warning alarm is not sounding	OFF
	Tire pressure warning alarm is sounding	ON

BCM (BODY CONTROL MODULE)

< ECU DIAGNOSIS >

Terminal Layout

INFOID:000000004495953

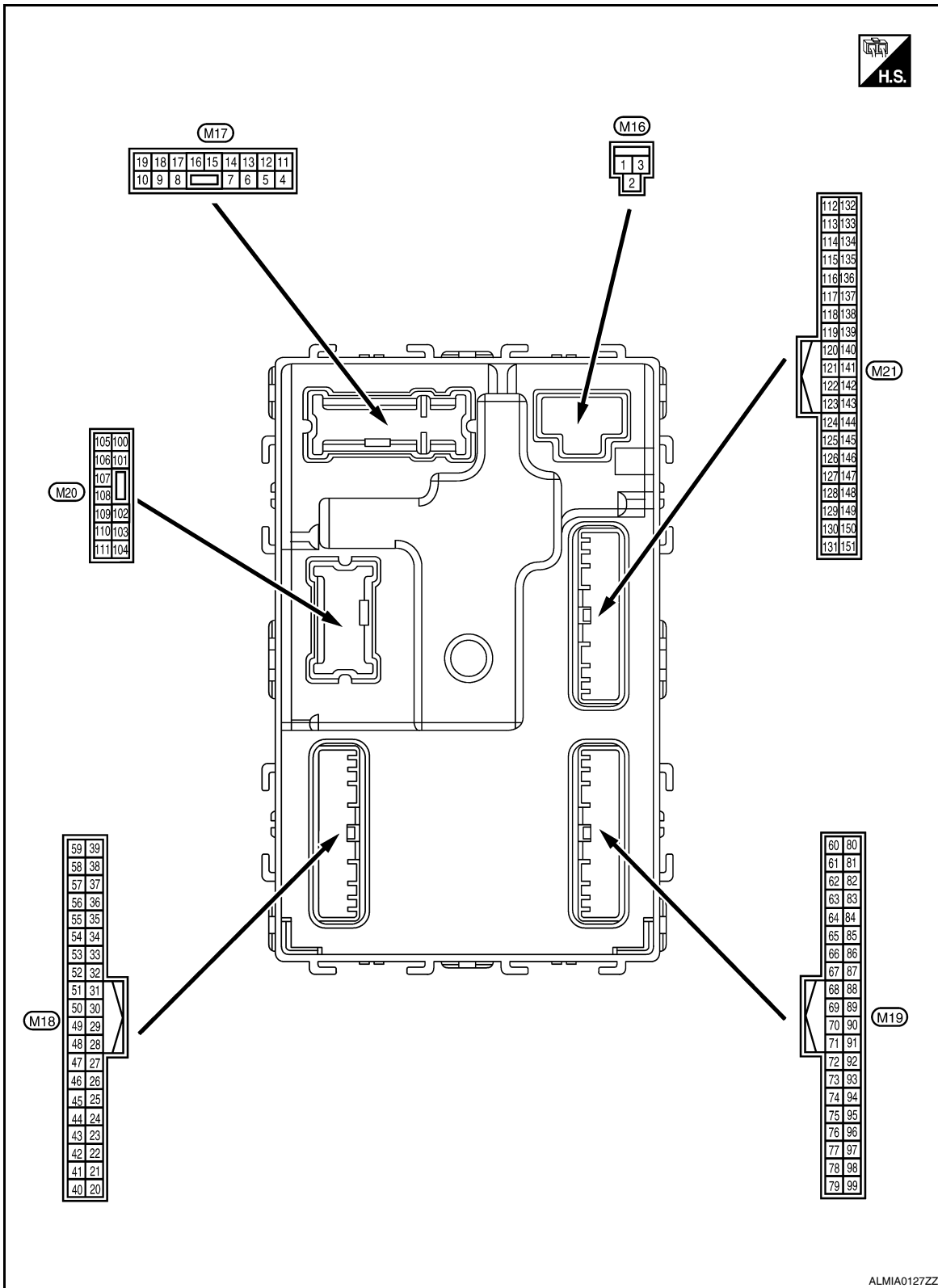

Physical Values

INFOID:000000004495954

A
B
C
D
E
F
G
H
I
J
K
L
M
N
O
P

MWI

BCM (BODY CONTROL MODULE)

< ECU DIAGNOSIS >

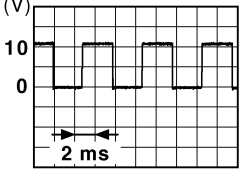
Terminal No. (Wire color)		Description		Condition		Value (Approx.)
		Signal name	Input/ Output			
(+)	(-)					
1 (W/B)	Ground	Battery power supply	Input	Ignition switch OFF		Battery voltage
2 (R/Y)	Ground	Battery power supply output	Output	Ignition switch OFF		Battery voltage
3 (L/W)	Ground	Ignition power supply output	Output	Ignition switch ON		Battery voltage
4 (P/W)	Ground	Interior room lamp power supply	Output	After passing the interior room lamp battery saver operation time		0V
				Any other time after passing the interior room lamp battery saver operation time		Battery voltage
5 (G/Y)	Ground	Front door RH UNLOCK	Output	Front door RH	UNLOCK (actuator is activated)	Battery voltage
					Other than UNLOCK (actuator is not activated)	0V
7 (R/W)	Ground	Step lamp	Output	Step lamp	ON	0V
					OFF	Battery voltage
8 (V)	Ground	All doors LOCK	Output	All doors	LOCK (actuator is activated)	Battery voltage
					Other than LOCK (actuator is not activated)	0V
9 (G)	Ground	Front door LH UNLOCK	Output	Front door LH	UNLOCK (actuator is activated)	Battery voltage
					Other than UNLOCK (actuator is not activated)	0V
10 ¹ (G/Y)	Ground	Rear door RH and rear door LH UNLOCK	Output	Rear door RH and rear door LH	UNLOCK (actuator is activated)	Battery voltage
					Other than UNLOCK (actuator is not activated)	0V
11 (Y/R)	Ground	Battery power supply	Input	Ignition switch OFF		Battery voltage
13 (B)	Ground	Ground	—	Ignition switch ON		0V
14 (R/Y)	Ground	Engine switch (push switch) illumination ground	Input	Tail lamp	OFF	0V
					ON	NOTE: When the illumination brightening/dimming level is in the neutral position 
15 (Y/L)	Ground	ACC indicator lamp	Output	Ignition switch	OFF	Battery voltage
					ACC or ON	0V

JSNIA0010GB

BCM (BODY CONTROL MODULE)

< ECU DIAGNOSIS >

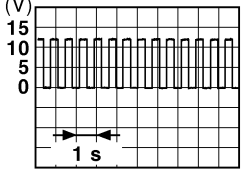
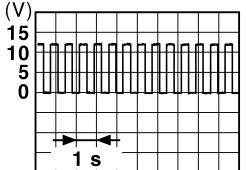
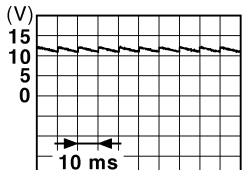
Terminal No. (Wire color)		Description		Condition	Value (Approx.)	
(+)	(-)	Signal name	Input/ Output			
17 (G/B)	Ground	Turn signal (RH)	Output	Turn signal switch OFF	0V	
				Turn signal switch ON	Turn signal switch RH	 6.5 V
18 (G/Y)	Ground	Turn signal (LH)	Output	Turn signal switch OFF	0V	
				Turn signal switch ON	Turn signal switch LH	 6.5 V
19 (Y)	Ground	Room lamp timer control	Output	Interior room lamp	OFF	Battery voltage
				ON	0V	
21 (P/B)	Ground	Optical sensor signal	Input	Ignition switch ON	When outside of the vehicle is bright	Close to 5V
				When outside of the vehicle is dark	Close to 0V	
22 (R/Y)	Ground	Clutch interlock switch	Input	Clutch interlock switch	OFF (clutch pedal is not depressed)	0V
				ON (clutch pedal is depressed)	Battery voltage	
24 (R/W)	Ground	Stop lamp switch 1	Input	—	Battery voltage	
26 (O/L)	Ground	Stop lamp switch 2	Input	Stop lamp switch	OFF (brake pedal is not depressed)	0V
				ON (brake pedal is depressed)	Battery voltage	
27 (G/W)	Ground	Front door lock assembly LH (unlock sensor)	Input	Front door LH	LOCK status	 11.8V
				UNLOCK status	0V	
29 (Y)	Ground	Key slot switch	Input	When Intelligent Key is inserted into key slot	Battery voltage	
				When Intelligent Key is not inserted into key slot	0V	
30 (V/Y)	Ground	ACC feedback signal	Input	Ignition switch	OFF	0
				ACC or ON	Battery voltage	

A
B
C
D
E
F
G
H
I
J
K
L
M
N
O
P

MWI

BCM (BODY CONTROL MODULE)

< ECU DIAGNOSIS >

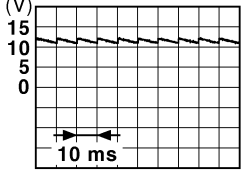
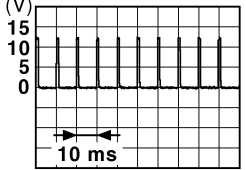
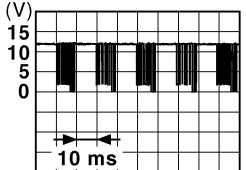
Terminal No. (Wire color)		Description		Condition		Value (Approx.)
(+)	(-)	Signal name	Input/ Output			
31 (G)	Ground	Rear window defogger feedback signal	Input	Rear window defogger switch	OFF	0V
					ON	Battery voltage
32 (R/B)	Ground	Front door RH switch	Input	Front door RH switch	OFF (when front door RH closes)	 11.8 V
					ON (when front door RH opens)	0V
33 (SB)	Ground	Compressor ON signal	Input	A/C switch	OFF	5V
					ON	0V
34 ² (L/R)	Ground	Front door lock assembly LH (key cylinder switch) (unlock)	Input	Front door lock assembly LH (key cylinder switch)	OFF (neutral)	5V
					ON (unlock)	0V
36 ² (GR)	Ground	Lock switch signal	Input	Door lock/unlock switch	Lock	Battery voltage
					Unlock	0V
37 (O)	Ground	Trunk lid opener cancel switch	Input	Trunk lid opener cancel switch	CANCEL	 1.1V
					ON	0V
38 (GR/W)	Ground	Rear window defogger ON signal	Input	Rear window defogger switch	OFF	5V
					ON	0V
39 ² (GR/R)	Ground	Unlock switch signal	Input	Door lock/unlock switch	Unlock	Battery voltage
					Lock	0V
40 ³ (Y/G)	Ground	Power window serial link	Input/ Output	Ignition switch ON	 10.2V	
				Ignition switch OFF or ACC	0V	
41 (W)	Ground	Engine switch (push switch) illumination	Output	Engine switch (push switch) illumination	ON	5.5V
					OFF	0V
42 (R)	Ground	LOCK indicator lamp	Output	LOCK indicator lamp	ON	0V
					OFF	Battery voltage

BCM (BODY CONTROL MODULE)

< ECU DIAGNOSIS >

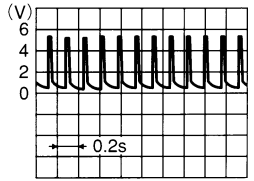
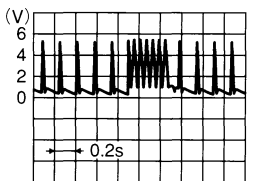
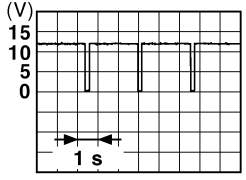
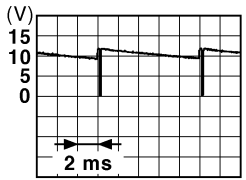
Terminal No. (Wire color)		Description		Condition	Value (Approx.)	
		Signal name	Input/ Output			
(+)	(-)					
45 (P)	Ground	Receiver & sensor ground	Input	Ignition switch ON	0V	
46 (V/W)	Ground	Receiver & sensor power supply output	Output	Ignition switch	OFF	0V
					ACC or ON	5.0V
47 (G/O)	Ground	Tire pressure receiver signal	Input/ Output	Ignition switch ON	Standby state	 <p style="text-align: right; font-size: small;">OCC3881D</p>
					When receiving the signal from the transmitter	 <p style="text-align: right; font-size: small;">OCC3880D</p>
48 (R/G)	Ground	Selector lever P/N position signal	Input	Selector lever	P or N position	12.0V
					Except P and N positions	0V
49 (L/O)	Ground	Security indicator signal	Output	Security indicator	Blinking	 <p style="text-align: right; font-size: small;">JPMIA0014GB</p> <p style="text-align: center;">11.3V</p>
					OFF	Battery voltage
50 (LG/B)	Ground	Combination switch OUTPUT 5	Output	Combination switch (Wiper intermittent dial 4)	All switch OFF	0V
					Lighting switch 1ST	 <p style="text-align: right; font-size: small;">JPMIA0031GB</p> <p style="text-align: center;">10.7V</p>
					Lighting switch high-beam	
					Lighting switch 2ND	
Turn signal switch RH						

A
B
C
D
E
F
G
H
I
J
K
L
M
O
P

MWI

BCM (BODY CONTROL MODULE)

< ECU DIAGNOSIS >

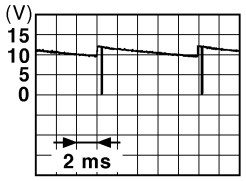
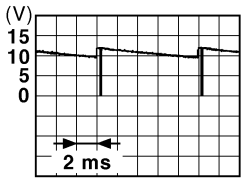
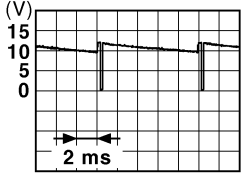
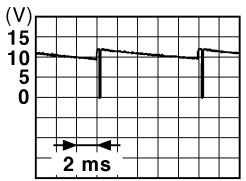
Terminal No. (Wire color)		Description		Condition	Value (Approx.)
(+)	(-)	Signal name	Input/ Output		
51 (L/W)	Ground	Combination switch OUTPUT 1	Output	Combination switch	0V
				All switch OFF (Wiper intermittent dial 4) Front wiper switch HI (Wiper intermittent dial 4) Any of the conditions below with all switch OFF <ul style="list-style-type: none"> • Wiper intermittent dial 1 • Wiper intermittent dial 2 • Wiper intermittent dial 3 • Wiper intermittent dial 6 • Wiper intermittent dial 7 	10.7V 
52 (G/B)	Ground	Combination switch OUTPUT 2	Output	Combination switch	0V
				All switch OFF (Wiper intermittent dial 4) Front washer switch ON (Wiper intermittent dial 4) Any of the conditions below with all switch OFF <ul style="list-style-type: none"> • Wiper intermittent dial 1 • Wiper intermittent dial 5 • Wiper intermittent dial 6 	10.7V 
53 (L/G/ R)	Ground	Combination switch OUTPUT 3	Output	Combination switch (Wiper intermit- tent dial 4)	0V
				All switch OFF Front wiper switch INT Front wiper switch LO Lighting switch AUTO	10.7V 
54 (G/Y)	Ground	Combination switch OUTPUT 4	Output	Combination switch (Wiper intermit- tent dial 4)	0V
				All switch OFF Front fog lamp switch ON Lighting switch 2ND Lighting switch flash-to- pass Turn signal switch LH	10.7V 
55 (BR/ W)	Ground	Front blower monitor	Input	Front blower mo- tor switch	ON Battery voltage OFF 0V
56 ² (L/B)	Ground	Front door lock as- sembly LH (key cylin- der switch) (lock)	Input	Front door lock assembly LH (key cylinder switch)	OFF (neutral) 5V ON (lock) 0V
57 (W)	Ground	Tire pressure warn- ing check switch	Input	—	5V

BCM (BODY CONTROL MODULE)

< ECU DIAGNOSIS >

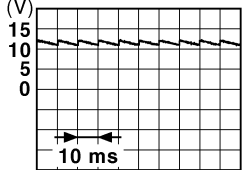
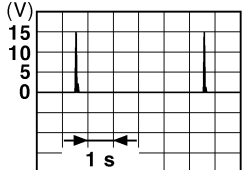
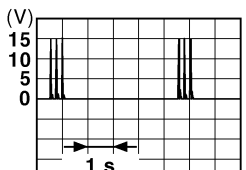
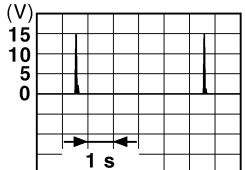
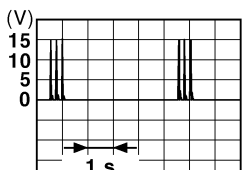
Terminal No. (Wire color)		Description		Condition	Value (Approx.)	
		Signal name	Input/ Output			
(+)	(-)					
58 (SB)	Ground	Front door LH switch	Input	Front door LH switch	OFF (front door LH CLOSE) ON (front door LH OPEN)	 <p style="text-align: right; margin-right: 50px;">JPMIA0011GB</p> <p style="text-align: center;">11.8V</p>
59 (G/R)	Ground	Rear window defogger relay	Output	Rear window defogger	Active	Battery voltage
					Not activated	0V
60 (B/R)	Ground	Front console antenna 2 (-)	Output	Ignition switch OFF	When Intelligent Key is in the passenger compartment	 <p style="text-align: right; margin-right: 50px;">JMKIA0062GB</p>
					When Intelligent Key is not in the passenger compartment	 <p style="text-align: right; margin-right: 50px;">JMKIA0063GB</p>
61 (W/R)	Ground	Center console antenna 2 (+)	Output	Ignition switch OFF	When Intelligent Key is in the passenger compartment	 <p style="text-align: right; margin-right: 50px;">JMKIA0062GB</p>
					When Intelligent Key is not in the passenger compartment	 <p style="text-align: right; margin-right: 50px;">JMKIA0063GB</p>

A
B
C
D
E
F
G
H
I
J
K
L
M
N
O
P

MWI

BCM (BODY CONTROL MODULE)

< ECU DIAGNOSIS >

Terminal No. (Wire color)		Description		Condition	Value (Approx.)
(+)	(-)	Signal name	Input/ Output		
62 ⁴ (B/Y)	Ground	Front outside handle RH antenna (-)	Output	When the front door RH request switch is operated with ignition switch OFF	<p style="text-align: right; font-size: small;">JMKIA0062GB</p>
				When Intelligent Key is not in the antenna detection area	<p style="text-align: right; font-size: small;">JMKIA0063GB</p>
63 ⁴ (LG)	Ground	Front outside handle RH antenna (+)	Output	When the front door RH request switch is operated with ignition switch OFF	<p style="text-align: right; font-size: small;">JMKIA0062GB</p>
				When Intelligent Key is not in the antenna detection area	<p style="text-align: right; font-size: small;">JMKIA0063GB</p>
64 ⁴ (V)	Ground	Front outside handle LH antenna (-)	Output	When the front door LH request switch is operated with ignition switch OFF	<p style="text-align: right; font-size: small;">JMKIA0062GB</p>
				When Intelligent Key is not in the antenna detection area	<p style="text-align: right; font-size: small;">JMKIA0063GB</p>

BCM (BODY CONTROL MODULE)

< ECU DIAGNOSIS >





Terminal No. (Wire color)		Description		Condition	Value (Approx.)
(+)	(-)	Signal name	Input/ Output		
65 ⁴ (P)	Ground	Front outside handle LH antenna (+)	Output	When the front door LH request switch is operat- ed with ignition switch OFF	<p>JMKIA0062GB</p>
				When Intelligent Key is not in the antenna detection area	<p>JMKIA0063GB</p>
66 (R)	Ground	Instrument panel an- tenna (-)	Output	Ignition switch OFF	<p>JMKIA0062GB</p>
				When Intelligent Key is not in the passenger compart- ment	<p>JMKIA0063GB</p>
67 (G)	Ground	Instrument panel an- tenna (+)	Output	Ignition switch OFF	<p>JMKIA0062GB</p>
				When Intelligent Key is not in the passenger compart- ment	<p>JMKIA0063GB</p>

A
B
C
D
E
F
G
H
I
J
K
L
M
O
P



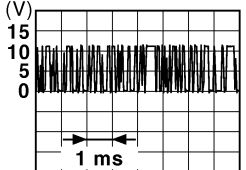
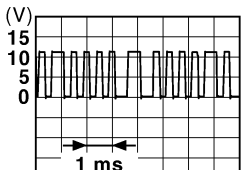

BCM (BODY CONTROL MODULE)

< ECU DIAGNOSIS >

Terminal No. (Wire color)		Description		Condition		Value (Approx.)
		Signal name	Input/ Output			
(+)	(-)					
68 (G/O)	Ground	NATS antenna amp (built in key slot)	Input/ Output	During waiting	Ignition switch is pressed while inserting the Intelli- gent Key into the key slot.	Just after pressing ignition switch. Pointer of tester should move.
69 (O)	Ground	NATS antenna amp (built in key slot)	Input/ Output	During waiting	Ignition switch is pressed while inserting the Intelli- gent Key into the key slot.	Just after pressing ignition switch. Pointer of tester should move.
70 (R/B)	Ground	Ignition relay-2 con- trol	Output	Ignition switch	OFF or ACC	0V
					ON	Battery voltage
71 (L/O)	Ground	Remote keyless entry receiver signal	Input/ Output	During waiting		 <p style="text-align: right; font-size: small;">JMKIA0064GB</p>
				When operating either button on Intelligent Key		 <p style="text-align: right; font-size: small;">JMKIA0065GB</p>
75 (R/Y)	Ground	Combination switch INPUT 5	Input	Combination switch	All switch OFF (Wiper intermittent dial 4)	 <p style="text-align: right; font-size: small;">JPMIA0041GB</p> <p style="text-align: center;">1.4V</p>
					Front fog lamp switch ON (Wiper intermittent dial 4)	 <p style="text-align: right; font-size: small;">JPMIA0037GB</p> <p style="text-align: center;">1.3V</p>
					Any of the conditions below with all switch OFF • Wiper intermittent dial 1 • Wiper intermittent dial 2 • Wiper intermittent dial 6 • Wiper intermittent dial 7	 <p style="text-align: right; font-size: small;">JPMIA0040GB</p> <p style="text-align: center;">1.3V</p>

BCM (BODY CONTROL MODULE)

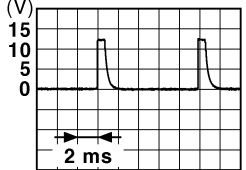
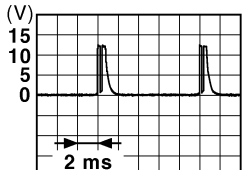
< ECU DIAGNOSIS >

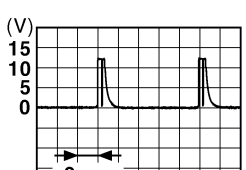
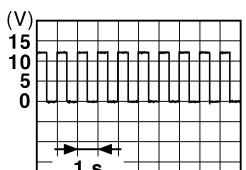
Terminal No. (Wire color)		Description		Condition	Value (Approx.)	
		Signal name	Input/ Output			
(+)	(-)					
76 (R/G)	Ground	Combination switch INPUT 3	Input	Combination switch	All switch OFF (Wiper intermittent dial 4)	 <small>JPMIA0041GB</small> 1.4V
					Lighting switch high-beam (Wiper intermittent dial 4)	 <small>JPMIA0036GB</small> 1.3V
					Lighting switch 2ND (Wiper intermittent dial 4)	 <small>JPMIA0037GB</small> 1.3V
					Any of the conditions below with all switch OFF • Wiper intermittent dial 1 • Wiper intermittent dial 2 • Wiper intermittent dial 3	 <small>JPMIA0040GB</small> 1.3V
77 (BR)	Ground	Engine switch (push switch)	Input	Engine switch (push switch)	Pressed	0V
					Not pressed	Battery voltage
78 (P)	Ground	CAN-L	Input/ Output	—	—	
79 (L)	Ground	CAN-H	Input/ Output	—	—	
80 (R/L)	Ground	Key slot illumination	Output	Key slot illumina- tion	OFF	0V
					Blinking	 <small>JPMIA0015GB</small> 6.5V
					ON	Battery voltage

A
B
C
D
E
F
G
H
I
J
K
L
M
MWI
O
P

MWI



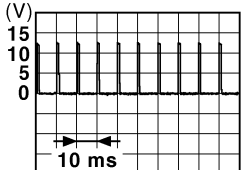
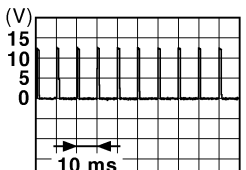

BCM (BODY CONTROL MODULE)

< ECU DIAGNOSIS >

Terminal No. (Wire color)		Description		Condition		Value (Approx.)
(+)	(-)	Signal name	Input/ Output			
81 (LG)	Ground	ON indicator lamp	Output	Ignition switch	OFF or ACC	0V
					ON	Battery voltage
83 (L)	Ground	ACC relay control	Output	Ignition switch	OFF	0V
					ACC or ON	Battery voltage
84 (Y/R)	Ground	CVT device	Output	—		Battery voltage
85 (L/O)	Ground	Electronic steering column lock condition No. 1	Input	Electronic steer- ing column lock	Lock status	0V
					Unlock status	Battery voltage
86 (G/R)	Ground	Electronic steering column lock condition No. 2	Input	Electronic steer- ing column lock	Lock status	Battery voltage
					Unlock status	0V
87 (G/B)	Ground	Selector lever P posi- tion switch	Input	Selector lever	P position	0V
					Any position other than P	Battery voltage
88 ⁴ (P/L)	Ground	Front door RH re- quest switch	Input	Front door RH re- quest switch	ON (pressed)	0V
					OFF (not pressed)	 <p style="text-align: right;">1.0V</p>
89 ⁴ (B/W)	Ground	Front door LH re- quest switch	Input	Front door LH re- quest switch	ON (pressed)	0V
					OFF (not pressed)	 <p style="text-align: right;">1.0V</p>
90 (Y)	Ground	Blower fan motor re- lay control	Output	Ignition switch	OFF or ACC	0V
					ON	Battery voltage
91 (L/R)	Ground	Remote keyless entry receiver power sup- ply	Output	Ignition switch OFF		Battery voltage
94 (G/Y)	Ground	Steering wheel lock unit power supply	Output	Ignition switch	OFF or ACC	Battery voltage
					ON	0V

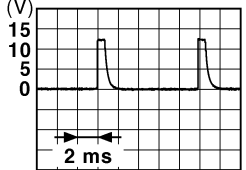
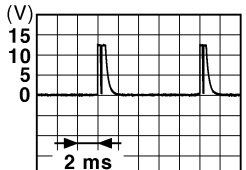
BCM (BODY CONTROL MODULE)

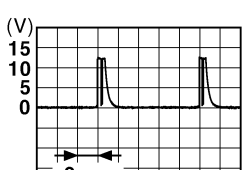
< ECU DIAGNOSIS >

Terminal No. (Wire color)		Description		Condition	Value (Approx.)
(+)	(-)	Signal name	Input/ Output		
95 (R/W)	Ground	Combination switch INPUT 1	Input	Combination switch (Wiper intermittent dial 4)	All switch OFF  1.4V
					Turn signal switch LH  1.3V
					Turn signal switch RH  1.3V
					Front wiper switch LO  1.3V
					Front washer switch ON  1.3V

A
B
C
D
E
F
G
H
I
J
K
L
M
O
P

MWI



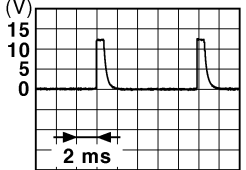
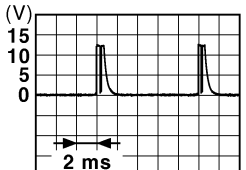
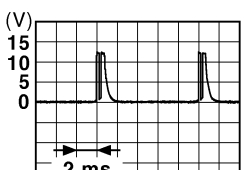
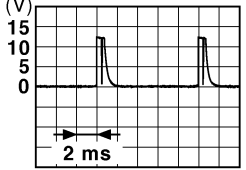

BCM (BODY CONTROL MODULE)

< ECU DIAGNOSIS >

Terminal No. (Wire color)		Description		Condition	Value (Approx.)
(+)	(-)	Signal name	Input/ Output		
96 (P/B)	Ground	Combination switch INPUT 4	Input	Combination switch	All switch OFF (Wiper intermittent dial 4)  <p style="text-align: right; font-size: small;">JPMIA0041GB</p> <p style="text-align: center;">1.4V</p>
					Lighting switch AUTO (Wiper intermittent dial 4)  <p style="text-align: right; font-size: small;">JPMIA0038GB</p> <p style="text-align: center;">1.3V</p>
					Lighting switch 1ST (Wiper intermittent dial 4)  <p style="text-align: right; font-size: small;">JPMIA0036GB</p> <p style="text-align: center;">1.3V</p>
					Any of the conditions below with all switch OFF <ul style="list-style-type: none"> • Wiper intermittent dial 1 • Wiper intermittent dial 5 • Wiper intermittent dial 6  <p style="text-align: right; font-size: small;">JPMIA0039GB</p> <p style="text-align: center;">1.3V</p>

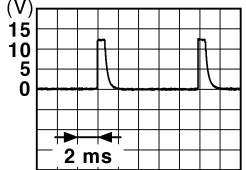
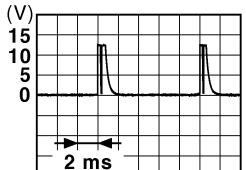
BCM (BODY CONTROL MODULE)

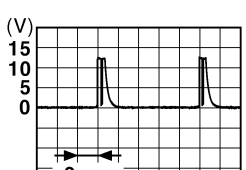
< ECU DIAGNOSIS >

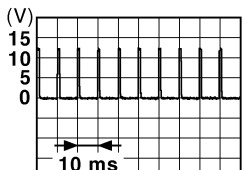
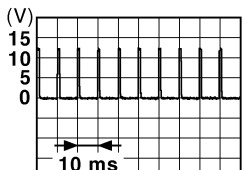
Terminal No. (Wire color)		Description		Condition	Value (Approx.)		
(+)	(-)	Signal name	Input/ Output				
97 (R/B)	Ground	Combination switch INPUT 2	Input	Combination switch (Wiper intermittent dial 4)	All switch OFF	 <p style="text-align: right;">1.4V</p>	
					Lighting switch flash-to-pass	 <p style="text-align: right;">1.3V</p>	
					Lighting switch 2ND	 <p style="text-align: right;">1.3V</p>	
					Front wiper switch INT	 <p style="text-align: right;">1.3V</p>	
					Front wiper switch HI	 <p style="text-align: right;">1.3V</p>	
					Pressed	0 V	
98 (G/O)	Ground	Hazard switch	Input	Hazard switch	<td>Not pressed</td> <td>  <p style="text-align: right;">1.1V</p> </td>	Not pressed	 <p style="text-align: right;">1.1V</p>

A
B
C
D
E
F
G
H
I
J
K
L
M
O
P

MWI

BCM (BODY CONTROL MODULE)

< ECU DIAGNOSIS >

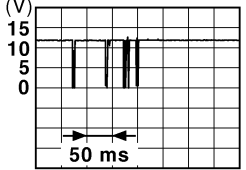
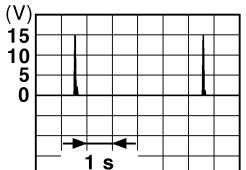
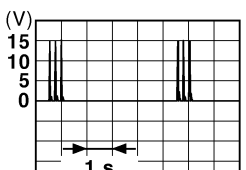
Terminal No. (Wire color)		Description		Condition	Value (Approx.)	
(+)	(-)	Signal name	Input/ Output			
99 (L/Y)	Ground	Electronic steering column lock unit com- munication	Input/ Output	Electronic steer- ing column lock	LOCK status	Battery voltage
					LOCK or UNLOCK	 <p style="text-align: right; font-size: small;">JMKIA0066GB</p>
					For 15 seconds after UN- LOCK	Battery voltage
				15 seconds or later after UNLOCK	0V	
103 (V)	Ground	Trunk lid opening	Output	Trunk lid	Open (trunk lid opener ac- tuator is activated)	Battery voltage
					Close (trunk lid opener ac- tuator is not activated)	0V
110 (V/W)	Ground	Trunk room lamp	Output	Trunk room lamp	ON	0V
					OFF	Battery voltage
114 (B)	Ground	Rear parcel shelf an- tenna 1 (-)	Output	Ignition switch OFF	When Intelligent Key is in the passenger compart- ment	 <p style="text-align: right; font-size: small;">JMKIA0062GB</p>
					When Intelligent Key is not in the passenger compart- ment	 <p style="text-align: right; font-size: small;">JMKIA0063GB</p>

BCM (BODY CONTROL MODULE)

< ECU DIAGNOSIS >

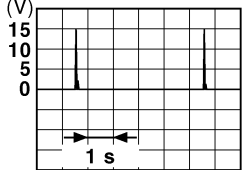
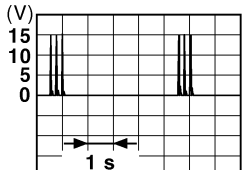
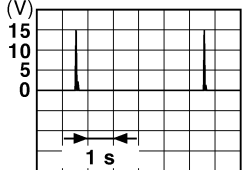
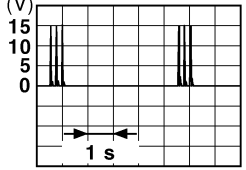
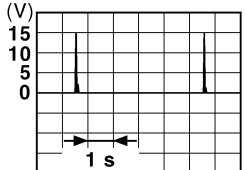
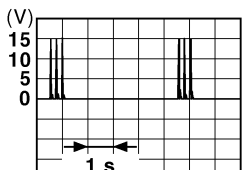
Terminal No. (Wire color)		Description		Condition	Value (Approx.)
(+)	(-)	Signal name	Input/ Output		
115 (W)	Ground	Rear parcel shelf antenna 1 (+)	Output	Ignition switch OFF	 <p style="text-align: right; font-size: small;">JMKIA0062GB</p>
				When Intelligent Key is not in the passenger compartment	 <p style="text-align: right; font-size: small;">JMKIA0063GB</p>
118 ⁴ (L/O)	Ground	Rear bumper antenna (-)	Output	When the trunk lid request switch is operated with ignition switch OFF	 <p style="text-align: right; font-size: small;">JMKIA0062GB</p>
				When Intelligent Key is not in the antenna detection area	 <p style="text-align: right; font-size: small;">JMKIA0063GB</p>
119 ⁴ (BR/W)	Ground	Rear bumper antenna (+)	Output	When the trunk lid request switch is operated with ignition switch OFF	 <p style="text-align: right; font-size: small;">JMKIA0062GB</p>
				When Intelligent Key is not in the antenna detection area	 <p style="text-align: right; font-size: small;">JMKIA0063GB</p>

A
B
C
D
E
F
G
H
I
J
K
L
M
O
P

MWI

BCM (BODY CONTROL MODULE)

< ECU DIAGNOSIS >

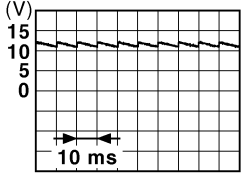
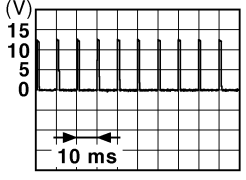
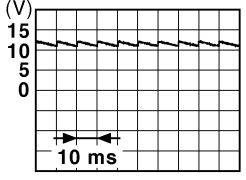
Terminal No. (Wire color)		Description		Condition		Value (Approx.)
(+)	(-)	Signal name	Input/ Output			
127 (BR/ W)	Ground	Ignition relay (IPDM E/R) control	Output	Ignition switch	OFF or ACC	Battery voltage
					ON	0V
130 (Y/G)	Ground	Trunk room lamp switch	Input	Trunk room lamp switch	OFF (trunk is closed)	 <p style="text-align: right; margin-right: 50px;">11.8V</p>
					ON (trunk is open)	0V
132 (R)	Ground	Starter motor relay control	Output	Ignition switch OFF (M/T vehi- cle)	When the clutch pedal is depressed	Battery voltage
					When the clutch pedal is not depressed	0V
				Ignition switch ON (other than M/ T vehicle)	When selector lever is in P or N position and the brake is depressed	Battery voltage
					When selector lever is in P or N position and the brake is not depressed	0V
141 (G/R)	Ground	Trunk request switch	Input	Trunk request switch	ON (pressed)	0V
					OFF (not pressed)	 <p style="text-align: right; margin-right: 50px;">1.0V</p>
144 ⁴ (GR)	Ground	Intelligent Key warn- ing buzzer	Output	Request switch buzzer	Sounding	0V
					Not sounding	Battery voltage
144 ⁵ (GR)	Ground	Outside warning buzzer	Output	Outside warning buzzer	Sounding	0V
					Not sounding	Battery voltage
147 (L/R)	Ground	Trunk lid opener switch	Input	Trunk lid opener switch	Pressed	0V
					Not pressed	Battery voltage
148 ¹ (R/W)	Ground	Rear door RH switch	Input	Rear door RH switch	OFF (when rear door RH closes)	 <p style="text-align: right; margin-right: 50px;">11.8V</p>
					ON (when rear door RH opens)	0V

BCM (BODY CONTROL MODULE)

< ECU DIAGNOSIS >

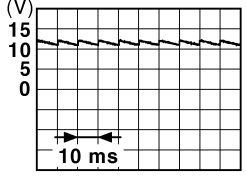
Terminal No. (Wire color)		Description		Condition	Value (Approx.)
(+)	(-)	Signal name	Input/ Output		
149 ¹ (R/B)	Ground	Rear door LH switch	Input	Rear door LH switch	 11.8V JPMIA0011GB
				OFF (when rear door LH closes)	ON (when rear door LH opens)

1: Sedan only

2: With LH front window anti-pinch

3: With LH and RH front window anti-pinch

4: With Intelligent Key

5: Without Intelligent Key

A
B
C
D
E
F
G
H
I
J
K
L
M
O
P

MWI

BCM (BODY CONTROL MODULE)

< ECU DIAGNOSIS >

Wiring Diagram-Coupe

INFOID:000000004495955

BCM (BODY CONTROL MODULE)

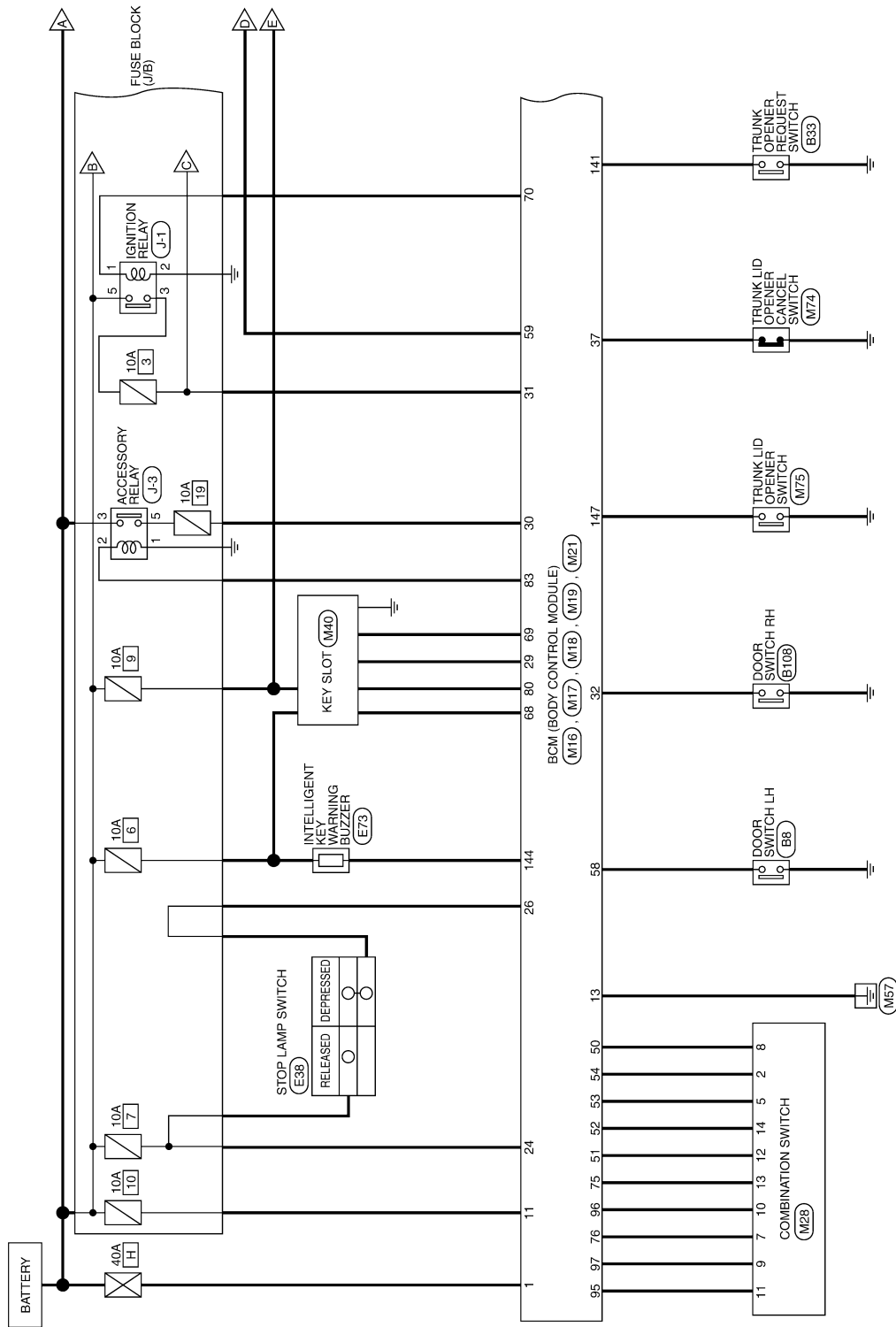

ABMWA0165GI

BCM (BODY CONTROL MODULE)

< ECU DIAGNOSIS >

— : DATA LINE

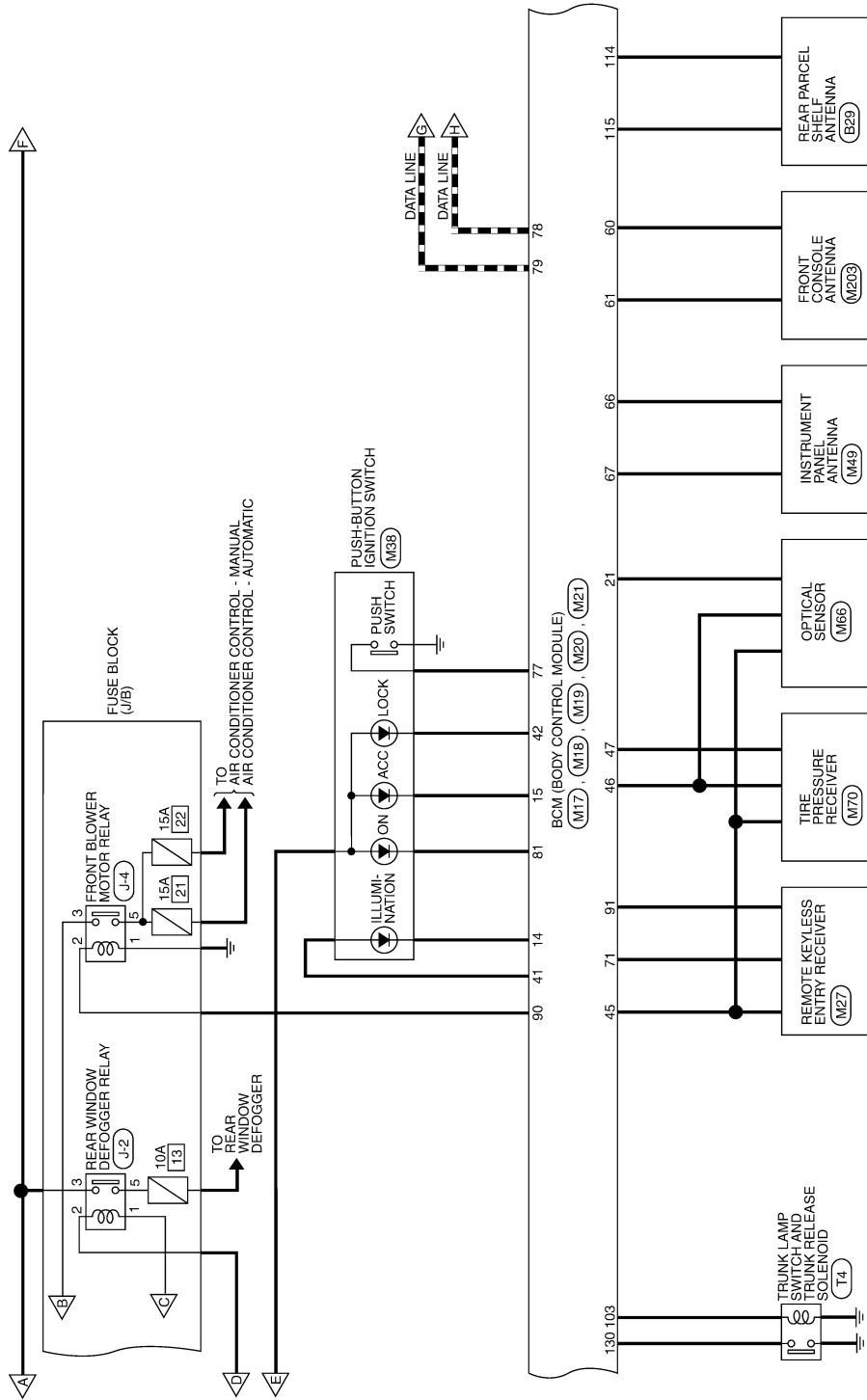

A
B
C
D
E
F
G
H
I
J
K
L
M
N
O
P

MWI

ABMWA0166GI

BCM (BODY CONTROL MODULE)

< ECU DIAGNOSIS >

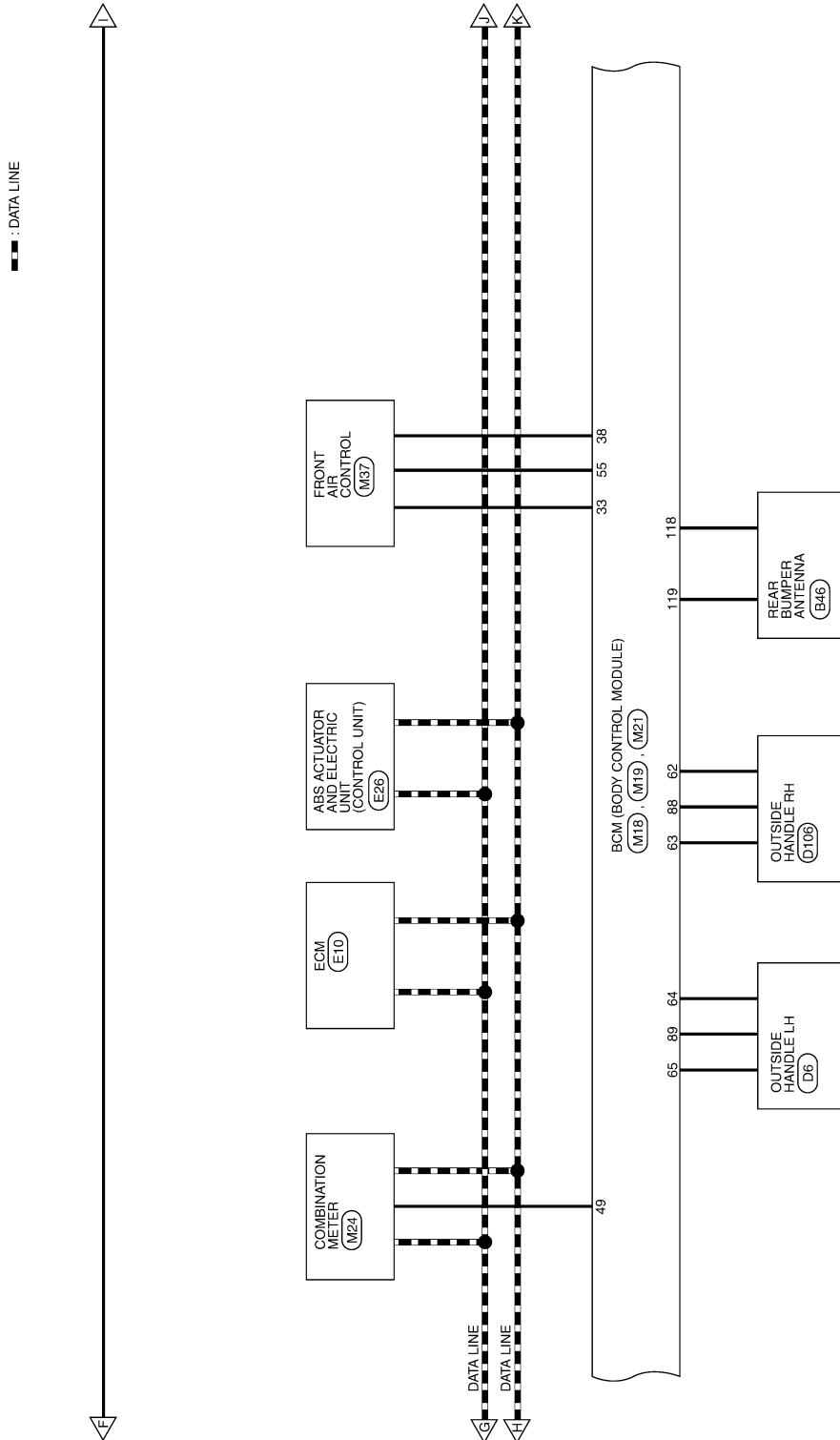

AAMWA0057GI

BCM (BODY CONTROL MODULE)

< ECU DIAGNOSIS >

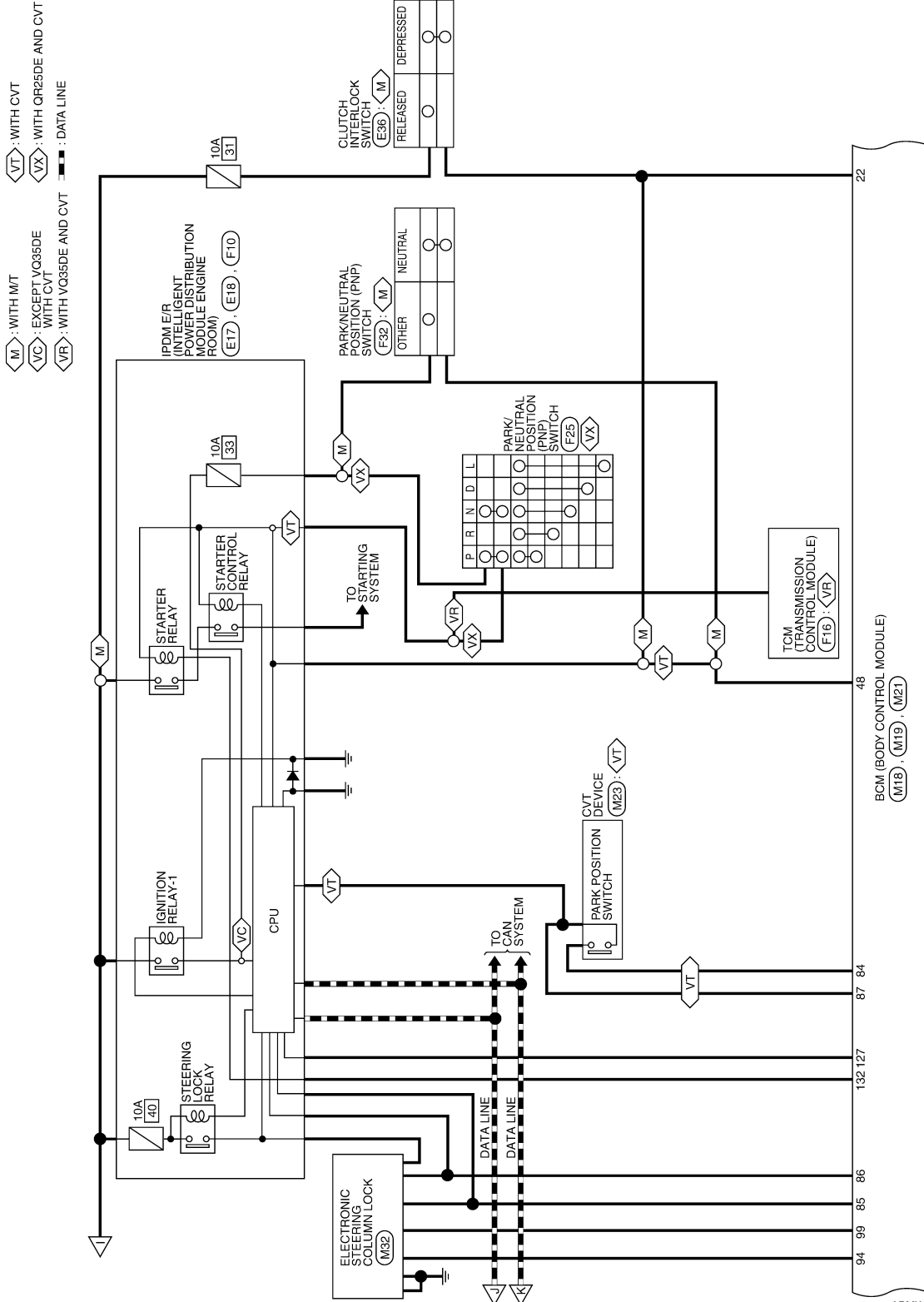

ABMWA0156GI

A
B
C
D
E
F
G
H
I
J
K
L
M
N
O
P

MWI

BCM (BODY CONTROL MODULE)

< ECU DIAGNOSIS >

<A6> : WITH LEFT POWER WINDOW ANTI-PINCH SYSTEM
 <A7> : WITH LEFT AND RIGHT POWER WINDOW ANTI-PINCH SYSTEM

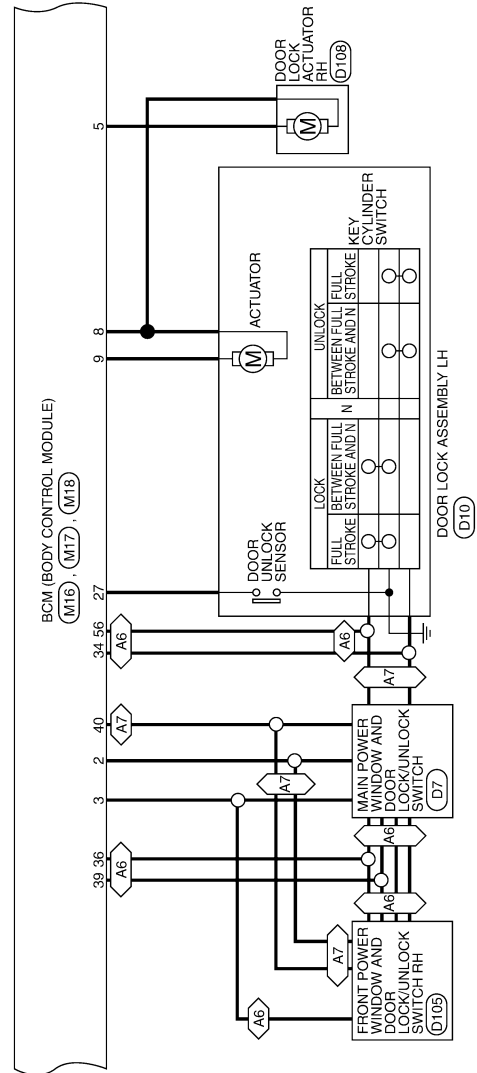

ABMWA0157GI

BCM (BODY CONTROL MODULE)

< ECU DIAGNOSIS >

○F : WITHOUT SUNROOF
 ○SL : WITH SUNROOF
 ○VN : WITH VANITY LAMPS

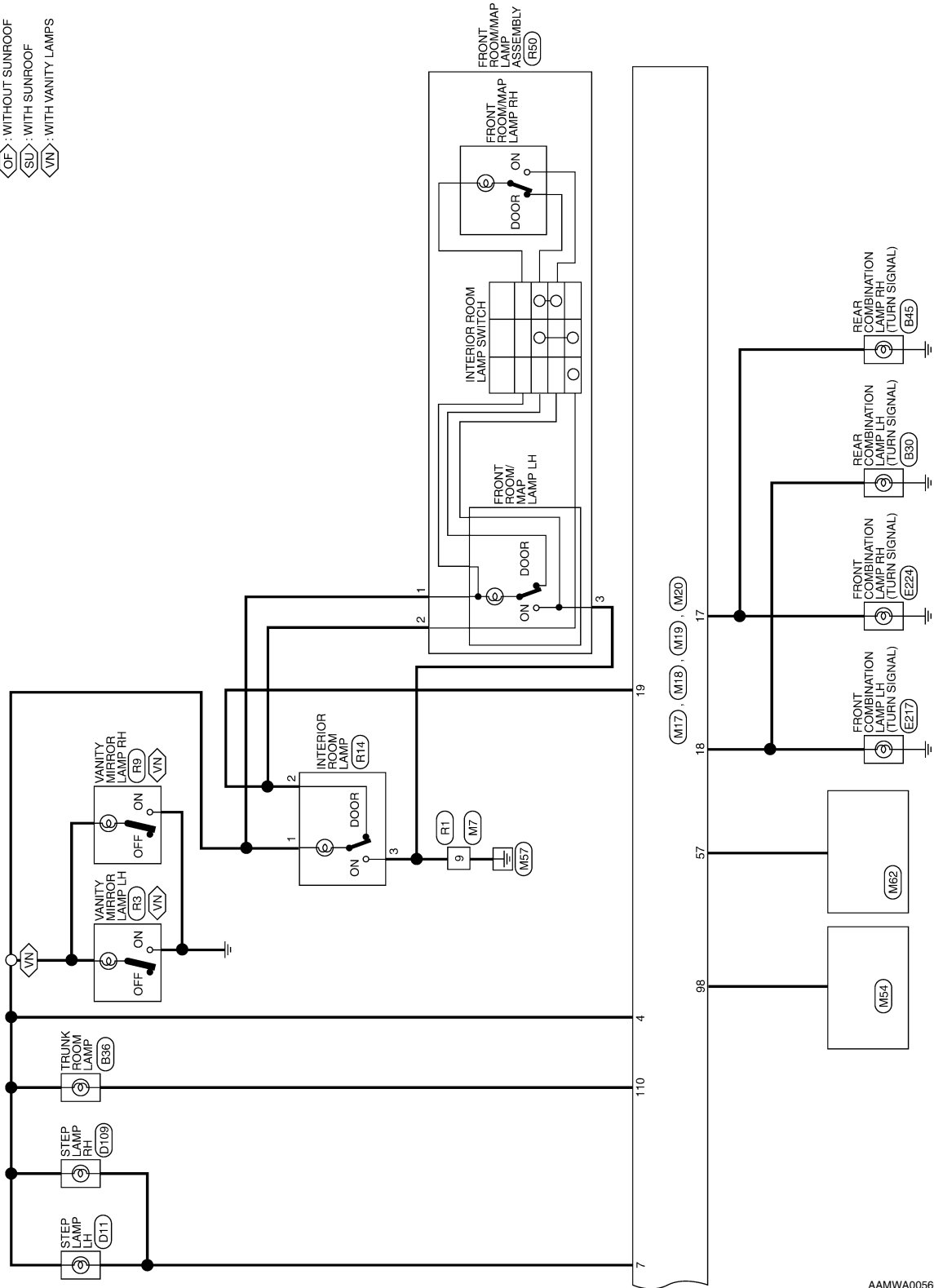

A
B
C
D
E
F
G
H
I
J
K
L
M
N
O
P

MWI

AAMWA0056GI

BCM (BODY CONTROL MODULE)

< ECU DIAGNOSIS >

BCM (BODY CONTROL MODULE) CONNECTORS

Connector No.	M16
Connector Name	BCM (BODY CONTROL MODULE)
Connector Color	BLACK



Terminal No.	Color of Wire	Signal Name
1	W/B	AT_POWER_F/L
2	R/Y	P/W_POWER_SUPPL_Y_PERM
3	L/W	POWER_WINDOW_POWER_SUPPLY (RAP)

Connector No.	M17
Connector Name	BCM (BODY CONTROL MODULE)
Connector Color	WHITE

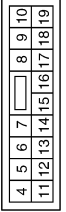

Terminal No.	Color of Wire	Signal Name
4	P/W	ROOM_LAMP_BAT_SAVER
5	G/Y	CDL_AS
6	-	-
7	R/W	STEP_LAMP_OUTPUT
8	V	CDL_COMMON

Terminal No.	Color of Wire	Signal Name
9	G	CDL_DR/FL
10	G/Y	CDL_RR_RL_BACK
11	Y/R	BAT_BCM_FUSE
12	-	-
13	B	GND1
14	R/Y	LOW_SIDE_PUSH_LED_OUTPUT
15	Y/L	ACC_LED
16	-	-
17	G/B	FR_FLASHER
18	G/Y	FL_FLASHER
19	Y	ROOM_LAMP_OUTPUT

Connector No.	M18
Connector Name	BCM (BODY CONTROL MODULE)
Connector Color	GREEN

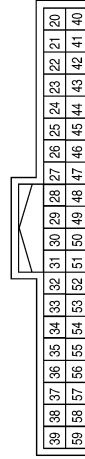

Terminal No.	Color of Wire	Signal Name
20	-	-
21	P/B	AUTO_LIGHT_SENSEN_R_INPUT1
22	R/Y	CLUTCH_SW
23	-	-
24	R/W	STOP_LAMP_LOW_SW
25	-	-
26	O/L	STOP_LAMP_HIGH_SW
27	G/W	DOOR_LOCK_STATUS
28	-	-

Terminal No.	Color of Wire	Signal Name
29	Y	FOB_IN_SW_1
30	V/Y	ACC_F/B
31	G	IGN_F/B
32	R/B	AS_DOOR_SW
33	SB	AIRCON_SW
34	L/R	DOOR_KEY/C_UNLOCK_SW
35	-	-
36	GR	CENTRAL_UNLOCK_SW
37	O	TRUNK_CANCEL_SW
38	GR/W	REAR_DEFOGGER_SW
39	GR/R	CENTRAL_UNLOCK_SW
40	Y/G	PW_K-LINE
41	W	PUSH_LED
42	R	S/L_LOCK_LED
43	-	-
44	-	-
45	P	GND_RF2_A/L

Terminal No.	Color of Wire	Signal Name
46	V/W	A/L_SENS_KEYLESS_TUNER_POWER_SUPPLY
47	G/O	KEYLESS_TUNER_SI
48	R/G	SHIFT_N/P
49	L/O	IMMO_LED
50	LG/B	INPUT_5
51	L/W	INPUT_1
52	G/B	INPUT_2
53	LG/R	INPUT_3
54	G/Y	INPUT_4
55	BR/W	BLOWER_FAN_SW
56	L/B	DOOR_KEY/C_LOCK_SW
57	W	TPMS_MODE_TRIGGER_SW
58	SB	DR_DOOR_SW
59	G/R	REAR_DEFOGGER_RLY

ABMIA0468GB

BCM (BODY CONTROL MODULE)

< ECU DIAGNOSIS >

Connector No.	M19
Connector Name	BCM (BODY CONTROL MODULE)
Connector Color	BLACK



79	78	77	76	75	74	73	72	71	70	69	68	67	66	65	64	63	62	61	60
99	98	97	96	95	94	93	92	91	90	89	88	87	86	85	84	83	82	81	80

Terminal No.	Color of Wire	Signal Name
60	B/R	ROOM ANT 2 B
61	W/R	ROOM ANT 2 A
62	B/Y	AS DOOR ANT B
63	LG	AS DOOR ANT A
64	V	DR DOOR ANT B
65	P	DR DOOR ANT A

Terminal No.	Color of Wire	Signal Name
82	-	-
83	L	ACC CONT
84	Y/R	AT_DEVICE_OUT
85	L/O	S/L_CONDITION_1
86	G/R	S/L_CONDITION_2
87	G/B	SHIFT_P
88	P/L	AS_REQUEST SWITCH
89	B/W	DR_REQUEST SWITCH
90	Y	IGN2_CONT
91	L/R	RF1_POWER_SUPPLY
92	-	-
93	-	-
94	G/Y	S/L_POWER_SUPPLY_12V
95	R/W	OUTPUT_1
96	P/B	OUTPUT_4
97	R/B	OUTPUT_2

Terminal No.	Color of Wire	Signal Name
98	G/O	HAZARD_SW
99	L/Y	S/L_K-LINE
66	R	ROOM ANT 1 B
67	G	ROOM ANT 1 A
68	G/O	FOB_READER_CLOCK
69	O	FOB_READER_DATA
70	R/B	IGN_ELEC_CONT
71	L/O	RF1_TUNER_SIGNAL
72	-	-
73	-	-
75	R/Y	OUTPUT 5
76	R/G	OUTPUT 3
77	BR	ENG_START_SW
78	P	CAN-L
79	L	CAN-H
80	R/L	FOB_SLOT_ILLUMINATION
81	LG	IGN_ON_LED

Connector No.	M20
Connector Name	BCM (BODY CONTROL MODULE)
Connector Color	WHITE



100	101	102	103	104		
105	106	107	108	109	110	111

Terminal No.	Color of Wire	Signal Name
100	-	-
101	-	-
102	-	-
103	V	CDL_BACK_TRUNK
104	-	-
105	-	-
106	-	-
107	-	-
108	-	-
109	-	-
110	V/W	TRUNK LAMP OUTPUT
111	-	-

ALMIA0061GB

A
B
C
D
E
F
G
H
I
J
K
L
M
N
O
P

BCM (BODY CONTROL MODULE)

< ECU DIAGNOSIS >

Connector No.	M28
Connector Name	COMBINATION SWITCH
Connector Color	WHITE

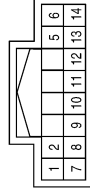

Terminal No.	Color of Wire	Signal Name
1	R/L	WASH_MTR
2	G/Y	INPUT_4
5	LG/R	INPUT_3
6	B	GND
7	R/G	OUTPUT_3
8	LG/B	INPUT_5
9	R/B	OUTPUT_2
10	P/B	OUTPUT_4
11	R/W	OUTPUT_1
12	L/W	INPUT_1
13	R/Y	OUTPUT_5
14	G/B	OUTPUT_2

Terminal No.	Color of Wire	Signal Name
124	-	-
125	-	-
126	-	-
127	BR/W	IGN_USM_CONT1
128	-	-
129	-	-
130	Y/G	TRUNK_SW
131	-	-
132	R	ST_CONT_USM
133	-	-
134	-	-
135	-	-
136	-	-
137	-	-
138	-	-
139	-	-
140	-	-
141	G/R	TRUNK_REQUEST_SW
142	-	-
143	-	-
144	G/R	BUZZER
145	-	-
146	-	-
147	L/R	BACK_TRUNK_OPENER
148	-	-
149	-	-
150	-	-
151	-	-

Connector No.	M21
Connector Name	BCM (BODY CONTROL MODULE)
Connector Color	GRAY

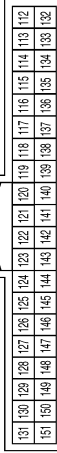

Terminal No.	Color of Wire	Signal Name
112	-	-
113	-	-
114	B	TRUNK_ANT_1_B
115	W	TRUNK_ANT_1_A
116	-	-
117	-	-
118	L/O	BACK_DOOR_ANT_B
119	BR/W	BACK_DOOR_ANT_A
120	-	-
121	-	-
123	-	-

ABMIA0469GB

BCM (BODY CONTROL MODULE)

< ECU DIAGNOSIS >

Wiring Diagram-Sedan

INFOID:000000004495956

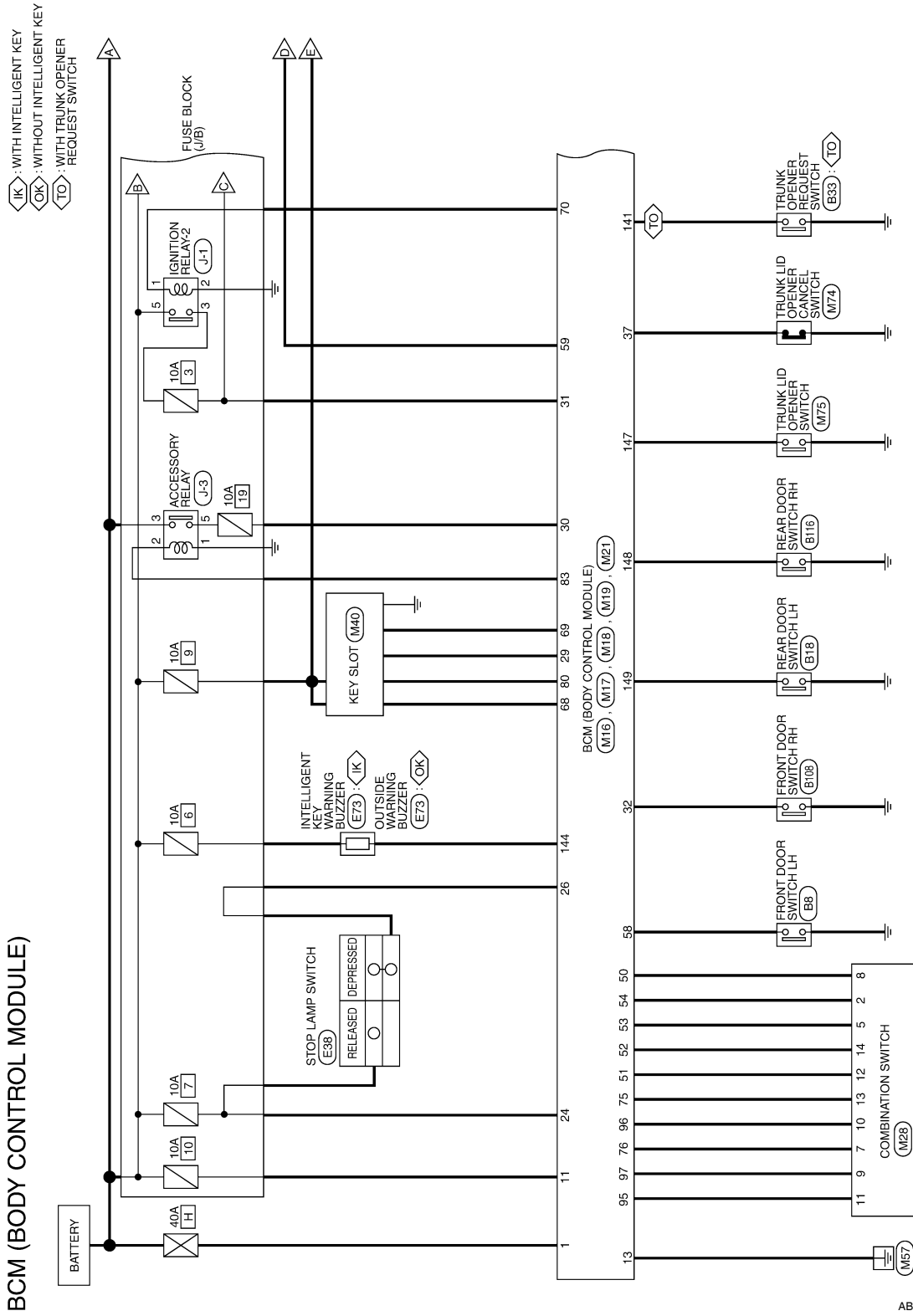

ABMWA0151GI

A
B
C
D
E
F
G
H
I
J
K
L
M
N
O
P

MWI

BCM (BODY CONTROL MODULE)

< ECU DIAGNOSIS >

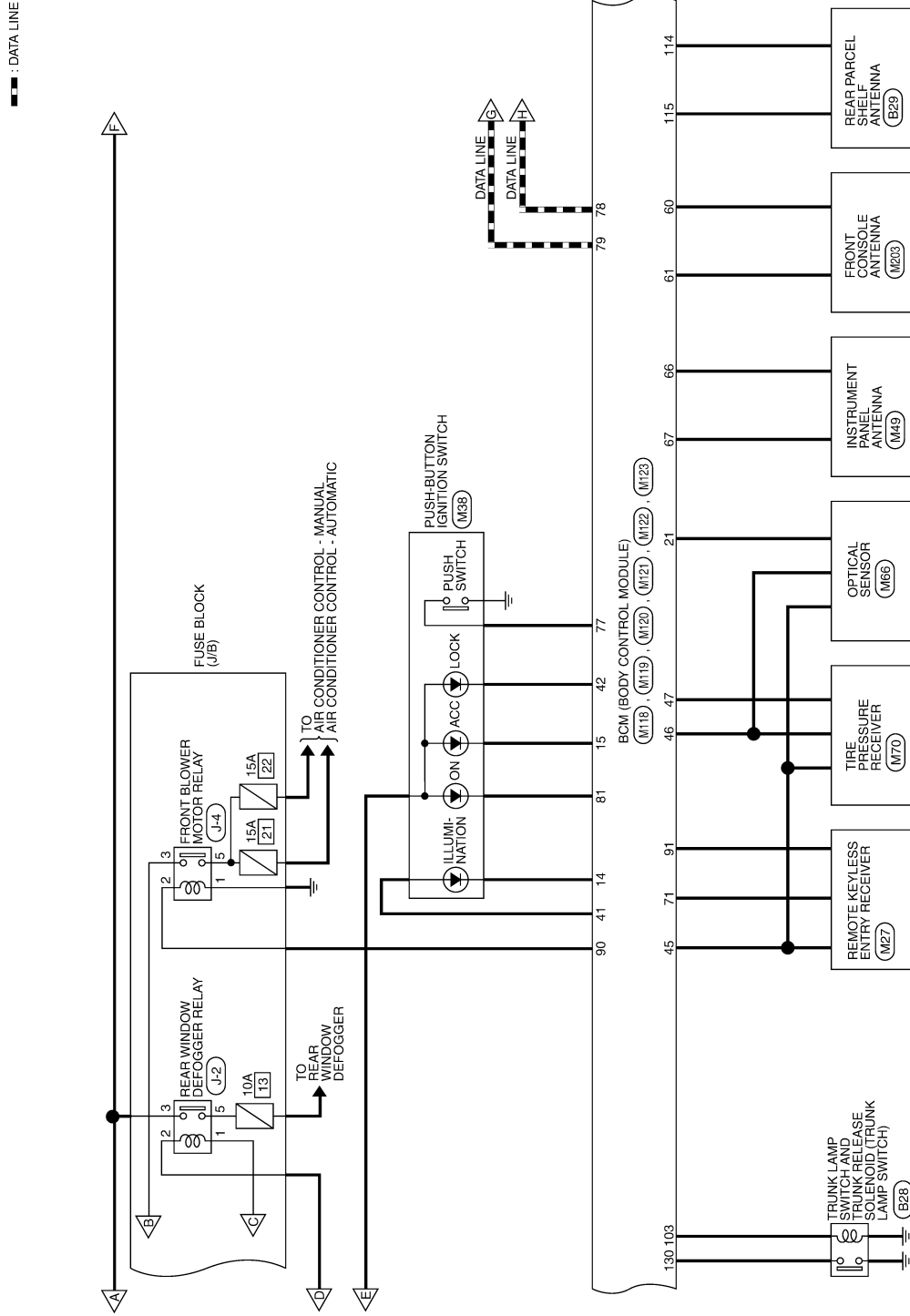

ABMWA0152GI

BCM (BODY CONTROL MODULE)

< ECU DIAGNOSIS >

— : DATA LINE
 (IK) : WITH INTELLIGENT KEY SYSTEM

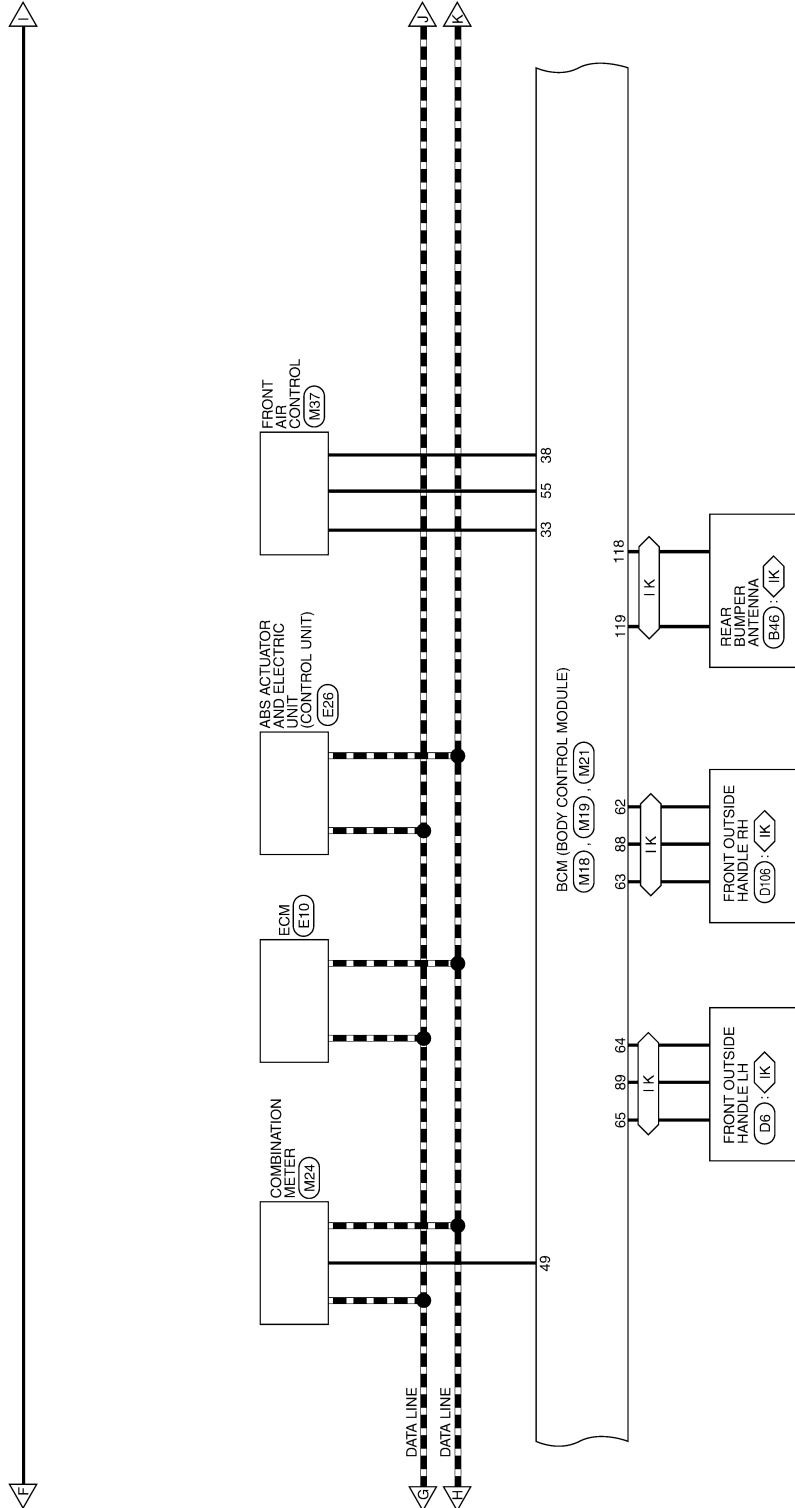

ABMWA0164GI

BCM (BODY CONTROL MODULE)

< ECU DIAGNOSIS >

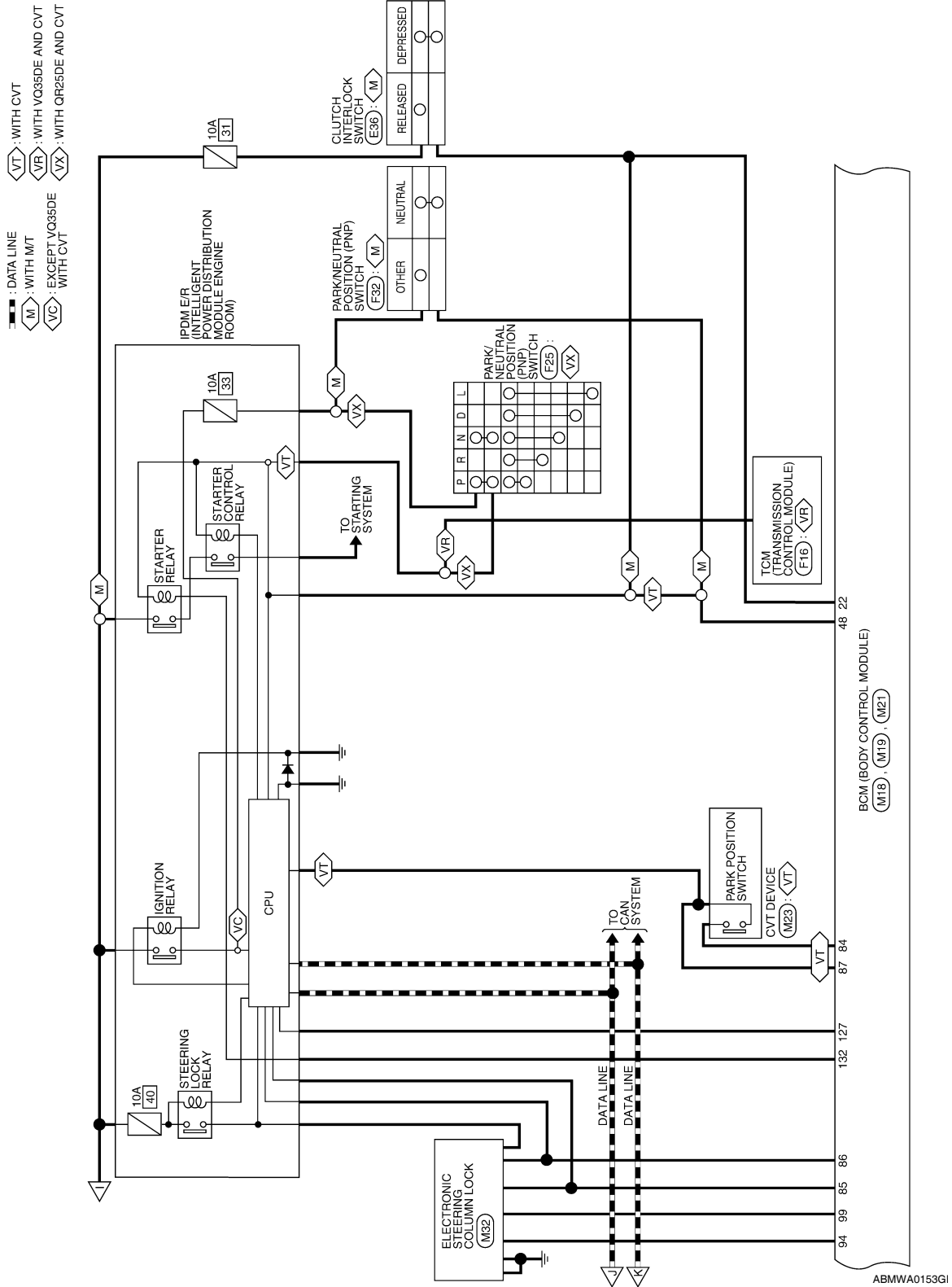

BCM (BODY CONTROL MODULE)

< ECU DIAGNOSIS >

<A1> : WITH LEFT FRONT ONLY POWER WINDOW ANTI-PINCH SYSTEM
 <A2> : WITH LEFT AND RIGHT FRONT POWER WINDOW ANTI-PINCH SYSTEM

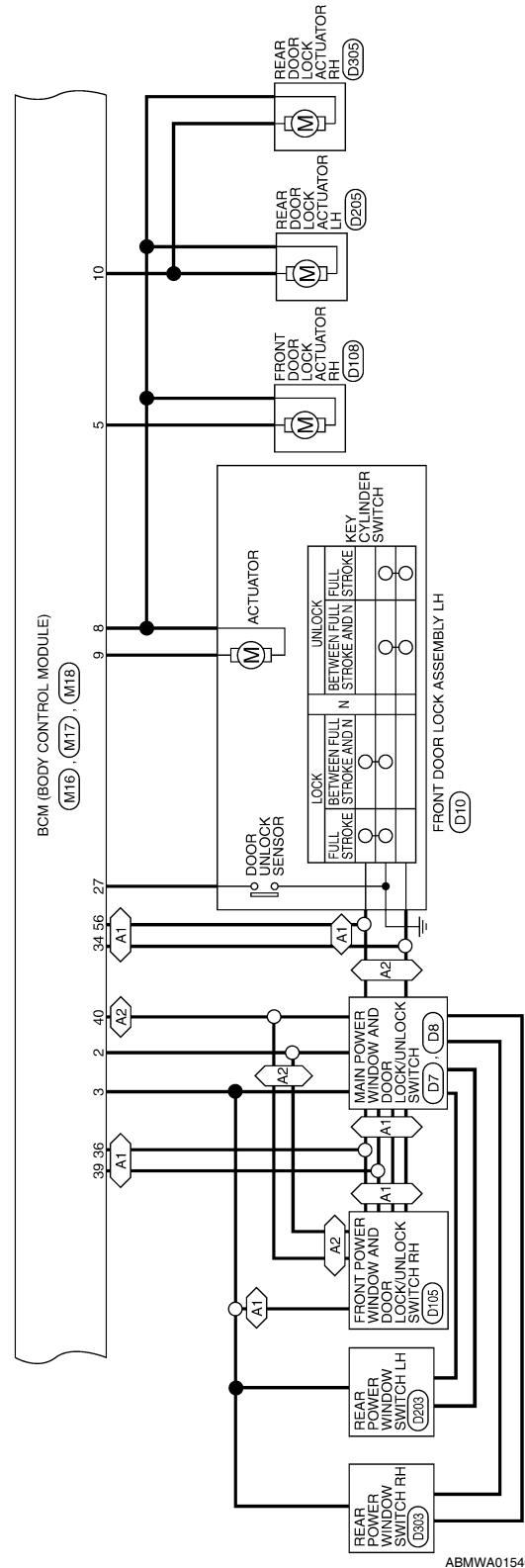

ABMWA0154GI

A
B
C
D
E
F
G
H
I
J
K
L
M
N
O
P

MWI

BCM (BODY CONTROL MODULE)

< ECU DIAGNOSIS >

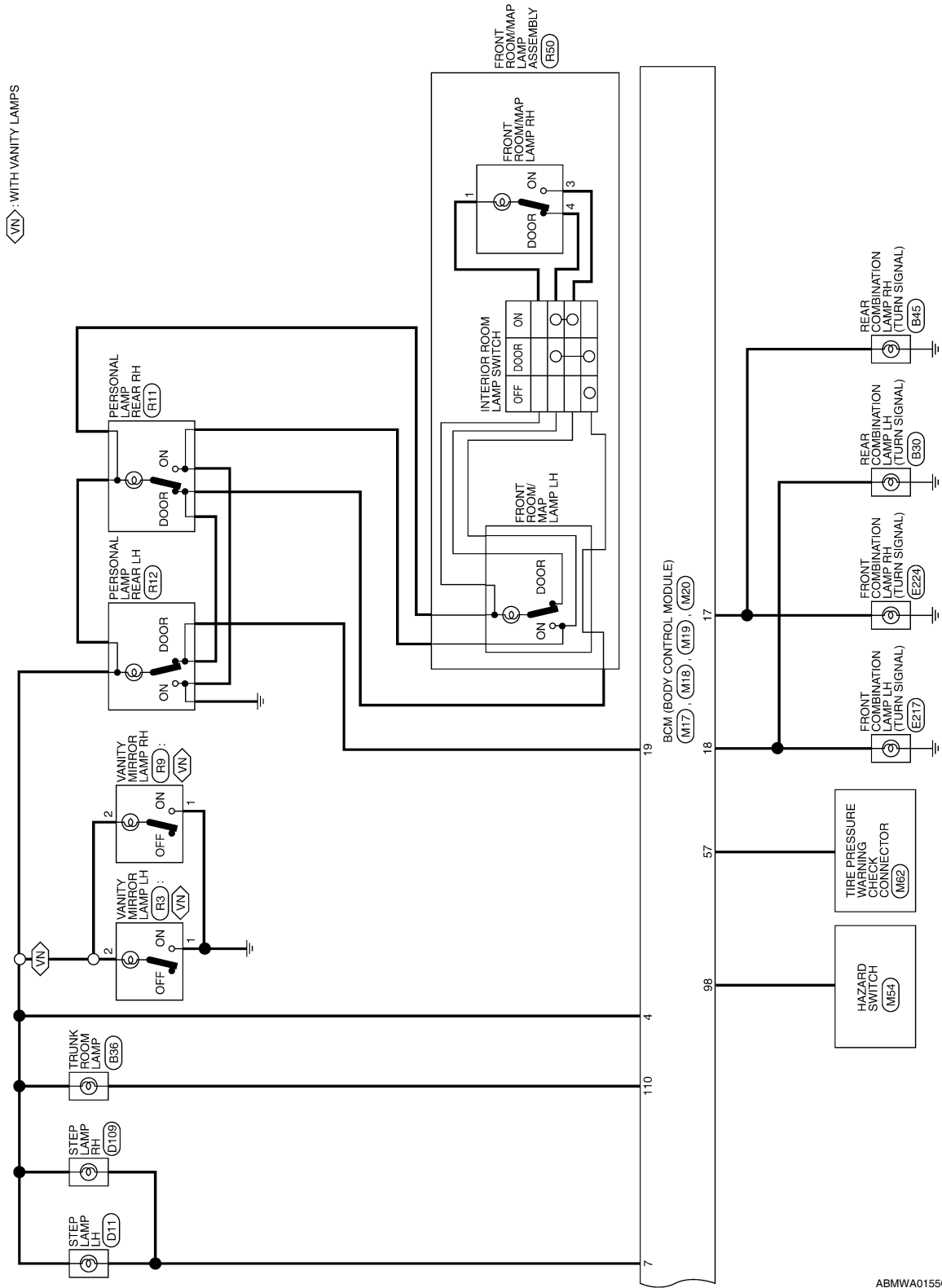

ABMWA0155GI

BCM (BODY CONTROL MODULE)

< ECU DIAGNOSIS >

BCM (BODY CONTROL MODULE) CONNECTORS

Connector No.	M16
Connector Name	BCM (BODY CONTROL MODULE)
Connector Color	BLACK



Terminal No.	Color of Wire	Signal Name
1	W/B	BAT_POWER_FL
2	R/Y	P/W_POWER_SUPPL Y_PERM
3	L/W	POWER_WINDOW_ POWER_SUPPLY (RAP)

Connector No.	M17
Connector Name	BCM (BODY CONTROL MODULE)
Connector Color	WHITE



Terminal No.	Color of Wire	Signal Name
4	P/W	ROOM_LAMP_BAT_ SAVER
5	G/Y	CDL_AS
6	-	-
7	R/W	STEP_LAMP_OUTPUT
8	V	CDL_COMMON

Terminal No.	Color of Wire	Signal Name
9	G	CDL_DR/FL
10	G/Y	CDL_RR_RL_BACK
11	Y/R	BAT_BCM_FUSE
12	-	-
13	B	GND1
14	R/Y	LOW_SIDE_PUSH_LE D_OUTPUT
15	Y/L	ACC_LED
16	-	-
17	G/B	FR_FLASHER
18	G/Y	FL_FLASHER
19	Y	ROOM_LAMP_OUTPUT

Connector No.	M18
Connector Name	BCM (BODY CONTROL MODULE)
Connector Color	GREEN

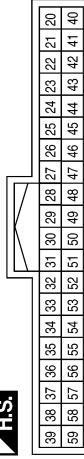

Terminal No.	Color of Wire	Signal Name
20	-	-
21	P/B	AUTO_LIGHT_SEN SOR_INPUT1
22	R/Y	CLUTCH_SW
23	-	-
24	R/W	STOP_LAMP_LOW_SW
25	-	-
26	O/L	STOP_LAMP_HIGH_SW

Terminal No.	Color of Wire	Signal Name
27	G/W	DOOR_LOCK_STATUS
28	-	-
29	Y	FOB_IN_SW_1
30	V/Y	ACC_F/B
31	G	IGN_F/B
32	R/B	AS_DOOR_SW
33	SB	AIRCON_SW
34	L/R	DOOR_KEY/C_ UNLOCK_SW
35	-	-
36	GR	CENTRAL_UNLOCK_SW
37	O	TRUNK_CANCEL_SW
38	GR/W	REAR_DEFOGGER_SW
39	GR/R	CENTRAL_UNLOCK_SW
40	Y/G	PW_K-LINE
41	W	PUSH_LED
42	R	S/L_LOCK_LED
43	-	-
44	-	-
45	P	GND_RF2_A/L
46	V/W	A/L_SENS_KEYLESS_ TUNER_POWER_SUP PLY

Terminal No.	Color of Wire	Signal Name
47	G/O	KEYLESS_TUNER_SI
48	R/G	SHIFT_IN/P
49	L/O	IMMO_LED
50	LG/B	INPUT_5
51	L/W	INPUT_1
52	G/B	INPUT_2
53	LG/R	INPUT_3
54	G/Y	INPUT_4
55	BR/W	BLOWER_FAN_SW
56	L/B	DOOR_KEY/C_LOCK_ SW
57	W	TPMS_MODE_TRIGG ER_SW
58	SB	DR_DOOR_SW
59	G/R	REAR_DEFOGGER_ RLY

AWMIA0292GB

A B C D E F G H I J K L M N O P

BCM (BODY CONTROL MODULE)

< ECU DIAGNOSIS >

Connector No.	M19
Connector Name	BCM (BODY CONTROL MODULE)
Connector Color	BLACK



79	78	77	76	75	74	73	72	71	70	69	68	67	66	65	64	63	62	61	60
----	----	----	----	----	----	----	----	----	----	----	----	----	----	----	----	----	----	----	----

Terminal No.	Color of Wire	Signal Name
60	B/R	ROOM_ANT_2_B
61	W/R	ROOM_ANT_2_A
62	B/Y	AS_DOOR_ANT_B
63	LG	AS_DOOR_ANT_A
64	V	DR_DOOR_ANT_B
65	P	DR_DOOR_ANT_A

Terminal No.	Color of Wire	Signal Name
66	R	ROOM_ANT_1_B
67	G	ROOM_ANT_1_A
68	G/O	FOB_READER_CLOCK
69	O	FOB_READER_DATA
70	R/B	IGN_ELEC_CONT
71	L/O	RF1_TUNER_SIGNAL
72	-	-
73	-	-
75	R/Y	OUTPUT_5
76	R/G	OUTPUT_3
77	BR	ENG_START_SW
78	P	CAN-L
79	L	CAN-H
80	R/L	FOB_SLOT_ILLUMINATION
81	LG	IGN_ON_LED
82	-	-
83	L	ACC_CONT

Terminal No.	Color of Wire	Signal Name
84	Y/R	AT_DEVICE_OUT
85	L/O	S/L_CONDITION_1
86	G/R	S/L_CONDITION_2
87	G/B	SHIFT_P
88	P/L	AS_REQUEST SWITCH
89	B/W	DR_REQUEST SWITCH
90	Y	IGN2_CONT
91	L/R	RF1_POWER_SUPPLY
92	-	-
93	-	-
94	G/Y	S/L_POWER_SUPPLY_12V
95	R/W	OUTPUT_1
96	P/B	OUTPUT_4
97	R/B	OUTPUT_2
98	G/O	HAZARD_SW
99	L/Y	S/L_K-LINE

Connector No.	M20
Connector Name	BCM (BODY CONTROL MODULE)
Connector Color	WHITE



100	101	102	103	104		
105	106	107	108	109	110	111

Terminal No.	Color of Wire	Signal Name
100	-	-
101	-	-
102	-	-
103	V	CDL_BACK_TRUNK
104	-	-
105	-	-
106	-	-
107	-	-
108	-	-
109	-	-
110	V/W	TRUNK_LAMP_OUTPUT
111	-	-

AWMIA0293GB

BCM (BODY CONTROL MODULE)

< ECU DIAGNOSIS >

Connector No.	M28
Connector Name	COMBINATION SWITCH
Connector Color	WHITE

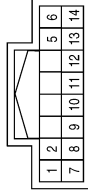

Terminal No.	Color of Wire	Signal Name
1	R/L	WASH_MTR
2	G/Y	OUTPUT_4
5	LG/R	OUTPUT_3
6	B	GND
7	R/G	INPUT_3
8	LG/B	OUTPUT_5
9	R/B	INPUT_2
10	P/B	INPUT_4
11	R/W	INPUT_1
12	L/W	OUTPUT_1
13	R/Y	INPUT_5
14	G/B	OUTPUT_2

Terminal No.	Color of Wire	Signal Name
119	BR/W	BACK_DOOR_ANT_A
120	-	-
121	-	-
122	-	-
123	-	-
124	-	-
125	-	-
126	-	-
127	BR/W	IGN_USM_CONT1
128	-	-
129	-	-
130	Y/G	TRUNK_SW
131	-	-
132	R	ST_CONT_USM
133	-	-
134	-	-
135	-	-
136	-	-
137	-	-
138	-	-
139	-	-
140	-	-
141	G/R	TRUNK_REQUEST_SW
142	-	-
143	-	-
144	GR	BUZZER
145	-	-
145	-	-
147	L/R	BACK_TRUNK_OPENER
148	R/W	RR_DOOR_SW
149	R/B	RL_DOOR_SW
150	-	-
151	-	-

Connector No.	M21
Connector Name	BCM (BODY CONTROL MODULE)
Connector Color	GRAY

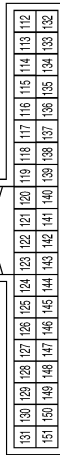

Terminal No.	Color of Wire	Signal Name
112	-	-
113	-	-
114	B	TRUNK_ANT_1_B
115	W	TRUNK_ANT_1_A
116	-	-
117	-	-
118	L/O	BACK_DOOR_ANT_B

Fail Safe

ABMIA0470GB

INFOID:000000004495957

Display contents of CONSULT	Fail-safe	Cancellation
B2013: ID DISCORD BCM-S/L	Inhibit engine cranking	Erase DTC
B2014: CHAIN OF S/L-BCM	Inhibit engine cranking	Erase DTC
B2190: NATS ANTENNA AMP	Inhibit engine cranking	Erase DTC

A
B
C
D
E
F
G
H
I
J
K
L
M
N
O
P

BCM (BODY CONTROL MODULE)

< ECU DIAGNOSIS >

Display contents of CONSULT	Fail-safe	Cancellation
B2191: DIFFERENCE OF KEY	Inhibit engine cranking	Erase DTC
B2192: ID DISCORD BCM-ECM	Inhibit engine cranking	Erase DTC
B2193: CHAIN OF BCM-ECM	Inhibit engine cranking	Erase DTC
B2195: ANTI-SCANNING	Inhibit engine cranking	Erase DTC
B2557: VEHICLE SPEED	Inhibit electronic steering column lock	When normal vehicle speed signals have been received from ABS actuator and electric unit (control unit) for 500 ms
B2560: STARTER CONT RELAY	Inhibit engine cranking	500 ms after the following CAN signal communication status has become consistent <ul style="list-style-type: none"> • Starter control relay signal • Starter relay status signal
B2562: LO VOLTAGE	<ul style="list-style-type: none"> • Inhibit engine cranking • Inhibit electronic steering column lock 	100 ms after the power supply voltage increases to more than 8.8 V
B2601: SHIFT POSITION	Inhibit electronic steering column lock	500 ms after the following signal reception status becomes consistent <ul style="list-style-type: none"> • Selector lever P position switch signal • P range signal (CAN)
B2602: SHIFT POSITION	Inhibit electronic steering column lock	5 seconds after the following BCM recognition conditions are fulfilled <ul style="list-style-type: none"> • Ignition switch is in the ON position • Selector lever P position switch signal: Except P position (battery voltage) • Vehicle speed: 4 /h or more
B2603: SHIFT POSI STATUS	Inhibit electronic steering column lock	500 ms after the following BCM recognition conditions are fulfilled <ul style="list-style-type: none"> • Ignition switch is in the ON position • Selector lever P position switch signal: Except P position (battery voltage) • Selector lever P/N position signal: Except P and N positions (0 V)
B2604: PNP SW	Inhibit electronic steering column lock	500 ms after any of the following BCM recognition conditions is fulfilled <ul style="list-style-type: none"> • Status 1 <ul style="list-style-type: none"> - Ignition switch is in the ON position - Selector lever P/N position signal: P and N position (battery voltage) - P range signal or N range signal (CAN): ON • Status 2 <ul style="list-style-type: none"> - Ignition switch is in the ON position - Selector lever P/N position signal: Except P and N positions (0 V) - P range signal and N range signal (CAN): OFF
B2605: PNP SW	Inhibit electronic steering column lock	500 ms after any of the following BCM recognition conditions is fulfilled <ul style="list-style-type: none"> • Ignition switch is in the ON position <ul style="list-style-type: none"> - Power position: IGN - Selector lever P/N position signal: Except P and N positions (0 V) - Interlock/PNP switch signal (CAN): OFF • Status 2 <ul style="list-style-type: none"> - Ignition switch is in the ON position - Selector lever P/N position signal: P or N position (battery voltage) - PNP switch signal (CAN): ON
B2606: S/L RELAY	Inhibit engine cranking	500 ms after the following CAN signal communication status has become consistent <ul style="list-style-type: none"> • Electronic steering column lock relay signal (Request signal) • Electronic steering column lock relay signal (Condition signal)
B2607: S/L RELAY	Inhibit engine cranking	500 ms after the following CAN signal communication status has become consistent <ul style="list-style-type: none"> • Electronic steering column lock relay signal (Request signal) • Electronic steering column lock relay signal (Condition signal)

BCM (BODY CONTROL MODULE)

< ECU DIAGNOSIS >

Display contents of CONSULT	Fail-safe	Cancellation
B2608: STARTER RELAY	Inhibit engine cranking	500 ms after the following signal communication status becomes consistent <ul style="list-style-type: none"> • Starter motor relay control signal • Starter relay status signal (CAN)
B2609: S/L STATUS	<ul style="list-style-type: none"> • Inhibit engine cranking • Inhibit electronic steering column lock 	When the following electronic steering column lock conditions agree <ul style="list-style-type: none"> • BCM electronic steering column lock control status • Electronic steering column lock condition No. 1 signal status • Electronic steering column lock condition No. 2 signal status
B260A: IGNITION RELAY	Inhibit engine cranking	500 ms after the following conditions are fulfilled <ul style="list-style-type: none"> • IGN relay (IPDM E/R) control signal: OFF (Battery voltage) • Ignition ON signal (CAN to IPDM E/R): OFF (Request signal) • Ignition ON signal (CAN from IPDM E/R): OFF (Condition signal)
B260F: ENG STATE SIG LOST	Maintains the power supply position attained at the time of DTC detection	When any of the following conditions is fulfilled <ul style="list-style-type: none"> • Power position changes to ACC • Receives engine status signal (CAN)
B2612: S/L STATUS	<ul style="list-style-type: none"> • Inhibit engine cranking • Inhibit electronic steering column lock 	When any of the following conditions is fulfilled <ul style="list-style-type: none"> • Electronic steering column lock unit status signal (CAN) is received normally • The BCM electronic steering column lock control status matches the electronic steering column lock status recognized by the electronic steering column lock unit status signal (CAN from IPDM E/R)
B2617: STARTER RELAY CIRC	Inhibit engine cranking	1 second after the starter motor relay control inside BCM becomes normal
B2618: BCM	Inhibit engine cranking	1 second after the ignition relay (IPDM E/R) control inside BCM becomes normal
B2619: BCM	Inhibit engine cranking	1 second after the electronic steering column lock unit power supply output control inside BCM becomes normal
B26E1: ENG STATE NO RECIV	Inhibit engine cranking	When any of the following conditions is fulfilled <ul style="list-style-type: none"> • Power position changes to ACC • Receives engine status signal (CAN)

DTC Inspection Priority Chart

INFOID:000000004495958

If some DTCs are displayed at the same time, perform inspections one by one based on the following priority chart.

Priority	DTC
1	<ul style="list-style-type: none"> • B2562: LOW VOLTAGE
2	<ul style="list-style-type: none"> • U1000: CAN COMM CIRCUIT • U1010: CONTROL UNIT (CAN)
3	<ul style="list-style-type: none"> • B2190: NATS ANTENNA AMP • B2191: DIFFERENCE OF KEY • B2192: ID DISCORD BCM-ECM • B2193: CHAIN OF BCM-ECM

BCM (BODY CONTROL MODULE)

< ECU DIAGNOSIS >

Priority	DTC
4	<ul style="list-style-type: none"> • B2013: ID DISCORD BCM-S/L • B2014: CHAIN OF S/L-BCM • B2553: IGNITION RELAY • B2555: STOP LAMP • B2556: PUSH-BTN IGN SW • B2557: VEHICLE SPEED • B2560: STARTER CONT RELAY • B2601: SHIFT POSITION • B2602: SHIFT POSITION • B2603: SHIFT POSI STATUS • B2604: PNP SW • B2605: PNP SW • B2606: S/L RELAY • B2607: S/L RELAY • B2608: STARTER RELAY • B2609: S/L STATUS • B260A: IGNITION RELAY • B260B: STEERING LOCK UNIT • B260C: STEERING LOCK UNIT • B260D: STEERING LOCK UNIT • B260F: ENG STATE SIG LOST • B2612: S/L STATUS • B2614: ACC RELAY CIRC • B2615: BLOWER RELAY CIRC • B2616: IGN RELAY CIRC • B2617: STARTER RELAY CIRC • B2618: BCM • B2619: BCM • B261A: PUSH-BTN IGN SW • B26E1: ENG STATE NO RECIV • C1729: VHCL SPEED SIG ERR • U0415: VEHICLE SPEED SIG
5	<ul style="list-style-type: none"> • C1704: LOW PRESSURE FL • C1705: LOW PRESSURE FR • C1706: LOW PRESSURE RR • C1707: LOW PRESSURE RL • C1708: [NO DATA] FL • C1709: [NO DATA] FR • C1710: [NO DATA] RR • C1711: [NO DATA] RL • C1712: [CHECKSUM ERR] FL • C1713: [CHECKSUM ERR] FR • C1714: [CHECKSUM ERR] RR • C1715: [CHECKSUM ERR] RL • C1716: [PRESSDATA ERR] FL • C1717: [PRESSDATA ERR] FR • C1718: [PRESSDATA ERR] RR • C1719: [PRESSDATA ERR] RL • C1720: [CODE ERR] FL • C1721: [CODE ERR] FR • C1722: [CODE ERR] RR • C1723: [CODE ERR] RL • C1724: [BATT VOLT LOW] FL • C1725: [BATT VOLT LOW] FR • C1726: [BATT VOLT LOW] RR • C1727: [BATT VOLT LOW] RL • C1734: CONTROL UNIT
6	<ul style="list-style-type: none"> • B2621: INSIDE ANTENNA • B2622: INSIDE ANTENNA • B2623: INSIDE ANTENNA

DTC Index

INFOID:000000004495959

NOTE:

BCM (BODY CONTROL MODULE)

< ECU DIAGNOSIS >

Details of time display

- CRNT: Displays when there is a malfunction now or after returning to the normal condition until turning ignition switch OFF → ON again.
- 1 - 39: Displayed if any previous malfunction is present when current condition is normal. It increases like 1 → 2 → 3...38 → 39 after returning to the normal condition whenever ignition switch OFF → ON. The counter remains at 39 even if the number of cycles exceeds it. It is counted from 1 again when turning ignition switch OFF → ON after returning to the normal condition if the malfunction is detected again.

CONSULT display	Fail-safe	Intelligent Key warning lamp ON	Tire pressure monitor warning lamp ON	Reference page
No DTC is detected. further testing may be required.	—	—	—	—
U1000: CAN COMM CIRCUIT	—	—	—	BCS-38
U1010: CONTROL UNIT (CAN)	—	—	—	BCS-39
U0415: VEHICLE SPEED SIG	—	—	—	BCS-40
B2013: ID DISCORD BCM-S/L	×	—	—	SEC-38
B2014: CHAIN OF S/L-BCM	×	—	—	SEC-39
B2190: NATS ANTENNA AMP	×	—	—	SEC-64
B2191: DIFFERENCE OF KEY	×	—	—	SEC-67
B2192: ID DISCORD BCM-ECM	×	—	—	SEC-68
B2193: CHAIN OF BCM-ECM	×	—	—	SEC-69
B2553: IGNITION RELAY	—	—	—	PCS-60
B2555: STOP LAMP	—	—	—	SEC-70
B2556: PUSH-BTN IGN SW	—	×	—	SEC-72
B2557: VEHICLE SPEED	×	×	—	SEC-74
B2560: STARTER CONT RELAY	×	×	—	SEC-75
B2562: LOW VOLTAGE	—	—	—	BCS-41
B2601: SHIFT POSITION	×	×	—	SEC-76
B2602: SHIFT POSITION	×	×	—	SEC-79
B2603: SHIFT POSI STATUS	×	×	—	SEC-81
B2604: PNP SW	×	×	—	SEC-84
B2605: PNP SW	×	×	—	SEC-86
B2606: S/L RELAY	×	×	—	SEC-88
B2607: S/L RELAY	×	×	—	SEC-89
B2608: STARTER RELAY	×	×	—	SEC-91
B2609: S/L STATUS	×	×	—	SEC-93
B260A: IGNITION RELAY	×	×	—	PCS-62
B260B: STEERING LOCK UNIT	—	×	—	SEC-97
B260C: STEERING LOCK UNIT	—	×	—	SEC-98
B260D: STEERING LOCK UNIT	—	×	—	SEC-99
B260F: ENG STATE SIG LOST	×	×	—	SEC-100
B2612: S/L STATUS	×	×	—	SEC-101
B2614: ACC RELAY CIRC	—	×	—	PCS-65
B2615: BLOWER RELAY CIRC	—	×	—	PCS-68
B2616: IGN RELAY CIRC	—	×	—	PCS-71
B2617: STARTER RELAY CIRC	×	×	—	SEC-105
B2618: BCM	×	×	—	PCS-74

BCM (BODY CONTROL MODULE)

< ECU DIAGNOSIS >

CONSULT display	Fail-safe	Intelligent Key warning lamp ON	Tire pressure monitor warning lamp ON	Reference page
B2619: BCM	×	×	—	SEC-107
B261A: PUSH-BTN IGN SW	—	×	—	SEC-108
B2621: INSIDE ANTENNA	—	—	—	DLK-59
B2622: INSIDE ANTENNA	—	—	—	DLK-62
B2623: INSIDE ANTENNA	—	—	—	DLK-65
B26E1: ENG STATE NO RES	×	×	—	SEC-110
C1704: LOW PRESSURE FL	—	—	×	WT-52
C1705: LOW PRESSURE FR	—	—	×	WT-52
C1706: LOW PRESSURE RR	—	—	×	WT-52
C1707: LOW PRESSURE RL	—	—	×	WT-52
C1708: [NO DATA] FL	—	—	×	WT-14
C1709: [NO DATA] FR	—	—	×	WT-14
C1710: [NO DATA] RR	—	—	×	WT-14
C1711: [NO DATA] RL	—	—	×	WT-14
C1712: [CHECKSUM ERR] FL	—	—	×	WT-16
C1713: [CHECKSUM ERR] FR	—	—	×	WT-16
C1714: [CHECKSUM ERR] RR	—	—	×	WT-16
C1715: [CHECKSUM ERR] RL	—	—	×	WT-16
C1716: [PRESSDATA ERR] FL	—	—	×	WT-18
C1717: [PRESSDATA ERR] FR	—	—	×	WT-18
C1718: [PRESSDATA ERR] RR	—	—	×	WT-18
C1719: [PRESSDATA ERR] RL	—	—	×	WT-18
C1720: [CODE ERR] FL	—	—	×	WT-16
C1721: [CODE ERR] FR	—	—	×	WT-16
C1722: [CODE ERR] RR	—	—	×	WT-16
C1723: [CODE ERR] RL	—	—	×	WT-16
C1724: [BATT VOLT LOW] FL	—	—	×	WT-16
C1725: [BATT VOLT LOW] FR	—	—	×	WT-16
C1726: [BATT VOLT LOW] RR	—	—	×	WT-16
C1727: [BATT VOLT LOW] RL	—	—	×	WT-16
C1729: VHCL SPEED SIG ERR	—	—	×	WT-19
C1734: CONTROL UNIT	—	—	×	WT-20

IPDM E/R (INTELLIGENT POWER DISTRIBUTION MODULE ENGINE ROOM)

< ECU DIAGNOSIS >

IPDM E/R (INTELLIGENT POWER DISTRIBUTION MODULE ENGINE ROOM)

Reference Value

INFOID:000000004501252

VALUES ON THE DIAGNOSIS TOOL

Monitor Item	Condition		Value/Status
RADFAN REQ	Engine idle speed	Changes depending on engine coolant temperature, air conditioner operation status, vehicle speed, etc.	0 - 100 %
AC COMP REQ	Engine running	A/C switch OFF	Off
		A/C switch ON (Compressor is operating)	On
TAIL&CLR REQ	Lighting switch OFF		Off
	Lighting switch 1ST, 2ND, HI or AUTO (Light is illuminated)		On
HL LO REQ	Lighting switch OFF		Off
	Lighting switch 2ND HI or AUTO (Light is illuminated)		On
HL HI REQ	Lighting switch OFF		Off
	Lighting switch HI		On
FR FOG REQ	Lighting switch 2ND or AUTO (Light is illuminated)	Front fog lamp switch OFF	Off
		<ul style="list-style-type: none"> • Front fog lamp switch ON • Daytime running light activated (Only for Canada models) 	On
FR WIP REQ	Ignition switch ON	Front wiper switch OFF	STOP
		Front wiper switch INT	1LOW
		Front wiper switch LO	Low
		Front wiper switch HI	Hi
WIP AUTO STOP	Ignition switch ON	Front wiper stop position	STOP P
		Any position other than front wiper stop position	ACT P
WIP PROT	Ignition switch ON	Front wiper operates normally	Off
		Front wiper stops at fail-safe operation	BLOCK
IGN RLY1 -REQ	Ignition switch OFF or ACC		Off
	Ignition switch ON		On
IGN RLY	Ignition switch OFF or ACC		Off
	Ignition switch ON		On
PUSH SW	Release the push-button ignition switch		Off
	Press the push-button ignition switch		On
INTER/NP SW	Ignition switch ON	CVT selector lever in any position other than P or N (CVT models)	Off
		Release clutch pedal (M/T models)	
	Ignition switch ON	CVT selector lever in P or N position (CVT models)	On
		Depress clutch pedal (M/T models)	
ST RLY CONT	Ignition switch ON		Off
	At engine cranking		On

IPDM E/R (INTELLIGENT POWER DISTRIBUTION MODULE ENGINE ROOM)

< ECU DIAGNOSIS >

Monitor Item	Condition	Value/Status
IHBT RLY -REQ	Ignition switch ON	Off
	At engine cranking	On
ST/INHI RLY	Ignition switch ON	Off
	At engine cranking	ST →INHI
	The status of starter relay or starter control relay cannot be recognized by the battery voltage malfunction, etc. when the starter relay is ON and the starter control relay is OFF	UNKWN
DETENT SW	Ignition switch ON <ul style="list-style-type: none"> • Press the selector button with CVT selector lever in P position • CVT selector lever in any position other than P 	Off
	Release the CVT selector button with CVT selector lever in P position NOTE: The lever is fixed ON for M/T	On
S/L RLY -REQ	None of the conditions below are present	Off
	<ul style="list-style-type: none"> • Open the driver door after the ignition switch is turned OFF (for a few seconds) • Press the push-button ignition switch when the steering lock is activated • Depress the clutch pedal when the steering lock is activated 	On
S/L STATE	Steering lock is activated	LOCK
	Steering lock is deactivated	UNLK
	[DTC B210A] is detected	UNKWN
DTRL REQ	NOTE: This item is displayed, but cannot be monitored.	Off
OIL P SW	Ignition switch OFF, ACC or engine running	Open
	Ignition switch ON	Close
THFT HRN REQ	Not operated	Off
	<ul style="list-style-type: none"> • Panic alarm is activated • Horn is activated with VEHICLE SECURITY (THEFT WARNING) SYSTEM 	On
HORN CHIRP	Not operated	Off
	Door locking with Intelligent Key (horn chirp mode)	On
CRNRNG LMP REQ	NOTE: This item is displayed, but cannot be monitored.	Off

IPDM E/R (INTELLIGENT POWER DISTRIBUTION MODULE ENGINE ROOM)

< ECU DIAGNOSIS >

TERMINAL LAYOUT

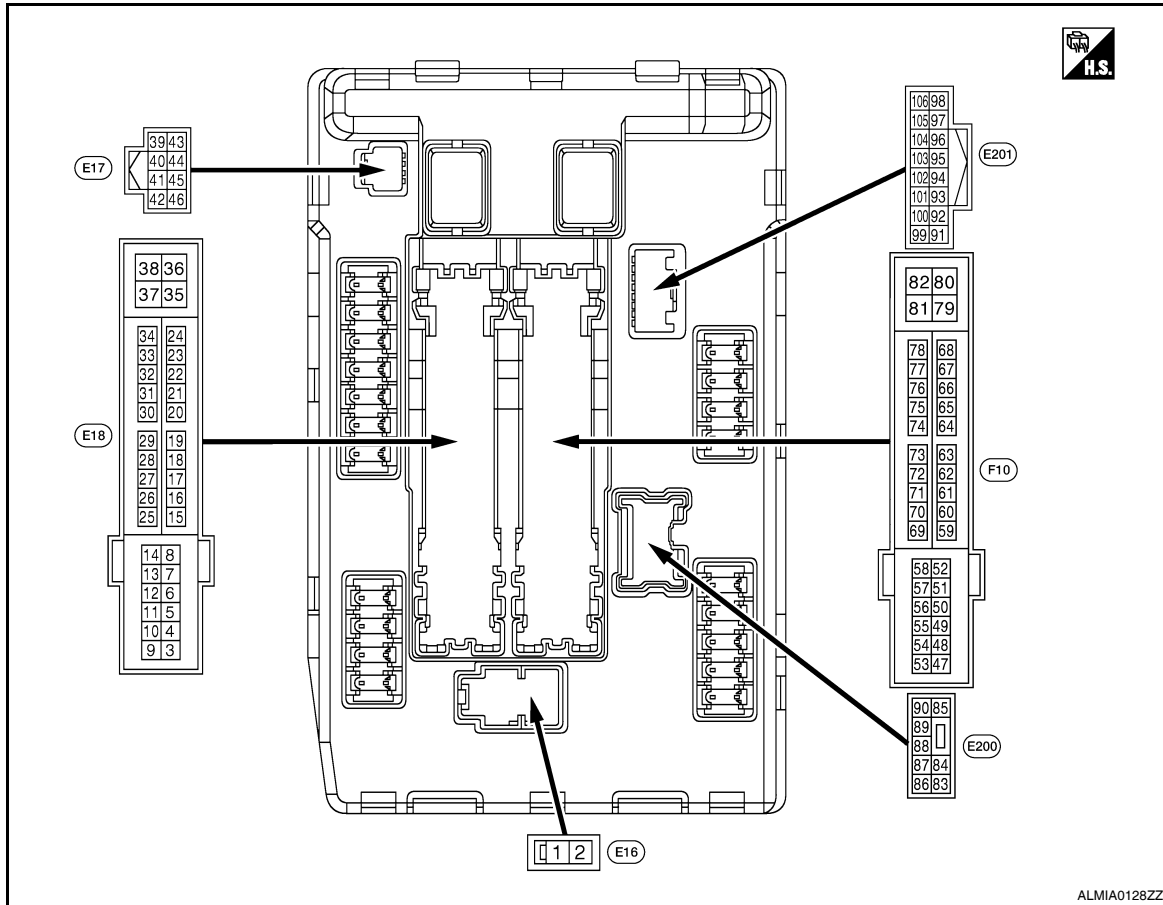

PHYSICAL VALUES

Terminal No. (Wire color)		Description		Condition		Value (Approx.)
+	-	Signal name	Input/ Output			
1 (R)	Ground	Battery power supply	Input	Ignition switch OFF		Battery voltage
2 (L)	Ground	Battery power supply	Input	Ignition switch OFF		Battery voltage
4 (L/R)	Ground	Front wiper LO	Output	Ignition switch OFF	Front wiper switch OFF	0V
				Ignition switch ON	Front wiper switch LO	Battery voltage
5 (L/B)	Ground	Front wiper HI	Output	Ignition switch OFF	Front wiper switch OFF	0V
				Ignition switch ON	Front wiper switch HI	Battery voltage
6 (SB)	Ground	Daytime light relay power supply (Canada models only)	Output	Ignition switch OFF		Battery voltage
7 (R/L)	Ground	Tail, license plate lamps & interior lamps	Output	Ignition switch OFF	Lighting switch OFF	0V
				Ignition switch ON	Lighting switch 1ST	Battery voltage
10 (R/B)	Ground	ECM relay power supply	Output	Ignition switch OFF (For a few seconds after turning ignition switch OFF)		0V
				<ul style="list-style-type: none"> Ignition switch ON Ignition switch OFF (More than a few seconds after turning ignition switch OFF) 		Battery voltage

A
B
C
D
E
F
G
H
I
J
K
L
M
N
O
P

IPDM E/R (INTELLIGENT POWER DISTRIBUTION MODULE ENGINE ROOM)

< ECU DIAGNOSIS >

Terminal No. (Wire color)		Description		Condition		Value (Approx.)
+	-	Signal name	Input/ Output			
11 (P/L)	Ground	Steering lock unit power supply	Output	Ignition switch OFF	A few seconds after opening the driver door	Battery voltage
				Ignition switch LOCK	Press the push-button ignition switch	Battery voltage
				Ignition switch ACC or ON		0V
12 (B)	Ground	Ground	—	Ignition switch ON		0V
13 (W)	Ground	Fuel pump power supply	Output	Approximately 1 second or more after turning the ignition switch ON		0V
				<ul style="list-style-type: none"> Approximately 1 second after turning the ignition switch ON Engine running 		Battery voltage
15 (G/W)	Ground	Ignition relay-1 power supply	Output	Ignition switch OFF		0V
				Ignition switch ON		Battery voltage
16 (L/Y)	Ground	Front wiper auto stop	Input	Ignition switch ON	Front wiper stop position	0V
					Any position other than front wiper stop position	Battery voltage
19 (L/Y)	Ground	Ignition relay-1 power supply	Output	Ignition switch OFF		0V
				Ignition switch ON		Battery voltage
20 (B/Y)	Ground	Ambient sensor ground	—	Ignition switch ON		0V
21 (O/B)	Ground	Ambient sensor	—	Ignition switch ON		5V
22 (W/R)	Ground	Refrigerant pressure sensor ground	—	Ignition switch ON		0V
23 (B/R)	Ground	Refrigerant pressure sensor	—	<ul style="list-style-type: none"> Ignition switch ON (READY) Both A/C switch and blower motor switch ON (electric compressor operates) 		1.0 - 4.0V
24 (BR/W)	Ground	Refrigerant pressure sensor power supply	—	Ignition switch ON		5V
25 (GR)	Ground	Ignition relay-1 power supply	Output	Ignition switch OFF		0V
				Ignition switch ON		Battery voltage
27 (BR/W)	Ground	Ignition relay monitor	Input	Ignition switch OFF or ACC		Battery voltage
				Ignition switch ON		0V
28 (BR)	Ground	Push-button ignition switch	Input	Press the push-button ignition switch		0V
				Release the push-button ignition switch		Battery voltage
30 (R/B)	Ground	Starter relay control	Input	CVT models	CVT selector lever in any position other than P or N (ignition switch ON)	0V
					CVT selector lever P or N (ignition switch ON)	Battery voltage
				M/T models	Release the clutch pedal	0V
					Depress the clutch pedal	Battery voltage

IPDM E/R (INTELLIGENT POWER DISTRIBUTION MODULE ENGINE ROOM)

< ECU DIAGNOSIS >

Terminal No. (Wire color)		Description		Condition	Value (Approx.)		
+	-	Signal name	Input/ Output				
32 (L/O)	Ground	Electronic steering column lock unit condition-1	Input	Electronic steering column lock is activated	0V	A	
				Electronic steering column lock is deactivated	Battery voltage	B	
33 (G/R)	Ground	Electronic steering column lock unit condition-2	Input	Electronic steering column lock is activated	Battery voltage	C	
				Electronic steering column lock is deactivated	0V	D	
34 (O/L)	Ground	Cooling fan relay-3 control	Input	Ignition switch OFF or ACC	0V	E	
				Ignition switch ON	0.7V		
35 (L/B)	Ground	Cooling fan motor control	Output	Ignition switch OFF or ACC	0V		
				Ignition switch ON	0.7V		
36 (G)	Ground	Battery power supply	Input	Ignition switch OFF	Battery voltage	F	
38 (R/W)	Ground	Cooling fan motor control	Output	Ignition switch OFF or ACC	0V	G	
				Ignition switch ON	0.7V		
39 (P)	—	CAN - L	Input/ Output	—	—	H	
40 (L)	—	CAN - H	Input/ Output	—	—		
41 (B)	Ground	Ground	—	Ignition switch ON	0V	I	
42 (SB)	Ground	Cooling fan relay-2 control	Input	Ignition switch OFF or ACC	0V	J	
				Ignition switch ON	0.7V		
43 (G/B)	Ground	CVT device (Detention switch)	Input	Ignition switch ON	Press the CVT selector button (CVT selector lever P)	Battery voltage	
				Ignition switch ON	<ul style="list-style-type: none"> CVT selector lever in any position other than P Release the CVT selector button (CVT selector lever P) 	0V	
44 (G/W)	Ground	Horn relay control	Input	The horn is deactivated	Battery voltage	M	
				The horn is activated	0V		
45 (L/O)	Ground	Anti theft horn relay control	Input	The horn is deactivated	Battery voltage		
				The horn is activated	0V	MWI	
46 (R)	Ground	Starter relay control	Input	CVT models	CVT selector lever in any position other than P or N (ignition switch ON)	0V	O
					CVT selector lever P or N (ignition switch ON)	Battery voltage	
				M/T models	Release the clutch pedal	0V	P
					Depress the clutch pedal	Battery voltage	
48 (Y/R)	Ground	A/C relay power supply	Output	Engine running	A/C switch OFF	0V	
					A/C switch ON (A/C compressor is operating)	Battery voltage	

IPDM E/R (INTELLIGENT POWER DISTRIBUTION MODULE ENGINE ROOM)

< ECU DIAGNOSIS >

Terminal No. (Wire color)		Description		Condition	Value (Approx.)
+	-	Signal name	Input/ Output		
49 (R/B)	Ground	ECM relay power supply (with VQ35DE)	Output	Ignition switch OFF (For a few seconds after turning ignition switch OFF)	0V
				<ul style="list-style-type: none"> Ignition switch ON Ignition switch OFF (More than a few seconds after turn- ing ignition switch OFF) 	Battery voltage
49 (B/R)	Ground	ECM relay power supply (without VQ35DE)	Output	Ignition switch OFF (For a few seconds after turning ignition switch OFF)	0V
				<ul style="list-style-type: none"> Ignition switch ON Ignition switch OFF (More than a few seconds after turn- ing ignition switch OFF) 	Battery voltage
51 (LG)	Ground	Ignition relay power supply	Output	Ignition switch OFF	0V
				Ignition switch ON	Battery voltage
52 (Y/G)	Ground	Ignition relay power supply	Output	Ignition switch OFF	0V
				Ignition switch ON	Battery voltage
53 (B/R)	Ground	ECM relay power supply (with VQ35DE)	Output	Ignition switch OFF (For a few seconds after turning ignition switch OFF)	0V
				<ul style="list-style-type: none"> Ignition switch ON Ignition switch OFF (More than a few seconds after turn- ing ignition switch OFF) 	Battery voltage
53 (R/B)	Ground	ECM relay power supply (without VQ35DE)	Output	Ignition switch OFF (For a few seconds after turning ignition switch OFF)	0V
				<ul style="list-style-type: none"> Ignition switch ON Ignition switch OFF (More than a few seconds after turn- ing ignition switch OFF) 	Battery voltage
54 (G/W)	Ground	Throttle control motor re- lay power supply	Output	Ignition switch OFF (For a few seconds after turning ignition switch OFF)	0V
				<ul style="list-style-type: none"> Ignition switch ON Ignition switch OFF (More than a few seconds after turn- ing ignition switch OFF) 	Battery voltage
55 (W/L)	Ground	ECM power supply	Output	Ignition switch OFF	Battery voltage
56 (R/Y)	Ground	Ignition relay power supply	Output	Ignition switch OFF	0V
				Ignition switch ON	Battery voltage
57 (O)	Ground	Ignition relay power supply	Output	Ignition switch OFF	0V
				Ignition switch ON	Battery voltage
58 (Y)	Ground	Ignition relay power supply	Output	Ignition switch OFF	0V
				Ignition switch ON	Battery voltage

IPDM E/R (INTELLIGENT POWER DISTRIBUTION MODULE ENGINE ROOM)

< ECU DIAGNOSIS >

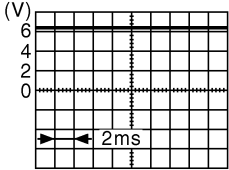
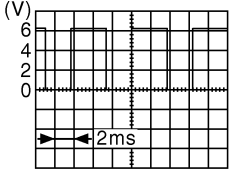
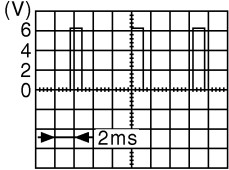
Terminal No. (Wire color)		Description		Condition	Value (Approx.)
+	-	Signal name	Input/ Output		
69 (W/B)	Ground	ECM relay control	Output	Ignition switch OFF (For a few seconds after turning ignition switch OFF)	Battery voltage
				• Ignition switch ON • Ignition switch OFF (More than a few seconds after turning ignition switch OFF)	0 - 1.5V
70 (O)	Ground	Throttle control motor relay control	Output	Ignition switch ON → OFF	0 - 1.0V ↓ Battery voltage ↓ 0V
				Ignition switch ON	0 - 1.0V
72 (R/B)	Ground	PNP switch signal	Input	Ignition switch ON	CVT selector lever in P or N position Battery voltage
				CVT selector lever in any position other than P or N position	0V
74 (Y)	Ground	Ignition relay power supply	Output	Ignition switch OFF	0V
				Ignition switch ON	Battery voltage
75 (P/L)	Ground	Oil pressure switch	Input	Ignition switch ON	Engine stopped 0V
				Engine running	Battery voltage
76 (GR)	Ground	Power generation command signal	Output	Ignition switch ON	 JPMIA0001GB 6.3V
				40% is set on "Active test", "ALTERNATOR DUTY" of "ENGINE"	 JPMIA0002GB 3.8V
				80% is set on "Active test", "ALTERNATOR DUTY" of "ENGINE"	 JPMIA0003GB 1.4V
77 (B/R)	Ground	Fuel pump relay control	Output	• Approximately 1 second after turning the ignition switch ON • Engine running	0 - 1.0V
				Approximately 1 second or more after turning the ignition switch ON	Battery voltage

A
B
C
D
E
F
G
H
I
J
K
L
M
N
O
P

MWI

IPDM E/R (INTELLIGENT POWER DISTRIBUTION MODULE ENGINE ROOM)

< ECU DIAGNOSIS >

Terminal No. (Wire color)		Description		Condition		Value (Approx.)
+	-	Signal name	Input/ Output			
80 (B/W)	Ground	Starter motor	Output	At engine cranking		Battery voltage
83 (R/Y)	Ground	Headlamp LO (RH)	Output	Ignition switch ON	Lighting switch OFF	0V
					Lighting switch 2ND	Battery voltage
84 (L)	Ground	Headlamp LO (LH)	Output	Ignition switch ON	Lighting switch OFF	0V
					Lighting switch 2ND	Battery voltage
86 (W/R)	Ground	Front fog lamp (RH)	Output	Lighting switch 2ND	<ul style="list-style-type: none"> • Front fog lamp switch ON • Daytime running light activated (Only for Canada models) 	Battery voltage
						Front fog lamp switch OFF
87 (L/Y)	Ground	Front fog lamp (LH)	Output	Lighting switch 2ND	<ul style="list-style-type: none"> • Front fog lamp switch ON • Daytime running light activated (Only for Canada models) 	Battery voltage
						Front fog lamp switch OFF
88 (R/W)	Ground	Washer pump power supply	Output	Ignition switch ON		Battery voltage
89 (L/W)	Ground	Headlamp HI (RH)	Output	Ignition switch ON	<ul style="list-style-type: none"> • Lighting switch HI • lighting switch PASS 	Battery voltage
						Lighting switch OFF
90 (G)	Ground	Headlamp HI (LH)	Output	Ignition switch ON	<ul style="list-style-type: none"> • Lighting switch HI • Lighting switch PASS 	Battery voltage
						Lighting switch OFF
91 (LG/R)	Ground	Parking lamp (RH)	Output	Ignition switch ON	Lighting switch 1ST	Battery voltage
						Lighting switch OFF
92 (LG/B)	Ground	Parking lamp (LH)	Output	Ignition switch ON	Lighting switch 1ST	Battery voltage
						Lighting switch OFF
99 (BR/W)	Ground	Ambient sensor ground	—	Ignition switch ON		0V
100 (SB)	Ground	Ambient sensor	—	Ignition switch ON		5V
101 (O/L)	Ground	Refrigerant pressure sensor ground	—	Ignition switch ON		0V
102 (R/B)	Ground	Refrigerant pressure sensor	—	<ul style="list-style-type: none"> • Ignition switch ON (READY) • Both A/C switch and blower motor switch ON (electric compressor operates) 		1.0 - 4.0V
103 (P)	Ground	Refrigerant pressure sensor power supply	—	Ignition switch ON		5V
105 (V)	Ground	Daytime light relay control	Output	Ignition switch ON	Daytime light system active	Battery voltage
				Ignition switch ON	Daytime light system inactive	0V

IPDM E/R (INTELLIGENT POWER DISTRIBUTION MODULE ENGINE ROOM)

< ECU DIAGNOSIS >

Wiring Diagram — Coupe

INFOID:000000004495961

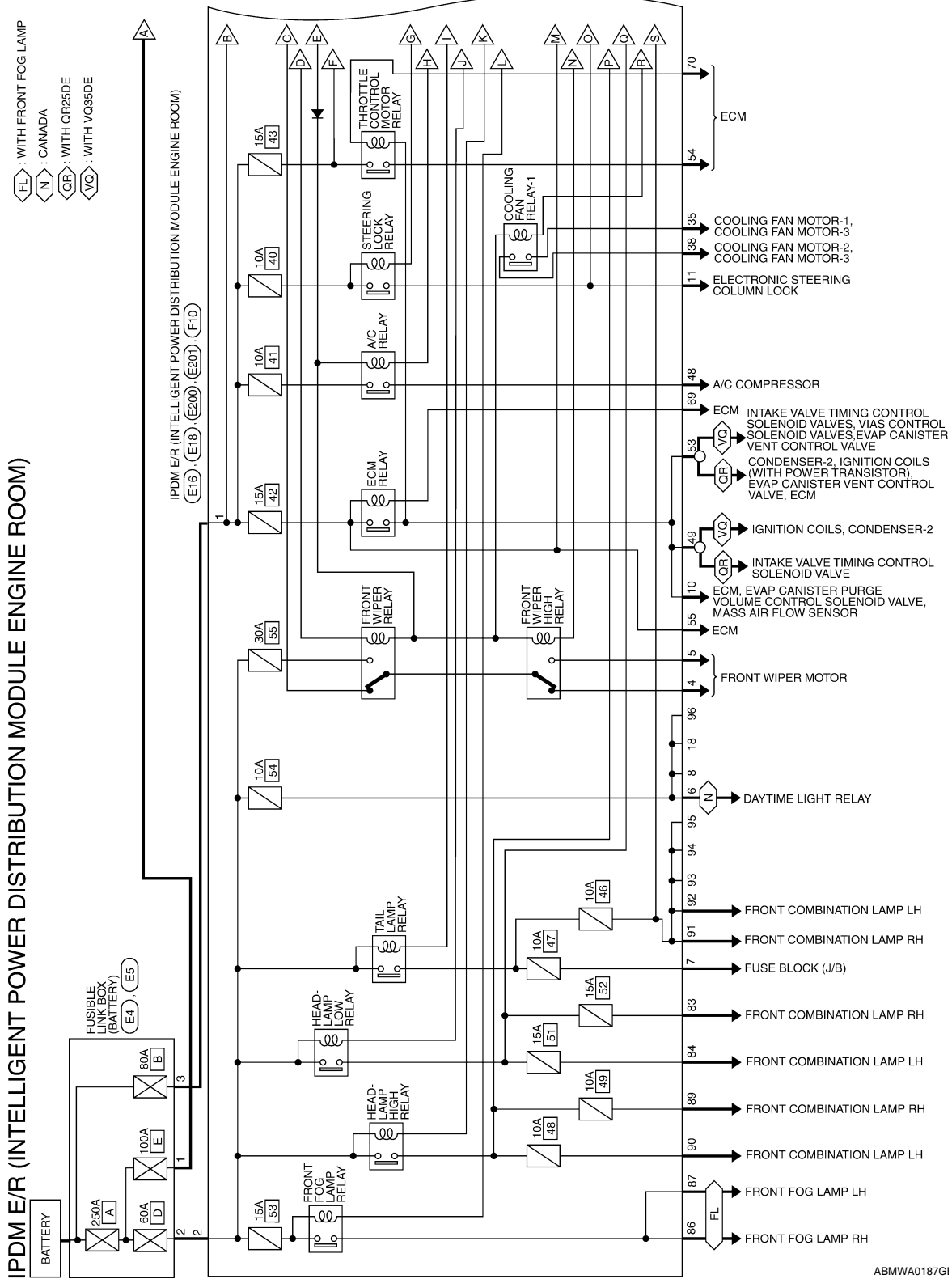

ABMWA0187GI

IPDM E/R (INTELLIGENT POWER DISTRIBUTION MODULE ENGINE ROOM)

< ECU DIAGNOSIS >

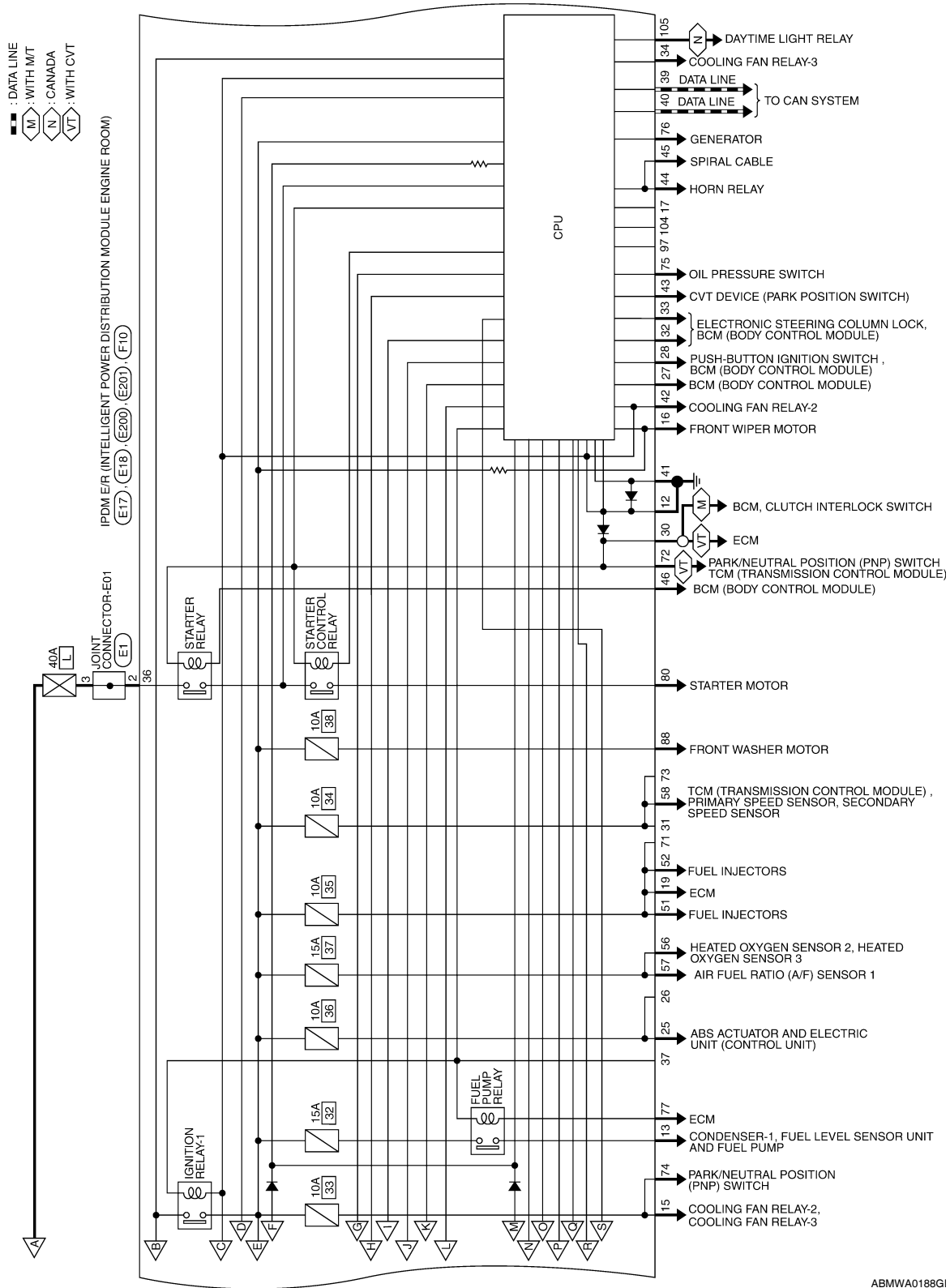

ABMWA0188GI

IPDM E/R (INTELLIGENT POWER DISTRIBUTION MODULE ENGINE ROOM)

< ECU DIAGNOSIS >

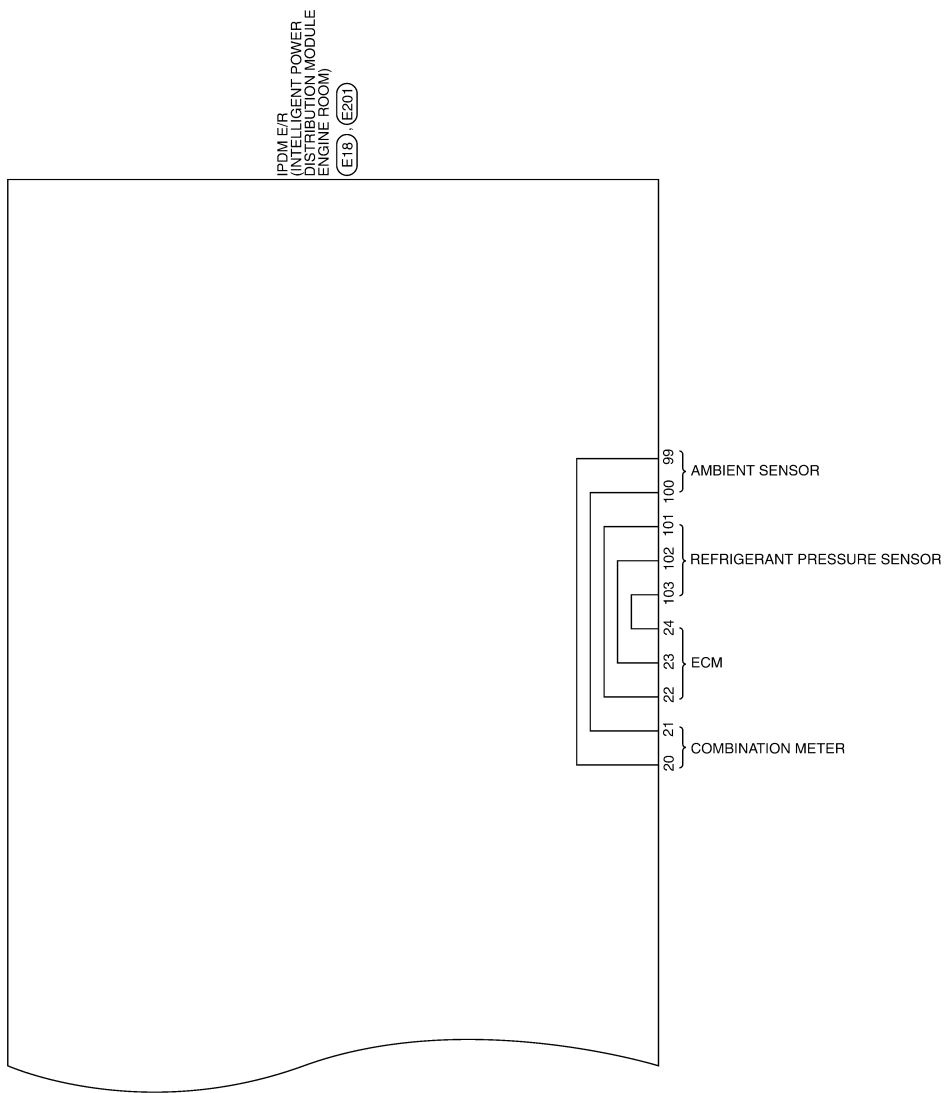

IPDM E/R
(INTELLIGENT POWER
DISTRIBUTION MODULE
ENGINE ROOM)
(E18) (E201)

A
B
C
D
E
F
G
H
I
J
K
L
M
N
O
P

MWI

ABMWA0189GI

IPDM E/R (INTELLIGENT POWER DISTRIBUTION MODULE ENGINE ROOM)

< ECU DIAGNOSIS >

IPDM E/R (INTELLIGENT POWER DISTRIBUTION MODULE ENGINE ROOM) CONNECTORS

Connector No.	E1
Connector Name	JOINT CONNECTOR-E01
Connector Color	WHITE



Terminal No.	Color of Wire	Signal Name
2	G	-
3	G	-

Connector No.	E4
Connector Name	FUSIBLE LINK BOX (BATTERY)
Connector Color	BROWN



Terminal No.	Color of Wire	Signal Name
1	B/W	-
2	B/Y	-

Connector No.	E5
Connector Name	FUSIBLE LINK BOX (BATTERY)
Connector Color	GRAY



Terminal No.	Color of Wire	Signal Name
3	R	-

Connector No.	E16
Connector Name	IPDM E/R (INTELLIGENT POWER DISTRIBUTION MODULE ENGINE ROOM)
Connector Color	BLACK



Terminal No.	Color of Wire	Signal Name
1	R	F/L_MAIN
2	L	F/L_USM

Connector No.	E17
Connector Name	IPDM E/R (INTELLIGENT POWER DISTRIBUTION MODULE ENGINE ROOM)
Connector Color	WHITE



Terminal No.	Color of Wire	Signal Name
39	P	CAN-L
40	L	CAN-H
41	B	GND (SIGNAL)
42	SB	MOTOR_FAN_RLY_MID
43	G/B	DETENT_SW
44	G/W	HORN_RLY
45	L/O	HORN SW
46	R	START_CONT

ABMIA0558GB

IPDM E/R (INTELLIGENT POWER DISTRIBUTION MODULE ENGINE ROOM)

< ECU DIAGNOSIS >

Connector No.	E18
Connector Name	IPDM E/R (INTELLIGENT POWER DISTRIBUTION MODULE ENGINE ROOM)
Connector Color	WHITE

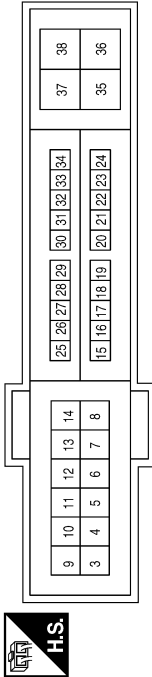

Terminal No.	Color of Wire	Signal Name
3	-	-
4	L/R	FR_WIPER_LO
5	L/B	FR_WIPER_HI
6	SB	DTRL
7	R/L	TAIL/ILLUMI



Terminal No.	Color of Wire	Signal Name
83	R/Y	HEADLAMP_LO_RH
84	L	HEADLAMP_LO_LH
85	-	-
86	W/R	FR_FOG_LAMP_RH
87	L/Y	FR_FOG_LAMP_LH
88	R/W	WASHER_MTR
89	L/W	HEADLAMP_HI_RH
90	G	HEADLAMP_HI_LH

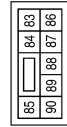

Connector No.	E200
Connector Name	IPDM E/R (INTELLIGENT POWER DISTRIBUTION MODULE ENGINE ROOM)
Connector Color	WHITE

Terminal No.	Color of Wire	Signal Name
8	-	-
9	-	-
10	R/B	ECM_VB
11	P/L	ESCL
12	B	GND (POWER)
13	W	FUEL_PUMP
14	-	-
15	GW	START_IG-E/R
16	L/Y	WIPER_AUTOSTOP
17	-	-
18	-	-
19	L/Y	BCM_IGNSW
20	BY	AMB_SENS_GND-E/R
21	O/B	AMB_SENS_SIG-E/R
22	W/R	PD_SENS_GND-E/R

Terminal No.	Color of Wire	Signal Name
23	B/R	PD_SENS_SIG-E/R
24	B/R/W	PD_SENS_PWR-E/R
25	GR	ABS_ECU
26	-	-
27	BR/W	IGN_SIGNAL
28	BR	PUSH_START_SW
29	-	-
30	R/B	CLUTCH_IL_SW
31	-	-
32	L/O	SL_CONDITION_1
33	G/R	SL_CONDITION_2
34	O/L	MOTOR_FAN_RLY_HI
35	L/B	MOTOR_FAN_LO
36	G	F/L_IGNSW
37	-	-
38	R/W	F/L_MOTOR_FAN

Connector No.	E201
Connector Name	IPDM E/R (INTELLIGENT POWER DISTRIBUTION MODULE ENGINE ROOM)
Connector Color	WHITE

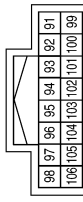

Terminal No.	Color of Wire	Signal Name
91	LG/R	CLEARANCE_RH
92	LG/B	CLEARANCE_LH
93	-	-
94	-	-
95	-	-
96	-	-
97	-	-

Terminal No.	Color of Wire	Signal Name
98	-	-
99	BR/W	AMB_SENS_GND-FEM
100	SB	AMB_SENS_SIG-FEM
101	O/L	PD_SENS_GND-FEM
102	R/B	PD_SENS_SIG-FEM
103	P	PD_SENS_PWR-FEM
104	-	-
105	V	DTRL_RLY
106	-	-

ABMIA0559GB

A
B
C
D
E
F
G
H
I
J
K
L
M
N
O
P



IPDM E/R (INTELLIGENT POWER DISTRIBUTION MODULE ENGINE ROOM)

< ECU DIAGNOSIS >

Connector No.	F10
Connector Name	IPDM E/R (INTELLIGENT POWER DISTRIBUTION MODULE ENGINE ROOM)
Connector Color	WHITE

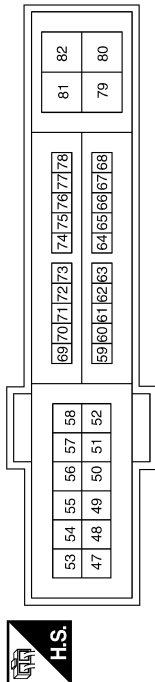

Terminal No.	Color of Wire	Signal Name
47	-	-
48	Y/R	A/C_COMP
49	B/R	ENG_SOL (WITH QR25DE)
49	R/B	IGN_SOL (WITH VQ35DE)

Terminal No.	Color of Wire	Signal Name
50	-	-
51	LG	INJECTOR_#1
52	Y/G	INJECTOR_#2
53	R/B	IGN_SOL (WITH QR25DE)
53	B/R	ENG_SOL (WITH VQ35DE)
54	G/W	ETC
55	W/L	ECM_BAT
56	R/Y	O2_SENS_#1
57	O	O2_SENS_#2
58	Y	AT_ECU
59	-	-
60	-	-
61	-	-
62	-	-
63	-	-
64	-	-

Terminal No.	Color of Wire	Signal Name
65	-	-
66	-	-
67	-	-
68	-	-
69	W/B	SSOF
70	O	MOTRLY
71	-	-
72	R/B	NPSW
73	-	-
74	Y	START_IG-EGI
75	P/L	OIL_PRESSURE_SW
76	GR	ALT_C
77	B/R	FPR
78	-	-
79	-	-
80	B/W	STARTER_MOTOR
81	-	-
82	-	-

ABMIA0560GB

IPDM E/R (INTELLIGENT POWER DISTRIBUTION MODULE ENGINE ROOM)

< ECU DIAGNOSIS >

Wiring Diagram — Sedan

INFOID:000000004495962

IPDM E/R (INTELLIGENT POWER DISTRIBUTION MODULE ENGINE ROOM)

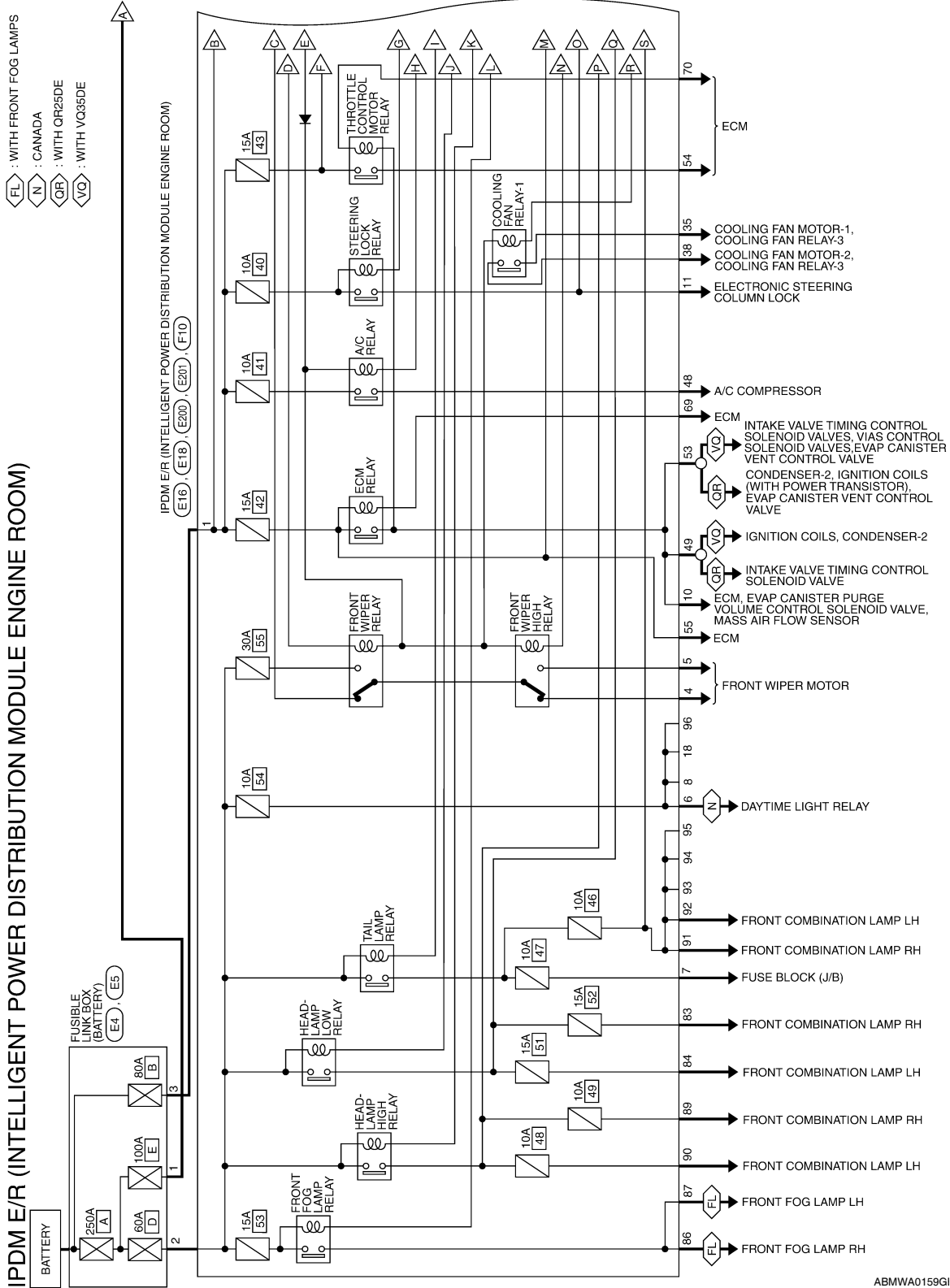

ABMWA0159GI

A
B
C
D
E
F
G
H
I
J
K
L
M
N
O
P

MWI

IPDM E/R (INTELLIGENT POWER DISTRIBUTION MODULE ENGINE ROOM)

< ECU DIAGNOSIS >

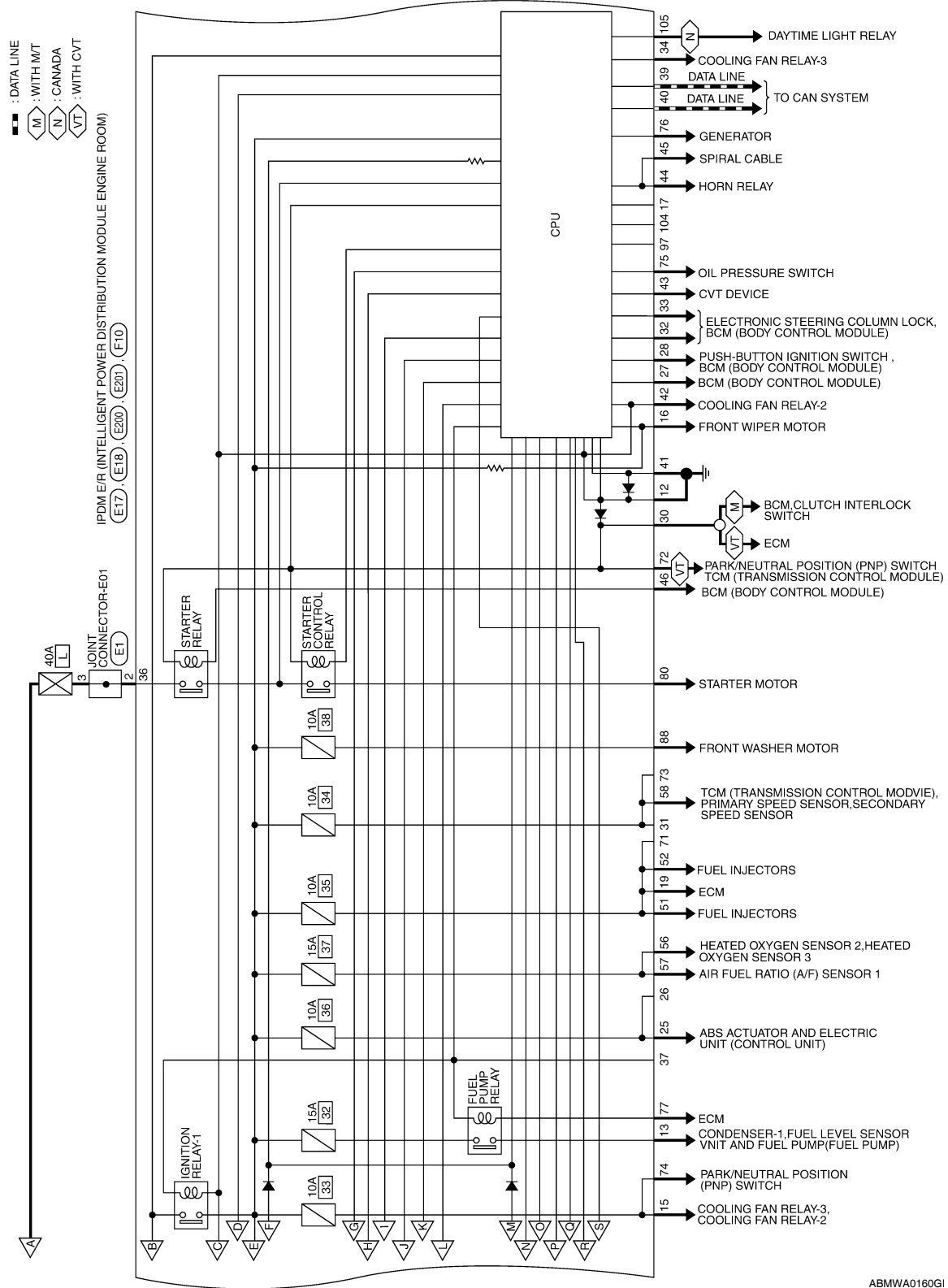

ABMWA0160GI

IPDM E/R (INTELLIGENT POWER DISTRIBUTION MODULE ENGINE ROOM)

< ECU DIAGNOSIS >

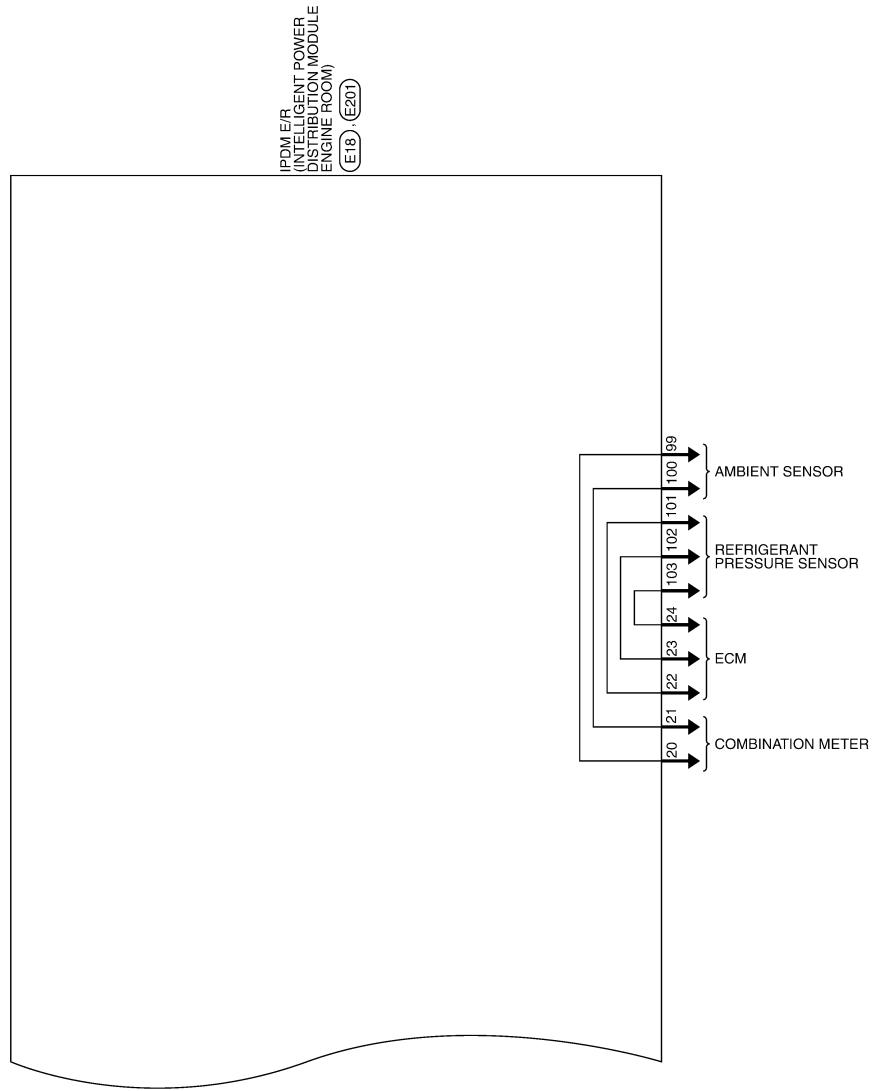

A

B

C

D

E

F

G

H

I

J

K

L

M

MWI

O

P

ABMWA0161GI

IPDM E/R (INTELLIGENT POWER DISTRIBUTION MODULE ENGINE ROOM)

< ECU DIAGNOSIS >

IPDM E/R (INTELLIGENT POWER DISTRIBUTION MODULE ENGINE ROOM) CONNECTORS

Connector No.	E1
Connector Name	JOINT CONNECTOR-E01
Connector Color	WHITE



Terminal No.	Color of Wire	Signal Name
2	G	-
3	G	-

Connector No.	E4
Connector Name	FUSIBLE LINK BOX (BATTERY)
Connector Color	BROWN



Terminal No.	Color of Wire	Signal Name
1	B/W	-
2	B/Y	-

Connector No.	E5
Connector Name	FUSIBLE LINK BOX (BATTERY)
Connector Color	GRAY



Terminal No.	Color of Wire	Signal Name
3	R	-

Connector No.	E16
Connector Name	IPDM E/R (INTELLIGENT POWER DISTRIBUTION MODULE ENGINE ROOM)
Connector Color	BLACK



Terminal No.	Color of Wire	Signal Name
1	R	F/L_MAIN
2	L	F/L_USM

Connector No.	E17
Connector Name	IPDM E/R (INTELLIGENT POWER DISTRIBUTION MODULE ENGINE ROOM)
Connector Color	WHITE

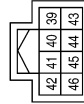

Terminal No.	Color of Wire	Signal Name
39	P	CAN-L
40	L	CAN-H
41	B	GND (SIGNAL)
42	SB	MOTOR_FAN_RLY_MID
43	G/B	DETENT_SW
44	G/W	HORN_RLY
45	L/O	HORN_SW
46	R	START_CONT

IPDM E/R (INTELLIGENT POWER DISTRIBUTION MODULE ENGINE ROOM)

< ECU DIAGNOSIS >

Terminal No.	Color of Wire	Signal Name
23	B/R	PD_SENS_SIG-E/R
24	BR/W	PD_SENS_PWR-E/R
25	GR	ABS_ECU
26	-	-
27	BR/W	IGN_SIGNAL
28	BR	PUSH_START_SW
29	-	-
30	R/B	CLUTCH_L/L_SW
31	-	-
32	L/O	SL_CONDITION_1
33	G/R	SL_CONDITION_2
34	O/L	MOTOR_FAN_RLY_HI
35	L/B	MOTOR_FAN_LO
36	G	F/L_IGNSW
37	-	-
38	R/W	F/L_MOTOR_FAN

Terminal No.	Color of Wire	Signal Name
8	-	-
9	-	-
10	R/B	ECM_VB
11	P/L	ESCL
12	B	GND (POWER)
13	W	FUEL_PUMP
14	-	-
15	G/W	START_IG-E/R
16	L/Y	WIPER_AUTOSTOP
17	-	-
18	-	-
19	L/Y	BCM_IGNSW
20	B/Y	AMB_SENS_GND-E/R
21	O/B	AMB_SENS_SIG-E/R
22	W/R	PD_SENS_GND-E/R

Connector No.	E18
Connector Name	IPDM E/R (INTELLIGENT POWER DISTRIBUTION MODULE ENGINE ROOM)
Connector Color	WHITE

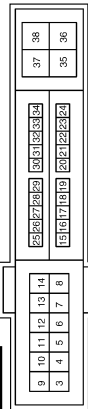

Terminal No.	Color of Wire	Signal Name
3	-	-
4	L/R	FR_WIPER_LO
5	L/B	FR_WIPER_HI
6	SB	DTRL
7	R/L	TAIL/ILLUMI

Terminal No.	Color of Wire	Signal Name
98	-	-
99	BR/W	AMB_SENS_GND-FEM
100	SB	AMB_SENS_SIG-FEM
101	O/L	PD_SENS_GND-FEM
102	R/B	PD_SENS_SIG-FEM
103	P	PD_SENS_PWR-FEM
104	-	-
105	V	DTRL_RLY
106	-	-

Connector No.	E201
Connector Name	IPDM E/R (INTELLIGENT POWER DISTRIBUTION MODULE ENGINE ROOM)
Connector Color	WHITE

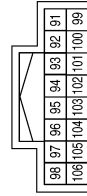

Terminal No.	Color of Wire	Signal Name
91	LG/R	CLEARANCE_RH
92	LG/B	CLEARANCE_LH
93	-	-
94	-	-
95	-	-
96	-	-
97	-	-

Connector No.	E200
Connector Name	IPDM E/R (INTELLIGENT POWER DISTRIBUTION MODULE ENGINE ROOM)
Connector Color	WHITE



Terminal No.	Color of Wire	Signal Name
83	R/Y	HEADLAMP_LO_RH
84	L	HEADLAMP_LO_LH
85	-	-
86	W/R	FR_FOG_LAMP_RH
87	L/Y	FR_FOG_LAMP_LH
88	R/W	WASHER_MTR
89	L/W	HEADLAMP_HI_RH
90	G	HEADLAMP_HI_LH

ABMIA0472GB

A B C D E F G H I J K L M N O P

MWI

IPDM E/R (INTELLIGENT POWER DISTRIBUTION MODULE ENGINE ROOM)

< ECU DIAGNOSIS >

Terminal No.	Color of Wire	Signal Name
65	-	-
66	-	-
67	-	-
68	-	-
69	W/B	SSOF
70	O	MOTRLY
71	-	-
72	R/B	NPSW
73	-	-
74	Y	START_IG-EGI
75	P/L	OIL_PRESSURE_SW
76	GR	ALT_C
77	B/R	FPR
78	-	-
79	-	-
80	B/W	STARTER_MOTOR
81	-	-
82	-	-

Terminal No.	Color of Wire	Signal Name
50	-	-
51	LG	INJECTOR_#1
52	Y/G	INJECTOR_#2
53	R/B	IGN_SOL (WITH QR25DE)
53	B/R	ENG_SOL (WITH VQ35DE)
54	G/W	ETC
55	W/L	ECM_BAT
56	R/Y	O2_SENS_#1
57	O	O2_SENS_#2
58	Y	AT_ECU
59	-	-
60	-	-
61	-	-
62	-	-
63	-	-
64	-	-

Connector No.	F10
Connector Name	IPDM E/R (INTELLIGENT POWER DISTRIBUTION MODULE ENGINE ROOM)
Connector Color	WHITE

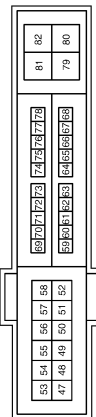

Terminal No.	Color of Wire	Signal Name
47	-	-
48	Y/R	A/C COMP
49	B/R	ENG SOL (WITH QR25DE)
49	R/B	IGN_SOL (WITH VQ35DE)

ABMIA0473GB

INFOID:000000004495963

Fail Safe

CAN COMMUNICATION CONTROL

When CAN communication with ECM and BCM is impossible, IPDM E/R performs fail-safe control. After CAN communication recovers normally, it also returns to normal control.

If No CAN Communication Is Available With ECM

IPDM E/R (INTELLIGENT POWER DISTRIBUTION MODULE ENGINE ROOM)

< ECU DIAGNOSIS >

Control part	Fail-safe in operation
Cooling fan	<ul style="list-style-type: none"> • Signals cooling fans ON when the ignition switch is turned ON • Signals cooling fans OFF when the ignition switch is turned OFF
A/C compressor	A/C relay OFF
Generator	Outputs the power generation command signal (PWM signal) 0%

If No CAN Communication Is Available With BCM

Control part	Fail-safe in operation
Headlamp	<ul style="list-style-type: none"> • Turns ON the headlamp low relay when the ignition switch is turned ON • Turns OFF the headlamp low relay when the ignition switch is turned OFF • Headlamp high relay OFF
<ul style="list-style-type: none"> • Parking lamps • License plate lamps • Illumination • Tail lamps 	<ul style="list-style-type: none"> • Turns ON the tail lamp relay when the ignition switch is turned ON • Turns OFF the tail lamp relay when the ignition switch is turned OFF
Front wiper	<ul style="list-style-type: none"> • The status just before activation of fail-safe control is maintained until the ignition switch is turned OFF while the front wiper is operating at LO or HI speed. • The wiper is operated at LO speed until the ignition switch is turned OFF if the fail-safe control is activated while the front wiper is set in the INT mode and the front wiper motor is operating.
Front fog lamps (if equipped)	Front fog lamp relay OFF
Horn	Horn OFF
Ignition relay	The status just before activation of fail-safe is maintained.
Starter motor	Starter control relay OFF
Electronic steering column lock unit	Electronic steering column lock relay OFF

IGNITION RELAY MALFUNCTION DETECTION FUNCTION

- IPDM E/R monitors the voltage at the contact circuit and excitation coil circuit of the ignition relay inside it.
- IPDM E/R judges the ignition relay error if the voltage differs between the contact circuit and the excitation coil circuit.
- If the ignition relay cannot turn OFF due to contact seizure, it activates the tail lamp relay for 10 minutes to alert the user to the ignition relay malfunction when the ignition switch is turned OFF.

DTC	Ignition switch	Ignition relay	Tail lamp relay
—	ON	ON	—
—	OFF	OFF	—
B2098: IGN RELAY ON	OFF	ON	ON (10 minutes)
B2099: IGN RELAY OFF	ON	OFF	—

NOTE:

The tail lamp turns OFF when the ignition switch is turned ON.

FRONT WIPER CONTROL

IPDM E/R detects front wiper stop position by a front wiper auto stop signal.

When a front wiper auto stop signal is in the conditions listed below, IPDM E/R stops power supply to wiper after repeating a front wiper 10 second activation and 20 second stop five times.

Ignition switch	Front wiper switch	Auto stop signal
ON	OFF	Front wiper stop position signal cannot be input 10 seconds.
	ON	The signal does not change for 10 seconds.

NOTE:

This operation status can be confirmed on the IPDM E/R “Data Monitor” that displays “BLOCK” for the item “WIP PROT” while the wiper is stopped.

IPDM E/R (INTELLIGENT POWER DISTRIBUTION MODULE ENGINE ROOM)

< ECU DIAGNOSIS >

STARTER MOTOR PROTECTION FUNCTION

IPDM E/R turns OFF the starter control relay to protect the starter motor when the starter control relay remains active for 90 seconds.

DTC Index

INFOID:000000004495964

CONSULT-III display	Fail-safe	TIME ^{NOTE}		Refer to
No DTC is detected. further testing may be required.	—	—	—	—
U1000: CAN COMM CIRCUIT	×	CRNT	1 – 39	PCS-20
B2098: IGN RELAY ON	×	CRNT	1 – 39	PCS-21
B2099: IGN RELAY OFF	—	CRNT	1 – 39	PCS-22
B2108: STRG LCK RELAY ON	—	CRNT	1 – 39	SEC-42
B2109: STRG LCK RELAY OFF	—	CRNT	1 – 39	SEC-43
B210A: STRG LCK STATE SW	—	CRNT	1 – 39	SEC-44
B210B: START CONT RLY ON	—	CRNT	1 – 39	SEC-48
B210C: START CONT RLY OFF	—	CRNT	1 – 39	SEC-49
B210D: STARTER RELAY ON	—	CRNT	1 – 39	SEC-50
B210E: STARTER RELAY OFF	—	CRNT	1 – 39	SEC-51
B210F: INTRLCK/PNP SW ON	—	CRNT	1 – 39	SEC-54
B2110: INTRLCK/PNP SW OFF	—	CRNT	1 – 39	SEC-59

NOTE:

The details of TIME display are as follows.

- CRNT: The malfunctions that are detected now
- 1 - 39: The number is indicated when it is normal at present and a malfunction was detected in the past. It increases like 0 → 1 → 2 ··· 38 → 39 after returning to the normal condition whenever IGN OFF → ON. It is fixed to 39 until the self-diagnosis results are erased if it is over 39. It returns to 0 when a malfunction is detected again in the process.

THE FUEL GAUGE POINTER DOES NOT MOVE

< SYMPTOM DIAGNOSIS >

SYMPTOM DIAGNOSIS

THE FUEL GAUGE POINTER DOES NOT MOVE

Description

INFOID:000000004204134

Fuel gauge needle will not move from a certain position.

Diagnosis Procedure

INFOID:000000004204135

1. CHECK COMBINATION METER INPUT SIGNAL

1. Select "METER/M&A" on CONSULT-III.
2. Using "FUEL METER" of "DATA MONITOR", compare the monitor value with the fuel gauge reading on the combination meter. Refer to [MWI-46, "Component Function Check"](#).

Does monitor value match fuel gauge reading?

YES >> GO TO 2

NO >> Replace combination meter. Refer to [MWI-176, "Removal and Installation"](#).

2. CHECK FUEL LEVEL SENSOR SIGNAL CIRCUIT

Check the fuel level sensor signal circuit. Refer to [MWI-46, "Diagnosis Procedure"](#).

Is the inspection result normal?

YES >> GO TO 3

NO >> Repair harness or connector.

3. CHECK FUEL LEVEL SENSOR UNIT

Perform a unit check for the fuel level sensor unit. Refer to [MWI-47, "Component Inspection"](#).

Is the inspection result normal?

YES >> GO TO 4

NO >> Replace fuel level sensor unit. Refer to [FL-6, "Removal and Installation"](#).

4. CHECK FLOAT INTERFERENCE

Check that the float arm does not interfere or bind with any of the components in the fuel tank.

Is the inspection result normal?

YES >> Replace combination meter. Refer to [MWI-176, "Removal and Installation"](#).

NO >> Repair or replace malfunctioning parts.

A
B
C
D
E
F
G
H
I
J
K
L
M
O
P

MWI

THE FUEL GAUGE POINTER DOES NOT MOVE TO "F" WHEN REFUELING

< SYMPTOM DIAGNOSIS >

THE FUEL GAUGE POINTER DOES NOT MOVE TO "F" WHEN REFUELING

Description

INFOID:000000004204136

The fuel gauge needle will not move to "F" position when refueling.

Diagnosis Procedure

INFOID:000000004204137

1.OBSERVE FUEL GAUGE

Does it take a long time for the pointer to move to FULL position?

YES or NO

YES >> GO TO 2

NO >> GO TO 3

2.IDENTIFY FUELING CONDITION

Was the vehicle fueled with the ignition switch ON?

YES or NO

YES >> Be sure to fuel the vehicle with the ignition switch OFF. Otherwise, it will take a long time to move to FULL position because of the characteristic of the fuel gauge.

NO >> GO TO 3

3.OBSERVE VEHICLE POSITION

Is the vehicle parked on an incline?

YES or NO

YES >> Check the fuel level indication with vehicle on a level surface.

NO >> GO TO 4

4.OBSERVE FUEL GAUGE POINTER

During driving, does the fuel gauge pointer move gradually toward EMPTY position?

YES or NO

YES >> Check the components. Refer to [MWI-47. "Component Inspection"](#).

NO >> The float arm may interfere or bind with any of the components in the fuel tank.

THE OIL PRESSURE WARNING LAMP DOES NOT TURN ON

< SYMPTOM DIAGNOSIS >

THE OIL PRESSURE WARNING LAMP DOES NOT TURN ON

Description

INFOID:000000004204138

The oil pressure warning lamp stays off when the ignition switch is turned ON.

Diagnosis Procedure

INFOID:000000004204139

1.CHECK OIL PRESSURE WARNING LAMP

Perform IPDM E/R auto active test. Refer to [PCS-14, "Diagnosis Description"](#).

Is oil pressure warning lamp illuminated?

YES >> GO TO 2

NO >> Replace combination meter. Refer to [MWI-176, "Removal and Installation"](#).

2.CHECK OIL PRESSURE SWITCH SIGNAL CIRCUIT

Check the oil pressure switch signal circuit. Refer to [MWI-48, "Diagnosis Procedure"](#).

Is the inspection result normal?

YES >> GO TO 3

NO >> Repair harness or connector.

3.CHECK OIL PRESSURE SWITCH UNIT

Perform a unit check for the oil pressure switch. Refer to [MWI-48, "Component Inspection"](#).

Is the inspection result normal?

YES >> Replace IPDM E/R. Refer to [PCS-48, "Removal and Installation"](#).

NO >> Replace oil pressure switch.

A
B
C
D
E
F
G
H
I
J
K
L
M
O
P

MWI

THE OIL PRESSURE WARNING LAMP DOES NOT TURN OFF

< SYMPTOM DIAGNOSIS >

THE OIL PRESSURE WARNING LAMP DOES NOT TURN OFF

Description

INFOID:000000004204140

The oil pressure warning lamp remains illuminated while the engine is running (normal oil pressure).

Diagnosis Procedure

INFOID:000000004204141

1. CHECK OIL PRESSURE WARNING LAMP

Perform IPDM E/R auto active test. Refer to [PCS-14, "Diagnosis Description"](#).

Is oil pressure warning lamp illuminated?

YES >> GO TO 2

NO >> Replace combination meter. Refer to [MWI-176, "Removal and Installation"](#).

2. CHECK IPDM E/R OUTPUT VOLTAGE

1. Turn ignition switch OFF.
2. Disconnect the oil pressure switch connector.
3. Turn ignition switch ON.
4. Check voltage between the oil pressure switch harness connector F41 terminal 1 and ground.

1 – Ground : Approx. 12V

Is the inspection result normal?

YES >> GO TO 3

NO >> GO TO 4

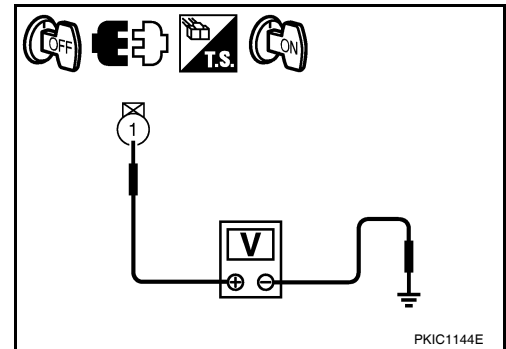

3. CHECK OIL PRESSURE SWITCH

Perform a unit check for the oil pressure switch. Refer to [MWI-48, "Component Inspection"](#).

Is the inspection result normal?

YES >> Replace IPDM E/R. Refer to [PCS-48, "Removal and Installation"](#).

NO >> Replace oil pressure switch.

4. CHECK OIL PRESSURE SWITCH SIGNAL CIRCUIT

Check the oil pressure switch signal circuit. Refer to [MWI-48, "Diagnosis Procedure"](#).

Is the inspection result normal?

YES >> Replace IPDM E/R. Refer to [PCS-48, "Removal and Installation"](#).

NO >> Repair harness or connector.

THE PARKING BRAKE RELEASE WARNING CONTINUES DISPLAYING, OR DOES NOT DISPLAY

< SYMPTOM DIAGNOSIS >

THE PARKING BRAKE RELEASE WARNING CONTINUES DISPLAYING, OR DOES NOT DISPLAY

Description

INFOID:000000004204142

- The parking brake warning is displayed while driving the vehicle even though the parking brake is released.
- The parking brake warning is not displayed even though driving the vehicle with the parking brake applied.

Diagnosis Procedure

INFOID:000000004204143

1. CHECK PARKING BRAKE WARNING LAMP OPERATION

1. Start engine.
2. Monitor "BRAKE" warning lamp while applying and releasing the parking brake.

BRAKE warning lamp

Parking brake applied : ON

Parking brake released : OFF

Is the inspection result normal?

YES >> Replace combination meter. Refer to [MWI-176, "Removal and Installation"](#).

NO >> GO TO 2

2. CHECK PARKING BRAKE SWITCH SIGNAL CIRCUIT

1. Turn ignition switch OFF.
2. Check the parking brake switch signal circuit. Refer to [MWI-49, "Diagnosis Procedure"](#).

Is the inspection result normal?

YES >> GO TO 3

NG >> Repair harness or connector.

3. CHECK PARKING BRAKE SWITCH UNIT

Perform a unit check for the parking brake switch. Refer to [MWI-50, "Component Inspection"](#).

Is the inspection result normal?

YES >> Replace combination meter. Refer to [MWI-176, "Removal and Installation"](#).

NO >> Replace parking brake switch.

A
B
C
D
E
F
G
H
I
J
K
L
M
O
P

MWI

THE LOW WASHER FLUID WARNING CONTINUES DISPLAYING, OR DOES NOT DISPLAY

< SYMPTOM DIAGNOSIS >

THE LOW WASHER FLUID WARNING CONTINUES DISPLAYING, OR DOES NOT DISPLAY

Description

INFOID:000000004204144

- The warning is still displayed even after washer fluid is added.
- The warning is not displayed even though the washer tank is empty.

Diagnosis Procedure

INFOID:000000004204145

1.CHECK WASHER LEVEL SWITCH SIGNAL CIRCUIT

Check the washer level switch signal circuit. Refer to [MWI-51. "Diagnosis Procedure"](#).

Is the inspection result normal?

- YES >> GO TO 2
NO >> Repair harness or connector.

2.CHECK WASHER LEVEL SWITCH UNIT

Perform a unit check for the washer level switch. Refer to [MWI-51. "Component Inspection"](#).

Is the inspection result normal?

- YES >> Replace combination meter. Refer to [MWI-176. "Removal and Installation"](#).
NO >> Replace washer level switch.

THE DOOR OPEN WARNING CONTINUES DISPLAYING, OR DOES NOT DISPLAY

< SYMPTOM DIAGNOSIS >

THE DOOR OPEN WARNING CONTINUES DISPLAYING, OR DOES NOT DISPLAY

Description

INFOID:000000004204146

- The door ajar warning is displayed even though all of the doors and the trunk are closed.
- The door ajar warning is not displayed even though a door or the trunk is ajar.

Diagnosis Procedure

INFOID:000000004204147

1. CHECK BCM INPUT SIGNAL

Connect CONSULT-III and check the BCM input signals. Refer to the following:

- Door switch - coupe: [DLK-69, "Component Function Check"](#)
- Door switch - sedan: [DLK-293, "Component Function Check"](#)
- Trunk lamp switch and trunk release solenoid - coupe: [DLK-93, "Component Function Check"](#)
- Trunk lamp switch and trunk release solenoid - sedan: [DLK-316, "Component Function Check"](#)

Is the inspection result normal?

- YES >> GO TO 2
NO >> GO TO 3

2. CHECK COMBINATION METER INPUT SIGNAL

1. Select "METER/M&A" on CONSULT-III.
2. Monitor "DOOR W/L" and "TRUNK/GLAS-H" of "DATA MONITOR" while opening and closing doors and trunk.

"DOOR W/L"

Door open : ON
Door closed : OFF

"TRUNK/GLAS-H"

Trunk open : ON
Trunk closed : OFF

Is the inspection result normal?

- YES >> Replace combination meter. Refer to [MWI-176, "Removal and Installation"](#).
NO >> Replace BCM. Refer to [BCS-96, "Removal and Installation"](#).

3. CHECK DOOR SWITCH SIGNAL CIRCUIT

Check the door switch signal circuit. Refer to the following:

- Coupe: [DLK-69, "Diagnosis Procedure"](#)
- Sedan: [DLK-293, "Diagnosis Procedure"](#)

Is the inspection result normal?

- YES >> GO TO 4
NO >> Repair harness or connector.

4. CHECK DOOR SWITCH UNIT

Perform a unit check for the door switch. Refer to the following:

- Coupe: [DLK-71, "Component Inspection"](#)
- Sedan: [DLK-295, "Component Inspection"](#)

Is the inspection result normal?

- YES >> GO TO 5
NO >> Replace door switch.

5. CHECK TRUNK LAMP SWITCH AND TRUNK RELEASE SOLENOID SIGNAL CIRCUIT

Check the trunk lamp switch and trunk release solenoid signal circuit. Refer to the following:

- Coupe: [DLK-93, "Diagnosis Procedure"](#)
- Sedan: [DLK-316, "Diagnosis Procedure"](#)

A
B
C
D
E
F
G
H
I
J
K
L
M
O
P

MWI

THE DOOR OPEN WARNING CONTINUES DISPLAYING, OR DOES NOT DISPLAY

< SYMPTOM DIAGNOSIS >

Is the inspection result normal?

YES >> GO TO 6

NO >> Repair harness or connector.

6. CHECK TRUNK LAMP SWITCH AND TRUNK RELEASE SOLENOID UNIT

Perform a unit check for the trunk lamp switch and trunk release solenoid. Refer to the following:

- Coupe: [DLK-94, "Component Inspection"](#)
- Sedan: [DLK-318, "Component Inspection"](#)

Is the inspection result normal?

YES >> Replace combination meter. Refer to [MWI-176, "Removal and Installation"](#).

NO >> Replace trunk lamp switch and trunk release solenoid.

THE AMBIENT TEMPERATURE DISPLAY IS INCORRECT

< SYMPTOM DIAGNOSIS >

THE AMBIENT TEMPERATURE DISPLAY IS INCORRECT

Description

INFOID:000000004204148

- The displayed ambient air temperature is higher than the actual temperature.
- The displayed ambient air temperature is lower than the actual temperature.

Diagnosis Procedure

INFOID:000000004204149

NOTE:

Check that the symptom is not applicable to the normal operating condition before starting diagnosis. Refer to [MWI-32, "INFORMATION DISPLAY : System Description"](#).

1.CHECK AMBIENT SENSOR SIGNAL CIRCUIT

Check the ambient sensor signal circuit. Refer to [MWI-53, "Diagnosis Procedure"](#).

Is the inspection result normal?

YES >> GO TO 2

NO >> Repair harness or connector.

2.CHECK AMBIENT SENSOR UNIT

Perform a unit check for the ambient sensor. Refer to [HAC-51, "Component Inspection"](#).

Is the inspection result normal?

YES >> Replace combination meter. Refer to [MWI-176, "Removal and Installation"](#).

NO >> Replace ambient sensor.

A
B
C
D
E
F
G
H
I
J
K
L
M
O
P

MWI

NORMAL OPERATING CONDITION

< SYMPTOM DIAGNOSIS >

NORMAL OPERATING CONDITION COMPASS

COMPASS : Description

INFOID:000000004204150

COMPASS

- The electronic compass is highly protected from changes in most magnetic fields. However, some large changes in magnetic fields can affect it. Some examples are (but not limited to): high tension power lines, large steel buildings, subways, steel bridges, automatic car washes, large piles of scrap metal, etc. While this does not happen very often, it is possible.
- During normal operation, the Compass Mirror will continuously update the compass calibration to adjust for gradual changes in the vehicle's magnetic "remnant" field. If the vehicle is subjected to high magnetic influences, the compass may appear to indicate false headings, become locked, or appear that it is unable to be calibrated. If this occurs, perform the calibration procedure.
- If at any time the compass continually displays the incorrect direction or the reading is erratic or locked, verify the correct zone variance.

Symptom Chart

Symptom	Cause	Solution / Reference
The compass display reads "C".	<ul style="list-style-type: none"> • Compass is not calibrated. • Incorrect zone variance setting. • Large change in magnetic field (Steel bridges, subways, concentrations of metal, car washes, etc.) • Compass was calibrated incorrectly or in the presence of a strong magnetic field. 	Perform Calibration. Refer to MWI-36, "Description" .
Compass shows the wrong direction.		
Compass does not change direction appears "Locked".		
Compass does not show all the directions, one or more is missing.		
The compass was calibrated but it "loses" calibration.		
On long trips the compass shows the wrong direction.		Perform Zone Variation Setting if correct reading is desired in that location. Refer to MWI-36, "Description" .

PRECAUTIONS

< PRECAUTION >

PRECAUTION

PRECAUTIONS

Supplemental Restraint System (SRS) "AIR BAG" and "SEAT BELT PRE-TENSIONER"

INFOID:000000004204151

The Supplemental Restraint System such as "AIR BAG" and "SEAT BELT PRE-TENSIONER", used along with a front seat belt, helps to reduce the risk or severity of injury to the driver and front passenger for certain types of collision. This system includes seat belt switch inputs and dual stage front air bag modules. The SRS system uses the seat belt switches to determine the front air bag deployment, and may only deploy one front air bag, depending on the severity of a collision and whether the front occupants are belted or unbelted. Information necessary to service the system safely is included in the SR and SB section of this Service Manual.

WARNING:

- To avoid rendering the SRS inoperative, which could increase the risk of personal injury or death in the event of a collision which would result in air bag inflation, all maintenance must be performed by an authorized NISSAN/INFINITI dealer.
- Improper maintenance, including incorrect removal and installation of the SRS, can lead to personal injury caused by unintentional activation of the system. For removal of Spiral Cable and Air Bag Module, see the SR section.
- Do not use electrical test equipment on any circuit related to the SRS unless instructed to in this Service Manual. SRS wiring harnesses can be identified by yellow and/or orange harnesses or harness connectors.

Necessary for Steering Wheel Rotation After Battery Disconnect

INFOID:000000004501283

NOTE:

- Before removing and installing any control units, first turn the push-button ignition switch to the LOCK position, then disconnect both battery cables.
- After finishing work, confirm that all control unit connectors are connected properly, then re-connect both battery cables.
- Always use CONSULT-III to perform self-diagnosis as a part of each function inspection after finishing work. If a DTC is detected, perform trouble diagnosis according to self-diagnosis results.

This vehicle is equipped with a push-button ignition switch and a steering lock unit.

If the battery is disconnected or discharged, the steering wheel will lock and cannot be turned.

If turning the steering wheel is required with the battery disconnected or discharged, follow the procedure below before starting the repair operation.

OPERATION PROCEDURE

1. Connect both battery cables.

NOTE:

Supply power using jumper cables if battery is discharged.

2. Carry the Intelligent Key or insert it to the key slot and turn the push-button ignition switch to ACC position. (At this time, the steering lock will be released.)
3. Disconnect both battery cables. The steering lock will remain released with both battery cables disconnected and the steering wheel can be turned.
4. Perform the necessary repair operation.
5. When the repair work is completed, re-connect both battery cables. With the brake pedal released, turn the push-button ignition switch from ACC position to ON position, then to LOCK position. (The steering wheel will lock when the push-button ignition switch is turned to LOCK position.)
6. Perform self-diagnosis check of all control units using CONSULT-III.

COMBINATION METER

< ON-VEHICLE REPAIR >

ON-VEHICLE REPAIR

COMBINATION METER

Removal and Installation

INFOID:000000004204152

REMOVAL

1. Open the fuse block cover, remove the instrument lower cover screw (A), then remove the instrument lower cover (1).
 - Disconnect the harness connectors.
 - Disconnect the aspirator tube.

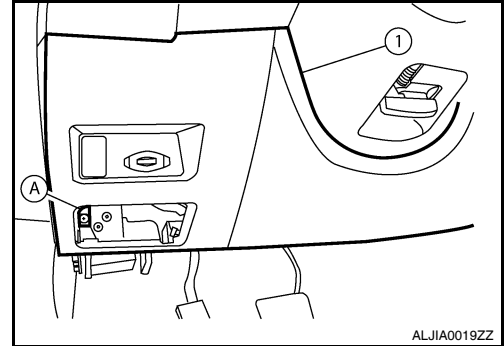

2. Remove the steering column screws (A), then remove both the steering wheel column upper (1) and lower (2) covers.
NOTE:
 - Turn steering wheel to access steering column cover screws.
 - Steering wheel removed for clarity.

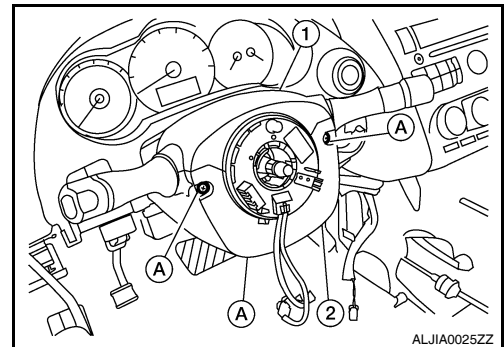

3. Remove the cluster lid A (1).
NOTE:
 - Steering wheel removed for clarity.

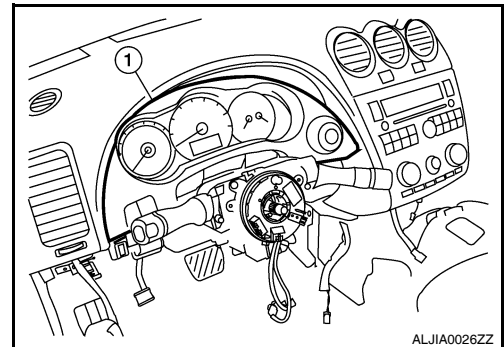

4. Remove the combination meter screws (A) using power tools, and pull out the combination meter (1).
5. Disconnect the combination meter connector, and remove the combination meter (1).

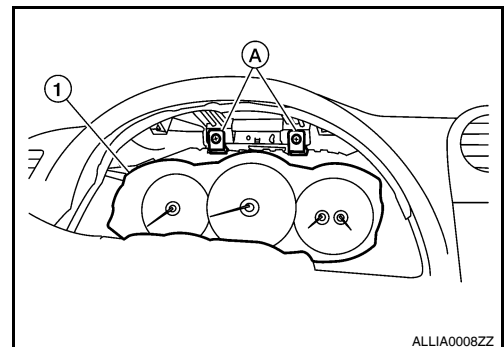

INSTALLATION

Installation is in the reverse order of removal.

COMBINATION METER

< DISASSEMBLY AND ASSEMBLY >

DISASSEMBLY AND ASSEMBLY

COMBINATION METER

Disassembly and Assembly

INFOID:000000004204153

DISASSEMBLY

1. Remove the combination meter. Refer to [IP-12. "Removal and Installation"](#).
2. Remove the combination meter lens (1) from the combination meter (2).

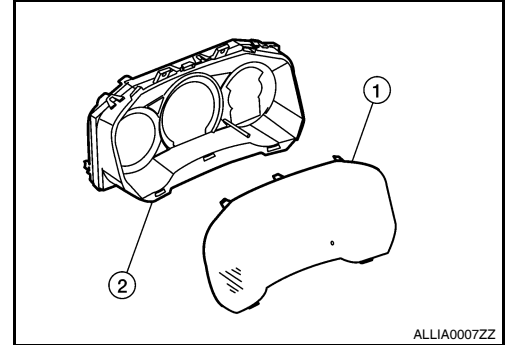

ASSEMBLY

Assembly is in the reverse order of disassembly.

A
B
C
D
E
F
G
H
I
J
K
L
M
O
P

MWI