

A
B
C

SECTION **WW**

WIPER & WASHER

CONTENTS

<p>BASIC INSPECTION 3</p> <p>DIAGNOSIS AND REPAIR WORKFLOW 3</p> <p style="padding-left: 20px;">Work Flow3</p> <p>FUNCTION DIAGNOSIS 6</p> <p>FRONT WIPER AND WASHER SYSTEM 6</p> <p style="padding-left: 20px;">System Diagram6</p> <p style="padding-left: 20px;">System Description6</p> <p style="padding-left: 20px;">Component Parts Location9</p> <p style="padding-left: 20px;">Component Description10</p> <p>DIAGNOSIS SYSTEM (BCM)11</p> <p>COMMON ITEM 11</p> <p style="padding-left: 20px;">COMMON ITEM : Diagnosis Description 11</p> <p style="padding-left: 20px;">COMMON ITEM : CONSULT-III Function 11</p> <p>WIPER12</p> <p style="padding-left: 20px;">WIPER : CONSULT - III Function 12</p> <p>DIAGNOSIS SYSTEM (IPDM E/R)13</p> <p style="padding-left: 20px;">Diagnosis Description 13</p> <p style="padding-left: 20px;">CONSULT - III Function (IPDM E/R) 16</p> <p>COMPONENT DIAGNOSIS19</p> <p>WIPER AND WASHER FUSE19</p> <p style="padding-left: 20px;">Description 19</p> <p style="padding-left: 20px;">Diagnosis Procedure 19</p> <p>FRONT WIPER MOTOR LO CIRCUIT20</p> <p style="padding-left: 20px;">Component Function Check 20</p> <p style="padding-left: 20px;">Diagnosis Procedure 20</p> <p>FRONT WIPER MOTOR HI CIRCUIT22</p> <p style="padding-left: 20px;">Component Function Check 22</p> <p style="padding-left: 20px;">Diagnosis Procedure 22</p> <p>FRONT WIPER AUTO STOP SIGNAL CIRCUIT24</p> <p style="padding-left: 20px;">Component Function Check 24</p>	<p style="padding-left: 20px;">Diagnosis Procedure24</p> <p>FRONT WIPER MOTOR GROUND CIRCUIT ...26</p> <p style="padding-left: 20px;">Diagnosis Procedure26</p> <p>FRONT WIPER AND WASHER SYSTEM27</p> <p style="padding-left: 20px;">Wiring Diagram-Coupe27</p> <p style="padding-left: 20px;">Wiring Diagram-Sedan32</p> <p>ECU DIAGNOSIS37</p> <p>BCM (BODY CONTROL MODULE)37</p> <p style="padding-left: 20px;">Reference Value37</p> <p style="padding-left: 20px;">Terminal Layout42</p> <p style="padding-left: 20px;">Physical Values42</p> <p style="padding-left: 20px;">Wiring Diagram-Coupe61</p> <p style="padding-left: 20px;">Wiring Diagram-Sedan70</p> <p style="padding-left: 20px;">Fail Safe78</p> <p style="padding-left: 20px;">DTC Inspection Priority Chart80</p> <p style="padding-left: 20px;">DTC Index81</p> <p>IPDM E/R (INTELLIGENT POWER DISTRIBUTION MODULE ENGINE ROOM)84</p> <p style="padding-left: 20px;">Reference Value84</p> <p style="padding-left: 20px;">Wiring Diagram — Coupe92</p> <p style="padding-left: 20px;">Wiring Diagram — Sedan98</p> <p style="padding-left: 20px;">Fail Safe103</p> <p style="padding-left: 20px;">DTC Index105</p> <p>SYMPTOM DIAGNOSIS 106</p> <p>FRONT WIPER AND WASHER SYSTEM SYMPTOMS 106</p> <p style="padding-left: 20px;">Symptom Table106</p> <p>FRONT WIPER DOES NOT OPERATE 108</p> <p style="padding-left: 20px;">Description108</p> <p style="padding-left: 20px;">Diagnosis Procedure108</p> <p>NORMAL OPERATING CONDITION 110</p> <p style="padding-left: 20px;">Description110</p>
---	---

A
B
C
D
E
F
G
H
I
J
K

WW

M
N
O
P

PRECAUTION	111	FRONT WIPER DRIVE ASSEMBLY	116
PRECAUTIONS	111	FRONT WIPER DRIVE ASSEMBLY : Removal and Installation	116
Supplemental Restraint System (SRS) AIR BAG and SEAT BELT PRE-TENSIONER	111	FRONT WASHER	118
Necessary for Steering Wheel Rotation After Battery Disconnect	111	WASHER TUBE	118
ON-VEHICLE REPAIR	112	WASHER TUBE : Layout	118
FRONT WIPER	112	FRONT WASHER NOZZLE	118
Exploded View	112	FRONT WASHER NOZZLE : Removal and Installation	118
FRONT WIPER BLADE REFILL	112	FRONT WASHER NOZZLE : Adjustment	119
FRONT WIPER BLADE REFILL : Removal and Installation	112	WASHER TANK	119
FRONT WIPER BLADE	115	WASHER TANK : Removal and Installation	119
FRONT WIPER BLADE : Removal and Installation	115	FRONT WASHER PUMP	120
FRONT WIPER ARMS	116	FRONT WASHER PUMP : Removal and Installation	120
FRONT WIPER ARMS : Removal and Installation.	116	FRONT WIPER AND WASHER SWITCH	121
		Removal and Installation	121

DIAGNOSIS AND REPAIR WORKFLOW

< BASIC INSPECTION >

BASIC INSPECTION

DIAGNOSIS AND REPAIR WORKFLOW

Work Flow

INFOID:000000004202185

OVERALL SEQUENCE

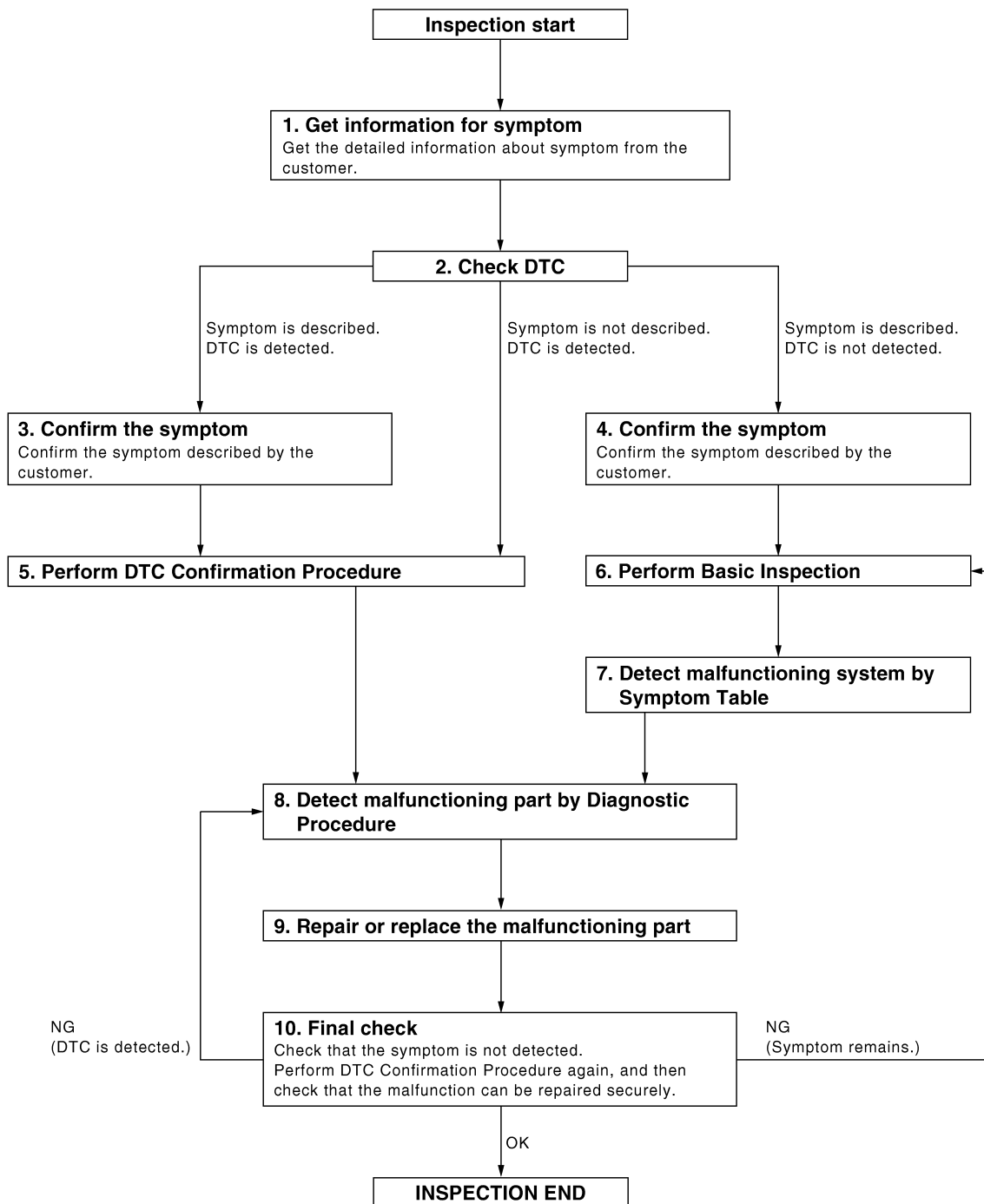

DETAILED FLOW

A
B
C
D
E
F
G
H
I
J
K
WW
M
N
O
P

DIAGNOSIS AND REPAIR WORKFLOW

< BASIC INSPECTION >

1. GET INFORMATION FOR SYMPTOM

Get the detailed information from the customer about the symptom (the condition and the environment when the incident/malfunction occurred).

>> GO TO 2

2. CHECK DTC

1. Check DTC.
2. Perform the following procedure if DTC is displayed.
 - Record DTC and freeze frame data (Print them out with CONSULT-III.)
 - Erase DTC.
 - Study the relationship between the cause detected by DTC and the symptom described by the customer.
3. Check related service bulletins for information.

Is any symptom described and any DTC detected?

Symptom is described, DTC is displayed>>GO TO 3

Symptom is described, DTC is not displayed>>GO TO 4

Symptom is not described, DTC is displayed>>GO TO 5

3. CONFIRM THE SYMPTOM

Confirm the symptom described by the customer.

Connect CONSULT-III to the vehicle in "DATA MONITOR" mode and check real time diagnosis results.

Verify relation between the symptom and the condition when the symptom is detected.

>> GO TO 5

4. CONFIRM THE SYMPTOM

Confirm the symptom described by the customer.

Connect CONSULT-III to the vehicle in "DATA MONITOR" mode and check real time diagnosis results.

Verify relation between the symptom and the condition when the symptom is detected.

>> GO TO 6

5. PERFORM DTC CONFIRMATION PROCEDURE

Perform DTC Confirmation Procedure for the displayed DTC, and then check that DTC is detected again.

At this time, always connect CONSULT-III to the vehicle, and check diagnostic results in real time.

If two or more DTCs are detected, refer to [BCS-90. "DTC Inspection Priority Chart"](#) and determine trouble diagnosis order.

NOTE:

- Freeze frame data is useful if the DTC is not detected.
- Perform Component Function Check if DTC Confirmation Procedure is not included in Service Manual. This simplified check procedure is an effective alternative though DTC cannot be detected during this check. If the result of Component Function Check is NG, it is the same as the detection of DTC by DTC Confirmation Procedure.

Is DTC detected?

YES >> GO TO 8

NO >> Refer to [GI-42. "Intermittent Incident"](#).

6. PERFORM BASIC INSPECTION

Perform [WW-3. "Work Flow"](#).

Inspection End>>GO TO 7

7. DETECT MALFUNCTIONING SYSTEM BY SYMPTOM TABLE

Detect malfunctioning system according to [WW-108. "Diagnosis Procedure"](#) based on the confirmed symptom in step 4, and determine the trouble diagnosis order based on possible causes and symptom.

>> GO TO 8

DIAGNOSIS AND REPAIR WORKFLOW

< BASIC INSPECTION >

8. DETECT MALFUNCTIONING PART BY DIAGNOSTIC PROCEDURE

Inspect according to Diagnostic Procedure of the system.

NOTE:

The Diagnostic Procedure described based on open circuit inspection. A short circuit inspection is also required for the circuit check in the Diagnostic Procedure.

Is malfunctioning part detected?

YES >> GO TO 9

NO >> Check voltage of related BCM terminals using CONSULT-III.

9. REPAIR OR REPLACE THE MALFUNCTIONING PART

1. Repair or replace the malfunctioning part.
2. Reconnect parts or connectors disconnected during Diagnostic Procedure again after repair and replacement.
3. Check DTC. If DTC is displayed, erase it.

>> GO TO 10

10. FINAL CHECK

When DTC was detected in step 2, perform DTC Confirmation Procedure or Component Function Check again, and then check that the malfunction have been repaired securely.

When symptom was described from the customer, refer to confirmed symptom in step 3 or 4, and check that the symptom is not detected.

Does the symptom reappear?

YES (DTC is detected)>>GO TO 8

YES (Symptom remains)>>GO TO 6

NO >> Inspection End.

A
B
C
D
E
F
G
H
I
J
K
M
N
O
P

WW

FRONT WIPER AND WASHER SYSTEM

< FUNCTION DIAGNOSIS >

FUNCTION DIAGNOSIS

FRONT WIPER AND WASHER SYSTEM

System Diagram

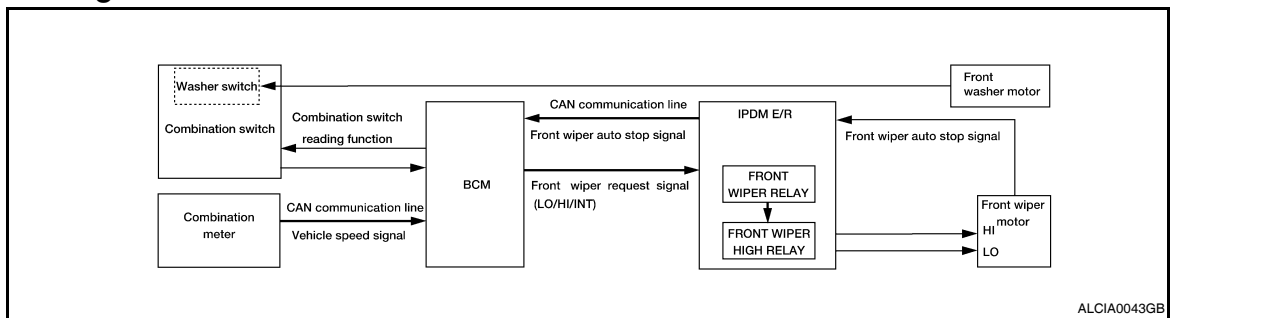

System Description

INFOID:000000004202187

OUTLINE

The front wiper is controlled by each function of BCM and IPDM E/R.

Control by BCM

- Combination switch reading function
- Front wiper control function

Control by IPDM E/R

- Front wiper control function
- Relay control function

FRONT WIPER BASIC OPERATION

- BCM detects the combination switch condition by the combination switch reading function.
- BCM transmits the front wiper request signal to IPDM E/R with CAN communication depending on each operating condition of the front wiper.
- IPDM E/R turns ON/OFF the integrated front wiper relay and the front wiper high relay according to the front wiper request signal. IPDM E/R provides the power supply to operate the front wiper HI/LO operation.

FRONT WIPER LO OPERATION

- BCM transmits the front wiper request signal (LO) to IPDM E/R with CAN communication according to the front wiper LO operating condition.

Front wiper LO operating condition

- Ignition switch ON
- Front wiper switch LO or front wiper switch MIST (while pressing)
- IPDM E/R turns ON the integrated front wiper relay according to the front wiper request signal (LO).

FRONT WIPER HI OPERATION

- BCM transmits the front wiper request signal (HI) to IPDM E/R with CAN communication according to the front wiper HI operating condition.

Front wiper HI operating condition

- Ignition switch ON
- Front wiper switch HI
- IPDM E/R turns ON the integrated front wiper relay and the front wiper high relay according to the front wiper request signal (HI).

FRONT WIPER INT OPERATION

- BCM transmits the front wiper request signal (INT) to IPDM E/R with CAN communication depending on the front wiper INT operating condition and intermittent operation delay interval according to the wiper intermittent dial position.

Front wiper INT operating condition

- Ignition switch ON
- Front wiper switch INT

FRONT WIPER AND WASHER SYSTEM

< FUNCTION DIAGNOSIS >

- IPDM E/R turns ON the integrated front wiper relay so that the front wiper is operated only once according to the front wiper request signal (INT).
- BCM detects stop position/except stop position of the front wiper motor according to the front wiper auto stop signal received from IPDM E/R with CAN communication.
- BCM transmits the front wiper request signal (INT) again after the intermittent operation delay interval.

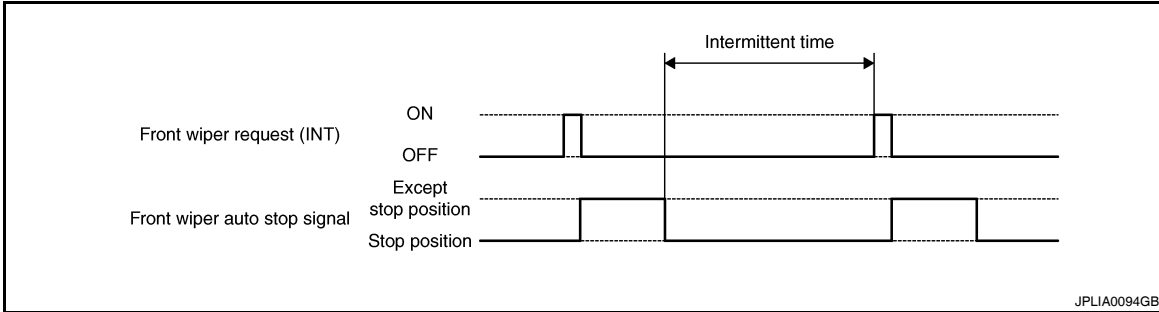

NOTE:

Front wiper intermittent operation can be set to the operation with vehicle speed by CONSULT-III. Refer to [BCS-26. "WIPER : CONSULT - III Function"](#).

Front wiper intermittent operation with vehicle speed

- BCM calculates the intermittent operation delay interval from the following
 - Vehicle speed signal (received from the combination meter with CAN communication)
 - Wiper intermittent dial position

Wiper intermittent dial position	Intermittent operation interval	Intermittent operation delay Interval (s)			
		Vehicle speed			
		Vehicle stopped or less than 5 km/h (3.1 MPH)	5 km/h (3.1MPH) or more or less than 35km/h (21.7 MPH)	35 km/h (21.7 MPH) or more or less than 65km/h (40.4 MPH)*	65 km/h (40.4MPH) or more
1	Short ↑	0.8	0.6	0.4	0.24
2		4	3	2	1.2
3		10	7.5	5	3
4		16	12	8	4.8
5		24	18	12	7.2
6	Long ↓	32	24	16	9.6
7		42	31.5	21	12.6

*: When without vehicle speed setting

FRONT WIPER AUTO STOP OPERATION

- BCM stops transmitting the front wiper request signal when the front wiper switch is turned OFF.
- IPDM E/R detects the front wiper auto stop signal from the front wiper motor and detects the front wiper motor position (stop position/except stop position).

FRONT WIPER AND WASHER SYSTEM

< FUNCTION DIAGNOSIS >

- When the front wiper request signal is stopped, IPDM E/R turns ON the front wiper relay until the front wiper motor returns to the stop position.

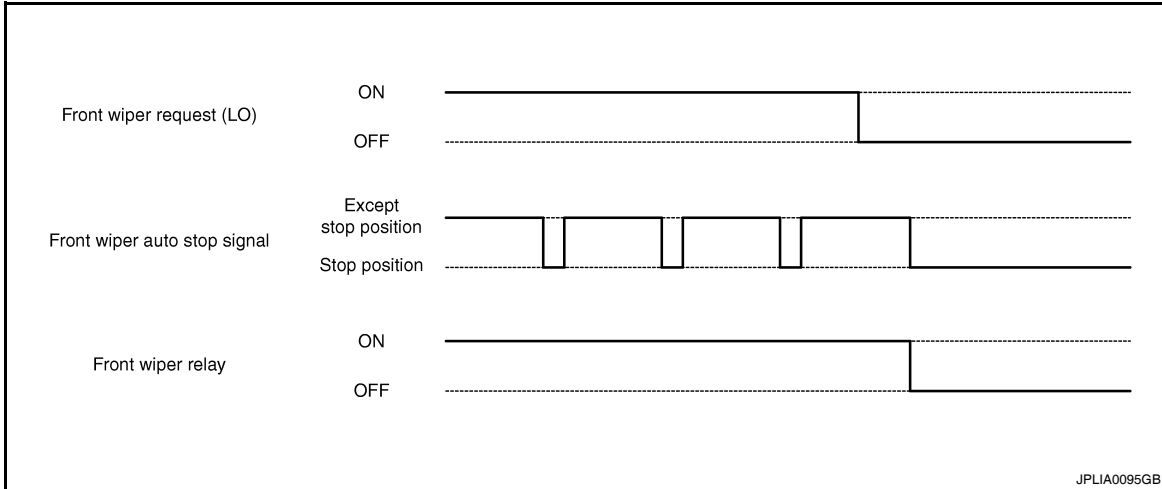

NOTE:

- BCM stops the transmitting of the front wiper request signal when the ignition switch OFF.
- IPDM E/R turns the front wiper relay OFF when the ignition switch OFF.

FRONT WIPER OPERATION LINKED WITH WASHER

- BCM transmits the front wiper request signal (LO) to IPDM E/R with CAN communication according to the washer linked operating condition of the front wiper.
- BCM transmits the front wiper request signal (LO) so that the front wiper operates approximately 2 times when the front washer switch OFF is detected.

Washer linked operating condition of front wiper

- Ignition switch ON
- Front washer switch ON (0.4 second or more)
- IPDM E/R turns ON the integrated front wiper relay according to the front wiper request signal (LO).
- The front washer motor is grounded through the combination switch when the front washer switch is ON.

FRONT WIPER FAIL-SAFE OPERATION

When the front wiper auto stop circuit is malfunctioning, IPDM E/R performs the fail-safe function. Refer to [PCS-43. "Fail Safe"](#).

FRONT WIPER AND WASHER SYSTEM

< FUNCTION DIAGNOSIS >

Component Parts Location

INFOID:00000004202188

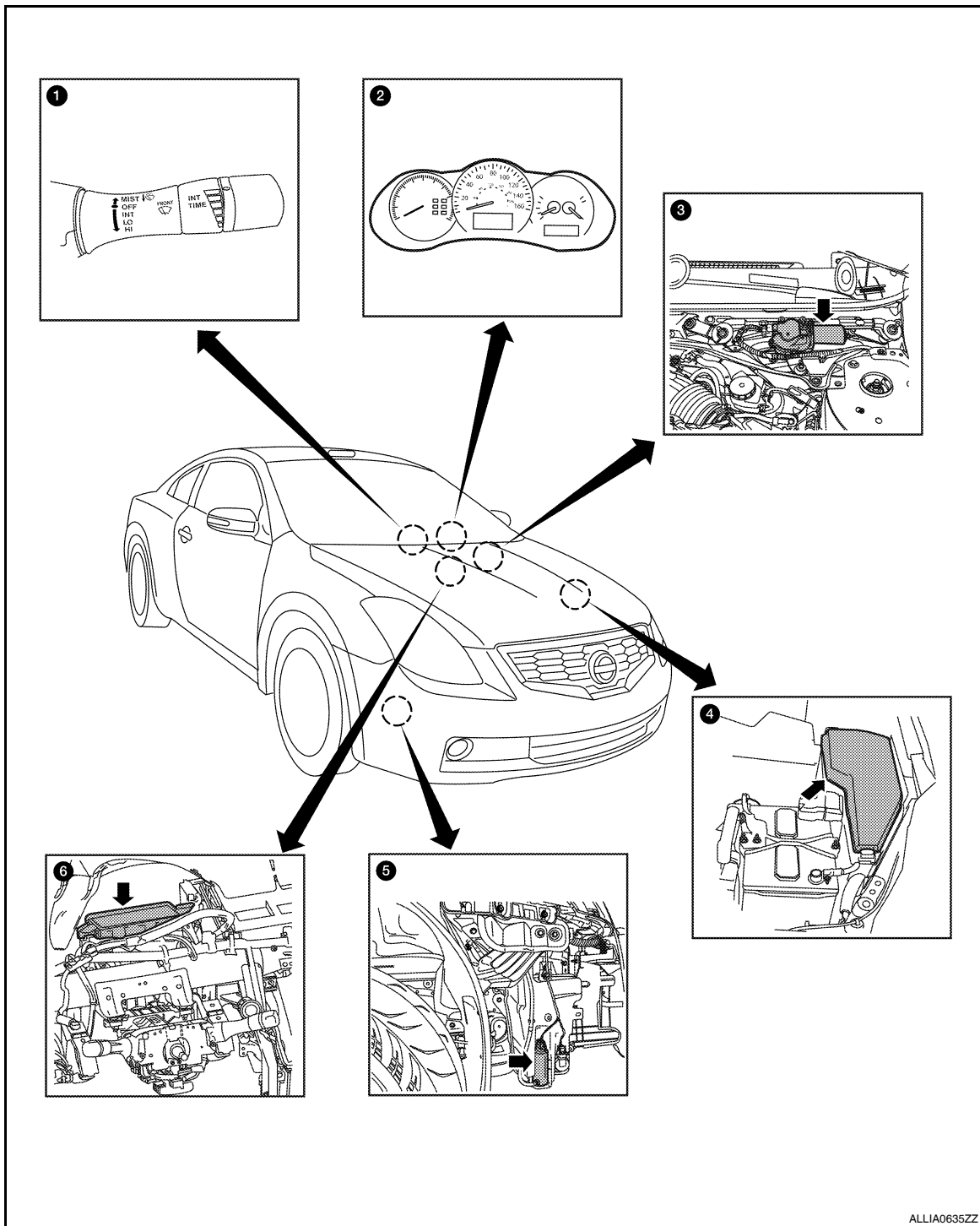

1. Combination switch M28 (wiper switch) (coupe shown, sedan similar)

2. Combination meter M24

3. Front wiper motor E25

4. IPDM E/R E17, E18, E200

5. Front washer motor E226

6. BCM M16, M17, M18, M19 (view with instrument panel removed)

ALLIA0635ZZ

FRONT WIPER AND WASHER SYSTEM

< FUNCTION DIAGNOSIS >

Component Description

INFOID:000000004202189

Part	Description
BCM	<ul style="list-style-type: none">• Judges the switch status by the combination switch reading function.• Requests (with CAN communication) the front wiper relay and the front wiper high relay ON to IPDM E/R.
IPDM E/R	<ul style="list-style-type: none">• Controls the integrated relay according to the request (with CAN communication) from BCM.• Performs the auto stop control of the front wiper.
Combination switch (Wiper & washer switch)	Refer to WW-6, "System Description" .
Combination meter	Transmits the vehicle speed signal to BCM with CAN communication.

DIAGNOSIS SYSTEM (BCM)

< FUNCTION DIAGNOSIS >

DIAGNOSIS SYSTEM (BCM)

COMMON ITEM

COMMON ITEM : Diagnosis Description

INFOID:000000004501347

BCM CONSULT-III FUNCTION

CONSULT-III performs the following functions via CAN communication with BCM.

Diagnosis mode	Function Description
WORK SUPPORT	Changes the setting for each system function.
SELF-DIAG RESULTS	Displays the diagnosis results judged by BCM.
CAN DIAG SUPPORT MNTR	Monitors the reception status of CAN communication viewed from BCM.
DATA MONITOR	The BCM input/output signals are displayed.
ACTIVE TEST	The signals used to activate each device are forcibly supplied from BCM.
ECU IDENTIFICATION	The BCM part number is displayed.
CONFIGURATION	This function is not used even though it is displayed.

SYSTEM APPLICATION

BCM can perform the following functions for each system.

NOTE:

It can perform the diagnosis modes except the following for all sub system selection items.

System	Sub system selection item	Diagnosis mode		
		WORK SUPPORT	DATA MONITOR	ACTIVE TEST
Door lock	DOOR LOCK	×	×	×
Rear window defogger	REAR DEFOGGER		×	×
Warning chime	BUZZER		×	×
Interior room lamp timer	INT LAMP	×	×	×
Remote keyless entry system	MUTI REMOTE ENT	×	×	×
Exterior lamp	HEADLAMP	×	×	×
Wiper and washer	WIPER	×	×	×
Turn signal and hazard warning lamps	FLASHER	×	×	×
Air conditioner	AIR CONDITONER		×	
Intelligent Key system	INTELLIGENT KEY	×	×	×
Combination switch	COMB SW		×	
BCM	BCM	×		
Immobilizer	IMMU		×	×
Interior room lamp battery saver	BATTERY SAVER	×	×	×
Trunk open	TRUNK		×	
Vehicle security system	THEFT ALM	×	×	×
RAP system	RETAINED PWR		×	
Signal buffer system	SIGNAL BUFFER		×	×
TPMS	AIR PRESSURE MONITOR	×	×	

COMMON ITEM : CONSULT-III Function

INFOID:000000004501348

ECU IDENTIFICATION

Displays the BCM part No.

SELF-DIAG RESULT

Refer to [BCS-91, "DTC Index"](#).

DIAGNOSIS SYSTEM (BCM)

< FUNCTION DIAGNOSIS >

WIPER

WIPER : CONSULT - III Function

INFOID:000000004501349

WORK SUPPORT

Service item	Setting item	Description
WIPER SPEED SETTING	ON	With vehicle speed (Front wiper intermittent time linked with the vehicle speed and wiper dial position)
	OFF*	Without vehicle speed (Front wiper intermittent time linked with the wiper dial position)

* : Factory setting

DATA MONITOR

Monitor Item [Unit]	Description
PUSH SW	Displays the status of the engine switch (push switch) judged by BCM.
VEH SPEED 1 [km/h]	Displays the value of the vehicle speed signal received from combination meter with CAN communication.
FR WIPER HI [OFF/ON]	Status of each switch judged by BCM using the combination switch reading function
FR WIPER LOW [OFF/ON]	
FR WASHER SW [OFF/ON]	
FR WIPER INT [OFF/ON]	
FR WIPER STOP [OFF/ON]	Displays the status of the front wiper auto stop signal received from IPDM E/R with CAN communication.
INT VOLUME [1 - 7]	Status of each switch judged by BCM using the combination switch reading function

ACTIVE TEST

Test item	Operation	Description
FRONT WIPER	HI	Transmits the front wiper request signal (HI) to IPDM E/R with CAN communication to operate the front wiper HI operation.
	LO	Transmits the front wiper request signal (LO) to IPDM E/R with CAN communication to operate the front wiper LO operation.
	INT	Transmits the front wiper request signal (INT) to IPDM E/R with CAN communication to operate the front wiper INT operation.
	OFF	Stops transmitting the front wiper request signal to stop the front wiper operation.

DIAGNOSIS SYSTEM (IPDM E/R)

< FUNCTION DIAGNOSIS >

DIAGNOSIS SYSTEM (IPDM E/R)

Diagnosis Description

INFOID:000000004501350

AUTO ACTIVE TEST

Description

In auto active test mode, the IPDM E/R sends a drive signal to the following systems to check their operation.

- Oil pressure warning lamp
- Front wiper (LO, HI)
- Parking lamps
- License plate lamps
- Tail lamps
- Front fog lamps (if equipped)
- Headlamps (LO, HI)
- A/C compressor (magnet clutch)
- Cooling fans

Operation Procedure

1. Close the hood and lift the wiper arms from the windshield. (Prevent windshield damage due to wiper operation)

NOTE:

When auto active test is performed with hood opened, sprinkle water on windshield beforehand.

2. Turn ignition switch OFF.
3. Turn the ignition switch ON, and within 20 seconds, press the front door switch LH 10 times. Then turn the ignition switch OFF.

CAUTION:

Close front door RH.

4. Turn the ignition switch ON within 10 seconds. After that the horn sounds once and the auto active test starts.
5. The oil pressure warning lamp starts blinking when the auto active test starts.
6. After a series of the following operations is repeated 3 times, auto active test is completed.

NOTE:

When auto active test mode has to be cancelled halfway through test, turn ignition switch OFF.

CAUTION:

- If auto active test mode cannot be actuated, check door switch system. Refer to [DLK-69](#), "[Component Function Check](#)".
- Do not start the engine.

Inspection in Auto Active Test Mode

A
B
C
D
E
F
G
H
I
J
K
M
N
O
P

WW

DIAGNOSIS SYSTEM (IPDM E/R)

< FUNCTION DIAGNOSIS >

When auto active test mode is actuated, the following 6 steps are repeated 3 times.

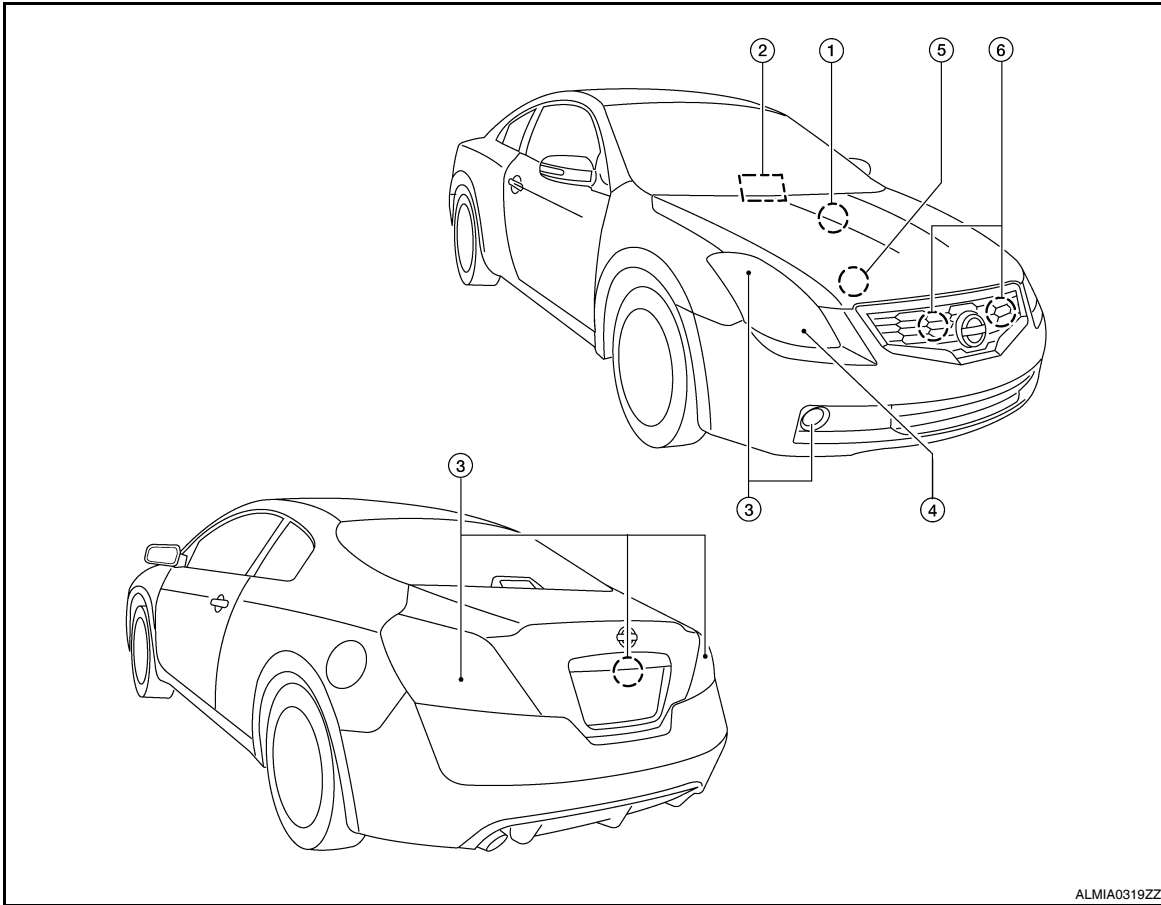

ALMIA0319ZZ

Operation sequence	Inspection Location	Operation
1	Oil pressure warning lamp	Blinks continuously during operation of auto active test
2	Front wiper	LO for 5 seconds → HI for 5 seconds
3	<ul style="list-style-type: none"> • Parking lamps • License plate lamps • Tail lamps • Front fog lamps (if equipped) 	10 seconds
4	Headlamps	LO ↔ HI 5 times
5	A/C compressor (magnet clutch)	ON ↔ OFF 5 times
6*	Cooling fans	MID for 5 seconds → HI for 5 seconds

*: Outputs duty ratio of 50% for 5 seconds → duty ratio of 100% for 5 seconds on the cooling fan control module.

DIAGNOSIS SYSTEM (IPDM E/R)

< FUNCTION DIAGNOSIS >

Concept of auto active test

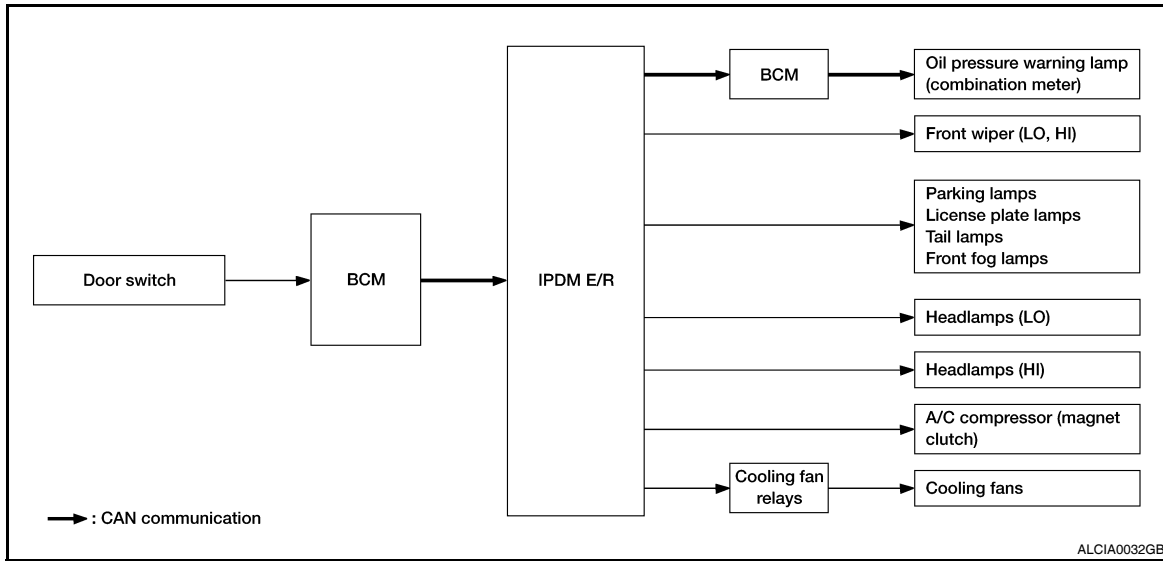

- IPDM E/R starts the auto active test with the door switch signals transmitted by BCM via CAN communication. Therefore, the CAN communication line between IPDM E/R and BCM is considered normal if the auto active test starts successfully.
- The auto active test facilitates troubleshooting if any systems controlled by IPDM E/R cannot be operated.

Diagnosis chart in auto active test mode

Symptom	Inspection contents	Possible cause	
Any of the following components do not operate <ul style="list-style-type: none"> • Parking lamps • License plate lamps • Tail lamps • Front fog lamps (if equipped) • Headlamp (HI, LO) • Front wiper 	Perform auto active test. Does the applicable system operate?	YES	BCM signal input circuit
		NO	<ul style="list-style-type: none"> • Lamp or motor • Lamp or motor ground circuit • Harness or connector between IPDM E/R and applicable system • IPDM E/R
A/C compressor does not operate	Perform auto active test. Does the magnet clutch operate?	YES	<ul style="list-style-type: none"> • Combination meter signal input circuit • CAN communication signal between combination meter and ECM • CAN communication signal between ECM and IPDM E/R
		NO	<ul style="list-style-type: none"> • Magnet clutch • Harness or connector between IPDM E/R and magnet clutch • IPDM E/R

DIAGNOSIS SYSTEM (IPDM E/R)

< FUNCTION DIAGNOSIS >

Symptom	Inspection contents		Possible cause
Oil pressure warning lamp does not operate	Perform auto active test. Does the oil pressure warning lamp blink?	YES	<ul style="list-style-type: none"> • Harness or connector between IPDM E/R and oil pressure switch • Oil pressure switch • IPDM E/R
		NO	<ul style="list-style-type: none"> • CAN communication signal between IPDM E/R and BCM • CAN communication signal between BCM and combination meter • Combination meter
Cooling fan does not operate	Perform auto active test. Does the cooling fan operate?	YES	<ul style="list-style-type: none"> • ECM signal input circuit • CAN communication signal between ECM and IPDM E/R
		NO	<ul style="list-style-type: none"> • Cooling fan • Harness or connector between cooling fan and cooling fan relays • Cooling fan relays • Harness or connector between IPDM E/R and cooling fan relays • IPDM E/R

CONSULT - III Function (IPDM E/R)

INFOID:000000004501351

APPLICATION ITEM

CONSULT-III performs the following functions via CAN communication with IPDM E/R.

Diagnosis mode	Description
ECU Identification	Allows confirmation of IPDM E/R part number.
Self Diagnostic Result	Displays the diagnosis results judged by IPDM E/R.
Data Monitor	Displays the real-time input/output data from IPDM E/R input/output data.
Active Test	IPDM E/R can provide a drive signal to electronic components to check their operations.
CAN Diag Support Monitor	The results of transmit/receive diagnosis of CAN communication can be read.

SELF DIAGNOSTIC

Refer to [PCS-45, "DTC Index"](#).

DATA MONITOR

Monitor item

Monitor Item [Unit]	MAIN SIG- NALS	Description
RADFAN REQ [%]	×	Displays the value of the cooling fan speed signal received from ECM via CAN communication.
AC COMP REQ [Off/On]	×	Displays the status of the A/C compressor request signal received from ECM via CAN communication.
TAIL&CLR REQ [Off/On]	×	Displays the status of the position light request signal received from BCM via CAN communication.
HL LO REQ [Off/On]	×	Displays the status of the low beam request signal received from BCM via CAN communication.
HL HI REQ [Off/On]	×	Displays the status of the high beam request signal received from BCM via CAN communication.

DIAGNOSIS SYSTEM (IPDM E/R)

< FUNCTION DIAGNOSIS >

Monitor Item [Unit]	MAIN SIG- NALS	Description
FR FOG REQ [Off/On]	×	Displays the status of the front fog light request signal received from BCM via CAN communication.
FR WIP REQ [Stop/1LOW/Low/Hi]	×	Displays the status of the front wiper request signal received from BCM via CAN communication.
WIP AUTO STOP [STOP P/ACT P]	×	Displays the status of the front wiper auto stop signal judged by IPDM E/R.
WIP PROT [Off/BLOCK]	×	Displays the status of the front wiper fail-safe operation judged by IPDM E/R.
IGN RLY1 -REQ [Off/On]		Displays the status of the ignition switch ON signal received from BCM via CAN communication.
IGN RLY [Off/On]	×	Displays the status of the ignition relay judged by IPDM E/R.
PUSH SW [Off/On]		Displays the status of the push-button ignition switch judged by IPDM E/R.
INTER/NP SW [Off/On]		Displays the status of the clutch interlock switch (M/T models) or CVT shift position (CVT models) judged by IPDM E/R.
ST RLY CONT [Off/On]		Displays the status of the starter relay status signal received from BCM via CAN communication.
IHBT RLY -REQ [Off/On]		Displays the status of the starter control relay signal received from BCM via CAN communication.
ST/INH RLY [Off/ ST /INH]		Displays the status of the starter relay and starter control relay judged by IPDM E/R.
DETENT SW [Off/On]		Displays the status of the CVT device (detention switch) judged by IPDM E/R.
S/L RLY -REQ [Off/On]		Displays the status of the electronic steering column lock relay request received from BCM via CAN communication.
S/L STATE [LOCK/UNLK/UNKWN]		Displays the status of the electronic steering column lock judged by IPDM E/R.
DTRL REQ [Off]		NOTE: This item is displayed, but cannot be monitored.
OIL P SW [Open/Close]		Displays the status of the oil pressure switch judged by IPDM E/R.
THFT HRN REQ [Off/On]		Displays the status of the theft warning horn request signal received from BCM via CAN communication.
HORN CHIRP [Off/On]		Displays the status of the horn reminder signal received from BCM via CAN communication.
CRNRNG LMP REQ [Off]		NOTE: This item is displayed, but cannot be monitored.

ACTIVE TEST

Test item

Test item	Operation	Description
CORNERING LAMP	Off	NOTE: This item is displayed, but cannot be monitored.
	LH	
	RH	
HORN	On	Operates horn relay 1 and horn relay 2 for 20 ms.
FRONT WIPER	Off	OFF
	Lo	Operates the front wiper relay.
	Hi	Operates the front wiper relay and front wiper high relay.

DIAGNOSIS SYSTEM (IPDM E/R)

< FUNCTION DIAGNOSIS >

Test item	Operation	Description
MOTOR FAN	1	OFF
	2	Outputs 50% pulse duty signal (PWM signal) to the cooling fan control module.
	3	Outputs 80% pulse duty signal (PWM signal) to the cooling fan control module.
	4	Outputs 100% pulse duty signal (PWM signal) to the cooling fan control module.
EXTERNAL LAMPS	Off	OFF
	TAIL	Operates the tail lamp relay.
	Lo	Operates the headlamp low relay.
	Hi	Operates the headlamp low relay and ON/OFF the headlamp high relay at 1 second intervals.
	Fog	Operates the front fog lamp relay.

WIPER AND WASHER FUSE

< COMPONENT DIAGNOSIS >

COMPONENT DIAGNOSIS

WIPER AND WASHER FUSE

Description

INFOID:000000004202195

Fuse list

Unit	Location	Fuse No.	Capacity
Front wiper motor	IPDM E/R	55	30 A
Front washer motor	IPDM E/R	38	10 A

Diagnosis Procedure

INFOID:000000004202196

1. CHECK FUSES

Check that the following fuses are not blown.

Unit	Location	Fuse No.	Capacity
Front wiper motor	IPDM E/R	55	30 A
Front washer motor	IPDM E/R	38	10 A

Is the fuse blown?

- YES >> Replace the blown fuse after repairing the affected circuit.
- NO >> The fuse is normal.

A
B
C
D
E
F
G
H
I
J
K
M
N
O
P

WW

FRONT WIPER MOTOR LO CIRCUIT

< COMPONENT DIAGNOSIS >

FRONT WIPER MOTOR LO CIRCUIT

Component Function Check

INFOID:000000004202197

1. CHECK FRONT WIPER LO OPERATION

⊗ IPDM E/R AUTO ACTIVE TEST

1. Start IPDM E/R auto active test. Refer to [PCS-14, "Diagnosis Description"](#).
2. Check that the front wiper operates at the LO operation.

Ⓟ CONSULT-III ACTIVE TEST

1. Select "FRONT WIPER" of IPDM E/R active test item.
2. While operating the test item, check that front wiper LO operation and OFF.

Lo : Front wiper LO operation

Off : Stop the front wiper.

Does the front wiper operate?

- YES >> Front wiper motor LO circuit is normal.
 NO >> Refer to [WW-20, "Diagnosis Procedure"](#).

Diagnosis Procedure

INFOID:000000004202198

1. CHECK FRONT WIPER MOTOR (LO) OUTPUT VOLTAGE

Ⓟ CONSULT-III ACTIVE TEST

1. Turn the ignition switch OFF.
2. Disconnect front wiper motor.
3. Turn the ignition switch ON.
4. Select "FRONT WIPER" of IPDM E/R active test item.
5. With operating the test item, check voltage between IPDM E/R harness connector and ground.

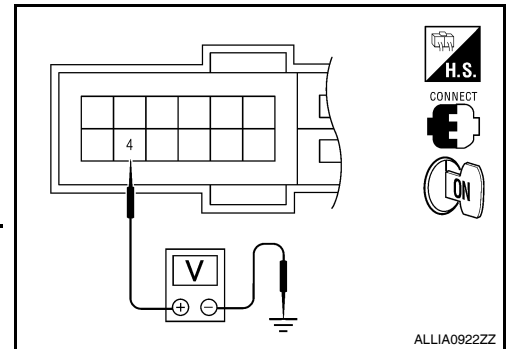

Terminals		Test item	Voltage (V) (Approx.)
(+)	(-)		
IPDM E/R		FRONT WIPER	Battery voltage
Connector	Terminal		
E18	4		
		Lo	Battery voltage
		Off	0V

Is the measurement normal?

- YES >> GO TO 2
 NO >> Replace IPDM E/R. Refer to [PCS-48, "Removal and Installation"](#).

2. CHECK FRONT WIPER MOTOR (LO) OPEN CIRCUIT

1. Turn the ignition switch OFF.
2. Disconnect IPDM E/R.
3. Check continuity between IPDM E/R harness connector (A) and front wiper motor harness connector (B).

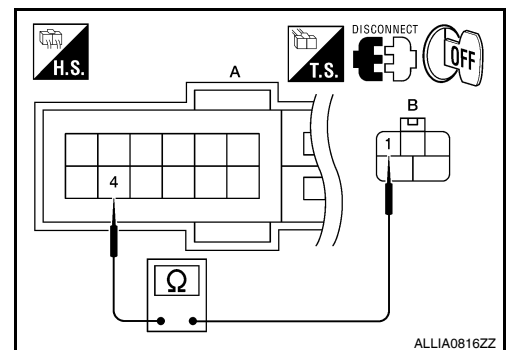

IPDM E/R		Front wiper motor		Continuity
Connector	Terminal	Connector	Terminal	
E18 (A)	4	E25 (B)	1	Yes

Does continuity exist?

- YES >> GO TO 3
 NO >> Repair or replace harness.

3. CHECK FRONT WIPER MOTOR (LO) SHORT CIRCUIT

FRONT WIPER MOTOR LO CIRCUIT

< COMPONENT DIAGNOSIS >

Check continuity between IPDM E/R harness connector and ground.

IPDM E/R		Ground	Continuity
Connector	Terminal		
E18	4		No

Does continuity exist?

YES >> Repair or replace harness.

NO >> Replace front wiper motor. Refer to [WW-116. "FRONT WIPER DRIVE ASSEMBLY : Removal and Installation"](#).

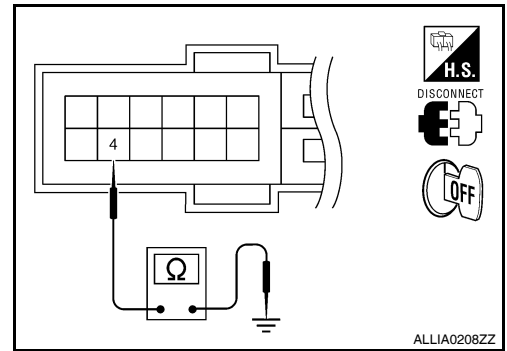

A
B
C
D
E
F
G
H
I
J
K
M
N
O
P

WW

FRONT WIPER MOTOR HI CIRCUIT

< COMPONENT DIAGNOSIS >

FRONT WIPER MOTOR HI CIRCUIT

Component Function Check

INFOID:000000004202199

1. CHECK FRONT WIPER HI OPERATION

⊗ IPDM E/R AUTO ACTIVE TEST

1. Start IPDM E/R auto active test. Refer to [PCS-14, "Diagnosis Description"](#).
2. Check that the front wiper operates at the HI operation.

Ⓟ CONSULT-III ACTIVE TEST

1. Select "FRONT WIPER" of IPDM E/R active test item.
2. While operating the test item, check that front wiper HI operation and OFF.

Hi : Front wiper HI operation

Off : Stop the front wiper.

Does the front wiper operate?

YES >> The front wiper motor HI circuit is normal.

NO >> Refer to [WW-20, "Diagnosis Procedure"](#).

Diagnosis Procedure

INFOID:000000004202200

1. CHECK FRONT WIPER MOTOR (HI) OUTPUT VOLTAGE

Ⓟ CONSULT-III ACTIVE TEST

1. Turn the ignition switch OFF.
2. Disconnect front wiper motor.
3. Turn the ignition switch ON.
4. Select "FRONT WIPER" of IPDM E/R active test item.
5. With operating the test item, check voltage between IPDM E/R harness connector and ground.

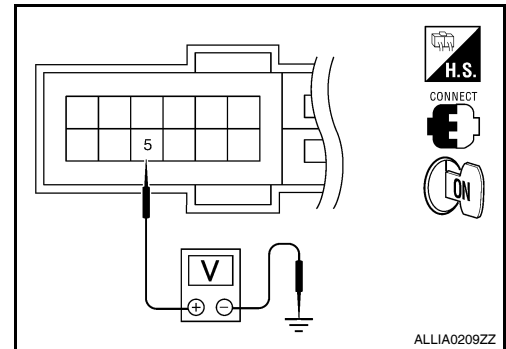

Terminals		Test item	Voltage (V) (Approx.)
(+)	(-)		
IPDM E/R		FRONT WIPER	Battery voltage
Connector	Terminal		
E18	5		
		Hi	Battery voltage
		Off	0V

Is the measurement normal?

YES >> GO TO 2

NO >> Replace IPDM E/R. Refer to [PCS-48, "Removal and Installation"](#).

2. CHECK FRONT WIPER MOTOR (HI) OPEN CIRCUIT

1. Turn the ignition switch OFF.
2. Disconnect IPDM E/R.
3. Check continuity between IPDM E/R harness connector (A) and front wiper motor harness connector (B).

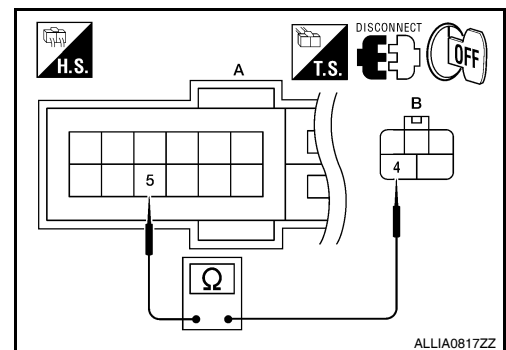

IPDM E/R		Front wiper motor		Continuity
Connector	Terminal	Connector	Terminal	
E18 (A)	5	E25 (B)	4	Yes

Does continuity exist?

YES >> GO TO 3

NO >> Repair or replace harness.

3. CHECK FRONT WIPER MOTOR (HI) SHORT CIRCUIT

FRONT WIPER MOTOR HI CIRCUIT

< COMPONENT DIAGNOSIS >

Check continuity between IPDM E/R harness connector and ground.

IPDM E/R		Ground	Continuity
Connector	Terminal		
E18	5		No

Does continuity exist?

YES >> Repair or replace harness.

NO >> Replace front wiper motor. Refer to [WW-116. "FRONT WIPER DRIVE ASSEMBLY : Removal and Installation"](#).

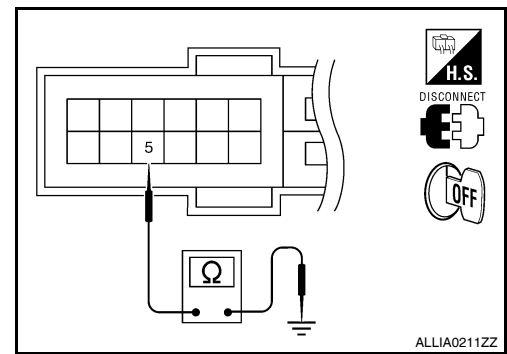

A
B
C
D
E
F
G
H
I
J
K
M
N
O
P

WW

FRONT WIPER AUTO STOP SIGNAL CIRCUIT

< COMPONENT DIAGNOSIS >

FRONT WIPER AUTO STOP SIGNAL CIRCUIT

Component Function Check

INFOID:000000004202201

1. CHECK FRONT WIPER (AUTO STOP) OPERATION

CONSULT-III DATA MONITOR

1. Select "FRONT WIPER STOP" of IPDM E/R DATA MONITOR item.
2. Operate the front wiper.
3. With the front wiper operation, check the monitor status.

Monitor item	Condition		Monitor status
FR WIPER STOP	Front wiper motor	Stop position	STOP P
		Except	ACT P

Is the status of item normal?

- YES >> Auto stop signal circuit is normal.
 NO >> Refer to [WW-24, "Diagnosis Procedure"](#).

Diagnosis Procedure

INFOID:000000004202202

1. CHECK FRONT WIPER MOTOR (AUTO STOP) OUTPUT VOLTAGE

1. Turn the ignition switch OFF.
2. Disconnect front wiper motor.
3. Turn the ignition switch ON.
4. Check voltage between IPDM E/R harness connector and ground.

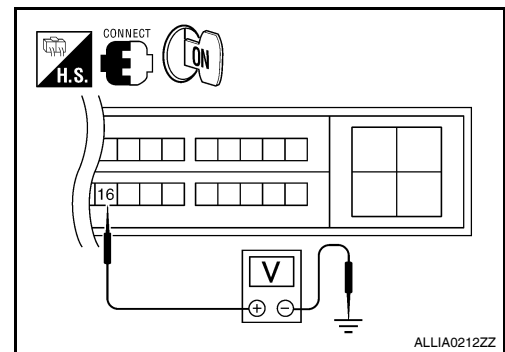

Terminals		Voltage (V) (Approx.)
(+)	(-)	
IPDM E/R		Ground
Connector	Terminal	
E18	16	
		Battery voltage

Is the measurement normal?

- YES >> GO TO 2
 NO >> Replace IPDM E/R. Refer to [PCS-48, "Removal and Installation"](#).

2. CHECK FRONT WIPER MOTOR (AUTO STOP) CIRCUIT CONTINUITY

1. Turn the ignition switch OFF.
2. Disconnect IPDM E/R.
3. Check continuity between IPDM E/R harness connector (A) and front wiper motor harness connector (B).

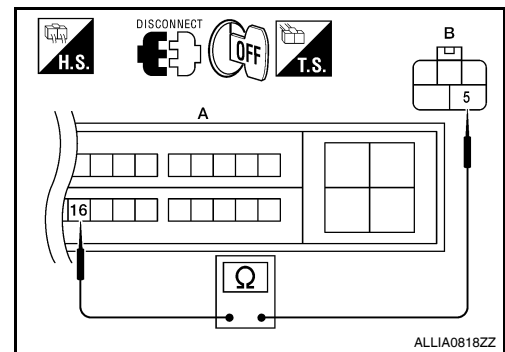

IPDM E/R		Front wiper motor		Continuity
Connector	Terminal	Connector	Terminal	
E18 (A)	16	E25 (B)	5	Yes

Does continuity exist?

- YES >> GO TO 3
 NO >> Repair or replace harness.

3. CHECK FRONT WIPER MOTOR (AUTO STOP) SHORT CIRCUIT

FRONT WIPER AUTO STOP SIGNAL CIRCUIT

< COMPONENT DIAGNOSIS >

Check continuity between IPDM E/R harness connector and ground.

IPDM E/R		Ground	Continuity
Connector	Terminal		
E18	16		No

Does continuity exist?

YES >> Repair or replace harness.

NO >> Replace front wiper motor. Refer to [WW-116. "FRONT WIPER DRIVE ASSEMBLY : Removal and Installation"](#).

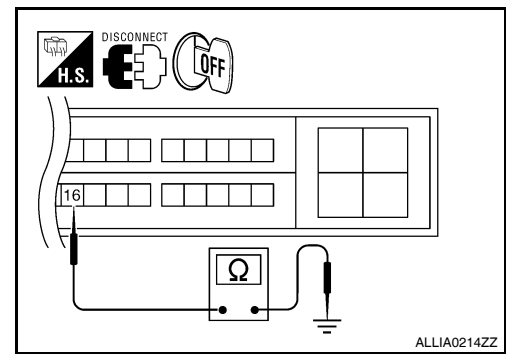

A
B
C
D
E
F
G
H
I
J
K
L
M
N
O
P

WW

FRONT WIPER MOTOR GROUND CIRCUIT

< COMPONENT DIAGNOSIS >

FRONT WIPER MOTOR GROUND CIRCUIT

Diagnosis Procedure

INFOID:000000004202203

1. CHECK FRONT WIPER MOTOR (GND) OPEN CIRCUIT

1. Turn the ignition switch OFF.
2. Disconnect front wiper motor.
3. Check continuity between front wiper motor harness connector and ground.

Front wiper motor		Ground	Continuity
Connector	Terminal		
E25	2		Yes

Does continuity exist?

- YES >> Front wiper motor ground circuit is normal.
NO >> Repair or replace harness.

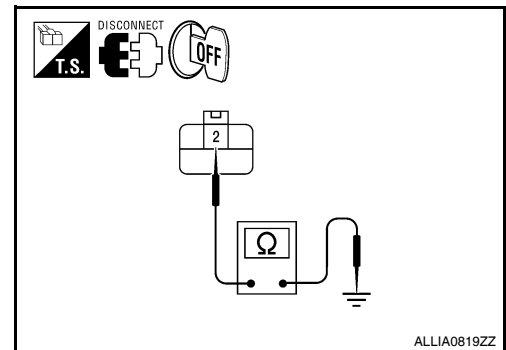

ALLIA0819ZZ

FRONT WIPER AND WASHER SYSTEM

< COMPONENT DIAGNOSIS >

FRONT WIPER AND WASHER SYSTEM

Wiring Diagram-Coupe

INFOID:000000004202204

--- : DATA LINE

FRONT WIPER AND WASHER SYSTEM

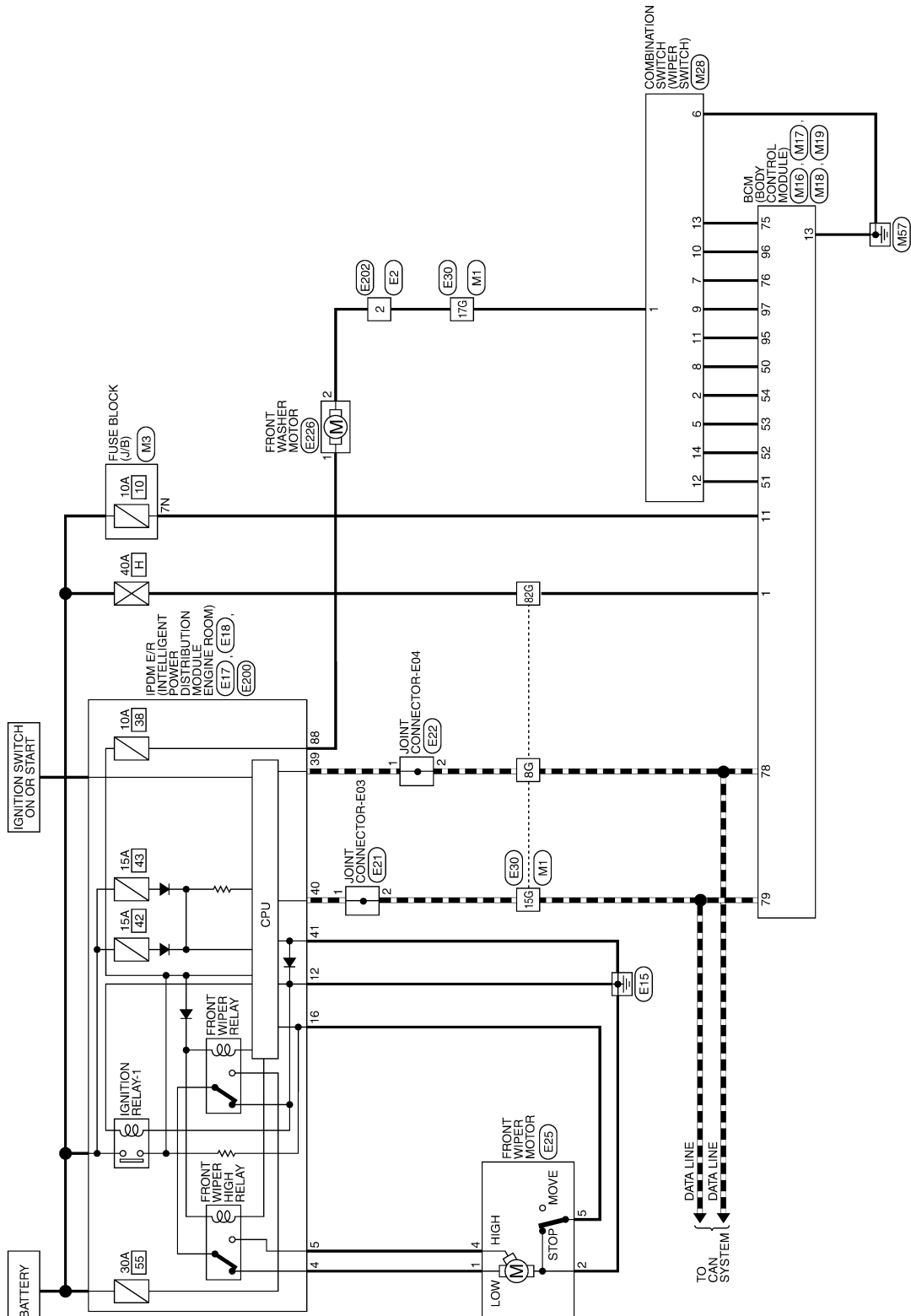

ABLWA0248GE

A
B
C
D
E
F
G
H
I
J
K
WW
M
N
O
P

FRONT WIPER AND WASHER SYSTEM

< COMPONENT DIAGNOSIS >

FRONT WIPER AND WASHER SYSTEM CONNECTORS

Connector No.	M1
Connector Name	WIRE TO WIRE
Connector Color	WHITE

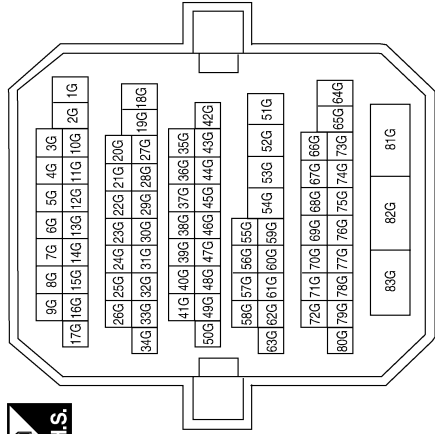

Terminal No.	Color of Wire	Signal Name
8G	P	-
15G	L	-
17G	R/L	-
82G	W/B	-

Connector No.	M3
Connector Name	FUSE BLOCK (J/B)
Connector Color	WHITE

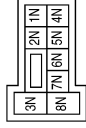

Terminal No.	Color of Wire	Signal Name
7N	Y/B	-

Connector No.	M16
Connector Name	BCM (BODY CONTROL MODULE)
Connector Color	BLACK



Connector No.	M17
Connector Name	BCM (BODY CONTROL MODULE)
Connector Color	WHITE



Terminal No.	Color of Wire	Signal Name
1	W/B	BAT_POWER_F/L

Connector No.	M18
Connector Name	BCM (BODY CONTROL MODULE)
Connector Color	GREEN

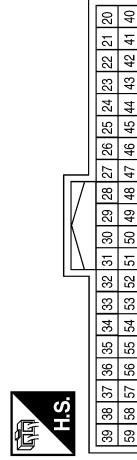

Terminal No.	Color of Wire	Signal Name
50	LG/B	INPUT_5
51	L/W	INPUT_1
52	G/B	INPUT_2
53	LG/R	INPUT_3
54	G/Y	INPUT_4

FRONT WIPER AND WASHER SYSTEM

< COMPONENT DIAGNOSIS >

Terminal No.	Color of Wire	Signal Name
8	LG/B	OUTPUT_5
9	R/B	INPUT_2
10	P/B	INPUT_4
11	R/W	INPUT_1
12	L/W	OUTPUT_1
13	R/Y	INPUT_5
14	G/B	OUTPUT_2

Connector No.	M28
Connector Name	COMBINATION SWITCH
Connector Color	WHITE

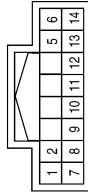

Terminal No.	Color of Wire	Signal Name
1	R/L	WASH_MTR
2	G/Y	OUTPUT_4
3	-	-
4	-	-
5	LG/R	OUTPUT_3
6	B	GND
7	R/G	INPUT_3

Connector No.	M19
Connector Name	BCM (BODY CONTROL MODULE)
Connector Color	BLACK

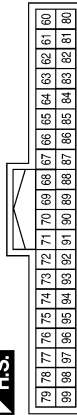

Terminal No.	Color of Wire	Signal Name
75	R/Y	OUTPUT_5
76	R/G	OUTPUT_3
78	P	CAN-L
79	L	CAN-H
95	R/W	OUTPUT_1
96	P/B	OUTPUT_4
97	R/B	OUTPUT_2

Connector No.	E17
Connector Name	IPDM E/R (INTELLIGENT POWER DISTRIBUTION MODULE ENGINE ROOM)
Connector Color	WHITE

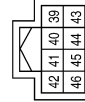

Terminal No.	Color of Wire	Signal Name
39	P	CAN-L
40	L	CAN-H
41	B	GND (SIGNAL)

Connector No.	E2
Connector Name	WIRE TO WIRE
Connector Color	WHITE



Terminal No.	Color of Wire	Signal Name
2	GR	-

ABLIA0887GB

FRONT WIPER AND WASHER SYSTEM

< COMPONENT DIAGNOSIS >

Connector No.	E18
Connector Name	IPDM E/R (INTELLIGENT POWER DISTRIBUTION MODULE ENGINE ROOM)
Connector Color	WHITE

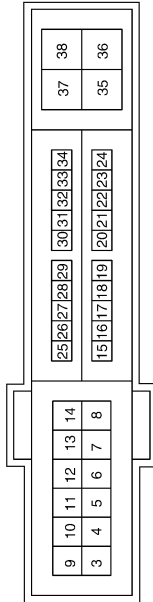

Terminal No.	Color of Wire	Signal Name
4	L/R	FR_WIPER_LO
5	Y	FR_WIPER_HI
12	B	GND (POWER)
16	L/Y	WIPER_AUTOSTOP

Connector No.	E21
Connector Name	JOINT CONNECTOR-E03
Connector Color	WHITE



Terminal No.	Color of Wire	Signal Name
1	L	-
2	L	-

Connector No.	E22
Connector Name	JOINT CONNECTOR-E04
Connector Color	WHITE



Terminal No.	Color of Wire	Signal Name
1	P	-
2	P	-

Connector No.	E25
Connector Name	FRONT WIPER MOTOR
Connector Color	GRAY



Terminal No.	Color of Wire	Signal Name
1	LG	-
2	B/Y	-
3	-	-
4	Y	-
5	R	-

FRONT WIPER AND WASHER SYSTEM

< COMPONENT DIAGNOSIS >

Connector No.	E200
Connector Name	IPDM E/R (INTELLIGENT POWER DISTRIBUTION MODULE ENGINE ROOM)
Connector Color	WHITE



85	84	83
90	89	88

Terminal No.	Color of Wire	Signal Name
88	R/W	WASHER_MTR

Terminal No.	Color of Wire	Signal Name
8	P	-
15G	L	-
17G	GR	-
82G	LG	-

Connector No.	E30
Connector Name	WIRE TO WIRE
Connector Color	WHITE

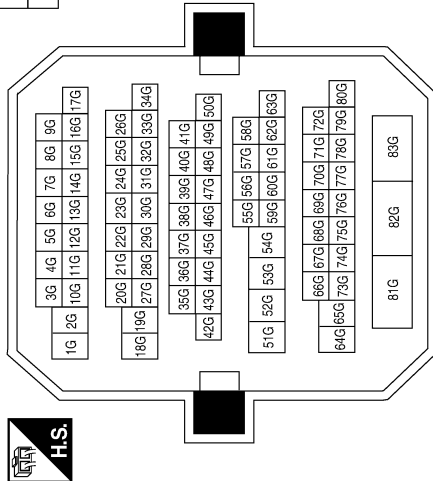

Connector No.	E226
Connector Name	FRONT WASHER MOTOR
Connector Color	BLACK



Terminal No.	Color of Wire	Signal Name
1	R/W	-
2	R/L	-

Connector No.	E202
Connector Name	WIRE TO WIRE
Connector Color	WHITE

3	2	1
8	7	6
5	4	



Terminal No.	Color of Wire	Signal Name
2	R/L	-

ABLIA0889GB

A
B
C
D
E
F
G
H
I
J
K
M
N
O
P

WW

FRONT WIPER AND WASHER SYSTEM

< COMPONENT DIAGNOSIS >

Wiring Diagram-Sedan

INFOID:000000004202205

--- : DATA LINE

FRONT WIPER AND WASHER SYSTEM

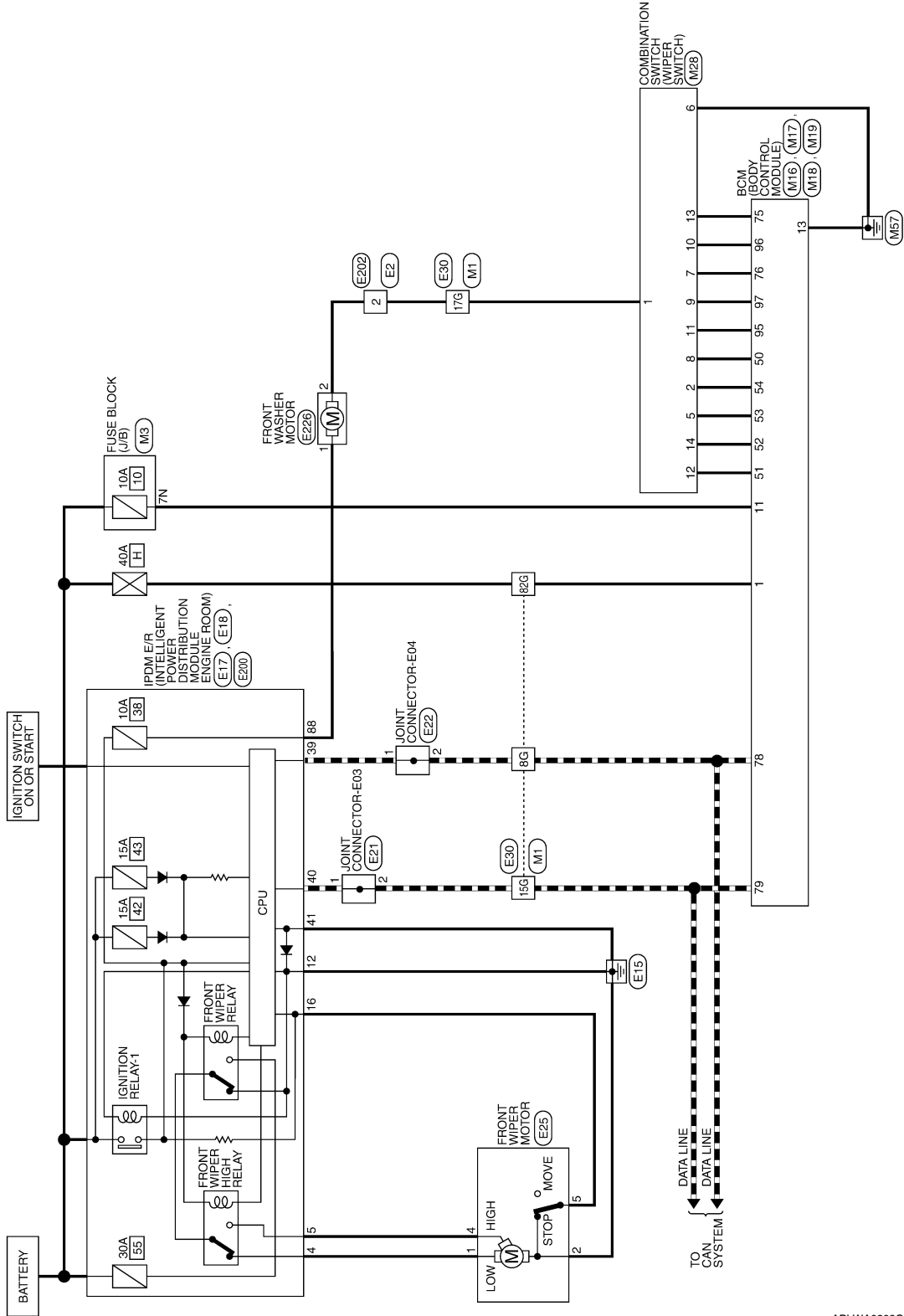

ABLWA0202GE

FRONT WIPER AND WASHER SYSTEM

< COMPONENT DIAGNOSIS >

FRONT WIPER AND WASHER SYSTEM CONNECTORS

Connector No.	M1
Connector Name	WIRE TO WIRE
Connector Color	WHITE

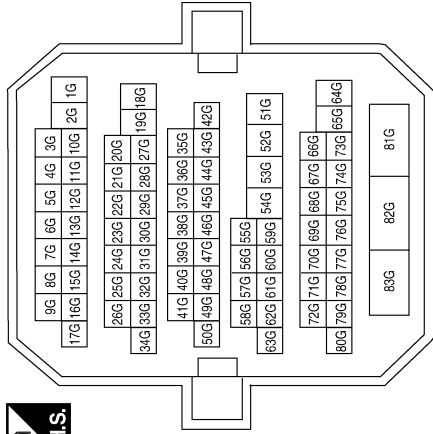

Terminal No.	Color of Wire	Signal Name
8G	P	-
15G	L	-
17G	R/L	-
82G	W/B	-

Connector No.	M3
Connector Name	FUSE BLOCK (J/B)
Connector Color	WHITE

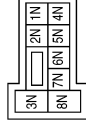

Terminal No.	Color of Wire	Signal Name
7N	Y/R	-

Connector No.	M16
Connector Name	BCM (BODY CONTROL MODULE)
Connector Color	BLACK



Connector No.	M17
Connector Name	BCM (BODY CONTROL MODULE)
Connector Color	WHITE

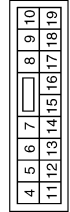

Terminal No.	Color of Wire	Signal Name
1	W/B	BAT_POWER_F/L

Connector No.	M18
Connector Name	BCM (BODY CONTROL MODULE)
Connector Color	GREEN

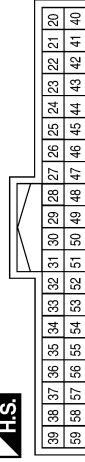

Terminal No.	Color of Wire	Signal Name
50	LG/B	INPUT_5
51	L/W	INPUT_1
52	G/B	INPUT_2
53	LG/R	INPUT_3
54	G/Y	INPUT_4

ABLIA0685GB

P O N M WW K J I H G F E D C B A

FRONT WIPER AND WASHER SYSTEM

< COMPONENT DIAGNOSIS >

Connector No.	E2
Connector Name	WIRE TO WIRE
Connector Color	WHITE

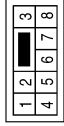

Terminal No.	Color of Wire	Signal Name
2	GR	-

Connector No.	M28
Connector Name	COMBINATION SWITCH
Connector Color	WHITE

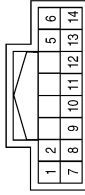

Terminal No.	Color of Wire	Signal Name
1	R/L	-
2	G/Y	-
5	LG/R	-
7	R/G	-
8	LG/B	-
9	R/B	-
10	P/B	-
11	R/W	-
12	L/W	-
13	R/Y	-
14	G/B	-

Connector No.	M19
Connector Name	BCM (BODY CONTROL MODULE)
Connector Color	BLACK

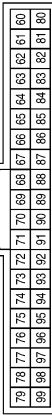

Terminal No.	Color of Wire	Signal Name
75	R/Y	-
76	R/G	-
78	P	-
79	L	-
95	R/W	-
96	P/B	-
97	R/B	-

Terminal No.	Color of Wire	Signal Name
4	L/R	FR_WIPER_LO
5	Y	FR_WIPER_HI
12	B	GND (POWER)
16	L/Y	WIPER_AUTOSTOP

Connector No.	E18
Connector Name	IPDM E/R (INTELLIGENT POWER DISTRIBUTION MODULE ENGINE ROOM)
Connector Color	WHITE

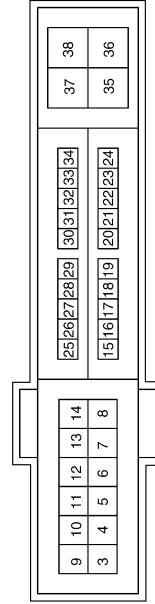

Connector No.	E17
Connector Name	IPDM E/R (INTELLIGENT POWER DISTRIBUTION MODULE ENGINE ROOM)
Connector Color	WHITE

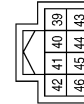

Terminal No.	Color of Wire	Signal Name
39	P	CAN-L
40	L	CAN-H
41	B	GND (SIGNAL)

ABLIA0686GB

FRONT WIPER AND WASHER SYSTEM

< COMPONENT DIAGNOSIS >

Connector No.	E21
Connector Name	JOINT CONNECTOR-E03
Connector Color	WHITE



Terminal No.	Color of Wire	Signal Name
1	L	-
2	L	-

Connector No.	E22
Connector Name	JOINT CONNECTOR-E04
Connector Color	WHITE



Terminal No.	Color of Wire	Signal Name
1	P	-
2	P	-

Connector No.	E25
Connector Name	FRONT WIPER MOTOR
Connector Color	GRAY



Terminal No.	Color of Wire	Signal Name
1	LG	-
2	B/Y	-
3	-	-
4	Y	-
5	R	-

Connector No.	E30
Connector Name	WIRE TO WIRE
Connector Color	WHITE

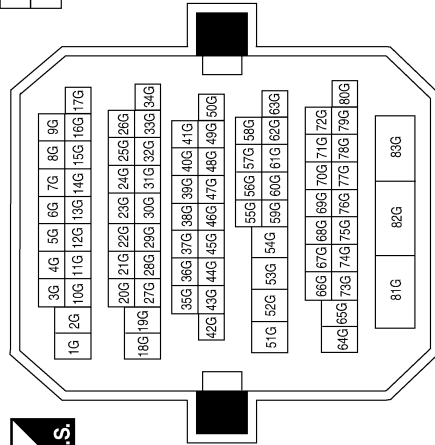

Terminal No.	Color of Wire	Signal Name
8	P	-
15G	L	-
17G	GR	-
82G	LG	-

Connector No.	E200
Connector Name	IPDM E/R (INTELLIGENT POWER DISTRIBUTION MODULE ENGINE ROOM)
Connector Color	WHITE



Terminal No.	Color of Wire	Signal Name
88	R/W	WASHER_MTR

ABLIA0687GB

A
B
C
D
E
F
G
H
I
J
K
M
N
O
P

WW

FRONT WIPER AND WASHER SYSTEM

< COMPONENT DIAGNOSIS >

Connector No.	E226
Connector Name	FRONT WASHER MOTOR
Connector Color	BLACK



Terminal No.	Color of Wire	Signal Name
1	R/W	—
2	R/L	—

Connector No.	E202
Connector Name	WIRE TO WIRE
Connector Color	WHITE



Terminal No.	Color of Wire	Signal Name
2	R/L	—

ALLIA0049GB

BCM (BODY CONTROL MODULE)

< ECU DIAGNOSIS >

ECU DIAGNOSIS

BCM (BODY CONTROL MODULE)

Reference Value

INFOID:000000004505080

VALUES ON THE DIAGNOSIS TOOL

Monitor Item	Condition	Value/Status
FR WIPER HI	Other than front wiper switch HI	OFF
	Front wiper switch HI	ON
FR WIPER LOW	Other than front wiper switch LO	OFF
	Front wiper switch LO	ON
FR WASHER SW	Front washer switch OFF	OFF
	Front washer switch ON	ON
FR WIPER INT	Other than front wiper switch INT	OFF
	Front wiper switch INT	ON
FR WIPER STOP	Front wiper is not in STOP position	OFF
	Front wiper is in STOP position	ON
INT VOLUME	Wiper intermittent dial is in a dial position 1 - 7	Wiper intermittent dial position
TURN SIGNAL R	Other than turn signal switch RH	OFF
	Turn signal switch RH	ON
TURN SIGNAL L	Other than turn signal switch LH	OFF
	Turn signal switch LH	ON
TAIL LAMP SW	Other than lighting switch 1ST and 2ND	OFF
	Lighting switch 1ST or 2ND	ON
HI BEAM SW	Other than lighting switch HI	OFF
	Lighting switch HI	ON
HEAD LAMP SW 1	Other than lighting switch 2ND	OFF
	Lighting switch 2ND	ON
HEAD LAMP SW 2	Other than lighting switch 2ND	OFF
	Lighting switch 2ND	ON
PASSING SW	Other than lighting switch PASS	OFF
	Lighting switch PASS	ON
AUTO LIGHT SW	Other than lighting switch AUTO	OFF
	Lighting switch AUTO	ON
FR FOG SW	Front fog lamp switch OFF	OFF
	Front fog lamp switch ON	ON
DOOR SW-DR	Driver door closed	OFF
	Driver door opened	ON
DOOR SW-AS	Passenger door closed	OFF
	Passenger door opened	ON
DOOR SW-RR	Rear door RH closed	OFF
	Rear door RH opened	ON
DOOR SW-RL	Rear door LH closed	OFF
	Rear door LH opened	ON

BCM (BODY CONTROL MODULE)

< ECU DIAGNOSIS >

Monitor Item	Condition	Value/Status
DOOR SW-BK	NOTE: This item is displayed, but cannot be monitored.	OFF
CDL LOCK SW	Other than power door lock switch LOCK	OFF
	Power door lock switch LOCK	ON
CDL UNLOCK SW	Other than power door lock switch UNLOCK	OFF
	Power door lock switch UNLOCK	ON
KEY CYL LK-SW	Other than driver door key cylinder LOCK position	OFF
	Driver door key cylinder LOCK position	ON
KEY CYL UN-SW	Other than driver door key cylinder UNLOCK position	OFF
	Driver door key cylinder UNLOCK position	ON
KEY CYL SW-TR	NOTE: This item is displayed, but cannot be monitored.	OFF
HAZARD SW	When hazard switch is not pressed	OFF
	When hazard switch is pressed	ON
REAR DEF SW	When rear window defogger switch is pressed	ON
TR CANCEL SW	Trunk lid opener cancel switch OFF	OFF
	Trunk lid opener cancel switch ON	ON
TR/BD OPEN SW	Trunk lid opener switch OFF	OFF
	While the trunk lid opener switch is turned ON	ON
TRNK/HAT MNTR	Trunk lid closed	OFF
	Trunk lid opened	ON
RKE-LOCK	When LOCK button of Intelligent Key is not pressed	OFF
	When LOCK button of Intelligent Key is pressed	ON
RKE-UNLOCK	When UNLOCK button of Intelligent Key is not pressed	OFF
	When UNLOCK button of Intelligent Key is pressed	ON
RKE-TR/BD	When TRUNK OPEN button of Intelligent Key is not pressed	OFF
	When TRUNK OPEN button of Intelligent Key is pressed	ON
RKE-PANIC	When PANIC button of Intelligent Key is not pressed	OFF
	When PANIC button of Intelligent Key is pressed	ON
RKE-P/W OPEN	When UNLOCK button of Intelligent Key is not pressed and held	OFF
	When UNLOCK button of Intelligent Key is pressed and held	ON
RKE-MODE CHG	When LOCK/UNLOCK button of Intelligent Key is not pressed and held simultaneously	OFF
	When LOCK/UNLOCK button of Intelligent Key is pressed and held simultaneously	ON
OPTICAL SENSOR	When outside of the vehicle is bright	Close to 5 V
	When outside of the vehicle is dark	Close to 0 V
REQ SW-DR	When driver door request switch is not pressed	OFF
	When driver door request switch is pressed	ON
REQ SW-AS	When passenger door request switch is not pressed	OFF
	When passenger door request switch is pressed	ON
REQ SW-BD/TR	When trunk request switch is not pressed	OFF
	When trunk request switch is pressed	ON
PUSH SW	When engine switch (push switch) is not pressed	OFF
	When engine switch (push switch) is pressed	ON

BCM (BODY CONTROL MODULE)

< ECU DIAGNOSIS >

Monitor Item	Condition	Value/Status	
IGN RLY2-F/B	Ignition switch OFF or ACC	OFF	A
	Ignition switch ON	ON	
ACC RLY-F/B	Ignition switch OFF	OFF	B
	Ignition switch ACC or ON	ON	
CLUTCH SW	When the clutch pedal is not depressed	OFF	C
	When the clutch pedal is depressed	ON	
BRAKE SW 1	When the brake pedal is not depressed	ON	D
	When the brake pedal is depressed	OFF	
DETE/CANCL SW	When selector lever is in P position	OFF	E
	When selector lever is in any position other than P	ON	
SFT PN/N SW	When selector lever is in any position other than P or N	OFF	F
	When selector lever is in P or N position	ON	
S/L-LOCK	Electronic steering column lock LOCK status	OFF	G
	Electronic steering column lock UNLOCK status	ON	
S/L-UNLOCK	Electronic steering column lock UNLOCK status	OFF	H
	Electronic steering column lock LOCK status	ON	
S/L RELAY-F/B	Ignition switch OFF or ACC	OFF	I
	Ignition switch ON	ON	
UNLK SEN-DR	Driver door UNLOCK status	OFF	J
	Driver door LOCK status	ON	
PUSH SW-IPDM	When engine switch (push switch) is not pressed	OFF	K
	When engine switch (push switch) is pressed	ON	
IGN RLY1 F/B	Ignition switch OFF or ACC	OFF	WW
	Ignition switch ON	ON	
DETE SW -IPDM	When selector lever is in P position	OFF	M
	When selector lever is in any position other than P	ON	
SFT PN -IPDM	When selector lever is in any position other than P or N	OFF	N
	When selector lever is in P or N position	ON	
SFT P-MET	When selector lever is in any position other than P	OFF	O
	When selector lever is in P position	ON	
SFT N-MET	When selector lever is in any position other than N	OFF	P
	When selector lever is in N position	ON	
ENGINE STATE	Engine stopped	STOP	
	While the engine stalls	STALL	
	At engine cranking	CRANK	
	Engine running	RUN	
S/L LOCK-IPDM	Electronic steering column lock LOCK status	OFF	
	Electronic steering column lock UNLOCK status	ON	
S/L UNLCK-IPDM	Electronic steering column lock UNLOCK status	OFF	
	Electronic steering column lock LOCK status	ON	
S/L RELAY-REQ	Ignition switch OFF or ACC	OFF	
	Ignition switch ON	ON	
VEH SPEED 1	While driving	Equivalent to speedometer reading	
VEH SPEED 2	While driving	Equivalent to speedometer reading	

BCM (BODY CONTROL MODULE)

< ECU DIAGNOSIS >

Monitor Item	Condition	Value/Status
DOOR STAT-DR	Driver door LOCK status	LOCK
	Wait with selective UNLOCK operation (5 seconds)	READY
	Driver door UNLOCK status	UNLK
DOOR STAT-AS	Passenger door LOCK status	LOCK
	Wait with selective UNLOCK operation (5 seconds)	READY
	Passenger door UNLOCK status	UNLK
ID OK FLAG	Ignition switch ACC or ON	RESET
	Ignition switch OFF	SET
PRMT ENG STAT	When the engine start is prohibited	RESET
	When the engine start is permitted	SET
PRMT RKE STAT	NOTE: This item is displayed, but cannot be monitored.	RESET
KEY SW -SLOT	When Intelligent Key is not inserted into key slot	OFF
	When Intelligent Key is inserted into key slot	ON
RKE OPE COUN1	During the operation of Intelligent Key	Operation frequency of Intelligent Key
RKE OPE COUN2	NOTE: This item is displayed, but cannot be monitored.	Operation frequency of Intelligent Key
CONFIRM ID ALL	The key ID that the key slot receives does not accord with any key ID registered to BCM.	YET
	The key ID that the key slot receives accords with any key ID registered to BCM.	DONE
CONFIRM ID4	The key ID that the key slot receives does not accord with the fourth key ID registered to BCM.	YET
	The key ID that the key slot receives accords with the fourth key ID registered to BCM.	DONE
CONFIRM ID3	The key ID that the key slot receives does not accord with the third key ID registered to BCM.	YET
	The key ID that the key slot receives accords with the third key ID registered to BCM.	DONE
CONFIRM ID2	The key ID that the key slot receives does not accord with the second key ID registered to BCM.	YET
	The key ID that the key slot receives accords with the second key ID registered to BCM.	DONE
CONFIRM ID1	The key ID that the key slot receives does not accord with the first key ID registered to BCM.	YET
	The key ID that the key slot receives accords with the first key ID registered to BCM.	DONE
TP 4	The ID of fourth key is not registered to BCM	YET
	The ID of fourth key is registered to BCM	DONE
TP 3	The ID of third key is not registered to BCM	YET
	The ID of third key is registered to BCM	DONE
TP 2	The ID of second key is not registered to BCM	YET
	The ID of second key is registered to BCM	DONE
TP 1	The ID of first key is not registered to BCM	YET
	The ID of first key is registered to BCM	DONE
AIR PRESS FL	Ignition switch ON (only when the signal from the transmitter is received)	Air pressure of front LH tire
AIR PRESS FR	Ignition switch ON (only when the signal from the transmitter is received)	Air pressure of front RH tire

BCM (BODY CONTROL MODULE)

< ECU DIAGNOSIS >

Monitor Item	Condition	Value/Status	
AIR PRESS RR	Ignition switch ON (only when the signal from the transmitter is received)	Air pressure of rear RH tire	A
AIR PRESS RL	Ignition switch ON (only when the signal from the transmitter is received)	Air pressure of rear LH tire	B
ID REGST FL1	When ID of front LH tire transmitter is registered	DONE	C
	When ID of front LH tire transmitter is not registered	YET	
ID REGST FR1	When ID of front RH tire transmitter is registered	DONE	D
	When ID of front RH tire transmitter is not registered	YET	
ID REGST RR1	When ID of rear RH tire transmitter is registered	DONE	E
	When ID of rear RH tire transmitter is not registered	YET	
ID REGST RL1	When ID of rear LH tire transmitter is registered	DONE	F
	When ID of rear LH tire transmitter is not registered	YET	
WARNING LAMP	Tire pressure indicator OFF	OFF	G
	Tire pressure indicator ON	ON	
BUZZER	Tire pressure warning alarm is not sounding	OFF	H
	Tire pressure warning alarm is sounding	ON	

A
B
C
D
E
F
G
H
I
J
K
L
M
N
O
P

WW

BCM (BODY CONTROL MODULE)

< ECU DIAGNOSIS >

Terminal Layout

INFOID:000000004505081

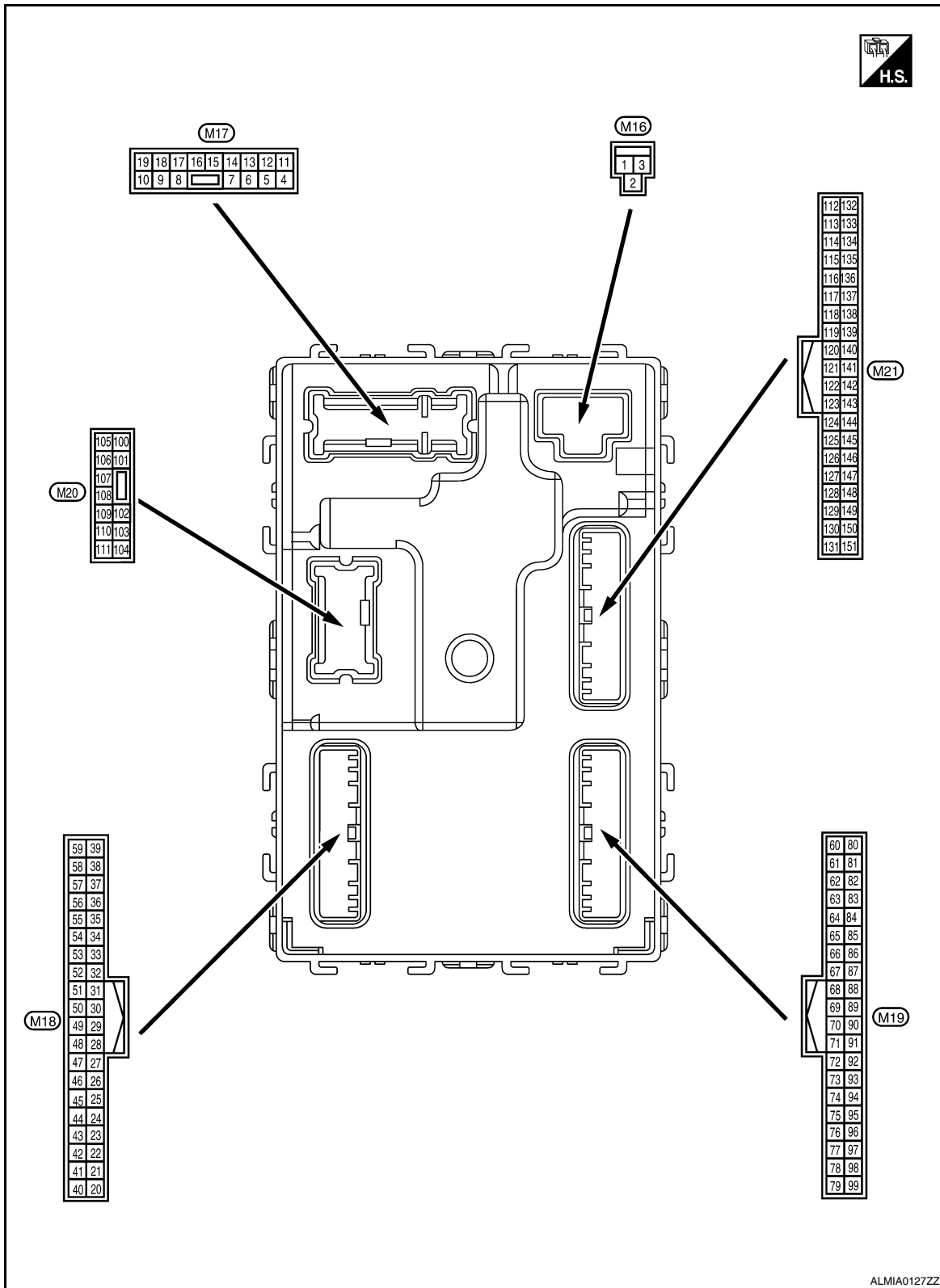

Physical Values

INFOID:000000004505082

BCM (BODY CONTROL MODULE)

< ECU DIAGNOSIS >

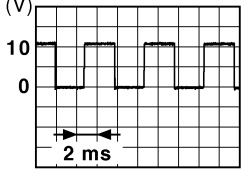
Terminal No. (Wire color)		Description		Condition		Value (Approx.)
		Signal name	Input/ Output			
(+)	(-)					
1 (W/B)	Ground	Battery power supply	Input	Ignition switch OFF		Battery voltage
2 (R/Y)	Ground	Battery power supply output	Output	Ignition switch OFF		Battery voltage
3 (L/W)	Ground	Ignition power supply output	Output	Ignition switch ON		Battery voltage
4 (P/W)	Ground	Interior room lamp power supply	Output	After passing the interior room lamp battery saver operation time		0V
				Any other time after passing the interior room lamp battery saver operation time		Battery voltage
5 (G/Y)	Ground	Front door RH UNLOCK	Output	Front door RH	UNLOCK (actuator is activated)	Battery voltage
					Other than UNLOCK (actuator is not activated)	0V
7 (R/W)	Ground	Step lamp	Output	Step lamp	ON	0V
					OFF	Battery voltage
8 (V)	Ground	All doors LOCK	Output	All doors	LOCK (actuator is activated)	Battery voltage
					Other than LOCK (actuator is not activated)	0V
9 (G)	Ground	Front door LH UNLOCK	Output	Front door LH	UNLOCK (actuator is activated)	Battery voltage
					Other than UNLOCK (actuator is not activated)	0V
10 ¹ (G/Y)	Ground	Rear door RH and rear door LH UNLOCK	Output	Rear door RH and rear door LH	UNLOCK (actuator is activated)	Battery voltage
					Other than UNLOCK (actuator is not activated)	0V
11 (Y/R)	Ground	Battery power supply	Input	Ignition switch OFF		Battery voltage
13 (B)	Ground	Ground	—	Ignition switch ON		0V
14 (R/Y)	Ground	Engine switch (push switch) illumination ground	Input	Tail lamp	OFF	0V
					ON	<p>NOTE: When the illumination brightening/dimming level is in the neutral position</p>  <p style="text-align: right; font-size: small;">JSNIA0010GB</p>
15 (Y/L)	Ground	ACC indicator lamp	Output	Ignition switch	OFF	Battery voltage
					ACC or ON	0V

BCM (BODY CONTROL MODULE)

< ECU DIAGNOSIS >

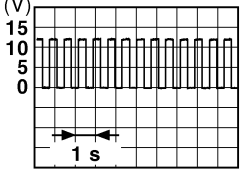
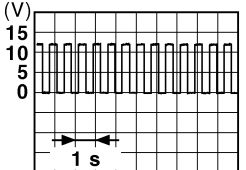
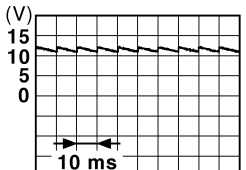
Terminal No. (Wire color)		Description		Condition	Value (Approx.)	
(+)	(-)	Signal name	Input/ Output			
17 (G/B)	Ground	Turn signal (RH)	Output	Ignition switch ON	Turn signal switch OFF	0V
				Turn signal switch RH	 6.5 V	
18 (G/Y)	Ground	Turn signal (LH)	Output	Ignition switch ON	Turn signal switch OFF	0V
				Turn signal switch LH	 6.5 V	
19 (Y)	Ground	Room lamp timer control	Output	Interior room lamp	OFF	Battery voltage
				ON	0V	
21 (P/B)	Ground	Optical sensor signal	Input	Ignition switch ON	When outside of the vehicle is bright	Close to 5V
				When outside of the vehicle is dark	Close to 0V	
22 (R/Y)	Ground	Clutch interlock switch	Input	Clutch interlock switch	OFF (clutch pedal is not depressed)	0V
				ON (clutch pedal is depressed)	Battery voltage	
24 (R/W)	Ground	Stop lamp switch 1	Input	—	Battery voltage	
26 (O/L)	Ground	Stop lamp switch 2	Input	Stop lamp switch	OFF (brake pedal is not depressed)	0V
				ON (brake pedal is depressed)	Battery voltage	
27 (G/W)	Ground	Front door lock assembly LH (unlock sensor)	Input	Front door LH	LOCK status	 11.8V
				UNLOCK status	0V	
29 (Y)	Ground	Key slot switch	Input	When Intelligent Key is inserted into key slot	Battery voltage	
				When Intelligent Key is not inserted into key slot	0V	
30 (V/Y)	Ground	ACC feedback signal	Input	Ignition switch	OFF	0
				ACC or ON	Battery voltage	

BCM (BODY CONTROL MODULE)

< ECU DIAGNOSIS >

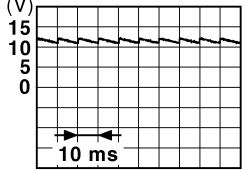
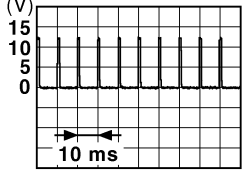
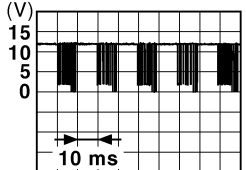
Terminal No. (Wire color)		Description		Condition		Value (Approx.)
(+)	(-)	Signal name	Input/ Output			
31 (G)	Ground	Rear window defogger feedback signal	Input	Rear window defogger switch	OFF	0V
					ON	Battery voltage
32 (R/B)	Ground	Front door RH switch	Input	Front door RH switch	OFF (when front door RH closes)	 11.8 V
					ON (when front door RH opens)	0V
33 (SB)	Ground	Compressor ON signal	Input	A/C switch	OFF	5V
					ON	0V
34 ² (L/R)	Ground	Front door lock assembly LH (key cylinder switch) (unlock)	Input	Front door lock assembly LH (key cylinder switch)	OFF (neutral)	5V
					ON (unlock)	0V
36 ² (GR)	Ground	Lock switch signal	Input	Door lock/unlock switch	Lock	Battery voltage
					Unlock	0V
37 (O)	Ground	Trunk lid opener cancel switch	Input	Trunk lid opener cancel switch	CANCEL	 1.1V
					ON	0V
38 (GR/W)	Ground	Rear window defogger ON signal	Input	Rear window defogger switch	OFF	5V
					ON	0V
39 ² (GR/R)	Ground	Unlock switch signal	Input	Door lock/unlock switch	Unlock	Battery voltage
					Lock	0V
40 ³ (Y/G)	Ground	Power window serial link	Input/ Output	Ignition switch ON	 10.2V	
				Ignition switch OFF or ACC	0V	
41 (W)	Ground	Engine switch (push switch) illumination	Output	Engine switch (push switch) illumination	ON	5.5V
				OFF	0V	
42 (R)	Ground	LOCK indicator lamp	Output	LOCK indicator lamp	ON	0V
				OFF	Battery voltage	

A
B
C
D
E
F
G
H
I
J
K
WW
M
N
O
P

BCM (BODY CONTROL MODULE)

< ECU DIAGNOSIS >

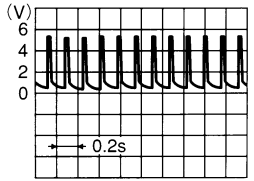
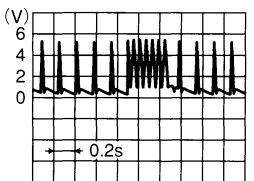
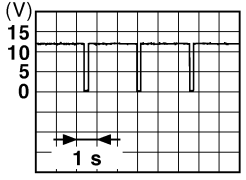
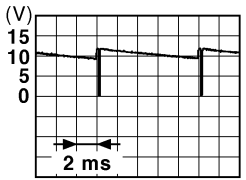
Terminal No. (Wire color)		Description		Condition	Value (Approx.)	
		Signal name	Input/ Output			
(+)	(-)					
45 (P)	Ground	Receiver & sensor ground	Input	Ignition switch ON	0V	
46 (V/W)	Ground	Receiver & sensor power supply output	Output	Ignition switch	OFF	0V
					ACC or ON	5.0V
47 (G/O)	Ground	Tire pressure receiver signal	Input/ Output	Ignition switch ON	Standby state	
					When receiving the signal from the transmitter	
48 (R/G)	Ground	Selector lever P/N position signal	Input	Selector lever	P or N position	12.0V
					Except P and N positions	0V
49 (L/O)	Ground	Security indicator signal	Output	Security indicator	ON	0V
					Blinking	
50 (LG/B)	Ground	Combination switch OUTPUT 5	Output	Combination switch (Wiper intermittent dial 4)	OFF	Battery voltage
					All switch OFF	0V
					Lighting switch 1ST	
					Lighting switch high-beam	
					Lighting switch 2ND	
Turn signal switch RH						

BCM (BODY CONTROL MODULE)

< ECU DIAGNOSIS >

Terminal No. (Wire color)		Description		Condition	Value (Approx.)
(+)	(-)	Signal name	Input/ Output		
51 (L/W)	Ground	Combination switch OUTPUT 1	Output	Combination switch	0V
				All switch OFF (Wiper intermittent dial 4)	10.7V
52 (G/B)	Ground	Combination switch OUTPUT 2	Output	Combination switch	0V
				Front wiper switch HI (Wiper intermittent dial 4)	10.7V
53 (LG/ R)	Ground	Combination switch OUTPUT 3	Output	Combination switch (Wiper intermit- tent dial 4)	0V
				Any of the conditions below with all switch OFF • Wiper intermittent dial 1 • Wiper intermittent dial 2 • Wiper intermittent dial 3 • Wiper intermittent dial 6 • Wiper intermittent dial 7	10.7V
54 (G/Y)	Ground	Combination switch OUTPUT 4	Output	Combination switch (Wiper intermit- tent dial 4)	0V
				Any of the conditions below with all switch OFF • Wiper intermittent dial 1 • Wiper intermittent dial 5 • Wiper intermittent dial 6	10.7V
55 (BR/ W)	Ground	Front blower monitor	Input	Front blower mo- tor switch	Battery voltage
				ON	0V
56 ² (L/B)	Ground	Front door lock as- sembly LH (key cylin- der switch) (lock)	Input	Front door lock assembly LH (key cylinder switch)	5V
				OFF (neutral)	0V
57 (W)	Ground	Tire pressure warn- ing check switch	Input	—	5V

A
B
C
D
E
F
G
H
I
J
K
WW
M
N
O
P

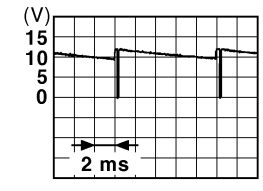
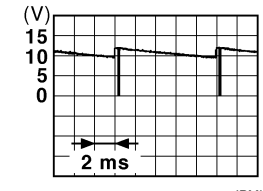
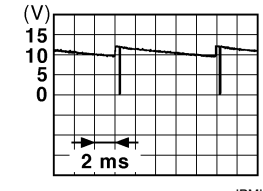

BCM (BODY CONTROL MODULE)

< ECU DIAGNOSIS >

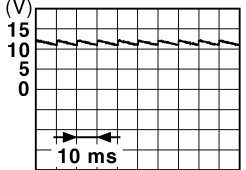
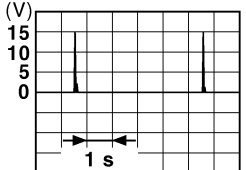
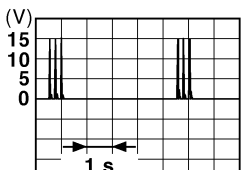
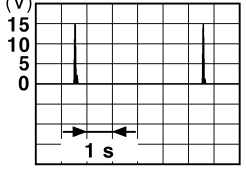
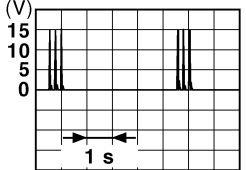
Terminal No. (Wire color)		Description		Condition	Value (Approx.)
(+)	(-)	Signal name	Input/ Output		
58 (SB)	Ground	Front door LH switch	Input	Front door LH switch	 <p style="text-align: center;">11.8V</p>
				ON (front door LH OPEN)	0V
59 (G/R)	Ground	Rear window defogger relay	Output	Rear window defogger	Active Battery voltage Not activated 0V
60 (B/R)	Ground	Front console antenna 2 (-)	Output	Ignition switch OFF	 <p style="text-align: center;">JMKIA0062GB</p>
					When Intelligent Key is not in the passenger compartment  <p style="text-align: center;">JMKIA0063GB</p>
61 (W/R)	Ground	Center console antenna 2 (+)	Output	Ignition switch OFF	 <p style="text-align: center;">JMKIA0062GB</p>
					When Intelligent Key is not in the passenger compartment  <p style="text-align: center;">JMKIA0063GB</p>

BCM (BODY CONTROL MODULE)

< ECU DIAGNOSIS >

Terminal No. (Wire color)		Description		Condition	Value (Approx.)
		Signal name	Input/ Output		
(+)	(-)				
62 ⁴ (B/Y)	Ground	Front outside handle RH antenna (-)	Output	When the front door RH request switch is operated with ignition switch OFF	<p style="text-align: right; font-size: small;">JMKIA0062GB</p>
				When Intelligent Key is not in the antenna detection area	<p style="text-align: right; font-size: small;">JMKIA0063GB</p>
63 ⁴ (LG)	Ground	Front outside handle RH antenna (+)	Output	When the front door RH request switch is operated with ignition switch OFF	<p style="text-align: right; font-size: small;">JMKIA0062GB</p>
				When Intelligent Key is not in the antenna detection area	<p style="text-align: right; font-size: small;">JMKIA0063GB</p>
64 ⁴ (V)	Ground	Front outside handle LH antenna (-)	Output	When the front door LH request switch is operated with ignition switch OFF	<p style="text-align: right; font-size: small;">JMKIA0062GB</p>
				When Intelligent Key is not in the antenna detection area	<p style="text-align: right; font-size: small;">JMKIA0063GB</p>

A
B
C
D
E
F
G
H
I
J
K
M
N
O
P

WW



BCM (BODY CONTROL MODULE)

< ECU DIAGNOSIS >

Terminal No. (Wire color)		Description		Condition	Value (Approx.)
(+)	(-)	Signal name	Input/ Output		
65 ⁴ (P)	Ground	Front outside handle LH antenna (+)	Output	When Intelligent Key is in the antenna detection area	<p style="text-align: right; font-size: small;">JMKIA0062GB</p>
				When the front door LH request switch is operat- ed with ignition switch OFF	<p style="text-align: right; font-size: small;">JMKIA0063GB</p>
66 (R)	Ground	Instrument panel an- tenna (-)	Output	When Intelligent Key is in the passenger compart- ment	<p style="text-align: right; font-size: small;">JMKIA0062GB</p>
				When Intelligent Key is not in the passenger compart- ment	<p style="text-align: right; font-size: small;">JMKIA0063GB</p>
67 (G)	Ground	Instrument panel an- tenna (+)	Output	When Intelligent Key is in the passenger compart- ment	<p style="text-align: right; font-size: small;">JMKIA0062GB</p>
				When Intelligent Key is not in the passenger compart- ment	<p style="text-align: right; font-size: small;">JMKIA0063GB</p>

BCM (BODY CONTROL MODULE)

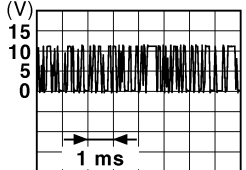
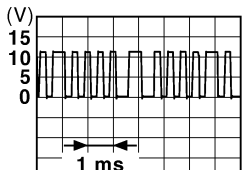
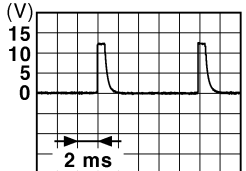
< ECU DIAGNOSIS >

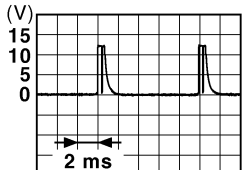

Terminal No. (Wire color)		Description		Condition		Value (Approx.)
		Signal name	Input/ Output			
(+)	(-)					
68 (G/O)	Ground	NATS antenna amp (built in key slot)	Input/ Output	During waiting	Ignition switch is pressed while inserting the Intelli- gent Key into the key slot.	Just after pressing ignition switch. Pointer of tester should move.
69 (O)	Ground	NATS antenna amp (built in key slot)	Input/ Output	During waiting	Ignition switch is pressed while inserting the Intelli- gent Key into the key slot.	Just after pressing ignition switch. Pointer of tester should move.
70 (R/B)	Ground	Ignition relay-2 con- trol	Output	Ignition switch	OFF or ACC	0V
					ON	Battery voltage
71 (L/O)	Ground	Remote keyless entry receiver signal	Input/ Output	During waiting		 <p style="text-align: right; font-size: small;">JMKIA0064GB</p>
				When operating either button on Intelligent Key		 <p style="text-align: right; font-size: small;">JMKIA0065GB</p>
75 (R/Y)	Ground	Combination switch INPUT 5	Input	Combination switch	All switch OFF (Wiper intermittent dial 4)	 <p style="text-align: right; font-size: small;">JPMIA0041GB</p> <p style="text-align: center;">1.4V</p>
					Front fog lamp switch ON (Wiper intermittent dial 4)	 <p style="text-align: right; font-size: small;">JPMIA0037GB</p> <p style="text-align: center;">1.3V</p>
					Any of the conditions below with all switch OFF • Wiper intermittent dial 1 • Wiper intermittent dial 2 • Wiper intermittent dial 6 • Wiper intermittent dial 7	 <p style="text-align: right; font-size: small;">JPMIA0040GB</p> <p style="text-align: center;">1.3V</p>

A
B
C
D
E
F
G
H
I
J
K
M
N
O
P

WW

BCM (BODY CONTROL MODULE)

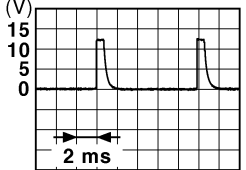
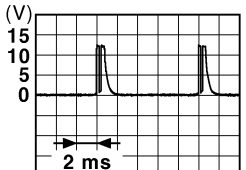
< ECU DIAGNOSIS >

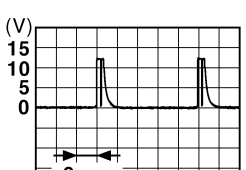
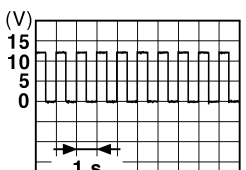
Terminal No. (Wire color)		Description		Condition	Value (Approx.)	
(+)	(-)	Signal name	Input/ Output			
76 (R/G)	Ground	Combination switch INPUT 3	Input	Combination switch	All switch OFF (Wiper intermittent dial 4)	 <small>JPMIA0041GB</small> 1.4V
					Lighting switch high-beam (Wiper intermittent dial 4)	 <small>JPMIA0036GB</small> 1.3V
					Lighting switch 2ND (Wiper intermittent dial 4)	 <small>JPMIA0037GB</small> 1.3V
					Any of the conditions below with all switch OFF • Wiper intermittent dial 1 • Wiper intermittent dial 2 • Wiper intermittent dial 3	 <small>JPMIA0040GB</small> 1.3V
77 (BR)	Ground	Engine switch (push switch)	Input	Engine switch (push switch)	Pressed	0V
					Not pressed	Battery voltage
78 (P)	Ground	CAN-L	Input/ Output	—	—	
79 (L)	Ground	CAN-H	Input/ Output	—	—	
80 (R/L)	Ground	Key slot illumination	Output	Key slot illumina- tion	OFF	0V
					Blinking	 <small>JPMIA0015GB</small> 6.5V
					ON	Battery voltage

BCM (BODY CONTROL MODULE)

< ECU DIAGNOSIS >



Terminal No. (Wire color)		Description		Condition		Value (Approx.)
		Signal name	Input/ Output			
(+)	(-)					
81 (LG)	Ground	ON indicator lamp	Output	Ignition switch	OFF or ACC	0V
					ON	Battery voltage
83 (L)	Ground	ACC relay control	Output	Ignition switch	OFF	0V
					ACC or ON	Battery voltage
84 (Y/R)	Ground	CVT device	Output	—		Battery voltage
85 (L/O)	Ground	Electronic steering column lock condition No. 1	Input	Electronic steer- ing column lock	Lock status	0V
					Unlock status	Battery voltage
86 (G/R)	Ground	Electronic steering column lock condition No. 2	Input	Electronic steer- ing column lock	Lock status	Battery voltage
					Unlock status	0V
87 (G/B)	Ground	Selector lever P posi- tion switch	Input	Selector lever	P position	0V
					Any position other than P	Battery voltage
88 ⁴ (P/L)	Ground	Front door RH re- quest switch	Input	Front door RH re- quest switch	ON (pressed)	0V
					OFF (not pressed)	<p style="text-align: right; font-size: small;">JPMIA0016GB 1.0V</p>
89 ⁴ (B/W)	Ground	Front door LH re- quest switch	Input	Front door LH re- quest switch	ON (pressed)	0V
					OFF (not pressed)	<p style="text-align: right; font-size: small;">JPMIA0016GB 1.0V</p>
90 (Y)	Ground	Blower fan motor re- lay control	Output	Ignition switch	OFF or ACC	0V
					ON	Battery voltage
91 (L/R)	Ground	Remote keyless entry receiver power sup- ply	Output	Ignition switch OFF		Battery voltage
94 (G/Y)	Ground	Steering wheel lock unit power supply	Output	Ignition switch	OFF or ACC	Battery voltage
					ON	0V

A
B
C
D
E
F
G
H
I
J
K
M
N
O
P

WW

BCM (BODY CONTROL MODULE)

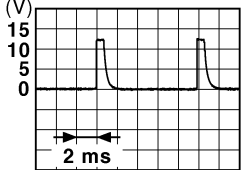
< ECU DIAGNOSIS >

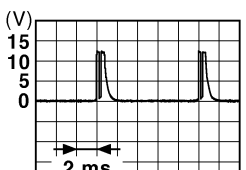
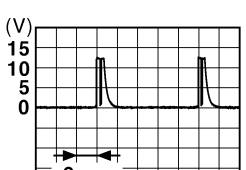
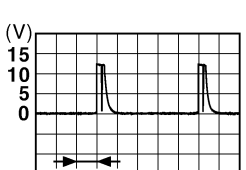
Terminal No. (Wire color)		Description		Condition	Value (Approx.)
(+)	(-)	Signal name	Input/ Output		
95 (R/W)	Ground	Combination switch INPUT 1	Input	Combination switch (Wiper intermittent dial 4)	All switch OFF <div style="text-align: right;">  <p>1.4V</p> </div>
					Turn signal switch LH <div style="text-align: right;">  <p>1.3V</p> </div>
					Turn signal switch RH <div style="text-align: right;">  <p>1.3V</p> </div>
					Front wiper switch LO <div style="text-align: right;">  <p>1.3V</p> </div>
					Front washer switch ON <div style="text-align: right;">  <p>1.3V</p> </div>

BCM (BODY CONTROL MODULE)

< ECU DIAGNOSIS >

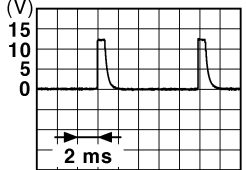
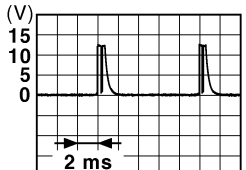
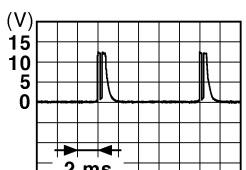
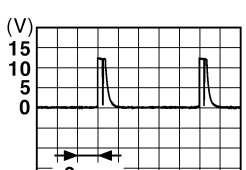

Terminal No. (Wire color)		Description		Condition	Value (Approx.)	
		Signal name	Input/ Output			
(+)	(-)					
96 (P/B)	Ground	Combination switch INPUT 4	Input	Combination switch	All switch OFF (Wiper intermittent dial 4)	 <small>JPMIA0041GB</small> 1.4V
					Lighting switch AUTO (Wiper intermittent dial 4)	 <small>JPMIA0038GB</small> 1.3V
					Lighting switch 1ST (Wiper intermittent dial 4)	 <small>JPMIA0036GB</small> 1.3V
					Any of the conditions below with all switch OFF • Wiper intermittent dial 1 • Wiper intermittent dial 5 • Wiper intermittent dial 6	 <small>JPMIA0039GB</small> 1.3V

A
B
C
D
E
F
G
H
I
J
K
M
N
O
P

WW

BCM (BODY CONTROL MODULE)

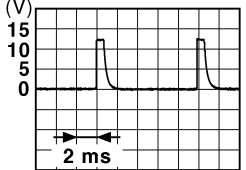
< ECU DIAGNOSIS >

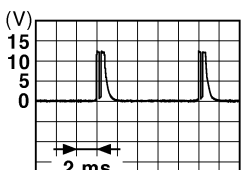
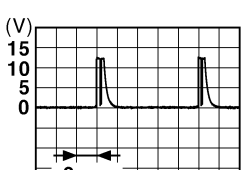
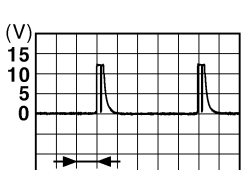
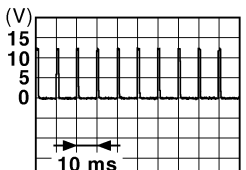
Terminal No. (Wire color)		Description		Condition	Value (Approx.)	
(+)	(-)	Signal name	Input/ Output			
97 (R/B)	Ground	Combination switch INPUT 2	Input	Combination switch (Wiper intermittent dial 4)	All switch OFF	 <p style="text-align: right;">JPMIA0041GB</p> <p style="text-align: center;">1.4V</p>
					Lighting switch flash-to-pass	 <p style="text-align: right;">JPMIA0037GB</p> <p style="text-align: center;">1.3V</p>
					Lighting switch 2ND	 <p style="text-align: right;">JPMIA0036GB</p> <p style="text-align: center;">1.3V</p>
					Front wiper switch INT	 <p style="text-align: right;">JPMIA0038GB</p> <p style="text-align: center;">1.3V</p>
					Front wiper switch HI	 <p style="text-align: right;">JPMIA0040GB</p> <p style="text-align: center;">1.3V</p>
					Pressed	0 V
98 (G/O)	Ground	Hazard switch	Input	Hazard switch	Not pressed	 <p style="text-align: right;">JPMIA0012GB</p> <p style="text-align: center;">1.1V</p>

BCM (BODY CONTROL MODULE)

< ECU DIAGNOSIS >

Terminal No. (Wire color)		Description		Condition	Value (Approx.)	
(+)	(-)	Signal name	Input/ Output			
99 (L/Y)	Ground	Electronic steering column lock unit com- munication	Input/ Output	Electronic steer- ing column lock	LOCK status	Battery voltage
					LOCK or UNLOCK	<p style="text-align: right; font-size: small;">JMKIA0066GB</p>
					For 15 seconds after UN- LOCK	Battery voltage
				15 seconds or later after UNLOCK	0V	
103 (V)	Ground	Trunk lid opening	Output	Trunk lid	Open (trunk lid opener ac- tuator is activated)	Battery voltage
					Close (trunk lid opener ac- tuator is not activated)	0V
110 (V/W)	Ground	Trunk room lamp	Output	Trunk room lamp	ON	0V
					OFF	Battery voltage
114 (B)	Ground	Rear parcel shelf an- tenna 1 (-)	Output	Ignition switch OFF	When Intelligent Key is in the passenger compart- ment	<p style="text-align: right; font-size: small;">JMKIA0062GB</p>
					When Intelligent Key is not in the passenger compart- ment	<p style="text-align: right; font-size: small;">JMKIA0063GB</p>

A
B
C
D
E
F
G
H
I
J
K
M
N
O
P

WW

BCM (BODY CONTROL MODULE)

< ECU DIAGNOSIS >

Terminal No. (Wire color)		Description		Condition	Value (Approx.)
(+)	(-)	Signal name	Input/ Output		
115 (W)	Ground	Rear parcel shelf antenna 1 (+)	Output	Ignition switch OFF	<p style="text-align: right; font-size: small;">JMKIA0062GB</p>
				When Intelligent Key is not in the passenger compartment	<p style="text-align: right; font-size: small;">JMKIA0063GB</p>
118 ⁴ (L/O)	Ground	Rear bumper antenna (-)	Output	When the trunk lid request switch is operated with ignition switch OFF	<p style="text-align: right; font-size: small;">JMKIA0062GB</p>
				When Intelligent Key is not in the antenna detection area	<p style="text-align: right; font-size: small;">JMKIA0063GB</p>
119 ⁴ (BR/W)	Ground	Rear bumper antenna (+)	Output	When the trunk lid request switch is operated with ignition switch OFF	<p style="text-align: right; font-size: small;">JMKIA0062GB</p>
				When Intelligent Key is not in the antenna detection area	<p style="text-align: right; font-size: small;">JMKIA0063GB</p>

BCM (BODY CONTROL MODULE)

< ECU DIAGNOSIS >

Terminal No. (Wire color)		Description		Condition		Value (Approx.)
(+)	(-)	Signal name	Input/ Output			
127 (BR/ W)	Ground	Ignition relay (IPDM E/R) control	Output	Ignition switch	OFF or ACC	Battery voltage
					ON	0V
130 (Y/G)	Ground	Trunk room lamp switch	Input	Trunk room lamp switch	OFF (trunk is closed)	<p style="text-align: right;">JPMIA0011GB 11.8V</p>
					ON (trunk is open)	0V
132 (R)	Ground	Starter motor relay control	Output	Ignition switch OFF (M/T vehi- cle)	When the clutch pedal is depressed	Battery voltage
					When the clutch pedal is not depressed	0V
				Ignition switch ON (other than M/ T vehicle)	When selector lever is in P or N position and the brake is depressed	Battery voltage
					When selector lever is in P or N position and the brake is not depressed	0V
141 (G/R)	Ground	Trunk request switch	Input	Trunk request switch	ON (pressed)	0V
					OFF (not pressed)	<p style="text-align: right;">JPMIA0016GB 1.0V</p>
144 ⁴ (GR)	Ground	Intelligent Key warn- ing buzzer	Output	Request switch buzzer	Sounding	0V
					Not sounding	Battery voltage
144 ⁵ (GR)	Ground	Outside warning buzzer	Output	Outside warning buzzer	Sounding	0V
					Not sounding	Battery voltage
147 (L/R)	Ground	Trunk lid opener switch	Input	Trunk lid opener switch	Pressed	0V
					Not pressed	Battery voltage
148 ¹ (R/W)	Ground	Rear door RH switch	Input	Rear door RH switch	OFF (when rear door RH closes)	<p style="text-align: right;">JPMIA0011GB 11.8V</p>
					ON (when rear door RH opens)	0V

A
B
C
D
E
F
G
H
I
J
K
M
N
O
P

WW

BCM (BODY CONTROL MODULE)

< ECU DIAGNOSIS >

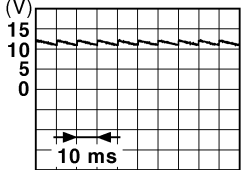
Terminal No. (Wire color)		Description		Condition		Value (Approx.)
(+)	(-)	Signal name	Input/ Output			
149 ¹ (R/B)	Ground	Rear door LH switch	Input	Rear door LH switch	OFF (when rear door LH closes)	 <p style="text-align: right; font-size: small;">JPMIA0011GB</p>
				ON (when rear door LH opens)	0V	

1: Sedan only

2: With LH front window anti-pinch

3: With LH and RH front window anti-pinch

4: With Intelligent Key

5: Without Intelligent Key

BCM (BODY CONTROL MODULE)

< ECU DIAGNOSIS >

Wiring Diagram-Coupe

INFOID:000000004505083

BCM (BODY CONTROL MODULE)

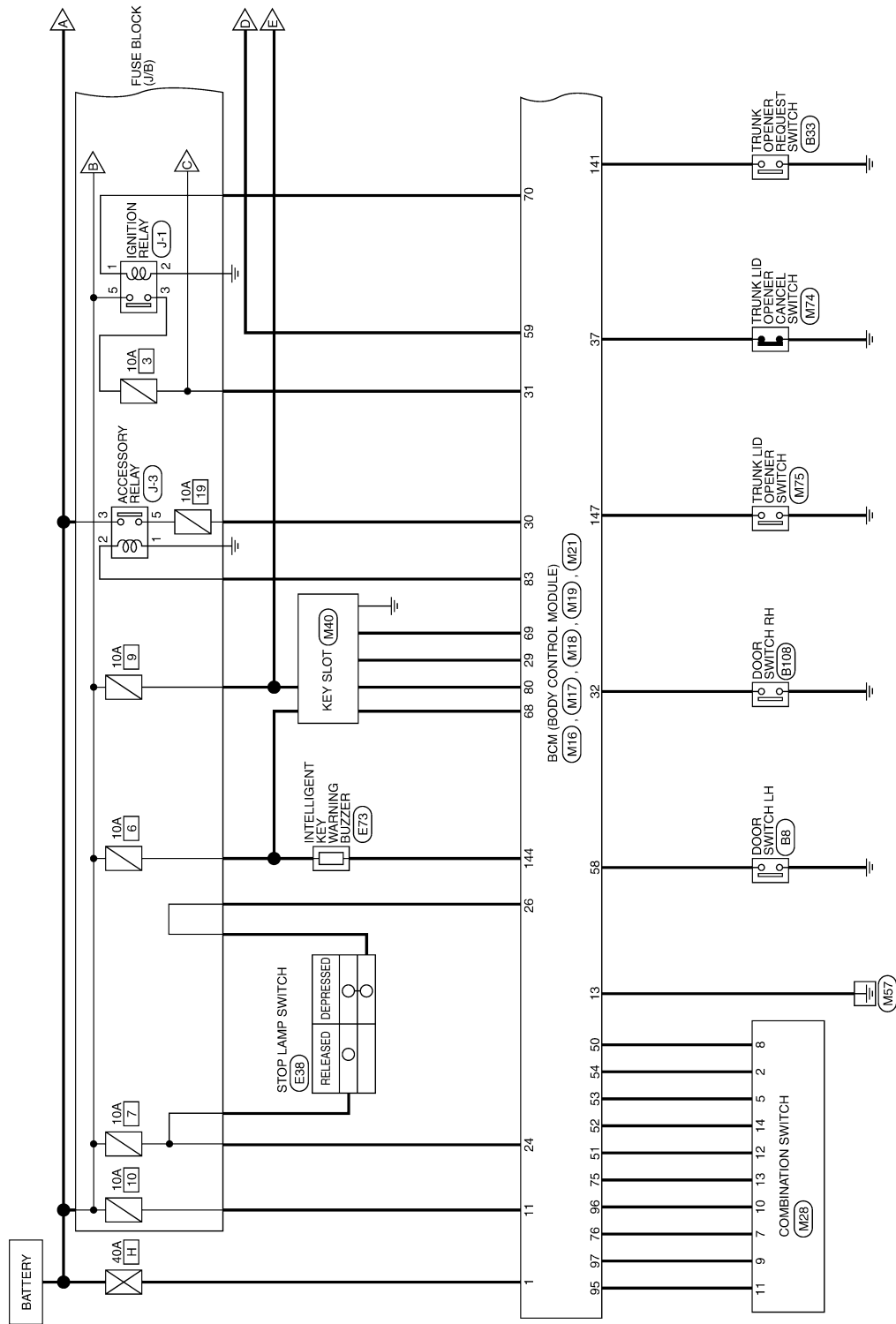

ABMWA0165GI

A
B
C
D
E
F
G
H
I
J
K
L
M
N
O
P

WW

BCM (BODY CONTROL MODULE)

< ECU DIAGNOSIS >

— : DATA LINE

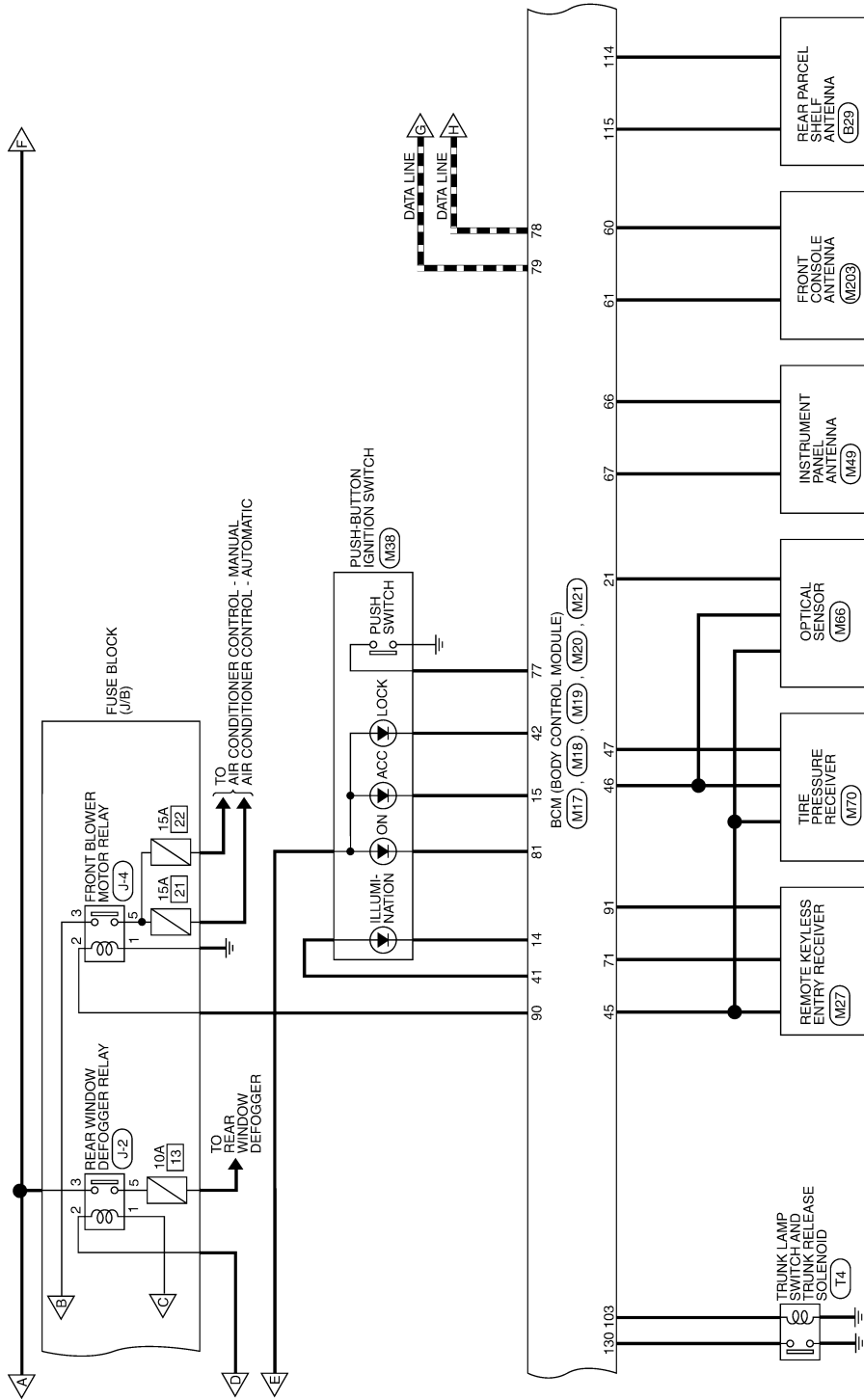

ABMWA0166GI

BCM (BODY CONTROL MODULE)

< ECU DIAGNOSIS >

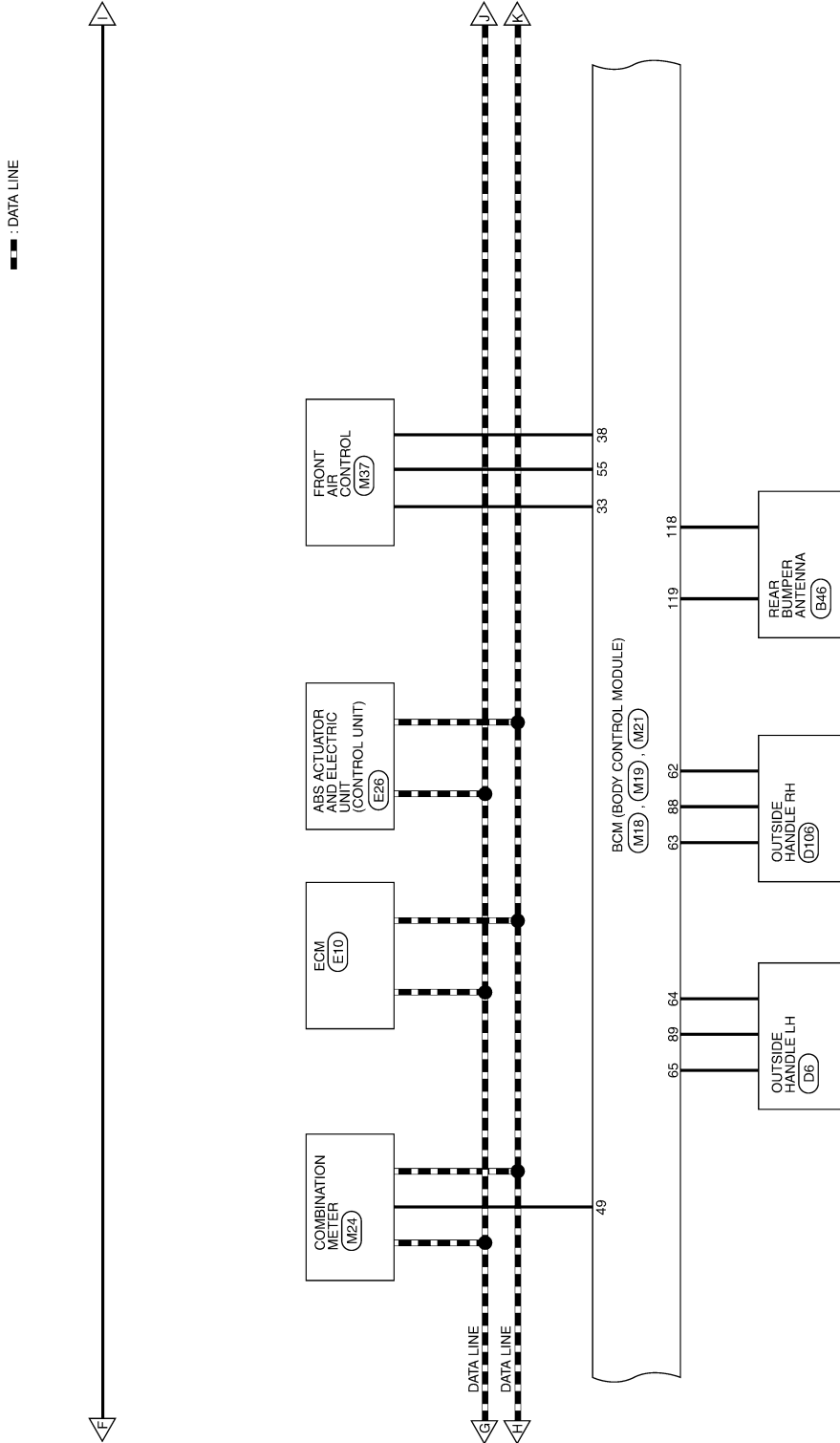

A
B
C
D
E
F
G
H
I
J
K
L
M
N
O
P

WW

AAMWA0057GI

BCM (BODY CONTROL MODULE)

< ECU DIAGNOSIS >

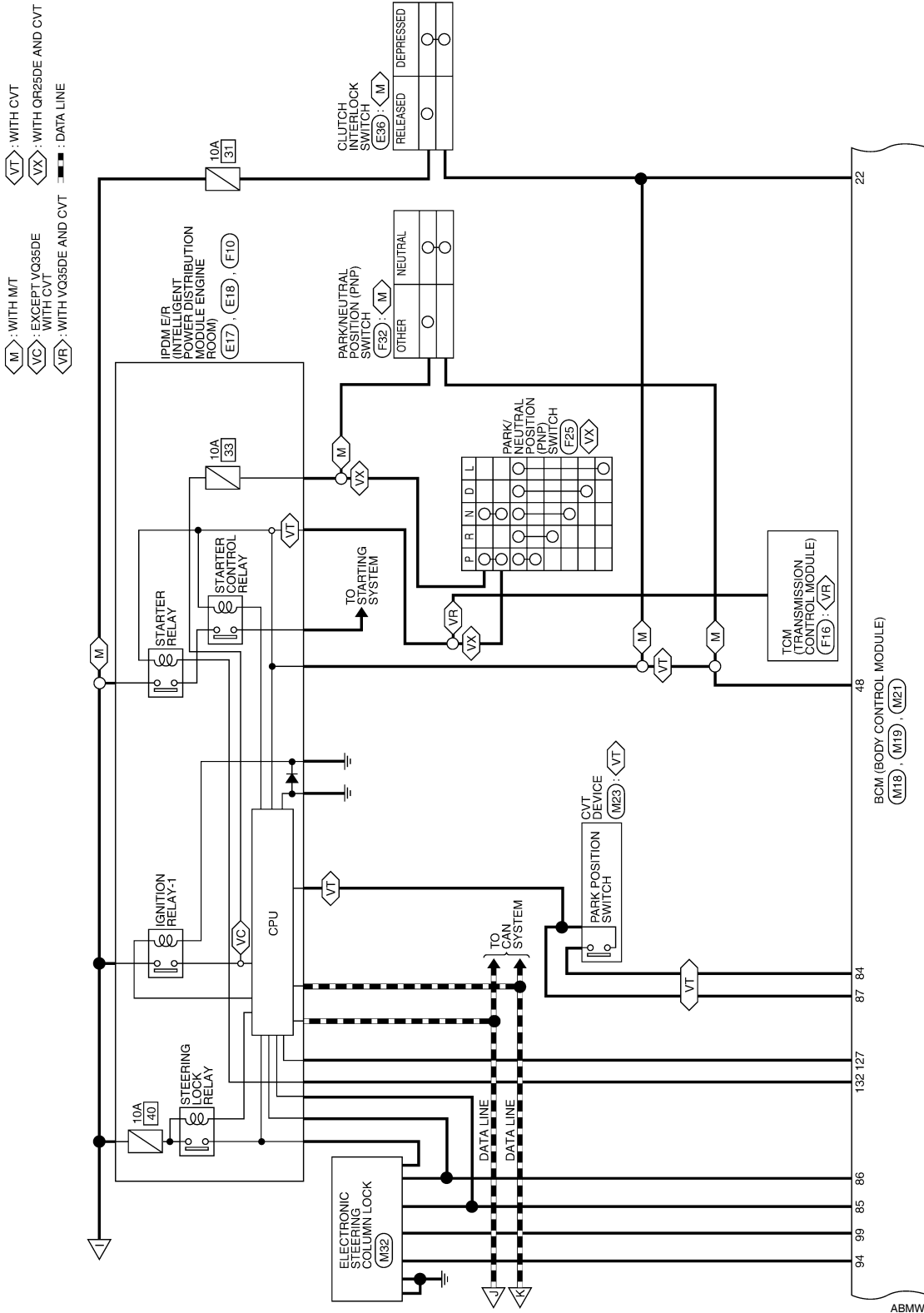

ABMWA0156GI

BCM (BODY CONTROL MODULE)

< ECU DIAGNOSIS >

<A6> : WITH LEFT POWER WINDOW ANTI-PINCH SYSTEM
 <A7> : WITH LEFT AND RIGHT POWER WINDOW ANTI-PINCH SYSTEM

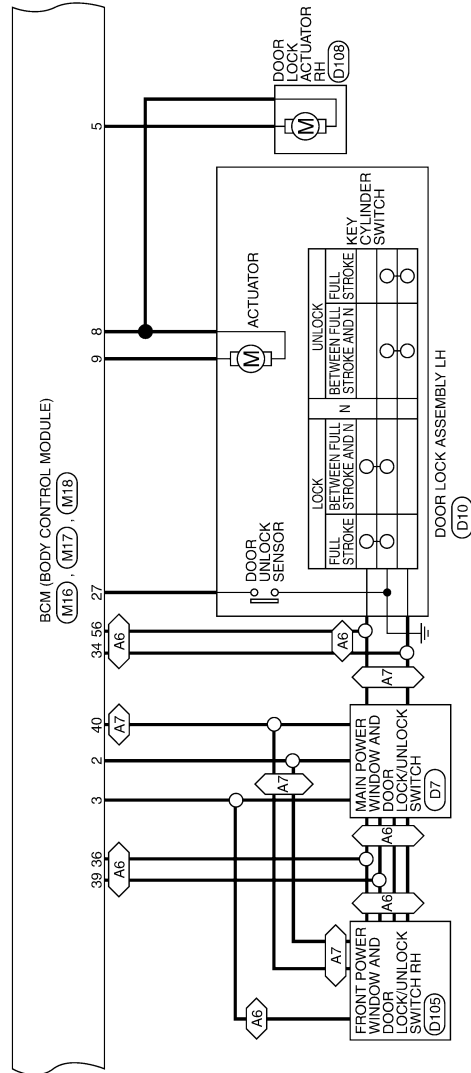

ABMWA0157GI

A
B
C
D
E
F
G
H
I
J
K
L
M
N
O
P

WW

BCM (BODY CONTROL MODULE)

< ECU DIAGNOSIS >

OF : WITHOUT SUNROOF
 SL : WITH SUNROOF
 VN : WITH VANITY LAMPS

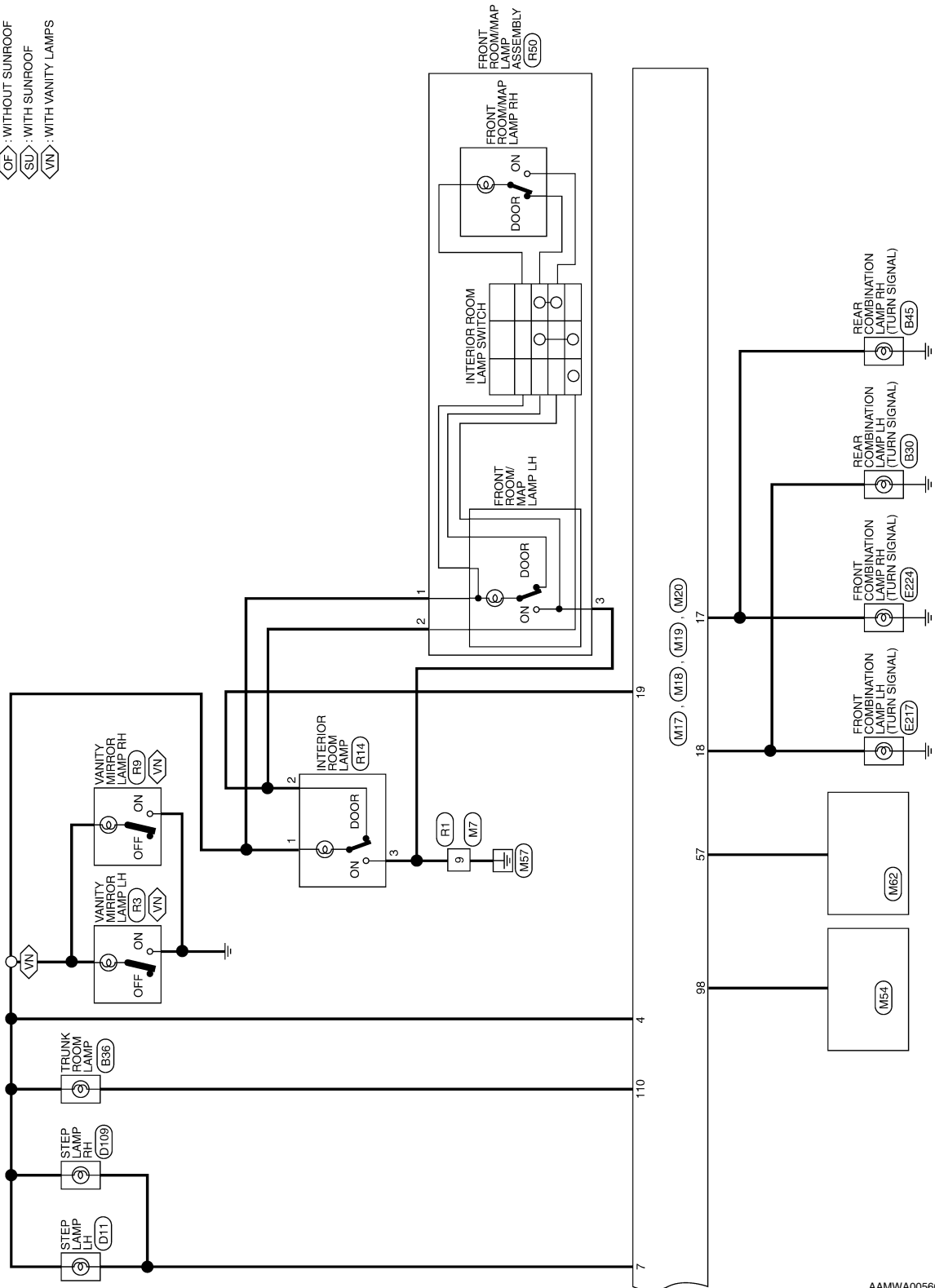

AAMWA0056GI

BCM (BODY CONTROL MODULE)

< ECU DIAGNOSIS >

BCM (BODY CONTROL MODULE) CONNECTORS

Connector No.	M16
Connector Name	BCM (BODY CONTROL MODULE)
Connector Color	BLACK



Terminal No.	Color of Wire	Signal Name
1	W/B	AT_POWER_F/L
2	R/Y	P/W_POWER_SUPPL_Y_PERM
3	L/W	POWER_WINDOW_POWER_SUPPLY (RAP)

Connector No.	M17
Connector Name	BCM (BODY CONTROL MODULE)
Connector Color	WHITE



Terminal No.	Color of Wire	Signal Name
4	P/W	ROOM_LAMP_BAT_SAVER
5	G/Y	CDL_AS
6	-	-
7	R/W	STEP_LAMP_OUTPUT
8	V	CDL_COMMON

Terminal No.	Color of Wire	Signal Name
9	G	CDL_DR/FL
10	G/Y	CDL_RR_RL_BACK
11	Y/R	BAT_BCM_FUSE
12	-	-
13	B	GND1
14	R/Y	LOW_SIDE_PUSH_LED_OUTPUT
15	Y/L	ACC_LED
16	-	-
17	G/B	FR_FLASHER
18	G/Y	FL_FLASHER
19	Y	ROOM_LAMP_OUTPUT

Connector No.	M18
Connector Name	BCM (BODY CONTROL MODULE)
Connector Color	GREEN

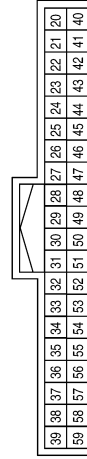

Terminal No.	Color of Wire	Signal Name
20	-	-
21	P/B	AUTO_LIGHT_SENSEN_R_INPUT1
22	R/Y	CLUTCH_SW
23	-	-
24	R/W	STOP_LAMP_LOW_SW
25	-	-
26	O/L	STOP_LAMP_HIGH_SW
27	G/W	DOOR_LOCK_STATUS
28	-	-

Terminal No.	Color of Wire	Signal Name
29	Y	FOB_IN_SW_1
30	V/Y	ACC_F/B
31	G	IGN_F/B
32	R/B	AS_DOOR_SW
33	SB	AIRCON_SW
34	L/R	DOOR_KEY/C_UNLOCK_SW
35	-	-
36	GR	CENTRAL_UNLOCK_SW
37	O	TRUNK_CANCEL_SW
38	GR/W	REAR_DEFOGGER_SW
39	GR/R	CENTRAL_UNLOCK_SW
40	Y/G	PW_K-LINE
41	W	PUSH_LED
42	R	S/L_LOCK_LED
43	-	-
44	-	-
45	P	GND_RF2_A/L

Terminal No.	Color of Wire	Signal Name
46	V/W	A/L_SENS_KEYLESS_TUNER_POWER_SUPPLY
47	G/O	KEYLESS_TUNER_SHIF
48	R/G	SHIFT_N/P
49	L/O	IMMO_LED
50	LG/B	INPUT_5
51	L/W	INPUT_1
52	G/B	INPUT_2
53	LG/R	INPUT_3
54	G/Y	INPUT_4
55	BR/W	BLOWER_FAN_SW
56	L/B	DOOR_KEY/C_LOCK_SW
57	W	TPMS_MODE_TRIGGER_SW
58	SB	DR_DOOR_SW
59	G/R	REAR_DEFOGGER_RLY

ABMIA0468GB

A B C D E F G H I J K L M N O P

WW

BCM (BODY CONTROL MODULE)

< ECU DIAGNOSIS >

Connector No.	M19
Connector Name	BCM (BODY CONTROL MODULE)
Connector Color	BLACK



79	78	77	76	75	74	73	72	71	70	69	68	67	66	65	64	63	62	61	60
99	98	97	96	95	94	93	92	91	90	89	88	87	86	85	84	83	82	81	80

Terminal No.	Color of Wire	Signal Name
60	B/R	ROOM_ANT_2_B
61	W/R	ROOM_ANT_2_A
62	B/Y	AS_DOOR_ANT_B
63	LG	AS_DOOR_ANT_A
64	V	DR_DOOR_ANT_B
65	P	DR_DOOR_ANT_A

Connector No.	M20
Connector Name	BCM (BODY CONTROL MODULE)
Connector Color	WHITE



100	101	102	103	104		
105	106	107	108	109	110	111

Terminal No.	Color of Wire	Signal Name
98	G/O	HAZARD_SW
99	L/Y	S/L_K-LINE
66	R	ROOM_ANT_1_B
67	G	ROOM_ANT_1_A
68	G/O	FOB_READER_CLOCK
69	O	FOB_READER_DATA
70	R/B	IGN_ELEC_CONT
71	L/O	RF1_TUNER_SIGNAL
72	-	-
73	-	-
75	R/Y	OUTPUT_5
76	R/G	OUTPUT_3
77	BR	ENG_START_SW
78	P	CAN-L
79	L	CAN-H
80	R/L	FOB_SLOT_ILLUMINATION
81	LG	IGN_ON_LED

Terminal No.	Color of Wire	Signal Name
100	-	-
101	-	-
102	-	-
103	V	CDL_BACK_TRUNK
104	-	-
105	-	-
106	-	-
107	-	-
108	-	-
109	-	-
110	V/W	TRUNK_LAMP_OUTPUT
111	-	-

Terminal No.	Color of Wire	Signal Name
82	-	-
83	L	ACC_CONT
84	Y/R	AT_DEVICE_OUT
85	L/O	S/L_CONDITION_1
86	G/R	S/L_CONDITION_2
87	G/B	SHIFT_P
88	P/L	AS_REQUEST_SWITCH
89	B/W	DR_REQUEST_SWITCH
90	Y	IGN2_CONT
91	L/R	RF1_POWER_SUPPLY
92	-	-
93	-	-
94	G/Y	S/L_POWER_SUPPLY_12V
95	R/W	OUTPUT_1
96	P/B	OUTPUT_4
97	R/B	OUTPUT_2

BCM (BODY CONTROL MODULE)

< ECU DIAGNOSIS >

Connector No.	M28
Connector Name	COMBINATION SWITCH
Connector Color	WHITE

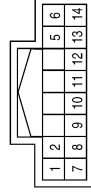

Terminal No.	Color of Wire	Signal Name
1	R/L	WASH_MTR
2	G/Y	INPUT_4
5	LG/R	INPUT_3
6	B	GND
7	R/G	OUTPUT_3
8	LG/B	INPUT_5
9	R/B	OUTPUT_2
10	P/B	OUTPUT_4
11	R/W	OUTPUT_1
12	L/W	INPUT_1
13	R/Y	OUTPUT_5
14	G/B	OUTPUT_2

Terminal No.	Color of Wire	Signal Name
124	-	-
125	-	-
126	-	-
127	BR/W	IGN_USM_CONT1
128	-	-
129	-	-
130	Y/G	TRUNK_SW
131	-	-
132	R	ST_CONT_USM
133	-	-
134	-	-
135	-	-
136	-	-
137	-	-
138	-	-
139	-	-
140	-	-
141	G/R	TRUNK_REQUEST_SW
142	-	-
143	-	-
144	G/R	BUZZER
145	-	-
146	-	-
147	L/R	BACK_TRUNK_OPENER
148	-	-
149	-	-
150	-	-
151	-	-

Connector No.	M21
Connector Name	BCM (BODY CONTROL MODULE)
Connector Color	GRAY

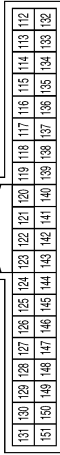

Terminal No.	Color of Wire	Signal Name
112	-	-
113	-	-
114	B	TRUNK_ANT_1_B
115	W	TRUNK_ANT_1_A
116	-	-
117	-	-
118	L/O	BACK_DOOR_ANT_B
119	BR/W	BACK_DOOR_ANT_A
120	-	-
121	-	-
123	-	-

ABMIA0469GB

A
B
C
D
E
F
G
H
I
J
K
L
M
N
O
P

WW

BCM (BODY CONTROL MODULE)

< ECU DIAGNOSIS >

Wiring Diagram-Sedan

INFOID:000000004505084

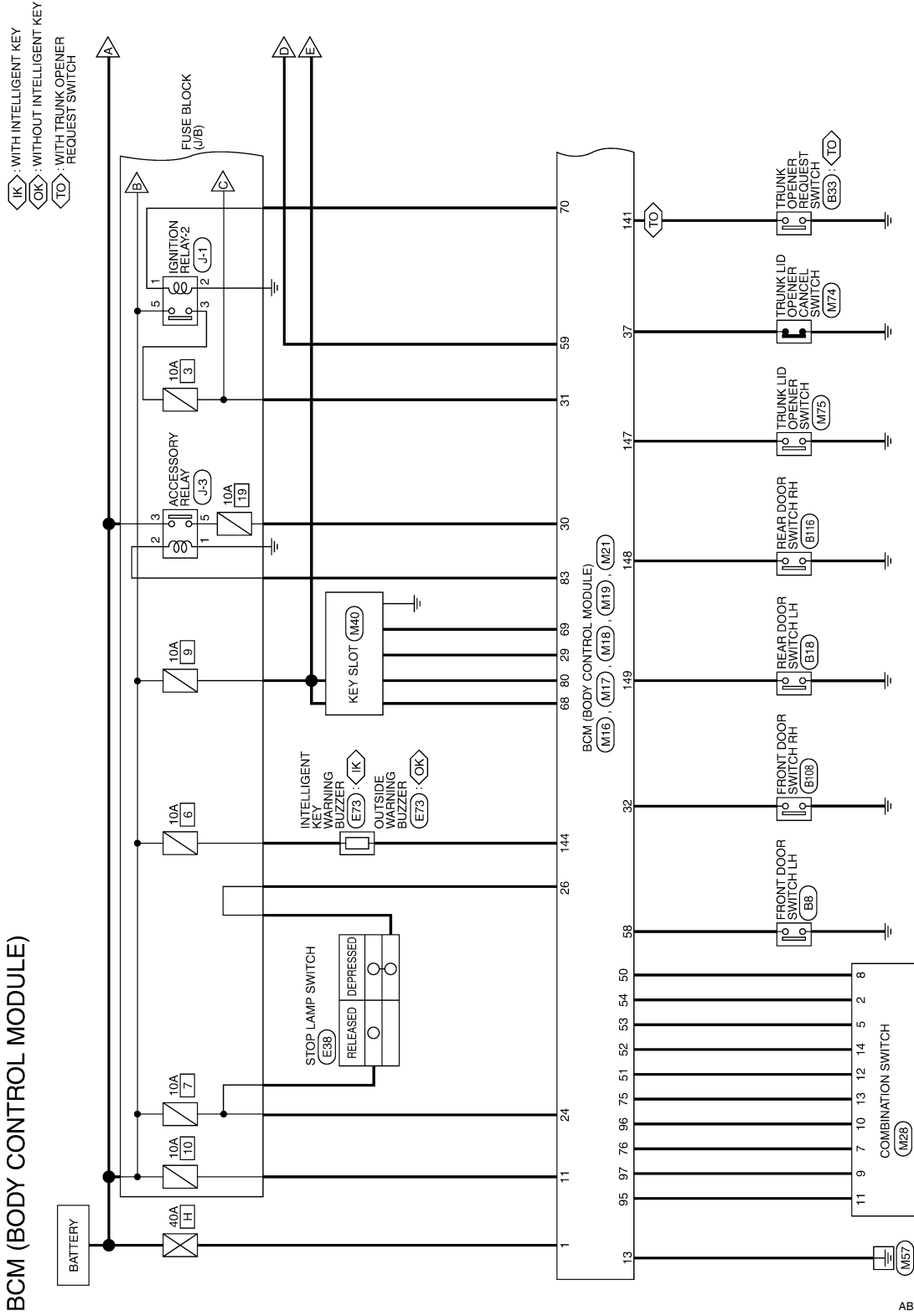

BCM (BODY CONTROL MODULE)

< ECU DIAGNOSIS >

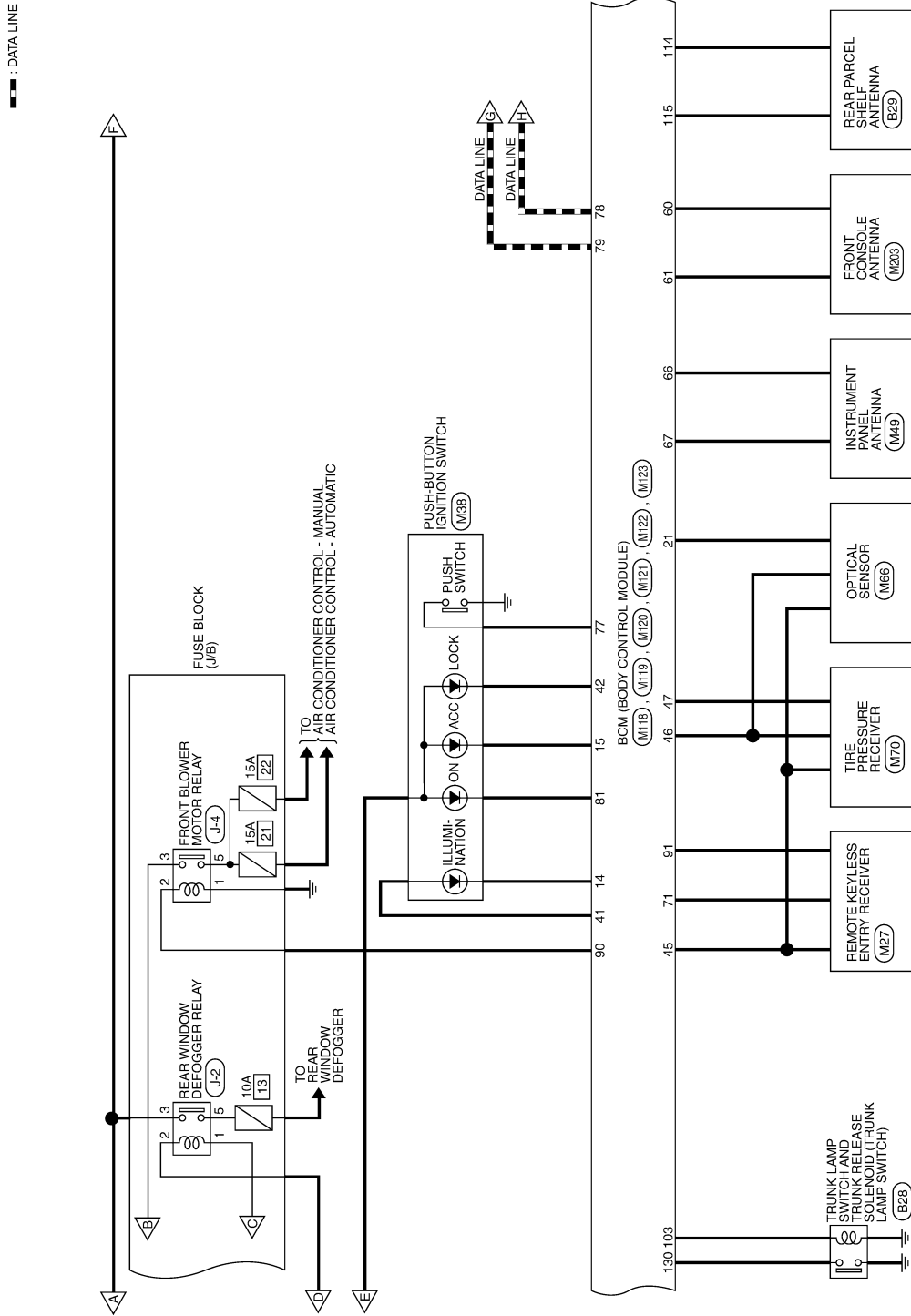

ABMWA0152GI

A
B
C
D
E
F
G
H
I
J
K
L
M
N
O
P

WW

BCM (BODY CONTROL MODULE)

< ECU DIAGNOSIS >

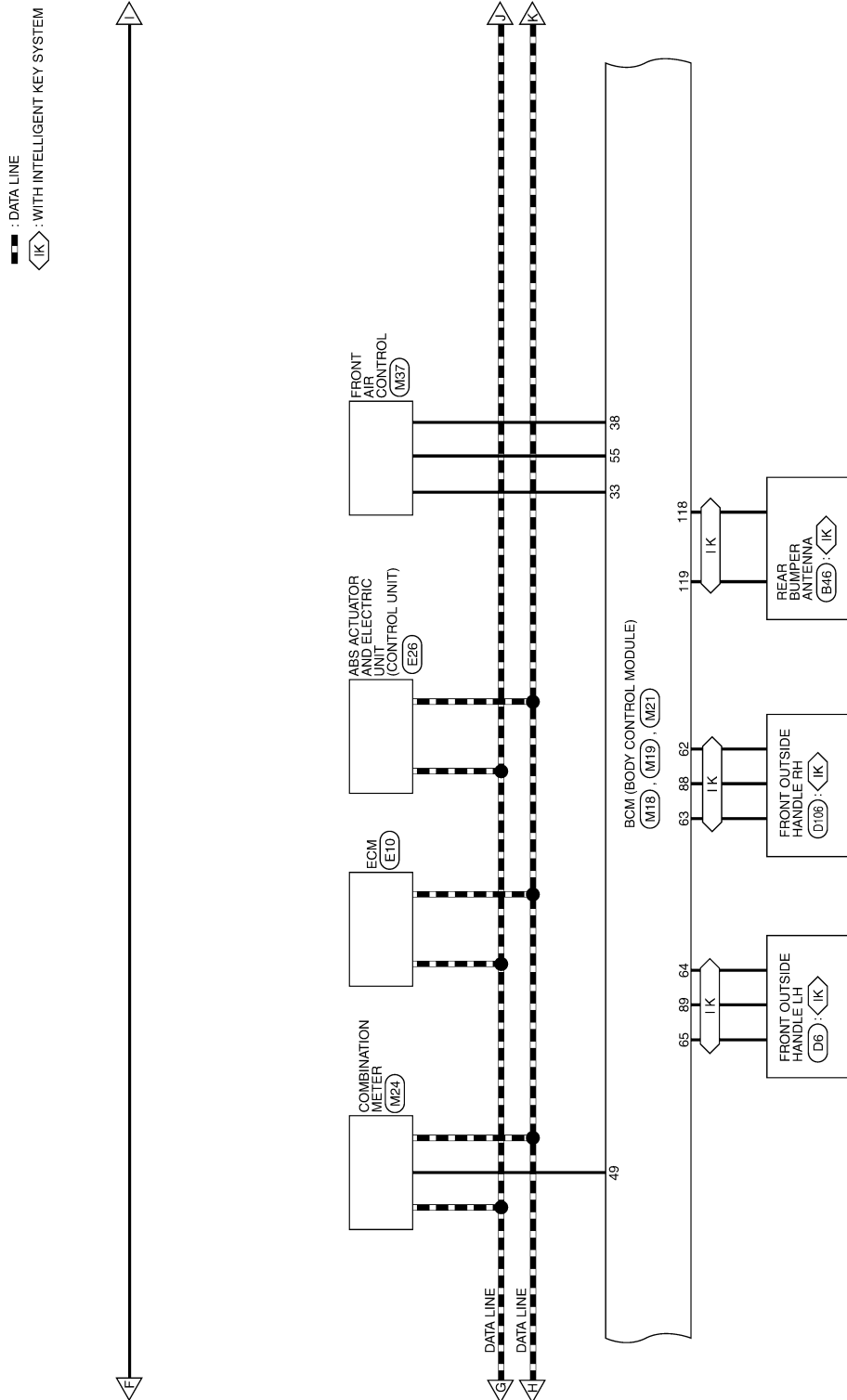

ABMWA0164GI

BCM (BODY CONTROL MODULE)

< ECU DIAGNOSIS >

- ▬ : DATA LINE
- ◁VT▷ : WITH CVT
- ◁M▷ : WITH M/T
- ◁VR▷ : WITH VQ35DE AND CVT
- ◁VC▷ : EXCEPT VQ35DE
- ◁VX▷ : WITH QR25DE AND CVT

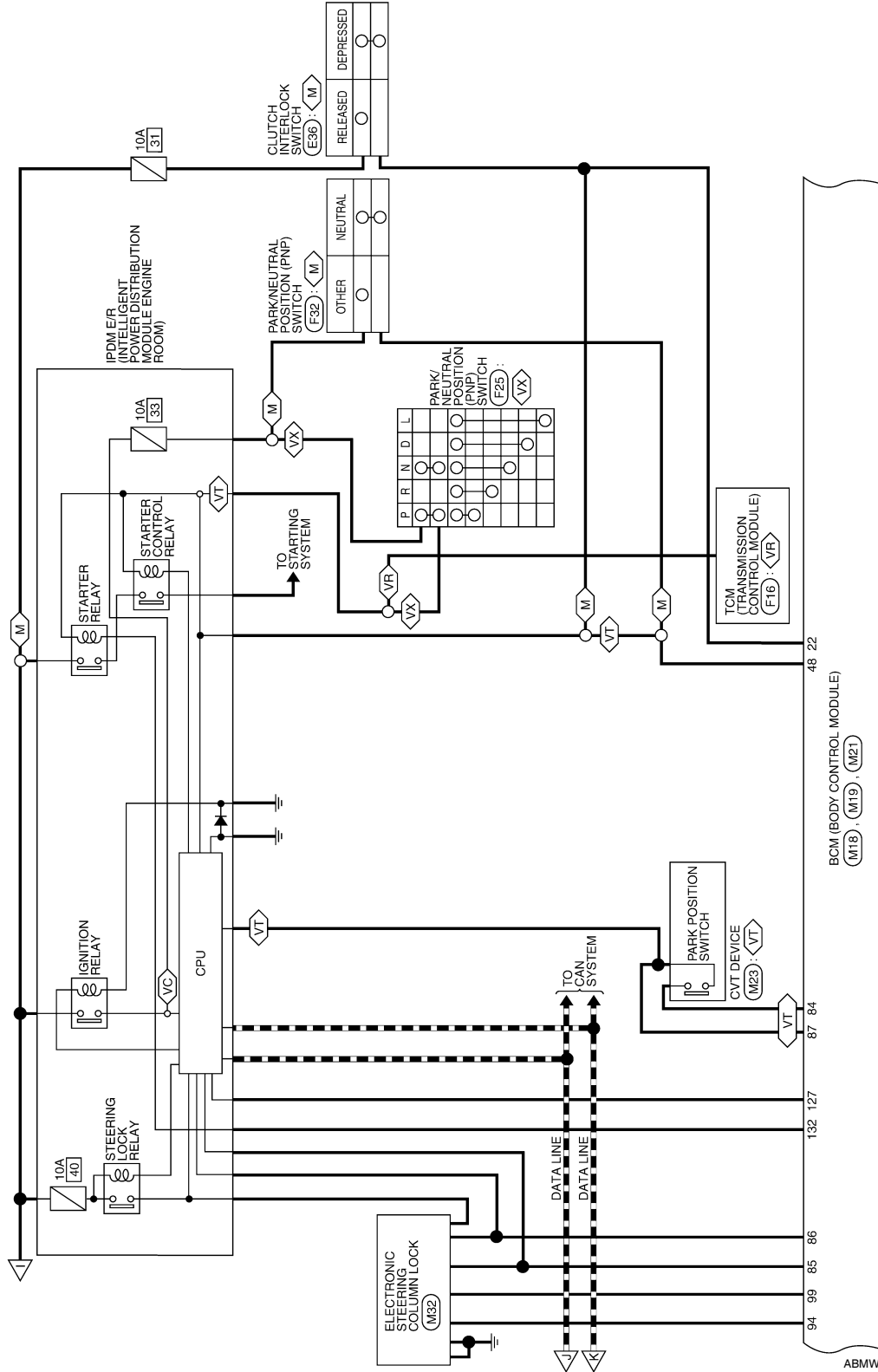

ABMWA0153GI

A
B
C
D
E
F
G
H
I
J
K
M
N
O
P

WW

BCM (BODY CONTROL MODULE)

< ECU DIAGNOSIS >

<A1> : WITH LEFT FRONT ONLY POWER WINDOW ANTI-PINCH SYSTEM
 <A2> : WITH LEFT AND RIGHT FRONT POWER WINDOW ANTI-PINCH SYSTEM

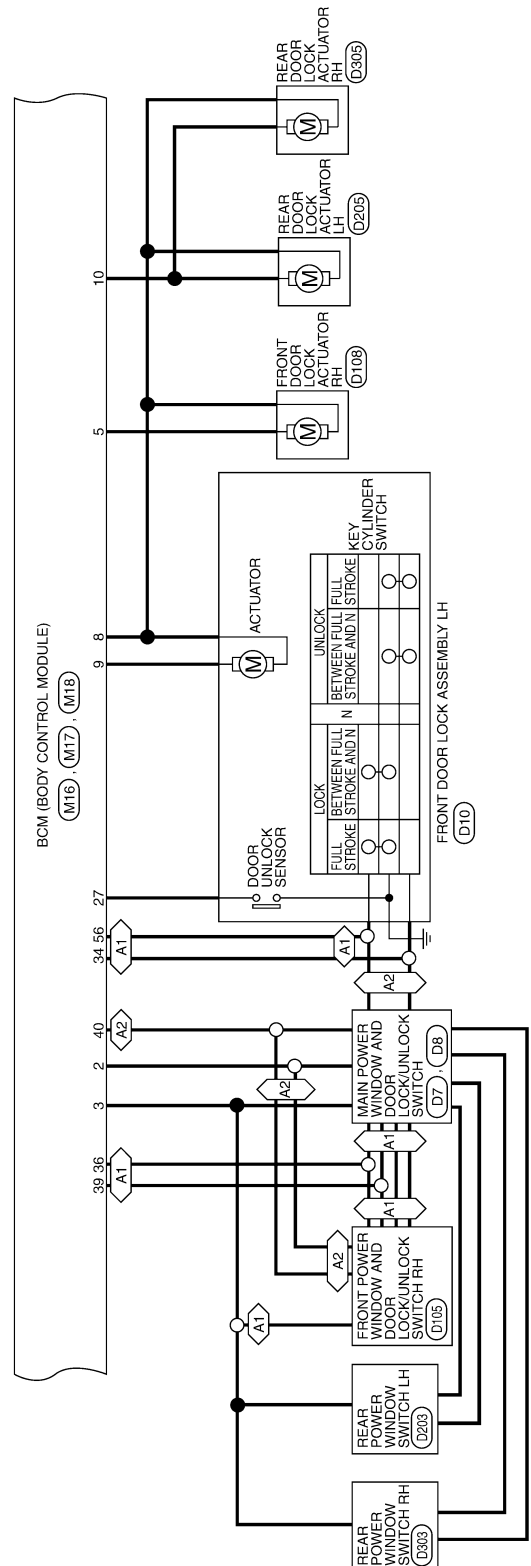

ABMWA0154GI

BCM (BODY CONTROL MODULE)

< ECU DIAGNOSIS >

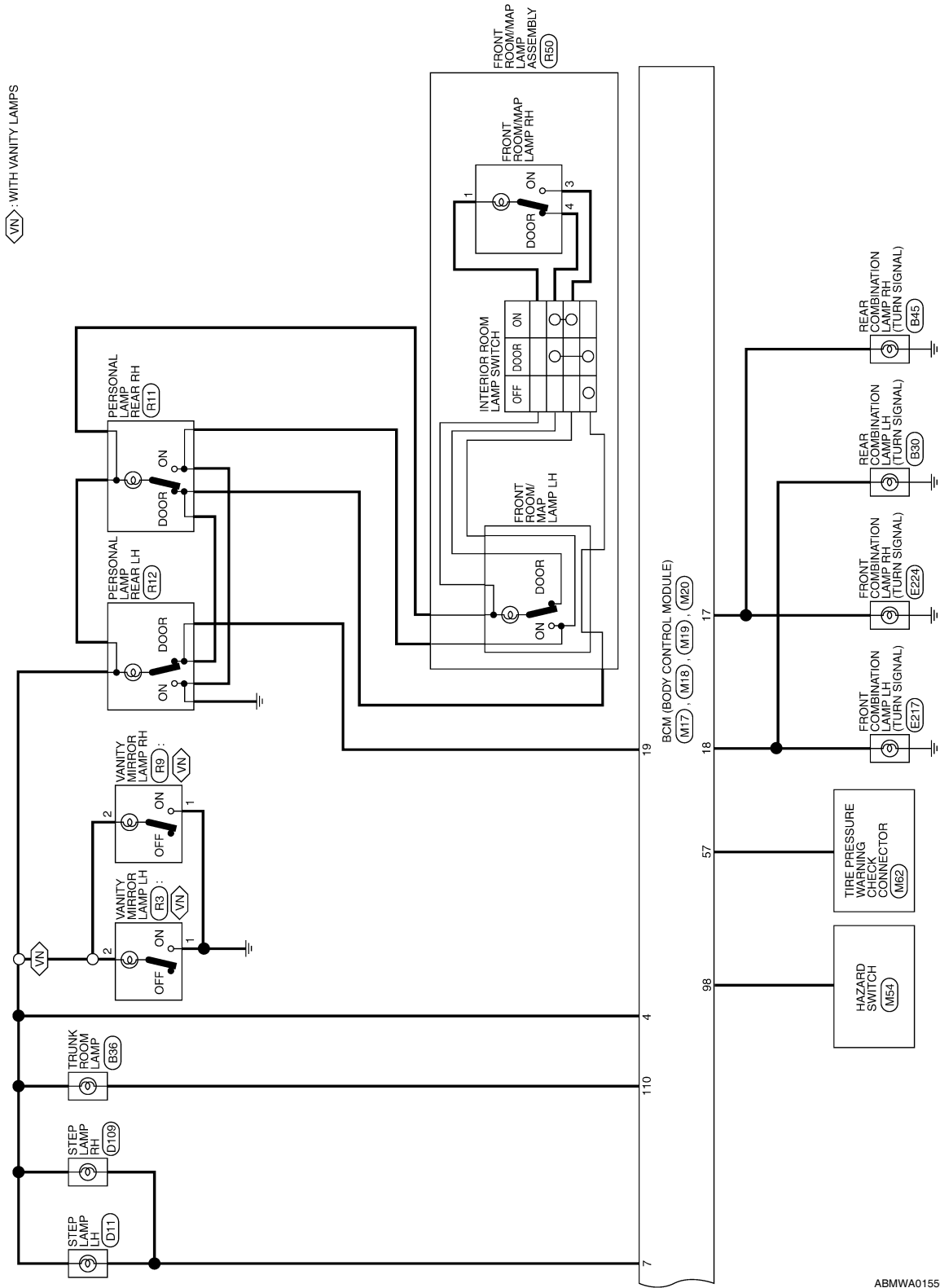

ABMWA0155GI

A
B
C
D
E
F
G
H
I
J
K
L
M
N
O
P

WW

BCM (BODY CONTROL MODULE)

< ECU DIAGNOSIS >

BCM (BODY CONTROL MODULE) CONNECTORS

Connector No.	M16
Connector Name	BCM (BODY CONTROL MODULE)
Connector Color	BLACK



Terminal No.	Color of Wire	Signal Name
1	W/B	BAT_POWER_FL
2	R/Y	P/W_POWER_SUPPLY_PERM
3	L/W	POWER_WINDOW_POWER_SUPPLY (RAP)

Connector No.	M17
Connector Name	BCM (BODY CONTROL MODULE)
Connector Color	WHITE

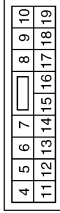

Terminal No.	Color of Wire	Signal Name
4	P/W	ROOM_LAMP_BAT_SAVER
5	G/Y	CDL_AS
6	-	-
7	R/W	STEP_LAMP_OUTPUT
8	V	CDL_COMMON

Terminal No.	Color of Wire	Signal Name
9	G	CDL_DR/FL
10	G/Y	CDL_RR_RL_BACK
11	Y/R	BAT_BCM_FUSE
12	-	-
13	B	GND1
14	R/Y	LOW_SIDE_PUSH_LED_OUTPUT
15	Y/L	ACC_LED
16	-	-
17	G/B	FR_FLASHER
18	G/Y	FL_FLASHER
19	Y	ROOM_LAMP_OUTPUT

Connector No.	M18
Connector Name	BCM (BODY CONTROL MODULE)
Connector Color	GREEN

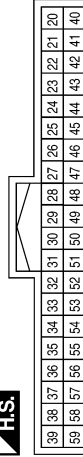

Terminal No.	Color of Wire	Signal Name
20	-	-
21	P/B	AUTO_LIGHT_SENSOR_INPUT1
22	R/Y	CLUTCH_SW
23	-	-
24	R/W	STOP_LAMP_LOW_SW
25	-	-
26	O/L	STOP_LAMP_HIGH_SW

Terminal No.	Color of Wire	Signal Name
27	G/W	DOOR_LOCK_STATUS
28	-	-
29	Y	FOB_IN_SW_1
30	V/Y	ACC_F/B
31	G	IGN_F/B
32	R/B	AS_DOOR_SW
33	SB	AIRCON_SW
34	L/R	DOOR_KEY/C_UNLOCK_SW
35	-	-
36	GR	CENTRAL_UNLOCK_SW
37	O	TRUNK_CANCEL_SW
38	GR/W	REAR_DEFOGGER_SW
39	GR/R	CENTRAL_UNLOCK_SW
40	Y/G	PW_K-LINE
41	W	PUSH_LED
42	R	S/L_LOCK_LED
43	-	-
44	-	-
45	P	GND_RF2_A/L
46	V/W	A/L_SENS_KEYLESS_TUNER_POWER_SUPPLY

Terminal No.	Color of Wire	Signal Name
47	G/O	KEYLESS_TUNER_SI
48	R/G	SHIFT_N/P
49	L/O	IMMO_LED
50	LG/B	INPUT_5
51	L/W	INPUT_1
52	G/B	INPUT_2
53	LG/R	INPUT_3
54	G/Y	INPUT_4
55	BR/W	BLOWER_FAN_SW
56	L/B	DOOR_KEY/C_LOCK_SW
57	W	TPMS_MODE_TRIGGER_SW
58	SB	DR_DOOR_SW
59	G/R	REAR_DEFOGGER_RLY

AWMIA0292GB

BCM (BODY CONTROL MODULE)

< ECU DIAGNOSIS >

Connector No.	M19
Connector Name	BCM (BODY CONTROL MODULE)
Connector Color	BLACK



79	78	77	76	75	74	73	72	71	70	69	68	67	66	65	64	63	62	61	60
----	----	----	----	----	----	----	----	----	----	----	----	----	----	----	----	----	----	----	----

Terminal No.	Color of Wire	Signal Name
60	B/R	ROOM_ANT_2_B
61	W/R	ROOM_ANT_2_A
62	B/Y	AS_DOOR_ANT_B
63	LG	AS_DOOR_ANT_A
64	V	DR_DOOR_ANT_B
65	P	DR_DOOR_ANT_A



100	101	102	103	104		
105	106	107	108	109	110	111

Connector No.	M20
Connector Name	BCM (BODY CONTROL MODULE)
Connector Color	WHITE

Terminal No.	Color of Wire	Signal Name
66	R	ROOM_ANT_1_B
67	G	ROOM_ANT_1_A
68	G/O	FOB_READER_CLOCK
69	O	FOB_READER_DATA
70	R/B	IGN_ELEC_CONT
71	L/O	RF1_TUNER_SIGNAL
72	-	-
73	-	-
75	R/Y	OUTPUT_5
76	R/G	OUTPUT_3
77	BR	ENG_START_SW
78	P	CAN-L
79	L	CAN-H
80	R/L	FOB_SLOT_ILLUMINATION
81	LG	IGN_ON_LED
82	-	-
83	L	ACC_CONT

Terminal No.	Color of Wire	Signal Name
84	Y/R	AT_DEVICE_OUT
85	L/O	S/L_CONDITION_1
86	G/R	S/L_CONDITION_2
87	G/B	SHIFT_P
88	P/L	AS_REQUEST_SWITCH
89	B/W	DR_REQUEST_SWITCH
90	Y	IGN2_CONT
91	L/R	RF1_POWER_SUPPLY
92	-	-
93	-	-
94	G/Y	S/L_POWER_SUPPLY_12V
95	R/W	OUTPUT_1
96	P/B	OUTPUT_4
97	R/B	OUTPUT_2
98	G/O	HAZARD_SW
99	L/Y	S/L_K-LINE

Terminal No.	Color of Wire	Signal Name
100	-	-
101	-	-
102	-	-
103	V	CDL_BACK_TRUNK
104	-	-
105	-	-
106	-	-
107	-	-
108	-	-
109	-	-
110	V/W	TRUNK_LAMP_OUTPUT
111	-	-

AWMIA0293GB

A
B
C
D
E
F
G
H
I
J
K
L
M
N
O
P

WW

BCM (BODY CONTROL MODULE)

< ECU DIAGNOSIS >

Connector No.	M28
Connector Name	COMBINATION SWITCH
Connector Color	WHITE

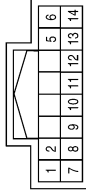

Terminal No.	Color of Wire	Signal Name
1	R/L	WASH_MTR
2	G/Y	OUTPUT_4
5	LG/R	OUTPUT_3
6	B	GND
7	R/G	INPUT_3
8	LG/B	OUTPUT_5
9	R/B	INPUT_2
10	P/B	INPUT_4
11	R/W	INPUT_1
12	L/W	OUTPUT_1
13	R/Y	INPUT_5
14	G/B	OUTPUT_2

Terminal No.	Color of Wire	Signal Name
119	BR/W	BACK_DOOR_ANT_A
120	-	-
121	-	-
122	-	-
123	-	-
124	-	-
125	-	-
126	-	-
127	BR/W	IGN_USM_CONT1
128	-	-
129	-	-
130	Y/G	TRUNK_SW
131	-	-
132	R	ST_CONT_USM
133	-	-
134	-	-
135	-	-
136	-	-
137	-	-
138	-	-
139	-	-
140	-	-
141	G/R	TRUNK_REQUEST_SW
142	-	-
143	-	-
144	GR	BUZZER
145	-	-
145	-	-
147	L/R	BACK_TRUNK_OPENER
148	R/W	RR_DOOR_SW
149	R/B	RL_DOOR_SW
150	-	-
151	-	-

Connector No.	M21
Connector Name	BCM (BODY CONTROL MODULE)
Connector Color	GRAY

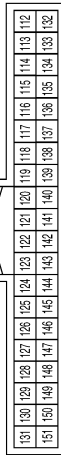

Terminal No.	Color of Wire	Signal Name
112	-	-
113	-	-
114	B	TRUNK_ANT_1_B
115	W	TRUNK_ANT_1_A
116	-	-
117	-	-
118	L/O	BACK_DOOR_ANT_B

ABMIA0470GB

INFOID:000000004505085

Fail Safe

Display contents of CONSULT	Fail-safe	Cancellation
B2013: ID DISCORD BCM-S/L	Inhibit engine cranking	Erase DTC
B2014: CHAIN OF S/L-BCM	Inhibit engine cranking	Erase DTC
B2190: NATS ANTENNA AMP	Inhibit engine cranking	Erase DTC

BCM (BODY CONTROL MODULE)

< ECU DIAGNOSIS >

Display contents of CONSULT	Fail-safe	Cancellation	
B2191: DIFFERENCE OF KEY	Inhibit engine cranking	Erase DTC	A
B2192: ID DISCORD BCM-ECM	Inhibit engine cranking	Erase DTC	
B2193: CHAIN OF BCM-ECM	Inhibit engine cranking	Erase DTC	B
B2195: ANTI-SCANNING	Inhibit engine cranking	Erase DTC	
B2557: VEHICLE SPEED	Inhibit electronic steering column lock	When normal vehicle speed signals have been received from ABS actuator and electric unit (control unit) for 500 ms	C
B2560: STARTER CONT RELAY	Inhibit engine cranking	500 ms after the following CAN signal communication status has become consistent <ul style="list-style-type: none"> • Starter control relay signal • Starter relay status signal 	D
B2562: LO VOLTAGE	<ul style="list-style-type: none"> • Inhibit engine cranking • Inhibit electronic steering column lock 	100 ms after the power supply voltage increases to more than 8.8 V	E
B2601: SHIFT POSITION	Inhibit electronic steering column lock	500 ms after the following signal reception status becomes consistent <ul style="list-style-type: none"> • Selector lever P position switch signal • P range signal (CAN) 	F
B2602: SHIFT POSITION	Inhibit electronic steering column lock	5 seconds after the following BCM recognition conditions are fulfilled <ul style="list-style-type: none"> • Ignition switch is in the ON position • Selector lever P position switch signal: Except P position (battery voltage) • Vehicle speed: 4 /h or more 	G
B2603: SHIFT POSI STATUS	Inhibit electronic steering column lock	500 ms after the following BCM recognition conditions are fulfilled <ul style="list-style-type: none"> • Ignition switch is in the ON position • Selector lever P position switch signal: Except P position (battery voltage) • Selector lever P/N position signal: Except P and N positions (0 V) 	H
B2604: PNP SW	Inhibit electronic steering column lock	500 ms after any of the following BCM recognition conditions is fulfilled <ul style="list-style-type: none"> • Status 1 <ul style="list-style-type: none"> - Ignition switch is in the ON position - Selector lever P/N position signal: P and N position (battery voltage) - P range signal or N range signal (CAN): ON • Status 2 <ul style="list-style-type: none"> - Ignition switch is in the ON position - Selector lever P/N position signal: Except P and N positions (0 V) - P range signal and N range signal (CAN): OFF 	I J K WW
B2605: PNP SW	Inhibit electronic steering column lock	500 ms after any of the following BCM recognition conditions is fulfilled <ul style="list-style-type: none"> • Ignition switch is in the ON position <ul style="list-style-type: none"> - Power position: IGN - Selector lever P/N position signal: Except P and N positions (0 V) - Interlock/PNP switch signal (CAN): OFF • Status 2 <ul style="list-style-type: none"> - Ignition switch is in the ON position - Selector lever P/N position signal: P or N position (battery voltage) - PNP switch signal (CAN): ON 	M N O
B2606: S/L RELAY	Inhibit engine cranking	500 ms after the following CAN signal communication status has become consistent <ul style="list-style-type: none"> • Electronic steering column lock relay signal (Request signal) • Electronic steering column lock relay signal (Condition signal) 	P
B2607: S/L RELAY	Inhibit engine cranking	500 ms after the following CAN signal communication status has become consistent <ul style="list-style-type: none"> • Electronic steering column lock relay signal (Request signal) • Electronic steering column lock relay signal (Condition signal) 	

BCM (BODY CONTROL MODULE)

< ECU DIAGNOSIS >

Display contents of CONSULT	Fail-safe	Cancellation
B2608: STARTER RELAY	Inhibit engine cranking	500 ms after the following signal communication status becomes consistent <ul style="list-style-type: none"> • Starter motor relay control signal • Starter relay status signal (CAN)
B2609: S/L STATUS	<ul style="list-style-type: none"> • Inhibit engine cranking • Inhibit electronic steering column lock 	When the following electronic steering column lock conditions agree <ul style="list-style-type: none"> • BCM electronic steering column lock control status • Electronic steering column lock condition No. 1 signal status • Electronic steering column lock condition No. 2 signal status
B260A: IGNITION RELAY	Inhibit engine cranking	500 ms after the following conditions are fulfilled <ul style="list-style-type: none"> • IGN relay (IPDM E/R) control signal: OFF (Battery voltage) • Ignition ON signal (CAN to IPDM E/R): OFF (Request signal) • Ignition ON signal (CAN from IPDM E/R): OFF (Condition signal)
B260F: ENG STATE SIG LOST	Maintains the power supply position attained at the time of DTC detection	When any of the following conditions is fulfilled <ul style="list-style-type: none"> • Power position changes to ACC • Receives engine status signal (CAN)
B2612: S/L STATUS	<ul style="list-style-type: none"> • Inhibit engine cranking • Inhibit electronic steering column lock 	When any of the following conditions is fulfilled <ul style="list-style-type: none"> • Electronic steering column lock unit status signal (CAN) is received normally • The BCM electronic steering column lock control status matches the electronic steering column lock status recognized by the electronic steering column lock unit status signal (CAN from IPDM E/R)
B2617: STARTER RELAY CIRC	Inhibit engine cranking	1 second after the starter motor relay control inside BCM becomes normal
B2618: BCM	Inhibit engine cranking	1 second after the ignition relay (IPDM E/R) control inside BCM becomes normal
B2619: BCM	Inhibit engine cranking	1 second after the electronic steering column lock unit power supply output control inside BCM becomes normal
B26E1: ENG STATE NO RECIV	Inhibit engine cranking	When any of the following conditions is fulfilled <ul style="list-style-type: none"> • Power position changes to ACC • Receives engine status signal (CAN)

DTC Inspection Priority Chart

INFOID:000000004505086

If some DTCs are displayed at the same time, perform inspections one by one based on the following priority chart.

Priority	DTC
1	<ul style="list-style-type: none"> • B2562: LOW VOLTAGE
2	<ul style="list-style-type: none"> • U1000: CAN COMM CIRCUIT • U1010: CONTROL UNIT (CAN)
3	<ul style="list-style-type: none"> • B2190: NATS ANTENNA AMP • B2191: DIFFERENCE OF KEY • B2192: ID DISCORD BCM-ECM • B2193: CHAIN OF BCM-ECM

BCM (BODY CONTROL MODULE)

< ECU DIAGNOSIS >

Priority	DTC		
4	<ul style="list-style-type: none"> • B2013: ID DISCORD BCM-S/L • B2014: CHAIN OF S/L-BCM • B2553: IGNITION RELAY • B2555: STOP LAMP • B2556: PUSH-BTN IGN SW • B2557: VEHICLE SPEED • B2560: STARTER CONT RELAY • B2601: SHIFT POSITION • B2602: SHIFT POSITION • B2603: SHIFT POSI STATUS • B2604: PNP SW • B2605: PNP SW • B2606: S/L RELAY • B2607: S/L RELAY • B2608: STARTER RELAY • B2609: S/L STATUS • B260A: IGNITION RELAY • B260B: STEERING LOCK UNIT • B260C: STEERING LOCK UNIT • B260D: STEERING LOCK UNIT • B260F: ENG STATE SIG LOST • B2612: S/L STATUS • B2614: ACC RELAY CIRC • B2615: BLOWER RELAY CIRC • B2616: IGN RELAY CIRC • B2617: STARTER RELAY CIRC • B2618: BCM • B2619: BCM • B261A: PUSH-BTN IGN SW • B26E1: ENG STATE NO RECIV • C1729: VHCL SPEED SIG ERR • U0415: VEHICLE SPEED SIG 	A B C D E F G H I	
	<ul style="list-style-type: none"> • C1704: LOW PRESSURE FL • C1705: LOW PRESSURE FR • C1706: LOW PRESSURE RR • C1707: LOW PRESSURE RL • C1708: [NO DATA] FL • C1709: [NO DATA] FR • C1710: [NO DATA] RR • C1711: [NO DATA] RL • C1712: [CHECKSUM ERR] FL • C1713: [CHECKSUM ERR] FR • C1714: [CHECKSUM ERR] RR • C1715: [CHECKSUM ERR] RL • C1716: [PRESSDATA ERR] FL • C1717: [PRESSDATA ERR] FR • C1718: [PRESSDATA ERR] RR • C1719: [PRESSDATA ERR] RL • C1720: [CODE ERR] FL • C1721: [CODE ERR] FR • C1722: [CODE ERR] RR • C1723: [CODE ERR] RL • C1724: [BATT VOLT LOW] FL • C1725: [BATT VOLT LOW] FR • C1726: [BATT VOLT LOW] RR • C1727: [BATT VOLT LOW] RL • C1734: CONTROL UNIT 	J K WW M N O P	
	6	<ul style="list-style-type: none"> • B2621: INSIDE ANTENNA • B2622: INSIDE ANTENNA • B2623: INSIDE ANTENNA 	

DTC Index

INFOID:000000004505087

NOTE:

BCM (BODY CONTROL MODULE)

< ECU DIAGNOSIS >

Details of time display

- CRNT: Displays when there is a malfunction now or after returning to the normal condition until turning ignition switch OFF → ON again.
- 1 - 39: Displayed if any previous malfunction is present when current condition is normal. It increases like 1 → 2 → 3...38 → 39 after returning to the normal condition whenever ignition switch OFF → ON. The counter remains at 39 even if the number of cycles exceeds it. It is counted from 1 again when turning ignition switch OFF → ON after returning to the normal condition if the malfunction is detected again.

CONSULT display	Fail-safe	Intelligent Key warning lamp ON	Tire pressure monitor warning lamp ON	Reference page
No DTC is detected. further testing may be required.	—	—	—	—
U1000: CAN COMM CIRCUIT	—	—	—	BCS-38
U1010: CONTROL UNIT (CAN)	—	—	—	BCS-39
U0415: VEHICLE SPEED SIG	—	—	—	BCS-40
B2013: ID DISCORD BCM-S/L	×	—	—	SEC-38
B2014: CHAIN OF S/L-BCM	×	—	—	SEC-39
B2190: NATS ANTENNA AMP	×	—	—	SEC-64
B2191: DIFFERENCE OF KEY	×	—	—	SEC-67
B2192: ID DISCORD BCM-ECM	×	—	—	SEC-68
B2193: CHAIN OF BCM-ECM	×	—	—	SEC-69
B2553: IGNITION RELAY	—	—	—	PCS-60
B2555: STOP LAMP	—	—	—	SEC-70
B2556: PUSH-BTN IGN SW	—	×	—	SEC-72
B2557: VEHICLE SPEED	×	×	—	SEC-74
B2560: STARTER CONT RELAY	×	×	—	SEC-75
B2562: LOW VOLTAGE	—	—	—	BCS-41
B2601: SHIFT POSITION	×	×	—	SEC-76
B2602: SHIFT POSITION	×	×	—	SEC-79
B2603: SHIFT POSI STATUS	×	×	—	SEC-81
B2604: PNP SW	×	×	—	SEC-84
B2605: PNP SW	×	×	—	SEC-86
B2606: S/L RELAY	×	×	—	SEC-88
B2607: S/L RELAY	×	×	—	SEC-89
B2608: STARTER RELAY	×	×	—	SEC-91
B2609: S/L STATUS	×	×	—	SEC-93
B260A: IGNITION RELAY	×	×	—	PCS-62
B260B: STEERING LOCK UNIT	—	×	—	SEC-97
B260C: STEERING LOCK UNIT	—	×	—	SEC-98
B260D: STEERING LOCK UNIT	—	×	—	SEC-99
B260F: ENG STATE SIG LOST	×	×	—	SEC-100
B2612: S/L STATUS	×	×	—	SEC-101
B2614: ACC RELAY CIRC	—	×	—	PCS-65
B2615: BLOWER RELAY CIRC	—	×	—	PCS-68
B2616: IGN RELAY CIRC	—	×	—	PCS-71
B2617: STARTER RELAY CIRC	×	×	—	SEC-105
B2618: BCM	×	×	—	PCS-74

BCM (BODY CONTROL MODULE)

< ECU DIAGNOSIS >

CONSULT display	Fail-safe	Intelligent Key warning lamp ON	Tire pressure monitor warning lamp ON	Reference page	
B2619: BCM	×	×	—	SEC-107	A
B261A: PUSH-BTN IGN SW	—	×	—	SEC-108	B
B2621: INSIDE ANTENNA	—	—	—	DLK-59	
B2622: INSIDE ANTENNA	—	—	—	DLK-62	C
B2623: INSIDE ANTENNA	—	—	—	DLK-65	
B26E1: ENG STATE NO RES	×	×	—	SEC-110	
C1704: LOW PRESSURE FL	—	—	×	WT-52	D
C1705: LOW PRESSURE FR	—	—	×	WT-52	
C1706: LOW PRESSURE RR	—	—	×	WT-52	E
C1707: LOW PRESSURE RL	—	—	×	WT-52	
C1708: [NO DATA] FL	—	—	×	WT-14	F
C1709: [NO DATA] FR	—	—	×	WT-14	
C1710: [NO DATA] RR	—	—	×	WT-14	G
C1711: [NO DATA] RL	—	—	×	WT-14	
C1712: [CHECKSUM ERR] FL	—	—	×	WT-16	H
C1713: [CHECKSUM ERR] FR	—	—	×	WT-16	
C1714: [CHECKSUM ERR] RR	—	—	×	WT-16	I
C1715: [CHECKSUM ERR] RL	—	—	×	WT-16	
C1716: [PRESSDATA ERR] FL	—	—	×	WT-18	J
C1717: [PRESSDATA ERR] FR	—	—	×	WT-18	
C1718: [PRESSDATA ERR] RR	—	—	×	WT-18	K
C1719: [PRESSDATA ERR] RL	—	—	×	WT-18	
C1720: [CODE ERR] FL	—	—	×	WT-16	WW
C1721: [CODE ERR] FR	—	—	×	WT-16	
C1722: [CODE ERR] RR	—	—	×	WT-16	M
C1723: [CODE ERR] RL	—	—	×	WT-16	
C1724: [BATT VOLT LOW] FL	—	—	×	WT-16	N
C1725: [BATT VOLT LOW] FR	—	—	×	WT-16	
C1726: [BATT VOLT LOW] RR	—	—	×	WT-16	O
C1727: [BATT VOLT LOW] RL	—	—	×	WT-16	
C1729: VHCL SPEED SIG ERR	—	—	×	WT-19	P
C1734: CONTROL UNIT	—	—	×	WT-20	

IPDM E/R (INTELLIGENT POWER DISTRIBUTION MODULE ENGINE ROOM)

< ECU DIAGNOSIS >

IPDM E/R (INTELLIGENT POWER DISTRIBUTION MODULE ENGINE ROOM)

Reference Value

INFOID:000000004505088

VALUES ON THE DIAGNOSIS TOOL

Monitor Item	Condition		Value/Status
RADFAN REQ	Engine idle speed	Changes depending on engine coolant temperature, air conditioner operation status, vehicle speed, etc.	0 - 100 %
AC COMP REQ	Engine running	A/C switch OFF	Off
		A/C switch ON (Compressor is operating)	On
TAIL&CLR REQ	Lighting switch OFF		Off
	Lighting switch 1ST, 2ND, HI or AUTO (Light is illuminated)		On
HL LO REQ	Lighting switch OFF		Off
	Lighting switch 2ND HI or AUTO (Light is illuminated)		On
HL HI REQ	Lighting switch OFF		Off
	Lighting switch HI		On
FR FOG REQ	Lighting switch 2ND or AUTO (Light is illuminated)	Front fog lamp switch OFF	Off
		<ul style="list-style-type: none"> • Front fog lamp switch ON • Daytime running light activated (Only for Canada models) 	On
FR WIP REQ	Ignition switch ON	Front wiper switch OFF	STOP
		Front wiper switch INT	1LOW
		Front wiper switch LO	Low
		Front wiper switch HI	Hi
WIP AUTO STOP	Ignition switch ON	Front wiper stop position	STOP P
		Any position other than front wiper stop position	ACT P
WIP PROT	Ignition switch ON	Front wiper operates normally	Off
		Front wiper stops at fail-safe operation	BLOCK
IGN RLY1 -REQ	Ignition switch OFF or ACC		Off
	Ignition switch ON		On
IGN RLY	Ignition switch OFF or ACC		Off
	Ignition switch ON		On
PUSH SW	Release the push-button ignition switch		Off
	Press the push-button ignition switch		On
INTER/NP SW	Ignition switch ON	CVT selector lever in any position other than P or N (CVT models)	Off
		Release clutch pedal (M/T models)	
	Ignition switch ON	CVT selector lever in P or N position (CVT models)	On
		Depress clutch pedal (M/T models)	
ST RLY CONT	Ignition switch ON		Off
	At engine cranking		On

IPDM E/R (INTELLIGENT POWER DISTRIBUTION MODULE ENGINE ROOM)

< ECU DIAGNOSIS >

Monitor Item	Condition	Value/Status
IHBT RLY -REQ	Ignition switch ON	Off
	At engine cranking	On
ST/INHI RLY	Ignition switch ON	Off
	At engine cranking	ST →INHI
	The status of starter relay or starter control relay cannot be recognized by the battery voltage malfunction, etc. when the starter relay is ON and the starter control relay is OFF	UNKWN
DETENT SW	Ignition switch ON <ul style="list-style-type: none"> • Press the selector button with CVT selector lever in P position • CVT selector lever in any position other than P 	Off
	Release the CVT selector button with CVT selector lever in P position NOTE: The lever is fixed ON for M/T	On
S/L RLY -REQ	None of the conditions below are present	Off
	<ul style="list-style-type: none"> • Open the driver door after the ignition switch is turned OFF (for a few seconds) • Press the push-button ignition switch when the steering lock is activated • Depress the clutch pedal when the steering lock is activated 	On
S/L STATE	Steering lock is activated	LOCK
	Steering lock is deactivated	UNLK
	[DTC B210A] is detected	UNKWN
DTRL REQ	NOTE: This item is displayed, but cannot be monitored.	Off
OIL P SW	Ignition switch OFF, ACC or engine running	Open
	Ignition switch ON	Close
THFT HRN REQ	Not operated	Off
	<ul style="list-style-type: none"> • Panic alarm is activated • Horn is activated with VEHICLE SECURITY (THEFT WARNING) SYSTEM 	On
HORN CHIRP	Not operated	Off
	Door locking with Intelligent Key (horn chirp mode)	On
CRNRNG LMP REQ	NOTE: This item is displayed, but cannot be monitored.	Off

A
B
C
D
E
F
G
H
I
J
K
M
N
O
P

WW

IPDM E/R (INTELLIGENT POWER DISTRIBUTION MODULE ENGINE ROOM)

< ECU DIAGNOSIS >

TERMINAL LAYOUT

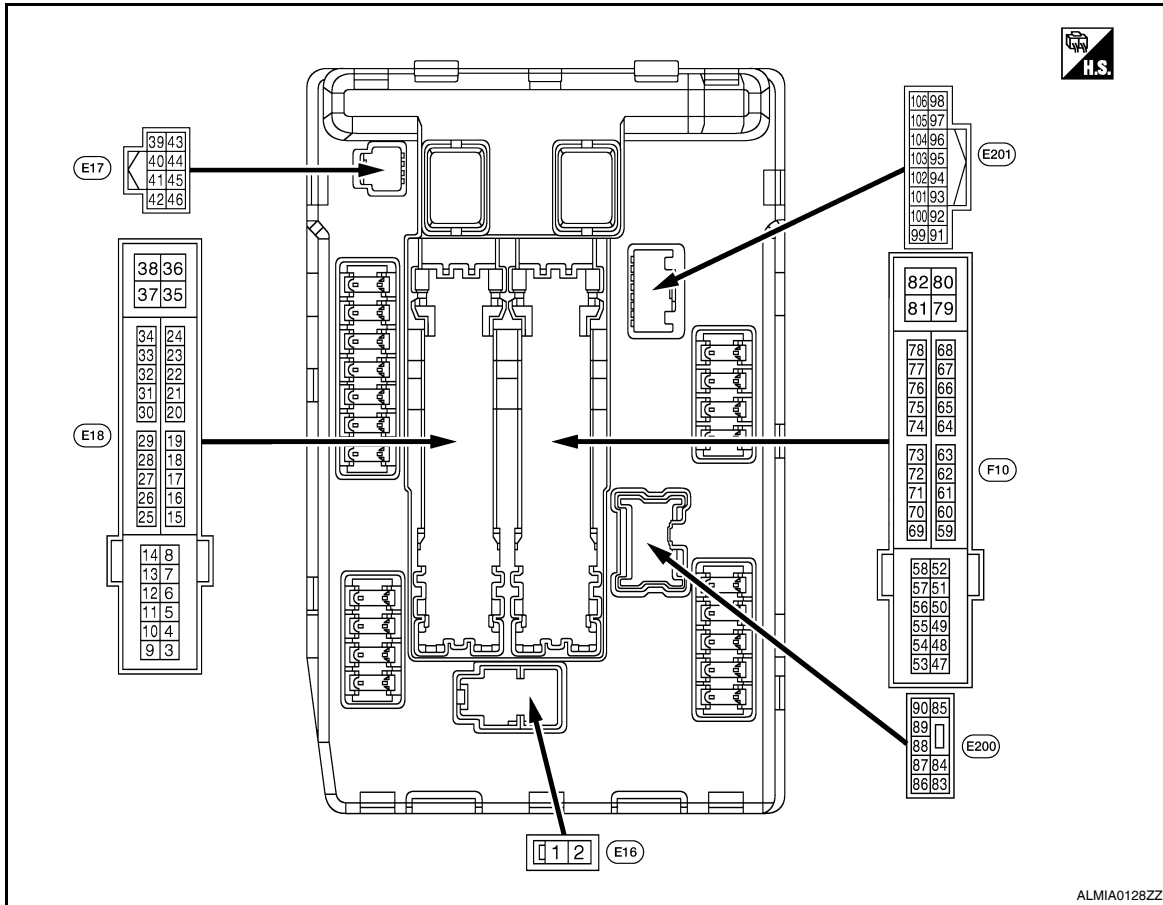

PHYSICAL VALUES

Terminal No. (Wire color)		Description		Condition		Value (Approx.)
+	-	Signal name	Input/ Output			
1 (R)	Ground	Battery power supply	Input	Ignition switch OFF		Battery voltage
2 (L)	Ground	Battery power supply	Input	Ignition switch OFF		Battery voltage
4 (L/R)	Ground	Front wiper LO	Output	Ignition switch OFF	Front wiper switch OFF	0V
				Ignition switch ON	Front wiper switch LO	Battery voltage
5 (L/B)	Ground	Front wiper HI	Output	Ignition switch OFF	Front wiper switch OFF	0V
				Ignition switch ON	Front wiper switch HI	Battery voltage
6 (SB)	Ground	Daytime light relay power supply (Canada models only)	Output	Ignition switch OFF		Battery voltage
7 (R/L)	Ground	Tail, license plate lamps & interior lamps	Output	Ignition switch OFF	Lighting switch OFF	0V
				Ignition switch ON	Lighting switch 1ST	Battery voltage
10 (R/B)	Ground	ECM relay power supply	Output	Ignition switch OFF (For a few seconds after turning ignition switch OFF)		0V
				<ul style="list-style-type: none"> Ignition switch ON Ignition switch OFF (More than a few seconds after turning ignition switch OFF) 		Battery voltage

IPDM E/R (INTELLIGENT POWER DISTRIBUTION MODULE ENGINE ROOM)

< ECU DIAGNOSIS >

Terminal No. (Wire color)		Description		Condition		Value (Approx.)	
+	-	Signal name	Input/ Output				
11 (P/L)	Ground	Steering lock unit power supply	Output	Ignition switch OFF	A few seconds after opening the driver door	Battery voltage	A
				Ignition switch LOCK	Press the push-button ignition switch	Battery voltage	B
				Ignition switch ACC or ON		0V	C
12 (B)	Ground	Ground	—	Ignition switch ON		0V	D
13 (W)	Ground	Fuel pump power supply	Output	Approximately 1 second or more after turning the ignition switch ON		0V	E
				<ul style="list-style-type: none"> Approximately 1 second after turning the ignition switch ON Engine running 		Battery voltage	F
15 (G/W)	Ground	Ignition relay-1 power supply	Output	Ignition switch OFF		0V	
				Ignition switch ON		Battery voltage	
16 (L/Y)	Ground	Front wiper auto stop	Input	Ignition switch ON	Front wiper stop position	0V	G
					Any position other than front wiper stop position	Battery voltage	
19 (L/Y)	Ground	Ignition relay-1 power supply	Output	Ignition switch OFF		0V	H
				Ignition switch ON		Battery voltage	
20 (B/Y)	Ground	Ambient sensor ground	—	Ignition switch ON		0V	I
21 (O/B)	Ground	Ambient sensor	—	Ignition switch ON		5V	J
22 (W/R)	Ground	Refrigerant pressure sensor ground	—	Ignition switch ON		0V	
23 (B/R)	Ground	Refrigerant pressure sensor	—	<ul style="list-style-type: none"> Ignition switch ON (READY) Both A/C switch and blower motor switch ON (electric compressor operates) 		1.0 - 4.0V	K
24 (BR/W)	Ground	Refrigerant pressure sensor power supply	—	Ignition switch ON		5V	WW
25 (GR)	Ground	Ignition relay-1 power supply	Output	Ignition switch OFF		0V	
				Ignition switch ON		Battery voltage	M
27 (BR/W)	Ground	Ignition relay monitor	Input	Ignition switch OFF or ACC		Battery voltage	
				Ignition switch ON		0V	N
28 (BR)	Ground	Push-button ignition switch	Input	Press the push-button ignition switch		0V	
				Release the push-button ignition switch		Battery voltage	
30 (R/B)	Ground	Starter relay control	Input	CVT models	CVT selector lever in any position other than P or N (ignition switch ON)	0V	O
					CVT selector lever P or N (ignition switch ON)	Battery voltage	P
				M/T models	Release the clutch pedal	0V	
					Depress the clutch pedal	Battery voltage	

IPDM E/R (INTELLIGENT POWER DISTRIBUTION MODULE ENGINE ROOM)

< ECU DIAGNOSIS >

Terminal No. (Wire color)		Description		Condition	Value (Approx.)	
+	-	Signal name	Input/ Output			
32 (L/O)	Ground	Electronic steering column lock unit condition-1	Input	Electronic steering column lock is activated	0V	
				Electronic steering column lock is deactivated	Battery voltage	
33 (G/R)	Ground	Electronic steering column lock unit condition-2	Input	Electronic steering column lock is activated	Battery voltage	
				Electronic steering column lock is deactivated	0V	
34 (O/L)	Ground	Cooling fan relay-3 control	Input	Ignition switch OFF or ACC	0V	
				Ignition switch ON	0.7V	
35 (L/B)	Ground	Cooling fan motor control	Output	Ignition switch OFF or ACC	0V	
				Ignition switch ON	0.7V	
36 (G)	Ground	Battery power supply	Input	Ignition switch OFF	Battery voltage	
38 (R/W)	Ground	Cooling fan motor control	Output	Ignition switch OFF or ACC	0V	
				Ignition switch ON	0.7V	
39 (P)	—	CAN - L	Input/ Output	—	—	
40 (L)	—	CAN - H	Input/ Output	—	—	
41 (B)	Ground	Ground	—	Ignition switch ON	0V	
42 (SB)	Ground	Cooling fan relay-2 control	Input	Ignition switch OFF or ACC	0V	
				Ignition switch ON	0.7V	
43 (G/B)	Ground	CVT device (Detention switch)	Input	Ignition switch ON	Press the CVT selector button (CVT selector lever P) • CVT selector lever in any position other than P • Release the CVT selector button (CVT selector lever P)	
				0V		
44 (G/W)	Ground	Horn relay control	Input	The horn is deactivated	Battery voltage	
				The horn is activated	0V	
45 (L/O)	Ground	Anti theft horn relay control	Input	The horn is deactivated	Battery voltage	
				The horn is activated	0V	
46 (R)	Ground	Starter relay control	Input	CVT models	CVT selector lever in any position other than P or N (ignition switch ON)	0V
					CVT selector lever P or N (ignition switch ON)	Battery voltage
				M/T models	Release the clutch pedal	0V
					Depress the clutch pedal	Battery voltage
48 (Y/R)	Ground	A/C relay power supply	Output	Engine running	A/C switch OFF	0V
					A/C switch ON (A/C compressor is operating)	Battery voltage

IPDM E/R (INTELLIGENT POWER DISTRIBUTION MODULE ENGINE ROOM)

< ECU DIAGNOSIS >

Terminal No. (Wire color)		Description		Condition	Value (Approx.)	
+	-	Signal name	Input/ Output			
49 (R/B)	Ground	ECM relay power supply (with VQ35DE)	Output	Ignition switch OFF (For a few seconds after turning ignition switch OFF)	0V	A
				• Ignition switch ON • Ignition switch OFF (More than a few seconds after turn- ing ignition switch OFF)	Battery voltage	B C
49 (B/R)	Ground	ECM relay power supply (without VQ35DE)	Output	Ignition switch OFF (For a few seconds after turning ignition switch OFF)	0V	D
				• Ignition switch ON • Ignition switch OFF (More than a few seconds after turn- ing ignition switch OFF)	Battery voltage	E
51 (LG)	Ground	Ignition relay power supply	Output	Ignition switch OFF	0V	F
				Ignition switch ON	Battery voltage	
52 (Y/G)	Ground	Ignition relay power supply	Output	Ignition switch OFF	0V	G
				Ignition switch ON	Battery voltage	
53 (B/R)	Ground	ECM relay power supply (with VQ35DE)	Output	Ignition switch OFF (For a few seconds after turning ignition switch OFF)	0V	H
				• Ignition switch ON • Ignition switch OFF (More than a few seconds after turn- ing ignition switch OFF)	Battery voltage	I
53 (R/B)	Ground	ECM relay power supply (without VQ35DE)	Output	Ignition switch OFF (For a few seconds after turning ignition switch OFF)	0V	J
				• Ignition switch ON • Ignition switch OFF (More than a few seconds after turn- ing ignition switch OFF)	Battery voltage	K
54 (G/W)	Ground	Throttle control motor re- lay power supply	Output	Ignition switch OFF (For a few seconds after turning ignition switch OFF)	0V	WW
				• Ignition switch ON • Ignition switch OFF (More than a few seconds after turn- ing ignition switch OFF)	Battery voltage	M
55 (W/L)	Ground	ECM power supply	Output	Ignition switch OFF	Battery voltage	N
56 (R/Y)	Ground	Ignition relay power supply	Output	Ignition switch OFF	0V	
				Ignition switch ON	Battery voltage	O
57 (O)	Ground	Ignition relay power supply	Output	Ignition switch OFF	0V	
				Ignition switch ON	Battery voltage	
58 (Y)	Ground	Ignition relay power supply	Output	Ignition switch OFF	0V	P
				Ignition switch ON	Battery voltage	

IPDM E/R (INTELLIGENT POWER DISTRIBUTION MODULE ENGINE ROOM)

< ECU DIAGNOSIS >

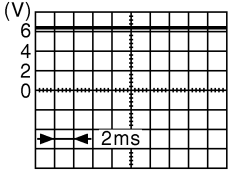
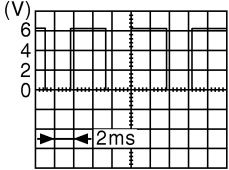
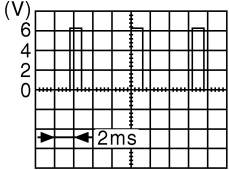
Terminal No. (Wire color)		Description		Condition	Value (Approx.)
+	-	Signal name	Input/ Output		
69 (W/B)	Ground	ECM relay control	Output	Ignition switch OFF (For a few seconds after turning ignition switch OFF)	Battery voltage
				<ul style="list-style-type: none"> Ignition switch ON Ignition switch OFF (More than a few seconds after turning ignition switch OFF) 	0 - 1.5V
70 (O)	Ground	Throttle control motor relay control	Output	Ignition switch ON → OFF	0 - 1.0V ↓ Battery voltage ↓ 0V
				Ignition switch ON	0 - 1.0V
72 (R/B)	Ground	PNP switch signal	Input	Ignition switch ON	Battery voltage
				CVT selector lever in P or N position	0V
74 (Y)	Ground	Ignition relay power supply	Output	Ignition switch OFF	0V
				Ignition switch ON	Battery voltage
75 (P/L)	Ground	Oil pressure switch	Input	Ignition switch ON	0V
				Engine stopped	Battery voltage
76 (GR)	Ground	Power generation command signal	Output	Ignition switch ON	 <p>6.3V</p>
				40% is set on "Active test", "ALTERNATOR DUTY" of "ENGINE"	 <p>3.8V</p>
				80% is set on "Active test", "ALTERNATOR DUTY" of "ENGINE"	 <p>1.4V</p>
77 (B/R)	Ground	Fuel pump relay control	Output	<ul style="list-style-type: none"> Approximately 1 second after turning the ignition switch ON Engine running 	0 - 1.0V
				Approximately 1 second or more after turning the ignition switch ON	Battery voltage

IPDM E/R (INTELLIGENT POWER DISTRIBUTION MODULE ENGINE ROOM)

< ECU DIAGNOSIS >

Terminal No. (Wire color)		Description		Condition		Value (Approx.)	
+	-	Signal name	Input/ Output				
80 (B/W)	Ground	Starter motor	Output	At engine cranking		Battery voltage	A
83 (R/Y)	Ground	Headlamp LO (RH)	Output	Ignition switch ON	Lighting switch OFF	0V	B
					Lighting switch 2ND	Battery voltage	C
84 (L)	Ground	Headlamp LO (LH)	Output	Ignition switch ON	Lighting switch OFF	0V	D
					Lighting switch 2ND	Battery voltage	E
86 (W/R)	Ground	Front fog lamp (RH)	Output	Lighting switch 2ND	<ul style="list-style-type: none"> Front fog lamp switch ON Daytime running light activated (Only for Canada models) 	Battery voltage	F
						Front fog lamp switch OFF	0V
87 (L/Y)	Ground	Front fog lamp (LH)	Output	Lighting switch 2ND	<ul style="list-style-type: none"> Front fog lamp switch ON Daytime running light activated (Only for Canada models) 	Battery voltage	H
						Front fog lamp switch OFF	0V
88 (R/W)	Ground	Washer pump power supply	Output	Ignition switch ON		Battery voltage	J
89 (L/W)	Ground	Headlamp HI (RH)	Output	Ignition switch ON	<ul style="list-style-type: none"> Lighting switch HI lighting switch PASS 	Battery voltage	K
						Lighting switch OFF	0V
90 (G)	Ground	Headlamp HI (LH)	Output	Ignition switch ON	<ul style="list-style-type: none"> Lighting switch HI Lighting switch PASS 	Battery voltage	M
						Lighting switch OFF	0V
91 (LG/R)	Ground	Parking lamp (RH)	Output	Ignition switch ON	Lighting switch 1ST	Battery voltage	O
						Lighting switch OFF	0V
92 (LG/B)	Ground	Parking lamp (LH)	Output	Ignition switch ON	Lighting switch 1ST	Battery voltage	
						Lighting switch OFF	0V
99 (BR/W)	Ground	Ambient sensor ground	—	Ignition switch ON		0V	WW
100 (SB)	Ground	Ambient sensor	—	Ignition switch ON		5V	M
101 (O/L)	Ground	Refrigerant pressure sensor ground	—	Ignition switch ON		0V	
102 (R/B)	Ground	Refrigerant pressure sensor	—	<ul style="list-style-type: none"> Ignition switch ON (READY) Both A/C switch and blower motor switch ON (electric compressor operates) 		1.0 - 4.0V	N
103 (P)	Ground	Refrigerant pressure sensor power supply	—	Ignition switch ON		5V	O
105 (V)	Ground	Daytime light relay control	Output	Ignition switch ON	Daytime light system active	Battery voltage	P
				Ignition switch ON	Daytime light system inactive	0V	

IPDM E/R (INTELLIGENT POWER DISTRIBUTION MODULE ENGINE ROOM)

< ECU DIAGNOSIS >

Wiring Diagram — Coupe

INFOID:000000004505089

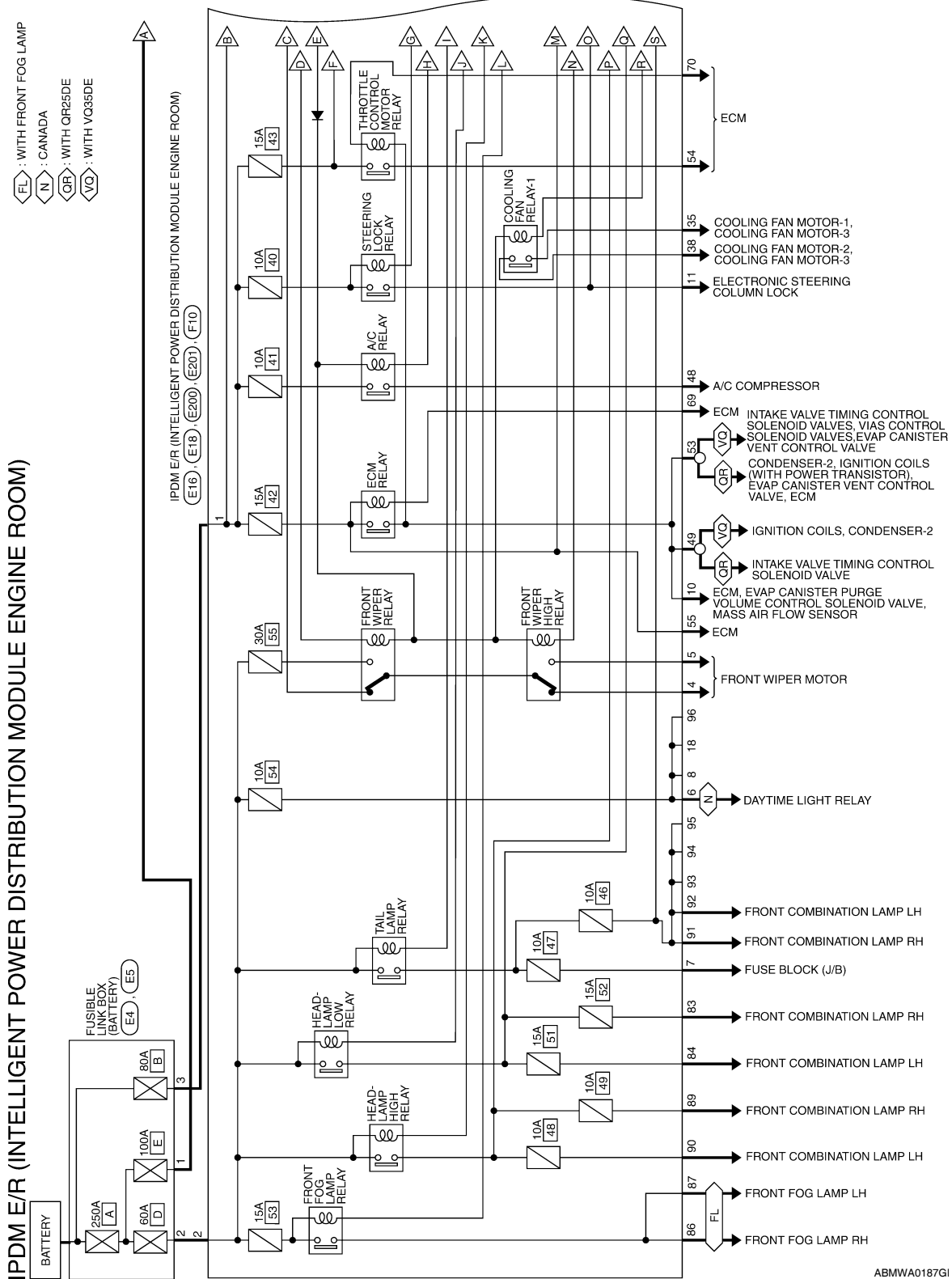

ABMWA0187GI

IPDM E/R (INTELLIGENT POWER DISTRIBUTION MODULE ENGINE ROOM)

< ECU DIAGNOSIS >

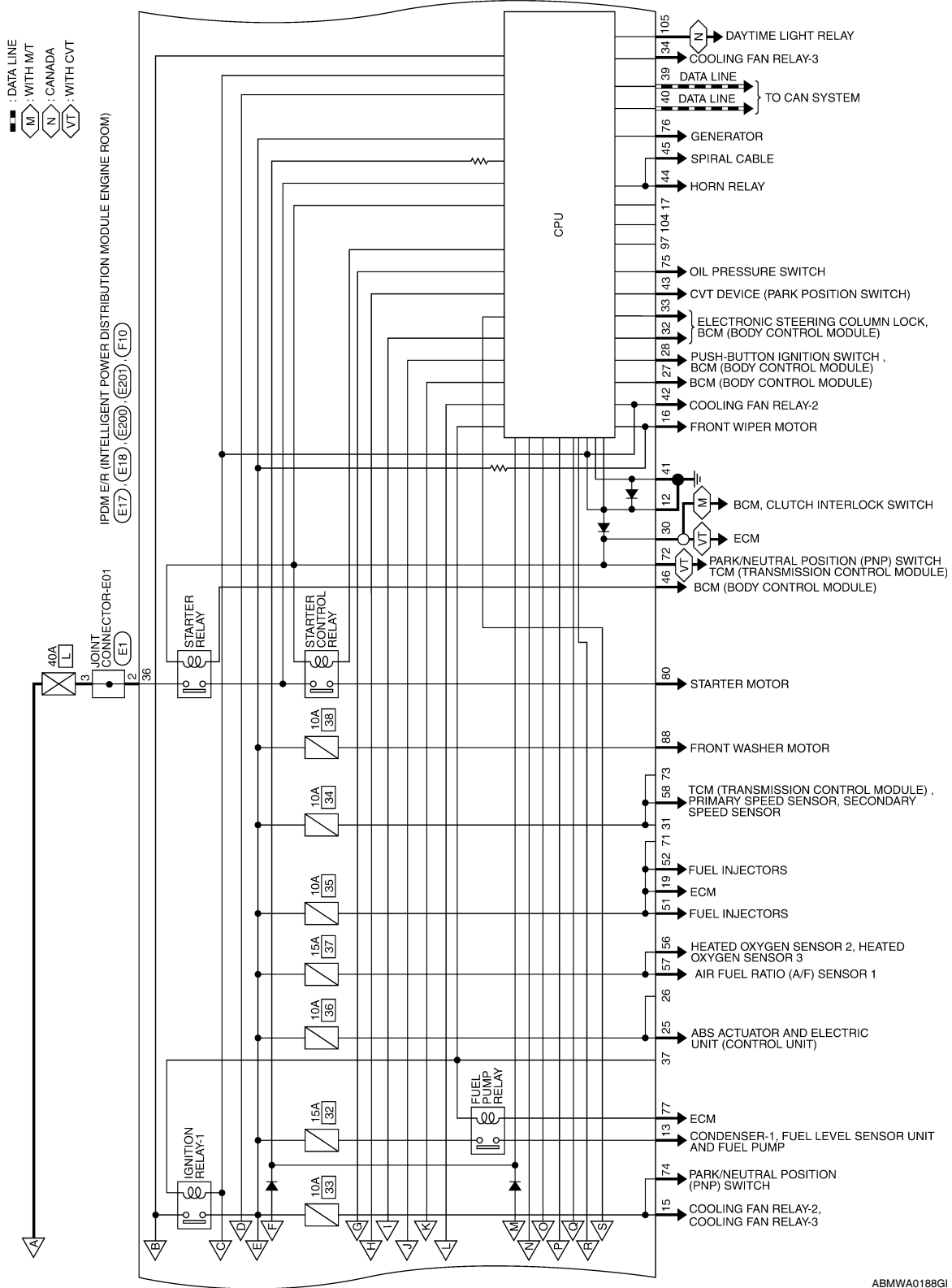

ABMWA0188GI

A
B
C
D
E
F
G
H
I
J
K
M
N
O
P

WW

IPDM E/R (INTELLIGENT POWER DISTRIBUTION MODULE ENGINE ROOM)

< ECU DIAGNOSIS >

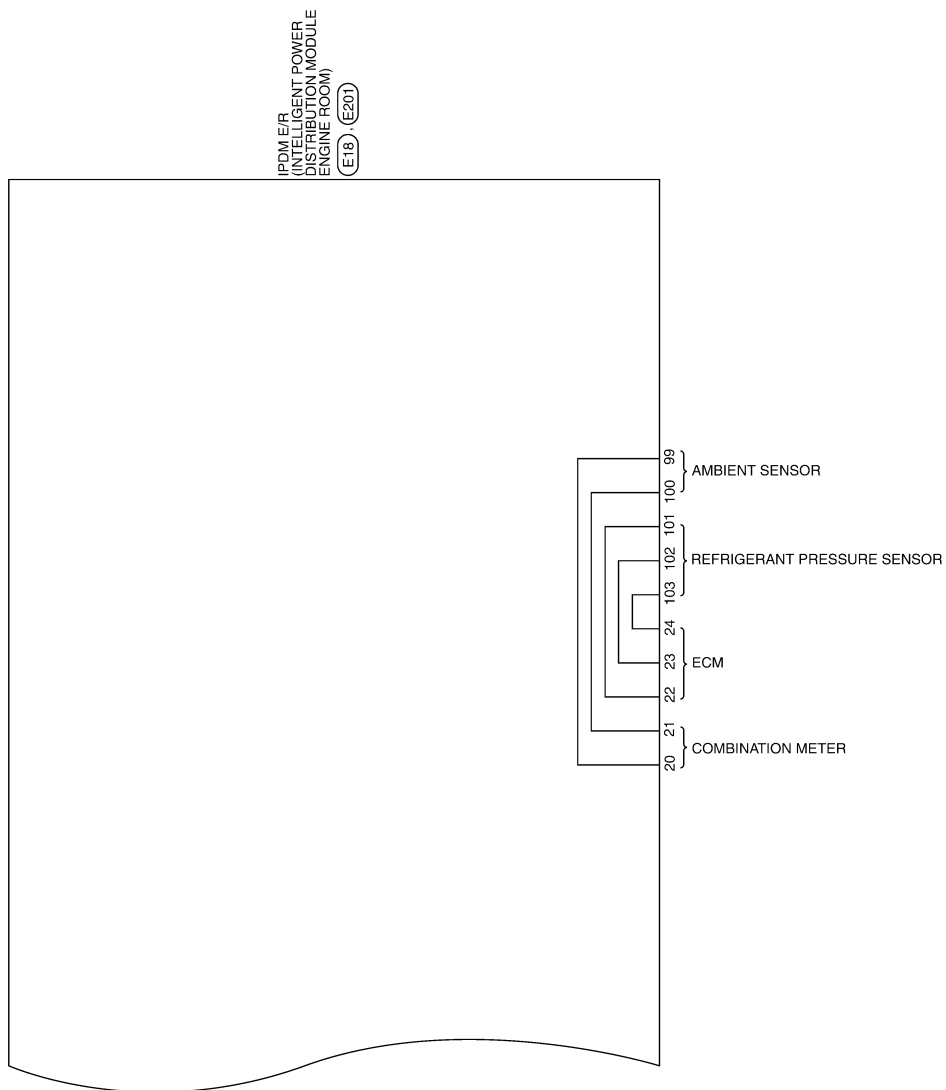

ABMWA0189GI

IPDM E/R (INTELLIGENT POWER DISTRIBUTION MODULE ENGINE ROOM)

< ECU DIAGNOSIS >

IPDM E/R (INTELLIGENT POWER DISTRIBUTION MODULE ENGINE ROOM) CONNECTORS

Connector No.	E1
Connector Name	JOINT CONNECTOR-E01
Connector Color	WHITE



Terminal No.	Color of Wire	Signal Name
2	G	-
3	G	-

Connector No.	E4
Connector Name	FUSIBLE LINK BOX (BATTERY)
Connector Color	BROWN



Terminal No.	Color of Wire	Signal Name
1	B/W	-
2	B/Y	-

Connector No.	E5
Connector Name	FUSIBLE LINK BOX (BATTERY)
Connector Color	GRAY



Terminal No.	Color of Wire	Signal Name
3	R	-

Connector No.	E16
Connector Name	IPDM E/R (INTELLIGENT POWER DISTRIBUTION MODULE ENGINE ROOM)
Connector Color	BLACK



Terminal No.	Color of Wire	Signal Name
1	R	F/L_MAIN
2	L	F/L_USM

Connector No.	E17
Connector Name	IPDM E/R (INTELLIGENT POWER DISTRIBUTION MODULE ENGINE ROOM)
Connector Color	WHITE



Terminal No.	Color of Wire	Signal Name
39	P	CAN-L
40	L	CAN-H
41	B	GND (SIGNAL)
42	SB	MOTOR_FAN_RLY_MID
43	G/B	DETENT_SW
44	G/W	HORN_RLY
45	L/O	HORN_SW
46	R	START_CONT

ABMIA0558GB

A
B
C
D
E
F
G
H
I
J
K
L
M
N
O
P

IPDM E/R (INTELLIGENT POWER DISTRIBUTION MODULE ENGINE ROOM)

< ECU DIAGNOSIS >

Connector No.	E18
Connector Name	IPDM E/R (INTELLIGENT POWER DISTRIBUTION MODULE ENGINE ROOM)
Connector Color	WHITE

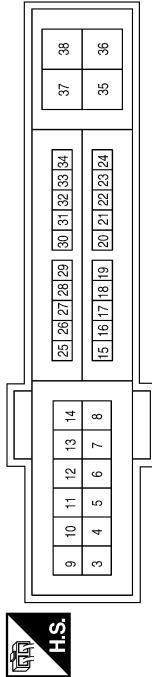

Terminal No.	Color of Wire	Signal Name
3	-	-
4	L/R	FR_WIPER_LO
5	L/B	FR_WIPER_HI
6	SB	DTRL
7	R/L	TAIL/ILLUMI

Terminal No.	Color of Wire	Signal Name
8	-	-
9	-	-
10	R/B	ECM_VB
11	P/L	ESCL
12	B	GND (POWER)
13	W	FUEL_PUMP
14	-	-
15	GW	START_IG-E/R
16	L/Y	WIPER_AUTOSTOP
17	-	-
18	-	-
19	L/Y	BCM_IGNSW
20	B/Y	AMB_SENS_GND-E/R
21	O/B	AMB_SENS_SIG-E/R
22	W/R	PD_SENS_GND-E/R

Terminal No.	Color of Wire	Signal Name
23	B/R	PD_SENS_SIG-E/R
24	B/R/W	PD_SENS_PWR-E/R
25	GR	ABS_ECU
26	-	-
27	B/R/W	IGN_SIGNAL
28	BR	PUSH_START_SW
29	-	-
30	R/B	CLUTCH_I/L_SW
31	-	-
32	L/O	SL_CONDITION_1
33	G/R	SL_CONDITION_2
34	O/L	MOTOR_FAN_RLY_HI
35	L/B	MOTOR_FAN_LO
36	G	F/L_IGNSW
37	-	-
38	R/W	F/L_MOTOR_FAN

Connector No.	E200
Connector Name	IPDM E/R (INTELLIGENT POWER DISTRIBUTION MODULE ENGINE ROOM)
Connector Color	WHITE

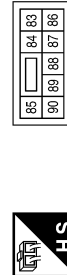

Terminal No.	Color of Wire	Signal Name
83	R/Y	HEADLAMP_LO_RH
84	L	HEADLAMP_LO_LH
85	-	-
86	W/R	FR_FOG_LAMP_RH
87	L/Y	FR_FOG_LAMP_LH
88	R/W	WASHER_MTR
89	L/W	HEADLAMP_HI_RH
90	G	HEADLAMP_HI_LH

Connector No.	E201
Connector Name	IPDM E/R (INTELLIGENT POWER DISTRIBUTION MODULE ENGINE ROOM)
Connector Color	WHITE

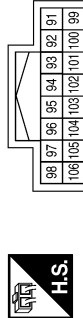

Terminal No.	Color of Wire	Signal Name
91	LG/R	CLEARANCE_RH
92	LG/B	CLEARANCE_LH
93	-	-
94	-	-
95	-	-
96	-	-
97	-	-

Terminal No.	Color of Wire	Signal Name
98	-	-
99	B/R/W	AMB_SENS_GND-FEM
100	SB	AMB_SENS_SIG-FEM
101	O/L	PD_SENS_GND-FEM
102	R/B	PD_SENS_SIG-FEM
103	P	PD_SENS_PWR-FEM
104	-	-
105	V	DTRL_RLY
106	-	-

ABMIA0559GB

IPDM E/R (INTELLIGENT POWER DISTRIBUTION MODULE ENGINE ROOM)

< ECU DIAGNOSIS >

Connector No.	F10
Connector Name	IPDM E/R (INTELLIGENT POWER DISTRIBUTION MODULE ENGINE ROOM)
Connector Color	WHITE

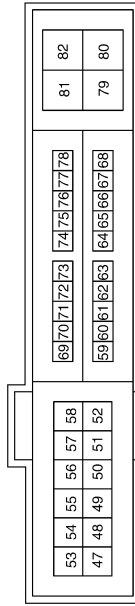

Terminal No.	Color of Wire	Signal Name
47	-	-
48	Y/R	A/C_COMP
49	B/R	ENG_SOL (WITH QR25DE)
49	R/B	IGN_SOL (WITH VQ35DE)

Terminal No.	Color of Wire	Signal Name
50	-	-
51	LG	INJECTOR_#1
52	Y/G	INJECTOR_#2
53	R/B	IGN_SOL (WITH QR25DE)
53	B/R	ENG_SOL (WITH VQ35DE)
54	G/W	ETC
55	W/L	ECM_BAT
56	R/Y	O2_SENS_#1
57	O	O2_SENS_#2
58	Y	AT_ECU
59	-	-
60	-	-
61	-	-
62	-	-
63	-	-
64	-	-

Terminal No.	Color of Wire	Signal Name
65	-	-
66	-	-
67	-	-
68	-	-
69	W/B	SSOF
70	O	MOTRLY
71	-	-
72	R/B	NPSW
73	-	-
74	Y	START_IG-EGI
75	P/L	OIL_PRESSURE_SW
76	GR	ALT_C
77	B/R	FPR
78	-	-
79	-	-
80	B/W	STARTER_MOTOR
81	-	-
82	-	-

A
B
C
D
E
F
G
H
I
J
K
M
N
O
P

WW

ABMIA0560GB

IPDM E/R (INTELLIGENT POWER DISTRIBUTION MODULE ENGINE ROOM)

< ECU DIAGNOSIS >

Wiring Diagram — Sedan

INFOID:000000004505090

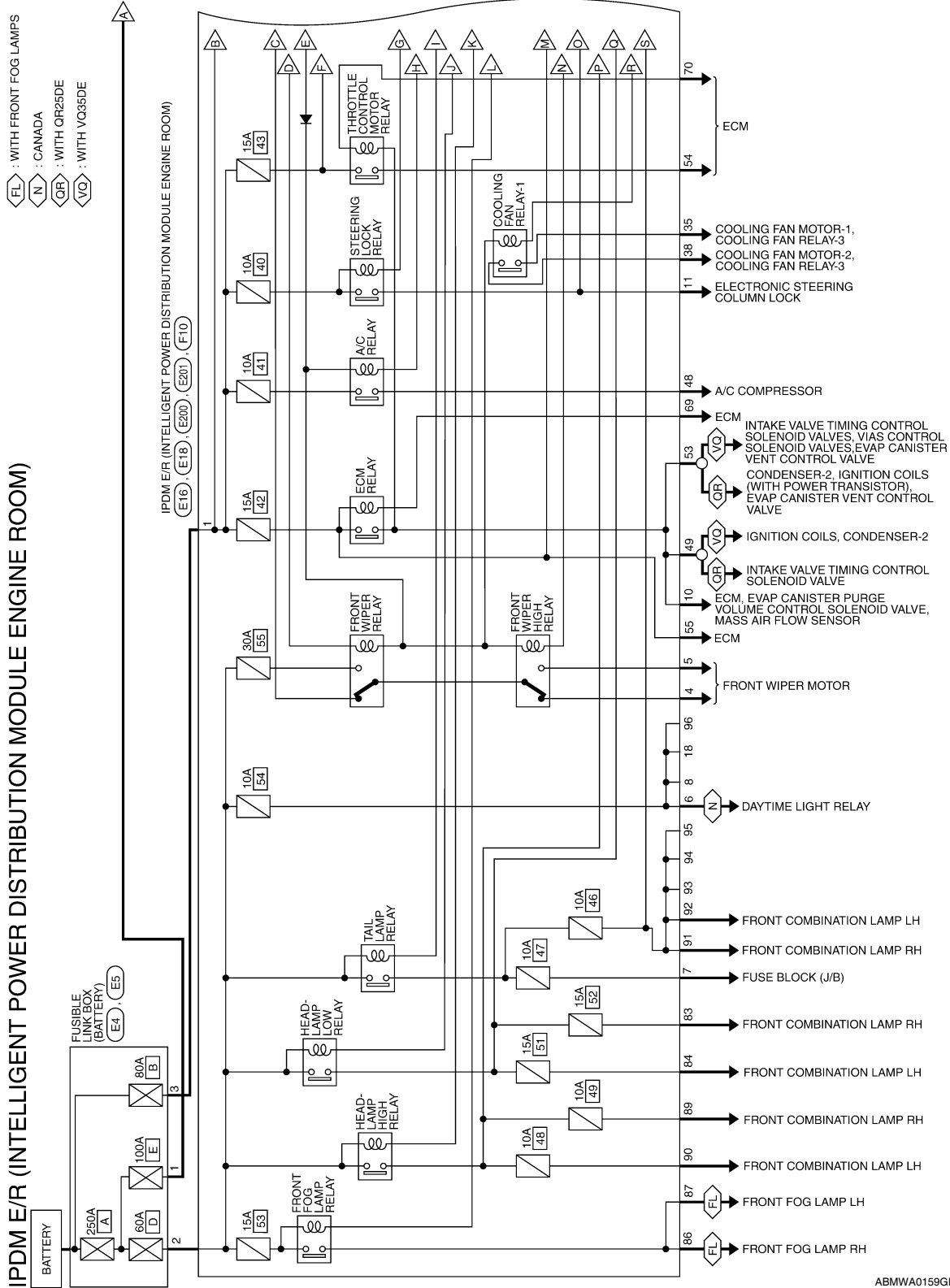

ABMWA0159GI

IPDM E/R (INTELLIGENT POWER DISTRIBUTION MODULE ENGINE ROOM)

< ECU DIAGNOSIS >

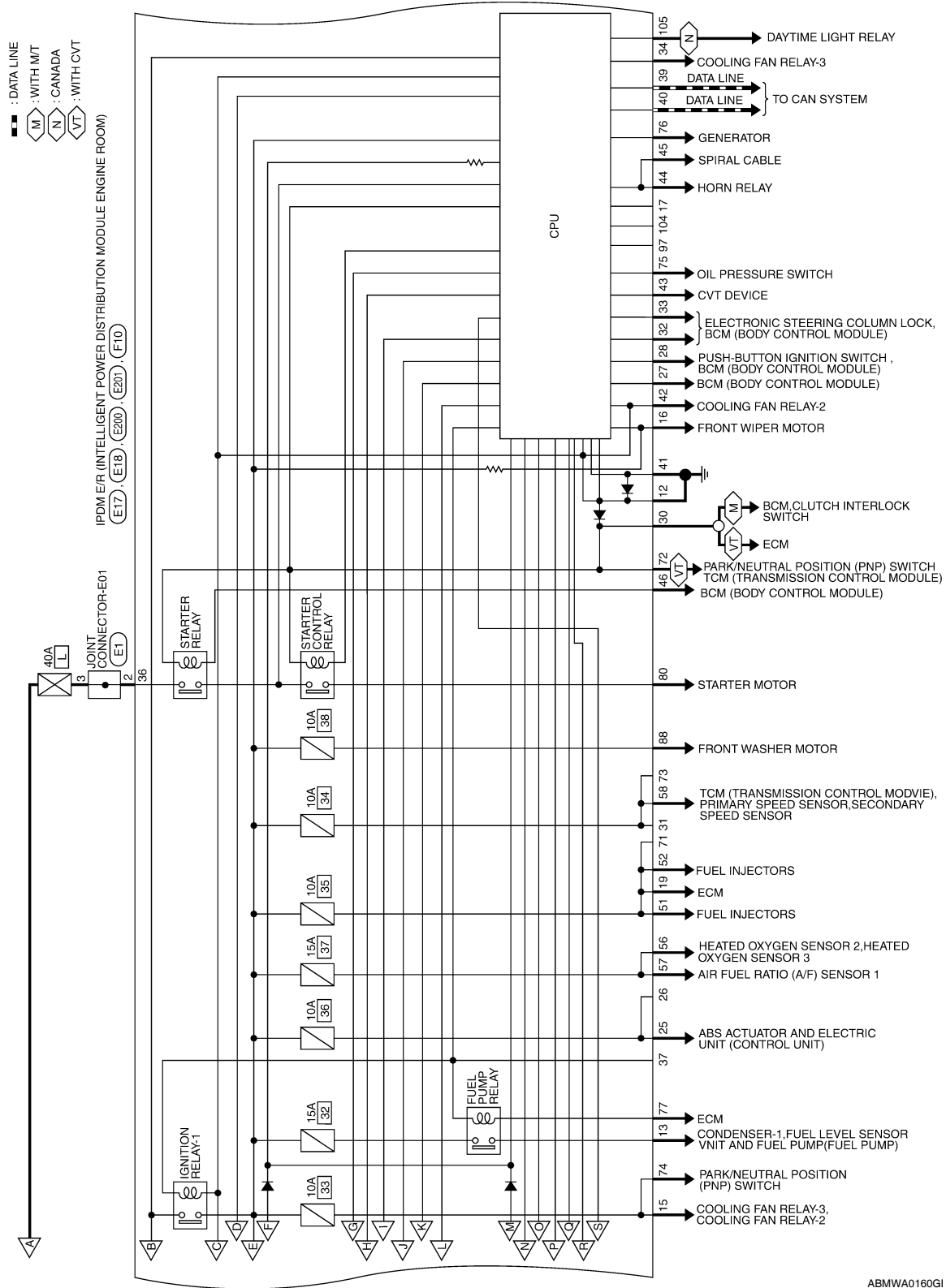

A
B
C
D
E
F
G
H
I
J
K
M
N
O
P

WW

ABMWA0160GI

IPDM E/R (INTELLIGENT POWER DISTRIBUTION MODULE ENGINE ROOM)

< ECU DIAGNOSIS >

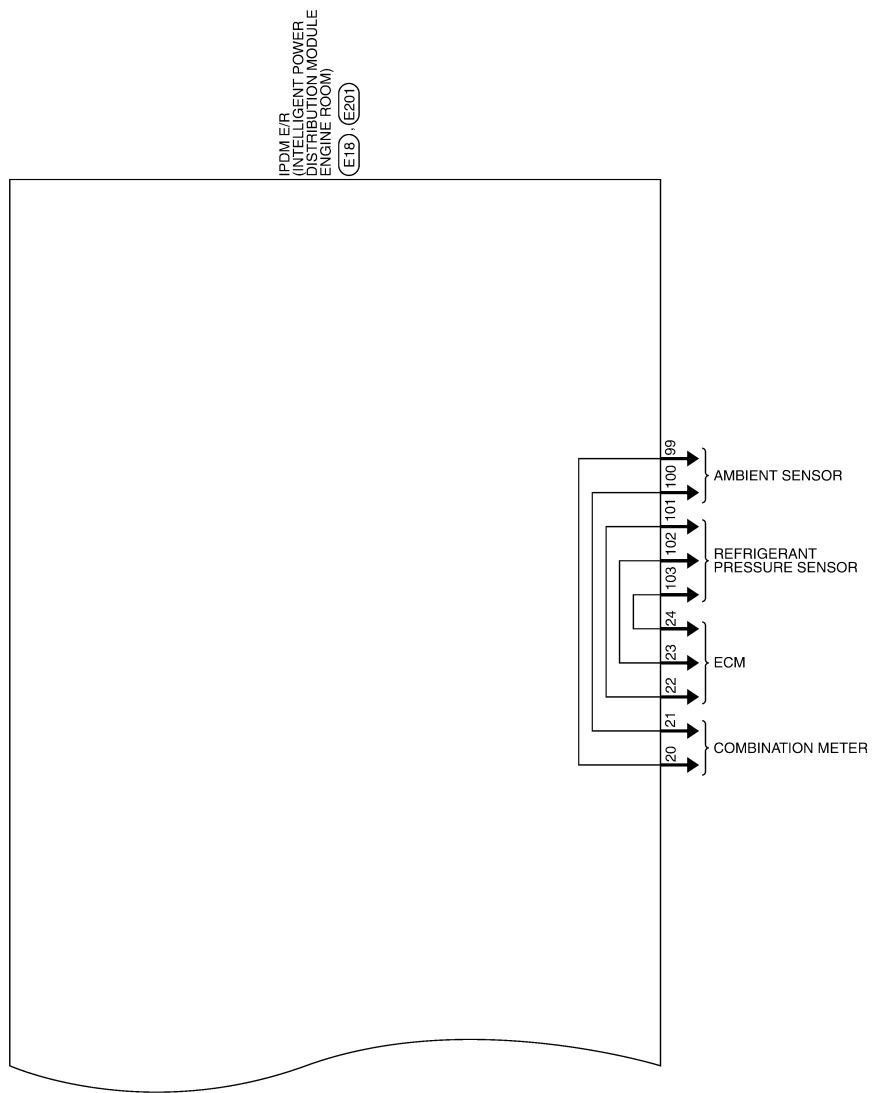

ABMWA0161GI

IPDM E/R (INTELLIGENT POWER DISTRIBUTION MODULE ENGINE ROOM)

< ECU DIAGNOSIS >

IPDM E/R (INTELLIGENT POWER DISTRIBUTION MODULE ENGINE ROOM) CONNECTORS

Connector No.	E1
Connector Name	JOINT CONNECTOR-E01
Connector Color	WHITE



Terminal No.	Color of Wire	Signal Name
2	G	-
3	G	-

Connector No.	E4
Connector Name	FUSIBLE LINK BOX (BATTERY)
Connector Color	BROWN



Terminal No.	Color of Wire	Signal Name
1	B/W	-
2	B/Y	-

Connector No.	E5
Connector Name	FUSIBLE LINK BOX (BATTERY)
Connector Color	GRAY



Terminal No.	Color of Wire	Signal Name
3	R	-

Connector No.	E16
Connector Name	IPDM E/R (INTELLIGENT POWER DISTRIBUTION MODULE ENGINE ROOM)
Connector Color	BLACK



Terminal No.	Color of Wire	Signal Name
1	R	F/L_MAIN
2	L	F/L_USM

Connector No.	E17
Connector Name	IPDM E/R (INTELLIGENT POWER DISTRIBUTION MODULE ENGINE ROOM)
Connector Color	WHITE



Terminal No.	Color of Wire	Signal Name
39	P	CAN-L
40	L	CAN-H
41	B	GND (SIGNAL)
42	SB	MOTOR_FAN_RLY_MID
43	G/B	DETENT_SW
44	G/W	HORN_RLY
45	L/O	HORN_SW
46	R	START_CONT

IPDM E/R (INTELLIGENT POWER DISTRIBUTION MODULE ENGINE ROOM)

< ECU DIAGNOSIS >

Connector No.	E18
Connector Name	IPDM E/R (INTELLIGENT POWER DISTRIBUTION MODULE ENGINE ROOM)
Connector Color	WHITE

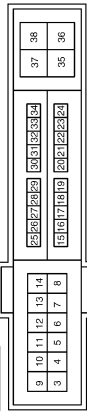

Terminal No.	Color of Wire	Signal Name
3	-	-
4	L/R	FR_WIPER_LO
5	L/B	FR_WIPER_HI
6	SB	DTRL
7	R/L	TAIL/ILLUMI

Terminal No.	Color of Wire	Signal Name
8	-	-
9	-	-
10	R/B	ECM_VB
11	P/L	ESCL
12	B	GND (POWER)
13	W	FUEL_PUMP
14	-	-
15	G/W	START_IG-E/R
16	L/Y	WIPER_AUTOSTOP
17	-	-
18	-	-
19	L/Y	BCM_IGNSW
20	B/Y	AMB_SENS_GND-E/R
21	O/B	AMB_SENS_SIG-E/R
22	W/R	PD_SENS_GND-E/R

Terminal No.	Color of Wire	Signal Name
23	B/R	PD_SENS_SIG-E/R
24	BR/W	PD_SENS_PWR-E/R
25	GR	ABS_ECU
26	-	-
27	BR/W	IGN_SIGNAL
28	BR	PUSH_START_SW
29	-	-
30	R/B	CLUTCH_I/L_SW
31	-	-
32	L/O	SL_CONDITION_1
33	G/R	SL_CONDITION_2
34	O/L	MOTOR_FAN_RLY_HI
35	L/B	MOTOR_FAN_LO
36	G	F/L_IGNSW
37	-	-
38	R/W	F/L_MOTOR_FAN

Connector No.	E200
Connector Name	IPDM E/R (INTELLIGENT POWER DISTRIBUTION MODULE ENGINE ROOM)
Connector Color	WHITE

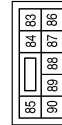

Terminal No.	Color of Wire	Signal Name
83	R/Y	HEADLAMP_LO_RH
84	L	HEADLAMP_LO_LH
85	-	-
86	W/R	FR_FOG_LAMP_RH
87	L/Y	FR_FOG_LAMP_LH
88	R/W	WASHER_MTR
89	L/W	HEADLAMP_HI_RH
90	G	HEADLAMP_HI_LH

Connector No.	E201
Connector Name	IPDM E/R (INTELLIGENT POWER DISTRIBUTION MODULE ENGINE ROOM)
Connector Color	WHITE

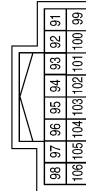

Terminal No.	Color of Wire	Signal Name
91	LG/R	CLEARANCE_RH
92	LG/B	CLEARANCE_LH
93	-	-
94	-	-
95	-	-
96	-	-
97	-	-

Terminal No.	Color of Wire	Signal Name
98	-	-
99	BR/W	AMB_SENS_GND-FEM
100	SB	AMB_SENS_SIG-FEM
101	O/L	PD_SENS_GND-FEM
102	R/B	PD_SENS_SIG-FEM
103	P	PD_SENS_PWR-FEM
104	-	-
105	V	DTRL_RLY
106	-	-

IPDM E/R (INTELLIGENT POWER DISTRIBUTION MODULE ENGINE ROOM)

< ECU DIAGNOSIS >

Terminal No.	Color of Wire	Signal Name
65	-	-
66	-	-
67	-	-
68	-	-
69	W/B	SSOF
70	O	MOTRLY
71	-	-
72	R/B	NPSW
73	-	-
74	Y	START_IG-EGI
75	P/L	OIL_PRESSURE_SW
76	GR	ALT_C
77	B/R	FPR
78	-	-
79	-	-
80	B/W	STARTER_MOTOR
81	-	-
82	-	-

Terminal No.	Color of Wire	Signal Name
50	-	-
51	LG	INJECTOR_#1
52	Y/G	INJECTOR_#2
53	R/B	IGN_SOL (WITH QR25DE)
53	B/R	ENG_SOL (WITH VQ35DE)
54	G/W	ETC
55	W/L	ECM_BAT
56	R/Y	O2_SENS_#1
57	O	O2_SENS_#2
58	Y	AT_ECU
59	-	-
60	-	-
61	-	-
62	-	-
63	-	-
64	-	-

Connector No.	F10
Connector Name	IPDM E/R (INTELLIGENT POWER DISTRIBUTION MODULE ENGINE ROOM)
Connector Color	WHITE

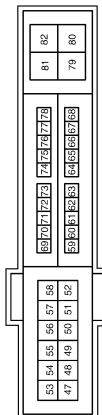

Terminal No.	Color of Wire	Signal Name
47	-	-
48	Y/R	A/C COMP
49	B/R	ENG SOL (WITH QR25DE)
49	R/B	IGN_SOL (WITH VQ35DE)

A
B
C
D
E
F
G
H
I
J
K
L
M
N
O
P

WW

ABMIA0473GB

INFOID:000000004505091

Fail Safe

CAN COMMUNICATION CONTROL

When CAN communication with ECM and BCM is impossible, IPDM E/R performs fail-safe control. After CAN communication recovers normally, it also returns to normal control.

If No CAN Communication Is Available With ECM

IPDM E/R (INTELLIGENT POWER DISTRIBUTION MODULE ENGINE ROOM)

< ECU DIAGNOSIS >

Control part	Fail-safe in operation
Cooling fan	<ul style="list-style-type: none"> • Signals cooling fans ON when the ignition switch is turned ON • Signals cooling fans OFF when the ignition switch is turned OFF
A/C compressor	A/C relay OFF
Generator	Outputs the power generation command signal (PWM signal) 0%

If No CAN Communication Is Available With BCM

Control part	Fail-safe in operation
Headlamp	<ul style="list-style-type: none"> • Turns ON the headlamp low relay when the ignition switch is turned ON • Turns OFF the headlamp low relay when the ignition switch is turned OFF • Headlamp high relay OFF
<ul style="list-style-type: none"> • Parking lamps • License plate lamps • Illumination • Tail lamps 	<ul style="list-style-type: none"> • Turns ON the tail lamp relay when the ignition switch is turned ON • Turns OFF the tail lamp relay when the ignition switch is turned OFF
Front wiper	<ul style="list-style-type: none"> • The status just before activation of fail-safe control is maintained until the ignition switch is turned OFF while the front wiper is operating at LO or HI speed. • The wiper is operated at LO speed until the ignition switch is turned OFF if the fail-safe control is activated while the front wiper is set in the INT mode and the front wiper motor is operating.
Front fog lamps (if equipped)	Front fog lamp relay OFF
Horn	Horn OFF
Ignition relay	The status just before activation of fail-safe is maintained.
Starter motor	Starter control relay OFF
Electronic steering column lock unit	Electronic steering column lock relay OFF

IGNITION RELAY MALFUNCTION DETECTION FUNCTION

- IPDM E/R monitors the voltage at the contact circuit and excitation coil circuit of the ignition relay inside it.
- IPDM E/R judges the ignition relay error if the voltage differs between the contact circuit and the excitation coil circuit.
- If the ignition relay cannot turn OFF due to contact seizure, it activates the tail lamp relay for 10 minutes to alert the user to the ignition relay malfunction when the ignition switch is turned OFF.

DTC	Ignition switch	Ignition relay	Tail lamp relay
—	ON	ON	—
—	OFF	OFF	—
B2098: IGN RELAY ON	OFF	ON	ON (10 minutes)
B2099: IGN RELAY OFF	ON	OFF	—

NOTE:

The tail lamp turns OFF when the ignition switch is turned ON.

FRONT WIPER CONTROL

IPDM E/R detects front wiper stop position by a front wiper auto stop signal.

When a front wiper auto stop signal is in the conditions listed below, IPDM E/R stops power supply to wiper after repeating a front wiper 10 second activation and 20 second stop five times.

Ignition switch	Front wiper switch	Auto stop signal
ON	OFF	Front wiper stop position signal cannot be input 10 seconds.
	ON	The signal does not change for 10 seconds.

NOTE:

This operation status can be confirmed on the IPDM E/R “Data Monitor” that displays “BLOCK” for the item “WIP PROT” while the wiper is stopped.

IPDM E/R (INTELLIGENT POWER DISTRIBUTION MODULE ENGINE ROOM)

< ECU DIAGNOSIS >

STARTER MOTOR PROTECTION FUNCTION

IPDM E/R turns OFF the starter control relay to protect the starter motor when the starter control relay remains active for 90 seconds.

DTC Index

INFOID:000000004505092

CONSULT-III display	Fail-safe	TIME ^{NOTE}		Refer to
No DTC is detected. further testing may be required.	—	—	—	—
U1000: CAN COMM CIRCUIT	×	CRNT	1 – 39	PCS-20
B2098: IGN RELAY ON	×	CRNT	1 – 39	PCS-21
B2099: IGN RELAY OFF	—	CRNT	1 – 39	PCS-22
B2108: STRG LCK RELAY ON	—	CRNT	1 – 39	SEC-42
B2109: STRG LCK RELAY OFF	—	CRNT	1 – 39	SEC-43
B210A: STRG LCK STATE SW	—	CRNT	1 – 39	SEC-44
B210B: START CONT RLY ON	—	CRNT	1 – 39	SEC-48
B210C: START CONT RLY OFF	—	CRNT	1 – 39	SEC-49
B210D: STARTER RELAY ON	—	CRNT	1 – 39	SEC-50
B210E: STARTER RELAY OFF	—	CRNT	1 – 39	SEC-51
B210F: INTRLCK/PNP SW ON	—	CRNT	1 – 39	SEC-54
B2110: INTRLCK/PNP SW OFF	—	CRNT	1 – 39	SEC-59

NOTE:

The details of TIME display are as follows.

- CRNT: The malfunctions that are detected now
- 1 - 39: The number is indicated when it is normal at present and a malfunction was detected in the past. It increases like 0 → 1 → 2 ··· 38 → 39 after returning to the normal condition whenever IGN OFF → ON. It is fixed to 39 until the self-diagnosis results are erased if it is over 39. It returns to 0 when a malfunction is detected again in the process.

A
B
C
D
E
F
G
H
I
J
K
M
N
O
P

WW

FRONT WIPER AND WASHER SYSTEM SYMPTOMS

< SYMPTOM DIAGNOSIS >

SYMPTOM DIAGNOSIS

FRONT WIPER AND WASHER SYSTEM SYMPTOMS

Symptom Table

INFOID:000000004202208

CAUTION:

Perform the self-diagnosis with CONSULT-III before performing the diagnosis by symptom. Perform the diagnosis by DTC if DTC is detected.

Symptom	Probable malfunction location	Inspection item	
Front wiper does not operate	HI only	<ul style="list-style-type: none"> • Combination switch • Harness between combination switch and BCM • BCM 	Combination switch Refer to BCS-10, "System Description" .
		<ul style="list-style-type: none"> • IPDM E/R • Harness between IPDM E/R and wiper motor • Front wiper motor 	Front wiper motor (HI) circuit Refer to WW-22, "Component Function Check" .
		Front wiper request signal <ul style="list-style-type: none"> • BCM • IPDM E/R 	IPDM E/R Data monitor "FR WIP REQ"
	LO and INT	<ul style="list-style-type: none"> • Combination switch • Harness between combination switch and BCM • BCM 	Combination switch Refer to BCS-10, "System Description" .
		<ul style="list-style-type: none"> • IPDM E/R • Harness between IPDM E/R and wiper motor • Front wiper motor 	Front wiper motor (LO) circuit Refer to WW-20, "Component Function Check" .
		Front wiper request signal <ul style="list-style-type: none"> • BCM • IPDM E/R 	IPDM E/R Data monitor "FR WIP REQ"
	INT only	<ul style="list-style-type: none"> • Combination switch • Harness between combination switch and BCM • BCM 	Combination switch Refer to BCS-10, "System Description" .
		Front wiper request signal <ul style="list-style-type: none"> • BCM • IPDM E/R 	IPDM E/R Data monitor "FR WIP REQ"
	HI, LO, and INT	SYMPTOM DIAGNOSIS Refer to WW-108, "Diagnosis Procedure" .	

FRONT WIPER AND WASHER SYSTEM SYMPTOMS

< SYMPTOM DIAGNOSIS >

Symptom		Probable malfunction location	Inspection item
Front wiper does not stop	HI only	<ul style="list-style-type: none"> • Combination switch • BCM 	Combination switch Refer to BCS-10. "System Description" .
		Front wiper request signal <ul style="list-style-type: none"> • BCM • IPDM E/R 	IPDM E/R Data monitor "FR WIP REQ"
		IPDM E/R	—
	LO only	<ul style="list-style-type: none"> • Combination switch • BCM 	Combination switch Refer to BCS-10. "System Description" .
		Front wiper request signal <ul style="list-style-type: none"> • BCM • IPDM E/R 	IPDM E/R Data monitor "FR WIP REQ"
		IPDM E/R	—
	INT only	<ul style="list-style-type: none"> • Combination switch • BCM 	Combination switch refer to BCS-10. "System Description" .
		Front wiper request signal <ul style="list-style-type: none"> • BCM • IPDM E/R 	IPDM E/R Data monitor "FR WIP REQ"
	Front wiper does not operate normally	Intermittent adjustment cannot be performed	<ul style="list-style-type: none"> • Combination switch • Harness between combination switch and BCM • BCM
BCM			—
Intermittent control linked with vehicle speed cannot be performed		Check the vehicle speed detection wiper setting. Refer to BCS-26. "WIPER : CONSULT - III Function" .	
Wiper is not linked to the washer operation		<ul style="list-style-type: none"> • Combination switch • Harness between combination switch and BCM • BCM 	Combination switch Refer to BCS-10. "System Diagram" .
		BCM	—
Does not return to stop position (Repeatedly operates for 10 seconds and then stops for 20 seconds. After that, it stops the operation.)	<ul style="list-style-type: none"> • IPDM E/R • Harness between IPDM E/R and front wiper motor • Front wiper motor 	Front wiper auto stop signal circuit Refer to WW-24. "Component Function Check" .	

A
B
C
D
E
F
G
H
I
J
K
M
N
O
P

WW

FRONT WIPER DOES NOT OPERATE

< SYMPTOM DIAGNOSIS >

FRONT WIPER DOES NOT OPERATE

Description

INFOID:000000004202209

The front wiper does not operate under any operation conditions

Diagnosis Procedure

INFOID:000000004202210

1. CHECK WIPER RELAY OPERATION

⊗ IPDM E/R AUTO ACTIVE TEST

1. Start IPDM E/R auto active test. Refer to [PCS-14, "Diagnosis Description"](#).
2. Check that the front wiper operates at the LO/HI operation.

Ⓟ CONSULT-III ACTIVE TEST

1. Select "FRONT WIPER" of IPDM E/R active test item.
2. While operating the test item, check that front wiper LO/HI operation and OFF.

Lo : Front wiper LO operation

Hi : Front wiper HI operation

Off : Stop the front wiper.

Does the front wiper operate?

YES >> GO TO 5

NO >> GO TO 2

2. CHECK FRONT WIPER MOTOR FUSE

1. Turn the ignition switch OFF.
2. Check that the front wiper motor fuse 30A (No. 55, located in the IPDM E/R) is not blown.

Is the fuse blown?

YES >> Replace the fuse after repairing the affected circuit.

NO >> GO TO 3

3. CHECK FRONT WIPER MOTOR (GND) OPEN CIRCUIT

1. Turn the ignition switch OFF.
2. Disconnect front wiper motor.
3. Check continuity between front wiper motor harness connector and ground.

Front wiper motor		Ground	Continuity
Connector	Terminal		
E25	2		Yes

Does continuity exist?

YES >> GO TO 4

NO >> Repair or replace harness.

4. CHECK FRONT WIPER MOTOR OUTPUT VOLTAGE

Ⓟ CONSULT-III ACTIVE TEST

1. Turn the ignition switch OFF.
2. Turn the ignition switch ON.
3. Select "FRONT WIPER" of IPDM E/R active test item.
4. With operating the test item, check voltage between IPDM E/R harness connector and ground.

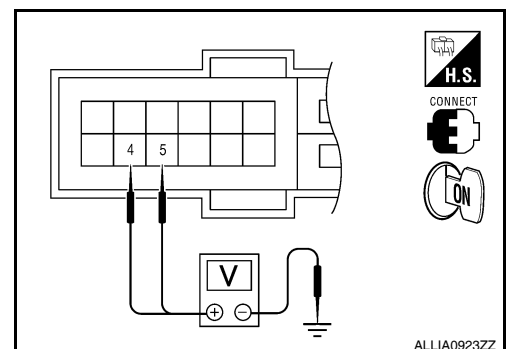
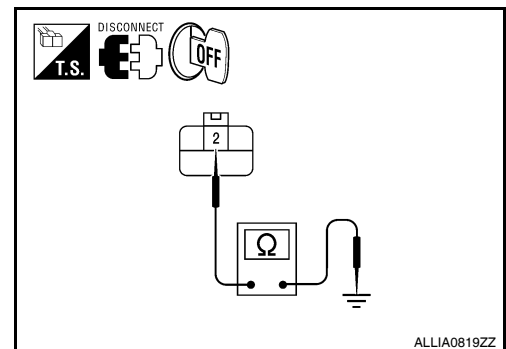

FRONT WIPER DOES NOT OPERATE

< SYMPTOM DIAGNOSIS >

Terminals		Test item	Voltage (V) (Approx.)		
(+)	(-)				
IPDM E/R		FRONT WIPER			
Connector	Terminal				
E18	4			Lo	Battery voltage
	5			Off	0 V
Ground		Hi	Battery voltage		
		Off	0 V		

Is the measurement normal?

YES LO circuit>>Refer to [WW-20, "Diagnosis Procedure"](#).

YES HI circuit>>Refer to [WW-22, "Diagnosis Procedure"](#).

NO >> Replace IPDM E/R. Refer to [PCS-48, "Removal and Installation"](#).

5. CHECK FRONT WIPER REQUEST SIGNAL INPUT

CONSULT-III DATA MONITOR

1. Select "FR WIP REQ" of IPDM E/R "DATA MONITOR" item.
2. Switch the front wiper switch to HI and LO.
3. With operating the front wiper switch, check the monitor status.

Monitor item	With operating the front wiper switch condition		Monitor status
	Front wiper switch HI	Front wiper switch LO	
FR WIP REQ	ON	ON	Hi
		OFF	Stop
	OFF	ON	Low
		OFF	Stop

Is the status of item normal?

YES >> Replace IPDM E/R. Refer to [PCS-48, "Removal and Installation"](#).

NO >> GO TO 6

6. CHECK COMBINATION SWITCH

1. Perform the inspection of the combination switch. Refer to [BCS-10, "System Description"](#).

Is combination switch normal?

YES >> Replace BCM. Refer to [BCS-96, "Removal and Installation"](#).

NO >> Repair or replace the malfunctioning parts.

A
B
C
D
E
F
G
H
I
J
K
M
N
O
P

WW

NORMAL OPERATING CONDITION

< SYMPTOM DIAGNOSIS >

NORMAL OPERATING CONDITION

Description

INFOID:000000004202211

FRONT WIPER MOTOR PROTECTION FUNCTION

- IPDM E/R may stop the front wiper to protect the front wiper motor if any obstruction (operation resistance) such as a large amount of snow is detected during the front wiper operation.
- At that time turn OFF the front wiper and remove the foreign object. Then wait for approximately 20 seconds or more and reactivate the front wiper. The wiper will operate normally.

PRECAUTIONS

< PRECAUTION >

PRECAUTION

PRECAUTIONS

Supplemental Restraint System (SRS) AIR BAG and SEAT BELT PRE-TENSIONER

INFOID:000000004202212

The Supplemental Restraint System such as "AIR BAG" and "SEAT BELT PRE-TENSIONER", used along with a front seat belt, helps to reduce the risk or severity of injury to the driver and front passenger for certain types of collision. This system includes seat belt switch inputs and dual stage front air bag modules. The SRS system uses the seat belt switches to determine the front air bag deployment, and may only deploy one front air bag, depending on the severity of a collision and whether the front occupants are belted or unbelted. Information necessary to service the system safely is included in the SR and SB section of this Service Manual.

WARNING:

- To avoid rendering the SRS inoperative, which could increase the risk of personal injury or death in the event of a collision which would result in air bag inflation, all maintenance must be performed by an authorized NISSAN/INFINITI dealer.
- Improper maintenance, including incorrect removal and installation of the SRS, can lead to personal injury caused by unintentional activation of the system. For removal of Spiral Cable and Air Bag Module, see the SR section.
- Do not use electrical test equipment on any circuit related to the SRS unless instructed to in this Service Manual. SRS wiring harnesses can be identified by yellow and/or orange harnesses or harness connectors.

Necessary for Steering Wheel Rotation After Battery Disconnect

INFOID:000000004513177

NOTE:

- Before removing and installing any control units, first turn the push-button ignition switch to the LOCK position, then disconnect both battery cables.
- After finishing work, confirm that all control unit connectors are connected properly, then re-connect both battery cables.
- Always use CONSULT-III to perform self-diagnosis as a part of each function inspection after finishing work. If a DTC is detected, perform trouble diagnosis according to self-diagnosis results.

This vehicle is equipped with a push-button ignition switch and a steering lock unit.

If the battery is disconnected or discharged, the steering wheel will lock and cannot be turned.

If turning the steering wheel is required with the battery disconnected or discharged, follow the procedure below before starting the repair operation.

OPERATION PROCEDURE

1. Connect both battery cables.

NOTE:

Supply power using jumper cables if battery is discharged.

2. Carry the Intelligent Key or insert it to the key slot and turn the push-button ignition switch to ACC position. (At this time, the steering lock will be released.)
3. Disconnect both battery cables. The steering lock will remain released with both battery cables disconnected and the steering wheel can be turned.
4. Perform the necessary repair operation.
5. When the repair work is completed, re-connect both battery cables. With the brake pedal released, turn the push-button ignition switch from ACC position to ON position, then to LOCK position. (The steering wheel will lock when the push-button ignition switch is turned to LOCK position.)
6. Perform self-diagnosis check of all control units using CONSULT-III.

FRONT WIPER

< ON-VEHICLE REPAIR >

ON-VEHICLE REPAIR

FRONT WIPER

Exploded View

INFOID:000000004202215

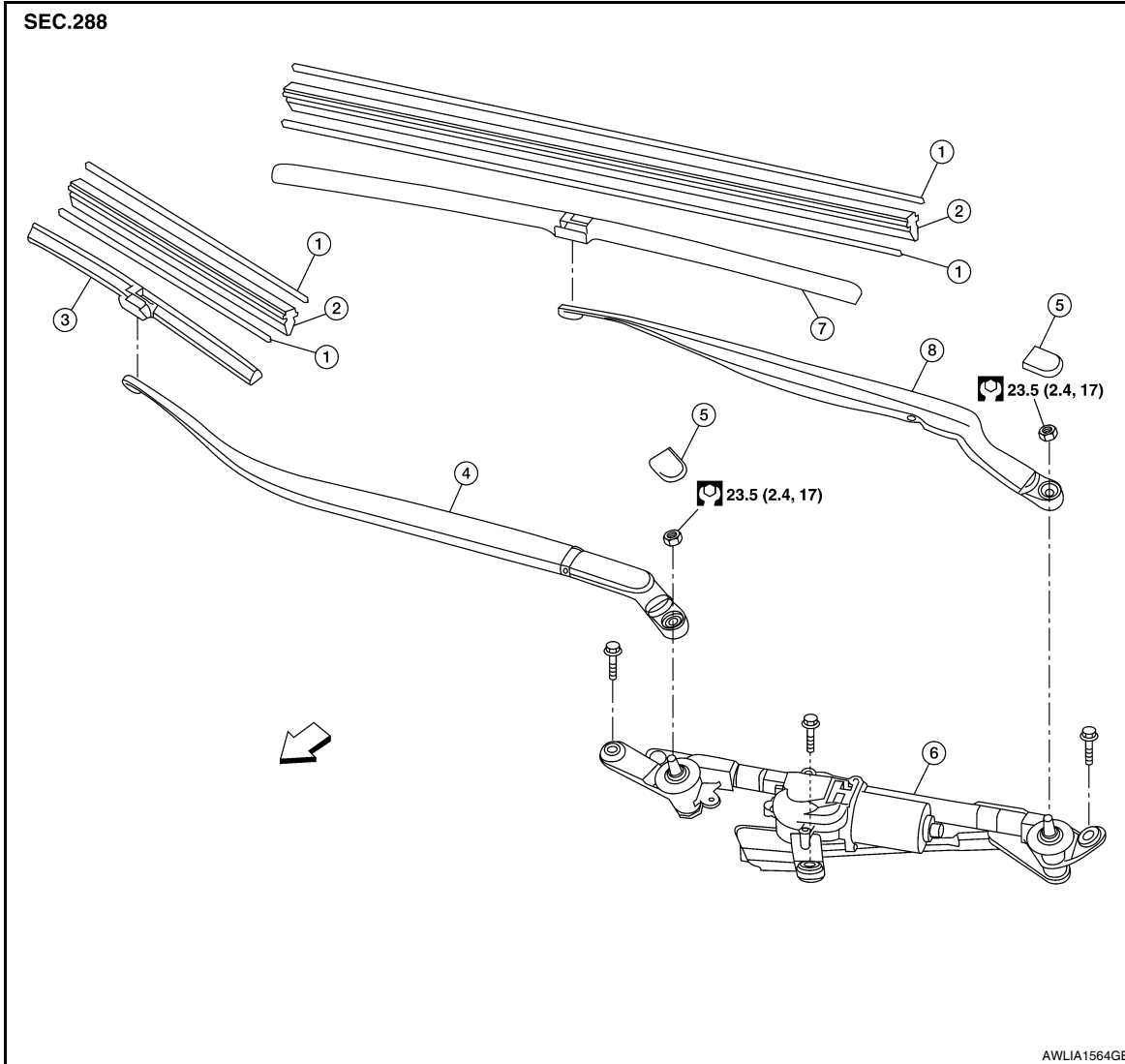

- | | | |
|--|-----------------------|--|
| 1. Rib (part of wiper blade refill) | 2. Wiper blade refill | 3. Front RH wiper blade assembly (includes wiper blade refill) |
| 4. Front RH wiper arm | 5. Wiper arm cap | 6. Front wiper drive assembly |
| 7. Front LH wiper blade assembly (includes wiper blade refill) | 8. Front LH wiper arm | ↔ Front |

FRONT WIPER BLADE REFILL

FRONT WIPER BLADE REFILL : Removal and Installation

INFOID:000000004202216

REMOVAL

1. Remove the front wiper blade. Refer to [WW-115, "FRONT WIPER BLADE : Removal and Installation"](#).

FRONT WIPER

< ON-VEHICLE REPAIR >

2. Hold the wiper blade refill lip at the end (A) of the front wiper blade (1) with a suitable tool (B) as shown, and pull it firmly in the direction (C).
 - U clip (part of the front wiper blade assembly) (D)

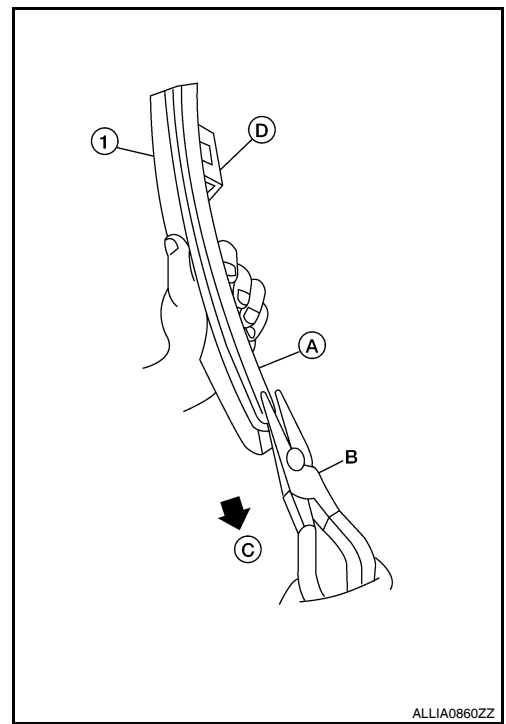

- If the wiper blade refill lip is torn due to wear, insert a suitable tool (A) into the space between the end of the wiper blade refill (1) and the front wiper blade (2) and pull the wiper blade refill (1) out as shown.

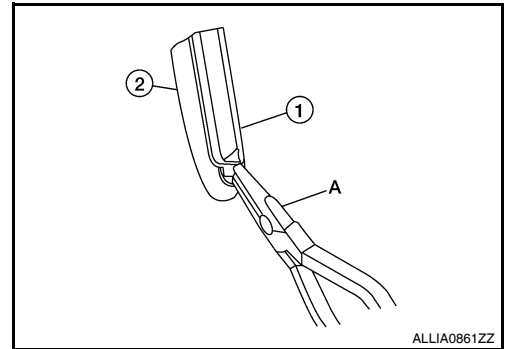

INSTALLATION

1. If the rib (A) has become detached from the wiper blade refill (1), check that the curve of the rib (A) is in the same direction as the curve of the wiper blade refill (1) and insert the rib (A) into the slit (B) in the wiper blade refill (1) as shown.

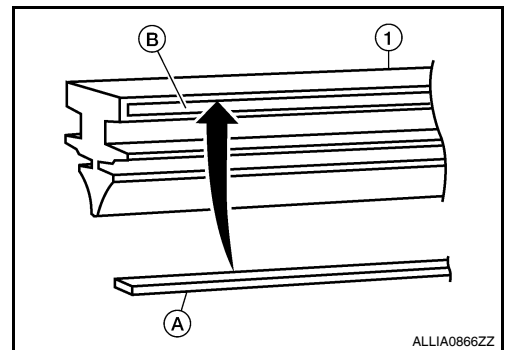

A
B
C
D
E
F
G
H
I
J
K
WW
M
N
O
P

FRONT WIPER

< ON-VEHICLE REPAIR >

- If the rib (A) has a notch (B), insert the rib (A) into the wiper blade refill (1) so the notch (B) fits over the protrusion (C) in the wiper blade refill (1) as shown.

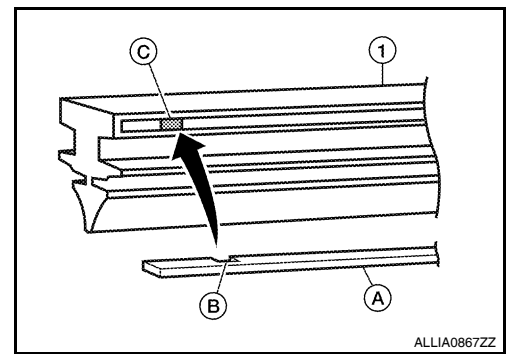

2. Insert the wiper blade refill (1) tip into the end of the front wiper blade (2) in the direction (C). Push the wiper blade refill (1) in while pressing it into the end of the front wiper blade (2) as shown. After the wiper blade refill is fully inserted, remove the holder (B).
- Tab [part of front wiper blade (2)] (A)

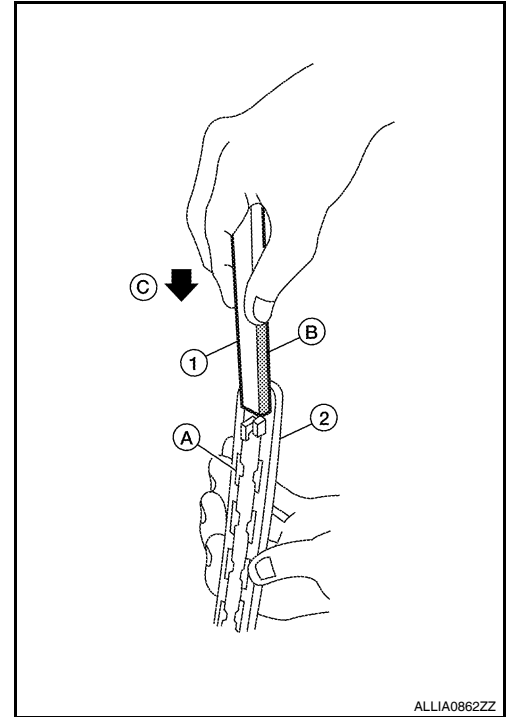

- Make sure to slide the refill into the front wiper blade so that the wiper blade refill is held by the tabs (A) on the front wiper blade as shown.

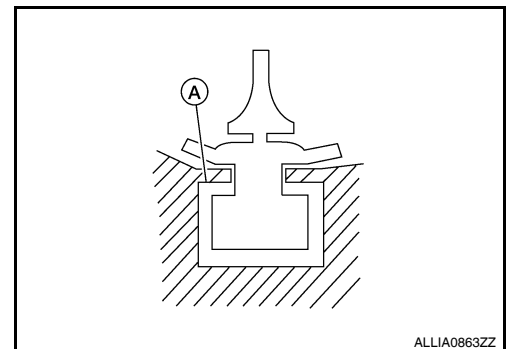

FRONT WIPER

< ON-VEHICLE REPAIR >

3. Push the wiper blade refill (1) until the tabs on the front wiper blade (2) fit into the stoppers (A) in the end of the wiper blade refill (1). Make sure the LOCK mark (B) on the wiper blade refill (1) is aligned with the lock point symbol (C) on the front wiper blade (2) as shown.

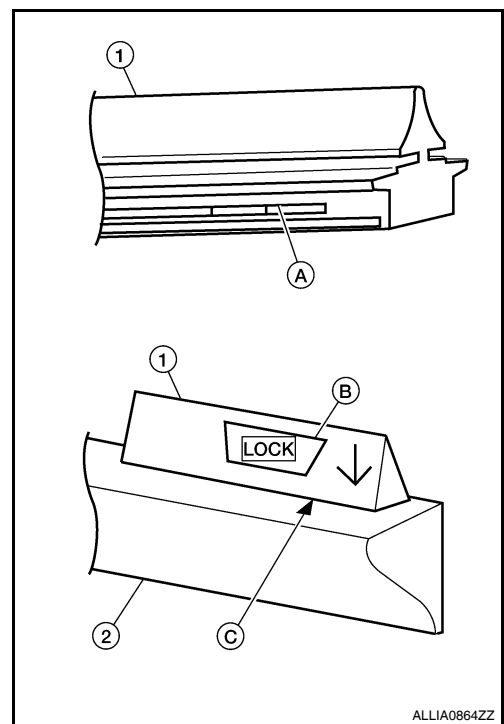

4. Before installing the front wiper blade assembly, make sure that the wiper blade refill (1) end is fully covered by the front wiper blade (2) in area (A) as shown.

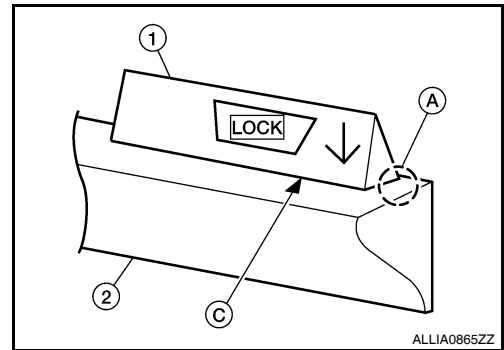

5. Install the front wiper blade. Refer to [WW-115. "FRONT WIPER BLADE : Removal and Installation"](#).

FRONT WIPER BLADE

FRONT WIPER BLADE : Removal and Installation

INFOID:000000004202217

REMOVAL

1. Lift the front wiper arm and wiper blade assembly away from the windshield.
2. Rotate the front wiper blade assembly and push the release tab (A), then move the front wiper blade assembly down (B) the front wiper arm.
3. Remove the front wiper blade assembly.

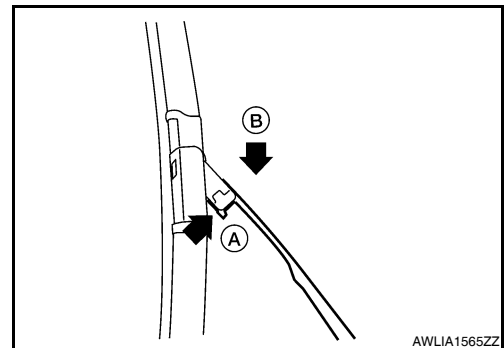

INSTALLATION

CAUTION:

- After the front wiper blade assembly installation, return the front wiper arm to the original position on the windshield to prevent damage when the hood is opened.

A
B
C
D
E
F
G
H
I
J
K
M
N
O
P

FRONT WIPER

< ON-VEHICLE REPAIR >

- Check that the front wiper blade assembly contacts the windshield properly; otherwise the front wiper arm may be damaged from wind pressure while driving.
1. Insert the front wiper blade assembly onto the front wiper arm and slide it up until it clicks into place.
 2. Rotate the front wiper blade assembly so the dimple is in the groove.
 3. Lay the front wiper arm and front wiper blade assembly back down on the windshield.

FRONT WIPER ARMS

FRONT WIPER ARMS : Removal and Installation

INFOID:000000004202218

REMOVAL

1. Turn wiper switch ON to operate wiper motor, and then turn wiper switch OFF (auto stop).
2. Open hood, remove arm caps, and remove wiper arm nuts.
3. Raise wiper arm, and remove wiper arm from the vehicle.

INSTALLATION

1. Clean up the pivot area as shown. This will reduce possibility of wiper arm looseness.

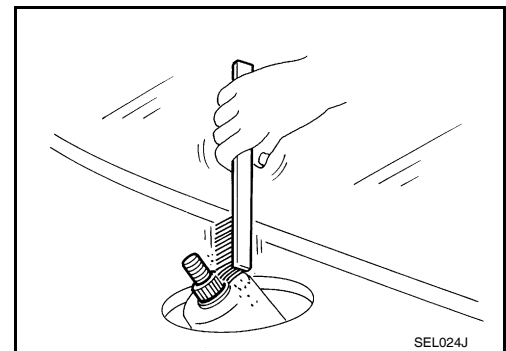

2. Prior to wiper arm installation, turn on wiper switch to operate wiper motor and then turn it "OFF" (auto stop).
3. Push wiper arm onto pivot shaft, paying attention to blind spline.
4. Lift the blade up and then set it down onto glass surface to set the blade center to clearance "A", "B", "C" and "D" immediately before temporarily tightening the wiper arm nuts.
5. Spray washer fluid. Turn on wiper switch to operate wiper motor and then turn it "OFF".
6. Make sure that wiper blades stop within clearance "A", "B", "C" and "D".

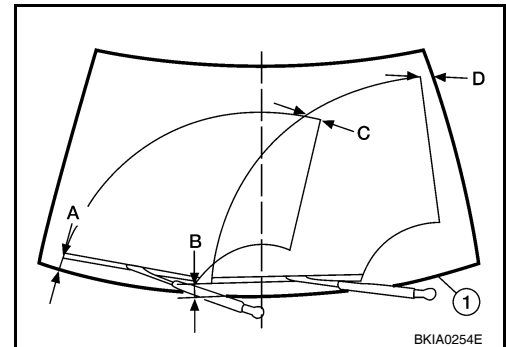

Clearance "A" : 41.3 ± 7.5 mm (1.626 ± 0.295 in)

Clearance "B" : 65.5 ± 7.5 mm (2.579 ± 0.295 in)

Clearance "C" : 27.8 mm (1.094 in)

Clearance "D" : 53.7 mm (2.114 in)

7. Tighten wiper arm nuts to specification. Refer to [WW-112. "Exploded View"](#).
8. Attach wiper arm caps.

ADJUSTMENT

To adjust the wiper arm stop location, the wiper arm must be removed and installed. Refer to [WW-116. "FRONT WIPER ARMS : Removal and Installation"](#).

FRONT WIPER DRIVE ASSEMBLY

FRONT WIPER DRIVE ASSEMBLY : Removal and Installation

INFOID:000000004202219

REMOVAL

1. Operate front wiper motor, and stop at the auto stop position.

FRONT WIPER

< ON-VEHICLE REPAIR >

2. Remove wiper arms. Refer to [WW-116. "FRONT WIPER ARMS : Removal and Installation"](#).
3. Remove the cowl top cover. For Sedan Refer to [EXT-39. "Removal and Installation"](#). For Coupe Refer to [EXT-18. "Removal and Installation"](#).
4. Remove the strut brace bolts (A), detach the wiper drive assembly harness clips, then remove the strut brace (1).

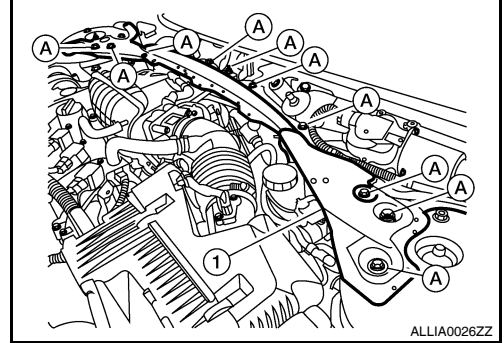

5. Detach the wiper drive harness clip from the wiper drive assembly frame.
6. Remove the front wiper drive assembly bolts (A), disconnect the wiper drive motor connector (B) and remove the front wiper drive assembly (1).

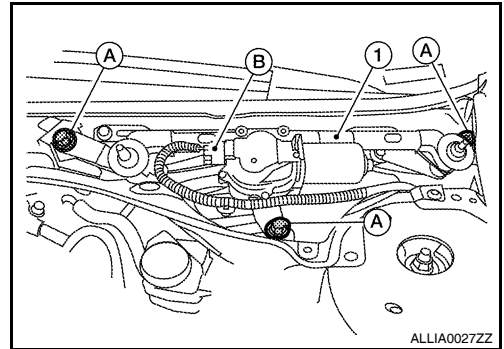

INSTALLATION

1. Install the front wiper drive assembly.
2. Connect wiper motor connector. Turn wiper switch ON to operate wiper motor, then turn wiper switch OFF (auto stop).
3. Attach the wiper drive harness clip to the wiper drive assembly frame.
4. Install the strut brace, then attach the wiper drive assembly harness clips.
5. Install the cowl top cover. For Sedan Refer to [EXT-39. "Removal and Installation"](#). For Coupe Refer to [EXT-18. "Removal and Installation"](#)
6. Attach the wiper arms. Refer to [WW-116. "FRONT WIPER ARMS : Removal and Installation"](#).
7. Adjustment of wiper arm stop location. Refer to [WW-116. "FRONT WIPER ARMS : Removal and Installation"](#).

A
B
C
D
E
F
G
H
I
J
K
L
M
N
O
P

WW

FRONT WASHER

< ON-VEHICLE REPAIR >

FRONT WASHER

WASHER TUBE

WASHER TUBE : Layout

INFOID:000000004202220

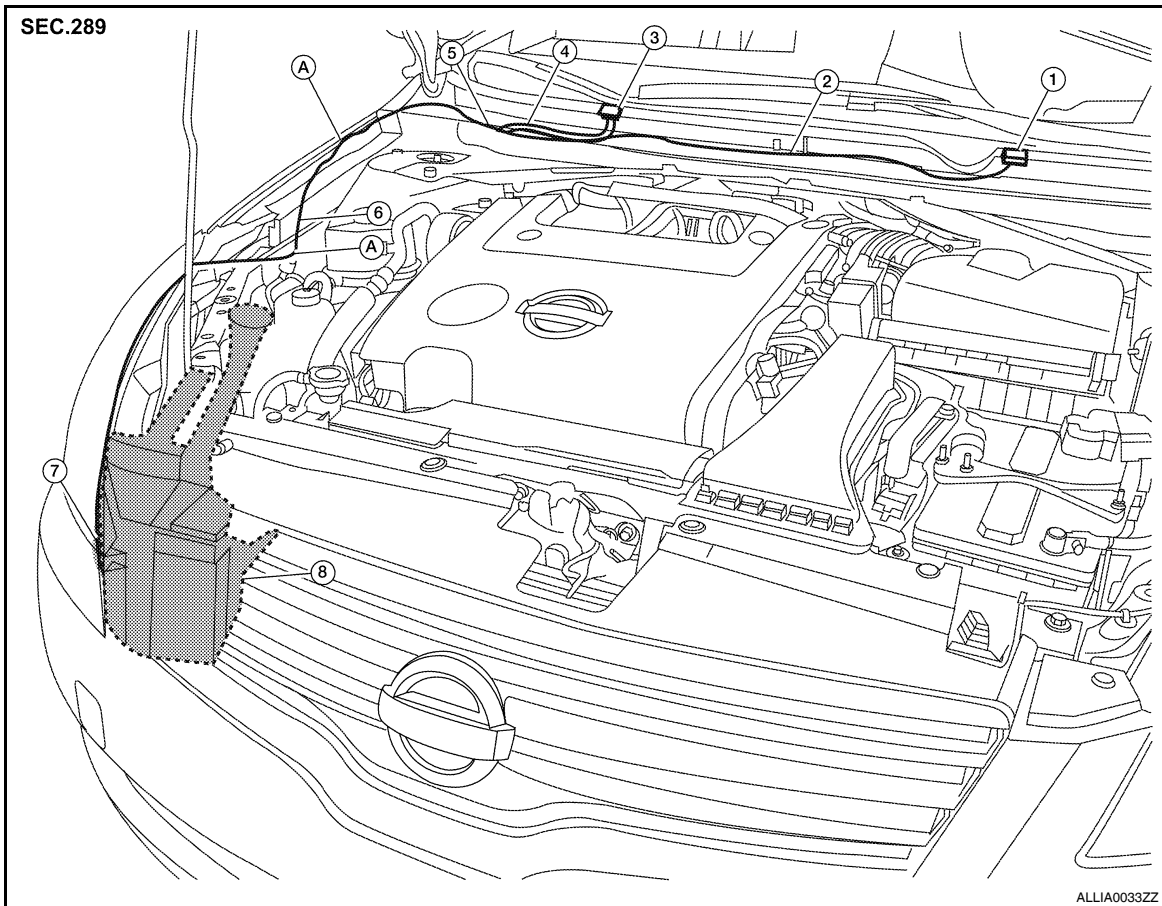

- | | | |
|--------------------------|--------------------------|---------------------|
| 1. Washer nozzle LH | 2. Washer nozzle hose LH | 3. Washer nozzle RH |
| 4. Washer nozzle hose RH | 5. Y-tube connector | 6. Clip |
| 7. Washer tank hose | 8. Washer tank | A. Tube connectors |

FRONT WASHER NOZZLE

FRONT WASHER NOZZLE : Removal and Installation

INFOID:000000004202221

REMOVAL

1. Remove the cowl top cover For Sedan Refer to [EXT-39, "Removal and Installation"](#). For Coupe Refer to [EXT-18, "Removal and Installation"](#)
2. Push washer nozzle tab (A), to release the washer nozzle (1) from the cowl top cover, then disconnect the washer nozzle hose (2).

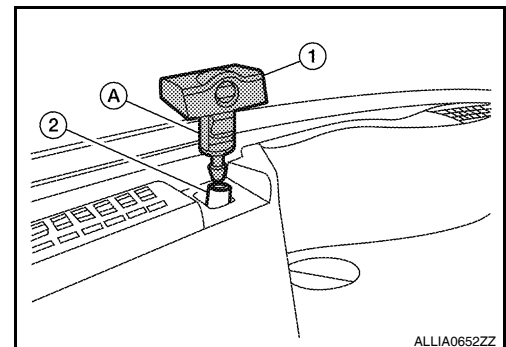

FRONT WASHER

< ON-VEHICLE REPAIR >

INSTALLATION

1. Installation is in the reverse order of removal.
2. Adjust nozzle spray location. Refer to [WW-119, "FRONT WASHER NOZZLE : Adjustment"](#).

FRONT WASHER NOZZLE : Adjustment

INFOID:000000004202222

Adjust spray positions to match the positions as shown.

Unit: mm (in)

Spray position	h (height)	l (width)	Height*1 (spray point area)
A	193.1 (7.53)	487.5 (7.53)	233 (9.17)
B	277.0 (10.91)	318.1 (19.59)	368 (14.49)
C	333.6 (13.13)	115.5 (4.55)	256 (10.08)
D	230.0 (9.06)	81.0 (3.19)	350 (13.78)
E	283.9 (11.18)	280.7 (11.05)	319 (12.56)
F	330.4 (13.01)	483.0 (19.03)	282 (11.10)

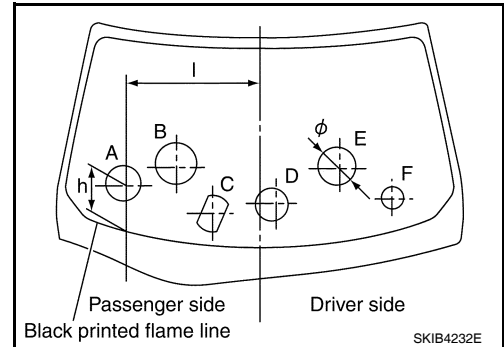

*1: Spray positions are aiming targets, heights are allowable spray patterns above the target points.

Insert a suitable tool (A) into the nozzle hole (B) and move up/down and left/right to adjust the spray position of the nozzle (1).

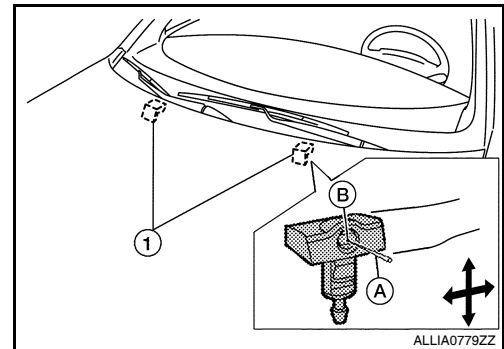

WASHER TANK

WASHER TANK : Removal and Installation

INFOID:000000004202223

REMOVAL

1. Remove the washer tank filler tube (1).

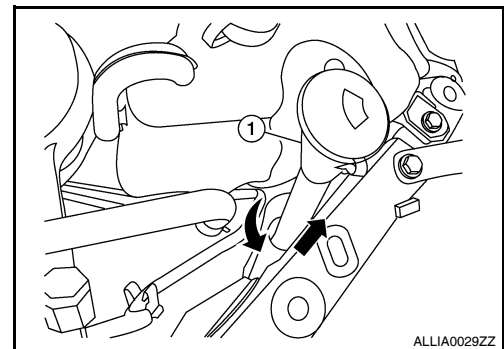

2. Remove engine under cover.
3. Position the RH fender protector back. For Sedan Refer to [EXT-40, "Removal and Installation"](#). For Coupe Refer to [EXT-19, "Removal and Installation"](#).

FRONT WASHER

< ON-VEHICLE REPAIR >

4. Disconnect the washer pump and washer fluid level sensor connectors (C), then detach the connector harness clip (B).
5. Remove the washer tank nuts (A), disconnect the washer pump hose and remove the washer tank (1).

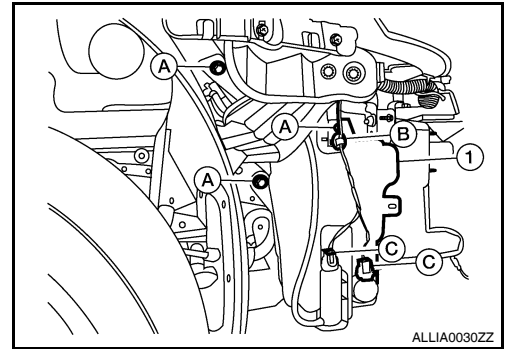

INSTALLATION

Installation is in the reverse order of removal.

CAUTION:

After installation, add Nissan specified fluid up to the upper level of washer tank inlet, and check for leaks. Refer to [MA-12, "Fluids and Lubricants"](#).

FRONT WASHER PUMP

FRONT WASHER PUMP : Removal and Installation

INFOID:000000004202224

Front washer pump is not available separately, it is part of the washer tank. Refer to [WW-119, "WASHER TANK : Removal and Installation"](#).

FRONT WIPER AND WASHER SWITCH

< ON-VEHICLE REPAIR >

FRONT WIPER AND WASHER SWITCH

Removal and Installation

INFOID:000000004202225

NOTE:

The wiper washer switch is part of the combination switch assembly.

REMOVAL

1. Remove the spiral cable. Refer to [SR-8, "Removal and Installation"](#).
2. Disconnect the combination switch connector and remove the combination switch assembly.

INSTALLATION

Installation is in the reverse order of removal.

A

B

C

D

E

F

G

H

I

J

K

WW

M

N

O

P