

SECTION **EX**
EXHAUST SYSTEM

A
EX
C
D
E
F
G
H
I
J
K
L
M

CONTENTS

PREPARATION	2	EXHAUST SYSTEM	3
Special Service Tool	2	Removal and Installation	3
Commercial Service Tool	2		

PREPARATION

PREPARATION

PFP:00002

Special Service Tool

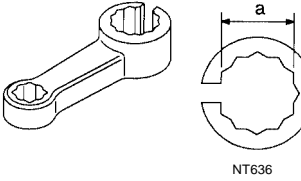

EBS00CDR

The actual shapes of Kent-Moore tools may differ from those of special service tools illustrated here.

Tool number (Kent-Moore No.) Tool name	Description
KV10114400 (J38365) Heated oxygen sensor wrench 	Loosening or tightening rear heated oxygen sensor a: 22 mm (0.87 in)

Commercial Service Tool

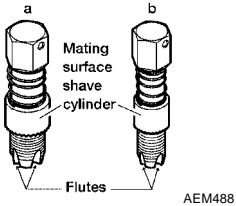
EBS00CDS

Tool name	Description
(J-43897-18) (J-43897-12) Oxygen sensor thread cleaner 	Reconditioning the exhaust system threads before installing a new oxygen sensor. Use with anti-seize lubricant shown in Commercial Service Tools. a: J-43897-18 18mm diameter, for Zirconia Oxygen Sensor b: J-43897-12 12mm diameter, for Titania Oxygen Sensor
Anti-seize lubricant Permatex™ 133AR or equivalent meeting MIL specification MIL-A-907 	Lubricating oxygen sensor thread cleaning tool when reconditioning exhaust system threads.

EXHAUST SYSTEM

EXHAUST SYSTEM

PFP:20100

Removal and Installation

EBS00CDT

A

CAUTION:

- Always replace the exhaust tube gaskets with new ones when reassembling the system.
- With the engine running, check all of the exhaust tube connections for exhaust gas leaks, and the entire system for any unusual noises.
- Check to ensure that the mounting brackets and mounting insulators are installed properly and are free from undue stress. Improper installation could result in excessive noise or vibration.
- Discard any heated oxygen sensor which has been dropped from a height of more than 0.5 m (19.7 in) onto a hard surface such as a concrete floor, replace it with a new one.
- Before installing a new oxygen sensor, clean the exhaust tube threads using Oxygen Sensor Thread Cleaner tool J-43897-18 or J-43897-12 and approved anti-seize lubricant.
- Do not over-tighten the oxygen sensor. Over-tightening may cause damage to the oxygen sensor, resulting in the MIL coming on.

EX

C

D

E

F

G

H

I

J

K

L

M

EXHAUST SYSTEM

KA24DE Models

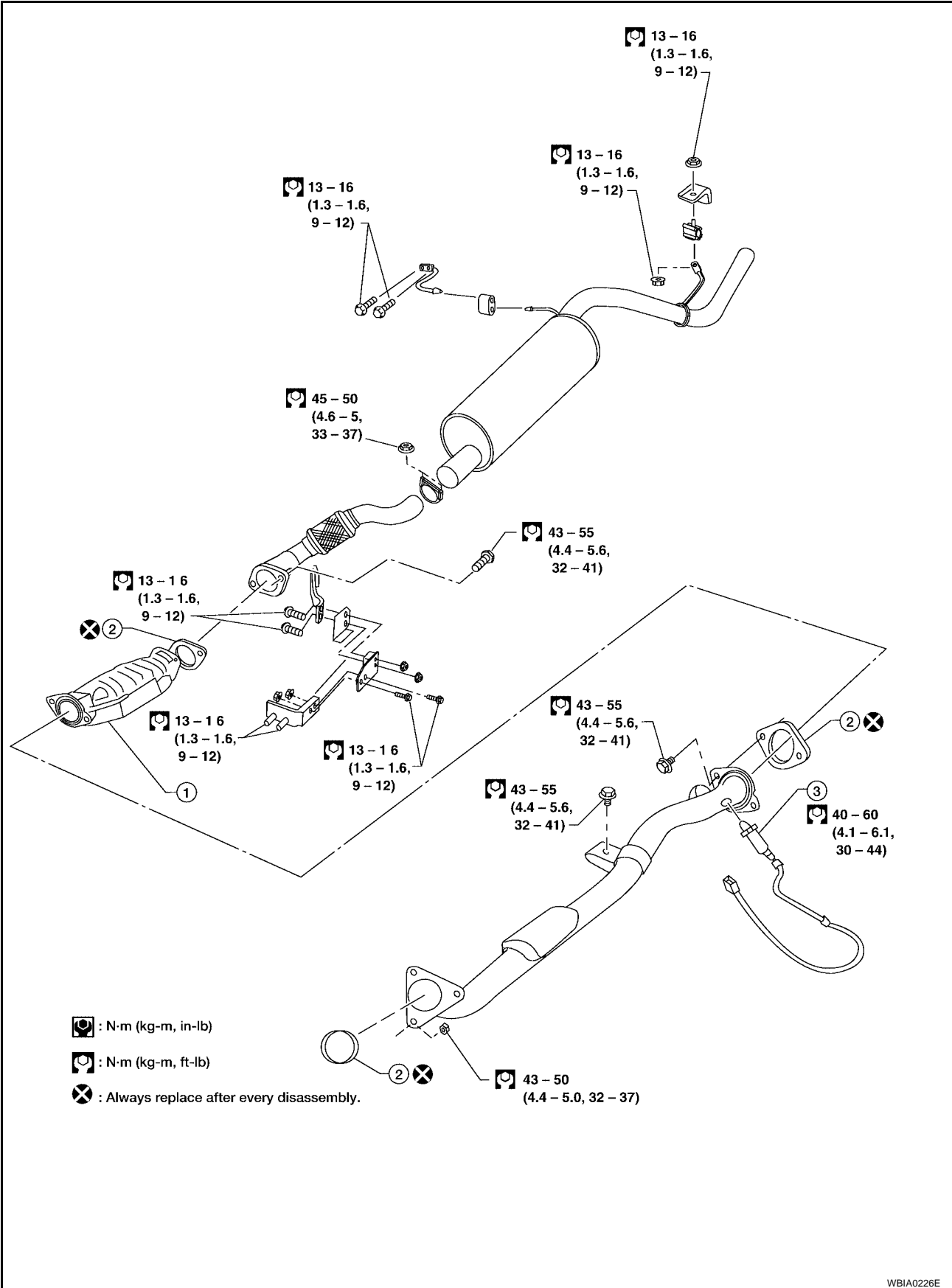

1. Three way convertor (under floor) 2. Gasket 3. Heated oxygen sensor 2 (rear)

EXHAUST SYSTEM

VG33E 2WD Models

SEC. 200

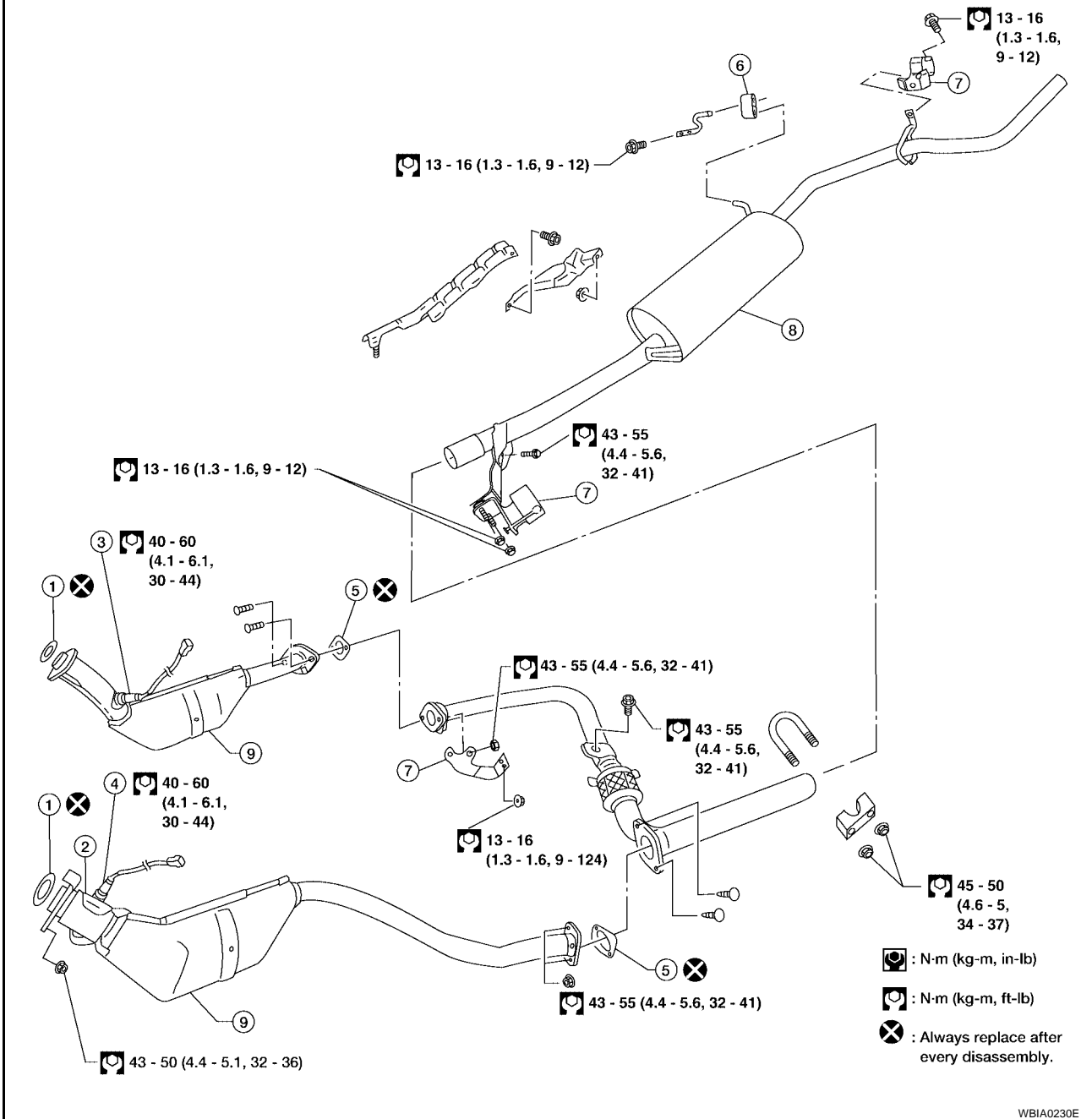

WBIA0230E

- | | | |
|------------------------------------|-------------------|------------------------------------|
| 1. Gasket | 2. Front tube | 3. Heated oxygen sensor 2 (bank 1) |
| 4. Heated oxygen sensor 2 (bank 2) | 5. Gasket | 6. Mounting rubber |
| 7. Mounting bracket | 8. Center muffler | 9. Three way convertor |

EXHAUST SYSTEM

VG33E 4WD Models

SEC. 200

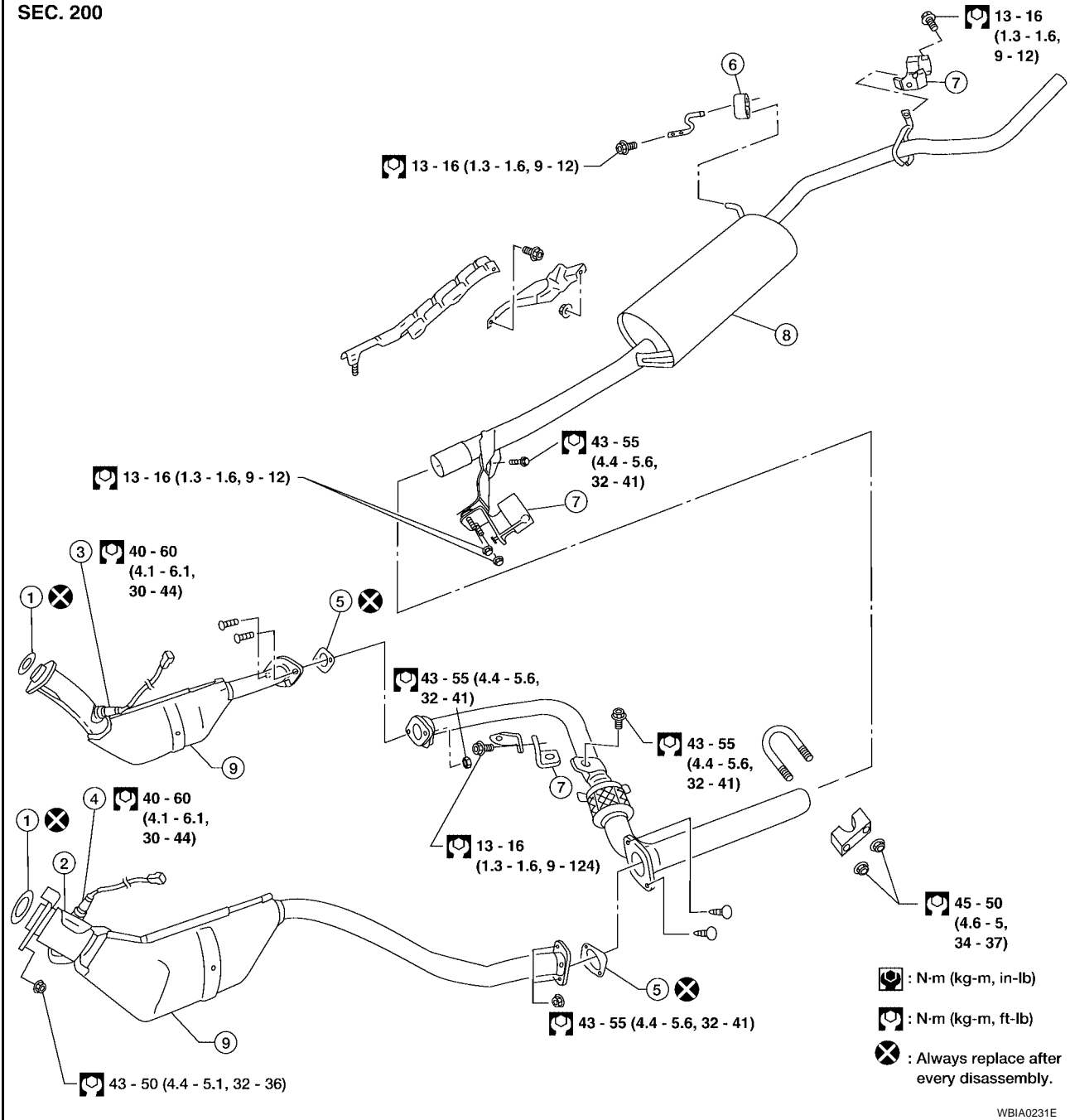

WBIA0231E

- | | | |
|------------------------------------|-------------------|------------------------------------|
| 1. Gasket | 2. Front tube | 3. Heated oxygen sensor 2 (bank 1) |
| 4. Heated oxygen sensor 2 (bank 2) | 5. Gasket | 6. Mounting rubber |
| 7. Mounting bracket | 8. Center muffler | 9. Three way convertor |

EXHAUST SYSTEM

VG33ER Models

SEC. 200

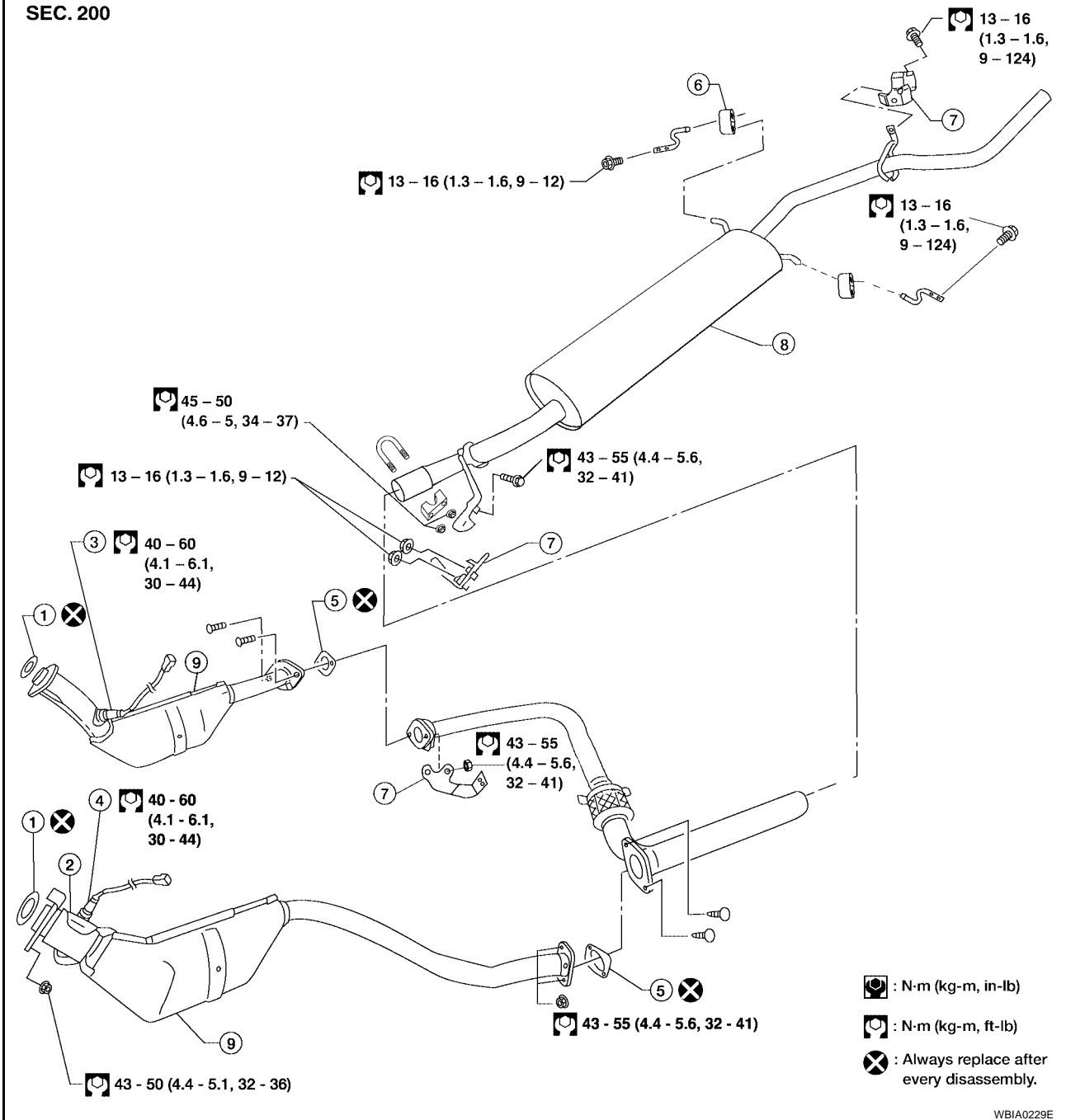

WBIA0229E

- | | | |
|------------------------------------|-------------------|------------------------------------|
| 1. Gasket | 2. Front tube | 3. Heated oxygen sensor 2 (bank 1) |
| 4. Heated oxygen sensor 2 (bank 2) | 5. Gasket | 6. Mounting rubber |
| 7. Mounting bracket | 8. Center muffler | 9. Three way convertor |

EXHAUST SYSTEM
