

SECTION **INT**  
INTERIOR

A  
B  
C  
D  
E  
F  
G  
H  
I  
INT  
K  
L  
M  
N  
O  
P

CONTENTS

<b>SYMPTOM DIAGNOSIS</b> .....	2	Commercial Service Tool .....	12
<b>SQUEAK AND RATTLE TROUBLE DIAG- NOSES</b> .....	2	<b>ON-VEHICLE REPAIR</b> .....	13
Work Flow .....	2	<b>DOOR FINISHER</b> .....	13
Generic Squeak and Rattle Troubleshooting .....	4	Removal and Installation .....	13
Diagnostic Worksheet .....	6	<b>BODY SIDE TRIM</b> .....	16
<b>CLIP AND FASTENER</b> .....	8	Component .....	16
Clip and Fastener .....	8	Removal and Installation .....	17
<b>PRECAUTION</b> .....	11	<b>FLOOR TRIM</b> .....	18
<b>PRECAUTIONS</b> .....	11	Removal and Installation .....	18
Precaution for Supplemental Restraint System (SRS) "AIR BAG" and "SEAT BELT PRE-TEN- SIONER" .....	11	<b>HEADLINING</b> .....	19
Service Notice .....	11	Removal and Installation .....	19
<b>PREPARATION</b> .....	12	<b>LUGGAGE FLOOR TRIM</b> .....	21
<b>PREPARATION</b> .....	12	Component .....	21
Special Service Tool .....	12	Removal and Installation .....	22
		<b>BACK DOOR TRIM</b> .....	24
		Removal and Installation .....	24

# SQUEAK AND RATTLE TROUBLE DIAGNOSES

< SYMPTOM DIAGNOSIS >

## SYMPTOM DIAGNOSIS

### SQUEAK AND RATTLE TROUBLE DIAGNOSES

#### Work Flow

INFOID:000000004065180

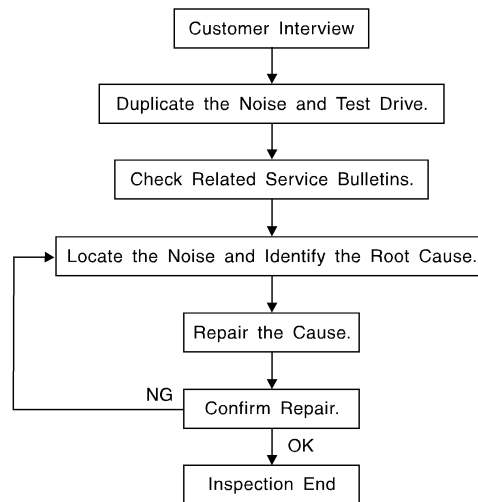

RA5731

#### CUSTOMER INTERVIEW

Interview the customer if possible, to determine the conditions that exist when the noise occurs. Use the Diagnostic Worksheet during the interview to document the facts and conditions when the noise occurs and any customer's comments; refer to [INT-6. "Diagnostic Worksheet"](#). This information is necessary to duplicate the conditions that exist when the noise occurs.

- The customer may not be able to provide a detailed description or the location of the noise. Attempt to obtain all the facts and conditions that exist when the noise occurs (or does not occur).
- If there is more than one noise in the vehicle, be sure to diagnose and repair the noise that the customer is concerned about. This can be accomplished by test driving the vehicle with the customer.
- After identifying the type of noise, isolate the noise in terms of its characteristics. The noise characteristics are provided so the customer, service adviser and technician are all speaking the same language when defining the noise.
- Squeak —(Like tennis shoes on a clean floor)  
Squeak characteristics include the light contact/fast movement/brought on by road conditions/hard surfaces = higher pitch noise/softer surfaces = lower pitch noises/edge to surface = chirping.
- Creak—(Like walking on an old wooden floor)  
Creak characteristics include firm contact/slow movement/twisting with a rotational movement/pitch dependent on materials/often brought on by activity.
- Rattle—(Like shaking a baby rattle)  
Rattle characteristics include the fast repeated contact/vibration or similar movement/loose parts/missing clip or fastener/incorrect clearance.
- Knock —(Like a knock on a door)  
Knock characteristics include hollow sounding/sometimes repeating/often brought on by driver action.
- Tick—(Like a clock second hand)  
Tick characteristics include gentle contacting of light materials/loose components/can be caused by driver action or road conditions.
- Thump—(Heavy, muffled knock noise)  
Thump characteristics include softer knock/dead sound often brought on by activity.
- Buzz—(Like a bumble bee)  
Buzz characteristics include high frequency rattle/firm contact.
- Often the degree of acceptable noise level will vary depending upon the person. A noise that you may judge as acceptable may be very irritating to the customer.
- Weather conditions, especially humidity and temperature, may have a great effect on noise level.

#### DUPLICATE THE NOISE AND TEST DRIVE

# SQUEAK AND RATTLE TROUBLE DIAGNOSES

## < SYMPTOM DIAGNOSIS >

If possible, drive the vehicle with the customer until the noise is duplicated. Note any additional information on the Diagnostic Worksheet regarding the conditions or location of the noise. This information can be used to duplicate the same conditions when you confirm the repair.

If the noise can be duplicated easily during the test drive, to help identify the source of the noise, try to duplicate the noise with the vehicle stopped by doing one or all of the following:

- 1) Close a door.
  - 2) Tap or push/pull around the area where the noise appears to be coming from.
  - 3) Rev the engine.
  - 4) Use a floor jack to recreate vehicle "twist".
  - 5) At idle, apply engine load (electrical load, A/T in drive position).
  - 6) Raise the vehicle on a hoist and hit a tire with a rubber hammer.
- Drive the vehicle and attempt to duplicate the conditions the customer states exist when the noise occurs.
  - If it is difficult to duplicate the noise, drive the vehicle slowly on an undulating or rough road to stress the vehicle body.

## CHECK RELATED SERVICE BULLETINS

After verifying the customer concern or symptom, check ASIST for Technical Service Bulletins (TSBs) related to that concern or symptom.

If a TSB relates to the symptom, follow the procedure to repair the noise.

## LOCATE THE NOISE AND IDENTIFY THE ROOT CAUSE

1. Narrow down the noise to a general area. To help pinpoint the source of the noise, use a listening tool (Chassis Ear: J-39570, Engine Ear: J-39565 and mechanic's stethoscope).
2. Narrow down the noise to a more specific area and identify the cause of the noise by:
  - removing the components in the area that you suspect the noise is coming from.  
Do not use too much force when removing clips and fasteners, otherwise clips and fasteners can be broken or lost during the repair, resulting in the creation of new noise.
  - tapping or pushing/pulling the component that you suspect is causing the noise.  
Do not tap or push/pull the component with excessive force, otherwise the noise will be eliminated only temporarily.
  - feeling for a vibration with your hand by touching the component(s) that you suspect is (are) causing the noise.
  - placing a piece of paper between components that you suspect are causing the noise.
  - looking for loose components and contact marks.  
Refer to [INT-4, "Generic Squeak and Rattle Troubleshooting"](#).

## REPAIR THE CAUSE

- If the cause is a loose component, tighten the component securely.
- If the cause is insufficient clearance between components:
  - separate components by repositioning or loosening and retightening the component, if possible.
  - insulate components with a suitable insulator such as urethane pads, foam blocks, felt cloth tape or urethane tape. A NISSAN Squeak and Rattle Kit (J-43980) is available through your authorized NISSAN Parts Department.

### **CAUTION:**

**Do not use excessive force as many components are constructed of plastic and may be damaged.**

**Always check with the Parts Department for the latest parts information.**

**The following materials are contained in the NISSAN Squeak and Rattle Kit (J-43980). Each item can be ordered separately as needed.**

**URETHANE PADS [1.5 mm (0.059 in) thick]**

**Insulates connectors, harness, etc.**

**76268-9E005: 100×135 mm (3.94×5.31 in)/76884-71L01: 60×85 mm (2.36×3.35 in)/76884-71L02: 15×25 mm (0.59×0.98 in)**

**INSULATOR (Foam blocks)**

**Insulates components from contact. Can be used to fill space behind a panel.**

**73982-9E000: 45 mm (1.77 in) thick, 50×50 mm (1.97×1.97 in)/73982-50Y00: 10 mm (0.39 in) thick, 50×50 mm (1.97×1.97 in)**

**INSULATOR (Light foam block)**

**80845-71L00: 30 mm (1.18 in) thick, 30×50 mm (1.18×1.97 in)**

**FELT CLOTH TAPE**

**Used to insulate where movement does not occur. Ideal for instrument panel applications.**

# SQUEAK AND RATTLE TROUBLE DIAGNOSES

## < SYMPTOM DIAGNOSIS >

**68370-4B000: 15×25 mm (0.59×0.98 in) pad/68239-13E00: 5 mm (0.20 in) wide tape roll.** The following materials not found in the kit can also be used to repair squeaks and rattles.

### **UHMW (TEFLON) TAPE**

Insulates where slight movement is present. Ideal for instrument panel applications.

### **SILICONE GREASE**

Used instead of UHMW tape that will be visible or not fit.

Note: Will only last a few months.

### **SILICONE SPRAY**

Use when grease cannot be applied.

### **DUCT TAPE**

Use to eliminate movement.

## CONFIRM THE REPAIR

Confirm that the cause of a noise is repaired by test driving the vehicle. Operate the vehicle under the same conditions as when the noise originally occurred. Refer to the notes on the Diagnostic Worksheet.

## Generic Squeak and Rattle Troubleshooting

INFOID:000000004065181

Refer to Table of Contents for specific component removal and installation information.

## INSTRUMENT PANEL

Most incidents are caused by contact and movement between:

1. The cluster lid A and instrument panel
2. Acrylic lens and combination meter housing
3. Instrument panel to front pillar garnish
4. Instrument panel to windshield
5. Instrument panel mounting pins
6. Wiring harnesses behind the combination meter
7. A/C defroster duct and duct joint

These incidents can usually be located by tapping or moving the components to duplicate the noise or by pressing on the components while driving to stop the noise. Most of these incidents can be repaired by applying felt cloth tape or silicone spray (in hard to reach areas). Urethane pads can be used to insulate wiring harness.

### **CAUTION:**

**Do not use silicone spray to isolate a squeak or rattle. If you saturate the area with silicone, you will not be able to recheck the repair.**

## CENTER CONSOLE

Components to pay attention to include:

1. Shifter assembly cover to finisher
2. A/C control unit and cluster lid C
3. Wiring harnesses behind audio and A/C control unit

The instrument panel repair and isolation procedures also apply to the center console.

## DOORS

Pay attention to the:

1. Finisher and inner panel making a slapping noise
2. Inside handle escutcheon to door finisher
3. Wiring harnesses tapping
4. Door striker out of alignment causing a popping noise on starts and stops

Tapping or moving the components or pressing on them while driving to duplicate the conditions can isolate many of these incidents. You can usually insulate the areas with felt cloth tape or insulator foam blocks from the NISSAN Squeak and Rattle Kit (J-43980) to repair the noise.

## TRUNK

Trunk noises are often caused by a loose jack or loose items put into the trunk by the owner.

In addition look for:

1. Trunk lid bumpers out of adjustment

# SQUEAK AND RATTLE TROUBLE DIAGNOSES

## < SYMPTOM DIAGNOSIS >

---

2. Trunk lid striker out of adjustment
3. The trunk lid torsion bars knocking together
4. A loose license plate or bracket

Most of these incidents can be repaired by adjusting, securing or insulating the item(s) or component(s) causing the noise.

## SUNROOF/HEADLINING

Noises in the sunroof/headlining area can often be traced to one of the following:

1. Sunroof lid, rail, linkage or seals making a rattle or light knocking noise
2. Sun visor shaft shaking in the holder
3. Front or rear windshield touching headliner and squeaking

Again, pressing on the components to stop the noise while duplicating the conditions can isolate most of these incidents. Repairs usually consist of insulating with felt cloth tape.

## OVERHEAD CONSOLE (FRONT AND REAR)

Overhead console noises are often caused by the console panel clips not being engaged correctly. Most of these incidents are repaired by pushing up on the console at the clip locations until the clips engage.

In addition look for:

1. Loose harness or harness connectors.
2. Front console map/reading lamp lens loose.
3. Loose screws at console attachment points.

## SEATS

When isolating seat noise it's important to note the position the seat is in and the load placed on the seat when the noise is present. These conditions should be duplicated when verifying and isolating the cause of the noise.

Cause of seat noise include:

1. Headrest rods and holder
2. A squeak between the seat pad cushion and frame
3. The rear seatback lock and bracket

These noises can be isolated by moving or pressing on the suspected components while duplicating the conditions under which the noise occurs. Most of these incidents can be repaired by repositioning the component or applying urethane tape to the contact area.

## UNDERHOOD

Some interior noise may be caused by components under the hood or on the engine wall. The noise is then transmitted into the passenger compartment.

Causes of transmitted underhood noise include:

1. Any component mounted to the engine wall
2. Components that pass through the engine wall
3. Engine wall mounts and connectors
4. Loose radiator mounting pins
5. Hood bumpers out of adjustment
6. Hood striker out of adjustment

These noises can be difficult to isolate since they cannot be reached from the interior of the vehicle. The best method is to secure, move or insulate one component at a time and test drive the vehicle. Also, engine RPM or load can be changed to isolate the noise. Repairs can usually be made by moving, adjusting, securing, or insulating the component causing the noise.

A

B

C

D

E

F

G

H

I

INT

K

L

M

N

O

P

# SQUEAK AND RATTLE TROUBLE DIAGNOSES

< SYMPTOM DIAGNOSIS >

## Diagnostic Worksheet

INFOID:000000004065182

Dear Customer:

We are concerned about your satisfaction with your vehicle. Repairing a squeak or rattle sometimes can be very difficult. To help us fix your vehicle right the first time, please take a moment to note the area of the vehicle where the squeak or rattle occurs and under what conditions. You may be asked to take a test drive with a service advisor or technician to ensure we confirm the noise you are hearing.

### SQUEAK & RATTLE DIAGNOSTIC WORKSHEET

#### I. WHERE DOES THE NOISE COME FROM? (circle the area of the vehicle)

The illustrations are for reference only, and may not reflect the actual configuration of your vehicle.

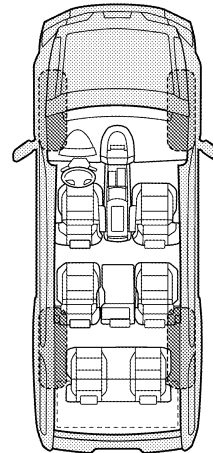
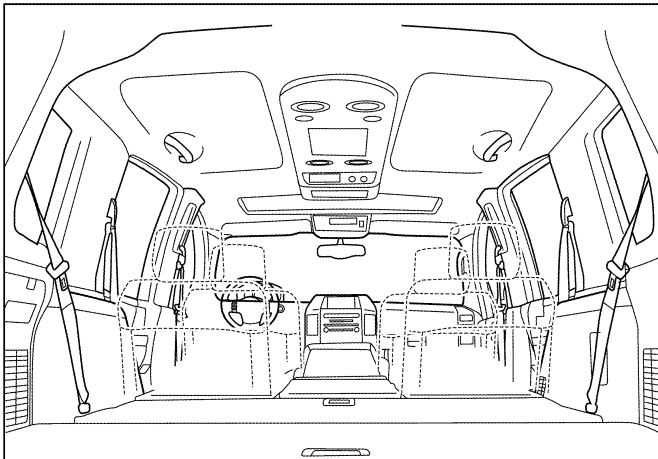
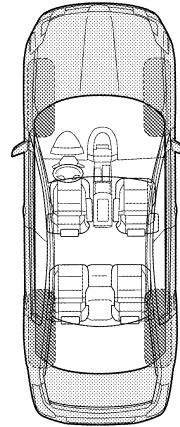
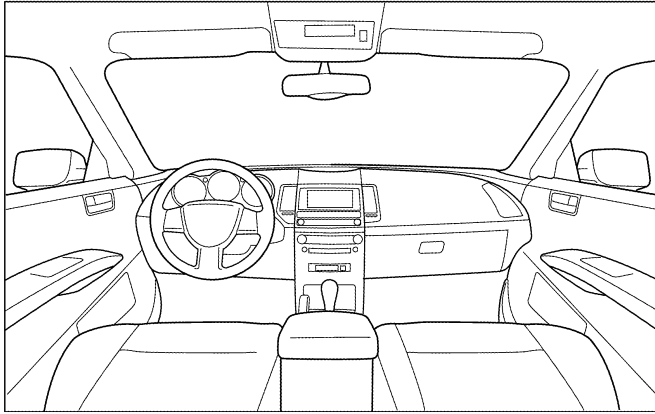

Continue to page 2 of the worksheet and briefly describe the location of the noise or rattle. In addition, please indicate the conditions which are present when the noise occurs.

# SQUEAK AND RATTLE TROUBLE DIAGNOSES

< SYMPTOM DIAGNOSIS >

## SQUEAK & RATTLE DIAGNOSTIC WORKSHEET - page 2

Briefly describe the location where the noise occurs:

---

---

### II. WHEN DOES IT OCCUR? (please check the boxes that apply)

- |   |  |
|---|--|
| <input type="checkbox"/> Anytime                      | <input type="checkbox"/> After sitting out in the rain |
| <input type="checkbox"/> 1st time in the morning      | <input type="checkbox"/> When it is raining or wet     |
| <input type="checkbox"/> Only when it is cold outside | <input type="checkbox"/> Dry or dusty conditions       |
| <input type="checkbox"/> Only when it is hot outside  | <input type="checkbox"/> Other:                        |

### III. WHEN DRIVING:

- Through driveways
- Over rough roads
- Over speed bumps
- Only about \_\_\_\_ mph
- On acceleration
- Coming to a stop
- On turns: left, right or either (circle)
- With passengers or cargo
- Other: \_\_\_\_\_
- After driving \_\_\_\_ miles or \_\_\_\_ minutes

### IV. WHAT TYPE OF NOISE

- Squeak (like tennis shoes on a clean floor)
- Creak (like walking on an old wooden floor)
- Rattle (like shaking a baby rattle)
- Knock (like a knock at the door)
- Tick (like a clock second hand)
- Thump (heavy muffled knock noise)
- Buzz (like a bumble bee)

### TO BE COMPLETED BY DEALERSHIP PERSONNEL

#### Test Drive Notes:

---

---

---

	YES	NO	Initials of person performing
Vehicle test driven with customer	<input type="checkbox"/>	<input type="checkbox"/>	_____
- Noise verified on test drive	<input type="checkbox"/>	<input type="checkbox"/>	_____
- Noise source located and repaired	<input type="checkbox"/>	<input type="checkbox"/>	_____
- Follow up test drive performed to confirm repair	<input type="checkbox"/>	<input type="checkbox"/>	_____

VIN: \_\_\_\_\_ Customer Name \_\_\_\_\_

W.O.# \_\_\_\_\_ Date: \_\_\_\_\_

This form must be attached to Work Order

KG@ / 60D

A  
B  
C  
D  
E  
F  
G  
H  
I  
INT  
K  
L  
M  
N  
O  
P







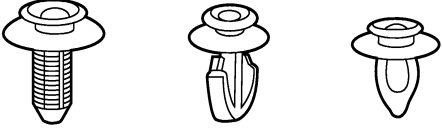

# CLIP AND FASTENER

< SYMPTOM DIAGNOSIS >

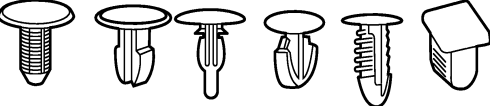
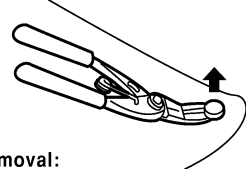
## CLIP AND FASTENER

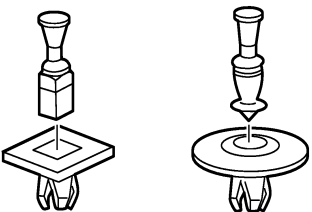
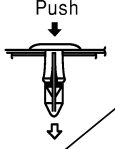
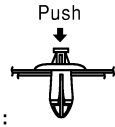
### Clip and Fastener

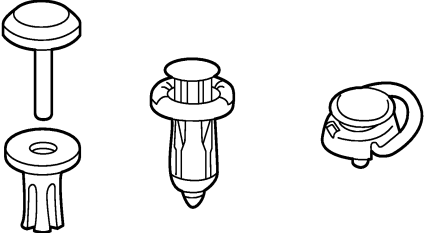
INFOID:000000004471351

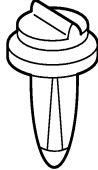
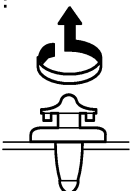







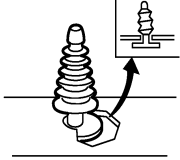
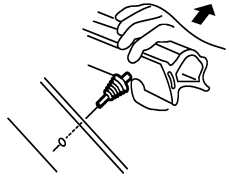

Symbol No.	Shapes	Removal & Installation
<p>C101</p> 		<p><b>Removal:</b> Remove by bending up with flat-bladed screwdrivers or clip remover.</p> 
<p>C103</p> 		 <p><b>Removal:</b> Remove with a clip remover.</p>
<p>C203</p> 		<p><b>Removal:</b> Push center pin to catching position. (Do not remove center pin by hitting it.)</p> <p>Push</p>  <p>Push</p>  <p><b>Installation:</b></p>
<p>C205</p> 		<p><b>Removal:</b> Flat-bladed screwdriver</p>  <p>Clip</p> <p>Finisher</p>
<p>C206</p> 		<p><b>Removal:</b></p> 

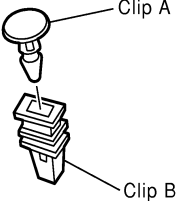
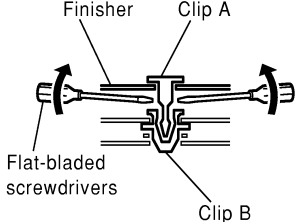
RIH 204D

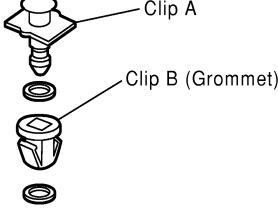
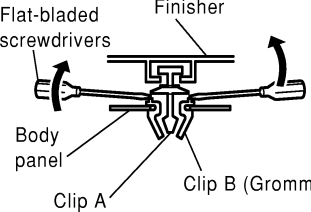

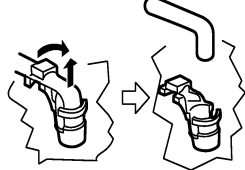
# CLIP AND FASTENER

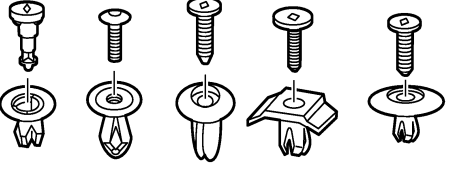
## < SYMPTOM DIAGNOSIS >









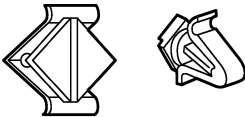

Symbol No.	Shapes	Removal & Installation
<p>CE103</p> 		<p><b>Removal:</b></p> 
<p>CF110</p> 		<p><b>Removal:</b></p> 
<p>CF118</p> 		<p><b>Removal:</b></p> 
<p>CR103</p> 		<p><b>Removal:</b> Holder portion of clip must be spread out to remove rod.</p> 
<p>CS101</p> 		<p><b>Removal:</b></p> <ol style="list-style-type: none"> <li>1. Screw out with a Phillips screwdriver.</li> <li>2. Remove female portion with flat-bladed screwdriver.</li> </ol> 

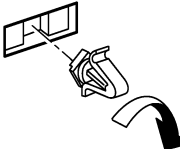
FIN# 205D

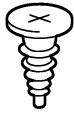
A  
B  
C  
D  
E  
F  
G  
H  
I  
INT  
K  
L  
M  
N  
O  
P

# CLIP AND FASTENER

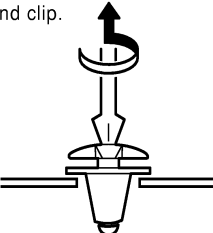
## < SYMPTOM DIAGNOSIS >

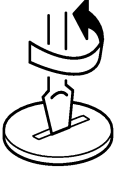
Symbol No.	Shapes	Removal & Installation	
CG101 		<b>Removal:</b>  Rotate 45° to remove	<b>Installation:</b> 
CS102 			
CS113 		<b>Removal:</b> Disconnect upper connection of clip with a flat-bladed screwdriver, then remove clip while inserting a flat-bladed screwdriver between body panel and clip. 	
C111 			

RIH 206D

# PRECAUTIONS

< PRECAUTION >

## PRECAUTION

### PRECAUTIONS

#### Precaution for Supplemental Restraint System (SRS) "AIR BAG" and "SEAT BELT PRE-TENSIONER"

INFOID:000000004065183

The Supplemental Restraint System such as "AIR BAG" and "SEAT BELT PRE-TENSIONER", used along with a front seat belt, helps to reduce the risk or severity of injury to the driver and front passenger for certain types of collision. This system includes seat belt switch inputs and dual stage front air bag modules. The SRS system uses the seat belt switches to determine the front air bag deployment, and may only deploy one front air bag, depending on the severity of a collision and whether the front occupants are belted or unbelted. Information necessary to service the system safely is included in the SR and SB section of this Service Manual.

#### **WARNING:**

- To avoid rendering the SRS inoperative, which could increase the risk of personal injury or death in the event of a collision which would result in air bag inflation, all maintenance must be performed by an authorized NISSAN/INFINITI dealer.
- Improper maintenance, including incorrect removal and installation of the SRS, can lead to personal injury caused by unintentional activation of the system. For removal of Spiral Cable and Air Bag Module, see the SR section.
- Do not use electrical test equipment on any circuit related to the SRS unless instructed to in this Service Manual. SRS wiring harnesses can be identified by yellow and/or orange harnesses or harness connectors.

#### Service Notice

INFOID:000000004065184

- When removing or installing various parts, place a cloth or padding on the vehicle body to prevent scratches.
- Handle trim, molding, instruments, grille, etc. carefully during removing or installing. Be careful not to soil or damage them.
- Apply sealing compound where necessary when installing parts.
- When applying sealing compound, be careful that the sealing compound does not protrude from parts.
- When replacing any metal parts (for example body outer panel, members, etc.), be sure to take rust prevention measures.

A

B

C

D

E

F

G

H

I

INT

K

L

M

N

O

P

# PREPARATION

< PREPARATION >

## PREPARATION

### PREPARATION

#### Special Service Tool

INFOID:000000004065185

The actual shapes of Kent-Moore tools may differ from those of special service tools illustrated here.

Tool number (Kent-Moore No.) Tool name	Description
— (J-39570) Chassis ear	Locating the noise
— (J-43980) NISSAN Squeak and Rattle kit	Repairing the cause of noise

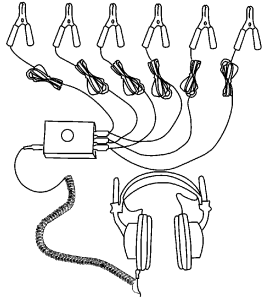

RA5728

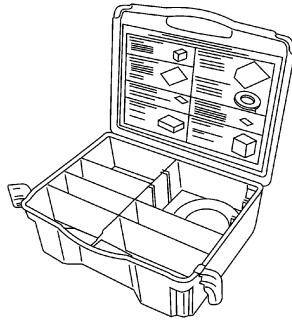

RA573/

#### Commercial Service Tool

INFOID:000000004065186

(Kent-Moore No.) Tool name	Description
(J-39565) Engine ear	Locating the noise

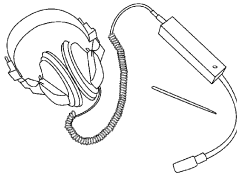

RI#EJ 884D

# DOOR FINISHER

< ON-VEHICLE REPAIR >

## ON-VEHICLE REPAIR

### DOOR FINISHER

#### Removal and Installation

INFOID:000000004065187

#### FRONT DOOR

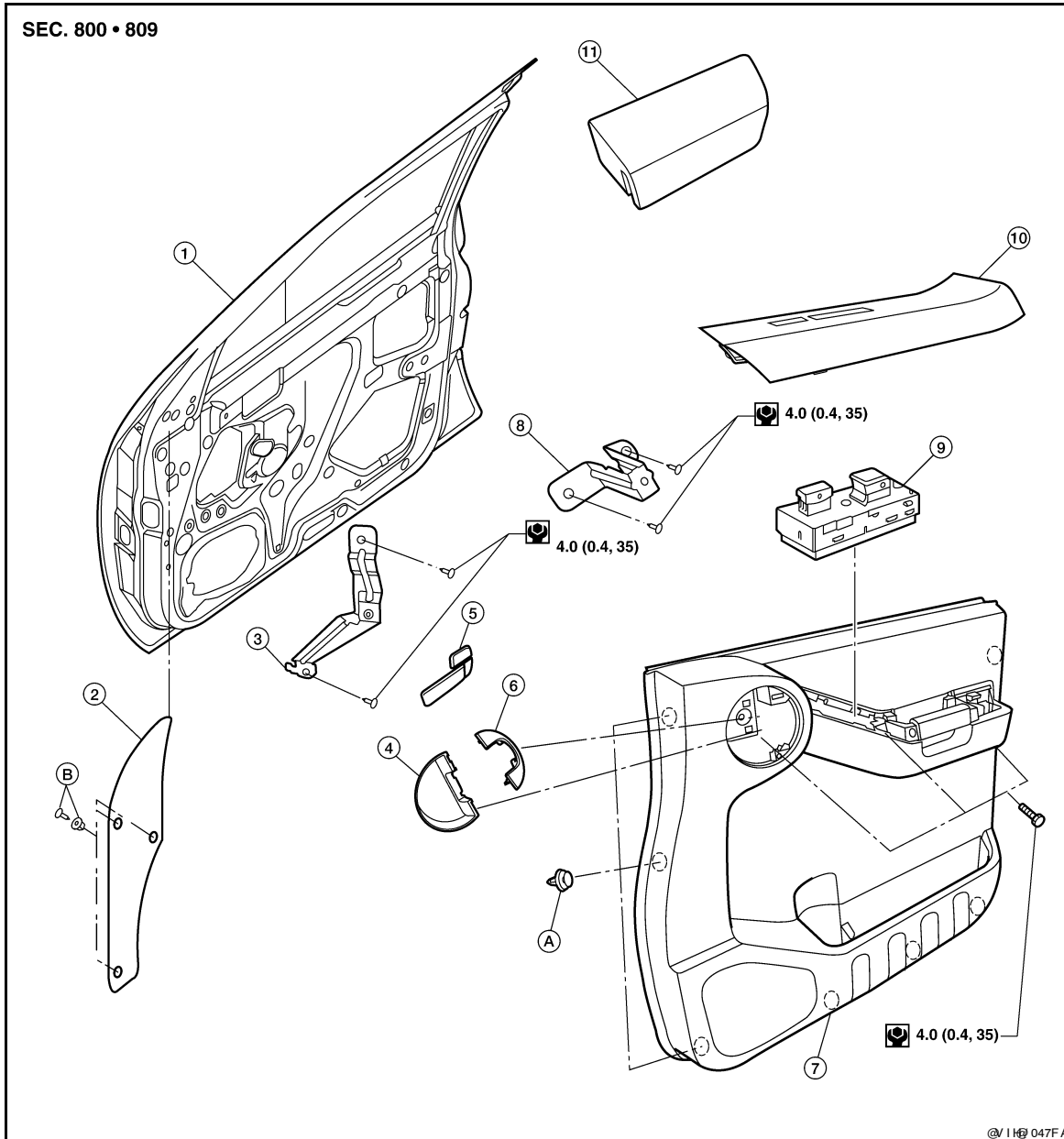

- |                                    |                           |                             |
|------------------------------------|---------------------------|-----------------------------|
| 1. Front door                      | 2. Mirror bolt cover      | 3. Front bracket            |
| 4. Pull handle escutcheon          | 5. Inside handle assembly | 6. Pull handle cover        |
| 7. Front door finisher (RH shown)  | 8. Rear bracket           | 9. Power window/lock switch |
| 10. Power window/lock switch cover | 11. Armrest               | A. Clip C101                |
| B. Clip C205                       | H. Pawl                   |                             |

#### Removal

1. Remove power window switch assembly.
  - Disconnect harness connectors.
2. Remove pull handle escutcheon.

A  
B  
C  
D  
E  
F  
G  
H  
I  
INT  
K  
L  
M  
N  
O  
P

# DOOR FINISHER

## < ON-VEHICLE REPAIR >

3. Remove pull handle cover and remove screw.
4. Lift armrest upward to release clips and remove armrest.
  - Remove front door finisher screws behind armrest.
5. Release clips and remove front door finisher.
  - Disconnect lock cable and handle cable from inside door handle assembly.

### Installation

Installation is in the reverse order of removal.

## REAR DOOR

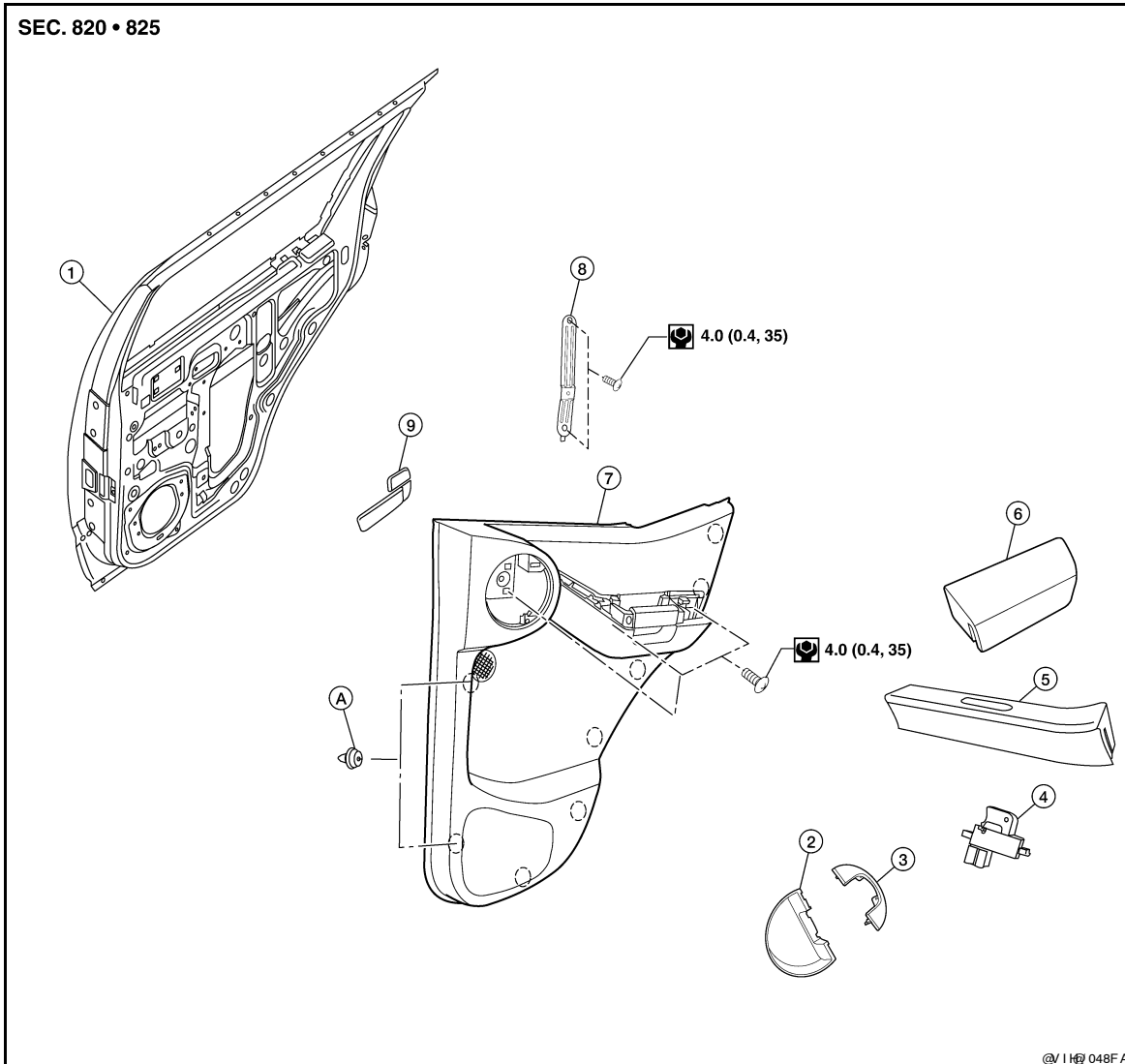

- |                        |                              |                                |
|------------------------|------------------------------|--------------------------------|
| 1. Rear door           | 2. Pull handle escutcheon    | 3. Pull handle cover           |
| 4. Power window switch | 5. Power window switch cover | 6. Armrest                     |
| 7. Rear door finisher  | 8. Rear door handle bracket  | 9. Inside door handle assembly |
| A. Clip C101           | (H) Pawl                     |                                |

### Removal

1. Remove power window switch assembly.
  - Disconnect harness connector.
2. Remove pull handle cover.
  - Remove rear door finisher screw behind pull handle cover.
3. Remove pull handle escutcheon.
4. Lift upward to release clips and remove armrest.

## DOOR FINISHER

### < ON-VEHICLE REPAIR >

---

- Remove rear door finisher screws behind armrest.
5. Release the clips and remove rear door finisher.
- Disconnect the rear door tweeter (if equipped).

#### Installation

Installation is in the reverse order of removal.

A

B

C

D

E

F

G

H

I

INT

K

L

M

N

O

P

# BODY SIDE TRIM

< ON-VEHICLE REPAIR >

## BODY SIDE TRIM

Component

INFOID:000000004065188

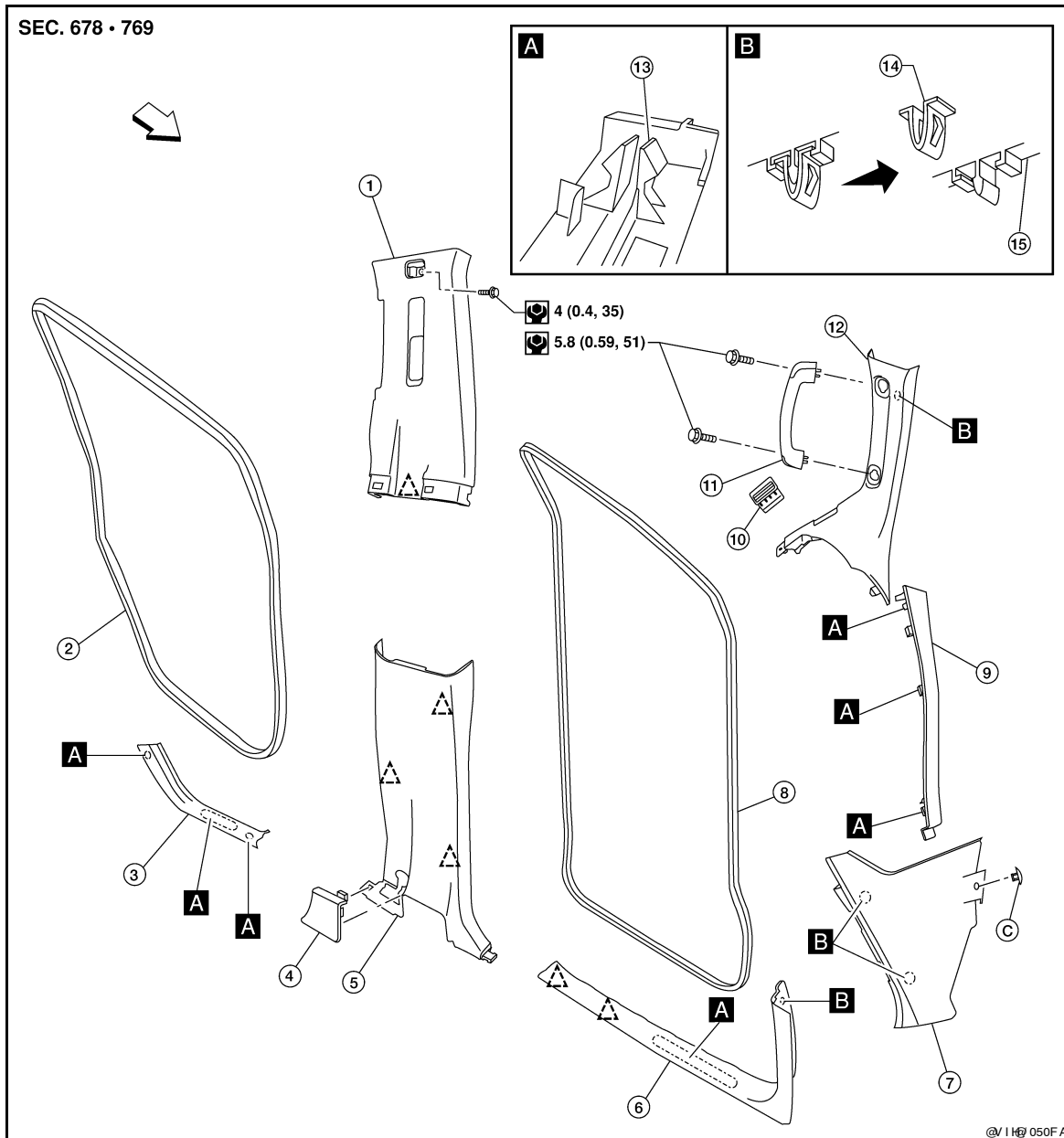

- |                                       |                                 |                                 |
|---------------------------------------|---------------------------------|---------------------------------|
| 1. Center pillar upper finisher       | 2. Rear door welt               | 3. Rear kick plate              |
| 4. Access cover (Passenger side only) | 5. Center pillar lower finisher | 6. Front kick plate             |
| 7. Lower dash side finisher           | 8. Front door welt              | 9. Front pillar lower finisher  |
| 10. LH side demister grille           | 11. Front pillar assist grip    | 12. Front pillar upper finisher |
| 13. Molded plastic clip               | 14. Metal clip                  | 15. Finisher                    |
| ↶ Vehicle front                       | C. Clip CS 113                  | △ Clip C103                     |
| (H) Pawl                              |                                 |                                 |

### CAUTION:

- Wrap the tip of flat-bladed screwdriver with a cloth when removing metal clips from finishers.
- When removing or installing body side door welts, do not allow butyl seal to come in contact with pillar finisher.



# BODY SIDE TRIM

< ON-VEHICLE REPAIR >

## Removal and Installation

INFOID:00000004065189

### LOWER DASH SIDE FINISHER

#### Removal

1. Remove front door welt.
2. Remove front kick plate.
3. Remove pushpin, release the clips and remove lower dash side finisher.

#### Installation

Installation is in the reverse order of removal.

### CENTER PILLAR LOWER FINISHER

#### Removal

1. Remove front and rear door welts.
2. Remove seat belt anchor. Refer to [SB-10. "Removal and Installation"](#).
  - On RH side, disconnect seat belt tension sensor.
3. Remove front and rear kick plates.
4. Remove center pillar lower finisher.

#### Installation

Installation is in the reverse order of removal.

### CENTER PILLAR UPPER FINISHER

#### Removal

1. Remove center pillar lower finisher.
2. Remove seat belt shoulder anchor and D-ring. Refer to [SB-10. "Removal and Installation"](#).
3. Remove center pillar upper finisher.

#### Installation

Installation is in the reverse order of removal.

### FRONT PILLAR LOWER FINISHER

#### Removal

1. Remove front door welt.
2. Remove front kick plate.
3. Remove the front pillar lower finisher.

#### Installation

Installation is in the reverse order of removal.

### FRONT PILLAR UPPER FINISHER

#### Removal

1. Remove the front pillar lower finisher.
2. Remove the front pillar assist grip bolts and assist grip.
3. Remove the front pillar upper finisher.

#### Installation

Installation is in the reverse order of removal.

### KICK PLATES

#### Removal

Release clips and remove front and/or rear kick plates.

#### Installation

Installation is in the reverse order of removal.

A

B

C

D

E

F

G

H

I

INT

K

L

M

N

O

P

# FLOOR TRIM

< ON-VEHICLE REPAIR >

## FLOOR TRIM

### Removal and Installation

INFOID:000000004065190

#### Front and Rear Floor Carpet

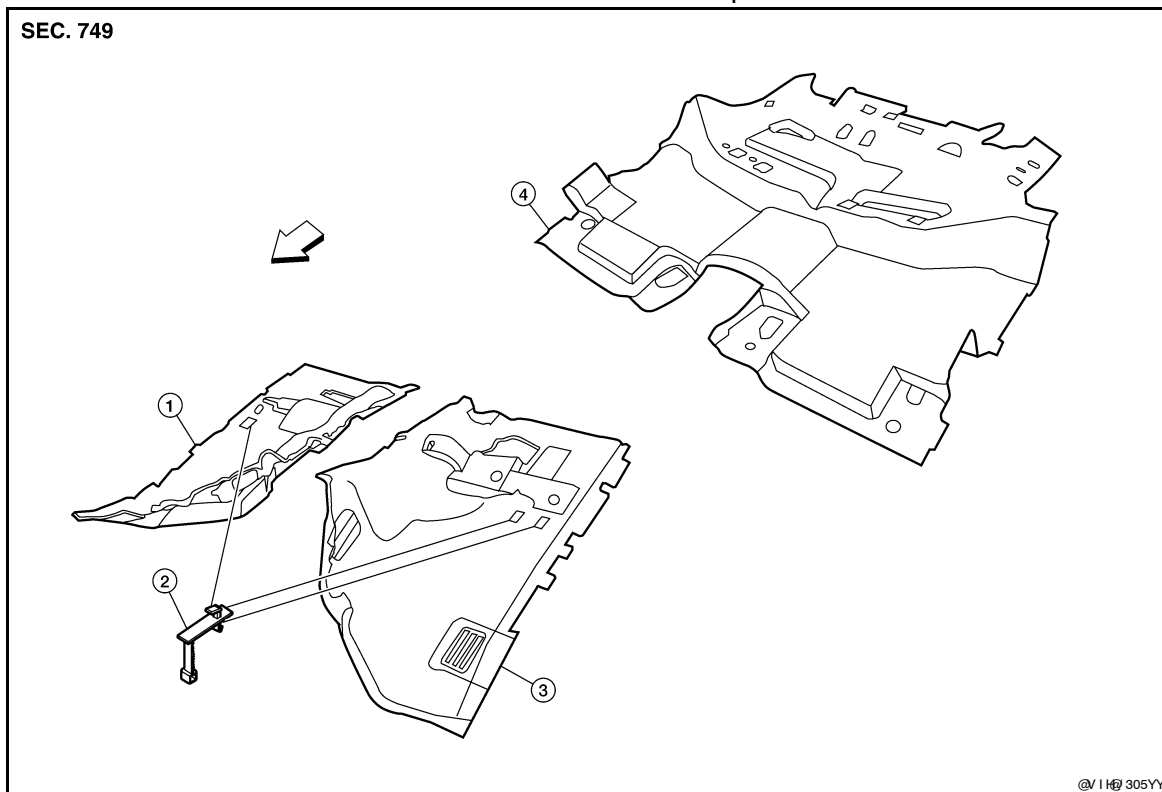

- 1. Front carpet RH
- 4. Rear carpet

- 2. Floor mat hooks
- ← Vehicle front

- 3. Front carpet LH

#### FRONT CARPET

##### Removal

1. Remove front seats. Refer to [SE-26, "Removal and Installation"](#).
2. Remove lower body side trim panels and kick plates. Refer to [INT-17, "Removal and Installation"](#).
3. Remove center console. Refer to [IP-18, "Exploded View"](#).
4. Remove floor mat hooks from front carpet RH/LH.
5. Remove front carpet RH and LH.

##### Installation

Installation is in the reverse order of removal.

#### REAR CARPET

##### Removal

1. Remove front seats. Refer to [SE-26, "Removal and Installation"](#).
2. Remove rear seats. Refer to [SE-29, "Removal and Installation"](#).
3. Remove luggage side lower finisher LH/RH. Refer to [INT-22, "Removal and Installation"](#).
4. Remove cargo floor rail LH/RH and end covers.
5. Remove luggage floor cover, storage tray and back door kick plate. Refer to [INT-22, "Removal and Installation"](#).
6. Remove the rear carpet.

##### Installation

Installation is in the reverse order of removal.

# HEADLINING

< ON-VEHICLE REPAIR >

## HEADLINING

### Removal and Installation

INFOID:000000004065191

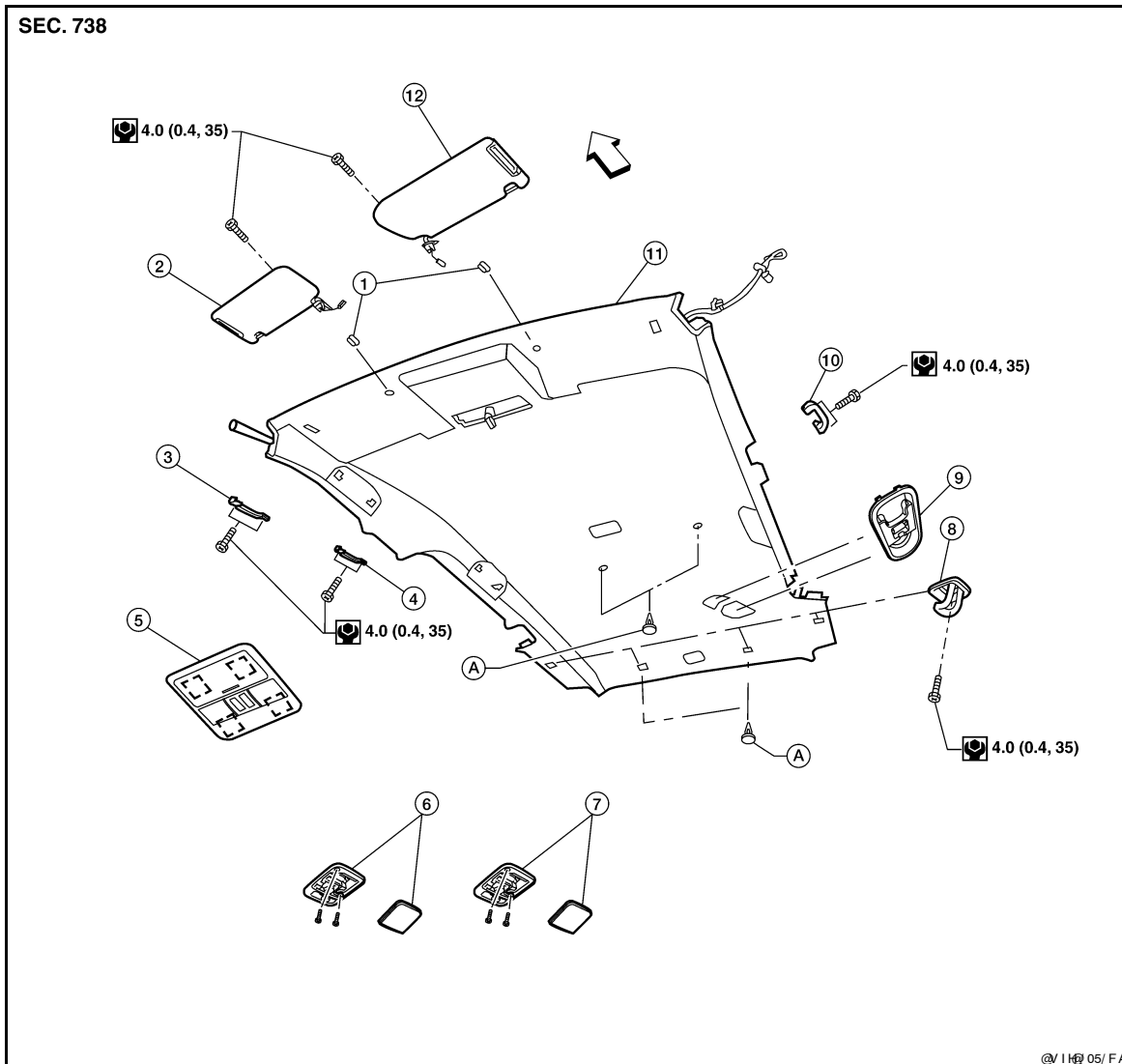

A  
B  
C  
D  
E  
F  
G  
H  
I

INT

K  
L

M  
N

O  
P

- |                            |                             |                              |
|----------------------------|-----------------------------|------------------------------|
| 1. Sun visor holders LH/RH | 2. Sun visor assembly RH    | 3. Front assist grip RH      |
| 4. Rear assist grip RH     | 5. Front room lamp assembly | 6. Center room lamp assembly |
| 7. Rear room lamp assembly | 8. Cargo hook               | 9. Seat belt escutcheon      |
| 10. Rear assist grip LH    | 11. Headlining              | 12. Sun visor assembly LH    |
| A. Clip C103               | ↔ Vehicle front             | ☐ Metal clip                 |

### REMOVAL

1. Disconnect both the negative and positive battery terminals.
2. Remove body side trim panels. Refer to [INT-17, "Removal and Installation"](#).
3. Remove luggage floor trim upper panels. Refer to [INT-22, "Removal and Installation"](#).
4. Remove sun visor assemblies, both LH/RH.
5. Remove sun visor holders LH/RH.
6. Remove cargo hooks.
7. Remove assist grips.
8. Release the clips and loosen the seat belt escutcheon from the headlining.
9. Remove the center and rear room lamp assemblies.

## HEADLINING

### < ON-VEHICLE REPAIR >

---

10. Remove headlining.

**NOTE:**

Use an assistant to steady the headlining while lowering from roof.

- Remove clips from center of headlining.
- Remove clips from rear of headlining.
- Disconnect rear washer tube at front connection, allow to drain.
- Disconnect harnesses and rear washer tube rear connections.
- Thread seat belt escutcheon through cutout in headlining.

### INSTALLATION

Installation is in the reverse order of removal.

# LUGGAGE FLOOR TRIM

< ON-VEHICLE REPAIR >

## LUGGAGE FLOOR TRIM

Component

INFOID:000000004065192

Luggage Trim - Side

SEC. 850

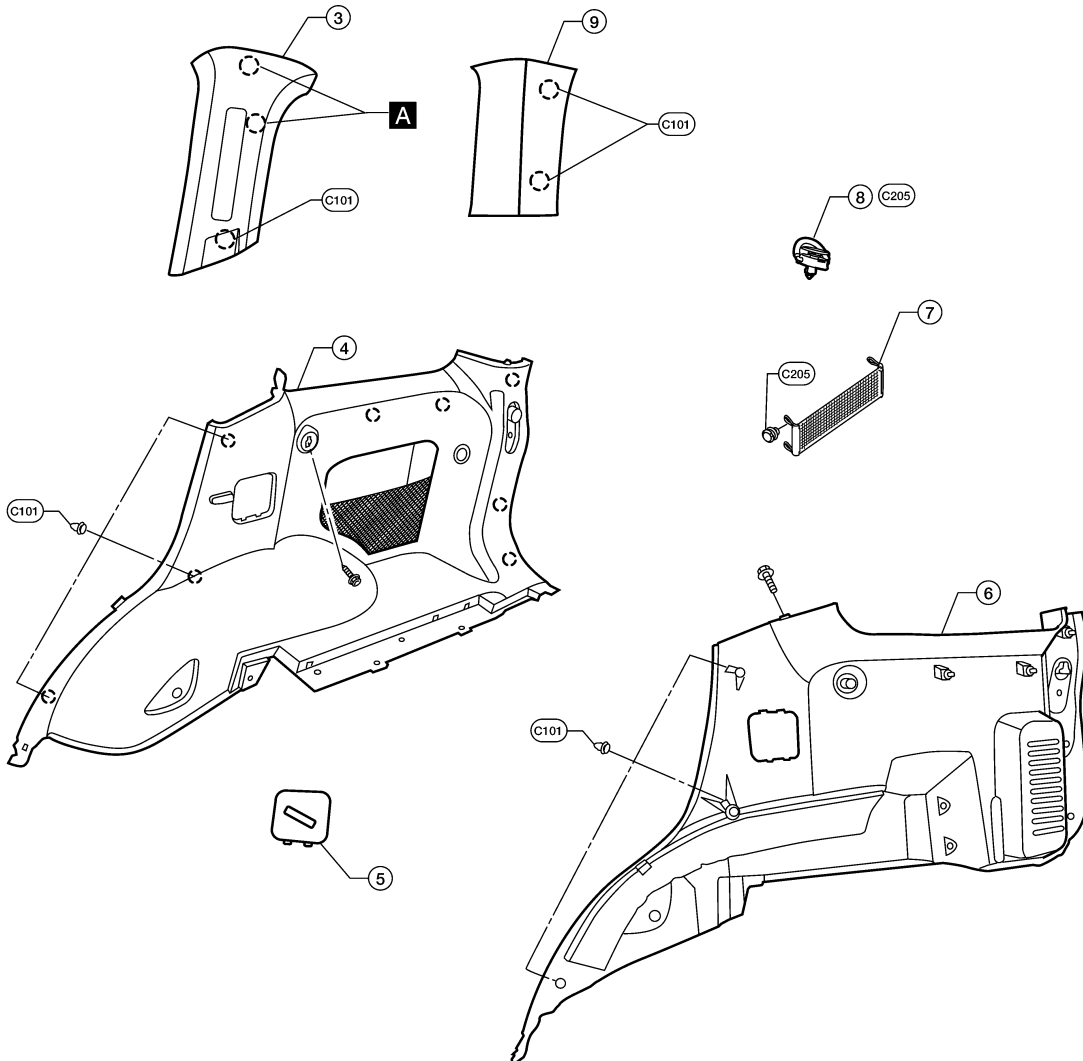
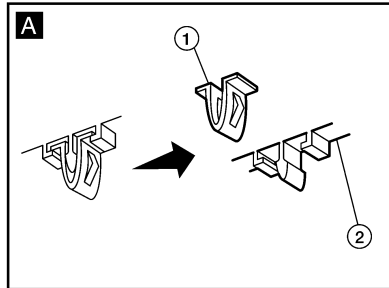

- 1. Metal clip
- 2. Garnish
- 3. Luggage side upper finisher RH
- 4. Luggage side lower finisher RH
- 5. Seat striker escutcheon
- 6. Luggage side lower finisher LH

V HED/ 71D

# LUGGAGE FLOOR TRIM

< ON-VEHICLE REPAIR >

7. Side cargo net

8. Cargo net hook

9. Rear pillar upper finisher RH

↶ Vehicle front

(H) Pawl

## Luggage Trim - Floor

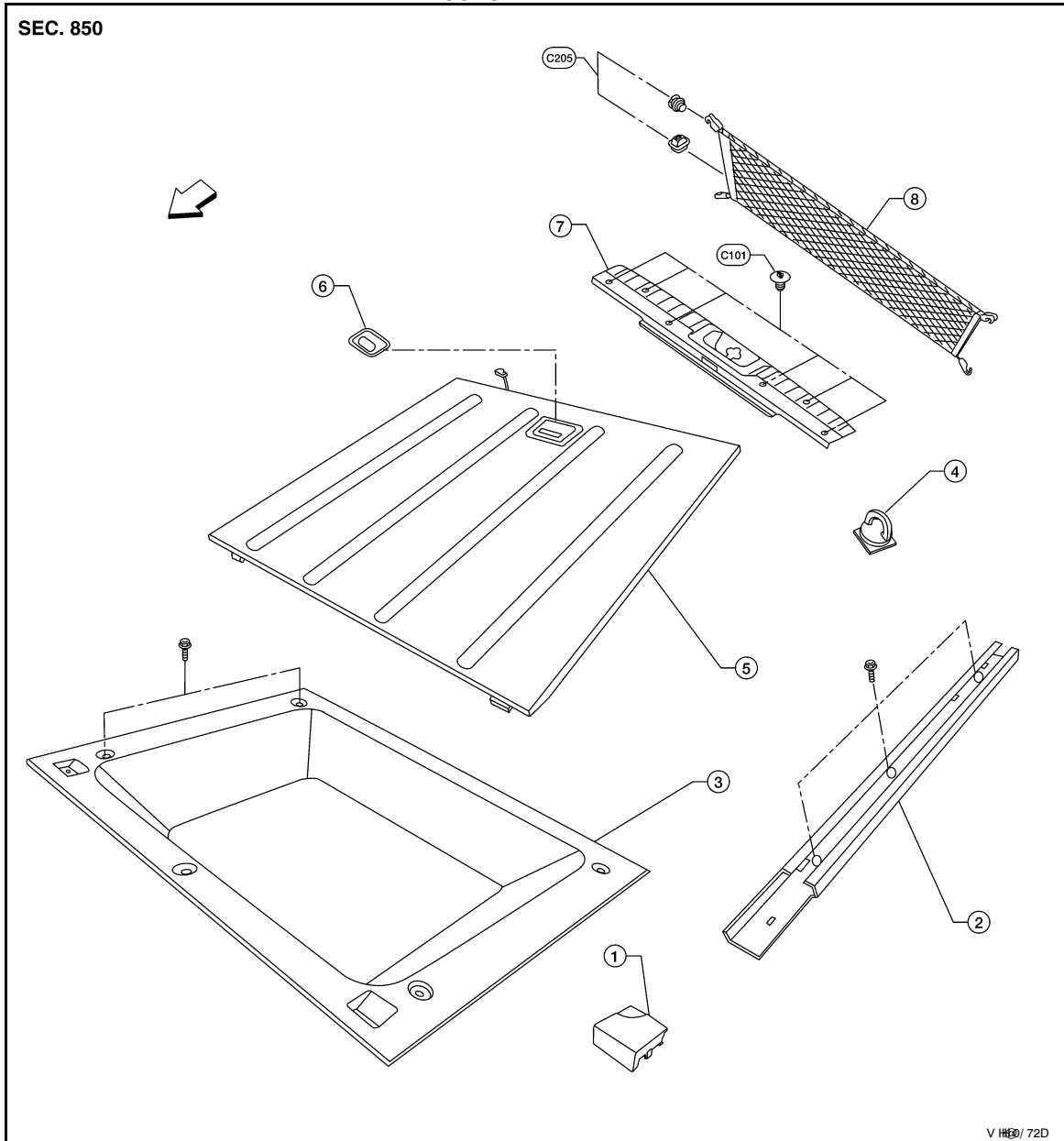

1. Cargo floor rail end cover

2. Cargo floor rail

3. Storage tray

4. Cargo hook

5. Luggage floor cover

6. Luggage floor cover latch

7. Back door kick plate

8. Cargo net

↶ Vehicle front

## Removal and Installation

INFOID:000000004065193

### REMOVAL

1. Disconnect the battery negative terminal.
2. Remove the luggage floor cover.
3. Remove the back door kick plate.
4. Remove the storage tray.
5. Remove the cargo hooks LH/RH.
6. Remove the cargo floor rail end covers LH/RH.

## LUGGAGE FLOOR TRIM

### < ON-VEHICLE REPAIR >

---

7. Remove the cargo floor rails LH/RH.
8. Remove the 2nd row seats. Refer to [SE-29, "Removal and Installation"](#).
9. Remove the 2nd row seat belts. Refer to [SB-5, "Removal and Installation of Rear Seat Belt"](#).
10. Remove the cargo net hooks LH/RH.
11. Remove the back door kick plate.
12. Remove the seat striker escutcheon LH/RH.
13. Remove the LH/RH luggage side lower finishers.
  - Disconnect the power point on the RH side.
14. Remove the luggage side upper finishers LH/RH.
15. Remove the rear pillar upper finishers LH/RH.

### INSTALLATION

Installation is in the reverse order of removal.

A

B

C

D

E

F

G

H

I

INT

K

L

M

N

O

P

# BACK DOOR TRIM

< ON-VEHICLE REPAIR >

## BACK DOOR TRIM

### Removal and Installation

INFOID:000000004065194

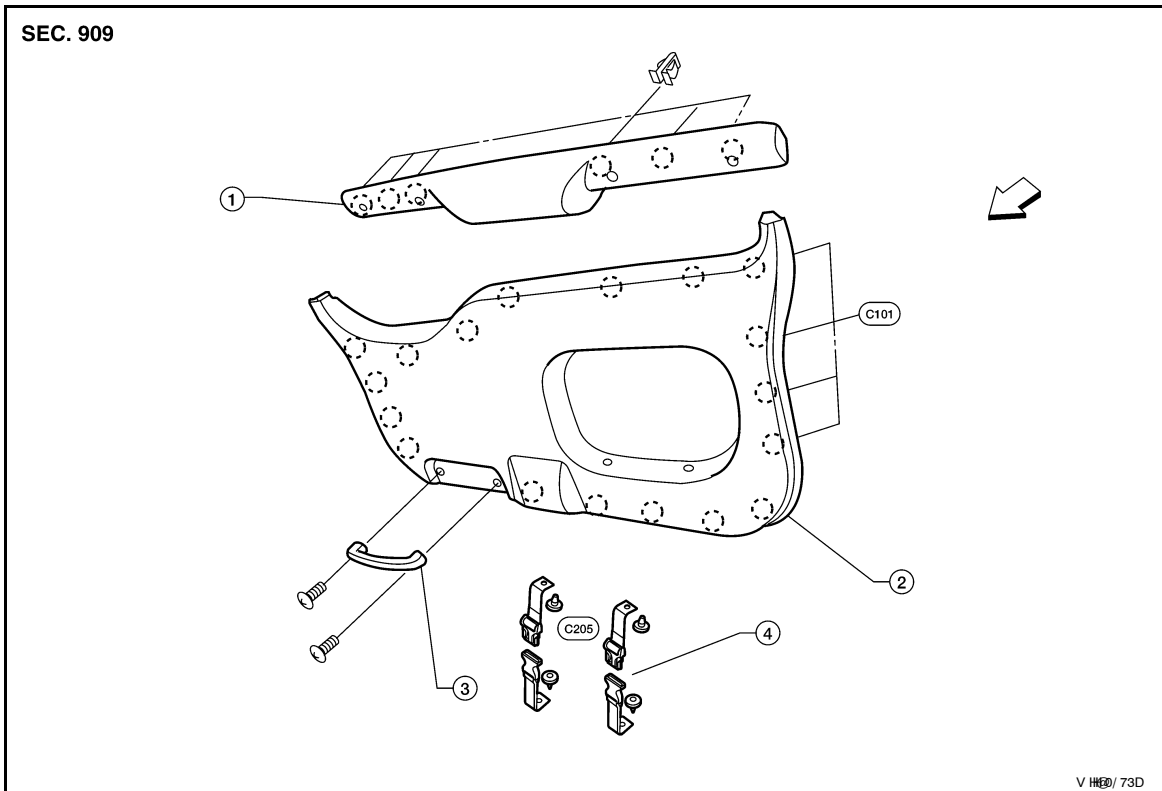

- 1. Back door upper finisher
  - 2. Back door lower finisher
  - 3. Back door pull handle
  - 4. First aid kit strap
- ← Vehicle front
- Ⓜ Pawl

### REMOVAL

1. Open the back door, release the clips and remove back door upper finisher.
2. Remove the back door pull handle.
3. Release the pushpins and remove the first aid kit straps.
4. Release the clips and remove back door finisher assembly.

### INSTALLATION

Installation is in the reverse order of removal.