

SECTION **BCS**

BODY CONTROL SYSTEM

A
B
C
D
E
F
G
H
I
J
L
M

CONTENTS

PRECAUTIONS	2	Schematic	9
Precautions for Supplemental Restraint System (SRS) "AIR BAG" and "SEAT BELT PRE-TENSIONER"	2	BCM Terminal Arrangement	11
BCM (BODY CONTROL MODULE)	3	Terminals and Reference Values for BCM	12
System Description	3	BCM Power Supply and Ground Circuit Check	16
BCM FUNCTION	3	CONSULT-II Function (BCM)	18
COMBINATION SWITCH READING FUNCTION	3	CONSULT-II OPERATION	18
CAN COMMUNICATION CONTROL	6	ITEMS OF EACH PART	19
BCM STATUS CONTROL	6	WORK SUPPORT	19
SYSTEMS CONTROLLED BY BCM DIRECTLY	7	CAN Communication Inspection Using CONSULT-II (Self-Diagnosis)	20
SYSTEMS CONTROLLED BY BCM AND IPDM E/R	7	Configuration	21
MAJOR COMPONENTS AND CONTROL SYSTEM	7	DESCRIPTION	21
CAN Communication System Description	8	READ CONFIGURATION PROCEDURE	21
		WRITE CONFIGURATION PROCEDURE	23
		Removal and Installation	27
		BCM	27

BCS

PRECAUTIONS

PRECAUTIONS

PF0:00001

Precautions for Supplemental Restraint System (SRS) “AIR BAG” and “SEAT BELT PRE-TENSIONER”

EKS00G0L

The Supplemental Restraint System such as “AIR BAG” and “SEAT BELT PRE-TENSIONER”, used along with a front seat belt, helps to reduce the risk or severity of injury to the driver and front passenger for certain types of collision. This system includes seat belt switch inputs and dual stage front air bag modules. The SRS system uses the seat belt switches to determine the front air bag deployment, and may only deploy one front air bag, depending on the severity of a collision and whether the front occupants are belted or unbelted. Information necessary to service the system safely is included in the SRS and SB section of this Service Manual.

WARNING:

- **To avoid rendering the SRS inoperative, which could increase the risk of personal injury or death in the event of a collision which would result in air bag inflation, all maintenance must be performed by an authorized NISSAN/INFINITI dealer.**
- **Improper maintenance, including incorrect removal and installation of the SRS, can lead to personal injury caused by unintentional activation of the system. For removal of Spiral Cable and Air Bag Module, see the SRS section.**
- **Do not use electrical test equipment on any circuit related to the SRS unless instructed to in this Service Manual. SRS wiring harnesses can be identified by yellow and/or orange harnesses or harness connectors.**

BCM (BODY CONTROL MODULE)

PF2:284B2

BCM (BODY CONTROL MODULE)

System Description

EKS00G0M

- BCM (body control module) controls the operation of various electrical units installed on the vehicle.

BCM FUNCTION

BCM has a combination switch reading function for reading the operation of combination switches (light, wiper washer, turn signal) in addition to the function for controlling the operation of various electrical components. Also, it functions as an interface that receives signals from the A/C control unit, and sends signals to ECM using CAN communication.

COMBINATION SWITCH READING FUNCTION

1. Description

- BCM reads combination switch (light, wiper) status, and controls various electrical components according to the results.
- BCM reads information of a maximum of 20 switches by combining five output terminals (OUTPUT 1-5) and five input terminals (INPUT 1-5).

2. Operation description

- BCM activates transistors of output terminals (OUTPUT 1-5) periodically and allows current to flow in turn.
- If any (1 or more) of the switches are turned ON, circuit of output terminals (OUTPUT 1-5) and input terminals (INPUT 1-5) becomes active.
- At this time, transistors of output terminals (OUTPUT 1-5) are activated to allow current to flow. When voltage of input terminals (INPUT 1-5) corresponding to that switch changes, interface in BCM detects voltage change and BCM determines that switch is ON.

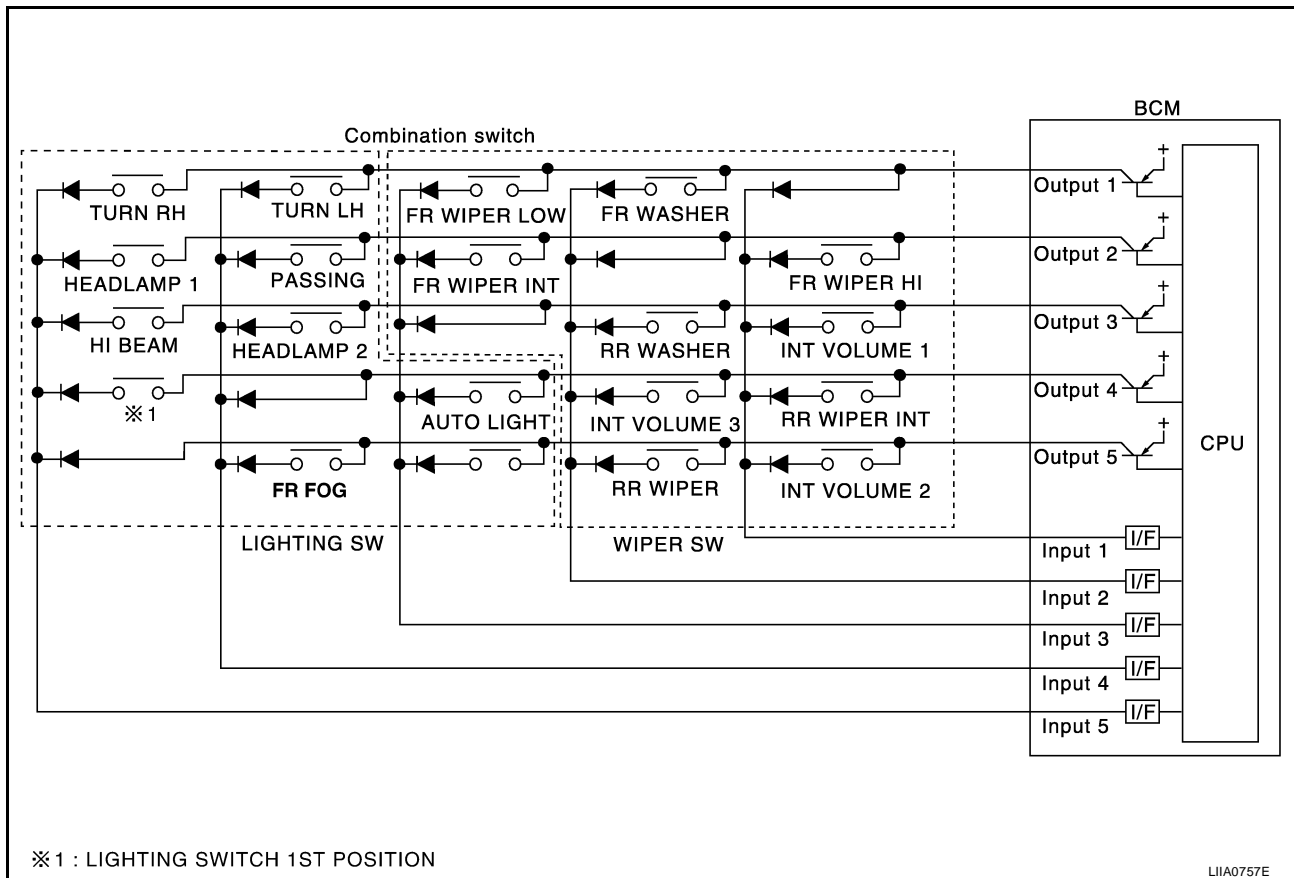

3. BCM - Operation table of combination switch

- BCM reads operation status of combination switch by the combination shown in the following table.

A
B
C
D
E
F
G
H
I
J
L
M

BCS

BCM (BODY CONTROL MODULE)

	COMB SW OUTPUT 1		COMB SW OUTPUT 2		COMB SW OUTPUT 3		COMB SW OUTPUT 4		COMB SW OUTPUT 5	
	ON	OFF	ON	OFF	ON	OFF	ON	OFF	ON	OFF
COMB SW INPUT 1	—	—	FR WIPER HI ON	FR WIPER HI OFF	INT VOLUME 1 ON	INT VOLUME 1 OFF	RR WIPER INT ON	RR WIPER INT OFF	INT VOLUME 2 ON	INT VOLUME 2 OFF
COMB SW INPUT 2	FR WASHER ON	FR WASHER OFF	—	—	RR WASHER ON	RR WASHER OFF	INT VOLUME 3 ON	INT VOLUME 3 OFF	RR WIPER ON	RR WIPER OFF
COMB SW INPUT 3	FR WIPER LOW ON	FR WIPER LOW OFF	FR WIPER INT ON	FR WIPER INT OFF	—	—	AUTO LIGHT ON	AUTO LIGHT OFF	—	—
COMB SW INPUT 4	TURN LH ON	TURN LH OFF	PASSING ON	PASSING OFF	HEAD-LAMP 2 ON	HEAD-LAMP 2 OFF	—	—	FR FOG ON	FR FOG OFF
COMB SW INPUT 5	TURN RH ON	TURN RH OFF	HEAD-LAMP 1 ON	HEAD-LAMP 1 OFF	HI BEAM ON	HI BEAM OFF	LIGHTING SW (1st) ON	LIGHTING SW (1st) OFF	—	—

SKIA4959E

NOTE:

Headlamp has a dual system switch.

4. Example operation: (When lighting switch 1st position turned ON)
- When lighting switch 1st position is turned ON, contact in combination switch turns ON. At this time if OUTPUT 4 transistor is activated, BCM detects that voltage changes in INPUT 5.
 - When OUTPUT 4 transistor is ON, BCM detects that voltage changes in INPUT 5, and judges lighting switch 1st position is ON. Then BCM sends tail lamp ON signal to IPDM E/R using CAN communication.
 - When OUTPUT 4 transistor is activated again, BCM detects that voltage changes in INPUT 5 and recognizes that lighting switch 1st position is continuously ON.

BCM (BODY CONTROL MODULE)

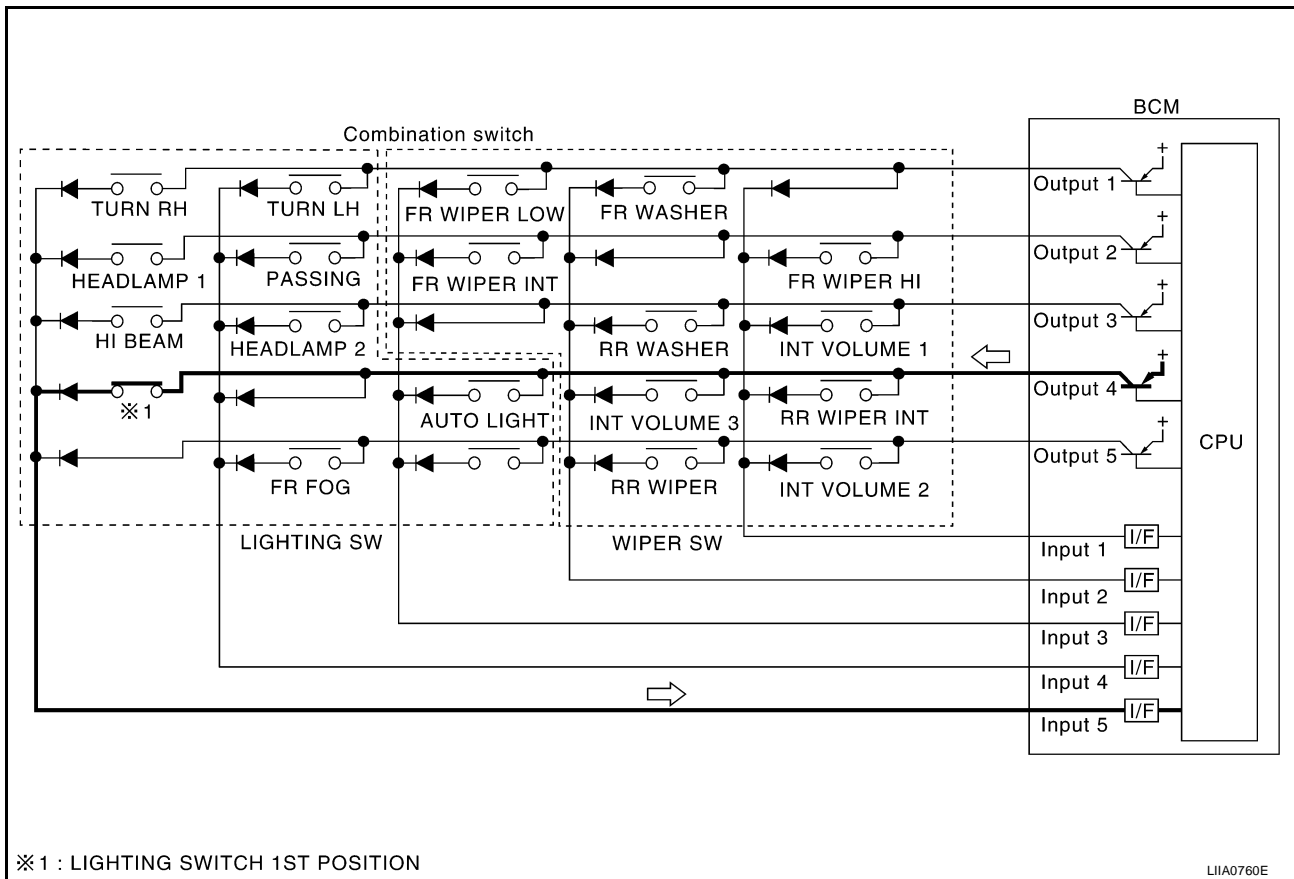

NOTE:

Each OUTPUT terminal transistor is activated at 10ms intervals. Therefore, after a switch is turned ON, electrical loads are activated with a time delay. But this time delay is so short that it cannot be noticed.

5. Operation mode

- Combination switch reading function has operation modes as follows:

Normal status

- When BCM is not in sleep status, OUTPUT terminals (1-5) each turn ON-OFF every 10 ms.

Sleep status

A
B
C
D
E
F
G
H
I
J
L
M

BCS

BCM (BODY CONTROL MODULE)

- When BCM is in sleep mode, transistors of OUTPUT 1 and 5 stop the output, and BCM enters low-current-consumption mode. OUTPUTS (2, 3, and 4) turn ON-OFF at 60ms intervals, and receives lighting switch input only.

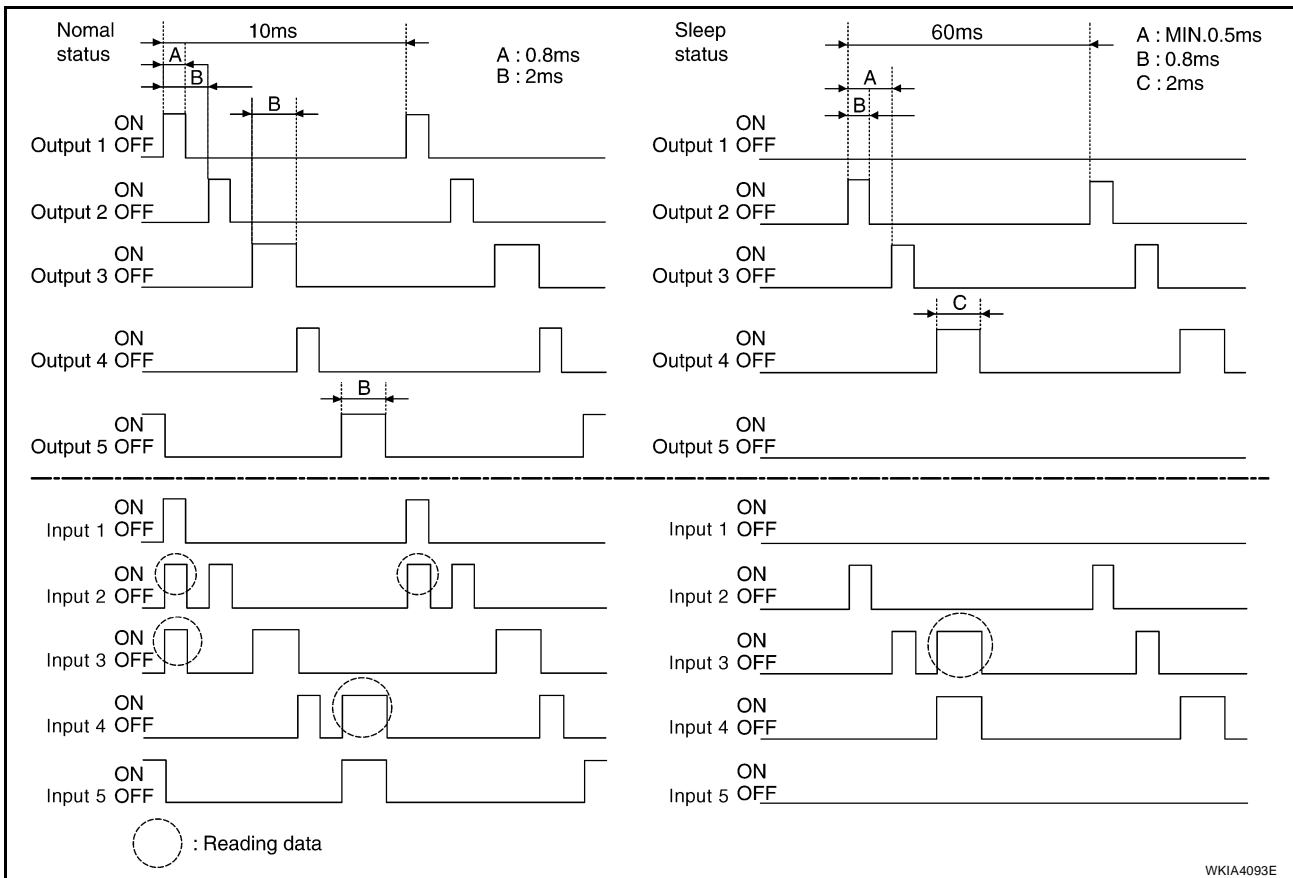

CAN COMMUNICATION CONTROL

CAN communication allows a high rate of information through the two communication lines (CAN-L, CAN-H) connecting the various control units in the system. Each control unit transmits/receives data, but selectively reads required data only.

BCM STATUS CONTROL

BCM changes its status depending on the operation status in order to save power consumption.

1. CAN communication status
 - With ignition switch ON, CAN communicates with other control units normally.
 - Control by BCM is being operated properly.
 - When ignition switch is OFF, switching to sleep mode is possible.
 - Even when ignition switch is OFF, if CAN communication with IPDM E/R and combination meter is active, CAN communication status is active.
2. Sleep transient status
 - This status shuts down CAN communication when ignition switch is turned OFF.
 - It transmits sleep request signal to IPDM E/R and combination meter.
 - Two seconds after CAN communication of all control units stops, CAN communication switches to inactive status.
3. CAN communication inactive status
 - With ignition switch OFF, CAN communication is not active.
 - With ignition switch OFF, control performed only by BCM is active.
 - Three seconds after CAN communication of all control units stops, CAN communication switches to inactive status.
4. Sleep status

BCM (BODY CONTROL MODULE)

- BCM is activated with low current consumption mode.
- CAN communication is not active.
- When CAN communication operation is detected, it switches to CAN communication status.
- When a state of the following switches changes, it switches to CAN communication state:
 - Ignition switch
 - Key switch
 - Hazard switch
 - Door lock/unlock switch
 - Front door switch (LH, RH)
 - Rear door switch (LH, RH)
 - Back door switch
 - Glass hatch ajar switch
 - Combination switch (passing, lighting switch 1st position, front fog lamp)
 - Keyfob (lock/unlock signal)
 - Front door lock assembly LH (key cylinder switch)
- When control performed only by BCM is required by switch, it shifts to CAN communication inactive mode.
- Status of combination switch reading function is changed.

SYSTEMS CONTROLLED BY BCM DIRECTLY

- Power door lock system. Refer to [BL-16, "POWER DOOR LOCK SYSTEM"](#) .
- Remote keyless entry system. Refer to [BL-41, "REMOTE KEYLESS ENTRY SYSTEM"](#) .
- Power window system. Refer to [GW-15, "POWER WINDOW SYSTEM"](#) . NOTE
- Sunroof system. Refer to [RF-10, "SUNROOF"](#) . NOTE
- Room lamp timer. Refer to [LT-115, "INTERIOR ROOM LAMP"](#) .
- Warning chime system. Refer to [DI-46, "WARNING CHIME"](#) .
- Turn signal and hazard warning lamps system. Refer to [LT-64, "TURN SIGNAL AND HAZARD WARNING LAMPS"](#) .
- Trailer turn signal and hazard warning lamps system. Refer to [LT-106, "TRAILER TOW"](#) .
- Rear wiper and washer system. Refer to [WW-31, "REAR WIPER AND WASHER SYSTEM"](#) .

NOTE:

Power supply only. No system control.

SYSTEMS CONTROLLED BY BCM AND IPDM E/R

- Panic system. Refer to [BL-41, "REMOTE KEYLESS ENTRY SYSTEM"](#) .
- Vehicle security system. Refer to [BL-68, "VEHICLE SECURITY \(THEFT WARNING\) SYSTEM"](#) .
- NVIS (NATS) system. Refer to [BL-100, "NVIS\(NISSAN Vehicle Immobilizer System-NATS\)"](#) .
- Headlamp, daytime light, auto light, tail lamp, fog lamp and battery saver control systems. Refer to [LT-5, "HEADLAMP \(FOR USA\)"](#) , [LT-29, "HEADLAMP \(FOR CANADA\) - DAYTIME LIGHT SYSTEM -"](#) , [LT-40, "AUTO LIGHT SYSTEM"](#) , [LT-56, "FRONT FOG LAMP"](#) , and [LT-90, "PARKING, LICENSE PLATE AND TAIL LAMPS"](#) .
- Front wiper and washer system. Refer to [WW-4, "FRONT WIPER AND WASHER SYSTEM"](#) .
- Rear window defogger system. Refer to [GW-70, "REAR WINDOW DEFOGGER"](#) .

MAJOR COMPONENTS AND CONTROL SYSTEM

System	Input	Output
Remote keyless entry system	Remote keyless entry receiver (keyfob)	<ul style="list-style-type: none"> ● All door locking actuators ● Turn signal lamps
Power door lock system	<ul style="list-style-type: none"> ● Front power door lock/unlock switch (LH, RH) ● All door switches ● Key switch 	All door locking actuators

BCM (BODY CONTROL MODULE)

System	Input	Output
Power supply [ignition (IGN)/retained accessory power (RAP)] to power window and sunroof	IGN/RAP supply	Power supply to power window and sunroof system
Power supply (BAT) to power window and sunroof	Battery power supply	Power supply to power window and sunroof system
Panic alarm	<ul style="list-style-type: none"> ● Key switch ● Remote keyless entry receiver (keyfob) 	IPDM E/R
Auto light system	<ul style="list-style-type: none"> ● Optical sensor ● Combination switch 	IPDM E/R
Battery saver control	<ul style="list-style-type: none"> ● Ignition switch ● Combination switch ● Front door switch LH and RH 	IPDM E/R
Headlamp	Combination switch	IPDM E/R
Tail lamp	Combination switch	IPDM E/R
Front fog lamp	Combination switch	IPDM E/R
Turn signal lamp	Combination switch	<ul style="list-style-type: none"> ● Turn signal lamp ● Combination meter
Hazard lamp	Hazard switch	<ul style="list-style-type: none"> ● Turn signal lamp ● Combination meter
Room lamp timer	<ul style="list-style-type: none"> ● Key switch ● Remote keyless entry receiver (keyfob) ● Main power window and door lock/unlock switch ● Front door lock assembly LH (key cylinder switch) ● All door switches 	Interior room lamp
Key warning chime	<ul style="list-style-type: none"> ● Key switch ● Front door switch LH 	Combination meter (warning buzzer)
Light warning chime	<ul style="list-style-type: none"> ● Combination switch ● Key switch ● Front door switch LH 	Combination meter (warning buzzer)
Vehicle-speed-sensing intermittent wiper	<ul style="list-style-type: none"> ● Combination switch ● Combination meter 	IPDM E/R
Rear window defogger	Rear window defogger switch	IPDM E/R
Air conditioner switch signal	Front air control	ECM
Blower fan switch signal	Front air control	ECM
Low tire pressure warning system	Remote keyless entry receiver	<ul style="list-style-type: none"> ● Combination meter ● Display control unit (with NAVI)
Trailer tow	Combination switch	Trailer turn signal relays
Vehicle security system	<ul style="list-style-type: none"> ● Remote keyless entry receiver (keyfob) ● Main power window and door lock/unlock switch ● Power window and door lock/unlock switch RH ● Front door lock assembly LH (key cylinder switch) ● All door switches ● Back door latch (door ajar switch) 	<ul style="list-style-type: none"> ● IPDM E/R ● Security indicator lamp

CAN Communication System Description

EKS00G0N

Refer to [LAN-25, "CAN COMMUNICATION"](#) .

BCM (BODY CONTROL MODULE)

Schematic

EKS00G00

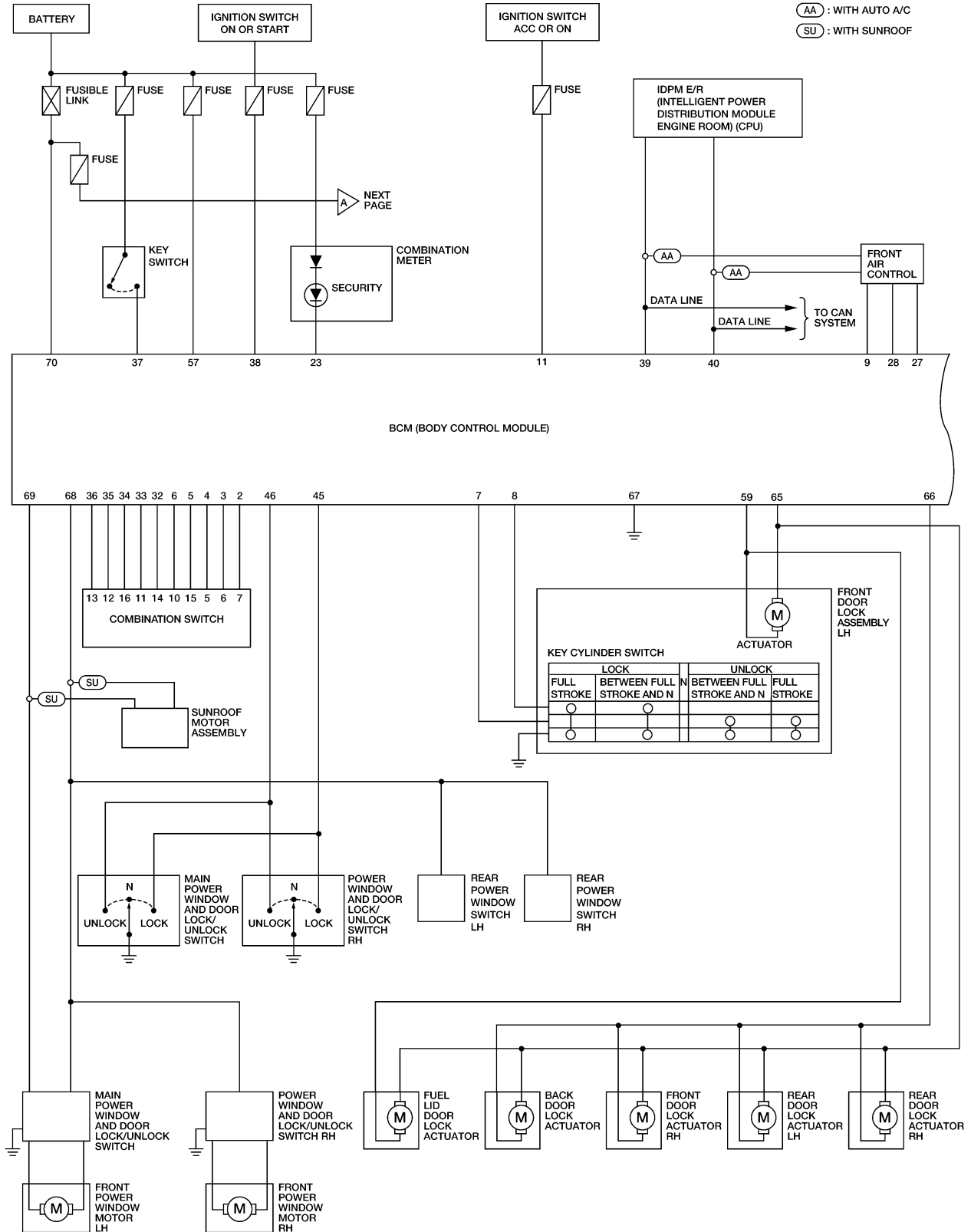

A
B
C
D
E
F
G
H
I
J
L
M

BCS

BCM (BODY CONTROL MODULE)

- AA : WITH AUTO A/C
- MP : WITH MAP LAMPS
- VN : WITH VANITY LAMPS
- XM : WITHOUT MAP LAMPS

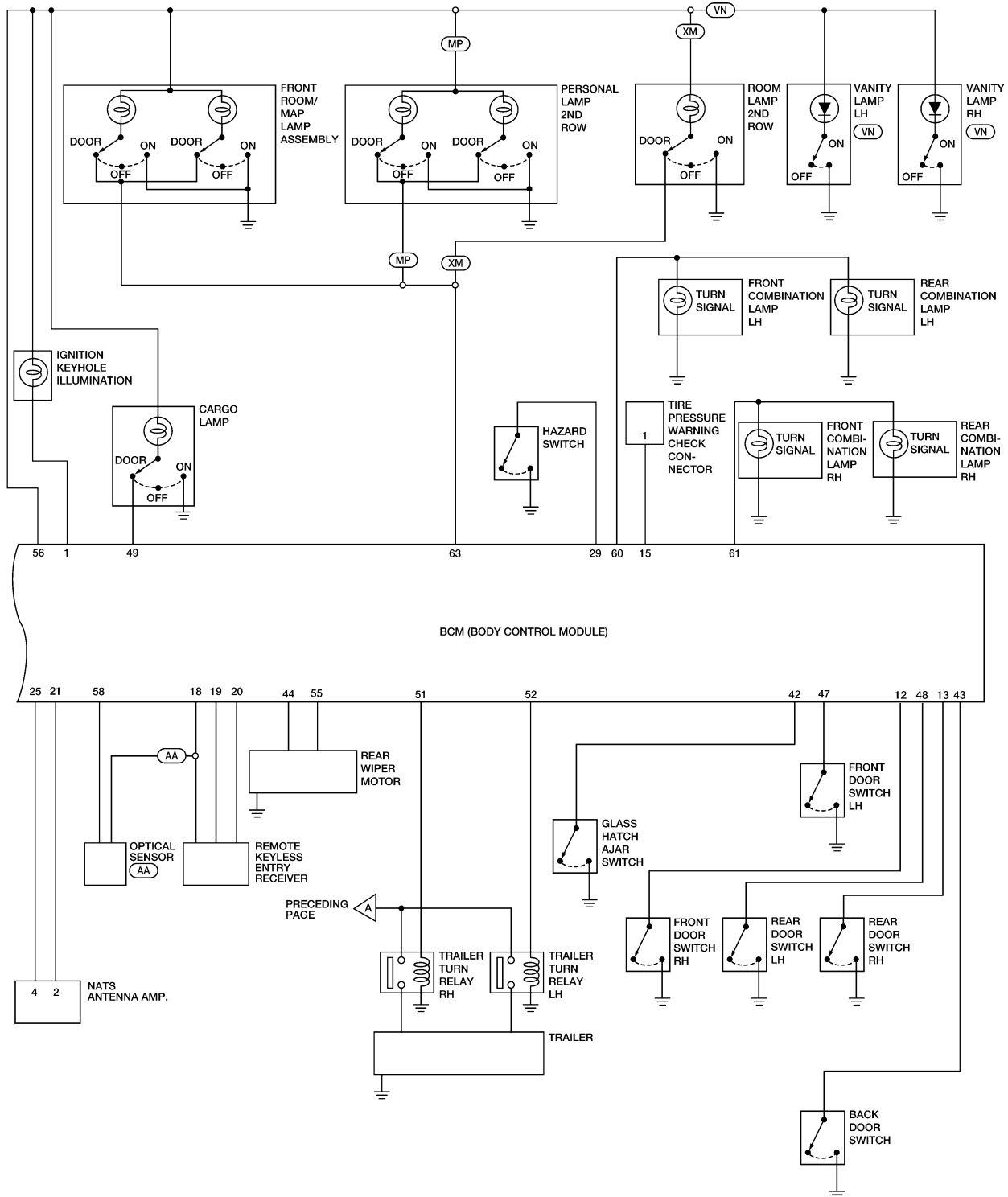

WIWA2295E

BCM (BODY CONTROL MODULE)

BCM Terminal Arrangement

EKS00HJY

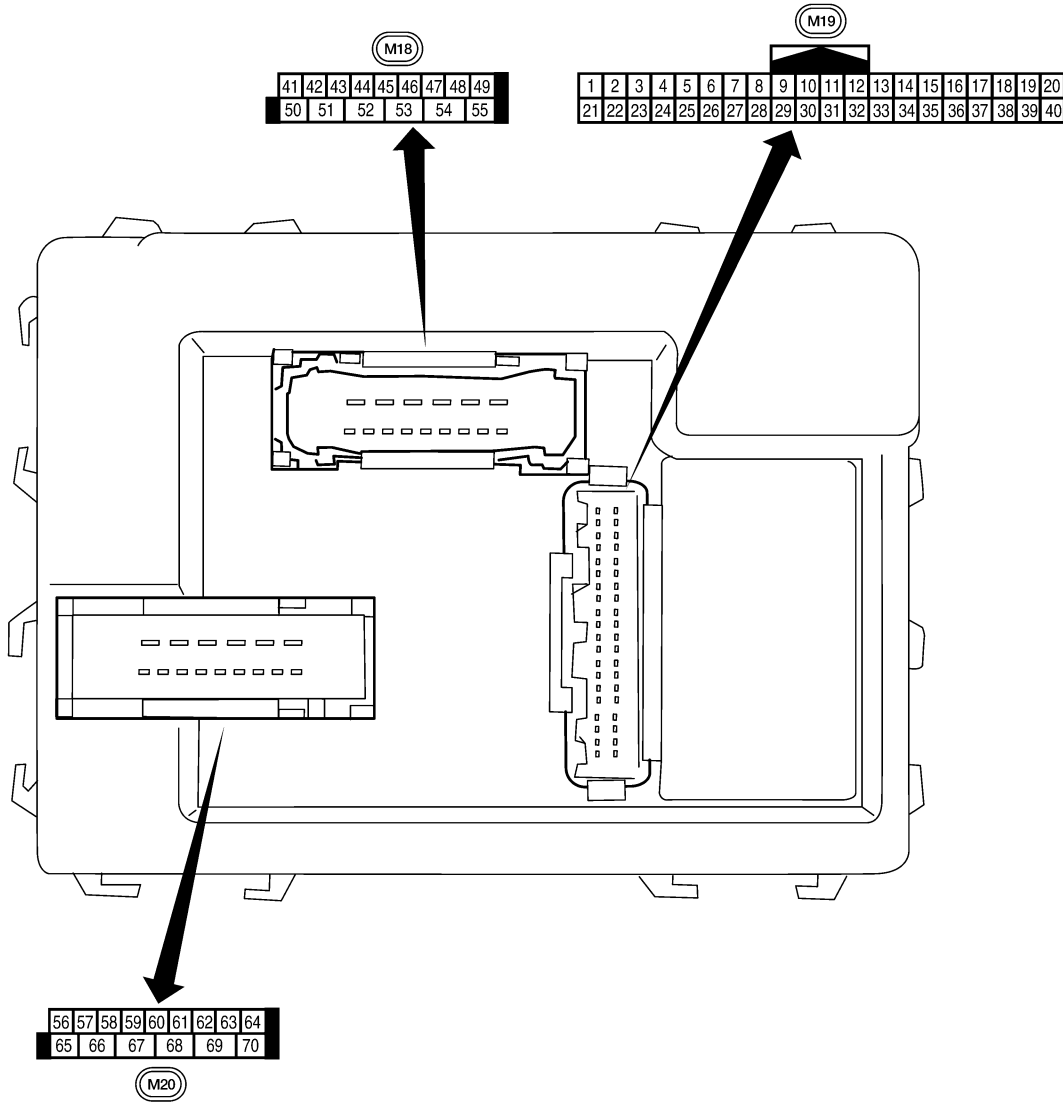

A
B
C
D
E
F
G
H
I
J
K
L
M

BCS

LKIA0682E

BCM (BODY CONTROL MODULE)

EKS00HJZ

Terminals and Reference Values for BCM

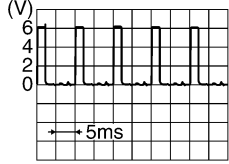
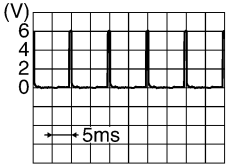
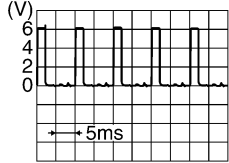
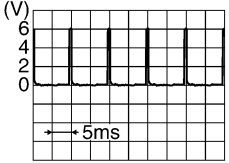
Terminal	Wire color	Signal name	Signal input/output	Measuring condition		Reference value or waveform (Approx.)
				Ignition switch	Operation or condition	
1	BR	Ignition keyhole illumination	Output	OFF	Door is locked (SW OFF)	Battery voltage
					Door is unlocked (SW ON)	0V
2	P	Combination switch input 5	Input	ON	Lighting, turn, wiper OFF Wiper dial position 4	 <p style="text-align: right; font-size: small;">SKIA5291E</p>
3	SB	Combination switch input 4	Input	ON	Lighting, turn, wiper OFF Wiper dial position 4	 <p style="text-align: right; font-size: small;">SKIA5292E</p>
4	V	Combination switch input 3	Input	ON	Lighting, turn, wiper OFF Wiper dial position 4	 <p style="text-align: right; font-size: small;">SKIA5291E</p>
5	L	Combination switch input 2	Input	ON	Lighting, turn, wiper OFF Wiper dial position 4	 <p style="text-align: right; font-size: small;">SKIA5292E</p>
6	R	Combination switch input 1				
7	GR	Front door lock assembly LH (key cylinder switch) unlock	Input	OFF	ON (open, 2nd turn)	Momentary 1.5V
8	SB	Front door lock assembly LH (key cylinder switch) lock			On (open)	Momentary 1.5V
			OFF (closed)	0V		
9	Y	Rear window defogger switch	Input	ON	Rear window defogger switch ON	0V
					Rear window defogger switch OFF	5V
11	G/B	Ignition switch (ACC or ON)	Input	ACC or ON	Ignition switch ACC or ON	Battery voltage
12	LG	Front door switch RH	Input	OFF	ON (open)	0V
					OFF (closed)	Battery voltage
13	L	Rear door switch RH	Input	OFF	ON (open)	0V
					OFF (closed)	Battery voltage
15	W	Tire pressure warning check connector	Input	OFF	—	5V

BCM (BODY CONTROL MODULE)



Terminal	Wire color	Signal name	Signal input/output	Measuring condition		Reference value or waveform (Approx.)
				Ignition switch	Operation or condition	
18	BR	Remote keyless entry receiver (Ground)	Output	OFF	—	0V
19	V	Remote keyless entry receiver (power supply)	Output	OFF	Ignition switch OFF	 LIIA1893E
20	G	Remote keyless entry receiver signal (Signal)	Input	OFF	Stand-by (keyfob buttons released)	 LIIA1894E
					When remote keyless entry receiver receives signal from keyfob (keyfob buttons pressed)	 LIIA1895E
21	GR	NATS antenna amp.	Input	OFF → ON	Ignition switch (OFF → ON)	Just after turning ignition switch ON: Pointer of tester should move for approx. 1 second, then return to battery voltage.
23	G	Security indicator lamp	Output	OFF	Goes OFF → illuminates (Every 2.4 seconds)	Battery voltage → 0V
25	BR	NATS antenna amp.	Input	OFF → ON	Ignition switch (OFF → ON)	Just after turning ignition switch ON: Pointer of tester should move for approx. 1 second, then return to battery voltage.
27	W	Compressor ON signal	Input	ON	A/C switch OFF	5V
					A/C switch ON	0V
28	R	Front blower monitor	Input	ON	Front blower motor OFF	Battery voltage
					Front blower motor ON	0V
29	G	Hazard switch	Input	OFF	ON	0V
					OFF	5V
32	O	Combination switch output 5	Output	ON	Lighting, turn, wiper OFF Wiper dial position 4	 SKIA5291E

A
B
C
D
E
F
G
H
I
J

BCS

L
M

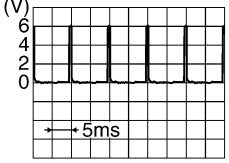
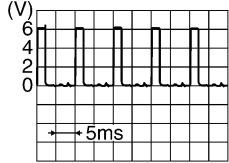
BCM (BODY CONTROL MODULE)

Terminal	Wire color	Signal name	Signal input/output	Measuring condition		Reference value or waveform (Approx.)
				Ignition switch	Operation or condition	
33	GR	Combination switch output 4	Output	ON	Lighting, turn, wiper OFF Wiper dial position 4	 <p style="text-align: right; font-size: small;">SKIA5292E</p>
34	G	Combination switch output 3	Output	ON	Lighting, turn, wiper OFF Wiper dial position 4	 <p style="text-align: right; font-size: small;">SKIA5291E</p>
35	BR	Combination switch output 2	Output	ON	Lighting, turn, wiper OFF Wiper dial position 4	 <p style="text-align: right; font-size: small;">SKIA5292E</p>
36	LG	Combination switch output 1				
37	B	Key switch	Input	OFF	Key inserted	Battery voltage
					Key removed	0V
38	W/R	Ignition switch (ON)	Input	ON	—	Battery voltage
39	L	CAN-H	—	—	—	—
40	P	CAN-L	—	—	—	—
42	LG	Glass hatch ajar switch	Input	OFF	ON (open)	0V
					OFF (closed)	Battery voltage
43	Y	Back door switch	Input	OFF	ON (open)	0V
					OFF (closed)	Battery voltage
44	O	Rear wiper auto stop	Input	ON	Rear wiper operating	0
					Rear wiper stopped	Battery
45	V	Lock switch	Input	OFF	ON (lock)	0V
					OFF	Battery voltage
46	LG	Unlock switch	Input	OFF	ON (unlock)	0V
					OFF	Battery voltage
47	GR	Front door switch LH	Input	OFF	ON (open)	0V
					OFF (closed)	Battery voltage
48	P	Rear door switch LH	Input	OFF	ON (open)	0V
					OFF (closed)	Battery voltage
49	L	Cargo lamp	Output	OFF	Any door open (ON)	0V
					All doors closed (OFF)	Battery voltage

BCM (BODY CONTROL MODULE)

Terminal	Wire color	Signal name	Signal input/output	Measuring condition		Reference value or waveform (Approx.)
				Ignition switch	Operation or condition	
51	O	Trailer turn signal (right)	Output	ON	Turn right ON	<p style="text-align: right; font-size: small;">SKIA3009J</p>
52	LG	Trailer turn signal (left)	Output	ON	Turn left ON	<p style="text-align: right; font-size: small;">SKIA3009J</p>
55	W	Rear wiper motor output	Output	ON	OFF	0
				ON		Battery voltage
56	V	Battery saver output	Output	OFF	30 minutes after ignition switch is turned OFF	0V
				ON	—	Battery voltage
57	R/Y	Battery power supply	Input	OFF	—	Battery voltage
58	W	Optical sensor	Input	ON	When optical sensor is illuminated	3.1V or more
					When optical sensor is not illuminated	0.6V or less
59	GR	Front door lock assembly LH and fuel lid door lock actuator (unlock)	Output	OFF	OFF (neutral)	0V
					ON (unlock)	Battery voltage
60	LG	Turn signal (left)	Output	ON	Turn left ON	<p style="text-align: right; font-size: small;">SKIA3009J</p>
61	G	Turn signal (right)	Output	ON	Turn right ON	<p style="text-align: right; font-size: small;">SKIA3009J</p>
63	BR	Interior room/map lamp	Output	OFF	Any door switch	ON (open) 0V OFF (closed) Battery voltage
65	V	All door lock actuators (lock)	Output	OFF	OFF (neutral)	0V
					ON (lock)	Battery voltage
66	L	Front door lock actuator RH, rear door lock actuators LH/RH and back door lock actuator (unlock)	Output	OFF	OFF (neutral)	0V
					ON (unlock)	Battery voltage

A
B
C
D
E
F
G
H
I
J

BCS

L
M

BCM (BODY CONTROL MODULE)

Terminal	Wire color	Signal name	Signal input/output	Measuring condition		Reference value or waveform (Approx.)
				Ignition switch	Operation or condition	
67	B	Ground	Input	ON	—	0V
68	O	Power window power supply (RAP)	Output	—	Ignition switch ON	Battery voltage
					Within 45 seconds after ignition switch OFF	Battery voltage
					More than 45 seconds after ignition switch OFF	0V
					When front door LH or RH is open or power window timer operates	0V
69	L	Power window power supply	Output	—	—	Battery voltage
70	W	Battery power supply	Input	OFF	—	Battery voltage

BCM Power Supply and Ground Circuit Check

EKS00HK0

1. CHECK FUSES AND FUSIBLE LINK

- Check 50A fusible link (letter **g** , located in the fuse and fusible link box).
- Check 10A fuses [No. 1, 4 and 18, located in the fuse block (J/B)].

OK or NG

OK >> GO TO 2.

NG >> If fuse is blown, be sure to eliminate cause of malfunction before installing new fuse. Refer to [PG-3, "PRECAUTIONS"](#).

2. CHECK BCM POWER SUPPLY CIRCUIT

1. Turn ignition switch OFF.
2. Disconnect BCM.
3. Check voltage between BCM connectors and ground.

Connector	Terminals		Power source	Condition	Voltage (V) (Approx.)
	(+)	(-)			
M18	11	Ground	ACC power supply	Ignition switch ACC or ON	Battery voltage
	38	Ground	Ignition power supply	Ignition switch ON or START	Battery voltage
M20	57	Ground	Battery power supply	Ignition switch OFF	Battery voltage
	70	Ground	Battery power supply	Ignition switch OFF	Battery voltage

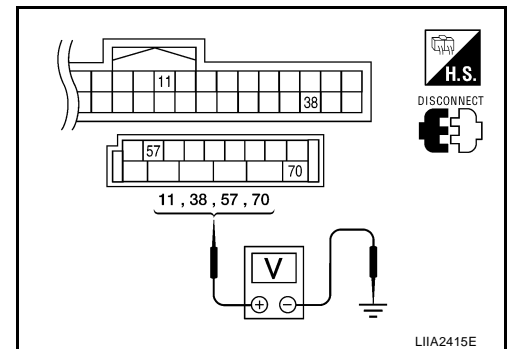

OK or NG

OK >> GO TO 3.

NG >> Repair or replace the harness.

BCM (BODY CONTROL MODULE)

3. CHECK GROUND CIRCUIT

Check continuity between BCM connector M20 terminal 67 and ground.

67 - Ground : Continuity should exist.

OK or NG

- OK >> Power supply and ground circuit is OK.
- NG >> Repair or replace harness.

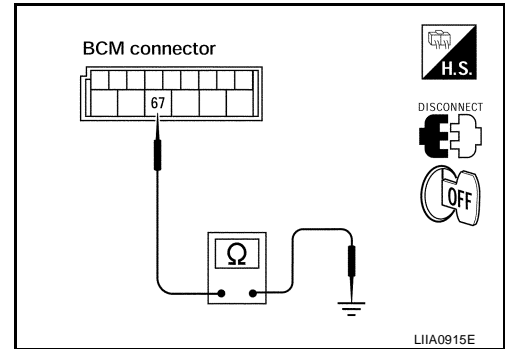

A
B
C
D
E
F
G
H
I
J
L
M

BCS

BCM (BODY CONTROL MODULE)

CONSULT-II Function (BCM)

EKS00G0P

CONSULT-II can display each diagnostic item using the diagnostic test modes shown following.

BCM diagnostic test item	Diagnostic mode	Content
Inspection by part	WORK SUPPORT	Supports inspections and adjustments. Commands are transmitted to the BCM for setting the status suitable for required operation, input/output signals are received from the BCM and received data is displayed.
	DATA MONITOR	Displays BCM input/output data in real time.
	ACTIVE TEST	Operation of electrical loads can be checked by sending drive signal to them.
	SELF-DIAG RESULTS	Displays BCM self-diagnosis results.
	CAN DIAG SUPPORT MNTR	The results of transmit/receive diagnosis of CAN communication can be read.
	ECU PART NUMBER	BCM part number can be read.
	CONFIGURATION	Performs BCM configuration read/write functions.

CONSULT-II OPERATION

CAUTION:

If CONSULT-II is used with no connection of CONSULT-II CONVERTER, malfunctions might be detected in self-diagnosis depending on control unit which carries out CAN communication.

1. With ignition switch OFF, connect CONSULT-II and CONSULT-II CONVERTER to data link connector and turn ignition switch ON.

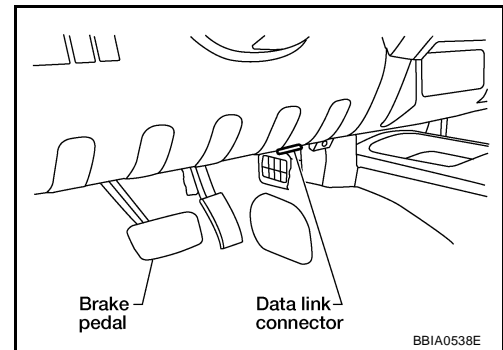

2. Touch "START (NISSAN BASED VHCL)".

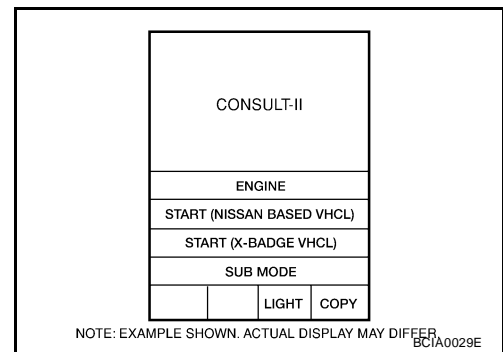

3. Touch "BCM" on "SELECT SYSTEM" screen.
If "BCM" is not indicated, go to [GI-40, "CONSULT-II Data Link Connector \(DLC\) Circuit"](#).

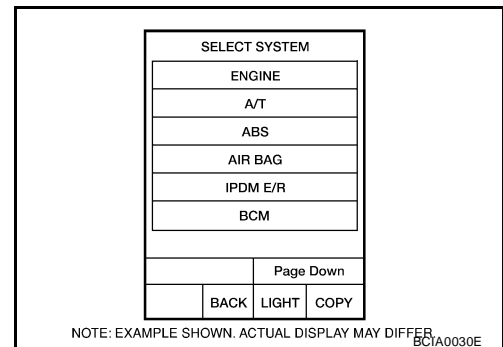

BCM (BODY CONTROL MODULE)

4. Select item to be diagnosed on "SELECT TEST ITEM" screen.

SELECT TEST ITEM			
HEAD LAMP			
WIPER			
FLASHER			
AIR CONDITIONER			
COMB SW			
BCM			
Scroll Up		Page Down	
BACK	LIGHT	COPY	
LKIA0183E			

A
B
C
D

ITEMS OF EACH PART

NOTE:
CONSULT-II will only display systems the vehicle possesses.

System and item	CONSULT-II display	Diagnostic test mode (Inspection by part)						
		WORK SUPPORT	SELF-DIAG RESULTS	CAN DIAG SUPPORT MNTR	DATA MONITOR	ECU PART NUMBER	ACTIVE TEST	CONFIGURATION
BCM	BCM	×	×	×		×		×
Power door lock system	DOOR LOCK	×			×		×	
Rear defogger	REAR DEFOGGER				×		×	
Warning chime	BUZZER				×		×	
Room lamp timer	INT LAMP	×			×		×	
Remote keyless entry system	MULTI REMOTE ENT	×			×		×	
Headlamp	HEAD LAMP	×			×		×	
Wiper	WIPER	×			×		×	
Turn signal lamp Hazard lamp	FLASHER				×		×	
Blower fan switch signal Air conditioner switch signal	AIR CONDITIONER				×			
Combination switch	COMB SW				×			
NVIS (NATS)	IMMU				×		×	
Interior lamp battery saver	BATTERY SAVER	×			×		×	
Back door	TRUNK				×		×	
Theft alarm	THEFT ALARM	×			×		×	
Retained accessory power control	RETAINED PWR	×			×		×	
Oil pressure sensor	SIGNAL BUFFER				×		×	
Air pressure monitor	AIR PRESSURE MONITOR	×	×		×		×	
Panic alarm	PANIC ALARM						×	

E
F
G
H
I
J
K
L
M

BCS

WORK SUPPORT

Operation Procedure

1. Touch "BCM" on "SELECT TEST ITEM" screen.
2. Touch "WORK SUPPORT" on "SELECT DIAG MODE" screen.

BCM (BODY CONTROL MODULE)

3. Touch "RESET SETTING VALUE" on "SELECT WORK ITEM" screen.
4. Touch "START".
5. "RESET SETTING VALUE OK?" is displayed, and touch "YES".
6. The setting will be changed and "COMPLETED" will be displayed.
7. Touch "END".

Display Item List

Item	Description
RESET SETTING VALUE	Return a value set with WORK SUPPORT of each system to a default value in factory shipment.

CAN Communication Inspection Using CONSULT-II (Self-Diagnosis)

EKS00G00

1. SELF-DIAGNOSTIC RESULT CHECK

CAUTION:

If CONSULT-II is used with no connection of CONSULT-II CONVERTER, malfunctions might be detected in self-diagnosis depending on control unit which carries out CAN communication.

1. Connect to CONSULT-II, and select "BCM" on "SELECT SYSTEM" screen.
2. Select "BCM" on "SELECT TEST ITEM" screen, and select "SELF-DIAG RESULTS".
3. Check display content in self-diagnostic results.

CONSULT-II display code	Diagnosis item
U1000	INITIAL DIAG
	TRANSMIT DIAG
	ECM
	IPDM E/R
	METER/M&A
	I-KEY

Contents displayed

No malfunction>>Inspection End

Malfunction in CAN communication system>>After printing the monitor items, go to [LAN-25, "CAN COMMUNICATION"](#).

BCM (BODY CONTROL MODULE)

EKS00G0R

Configuration DESCRIPTION

CONFIGURATION has two functions as follows:

- READ CONFIGURATION is the function to confirm vehicle configuration of current BCM.
- WRITE CONFIGURATION is the function to write vehicle configuration on BCM.

CAUTION:

- When replacing BCM, you must perform WRITE CONFIGURATION with CONSULT-II.
- Complete the procedure of WRITE CONFIGURATION in order.
- If you set incorrect WRITE CONFIGURATION, incidents will occur.
- Configuration is different for each vehicle model. Confirm configuration of each vehicle model.

READ CONFIGURATION PROCEDURE

CAUTION:

If CONSULT-II is used with no connection of CONSULT-II CONVERTER, malfunctions might be detected in self-diagnosis depending on control unit which carries out CAN communication.

1. With ignition switch OFF, connect CONSULT-II and CONSULT-II CONVERTER to data link connector and turn ignition switch ON.

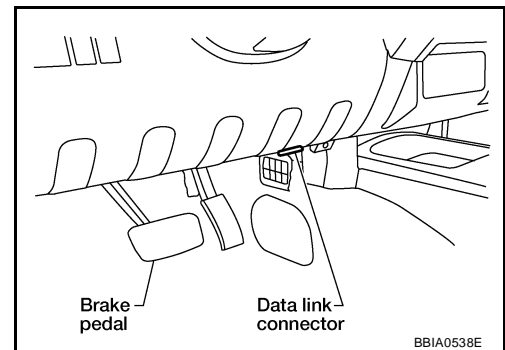

2. Touch "START (NISSAN BASED VHCL)".

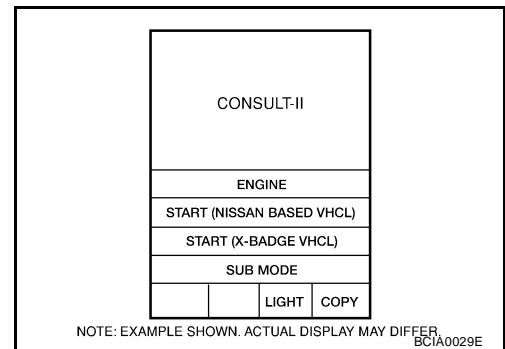

3. Touch "BCM" on "SELECT SYSTEM" screen.
If "BCM" is not indicated, go to [GI-40, "CONSULT-II Data Link Connector \(DLC\) Circuit"](#).

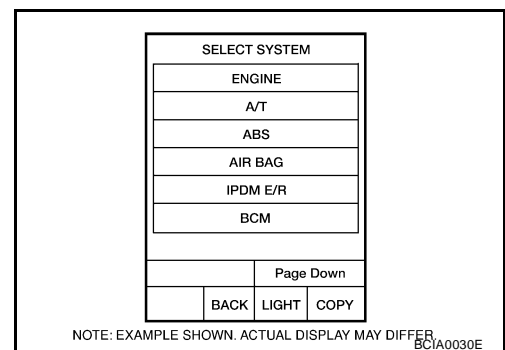

A
B
C
D
E
F
G
H
I
J
L
M

BCS

BCM (BODY CONTROL MODULE)

4. Touch "BCM" on "SELECT TEST ITEM" screen.

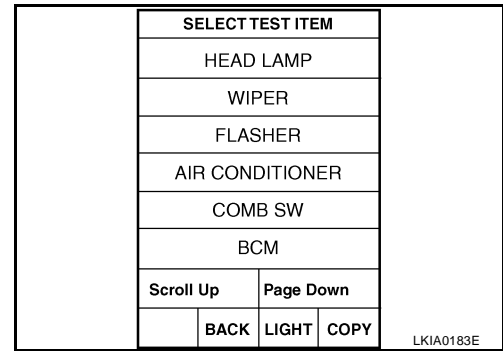

5. Touch "CONFIGURATION" on "SELECT DIAG MODE" screen.

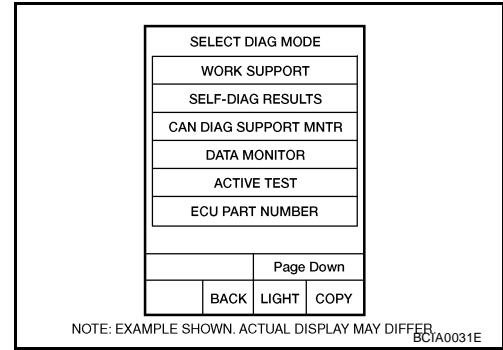

6. Touch "R51/D40/N51" and "OK" on "VEHICLE SELECT" screen. For canceling, touch "CANCEL" on "VEHICLE SELECT" screen.

NOTE:

Confirm vehicle model. Refer to [GI-48, "Model Variation"](#) in GI section.

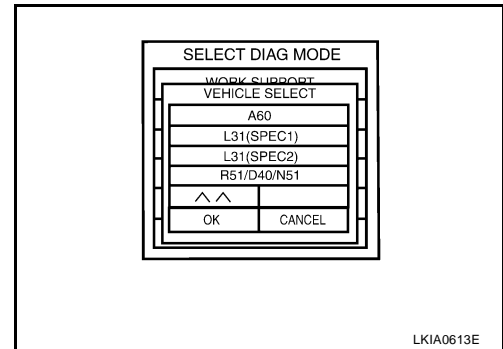

7. Touch "READ CONFIGURATION" on "SELECT CONFIG ITEM" screen.

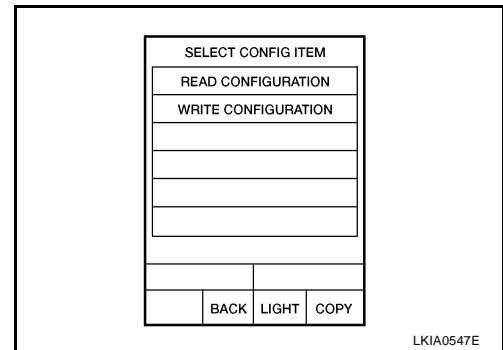

BCM (BODY CONTROL MODULE)

8. Configuration of current BCM is printed out automatically. A listing of manual setting items and auto setting items will be displayed. Auto setting items are preset and cannot be changed. Manual setting items can be set by using WRITE CONFIGURATION PROCEDURE. Refer to [BCS-23, "WRITE CONFIGURATION PROCEDURE"](#) .

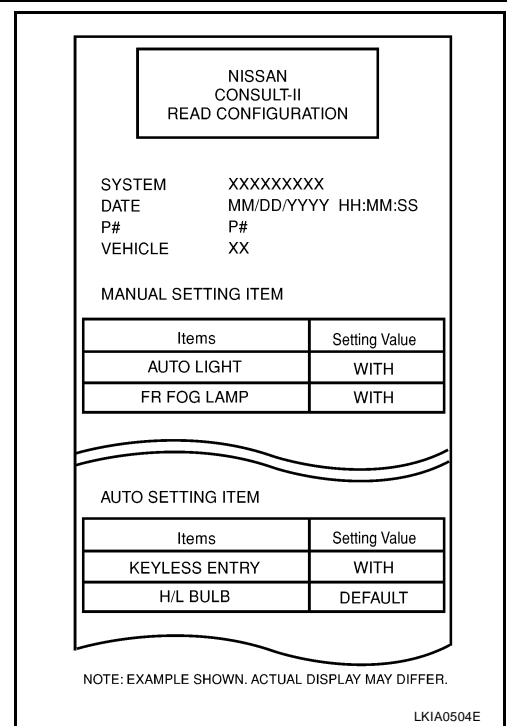

9. Touch "BACK" on "READ CONFIGURATION" screen.

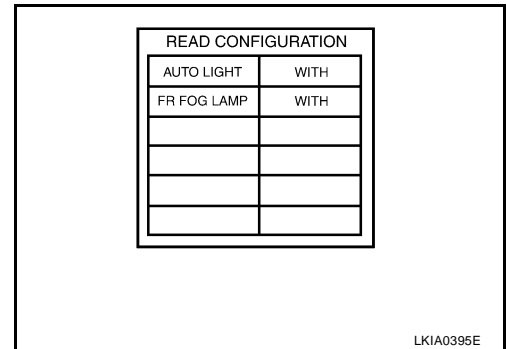

WRITE CONFIGURATION PROCEDURE

CAUTION:

If CONSULT-II is used with no connection of CONSULT-II CONVERTER, malfunctions might be detected in self-diagnosis depending on control unit which carries out CAN communication.

1. With ignition switch OFF, connect CONSULT-II and CONSULT-II CONVERTER to data link connector and turn ignition switch ON.

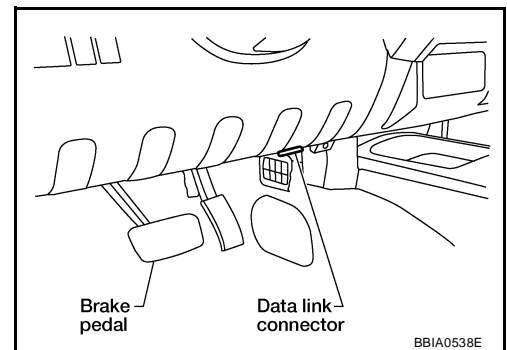

BCM (BODY CONTROL MODULE)

2. Touch "START (NISSAN BASED VHCL)".

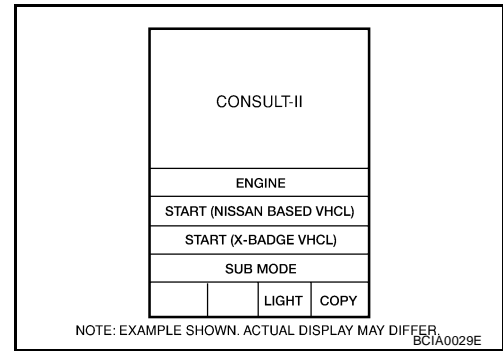

3. Touch "BCM" on "SELECT SYSTEM" screen.
If "BCM" is not indicated, go to [GI-40, "CONSULT-II Data Link Connector \(DLC\) Circuit"](#).

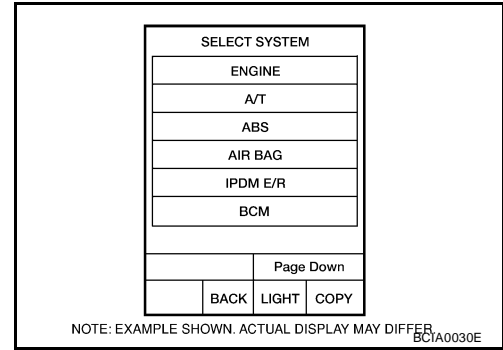

4. Touch "BCM" on "SELECT TEST ITEM" screen.

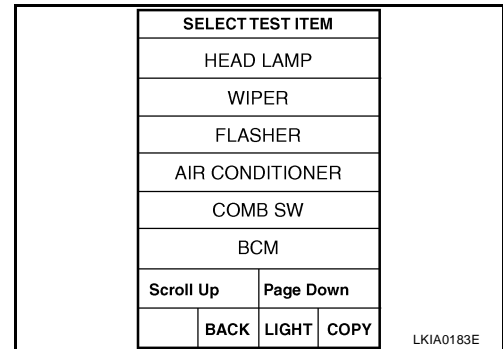

5. Touch "CONFIGURATION" on "SELECT DIAG MODE" screen.

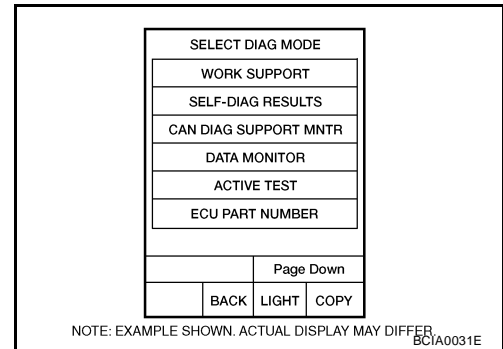

BCM (BODY CONTROL MODULE)

6. Touch "R51/D40/N51" and "OK" on "VEHICLE SELECT" screen. For canceling, touch "CANCEL" on "VEHICLE SELECT" screen.

NOTE:

Confirm vehicle model on IDENTIFICATION PLATE. Refer to [GI-48, "Model Variation"](#).

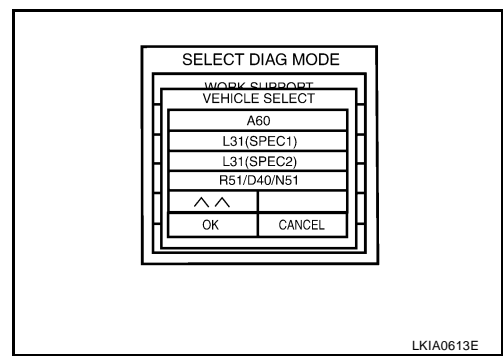

LKIA0613E

7. Touch "WRITE CONFIGURATION" on "SELECT CONFIG ITEM" screen.

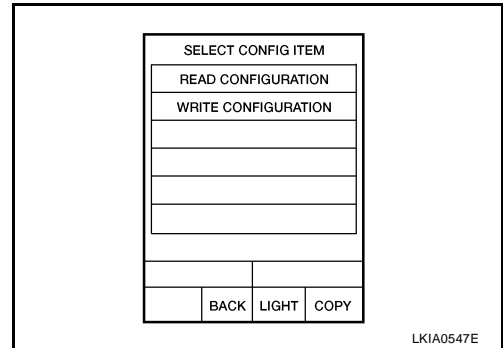

LKIA0547E

8. Touch "YES". For canceling, touch "NO".

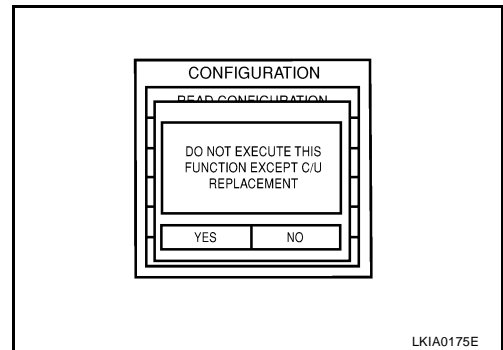

LKIA0175E

9. Using the following flow chart, identify the correct model and configuration list. Confirm and/or change setting value for each item according to the configuration list. Depending on CONSULT-II software version being used, some or all of the write configuration items shown in the following configuration lists may be displayed. If an item does not appear on the CONSULT-II "WRITE CONFIGURATION" screen(s), then it is an auto setting item and it cannot be manually set or changed.

NOTE:

Confirm vehicle model on IDENTIFICATION PLATE. Refer to [GI-48, "Model Variation"](#).

ITEM	SET VAL
AUTO LIGHT	WITH ⇔ WITHOUT
DTRL	WITH ⇔ WITHOUT
SPEED SENS WIP	WITH ⇔ WITHOUT

10. Touch "CHNG SETTING" on "WRITE CONFIGURATION" screen.

CAUTION:

Make sure to touch "CHNG SETTING" even if the indicated configuration of new BCM is same as the desirable configuration.

If not, configuration which is set automatically by selecting vehicle model cannot be memorized.

A
B
C
D
E
F
G
H
I
J

BCS

L
M

BCM (BODY CONTROL MODULE)

11. Touch "OK" on "WRITE CONFIGURATION" screen.
If "CANCEL" is touched, it will return to previous screen.

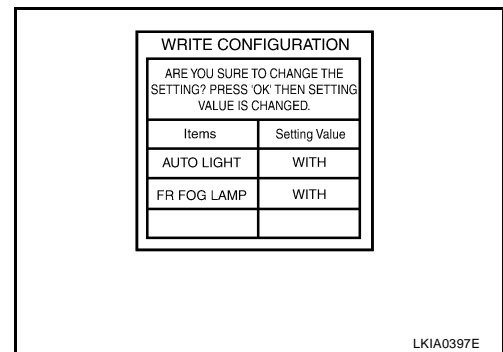

12. Wait until the next screen during setting.

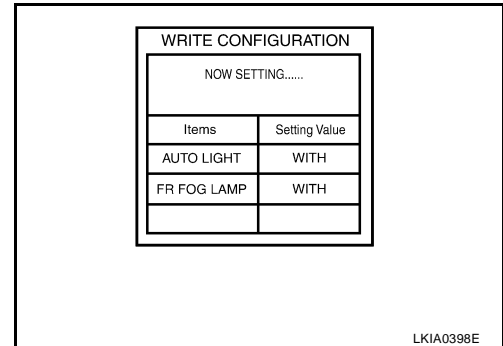

13. WRITE CONFIGURATION results are printed out automatically. Confirm "WRITE CONFIGURATION" is correctly executed by comparing sheet automatically printed out with applicable configuration list shown in step 9.

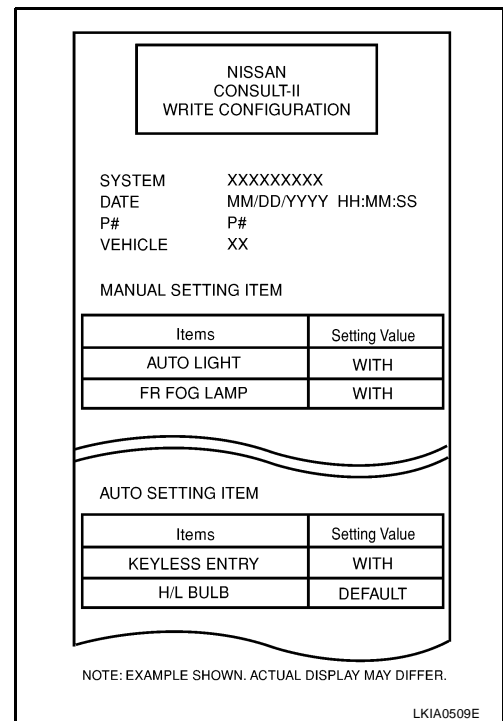

14. Touch "OK" on "WRITE CONFIGURATION" screen.
WRITE CONFIGURATION is completed.

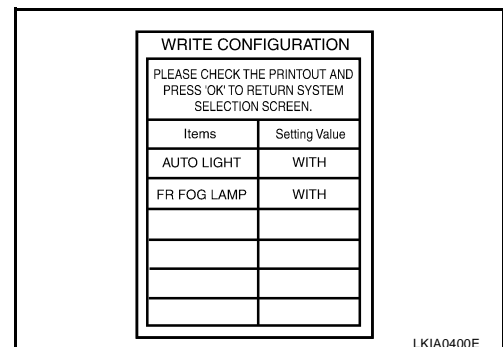

BCM (BODY CONTROL MODULE)

EKS00G0S

Removal and Installation

BCM

Removal

NOTE:

If possible, before removing BCM, retrieve current BCM configuration to use for reference when configuring brand-new BCM after installation. Refer to [BCS-21, "Configuration"](#).

1. Disconnect battery negative terminal.
2. Remove lower instrument panel LH. Refer to [IP-14, "LOWER INSTRUMENT PANEL LH"](#).
3. Remove knee protector. Refer to [IP-10, "Removal and Installation"](#).
4. Remove BCM screws and release BCM.
5. Disconnect BCM connectors and then remove BCM.

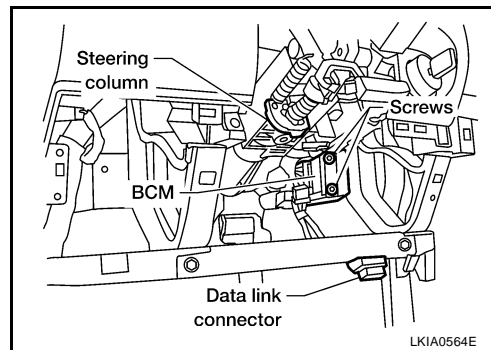

Installation

Installation is in the reverse order of removal.

NOTE:

- When replacing BCM, it must be configured. Refer to [BCS-21, "Configuration"](#).
- When replacing BCM, perform initialization of NATS system and registration of all NATS ignition key IDs. Refer to [BL-100, "NVIS\(NISSAN Vehicle Immobilizer System-NATS\)"](#).
- When replacing BCM, perform ID registration procedure of low tire pressure warning system. Refer to [WT-14, "ID Registration Procedure"](#).
- When replacing BCM, register the remote keyless entry system keyfob ID codes. Refer to [BL-64, "ID Code Entry Procedure"](#).
- When replacing BCM, perform adjustment procedure for the steering angle sensor. Refer to [BRC-128, "Adjustment of Steering Angle Sensor Neutral Position"](#).

BCS

BCM (BODY CONTROL MODULE)
