

NISSAN

# NISSAN 240SX CONVERTIBLE

1992

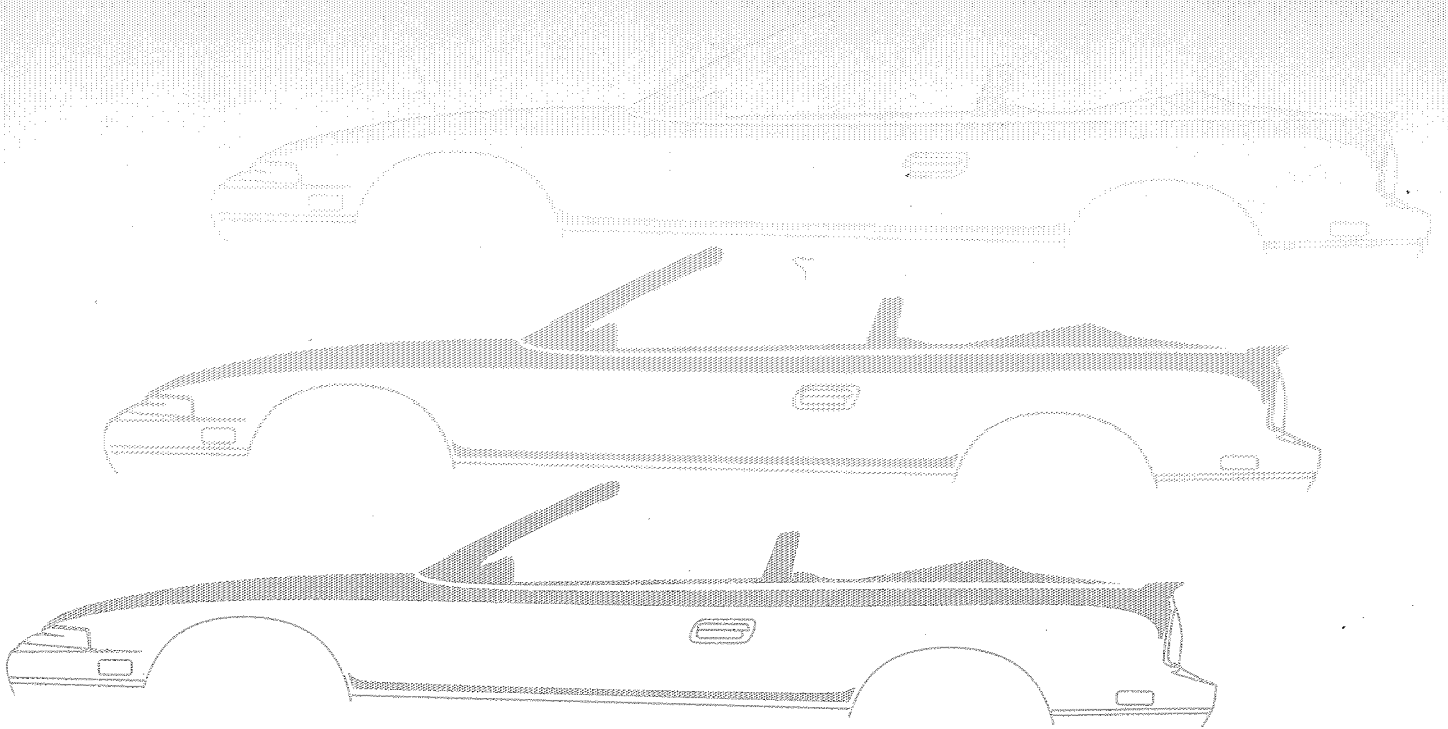

**SERVICE MANUAL SUPPLEMENT**

---

# FOREWORD

---

This Service Manual Supplement contains repair procedures for the 1992 Nissan 240SX Coupe and 240SX Convertible. The Supplement covers Convertible matters only. If there are systems in common between the 240SX Coupe and the 240SX Convertible models, then the regular Nissan 240SX Service Manual is the best source of information. In order to assure your safety and the efficient functioning of the vehicle, refer to the applicable manual before and during the performance of any repair task.

This Service Manual Supplement is based on the latest product information available at the time of publication. Nissan reserves the right to make changes in specifications, design or methods at any time without prior notice.

---

## IMPORTANT SAFETY NOTICE

The proper performance of service is essential to the safety of the technician and the efficient functioning of the vehicle. The service methods in this Service Manual Supplement are described in such a manner that the service may be performed safely and accurately. If you choose to use service procedures, tools or parts not specifically recommended by Nissan, you must first completely satisfy yourself that neither your safety nor the vehicle's safety will be jeopardized by the service methods selected.



# NISSAN 240SX CONVERTIBLE SERVICE MANUAL SUPPLEMENT

## TABLE OF CONTENTS

	Page
General Information .....	C-1
Theory of Operation .....	C-2
Safety Information .....	C-5
Top and Rear Window Appearance Care .....	C-5
Convertible Top Operation .....	C-5

## CONVERTIBLE COMPONENT REPAIR INFORMATION

	Chapter
Windshield Header Trim .....	1
Windshield Header Molding .....	2
Weatherstrips and Retainers .....	3
Rear Seat .....	4
Quarter Trim Panel .....	5
Quarter Window and Regulator .....	6
Door and Door Window .....	7
Seat Belts .....	8
Back and Quarter Belt Moldings .....	9
Headliner Assembly .....	10
Top Cover Assembly .....	11
Backlite Assembly .....	12
Stay Pads, Side and Rear .....	13
No. 1 Bow .....	14
No. 2 Bow .....	15
No. 3 Bow .....	16
No. 4 Bow .....	17
Rear and Side Rail .....	18
Hydraulic System .....	19
Electrical .....	20
Deck Lid Hinge and Trunk Trim .....	21
Body Structural .....	22
Index .....	23

The 240SX Convertible is equipped with a transmission gear selector sensing switch (inhibitor switch). This switch senses what gear position the transmission gear selector is in. The inhibitor switch will permit operation of the convertible top only when the transmission gear selector is in the "P" (PARK) position. Before lowering or raising the top, using the TOP-DOWN/TOP-UP switch, the following conditions must be met.

**WARNING: Releasing the convertible top clamp latches while the vehicle is in motion may cause injury to the driver or passengers and damage to the convertible top or vehicle may result.**

- o The vehicle must be at a complete stop.
- o The transmission gear selector must be in the "P" position.
- o The engine should be started.
- o Ensure that all side and quarter windows are in the **DOWN** position.
- o The bypass valve must be closed (see Chapter 19).

## THEORY OF OPERATION

For the complete procedure for lowering or raising the top refer Convertible Top Operation (see C-5).

### Lowering the Top

The following functions occur when lowering the top using the "TOP DOWN" switch.

To lower the un-latched convertible top, press and hold the "TOP DOWN" switch on the instrument panel.

When the engine is started, the "TOP DOWN" switch is pressed and the transmission gear selector in "P" (PARK):

- o Power is directed from the inhibitor switch through the "TOP DOWN" switch, then to the "top down" relay coil portion of the top stack logic relay.
- o Power is directed from the ignition switch through two (2) 20 amp fuses, then to the "normally open" contact of the "top down" relay which supplies power to the hydraulic pump's electrical system.

### Lowering the Top (cont'd)

**NOTE: The top stack logic relay consists of two independent relays that are used to control current direction to the hydraulic pump's electrical motor.**

When the "top down" relay is energized, it makes electrical contact, supplying the hydraulic pump electrical circuit.

The hydraulic pump/motor is then activated and the top begins to lower.

Once the top has contacted the down stops, it will not lower any further. To make sure the top has lowered completely, look for no noticeable downward movement of the top stack. You should hear the sound of the hydraulic pump slowing down.

### Raising the Top

To raise the convertible top, press and hold the "TOP-UP" switch on the instrument panel.

When the engine is started, the "TOP-UP" switch is pressed and the transmission gear selector is in "P" (PARK):

- o Power is directed from the inhibitor switch through the Top-Up switch, then to the "top up" relay coil portion of the topstack logic relay.
- o Power is directed from the ignition switch through two (2) 20 amp fuses, then to the "normally open" contact of the "top up" relay which supplies power to the hydraulic pump's electrical system.

**NOTE: The top stack logic relay consists of two independent relays that are used to control current direction to the hydraulic pump's electrical motor.**

When the "top up" relay is energized, it makes electrical contact supplying the hydraulic pump electrical circuit.

The hydraulic pump/motor is then activated and the top begins to raise.

Once the top has completed its upward travel stopping near the windshield header, release the Top-Up switch.

Secure the top to the windshield header.

## SAFETY INFORMATION

### Convertible Rear Seat and Seat Belt

The 240SX Convertible is designed as a 4 passenger vehicle, with seating for two persons ONLY in the rear seat.

#### WARNING:

1. Do not allow more than two persons to occupy the rear seat while the vehicle is in motion.
2. While driving, each occupant of the vehicle should be secured by the appropriate seat belt.
3. Do not allow more than one person to use the same seat belt. Failure to observe the above warnings could result in serious personal injury in the event of an accident.

## TOP AND REAR WINDOW APPEARANCE CARE

**CAUTION:** Do not use harsh or abrasive cleaners or bleaching agents on the top material or damage may result.

### Cloth Top

1. Rinse top with fresh water. Wash using mild soap, lukewarm water (never hot) and a sponge. Finally, rinse the top with enough clean water to remove all traces of soap. Be careful to rinse any cleaner off the body as it may cause streaking if allowed to dry on the painted surfaces.
2. After cleaning, always be sure the top is completely dry before it is lowered. Lowering the top while it is wet or damp may cause interior water damage, water stains or mildew of the top and rear window material.

### Rear Window (Backlite)

This convertible has a flexible rear window. Due to its material composition, the window is extremely susceptible to scratches and abrasions. To avoid damage to rear window, clean it as follows:

1. Generously rinse the rear window with water to loosen all dust and dirt. Start at the top of the window, using a back and forth motion. Do not spray the top.
2. Gently wash the window with warm or cold (never hot) water and a mild neutral soap. Dip your cloth into the wash bucket frequently. Change the wash water frequently to reduce the possibility of water-borne dirt scratching the window. Do not rub hard. Let the soap and water remove the dirt.
3. Rinse the window thoroughly with fresh water. If any soap dries on the window, it may cause streaking.
4. Dry the window with a soft cotton cloth. The main purpose of drying is to remove excess water so that the window will air dry without water spots. Do not rub or press hard, as this might scratch the window.
5. Before lowering the top, make sure to remove any water that may have accumulated during cleaning in the top stowage well behind the rear seat.

#### CAUTION:

- o If the coating on the rear window is scratched or removed, the window will become hazed and may allow mildew to form. These conditions will rapidly degrade the rear window and possibly damage the top material also.
- o Mildew may occur more rapidly if the top remains lowered for extended lengths of time under damp conditions. Mildew appears brownish in color and may give off an undesirable odor. No amount of cleaning can reverse this condition. If it occurs, the window must be replaced.
- o Do not use a dry cloth to remove even the slightest amount of dust. Use a soft cotton cloth saturated with water and gently wipe crosswise on the window.
- o Do not use a scraper, de-icing chemicals or sprays to remove frost, snow or ice from the window. In an emergency, warm water (never hot) may be used. Hot water may cause permanent warping or shrinking of the window material.
- o Do not use solvents, such as: alcohol, nail polish remover or paint thinners on the window.

**Rear Window (cont'd)**

- o Do not use bleach, ammonia, window cleaner or all-purpose household cleaners on the window.
- o Do not use surface protectants, beautifiers or silicone-based dressings on the window. These chemical solutions will remove the protective coating from the window.
- o Do not use plastic cleaners, polishes or waxes on the window.
- o Do not apply advertising stickers, gummed labels or adhesive tape to the window. Such items will damage the rear window.

**CONVERTIBLE TOP OPERATION****WARNING:**

1. **When raising or lowering the top, keep hands clear from the hinges of the top side rails and any part of the top linkage.**
2. **Keep hands and any part of the body away from moving parts such as power windows and the top of the windshield where the convertible top secures.**
3. **Before and during up or down operation of the convertible top, and side and quarter windows, make sure that your passengers are made aware of your intentions. Otherwise, personal injury may result from the top, or side and quarter windows unexpectedly raising or lowering.**
4. **The vehicle should never be driven with the top partially lowered. Make sure the top has been either fully secured to the windshield header or fully lowered and the boot installed before driving.**
5. **Before lowering the top, make sure to wipe dry the top stowage well behind the rear seat of any water that may have accumulated during cleaning or inclement weather.**
6. **Make sure the bypass valve on the motor/pump assembly is closed before operating the top electrically.**

**CAUTION:**

- o Make sure there are no packages in the top stowage well when raising or lowering the convertible top. Even small items may interfere with top operation and can cause damage.
- o Do not sit or place excessive weight on the top when the top is up, or down. Damage to the top may result.
- o Do not use an automatic car wash to clean this convertible. Damage to the convertible top may result.
- o Do not raise or lower the top when the temperature is below 41° F (5°C). Damage to the top material and/or rear window may result.
- o Do not lower the top when the rear window is dirty. Grit and accumulated foreign matter may scratch the window.
- o Do not lower the top if the top is damp or wet. Interior water damage, stains or mildew of the top material may result.

**CONVERTIBLE TOP OPERATION (cont'd)****LOWERING THE CONVERTIBLE TOP**

1. Set the parking brake and put the transmission gear selector in "P" (PARK).
2. Remove all items or packages from between the rear seat back and the top stowage well.
3. Start engine.
4. Ensure that all side and quarter windows are in the **DOWN** position.
5. Detach the headliner retainers from inside the top rails.

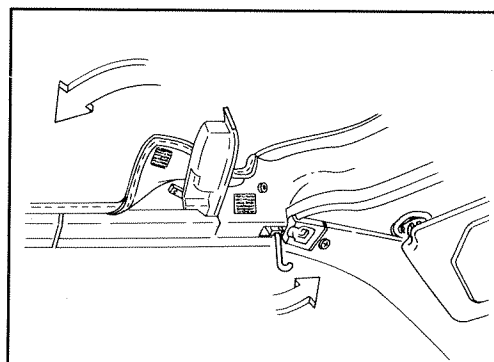
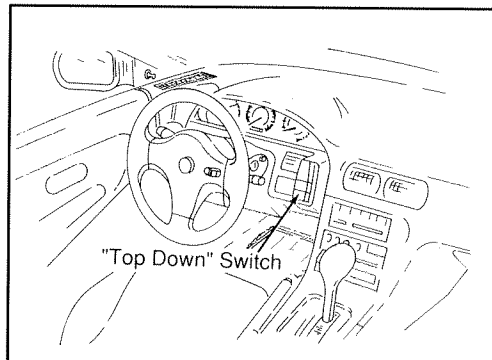
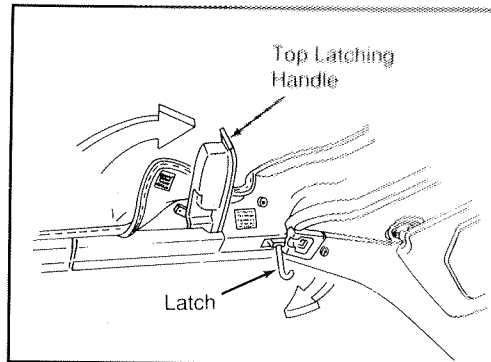
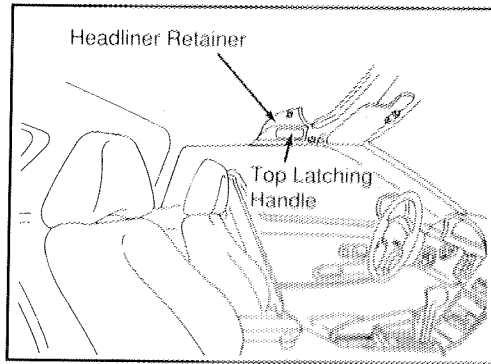

6. Pull each clamp latching handle forward until the latch is unhooked from the striker on the windshield header.
7. Press the TOP-DOWN switch until the top is 7 inches (180 mm) or more from the windshield header, then release the switch.
8. Push each clamp latching handle towards the top side rail until the handle is in its closed position.

**WARNING:** Make sure clamp latching handles are in the closed position when lowering the top. Otherwise personal injury to your passengers may result.

**CAUTION:** If the clamp latching handles remain open, damage to the handles or vehicle may result.

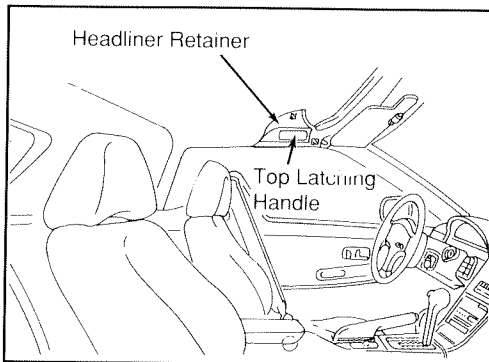
**LOWERING THE CONVERTIBLE TOP (cont'd)**

9. Re-attach the headliner retainers.
10. Continue pressing the TOP-DOWN switch until the top is completely down, then release the switch.
11. If desired, raise the side and quarter windows.
12. Turn the ignition switch "OFF".

**CAUTION:** To avoid damaging the top, do not sit or place excessive weight on the top when the top is in its lowered position.

**Top Boot Installation****Install**

1. Remove the boot from the protective bag stored in the luggage compartment and close the trunk lid.

**CAUTION:** The top boot should always be used to cover the convertible top when it is completely lowered. This will protect the top and also cover the exposed top operating mechanism and frame parts that could cause personal injury under some circumstances.

2. Place the boot in position over the lowered top.

**CAUTION:** To avoid damaging the top boot, make sure the clamp latching handles are in the CLOSED position before installing the boot.

3. Tuck the outer lip of the boot under the quarter and back belt trim moldings.
4. Secure the boot snaps to the quarter trim panels.
5. Tuck the inside corners of the boot down between the quarter trim panels and the seat back.
6. Attach the Velcro strip on the boot to the mating strip on the rear seat back support.

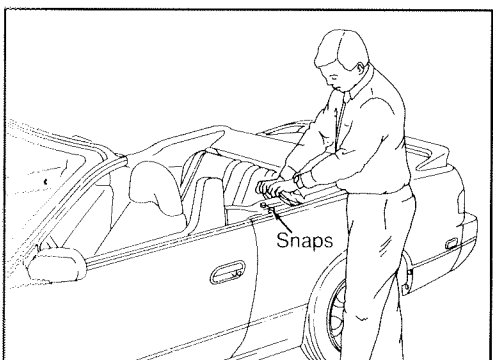
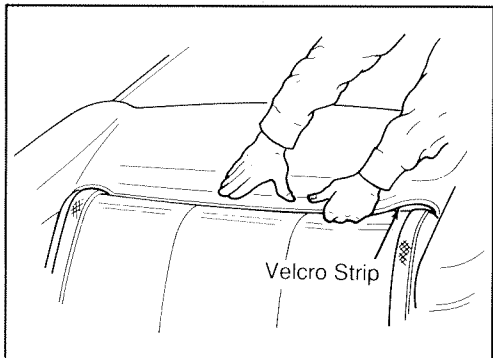
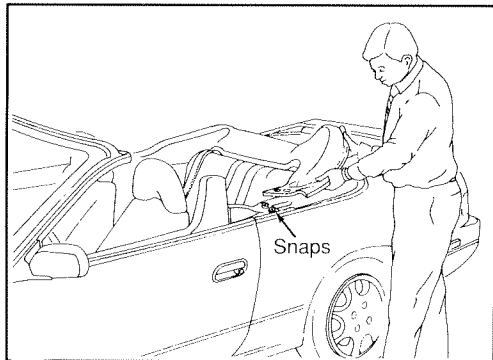
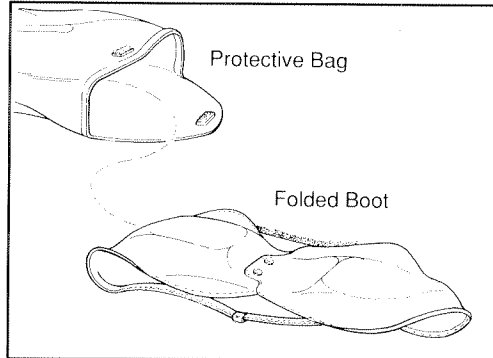
**Remove**

1. Unsnap the boot from the quarter trim panels.

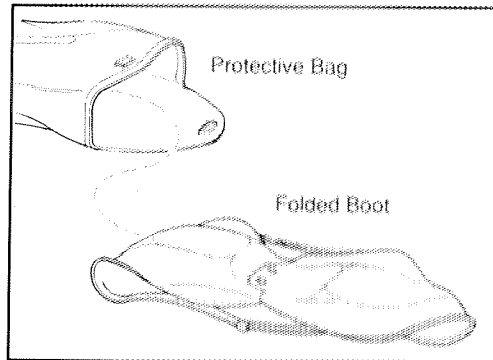
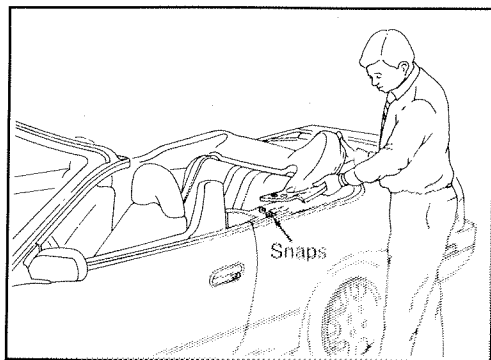

### Top Boot Installation (cont'd)

2. Detach the boot from the Velcro strip and remove the boot.
3. Place the boot upside down on a clean surface.

**NOTE:** Nissan strongly recommends the boot not be placed on the deck lid or hood when folding it. Otherwise, scratches to the vehicle finish may result.

4. Fold one leg of the boot to the middle of the boot assembly. Then, fold the second leg overlapping the first.
5. Place the boot in its protective bag and store it in the luggage compartment.

### RAISING THE CONVERTIBLE TOP

**WARNING:** When raising the top, always make sure your head and the passenger's head are clear of the top side rails, as the side rails travel downward toward the windshield header.

Always make sure both top latching handles are in the **CLOSED** position while raising the top. Otherwise, they may cause injury to the driver or front seat passenger as the top moves forward.

1. Set the parking brake and put the transmission gear selector in "P" (PARK).
2. Remove the boot if it is installed over the lowered top. Store the boot in its protective case in the luggage compartment.
3. Start the engine.
4. Ensure that all side and quarter windows are in the **DOWN** position.

**CAUTION:** Be sure to lower all side and quarter windows. Otherwise damage to the windows and/or convertible top mechanism may result.

5. Press the TOP-UP switch until the top is about 7 inches (180 mm) from the windshield header, then release the switch.

**NOTE:** If the top does not raise, make sure the bypass valve is closed (see Chapter 19). If the top still does not operate (see Raising The Top Manually, C-9).

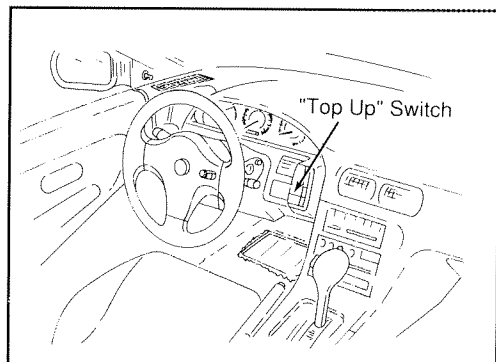

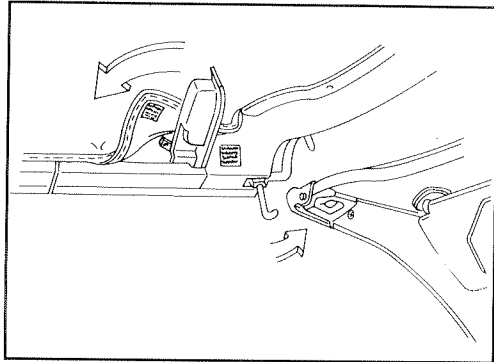
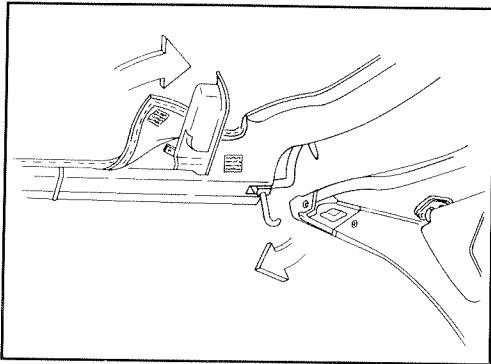

**RAISING THE CONVERTIBLE TOP (cont'd)**

6. Detach the headliner retainers from inside the top rails.
7. Pull each clamp latching handle forward to its full open position.
8. Continue pressing the "Top Up" switch until the top is fully - raised toward the windshield header, then, release the switch.
9. Using the handle recessed in the header bow, pull downward to engage the guide pins into the receiver holes in the windshield header.
10. Still holding the top in place, push each top latching handle toward the top side rail until the handle is in its closed position.
11. Make sure the top is fully-secured by visually checking that the latches are properly seated in the strikers. Also, push up firmly on the top side rails.
12. Re-attach the headliner retainers.
13. If desired, raise the side and quarter windows.

**CAUTION: To avoid damaging the top, do not sit or place excessive weight on the top when it is in its raised position.**

**RAISING THE TOP MANUALLY**

In the event the power mechanism for the top does not operate, you may raise the top manually by using the following procedure:

1. Set the parking brake and put the transmission gear selector in "P" (PARK).
2. Start the engine.
3. Ensure that all side and quarter windows are in the **DOWN** position.

**CAUTION: If the battery is discharged such that the engine cannot be started, and the windows cannot be lowered, open both doors before raising the top.**

4. Open the trunk lid. Reach into the right trunk trim panel surrounding the hydraulic pump.
5. Open the bypass valve by turning the valve handle clockwise 90°.

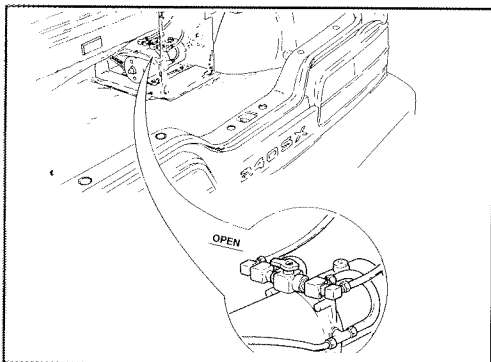

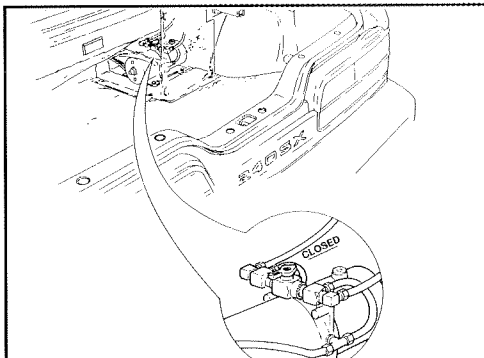
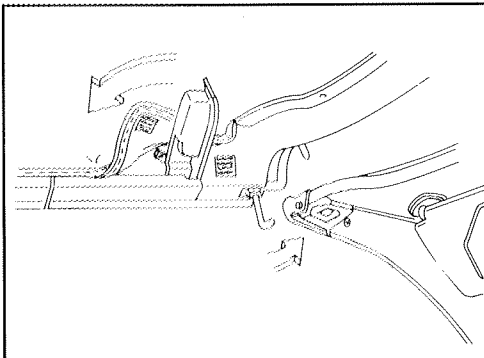
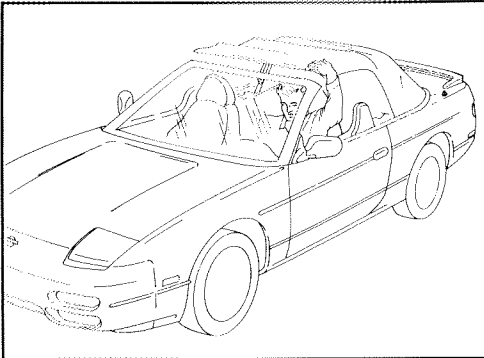
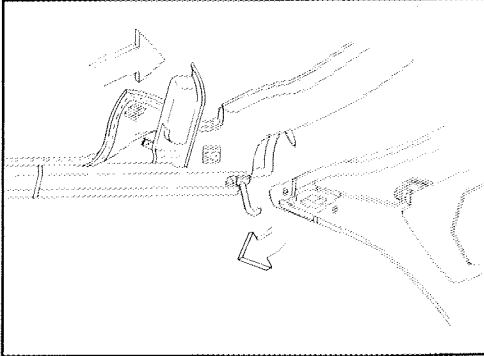
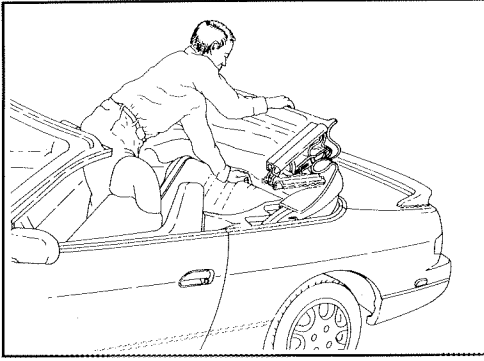

### RAISING THE TOP MANUALLY (cont'd)

6. Standing in the rear of the vehicle, place one hand on the back of the rear seat. With the other, grasp the center of the header bow.
7. Lift and slowly raise the top until it is about 7 inches (180 mm) from the windshield header.
8. Detach the headliner retainers from inside the top rails.
9. Pull each clamp latching handle to its full open position.
10. Sitting in the front seat, grasp the outside forward edge of the top and pull down until the guide pins drop into the receiver holes in the windshield header.
11. While holding the top in place, push each clamp latching handle toward the top rail until the handle is in **CLOSED** position. Make sure the latches are fully-secured by pushing up on the top side rails firmly.
12. Make sure the top is fully-secured by visually checking that the latches are properly seated in the strikers. Also push up firmly on the top side rails.
13. Re-attach the headliner retainers.
14. Close the bypass valve by turning the valve handle counter-clockwise.
 

**NOTE: To raise or lower the top electrically, the bypass valve must be CLOSED.**
15. Close the trunk lid.
 

**NOTE: If the system does not operate properly, take your vehicle to a Nissan dealer for diagnosis and repair.**
16. Turn ignition switch "**OFF**".

**LOWERING THE TOP MANUALLY**

In the event the power mechanism for the top does not operate, you may lower the top manually by using the following procedure:

1. Set the parking brake and put the transmission gear selector in "P" (PARK).
2. Remove all items or packages from between the rear seat back and the top stowage well.
3. Start the engine.
4. Ensure that all side and quarter windows are in the **DOWN** position.

**WARNING: If the battery is discharged such that the engine cannot be started, and the windows cannot be lowered, open both doors before lowering the top.**

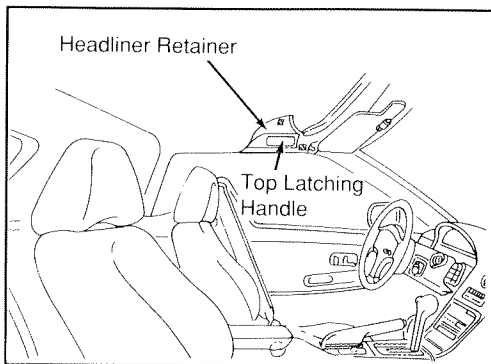

5. Detach the headliner retainers from inside the top rails.

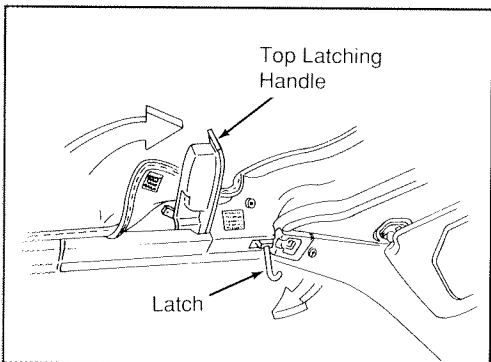

6. Pull each clamp latching handle forward until the latch is unhooked from the striker on the windshield header.

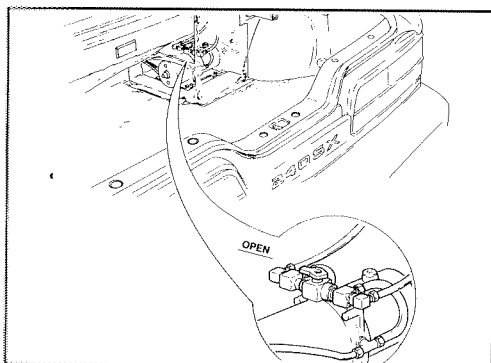

7. Open the trunk lid. Reach into the right trunk trim panel surrounding the hydraulic pump.
8. Open the bypass valve by turning the valve handle clockwise 90°.

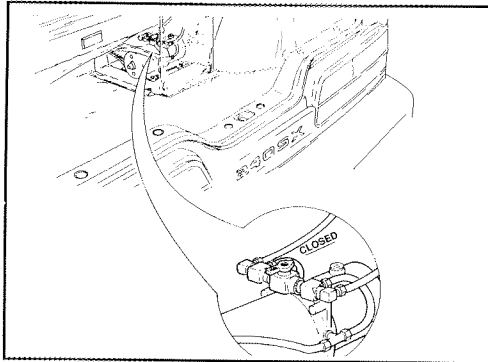
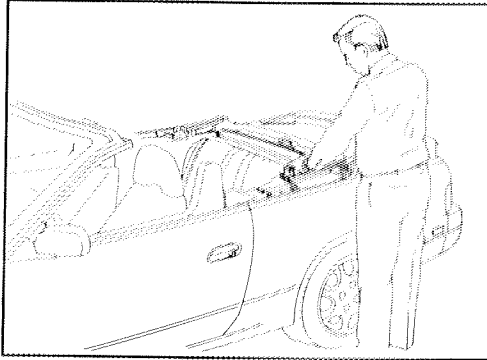
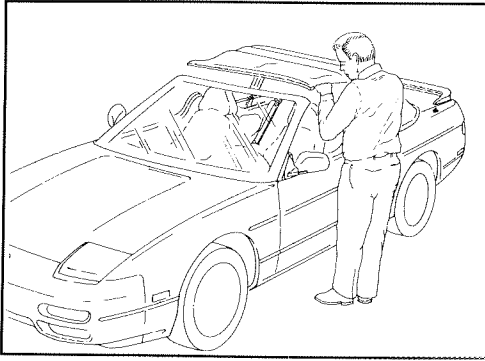

### LOWERING THE TOP MANUALLY (cont'd)

9. Stand at either side of the vehicle. Place the palm of your hand against the underside of the forward-most edge of the top.

**WARNING: Use the palm of your hand to lift the top. Do not wrap your fingers around the top side rails or personal injury may result.**

10. Lift the forward section of the top. Slowly bring it rearward until it is halfway down.
11. Push each latching handle towards the top side rail until the handle is in the closed position.
12. Re-attach the headliner retainers.
13. Continue to lower the top until it is completely lowered.

14. Close the bypass valve by turning the valve handle counterclockwise.

**NOTE: To raise or lower the convertible top electrically, the bypass valve must be closed.**

15. Close the trunk lid.

**NOTE: If the system is not operating properly, take your vehicle to a Nissan dealer for diagnosis and repair.**

16. Turn the ignition switch "OFF".

---

# WINDSHIELD HEADER TRIM

	page
WINDSHIELD HEADER TRIM COMPONENTS .....	1-2
WINDSHIELD GARNISH MOLDING .....	1-3
OUTER TRIM CAP .....	1-5
INNER REAR VIEW MIRROR .....	1-7
MIRROR ATTACHING BUTTON .....	1-8

WINDSHIELD HEADER TRIM COMPONENTS

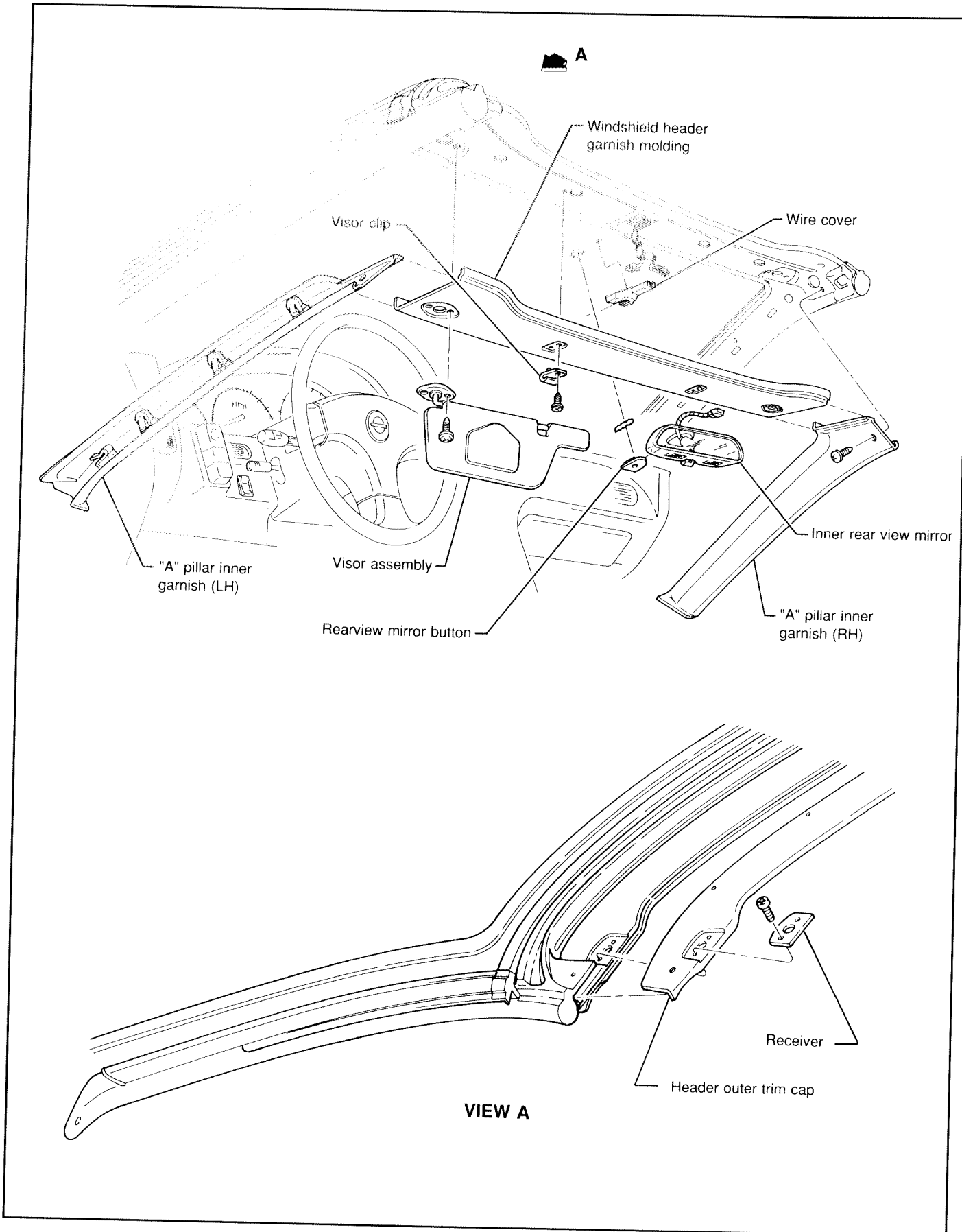

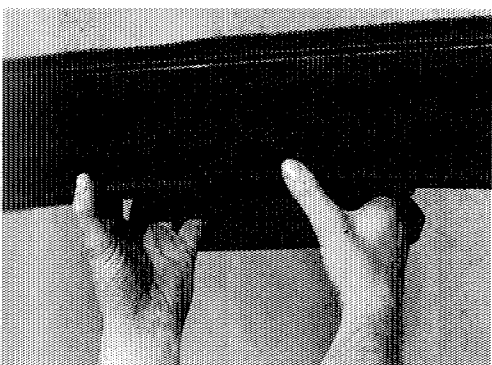
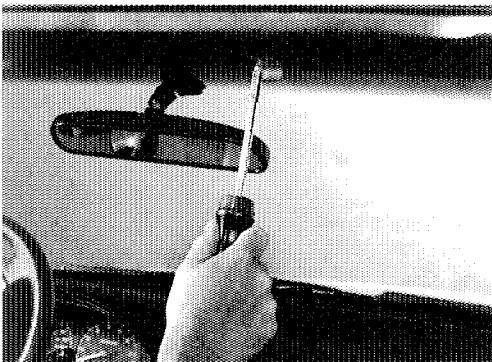
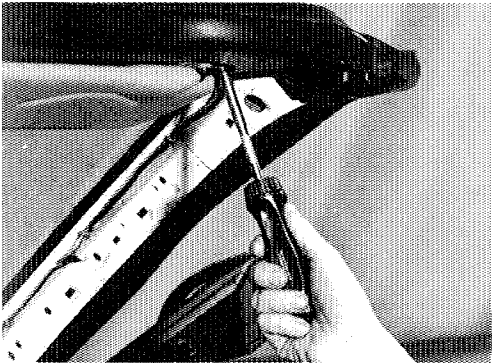
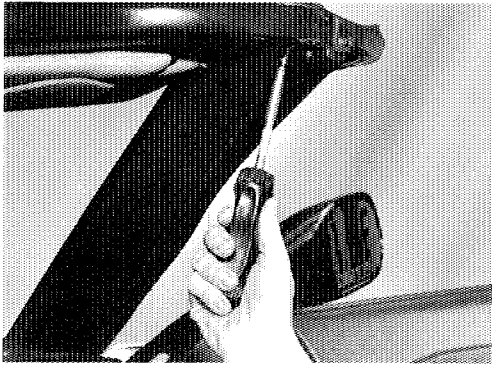

## WINDSHIELD GARNISH MOLDING

### REMOVE

1. LOWER CONVERTIBLE TOP.
2. REMOVE "A" PILLAR INNER GARNISH.
  - (a) Remove screw from top of garnish.
  - (b) Remove by first pulling out at the top, then pull garnish up and away from "A" pillar.
  - (c) Repeat step 2 for other side of vehicle.
3. REMOVE VISOR ASSEMBLY.
  - (a) Remove two (2) screws and visor from header.
  - (b) Repeat step 3 for other side of vehicle.
4. REMOVE VISOR CLIP.
  - (a) Remove screw and clip from header.
  - (b) Repeat step for other side of vehicle.
5. REMOVE WINDSHIELD HEADER GARNISH MOLDING.
 

Slide garnish molding forward and remove from vehicle.

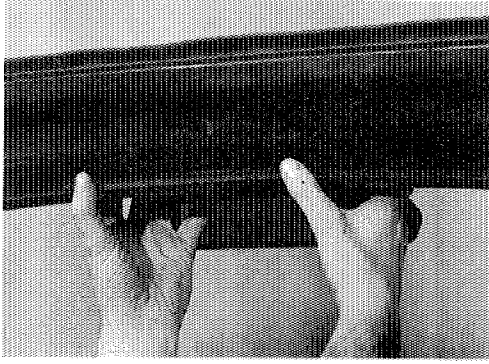

## WINDSHIELD GARNISH MOLDING (cont'd)

### INSTALL

1. INSTALL WINDSHIELD HEADER GARNISH MOLDING.

Position garnish molding forward of header; then, slide it rearward into place.

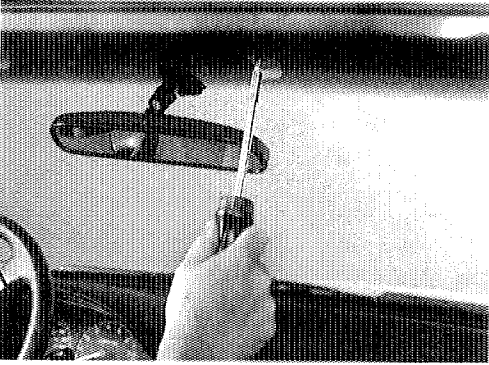

2. INSTALL VISOR CLIP.

- (a) Align garnish molding visor clip holes with header clip holes.
- (b) Position visor clip and secure using one (1) screw.
- (c) Repeat step 2 for other side of vehicle.

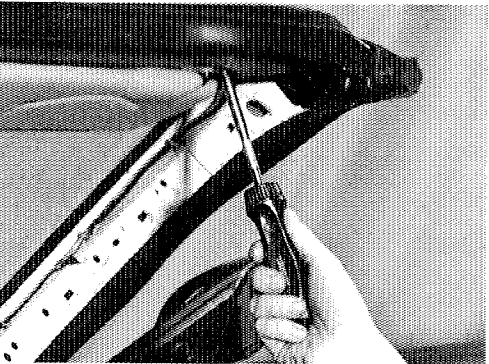

3. INSTALL VISOR ASSEMBLY.

- (a) Align garnish molding visor holes with header visor holes.
- (b) Position visor and secure using two (2) screws.
- (c) Repeat step 3 for other side of vehicle.

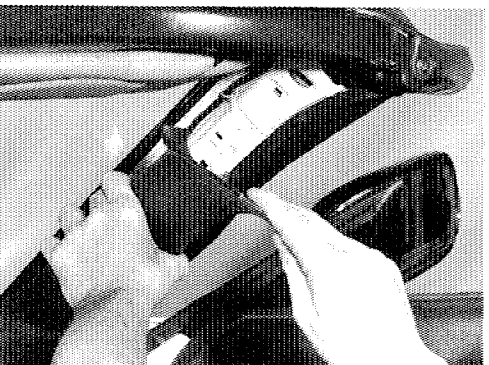

4. INSTALL "A" PILLAR INNER GARNISH.

- (a) Position garnish lower retainer to "A" pillar and push down to engage.
- (b) Firmly push remaining retainers into "A" pillar.



- (c) Install screw at top of inner garnish.
- (d) Repeat step 4 for other side of vehicle.



## OUTER TRIM CAP

### REMOVE

1. LOWER CONVERTIBLE TOP.
2. REMOVE RETAINER AT TOP OF EACH "A" PILLAR SECURING WEATHERSTRIP.

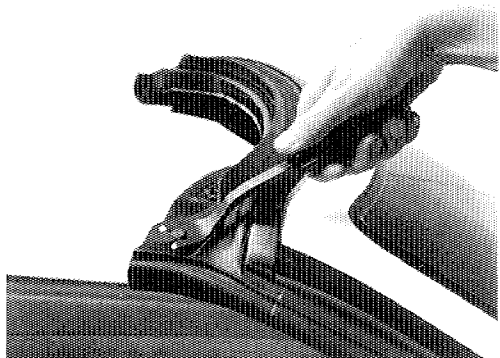

3. DETACH FRONT HEADER WEATHERSTRIP FROM RETAINER.

Using a suitable release agent (3M P/N 051135-08971 or equivalent) and a flat-bladed tool, remove weatherstrip from retainer.

**NOTE: ONLY remove front header weatherstrip from front header weatherstrip retainer.**

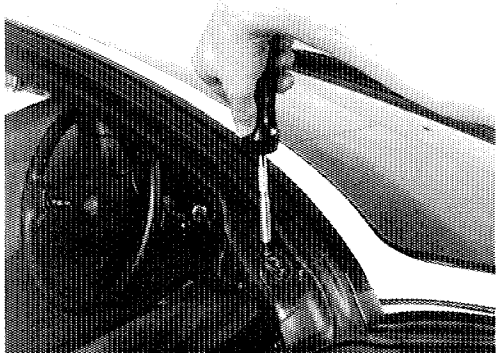

4. REMOVE FRONT HEADER LATCH RECEIVERS.
  - (a) Remove two (2) screws and latch receiver.
  - (b) Repeat step (a) on other side of vehicle.

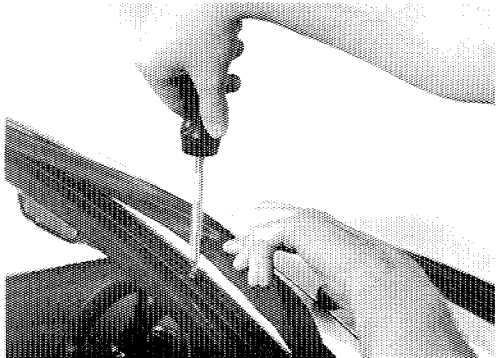

5. REMOVE HEADER OUTER TRIM CAP.
  - (a) Hold weatherstrip material up from retainer and remove nine (9) screws.

**NOTE: Do not pull weatherstrip so as to disturb weatherstrip-to-header adhesive tape seal.**

  - (b) Pull outer trim cap, with retainer attached, from windshield header.

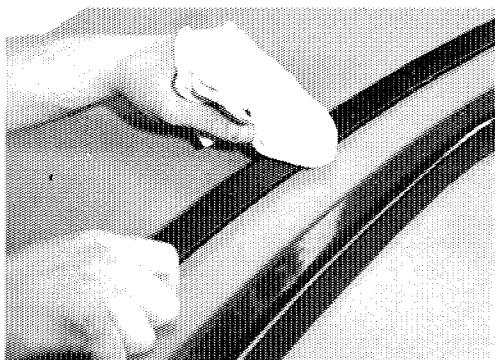

6. DETACH WEATHERSTRIP RETAINER FROM OUTER TRIM CAP.

- (a) Using a suitable release agent (3M P/N 051135-08971 or equivalent) separate retainer from outer trim cap.
- (b) Clean any traces of foam tape from weatherstrip retainer.

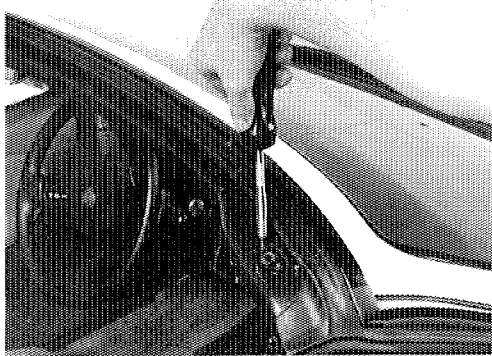
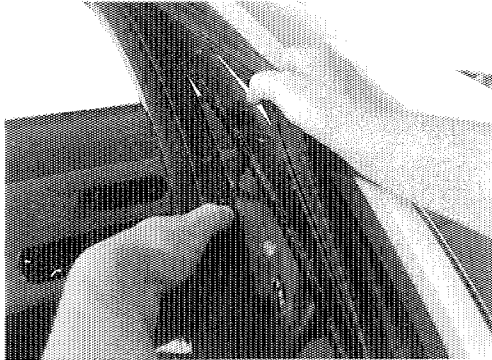
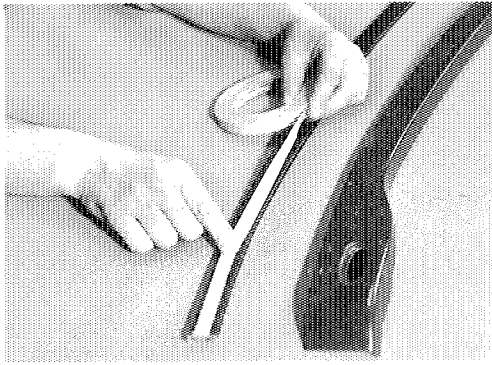

## OUTER TRIM CAP (cont'd)

### INSTALL

1. ATTACH WEATHERSTRIP RETAINER TO OUTER TRIM CAP.
  - (a) Apply foam tape to bottom of weatherstrip retainer.
  - (b) Align weatherstrip retainer mounting holes with outer trim cap holes and press together.

2. INSTALL HEADER OUTER TRIM CAP.

- (a) Starting at one end, hold weatherstrip up while inserting outer trim cap and retainer.

**NOTE: Do not pull weatherstrip so as to disturb weatherstrip-to-header adhesive tape seal.**

- (b) Hold weatherstrip up from retainer and install nine (9) screws.

3. INSTALL FRONT HEADER LATCH RECEIVERS.

- (a) Position latch receiver (round base left side, slotted base right side) to header.

- (b) Secure latch receivers using two (2) screws each.

4. APPLY ADHESIVE TO FRONT HEADER WEATHERSTRIP RETAINER.

Apply a continuous bead of adhesive (3M P/N 051135-08008 or equivalent) to the front weatherstrip retainer.

**NOTE: Insure weatherstrip adhesive fills void at center of weatherstrip mounting surface.**

5. INSTALL FRONT HEADER WEATHERSTRIP.

- (a) Secure weatherstrip ends to top of "A" pillars using retainers (push pins).

- (b) Starting at ends, then working toward center, install weatherstrip to retainer using a flat-bladed tool.

## INNER REAR VIEW MIRROR

## REMOVE

1. REMOVE WINDSHIELD HEADER GARNISH MOLDING (See Windshield Garnish Molding in this chapter).
2. REMOVE REAR VIEW MIRROR WIRE COVER.

Grasp wire cover, pull upward and remove.

3. REMOVE INNER REAR VIEW MIRROR.

(a) Disconnect wire harness connector.

(b) Loosen set screw and remove mirror.

## INSTALL

1. INSTALL INNER REAR VIEW MIRROR.

(a) Position mirror to button and tighten set screw.

**Torque: 1.5 N·m (13 in. lb.)**

(b) Connect wire harness connector.

**NOTE: Wire harness connector must be wrapped with foam tape to prevent rattles.**

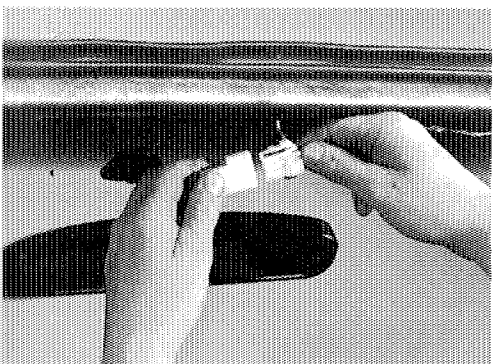
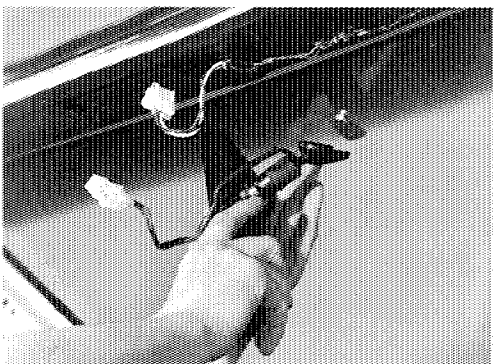
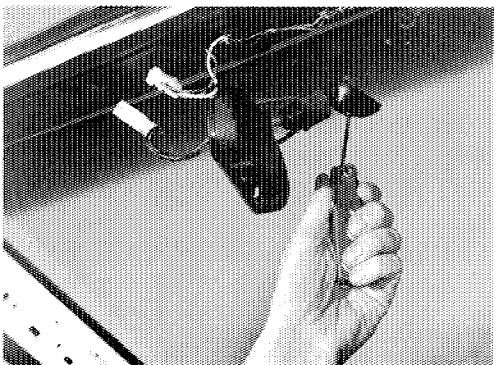
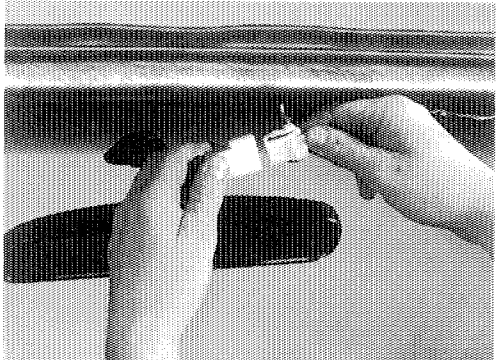
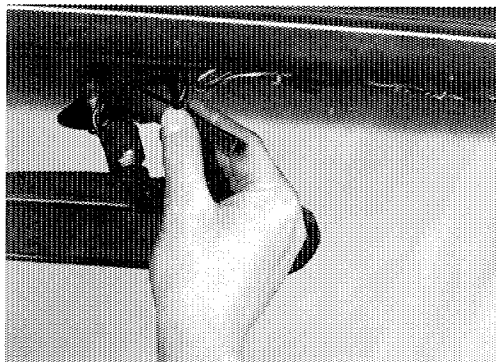

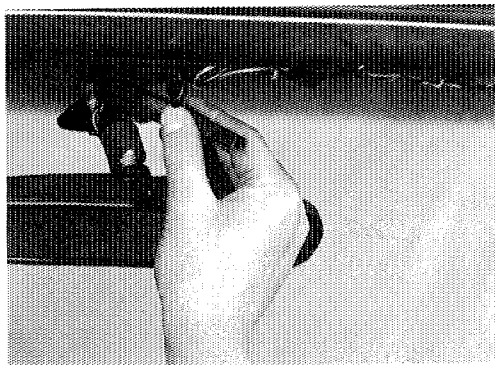

### INNER REAR VIEW MIRROR (con't)

2. INSTALL REAR VIEW MIRROR WIRE COVER.
  
3. INSTALL WINDSHIELD HEADER GARNISH MOLDING, (See Windshield Garnish Molding in this chapter.

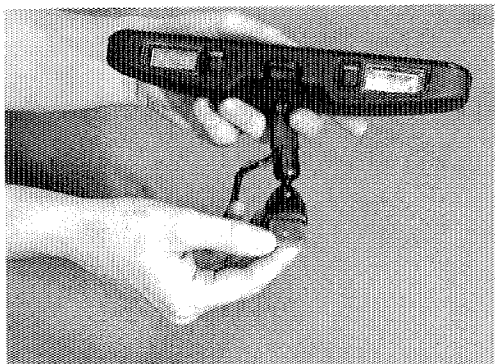

### MIRROR ATTACHING BUTTON

#### INSTALL

1. REMOVE WINDSHIELD HEADER GARNISH MOLDING, (See Windshield Garnish Molding in this chapter.
  
2. REMOVE BUTTON FROM INNER REAR VIEW MIRROR IF IT IS TO BE REUSED.  
Loosen set screw and remove button from mirror.
  
3. DETERMINE REAR VIEW MIRROR BUTTON LOCATION.
  - (a) Measure and mark, 150 mm (5-7/8 in.) down from top of windshield.
  - (b) Measure across windshield and draw a small circle (2 in. dia.) where lines intersect.
  
4. CLEAN REAR VIEW MIRROR BUTTON LOCATION.
  - (a) Clean circled area of windshield, inside surface, with glass cleaning solution and allow to dry.
  - (b) Clean area with alcohol to remove any traces of cleaning solution.

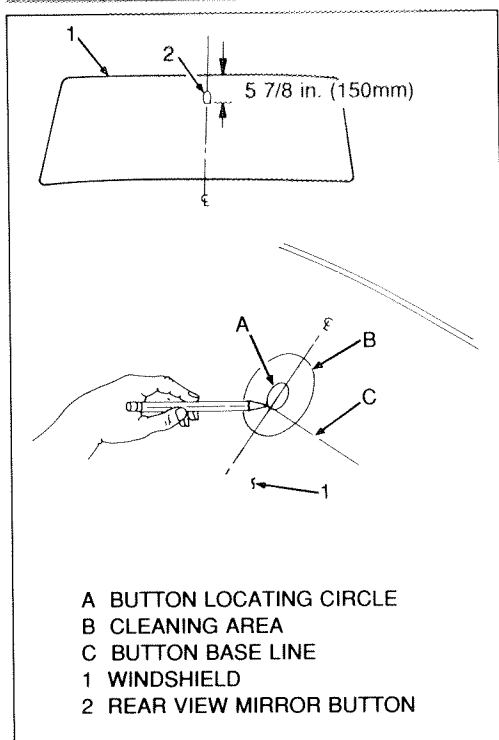

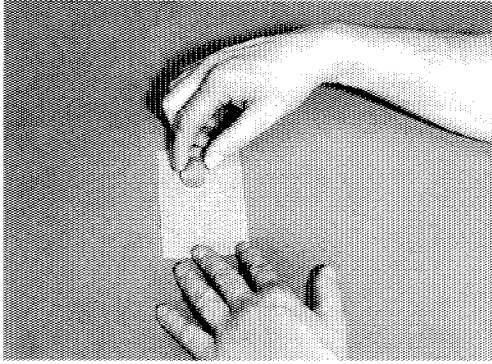

### MIRROR ATTACHING BUTTON (cont'd)

5. PREPARE REAR VIEW MIRROR ATTACHING BUTTON.
  - (a) Using a piece of fine grit (340X or 360X) emery cloth or sandpaper, sand the bonding surface of the rear view mirror attaching button.

**NOTE: If the original attaching button is to be reused, all traces of the factory installed adhesive must be removed prior to installation.**
  - (b) Clean the button sanded surface with alcohol and let dry.
6. INSTALL REAR VIEW MIRROR ATTACHING BUTTON.
  - (a) Lightly apply adhesive accelerator to bonding surfaces of attaching button and windshield.
  - (b) Allow adhesive accelerator to dry completely.
  - (c) Apply two (2) drops of adhesive to attaching button bonding surface.
  - (e) Using a toothpick, evenly distribute adhesive over entire bonding surface of attaching button.
  - (f) With attaching button rounded end pointing up, position button to pre-marked location on windshield.
  - (g) Firmly press attaching button against windshield for 30 to 60 seconds.
  - (h) After five minutes, remove any excess adhesive with an alcohol-moistened paper towel and a single-edge razor blade.
7. INSTALL INNER REAR VIEW MIRROR, (See Inner Rear View Mirror in this chapter).
8. INSTALL WINDSHIELD HEADER GARNISH MOLDING, (See Windshield Garnish Molding in this chapter).

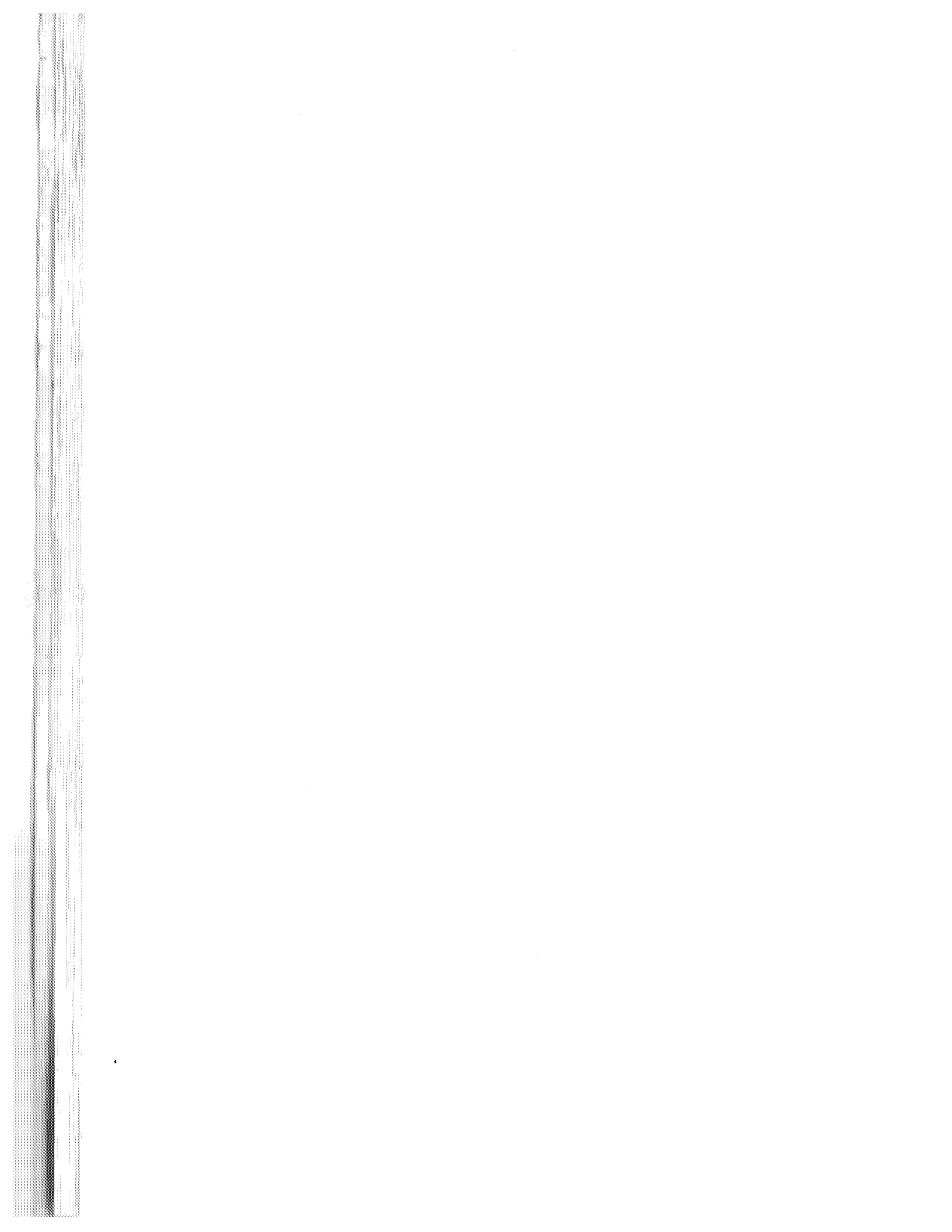

---

# WINDSHIELD HEADER MOLDING

	page
WINDSHIELD HEADER MOLDING COMPONENTS .....	2-2
HEADER MOLDING CAP .....	2-3
WINDSHIELD HEADER MOLDING .....	2-4

WINDSHIELD HEADER MOLDING COMPONENTS

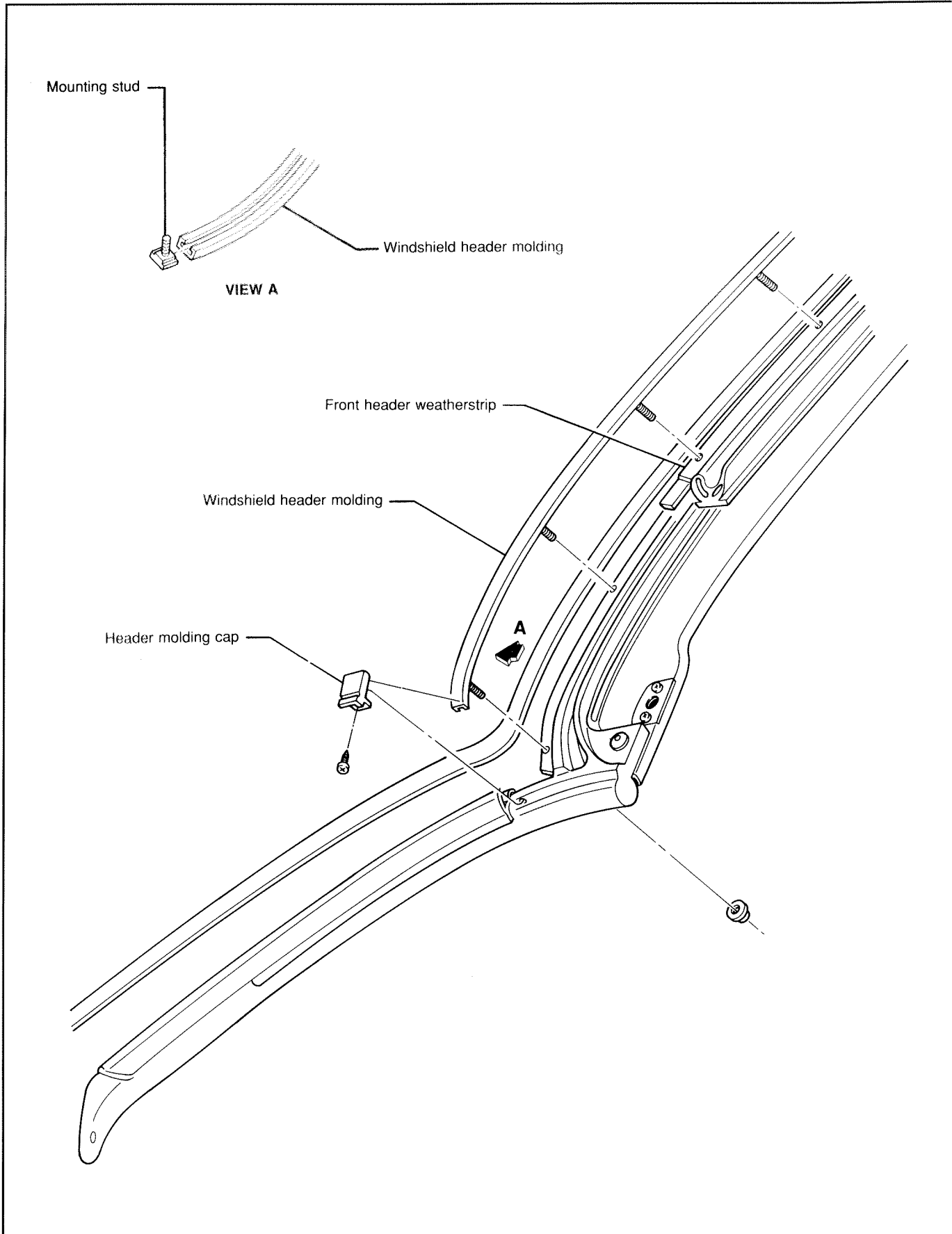



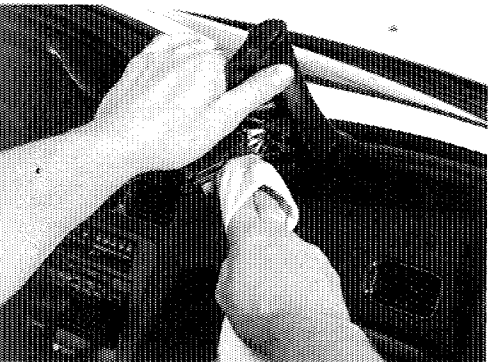
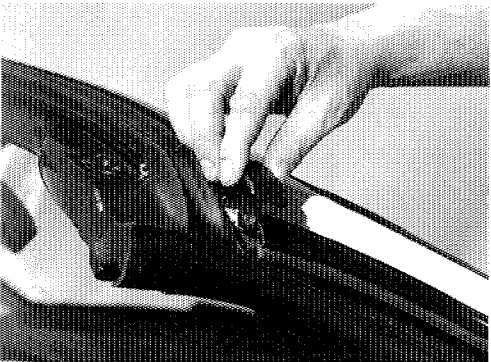

## HEADER MOLDING CAP

### REMOVE

1. DETACH FRONT HEADER WEATHERSTRIP ASSEMBLY AT TOP OF "A" PILLAR.
  - (a) Remove retainer (push pin) from weatherstrip at top of "A" pillar.
  - (b) Using release agent (3M P/N 051135-08971 or equivalent) break weatherstrip cement bond to retainer.
  - (c) Using a flat-bladed tool, loosen weatherstrip from "A" pillar top, downward 5 to 6 inches.
  
2. REMOVE WINDSHIELD HEADER MOLDING CAP.
  - (a) Remove screw and cap.
  - (b) Repeat steps 1 and 2 for other side of vehicle.

### INSTALL

1. INSTALL WINDSHIELD HEADER MOLDING CAP.
  - (a) Position cap between "A" pillar and weatherstrip retainer while aligning mounting hole.
  - (b) Secure cap with screw.
  
2. ATTACH FRONT HEADER WEATHERSTRIP ASSEMBLY TO "A" PILLAR.
  - (a) Clean excess adhesive from weatherstrip and retainer.

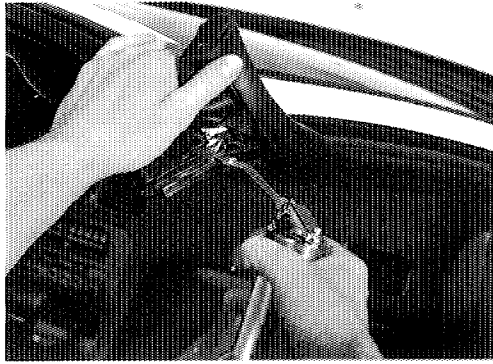

### HEADER MOLDING CAP (cont'd)

- (b) Apply a continuous bead of weatherstrip adhesive (3M P/N 051135-08008 or equivalent) to weatherstrip retainer.

**NOTE: Insure weatherstrip adhesive fills void at center of weatherstrip mounting surface.**

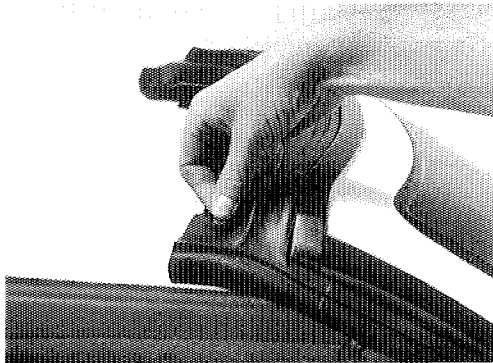

- (c) Position weatherstrip to top of "A" pillar and secure with retainer (push pin).

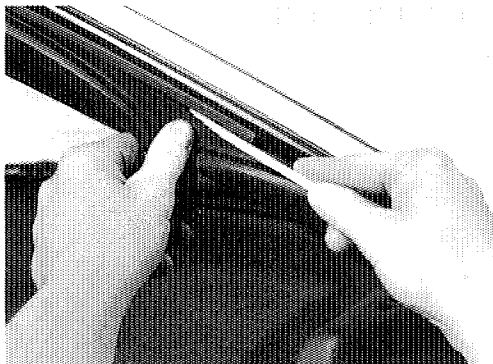

- (d) Install weatherstrip starting at center of "A" pillar then working upward to top of "A" pillar.

- (e) Repeat steps 1 and 2 for other side of vehicle.

**NOTE: Do not "stretch" weatherstrip so as to create a bulge at top of "A" pillar**

### WINDSHIELD HEADER MOLDING

#### REMOVE

1. REMOVE RIGHT AND LEFT HEADER MOLDING CAPS (see Header Molding Cap in this chapter).
2. REMOVE WINDSHIELD HEADER GARNISH MOLDING (see 1-3)

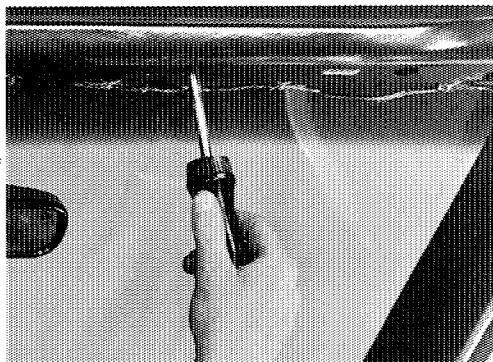

3. REMOVE WINDSHIELD HEADER MOLDING.

Remove seven (7) nuts and header molding from vehicle.

**NOTE: If header molding is to be replaced, transfer mounting studs to new molding.**

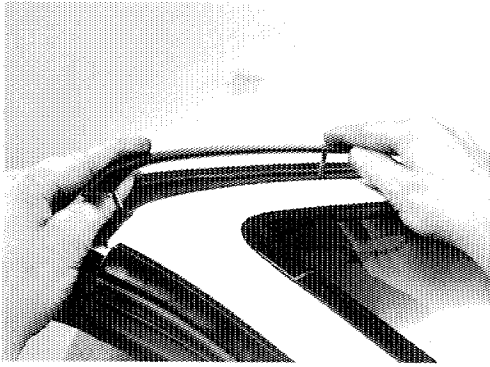

## WINDSHIELD HEADER MOLDING (cont'd)

### INSTALL

1. INSTALL WINDSHIELD HEADER MOLDING.
  - (a) Position molding retainer studs to holes in windshield header.
  - (b) Install seven (7) nuts to molding retainer studs. Do not tighten nuts at this time.
2. INSTALL WINDSHIELD HEADER MOLDING CAPS (see Header Molding Cap in this chapter).

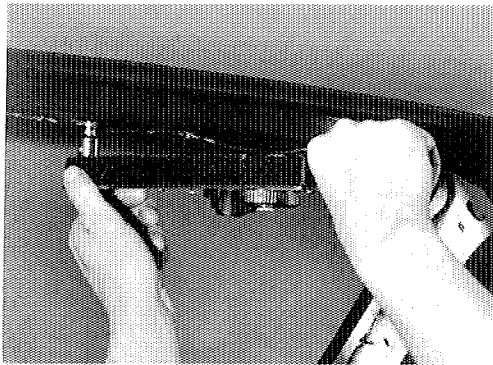

3. SECURE WINDSHIELD HEADER MOLDING TO HEADER.

While maintaining header molding alignment to header molding caps, tighten seven (7) molding nuts.

**Torque: 1.5 N·m (13 in. lb.)**
5. INSTALL WINDSHIELD HEADER GARNISH MOLDINGS (see 1-4).

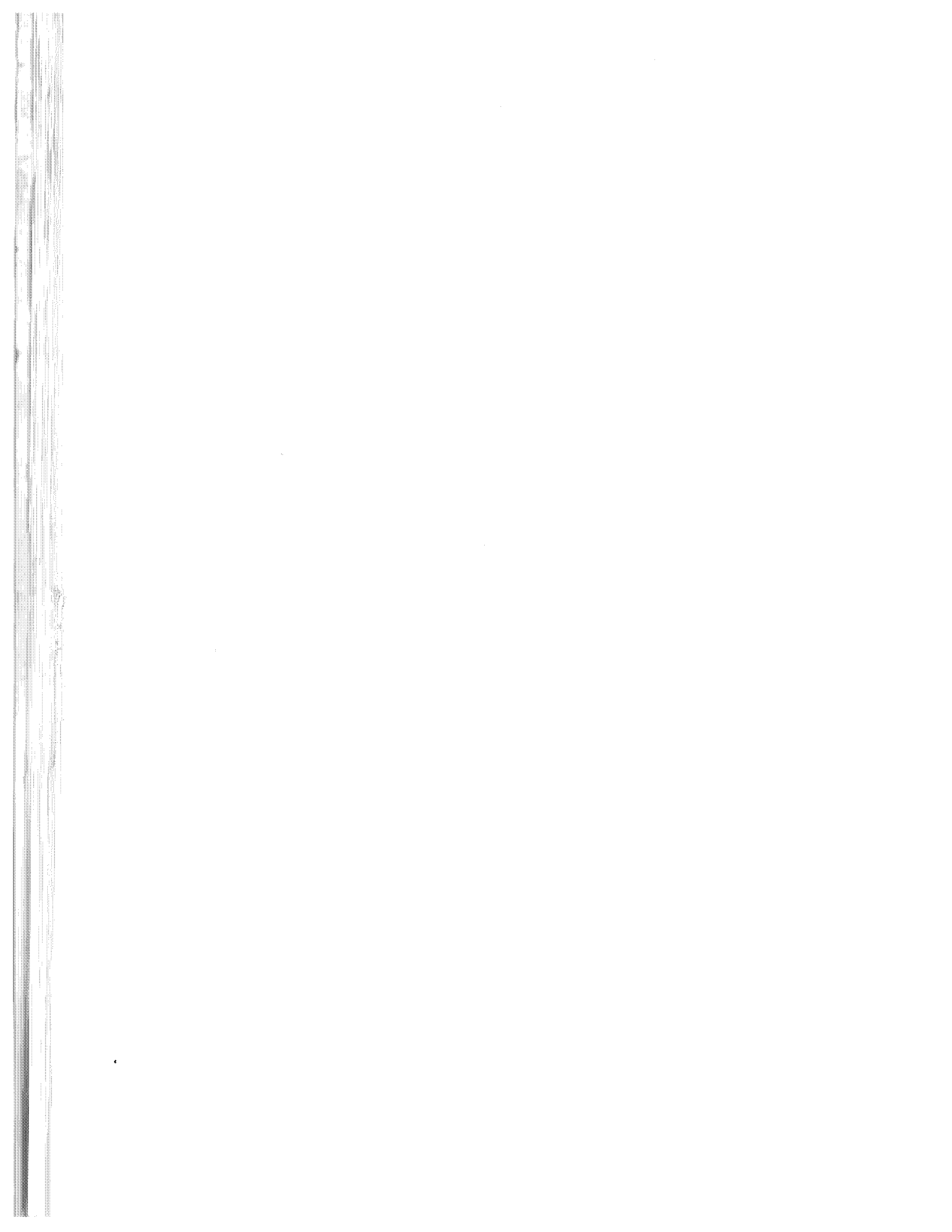

# WEATHERSTRIPS AND RETAINERS

	page
WEATHERSTRIP AND RETAINER COMPONENTS .....	3-2
ADJUSTMENT .....	3-5
INSPECTING .....	3-5
SEAL TESTING .....	3-5
WIND NOISE .....	3-7
FRONT HEADER WEATHERSTRIP .....	3-8
FRONT HEADER WEATHERSTRIP RETAINER .....	3-10
A-PILLAR WEATHERSTRIP RETAINER .....	3-11
FRONT RAIL WEATHERSTRIP .....	3-12
FRONT RAIL WEATHERSTRIP RETAINER .....	3-13
CENTER RAIL WEATHERSTRIP .....	3-15
CENTER RAIL WEATHERSTRIP RETAINER .....	3-16
REAR RAIL WEATHERSTRIP .....	3-17
QUARTER WINDOW INNER WEATHERSTRIP .....	3-19
QUARTER BELT OUTER WEATHERSTRIP .....	3-20
B-PILLAR MUCKET .....	3-20

WEATHERSTRIP AND RETAINER COMPONENTS

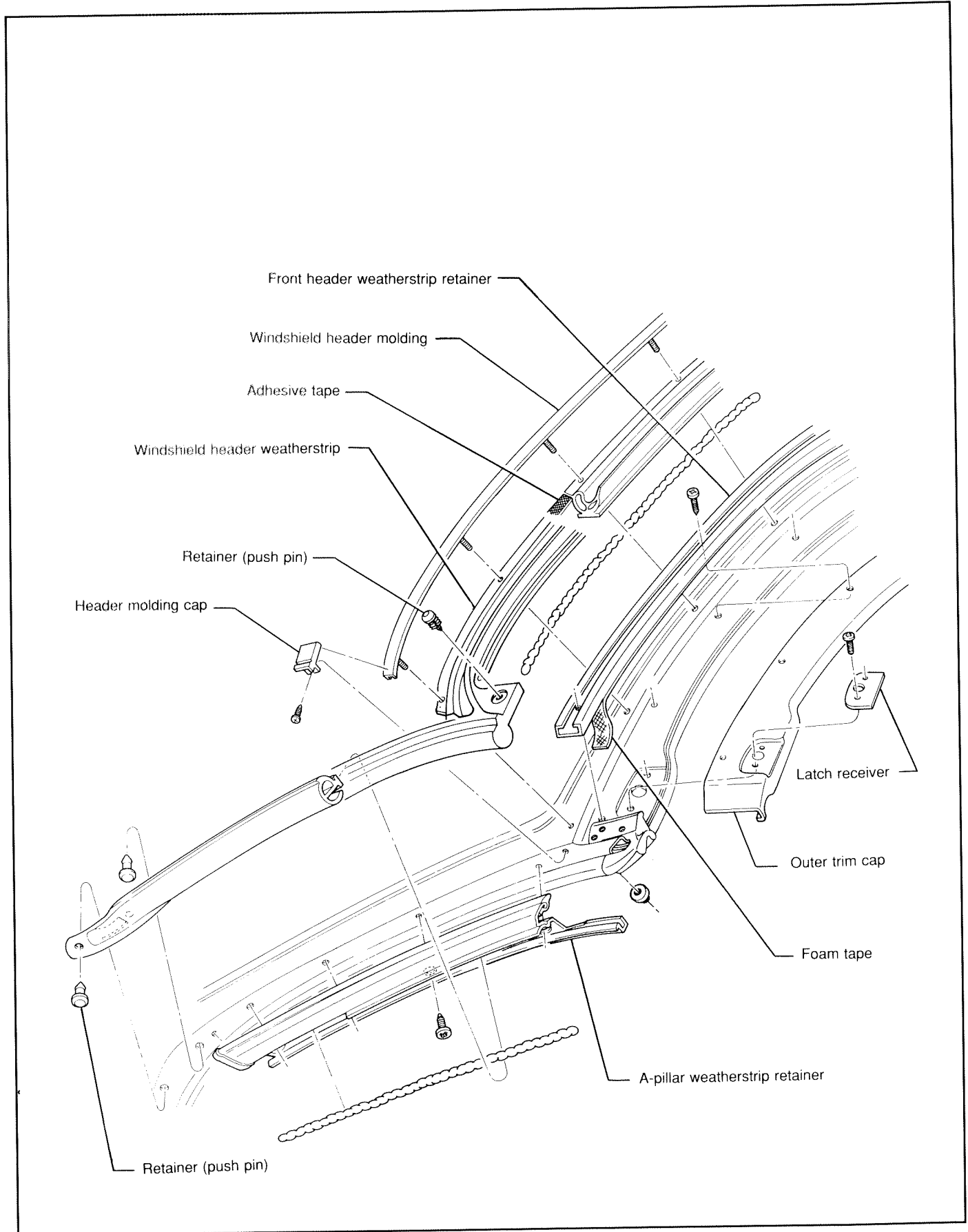

WEATHERSTRIP AND RETAINER COMPONENTS

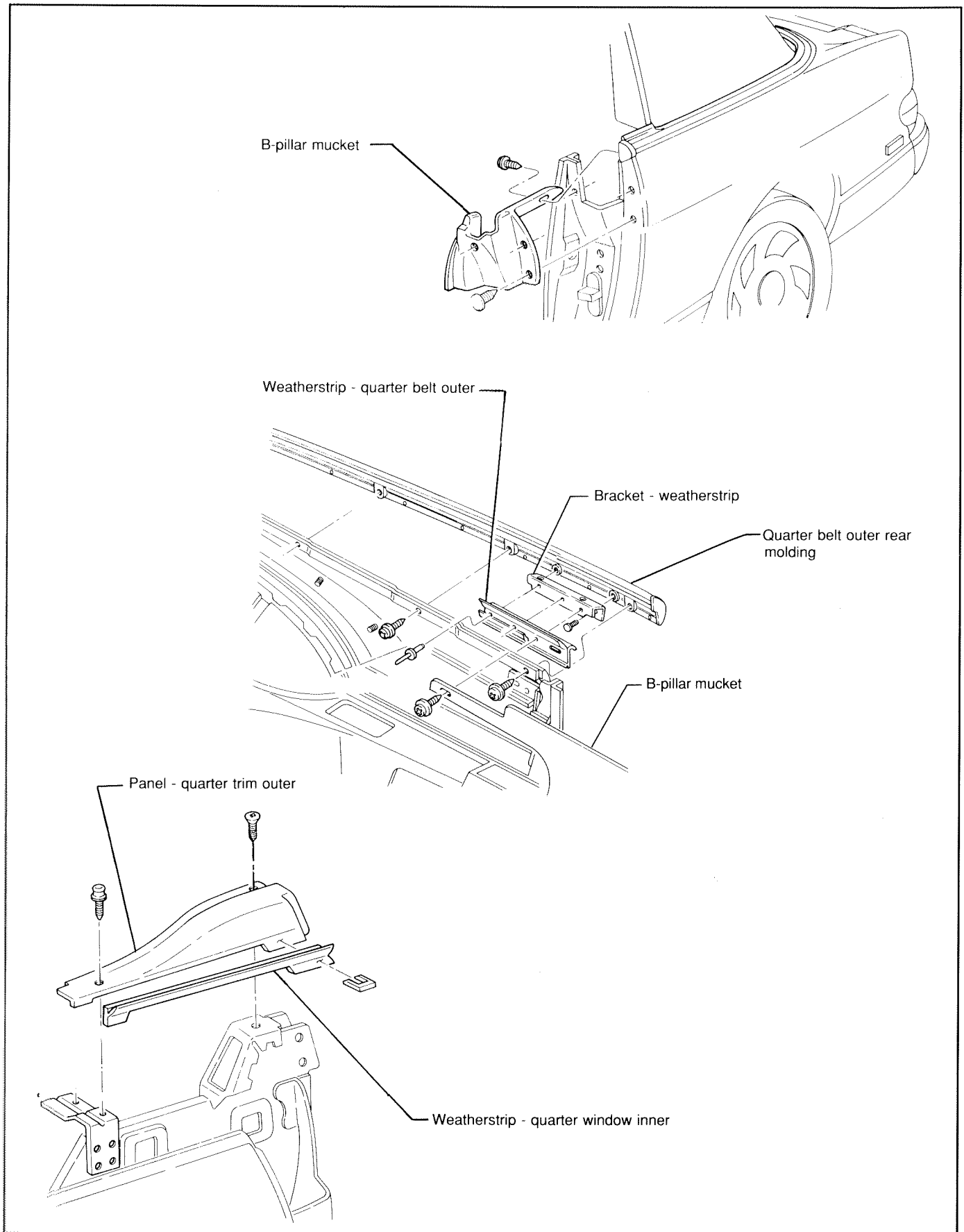

WEATHERSTRIP AND RETAINER COMPONENTS

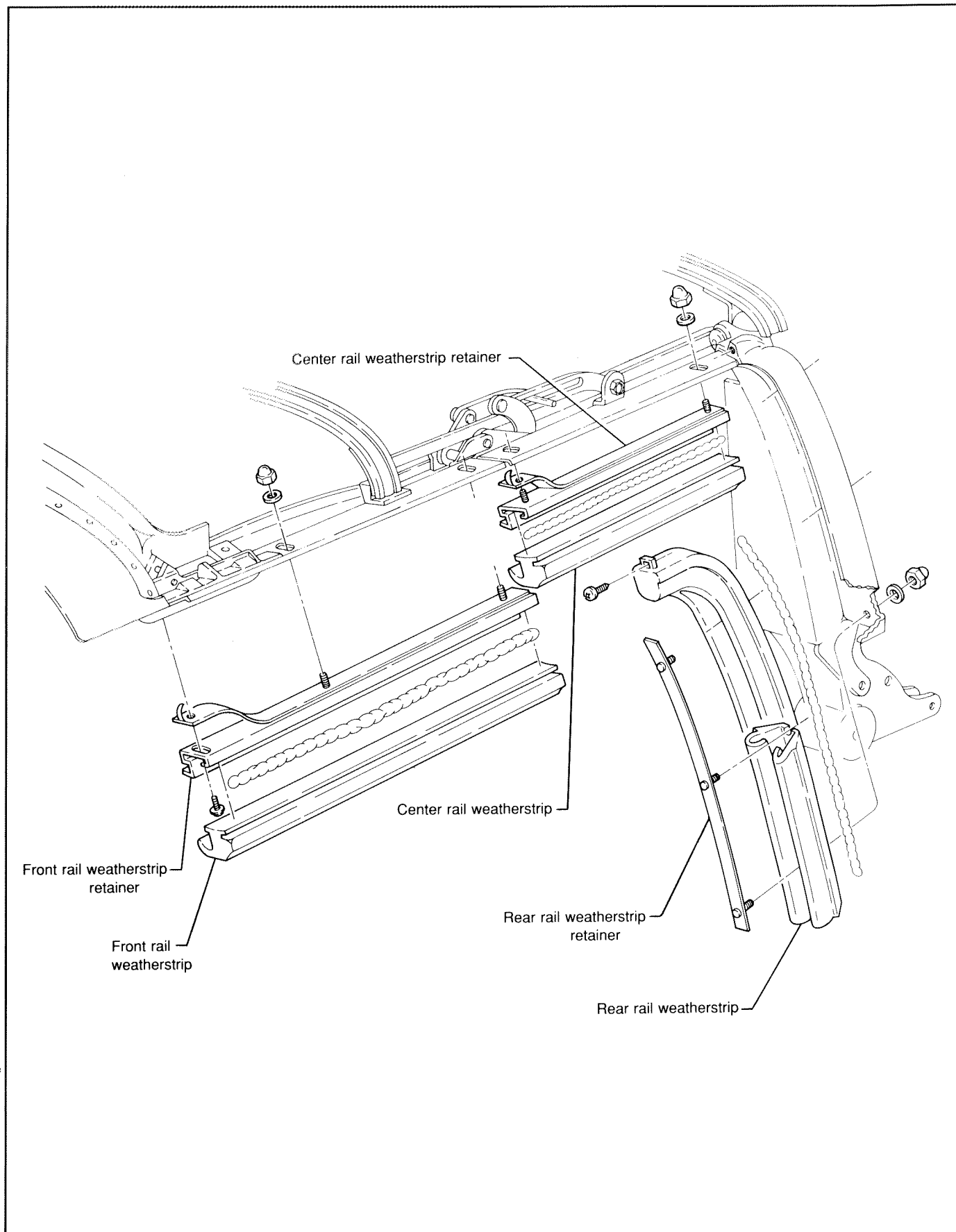



## ADJUSTMENT

Sealing problems may sometimes be the result of improper operation and/or adjustment of the top stack mechanism. Other components can effect sealing capabilities, such as: door glass or quarter windows and molding adjustments.

Some weatherstrip assemblies used on this vehicle are easily adjusted by loosening the retainer fasteners and moving the retainers. Some weatherstrips must be removed from their retainer or a component to be re-positioned, then re-attached.

All components must be in place and adjusted correctly for the weatherstrips to function properly. Refer to the respective chapters for adjustment procedures of components directly relating to the weatherstrip.

## INSPECTING

Prior to performing water or air leak tests, it is recommended that a thorough visual inspection be performed. Thoroughly inspect the entire convertible top and all sealing areas for gaps, torn or deteriorated weatherstrips, loose or missing parts, and misaligned components such as window glass.

## SEAL TESTING

The Nissan convertible vehicle is designed to operate under normal environmental conditions. It's sealing capabilities do not take into consideration unnatural conditions such as high pressure car washes. With this in mind, an air or water leak determined to originate from the top stack or its sealing areas can be isolated using the procedures outlined below.

## WATER LEAK TEST

The first step in diagnosing a water leak is to determine under what conditions the leak occurs. Once the general area has been determined, localized testing using a water hose or compressed air will isolate the exact entry point. It may be necessary to remove interior panels or moldings to locate leaks or confirm repairs. Always begin testing at the base of the suspected area and slowly continue upward.

**WATER LEAK TEST (cont'd)**

1. The use of an assistant inside the vehicle may be helpful.
2. Starting at base of suspected area, apply water using a hose. Water flow should not exceed 22 psi and be unrestricted (no nozzle).
3. Slowly move hose upward over suspected leak area to pinpoint leak.
4. If possible, determine if more than one leak exists in suspected area.
5. Refer to individual component procedures when performing water leak repairs.

**AIR PRESSURE TEST**

1. Block-off right and left side pressure relief valves located in luggage compartment behind rear wheelhouse with clean rags and close deck lid.
2. Raise all side windows, latch top to windshield header and close doors.
3. Pressurize vehicle's passenger/luggage compartment by moving heater control to "VENT" and blower motor to "HIGH" position.
4. Observe suspected area for escaping air by applying a soapy-water solution to area in question.
5. Watch for air bubbles at suspected leak area. Air bubbles indicate a poor seal.

**NOTE: Some air escaping at sides of backlite from under top cover is normal.**

6. Refer to individual component procedures when performing water leak repairs.

**CHALK TEST**

1. Using a suitable household cleaner, clean weatherstrip in question and its mating surface.
2. Carefully apply an un-broken line of powdered chalk or talc to contact surface of the seal in question.
3. Slowly close or mate components pressing weatherstrip firmly against its mating surface.
4. Slowly, separate components and visually inspect weatherstrip and mating surface. If seal is good, chalk line will be distorted and a mirror image will appear on the mating surface. If seal is faulty, chalk line will not distort.
5. Refer to individual component procedures when performing water leak repairs.

## WIND NOISE

Wind noise from door window, quarter window, and windshield header weatherstrips may be eliminated by a component adjustment. Refer to the respective chapters for adjustment procedures of components directly relating to the weatherstrip.

Road test the vehicle to determine the source or area of the wind noise.

1. A "whistle" type wind noise is caused by air passing over a protruding edge or air from the passenger compartment leaking to the outside.
2. A wind "roar" is created when outside air passes over an opening.
3. A "rush" sound is caused by outside air passing over the vehicle body.

Once the general area of the wind noise is located, tape can be applied to moldings or gaps until the wind noise is eliminated. Most wind noise repairs are similar to water leak repairs. Refer to individual component procedures when performing wind noise repairs.

e  
g

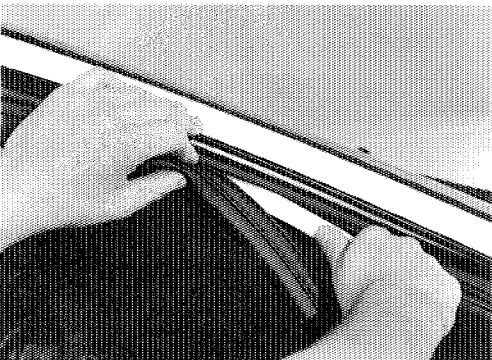
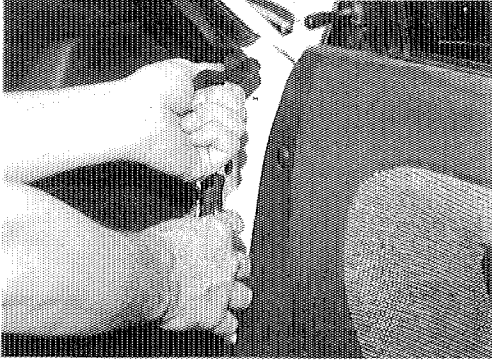
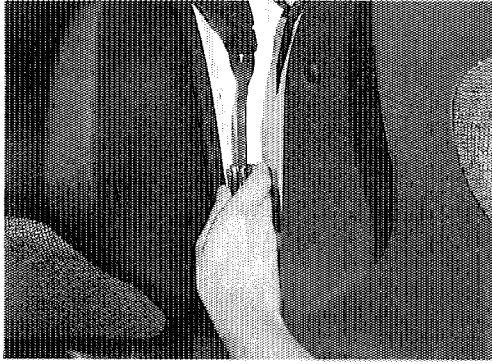

## FRONT HEADER WEATHERSTRIP

### REMOVE

1. REMOVE WINDSHIELD HEADER MOLDING (See 2-4).
2. REMOVE FRONT HEADER WEATHERSTRIP.
  - (a) Remove weatherstrip lower retainer (push pin).
  - (b) Pull upward on weatherstrip end, and remove second retainer (push pin).
  - (c) Repeat (a) and (b) for the other side of vehicle.
  - (d) Using a suitable release agent (3M P/N 051135-08971 or equivalent) and a flat-bladed tool, remove weatherstrip from A-pillar retainer.
  - (e) Remove retainer (push pin) securing weatherstrip to top of A-pillar.
  - (f) Using the above method, continue to remove weatherstrip from header retainer, and other side of vehicle.

**CAUTION: Adhesive tape is applied between weatherstrip and windshield header. Do not tear or damage the weatherstrip during removal. If damaged, weatherstrip must be replaced.**

### INSTALL

1. CLEAN FRONT WEATHERSTRIP RETAINERS.
  - (a) Remove excess adhesive from front header and both A-pillar weatherstrip retainers.
  - (b) Clean adhesive tape from weatherstrip and windshield header.

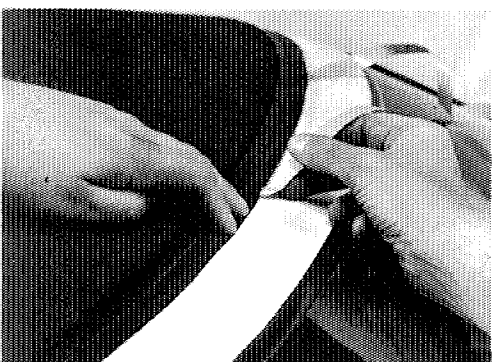
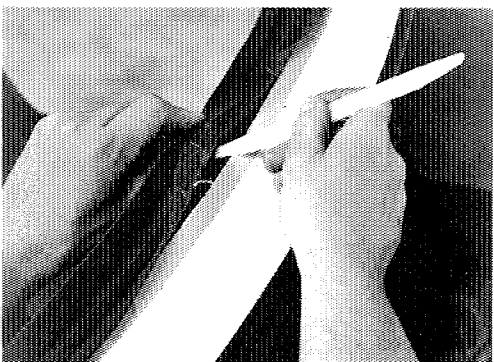
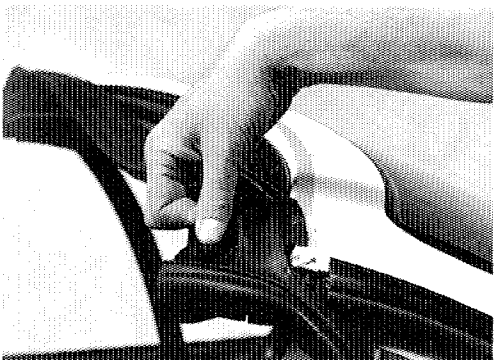
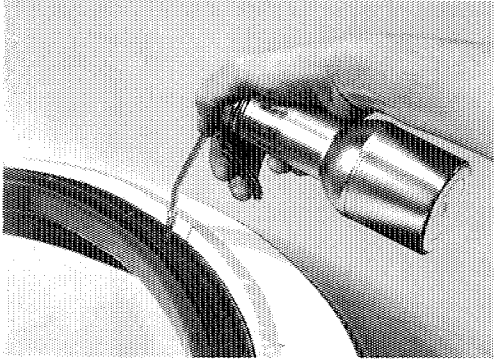
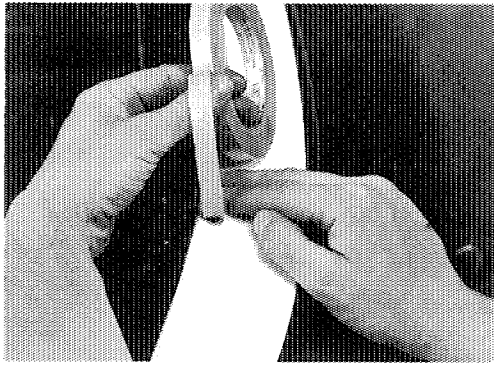

### FRONT HEADER WEATHERSTRIP (cont'd)

#### 2. INSTALL FRONT HEADER WEATHERSTRIP TO WINDSHIELD HEADER.

- (a) Install a new strip of 1/2 in. wide adhesive tape across windshield header. Tape should cover header molding stud holes. Do not pull backing from tape at this time.

- (b) Apply a continuous bead of adhesive (3M P/N 051135-08008 or equivalent) to front header weatherstrip retainer.

**NOTE: Insure weatherstrip adhesive fills void at center of weatherstrip mounting surface.**

- (c) Secure front header weatherstrip end (corner) to top of A-pillar using retainer (push pin).

- (d) Repeat (c) on other side of vehicle.

- (e) Starting at ends, then alternating from side-to-side working toward center, install weatherstrip to front header weatherstrip retainer using a flat-bladed tool.

- (f) Latch top to header.

- (g) Lift header weatherstrip forward edge and remove adhesive tape backing.

- (h) Firmly press weatherstrip onto windshield header.

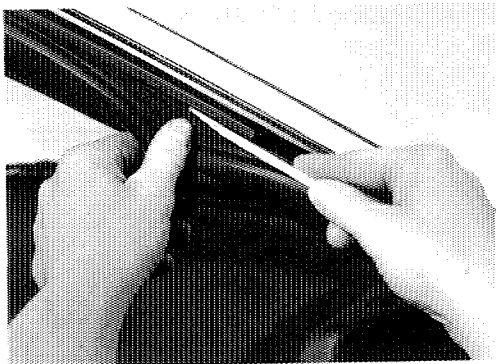
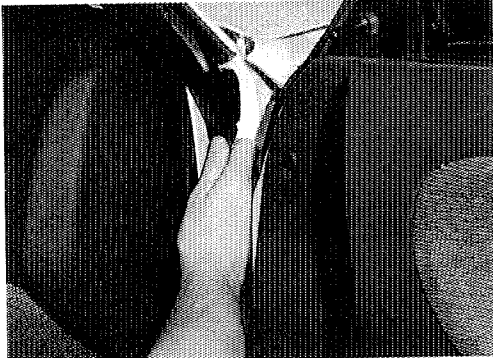
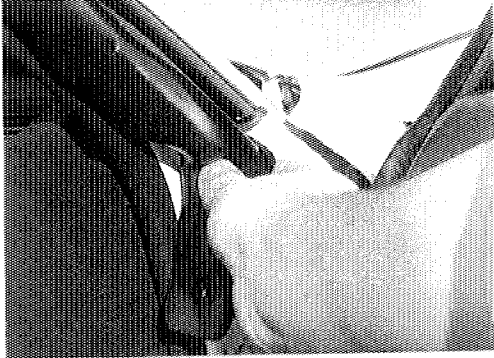
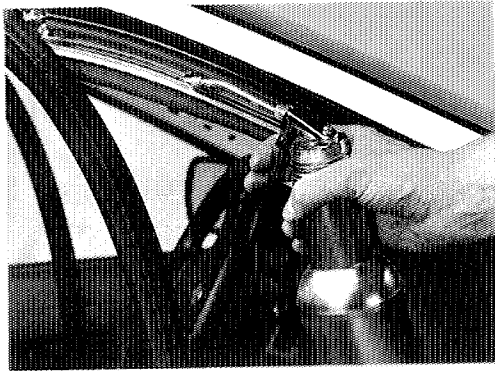

### FRONT HEADER WEATHERSTRIP (cont'd)

#### 3. INSTALL FRONT HEADER WEATHERSTRIP TO A-PILLAR.

- (a) Apply a continuous bead of adhesive (3M P/N 051135-08008 or equivalent) to A-pillar weatherstrip retainer.

**NOTE: Insure weatherstrip adhesive fills void at center of weatherstrip mounting surface.**

- (b) Lift up weatherstrip lower end and install one retainer (push pin).

- (c) Install second, lower weatherstrip retainer (push pin).

- (d) Install weatherstrip to A-pillar retainer alternating from top to bottom working toward center using a flat-bladed tool.

- (e) Repeat step 3 for the other side of vehicle.

#### 4. INSTALL WINDSHIELD HEADER MOLDING (See 2-5).

### FRONT HEADER WEATHERSTRIP RETAINER

#### REMOVE

1. REMOVE FRONT HEADER WEATHERSTRIP RETAINER, (see Outer Trim Cap in 1-5).

#### INSTALL

1. INSTALL FRONT HEADER WEATHERSTRIP RETAINER, (see Outer Trim Cap in 1-6).

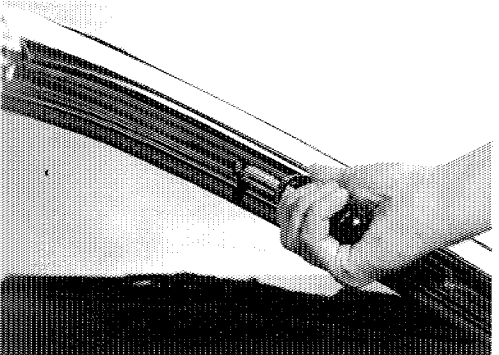
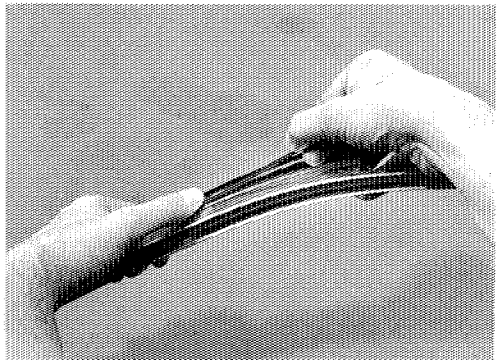
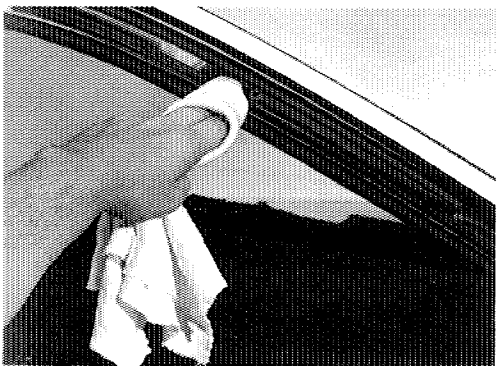
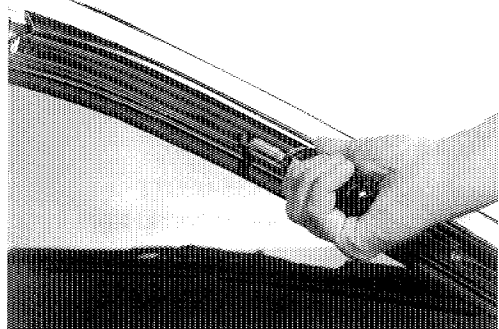

## A-PILLAR WEATHERSTRIP RETAINER

### REMOVE

1. REMOVE RETAINER SECURING WEATHERSTRIP TO TOP OF A-PILLAR.
2. REMOVE FRONT HEADER WEATHERSTRIP FROM A-PILLAR WEATHERSTRIP RETAINER (see Front Header Weatherstrip in this chapter).

**CAUTION: If weatherstrip is to be reused, do not tear or damage the weatherstrip during removal. If damaged, weatherstrip must be replaced.**

3. REMOVE A-PILLAR WEATHERSTRIP RETAINER.  
Remove four (4) screws, and A-pillar weatherstrip retainer.

4. CLEAN A-PILLAR WEATHERSTRIP RETAINER.
  - (a) Remove excess adhesive from front A-pillar weatherstrip retainer.
  - (b) Clean adhesive tape from retainer and header A-pillar.

### INSTALL

1. INSTALL A-PILLAR WEATHERSTRIP RETAINER.
  - (a) If necessary, install new foam tape to retainer. Tape should be installed forward of retainer mounting holes.
  - (b) Position A-pillar weatherstrip retainer to A-pillar and secure using four (4) screws.
2. INSTALL FRONT HEADER WEATHERSTRIP TO A-PILLAR WEATHERSTRIP RETAINER (see Front Header Weatherstrip in this chapter).



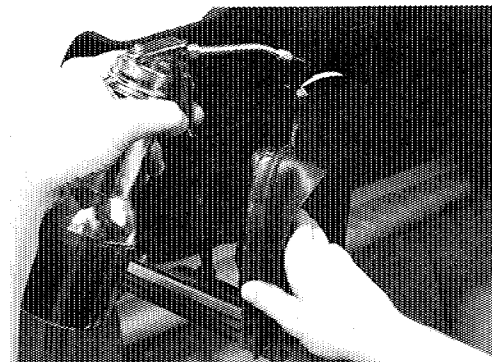
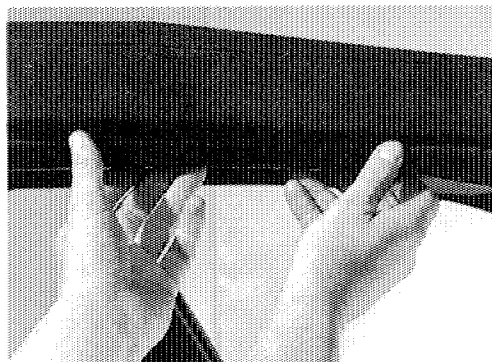
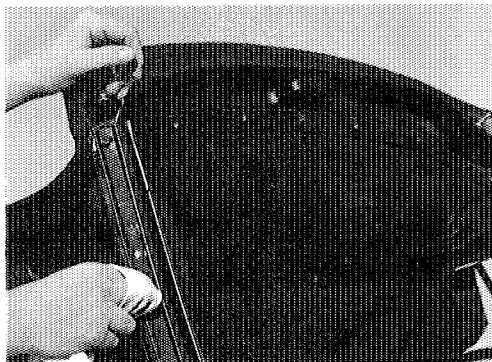
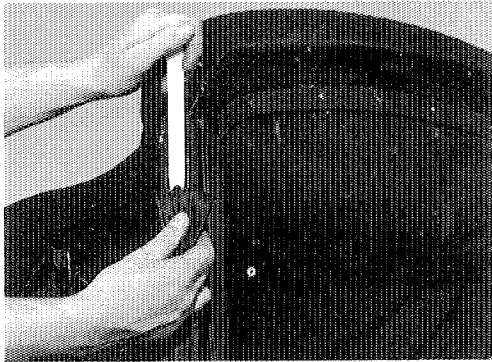
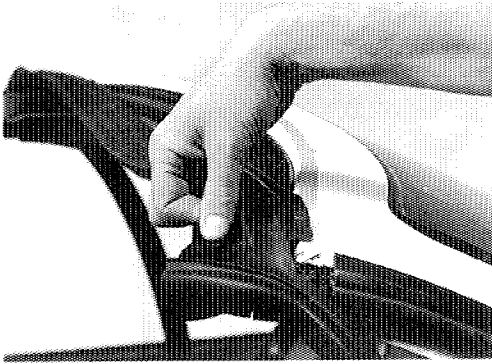

3. INSTALL UPPER A-PILLAR WEATHERSTRIP RETAINER.

## FRONT RAIL WEATHERSTRIP

### REMOVE

1. LOWER CONVERTIBLE TOP.
2. REMOVE FRONT RAIL WEATHERSTRIP.

Using a suitable release agent (3M P/N 051135-08971 or equivalent) and a flat-bladed tool, remove weatherstrip from front rail retainer.

3. CLEAN FRONT RAIL WEATHERSTRIP RETAINER.

Remove excess adhesive from front rail weatherstrip retainer.

### INSTALL

1. INSTALL FRONT RAIL WEATHERSTRIP.
  - (a) Without adhesive, use a flat-bladed tool to install front rail weatherstrip to retainer.
  - (b) Raise and latch top to header.
  - (c) Position weatherstrip in retainer to achieve all-around satisfactory seal, then lower top.
  - (d) While holding rear half of weatherstrip in retainer, pull the front half out.
  - (e) Apply a continuous bead of adhesive (3M P/N 051135-08008 or equivalent) to exposed portion of retainer.

**NOTE: Insure weatherstrip adhesive fills void at center of weatherstrip mounting surface.**





### FRONT RAIL WEATHERSTRIP (cont'd)

- (f) Using a flat-bladed tool, install weatherstrip into front rail weatherstrip retainer.
- (g) Repeat (d) through (f) to install rear half of front rail weatherstrip.
- (h) Check front rail weatherstrip fit.

### FRONT RAIL WEATHERSTRIP RETAINER

#### REMOVE

**NOTE: The front rail weatherstrip and retainer can be removed as an assembly. To do this, release only the front portion of the seal (step 2) enough to reveal attaching screw, then proceed to step 3.**

1. LOWER CONVERTIBLE TOP.

2. REMOVE FRONT RAIL WEATHERSTRIP.

Using a suitable release agent (3M P/N 051135-08971 or equivalent ) remove weatherstrip from front rail retainer.

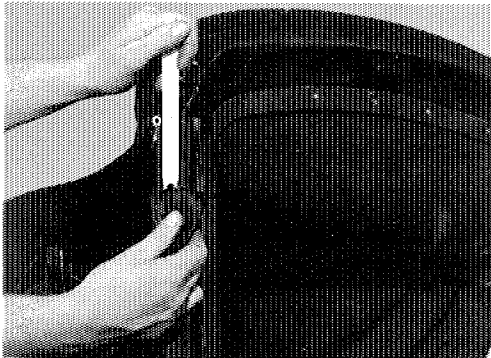

3. MARK FRONT RAIL WEATHERSTRIP RETAINER-TO-FRONT RAIL LOCATION.

With a pencil, mark location of front rail weatherstrip retainer washers on top side of front rail.

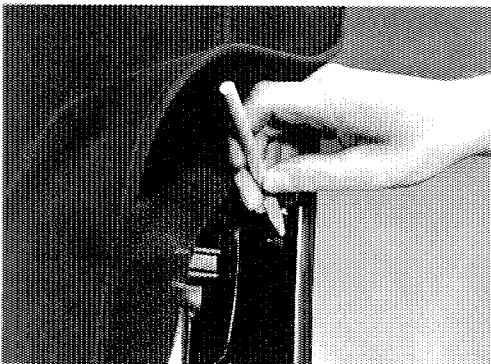

4. REMOVE FRONT RAIL WEATHERSTRIP RETAINER.

- (a) Remove screw at front of retainer.

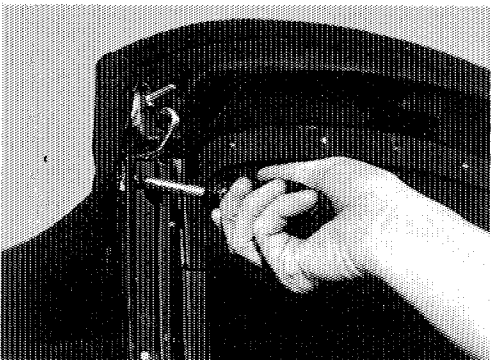

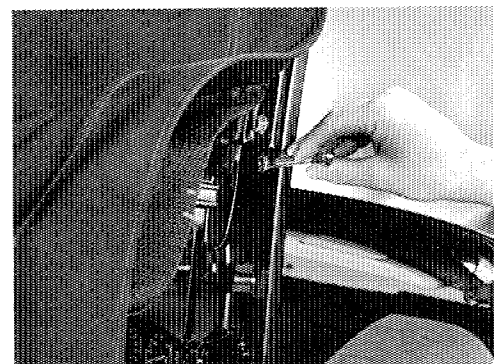
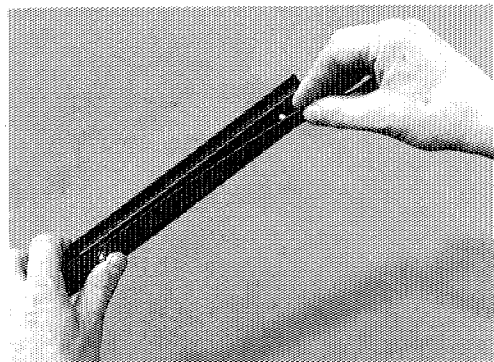
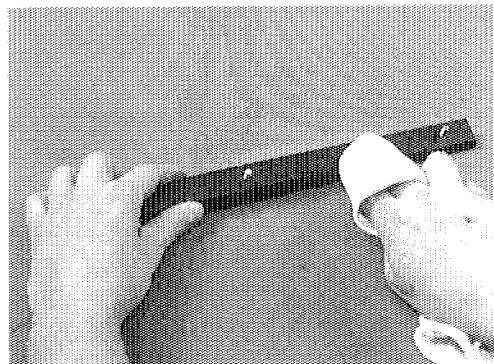
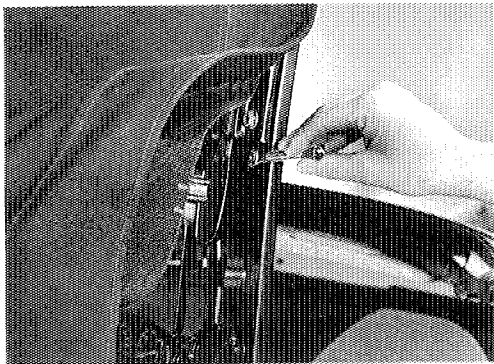

### FRONT RAIL WEATHERSTRIP RETAINER (cont'd)

- (b) Remove two (2) nuts with washers and front rail weatherstrip retainer.

#### 5. CLEAN FRONT RAIL WEATHERSTRIP RETAINER.

- (a) Remove excess adhesive from front rail weatherstrip retainer.
- (b) Clean foam tape from retainer and front rail.

### INSTALL

#### 1. INSTALL NEW FOAM TAPE TO RETAINER.

Cut tape to fit over retainer mounting studs.

#### 2. INSTALL FRONT RAIL WEATHERSTRIP RETAINER.

- (a) Position weatherstrip retainer to front rail reference marks and secure using two (2) nuts with washers. Do not Torque nuts.

- (b) Install screw at front of retainer. Do not tighten screw at this time.

#### 3. INSTALL FRONT RAIL WEATHERSTRIP TO RETAINER WITHOUT ADHESIVE AND CHECK FIT.

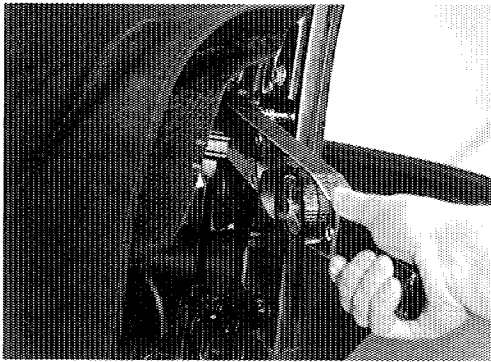
**FRONT RAIL WEATHERSTRIP RETAINER (cont'd)**

4. TIGHTEN TWO (2) RETAINER NUTS.

Torque: 3 N·m (27 in. lb.)

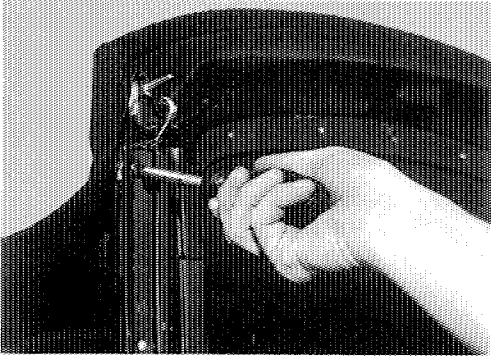

5. TIGHTEN FRONT WEATHERSTRIP RETAINER SCREW.

6. INSTALL FRONT RAIL WEATHERSTRIP (see Front Rail Weatherstrip in this chapter).

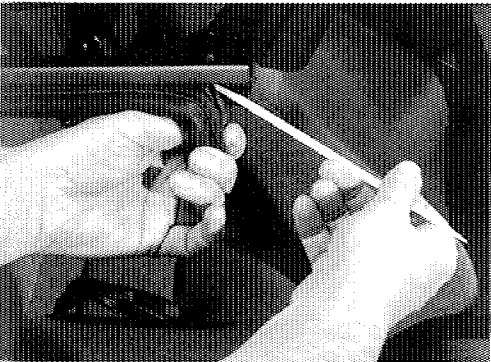
**CENTER RAIL WEATHERSTRIP****REMOVE**

1. LOWER CONVERTIBLE TOP HALFWAY.
2. REMOVE CENTER RAIL WEATHERSTRIP.

Using a suitable release agent (3M P/N 051135-08971 or equivalent) and a flat-bladed tool, remove weatherstrip from retainer.

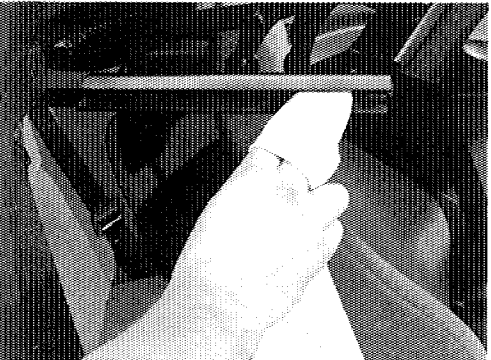

3. CLEAN CENTER RAIL WEATHERSTRIP RETAINER.

Remove excess adhesive from center rail weatherstrip retainer.

**INSTALL**

1. INSTALL CENTER RAIL WEATHERSTRIP.
  - (a) Without adhesive, use a flat-bladed tool to install center rail weatherstrip to retainer.
  - (b) Raise and latch top to header.
  - (c) Position weatherstrip in retainer to achieve all-around satisfactory seal, then lower top.

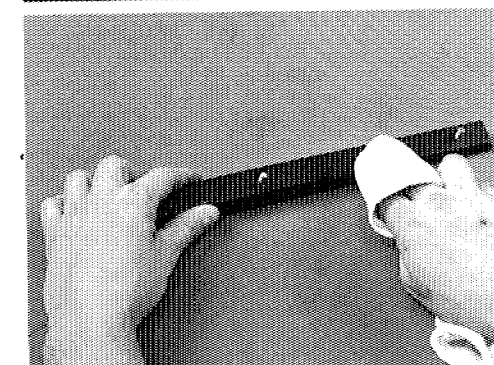
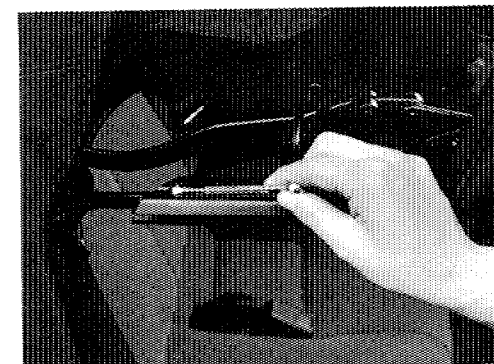
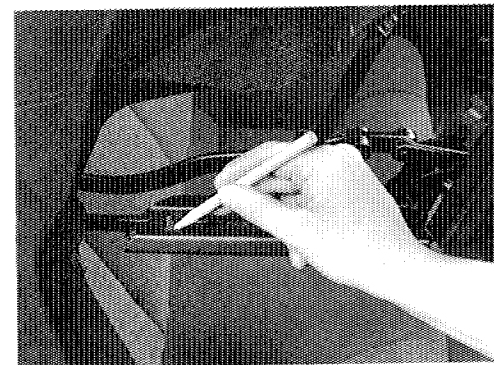
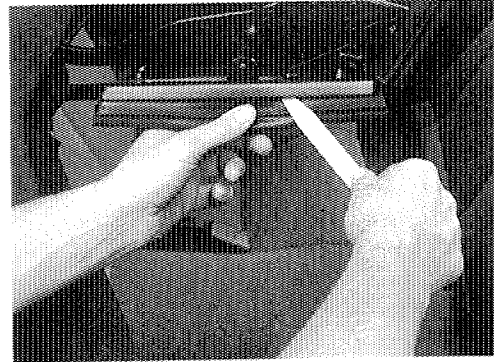
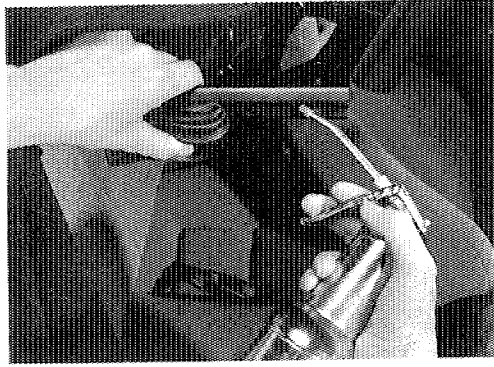

### CENTER RAIL WEATHERSTRIP (cont'd)

- (d) While holding rear half of weatherstrip in retainer, pull the front half up.
- (e) Apply a continuous bead of adhesive (3M P/N 051135-08008 or equivalent), to exposed portion of retainer.

**NOTE: Insure weatherstrip adhesive fills void at center of weatherstrip mounting surface.**

- (f) Using a flat-bladed tool, install weatherstrip into center rail weatherstrip retainer.
- (g) Repeat (d) through (f) to install rear half of center rail weatherstrip.
- (h) Check center rail weatherstrip fit.

### CENTER RAIL WEATHERSTRIP RETAINER

#### REMOVE

1. REMOVE CENTER RAIL WEATHERSTRIP (see Center Rail Weatherstrip in this section).
2. MARK CENTER RAIL WEATHERSTRIP RETAINER-TO-CENTER RAIL LOCATION.

With a pencil, mark location of center rail weatherstrip retainer washers on top side of center rail.

3. REMOVE CENTER RAIL WEATHERSTRIP RETAINER.  
Remove two (2) nuts with washers, and weatherstrip retainer.

4. CLEAN CENTER RAIL WEATHERSTRIP RETAINER.
  - (a) Remove excess adhesive from center rail weatherstrip retainer.
  - (b) Clean foam tape from retainer.

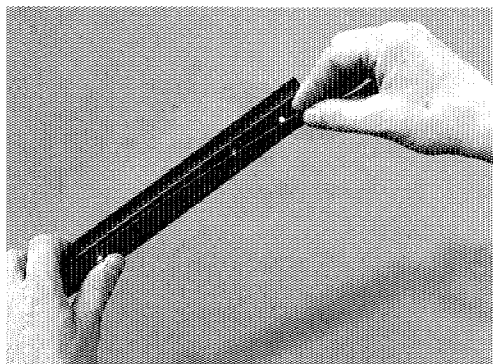

## CENTER RAIL WEATHERSTRIP RETAINER (cont'd)

### INSTALL

1. INSTALL NEW FOAM TAPE TO CENTER RAIL WEATHERSTRIP RETAINER.

Apply tape to outside of retainer mounting studs.

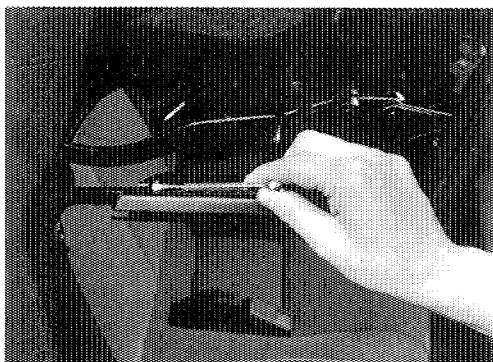

2. INSTALL CENTER RAIL WEATHERSTRIP RETAINER.

Position weatherstrip retainer to center rail reference marks and secure using two (2) nuts with washers. Do not torque nuts at this time.



3. INSTALL CENTER RAIL WEATHERSTRIP TO RETAINER WITHOUT ADHESIVE AND CHECK FIT.

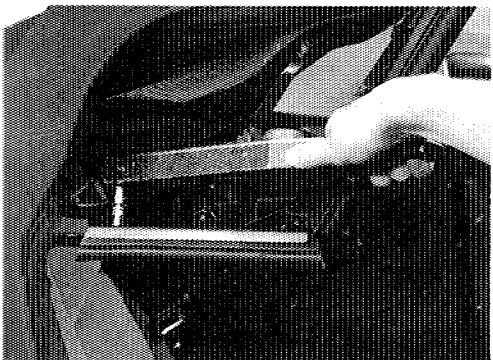

4. TIGHTEN TWO (2) RETAINER NUTS.

**Torque: 3 N·m (27 in. lb.)**

5. INSTALL CENTER RAIL WEATHERSTRIP (see Center Rail Weatherstrip in this chapter).



## REAR RAIL WEATHERSTRIP

### REMOVE

1. LOWER CONVERTIBLE TOP HALFWAY.
2. REMOVE REAR RAIL WEATHERSTRIP.
  - (a) Remove screw from top of weatherstrip.



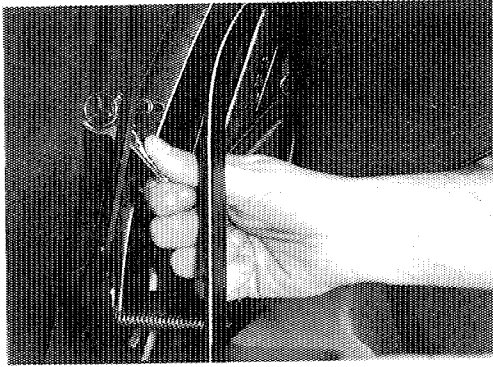

### REAR RAIL WEATHERSTRIP (cont'd)

- (b) Remove three (3) nuts and washers from rear of rear rail seal carrier.

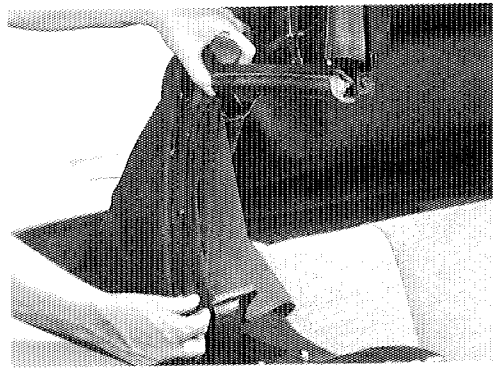

- (c) Remove weatherstrip assembly from rear rail.
- (d) Remove rear rail weatherstrip retainer from weatherstrip.

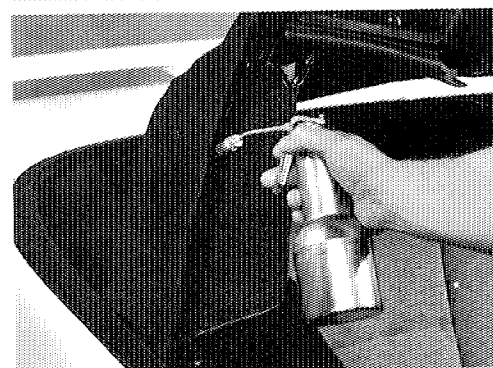

### INSTALL

#### 1. INSTALL REAR RAIL WEATHERSTRIP.

- (a) Align weatherstrip retainer studs to weatherstrip holes and install retainer.
- (b) Apply adhesive (3M P/N 051135-08008 or equivalent) to the rear rail weatherstrip mounting surface.

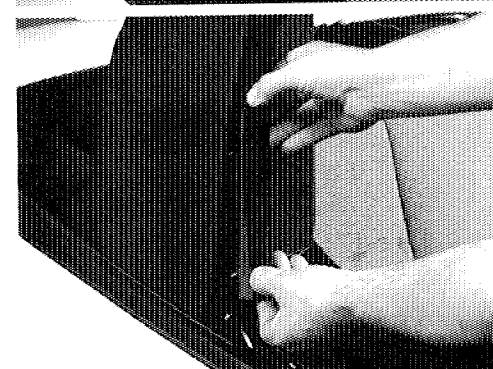

- (c) Position weatherstrip with retainer into rear rail seal carrier, aligning retainer studs with holes provided in seal carrier.

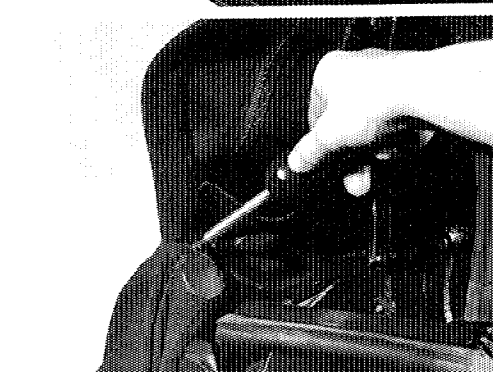

- (d) Install screw at top of weatherstrip.

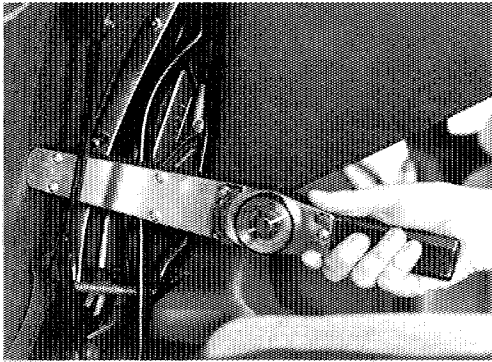

### REAR RAIL WEATHERSTRIP (cont'd)

- (e) Secure rear rail weatherstrip assembly using three (3) nuts with washers.

**Torque: 3 N·m (27 in. lb.)**

2. RAISE AND LATCH TOP TO WINDSHIELD HEADER.
3. RAISE QUARTER WINDOW AND CHECK QUARTER WINDOW-TO-REAR RAIL WEATHERSTRIP ALIGNMENT (see 6-1).

**NOTE: Quarter window-to-weatherstrip alignment can be obtained by adjusting the quarter window guide.**

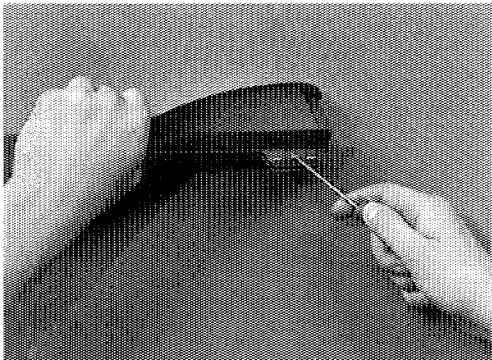

### QUARTER WINDOW INNER WEATHERSTRIP

#### REMOVE

1. REMOVE QUARTER TRIM OUTER PANEL (see 5-5).
2. REMOVE QUARTER WINDOW INNER WEATHERSTRIP.

On a clean work surface, remove staples and inner weatherstrip from outer panel.

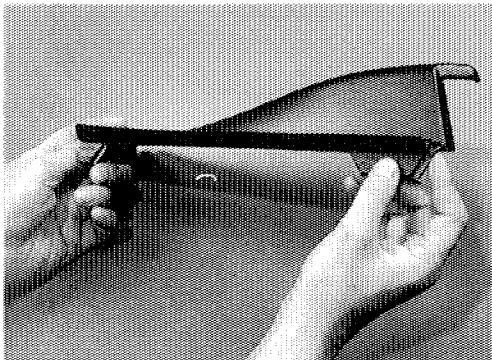

#### INSTALL

1. INSTALL QUARTER WINDOW INNER WEATHERSTRIP.
  - (a) Position front edge of weatherstrip to front edge of quarter trim outer panel.

- (b) Secure weatherstrip to outer trim panel using four (4) .25 x .31 divergent point staples.

2. INSTALL QUARTER TRIM OUTER PANEL AND QUARTER TRIM PANEL (see 5-5).

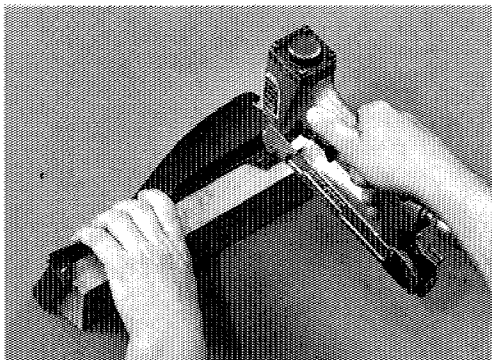

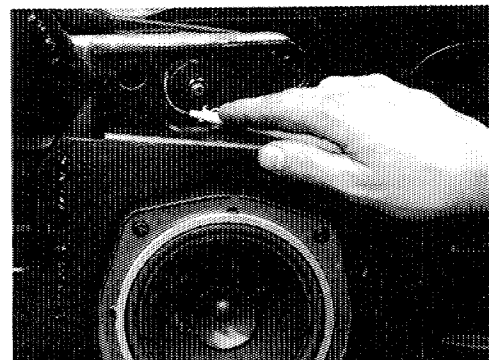
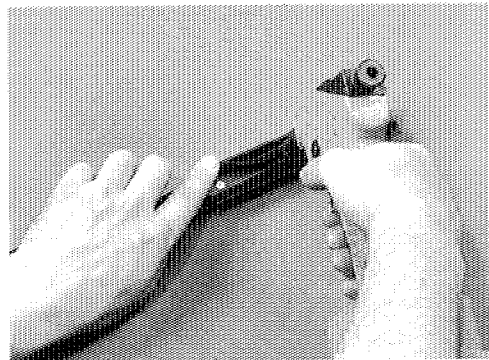
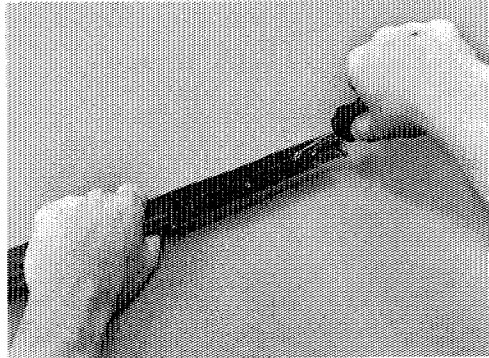
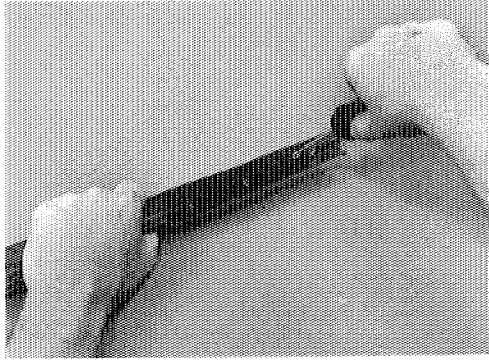
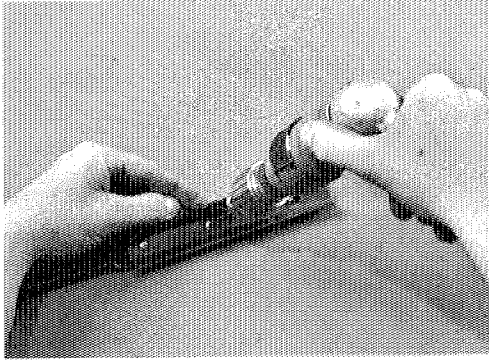

## QUARTER BELT OUTER WEATHERSTRIP

### REMOVE

1. REMOVE QUARTER BELT OUTER MOLDING (see 9-4).
2. REMOVE QUARTER BELT OUTER WEATHERSTRIP.
  - (a) Using a 1/8 in. drill bit, remove (2) rivets and weatherstrip from bracket.
  - (b) Remove two (2) weatherstrip bracket attaching screws and bracket.

### INSTALL

1. INSTALL QUARTER BELT OUTER WEATHERSTRIP.
  - (a) Secure weatherstrip bracket to belt molding using two (2) screws.
  - (b) Position weatherstrip to bracket and secure using two (2) 1/8 x .125 rivets.

**NOTE: Install rivets ONLY to rear and center weatherstrip mounting holes.**

2. INSTALL QUARTER BELT OUTER MOLDING (see 9-5).

## B-PILLAR MUCKET

### REMOVE

1. REMOVE QUARTER TRIM OUTER PANEL (see 5-5).
2. REPOSITION QUARTER WINDOW AND GUIDE ASSEMBLY.
  - (a) Using a pencil, mark location of three (3) quarter window guide assembly nuts on inner body panels.



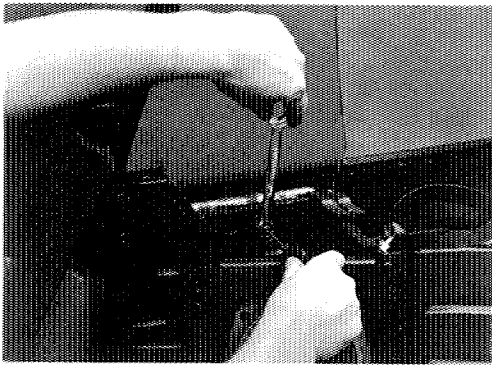

### B-PILLAR MUCKET (cont,d)

- (b) While holding guide adjusting studs, remove three (3) quarter window guide mounting nuts.

**NOTE: Do not allow adjuster stud to turn or quarter window adjustment will be effected.**

- (c) Reposition quarter window and guide allowing access to mucket screw.

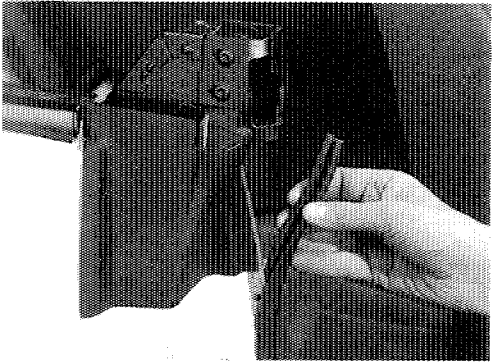

### 3. REMOVE B-PILLAR MUCKET.

- (a) Pull windlace from pinch weld flange enough to allow mucket removal.

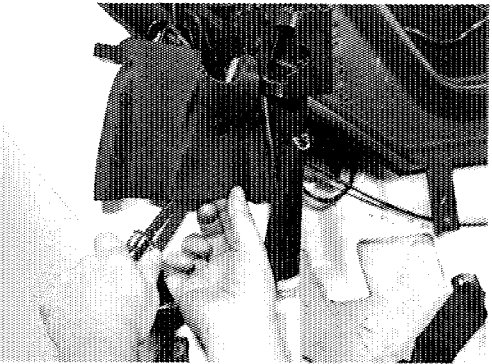

- (b) Remove four (4) retainers and mucket from B-pillar.

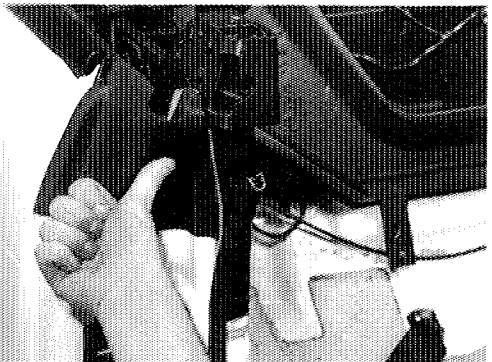

### INSTALL

#### 1. INSTALL B-PILLAR MUCKET.

- (a) Position mucket to B-pillar and secure using four (4) retainers.
- (b) Position windlace and press onto pinch weld flange.

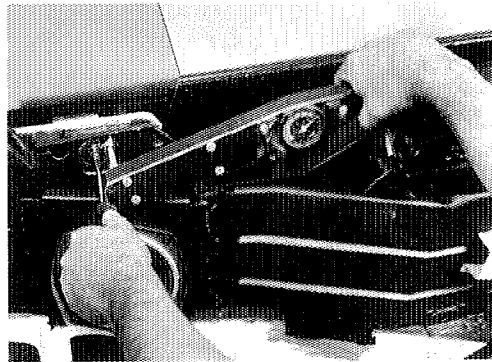
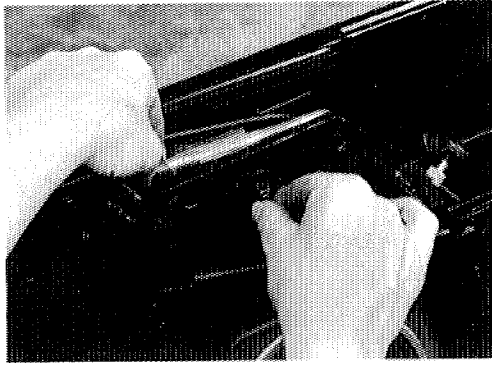

### B-PILLAR MUCKET (cont,d)

#### 2. INSTALL QUARTER WINDOW AND GUIDE ASSEMBLY.

- (a) Position quarter window guide mounting studs to body panel and install three (3) nuts finger tight.

**NOTE: Do not allow adjuster studs to turn or quarter window adjustment will be effected.**

- (b) Align quarter window guide mounting nut washers with reference marks and tighten.

**Torque: 28 N·m (21 ft. lb.)**

#### 3. INSTALL QUARTER TRIM OUTER PANEL (see 5-5).

# REAR SEAT

	page
REAR SEAT COMPONENTS .....	4-2
REAR SEAT CUSHION .....	4-3
REAR SEAT CUSHION COVER .....	4-4
REAR SEAT BACK.....	4-5
REAR SEAT BACK COVER.....	4-6

REAR SEAT COMPONENTS

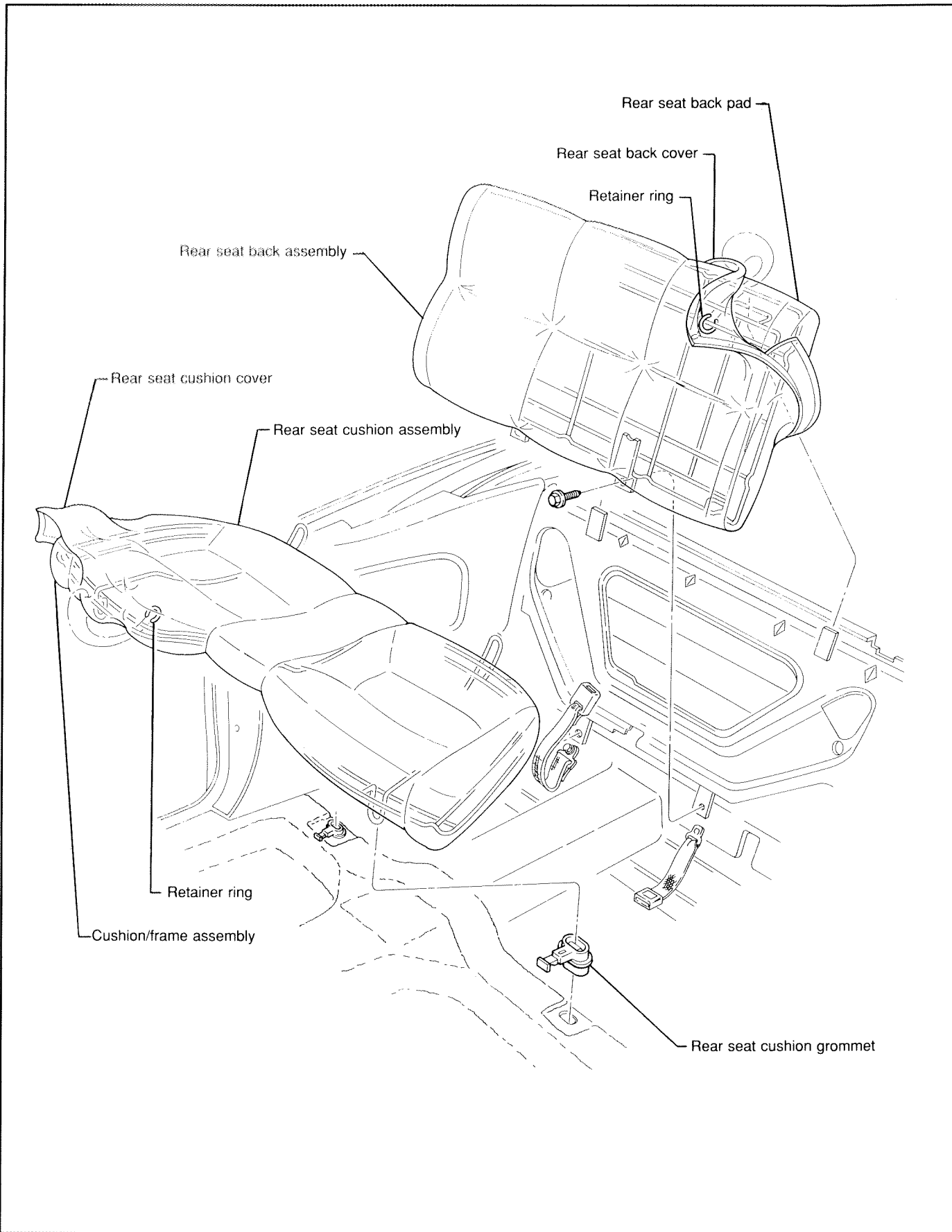

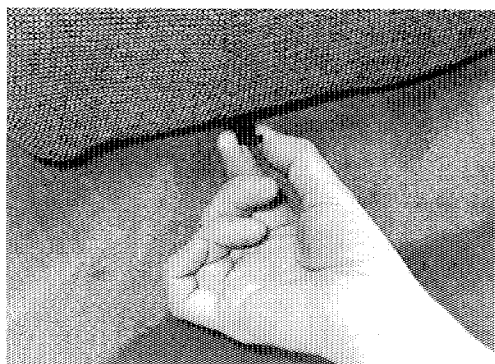

## REAR SEAT CUSHION

### REMOVE

1. REMOVE REAR SEAT CUSHION.

- (a) Pull grommet release handle forward.

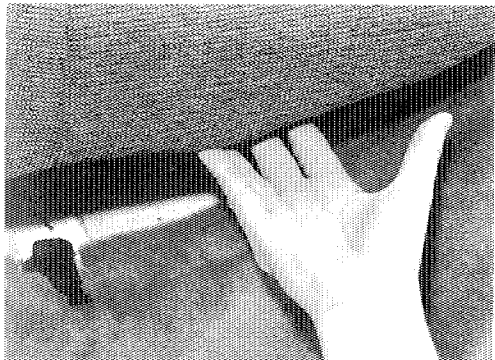

- (b) Lift up front edge of seat cushion.

- (c) Repeat step 1 for other side of seat.

- (d) Pull cushion forward and up to remove cushion from vehicle.

### INSTALL

1. INSTALL REAR SEAT CUSHION.

- (a) Position seat belt buckles above rear seat cushion.

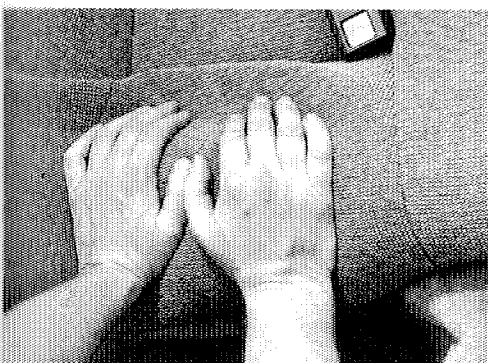

- (b) Place rear seat cushion frame loops into grommets and push down firmly.

**REAR SEAT CUSHION COVER****REMOVE**

1. REMOVE REAR SEAT CUSHION (see Rear Seat Cushion in this chapter).
2. REMOVE REAR SEAT CUSHION COVER.
  - (a) Using a suitable tool, remove cover retaining rings.
  - (b) Pull cover material from cushion and seat frame.

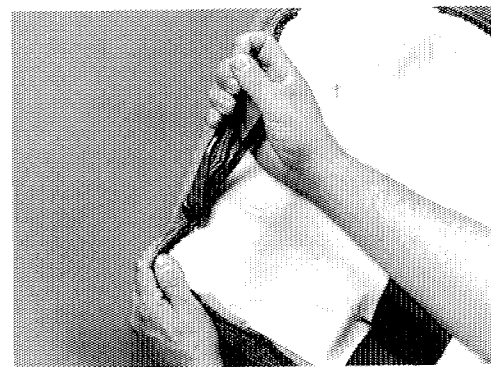
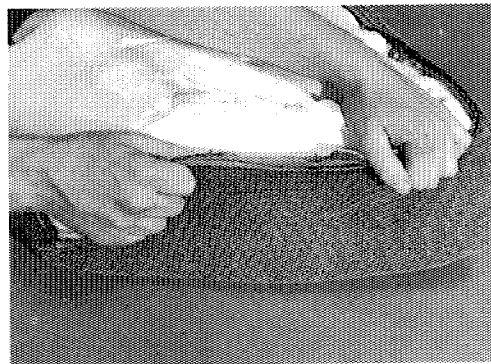
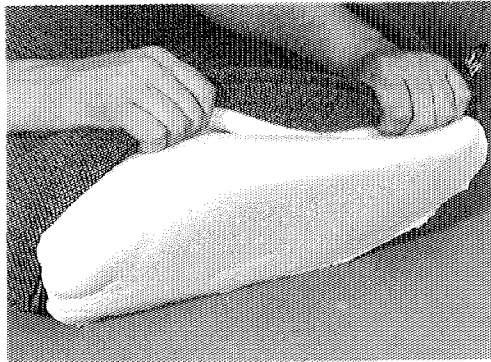
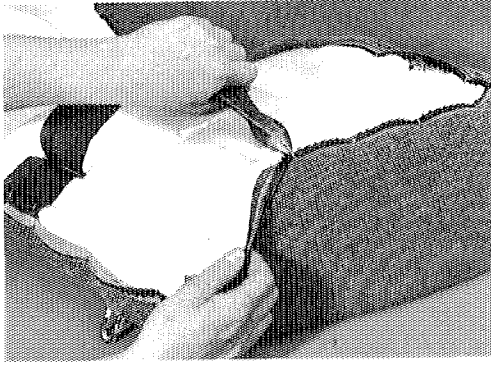
**INSTALL**

1. INSTALL REAR SEAT CUSHION COVER.
  - (a) Position cover material over seat cushion.
  - (b) Using retaining rings, secure seat cover to cushion and frame.

**NOTE: Insure proper alignment of seat cover material to seat cushion while installing retaining rings**
2. INSTALL REAR SEAT CUSHION (see Rear Seat Cushion in th chapter).

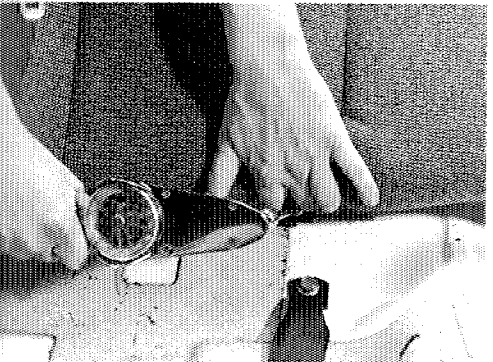
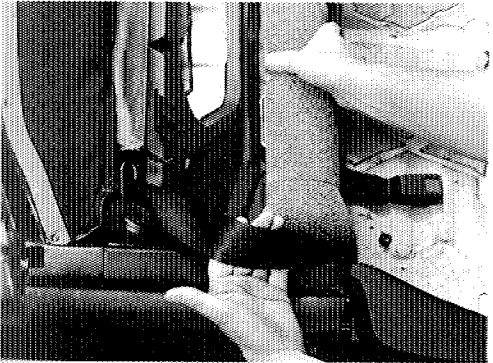
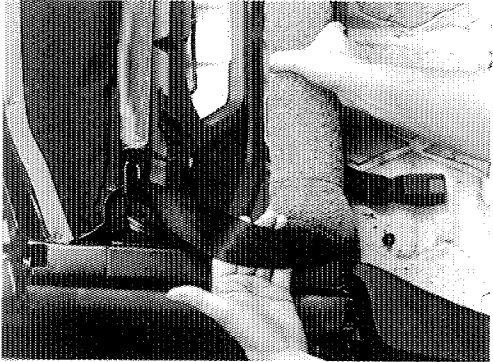
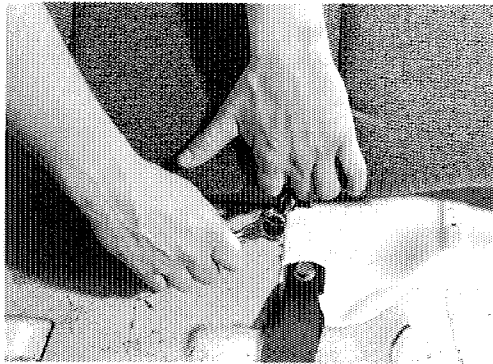

## REAR SEAT BACK

### REMOVE

1. REMOVE REAR SEAT CUSHION (see Rear Seat Cushion in this chapter).
2. REMOVE REAR SEAT BACK.
  - (a) Remove two (2) bolts securing rear seat back to seatback rear brace.
  - (b) Lift rear seat back up and off rear seat back brace retainers and remove seat back from vehicle.

### INSTALL

1. INSTALL REAR SEAT BACK.
  - (a) Position rear seat back over seat back brace retainers and push down firmly.
  - (b) Align lower attaching brackets to tabs on the seat back brace and install two (2) bolts.

**Torque: 10 N·m (88 in. lb.)**

2. INSTALL REAR SEAT CUSHION (see Rear Seat Cushion in this chapter).

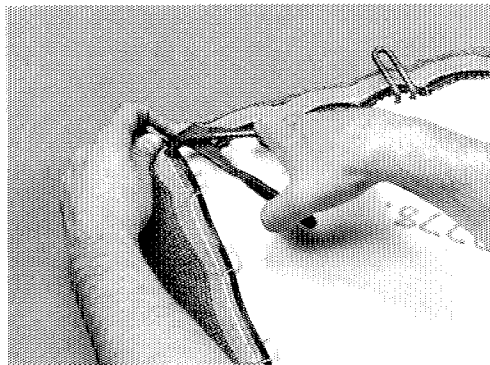
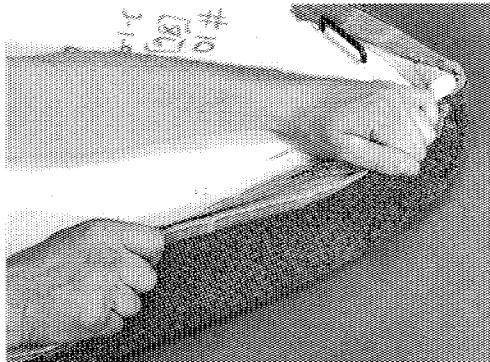
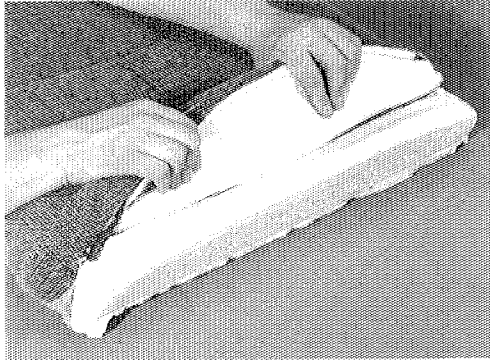

## REAR SEAT BACK COVER

### REMOVE

1. REMOVE REAR SEAT BACK (see Rear Seat Back in this chapter).
2. REMOVE REAR SEAT BACK COVER.
  - (a) Using a suitable tool, remove cover retaining rings.
  - (b) Pull cover material from cushion and seat frame.

### INSTALL

1. INSTALL REAR SEAT BACK COVER.
  - (a) Position cover material over seat cushion.
  - (b) Align openings in lower edge of cover with seat frame attaching brackets.
  - (c) Using retaining rings, secure seat back cover to cushion and frame.

**NOTE: Insure proper alignment of seat cover material to seat cushion while installing retaining rings.**
2. INSTALL REAR SEAT BACK (see Rear Seat Back in this chapter).



# QUARTER TRIM PANEL

	page
QUARTER TRIM PANEL COMPONENTS .....	5-2
QUARTER TRIM PANEL .....	5-3
SPEAKER GRILLE ASSEMBLY .....	5-4
QUARTER TRIM OUTER PANEL .....	5-5
QUARTER TRIM PANEL BRACKETS .....	5-6

QUARTER TRIM PANEL COMPONENTS

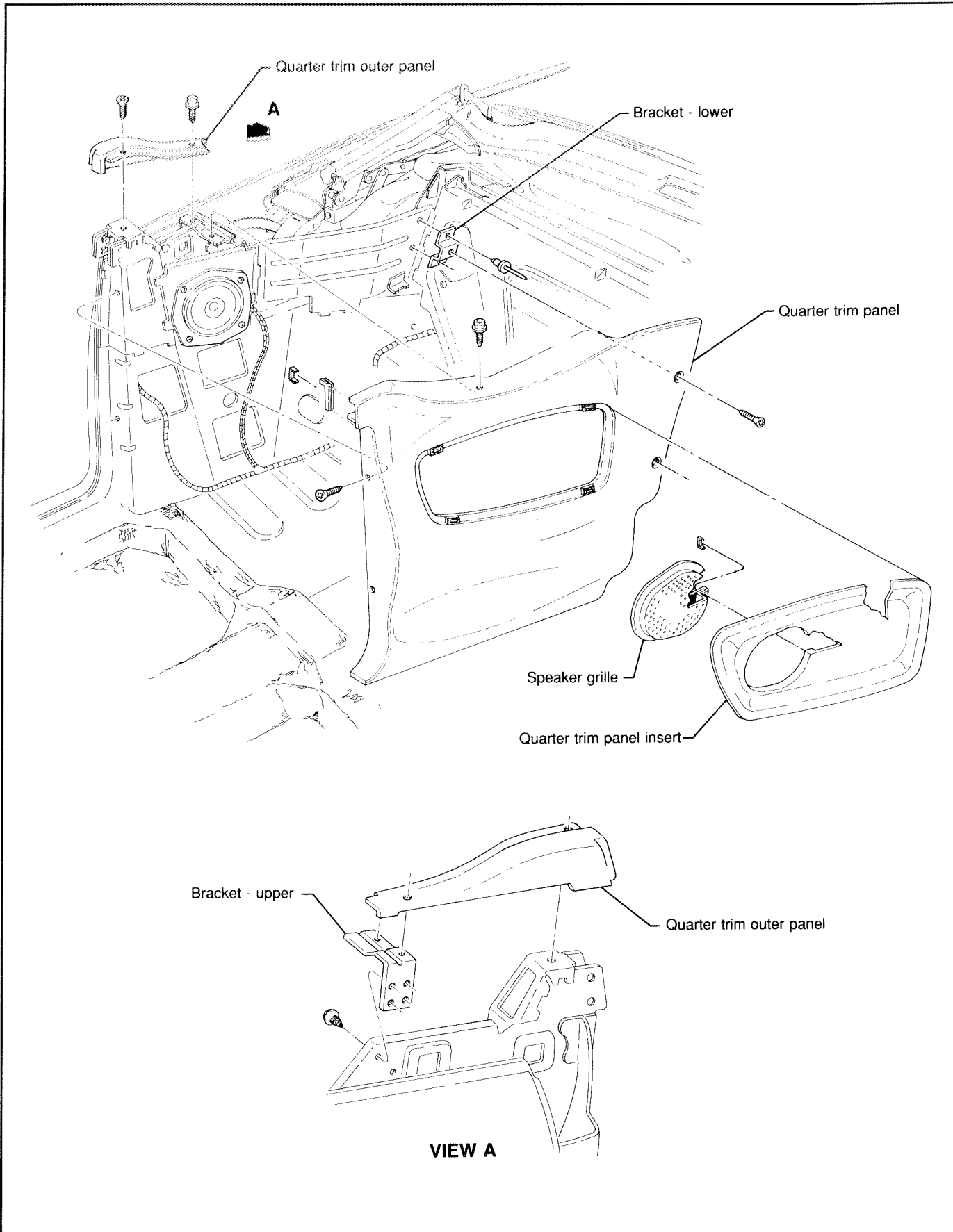

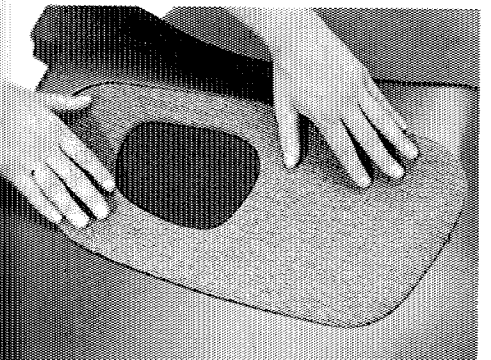
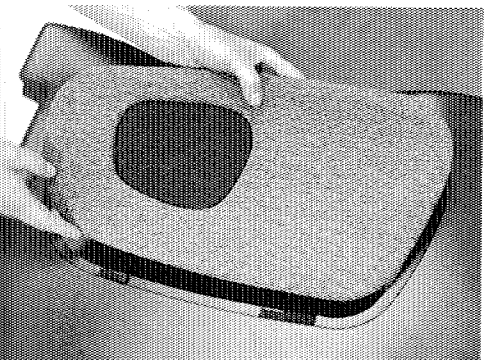
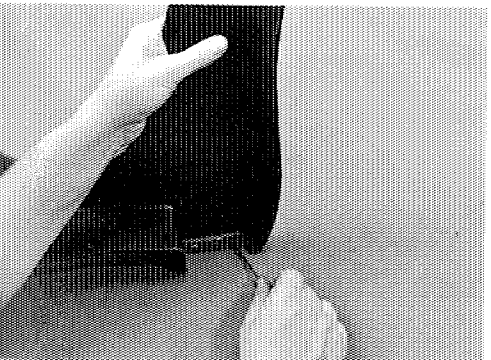
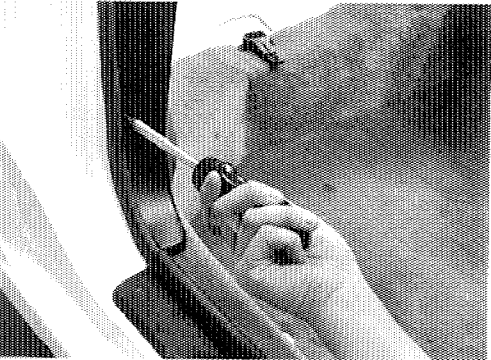
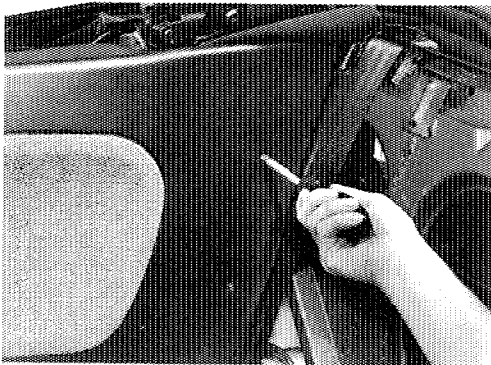

**QUARTER TRIM PANEL**

**REMOVE**

1. REMOVE REAR SEAT BACK (see 4-5).
2. REMOVE QUARTER TRIM PANEL.
  - (a) Remove two (2) screws at rear and one snap from top of quarter trim panel.
  - (b) Remove two (2) screws securing trim panel to "B" pillar, and panel from vehicle.

**DISASSEMBLE**

1. REMOVE QUARTER TRIM PANEL ESCUTCHEON.  
Remove staples and escutcheon from quarter trim panel.
2. REMOVE QUARTER TRIM PANEL INSERT ASSEMBLY.  
Remove quarter trim insert assembly from panel by pulling apart velcro strips.

**ASSEMBLE**

1. INSTALL QUARTER TRIM PANEL INSERT ASSEMBLY.  
Position insert to quarter trim panel and secure by engaging velcro strips.

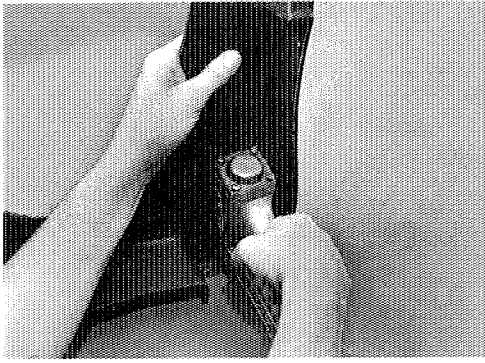

### QUARTER TRIM PANEL (cont'd)

2. INSTALL QUARTER TRIM PANEL ESCUTCHEON.

Position escutcheon to quarter trim panel and secure using five (5) 1/8 x 1/2 in. divergent staples.

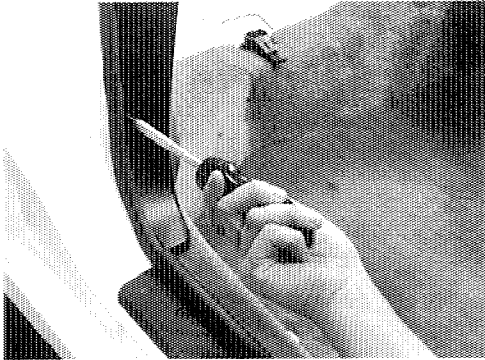

### INSTALL

1. INSTALL QUARTER TRIM PANEL.

(a) Position quarter trim panel and secure panel to "B" pillar using two (2) screws.

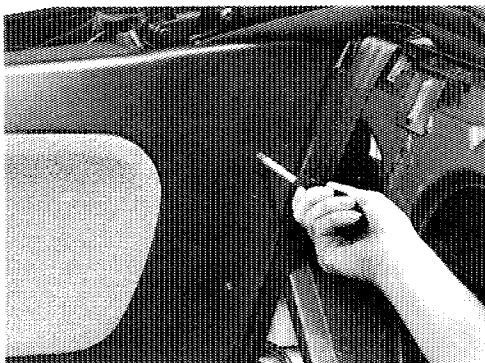

(b) Secure rear of quarter trim panel to lower bracket using two (2) screws.

(c) Install snap securing top of quarter trim panel to upper bracket.

2. INSTALL REAR SEAT BACK AND CUSHION (see 4-5).

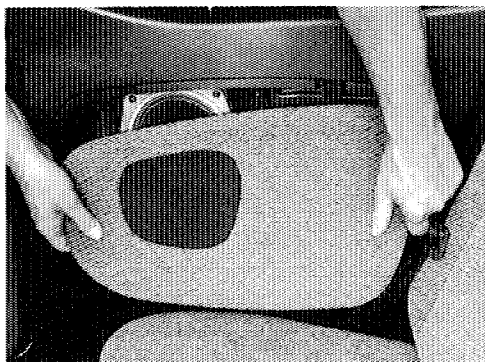

### SPEAKER GRILLE ASSEMBLY

#### REMOVE

1. REMOVE QUARTER TRIM PANEL INSERT.

Pull insert away from trim panel disengaging velcro strips.

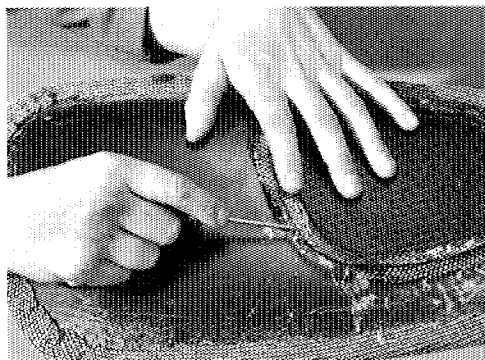

2. REMOVE SPEAKER GRILLE ASSEMBLY.

Remove staples and speaker grille from trim panel insert.

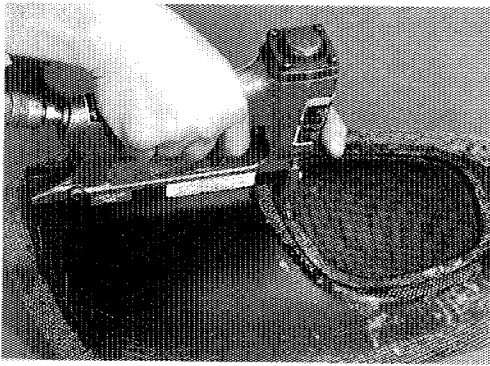

### SPEAKER GRILLE ASSEMBLY (cont'd)

#### INSTALL

1. INSTALL SPEAKER GRILLE ASSEMBLY TO QUARTER TRIM PANEL INSERT.

Position speaker to trim panel insert and secure using ten (10) 1/8 x 1/2 in. divergent staples.

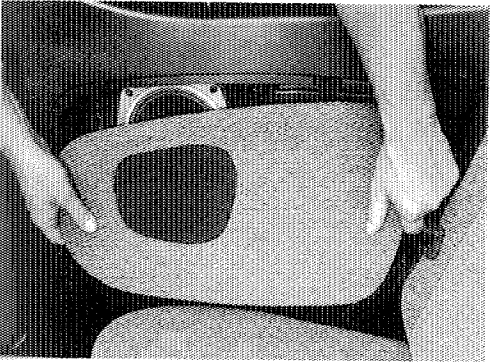

2. INSTALL QUARTER TRIM PANEL INSERT.

Position insert to quarter trim panel and engage velcro strips.

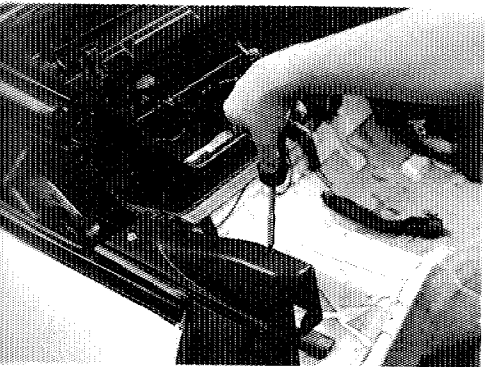

### QUARTER TRIM OUTER PANEL

#### REMOVE

1. REMOVE QUARTER TRIM PANEL (see Quarter Trim Panel in this chapter).
2. REMOVE QUARTER TRIM OUTER PANEL.

Remove one screw and one snap and panel from upper bracket.

**NOTE: To replace quarter window inner weatherstrip (see 3-19)**

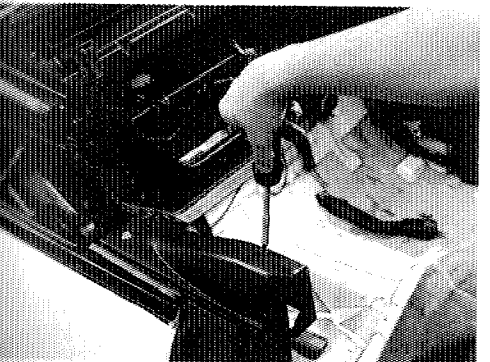

#### INSTALL

1. INSTALL QUARTER TRIM OUTER PANEL.

Position trim outer panel to upper bracket and secure using one screw and one snap.

2. INSTALL QUARTER TRIM PANEL (see Quarter Trim Panel in this chapter).

3

WO

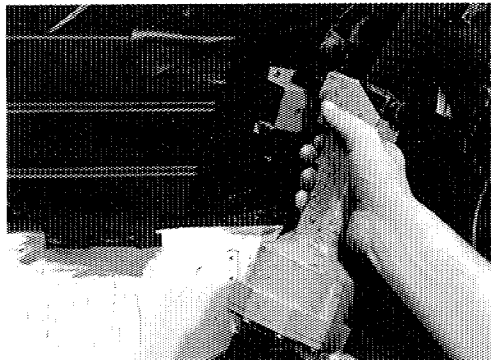
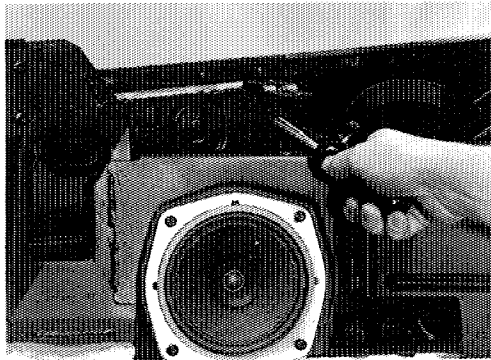
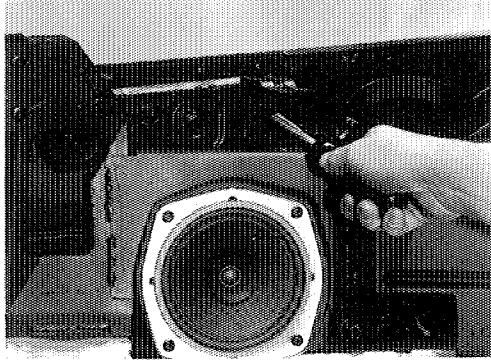
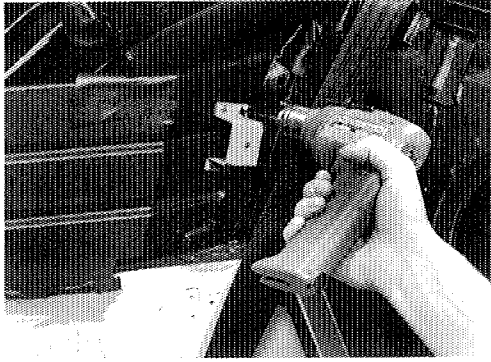

## QUARTER TRIM PANEL BRACKETS

### REMOVE

1. REMOVE QUARTER TRIM PANEL (see Quarter Trim Panel in this chapter).
2. REMOVE TRIM PANEL LOWER BRACKET.  
Using a 1/8 in. drill bit, remove two (2) rivets, and bracket from body brace.
3. REMOVE QUARTER TRIM OUTER PANEL (see Quarter Trim Outer Panel in this chapter).
4. REMOVE QUARTER TRIM PANEL UPPER BRACKET.  
Remove two (2) screws, and bracket from inner-upper body panel.

### INSTALL

1. INSTALL QUARTER TRIM PANEL UPPER BRACKET.  
Position upper bracket to inner-upper body panel and secure using two (2) screws.  
**Torque: 3 N·m (26 in. lb.)**
2. INSTALL QUARTER TRIM OUTER PANEL (see Quarter Trim Outer Panel in this chapter).
3. INSTALL QUARTER TRIM PANEL LOWER BRACKET.  
Position bracket to body brace and secure using two (2) 1/8 x .125 dome head stainless steel rivets.
4. INSTALL QUARTER TRIM PANEL (see Quarter Trim Panel in this chapter).

# QUARTER WINDOW AND REGULATOR

	page
QUARTER WINDOW AND REGULATOR	
COMPONENTS .....	6-2
ADJUSTMENTS .....	6-3
QUARTER WINDOW AND GUIDE .....	6-4
REGULATOR BRACKET AND MOTOR .....	6-6

QUARTER WINDOW AND REGULATOR COMPONENTS

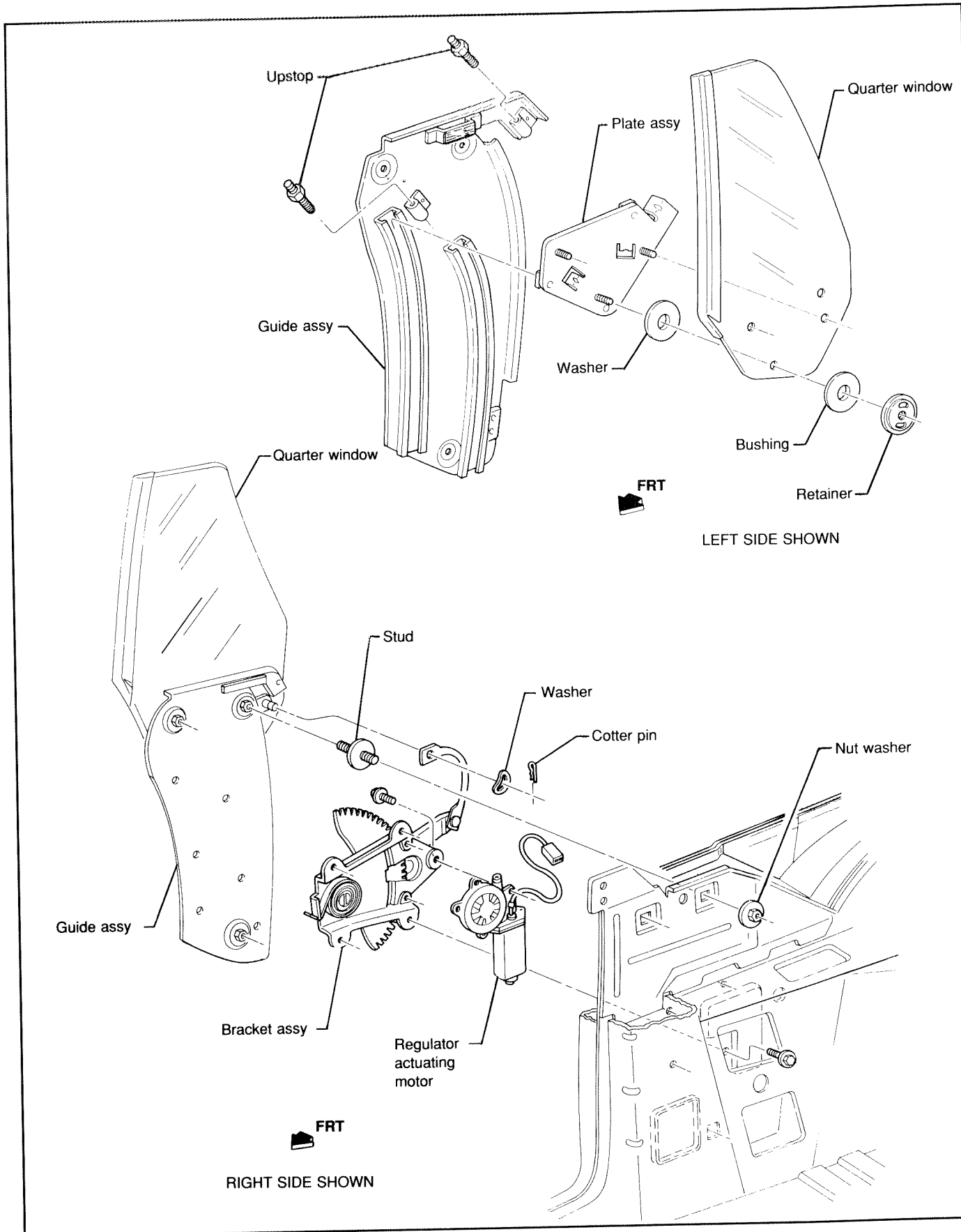



**ADJUSTMENTS**

**QUARTER WINDOW**

**NOTE:** Door window alignment must be correct before quarter window can be properly aligned.

1. REMOVE QUARTER TRIM PANEL (see 5-3).
2. RELEASE CONVERTIBLE TOP FROM WINDSHIELD HEADER.
3. MARK QUARTER WINDOW GUIDE ASSEMBLY NUT LOCATIONS.

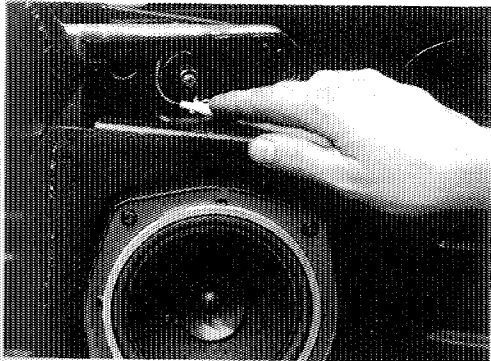

4. ADJUST QUARTER WINDOW.

- (a) Loosen three (3) quarter window guide assembly nuts to move quarter window fore or aft as necessary.

**Specification:** While maintaining a satisfactory seal, metal edge of quarter window sash should be parallel and 10mm from door glass edge.

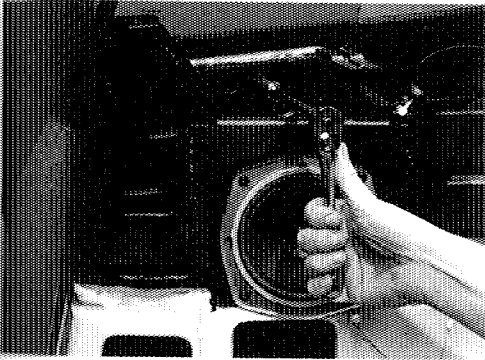

- (b) Rotate three (3) adjuster studs to adjust quarter window contact with: belt molding, door window, and rear rail seal.

**Specification:** With quarter window in full UP position, weatherstrip lip should contact glass evenly along entire length of weatherstrip.

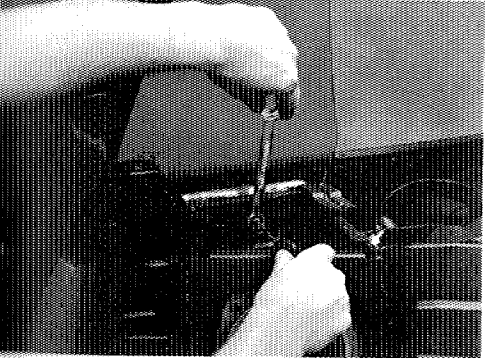

- (c) Adjust window height using two (2) set screws, with locking nuts, located on the guide assembly. Before adjusting window height DOWN, lower window off of the "up-stops".

**Specification:** Quarter glass height should be equal to door glass height when fully raised. When height adjustment is correct, fully raise quarter window glass against "up-stops" and tighten locking nuts.

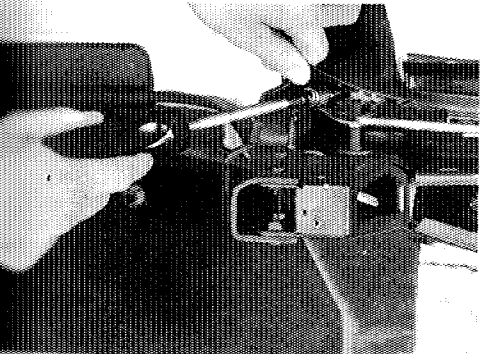

w

**ADJUSTMENTS (cont'd)**

5. SECURE CONVERTIBLE TOP TO WINDSHIELD HEADER.
6. CHECK QUARTER WINDOW-TO-TOP STACK SIDE RAIL WEATHERSTRIP FIT.

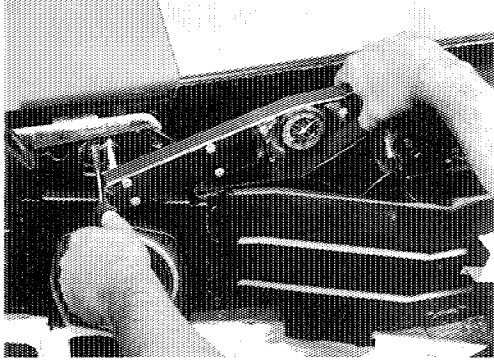

7. TIGHTEN QUARTER WINDOW GUIDE ASSEMBLY NUTS.  
**Torque: 28 N·m (21 ft. lb.)**
8. INSTALL QUARTER TRIM PANEL (see 5-3).

**QUARTER WINDOW AND GUIDE****REMOVE**

1. LOWER CONVERTIBLE TOP.
2. REMOVE QUARTER TRIM PANEL (see 5-3).
3. DISCONNECT REGULATOR LINK.
  - (a) Remove cotter pin and washer.
  - (b) While holding quarter window glass, disconnect link from guide assembly.
  - (c) Lower glass on guide assembly by hand.
4. MARK QUARTER WINDOW GUIDE ASSEMBLY NUT LOCATIONS.

Using a pencil, mark location of three (3) guide assembly nuts or inner body panels.

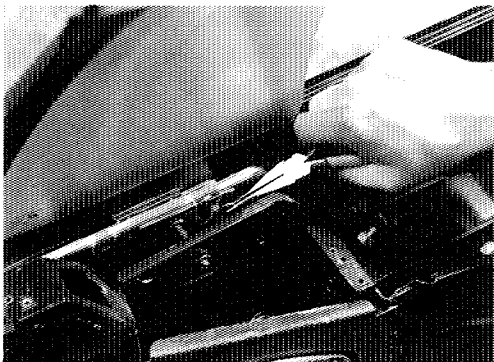

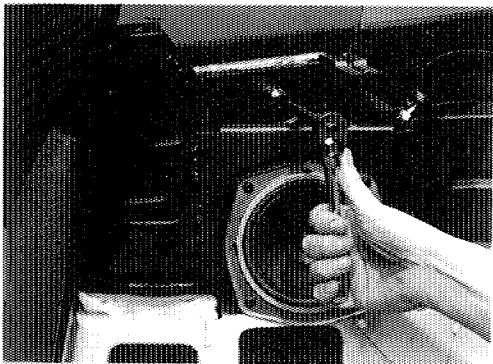

**QUARTER WINDOW AND GUIDE (cont'd)**

5. REMOVE QUARTER WINDOW AND GUIDE ASSEMBLY.

- (a) Remove three (3) guide assembly nuts.
- (b) Remove top rear adjuster stud.
- (c) Shift quarter window and guide assembly rearward and lift assembly from vehicle.

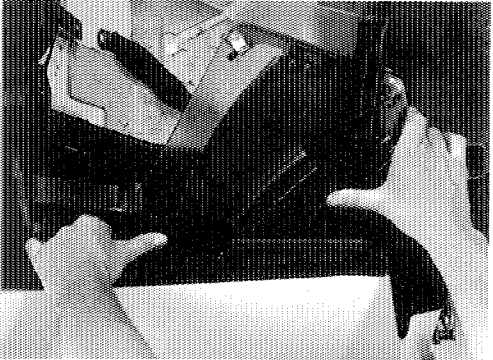

**DISASSEMBLE**

1. SEPARATE QUARTER WINDOW FROM GUIDE.

- (a) Remove three (3) retainers.
- (b) Remove three (3) bushings, window glass and three (3) washers from guide assembly.

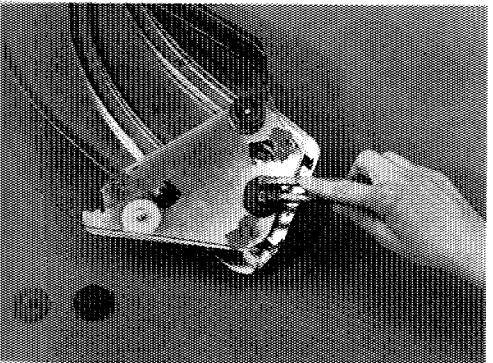

**ASSEMBLE**

1. ATTACH QUARTER WINDOW TO GUIDE.

- (a) Install three (3) washers to guide.
- (b) Install quarter window glass, three (3) bushings and retainers to guide.

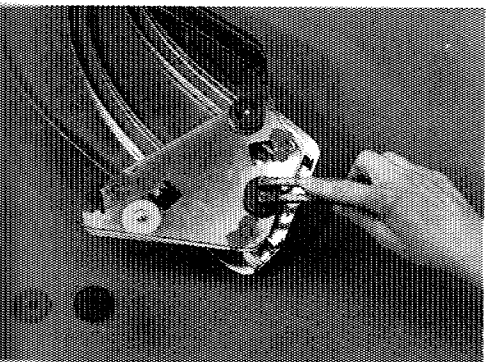

**INSTALL**

1. INSTALL QUARTER WINDOW AND GUIDE ASSEMBLY.

- (a) Position window and guide assembly into vehicle and install rear adjuster stud.

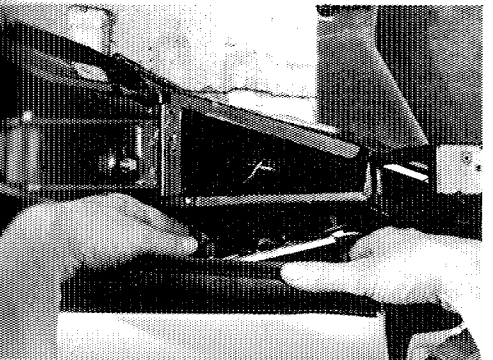

on

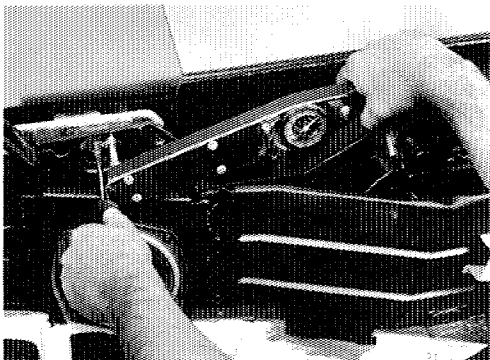
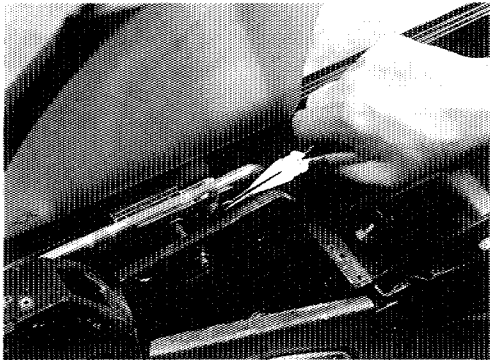
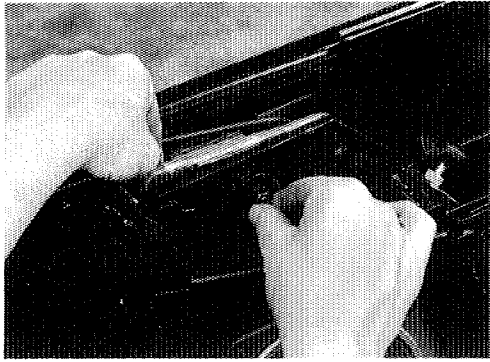

### QUARTER WINDOW AND GUIDE (cont'd)

- (b) Position guide assembly studs to inner body panels.
- (c) Install three (3) nuts to guide assembly. Do not torque nuts at this time.

#### 2. CONNECT REGULATOR LINK.

- (a) Manually raise window.
- (b) While holding quarter window glass, attach link to guide assembly.
- (c) Install washer and cotter pin.

#### 3. ADJUST QUARTER WINDOW, (see Adjustment in this chapter)

#### 4. TIGHTEN THREE (3) GUIDE ASSEMBLY NUTS.

**Torque: 28 N·m (21 ft. lb.)**

#### 5. INSTALL QUARTER TRIM PANEL (see 5-3).

#### 6. RAISE AND SECURE CONVERTIBLE TOP.

### REGULATOR BRACKET/MOTOR

#### REMOVE

1. REMOVE QUARTER WINDOW AND GUIDE (see Quarter Window and Guide in this chapter).

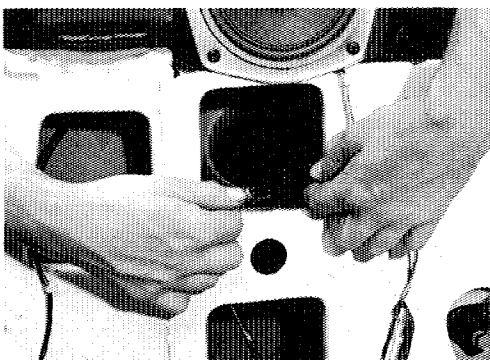

#### 2. REMOVE REGULATOR BRACKET AND MOTOR.

- (a) Disconnect regulator motor electrical connector.
- (b) Remove wire harness with grommet from body panel.

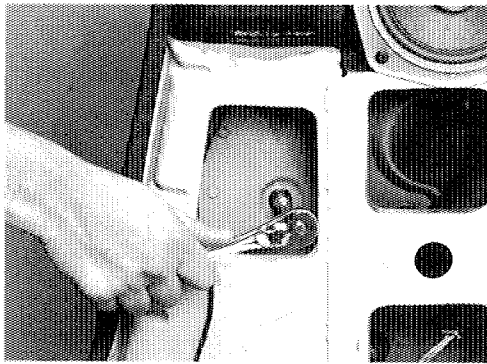

**REGULATOR BRACKET/MOTOR (cont'd)**

- (c) While holding regulator and motor assembly, remove four (4) regulator bracket bolts.
- (d) Lift regulator and motor assembly from vehicle.

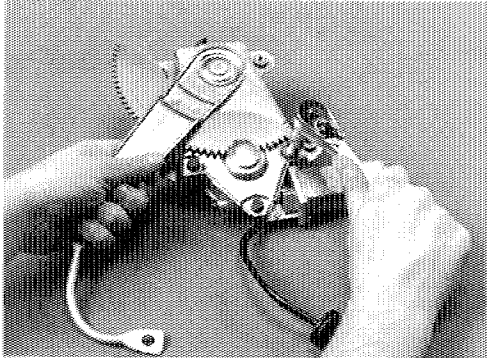

**DISASSEMBLE**

- 1. SEPARATE REGULATOR AND MOTOR.
  - (a) Remove three (3) bolts securing motor to the regulator bracket.
  - (b) Remove motor from bracket.

**WARNING:** Regulator bracket is spring loaded to motor. Have a helper hold the motor/regulator assembly in place as bolts are removed.

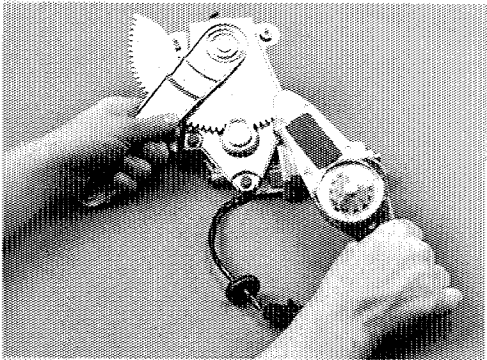

**ASSEMBLE**

- 1. ATTACH MOTOR TO REGULATOR ASSEMBLY.
  - (a) Install motor to regulator using three (3) bolts.  
**Torque: 11.5 N·m (105 in. lb.)**

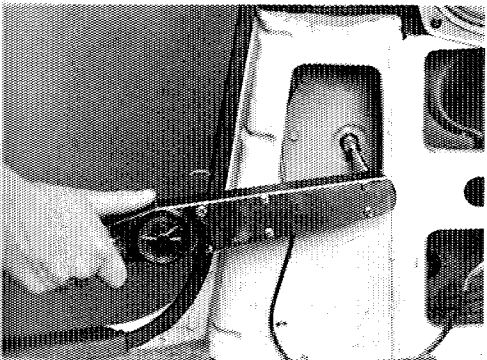

**INSTALL**

- 1. INSTALL REGULATOR BRACKET AND MOTOR.
  - (a) Lower regulator and bracket into vehicle.
  - (b) Install four (4) regulator bracket bolts.  
**Torque: 11.5 N·m (105 in. lb.)**

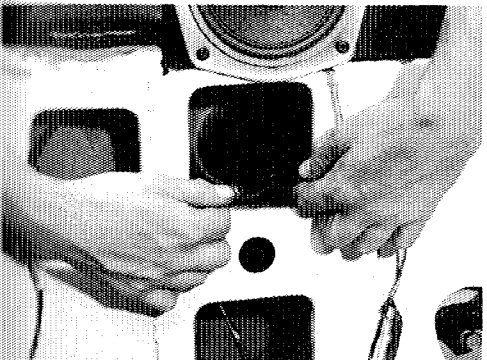

- (c) Connect motor electrical connector.
- (d) Install wire harness grommet to body panel.

- 2. INSTALL QUARTER WINDOW AND GUIDE (see Quarter Window and Guide in this chapter).

its

er).

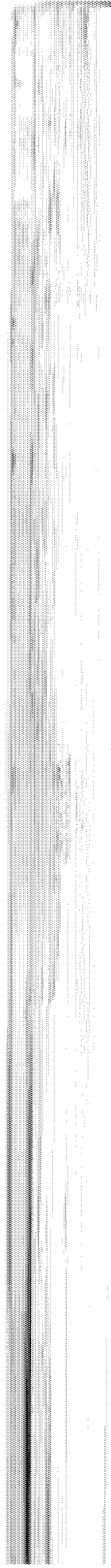

# DOOR AND DOOR WINDOW

	page
DOOR AND DOOR WINDOW COMPONENTS .....	7-2
ADJUSTMENTS .....	7-4
DOOR PANEL .....	7-7
DOOR PANEL FINISHER BRACKETS .....	7-12
DOOR WINDOW .....	7-13
SECONDARY PIN .....	7-15
SECONDARY PIN RECEIVER .....	7-16
GUIDE PIN .....	7-17
GUIDE PIN LOCATOR .....	7-17

DOOR AND DOOR WINDOW COMPONENTS

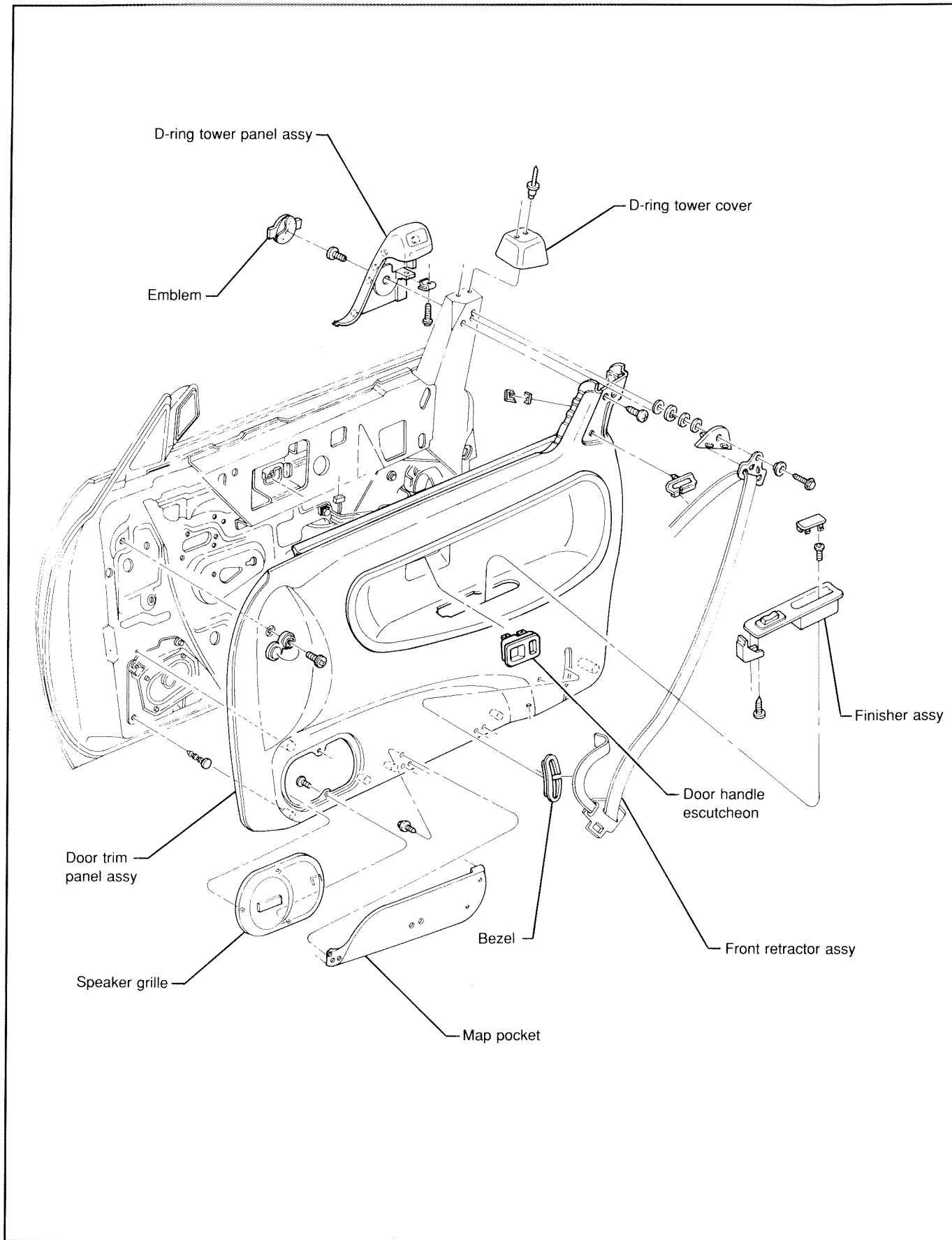



DOOR AND DOOR WINDOW COMPONENTS  
(cont'd)

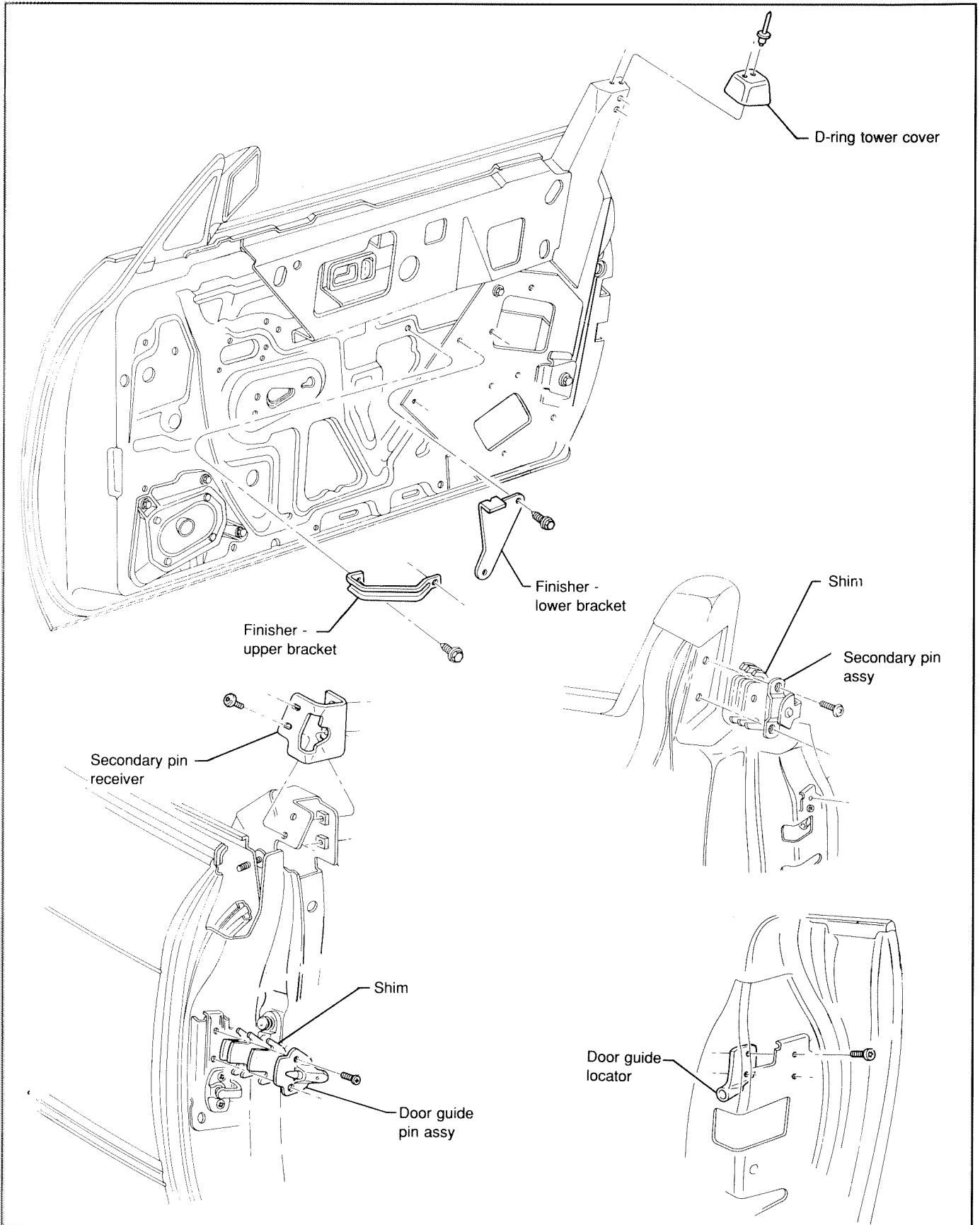

## ADJUSTMENTS

**NOTE:** Door-to-body alignment must be correct before aligning the secondary pin or receiver. Refer to vehicle Service Manual for door alignment procedures.

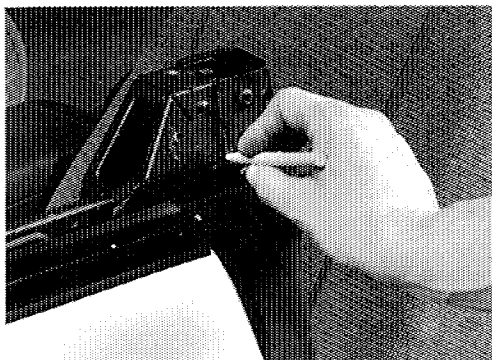
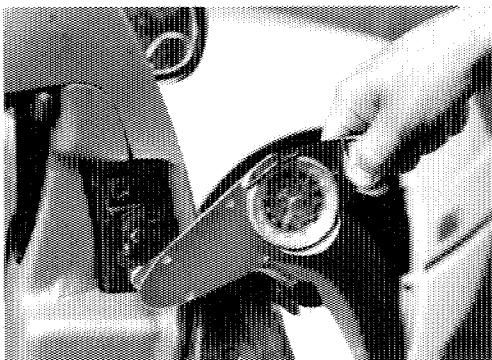
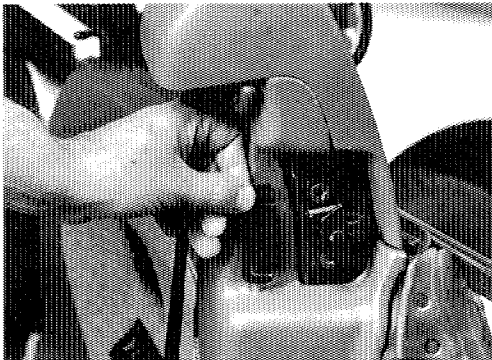
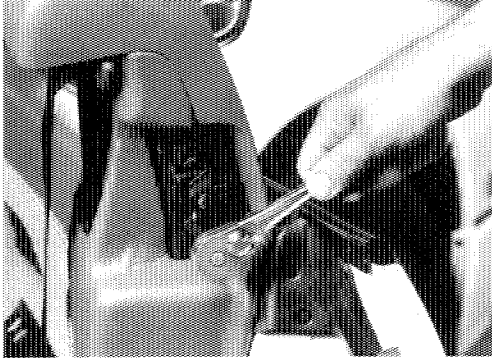

### SECONDARY PIN AND RECEIVER

1. ALIGN SECONDARY PIN TO SECONDARY PIN RECEIVER.
  - (a) Loosen secondary pin assembly screws. Do not completely remove screws.

- (b) Add or remove secondary pin assembly shims as required.

**NOTE:** Secondary pin assembly should be as far forward as possible without coming in contact with the front edge of the receiver assembly.

**CAUTION:** Do not exceed six (6) shims.

2. TIGHTEN SECONDARY PIN ASSEMBLY SCREWS.

**Torque:** 13 N·m (10 ft. lb.)

**NOTE:** If secondary pin alignment cannot be accomplished with the above procedure, continue to step 3.

3. ALIGN SECONDARY PIN RECEIVER.

- (a) Remove outer quarter trim panel (see 5-5).
  - (b) Using a pencil, mark receiver to B-pillar location.

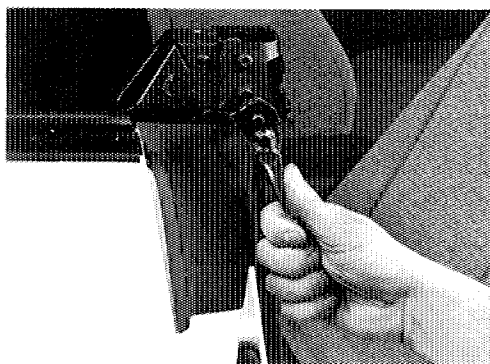

### ADJUSTMENTS (cont'd)

- (c) Loosen four (4) secondary pin receiver screws and adjust as necessary.

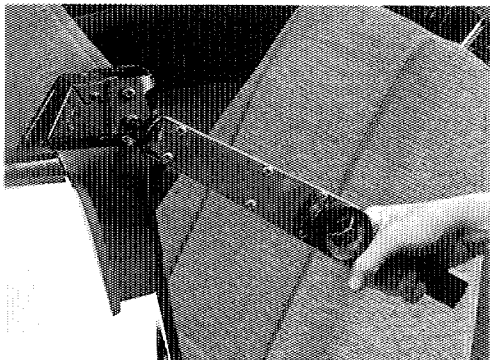

4. TIGHTEN SECONDARY PIN RECEIVER SCREWS.

**Torque: 5 N·m (44 in. lb.)**

5. CHECK SECONDARY PIN ALIGNMENT.

**NOTE: Secondary pin assembly should be as far forward as possible without coming in contact with the front edge of the receiver assembly.**

6. INSTALL QUARTER TRIM PANELS (see 5-5).

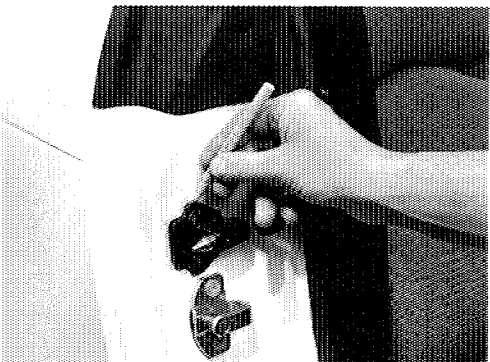

### DOOR GUIDE PIN ASSEMBLY

**NOTE: Door-to-body alignment must be correct before aligning the door guide pin. Refer to vehicle Service Manual for door alignment procedures.**

1. ADJUST DOOR GUIDE PIN.

- (a) Using a pencil, mark guide pin mounting location on B-pillar.

- (b) Loosen door guide pin mounting screws. Note number of shims under guide pin.

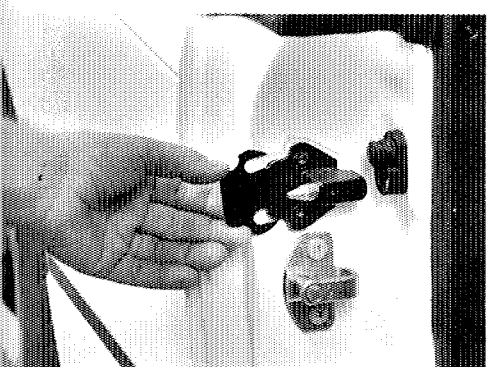
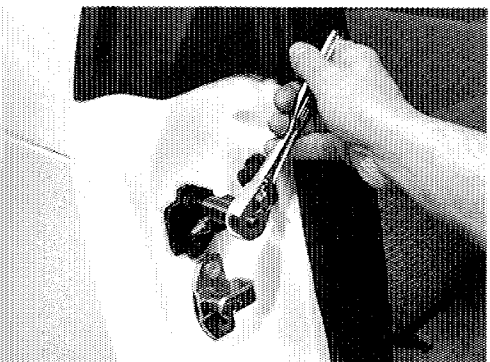

2. ADJUST GUIDE PIN ASSEMBLY AS REQUIRED.

- (a) Adjust shim thickness by adding or removing shims.

- (b) Move guide pin assembly to desired location.

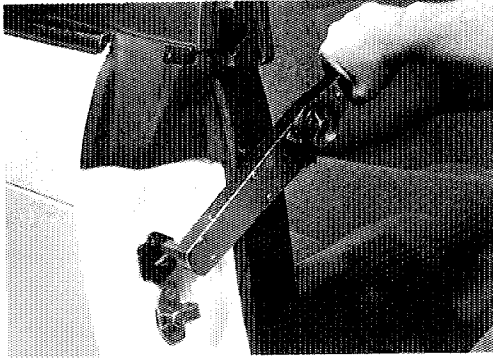

### ADJUSTMENTS (cont'd)

3. TIGHTEN GUIDE PIN SCREWS.
  - (a) Hold guide pin in desired position.
  - (b) Tighten guide pin screws.
 

**Torque: 5 N·m (44 in. lb.)**
4. CHECK GUIDE PIN TO GUIDE PIN LOCATOR ALIGNMENT.
 

**NOTE: Guide pin should be centered to guide pin receiver when door is closed.**

### DOOR WINDOW

1. REMOVE DOOR PANEL (see Door Panel in this section).

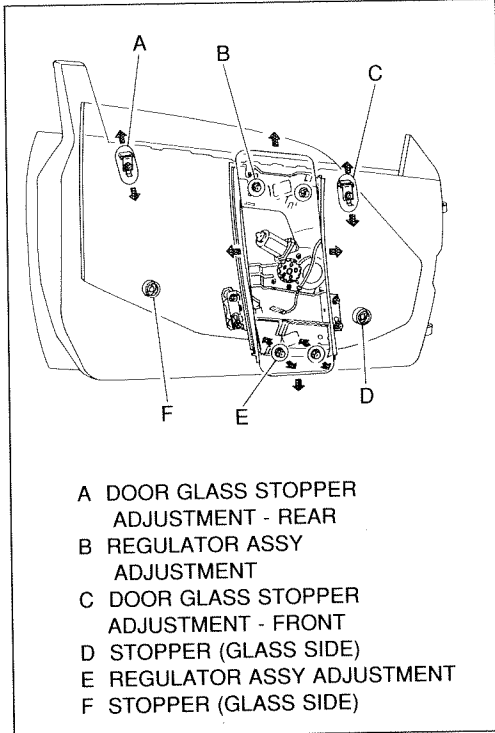

2. ADJUST DOOR WINDOW.

- (a) Loosen window regulator nuts to adjust window fore and aft or turn studs to adjust tilt of glass.
- (b) Loosen front and/or rear stopper nuts to adjust window height and front-to-rear angle.

#### Specification:

- o Even pressure of door window on inner and outer door window weatherstrips.
- o Front edge of door window to be parallel to "A" pillar molding.
- o Rear edge of door window to be parallel to quarter window sash seal.
- o Door window height to be adjusted to provide a good "wrap" on side rail weatherstrips.

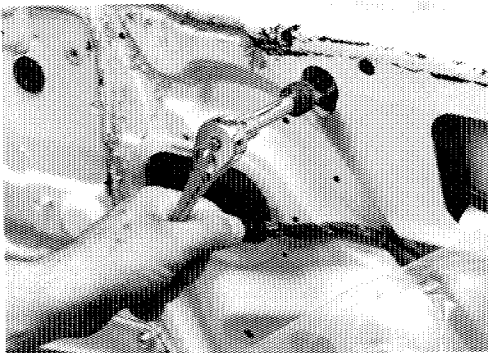
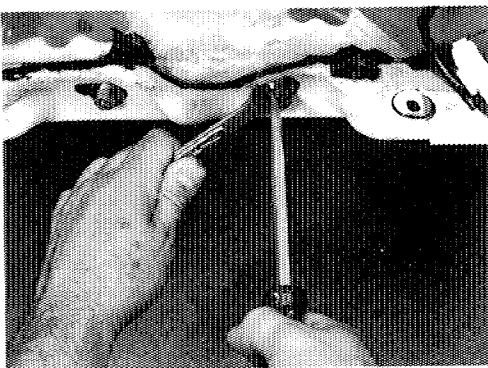

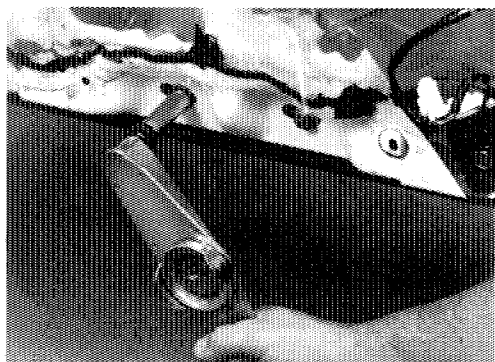

### ADJUSTMENTS (cont'd)

3. TIGHTEN DOOR WINDOW ADJUSTMENT NUTS.

- (a) Regulator nuts.

**Torque: 15 N·m (11 ft. lb.)**

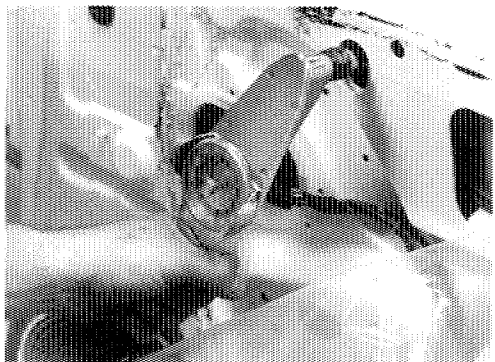

- (b) Glass stopper adjustment nuts.

**Torque: 6 N·m (53 in. lb.)**

4. INSTALL DOOR PANEL (see Door Panel in this chapter).



### DOOR PANEL

#### REMOVE

1. REMOVE D-RING TOWER PANEL ASSEMBLY.

- (a) Carefully pry emblem from D-ring tower panel and remove screw.

**CAUTION: Do not damage panel or emblem. Emblem can be reused.**

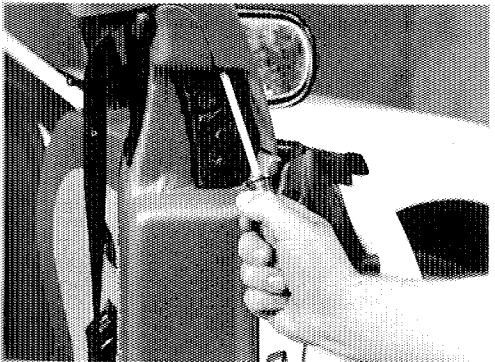

- (b) Remove screw securing rear of D-ring tower panel to door panel.

- (c) Pull D-ring tower panel from door trim panel by releasing velcro fasteners.

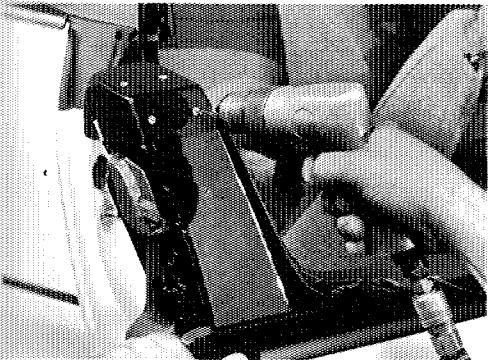

2. REMOVE D-RING COVER.

Using a 1/8 in. drill bit, remove four (4) rivets from door D-ring tower and cover.

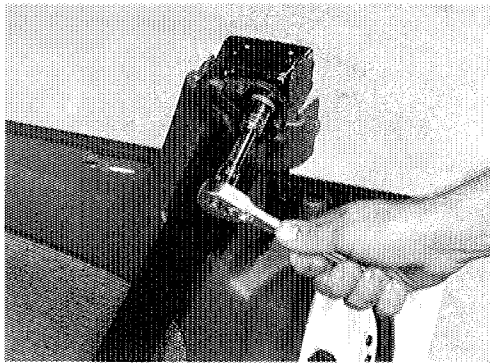
**DOOR PANEL (cont'd)**

3. REMOVE FRONT RETRACTOR ASSEMBLY UPPER D-RING ANCHOR BOLT.

Remove anchor bolt. Note number and position of spacers and washers.

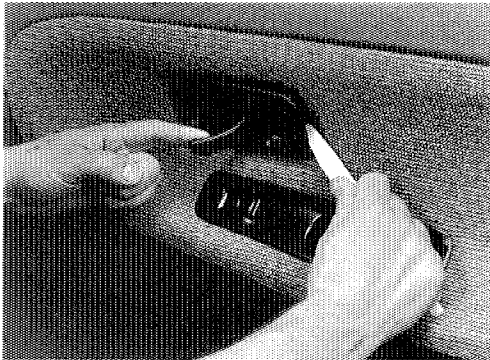

4. REMOVE DOOR INSIDE HANDLE ESCUTCHEON.

Using a suitable tool, pull outward on escutcheon to release four (4) retaining tabs.

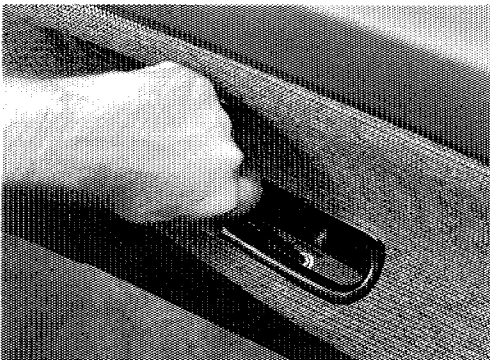

5. REMOVE DOOR PANEL INSERT ASSEMBLY.

- (a) Remove pull handle cap and screw from bottom of insert assembly.

- (b) Lift up and rearward on insert.

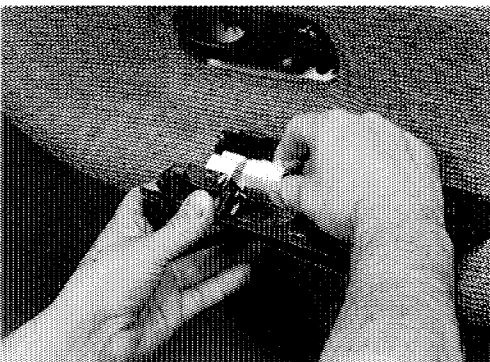

- (c) Disconnect wire harness from insert switch assembly and remove insert from vehicle.

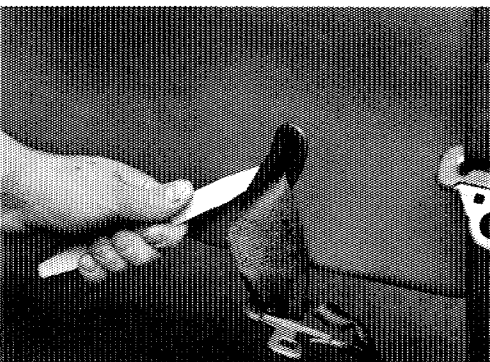

6. REMOVE SEAT BELT UPPER AND LOWER BEZEL.

- (a) Starting at lower bezel slot, pull outward on bezel to remove from panel.

- (b) Remove bezel from seat belt webbing.

- (c) Repeat (a) and (b) for upper bezel.

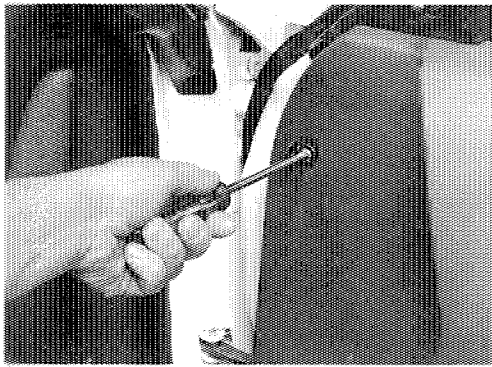

**DOOR PANEL (cont'd)**

## 7. REMOVE DOOR PANEL.

- (a) Remove screw at front of door panel.
- (b) Remove screw from door tower.

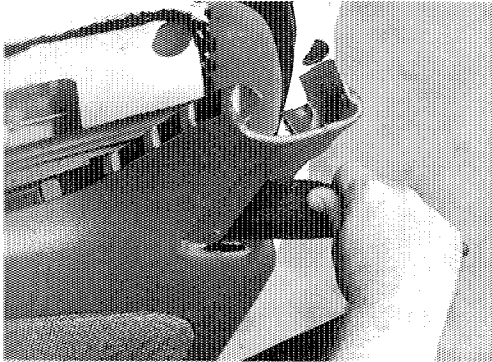

- (c) Using a suitable tool, release door panel retainers and remove door panel from door.
- (d) Slip seat belt webbing through belt opening slots provided in door panel and remove panel from vehicle.

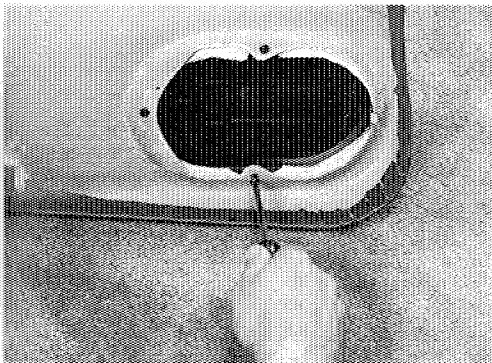
**DISASSEMBLE**

## 1. REMOVE SPEAKER GRILLE.

Remove three (3) screws and grille from door panel.

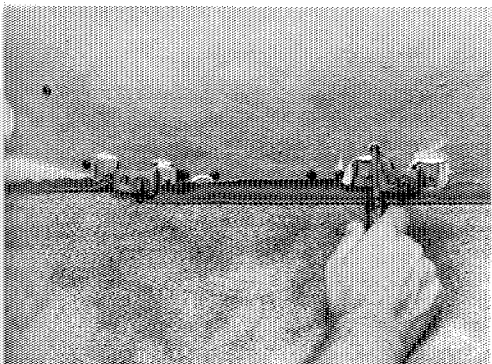

## 2. REMOVE MAP POCKET.

Remove seven (7) screws and map pocket from door panel.

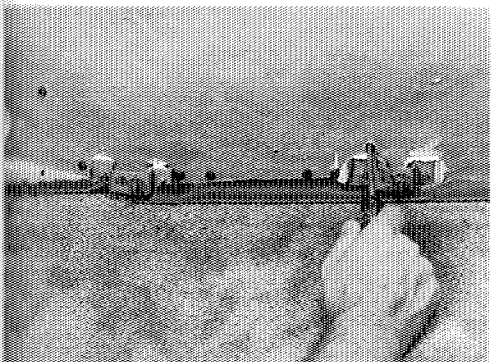
**ASSEMBLE**

## 1. INSTALL MAP POCKET.

Position map pocket to door panel and secure using seven (7) screws.

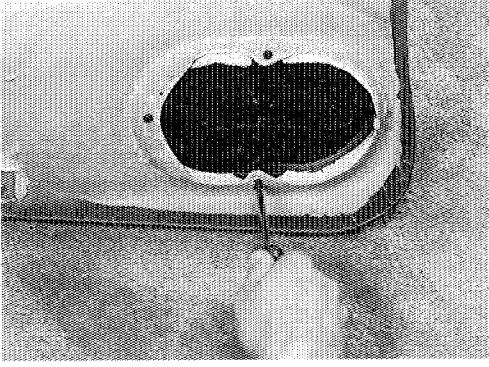

### DOOR PANEL (cont'd)

#### 2. INSTALL SPEAKER GRILLE.

- (a) Position speaker grille, aligning speaker grille tab, to door panel.
- (b) Secure speaker grille to door panel using three (3) screws.

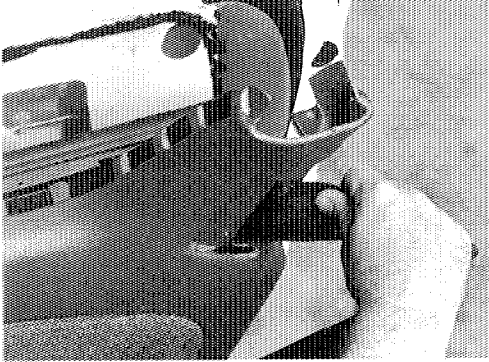

### INSTALL

#### 1. INSTALL DOOR PANEL.

- (a) Position seat belt webbing in upper and lower door panel belt openings.

**NOTE: Insure belt webbing is not twisted or tangled behind door panel.**

- (b) Press door panel retainers into door frame.

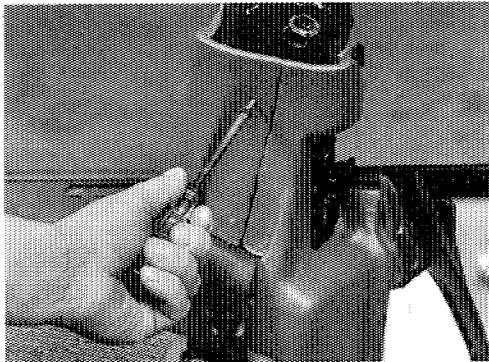

- (c) Install screw at front of door panel.
- (d) Install door panel screw to door tower.

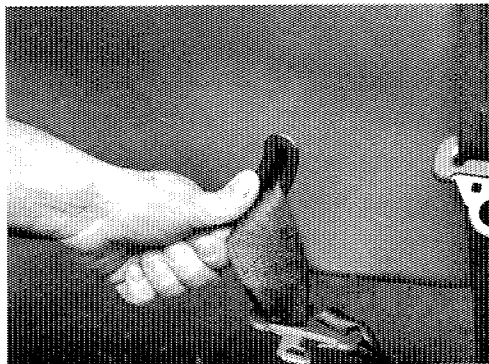

#### 2. INSTALL SEAT BELT UPPER AND LOWER BEZELS.

- (a) Position lower bezel to seat belt webbing.
- (b) Press bezel into door panel.
- (c) Repeat (a) and (b) for upper bezel.

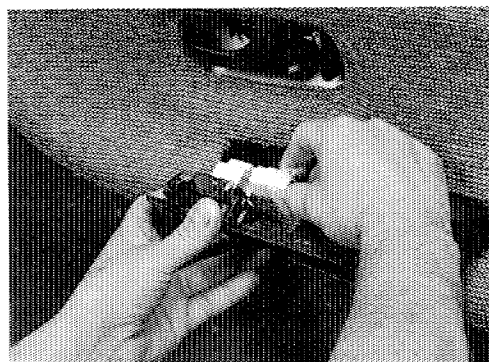

#### 3. INSTALL DOOR PANEL INSERT.

- (a) Connect wire harness to window switch assembly.

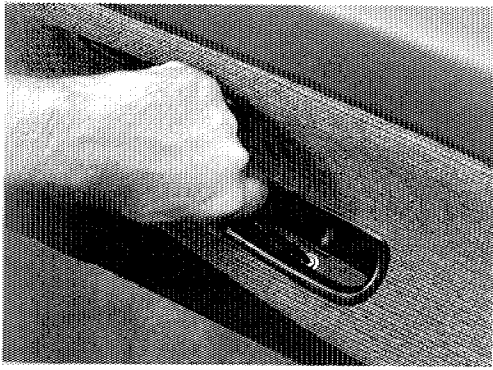

**DOOR PANEL (cont'd)**

- (b) Position insert to door panel and install screw.
- (c) Install pull handle cap.



4. INSTALL DOOR INSIDE HANDLE ESCUTCHEON.
  - (a) Align four (4) escutcheon tabs with door inside handle.
  - (b) Snap escutcheon into place.



5. INSTALL FRONT RETRACTOR ASSEMBLY UPPER D-RING ANCHOR BOLT AND WASHERS.

**Torque: 49 N·m (36 ft. lb.)**

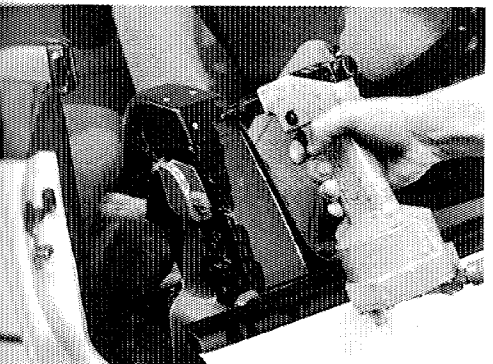

6. INSTALL D-RING COVER.
 

Position D-ring cover to door tower and secure using four (4) 1/8 x .156 rivets.

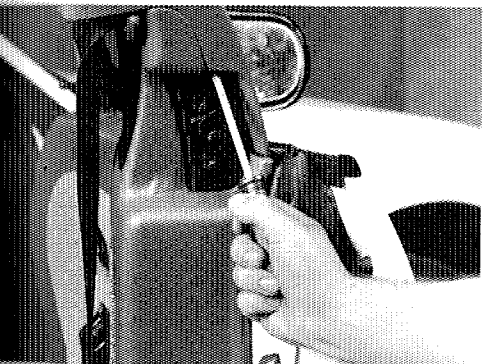

7. INSTALL D-RING TOWER PANEL ASSEMBLY
  - (a) Position tower panel to door and door panel, engaging velcro fasteners.
  - (b) Secure rear of D-ring tower panel to door panel with one (1) screw.

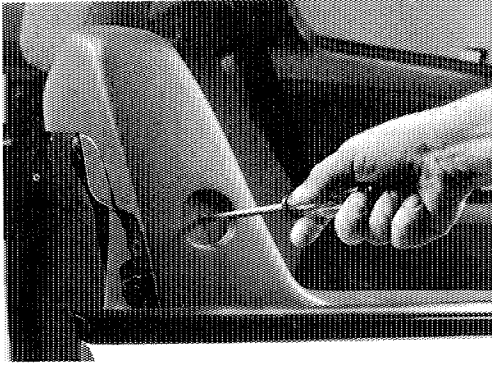
**DOOR PANEL (cont'd)**

- (c) Secure D-ring tower panel to door tower with screw.

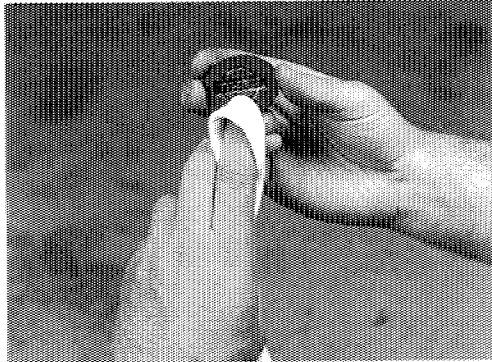
**8. INSTALL D-RING TOWER PANEL EMBLEM.**

- (a) If using original emblem, remove adhesive using release agent (3M P/N 051135-08971 or equivalent).

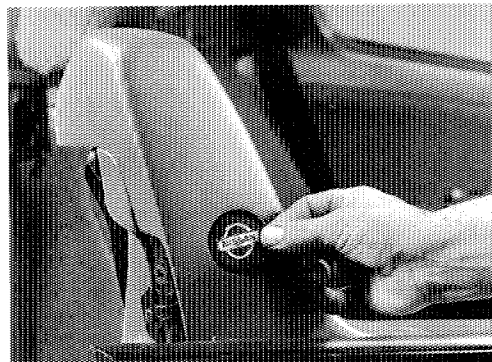

- (b) Cut double-sided tape (3M P/N 021200-06377 or equivalent) to size and apply to back of emblem.

- (c) Pull backing from tape and press emblem to D-ring tower panel.

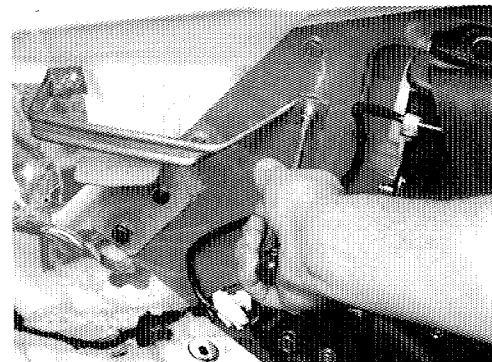
**DOOR PANEL FINISHER BRACKETS****REMOVE**

1. REMOVE DOOR PANEL (see Door Panel in this chapter).
2. REMOVE POWER WINDOW FINISHER UPPER BRACKET.  
Remove two (2) screws and upper bracket from door frame.

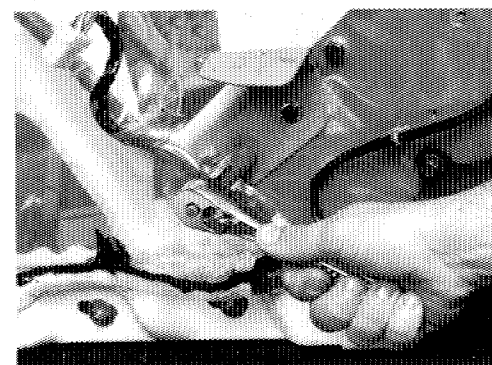

3. REMOVE POWER WINDOW FINISHER LOWER BRACKET.  
Remove two (2) screws and lower bracket from retractor assembly mounting plate.

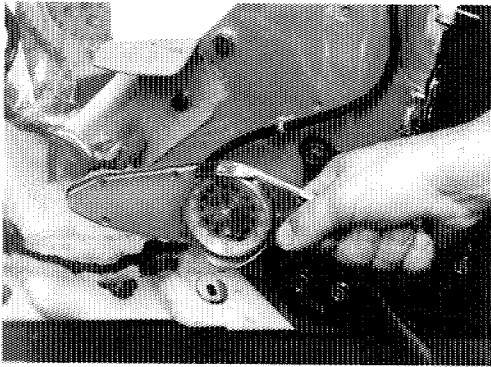

## DOOR PANEL FINISHER BRACKETS (cont'd)

### INSTALL

1. INSTALL POWER WINDOW FINISHER LOWER BRACKET.  
Install lower bracket to retractor assembly mounting plate using two (2) screws.

**Torque: 49 N·m (36 ft. lb.)**

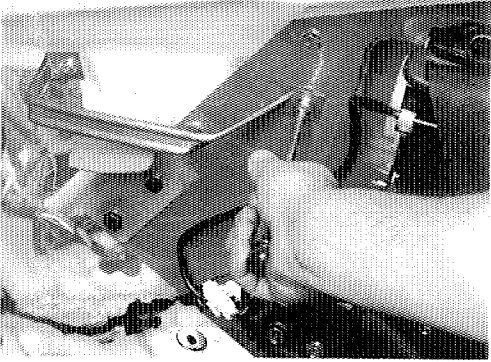

2. INSTALL POWER WINDOW FINISHER UPPER BRACKET.  
Install upper bracket to door frame using two (2) screws.
3. INSTALL DOOR PANEL (see Door Panel in this chapter).

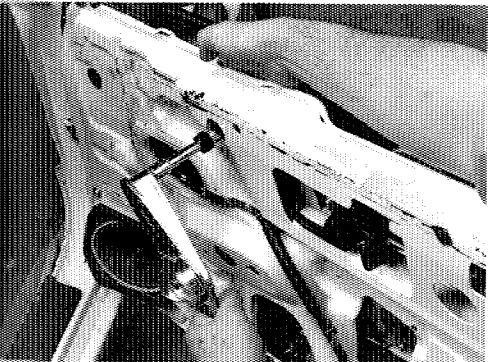

## DOOR WINDOW

### REMOVE

1. REMOVE DOOR PANEL (see Door Panel in this chapter).
2. REMOVE DOOR GLASS FRONT STOPPER ADJUSTMENT.
  - (a) Mark stopper adjustment location on door frame.
  - (b) Remove nut and front stopper adjustment from door frame.
3. REMOVE BOTH FRONT SEAT BELT RETRACTOR ASSEMBLIES FROM MOUNTING PLATE (see 8-7).
4. REMOVE FRONT SEAT BELT RETRACTOR MOUNTING PLATE
  - (a) Fold lower portion of sealing screen upward to access retractor mounting plate bolts.

- (b) Remove four (4) bolts securing retractor mounting plate to door frame.

**CAUTION: Note size and location of each bolt and washer.**

- (c) Suspend retractor plate from door frame using mechanics wire.

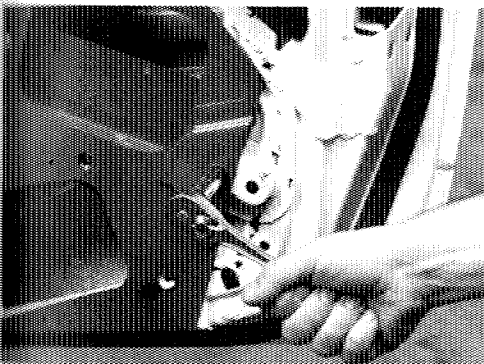

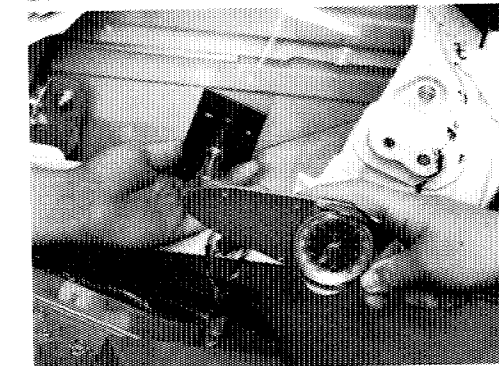
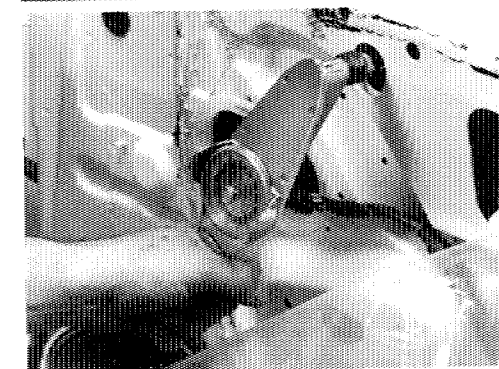
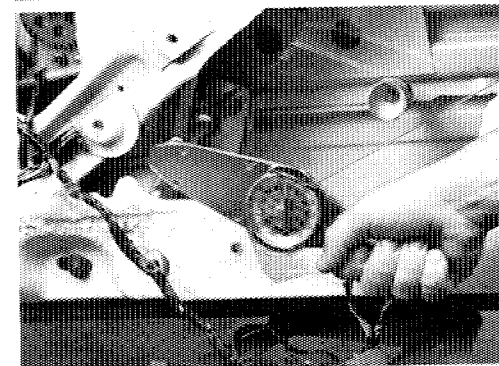
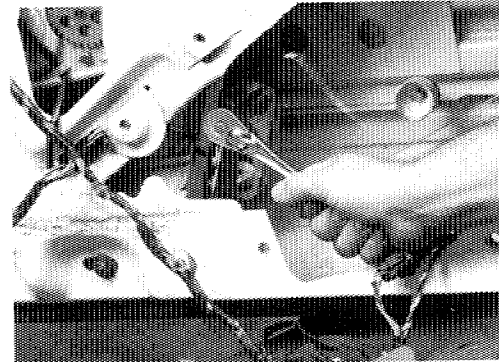
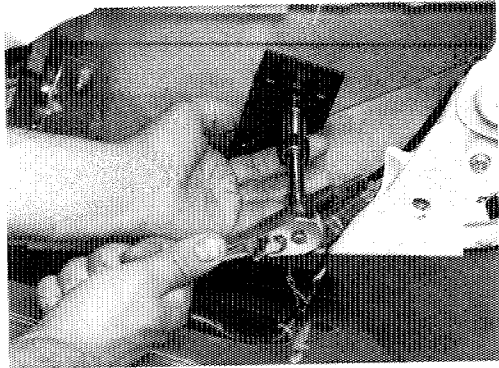

### DOOR WINDOW (cont'd)

5. REMOVE DOOR GLASS REAR STOPPER.  
Remove nut and door glass rear stopper from door glass.
6. REMOVE DOOR WINDOW.
  - (a) Remove four (4) window-to-regulator mounting nuts.
  - (b) Remove window from door.

### INSTALL

1. INSTALL DOOR WINDOW.
  - (a) Position window into door and mounting studs into regulator.
  - (b) Install four (4) window-to-regulator mounting nuts.  
**Torque: 14 N·m (10 ft. lb.)**
2. INSTALL DOOR GLASS FRONT STOPPER ADJUSTMENT.
  - (a) Align stopper adjustment with pencil mark.
  - (b) Install stopper adjustment nut.  
**Torque: 6 N·m (53 in. lb.)**
4. INSTALL DOOR GLASS REAR STOPPER.  
Position stopper to glass and secure with nut.  
**Torque: 6 N·m (53 in. lb.)**

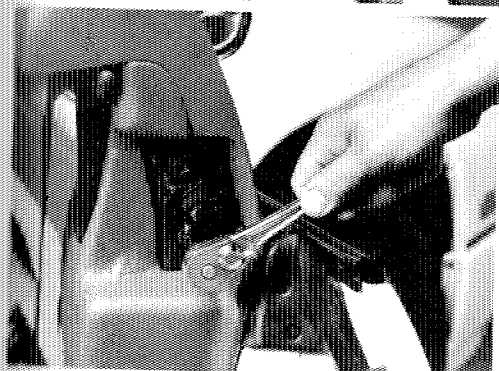
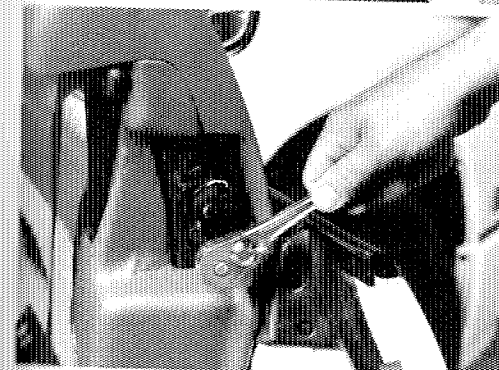
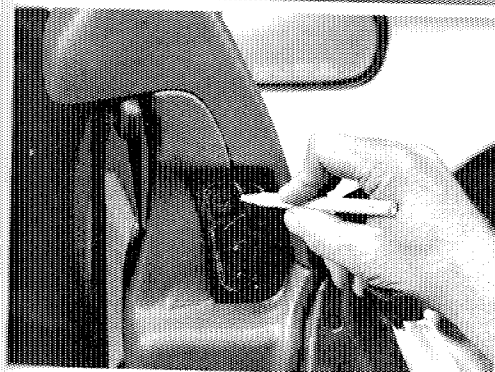
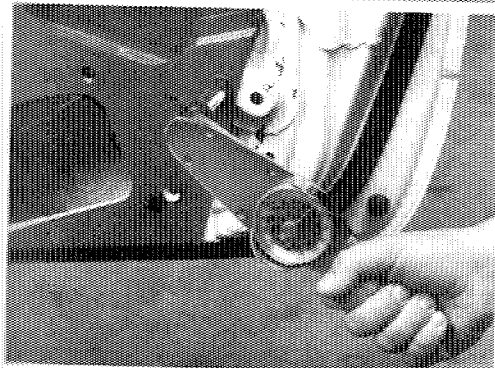
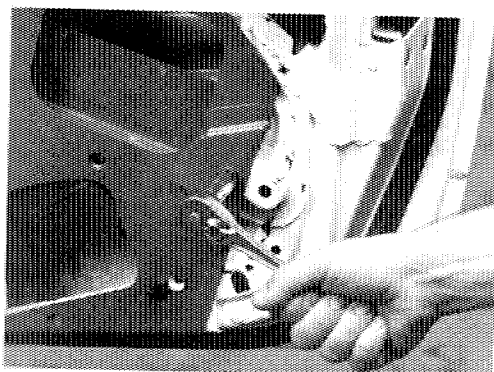

## DOOR WINDOW (cont'd)

5. INSTALL FRONT SEAT BELT RETRACTOR MOUNTING PLATE.
  - (a) Position retractor mounting plate to door and install four (4) bolts. Do not torque until all bolts are started.
 

**CAUTION: Insure bolts and washers are in same location as removed.**
  - (b) Fold sealing screen down over retractor plate and attach sealing screen adhesive to door.
6. INSTALL BOTH FRONT SEAT BELT RETRACTOR ASSEMBLIES TO MOUNTING PLATE (see 8-10).
7. TORQUE FRONT SEAT BELT RETRACTOR MOUNTING PLATE BOLTS.
 

**Torque: M10 Bolts: 49 N·m (36 ft. lb.)**

**Torque: M8 Bolts: 13 N·m (10 ft. lb.)**
8. INSTALL DOOR PANEL (see Door Panel in this chapter).

## SECONDARY PIN

### REMOVE

1. REMOVE SECONDARY PIN ASSEMBLY.
  - (a) Mark secondary pin mounting location on door.
  - (b) Remove two (2) screws and secondary pin assembly noting number of shims.

### INSTALL

1. INSTALL SECONDARY PIN ASSEMBLY.
  - (a) Align secondary pin and shims to location marks on door.
  - (b) Install two (2) secondary pin screws. Do not torque bolts.



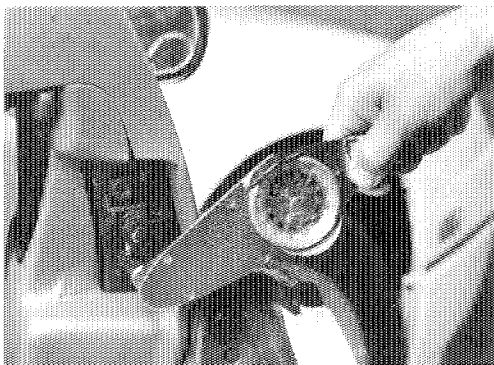

### SECONDARY PIN (cont'd)

2. CHECK SECONDARY PIN ADJUSTMENT (see Adjustments in this chapter).

**Torque: 13 N·m (10 ft. lb.)**

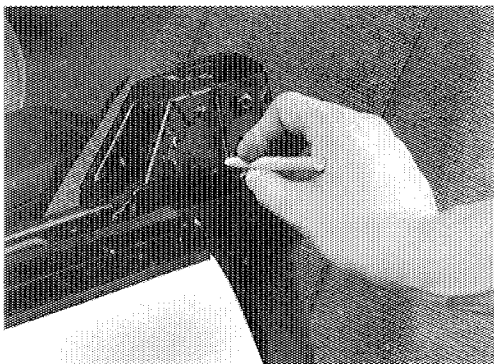

### SECONDARY PIN RECEIVER

#### REMOVE

1. REMOVE OUTER QUARTER TRIM PANEL (see 5-5).
2. REMOVE SECONDARY PIN RECEIVER.
  - (a) Mark location of secondary pin receiver on B-pillar reinforcement.

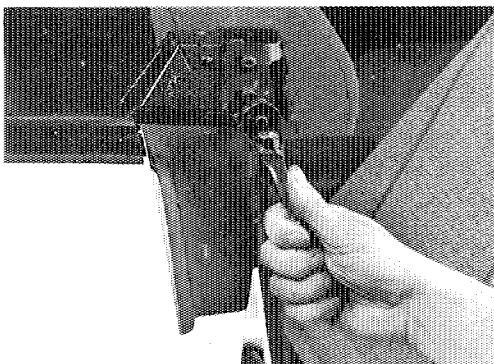

- (b) Remove four (4) screws and receiver.

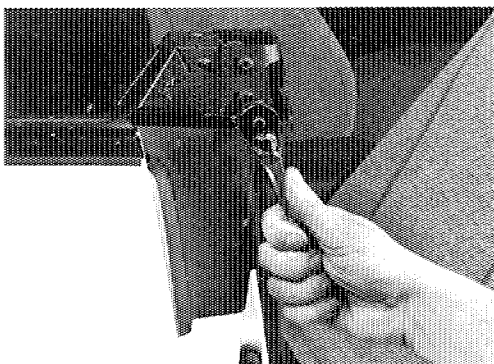

#### INSTALL

1. INSTALL SECONDARY PIN RECEIVER.
  - (a) Align secondary pin receiver with pencil marks on B-pillar reinforcement.
  - (b) Install four (4) screws. Do not torque screws.

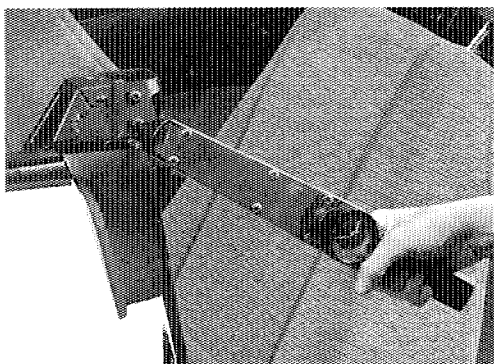

2. CHECK ALIGNMENT OF SECONDARY PIN RECEIVER TO SECONDARY PIN (see Adjustments in this chapter).

**Torque: 5 N·m (44 in. lb.)**

3. INSTALL QUARTER TRIM PANELS (see 5-5).

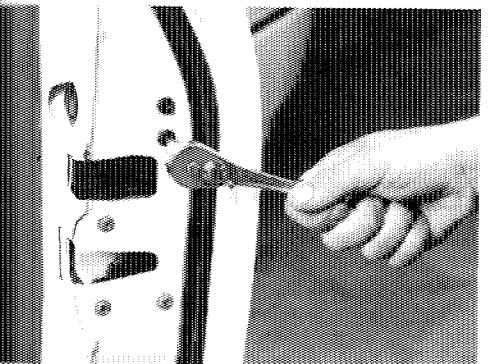
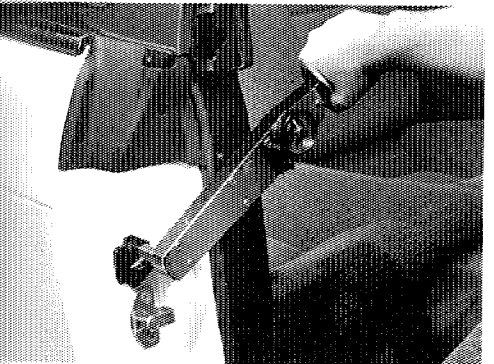
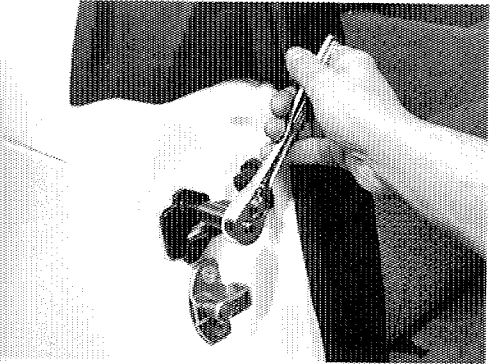
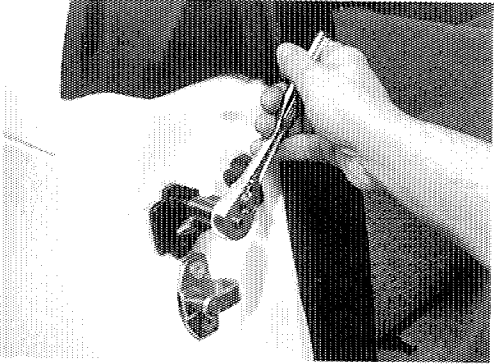
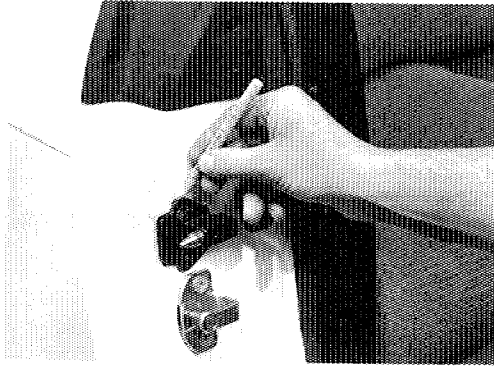

## GUIDE PIN

### REMOVE

1. REMOVE GUIDE PIN ASSEMBLY.
  - (a) Mark guide pin location on B-pillar.
  - (b) Remove two (2) screws and guide pin assembly noting number of shims.

### INSTALL

1. INSTALL GUIDE PIN ASSEMBLY.
  - (a) Align guide pin and shims to marks on B-pillar.
  - (b) Install two (2) guide pin assembly screws. Do not torque screws.
2. CHECK GUIDE PIN ALIGNMENT (see Adjustments in this chapter).

**Torque: 5 N·m (44 in. lb.)**

## GUIDE PIN LOCATOR

### REMOVE

1. REMOVE GUIDE PIN LOCATOR ASSEMBLY.
 

**CAUTION: Sharp edges, use care around door cut-outs.**

  - (a) Hold locator and remove two (2) screws.
  - (b) Remove locator through locator cut-out.

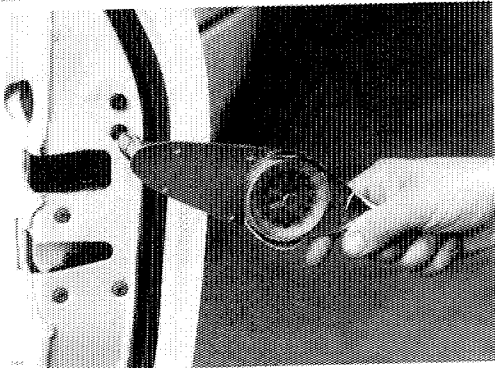
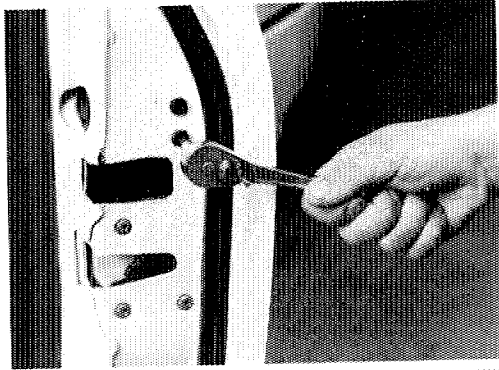

## GUIDE PIN LOCATOR (cont'd)

### INSTALL

2. INSTALL GUIDE PIN LOCATOR ASSEMBLY.
  - (a) Position locator through door locator cut-out.
  - (b) Secure locator using two (2) screws. Do not torque screws.

3. CHECK LOCATOR TO GUIDE PIN ALIGNMENT (see Adjustments in this chapter).

**Torque: 4 N·m (35 in. lb.)**



# SEAT BELTS

	page
SEAT BELT COMPONENTS .....	8-2
INSPECTING SEAT BELT SYSTEM .....	8-4
FRONT SEAT BUCKLE ASSEMBLY .....	8-5
FRONT RETRACTOR ASSEMBLY .....	8-7
REAR COMPARTMENT BUCKLE ASSEMBLY .....	8-9
REAR SEAT RETRACTOR ASSEMBLY .....	8-10
CHILD SEAT RESTRAINT ANCHOR .....	8-12

s.

SEAT BELT COMPONENTS

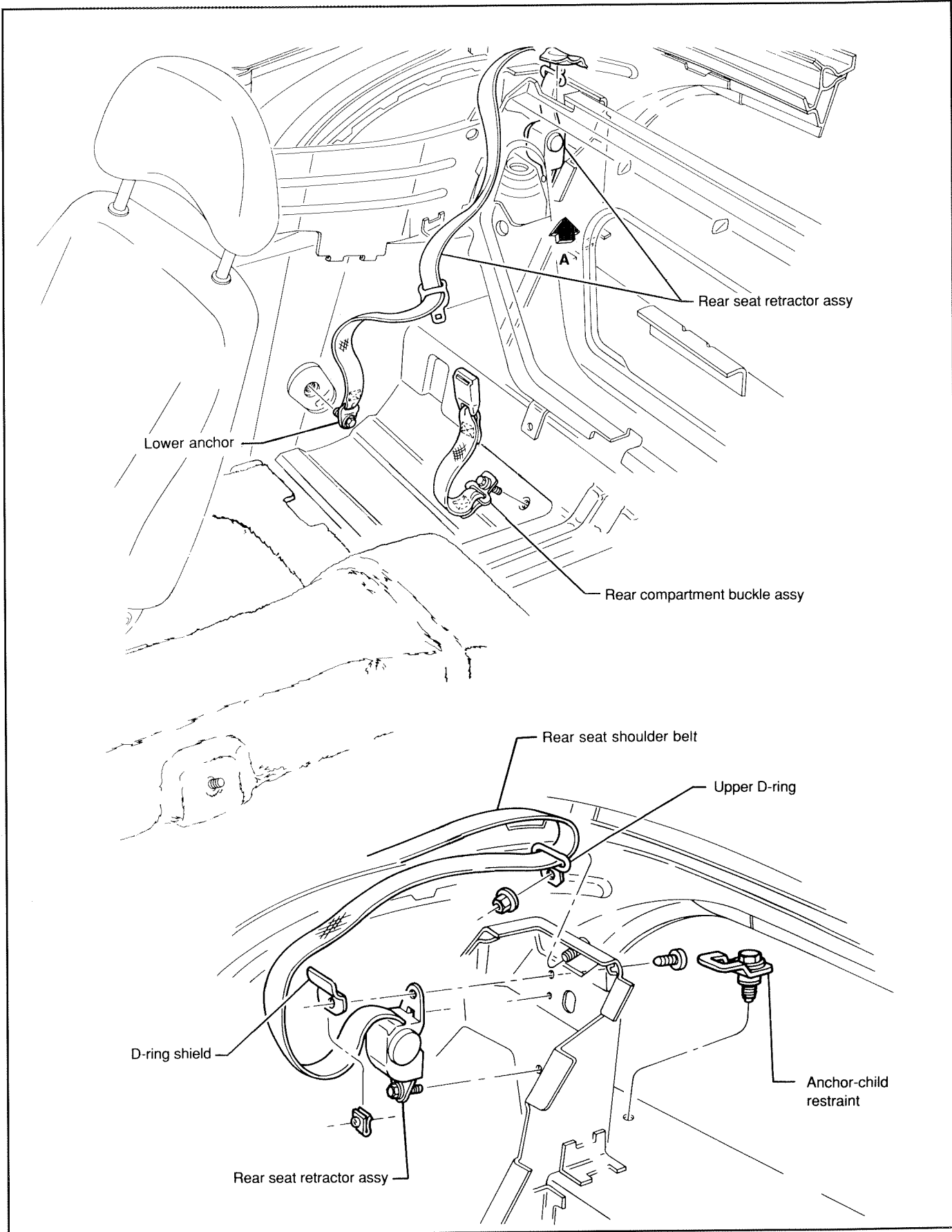

SEAT BELT COMPONENTS (cont'd)

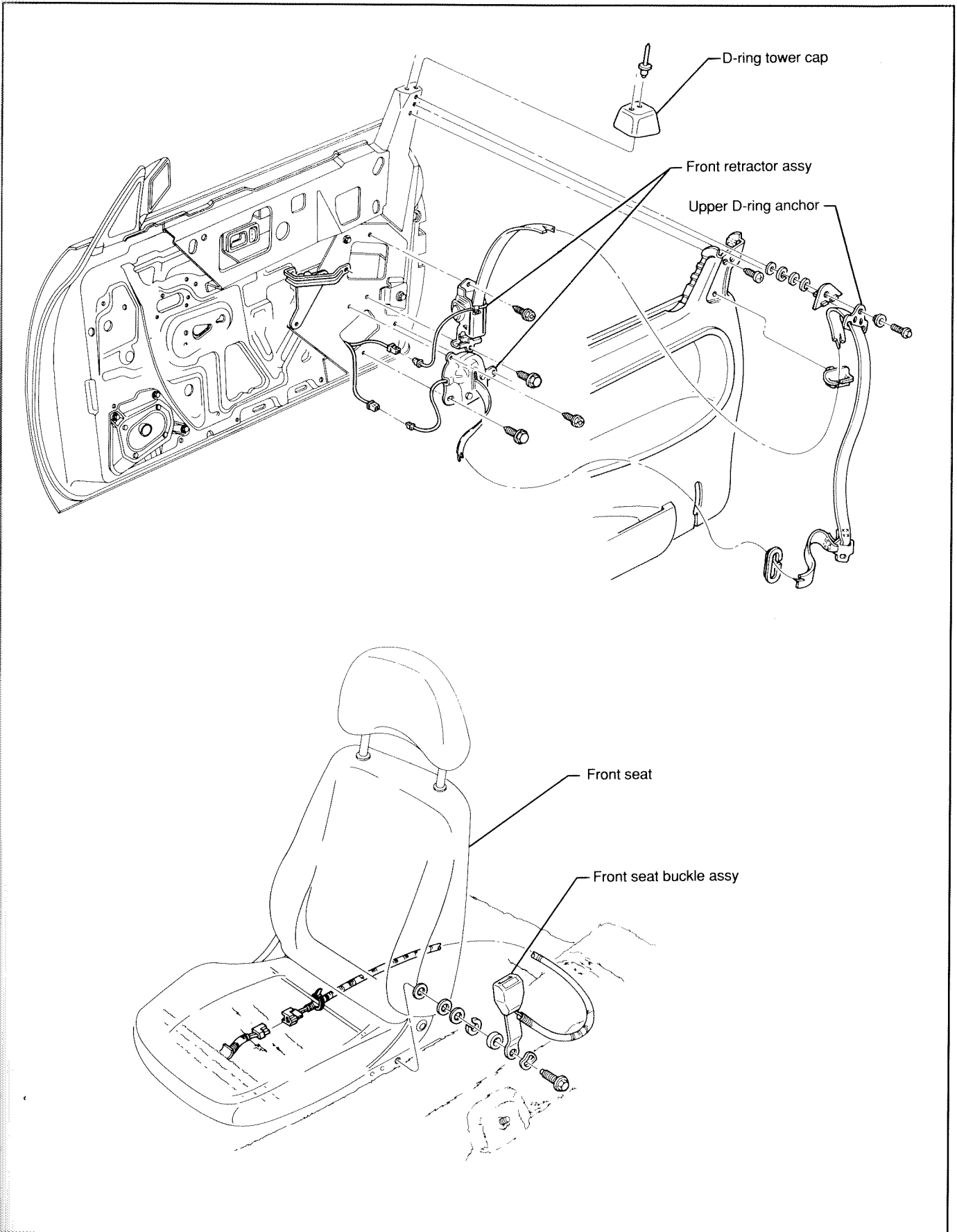

## INSPECTING SEAT BELT SYSTEM

### CAUTION:

- o All seat belt assemblies, including retractors and attaching hardware, should be inspected after any collision. Nissan recommends that all seat belt assemblies in use during a collision be replaced unless the collision was minor and the belts show no damage and continue to operate properly. Seat belt assemblies not in use during a collision should also be inspected and replaced if either damage or improper operation is noted.
- o If the condition of any component of a seat belt is questionable, do not have the seat belt repaired, but replaced as a belt assembly.
- o If the webbing is cut, frayed or damaged, replace the belt assembly.
- o Do not spill drinks, oil, etc. on the inner lap belt buckle. Never oil the tongue and buckle.
- o Use a NISSAN genuine seat belt assembly.

### FUNCTIONAL CHECK

1. Pull belt webbing from upper and lower door retractors checking for smooth consistent operation.
2. Check function of seat belt buckle and tongue when buckled and released.
3. With front seat belt tongue inserted into buckle, open the door. The front seat belt assembly should allow smooth operation of the door while permitting easy entry. If the belt assembly prevents opening of the door, close the door and open again slowly.
4. When seated and the door closed, the seat belt should adjust to seat and body position. While in this position, grasp the shoulder belt and pull quickly forward. The retractor should lock and restrict further belt movement.
5. Sit in rear seat and fasten rear seat belt. Check retractor for smooth consistent operation and function of buckle and tongue when buckled or released. Grasp shoulder belt and pull quickly forward. The retractor should lock and prevent further belt movement.
6. Check proper operation of seat belt warning light and chime by first buckling both front seat belts. Turn ignition switch "ON". The warning light should flash for approximately 6 seconds. If one or both seat belts are disconnected, the warning light should glow continuously for approximately 100 seconds and the warning chime should sound for approximately 6 seconds. If the seat belt warning light stays "ON" continuously or the warning light or chime does not work, refer to Electrical Diagnosis (see 20-20).
7. To inspect or check seat belt anchor bolts and attaching hardware, see appropriate areas in this section.

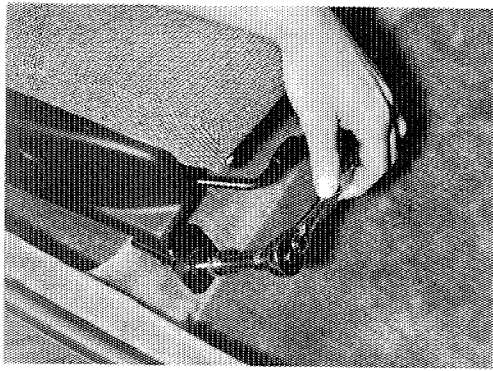

## FRONT SEAT BUCKLE ASSEMBLY

### REMOVE

1. REMOVE FRONT SEAT.
  - (a) Move seat fully rearward.
  - (b) Remove two (2) front bolts securing seat rails to floor pan.

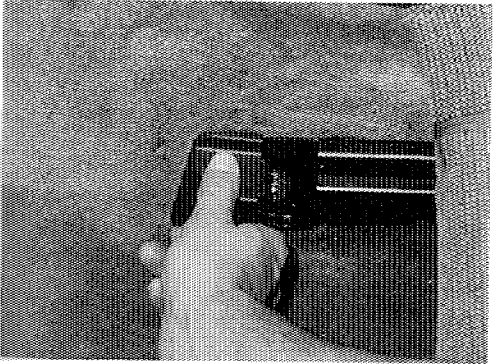

- (c) Move seat fully forward and fold seat back forward.
- (d) Remove two (2) rear slide rail covers.

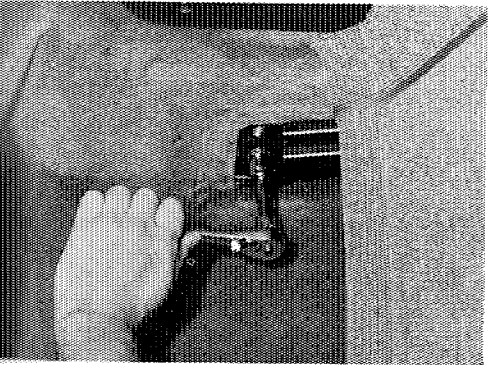

- (e) Remove rear inner slide rail attaching nut.
- (f) Remove rear outer slide rail attaching bolt.



- (g) Reaching below front seat, disconnect seat belt buckle wire harness and remove seat assembly from vehicle.

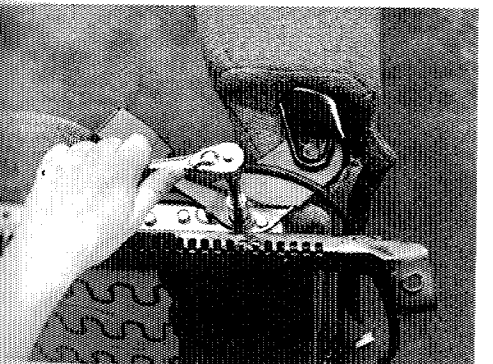

2. REMOVE FRONT SEAT BUCKLE ASSEMBLY.
  - (a) Remove bolt securing buckle assembly to front seat.

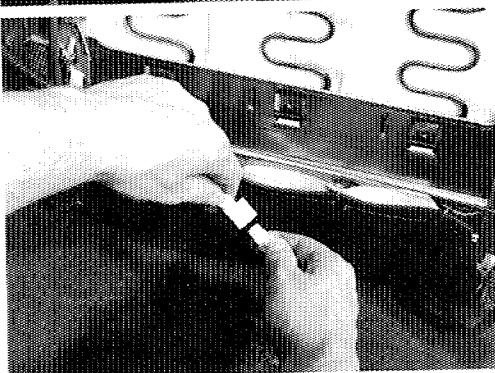
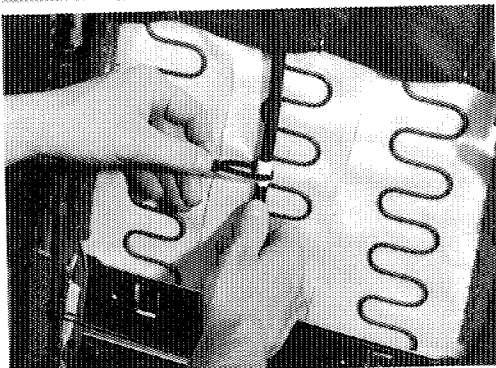
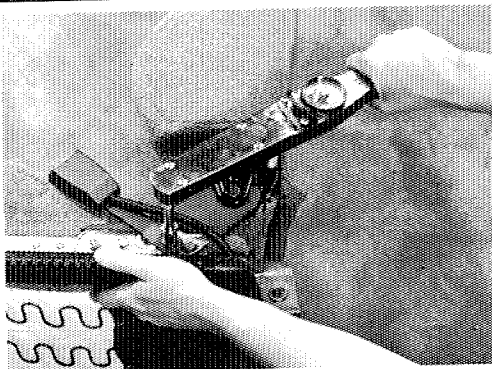
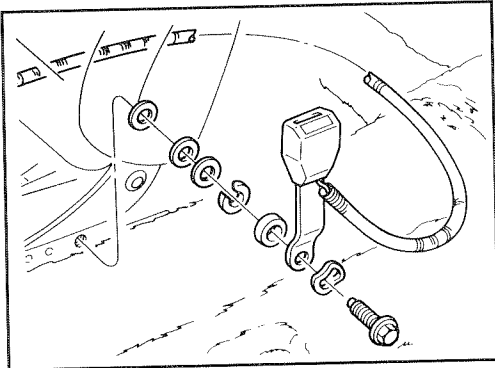
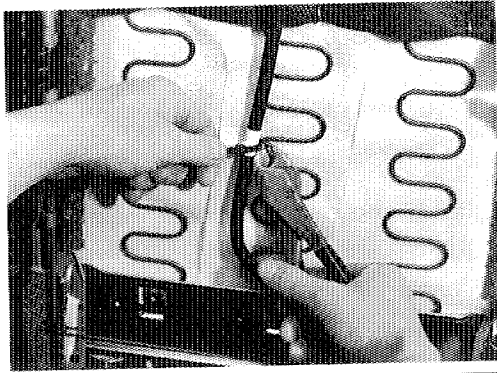

## FRONT SEAT BUCKLE ASSEMBLY (cont'd)

- (b) Remove two (2) wire ties securing buckle assembly wire harness to front seat and remove buckle assembly.

### INSTALL

1. INSTALL FRONT SEAT BUCKLE ASSEMBLY TO FRONT SEAT.

- (a) Position buckle assembly to front seat and install attaching bolt.

**NOTE:** Insure all washers, spacers, and bushings are in proper order and buckle assembly is positioned above "stop" on side of seat.

**Torque:** 49 N·m (37 ft. lb.)

- (b) Secure buckle assembly wire harness to front seat using two (2) wire harness ties.

2. INSTALL FRONT SEAT.

- (a) Place seat assembly in vehicle and connect buckle assembly electrical connector to body harness.

- (b) Align rear of inner slide rail to floor pan stud and install nut. Do not tighten nut at this time.

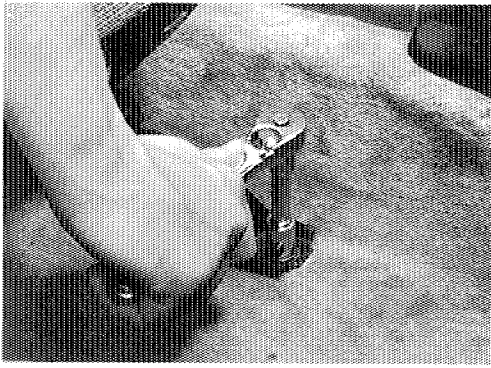
**FRONT SEAT BUCKLE ASSEMBLY (cont'd)**

- (c) Install outer slide rail rear attaching bolt. Do not tighten bolt at this time.

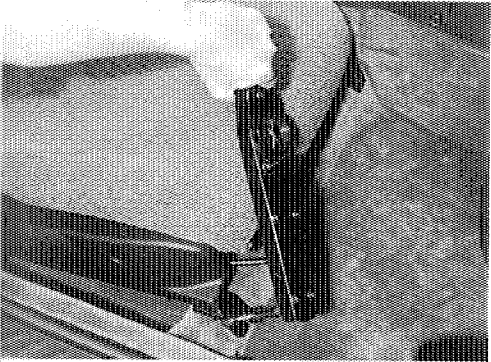

- (d) Move seat fully rearward and install two (2) front seat rail attaching bolts.

**Torque two (2) front and one rear attaching bolts:  
49 N·m (37 ft. lb.)**

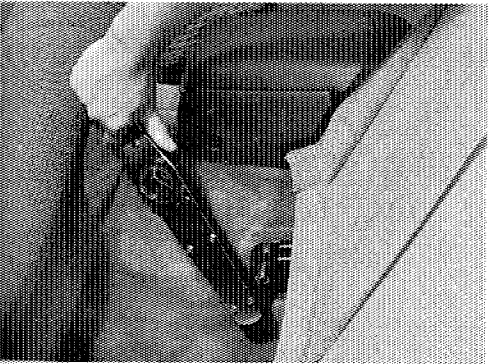

- (e) Tighten front seat rail rear attaching nut.

**Torque: 29 N·m (22 ft. lb.)**

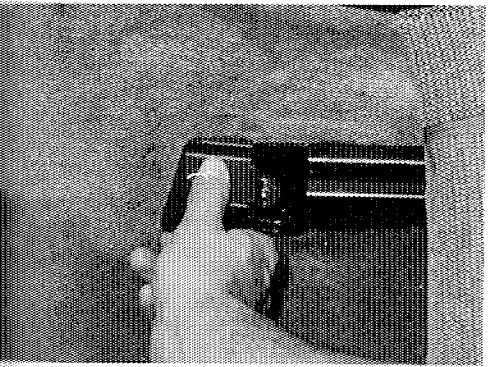

- (f) Install two (2) rear slide rail covers.

3. CHECK SEAT BELT OPERATION (see Functional Check in this section).

**FRONT RETRACTOR ASSEMBLY****REMOVE**

1. REMOVE DOOR D-RING TOWER PANEL (see 7-6).
2. REMOVE D-RING COVER.

Using a 1/8 in. drill bit, remove four (4) rivets from door D- ring tower and cover.



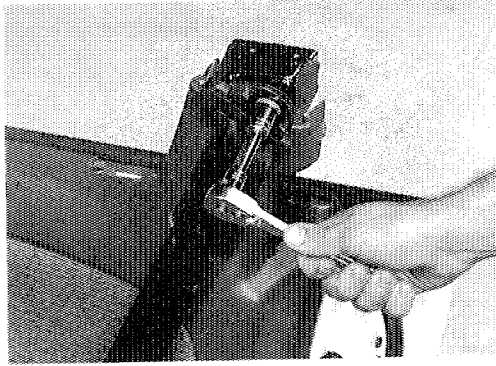

**FRONT RETRACTOR ASSEMBLY (cont'd)**

3. REMOVE UPPER D-RING ANCHOR BOLT, SPACERS AND LOCK WASHER.
4. REMOVE DOOR TRIM PANEL ASSEMBLY (see 7-7).

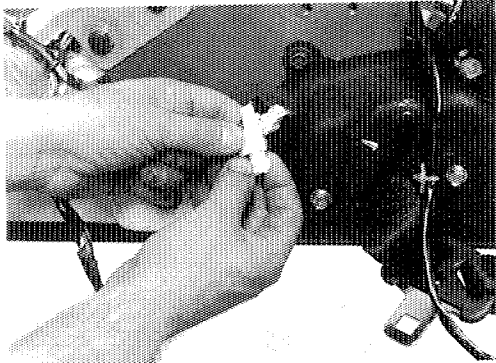

5. REMOVE FRONT RETRACTOR ASSEMBLY.
  - (a) Disconnect two (2) harness connectors.

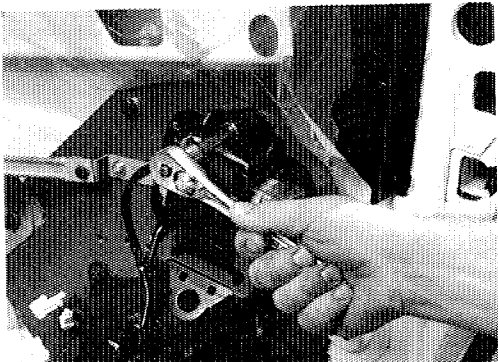

- (b) Remove two (2) upper retractor attaching bolts, top bolt first.

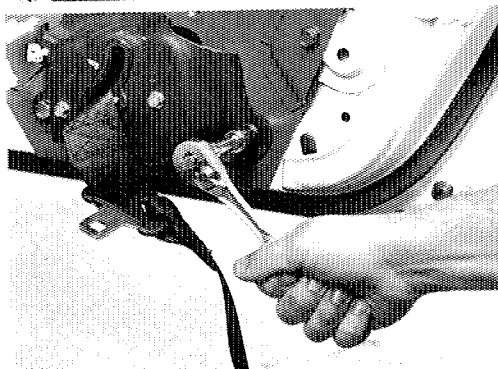

- (c) Remove three (3) lower retractor attaching bolts, top bolt first, and retractor assembly from door.

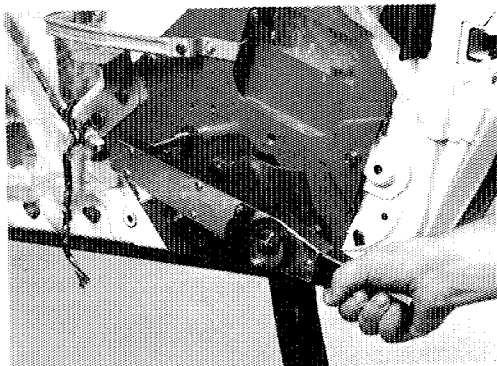
**INSTALL**

1. INSTALL FRONT RETRACTOR ASSEMBLY.
  - (a) Position lower retractor to door and install three (3) bolts.
    - Torque M6 Bolt: 6 N·m (53 in. lb.)**
    - Torque M10 Bolt: 49 N·m (36 ft. lb.)**



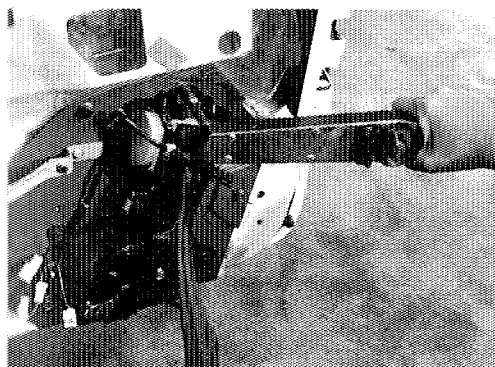

### FRONT RETRACTOR ASSEMBLY (cont'd)

- (b) Keep belt webbing straight and secure upper retractor to door using two (2) bolts.

**Torque M6 Bolt: 6 N·m (53 in. lb.)**

**Torque 7/16 Bolt: 49 N·m (36 ft. lb.)**

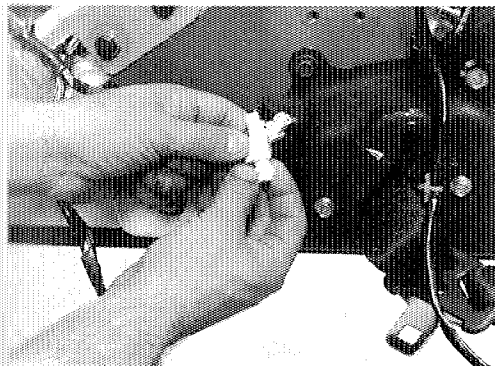

- (c) Connect two (2) retractor harness connectors to door harness.

2. INSTALL DOOR TRIM PANEL ASSEMBLY (see 7-10).

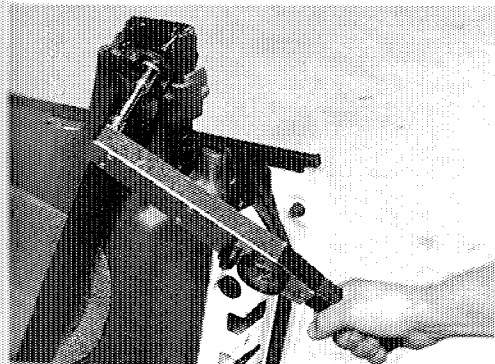

3. INSTALL UPPER D-RING ANCHOR BOLT WITH SPACERS AND LOCK WASHER TO DOOR TOWER.

**Torque: 49 N·m (36 ft. lb.)**

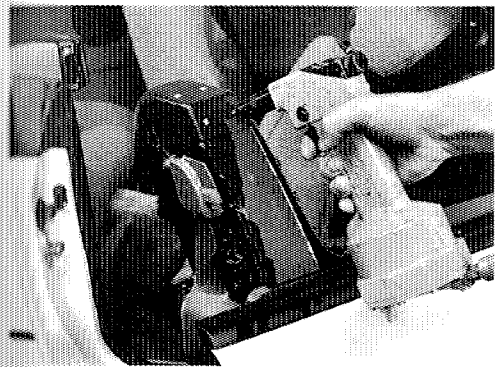

4. INSTALL D-RING COVER.

Position D-ring cover to door tower and secure using four (4) 1/8 in. x .156 rivets.

5. INSTALL DOOR D-RING TOWER PANEL ASSEMBLY (see 7-11).

6. CHECK SEAT BELT OPERATION (see Functional Check in this chapter).

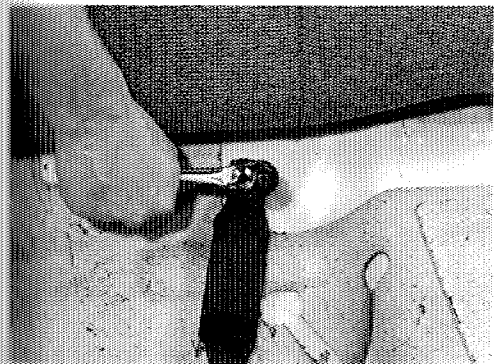

### REAR COMPARTMENT BUCKLE ASSEMBLY

#### REMOVE

1. REMOVE REAR SEAT BACK (see 4-5).
2. REMOVE REAR COMPARTMENT BUCKLE ASSEMBLY.  
Remove anchor bolt and buckle assembly.

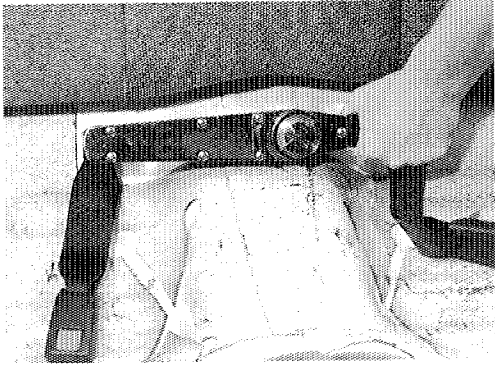

## REAR COMPARTMENT BUCKLE ASSEMBLY (cont'd)

### INSTALL

1. INSTALL REAR COMPARTMENT BUCKLE ASSEMBLY.
  - (a) Position buckle assembly anchor plate to floor pan with belt webbing pointed down, and secure with anchor bolt.
 

**Torque: 27 N·m (19 ft. lb.)**
2. INSTALL REAR SEAT BACK (see 4-5)
3. CHECK SEAT BELT OPERATION (see Functional Check in this section).

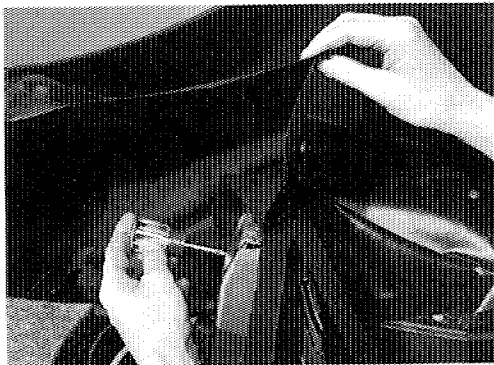

## REAR SEAT RETRACTOR ASSEMBLY

### REMOVE

1. REMOVE REAR SEAT BACK (see 4-5).
2. REMOVE REAR SEAT RETRACTOR ASSEMBLY.
  - (a) Reaching through rear brace assembly, remove retractor upper mounting screw and D-ring shield.
  - (b) Remove retractor assembly lower mounting bolt.
  - (c) Remove nut from upper D-ring anchor and D-ring from rear seat reinforcement stud.

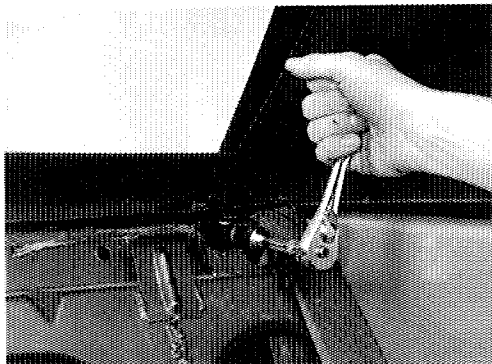
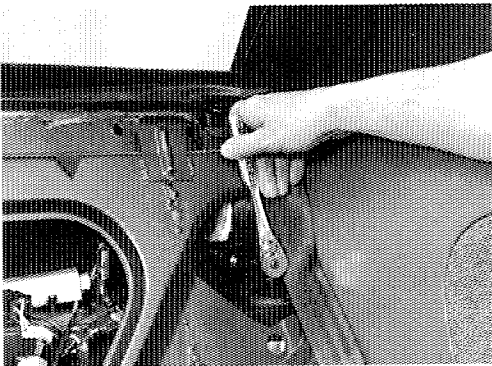

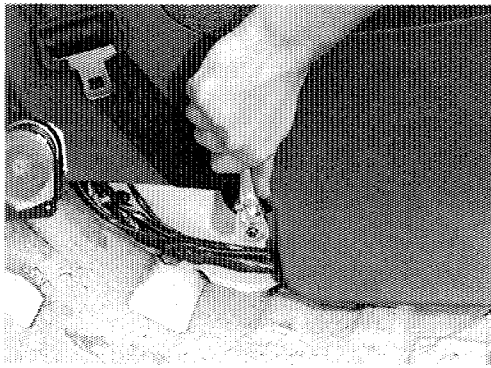

## REAR SEAT RETRACTOR ASSEMBLY (cont'd)

- (d) Remove bolt from belt lower anchor and rear seat retractor assembly from vehicle.

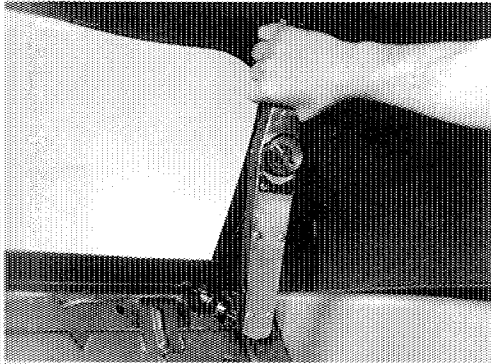

### INSTALL

#### 1. INSTALL REAR SEAT RETRACTOR ASSEMBLY.

- (a) Secure upper D-ring anchor to rear seat reinforcement stud with belt webbing UP using nut.

**Torque: 49 N·m (36 ft. lb.)**

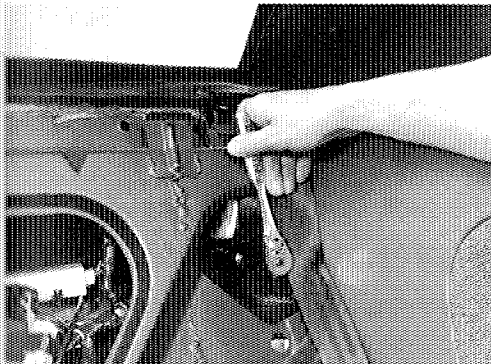

- (b) Position retractor to rear seat reinforcement and install lower mounting bolt. Do not tighten bolt at this time.

**NOTE: Retractor TAB must be aligned with hole in rear seat reinforcement.**



- (c) Reaching through rear brace assembly, install retractor upper mounting screw while holding D-ring shield to retractor.

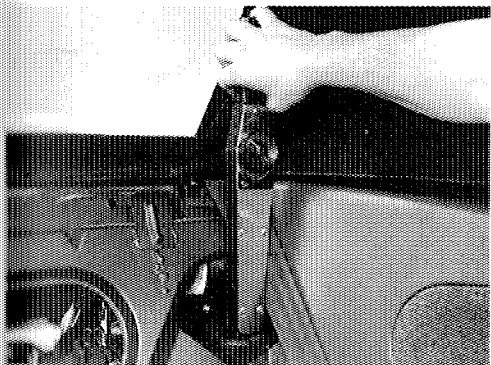

- (d) Tighten retractor lower mounting bolt.

**Torque: 27 N·m (19 ft. lb.)**

belt

this

or

rear

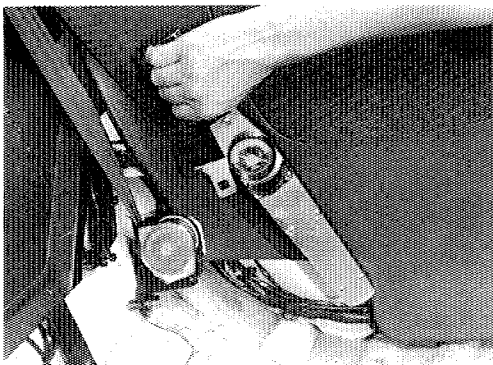

### REAR SEAT RETRACTOR ASSEMBLY (cont'd)

- (e) Position belt lower anchor to "B" pillar brace with belt webbing UP and install bolt.

**Torque: 27 N·m (19 ft. lb.)**

2. INSTALL REAR SEAT BACK (see 4-5).
3. CHECK SEAT BELT OPERATION (see Functional Check in this section).

### CHILD SEAT RESTRAINT ANCHOR

1. OPEN REAR DECK LID.
2. INSTALL CHILD SEAT RESTRAINT ANCHOR ASSEMBLY.
  - (a) Install spacer, anchor, washer and bolt to either right or left mounting position.

**NOTE: A weld-nut is provided on either side of the shock tower support panel for the purpose of mounting the child seat restraint anchor.**

3. TIGHTEN CHILD SEAT RESTRAINT ANCHOR BOLT.

**CAUTION: Anchor opening must face toward front of vehicle.**

**Torque: 20 N·m (15 ft. lb.)**

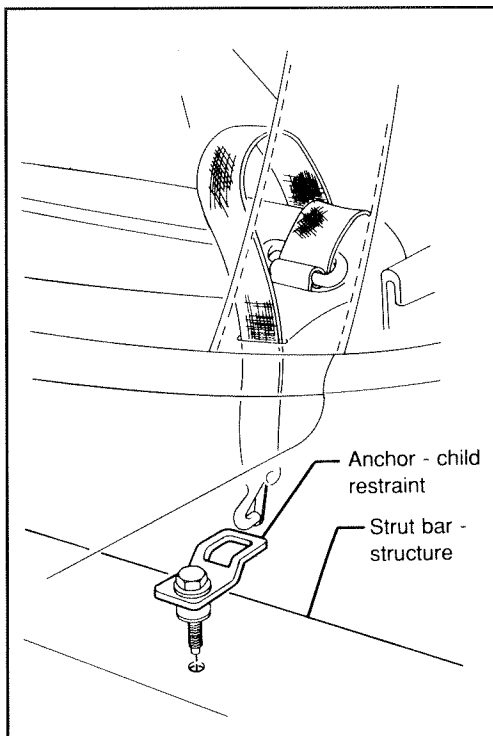

# BACK AND QUARTER BELT MOLDINGS

page

BACK AND QUARTER BELT MOLDING COMPONENTS .....	9-2
BACK BELT CENTER MOLDING .....	9-3
QUARTER BELT OUTER MOLDING .....	9-4
QUARTER BELT MOLDING ISOLATOR .....	9-6

nis

eft

f

if

BACK AND QUARTER BELT MOLDING COMPONENTS

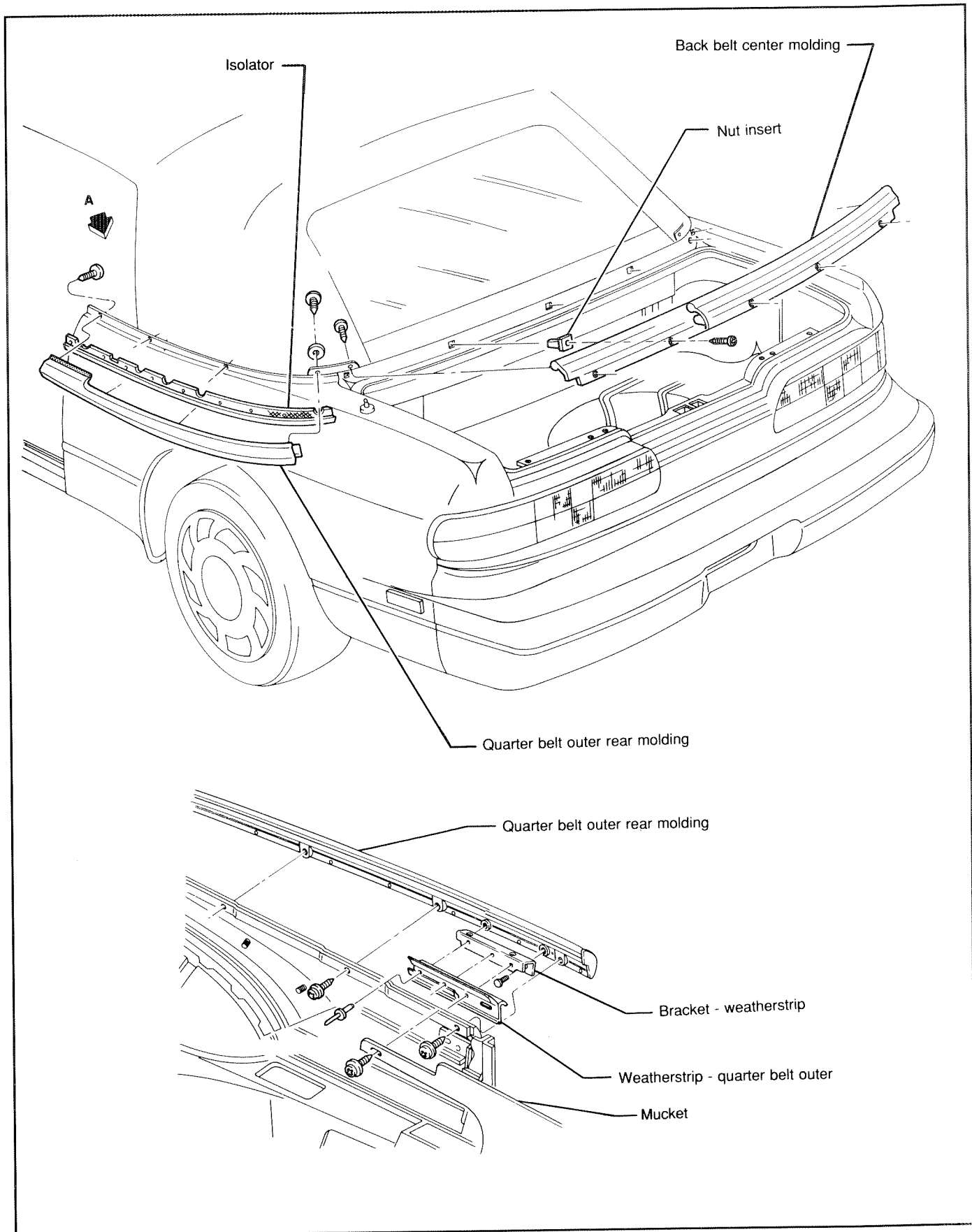

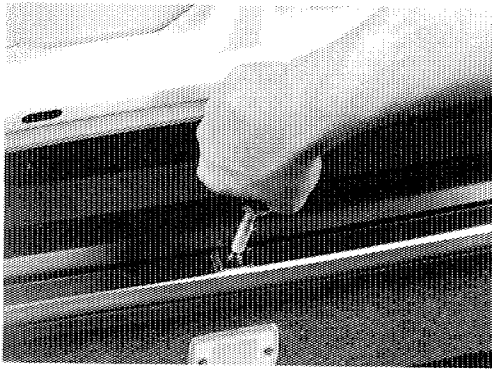

**BACK BELT CENTER MOLDING**

**REMOVE**

1. LOWER CONVERTIBLE TOP HALFWAY.
2. RAISE REAR DECK LID.
3. REMOVE BACK BELT CENTER MOLDING.
  - (a) Remove five (5) screws from molding lower edge.

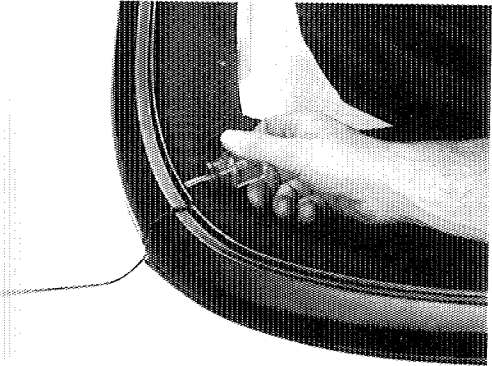

- (b) Remove two (2) screws, one at each end, from underside of rear drain trough.

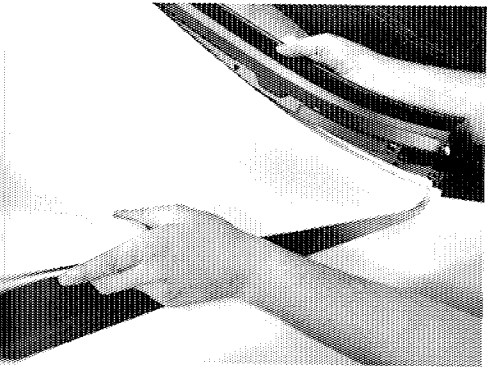

- (c) Lower rear deck lid and remove back belt molding from vehicle.

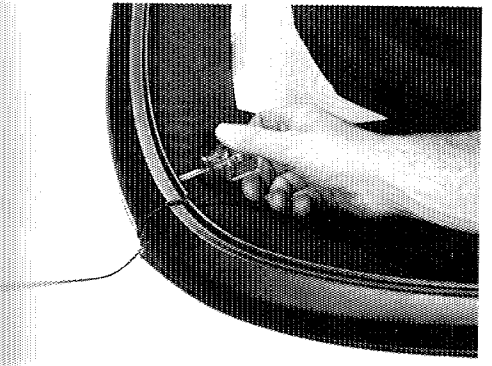

**INSTALL**

1. INSTALL BACK BELT CENTER MOLDING.
  - (a) Position back belt center molding to rear drain trough and install five (5) screws to underside of drain trough.

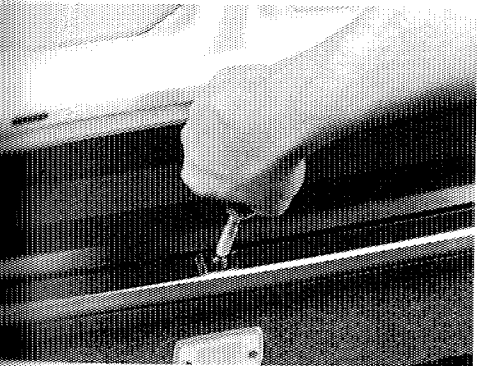

- (b) Install five (5) screws to molding lower edge.



## QUARTER BELT OUTER MOLDING

## REMOVE

1. LOWER CONVERTIBLE TOP HALFWAY.
2. REMOVE QUARTER TRIM PANEL UPPER BRACKET (see 5-6).

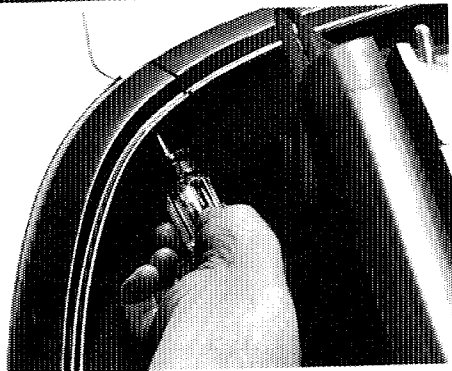
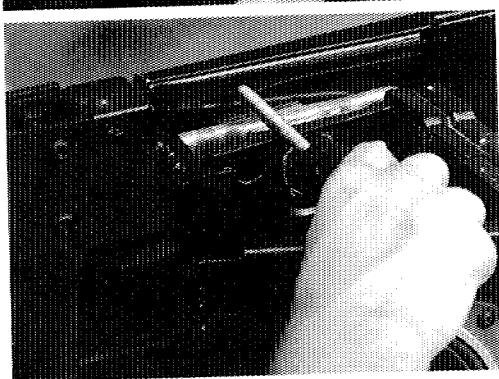
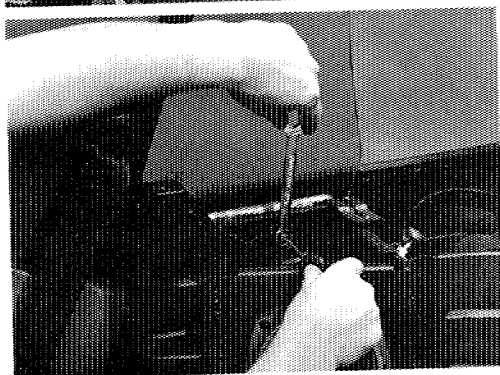
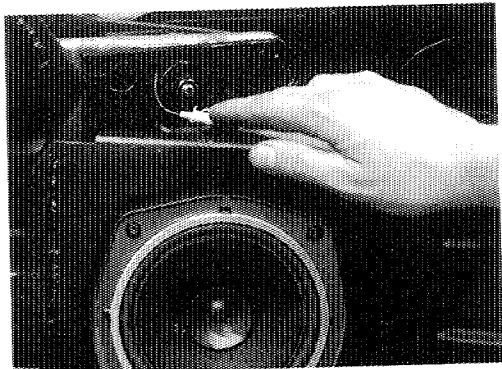

3. REPOSITION QUARTER WINDOW AND GUIDE ASSEMBLY.
  - (a) Using a pencil, mark location of three (3) quarter window guide mounting nuts.
  - (b) While holding window guide adjusting studs, remove three (3) quarter window guide mounting nuts.
 

**NOTE: Do not allow adjuster stud to turn or quarter window adjustment will be affected.**
  - (c) Re-position quarter window and guide assembly and remove mocket screw.
4. REMOVE QUARTER BELT OUTER MOLDING.
  - (a) Remove rear screw and washer from underside of corner drain trough.



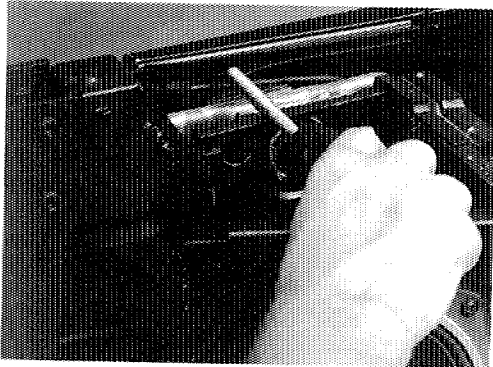

**QUARTER BELT OUTER MOLDING (cont'd)**

- (b) Remove mocket screw from quarter belt molding weatherstrip bracket.

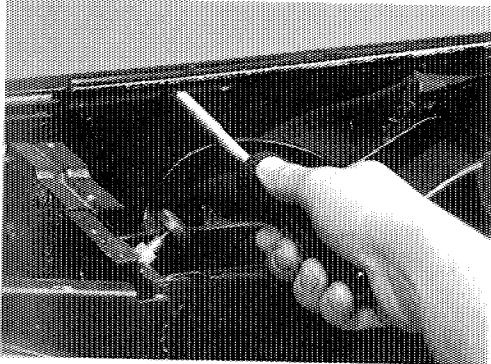

- (c) Remove three (3) screws from underside of corner drain trough.

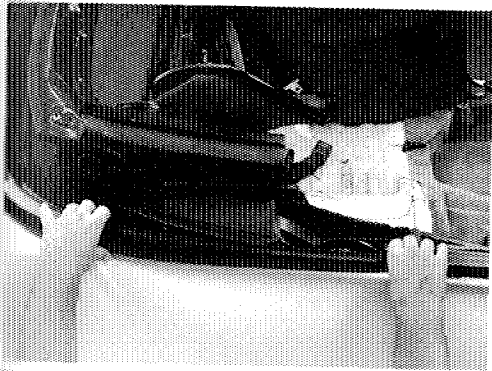

- (d) Remove quarter belt outer molding first lifting front of molding, then sliding molding out from under back belt molding.

**5. REMOVE QUARTER BELT OUTER WEATHERSTRIP AND BRACKET (see 3-20).**

**INSTALL**

1. INSTALL QUARTER BELT OUTER WEATHERSTRIP AND BRACKET (see 3-20).

2. INSTALL QUARTER BELT OUTER REAR MOLDING.

- (a) Insert rear tab of quarter belt molding, under back belt molding.

- (b) Starting from front of quarter belt molding, install three (3) screws. Do not tighten screws at this time.

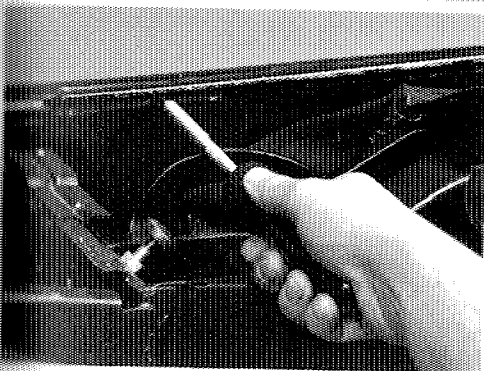

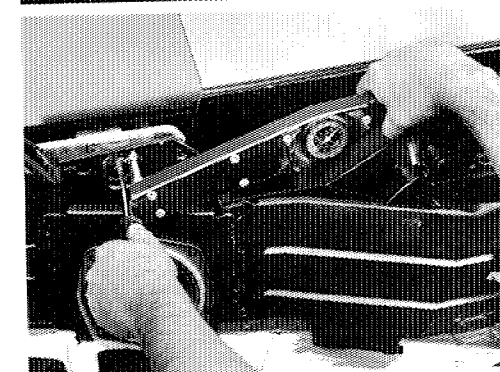
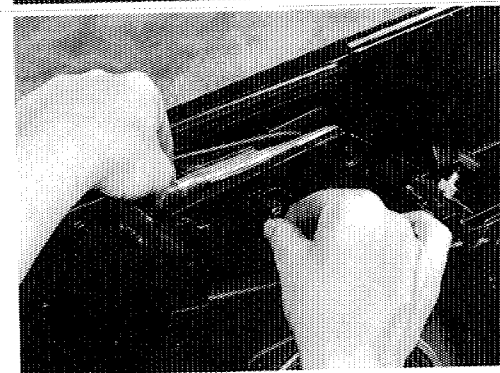
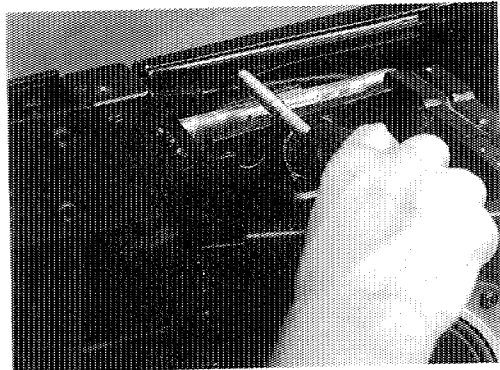
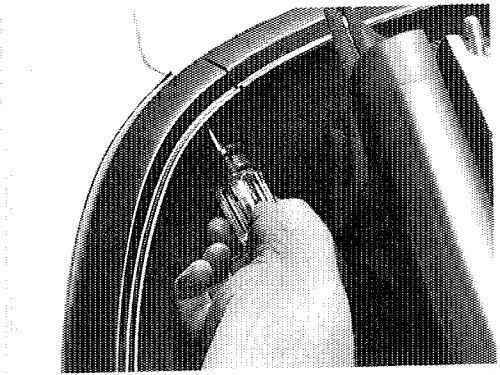

### QUARTER BELT OUTER MOLDING (cont'd)

- (c) Install rear screw with washer, and tighten.
- (d) Tighten remaining three (3) screws.

- (e) Install mocket screw to quarter belt molding weatherstrip bracket.

### 3. INSTALL QUARTER WINDOW AND GUIDE ASSEMBLY.

- (a) Position quarter window guide mounting stud to body panel and install three (3) nuts finger tight.

**NOTE: Do not allow adjuster studs to turn or quarter window adjustment will be effected.**

- (b) Align quarter window guide assembly nut with reference marks and tighten.

**Torque: 28 N·m (21 ft. lb.)**

- 4. INSTALL QUARTER TRIM OUTER PANEL, AND QUARTER TRIM PANEL (see 5-5).
- 5. RAISE AND SECURE TOP TO WINDSHIELD HEADER.

### QUARTER BELT MOLDING ISOLATOR

#### REMOVE

- 1. REMOVE QUARTER BELT OUTER MOLDING (see Quarter Belt Outer Molding in this chapter).
- 2. REMOVE QUARTER BELT OUTER WEATHERSTRIP AND BRACKET (see 3-20).

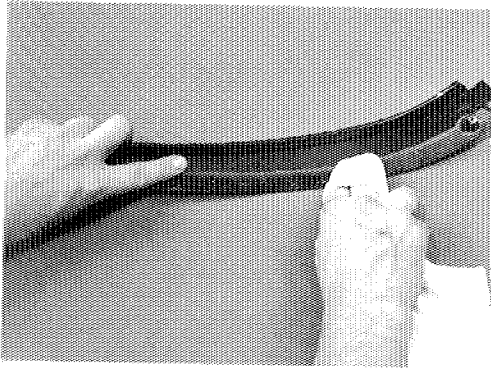

**QUARTER BELT MOLDING ISOLATOR (cont'd)**

3. REMOVE ISOLATOR FROM BELT MOLDING.
  - (a) Pull isolator strip from molding.
  - (b) Using a suitable release agent (3M P/N 051135-08971) or equivalent, clean isolator adhesive from molding.

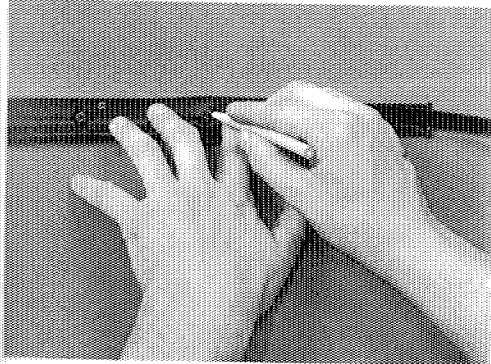

**INSTALL**

1. CUT NEW ISOLATOR STRIP.
  - (a) Position isolator material to inside of quarter belt outer molding with isolator LIP facing out.
  - (b) Mark and cut isolator material to clear molding mounting bosses.

**NOTE: Cut isolator slightly longer than molding.**

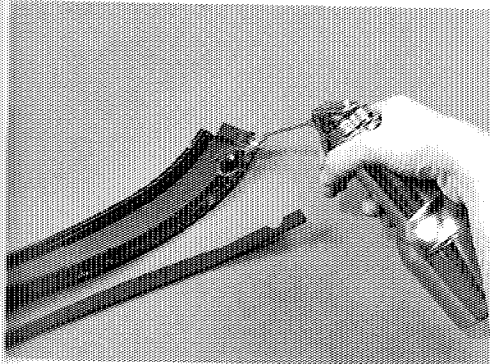

2. INSTALL ISOLATOR TO BELT MOLDING.
  - (a) Apply a continuous bead of adhesive (3M P/N 051135-08008) or equivalent to belt molding inside surface.

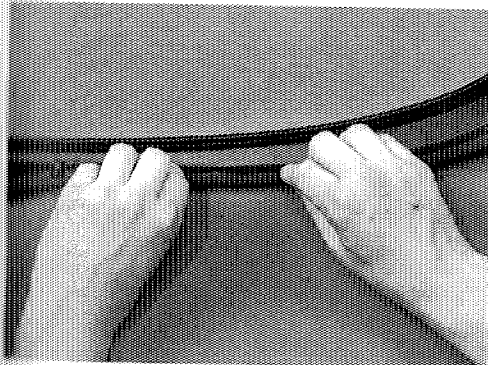

- (b) Position isolator to molding pressing isolator LIP tightly against molding lower edge.
  - (c) Firmly press isolator to belt molding inner surface.
  - (d) Trim isolator ends even with molding ends.

3. INSTALL QUARTER BELT OUTER WEATHERSTRIP AND BRACKET (see 3-20).
4. INSTALL QUARTER BELT OUTER MOLDING (see Quarter Belt Outer Molding in this chapter).



---

# HEADLINER ASSEMBLY

	page
HEADLINER ASSEMBLY COMPONENTS .....	10-2
HEADLINER ASSEMBLY .....	10-3

HEADLINER ASSEMBLY COMPONENTS

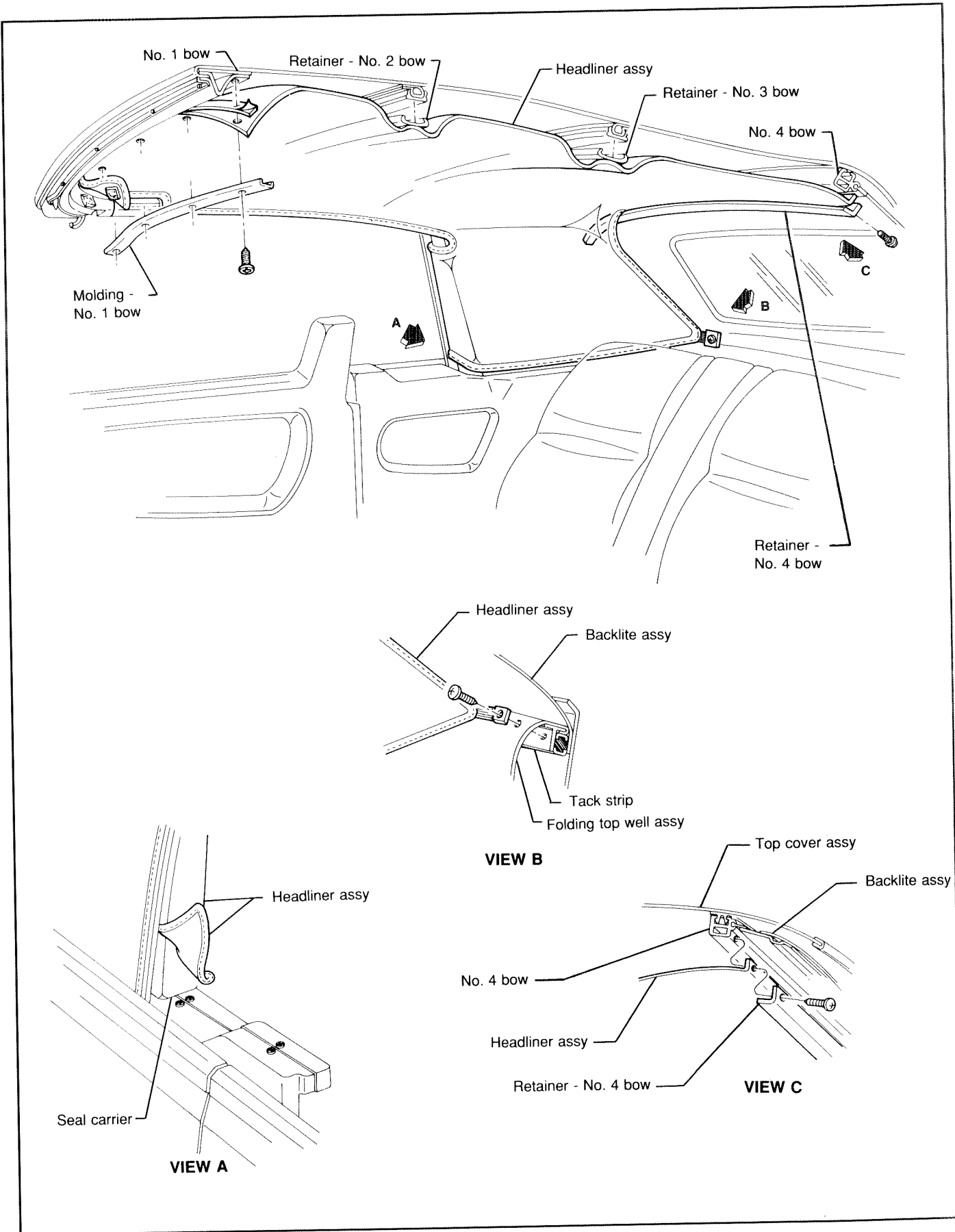

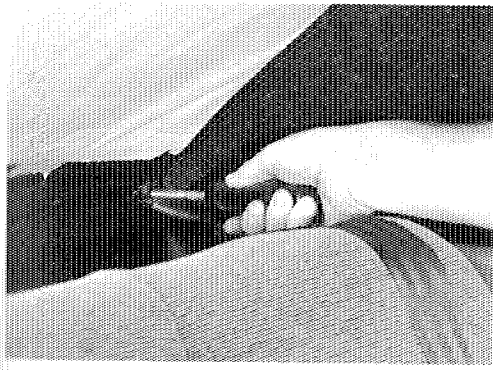

## HEADLINER ASSEMBLY

### REMOVE

1. REMOVE RIGHT AND LEFT SCREWS SECURING HEADLINER RETAINER STRAPS TO TACK STRIP.
2. REMOVE RIGHT AND LEFT REAR RAIL WEATHERSTRIP ASSEMBLIES.

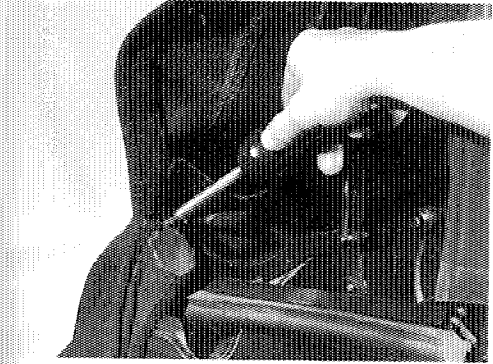

- (a) Lower convertible top halfway.
- (b) Lower quarter window.
- (c) Remove screw from top of weatherstrip.

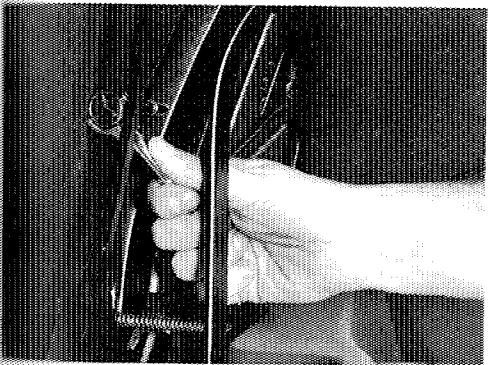

- (d) Remove three (3) nuts and washers from inside of rear rail seal carrier.
- (e) Pull seal from seal carrier.

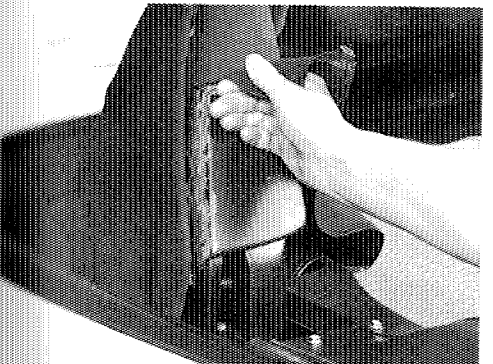

3. REMOVE HEADLINER MATERIAL FROM SEAL CARRIER.  
Carefully break cement bond by pulling material away from seal carrier.

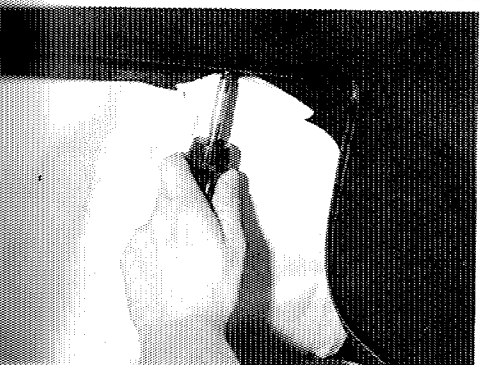

4. REMOVE HEADLINER FROM NO. 4 BOW.
  - (a) Remove nine (9) screws and retainer.
  - (b) Carefully break cement bond by pulling material away from No. 4 bow.



## HEADLINER ASSEMBLY (cont'd)

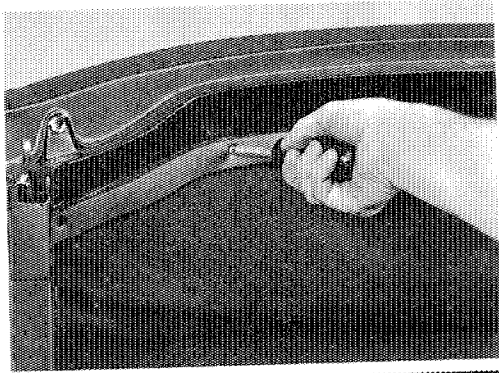

5. REMOVE HEADLINER FROM NO. 1 BOW.
  - (a) Remove seven (7) screws and headliner molding.

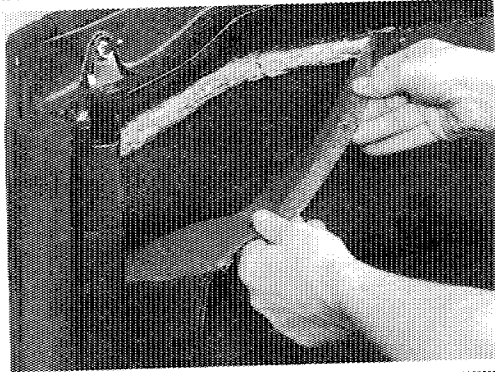

- (b) Carefully break cement bond by pulling material away from No. 1 bow.

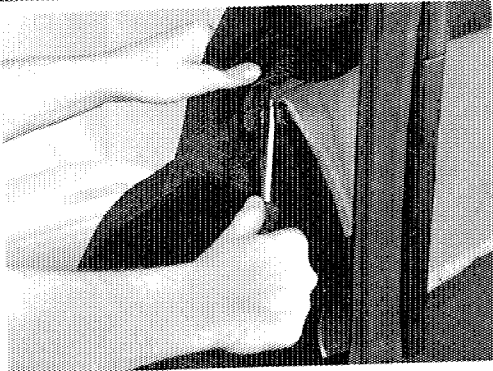

6. REMOVE HEADLINER FROM NO. 2 AND NO. 3 BOW ASSEMBLIES.
  - (a) Starting at one side, pry headliner retainer from bow.
  - (b) Remove headliner from vehicle.

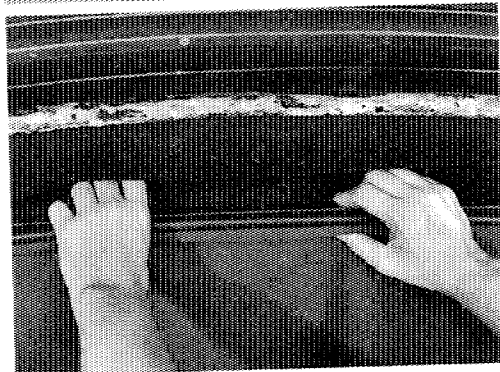

## INSTALL

1. ATTACH HEADLINER TO NO. 2 AND NO. 3 BOWS.
  - (a) Center headliner retainer to center of bow.

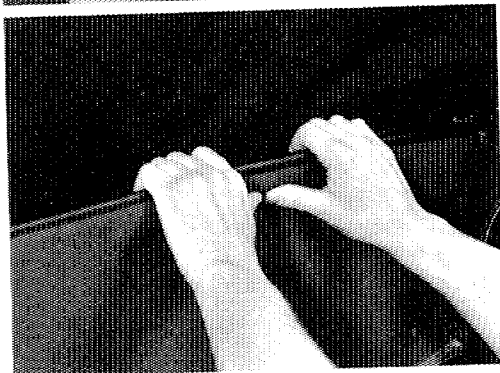

- (b) Press retainer onto bow.
  - (c) Raise top to windshield header.

**NOTE: Do not latch convertible top.**



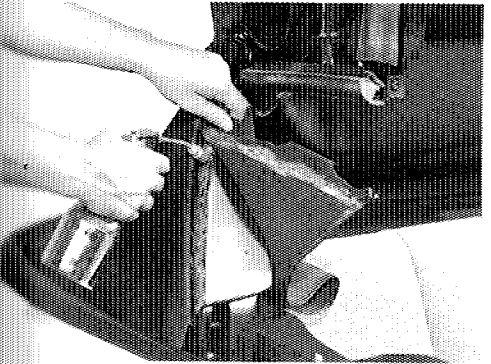
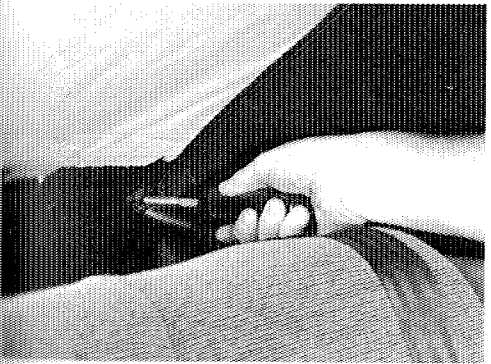
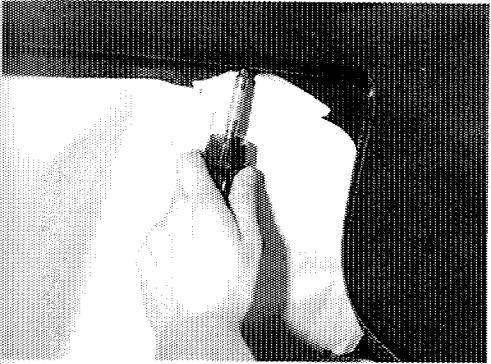
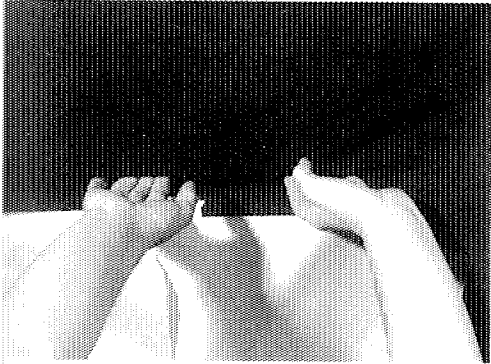
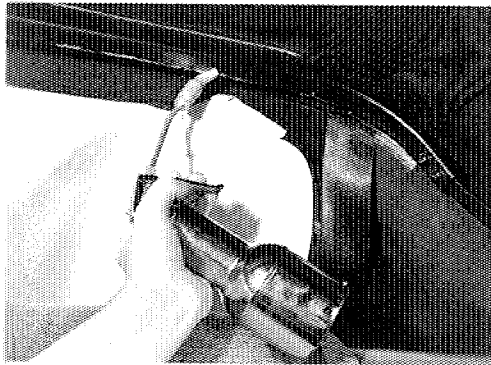

## HEADLINER ASSEMBLY (cont'd)

### 2. ATTACH HEADLINER TO NO. 4 BOW.

- (a) Apply adhesive (3M P/N 051135-08031 or equivalent) along the rear edge of No. 4 bow and headliner material.

- (b) Center headliner to No. 4 bow.

- (c) Attach headliner starting from the center and working to the outside edges.

**NOTE:** To prevent wrinkles, pull rearward on the headliner while attaching to No. 4 bow.

### 3. INSTALL NO. 4 BOW RETAINER.

- (a) Raise convertible top off header.
- (b) Install retainer using nine (9) screws.

### 4. INSTALL HEADLINER RETAINER STRAPS.

- (a) Secure right and left retainer straps to the rear drain trough using two (2) screws.

### 5. INSTALL HEADLINER TO SEAL CARRIERS.

- (a) Apply adhesive (3M P/N 051135-08031 or equivalent) to seal carrier and headliner material.

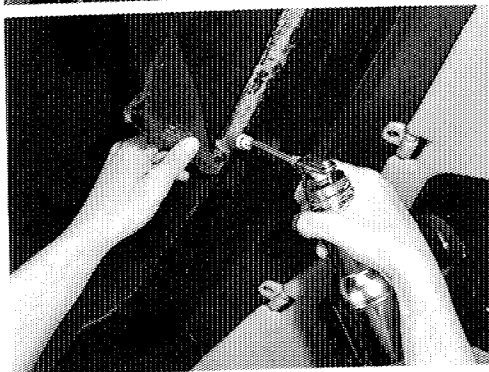
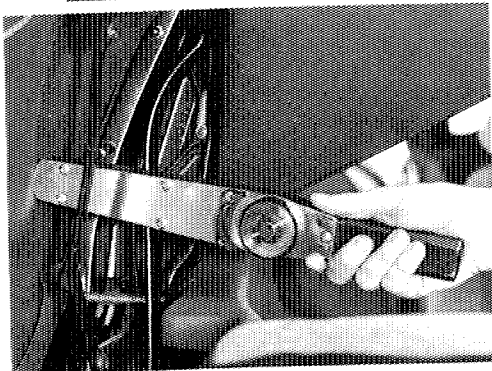
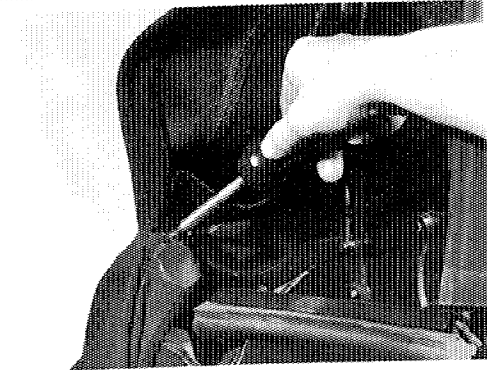
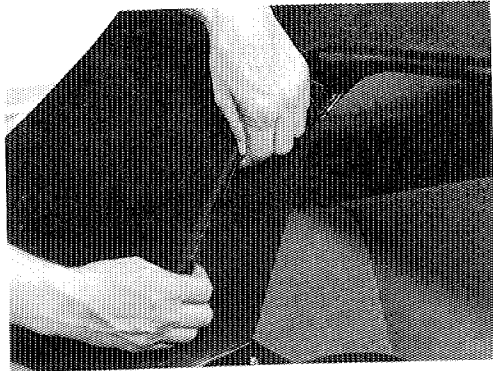

## HEADLINER ASSEMBLY (cont'd)

- (b) Attach headliner material to seal carrier.

**NOTE: Pull material tight to remove any wrinkles on the inside sail panel area.**

- (c) Trim headliner material from bottom of seal carrier groove.  
 (d) Repeat on other side of vehicle.

### 6. INSTALL RIGHT AND LEFT SIDE REAR RAIL WEATHERSTRIP ASSEMBLY.

- (a) Apply adhesive (3M P/N 051135-08008 or equivalent) to rear rail seal carrier groove and weatherstrip assembly.

- (b) Position weatherstrip in seal carrier.  
 (c) Install weatherstrip screw.

- (d) Secure weatherstrip using three (3) washers and nuts.  
**Torque: 3 N·m (26 in. lb.)**

### 7. INSTALL HEADLINER TO NO. 1 BOW.

- (a) Apply adhesive (3M P/N 051135-08031 or equivalent) to No. 1 bow headliner attaching area and to headliner material.

- (b) Raise and latch convertible top to header.

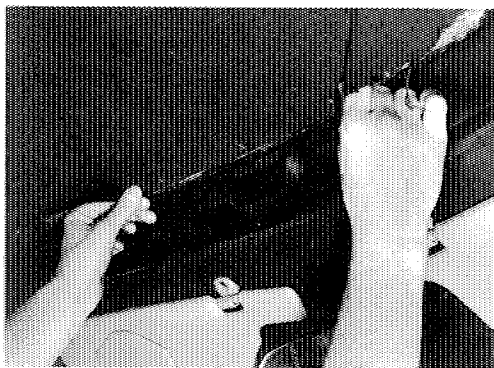
**HEADLINER ASSEMBLY (cont'd)**

- (c) Center headliner to No. 1 bow.
- (d) Attach headliner starting from center and working to outside edges.

**NOTE: Pull material tight to remove wrinkles in headliner material.**

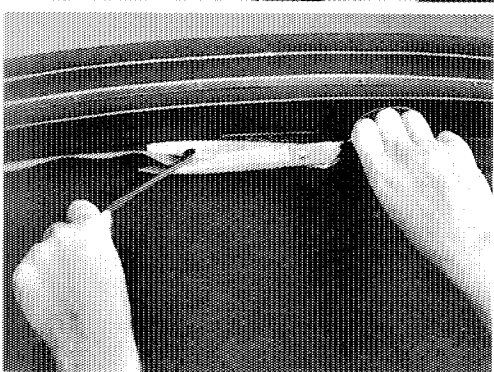

- (e) Trim excess headliner material along location of molding front edge.

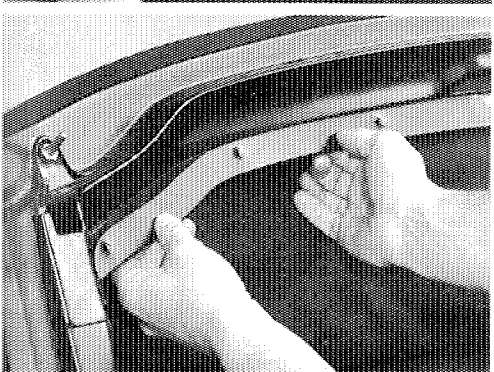

- 8. **INSTALL HEADLINER BOW NO. 1 MOLDING.**  
Secure molding using seven (7) screws.

- 9. **LOWER AND RAISE CONVERTIBLE TOP TWICE AND CHECK FOR WRINKLES IN HEADLINER.**

e.

to

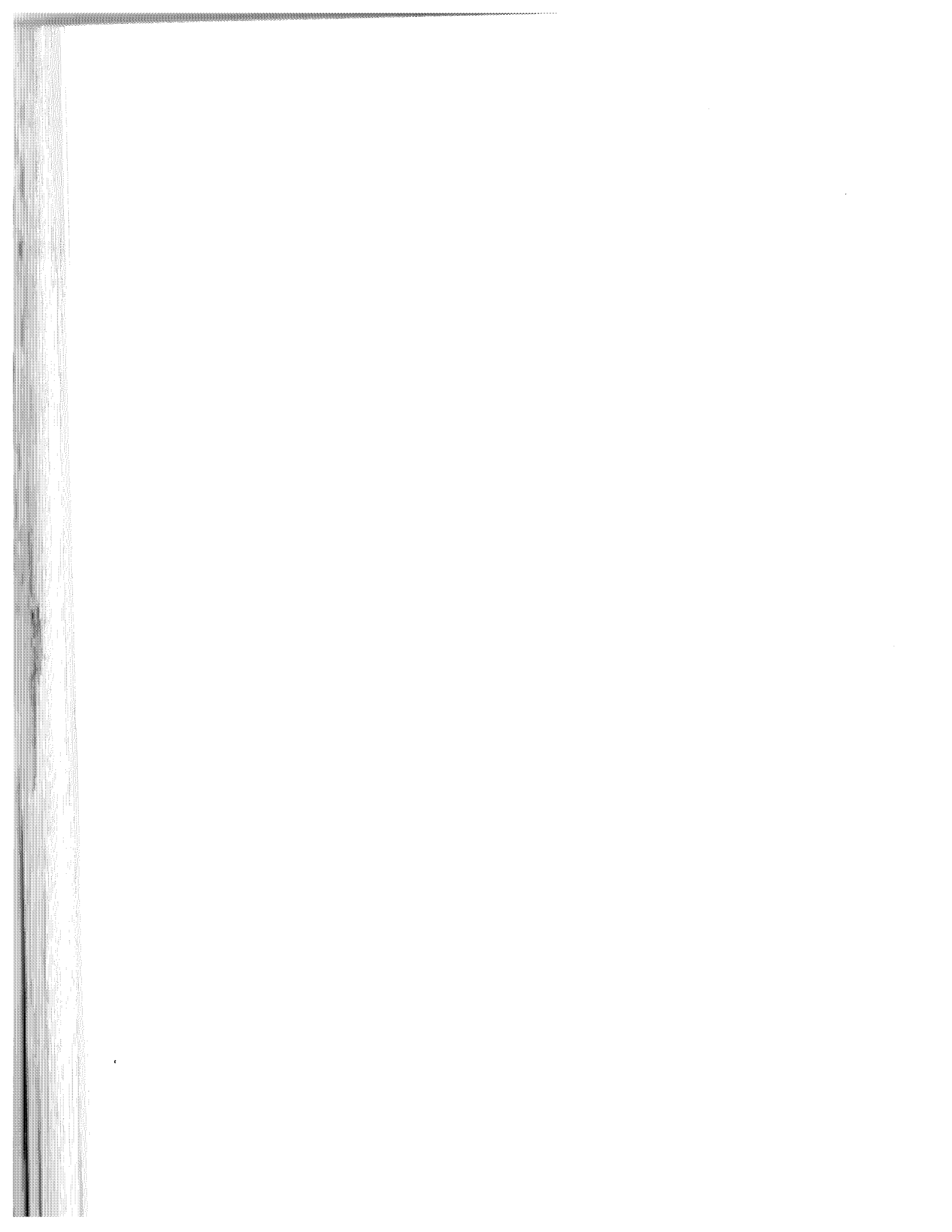

---

# TOP COVER ASSEMBLY

	page
TOP COVER ASSEMBLY COMPONENTS .....	11-2
TOP COVER ASSEMBLY .....	11-3

TOP COVER ASSEMBLY COMPONENTS

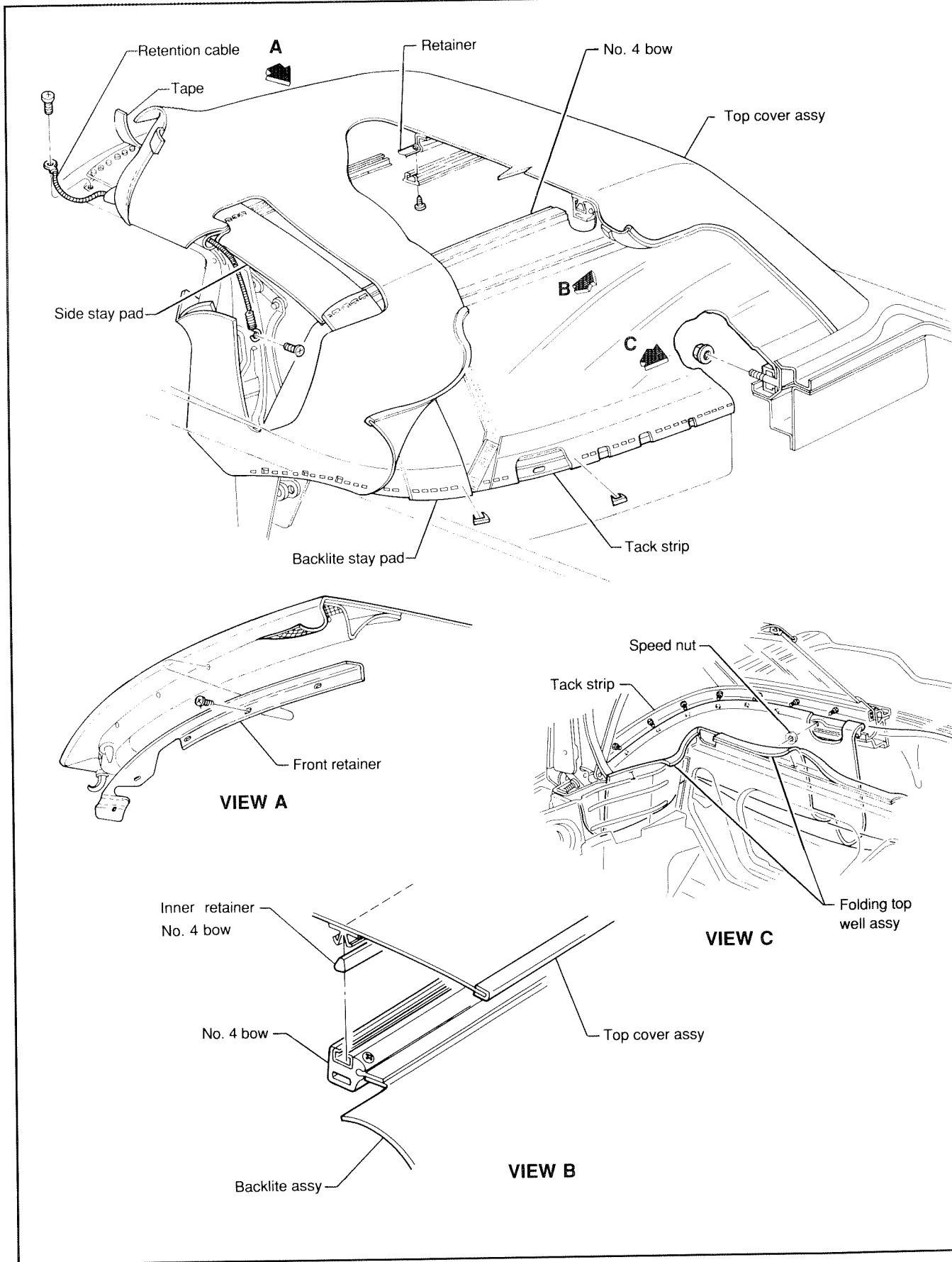

## TOP COVER ASSEMBLY

## REMOVE

**NOTE:** To help prevent damage, tape a protective cover to the belt moldings, trunk lid and quarter panels. Also, cover both sides of the backlite.

1. REMOVE BOTH QUARTER TRIM PANELS (see 5-4).
2. REMOVE HEADLINER ASSEMBLY, (see 10-3).
3. REMOVE FOLDING TOP WELL ASSEMBLY.
  - (a) Mark edge of folding top well material on body brace rear and side panels.
  - (b) Carefully break cement bond by pulling well material from body brace panels.
  - (c) Remove seventeen (17) speed nuts and well plastic extrusion from tack strip studs.
4. REMOVE TOP COVER ASSEMBLY FROM NO. 1 BOW.
  - (a) Mark top cover material along No. 1 bow front edge.

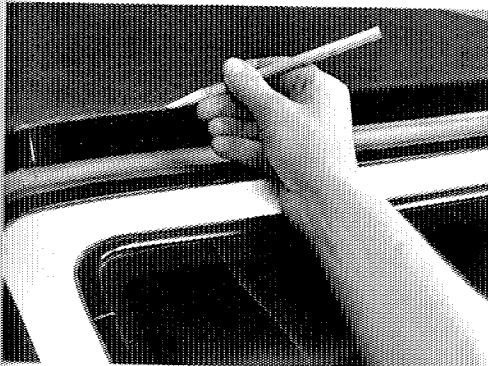
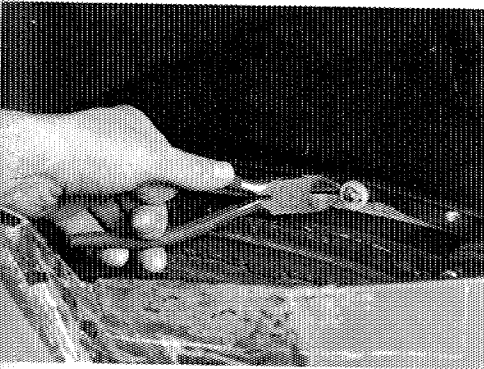
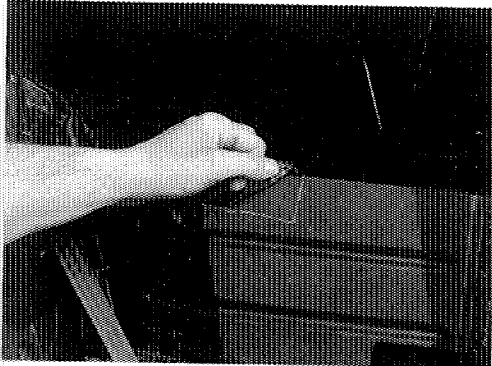

## TOP COVER ASSEMBLY (cont'd)

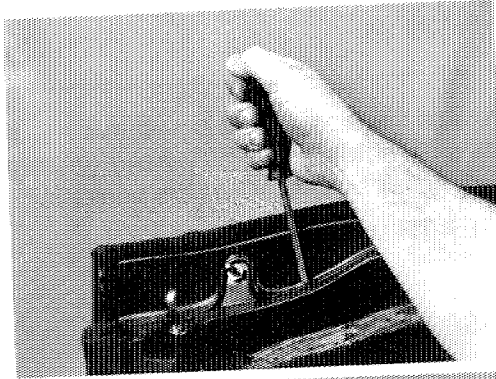

- (b) Remove six (6) screws and front retainer from No. 1 bow.
- (c) Remove front rail weatherstrip retainers (see 3-13)

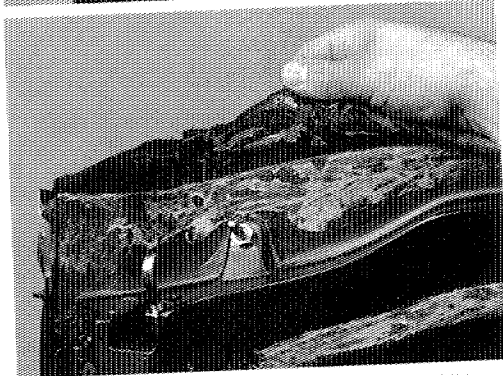

- (d) Carefully break cement bond by pulling top cover material away from No. 1 bow.

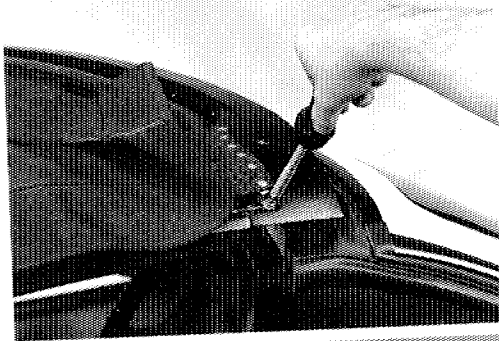

- 5. REMOVE RIGHT AND LEFT RETENTION CABLE SCREWS.

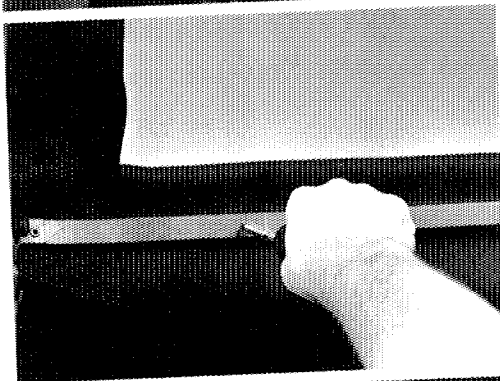

- 6. REMOVE TOP COVER FROM NO. 2 AND NO. 3 BOWS.
  - (a) Remove three (3) screws from underside of No. 2 bow.
  - (b) Hold top cover away from No. 2 bow and slide retainer from top cover pocket.
  - (c) Repeat (a) and (b) for No. 3 bow.



- 7. REMOVE TOP COVER FROM RIGHT AND LEFT SEAL CARRIERS.  
Carefully break cement bond by pulling top cover material from seal carrier groove.



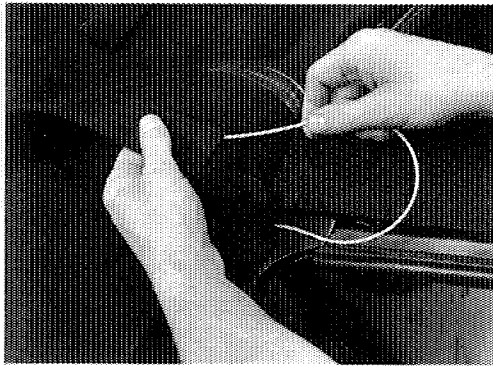

### TOP COVER ASSEMBLY (cont'd)

8. REMOVE RIGHT AND LEFT SIDE RETENTION CABLES FROM TOP COVER ASSEMBLY.

Pull cable from top cover pocket.

**NOTE: Leave retention cables attached to rear rails.**

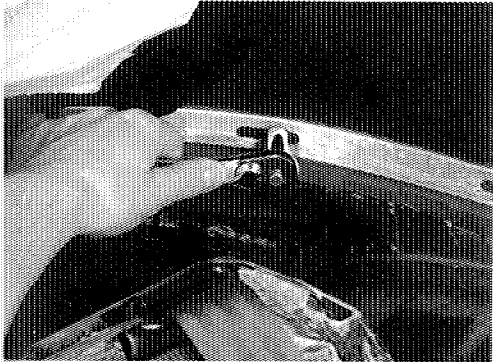

9. REMOVE TACK STRIP AND TOP COVER FROM REAR DRAIN TROUGH ASSEMBLY.

- (a) Remove seventeen (17) nuts from tack strip.
- (b) Pull the tack strip forward while gently pulling inward on the tack strip ends.

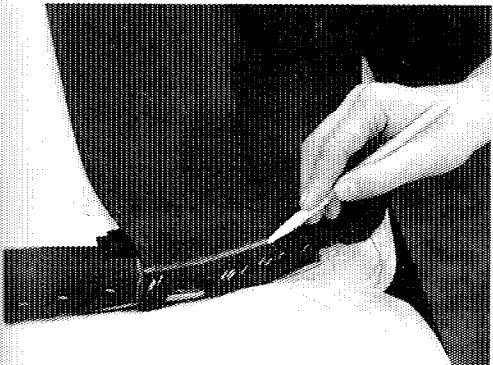

10. MARK TOP COVER LOCATION ON TACK STRIP AND BACKLITE.

- (a) Mark tack strip upper edge on the outside while holding top cover material tightly against tack strip.
- (b) Mark location of top cover right and left window opening edges on backlite material.

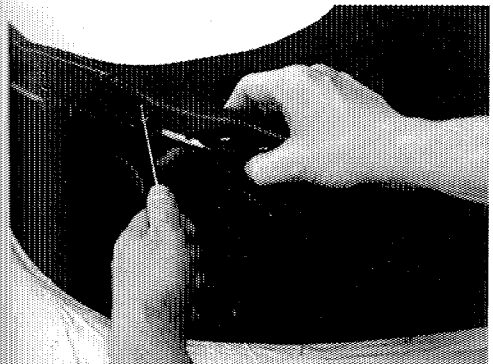

11. REMOVE TOP COVER ASSEMBLY RIGHT AND LEFT SIDE PANELS FROM TACK STRIP.

Using a suitable tool, remove staples securing top cover to tack strip.

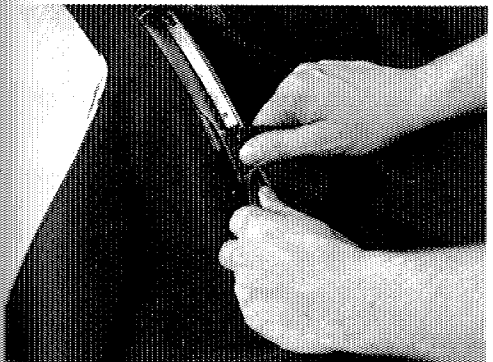

12. REMOVE TOP COVER FROM NO. 4 BOW.

- (a) Fold side of top cover material over No. 4 bow to expose top cover retainer insert.
- (b) Slide stay pad tack strip down for No. 4 bow inner retainer removal clearance.

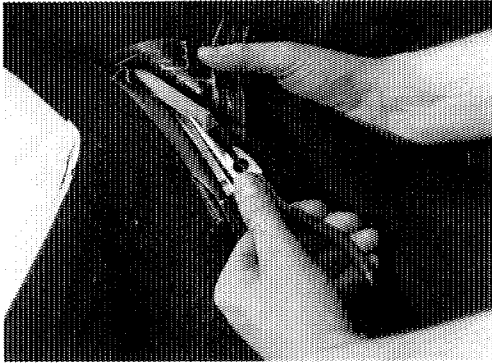

### TOP COVER ASSEMBLY (cont'd)

- (c) Pull top cover No. 4 bow inner retainer from top cover retainer.

**NOTE:** It may be necessary to "start" the retainer from other side of vehicle using a hammer and drift.

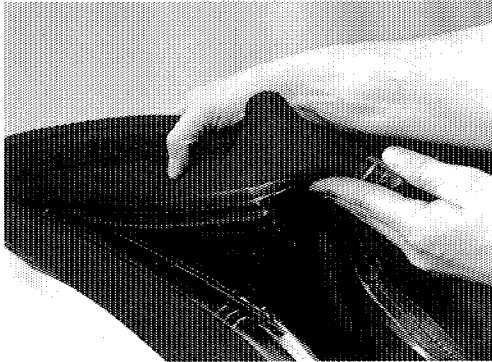

13. REMOVE TOP COVER ASSEMBLY FROM VEHICLE.

Pull top cover No. 4 bow retainer from bow assembly and remove top cover from vehicle.

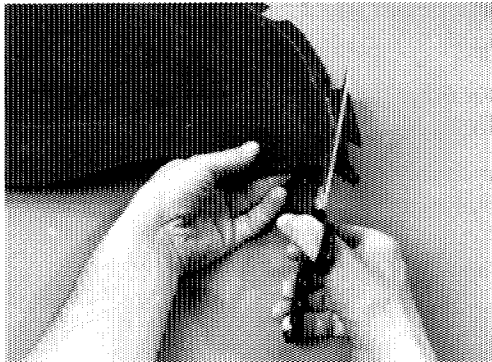

### NEW TOP COVER PREPARATION

1. CUT "REMOVED" TOP COVER SIDE PANELS.

Following line drawn to indicate tack strip upper edge, cut material away from REMOVED top.

2. OPEN "NEW" TOP COVER, OUTER SURFACE UP, ON A LARGE WORK SURFACE.

3. POSITION "REMOVED" TOP COVER OVER "NEW" ONE, OUTER SURFACE UP.

Align rear and side window opening edges of both tops to each other.

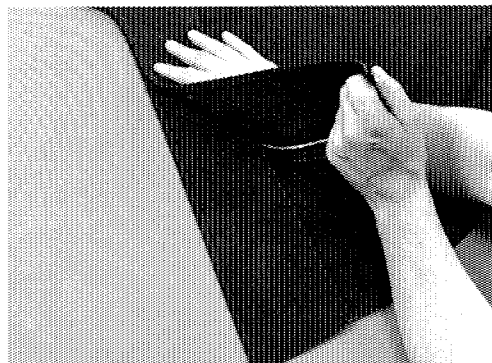

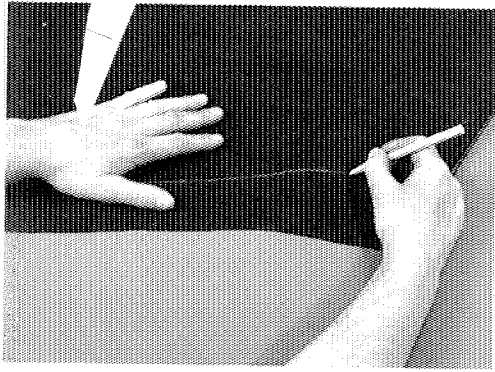
**TOP COVER ASSEMBLY (cont'd)**

4. DRAW "NEW" TOP COVER ASSEMBLY TACK STRIP REFERENCE LINE.

Trace cut edge of REMOVED top side panels to NEW top side panels.

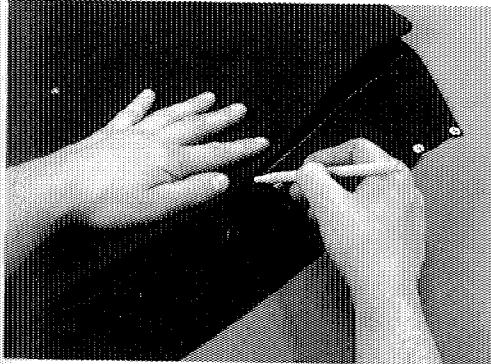

5. TRANSFER NO. 1 BOW REFERENCE LINE TO "NEW" TOP COVER.

- (a) Align NEW and REMOVED top cover side flap front edges.  
 (b) Fold REMOVED top cover along reference line and mark NEW top cover.

**INSTALL**

1. INSTALL TOP COVER ASSEMBLY TO NO. 4 BOW.

Insert top cover into slot in No. 4 bow and center side to side.

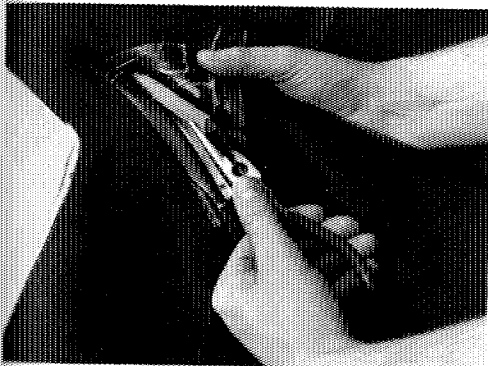

2. INSTALL NO. 4 BOW TOP COVER RETAINER INSERT.

- (a) Position retainer insert to top cover retainer and No. 4 bow.  
 (b) Push the insert into the top cover retainer while holding the top cover in place.  
 (c) Verify top cover centering in No. 4 bow and position of No. 4 bow tack strip.

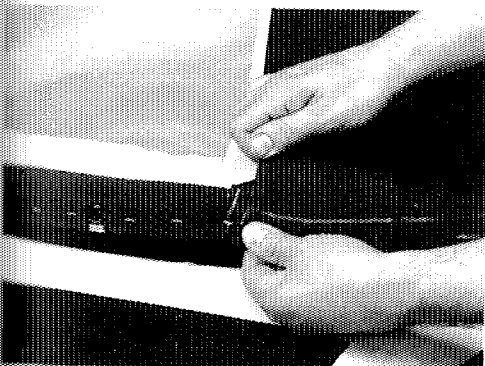

3. ALIGN TOP COVER ASSEMBLY RIGHT AND LEFT SIDE PANELS TO TACK STRIP.

- (a) Align edge of top cover rear window opening to pencil mark on backlite.  
 (b) Align tack strip pencil line on top cover with top edge of tack strip.

om  
riff.

each

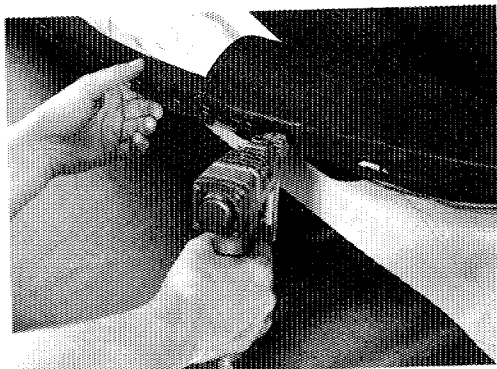

### TOP COVER ASSEMBLY (cont'd)

4. INSTALL TOP COVER TO TACK STRIP.

Starting at rear window opening, use .31 x .31 monel staples on single layers and .50 x .31 stainless steel divergent staples on multiple layers.

**NOTE: Keep material taut while maintaining top cover alignment to tack strip upper edge.**

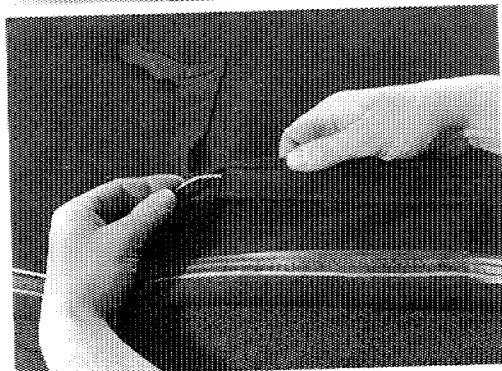

5. INSTALL RIGHT AND LEFT SIDE RETENTION CABLES TO TOP COVER.

**NOTE: Use of a stiff wire attached to cable end will aid installation of retention cables.**

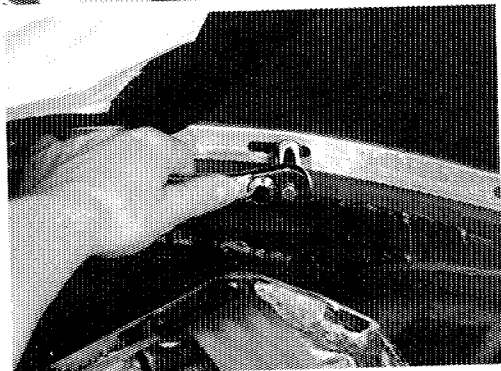

6. INSTALL TOP COVER AND TACK STRIP TO REAR DRAIN TROUGH ASSEMBLY.

- (a) Gently pull inward on tack strip ends while positioning tack strip to mounting studs.
- (b) Install seventeen (17) nuts to tack strip studs.
- (c) Tighten nuts starting from the center, then working out. Do not torque nuts at this time.

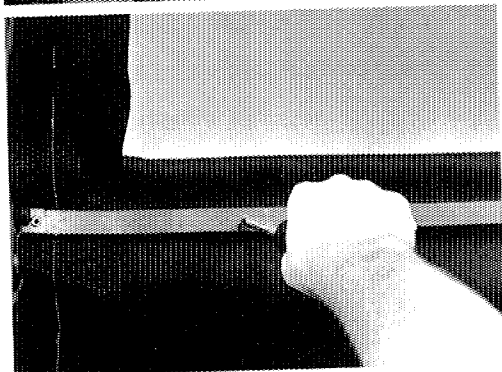

7. INSTALL TOP COVER TO NO. 3 AND NO. 2 BOWS.

- (a) Install No. 3 bow top cover retainer to top cover.
- (b) Install three (3) screws to No. 3 bow and top cover retainer.
- (c) Repeat (a) and (b) for No. 2 bow.

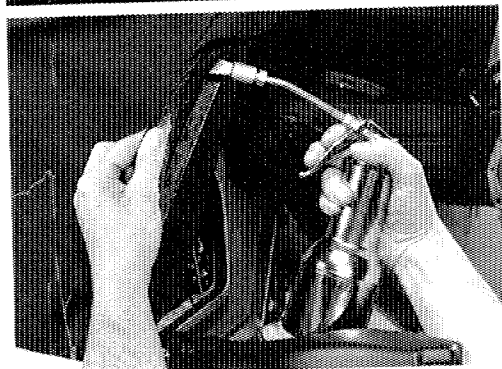

8. INSTALL TOP COVER TO SEAL CARRIERS.

- (a) Apply adhesive (3M P/N 051135-08031 or equivalent) to seal carrier top cover area and top cover glue flap.

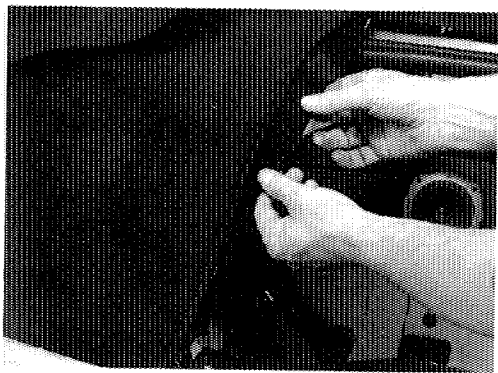

### TOP COVER ASSEMBLY (cont'd)

- (b) Position top cover wear flap on outside of seal carrier and fold glue flap material into seal carrier.

**NOTE: Top cover binding should be straight and turned slightly inward.**

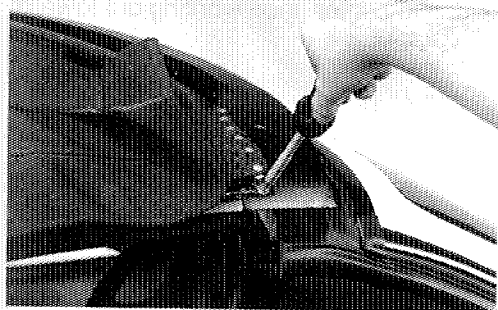

#### 9. INSTALL TOP COVER ASSEMBLY TO NO. 1 BOW.

- (a) Secure right and left retention cables to No. 1 bow using two (2) screws.

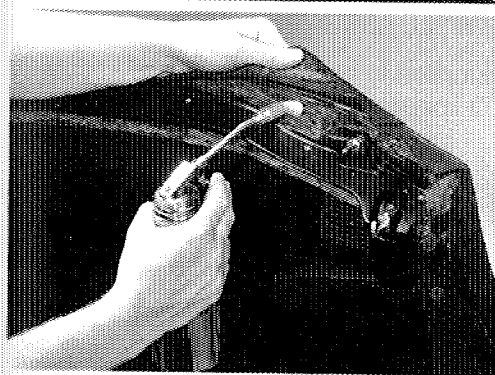

- (b) Apply adhesive (3M P/N 051135-08031 or equivalent) to top cover area of No. 1 bow and top cover material.

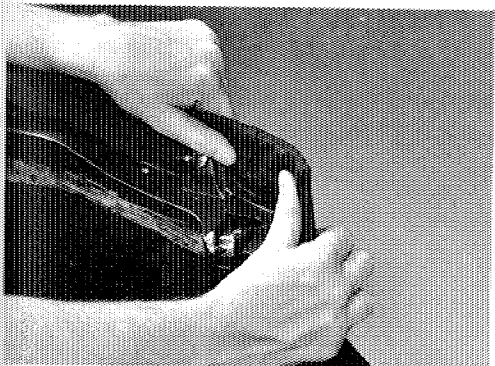

- (c) Fold side flap material under bow aligning front edge of flap with edge of bow.
- (d) Fold top cover material over No. 1 bow aligning reference line to No. 1 bow front edge.

#### 10. CHECK TOP COVER ASSEMBLY FIT.

- (a) Raise and latch convertible top to header.
- (b) Check top cover fit at No. 1 bow, tack strip and seal carriers. Make adjustments as required.
- (c) Release convertible top from header.



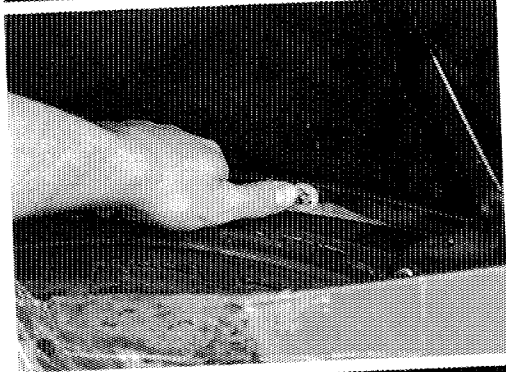
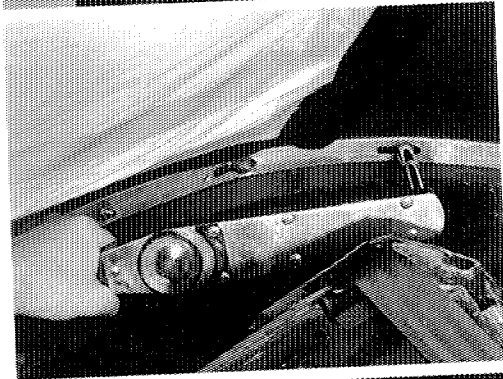
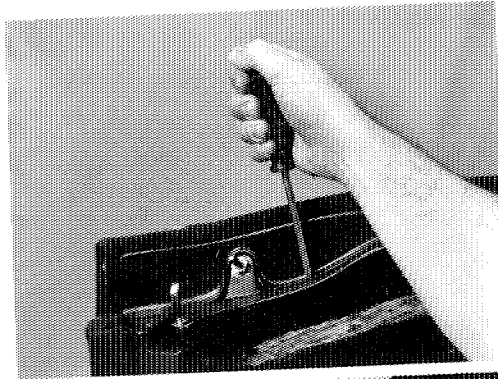

### TOP COVER ASSEMBLY (cont'd)

11. INSTALL TOP COVER ASSEMBLY FRONT RETAINER.
  - (a) Position retainer to No. 1 bow and secure using six (6) screws.
  - (b) Install front rail weatherstrip retainers (see 3-14)
  
12. TIGHTEN TACK STRIP NUTS.
 

Tighten tack strip nuts starting in center, then working out toward ends.

**Torque: 8 N·m (71 in. lb.)**
  
13. INSTALL FOLDING TOP WELL ASSEMBLY.
  - (a) Install well plastic extrusion to tack strip studs and secure using seventeen (17) speed nuts.
  
  - (b) Apply Adhesive (3M P/N 051135-08031 or equivalent) to body brace panels and well material.
  - (c) Starting in center, align well material with pencil mark on body panels, then work out toward ends.
  
14. INSTALL HEADLINER ASSEMBLY, (see 10-4).
15. INSTALL BOTH QUARTER TRIM PANELS, (see 5-5).
16. LOWER AND RAISE CONVERTIBLE TOP TWICE. CHECK FOR WAVES OR WRINKLES IN TOP COVER.

# BACKLITE ASSEMBLY

	page
BACKLITE ASSEMBLY COMPONENTS.....	12-2
BACKLITE WINDOW SERVICE .....	12-3
WINDOW WRINKLES OR WAVES .....	12-3
BACKLITE ASSEMBLY .....	12-4

ard

re

o

n

<

BACKLITE ASSEMBLY COMPONENTS

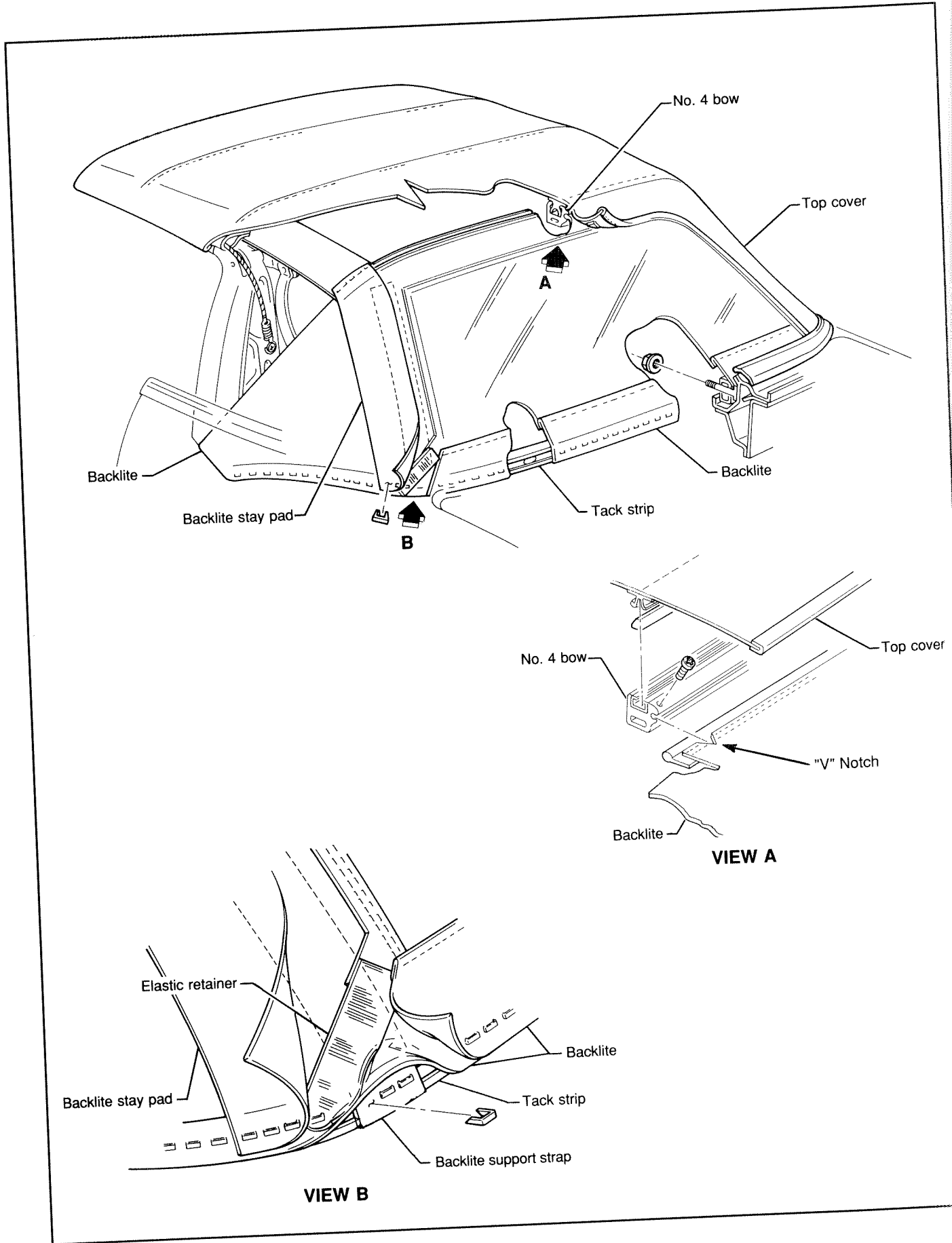



## BACKLITE WINDOW SERVICE

The backlite window is extremely susceptible to scratches and abrasions. Use extreme care when working on or around the backlite window area.

If the coating on the rear window is scratched or damaged, the backlite assembly must be replaced.

When cleaning the backlite after performing a convertible top repair, do not use solvents or household window cleaners as these products may remove the protective coating from the window. Also, do not use protectants, beautifiers or silicone-based dressings.

Refer to Rear Window Appearance Care, in General Information for rear window cleaning information.

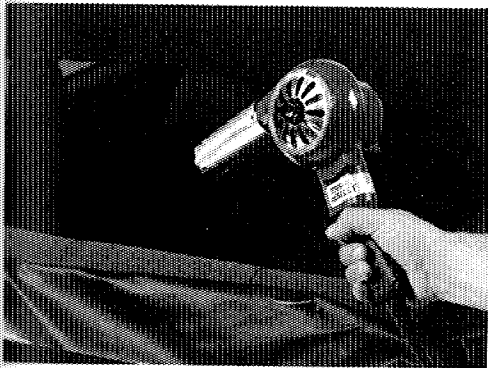

## WINDOW WRINKLES OR WAVES

**CAUTION:** Excess heat may damage backlite. Use extreme care when performing this procedure. Individual hot-air guns heat differently, adjust heating time accordingly.

Apply heat using a hot-air gun. Hold hot-air gun 50mm (2 in.) from window surface and move in a circular motion for 5 minutes. Allow 20 minutes cooling time before inspecting.

**NOTE:** If wrinkle or wave remains, it may be necessary to reposition or replace the backlite assembly.

## BACKLITE ASSEMBLY

## REMOVE

**NOTE:** To help prevent damage, tape a protective cover to the belt moldings, trunk lid, and quarter panels.

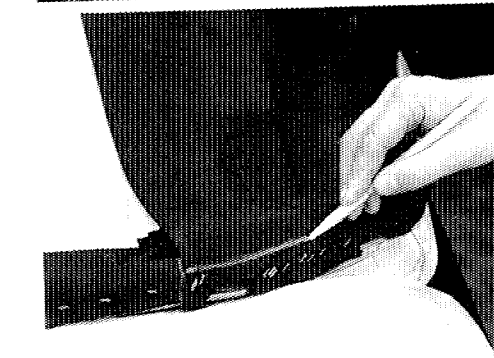
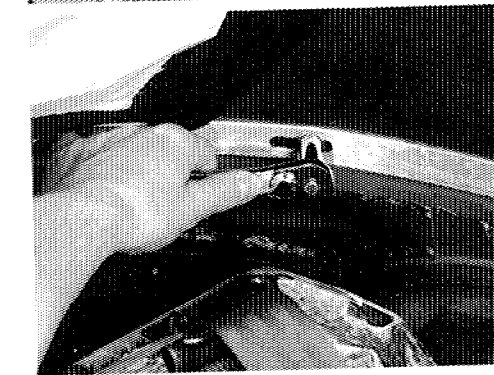
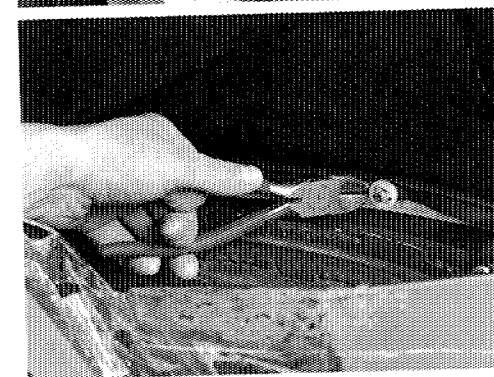
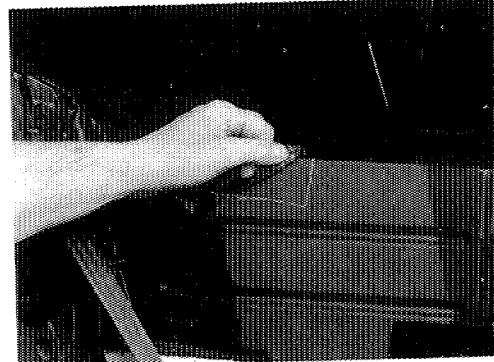
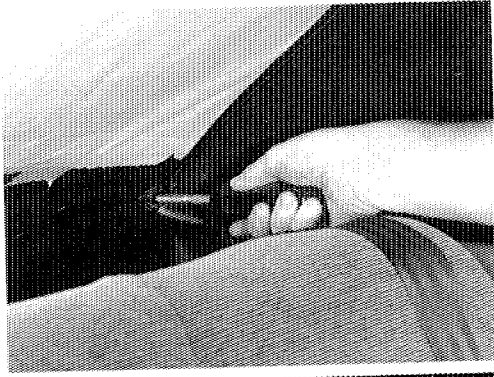

1. REMOVE TWO (2) HEADLINER SAIL PANEL SCREWS FROM TACK STRIP.
2. REMOVE BOTH QUARTER TRIM PANELS (see 5-3).
3. REMOVE FOLDING TOP WELL ASSEMBLY.
  - (a) Mark folding top well material edge on body brace panels.
  - (b) Carefully break cement bond by pulling well material from body brace panels.
  - (c) Remove seventeen (17) speed nuts and well plastic extrusion from track strip studs.
4. REMOVE TACK STRIP AND TOP COVER FROM REAR DRAIN TROUGH ASSEMBLY.
  - (a) Release top from header.
  - (b) Remove seventeen (17) nuts from tack strip.
  - (c) Gently pull inward on tack strip ends while pulling tack strip forward.
5. MARK TOP COVER LOCATION ON TACK STRIP AND BACKLITE.
  - (a) Mark tack strip upper edge on the outside while holding top cover material tightly against tack strip.

**BACKLITE ASSEMBLY (cont'd)**

- (b) Mark location of top cover right and left window opening edges on backlite material.

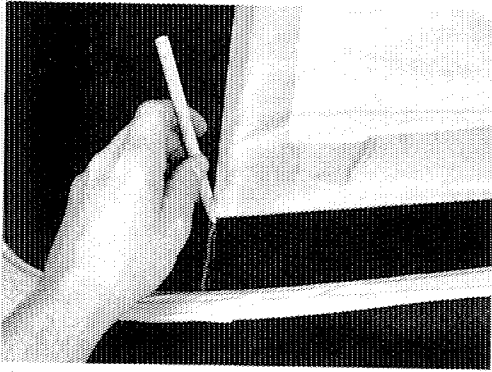

6. REMOVE TOP COVER ASSEMBLY RIGHT AND LEFT SIDE PANELS FROM TACK STRIP.

- (a) Using a suitable tool, remove staples securing top cover to tack strip.

- (b) Fold top cover material over No. 4 bow.

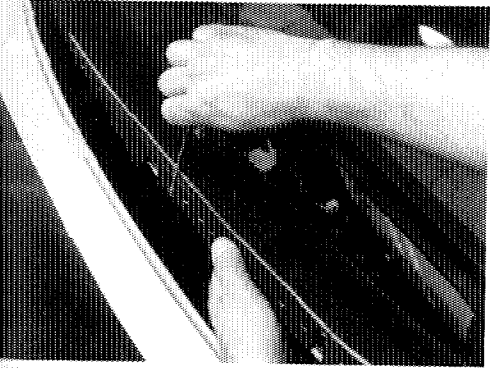

7. MARK RIGHT AND LEFT BACKLITE STAY PAD LOCATION.

Mark stay pad location on tack strip.

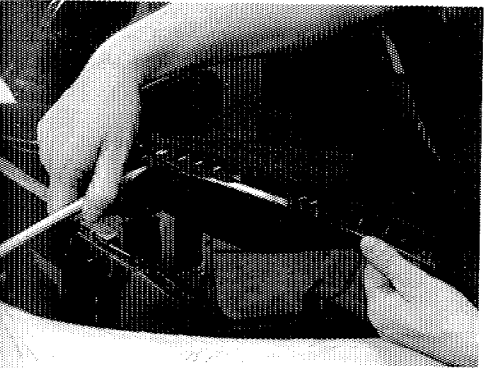

8. DETACH BACKLITE STAY PADS FROM TACK STRIP.

- (a) Using a suitable tool, remove staples securing stay pad to tack strip.

- (b) Remove backlite stay pad staples on opposite side.

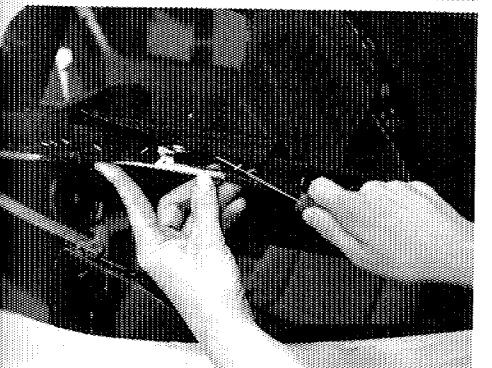

9. MARK BACKLITE TO TACK STRIP LOCATION.

- (a) Mark tack strip upper edge on backlite while holding material tightly against tack strip.



OM

Is.  
m

strip

g top

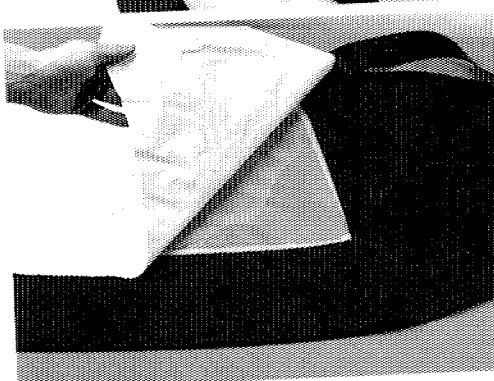
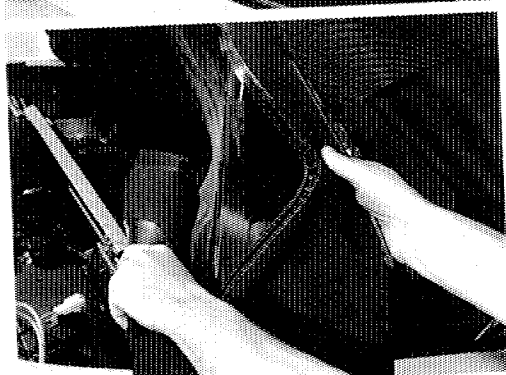
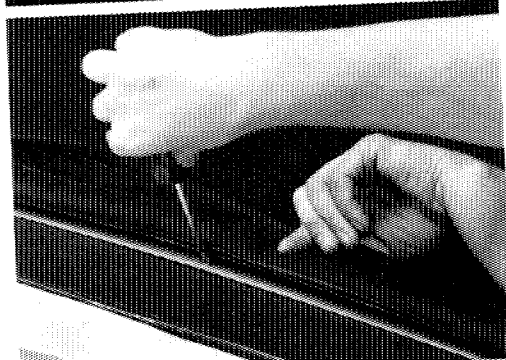
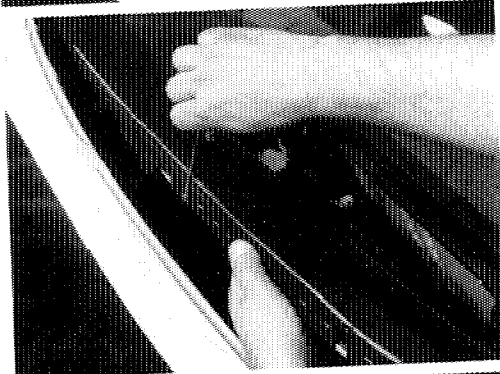
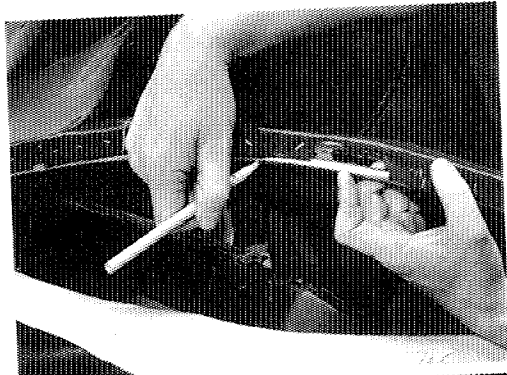

### BACKLITE ASSEMBLY (cont'd)

- (b) Mark center of backlite to tack strip and No. 4 bow.
- (c) Mark right and left side backlite elastic strap to tack strip locations.

### 10. REMOVE BACKLITE ASSEMBLY.

- (a) Using a suitable tool, remove backlite staples from tack strip.

- (b) Mark location of both backlite support straps and detach from tack strip.

- (c) Remove locking screw from center of No. 4 bow.

- (d) From side of vehicle, pull backlite assembly from No. 4 bow.

### NEW BACKLITE ASSEMBLY PREPARATION

#### 1. INSPECT BACKLITE ASSEMBLY.

- (a) Partially pull protective cover from backlite window.
- (b) Inspect window for scratches or damage to either side then re-attach protective cover.

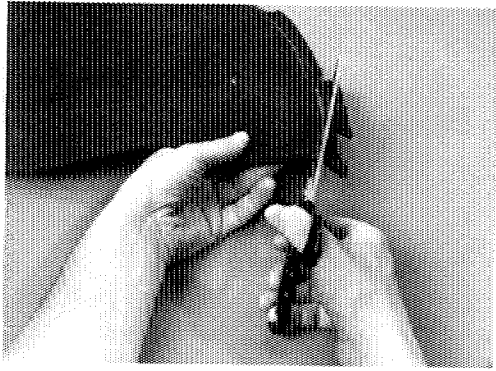

### BACKLITE ASSEMBLY (cont'd)

#### 3. CUT REMOVED BACKLITE ASSEMBLY.

Cut REMOVED backlite following line drawn indicating tack strip upper edge.

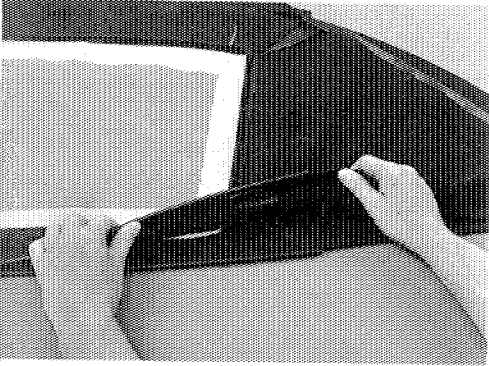

#### 2. TRANSFER BACKLITE ASSEMBLY REFERENCE MARKS.

- (a) Lay NEW backlite, outer surface up, on a large work surface.
- (b) Position REMOVED backlite over NEW backlite. Align bow retainers and center window opening edges.

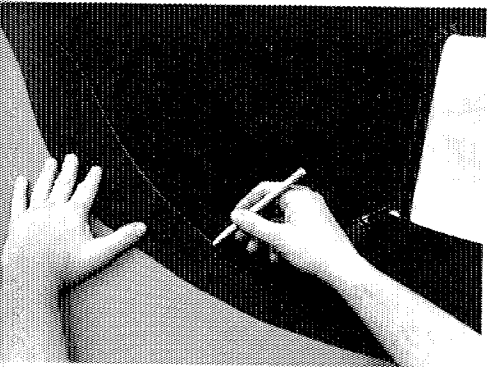

#### 4. DRAW NEW BACKLITE ASSEMBLY TACK STRIP REFERENCE LINE.

- (a) Trace cut edge of the removed backlite onto new backlite.
- (b) Transfer top cover alignment marks from removed backlite to new backlite.

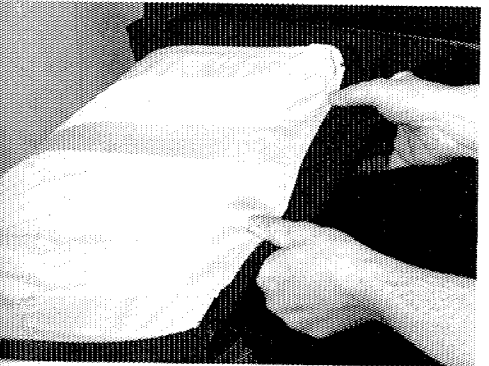

### INSTALL

#### 1. INSTALL BACKLITE ASSEMBLY TO NO.4 BOW.

- (a) From side of vehicle, insert backlite retainer into groove on rear of No. 4 bow.

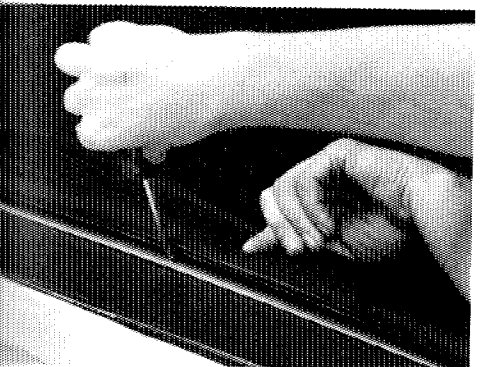

- (b) Align the "V" notch in the backlite material with the locking screw hole in the No. 4 bow; install locking screw.

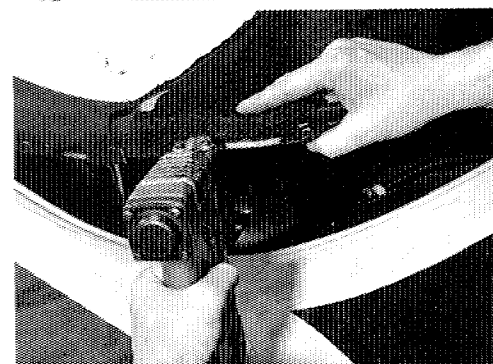
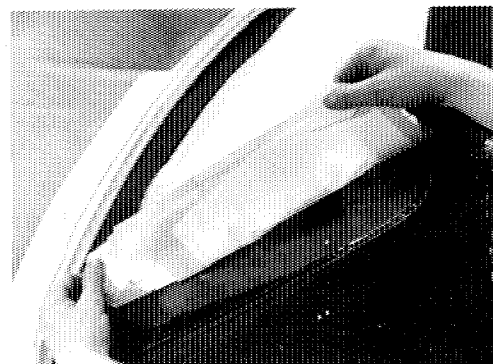
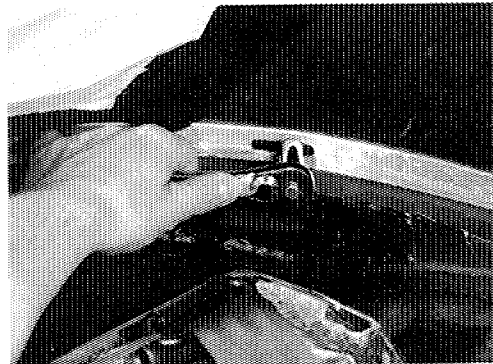
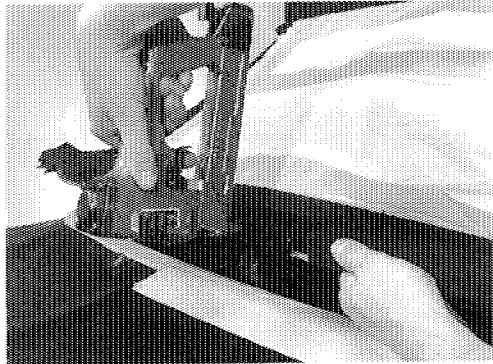
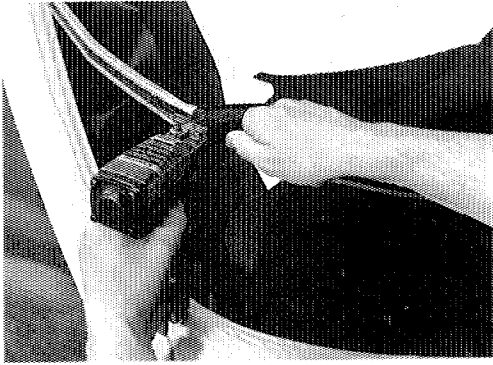

## BACKLITE ASSEMBLY (cont'd)

2. ALIGN BACKLITE ASSEMBLY TO TACK STRIP.
  - (a) Center backlite assembly to tack strip center mark.
  - (b) Align backlite tack strip reference line to tack strip upper edge.
3. SECURE BACKLITE ASSEMBLY TO TACK STRIP.
  - (a) Position both backlite support straps to reference marks on tack strip and secure using .31 x .31 monel staples.
  - (b) Secure backlite to tack strip starting from center, then working out using .31 x .31 monel staples. Keep backlite material taut while maintaining backlite-to-tack strip upper edge alignment.
4. CHECK BACKLITE INSTALLATION.
  - (a) Install tack strip to mounting studs by gently pulling in on tack strip ends while positioning on studs.
  - (b) Install seventeen (17) nuts to studs starting from center, than working out to tack strip ends. Do not torque nuts.
  - (c) Latch convertible top to windshield header.
  - (d) Remove protective covering from both sides of backlite window.
 

**NOTE: Backlite assembly should be taut and wrinkle free. Backlite window should be free of wrinkles or waves. If slight wrinkles or waves are present, (see Window Wrinkles or Waves in this chapter).**
  - (e) Re-install protective covering to both sides of backlite window.
5. INSTALL STAY PADS.
  - (a) Release convertible top from windshield header and remove tack strip from mounting studs.
  - (b) Position backlite stay pad to reference marks on tack strip and secure using .50 x .31 divergent point stainless steel staples.

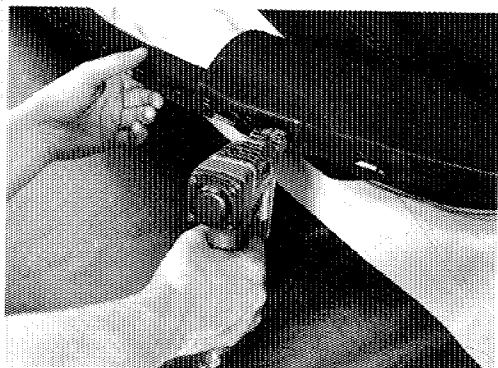

**BACKLITE ASSEMBLY (cont'd)****6. INSTALL TOP COVER SIDE PANELS TO TACK STRIP.**

- (a) Position side panel to tack strip and backlite reference marks.
- (b) Staple side panel to tack strip starting at backlite window opening using .31 x .31 monel staples. Keep material taut while maintaining top cover alignment to tack strip upper edge.

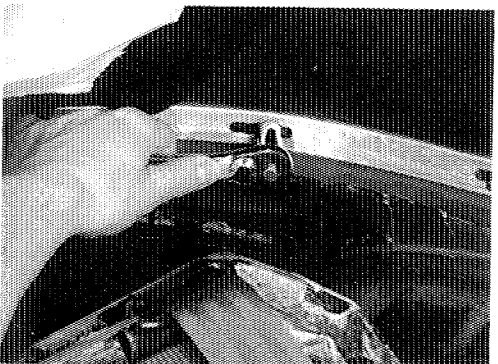
**7. INSTALL TACK STRIP TO REAR DRAIN TROUGH ASSEMBLY.**

- (a) Gently pull inward on tack strip ends while positioning tack strip on studs.
- (b) Install seventeen (17) nuts to tack strip studs starting from center and working out toward tack strip ends. Do not torque at this time.

**8. CHECK TOP COVER ASSEMBLY INSTALLATION**

- (a) Latch convertible top to windshield header.
- (b) Top cover should be taut and free of wrinkles around belt molding. If not, remove tack strip from drain trough and adjust top cover material as required.

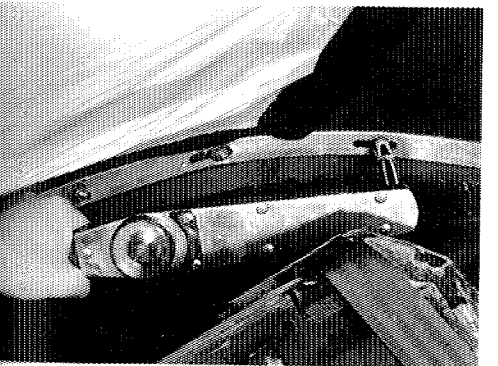
**9. TIGHTEN TACK STRIP NUTS.**

Tighten tack strip nuts starting at center, then working out toward tack strip ends.

**Torque: 8 N·m (71 in. lb.)**

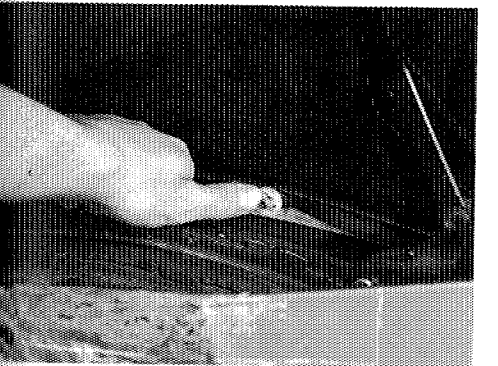
**10. INSTALL FOLDING TOP WELL ASSEMBLY.**

- (a) Install well plastic extrusion to tack strip studs and secure using seventeen (17) speed nuts.

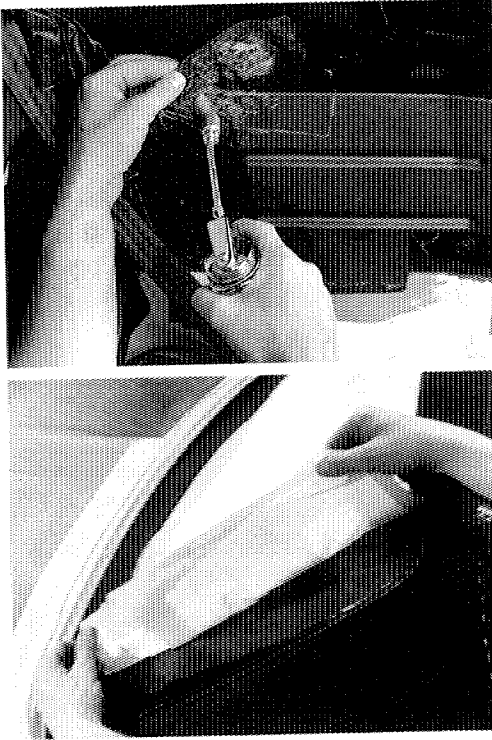

### BACKLITE ASSEMBLY (cont'd)

- (b) Apply adhesive (3M P/N 051135-08031) or equivalent, to body brace panels and well material.
- (c) Starting in center, align well material with pencil mark on body panels and install working toward ends.

12. INSTALL TWO (2) HEADLINER SAIL PANEL SCREWS TO TACK STRIP.
13. REMOVE PROTECTIVE COVERING FROM REAR BACKLITE.

14. LOWER AND RAISE TOP TWICE. CHECK FOR WAVES OR WRINKLES IN TOP COVER OR BACKLITE.

**NOTE: If wrinkles or waves are present in backlite window, (see Window Wrinkles or Waves in the chapter).**

**NOTE: For backlite window cleaning information (see Rear Window Appearance Care in General Information Chapter).**

15. INSTALL BOTH QUARTER TRIM PANELS (see 5-4).



# STAY PADS, SIDE AND BACKLITE

	page
STAY PAD COMPONENTS .....	13-2
TOP BOW ALIGNMENT TOOL .....	13-2
BACKLITE STAY PAD .....	13-3
SIDE STAY PAD .....	13-7

t, to  
on

O

CLITE.

OR

e  
in this

(see  
I

STAY PAD COMPONENTS

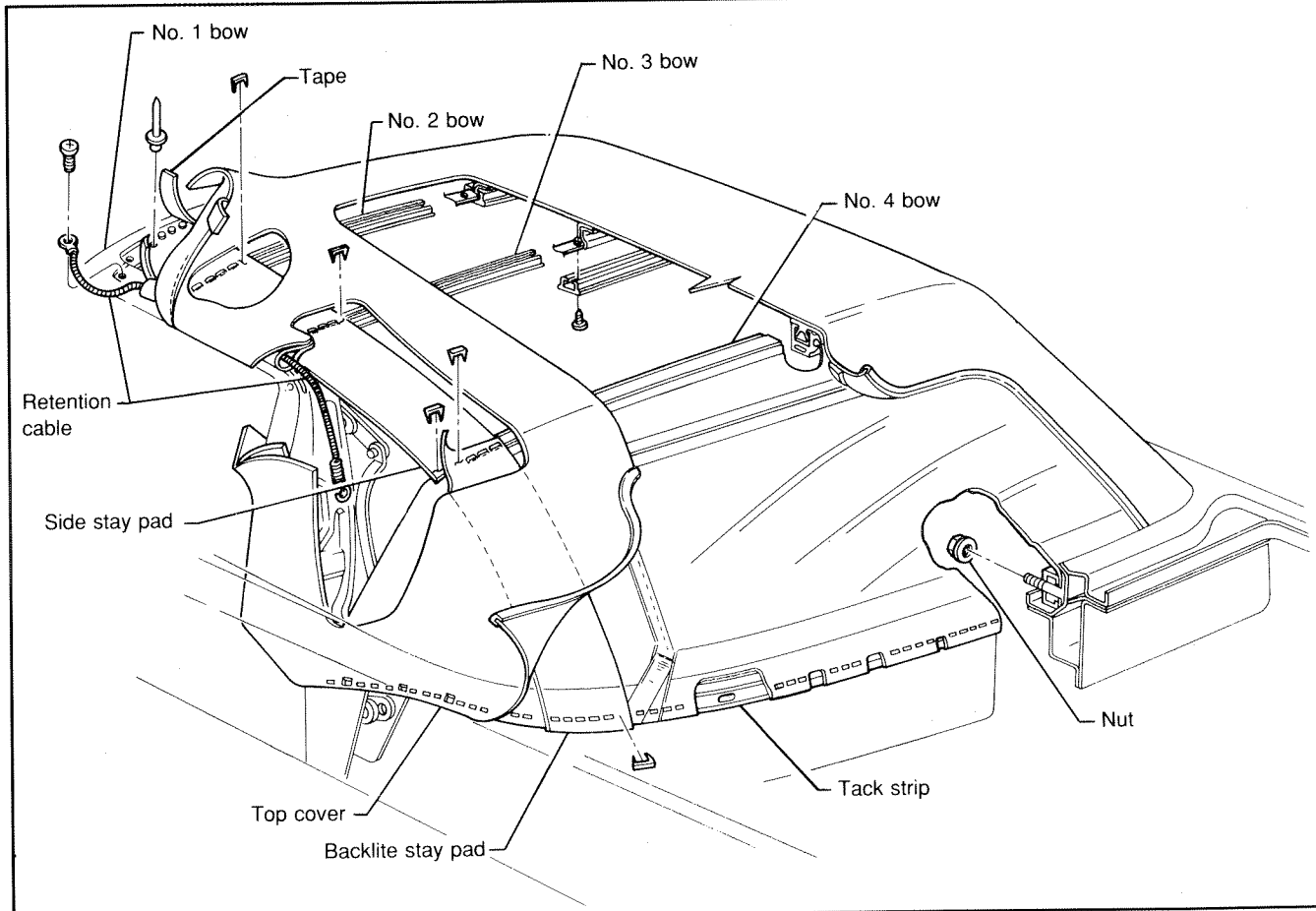

BOW ALIGNMENT TOOL

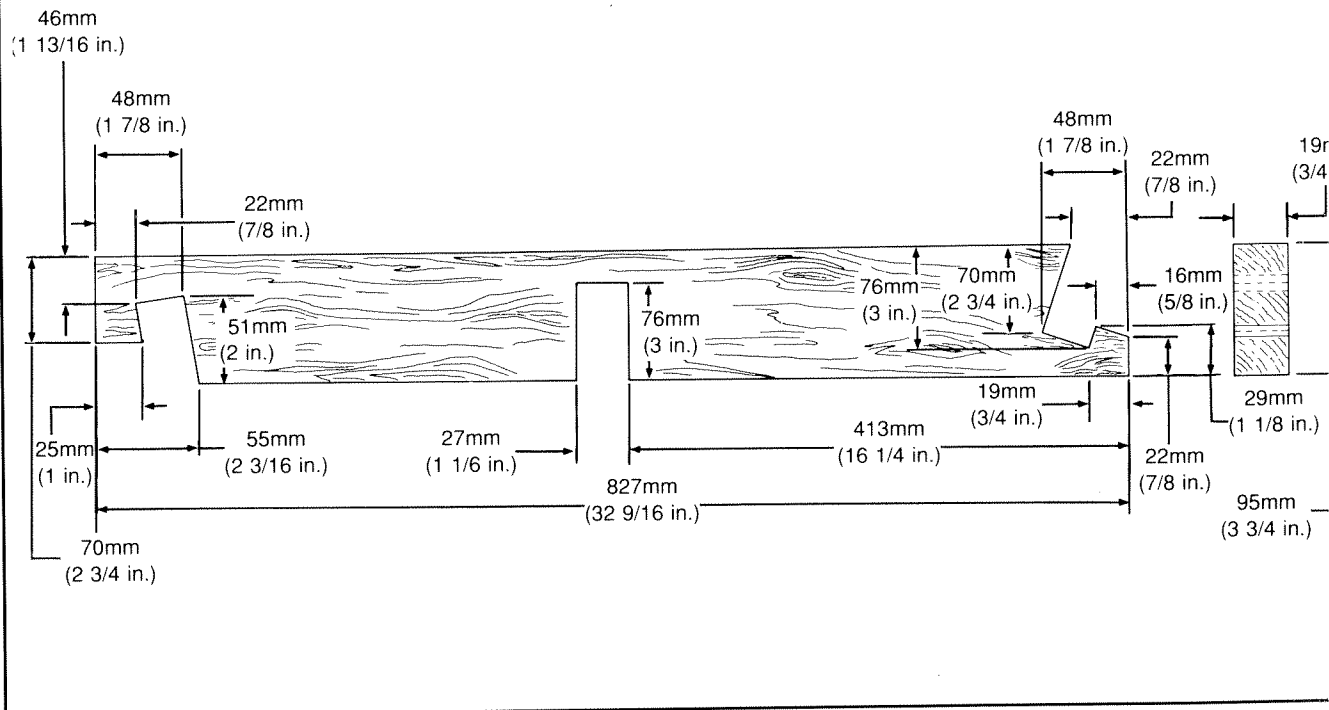

**BACKLITE STAY PAD****REMOVE**

**NOTE:** To help prevent damage, tape a protective cover to the belt moldings, trunk lid, quarter panels and both sides of backlite.

1. REMOVE BOTH QUARTER TRIM PANELS (see 5-3).
2. REMOVE TWO (2) HEADLINER SAIL PANEL SCREWS FROM TACK STRIP.
3. REMOVE FOLDING TOP WELL ASSEMBLY.
  - (a) Mark edge of folding top well material on body brace rear and side panels.
  - (b) Carefully break cement bond by pulling well material from body brace panels
  - (c) Remove retainers and plastic well extrusion from tack strip studs.
4. DISCONNECT TACK STRIP FROM REAR DRAIN TROUGH.
  - (a) Remove seventeen (17) nuts from tack strip.
  - (b) Pull the tack strip forward while gently pulling inward on tack strip ends.

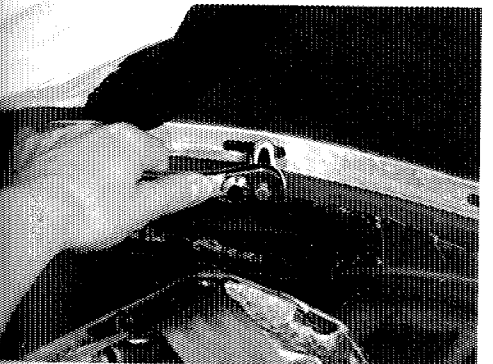
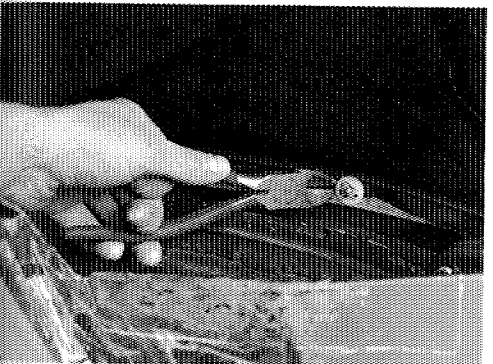
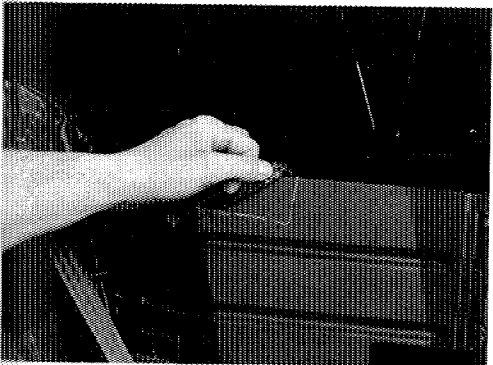
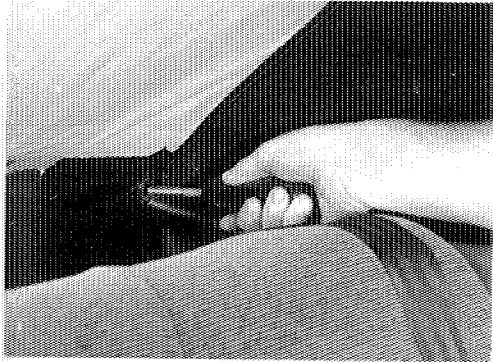

19mm  
(3/4 in.)

n  
in.)

1  
in.)

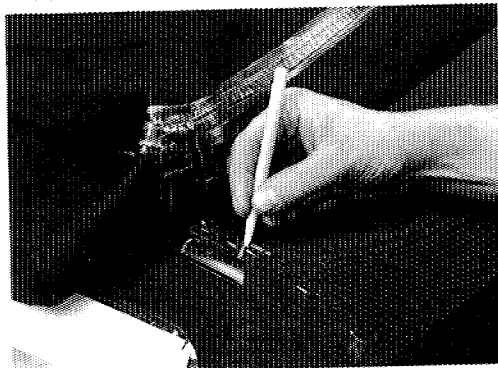
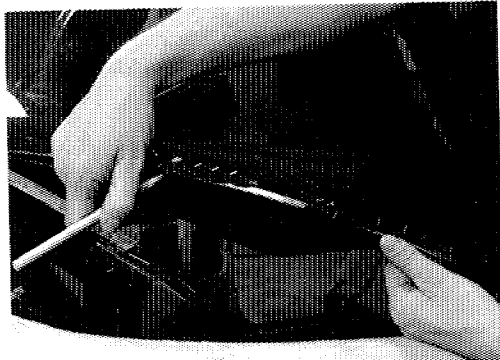
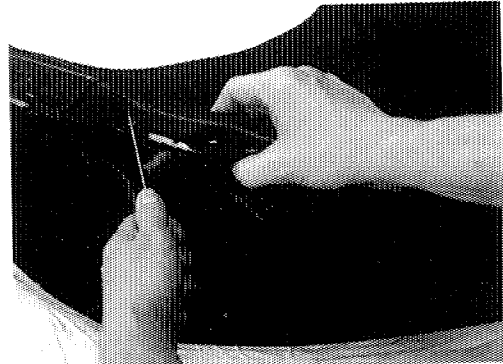
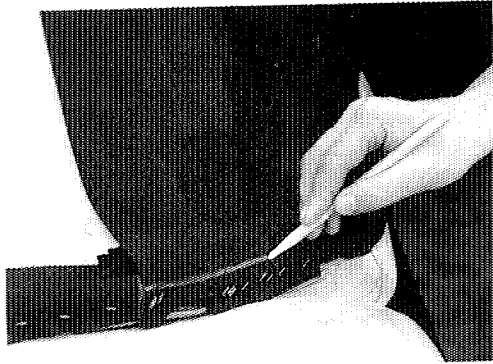

### BACKLITE STAY PAD (cont'd)

5. MARK TOP COVER LOCATION ON TACK STRIP AND BACKLITE.
  - (a) Mark tack strip upper edge on outside while holding top cover material tightly against tack strip.
  - (b) Mark location of top cover right and left window opening edges on backlite material.
6. REMOVE TOP COVER ASSEMBLY FROM TACK STRIP.  
Using a suitable tool, remove staples securing top cover to tack strip.
7. MARK BACKLITE STAY PAD MOUNTING POINTS.
  - (a) Mark stay pad location on tack strip.

- (b) Mark stay pad location to No. 4 bow.

**NOTE: If both backlite stay pads are to be removed, label RIGHT and LEFT stay pad.**



### BACKLITE STAY PAD (cont'd)

8. REMOVE BACKLITE STAY PAD.
  - (a) Using an awl, remove backlite stay pad staples from No. 4 bow.
  - (b) Remove stay pad staples from tack strip and stay pad from vehicle.

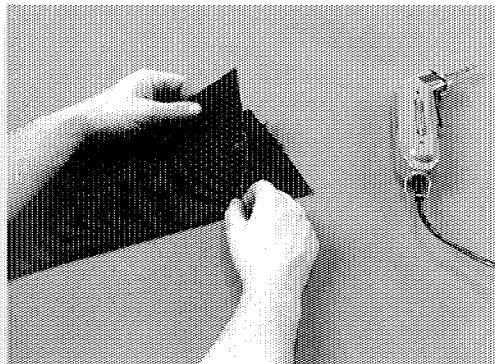

### NEW BACKLITE STAY PAD PREPARATION

**NOTE:** Backlite stay pads are available pre-cut or can be made from bulk material. If bulk backlite stay pad material is to be used, follow New Side Stay Pad Preparation procedures.

1. WHEN INSTALLING NEW STAY PAD, USE THE FOLLOWING PROCEDURE.
  - (a) On a flat work surface, place REMOVED stay pad over NEW stay pad material aligning ends of both stay pads.
  - (b) Cut NEW material to equal length of REMOVED stay pad using a "hot" knife or other type of hot-cutting device.

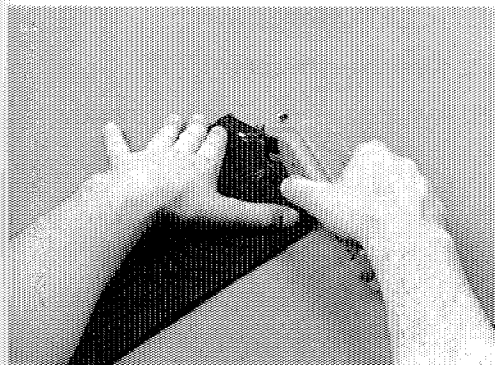

**NOTE:** Do not use scissors or saw blade to cut stay pad material. They will fray stay pad material fibers.

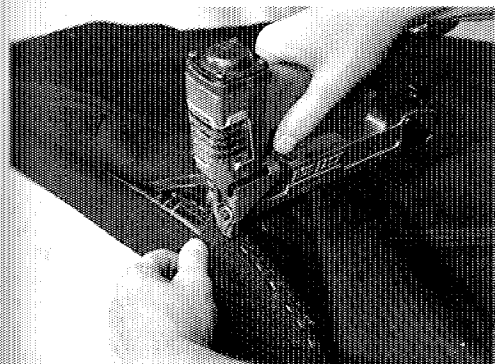

### INSTALL

1. INSTALL BACKLITE STAY PAD.
  - (a) Position stay pad to No. 4 bow reference marks and staple in place using .50 x .31 divergent point stainless steel staples.
  - (b) Position stay pad to tack strip reference marks and staple in place using .50 x .31 divergent point stainless steel staples.

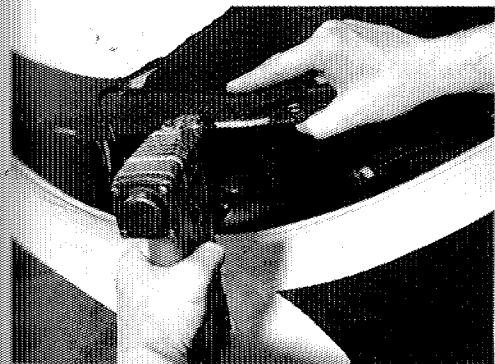

**NOTE:** Keep material flat and avoid stretching.

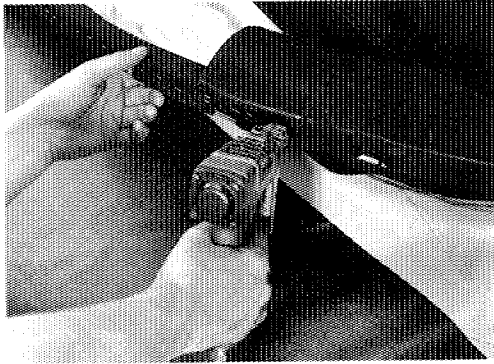
**BACKLITE STAY PAD (cont'd)**

2. INSTALL TOP COVER ASSEMBLY TO TACK STRIP.
  - (a) Position top cover to tack strip and backlite reference marks.
  - (b) Starting at rear window opening, use .31 x .31 monel staples on single layers and .50 x .31 divergent point stainless steel staples on multiple layers.

**NOTE: Keep material taut while maintaining top cover alignment to tack strip upper edge.**

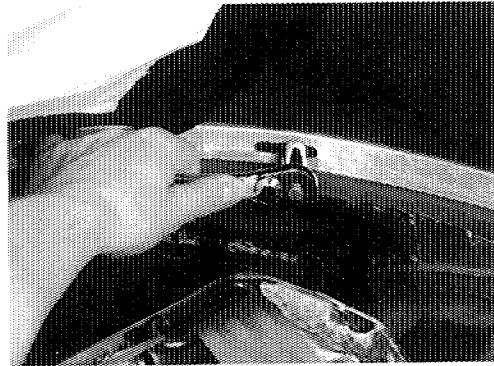

3. INSTALL TACK STRIP TO REAR DRAIN TROUGH ASSEMBLY.
  - (a) Gently pull inward on tack strip ends while positioning tack strip to studs.
  - (b) Install seventeen (17) nuts to tack strip studs. Do not torque nuts at this time.

4. CHECK TOP COVER INSTALLATION.
  - (a) Raise top and latch to windshield header.
  - (b) Insure top is taut and free of wrinkles along belt molding.

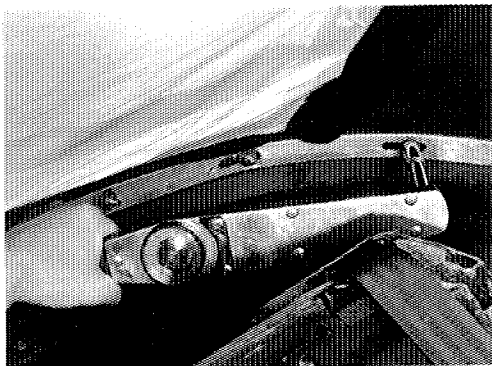

5. TIGHTEN SEVENTEEN (17) TACK STRIP NUTS.
 

Tighten tack strip nuts starting in center, then working out toward ends.

**Torque: 8 N·m (71 in. lb.)**

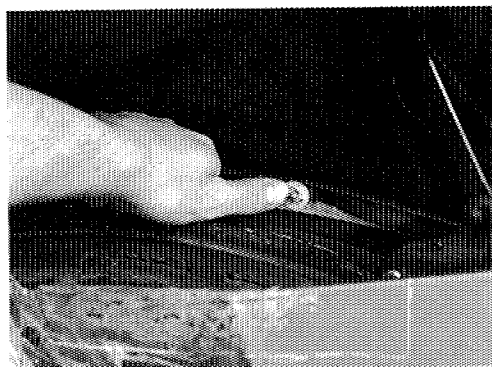

6. INSTALL FOLDING TOP WELL ASSEMBLY.
  - (a) Install well plastic extrusion to tack strip studs and secure using retainers.

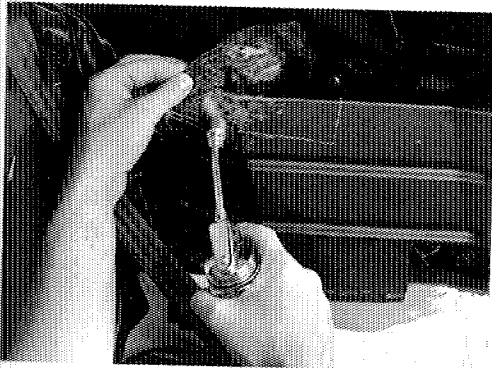

**BACKLITE STAY PAD (cont'd)**

- (b) Apply adhesive (3M P/N 051135-08031 or equivalent) to body brace panels and well material.
- (c) Starting at center, position well material to body panels working out toward ends.

over

tack

orque

ing.

oward

sure

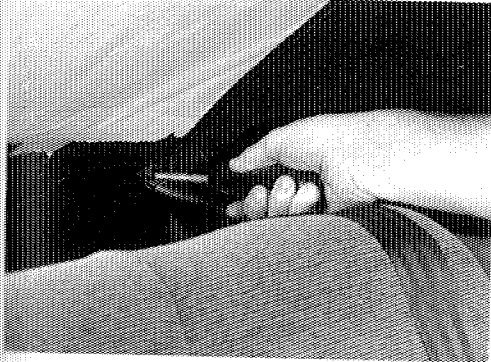

- 7. INSTALL HEADLINER SAIL PANEL.  
Secure sail panels to tack strip using two (2) screws.
- 8. INSTALL BOTH QUARTER TRIM PANELS (see 5-4).

**SIDE STAY PAD**

**REMOVE**

The side stay pads can be replaced separately without completely removing the top cover assembly.

**NOTE: Cover backlite window, belt moldings, trunk lid and quarter panels with protective covers.**

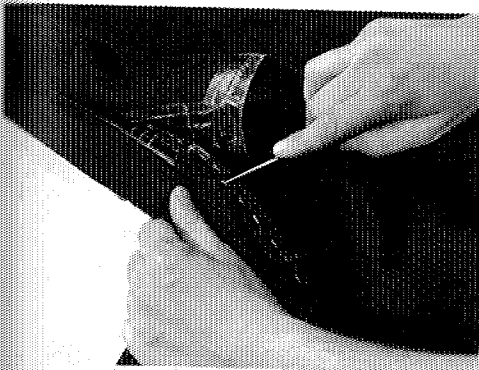

- 1. REMOVE TOP COVER FROM TACK STRIP AND REAR RAIL SEAL CARRIER (see 11-3).
- 2. DISCONNECT BACKLITE STAY PAD FROM NO. 4 BOW.
  - (a) Mark backlite stay pad location on No. 4 bow.
  - (b) Using a suitable tool, remove staples securing stay pad to No.4 bow.
- 3. REMOVE FRONT RAIL WEATHERSTRIP AND RETAINER FROM SIDE TO BE SERVICED (see 3-13).
- 4. REMOVE TOP COVER ASSEMBLY FROM NO. 1 BOW (see 11-3).

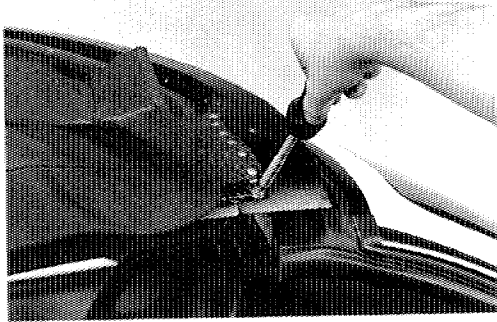

**SIDE STAY PAD (cont'd)**

5. REMOVE RETENTION CABLE SCREW FROM NO. 1 BOW.

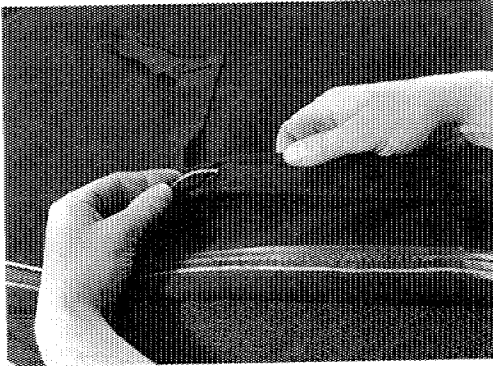

6. POSITION TOP COVER ASSEMBLY TO ACCESS SIDE STAY PAD.

- (a) Fold top cover lengthwise toward center of vehicle.
- (b) While folding top material, pull retention cable from top cover assembly pocket.

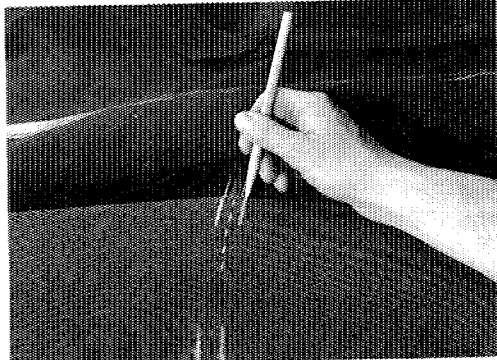

7. MARK SIDE STAY PAD MOUNTING POINTS.

- (a) Mark side stay pad location to each bow.
- (b) Mark bow location to side stay pad.

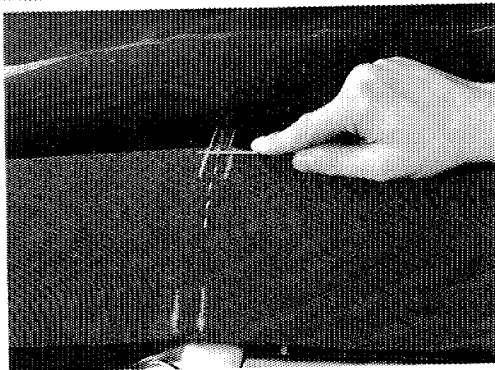

8. REMOVE SIDE STAY PAD.

- (a) Using an awl, remove staples securing stay pad to No. 2 and 4 bows.



- (b) Remove tape cover from rivets.
- (c) Using a drill with a 3.2mm (1/8 in.) bit, remove stay pad rivets from No. 1 bow and stay pad from vehicle.

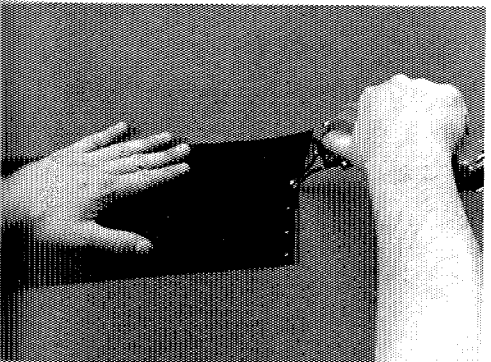
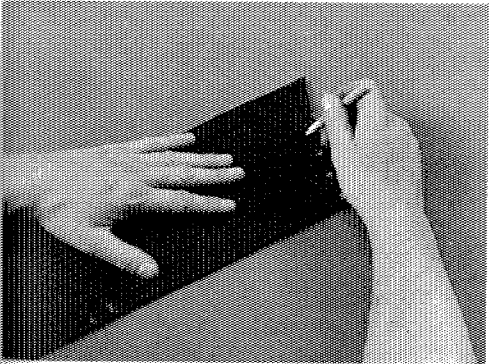
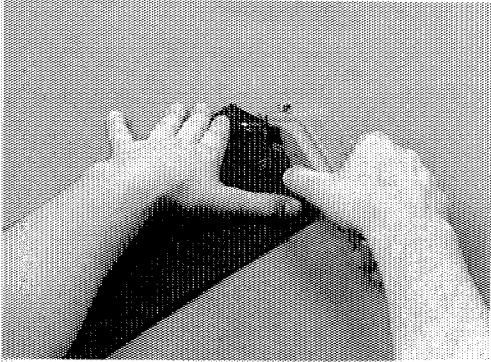
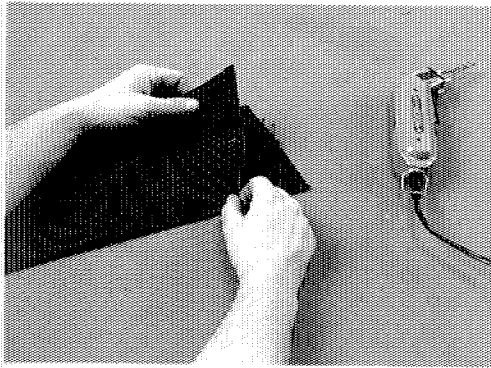

## SIDE STAY PAD (cont'd)

### NEW SIDE STAY PAD PREPARATION

**NOTE:** Side stay pads are available pre-cut or can be made from bulk material. If bulk stay pad material is to be used, follow New Side Stay Pad Preparation procedures.

#### 1. MATCH-MARK AND CUT NEW SIDE STAY PAD.

- (a) On a flat work surface, place REMOVED stay pad over NEW stay pad material aligning ends of both stay pads.
- (b) Cut NEW material to equal the length of REMOVED stay pad using a "hot" knife or other type of hot-cutting device.

**NOTE:** Do not use scissors or saw blade to cut stay pad material. They will fray stay pad material fibers.

#### 2. PIERCE SIDE STAY PAD RIVET HOLES.

- (a) Transfer reference marks to new stay pad. Include location of rivets.
- (b) Using a soldering gun equipped with a "pencil" tip, melt holes into stay pad material at rivet locations. Holes should be 3.2 mm (1/8 in.) dia.

**NOTE:** Do not drill rivet holes into stay pad material. Drilling will fray stay pad fibers.

)W.

STAY

op

No. 2, 3

y pad

## SIDE STAY PAD (cont'd)

## INSTALL

Alignment of No 2, 3, and 4 bows must be maintained during stay pad installation. Use the dimensions provided in the illustration on page 13-2 to fabricate a top bow alignment tool. If both side stay pads are removed, it may be necessary to fabricate two (2) top bow alignment tools.

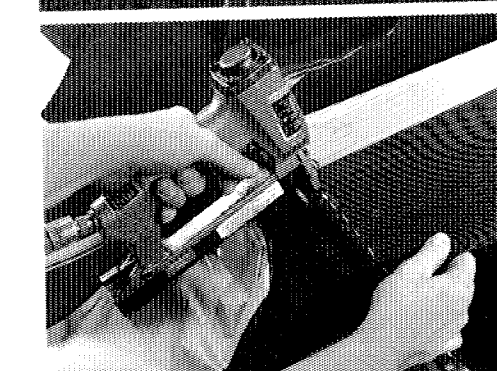
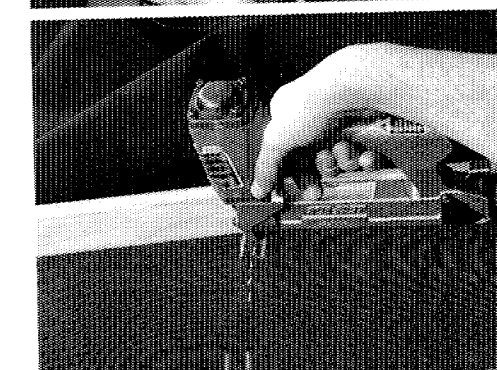
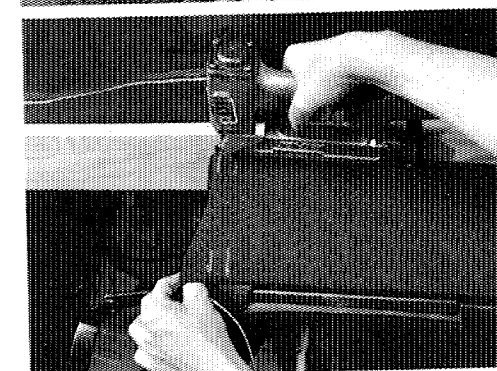
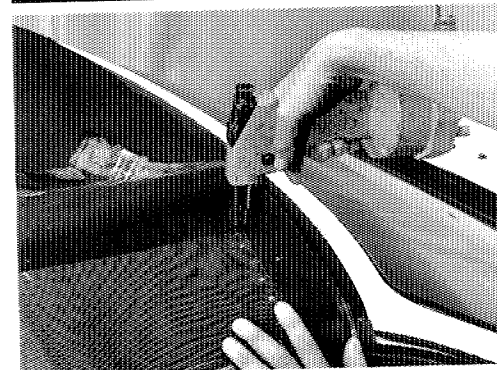
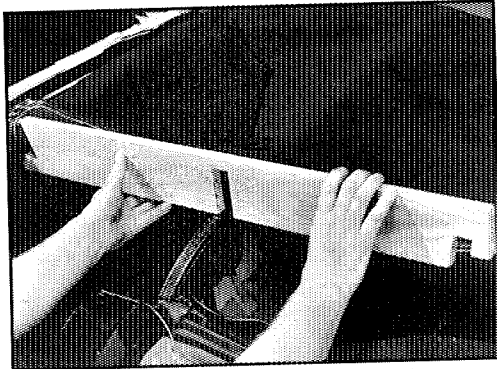

1. INSTALL SIDE STAY PAD TO NO. 1 BOW.

- (a) Secure stay pad to No. 1 bow using five (5) 1/8 x .187 aluminum large flange rivets.
- (b) Install tape cover over rivets.

2. POSITION TOP BOW ALIGNMENT TOOL.

Place tool over No. 2 and 3 bows and under No. 4 bow.

3. INSTALL SIDE STAY PAD TO NO. 2 AND 3 BOW ASSEMBLIES.

Position stay pad to No. 2 and 3 bow reference marks and secure using .50 x .31 stainless steel heavy-duty staples.

**NOTE: Keep material flat and avoid stretching.**

4. INSTALL SIDE STAY PAD TO NO. 4 BOW ASSEMBLY.

Position stay pad to No. 4 bow reference marks and secure using .50 x .31 stainless steel heavy-duty staples.

**NOTE: Keep material flat and avoid stretching.**

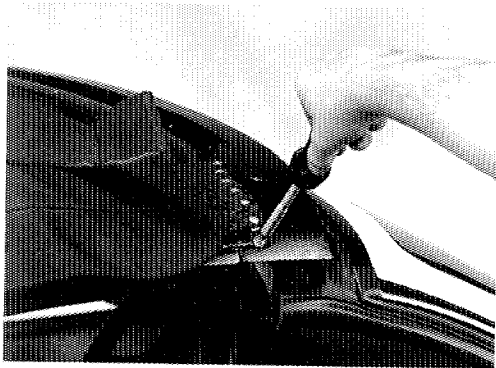
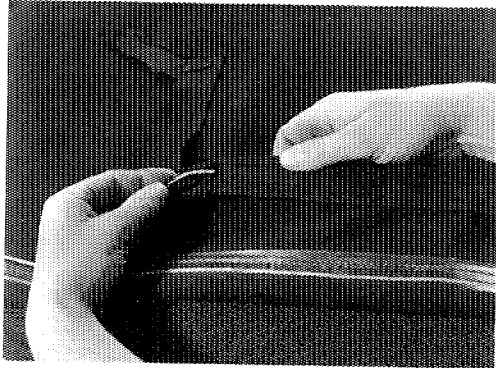
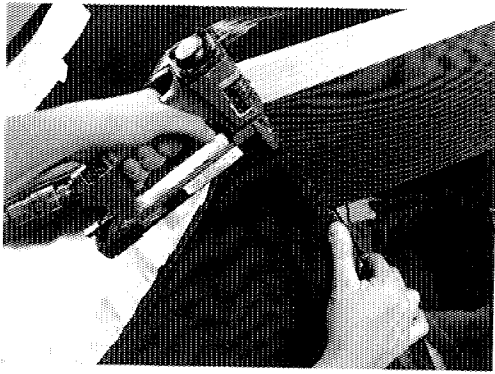

### SIDE STAY PAD (cont'd)

5. INSTALL BACKLITE STAY PAD.

Position stay pad to No. 4 bow reference marks and secure using .50 x .31 stainless steel staples.

6. POSITION TOP COVER ASSEMBLY TO TOP BOWS.

(a) Remove top bow alignment tool from vehicle.

(b) Install retention cable to top cover assembly pocket.

**NOTE: Use of a stiff wire will aid installation of retention cable.**

(c) Fold top cover material over top bows.

7. INSTALL RETENTION CABLE SCREW.

8. INSTALL TOP COVER ASSEMBLY TO NO. 1 BOW (see 11-9).

9. INSTALL FRONT RAIL WEATHERSTRIP AND RETAINER (see 3-15).

10. INSTALL TOP COVER TO TACK STRIP AND REAR RAIL SEAL CARRIER (see 11-7).

11. CYCLE CONVERTIBLE TOP UP AND DOWN TWO TIMES TO CHECK OPERATION.

(a) Top stack operation should be smooth and consistent.

(b) Inspect appearance and fit of top cover.

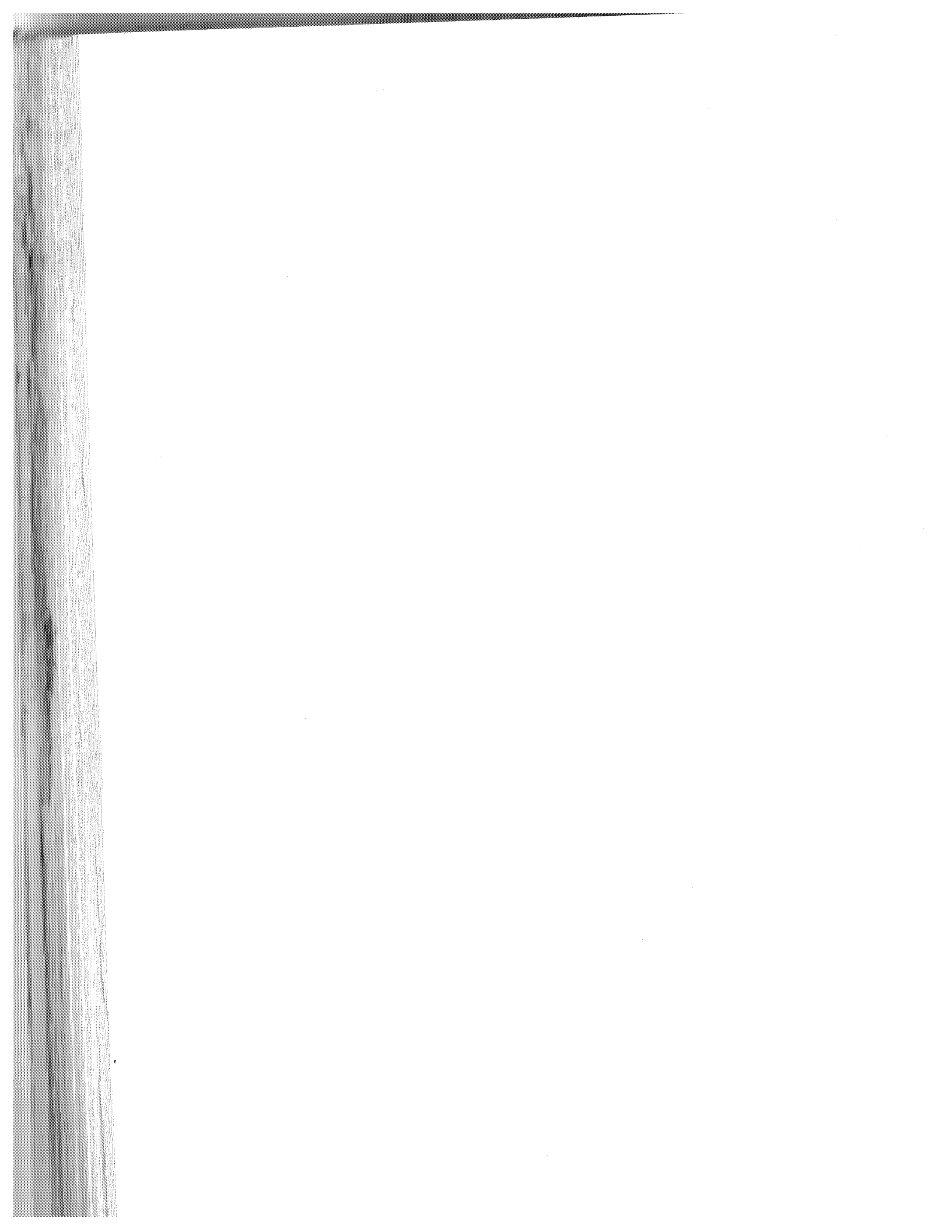

# NO. 1 BOW

	page
NO. 1 BOW COMPONENTS .....	14-2
ADJUSTMENT, CLAMP LATCH .....	14-3
CLAMP ASSEMBLY .....	14-4
NO. 1 BOW .....	14-7

NO. 1 BOW COMPONENTS

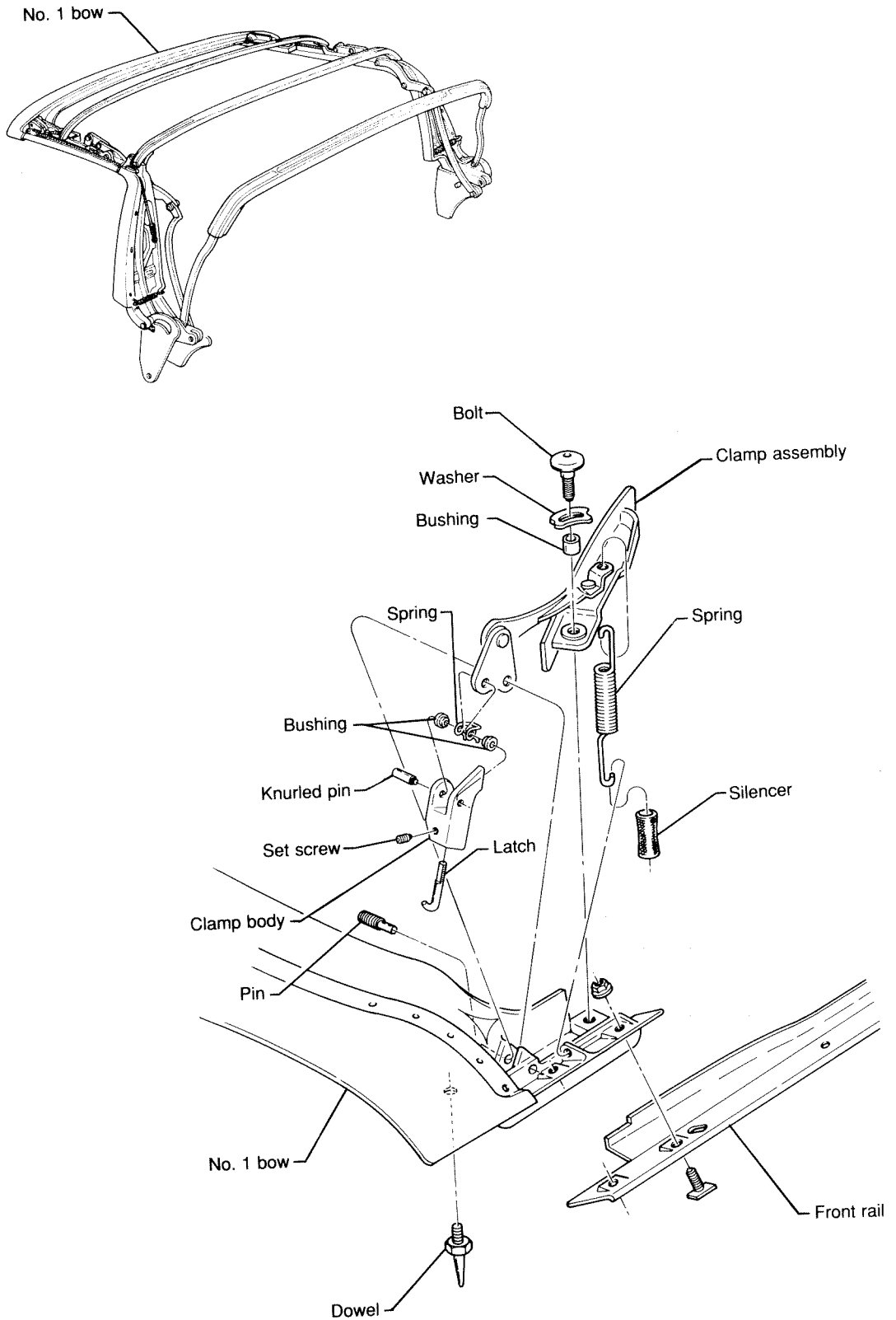



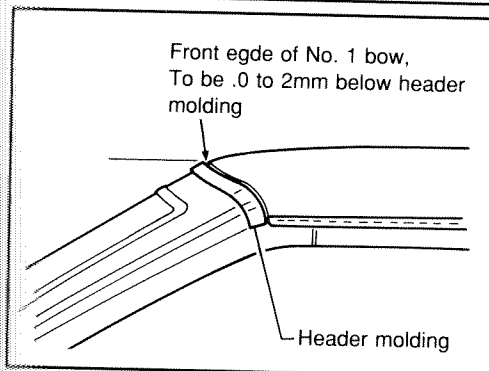
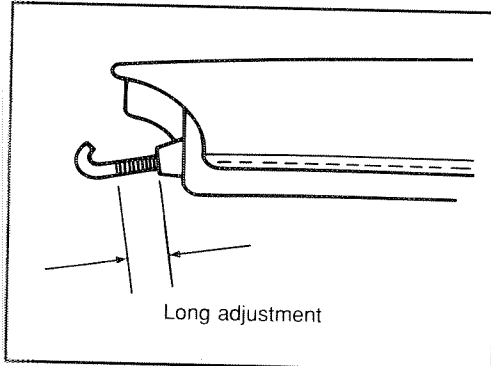
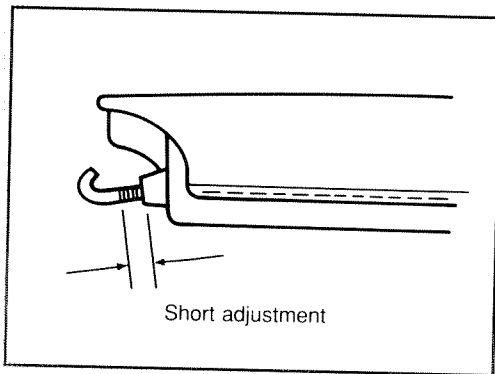

## ADJUSTMENT, CLAMP LATCH

Adjustment of the clamp latch determines the sealing quality of the No. 1 bow to the windshield header and latching or releasing effort of the clamp mechanism.

A "long" clamp latch adjustment can be identified by low latching effort or the No. 1 bow setting too high off the windshield header. This condition can cause wind noise and water leaks.

A "short" clamp latch adjustment will cause excessively high latching effort and No. 1 bow to "sink" below the windshield header when latched. This condition may cause weatherstrip damage or clamp latch failure.

Use the following procedure to adjust the clamp latch.

**NOTE: If for any reason a clamp latch is in need of adjustment, both sides of the vehicle should be checked and, if necessary, adjusted.**

1. Raise convertible top and secure to windshield header.
  - (a) Note latch operation and latching effort.
  - (b) Latching effort should be equal on both sides.
2. Check No. 1 bow-to-header fit.
  - (a) No. 1 bow should be flush to 2mm below windshield header trim.
  - (b) Check other side of vehicle.
3. Adjust clamp latch.
  - (a) Raise convertible top off windshield header.
  - (b) Loosen clamp latch set screw.
  - (c) Turn clamp latch in desired direction.

**NOTE: Clamp latch curve (hook) must face forward.**

  - (d) Raise convertible top and check clamp latch adjustment.
  - (e) Lower convertible top and tighten clamp latch set screw.

**Torque: 10 N·m (88 in. lb.)**

  - (f) Repeat on other side of vehicle.

**CLAMP ASSEMBLY****REMOVE**

1. RAISE CONVERTIBLE TOP HALFWAY.
2. REMOVE CLAMP ASSEMBLY SPRING, SCREW AND WASHER.
3. REMOVE CLAMP ASSEMBLY FROM NO. 1 BOW.
  - (a) Remove clamp assembly pivot pin.

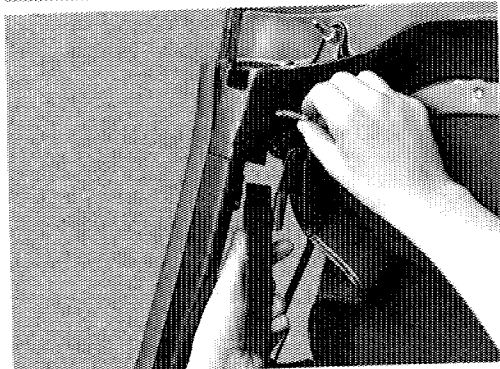
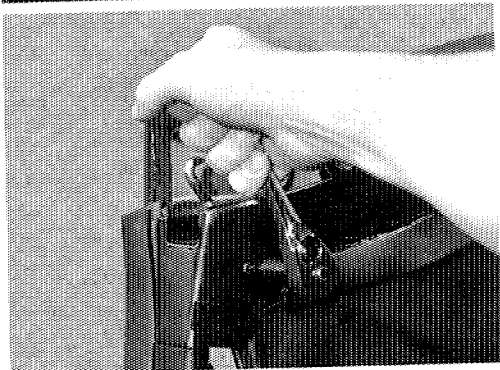
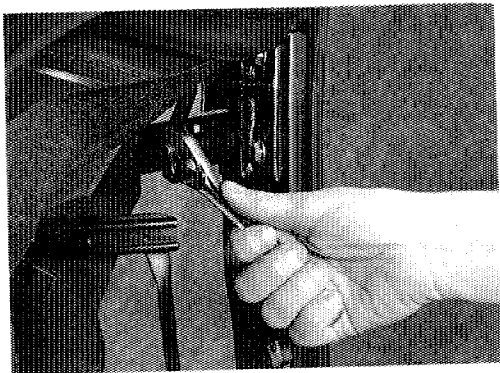

- (b) Remove handle assembly from vehicle.

**DISASSEMBLE**

1. REMOVE CLAMP LATCH.
  - (a) Remove clamp latch set screw.
  - (b) Measure and record length of latch.
  - (c) Remove clamp latch from clamp body.

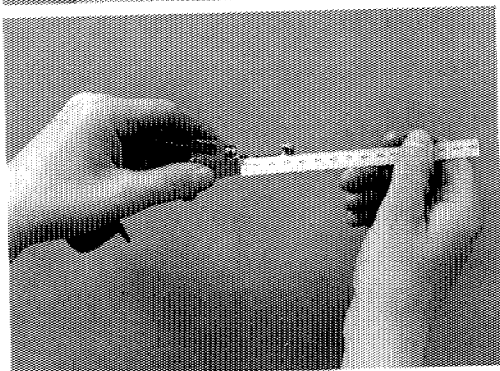
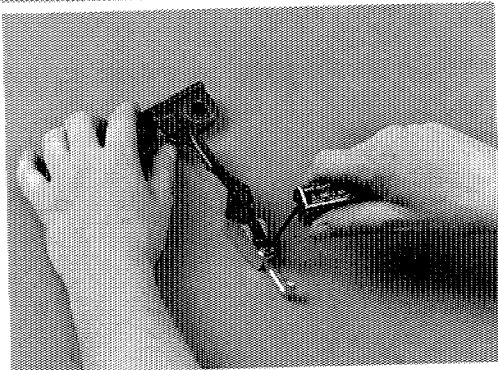

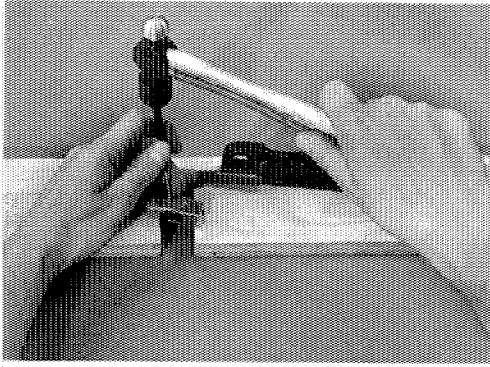
**CLAMP ASSEMBLY (cont'd)**

2. REMOVE CLAMP BODY.
  - (a) Using a 3mm punch, remove knurled pin from clamp body.
  - (b) Remove torsion spring and two (2) bushings.

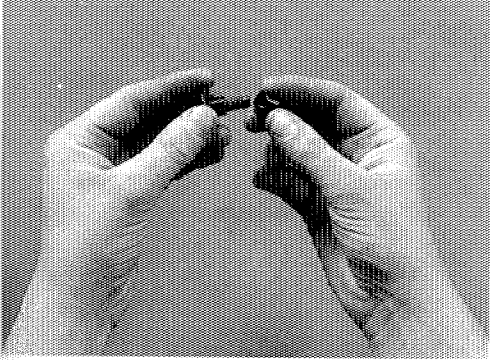

3. REMOVE BUSHING FROM CLAMP ASSEMBLY SCREW.

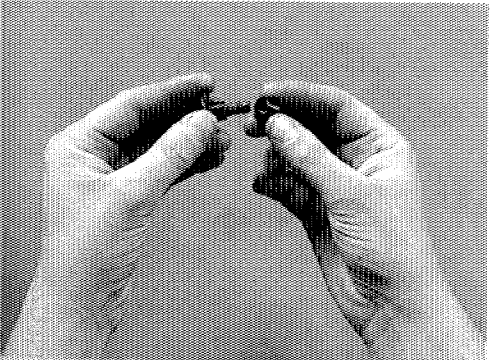
**ASSEMBLE**

1. INSTALL BUSHING TO CLAMP ASSEMBLY SCREW.

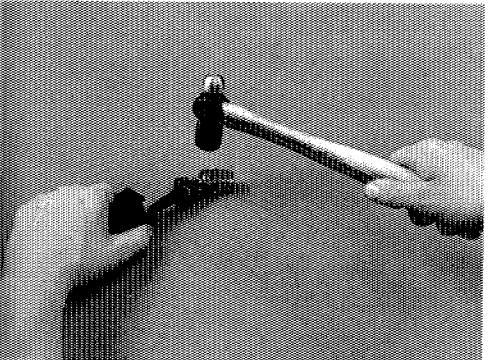

2. INSTALL CLAMP BODY.
  - (a) Position torsion spring, two (2) bushings and clamp body to clamp assembly pivot.

**NOTE: Position spring ends into two (2) holes provided in clamp body**

- (b) Press knurled pin into clamp body.

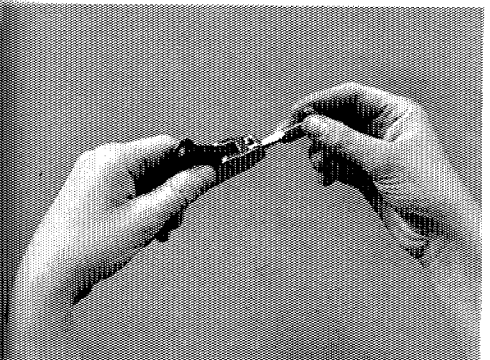

3. INSTALL CLAMP LATCH.

Thread clamp latch into clamp body to "measured length" when removed.

**NOTE: Clamp latch curve (hook) must face forward when latch is installed.**

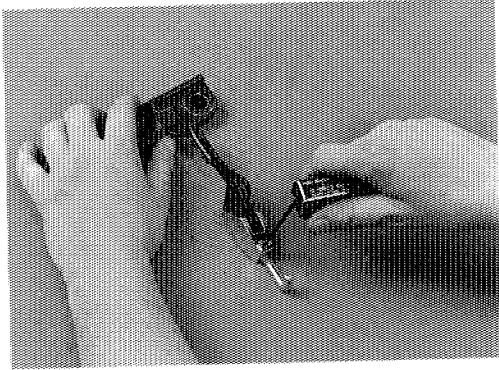

### CLAMP ASSEMBLY (cont'd)

4. INSTALL CLAMP LATCH SET SCREW. DO NOT TORQUE SET SCREW AT THIS TIME.



#### INSTALL

1. INSTALL CLAMP ASSEMBLY TO NO. 1 BOW.
  - (a) Position clamp assembly to No. 1 bow.
  - (b) Apply Loctite (P/N 271 or equivalent) to pin threads.
  - (c) Install pivot pin to No. 1 bow and clamp pivot.
  - (d) Tighten clamp assembly pivot pin.

**Torque: 22 N·m (16 ft. lb.)**

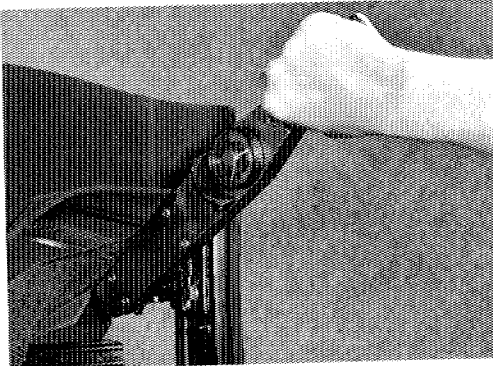

2. INSTALL CLAMP HANDLE ASSEMBLY.
  - (a) Apply Loctite (P/N 271 or equivalent) to screw threads.
  - (b) Position clamp handle to No. 1 bow and install washer and screw.

**Torque: 17 N·m (13 ft. lb.)**

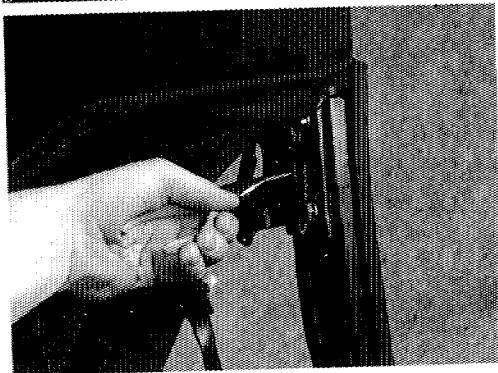

3. CONNECT SPRING WITH SILENCER TO NO. 1 BOW AND CLAMP ASSEMBLY.
4. CHECK CLAMP ASSEMBLY OPERATION, (see Adjustment in this chapter).

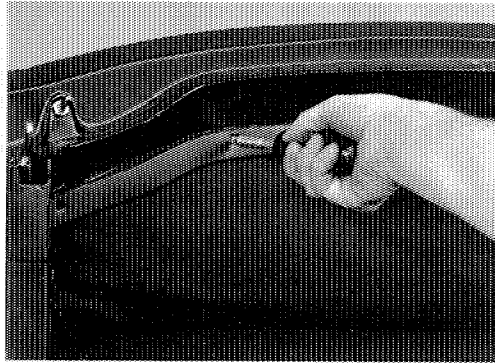
**NO. 1 BOW****REMOVE**

1. LOWER CONVERTIBLE TOP HALFWAY.
2. REMOVE HEADLINER FROM NO. 1 BOW
  - (a) Remove seven (7) screws and headliner molding.
  - (b) Carefully break cement bond by pulling material away from No. 1 bow.

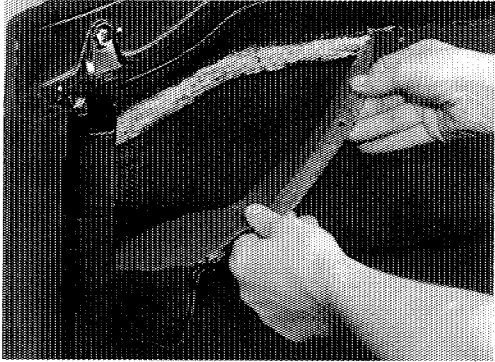

3. REMOVE TOP COVER FROM NO.1 BOW, (see 11-3).
4. DISCONNECT BOTH SIDE STAY PADS FROM NO.1 BOW.
  - (a) Remove tape cover from rivets.
  - (b) Using a drill with a 3.2mm (1/8 in.) bit, remove stay pad rivets from No.1 bow.

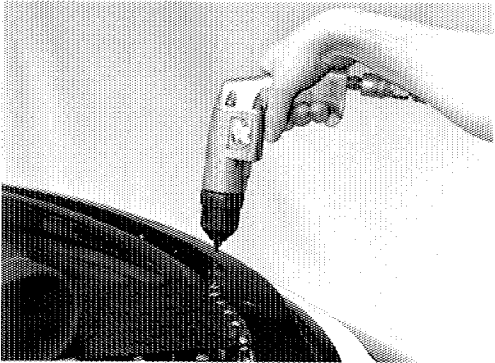

5. REMOVE NO.1 BOW.

Remove four (4) nuts and bolts securing No.1 bow to the right and left front rail assemblies.

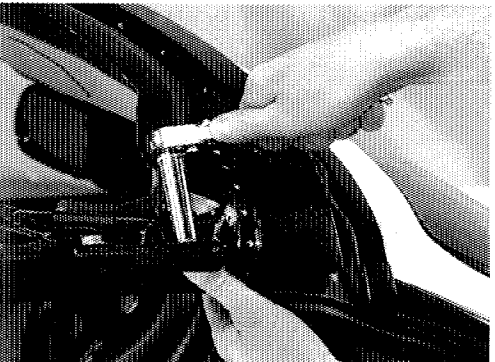
**DISASSEMBLE**

1. REMOVE TWO (2) DOWELS FROM NO. 1 BOW.





## NO. 1 BOW (cont'd)

2. REMOVE CLAP ASSEMBLY PIVOT PIN.

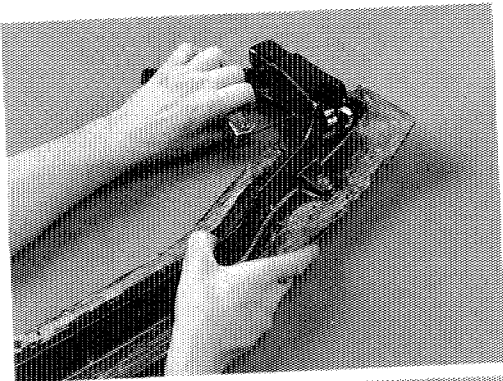

3. REMOVE CLAMP ASSEMBLY SPRING.

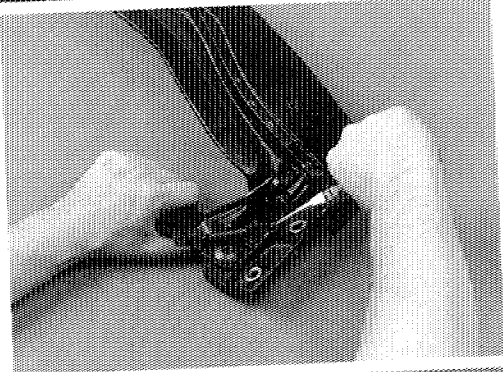

4. REMOVE CLAMP HANDLE ASSEMBLY SCREW AND WASHER.

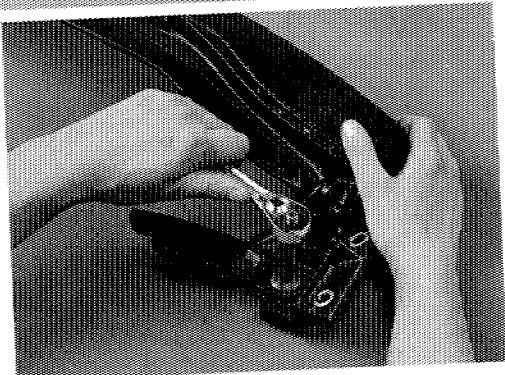

5. REMOVE CLAMP ASSEMBLY FROM NO. 1 BOW

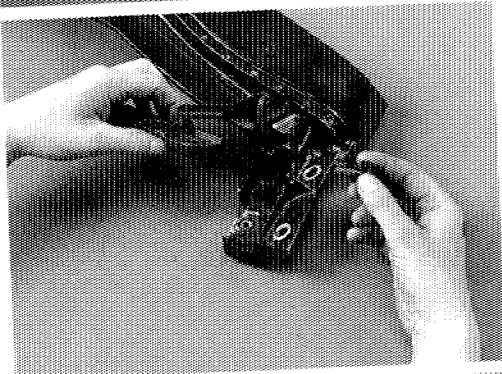

## ASSEMBLE

1. INSTALL CLAMP ASSEMBLY TO NO. 1 BOW.

(a) Position clamp assembly into No. 1 bow.

(b) Apply Loctite (P/N 271 or equivalent) to clamp handle screw threads and install washer and screw.

**Torque: 17 N·m (13 ft. lb.)**

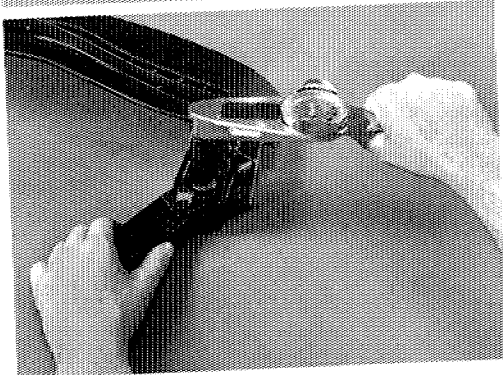

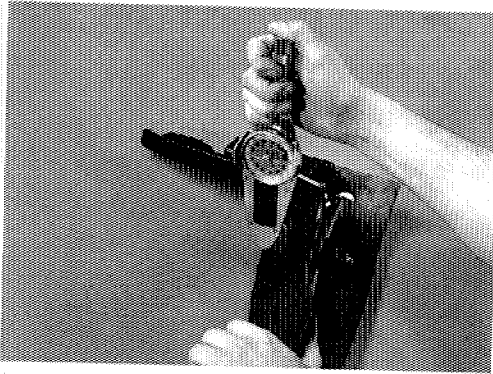
**NO. 1 BOW (cont'd)**

2. INSTALL CLAMP ASSEMBLY PIVOT PIN.

Apply Loctite (P/N 271 or equivalent) to pivot pin threads and install pivot pin.

**Torque: 22 N·m (16 ft. lb)**



3. INSTALL CLAMP ASSEMBLY SPRING.

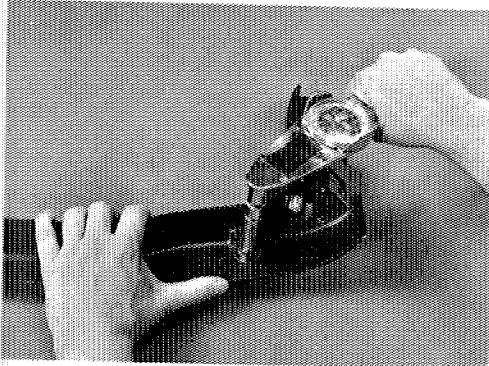

4. INSTALL TWO (2) DOWELS TO NO. 1 BOW.

Apply Loctite (P/N 271 or equivalent) to dowel threads and install dowels.

**Torque: 17 N·m (13 ft. lb)**

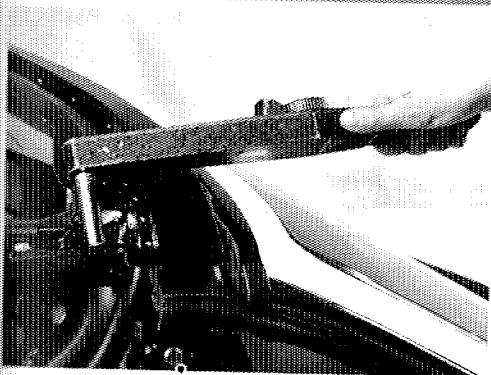
**INSTALL**

1. INSTALL NO.1 BOW

- (a) Position No.1 bow to right and left side rails.
- (b) Apply Loctite (P/N 271 or equivalent) to bolt threads and install (4) bolts and nuts.

**Torque : 23 N·m (17 ft. lb.)**

2. CONNECT BOTH SIDS STAY PADS TO NO.1 BOW.

- (a) Position No.1 bow to windshield header. Do not latch.
- (b) Secure stay pads to No.1 bow using six (6) 1/8 x .187 aluminum large flange rivets per side.
- (c) Install tape cover to rivets.

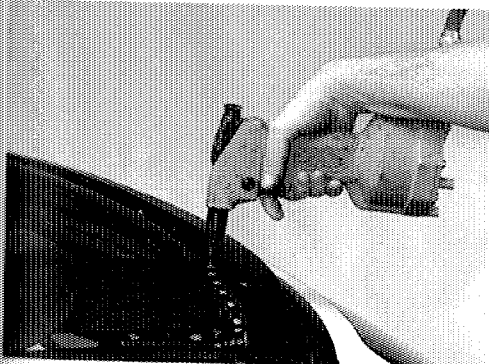



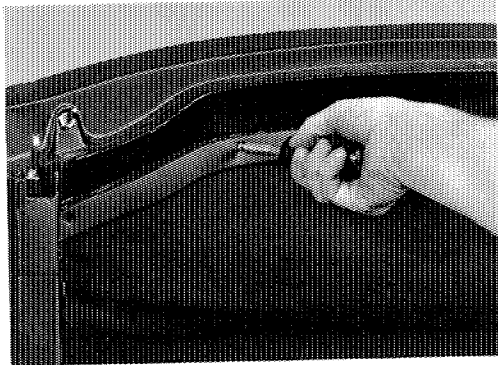
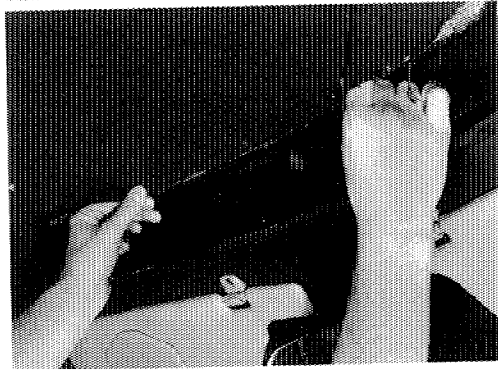
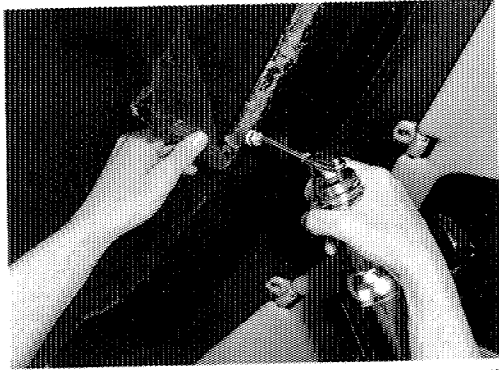

### NO. 1 BOW (cont'd)

3. INSTALL TOP COVER TO NO.1 BOW, (see 11-9).
4. INSTALL HEADLINER TO NO.1 BOW.
  - (a) Latch No.1 Bow to windshield header.
  - (b) Apply adhesive (3M P/N 051135-08031 or equivalent) to headliner area of No.1 bow and headliner material.
  - (c) Starting at center attach headliner material to No. 1 bow.

**NOTE: To prevent wrinkles pull forward on headliner while attaching to No.1 bow.**

5. INSTALL HEADLINER MOLDING.
 

Using seven (7) screws, secure molding to No. 1 bow.
6. LOWER AND RAISE TOP TWICE AND CHECK TOP STACK OPERATION.
  - (a) Top stack operation should be smooth and consistent.
  - (b) Check No.1 bow alignment with windshield header.
  - (c) Check top stack latch alignment and operation.

# NO. 2 BOW

	page
NO. 2 BOW COMPONENTS .....	15-2
NO. 2 BOW .....	15-3

it)  
il.

NO. 2 BOW COMPONENTS

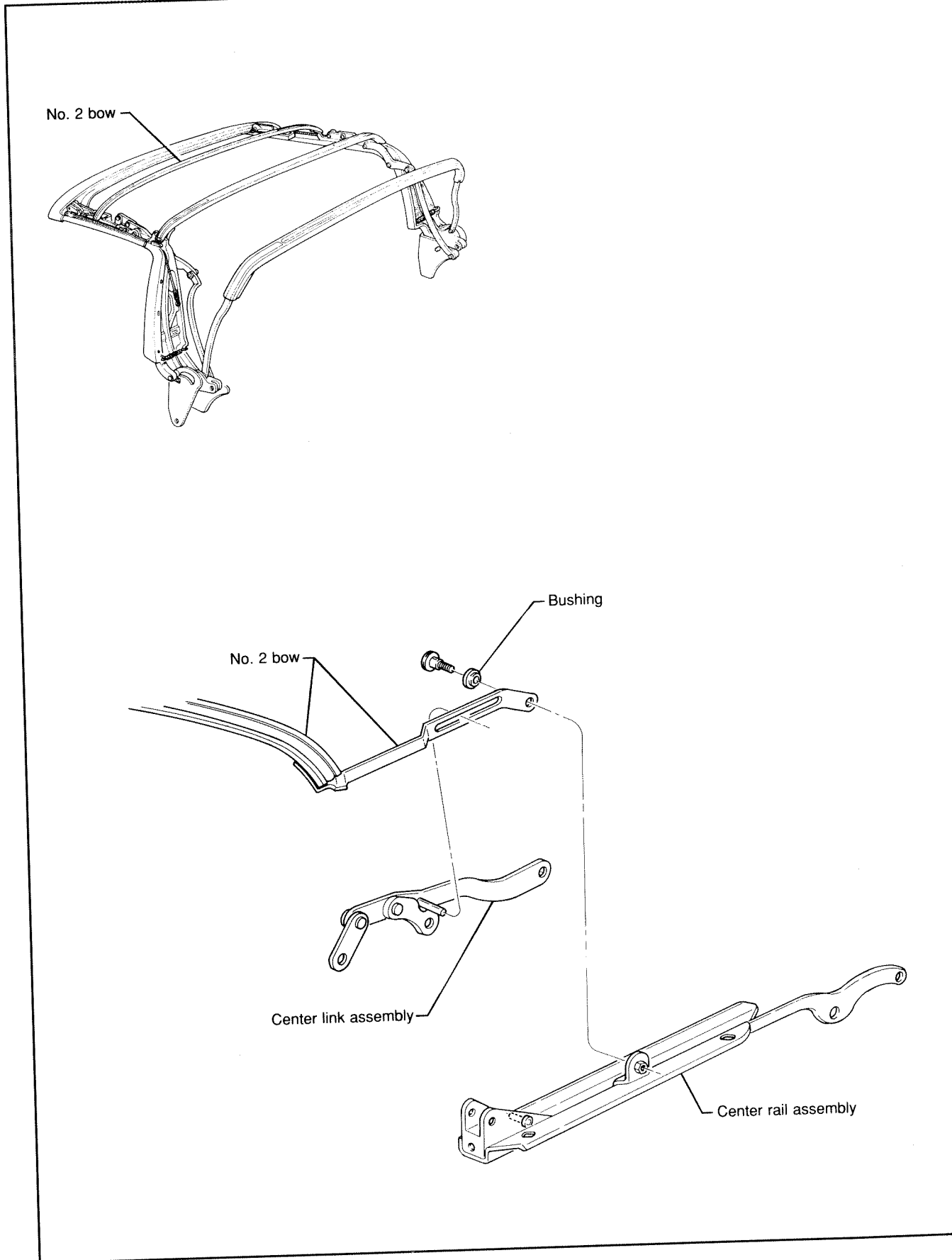

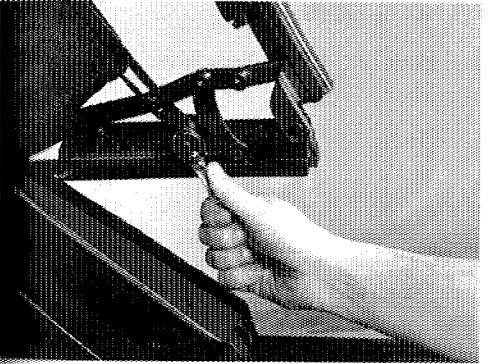
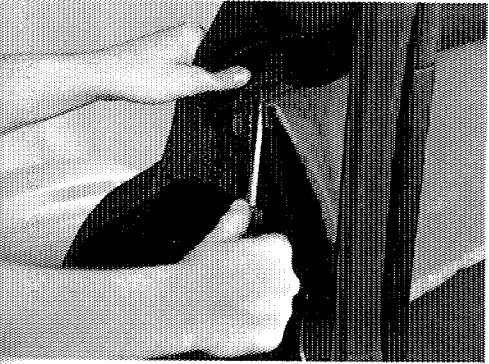
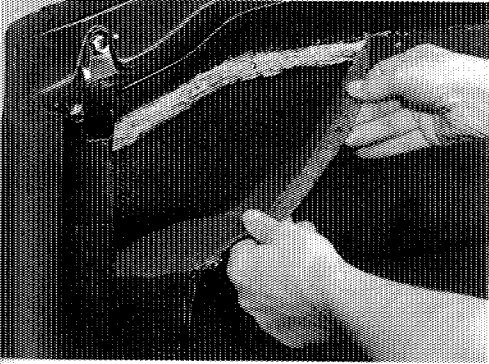
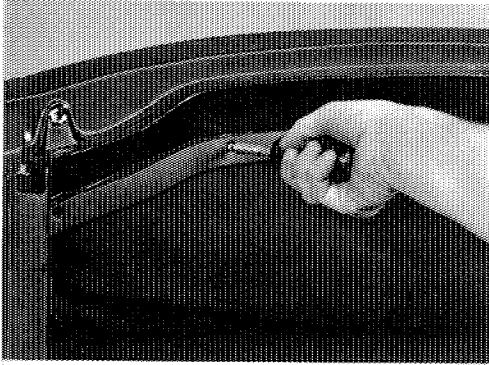

## NO. 2 BOW

### REMOVE

1. LOWER CONVERTIBLE TOP HALFWAY.
2. REMOVE HEADLINER FROM NO. 1 BOW.
  - (a) Remove seven (7) screws and headliner molding.
  - (b) Carefully break cement bond by pulling material away from No. 1 bow.
3. REMOVE HEADLINER FROM NO. 2 BOW.
 

Starting at one side, pry headliner retainer from No. 2 bow.
4. DISCONNECT TOP COVER FROM NO. 2 BOW.
  - (a) Remove three (3) screws from No. 2 bow and top cover retainer.
5. REMOVE NO. 2 BOW.
  - (a) Remove two (2) bolts and bushings securing No. 2 bow control links to center rail assemblies.
  - (b) Maneuver control links over center link pins.



### NO. 2 BOW (cont'd)

- (c) Mark side stay pad to No. 2 bow locations.
- (d) Use an awl, remove staples securing side stay pads to No. 2 bow and remove bow from vehicle.

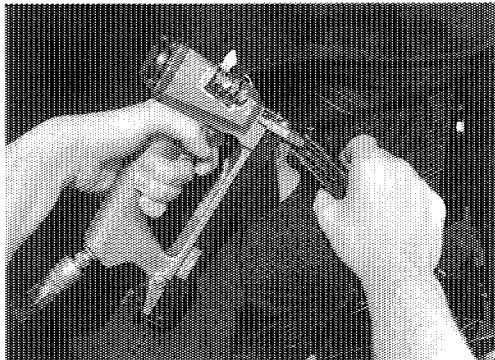

### INSTALL

**NOTE: If installing a new No. 2 bow, assemble bow and control links using rivets provided in service package.**

#### 1. INSTALL SIDE STAY PADS TO NO. 2 BOW.

Position side stay pads to No. 2 bow reference marks and secure using .50 x .31 monel staples.

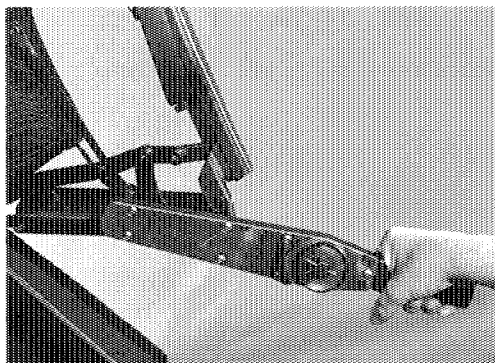

#### 2. INSTALL NO. 2 BOW.

- (a) Position control links over center link pins.
- (b) Apply Loctite (P/N 271 or equivalent) to bolt threads.
- (c) Secure No. 2 bow to center links using two (2) bushings and bolts.

**Torque: 5 N·m (44 in. lb.)**



#### 3. INSTALL TOP COVER TO NO. 2 BOW.

- (a) Position top cover No. 2 bow retainer to No. 2 bow.
- (b) Secure top cover to No. 2 bow using three (3) screws.

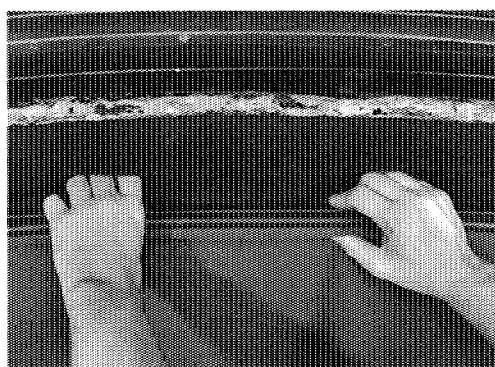

#### 4. INSTALL HEADLINER TO NO. 2 BOW.

Center headliner with No. 2 bow and press headliner retainer onto bow.

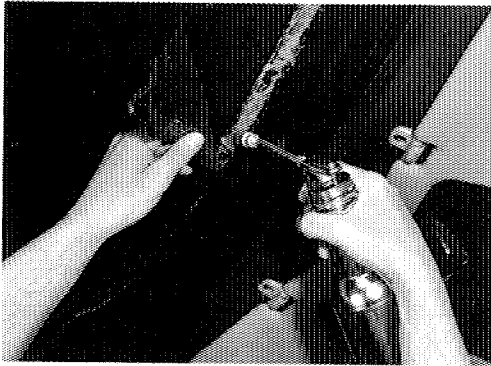
**NO. 2 BOW (cont'd)****5. INSTALL HEADLINER TO NO. 1 BOW.**

- (a) Apply adhesive (3M P/N 051135-08031 or equivalent), to No. 1 bow headliner area and headliner material.
- (b) Raise and latch convertible top to header.

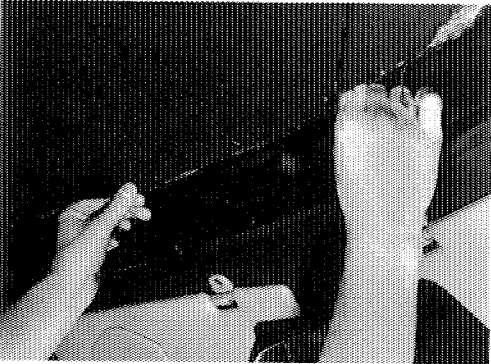

- (c) Center headliner to No. 1 bow.
- (d) Attach headliner starting from center then working outward toward ends.

**NOTE: Pull material tight to remove wrinkles in headliner material.**

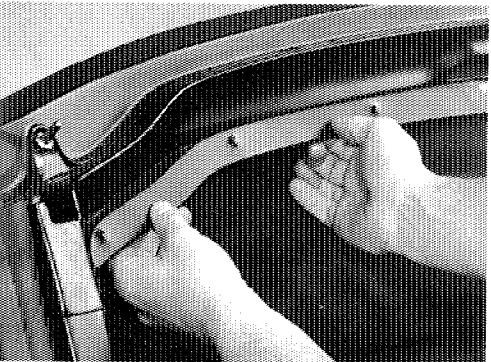
**6. INSTALL HEADLINER BOW NO. 1 MOLDING.**

Secure molding using seven (7) screws.

**7. LOWER AND RAISE TOP TWICE AND CHECK TOP STACK OPERATION.**

Top stack assembly operation should be smooth and consistent.

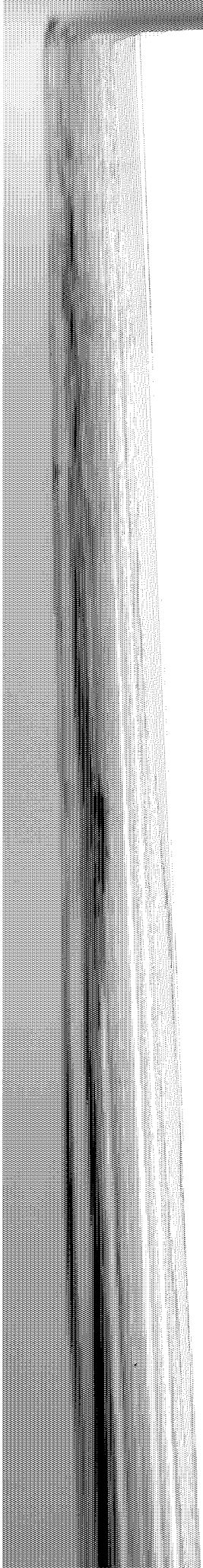



---

# NO. 3 BOW

	page
NO. 3 BOW COMPONENTS .....	16-2
NO. 3 BOW .....	16-3

NO. 3 BOW COMPONENTS

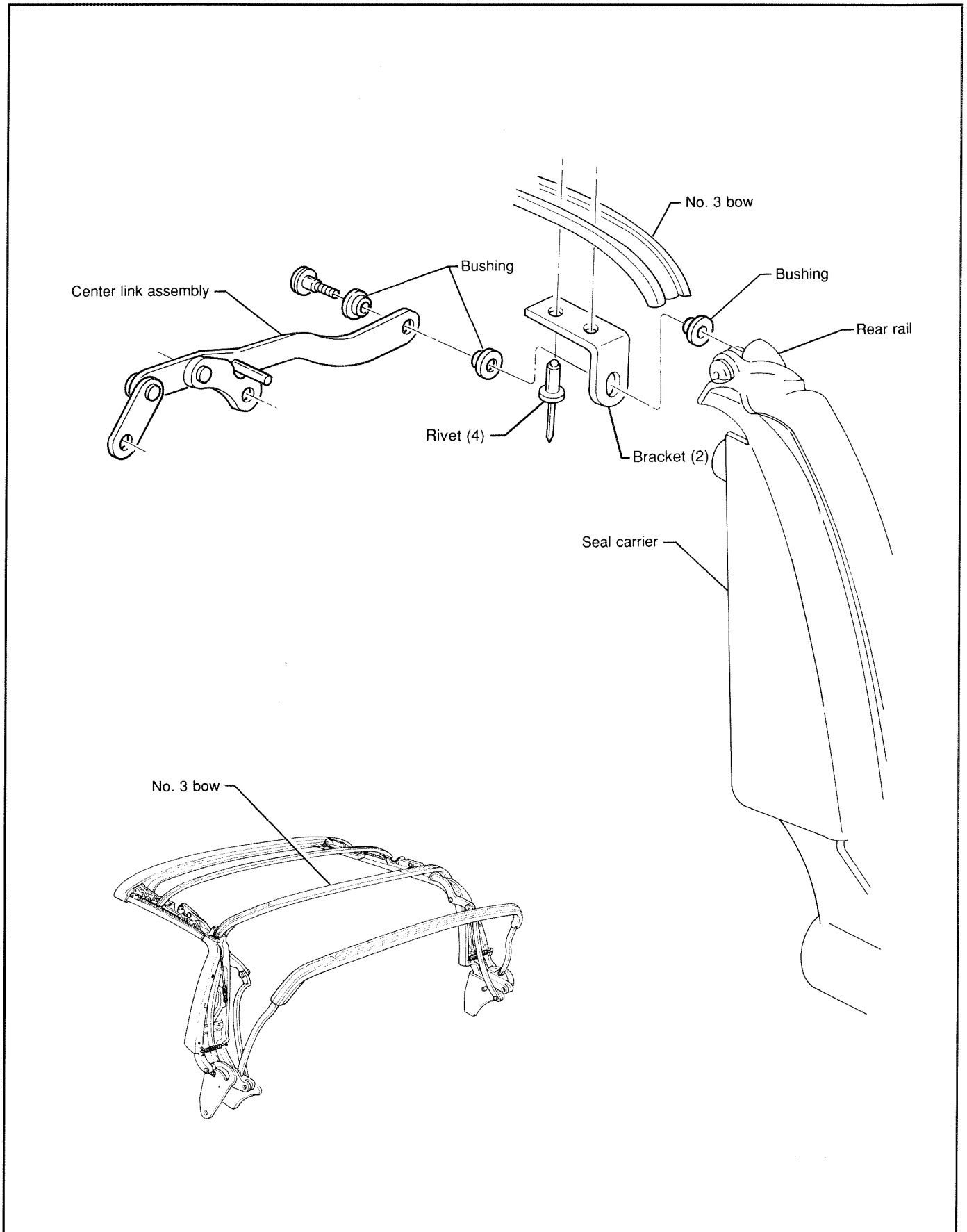

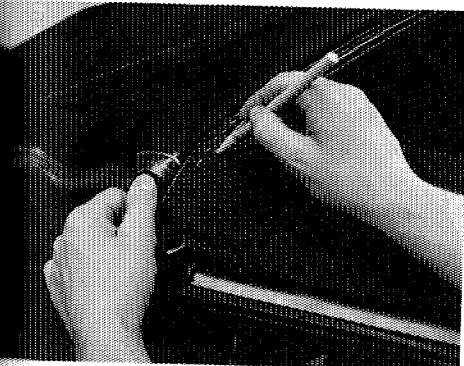
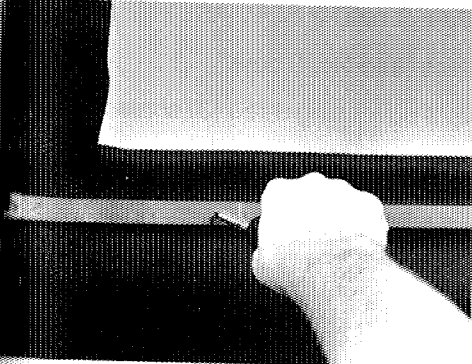
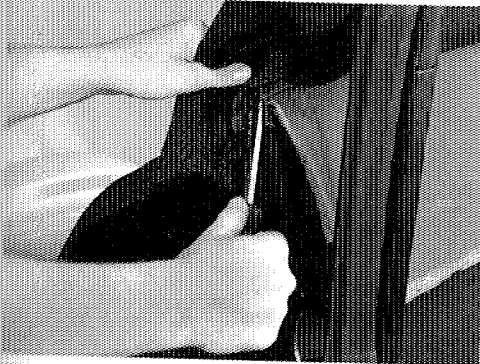
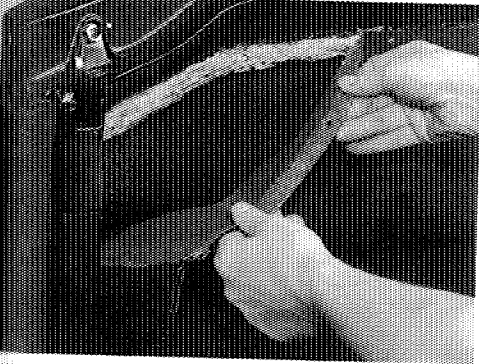
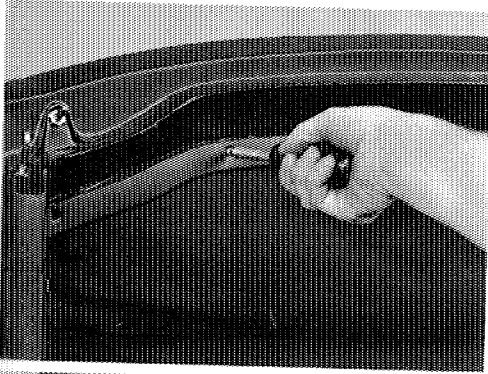
**NO. 3 BOW****REMOVE**

1. LOWER CONVERTIBLE TOP HALFWAY.
2. REMOVE HEADLINER FROM NO. 1 BOW.
  - (a) Remove seven (7) screws and headliner molding.
  - (b) Carefully break cement bond by pulling material away from No. 1 bow.
3. REMOVE HEADLINER FROM NO. 2 AND 3 BOW ASSEMBLIES.
  - (a) Starting at one side, pry headliner retainer from No. 2 bow.
  - (b) Repeat step (a) for No. 3 bow.
4. REMOVE TOP COVER FROM NO. 1 BOW (see 11-3).
5. REMOVE TOP COVER FROM NO. 2 AND 3 BOWS.
  - (a) Remove three (3) screws each from bows and top cover retainers.
  - (b) Fold top cover rearward over No. 4 bow.
6. REMOVE NO. 3 BOW.
  - (a) Mark both side stay pad to No. 3 bow locations.
  - (b) Using an awl, remove staples securing both side stay pads to No. 3 bow.

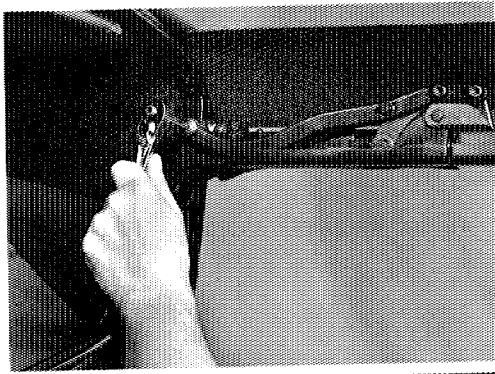

### NO. 3 BOW (cont'd)

- (c) Remove two (2) bolts and six (6) bushings securing No. 3 bow and center links to rear rail assemblies.
- (d) Remove No. 3 bow from vehicle.

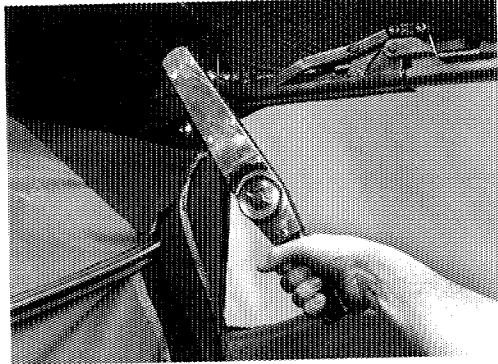

### INSTALL

#### 1. ASSEMBLE & INSTALL NO. 3 BOW TO REAR RAIL ASSEMBLY.

- (a) Position bracket to bottom of No. 3 bow and secure using two (2) 3/16" x .250" rivets. Repeat step 1a on other end of No. 3 bow.
- (b) Apply Loctite (P/N 271 or equivalent) to bolt threads.  
**Torque: 17 N·m (13 ft. lb.)**
- (c) Position No. 3 bow between center link and rear rail. Secure using three (3) bushings and one (1) bolt, each side.

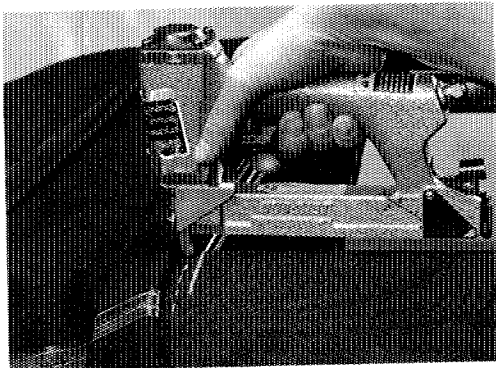

#### 2. INSTALL SIDE STAY PADS TO NO. 3 BOW.

Position side stay pad reference marks to No. 3 bow and secure using .50 x .31 monel staples.

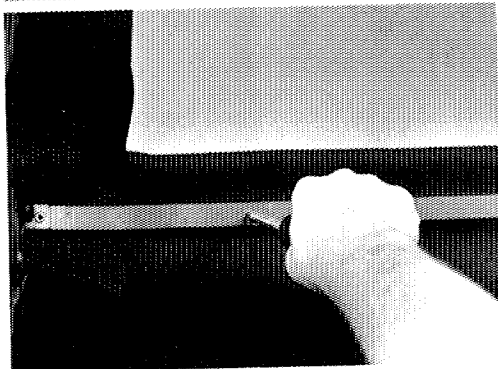

#### 3. INSTALL TOP COVER TO NO. 3 AND 2 BOW ASSEMBLIES.

- (a) Position Top cover retainer into No. 3 bow.
- (b) Secure top cover to No. 3 bow using three (3) screws.
- (c) Repeat steps (a) and (b) for No. 2 bow.



#### 4. INSTALL TOP COVER TO NO. 1 BOW, (see 11-9).

#### 5. INSTALL HEADLINER TO NO. 3 AND 2 BOW.

- (a) Center headliner with No. 3 bow and press headliner retainer onto bow.
- (b) Repeat step (a) for No. 2 bow.

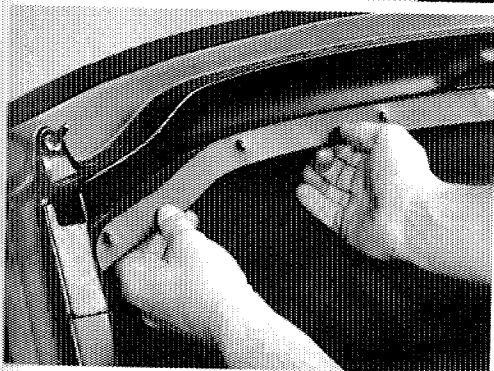
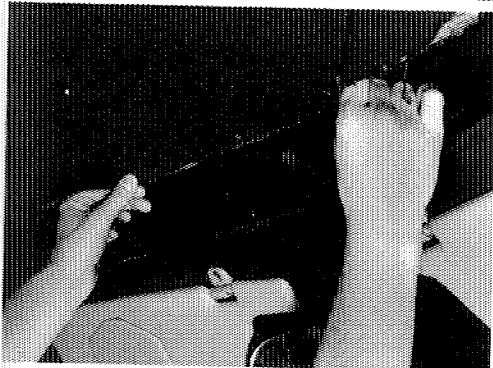
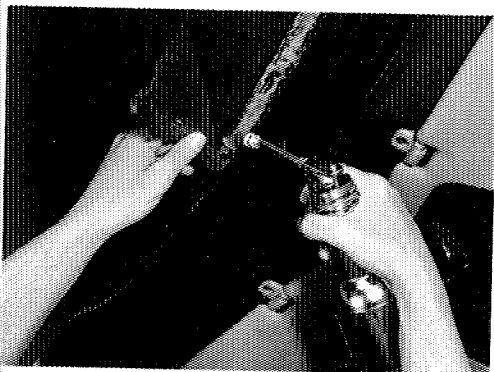

### NO. 3 BOW (cont'd)

#### 6. INSTALL HEADLINER TO NO. 1 BOW.

(a) Apply adhesive (3M P/N 051135-08031 or equivalent) to No. 1 bow and headliner material.

(b) Raise and latch top to header.

(c) Center headliner to No. 1 bow.

(d) Attach headliner starting from center then working outward toward ends.

**NOTE: Pull material tight to remove wrinkles in headliner material.**

#### 7. INSTALL HEADLINER BOW NO. 1 MOLDING.

Secure molding using seven (7) screws.

#### 8. LOWER AND RAISE TOP TWICE AND CHECK TOP STACK OPERATION.

Top stack assembly operation should be smooth and consistent.

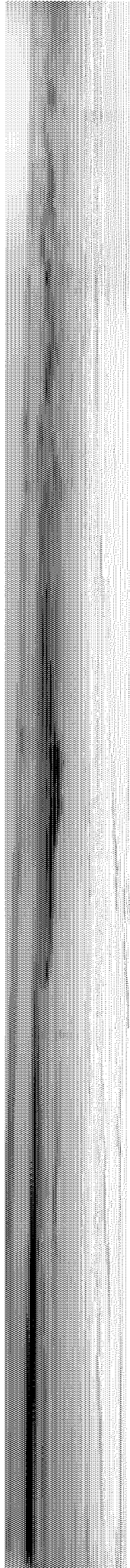

---

# NO. 4 BOW

	page
NO. 4 BOW COMPONENTS .....	17-2
NO. 4 BOW .....	17-3



NO. 4 BOW COMPONENTS

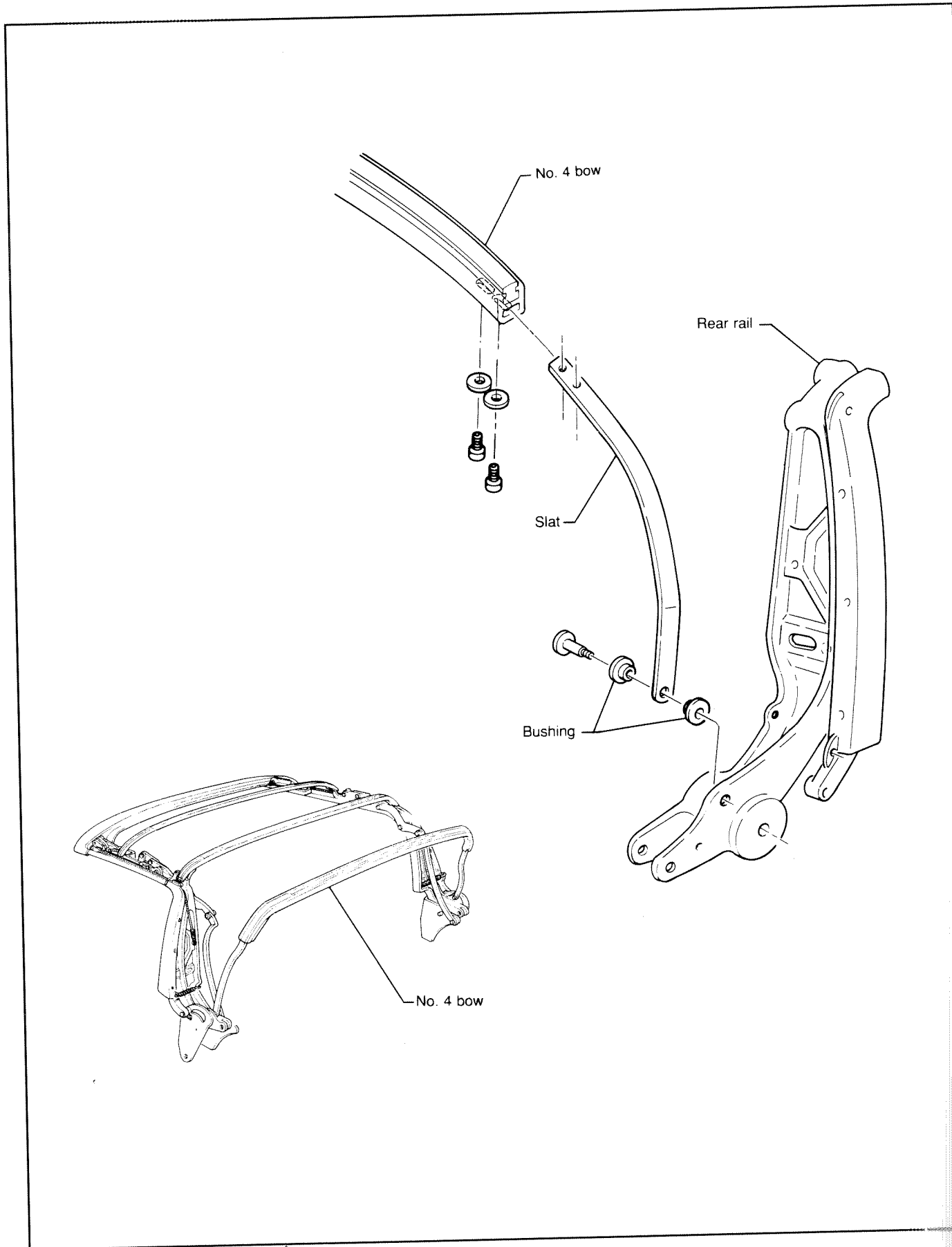

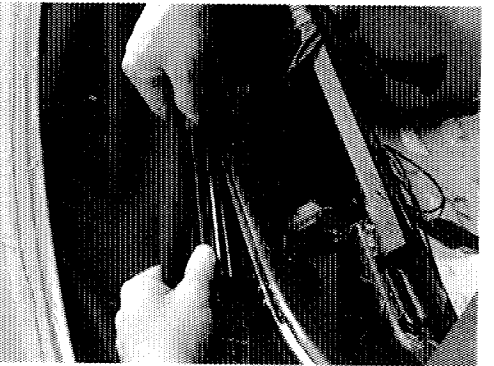
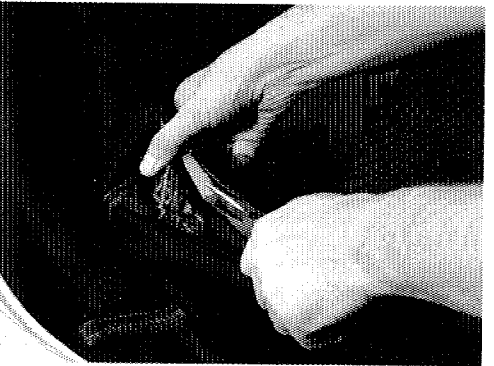
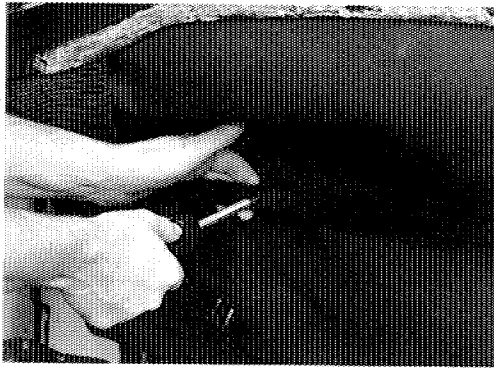

## NO. 4 BOW

### REMOVE

**NOTE:** To help prevent damage, tape a protective cover to the belt moldings, deck lid, quarter panels and both sides of backlite.

1. REMOVE HEADLINER ASSEMBLY (see 10-3).
2. REMOVE TOP COVER FROM NO. 1 BOW (see 11-3).
3. REMOVE TOP COVER FROM 2 AND 3 BOWS.  
Remove three (3) screws each from bows and top cover retainers.
4. REMOVE TOP COVER FROM RIGHT AND LEFT SEAL CARRIERS.  
Carefully break cement bond by pulling top cover material from seal carrier groove.
5. REMOVE TOP COVER FROM NO. 4 BOW.
  - (a) Fold top cover side material over No. 4 bow.
  - (b) Slide stay pad tack strip down for retainer removal clearance.
  - (c) Pull top cover No. 4 bow inner retainer from top cover retainer.
  - (d) Remove top cover No. 4 bow retainer from No. 4 bow groove.
  - (e) Fold top cover assembly rearward onto trunk lid.

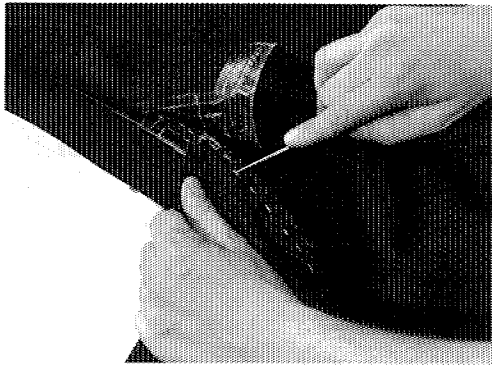
**NO. 4 BOW (cont'd)**

6. REMOVE STAY PADS FROM NO. 4 BOW.
  - (a) Using an awl, remove staples securing side and backlite stay pads to No. 4 bow.
  - (b) Repeat step (a) on other side of vehicle.

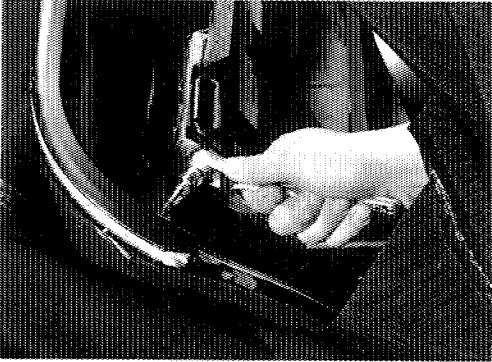

7. REMOVE NO. 4 BOW ASSEMBLY.
  - (a) Remove two (2) screws from each slat and pull No. 4 bow from slats.

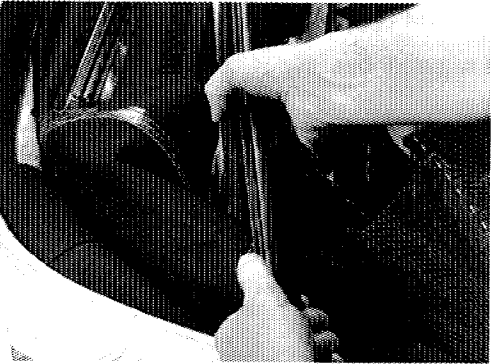

- (b) Mark center of backlite to No. 4 bow and remove screw.
  - (c) Rotate bow and slide from backlite assembly removing bow from vehicle.

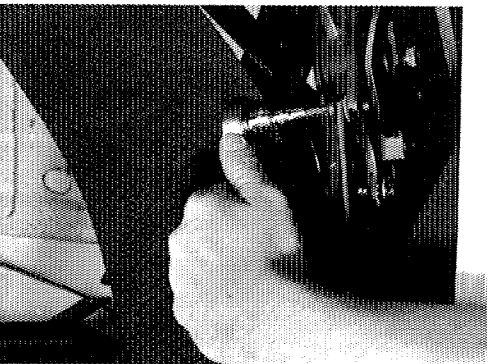

8. REMOVE NO. 4 BOW SLATS.
  - (b) Remove two (2) bolts and four (4) bushings securing bow slats to rear rail assemblies.

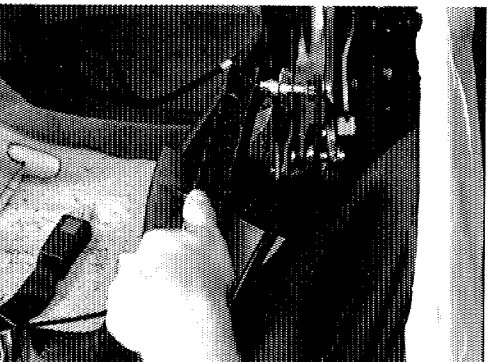
**INSTALL**

1. INSTALL NO. 4 BOW SLATS.
  - (a) Position No. 4 bow slats to rear rails.
  - (b) Apply Loctite (P/N 271 or equivalent) to bolt threads and install two (2) bolts and four (4) bushings.

**Torque: 17 N·m (13 ft. lb.)**

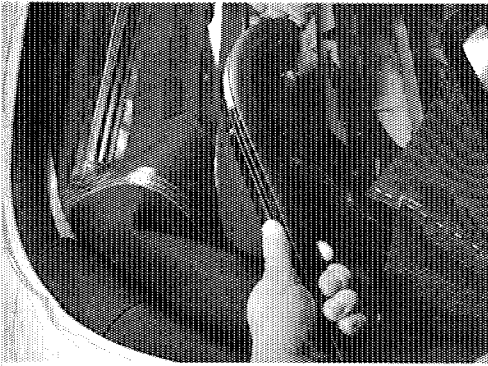
**NO. 4 BOW (cont'd)****2. INSTALL NO. 4 BOW.**

- (a) Center backlite in No. 4 bow groove and install screw.



- (b) Position No. 4 bow to slats.

- (c) Apply Loctite (P/N 271 or equivalent) to screw threads and install two (2) screws each side.

**Torque: 10 N·m (88 in. lb.)**

**3. INSTALL STAY PADS TO NO. 4 BOW.**

- (a) Secure side stay pad to No. 4 bow tack strip **FIRST**, using .31 x .31 monel staples.

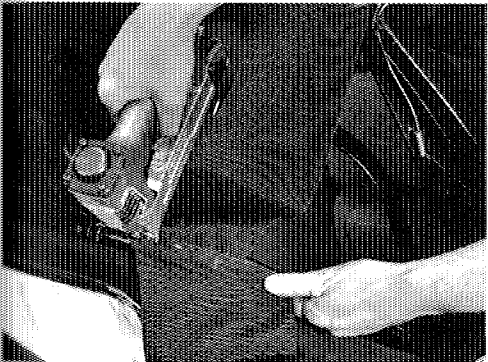

- (b) Secure backlite stay pad to No. 4 bow tack strip using .50 x .31 stainless steel heavy-duty staples.

- (c) Repeat steps (a) and (b) for other side of vehicle.

**4. INSTALL TOP COVER TO NO. 4 BOW.**

- (a) Insert top cover No. 4 bow retainer into slot in No. 4 bow.

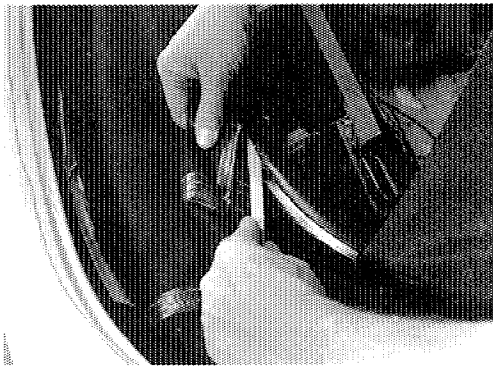
**NO. 4 BOW (cont'd)**

- (b) Hold top cover centered in No. 4 bow and install inner retainer.
- (c) Verify top cover centering in No. 4 bow.

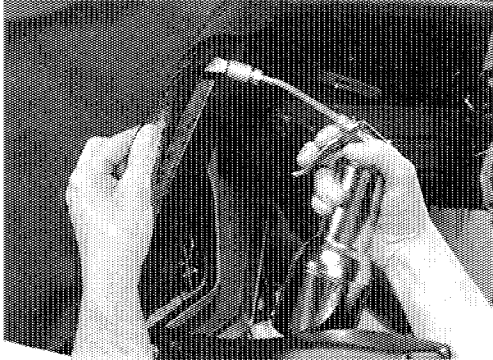
**5. INSTALL TOP COVER TO SEAL CARRIERS.**

- (a) Apply adhesive (3M P/N 051135-0831 or equivalent) to carrier groove and top cover glue flap.



- (b) Position top cover wear flap on outside of seal carrier and fold glue flap material into seal carrier.

**NOTE: Top cover binding should be straight and turned slightly inward.**

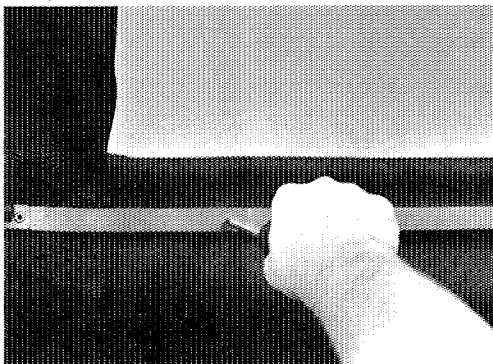
**6. INSTALL TOP COVER TO NO. 3 AND 2 BOW ASSEMBLY**

- (a) Position Top cover retainer into No. 3 bow.
- (b) Secure top cover using three (3) screws.
- (c) Repeat steps (a) and (b) for No. 2 bow.

**8. INSTALL TOP COVER TO NO. 1 BOW, (see 11-9).****9. INSTALL HEADLINER ASSEMBLY (see 10-4).****10. LOWER AND RAISE CONVERTIBLE TOP TWICE AND CH TOP STACK OPERATION.**

Top stack assembly operation should be smooth and consist

# REAR AND SIDE RAIL

	page
REAR AND SIDE RAIL COMPONENTS .....	18-2
TOP STACK ADJUSTMENT .....	18-4
REAR RAIL AND MAIN PIVOT .....	18-6
SIDE RAIL ASSEMBLY .....	18-12
NO. 2 BOW BUMPER .....	18-16

er

) to seal

er and

id

BLIES.

) CHECK

)nsistent

REAR AND SIDE RAIL COMPONENTS

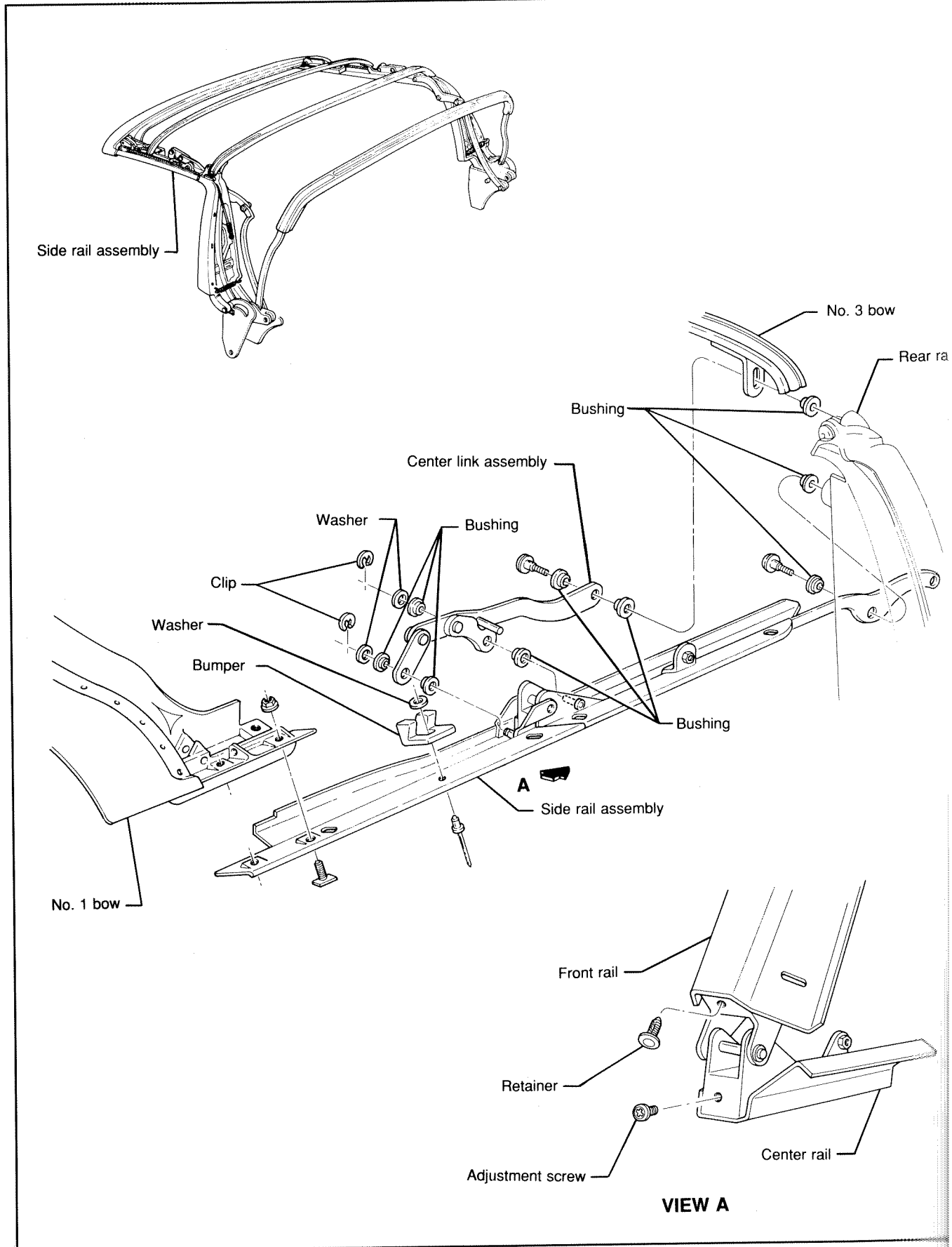



REAR AND SIDE RAIL COMPONENTS (cont'd)

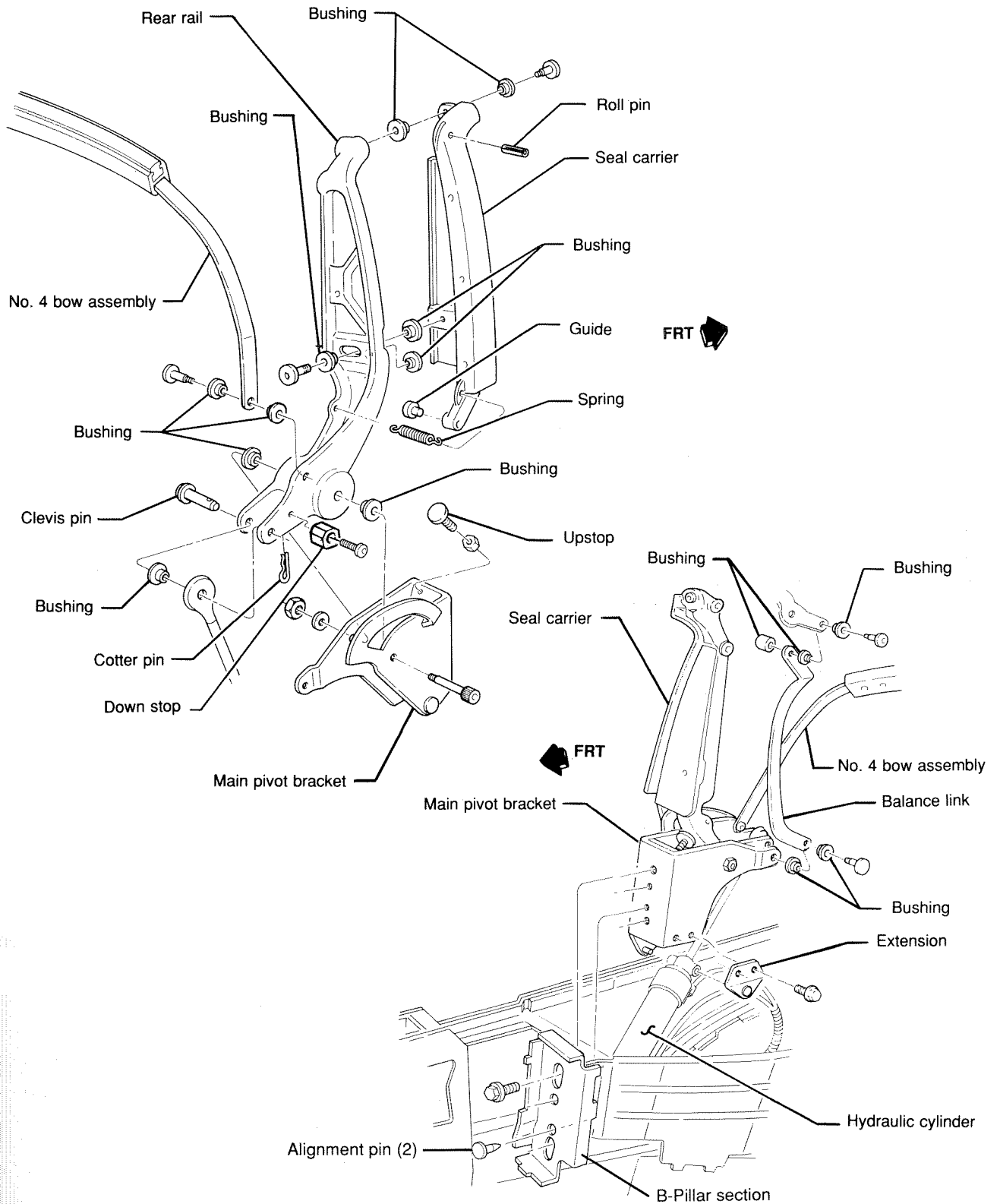

rear rail

## TOP STACK ADJUSTMENT

### TOP DOWN STOP

If "down stop" is too HIGH, top boot will not fit over top stack assembly. If "down stop" is too LOW, rapid top cover degradation will occur.

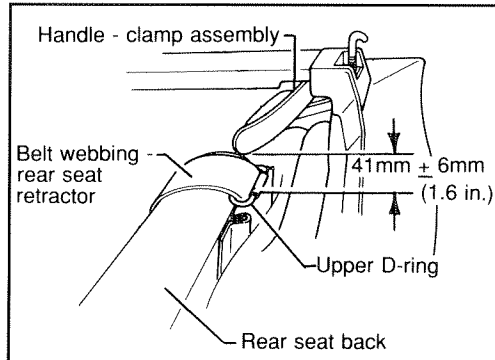

1. LOWER TOP TO FULL DOWN POSITION.
2. MEASURE DISTANCE BETWEEN LOWEST EDGE OF RELEASE HANDLES AND SEAT BELT "D" RINGS, BOTH SIDES.

Open release handle and position handle over "D" ring.

**Specification: 41mm +/- 6mm**

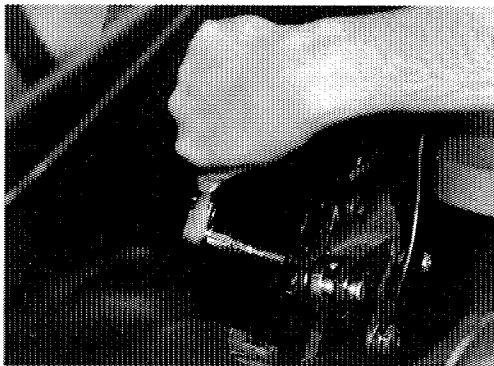

3. ADJUST TOP DOWN STOP.
  - (a) Raise top enough to access down stop block screw.
  - (b) Loosen screw and turn "eccentric" block as required.
  - (c) Tighten down stop block screw.

**Torque: 17 N·m (13 ft. lb.)**

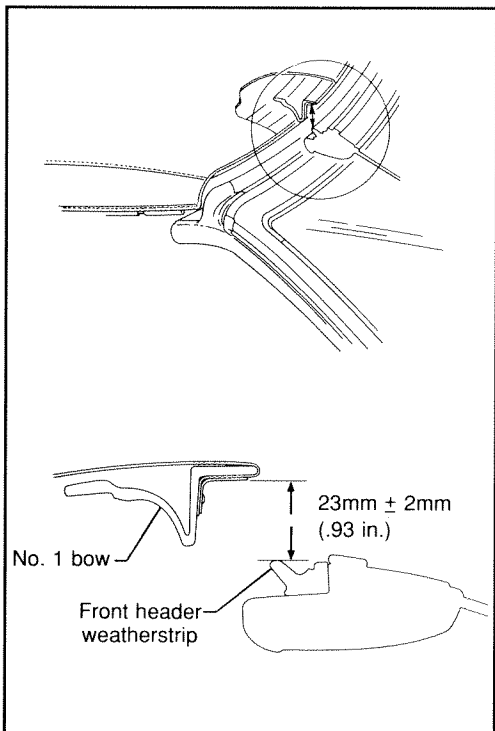

4. CHECK TOP DOWN HEIGHT.
  - (a) Cycle top up and down two (2) times.
  - (b) Repeat step 1 and step 2 if necessary.

### TOP UPSTOP

Right and left side up stops must be adjusted evenly to prevent No. 1 bow-to-header misalignment.

1. LOWER AND RAISE TOP, DO NOT LATCH TOP TO WINDSHIELD HEADER.
2. MEASURE DISTANCE BETWEEN TOP OF WINDSHIELD HEADER SEAL AND SEALING SURFACE OF NO. 1 BOW.

**Specification: 23mm +/- 2mm**

3. ADJUST TOP UPSTOP.
  - (a) Raise top enough to move rear rail off top upstop.

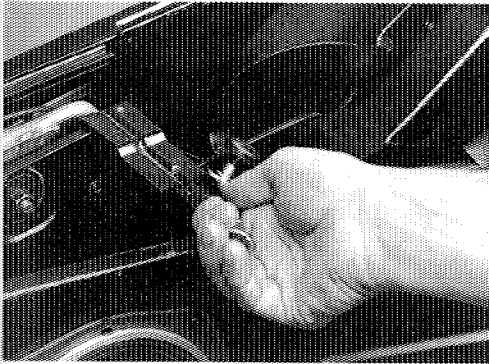

**TOP STACK ADJUSTMENT (cont'd)**

- (b) Loosen jam nut and adjust upstop as required.
- (c) Tighten jam nut.

**Torque: 17 N·m (13 ft. lb.)**

**4. CHECK TOP UPSTOP ADJUSTMENT.**

- (a) Cycle top up and down two (2) times latching top to header each time.
- (b) Check for: (1) dowel pin to receiver alignment; (2) effort required to pull No. 1 bow to header when latching.

**SIDE RAIL ADJUSTMENT**

**NOTE: When checking side rail alignment, it is important to also consider door and quarter glass alignment.**

1. RAISE AND LATCH TOP TO WINDSHIELD HEADER.
2. RAISE DOOR AND QUARTER GLASS.
3. CHECK SIDE RAIL WEATHERSTRIP-TO-GLASS ALIGNMENT.

**NOTE: Door and quarter glass alignment must be correct before checking weatherstrip seal.**

Side rail weatherstrip should be parallel to top edge of door and quarter glass while maintaining a satisfactory seal.

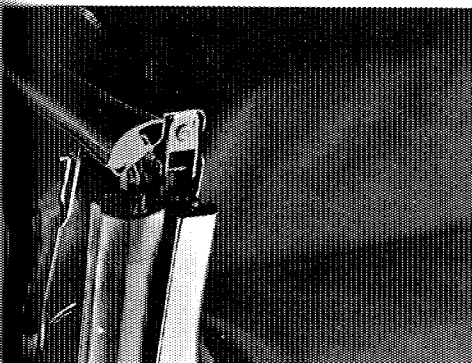

**4. ADJUST FRONT AND CENTER RAIL ALIGNMENT.**

- (a) Raise top to expose adjustment screw at end of front rail assembly.

**NOTE: Be sure plastic retainer "button" is in center rail assembly.**

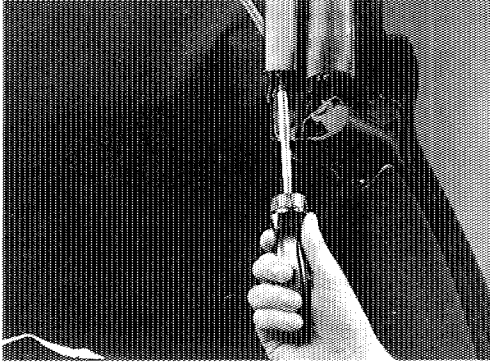

### TOP STACK ADJUSTMENT (cont'd)

- (b) Rotate adjustment screw as required to adjust side rail assembly parallel with door glass upper edge.

### 5. CHECK FRONT TO CENTER RAIL ALIGNMENT.

- (a) Cycle top up and down two (2) times then latch top to header.
- (b) Check that side rail weatherstrip is parallel to top edge of door glass while maintaining a satisfactory seal.

## REAR RAIL AND MAIN PIVOT

### REMOVE

**NOTE: Tape a protective cover to belt moldings, trunk lid, quarter panels and both sides of the backlite.**

1. REMOVE HEADLINER ASSEMBLY (see 10-3).
2. REMOVE QUARTER TRIM PANELS (see 5-3).

### 3. REMOVE REAR SPEAKER ASSEMBLY.

**NOTE: Remove speaker ONLY if main pivot bracket is to be removed.**

- (a) Remove four (4) screws securing speaker to body panel.
- (b) Disconnect speaker electrical connector and remove speaker.

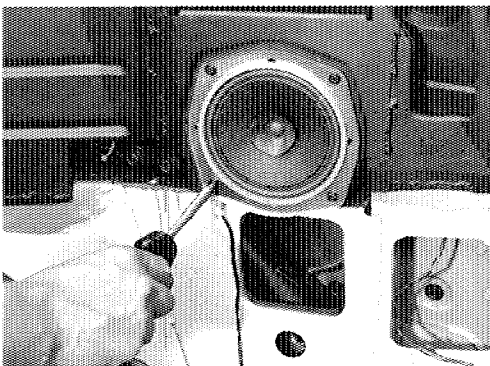

4. REMOVE TOP COVER FROM RIGHT AND LEFT SEAL CARRIERS AND TOP COVER TACK STRIP FROM DRAIN TROUGH (see 11-3).

**REAR RAIL AND MAIN PIVOT (cont'd)**

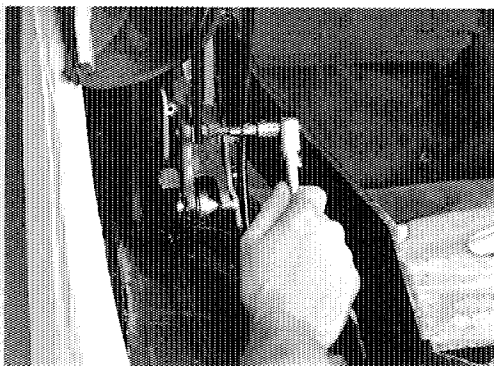

5. REMOVE NO. 4 BOW.
  - (a) Remove bolt securing No. 4 bow to rear rail, both sides.
  - (b) Fold top cover, backlite and No. 4 bow forward onto No. 1 and 2 bows.

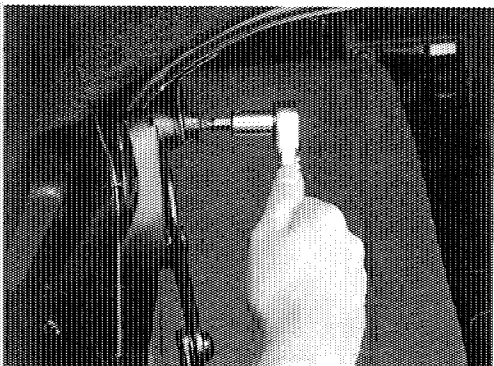

6. REMOVE NO. 3 BOW FROM REAR RAIL.
  - (a) Remove three (3) top cover retainer screws from No. 3 bow.
  - (b) Remove bolt securing No. 3 bow and center link assembly to rear rail, both sides.

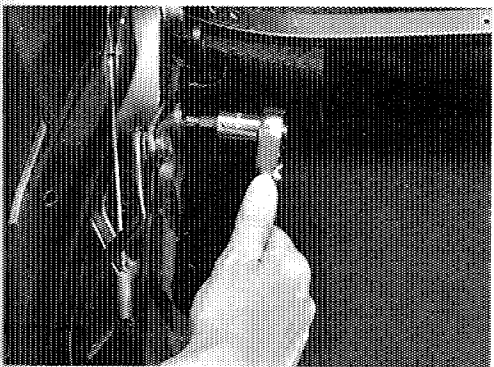

7. REMOVE BOLT SECURING CENTER RAIL TO REAR RAIL.

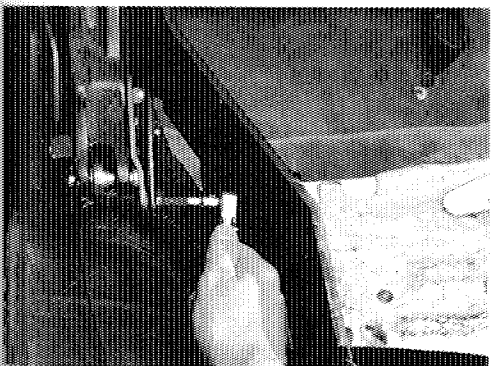

8. REMOVE BOLT SECURING BALANCE LINK TO MAIN PIVOT BRACKET.

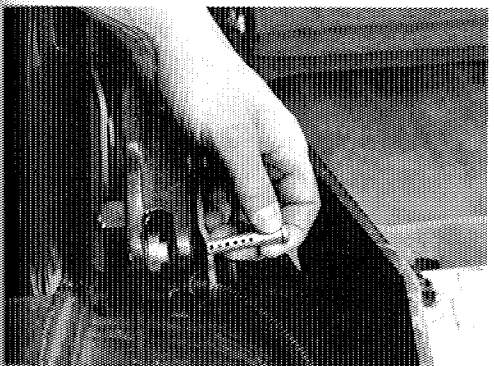

9. DISCONNECT REAR RAIL FROM HYDRAULIC CYLINDER ROD.  
Remove cotter pin and clevis pin from rear rail and hydraulic cylinder rod.

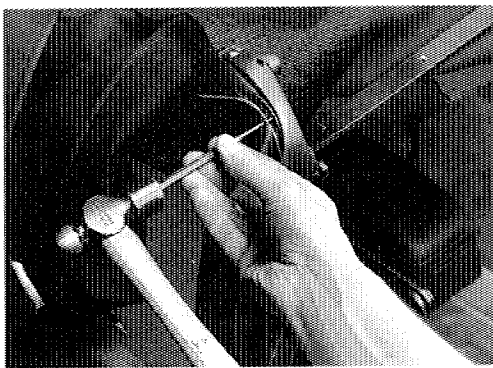

### REAR RAIL AND MAIN PIVOT (cont'd)

#### 10. RE-POSITION RETENTION CABLE.

Drive roll pin out of rear rail enough to allow removal of retentive cable.

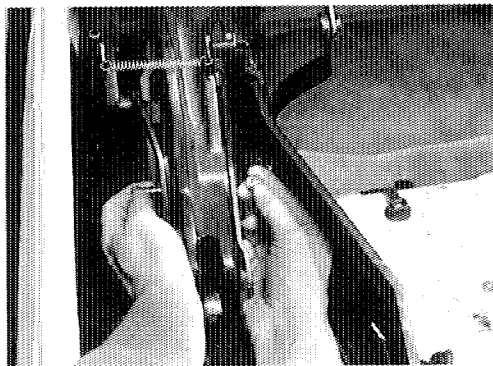

#### 11. REMOVE REAR RAIL ASSEMBLY.

- (a) Remove rear rail pivot bolt, washer and nut.
- (b) Remove rear rail from main pivot bracket.

**NOTE:** If removing main pivot bracket **ONLY**, continue to step 12 on page 18-10.

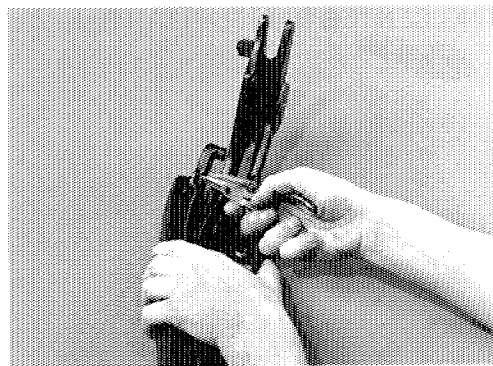

### DISASSEMBLE

#### 1. REMOVE SEAL CARRIER FROM REAR RAIL.

- (a) Disconnect spring from seal carrier and rear rail.

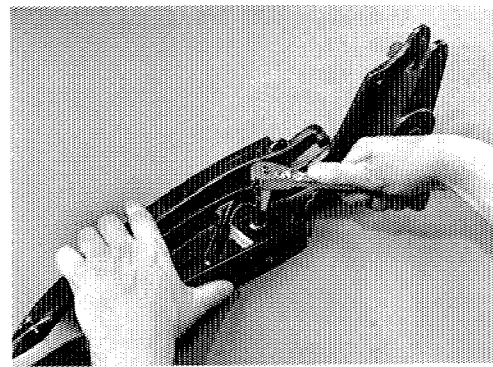

- (b) Remove two (2) bolts from seal carrier and seal carrier from rear rail.

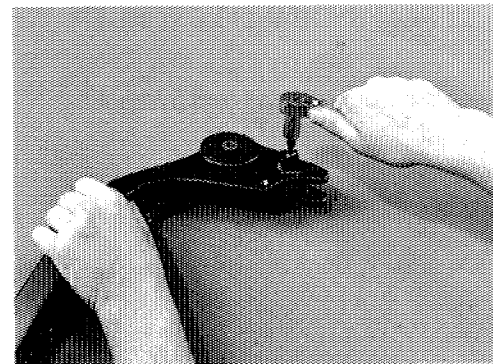

#### 2. REMOVE DOWN STOP ECCENTRIC BLOCK.

Note position of eccentric block, remove down stop screw and block.



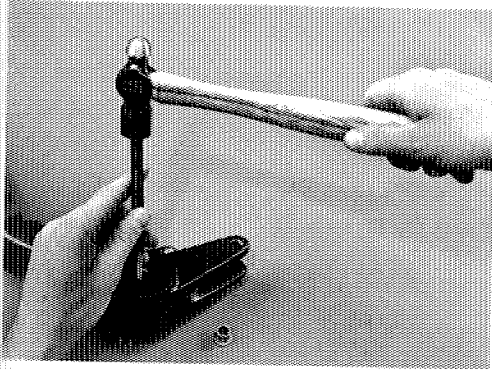

**REAR RAIL AND MAIN PIVOT (cont'd)**

3. REMOVE REAR RAIL PIVOT BOLT BUSHINGS.  
Using a punch, remove two (2) bushings from rear rail.

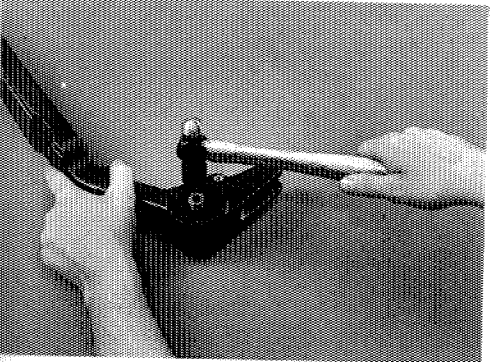

**ASSEMBLE**

1. INSTALL REAR RAIL PIVOT BOLT BUSHINGS.  
Gently tap two (2) bushings into rear rail.

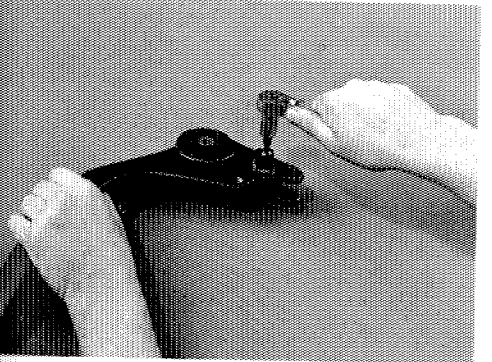

2. INSTALL DOWN STOP ECCENTRIC BLOCK.
  - (a) Position eccentric block to rear rail in same position as when removed.
  - (b) Install down stop screw. Do not torque screw at this time.

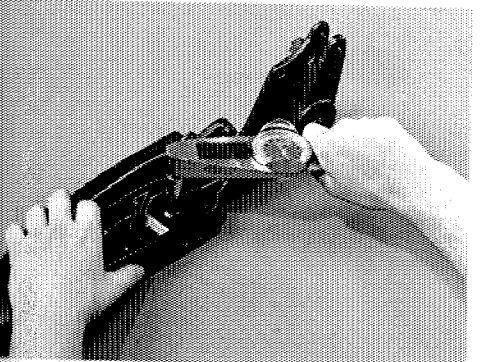

3. INSTALL SEAL CARRIER TO REAR RAIL.
  - (a) Apply general purpose lubricant to rear rail slot.
  - (b) Apply Loctite (P/N 271 or equivalent) to bolt threads and secure seal carrier to rear rail using two (2) bolts.

**Torque: 6 N·m (53 in. lb.)**

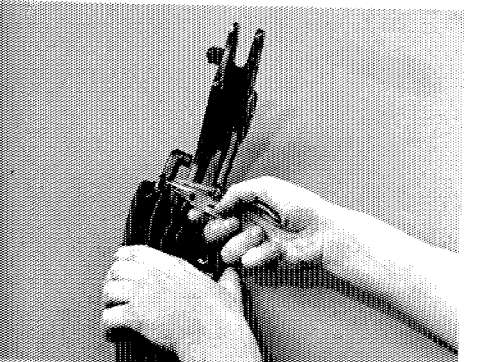

- (c) Connect spring to seal carrier and rear rail.



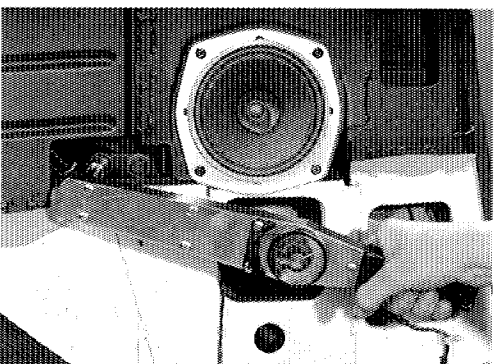
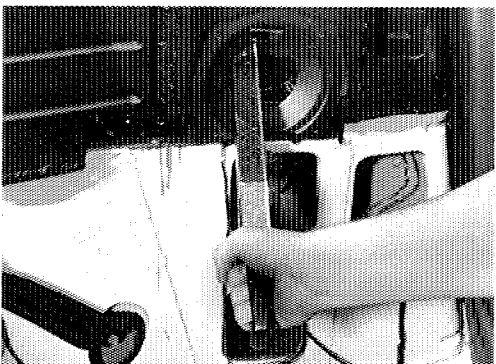
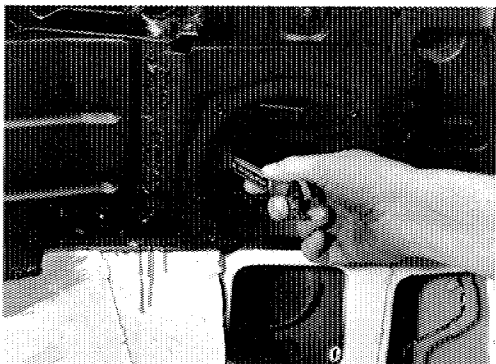
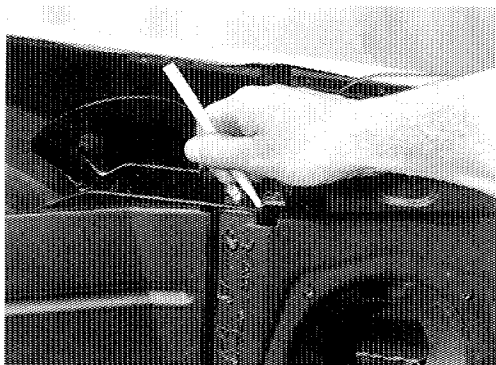
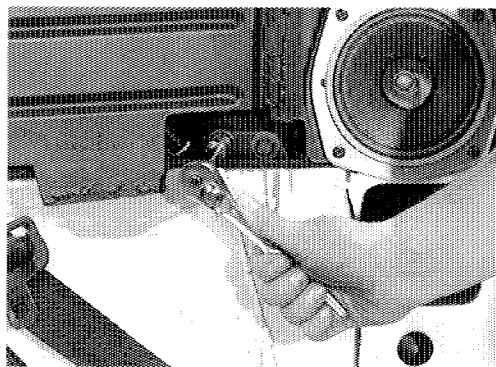

## REAR RAIL AND MAIN PIVOT (cont'd)

**NOTE:** Continue with **REMOVAL** procedure **ONLY** if main pivot bracket is to be removed. If main pivot bracket is not removed, go to **INSTALL** step 3.

12. REMOVE TWO (2) BOLTS FROM MAIN PIVOT BRACKET EXTENSION AND REMOVE EXTENSION PLATE.
13. REMOVE MAIN PIVOT BRACKET ASSEMBLY.
  - (a) Remove hydraulic cylinder from main pivot bracket pin.
  - (b) Using a pencil, mark pivot bracket to body panel location.
  - (c) Remove two (2) bolts securing main pivot bracket to body panel and remove main pivot bracket from vehicle.

## INSTALL

1. INSTALL MAIN PIVOT BRACKET ASSEMBLY.
  - (a) Position main bracket to body panel alignment marks.
 

**NOTE:** Four (4) alignment pins (2 per side) are welded to the B-pillar section panel to aid top stack installation. Should the main pivot bracket require replacement, the alignment pins must be removed.
  - (b) Apply Loctite (P/N 271 or equivalent) to bolt threads.
 

**Torque: 18 N·m (13 ft. lb.)**
2. INSTALL MAIN PIVOT EXTENSION AND HYDRAULIC CYLINDER.
  - (a) Position hydraulic cylinder to main pivot bracket pin.
  - (b) Apply Loctite (P/N 271 or equivalent) to bolt threads and install extension using two (2) bolts.
 

**Torque: 22 N·m (16 ft. lb.)**

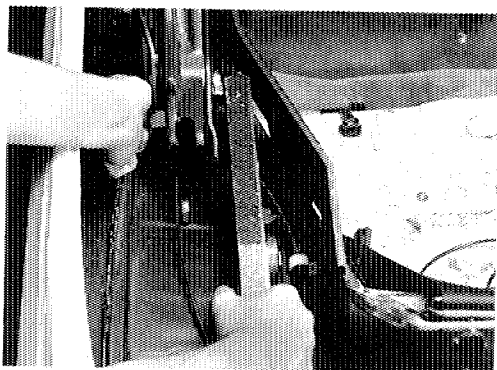

**REAR RAIL AND MAIN PIVOT (cont'd)**

3. INSTALL REAR RAIL ASSEMBLY.

Apply Loctite (P/N 271 or equivalent) to bolt threads and secure rear rail to main pivot bracket using one bolt, washer, and nut.

**Torque: 22 N·m (16 ft. lb.)**

**NOTE: Pull outward on seal carrier when installing rear rail to main pivot and insure guide button is positioned to main pivot "ramp".**

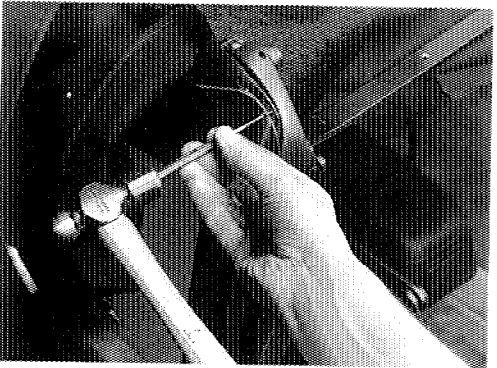

4. POSITION RETENTION CABLE IN SEAL CARRIER SLOT AND TAP ROLL PIN IN PLACE.

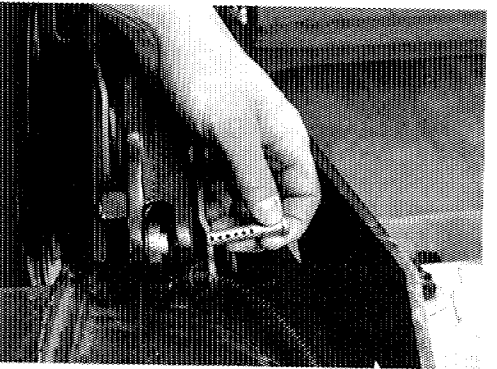

5. CONNECT REAR RAIL TO HYDRAULIC CYLINDER.

Align cylinder rod to rear rail and install clevis pin, washer and cotter pin.

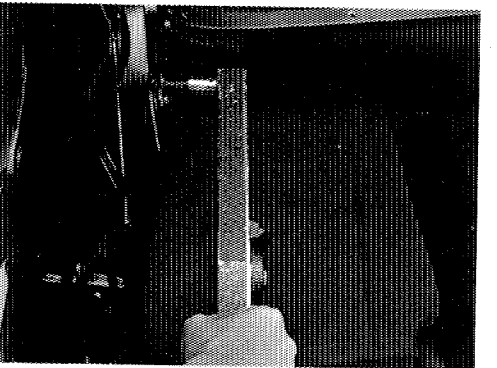

6. INSTALL CENTER RAIL TO REAR RAIL.

Apply Loctite (P/N 271 or equivalent) to bolt threads and secure center rail to rear rail with bolt.

**Torque: 17 N·m (13 ft. lb.)**

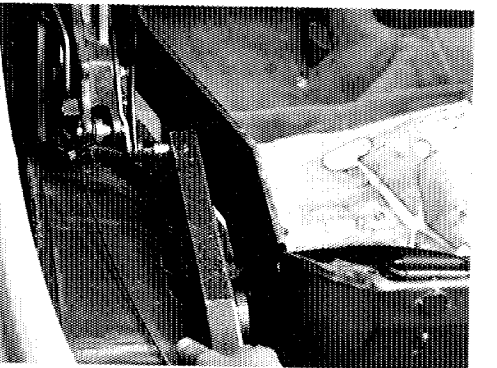

7. INSTALL BALANCE LINK TO MAIN PIVOT BRACKET.

Apply Loctite (P/N 271 or equivalent) to bolt threads and secure balance link to main pivot bracket with bolt.

**Torque: 17 N·m (13 ft. lb.)**

in  
cket

on.

ody

ded  
k

ust

nd

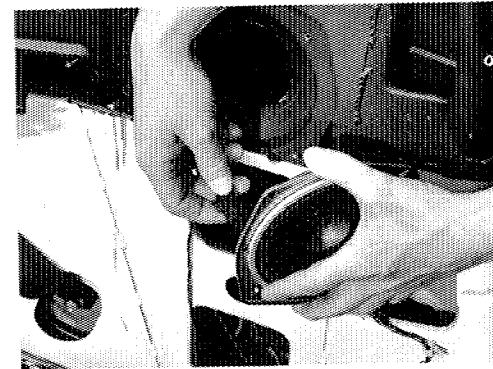
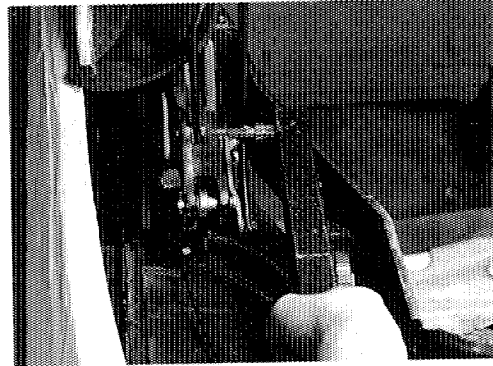
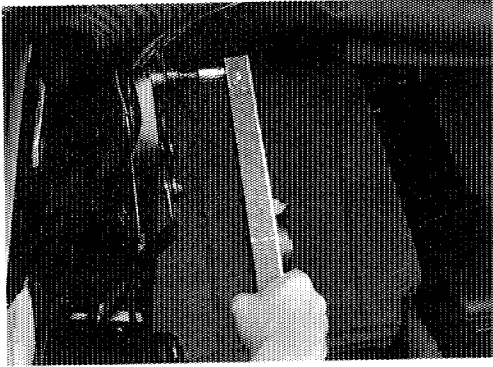

## REAR RAIL AND MAIN PIVOT (cont'd)

8. INSTALL NO. 3 BOW TO REAR RAIL.
  - (a) Position bow and center link assembly to rear rail.
  - (b) Apply Loctite (P/N 271 or equivalent) to bolt threads and install bolt, both sides.
 

**Torque: 17 N.m (13 ft. lb.)**
  - (c) Position top cover and retainer to No. 3 bow and install three (3) screws.
9. INSTALL NO. 4 BOW TO REAR RAIL ASSEMBLY.
  - (a) Fold top cover, backlite and No. 4 bow rearward positioning bow to rear rail.
  - (b) Apply Loctite (P/N 271 or equivalent) to bolt threads and secure No. 4 bow to rear rail with one (1) bolt and (2) bushings, each side.
 

**Torque: 17 N.m (13 ft. lb.)**
10. INSTALL TOP COVER WITH TACK STRIP TO DRAIN TROUGH AND TOP COVER TO RIGHT AND LEFT SEAL CARRIERS (see 11-7).
11. INSTALL REAR SPEAKER ASSEMBLY IF REMOVED.
  - (a) Connect speaker electrical connector.
  - (b) Position speaker to body panel and secure using four (4) screws.
12. INSTALL QUARTER TRIM PANEL (see 5-5).
13. ADJUST TOP UP AND DOWN STOPS (see Top Stack Adjustment in this chapter).
14. INSTALL HEADLINER ASSEMBLY (see 10-4).

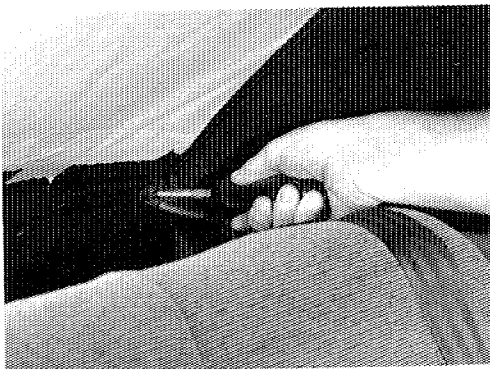

## SIDE RAIL ASSEMBLY

### REMOVE

1. REMOVE TOP COVER FROM NO. 1 BOW, (see 11-3).
2. REMOVE SCREW ATTACHING HEADLINER TO DRAIN TROUGH.

**SIDE RAIL ASSEMBLY (cont'd)**

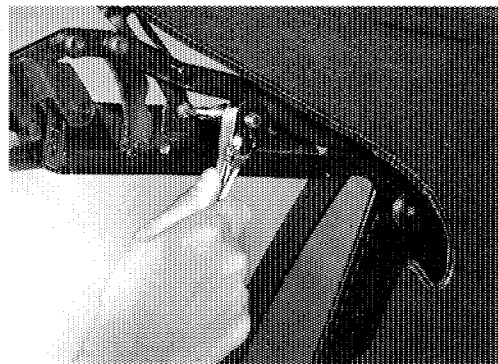

3. REMOVE BOLT FROM NO. 2 BOW CONTROL LINK AND CENTER RAIL.

Remove bolt and bushing from side to be serviced.

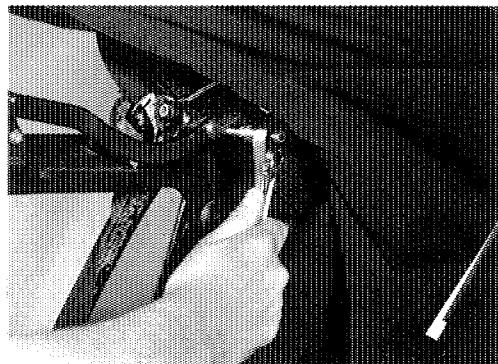

4. REMOVE BOLT FROM NO. 3 BOW ASSEMBLY, CENTER LINK AND REAR RAIL.

Remove bolt and three (3) bushings.

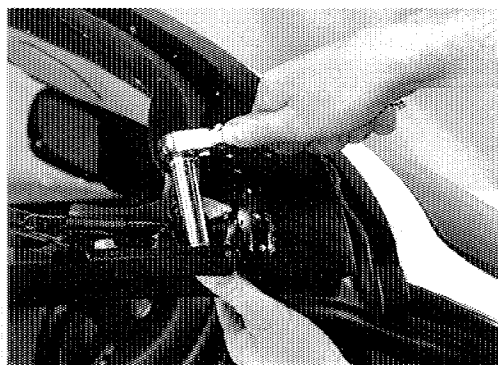

5. REMOVE TWO (2) NUTS AND BOLTS FROM NO. 1 BOW.

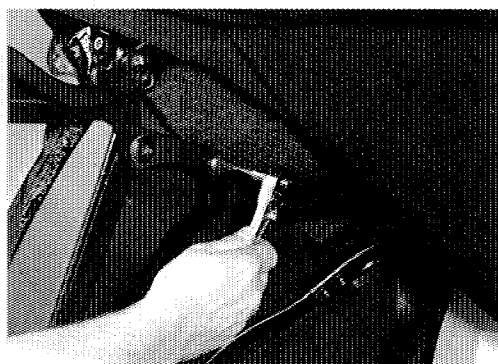

6. REMOVE BOLT FROM CENTER RAIL AND BALANCE LINK.

Hold side rail assembly to prevent it from "pivoting" and remove bolt and two (2) bushings.

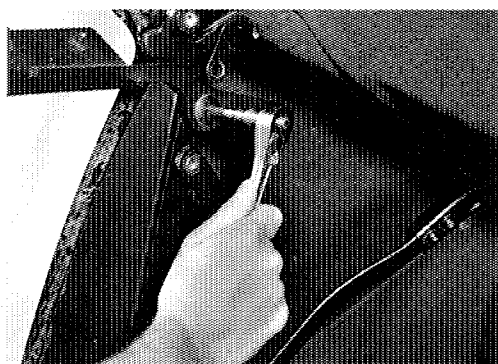

7. REMOVE CENTER RAIL TO REAR RAIL BOLT.

Hold side rail assembly and remove bolt and bushing.

**SIDE RAIL ASSEMBLY (cont'd)**

## 8. REMOVE SIDE RAIL ASSEMBLY.

Carefully remove complete side rail assembly with center link from top stack assembly.

**DISASSEMBLE**

## 1. REMOVE WEATHERSTRIP AND RETAINER.

Remove two (2) nuts and weatherstrip with retainer from center rail.

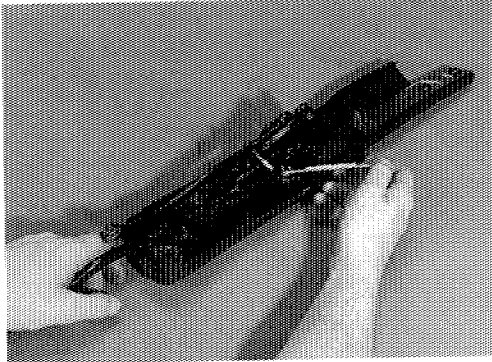

## 2. REMOVE CENTER LINK ASSEMBLY.

- (a) Remove E clip and washer from front rail pin.
- (b) Remove E clip and washer from center rail pin and remove center link from side rail assembly.

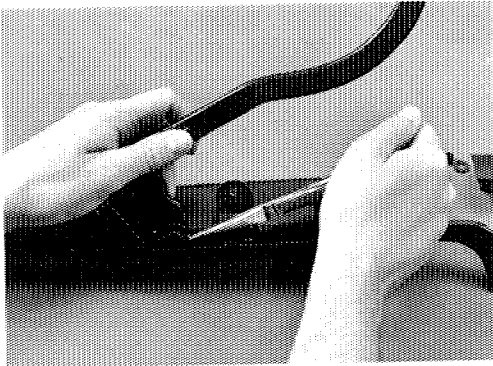
**ASSEMBLE**

## 1. INSTALL CENTER LINK ASSEMBLY.

- (a) Position center link to center rail pin, install washer and E clip.
- (b) Position center link to front rail pin, install washer and E clip.

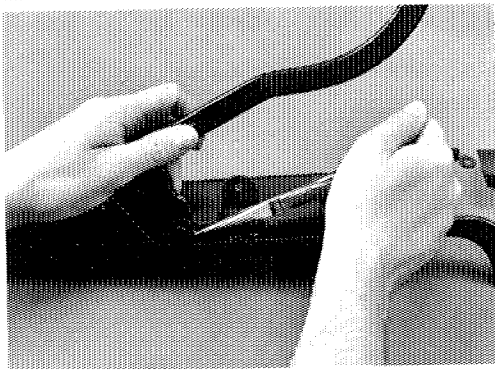

## 2. INSTALL CENTER RAIL WEATHERSTRIP AND RETAINER.

Secure retainer using two (2) nuts and washers. Do not torque nuts at this time.

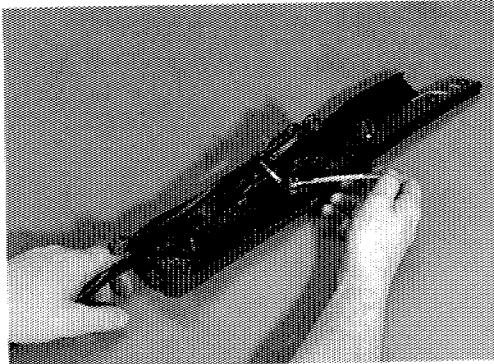



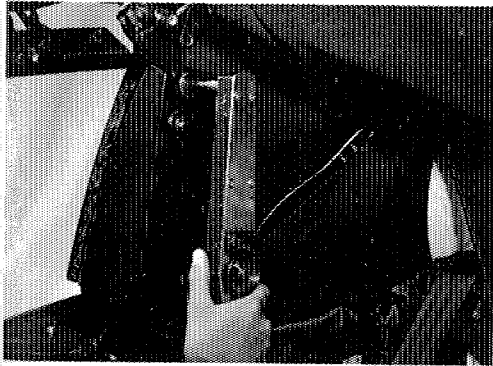

**SIDE RAIL ASSEMBLY (cont'd)**

**INSTALL**

1. INSTALL SIDE RAIL ASSEMBLY TO REAR RAIL.
  - (a) Align side rail assembly to rear rail.
  - (b) Apply Loctite (P/N 271 or equivalent) to bolt threads and install two (2) bushings and bolt.

**Torque: 17 N·m (13 ft. lb.)**

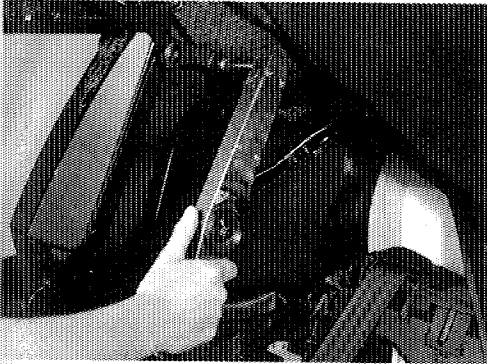

2. INSTALL BALANCE LINK TO SIDE RAIL ASSEMBLY.
  - (a) Align balance link to side rail assembly.
  - (b) Apply Loctite (P/N 271 or equivalent) to bolt threads and install two (2) bushings and bolt.

**Torque: 17 N·m (13 ft. lb.)**

3. INSTALL SIDE RAIL ASSEMBLY TO NO. 1 BOW.

- (a) Position side rail assembly to No. 1 bow.
- (b) Apply Loctite (P/N 271 or equivalent) to bolt threads and install four (4) bolts and nuts.

**Torque: 22 N·m (16 ft. lb.)**

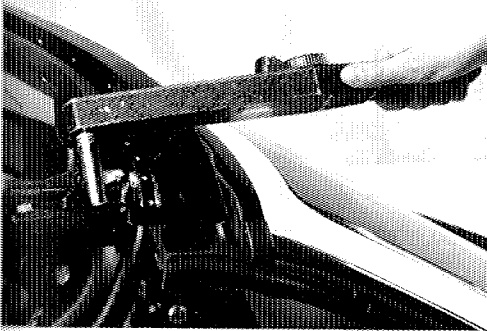

4. INSTALL CENTER LINK AND NO. 3 BOW ASSEMBLY TO REAR RAIL.

- (a) Position center link and No. 3 bow to rear rail.
- (b) Apply Loctite (P/N 271 or equivalent) to bolt threads and install three (3) bushings and bolt.

**Torque: 17 N·m (13 ft. lb.)**

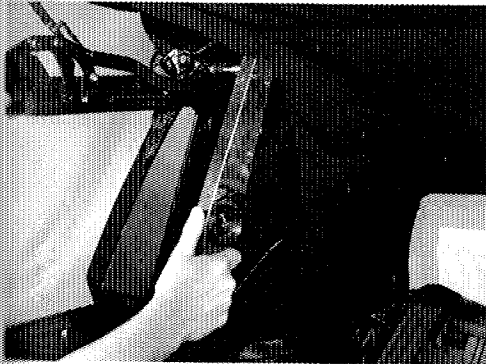

5. INSTALL NO. 2 BOW TO CENTER RAIL.

- (a) Align No. 2 bow control link slots to center rail pins.
- (b) Apply Loctite (P/N 271 or equivalent) to bolt threads and install two (2) bushings and bolt.

**Torque: 5 N·m (44 in. lb.)**



r link

om

n and

asher

sher and

INER.

torque

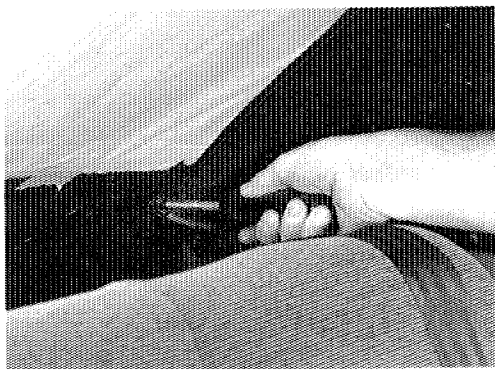

### SIDE RAIL ASSEMBLY (cont'd)

6. INSTALL HEADLINER ASSEMBLY TO DRAIN TROUGH.  
Install headliner rear strap to drain trough with screw.
7. INSTALL TOP COVER TO NO. 1 BOW (see 11-9).
8. ADJUST SIDE RAIL ASSEMBLY (see Top Stack Adjustment in this chapter).
9. LOWER AND RAISE TOP TWICE AND CHECK TOP STACK OPERATION.
  - (a) Top stack operation should be smooth and constant.
  - (b) Check door and quarter window to side rail weatherstrip alignment.



### NO. 2 BOW BUMPER

#### REMOVE

1. LOWER CONVERTIBLE TOP HALFWAY.
2. REMOVE NO. 2 BOW BUMPER.  
Using a drill with a 1/8 in. bit, remove bumper rivet and bumper from side rail.

#### INSTALL

1. INSTALL NO. 2 BOW BUMPER.  
Position bumper with a suitable washer to side rail and secure using one (1) 1/8 x .375 rivet.
2. RAISE AND LATCH CONVERTIBLE TOP AND CHECK BUMPER INSTALLATION.





# HYDRAULIC SYSTEM

	Page
HYDRAULIC SYSTEM COMPONENTS .....	19-2
THEORY OF OPERATION .....	19-4
DIAGNOSTIC FLOW CHART .....	19-5
PRELIMINARY INSPECTION .....	19-6
SYSTEM OPERATION CHECK .....	19-7
ADDING FLUID .....	19-7
BLEEDING PROCEDURE .....	19-8
CYLINDER ASSEMBLY .....	19-11
MOTOR/PUMP ASSEMBLY .....	19-14
HOSE ASSEMBLY .....	19-19

ent in  
ACK  
istent.

umper

secure

<

HYDRAULIC SYSTEM COMPONENTS

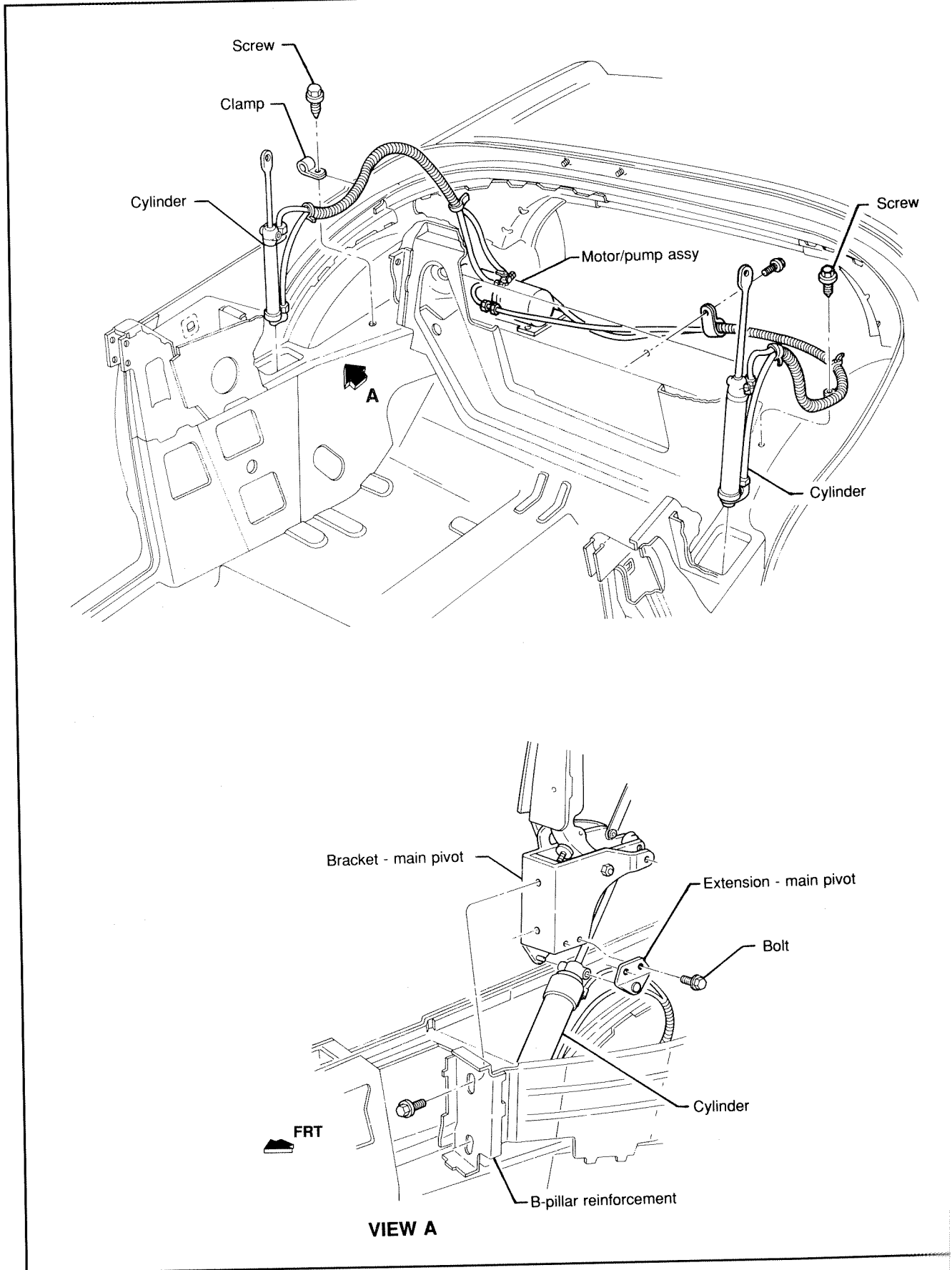

HYDRAULIC SYSTEM COMPONENTS (Cont'd)

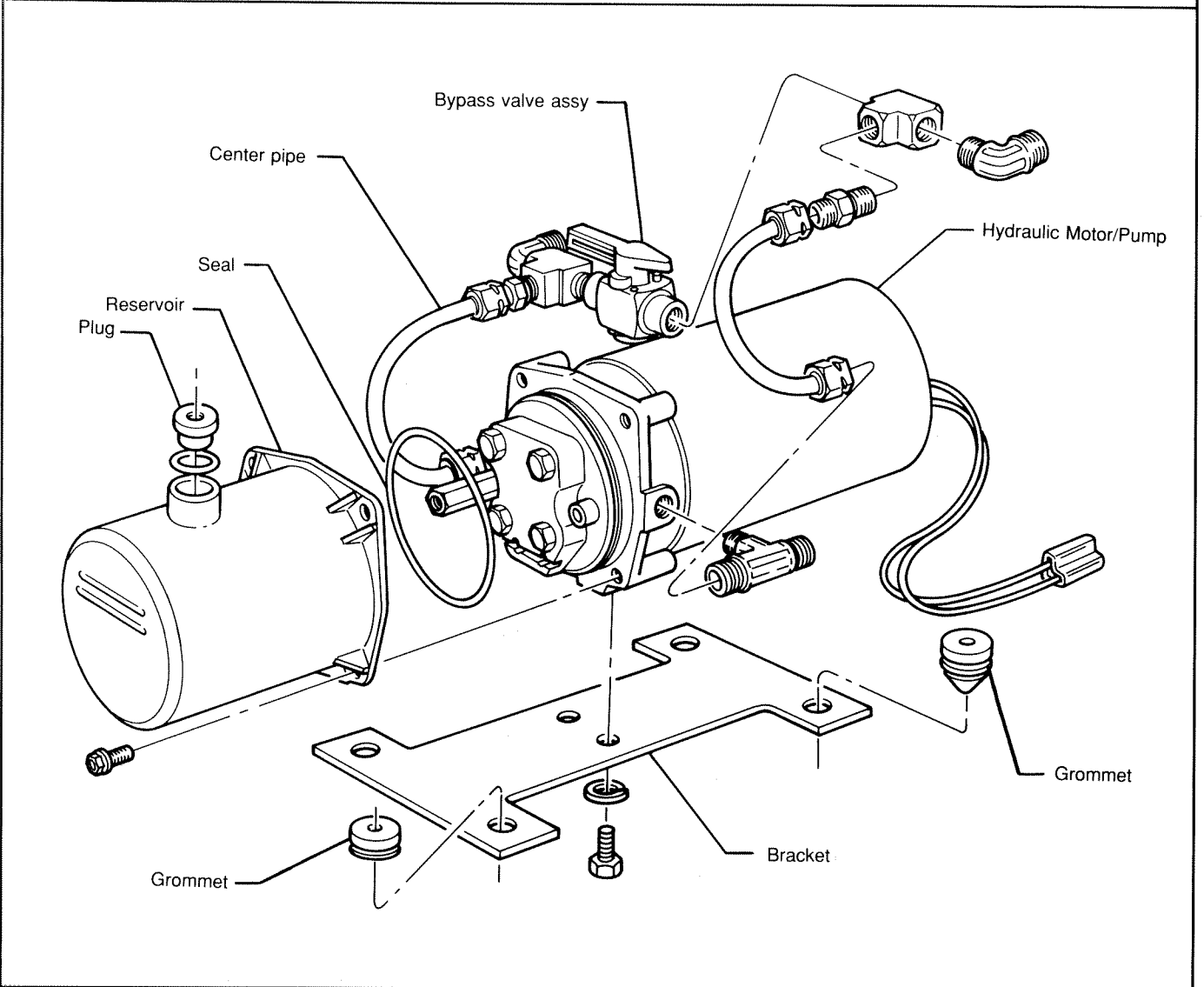
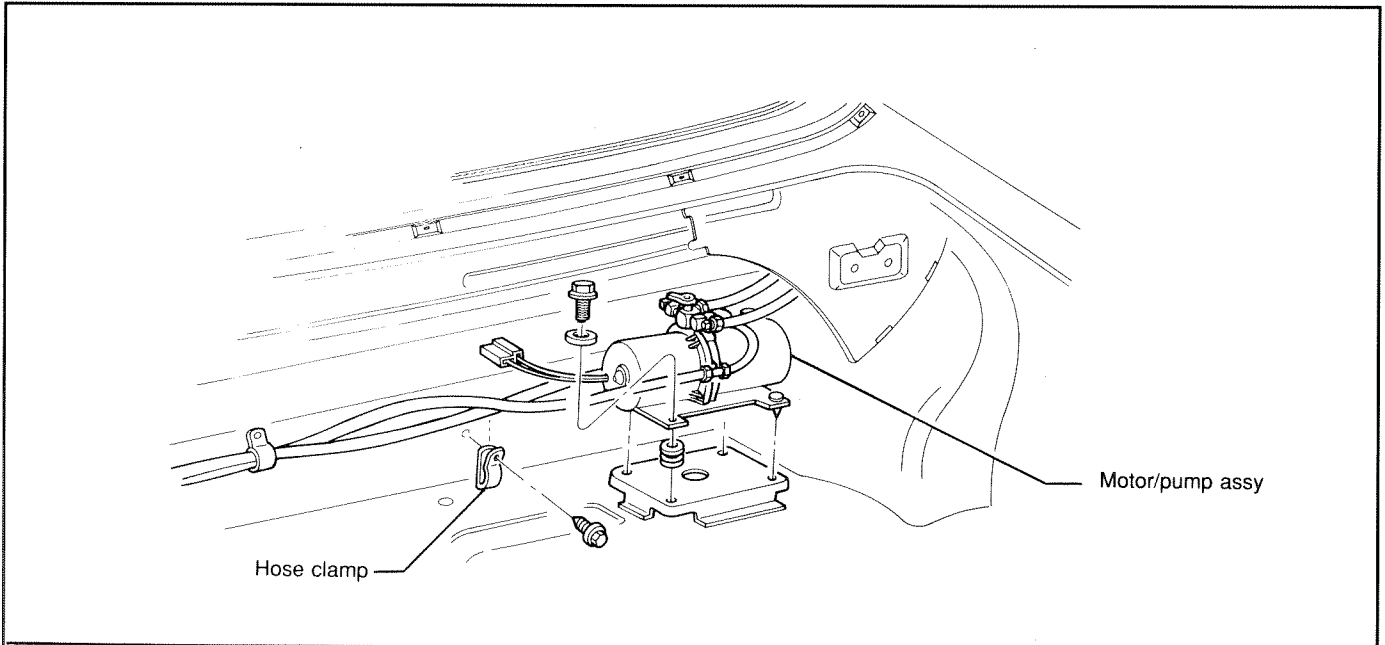

## THEORY OF OPERATION

The 240SX convertible top assembly is powered by a hydraulic system consisting of a reversible electric motor/hydraulic pump assembly with an attached reservoir. A bypass valve is attached to the top of the motor/pump assembly. Two double-action hydraulic cylinders are connected to the motor/pump assembly by hydraulic hoses. The hydraulic system uses SAE 10W motor oil.

**NOTICE: Before operating the convertible top:**

- Place transmission selector lever in "P" (park).
- Turn ignition switch to "ON".
- Lower door and quarter windows.
- Release top latches from the windshield header.

### TOP OPEN

When the convertible top motor/pump is activated in the top OPEN direction, the hydraulic pump rotates sending fluid through the "pink" hoses to the top of each hydraulic cylinder. The fluid forces the cylinder piston rod down, thus, lowering the convertible top. Fluid in the bottom of the cylinder returns to the pump through the "white" hoses, then re-circulated to the top of the cylinder.

### TOP CLOSE

When the convertible top motor/pump is activated in the top DOWN direction, the hydraulic pump rotates sending fluid through the "white" hoses to the bottom of each hydraulic cylinder. The fluid forces the cylinder piston rod up, raising the convertible top. Fluid in the top of the cylinder returns to the pump through the "pink" hoses, then re-circulated to the bottom of the cylinder.

### BYPASS VALVE ASSEMBLY

A bypass valve assembly is attached to the top of the motor/pump assembly between the right and left hydraulic cylinder hose connections. In the event of a mechanical or electrical failure, the bypass valve can be rotated 90° to the OPEN position. This will allow the convertible top to be raised or lowered MANUALLY. Should the motor/pump be activated with the manual bypass valve in the OPEN position, the convertible top will neither raise nor lower. The manual bypass valve must be in the CLOSED position for normal operation.

HYDRAULIC SYSTEM DIAGNOSTIC FLOW CHART

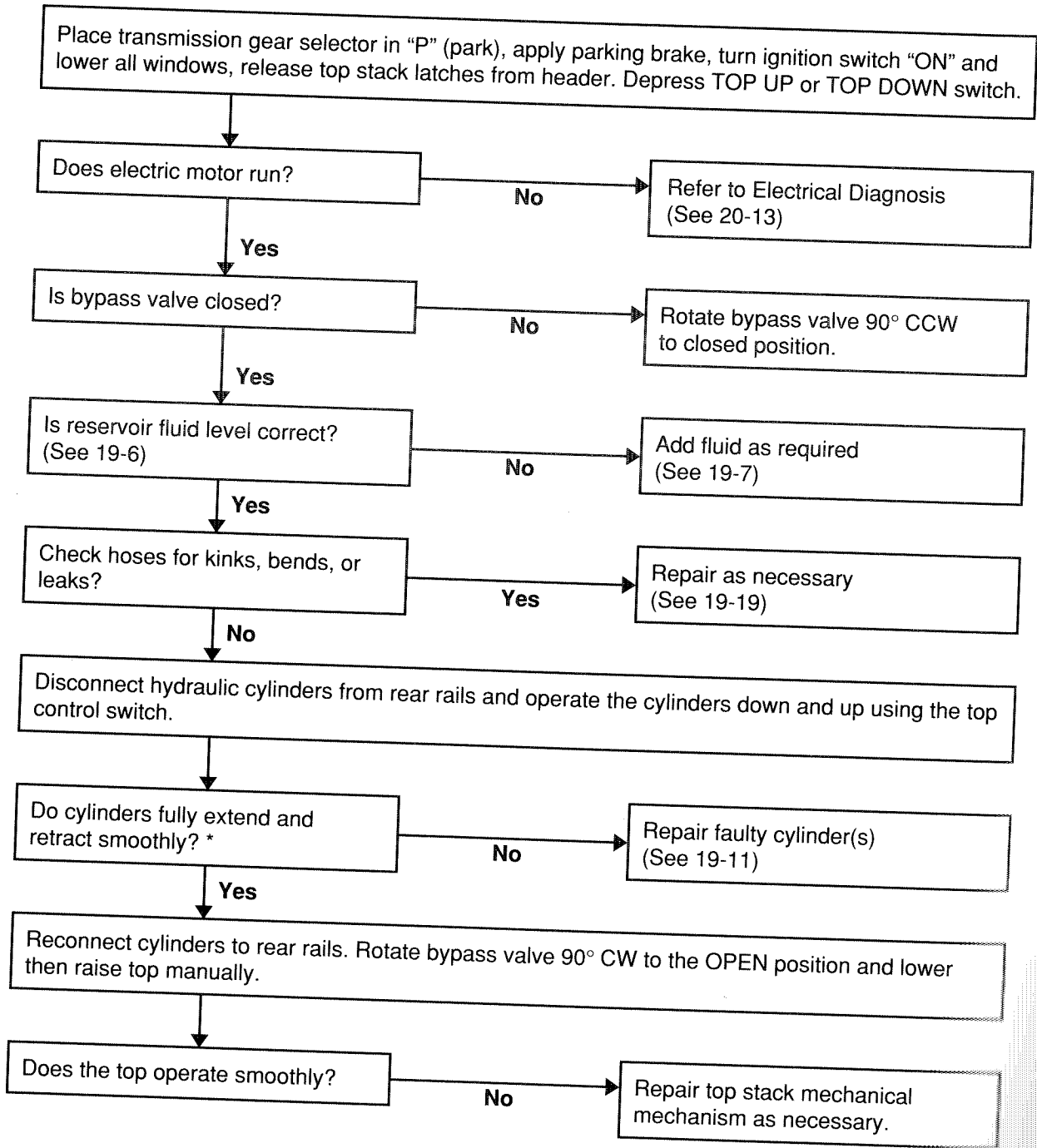

\* Some differences in cylinder speed when disconnected is normal.

## PRELIMINARY INSPECTION

Failures in the hydraulic system can be caused by incorrect fluid leaks, obstructed or kinked hoses, faulty operation of the motor/pump assembly or cylinders.

### FLUID LEVEL

**NOTE: Vehicle must be parked on a level surface with the top in the DOWN position.**

- (a) Remove right side luggage compartment trim panel.
- (b) Check oil level using reference lines on side of reservoir. Oil level should be between lines.
- (c) If low, refer to Adding Fluid in this chapter.

**CAUTION: Do not overfill. Overfilling may cause excessive pressure within the hydraulic system.**

### CYLINDER ASSEMBLY

To insure proper operation of the hydraulic cylinders the cylinder rods should be cleaned and lubricated on a regular basis. When lowering the top, inspect each cylinder rod for corrosion, dirt or rust. Wipe each cylinder rod with a clean cloth dampened with high grade, light industrial white mineral oil.

**CAUTION: Do not allow mineral oil to contact paint or trim parts.**

### MOTOR/PUMP ASSEMBLY

Check motor/pump assembly for leaks, damaged or broken parts. The motor/pump mounting hardware, bracket, bypass valve assembly, reservoir and seal are serviceable. The hydraulic pump and electric motor assembly are serviced as a complete unit only. If either part should fail, the motor and pump must be replaced as an assembly.

## SYSTEM OPERATION CHECK

- (a) Operate top UP and DOWN several times and observe for smooth consistent operation of hydraulic system.
- (b) If the hydraulic pump electric motor does not run, refer to Electrical Diagnosis (20-14).
- (c) If top does not operate properly (see Hydraulic System Diagnosis Flow Chart in this chapter).
- (d) If top hesitates or surges, check for air bubbles in the hydraulic hoses. To resolve (see Hydraulic System Bleeding in this chapter).

## ADDING FLUID

**NOTE: Vehicle must be on a level surface with top in lowered position.**

1. REMOVE RIGHT WHEELHOUSE COVER.
  - (a) Remove one (1) screw from wheelhouse cover and drain trough.
  - (b) Lift wheelhouse cover lower edge to disengage velcro and remove cover.
2. POSITION SHOP TOWEL AROUND BASE OF MOTOR/PUMP ASSEMBLY SHOULD ANY OIL BE SPILLED.
3. ADD FLUID USING SAE 10W MOTOR OIL.
  - (a) Remove reservoir filler plug.
  - (b) Add 10W motor oil until level is between reservoir indicator lines.
  - (c) Install reservoir filler plug.

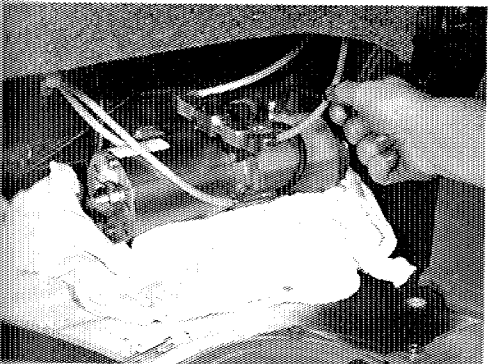
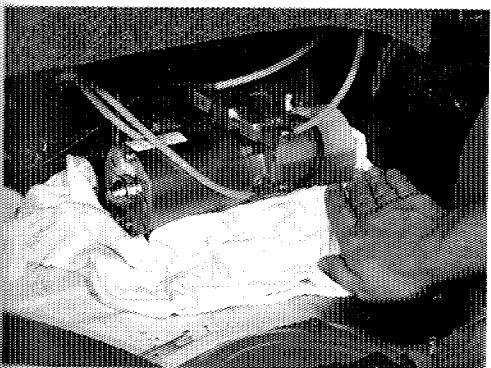
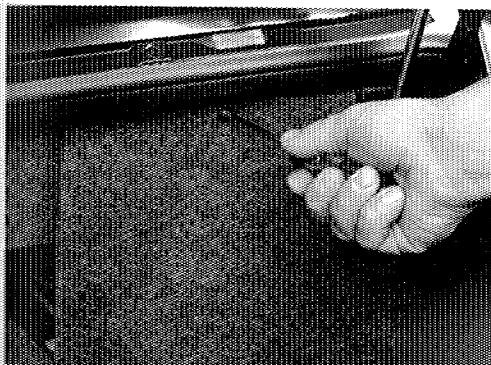



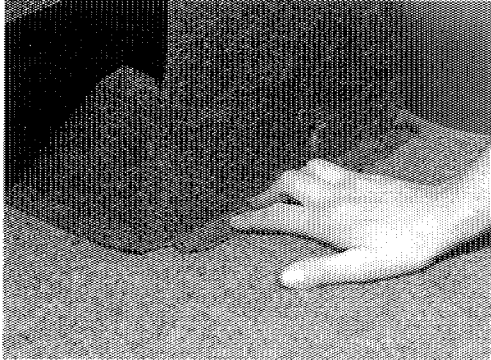
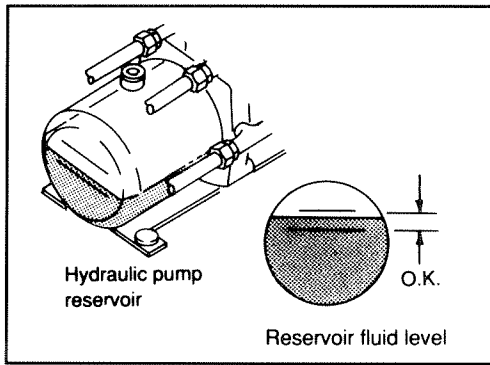

#### ADDING FLUID (cont'd)

4. CHECK OPERATION OF CONVERTIBLE TOP (see System Operation Check in this chapter).  
Check fluid level with top in the "down" position and add fluid if necessary.

5. INSTALL RIGHT WHEELHOUSE COVER.

- (a) Position right wheelhouse cover to right wheelhouse and secure to drain trough using one (1) screw.
- (b) Press down to wheelhouse cover lower edge to engage velcro to trunk floor carpet.

#### BLEEDING PROCEDURE

**NOTE:** When performing this procedure, do not allow the fluid level to drop below the bottom indicator line on the reservoir.

**CAUTION:** During bleeding procedure, insure cylinder rod does not come in contact with body panels, top stack or cover when extending.

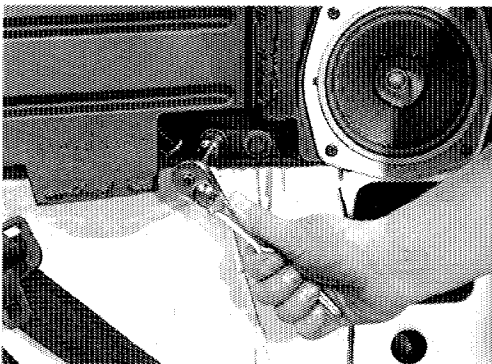
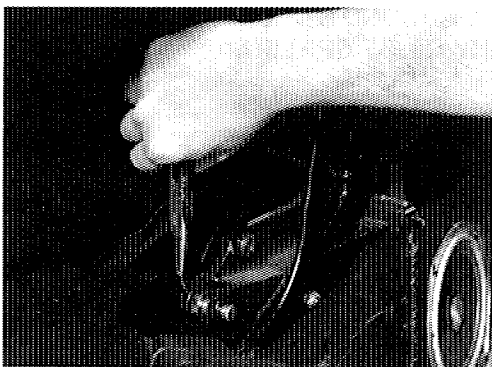

1. REMOVE BOTH QUARTER TRIM PANELS (5-3).
2. DISCONNECT CYLINDER ROD FROM REAR RAIL.
  - (a) Remove cotter pin and washer from cylinder clevis pin.
  - (b) Remove cylinder clevis pin.
  - (c) Repeat step 2 (a) and (b) on other side of vehicle.
3. REPOSITION CYLINDER ASSEMBLY.
  - (a) Remove two (2) main pivot bracket extension bolts and extension.
  - (b) Position cylinder so cylinder rod will not come in contact with body parts, top stack, or cover when fully extended.
  - (c) Repeat step 3 (a) and (b) on other side of vehicle.

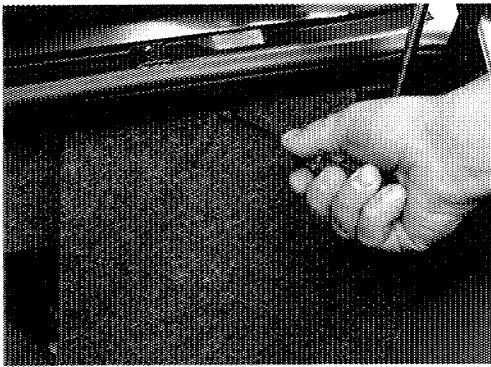
**BLEEDING PROCEDURE (cont'd)**

## 4. REMOVE RIGHT WHEELHOUSE COVER.

- (a) Remove one (1) screw from wheelhouse cover and drain trough.
- (b) Lift wheelhouse cover lower edge to disengage velcro and remove wheelhouse cover from vehicle.

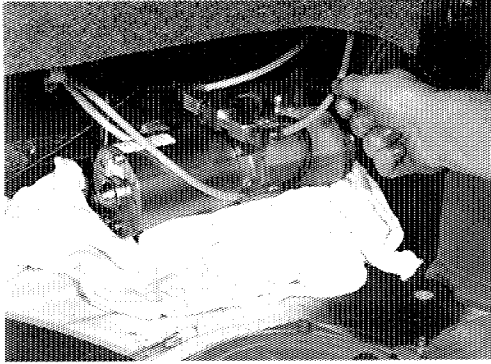

## 5. POSITION HOSE ASSEMBLY FOR BLEEDING.

- (a) Remove reservoir filler plug.

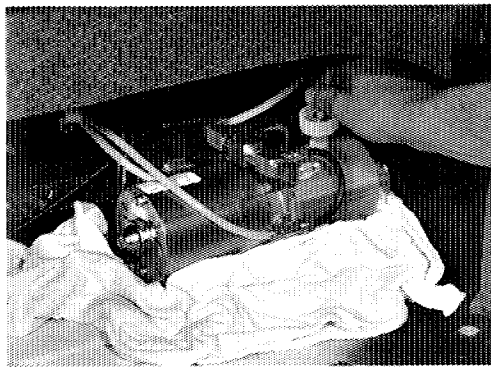

- (b) Disconnect one "pink" hose from motor/pump assembly and position to motor/pump reservoir opening.

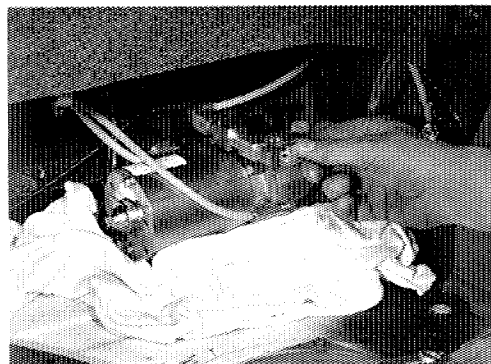

## 6. CAP-OFF MOTOR/PUMP FITTING.

Using a rubber plug, such as a vacuum fitting cap, seal the "open" pump fitting.

**NOTE: Fitting must be sealed to prevent air from entering the system.**

## 7. BLEED HYDRAULIC SYSTEM.

Depress TOP UP switch. After cylinders are fully-extended, continue to depress switch until hose being bled is free of air bubbles.

**CAUTION: Insure cylinder rod does not come in contact with body panels, top stack or cover when extending.**

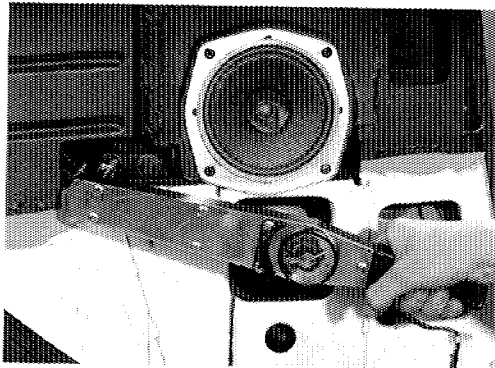
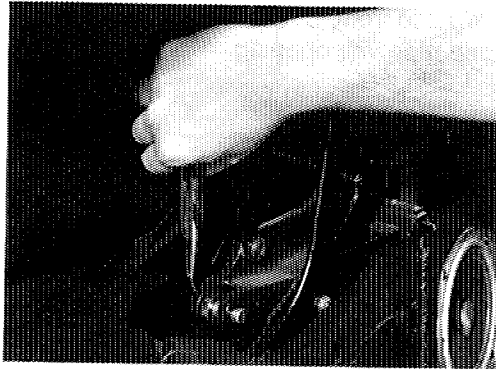
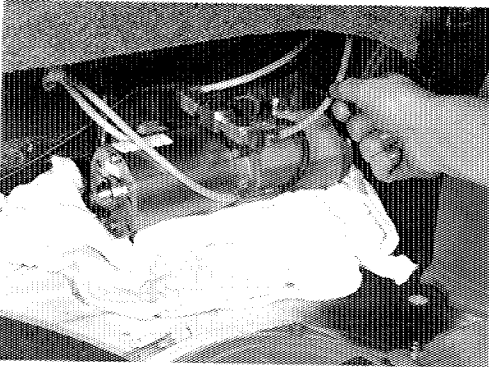
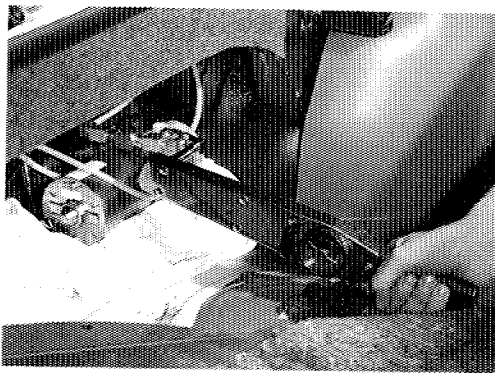

## BLEEDING PROCEDURE (cont'd)

8. CONNECT "PINK" HOSE TO MOTOR/PUMP FITTING.
  - (a) Remove hose from reservoir and install to motor/pump assembly fitting.
 

**Torque: 7 N·m (61 in. lb.)**
  - (b) If low, add fluid to reservoir.
  - (c) Repeat steps 5 through 7 for other cylinder.
  
9. INSTALL RESERVOIR FILLER PLUG.
  - (a) If low, add fluid to reservoir (see Adding Fluid in this chapter).
  - (b) Install reservoir filler plug.
  
10. CONNECT CYLINDER ROD TO REAR RAIL.
  - (a) Rotate bypass valve 90° to the OPEN position.
  - (b) Position cylinder rod to rear rail and install clevis pin.
  - (c) Install washer and cotter pin to clevis pin.
  
11. INSTALL MAIN PIVOT BRACKET EXTENSION.
  - (a) Position cylinder to pivot bracket pin and install extension using two (2) bolts.
 

**Torque: 22 N·m (17 ft. lb.)**
  - (b) Repeat steps 10 (b) through 11 (a) for other side of vehicle.
  - (c) Rotate bypass valve to CLOSED position.
  
12. INSTALL BOTH QUARTER TRIM PANELS AND REAR SEAT (see 5-4).
13. CHECK HYDRAULIC SYSTEM OPERATION (see System Operation Check in this chapter).

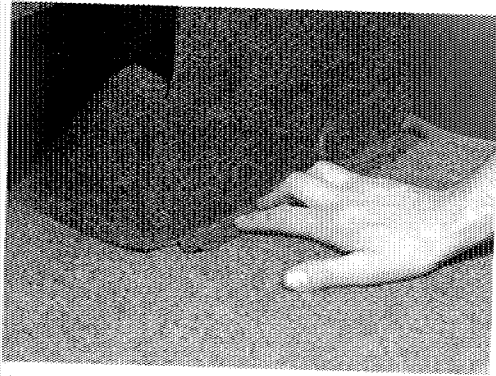
**BLEEDING PROCEDURE (cont'd)**

14. INSTALL RIGHT WHEELHOUSE COVER.
  - (a) Position right wheelhouse cover to right wheelhouse and secure using one (1) screw.
  - (b) Press down on wheelhouse cover lower edge to engage velcro to trunk floor carpet.

**CYLINDER ASSEMBLY****REMOVE**

**NOTE:** Replacement cylinder assemblies are supplied filled with oil. Do not remove sealing caps from cylinder until you are ready to connect hydraulic hoses.

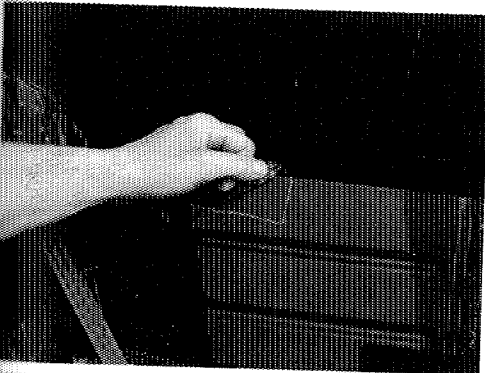

1. REMOVE QUARTER TRIM OUTER PANEL (5-5).
2. REMOVE FOLDING TOP WELL MATERIAL FROM SIDE TO BE SERVICED.
  - (a) Mark edge of folding top well material on body brace rear and side panel.
  - (b) Carefully break cement bond by pulling well material from body brace panels.

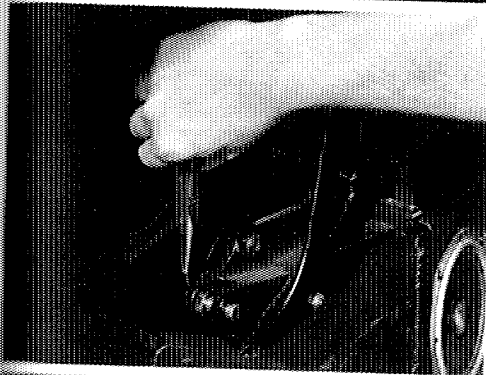

3. DISCONNECT CYLINDER FROM TOP STACK REAR RAIL.
  - (a) Remove cotter pin and washer from cylinder clevis pin.
  - (b) Remove cylinder clevis pin.

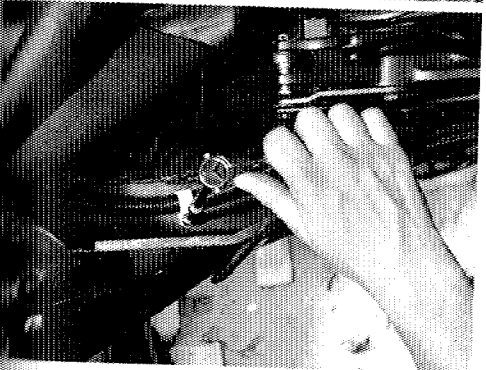

4. REMOVE HOSE ASSEMBLY CLAMP.  
Remove screw from hose clamp and body panel.

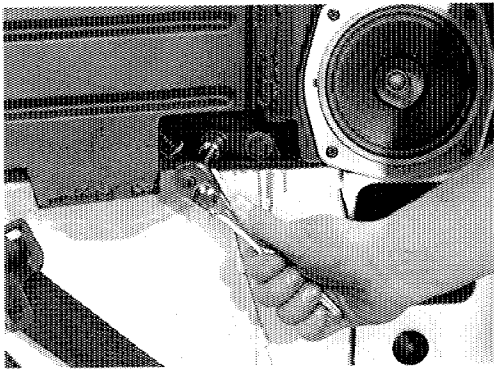

### CYLINDER ASSEMBLY (cont'd)

5. REMOVE MAIN PIVOT BRACKET EXTENSION.  
Remove (2) bolts and extension from pivot bracket.

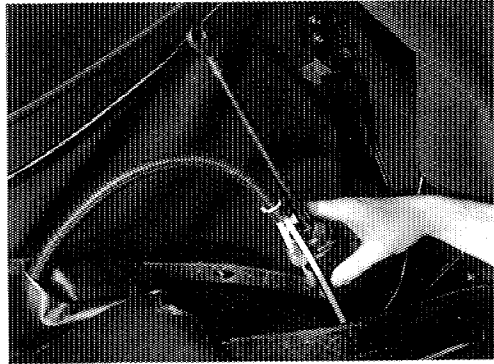

6. REMOVE CYLINDER ASSEMBLY.
  - (a) Lift cylinder from top well area and place in rear passenger compartment.

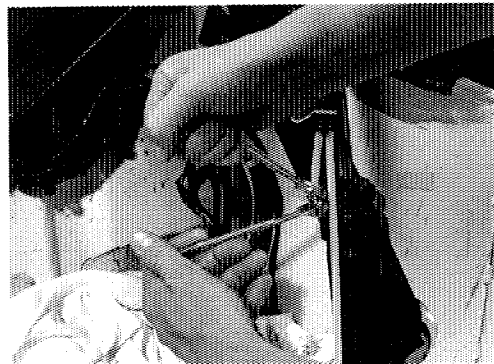

- (b) Position a shop towel around base of cylinder.
- (c) Disconnect two (2) hoses from cylinder and remove cylinder from vehicle.

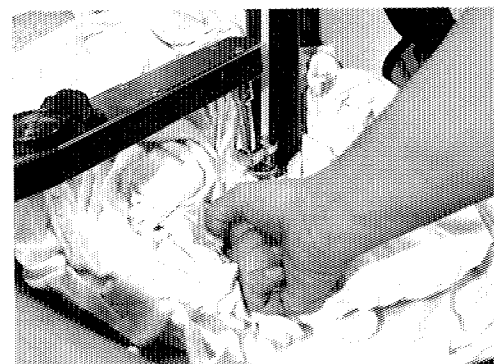

### INSTALL

1. INSTALL CYLINDER ASSEMBLY.
  - (a) Connect "white" hose to cylinder lower fitting.
  - (b) Connect "pink" hose to cylinder upper fitting.

**Torque both fittings: 7 N·m (61 in. lb.)**

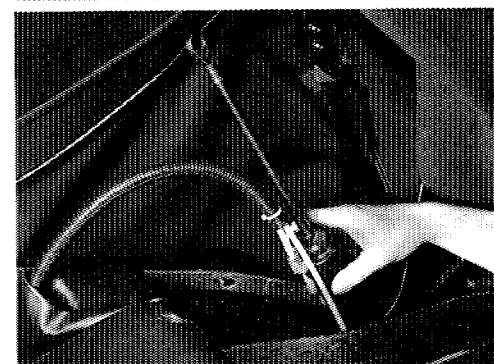

- (c) Position cylinder into top well area.

**NOTE: Insure cylinder is positioned correctly and hoses will not pinch or kink when top is operated.**



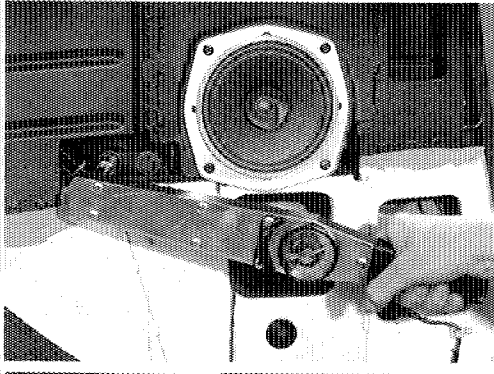

### CYLINDER ASSEMBLY (cont'd)

#### 2. INSTALL MAIN PIVOT BRACKET EXTENSION.

- (a) Position cylinder to main pivot bracket pin.
- (b) Position extension to cylinder and pivot bracket and secure using two (2) bolts.

**Torque: 22 N·m (17 ft. lb.)**

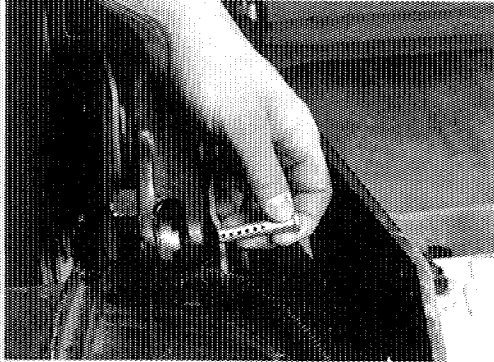

#### 3. CONNECT CYLINDER ROD TO TOP STACK REAR RAIL.

- (a) Rotate bypass valve 90° clockwise.
- (b) Position cylinder rod to rear rail and install clevis pin.

**NOTE: Insure cylinder rod bushing is in place.**

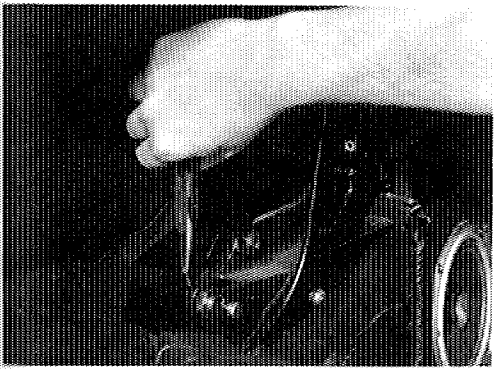

- (c) Install washer and cotter pin to clevis pin.
- (d) Rotate bypass valve 90° counterclockwise.

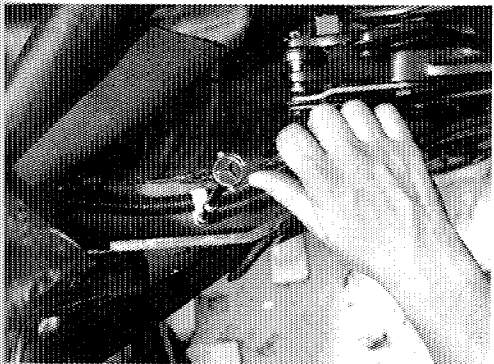

#### 4. INSTALL HOSE ASSEMBLY CLAMP.

Position clamp to hose assembly and secure to body using screw.

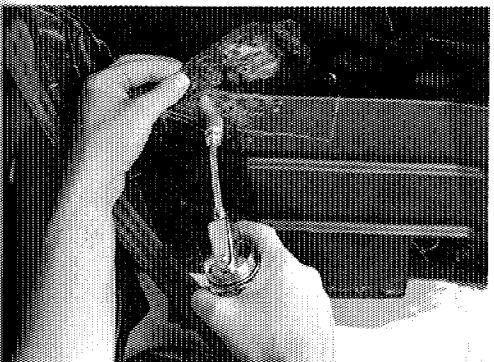

#### 5. INSTALL FOLDING TOP WELL MATERIAL.

- (a) Apply adhesive (3M P/N 051135-08031 or equivalent) to body brace panels and well material.
- (b) Position folding well material to body panel working outward toward end of material.

senger

ind  
3

**CYLINDER ASSEMBLY (cont'd)**

6. INSTALL QUARTER TRIM OUTER PANEL (5-5).
7. CHECK HYDRAULIC SYSTEM OPERATION (see System Operation Check in this chapter).

**MOTOR/PUMP ASSEMBLY**

The motor/pump mounting hardware, bracket, bypass valve assembly, reservoir and seal are serviceable. The hydraulic pump and electric motor assembly is serviced as a complete unit. If either part should fail, the motor and pump must be replaced as an assembly.

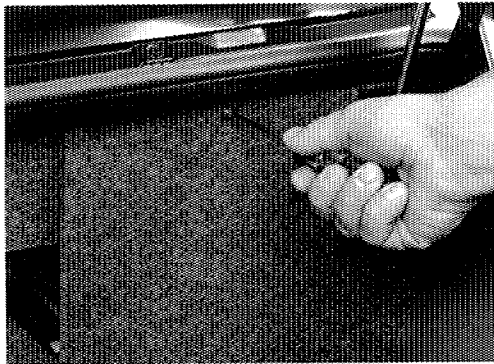
**REMOVE**

1. REMOVE RIGHT WHEELHOUSE COVER.
  - (a) Remove one (1) screw from wheelhouse cover and drain trough.
  - (b) Lift wheelhouse cover lower edge to disengage velcro and remove cover.
  
2. REMOVE MOTOR/PUMP ASSEMBLY FROM MOUNTING BASE.
  - (a) Disconnect electrical connector.
  
  - (b) Remove bolt and washer securing motor/pump bracket to mounting base.

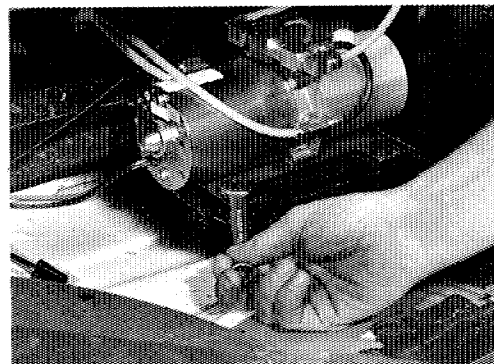
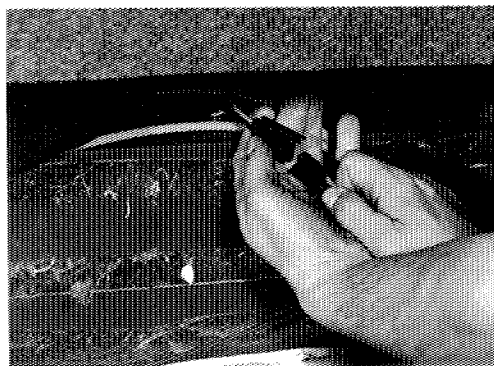



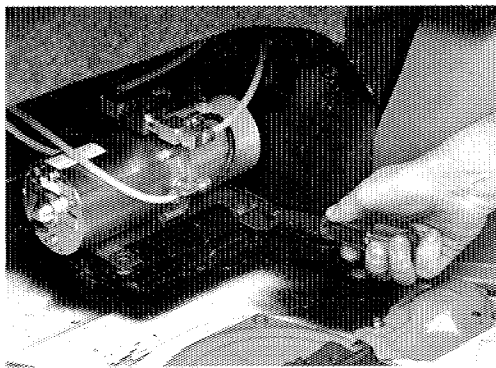

### MOTOR/PUMP ASSEMBLY (cont'd)

- (c) Pry up on motor/pump bracket to release rubber mounting grommets from mounting base.

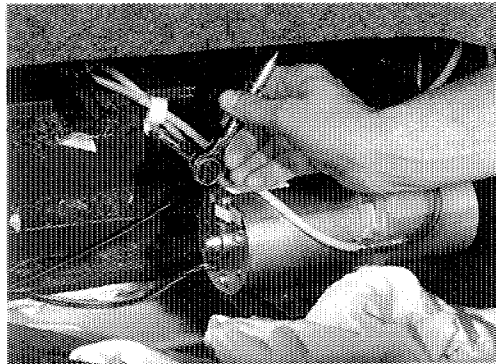

#### 4. DISCONNECT HOSE ASSEMBLY.

- (a) Remove hose assembly clamp.

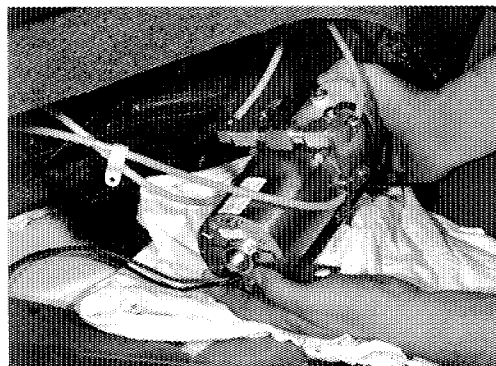

- (b) Position motor/pump assembly to allow access to hose fittings.

**NOTE: Do not kink hoses.**

- (c) Place shop towels around motor/pump assembly.

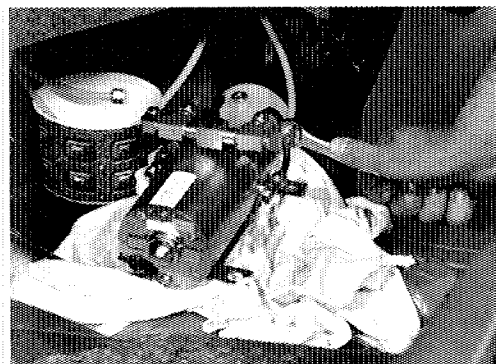

- (d) Disconnect "pink" and "white" hoses from motor/pump assembly.

**NOTE: Plug or place hose ends into a container as they are removed to prevent oil leakage.**

- (e) Remove motor/pump assembly from vehicle.

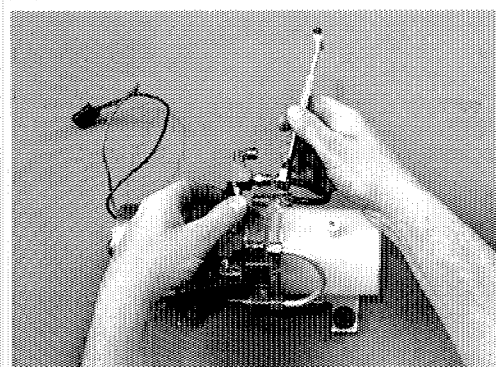

### DISASSEMBLE

#### 1. REMOVE BYPASS VALVE ASSEMBLY.

- (a) Disconnect right and left center pipes and remove bypass valve.
- (b) Remove center pipe "T" fittings from bypass valve.

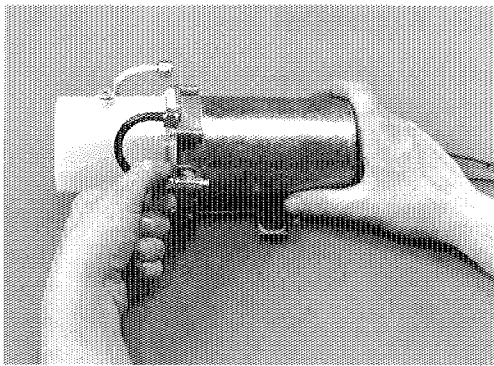

### MOTOR/PUMP ASSEMBLY (cont'd)

#### 2. REMOVE CENTER PIPE.

**CAUTION:** Label position of "black" and "silver" pipes to aid re-assembly.

- (a) Disconnect center pipe at pump body fitting.
- (b) Remove center pipe "T" fitting from pump body.

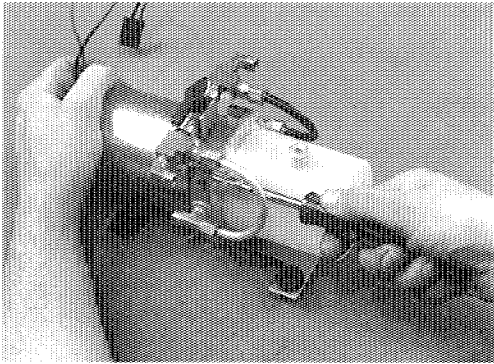

#### 3. REMOVE RESERVOIR AND SEAL.

- (a) Drain reservoir into a container.
- (b) Remove four (4) screws securing reservoir to pump body.

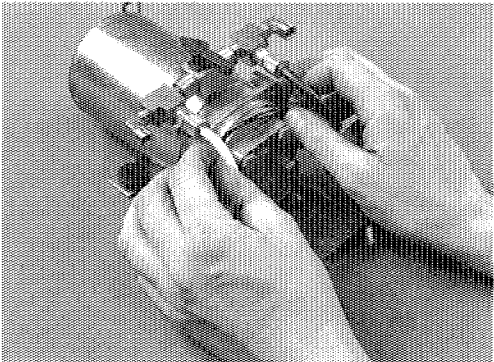

- (c) Remove reservoir and seal from pump body.

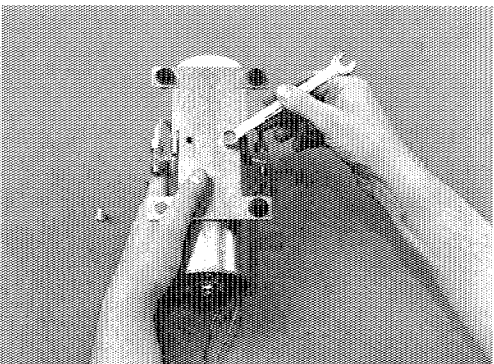

#### 4. REMOVE MOTOR/PUMP BRACKET.

- (a) Note "mounting bolt grommet" position and remove two (2) bolts and washers securing bracket to pump body.
- (b) Remove four (4) rubber grommets from bracket.

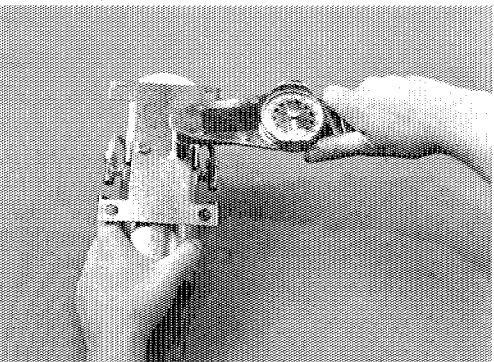

### ASSEMBLE

#### 1. INSTALL MOTOR/PUMP BRACKET.

- (a) Install bracket to pump body using two (2) washers and bolts.

**Torque: 9 N·m (78 in. lb.)**

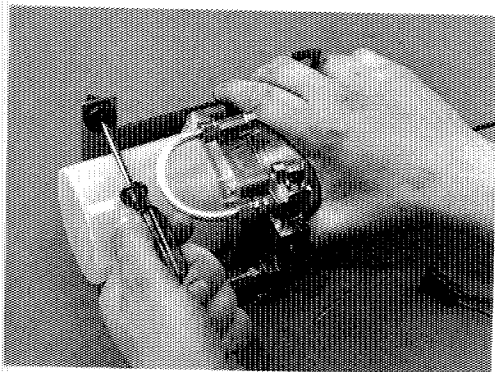

### MOTOR/PUMP ASSEMBLY (cont'd)

- (b) Install four (4) grommets to bracket. Insure mounting bolt grommet is positioned as noted during disassembly.

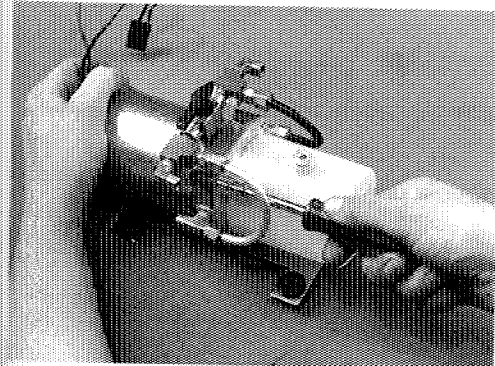

### 2. INSTALL RESERVOIR AND SEAL.

- (a) Install seal to pump body.
- (b) Install reservoir to pump body using four (4) screws.

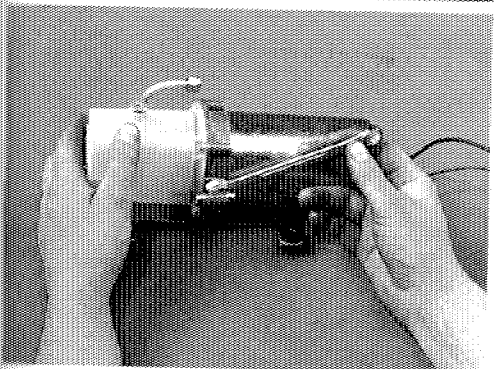

### 3. INSTALL CENTER PIPE.

- (a) Apply pipe thread sealer (Loctite P/N 592 or equivalent) to pump body "T" fitting.
- (b) Install "T" fitting to pump body. Insure fitting is tight while remaining horizontal with pump.
- (c) Connect center pipe to pump "T" fitting, noting pipe color.

**NOTE: Do not tighten pipe "T" fitting until center pipe is connected to bypass valve. If bypass valve is removed, see Install Bypass Valve in this chapter.**

**Torque: 7 N·m (61 in. lb.)**

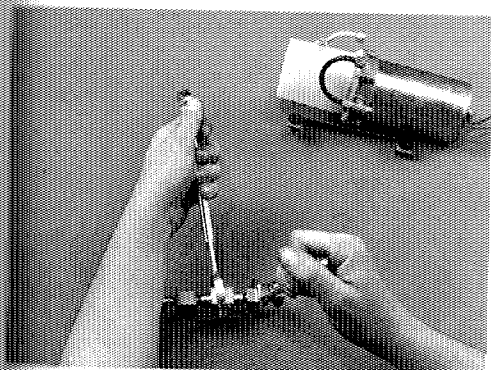

### 4. INSTALL BYPASS VALVE.

- (a) Apply pipe thread sealer (Loctite P/N 592 or equivalent) to bypass valve "T" fitting.
- (b) Install "T" fitting to bypass valve. Insure fitting is tight while remaining horizontal with valve.

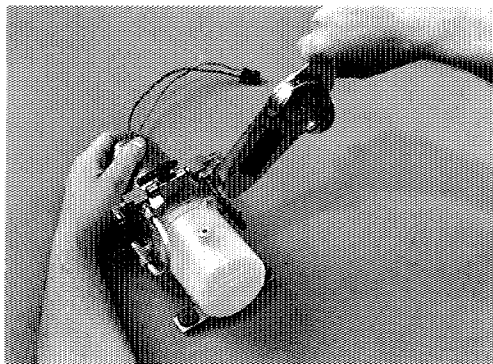

### MOTOR/PUMP ASSEMBLY (cont'd)

- (c) Connect center pipe to bypass valve fitting.

**Torque: 7 N·m (61 in. lb.)**

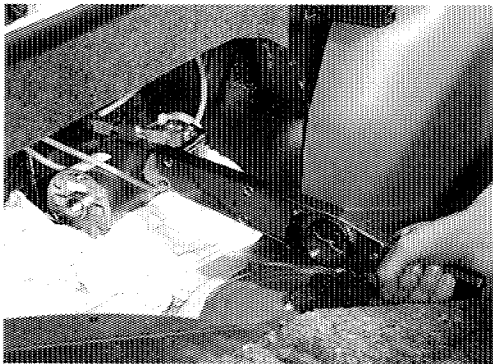

### INSTALL

1. CONNECT HOSE ASSEMBLIES.

- (a) Connect cylinder "pink" hoses to side of pump with "black" center pipe.  
 (b) Connect cylinder "white" hoses to side of pump with "silver" center pipe.

**Torque: 7 N·m (61 in. lb.)**

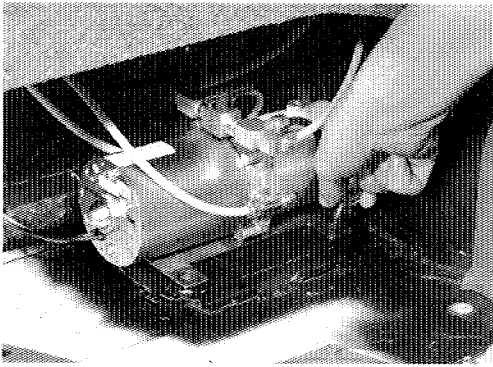

2. INSTALL MOTOR/PUMP ASSEMBLY.

- (a) Fill reservoir to indicator line with 10W motor oil (see Adding Fluid in this chapter).  
 (b) Position motor/pump assembly to base. Using a blunt tool, push three (3) mounting bracket grommets into base holes.

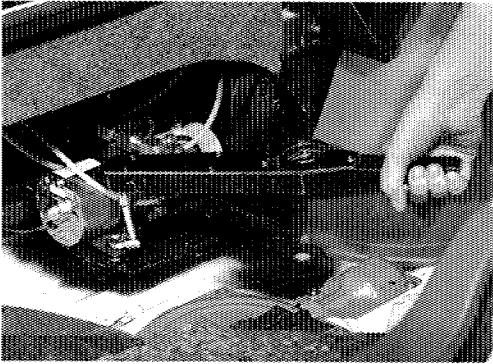

- (c) Secure mounting bracket to base with bolt and washer.

**Torque: 15 N·m (11 lb. ft.).**

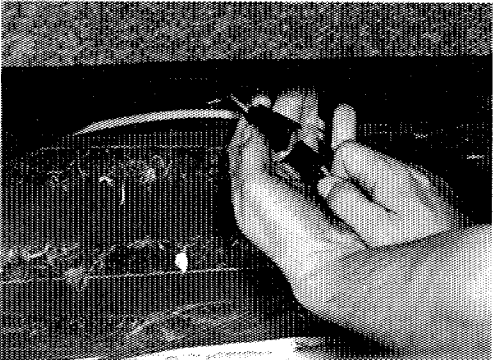

- (d) Connect electrical connector.

3. CHECK HYDRAULIC SYSTEM OPERATION (see System Operation Check in this chapter).



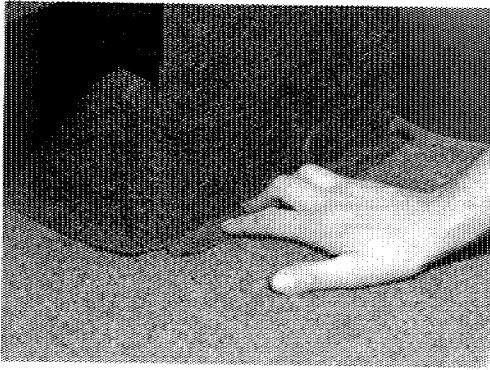

## MOTOR/PUMP ASSEMBLY (cont'd)

4. INSTALL RIGHT WHEELHOUSE COVER.
  - (a) Position right wheelhouse cover to right wheelhouse and secure using one (1) screw.
  - (b) Press down on wheelhouse cover lower edge to engage velcro to trunk floor carpet.

## HOSE ASSEMBLY

### REMOVE

1. REPOSITION MOTOR/PUMP ASSEMBLY ALLOWING ACCESS TO HOSE ASSEMBLIES (see Motor/Pump Assembly in this chapter).

2. DISCONNECT HOSE ASSEMBLY AT MOTOR/PUMP ASSEMBLY.

- (a) Place shop towels around motor/pump assembly.
- (b) Disconnect hose assembly "pink" and "white" hoses from motor/pump.

**NOTE: Only disconnect hoses from side to be serviced.**

3. REMOVE HOSE ASSEMBLY CLAMPS.

- (a) For right side: remove one (1) hose assembly clamp.

- (b) For left side: remove four (4) hose assembly clamps.

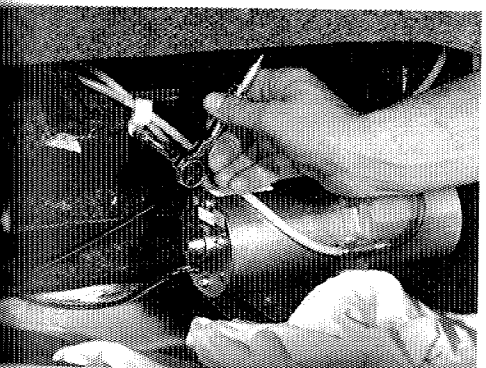
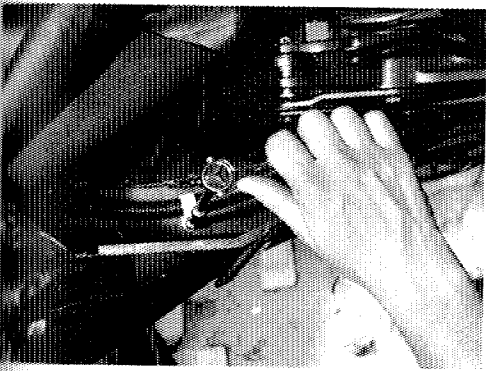
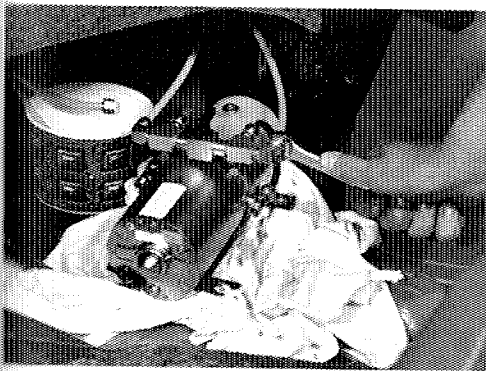

black"

"silver"

e

nt tool,  
e holes.

her.

em

**HOSE ASSEMBLY (cont'd)**

4. DISCONNECT HOSE ASSEMBLY FROM CYLINDER (see Cylinder Assembly in this chapter).
5. REMOVE HOSE ASSEMBLY FROM VEHICLE.

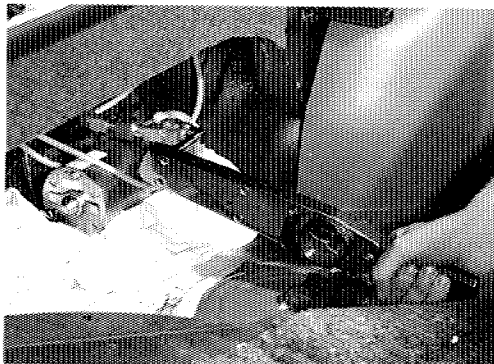
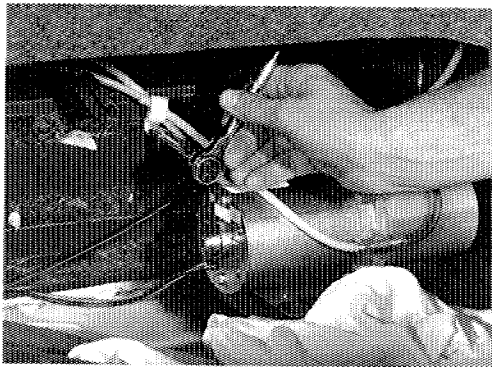
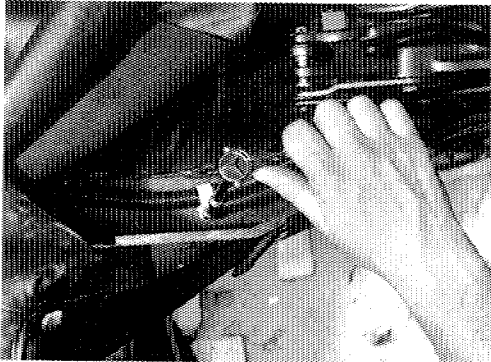
**INSTALL**

1. POSITION HOSE ASSEMBLY TO VEHICLE.
2. CONNECT HOSE ASSEMBLY TO CYLINDER (see Cylinder Assembly in this chapter).
3. INSTALL HOSE ASSEMBLY CLAMPS.
  - (a) For right side: secure one (1) hose assembly clamp with screw.
  - (b) For left side: secure four (4) hose assembly clamps with four (4) screws.
4. INSTALL HOSE ASSEMBLY TO MOTOR/PUMP ASSEMBLY.
  - (a) Connect "pink" hose to side of pump with "black" center pipe.
  - (b) Connect "white" hose to side of pump with "silver" center pipe.

**Torque: 7 N·m (61 in. lb.)**
5. INSTALL MOTOR/PUMP ASSEMBLY (see Motor/Pump Assembly in this chapter).
6. BLEED HOSE ASSEMBLY (see Bleeding Procedure in this chapter).

# ELECTRICAL

	Page
ELECTRICAL COMPONENTS .....	20-2
TOP UP/TOP DOWN SWITCHES .....	20-3
QUARTER WINDOW SWITCH .....	20-3
FOLDING TOP LOGIC RELAY .....	20-4
QUARTER WINDOW RELAY .....	20-4
POWER WINDOW AMPLIFIER .....	20-4
AUTOMATIC RESTRAINT CONTROLLER .....	20-5
TRUNK ROOM LAMP SWITCH .....	20-5
TRUNK ROOM LAMP .....	20-6
FOLDING TOP LOGIC RELAY REAR JUMPER .....	20-7
PREFACE TO ELECTRICAL HARNESS LAYOUT AND WIRING DIAGRAMS .....	20-9
MAIN BODY HARNESS LAYOUT .....	20-10
MAIN INSTRUMENT PANEL HARNESS LAYOUT .....	20-14
DOOR (R/L) HARNESS LAYOUT .....	20-17
HYDRAULIC MOTOR/PUMP ELECTRICAL SYSTEM .....	20-18
AUTOMATIC RESTRAINT SYSTEM (FRONT) .....	20-26
POWER WINDOWS .....	20-32
CLEARANCE, LICENSE, TAIL AND STOP LAMPS .....	20-40
MAIN CIRCUIT DIAGRAM (Fold-Out) .....	20-41



ELECTRICAL COMPONENTS

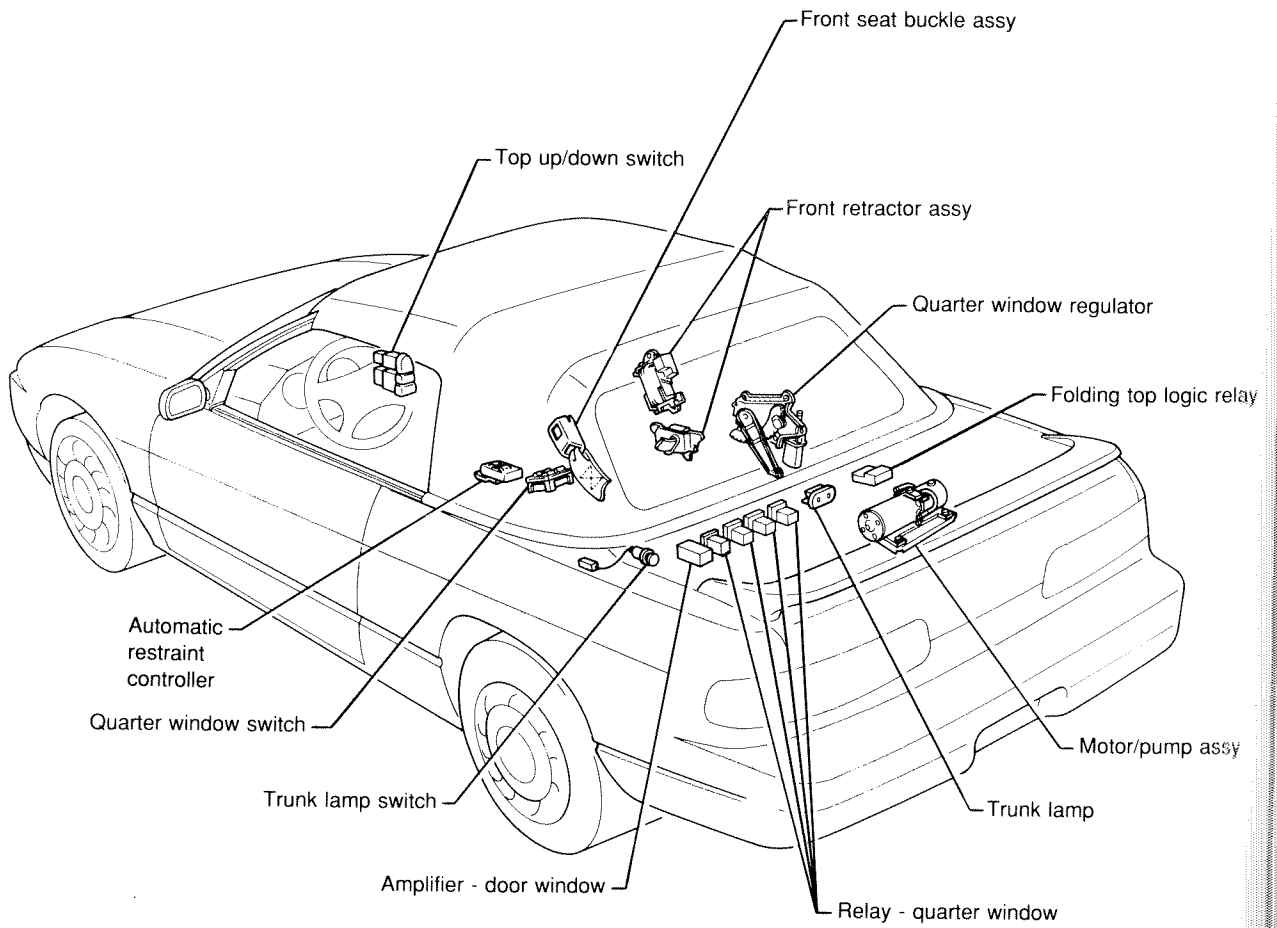

## TOP UP/TOP DOWN SWITCH

### REMOVE

1. REMOVE COMBINATION METER BEZEL FROM INSTRUMENT PANEL (see vehicle Service Manual).
2. REMOVE TOP UP/TOP DOWN SWITCH FROM COMBINATION METER BEZEL.
  - (a) Disconnect harness connector.
  - (b) Release pawls securing switch to combination meter bezel.
3. CHECK TOP UP/TOP DOWN SWITCH OPERATION (see Hydraulic Motor/Pump Electrical Diagnostic Procedures in this chapter).

### INSTALL

1. INSTALL TOP UP/TOP DOWN SWITCH.
  - (a) Position switch to combination meter bezel and lock pawls in place.
  - (b) Connect harness connector to switch.
2. INSTALL COMBINATION METER BEZEL TO INSTRUMENT PANEL (see vehicle Service Manual).
3. CHECK CONVERTIBLE TOP OPERATION.

## QUARTER WINDOW SWITCH

### REMOVE

1. REMOVE CONSOLE (see vehicle Service Manual).
2. REMOVE QUARTER WINDOW SWITCH FROM CONSOLE.
 

Release pawls securing switch to console.

### INSTALL

1. INSTALL QUARTER WINDOW SWITCH TO CONSOLE.
 

**NOTE: Position switch and press into console engaging locking pawls.**
2. INSTALL CONSOLE (see vehicle Service Manual).
3. CHECK QUARTER WINDOW OPERATION.

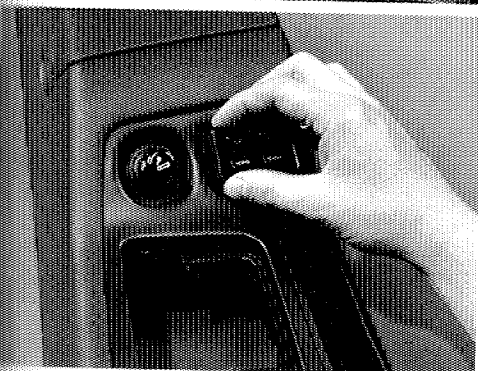
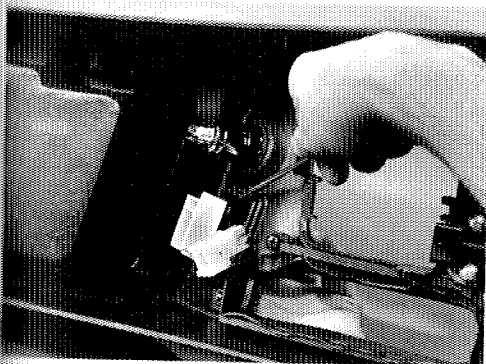

gic relay

p assy

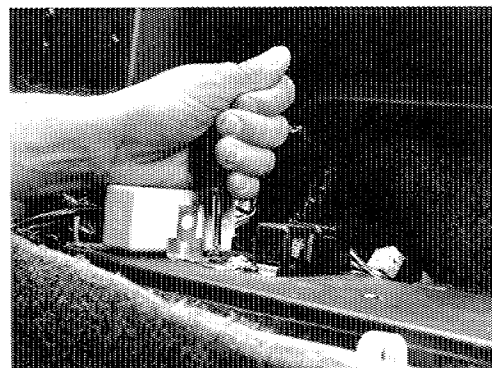
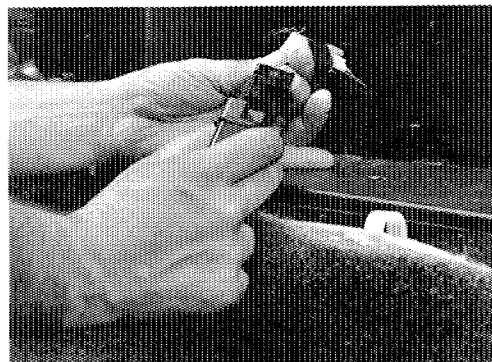
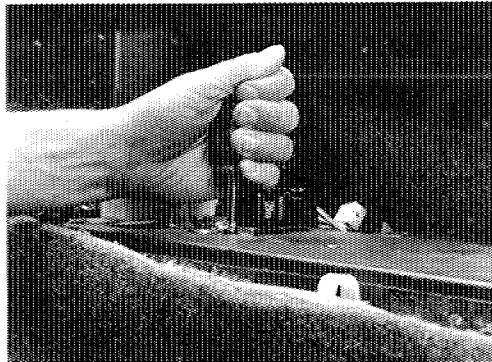
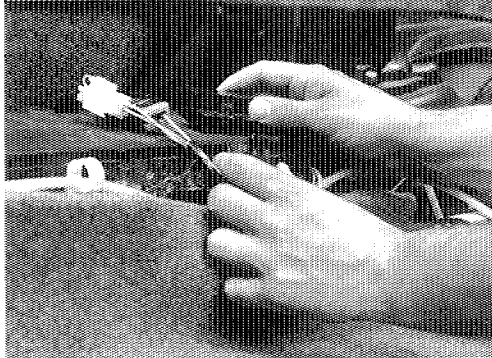
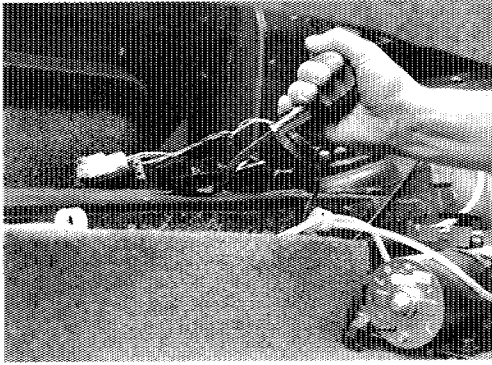

## FOLDING TOP LOGIC RELAY

### REMOVE

1. OPEN REAR DECK LID AND REMOVE RIGHT WHEELHOUSE COVER ASSEMBLY (see 21-7).
2. REMOVE FOLDING TOP LOGIC RELAY.
  - (a) Disconnect rear jumper connector from relay.
  - (b) Pry relay retainer from body panel.

### INSTALL

1. INSTALL FOLDING TOP LOGIC RELAY.
  - (a) Push relay retainer into position on body panel.
  - (b) Connect rear jumper connector to relay.
2. INSTALL RIGHT WHEELHOUSE COVER ASSEMBLY (see 21-8).
3. CHECK CONVERTIBLE TOP OPERATION AND CLOSE REAR DECK LID.

## QUARTER WINDOW RELAY

### REMOVE

1. OPEN REAR DECK LID.
2. REMOVE QUARTER WINDOW RELAY.
  - (a) Remove screw from quarter window relay.
  - (b) Disconnect quarter window relay electrical connector.

### INSTALL

1. INSTALL QUARTER WINDOW RELAY.
  - (a) Connect electrical connector.
  - (b) Position relay and secure with screw.
2. CHECK QUARTER WINDOW OPERATION AND CLOSE REAR DECK LID.

## POWER WINDOW AMPLIFIER

### REMOVE

1. OPEN REAR DECK LID
2. REMOVE POWER WINDOW AMPLIFIER
  - (a) Remove screw from power window amplifier.
  - (b) Disconnect amplifier electrical connector.

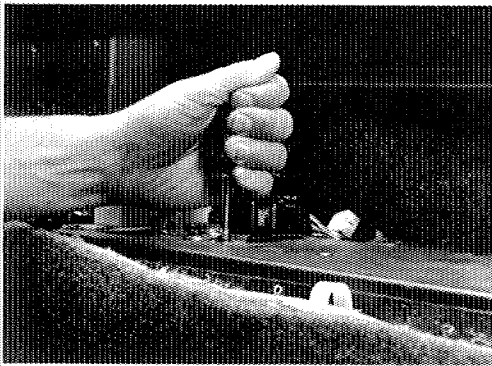

## POWER WINDOW AMPLIFIER (cont)

### INSTALL

1. INSTALL POWER WINDOW AMPLIFIER.
  - (a) Connect amplifier electrical connector.
  - (b) Position amplifier and secure with screw.
2. CHECK POWER WINDOW OPERATION AND CLOSE REAR DECK LID.

## AUTOMATIC RESTRAINT CONTROLLER

### REMOVE

1. REMOVE CONSOLE (see vehicle Service Manual).
2. REMOVE AUTOMATIC RESTRAINT CONTROLLER.
  - (a) Disconnect controller electrical connector.
  - (b) Remove two (2) screws and controller from vehicle.

### INSTALL

1. INSTALL AUTOMATIC RESTRAINT CONTROLLER.
  - (a) Position controller to body panel and secure using two (2) screws.
  - (b) Connect electrical connector to controller.
2. CHECK AUTOMATIC RESTRAINT SYSTEM (see Functional Check, 8-4).
3. INSTALL CONSOLE (see vehicle Service Manual).

## TRUNK ROOM LAMP SWITCH

### REMOVE

1. REMOVE LEFT DECK LID HINGE ASSEMBLY FROM REAR BRACE (see 21-5).
2. REMOVE TRUNK ROOM LAMP SWITCH.
  - (a) Pry switch from back belt wheelhouse brace.
  - (b) Disconnect switch electrical connector.

### INSTALL

1. INSTALL TRUNK ROOM LAMP SWITCH.
  - (a) Connect electrical connector to main harness.
  - (b) Push switch into back belt wheelhouse brace opening.
2. INSTALL LEFT DECK LID HINGE ASSEMBLY (see 21-6).

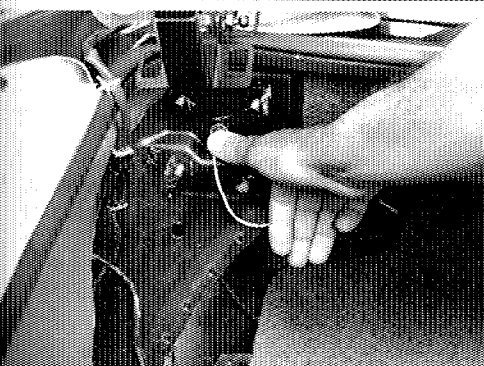
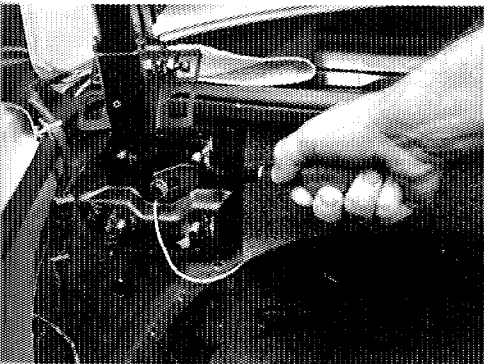

HOUSE

(see 21-

REAR

tor.

SE

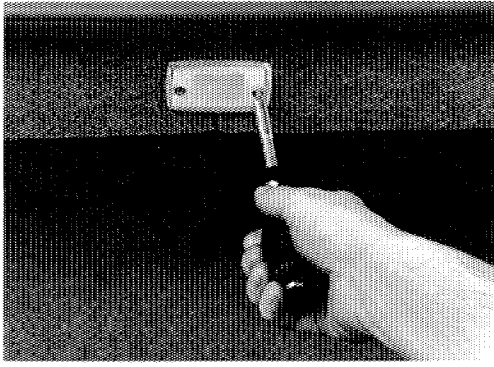

## TRUNK ROOM LAMP

### REMOVE

1. REMOVE TRUNK ROOM LAMP.
  - (a) Remove two (2) screws and trunk lamp from rear drain trough.
  - (b) Disconnect trunk lamp electrical connector.

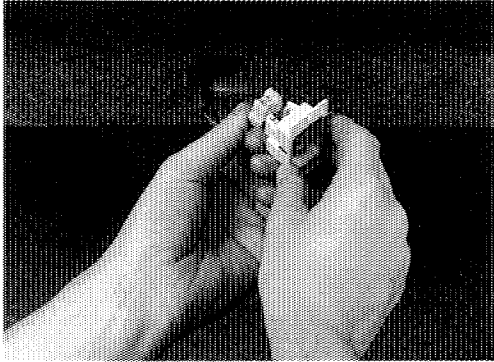

### INSTALL

1. INSTALL TRUNK ROOM LAMP.
  - (a) Connect trunk room lamp electrical connector.
  - (b) Position lamp and install two (2) screws.

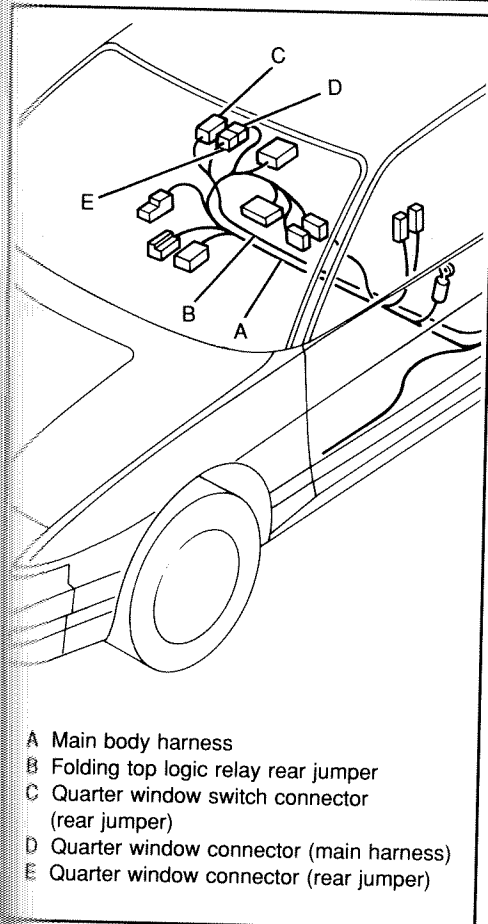
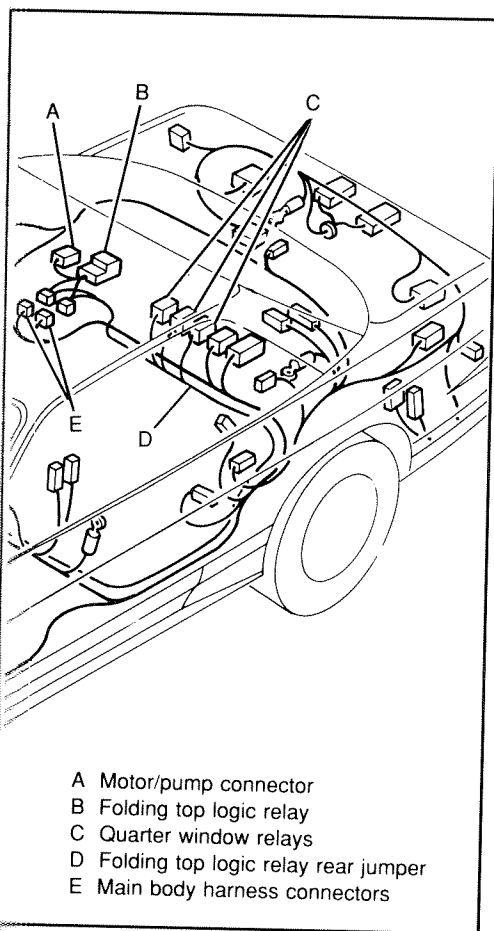

## FOLDING TOP LOGIC RELAY REAR JUMPER

### REMOVE

1. REMOVE DRIVERS SIDE FRONT SEAT (see vehicle Service Manual).
2. REMOVE LEFT QUARTER TRIM PANEL (see 5-5).
3. DISCONNECT FOLDING TOP LOGIC RELAY REAR JUMPER FROM RIGHT SIDE COMPONENTS .
  - (a) Disconnect rear jumper connectors from folding top logic relay and motor/pump assembly.
  - (b) Disconnect two (2) rear jumper connectors from main harness connectors.
4. DISCONNECT FOLDING TOP LOGIC RELAY REAR JUMPER FROM QUARTER WINDOW RELAYS.
  - (a) Remove and discard harness retainers as required.
  - (b) Disconnect three (3) rear jumper connectors from quarter window relays located on left side of strut bar.
5. REMOVE LEFT FRONT KICK PLATE.
 

Remove five (5) clips and kick plate.
6. REMOVE FOLDING TOP LOGIC RELAY JUMPER FROM FRONT FLOOR.
  - (a) Reposition drivers side floor carpet to expose main body harness and rear jumper.
  - (b) Remove and discard harness retainers.
7. REMOVE FLOOR CONSOLE (see vehicle Service Manual).
8. DISCONNECT FOLDING TOP LOGIC RELAY REAR JUMPER AT CONSOLE.
  - (a) Disconnect rear jumper from main body harness quarter window switch connector.
  - (b) Remove folding top logic relay rear jumper from vehicle.

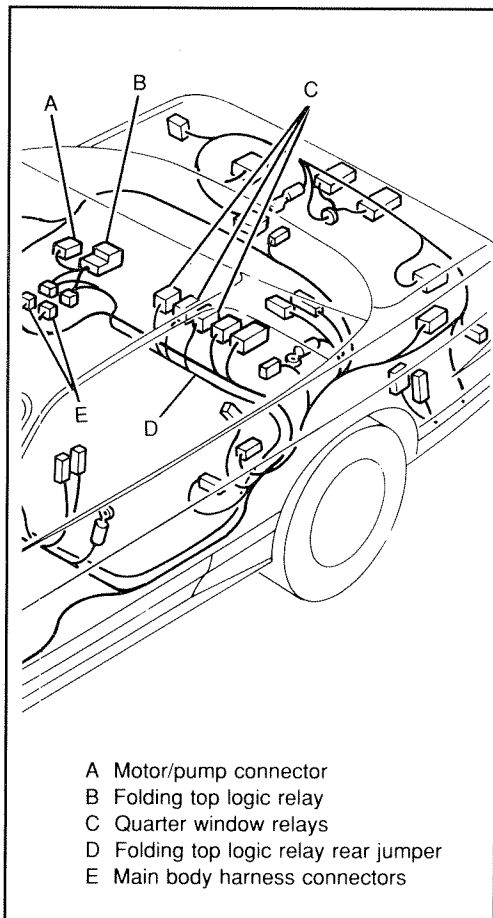
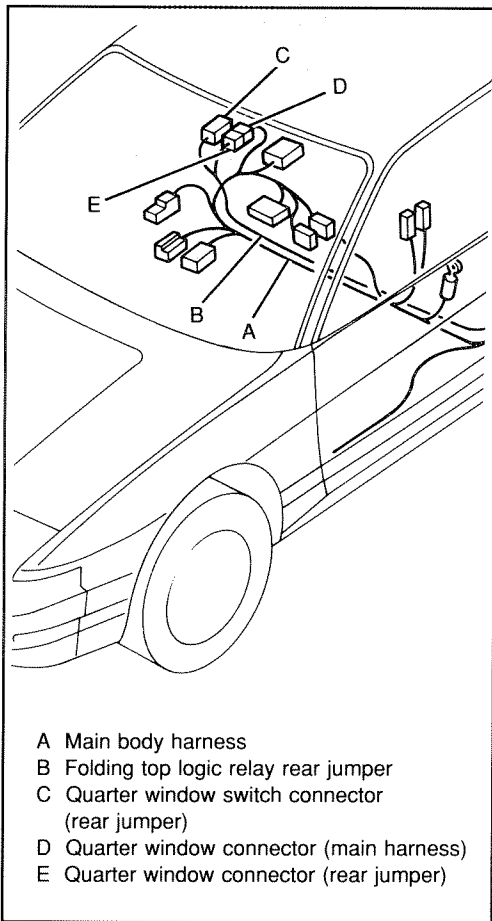

## FOLDING TOP LOGIC RELAY REAR JUMPER (cont'd)

### INSTALL

1. INSTALL FOLDING TOP LOGIC RELAY REAR JUMPER AT CONSOLE.
  - (a) Position rear jumper to vehicle and connect to body harness quarter window switch connector.
  - (b) Connect rear jumper connector to quarter window switch.
2. INSTALL FLOOR CONSOLE (see vehicle Service Manual).
3. INSTALL FOLDING TOP LOGIC RELAY REAR JUMPER TO FRONT FLOOR.
  - (a) Route rear jumper along second cross member and front floor, then rearward.
  - (b) Secure main body harness and rear jumper using retainers.
  - (c) Position driver's side carpet to front floor.
4. INSTALL LEFT FRONT KICK PLATE USING FIVE (5) CLIPS.
5. INSTALL FOLDING TOP LOGIC RELAY REAR JUMPER TO QUARTER WINDOW RELAYS.
  - (a) Connect three (3) rear jumper connectors to three (3) quarter window relays.
  - (b) Secure rear jumper and main body harness to B-pillar support panels using retainers.
6. INSTALL FOLDING TOP LOGIC RELAY REAR JUMPER TO RIGHT SIDE COMPONENTS.
  - (a) Connect two (2) rear jumper connectors to body main harness connectors.
  - (b) Connect rear jumper connectors to logic relay and motor/pump assembly.
  - (c) Secure rear jumper and main body harness using retainers.
7. INSTALL LEFT QUARTER TRIM PANEL (see 5-5).
8. INSTALL DRIVERS SIDE FRONT SEAT (see vehicle Service Manual).



# PREFACE TO ELECTRICAL HARNESS LAYOUT AND WIRING DIAGRAMS

Certain harness layout and wiring diagrams have been modified with respect to the base vehicle — the 240SX Coupe — for use in the 240SX convertible. As you will note, although some harness layout and wiring are common to the 240SX Coupe, certain ones have been changed in some way; for example: by the addition of a longer trunk harness or by changes in connector shapes and/or wire colors. Other circuits, such as those for the convertible top pump/motor, will not be found in the 240SX Coupe, in any form.

The “Rule of Thumb” for the 240SX Convertible Service Manual Supplement, and particularly, with respect to electrical information, is that it should be used with the regular Nissan 240SX Service Manual. The Convertible Supplement covers convertible matters only.

If there are systems in common between the 240SX Coupe and the 240SX Convertible models the Regular Nissan 240SX Service Manual is the best source of information.

### MAIN BODY HARNESS LAYOUT

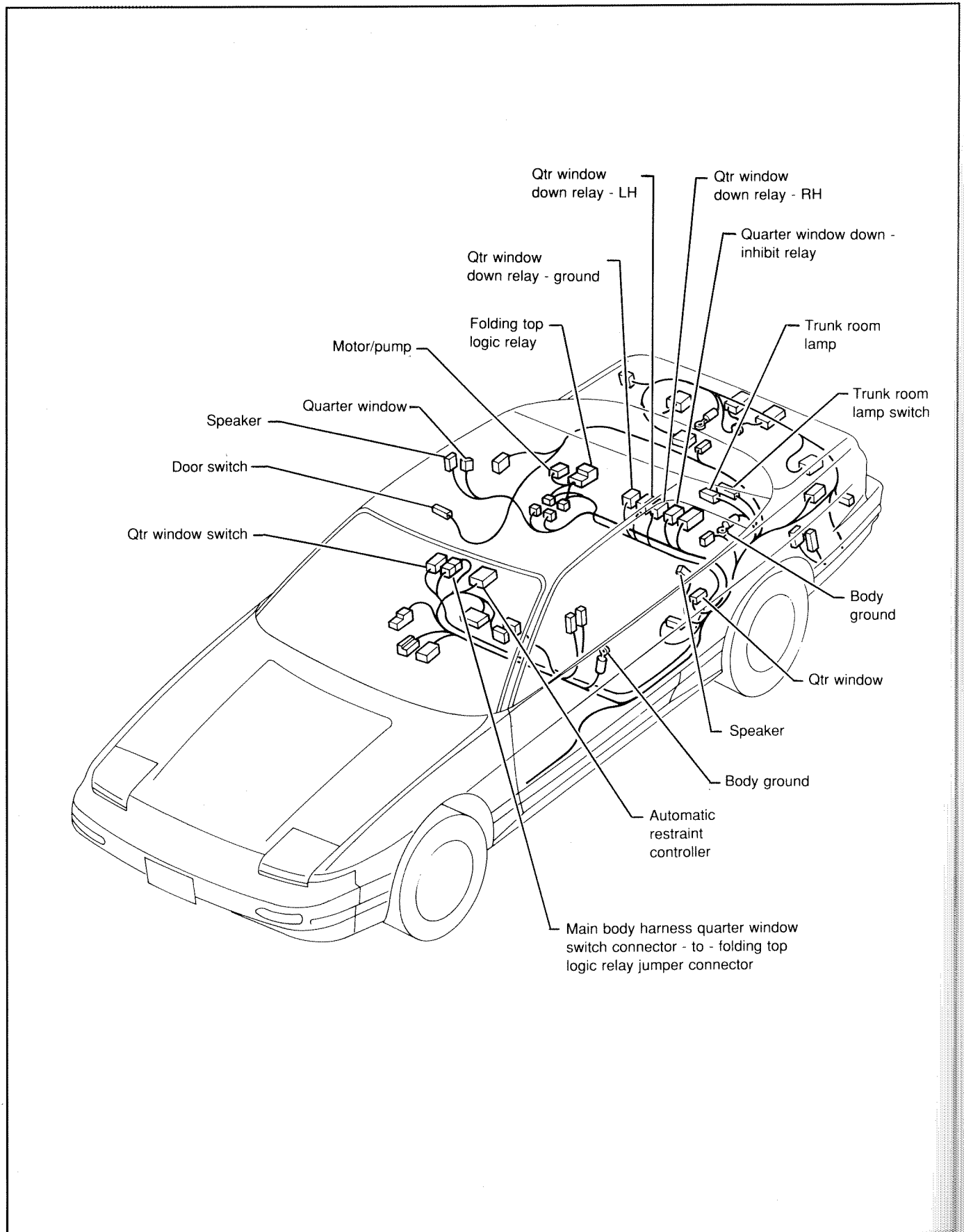

ELECTRICAL

NOTES

om  
itch

Main Harness (Cont'd)

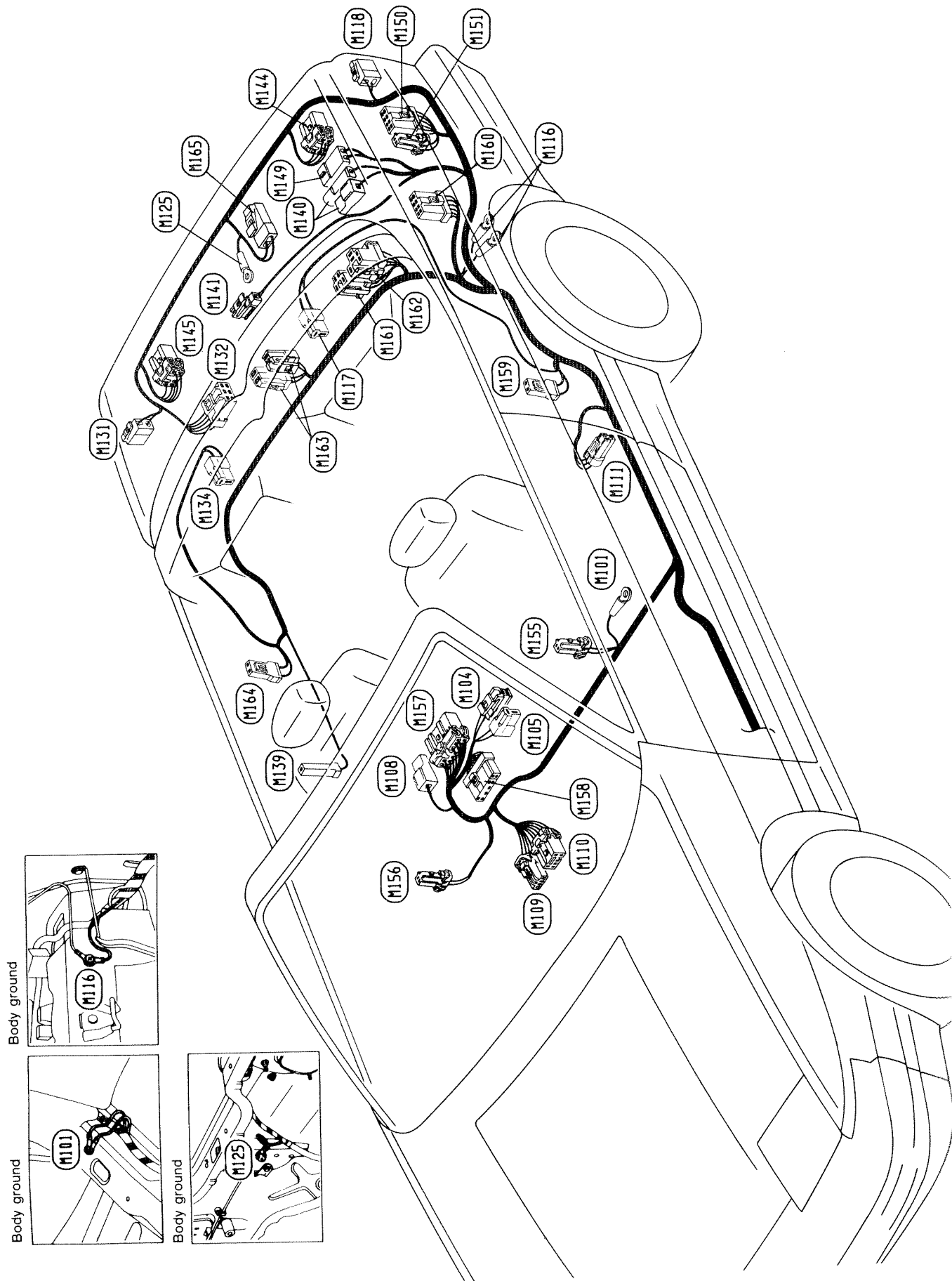

Main Harness (Cont'd)

- (1133) : Body ground
- (1184) : Ashtray illumination
- (1195) : Cigarette lighter
- (1108) : Parking brake switch
- (1109) : A/T device (A/T illumination and O.D. control switch)
- (1110) : Shift lock solenoid (A/T model)
- (1111) : Door switch L.H.
- (1116) : Body ground
- (1117) : Rear speaker L.H.
- (1118) : Rear side marker lamp L.H.
- (1125) : Body ground
- (1131) : Rear side marker lamp R.H.
- (1132) : Fuel tank gauge unit
- (1134) : Rear speaker R.H.
- (1139) : Door switch R.H.
- (1140) : Trunk room lamp switch
- (1141) : Trunk room lamp
- (1144) : Rear combination lamp L.H.
- (1145) : Rear combination lamp R.H.
- (1149) : To high-mounted stop lamp sub-harness
- (1150) : Auto antenna timer
- (1151) : Auto antenna motor
- (1155) : Seat belt switch L.H.
- (1156) : Seat belt switch R.H.
- (1157) : Seat belt control unit
- (1158) : Power window sub-switch (Quarter)
- (1159) : Power window regulator (Quarter L.H.)
- (1160) : Power window amplifier
- (1161) : Diode
- (1162) : Power window relay (Quarter)
- (1163) : Convertible top actuator
- (1164) : Power window regulator (Quarter R.H.)
- (1165) : To license lamp harness

Diode (1161)

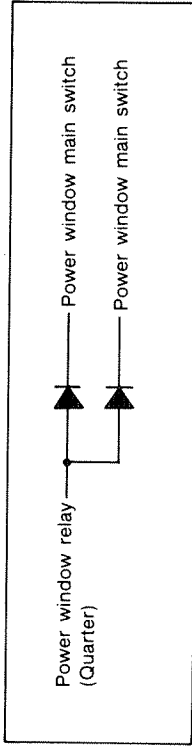

NOTES

# MAIN INSTRUMENT PANEL HARNESS LAYOUT

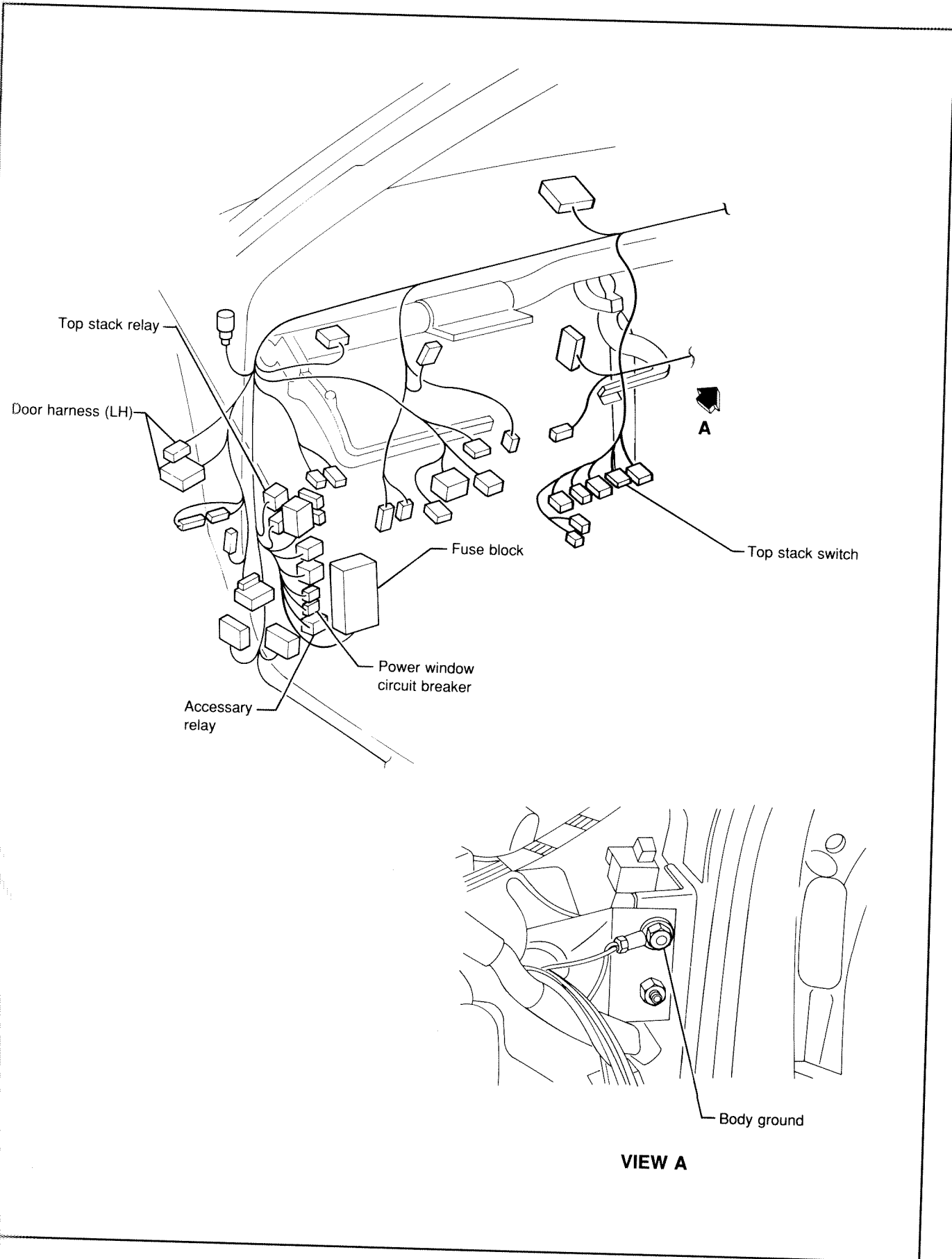



MAIN INSTRUMENT PANEL HARNESS LAYOUT (Cont'd)

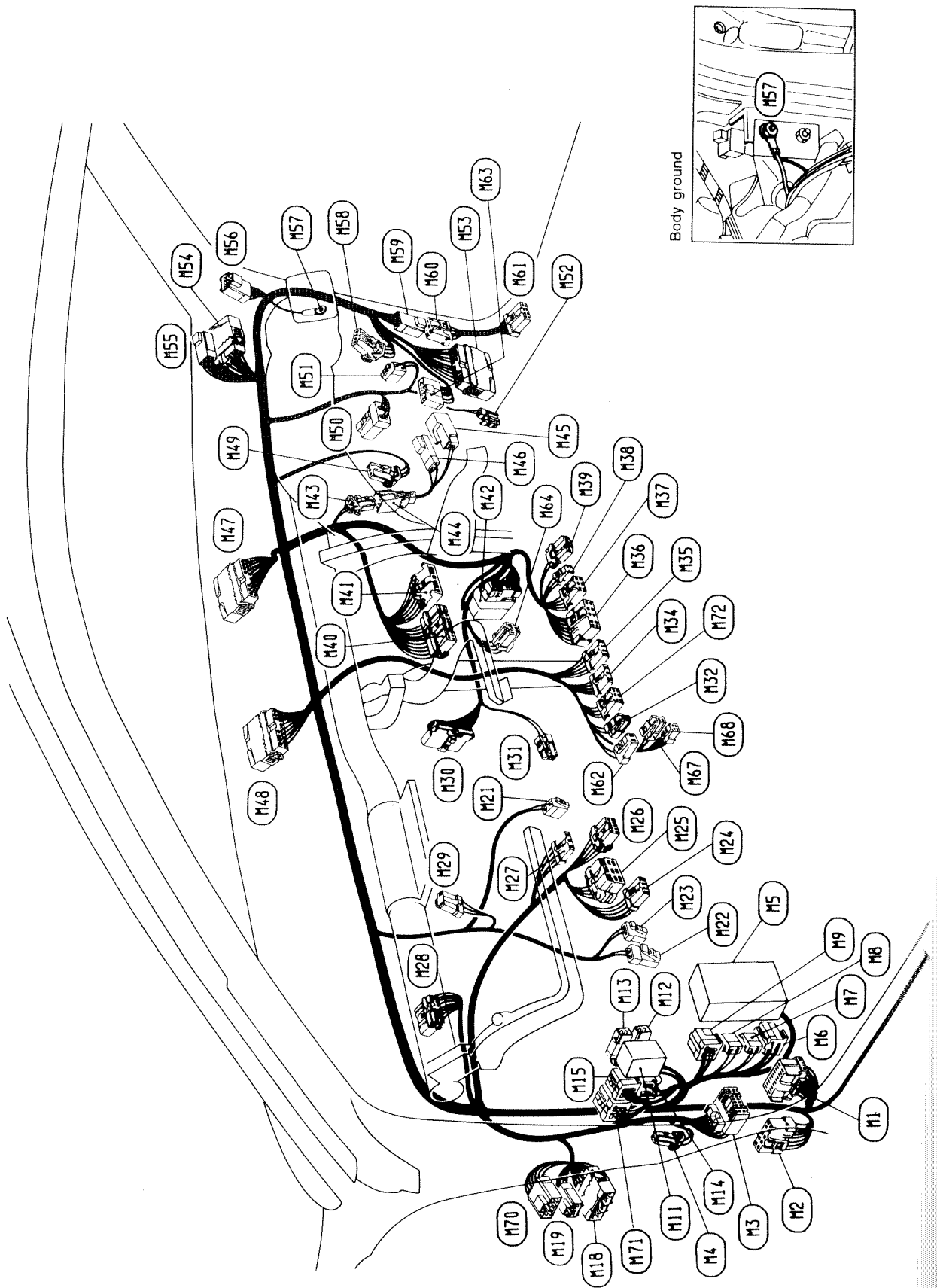

MAIN INSTRUMENT PANEL HARNESS LAYOUT (Cont'd)

- (M1) : Time control unit
- (M2) : Headlamp timer
- (M3) : Diagnostic connector for CONSULT
- (M4) : Warning chime
- (M5) : Fuse block
- (M6) : Accessory relay-1
- (M7) : Circuit breaker (Model with power window system)
- (M8) : Circuit breaker (For U.S.A.)
- (M9) : Ignition relay (Model with power window system)
- (M10) : To engine room harness (E101) (S.M.J.)
- (M11) : To engine room harness (E102) (Blue)
- (M12) : To engine room harness (E103) (Black)
- (M13) : Bulb check relay
- (M14) : Rear window defogger relay
- (M15) : To door harness L.H. (M1)
- (M16) : To door harness L.H. (M2)
- (M17) : Kickdown switch (A/T model)
- (M18) : A.S.C.D. cancel switch (Model with A.S.C.D.)
- (M19) : Stop lamp switch
- (M20) : A.S.C.D. main switch (Model with A.S.C.D.)
- (M21) : Headlamp retractor switch
- (M22) : Illumination control switch
- (M23) : Not used
- (M24) : Shift lock control unit (A/T model)
- (M25) : Combination flasher unit
- (M26) : Mode door motor
- (M27) : Foot lamp L.H.
- (M28) : O.D. off indicator lamp
- (M29) : Rear window defogger switch
- (M30) : Hazard switch
- (M31) : Radio
- (M32) : Radio
- (M33) : Cassette deck
- (M34) : Cassette deck
- (M35) : Push control unit
- (M36) : Fan switch
- (M37) : Diode
- (M38) : To sub-harness (M44)
- (M39) : To main harness (M43)
- (M40) : Glove box lamp
- (M41) : Glove box lamp switch
- (M42) : To instrument harness (M11) (Black)
- (M43) : To instrument harness (M12) (White)
- (M44) : Thermo control amplifier
- (M45) : Heater resistor
- (M46) : Blower motor
- (M47) : Foot lamp R.H.

- (M53) : To E.F.I. harness (F1)
- (M54) : To door harness R.H. (M101)
- (M55) : To door harness R.H. (M102)
- (M56) : To room lamp harness (R1)
- (M57) : Body ground
- (M58) : Intake door motor
- (M59) : To sub-harness (M60)
- (M60) : To main harness (M59)
- (M61) : Door lock timer
- (M62) : Washer warning lamp (Model with A.S.C.D.)
- (M63) : To engine room harness (E119)
- (M64) : Blower relay
- (M65) : Not used
- (M66) : Not used
- (M67) : To door harness L.H.
- (M68) : To door harness L.H.
- (M69) : Top main relay
- (M70) : Top stack control switch

Diode (M42)

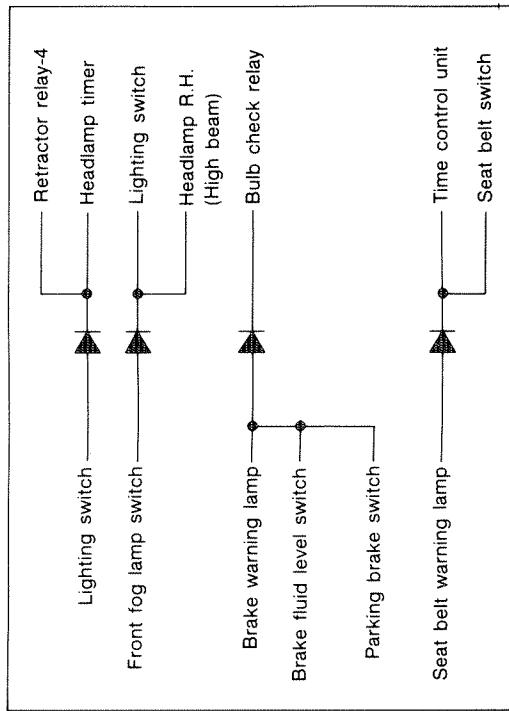

Door Harness L.H.

- ⓪1 : To main harness (M18)
- ⓪4 : Door speaker
- ⓪6 : Power window regulator
- ⓪7 : Power window main switch
- ⓪9 : Door lock actuator

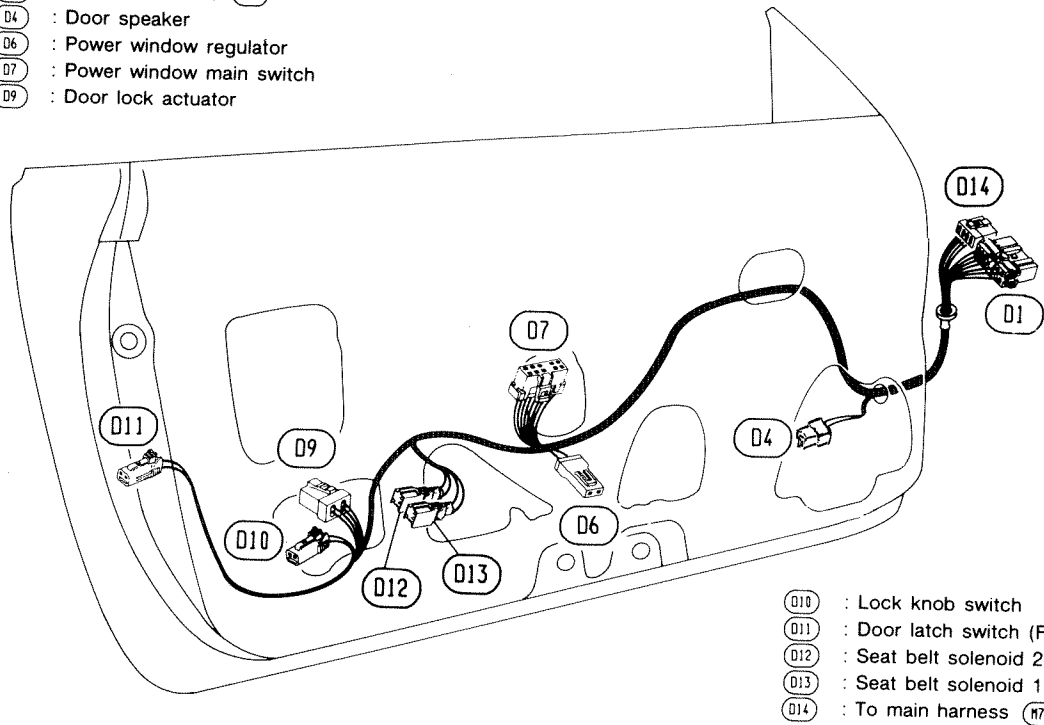

- ⓪10 : Lock knob switch
- ⓪11 : Door latch switch (For U.S.A.)
- ⓪12 : Seat belt solenoid 2
- ⓪13 : Seat belt solenoid 1
- ⓪14 : To main harness (M70)

MEL919

Door Harness R.H.

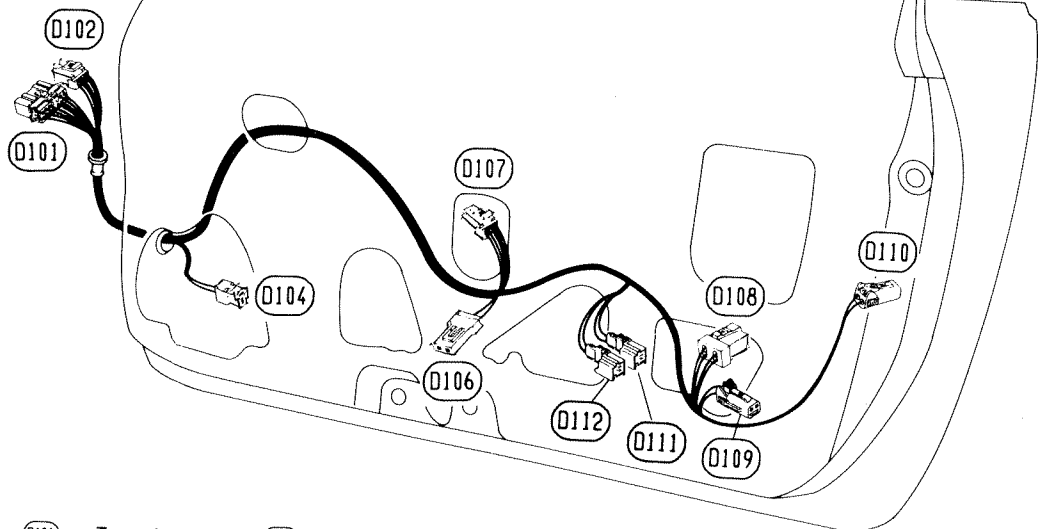

- ⓪101 : To main harness (M54)
- ⓪102 : To main harness (M55)
- ⓪104 : Door speaker
- ⓪106 : Power window regulator
- ⓪107 : Power window sub switch
- ⓪108 : Door lock actuator
- ⓪109 : Lock knob switch
- ⓪110 : Door latch switch (For U.S.A.)
- ⓪111 : Seat belt solenoid 2
- ⓪112 : Seat belt solenoid 1

MEL920A

---

**HYDRAULIC MOTOR/PUMP ELECTRICAL SYSTEM**

	page
<b>CIRCUIT DIAGRAM .....</b>	<b>20-19</b>
<b>PRELIMINARY CHECK .....</b>	<b>20-21</b>
<b>ELECTRICAL DIAGNOSTIC PROCEDURES .....</b>	<b>20-22</b>

# HYDRAULIC MOTOR/PUMP CIRCUIT DIAGRAM

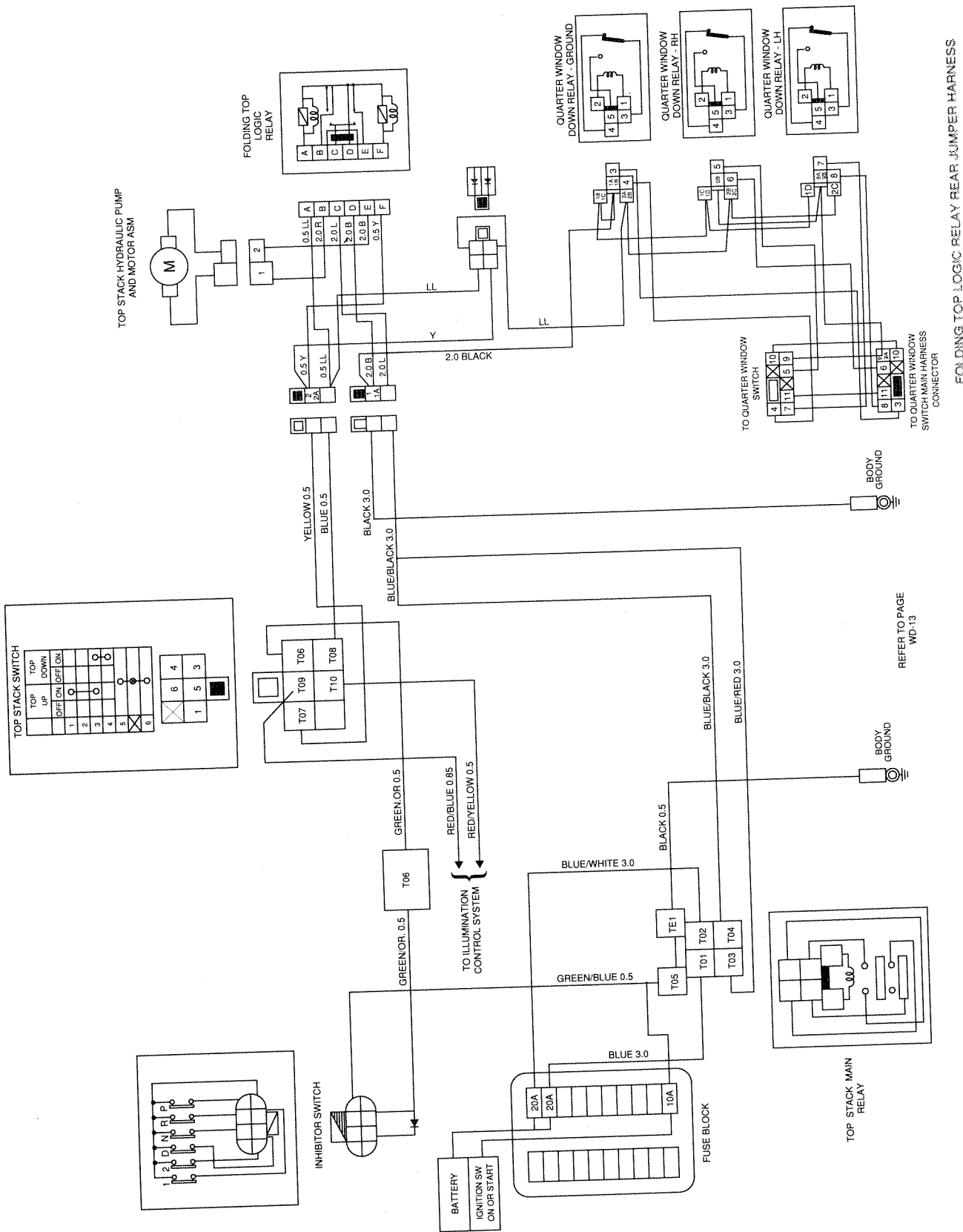

REFER TO PAGE  
WD-15

FOLDING TOP LOGIC RELAY REAR JUMPER HARNESS



### HYDRAULIC MOTOR/PUMP PRELIMINARY CHECK

Condition: convertible top will not raise/lower

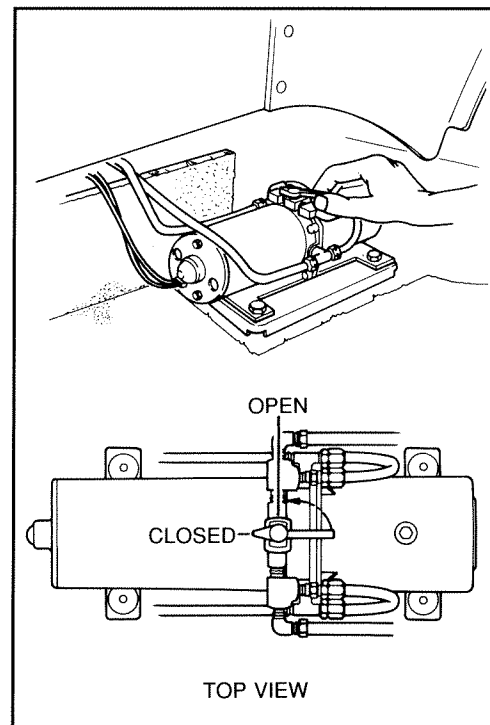
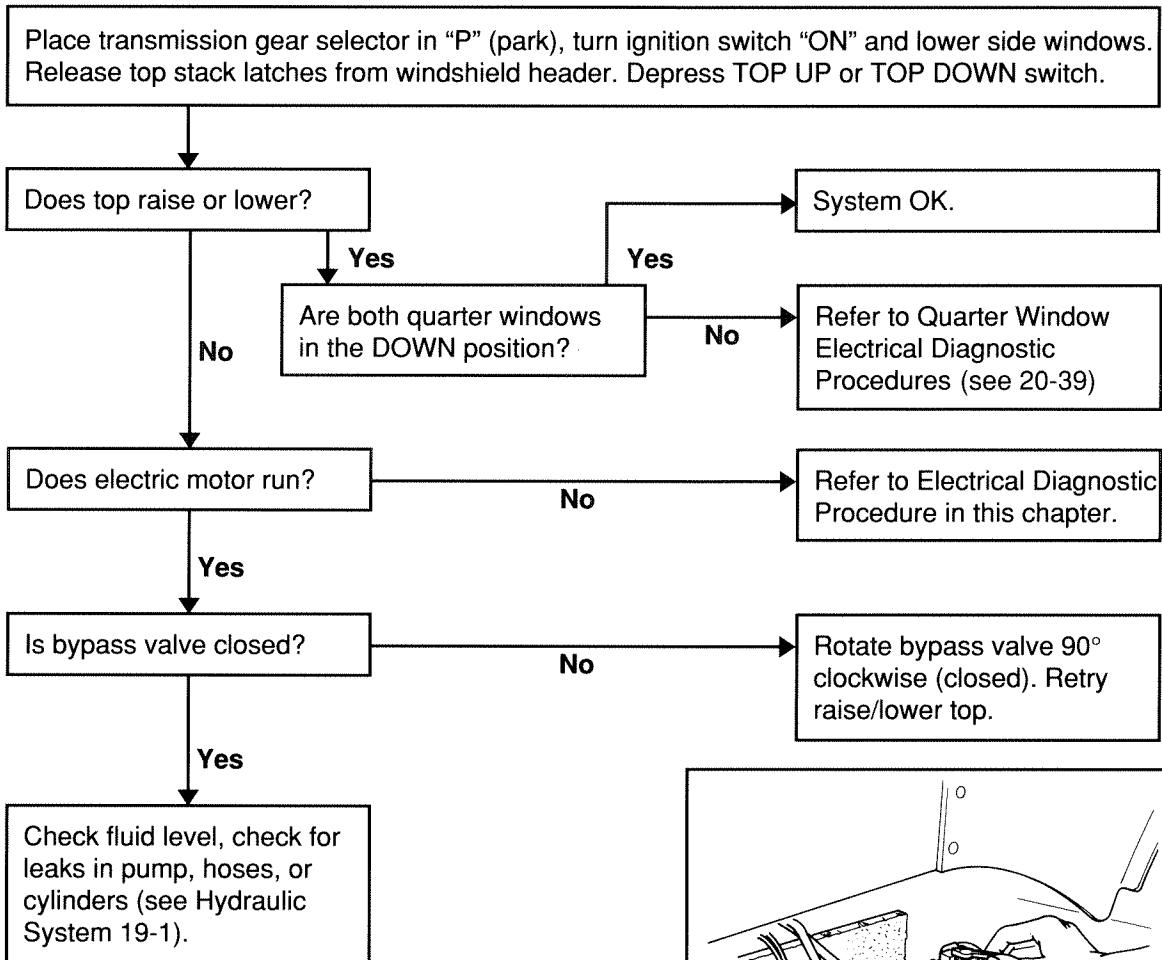



### HYDRAULIC MOTOR/PUMP ELECTRICAL DIAGNOSTIC PROCEDURE

Condition: hydraulic pump electrical motor will not operate

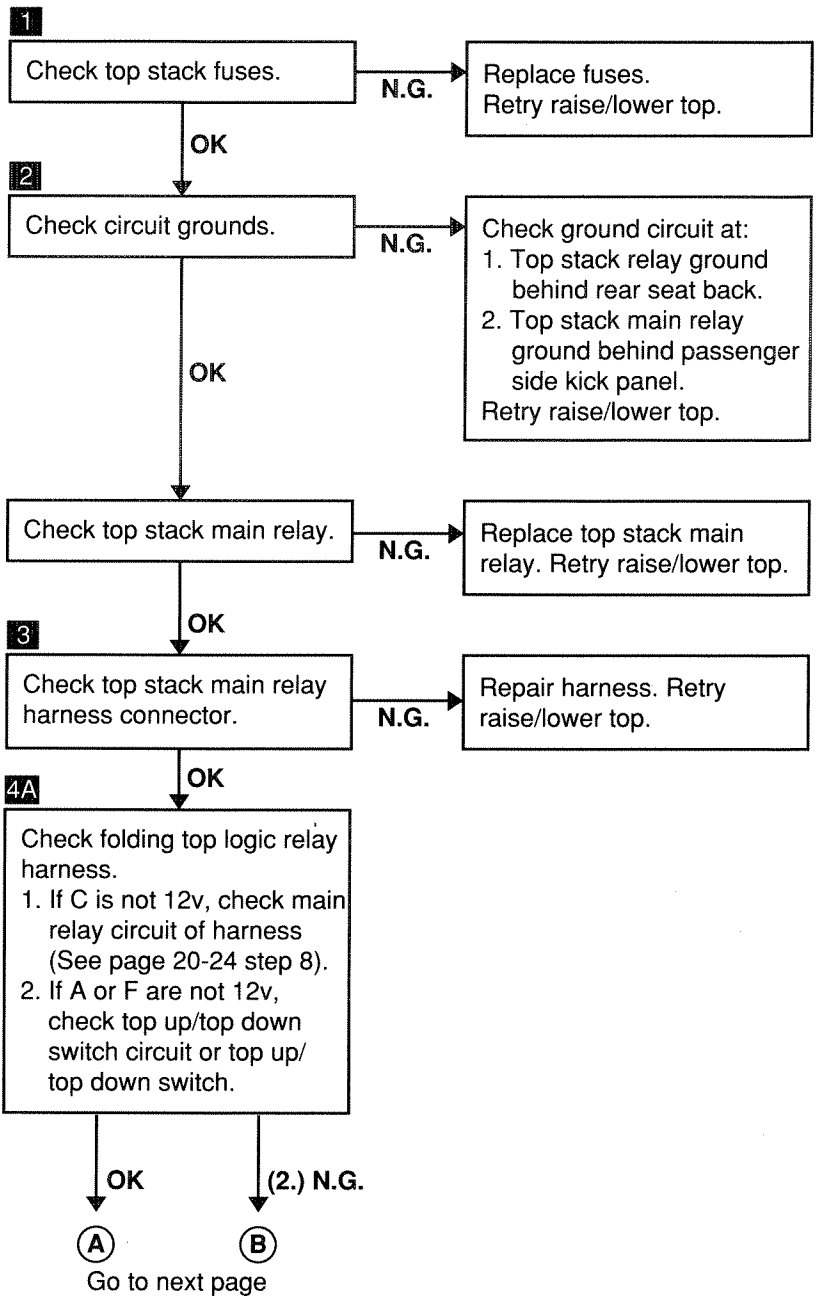
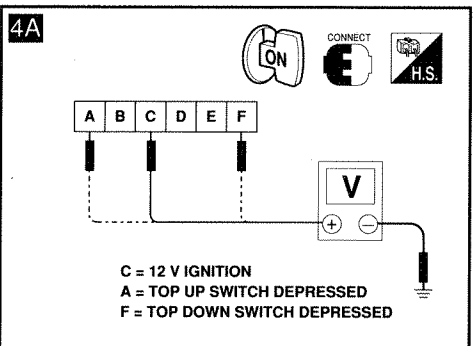
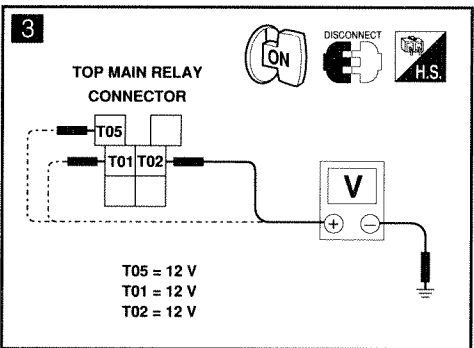
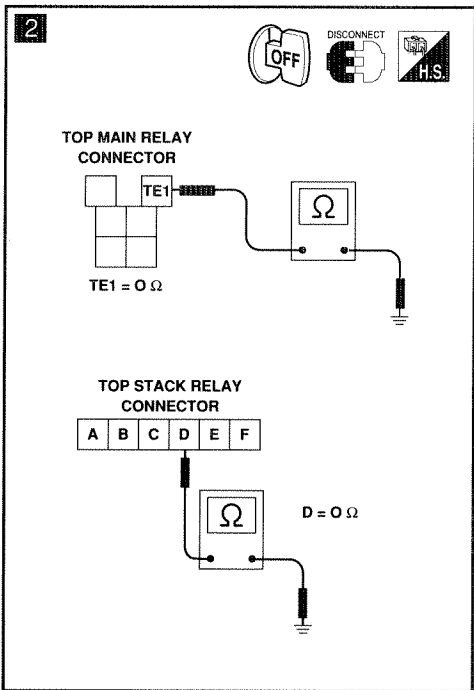
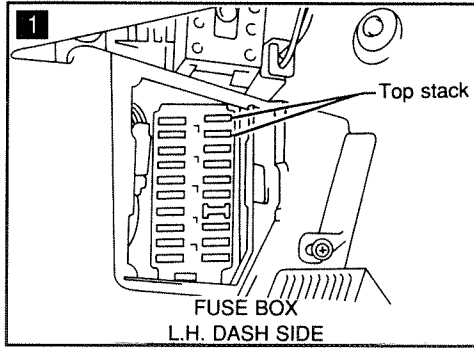

**HYDRAULIC MOTOR/PUMP ELECTRICAL DIAGNOSTIC PROCEDURE (Cont'd)**

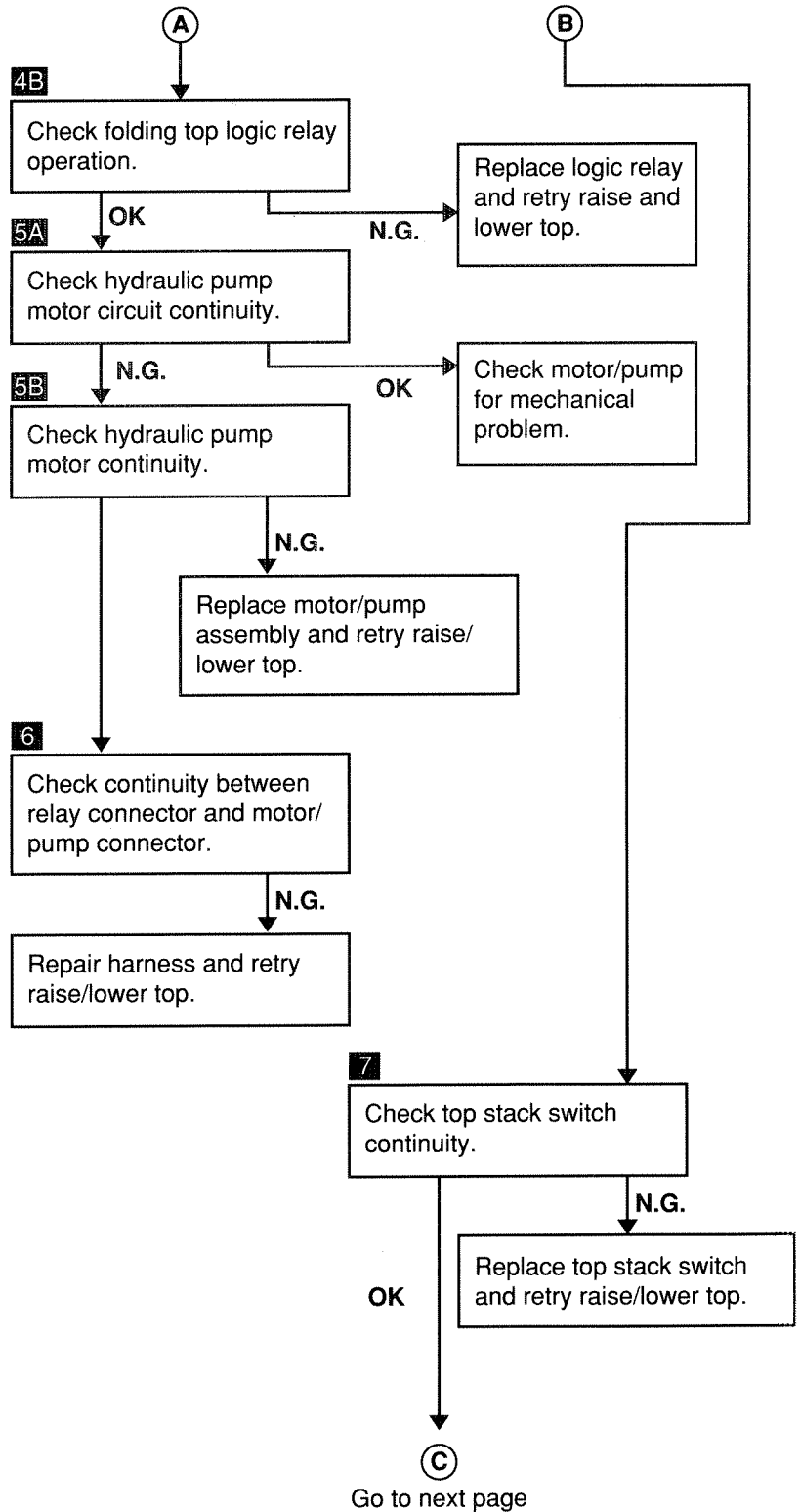
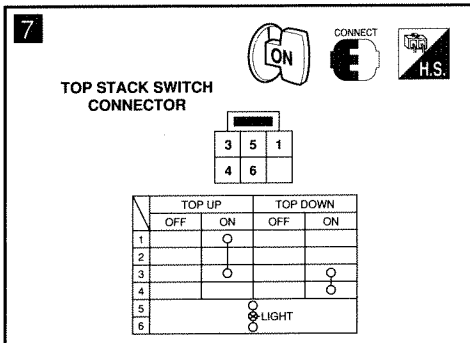
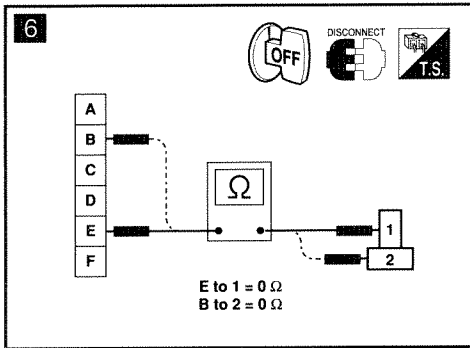
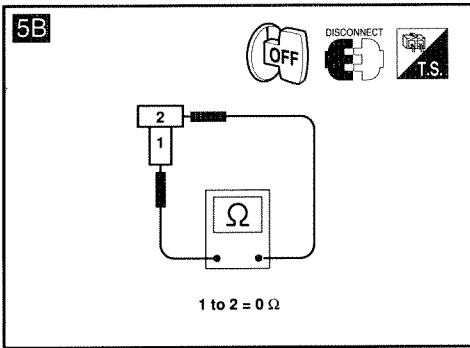
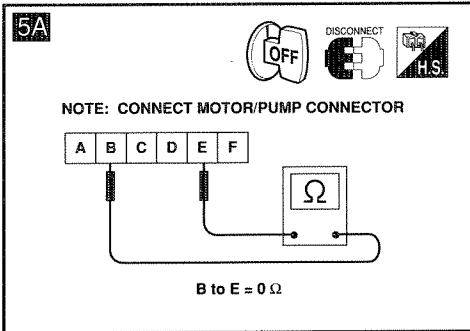
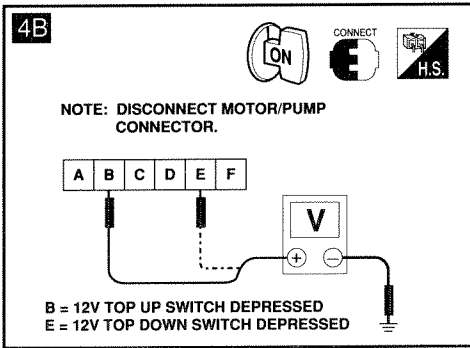

HYDRAULIC MOTOR/PUMP  
ELECTRICAL DIAGNOSTIC PROCEDURE (Cont'd)

nt'd)



ritch  
top.

al Supplement

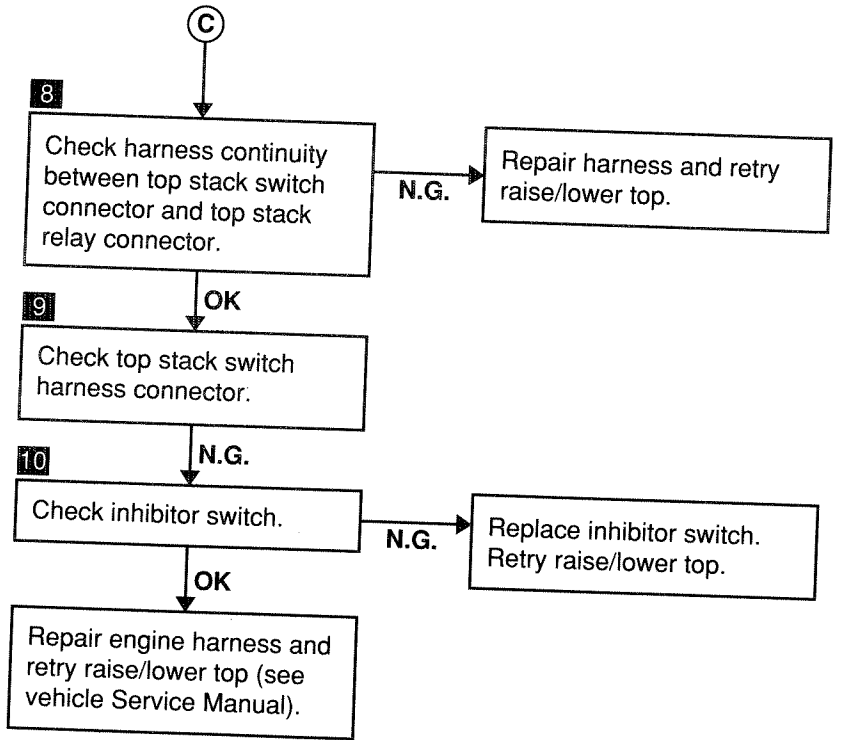
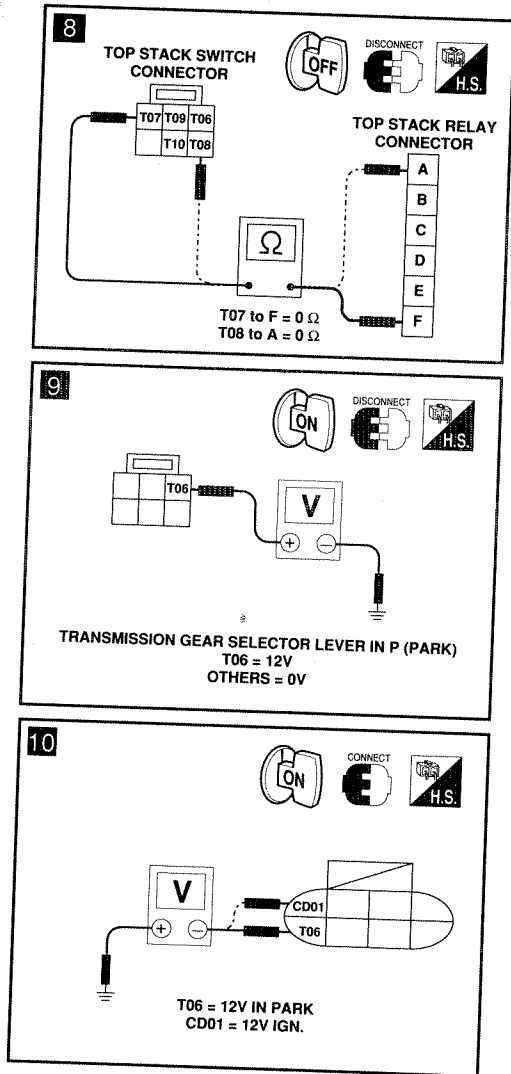



**AUTOMATIC RESTRAINT SYSTEM (FRONT)**

	page
CIRCUIT DIAGRAM .....	20-27
PRELIMINARY CHECK .....	20-28
ELECTRICAL DIAGNOSTIC PROCEDURES.....	20-29

# AUTOMATIC RESTRAINT SYSTEM CIRCUIT DIAGRAM

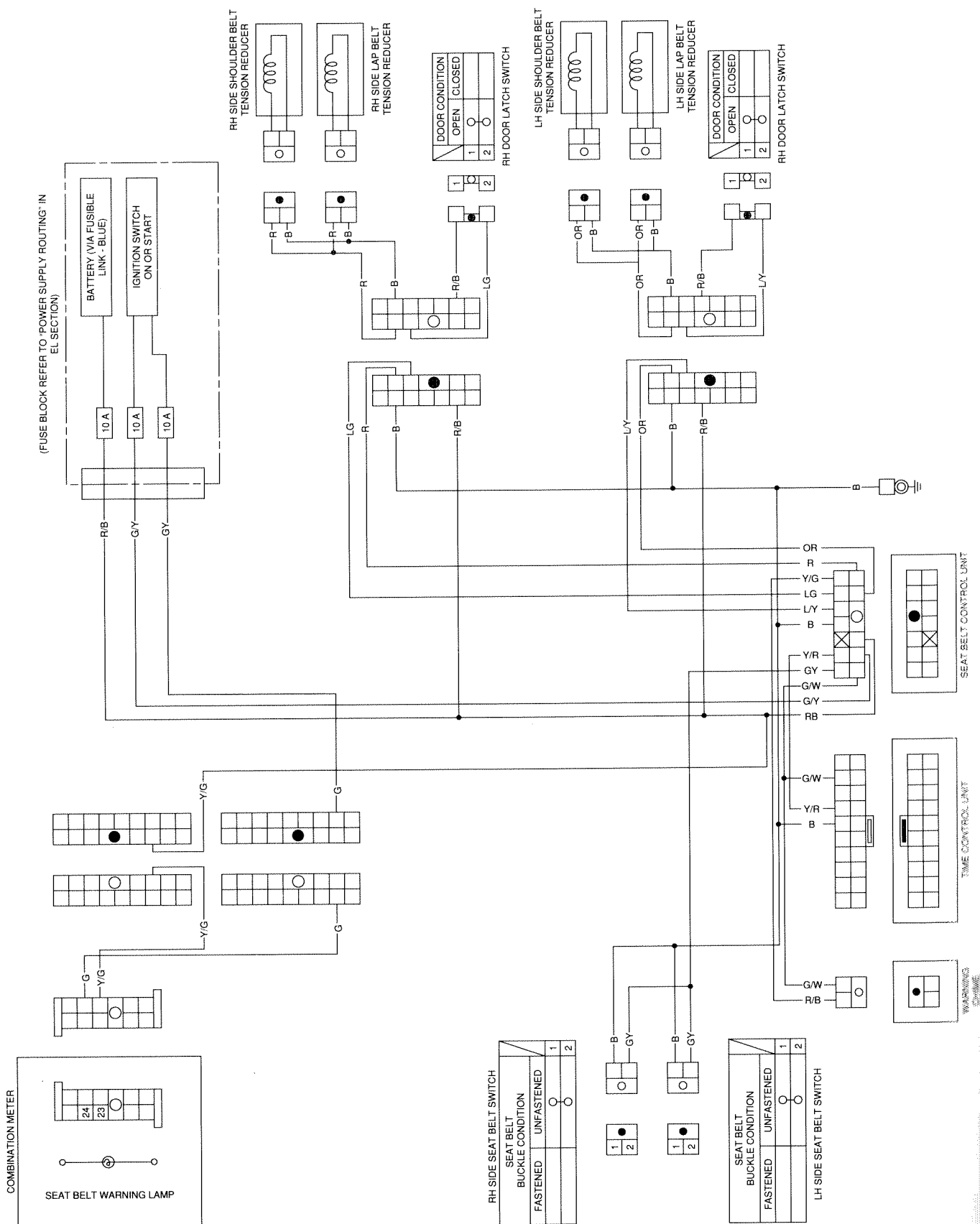

**AUTOMATIC RESTRAINT SYSTEM  
PRELIMINARY CHECK**

Condition: verify restraint system electrical operation

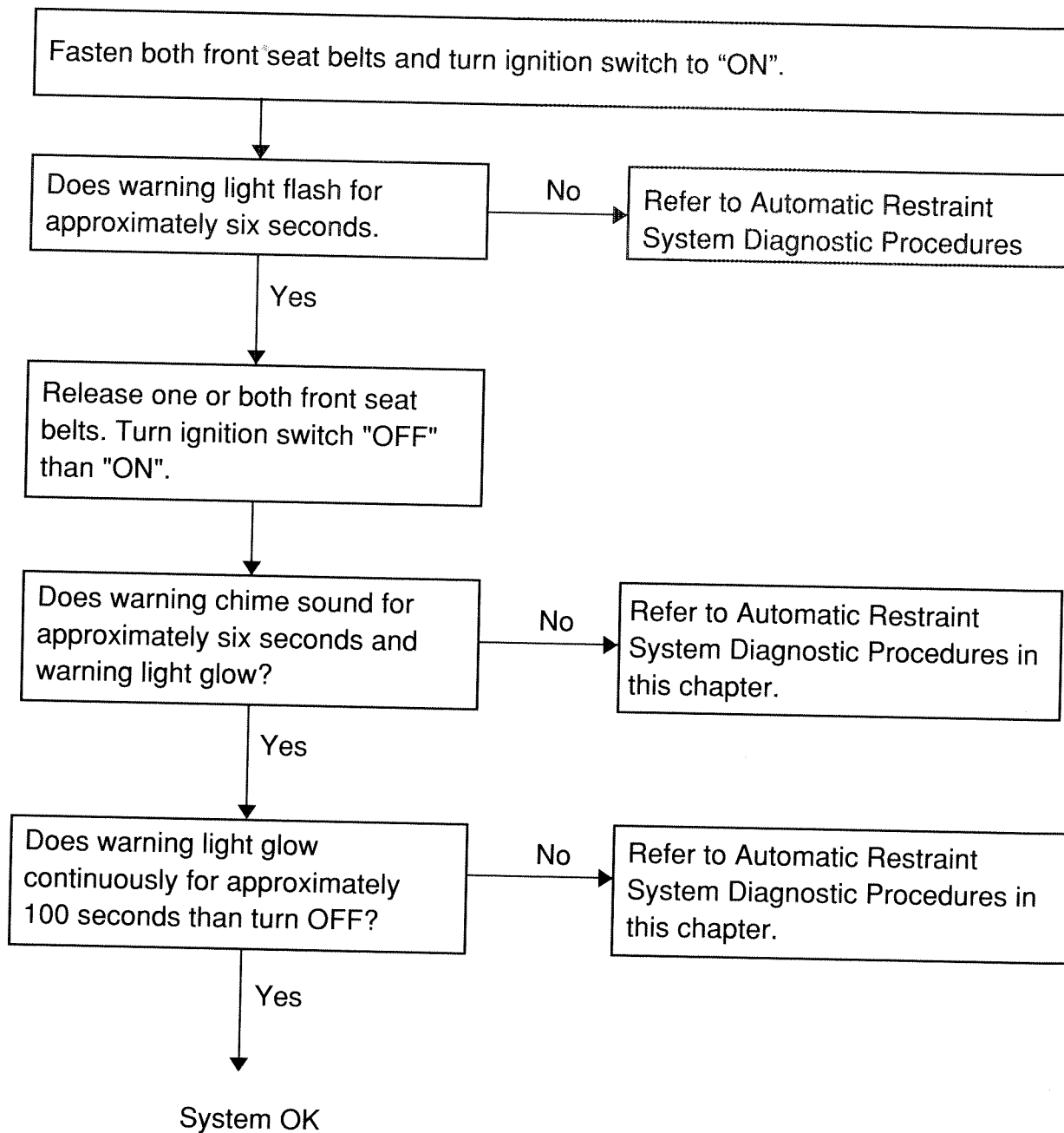



**AUTOMATIC RESTRAINT SYSTEM  
ELECTRICAL DIAGNOSTIC PROCEDURES**

**Preparation for Trouble Diagnoses**

1. Remove floor center console (see vehicle Service Manual).
2. Disconnect harness automatic restraint controller connector.

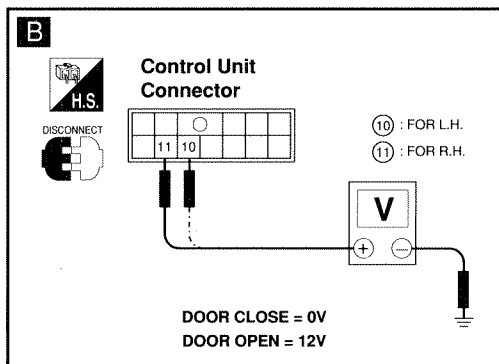
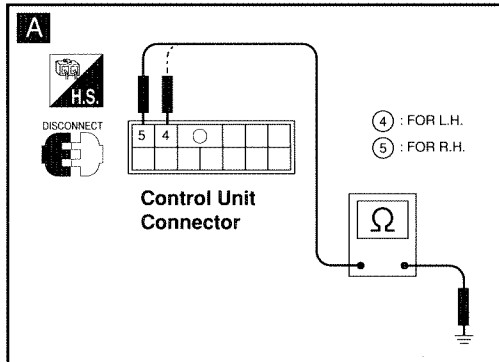
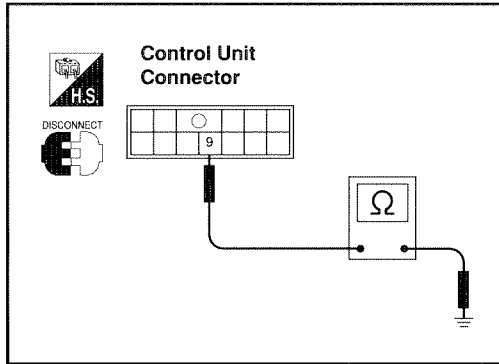
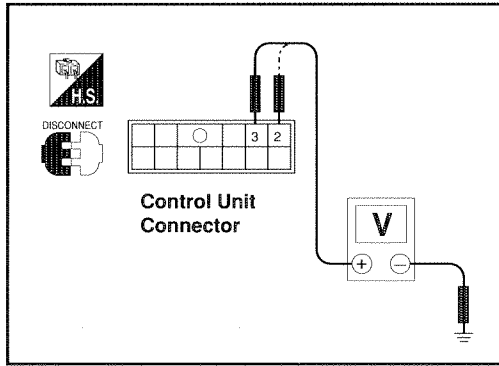

**Power Supply Circuit Check**

Terminals		Ignition Switch	
⊕	⊖	OFF or ACC	ON
②	Ground	0V	12V
③	Ground	12V	12V

**Ground Circuit Check**

Terminals	Continuity
⑨ Ground	Yes

**Trouble Diagnoses**

**SYMPTOM:**

Warning lamp flashes continuously.

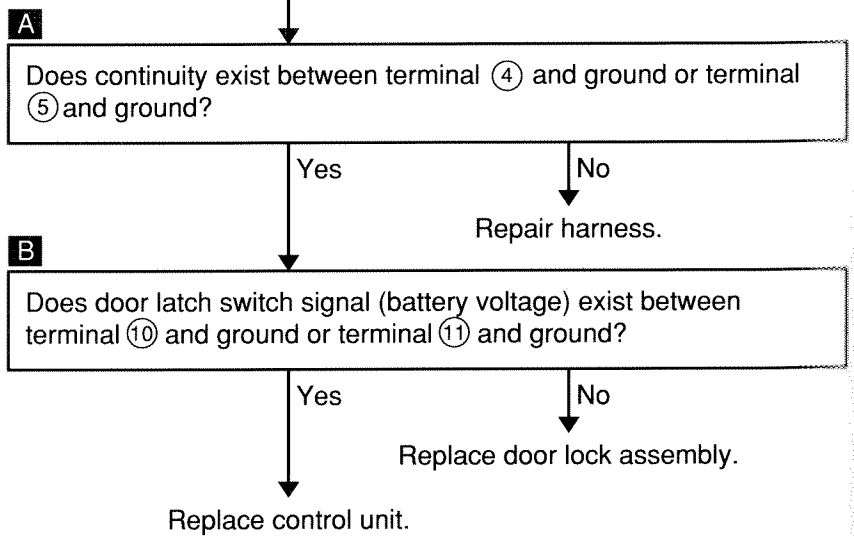

**AUTOMATIC RESTRAINT SYSTEM (Cont'd)**

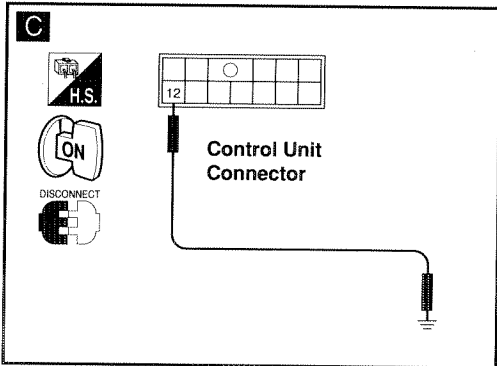

**SYMPTOM:** Warning lamp does not flash when ignition switch is "ON".

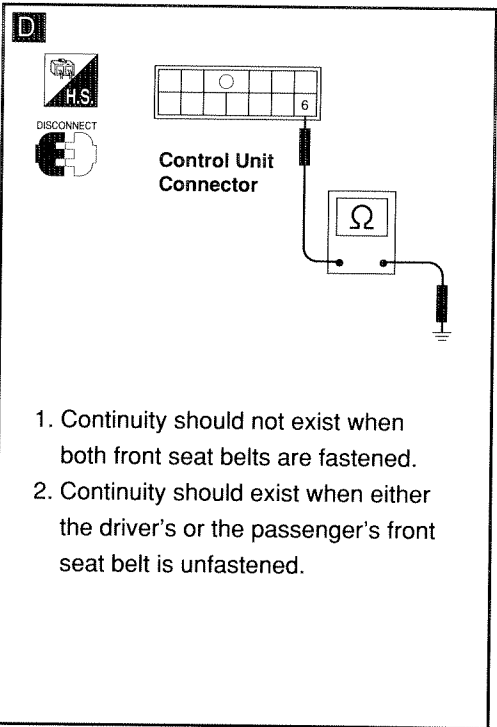
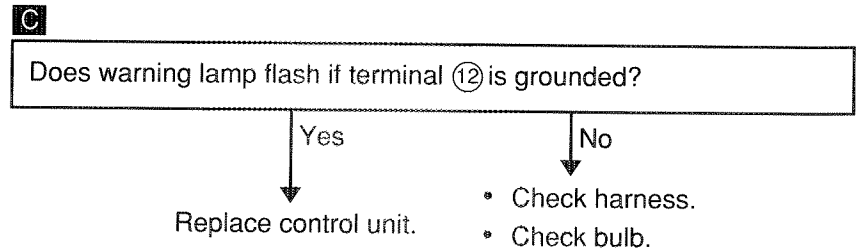

**SYMPTOM:** Warning chime does not operate for 6 seconds after ignition switch is ON, when releasing belt from buckle.

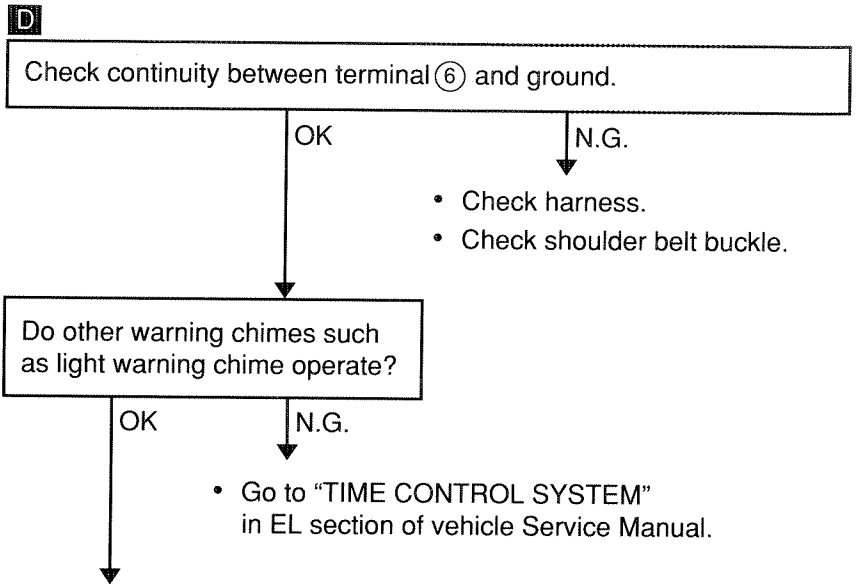

Check harness between terminal ① and chime.

NOTES

**POWER WINDOWS**

	page
ELECTRICAL DIAGRAM .....	20-33
SYMPTOMS .....	20-34
PRELIMINARY CHECK .....	20-35
ELECTRICAL DIAGNOSTIC PROCEDURES .....	20-36

# POWER WINDOWS ELECTRICAL DIAGRAM

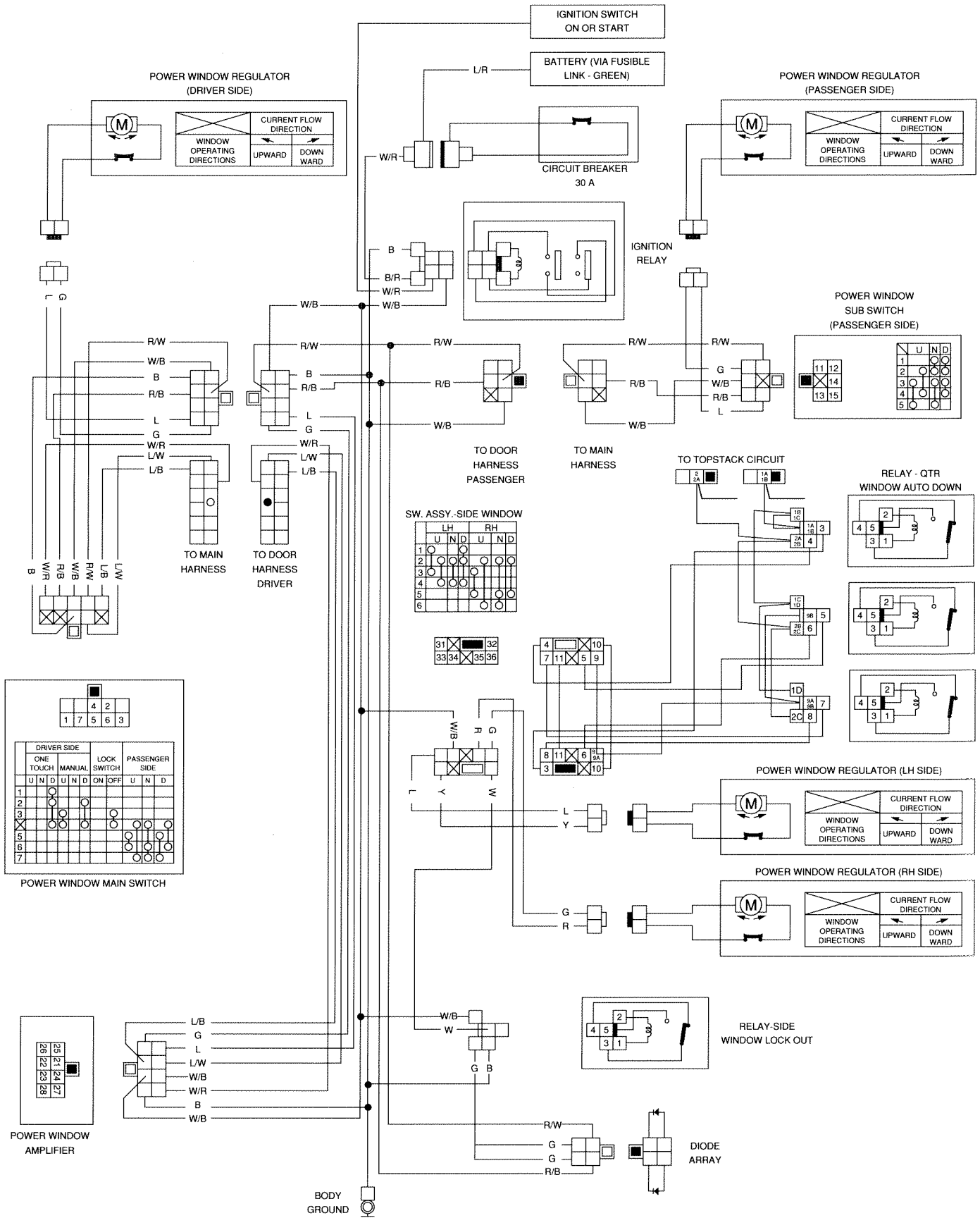

		4	2	
1	7	5	6	3

DRIVER SIDE		PASSENGER SIDE	
ONE TOUCH	MANUAL	LOCK SWITCH	
U	N	D	ON OFF
1	○	○	○
2	○	○	○
3	○	○	○
4	○	○	○
5	○	○	○
6	○	○	○
7	○	○	○

LH		RH	
U	N	D	U
1	2	3	4
○	○	○	○
○	○	○	○
○	○	○	○
○	○	○	○
○	○	○	○
○	○	○	○

31	32
33	34
35	36

4	10
7	11
5	9

8	11	6	10
3	7	5	9

16	18
17	19
20	21

16	18
17	19
20	21

16	18
17	19
20	21

16	18
17	19
20	21

16	18
17	19
20	21

16	18
17	19
20	21

16	18
17	19
20	21

16	18
17	19
20	21

**Symptoms**

Door windows do not operate "up" or "down" when switch is depressed.	●	●			
Both quarter windows do not operate "up" or "down" when switch is depressed.	●	●	●		
One quarter window does not operate "up" or "down" when switch is depressed.	●	●			●
Both quarter windows do not operate "up" when TOP UP switch is depressed.	●	●		●	
Preliminary Check.					
Power Windows Electrical Diagram.					
Power Quarter Window Electrical Diagnostic Procedure #1.					
Power Quarter Window Electrical Diagnostic Procedure #2.					
Power Quarter Window Electrical Diagnostic Procedure #1 (Step 6).					

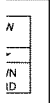
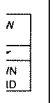
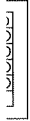
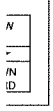

**POWER WINDOWS  
PRELIMINARY CHECK**

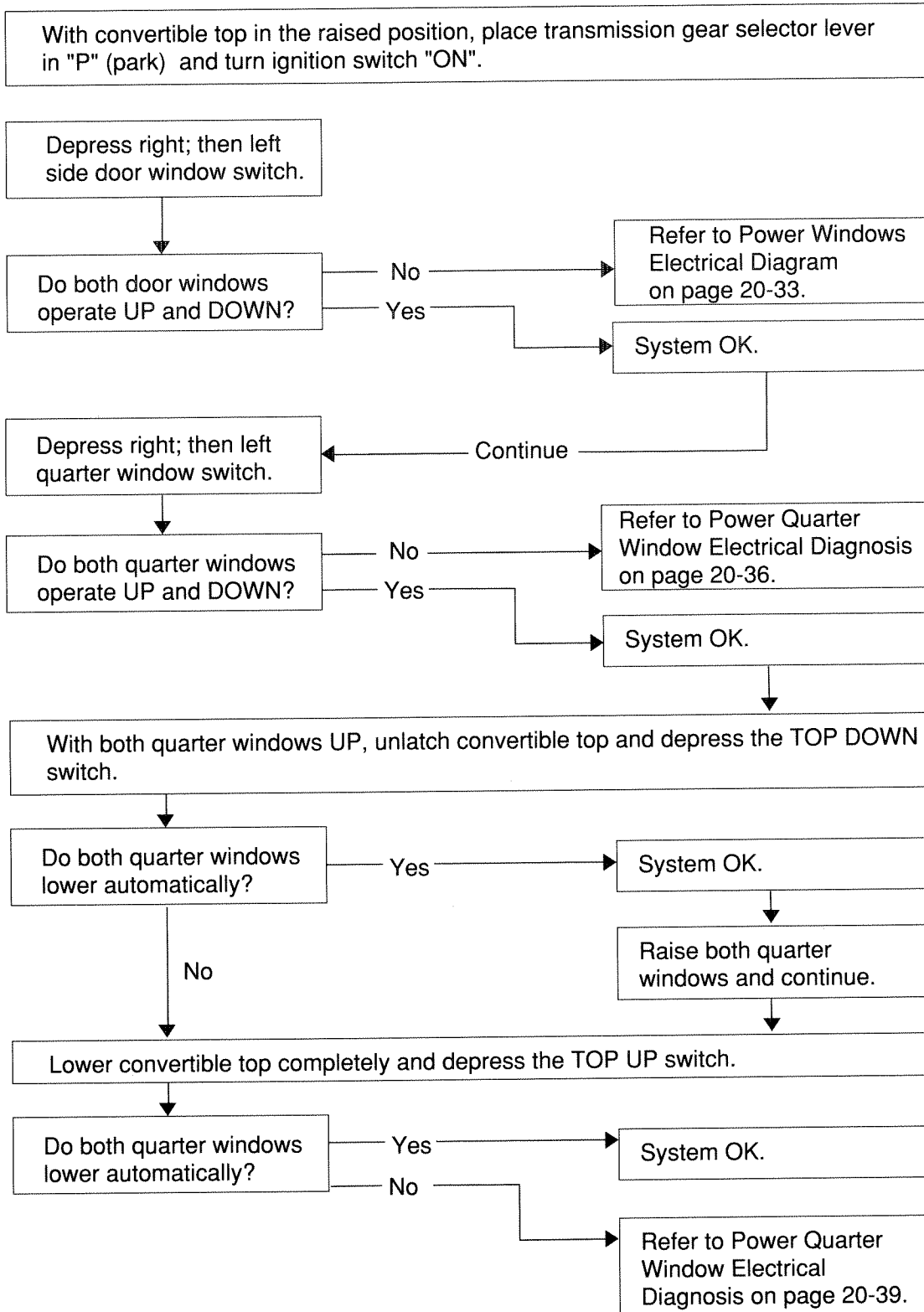



### POWER QUARTER WINDOWS ELECTRICAL DIAGNOSTIC PROCEDURE #1

Condition: 1. Both quarter windows do not operate (start at 1).  
 2. One quarter window does not operate (start at 6).

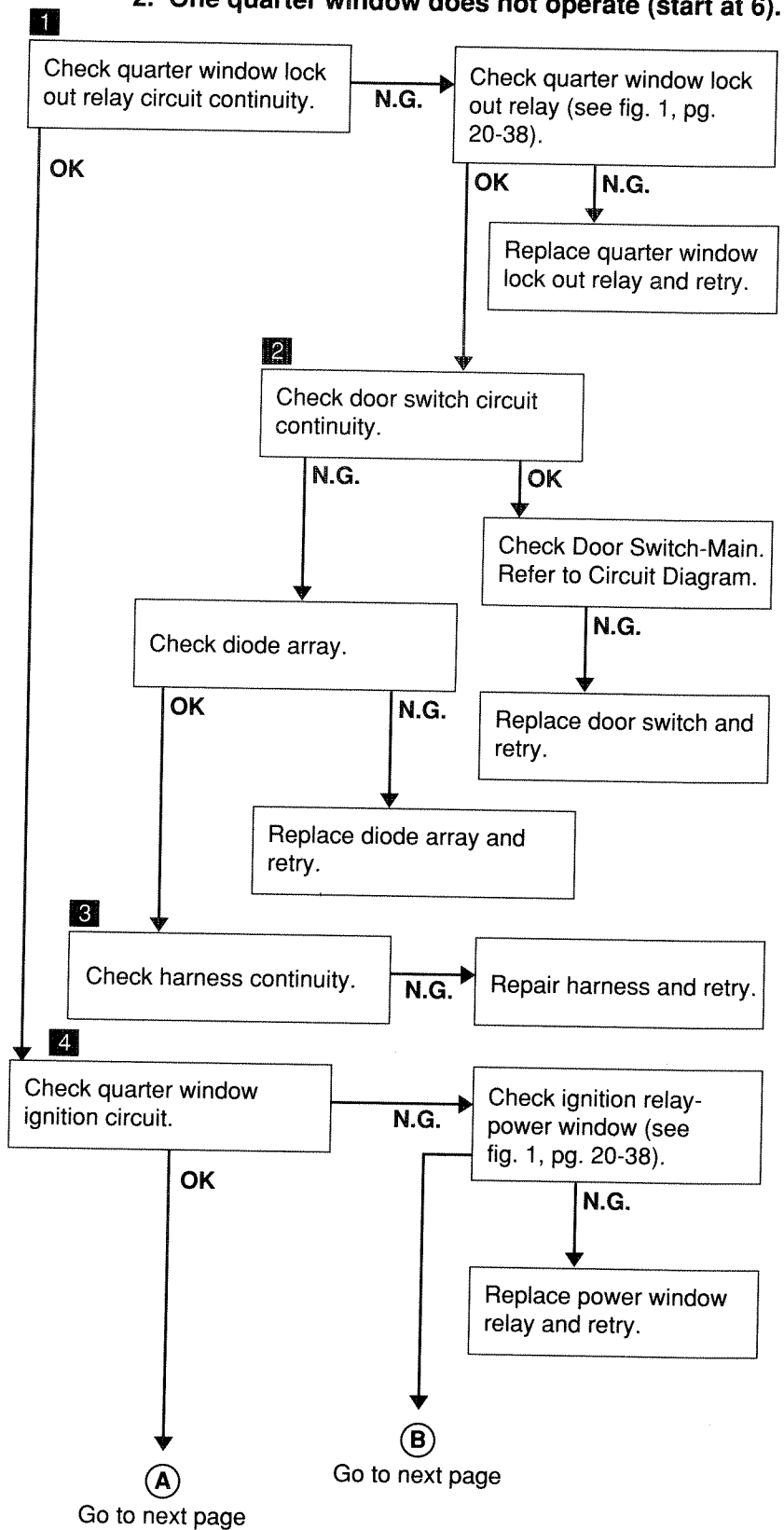
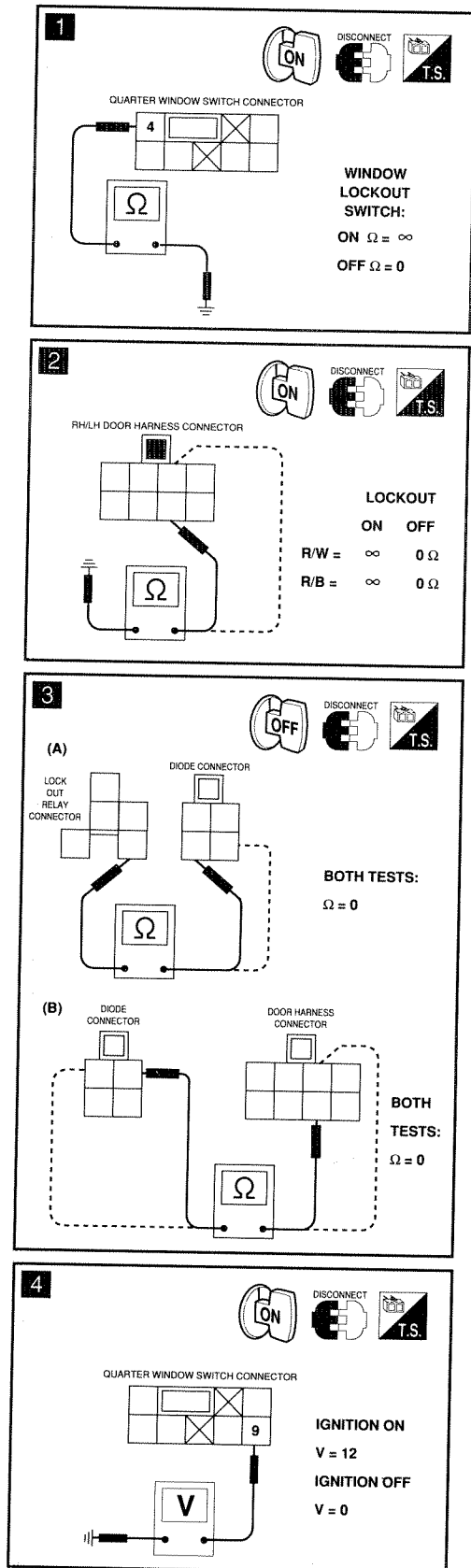

### POWER QUARTER WINDOWS ELECTRICAL DIAGNOSTIC PROCEDURE (Cont'd)

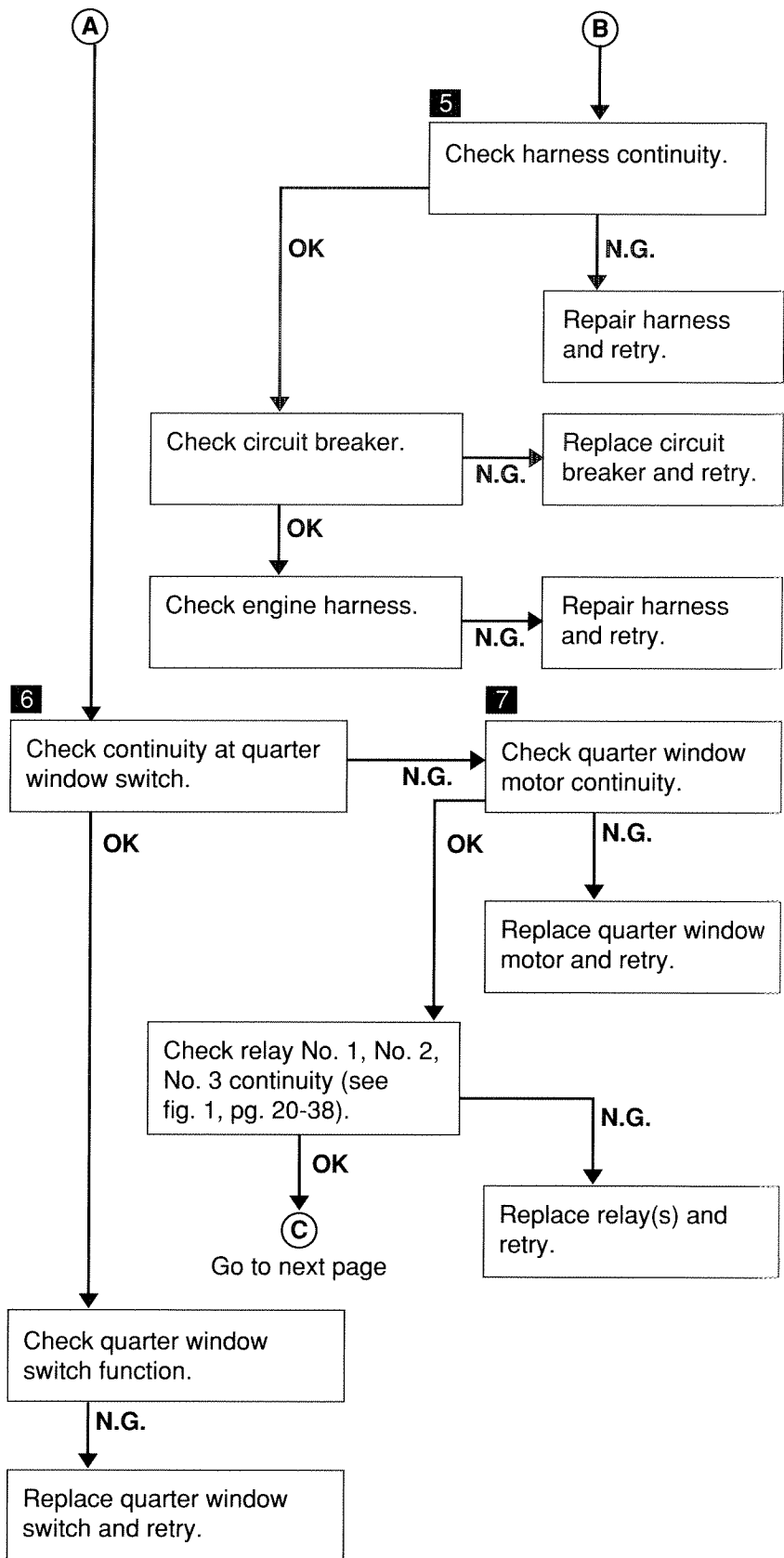
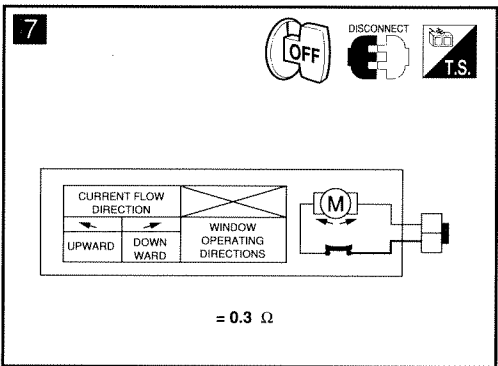
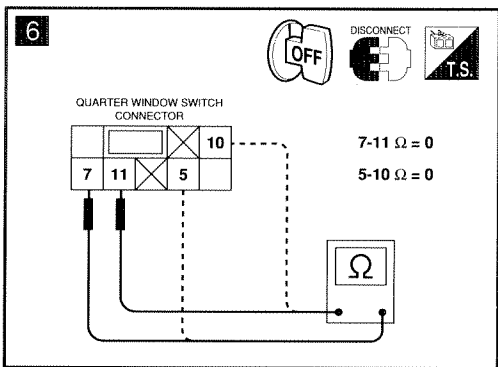
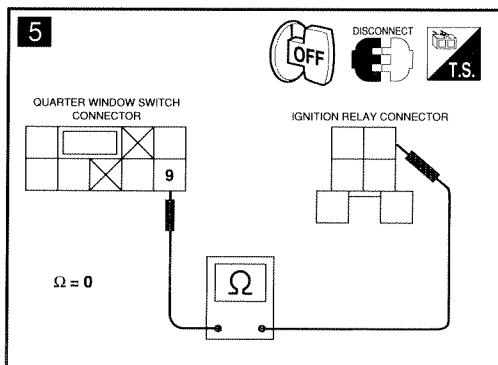

POWER QUARTER WINDOWS ELECTRICAL DIAGNOSTIC PROCEDURE (Cont'd)

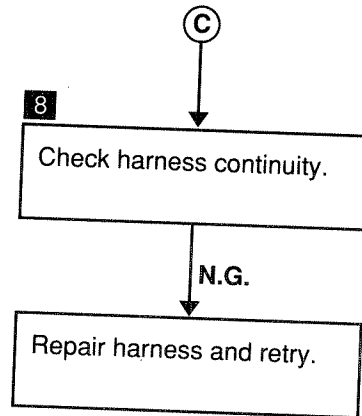
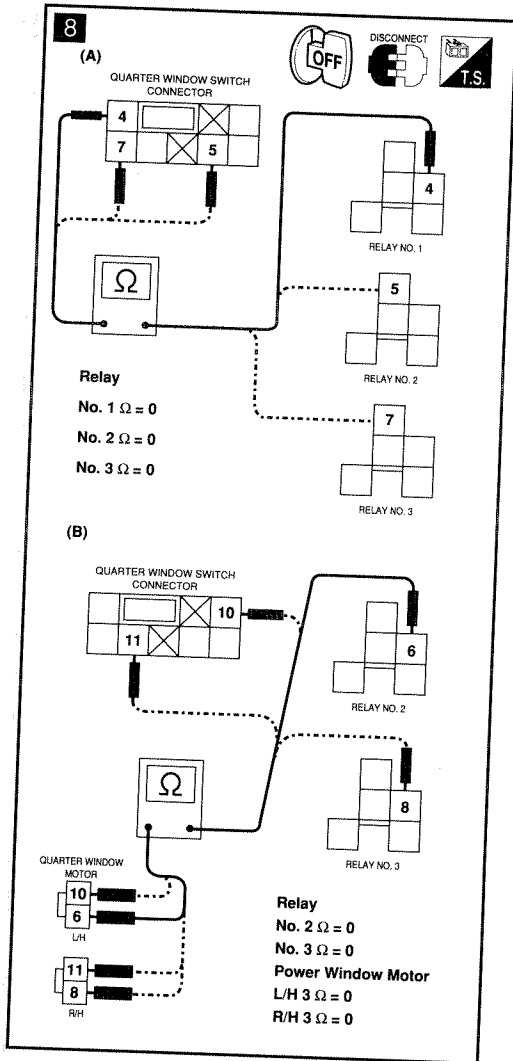
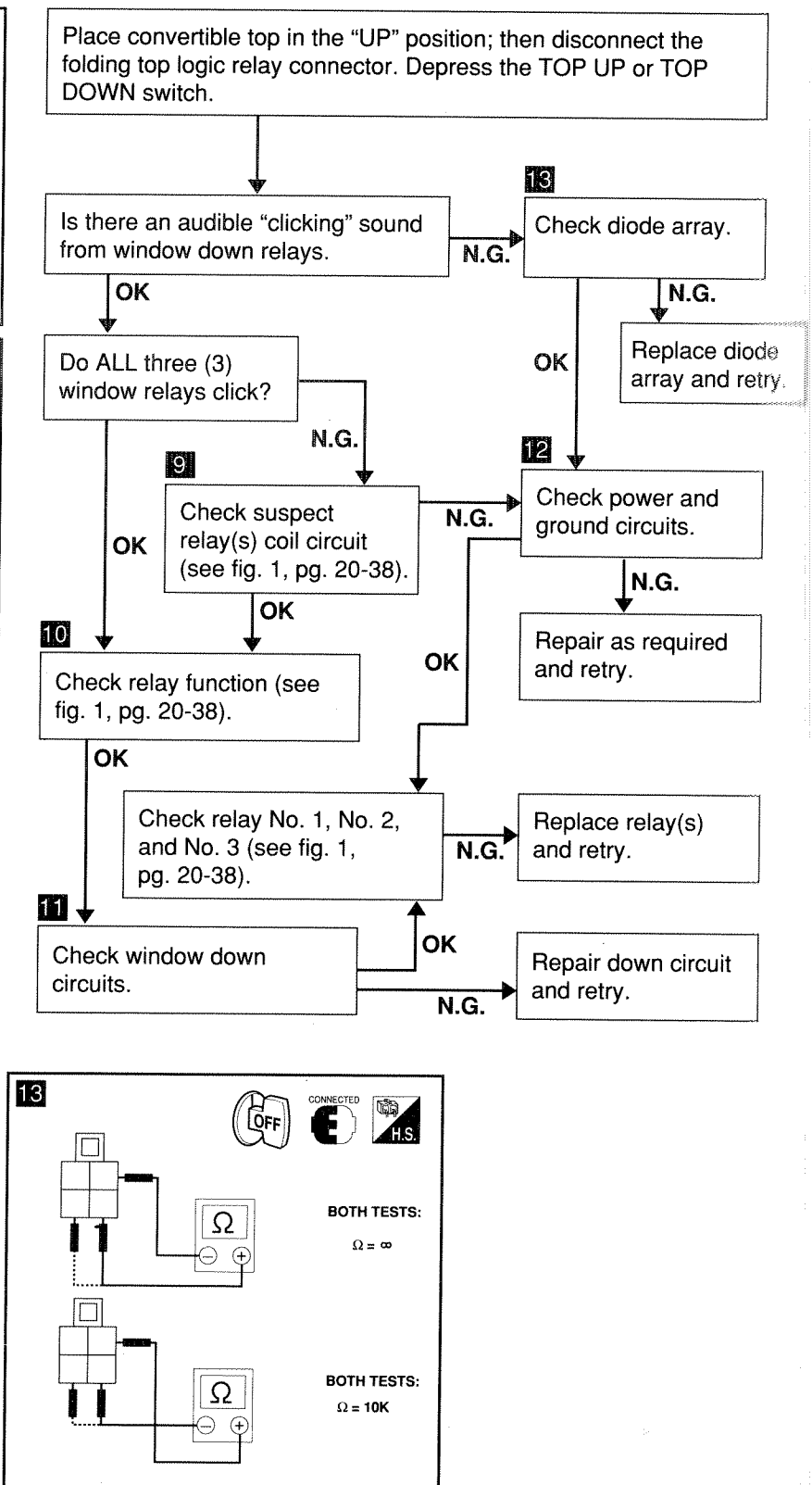
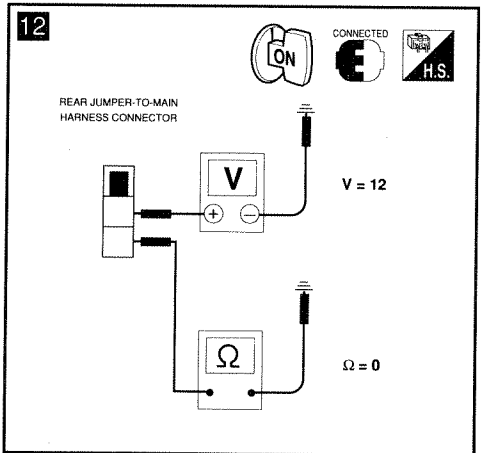
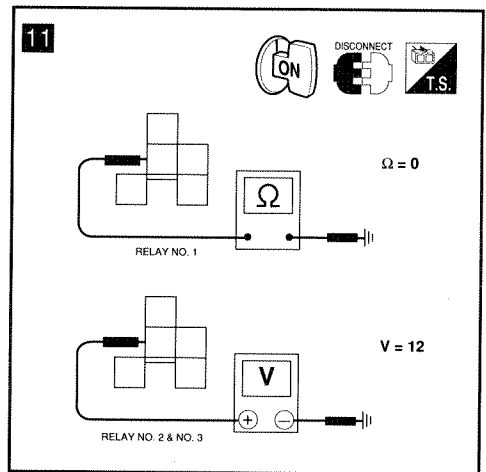
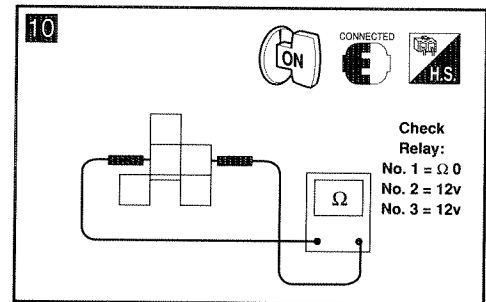
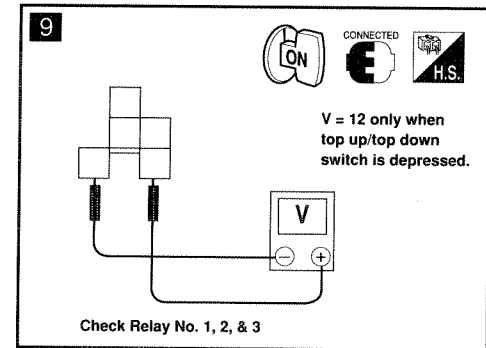

Figure 1

Type	Outer View	Circuit	Connector Symbol and Connection	Case Color
One Transfer or 1T				BLACK
Two Make or 2M				BROWN

### POWER QUARTER WINDOWS ELECTRICAL DIAGNOSTIC PROCEDURE #2.

Condition: Both quarter windows do not lower automatically when convertible top is raised or lowered.



# Clearance, License, Tail and Stop Lamps/Wiring Diagram

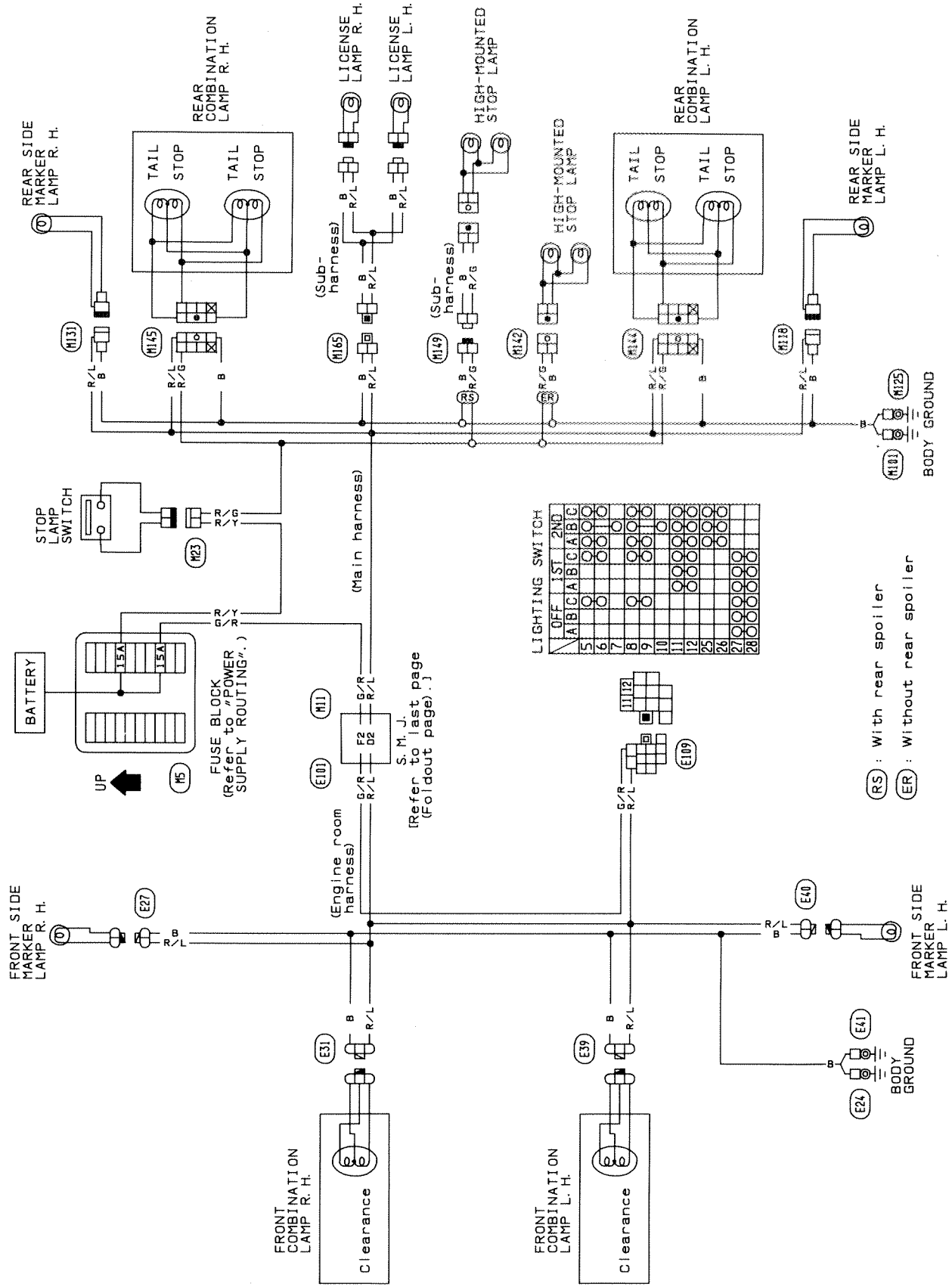

LIGHTING SWITCH

	OFF	1ST	2ND
A	○	○	○
B	○	○	○
C	○	○	○
D	○	○	○
E	○	○	○
F	○	○	○
G	○	○	○
H	○	○	○
I	○	○	○
J	○	○	○
K	○	○	○
L	○	○	○
M	○	○	○
N	○	○	○
O	○	○	○
P	○	○	○
Q	○	○	○
R	○	○	○
S	○	○	○
T	○	○	○
U	○	○	○
V	○	○	○
W	○	○	○
X	○	○	○
Y	○	○	○
Z	○	○	○

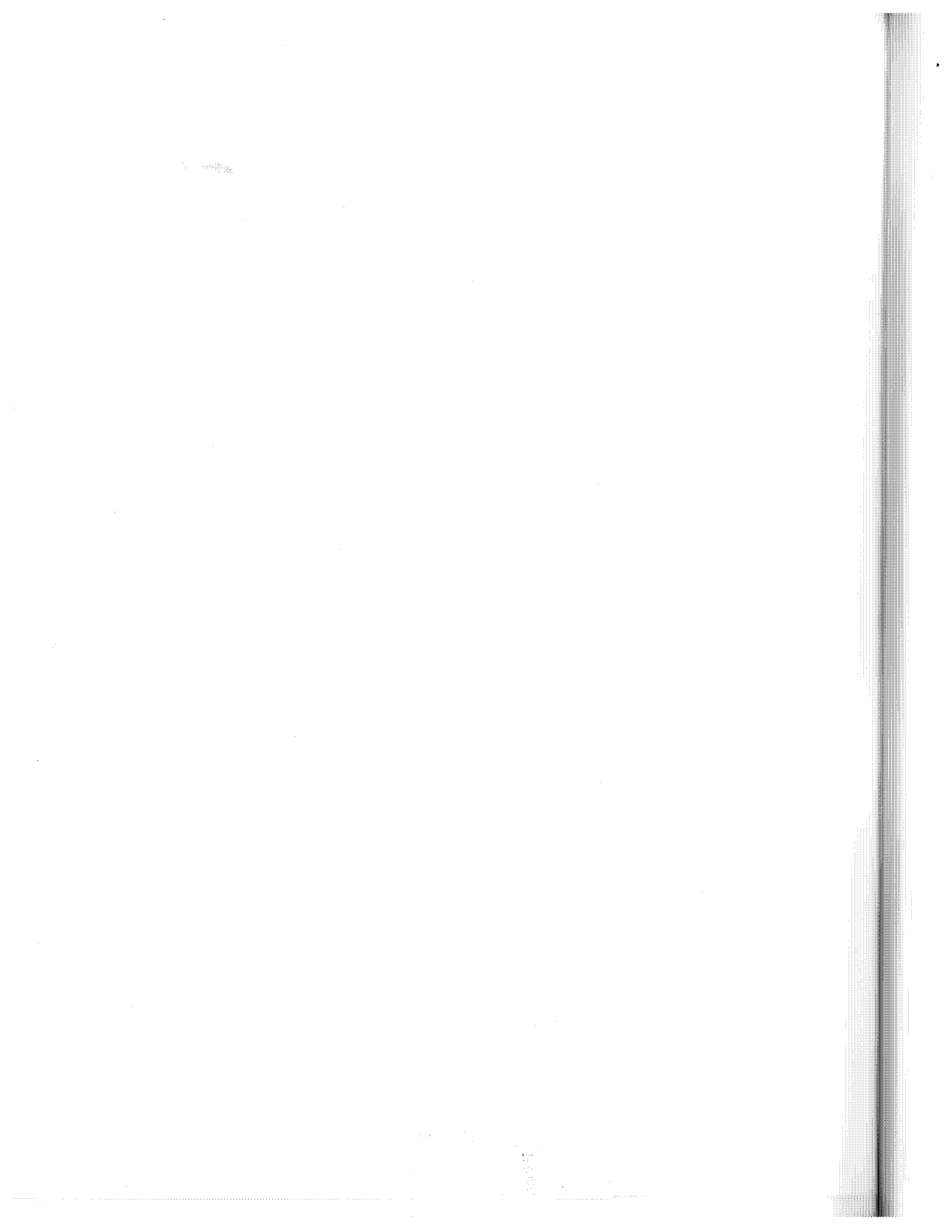

MAIN CIRCUIT DIAGRAM

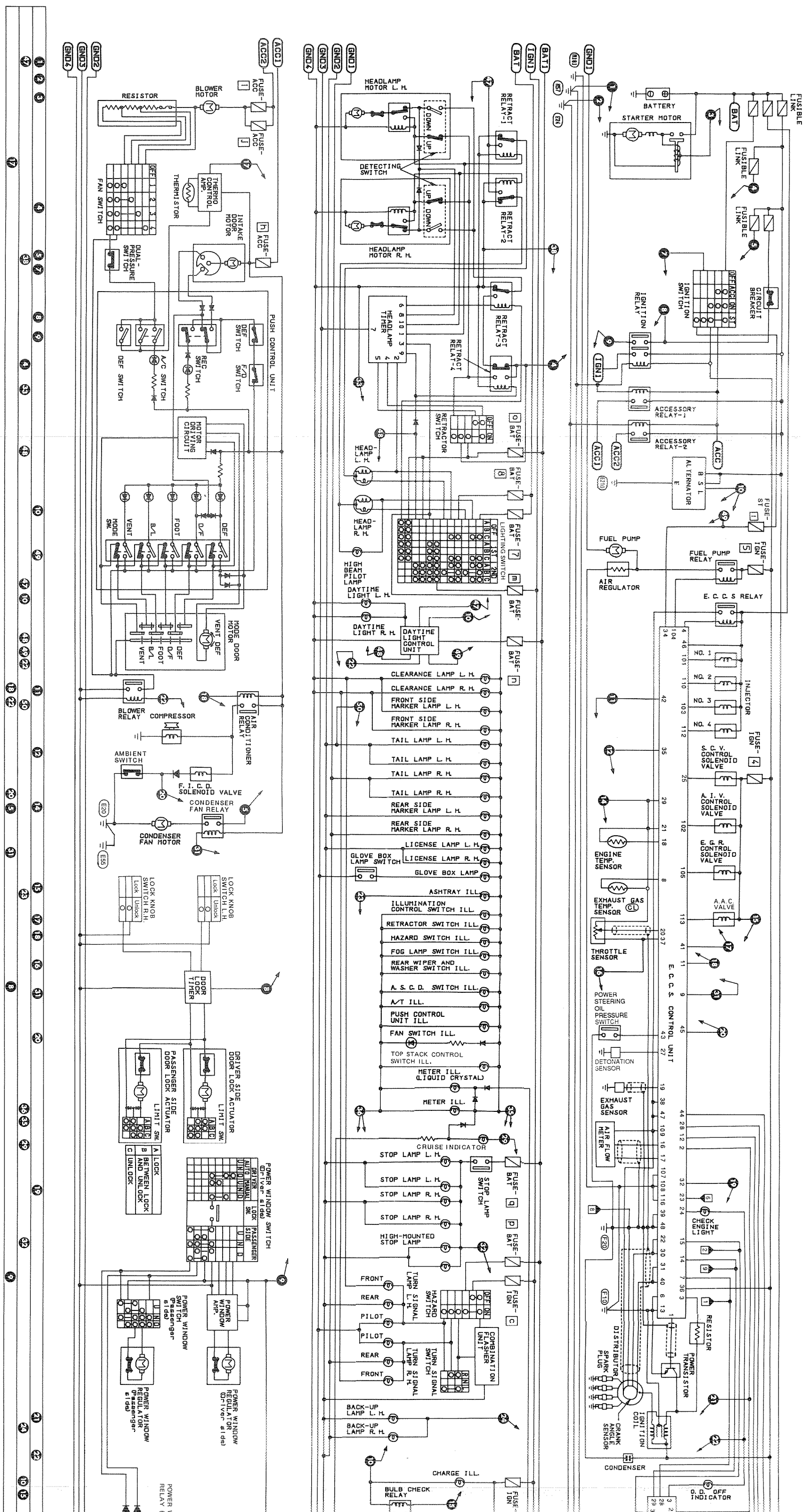



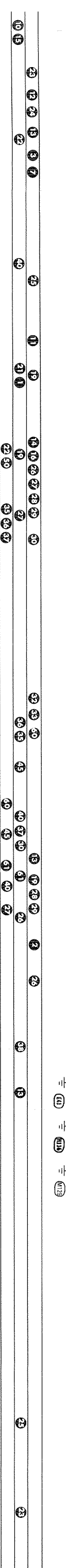
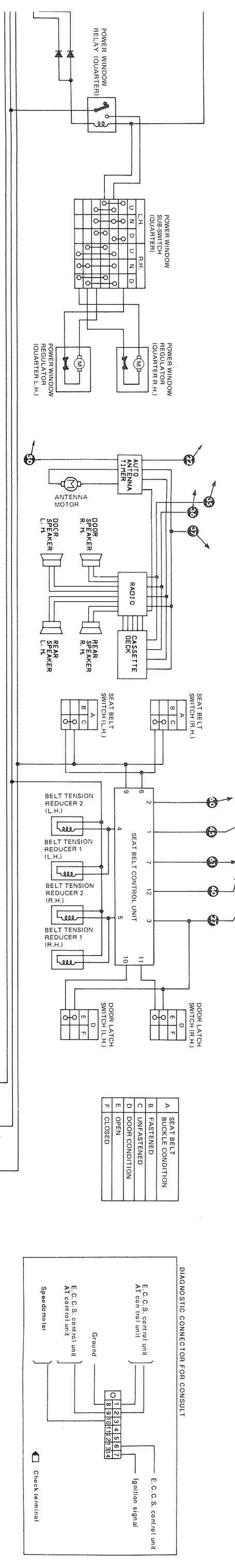
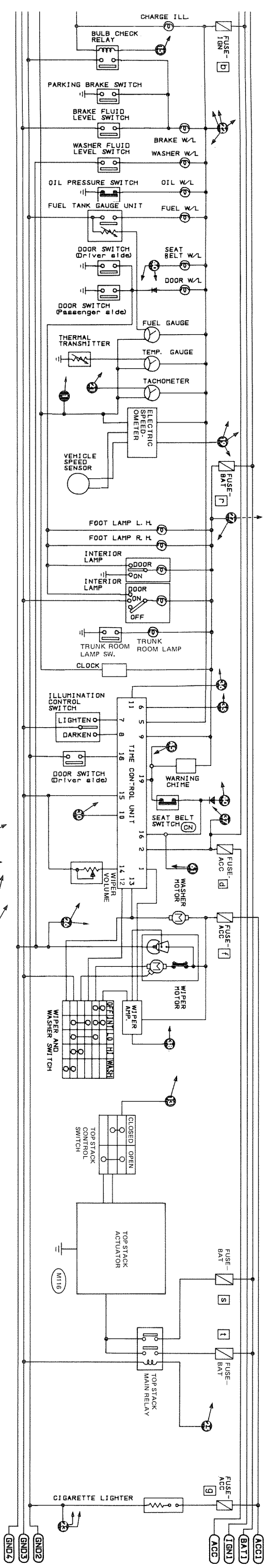
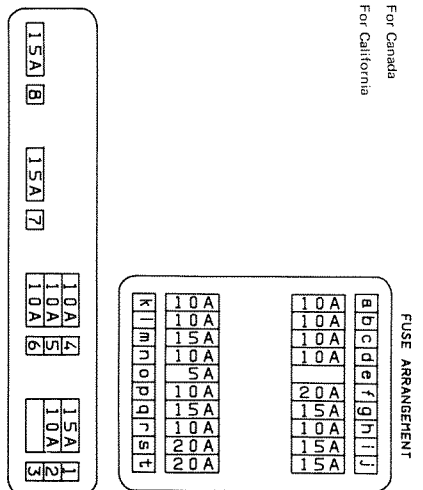
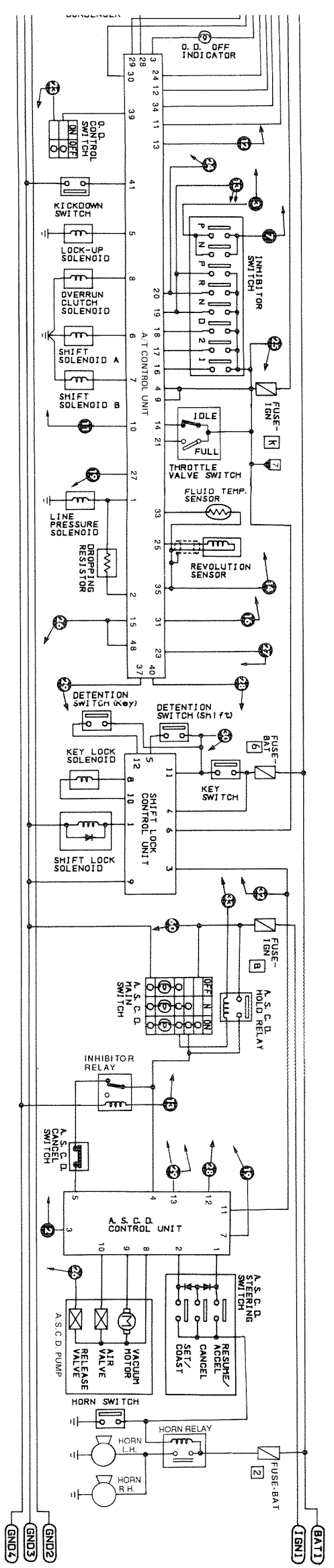

CA For California  
CAN For Canada



# DECK LID HINGE AND TRUNK TRIM

	page
DECK LID HINGE AND TRUNK TRIM COMPONENTS .....	21-2
ADJUSTMENTS .....	21-3
GAS STRUT .....	21-4
DECK LID HINGE ASSEMBLY .....	21-5
TRUNK TRIM .....	21-7

DECK LID HINGE AND TRUNK TRIM COMPONENTS

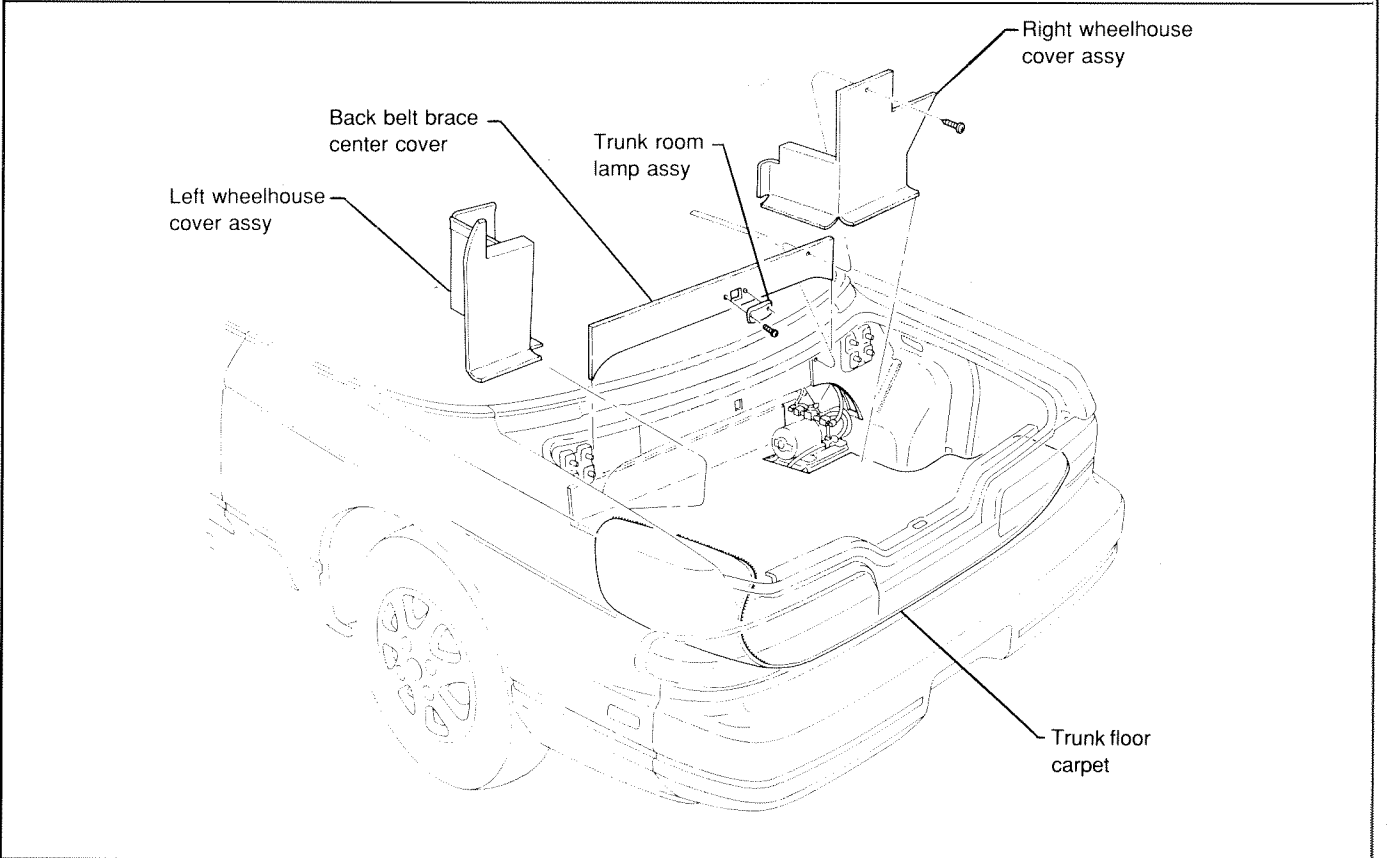
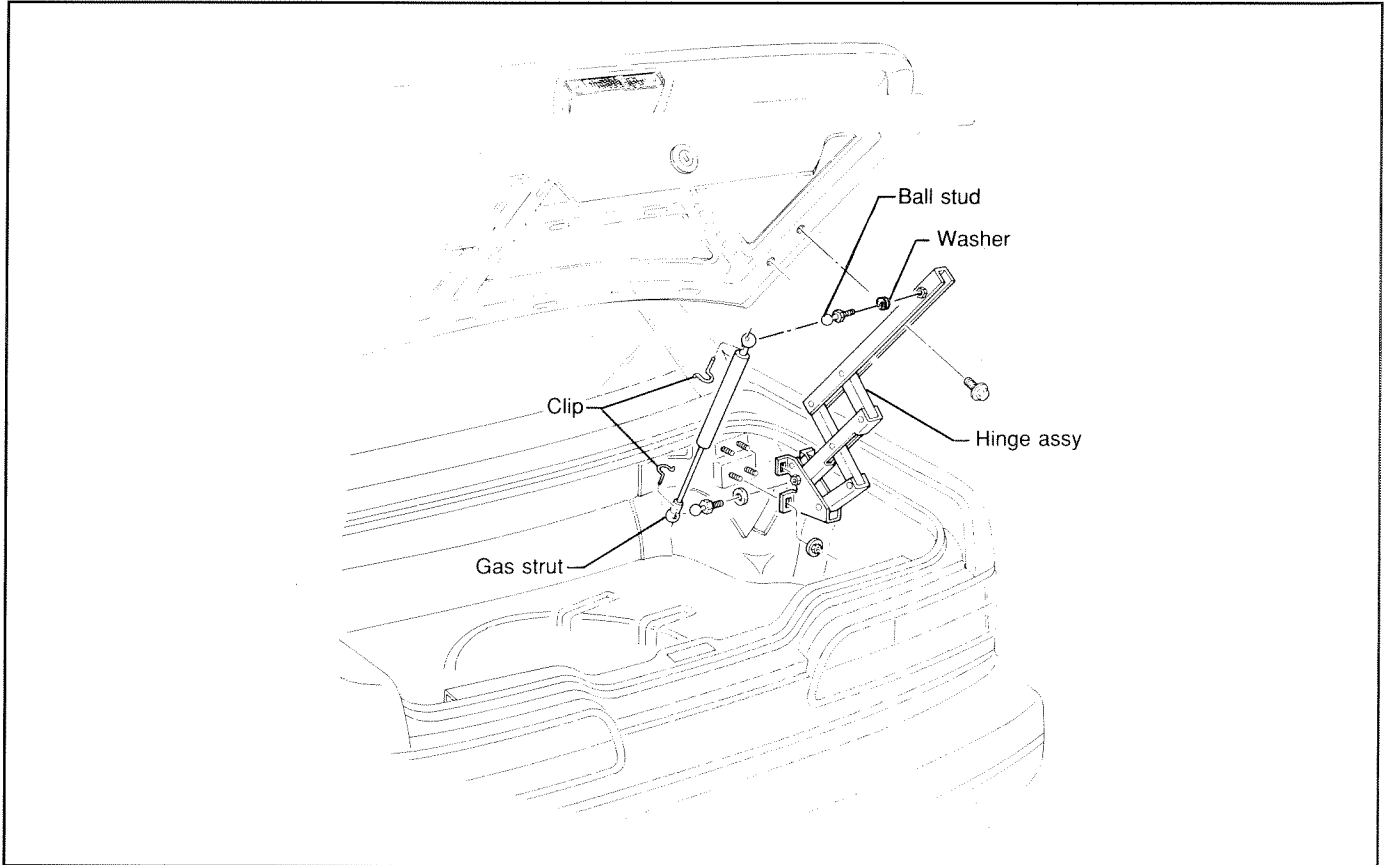

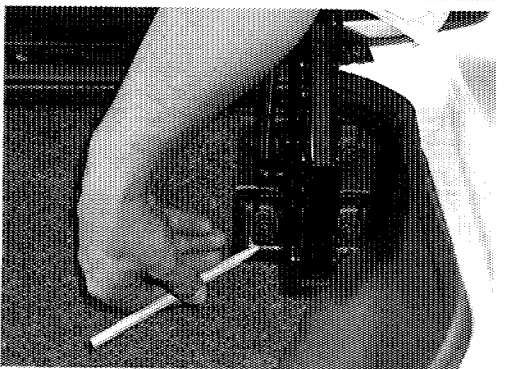
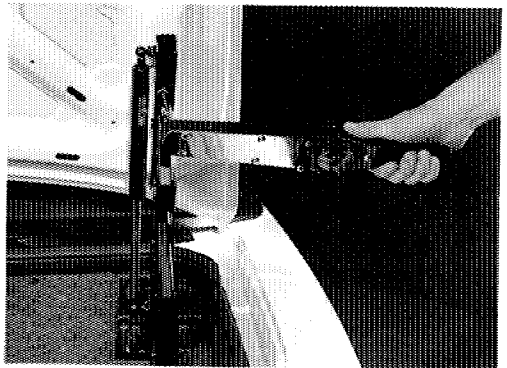
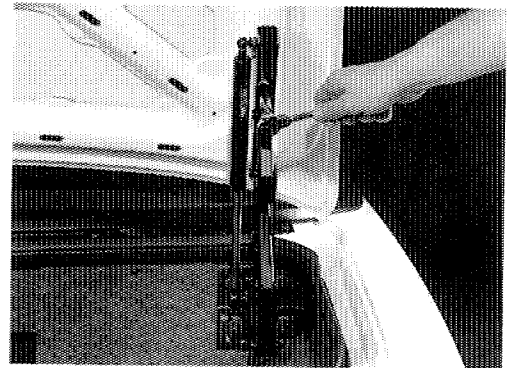
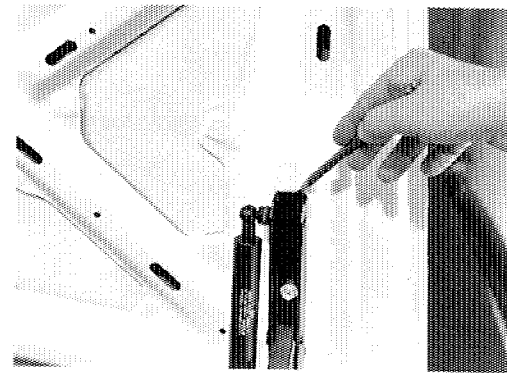

## ADJUSTMENTS

### FORE AND AFT

1. RAISE DECK LID.
2. MARK DECK LID-TO-HINGE BRACKET LOCATION.  
Using a pencil, draw a line on deck lid along side and across the end of hinge bracket.
3. ADJUST DECK LID.
  - (a) Loosen two (2) bolts securing deck lid to hinge bracket.
  - (b) Move deck lid to desired position.
  - (c) Tighten two (2) hinge bracket-to-deck lid bolts.  
**Torque: 10 N·m (88 in. lb.)**
  - (d) Close deck lid and check alignment. If necessary, repeat steps 1 through 3 on other side of vehicle.

### UP AND DOWN

**NOTE: This procedure is for the forward edge of rear deck lid only. Refer to the vehicle Service Manual for deck lid latch or striker adjustment.**

1. RAISE DECK LID.
2. MARK HINGE PLATE-TO-BODY REINFORCEMENT LOCATION.

Using a pencil, draw a line on body reinforcement along side and across top of hinge plate assembly.

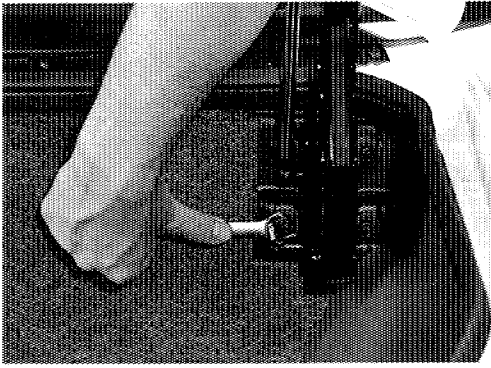

### ADJUSTMENTS (cont'd)

3. ADJUST DECK LID HINGE.
  - (a) Loosen four (4) nuts securing hinge plate to reinforcement.
  - (b) Move hinge to desired position.
  - (c) Tighten four (4) hinge plate-to-reinforcement nuts.  
**Torque: 25 N·m (18 ft. lb.)**
  - (d) Close deck lid and check alignment. If necessary, repeat steps 1 through 3 on other side of vehicle.

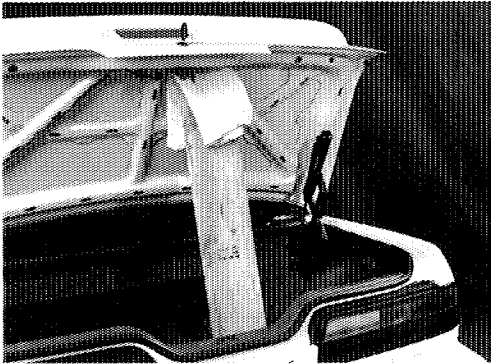
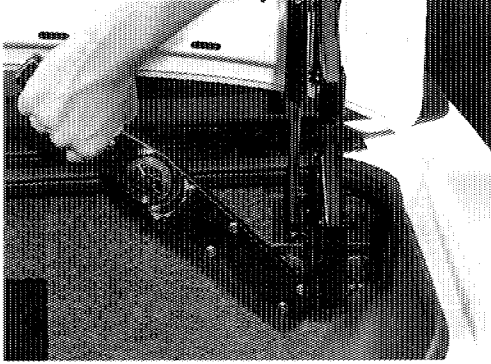

### GAS STRUT

#### REMOVE

1. SUITABLY SUPPORT DECK LID IN FULL OPEN POSITION.
2. REMOVE DECK LID GAS STRUT.

#### WARNING:

- o Be careful not to scratch or nick gas strut rod. A damaged strut rod may cause gas leakage.
- o Contents of the gas strut are under pressure. Do not take apart, puncture, apply heat or allow fire near gas strut.

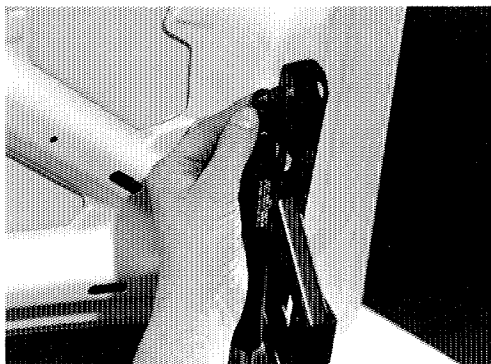

- (a) Remove clip from upper end of gas strut, and remove strut from ball stud.
- (b) Remove clip from lower end of gas strut, and remove strut from vehicle.

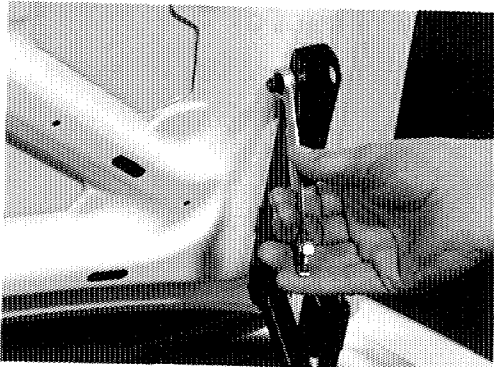
**GAS STRUT (cont'd)**

3. REMOVE BALL STUD AND WASHER.

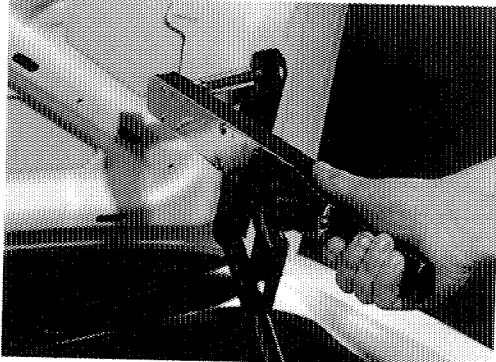
**INSTALL**

1. INSTALL WASHER AND BALL STUD.

**Torque: 13 N·m (115 in. lb.)**

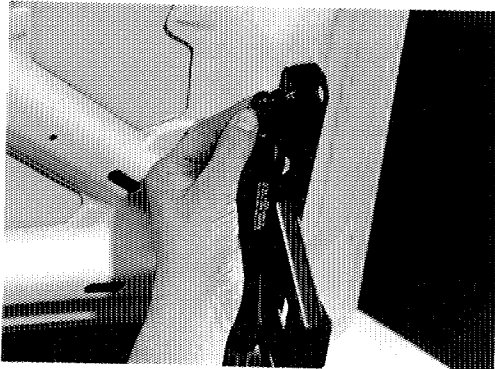

2. INSTALL DECK LID GAS STRUT.

- (a) Position lower end of strut to hinge assembly ball stud and install clip.
- (b) Position upper end of strut to hinge assembly ball stud and install clip.

**NOTE: It may be necessary to slightly compress the gas strut by hand when placing it on the upper stud.**

3. REPEAT GAS STRUT PROCEDURE IF OTHER SIDE IS TO BE REPLACED.
4. REMOVE DECK LID SUPPORT AND CHECK OPERATION OF GAS STRUT.

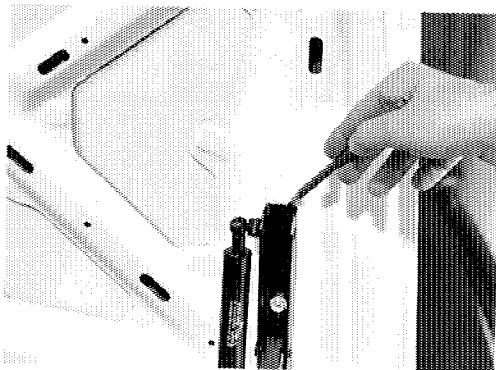
**DECK LID HINGE ASSEMBLY****REMOVE**

1. RAISE DECK LID.
2. MARK DECK LID HINGE LOCATION.
  - (a) Using a pencil, draw a line on deck lid along side and across end of hinge.

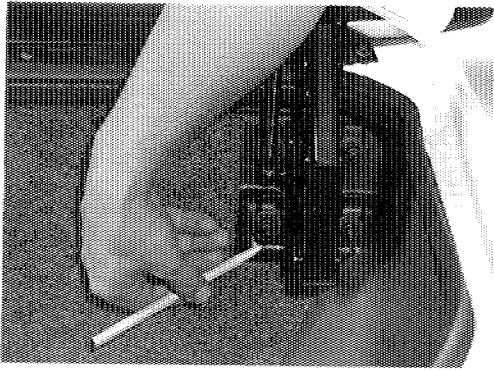

### DECK LID HINGE ASSEMBLY (cont'd)

- (b) Draw a line on body reinforcement along side and across top of hinge assembly.

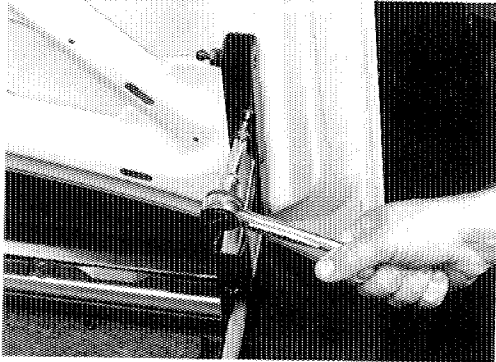

### 3. REMOVE DECK LID HINGE ASSEMBLY.

- (a) Remove gas strut from hinge (see 21-4).
- (b) Remove two (2) bolts securing deck lid hinge bracket to deck lid.

**NOTE: Place a protective cover below the deck lid lower edge on side being serviced.**

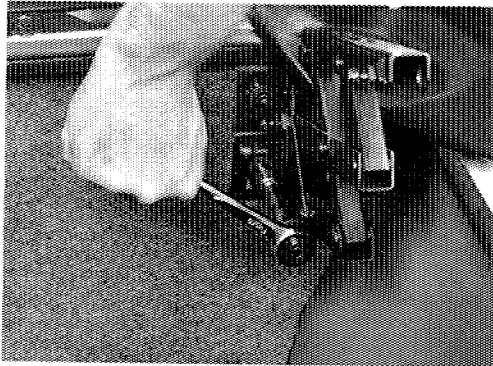

- (c) Remove four (4) nuts securing deck lid hinge plate to body reinforcement, and hinge assembly from vehicle

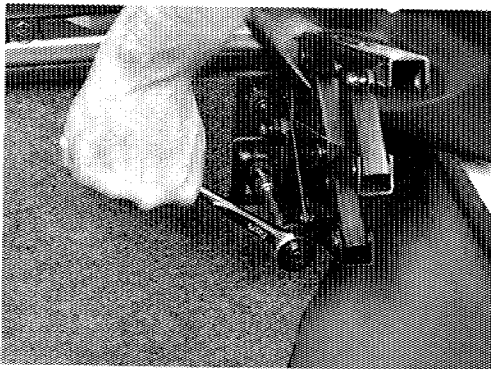

### INSTALL

#### 1. INSTALL DECK LID HINGE ASSEMBLY.

- (a) Position deck lid hinge plate to location marks on the body reinforcement.
- (b) Install four (4) nuts. Do not torque nuts at this time.

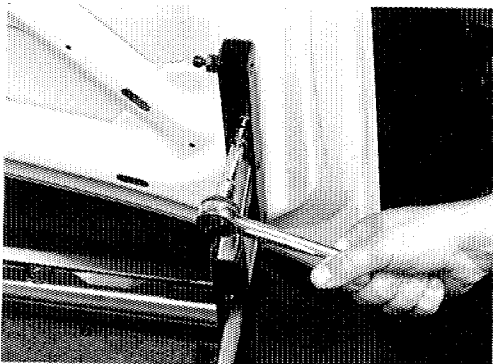

- (c) Position deck lid hinge bracket to location marks on the deck lid.
- (e) Install two (2) bolts. Do not torque bolts at this time.
- (d) Install gas strut (see Gas Strut in the chapter).



**DECK LID HINGE ASSEMBLY (cont'd)**

3. REPEAT DECK LID HINGE ASSEMBLY PROCEDURE IF OTHER SIDE IS TO BE REPLACED.
4. CHECK DECK LID ALIGNMENT IF NECESSARY (see Adjustments in this chapter).

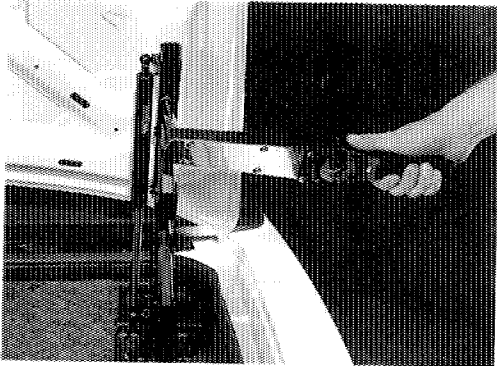

5. TORQUE TWO (2) DECK LID HINGE BRACKET-TO-DECK LID BOLTS.

**Torque: 10 N·m (88 in. lb.)**

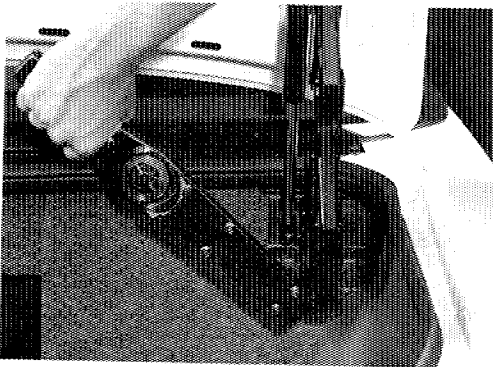

6. TORQUE FOUR (4) DECK LID HINGE PLATE-TO-BODY REINFORCEMENT NUTS.

**Torque: 25 N·m (18 ft. lb.)**

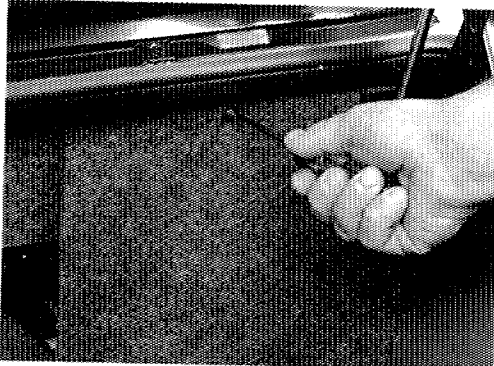
**TRUNK TRIM****REMOVE**

1. RAISE REAR DECK LID.
2. REMOVE RIGHT WHEELHOUSE COVER.
  - (a) Remove one (1) screw from wheelhouse cover and drain trough.
  - (b) Lift wheelhouse cover lower edge to disengage velcro and remove wheelhouse cover from vehicle.

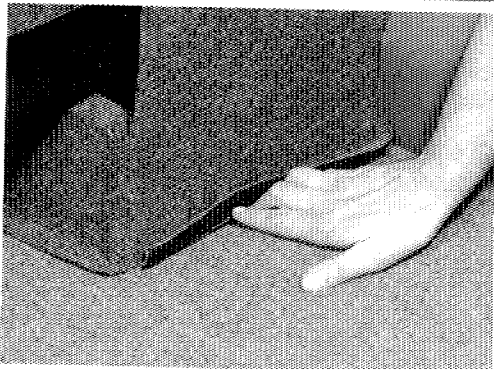

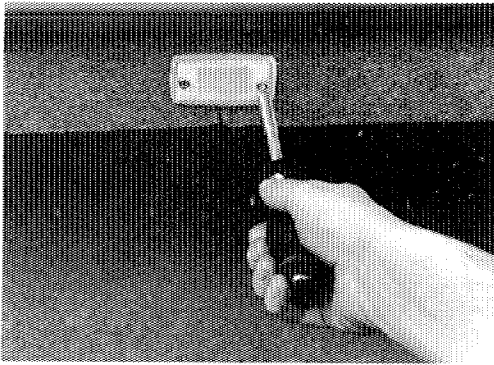

### TRUNK TRIM (cont'd)

#### 3. REMOVE BACK BELT BRACE CENTER COVER.

- (a) Remove two (2) screws and trunk room lamp from rear drain trough.
- (b) Disconnect trunk room lamp electrical connector.
- (c) Remove center cover starting at one end and pull material from drain trough.
- (d) Using a suitable release agent (3M P/N 051135-08971 or equivalent), remove excess adhesive from drain trough.

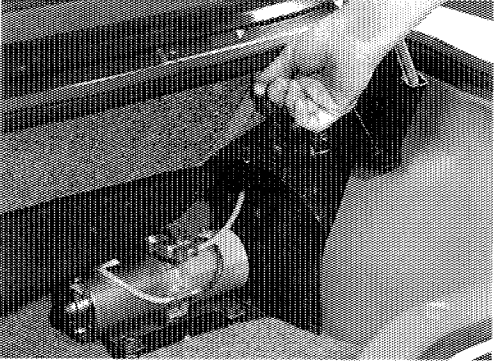

#### 4. REMOVE LEFT WHEELHOUSE COVER.

Lift wheelhouse cover lower edge to disengage velcro and remove wheelhouse cover from vehicle.

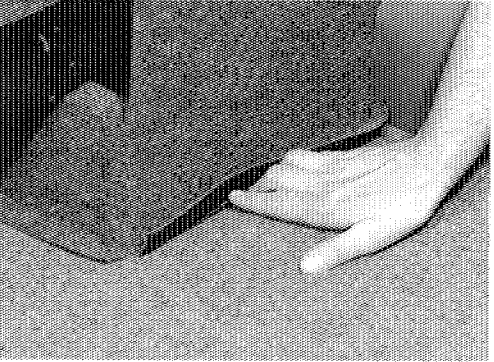

### INSTALL

#### 1. INSTALL LEFT WHEELHOUSE COVER.

- (a) Position wheelhouse cover to left wheelhouse.
- (b) Press down on wheelhouse cover lower edge to engage velcro to trunk floor carpet.

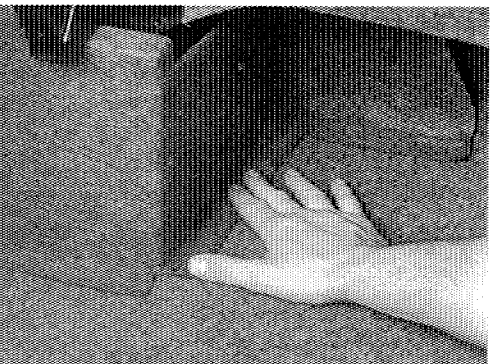

#### 2. INSTALL BACK BELT BRACE CENTER COVER.

- (a) Apply adhesive (3M P/N 051135-08031 or equivalent) to drain trough and cover material.
- (b) Install cover material starting at center trunk lamp opening. Keep lower edge of material even with lower edge of drain trough.

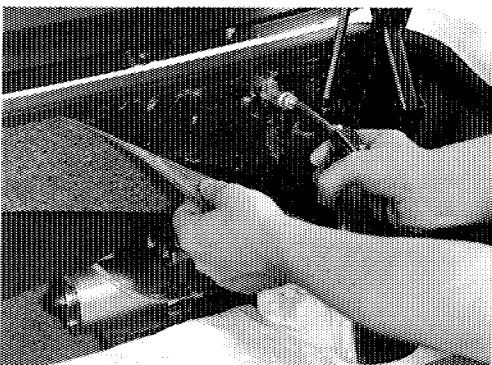

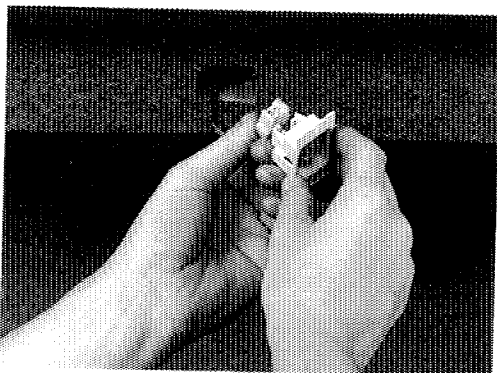

## TRUNK TRIM (cont'd)

- (c) Connect trunk room lamp electrical connector.
- (d) Secure trunk room lamp to rear drain trough using two (2) screws.

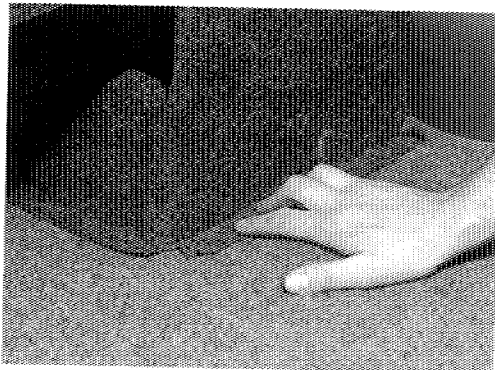

- 3. INSTALL RIGHT WHEELHOUSE COVER.
  - (a) Position right wheelhouse cover to right wheelhouse and secure to drain trough using one (1) screw.
  - (b) Press down on wheelhouse cover lower edge to engage velcro to trunk floor carpet.

\*

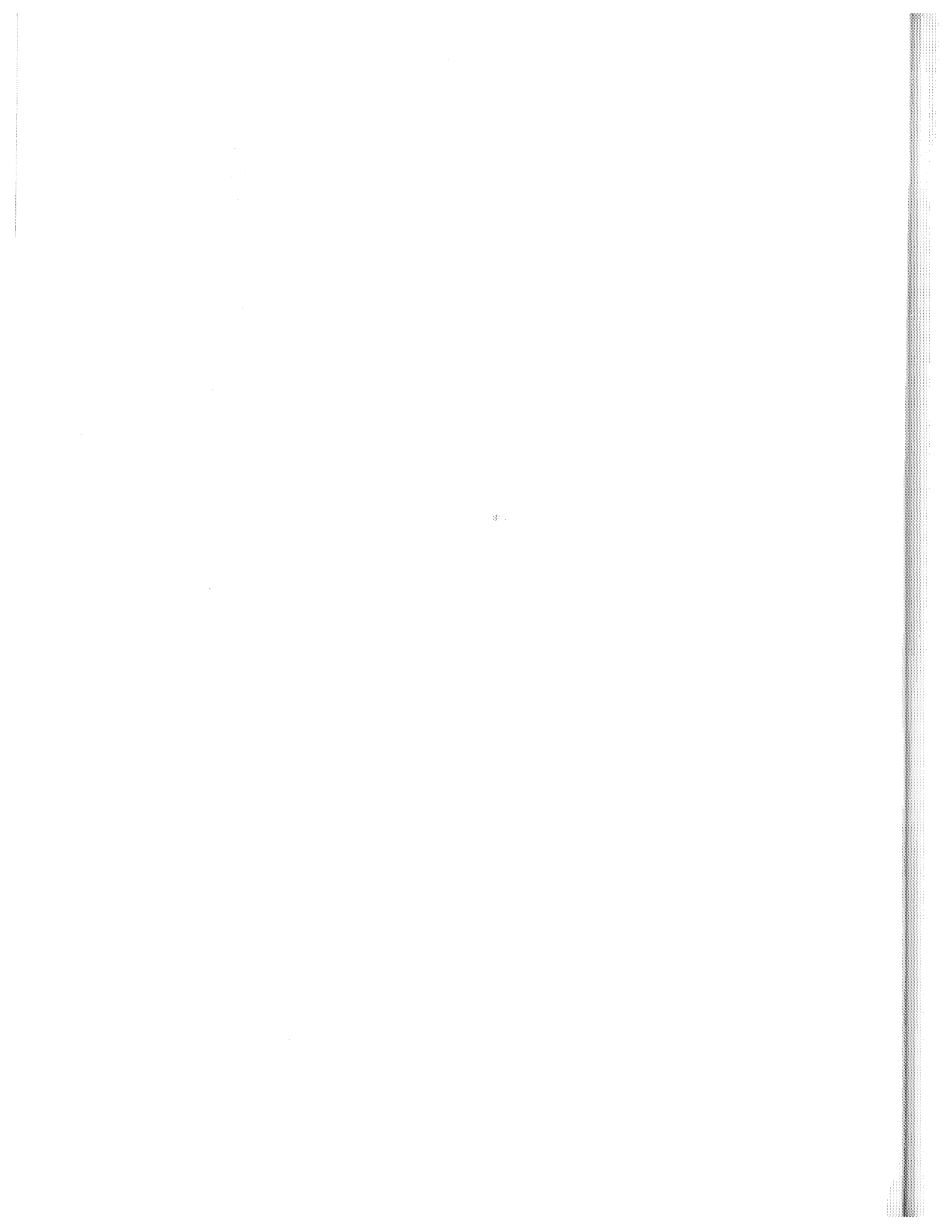

# BODY, STRUCTURE

	Page
<b>ASC INCORPORATED INSTALLED COMPONENTS</b>	
WINDSHIELD HEADER COMPONENTS.....	22 - 2
"B" PILLAR COMPONENTS.....	22 - 2
QUARTER BELT AND SIDE TROUGH COMPONENTS.....	22 - 3
REAR BRACE AND DRAIN TROUGH COMPONENTS.....	22 - 3
<b>NISSAN JAPAN INSTALLED COMPONENTS</b>	
REAR PILLAR MODIFICATIONS / SUPPORTS REAR FLOOR MODIFICATIONS / SUPPORTS.....	22 - 4
A - PILLAR AND SILL MODIFICATIONS / REINFORCEMENTS.....	22 - 5
STRUCTURAL REINFORCEMENT COMPONENTS.....	22 - 6
UNDERSIDE VEHICLE COMPONENTS.....	22 - 7
DOOR MODIFICATIONS / REINFORCEMENTS REAR FLOOR MODIFICATIONS / REINFORCEMENTS.....	22 - 8
FRONT FLOOR MODIFICATIONS / SUPPORTS.....	22 - 9

ASC INCORPORATED INSTALLED COMPONENTS

WINDSHIELD HEADER COMPONENTS

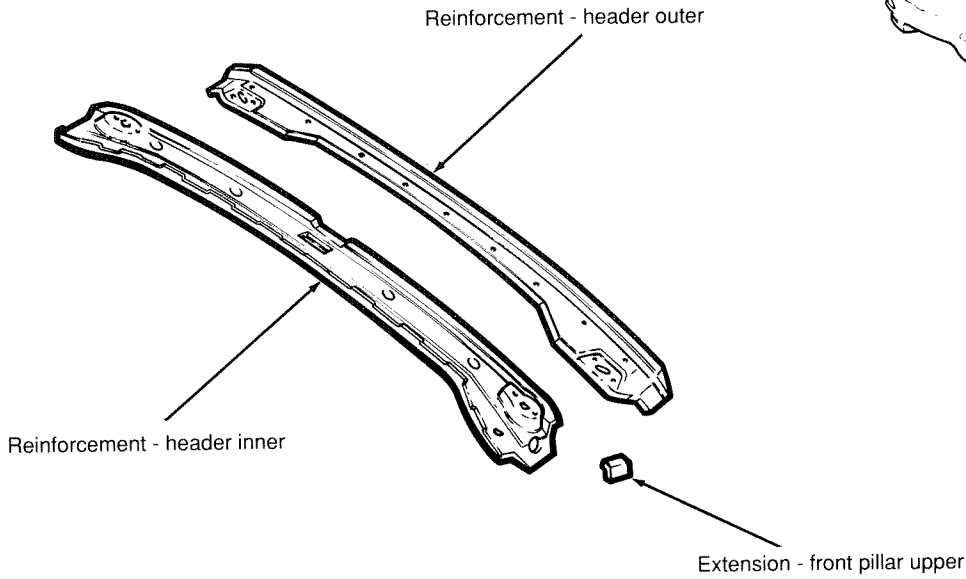
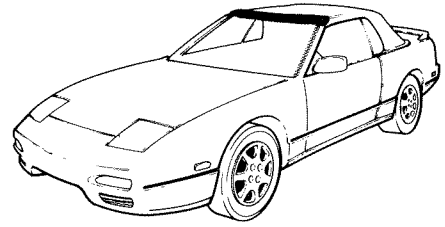

B - PILLAR COMPONENTS

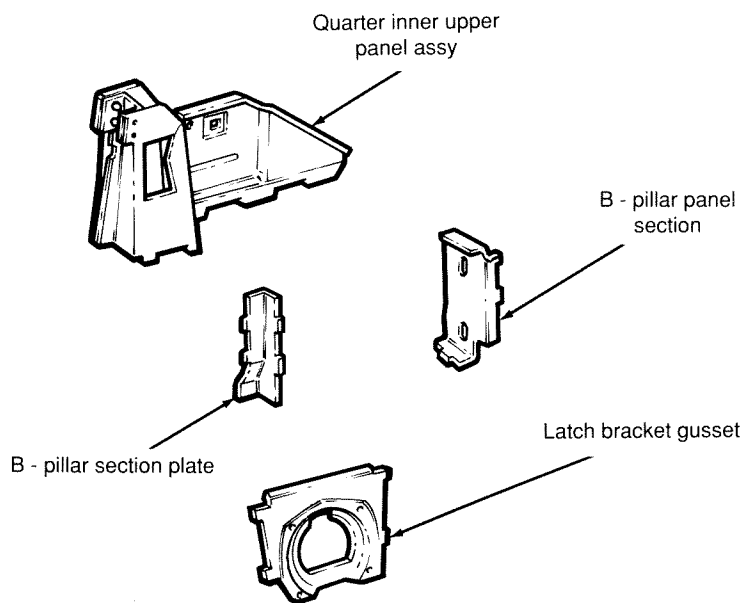
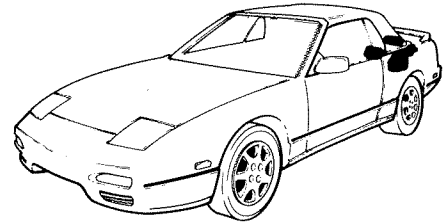

ASC INCORPORATED INSTALLED COMPONENTS (cont'd)

QUARTER BELT AND SIDE TROUGH COMPONENTS

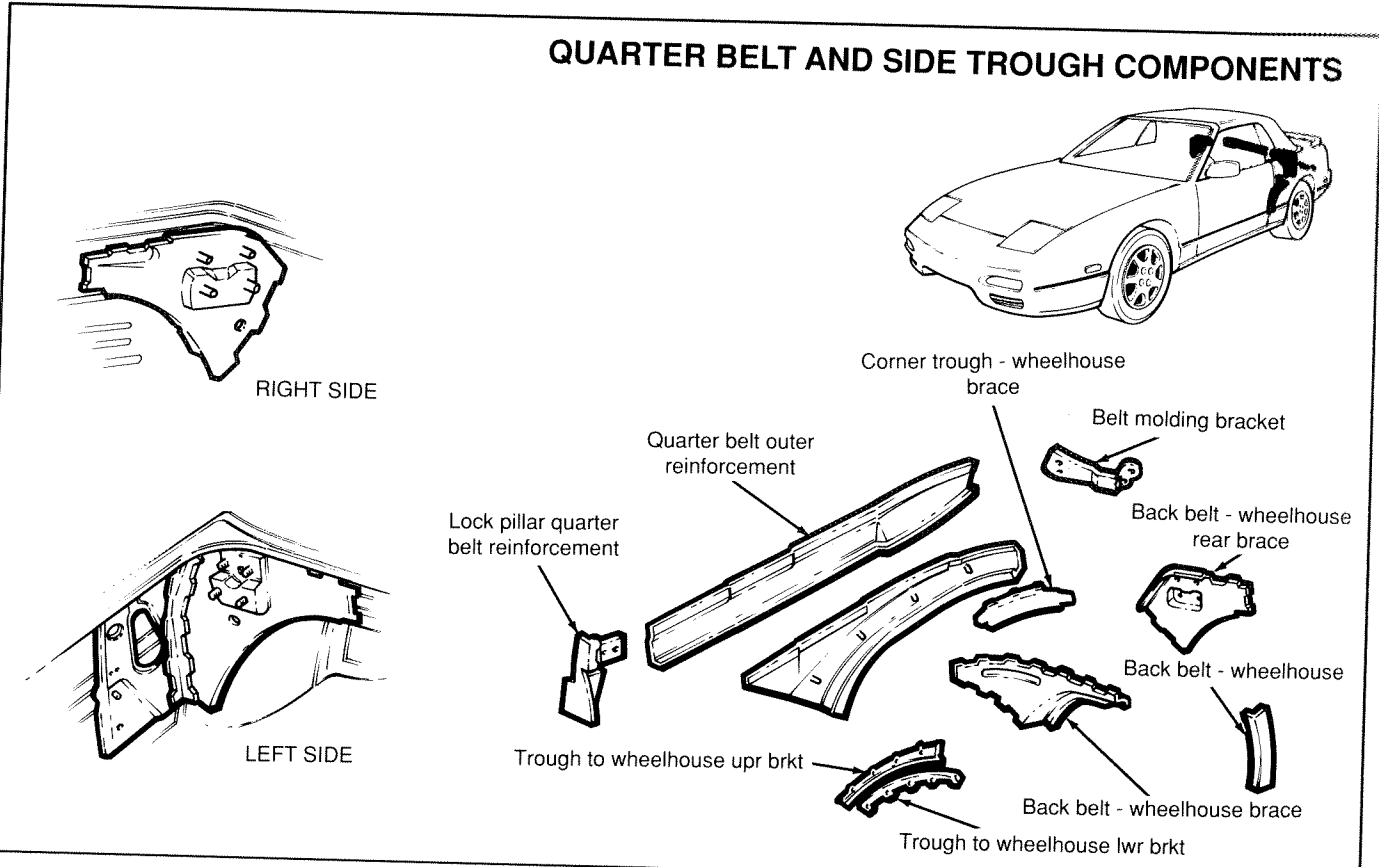

REAR BRACE AND DRAIN TROUGH COMPONENTS

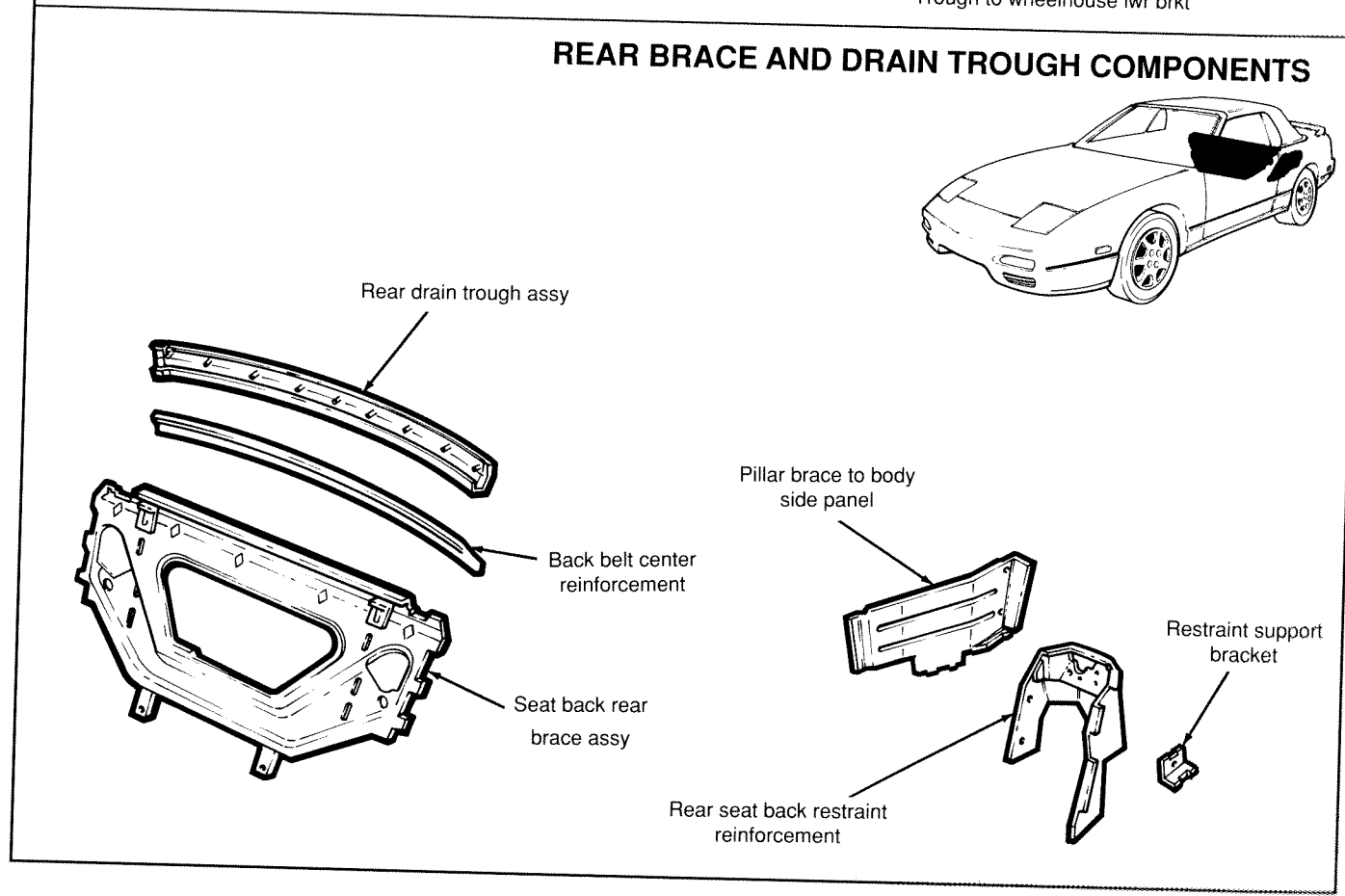



NISSAN JAPAN INSTALLED COMPONENTS

REAR PILLAR MODIFICATIONS / SUPPORTS

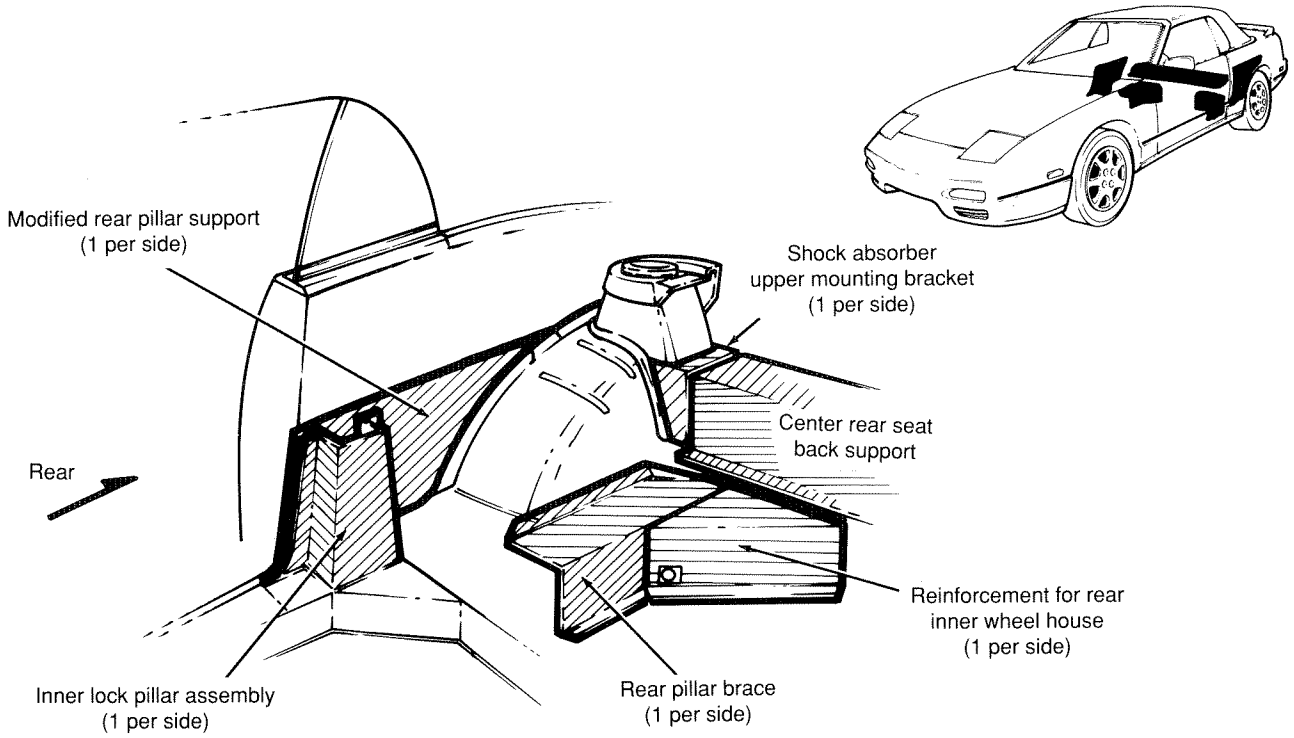

REAR FLOOR MODIFICATIONS / REINFORCEMENTS

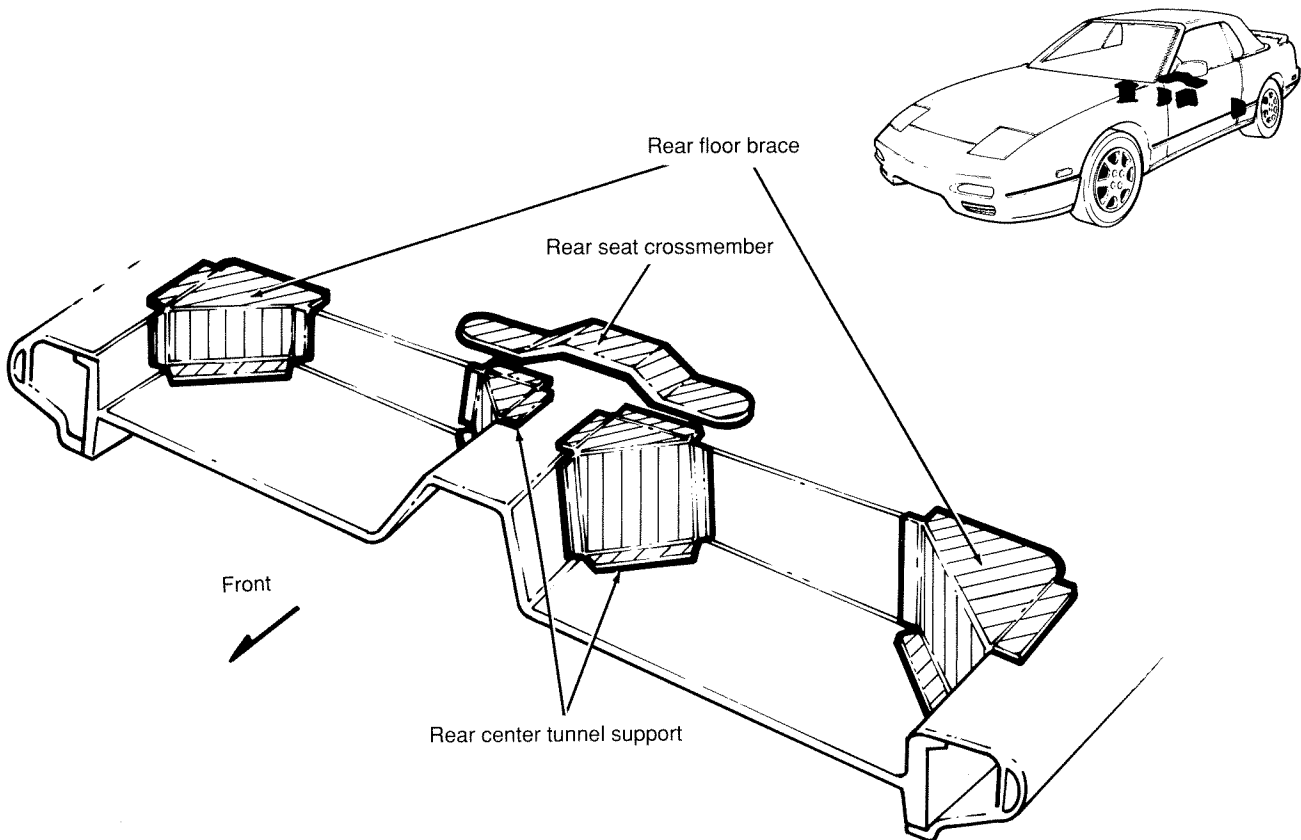

NISSAN JAPAN INSTALLED COMPONENTS

A - PILLAR AND SILL MODIFICATIONS / REINFORCEMENTS

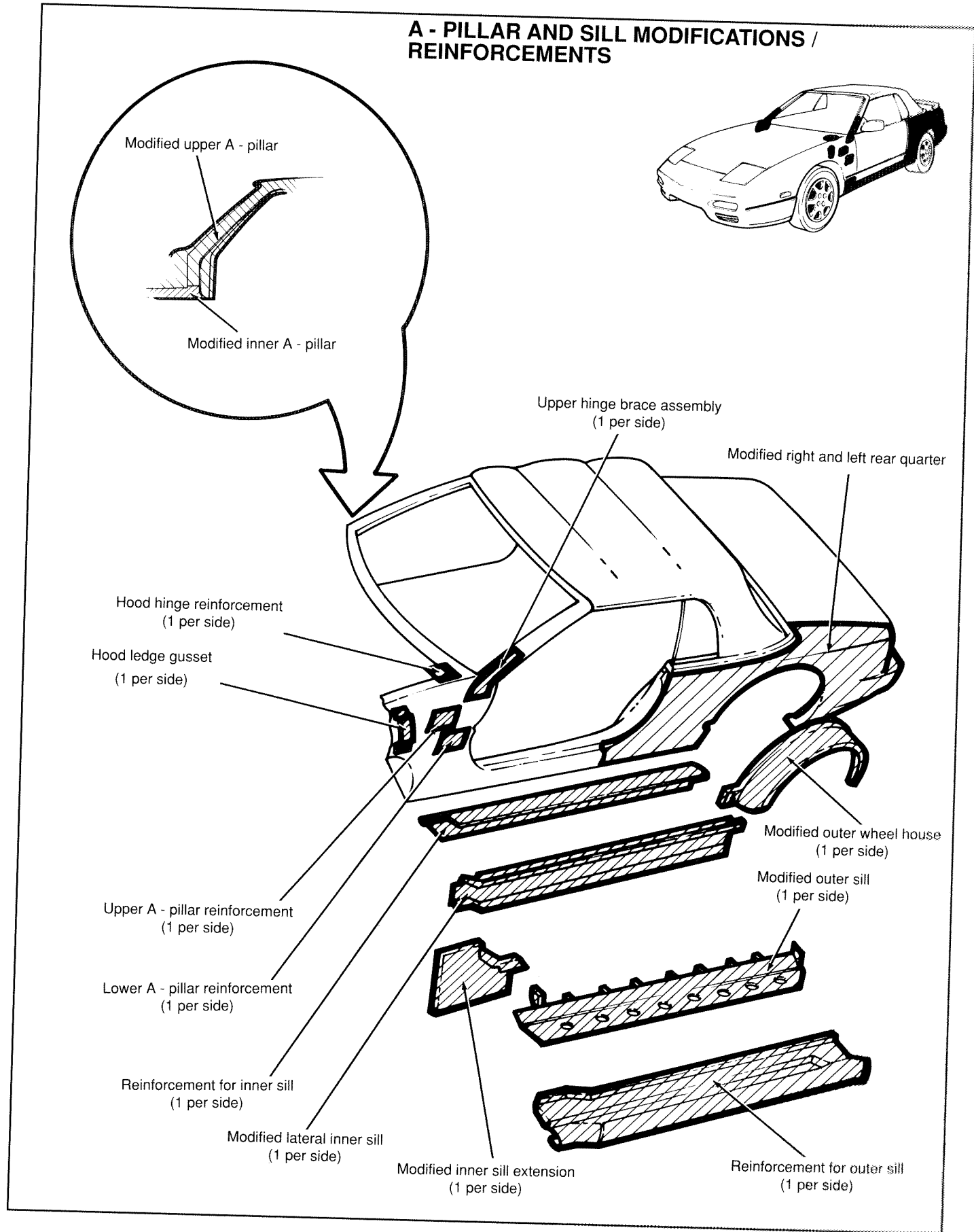

NISSAN JAPAN INSTALLED COMPONENTS

STRUCTURAL REINFORCEMENT COMPONENTS

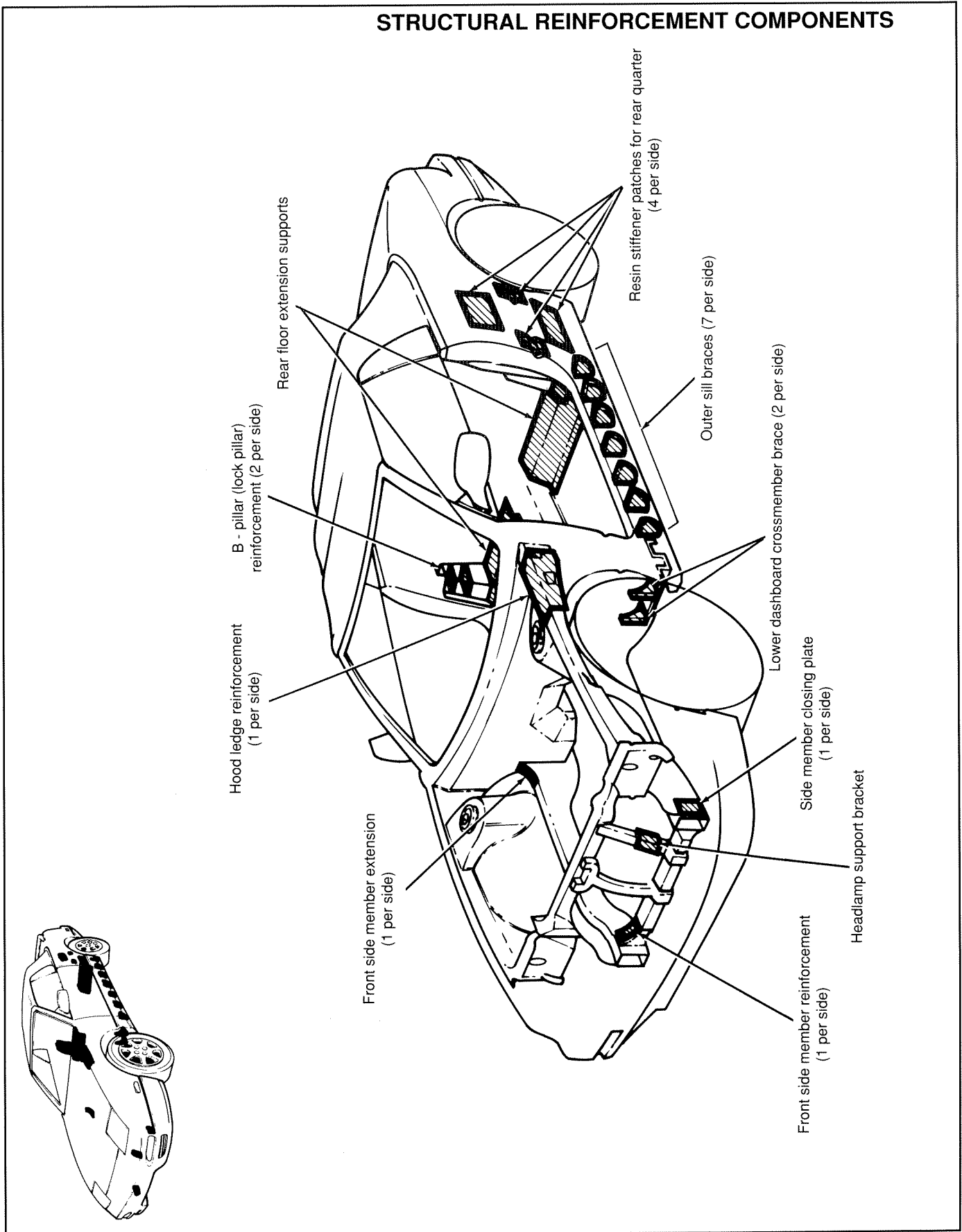

NISSAN JAPAN INSTALLED COMPONENTS

UNDERSIDE VEHICLE COMPONENTS

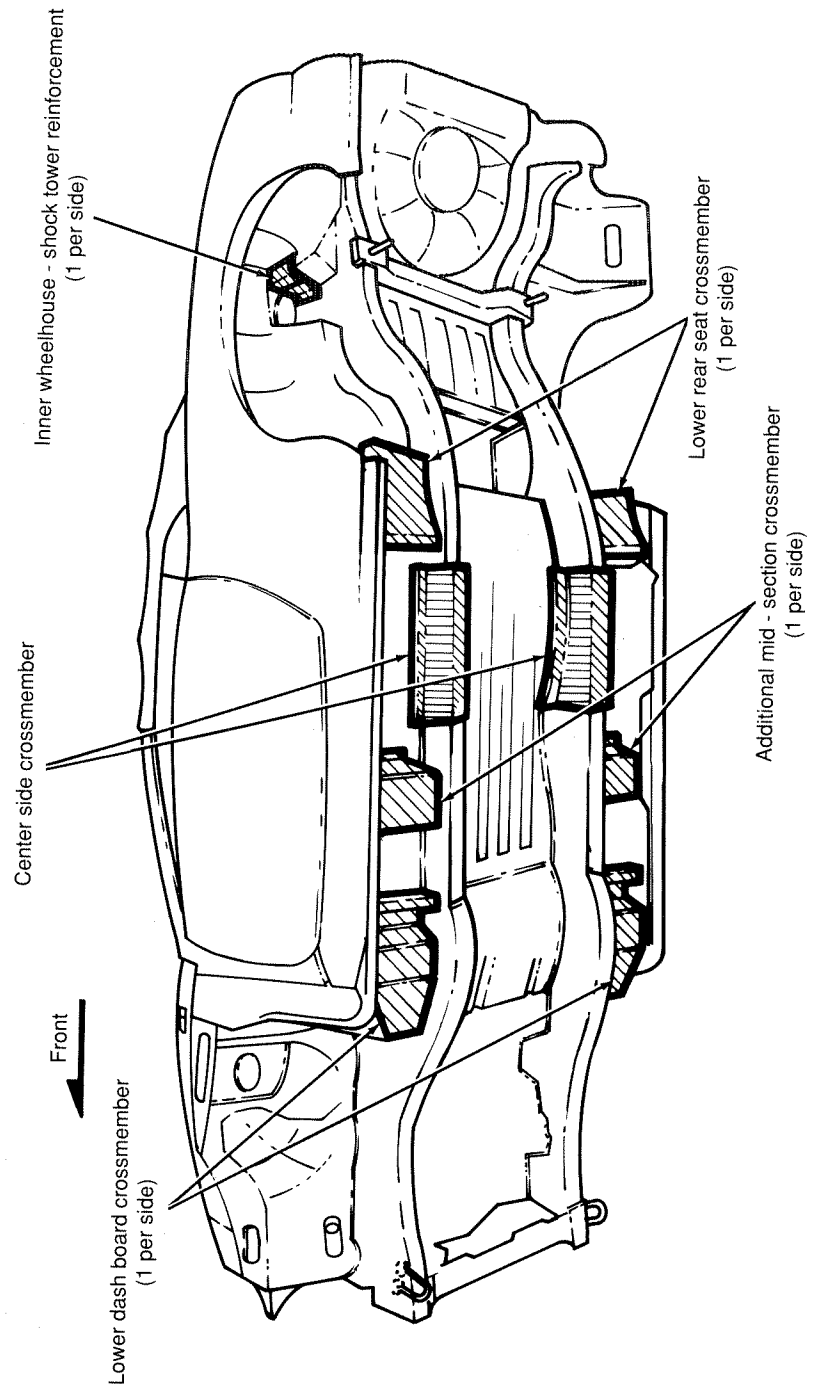
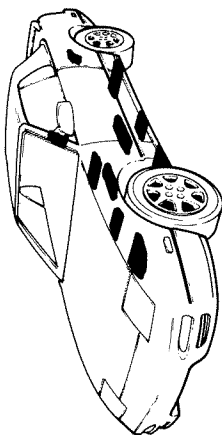

NISSAN JAPAN INSTALLED COMPONENTS

DOOR MODIFICATIONS / REINFORCEMENTS

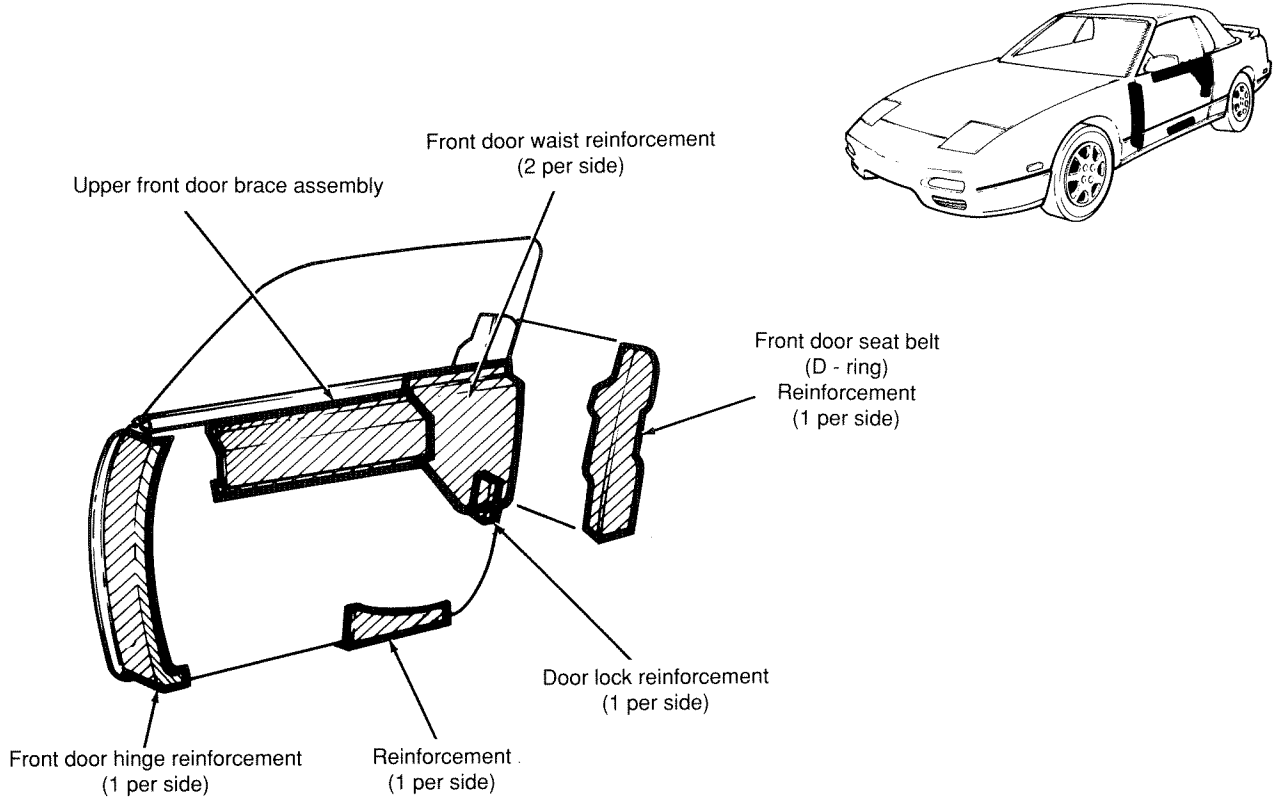

REAR FLOOR MODIFICATIONS / REINFORCEMENTS

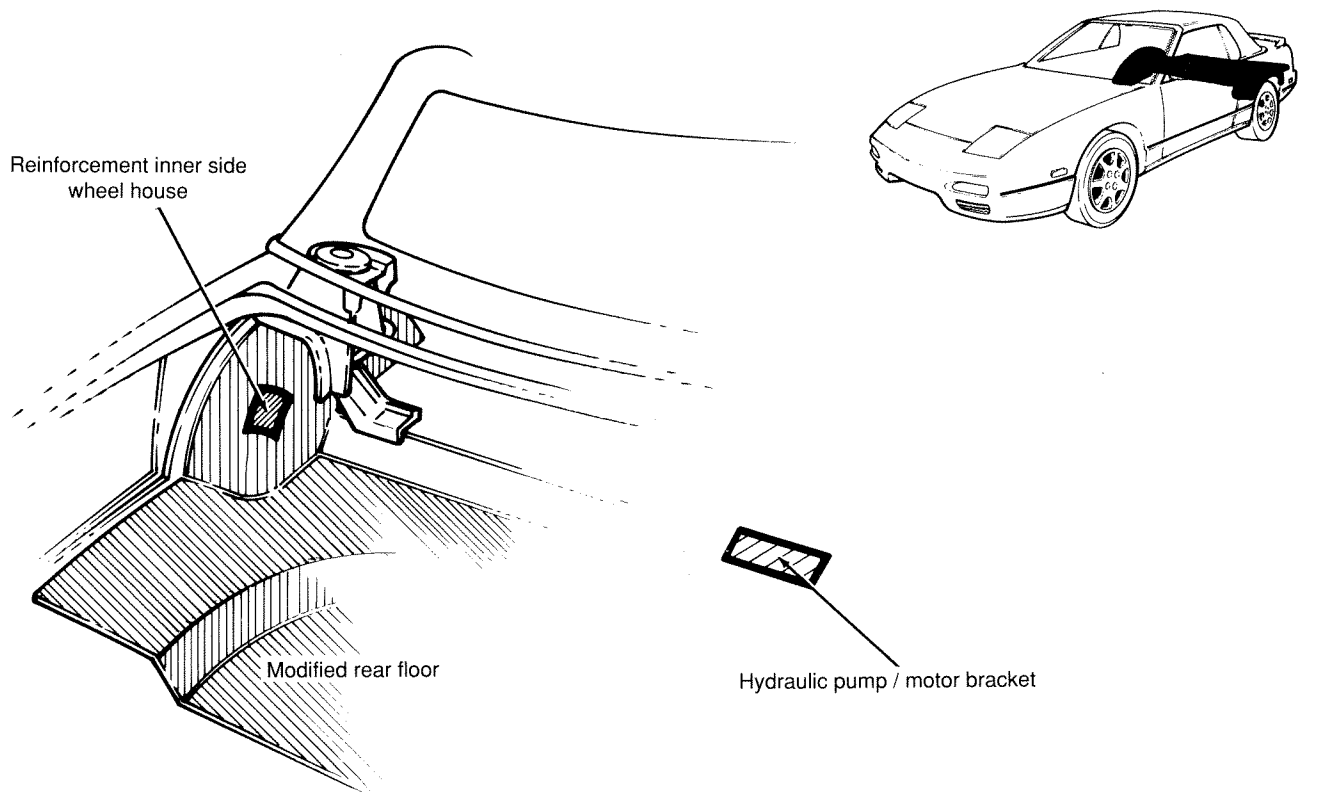

NISSAN JAPAN INSTALLED COMPONENTS

FRONT FLOOR MODIFICATIONS / SUPPORTS

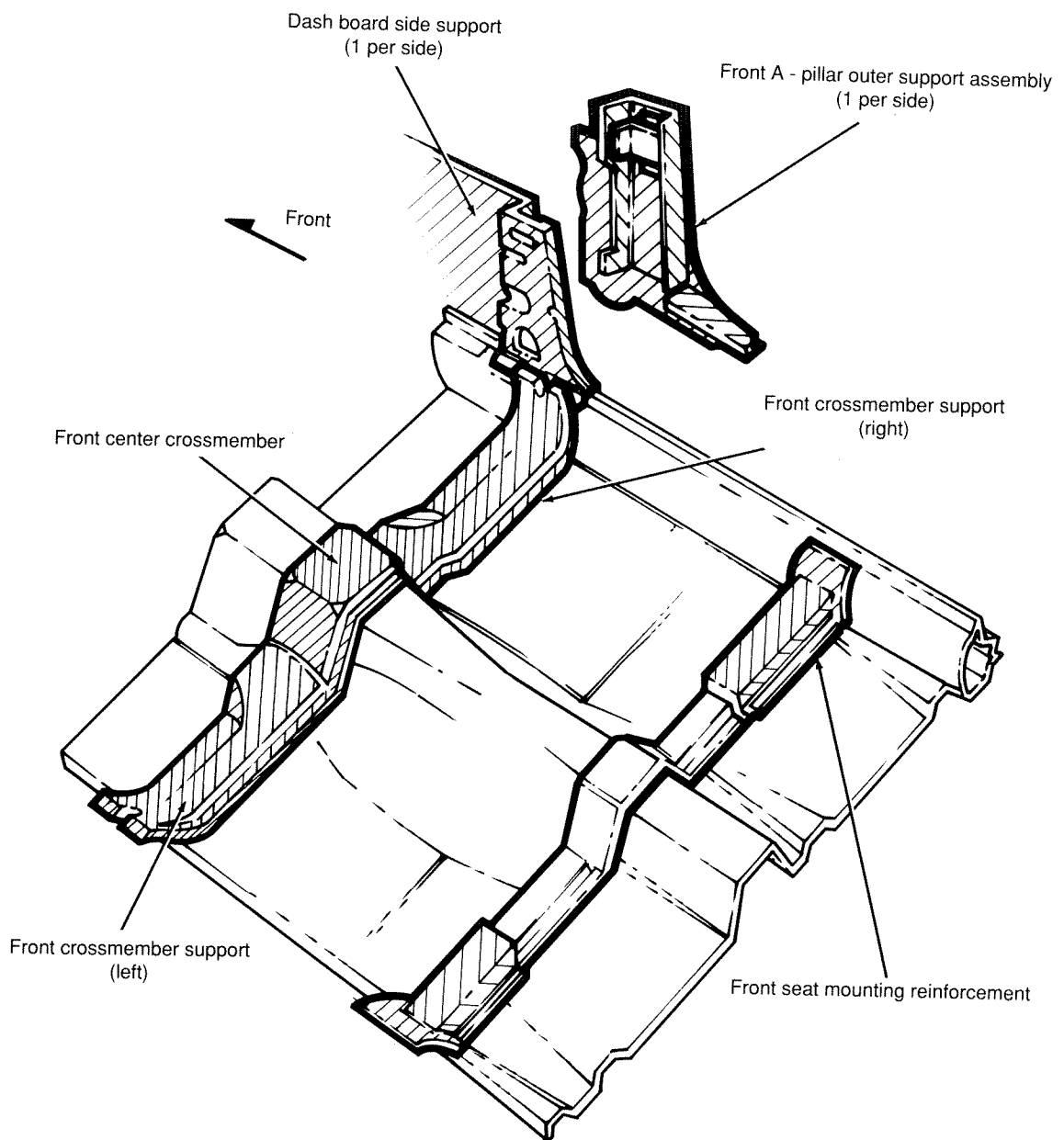
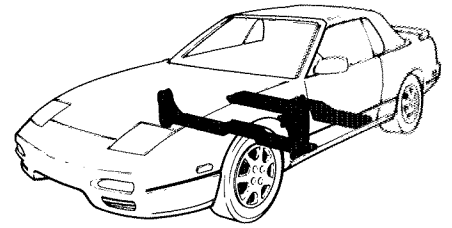

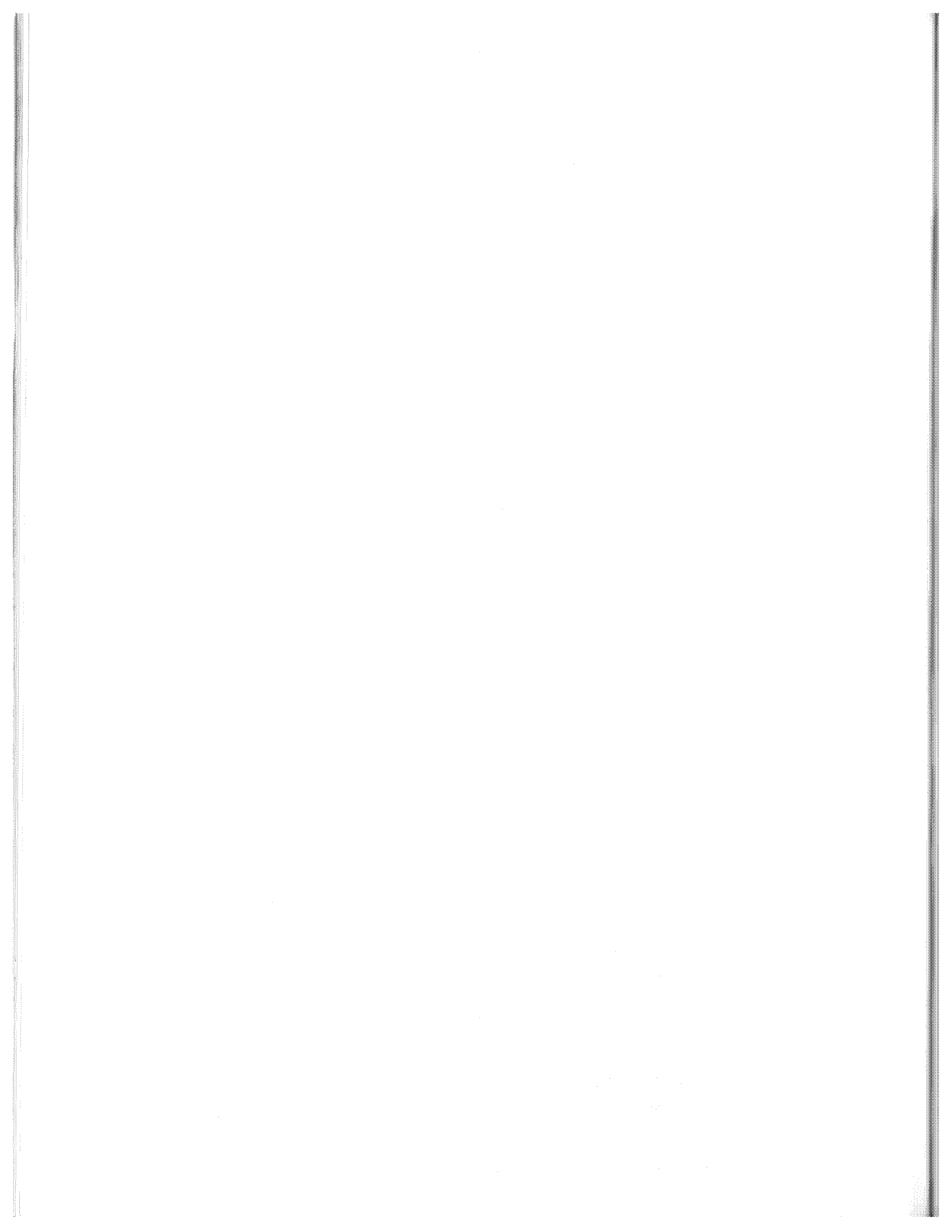



**A**

Amplifier, Power Window .....	20-4
Anchor, Child Seat Restraint .....	8-2, 12
ASC Incorporated Installed Components .....	22-2
Automatic Restraint System .....	20-26
Automatic Restraint System, Circuit Diagram .....	20-27
Automatic Restraint System, Diagnostic Procedures .....	20-29
Automatic Restraint System, Preliminary Check .....	20-28

**B**

B-Pillar Components, Structure .....	22-2
Back and Quarter Belt Moldings .....	9-1
Backlite Assembly .....	C-4; 12-2
Backlite Assembly, Remove and Install .....	12-4
Backlite Window Service .....	12-3
Backlite, Wrinkles or Waves .....	12-3
Ball Stud, Deck Lid Hinge .....	21-5
Bezel, Door Panel Seat Belt .....	7-8
Body Structure .....	22-1
Bow, No. 1 .....	14-1
Bow, No. 2 .....	15-1
Bow, No. 3 .....	16-1
Bow, No. 4 .....	17-1
Bracket, Main Pivot .....	18-10
Bracket, Motor/Pump .....	19-16
Bracket, Quarter Belt Outer Weatherstrip .....	3-20
Brackets, Door Panel Finisher .....	7-12
Brackets, Quarter Trim Panel .....	5-6
Buckle Assembly, Front Seat .....	8-5
Buckle Assembly, Rear Compartment .....	8-9
Bumper, No. 2 Bow .....	18-16
Button, Mirror Attaching .....	1-8

**C**

Cable, Retention .....	11-4; 18-8
Cap, Header Molding .....	2-3
Cap, Outer Trim .....	1-5
Circuit Diagram, Main (Fold-Out) .....	20-41
Clamp Assembly .....	14-4

**C (cont'd)**

Clamps, Hydraulic Hose .....	19-19
Clamp Latch, Adjustment .....	14-3
Controller, Automatic Restraint .....	20-5
Convertible Top Operation .....	C-5
Cover, Back Belt Brace Center .....	21-8
Cover, D-Ring .....	7-7; 8-7
Cover, D-Ring Tower .....	7-7
Cover, Left Wheelhouse .....	21-8
Cover, Rear Seat Back .....	4-6
Cover, Rear Seat Cushion .....	4-4
Cover, Right Wheelhouse .....	21-7
Cylinder Assembly, Hydraulic System .....	19-11

**D**

Deck Lid Hinge, Adjustment .....	21-3
Deck Lid Hinge and Trunk Trim .....	21-1
Door and Door Window .....	7-1
Door and Door Window, Adjustments .....	7-4
Door Panel .....	7-7
Dowel, No. 1 Bow .....	14-7
Down Stop, Rear Rail .....	18-4, 8

**E**

Electrical .....	20-1
Extension, Main Pivot Bracket .....	18-10

**G**

Gas Strut .....	21-4
General Information .....	C-2
Grille, Door Speaker .....	7-9
Grille, Quarter Trim Panel Speaker .....	5-4

**H**

Harness Layout, Door .....	20-17
Harness Layout, Main Body .....	20-10
Harness Layout, Main Instrument Panel .....	20-14
Headliner Assembly, Remove and Install .....	10-3
Headliner Assembly .....	10-1
Hinge Assembly, Deck Lid .....	21-5

**H (cont'd)**

Hose Assembly, Hydraulic .....	19-19
Hydraulic Electrical System, Circuit Diagram .....	20-19, 20
Hydraulic Electrical System, Diagnostic Procedures .....	20-22
Hydraulic Electrical System, Preliminary Check .....	20-21
Hydraulic Motor/Pump Electrical System .....	20-18
Hydraulic System .....	19-1
Hydraulic System, Adding Fluid .....	19-7
Hydraulic System, Bleeding Procedure .....	19-8
Hydraulic System, Diagnostic Flow Chart .....	19-5
Hydraulic System Operation Check .....	19-7
Hydraulic System Preliminary Inspection .....	19-6
Hydraulic System, Theory of Operation .....	19-4

**I**

Inner Retainer, No. 4 Bow Top Cover .....	11-5
Isolator, Quarter Belt Molding .....	9-6

**L**

Lamps, Clearance, License, Tail and Stop .....	20-40
Lamp, Trunk Room .....	20-6
Link Assembly, Center .....	18-14
Link, Balance .....	18-7, 13
Locator, Guide Pin .....	7-17

**M**

Main Pivot .....	18-7
Mirror, Inner Rear View .....	1-7
Molding, Back Belt Center .....	9-3
Molding, No. 1 Bow .....	10-2, 4
Molding, Quarter Belt Outer .....	9-4
Molding, Windshield Garnish .....	1-2, 3
Molding, Windshield Header .....	2-1
Molding, Windshield Header, Remove and Install .....	2-4
Motor/Pump Assembly, Hydraulic .....	19-14
Mocket, B-Pillar .....	3-20

**N**

Nissan Japan Installed Components .....	22-4
---	------

**P**

Panel, D-Ring Tower .....	7-7
Panel, Door .....	7-7
Pin, Clevis .....	18-7
Pin, Guide .....	7-17
Pin, Secondary .....	7-15
Pipe, Center .....	19-16
Plate, Front Seat Belt Retractor Mounting .....	7-13
Pocket, Door Map .....	7-9
Power Window, Electrical Diagram .....	20-33
Power Windows .....	20-32
Power Window, Diagnostic Procedures .....	20-36, 37, 38, 39
Power Window, Preliminary Check .....	20-35

**Q**

Quarter Belt and Side Trough Components .....	22-3
Quarter Trim Panel .....	5-1
Quarter Window and Regulator, Adjustment .....	6-3
Quarter Window and Guide .....	6-4
Quarter Window and Regulator .....	6-1

**R**

Rear and Side Rail .....	18-1
Rear Brace and Drain Trough Components .....	22-3
Rear Jumper, Folding Top Logic Relay .....	20-7
Rear Rail .....	18-7
Rear Seat .....	4-1
Receiver, Latch .....	1-5
Receiver, Secondary Pin .....	7-16
Regulator Bracket and Motor, Quarter Window .....	6-6
Relay, Folding Top Logic .....	20-4
Reservoir, Motor/Pump .....	19-5, 6, 16
Retainer, A-Pillar Weatherstrip .....	3-11
Retainer, Center Rail Weatherstrip .....	3-16
Retainer, Front Header Weatherstrip .....	3-10
Retainer, Front Rail Weatherstrip .....	3-13
Retainer, No. 2 and 3 Bow Top Cover .....	11-4
Retainer, No. 4 Bow Headliner .....	10-3, 5
Retainer, Rear Rail Weatherstrip .....	3-18
Retainer, Top Cover Front .....	11-4

**R (cont'd)**

Retractor Assembly, Front .....	8-7
Retractor Assembly, Rear Seat .....	8-10

**S**

Safety Information .....	C-4
Seal Carrier, Rear Rail .....	18-3
Seal, Motor/Pump Reservoir .....	19-16
Seat Back, Rear .....	4-5
Seat Belts .....	8-1
Seat Belt System, Inspecting .....	8-4
Seat Cushion, Rear .....	4-3
Side Rail Assembly .....	18-12
Slat, No. 4 Bow .....	17-4
Stay Pad, Backlite .....	13-3
Stay Pad, Side .....	13-7
Stay Pads, Side and Back .....	13-1
Stopper, Adjustment, Door Window .....	7-6
Stopper, Door Window Rear .....	7-14
Switch, Quarter Window .....	20-3
Switch, Top Up/Top Down .....	20-3
Switch, Trunk Room Lamp .....	20-5

**T**

Tack Strip .....	11-5; 12-4; 13-3
Theory of Operation, General Information .....	C-2
Top and Rear Window Appearance Care .....	C-4
Top Bow Alignment, Tool .....	13-2
Top Cover Assembly .....	11-1
Top Cover Assembly, Remove and Install .....	11-3
Top Stack, Adjustment .....	18-4
Trim Panel, Quarter .....	5-3
Trim Panel, Quarter Outer .....	5-5
Trim, Trunk .....	21-7
Trim, Windshield Header .....	1-1

**U**

Up Stop, Main Pivot Bracket .....	18-4
-----------------------------------	------

**V**

Valve, Bypass .....	C-9, 10, 11, 12; 19-4, 13, 15, 17
Visor Assembly .....	1-3

**W**

Weatherstrips, Adjustment .....	3-5
Weatherstrip, Center Rail .....	3-15
Weatherstrip, Front Header .....	3-8
Weatherstrip, Front Rail .....	3-12
Weatherstrip, Quarter Belt Outer .....	3-20
Weatherstrip, Quarter Window Inner .....	3-19
Weatherstrip, Rear Rail .....	3-17
Weatherstrip Seal Testing .....	3-5
Weatherstrip Wind Noise .....	3-7
Weatherstrips, Inspecting .....	3-5
Weatherstrips and Retainers .....	3-1
Well Assembly, Folding Top .....	11-3
Window, Door .....	7-13
Windshield Header Components, Structure .....	22-2

# NOTES

---





**NISSAN MOTOR CORPORATION IN U.S.A.**

**Edition: October 1991**  
**Printing: October 1991**  
**Publication No. SM2E-0S13C0**  
Printed in U.S.A.