

SECTION **BCS**

BODY CONTROL SYSTEM

A
B
C
D
E
F
G
H
I
J
L
M

CONTENTS

<p>PRECAUTIONS 2</p> <p> Precautions for Supplemental Restraint System (SRS) "AIR BAG" and "SEAT BELT PRE-TENSIONER" 2</p> <p>BCM (BODY CONTROL MODULE) 3</p> <p> System Description 3</p> <p> BCM FUNCTION 3</p> <p> COMBINATION SWITCH READING FUNCTION 3</p> <p> CAN COMMUNICATION CONTROL 6</p> <p> BCM STATUS CONTROL 6</p> <p> SYSTEMS CONTROLLED BY BCM DIRECTLY 7</p> <p> SYSTEMS CONTROLLED BY BCM AND IPDM E/R 7</p> <p> MAJOR COMPONENTS AND CONTROL SYSTEM 7</p> <p> CAN Communication System Description 8</p>	<p> Schematic 9</p> <p> BCM Terminal Arrangement 11</p> <p> Terminals and Reference Values for BCM 12</p> <p> BCM Power Supply and Ground Circuit Check 17</p> <p> CONSULT-II Function (BCM) 18</p> <p> CONSULT-II START PROCEDURE 18</p> <p> ITEMS OF EACH PART 18</p> <p> WORK SUPPORT 19</p> <p> CAN Communication Inspection Using CONSULT-II (Self-Diagnosis) 19</p> <p> Configuration 20</p> <p> DESCRIPTION 20</p> <p> READ CONFIGURATION PROCEDURE 20</p> <p> WRITE CONFIGURATION PROCEDURE 22</p> <p> Removal and Installation 26</p> <p> BCM 26</p>
---	--

BCS

PRECAUTIONS

PRECAUTIONS

PFP:00001

Precautions for Supplemental Restraint System (SRS) “AIR BAG” and “SEAT BELT PRE-TENSIONER”

EKS00J31

The Supplemental Restraint System such as “AIR BAG” and “SEAT BELT PRE-TENSIONER”, used along with a front seat belt, helps to reduce the risk or severity of injury to the driver and front passenger for certain types of collision. This system includes seat belt switch inputs and dual stage front air bag modules. The SRS system uses the seat belt switches to determine the front air bag deployment, and may only deploy one front air bag, depending on the severity of a collision and whether the front occupants are belted or unbelted. Information necessary to service the system safely is included in the SRS and SB section of this Service Manual.

WARNING:

- To avoid rendering the SRS inoperative, which could increase the risk of personal injury or death in the event of a collision which would result in air bag inflation, all maintenance must be performed by an authorized NISSAN/INFINITI dealer.
- Improper maintenance, including incorrect removal and installation of the SRS, can lead to personal injury caused by unintentional activation of the system. For removal of Spiral Cable and Air Bag Module, see the SRS section.
- Do not use electrical test equipment on any circuit related to the SRS unless instructed to in this Service Manual. SRS wiring harnesses can be identified by yellow and/or orange harnesses or harness connectors.

BCM (BODY CONTROL MODULE)

PF2:284B2

EKS00J32

BCM (BODY CONTROL MODULE)

System Description

- BCM (body control module) controls the operation of various electrical units installed on the vehicle.

BCM FUNCTION

BCM has a combination switch reading function for reading the operation of combination switches (light, wiper washer, turn signal) in addition to the function for controlling the operation of various electrical components. Also, it functions as an interface that receives signals from the front air control, and sends signals to ECM using CAN communication.

COMBINATION SWITCH READING FUNCTION

1. Description

- BCM reads combination switch (light, wiper) status, and controls various electrical components according to the results.
- BCM reads information of a maximum of 20 switches by combining five output terminals (OUTPUT 1-5) and five input terminals (INPUT 1-5).

2. Operation description

- BCM activates transistors of output terminals (OUTPUT 1-5) periodically and allows current to flow in turn.
- If any (1 or more) of the switches are turned ON, circuit of output terminals (OUTPUT 1-5) and input terminals (INPUT 1-5) becomes active.
- At this time, transistors of output terminals (OUTPUT 1-5) are activated to allow current to flow. When voltage of input terminals (INPUT 1-5) corresponding to that switch changes, interface in BCM detects voltage change and BCM determines that switch is ON.

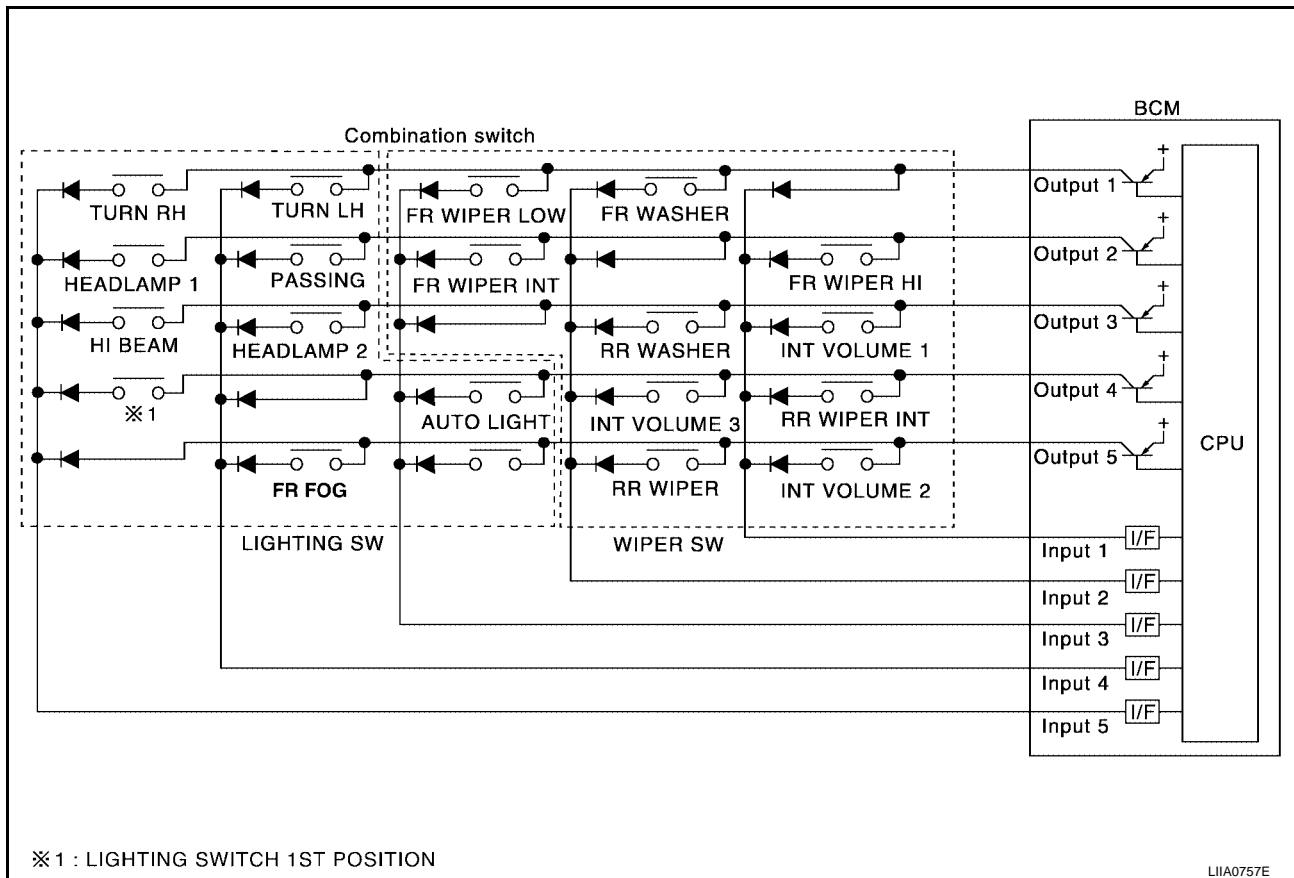

3. BCM - Operation table of combination switch

- BCM reads operation status of combination switch by the combination shown in the following table.

A
B
C
D
E
F
G
H
I
J
L
M

BCS

BCM (BODY CONTROL MODULE)

	COMB SW OUTPUT 1		COMB SW OUTPUT 2		COMB SW OUTPUT 3		COMB SW OUTPUT 4		COMB SW OUTPUT 5	
	ON	OFF	ON	OFF	ON	OFF	ON	OFF	ON	OFF
COMB SW INPUT 1	—	—	FR WIPER HI ON	FR WIPER HI OFF	INT VOLUME 1 ON	INT VOLUME 1 OFF	RR WIPER INT ON	RR WIPER INT OFF	INT VOLUME 2 ON	INT VOLUME 2 OFF
COMB SW INPUT 2	FR WASHER ON	FR WASHER OFF	—	—	RR WASHER ON	RR WASHER OFF	INT VOLUME 3 ON	INT VOLUME 3 OFF	RR WIPER ON	RR WIPER OFF
COMB SW INPUT 3	FR WIPER LOW ON	FR WIPER LOW OFF	FR WIPER INT ON	FR WIPER INT OFF	—	—	AUTO LIGHT ON	AUTO LIGHT OFF	—	—
COMB SW INPUT 4	TURN LH ON	TURN LH OFF	PASSING ON	PASSING OFF	HEAD-LAMP 2 ON	HEAD-LAMP 2 OFF	—	—	FR FOG ON	FR FOG OFF
COMB SW INPUT 5	TURN RH ON	TURN RH OFF	HEAD-LAMP 1 ON	HEAD-LAMP 1 OFF	HI BEAM ON	HI BEAM OFF	LIGHTING SW (1st) ON	LIGHTING SW (1st) OFF	—	—

SKIA4959E

NOTE:

Headlamp has a dual system switch.

4. Example operation: (When lighting switch 1st position turned ON)
- When lighting switch 1st position is turned ON, contact in combination switch turns ON. At this time if OUTPUT 4 transistor is activated, BCM detects that voltage changes in INPUT 5.
 - When OUTPUT 4 transistor is ON, BCM detects that voltage changes in INPUT 5, and judges lighting switch 1st position is ON. Then BCM sends tail lamp ON signal to IPDM E/R using CAN communication.
 - When OUTPUT 4 transistor is activated again, BCM detects that voltage changes in INPUT 5 and recognizes that lighting switch 1st position is continuously ON.

BCM (BODY CONTROL MODULE)

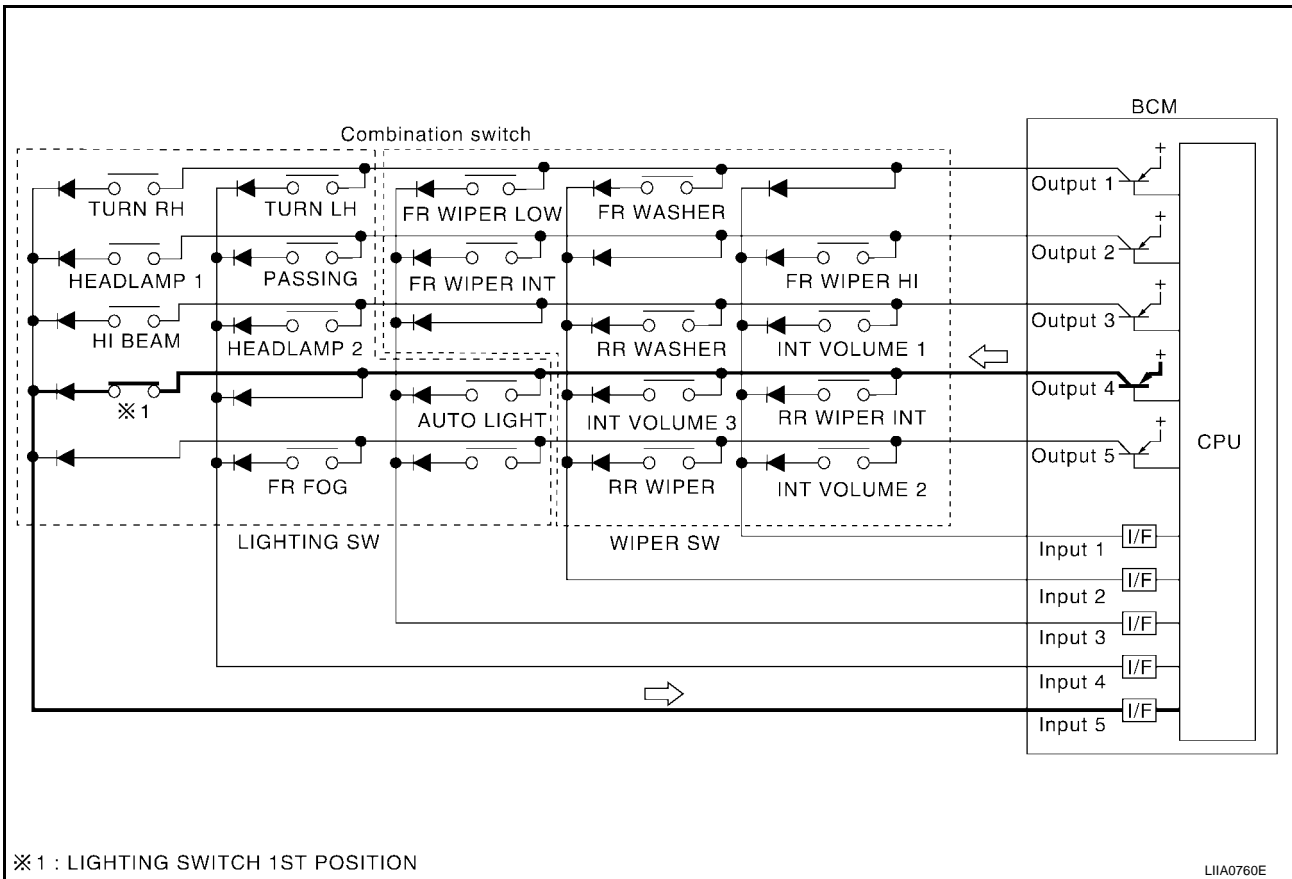

NOTE:

Each OUTPUT terminal transistor is activated at 10ms intervals. Therefore, after a switch is turned ON, electrical loads are activated with a time delay. But this time delay is so short that it cannot be noticed.

5. Operation mode

- Combination switch reading function has operation modes as follows:

Normal status

- When BCM is not in sleep status, OUTPUT terminals (1-5) each turn ON-OFF every 10ms.

Sleep status

A
B
C
D
E
F
G
H
I
J
L
M

BCS

BCM (BODY CONTROL MODULE)

- When BCM is in sleep mode, transistors of OUTPUT 1 and 5 stop the output, and BCM enters low-current-consumption mode. OUTPUTS (2, 3, and 4) turn ON-OFF at 60ms intervals, and receives lighting switch input only.

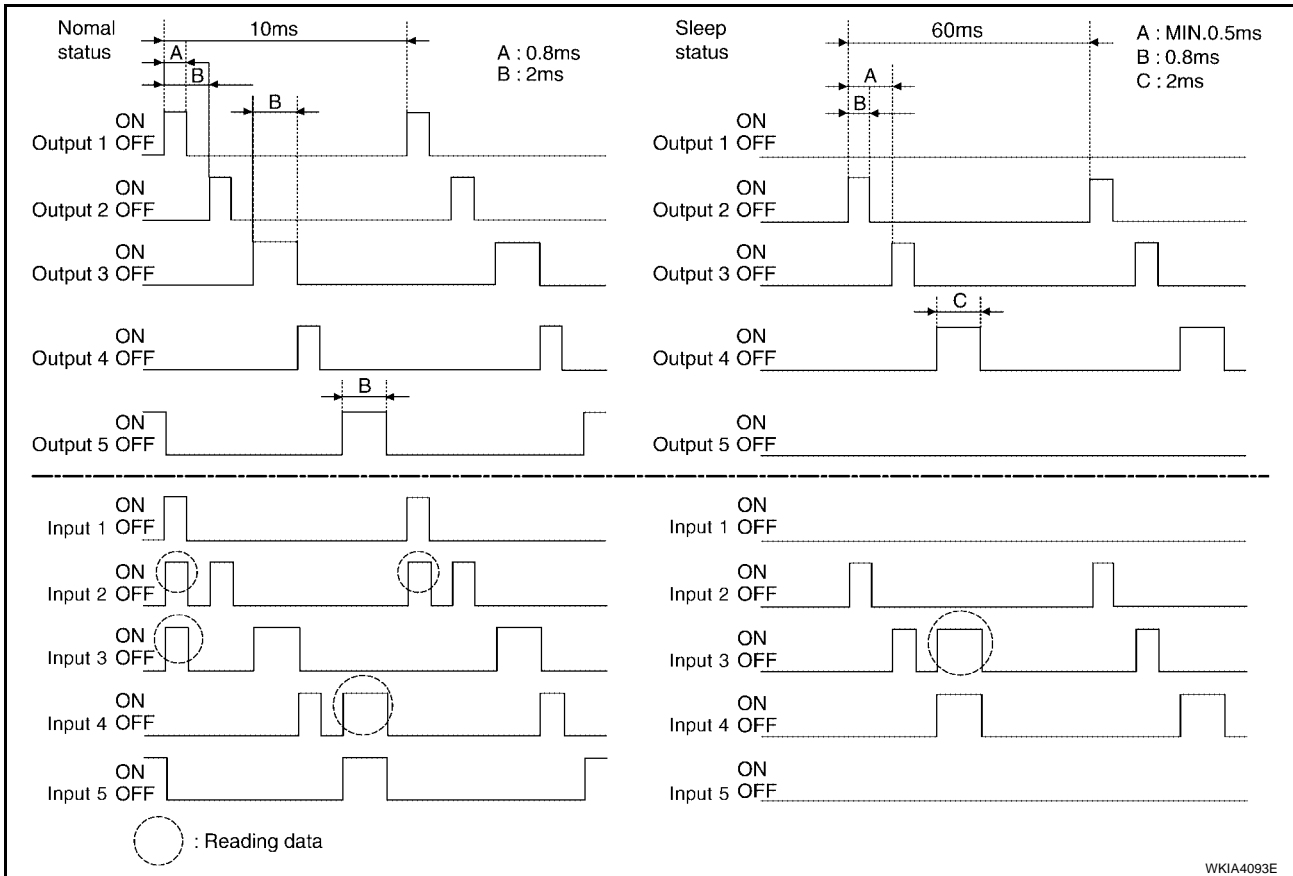

CAN COMMUNICATION CONTROL

CAN communication allows a high rate of information through the two communication lines (CAN-L, CAN-H) connecting the various control units in the system. Each control unit transmits/receives data, but selectively reads required data only.

BCM STATUS CONTROL

BCM changes its status depending on the operation status in order to reduce power consumption.

- CAN communication status
 - With ignition switch ON, CAN communicates with other control units normally.
 - Control by BCM is being operated properly.
 - When ignition switch is OFF, switching to sleep mode is possible.
 - Even when ignition switch is OFF, if CAN communication with IPDM E/R and combination meter is active, CAN communication status is active.
- Sleep transient status
 - This status shuts down CAN communication when ignition switch is turned OFF.
 - It transmits sleep request signal to IPDM E/R and combination meter.
 - Two seconds after CAN communication of all control units stops, CAN communication switches to inactive status.
- CAN communication inactive status
 - With ignition switch OFF, CAN communication is not active.
 - With ignition switch OFF, control performed only by BCM is active.
 - Three seconds after CAN communication of all control units stops, CAN communication switches to inactive status.
- Sleep status

BCM (BODY CONTROL MODULE)

- BCM is activated with low current consumption mode.
- CAN communication is not active.
- When CAN communication operation is detected, it switches to CAN communication status.
- When a state of the following switches changes, it switches to CAN communication state:
 - Ignition switch
 - Key switch (insert)
 - Hazard switch
 - Main door lock/unlock switch
 - Front door switch (LH, RH)
 - Rear door switch (LH, RH)
 - Back door switch (without power back door)
 - Back door latch (door ajar switch) (with power back door)
 - Combination switch (passing, lighting switch 1st position, front fog lamp)
 - Keyfob (lock/unlock signal)
 - Front door lock assembly LH (key cylinder switch)
- When control performed only by BCM is required by switch, it shifts to CAN communication inactive mode.
- Status of combination switch reading function is changed.

SYSTEMS CONTROLLED BY BCM DIRECTLY

- Power door lock system. Refer to [BL-16, "POWER DOOR LOCK SYSTEM"](#) .
- Remote keyless entry system. Refer to [BL-37, "REMOTE KEYLESS ENTRY SYSTEM"](#) .
- Power window system. Refer to [GW-16, "POWER WINDOW SYSTEM"](#) . NOTE
- Sunroof system. Refer to [RF-10, "SUNROOF"](#) . NOTE
- Room lamp timer. Refer to [LT-107, "INTERIOR ROOM LAMP"](#) .
- Warning chime system. Refer to [DI-37, "WARNING CHIME"](#) .
- Turn signal and hazard warning lamps system. Refer to [LT-60, "TURN SIGNAL AND HAZARD WARNING LAMPS"](#) .
- Trailer turn signal and hazard warning lamps system (if equipped). Refer to [LT-99, "TRAILER TOW"](#) .
- Rear wiper and washer system. Refer to [WW-29, "REAR WIPER AND WASHER SYSTEM"](#) .

NOTE:

Power supply only. No system control.

SYSTEMS CONTROLLED BY BCM AND IPDM E/R

- Panic system. Refer to [BL-37, "REMOTE KEYLESS ENTRY SYSTEM"](#) .
- Vehicle security system. Refer to [BL-64, "VEHICLE SECURITY \(THEFT WARNING\) SYSTEM"](#) .
- NVIS (NATS) system. Refer to [BL-125, "NVIS\(NISSAN Vehicle Immobilizer System-NATS\)"](#) .
- Headlamp, daytime light, front fog lamp, tail lamp, auto light and battery saver control systems. Refer to [LT-5, "HEADLAMP \(FOR USA\)"](#) , [LT-28, "HEADLAMP \(FOR CANADA\) - DAYTIME LIGHT SYSTEM -"](#) , [LT-51, "FRONT FOG LAMP"](#) , [LT-86, "PARKING, LICENSE PLATE AND TAIL LAMPS"](#) , or [LT-40, "AUTO LIGHT SYSTEM"](#) .
- Front wiper and washer system. Refer to [WW-4, "FRONT WIPER AND WASHER SYSTEM"](#) .
- Rear window defogger system. Refer to [GW-68, "REAR WINDOW DEFOGGER"](#) .

MAJOR COMPONENTS AND CONTROL SYSTEM

System	Input	Output
Remote keyless entry system	Remote keyless entry receiver (keyfob)	<ul style="list-style-type: none"> ● All door locking actuators ● Back door opener actuator ● Turn signal lamps
Power door lock system	<ul style="list-style-type: none"> ● Front power door lock/unlock switch (LH, RH) ● All door switches ● Key switch 	All door locking actuators

BCM (BODY CONTROL MODULE)

System	Input	Output
Power supply [ignition (IGN)/retained accessory power (RAP)] to power window and sunroof	IGN/RAP supply	Power supply to power window and sunroof system
Power supply (BAT) to power window and sunroof	Battery power supply	Power supply to power window and sunroof system
Panic alarm	<ul style="list-style-type: none"> ● Key switch ● Remote keyless entry receiver (keyfob) 	IPDM E/R
Auto light system	<ul style="list-style-type: none"> ● Optical sensor ● Combination switch 	IPDM E/R
Battery saver control	<ul style="list-style-type: none"> ● Ignition switch ● Combination switch ● Front door switch LH and RH 	IPDM E/R
Headlamp	Combination switch	IPDM E/R
Tail lamp	Combination switch	IPDM E/R
Front fog lamp	Combination switch	IPDM E/R
Turn signal lamp	Combination switch	<ul style="list-style-type: none"> ● Turn signal lamp ● Combination meter
Hazard lamp	Hazard switch	<ul style="list-style-type: none"> ● Turn signal lamp ● Combination meter
Room lamp timer	<ul style="list-style-type: none"> ● Key switch ● Remote keyless entry receiver (keyfob) ● Main power window and door lock/unlock switch ● Front door lock assembly LH (key cylinder switch) ● All door switches 	Interior room lamp
Key warning chime	<ul style="list-style-type: none"> ● Key switch ● Front door switch LH 	Combination meter (warning buzzer)
Light warning chime	<ul style="list-style-type: none"> ● Combination switch ● Key switch ● Front door switch LH 	Combination meter (warning buzzer)
Vehicle-speed-sensing intermittent wiper	<ul style="list-style-type: none"> ● Combination switch ● Combination meter 	IPDM E/R
Rear window defogger	Rear window defogger switch	IPDM E/R
Air conditioner switch signal	Front air control	ECM
Blower fan switch signal	Front air control	ECM
Low tire pressure warning system	Remote keyless entry receiver	<ul style="list-style-type: none"> ● Combination meter ● Display control unit
Trailer tow (if equipped)	Combination switch	Trailer turn signal relays
Vehicle security system	<ul style="list-style-type: none"> ● Remote keyless entry receiver (keyfob) ● Main power window and door lock/unlock switch ● Power window and door lock/unlock switch RH ● Front door lock assembly LH (key cylinder switch) ● All door switches ● Back door latch (door ajar switch) (with power back door) ● Back door switch (without power back door) 	<ul style="list-style-type: none"> ● IPDM E/R ● Security indicator lamp

CAN Communication System Description

EKS00J33

Refer to [LAN-4, "SYSTEM DESCRIPTION"](#) .

BCM (BODY CONTROL MODULE)

EKS00J34

Schematic

- (PV) : WITH REAR POWER VENT WINDOWS
- (PB) : WITH POWER BACK DOOR
- (SU) : WITH SUNROOF
- (TT) : TRAILER TOW 7 PIN
- (XB) : WITHOUT POWER BACK DOOR

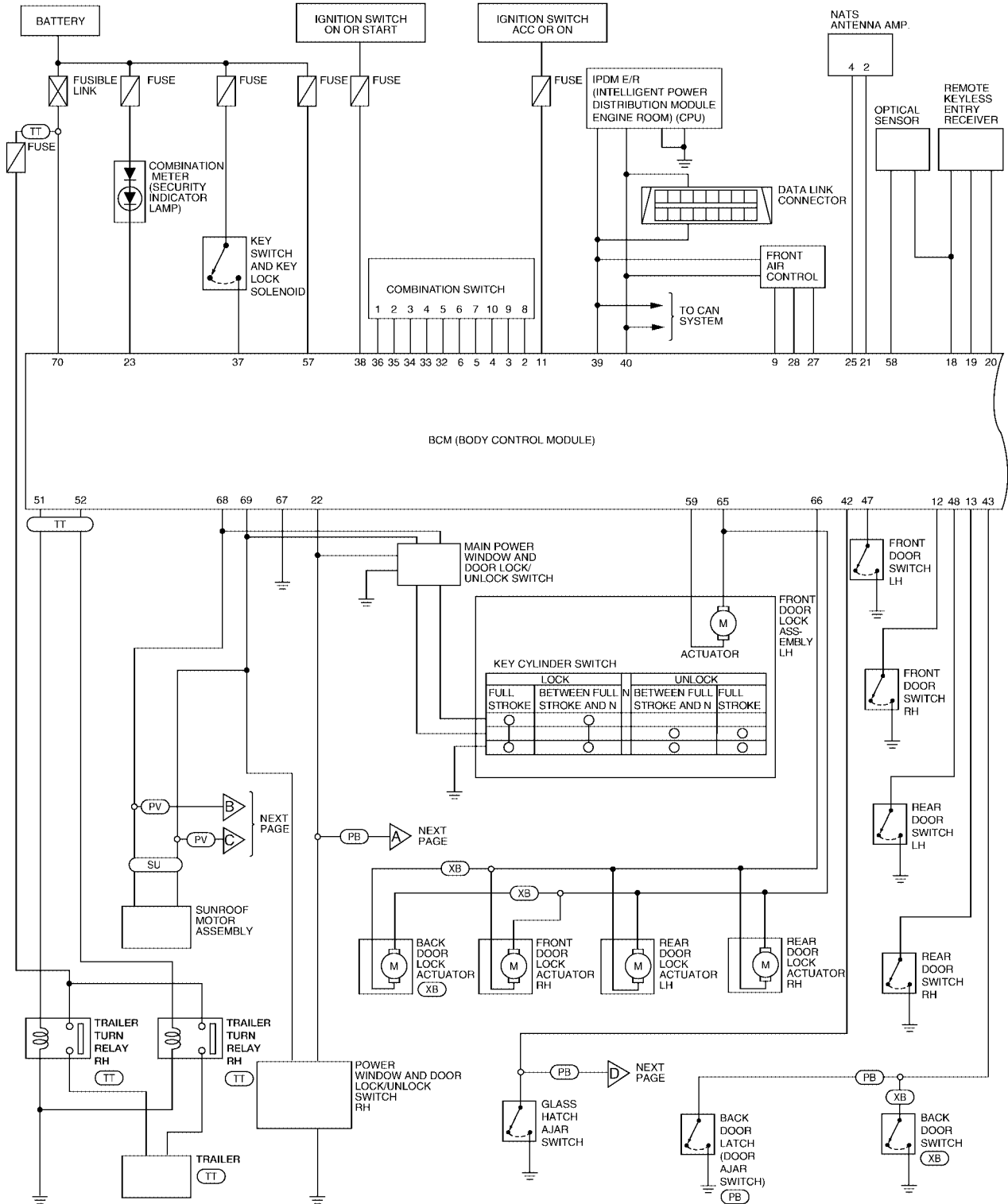

WKWA3516E

A
B
C
D
E
F
G
H
I
J
K
L
M

BCS

BCM (BODY CONTROL MODULE)

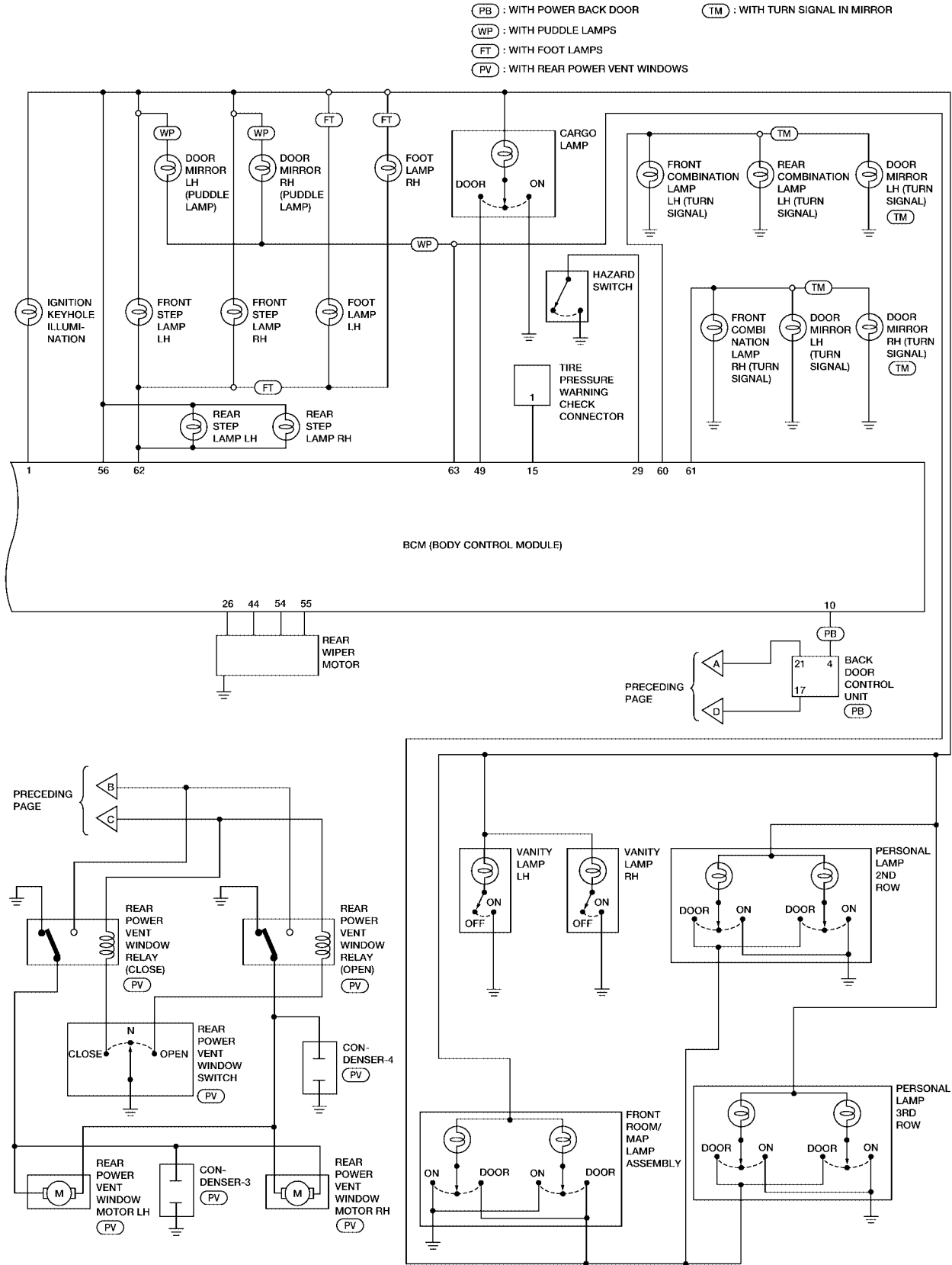

WKWA5221E

BCM (BODY CONTROL MODULE)

BCM Terminal Arrangement

EKS00JKZ

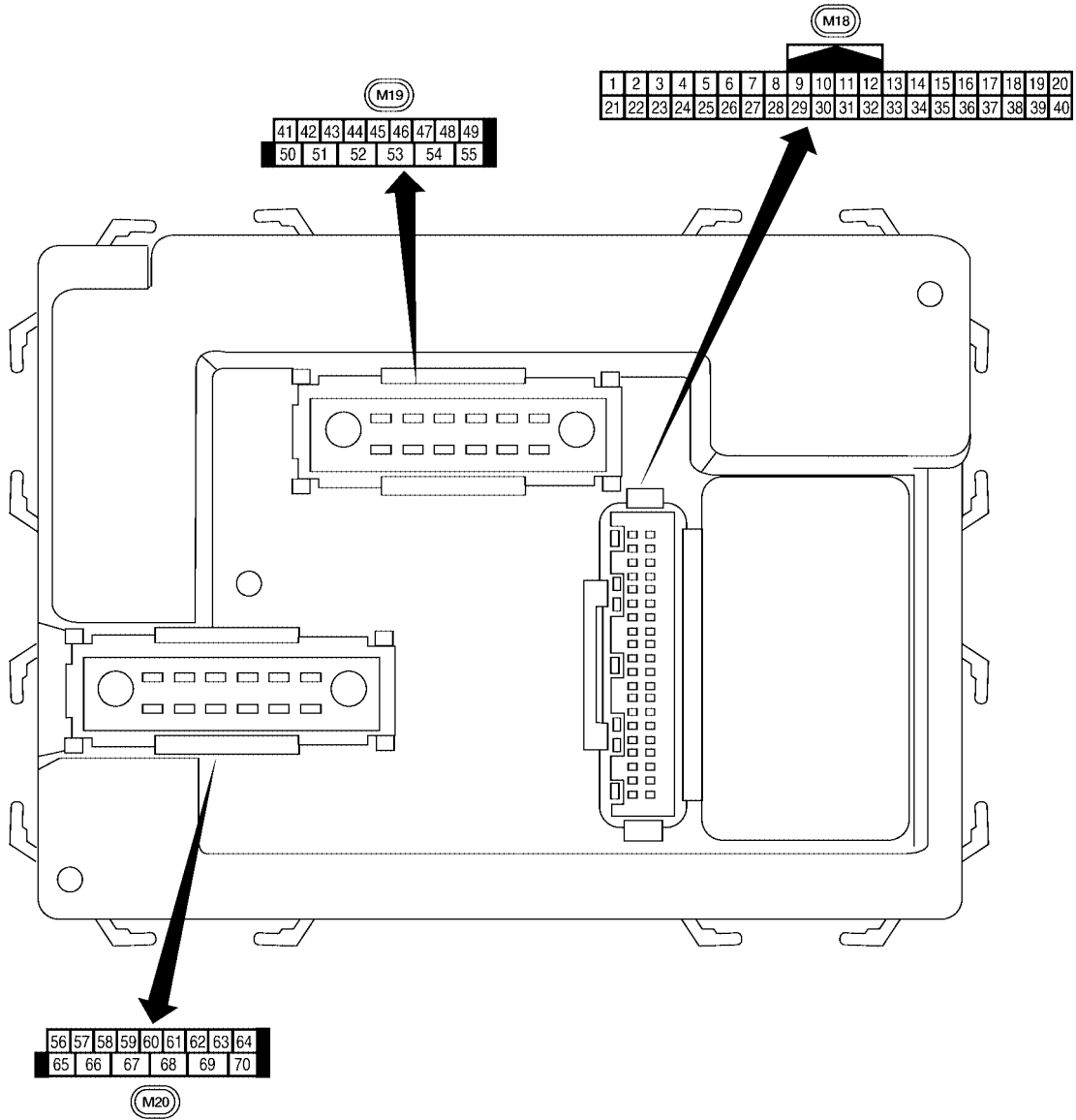

A
B
C
D
E
F
G
H
I
J
L
M



BCS

LIA2443E

BCM (BODY CONTROL MODULE)

EKS00JL0

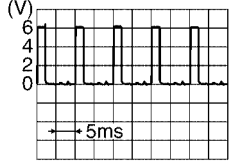
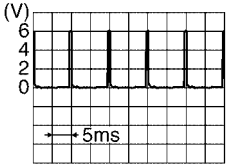
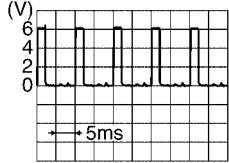
Terminals and Reference Values for BCM

Terminal	Wire color	Signal name	Signal input/output	Measuring condition		Reference value or waveform (Approx.)
				Ignition switch	Operation or condition	
1	BR/W	Ignition keyhole illumination	Output	OFF	Door is locked (SW OFF)	Battery voltage
					Door is unlocked (SW ON)	0V
2	SB	Combination switch input 5	Input	ON	Lighting, turn, wiper OFF Wiper dial position 4	 <p style="text-align: right; font-size: small;">SKIA5291E</p>
3	G/Y	Combination switch input 4	Input	ON	Lighting, turn, wiper OFF Wiper dial position 4	 <p style="text-align: right; font-size: small;">SKIA5292E</p>
4	Y	Combination switch input 3	Input	ON	Lighting, turn, wiper OFF Wiper dial position 4	 <p style="text-align: right; font-size: small;">SKIA5291E</p>
5	G/B	Combination switch input 2	Input	ON	Lighting, turn, wiper OFF Wiper dial position 4	 <p style="text-align: right; font-size: small;">SKIA5292E</p>
6	V	Combination switch input 1				
9	Y/B	Rear window defogger switch	Input	ON	Rear window defogger switch ON	0V
				OFF	Rear window defogger switch OFF	5V
10	G	Hazard lamp flash	Input	OFF	ON (opening or closing)	0V
					OFF (other than above)	Battery voltage
11	O	Ignition switch (ACC or ON)	Input	ACC or ON	Ignition switch ACC or ON	Battery voltage
12	R/L	Front door switch RH	Input	OFF	ON (open)	0V
					OFF (closed)	Battery voltage
13	GR	Rear door switch RH	Input	OFF	ON (open)	0V
					OFF (closed)	Battery voltage
15	L/W	Tire pressure warning check connector	Input	OFF	—	5V
18	P	Remote keyless entry receiver and optical sensor (ground)	Output	OFF	—	0V

BCM (BODY CONTROL MODULE)

Terminal	Wire color	Signal name	Signal input/output	Measuring condition		Reference value or waveform (Approx.)
				Ignition switch	Operation or condition	
19	V/W	Remote keyless entry receiver (power supply)	Output	OFF	Ignition switch OFF	<p style="text-align: right; font-size: small;">LIIA1893E</p>
20	G/W	Remote keyless entry receiver signal (Signal)	Input	OFF	Stand-by (keyfob buttons released)	<p style="text-align: right; font-size: small;">LIIA1894E</p>
					When remote keyless entry receiver receives signal from keyfob (keyfob buttons pressed)	<p style="text-align: right; font-size: small;">LIIA1895E</p>
21	G	NATS antenna amp.	Input	OFF → ON	Ignition switch (OFF → ON)	Just after turning ignition switch ON: Pointer of tester should move for approx. 1 second, then return to battery voltage.
22	W/V	BUS	—	—	Ignition switch ON or power window timer operates	<p style="text-align: right; font-size: small;">PIIA2344E</p>
23	G/O	Security indicator lamp	Output	OFF	Goes OFF → illuminates (Every 2.4 seconds)	Battery voltage → 0V
25	BR	NATS antenna amp.	Input	OFF → ON	Ignition switch (OFF → ON)	Just after turning ignition switch ON: Pointer of tester should move for approx. 1 second, then return to battery voltage.
26	Y/L	Rear wiper auto stop switch 2	Input	ON	Rise up position (rear wiper arm on stopper)	0V
					A Position (full clockwise stop position)	0V
					Forward sweep (counterclockwise direction)	Fluctuating
					B Position (full counterclockwise stop position)	Battery voltage
					Reverse sweep (clockwise direction)	Fluctuating
27	W/R	Compressor ON signal	Input	ON	A/C switch OFF	5V
					A/C switch ON	0V
28	L/R	Front blower monitor	Input	ON	Front blower motor OFF	Battery voltage
					Front blower motor ON	0V

A
B
C
D
E
F
G
H
I
J



L
M

BCM (BODY CONTROL MODULE)

Terminal	Wire color	Signal name	Signal input/output	Measuring condition		Reference value or waveform (Approx.)
				Ignition switch	Operation or condition	
29	W/B	Hazard switch	Input	OFF	ON	0V
					OFF	5V
32	R/G	Combination switch output 5	Output	ON	Lighting, turn, wiper OFF Wiper dial position 4	<p style="text-align: right; font-size: small;">SKIA5291E</p>
33	R/Y	Combination switch output 4	Output	ON	Lighting, turn, wiper OFF Wiper dial position 4	<p style="text-align: right; font-size: small;">SKIA5292E</p>
34	L	Combination switch output 3	Output	ON	Lighting, turn, wiper OFF Wiper dial position 4	<p style="text-align: right; font-size: small;">SKIA5291E</p>
35	O/B	Combination switch output 2	Output	ON	Lighting, turn, wiper OFF Wiper dial position 4	<p style="text-align: right; font-size: small;">SKIA5292E</p>
36	R/W	Combination switch output 1				
37	B/R	Key switch and key lock solenoid	Input	OFF	Key inserted	Battery voltage
					Key removed	0V
38	W/L	Ignition switch (ON)	Input	ON	—	Battery voltage
39	L	CAN-H	—	—	—	—
40	P	CAN-L	—	—	—	—
42	GR	Glass hatch ajar switch	Input	ON	Glass hatch open	0
					Glass hatch closed	Battery
43	R/B	Back door switch (without power back door) or back door latch (door ajar switch) (with power back door)	Input	OFF	ON (open)	0V
					OFF (closed)	Battery voltage

BCM (BODY CONTROL MODULE)

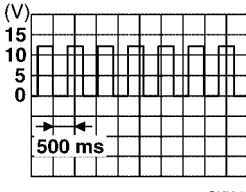
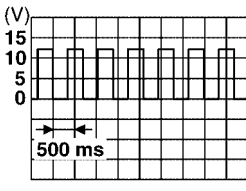
Terminal	Wire color	Signal name	Signal input/output	Measuring condition		Reference value or waveform (Approx.)
				Ignition switch	Operation or condition	
44	O	Rear wiper auto stop switch 1	Input	ON	Rise up position (rear wiper arm on stopper)	0V
					A Position (full clockwise stop position)	Battery voltage
					Forward sweep (counterclockwise direction)	Fluctuating
					B Position (full counterclockwise stop position)	0V
					Reverse sweep (clockwise direction)	Fluctuating
47	SB	Front door switch LH	Input	OFF	ON (open)	0V
					OFF (closed)	Battery voltage
48	R/Y	Rear door switch LH	Input	OFF	ON (open)	0V
					OFF (closed)	Battery voltage
49	R	Cargo lamp	Output	OFF	Any door open (ON)	0V
					All doors closed (OFF)	Battery voltage
51	Y/B	Trailer turn signal (right)	Output	ON	Turn right ON	
52	G/B	Trailer turn signal (left)	Output	ON	Turn left ON	
54	Y	Rear wiper output circuit 2	Input	ON	Rise up position (rear wiper arm on stopper)	0V
					A Position (full clockwise stop position)	0V
					Forward sweep (counterclockwise direction)	0V
					B Position (full counterclockwise stop position)	Battery voltage
					Reverse sweep (clockwise direction)	Battery voltage
55	SB	Rear wiper output circuit 1	Output	ON	OFF	0
					ON	Battery voltage
56	R/G	Battery saver output	Output	OFF	30 minutes after ignition switch is turned OFF	0V
				ON	—	Battery voltage
57	Y/R	Battery power supply	Input	OFF	—	Battery voltage

A
B
C
D
E
F
G
H
I
J
L
M

BCS

BCM (BODY CONTROL MODULE)

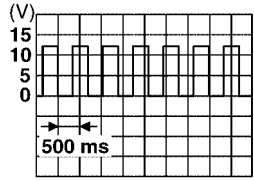
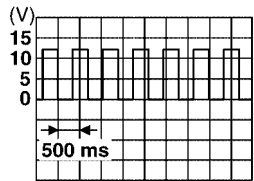
Terminal	Wire color	Signal name	Signal input/output	Measuring condition		Reference value or waveform (Approx.)	
				Ignition switch	Operation or condition		
58	W/R	Optical sensor	Input	ON	When optical sensor is illuminated	3.1V or more	
					When optical sensor is not illuminated	0.6V or less	
59	G	Front door lock assembly LH actuator (unlock)	Output	OFF	OFF (neutral)	0V	
					ON (unlock)	Battery voltage	
60	G/B	Turn signal (left)	Output	ON	Turn left ON		
61	G/Y	Turn signal (right)	Output	ON	Turn right ON		
62	R/W	Step lamp LH and RH	Output	OFF	ON (any door open)	0V	
					OFF (all doors closed)	Battery voltage	
63	L	Interior room/map lamp	Output	OFF	Any door switch	ON (open)	0V
						OFF (closed)	Battery voltage
65	V	All door lock actuators (lock)	Output	OFF	OFF (neutral)	0V	
					ON (lock)	Battery voltage	
66	G/Y	Front door lock actuator RH, rear door lock actuators LH/RH and back door lock actuator (unlock)	Output	OFF	OFF (neutral)	0V	
					ON (unlock)	Battery voltage	
67	B	Ground	Input	ON	—	0V	
68	W/L	Power window power supply (RAP)	Output	—	Ignition switch ON	Battery voltage	
					Within 45 seconds after ignition switch OFF	Battery voltage	
					More than 45 seconds after ignition switch OFF	0V	
					When front door LH or RH is open or power window timer operates	0V	
69	W/R	Power window power supply	Output	—	—	Battery voltage	
70	W/B	Battery power supply	Input	OFF	—	Battery voltage	

BCM (BODY CONTROL MODULE)

EKS00JL1

BCM Power Supply and Ground Circuit Check

1. CHECK FUSES AND FUSIBLE LINK

- Check 50A fusible link (letter f , located in the fuse and fusible link box).
- Check 10A fuse [No. 4, located in the fuse block (J/B)] and 15A fuse [No. 22, located in the fuse block (J/B)].
- Check 10A fuse (No. 59, located in the fuse and relay box).

OK or NG

OK >> GO TO 2.

NG >> If fuse is blown, be sure to eliminate cause of malfunction before installing new fuse.

2. CHECK BCM POWER SUPPLY CIRCUIT

1. Turn ignition switch OFF.
2. Disconnect BCM.
3. Check voltage between BCM connectors and ground.

Connector	Terminals		Power source	Condition	Voltage (V) (Approx.)
	(+)	(-)			
M18	11	Ground	ACC power supply	Ignition switch ACC or ON	Battery voltage
	38	Ground	Ignition power supply	Ignition switch ON or START	Battery voltage
M20	57	Ground	Battery power supply	Ignition switch OFF	Battery voltage
	70	Ground	Battery power supply	Ignition switch OFF	Battery voltage

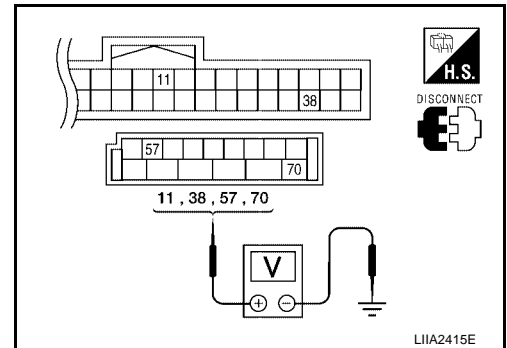

OK or NG

OK >> GO TO 3.

NG >> Repair or replace the harness.

3. CHECK GROUND CIRCUIT

Check continuity between BCM connector M20 terminal 67 and ground.

67 - Ground : Continuity should exist.

OK or NG

OK >> Power supply and ground circuit is OK.

NG >> Repair or replace harness.

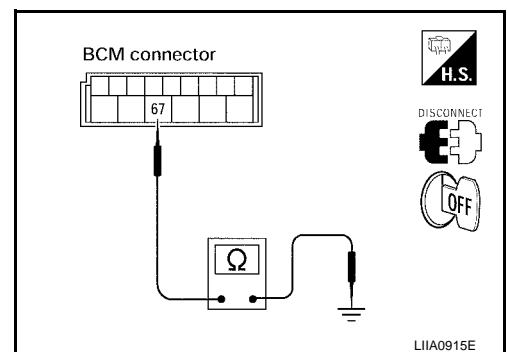

BCM (BODY CONTROL MODULE)

CONSULT-II Function (BCM)

EKS00J35

CONSULT-II can display each diagnostic item using the diagnostic test modes shown following.

BCM diagnostic test item	Diagnostic mode	Content
Inspection by part	WORK SUPPORT	Supports inspections and adjustments. Commands are transmitted to the BCM for setting the status suitable for required operation, input/output signals are received from the BCM and received data is displayed.
	DATA MONITOR	Displays BCM input/output data in real time.
	ACTIVE TEST	Operation of electrical loads can be checked by sending drive signal to them.
	SELF-DIAG RESULTS	Displays BCM self-diagnosis results.
	CAN DIAG SUPPORT MNTR	The results of transmit/receive diagnosis of CAN communication can be read.
	ECU PART NUMBER	BCM part number can be read.
	CONFIGURATION	Performs BCM configuration read/write functions.

CONSULT-II START PROCEDURE

Refer to [GI-38, "CONSULT-II Start Procedure"](#).

ITEMS OF EACH PART

NOTE:

CONSULT-II will only display systems the vehicle possesses.

System and item	CONSULT-II display	Diagnostic test mode (Inspection by part)						
		WORK SUPPORT	SELF-DIAG RESULTS	CAN DIAG SUPPORT MNTR	DATA MONITOR	ECU PART NUMBER	ACTIVE TEST	CONFIGURATION
BCM	BCM	×	×	×		×		×
Power door lock system	DOOR LOCK	×			×		×	
Rear defogger	REAR DEFOGGER				×		×	
Warning chime	BUZZER				×		×	
Room lamp timer	INT LAMP	×			×		×	
Remote keyless entry system	MULTI REMOTE ENT	×			×		×	
Headlamp	HEAD LAMP	×			×		×	
Wiper (front/rear)	WIPER	×			×		×	
Turn signal lamp Hazard lamp	FLASHER				×		×	
Blower fan switch signal Air conditioner switch signal	AIR CONDITIONER				×			
Combination switch	COMB SW				×			
NVIS (NATS)	IMMU				×		×	
Interior lamp battery saver	BATTERY SAVER	×			×		×	
Back door	TRUNK				×		×	
Theft alarm	THEFT ALM	×			×		×	
Retained accessory power control	RETAINED PWR	×			×		×	
Oil pressure switch	SIGNAL BUFFER				×		×	
Low tire pressure system	AIR PRESSURE MONITOR	×	×		×		×	
Panic alarm	PANIC ALARM						×	

BCM (BODY CONTROL MODULE)

WORK SUPPORT

Display Item List

Item	Description
RESET SETTING VALUE	Return a value set with WORK SUPPORT of each system to a default value in factory shipment.

CAN Communication Inspection Using CONSULT-II (Self-Diagnosis)

EKS00J36

1. SELF-DIAGNOSTIC RESULT CHECK

CAUTION:

If CONSULT-II is used with no connection of CONSULT-II CONVERTER, malfunctions might be detected in self-diagnosis depending on control unit which carries out CAN communication.

1. Connect to CONSULT-II, and select "BCM" on "SELECT SYSTEM" screen.
2. Select "BCM" on "SELECT TEST ITEM" screen, and select "SELF-DIAG RESULTS".
3. Check display content in self-diagnostic results.

CONSULT-II display code	Diagnosis item
U1000	INITIAL DIAG
	TRANSMIT DIAG
	ECM
	IPDM E/R
	METER/M&A
	I-KEY

Contents displayed

No malfunction>> Inspection End

Malfunction in CAN communication system>> After printing the monitor items, go to [LAN-7, "TROUBLE DIAGNOSIS"](#).

A

B

C

D

E

F

G

H

I

J

BCS

L

M

BCM (BODY CONTROL MODULE)

EKS00J37

Configuration DESCRIPTION

CONFIGURATION has two functions as follows:

- READ CONFIGURATION is the function to confirm vehicle configuration of current BCM.
- WRITE CONFIGURATION is the function to write vehicle configuration on BCM.

CAUTION:

- When replacing BCM, you must perform WRITE CONFIGURATION with CONSULT-II.
- Complete the procedure of WRITE CONFIGURATION in order.
- If you set incorrect WRITE CONFIGURATION, incidents will occur.
- Configuration is different for each vehicle model. Confirm configuration of each vehicle model.

READ CONFIGURATION PROCEDURE

CAUTION:

If CONSULT-II is used with no connection of CONSULT-II CONVERTER, malfunctions might be detected in self-diagnosis depending on control unit which carries out CAN communication.

1. With ignition switch OFF, connect CONSULT-II and CONSULT-II CONVERTER to data link connector and turn ignition switch ON.

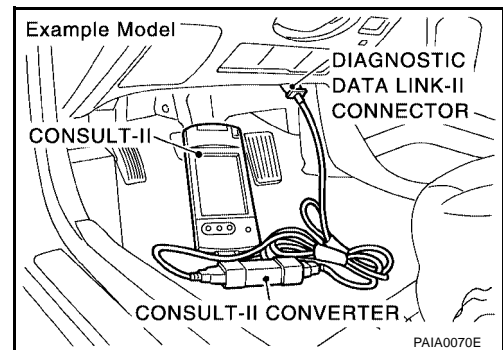

2. Touch "START (NISSAN BASED VHCL)".

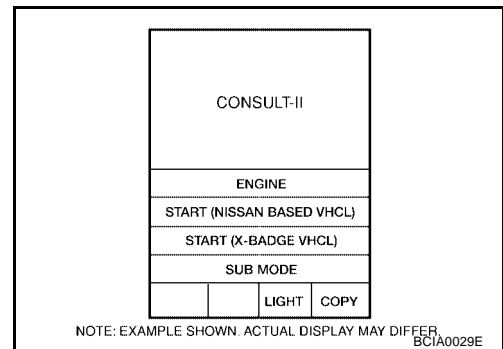

3. Touch "BCM" on "SELECT SYSTEM" screen.
If "BCM" is not indicated, go to [GI-40, "CONSULT-II Data Link Connector \(DLC\) Circuit"](#) .

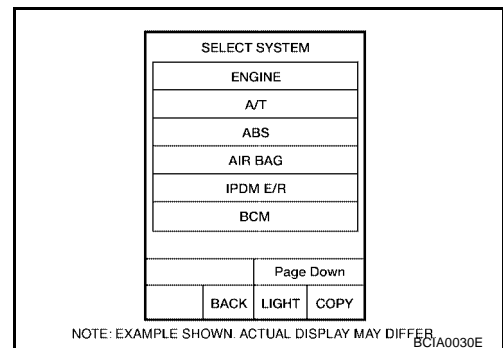

BCM (BODY CONTROL MODULE)

4. Touch "BCM" on "SELECT TEST ITEM" screen.

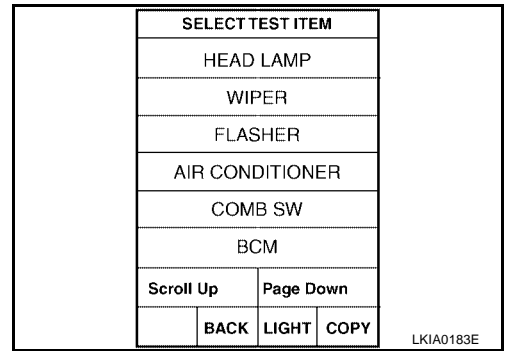

A
B
C
D

5. Touch "CONFIGURATION" on "SELECT DIAG MODE" screen.

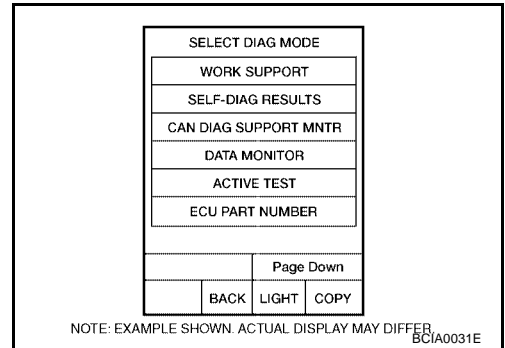

E
F
G

6. Touch "TA60" and "OK" on "VEHICLE SELECT" screen. For canceling, touch "CANCEL" on "VEHICLE SELECT" screen.

NOTE:

Confirm vehicle model. Refer to [GI-48, "Model Variation"](#) in GI section.

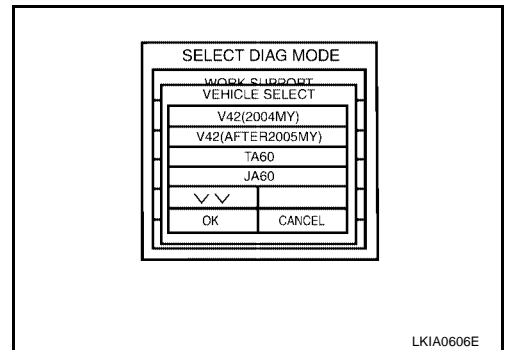

H
I
J

BCS

7. Touch "READ CONFIGURATION" on "SELECT CONFIG ITEM" screen.

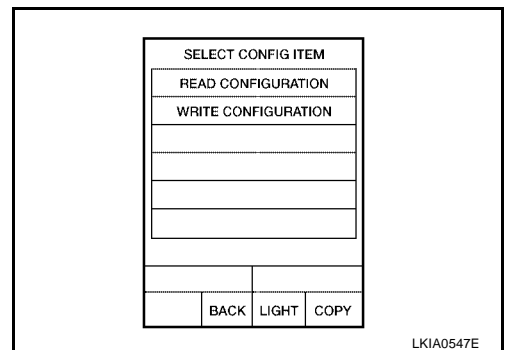

L
M

BCM (BODY CONTROL MODULE)

8. Configuration of current BCM is printed out automatically. A listing of manual setting items and auto setting items will be displayed. Auto setting items are preset and cannot be changed. Manual setting items can be set by using WRITE CONFIGURATION PROCEDURE. Refer to [BCS-22, "WRITE CONFIGURATION PROCEDURE"](#) .

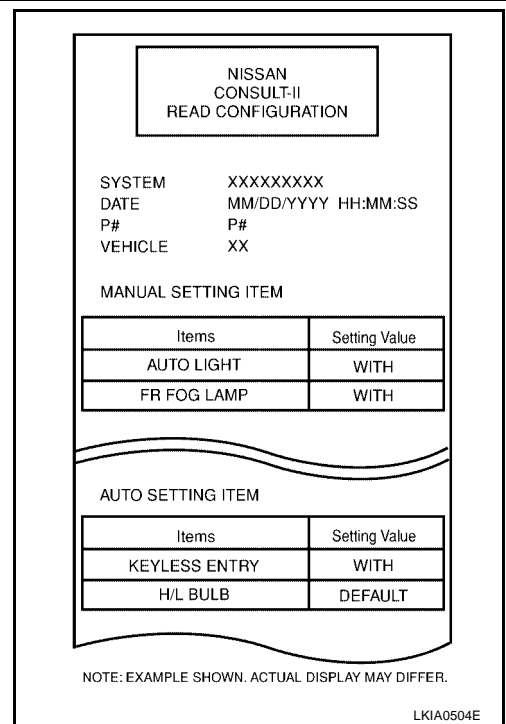

9. Touch "BACK" on "READ CONFIGURATION" screen.

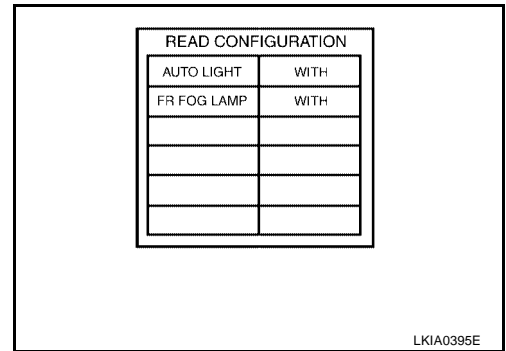

WRITE CONFIGURATION PROCEDURE

CAUTION:

If CONSULT-II is used with no connection of CONSULT-II CONVERTER, malfunctions might be detected in self-diagnosis depending on control unit which carries out CAN communication.

1. With ignition switch OFF, connect CONSULT-II and CONSULT-II CONVERTER to data link connector and turn ignition switch ON.

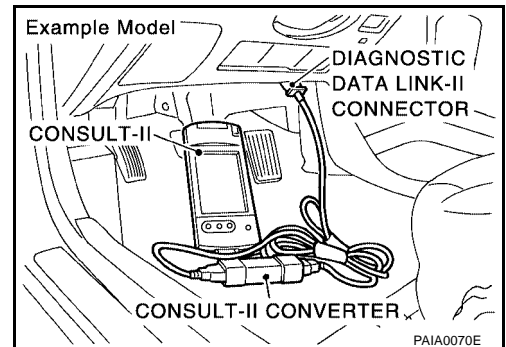

BCM (BODY CONTROL MODULE)

2. Touch "START (NISSAN BASED VHCL)".

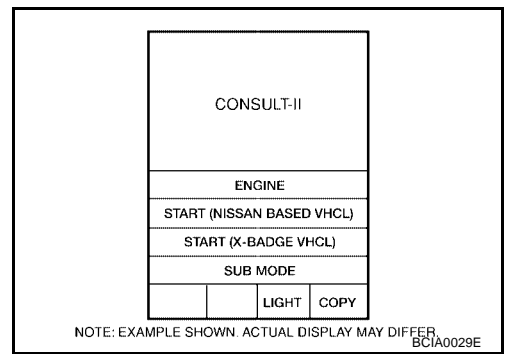

A
B
C
D

3. Touch "BCM" on "SELECT SYSTEM" screen.
If "BCM" is not indicated, go to [GI-40, "CONSULT-II Data Link Connector \(DLC\) Circuit"](#) .

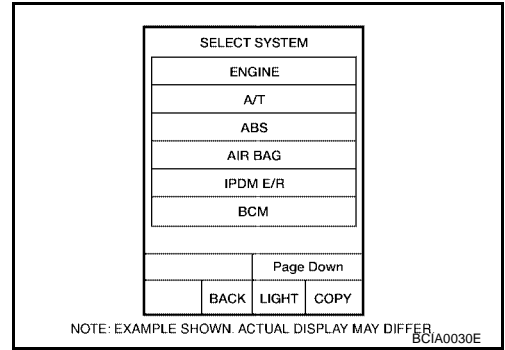

E
F
G

4. Touch "BCM" on "SELECT TEST ITEM" screen.

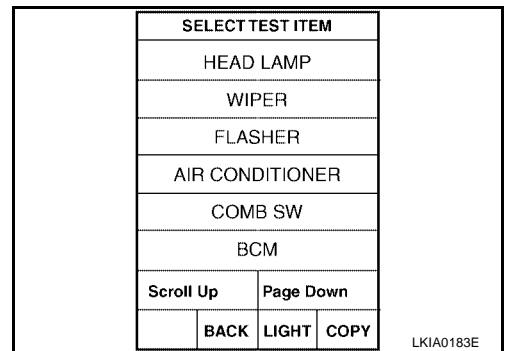

H
I
J

BCS

5. Touch "CONFIGURATION" on "SELECT DIAG MODE" screen.

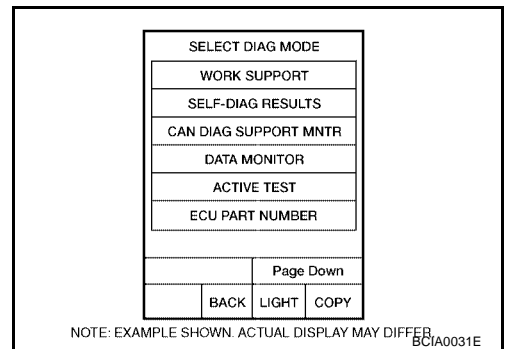

L
M

BCM (BODY CONTROL MODULE)

6. Touch "TA60" and "OK" on "VEHICLE SELECT" screen. For canceling, touch "CANCEL" on "VEHICLE SELECT" screen.

NOTE:

Confirm vehicle model. Refer to [GI-48, "Model Variation"](#) in GI section.

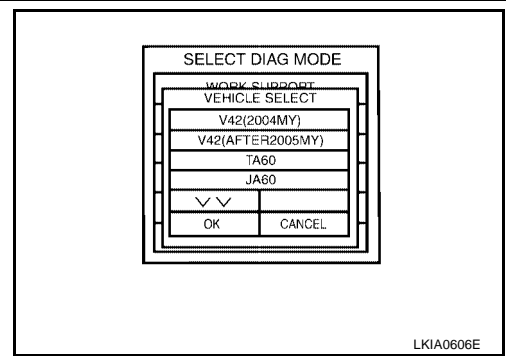

LKIA0606E

7. Touch "WRITE CONFIGURATION" on "SELECT CONFIG ITEM" screen.

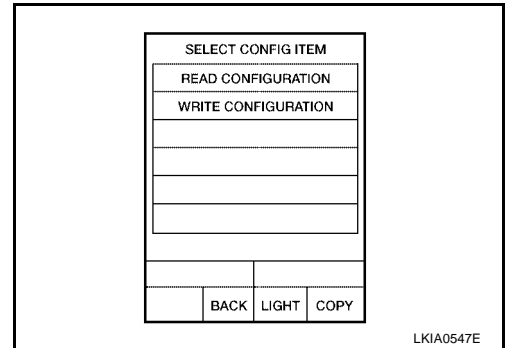

LKIA0547E

8. Touch "YES".
For canceling, touch "NO".

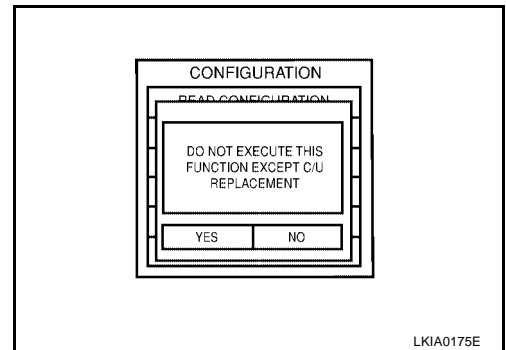

LKIA0175E

9. Set by touching selection on "WRITE CONFIGURATION" screen based on the following ITEM LIST.

ITEM	SET VAL
FR FOG LAMP	WITH ⇔ WITHOUT
DTRL	WITH ⇔ WITHOUT
SPEED SNS WIP	WITH ⇔ WITHOUT
DISPLAY STYLE	MODE2 ^{NOTE}
THEFT ALARM	WITH ⇔ WITHOUT

NOTE:

Do not apply MODE1, MODE3 or MODE4.

NOTE:

Confirm vehicle model. Refer to [GI-48, "Model Variation"](#) in GI section.

10. Touch "CHNG SETTING" on "WRITE CONFIGURATION" screen.

CAUTION:

Make sure to touch "CHNG SETTING" even if the indicated configuration of new BCM is same as the desirable configuration.

If not, configuration which is set automatically by selecting vehicle model cannot be memorized.

BCM (BODY CONTROL MODULE)

11. Touch "OK" on "WRITE CONFIGURATION" screen.
If "CANCEL" is touched, it will return to previous screen.

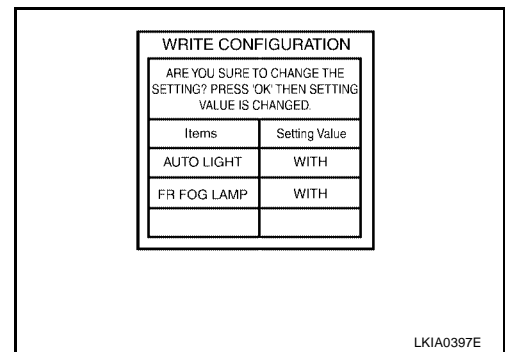

12. Wait until the next screen during setting.

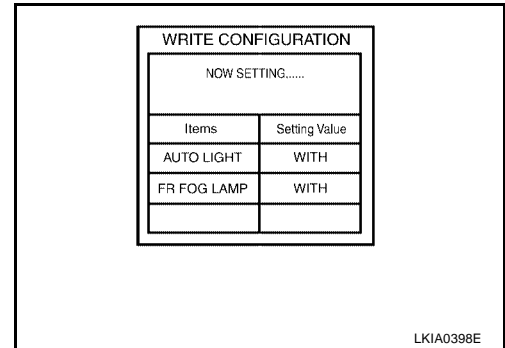

13. WRITE CONFIGURATION results are printed out automatically. Confirm "WRITE CONFIGURATION" is correctly executed by comparing sheet automatically printed out with applicable configuration list shown in step 9.

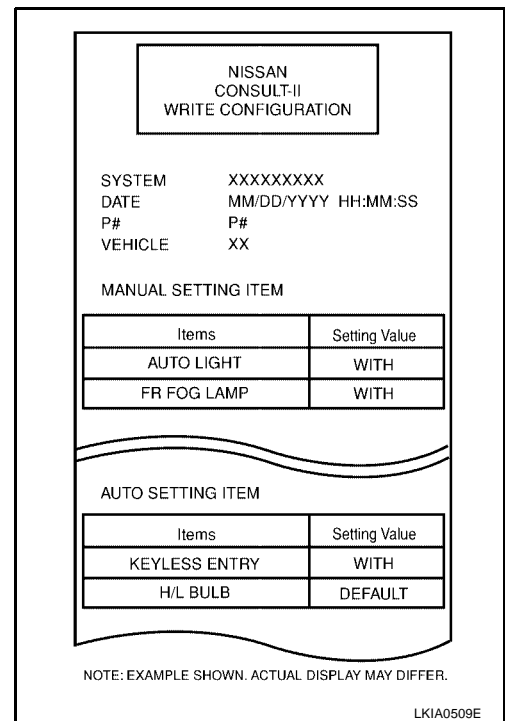

14. Touch "OK" on "WRITE CONFIGURATION" screen.
WRITE CONFIGURATION is completed.

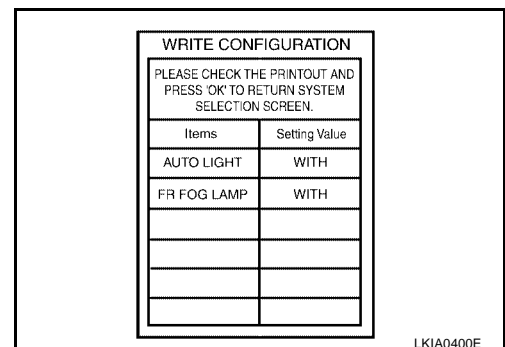

A
B
C
D
E
F
G
H
I
J
L
M

BCS

BCM (BODY CONTROL MODULE)

EKS00J38

Removal and Installation

BCM

Removal

NOTE:

If possible, before removing BCM, retrieve current BCM configuration to use for reference when configuring brand-new BCM after installation. Refer to [BCS-20, "Configuration"](#) .

1. Disconnect negative battery cable.
2. Remove lower knee protector. Refer to [IP-12, "LOWER INSTRUMENT PANEL LH"](#) .
3. Remove screw and release BCM.
4. Disconnect connectors and then remove BCM.

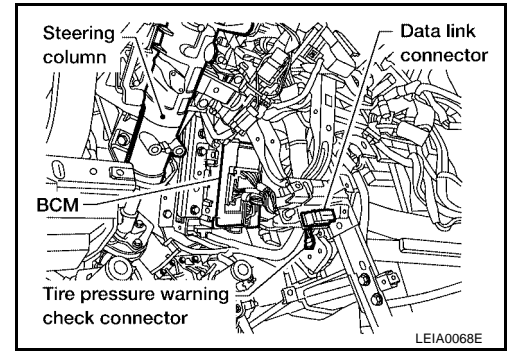

Installation

Installation is in the reverse order of removal.

NOTE:

- When replacing BCM, it must be configured. Refer to [BCS-20, "Configuration"](#) .
- When replacing BCM, perform initialization of NATS system and registration of all NATS ignition key IDs. Refer to [BL-125, "NVIS\(NISSAN Vehicle Immobilizer System-NATS\)"](#) .
- When replacing BCM, perform ID registration procedure of low tire pressure warning system. Refer to [WT-13, "ID Registration Procedure"](#) .