

SECTION **RF**  
ROOF

A  
B  
C

CONTENTS

<b>BASIC INSPECTION</b> .....	3	SUNROOF MOTOR ASSEMBLY : Special Repair Requirement .....	10	F
<b>DIAGNOSIS AND REPAIR WORKFLOW</b> .....	3	<b>SUNROOF SWITCH CIRCUIT</b> .....	11	G
Work Flow .....	3	Description .....	11	
<b>INSPECTION AND ADJUSTMENT</b> .....	5	Component Function Check .....	11	
<b>ADDITIONAL SERVICE WHEN REPLACING CONTROL UNIT</b> .....	5	Diagnosis Procedure .....	11	H
ADDITIONAL SERVICE WHEN REPLACING CONTROL UNIT : Description .....	5	<b>DOOR SWITCH</b> .....	13	
ADDITIONAL SERVICE WHEN REPLACING CONTROL UNIT : Special Repair Requirement .....	5	Description .....	13	
<b>BASIC INSPECTION</b> .....	5	Component Function Check .....	13	I
BASIC INSPECTION : Special Repair Requirement .....	5	Diagnosis Procedure .....	13	
<b>FUNCTION DIAGNOSIS</b> .....	6	<b>ECU DIAGNOSIS</b> .....	15	J
<b>SUNROOF SYSTEM</b> .....	6	<b>BCM (BODY CONTROL MODULE)</b> .....	15	
System Diagram .....	6	Reference Value .....	15	
System Description .....	6	<b>SUNROOF SYSTEM</b> .....	16	RF
Component Parts Location .....	7	Reference Value .....	16	
Component Description .....	7	Wiring Diagram .....	17	L
<b>DIAGNOSIS SYSTEM (BCM)</b> .....	8	<b>SYMPTOM DIAGNOSIS</b> .....	21	
<b>COMMON ITEM</b> .....	8	<b>SUNROOF DOES NOT OPERATE PROPERLY</b> .....	21	M
COMMON ITEM : CONSULT-III Function (BCM - COMMON ITEM) .....	8	Diagnosis Procedure .....	21	
<b>RETAINED PWR</b> .....	8	<b>AUTO OPERATION DOES NOT OPERATE</b> ....	22	N
RETAINED PWR : CONSULT-III Function (BCM - RETAINED PWR) .....	8	Diagnosis Procedure .....	22	
<b>COMPONENT DIAGNOSIS</b> .....	9	<b>DOES NOT STOP FULLY-OPEN OR FULLY-CLOSED POSITION</b> .....	23	O
<b>POWER SUPPLY AND GROUND CIRCUIT</b> .....	9	Diagnosis Procedure .....	23	
<b>SUNROOF MOTOR ASSEMBLY</b> .....	9	<b>RETAINED POWER OPERATION DOES NOT OPERATE PROPERLY</b> .....	24	P
SUNROOF MOTOR ASSEMBLY : Diagnosis Procedure .....	9	Diagnosis Procedure .....	24	
		<b>SUNROOF DOES NOT OPERATE ANTI-PINCH FUNCTION</b> .....	25	
		Diagnosis Procedure .....	25	

<b>SQUEAK AND RATTLE TROUBLE DIAG- NOSES</b> .....	<b>26</b>	<b>PREPARATION</b> .....	<b>33</b>
Work Flow .....	26	<b>PREPARATION</b> .....	<b>33</b>
Inspection Procedure .....	28	Special Service Tool .....	33
Diagnostic Worksheet .....	30	Commercial Service Tool .....	33
<b>PRECAUTION</b> .....	<b>32</b>	<b>ON-VEHICLE REPAIR</b> .....	<b>34</b>
<b>PRECAUTIONS</b> .....	<b>32</b>	<b>SUNROOF SYSTEM</b> .....	<b>34</b>
Precaution for Supplemental Restraint System (SRS) "AIR BAG" and "SEAT BELT PRE-TEN- SIONER" .....	32	Inspection .....	34
Precaution .....	32	Exploded View .....	37
		Removal and Installation .....	38

# DIAGNOSIS AND REPAIR WORKFLOW

< BASIC INSPECTION >

## BASIC INSPECTION

### DIAGNOSIS AND REPAIR WORKFLOW

Work Flow

INFOID:000000001531026

OVERALL SEQUENCE

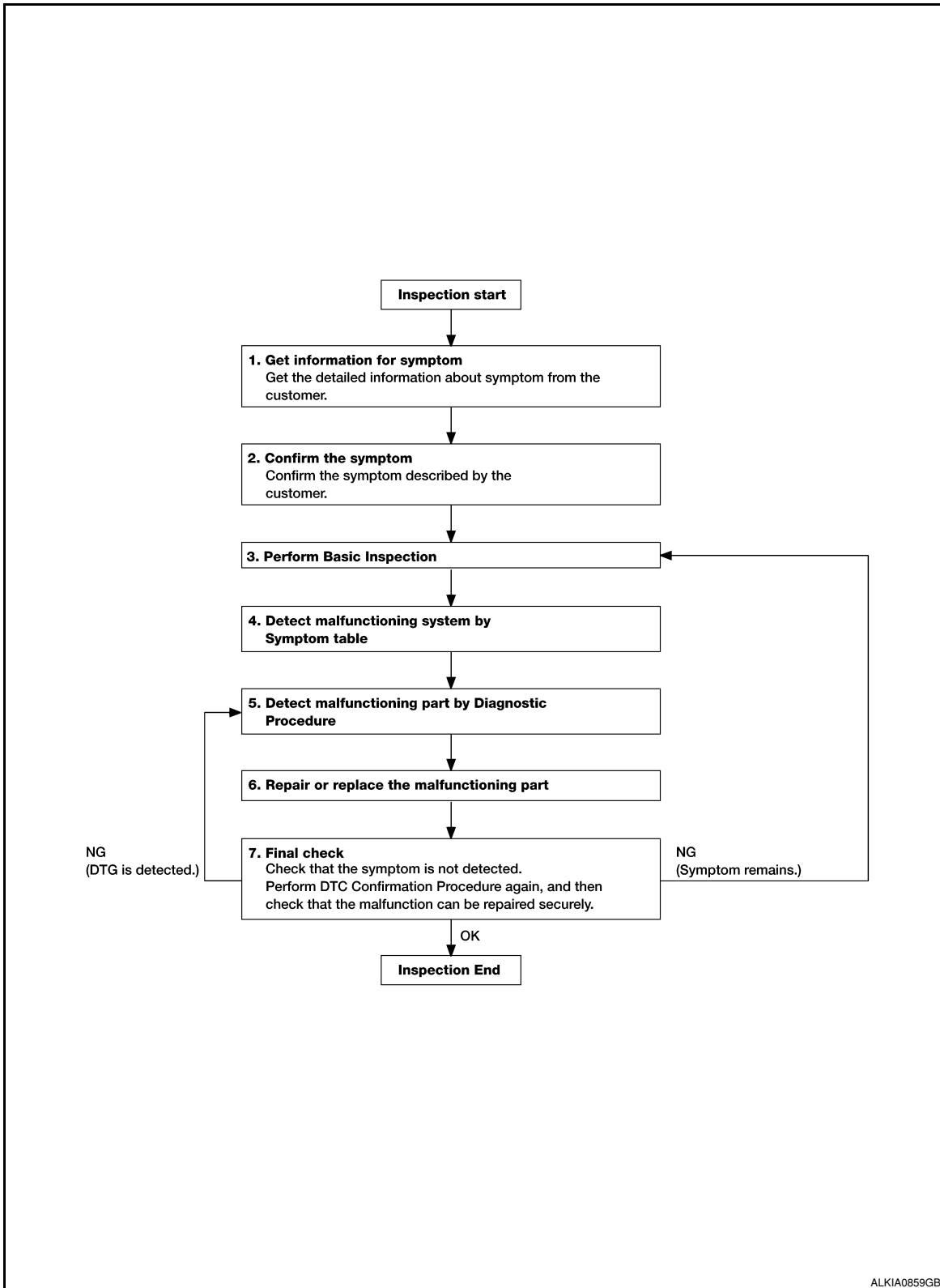

DETAILED FLOW

A  
B  
C  
D  
E  
F  
G  
H  
I  
J  
RF  
L  
M  
N  
O  
P

# DIAGNOSIS AND REPAIR WORKFLOW

< BASIC INSPECTION >

---

## 1. GET INFORMATION FOR SYMPTOM

---

Get the detailed information from the customer about the symptom (the condition and the environment when the incident/malfunction occurred).

>> GO TO 2

## 2. CONFIRM THE SYMPTOM

---

Confirm the symptom described by the customer.

Verify relation between the symptom and the condition when the symptom is detected.

>> GO TO 3

## 3. PERFORM BASIC INSPECTION

---

Perform [RF-5. "BASIC INSPECTION : Special Repair Requirement"](#).

Inspection End>>GO TO 4

## 4. DETECT MALFUNCTIONING SYSTEM BY SYMPTOM DIAGNOSIS

---

Detect malfunctioning system according to symptom diagnosis based on the confirmed symptom in step 4, and determine the trouble diagnosis order based on possible causes and symptom.

>> GO TO 5

## 5. DETECT MALFUNCTIONING PART BY DIAGNOSTIC PROCEDURE

---

Inspect according to Diagnostic Procedure of the system.

### **NOTE:**

The Diagnostic Procedure described based on open circuit inspection. A short circuit inspection is also required for the circuit check in the Diagnostic Procedure.

Is malfunctioning part detected?

YES >> GO TO 6

NO >> Check voltage of related BCM terminals using CONSULT-III.

## 6. REPAIR OR REPLACE THE MALFUNCTIONING PART

---

1. Repair or replace the malfunctioning part.
2. Reconnect parts or connectors disconnected during Diagnostic Procedure.

>> GO TO 7

## 7. FINAL CHECK

---

When symptom was described from the customer, refer to confirmed symptom in step 3 or 4, and check that the symptom is not detected.

Does the symptom reappear?

YES >> GO TO 5

NO >> Inspection End.

# INSPECTION AND ADJUSTMENT

< BASIC INSPECTION >

## INSPECTION AND ADJUSTMENT

### ADDITIONAL SERVICE WHEN REPLACING CONTROL UNIT

#### ADDITIONAL SERVICE WHEN REPLACING CONTROL UNIT : Description

INFOID:000000001531027

#### MEMORY RESET PROCEDURE

1. Please observe the following instructions at confirming the sunroof operation.

**NOTE:**

Do not disconnect the electronic power while the sunroof is operating or within 5 seconds after the sunroof stops. (to wipe-out the memory of lid position and operating friction.)

2. Initialization of system should be conducted after the following conditions.
  - When the sunroof motor is changed.
  - When the sunroof does not operate normally. (Incomplete initialization conditions)

#### ADDITIONAL SERVICE WHEN REPLACING CONTROL UNIT : Special Repair Requirement

INFOID:000000001531028

#### INITIALIZATION PROCEDURE

If the sunroof does not close or open automatically, use the following procedure to return sunroof operation to normal.

1. Turn ignition switch ON.
2. Push and hold the sunroof tilt switch in the forward (DOWN) position until the sunroof is fully closed.
3. After the sunroof has closed all the way, push and hold the tilt switch forward (DOWN) again for more than 2 seconds to re-learn motor position.
4. Initialization is complete if the sunroof operates normally.

#### BASIC INSPECTION

#### BASIC INSPECTION : Special Repair Requirement

INFOID:000000001531029

#### BASIC INSPECTION

##### 1.INSPECTION START

1. Check the service history.
2. Check the following parts.
  - Fuse/circuit breaker blown.
  - Poor connection, open or short circuit of harness connector.
  - Battery voltage.

Is the inspection result normal?

YES >> Inspection End.

NO >> Repair or replace the malfunctioning parts.

A  
B  
C  
D  
E  
F  
G  
H  
I  
J  
RF  
L  
M  
N  
O  
P

# SUNROOF SYSTEM

< FUNCTION DIAGNOSIS >

## FUNCTION DIAGNOSIS

### SUNROOF SYSTEM

#### System Diagram

INFOID:000000001531030

#### SUNROOF

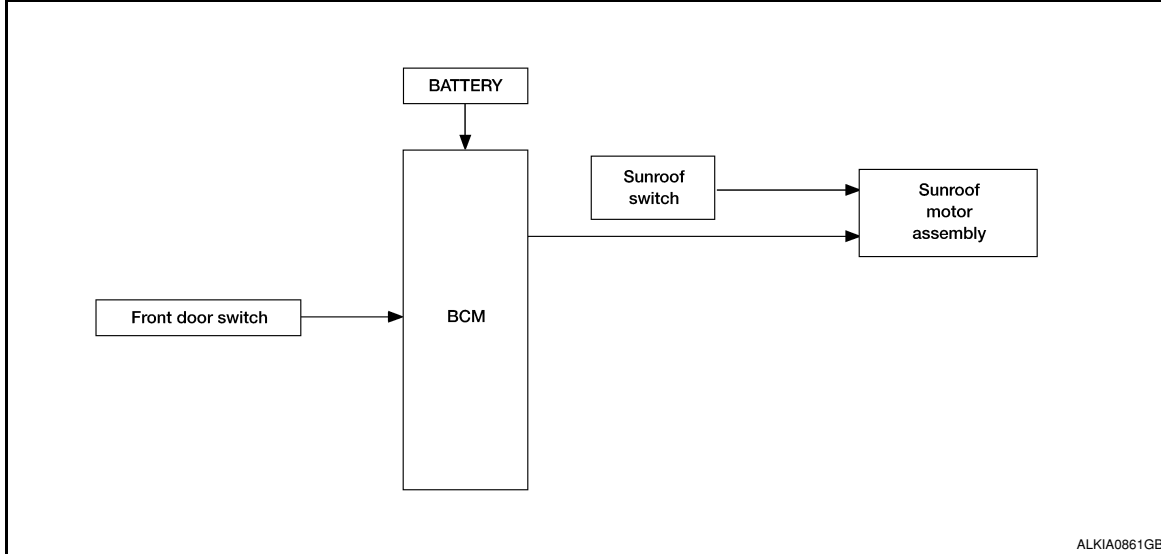

#### System Description

INFOID:000000001531031

### SUNROOF SYSTEM

#### INPUT/OUTPUT SIGNAL CHART

Item	Input signal to sunroof motor assembly	Sunroof motor function	Actuator
Sunroof switch	Sunroof switch signal (tilt down or slide open)	Sunroof control	Sunroof motor
	Sunroof switch signal (tilt up or slide close)		
BCM	RAP signal		

#### SUNROOF OPERATION

- The sunroof motor assembly operates with a power supply that is output from the BCM while the ignition switch is ON or retained power is operating.
- The tilt up/down & slide open/close signals from the sunroof switch enable the sunroof motor to move arbitrarily.

#### AUTO OPERATION

The sunroof AUTO feature makes it possible to slide open and slide close or tilt up and tilt down the sunroof without holding the sunroof switch in the slide open/tilt down or slide close/tilt up position.

#### RETAINED POWER OPERATION

Retained power operation is an additional power supply function that enables the sunroof system to operate up to 45 seconds after the ignition switch is turned OFF.

Retained power function cancel conditions

- When a front door is opened (door switch ON)
- When ignition switch is turned ON again.
- When 45 seconds elapse on the timer.

# SUNROOF SYSTEM

< FUNCTION DIAGNOSIS >

## Component Parts Location

INFOID:000000001531032

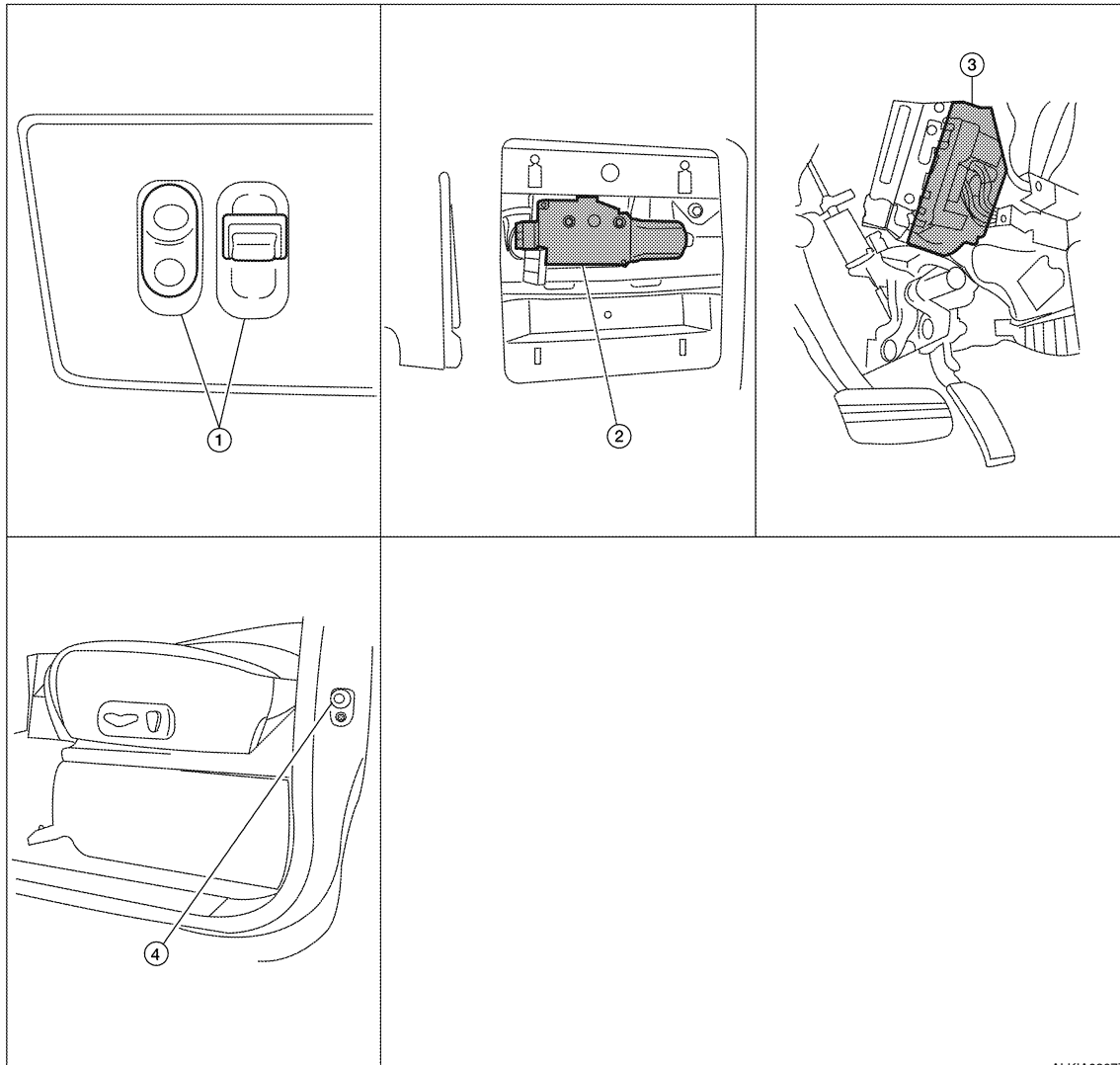

A  
B  
C  
D  
E  
F  
G  
H  
I  
J

RF

ALKIA0867ZZ

L  
M

- 1. Sunroof switch R104
- 2. Sunroof motor assembly R4
- 3. BCM M18, M19, M20 (View with instrument panel removed)
- 4. Front door switch LH B8, RH B108

## Component Description

INFOID:000000001531033

N  
O  
P

Component	Function
BCM	Supplies power to the sunroof motor assembly.
Sunroof switch	Transmits tilt up/down & slide open/close operation signal to sunroof motor assembly.
Sunroof motor assembly	The sunroof motor and integrated CPU enables tilt up/down & slide open/close as requested by the sunroof switch.
Front door switch	Detects door open/close condition and transmits to BCM.

# DIAGNOSIS SYSTEM (BCM)

< FUNCTION DIAGNOSIS >

## DIAGNOSIS SYSTEM (BCM)

### COMMON ITEM

COMMON ITEM : CONSULT-III Function (BCM - COMMON ITEM)

INFOID:000000001531034

### APPLICATION ITEM

CONSULT-III performs the following functions via CAN communication with BCM.

Diagnosis mode	Function Description
WORK SUPPORT	Changes the setting for each system function.
SELF-DIAG RESULTS	Displays the diagnosis results judged by BCM. Refer to <a href="#">BCS-51, "DTC Index"</a> .
CAN DIAG SUPPORT MNTR	Monitors the reception status of CAN communication viewed from BCM.
DATA MONITOR	The BCM input/output signals are displayed.
ACTIVE TEST	The signals used to activate each device are forcibly supplied from BCM.
ECU IDENTIFICATION	The BCM part number is displayed.
CONFIGURATION	This function is not used even though it is displayed.

### SYSTEM APPLICATION

BCM can perform the following functions for each system.

System	Sub system selection item	Diagnosis mode		
		WORK SUPPORT	DATA MONITOR	ACTIVE TEST
BCM	BCM	×		
	RETAINED PWR	×	×	×

### RETAINED PWR

RETAINED PWR : CONSULT-III Function (BCM - RETAINED PWR)

INFOID:000000001531035

### WORK SUPPORT

Work Support Item	Description
RETAINED PWR SET	MODE 1 MODE 2 MODE 3

### DATA MONITOR

Monitor Item	Description
IGN ON SW	Indicates [ON/OFF] condition of the ignition switch.
DOOR SW-DR	Indicates [ON/OFF] condition of the front door switch LH.
DOOR SW-AS	Indicates [ON/OFF] condition of the front door switch RH.

### ACTIVE TEST

Active Test Item	Description
RETAINED PWR	Turns retained power function [ON/OFF].



# POWER SUPPLY AND GROUND CIRCUIT

< COMPONENT DIAGNOSIS >

## COMPONENT DIAGNOSIS

### POWER SUPPLY AND GROUND CIRCUIT SUNROOF MOTOR ASSEMBLY

#### SUNROOF MOTOR ASSEMBLY : Diagnosis Procedure

INFOID:000000001531038

#### SUNROOF MOTOR ASSEMBLY

### 1. CHECK SUNROOF MOTOR POWER SUPPLY

1. Turn ignition switch OFF.
2. Disconnect sunroof motor assembly connector R4.
3. Turn ignition switch ON.
4. Check voltage between sunroof motor assembly connector R4 terminals 1 and 5 and ground.

(+)		(-)	Voltage
Connector	Terminal		
R4	1	Ground	Battery voltage
	5		

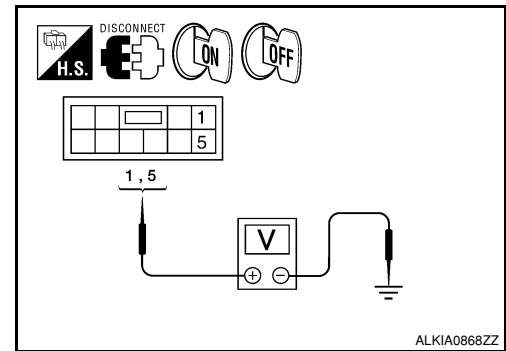

Is the voltage as specified?

YES >> GO TO 4

NO >> GO TO 2

### 2. CHECK SUNROOF MOTOR POWER SUPPLY

1. Turn ignition switch OFF.
2. Disconnect BCM connector M20.
3. Check continuity between BCM connector M20 (A) and sunroof motor assembly connector R4 (B).

A		B		Continuity
Connector	Terminal	Connector	Terminal	
M20	68	R4	1	Yes
	69		5	

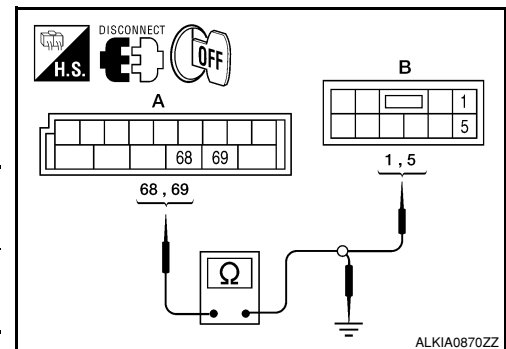

4. Check continuity between BCM connector M20 (A) and ground.

A		—	Continuity
Connector	Terminal		
M20	68	Ground	No
	69		

Are the continuity test results as specified?

YES >> GO TO 3

NO >> Repair or replace harness.

### 3. CHECK BCM OUTPUT SIGNAL

# POWER SUPPLY AND GROUND CIRCUIT

## < COMPONENT DIAGNOSIS >

1. Connect BCM connector M20.
2. Turn ignition switch ON.
3. Check voltage between BCM connector M20 and ground.

(+)		(-)	Voltage
Connector	Terminal		
M20	68	Ground	Battery voltage
	69		

Is the voltage reading as specified?

- YES >> Check condition of harness and connector.  
 NO >> Replace BCM. Refer to [BCS-54. "Removal and Installation"](#).

## 4. CHECK GROUND CIRCUIT

1. Turn ignition switch OFF.
2. Check continuity between sunroof motor assembly connector R4 terminal 7 and ground.

Connector	Terminal	—	Continuity
R4	7	Ground	Yes

Is the continuity test result as specified?

- YES >> Power supply and ground circuits are OK.  
 NO >> Repair or replace harness.

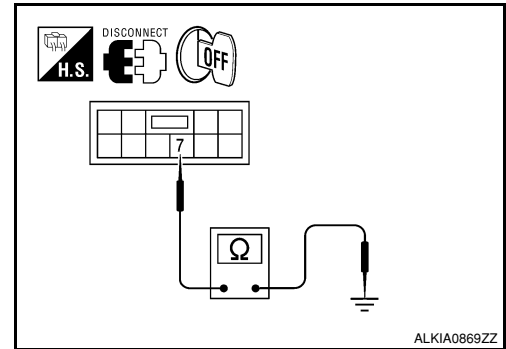
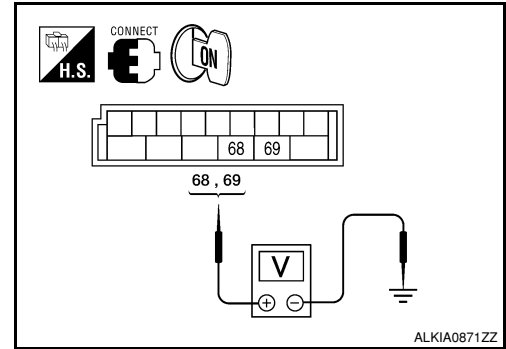

## SUNROOF MOTOR ASSEMBLY : Special Repair Requirement

INFOID:000000001531040

### 1. PERFORM INITIALIZATION PROCEDURE

Perform initialization procedure.

Refer to [RF-5. "ADDITIONAL SERVICE WHEN REPLACING CONTROL UNIT : Special Repair Requirement"](#).

Does the sunroof motor assembly operate properly?

- YES >> Repair is complete.  
 NO >> Check fitting adjustment.

# SUNROOF SWITCH CIRCUIT

< COMPONENT DIAGNOSIS >

## SUNROOF SWITCH CIRCUIT

### Description

INFOID:000000001531036

The BCM supplies power to the integrated CPU of the sunroof motor assembly. The tilt and slide functions of the sunroof motor assembly is controlled by the sunroof switch.

### Component Function Check

INFOID:000000001531037

#### 1. CHECK SUNROOF MOTOR FUNCTION

Do tilt up/down & slide open/close functions operate normally with sunroof switch?

Is the inspection result normal?

YES >> Sunroof motor assembly is OK.

NO >> Refer to [RF-9. "SUNROOF MOTOR ASSEMBLY : Diagnosis Procedure"](#).

### Diagnosis Procedure

INFOID:000000001534443

#### 1. CHECK SUNROOF SWITCH INPUT SIGNAL

1. Turn ignition switch ON.
2. Check voltage between sunroof switch connector and ground.

Connector	Terminals		Sunroof switch position	Voltage (V) (Approx.)
	(+)	(-)		
R104	1	2	SLIDE CLOSE	0V
			Other than above	Battery voltage
	3		SLIDE OPEN	0V
			Other than above	Battery voltage
	4		TILT UP	0V
			Other than above	Battery voltage
	6		TILT DOWN	0V
			Other than above	Battery voltage

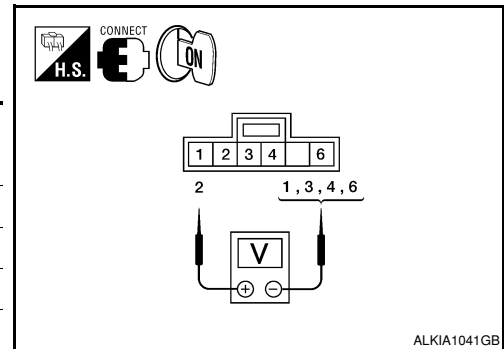

Are the voltage measurements as specified?

YES >> Sunroof switch is operating normally.

NO >> GO TO 2

#### 2. CHECK SUNROOF SWITCH CIRCUITS

1. Turn ignition switch OFF.
2. Disconnect sunroof motor assembly connector R4 and sunroof switch connector R104.
3. Check continuity between sunroof switch connector R104 (A) and sunroof motor assembly connector R4 (B).

A		B		Continuity
Connector	Terminal	Connector	Terminal	
R104	1	R4	3	Yes
	2		8	
	3		9	
	4		4	
	6		10	

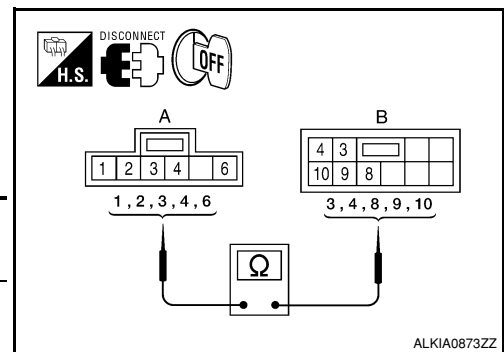

4. Check continuity between sunroof switch connector R104 (A) and ground.

# SUNROOF SWITCH CIRCUIT

## < COMPONENT DIAGNOSIS >

A		—	Continuity
Connector	Terminal		
R104	1	Ground	No
	2		
	3		
	4		
	6		

Are the continuity test results as specified?

YES >> GO TO 3

NO >> Repair harness or connector.

### 3. CHECK SUNROOF SWITCH

1. Check continuity between sunroof switch terminals.

Terminals	Sunroof switch position	Continuity
1	SLIDE CLOSE	Yes
	Other than above	No
3	SLIDE OPEN	Yes
	Other than above	No
4	TILT UP	Yes
	Other than above	No
6	TILT DOWN	Yes
	Other than above	No

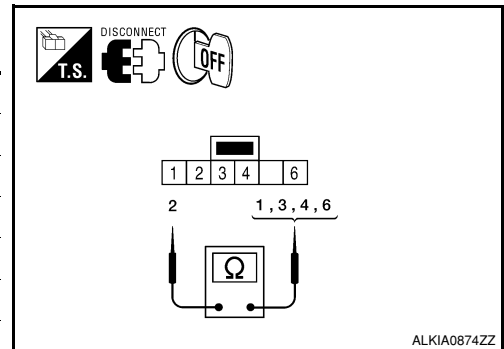

Are the continuity test results as specified?

YES >> Sunroof switch is operating normally.

NO >> Replace sunroof switch (map lamp assembly). Refer to [INL-58. "Removal and Installation"](#).

# DOOR SWITCH

< COMPONENT DIAGNOSIS >

## DOOR SWITCH

### Description

INFOID:000000001531041

Detects door open/close condition and transmits the signal to BCM.

### Component Function Check

INFOID:000000001531042

#### 1. CHECK DOOR SWITCH INPUT SIGNAL

Check ("DOOR SW-DR" and "DOOR SW-AS") in "DATA MONITOR" mode with CONSULT-III.

Monitor item	Condition
DOOR SW-DR	OPEN : ON
	CLOSE : OFF
DOOR SW-AS	OPEN : ON
	CLOSE : OFF

Is the inspection result normal?

- YES >> Door switch circuit is OK.
- NO >> Refer to [RF-13, "Diagnosis Procedure"](#).

### Diagnosis Procedure

INFOID:000000001531043

#### 1. CHECK FRONT DOOR SWITCH

Check front door switches.

Terminal	Switch condition	Continuity
2	Pressed	No
	Released	Yes

Are the continuity test results as specified?

- YES >> GO TO 2
- NO >> Replace front door switch.

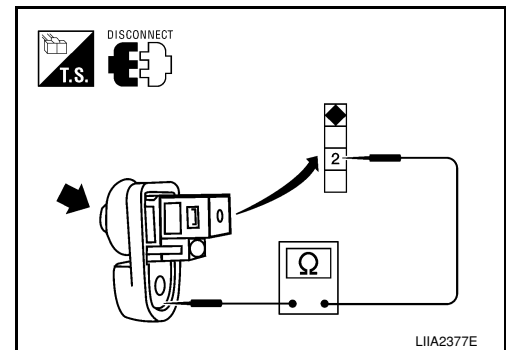

#### 2. CHECK FRONT DOOR SWITCH INPUT SIGNAL

Check voltage between BCM connectors M18 and M19 and ground.

(+)		(-)	Front door condition	Voltage	
Connector	Terminal				
M18	12	Ground	RH	OPEN	0V
				CLOSE	Battery voltage
M19	47		LH	OPEN	0V
				CLOSE	Battery voltage

Are the voltage readings as specified?

- YES >> Replace BCM. Refer to [BCS-54, "Removal and Installation"](#).
- NO >> GO TO 3

#### 3. CHECK HARNESS CONTINUITY

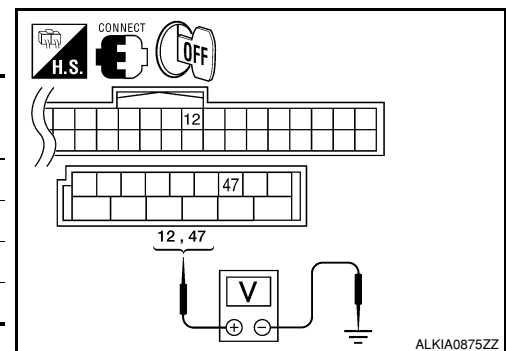

# DOOR SWITCH

## < COMPONENT DIAGNOSIS >

1. Turn ignition switch OFF.
2. Disconnect BCM connectors M18 and M19 and front door switch connectors B8 and B108.
3. Check continuity between BCM connectors M18 and M19 (A) and front door switch connectors B8 and B108 (B).

A		B		Continuity
Connector	Terminal	Connector	Terminal	
M18	12	RH	B108	Yes
M19	47	LH	B8	

4. Check continuity between BCM connectors M18 and M19 (A) and ground.

A		—	Continuity
Connector	Terminal		
M18	12	Ground	No
M19	47		

Are the continuity test results as specified?

- YES >> Replace BCM. Refer to [BCS-54. "Removal and Installation"](#).  
 NO >> Repair or replace harness.

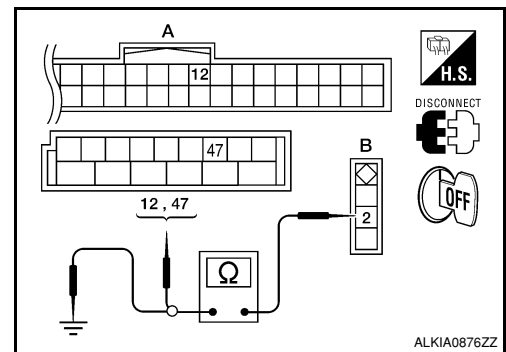

# BCM (BODY CONTROL MODULE)

< ECU DIAGNOSIS >

## ECU DIAGNOSIS

BCM (BODY CONTROL MODULE)

Reference Value

INFOID:000000001531045

VALUES ON THE DIAGNOSIS TOOL

Monitor Item	Condition	Value/Status
DOOR SW-DR	Front door LH closed	OFF
	Front door LH opened	ON
DOOR SW-AS	Front door RH closed	OFF
	Front door LH opened	ON

### TERMINAL LAYOUT

Refer to [BCS-41, "Terminal Layout"](#).

### PHYSICAL VALUES

Refer to [BCS-41, "Physical Values"](#).

### WIRING DIAGRAM

Refer to [BCS-47, "Wiring Diagram"](#).

### DTC INSPECTION

Refer to [BCS-50, "DTC Inspection Priority Chart"](#).

### DTC INDEX

Refer to [BCS-51, "DTC Index"](#).

A  
B  
C  
D  
E  
F  
G  
H  
I  
J  
L  
M  
N  
O  
P

RF

# SUNROOF SYSTEM

< ECU DIAGNOSIS >

## SUNROOF SYSTEM

Reference Value

INFOID:000000001531046

### TERMINAL LAYOUT

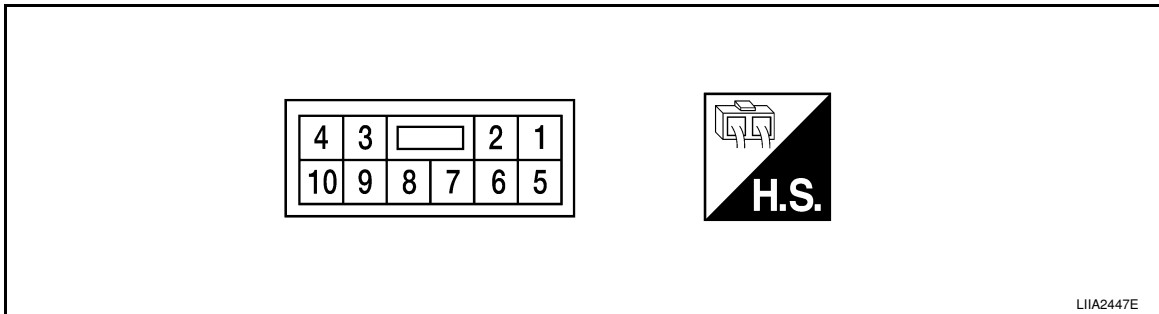

### PHYSICAL VALUES

Terminal No. (Wire color)		Description		Condition	Voltage (V) (Approx.)
+	-	Signal name	Input/ Output		
1 (W/L)	Ground	RAP signal	Input	Ignition switch ON	Battery voltage
				Within 45 seconds after ignition switch is turned OFF	Battery voltage
				When front door LH or RH is open while retained power is operating	0V
3 (P/W)	Ground	Sunroof switch CLOSE signal	Input	Ignition switch is ON and sunroof switch in CLOSE position	0V
				Other than above	Battery voltage
4 (O)	Ground	Sunroof switch TILT UP signal	Input	Ignition switch is ON and sunroof switch in TILT UP position	0V
				Other than above	Battery voltage
5 (W/R)	Ground	BAT power supply	Input	—	Battery voltage
7 (B)	Ground	Ground	Input	—	Less than 0.2V
8 (Y)	Ground	Sunroof switch ground	Output	—	Less than 0.2V
9 (P)	Ground	Sunroof switch OPEN signal	Input	Ignition switch ON and sunroof switch in OPEN position	0V
				Other than above	Battery voltage
10 (L/R)	Ground	Sunroof switch TILT DOWN signal	Input	Ignition switch ON and sunroof switch in TILT DOWN position	0
				Other than above	Battery voltage



# SUNROOF SYSTEM

< ECU DIAGNOSIS >

## Wiring Diagram

INFOID:000000001531047

SUNROOF

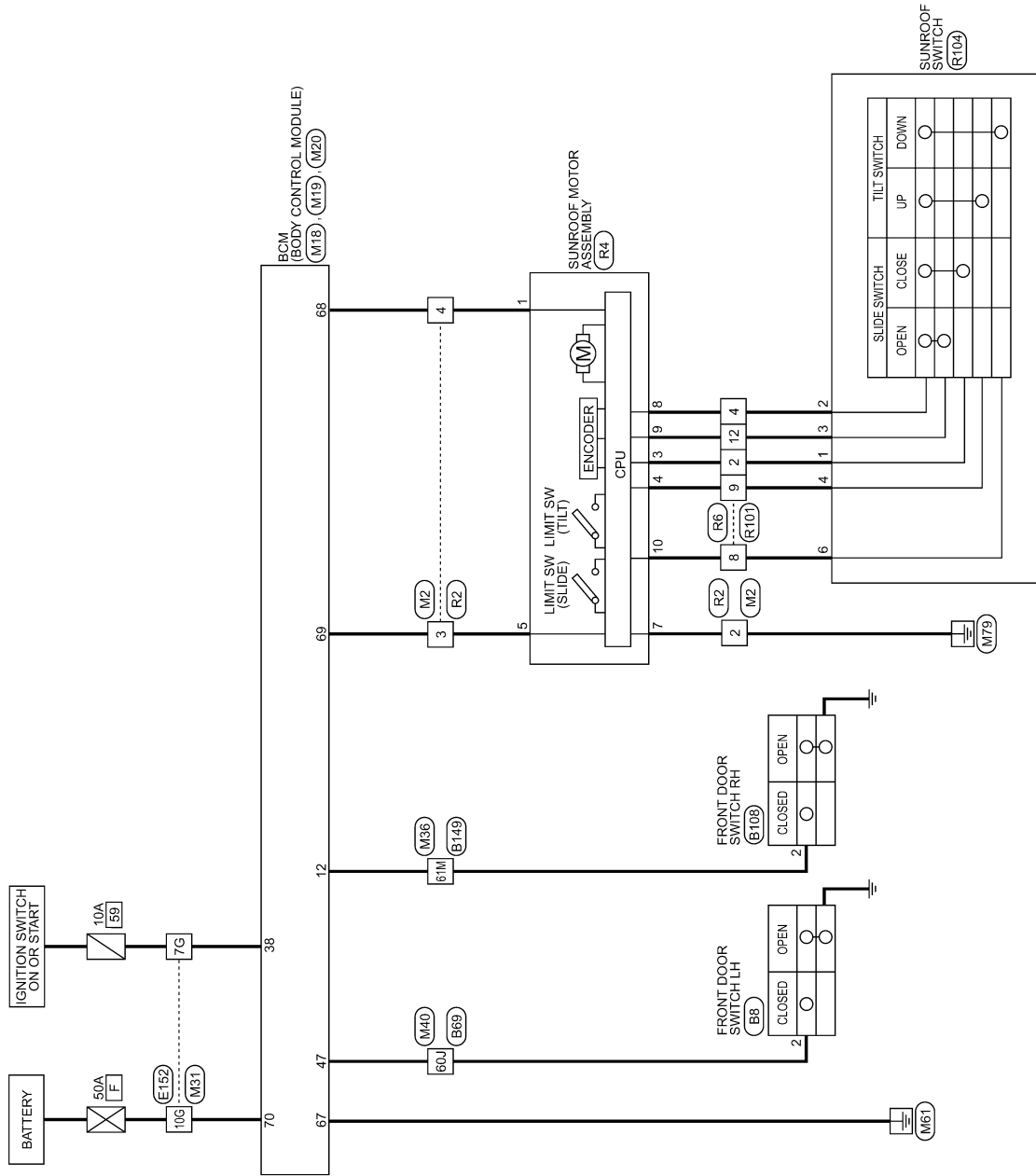

A  
B  
C  
D  
E  
F  
G  
H  
I  
J  
RF  
L  
M  
N  
O  
P

ALKWA0120GE

# SUNROOF SYSTEM

< ECU DIAGNOSIS >

## SUNROOF CONNECTORS

Connector No.	M2
Connector Name	WIRE TO WIRE
Connector Color	WHITE

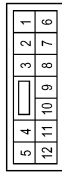

Terminal No.	Color of Wire	Signal Name
2	B	-
3	W/R	-
4	W/L	-

Connector No.	M18
Connector Name	BCM (BODY CONTROL MODULE)
Connector Color	WHITE



Terminal No.	Color of Wire	Signal Name
12	R/L	DOOR SW (AS)
38	W/L	IGN SW

Connector No.	M19
Connector Name	BCM (BODY CONTROL MODULE)
Connector Color	WHITE



Terminal No.	Color of Wire	Signal Name
47	SB	DOOR SW (DR)

Connector No.	M20
Connector Name	BCM (BODY CONTROL MODULE)
Connector Color	BLACK

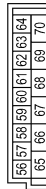

Terminal No.	Color of Wire	Signal Name
67	B	GND (POWER)
68	W/L	POWER WINDOW POWER SUPPLY (RAP)
69	W/R	POWER WINDOW POWER SUPPLY (BAT)
70	W/B	BATT (FL)

Connector No.	M31
Connector Name	WIRE TO WIRE
Connector Color	WHITE

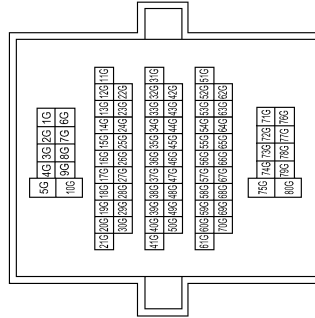

Terminal No.	Color of Wire	Signal Name
7G	W/L	-
10G	W/B	-

Connector No.	M36
Connector Name	WIRE TO WIRE
Connector Color	WHITE

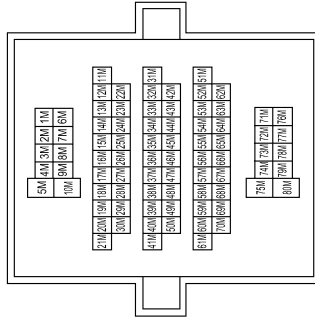

Terminal No.	Color of Wire	Signal Name
61M	R/L	-

ALKIA0863GB

# SUNROOF SYSTEM

< ECU DIAGNOSIS >

Terminal No.	Color of Wire	Signal Name
7G	L/W	-
10G	W/B	-

Connector No.	E152
Connector Name	WIRE TO WIRE
Connector Color	WHITE

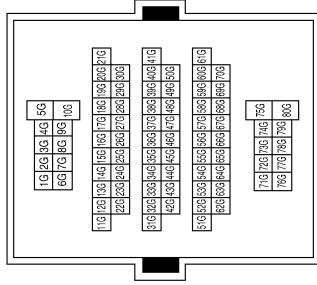

Connector No.	M40
Connector Name	WIRE TO WIRE
Connector Color	WHITE

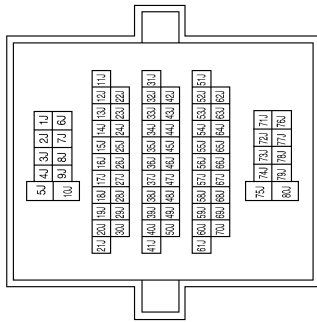

Terminal No.	Color of Wire	Signal Name
60J	SB	-

Connector No.	B108
Connector Name	FRONT DOOR SWITCH RH
Connector Color	WHITE

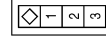

Connector No.	B69
Connector Name	WIRE TO WIRE
Connector Color	WHITE

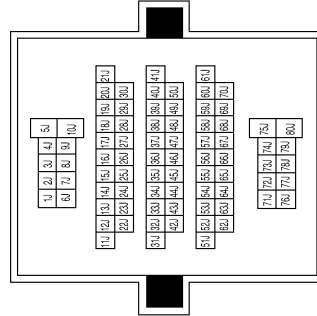

Connector No.	B8
Connector Name	FRONT DOOR SWITCH LH
Connector Color	WHITE

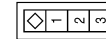

Terminal No.	Color of Wire	Signal Name
2	R/L	-

Terminal No.	Color of Wire	Signal Name
60J	SB	-

Terminal No.	Color of Wire	Signal Name
2	SB	-

ALKIA0864GB

A B C D E F G H I J L M N O P RF

# SUNROOF SYSTEM

< ECU DIAGNOSIS >

Connector No.	R4
Connector Name	WIRE TO WIRE
Connector Color	WHITE

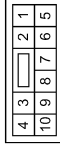

Terminal No.	Color of Wire	Signal Name
1	W/L	IGN
3	P/W	SLIDE_CLOSE
4	O	TILT_UP
5	W/R	B+
7	B	GND
8	Y	SW_GND
9	P	SLIDE_OPEN
10	L/R	TILT_DOWN

Connector No.	R2
Connector Name	WIRE TO WIRE
Connector Color	WHITE

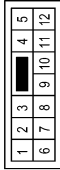

Terminal No.	Color of Wire	Signal Name
2	B	-
3	W/R	-
4	W/L	-

Connector No.	B149
Connector Name	WIRE TO WIRE
Connector Color	WHITE

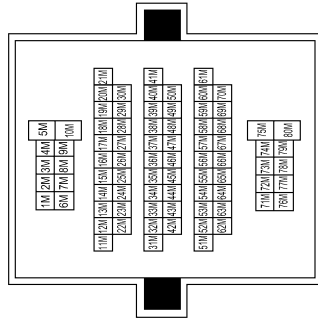

Terminal No.	Color of Wire	Signal Name
61M	R/L	-

Connector No.	R104
Connector Name	SUNROOF SWITCH
Connector Color	GRAY



Terminal No.	Color of Wire	Signal Name
1	P/W	-
2	Y	-
3	P	-
4	O	-
6	L/R	-

Connector No.	R101
Connector Name	WIRE TO WIRE
Connector Color	WHITE

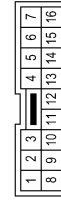

Terminal No.	Color of Wire	Signal Name
2	P/W	-
4	Y	-
8	L/R	-
9	O	-
12	P	-

Connector No.	R6
Connector Name	WIRE TO WIRE
Connector Color	WHITE

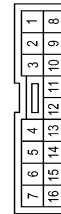

Terminal No.	Color of Wire	Signal Name
2	P/W	-
4	Y	-
8	L/R	-
9	O	-
12	P	-

ALKIA0865GB

# SUNROOF DOES NOT OPERATE PROPERLY

< SYMPTOM DIAGNOSIS >

## SYMPTOM DIAGNOSIS

### SUNROOF DOES NOT OPERATE PROPERLY

#### Diagnosis Procedure

INFOID:000000001531048

#### 1. CHECK BCM POWER SUPPLY AND GROUND CIRCUIT

Check BCM power supply and ground circuit.  
Refer to [BCS-32, "Diagnosis Procedure"](#).

>> GO TO 2

#### 2. CHECK SUNROOF MOTOR ASSEMBLY POWER SUPPLY AND GROUND CIRCUIT

Check sunroof motor assembly power supply and ground circuit.  
Refer to [RF-11, "Component Function Check"](#).

>> GO TO 3

#### 3. CHECK SUNROOF SWITCH CIRCUIT

Check sunroof switch circuit.  
Refer to [RF-11, "Diagnosis Procedure"](#).

Is the inspection result normal?

>> Check intermittent incident. Refer to [GI-39, "Intermittent Incident"](#).

A  
B  
C  
D  
E  
F  
G  
H  
I  
J  
L  
M  
N  
O  
P

RF

## AUTO OPERATION DOES NOT OPERATE

< SYMPTOM DIAGNOSIS >

---

### AUTO OPERATION DOES NOT OPERATE

#### Diagnosis Procedure

INFOID:000000001531049

#### 1. PERFORM INITIALIZATION PROCEDURE

---

Perform initialization procedure.

Refer to [RF-5, "ADDITIONAL SERVICE WHEN REPLACING CONTROL UNIT : Special Repair Requirement"](#).

Is the inspection result normal?

>> Check intermittent incident. Refer to [GI-39, "Intermittent Incident"](#).

# DOES NOT STOP FULLY-OPEN OR FULLY-CLOSED POSITION

< SYMPTOM DIAGNOSIS >

---

## DOES NOT STOP FULLY-OPEN OR FULLY-CLOSED POSITION

### Diagnosis Procedure

INFOID:000000001531050

#### 1. PERFORM INITIALIZATION PROCEDURE

---

Perform initialization procedure.

Refer to [RF-5, "ADDITIONAL SERVICE WHEN REPLACING CONTROL UNIT : Special Repair Requirement"](#).

Is the inspection result normal?

>> Check intermittent incident. Refer to [GI-39, "Intermittent Incident"](#).

A  
B  
C  
D  
E  
F  
G  
H  
I  
J  
RF  
L  
M  
N  
O  
P

## RETAINED POWER OPERATION DOES NOT OPERATE PROPERLY

< SYMPTOM DIAGNOSIS >

---

## RETAINED POWER OPERATION DOES NOT OPERATE PROPERLY

### Diagnosis Procedure

INFOID:000000001531051

#### 1. CHECK FRONT DOOR SWITCH

---

Check front door switch.

Refer to [RF-13, "Component Function Check"](#).

Is the inspection result normal?

>> Check intermittent incident. Refer to [GI-39, "Intermittent Incident"](#).



# SUNROOF DOES NOT OPERATE ANTI-PINCH FUNCTION

< SYMPTOM DIAGNOSIS >

## SUNROOF DOES NOT OPERATE ANTI-PINCH FUNCTION

### Diagnosis Procedure

INFOID:000000001531052

#### 1. PERFORM INITIALIZATION PROCEDURE

Perform initialization procedure.

Refer to [RF-5, "ADDITIONAL SERVICE WHEN REPLACING CONTROL UNIT : Special Repair Requirement"](#).

Is the inspection result normal?

>> Check intermittent incident. Refer to [GI-39, "Intermittent Incident"](#).

A  
B  
C  
D  
E  
F  
G  
H  
I  
J  
RF  
L  
M  
N  
O  
P

# SQUEAK AND RATTLE TROUBLE DIAGNOSES

< SYMPTOM DIAGNOSIS >

## SQUEAK AND RATTLE TROUBLE DIAGNOSES

### Work Flow

INFOID:000000001531053

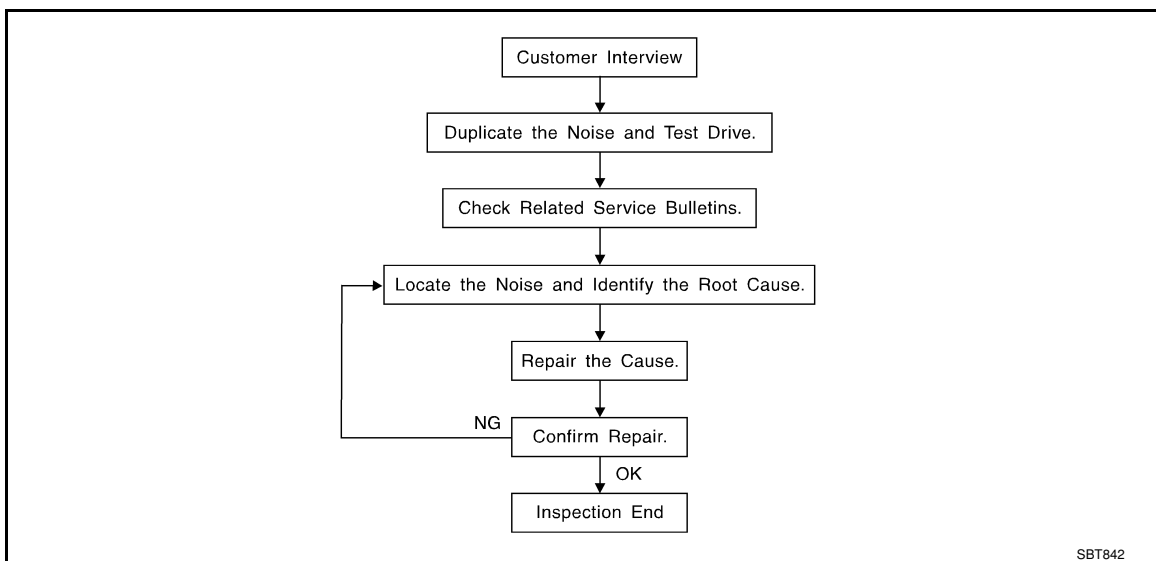

### CUSTOMER INTERVIEW

Interview the customer if possible, to determine the conditions that exist when the noise occurs. Use the Diagnostic Worksheet during the interview to document the facts and conditions when the noise occurs and any customer's comments; refer to [RF-30, "Diagnostic Worksheet"](#). This information is necessary to duplicate the conditions that exist when the noise occurs.

- The customer may not be able to provide a detailed description or the location of the noise. Attempt to obtain all the facts and conditions that exist when the noise occurs (or does not occur).
- If there is more than one noise in the vehicle, be sure to diagnose and repair the noise that the customer is concerned about. This can be accomplished by test driving the vehicle with the customer.
- After identifying the type of noise, isolate the noise in terms of its characteristics. The noise characteristics are provided so the customer, service adviser and technician are all speaking the same language when defining the noise.
- Squeak —(Like tennis shoes on a clean floor)  
Squeak characteristics include the light contact/fast movement/brought on by road conditions/hard surfaces=higher pitch noise/softer surfaces=lower pitch noises/edge to surface=chirping
- Creak—(Like walking on an old wooden floor)  
Creak characteristics include firm contact/slow movement/twisting with a rotational movement/pitch dependent on materials/often brought on by activity.
- Rattle—(Like shaking a baby rattle)  
Rattle characteristics include the fast repeated contact/vibration or similar movement/loose parts/missing clip or fastener/incorrect clearance.
- Knock —(Like a knock on a door)  
Knock characteristics include hollow sounding/sometimes repeating/often brought on by driver action.
- Tick—(Like a clock second hand)  
Tick characteristics include gentle contacting of light materials/loose components/can be caused by driver action or road conditions.
- Thump—(Heavy, muffled knock noise)  
Thump characteristics include softer knock/dead sound often brought on by activity.
- Buzz—(Like a bumble bee)  
Buzz characteristics include high frequency rattle/firm contact.
- Often the degree of acceptable noise level will vary depending upon the person. A noise that you may judge as acceptable may be very irritating to the customer.
- Weather conditions, especially humidity and temperature, may have a great effect on noise level.

### DUPLICATE THE NOISE AND TEST DRIVE

If possible, drive the vehicle with the customer until the noise is duplicated. Note any additional information on the Diagnostic Worksheet regarding the conditions or location of the noise. This information can be used to duplicate the same conditions when you confirm the repair.

# SQUEAK AND RATTLE TROUBLE DIAGNOSES

## < SYMPTOM DIAGNOSIS >

If the noise can be duplicated easily during the test drive, to help identify the source of the noise, try to duplicate the noise with the vehicle stopped by doing one or all of the following:

- 1) Close a door.
  - 2) Tap or push/pull around the area where the noise appears to be coming from.
  - 3) Rev the engine.
  - 4) Use a floor jack to recreate vehicle "twist".
  - 5) At idle, apply engine load (electrical load, half-clutch on M/T model, drive position A/T model).
  - 6) Raise the vehicle on a hoist and hit a tire with a rubber hammer.
- Drive the vehicle and attempt to duplicate the conditions the customer states exist when the noise occurs.
  - If it is difficult to duplicate the noise, drive the vehicle slowly on an undulating or rough road to stress the vehicle body.

## CHECK RELATED SERVICE BULLETINS

After verifying the customer concern or symptom, check ASIST for Technical Service Bulletins (TSBs) related to that concern or symptom.

If a TSB relates to the symptom, follow the procedure to repair the noise.

## LOCATE THE NOISE AND IDENTIFY THE ROOT CAUSE

1. Narrow down the noise to a general area. To help pinpoint the source of the noise, use a listening tool (Chassis Ear: J-39570, Engine Ear and mechanics stethoscope).
2. Narrow down the noise to a more specific area and identify the cause of the noise by:
  - removing the components in the area that you suspect the noise is coming from.  
Do not use too much force when removing clips and fasteners, otherwise clips and fastener can be broken or lost during the repair, resulting in the creation of new noise.
  - tapping or pushing/pulling the component that you suspect is causing the noise.  
Do not tap or push/pull the component with excessive force, otherwise the noise will be eliminated only temporarily.
  - feeling for a vibration with your hand by touching the component(s) that you suspect is (are) causing the noise.
  - placing a piece of paper between components that you suspect are causing the noise.
  - looking for loose components and contact marks.  
Refer to [RF-28. "Inspection Procedure"](#).

## REPAIR THE CAUSE

- If the cause is a loose component, tighten the component securely.
- If the cause is insufficient clearance between components:
  - separate components by repositioning or loosening and retightening the component, if possible.
  - insulate components with a suitable insulator such as urethane pads, foam blocks, felt cloth tape or urethane tape. A Nissan Squeak and Rattle Kit (J-43980) is available through your authorized Nissan Parts Department.

### **CAUTION:**

**Do not use excessive force as many components are constructed of plastic and may be damaged.**

### **NOTE:**

Always check with the Parts Department for the latest parts information.

The following materials are contained in the Nissan Squeak and Rattle Kit (J-43980). Each item can be ordered separately as needed.

URETHANE PADS [1.5 mm (0.059 in) thick]

Insulates connectors, harness, etc.

76268-9E005: 100 × 135 mm (3.94 × 5.31 in)/76884-71L01: 60 × 85 mm (2.36 × 3.35 in)/76884-71L02: 15 × 25 mm (0.59 × 0.98 in)

INSULATOR (Foam blocks)

Insulates components from contact. Can be used to fill space behind a panel.

73982-9E000: 45 mm (1.77 in) thick, 50 × 50 mm (1.97 × 1.97 in)/73982-

50Y00: 10 mm (0.39 in) thick, 50 × 50 mm (1.97 × 1.97 in)

INSULATOR (Light foam block)

80845-71L00: 30 mm (1.18 in) thick, 30 × 50 mm (1.18 × 1.97 in)

FELT CLOTHTAPE

Used to insulate where movement does not occur. Ideal for instrument panel applications.

68370-4B000: 15 × 25 mm (0.59 × 0.98 in) pad/68239-13E00: 5 mm (0.20 in) wide tape roll

The following materials, not found in the kit, can also be used to repair squeaks and rattles.

UHMW (TEFLON) TAPE

# SQUEAK AND RATTLE TROUBLE DIAGNOSES

## < SYMPTOM DIAGNOSIS >

---

Insulates where slight movement is present. Ideal for instrument panel applications.

### SILICONE GREASE

Used in place of UHMW tape that will be visible or not fit. Will only last a few months.

### SILICONE SPRAY

Use when grease cannot be applied.

### DUCT TAPE

Use to eliminate movement.

## CONFIRM THE REPAIR

Confirm that the cause of a noise is repaired by test driving the vehicle. Operate the vehicle under the same conditions as when the noise originally occurred. Refer to the notes on the Diagnostic Worksheet.

## Inspection Procedure

INFOID:000000001531054

Refer to Table of Contents for specific component removal and installation information.

## INSTRUMENT PANEL

Most incidents are caused by contact and movement between:

1. The cluster lid A and instrument panel
2. Acrylic lens and combination meter housing
3. Instrument panel to front pillar garnish
4. Instrument panel to windshield
5. Instrument panel mounting pins
6. Wiring harnesses behind the combination meter
7. A/C defroster duct and duct joint

These incidents can usually be located by tapping or moving the components to duplicate the noise or by pressing on the components while driving to stop the noise. Most of these incidents can be repaired by applying felt cloth tape or silicon spray (in hard to reach areas). Urethane pads can be used to insulate wiring harness.

### **CAUTION:**

**Do not use silicone spray to isolate a squeak or rattle. If you saturate the area with silicone, you will not be able to recheck the repair.**

## CENTER CONSOLE

Components to pay attention to include:

1. Shifter assembly cover to finisher
2. A/C control unit and cluster lid C
3. Wiring harnesses behind audio and A/C control unit

The instrument panel repair and isolation procedures also apply to the center console.

## DOORS

Pay attention to the:

1. Finisher and inner panel making a slapping noise
2. Inside handle escutcheon to door finisher
3. Wiring harnesses tapping
4. Door striker out of alignment causing a popping noise on starts and stops

Tapping or moving the components or pressing on them while driving to duplicate the conditions can isolate many of these incidents. You can usually insulate the areas with felt cloth tape or insulator foam blocks from the Nissan Squeak and Rattle Kit (J-43980) to repair the noise.

## TRUNK

Trunk noises are often caused by a loose jack or loose items put into the trunk by the owner.

In addition look for:

1. Trunk lid dumpers out of adjustment
2. Trunk lid striker out of adjustment
3. The trunk lid torsion bars knocking together
4. A loose license plate or bracket

# SQUEAK AND RATTLE TROUBLE DIAGNOSES

## < SYMPTOM DIAGNOSIS >

Most of these incidents can be repaired by adjusting, securing or insulating the item(s) or component(s) causing the noise.

### SUNROOF/HEADLINING

Noises in the sunroof/headlining area can often be traced to one of the following:

1. Sunroof lid, rail, linkage or seals making a rattle or light knocking noise
2. Sunvisor shaft shaking in the holder
3. Front or rear windshield touching headlining and squeaking

Again, pressing on the components to stop the noise while duplicating the conditions can isolate most of these incidents. Repairs usually consist of insulating with felt cloth tape.

### SEATS

When isolating seat noise it's important to note the position the seat is in and the load placed on the seat when the noise is present. These conditions should be duplicated when verifying and isolating the cause of the noise.

Cause of seat noise include:

1. Headrest rods and holder
2. A squeak between the seat pad cushion and frame
3. The rear seatback lock and bracket

These noises can be isolated by moving or pressing on the suspected components while duplicating the conditions under which the noise occurs. Most of these incidents can be repaired by repositioning the component or applying urethane tape to the contact area.

### UNDERHOOD

Some interior noise may be caused by components under the hood or on the engine wall. The noise is then transmitted into the passenger compartment.

Causes of transmitted underhood noise include:

1. Any component mounted to the engine wall
2. Components that pass through the engine wall
3. Engine wall mounts and connectors
4. Loose radiator mounting pins
5. Hood bumpers out of adjustment
6. Hood striker out of adjustment

These noises can be difficult to isolate since they cannot be reached from the interior of the vehicle. The best method is to secure, move or insulate one component at a time and test drive the vehicle. Also, engine RPM or load can be changed to isolate the noise. Repairs can usually be made by moving, adjusting, securing, or insulating the component causing the noise.

A  
B  
C  
D  
E  
F  
G  
H  
I  
J  
RF  
L  
M  
N  
O  
P

# SQUEAK AND RATTLE TROUBLE DIAGNOSES

< SYMPTOM DIAGNOSIS >

## Diagnostic Worksheet

INFOID:000000001531055

Dear Customer:

We are concerned about your satisfaction with your vehicle. Repairing a squeak or rattle sometimes can be very difficult. To help us fix your vehicle right the first time, please take a moment to note the area of the vehicle where the squeak or rattle occurs and under what conditions. You may be asked to take a test drive with a service advisor or technician to ensure we confirm the noise you are hearing.

### SQUEAK & RATTLE DIAGNOSTIC WORKSHEET

#### I. WHERE DOES THE NOISE COME FROM? (circle the area of the vehicle)

The illustrations are for reference only, and may not reflect the actual configuration of your vehicle.

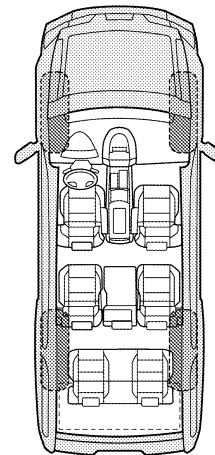
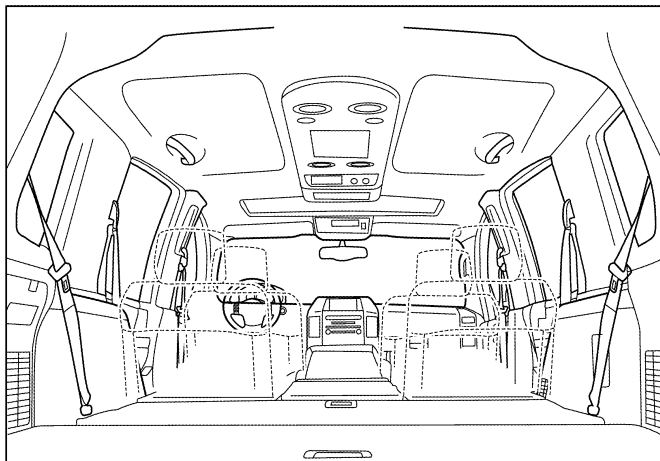
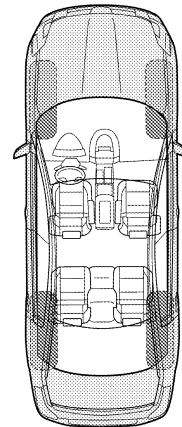
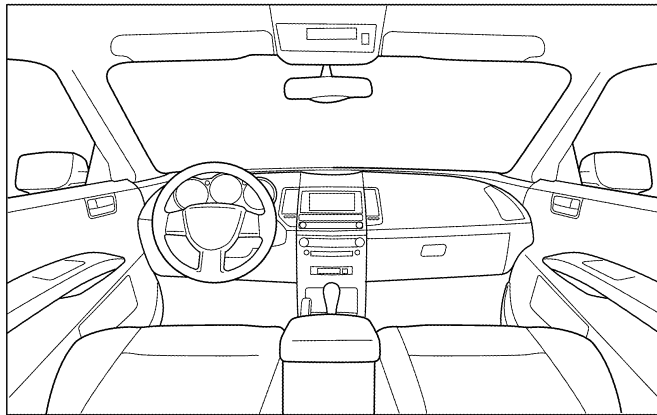

Continue to page 2 of the worksheet and briefly describe the location of the noise or rattle. In addition, please indicate the conditions which are present when the noise occurs.

# SQUEAK AND RATTLE TROUBLE DIAGNOSES

< SYMPTOM DIAGNOSIS >

## SQUEAK & RATTLE DIAGNOSTIC WORKSHEET - page 2

Briefly describe the location where the noise occurs:

---

---

### II. WHEN DOES IT OCCUR? (please check the boxes that apply)

- |   |  |
|---|--|
| <input type="checkbox"/> Anytime                      | <input type="checkbox"/> After sitting out in the rain |
| <input type="checkbox"/> 1st time in the morning      | <input type="checkbox"/> When it is raining or wet     |
| <input type="checkbox"/> Only when it is cold outside | <input type="checkbox"/> Dry or dusty conditions       |
| <input type="checkbox"/> Only when it is hot outside  | <input type="checkbox"/> Other:                        |

### III. WHEN DRIVING:

- Through driveways
- Over rough roads
- Over speed bumps
- Only about \_\_\_\_ mph
- On acceleration
- Coming to a stop
- On turns: left, right or either (circle)
- With passengers or cargo
- Other: \_\_\_\_\_
- After driving \_\_\_\_ miles or \_\_\_\_ minutes

### IV. WHAT TYPE OF NOISE

- Squeak (like tennis shoes on a clean floor)
- Creak (like walking on an old wooden floor)
- Rattle (like shaking a baby rattle)
- Knock (like a knock at the door)
- Tick (like a clock second hand)
- Thump (heavy muffled knock noise)
- Buzz (like a bumble bee)

### TO BE COMPLETED BY DEALERSHIP PERSONNEL

#### Test Drive Notes:

---

---

---

	YES	NO	Initials of person performing
Vehicle test driven with customer	<input type="checkbox"/>	<input type="checkbox"/>	_____
- Noise verified on test drive	<input type="checkbox"/>	<input type="checkbox"/>	_____
- Noise source located and repaired	<input type="checkbox"/>	<input type="checkbox"/>	_____
- Follow up test drive performed to confirm repair	<input type="checkbox"/>	<input type="checkbox"/>	_____

VIN: \_\_\_\_\_ Customer Name \_\_\_\_\_

W.O.# \_\_\_\_\_ Date: \_\_\_\_\_

This form must be attached to Work Order

LAI A0071E

A  
B  
C  
D  
E  
F  
G  
H  
I  
J  
RF  
L  
M  
N  
O  
P

# PRECAUTIONS

< PRECAUTION >

## PRECAUTION

### PRECAUTIONS

#### Precaution for Supplemental Restraint System (SRS) "AIR BAG" and "SEAT BELT PRE-TENSIONER"

INFOID:000000001536794

The Supplemental Restraint System such as "AIR BAG" and "SEAT BELT PRE-TENSIONER", used along with a front seat belt, helps to reduce the risk or severity of injury to the driver and front passenger for certain types of collision. This system includes seat belt switch inputs and dual stage front air bag modules. The SRS system uses the seat belt switches to determine the front air bag deployment, and may only deploy one front air bag, depending on the severity of a collision and whether the front occupants are belted or unbelted. Information necessary to service the system safely is included in the SR and SB section of this Service Manual.

#### **WARNING:**

- **To avoid rendering the SRS inoperative, which could increase the risk of personal injury or death in the event of a collision which would result in air bag inflation, all maintenance must be performed by an authorized NISSAN/INFINITI dealer.**
- **Improper maintenance, including incorrect removal and installation of the SRS, can lead to personal injury caused by unintentional activation of the system. For removal of Spiral Cable and Air Bag Module, see the SR section.**
- **Do not use electrical test equipment on any circuit related to the SRS unless instructed to in this Service Manual. SRS wiring harnesses can be identified by yellow and/or orange harnesses or harness connectors.**

#### Precaution

INFOID:000000001536795

- Disconnect both battery cables in advance.
- Never tamper with or force air bag lid open, as this may adversely affect air bag performance.
- Be careful not to scratch pad and other parts.
- When removing or disassembling any part, be careful not to damage or deform it. Protect parts which may get in the way with cloth.
- When removing parts with a screwdriver or other tool, protect parts by wrapping them with vinyl or tape.
- Keep removed parts protected with cloth.
- If a clip is deformed or damaged, replace it.
- If an un reusable part is removed, replace it with a new one.
- Tighten bolts and nuts firmly to the specified torque.
- After re-assembly has been completed, make sure each part functions correctly.
- Remove stains in the following way.

#### Water-soluble stains:

Dip a soft cloth in warm water, and then squeeze it tightly. After wiping the stain, wipe with a soft dry cloth.

#### Oil stain:

Dissolve a synthetic detergent in warm water (density of 2 to 3% or less), dip the cloth, then clean off the stain with the cloth. Next, dip the cloth in fresh water and squeeze it tightly. Then clean off the detergent completely. Then wipe the area with a soft dry cloth.

- Do not use any organic solvent, such as thinner or benzine.



# PREPARATION

< PREPARATION >

## PREPARATION

### PREPARATION

#### Special Service Tool

INFOID:000000001536796

The actual shapes of Kent-Moore tools may differ from those of special service tools illustrated here.

Tool number (Kent-Moore No.) Tool name	Description
— (J-39570) Chassis ear	Locating the noise
— (J-43980) NISSAN Squeak and Rattle Kit	Repairing the cause of noise

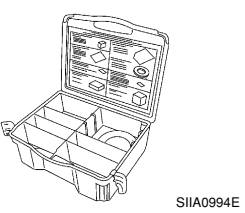
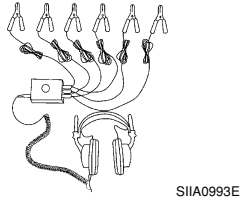

#### Commercial Service Tool

INFOID:000000001536797

(Kent-Moore No.) Tool name	Description
(J-39565) Engine ear	Locating the noise

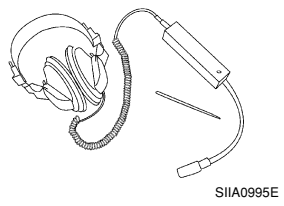

# SUNROOF SYSTEM

< ON-VEHICLE REPAIR >

## ON-VEHICLE REPAIR

### SUNROOF SYSTEM

#### Inspection

INFOID:000000001536798

#### WIND DEFLECTOR

1. Open glass lid assembly fully.
2. Visually check for proper installation, damaged/deteriorated components, or foreign objects within mechanism. Correct as required for smooth operation.
3. Check for grease at the wind deflector arm (1) and pivot areas. If necessary, apply a sufficient amount of grease for non-binding operation.

←:Vehicle front

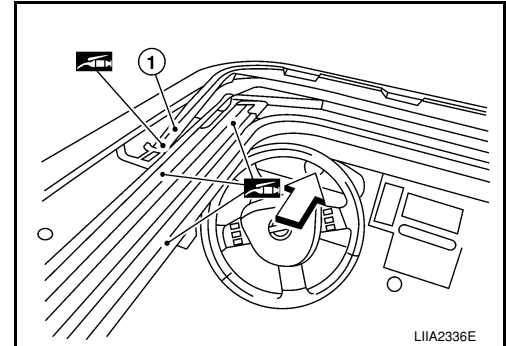

4. Check that the wind deflector (1) moves freely within the sunroof unit assembly while manually pressing down and releasing. If a malfunction is detected, remove the sunroof unit assembly and visually inspect. If damage is found, replace either wind deflector (1) or sunroof unit assembly as required.

←:Vehicle front

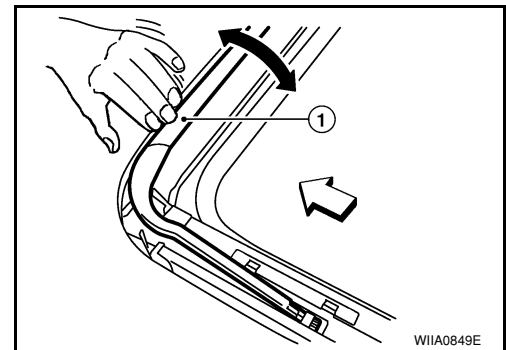

#### WEATHERSTRIP

Visually check weatherstrip for any damage, deterioration, or flattening.

- In the case of leakage around glass lid, close glass lid and pour water around it to find the damaged or gaped portion, remove glass lid assembly.
- If any damage is found, replace glass lid assembly.

#### **CAUTION:**

**Do not remove the weatherstrip.**

#### LINK AND WIRE ASSEMBLY

##### **NOTE:**

Before replacing any suspect part, carefully ensure it is the source of the noise being experienced.

1. Visually check to determine if a sufficient amount of petroleum jelly has been applied to the wire or rail groove. If not, add petroleum jelly as required.
2. Check wire for any damage or deterioration. If any damage is found, remove rear guide, then replace wire.

#### DRAIN HOSES

# SUNROOF SYSTEM

## < ON-VEHICLE REPAIR >

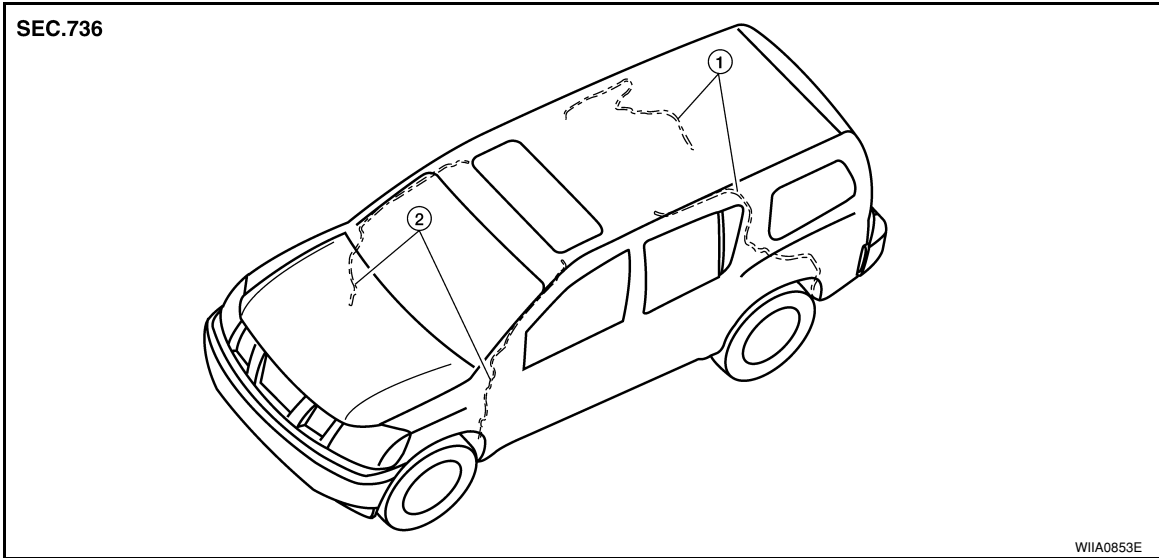

1. Rear drain hoses
2. Front drain hoses

### Removal

1. Remove the headlining. Refer to [INT-16, "Removal and Installation"](#).
2. Visually check the drain hoses for proper connections, damage or deterioration.

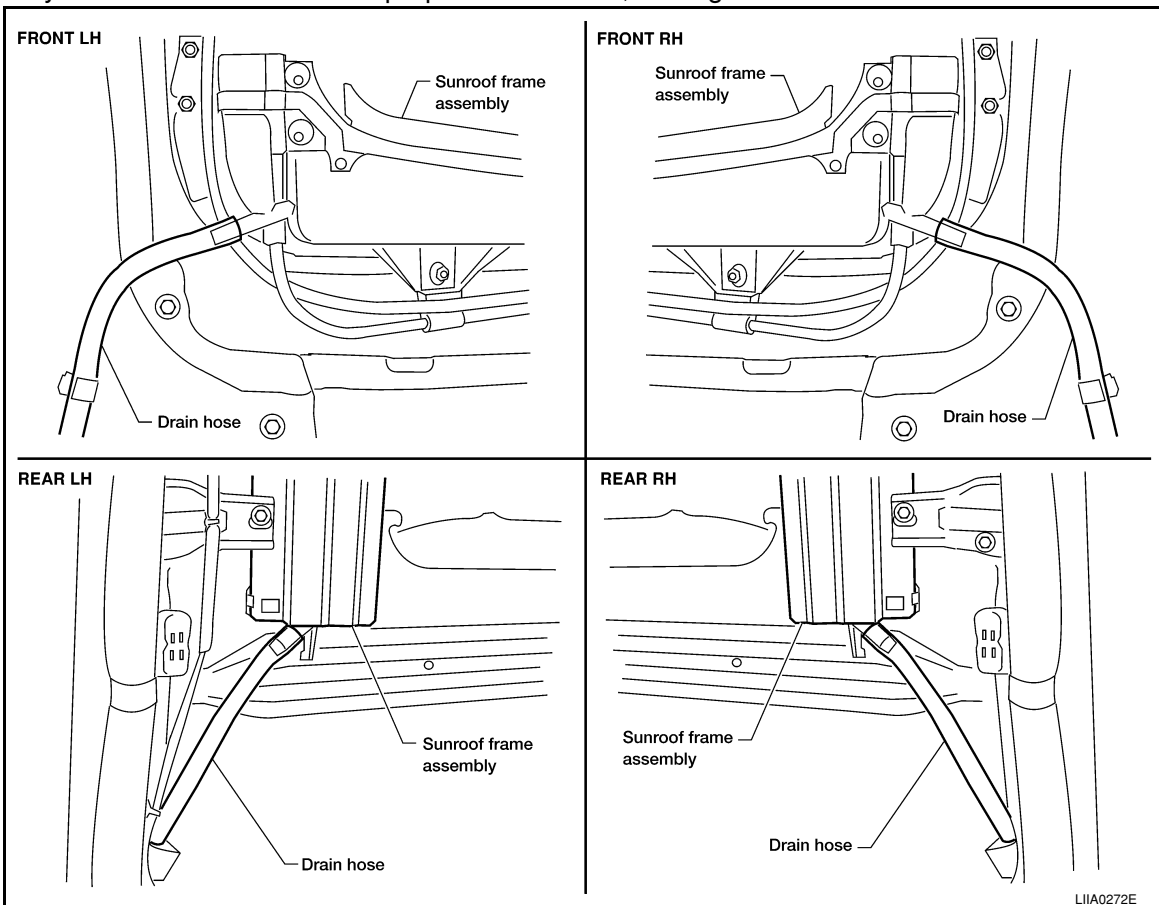

3. Remove each drain hose and check visually for damage, cracks or deterioration.
  - Pour water through the drain hose to check for damage.If any damage is found, replace the drain hose.

### Installation

Installation is in the reverse order of removal.

# SUNROOF SYSTEM

< ON-VEHICLE REPAIR >

## GAP ADJUSTMENT

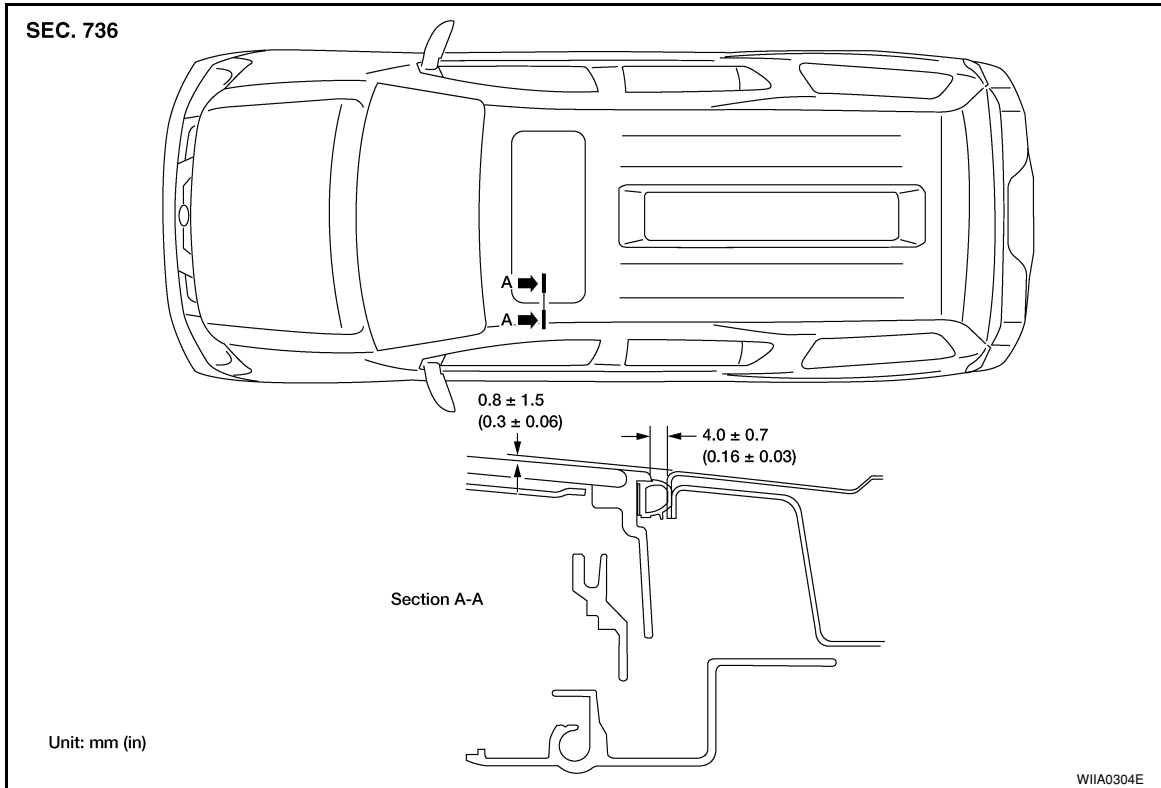

### NOTE:

If any gap or height difference between glass lid and roof panel is found, check glass lid fit and adjust as follows:

1. Open sunshade assembly.
2. Loosen glass lid securing screws (two each on left and right sides), then tilt glass lid down.
3. Manually adjust glass lid from outside of vehicle so it resembles "A - A" as shown.
4. After adjusting glass lid tilt glass lid up and tighten screws.
5. Tilt glass lid up and down several times to check that it moves smoothly.

### HEIGHT DIFFERENCE ADJUSTMENT

If an excessive height difference between glass lid assembly and roof panel is found, adjust in the following manner:

1. Remove headlining. Refer to [INT-16. "Removal and Installation"](#).
2. Loosen sunroof frame assembly nuts and sunroof bracket bolts.
3. Add shims until gap is within specification "A-A".

### NOTE:

Temporarily snug nuts and bolts to prevent movement between each adjustment.

4. Tilt glass lid assembly up and down several times to check that it moves and seals properly.
5. Tighten sunroof frame assembly nuts and sunroof bracket bolts.

### NOTE:

First tighten left front then right rear sunroof frame assembly to prevent uneven torque while tightening remaining sunroof bracket bolts.

6. Install headlining. Refer to [INT-16. "Removal and Installation"](#).

# SUNROOF SYSTEM

< ON-VEHICLE REPAIR >

## Exploded View

INFOID:000000001536799

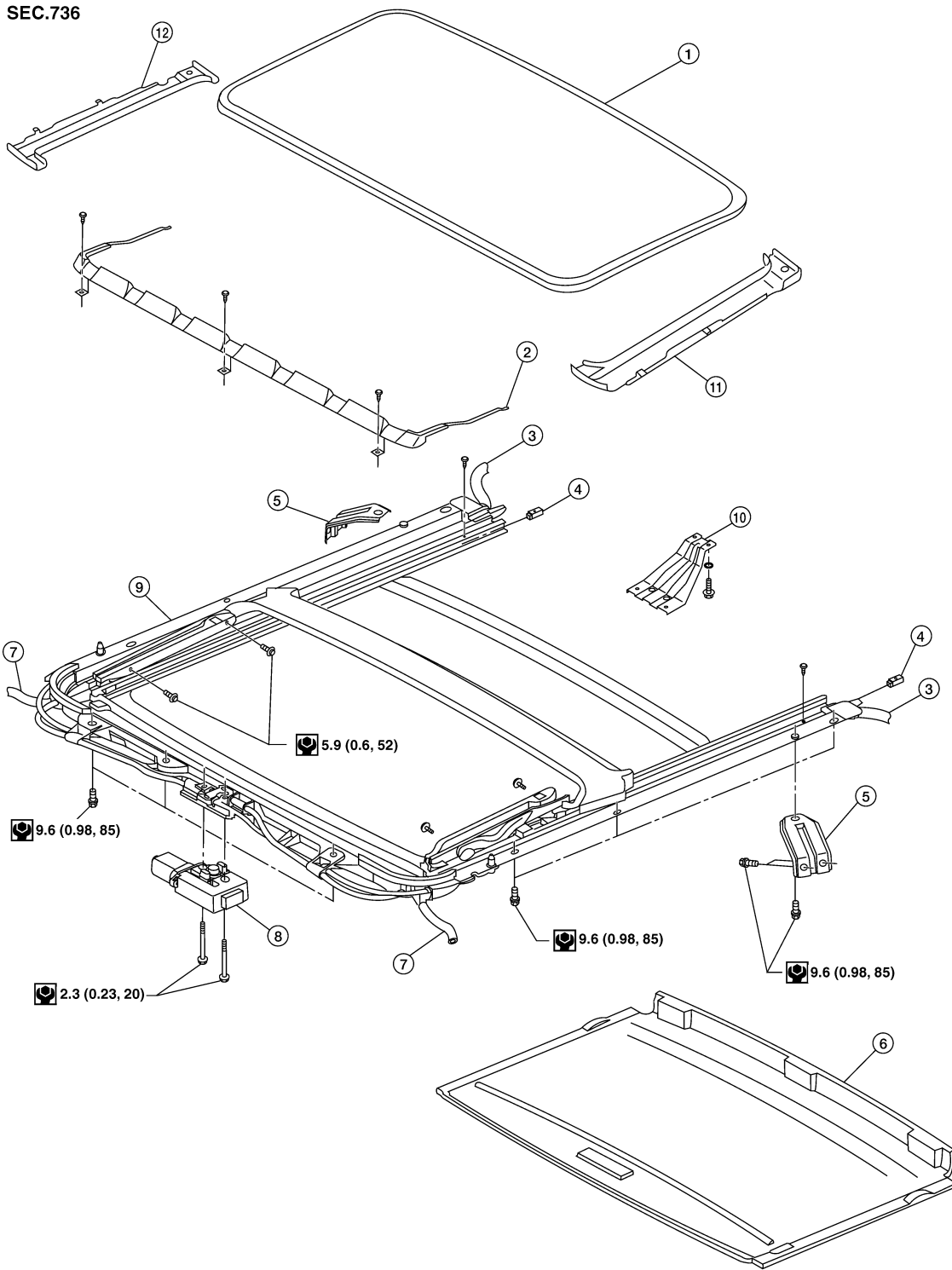

: N·m (kg·m, in·lb)

- |                              |                           |                           |
|------------------------------|---------------------------|---------------------------|
| 1. Glass lid assembly        | 2. Wind deflector         | 3. Rear drain hoses       |
| 4. Shade stoppers            | 5. Sunroof bracket        | 6. Sunshade assembly      |
| 7. Front drain hoses         | 8. Sunroof motor assembly | 9. Sunroof frame assembly |
| 10. Overhead console bracket | 11. Side cover LH         | 12. Side cover RH         |

WIIA0657E

A  
B  
C  
D  
E  
F  
G  
H  
I  
J  
RF  
L  
M  
N  
O  
P

# SUNROOF SYSTEM

< ON-VEHICLE REPAIR >

## CAUTION:

- Always work with a helper.
- Before removal, fully close the glass lid assembly. Then, after removal, do not move the motor assembly.
- After installing the sunroof and glass lid, check gap adjustment to ensure there is no malfunction.

## NOTE:

- After any adjustment, check sunroof operation and glass lid alignment.
- Handle glass lid with care so not to cause damage.
- For easier installation, mark each point before removal.

## Removal and Installation

INFOID:000000001536800

### SUNROOF UNIT

## CAUTION:

- Always work with a helper.
- When taking sunroof unit out, use shop cloths to protect the seats and trim from damage.
- After installing the sunroof unit and glass lid, be sure to check gap adjustment to ensure there is no malfunction.

### Removal

1. Remove headlining. Refer to [INT-16. "Removal and Installation"](#).
2. Remove the sunroof glass lid. Refer to [RF-38. "Removal and Installation"](#).
3. Remove overhead console bracket.
4. Disconnect the drain hoses.
5. Remove front sunroof bolts.
6. Remove rear sunroof bracket bolts.
7. Remove the side bolts and the sunroof unit.

### Installation

1. Position the sunroof frame assembly and install the side bolts.
2. Install the rear brackets.
3. Install the front sunroof frame assembly bolts.
4. Connect drain hoses.
5. Install the overhead console bracket.
6. Install the sunroof glass lid. Refer to [RF-38. "Removal and Installation"](#).
7. Install headlining. Refer to [INT-16. "Removal and Installation"](#).

### GLASS LID

#### Removal

1. Open sunshade.
2. Ensure glass lid is closed.
3. Remove side cover LH and RH.
4. Remove the screws securing glass lid to the sunroof frame assembly.
5. Remove the glass lid assembly.

#### NOTE:

- After any adjustment, check sunroof operation and glass lid alignment.
- Handle glass lid with care so not to cause damage.
- For easier installation, mark each point before removal.

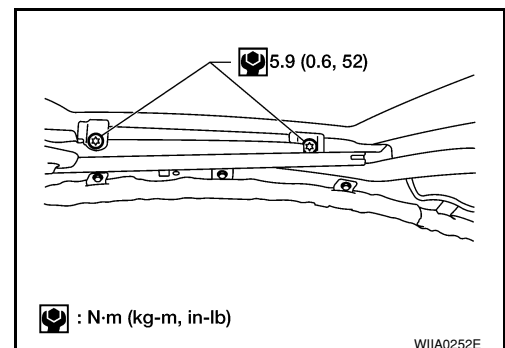

#### Installation

1. Position glass lid to sunroof assembly.

# SUNROOF SYSTEM

## < ON-VEHICLE REPAIR >

2. Install the glass lid assembly screws. (First tighten left front bolt, then tighten right rear bolt on glass lid to prevent lid from moving while tightening other bolts.)
3. Adjust the glass lid assembly. Refer to [RF-34. "Inspection"](#)
4. Install side cover LH and RH.

## WIND DEFLECTOR

### Removal

1. Open the sunroof.
2. Remove screws from the left, center, and right side wind deflector holders.
3. Remove the wind deflector from the sunroof frame assembly.

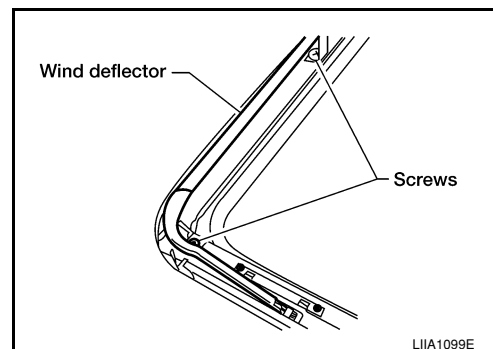

### Installation

Installation is in the reverse order of removal.

## SUNSHADE

### Removal

1. Remove the sunroof frame assembly. Refer to [RF-37. "Exploded View"](#).
2. Remove the sunshade stoppers (2 points) from the rear end of the sunroof frame assembly.
3. Remove the sunshade assembly from the rear end of the sunroof frame assembly.

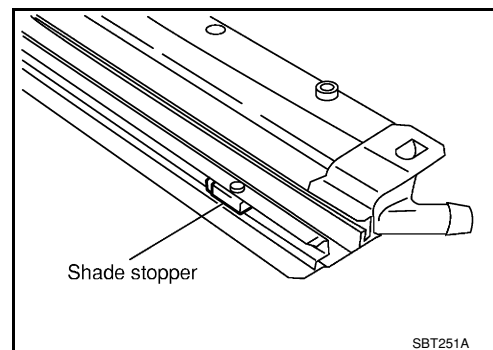

### Installation

Installation is in the reverse order of removal.

## SUNROOF MOTOR

### Removal

#### CAUTION:

- When removing the sunroof motor, be sure to place the link and wire assembly in the symmetrical and fully closed position.
  - Never run the removed motor as a single unit.
1. Position the sunroof assembly in the fully closed position.
  2. Disconnect the negative battery cable.
  3. Remove the roof console assembly. Refer to [INT-16. "Removal and Installation"](#).

# SUNROOF SYSTEM

## < ON-VEHICLE REPAIR >

4. Disconnect the sunroof motor harness connector (2).
5. Remove the sunroof motor screws (3), then remove the sunroof motor (1).

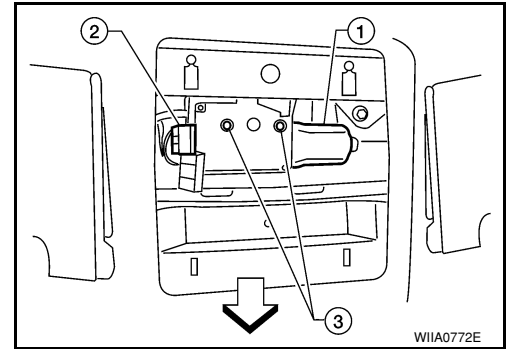

### Installation

#### **CAUTION:**

**Before installing the sunroof motor assembly, be sure to place the link and wire assembly in the symmetrical and fully closed position.**

- ←: Vehicle front

1. Move the sunroof motor (1) laterally little by little so that the gear is completely engaged into the wire on the sunroof unit and the installation surface becomes parallel. Then, secure the motor with screws (3).
2. Connect the wire harness connector (2) to the sunroof motor (1).
3. Install the roof console assembly. Refer to [INT-16, "Removal and Installation"](#).
4. Reset the sunroof motor memory. Refer to [RF-5, "ADDITIONAL SERVICE WHEN REPLACING CONTROL UNIT : Special Repair Requirement"](#)

