

SECTION **SEC**

SECURITY CONTROL SYSTEM

CONTENTS

WITH INTELLIGENT KEY SYSTEM	COMMON ITEM	20	A
BASIC INSPECTION	COMMON ITEM : CONSULT-III Function (BCM -		B
	COMMON ITEM)	20	C
DIAGNOSIS AND REPAIR WORKFLOW	IMMU	20	D
Work Flow	IMMU : CONSULT-III Function (BCM - IMMU)	21	E
INSPECTION AND ADJUSTMENT	THEFT ALM	21	F
ADDITIONAL SERVICE WHEN REPLACING	THEFT ALM : CONSULT-III Function (BCM -		G
CONTROL UNIT	THEFT ALM)	21	H
ADDITIONAL SERVICE WHEN REPLACING	DIAGNOSIS SYSTEM (INTELLIGENT KEY		I
CONTROL UNIT : Special Repair Requirement	UNIT)	22	J
	CONSULT-III Function (INTELLIGENT KEY)	22	
ECM RE-COMMUNICATING FUNCTION	COMPONENT DIAGNOSIS	24	
ECM RE-COMMUNICATING FUNCTION : De-	U1000 CAN COMM CIRCUIT	24	
scription	Description	24	
ECM RE-COMMUNICATING FUNCTION : Spe-	DTC Logic	24	
cial Repair Requirement	Diagnosis Procedure	24	
FUNCTION DIAGNOSIS	U1010 CONTROL UNIT (CAN)	25	
	Description	25	
INTELLIGENT KEY SYSTEM/ENGINE	DTC Logic	25	
START FUNCTION	Diagnosis Procedure	25	
System Diagram	Special Repair Requirement	25	
System Description	B2013 ID DISCORD I-KEY-STRG	26	
Component Parts Location	Description	26	
Component Description	DTC Logic	26	
NVIS (NISSAN VEHICLE IMMOBILIZER SYS-	Diagnosis Procedure	26	
TEM-NATS)	B2190, P1614 NATS ANTENNA AMP.	29	
System Diagram	Description	29	
System Description	DTC Logic	29	
Component Parts Location	Diagnosis Procedure	29	
Component Description	B2191, P1615 DIFFERENCE OF KEY	32	
VEHICLE SECURITY SYSTEM	Description	32	
System Diagram	DTC Logic	32	
System Description	Diagnosis Procedure	32	
Component Parts Location			
Component Description			
DIAGNOSIS SYSTEM (BCM)			

SEC

B2192, P1611 ID DISCORD, IMMU-ECM	33	Wiring Diagram - NVIS	69
Description	33	Fail Safe	77
DTC Logic	33	DTC Inspection Priority Chart	78
Diagnosis Procedure	33	DTC Index	78
B2193, P1612 CHAIN OF ECM-IMMU	35	INTELLIGENT KEY UNIT	80
Description	35	Reference Value - Intelligent Key Unit	80
DTC Logic	35	Wiring Diagram - INTELLIGENT KEY SYSTEM/ ENGINE START FUNCTION -	83
Diagnosis Procedure	35	Fail Safe	95
B2194 ID DISCORD IMMU-I-KEY	36	DTC Inspection Priority Chart	95
Description	36	DTC Index	95
DTC Logic	36	IPDM E/R (INTELLIGENT POWER DISTRI- BUTION MODULE ENGINE ROOM)	96
Diagnosis Procedure	36	Reference Value	96
B2552 INTELLIGENT KEY	37	Terminal Layout	98
Description	37	Physical Values	98
DTC Logic	37	Fail Safe	102
Diagnosis Procedure	37	DTC Index	103
Special Repair Requirement	37	SYMPTOM DIAGNOSIS	104
B2590 ID DISCORD BCM-I-KEY	38	INTELLIGENT KEY SYSTEM/ENGINE START FUNCTION SYMPTOMS	104
Description	38	Symptom Table	104
DTC Logic	38	VEHICLE SECURITY SYSTEM SYMPTOMS ..	105
Diagnosis Procedure	38	Symptom Table	105
P1610 LOCK MODE	39	NISSAN VEHICLE IMMOBILIZER SYSTEM- NATS SYMPTOMS	106
Description	39	Symptom Table	106
DTC Logic	39	ON-VEHICLE MAINTENANCE	107
Diagnosis Procedure	39	PRE-INSPECTION FOR DIAGNOSTIC	107
POWER SUPPLY AND GROUND CIRCUIT	40	Basic Inspection	107
INTELLIGENT KEY UNIT	40	Vehicle Security Operation Check	107
INTELLIGENT KEY UNIT : Diagnosis Procedure...	40	ON-VEHICLE REPAIR	109
BCM	40	INTELLIGENT KEY UNIT	109
BCM : Diagnosis Procedure	40	Removal and Installation	109
KEY CYLINDER SWITCH	42	WITHOUT INTELLIGENT KEY SYSTEM	
Description	42	BASIC INSPECTION	111
Component Function Check	42	DIAGNOSIS AND REPAIR WORKFLOW	111
Diagnosis Procedure	42	Work Flow	111
IGNITION KNOB SWITCH	44	INSPECTION AND ADJUSTMENT	114
Ignition Knob Switch Check	44	ADDITIONAL SERVICE WHEN REPLACING CONTROL UNIT	114
HORN FUNCTION	46	ADDITIONAL SERVICE WHEN REPLACING CONTROL UNIT : Special Repair Requirement ..	114
Symptom Table	46	ECM RE-COMMUNICATING FUNCTION	114
VEHICLE SECURITY INDICATOR	47	ECM RE-COMMUNICATING FUNCTION : De- scription	114
Description	47		
Component Function Check	47		
Diagnosis Procedure	47		
ECU DIAGNOSIS	49		
BCM (BODY CONTROL MODULE)	49		
Reference Value	49		
Terminal Layout	52		
Physical Values	52		
Wiring Diagram - VEHICLE SECURITY SYSTEM..	58		

ECM RE-COMMUNICATING FUNCTION : Special Repair Requirement	114	Diagnosis Procedure	131
FUNCTION DIAGNOSIS	115	P1610 LOCK MODE	132
NVIS (NISSAN VEHICLE IMMOBILIZER SYSTEM-NATS)	115	Description	132
System Diagram	115	DTC Logic	132
System Description	115	Diagnosis Procedure	132
Component Parts Location	116	POWER SUPPLY AND GROUND CIRCUIT ..	133
Component Description	117	BCM	133
VEHICLE SECURITY SYSTEM	118	BCM : Diagnosis Procedure	133
System Diagram	118	KEY CYLINDER SWITCH	134
System Description	118	Description	134
Component Parts Location	119	Component Function Check	134
Component Description	120	Diagnosis Procedure	134
DIAGNOSIS SYSTEM (BCM)	121	HORN FUNCTION	136
COMMON ITEM	121	Symptom Table	136
COMMON ITEM : CONSULT-III Function (BCM - COMMON ITEM)	121	VEHICLE SECURITY INDICATOR	137
IMMU	121	Description	137
IMMU : CONSULT-III Function (BCM - IMMU)	122	Component Function Check	137
THEFT ALM	122	Diagnosis Procedure	137
THEFT ALM : CONSULT-III Function (BCM - THEFT ALM)	122	ECU DIAGNOSIS	139
COMPONENT DIAGNOSIS	123	BCM (BODY CONTROL MODULE)	139
U1000 CAN COMM CIRCUIT	123	Reference Value	139
Description	123	Terminal Layout	142
DTC Logic	123	Physical Values	142
Diagnosis Procedure	123	Wiring Diagram - VEHICLE SECURITY SYSTEM.	148
U1010 CONTROL UNIT (CAN)	124	Wiring Diagram - NVIS -	159
Description	124	Fail Safe	165
DTC Logic	124	DTC Inspection Priority Chart	166
Diagnosis Procedure	124	DTC Index	166
Special Repair Requirement	124	IPDM E/R (INTELLIGENT POWER DISTRIBUTION MODULE ENGINE ROOM)	168
B2190, P1614 NATS ANTENNA AMP.	125	Reference Value	168
Description	125	Terminal Layout	170
DTC Logic	125	Physical Values	170
Diagnosis Procedure	125	Fail Safe	174
B2191, P1615 DIFFERENCE OF KEY	128	DTC Index	175
Description	128	SYMPTOM DIAGNOSIS	176
DTC Logic	128	VEHICLE SECURITY SYSTEM SYMPTOMS .	176
Diagnosis Procedure	128	Symptom Table	176
B2192, P1611 ID DISCORD, IMMU-ECM	129	NISSAN VEHICLE IMMOBILIZER SYSTEM-NATS SYMPTOMS	177
Description	129	Symptom Table	177
DTC Logic	129	ON-VEHICLE MAINTENANCE	178
Diagnosis Procedure	129	PRE-INSPECTION FOR DIAGNOSTIC	178
B2193, P1612 CHAIN OF ECM-IMMU	131	Basic Inspection	178
Description	131	ON-VEHICLE REPAIR	179
DTC Logic	131	VEHICLE SECURITY SYSTEM	179

A
B
C
D
E
F
G
H
I
J
L
M
N
O
P

SEC

DIAGNOSIS AND REPAIR WORKFLOW

< BASIC INSPECTION >

[WITH INTELLIGENT KEY SYSTEM]

BASIC INSPECTION

DIAGNOSIS AND REPAIR WORKFLOW

Work Flow

INFOID:000000003710541

OVERALL SEQUENCE

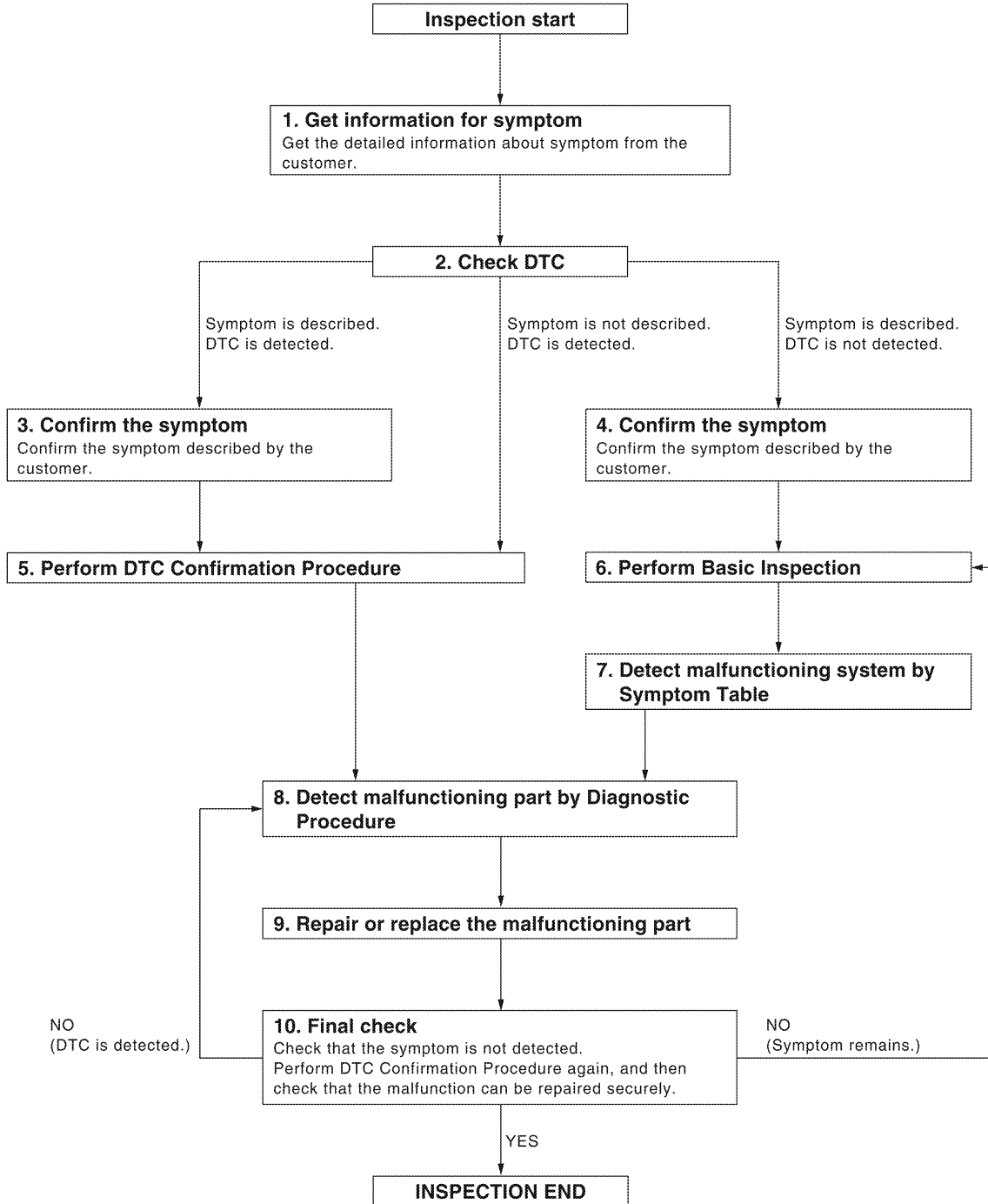

DETAILED FLOW

A
B
C
D
E
F
G
H
I
J
L
M
N
O
P

SEC

DIAGNOSIS AND REPAIR WORKFLOW

< BASIC INSPECTION >

[WITH INTELLIGENT KEY SYSTEM]

1.GET INFORMATION FOR SYMPTOM

Get the detailed information from the customer about the symptom (the condition and the environment when the incident/malfunction occurred).

>> GO TO 2.

2.CHECK DTC

1. Check DTC for Intelligent Key unit and BCM.
2. Perform the following procedure if DTC is displayed.
 - Erase DTC.
 - Study the relationship between the cause detected by DTC and the symptom described by the customer.
3. Check related service bulletins for information.

Is any symptom described and any DTC detected?

- Symptom is described, DTC is displayed>>GO TO 3.
- Symptom is described, DTC is not displayed>>GO TO 4.
- Symptom is not described, DTC is displayed>>GO TO 5.

3.CONFIRM THE SYMPTOM

Confirm the symptom described by the customer.
Connect CONSULT-III to the vehicle in "DATA MONITOR" mode and check real-time diagnosis results.
Verify relation between the symptom and the condition when the symptom is detected.

>> GO TO 5.

4.CONFIRM THE SYMPTOM

Confirm the symptom described by the customer.
Connect CONSULT-III to the vehicle in "DATA MONITOR" mode and check real-time diagnosis results.
Verify relation between the symptom and the condition when the symptom is detected.

>> GO TO 6.

5.PERFORM DTC CONFIRMATION PROCEDURE

Perform DTC Confirmation Procedure for the displayed DTC, and then check that DTC is detected again.
If two or more DTCs are detected, refer to [SEC-95, "DTC Inspection Priority Chart"](#) (Intelligent Key unit), [SEC-78, "DTC Inspection Priority Chart"](#) (BCM) and determine trouble diagnosis order.

Is DTC detected?

- YES >> GO TO 8.
- NO >> Refer to [GI-37, "Intermittent Incident"](#).

6.PERFORM BASIC INSPECTION

Perform Basic Inspection. Refer to [SEC-107, "Basic Inspection"](#).

>> GO TO 7.

7.DETECT MALFUNCTIONING SYSTEM BY SYMPTOM TABLE

Detect malfunctioning system according to Symptom Table based on the confirmed symptom in step 4.

>> GO TO 8.

8.DETECT MALFUNCTIONING PART BY DIAGNOSTIC PROCEDURE

Inspect according to Diagnostic Procedure of the system.

NOTE:

The Diagnostic Procedure is described based on open circuit inspection. A short circuit inspection is also required for the circuit check in the Diagnostic Procedure.

>> GO TO 9.

DIAGNOSIS AND REPAIR WORKFLOW

< BASIC INSPECTION >

[WITH INTELLIGENT KEY SYSTEM]

9. REPAIR OR REPLACE THE MALFUNCTIONING PART

1. Repair or replace the malfunctioning part.
2. Reconnect parts or connectors disconnected during Diagnostic Procedure again after repair and replacement.
3. Check DTC. If DTC is displayed, erase it.

>> GO TO 10.

10. FINAL CHECK

When DTC was detected in step 9, perform DTC Confirmation Procedure or Component Function Check again, and then check that the malfunctions have been fully repaired.

When symptom was described by the customer, refer to the confirmed symptom in step 3 or 4, and check that the symptom is not detected.

Does the symptom reappear?

YES (DTC is detected)>>GO TO 8.

YES (Symptom remains)>>GO TO 6.

NO >> Inspection End.

A
B
C
D
E
F
G
H
I
J
L
M
N
O
P

SEC

INSPECTION AND ADJUSTMENT

< BASIC INSPECTION >

[WITH INTELLIGENT KEY SYSTEM]

INSPECTION AND ADJUSTMENT

ADDITIONAL SERVICE WHEN REPLACING CONTROL UNIT

ADDITIONAL SERVICE WHEN REPLACING CONTROL UNIT : Special Repair Requirement

INFOID:000000003710542

Refer to the CONSULT-III Operation Manual-NATS.

ECM RE-COMMUNICATING FUNCTION

ECM RE-COMMUNICATING FUNCTION : Description

INFOID:000000003710543

Performing following procedure can automatically perform re-communication of ECM and BCM, but only when the ECM has been replaced with a new one (*1).

*1: New one means an ECM which has never been energized on-board.

(In this step, initialization procedure by CONSULT-III is not necessary)

NOTE:

- When registering new Key IDs or replacing the ECM that is not brand new, refer to CONSULT-III Operation Manual NATS.
- If multiple keys are attached to the key holder, separate them before work.
- Distinguish keys with unregistered key ID from those with registered ID.

ECM RE-COMMUNICATING FUNCTION : Special Repair Requirement

INFOID:000000003710544

1. PERFORM ECM RE-COMMUNICATING FUNCTION

1. Install ECM.
2. Using a registered key (*2), turn ignition switch to "ON".
*2: To perform this step, use the key that has been used before performing ECM replacement.
3. Maintain ignition switch in "ON" position for at least 5 seconds.
4. Turn ignition switch to "OFF".
5. Start engine.

Can engine be started?

YES >> Procedure is completed.

NO >> Initialize control unit. Refer to CONSULT-III Operation Manual NATS.

INTELLIGENT KEY SYSTEM/ENGINE START FUNCTION

< FUNCTION DIAGNOSIS >

[WITH INTELLIGENT KEY SYSTEM]

FUNCTION DIAGNOSIS

INTELLIGENT KEY SYSTEM/ENGINE START FUNCTION

System Diagram

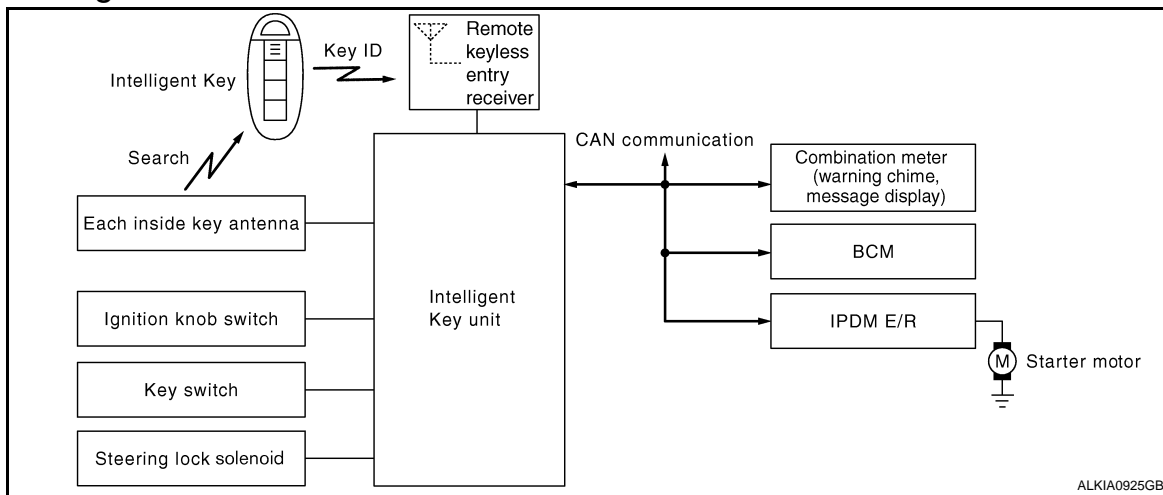

System Description

INFOID:000000003710546

INPUT/OUTPUT SIGNAL CHART

Intelligent Key Unit

Switch/Input signal	Input signal to Intelligent Key unit	Intelligent Key unit function	Actuator/Output signal
Key switch	Mechanical key (insert/remove)	Engine start function	<ul style="list-style-type: none"> KEY warning lamp/buzzer Steering lock unit Starter relay request (to IPDM E/R) Inside key antenna (Front and rear center console, overhead console, luggage compartment) Key interlock solenoid
Ignition knob switch	Ignition knob (push/release)		
Steering lock unit	Steering lock (lock/unlock)		
Inside key antenna (Front and rear center console, overhead console, luggage compartment)	Intelligent key (inside antenna detection area or not.)		

IPDM E/R

Switch/Input signal	Input signal to IPDM E/R	IPDM E/R function	Actuator/Output signal
Park/neutral position switch	P, N range	Engine start function	<ul style="list-style-type: none"> Starter relay Starter motor

BCM

Switch/Input signal	Input signal to BCM	BCM function	Actuator/Output signal
Key switch	Brake (press/release)	Engine start function	<ul style="list-style-type: none"> Inside key antenna (Front and rear center console, overhead console, luggage compartment)

SYSTEM DESCRIPTION

- The engine start function of Intelligent Key system is a system that makes it possible to start and stop the engine without using the key. It verifies the electronic ID using two-way communications when pressing the ignition knob switch while carrying the Intelligent Key, which operates based on the results of electronic ID verification for Intelligent Key using two-way communications between the Intelligent Key and the vehicle.

NOTE:

The driver should carry the Intelligent Key at all times.

INTELLIGENT KEY SYSTEM/ENGINE START FUNCTION

< FUNCTION DIAGNOSIS >

[WITH INTELLIGENT KEY SYSTEM]

- Intelligent Key has 2 IDs (for Intelligent Key and for NATS). It can perform the door lock/unlock operation and the engine start operation when the registered Intelligent Key is carried.
- When the Intelligent Key battery is discharged, it can be used as emergency back-up by inserting the mechanical key set in the Intelligent Key to the ignition key cylinder. At that time, perform the NATS ID verification. If it is used when the Intelligent Key is carried, perform the Intelligent Key ID verification.
- If the ID is successfully verified, and when the ignition knob switch is pressed, steering lock will be released and initiating the engine will be possible.
- The door lock/unlock operation can be performed when the Intelligent Key battery is discharged, by operating the driver door key cylinder using the mechanical key set in the Intelligent Key.
- Up to 4 Intelligent Keys can be registered (including the standard Intelligent Key) on request from the owner.

NOTE:

- Refer to [SEC-20, "COMMON ITEM : CONSULT-III Function \(BCM - COMMON ITEM\)"](#) for any functions other than engine start function of Intelligent Key system.

PRECAUTIONS FOR INTELLIGENT KEY SYSTEM

- **For vehicles equipped with the Intelligent Key system, the transponder [the chip for NATS ID verification] is integrated into the Intelligent Key. Therefore, the Intelligent Key alone is capable of providing security clearance for the engine to start. Also, when the mechanical key alone is inserted into the key cylinder, performs the NATS ID verification to allow the engine to start. For vehicles without Intelligent Key system, the transponder is integrated into the mechanical key which must be inserted into the key cylinder to perform the NATS ID verification to allow the engine to start.**

OPERATION WHEN INTELLIGENT KEY IS CARRIED

1. When the ignition knob switch is ON, the Intelligent Key unit transmits the request signal to the Intelligent Key.
2. The Intelligent Key receives the request signal and transmits the Intelligent Key ID signal to the Intelligent Key unit.
3. The Intelligent Key unit receives the Intelligent Key ID signal and verifies it with the registered ID.
4. Intelligent Key unit transmits the steering lock/unlock signal to steering lock unit if the verification results are OK. For detail of key warning lamp operation, refer to [DLK-115, "Diagnosis Procedure"](#).
5. Release of the steering lock.
6. BCM transmits the starter request signal via CAN communication to IPDM E/R and turns the starter relay in IPDM E/R ON if BCM judges that the engine start condition is satisfied.
7. IPDM E/R turns the starter control relay ON when receiving the starter request signal.
8. When shift position is in P or N position, battery power is supplied through the starter relay and operate the starter motor and to start the cranking.

CAUTION:

If a malfunction is detected in the Intelligent Key system, the "NO KEY" warning message will be displayed in the combination meter. At that time, the engine cannot be started.

OPERATION RANGE

Engine can be started when Intelligent Key is inside the vehicle. However, sometimes engine might not start when Intelligent Key is on instrument panel or in glove box.

OPERATION WHEN MECHANICAL KEY IS USED

When the Intelligent Key battery is discharged, performs the NATS ID verification between the integrated transponder and BCM by inserting the mechanical key into the key cylinder, and then the engine can be started. For details relating to starting the engine using mechanical key, refer to [SEC-13, "System Description"](#).

STEERING LOCK OPERATION

Steering is locked by steering lock unit when ignition switch is in the LOCK position (the ignition knob is released) and key switch is OFF (key is removed from ignition key cylinder).

INTELLIGENT KEY SYSTEM/ENGINE START FUNCTION

< FUNCTION DIAGNOSIS >

[WITH INTELLIGENT KEY SYSTEM]

Component Parts Location

INFOID:000000003710547

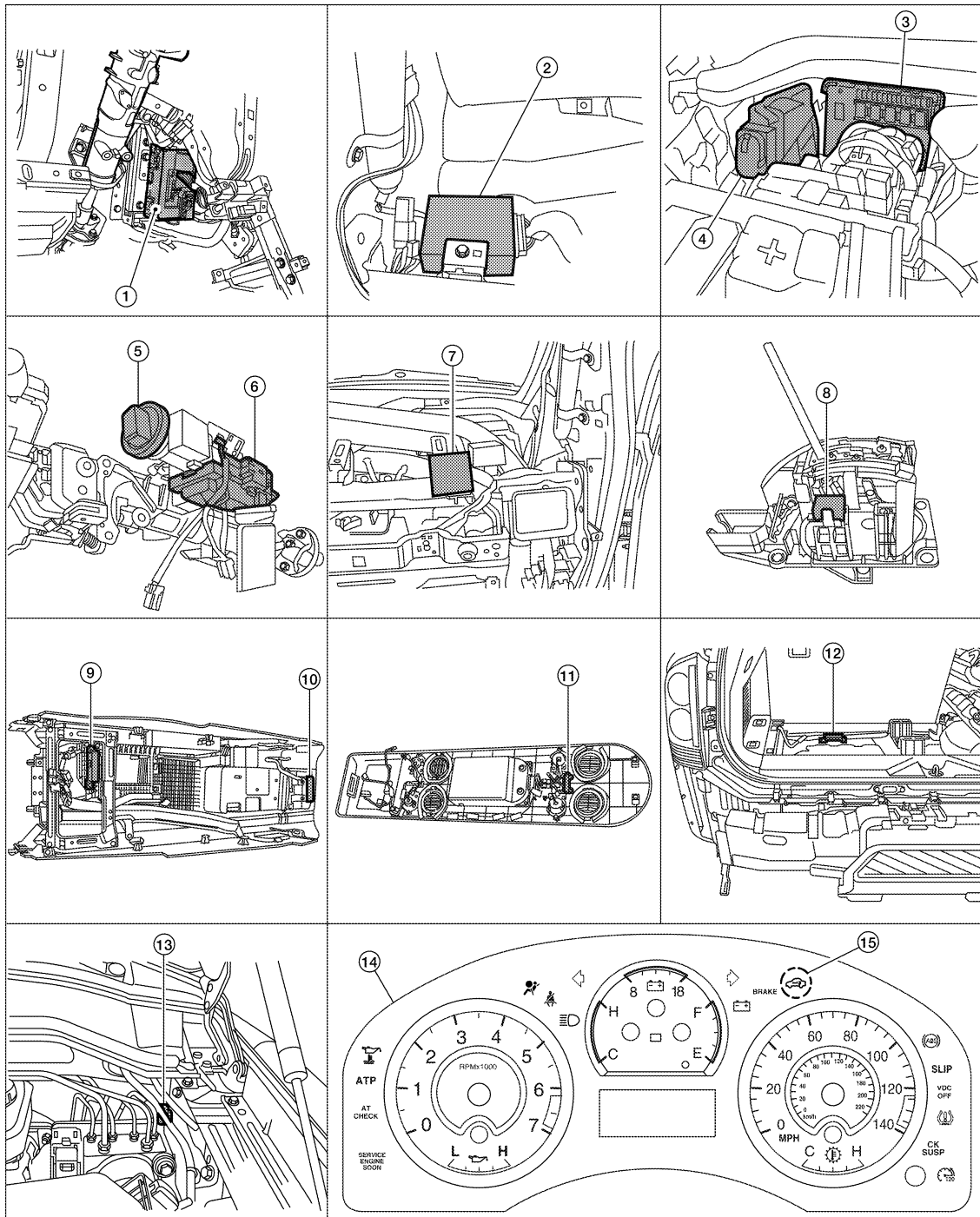

- | | | |
|---|---|--|
| 1. BCM M18, M20
(view with instrument panel LH removed) | 2. Intelligent Key unit M70
(view with instrument panel LH removed) | 3. IPDM E/R
E119, E120, E122, E124 |
| 4. ECM E16 | 5. Key switch and ignition knob switch M12
(view with steering column removed) | 6. Steering lock solenoid M15 |
| 7. Remote keyless entry receiver M25
(view with instrument panel RH removed) | 8. A/T device (park position switch) M203
(view with center console removed) | 9. Inside key antenna 3 (front of center console) M210
(view with center console removed) |

ALKIA0700ZZ

A
B
C
D
E
F
G
H
I
J
K
L
M
N
O
P

SEC

INTELLIGENT KEY SYSTEM/ENGINE START FUNCTION

< FUNCTION DIAGNOSIS >

[WITH INTELLIGENT KEY SYSTEM]

- | | | |
|--|---|---|
| 10. Inside key antenna 1 (rear of center console) M209 | 11. Inside key antenna 4 (overhead console area) R210
(view with overhead console removed) | 12. Inside key antenna 2 (luggage compartment) B76
(view with rear carpet removed) |
| 13. Intelligent Key warning buzzer E25 | 14. Combination meter M24 | 15. Vehicle security indicator lamp |

Component Description

INFOID:000000003710548

Item	Function
Intelligent Key unit	Receives lock/unlock signal from remote keyless entry receiver, and then transmits to BCM.
BCM	Verifies the received signal from Intelligent Key, then informs ECM whether to allow engine start.
Remote keyless entry receiver	Receives lock/unlock signal from the Intelligent Key, and then transmits to Intelligent Key unit.
Intelligent Key	Transmits button operation to remote keyless entry receiver.
Steering lock solenoid	Locks the steering wheel when the ignition key is off and the Intelligent Key is outside the vehicle.
Inside key antenna	Detects if Intelligent Key is inside the vehicle.
Intelligent Key warning buzzer	Warns the user of the lock/unlock condition and inappropriate operations with the buzzer sound.
A/T device (park position switch)	Detects whether the shift lever is in park.

NVIS (NISSAN VEHICLE IMMOBILIZER SYSTEM-NATS)

< FUNCTION DIAGNOSIS >

[WITH INTELLIGENT KEY SYSTEM]

NVIS (NISSAN VEHICLE IMMOBILIZER SYSTEM-NATS)

System Diagram

INFOID:000000003710549

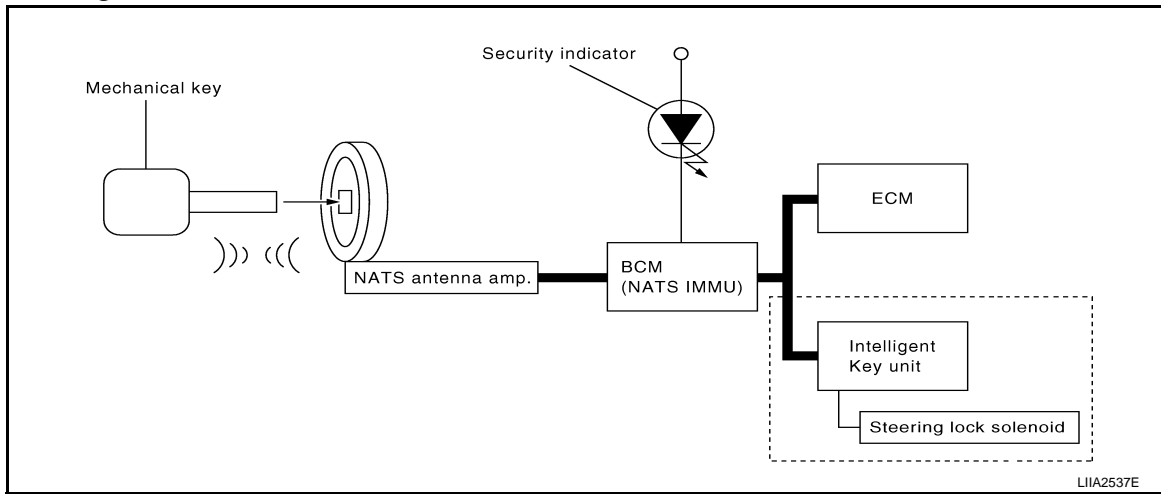

System Description

INFOID:000000003710550

INPUT/OUTPUT SIGNAL CHART

Intelligent Key Unit

Switch/Input signal	Input signal to BCM	BCM function	Actuator/Output signal
Ignition knob switch	Ignition knob (push/release)	NATS	<ul style="list-style-type: none"> Steering lock solenoid
Key switch	Mechanical key (Insert/remove)		
Steering lock solenoid	Steering (lock/unlock)		
ECM	Engine status signal		

BCM

Switch/Input signal	Input signal to BCM	BCM function	Actuator/Output signal
NATS antenna amp.	Key ID	NATS	<ul style="list-style-type: none"> Security indicator lamp Starter request
ECM	Engine status signal		

SYSTEM DESCRIPTION

NATS (Nissan Anti-Theft System) has the following immobilizer functions:

- Engine immobilizer shows high anti-theft performance to prevent engine from starting by other than the owner.
- Only a key with key ID registered in BCM and ECM can start engine, and shows high anti-theft performance to prevent key from being copied or stolen.
- Security indicator always flashes with mechanical key removed condition (key switch: OFF) and ignition knob released condition on LOCK position (ignition knob switch: OFF).
- Therefore, NATS warns outsiders that the vehicle is equipped with the anti-theft system. Refer to [SEC-17, "System Description"](#).
- If system detects malfunction, security indicator illuminates when ignition switch is turned to ON position.
- If the owner requires, ignition key ID or mechanical key ID can be registered for up to 4 keys.
- During trouble diagnosis or when the following parts have been replaced, and if mechanical key is added, registration* is required.

*1: All keys kept by the owner of the vehicle should be registered with mechanical key.

- ECM
- BCM

A
B
C
D
E
F
G
H
I
J
L
M
N
O
P

SEC

NVIS (NISSAN VEHICLE IMMOBILIZER SYSTEM-NATS)

[WITH INTELLIGENT KEY SYSTEM]

< FUNCTION DIAGNOSIS >

- Mechanical key
- Intelligent Key unit
- Remote keyless entry receiver
- Steering lock solenoid
- NATS trouble diagnosis, system initialization and additional registration of other mechanical key IDs must be carried out using CONSULT-III.
When NATS initialization has been completed, the ID of the inserted mechanical key or mechanical key IDs can be carried out.
- Possible symptom of NATS malfunction is "Engine cannot start". Identify the possible causes according to "Work Flow", Refer to [SEC-5, "Work Flow"](#).
- If ECM other than Genuine NISSAN is installed, the engine cannot be started. For ECM replacement procedure, refer to [SEC-8, "ECM RE-COMMUNICATING FUNCTION : Description"](#).

PRECAUTIONS FOR KEY REGISTRATION

- The key registration is a procedure that erases the current NATS ID once, and then re-registers a new ID. Therefore the registered Intelligent Key is necessary for this procedure. Before starting the registration operation collect all registered Intelligent Keys from the customer.
- The NATS ID registration is the procedure that registers the ID stored into the transponder (integrated in mechanical key) to BCM.
The Intelligent Key ID registration is the procedure that registers the ID to Intelligent Key unit.
- When performing the Intelligent Key system registration only, the engine cannot be started by inserting the key into the key cylinder. When performing the NATS registration only, the engine cannot be started by using the mechanical key.

SECURITY INDICATOR

- Always flashes with ignition knob released (ignition knob switch: LOCK) condition on ignition knob LOCK position.
- Always flashes with ignition knob released (ignition knob switch: LOCK) condition on mechanical key removed position.

MAINTENANCE INFORMATION

CAUTION:

It is necessary to perform NATS ID registration when replacing any of the following part. If it's not (or fail to do so), the electrical system may not operate properly.

- **Intelligent Key unit**
- **BCM**
- **ECM**
- **Mechanical key**
- **Steering lock solenoid**
- **NATS antenna amp.**

NVIS (NISSAN VEHICLE IMMOBILIZER SYSTEM-NATS)

< FUNCTION DIAGNOSIS >

[WITH INTELLIGENT KEY SYSTEM]

Component Parts Location

INFOID:000000003710551

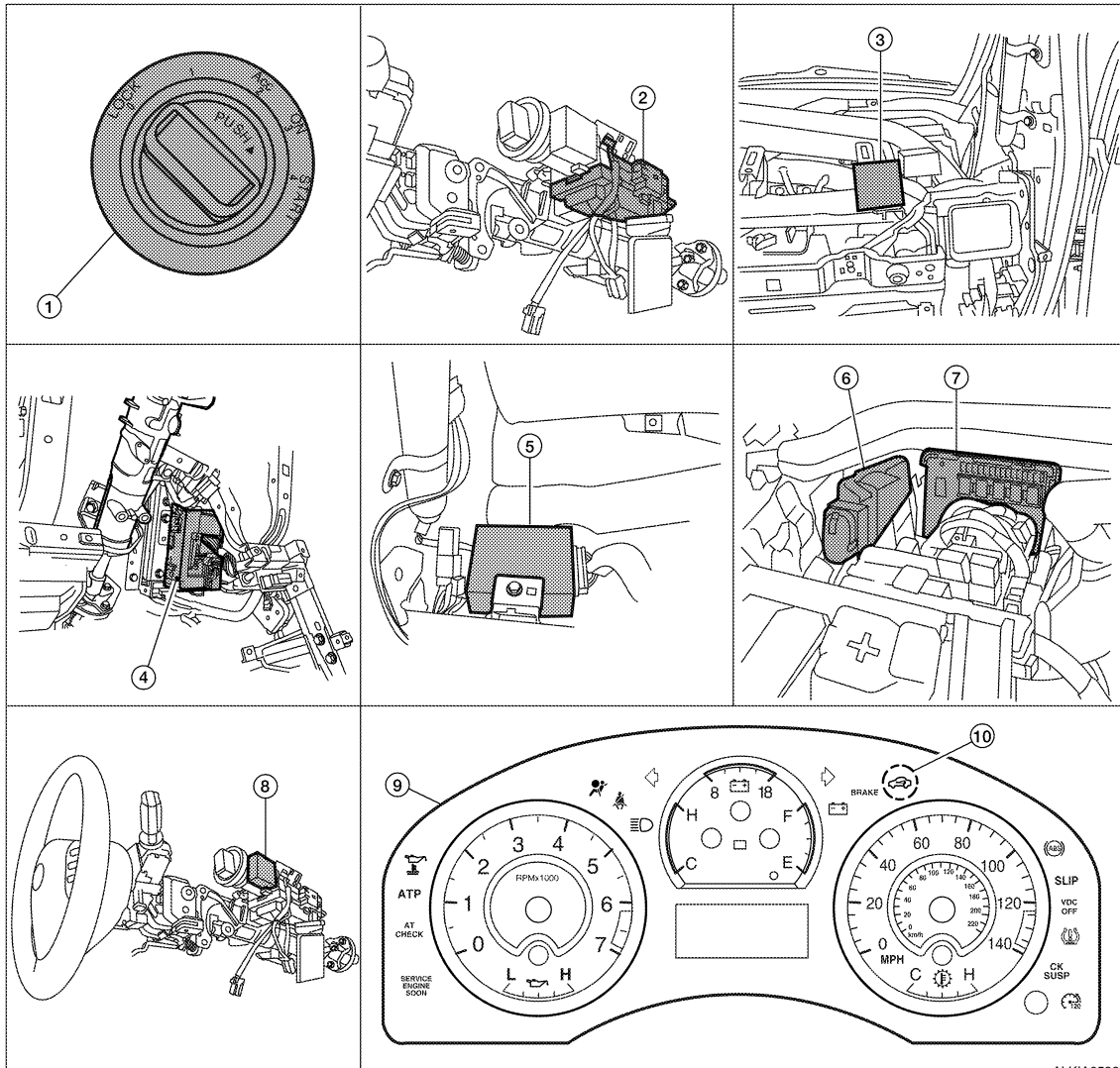

- | | | |
|---|--|---|
| 1. Key switch and ignition knob switch M12 | 2. Steering lock solenoid M15
(view with steering column removed) | 3. Remote keyless entry receiver M25
(view with instrument panel RH removed) |
| 4. BCM M18, M20
(view with instrument panel LH removed) | 5. Intelligent Key unit M70
(view with instrument panel LH removed) | 6. ECM E16 |
| 7. IPDM E/R E119, E120, E121, E122, E124
(view with cover removed) | 8. NATS antenna amp. M21 | 9. Combination meter M24 |
| 10. Security indicator lamp | | |

Component Description

INFOID:000000003710552

Item	Function
Intelligent Key unit	Receives lock/unlock signal from remote keyless entry receiver, and then transmits to BCM.
BCM	Controls the door lock function and room lamp function.
Remote keyless entry receiver	Receives lock/unlock signal from the Intelligent Key, and then transmits to Intelligent Key unit.
Intelligent Key	Transmits button operation to remote keyless entry receiver.
Steering lock solenoid	Locks the steering wheel when the ignition key is off and the Intelligent Key is outside the vehicle.

A
B
C
D
E
F
G
H
I
J
K
L
M
N
O
P

SEC

NVIS (NISSAN VEHICLE IMMOBILIZER SYSTEM-NATS)

< FUNCTION DIAGNOSIS >

[WITH INTELLIGENT KEY SYSTEM]

Item	Function
Inside key antenna	Detects if Intelligent Key is inside the vehicle.
Intelligent Key warning buzzer	Warns the user of the lock/unlock condition and inappropriate operations with the buzzer sound.
Ignition knob switch	Monitors the status of the ignition knob switch.
NATS antenna amp.	Detects the mechanical key presence in the ignition key cylinder.
Security indicator	Indicates the status of the security system.
IPDM E/R	Monitors the ignition switch and the park switch signal from the TCM.

VEHICLE SECURITY SYSTEM

< FUNCTION DIAGNOSIS >

[WITH INTELLIGENT KEY SYSTEM]

VEHICLE SECURITY SYSTEM

System Diagram

INFOID:000000003710553

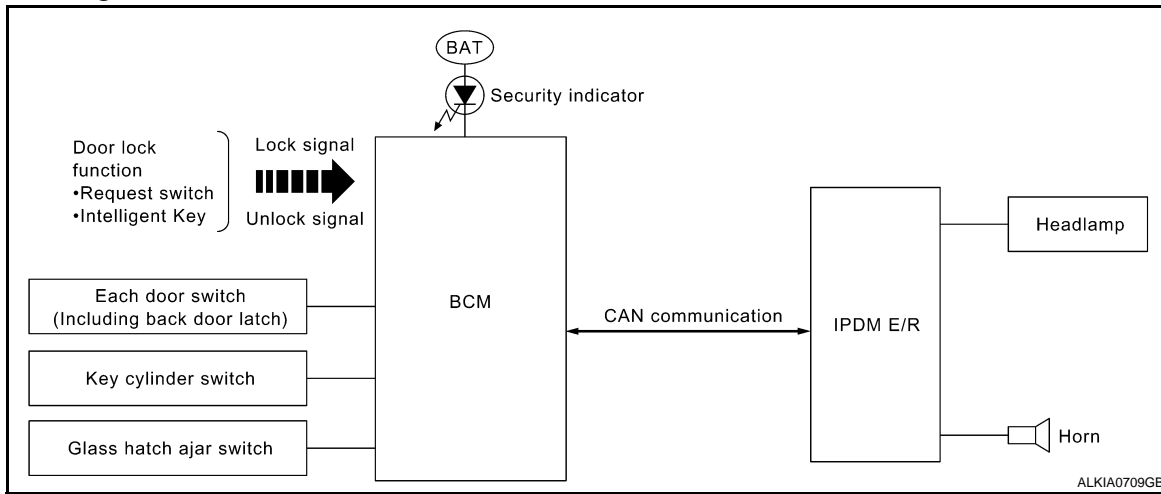

System Description

INFOID:000000003710554

DESCRIPTION

The security system provides an audible and visual alarm when an unauthorized access to the vehicle is detected while the system is in armed phase.

The security system consist of the BCM managing the audible alarm (horn) and the visual alarm (headlamps).

OPERATION FLOW

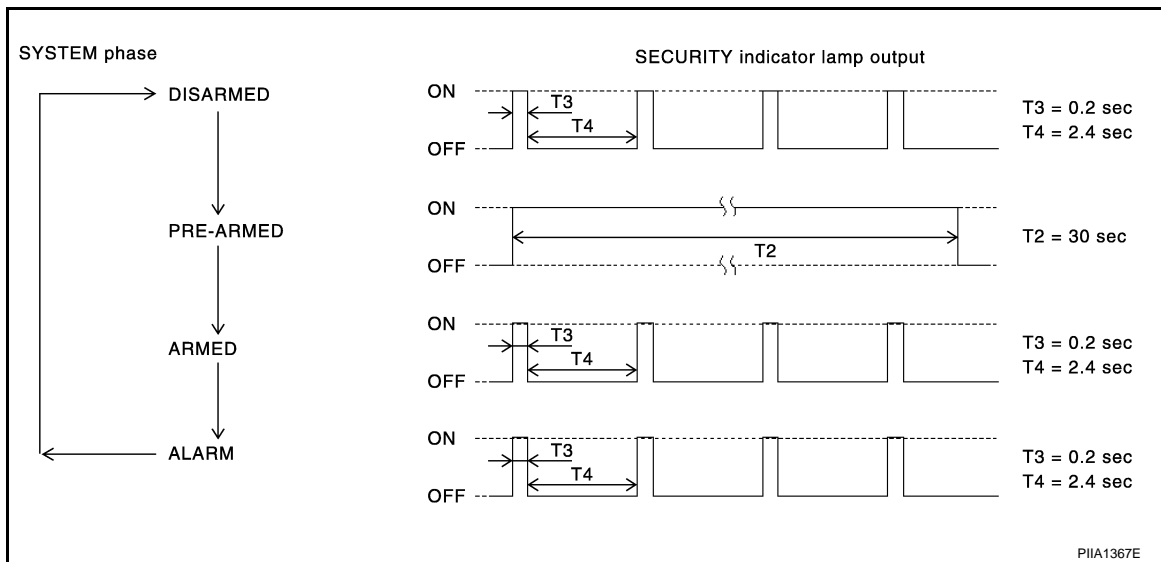

Disarmed Phase

When the vehicle is being driven or when doors are open, the theft warning system is set in the disarmed phase on the assumption that the owner is inside or near the vehicle.

Pre-Armed Phase And Armed Phase

The vehicle security system turns into the pre-armed phase when ignition switch is in OFF position, all doors are closed and locked (using Intelligent Key, door request switch or auto relock function). The system automatically shifts into the armed phase.

Condition of Activating The System

When the following condition is performed in armed phase, the system sounds the horns and flashes the headlamps for about 30 seconds.

- Any door is opened.

A
B
C
D
E
F
G
H
I
J
L
M
N
O
P

SEC

VEHICLE SECURITY SYSTEM

[WITH INTELLIGENT KEY SYSTEM]

< FUNCTION DIAGNOSIS >

Condition of Deactivating The System

When one of the following operations is performed, the armed phase is canceled.

- Unlock the doors with Intelligent Key or door request switch.
- Use the mechanical key to unlock the driver door using the door key cylinder.

Component Parts Location

INFOID:000000003710555

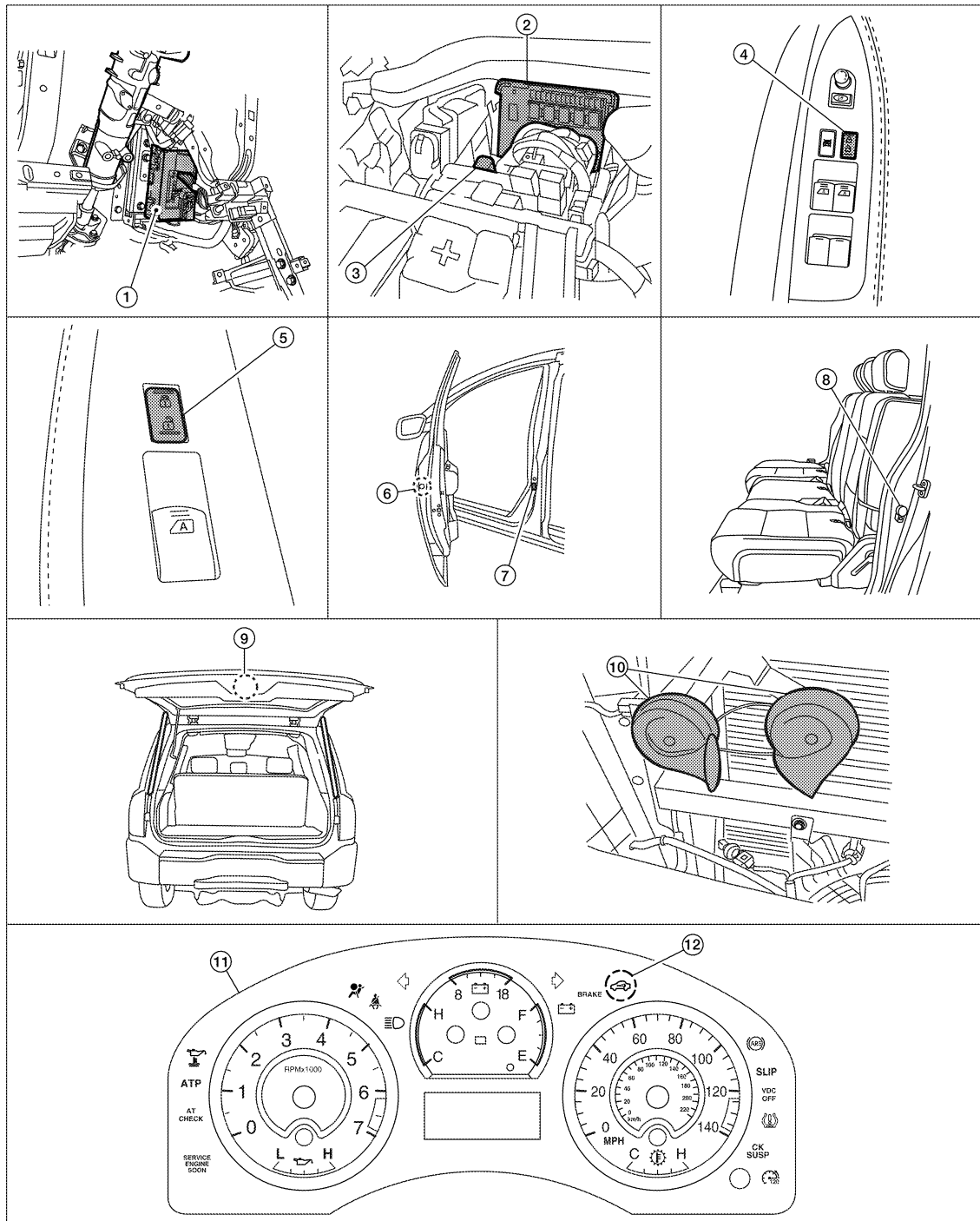

ALKIA0540ZZ

- | | | |
|---|---|--|
| 1. BCM M18, M19, M20
(view with instrument panel LH removed) | 2. IPDM E/R E122, E124
(view with cover removed) | 3. Horn relay H-1 |
| 4. Main power window and door lock/unlock switch D7, D8 | 5. Power window and door lock/unlock switch RH D105 | 6. Front door lock assembly LH (key cylinder switch) D14 |

VEHICLE SECURITY SYSTEM

< FUNCTION DIAGNOSIS >

[WITH INTELLIGENT KEY SYSTEM]

- | | | |
|---|---------------------------------------|--|
| 7. Front door switch LH B8
RH B108 | 8. Rear door switch LH B18
RH B116 | 9. Back door latch (door ajar switch) D503
Glass hatch ajar switch D707 |
| 10. Horn E3
(view with front grille removed) | 11. Combination meter M24 | 12. Security indicator lamp |

Component Description

INFOID:000000003710556

Item	Function
BCM	Controls the door lock function and room lamp function.
Door switch	Provides the BCM with the status of each monitored door.
Security indicator	Indicates the status of the security system.
IPDM E/R	Controls the horn and headlamp operation.
Horn	Sounds when the vehicle security system is triggered.

A
B
C
D
E
F
G
H
I
J
L
M
N
O
P

SEC

DIAGNOSIS SYSTEM (BCM)

< FUNCTION DIAGNOSIS >

[WITH INTELLIGENT KEY SYSTEM]

DIAGNOSIS SYSTEM (BCM)

COMMON ITEM

COMMON ITEM : CONSULT-III Function (BCM - COMMON ITEM)

INFOID:000000004173718

APPLICATION ITEM

CONSULT-III performs the following functions via CAN communication with BCM.

Diagnosis mode	Function Description
WORK SUPPORT	Changes the setting for each system function.
SELF-DIAG RESULTS	Displays the diagnosis results judged by BCM. Refer to BCS-53. "DTC Index" .
CAN DIAG SUPPORT MNTR	Monitors the reception status of CAN communication viewed from BCM.
DATA MONITOR	The BCM input/output signals are displayed.
ACTIVE TEST	The signals used to activate each device are forcibly supplied from BCM.
ECU IDENTIFICATION	The BCM part number is displayed.
CONFIGURATION	<ul style="list-style-type: none"> Enables to read and save the vehicle specification. Enables to write the vehicle specification when replacing BCM.

SYSTEM APPLICATION

BCM can perform the following functions for each system.

NOTE:

It can perform the diagnosis modes except the following for all sub system selection items.

System	Sub system selection item	Diagnosis mode		
		WORK SUPPORT	DATA MONITOR	ACTIVE TEST
BCM	BCM	×		
Door lock	DOOR LOCK	×	×	×
Rear window defogger	REAR DEFOGGER		×	
Warning chime	BUZZER		×	×
Interior room lamp timer	INT LAMP	×	×	×
Remote keyless entry system	MULTI REMOTE ENT	×	×	×
Exterior lamp	HEAD LAMP	×	×	×
Wiper and washer	WIPER	×	×	×
Turn signal and hazard warning lamps	FLASHER		×	×
Air conditioner	AIR CONDITONER		×	
Intelligent Key system*	INTELLIGENT KEY		×	
Combination switch	COMB SW		×	
Immobilizer	IMMU		×	×
Interior room lamp battery saver	BATTERY SAVER	×	×	×
Back door open	TRUNK		×	×
RAP (retained accessory power)	RETAINED PWR	×	×	×
Signal buffer system	SIGNAL BUFFER		×	×
TPMS (tire pressure monitoring system)	AIR PRESSURE MONITOR	×	×	×
Vehicle security system	PANIC ALARM			×

*: With Intelligent Key

IMMU

DIAGNOSIS SYSTEM (BCM)

[WITH INTELLIGENT KEY SYSTEM]

< FUNCTION DIAGNOSIS >

IMMU : CONSULT-III Function (BCM - IMMU)

INFOID:000000004173719

DATA MONITOR

Monitor Item [Unit]	Description
IGN ON SW [ON/OFF]	Indicates condition of ignition switch in ON position.

ACTIVE TEST

Test Item	Description
THEFT IND	This test is able to check security indicator operation [ON/OFF].

THEFT ALM

THEFT ALM : CONSULT-III Function (BCM - THEFT ALM)

INFOID:000000004173720

WORK SUPPORT

Work Item	Description
SECURITY ALARM SET	Vehicle security function mode can be changed in this mode. <ul style="list-style-type: none">• ON: Vehicle security function is ON.• OFF: Vehicle security function is OFF.

A
B
C
D
E
F
G
H
I
J
L
M
N
O
P

SEC

DIAGNOSIS SYSTEM (INTELLIGENT KEY UNIT)

< FUNCTION DIAGNOSIS >

[WITH INTELLIGENT KEY SYSTEM]

DIAGNOSIS SYSTEM (INTELLIGENT KEY UNIT)

CONSULT-III Function (INTELLIGENT KEY)

INFOID:000000004173721

APPLICATION ITEM

CONSULT-III performs the following functions via CAN communication with Intelligent Key unit.

Diagnosis mode	Function Description
WORK SUPPORT	Changes the setting for each system function.
SELF-DIAG RESULTS	Displays the diagnosis results judged by Intelligent Key unit.
CAN DIAG SUPPORT MNTR	Monitors the reception status of CAN communication viewed from Intelligent Key unit.
DATA MONITOR	The Intelligent Key unit input/output signals are displayed.
ACTIVE TEST	The signals used to activate each device are forcibly supplied from Intelligent Key unit.
ECU IDENTIFICATION	The Intelligent Key unit part number is displayed.

SELF-DIAG RESULT

Refer to [DLK-165. "DTC Index"](#).

DATA MONITOR

Monitor Item	Condition
PUSH SW	Indicates [ON (pushed)/OFF (released)] condition of ignition knob switch.
KEY SW	Indicates [ON (inserted)/OFF (removed)] condition of key switch.
DR REQ SW	Indicates [ON (pressed)/OFF (released)] condition of door request switch (driver side).
AS REQ SW	Indicates [ON (pressed)/OFF (released)] condition of door request switch (passenger side).
BD/TR REQ SW	This item is shown but not monitored.
IGN SW	Indicates [ON (ON or START position)/OFF (other than ON and START position)] condition of ignition switch ON position.
ACC SW	Indicates [ON/OFF] condition of ignition switch ACC position.
STOP LAMP SW	Indicates [ON/OFF] condition of stop lamp switch.
P RANGE SW	Indicates [ON/OFF] position of shift lever park position switch.
BD OPEN SW	This item is shown but not monitored.
TR CANCEL SW	This item is shown but not monitored.
DOOR LOCK SIG	Indicates [ON/OFF] condition of LOCK signal from Intelligent Key.
DOOR UNLOCK SIG	Indicates [ON/OFF] condition of UNLOCK signal from Intelligent Key.
KEYLESS TRUNK SW	This item is shown but not monitored.
KEYLESS PANIC SW	Indicates [ON (pressed)/OFF (released)] condition of Intelligent Key panic button.
KEYLS PSD LH	This item is shown but not monitored.
KEYLS PSD RH	This item is shown but not monitored.
KEYLS PBD SIG	Indicates [ON (pressed)/OFF (released)] condition of Intelligent Key back door button.
DOOR SW DR	Indicates [OPEN/CLOSE] condition of front door switch (driver side) from BCM via CAN communication.
DOOR SW AS	Indicates [OPEN/CLOSE] condition of front door switch (passenger side) from BCM via CAN communication.
DOOR SW RR	Indicates [OPEN/CLOSE] condition of rear door switch (RH) from BCM via CAN communication.
DOOR SW RL	Indicates [OPEN/CLOSE] condition of rear door switch (LH) from BCM via CAN communication.
DOOR BK SW	Indicates [OPEN/CLOSE] condition of back door switch from BCM via CAN communication.

DIAGNOSIS SYSTEM (INTELLIGENT KEY UNIT)

< FUNCTION DIAGNOSIS >

[WITH INTELLIGENT KEY SYSTEM]

Monitor Item	Condition
TRUNK SW	This item is shown but not monitored.
VEHICLE SPEED	Displays the vehicle speed signal received from combination meter by numerical value [km/h].

ACTIVE TEST

Test item	Description
DOOR LOCK/UNLOCK	<p>This test is able to check door lock/unlock operation.</p> <ul style="list-style-type: none"> • ALL UNLK: All door lock actuators are unlocked. • DR UNLK: Door lock actuator (driver side) is unlocked. • AS UNLK: Door lock actuator (passenger side) is unlocked. • BK UNLK: This item is indicated, but inactive. • LOCK: All door lock actuator is locked.
ANTENNA	<p>This test is able to check Intelligent Key antenna operation. When the following condition are met, hazard warning lamps flash.</p> <ul style="list-style-type: none"> • ROOM ANT1: Inside key antenna (front of center console) detects Intelligent Key, when "ROOM ANT1" is selected. • ROOM ANT2: Inside key antenna (rear luggage area) detects Intelligent Key, when "ROOM ANT2" is selected. • ROOM ANT3: Inside key antenna (rear of center console) detects Intelligent Key, when "ROOM ANT3" is selected. • ROOM ANT4: Inside key antenna (roof console) detects Intelligent Key, when "ROOM ANT4" is selected. • DRIVER ANT: Outside key antenna (driver side) detects Intelligent Key, when "DRIVER ANT" is selected. • ASSIST ANT: Outside key antenna (passenger side) detects Intelligent Key, when "ASSIST ANT" is selected. • BK DOOR ANT: Outside key antenna (rear bumper) detects Intelligent Key, when "BK DOOR ANT" is selected.
OUTSIDE BUZZER	<p>This test is able to check Intelligent Key warning buzzer operation.</p> <ul style="list-style-type: none"> • ON • OFF
INSIDE BUZZER	<p>This test is able to check warning chime in combination meter operation.</p> <ul style="list-style-type: none"> • TAKE OUT: Take away warning chime sounds. • KNOB: Ignition knob switch warning chime sounds. • KEY: Key warning chime sounds. • OFF

A
B
C
D
E
F
G
H
I
J
L
M
N
O
P

SEC

U1000 CAN COMM CIRCUIT

< COMPONENT DIAGNOSIS >

[WITH INTELLIGENT KEY SYSTEM]

COMPONENT DIAGNOSIS

U1000 CAN COMM CIRCUIT

Description

INFOID:000000003710561

CAN (Controller Area Network) is a serial communication line for real time applications. It is an on-vehicle multiplex communication line with high data communication speed and excellent error detection ability. Modern vehicle is equipped with many electronic control unit, and each control unit shares information and links with other control units during operation (not independent). In CAN communication, control units are connected with 2 communication lines (CAN-H line, CAN-L line) allowing a high rate of information transmission with less wiring. Each control unit transmits/receives data but selectively reads required data only. CAN Communication Signal Chart, refer to [LAN-4, "System Description"](#).

DTC Logic

INFOID:000000003710562

DTC DETECTION LOGIC

DTC	CONSULT-III display description	DTC Detection Condition	Possible cause
U1000	CAN COMM CIRCUIT	When Intelligent Key unit cannot communicate CAN communication signal continuously for 2 seconds or more.	In CAN communication system, any item (or items) of the following listed below is malfunctioning. <ul style="list-style-type: none">• Transmission• Receiving (BCM)• Receiving (ECM)• Receiving (METER/M&A)

Diagnosis Procedure

INFOID:000000003710563

1. PERFORM SELF DIAGNOSTIC

1. Turn ignition switch ON and wait for 2 seconds or more.
2. Check "Self Diagnostic Result".

Is "CAN COMM CIRCUIT" displayed?

- YES >> Refer to [LAN-5, "CAN Communication Control Circuit"](#).
NO >> Refer to [GI-37, "Intermittent Incident"](#).

U1010 CONTROL UNIT (CAN)

< COMPONENT DIAGNOSIS >

[WITH INTELLIGENT KEY SYSTEM]

U1010 CONTROL UNIT (CAN)

Description

INFOID:000000003710564

CAN (Controller Area Network) is a serial communication line for real time applications. It is an on-vehicle multiplex communication line with high data communication speed and excellent error detection ability. Modern vehicle is equipped with many electronic control unit, and each control unit shares information and links with other control units during operation (not independent). In CAN communication, control units are connected with 2 communication lines (CAN-H line, CAN-L line) allowing a high rate of information transmission with less wiring. Each control unit transmits/receives data but selectively reads required data only. CAN Communication Signal Chart, refer to [LAN-46, "CAN Communication Signal Chart"](#).

DTC Logic

INFOID:000000003710565

DTC DETECTION LOGIC

DTC	CONSULT-III display description	DTC Detection Condition	Possible cause
U1010	CONTROL UNIT (CAN)	When detecting error during the initial diagnosis of CAN controller of Intelligent Key unit.	Intelligent Key unit

Diagnosis Procedure

INFOID:000000003710566

1. REPLACE INTELLIGENT KEY UNIT

When DTC [U1010] is detected, replace Intelligent Key unit.

>> Replace Intelligent Key unit. Refer to [SEC-109, "Removal and Installation"](#).

Special Repair Requirement

INFOID:000000003710567

1. REQUIRED WORK WHEN REPLACING INTELLIGENT KEY UNIT

Initialize control unit. Refer to CONSULT-III Operation Manual.

>> Work end.

A
B
C
D
E
F
G
H
I
J

SEC

B2013 ID DISCORD I-KEY-STRG

< COMPONENT DIAGNOSIS >

[WITH INTELLIGENT KEY SYSTEM]

B2013 ID DISCORD I-KEY-STRG

Description

INFOID:000000003710568

Intelligent Key unit performs the ID verification with the steering lock solenoid and releases the steering lock if both Intelligent Key unit and steering lock solenoid ID are same. Intelligent Key unit starts the communication with the steering lock solenoid when Intelligent Key is carried into the vehicle and the ignition knob switch is pressed.

DTC Logic

INFOID:000000003710569

DTC DETECTION LOGIC

DTC No.	Trouble diagnosis name	DTC detecting condition	Possible cause
B2013	STRG COMM 1	The ID verification results between Intelligent Key unit and steering control unit are NG. The registration is necessary.	Steering lock solenoid

DTC CONFIRMATION PROCEDURE

1.PERFORM DTC CONFIRMATION PROCEDURE

1. Press the ignition knob switch.
2. Check "Self diagnostic result" with CONSULT-III.

Is DTC detected?

- YES >> Refer to [SEC-26. "Diagnosis Procedure"](#).
NO >> INSPECTION END.

Diagnosis Procedure

INFOID:000000003710570

1.PERFORM INITIALIZATION

Perform initialization with CONSULT-III. Re-register all mechanical keys.

For initialization and registration of mechanical key. Refer to "CONSULT-III Operation Manual".

Can the system be initialized and can steering lock be released with re-registered mechanical key?

- YES >> Steering lock solenoid was unregistered.
NO >> GO TO 2

2.CHECK STEERING LOCK SOLENOID POWER SUPPLY-1

1. Turn ignition switch OFF.
2. Disconnect steering lock solenoid connector.
3. Check voltage between steering lock solenoid harness connector and ground.

Terminals		Voltage (V) (Approx.)
(+)	(-)	
Steering lock solenoid connector	Terminal	
M15	1	Battery voltage

Is the inspection result normal?

- YES >> GO TO 3
NO >> Repair or replace harness.

3.CHECK STEERING LOCK SOLENOID GROUND CIRCUIT

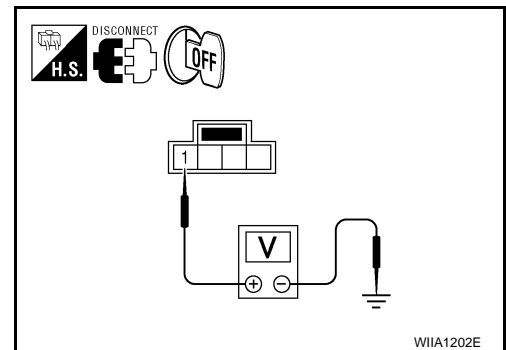

B2013 ID DISCORD I-KEY-STRG

< COMPONENT DIAGNOSIS >

[WITH INTELLIGENT KEY SYSTEM]

Check continuity between steering lock solenoid harness connector and ground.

Terminals		(-)	Continuity
(+) Steering lock solenoid connector			
Terminal			
M15	4	Ground	Yes

Is the inspection result normal?

YES >> GO TO 4

NO >> Repair or replace harness.

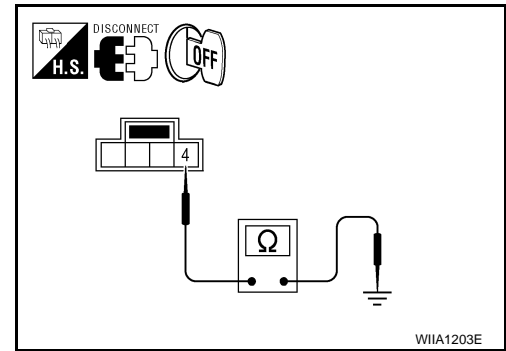

4. CHECK STEERING LOCK SOLENOID COMMUNICATION CIRCUITS

1. Disconnect Intelligent Key unit connector.
2. Check continuity between steering lock solenoid connector (A) M15 terminals 2, 3 and Intelligent Key unit connector (B) M70 terminals 1, 32.

Terminals				Continuity
Steering lock solenoid connector	Terminal	Intelligent Key unit connector	Terminal	
M15	2	M70	1	Yes
	3		32	

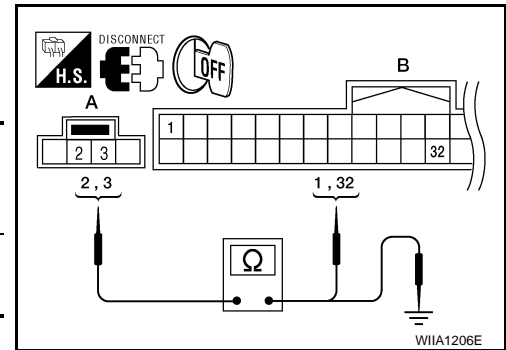

3. Check continuity between steering lock solenoid connector (A) M15 terminals 2, 3 and ground.

Terminals		Terminals	Continuity
Steering lock solenoid connector			
M15	2	Ground	No
	3		

Is the inspection result normal?

YES >> GO TO 5

NO >> Repair or replace harness.

5. CHECK INTELLIGENT KEY UNIT POWER SUPPLY-2

1. Connect Intelligent Key unit connector.
2. Check voltage between Intelligent Key unit harness connector and ground.

Terminals			Voltage (V) (Approx.)
(+) Intelligent Key unit connector		(-) Terminal	
Terminal			
M70	1	Ground	5

Is the inspection result normal?

YES >> GO TO 6

NO >> Replace Intelligent Key unit. Refer to [SEC-109](#), "[Removal and Installation](#)".

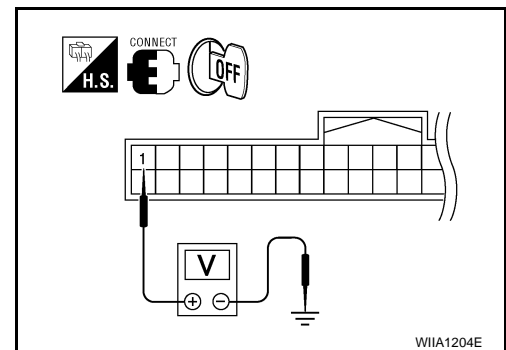

6. CHECK STEERING LOCK SOLENOID COMMUNICATION CIRCUIT

1. Connect steering lock solenoid connector.

A
B
C
D
E
F
G
H
I
J
K
L
M
N
O
P

SEC

B2013 ID DISCORD I-KEY-STRG

< COMPONENT DIAGNOSIS >

[WITH INTELLIGENT KEY SYSTEM]

- Using an oscilloscope, check voltage between Intelligent Key unit connector and ground.

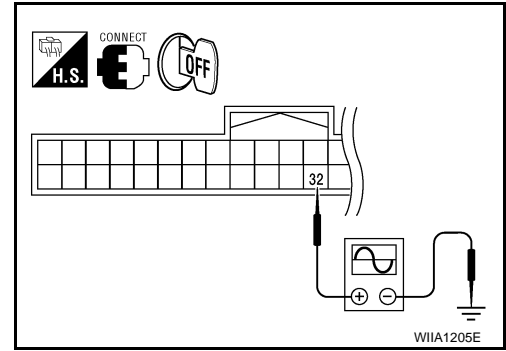

Terminals		(-)	Condition	Voltage (V) (Approx.)
(+)	Terminal			
Intelligent Key unit connector				
M70	32	Ground	Steering lock	
			Ignition knob is pushed	<p>SIIA1911J</p>
			LOCK status	5
			LOCK ⇔ UNLOCK	<p>JMKIA0433ZZ</p>
			For 15 seconds after UNLOCK	5
			15 seconds later UNLOCK	0

Is the inspection result normal?

YES >> Replace Steering lock solenoid.

NO >> Replace Intelligent Key unit. Refer to [SEC-109, "Removal and Installation"](#).

B2190, P1614 NATS ANTENNA AMP.

< COMPONENT DIAGNOSIS >

[WITH INTELLIGENT KEY SYSTEM]

B2190, P1614 NATS ANTENNA AMP.

Description

INFOID:000000003710571

Performs ID verification through BCM and NATS antenna amplifier when ignition knob switch is pressed. Prohibits the release of steering lock or start of engine when an unregistered ID of mechanical key is used.

DTC Logic

INFOID:000000003710572

DTC DETECTION LOGIC

DTC No.	Trouble diagnosis name	DTC detecting condition	Possible cause
B2190	NATS ANTENNA AMP	• Inactive communication between NATS antenna amp. and BCM. • Mechanical key is malfunctioning.	• Harness or connectors (The NATS antenna amp. circuit is open or shorted) • Mechanical key • NATS antenna amp. • BCM
P1614			

DTC CONFIRMATION PROCEDURE

1. PERFORM DTC CONFIRMATION PROCEDURE

1. Insert mechanical key into the key cylinder.
2. Press the ignition knob switch.
3. Check "Self diagnostic result" with CONSULT-III.

Is DTC detected?

YES >> Refer to [SEC-29, "Diagnosis Procedure"](#).

NO >> INSPECTION END.

Diagnosis Procedure

INFOID:000000003710573

1. CHECK NATS ANTENNA AMP. INSTALLATION

Check NATS antenna amp. installation. Refer to [SEC-15, "Component Parts Location"](#).

Is the inspection result normal?

YES >> GO TO 2

NO >> Reinstall NATS antenna amp. correctly.

2. CHECK NVIS (NATS) IGNITION KEY ID CHIP

Start engine with another registered NATS ignition key.

Does the engine start?

YES >> • Ignition key ID chip is malfunctioning.

• Replace the ignition key.

• Perform initialization with CONSULT-III.

For initialization, refer to "CONSULT-III Operation Manual".

NO >> GO TO 3

3. CHECK POWER SUPPLY FOR NATS ANTENNA AMP.

1. Turn ignition switch ON.
2. Check voltage between NATS antenna amp. connector M21 terminal 1 and ground.

A
B
C
D
E
F
G
H
I
J
L
M
N
O
P

SEC

B2190, P1614 NATS ANTENNA AMP.

< COMPONENT DIAGNOSIS >

[WITH INTELLIGENT KEY SYSTEM]

1 - Ground : Battery voltage

Is the inspection result normal?

- YES >> GO TO 4
- NO >> Repair or replace fuse or harness.

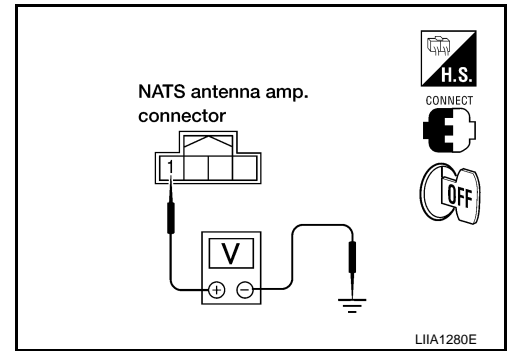

4.CHECK NATS ANTENNA AMP. GROUND LINE CIRCUIT

1. Turn ignition switch OFF.
2. Disconnect NATS antenna amp. connector.
3. Check continuity between NATS antenna amp. connector M21 terminal 3 and ground.

3 - Ground : Continuity should exist.

Is the inspection result normal?

- YES >> GO TO 5
- NO >> • Repair or replace harness.

NOTE:

If harness is OK, replace BCM, refer to [BCS-56, "Removal and Installation"](#). Perform initialization with CONSULT-III. For initialization, refer to "CONSULT-III Operation Manual".

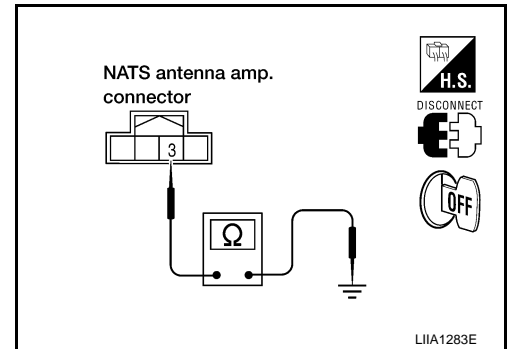

5.CHECK NATS ANTENNA AMP. SIGNAL LINE- 1

1. Connect NATS antenna amp. connector.
2. Turn ignition switch ON.
3. Check voltage between NATS antenna amp. connector M21 terminal 2 and ground with analog tester.

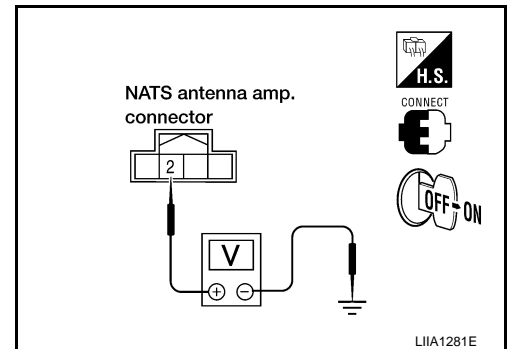

Terminals		Position of ignition key cylinder	Voltage (V) (Approx.)
(+)	(-)		
2	Ground	Before inserting ignition key	Battery voltage
		After inserting ignition key	Pointer of tester should move for approx. 30 seconds, then return to battery voltage
		Just after turning ignition switch ON	Pointer of tester should move for approx. 1 second, then return to battery voltage

Is the inspection result normal?

- YES >> GO TO 6
- NO >> • Repair or replace harness.

NOTE:

If harness is OK, replace BCM, refer to [BCS-56, "Removal and Installation"](#). Perform initialization with CONSULT-III. For initialization, refer to "CONSULT-III Operation Manual".

B2190, P1614 NATS ANTENNA AMP.

< COMPONENT DIAGNOSIS >

[WITH INTELLIGENT KEY SYSTEM]

6. CHECK NATS ANTENNA AMP. SIGNAL LINE- 2

Check voltage between NATS antenna amp. connector M21 terminal 4 and ground with analog tester.

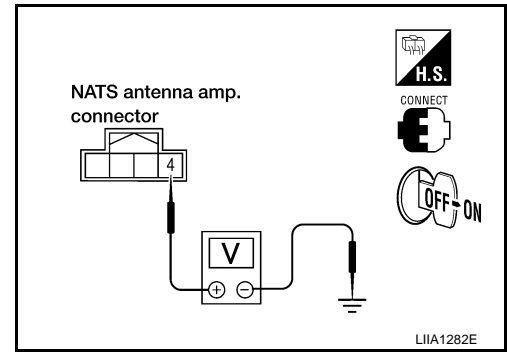

Terminals		Position of ignition key cylinder	Voltage (V) (Approx.)
(+)	(-)		
4	Ground	Before inserting ignition key	Battery voltage
		After inserting ignition key	Pointer of tester should move for approx. 30 seconds, then return to battery voltage
		Just after turning ignition switch ON	Pointer of tester should move for approx. 1 second, then return to battery voltage

Is the inspection result normal?

YES >> NATS antenna amp. is malfunctioning.

NO >> • Repair or replace harness.

NOTE:

If harness is OK, replace BCM, refer to [BCS-56. "Removal and Installation"](#). Perform initialization with CONSULT-III. For initialization, refer to "CONSULT-III Operation Manual".

A
B
C
D
E
F
G
H
I
J
L
M
N
O
P

SEC

B2191, P1615 DIFFERENCE OF KEY

< COMPONENT DIAGNOSIS >

[WITH INTELLIGENT KEY SYSTEM]

B2191, P1615 DIFFERENCE OF KEY

Description

INFOID:000000003710574

Performs ID verification through BCM when ignition knob switch is pressed.
Prohibits the release of steering lock or start of engine when an unregistered ID of mechanical key is used.

DTC Logic

INFOID:000000003710575

DTC DETECTION LOGIC

DTC No.	Trouble diagnosis name	DTC detecting condition	Possible cause
B2191 P1615	DIFFERENCE OF KEY	The ID verification results between BCM and mechanical key are NG. The registration is necessary.	Mechanical key

DTC CONFIRMATION PROCEDURE

1. PERFORM DTC CONFIRMATION PROCEDURE

1. Insert mechanical key into the key cylinder.
2. Press the ignition knob switch.
3. Check "Self diagnostic result" with CONSULT-III.

Is DTC detected?

- YES >> Refer to [SEC-32, "Diagnosis Procedure"](#).
NO >> INSPECTION END.

Diagnosis Procedure

INFOID:000000003710576

1. PERFORM INITIALIZATION

Perform initialization with CONSULT-III. Re-register all mechanical keys.

For initialization and registration of mechanical key. Refer to "CONSULT-III Operation Manual".

Can the system be initialized and can the engine be started with re-registered mechanical key?

- YES >> Mechanical key was unregistered.
NO >> BCM is malfunctioning.
- Replace BCM. Refer to [BCS-56, "Removal and Installation"](#).
 - Perform initialization again

B2192, P1611 ID DISCORD, IMMUECM

< COMPONENT DIAGNOSIS >

[WITH INTELLIGENT KEY SYSTEM]

B2192, P1611 ID DISCORD, IMMUECM

Description

INFOID:000000003710577

BCM performs the ID verification with ECM that allows the engine to start. BCM starts the communication with ECM if ignition switch is turned ON and starts the engine if the ID is OK. ECM prevents the engine from starting if the ID is not registered.

DTC Logic

INFOID:000000003710578

DTC DETECTION LOGIC

NOTE:

- If DTC B2192 is displayed with DTC U1000, first perform the trouble diagnosis for DTC U1000. Refer to [SEC-24, "DTC Logic"](#).
- If DTC B2192 is displayed with DTC U1010, first perform the trouble diagnosis for DTC U1010. Refer to [SEC-25, "DTC Logic"](#).

DTC No.	Trouble diagnosis name	DTC detecting condition	Possible cause
B2192 P1611	ID DISCORD BCM-ECM	The ID verification results between BCM and ECM are NG. The registration is necessary.	<ul style="list-style-type: none">• BCM• ECM

DTC CONFIRMATION PROCEDURE

1. PERFORM DTC CONFIRMATION PROCEDURE

1. Turn ignition switch ON.
2. Check "Self diagnostic result" with CONSULT-III.

Is DTC detected?

- YES >> Refer to [SEC-33, "Diagnosis Procedure"](#).
NO >> INSPECTION END.

Diagnosis Procedure

INFOID:000000003710579

1. PERFORM INITIALIZATION

Perform initialization with CONSULT-III. Re-register all mechanical keys.

For initialization and registration of mechanical key. Refer to "CONSULT-III Operation Manual".

Can the system be initialized and can the engine be started with re-registered mechanical key?

- YES >> ID was unregistered.
NO >> GO TO 2

2. PEPLACE BCM

1. Replace BCM. Refer to [BCS-56, "Removal and Installation"](#).
2. Perform initialization with CONSULT-III. Re-register all mechanical keys.
For initialization and registration of mechanical key. Refer to "CONSULT-III Operation Manual".

Can the system be initialized and can the engine be started with re-registered mechanical key?

- YES >> BCM is malfunctioning.
NO >> GO TO 3

3. PEPLACE ECM

1. Replace ECM. Refer to Removal and Installation.
2. Perform initialization with CONSULT-III. Re-register all mechanical keys.
For initialization and registration of mechanical key. Refer to "CONSULT-III Operation Manual".

Can the system be initialized and can the engine be started with re-registered mechanical key?

- YES >> ECM is malfunctioning.
NO >> GO TO 4

4. CHECK INTERMITTENT INCIDENT

Refer to [GI-37, "Intermittent Incident"](#).

B2192, P1611 ID DISCORD, IMMU-ECM

< COMPONENT DIAGNOSIS >

[WITH INTELLIGENT KEY SYSTEM]

>> INSPECTION END

B2193, P1612 CHAIN OF ECM-IMMU

< COMPONENT DIAGNOSIS >

[WITH INTELLIGENT KEY SYSTEM]

B2193, P1612 CHAIN OF ECM-IMMU

Description

INFOID:000000003710580

BCM performs the ID verification with ECM that allows the engine to start. BCM starts the communication with ECM if ignition switch is turned ON and starts the engine if the ID is OK. ECM prevents the engine from starting if the ID is not registered.

DTC Logic

INFOID:000000003710581

DTC DETECTION LOGIC

NOTE:

- If DTC B2193 is displayed with DTC U1000, first perform the trouble diagnosis for DTC U1000. Refer to [SEC-24, "DTC Logic"](#).
- If DTC B2193 is displayed with DTC U1010, first perform the trouble diagnosis for DTC U1010. Refer to [SEC-25, "DTC Logic"](#).

DTC No.	Trouble diagnosis name	DTC detecting condition	Possible cause
B2193	CHAIN OF BCM-ECM	Inactive communication between ECM and BCM	<ul style="list-style-type: none">• Harness or connectors (The CAN communication line is open or short)• BCM• ECM
P1612			

DTC CONFIRMATION PROCEDURE

1. PERFORM DTC CONFIRMATION PROCEDURE

1. Turn ignition switch ON.
2. Check "Self diagnostic result" with CONSULT-III.

Is DTC detected?

- YES >> Refer to [SEC-35, "Diagnosis Procedure"](#).
NO >> INSPECTION END

Diagnosis Procedure

INFOID:000000003710582

1. REPLACE BCM

1. Replace BCM. Refer to [BCS-56, "Removal and Installation"](#).
2. Perform initialization with CONSULT-III.
For initialization, refer to "CONSULT-III Operation Manual".

Does the engine start?

- YES >> BCM was malfunctioning.
NO >> ECM is malfunctioning.
 - Replace ECM.
 - Perform ECM re-communicating function.

B2194 ID DISCORD IMMU-I-KEY

< COMPONENT DIAGNOSIS >

[WITH INTELLIGENT KEY SYSTEM]

B2194 ID DISCORD IMMU-I-KEY

Description

INFOID:000000003710583

BCM performs the ID verification with Intelligent Key unit that allows the engine to start. BCM starts the communication with Intelligent Key unit if ignition switch is turned ON and starts the engine if the ID is OK. BCM prevents the engine from starting if the ID is not registered.

DTC Logic

INFOID:000000003710584

DTC DETECTION LOGIC

DTC No.	Trouble diagnosis name	DTC detecting condition	Possible cause
B2194	DISCORD BCM-I-KEY	The ID verification results between BCM and Intelligent Key unit are NG. The registration is necessary.	<ul style="list-style-type: none">• BCM• Intelligent Key unit

DTC CONFIRMATION PROCEDURE

1. PERFORM DTC CONFIRMATION PROCEDURE

1. Turn ignition switch ON.
2. Check "Self diagnostic result" with CONSULT-III.

Is DTC detected?

- YES >> Refer to [SEC-36, "Diagnosis Procedure"](#).
NO >> INSPECTION END.

Diagnosis Procedure

INFOID:000000003710585

1. PERFORM INITIALIZATION

1. Perform initialization with CONSULT-III. Re-register all mechanical keys.
For initialization and registration of mechanical key. Refer to "CONSULT-III Operation Manual".
2. Check "Self diagnostic result" with CONSULT-III.

Is DTC detected?

- YES >> GO TO 2
NO >> ID was unregistered.

2. REPLACE BCM

1. Turn ignition switch OFF.
2. Replace BCM. Refer to [BCS-56, "Removal and Installation"](#).
3. Perform initialization with CONSULT-III. Re-register all mechanical keys.
For initialization and registration of mechanical key. Refer to "CONSULT-III Operation Manual".

Can the system be initialized and can the engine be started?

- YES >> BCM is malfunctioning.
NO >> GO TO 3

3. CHECK INTERMITTENT INCIDENT

Refer to [GI-37, "Intermittent Incident"](#).

>> INSPECTION END

B2552 INTELLIGENT KEY

< COMPONENT DIAGNOSIS >

[WITH INTELLIGENT KEY SYSTEM]

B2552 INTELLIGENT KEY

Description

INFOID:000000003710586

Intelligent key unit performs engine start operation and steering lock control by crosschecking ID with the Intelligent key.

DTC Logic

INFOID:000000003710587

DTC DETECTION LOGIC

DTC No.	Trouble diagnosis name	DTC detecting condition	Possible cause
B2552	INTELLIGENT KEY UNIT	Malfunction is detected inside Intelligent key unit.	Intelligent Key unit

DTC CONFIRMATION PROCEDURE

1. PERFORM DTC CONFIRMATION PROCEDURE

1. Turn ignition switch ON.
2. Check "Self diagnostic result" with CONSULT-III.

Is DTC detected?

- YES >> Refer to [SEC-37, "Diagnosis Procedure"](#).
NO >> INSPECTION END.

Diagnosis Procedure

INFOID:000000003710588

1. REPLACE INTELLIGENT KEY UNIT

1. Replace Intelligent Key unit.
2. Perform initialization with CONSULT-III. Re-register all mechanical keys. Refer to "CONSULT-III Operation Manual".
3. Start the engine.

Does the engine start?

- YES >> INSPECTION END
NO >> Perform "DTC confirmation procedure". Refer to [SEC-37, "DTC Logic"](#).

Special Repair Requirement

INFOID:000000003710589

1. REQUIRED WORK WHEN REPLACING INTELLIGENT KEY UNIT

Initialize control unit. Refer to CONSULT-III Operation Manual.

>> Work end.

A
B
C
D
E
F
G
H
I
J
L
M
N
O
P

SEC

B2590 ID DISCORD BCM-I-KEY

< COMPONENT DIAGNOSIS >

[WITH INTELLIGENT KEY SYSTEM]

B2590 ID DISCORD BCM-I-KEY

Description

INFOID:000000003710590

Intelligent Key unit performs the ID verification with BCM that allows the engine to start. BCM starts the engine if the ID is OK and prevents the engine from starting if the ID is not registered.

DTC Logic

INFOID:000000003710591

DTC DETECTION LOGIC

NOTE:

- If DTC B2590 is displayed with DTC U1000, first perform the trouble diagnosis for DTC U1000. Refer to [SEC-24, "DTC Logic"](#).
- If DTC B2590 is displayed with DTC U1010, first perform the trouble diagnosis for DTC U1010. Refer to [SEC-25, "DTC Logic"](#).

DTC No.	Trouble diagnosis name	DTC detecting condition	Possible cause
B2590	ID DISCORD BCM-I-KEY	The ID verification results between BCM and Intelligent Key unit are NG. The registration is necessary.	<ul style="list-style-type: none">• BCM• Intelligent Key unit

DTC CONFIRMATION PROCEDURE

1. PERFORM DTC CONFIRMATION PROCEDURE

1. Turn ignition switch ON.
2. Check "Self diagnostic result" with CONSULT-III.

Is DTC detected?

- YES >> Refer to [SEC-38, "Diagnosis Procedure"](#).
NO >> INSPECTION END

Diagnosis Procedure

INFOID:000000003710592

1. PERFORM INITIALIZATION

Perform initialization with CONSULT-III. Re-register all mechanical keys.

For initialization and registration of mechanical key. Refer to "CONSULT-III Operation Manual".

Can the system be initialized and can the engine be started with re-registered mechanical key?

- YES >> ID was unregistered.
NO >> BCM is malfunctioning.
 - Replace BCM. Refer to REMOVAL PROCEDURE.
 - Perform initialization again

P1610 LOCK MODE

< COMPONENT DIAGNOSIS >

[WITH INTELLIGENT KEY SYSTEM]

P1610 LOCK MODE

Description

INFOID:000000003710593

When the starting operation is carried more than five times consecutively under the following conditions, NATS will shift to the mode which prevents the engine from being started.

- Unregistered mechanical key is used.
- BCM or ECM's malfunctioning.

DTC Logic

INFOID:000000003710594

DTC DETECTION LOGIC

DTC No.	Trouble diagnosis name	DTC detecting condition	Possible cause
P1610	LOCK MODE	When the starting operation is carried out five or more times consecutively under the following conditions. <ul style="list-style-type: none">• Unregistered mechanical key• BCM or ECM's malfunctioning.	—

DTC CONFIRMATION PROCEDURE

1.PERFORM DTC CONFIRMATION PROCEDURE

1. Turn ignition switch ON.
2. Check "Self diagnostic result" with CONSULT-III.

Is DTC detected?

- YES >> Refer to [SEC-39, "Diagnosis Procedure"](#).
NO >> INSPECTION END

Diagnosis Procedure

INFOID:000000003710595

1.CHECK ENGINE START FUNCTION

1. Perform the check for DTC except DTC P1610.
2. Use CONSULT-III to erase DTC after fixing.
3. Check that engine can start with registered mechanical key.

Does the engine start?

- YES >> INSPECTION END
NO >> GO TO 2

2.CHECK INTERMITTENT INCIDENT

Refer to [GI-37, "Intermittent Incident"](#).

>> INSPECTION END

A
B
C
D
E
F
G
H
I
J
L
M
N
O
P

SEC

POWER SUPPLY AND GROUND CIRCUIT

< COMPONENT DIAGNOSIS >

[WITH INTELLIGENT KEY SYSTEM]

POWER SUPPLY AND GROUND CIRCUIT INTELLIGENT KEY UNIT

INTELLIGENT KEY UNIT : Diagnosis Procedure

INFOID:000000004176265

1. CHECK POWER SUPPLY CIRCUIT

1. Turn ignition switch OFF.
2. Disconnect Intelligent Key unit connector.
3. Check voltage between Intelligent Key unit harness connector M70 terminals 6, 11 and ground.

Connector	Terminals		Ignition switch position	
	(+)	(-)	OFF	ON
M70	6	Ground	0V	Battery voltage
	11		Battery voltage	Battery voltage

Is the inspection result normal?

- YES >> GO TO 2
NO >> Repair or replace Intelligent Key power supply circuit.

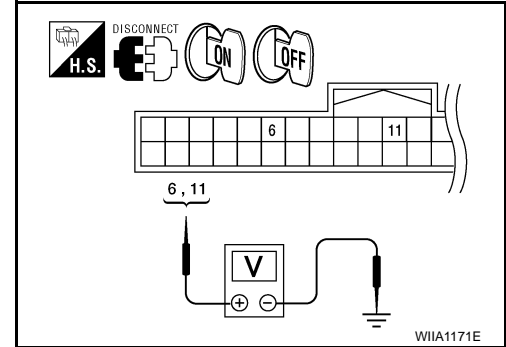

2. CHECK GROUND CIRCUIT

Check continuity between Intelligent Key unit harness connector M70 terminal 12 and ground.

12 - Ground : Continuity should exist.

Is the inspection result normal?

- YES >> Power supply and ground circuits are OK.
NO >> Repair or replace the Intelligent Key unit ground circuit.

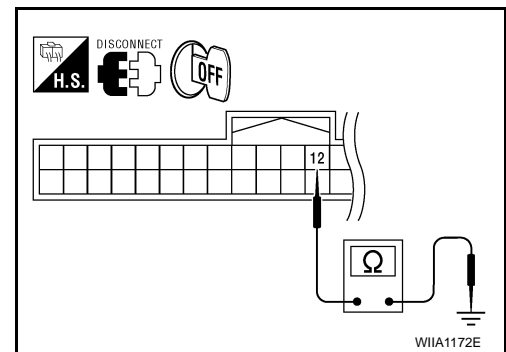

BCM

BCM : Diagnosis Procedure

INFOID:000000004176266

1. CHECK FUSES AND FUSIBLE LINK

Check that the following fuses and fusible link are not blown.

Terminal No.	Signal name	Fuses and fusible link No.
57	Battery power supply	22 (15A)
70		F (50A)
11	Ignition ACC or ON	4 (10A)
38	Ignition ON or START	59 (10A)

Is the fuse blown?

- YES >> Replace the blown fuse or fusible link after repairing the affected circuit.
NO >> GO TO 2

2. CHECK POWER SUPPLY CIRCUIT

POWER SUPPLY AND GROUND CIRCUIT

[WITH INTELLIGENT KEY SYSTEM]

< COMPONENT DIAGNOSIS >

1. Turn ignition switch OFF.
2. Disconnect BCM.
3. Check voltage between BCM harness connector and ground.

Connector	Terminals		Power source	Condition	Voltage (V) (Approx.)
	(+)	(-)			
M18	11	Ground	ACC power supply	Ignition switch ACC or ON	Battery voltage
	38	Ground	Ignition power supply	Ignition switch ON or START	Battery voltage
M20	57	Ground	Battery power supply	Ignition switch OFF	Battery voltage
	70	Ground	Battery power supply	Ignition switch OFF	Battery voltage

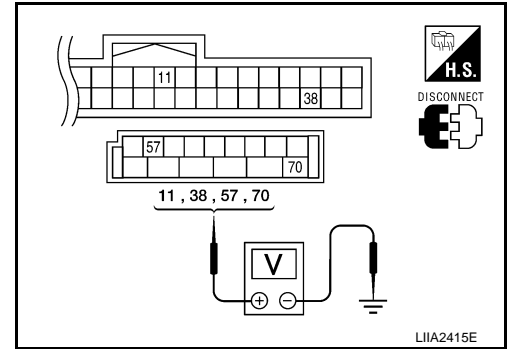

Is the measurement value normal?

- YES >> GO TO 3
 NO >> Repair or replace harness.

3. CHECK GROUND CIRCUIT

Check continuity between BCM harness connector and ground.

BCM		Ground	Continuity
Connector	Terminal		
M20	67		Yes

Does continuity exist?

- YES >> Inspection End.
 NO >> Repair or replace harness.

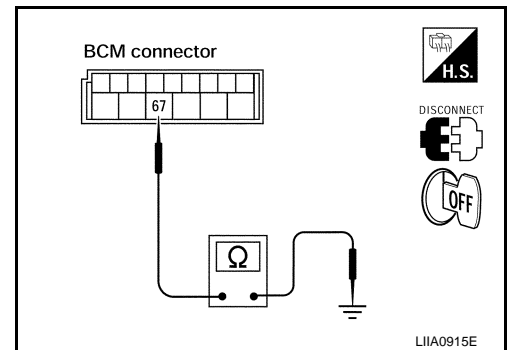

A
B
C
D
E
F
G
H
I
J
L
M
N
O
P

SEC

KEY CYLINDER SWITCH

< COMPONENT DIAGNOSIS >

[WITH INTELLIGENT KEY SYSTEM]

KEY CYLINDER SWITCH

Description

INFOID:000000003710598

The main power window and door lock/unlock switch detects condition of the door key cylinder switch and transmits to BCM as the LOCK or UNLOCK signal.

Component Function Check

INFOID:000000003710599

1. CHECK DOOR KEY CYLINDER SWITCH INPUT SIGNAL

Check "KEY CYL LK-SW" AND "KEY CYL UN-SW" in DATA MONITOR mode for "POWER DOOR LOCK SYSTEM" with CONSULT-III.

Monitor item	Condition
KEY CYL LK-SW	Lock : ON
	Neutral / Unlock : OFF
KEY CYL UN-SW	Unlock : ON
	Neutral / Lock : OFF

Is the inspection result normal?

- YES >> Key cylinder switch is OK.
- NO >> Refer to [SEC-42, "Diagnosis Procedure"](#).

Diagnosis Procedure

INFOID:000000003710600

1. CHECK DOOR KEY CYLINDER SWITCH LH

With CONSULT-III

Check front door lock assembly LH (key cylinder switch) ("KEY CYL LK-SW") and ("KEY CYL UN-SW") in DATA MONITOR mode with CONSULT-III.

- When key inserted in left front key cylinder is turned to LOCK:

KEY CYL LK-SW : ON

- When key inserted in left front key cylinder is turned to UNLOCK:

KEY CYL UN-SW : ON

Without CONSULT-III

Check voltage between main power window and door lock/unlock switch connector D7 terminals 4, 6 and ground.

Connector	Terminals		Condition of left front key cylinder	Voltage (V) (Approx.)
	(+)	(-)		
D7	4	Ground	Neutral/Unlock	5
			Lock	0
	6		Neutral/Lock	5
			Unlock	0

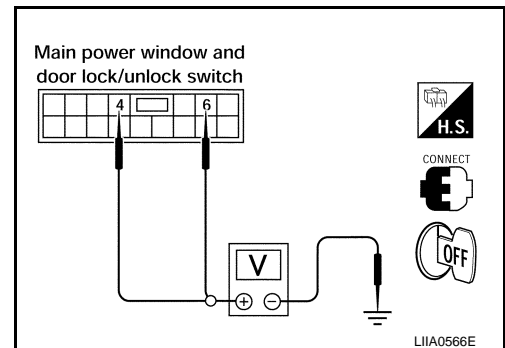

Is the inspection result normal?

- YES >> Key cylinder switch signal is OK.
- NO >> GO TO 2

2. CHECK DOOR KEY CYLINDER SWITCH LH GROUND HARNESS

1. Turn ignition switch OFF.
2. Disconnect front door lock assembly LH (key cylinder switch).

KEY CYLINDER SWITCH

[WITH INTELLIGENT KEY SYSTEM]

< COMPONENT DIAGNOSIS >

3. Check continuity between front door lock assembly LH (key cylinder switch) connector (A) D14 terminal 5 and body ground.

Connector	Terminals	Continuity
D14	5 – Ground	Yes

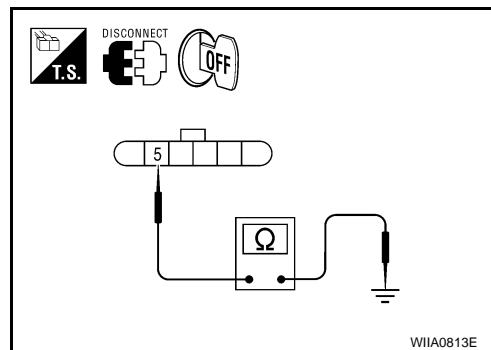

Is the inspection result normal?

- YES >> GO TO 3
NO >> Repair or replace harness.

3.CHECK DOOR KEY CYLINDER SWITCH LH

Check continuity between front door lock assembly LH (key cylinder switch) terminals.

Terminals	Condition	Continuity
1 – 5	Key is turned to UNLOCK or neutral.	No
	Key is turned to LOCK.	Yes
5 – 6	Key is turned to LOCK or neutral.	No
	Key is turned to UNLOCK.	Yes

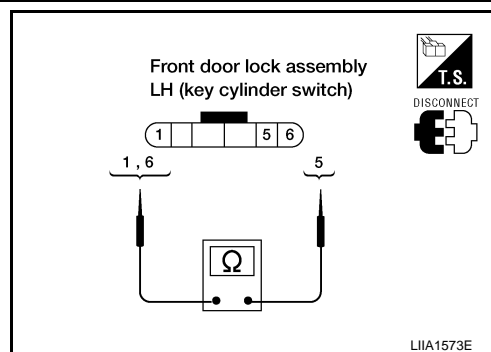

Is the inspection result normal?

- YES >> GO TO 4
NO >> Replace front door lock assembly LH (key cylinder switch). Refer to [DLK-232. "Removal and Installation"](#).

4.CHECK DOOR KEY CYLINDER HARNESS

Check continuity between main power window and door lock/unlock switch connector (A) D7 terminals 4, 6 and front door lock assembly LH (key cylinder switch) connector (B) D14 terminals 1, 6 and body ground.

Connector	Terminals	Connector	Terminals	Continuity
A: Main power window and door lock/unlock switch	4	B: Front door lock assembly LH (key cylinder switch)	1	Yes
	6		6	Yes
	4, 6	Ground	No	

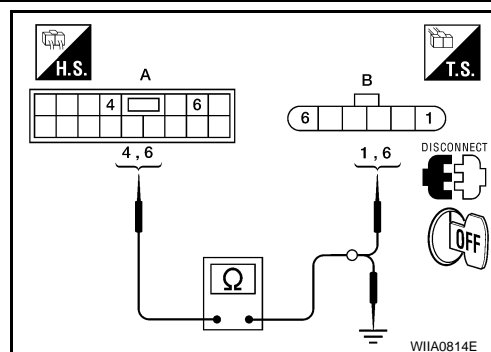

Is the inspection result normal?

- YES >> Replace main power window and door lock/unlock switch.
NO >> Repair or replace harness.

IGNITION KNOB SWITCH

< COMPONENT DIAGNOSIS >

[WITH INTELLIGENT KEY SYSTEM]

IGNITION KNOB SWITCH

Ignition Knob Switch Check

INFOID:000000003710601

1. CHECK IGNITION KNOB SWITCH

④ With CONSULT-III

Display "PUSH SW" on DATA MONITOR screen, and check if ON/OFF display is linked to ignition switch operation.

Monitor item	Condition
PUSH SW	Ignition switch is pushed: ON
	Ignition switch is released: OFF

⊗ Without CONSULT-III

- Turn ignition switch OFF.
- Disconnect Intelligent Key unit connector.
- Check voltage between Intelligent Key unit harness connector M70 terminal 27 and ground.

Connector	Terminals		Condition	Voltage (V) (Approx.)
	(+)	(-)		
M70	27	Ground	Ignition switch is pushed	Battery voltage
			Ignition switch is released	0

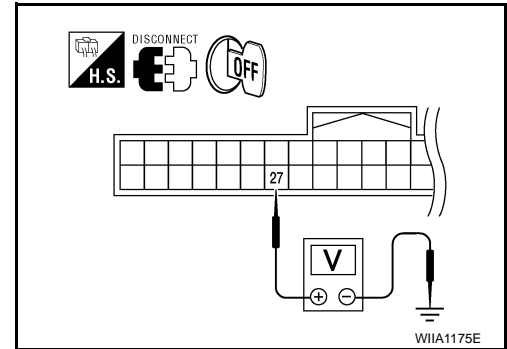

Is the inspection result normal?

- YES >> Ignition knob switch is OK.
 NO >> GO TO 2

2. CHECK IGNITION KNOB SWITCH POWER SUPPLY CIRCUIT

- Turn ignition switch OFF.
- Disconnect key switch and ignition knob switch connector.
- Check voltage between key switch and ignition knob switch harness connector M12 terminal 1 and ground.

1 - Ground : **Battery voltage**

Is the inspection result normal?

- YES >> GO TO 3
 NO >> Repair or replace key switch and ignition knob switch power supply circuit.

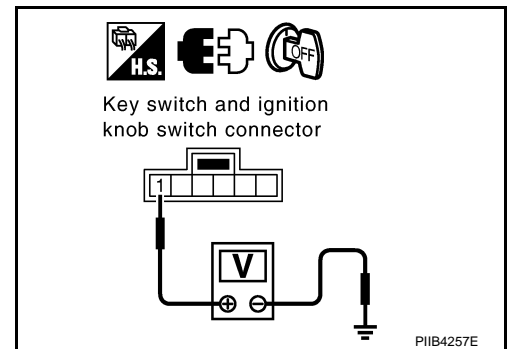

3. CHECK IGNITION KNOB SWITCH OPERATION

Check continuity between key switch and ignition knob switch terminals 1 and 2.

IGNITION KNOB SWITCH

< COMPONENT DIAGNOSIS >

[WITH INTELLIGENT KEY SYSTEM]

Component	Terminals		Condition	Continuity
Ignition knob switch	1	2	Ignition switch is pushed	Yes
			Ignition switch is released	No

Is the inspection result normal?

YES >> GO TO 4

NO >> Replace key switch and ignition knob switch.

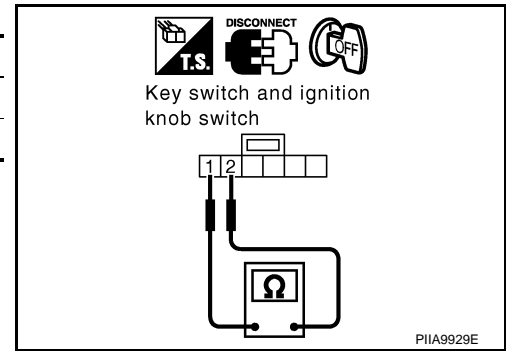

4. CHECK IGNITION KNOB SWITCH CIRCUIT

1. Check continuity between Intelligent Key unit harness connector (A) M70 terminal 27 and key switch and ignition knob switch harness connector (B) M12 terminal 2.

27 - 2 : Continuity should exist.

2. Check continuity between Intelligent Key unit harness connector M70 terminal 27 and ground.

27 - Ground : Continuity should not exist.

Is the inspection result normal?

YES >> Check the condition of harness and harness connector.

NO >> Repair or replace harness between Intelligent Key unit and key switch and ignition knob switch.

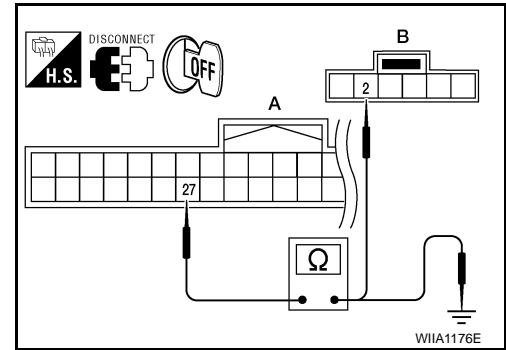

A
B
C
D
E
F
G
H
I
J
L
M
N
O
P

SEC

HORN FUNCTION

< COMPONENT DIAGNOSIS >

[WITH INTELLIGENT KEY SYSTEM]

HORN FUNCTION

Symptom Table

INFOID:000000003710602

HAZARD AND HORN REMINDER FUNCTION MALFUNCTION

NOTE:

- Before performing the diagnosis in the following table, check “Work flow”. Refer to [DLK-8, "Work Flow"](#).
- If the following symptoms are detected, check systems shown in the “Diagnosis/service procedure” column in this order.

Conditions of Vehicle (Operating Conditions)

- “ANSWER BACK FUNCTION” is ON when setting on CONSULT-III.
- Ignition switch is in OFF position.
- All doors are closed.

Symptom	Diagnosis/service procedure	Reference page
Hazard reminder does not operate by request switch. (Horn reminder operate.)	1. Check “HAZARD ANSWER BACK” setting in “WORK SUPPORT”.	SEC-22
	2. Check hazard function.	DLK-112
	3. Check Intermittent Incident.	GI-37
Hazard reminder does not operate by Intelligent Key. (Horn reminder operate.)	1. Check “HAZARD ANSWER BACK” setting in “WORK SUPPORT”.	SEC-22
	2. Check hazard function.	DLK-112
	3. Check Intelligent Key battery inspection.	DLK-106
Horn reminder does not operate by request switch. (Hazard reminder operate.)	1. Check “ANSWER BACK WITH I-KEY LOCK” or “ANSWER BACK WITH I-KEY UNLOCK” setting in “WORK SUPPORT”.	SEC-22
	2. Check Intelligent Key warning buzzer.	DLK-95
	3. Check Intermittent Incident.	GI-37
Horn reminder does not operate by Intelligent Key. (Hazard reminder operate.)	1. Check “HORN WITH KEYLESS LOCK” setting in “WORK SUPPORT”.	SEC-22
	2. Check horn function.	DLK-108
	3. Check Intermittent Incident.	GI-37

VEHICLE SECURITY INDICATOR

< COMPONENT DIAGNOSIS >

[WITH INTELLIGENT KEY SYSTEM]

VEHICLE SECURITY INDICATOR

Description

INFOID:000000003710603

- Vehicle security indicator is built in combination meter.
- NATS (Nissan Anti-Theft System) and vehicle security system conditions are indicated by blink or illumination of vehicle security indicator.

Component Function Check

INFOID:000000003710604

1.CHECK FUNCTION

1. Perform "THEFT IND" in the "Active Test" mode with CONSULT-III.
2. Check vehicle security indicator operation.

Test item		Description	
THEFT IND	ON	Vehicle security indicator	ON
	OFF		OFF

Is the inspection result normal?

- YES >> INSPECTION END.
NO >> Refer to [SEC-47, "Diagnosis Procedure"](#).

Diagnosis Procedure

INFOID:000000003710605

1.SECURITY INDICATOR LAMP ACTIVE TEST

With CONSULT-III
Check "THEFT IND" in "ACTIVE TEST" mode with CONSULT-III.

- Without CONSULT-III
1. Disconnect BCM.
 2. Check voltage between BCM harness connector M18 terminal 23 and ground.

Connector	Terminals		Condition	Voltage (V) (Approx.)
	(+)	(-)		
M18	23	Ground	ON	0
			OFF	Battery voltage

Is the inspection result normal?

- YES >> Security indicator lamp is OK.
NO >> GO TO 2

2.SECURITY INDICATOR LAMP CHECK

Check security indicator lamp condition.

Is the inspection result normal?

- YES >> GO TO 3
NO >> Replace security indicator lamp.

3.CHECK HARNESS CONTINUITY

1. Turn ignition switch OFF.
2. Disconnect BCM and security indicator lamp connector.

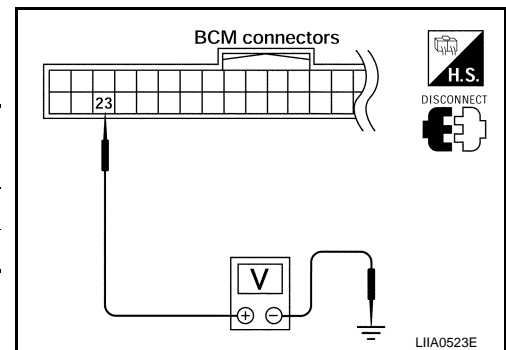

VEHICLE SECURITY INDICATOR

[WITH INTELLIGENT KEY SYSTEM]

< COMPONENT DIAGNOSIS >

3. Check continuity between BCM connector (A) M18 terminal 23 and security indicator lamp harness connector (B) M24 terminal 28.

23 - 28 : Continuity should exist.

4. Check continuity between BCM connector (A) M18 terminal 23 and ground.

23 - Ground : Continuity should not exist.

Is the inspection result normal?

YES >> Check the following:

- 10A fuse [No. 19, located in fuse block (J/B)]
- Harness for open or short between security indicator lamp and fuse

NO >> Repair or replace harness.

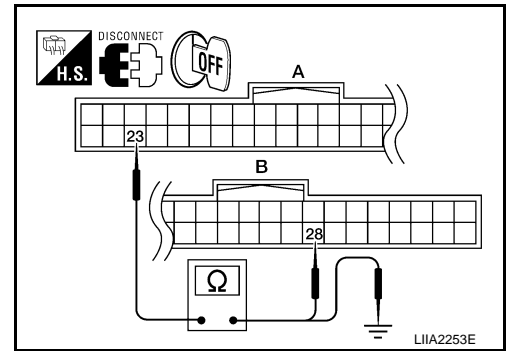

BCM (BODY CONTROL MODULE)

< ECU DIAGNOSIS >

[WITH INTELLIGENT KEY SYSTEM]

ECU DIAGNOSIS

BCM (BODY CONTROL MODULE)

Reference Value

INFOID:000000004173722

VALUES ON THE DIAGNOSIS TOOL

Monitor Item	Condition	Value/Status
AIR COND SW	A/C switch OFF	OFF
	A/C switch ON	ON
AUT LIGHT SYS	Outside of the room is dark	OFF
	Outside of the room is bright	ON
AUTO LIGHT SW	Lighting switch OFF	OFF
	Lighting switch AUTO	ON
BACK DOOR SW	Back door closed	OFF
	Back door opened	ON
CDL LOCK SW	Door lock/unlock switch does not operate	OFF
	Press door lock/unlock switch to the LOCK side	ON
CDL UNLOCK SW	Door lock/unlock switch does not operate	OFF
	Press door lock/unlock switch to the UNLOCK side	ON
DOOR SW-AS	Front door RH closed	OFF
	Front door RH opened	ON
DOOR SW-DR	Front door LH closed	OFF
	Front door LH opened	ON
DOOR SW-RL	Rear door LH closed	OFF
	Rear door LH opened	ON
DOOR SW-RR	Rear door RH closed	OFF
	Rear door RH opened	ON
ENGINE RUN	Engine stopped	OFF
	Engine running	ON
FR FOG SW	Front fog lamp switch OFF	OFF
	Front fog lamp switch ON	ON
FR WASHER SW	Front washer switch OFF	OFF
	Front washer switch ON	ON
FR WIPER LOW	Front wiper switch OFF	OFF
	Front wiper switch LO	ON
FR WIPER HI	Front wiper switch OFF	OFF
	Front wiper switch HI	ON
FR WIPER INT	Front wiper switch OFF	OFF
	Front wiper switch INT	ON
FR WIPER STOP	Any position other than front wiper stop position	OFF
	Front wiper stop position	ON
HAZARD SW	When hazard switch is not pressed	OFF
	When hazard switch is pressed	ON
LIGHT SW 1ST	Lighting switch OFF	OFF
	Lighting switch 1st	ON

A
B
C
D
E
F
G
H
I
J
L
M
N
O
P

SEC

BCM (BODY CONTROL MODULE)

< ECU DIAGNOSIS >

[WITH INTELLIGENT KEY SYSTEM]

Monitor Item	Condition	Value/Status
HEADLAMP SW1	Headlamp switch OFF	OFF
	Headlamp switch 1st	ON
HEADLAMP SW2	Headlamp switch OFF	OFF
	Headlamp switch 1st	ON
HI BEAM SW	High beam switch OFF	OFF
	High beam switch HI	ON
H/L WASH SW	NOTE: The item is indicated, but not monitored	OFF
IGN ON SW	Ignition switch OFF or ACC	OFF
	Ignition switch ON	ON
IGN SW CAN	Ignition switch OFF or ACC	OFF
	Ignition switch ON	ON
INT VOLUME	Wiper intermittent dial is in a dial position 1 - 7	1 - 7
I-KEY LOCK ¹	LOCK button of Intelligent Key is not pressed	OFF
	LOCK button of Intelligent Key is pressed	ON
I-KEY UNLOCK ¹	UNLOCK button of Intelligent Key is not pressed	OFF
	UNLOCK button of Intelligent Key is pressed	ON
KEY ON SW	Mechanical key is removed from key cylinder	OFF
	Mechanical key is inserted to key cylinder	ON
KEYLESS LOCK ²	LOCK button of key fob is not pressed	OFF
	LOCK button of key fob is pressed	ON
KEYLESS UNLOCK ²	UNLOCK button of key fob is not pressed	OFF
	UNLOCK button of key fob is pressed	ON
OIL PRESS SW	<ul style="list-style-type: none"> • Ignition switch OFF or ACC • Engine running 	OFF
	Ignition switch ON	ON
PASSING SW	Other than lighting switch PASS	OFF
	Lighting switch PASS	ON
PUSH SW ¹	Return to ignition switch to LOCK position	OFF
	Press ignition switch	ON
REAR DEF SW	Rear window defogger switch OFF	OFF
	Rear window defogger switch ON	ON
RKE LOCK AND UNLOCK ²	NOTE: The item is indicated, but not monitored	OFF
		ON
RR WASHER SW	Rear washer switch OFF	OFF
	Rear washer switch ON	ON
RR WIPER INT	Rear wiper switch OFF	OFF
	Rear wiper switch INT	ON
RR WIPER ON	Rear wiper switch OFF	OFF
	Rear wiper switch ON	ON
RR WIPER STOP	Rear wiper stop position	OFF
	Other than rear wiper stop position	ON
TAIL LAMP SW	Lighting switch OFF	OFF
	Lighting switch 1ST	ON

BCM (BODY CONTROL MODULE)

< ECU DIAGNOSIS >

[WITH INTELLIGENT KEY SYSTEM]

Monitor Item	Condition	Value/Status
TRNK OPNR SW	When back door opener switch is not pressed	OFF
	When back door opener switch is pressed	ON
TURN SIGNAL L	Turn signal switch OFF	OFF
	Turn signal switch LH	ON
TURN SIGNAL R	Turn signal switch OFF	OFF
	Turn signal switch RH	ON
VEHICLE SPEED	While driving	Equivalent to speedometer reading

1: With Intelligent Key

2: With remote keyless entry system

A

B

C

D

E

F

G

H

I

J

SEC

L

M

N

O

P

BCM (BODY CONTROL MODULE)

[WITH INTELLIGENT KEY SYSTEM]

< ECU DIAGNOSIS >

Terminal Layout

INFOID:000000004173723

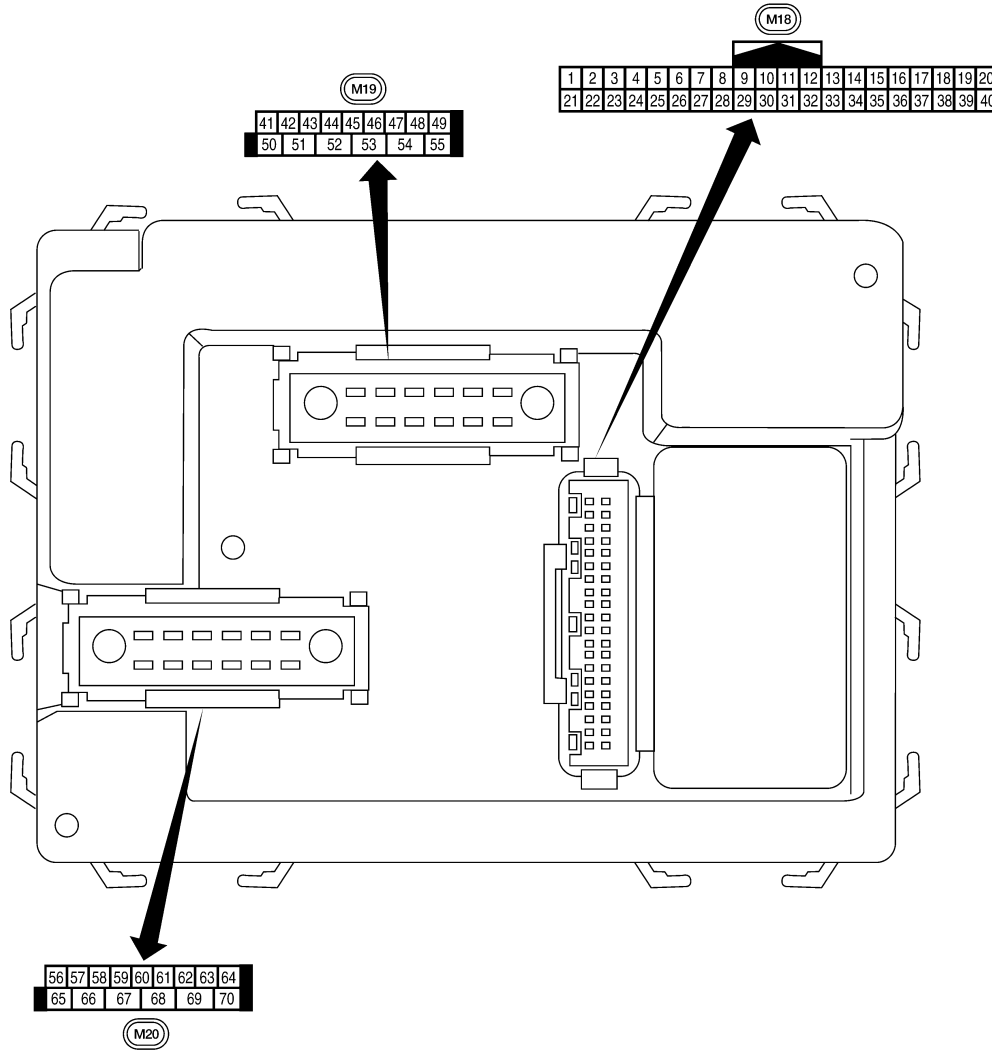

Physical Values



LIA2443E

INFOID:000000004173724

BCM (BODY CONTROL MODULE)

[WITH INTELLIGENT KEY SYSTEM]

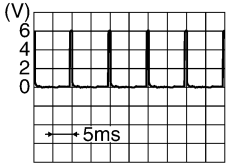
< ECU DIAGNOSIS >

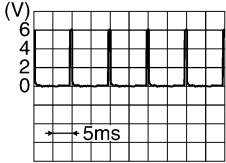
Terminal	Wire color	Signal name	Signal input/output	Measuring condition		Reference value or waveform (Approx.)
				Ignition switch	Operation or condition	
1	BR/W	Ignition keyhole illumination	Output	OFF	Door is locked (SW OFF)	Battery voltage
					Door is unlocked (SW ON)	0V
2	SB	Combination switch input 5	Input	ON	Lighting, turn, wiper OFF Wiper dial position 4	 <p style="text-align: right; font-size: small;">SKIA5291E</p>
3	G/Y	Combination switch input 4	Input	ON	Lighting, turn, wiper OFF Wiper dial position 4	 <p style="text-align: right; font-size: small;">SKIA5292E</p>
4	Y	Combination switch input 3	Input	ON	Lighting, turn, wiper OFF Wiper dial position 4	 <p style="text-align: right; font-size: small;">SKIA5291E</p>
5	G/B	Combination switch input 2	Input	ON	Lighting, turn, wiper OFF Wiper dial position 4	 <p style="text-align: right; font-size: small;">SKIA5292E</p>
6	V	Combination switch input 1				
9	GR/R	Rear window defogger switch	Input	ON	Rear window defogger switch ON	0V
					Rear window defogger switch OFF	5V
10	G	Hazard lamp flash	Input	OFF	ON (opening or closing)	0V
					OFF (other than above)	Battery voltage
11	O	Ignition switch (ACC or ON)	Input	ACC or ON	Ignition switch ACC or ON	Battery voltage
12	R/L	Front door switch RH	Input	OFF	ON (open)	0V
					OFF (closed)	Battery voltage
13	GR	Rear door switch RH	Input	OFF	ON (open)	0V
					OFF (closed)	Battery voltage
15	L/W	Tire pressure warning check connector	Input	OFF	—	5V
18	P	Remote keyless entry receiver and optical sensor (ground)	Output	OFF	—	0V

A
B
C
D
E
F
G
H
I
J
L
M
N
O
P

SEC

BCM (BODY CONTROL MODULE)

[WITH INTELLIGENT KEY SYSTEM]



< ECU DIAGNOSIS >

Terminal	Wire color	Signal name	Signal input/output	Measuring condition		Reference value or waveform (Approx.)
				Ignition switch	Operation or condition	
19	V/W	Remote keyless entry receiver (power supply)	Output	OFF	Ignition switch OFF	<p style="text-align: right;">LIA1893E</p>
20	G/W	Remote keyless entry receiver (signal)	Input	OFF	Stand-by (keyfob buttons released)	<p style="text-align: right;">LIA1894E</p>
					When remote keyless entry receiver receives signal from keyfob (keyfob buttons pressed)	<p style="text-align: right;">LIA1895E</p>
21	G	NATS antenna amp.	Input	OFF → ON	Ignition switch (OFF → ON)	Just after turning ignition switch ON: Pointer of tester should move for approx. 1 second, then return to battery voltage.
22	W/V	BUS	—	—	Ignition switch ON or power window timer operates	<p style="text-align: right;">PIIA2344E</p>
23	G/O	Security indicator lamp	Output	OFF	Goes OFF → illuminates (Every 2.4 seconds)	Battery voltage → 0V
25	BR	NATS antenna amp.	Input	OFF → ON	Ignition switch (OFF → ON)	Just after turning ignition switch ON: Pointer of tester should move for approx. 1 second, then return to battery voltage.
26	Y/L	Rear wiper auto stop switch 2	Input	ON	Rise up position (rear wiper arm on stopper)	0V
					A Position (full clockwise stop position)	0V
					Forward sweep (counterclockwise direction)	Fluctuating
					B Position (full counterclockwise stop position)	Battery voltage
					Reverse sweep (clockwise direction)	Fluctuating
27	W/R	Compressor ON signal	Input	ON	A/C switch OFF	5V
					A/C switch ON	0V

BCM (BODY CONTROL MODULE)

[WITH INTELLIGENT KEY SYSTEM]

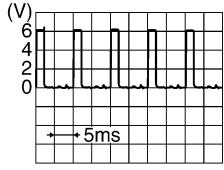
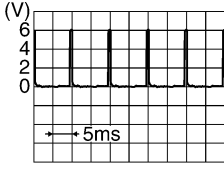
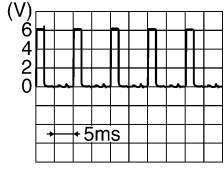
< ECU DIAGNOSIS >

Terminal	Wire color	Signal name	Signal input/output	Measuring condition		Reference value or waveform (Approx.)
				Ignition switch	Operation or condition	
28	L/R	Front blower monitor	Input	ON	Front blower motor OFF	Battery voltage
					Front blower motor ON	0V
29	W/B	Hazard switch	Input	OFF	ON	0V
					OFF	5V
32	R/G	Combination switch output 5	Output	ON	Lighting, turn, wiper OFF Wiper dial position 4	 <p style="text-align: right; font-size: small;">SKIA5291E</p>
33	R/Y	Combination switch output 4	Output	ON	Lighting, turn, wiper OFF Wiper dial position 4	 <p style="text-align: right; font-size: small;">SKIA5292E</p>
34	L	Combination switch output 3	Output	ON	Lighting, turn, wiper OFF Wiper dial position 4	 <p style="text-align: right; font-size: small;">SKIA5291E</p>
35	O/B	Combination switch output 2	Output	ON	Lighting, turn, wiper OFF Wiper dial position 4	 <p style="text-align: right; font-size: small;">SKIA5292E</p>
36	R/W	Combination switch output 1				
37 ¹	B/R	Key switch and ignition knob switch	Input	OFF	Intelligent Key inserted	Battery voltage
					Intelligent Key inserted	0V
37 ²	B/R	Key switch and key lock solenoid	Input	OFF	Key inserted	Battery voltage
					Key inserted	0V
38	W/L	Ignition switch (ON)	Input	ON	—	Battery voltage
39	L	CAN-H	—	—	—	—
40	P	CAN-L	—	—	—	—
42	GR	Glass hatch ajar switch	Input	ON	Glass hatch open	0
					Glass hatch closed	Battery
43	R/B	Back door switch (without power back door) or back door latch (door ajar switch) (with power back door)	Input	OFF	ON (open)	0V
					OFF (closed)	Battery voltage

A
B
C
D
E
F
G
H
I
J
L
M
N
O
P

SEC

BCM (BODY CONTROL MODULE)

< ECU DIAGNOSIS >

[WITH INTELLIGENT KEY SYSTEM]

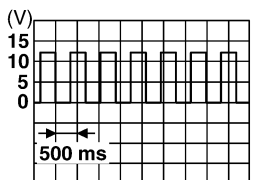
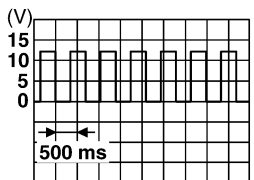
Terminal	Wire color	Signal name	Signal input/output	Measuring condition		Reference value or waveform (Approx.)
				Ignition switch	Operation or condition	
44	O	Rear wiper auto stop switch 1	Input	ON	Rise up position (rear wiper arm on stopper)	0V
					A Position (full clockwise stop position)	Battery voltage
					Forward sweep (counterclockwise direction)	Fluctuating
					B Position (full counterclockwise stop position)	0V
					Reverse sweep (clockwise direction)	Fluctuating
47	SB	Front door switch LH	Input	OFF	ON (open)	0V
					OFF (closed)	Battery voltage
48	R/Y	Rear door switch LH	Input	OFF	ON (open)	0V
					OFF (closed)	Battery voltage
49	R	Cargo lamp	Output	OFF	Any door open (ON)	0V
					All doors closed (OFF)	Battery voltage
51	G/Y	Trailer turn signal (right)	Output	ON	Turn right ON	 <p style="text-align: right; font-size: small;">SKIA3009J</p>
52	G/B	Trailer turn signal (left)	Output	ON	Turn left ON	 <p style="text-align: right; font-size: small;">SKIA3009J</p>
54	Y	Rear wiper output circuit 2	Input	ON	Rise up position (rear wiper arm on stopper)	0V
					A Position (full clockwise stop position)	0V
					Forward sweep (counterclockwise direction)	0V
					B Position (full counterclockwise stop position)	Battery voltage
					Reverse sweep (clockwise direction)	Battery voltage
55	SB	Rear wiper output circuit 1	Output	ON	OFF	0
					ON	Battery voltage
56	R/G	Battery saver output	Output	OFF	30 minutes after ignition switch is turned OFF	0V
				ON	—	Battery voltage
57	Y/R	Battery power supply	Input	OFF	—	Battery voltage

BCM (BODY CONTROL MODULE)

< ECU DIAGNOSIS >

[WITH INTELLIGENT KEY SYSTEM]

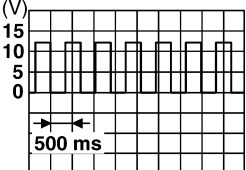
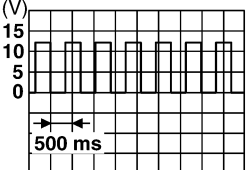
Terminal	Wire color	Signal name	Signal input/output	Measuring condition		Reference value or waveform (Approx.)
				Ignition switch	Operation or condition	
58	W/R	Optical sensor	Input	ON	When optical sensor is illuminated	3.1V or more
					When optical sensor is not illuminated	0.6V or less
59	G	Front door lock assembly LH actuator (unlock)	Output	OFF	OFF (neutral)	0V
					ON (unlock)	Battery voltage
60	G/B	Turn signal (left)	Output	ON	Turn left ON	 <p style="text-align: right; font-size: small;">SKIA3009J</p>
61	G/Y	Turn signal (right)	Output	ON	Turn right ON	 <p style="text-align: right; font-size: small;">SKIA3009J</p>
62	R/W	Step lamp LH and RH	Output	OFF	ON (any door open)	0V
					OFF (all doors closed)	Battery voltage
63	L	Interior room/map lamp	Output	OFF	Any door switch ON (open)	0V
					OFF (closed)	Battery voltage
65	V	All door lock actuators (lock)	Output	OFF	OFF (neutral)	0V
					ON (lock)	Battery voltage
66	G/Y	Front door lock actuator RH, rear door lock actuators LH/RH and back door lock actuator (unlock)	Output	OFF	OFF (neutral)	0V
					ON (unlock)	Battery voltage
67	B	Ground	Input	ON	—	0V
68	W/L	Power window power supply (RAP)	Output	—	Ignition switch ON	Battery voltage
					Within 45 seconds after ignition switch OFF	Battery voltage
					More than 45 seconds after ignition switch OFF	0V
					When front door LH or RH is open or power window timer operates	0V
69	W/R	Power window power supply	Output	—	—	Battery voltage
70	W/B	Battery power supply	Input	OFF	—	Battery voltage

1: With Intelligent Key system

2: With remote keyless entry system

A
B
C
D
E
F
G
H
I
J
L
M
N
O
P

SEC

BCM (BODY CONTROL MODULE)

[WITH INTELLIGENT KEY SYSTEM]

< ECU DIAGNOSIS >

Wiring Diagram - VEHICLE SECURITY SYSTEM

INFOID:000000003710607

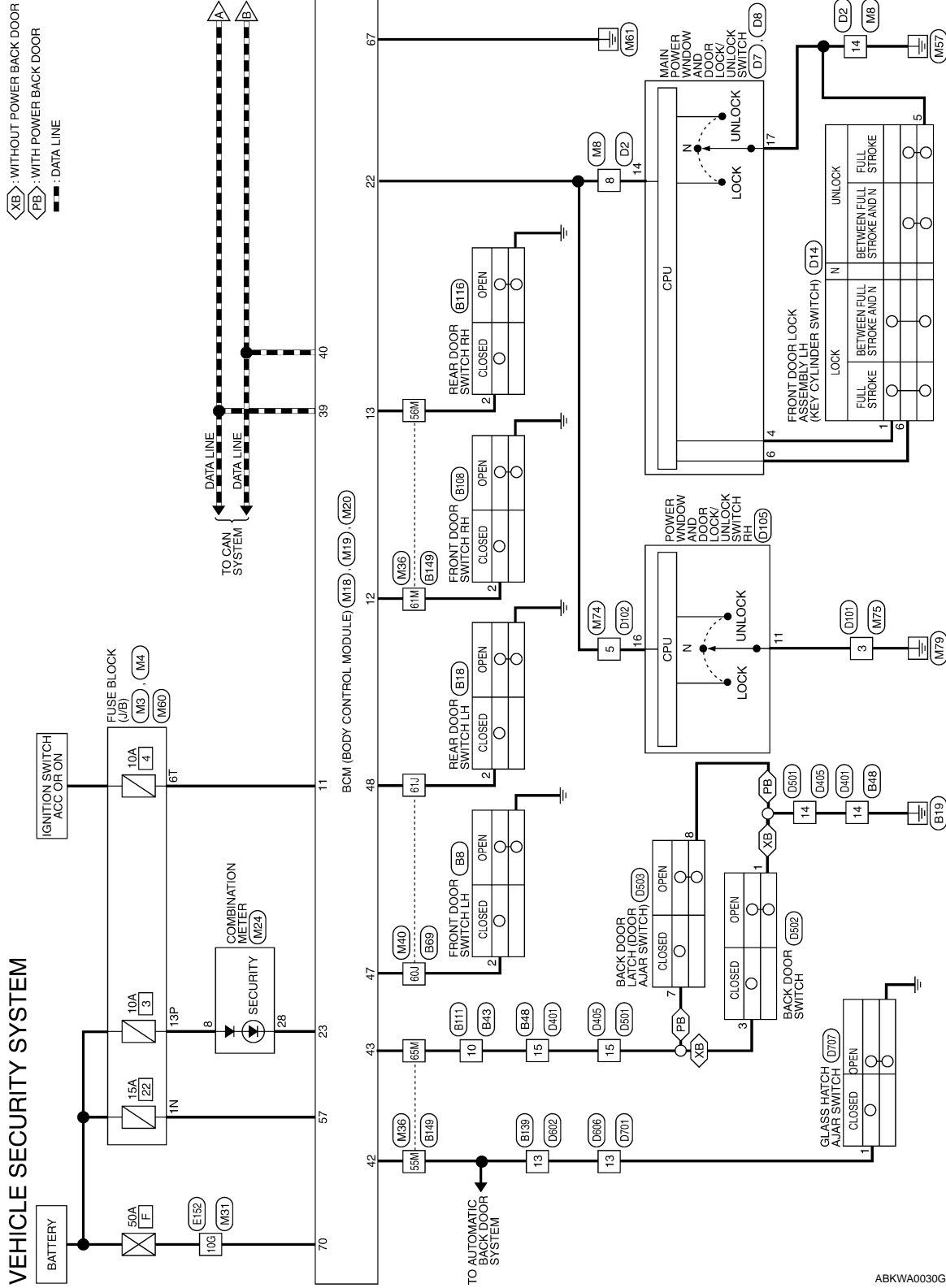

ABKWA0030GE

BCM (BODY CONTROL MODULE)

[WITH INTELLIGENT KEY SYSTEM]

< ECU DIAGNOSIS >

— : DATA LINE

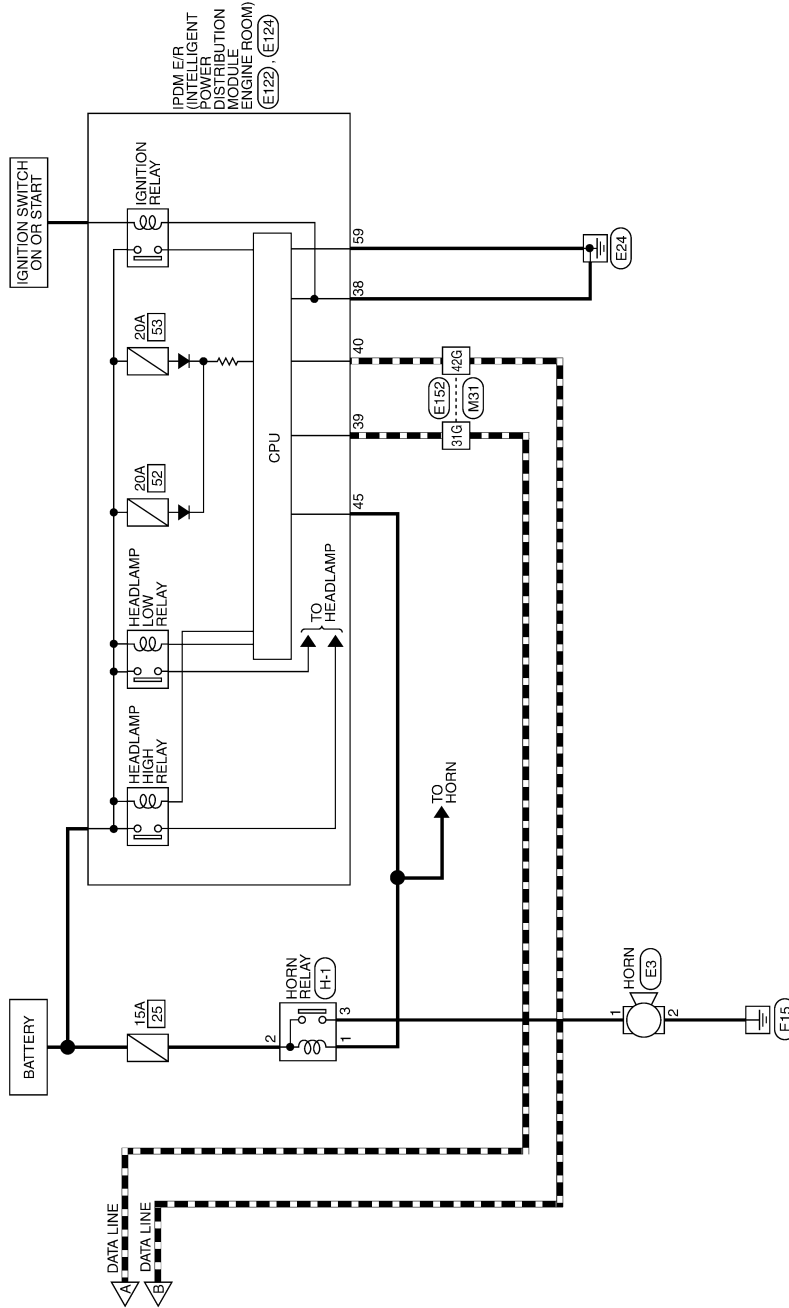

A
B
C
D
E
F
G
H
I
J
L
M
N
O
P

SEC

ALKWA0080GE

BCM (BODY CONTROL MODULE)

[WITH INTELLIGENT KEY SYSTEM]

< ECU DIAGNOSIS >

VEHICLE SECURITY SYSTEM CONNECTORS

Connector No.	M3
Connector Name	FUSE BLOCK (J/B)
Connector Color	WHITE

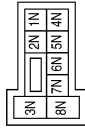

Terminal No.	Color of Wire	Signal Name
1N	Y/R	-

Connector No.	M4
Connector Name	FUSE BLOCK (J/B)
Connector Color	WHITE



Terminal No.	Color of Wire	Signal Name
13P	P	-

Connector No.	M8
Connector Name	WIRE TO WIRE
Connector Color	WHITE

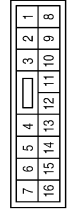

Terminal No.	Color of Wire	Signal Name
8	W/V	-
14	B	-

Connector No.	M18
Connector Name	BCM (BODY CONTROL MODULE)
Connector Color	WHITE

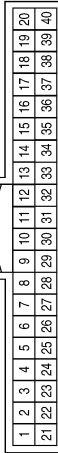

Terminal No.	Color of Wire	Signal Name
11	O	ACC SW
12	R/L	DOOR SW (AS)
13	GR	DOOR SW (RR)
22	W/V	ANTI-PINCH SERIAL LINK (RX, TX)
23	G/O	SECURITY INDICATOR OUTPUT
39	L	CAN-H
40	P	CAN-L

Connector No.	M19
Connector Name	BCM (BODY CONTROL MODULE)
Connector Color	WHITE

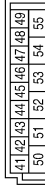

Terminal No.	Color of Wire	Signal Name
42	GR	GLASS HATCH SW
43	R/B	BACK DOOR SW
47	SB	DOOR SW (DR)
48	R/Y	DOOR SW (RL)

Connector No.	M20
Connector Name	BCM (BODY CONTROL MODULE)
Connector Color	BLACK

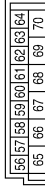

Terminal No.	Color of Wire	Signal Name
57	Y/R	BAT(FUSE)
67	B	GND (POWER)
70	W/B	BATT (F/L)

ABKIA0080GB

BCM (BODY CONTROL MODULE)

[WITH INTELLIGENT KEY SYSTEM]

< ECU DIAGNOSIS >

Terminal No.	Color of Wire	Signal Name
10G	W/B	-
31G	L	-
42G	P	-

Connector No.	M31
Connector Name	WIRE TO WIRE
Connector Color	WHITE

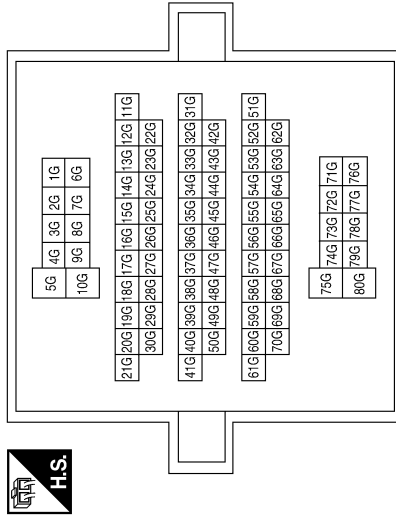

Connector No.	M24
Connector Name	COMBINATION METER
Connector Color	WHITE

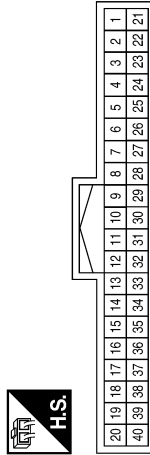

Connector No.	M36
Connector Name	WIRE TO WIRE
Connector Color	WHITE

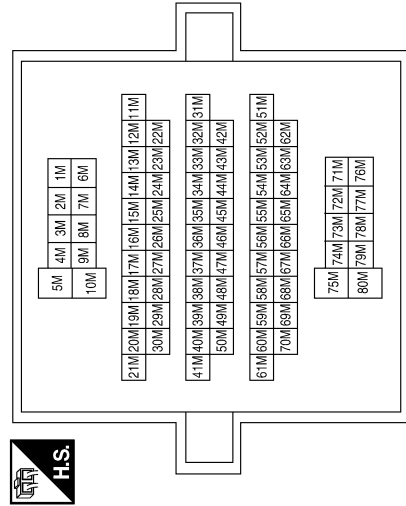

Connector No.	M36
Connector Name	WIRE TO WIRE
Connector Color	WHITE

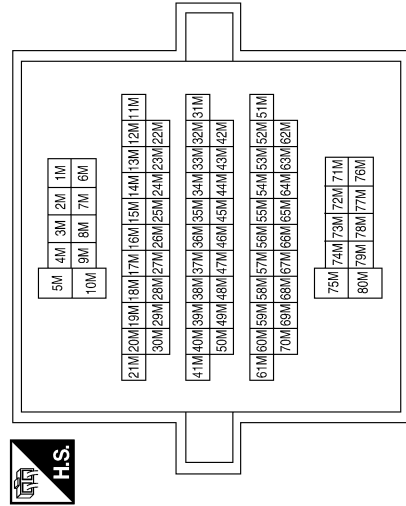

* : REFER TO HARNESS LAYOUT OF PG SECTION FOR DEFINITION OF TYPE A AND TYPE B.

AAKIA0160GB

A
B
C
D
E
F
G
H
I
J
L
M
N
O
P

SEC

BCM (BODY CONTROL MODULE)

[WITH INTELLIGENT KEY SYSTEM]

< ECU DIAGNOSIS >

Connector No.	M60
Connector Name	FUSE BLOCK (J/B)
Connector Color	WHITE

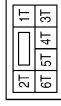

Terminal No.	Color of Wire	Signal Name
6T	O	-

Terminal No.	Color of Wire	Signal Name
60J	SB	-
61J	R/Y	-

Connector No.	M40
Connector Name	WIRE TO WIRE
Connector Color	WHITE

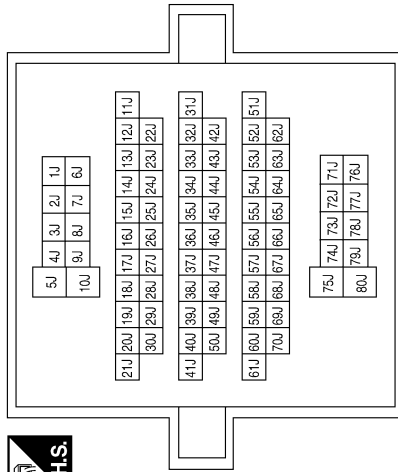

Connector No.	E3
Connector Name	HORN
Connector Color	BLACK



Terminal No.	Color of Wire	Signal Name
1	G	-
2	B	-

Connector No.	M75
Connector Name	WIRE TO WIRE
Connector Color	WHITE

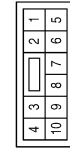

Terminal No.	Color of Wire	Signal Name
3	B	-

Connector No.	M74
Connector Name	WIRE TO WIRE
Connector Color	BROWN

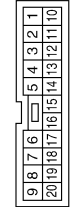

Terminal No.	Color of Wire	Signal Name
5	W/V	-

ABKIA0082GB

BCM (BODY CONTROL MODULE)

< ECU DIAGNOSIS >

[WITH INTELLIGENT KEY SYSTEM]

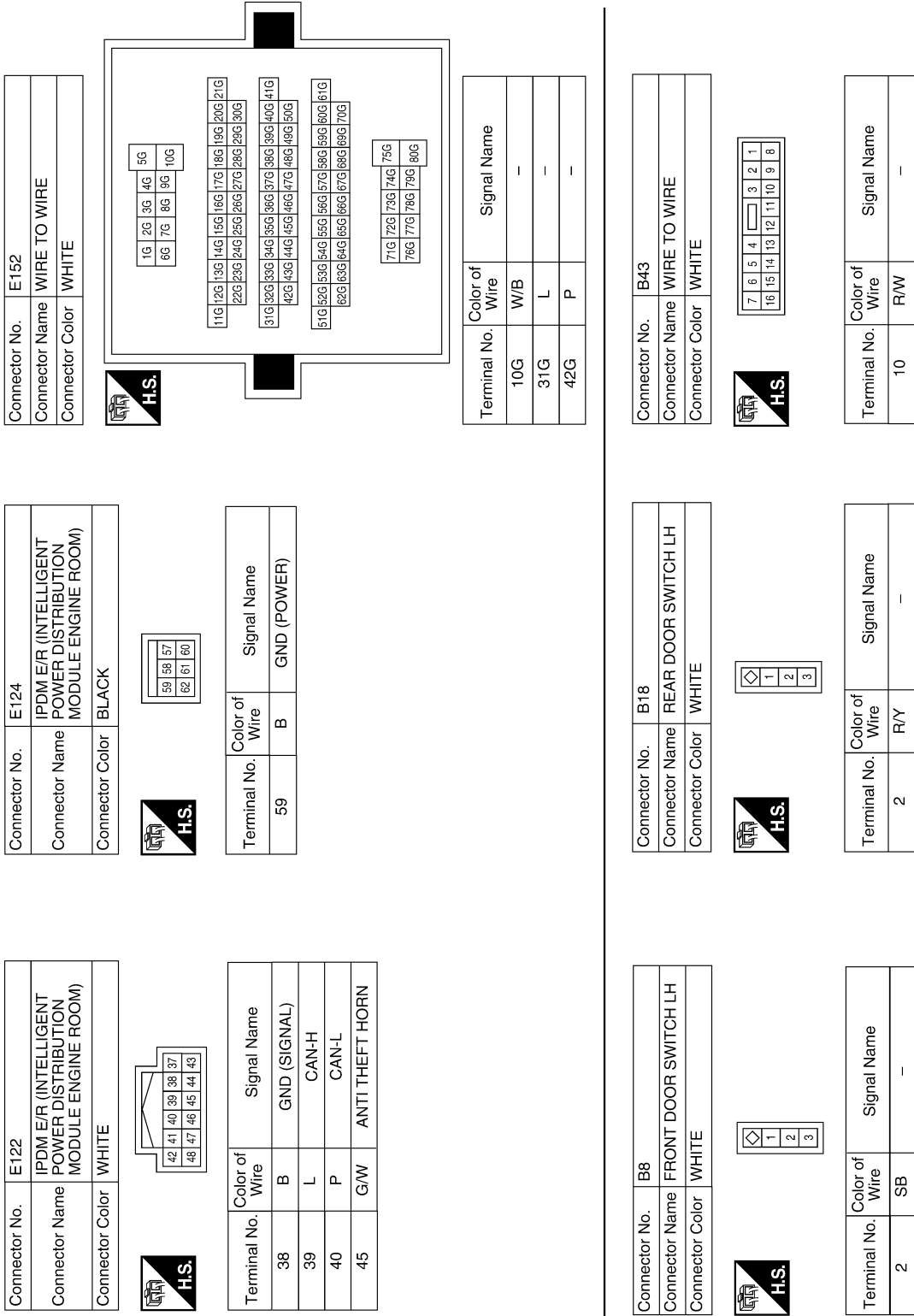

ABKIA0083GB

A
B
C
D
E
F
G
H
I
J
K
L
M
N
O
P

SEC

BCM (BODY CONTROL MODULE)

[WITH INTELLIGENT KEY SYSTEM]

< ECU DIAGNOSIS >

Terminal No.	Color of Wire	Signal Name
60J	SB	-
61J	R/Y	-

Connector No.	B69
Connector Name	WIRE TO WIRE
Connector Color	WHITE

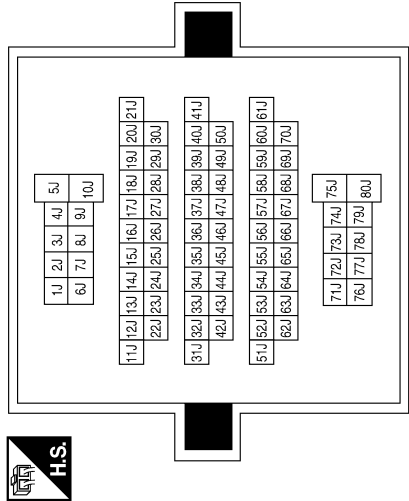

Connector No.	B48
Connector Name	WIRE TO WIRE
Connector Color	WHITE

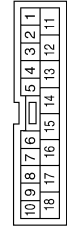

Terminal No.	Color of Wire	Signal Name
14	B	-
15	R/W	-

Connector No.	B116
Connector Name	REAR DOOR SWITCH RH
Connector Color	WHITE



Connector No.	B111
Connector Name	WIRE TO WIRE
Connector Color	WHITE

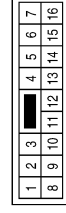

Connector No.	B108
Connector Name	FRONT DOOR SWITCH RH
Connector Color	WHITE



Terminal No.	Color of Wire	Signal Name
2	GR	-

Terminal No.	Color of Wire	Signal Name
10	R/W	-

Terminal No.	Color of Wire	Signal Name
2	R/L	-

AAKIA0102GB

BCM (BODY CONTROL MODULE)

[WITH INTELLIGENT KEY SYSTEM]

< ECU DIAGNOSIS >

Connector No.	B139
Connector Name	WIRE TO WIRE
Connector Color	WHITE

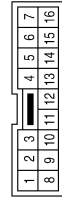

Terminal No.	Color of Wire	Signal Name
13	GR	-

Connector No.	B149
Connector Name	WIRE TO WIRE
Connector Color	WHITE

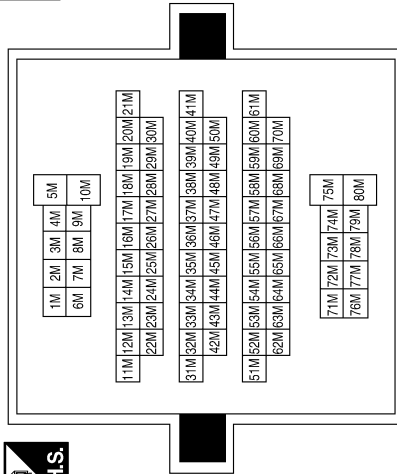

Terminal No.	Color of Wire	Signal Name
55M	GR	-
56M	GR	-
61M	R/L	-
65M	R/B	-

Connector No.	D2
Connector Name	WIRE TO WIRE
Connector Color	WHITE

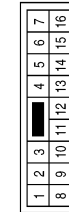

Terminal No.	Color of Wire	Signal Name
8	LG/W	-
14	B	-

Connector No.	D7
Connector Name	MAIN POWER WINDOW AND DOOR LOCK/UNLOCK SWITCH
Connector Color	WHITE

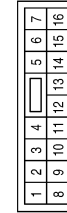

Terminal No.	Color of Wire	Signal Name
4	L	LOCK
6	R	UNLOCK
14	LG/W	ANTI PINCH SERIAL LINK

Connector No.	D8
Connector Name	MAIN POWER WINDOW AND DOOR LOCK/UNLOCK SWITCH
Connector Color	WHITE

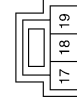

Terminal No.	Color of Wire	Signal Name
17	B	GND

ABKIA0084GB

A
B
C
D
E
F
G
H
I
J
K
L
M
N
O
P

SEC

BCM (BODY CONTROL MODULE)

[WITH INTELLIGENT KEY SYSTEM]

< ECU DIAGNOSIS >

Connector No.	D102
Connector Name	WIRE TO WIRE
Connector Color	BROWN

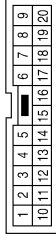

Terminal No.	5	Color of Wire	LG/W	Signal Name	—
--------------	---	---------------	------	-------------	---

Connector No.	D101
Connector Name	WIRE TO WIRE
Connector Color	WHITE



Terminal No.	3	Color of Wire	B	Signal Name	—
--------------	---	---------------	---	-------------	---

Connector No.	D14
Connector Name	FRONT DOOR LOCK ASSEMBLY LH
Connector Color	BLACK

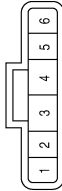

Terminal No.	1	Color of Wire	L	Signal Name	LOCK
5	B	GND			
6	R	UNLOCK			

Connector No.	D405
Connector Name	WIRE TO WIRE
Connector Color	WHITE

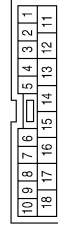

Terminal No.	14	Color of Wire	B	Signal Name	—
15	R/W	R/W			

Connector No.	D401
Connector Name	WIRE TO WIRE
Connector Color	WHITE

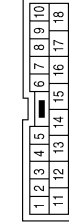

Terminal No.	14	Color of Wire	B	Signal Name	—
15	R/W	R/W			

Connector No.	D105
Connector Name	POWER WINDOW AND DOOR LOCK/UNLOCK SWITCH RH
Connector Color	WHITE

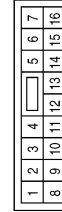

Terminal No.	11	Color of Wire	B	Signal Name	GND
16	LG/W	ANTI PINCH SERIAL LINK			

ABKIA0085GB

BCM (BODY CONTROL MODULE)

[WITH INTELLIGENT KEY SYSTEM]

< ECU DIAGNOSIS >

Connector No.	D503
Connector Name	BACK DOOR LATCH
Connector Color	WHITE

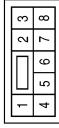

Terminal No.	Color of Wire	Signal Name
7	R/W	-
8	B	-

Connector No.	D502
Connector Name	BACK DOOR SWITCH
Connector Color	WHITE

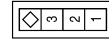

Terminal No.	Color of Wire	Signal Name
1	B	-
3	R/W	-

Connector No.	D501
Connector Name	WIRE TO WIRE
Connector Color	WHITE



Terminal No.	Color of Wire	Signal Name
14	B	-
15	R/W	-

Connector No.	D701
Connector Name	WIRE TO WIRE
Connector Color	WHITE



Terminal No.	Color of Wire	Signal Name
13	GR	-

Connector No.	D606
Connector Name	WIRE TO WIRE
Connector Color	WHITE

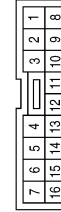

Terminal No.	Color of Wire	Signal Name
13	GR	-

Connector No.	D602
Connector Name	WIRE TO WIRE
Connector Color	WHITE

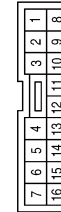

Terminal No.	Color of Wire	Signal Name
13	GR	-

A
B
C
D
E
F
G
H
I
J
L
M
N
O
P

SEC

ABKIA0086GB

BCM (BODY CONTROL MODULE)

< ECU DIAGNOSIS >

[WITH INTELLIGENT KEY SYSTEM]

Connector No.	H-1
Connector Name	FUSE AND FUSIBLE LINK BOX
Connector Color	-

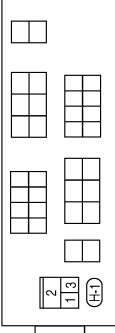

Terminal No.	Color of Wire	Signal Name
1	R/W	-
2	G/B	-
3	G	-

Connector No.	D707
Connector Name	GLASS HATCH AJAR SWITCH
Connector Color	BLACK



Terminal No.	Color of Wire	Signal Name
1	GR	-

ABKIA0087GB

BCM (BODY CONTROL MODULE)

[WITH INTELLIGENT KEY SYSTEM]

< ECU DIAGNOSIS >

Wiring Diagram - NVIS

INFOID:000000003710608

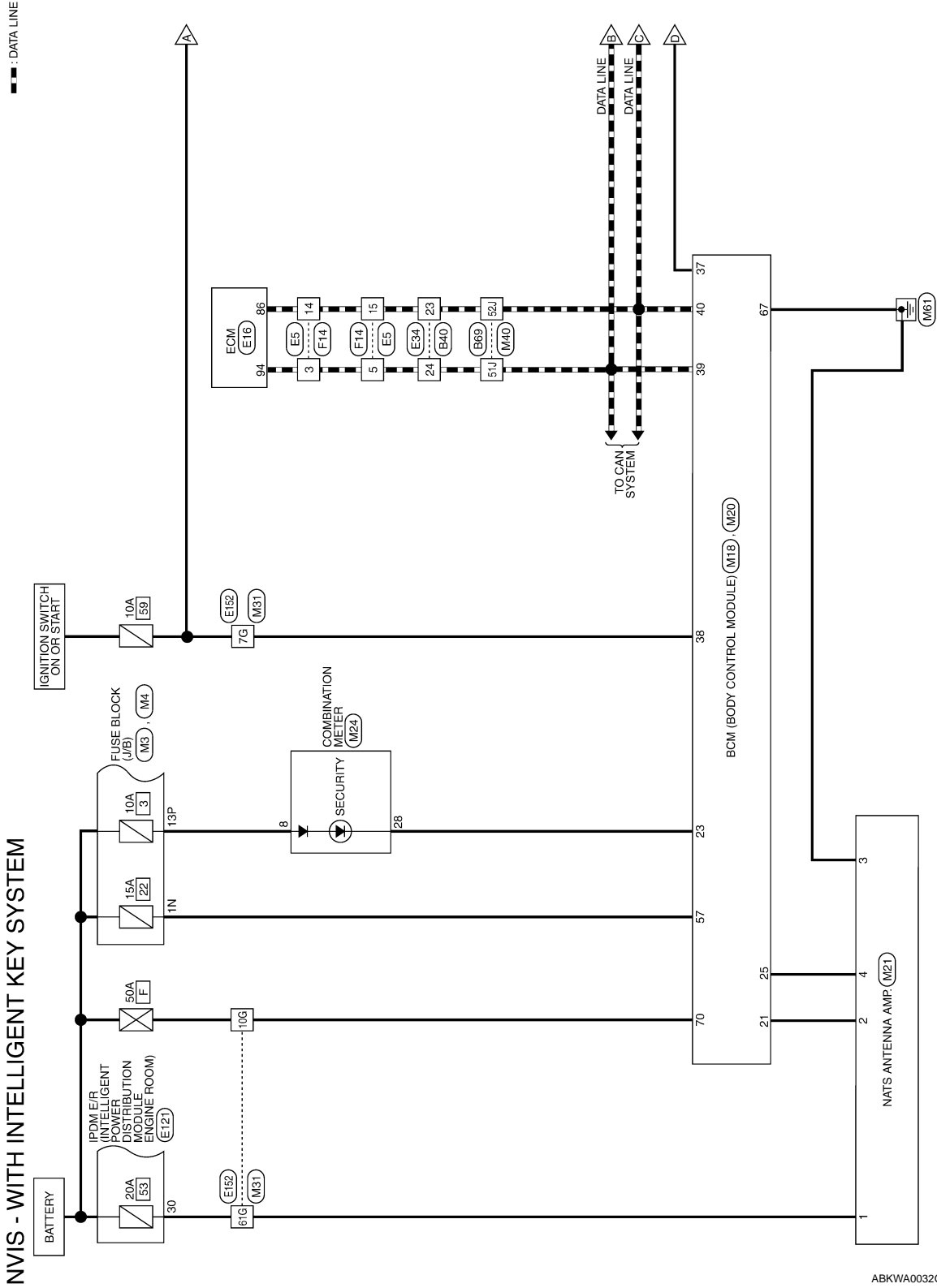

ABKWA0032GE

A
B
C
D
E
F
G
H
I
J
L
M
N
O
P

SEC

BCM (BODY CONTROL MODULE)

[WITH INTELLIGENT KEY SYSTEM]

< ECU DIAGNOSIS >

— : DATA LINE

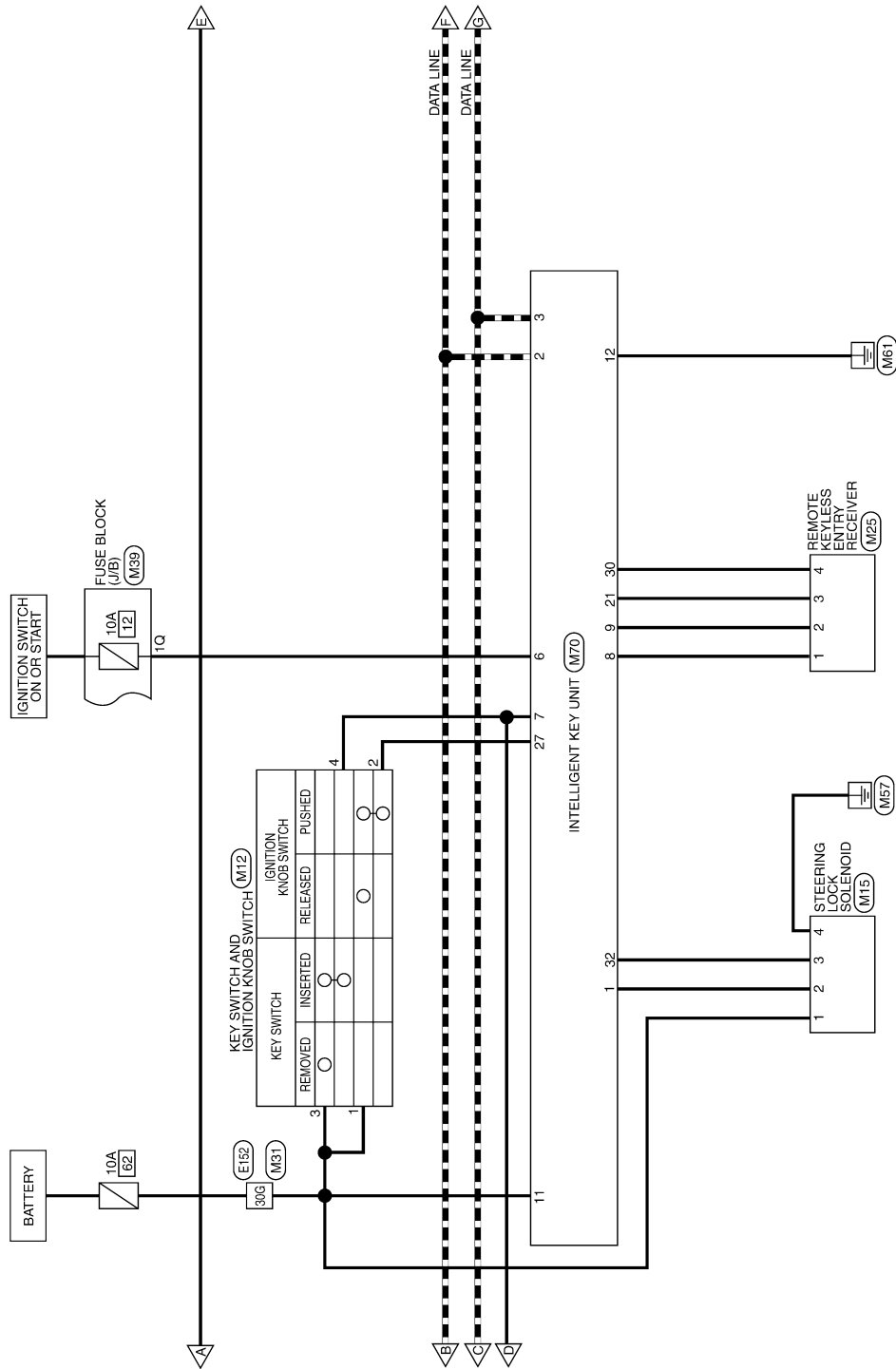

ABKWA0033GE

BCM (BODY CONTROL MODULE)

[WITH INTELLIGENT KEY SYSTEM]

< ECU DIAGNOSIS >

— : DATA LINE

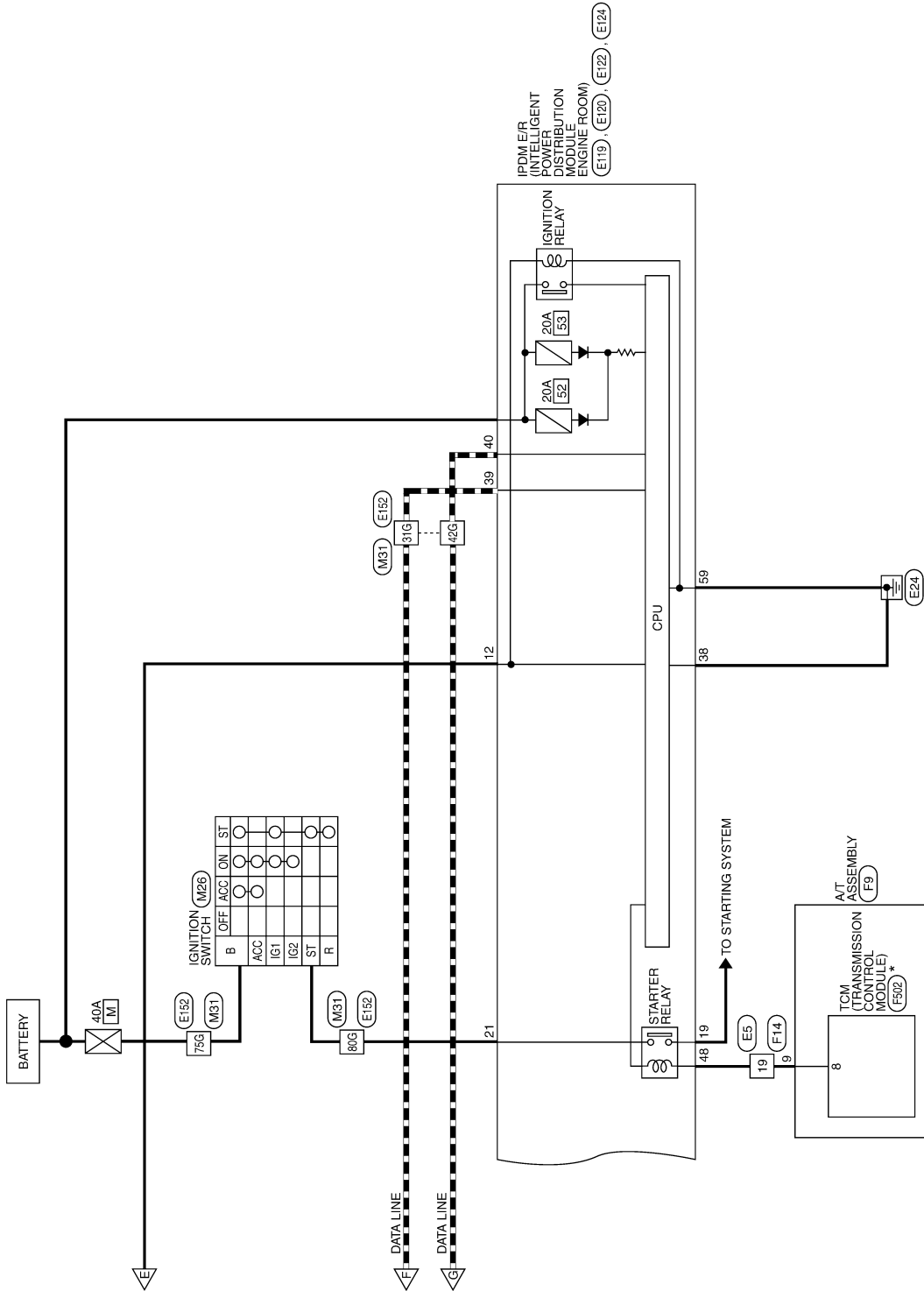

*: THIS CONNECTOR IS NOT SHOWN IN "HARNES LAYOUT" OF PG SECTION.

ABKWA0034GE

A
B
C
D
E
F
G
H
I
J
L
M
N
O
P

SEC

BCM (BODY CONTROL MODULE)

[WITH INTELLIGENT KEY SYSTEM]

< ECU DIAGNOSIS >

NVIS CONNECTORS - WITH INTELLIGENT KEY SYSTEM

Connector No.	M3
Connector Name	FUSE BLOCK (J/B)
Connector Color	WHITE

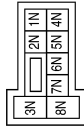

Terminal No.	Color of Wire	Signal Name
1N	Y/R	-

Connector No.	M4
Connector Name	FUSE BLOCK (J/B)
Connector Color	WHITE



Terminal No.	Color of Wire	Signal Name
13P	P	-

Connector No.	M12
Connector Name	KEY SWITCH AND IGNITION KNOB SWITCH
Connector Color	GRAY

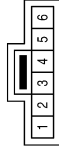

Terminal No.	Color of Wire	Signal Name
1	Y	-
2	R/B	-
3	Y	-
4	B/R	-

Connector No.	M15
Connector Name	STEERING LOCK SOLENOID
Connector Color	WHITE

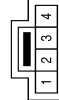

Terminal No.	Color of Wire	Signal Name
1	G/Y	B+
2	L/Y	5V PWR
3	L/O	SIG
4	B	GND

Connector No.	M18
Connector Name	BCM (BODY CONTROL MODULE)
Connector Color	WHITE

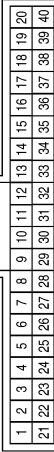
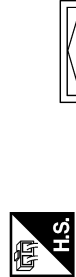

Terminal No.	Color of Wire	Signal Name
21	G	IMMOBILIZER ANTENNA SIGNAL (CLOCK)
23	G/O	SECURITY INDICATOR OUTPUT
25	BR	IMMOBILIZER ANTENNA SIGNAL (RX, TX)
37	B/R	KEY SW
38	W/L	IGN SW
39	L	CAN-H
40	P	CAN-L

Connector No.	M20
Connector Name	BCM (BODY CONTROL MODULE)
Connector Color	BLACK

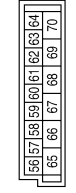

Terminal No.	Color of Wire	Signal Name
57	Y/R	BAT (FUSE)
67	B	GND (POWER)
70	W/B	BATT (F/L)

ABKIA0088GB

BCM (BODY CONTROL MODULE)

[WITH INTELLIGENT KEY SYSTEM]

< ECU DIAGNOSIS >

Connector No.	M21
Connector Name	NATS ANTENNA AMP.
Connector Color	WHITE

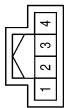

Terminal No.	Color of Wire	Signal Name
1	W	+12
2	G	SCL (CLOCK)
3	B	GND
4	BR	SCL (TX,RX)

Connector No.	M24
Connector Name	COMBINATION METER
Connector Color	WHITE



20	19	18	17	16	15	14	13	12	11	10	9	8	7	6	5	4	3	2	1
40	39	38	37	36	35	34	33	32	31	30	29	28	27	26	25	24	23	22	21

Terminal No.	Color of Wire	Signal Name
8	Y/R	BATTERY (TYPE A*)
8	P	BATTERY (TYPE B*)
28	G/O	SECURITY

Connector No.	M25
Connector Name	REMOTE KEYLESS ENTRY RECEIVER
Connector Color	BLACK



Terminal No.	Color of Wire	Signal Name
1	G	GND
2	GR	SIG
3	B/W	RSSI
4	G/B	5V

Connector No.	M26
Connector Name	IGNITION SWITCH
Connector Color	WHITE



Terminal No.	Color of Wire	Signal Name
B	G	-
ST	BR	-

Connector No.	M31
Connector Name	WIRE TO WIRE
Connector Color	WHITE

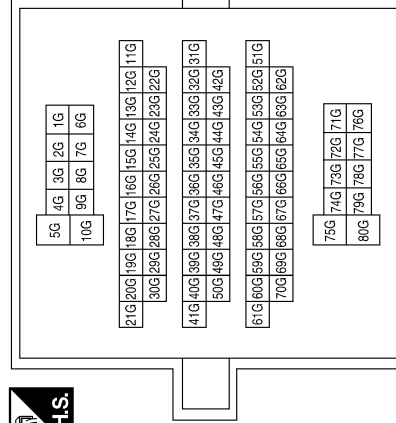

Terminal No.	Color of Wire	Signal Name
7G	W/L	-
10G	W/B	-
30G	Y	-
31G	L	-
42G	P	-
61G	W	-
75G	G	-
80G	BR	-

AAKIA016165

* REFER TO HARNESS LAYOUT OF PG SECTION FOR DEFINITION OF TYPE A AND TYPE B.

A B C D E F G H I J L M N O P

SEC

BCM (BODY CONTROL MODULE)

[WITH INTELLIGENT KEY SYSTEM]

< ECU DIAGNOSIS >

Terminal No.	Color of Wire	Signal Name
51J	L	-
52J	P	-

Connector No.	M40
Connector Name	WIRE TO WIRE
Connector Color	WHITE

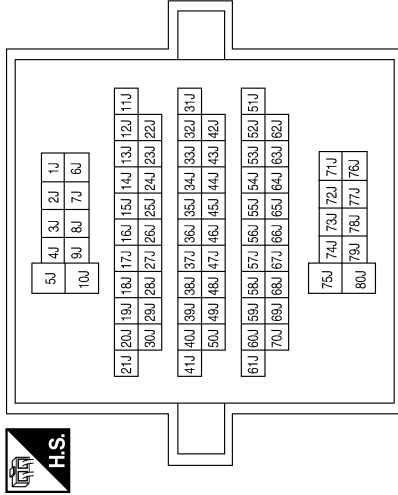

Connector No.	M39
Connector Name	FUSE BLOCK (J/B)
Connector Color	WHITE

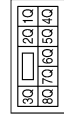

Terminal No.	Color of Wire	Signal Name
1Q	G/R	-

Connector No.	E5
Connector Name	WIRE TO WIRE
Connector Color	WHITE

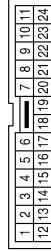

Terminal No.	Color of Wire	Signal Name
3	L	-
5	L	-
14	P	-
15	P	-
19	B/R	-

Terminal No.	Color of Wire	Signal Name
3	P	CAN-L
6	G/R	IGN SW INPUT
7	B/R	KEY SW INPUT
8	G	RF TUNER GND
9	GR	RF TUNER SIGNAL
11	Y	BAT
12	B	GND
21	B/W	RF TUNER RSSI
27	R/B	PUSH SW INPUT
30	G/B	RF TUNER 5V OUT
32	L/O	STRG C/U SIG

Connector No.	M70
Connector Name	INTELLIGENT KEY UNIT
Connector Color	WHITE

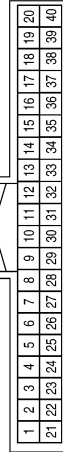

Terminal No.	Color of Wire	Signal Name
1	L/Y	STRG C/U 5V OUTPUT
2	L	CAN-H

ABKIA0090GB

BCM (BODY CONTROL MODULE)

[WITH INTELLIGENT KEY SYSTEM]

< ECU DIAGNOSIS >

Connector No.	E119
Connector Name	IPDM E/R (INTELLIGENT POWER DISTRIBUTION MODULE ENGINE ROOM)
Connector Color	WHITE



Terminal No.	Color of Wire	Signal Name
12	L/W	IGN SW (IG)

Connector No.	E34
Connector Name	WIRE TO WIRE
Connector Color	WHITE

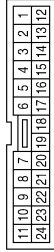

Terminal No.	Color of Wire	Signal Name
23	P	-
24	L	-

Connector No.	E16
Connector Name	ECM
Connector Color	BLACK

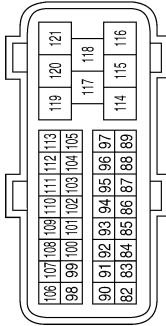

Terminal No.	Color of Wire	Signal Name
86	P	CAN-L
94	L	CAN-H

Connector No.	E122
Connector Name	IPDM E/R (INTELLIGENT POWER DISTRIBUTION MODULE ENGINE ROOM)
Connector Color	WHITE

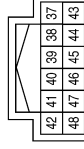

Terminal No.	Color of Wire	Signal Name
38	B	GND (SIGNAL)
39	L	CAN-H
40	P	CAN-L
48	B/R	INHIBIT SW

Connector No.	E121
Connector Name	IPDM E/R (INTELLIGENT POWER DISTRIBUTION MODULE ENGINE ROOM)
Connector Color	BROWN



Terminal No.	Color of Wire	Signal Name
30	W	ECM BAT

Connector No.	E120
Connector Name	IPDM E/R (INTELLIGENT POWER DISTRIBUTION MODULE ENGINE ROOM)
Connector Color	WHITE

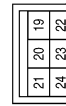

Terminal No.	Color of Wire	Signal Name
19	W/R	STARTER MTR
21	BR	IGN SW (ST)

ABKIA0091GB

A
B
C
D
E
F
G
H
I
J
K
L
M
N
O
P

SEC

BCM (BODY CONTROL MODULE)

< ECU DIAGNOSIS >

[WITH INTELLIGENT KEY SYSTEM]

Connector No.	E124
Connector Name	IPDM E/R (INTELLIGENT POWER DISTRIBUTION MODULE ENGINE ROOM)
Connector Color	BLACK



Terminal No.	Color of Wire	Signal Name
59	B	GND (POWER)

Connector No.	E152
Connector Name	WIRE TO WIRE
Connector Color	WHITE

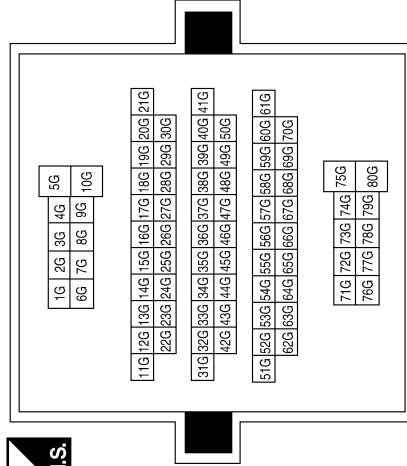

Terminal No.	Color of Wire	Signal Name
7G	L/W	-
10G	W/B	-
30G	Y	-
31G	L	-
42G	P	-
61G	W	-
75G	G	-
80G	BR	-

Connector No.	F9
Connector Name	A/T ASSEMBLY
Connector Color	GREEN

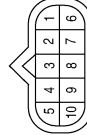

Terminal No.	Color of Wire	Signal Name
9	B/R	-

Connector No.	F14
Connector Name	WIRE TO WIRE
Connector Color	WHITE

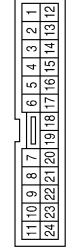

Terminal No.	Color of Wire	Signal Name
3	L	-
5	L	-
14	P	-
15	P	-
19	B/R	-

Connector No.	F502
Connector Name	TCM (TRANSMISSION CONTROL MODULE)
Connector Color	GRAY

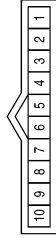

Terminal No.	Color of Wire	Signal Name
8	G	START-RLY

BCM (BODY CONTROL MODULE)

[WITH INTELLIGENT KEY SYSTEM]

< ECU DIAGNOSIS >

Terminal No.	Color of Wire	Signal Name
51J	L	-
52J	P	-

Connector No.	B69
Connector Name	WIRE TO WIRE
Connector Color	WHITE

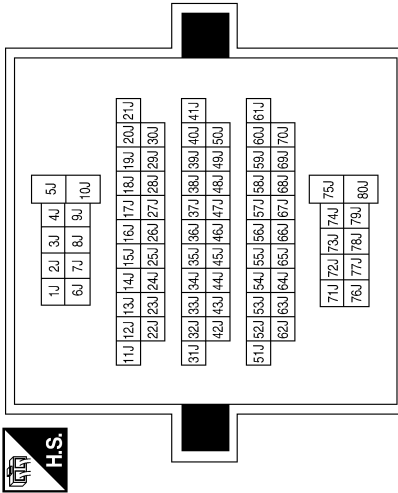

Connector No.	B40
Connector Name	WIRE TO WIRE
Connector Color	WHITE

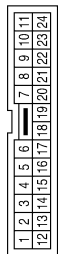

Terminal No.	Color of Wire	Signal Name
23	P	-
24	L	-

Fail Safe

Fail-safe index

BCM performs fail-safe control when any DTC listed below is detected.

ABKIA0093GB

INFOID:000000004173725

A
B
C
D
E
F
G
H
I
J
L
M
N
O
P

SEC

BCM (BODY CONTROL MODULE)

[WITH INTELLIGENT KEY SYSTEM]

< ECU DIAGNOSIS >

Display contents of CONSULT	Fail-safe	Cancellation
U1000: CAN COMM CIRCUIT	Inhibit engine cranking	When the BCM re-establishes communication with the other modules.
U1010: CONTROL UNIT (CAN)	Inhibit engine cranking	When the BCM re-start communicating with the other modules.

DTC Inspection Priority Chart

INFOID:000000004173726

If some DTCs are displayed at the same time, perform inspections one by one based on the following priority chart.

Priority	DTC
1	<ul style="list-style-type: none"> • U1000: CAN COMM CIRCUIT • U1010: CONTROL UNIT (CAN)
2	<ul style="list-style-type: none"> • B2190: NATS ANTENNA AMP • B2191: DIFFERENCE OF KEY • B2192: ID DISCORD BCM-ECM • B2193: CHAIN OF BCM-ECM • B2013: STRG COMM 1 • B2552: INTELLIGENT KEY • B2590: NATS MALFUNCTION
3	<ul style="list-style-type: none"> • C1729: VHCL SPEED SIG ERR
4	<ul style="list-style-type: none"> • C1704: LOW PRESSURE FL • C1705: LOW PRESSURE FR • C1706: LOW PRESSURE RR • C1707: LOW PRESSURE RL • C1708: [NO DATA] FL • C1709: [NO DATA] FR • C1710: [NO DATA] RR • C1711: [NO DATA] RL • C1712: [CHECKSUM ERR] FL • C1713: [CHECKSUM ERR] FR • C1714: [CHECKSUM ERR] RR • C1715: [CHECKSUM ERR] RL • C1716: [PRESSDATA ERR] FL • C1717: [PRESSDATA ERR] FR • C1718: [PRESSDATA ERR] RR • C1719: [PRESSDATA ERR] RL • C1720: [CODE ERR] FL • C1721: [CODE ERR] FR • C1722: [CODE ERR] RR • C1723: [CODE ERR] RL • C1724: [BATT VOLT LOW] FL • C1725: [BATT VOLT LOW] FR • C1726: [BATT VOLT LOW] RR • C1727: [BATT VOLT LOW] RL • C1735: IGNITION SIGNAL

DTC Index

INFOID:000000004173727

NOTE:

- Details of time display
- CRNT: Displays when there is a malfunction now or after returning to the normal condition until turning ignition switch OFF → ON again.
- 1 - 39: Displayed if any previous malfunction is present when current condition is normal. It increases like 1 → 2 → 3...38 → 39 after returning to the normal condition whenever ignition switch OFF → ON. The counter remains at 39 even if the number of cycles exceeds it. It is counted from 1 again when turning ignition switch OFF → ON after returning to the normal condition if the malfunction is detected again.

BCM (BODY CONTROL MODULE)

< ECU DIAGNOSIS >

[WITH INTELLIGENT KEY SYSTEM]

CONSULT display	Fail-safe	Intelligent Key warning lamp ON	Tire pressure monitor warning lamp ON	Reference page
No DTC is detected. further testing may be required.	—	—	—	—
U1000: CAN COMM CIRCUIT	—	—	—	BCS-31
U1010: CONTROL UNIT (CAN)	—	—	—	BCS-32
B2013: STRG COMM 1	—	—	—	SEC-26
B2190: NATS ANTENA AMP	—	—	—	SEC-29 (with I- Key), SEC-125 (without I-Key)
B2191: DIFFERENCE OF KEY	—	—	—	SEC-32 (with I- Key), SEC-128 (without I-Key)
B2192: ID DISCORD BCM-ECM	—	—	—	SEC-33 (with I- Key), SEC-129 (without I-Key)
B2193: CHAIN OF BCM-ECM	—	—	—	SEC-35 (with I- Key), SEC-131 (without I-Key)
B2552: INTELLIGENT KEY	—	—	—	SEC-37
B2590: NATS MALFUNCTION	—	—	—	SEC-38
C1704: LOW PRESSURE FL	—	—	—	WT-33
C1705: LOW PRESSURE FR	—	—	—	WT-33
C1706: LOW PRESSURE RR	—	—	—	WT-33
C1707: LOW PRESSURE RL	—	—	—	WT-33
C1708: [NO DATA] FL	—	—	—	WT-14
C1709: [NO DATA] FR	—	—	—	WT-16
C1710: [NO DATA] RR	—	—	—	WT-16
C1711: [NO DATA] RL	—	—	—	WT-16
C1712: [CHECKSUM ERR] FL	—	—	—	WT-16
C1713: [CHECKSUM ERR] FR	—	—	—	WT-16
C1714: [CHECKSUM ERR] RR	—	—	—	WT-16
C1715: [CHECKSUM ERR] RL	—	—	—	WT-16
C1716: [PRESSDATA ERR] FL	—	—	—	WT-18
C1717: [PRESSDATA ERR] FR	—	—	—	WT-16
C1718: [PRESSDATA ERR] RR	—	—	—	WT-16
C1719: [PRESSDATA ERR] RL	—	—	—	WT-16
C1720: [CODE ERR] FL	—	—	—	WT-16
C1721: [CODE ERR] FR	—	—	—	WT-16
C1722: [CODE ERR] RR	—	—	—	WT-16
C1723: [CODE ERR] RL	—	—	—	WT-16
C1724: [BATT VOLT LOW] FL	—	—	—	WT-16
C1725: [BATT VOLT LOW] FR	—	—	—	WT-16
C1726: [BATT VOLT LOW] RR	—	—	—	WT-16
C1727: [BATT VOLT LOW] RL	—	—	—	WT-16
C1729: VHCL SPEED SIG ERR	—	—	—	WT-19
C1735: IGN_CIRCUIT_OPEN	—	—	—	—

A
B
C
D
E
F
G
H
I
J
L
M
N
O
P

SEC

INTELLIGENT KEY UNIT

< ECU DIAGNOSIS >

[WITH INTELLIGENT KEY SYSTEM]

INTELLIGENT KEY UNIT

Reference Value - Intelligent Key Unit

INFOID:000000004173728

TERMINAL LAYOUT

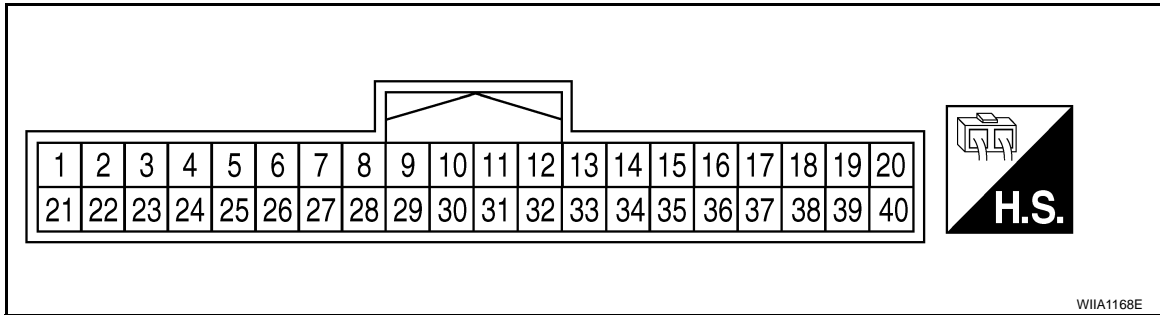

PHYSICAL VALUES

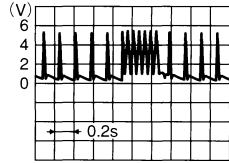
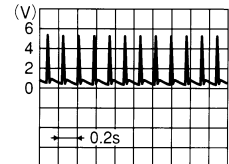
Terminal	Wire Color	Item	Condition		Voltage (V) Approx.	
			Ignition Switch Position	Operation or Conditions		
1	L/Y	Steering lock solenoid power supply	LOCK	—	5	
2	L	CAN-H	—	—	—	
3	P	CAN-L	—	—	—	
4	GR	Intelligent Key warning buzzer (front of vehicle)	LOCK	Operate door request switch.	Buzzer OFF	Battery voltage
					Buzzer ON	0
5	B/W	Front door request switch LH	—	Press front door request switch LH.		0
				Other than above		Battery voltage
6	G/R	Ignition switch (ON)	ON	—	Battery voltage	
7	B/R	Key switch	LOCK	Insert mechanical key into ignition key cylinder.		Battery voltage
				Remove mechanical key from ignition key cylinder.		0
8	G	Remote keyless entry receiver ground	—	—	0	
9	GR	Remote keyless entry receiver signal	—	When remote keyless entry receiver receives signal from keyfob.		
				Stand-by		
11	Y	Power source (Fuse)	—	—	Battery voltage	
12	B	Ground	—	—	0	

INTELLIGENT KEY UNIT

< ECU DIAGNOSIS >

[WITH INTELLIGENT KEY SYSTEM]

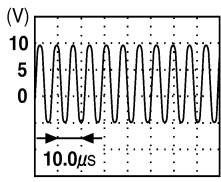
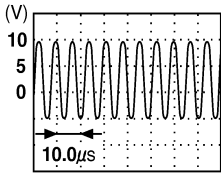
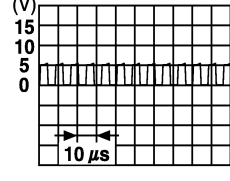
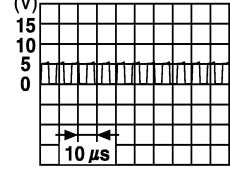
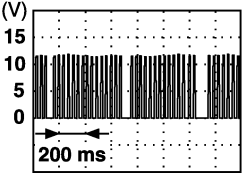
Terminal	Wire Color	Item	Condition		Voltage (V) Approx.
			Ignition Switch Position	Operation or Conditions	
13	B/W	Inside key antenna 3 (front of center console) (+) signal	LOCK	Any door open → all doors closed	 PIIB7441E
14	W/G	Inside key antenna 3 (front of center console) (-) signal			
15	G	Inside key antenna 1 (rear of center console) (+) signal	LOCK	Any door open → all doors closed	 PIIB7441E
16	L	Inside key antenna 1 (rear of center console) (-) signal			
17	W/L	Rear bumper antenna (+) signal	LOCK	Lift back door handle (close switch).	 SIIA1910J
18	W/R	Rear bumper antenna (-) signal			
19	P	Front outside antenna LH (+) signal	LOCK	Press front door request switch LH.	 SIIA1910J
20	V	Front outside antenna LH (-) signal			
21	B/W	Remote keyless entry receiver RSSI signal	—	—	 PIIA2344E
23	L/W	Power back door output	—	Power liftgate switch ON.	0
				Power liftgate switch OFF.	Battery voltage
25	P/L	Front door request switch RH	—	Press front door request switch RH.	0
				Other than above	Battery voltage
27	R/B	Ignition knob switch	—	Press ignition switch.	Battery voltage
				Return ignition switch to LOCK position.	0
28	R	Unlock sensor (driver side)	—	Door (driver side) is locked.	5
				Door (driver side) is unlocked.	0
29	LG/W	Back door open switch input	—	Back door handle switch ON.	0
				Back door handle switch OFF.	Battery voltage



A
B
C
D
E
F
G
H
I
J
L
M
N
O
P

SEC

INTELLIGENT KEY UNIT

[WITH INTELLIGENT KEY SYSTEM]

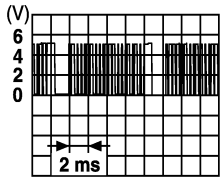
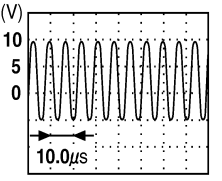
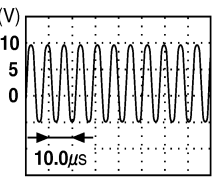
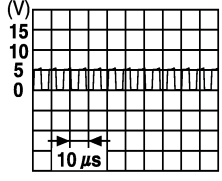
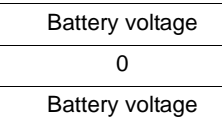
< ECU DIAGNOSIS >

Terminal	Wire Color	Item	Condition		Voltage (V) Approx.
			Ignition Switch Position	Operation or Conditions	
30	G/B	Remote keyless entry receiver power supply	—	—	5
32	L/O	Steering lock solenoid communication signal	LOCK	When Intelligent Key is inside vehicle, press ignition knob switch.	 <p style="text-align: right; font-size: small;">SIIA1911J</p>
				Other than above	5
33	W	Rear parcel shelf antenna (+) signal	LOCK	Press ignition knob switch: ON (Ignition knob switch)	 <p style="text-align: right; font-size: small;">PIIB7441E</p>
34	BR	Rear parcel shelf antenna (-) signal			 <p style="text-align: right; font-size: small;">PIIB7441E</p>
35	O	Inside key antenna 2 (luggage compartment) (+) signal	LOCK	Back door open → all doors closed	 <p style="text-align: right; font-size: small;">SIIA1910J</p>
36	R	Inside key antenna 2 (luggage compartment) (-) signal			 <p style="text-align: right; font-size: small;">SIIA1910J</p>
37	LG	Front outside antenna (+) signal RH	LOCK	Press front door request switch RH.	 <p style="text-align: right; font-size: small;">SIIA1910J</p>
38	B/Y	Front outside antenna (-) signal RH			 <p style="text-align: right; font-size: small;">SIIA1910J</p>
39	L/R	P range switch	—	Selector lever is in "P" position.	0
			—	Other than above	Battery voltage
40	V	AS select unlock output	—	UNLOCK with rear door locks disabled.	0
			—	Other than above	Battery voltage

INTELLIGENT KEY UNIT

< ECU DIAGNOSIS >

[WITH INTELLIGENT KEY SYSTEM]

Wiring Diagram - INTELLIGENT KEY SYSTEM/ENGINE START FUNCTION -

INFOID:000000003710613

- - - : DATA LINE

INTELLIGENT KEY SYSTEM/ENGINE START FUNCTION

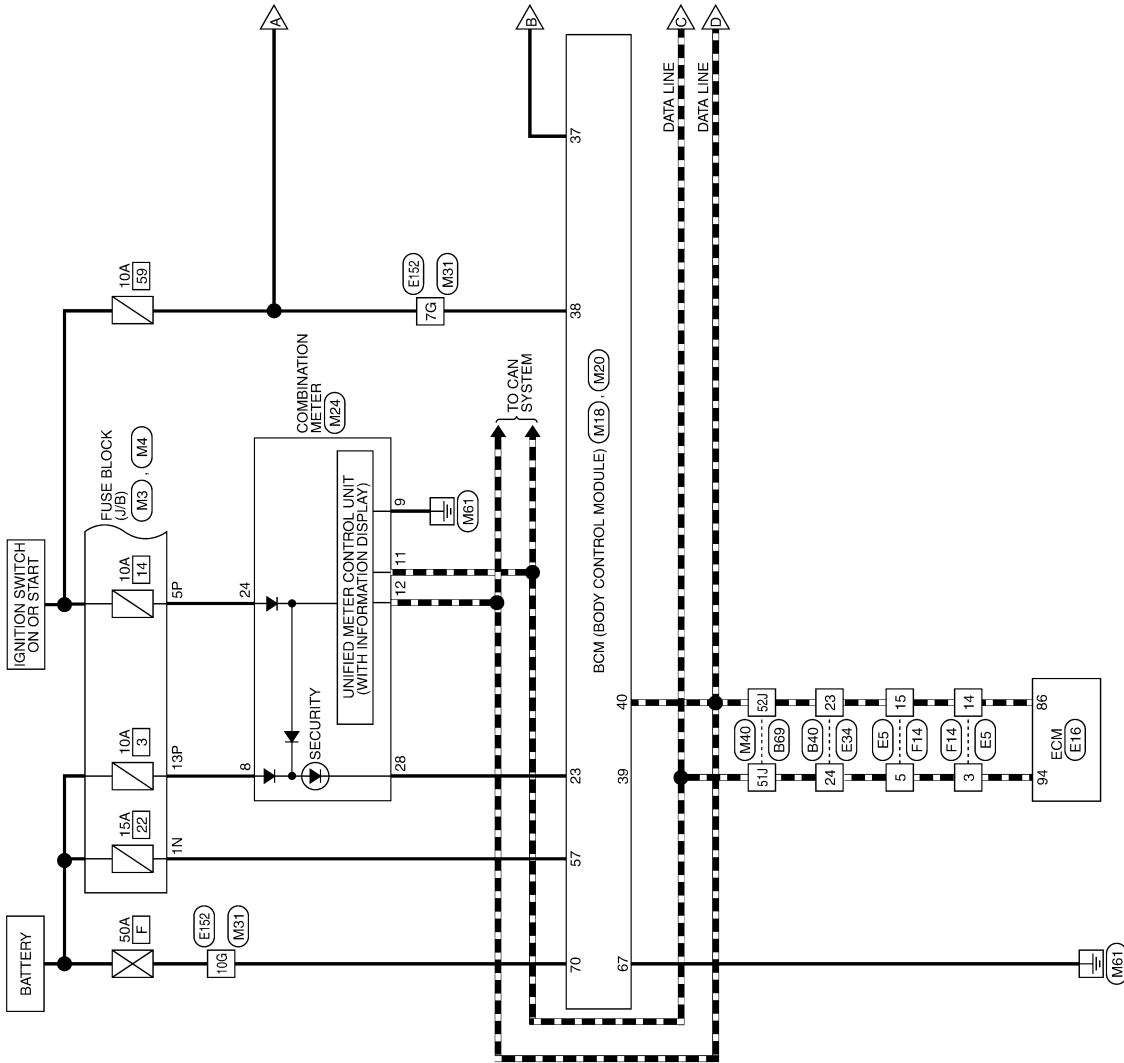

A
B
C
D
E
F
G
H
I
J
L
M
N
O
P

SEC

ABKWA0035GE

INTELLIGENT KEY UNIT

[WITH INTELLIGENT KEY SYSTEM]

< ECU DIAGNOSIS >

— : DATA LINE

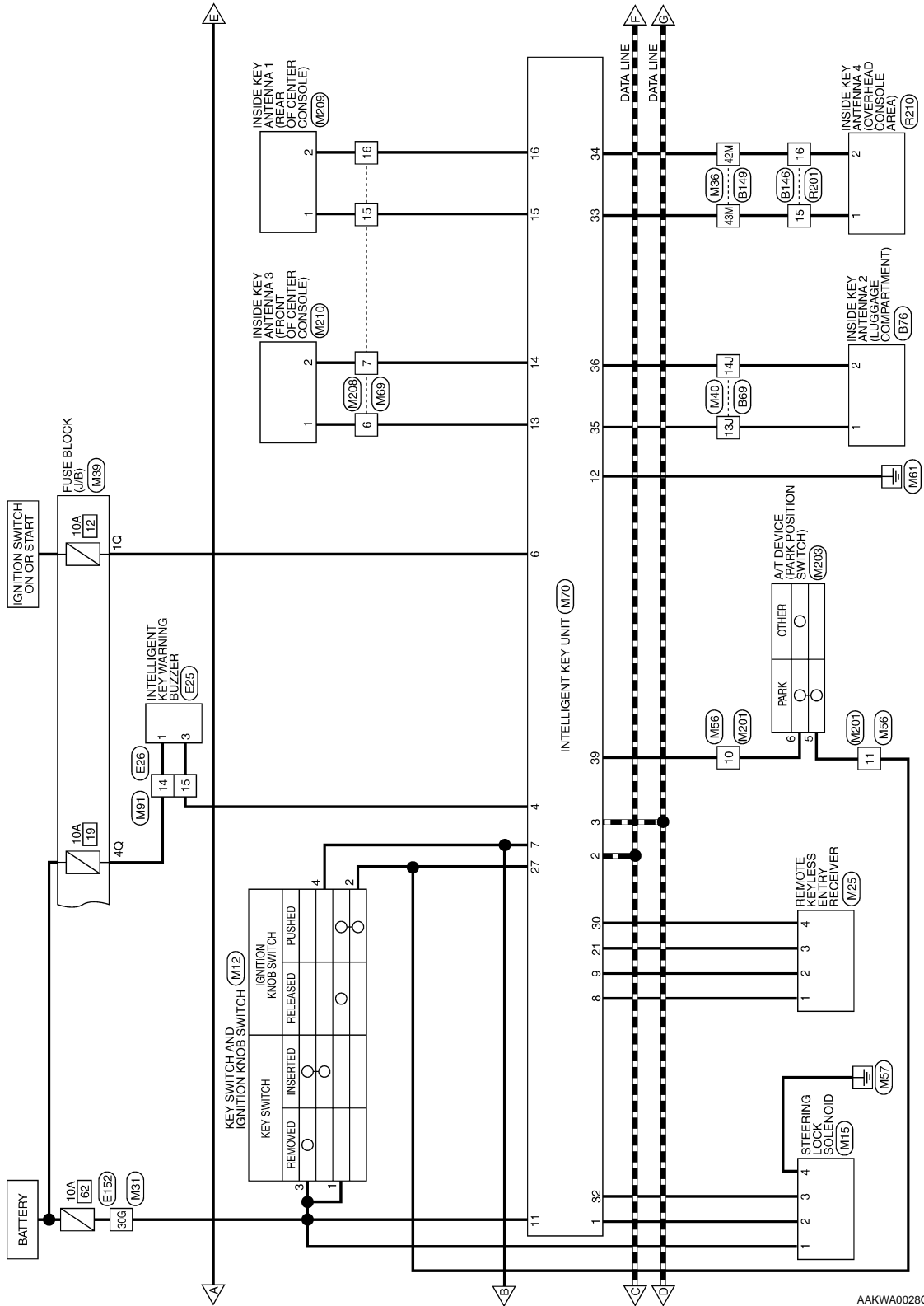

AAKWA0028GE

INTELLIGENT KEY UNIT

[WITH INTELLIGENT KEY SYSTEM]

< ECU DIAGNOSIS >

■ : DATA LINE

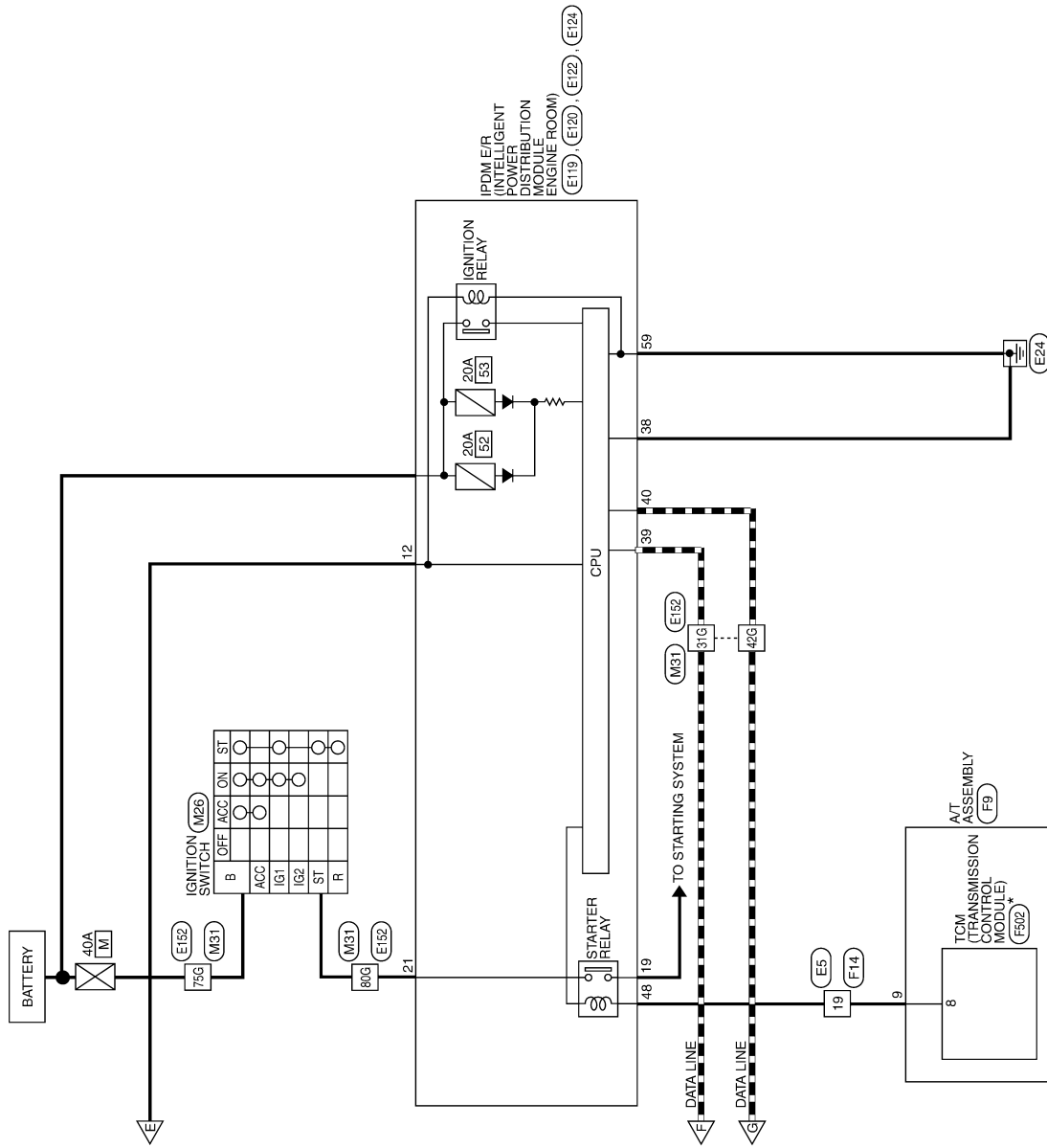

* THIS CONNECTOR IS NOT SHOWN IN "HARNES LAYOUT" OF PG SECTION.

ABKWA0036C

A
B
C
D
E
F
G
H
I
J
L
M
N
O
P

SEC

INTELLIGENT KEY SYSTEM/ENGINE START FUNCTION CONNECTORS

Connector No.	M3
Connector Name	FUSE BLOCK (J/B)
Connector Color	WHITE

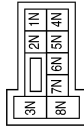

Terminal No.	Color of Wire	Signal Name
1N	Y/R	-

Connector No.	M4
Connector Name	FUSE BLOCK (J/B)
Connector Color	WHITE



Terminal No.	Color of Wire	Signal Name
5P	O/L	-
13P	P	-

Connector No.	M12
Connector Name	KEY SWITCH AND IGNITION KNOB SWITCH
Connector Color	GRAY

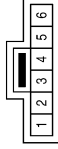

Terminal No.	Color of Wire	Signal Name
1	Y	-
2	R/B	-
3	Y	-
4	B/R	-

Connector No.	M15
Connector Name	STEERING LOCK SOLENOID
Connector Color	WHITE



Terminal No.	Color of Wire	Signal Name
1	G/Y	B+
2	L/Y	5V PWR
3	L/O	SIG
4	B	GND

Connector No.	M18
Connector Name	BCM (BODY CONTROL MODULE)
Connector Color	WHITE

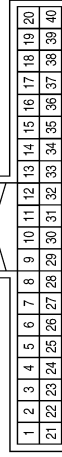
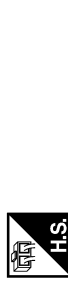

Terminal No.	Color of Wire	Signal Name
23	G/O	SECURITY INDICATOR OUTPUT
37	B/R	KEY SW
38	W/L	IGN SW
39	L	CAN-H
40	P	CAN-L

Connector No.	M20
Connector Name	BCM (BODY CONTROL MODULE)
Connector Color	BLACK

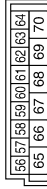

Terminal No.	Color of Wire	Signal Name
57	Y/R	BAT (FUSE)
67	B	GND (POWER)
70	W/B	BATT (F/L)

INTELLIGENT KEY UNIT

[WITH INTELLIGENT KEY SYSTEM]

< ECU DIAGNOSIS >

Connector No.	M26
Connector Name	IGNITION SWITCH
Connector Color	WHITE



B	ST	6G
R	HCC	6Z

Terminal No.	Color of Wire	Signal Name
B	G	-
ST	BR	-

Connector No.	M25
Connector Name	REMOTE KEYLESS ENTRY RECEIVER
Connector Color	BLACK



1	2	3	4
---	---	---	---

Terminal No.	Color of Wire	Signal Name
1	G	GND
2	GR	SIG
3	B/W	RSSI
4	G/B	5V

Connector No.	M24
Connector Name	COMBINATION METER
Connector Color	WHITE



20	19	18	17	16	15	14	13	12	11	10	9	8	7	6	5	4	3	2	1
40	39	38	37	36	35	34	33	32	31	30	29	28	27	26	25	24	23	22	21

Terminal No.	Color of Wire	Signal Name
8	Y/R	BATTERY (TYPE A*)
8	P	BATTERY (TYPE B*)
9	B	GND
11	L	CAN-H
12	P	CAN-L
24	O/L	RUN START
28	G/O	SECURITY

Connector No.	M31
Connector Name	WIRE TO WIRE
Connector Color	WHITE

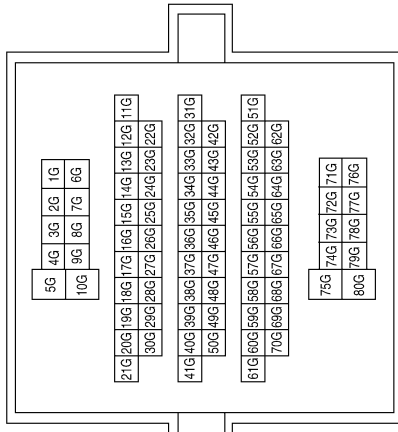

* : REFER TO HARNESS LAYOUT OF PG SECTION FOR DEFINITION OF TYPE A AND TYPE B.

AAKIA0162GB

A B C D E F G H I J L M N O P

SEC

INTELLIGENT KEY UNIT

< ECU DIAGNOSIS >

[WITH INTELLIGENT KEY SYSTEM]

Connector No.	M36
Connector Name	WIRE TO WIRE
Connector Color	WHITE

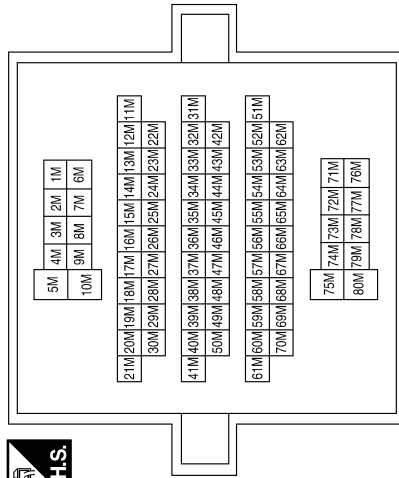

Terminal No.	Color of Wire	Signal Name
42M	BR	-
43M	W	-

Connector No.	M39
Connector Name	FUSE BLOCK (J/B)
Connector Color	WHITE



Terminal No.	Color of Wire	Signal Name
1Q	G/R	-
4Q	Y/R	-

Connector No.	M40
Connector Name	WIRE TO WIRE
Connector Color	WHITE

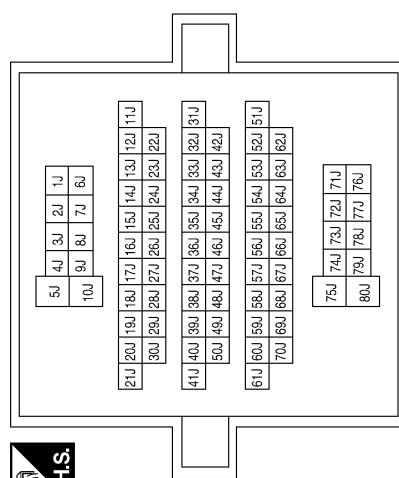

Terminal No.	Color of Wire	Signal Name
13J	O	-
14J	R	-
51J	L	-
52J	P	-

Connector No.	M56
Connector Name	WIRE TO WIRE
Connector Color	WHITE

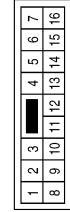

Terminal No.	Color of Wire	Signal Name
10	L/R	-
11	R/B	-

AAKIA0099GB

INTELLIGENT KEY UNIT

< ECU DIAGNOSIS >

[WITH INTELLIGENT KEY SYSTEM]

Connector No.	M69
Connector Name	WIRE TO WIRE
Connector Color	BROWN

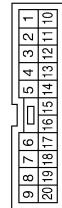

Terminal No.	Color of Wire	Signal Name
6	B/W	-
7	W/G	-
15	G	-
16	L	-

Connector No.	M70
Connector Name	INTELLIGENT KEY UNIT
Connector Color	WHITE

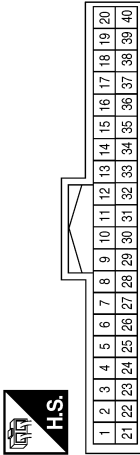

Terminal No.	Color of Wire	Signal Name
1	L/Y	STRG C/U 5V OUTPUT
2	L	CAN-H
3	P	CAN-L
4	GR	OUTSIDE BUZZER OUTPUT
6	G/R	IGN SW INPUT
7	B/R	KEY SW INPUT
8	G	RF TUNER GND

Terminal No.	Color of Wire	Signal Name
9	GR	RF TUNER SIGNAL
11	Y	BAT
12	B	GND
13	B/W	ROOM ANT3 (+)
14	W/G	ROOM ANT3 (-)
15	G	ROOM ANT1 (+)
16	L	ROOM ANT1 (-)
21	B/W	RF TUNER RSSI
27	R/B	PUSH SW INPUT
30	G/B	RF TUNER 5V OUTPUT
32	L/O	STRG C/U SIG
33	W	ROOM ANT4 (+)
34	BR	ROOM ANT4 (-)
35	O	ROOM ANT2 (+)
36	R	ROOM ANT2 (-)
39	L/R	P RANGE SW INPUT

Connector No.	M91
Connector Name	WIRE TO WIRE
Connector Color	WHITE

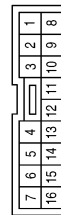

Terminal No.	Color of Wire	Signal Name
14	Y/R	-
15	GR	-

Connector No.	M201
Connector Name	WIRE TO WIRE
Connector Color	WHITE



Terminal No.	Color of Wire	Signal Name
10	L/R	-
11	R/B	-

Connector No.	M203
Connector Name	ANT DEVICE (WITH INTELLIGENT KEY SYSTEM)
Connector Color	WHITE



Terminal No.	Color of Wire	Signal Name
5	R/B	-
6	L/R	-

ABKIA0096GB

A
B
C
D
E
F
G
H
I
J
K
L
M
N
O
P

SEC

INTELLIGENT KEY UNIT

< ECU DIAGNOSIS >

[WITH INTELLIGENT KEY SYSTEM]

Connector No.	M210
Connector Name	INSIDE KEY ANTENNA 3 (FRONT OF CENTER CONSOLE)
Connector Color	GRAY



Terminal No.	Color of Wire	Signal Name
1	B/W	-
2	W/G	-

Connector No.	M209
Connector Name	INSIDE KEY ANTENNA 1 (REAR OF CENTER CONSOLE)
Connector Color	WHITE



Terminal No.	Color of Wire	Signal Name
1	G	-
2	L	-

Connector No.	M208
Connector Name	WIRE TO WIRE
Connector Color	BROWN

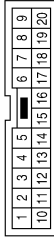

Terminal No.	Color of Wire	Signal Name
6	B/W	-
7	W/G	-
15	G	-
16	L	-

Connector No.	E25
Connector Name	INTELLIGENT KEY WARNING BUZZER
Connector Color	BROWN



Terminal No.	Color of Wire	Signal Name
1	Y/R	-
3	GR	-

Connector No.	E16
Connector Name	ECM
Connector Color	BLACK

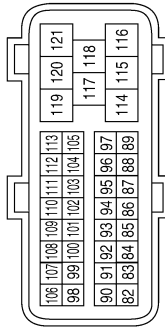

Terminal No.	Color of Wire	Signal Name
86	P	CAN-L
94	L	CAN-H

Connector No.	E5
Connector Name	WIRE TO WIRE
Connector Color	WHITE

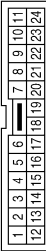

Terminal No.	Color of Wire	Signal Name
3	L	-
5	L	-
14	P	-
15	P	-
19	B/R	-

ABKIA0097GB

INTELLIGENT KEY UNIT

< ECU DIAGNOSIS >

[WITH INTELLIGENT KEY SYSTEM]

Connector No.	E119
Connector Name	IPDM E/R (INTELLIGENT POWER DISTRIBUTION MODULE ENGINE ROOM)
Connector Color	WHITE

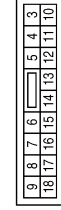

Terminal No.	Color of Wire	Signal Name
12	L/W	IGN SW (IG)

Connector No.	E34
Connector Name	WIRE TO WIRE
Connector Color	WHITE

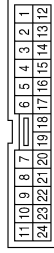

Terminal No.	Color of Wire	Signal Name
23	P	-
24	L	-

Connector No.	E26
Connector Name	WIRE TO WIRE
Connector Color	WHITE

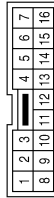

Terminal No.	Color of Wire	Signal Name
14	Y/R	-
15	GR	-

Connector No.	E124
Connector Name	IPDM E/R (INTELLIGENT POWER DISTRIBUTION MODULE ENGINE ROOM)
Connector Color	BLACK



Terminal No.	Color of Wire	Signal Name
59	B	GND (POWER)

Connector No.	E122
Connector Name	IPDM E/R (INTELLIGENT POWER DISTRIBUTION MODULE ENGINE ROOM)
Connector Color	WHITE

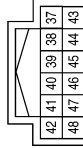

Terminal No.	Color of Wire	Signal Name
38	B	GND (SIGNAL)
39	L	CAN-H
40	P	CAN-L
48	B/R	INHIBIT SW

Connector No.	E120
Connector Name	IPDM E/R (INTELLIGENT POWER DISTRIBUTION MODULE ENGINE ROOM)
Connector Color	WHITE



Terminal No.	Color of Wire	Signal Name
19	W/R	STARTER MTR
21	BR	IGN SW (ST)

ABKIA0098GB

A
B
C
D
E
F
G
H
I
J
L
M
N
O
P

SEC

INTELLIGENT KEY UNIT

< ECU DIAGNOSIS >

[WITH INTELLIGENT KEY SYSTEM]

Connector No.	F9
Connector Name	A/T ASSEMBLY
Connector Color	GREEN

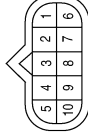

Terminal No.	Color of Wire	Signal Name
9	B/R	—

Terminal No.	Color of Wire	Signal Name
7G	LW	—
10G	W/B	—
30G	Y	—
31G	L	—
42G	P	—
75G	G	—
80G	BR	—

Connector No.	E152
Connector Name	WIRE TO WIRE
Connector Color	WHITE

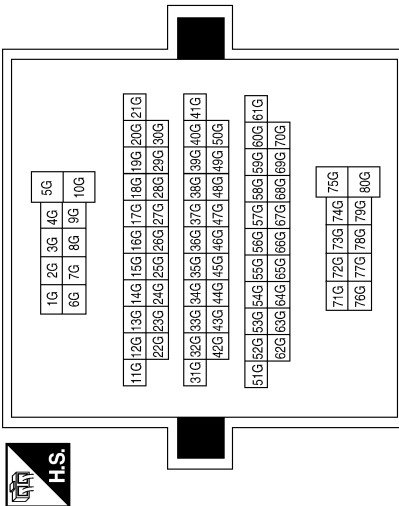

Connector No.	B40
Connector Name	WIRE TO WIRE
Connector Color	WHITE

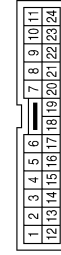

Terminal No.	Color of Wire	Signal Name
23	P	—
24	L	—

Connector No.	F502
Connector Name	TCM (TRANSMISSION CONTROL MODULE)
Connector Color	GRAY



Terminal No.	Color of Wire	Signal Name
8	G	START-RLY

Connector No.	F14
Connector Name	WIRE TO WIRE
Connector Color	WHITE

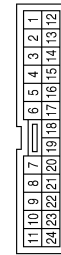

Terminal No.	Color of Wire	Signal Name
3	L	—
5	L	—
14	P	—
15	P	—
19	B/R	—

ABKIA0099GB

INTELLIGENT KEY UNIT

[WITH INTELLIGENT KEY SYSTEM]

< ECU DIAGNOSIS >

Connector No.	B76
Connector Name	INSIDE KEY ANTENNA 2 (LUGGAGE COMPARTMENT)
Connector Color	GRAY



Terminal No.	Color of Wire	Signal Name
1	O	-
2	R	-

Terminal No.	Color of Wire	Signal Name
13J	O	-
14J	R	-
51J	L	-
52J	P	-

Connector No.	B69
Connector Name	WIRE TO WIRE
Connector Color	WHITE

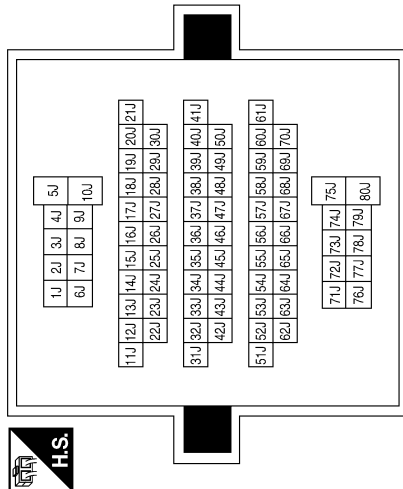

Terminal No.	Color of Wire	Signal Name
42M	BR	-
43M	W	-

Connector No.	B149
Connector Name	WIRE TO WIRE
Connector Color	WHITE

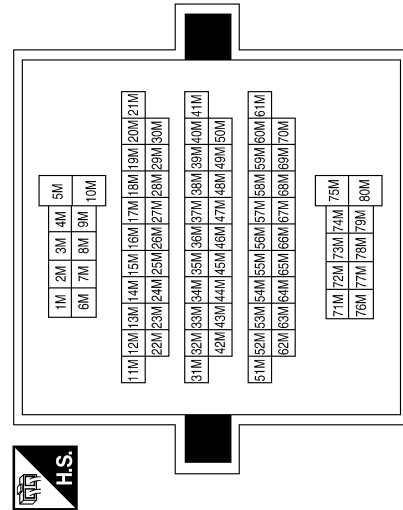

Connector No.	B146
Connector Name	WIRE TO WIRE
Connector Color	BROWN

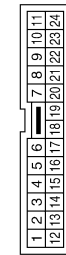

Terminal No.	Color of Wire	Signal Name
15	W	-
16	BR	-

A
B
C
D
E
F
G
H
I
J
K
L
M
N
O
P

SEC

INTELLIGENT KEY UNIT

< ECU DIAGNOSIS >

[WITH INTELLIGENT KEY SYSTEM]

Connector No.	R210
Connector Name	INSIDE KEY ANTENNA 4 (OVERHEAD CONSOLE AREA)
Connector Color	WHITE



Terminal No.	Color of Wire	Signal Name
1	W	-
2	BR	-

Connector No.	R201
Connector Name	WIRE TO WIRE
Connector Color	BROWN

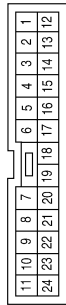

Terminal No.	Color of Wire	Signal Name
15	W	-
16	BR	-

AAKIA0101GB

INTELLIGENT KEY UNIT

< ECU DIAGNOSIS >

[WITH INTELLIGENT KEY SYSTEM]

Fail Safe

INFOID:000000003710614

Display contents of CONSULT-III	Fail-safe	Cancellation
B2013: STRG COMM 1	<ul style="list-style-type: none"> Inhibits steering lock unlocking 	Erase DTC
B2552: INTELLIGENT KEY	<ul style="list-style-type: none"> Inhibits steering lock unlocking Inhibits engine cranking (BCM) Fuel cut (ECM) 	Erase DTC
B2590: NATS MALFUNCTION	<ul style="list-style-type: none"> Inhibits steering lock unlocking Inhibits engine cranking (BCM) Fuel cut (ECM) 	Erase DTC

DTC Inspection Priority Chart

INFOID:000000003710615

If some DTCs are displayed at the same time, perform inspections one by one based on the following priority chart.

Priority	DTC
1	<ul style="list-style-type: none"> U1000: CAN COMM CIRCUIT U1010: CONTROL UNIT (CAN) B2552: INTELLIGENT KEY
2	<ul style="list-style-type: none"> B2013: STRG COMM 1 B2590: NATS MALFUNCTION

DTC Index

INFOID:000000003710616

NOTE:

Details of time display

- CRNT: Displays when there is a malfunction now or after returning to the normal condition until turning ignition switch OFF → ON again.
- 1 - 39: Displayed if any previous malfunction is present when current condition is normal. It increases like 1 → 2 → 3...38 → 39 after returning to the normal condition whenever ignition switch OFF → ON. The counter remains at 39 even if the number of cycles exceeds it. It is counted from 1 again when turning ignition switch OFF → ON after returning to the normal condition if the malfunction is detected again.

CONSULT display	Detection condition	Fail-safe	Diagnosis
No DTC is detected. further testing may be required.	—	—	—
U1000: CAN COMM CIRCUIT	Intelligent Key unit cannot receive CAN communication signal continuously for 2 seconds or more.	—	Check CAN communication system. Refer to SEC-24
U1010: CONTROL UNIT (CAN)	Intelligent Key unit detects internal CAN communication circuit malfunction.	—	Replace Intelligent Key unit.
B2013: STRG COMM 1	The ID verification result between Intelligent key unit and steering lock solenoid are NG. Or Intelligent Key unit cannot communicate with steering lock solenoid.	×	Perform steering lock solenoid ID registration with CONSULT-III
B2552: INTELLIGENT KEY	Intelligent Key unit internal malfunction.	×	Replace Intelligent Key unit.
B2590: NATS MALFUNCTION	The ID verification result between Intelligent key unit and BCM are NG. Or Intelligent Key unit cannot communicate with BCM.	×	Check NATS Refer to SEC-38

IPDM E/R (INTELLIGENT POWER DISTRIBUTION MODULE ENGINE ROOM)

< ECU DIAGNOSIS >

[WITH INTELLIGENT KEY SYSTEM]

IPDM E/R (INTELLIGENT POWER DISTRIBUTION MODULE ENGINE ROOM)

Reference Value

INFOID:000000004176244

VALUES ON THE DIAGNOSIS TOOL

Monitor Item	Condition		Value/Status
MOTOR FAN REQ	Engine idle speed	Changes depending on engine coolant temperature, air conditioner operation status, vehicle speed, etc.	0 - 100 %
A/C COMP REQ	A/C switch OFF		OFF
	A/C switch ON		ON
TAIL&CLR REQ	Lighting switch OFF		OFF
	Lighting switch 1ST, 2ND, HI or AUTO (Light is illuminated)		ON
HL LO REQ	Lighting switch OFF		OFF
	Lighting switch 2ND HI or AUTO (Light is illuminated)		ON
HL HI REQ	Lighting switch OFF		OFF
	Lighting switch HI		ON
FR FOG REQ	Lighting switch 2ND or AUTO (Light is illuminated)	Front fog lamp switch OFF	OFF
		<ul style="list-style-type: none"> • Front fog lamp switch ON • Daytime light activated (Canada only) 	ON
H L WASHER REQ	NOTE: This item is displayed, but cannot be monitored.		OFF
FR WIP REQ	Ignition switch ON	Front wiper switch OFF	STOP
		Front wiper switch INT	1LOW
		Front wiper switch LO	LOW
		Front wiper switch HI	HI
WIP AUTO STOP	Ignition switch ON	Front wiper stop position	STOP P
		Any position other than front wiper stop position	ACT P
WIP PROT	Ignition switch ON	Front wiper operates normally	OFF
		Front wiper stops at fail-safe operation	BLOCK
ST RLY REQ	Ignition switch OFF or ACC		OFF
	Ignition switch START		ON
IGN RLY	Ignition switch OFF or ACC		OFF
	Ignition switch ON		ON
RR DEF REQ	Rear defogger switch OFF		OFF
	Rear defogger switch ON		ON
OIL P SW	Ignition switch OFF, ACC or engine running		OPEN
	Ignition switch ON		CLOSE
DTRL REQ	NOTE: This item is displayed, but cannot be monitored.		OFF
HOOD SW	NOTE: This item is displayed, but cannot be monitored.		OFF

IPDM E/R (INTELLIGENT POWER DISTRIBUTION MODULE ENGINE ROOM)

< ECU DIAGNOSIS >

[WITH INTELLIGENT KEY SYSTEM]

Monitor Item	Condition	Value/Status
THFT HRN REQ	Not operated	OFF
	<ul style="list-style-type: none">• Panic alarm is activated• Horn is activated with VEHICLE SECURITY (THEFT WARNING) SYSTEM	ON
HORN CHIRP	Not operated	OFF
	Door locking with keyfob or Intelligent Key (if equipped) (horn chirp mode)	ON

A

B

C

D

E

F

G

H

I

J

SEC

L

M

N

O

P

IPDM E/R (INTELLIGENT POWER DISTRIBUTION MODULE ENGINE ROOM)

< ECU DIAGNOSIS >

[WITH INTELLIGENT KEY SYSTEM]

INFOID:000000004176245

Terminal Layout

TERMINAL LAYOUT

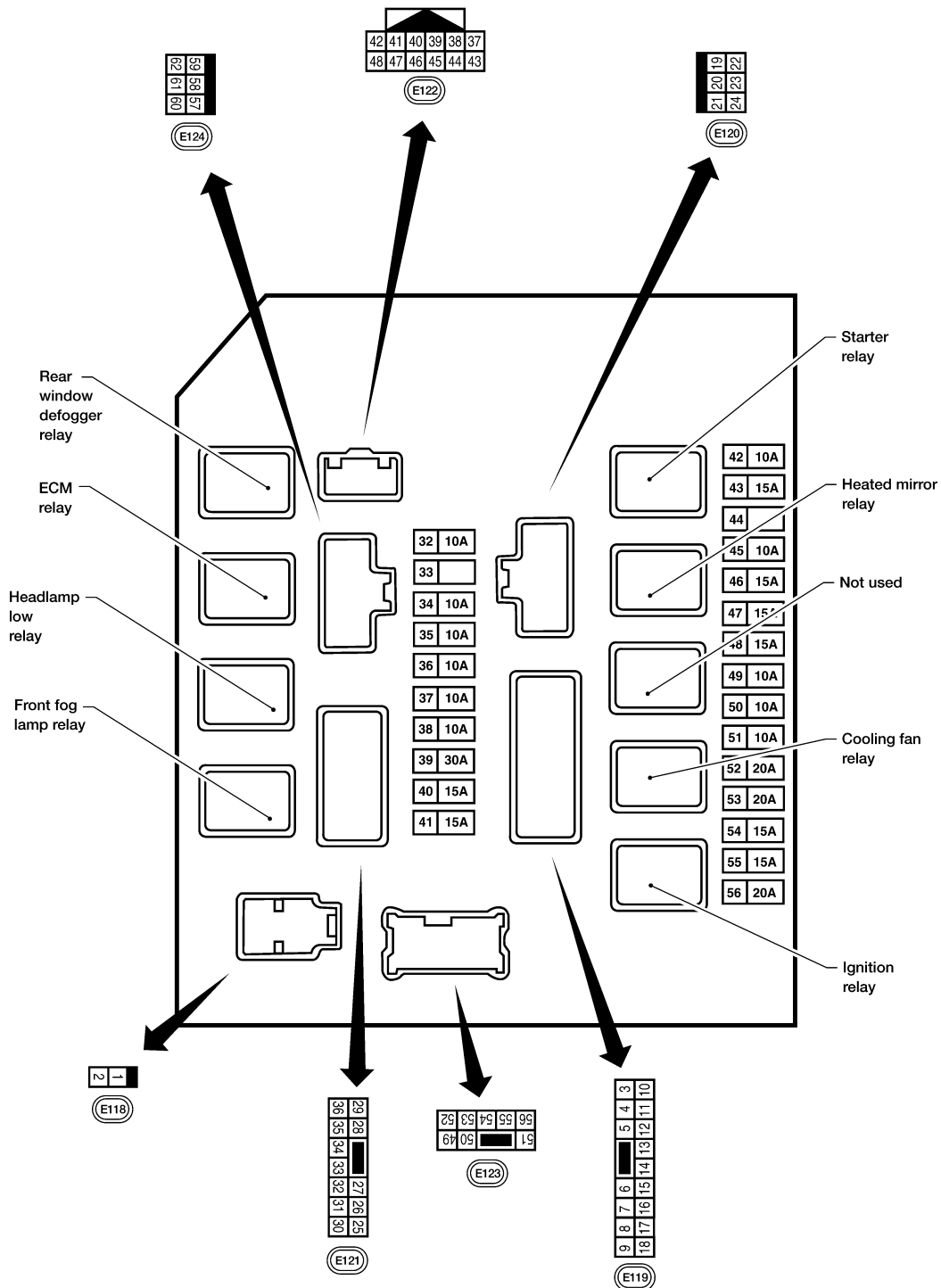

Physical Values

PHYSICAL VALUES

WKIA5852E

INFOID:000000004176246

IPDM E/R (INTELLIGENT POWER DISTRIBUTION MODULE ENGINE ROOM)

< ECU DIAGNOSIS >

[WITH INTELLIGENT KEY SYSTEM]

Terminal	Wire color	Signal name	Signal input/output	Measuring condition		Reference value (Approx.)
				Ignition switch	Operation or condition	
1	B/Y	Battery power supply	Input	OFF	—	Battery voltage
2	R	Battery power supply	Input	OFF	—	Battery voltage
3	BR	ECM relay	Output	—	Ignition switch ON or START	Battery voltage
					Ignition switch OFF or ACC	0V
4	W/L	ECM relay	Output	—	Ignition switch ON or START	Battery voltage
					Ignition switch OFF or ACC	0V
6	L	Throttle control motor relay	Output	—	Ignition switch ON or START	Battery voltage
					Ignition switch OFF or ACC	0V
7	W/B	ECM relay control	Input	—	Ignition switch ON or START	0V
					Ignition switch OFF or ACC	Battery voltage
8	R/B	Fuse 54	Output	—	Ignition switch ON or START	Battery voltage
					Ignition switch OFF or ACC	0V
10	G	Fuse 45	Output	ON	Daytime light system active	0V
					Daytime light system inactive	Battery voltage
11	Y/B	A/C compressor	Output	ON or START	A/C switch ON or defrost A/C switch	Battery voltage
					A/C switch OFF or defrost A/C switch	0V
12	L/W	Ignition switch supplied power	Input	—	OFF or ACC	0V
					ON or START	Battery voltage
13	B/Y	Fuel pump relay	Output	—	Ignition switch ON or START	Battery voltage
					Ignition switch OFF or ACC	0V
14	Y/R	Fuse 49	Output	—	Ignition switch ON or START	Battery voltage
					Ignition switch OFF or ACC	0V
15	LG/B	Fuse 50 (VDC)	Output	—	Ignition switch ON or START	Battery voltage
					Ignition switch OFF or ACC	0V
15	GR	Fuse 50 (ABS)	Output	—	Ignition switch ON or START	Battery voltage
					Ignition switch OFF or ACC	0V
16	G	Fuse 51	Output	—	Ignition switch ON or START	Battery voltage
					Ignition switch OFF or ACC	0V
17	W	Fuse 55	Output	—	Ignition switch ON or START	Battery voltage
					Ignition switch OFF or ACC	0V
19	W/R	Starter motor	Output	START	—	Battery voltage
21	BR	Ignition switch supplied power	Input	—	OFF or ACC	0V
					START	Battery voltage
22	G	Battery power supply	Output	OFF	—	Battery voltage
23	GR/W	Door mirror defogger output signal	Output	—	When rear defogger switch is ON	Battery voltage
					When raker defogger switch is OFF	0V

A
B
C
D
E
F
G
H
I
J
K
L
M
N
O
P

SEC

IPDM E/R (INTELLIGENT POWER DISTRIBUTION MODULE ENGINE ROOM)

< ECU DIAGNOSIS >

[WITH INTELLIGENT KEY SYSTEM]

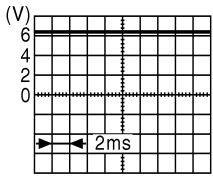
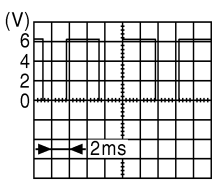
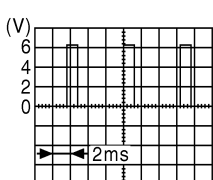
Terminal	Wire color	Signal name	Signal input/output	Measuring condition		Reference value (Approx.)
				Ignition switch	Operation or condition	
24	L	Cooling fan relay	Output	—	Conditions correct for cooling fan operation	Battery voltage
					Conditions not correct for cooling fan operation	0V
27	W/B	Fuse 38	Output	—	Ignition switch ON or START	Battery voltage
					Ignition switch OFF or ACC	0V
30	W	Fuse 53	Output	—	Ignition switch ON or START	Battery voltage
					Ignition switch OFF or ACC	0V
32	L	Wiper low speed signal	Output	ON or START	Wiper switch OFF	Battery voltage
					LO or INT	0V
35	L/B	Wiper high speed signal	Output	ON or START	Wiper switch OFF, LO, INT	Battery voltage
					HI	0V
37	Y	Power generation command signal	Output	—	Ignition switch ON	 <p style="text-align: right; font-size: small;">JPMA0001GB</p> <p style="text-align: center;">6.3 V</p>
					40% is set on "Active test," "ALTERNATOR DUTY" of "ENGINE"	 <p style="text-align: right; font-size: small;">JPMA0002GB</p> <p style="text-align: center;">3.8 V</p>
					40% is set on "Active test," "ALTERNATOR DUTY" of "ENGINE"	 <p style="text-align: right; font-size: small;">JPMA0003GB</p> <p style="text-align: center;">1.4 V</p>
38	B	Ground	Input	—	—	0V
39	L	CAN-H	—	ON	—	—
40	P	CAN-L	—	ON	—	—
42	GR	Oil pressure switch	Input	—	Engine running	Battery voltage
					Engine stopped	0V
43	L/Y	Wiper auto stop signal	Input	ON or START	Wiper switch OFF, LO, INT	Battery voltage
44	BR	Daytime light relay control	Input	ON	Daytime light system active	0V
					Daytime light system inactive	Battery voltage

IPDM E/R (INTELLIGENT POWER DISTRIBUTION MODULE ENGINE ROOM)

< ECU DIAGNOSIS >

[WITH INTELLIGENT KEY SYSTEM]

Terminal	Wire color	Signal name	Signal input/output	Measuring condition		Reference value (Approx.)	
				Ignition switch	Operation or condition		
45	G/W	Horn relay control	Input	ON	When door locks are operated using keyfob or Intelligent Key (if equipped) (OFF → ON)*	Battery voltage → 0V	
46	GR	Fuel pump relay control	Input	—	Ignition switch ON or START	0V	
					Ignition switch OFF or ACC	Battery voltage	
47	O	Throttle control motor relay control	Input	—	Ignition switch ON or START	0V	
					Ignition switch OFF or ACC	Battery voltage	
48	B/R	Starter relay (inhibit switch)	Input	ON or START	Selector lever in "P" or "N"	0V	
					Selector lever any other position	Battery voltage	
49	R/L	Trailer tow relay	Output	ON	Lighting switch must be in the 1st position	OFF	0V
						ON	Battery voltage
50	W/R	Front fog lamp (LH)	Output	ON or START	Lighting switch must be in the 2nd position (LOW beam is ON) and the front fog lamp switch	OFF	0V
						ON	Battery voltage
51	W/R	Front fog lamp (RH)	Output	ON or START	Lighting switch must be in the 2nd position (LOW beam is ON) and the front fog lamp switch	OFF	0V
						ON	Battery voltage
52	L	LH low beam head-lamp	Output	—	Lighting switch in 2nd position	Battery voltage	
54	R/Y	RH low beam head-lamp	Output	—	Lighting switch in 2nd position	Battery voltage	
55	G	LH high beam head-lamp	Output	—	Lighting switch in 2nd position and placed in HIGH or PASS position	Battery voltage	
56	L/Y	RH high beam head-lamp	Output	—	Lighting switch in 2nd position and placed in HIGH or PASS position	Battery voltage	
57	R/L	Parking, license, and tail lamp	Output	ON	Lighting switch 1st position	OFF	0V
						ON	Battery voltage
59	B	Ground	Input	—	—	0V	
60	B/W	Rear window defogger relay	Output	ON or START	Rear defogger switch ON	Battery voltage	
					Rear defogger switch OFF	0V	
61	BR	Fuse 32	Output	OFF	—	Battery voltage	

*: When horn reminder is ON

A
B
C
D
E
F
G
H
I
J
L
M
N
O
P

SEC

IPDM E/R (INTELLIGENT POWER DISTRIBUTION MODULE ENGINE ROOM)

< ECU DIAGNOSIS >

[WITH INTELLIGENT KEY SYSTEM]

Fail Safe

INFOID:000000004176247

CAN COMMUNICATION CONTROL

When CAN communication with ECM and BCM is impossible, IPDM E/R performs fail-safe control. After CAN communication recovers normally, it also returns to normal control.

If No CAN Communication Is Available With ECM

Control part	Fail-safe in operation
Cooling fan	<ul style="list-style-type: none">• Turns ON the cooling fan relay when the ignition switch is turned ON• Turns OFF the cooling fan relay when the ignition switch is turned OFF

If No CAN Communication Is Available With BCM

Control part	Fail-safe in operation
Headlamp	<ul style="list-style-type: none">• Turns ON the headlamp low relay when the ignition switch is turned ON• Turns OFF the headlamp low relay when the ignition switch is turned OFF• Headlamp high relay OFF
<ul style="list-style-type: none">• Parking lamps• License plate lamps• Tail lamps	<ul style="list-style-type: none">• Turns ON the tail lamp relay when the ignition switch is turned ON• Turns OFF the tail lamp relay when the ignition switch is turned OFF
Front wiper	<ul style="list-style-type: none">• The status just before activation of fail-safe control is maintained until the ignition switch is turned OFF while the front wiper is operating at LO or HI speed.• The wiper is operated at LO speed until the ignition switch is turned OFF if the fail-safe control is activated while the front wiper is set in the INT mode and the front wiper motor is operating.
Rear window defogger	Rear window defogger relay OFF
A/C compressor	A/C relay OFF
Front fog lamps	Front fog lamp relay OFF

IGNITION RELAY MALFUNCTION DETECTION FUNCTION

- IPDM E/R monitors the voltage at the contact circuit and excitation coil circuit of the ignition relay inside it.
- IPDM E/R judges the ignition relay error if the voltage differs between the contact circuit and the excitation coil circuit.
- If the ignition relay cannot turn OFF due to contact seizure, it activates the tail lamp relay for 10 minutes to alert the user to the ignition relay malfunction when the ignition switch is turned OFF.

Ignition switch	Ignition relay	Tail lamp relay
ON	ON	—
OFF	OFF	—

NOTE:

The tail lamp turns OFF when the ignition switch is turned ON.

FRONT WIPER CONTROL

IPDM E/R detects front wiper stop position by a front wiper auto stop signal.

When a front wiper auto stop signal is in the conditions listed below, IPDM E/R stops power supply to wiper after repeating a front wiper 10 second activation and 20 second stop five times.

Ignition switch	Front wiper switch	Auto stop signal
ON	OFF	Front wiper stop position signal cannot be input 10 seconds.
	ON	The signal does not change for 10 seconds.

NOTE:

This operation status can be confirmed on the IPDM E/R "DATA MONITOR" that displays "Block" for the item "WIP PROT" while the wiper is stopped.

STARTER MOTOR PROTECTION FUNCTION

IPDM E/R (INTELLIGENT POWER DISTRIBUTION MODULE ENGINE ROOM)

< ECU DIAGNOSIS >

[WITH INTELLIGENT KEY SYSTEM]

IPDM E/R turns OFF the starter control relay to protect the starter motor when the starter control relay remains active for 90 seconds.

DTC Index

INFOID:000000004176248

CONSULT-III display	Fail-safe	TIME ^{NOTE}		Refer to
No DTC is detected. further testing may be required.	—	—	—	—
U1000: CAN COMM CIRCUIT	×	CRNT	1 – 39	PCS-18

NOTE:

The details of TIME display are as follows.

- CRNT: The malfunctions that are detected now
- 1 - 39: The number is indicated when it is normal at present and a malfunction was detected in the past. It increases like 0 → 1 → 2 ... 38 → 39 after returning to the normal condition whenever IGN OFF → ON. It is fixed to 39 until the self-diagnosis results are erased if it is over 39. It returns to 0 when a malfunction is detected again in the process.

A
B
C
D
E
F
G
H
I
J
L
M
N
O
P

SEC

INTELLIGENT KEY SYSTEM/ENGINE START FUNCTION SYMPTOMS

< SYMPTOM DIAGNOSIS >

[WITH INTELLIGENT KEY SYSTEM]

SYMPTOM DIAGNOSIS

INTELLIGENT KEY SYSTEM/ENGINE START FUNCTION SYMPTOMS

Symptom Table

INFOID:000000003710620

NOTE:

- Before performing the diagnosis in the following table, check "[SEC-5, "Work Flow"](#)".
- Check that vehicle is under the condition shown in "Conditions of vehicle" before starting diagnosis, and check each symptom.
- Engine cranking is enabled when the shift lever is in the "Park" position, and in the "Neutral" position only if the brake pedal is depressed.
- If the following symptoms are detected, check systems shown in the "Diagnosis/service procedure" column in this order.

CONDITIONS OF VEHICLE (OPERATING CONDITIONS)

- Engine start function is ON when setting on CONSULT-III.
- Mechanical key is not inserted in key cylinder.
- One or more of Intelligent Keys with registered Intelligent Key ID is in the vehicle.

Symptom	Diagnosis/service procedure	Reference page
Ignition switch does not turn on with Intelligent Key. [LCD displays "KEY DETECTED"]	1. Check steering lock solenoid.	SEC-26
	2. Replace Intelligent Key unit.	SEC-109
Ignition switch does not turn on with Intelligent Key. [LCD does not display "KEY DETECTED"]	1. Check Intelligent Key unit power supply and ground circuit.	DLK-69
	2. Check ignition knob switch.	DLK-116
	3. Check key switch (BCM input).	DLK-115
	4. Check key switch (Intelligent Key unit input).	DLK-113
	5. Replace Intelligent Key unit.	SEC-109
Ignition switch does not turn on with Intelligent Key. [LCD displays " NO KEY DETECTED"]	1a. Check inside key antenna 1 (rear of center console).	DLK-61
	1b. Check inside key antenna 2 (luggage compartment).	DLK-63
	1c. Check inside key antenna 3 (front of center console).	DLK-65
	1d. Check inside key antenna 4 (overhead console area).	DLK-67
	2. Replace Intelligent Key unit.	SEC-109
Ignition switch does not turn on with mechanical key	1. Check key switch (BCM input).	DLK-115
	2. Check key switch (Intelligent Key unit input).	DLK-113
Engine cannot be cranked with transmission in "Park" or in "Neutral" position with brake pedal depressed	1. Check transmission signal.	TM-45
	2. Check stop lamp switch.	EXL-84

VEHICLE SECURITY SYSTEM SYMPTOMS

< SYMPTOM DIAGNOSIS >

[WITH INTELLIGENT KEY SYSTEM]

VEHICLE SECURITY SYSTEM SYMPTOMS

Symptom Table

INFOID:000000003710621

Procedure		Diagnostic procedure	Refer to page
Symptom			
1	Vehicle security system cannot be set by	Door switch	Check door switch (LF, RF, LR, RR, back) DLK-72
		Glass ajar switch	Check glass ajar switch DLK-127
		Intelligent Key	Check Intelligent Key system DLK-8
		Key cylinder switch	Check key cylinder switch DLK-80
		—	Check Intermittent Incident GI-37
	Security indicator does not turn ON.		Check vehicle security indicator SEC-47
		Check Intermittent Incident GI-37	
2	* Vehicle security system does not sound alarm when	Any door is opened.	Check door switch (LF, RF, LR, RR, back) DLK-72
		Glass ajar switch	Check glass ajar switch DLK-127
		—	Check Intermittent Incident GI-37
3	Vehicle security alarm does not activate.	Horn alarm	Check horn switch —
			Check Intermittent Incident GI-37
4	Vehicle security system cannot be canceled by	Intelligent Key	Check Intelligent Key system DLK-8
		Key cylinder switch	Check key cylinder switch DLK-80
		—	Check Intermittent Incident GI-37

*: Check the system is in the armed phase.

A
B
C
D
E
F
G
H
I
J
L
M
N
O
P

SEC

NISSAN VEHICLE IMMOBILIZER SYSTEM-NATS SYMPTOMS

< SYMPTOM DIAGNOSIS >

[WITH INTELLIGENT KEY SYSTEM]

NISSAN VEHICLE IMMOBILIZER SYSTEM-NATS SYMPTOMS

Symptom Table

INFOID:000000003710622

NOTE:

- Before performing the diagnosis in the following table, check "[SEC-5. "Work Flow"](#)".
- Check that vehicle is under the condition shown in "Conditions of vehicle" before starting diagnosis, and check each symptom.
- If the following symptoms are detected, check systems shown in the "Diagnosis/service procedure" column in this order.

CONDITIONS OF VEHICLE (OPERATING CONDITIONS)

- Mechanical key is not inserted into key cylinder.
- Ignition knob switch is not depressed.

Symptom	Diagnosis/service procedure	Reference page
Security indicator does not turn ON or flash.	1. Check vehicle security indicator	SEC-47
	2. Check Intermittent Incident	GI-37

ON-VEHICLE MAINTENANCE

PRE-INSPECTION FOR DIAGNOSTIC

Basic Inspection

INFOID:000000003710623

The engine start function, door lock function, power distribution system and NATS-IVIS/NMS in the Intelligent Key system are closely related to each other regarding control. Narrow down the functional area in question by performing basic inspection to identify which function is malfunctioning. The vehicle security function can operate only when the door lock and power distribution system are operating normally. Therefore, it is easy to identify any factor unique to the vehicle security system by performing the vehicle security operation check after basic inspection.

1. CHECK DOOR LOCK OPERATION

1. Check the door lock for normal operation with the Intelligent Key controller and door request switch.
2. Successful door lock operation with the Intelligent Key and request SW indicates that the remote keyless entry receiver and inside key antenna required for engine start are functioning normally.
3. Identify the malfunctioning point by referring to the DLK section if the door cannot be unlocked.

Can the door be locked with the Intelligent Key and door request switch?

YES >> GO TO 2.

NO >> Refer to [DLK-202, "Symptom Table"](#).

2. CHECK ENGINE STARTING

Checks that the engine starts when operating the Intelligent Key.

Does the engine start?

YES >> GO TO 3.

NO >> Refer to [SEC-104, "Symptom Table"](#).

3. CHECK STEERING LOCKING

1. Does the steering lock when operating door switch after switching the power supply from ON position (or ACC position) to LOCK position?
2. If door switch is malfunctioning, BCM cannot lock the steering. If BCM does not detect DTC, steering lock solenoid is normal.

Does steering lock?

YES >> GO TO 4.

NO >> Refer to [DLK-99, "Diagnosis Procedure"](#).

4. CHECK IGNITION KNOB SWITCH OPERATION

Press ignition knob switch to check switch operation.

Does the combination meter display any message?

YES >> GO TO 5.

NO >> Refer to [SEC-44, "Ignition Knob Switch Check"](#).

5. CHECK VEHICLE SECURITY SYSTEM

1. Check the vehicle security system for normal operation.
2. The vehicle security function can operate only when the door lock and power distribution functions are operating normally. Therefore, it is easy to identify any factor unique to the vehicle security by performing the vehicle security operation check after this basic inspection.

>> Go to [SEC-107, "Vehicle Security Operation Check"](#).

Vehicle Security Operation Check

INFOID:000000003710624

1. INSPECTION START

Turn ignition switch "OFF".

NOTE:

Before starting operation check, open front windows.

PRE-INSPECTION FOR DIAGNOSTIC

< ON-VEHICLE MAINTENANCE >

[WITH INTELLIGENT KEY SYSTEM]

>> GO TO 2

2. CHECK SECURITY INDICATOR LAMP

1. Lock doors using Intelligent Key or mechanical key.
2. Check that security indicator lamp illuminates for 30 seconds.

Security indicator lamp should illuminate.

OK >> GO TO 3

NG >> Perform diagnosis and repair. Refer to [SEC-47. "Diagnosis Procedure"](#).

3. CHECK ALARM FUNCTION

1. After 30 seconds, security indicator lamp will start to blink.
2. Open any door before unlocking with Intelligent Key or mechanical key, or open back door or glass hatch without the presence of Intelligent Key.

Does the alarm function properly?

YES >> GO TO 4

NO >> Check the following.

- The vehicle security system does not phase in alarm mode. Refer to [SEC-104. "Symptom Table"](#).
- Alarm (horn and headlamps) does not operate. Refer to [SEC-104. "Symptom Table"](#).

4. CHECK ALARM CANCEL OPERATION

Unlock any door using Intelligent Key or mechanical key.

Alarm (horn and headlamps) should stop.

OK >> Inspection End.

NG >> Check door lock function. Refer to [SEC-105. "Symptom Table"](#).

ON-VEHICLE REPAIR

INTELLIGENT KEY UNIT

Removal and Installation

INFOID:000000004199509

REMOTE KEYLESS ENTRY RECEIVER

Removal

1. Remove the instrument panel. Refer to [IP-11, "Removal and Installation"](#).
2. Disconnect the wire harness (1), remove the bolt (A) and the RKE receiver (2).

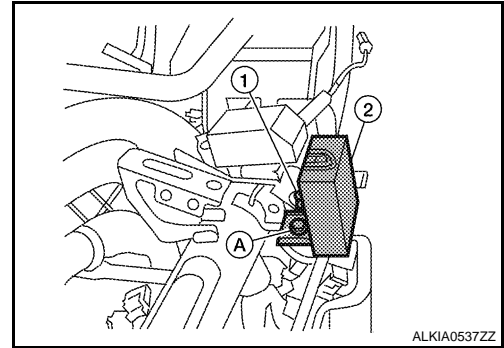

Installation

Installation is in the reverse order of removal.

INTELLIGENT KEY UNIT

Removal

1. Remove the instrument panel. Refer to [IP-11, "Removal and Installation"](#).
2. Disconnect the wire harness (1), remove the bolt (A) and the Intelligent key unit (2).

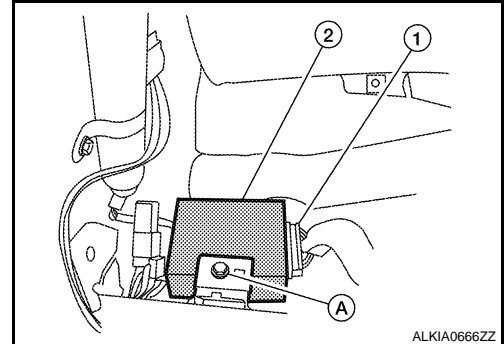

Installation

Installation is in the reverse order of removal.

NATS ANTENNA AMP

NOTE:

- If NATS antenna amp. is not installed correctly, NVIS (NATS) system will not operate properly and "SELF-DIAG RESULTS" on CONSULT-III screen will show "LOCK MODE" or "CHAIN OF IMMU-KEY".
- Initialization is not necessary when only the NATS antenna amp. is replaced with a new one.

Removal

1. Disconnect the battery negative terminal.
2. Remove the steering column covers. Refer to [IP-10, "Exploded View"](#).

A
B
C
D
E
F
G
H
I
J
L
M
N
O
P

SEC

INTELLIGENT KEY UNIT

< ON-VEHICLE REPAIR >

[WITH INTELLIGENT KEY SYSTEM]

3. Remove the bolt, disconnect the electrical connector, and remove the NATS antenna amp (1).

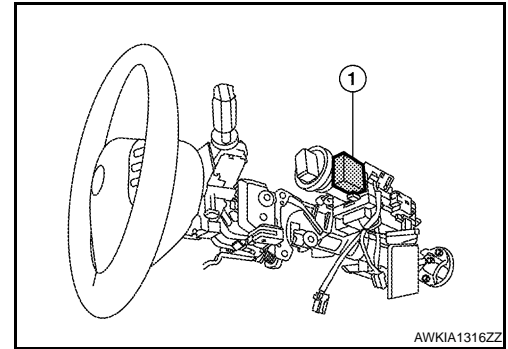

AWKIA1316ZZ

Installation

Installation is in the reverse order of removal.

DIAGNOSIS AND REPAIR WORKFLOW

< BASIC INSPECTION >

[WITHOUT INTELLIGENT KEY SYSTEM]

BASIC INSPECTION

DIAGNOSIS AND REPAIR WORKFLOW

Work Flow

INFOID:000000003710626

OVERALL SEQUENCE

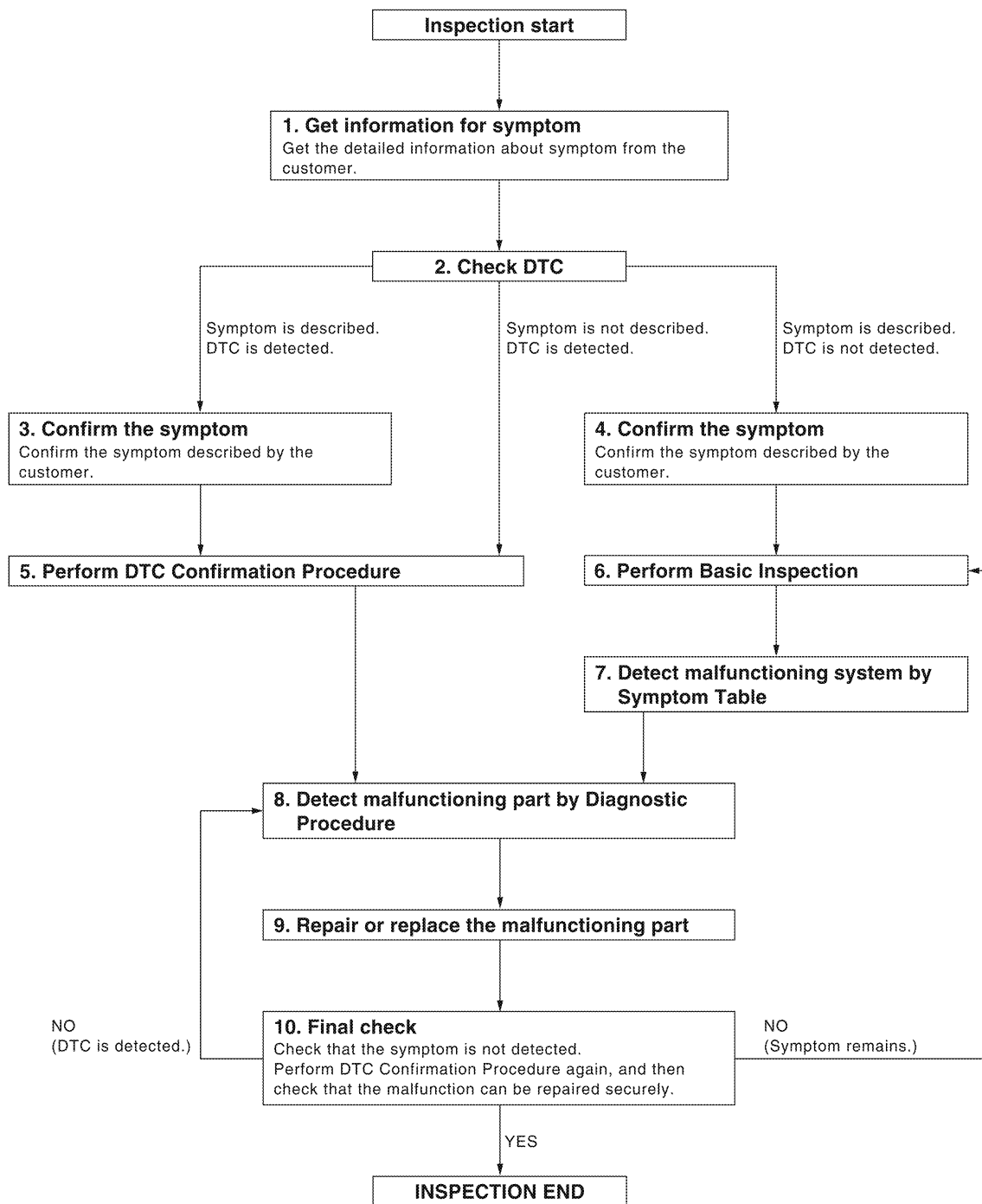

A
B
C
D
E
F
G
H
I
J
L
M
N
O
P

SEC

DETAILED FLOW

ALKIA0538GB

DIAGNOSIS AND REPAIR WORKFLOW

< BASIC INSPECTION >

[WITHOUT INTELLIGENT KEY SYSTEM]

1.GET INFORMATION FOR SYMPTOM

Get the detailed information from the customer about the symptom (the condition and the environment when the incident/malfunction occurred).

>> GO TO 2

2.CHECK DTC

1. Check DTC for Intelligent Key unit and BCM.
2. Perform the following procedure if DTC is displayed.
 - Erase DTC.
 - Study the relationship between the cause detected by DTC and the symptom described by the customer.
3. Check related service bulletins for information.

Is any symptom described and any DTC detected?

Symptom is described, DTC is displayed>>GO TO 3

Symptom is described, DTC is not displayed>>GO TO 4

Symptom is not described, DTC is displayed>>GO TO 5

3.CONFIRM THE SYMPTOM

Confirm the symptom described by the customer.

Connect CONSULT-III to the vehicle in "DATA MONITOR" mode and check real-time diagnosis results.

Verify relation between the symptom and the condition when the symptom is detected.

>> GO TO 5

4.CONFIRM THE SYMPTOM

Confirm the symptom described by the customer.

Connect CONSULT-III to the vehicle in "DATA MONITOR " mode and check real-time diagnosis results.

Verify relation between the symptom and the condition when the symptom is detected.

>> GO TO 6

5.PERFORM DTC CONFIRMATION PROCEDURE

Perform DTC Confirmation Procedure for the displayed DTC, and then check that DTC is detected again.

If two or more DTCs are detected, refer to [SEC-166, "DTC Inspection Priority Chart"](#) (BCM) and determine trouble diagnosis order.

Is DTC detected?

YES >> GO TO 8

NO >> Refer to [GI-37, "Intermittent Incident"](#).

6.PERFORM BASIC INSPECTION

Perform Basic Inspection. Refer to [SEC-178, "Basic Inspection"](#).

>> GO TO 7

7.DETECT MALFUNCTIONING SYSTEM BY SYMPTOM TABLE

Detect malfunctioning system according to Symptom Table based on the confirmed symptom in step 4.

>> GO TO 8

8.DETECT MALFUNCTIONING PART BY DIAGNOSTIC PROCEDURE

Inspect according to Diagnostic Procedure of the system.

NOTE:

The Diagnostic Procedure is described based on open circuit inspection. A short circuit inspection is also required for the circuit check in the Diagnostic Procedure.

>> GO TO 9

DIAGNOSIS AND REPAIR WORKFLOW

< BASIC INSPECTION >

[WITHOUT INTELLIGENT KEY SYSTEM]

9. REPAIR OR REPLACE THE MALFUNCTIONING PART

1. Repair or replace the malfunctioning part.
2. Reconnect parts or connectors disconnected during Diagnostic Procedure again after repair and replacement.
3. Check DTC. If DTC is displayed, erase it.

>> GO TO 10

10. FINAL CHECK

When DTC was detected in step 9, perform DTC Confirmation Procedure or Component Function Check again, and then check that the malfunctions have been fully repaired.

When symptom was described by the customer, refer to the confirmed symptom in step 3 or 4, and check that the symptom is not detected.

Does the symptom reappear?

- YES (DTC is detected)>>GO TO 8
- YES (Symptom remains)>>GO TO 6
- NO >> Inspection End.

A
B
C
D
E
F
G
H
I
J
L
M
N
O
P

SEC

INSPECTION AND ADJUSTMENT

< BASIC INSPECTION >

[WITHOUT INTELLIGENT KEY SYSTEM]

INSPECTION AND ADJUSTMENT

ADDITIONAL SERVICE WHEN REPLACING CONTROL UNIT

ADDITIONAL SERVICE WHEN REPLACING CONTROL UNIT : Special Repair Requirement

INFOID:000000003710627

Refer to the CONSULT-III Operation Manual-NATS.

ECM RE-COMMUNICATING FUNCTION

ECM RE-COMMUNICATING FUNCTION : Description

INFOID:000000003710628

Performing following procedure can automatically perform re-communication of ECM and BCM, but only when the ECM has been replaced with a new one (*1).

*1: New one means an ECM which has never been energized on-board.

(In this step, initialization procedure by CONSULT-III is not necessary)

NOTE:

- When registering new Key IDs or replacing the ECM that is not brand new, refer to CONSULT-III Operation Manual NATS.
- If multiple keys are attached to the key holder, separate them before work.
- Distinguish keys with unregistered key ID from those with registered ID.

ECM RE-COMMUNICATING FUNCTION : Special Repair Requirement

INFOID:000000003710629

1. PERFORM ECM RE-COMMUNICATING FUNCTION

1. Install ECM.
2. Using a registered key (*2), turn ignition switch to "ON".
*2: To perform this step, use the key that has been used before performing ECM replacement.
3. Maintain ignition switch in "ON" position for at least 5 seconds.
4. Turn ignition switch to "OFF".
5. Start engine.

Can engine be started?

YES >> Procedure is completed.

NO >> Initialize control unit. Refer to CONSULT-III Operation Manual NATS.

NVIS (NISSAN VEHICLE IMMOBILIZER SYSTEM-NATS)

< FUNCTION DIAGNOSIS >

[WITHOUT INTELLIGENT KEY SYSTEM]

FUNCTION DIAGNOSIS

NVIS (NISSAN VEHICLE IMMOBILIZER SYSTEM-NATS)

System Diagram

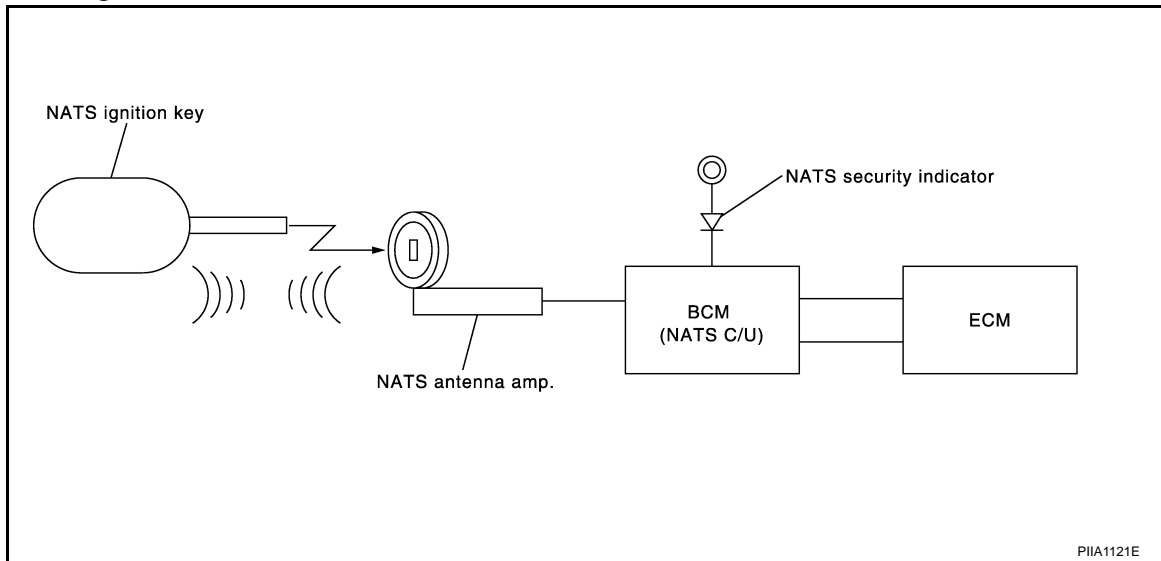

System Description

INFOID:000000003710631

INPUT/OUTPUT SIGNAL CHART

BCM

Switch/Input signal	Input signal to BCM	BCM function	Actuator/Output signal
NATS antenna amp.	Key ID	NATS	<ul style="list-style-type: none"> • Security indicator lamp • Starter request
ECM	Engine status signal		

SYSTEM DESCRIPTION

NATS (Nissan Anti-Theft System) has the following immobilizer functions:

- Engine immobilizer shows high anti-theft performance to prevent engine from starting by other than the owner.
- Only a key with key ID registered in BCM and ECM can start engine, and shows high anti-theft performance to prevent key from being copied or stolen.
- Security indicator always flashes with mechanical key removed condition (key switch: OFF) and ignition knob released condition on LOCK position (ignition knob switch: OFF).
- Therefore, NATS warns outsiders that the vehicle is equipped with the anti-theft system. Refer to [SEC-118, "System Description"](#).
- If system detects malfunction, security indicator illuminates when ignition switch is turned to ON position.
- If the owner requires, ignition key ID or mechanical key ID can be registered for up to 5 keys.
- During trouble diagnosis or when the following parts have been replaced, and if ignition key is added, registration* is required.

*1: All keys kept by the owner of the vehicle should be registered with mechanical key.

- ECM
- BCM
- Ignition key
- Remote keyless entry receiver
- NATS trouble diagnosis, system initialization and additional registration of other mechanical key IDs must be carried out using CONSULT-III.

When NATS initialization has been completed, the ID of the inserted mechanical key or mechanical key IDs can be carried out.

A
B
C
D
E
F
G
H
I
J
L
M
N
O
P

SEC

NVIS (NISSAN VEHICLE IMMOBILIZER SYSTEM-NATS)

< FUNCTION DIAGNOSIS >

[WITHOUT INTELLIGENT KEY SYSTEM]

- Possible symptom of NATS malfunction is "Engine cannot start". Identify the possible causes according to "Work Flow", Refer to [SEC-111, "Work Flow"](#).
- If ECM other than Genuine NISSAN is installed, the engine cannot be started. For ECM replacement procedure, refer to [SEC-114, "ECM RE-COMMUNICATING FUNCTION : Description"](#).

PRECAUTIONS FOR KEY REGISTRATION

- The key registration is a procedure that erases the current NATS ID once, and then re-registers a new ID. Therefore the registered key is necessary for this procedure. Before starting the registration operation collect all registered Keys from the customer.
- The NATS ID registration is the procedure that registers the ID stored into the transponder (integrated in mechanical key) to BCM.
The key ID registration is the procedure that registers the ID to the BCM.
- When performing the key system registration only, the engine cannot be started by inserting the key into the key cylinder. When performing the NATS registration only, the engine cannot be started by using the ignition key.

SECURITY INDICATOR

- Always flashes with ignition key in the OFF position.

MAINTENANCE INFORMATION

CAUTION:

It is necessary to perform NATS ID registration when replacing any of the following part. If it's not (or fail to do so), the electrical system may not operate properly.

- BCM
- ECM
- IPDM E/R
- Ignition key
- NATS antenna amp.
- Combination meter

Component Parts Location

INFOID:000000003710632

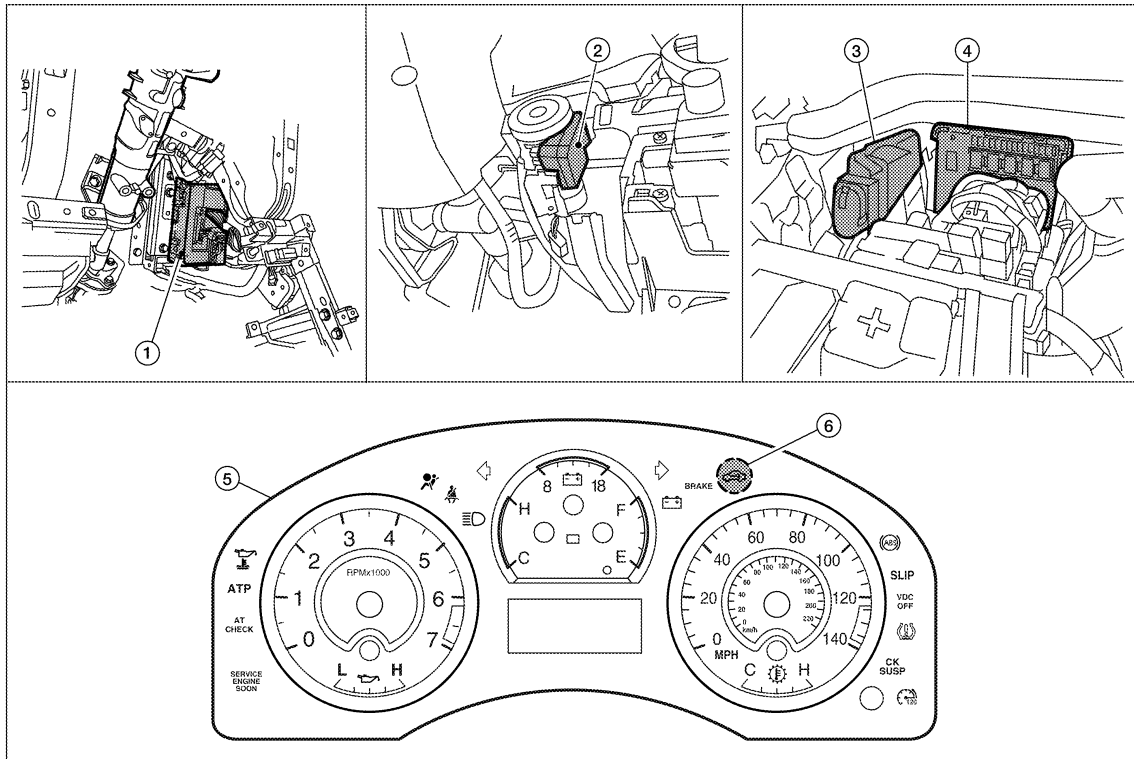

ALKIA0701ZZ

NVIS (NISSAN VEHICLE IMMOBILIZER SYSTEM-NATS)

< FUNCTION DIAGNOSIS >

[WITHOUT INTELLIGENT KEY SYSTEM]

- | | | |
|---|--------------------------|----------------------------|
| 1. BCM M18, M20
(view with instrument panel LH removed) | 2. NATS antenna amp. M21 | 3. ECM E16 |
| 4. IPDM E/R E119, E120, E121, E122, E124
(view with cover removed) | 5. Combination meter M24 | 6. Security indicator lamp |

A
B

Component Description

INFOID:000000003710633

Item	Function
BCM	Verifies the received signal from the ignition key ID, then informs ECM whether to allow engine start.
Remote keyless entry receiver	Receives lock/unlock signal from the keyfob, and then transmits to the BCM.
NATS antenna amp.	Detects the ignition key presence in the ignition key cylinder.
Security indicator	Indicates the status of the security system.
IPDM E/R	Powers-up the horn and the headlamps in case of a security breach.

C
D
E
F
G
H
I
J

SEC

L
M
N
O
P

VEHICLE SECURITY SYSTEM

< FUNCTION DIAGNOSIS >

[WITHOUT INTELLIGENT KEY SYSTEM]

VEHICLE SECURITY SYSTEM

System Diagram

INFOID:000000003710634

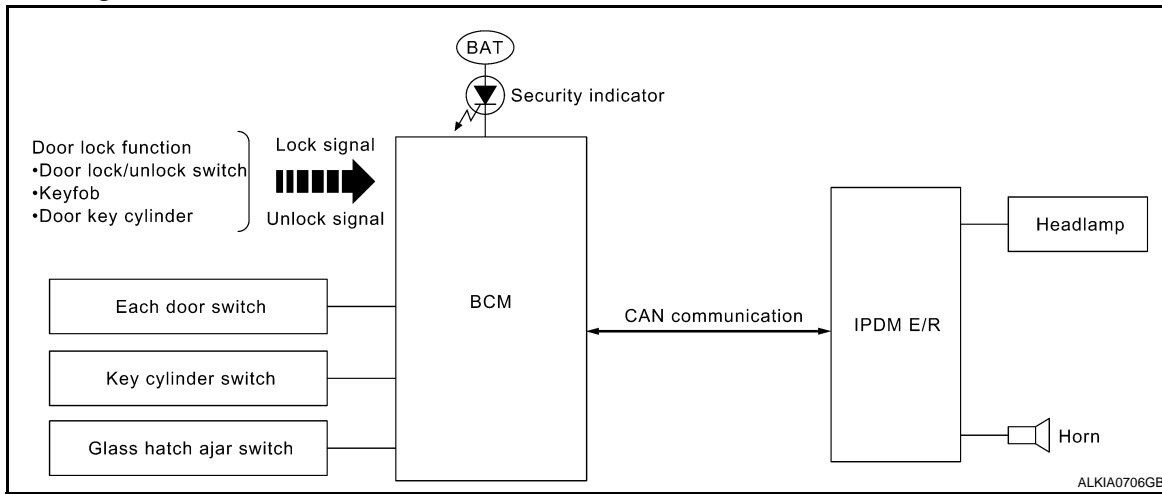

System Description

INFOID:000000003710635

DESCRIPTION

The security system provides an audible and visual alarm when an unauthorized access to the vehicle is detected while the system is in armed phase.

The security system consist of the BCM managing the audible alarm (horn) and the visual alarm (headlamps).

OPERATION FLOW

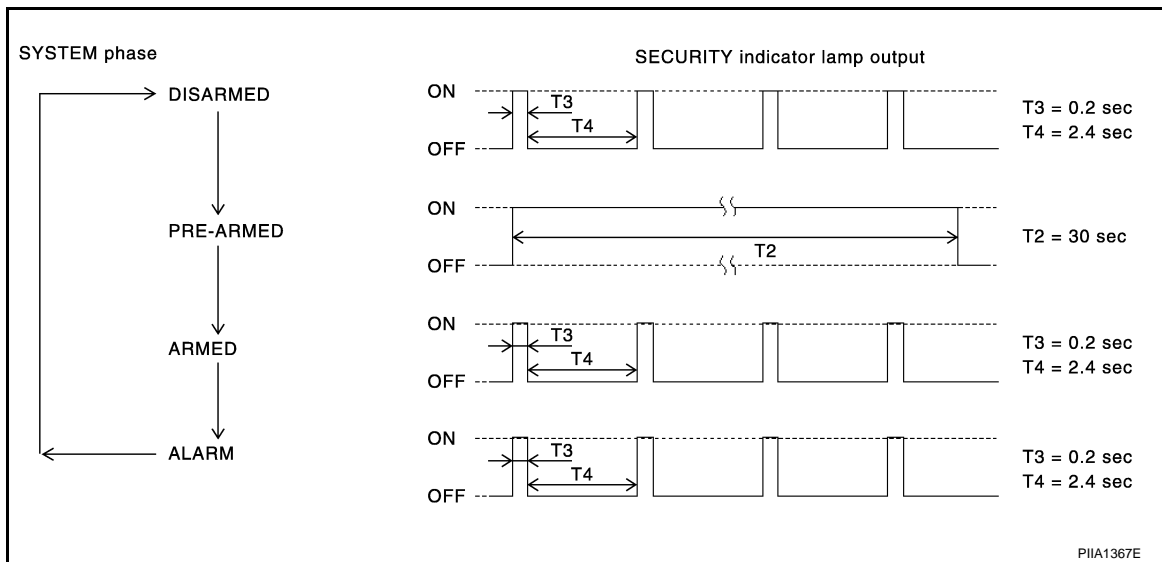

Disarmed Phase

When the vehicle is being driven or when doors are open, the theft warning system is set in the disarmed phase on the assumption that the owner is inside or near the vehicle.

Pre-Armed Phase And Armed Phase

The vehicle security system turns into the pre-armed phase when ignition switch is in OFF position, all doors are closed and locked (using keyfob, doorlock/unlock switch, driver key cylinder or auto relock function). The system automatically shifts into the armed phase.

Condition of Activating The System

When the following condition is performed in armed phase, the system sounds the horns and flashes the headlamps for about 30 seconds.

- Any door is opened.

VEHICLE SECURITY SYSTEM

[WITHOUT INTELLIGENT KEY SYSTEM]

< FUNCTION DIAGNOSIS >

Condition of Deactivating The System

When one of the following operations is performed, the armed phase is canceled.

- Unlock the doors with keyfob.
- Use the mechanical key to unlock the driver door using the door key cylinder.

Component Parts Location

INFOID:000000003710636

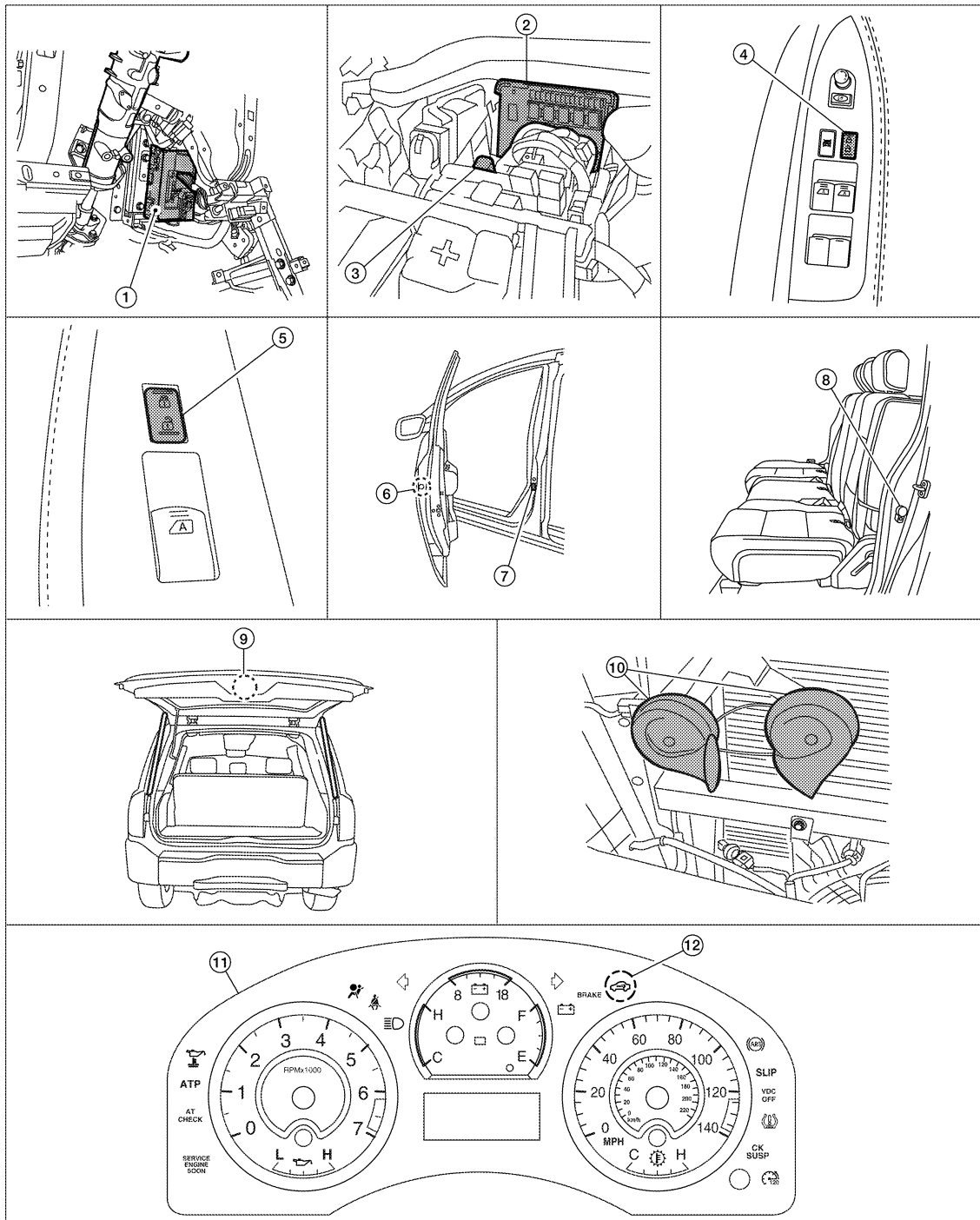

- | | | |
|---|---|--|
| 1. BCM M18, M19, M20
(view with instrument panel LH removed) | 2. IPDM E/R E122, E124
(view with cover removed) | 3. Horn relay H-1 |
| 4. Main power window and door lock/unlock switch D7, D8 | 5. Power window and door lock/unlock switch RH D105 | 6. Front door lock assembly LH (key cylinder switch) D14 |

ALKIA0540ZZ

A
B
C
D
E
F
G
H
I
J
L
M
N
O
P

SEC

VEHICLE SECURITY SYSTEM

[WITHOUT INTELLIGENT KEY SYSTEM]

< FUNCTION DIAGNOSIS >

- | | | |
|---|---------------------------------------|--|
| 7. Front door switch LH B8
RH B108 | 8. Rear door switch LH B18
RH B116 | 9. Back door latch (door ajar switch) (with
power back door) D503
Back door switch (without power back
door) D502
Glass hatch ajar switch D707 |
| 10. Horn E3
(view with front grille removed) | 11. Combination meter M24 | 12. Security indicator lamp |

Component Description

INFOID:000000003710637

Item	Function
BCM	Verifies the received signal from ignition key, then informs ECM whether to allow engine start.
Door switch	Provides the BCM with the status of each monitored door.
Security indicator	Indicates the status of the security system.
IPDM E/R	Controls the horn and headlamps operation.
Horn	Sounds when the vehicle security system is triggered.

DIAGNOSIS SYSTEM (BCM)

[WITHOUT INTELLIGENT KEY SYSTEM]

< FUNCTION DIAGNOSIS >

DIAGNOSIS SYSTEM (BCM)

COMMON ITEM

COMMON ITEM : CONSULT-III Function (BCM - COMMON ITEM)

INFOID:000000004176249

APPLICATION ITEM

CONSULT-III performs the following functions via CAN communication with BCM.

Diagnosis mode	Function Description
WORK SUPPORT	Changes the setting for each system function.
SELF-DIAG RESULTS	Displays the diagnosis results judged by BCM. Refer to BCS-53, "DTC Index" .
CAN DIAG SUPPORT MNTR	Monitors the reception status of CAN communication viewed from BCM.
DATA MONITOR	The BCM input/output signals are displayed.
ACTIVE TEST	The signals used to activate each device are forcibly supplied from BCM.
ECU IDENTIFICATION	The BCM part number is displayed.
CONFIGURATION	<ul style="list-style-type: none"> Enables to read and save the vehicle specification. Enables to write the vehicle specification when replacing BCM.

SYSTEM APPLICATION

BCM can perform the following functions for each system.

NOTE:

It can perform the diagnosis modes except the following for all sub system selection items.

System	Sub system selection item	Diagnosis mode		
		WORK SUPPORT	DATA MONITOR	ACTIVE TEST
BCM	BCM	×		
Door lock	DOOR LOCK	×	×	×
Rear window defogger	REAR DEFOGGER		×	
Warning chime	BUZZER		×	×
Interior room lamp timer	INT LAMP	×	×	×
Remote keyless entry system	MULTI REMOTE ENT	×	×	×
Exterior lamp	HEAD LAMP	×	×	×
Wiper and washer	WIPER	×	×	×
Turn signal and hazard warning lamps	FLASHER		×	×
Air conditioner	AIR CONDITONER		×	
Intelligent Key system*	INTELLIGENT KEY		×	
Combination switch	COMB SW		×	
Immobilizer	IMMU		×	×
Interior room lamp battery saver	BATTERY SAVER	×	×	×
Back door open	TRUNK		×	×
RAP (retained accessory power)	RETAINED PWR	×	×	×
Signal buffer system	SIGNAL BUFFER		×	×
TPMS (tire pressure monitoring system)	AIR PRESSURE MONITOR	×	×	×
Vehicle security system	PANIC ALARM			×

*: With Intelligent Key

IMMU

DIAGNOSIS SYSTEM (BCM)

< FUNCTION DIAGNOSIS >

[WITHOUT INTELLIGENT KEY SYSTEM]

IMMU : CONSULT-III Function (BCM - IMMU)

INFOID:000000004176250

DATA MONITOR

Monitor Item [Unit]	Description
IGN ON SW [ON/OFF]	Indicates condition of ignition switch in ON position.

ACTIVE TEST

Test Item	Description
THEFT IND	This test is able to check security indicator operation [ON/OFF].

THEFT ALM

THEFT ALM : CONSULT-III Function (BCM - THEFT ALM)

INFOID:000000004176251

WORK SUPPORT

Work Item	Description
SECURITY ALARM SET	Vehicle security function mode can be changed in this mode. <ul style="list-style-type: none">• ON: Vehicle security function is ON.• OFF: Vehicle security function is OFF.

U1000 CAN COMM CIRCUIT

< COMPONENT DIAGNOSIS >

[WITHOUT INTELLIGENT KEY SYSTEM]

COMPONENT DIAGNOSIS

U1000 CAN COMM CIRCUIT

Description

INFOID:000000003710641

CAN (Controller Area Network) is a serial communication line for real time applications. It is an on-vehicle multiplex communication line with high data communication speed and excellent error detection ability. Modern vehicle is equipped with many electronic control unit, and each control unit shares information and links with other control units during operation (not independent). In CAN communication, control units are connected with 2 communication lines (CAN-H line, CAN-L line) allowing a high rate of information transmission with less wiring. Each control unit transmits/receives data but selectively reads required data only.

CAN Communication Signal Chart, refer to [LAN-46, "CAN Communication Signal Chart"](#).

DTC Logic

INFOID:000000003710642

DTC DETECTION LOGIC

DTC	CONSULT-III display description	DTC Detection Condition	Possible cause
U1000	CAN COMM CIRCUIT	When BCM cannot communicate CAN communication signal continuously for 2 seconds or more.	In CAN communication system, any item (or items) of the following listed below is malfunctioning. <ul style="list-style-type: none">• Receiving (TCM)• Receiving (IPDM E/R)• Receiving (ECM)• Receiving (METER/M&A)• Receiving (MULTI AV)

Diagnosis Procedure

INFOID:000000003710643

1. PERFORM SELF DIAGNOSTIC

1. Turn ignition switch ON and wait for 2 seconds or more.
2. Check "Self Diagnostic Result".

Is "CAN COMM CIRCUIT" displayed?

- YES >> Refer to [LAN-5, "CAN Communication Control Circuit"](#).
NO >> Refer to [GI-37, "Intermittent Incident"](#).

SEC

U1010 CONTROL UNIT (CAN)

< COMPONENT DIAGNOSIS >

[WITHOUT INTELLIGENT KEY SYSTEM]

U1010 CONTROL UNIT (CAN)

Description

INFOID:000000003710644

CAN (Controller Area Network) is a serial communication line for real time applications. It is an on-vehicle multiplex communication line with high data communication speed and excellent error detection ability. Modern vehicle is equipped with many electronic control unit, and each control unit shares information and links with other control units during operation (not independent). In CAN communication, control units are connected with 2 communication lines (CAN-H line, CAN-L line) allowing a high rate of information transmission with less wiring. Each control unit transmits/receives data but selectively reads required data only. CAN Communication Signal Chart, refer to [LAN-46. "CAN Communication Signal Chart"](#).

DTC Logic

INFOID:000000003710645

DTC DETECTION LOGIC

DTC	CONSULT-III display description	DTC Detection Condition	Possible cause
U1010	CONTROL UNIT (CAN)	When detecting error during the initial diagnosis of CAN controller of BCM.	BCM

Diagnosis Procedure

INFOID:000000003710646

1. REPLACE BCM

When DTC [U1010] is detected, replace BCM.

>> Replace BCM. Refer to [BCS-56. "Removal and Installation"](#).

Special Repair Requirement

INFOID:000000003710647

1. REQUIRED WORK WHEN REPLACING BCM

Initialize BCM. Refer to CONSULT-III Operation Manual.

>> Work end.

B2190, P1614 NATS ANTENNA AMP.

< COMPONENT DIAGNOSIS >

[WITHOUT INTELLIGENT KEY SYSTEM]

B2190, P1614 NATS ANTENNA AMP.

Description

INFOID:000000003710648

Performs ID verification through BCM and NATS antenna amplifier when ignition key is inserted and ignition switch turned ON.

Prohibits the start of engine when an unregistered ID of ignition key is used.

DTC Logic

INFOID:000000003710649

DTC DETECTION LOGIC

DTC No.	Trouble diagnosis name	DTC detecting condition	Possible cause
B2190	NATS ANTENNA AMP	• Inactive communication between NATS antenna amp. and BCM. • Ignition key is malfunctioning.	• Harness or connectors (The NATS antenna amp. circuit is open or shorted) • Ignition key • NATS antenna amp. • BCM
P1614			

DTC CONFIRMATION PROCEDURE

1. PERFORM DTC CONFIRMATION PROCEDURE

1. Insert ignition key into the key cylinder.
2. Turn ignition switch ON.
3. Check "Self diagnostic result" with CONSULT-III.

Is DTC detected?

- YES >> Refer to [SEC-125, "Diagnosis Procedure"](#).
NO >> INSPECTION END.

Diagnosis Procedure

INFOID:000000003710650

1. CHECK NATS ANTENNA AMP. INSTALLATION

Check NATS antenna amp. installation. Refer to [SEC-179, "Removal and Installation"](#).

Is the inspection result normal?

- YES >> GO TO 2
NO >> Reinstall NATS antenna amp. correctly.

2. CHECK NVIS (NATS) IGNITION KEY ID CHIP

Start engine with another registered NATS ignition key.

Does the engine start?

- YES >> • Ignition key ID chip is malfunctioning.
• Replace the ignition key.
• Perform initialization with CONSULT-III.
For initialization, refer to "CONSULT-III Operation Manual".
NO >> GO TO 3

3. CHECK POWER SUPPLY FOR NATS ANTENNA AMP.

1. Turn ignition switch ON.
2. Check voltage between NATS antenna amp. connector M21 terminal 1 and ground.

A
B
C
D
E
F
G
H
I
J
L
M
N
O
P

SEC

B2190, P1614 NATS ANTENNA AMP.

< COMPONENT DIAGNOSIS >

[WITHOUT INTELLIGENT KEY SYSTEM]

1 - Ground : Battery voltage

Is the inspection result normal?

- YES >> GO TO 4
- NO >> Repair or replace fuse or harness.

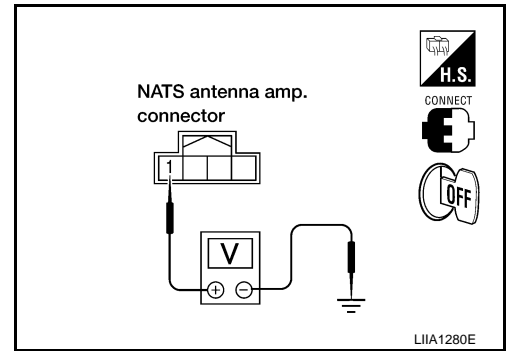

4.CHECK NATS ANTENNA AMP. GROUND LINE CIRCUIT

1. Turn ignition switch OFF.
2. Disconnect NATS antenna amp. connector.
3. Check continuity between NATS antenna amp. connector M21 terminal 3 and ground.

3 - Ground : Continuity should exist.

Is the inspection result normal?

- YES >> GO TO 5
- NO >> • Repair or replace harness.

NOTE:

If harness is OK, replace BCM, refer to [BCS-56, "Removal and Installation"](#). Perform initialization with CONSULT-III. For initialization, refer to "CONSULT-III Operation Manual".

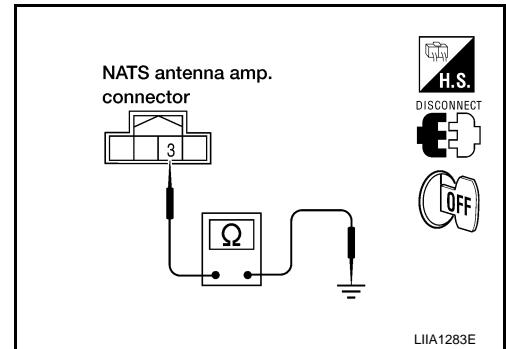

5.CHECK NATS ANTENNA AMP. SIGNAL LINE- 1

1. Connect NATS antenna amp. connector.
2. Turn ignition switch ON.
3. Check voltage between NATS antenna amp. connector M21 terminal 2 and ground with analog tester.

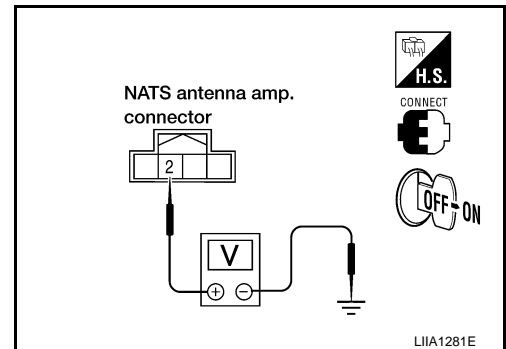

Terminals		Position of ignition key cylinder	Voltage (V) (Approx.)
(+)	(-)		
2	Ground	Before inserting ignition key	Battery voltage
		After inserting ignition key	Pointer of tester should move for approx. 30 seconds, then return to battery voltage
		Just after turning ignition switch ON	Pointer of tester should move for approx. 1 second, then return to battery voltage

Is the inspection result normal?

- YES >> GO TO 6
- NO >> • Repair or replace harness.

NOTE:

If harness is OK, replace BCM, refer to [BCS-56, "Removal and Installation"](#). Perform initialization with CONSULT-III. For initialization, refer to "CONSULT-III Operation Manual".

B2190, P1614 NATS ANTENNA AMP.

< COMPONENT DIAGNOSIS >

[WITHOUT INTELLIGENT KEY SYSTEM]

6. CHECK NATS ANTENNA AMP. SIGNAL LINE- 2

Check voltage between NATS antenna amp. connector M21 terminal 4 and ground with analog tester.

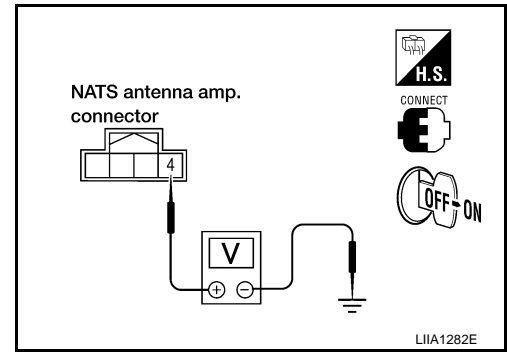

Terminals		Position of ignition key cylinder	Voltage (V) (Approx.)
(+)	(-)		
4	Ground	Before inserting ignition key	Battery voltage
		After inserting ignition key	Pointer of tester should move for approx. 30 seconds, then return to battery voltage
		Just after turning ignition switch ON	Pointer of tester should move for approx. 1 second, then return to battery voltage

Is the inspection result normal?

YES >> NATS antenna amp. is malfunctioning.

NO >> • Repair or replace harness.

NOTE:

If harness is OK, replace BCM, refer to [BCS-56. "Removal and Installation"](#). Perform initialization with CONSULT-III. For initialization, refer to "CONSULT-III Operation Manual".

A
B
C
D
E
F
G
H
I
J
L
M
N
O
P

SEC

B2191, P1615 DIFFERENCE OF KEY

< COMPONENT DIAGNOSIS >

[WITHOUT INTELLIGENT KEY SYSTEM]

B2191, P1615 DIFFERENCE OF KEY

Description

INFOID:000000003710651

Performs ID verification through BCM when ignition knob switch is pressed.
Prohibits the release of steering lock or start of engine when an unregistered ID of mechanical key is used.

DTC Logic

INFOID:000000003710652

DTC DETECTION LOGIC

DTC No.	Trouble diagnosis name	DTC detecting condition	Possible cause
B2191 P1615	DIFFERENCE OF KEY	The ID verification results between BCM and mechanical key are NG. The registration is necessary.	Mechanical key

DTC CONFIRMATION PROCEDURE

1. PERFORM DTC CONFIRMATION PROCEDURE

1. Insert mechanical key into the key cylinder.
2. Check "Self diagnostic result" with CONSULT-III.

Is DTC detected?

- YES >> Refer to [SEC-128, "Diagnosis Procedure"](#).
NO >> INSPECTION END.

Diagnosis Procedure

INFOID:000000003710653

1. PERFORM INITIALIZATION

Perform initialization with CONSULT-III. Re-register all mechanical keys.
For initialization and registration of mechanical key. Refer to "CONSULT-III Operation Manual".

Can the system be initialized and can the engine be started with re-registered mechanical key?

- YES >> Mechanical key was unregistered.
NO >> BCM is malfunctioning.
- Replace BCM. Refer to [BCS-56, "Removal and Installation"](#).
 - Perform initialization again

B2192, P1611 ID DISCORD, IMMU-ECM

< COMPONENT DIAGNOSIS >

[WITHOUT INTELLIGENT KEY SYSTEM]

B2192, P1611 ID DISCORD, IMMU-ECM

Description

INFOID:000000003710654

BCM performs the ID verification with ECM that allows the engine to start. BCM starts the communication with ECM if ignition switch is turned ON and starts the engine if the ID is OK. ECM prevents the engine from starting if the ID is not registered.

DTC Logic

INFOID:000000003710655

DTC DETECTION LOGIC

NOTE:

- If DTC B2192 is displayed with DTC U1000, first perform the trouble diagnosis for DTC U1000. Refer to [SEC-123, "DTC Logic"](#).
- If DTC B2192 is displayed with DTC U1010, first perform the trouble diagnosis for DTC U1010. Refer to [SEC-124, "DTC Logic"](#).

DTC No.	Trouble diagnosis name	DTC detecting condition	Possible cause
B2192	ID DISCORD BCM-ECM	The ID verification results between BCM and ECM are NG. The registration is necessary.	• BCM • ECM
P1611			

DTC CONFIRMATION PROCEDURE

1. PERFORM DTC CONFIRMATION PROCEDURE

1. Turn ignition switch ON.
2. Check "Self diagnostic result" with CONSULT-III.

Is DTC detected?

- YES >> Refer to [SEC-129, "Diagnosis Procedure"](#).
NO >> INSPECTION END.

Diagnosis Procedure

INFOID:000000003710656

1. PERFORM INITIALIZATION

Perform initialization with CONSULT-III. Re-register all mechanical keys.
For initialization and registration of mechanical key. Refer to "CONSULT-III Operation Manual".
Can the system be initialized and can the engine be started with re-registered mechanical key?

- YES >> ID was unregistered.
NO >> GO TO 2

2. PEPLACE BCM

1. Replace BCM. Refer to [BCS-56, "Removal and Installation"](#).
2. Perform initialization with CONSULT-III. Re-register all mechanical keys.
For initialization and registration of mechanical key. Refer to "CONSULT-III Operation Manual".

Can the system be initialized and can the engine be started with re-registered mechanical key?

- YES >> BCM is malfunctioning.
NO >> GO TO 3

3. PEPLACE ECM

1. Replace ECM. Refer to Removal and Installation.
2. Perform initialization with CONSULT-III. Re-register all mechanical keys.
For initialization and registration of mechanical key. Refer to "CONSULT-III Operation Manual".

Can the system be initialized and can the engine be started with re-registered mechanical key?

- YES >> ECM is malfunctioning.
NO >> GO TO 4

4. CHECK INTERMITTENT INCIDENT

Refer to [GI-37, "Intermittent Incident"](#).

B2192, P1611 ID DISCORD, IMMU-ECM

< COMPONENT DIAGNOSIS >

[WITHOUT INTELLIGENT KEY SYSTEM]

>> INSPECTION END

B2193, P1612 CHAIN OF ECM-IMMU

< COMPONENT DIAGNOSIS >

[WITHOUT INTELLIGENT KEY SYSTEM]

B2193, P1612 CHAIN OF ECM-IMMU

Description

INFOID:000000003710657

BCM performs the ID verification with ECM that allows the engine to start. BCM starts the communication with ECM if ignition switch is turned ON and starts the engine if the ID is OK. ECM prevents the engine from starting if the ID is not registered.

DTC Logic

INFOID:000000003710658

DTC DETECTION LOGIC

NOTE:

- If DTC B2193 is displayed with DTC U1000, first perform the trouble diagnosis for DTC U1000. Refer to [SEC-123, "DTC Logic"](#).
- If DTC B2193 is displayed with DTC U1010, first perform the trouble diagnosis for DTC U1010. Refer to [SEC-124, "DTC Logic"](#).

DTC No.	Trouble diagnosis name	DTC detecting condition	Possible cause
B2193	CHAIN OF BCM-ECM	Inactive communication between ECM and BCM	<ul style="list-style-type: none">• Harness or connectors (The CAN communication line is open or short)• BCM• ECM
P1612			

DTC CONFIRMATION PROCEDURE

1. PERFORM DTC CONFIRMATION PROCEDURE

1. Turn ignition switch ON.
2. Check "Self diagnostic result" with CONSULT-III.

Is DTC detected?

- YES >> Refer to [SEC-131, "Diagnosis Procedure"](#).
NO >> INSPECTION END

Diagnosis Procedure

INFOID:000000003710659

1. REPLACE BCM

1. Replace BCM. Refer to [BCS-56, "Removal and Installation"](#).
2. Perform initialization with CONSULT-III.
For initialization, refer to "CONSULT-III Operation Manual".

Does the engine start?

- YES >> BCM was malfunctioning.
NO >> ECM is malfunctioning.
 - Replace ECM.
 - Perform ECM re-communicating function.

A
B
C
D
E
F
G
H
I
J
L
M
N
O
P

SEC

P1610 LOCK MODE

< COMPONENT DIAGNOSIS >

[WITHOUT INTELLIGENT KEY SYSTEM]

P1610 LOCK MODE

Description

INFOID:000000003710660

When the starting operation is carried more than five times consecutively under the following conditions, NATS will shift to the mode which prevents the engine from being started.

- Unregistered mechanical key is used.
- BCM or ECM's malfunctioning.

DTC Logic

INFOID:000000003710661

DTC DETECTION LOGIC

DTC No.	Trouble diagnosis name	DTC detecting condition	Possible cause
P1610	LOCK MODE	When the starting operation is carried out five or more times consecutively under the following conditions. <ul style="list-style-type: none">• Unregistered mechanical key• BCM or ECM's malfunctioning.	—

DTC CONFIRMATION PROCEDURE

1.PERFORM DTC CONFIRMATION PROCEDURE

1. Turn ignition switch ON.
2. Check "Self diagnostic result" with CONSULT-III.

Is DTC detected?

- YES >> Refer to [SEC-132, "Diagnosis Procedure"](#).
NO >> INSPECTION END

Diagnosis Procedure

INFOID:000000003710662

1.CHECK ENGINE START FUNCTION

1. Perform the check for DTC except DTC P1610.
2. Use CONSULT-III to erase DTC after fixing.
3. Check that engine can start with registered mechanical key.

Does the engine start?

- YES >> INSPECTION END
NO >> GO TO 2

2.CHECK INTERMITTENT INCIDENT

Refer to [GI-37, "Intermittent Incident"](#).

>> INSPECTION END

POWER SUPPLY AND GROUND CIRCUIT

< COMPONENT DIAGNOSIS >

[WITHOUT INTELLIGENT KEY SYSTEM]

POWER SUPPLY AND GROUND CIRCUIT

BCM

BCM : Diagnosis Procedure

INFOID:000000004176267

1. CHECK FUSES AND FUSIBLE LINK

Check that the following fuses and fusible link are not blown.

Terminal No.	Signal name	Fuses and fusible link No.
57	Battery power supply	22 (15A)
70		F (50A)
11	Ignition ACC or ON	4 (10A)
38	Ignition ON or START	59 (10A)

Is the fuse blown?

YES >> Replace the blown fuse or fusible link after repairing the affected circuit.

NO >> GO TO 2

2. CHECK POWER SUPPLY CIRCUIT

- Turn ignition switch OFF.
- Disconnect BCM.
- Check voltage between BCM harness connector and ground.

Connector	Terminals		Power source	Condition	Voltage (V) (Approx.)
	(+)	(-)			
M18	11	Ground	ACC power supply	Ignition switch ACC or ON	Battery voltage
	38	Ground	Ignition power supply	Ignition switch ON or START	Battery voltage
M20	57	Ground	Battery power supply	Ignition switch OFF	Battery voltage
	70	Ground	Battery power supply	Ignition switch OFF	Battery voltage

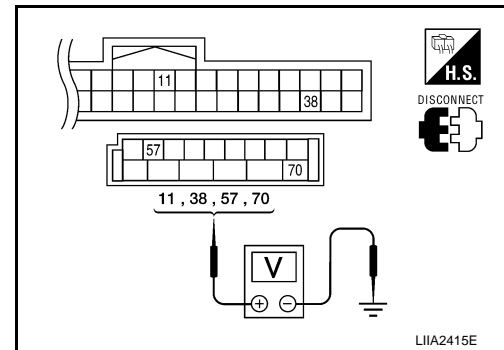

Is the measurement value normal?

YES >> GO TO 3

NO >> Repair or replace harness.

3. CHECK GROUND CIRCUIT

Check continuity between BCM harness connector and ground.

BCM		Ground	Continuity
Connector	Terminal		
M20	67		Yes

Does continuity exist?

YES >> Inspection End.

NO >> Repair or replace harness.

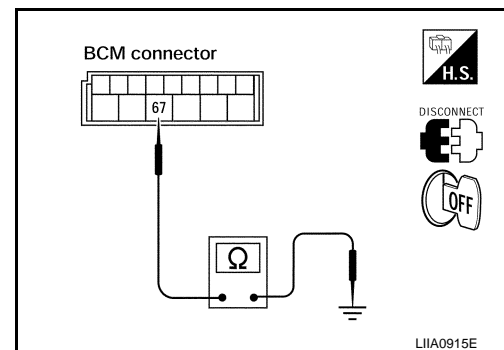

KEY CYLINDER SWITCH

< COMPONENT DIAGNOSIS >

[WITHOUT INTELLIGENT KEY SYSTEM]

KEY CYLINDER SWITCH

Description

INFOID:000000003710664

The main power window and door lock/unlock switch detects condition of the door key cylinder switch and transmits to BCM as the LOCK or UNLOCK signal.

Component Function Check

INFOID:000000003710665

1. CHECK DOOR KEY CYLINDER SWITCH INPUT SIGNAL

Check "KEY CYL LK-SW" AND "KEY CYL UN-SW" in DATA MONITOR mode for "POWER DOOR LOCK SYSTEM" with CONSULT-III.

Monitor item	Condition
KEY CYL LK-SW	Lock : ON
	Neutral / Unlock : OFF
KEY CYL UN-SW	Unlock : ON
	Neutral / Lock : OFF

Is the inspection result normal?

- YES >> Key cylinder switch is OK.
- NO >> Refer to [SEC-134. "Diagnosis Procedure"](#).

Diagnosis Procedure

INFOID:000000003710666

1. CHECK DOOR KEY CYLINDER SWITCH LH

④ With CONSULT-III

Check front door lock assembly LH (key cylinder switch) ("KEY CYL LK-SW") and ("KEY CYL UN-SW") in DATA MONITOR mode with CONSULT-III.

- When key inserted in left front key cylinder is turned to LOCK:

KEY CYL LK-SW : ON

- When key inserted in left front key cylinder is turned to UNLOCK:

KEY CYL UN-SW : ON

⊗ Without CONSULT-III

Check voltage between main power window and door lock/unlock switch connector D7 terminals 4, 6 and ground.

Connector	Terminals		Condition of left front key cylinder	Voltage (V) (Approx.)
	(+)	(-)		
D7	4	Ground	Neutral/Unlock	5
			Lock	0
	6		Neutral/Lock	5
			Unlock	0

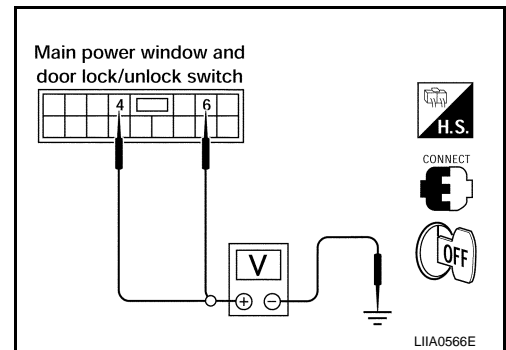

Is the inspection result normal?

- YES >> Key cylinder switch signal is OK.
- NO >> GO TO 2

2. CHECK DOOR KEY CYLINDER SWITCH LH GROUND HARNESS

1. Turn ignition switch OFF.
2. Disconnect front door lock assembly LH (key cylinder switch).

KEY CYLINDER SWITCH

[WITHOUT INTELLIGENT KEY SYSTEM]

< COMPONENT DIAGNOSIS >

3. Check continuity between front door lock assembly LH (key cylinder switch) connector (A) D14 terminal 5 and body ground.

Connector	Terminals	Continuity
D14	5 – Ground	Yes

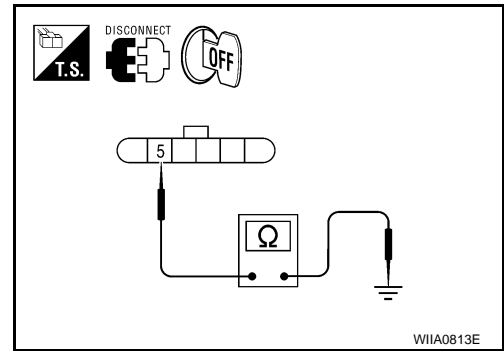

Is the inspection result normal?

YES >> GO TO 3

NO >> Repair or replace harness.

3.CHECK DOOR KEY CYLINDER SWITCH LH

Check continuity between front door lock assembly LH (key cylinder switch) terminals.

Terminals	Condition	Continuity
1 – 5	Key is turned to UNLOCK or neutral.	No
	Key is turned to LOCK.	Yes
5 – 6	Key is turned to LOCK or neutral.	No
	Key is turned to UNLOCK.	Yes

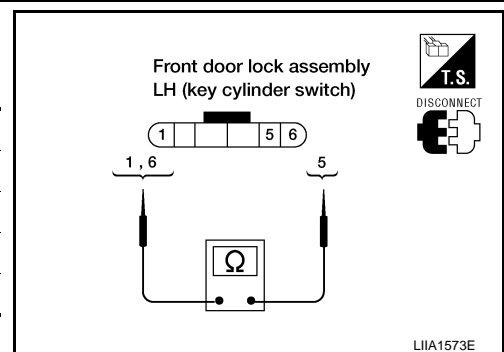

Is the inspection result normal?

YES >> GO TO 4

NO >> Replace front door lock assembly LH (key cylinder switch). Refer to [DLK-388. "Removal and Installation"](#).

4.CHECK DOOR KEY CYLINDER HARNESS

Check continuity between main power window and door lock/unlock switch connector (A) D7 terminals 4, 6 and front door lock assembly LH (key cylinder switch) connector (B) D14 terminals 1, 6 and body ground.

Connector	Terminals	Connector	Terminals	Continuity
A: Main power window and door lock/unlock switch	4	B: Front door lock assembly LH (key cylinder switch)	1	Yes
	6		6	Yes
	4, 6	Ground	No	

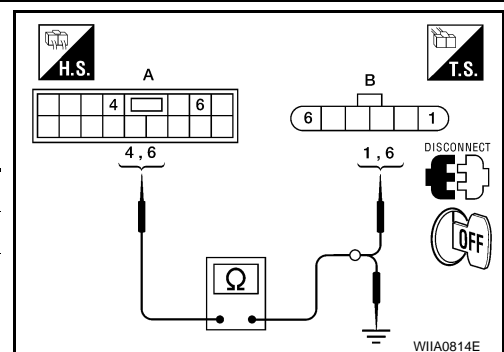

Is the inspection result normal?

YES >> Replace main power window and door lock/unlock switch.

NO >> Repair or replace harness.

HORN FUNCTION

< COMPONENT DIAGNOSIS >

[WITHOUT INTELLIGENT KEY SYSTEM]

HORN FUNCTION

Symptom Table

INFOID:000000003710667

HAZARD AND HORN REMINDER FUNCTION MALFUNCTION

NOTE:

- Before performing the diagnosis in the following table, check “Work flow”. Refer to [DLK-8, "Work Flow"](#).
- If the following symptoms are detected, check systems shown in the “Diagnosis/service procedure” column in this order.

Conditions of Vehicle (Operating Conditions)

- “ANSWER BACK FUNCTION” is ON when setting on CONSULT-III.
- Ignition switch is in OFF position.
- All doors are closed.

Symptom	Diagnosis/service procedure	Reference page
Hazard reminder does not operate by keyfob. (Horn reminder operate.)	1. Check “HAZARD LAMP SET” setting in “WORK SUPPORT”.	SEC-122
	2. Check hazard function.	DLK-112
	3. Check keyfob battery.	DLK-286
Horn reminder does not operate by keyfob. (Hazard reminder operate.)	1. Check “HORN WITH KEYLESS LOCK” setting in “WORK SUPPORT”.	SEC-122
	2. Check horn function.	DLK-108
	3. Check Intermittent Incident.	GI-37

VEHICLE SECURITY INDICATOR

< COMPONENT DIAGNOSIS >

[WITHOUT INTELLIGENT KEY SYSTEM]

VEHICLE SECURITY INDICATOR

Description

INFOID:000000003710668

- Vehicle security indicator is built in combination meter.
- NATS (Nissan Anti-Theft System) and vehicle security system conditions are indicated by blink or illumination of vehicle security indicator.

Component Function Check

INFOID:000000003710669

1.CHECK FUNCTION

1. Perform "THEFT IND" in the "Active Test" mode with CONSULT-III.
2. Check vehicle security indicator operation.

Test item		Description	
THEFT IND	ON	Vehicle security indicator	ON
	OFF		OFF

Is the inspection result normal?

YES >> INSPECTION END.

NO >> Refer to [SEC-137, "Diagnosis Procedure"](#).

Diagnosis Procedure

INFOID:000000003710670

1.SECURITY INDICATOR LAMP ACTIVE TEST

With CONSULT-III

Check "THEFT IND" in "ACTIVE TEST" mode with CONSULT-III.

Without CONSULT-III

1. Disconnect BCM.
2. Check voltage between BCM harness connector M18 terminal 23 and ground.

Connector	Terminals		Condition	Voltage (V) (Approx.)
	(+)	(-)		
M18	23	Ground	ON	0
			OFF	Battery voltage

Is the inspection result normal?

YES >> Security indicator lamp is OK.

NO >> GO TO 2

2.SECURITY INDICATOR LAMP CHECK

Check security indicator lamp condition.

Is the inspection result normal?

YES >> GO TO 3

NO >> Replace security indicator lamp.

3.CHECK HARNESS CONTINUITY

1. Turn ignition switch OFF.
2. Disconnect BCM and security indicator lamp connector.

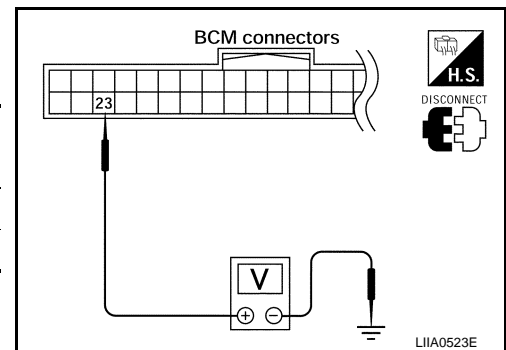

VEHICLE SECURITY INDICATOR

[WITHOUT INTELLIGENT KEY SYSTEM]

< COMPONENT DIAGNOSIS >

3. Check continuity between BCM connector (A) M18 terminal 23 and security indicator lamp harness connector (B) M24 terminal 28.

23 - 28 : Continuity should exist.

4. Check continuity between BCM connector (A) M18 terminal 23 and ground.

23 - Ground : Continuity should not exist.

Is the inspection result normal?

YES >> Check the following:

- 10A fuse [No. 19, located in fuse block (J/B)]
- Harness for open or short between security indicator lamp and fuse

NO >> Repair or replace harness.

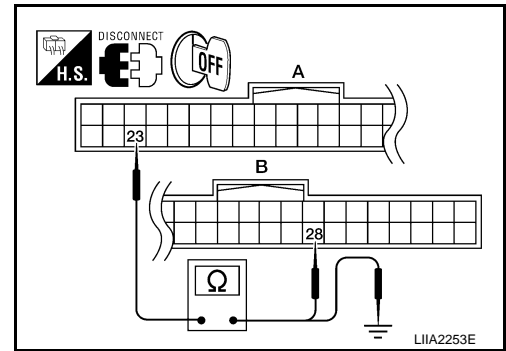

BCM (BODY CONTROL MODULE)

[WITHOUT INTELLIGENT KEY SYSTEM]

< ECU DIAGNOSIS >

ECU DIAGNOSIS

BCM (BODY CONTROL MODULE)

Reference Value

INFOID:000000004176253

VALUES ON THE DIAGNOSIS TOOL

Monitor Item	Condition	Value/Status
AIR COND SW	A/C switch OFF	OFF
	A/C switch ON	ON
AUT LIGHT SYS	Outside of the room is dark	OFF
	Outside of the room is bright	ON
AUTO LIGHT SW	Lighting switch OFF	OFF
	Lighting switch AUTO	ON
BACK DOOR SW	Back door closed	OFF
	Back door opened	ON
CDL LOCK SW	Door lock/unlock switch does not operate	OFF
	Press door lock/unlock switch to the LOCK side	ON
CDL UNLOCK SW	Door lock/unlock switch does not operate	OFF
	Press door lock/unlock switch to the UNLOCK side	ON
DOOR SW-AS	Front door RH closed	OFF
	Front door RH opened	ON
DOOR SW-DR	Front door LH closed	OFF
	Front door LH opened	ON
DOOR SW-RL	Rear door LH closed	OFF
	Rear door LH opened	ON
DOOR SW-RR	Rear door RH closed	OFF
	Rear door RH opened	ON
ENGINE RUN	Engine stopped	OFF
	Engine running	ON
FR FOG SW	Front fog lamp switch OFF	OFF
	Front fog lamp switch ON	ON
FR WASHER SW	Front washer switch OFF	OFF
	Front washer switch ON	ON
FR WIPER LOW	Front wiper switch OFF	OFF
	Front wiper switch LO	ON
FR WIPER HI	Front wiper switch OFF	OFF
	Front wiper switch HI	ON
FR WIPER INT	Front wiper switch OFF	OFF
	Front wiper switch INT	ON
FR WIPER STOP	Any position other than front wiper stop position	OFF
	Front wiper stop position	ON
HAZARD SW	When hazard switch is not pressed	OFF
	When hazard switch is pressed	ON
LIGHT SW 1ST	Lighting switch OFF	OFF
	Lighting switch 1st	ON

A
B
C
D
E
F
G
H
I
J
L
M
N
O
P

SEC

BCM (BODY CONTROL MODULE)

< ECU DIAGNOSIS >

[WITHOUT INTELLIGENT KEY SYSTEM]

Monitor Item	Condition	Value/Status
HEADLAMP SW1	Headlamp switch OFF	OFF
	Headlamp switch 1st	ON
HEADLAMP SW2	Headlamp switch OFF	OFF
	Headlamp switch 1st	ON
HI BEAM SW	High beam switch OFF	OFF
	High beam switch HI	ON
H/L WASH SW	NOTE: The item is indicated, but not monitored	OFF
IGN ON SW	Ignition switch OFF or ACC	OFF
	Ignition switch ON	ON
IGN SW CAN	Ignition switch OFF or ACC	OFF
	Ignition switch ON	ON
INT VOLUME	Wiper intermittent dial is in a dial position 1 - 7	1 - 7
I-KEY LOCK ¹	LOCK button of Intelligent Key is not pressed	OFF
	LOCK button of Intelligent Key is pressed	ON
I-KEY UNLOCK ¹	UNLOCK button of Intelligent Key is not pressed	OFF
	UNLOCK button of Intelligent Key is pressed	ON
KEY ON SW	Mechanical key is removed from key cylinder	OFF
	Mechanical key is inserted to key cylinder	ON
KEYLESS LOCK ²	LOCK button of key fob is not pressed	OFF
	LOCK button of key fob is pressed	ON
KEYLESS UNLOCK ²	UNLOCK button of key fob is not pressed	OFF
	UNLOCK button of key fob is pressed	ON
OIL PRESS SW	<ul style="list-style-type: none"> • Ignition switch OFF or ACC • Engine running 	OFF
	Ignition switch ON	ON
PASSING SW	Other than lighting switch PASS	OFF
	Lighting switch PASS	ON
PUSH SW ¹	Return to ignition switch to LOCK position	OFF
	Press ignition switch	ON
REAR DEF SW	Rear window defogger switch OFF	OFF
	Rear window defogger switch ON	ON
RKE LOCK AND UNLOCK ²	NOTE: The item is indicated, but not monitored	OFF
		ON
RR WASHER SW	Rear washer switch OFF	OFF
	Rear washer switch ON	ON
RR WIPER INT	Rear wiper switch OFF	OFF
	Rear wiper switch INT	ON
RR WIPER ON	Rear wiper switch OFF	OFF
	Rear wiper switch ON	ON
RR WIPER STOP	Rear wiper stop position	OFF
	Other than rear wiper stop position	ON
TAIL LAMP SW	Lighting switch OFF	OFF
	Lighting switch 1ST	ON

BCM (BODY CONTROL MODULE)

[WITHOUT INTELLIGENT KEY SYSTEM]

< ECU DIAGNOSIS >

Monitor Item	Condition	Value/Status
TRNK OPNR SW	When back door opener switch is not pressed	OFF
	When back door opener switch is pressed	ON
TURN SIGNAL L	Turn signal switch OFF	OFF
	Turn signal switch LH	ON
TURN SIGNAL R	Turn signal switch OFF	OFF
	Turn signal switch RH	ON
VEHICLE SPEED	While driving	Equivalent to speedometer reading

1: With Intelligent Key

2: With remote keyless entry system

A
B
C
D
E
F
G
H
I
J
L
M
N
O
P

SEC

BCM (BODY CONTROL MODULE)

[WITHOUT INTELLIGENT KEY SYSTEM]

< ECU DIAGNOSIS >

Terminal Layout

INFOID:000000004176254

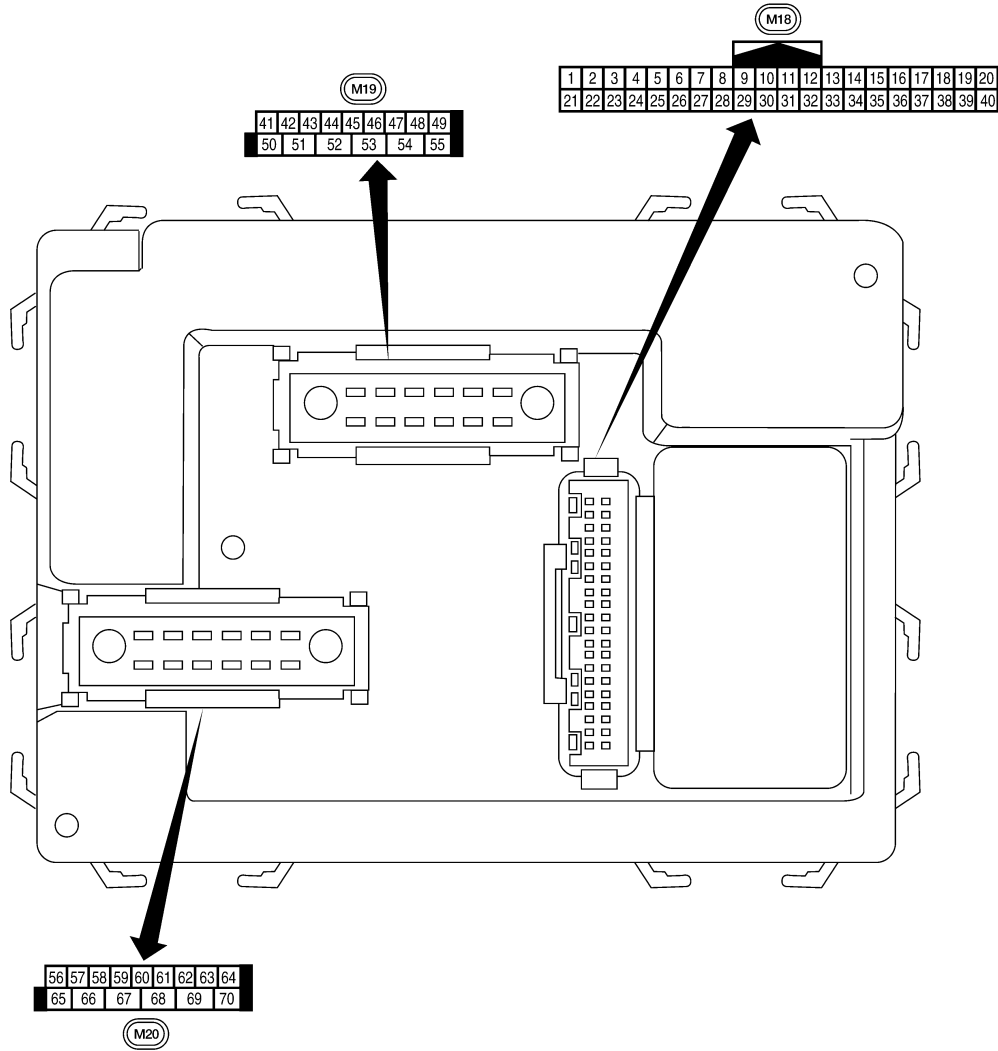

Physical Values

LIA2443E

INFOID:000000004176255

BCM (BODY CONTROL MODULE)

[WITHOUT INTELLIGENT KEY SYSTEM]

< ECU DIAGNOSIS >

Terminal	Wire color	Signal name	Signal input/output	Measuring condition		Reference value or waveform (Approx.)
				Ignition switch	Operation or condition	
1	BR/W	Ignition keyhole illumination	Output	OFF	Door is locked (SW OFF)	Battery voltage
					Door is unlocked (SW ON)	0V
2	SB	Combination switch input 5	Input	ON	Lighting, turn, wiper OFF Wiper dial position 4	<p style="text-align: right; font-size: small;">SKIA5291E</p>
3	G/Y	Combination switch input 4	Input	ON	Lighting, turn, wiper OFF Wiper dial position 4	<p style="text-align: right; font-size: small;">SKIA5292E</p>
4	Y	Combination switch input 3	Input	ON	Lighting, turn, wiper OFF Wiper dial position 4	<p style="text-align: right; font-size: small;">SKIA5291E</p>
5	G/B	Combination switch input 2	Input	ON	Lighting, turn, wiper OFF Wiper dial position 4	<p style="text-align: right; font-size: small;">SKIA5292E</p>
6	V	Combination switch input 1				
9	GR/R	Rear window defogger switch	Input	ON	Rear window defogger switch ON	0V
					Rear window defogger switch OFF	5V
10	G	Hazard lamp flash	Input	OFF	ON (opening or closing)	0V
					OFF (other than above)	Battery voltage
11	O	Ignition switch (ACC or ON)	Input	ACC or ON	Ignition switch ACC or ON	Battery voltage
12	R/L	Front door switch RH	Input	OFF	ON (open)	0V
					OFF (closed)	Battery voltage
13	GR	Rear door switch RH	Input	OFF	ON (open)	0V
					OFF (closed)	Battery voltage
15	L/W	Tire pressure warning check connector	Input	OFF	—	5V
18	P	Remote keyless entry receiver and optical sensor (ground)	Output	OFF	—	0V

A
B
C
D
E
F
G
H
I
J
L
M
N
O
P

SEC

BCM (BODY CONTROL MODULE)

[WITHOUT INTELLIGENT KEY SYSTEM]



< ECU DIAGNOSIS >

Terminal	Wire color	Signal name	Signal input/output	Measuring condition		Reference value or waveform (Approx.)
				Ignition switch	Operation or condition	
19	V/W	Remote keyless entry receiver (power supply)	Output	OFF	Ignition switch OFF	<p style="text-align: right;">LIA1893E</p>
20	G/W	Remote keyless entry receiver (signal)	Input	OFF	Stand-by (keyfob buttons released)	<p style="text-align: right;">LIA1894E</p>
					When remote keyless entry receiver receives signal from keyfob (keyfob buttons pressed)	<p style="text-align: right;">LIA1895E</p>
21	G	NATS antenna amp.	Input	OFF → ON	Ignition switch (OFF → ON)	Just after turning ignition switch ON: Pointer of tester should move for approx. 1 second, then return to battery voltage.
22	W/V	BUS	—	—	Ignition switch ON or power window timer operates	<p style="text-align: right;">PIIA2344E</p>
23	G/O	Security indicator lamp	Output	OFF	Goes OFF → illuminates (Every 2.4 seconds)	Battery voltage → 0V
25	BR	NATS antenna amp.	Input	OFF → ON	Ignition switch (OFF → ON)	Just after turning ignition switch ON: Pointer of tester should move for approx. 1 second, then return to battery voltage.
26	Y/L	Rear wiper auto stop switch 2	Input	ON	Rise up position (rear wiper arm on stopper)	0V
					A Position (full clockwise stop position)	0V
					Forward sweep (counterclockwise direction)	Fluctuating
					B Position (full counterclockwise stop position)	Battery voltage
					Reverse sweep (clockwise direction)	Fluctuating
27	W/R	Compressor ON signal	Input	ON	A/C switch OFF	5V
					A/C switch ON	0V

BCM (BODY CONTROL MODULE)

[WITHOUT INTELLIGENT KEY SYSTEM]

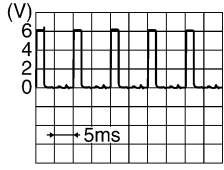
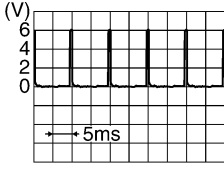
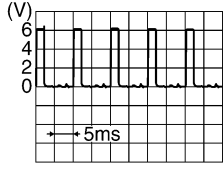
< ECU DIAGNOSIS >

Terminal	Wire color	Signal name	Signal input/output	Measuring condition		Reference value or waveform (Approx.)
				Ignition switch	Operation or condition	
28	L/R	Front blower monitor	Input	ON	Front blower motor OFF	Battery voltage
					Front blower motor ON	0V
29	W/B	Hazard switch	Input	OFF	ON	0V
					OFF	5V
32	R/G	Combination switch output 5	Output	ON	Lighting, turn, wiper OFF Wiper dial position 4	 <p style="text-align: right; font-size: small;">SKIA5291E</p>
33	R/Y	Combination switch output 4	Output	ON	Lighting, turn, wiper OFF Wiper dial position 4	 <p style="text-align: right; font-size: small;">SKIA5292E</p>
34	L	Combination switch output 3	Output	ON	Lighting, turn, wiper OFF Wiper dial position 4	 <p style="text-align: right; font-size: small;">SKIA5291E</p>
35	O/B	Combination switch output 2	Output	ON	Lighting, turn, wiper OFF Wiper dial position 4	 <p style="text-align: right; font-size: small;">SKIA5292E</p>
36	R/W	Combination switch output 1				
37 ¹	B/R	Key switch and ignition knob switch	Input	OFF	Intelligent Key inserted	Battery voltage
					Intelligent Key inserted	0V
37 ²	B/R	Key switch and key lock solenoid	Input	OFF	Key inserted	Battery voltage
					Key inserted	0V
38	W/L	Ignition switch (ON)	Input	ON	—	Battery voltage
39	L	CAN-H	—	—	—	—
40	P	CAN-L	—	—	—	—
42	GR	Glass hatch ajar switch	Input	ON	Glass hatch open	0
					Glass hatch closed	Battery
43	R/B	Back door switch (without power back door) or back door latch (door ajar switch) (with power back door)	Input	OFF	ON (open)	0V
					OFF (closed)	Battery voltage

A
B
C
D
E
F
G
H
I
J
L
M
N
O
P

SEC

BCM (BODY CONTROL MODULE)

[WITHOUT INTELLIGENT KEY SYSTEM]

< ECU DIAGNOSIS >

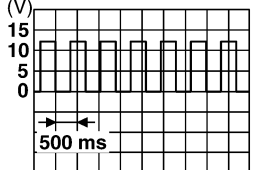
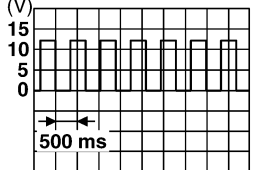
Terminal	Wire color	Signal name	Signal input/output	Measuring condition		Reference value or waveform (Approx.)
				Ignition switch	Operation or condition	
44	O	Rear wiper auto stop switch 1	Input	ON	Rise up position (rear wiper arm on stopper)	0V
					A Position (full clockwise stop position)	Battery voltage
					Forward sweep (counterclockwise direction)	Fluctuating
					B Position (full counterclockwise stop position)	0V
					Reverse sweep (clockwise direction)	Fluctuating
47	SB	Front door switch LH	Input	OFF	ON (open)	0V
					OFF (closed)	Battery voltage
48	R/Y	Rear door switch LH	Input	OFF	ON (open)	0V
					OFF (closed)	Battery voltage
49	R	Cargo lamp	Output	OFF	Any door open (ON)	0V
					All doors closed (OFF)	Battery voltage
51	G/Y	Trailer turn signal (right)	Output	ON	Turn right ON	 <p style="text-align: right; font-size: small;">SKIA3009J</p>
52	G/B	Trailer turn signal (left)	Output	ON	Turn left ON	 <p style="text-align: right; font-size: small;">SKIA3009J</p>
54	Y	Rear wiper output circuit 2	Input	ON	Rise up position (rear wiper arm on stopper)	0V
					A Position (full clockwise stop position)	0V
					Forward sweep (counterclockwise direction)	0V
					B Position (full counterclockwise stop position)	Battery voltage
					Reverse sweep (clockwise direction)	Battery voltage
55	SB	Rear wiper output circuit 1	Output	ON	OFF	0
					ON	Battery voltage
56	R/G	Battery saver output	Output	OFF	30 minutes after ignition switch is turned OFF	0V
				ON	—	Battery voltage
57	Y/R	Battery power supply	Input	OFF	—	Battery voltage

BCM (BODY CONTROL MODULE)

[WITHOUT INTELLIGENT KEY SYSTEM]

< ECU DIAGNOSIS >

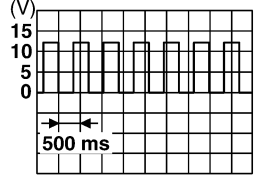
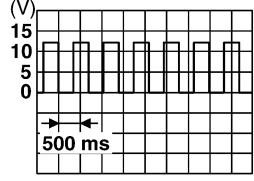
Terminal	Wire color	Signal name	Signal input/output	Measuring condition		Reference value or waveform (Approx.)
				Ignition switch	Operation or condition	
58	W/R	Optical sensor	Input	ON	When optical sensor is illuminated	3.1V or more
					When optical sensor is not illuminated	0.6V or less
59	G	Front door lock assembly LH actuator (unlock)	Output	OFF	OFF (neutral)	0V
					ON (unlock)	Battery voltage
60	G/B	Turn signal (left)	Output	ON	Turn left ON	 <p style="text-align: right; font-size: small;">SKIA3009J</p>
61	G/Y	Turn signal (right)	Output	ON	Turn right ON	 <p style="text-align: right; font-size: small;">SKIA3009J</p>
62	R/W	Step lamp LH and RH	Output	OFF	ON (any door open)	0V
					OFF (all doors closed)	Battery voltage
63	L	Interior room/map lamp	Output	OFF	Any door switch ON (open)	0V
					OFF (closed)	Battery voltage
65	V	All door lock actuators (lock)	Output	OFF	OFF (neutral)	0V
					ON (lock)	Battery voltage
66	G/Y	Front door lock actuator RH, rear door lock actuators LH/RH and back door lock actuator (unlock)	Output	OFF	OFF (neutral)	0V
					ON (unlock)	Battery voltage
67	B	Ground	Input	ON	—	0V
68	W/L	Power window power supply (RAP)	Output	—	Ignition switch ON	Battery voltage
					Within 45 seconds after ignition switch OFF	Battery voltage
					More than 45 seconds after ignition switch OFF	0V
					When front door LH or RH is open or power window timer operates	0V
69	W/R	Power window power supply	Output	—	—	Battery voltage
70	W/B	Battery power supply	Input	OFF	—	Battery voltage

1: With Intelligent Key system

2: With remote keyless entry system

A
B
C
D
E
F
G
H
I
J
L
M
N
O
P

SEC

BCM (BODY CONTROL MODULE)

[WITHOUT INTELLIGENT KEY SYSTEM]

< ECU DIAGNOSIS >

Wiring Diagram - VEHICLE SECURITY SYSTEM

INFOID:000000004176264

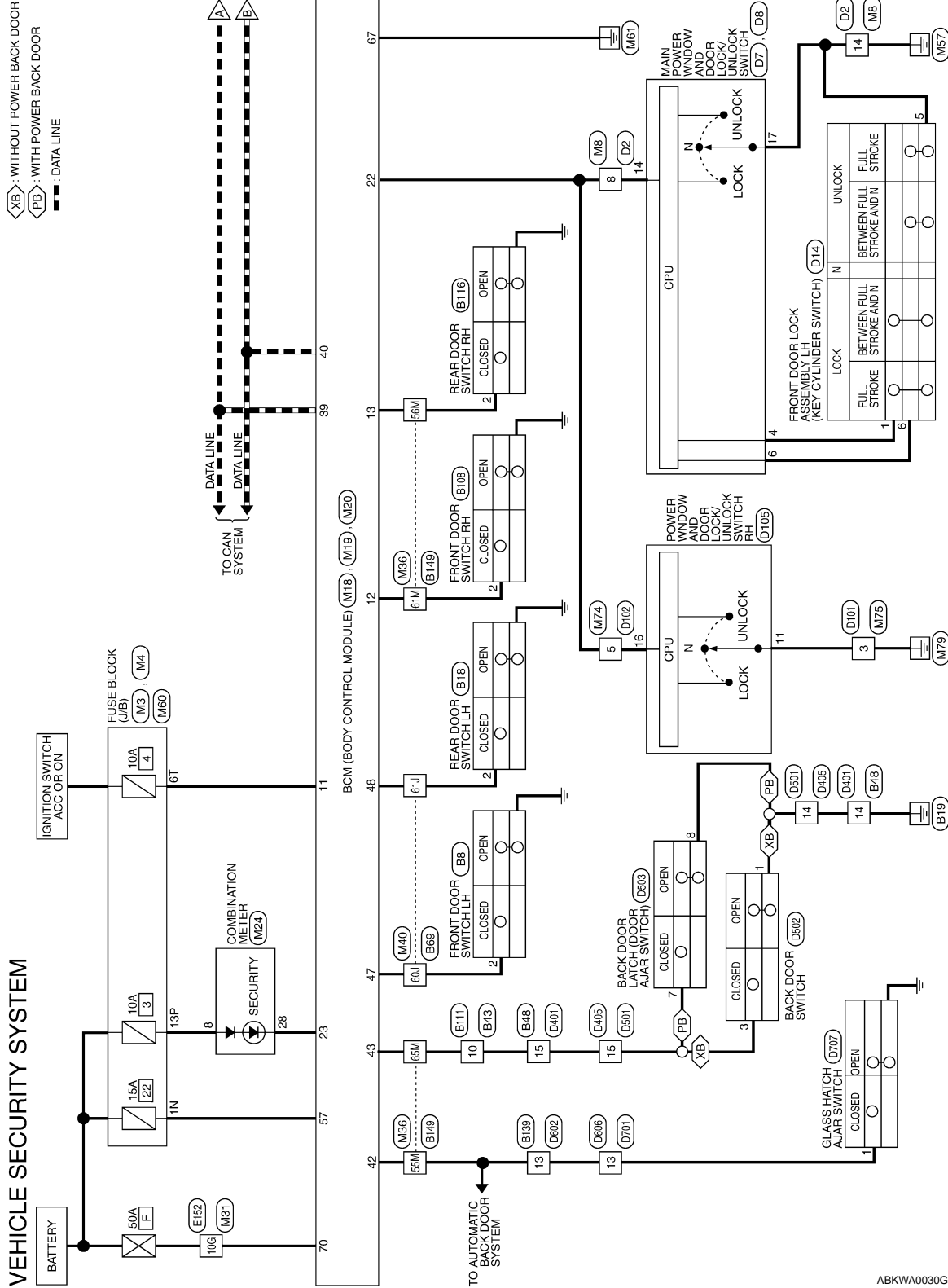

ABKWA0030GE

BCM (BODY CONTROL MODULE)

[WITHOUT INTELLIGENT KEY SYSTEM]

< ECU DIAGNOSIS >

— : DATA LINE

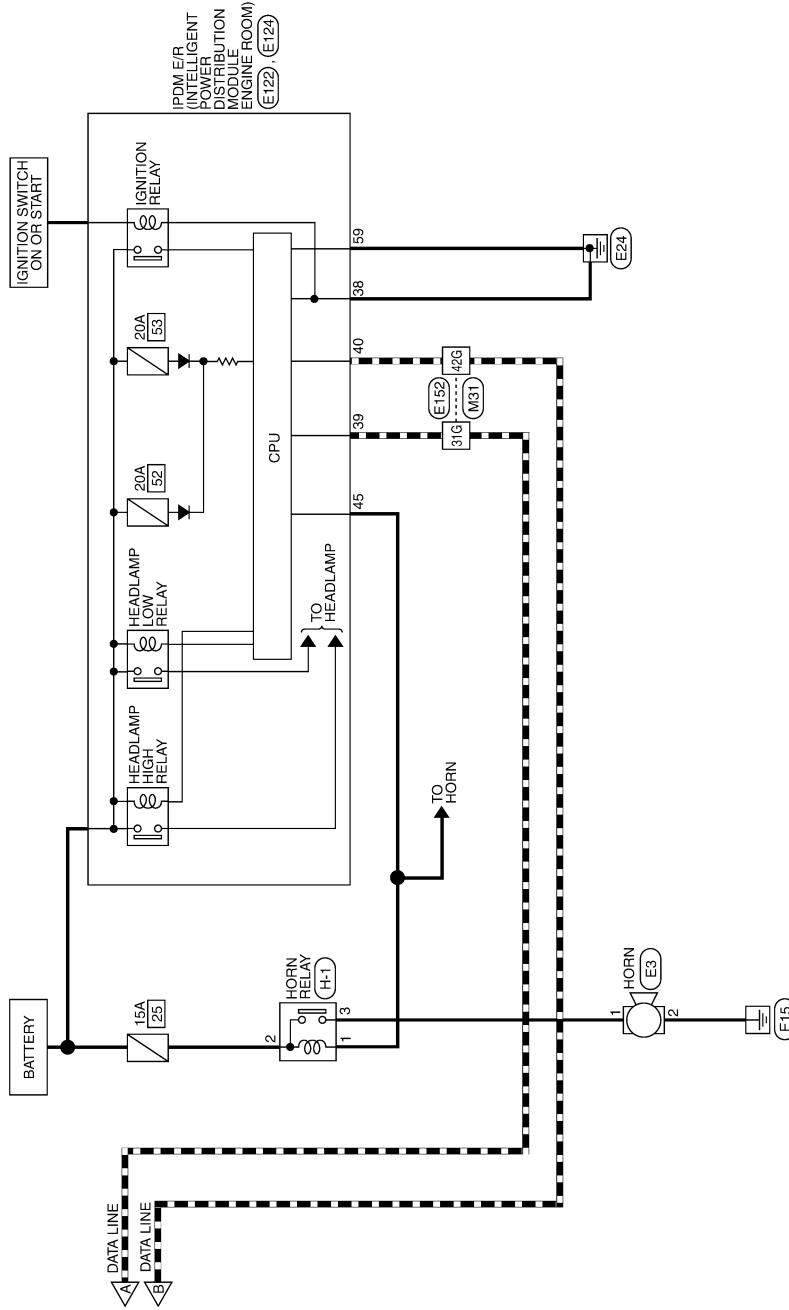

A
B
C
D
E
F
G
H
I
J
L
M
N
O
P

SEC

ALKWA0080GE

BCM (BODY CONTROL MODULE)

[WITHOUT INTELLIGENT KEY SYSTEM]

< ECU DIAGNOSIS >

VEHICLE SECURITY SYSTEM CONNECTORS

Connector No.	M3
Connector Name	FUSE BLOCK (J/B)
Connector Color	WHITE

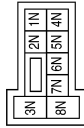

Terminal No.	Color of Wire	Signal Name
1N	Y/R	-

Connector No.	M4
Connector Name	FUSE BLOCK (J/B)
Connector Color	WHITE



Terminal No.	Color of Wire	Signal Name
13P	P	-

Connector No.	M8
Connector Name	WIRE TO WIRE
Connector Color	WHITE

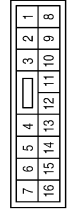

Terminal No.	Color of Wire	Signal Name
8	W/V	-
14	B	-

Connector No.	M18
Connector Name	BCM (BODY CONTROL MODULE)
Connector Color	WHITE

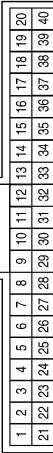

Terminal No.	Color of Wire	Signal Name
11	O	ACC SW
12	R/L	DOOR SW (AS)
13	GR	DOOR SW (RR)
22	W/V	ANTI-PINCH SERIAL LINK (RX, TX)
23	G/O	SECURITY INDICATOR OUTPUT
39	L	CAN-H
40	P	CAN-L

Connector No.	M19
Connector Name	BCM (BODY CONTROL MODULE)
Connector Color	WHITE

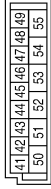

Terminal No.	Color of Wire	Signal Name
42	GR	GLASS HATCH SW
43	R/B	BACK DOOR SW
47	SB	DOOR SW (DR)
48	R/Y	DOOR SW (RL)

Connector No.	M20
Connector Name	BCM (BODY CONTROL MODULE)
Connector Color	BLACK



Terminal No.	Color of Wire	Signal Name
57	Y/R	BAT(FUSE)
67	B	GND (POWER)
70	W/B	BATT (F/L)

ABKIA0080GB

BCM (BODY CONTROL MODULE)

[WITHOUT INTELLIGENT KEY SYSTEM]

< ECU DIAGNOSIS >

Terminal No.	Color of Wire	Signal Name
10G	W/B	-
31G	L	-
42G	P	-

Connector No.	M31
Connector Name	WIRE TO WIRE
Connector Color	WHITE

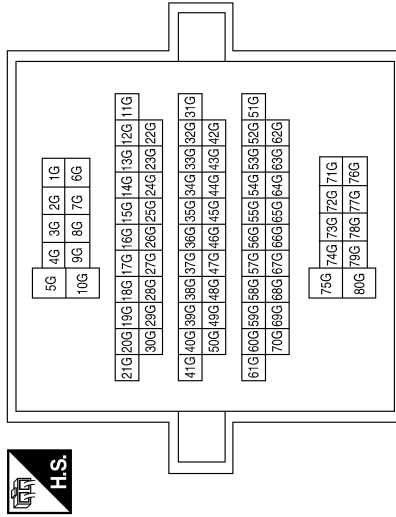

Connector No.	M24
Connector Name	COMBINATION METER
Connector Color	WHITE

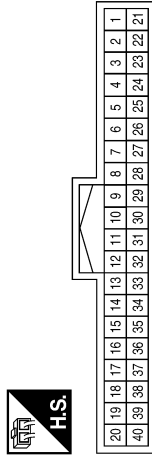

Terminal No.	Color of Wire	Signal Name
55M	GR	-
56M	GR	-
61M	R/L	-
65M	R/B	-

Connector No.	M36
Connector Name	WIRE TO WIRE
Connector Color	WHITE

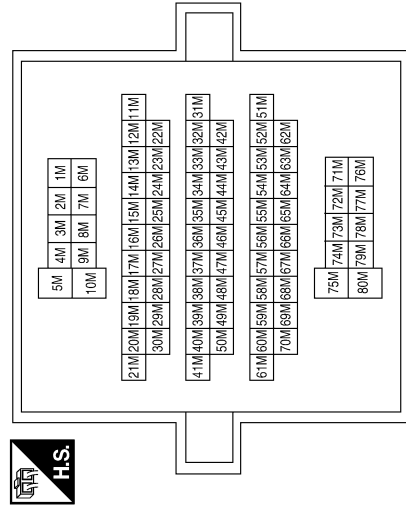

* : REFER TO HARNESS LAYOUT OF PG SECTION FOR DEFINITION OF TYPE A AND TYPE B.

AAKIA0163GB

A
B
C
D
E
F
G
H
I
J
K
L
M
N
O
P

SEC

BCM (BODY CONTROL MODULE)

[WITHOUT INTELLIGENT KEY SYSTEM]

< ECU DIAGNOSIS >

Connector No.	M60
Connector Name	FUSE BLOCK (J/B)
Connector Color	WHITE

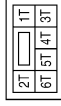

Terminal No.	Color of Wire	Signal Name
6T	O	-

Terminal No.	Color of Wire	Signal Name
60J	SB	-
61J	R/Y	-

Connector No.	M40
Connector Name	WIRE TO WIRE
Connector Color	WHITE

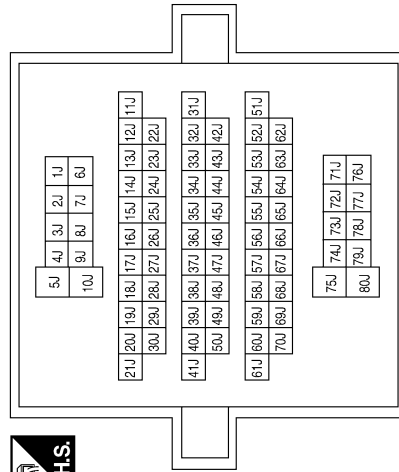

Connector No.	E3
Connector Name	HORN
Connector Color	BLACK



Terminal No.	Color of Wire	Signal Name
1	G	-
2	B	-

Connector No.	M75
Connector Name	WIRE TO WIRE
Connector Color	WHITE

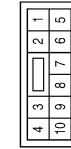

Terminal No.	Color of Wire	Signal Name
3	B	-

Connector No.	M74
Connector Name	WIRE TO WIRE
Connector Color	BROWN

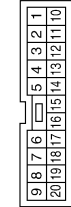

Terminal No.	Color of Wire	Signal Name
5	W/V	-

ABKIA0082GB

BCM (BODY CONTROL MODULE)

[WITHOUT INTELLIGENT KEY SYSTEM]

< ECU DIAGNOSIS >

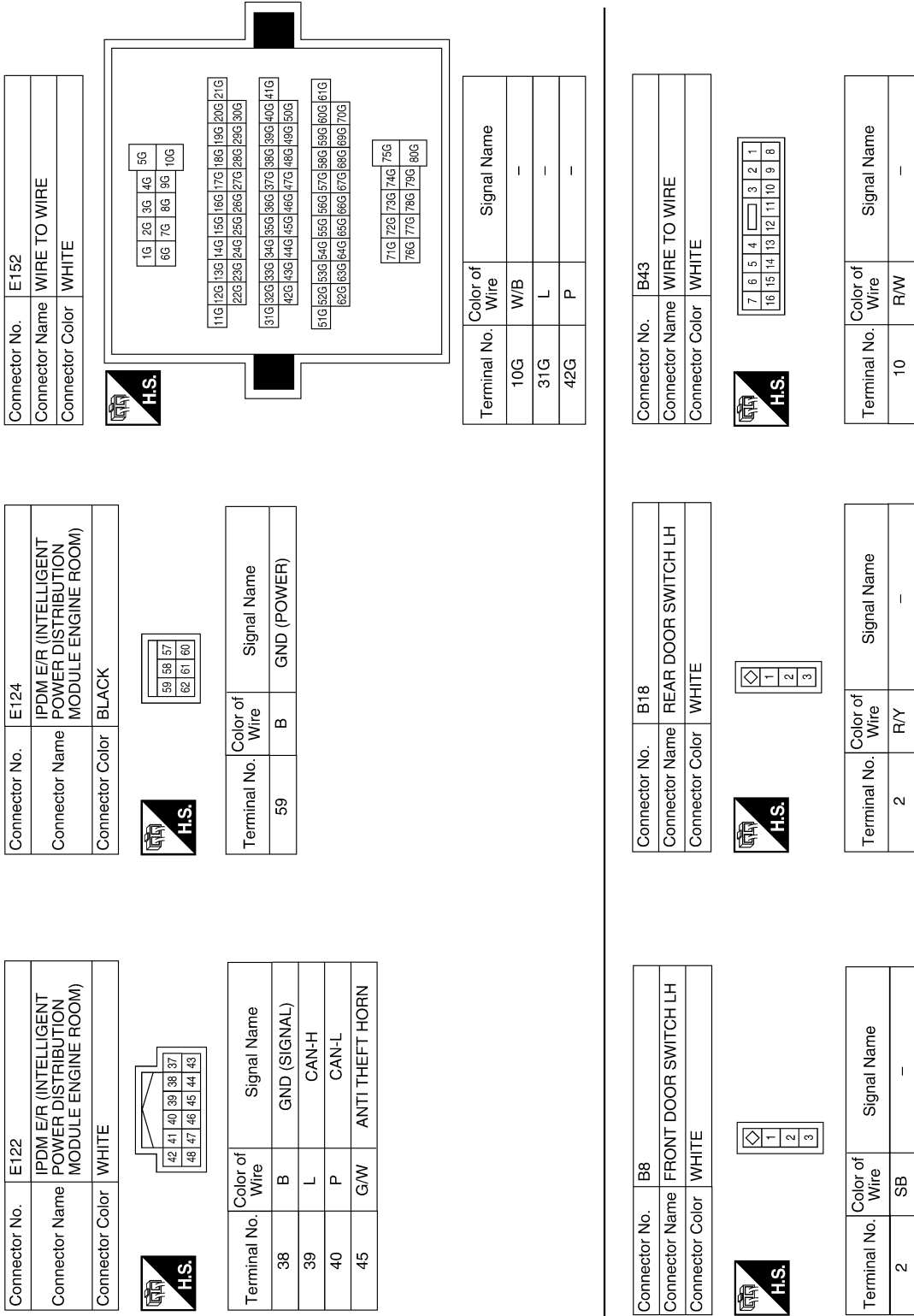

Connector No.	E122
Connector Name	IPDM E/R (INTELLIGENT POWER DISTRIBUTION MODULE ENGINE ROOM)
Connector Color	WHITE

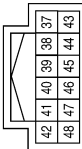

Terminal No.	Color of Wire	Signal Name
38	B	GND (SIGNAL)
39	L	CAN-H
40	P	CAN-L
45	GW	ANTI THEFT HORN

Connector No.	E124
Connector Name	IPDM E/R (INTELLIGENT POWER DISTRIBUTION MODULE ENGINE ROOM)
Connector Color	BLACK



Terminal No.	Color of Wire	Signal Name
59	B	GND (POWER)

Connector No.	E152
Connector Name	WIRE TO WIRE
Connector Color	WHITE

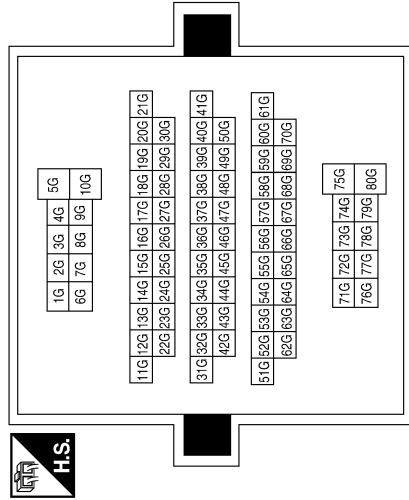

Terminal No.	Color of Wire	Signal Name
10G	W/B	-
31G	L	-
42G	P	-

Connector No.	B8
Connector Name	FRONT DOOR SWITCH LH
Connector Color	WHITE

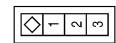

Terminal No.	Color of Wire	Signal Name
2	SB	-

Connector No.	B18
Connector Name	REAR DOOR SWITCH LH
Connector Color	WHITE

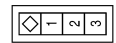

Terminal No.	Color of Wire	Signal Name
2	R/Y	-

Connector No.	B43
Connector Name	WIRE TO WIRE
Connector Color	WHITE



Terminal No.	Color of Wire	Signal Name
10	R/W	-

ABKIA0083GB

A
B
C
D
E
F
G
H
I
J
K
L
M
N
O
P

SEC

BCM (BODY CONTROL MODULE)

[WITHOUT INTELLIGENT KEY SYSTEM]

< ECU DIAGNOSIS >

Terminal No.	Color of Wire	Signal Name
60J	SB	-
61J	R/Y	-

Connector No.	B69
Connector Name	WIRE TO WIRE
Connector Color	WHITE

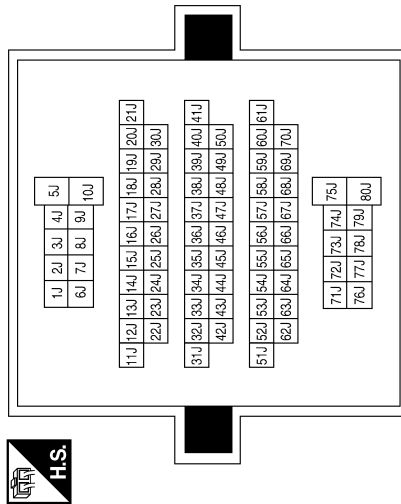

Connector No.	B48
Connector Name	WIRE TO WIRE
Connector Color	WHITE

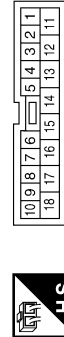

Terminal No.	Color of Wire	Signal Name
14	B	-
15	R/W	-

Connector No.	B116
Connector Name	REAR DOOR SWITCH RH
Connector Color	WHITE

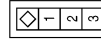

Connector No.	B111
Connector Name	WIRE TO WIRE
Connector Color	WHITE

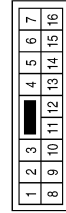

Connector No.	B108
Connector Name	FRONT DOOR SWITCH RH
Connector Color	WHITE

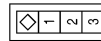

Terminal No.	Color of Wire	Signal Name
2	GR	-

Terminal No.	Color of Wire	Signal Name
10	R/W	-

Terminal No.	Color of Wire	Signal Name
2	R/L	-

AAKIA0102GB

BCM (BODY CONTROL MODULE)

[WITHOUT INTELLIGENT KEY SYSTEM]

< ECU DIAGNOSIS >

Connector No.	B139
Connector Name	WIRE TO WIRE
Connector Color	WHITE

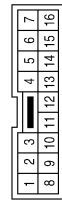

Terminal No.	Color of Wire	Signal Name
13	GR	-

Connector No.	B149
Connector Name	WIRE TO WIRE
Connector Color	WHITE

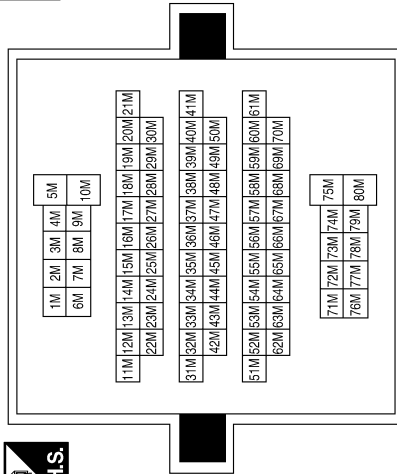

Terminal No.	Color of Wire	Signal Name
55M	GR	-
56M	GR	-
61M	R/L	-
65M	R/B	-

Connector No.	D2
Connector Name	WIRE TO WIRE
Connector Color	WHITE

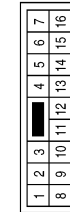

Terminal No.	Color of Wire	Signal Name
8	LG/W	-
14	B	-

Connector No.	D7
Connector Name	MAIN POWER WINDOW AND DOOR LOCK/UNLOCK SWITCH
Connector Color	WHITE

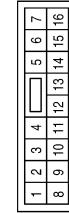

Terminal No.	Color of Wire	Signal Name
4	L	LOCK
6	R	UNLOCK
14	LG/W	ANTI PINCH SERIAL LINK

Connector No.	D8
Connector Name	MAIN POWER WINDOW AND DOOR LOCK/UNLOCK SWITCH
Connector Color	WHITE

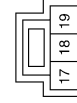

Terminal No.	Color of Wire	Signal Name
17	B	GND

ABKIA0084GB

A
B
C
D
E
F
G
H
I
J
K
L
M
N
O
P

SEC

BCM (BODY CONTROL MODULE)

[WITHOUT INTELLIGENT KEY SYSTEM]

< ECU DIAGNOSIS >

Connector No.	D102
Connector Name	WIRE TO WIRE
Connector Color	BROWN

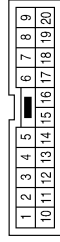

Terminal No.	5	Color of Wire	LG/W	Signal Name	—
--------------	---	---------------	------	-------------	---

Connector No.	D101
Connector Name	WIRE TO WIRE
Connector Color	WHITE

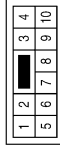

Terminal No.	3	Color of Wire	B	Signal Name	—
--------------	---	---------------	---	-------------	---

Connector No.	D14
Connector Name	FRONT DOOR LOCK ASSEMBLY LH
Connector Color	BLACK

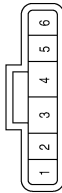

Terminal No.	1	Color of Wire	L	Signal Name	LOCK
5	B	GND			
6	R	UNLOCK			

Connector No.	D405
Connector Name	WIRE TO WIRE
Connector Color	WHITE

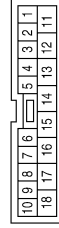

Terminal No.	14	Color of Wire	B	Signal Name	—
15	R/W	—			

Connector No.	D401
Connector Name	WIRE TO WIRE
Connector Color	WHITE

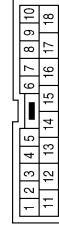

Terminal No.	14	Color of Wire	B	Signal Name	—
15	R/W	—			

Connector No.	D105
Connector Name	POWER WINDOW AND DOOR LOCK/UNLOCK SWITCH RH
Connector Color	WHITE

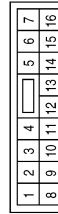

Terminal No.	11	Color of Wire	B	Signal Name	GND
16	LG/W	ANTI PINCH SERIAL LINK			

ABKIA0085GB

BCM (BODY CONTROL MODULE)

[WITHOUT INTELLIGENT KEY SYSTEM]

< ECU DIAGNOSIS >

Connector No.	D501
Connector Name	WIRE TO WIRE
Connector Color	WHITE

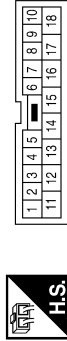

Terminal No.	Color of Wire	Signal Name
14	B	-
15	R/W	-

Connector No.	D502
Connector Name	BACK DOOR SWITCH
Connector Color	WHITE



Terminal No.	Color of Wire	Signal Name
1	B	-
3	R/W	-

Connector No.	D503
Connector Name	BACK DOOR LATCH
Connector Color	WHITE

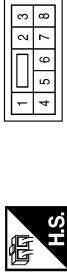

Terminal No.	Color of Wire	Signal Name
7	R/W	-
8	B	-

Connector No.	D602
Connector Name	WIRE TO WIRE
Connector Color	WHITE



Terminal No.	Color of Wire	Signal Name
13	GR	-

Connector No.	D606
Connector Name	WIRE TO WIRE
Connector Color	WHITE



Terminal No.	Color of Wire	Signal Name
13	GR	-

Connector No.	D701
Connector Name	WIRE TO WIRE
Connector Color	WHITE

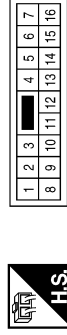

Terminal No.	Color of Wire	Signal Name
13	GR	-

A
B
C
D
E
F
G
H
I
J
L
M
N
O
P

SEC

BCM (BODY CONTROL MODULE)

[WITHOUT INTELLIGENT KEY SYSTEM]

< ECU DIAGNOSIS >

Connector No.	H-1
Connector Name	FUSE AND FUSIBLE LINK BOX
Connector Color	-

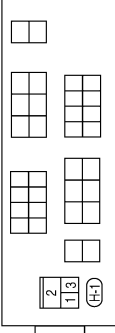

Terminal No.	Color of Wire	Signal Name
1	R/W	-
2	G/B	-
3	G	-

Connector No.	D707
Connector Name	GLASS HATCH AJAR SWITCH
Connector Color	BLACK



Terminal No.	Color of Wire	Signal Name
1	GR	-

ABKIA0087GB

BCM (BODY CONTROL MODULE)

[WITHOUT INTELLIGENT KEY SYSTEM]

< ECU DIAGNOSIS >

Wiring Diagram - NVIS -

INFOID:000000003710673

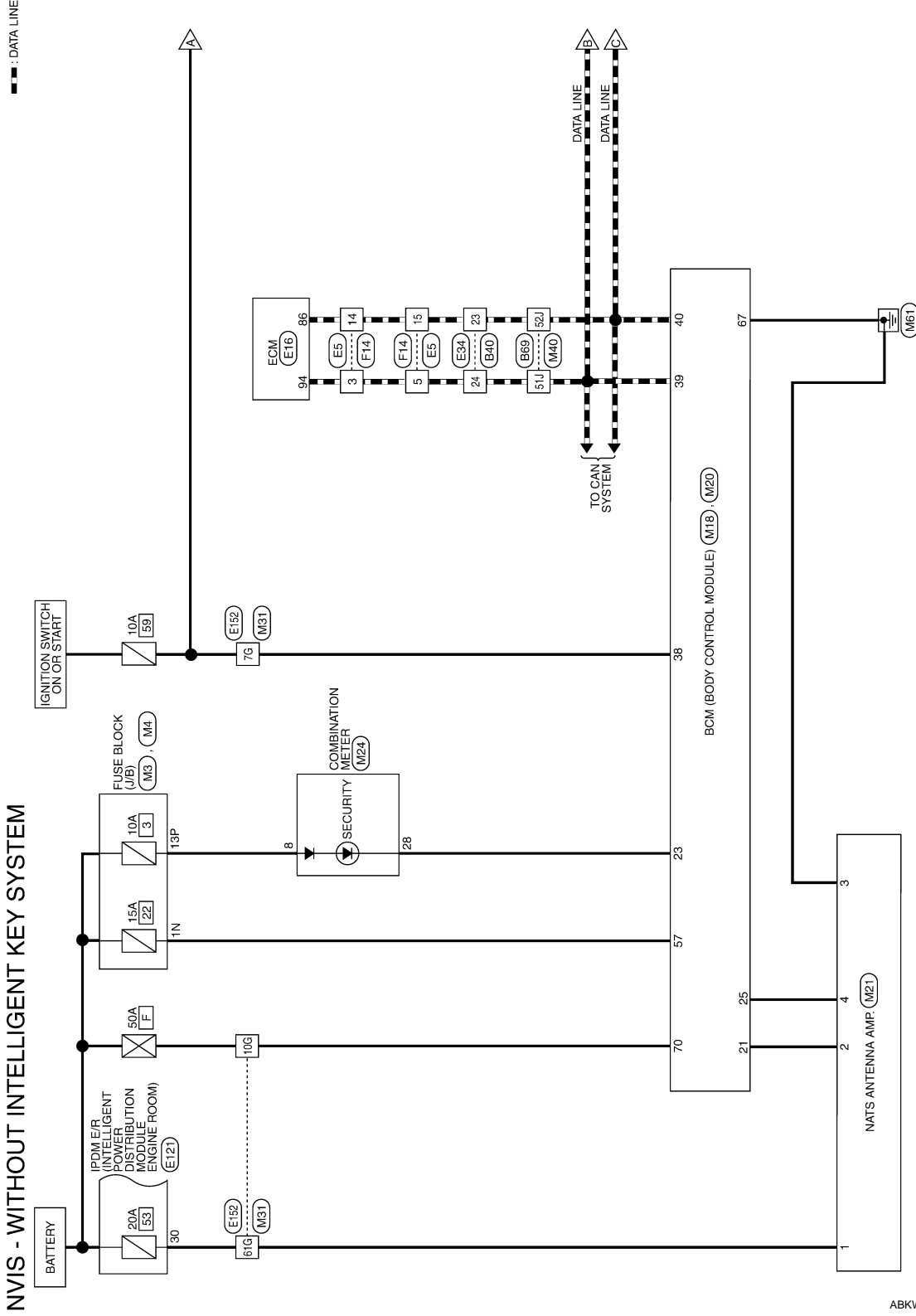

ABKWA0037GE

A
B
C
D
E
F
G
H
I
J
K
L
M
N
O
P

SEC

BCM (BODY CONTROL MODULE)

[WITHOUT INTELLIGENT KEY SYSTEM]

< ECU DIAGNOSIS >

— : DATA LINE

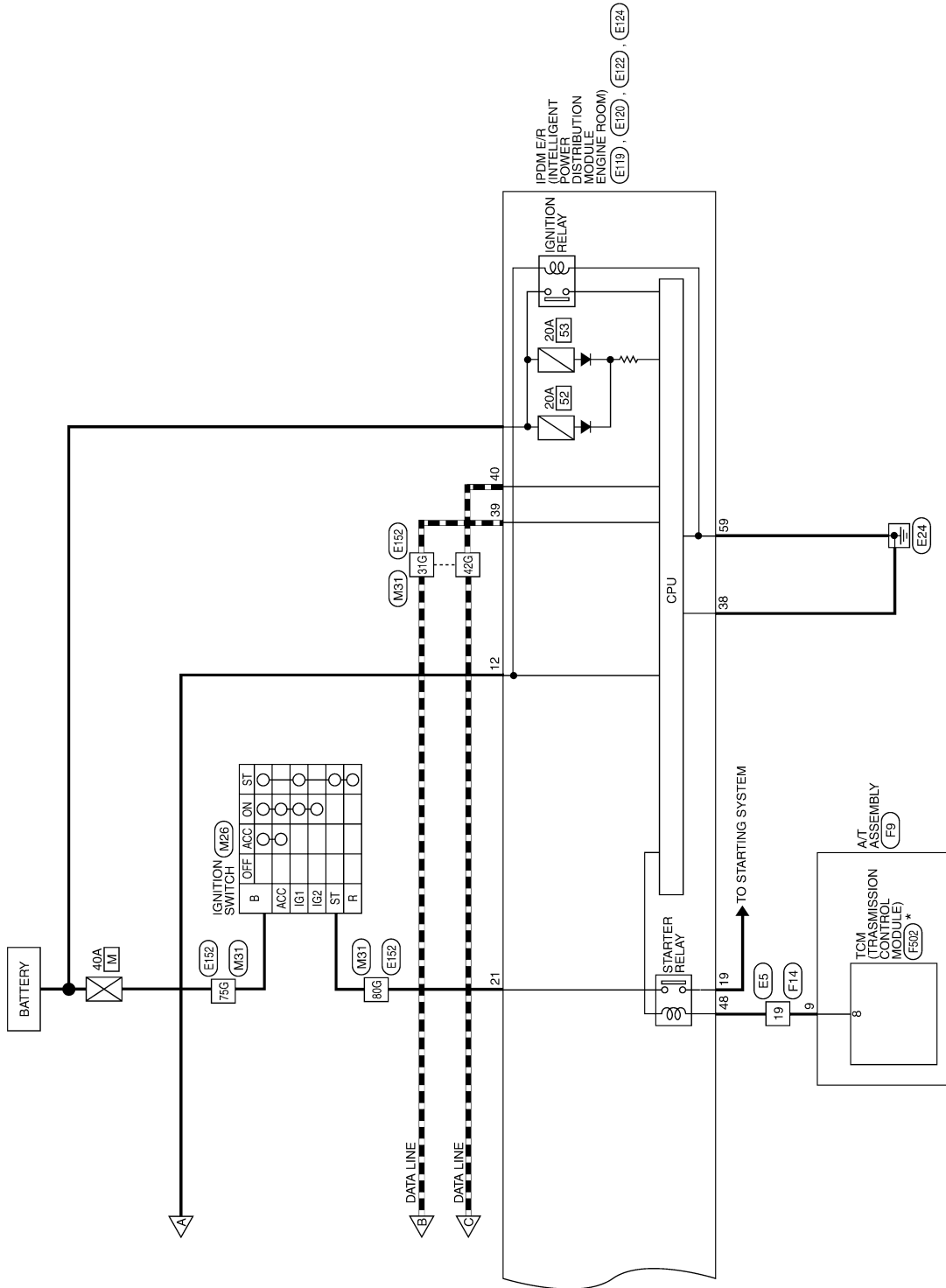

*: THIS CONNECTOR IS NOT SHOWN IN "HARNES LAYOUT" OF PG SECTION.

ABKWA0038GE

BCM (BODY CONTROL MODULE)

[WITHOUT INTELLIGENT KEY SYSTEM]

< ECU DIAGNOSIS >

NVIS CONNECTORS - WITHOUT INTELLIGENT KEY SYSTEM

Connector No.	M3
Connector Name	FUSE BLOCK (J/B)
Connector Color	WHITE

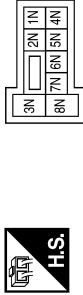

Connector No.	M4
Connector Name	FUSE BLOCK (J/B)
Connector Color	WHITE

Terminal No.	1N	Color of Wire	Y/R	Signal Name	-
--------------	----	---------------	-----	-------------	---

Terminal No.	13P	Color of Wire	P	Signal Name	-
--------------	-----	---------------	---	-------------	---

Connector No.	M18
Connector Name	BCM (BODY CONTROL MODULE)
Connector Color	WHITE

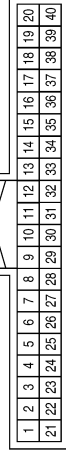

Terminal No.	Color of Wire	Signal Name
21	G	IMMOBILIZER ANTENNA SIGNAL (CLOCK)
23	G/O	SECURITY INDICATOR OUTPUT
25	BR	IMMOBILIZER ANTENNA SIGNAL (RX, TX)
38	W/L	IGN SW
39	L	CAN-H
40	P	CAN-L

Connector No.	M20
Connector Name	BCM (BODY CONTROL MODULE)
Connector Color	BLACK



Terminal No.	Color of Wire	Signal Name
57	P	BAT (FUSE)
67	B	GND (POWER)
70	W/B	BATT (F/L)

Connector No.	M21
Connector Name	NATS ANTENNA AMP.
Connector Color	WHITE

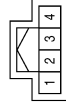

Terminal No.	Color of Wire	Signal Name
1	W	+12V
2	G	SCL (CLOCK)
3	B	GND
4	BR	SCL (TX,RX)

Connector No.	M24
Connector Name	COMBINATION METER
Connector Color	WHITE

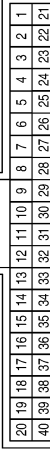

Terminal No.	Color of Wire	Signal Name
8	Y/R	BATTERY (TYPE A*)
8	P	BATTERY (TYPE B*)
28	G/O	SECURITY

* : REFER TO HARNESS LAYOUT OF PG SECTION FOR DEFINITION OF TYPE A AND TYPE B.

AAKIA0164GB

A B C D E F G H I J K L M N O P

SEC

BCM (BODY CONTROL MODULE)

[WITHOUT INTELLIGENT KEY SYSTEM]

< ECU DIAGNOSIS >

Connector No.	M26
Connector Name	IGNITION SWITCH
Connector Color	WHITE



B	ST	61
R	ACC	62

Terminal No.	Color of Wire	Signal Name
B	G	-
ST	BR	-

Connector No.	M31
Connector Name	WIRE TO WIRE
Connector Color	WHITE

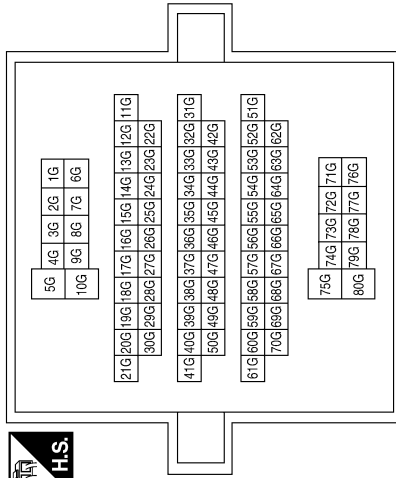

Terminal No.	Color of Wire	Signal Name
7G	W/L	-
10G	W/B	-
31G	L	-
42G	P	-
61G	GW	-
75G	G	-
80G	BR	-

Connector No.	M40
Connector Name	WIRE TO WIRE
Connector Color	WHITE

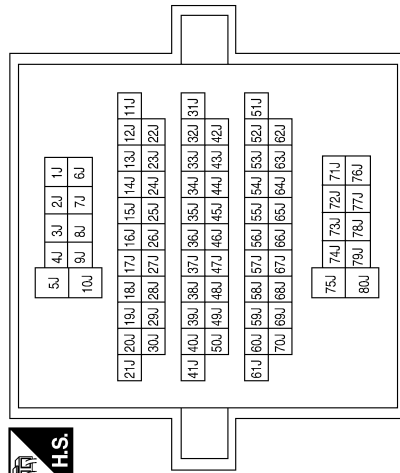

Terminal No.	Color of Wire	Signal Name
51J	L	-
52J	P	-

Connector No.	E5
Connector Name	WIRE TO WIRE
Connector Color	WHITE



1	2	3	4	5	6	7	8	9	10	11		
12	13	14	15	16	17	18	19	20	21	22	23	24

Terminal No.	Color of Wire	Signal Name
3	L	-
5	L	-
14	P	-
15	P	-
19	B/R	-

ABKIA0101GB

BCM (BODY CONTROL MODULE)

[WITHOUT INTELLIGENT KEY SYSTEM]

< ECU DIAGNOSIS >

Connector No.	E119
Connector Name	IPDM E/R (INTELLIGENT POWER DISTRIBUTION MODULE ENGINE ROOM)
Connector Color	WHITE

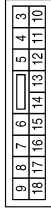

Terminal No.	Color of Wire	Signal Name
12	L/W	IGN SW (IG)

Connector No.	E34
Connector Name	WIRE TO WIRE
Connector Color	WHITE

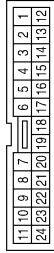

Terminal No.	Color of Wire	Signal Name
23	P	-
24	L	-

Connector No.	E16
Connector Name	ECM
Connector Color	BLACK

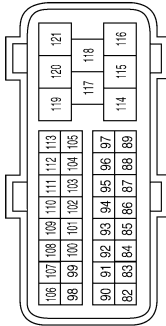

Terminal No.	Color of Wire	Signal Name
86	P	CAN-L
94	L	CAN-H

Connector No.	E122
Connector Name	IPDM E/R (INTELLIGENT POWER DISTRIBUTION MODULE ENGINE ROOM)
Connector Color	WHITE

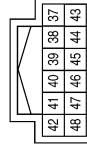

Terminal No.	Color of Wire	Signal Name
38	B	GND (SIGNAL)
39	L	CAN-H
40	P	CAN-L
48	B/R	INHIBIT SW

Connector No.	E121
Connector Name	IPDM E/R (INTELLIGENT POWER DISTRIBUTION MODULE ENGINE ROOM)
Connector Color	BROWN



Terminal No.	Color of Wire	Signal Name
30	W	ECM BAT

Connector No.	E120
Connector Name	IPDM E/R (INTELLIGENT POWER DISTRIBUTION MODULE ENGINE ROOM)
Connector Color	WHITE



Terminal No.	Color of Wire	Signal Name
19	W/R	STARTER MTR
21	BR	IGN SW (ST)

A
B
C
D
E
F
G
H
I
J
L
M
N
O
P

SEC

BCM (BODY CONTROL MODULE)

[WITHOUT INTELLIGENT KEY SYSTEM]

< ECU DIAGNOSIS >

Connector No.	E124
Connector Name	IPDM E/R (INTELLIGENT POWER DISTRIBUTION MODULE ENGINE ROOM)
Connector Color	BLACK



Terminal No.	Color of Wire	Signal Name
59	B	GND (POWER)

Connector No.	E152
Connector Name	WIRE TO WIRE
Connector Color	WHITE

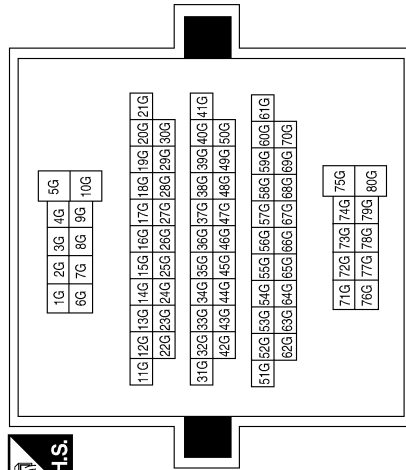

Terminal No.	Color of Wire	Signal Name
7G	L/W	-
10G	W/B	-
31G	L	-
42G	P	-
61G	W	-
75G	G	-
80G	BR	-

Connector No.	F9
Connector Name	A/T ASSEMBLY
Connector Color	GREEN

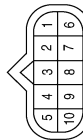

Terminal No.	Color of Wire	Signal Name
9	B/R	-

Connector No.	F14
Connector Name	WIRE TO WIRE
Connector Color	WHITE

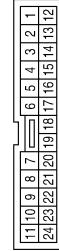

Terminal No.	Color of Wire	Signal Name
3	L	-
5	L	-
14	P	-
15	P	-
19	B/R	-

Connector No.	F502
Connector Name	TCM (TRANSMISSION CONTROL MODULE)
Connector Color	GRAY

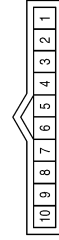

Terminal No.	Color of Wire	Signal Name
8	G	START-RLY

BCM (BODY CONTROL MODULE)

[WITHOUT INTELLIGENT KEY SYSTEM]

< ECU DIAGNOSIS >

Terminal No.	Color of Wire	Signal Name
51J	L	-
52J	P	-

Connector No.	B69
Connector Name	WIRE TO WIRE
Connector Color	WHITE

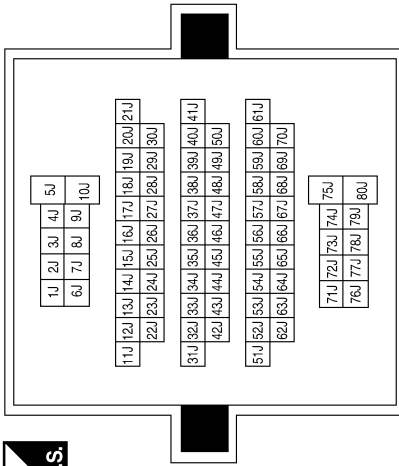

Connector No.	B40
Connector Name	WIRE TO WIRE
Connector Color	WHITE

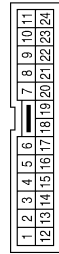

Terminal No.	Color of Wire	Signal Name
23	P	-
24	L	-

Fail Safe

Fail-safe index

BCM performs fail-safe control when any DTC listed below is detected.

A
B
C
D
E
F
G
H
I
J
L
M
N
O
P

SEC

ABKIA0104GB

INFOID:000000004176256

BCM (BODY CONTROL MODULE)

[WITHOUT INTELLIGENT KEY SYSTEM]

< ECU DIAGNOSIS >

Display contents of CONSULT	Fail-safe	Cancellation
U1000: CAN COMM CIRCUIT	Inhibit engine cranking	When the BCM re-establishes communication with the other modules.
U1010: CONTROL UNIT (CAN)	Inhibit engine cranking	When the BCM re-start communicating with the other modules.

DTC Inspection Priority Chart

INFOID:000000004176257

If some DTCs are displayed at the same time, perform inspections one by one based on the following priority chart.

Priority	DTC
1	<ul style="list-style-type: none">• U1000: CAN COMM CIRCUIT• U1010: CONTROL UNIT (CAN)
2	<ul style="list-style-type: none">• B2190: NATS ANTENNA AMP• B2191: DIFFERENCE OF KEY• B2192: ID DISCORD BCM-ECM• B2193: CHAIN OF BCM-ECM• B2013: STRG COMM 1• B2552: INTELLIGENT KEY• B2590: NATS MALFUNCTION
3	<ul style="list-style-type: none">• C1729: VHCL SPEED SIG ERR
4	<ul style="list-style-type: none">• C1704: LOW PRESSURE FL• C1705: LOW PRESSURE FR• C1706: LOW PRESSURE RR• C1707: LOW PRESSURE RL• C1708: [NO DATA] FL• C1709: [NO DATA] FR• C1710: [NO DATA] RR• C1711: [NO DATA] RL• C1712: [CHECKSUM ERR] FL• C1713: [CHECKSUM ERR] FR• C1714: [CHECKSUM ERR] RR• C1715: [CHECKSUM ERR] RL• C1716: [PRESSDATA ERR] FL• C1717: [PRESSDATA ERR] FR• C1718: [PRESSDATA ERR] RR• C1719: [PRESSDATA ERR] RL• C1720: [CODE ERR] FL• C1721: [CODE ERR] FR• C1722: [CODE ERR] RR• C1723: [CODE ERR] RL• C1724: [BATT VOLT LOW] FL• C1725: [BATT VOLT LOW] FR• C1726: [BATT VOLT LOW] RR• C1727: [BATT VOLT LOW] RL• C1735: IGNITION SIGNAL

DTC Index

INFOID:000000004176258

NOTE:

- Details of time display
- CRNT: Displays when there is a malfunction now or after returning to the normal condition until turning ignition switch OFF → ON again.
- 1 - 39: Displayed if any previous malfunction is present when current condition is normal. It increases like 1 → 2 → 3...38 → 39 after returning to the normal condition whenever ignition switch OFF → ON. The counter remains at 39 even if the number of cycles exceeds it. It is counted from 1 again when turning ignition switch OFF → ON after returning to the normal condition if the malfunction is detected again.

BCM (BODY CONTROL MODULE)

[WITHOUT INTELLIGENT KEY SYSTEM]

< ECU DIAGNOSIS >

CONSULT display	Fail-safe	Intelligent Key warning lamp ON	Tire pressure monitor warning lamp ON	Reference page
No DTC is detected. further testing may be required.	—	—	—	—
U1000: CAN COMM CIRCUIT	—	—	—	BCS-31
U1010: CONTROL UNIT (CAN)	—	—	—	BCS-32
B2013: STRG COMM 1	—	—	—	SEC-26
B2190: NATS ANTENA AMP	—	—	—	SEC-29 (with I- Key), SEC-125 (without I-Key)
B2191: DIFFERENCE OF KEY	—	—	—	SEC-32 (with I- Key), SEC-128 (without I-Key)
B2192: ID DISCORD BCM-ECM	—	—	—	SEC-33 (with I- Key), SEC-129 (without I-Key)
B2193: CHAIN OF BCM-ECM	—	—	—	SEC-35 (with I- Key), SEC-131 (without I-Key)
B2552: INTELLIGENT KEY	—	—	—	SEC-37
B2590: NATS MALFUNCTION	—	—	—	SEC-38
C1704: LOW PRESSURE FL	—	—	—	WT-33
C1705: LOW PRESSURE FR	—	—	—	WT-33
C1706: LOW PRESSURE RR	—	—	—	WT-33
C1707: LOW PRESSURE RL	—	—	—	WT-33
C1708: [NO DATA] FL	—	—	—	WT-14
C1709: [NO DATA] FR	—	—	—	WT-16
C1710: [NO DATA] RR	—	—	—	WT-16
C1711: [NO DATA] RL	—	—	—	WT-16
C1712: [CHECKSUM ERR] FL	—	—	—	WT-16
C1713: [CHECKSUM ERR] FR	—	—	—	WT-16
C1714: [CHECKSUM ERR] RR	—	—	—	WT-16
C1715: [CHECKSUM ERR] RL	—	—	—	WT-16
C1716: [PRESSDATA ERR] FL	—	—	—	WT-18
C1717: [PRESSDATA ERR] FR	—	—	—	WT-16
C1718: [PRESSDATA ERR] RR	—	—	—	WT-16
C1719: [PRESSDATA ERR] RL	—	—	—	WT-16
C1720: [CODE ERR] FL	—	—	—	WT-16
C1721: [CODE ERR] FR	—	—	—	WT-16
C1722: [CODE ERR] RR	—	—	—	WT-16
C1723: [CODE ERR] RL	—	—	—	WT-16
C1724: [BATT VOLT LOW] FL	—	—	—	WT-16
C1725: [BATT VOLT LOW] FR	—	—	—	WT-16
C1726: [BATT VOLT LOW] RR	—	—	—	WT-16
C1727: [BATT VOLT LOW] RL	—	—	—	WT-16
C1729: VHCL SPEED SIG ERR	—	—	—	WT-19
C1735: IGN_CIRCUIT_OPEN	—	—	—	—

A
B
C
D
E
F
G
H
I
J
L
M
N
O
P

SEC

IPDM E/R (INTELLIGENT POWER DISTRIBUTION MODULE ENGINE ROOM)

< ECU DIAGNOSIS >

[WITHOUT INTELLIGENT KEY SYSTEM]

IPDM E/R (INTELLIGENT POWER DISTRIBUTION MODULE ENGINE ROOM)

Reference Value

INFOID:000000004176259

VALUES ON THE DIAGNOSIS TOOL

Monitor Item	Condition		Value/Status
MOTOR FAN REQ	Engine idle speed	Changes depending on engine coolant temperature, air conditioner operation status, vehicle speed, etc.	0 - 100 %
A/C COMP REQ	A/C switch OFF		OFF
	A/C switch ON		ON
TAIL&CLR REQ	Lighting switch OFF		OFF
	Lighting switch 1ST, 2ND, HI or AUTO (Light is illuminated)		ON
HL LO REQ	Lighting switch OFF		OFF
	Lighting switch 2ND HI or AUTO (Light is illuminated)		ON
HL HI REQ	Lighting switch OFF		OFF
	Lighting switch HI		ON
FR FOG REQ	Lighting switch 2ND or AUTO (Light is illuminated)	Front fog lamp switch OFF	OFF
		<ul style="list-style-type: none"> • Front fog lamp switch ON • Daytime light activated (Canada only) 	ON
H L WASHER REQ	NOTE: This item is displayed, but cannot be monitored.		OFF
FR WIP REQ	Ignition switch ON	Front wiper switch OFF	STOP
		Front wiper switch INT	1LOW
		Front wiper switch LO	LOW
		Front wiper switch HI	HI
WIP AUTO STOP	Ignition switch ON	Front wiper stop position	STOP P
		Any position other than front wiper stop position	ACT P
WIP PROT	Ignition switch ON	Front wiper operates normally	OFF
		Front wiper stops at fail-safe operation	BLOCK
ST RLY REQ	Ignition switch OFF or ACC		OFF
	Ignition switch START		ON
IGN RLY	Ignition switch OFF or ACC		OFF
	Ignition switch ON		ON
RR DEF REQ	Rear defogger switch OFF		OFF
	Rear defogger switch ON		ON
OIL P SW	Ignition switch OFF, ACC or engine running		OPEN
	Ignition switch ON		CLOSE
DTRL REQ	NOTE: This item is displayed, but cannot be monitored.		OFF
HOOD SW	NOTE: This item is displayed, but cannot be monitored.		OFF

IPDM E/R (INTELLIGENT POWER DISTRIBUTION MODULE ENGINE ROOM)

< ECU DIAGNOSIS >

[WITHOUT INTELLIGENT KEY SYSTEM]

Monitor Item	Condition	Value/Status
THFT HRN REQ	Not operated	OFF
	<ul style="list-style-type: none">• Panic alarm is activated• Horn is activated with VEHICLE SECURITY (THEFT WARNING) SYSTEM	ON
HORN CHIRP	Not operated	OFF
	Door locking with keyfob or Intelligent Key (if equipped) (horn chirp mode)	ON

A

B

C

D

E

F

G

H

I

J

SEC

L

M

N

O

P

IPDM E/R (INTELLIGENT POWER DISTRIBUTION MODULE ENGINE ROOM)

< ECU DIAGNOSIS >

[WITHOUT INTELLIGENT KEY SYSTEM]

INFOID:000000004176260

Terminal Layout

TERMINAL LAYOUT

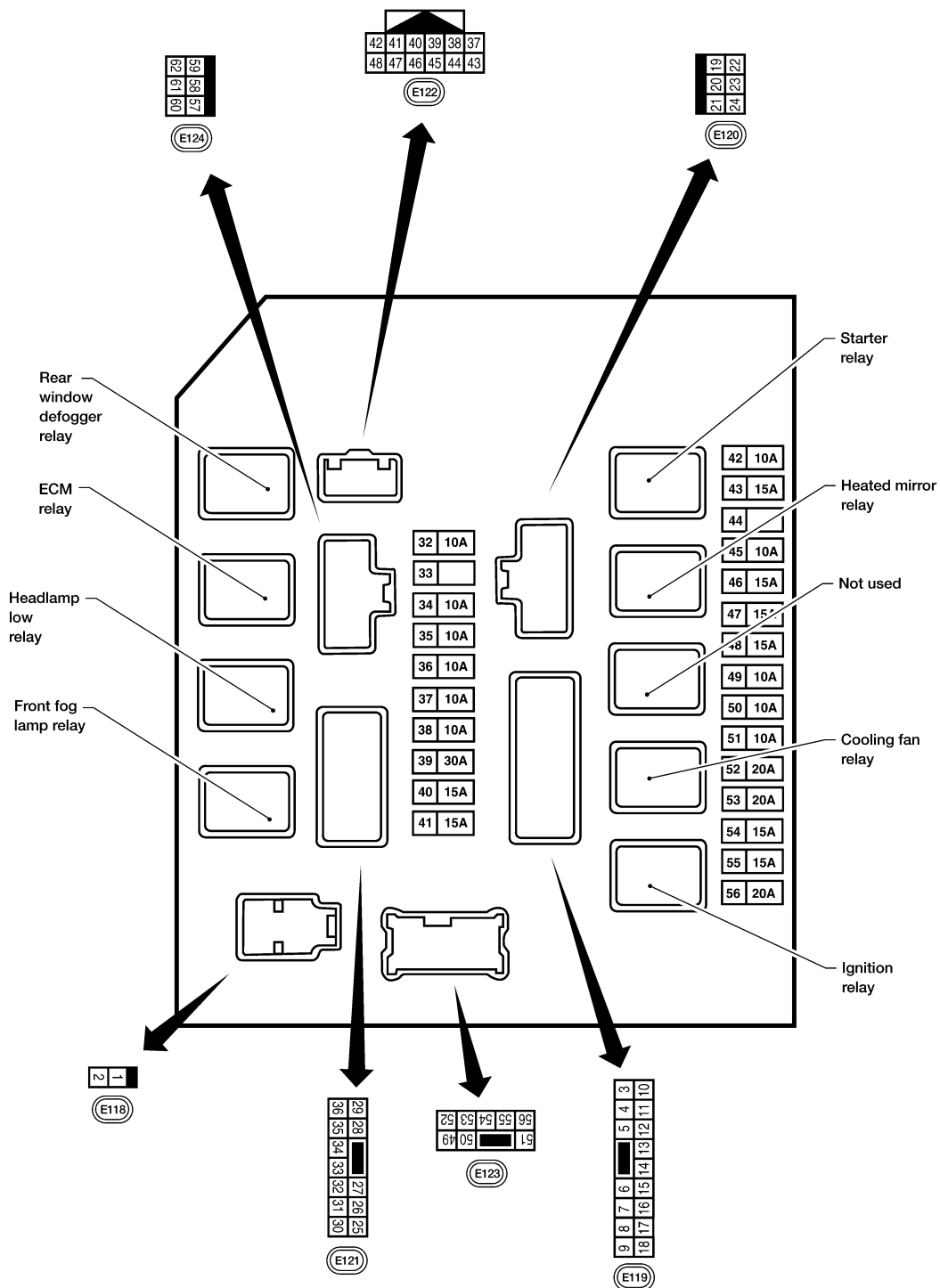

WKIA5852E

Physical Values

PHYSICAL VALUES

INFOID:000000004176261

IPDM E/R (INTELLIGENT POWER DISTRIBUTION MODULE ENGINE ROOM)
[WITHOUT INTELLIGENT KEY SYSTEM]

< ECU DIAGNOSIS >

Terminal	Wire color	Signal name	Signal input/output	Measuring condition		Reference value (Approx.)
				Ignition switch	Operation or condition	
1	B/Y	Battery power supply	Input	OFF	—	Battery voltage
2	R	Battery power supply	Input	OFF	—	Battery voltage
3	BR	ECM relay	Output	—	Ignition switch ON or START	Battery voltage
					Ignition switch OFF or ACC	0V
4	W/L	ECM relay	Output	—	Ignition switch ON or START	Battery voltage
					Ignition switch OFF or ACC	0V
6	L	Throttle control motor relay	Output	—	Ignition switch ON or START	Battery voltage
					Ignition switch OFF or ACC	0V
7	W/B	ECM relay control	Input	—	Ignition switch ON or START	0V
					Ignition switch OFF or ACC	Battery voltage
8	R/B	Fuse 54	Output	—	Ignition switch ON or START	Battery voltage
					Ignition switch OFF or ACC	0V
10	G	Fuse 45	Output	ON	Daytime light system active	0V
					Daytime light system inactive	Battery voltage
11	Y/B	A/C compressor	Output	ON or START	A/C switch ON or defrost A/C switch	Battery voltage
					A/C switch OFF or defrost A/C switch	0V
12	L/W	Ignition switch supplied power	Input	—	OFF or ACC	0V
					ON or START	Battery voltage
13	B/Y	Fuel pump relay	Output	—	Ignition switch ON or START	Battery voltage
					Ignition switch OFF or ACC	0V
14	Y/R	Fuse 49	Output	—	Ignition switch ON or START	Battery voltage
					Ignition switch OFF or ACC	0V
15	LG/B	Fuse 50 (VDC)	Output	—	Ignition switch ON or START	Battery voltage
					Ignition switch OFF or ACC	0V
15	GR	Fuse 50 (ABS)	Output	—	Ignition switch ON or START	Battery voltage
					Ignition switch OFF or ACC	0V
16	G	Fuse 51	Output	—	Ignition switch ON or START	Battery voltage
					Ignition switch OFF or ACC	0V
17	W	Fuse 55	Output	—	Ignition switch ON or START	Battery voltage
					Ignition switch OFF or ACC	0V
19	W/R	Starter motor	Output	START	—	Battery voltage
21	BR	Ignition switch supplied power	Input	—	OFF or ACC	0V
					START	Battery voltage
22	G	Battery power supply	Output	OFF	—	Battery voltage
23	GR/W	Door mirror defogger output signal	Output	—	When rear defogger switch is ON	Battery voltage
					When raker defogger switch is OFF	0V

A
B
C
D
E
F
G
H
I
J
K
L
M
N
O
P

SEC

IPDM E/R (INTELLIGENT POWER DISTRIBUTION MODULE ENGINE ROOM)

< ECU DIAGNOSIS >

[WITHOUT INTELLIGENT KEY SYSTEM]

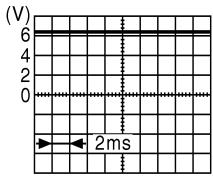
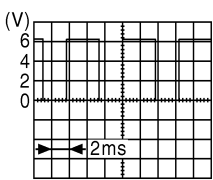
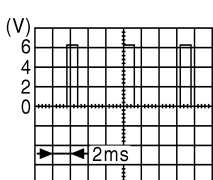
Terminal	Wire color	Signal name	Signal input/output	Measuring condition		Reference value (Approx.)
				Ignition switch	Operation or condition	
24	L	Cooling fan relay	Output	—	Conditions correct for cooling fan operation	Battery voltage
					Conditions not correct for cooling fan operation	0V
27	W/B	Fuse 38	Output	—	Ignition switch ON or START	Battery voltage
					Ignition switch OFF or ACC	0V
30	W	Fuse 53	Output	—	Ignition switch ON or START	Battery voltage
					Ignition switch OFF or ACC	0V
32	L	Wiper low speed signal	Output	ON or START	Wiper switch OFF	Battery voltage
					LO or INT	0V
35	L/B	Wiper high speed signal	Output	ON or START	Wiper switch OFF, LO, INT	Battery voltage
					HI	0V
37	Y	Power generation command signal	Output	—	Ignition switch ON	 <p style="text-align: right; font-size: small;">JPMA0001GB</p> <p style="text-align: center;">6.3 V</p>
					40% is set on "Active test," "ALTERNATOR DUTY" of "ENGINE"	 <p style="text-align: right; font-size: small;">JPMA0002GB</p> <p style="text-align: center;">3.8 V</p>
					40% is set on "Active test," "ALTERNATOR DUTY" of "ENGINE"	 <p style="text-align: right; font-size: small;">JPMA0003GB</p> <p style="text-align: center;">1.4 V</p>
38	B	Ground	Input	—	—	0V
39	L	CAN-H	—	ON	—	—
40	P	CAN-L	—	ON	—	—
42	GR	Oil pressure switch	Input	—	Engine running	Battery voltage
					Engine stopped	0V
43	L/Y	Wiper auto stop signal	Input	ON or START	Wiper switch OFF, LO, INT	Battery voltage
44	BR	Daytime light relay control	Input	ON	Daytime light system active	0V
					Daytime light system inactive	Battery voltage

IPDM E/R (INTELLIGENT POWER DISTRIBUTION MODULE ENGINE ROOM)

< ECU DIAGNOSIS >

[WITHOUT INTELLIGENT KEY SYSTEM]

Terminal	Wire color	Signal name	Signal input/output	Measuring condition		Reference value (Approx.)	
				Ignition switch	Operation or condition		
45	G/W	Horn relay control	Input	ON	When door locks are operated using keyfob or Intelligent Key (if equipped) (OFF → ON)*	Battery voltage → 0V	
46	GR	Fuel pump relay control	Input	—	Ignition switch ON or START	0V	
					Ignition switch OFF or ACC	Battery voltage	
47	O	Throttle control motor relay control	Input	—	Ignition switch ON or START	0V	
					Ignition switch OFF or ACC	Battery voltage	
48	B/R	Starter relay (inhibit switch)	Input	ON or START	Selector lever in "P" or "N"	0V	
					Selector lever any other position	Battery voltage	
49	R/L	Trailer tow relay	Output	ON	Lighting switch must be in the 1st position	OFF	0V
						ON	Battery voltage
50	W/R	Front fog lamp (LH)	Output	ON or START	Lighting switch must be in the 2nd position (LOW beam is ON) and the front fog lamp switch	OFF	0V
						ON	Battery voltage
51	W/R	Front fog lamp (RH)	Output	ON or START	Lighting switch must be in the 2nd position (LOW beam is ON) and the front fog lamp switch	OFF	0V
						ON	Battery voltage
52	L	LH low beam head-lamp	Output	—	Lighting switch in 2nd position	Battery voltage	
54	R/Y	RH low beam head-lamp	Output	—	Lighting switch in 2nd position	Battery voltage	
55	G	LH high beam head-lamp	Output	—	Lighting switch in 2nd position and placed in HIGH or PASS position	Battery voltage	
56	L/Y	RH high beam head-lamp	Output	—	Lighting switch in 2nd position and placed in HIGH or PASS position	Battery voltage	
57	R/L	Parking, license, and tail lamp	Output	ON	Lighting switch 1st position	OFF	0V
						ON	Battery voltage
59	B	Ground	Input	—	—	0V	
60	B/W	Rear window defogger relay	Output	ON or START	Rear defogger switch ON	Battery voltage	
					Rear defogger switch OFF	0V	
61	BR	Fuse 32	Output	OFF	—	Battery voltage	

*: When horn reminder is ON

A
B
C
D
E
F
G
H
I
J
L
M
N
O
P

SEC

IPDM E/R (INTELLIGENT POWER DISTRIBUTION MODULE ENGINE ROOM)

< ECU DIAGNOSIS >

[WITHOUT INTELLIGENT KEY SYSTEM]

INFOID:000000004176262

Fail Safe

CAN COMMUNICATION CONTROL

When CAN communication with ECM and BCM is impossible, IPDM E/R performs fail-safe control. After CAN communication recovers normally, it also returns to normal control.

If No CAN Communication Is Available With ECM

Control part	Fail-safe in operation
Cooling fan	<ul style="list-style-type: none">• Turns ON the cooling fan relay when the ignition switch is turned ON• Turns OFF the cooling fan relay when the ignition switch is turned OFF

If No CAN Communication Is Available With BCM

Control part	Fail-safe in operation
Headlamp	<ul style="list-style-type: none">• Turns ON the headlamp low relay when the ignition switch is turned ON• Turns OFF the headlamp low relay when the ignition switch is turned OFF• Headlamp high relay OFF
<ul style="list-style-type: none">• Parking lamps• License plate lamps• Tail lamps	<ul style="list-style-type: none">• Turns ON the tail lamp relay when the ignition switch is turned ON• Turns OFF the tail lamp relay when the ignition switch is turned OFF
Front wiper	<ul style="list-style-type: none">• The status just before activation of fail-safe control is maintained until the ignition switch is turned OFF while the front wiper is operating at LO or HI speed.• The wiper is operated at LO speed until the ignition switch is turned OFF if the fail-safe control is activated while the front wiper is set in the INT mode and the front wiper motor is operating.
Rear window defogger	Rear window defogger relay OFF
A/C compressor	A/C relay OFF
Front fog lamps	Front fog lamp relay OFF

IGNITION RELAY MALFUNCTION DETECTION FUNCTION

- IPDM E/R monitors the voltage at the contact circuit and excitation coil circuit of the ignition relay inside it.
- IPDM E/R judges the ignition relay error if the voltage differs between the contact circuit and the excitation coil circuit.
- If the ignition relay cannot turn OFF due to contact seizure, it activates the tail lamp relay for 10 minutes to alert the user to the ignition relay malfunction when the ignition switch is turned OFF.

Ignition switch	Ignition relay	Tail lamp relay
ON	ON	—
OFF	OFF	—

NOTE:

The tail lamp turns OFF when the ignition switch is turned ON.

FRONT WIPER CONTROL

IPDM E/R detects front wiper stop position by a front wiper auto stop signal.

When a front wiper auto stop signal is in the conditions listed below, IPDM E/R stops power supply to wiper after repeating a front wiper 10 second activation and 20 second stop five times.

Ignition switch	Front wiper switch	Auto stop signal
ON	OFF	Front wiper stop position signal cannot be input 10 seconds.
	ON	The signal does not change for 10 seconds.

NOTE:

This operation status can be confirmed on the IPDM E/R "DATA MONITOR" that displays "Block" for the item "WIP PROT" while the wiper is stopped.

STARTER MOTOR PROTECTION FUNCTION

IPDM E/R (INTELLIGENT POWER DISTRIBUTION MODULE ENGINE ROOM)

< ECU DIAGNOSIS >

[WITHOUT INTELLIGENT KEY SYSTEM]

IPDM E/R turns OFF the starter control relay to protect the starter motor when the starter control relay remains active for 90 seconds.

DTC Index

INFOID:000000004176263

CONSULT-III display	Fail-safe	TIME ^{NOTE}		Refer to
No DTC is detected. further testing may be required.	—	—	—	—
U1000: CAN COMM CIRCUIT	×	CRNT	1 – 39	PCS-18

NOTE:

The details of TIME display are as follows.

- CRNT: The malfunctions that are detected now
- 1 - 39: The number is indicated when it is normal at present and a malfunction was detected in the past. It increases like 0 → 1 → 2 ... 38 → 39 after returning to the normal condition whenever IGN OFF → ON. It is fixed to 39 until the self-diagnosis results are erased if it is over 39. It returns to 0 when a malfunction is detected again in the process.

A
B
C
D
E
F
G
H
I
J
L
M
N
O
P

SEC

VEHICLE SECURITY SYSTEM SYMPTOMS

< SYMPTOM DIAGNOSIS >

[WITHOUT INTELLIGENT KEY SYSTEM]

SYMPTOM DIAGNOSIS

VEHICLE SECURITY SYSTEM SYMPTOMS

Symptom Table

INFOID:000000003710680

Procedure		Diagnostic procedure	Refer to page	
Symptom				
1	Vehicle security system cannot be set by	Door switch	Check door switch (LF, RF, LR, RR, back)	DLK-267
		Glass ajar switch	Check glass ajar switch	DLK-303
		Key cylinder switch	Check key cylinder switch	DLK-275
		—	Check Intermittent Incident	GI-37
	Security indicator does not turn ON.		Check vehicle security indicator	SEC-137
		Check Intermittent Incident	GI-37	
2	* Vehicle security system does not sound alarm when	Any door is opened.	Check door switch (LF, RF, LR, RR, back)	DLK-267
		Glass ajar switch	Check glass ajar switch	DLK-303
		—	Check Intermittent Incident	GI-37
3	Vehicle security alarm does not activate.	Horn alarm	Check horn switch	—
			Check Intermittent Incident	GI-37
4	Vehicle security system cannot be canceled by	Key cylinder switch	Check key cylinder switch	DLK-292
			Check Intermittent Incident	GI-37

*: Check the system is in the armed phase.

NISSAN VEHICLE IMMOBILIZER SYSTEM-NATS SYMPTOMS

< SYMPTOM DIAGNOSIS >

[WITHOUT INTELLIGENT KEY SYSTEM]

NISSAN VEHICLE IMMOBILIZER SYSTEM-NATS SYMPTOMS

Symptom Table

INFOID:000000003710681

NOTE:

- Before performing the diagnosis in the following table, check "[SEC-111, "Work Flow"](#)".
- Check that vehicle is under the condition shown in "Conditions of vehicle" before starting diagnosis, and check each symptom.
- If the following symptoms are detected, check systems shown in the "Diagnosis/service procedure" column in this order.

CONDITIONS OF VEHICLE (OPERATING CONDITIONS)

- Mechanical key is not inserted into key cylinder.
- Ignition knob switch is not depressed.

Symptom	Diagnosis/service procedure	Reference page
Security indicator does not turn ON or flash.	1. Check vehicle security indicator	SEC-137
	2. Check Intermittent Incident	GI-37

A
B
C
D
E
F
G
H
I
J
L
M
N
O
P

SEC

ON-VEHICLE MAINTENANCE

PRE-INSPECTION FOR DIAGNOSTIC

Basic Inspection

INFOID:000000003710682

1. INSPECTION START

Turn ignition switch "OFF".

NOTE:

Before starting operation check, open front windows.

>> GO TO 2.

2. CHECK SECURITY INDICATOR LAMP

1. Lock doors using keyfob or mechanical key.
2. Check that security indicator lamp illuminates for 30 seconds.

Does the security indicator lamp illuminate?

YES >> GO TO 3.

NO >> Perform diagnosis and repair. Refer to [SEC-137. "Component Function Check"](#).

3. CHECK ALARM FUNCTION

1. After 30 seconds, security indicator lamp will start to blink.
2. Open any door before unlocking with keyfob or mechanical key, or open back door or glass hatch without keyfob.

Does the alarm function properly?

YES >> GO TO 4.

NO >> Check the following.

- The vehicle security system does not phase in alarm mode. Refer to [SEC-176. "Symptom Table"](#).
- Alarm (horn and headlamps) does not operate. Refer to [SEC-176. "Symptom Table"](#).

4. CHECK ALARM CANCEL OPERATION

Unlock any door using keyfob or mechanical key.

Alarm (horn and headlamps) should stop.

OK >> Inspection End.

NG >> Check door lock function. Refer to [DLK-246. "DOOR LOCK AND UNLOCK SWITCH : System Description"](#).

ON-VEHICLE REPAIR

VEHICLE SECURITY SYSTEM

Removal and Installation

INFOID:000000003710683

REMOTE KEYLESS ENTRY RECEIVER

Removal

1. Remove the instrument panel. Refer to [JP-11, "Removal and Installation"](#).
2. Disconnect the wire harness (1), remove the bolt (A), and the RKE receiver (2).

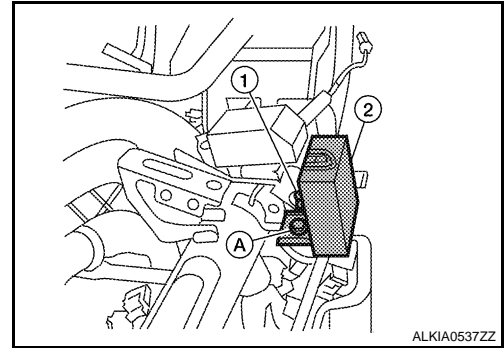

Installation

Installation is in the reverse order of removal.

NATS ANTENNA AMP

NOTE:

- If NATS antenna amp. is not installed correctly, NVIS (NATS) system will not operate properly and "SELF-DIAG RESULTS" on CONSULT -III screen will show "LOCK MODE" or "CHAIN OF IMMU-KEY"
- Initialization is not necessary when only the NATS antenna amp. is replaced with a new one.

Removal

1. Disconnect the battery negative terminal.
2. Remove the steering column covers. Refer to [JP-10, "Exploded View"](#).
3. Remove the bolt, disconnect the electrical connector, and remove the NATS antenna amp (1).

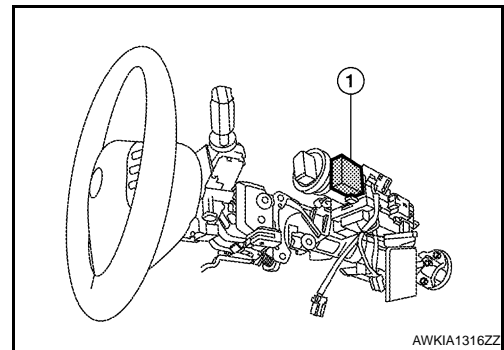

Installation

Installation is in the reverse order of removal.

A
B
C
D
E
F
G
H
I
J
L
M
N
O
P

SEC