

# SECTION **BCS**

## BODY CONTROL SYSTEM

A  
B  
C

### CONTENTS

<b>FUNCTION DIAGNOSIS</b> .....	<b>HEADLAMP</b> .....	F
	HEADLAMP : CONSULT-III Function (BCM - HEAD LAMP) .....	
<b>BODY CONTROL SYSTEM</b> .....	<b>WIPER</b> .....	G
System Description .....	WIPER : CONSULT - III Function (BCM - WIPER)...19	
Component Parts Location .....	<b>FLASHER</b> .....	H
<b>COMBINATION SWITCH READING SYSTEM</b> .....	FLASHER : CONSULT-III Function (BCM - FLASHER) .....	
..... 5	<b>INTELLIGENT KEY</b> .....	I
System Diagram .....	INTELLIGENT KEY : CONSULT-III Function (BCM - INTELLIGENT KEY) .....	
System Description .....	<b>COMB SW</b> .....	J
Component Parts Location .....	COMB SW : CONSULT-III Function (BCM - COMB SW) .....	
<b>SIGNAL BUFFER SYSTEM</b> .....	<b>BCM</b> .....	K
System Diagram .....	BCM : CONSULT-III Function (BCM - BCM) .....	
System Description .....	<b>IMMU</b> .....	L
<b>POWER CONSUMPTION CONTROL SYSTEM</b> .....	IMMU : CONSULT-III Function (BCM - IMMU) .....	
System Diagram .....	<b>BATTERY SAVER</b> .....	N
System Description .....	BATTERY SAVER : CONSULT-III Function (BCM - BATTERY SAVER) .....	
Component Parts Location .....	<b>TRUNK</b> .....	O
<b>DIAGNOSIS SYSTEM (BCM)</b> .....	TRUNK : CONSULT-III Function (BCM - TRUNK)...27	
<b>COMMON ITEM</b> .....	<b>THEFT ALM</b> .....	P
COMMON ITEM : CONSULT-III Function (BCM - COMMON ITEM) .....	THEFT ALM : CONSULT-III Function (BCM - THEFT) .....	
<b>DOOR LOCK</b> .....	<b>RETAINED PWR</b> .....	
DOOR LOCK : CONSULT-III Function (BCM - DOOR LOCK) .....	RETAINED PWR : CONSULT-III Function (BCM - RETAINED PWR) .....	
<b>REAR WINDOW DEFOGGER</b> .....	<b>SIGNAL BUFFER</b> .....	
REAR WINDOW DEFOGGER : CONSULT-III Function (BCM - REAR DEFOGGER) .....	SIGNAL BUFFER : CONSULT-III Function (BCM - SIGNAL BUFFER) .....	
<b>BUZZER</b> .....		
BUZZER : CONSULT-III Function (BCM - BUZZER) .....		
<b>INT LAMP</b> .....		
INT LAMP : CONSULT-III Function (BCM - INT LAMP) .....		

BCS

<b>AIR PRESSURE MONITOR</b> .....	<b>29</b>	Special Repair Requirement .....	40
AIR PRESSURE MONITOR : Diagnosis Description .....	29	<b>COMBINATION SWITCH OUTPUT CIRCUIT</b> ...	<b>41</b>
AIR PRESSURE MONITOR : CONSULT-III Function (BCM - AIR PRESSURE MONITOR) .....	31	Diagnosis Procedure .....	41
<b>COMPONENT DIAGNOSIS</b> .....	<b>33</b>	Special Repair Requirement .....	42
<b>U1000 CAN COMM CIRCUIT</b> .....	<b>33</b>	<b>ECU DIAGNOSIS</b> .....	<b>43</b>
Description .....	33	<b>BCM (BODY CONTROL MODULE)</b> .....	<b>43</b>
DTC Logic .....	33	Reference Value .....	43
Diagnosis Procedure .....	33	Wiring Diagram — BCM — .....	66
<b>U1010 CONTROL UNIT (CAN)</b> .....	<b>34</b>	Fail Safe .....	71
DTC Logic .....	34	DTC Inspection Priority Chart .....	73
Diagnosis Procedure .....	34	DTC Index .....	74
Special Repair Requirement .....	34	<b>SYMPTOM DIAGNOSIS</b> .....	<b>77</b>
<b>U0415 VEHICLE SPEED SIG</b> .....	<b>35</b>	<b>COMBINATION SWITCH SYSTEM SYMPTOMS</b> .....	<b>77</b>
Description .....	35	Symptom Table .....	77
DTC Logic .....	35	<b>PRECAUTION</b> .....	<b>78</b>
Diagnosis Procedure .....	35	<b>PRECAUTIONS</b> .....	<b>78</b>
<b>B2562 LOW VOLTAGE</b> .....	<b>36</b>	Precaution for Supplemental Restraint System (SRS) "AIR BAG" and "SEAT BELT PRE-TENSIONER" .....	78
DTC Logic .....	36	<b>ON-VEHICLE REPAIR</b> .....	<b>79</b>
Diagnosis Procedure .....	36	<b>BCM (BODY CONTROL MODULE)</b> .....	<b>79</b>
Special Repair Requirement .....	36	Exploded View .....	79
<b>B2563 HI VOLTAGE</b> .....	<b>37</b>	Removal and Installation .....	79
DTC Logic .....	37	<b>COMBINATION SWITCH</b> .....	<b>80</b>
Diagnosis Procedure .....	37	Exploded View .....	80
Special Repair Requirement .....	37	Removal and Installation .....	80
<b>POWER SUPPLY AND GROUND CIRCUIT</b> ....	<b>38</b>		
Diagnosis Procedure .....	38		
<b>COMBINATION SWITCH INPUT CIRCUIT</b> .....	<b>39</b>		
Diagnosis Procedure .....	39		

# BODY CONTROL SYSTEM

< FUNCTION DIAGNOSIS >

## FUNCTION DIAGNOSIS

### BODY CONTROL SYSTEM

#### System Description

INFOID:000000000963861

#### OUTLINE

- BCM (Body Control Module) controls the various electrical components. It inputs the information required to the control from CAN communication and the signal received from each switch and sensor.
- BCM has combination switch reading function for reading the operation status of combination switches (light, turn signal, wiper and washer) in addition to a function for controlling the operation of various electrical components. It also has the signal transmission function as the passed point of signal and the power saving control function that reduces the power consumption with the ignition switch OFF.
- BCM is equipped with the diagnosis function that performs the diagnosis with CONSULT-III and various settings.

#### BCM control function list

System	Refer to
Combination switch reading system	<a href="#">BCS-5, "System Description"</a>
Signal buffer system	<a href="#">BCS-9, "System Description"</a>
Power consumption control system	<a href="#">BCS-10, "System Description"</a>
Auto light system	<a href="#">EXL-13, "System Description"</a>
Turn signal and hazard warning lamp system	<a href="#">EXL-25, "System Description"</a>
Headlamp system	<a href="#">EXL-9, "System Description"</a>
Front fog lamp system	<a href="#">EXL-23, "System Description"</a>
Exterior lamp battery saver system	<a href="#">EXL-29, "System Description"</a>
Daytime running light system	<a href="#">EXL-16, "System Description"</a>
Interior room lamp control system	<a href="#">INL-6, "System Description"</a>
Step lamp system	
Interior room lamp battery saver system	<a href="#">INL-9, "System Description"</a>
Front wiper and washer system	<a href="#">WW-6, "System Description"</a>
Warning chime system	<a href="#">WCS-4, "WARNING CHIME SYSTEM : System Description"</a>
Door lock system	<a href="#">DLK-10, "DOOR LOCK AND UNLOCK SWITCH : System Description"</a>
Trunk open system	<a href="#">DLK-24, "TRUNK LID OPENER SWITCH : System Description"</a>
Infiniti Vehicle Immobilizer System (IVIS) - NATS	<a href="#">SEC-17, "System Description"</a>
Vehicle security system	<a href="#">SEC-23, "System Description"</a>
Panic alarm	
Automatic drive positioner system	<a href="#">ADP-15, "AUTOMATIC DRIVE POSITIONER SYSTEM : System Description"</a>
Rear window defogger system	<a href="#">DEF-4, "System Description"</a>

# BODY CONTROL SYSTEM

## < FUNCTION DIAGNOSIS >

System		Refer to
Intelligent Key system/engine start system	Door lock function	<ul style="list-style-type: none"> <li>• <a href="#">DLK-13, "DOOR REQUEST SWITCH : System Description"</a> (door request switch)</li> <li>• <a href="#">DLK-18, "INTELLIGENT KEY : System Description"</a> (Intelligent Key)</li> </ul>
	Trunk open function	<ul style="list-style-type: none"> <li>• <a href="#">DLK-27, "TRUNK REQUEST SWITCH : System Description"</a> (trunk request switch)</li> <li>• <a href="#">DLK-32, "INTELLIGENT KEY : System Description"</a> (Intelligent Key)</li> </ul>
	Warning function	<a href="#">DLK-37, "System Description"</a>
	Key reminder function	<a href="#">DLK-45, "System Description"</a>
	Engine start function	<a href="#">SEC-9, "System Description"</a>
Power window system		<ul style="list-style-type: none"> <li>• <a href="#">PWC-9, "System Description"</a> (front and rear window anti-pinch)</li> <li>• <a href="#">PWC-130, "System Description"</a> (front window anti-pinch)</li> </ul>
Retained accessory power (RAP) system		<a href="#">PWC-9, "System Description"</a>
Tire pressure monitor system (TPMS) - AIR PRESSURE MONITOR		<a href="#">WT-7, "System Description"</a>

## Component Parts Location

INFOID:000000000963862

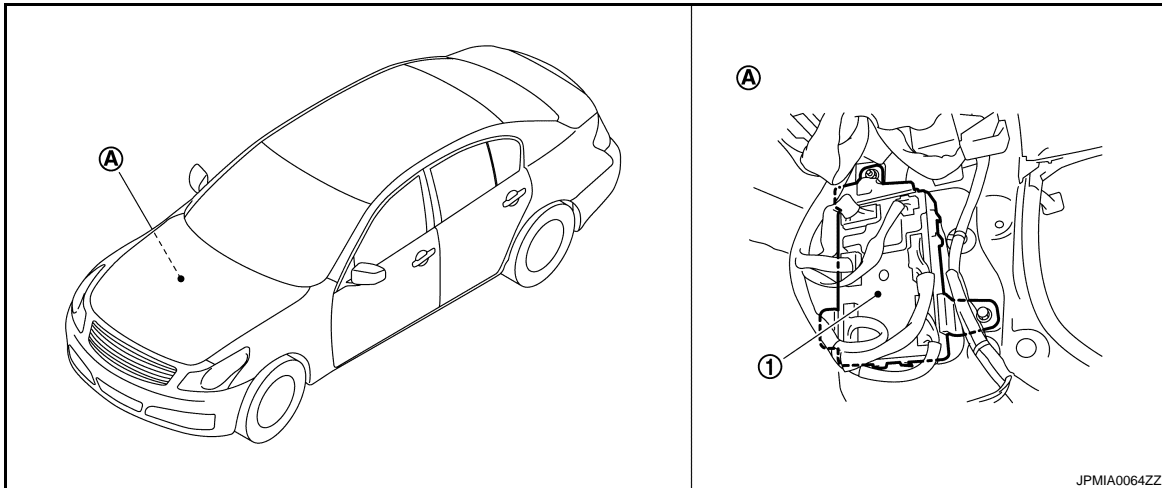

JPMIA0064ZZ

1. BCM
- A. Dash side lower (passenger side)

# COMBINATION SWITCH READING SYSTEM

< FUNCTION DIAGNOSIS >

## COMBINATION SWITCH READING SYSTEM

### System Diagram

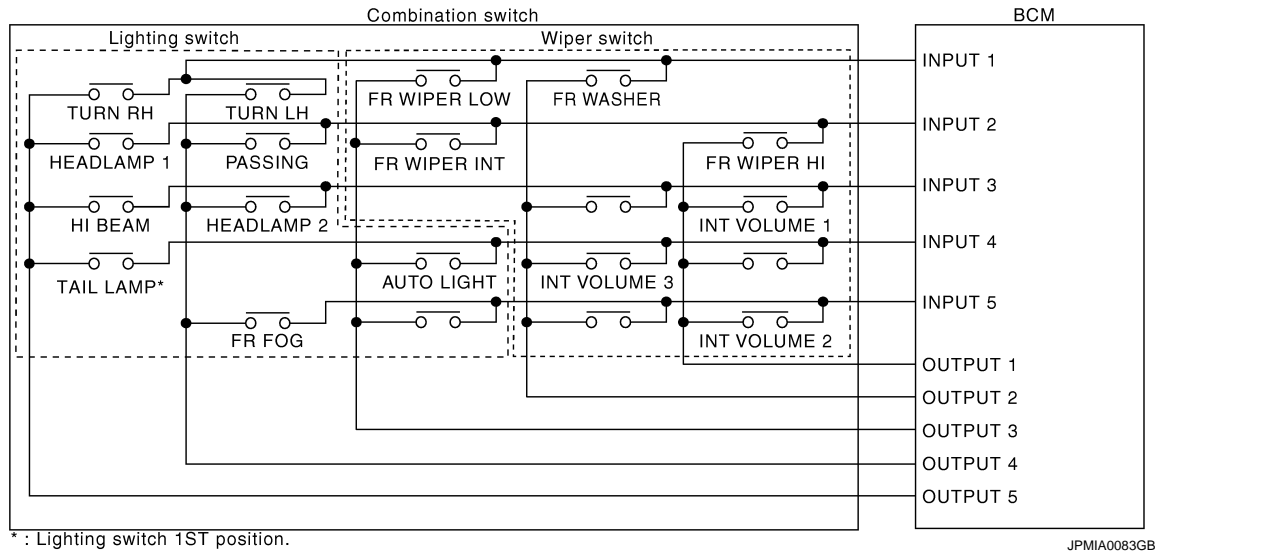

### System Description

#### OUTLINE

- BCM reads the status of the combination switch (light, turn signal, wiper and washer) and recognizes the status of each switch.
- BCM is a combination of 5 output terminals (OUTPUT 1 - 5) and 5 input terminals (INPUT 1 - 5). It reads a maximum of 20 switch status.

### COMBINATION SWITCH MATRIX

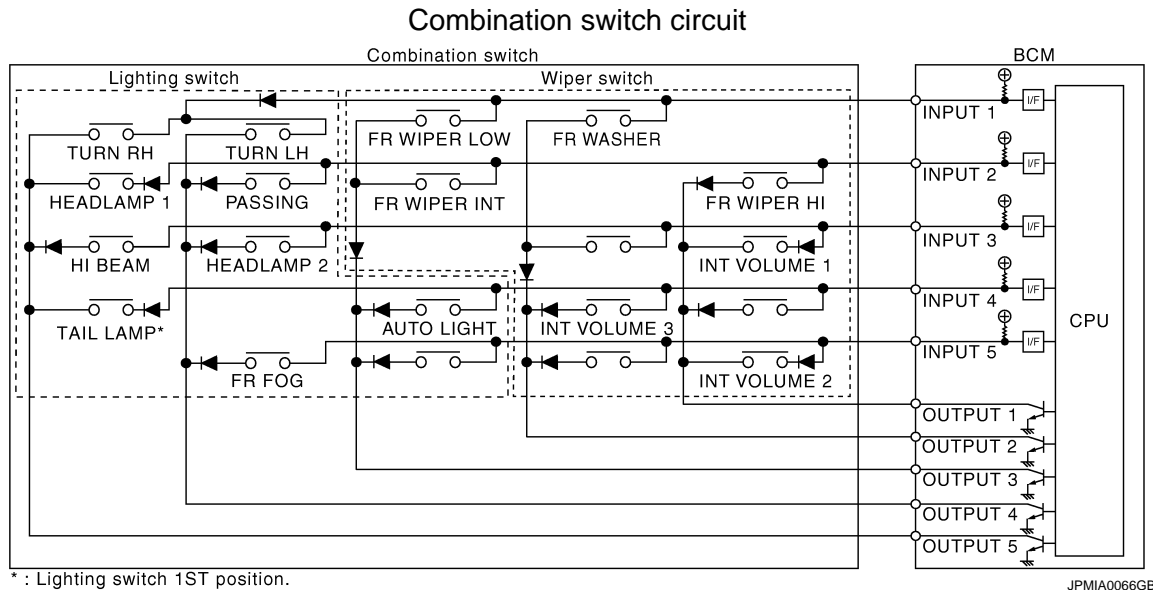

Combination switch INPUT-OUTPUT system list

System	OUTPUT 1	OUTPUT 2	OUTPUT 3	OUTPUT 4	OUTPUT 5
INPUT 1	—	FR WASHER	FR WIPER LOW	TURN LH	TURN RH
INPUT 2	FR WIPER HI	—	FR WIPER INT	PASSING	HEADLAMP 1
INPUT 3	INT VOLUME 1	—	—	HEADLAMP 2	HI BEAM

# COMBINATION SWITCH READING SYSTEM

## < FUNCTION DIAGNOSIS >

System	OUTPUT 1	OUTPUT 2	OUTPUT 3	OUTPUT 4	OUTPUT 5
INPUT 4	—	INT VOLUME 3	AUTO LIGHT	—	TAIL LAMP
INPUT 5	INT VOLUME 2	—	—	FR FOG	—

### NOTE:

Headlamp has a dual system switch.

## COMBINATION SWITCH READING FUNCTION

### Description

- BCM reads the status of the combination switch at 10 ms interval normally.

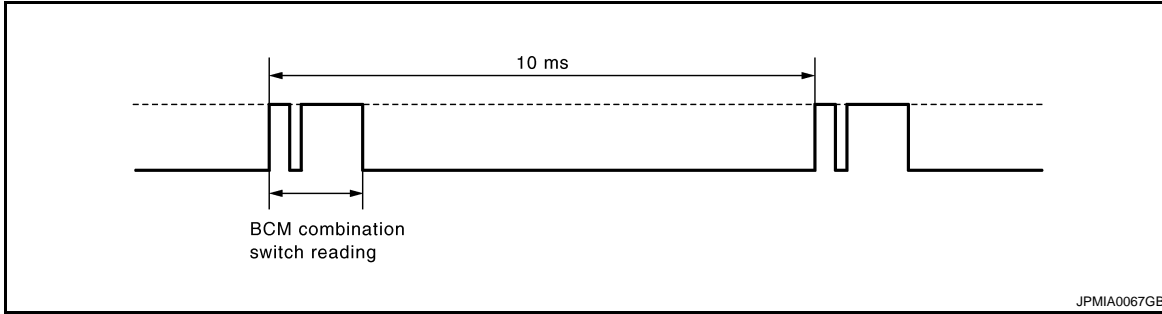

### NOTE:

BCM reads the status of the combination switch at 60 ms interval when BCM is controlled at low power consumption mode.

- BCM operates as follows and judges the status of the combination switch.
  - INPUT 1 - 5 outputs the voltage waveforms of 5 systems simultaneously.
  - It operates the transistor on OUTPUT side in the following order: OUTPUT 5 → 4 → 3 → 2 → 1.
  - The voltage waveform of INPUT corresponding to the formed circuit changes according to the operation of the transistor on OUTPUT side if any (1 or more) switches are ON.
  - It reads this change of the voltage as the status signal of the combination switch.

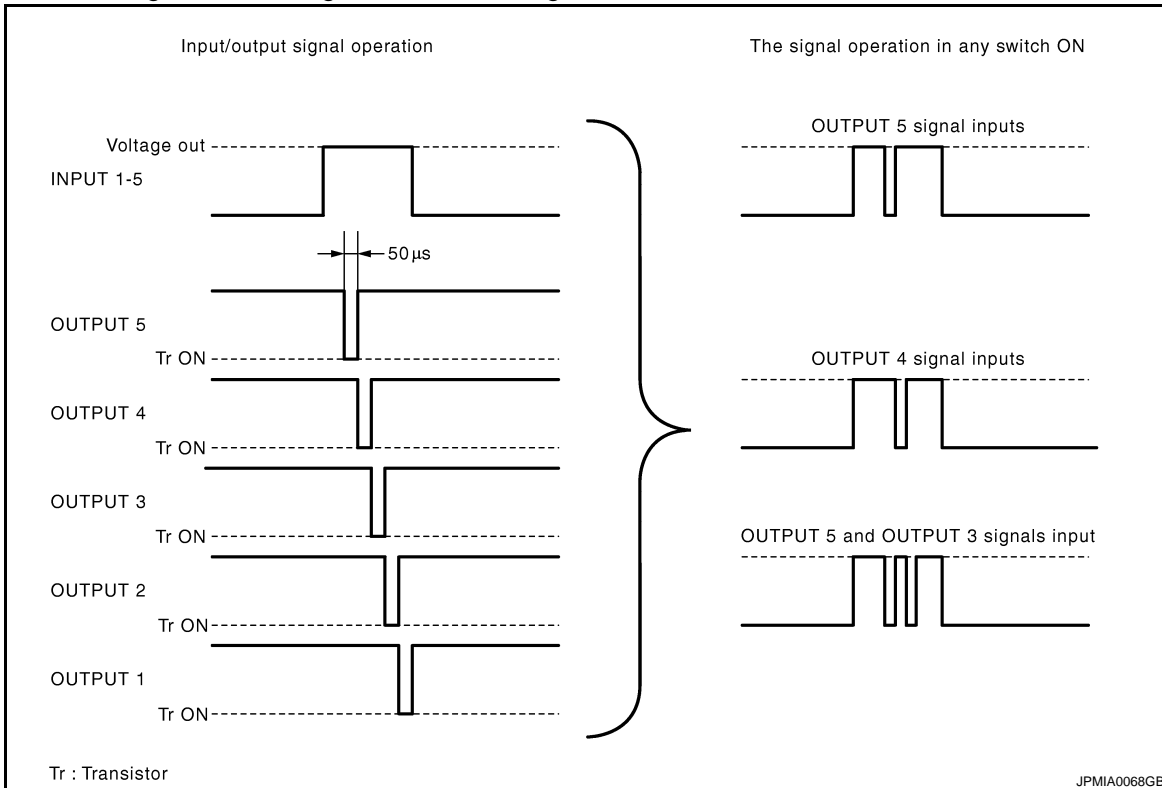

### Operation Example

In the following operation example, the combination of the status signals of the combination switch is replaced as follows: INPUT 1 - 5 to "1 - 5" and OUTPUT 1 - 5 to "A - E".

Example 1: When a switch (TURN RH switch) is turned ON

# COMBINATION SWITCH READING SYSTEM

## < FUNCTION DIAGNOSIS >

- The circuit between INPUT 1 and OUTPUT 5 is formed when the TURN RH switch is turned ON.

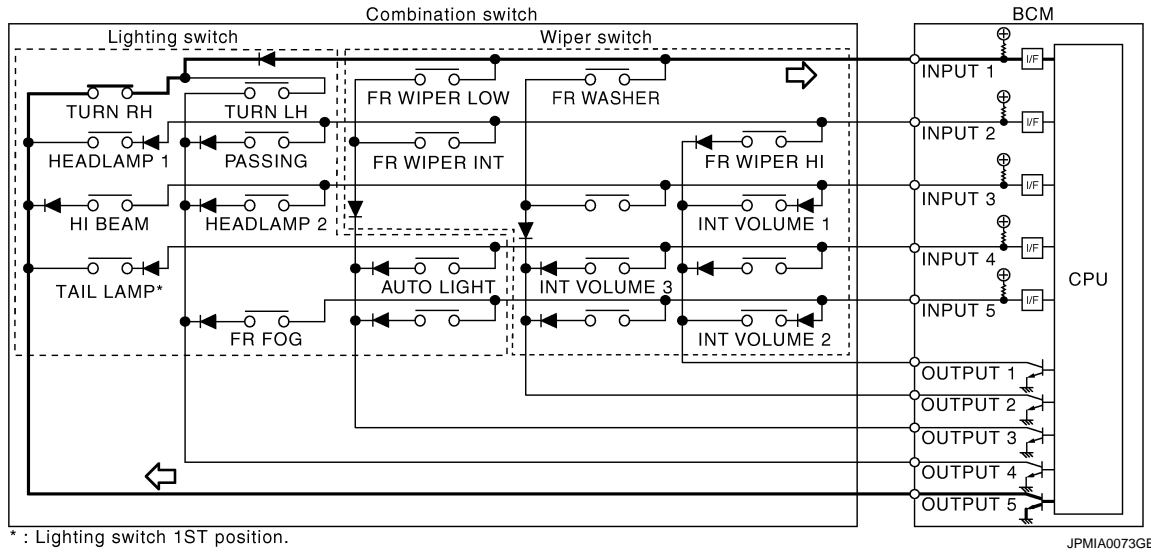

- BCM detects the combination switch status signal "1E" when the signal of OUTPUT 5 is input to INPUT 1.
- BCM judges that the TURN RH switch is ON when the signal "1E" is detected.

Example 2: When some switches (turn RH switch, front wiper LO switch) are turned ON

- The circuits between INPUT 1 and OUTPUT 5 and between INPUT 1 and OUTPUT 3 are formed when the TURN RH switch and FR WIPER LOW switch are turned ON.

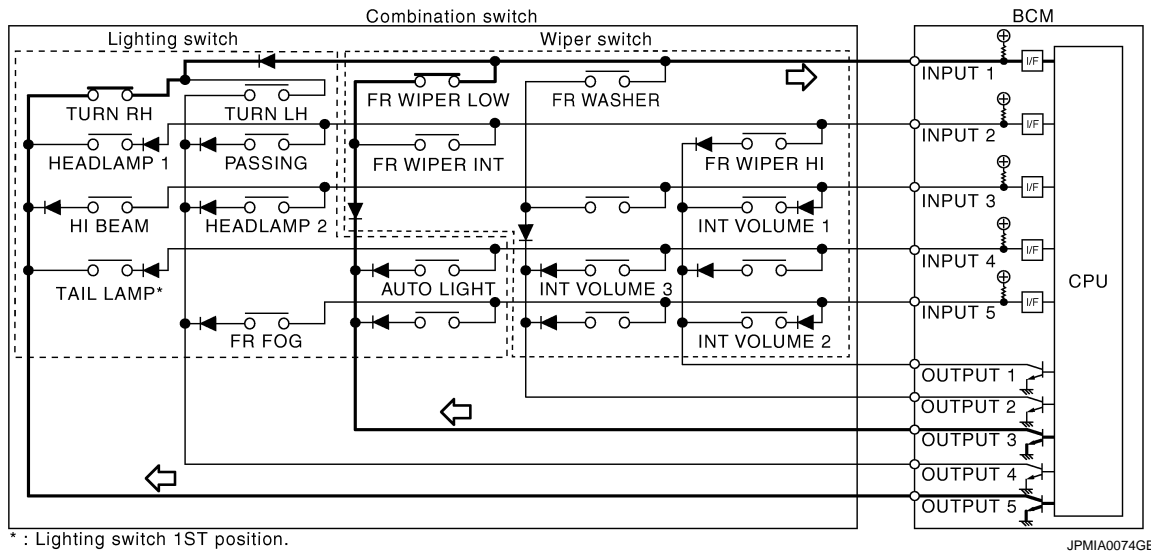

- BCM detects the combination switch status signal "1CE" when the signals of OUTPUT 3 and OUTPUT 5 are input to INPUT 1.
- BCM judges that the TURN RH switch and FR WIPER LOW switch are ON when the signal "1CE" is detected.

WIPER INTERMITTENT DIAL POSITION SETTING (FRONT WIPER INTERMITTENT OPERATION)

BCM judges the wiper intermittent dial 1 - 7 by the status of INT VOLUME 1, 2 and 3 switches.

# COMBINATION SWITCH READING SYSTEM

## < FUNCTION DIAGNOSIS >

Wiper intermittent dial position	Intermittent operation delay interval	INT VOLUME switch ON/OFF status		
		INT VOLUME 1 switch	INT VOLUME 2 switch	INT VOLUME 3 switch
1	Short	ON	ON	ON
2		ON	ON	OFF
3		ON	OFF	OFF
4	↑ ↓ Long	OFF	OFF	OFF
5		OFF	OFF	ON
6		OFF	ON	ON
7		OFF	ON	OFF

## Component Parts Location

INFOID:000000000963865

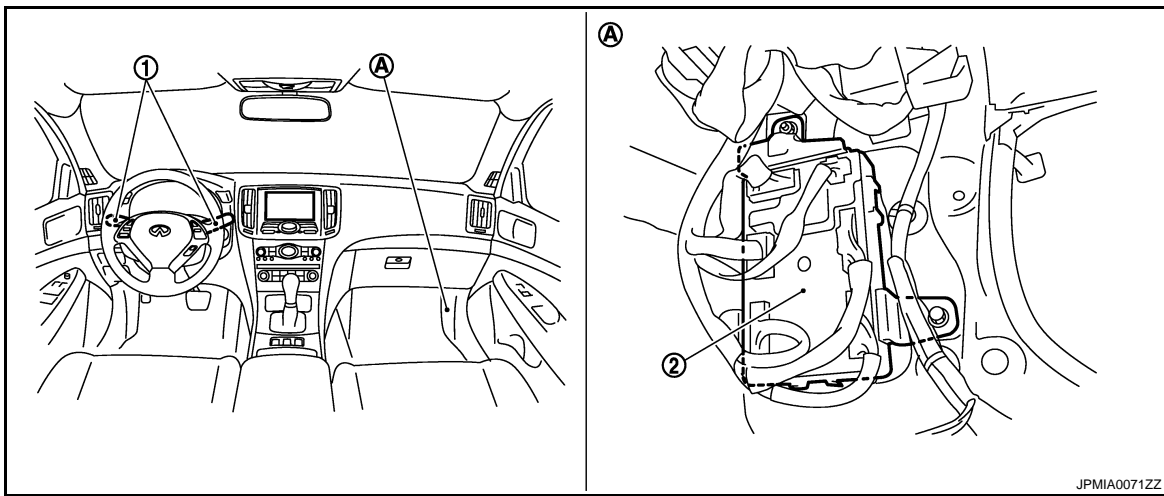

JPMIA0071ZZ

- 1. Combination switch
- 2. BCM
- A. Dash side lower (passenger side)



# SIGNAL BUFFER SYSTEM

< FUNCTION DIAGNOSIS >

## SIGNAL BUFFER SYSTEM

### System Diagram

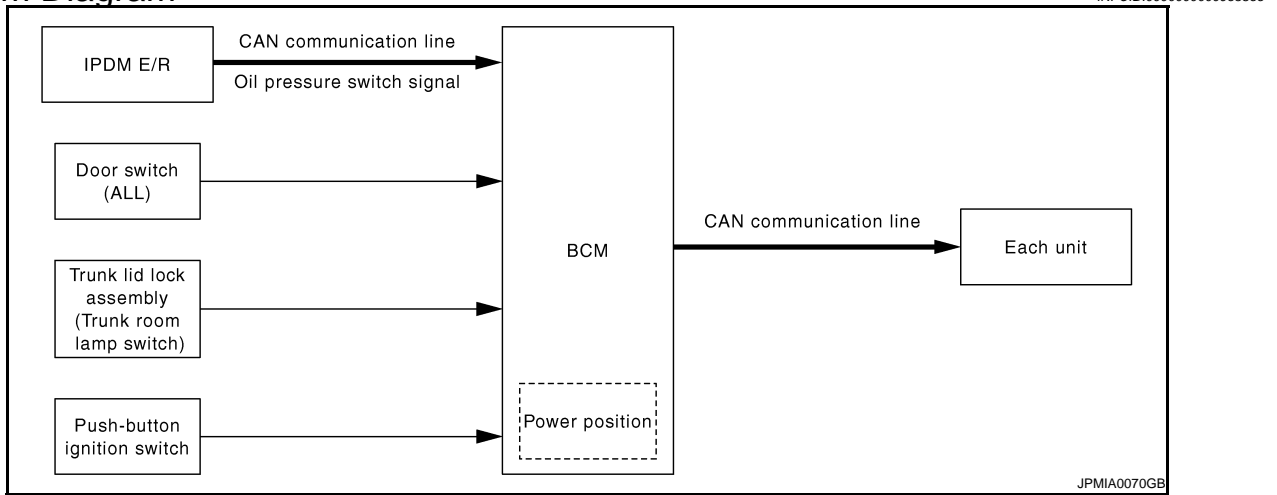

### System Description

INFOID:000000000963867

#### OUTLINE

BCM has the signal transmission function that outputs/transmits each input/received signal to each unit.

#### Signal transmission function list

Signal name	Input	Output	Description
<ul style="list-style-type: none"> <li>Ignition switch ON signal</li> <li>Ignition switch signal</li> </ul>	Push-button ignition switch (push switch)	<ul style="list-style-type: none"> <li>IPDM E/R (CAN)</li> <li>Driver seat control unit (CAN)</li> </ul>	Inputs the push-button ignition switch (push switch) signal and transmits the ignition switch status judged with BCM via CAN communication.
Door switch signal	Any door switch	<ul style="list-style-type: none"> <li>Combination meter (via unified meter and A/C amp.) (CAN)</li> <li>IPDM E/R (CAN)</li> <li>Driver seat control unit (CAN)</li> <li>AV control unit (CAN)</li> </ul>	Inputs the door switch signal and transmits it via CAN communication.
Trunk switch signal	Trunk room lamp switch	<ul style="list-style-type: none"> <li>Combination meter (via unified meter and A/C amp.) (CAN)</li> <li>AV control unit (CAN)</li> </ul>	Inputs the trunk room lamp switch signal and transmits the trunk switch signal via CAN communication.
Oil pressure switch signal	IPDM E/R (CAN)	Combination meter (via unified meter and A/C amp.) (CAN)	Transmits the received oil pressure switch signal via CAN communication.

A  
B  
C  
D  
E  
F  
G  
H  
I  
J  
K  
L  
N  
O  
P

BCS

# POWER CONSUMPTION CONTROL SYSTEM

< FUNCTION DIAGNOSIS >

## POWER CONSUMPTION CONTROL SYSTEM

### System Diagram

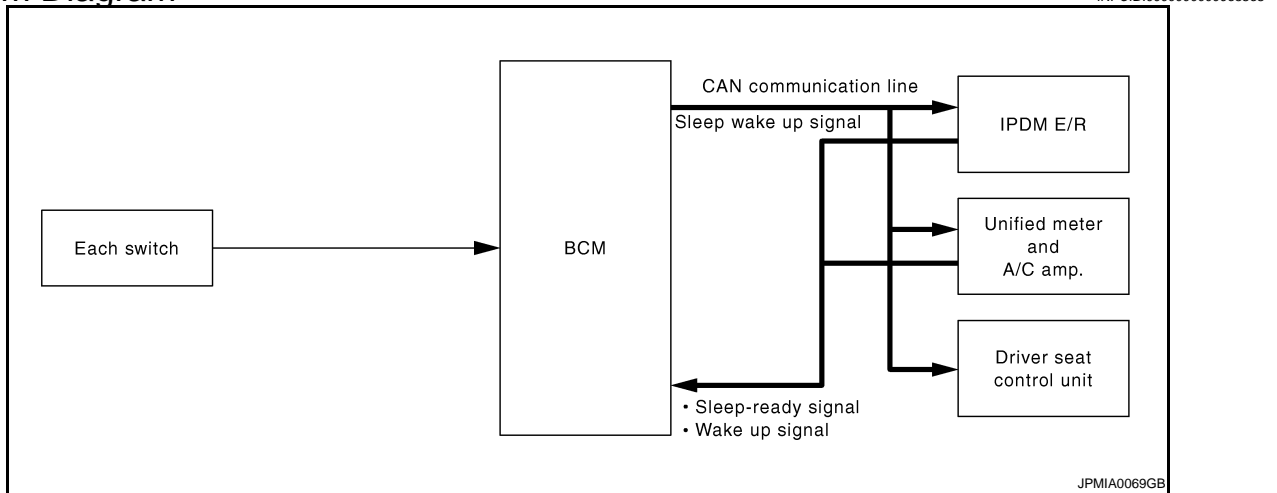

### System Description

INFOID:000000000963869

#### OUTLINE

- BCM incorporates a power saving control function that reduces the power consumption according to the vehicle status.
- BCM switches the status (control mode) by itself with the power saving control function. It performs the sleep request to each unit [IPDM E/R, combination meter (unified meter and A/C amp.) and driver seat control unit] that operates with the ignition switch OFF.

#### Normal mode (wake-up)

- CAN communication is normally performed with other units
- Each control with BCM is operating properly

#### CAN communication sleep mode (CAN sleep)

- CAN transmission is stopped
- Control with BCM only is operating

#### Low power consumption mode (BCM sleep)

- Low power consumption control is active
- CAN transmission is stopped

#### LOW POWER CONSUMPTION CONTROL WITH BCM

BCM reduces the power consumption with the following operation in the low power consumption mode.

- The reading interval of the each switches changes from 10 ms interval to 60 ms interval.

#### Sleep mode activation

- BCM receives the sleep-ready signal (ready) from IPDM E/R and unified meter and A/C amp. via CAN communication.
- BCM transmits the sleep wake up signal (sleep) to each unit when all of the CAN sleep conditions are fulfilled.
- Each unit stops the transmission of CAN communication with the sleep wake up signal. BCM is in CAN communication sleep mode.
- BCM is in the low power consumption mode and perform the low power consumption control when all of the BCM sleep conditions are fulfilled with CAN sleep condition.

# POWER CONSUMPTION CONTROL SYSTEM

## < FUNCTION DIAGNOSIS >

### Sleep condition

CAN sleep condition	BCM sleep condition
<ul style="list-style-type: none"> <li>Receiving the sleep-ready signal (ready) from all units</li> <li>Ignition switch: OFF</li> <li>Vehicle security system and panic alarm: Not operation</li> <li>Warning lamp: Not operation</li> <li>Intelligent Key system buzzer: Not operation</li> <li>Trunk room lamp switch status: No change</li> <li>Brake switch: OFF</li> <li>Key slot (card switch) status: No change</li> <li>Turn signal indicator lamp: Not operation</li> <li>Exterior lamp: OFF</li> <li>Door lock status: No change</li> <li>CONSULT-III communication status: Not communication</li> <li>Meter display signal: Non-transmission</li> <li>Steering lock operation: Not operation</li> <li>Door switch status: No change</li> <li>Rear window defogger: OFF</li> </ul>	<ul style="list-style-type: none"> <li>Interior room lamp battery saver: Time out</li> <li>RAP system: OFF</li> <li>Power window switch communication: No transmission</li> <li>Push-button ignition switch illumination: OFF</li> <li>Infiniti Vehicle Immobilizer System (IVIS) - NATS: Not operation</li> <li>Remote keyless entry receiver communication status: No communication</li> <li>Tire pressure monitor system (TPMS) - AIR PRESSURE MONITOR: Stop</li> </ul>

### Wake-up operation

- BCM changes from the low power consumption mode to the CAN communication sleep mode when the any of the BCM wake-up conditions is fulfilled. Only the control with BCM is activated.
- BCM transmits the sleep wake up signal (wake up) to each unit when any of the CAN wake-up conditions is fulfilled. It changes from the low power consumption mode or the CAN communication sleep mode to the normal mode.
- Each unit starts the transmission of CAN communication with the sleep wake up signal. In addition, the unified meter and A/C amp. transmits the wake up signal to BCM via CAN communication to report the CAN communication start.

### Wake-up condition

BCM wake-up condition	CAN wake-up condition
<ul style="list-style-type: none"> <li>Trunk lid opener switch: OFF → ON</li> <li>Power window switch communication: Receiving</li> <li>Remote keyless entry receiver: Receiving</li> </ul>	<ul style="list-style-type: none"> <li>Receiving the sleep-ready signal (Not-ready) from any units</li> <li>Key slot (key switch): OFF → ON, ON → OFF</li> <li>Push-button ignition switch (push switch): OFF → ON</li> <li>Hazard switch: OFF → ON</li> <li>PASSING switch: OFF → ON, ON → OFF</li> <li>TAIL LAMP switch: OFF → ON</li> <li>Driver door switch: OFF → ON, ON → OFF</li> <li>Passenger door switch: OFF → ON, ON → OFF</li> <li>Rear RH door switch: OFF → ON, ON → OFF</li> <li>Rear LH door switch: OFF → ON, ON → OFF</li> <li>Trunk room lamp switch: OFF → ON, ON → OFF</li> <li>Driver door request switch: OFF → ON</li> <li>Passenger door request switch: OFF → ON</li> <li>Trunk request switch: OFF → ON</li> <li>Stop lamp switch 2 signal: ON</li> <li>Clutch interlock switch: OFF → ON</li> </ul>

## Component Parts Location

INFOID:000000000963870

# POWER CONSUMPTION CONTROL SYSTEM

## < FUNCTION DIAGNOSIS >

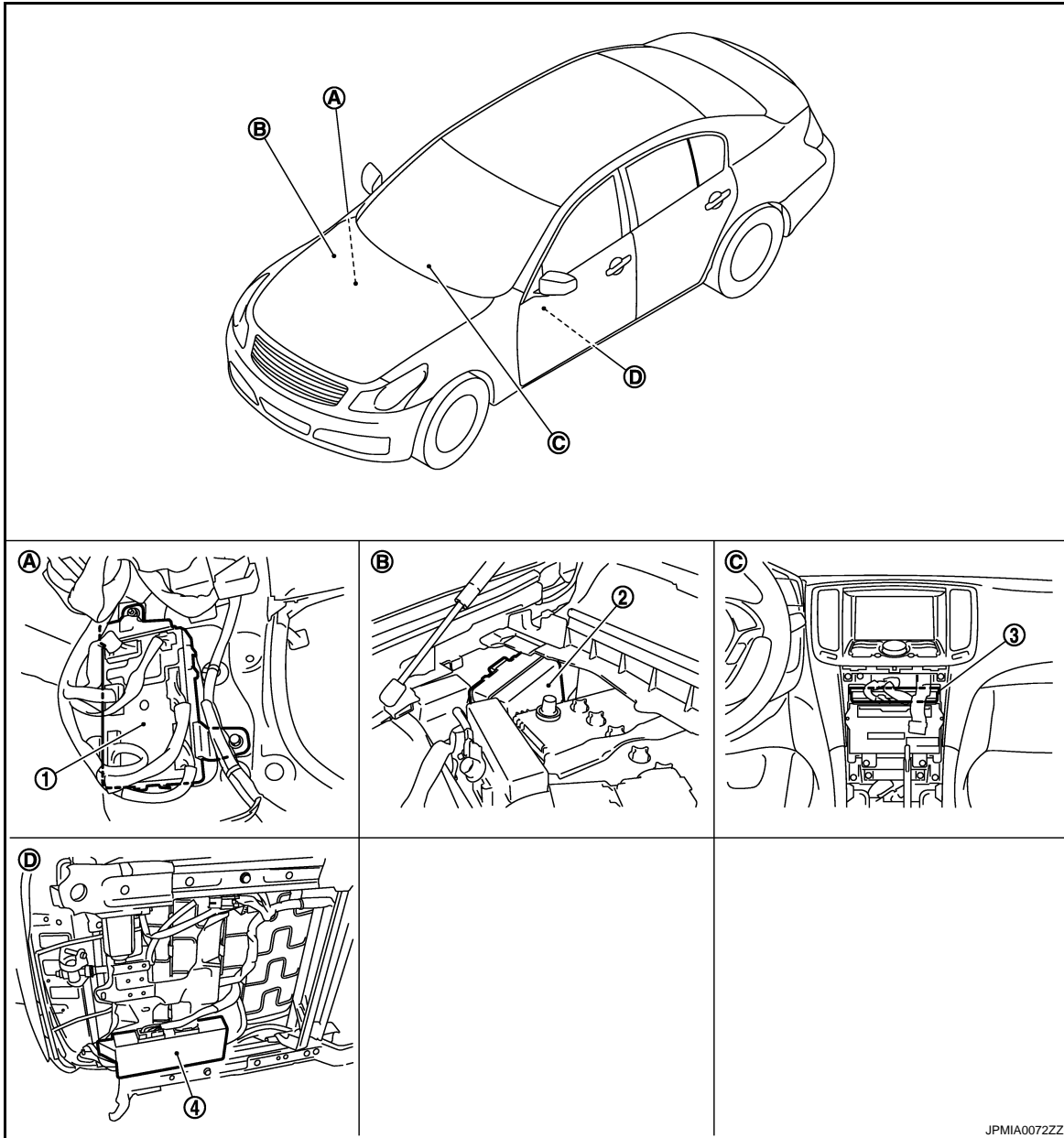

- |   |                                |                               |
|---|--------------------------------|-------------------------------|
| 1. BCM  | 2. IPDM E/R                    | 3. Unified meter and A/C amp. |
| 4. Driver seat control unit                   |                                |                               |
| A. Dash side lower (passenger side)           | B. Engine room dash panel (RH) | C. Behind Cluster lid C       |
| D. Backside of the seat cushion (driver seat) |                                |                               |

# DIAGNOSIS SYSTEM (BCM)

< FUNCTION DIAGNOSIS >

## DIAGNOSIS SYSTEM (BCM)

### COMMON ITEM

#### COMMON ITEM : CONSULT-III Function (BCM - COMMON ITEM)

INFOID:000000000963871

#### APPLICATION ITEM

CONSULT-III performs the following functions via CAN communication with BCM.

Diagnosis mode	Function Description
WORK SUPPORT	Changes the setting for each system function.
SELF-DIAG RESULTS	Displays the diagnosis results judged by BCM. Refer to <a href="#">BCS-74, "DTC Index"</a> .
CAN DIAG SUPPORT MNTR	Monitors the reception status of CAN communication viewed from BCM.
DATA MONITOR	The BCM input/output signals are displayed.
ACTIVE TEST	The signals used to activate each device are forcibly supplied from BCM.
ECU IDENTIFICATION	The BCM part number is displayed.
CONFIGURATION	This function is not used even though it is displayed.

#### SYSTEM APPLICATION

BCM can perform the following functions for each system.

#### NOTE:

It can perform the diagnosis modes except the following for all sub system selection items.

System	Sub system selection item	Diagnosis mode		
		WORK SUPPORT	DATA MONITOR	ACTIVE TEST
Door lock	DOOR LOCK	×	×	×
Rear window defogger	REAR DEFOGGER		×	×
Warning chime	BUZZER		×	×
Interior room lamp timer	INT LAMP	×	×	×
Exterior lamp	HEAD LAMP	×	×	×
Wiper and washer	WIPER	×	×	×
Turn signal and hazard warning lamps	FLASHER	×	×	×
Air conditioner*	AIR CONDITONER		×	
Intelligent Key system	INTELLIGENT KEY	×	×	×
Combination switch	COMB SW		×	
BCM	BCM	×		
IVIS - NATS	IMMU		×	×
Interior room lamp battery saver	BATTERY SAVER	×	×	×
Trunk open	TRUNK		×	
Vehicle security system	THEFT ALM	×	×	×
RAP system	RETAINED PWR		×	
Signal buffer system	SIGNAL BUFFER		×	×
TPMS	TPMS (AIR PRESSURE MONI-TOR)	×	×	×

\*: This item is displayed, but is not used.

## DOOR LOCK

#### DOOR LOCK : CONSULT-III Function (BCM - DOOR LOCK)

INFOID:000000000963872

#### BCM CONSULT-III FUNCTION

CONSULT-III performs the following functions via CAN communication with BCM.

# DIAGNOSIS SYSTEM (BCM)

## < FUNCTION DIAGNOSIS >

Diagnosis mode	Function Description
WORK SUPPORT	Changes the setting for each system function.
DATA MONITOR	The BCM input/output signals are displayed.
ACTIVE TEST	The signals used to activate each device are forcibly supplied from BCM.

### WORK SUPPORT

Monitor item	Description
DOOR LOCK-UNLOCK SET	Selective unlock function mode can be changed to operate (WITH) or not operate (WITHOUT) with this mode.
D/LOCK VHCL SPD AJT	Lock with speed customize function mode can be changed to operate (WITH) or not operate (WITHOUT) with this mode.

### DATA MIONITOR

Monitor Item	Contents
REQ SW-DR	Indicated [ON/OFF] condition of door request switch (driver side).
REQ SW-AS	Indicated [ON/OFF] condition of door request switch (passenger side).
REQ SW-BD/TR	Indicated [ON/OFF] condition of trunk opener request switch.
DOOR SW-DR	Indicated [ON/OFF] condition of front door switch (driver side).
DOOR SW-AS	Indicated [ON/OFF] condition of front door switch (passenger side).
DOOR SW-RR	Indicated [ON/OFF] condition of rear door switch RH.
DOOR SW-RL	Indicated [ON/OFF] condition of rear door switch LH.
DOOR SW-BK	<b>NOTE:</b> This item is displayed, but cannot be monitored.
CDL LOCK SW	Indicated [ON/OFF] condition of lock signal from door lock unlock switch.
CDL UNLOCK SW	Indicated [ON/OFF] condition of unlock signal from door lock unlock switch.
KEY CYL LK-SW	Indicated [ON/OFF] condition of lock signal from key cylinder.
KEY CYL UN-SW	Indicated [ON/OFF] condition of unlock signal from key cylinder.

### ACTIVE TEST

Test item	Description
DOOR LOCK	<p>This test is able to check door lock/unlock operation.</p> <ul style="list-style-type: none"> <li>The all door lock actuators are locked when "LOCK" on CONSULT-III screen is touched.</li> <li>The all door lock actuators are unlocked when "ALL UNLK" on CONSULT-III screen is touched.</li> <li>The door lock actuator (driver side) is unlocked when "DR UNLK" on CONSULT-III screen is touched.</li> <li>The door lock actuator (passenger side) is unlocked when "AS UNLK" on CONSULT- III screen is touched.</li> <li>The door lock actuator (other) is unlocked when "OTR ULK" on CONSULT-III screen is touched.</li> </ul>

### REAR WINDOW DEFOGGER

#### REAR WINDOW DEFOGGER : CONSULT-III Function (BCM - REAR DEFOGGER)

INFOID:000000000963873

#### Data monitor

Monitor Item	Description
REAR DEF SW	This is displayed even when it is not equipped.
PUSH SW	Indicates [ON/OFF] condition of push switch.

### ACTIVE TEST

# DIAGNOSIS SYSTEM (BCM)

## < FUNCTION DIAGNOSIS >

Test Item	Description
REAR DEFOGGER	This test is able to check rear window defogger operation. Rear window defogger operates when "ON" on CONSULT-III screen is touched.

## BUZZER

### BUZZER : CONSULT-III Function (BCM - BUZZER)

INFOID:000000000963874

#### CONSULT-III APPLICATION ITEMS

Test item	Diagnosis mode	Description
BUZZER	Data Monitor	Displays BCM input data in real time.
	Active Test	Operation of electrical loads can be checked by sending driving signal to them.

#### DATA MONITOR

Display item [Unit]	Description
VEH SPEED 1 [Km/h]	Value of vehicle speed signal received from ABS actuator and electric unit (control unit) with CAN communication line.
PUSH SW [On/Off]	Status of push button ignition switch judged by BCM.
UNLK SEN-DR [On/Off]	Status of unlock sensor judged by BCM.
KEY SW-SLOT [On/Off]	Status of key slot judged by BCM.
TAIL LAMP SW [On/Off]	Status of each switch judged by BCM using the combination switch readout function.
FR FOG SW [On/Off]	Status of front fog lamp switch judged by BCM.
DOOR SW-DR [On/Off]	Status of driver side door switch judged by BCM.

#### ACTIVE TEST

Display item [Unit]	Description
IGN KEY WARN ALM	The key warning chime operation can be checked by operating the relevant function (On/Off).
SEAT BELT WARN TEST	The seat belt warning chime operation can be checked by operating the relevant function (On/Off).
ID REGIST WARNING	The ID regist warning chime operation can be checked by operating the relevant function (On/Off).
LIGHT WARN ALM	The light warning chime operation can be checked by operating the relevant function (On/Off).
RUN FLAT/T WARN BUZZER	The run-flat tire warning chime operation can be checked by operating the relevant function (On/Off).

## INT LAMP

### INT LAMP : CONSULT-III Function (BCM - INT LAMP)

INFOID:000000000963875

# DIAGNOSIS SYSTEM (BCM)

< FUNCTION DIAGNOSIS >

## WORK SUPPORT

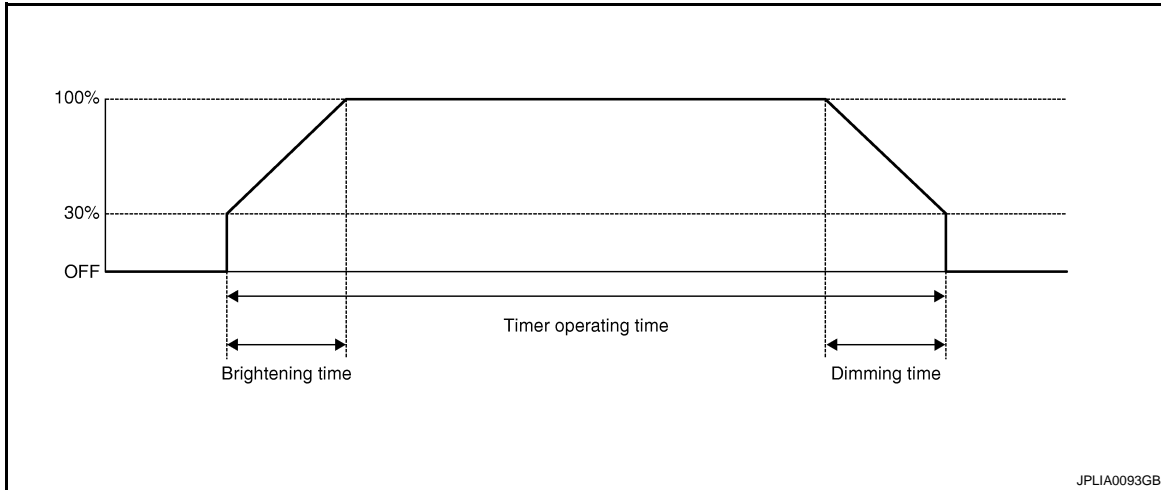

Service item	Setting item	Setting
ROOM LAMP TIMER SET	MODE 2	7.5 sec.
	MODE 3*	15 sec.
	MODE 4	30 sec.
SET I/L D-UNLCK INTCON	ON*	With the interior room lamp timer function
	OFF	Without the interior room lamp timer function
ROOM LAMP ON TIME SET	MODE 1	0.5 sec.
	MODE 2*	1 sec.
	MODE 3	2 sec.
	MODE 4	3 sec.
	MODE 5	0 sec.
ROOM LAMP OFF TIME SET	MODE 1	0.5 sec.
	MODE 2	1 sec.
	MODE 3	2 sec.
	MODE 4*	3 sec.
	MODE 5	0 sec.
R LAMP TIMER LOGIC SET	ON*	Interior room lamp timer activates with synchronizing all doors.
	OFF	Interior room lamp timer activates with synchronizing the driver door only.

\*: Initial setting

## DATA MONITOR

Monitor item [Unit]	Description
REQ SW-DR [ON/OFF]	The switch status input from request switch (driver side)
REQ SW-AS [ON/OFF]	The switch status input from front request switch (passenger side)
PUSH SW [ON/OFF]	The switch status input from push-button ignition switch
ACC RLY-F/B [ON/OFF]	ACC relay feedback signal status input from ACC relay
KEY SW-SLOT [ON/OFF]	Key switch status input from key slot



# DIAGNOSIS SYSTEM (BCM)

## < FUNCTION DIAGNOSIS >

Monitor item [Unit]	Description
DOOR SW-DR [ON/OFF]	The switch status input from front door switch (driver side)
DOOR SW-AS [ON/OFF]	The switch status input from front door switch (passenger side)
DOOR SW-RR [ON/OFF]	The switch status input from rear door switch RH
DOOR SW- RL [ON/OFF]	The switch status input from rear door switch LH
DOOR SW-BK [ON/OFF]	<b>NOTE:</b> The item is indicated, but not monitored.
CDL LOCK SW [ON/OFF]	Lock switch status received from central door lock switch by power window switch serial link
CDL UNLOCK SW [ON/OFF]	Unlock switch status received from central door lock switch by power window switch serial link
KEY CYL LK-SW [ON/OFF]	Lock switch status received from key cylinder switch by power window switch serial link
KEY CYL UN-SW [ON/OFF]	Unlock switch status received from key cylinder switch by power window switch serial link
TRNK/HAT MNTR [ON/OFF]	The switch status input from trunk room lamp switch
RKE-LOCK [ON/OFF]	Lock signal status received from remote keyless entry receiver
RKE-UNLOCK [ON/OFF]	Unlock signal status received from remote keyless entry receiver

## ACTIVE TEST

Test item	Operation	Description
INT LAMP	ON	Outputs the interior room lamp control signal to turn map lamp and personal lamp ON (Map lamp switch is in DOOR position).
	OFF	Stops the interior room lamp control signal to turn map lamp and personal lamp OFF.
STEP LAMP TEST	ON	Outputs the step lamp control signal to turn step lamp ON.
	OFF	Stops the step lamp control signal to turn step lamp OFF.
LUGGAGE LAMP TEST	ON	Outputs the trunk room lamp control signal to turn step lamp ON.
	OFF	Stops the trunk room lamp control signal to turn step lamp ON.

## HEADLAMP

### HEADLAMP : CONSULT-III Function (BCM - HEAD LAMP)

INFOID:000000000963876

## WORK SUPPORT

Service item	Setting item	Setting
BATTERY SAVER SET	ON*	With the exterior lamp battery saver function
	OFF	Without the exterior lamp battery saver function

# DIAGNOSIS SYSTEM (BCM)

## < FUNCTION DIAGNOSIS >

Service item	Setting item	Setting
ILL DELAY SET	MODE 1*	45 sec.
	MODE 2	Without the function
	MODE 3	30 sec.
	MODE 4	60 sec.
	MODE 5	90 sec.
	MODE 6	120 sec.
	MODE 7	150 sec.
	MODE 8	180 sec.
Sets delay timer function timer operation time. (All doors closed)		
CUSTOM A/LIGHT SETTING	MODE 1*	Normal
	MODE 2	More sensitive setting than normal setting (Turns ON earlier than normal operation.)
	MODE 3	More sensitive setting than MODE 2 (Turns ON earlier than MODE 2.)
	MODE 4	Less sensitive setting than normal setting (Turns ON later than normal operation.)

\*: Initial setting

## DATA MONITOR

Monitor item [Unit]	Description
PUSH SW [ON/OFF]	The switch status input from push-button ignition switch
ENGINE STATE [STOP/STALL/CRANK/RUN]	The engine status received from ECM with CAN communication
VEH SPEED 1 [km/h]	The value of the vehicle speed received from unified meter and A/C amp. with CAN communication
KEY SW-SLOT [ON/OFF]	Key switch status input from key slot
TURN SIGNAL R [ON/OFF]	Each switch status that BCM judges from the combination switch reading function
TURN SIGNAL L [ON/OFF]	
TAIL LAMP SW [ON/OFF]	
HI BEAM SW [ON/OFF]	
HEAD LAMP SW1 [ON/OFF]	
HEAD LAMP SW2 [ON/OFF]	
PASSING SW [ON/OFF]	
AUTO LIGHT SW [ON/OFF]	
FR FOG SW [ON/OFF]	
RR FOG SW [ON/OFF]	
DOOR SW-DR [ON/OFF]	
DOOR SW-AS [ON/OFF]	The switch status input from front door switch (passenger side)

# DIAGNOSIS SYSTEM (BCM)

## < FUNCTION DIAGNOSIS >

Monitor item [Unit]	Description
DOOR SW-RR [ON/OFF]	The switch status input from rear door switch RH
DOOR SW- RL [ON/OFF]	The switch status input from rear door switch LH
DOOR SW-BK [ON/OFF]	<b>NOTE:</b> The item is indicated, but not monitored.
OPTICAL SENSOR [V]	The value of exterior brightness voltage input from the optical sensor

## ACTIVE TEST

Test item	Operation	Description
TAIL LAMP	ON	Transmits the position light request signal to IPDM E/R with CAN communication to turn the tail lamp ON.
	OFF	Stops the tail lamp request signal transmission.
HEAD LAMP	HI	Transmits the high beam request signal with CAN communication to turn the headlamp (HI).
	LO	Transmits the low beam request signal with CAN communication to turn the headlamp (LO).
	OFF	Stops the high & low beam request signal transmission.
FR FOG LAMP	ON	Transmits the front fog lights request signal to IPDM E/R with CAN communication to turn the front fog lamp ON.
	OFF	Stops the front fog lights request signal transmission.
RR FOG LAMP	ON	<b>NOTE:</b>
	OFF	The item is indicated, but cannot be tested.
DAYTIME RUNNING LIGHT	ON	<b>NOTE:</b>
	OFF	The item is indicated, but cannot be tested.
CORNERING LAMP	RH	<b>NOTE:</b>
	LH	The item is indicated, but cannot be tested.
	OFF	
ILL DIM SIGNAL	ON	<b>NOTE:</b>
	OFF	The item is indicated, but cannot be tested.

## WIPER

### WIPER : CONSULT - III Function (BCM - WIPER)

INFOID:000000000963877

BCS

## WORK SUPPORT

Service item	Setting item	Description
WIPER SPEED SETTING	ON	With vehicle speed (Front wiper intermittent time linked with the vehicle speed and wiper intermittent dial position)
	OFF*	Without vehicle speed (Front wiper intermittent time linked with the wiper intermittent dial position)

\*:Factory setting

## DATA MONITOR

# DIAGNOSIS SYSTEM (BCM)

## < FUNCTION DIAGNOSIS >

Monitor Item [Unit]	Description
PUSH SW	Displays the status of the engine switch (push switch) judged by BCM.
VEH SPEED 1 [km/h]	Displays the value of the vehicle speed signal received from unified meter and A/C amp. with CAN communication.
FR WIPER HI [OFF/ON]	Status of each switch judged by BCM using the combination switch reading function
FR WIPER LOW [OFF/ON]	
FR WASHER SW [OFF/ON]	
FR WIPER INT [OFF/ON]	
FR WIPER STOP [OFF/ON]	Displays the status of the front wiper auto stop signal received from IPDM E/R with CAN communication.
INT VOLUME [1 - 7]	Status of each switch judged by BCM using the combination switch reading function

## ACTIVE TEST

Test item	Operation	Description
FRONT WIPER	HI	Transmits the front wiper request signal (HI) to IPDM E/R with CAN communication to operate the front wiper HI operation.
	LO	Transmits the front wiper request signal (LO) to IPDM E/R with CAN communication to operate the front wiper LO operation.
	INT	Transmits the front wiper request signal (INT) to IPDM E/R with CAN communication to operate the front wiper INT operation.
	OFF	Stops transmitting the front wiper request signal to stop the front wiper operation.

## FLASHER

### FLASHER : CONSULT-III Function (BCM - FLASHER)

INFOID:000000000963878

## WORK SUPPORT

Service item	Setting item	Setting	
HAZARD ANSWER BACK	LOCK ONLY*	With locking only	Sets the hazard warning lamp answer back function when the door is lock/unlock with the request switch or the key fob.
	UNLK ONLY	With unlocking only	
	LOCK/UNLK	With locking/unlocking	
	OFF	Without the function	

\*: Initial setting

## DATA MONITOR

Monitor item [Unit]	Description
REQ SW-DR [ON/OFF]	The switch status input from the request switch (driver side)
REQ SW-AS [ON/OFF]	The switch status input from the request switch (passenger side)
PUSH SW [ON/OFF]	The switch status input from the push-button ignition switch

# DIAGNOSIS SYSTEM (BCM)

## < FUNCTION DIAGNOSIS >

Monitor item [Unit]	Description
TURN SIGNAL R [ON/OFF]	Each switch condition that BCM judges from the combination switch reading function
TURN SIGNAL L [ON/OFF]	
HAZARD SW [ON/OFF]	The switch status input from the hazard switch
RKE-LOCK [ON/OFF]	Lock signal status received from the remote keyless entry receiver
RKE-UNLOCK [ON/OFF]	Unlock signal status received from the remote keyless entry receiver
RKE-PANIC [ON/OFF]	Panic alarm signal status received from the remote keyless entry receiver

## ACTIVE TEST

Test item	Operation	Description
FLASHER	RH	Outputs the voltage to blink the right side turn signal lamps.
	LH	Outputs the voltage to blink the left side turn signal lamps.
	OFF	Stops the voltage to turn the turn signal lamps OFF.

## INTELLIGENT KEY

### INTELLIGENT KEY : CONSULT-III Function (BCM - INTELLIGENT KEY)

INFOID:000000000963879

#### BCM CONSULT-III FUNCTION

CONSULT-III performs the following functions via CAN communication with BCM.

Diagnosis mode	Function Description
WORK SUPPORT	Changes the setting for each system function.
SELF-DIAG RESULTS	Displays the diagnosis results judged by BCM.
DATA MONITOR	The BCM input/output signals are displayed.
ACTIVE TEST	The signals used to activate each device are forcibly supplied from BCM.

## WORK SUPPORT

Monitor item	Description
REMO CONT ID CONFIR	It can be checked whether Intelligent Key ID code is registered or not in this mode.
LOCK/UNLOCK BY I-KEY	Door lock/unlock function by door request switch (driver side, passenger side and trunk) mode can be changed to operate (ON) or not operate (OFF) in this mode.
ENGINE START BY I-KEY	Engine start function mode can be changed to operate (ON) or not operate (OFF) with this mode.
TRUNK/GLASS HATCH OPEN	Buzzer reminder function mode by trunk opener request switch can be changed to operate (ON) or not operate (OFF) with this mode.
PANIC ALARM SET	<p>Panic alarm button pressing time on Intelligent Key remote control button can be selected from the following with this mode.</p> <ul style="list-style-type: none"> <li>• 0.5 sec.</li> <li>• 1.5 sec.</li> <li>• OFF: Non-operation</li> </ul>
PW DOWN SET	<p>Unlock button pressing time on Intelligent Key button can be selected from the following with this mode.</p> <ul style="list-style-type: none"> <li>• 3 sec.</li> <li>• 5 sec.</li> <li>• OFF: Non-operation</li> </ul>

## DIAGNOSIS SYSTEM (BCM)

### < FUNCTION DIAGNOSIS >

Monitor item	Description
TRUNK OPEN DELAY	Trunk button pressing time on Intelligent Key button can be selected from the following with this mode. <ul style="list-style-type: none"> <li>• 0.5 sec.</li> <li>• 1.5 sec.</li> <li>• OFF: Non-operation</li> </ul>
LO- BATT OF KEY FOB WARN	Intelligent Key low battery warning mode can be changed to operate (ON) or not operate (OFF) with this mode.
ANTI KEY LOCK IN FUNCTI	Key reminder function mode can be changed to operate (ON) or not operate (OFF) with this mode.
HORN WITH KEYLESS LOCK	Horn reminder function mode by Intelligent Key button can be changed to operate (ON) or not operate (OFF) with this mode.
HAZARD ANSWER BACK	Hazard reminder function mode can be selected from the following with this mode. <ul style="list-style-type: none"> <li>• LOCK ONLY: Door lock operation only</li> <li>• UNLOCK ONLY: Door unlock operation only</li> <li>• LOCK AND UNLOCK: Lock/unlock operation</li> <li>• OFF: Non operation</li> </ul>
ANS BACK I-KEY LOCK	Buzzer reminder function (lock operation) mode by door request switch (driver side and passenger side) can be selected from the following with this mode. <ul style="list-style-type: none"> <li>• HORN CHIRP: Sound horn</li> <li>• BUZZER: Sound Intelligent Key warning buzzer</li> <li>• OFF: Non-operation</li> </ul>
ANS BACK I-KEY UNLOCK	Buzzer reminder function (unlock operation) mode by door request switch can be changed to operate (ON) or not operate (OFF) with this mode.
SHORT CRANKING OUTPUT	Starter motor can operate during the times below. <ul style="list-style-type: none"> <li>• 70 msec</li> <li>• 100 msec</li> <li>• 200 msec</li> </ul>
INSIDE ANT DIAGNOSIS	This function allows inside key antenna self-diagnosis.

### SELF-DIAG RESULT

Refer to [BCS-74, "DTC Index"](#).

### DATA MONITOR

Monitor Item	Condition
REQ SW-DR	Indicates [ON/OFF] condition of door request switch (driver side).
REQ SW-AS	Indicates [ON/OFF] condition of door request switch (passenger side).
REQ SW-BD/TR	Indicates [ON/OFF] condition of trunk opener request switch.
PUSH SW	Indicates [ON/OFF] condition of push-button ignition switch.
CLUCH SW	Indicates [ON/OFF] condition of clutch switch.
BRAKE SW 1	Indicates [ON/OFF] condition of brake switch.
DETE/CANCL SW	Indicates [ON/OFF] condition of P position.
SFT PN/N SW	Indicates [ON/OFF] condition of P or N position.
S/L -LOCK	Indicates [ON/OFF] condition of steering lock (LOCK).
S/L -UNLOCK	Indicates [ON/OFF] condition of steering lock (UNLOCK).
S/L RELAY-F/B	Indicates [ON/OFF] condition of ignition switch.
UNLK SEN-DR	Indicates [ON/OFF] condition of driver door UNLOCK status.
PUSH SW -IPDM	Indicates [ON/OFF] condition of push-button ignition switch.
IGN RLY1 F/B	Indicates [ON/OFF] condition of ignition relay 1.
DETE SW -IPDM	Indicates [ON/OFF] condition of P position.
SFT PN -IPDM	Indicates [ON/OFF] condition of P or N position.
SFT P -MET	Indicates [ON/OFF] condition of P position.
SFT N -MET	Indicates [ON/OFF] condition of N position.

# DIAGNOSIS SYSTEM (BCM)

## < FUNCTION DIAGNOSIS >

Monitor Item	Condition	
ENGINE STATE	Indicates [STOP/START/CRANK/RUN] condition of engine states.	A
S/L LOCK-IPDM	Indicates [ON/OFF] condition of steering lock (LOCK).	
S/L UNLOCK-IPDM	Indicates [ON/OFF] condition of steering lock (UNLOCK).	B
S/L RELAY-REQ	Indicates [ON/OFF] condition of steering lock relay.	
VEH SPEED 1	Display the vehicle speed signal received from combination meter by numerical value [Km/h].	
VEH SPEED 2	Display the vehicle speed signal received from ABS or VDC or CVT by numerical value [Km/h].	C
DOOR STAT-DR	Indicates [LOCK/READY/UNLK] condition of driver side door status.	
DOOR STAT-AS	Indicates [LOCK/READY/UNLK] condition of passenger side door status.	D
KEY SW -SLOT	Indicates [ON/OFF] condition of key slot.	
RKE OPE COUN1	When remote keyless entry receiver receives the signal transmitted while operating on Intelligent Key, the numerical value start changing.	E
RKE OPE COUN2	<b>NOTE:</b> This item is displayed, but cannot be monitored.	
TRNK/HAT MNTR	Indicates [ON/OFF] condition of trunk lid.	F
RKE-LOCK	Indicates [ON/OFF] condition of LOCK signal from Intelligent Key.	
RKE-UNLOCK	Indicates [ON/OFF] condition of UNLOCK signal from Intelligent Key.	
RKE-TR/BD	Indicates [ON/OFF] condition of TRUNK OPEN signal from Intelligent Key.	G
RKE-PANIC	Indicates [ON/OFF] condition of PANIC button of Intelligent Key.	
RKE-P/W OPEN	Indicates [ON/OFF] condition of P/W DOWN signal from Intelligent Key.	H
RKE-MODE CHG	Indicates [ON/OFF] condition of MODE CHANGE signal from Intelligent Key.	

## ACTIVE TEST

Test item	Description	
BATTERY SAVER	This test is able to check interior room lamp operation. The interior room lamp will be activated after "ON" on CONSULT-III screen is touched.	J
PW REMOTO DOWN SET	This test is able to check power window down operation. The power window down will be activated after "ON" on CONSULT-III screen is touched.	
OUTSIDE BUZZER	This test is able to check Intelligent Key warning buzzer operation. Intelligent Key warning buzzer sounds when "ON" on CONSULT-III screen is touched.	K
INSIDE BUZZER	This test is able to check warning chime in combination meter operation. <ul style="list-style-type: none"> <li>• Take away warning chime sounds when "TAKE OUT" on CONSULT-III screen is touched.</li> <li>• Key warning chime sounds when "KEY WARN" on CONSULT-III screen is touched.</li> <li>• P position warning chime sounds when "P RNG WARN" on CONSULT-III screen is touched.</li> <li>• ACC warning chime sounds when "ACC WARN" on CONSULT-III screen is touched.</li> </ul>	L
INDICATOR	This test is able to check warning lamp operation. <ul style="list-style-type: none"> <li>• "KEY" Warning lamp illuminates when "KEY IND ON" on CONSULT-III screen is touched.</li> <li>• "KEY" Warning lamp flashes when "KEY IND FSH" on CONSULT-III screen is touched.</li> </ul>	
INT LAMP	This test is able to check interior room lamp operation. The interior room lamp will be activated after "ON" on CONSULT-III screen is touched.	N

BCS

N

O

P

# DIAGNOSIS SYSTEM (BCM)

## < FUNCTION DIAGNOSIS >

Test item	Description
LCD	<p>This test is able to check meter display information</p> <ul style="list-style-type: none"> <li>• Engine start information displays when "BRAKE/P" on CONSULT-III screen is touched.</li> <li>• Engine start information displays when "BRAKE/P/ON" on CONSULT-III screen is touched.</li> <li>• Key ID warning displays when "KEY ID NG" on CONSULT-III screen is touched.</li> <li>• Steering lock information displays when "STLCK RELES" on CONSULT-III screen is touched.</li> <li>• P position warning displays when "P RNG IND" on CONSULT-III screen is touched.</li> <li>• Intelligent Key insert information displays when "INSERT KEY" on CONSULT-III screen is touched.</li> <li>• Intelligent Key low battery warning displays when "KEY BAT LOW" on CONSULT-III screen is touched.</li> <li>• Take away through window warning displays when "TK AWAY WDW" on CONSULT-III screen is touched.</li> <li>• Take away warning display when "TAKE AWAY" on CONSULT-III screen is touched.</li> <li>• OFF position warning display when "IGN OFF WARN" on CONSULT-III screen is touched.</li> </ul>
TRUNK/GLASS HATCH	<p>This test is able to check trunk lid opener actuator open operation. This actuator opens when "ON" on CONSULT-III screen is touched.</p>
FLASHER	<p>This test is able to check security hazard lamp operation. The hazard lamps will be activated after "ON" on CONSULT-III screen is touched.</p>
HORN	<p>This test is able to check horn operation. The horn will be activated after "ON" on CONSULT-III screen is touched.</p>
IGN CONT2	<p>This test is able to check security hazard lamp operation. The hazard lamps will be activated after "ON" on CONSULT-III screen is touched.</p>
P RANGE	<p>This test is able to check A/T device power supply A/T device power is supplied when "ON" on CONSULT-III screen is touched.</p>
ENGINE SW ILLUMI	<p>This test is able to check push-ignition switch illumination operation. Push-ignition switch illumination illuminates when "ON" on CONSULT-III screen is touched.</p>
LOCK INDCATOR	<p>This test is able to check LOCK indicator in push-ignition switch operation. LOCK indicator in push-ignition switch illuminates when "ON" on CONSULT-III screen is touched.</p>
ACC INDCATOR	<p>This test is able to check ACC indicator in push-ignition switch operation. LOCK indicator in push-ignition switch illuminates when "ON" on CONSULT-III screen is touched.</p>
IGNITION ON IND	<p>This test is able to check INGITION ON indicator in push-ignition switch operation. LOCK indicator in push-ignition switch illuminates when "ON" on CONSULT-III screen is touched.</p>
KEY SLOT ILLUMI	<p>This test is able to check key slot illumination operation. Key slot illumination flash when "ON" on CONSULT-III screen is touched.</p>

## COMB SW

### COMB SW : CONSULT-III Function (BCM - COMB SW)

INFOID:000000000963880

## DATA MONITOR

Monitor item [UNIT]	Description
FR WIPER HI [OFF/ON]	Displays the status of the FR WIPER HI switch in combination switch judged by BCM with the combination switch reading function.
FR WIPER LOW [OFF/ON]	Displays the status of the FR WIPER LOW switch in combination switch judged by BCM with the combination switch reading function.
FR WASHER SW [OFF/ON]	Displays the status of the FR WASHER switch in combination switch judged by BCM with the combination switch reading function.
FR WIPER INT [OFF/ON]	Displays the status of the FR WIPER INT switch in combination switch judged by BCM with the combination switch reading function.
FR WIPER STOP [OFF/ON]	Displays the status of the front wiper stop position signal received from IPDM E/R via CAN communication.
INT VOLUME [1 - 7]	Displays the status of wiper intermittent dial position judged by BCM with the combination switch reading function
TURN SIGNAL R [OFF/ON]	Displays the status of the TURN RH switch in combination switch judged by BCM with the combination switch reading function.



# DIAGNOSIS SYSTEM (BCM)

## < FUNCTION DIAGNOSIS >

Monitor item [UNIT]	Description
TURN SIGNAL L [OFF/ON]	Displays the status of the TURN LH switch in combination switch judged by BCM with the combination switch reading function.
TAIL LAMP SW [OFF/ON]	Displays the status of the TAIL LAMP switch in combination switch judged by BCM with the combination switch reading function.
HI BEAM SW [OFF/ON]	Displays the status of the HI BEAM switch in combination switch judged by BCM with the combination switch reading function.
HEAD LAMP SW 1 [OFF/ON]	Displays the status of the HEADLAMP 1 switch in combination switch judged by BCM with the combination switch reading function.
HEAD LAMP SW 2 [OFF/ON]	Displays the status of the HEADLAMP 2 switch in combination switch judged by BCM with the combination switch reading function.
PASSING SW [OFF/ON]	Displays the status of the PASSING switch in combination switch judged by BCM with the combination switch reading function.
AUTO LIGHT SW [OFF/ON]	Displays the status of the AUTO LIGHT switch in combination switch judged by BCM with the combination switch reading function.
FR FOG SW [OFF/ON]	Displays the status of the FR FOG switch in combination switch judged by BCM with the combination switch reading function.

## BCM

### BCM : CONSULT-III Function (BCM - BCM)

INFOID:000000000963881

## WORK SUPPORT

Item	Description
RESET SETTING VALUE	Return a value set with WORK SUPPORT of each system to a default value in factory shipment.

## IMMU

### IMMU : CONSULT-III Function (BCM - IMMU)

INFOID:000000000963882

## APPLICATION ITEM

CONSULT-III performs the following functions via CAN communication with BCM.

Diagnosis mode	Function Description
DATA MONITOR	The BCM input/output signals are displayed.
ACTIVE TEST	The signals used to activate each device are forcibly supplied from BCM.

## DATA MONITOR

Monitor item	Content
CONFIRM ID ALL	Indicates [YET] at all time. Switch to [DONE] when a registered Intelligent Key is inserted into the key slot.
CONFIRM ID4	
CONFIRM ID3	
CONFIRM ID2	
CONFIRM ID1	
TP 4	Indicates the number of ID which has been registered.
TP 3	
TP 2	
TP 1	
PUSH SW	Indicates [ON/OFF] condition of push-button ignition switch.
KEY SW -SLOT	Indicates [ON/OFF] condition of key slot.

## ACTIVE TEST

# DIAGNOSIS SYSTEM (BCM)

## < FUNCTION DIAGNOSIS >

Test item	Description
THEFT IND	This test is able to check security indicator lamp operation. The lamp will be turned on when "ON" on CONSULT-III screen touched.

## BATTERY SAVER

### BATTERY SAVER : CONSULT-III Function (BCM - BATTERY SAVER)

INFOID:000000000963883

## WORK SUPPORT

Service item	Setting item	Setting	
BATTERY SAVER SET	ON*	With the exterior lamp battery saver function	
	OFF	Without the exterior lamp battery saver function	
ROOM LAMP BAT SAV SET	ON*	With the interior room lamp battery saver function	
	OFF	Without the interior room lamp battery saver function	
ROOM LAMP TIMER SET	MODE 1*	30 min.	Sets the interior room lamp battery saver timer operating time.
	MODE 2	60 min.	

\*: Initial setting

## DATA MONITOR

Monitor item [Unit]	Description
REQ SW-DR [ON/OFF]	The switch status input from request switch (driver side)
REQ SW-AS [ON/OFF]	The switch status input from front request switch (passenger side)
PUSH SW [ON/OFF]	The switch status input from push-button ignition switch
ACC RLY-F/B [ON/OFF]	ACC relay feedback signal status input from ACC relay
KEY SW-SLOT [ON/OFF]	Key switch status input from key slot
DOOR SW-DR [ON/OFF]	The switch status input from front door switch (driver side)
DOOR SW-AS [ON/OFF]	The switch status input from front door switch (passenger side)
DOOR SW-RR [ON/OFF]	The switch status input from rear door switch RH
DOOR SW- RL [ON/OFF]	The switch status input from rear door switch LH
DOOR SW-BK [ON/OFF]	<b>NOTE:</b> The item is indicated, but not monitored.
CDL LOCK SW [ON/OFF]	Lock switch status received from central door lock switch by power window switch serial link
CDL UNLOCK SW [ON/OFF]	Unlock switch status received from central door lock switch by power window switch serial link
KEY CYL LK-SW [ON/OFF]	Lock switch status received from key cylinder switch by power window switch serial link
KEY CYL UN-SW [ON/OFF]	Unlock switch status received from key cylinder switch by power window switch serial link
TRNK/HAT MNTR [ON/OFF]	The switch status input from trunk room lamp switch

# DIAGNOSIS SYSTEM (BCM)

## < FUNCTION DIAGNOSIS >

Monitor item [Unit]	Description
RKE-LOCK [ON/OFF]	Lock signal status received from remote keyless entry receiver
RKE-UNLOCK [ON/OFF]	Unlock signal status received from remote keyless entry receiver

## ACTIVE TEST

Test item	Operation	Description
BATTERY SAVER	OFF	Cuts the interior room lamp power supply to turn interior room lamp OFF.
	ON	Outputs the interior room lamp power supply to turn interior room lamp ON.*

\*: Each lamp switch is in ON position.

## TRUNK

### TRUNK : CONSULT-III Function (BCM - TRUNK)

INFOID:000000000963884

#### BCM CONSULT-III FUNCTION

CONSULT-III performs the following functions via CAN communication with BCM.

Diagnosis mode	Function Description
DATA MONITOR	The BCM input/output signals are displayed.
ACTIVE TEST	The signals used to activate each device are forcibly supplied from BCM.

## DATA MONITOR

Monitor Item	Contents
PUSH SW	Indicates [ON/OFF] condition of push switch.
UNLK SEN -DR	Indicates [ON/OFF] condition of unlock sensor.
VEH SPEED 1	Indicates [Km/h] condition of vehicle speed signal from combination meter.
KEY CYL SW-TR	<b>NOTE:</b> This item is displayed, but cannot be monitored.
TR CANCEL SW	Indicates [ON/OFF] condition of trunk lid opener cancel switch.
TR/BD OPEN SW	Indicates [ON/OFF] condition of trunk lid opener switch.
TRNK/HAT MNTR	Indicates [ON/OFF] condition of trunk room lamp switch.
RKE-TR/BD	Indicates [ON/OFF] condition of trunk open signal from Intelligent Key remote controller button.

## ACTIVE TEST

Test item	Description
TRUNK/GLASS HATCH	This test is able to check trunk open operation. Trunk open when "OPEN" on CONSULT-III screen is touched.

## THEFT ALM

### THEFT ALM : CONSULT-III Function (BCM - THEFT)

INFOID:000000000963885

#### APPLICATION ITEM

CONSULT-III performs the following functions via CAN communication with BCM.

Diagnosis mode	Function Description
WORK SUPPORT	Changes the setting for each system function.
DATA MONITOR	The BCM input/output signals are displayed.
ACTIVE TEST	The signals used to activate each device are forcibly supplied from BCM.

# DIAGNOSIS SYSTEM (BCM)

## < FUNCTION DIAGNOSIS >

### DATA MONITOR

Monitored Item	Description
REQ SW-DR	Indicates [ON/OFF] condition of door request switch (driver side).
REQ SW-AS	Indicates [ON/OFF] condition of door request switch (passenger side).
REQ SW-BD/TR	Indicates [ON/OFF] condition of trunk opener request switch.
PUSH SW	Indicates [ON/OFF] condition of push-button ignition switch
UNLK SEN-DR	Indicates [ON/OFF] condition of driver door UNLOCK status.
KEY SW -SLOT	Indicates [ON/OFF] condition of key slot.
DOOR SW-DR	Indicates [ON/OFF] condition of front door switch LH.
DOOR SW-AS	Indicates [ON/OFF] condition of front door switch RH.
DOOR SW-RR	Indicates [ON/OFF] condition of rear door switch RH.
DOOR SW-RL	Indicates [ON/OFF] condition of rear door switch LH.
DOOR SW-BK	This is displayed even when it is not equipped.
CDL LOCK SW	Indicates [ON/OFF] condition of lock signal from door lock/unlock switch LH and RH.
CDL UNLOCK SW	Indicates [ON/OFF] condition of unlock signal from door lock/unlock switch LH and RH.
KEY CYL LK-SW	Indicates [ON/OFF] condition of lock signal from front door key cylinder switch.
KEY CYL UN-SW	Indicates [ON/OFF] condition of unlock signal from front door key cylinder switch.
KEY CYL SW-TR	This is displayed even when it is not equipped.
TR/BD OPEN SW	Indicates [ON/OFF] condition of trunk lid opener switch.
TRNK/HAT MNTR	Indicates [ON/OFF] condition of trunk room lamp switch.
RKE-LOCK	Indicates [ON/OFF] condition of LOCK signal from Intelligent Key.
RKE-UNLOCK	Indicates [ON/OFF] condition of UNLOCK signal from Intelligent Key.
RKE-TR/BD	Indicates [ON/OFF] condition of TRUNK OPEN signal from Intelligent Key.

### WORK SUPPORT

Test Item	Description
SECURITY ALARM SET	This mode is able to confirm and change security alarm ON-OFF setting.
THEFT ALM TRG	The switch which triggered vehicle security alarm is recorded. This mode is able to confirm and erase the record of vehicle security alarm. The trigger data can be erased by touching "CLEAR" on CONSULT-III screen.

### ACTIVE TEST

Test Item	Description
THEFT IND	This test is able to check security indicator lamp operation. The lamp will be turned on when "ON" on CONSULT-III screen is touched.
VEHICLE SECURITY HORN	This test is able to check vehicle security horn operation. The horns will be activated for 0.5 seconds after "ON" on CONSULT-III screen is touched.
HEADLAMP(HI)	This test is able to check vehicle security lamp operation. The headlamps will be activated for 0.5 seconds after "ON" on CONSULT-III screen is touched.
FLASHER	This test is able to check vehicle security hazard lamp operation. The hazard lamps will be activated after "ON" on CONSULT-III screen is touched.

### RETAINED PWR

#### RETAINED PWR : CONSULT-III Function (BCM - RETAINED PWR)

INFOID:000000000963886

Data monitor

# DIAGNOSIS SYSTEM (BCM)

## < FUNCTION DIAGNOSIS >

Monitor Item	Description
DOOR SW-DR	Indicates [ON/OFF] condition of driver side door switch.
DOOR SW-AS	Indicates [ON/OFF] condition of passenger side door switch.

## SIGNAL BUFFER

### SIGNAL BUFFER : CONSULT-III Function (BCM - SIGNAL BUFFER)

INFOID:000000000963887

### DATA MONITOR

Monitor item [UNIT]	Description
PUSH SW [OFF/ON]	Displays the status of the push-button ignition switch (push switch) judged by BCM.

### ACTIVE TEST

Test item	Operation	Description
OIL PRESSURE SW	OFF	OFF
	ON	BCM transmits the oil pressure switch signal to the unified meter and A/C amp. via CAN communication, which illuminates the oil pressure warning lamp in the combination meter.

## AIR PRESSURE MONITOR

### AIR PRESSURE MONITOR : Diagnosis Description

INFOID:000000000963888

#### DESCRIPTION

During driving, the TPMS receives the signal transmitted from the transmitter installed in each wheel, when the tire pressure becomes low. The control unit (BCM) of this system has pressure judgment and trouble diagnosis functions.

When the TPMS detects low inflation pressure or another unusual symptom, the warning lamps in the combination meter comes on.

#### SELF DIAGNOSTIC PROCEDURE (WITH CONSULT-III)

☑ With CONSULT-III

- Touch "SELF-DIAG RESULT" display shows malfunction experienced since the last erasing operation. Refer to [WT-74, "DTC Index"](#).

#### SELF DIAGNOSTIC PROCEDURE (WITHOUT CONSULT-III)

☒ Without CONSULT-III

To start the self-diagnostic results mode, ground terminal of the tire pressure warning check connector. The malfunction location is indicated by the warning lamp flashing.

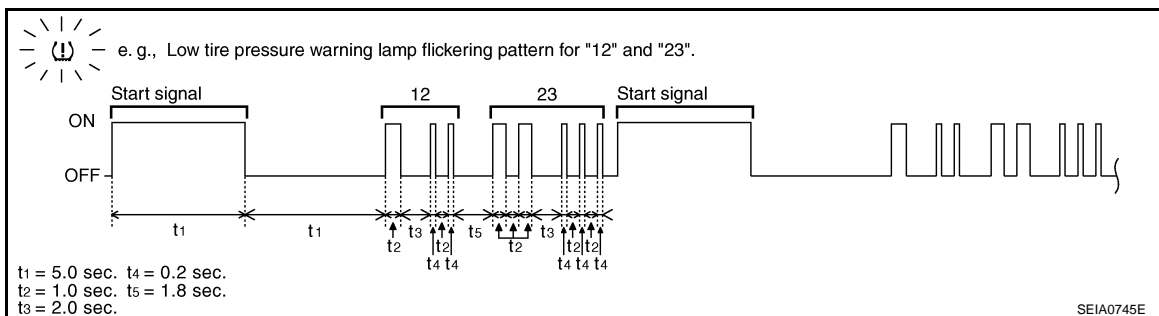

#### NOTE:

When the low tire warning lamp flashes 5 Hz and continues repeating it, the system is normal.

## DIAGNOSIS SYSTEM (BCM)

### < FUNCTION DIAGNOSIS >

Flickering pattern	Items	Diagnostic items detected when...	Check item
15	Tire pressure value (Front LH)	Front LH tire pressure drops to 181 kPa (1.8 kg/cm <sup>2</sup> , 26 psi) or less.	-
16	Tire pressure value (Front RH)	Front RH tire pressure drops to 181 kPa (1.8 kg/cm <sup>2</sup> , 26 psi) or less.	
17	Tire pressure value (Rear RH)	Rear RH tire pressure drops to 181 kPa (1.8 kg/cm <sup>2</sup> , 26 psi) or less.	
18	Tire pressure value (Rear LH)	Rear LH tire pressure drops to 181 kPa (1.8 kg/cm <sup>2</sup> , 26 psi) or less.	
21	Transmitter no data (Front LH)	Data from front LH transmitter can not be received.	<a href="#">WT-16</a>
22	Transmitter no data (Front RH)	Data from front RH transmitter can not be received.	
23	Transmitter no data (Rear RH)	Data from Rear RH transmitter can not be received.	
24	Transmitter no data (Rear LH)	Data from Rear LH transmitter can not be received.	
31	Transmitter checksum error (Front LH)	Checksum data from front LH transmitter is malfunctioning.	<a href="#">WT-19</a>
32	Transmitter checksum error (Front RH)	Checksum data from front RH transmitter is malfunctioning.	
33	Transmitter checksum error (Rear RH)	Checksum data from rear RH transmitter is malfunctioning.	
34	Transmitter checksum error (Rear LH)	Checksum data from rear RH transmitter is malfunctioning.	
35	Transmitter pressure data error (Front LH)	Air pressure data from front LH transmitter is malfunction.	<a href="#">WT-22</a>
36	Transmitter pressure data error (Front RH)	Air pressure data from front RH transmitter is malfunction.	
37	Transmitter pressure data error (Rear RH)	Air pressure data from rear RH transmitter is malfunction.	
38	Transmitter pressure data error (Rear LH)	Air pressure data from rear LH transmitter is malfunction.	
41	Transmitter function code error (Front LH)	Function code data from front LH transmitter is malfunction.	<a href="#">WT-24</a>
42	Transmitter function code error (Front RH)	Function code data from front RH transmitter is malfunction.	
43	Transmitter function code error (Rear RH)	Function code data from rear RH transmitter is malfunction.	
44	Transmitter function code error (Rear LH)	Function code data from rear LH transmitter is malfunction.	
45	Transmitter battery voltage low (Front LH)	Battery voltage of front LH transmitter drops.	<a href="#">WT-27</a>
46	Transmitter battery voltage low (Front RH)	Battery voltage of front RH transmitter drops.	
47	Transmitter battery voltage low (Rear RH)	Battery voltage of rear RH transmitter drops.	
48	Transmitter battery voltage low (Rear LH)	Battery voltage of rear LH transmitter drops.	
52	Vehicle speed signal error	Speed signal is not detected.	<a href="#">WT-30</a>
53	BCM failure about TPMS	Tire pressure monitoring system malfunction in BCM	<a href="#">WT-31</a>
No flickering	Tire pressure warning check switch	Tire pressure warning switch circuit is open.	-

### ERASE SELF-DIAGNOSIS

 With CONSULT-III

1. Perform applicable inspection of malfunctioning item and then repair or replace.

# DIAGNOSIS SYSTEM (BCM)

## < FUNCTION DIAGNOSIS >

2. Turn ignition switch "ON" and select "SELF-DIAG RESULTS" mode for "AIR PRESSURE MONITOR" with CONSULT-III.
3. Touch "ERASE" on CONSULT-III screen to erase memory.

### ⊗ Without CONSULT-III

- In order to make it easier to find the cause of hard-to-duplicate malfunctions, malfunction information is stored into the control unit as necessary during use by the user. This memory is not erased no matter how many times the ignition switch is turned "ON" and "OFF".
- However, this information is erased by turning ignition switch "OFF" after performing self-diagnostic or by erasing the memory using the CONSULT-III.

## AIR PRESSURE MONITOR : CONSULT-III Function (BCM - AIR PRESSURE MONITOR)

INFOID:000000000963889

### WORK SUPPORT MODE

#### ID Read

The registered ID number is displayed.

#### ID Regist

Refer to [WT-5, "ID REGISTRATION PROCEDURE : Special Repair Requirement"](#).

### SELF-DIAG RESULTS MODE

#### Operation Procedure

Refer to [WT-74, "DTC Index"](#).

### DATA MONITOR MODE

Screen of data monitor mode is displayed.

#### NOTE:

When malfunction is detected, CONSULT-III perform REAL-TIME DIAGNOSIS. Also, any malfunction detected while in this mode will be displayed at real time.

#### Display item list

Monitor	Condition	Specification
VEHICLE SPEED	Drive vehicle.	Vehicle speed (km/h, MPH)
AIR PRESS FL AIR PRESS FR AIR PRESS RR AIR PRESS RL	<ul style="list-style-type: none"> <li>• Drive vehicle for a few minutes.</li> <li>or</li> <li>• Ignition switch ON and activation tool is transmitting activation signals.</li> </ul>	Tire pressure (kPa or Psi)
ID REGST FL ID REGST FR ID REGST RR ID REGST RL	Ignition switch ON	Registration ID : DONE No registration : YET
WARNING LAMP		Low tire pressure warning lamp on: ON Low tire pressure warning lamp off: OFF
BUZZER		Buzzer in combination meter on: ON Buzzer in combination meter off: OFF

#### NOTE:

Before performing the self-diagnosis, be sure to register the ID, or erase the actual malfunction location may be different from that displayed on CONSULT-III.

### ACTIVE TEST MODE

#### NOTE:

Before performing the self-diagnosis, be sure to register the ID, or erase the actual malfunction may be different from that displayed on CONSULT-III.

### TEST ITEM LIST

Test item	Content
WARNING LAMP	This test is able to check to make sure that the warning lamp turns on.
ID REGIST WARNING	This test is able to check to make sure that the buzzer sounds or the warning lamp turns on.

## DIAGNOSIS SYSTEM (BCM)

### < FUNCTION DIAGNOSIS >

Test item	Content
RUN FLAT/T WARN BUZZER	This test is able to check to make sure that the buzzer sounds.
FLASHER	This test is able to check to make sure that each turn signal lamp turns on.
HORN	This test is able to check to make sure that the horn sounds.



# U1000 CAN COMM CIRCUIT

< COMPONENT DIAGNOSIS >

## COMPONENT DIAGNOSIS

### U1000 CAN COMM CIRCUIT

#### Description

INFOID:000000000963890

CAN (Controller Area Network) is a serial communication line for real time applications. It is an on-vehicle multiplex communication line with high data communication speed and excellent error detection ability. Modern vehicle is equipped with many electronic control unit, and each control unit shares information and links with other control units during operation (not independent). In CAN communication, control units are connected with 2 communication lines (CAN H-line, CAN L-line) allowing a high rate of information transmission with less wiring. Each control unit transmits/receives data but selectively reads required data only.

CAN Communication Signal Chart. Refer to [LAN-28, "CAN Communication Signal Chart"](#).

#### DTC Logic

INFOID:000000000963891

#### DTC DETECTION LOGIC

DTC	CONSULT-III display description	DTC Detection Condition	Possible cause
U1000	CAN COMM CIRCUIT	When BCM cannot communicate CAN communication signal continuously for 2 seconds or more.	In CAN communication system, any item (or items) of the following listed below is malfunctioning. <ul style="list-style-type: none"><li>• Transmission</li><li>• Receiving (ECM)</li><li>• Receiving (VDC/TCS/ABS)</li><li>• Receiving (METER/M&amp;A)</li><li>• Receiving (TCM)</li><li>• Receiving (MULTI AV)</li><li>• Receiving (IPDM E/R)</li></ul>

#### Diagnosis Procedure

INFOID:000000000963892

#### 1.PERFORM SELF DIAGNOSTIC

1. Turn ignition switch ON and wait for 2 second or more.
2. Check "Self Diagnostic Result".

Is "CAN COMM CIRCUIT" displayed?

- YES >> Refer to [LAN-18, "Trouble Diagnosis Flow Chart"](#).  
NO >> Refer to [GI-39, "Intermittent Incident"](#).

A  
B  
C  
D  
E  
F  
G  
H  
I  
J  
K  
L  
N  
O  
P

BCS

# U1010 CONTROL UNIT (CAN)

< COMPONENT DIAGNOSIS >

## U1010 CONTROL UNIT (CAN)

### DTC Logic

INFOID:000000000963893

### DTC DETECTION LOGIC

DTC	CONSULT-III display description	DTC Detection Condition	Possible cause
U1010	CONTROL UNIT (CAN)	BCM detected internal CAN communication circuit malfunction.	BCM

### Diagnosis Procedure

INFOID:000000000963894

#### 1.REPLACE BCM

When DTC [U1010] is detected, replace BCM.

>> Replace BCM.

### Special Repair Requirement

INFOID:000000000963895

#### 1.REQUIRED WORK WHEN REPLACING BCM

Initialize IVIS by CONSULT-III. For the details of initialization refer to CONSULT-III operation manual NATS-IVIS/NVIS.

>> Work end.

# U0415 VEHICLE SPEED SIG

< COMPONENT DIAGNOSIS >

## U0415 VEHICLE SPEED SIG

### Description

INFOID:000000000963896

U0415 is displayed if any unusual condition is present in the reception status of the vehicle speed signal from the ABS actuator and electric unit (control unit).

### DTC Logic

INFOID:000000000963897

### DTC DETECTION LOGIC

DTC	CONSULT-III display description	DTC Detection Condition	Probable cause
U0415	VEHICLE SPEED SIG	When the vehicle speed signal received from the ABS actuator and electric unit (control unit) remains abnormal for 2 seconds or more.	<ul style="list-style-type: none"><li>• ABS actuator and electric unit (control unit)</li><li>• BCM</li></ul>

### DTC CONFIRMATION PROCEDURE

#### 1. DTC CONFIRMATION

1. Erase the DTC.
2. Turn ignition switch OFF.
3. Perform the "Self-Diag Results" of CONSULT-III, when passed 2 seconds or more after the ignition switch is turned ON.

#### Is any DTC detected?

- YES >> Refer to [BCS-35, "Diagnosis Procedure"](#).  
NO >> INSPECTION END

### Diagnosis Procedure

INFOID:000000000963898

#### 1. ABS ACTUATOR AND ELECTRIC UNIT (CONTROL UNIT) SELF-DIAG RESULTS

Perform "Self-Diag Results" of ABS actuator and electric unit (control unit) with CONSULT-III. Refer to [TM-114, "CONSULT-III Function \(TRANSMISSION\)"](#).

#### Is any DTC detected?

- YES >> Repair or replace the malfunctioning part.  
NO >> Replace BCM.

A  
B  
C  
D  
E  
F  
G  
H  
I  
J  
K  
L  
N  
O  
P

BCS

# B2562 LOW VOLTAGE

< COMPONENT DIAGNOSIS >

## B2562 LOW VOLTAGE

### DTC Logic

INFOID:000000000963899

### DTC DETECTION LOGIC

DTC	CONSULT-III display description	DTC Detection Condition	Possible cause
B2562	LOW VOLTAGE	When the power supply voltage to BCM remains less than 8.8 V for 1.5 seconds or more	Harness or connector (power supply circuit)

### DTC CONFIRMATION PROCEDURE

#### 1. DTC CONFIRMATION

1. Erase DTC.
2. Turn ignition switch OFF.
3. Perform the "Self-Diag Results" of CONSULT-III, when passed 1.5 seconds or more after the ignition switch is turned ON.

#### Is any DTC detected?

- YES >> Refer to [BCS-36, "Diagnosis Procedure"](#).  
NO >> INSPECTION END

### Diagnosis Procedure

INFOID:000000000963900

#### 1. CHECK POWER SUPPLY CIRCUIT

Check BCM power supply circuit. Refer to [BCS-38, "Diagnosis Procedure"](#).

#### Is the circuit normal?

- YES >> Replace BCM.  
NO >> Repair the malfunctioning part.

### Special Repair Requirement

INFOID:000000000963901

#### 1. REQUIRED WORK WHEN REPLACING BCM

Initialize IVIS by CONSULT-III. For the details of initialization refer to CONSULT-III operation manual NATS-IVIS/NVIS.

>> Work end.

# B2563 HI VOLTAGE

< COMPONENT DIAGNOSIS >

## B2563 HI VOLTAGE

### DTC Logic

INFOID:000000000963902

### DTC DETECTION LOGIC

DTC	CONSULT-III display description	DTC Detection Condition	Possible cause
B2563	HI VOLTAGE	When the power supply voltage to BCM remains more than 18 V for 90 seconds or more	Harness or connector (power supply circuit)

### DTC CONFIRMATION PROCEDURE

#### 1. DTC CONFIRMATION

1. Erase DTC.
2. Turn ignition switch OFF.
3. Perform the "Self-Diag Results" of CONSULT-III, when passed 90 seconds or more after the ignition switch is turned ON.

#### Is any DTC detected?

- YES >> Refer to [BCS-37, "Diagnosis Procedure"](#).  
NO >> INSPECTION END

### Diagnosis Procedure

INFOID:000000000963903

#### 1. CHECK POWER SUPPLY CIRCUIT

Check BCM power supply circuit. Refer to [BCS-38, "Diagnosis Procedure"](#).

#### Is the circuit normal?

- YES >> Replace BCM.  
NO >> Repair the malfunctioning part.

### Special Repair Requirement

INFOID:000000000963904

#### 1. REQUIRED WORK WHEN REPLACING BCM

Initialize IVIS by CONSULT-III. For the details of initialization refer to CONSULT-III operation manual NATS-IVIS/NVIS.

>> Work end.

A  
B  
C  
D  
E  
F  
G  
H  
I  
J  
K  
L

BCS

N  
O  
P

# POWER SUPPLY AND GROUND CIRCUIT

< COMPONENT DIAGNOSIS >

## POWER SUPPLY AND GROUND CIRCUIT

### Diagnosis Procedure

INFOID:000000000963905

#### 1. CHECK FUSE AND FUSIBLE LINK

Check that the following fuse and fusible link are not blown.

Terminal No.	Signal name	Fuse and fusible link No.
1	Battery power supply	K
11		10

#### Is the fuse fusing?

- YES >> Replace the blown fuse or fusible link after repairing the affected circuit if a fuse or fusible link is blown.  
NO >> GO TO 2.

#### 2. CHECK POWER SUPPLY CIRCUIT

1. Turn ignition switch OFF.
2. Disconnect BCM connectors.
3. Check voltage between BCM harness connector and ground.

Terminals		Voltage (Approx.)
(+)	(-)	
BCM		Ground  Battery voltage
Connector	Terminal	
M118	1	
M119	11	

#### Is the measurement value normal?

- YES >> GO TO 3.  
NO >> Repair harness or connector.

#### 3. CHECK GROUND CIRCUIT

Check continuity between BCM harness connector and ground.

BCM		Ground	Continuity
Connector	Terminal		
M119	13		Existed

#### Does continuity exist?

- YES >> INSPECTION END  
NO >> Repair harness or connector.

# COMBINATION SWITCH INPUT CIRCUIT

< COMPONENT DIAGNOSIS >

## COMBINATION SWITCH INPUT CIRCUIT

### Diagnosis Procedure

INFOID:000000000963906

#### 1. CHECK INPUT 1 - 5 SYSTEM CIRCUIT FOR OPEN

1. Turn the ignition switch OFF.
2. Disconnect the BCM and combination switch connectors.
3. Check continuity between BCM harness connector and combination switch harness connector.

System	BCM		Combination switch		Continuity
	Connector	Terminal	Connector	Terminal	
INPUT 1	M122	107	M33	11	Existed
INPUT 2		109		9	
INPUT 3		88		7	
INPUT 4		108		10	
INPUT 5		87		13	

Does continuity exist?

YES >> GO TO 2.

NO >> Repair the harnesses or connectors.

#### 2. CHECK INPUT 1 - 5 SYSTEM CIRCUIT FOR SHORT

Check for continuity between BCM harness connector and ground.

System	BCM		Continuity
	Connector	Terminal	
INPUT 1	M122	107	Ground  Not existed
INPUT 2		109	
INPUT 3		88	
INPUT 4		108	
INPUT 5		87	

Does continuity exist?

YES >> Repair the harnesses or connectors.

NO >> GO TO 3.

#### 3. CHECK BCM OUTPUT VOLTAGE

1. Connect the BCM connector.
2. Check voltage between BCM harness connector and ground.

System	Terminals		Voltage (Approx.)
	(+)	(-)	
	BCM		
	Connector	Terminal	
INPUT 1	M122	107	Ground  Refer to <a href="#">BCS-43</a> , "Reference Value".
INPUT 2		109	
INPUT 3		88	
INPUT 4		108	
INPUT 5		87	

Is the measurement value normal?

YES >> GO TO 4.

NO >> Replace BCM.

A

B

C

D

E

F

G

H

I

J

K

L

BCS

N

O

P

# COMBINATION SWITCH INPUT CIRCUIT

## < COMPONENT DIAGNOSIS >

### 4. CHECK BCM INPUT SIGNAL

1. Connect the combination switch connector.
2. Turn ON any switch in the system that is malfunctioning.
3. Check voltage between BCM harness connector and ground.

System	Terminals		Voltage (Approx.)
	(+)	(-)	
	BCM		
Connector	Terminal	Ground	Refer to <a href="#">BCS-43</a> , "Reference Value".
INPUT 1	107		
INPUT 2	109		
INPUT 3	88		
INPUT 4	108		
INPUT 5	87		

Is the measurement value normal when any of the switches is turned ON?

- YES >> Replace BCM.  
NO >> Replace the combination switch.

### Special Repair Requirement

INFOID:000000000963907

### 1. REQUIRED WORK WHEN REPLACING BCM

Initialize IVIS by CONSULT-III. For the details of initialization refer to CONSULT-III operation manual NATS-IVIS/NVIS.

>> Work end.



# COMBINATION SWITCH OUTPUT CIRCUIT

< COMPONENT DIAGNOSIS >

## COMBINATION SWITCH OUTPUT CIRCUIT

### Diagnosis Procedure

INFOID:000000000963908

#### 1. CHECK OUTPUT 1 - 5 SYSTEM CIRCUIT FOR OPEN

1. Turn the ignition switch OFF.
2. Disconnect the BCM and combination switch connectors.
3. Check continuity between BCM harness connector and combination switch harness connector.

System	BCM		Combination switch		Continuity
	Connector	Terminal	Connector	Terminal	
OUTPUT 1	M123	143	M33	12	Existed
OUTPUT 2		144		14	
OUTPUT 3		145		5	
OUTPUT 4		146		2	
OUTPUT 5		142		8	

Does continuity exist?

YES >> GO TO 2.

NO >> Repair the harnesses or connectors.

#### 2. CHECK OUTPUT 1 - 5 SYSTEM CIRCUIT FOR SHORT

Check for continuity between BCM harness connector and ground.

System	BCM		Continuity
	Connector	Terminal	
OUTPUT 1	M123	143	Not existed
OUTPUT 2		144	
OUTPUT 3		145	
OUTPUT 4		146	
OUTPUT 5		142	

Does continuity exist?

YES >> Repair the harnesses or connectors.

NO >> GO TO 3.

#### 3. CHECK COMBINATION SWITCH OUTPUT VOLTAGE

1. Connect the combination switch connector.
2. Turn ON any switch in the system that is malfunctioning.
3. Check voltage between combination switch harness connector and ground.

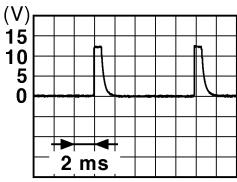
System	Terminals		Value (Approx.)
	(+)	(-)	
	Combination switch Connector	Terminal	
OUTPUT 1	M33	12	 1.4 V
OUTPUT 2		14	
OUTPUT 3		5	
OUTPUT 4		2	
OUTPUT 5		8	

A  
B  
C  
D  
E  
F  
G  
H  
I  
J  
K  
L  
N  
O  
P

## COMBINATION SWITCH OUTPUT CIRCUIT

### < COMPONENT DIAGNOSIS >

---

Is the measurement value normal when any of the switches is turned ON?

YES >> Replace BCM.

NO >> Replace the combination switch.

### Special Repair Requirement

INFOID:000000000963909

### 1. REQUIRED WORK WHEN REPLACING BCM

---

Initialize IVIS by CONSULT-III. For the details of initialization refer to CONSULT-III operation manual NATS-IVIS/NVIS.

>> Work end.

# BCM (BODY CONTROL MODULE)

< ECU DIAGNOSIS >

## ECU DIAGNOSIS

### BCM (BODY CONTROL MODULE)

Reference Value

INFOID:000000000963910

#### VALUES ON THE DIAGNOSIS TOOL

Monitor Item	Condition	Value/Status
FR WIPER HI	Other than front wiper switch HI	OFF
	Front wiper switch HI	ON
FR WIPER LOW	Other than front wiper switch LO	OFF
	Front wiper switch LO	ON
FR WASHER SW	Front washer switch OFF	OFF
	Front washer switch ON	ON
FR WIPER INT	Other than front wiper switch INT	OFF
	Front wiper switch INT	ON
FR WIPER STOP	Front wiper is not in STOP position	OFF
	Front wiper is in STOP position	ON
INT VOLUME	Wiper intermittent dial is in a dial position 1 - 7	Wiper intermittent dial position
TURN SIGNAL R	Other than turn signal switch RH	OFF
	Turn signal switch RH	ON
TURN SIGNAL L	Other than turn signal switch LH	OFF
	Turn signal switch LH	ON
TAIL LAMP SW	Other than lighting switch 1ST and 2ND	OFF
	Lighting switch 1ST or 2ND	ON
HI BEAM SW	Other than lighting switch HI	OFF
	Lighting switch HI	ON
HEAD LAMP SW 1	Other than lighting switch 2ND	OFF
	Lighting switch 2ND	ON
HEAD LAMP SW 2	Other than lighting switch 2ND	OFF
	Lighting switch 2ND	ON
PASSING SW	Other than lighting switch PASS	OFF
	Lighting switch PASS	ON
AUTO LIGHT SW	Other than lighting switch AUTO	OFF
	Lighting switch AUTO	ON
FR FOG SW	Front fog lamp switch OFF	OFF
	Front fog lamp switch ON	ON
RR FOG SW	<b>NOTE:</b> The item is indicated, but not monitored.	OFF
DOOR SW-DR	Driver door closed	OFF
	Driver door opened	ON
DOOR SW-AS	Passenger door closed	OFF
	Passenger door opened	ON
DOOR SW-RR	Rear RH door closed	OFF
	Rear RH door opened	ON

## BCM (BODY CONTROL MODULE)

### < ECU DIAGNOSIS >

Monitor Item	Condition	Value/Status
DOOR SW-RL	Rear LH door closed	OFF
	Rear LH door opened	ON
DOOR SW-BK	<b>NOTE:</b> The item is indicated, but not monitored.	OFF
CDL LOCK SW	Other than power door lock switch LOCK	OFF
	Power door lock switch LOCK	ON
CDL UNLOCK SW	Other than power door lock switch UNLOCK	OFF
	Power door lock switch UNLOCK	ON
KEY CYL LK-SW	Other than driver door key cylinder LOCK position	OFF
	Driver door key cylinder LOCK position	ON
KEY CYL UN-SW	Other than driver door key cylinder UNLOCK position	OFF
	Driver door key cylinder UNLOCK position	ON
KEY CYL SW-TR	<b>NOTE:</b> The item is indicated, but not monitored.	OFF
HAZARD SW	Hazard switch is not pressed	OFF
	Hazard switch is pressed	ON
REAR DEF SW	<b>NOTE:</b> The item is indicated, but not monitored.	OFF
H/L WASH SW	<b>NOTE:</b> The item is indicated, but not monitored.	OFF
TR CANCEL SW	Trunk lid opener cancel switch OFF	OFF
	Trunk lid opener cancel switch ON	ON
TR/BD OPEN SW	Trunk lid opener switch OFF	OFF
	While the trunk lid opener switch is turned ON	ON
TRNK/HAT MNTR	Trunk lid closed	OFF
	Trunk lid opened	ON
RKE-LOCK	LOCK button of Intelligent Key is not pressed	OFF
	LOCK button of Intelligent Key is pressed	ON
RKE-UNLOCK	UNLOCK button of Intelligent Key is not pressed	OFF
	UNLOCK button of Intelligent Key is pressed	ON
RKE-TR/BD	TRUNK OPEN button of Intelligent Key is not pressed	OFF
	TRUNK OPEN button of Intelligent Key is pressed	ON
RKE-PANIC	PANIC button of Intelligent Key is not pressed	OFF
	PANIC button of Intelligent Key is pressed	ON
RKE-P/W OPEN	UNLOCK button of Intelligent Key is not pressed	OFF
	UNLOCK button of Intelligent Key is pressed and held	ON
RKE-MODE CHG	LOCK/UNLOCK button of Intelligent Key is not pressed and held simultaneously	OFF
	LOCK/UNLOCK button of Intelligent Key is pressed and held simultaneously	ON
OPTICAL SENSOR	Outside of the vehicle bright	Close to 5 V
	Outside of the vehicle dark	Close to 0 V
REQ SW-DR	Driver door request switch is not pressed	OFF
	Driver door request switch is pressed	ON
REQ SW-AS	Passenger door request switch is not pressed	OFF
	Passenger door request switch is pressed	ON

# BCM (BODY CONTROL MODULE)

## < ECU DIAGNOSIS >

Monitor Item	Condition	Value/Status	
REQ SW-BD/TR	Trunk request switch is not pressed	OFF	A
	Trunk request switch is pressed	ON	
PUSH SW	Push-button ignition switch (push switch) is not pressed	OFF	B
	Push-button ignition switch (push switch) is pressed	ON	
IGN RLY2 -F/B	Ignition switch in OFF or ACC position	OFF	C
	Ignition switch in ON position	ON	
ACC RLY -F/B	Ignition switch in OFF position	OFF	D
	Ignition switch in ACC or ON position	ON	
CLUCH SW	The clutch pedal is not depressed	OFF	E
	The clutch pedal is depressed	ON	
BRAKE SW 1	The brake pedal is not depressed	ON	E
	The brake pedal is depressed	OFF	
DETE/CANCL SW	Selector lever in P position	OFF	F
	Selector lever in any position other than P	ON	
SFT PN/N SW	Selector lever in any position other than P and N	OFF	G
	Selector lever in P or N position	ON	
S/L -LOCK	Steering is locked	OFF	H
	Steering is unlocked	ON	
S/L -UNLOCK	Steering is unlocked	OFF	H
	Steering is locked	ON	
S/L RELAY-F/B	Ignition switch is OFF or ACC position	OFF	I
	Ignition switch is ON position	ON	
UNLK SEN-DR	Driver door is unlocked	OFF	J
	Driver door is locked	ON	
PUSH SW -IPDM	Push-button ignition switch (push-switch) is not pressed	OFF	K
	Push-button ignition switch (push-switch) is pressed	ON	
IGN RLY1 -F/B	Ignition switch is OFF or ACC position	OFF	L
	Ignition switch is ON position	ON	
DETE SW -IPDM	Selector lever in P position	OFF	L
	Selector lever in any position other than P	ON	
SFT PN -IPDM	Selector lever in any position other than P and N	OFF	BCS
	Selector lever in P or N position	ON	
SFT P -MET	Selector lever in any position other than P	OFF	N
	Selector lever in P position	ON	
SFT N -MET	Selector lever in any position other than N	OFF	O
	Selector lever in N position	ON	
ENGINE STATE	Engine stopped	STOP	P
	While the engine stalls	STALL	
	At engine cranking	CRANK	
	Engine running	RUN	
S/L LOCK-IPDM	Steering is locked	OFF	P
	Steering is unlocked	ON	
S/L UNLK-IPDM	Steering is unlocked	OFF	P
	Steering is locked	ON	

## BCM (BODY CONTROL MODULE)

### < ECU DIAGNOSIS >

Monitor Item	Condition	Value/Status
S/L RELAY-REQ	Ignition switch in OFF or ACC position	OFF
	Ignition switch in ON position	ON
VEH SPEED 1	While driving	Equivalent to speedometer reading
VEH SPEED 2	While driving	Equivalent to speedometer reading
DOOR STAT-DR	Driver door is locked	LOCK
	Wait with selective UNLOCK operation (5 seconds)	READY
	Driver door is unlocked	UNLK
DOOR STAT-AS	Passenger door is locked	LOCK
	Wait with selective UNLOCK operation (5 seconds)	READY
	Passenger door is unlocked	UNLK
ID OK FLAG	Ignition switch in ACC or ON position	RESET
	Ignition switch in OFF position	SET
PRMT ENG STRT	The engine start is prohibited	RESET
	The engine start is permitted	SET
PRMT RKE STRT	<b>NOTE:</b> The item is indicated, but not monitored.	RESET
KEY SW -SLOT	Intelligent Key is not inserted into key slot	OFF
	Intelligent Key is inserted into key slot	ON
RKE OPE COUN1	During the operation of Intelligent Key	Operation frequency of Intelligent Key
RKE OPE COUN2	<b>NOTE:</b> The item is indicated, but not monitored.	—
AIR PRESS FL	Ignition switch ON (Only when the signal from the transmitter is received)	Air pressure of front LH tire
AIR PRESS FR	Ignition switch ON (Only when the signal from the transmitter is received)	Air pressure of front RH tire
AIR PRESS RR	Ignition switch ON (Only when the signal from the transmitter is received)	Air pressure of rear RH tire
AIR PRESS RL	Ignition switch ON (Only when the signal from the transmitter is received)	Air pressure of rear LH tire
ID REGST FL1	ID of front LH tire transmitter is registered	DONE
	ID of front LH tire transmitter is not registered	YET
ID REGST FR1	ID of front RH tire transmitter is registered	DONE
	ID of front RH tire transmitter is not registered	YET
ID REGST RR1	ID of rear RH tire transmitter is registered	DONE
	ID of rear RH tire transmitter is not registered	YET
ID REGST RL1	ID of rear LH tire transmitter is registered	DONE
	ID of rear LH tire transmitter is not registered	YET
WARNING LAMP	Tire pressure indicator OFF	OFF
	Tire pressure indicator ON	ON
BUZZER	Tire pressure warning alarm is not sounding	OFF
	Tire pressure warning alarm is sounding	ON

# BCM (BODY CONTROL MODULE)

< ECU DIAGNOSIS >

## TERMINAL LAYOUT

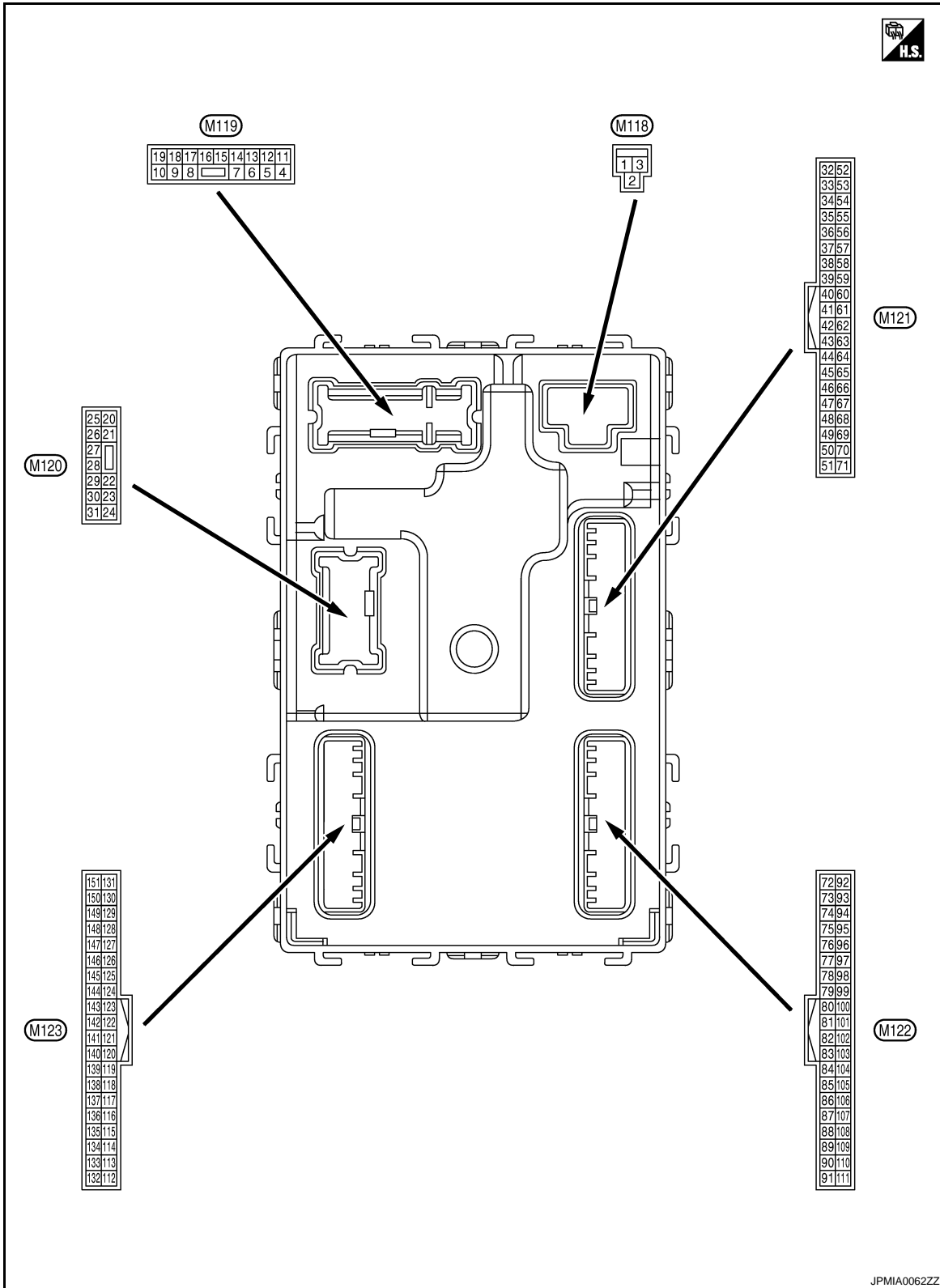

PHYSICAL VALUES

A  
B  
C  
D  
E  
F  
G  
H  
I  
J  
K  
L  
M  
N  
O  
P

BCS

# BCM (BODY CONTROL MODULE)

## < ECU DIAGNOSIS >

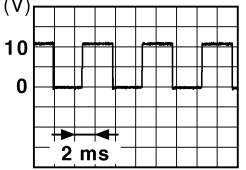
Terminal No. (Wire color)		Description		Condition		Value (Approx.)
+	-	Signal name	Input/ Output			
1 (W)	Ground	Battery power supply	Input	Ignition switch OFF		Battery voltage
2 (Y)	Ground	P/W power supply (BAT)	Output	Ignition switch OFF		Battery voltage
3 (O)	Ground	P/W power supply (RAP)	Output	Ignition switch ON		Battery voltage
4 (LG)	Ground	Interior room lamp power supply	Output	After passing the interior room lamp battery saver operation time		0 V
				Any other time after passing the interior room lamp battery saver operation time		Battery voltage
5 (V)	Ground	Passenger door UN- LOCK	Output	Passenger door	UNLOCK (Actuator is activated)	Battery voltage
					Other than UNLOCK (Actuator is not activated)	0 V
7 (Y)	Ground	Step lamp	Output	Step lamp	ON	0 V
					OFF	Battery voltage
8 (V)	Ground	All doors, fuel lid LOCK	Output	All doors, fuel lid	LOCK (Actuator is activated)	Battery voltage
					Other than LOCK (Actuator is not activated)	0 V
9 (G)	Ground	Driver door, fuel lid UNLOCK	Output	Driver door, fuel lid	UNLOCK (Actuator is activated)	Battery voltage
					Other than UNLOCK (Actuator is not activated)	0 V
10 (BR)	Ground	Rear RH door and rear LH door UN- LOCK	Output	Rear RH door and rear LH door	UNLOCK (Actuator is activated)	Battery voltage
					Other than UNLOCK (Actuator is not activated)	0 V
11 (R)	Ground	Battery power supply	Input	Ignition switch OFF		Battery voltage
13 (B)	Ground	Ground	—	Ignition switch ON		0 V
14 (W)	Ground	Push-button ignition switch illumination ground	Output	Tail lamp	OFF	0 V
					ON	<p><b>NOTE:</b> When the illumination brightening/dimming level is in the neutral position</p>  <p style="text-align: right;">JSNIA0010GB</p>
15 (Y)	Ground	ACC indicator lamp	Output	Ignition switch	OFF	Battery voltage
					ACC or ON	0 V



# BCM (BODY CONTROL MODULE)

## < ECU DIAGNOSIS >

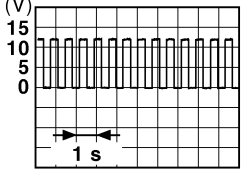
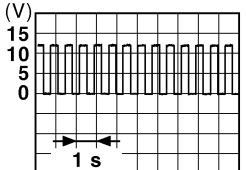
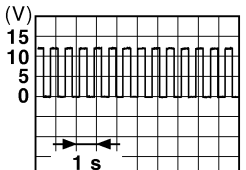
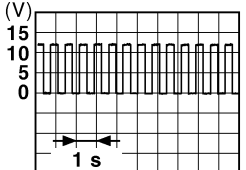
Terminal No. (Wire color)		Description		Condition	Value (Approx.)
+	-	Signal name	Input/ Output		
17 (W)	Ground	Turn signal (front RH)	Output	Ignition switch ON	Turn signal switch OFF
				Turn signal switch RH	0 V
					 <p style="text-align: center;">6.5 V</p>
18 (O)	Ground	Turn signal (front LH)	Output	Ignition switch ON	Turn signal switch OFF
				Turn signal switch LH	0 V
					 <p style="text-align: center;">6.5 V</p>
19 (V)	Ground	Room lamp timer control	Output	Interior room lamp	OFF
				ON	Battery voltage
20 (V)	Ground	Turn signal (rear RH)	Output	Ignition switch ON	Turn signal switch OFF
				Turn signal switch RH	0 V
					 <p style="text-align: center;">6.5 V</p>
23 (G)	Ground	Trunk lid opening.	Output	Trunk lid	Open (Trunk lid opener actuator is activated)
				Close (Trunk lid opener actuator is not activated)	Battery voltage
					0 V
25 (G)	Ground	Turn signal (rear LH)	Output	Ignition switch ON	Turn signal switch OFF
				Turn signal switch LH	0 V
					 <p style="text-align: center;">6.5 V</p>
30 (R)	Ground	Trunk room lamp	Output	Trunk room lamp	ON
				OFF	Battery voltage

A  
B  
C  
D  
E  
F  
G  
H  
I  
J  
K  
L  
N  
O  
P

BCS

# BCM (BODY CONTROL MODULE)

## < ECU DIAGNOSIS >

Terminal No. (Wire color)		Description		Condition	Value (Approx.)
+	-	Signal name	Input/ Output		
34 (SB)	Ground	Trunk room antenna 1 (-)	Output	Ignition switch OFF	<p style="text-align: right; font-size: small;">JMKIA0062GB</p>
				When Intelligent Key is not in the passenger compart- ment	<p style="text-align: right; font-size: small;">JMKIA0063GB</p>
35 (V)	Ground	Trunk room antenna 1 (+)	Output	Ignition switch OFF	<p style="text-align: right; font-size: small;">JMKIA0062GB</p>
				When Intelligent Key is not in the passenger compart- ment	<p style="text-align: right; font-size: small;">JMKIA0063GB</p>
38 (B)	Ground	Rear bumper anten- na (-)	Output	When the trunk lid request switch is operated with ignition switch OFF	<p style="text-align: right; font-size: small;">JMKIA0062GB</p>
				When Intelligent Key is not in the antenna detection area	<p style="text-align: right; font-size: small;">JMKIA0063GB</p>

# BCM (BODY CONTROL MODULE)

## < ECU DIAGNOSIS >

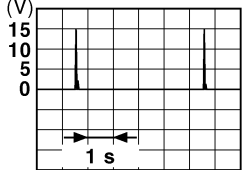
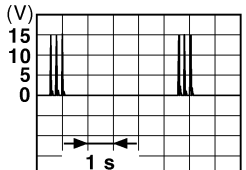
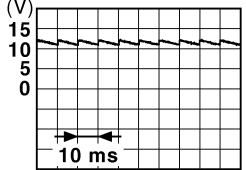
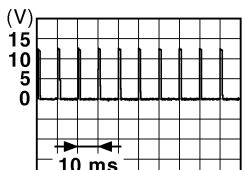
Terminal No. (Wire color)		Description		Condition	Value (Approx.)
		Signal name	Input/ Output		
+	-				
39 (W)	Ground	Rear bumper antenna (+)	Output	When Intelligent Key is in the antenna detection area	 <p style="text-align: right; font-size: small;">JMKIA0062GB</p>
				When Intelligent Key is not in the antenna detection area	 <p style="text-align: right; font-size: small;">JMKIA0063GB</p>
47 (Y)	Ground	Ignition relay (IPDM E/R) control	Output	Ignition switch	OFF or ACC Battery voltage ON 0 V
50 (R)	Ground	Trunk room lamp switch	Input	Trunk room lamp switch	 <p style="text-align: right; font-size: small;">JPMIA0011GB</p> 11.8 V
				ON (Trunk is open)	0 V
52 (SB)	Ground	Starter relay control	Output	Ignition switch OFF (M/T models)	When the clutch pedal is depressed Battery voltage When the clutch pedal is not depressed 0 V
				Ignition switch ON (A/T models)	When selector lever is in P or N position and the brake is depressed Battery voltage
					When selector lever is in P or N position and the brake is not depressed 0 V
61 (W)	Ground	Trunk request switch	Input	Trunk request switch	ON (Pressed) 0 V OFF (Not pressed)
				 <p style="text-align: right; font-size: small;">JPMIA0016GB</p> 1.0 V	
64 (V)	Ground	Request switch buzzer	Output	Request switch buzzer	Sounding 0 V Not sounding Battery voltage

A  
B  
C  
D  
E  
F  
G  
H  
I  
J  
K  
L  
N  
O  
P

BCS

# BCM (BODY CONTROL MODULE)

## < ECU DIAGNOSIS >

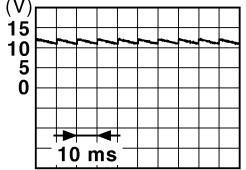
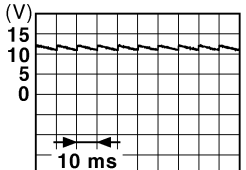
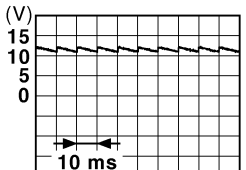
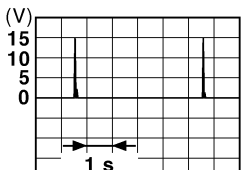
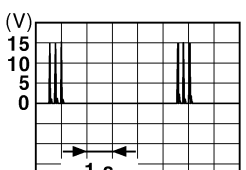
Terminal No. (Wire color)		Description		Condition	Value (Approx.)	
+	-	Signal name	Input/ Output			
67 (GR)	Ground	Trunk lid opener switch	Input	Trunk lid opener switch	Pressed	0 V
					Not pressed	 <p style="text-align: right; font-size: small;">JPMIA0011GB</p> <p style="text-align: center;">11.8 V</p>
68 (BR)	Ground	Rear RH door switch	Input	Rear RH door switch	OFF (When rear RH door closes)	 <p style="text-align: right; font-size: small;">JPMIA0011GB</p> <p style="text-align: center;">11.8 V</p>
					ON (When rear RH door opens)	0 V
69 (R)	Ground	Rear LH door switch	Input	Rear LH door switch	OFF (When rear LH door closes)	 <p style="text-align: right; font-size: small;">JPMIA0011GB</p> <p style="text-align: center;">11.8 V</p>
					ON (When rear LH door opens)	0 V
72 (R)	Ground	Room antenna 2 (-) (center console)	Output	Ignition switch OFF	When Intelligent Key is in the passenger compart- ment	 <p style="text-align: right; font-size: small;">JMKIA0062GB</p>
					When Intelligent Key is not in the passenger compart- ment	 <p style="text-align: right; font-size: small;">JMKIA0063GB</p>

# BCM (BODY CONTROL MODULE)

## < ECU DIAGNOSIS >

Terminal No. (Wire color)		Description		Condition	Value (Approx.)
+	-	Signal name	Input/ Output		
73 (G)	Ground	Room antenna 2 (+) (center console)	Output	Ignition switch OFF	<p>JMKIA0062GB</p>
				When Intelligent Key is not in the passenger compart- ment	<p>JMKIA0063GB</p>
74 (SB)	Ground	Passenger door an- tenna (-)	Output	When the pas- senger door re- quest switch is operated with ig- nition switch OFF	<p>JMKIA0062GB</p>
				When Intelligent Key is not in the antenna detection area	<p>JMKIA0063GB</p>
75 (BR)	Ground	Passenger door an- tenna (+)	Output	When the pas- senger door re- quest switch is operated with ig- nition switch OFF	<p>JMKIA0062GB</p>
				When Intelligent Key is not in the antenna detection area	<p>JMKIA0063GB</p>

A  
B  
C  
D  
E  
F  
G  
H  
I  
J  
K  
L  
N  
O  
P

BCS

# BCM (BODY CONTROL MODULE)

## < ECU DIAGNOSIS >

Terminal No. (Wire color)		Description		Condition	Value (Approx.)
+	-	Signal name	Input/ Output		
76 (V)	Ground	Driver door antenna (-)	Output	When Intelligent Key is in the antenna detection area	
				When the driver door request switch is operat- ed with ignition switch OFF	
77 (LG)	Ground	Driver door antenna (+)	Output	When Intelligent Key is in the antenna detection area	
				When the driver door request switch is operat- ed with ignition switch OFF	
78 (Y)	Ground	Room antenna (-) (in- strument panel)	Output	Ignition switch OFF	
				When Intelligent Key is in the passenger compart- ment	

# BCM (BODY CONTROL MODULE)

## < ECU DIAGNOSIS >



Terminal No. (Wire color)		Description		Condition	Value (Approx.)	
		Signal name	Input/ Output			
+	-					
79 (BR)	Ground	Room antenna (+) (instrument panel)	Output	Ignition switch OFF		
				When Intelligent Key is not in the passenger compart- ment		
80 (GR)	Ground	NATS antenna amp (built in key slot)	Input/ Output	During waiting	Ignition switch is pressed while inserting the Intelli- gent Key into the key slot.	Just after pressing ignition switch. Pointer of tester should move.
81 (W)	Ground	NATS antenna amp (built in key slot)	Input/ Output	During waiting	Ignition switch is pressed while inserting the Intelli- gent Key into the key slot.	Just after pressing ignition switch. Pointer of tester should move.
82 (R)	Ground	Ignition relay (relay box) control	Output	Ignition switch	OFF or ACC	0 V
					ON	Battery voltage
83 (Y)	Ground	Remote keyless entry receiver signal	Input/ Output	During waiting		
				When operating either button on Intelligent Key		

A  
B  
C  
D  
E  
F  
G  
H  
I  
J  
K  
L  
N  
O  
P

BCS

# BCM (BODY CONTROL MODULE)

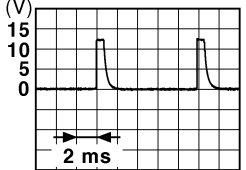

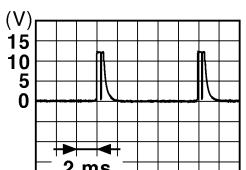
## < ECU DIAGNOSIS >

Terminal No. (Wire color)		Description		Condition	Value (Approx.)
+	-	Signal name	Input/ Output		
87 (BR)	Ground	Combination switch INPUT 5	Input	All switch OFF (Wiper intermittent dial 4)	 <p style="text-align: right; font-size: small;">JPMIA0041GB</p> <p style="text-align: center;">1.4 V</p>
				Front fog lamp switch ON (Wiper intermittent dial 4)	 <p style="text-align: right; font-size: small;">JPMIA0037GB</p> <p style="text-align: center;">1.3 V</p>
				Any of the conditions below with all switch OFF <ul style="list-style-type: none"> <li>• Wiper intermittent dial 1</li> <li>• Wiper intermittent dial 2</li> <li>• Wiper intermittent dial 6</li> <li>• Wiper intermittent dial 7</li> </ul>	 <p style="text-align: right; font-size: small;">JPMIA0040GB</p> <p style="text-align: center;">1.3 V</p>

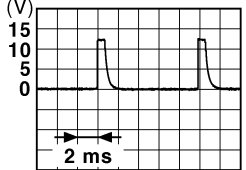
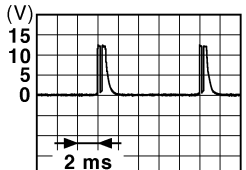

# BCM (BODY CONTROL MODULE)

## < ECU DIAGNOSIS >

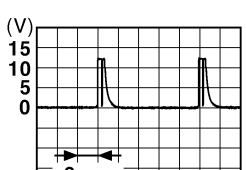
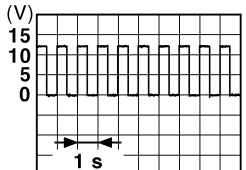
Terminal No. (Wire color)		Description		Condition	Value (Approx.)	
		Signal name	Input/ Output			
+	-					
88 (V)	Ground	Combination switch INPUT 3	Input	Combination switch	All switch OFF (Wiper intermittent dial 4)	 <p style="text-align: right; font-size: small;">JPMIA0041GB</p> <p style="text-align: center;">1.4 V</p>
					Lighting switch HI (Wiper intermittent dial 4)	 <p style="text-align: right; font-size: small;">JPMIA0036GB</p> <p style="text-align: center;">1.3 V</p>
					Lighting switch 2ND (Wiper intermittent dial 4)	 <p style="text-align: right; font-size: small;">JPMIA0037GB</p> <p style="text-align: center;">1.3 V</p>
					Any of the conditions below with all switches OFF	<ul style="list-style-type: none"> <li>• Wiper intermittent dial 1</li> <li>• Wiper intermittent dial 2</li> <li>• Wiper intermittent dial 3</li> </ul>  <p style="text-align: right; font-size: small;">JPMIA0040GB</p> <p style="text-align: center;">1.3 V</p>
89 (BR)	Ground	Push-button ignition switch (push switch)	Input	Push-button igni- tion switch (push switch)	Pressed	0 V
					Not pressed	Battery voltage
90 (P)	Ground	CAN - L	Input/ Output	—	—	
91 (L)	Ground	CAN - H	Input/ Output	—	—	
92 (LG)	Ground	Key slot illumination	Output	Key slot illumina- tion	OFF	0 V
					Blinking	 <p style="text-align: right; font-size: small;">JPMIA0015GB</p> <p style="text-align: center;">6.5 V</p>
					ON	Battery voltage

A  
B  
C  
D  
E  
F  
G  
H  
I  
J  
K  
L

BCS

N  
O  
P



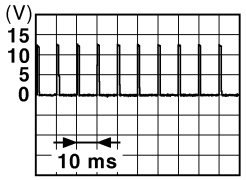
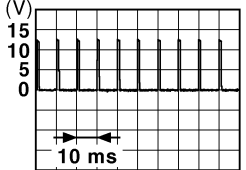

# BCM (BODY CONTROL MODULE)

## < ECU DIAGNOSIS >

Terminal No. (Wire color)		Description		Condition		Value (Approx.)
+	-	Signal name	Input/ Output			
93 (V)	Ground	ON indicator lamp	Output	Ignition switch	OFF or ACC	0 V
					ON	Battery voltage
95 (O)	Ground	ACC relay control	Output	Ignition switch	OFF	0 V
					ACC or ON	Battery voltage
96 (GR)	Ground	A/T device (detention switch) power supply	Output	—		Battery voltage
97 (L)	Ground	Steering lock condition No. 1	Input	Steering lock	LOCK status	0 V
					UNLOCK status	Battery voltage
98 (P)	Ground	Steering lock condition No. 2	Input	Steering lock	LOCK status	Battery voltage
					UNLOCK status	0 V
99 (R)	Ground	Selector lever P position switch	Input	Selector lever	P position	0 V
					Any position other than P	Battery voltage
100 (G)	Ground	Passenger door request switch	Input	Passenger door request switch	ON (Pressed)	0 V
					OFF (Not pressed)	 <p style="text-align: center;">1.0 V</p>
101 (SB)	Ground	Driver door request switch	Input	Driver door request switch	ON (Pressed)	0 V
					OFF (Not pressed)	 <p style="text-align: center;">1.0 V</p>
102 (O)	Ground	Blower fan motor relay control	Output	Ignition switch	OFF or ACC	0 V
					ON	Battery voltage
103 (LG)	Ground	Remote keyless entry receiver power supply	Output	Ignition switch OFF		Battery voltage
106 (W)	Ground	Steering wheel lock unit power supply	Output	Ignition switch	OFF or ACC	Battery voltage
					ON	0 V

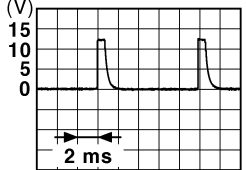
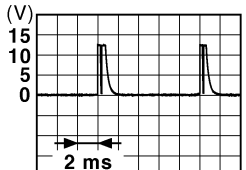
# BCM (BODY CONTROL MODULE)

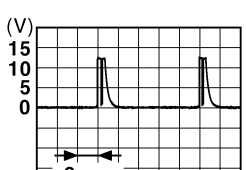
## < ECU DIAGNOSIS >

Terminal No. (Wire color)		Description		Condition	Value (Approx.)	
		Signal name	Input/ Output			
+	-					
107 (LG)	Ground	Combination switch INPUT 1	Input	Combination switch (Wiper intermittent dial 4)	All switch OFF	 <p style="text-align: right;">1.4 V</p>
					Turn signal switch LH	 <p style="text-align: right;">1.3 V</p>
					Turn signal switch RH	 <p style="text-align: right;">1.3 V</p>
					Front wiper switch LO	 <p style="text-align: right;">1.3 V</p>
					Front washer switch ON	 <p style="text-align: right;">1.3 V</p>

A  
B  
C  
D  
E  
F  
G  
H  
I  
J  
K  
L  
N  
O  
P

BCS



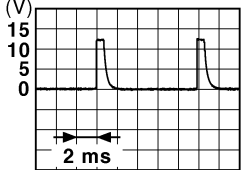
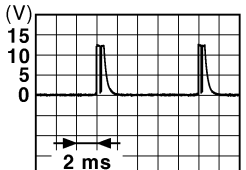
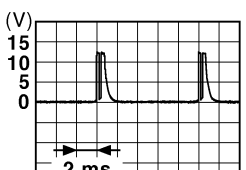

# BCM (BODY CONTROL MODULE)

## < ECU DIAGNOSIS >

Terminal No. (Wire color)		Description		Condition	Value (Approx.)	
		Signal name	Input/ Output			
+	-					
108 (R)	Ground	Combination switch INPUT 4	Input	Combination switch	All switch OFF (Wiper intermittent dial 4)	 <p style="text-align: right; margin-right: 50px;">1.4 V</p> <p style="text-align: right; font-size: small;">JPMIA0041GB</p>
					Lighting switch AUTO (Wiper intermittent dial 4)	 <p style="text-align: right; margin-right: 50px;">1.3 V</p> <p style="text-align: right; font-size: small;">JPMIA0038GB</p>
					Lighting switch 1ST (Wiper intermittent dial 4)	 <p style="text-align: right; margin-right: 50px;">1.3 V</p> <p style="text-align: right; font-size: small;">JPMIA0036GB</p>
					Any of the conditions below with all switches OFF	<ul style="list-style-type: none"> <li>• Wiper intermittent dial 1</li> <li>• Wiper intermittent dial 5</li> <li>• Wiper intermittent dial 6</li> </ul>

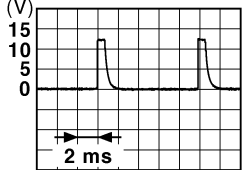
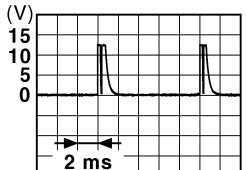
# BCM (BODY CONTROL MODULE)

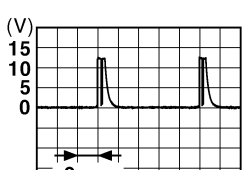
## < ECU DIAGNOSIS >

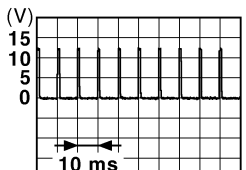
Terminal No. (Wire color)		Description		Condition	Value (Approx.)	
		Signal name	Input/ Output			
+	-					
109 (Y)	Ground	Combination switch INPUT 2	Input	Combination switch (Wiper intermittent dial 4)	All switch OFF	 1.4 V
					Lighting switch PASS	 1.3 V
					Lighting switch 2ND	 1.3 V
					Front wiper switch INT	 1.3 V
					Front wiper switch HI	 1.3 V
					Pressed	0 V
110 (G)	Ground	Hazard switch	Input	Hazard switch	Not pressed	 1.1 V

A  
B  
C  
D  
E  
F  
G  
H  
I  
J  
K  
L  
N  
O  
P

BCS

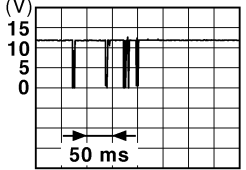
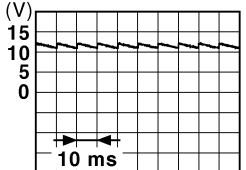

# BCM (BODY CONTROL MODULE)

## < ECU DIAGNOSIS >

Terminal No. (Wire color)		Description		Condition	Value (Approx.)		
+	-	Signal name	Input/ Output				
111 (Y)	Ground	Steering lock unit communication	Input/ Output	Steering lock	LOCK status	Battery voltage	
					LOCK or UNLOCK	 <p style="text-align: right; font-size: small;">JMkia0066GB</p>	
					For 15 seconds after UN- LOCK	Battery voltage	
					15 seconds or later after UNLOCK	0 V	
113 (P)	Ground	Optical sensor signal	Input	Ignition switch ON	When bright outside of the vehicle	Close to 5 V	
					When dark outside of the vehicle	Close to 0 V	
114 (R)	Ground	Clutch interlock switch	Input	Clutch interlock switch	OFF (Clutch pedal is not depressed)	0 V	
						ON (Clutch pedal is de- pressed)	Battery voltage
116 (SB)	Ground	Stop lamp switch 1	Input	—		Battery voltage	
118 (P)	Ground	Stop lamp switch 2	Input	Stop lamp switch	OFF (Brake pedal is not depressed)	0 V	
						ON (Brake pedal is de- pressed)	Battery voltage
				ICC brake hold relay (With ICC)	OFF	0 V	
					ON	Battery voltage	
119 (SB)	Ground	Front door lock as- sembly driver side (unlock sensor)	Input	Driver door	LOCK status	 <p style="text-align: right; font-size: small;">JPMIA0011GB</p>	
						UNLOCK status	0 V
							11.8 V
121 (R)	Ground	Key slot switch	Input	When Intelligent Key is inserted into key slot	Battery voltage		
				When Intelligent Key is not inserted into key slot	0 V		
122 (V)	Ground	ACC feedback signal	Input	Ignition switch	OFF	0 V	
					ACC or ON	Battery voltage	
123 (W)	Ground	IGN feedback signal	Input	Ignition switch	OFF or ACC	0 V	
					ON	Battery voltage	

# BCM (BODY CONTROL MODULE)

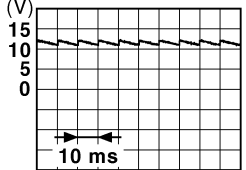
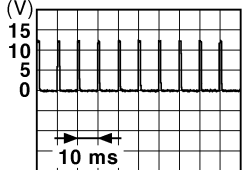
## < ECU DIAGNOSIS >

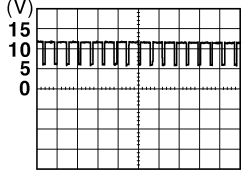

Terminal No. (Wire color)		Description		Condition	Value (Approx.)	
		Signal name	Input/ Output			
+	-					
124 (LG)	Ground	Passenger door switch	Input	Passenger door switch	OFF (When passenger door closes)	 <p style="text-align: right; font-size: small;">JPMIA0011GB</p>
					ON (When passenger door opens)	0 V
129 (O)	Ground	Trunk lid opener cancel switch	Input	Trunk lid opener cancel switch	CANCEL	 <p style="text-align: right; font-size: small;">JPMIA0012GB</p>
					ON	0 V
132 (V)	Ground	Power window switch communication	Input/ Output	Ignition switch ON		 <p style="text-align: right; font-size: small;">JPMIA0013GB</p>
					Ignition switch OFF or ACC	0 V
133 (W)	Ground	Push-button ignition switch illumination	Output	Push-button ignition switch illumination	ON (When tail lamps OFF)	5.5 V
					ON (When tail lamps ON)	<p><b>NOTE:</b> The pulse width of this wave is varied by the illumination bright- ening/dimming level.</p>  <p style="text-align: right; font-size: small;">JPMIA0159GB</p>
					OFF	0 V
134 (GR)	Ground	LOCK indicator lamp	Output	LOCK indicator lamp	ON	0 V
					OFF	Battery voltage
137 (O)	Ground	Receiver and sensor ground	Input	Ignition switch ON		0 V
138 (V)	Ground	Receiver and sensor power supply output	Output	Ignition switch	OFF	0 V
					ACC or ON	5.0 V

A  
B  
C  
D  
E  
F  
G  
H  
I  
J  
K  
L  
N  
O  
P

BCS

# BCM (BODY CONTROL MODULE)

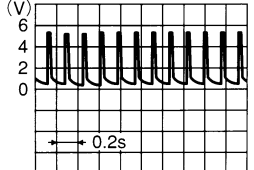
## < ECU DIAGNOSIS >

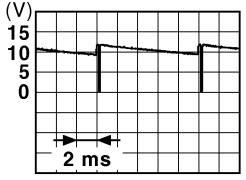
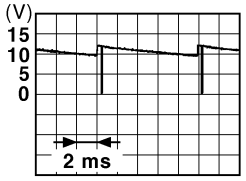
Terminal No. (Wire color)		Description		Condition	Value (Approx.)
+	-	Signal name	Input/ Output		
139 (L)	Ground	Tire pressure receiver signal	Input/ Output	Ignition switch ON	Standby state  OCC3881D
				When receiving the signal from the transmitter  OCC3880D	
140 (GR)	Ground	Selector lever P/N position signal	Input	Selector lever	P or N position 12.0 V Except P and N positions 0 V
				141 (G)	Ground
OFF Battery voltage					
142 (O)	Ground	Combination switch OUTPUT 5	Output	Combination switch (Wiper intermittent dial 4)	All switch OFF 0 V
					Lighting switch 1ST
					Lighting switch HI
					Lighting switch 2ND
Turn signal switch RH  JPMIA0031GB 10.7 V					
143 (P)	Ground	Combination switch OUTPUT 1	Output	Combination switch	All switch OFF (Wiper intermittent dial 4) 0 V
					Front wiper switch HI (Wiper intermittent dial 4)
					Any of the conditions below with all switch OFF <ul style="list-style-type: none"> <li>• Wiper intermittent dial 1</li> <li>• Wiper intermittent dial 2</li> <li>• Wiper intermittent dial 3</li> <li>• Wiper intermittent dial 6</li> <li>• Wiper intermittent dial 7</li> </ul>  JPMIA0032GB 10.7 V



# BCM (BODY CONTROL MODULE)

## < ECU DIAGNOSIS >

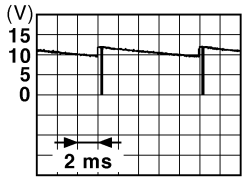
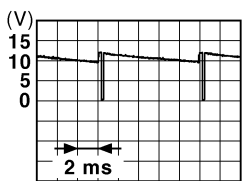
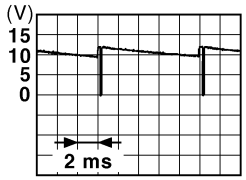
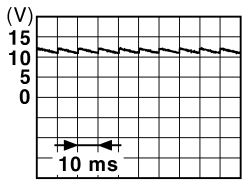
Terminal No. (Wire color)		Description		Condition	Value (Approx.)	
+	-	Signal name	Input/ Output			
144 (G)	Ground	Combination switch OUTPUT 2	Output	Combination switch	All switch OFF (Wiper intermittent dial 4)	0 V
					Front washer switch ON (Wiper intermittent dial 4)	
Any of the conditions below with all switches OFF					10.7 V	
<ul style="list-style-type: none"> <li>• Wiper intermittent dial 1</li> <li>• Wiper intermittent dial 5</li> <li>• Wiper intermittent dial 6</li> </ul>						
145 (L)	Ground	Combination switch OUTPUT 3	Output	Combination switch (Wiper intermit- tent dial 4)	All switches OFF	0 V
					Front wiper switch INT	
					Front wiper switch LO	
					Lighting switch AUTO	
					10.7 V	
146 (SB)	Ground	Combination switch OUTPUT 4	Output	Combination switch (Wiper intermit- tent dial 4)	All switch OFF	0 V
					Front fog lamp switch ON	
					Lighting switch 2ND	
					Lighting switch PASS	
					Turn signal switch LH	
					10.7 V	
149 (W)	Ground	Tire pressure warn- ing check switch	Input	—	5 V	
150 (GR)	Ground	Driver door switch	Input	Driver door switch	OFF (When driver door closes)	
					ON (When driver door opens)	
151 (G)	Ground	Rear window defog- ger relay	Output	Rear window de- fogger	Active	0 V
					Not activated	Battery voltage

A  
B  
C  
D  
E  
F  
G  
H  
I  
J  
K  
L  
N  
O  
P

BCS

# BCM (BODY CONTROL MODULE)

< ECU DIAGNOSIS >

## Wiring Diagram — BCM —

INFOID:00000000963911

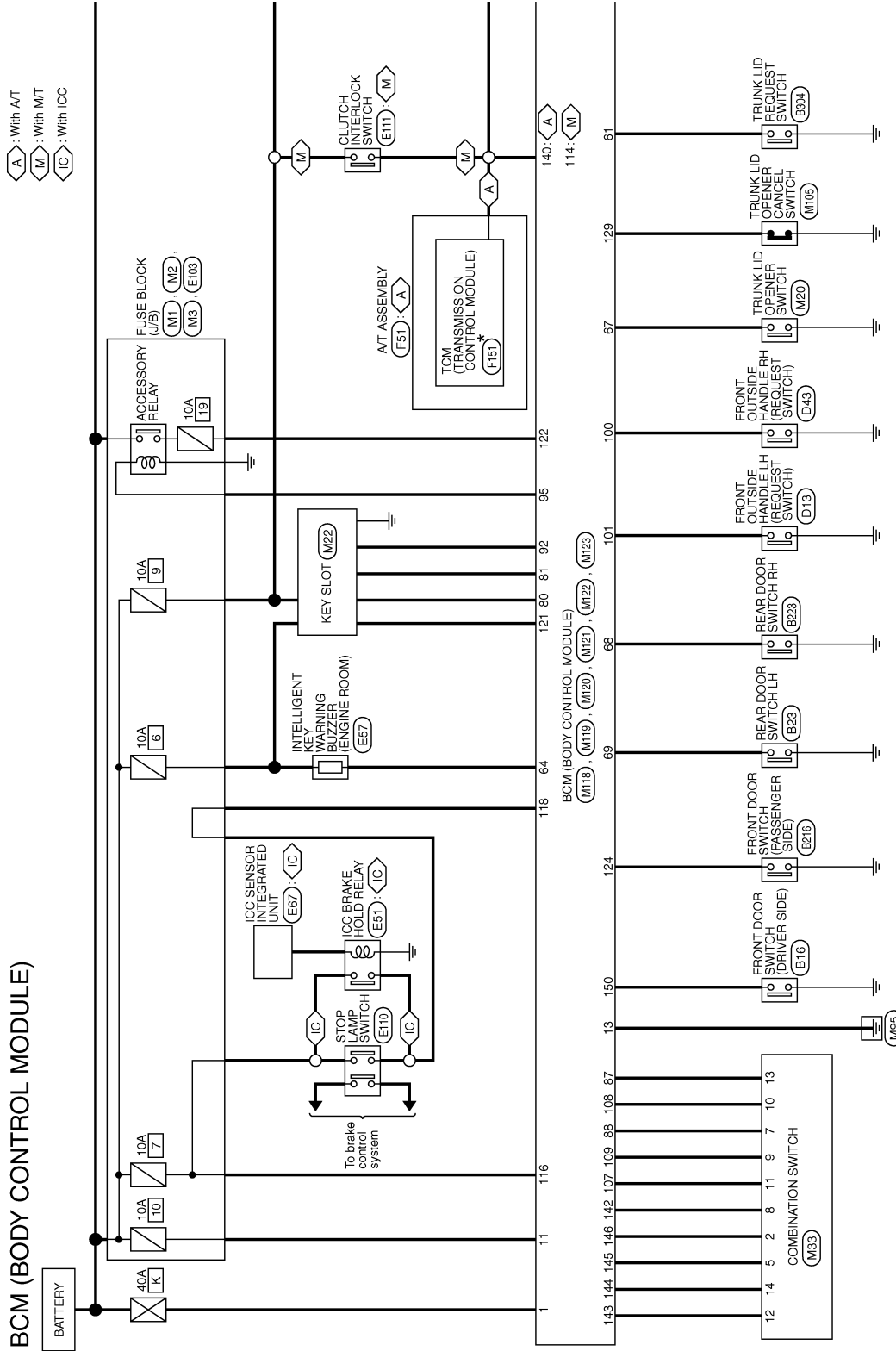

\*: This connector is not shown in "Harness Layout".

2006/09/15

JCMWA0005Gf

# BCM (BODY CONTROL MODULE)

< ECU DIAGNOSIS >

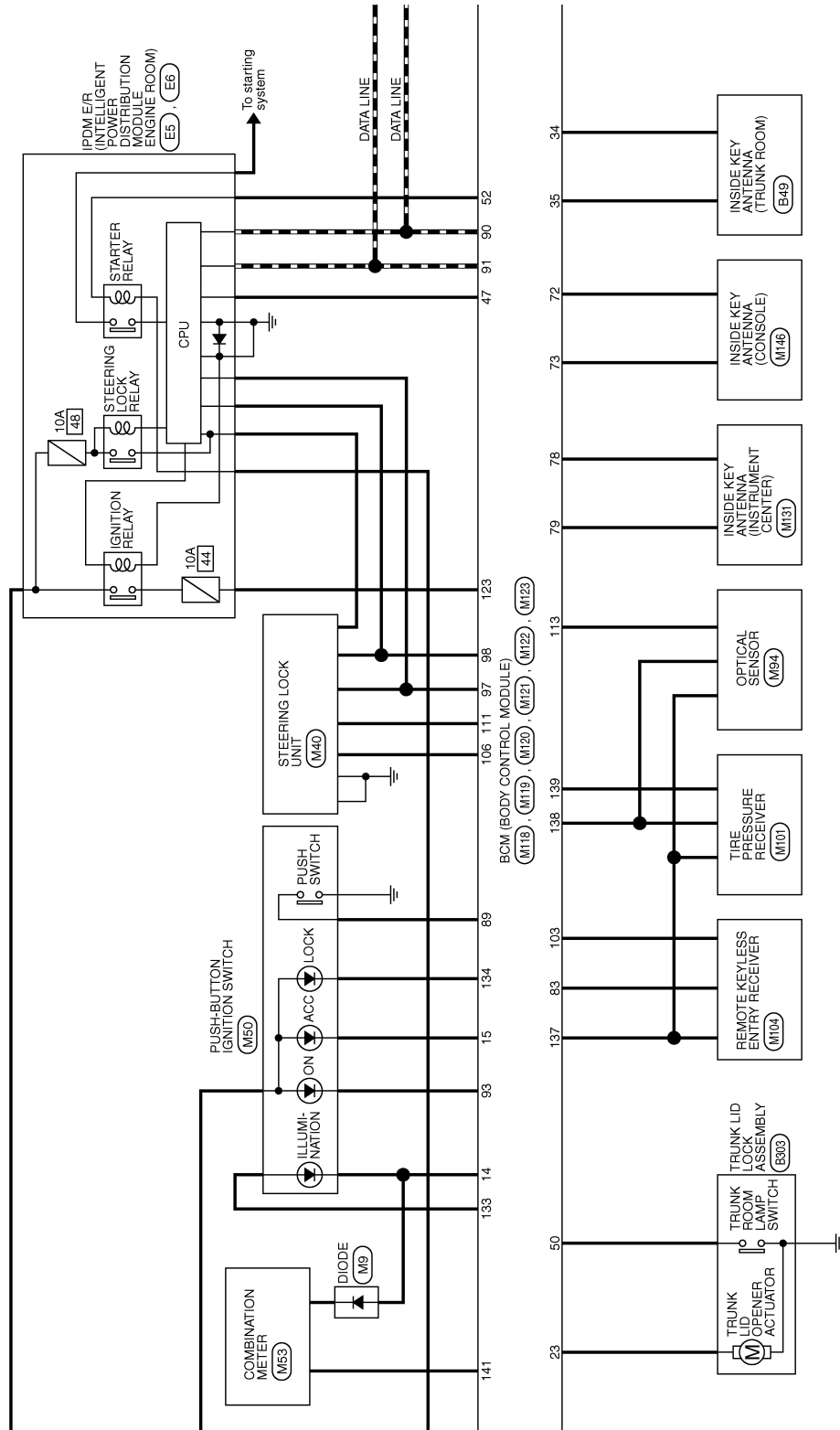

JCMWA0006G1

A  
B  
C  
D  
E  
F  
G  
H  
I  
J  
K  
L  
N  
O  
P

BCS

# BCM (BODY CONTROL MODULE)

< ECU DIAGNOSIS >

- ◊ A : With AT
- ◊ NV : With NAVI
- ◊ ON : Without NAVI
- ◊ RE : With sunroof
- ◊ AN : With rear anti-pinch system
- ◊ OA : Without rear anti-pinch system
- ◊ SP : With sports seat
- ◊ PM : With automatic drive positioner

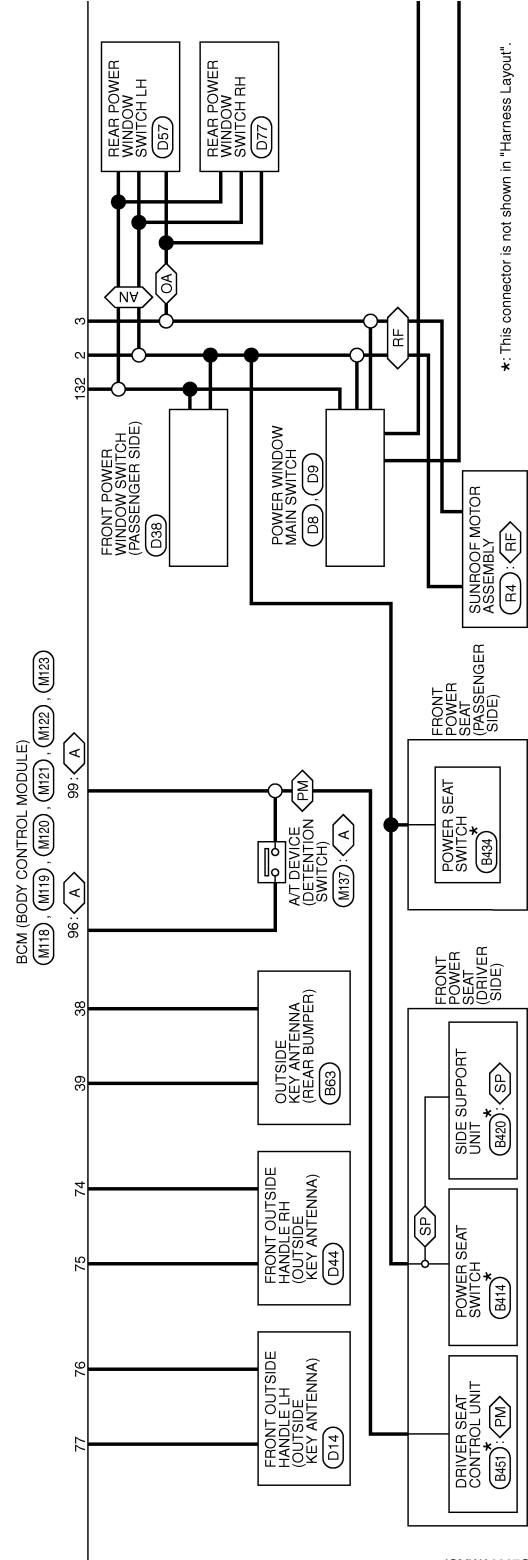
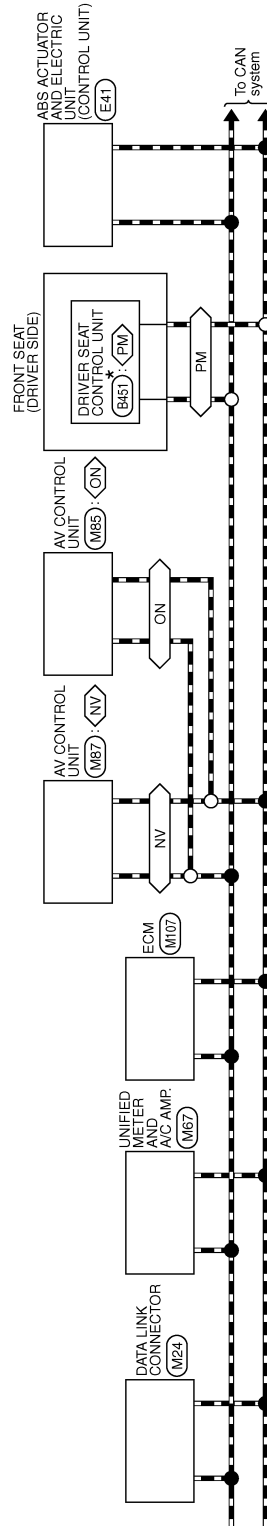

\*: This connector is not shown in "Harness Layout".

JCMWA0007G1

# BCM (BODY CONTROL MODULE)

< ECU DIAGNOSIS >

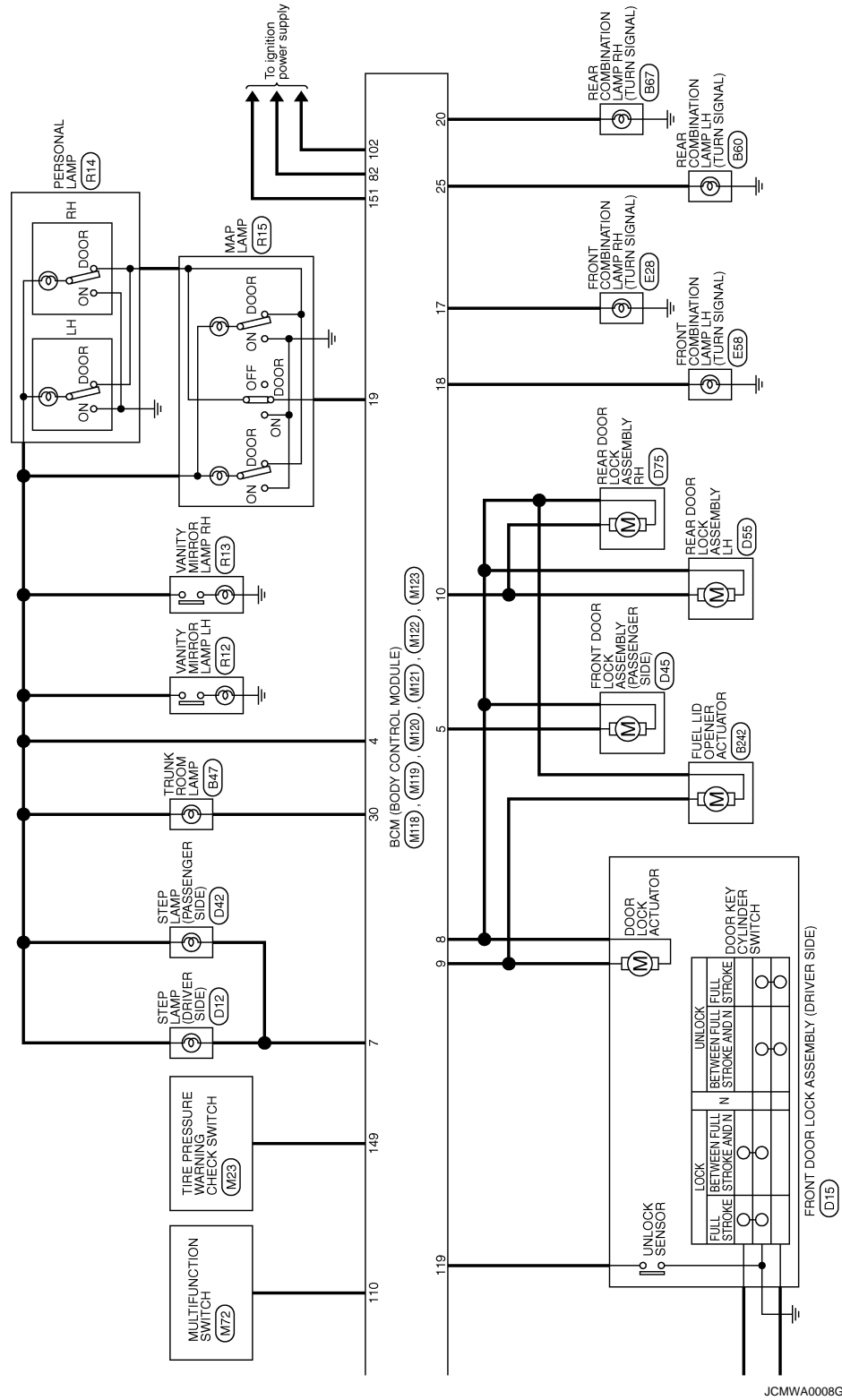

JCMWA0008G1

A  
B  
C  
D  
E  
F  
G  
H  
I  
J  
K  
L  
N  
O  
P

BCS

# BCM (BODY CONTROL MODULE)

< ECU DIAGNOSIS >

## BCM (BODY CONTROL MODULE)

Connector No.	M33
Connector Name	COMBINATION SWITCH
Connector Type	TH16FW-NH

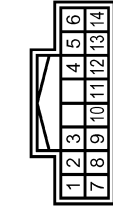

Terminal No.	Color of Wire	Signal Name
2	SB	OUTPUT 4
5	L	OUTPUT 3
7	V	INPUT 3
8	O	OUTPUT 5
9	Y	INPUT 2
10	R	INPUT 4
11	LG	INPUT 1
12	P	OUTPUT 1
13	BR	INPUT 5
14	G	OUTPUT 2

Connector No.	M120
Connector Name	BCM (BODY CONTROL MODULE)
Connector Type	NS12FW-CS

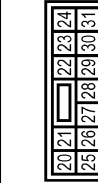

Terminal No.	Color of Wire	Signal Name
20	V	REAR FLASHER OUTPUT(RIGHT)
23	G	TRUNK OPENER OUTPUT
24	G	REAR FLASHER OUTPUT(LEFT)
30	R	TRUNK LAMP OUTPUT

Connector No.	M118
Connector Name	BCM (BODY CONTROL MODULE)
Connector Type	M03FB-LC

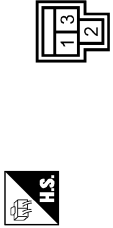

Terminal No.	Color of Wire	Signal Name
1	W	BAT (E/L)
2	Y	POWER WINDOW POWER SUPPLY(BAT)
3	O	POWER WINDOW POWER SUPPLY(RAP)

Connector No.	M121
Connector Name	BCM (BODY CONTROL MODULE)
Connector Type	TH40FGY-NH

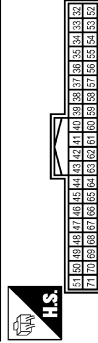

Terminal No.	Color of Wire	Signal Name
34	SB	TRUNK ANTI-
35	V	TRUNK ANTI+
38	B	BACK ANTI-
39	W	BACK ANTI+
47	Y	ING USM CONTI
50	R	TRUNK SW
52	SB	ST CONT USM
61	W	TRUNK REQUEST SW
64	V	BUZZER
67	GR	INTERIOR TRUNK SW
68	BR	DOOR SW (RR RH)

Connector No.	M119
Connector Name	BCM (BODY CONTROL MODULE)
Connector Type	NS18FW-CS

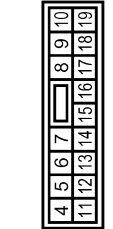

Terminal No.	Color of Wire	Signal Name
4	LG	BAT SAVER OUTPUT
5	V	DOOR UNLOCK OUTPUT (AS)
7	Y	STEP LAMP OUTPUT
8	Y	DOOR LOCK OUTPUT (ALL)
9	G	DOOR UNLOCK OUTPUT (RR)
10	BR	DOOR UNLOCK OUTPUT (RR)
11	R	BAT FUSE
13	B	GND
14	W	RING/SW LED GND
15	Y	ACC LED
17	W	FRONT FLASHER OUTPUT(RIGHT)

69	R	DOOR SW (RR LH)
----	---	-----------------

18	O	FRONT FLASHER OUTPUT(LEFT)
19	V	ROOM LAMP OUTPUT

JCMWA0009G1

# BCM (BODY CONTROL MODULE)

< ECU DIAGNOSIS >

A  
B  
C  
D  
E  
F  
G  
H  
I  
J  
K  
L  
N  
O  
P

133	W	RMG/SW LED
134	GR	LOCK LED
137	O	SENSOR GND
138	V	AUTO LIGHT SENSOR POWER SUPPLY
139	L	RECEIVER SIGNAL
140	GR	SHIFT N/P
141	G	SECURITY INDICATOR OUTPUT
142	O	COMBI SW OUTPUT 5
143	P	COMBI SW OUTPUT 1
144	G	COMBI SW OUTPUT 2
145	L	COMBI SW OUTPUT 3
146	SB	COMBI SW OUTPUT 4
149	W	MODE TRG SW
150	GR	DOOR SW (DR)
151	G	REAR DEFOGGER OUTPUT

Connector No.	M123
Connector Name	BCM (BODY CONTROL MODULE)
Connector Type	TH40FC-NH

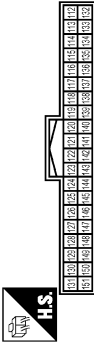

Terminal No.	Color of Wire	Signal Name
113	P	AUTO LIGHT SENSOR INPUT
114	R	CLUTCH SW
116	SB	STOP LAMP LOW
118	P	STOP LAMP HIGH
119	SB	DR CONDITION SW
121	R	KEY SWITCH SIGNAL
122	V	ACC F/B
123	W	IGN F/B
124	LG	DOOR SW (AS)
129	O	TRUNK CANCEL SW
132	V	POWER WINDOW SERIAL LINK

83	Y	KEYLESS TUNER SIGNAL
87	BR	COMBI SW INPUT 5
88	V	COMBI SW INPUT 3
89	BR	ENG SW
90	P	GAN-H
91	L	GAN-H
92	LG	KEY SLOT ILL ON LED
93	V	ACC CONT
95	O	A/T DEVICE
96	GR	S/L CONDITION 1
97	L	S/L CONDITION 2
98	P	AS REQUEST SW
99	R	SHIFT P
100	G	DR REQUEST SW
101	SB	IGN2 CONT
102	O	KEYLESS TUNER POWER SUPPLY
103	LG	S/L TRV (CRUI)
106	W	COMBI SW INPUT 1
107	LG	COMBI SW INPUT 4
108	R	COMBI SW INPUT 2
109	Y	HAZARD SW
110	G	S/L (K LINE)
111	Y	

## BCM (BODY CONTROL MODULE)

Connector No.	M122
Connector Name	BCM (BODY CONTROL MODULE)
Connector Type	TH40FB-NH

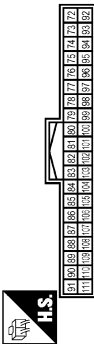

Terminal No.	Color of Wire	Signal Name
72	R	ROOM ANT2-
73	G	ROOM ANT2+
74	SB	AS DOOR ANT-
75	BR	AS DOOR ANT+
76	V	DR DOOR ANT-
77	LG	DR DOOR ANT+
78	Y	ROOM ANT1-
79	BR	ROOM ANT1+
80	GR	IMMOBI ANTENNA CONTROL
81	W	IMMOBI ANTENNA SIGNAL
82	R	IGN ELEC CONT

## Fail Safe

JCMWA0010GI

INFOID:000000000963912

Display contents of CONSULT	Fail-safe	Cancellation
B2013: ID DISCORD BCM-S/L	Inhibit engine cranking	Erase DTC
B2014: CHAIN OF S/L-BCM	Inhibit engine cranking	Erase DTC
B2190: NATS ANTENNA AMP	Inhibit engine cranking	Erase DTC

## BCM (BODY CONTROL MODULE)

### < ECU DIAGNOSIS >

Display contents of CONSULT	Fail-safe	Cancellation
B2191: DIFFERENCE OF KEY	Inhibit engine cranking	Erase DTC
B2192: ID DISCORD BCM-ECM	Inhibit engine cranking	Erase DTC
B2193: CHAIN OF BCM-ECM	Inhibit engine cranking	Erase DTC
B2557: VEHICLE SPEED	Inhibit steering lock	When normal vehicle speed signals have been received from ABS actuator and electric unit (control unit) for 500 ms
B2560: STARTER CONT RELAY	Inhibit engine cranking	500 ms after the following CAN signal communication status has become consistent <ul style="list-style-type: none"> <li>• Starter control relay signal</li> <li>• Starter relay status signal</li> </ul>
B2563: HI VOLTAGE	<ul style="list-style-type: none"> <li>• Inhibit engine cranking</li> <li>• Inhibit steering lock</li> </ul>	500 ms after the power supply voltage decreases to less than 18 V
B2601: SHIFT POSITION	Inhibit steering lock	500 ms after the following signal reception status becomes consistent <ul style="list-style-type: none"> <li>• Selector lever P position switch signal</li> <li>• P range signal (CAN)</li> </ul>
B2602: SHIFT POSITION	Inhibit steering lock	5 seconds after the following BCM recognition conditions are fulfilled <ul style="list-style-type: none"> <li>• Ignition switch is in the ON position</li> <li>• Selector lever P position switch signal: Except P position (battery voltage)</li> <li>• Vehicle speed: 4 /h or more</li> </ul>
B2603: SHIFT POSI STATUS	Inhibit steering lock	500 ms after the following BCM recognition conditions are fulfilled <ul style="list-style-type: none"> <li>• Ignition switch is in the ON position</li> <li>• Selector lever P position switch signal: Except P position (battery voltage)</li> <li>• Selector lever P/N position signal: Except P and N positions (0 V)</li> </ul>
B2604: PNP SW	Inhibit steering lock	500 ms after any of the following BCM recognition conditions is fulfilled <ul style="list-style-type: none"> <li>• Status 1               <ul style="list-style-type: none"> <li>- Ignition switch is in the ON position</li> <li>- Selector lever P/N position signal: P and N position (battery voltage)</li> <li>- P range signal or N range signal (CAN): ON</li> </ul> </li> <li>• Status 2               <ul style="list-style-type: none"> <li>- Ignition switch is in the ON position</li> <li>- Selector lever P/N position signal: Except P and N positions (0 V)</li> <li>- P range signal and N range signal (CAN): OFF</li> </ul> </li> </ul>
B2605: PNP SW	Inhibit steering lock	500 ms after any of the following BCM recognition conditions is fulfilled <ul style="list-style-type: none"> <li>• Ignition switch is in the ON position               <ul style="list-style-type: none"> <li>- Power position: IGN</li> <li>- Selector lever P/N position signal: Except P and N positions (0 V)</li> <li>- Interlock/PNP switch signal (CAN): OFF</li> </ul> </li> <li>• Status 2               <ul style="list-style-type: none"> <li>- Ignition switch is in the ON position</li> <li>- Selector lever P/N position signal: P or N position (battery voltage)</li> <li>- PNP switch signal (CAN): ON</li> </ul> </li> </ul>
B2606: S/L RELAY	Inhibit engine cranking	500 ms after the following CAN signal communication status has become consistent <ul style="list-style-type: none"> <li>• Steering lock relay signal (Request signal)</li> <li>• Steering lock relay signal (Condition signal)</li> </ul>
B2607: S/L RELAY	Inhibit engine cranking	500 ms after the following CAN signal communication status has become consistent <ul style="list-style-type: none"> <li>• Steering lock relay signal (Request signal)</li> <li>• Steering lock relay signal (Condition signal)</li> </ul>



## BCM (BODY CONTROL MODULE)

### < ECU DIAGNOSIS >

Display contents of CONSULT	Fail-safe	Cancellation
B2608: STARTER RELAY	Inhibit engine cranking	500 ms after the following signal communication status becomes consistent <ul style="list-style-type: none"> <li>• Starter motor relay control signal</li> <li>• Starter relay status signal (CAN)</li> </ul>
B2609: S/L STATUS	<ul style="list-style-type: none"> <li>• Inhibit engine cranking</li> <li>• Inhibit steering lock</li> </ul>	When the following steering lock conditions agree <ul style="list-style-type: none"> <li>• BCM steering lock control status</li> <li>• Steering lock condition No. 1 signal status</li> <li>• Steering lock condition No. 2 signal status</li> </ul>
B260A: IGNITION RELAY	Inhibit engine cranking	500 ms after the following conditions are fulfilled <ul style="list-style-type: none"> <li>• IGN relay (IPDM E/R) control signal: OFF (Battery voltage)</li> <li>• Ignition ON signal (CAN to IPDM E/R): OFF (Request signal)</li> <li>• Ignition ON signal (CAN from IPDM E/R): OFF (Condition signal)</li> </ul>
B260F: ENG STATE SIG LOST	Maintains the power supply position attained at the time of DTC detection	When any of the following conditions is fulfilled <ul style="list-style-type: none"> <li>• Power position changes to ACC</li> <li>• Receives engine status signal (CAN)</li> </ul>
B2612: S/L STATUS	<ul style="list-style-type: none"> <li>• Inhibit engine cranking</li> <li>• Inhibit steering lock</li> </ul>	When any of the following conditions is fulfilled <ul style="list-style-type: none"> <li>• Steering lock unit status signal (CAN) is received normally</li> <li>• The BCM steering lock control status matches the steering lock status recognized by the steering lock unit status signal (CAN from IPDM E/R)</li> </ul>
B2617: STARTER RELAY CIRC	Inhibit engine cranking	1 second after the starter motor relay control inside BCM becomes normal
B2618: BCM	Inhibit engine cranking	1 second after the ignition relay (IPDM E/R) control inside BCM becomes normal
B2619: BCM	Inhibit engine cranking	1 second after the steering lock unit power supply output control inside BCM becomes normal
B261E: VEHICLE TYPE	Inhibit engine cranking	BCM initialization
B26E1: ENG STATE NO RECIV	Inhibit engine cranking	When any of the following conditions is fulfilled <ul style="list-style-type: none"> <li>• Power position changes to ACC</li> <li>• Receives engine status signal (CAN)</li> </ul>

### DTC Inspection Priority Chart

INFOID:000000000963913

If some DTCs are displayed at the same time, perform inspections one by one based on the following priority chart.

Priority	DTC
1	<ul style="list-style-type: none"> <li>• B2562: LOW VOLTAGE</li> <li>• B2563: HI VOLTAGE</li> </ul>
2	<ul style="list-style-type: none"> <li>• U1000: CAN COMM CIRCUIT</li> <li>• U1010: CONTROL UNIT (CAN)</li> </ul>
3	<ul style="list-style-type: none"> <li>• B2190: NATS ANTENA AMP</li> <li>• B2191: DIFFERENCE OF KEY</li> <li>• B2192: ID DISCORD BCM-ECM</li> <li>• B2193: CHAIN OF BCM-ECM</li> </ul>

# BCM (BODY CONTROL MODULE)

## < ECU DIAGNOSIS >

Priority	DTC
4	<ul style="list-style-type: none"> <li>• B2013: ID DISCORD BCM-S/L</li> <li>• B2014: CHAIN OF S/L-BCM</li> <li>• B2553: IGNITION RELAY</li> <li>• B2555: STOP LAMP</li> <li>• B2556: PUSH-BTN IGN SW</li> <li>• B2557: VEHICLE SPEED</li> <li>• B2560: STARTER CONT RELAY</li> <li>• B2601: SHIFT POSITION</li> <li>• B2602: SHIFT POSITION</li> <li>• B2603: SHIFT POSI STATUS</li> <li>• B2604: PNP SW</li> <li>• B2605: PNP SW</li> <li>• B2606: S/L RELAY</li> <li>• B2607: S/L RELAY</li> <li>• B2608: STARTER RELAY</li> <li>• B2609: S/L STATUS</li> <li>• B260A: IGNITION RELAY</li> <li>• B260B: STEERING LOCK UNIT</li> <li>• B260C: STEERING LOCK UNIT</li> <li>• B260D: STEERING LOCK UNIT</li> <li>• B260F: ENG STATE SIG LOST</li> <li>• B2611: ACC RELAY</li> <li>• B2612: S/L STATUS</li> <li>• B2614: ACC RELAY CIRC</li> <li>• B2615: BLOWER RELAY CIRC</li> <li>• B2616: IGN RELAY CIRC</li> <li>• B2617: STARTER RELAY CIRC</li> <li>• B2618: BCM</li> <li>• B2619: BCM</li> <li>• B261A: PUSH-BTN IGN SW</li> <li>• B261E: VEHICLE TYPE</li> <li>• B26E1: ENG STATE NO RECIV</li> <li>• C1729: VHCL SPEED SIG ERR</li> <li>• U0415: VEHICLE SPEED SIG</li> </ul>
5	<ul style="list-style-type: none"> <li>• C1704: LOW PRESSURE FL</li> <li>• C1705: LOW PRESSURE FR</li> <li>• C1706: LOW PRESSURE RR</li> <li>• C1707: LOW PRESSURE RL</li> <li>• C1708: [NO DATA] FL</li> <li>• C1709: [NO DATA] FR</li> <li>• C1710: [NO DATA] RR</li> <li>• C1711: [NO DATA] RL</li> <li>• C1712: [CHECKSUM ERR] FL</li> <li>• C1713: [CHECKSUM ERR] FR</li> <li>• C1714: [CHECKSUM ERR] RR</li> <li>• C1715: [CHECKSUM ERR] RL</li> <li>• C1716: [PRESSDATA ERR] FL</li> <li>• C1717: [PRESSDATA ERR] FR</li> <li>• C1718: [PRESSDATA ERR] RR</li> <li>• C1719: [PRESSDATA ERR] RL</li> <li>• C1720: [CODE ERR] FL</li> <li>• C1721: [CODE ERR] FR</li> <li>• C1722: [CODE ERR] RR</li> <li>• C1723: [CODE ERR] RL</li> <li>• C1724: [BATT VOLT LOW] FL</li> <li>• C1725: [BATT VOLT LOW] FR</li> <li>• C1726: [BATT VOLT LOW] RR</li> <li>• C1727: [BATT VOLT LOW] RL</li> <li>• C1734: CONTROL UNIT</li> </ul>
6	<ul style="list-style-type: none"> <li>• B2621: INSIDE ANTENNA</li> <li>• B2622: INSIDE ANTENNA</li> <li>• B2623: INSIDE ANTENNA</li> </ul>

## BCM (BODY CONTROL MODULE)

### < ECU DIAGNOSIS >

#### NOTE:

- Details of time display
- CRNT: Displays when there is a malfunction now or after returning to the normal condition until turning ignition switch OFF → ON again.
- 1 - 39: Displayed if any previous malfunction is present when current condition is normal. It increases like 1 → 2 → 3...38 → 39 after returning to the normal condition whenever ignition switch OFF → ON. The counter remains at 39 even if the number of cycles exceeds it. It is counted from 1 again when turning ignition switch OFF → ON after returning to the normal condition if the malfunction is detected again.

CONSULT display	Fail-safe	Intelligent Key warning lamp ON	Tire pressure monitor warning lamp ON	Reference page
No DTC is detected. further testing may be required.	—	—	—	—
U1000: CAN COMM CIRCUIT	—	—	—	<a href="#">BCS-33</a>
U1010: CONTROL UNIT (CAN)	—	—	—	<a href="#">BCS-34</a>
U0415: VEHICLE SPEED SIG	—	—	—	<a href="#">BCS-35</a>
B2013: ID DISCORD BCM-S/L	×	—	—	<a href="#">SEC-43</a>
B2014: CHAIN OF S/L-BCM	×	—	—	<a href="#">SEC-44</a>
B2190: NATS ANTENNA AMP	×	—	—	<a href="#">SEC-37</a>
B2191: DIFFERENCE OF KEY	×	—	—	<a href="#">SEC-40</a>
B2192: ID DISCORD BCM-ECM	×	—	—	<a href="#">SEC-41</a>
B2193: CHAIN OF BCM-ECM	×	—	—	<a href="#">SEC-42</a>
B2553: IGNITION RELAY	—	—	—	<a href="#">PCS-48</a>
B2555: STOP LAMP	—	—	—	<a href="#">SEC-47</a>
B2556: PUSH-BTN IGN SW	—	×	—	<a href="#">SEC-49</a>
B2557: VEHICLE SPEED	×	×	—	<a href="#">SEC-51</a>
B2560: STARTER CONT RELAY	×	×	—	<a href="#">SEC-52</a>
B2562: LOW VOLTAGE	—	—	—	<a href="#">BCS-36</a>
B2563: HI VOLTAGE	×	×	—	<a href="#">BCS-37</a>
B2601: SHIFT POSITION	×	×	—	<a href="#">SEC-53</a>
B2602: SHIFT POSITION	×	×	—	<a href="#">SEC-56</a>
B2603: SHIFT POSI STATUS	×	×	—	<a href="#">SEC-58</a>
B2604: PNP SW	×	×	—	<a href="#">SEC-61</a>
B2605: PNP SW	×	×	—	<a href="#">SEC-63</a>
B2606: S/L RELAY	×	×	—	<a href="#">SEC-65</a>
B2607: S/L RELAY	×	×	—	<a href="#">SEC-66</a>
B2608: STARTER RELAY	×	×	—	<a href="#">SEC-68</a>
B2609: S/L STATUS	×	×	—	<a href="#">SEC-70</a>
B260A: IGNITION RELAY	×	×	—	<a href="#">PCS-50</a>
B260B: STEERING LOCK VNIT	—	×	—	<a href="#">SEC-74</a>
B260C: STEERING LOCK VNIT	—	×	—	<a href="#">SEC-75</a>
B260D: STEERING LOCK VNIT	—	×	—	<a href="#">SEC-76</a>
B260F: ENG STATE SIG LOST	×	×	—	<a href="#">SEC-77</a>
B2611: ACC RELAY	—	—	—	<a href="#">PCS-52</a>
B2612: S/L STATUS	×	×	—	<a href="#">SEC-79</a>
B2614: ACC RELAY CIRC	—	×	—	<a href="#">PCS-54</a>
B2615: BLOWER RELAY CIRC	—	×	—	<a href="#">PCS-57</a>

## BCM (BODY CONTROL MODULE)

### < ECU DIAGNOSIS >

CONSULT display	Fail-safe	Intelligent Key warning lamp ON	Tire pressure monitor warning lamp ON	Reference page
B2616: IGN RELAY CIRC	—	×	—	<a href="#">PCS-60</a>
B2617: STARTER RELAY CIRC	×	×	—	<a href="#">SEC-83</a>
B2618: BCM	×	×	—	<a href="#">PCS-63</a>
B2619: BCM	×	×	—	<a href="#">SEC-85</a>
B261A: PUSH-BTN IGN SW	—	×	—	<a href="#">SEC-86</a>
B261E: VEHICLE TYPE	×	× (Turn ON for 15 seconds)	—	<a href="#">SEC-88</a>
B2621: INSIDE ANTENNA	—	—	—	<a href="#">DLK-58</a>
B2622: INSIDE ANTENNA	—	—	—	<a href="#">DLK-60</a>
B2623: INSIDE ANTENNA	—	—	—	<a href="#">DLK-62</a>
B26E1: ENG STATE NO RES	×	×	—	<a href="#">SEC-78</a>
C1704: LOW PRESSURE FL	—	—	×	<a href="#">WT-14</a>
C1705: LOW PRESSURE FR	—	—	×	<a href="#">WT-14</a>
C1706: LOW PRESSURE RR	—	—	×	<a href="#">WT-14</a>
C1707: LOW PRESSURE RL	—	—	×	<a href="#">WT-14</a>
C1708: [NO DATA] FL	—	—	×	<a href="#">WT-16</a>
C1709: [NO DATA] FR	—	—	×	<a href="#">WT-16</a>
C1710: [NO DATA] RR	—	—	×	<a href="#">WT-16</a>
C1711: [NO DATA] RL	—	—	×	<a href="#">WT-16</a>
C1712: [CHECKSUM ERR] FL	—	—	×	<a href="#">WT-19</a>
C1713: [CHECKSUM ERR] FR	—	—	×	<a href="#">WT-19</a>
C1714: [CHECKSUM ERR] RR	—	—	×	<a href="#">WT-19</a>
C1715: [CHECKSUM ERR] RL	—	—	×	<a href="#">WT-19</a>
C1716: [PRESSDATA ERR] FL	—	—	×	<a href="#">WT-22</a>
C1717: [PRESSDATA ERR] FR	—	—	×	<a href="#">WT-22</a>
C1718: [PRESSDATA ERR] RR	—	—	×	<a href="#">WT-22</a>
C1719: [PRESSDATA ERR] RL	—	—	×	<a href="#">WT-22</a>
C1720: [CODE ERR] FL	—	—	×	<a href="#">WT-24</a>
C1721: [CODE ERR] FR	—	—	×	<a href="#">WT-24</a>
C1722: [CODE ERR] RR	—	—	×	<a href="#">WT-24</a>
C1723: [CODE ERR] RL	—	—	×	<a href="#">WT-24</a>
C1724: [BATT VOLT LOW] FL	—	—	×	<a href="#">WT-27</a>
C1725: [BATT VOLT LOW] FR	—	—	×	<a href="#">WT-27</a>
C1726: [BATT VOLT LOW] RR	—	—	×	<a href="#">WT-27</a>
C1727: [BATT VOLT LOW] RL	—	—	×	<a href="#">WT-27</a>
C1729: VHCL SPEED SIG ERR	—	—	×	<a href="#">WT-30</a>
C1734: CONTROL UNIT	—	—	×	<a href="#">WT-31</a>

# COMBINATION SWITCH SYSTEM SYMPTOMS

< SYMPTOM DIAGNOSIS >

## SYMPTOM DIAGNOSIS

### COMBINATION SWITCH SYSTEM SYMPTOMS

#### Symptom Table

INFOID:000000000963915

1. Perform "Data Monitor" of CONSULT-III to check for any malfunctioning item.
2. Check the malfunction combinations.

Malfunction item: x

Malfunction combination	Data monitor item													
	FR WIPER HI	FR WIPER LOW	FR WASHER SW	FR WIPER INT	INT VOLUME	TURN SIGNAL R	TURN SIGNAL L	TAIL LAMP SW	HI BEAM SW	HEAD LAMP SW 1	HEAD LAMP SW 2	PASSING SW	AUTO LIGHT SW	FR FOG SW
A		x	x			x	x							
B	x			x						x		x		
C					x				x		x			
D					x			x					x	
E					x									x
F	x				x									
G			x		x									
H		x		x									x	
I							x				x	x		x
J						x		x	x	x				
K	All Items													
L	If only one item is detected or the item is not applicable to the combinations A to K													

3. Identify the malfunctioning part from the agreed combination and repair or replace the part.

Malfunction combination	Malfunctioning part	Repair or replace
A	Combination switch INPUT 1 circuit	Inspect the combination switch input circuit applicable to the malfunctioning part. Refer to <a href="#">BCS-39, "Diagnosis Procedure"</a> .
B	Combination switch INPUT 2 circuit	
C	Combination switch INPUT 3 circuit	
D	Combination switch INPUT 4 circuit	
E	Combination switch INPUT 5 circuit	
F	Combination switch OUTPUT 1 circuit	Inspect the combination switch output circuit applicable to the malfunctioning part. Refer to <a href="#">BCS-41, "Diagnosis Procedure"</a> .
G	Combination switch OUTPUT 2 circuit	
H	Combination switch OUTPUT 3 circuit	
I	Combination switch OUTPUT 4 circuit	
J	Combination switch OUTPUT 5 circuit	
K	BCM	Replace BCM.
L	Combination switch	Replace the combination switch.

# PRECAUTIONS

< PRECAUTION >

---

## PRECAUTION

### PRECAUTIONS

#### Precaution for Supplemental Restraint System (SRS) "AIR BAG" and "SEAT BELT PRE-TENSIONER"

INFOID:000000000963916

The Supplemental Restraint System such as "AIR BAG" and "SEAT BELT PRE-TENSIONER", used along with a front seat belt, helps to reduce the risk or severity of injury to the driver and front passenger for certain types of collision. This system includes seat belt switch inputs and dual stage front air bag modules. The SRS system uses the seat belt switches to determine the front air bag deployment, and may only deploy one front air bag, depending on the severity of a collision and whether the front occupants are belted or unbelted. Information necessary to service the system safely is included in the SRS and SB section of this Service Manual.

**WARNING:**

- To avoid rendering the SRS inoperative, which could increase the risk of personal injury or death in the event of a collision which would result in air bag inflation, all maintenance must be performed by an authorized NISSAN/INFINITI dealer.
- Improper maintenance, including incorrect removal and installation of the SRS, can lead to personal injury caused by unintentional activation of the system. For removal of Spiral Cable and Air Bag Module, see the SRS section.
- Do not use electrical test equipment on any circuit related to the SRS unless instructed to in this Service Manual. SRS wiring harnesses can be identified by yellow and/or orange harnesses or harness connectors.

# BCM (BODY CONTROL MODULE)

< ON-VEHICLE REPAIR >

## ON-VEHICLE REPAIR

### BCM (BODY CONTROL MODULE)

Exploded View

INFOID:000000000963917

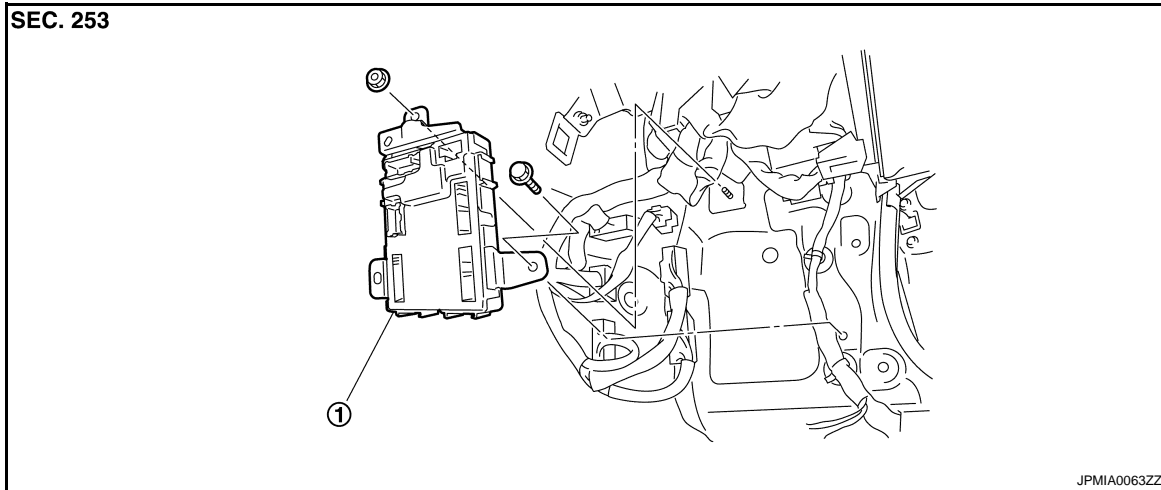

1. BCM

### Removal and Installation

INFOID:000000000963918

#### REMOVAL

1. Remove instrument side finisher (RH). Refer to [IP-12, "Removal and Installation"](#).
2. Remove dash side finisher (passenger side). Refer to [INT-13, "Removal and Installation"](#).
3. Remove bolt and nut.
4. Remove BCM and disconnect the connector.

#### INSTALLATION

Install in the reverse order of removal.

A  
B  
C  
D  
E  
F  
G  
H  
I  
J  
K  
L

BCS

N  
O  
P

# COMBINATION SWITCH

< ON-VEHICLE REPAIR >

## COMBINATION SWITCH

Exploded View

INFOID:000000000963919

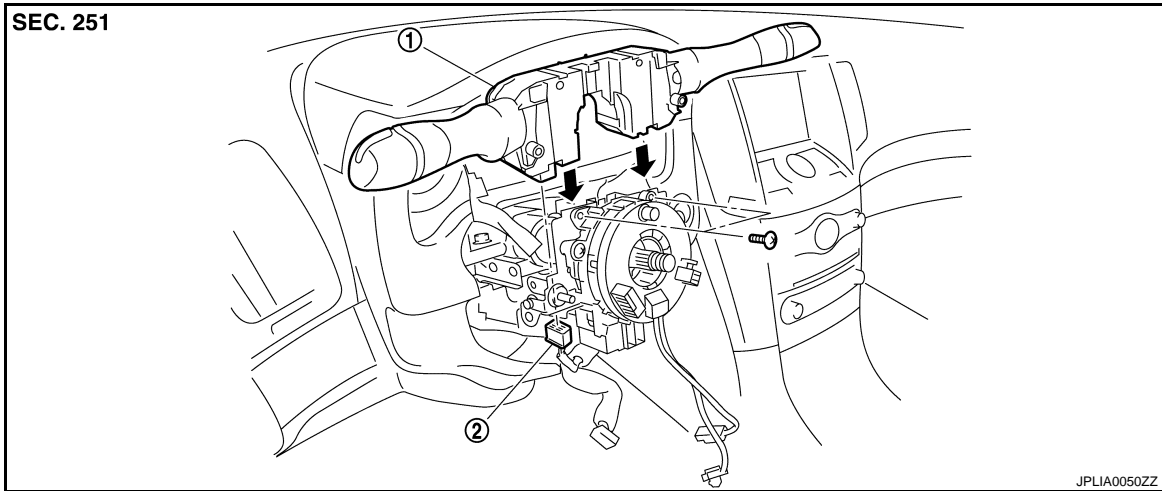

1. Combination switch

2. Combination switch connector

## Removal and Installation

INFOID:000000000963920

### REMOVAL

1. Remove steering column cover. Refer to [IP-12. "Removal and Installation"](#).
2. Remove screws.
3. Disconnect the connector.
4. Pull up the combination switch to remove it.

### INSTALLATION

Install in the reverse order of removal.