

SECTION **GI**  
GENERAL INFORMATION

B  
C  
D  
E  
F  
G  
H  
I  
J  
K  
L  
M  
N  
O  
P

CONTENTS

<b>HOW TO USE THIS MANUAL .....</b>	<b>3</b>	<b>PRECAUTION .....</b>	<b>24</b>
<b>HOW TO USE THIS MANUAL .....</b>	<b>3</b>	<b>PRECAUTIONS .....</b>	<b>24</b>
Description .....	3	Description .....	24
Terms .....	3	Supplemental Restraint System (SRS) "AIR BAG" and "SEAT BELT PRE-TENSIONER" .....	24
Units .....	3	Precautions For Xenon Headlamp Service .....	24
Contents .....	3	NVIS/IVIS (NISSAN/INFINITI VEHICLE IMMOBILIZER SYSTEM - NATS) (If Equipped) .....	24
Relation between Illustrations and Descriptions .....	3	Precaution Necessary for Steering Wheel Rotation after Battery Disconnect .....	25
Components .....	4	Procedures without Cowl Top Cover .....	25
<b>HOW TO FOLLOW TROUBLE DIAGNOSES.....</b>	<b>6</b>	General Precautions .....	26
Description .....	6	Three Way Catalyst .....	27
How to Follow Test Groups in Trouble Diagnosis.....	6	Multiport Fuel Injection System or Engine Control System .....	28
Key to Symbols Signifying Measurements or Procedures .....	7	Hoses .....	28
<b>HOW TO READ WIRING DIAGRAMS .....</b>	<b>9</b>	Engine Oils .....	29
Connector symbols .....	9	Air Conditioning .....	29
Sample/wiring diagram -example- .....	9	<b>FUEL .....</b>	<b>29</b>
Description .....	10	FUEL : Unleaded Premium Gasoline Recommended .....	29
<b>ABBREVIATIONS .....</b>	<b>13</b>	<b>LIFTING POINT .....</b>	<b>30</b>
Abbreviation List .....	13	Commercial Service Tools .....	30
<b>TIGHTENING TORQUE OF STANDARD BOLTS .....</b>	<b>14</b>	Garage Jack and Safety Stand and 2-Pole Lift .....	30
Tightening Torque Table .....	14	Board-On Lift .....	31
<b>RECOMMENDED CHEMICAL PRODUCTS AND SEALANTS .....</b>	<b>15</b>	<b>TOW TRUCK TOWING .....</b>	<b>32</b>
Recommended Chemical Products and Sealants... ..	15	Tow Truck Towing .....	32
<b>TERMINOLOGY .....</b>	<b>16</b>	Vehicle Recovery (Freeing a Stuck Vehicle) .....	33
SAE J1930 Terminology List .....	16	<b>BASIC INSPECTION .....</b>	<b>35</b>
<b>FEATURES OF NEW MODEL .....</b>	<b>20</b>	<b>SERVICE INFORMATION FOR ELECTRICAL INCIDENT .....</b>	<b>35</b>
<b>IDENTIFICATION INFORMATION .....</b>	<b>20</b>	Work Flow .....	35
Model Variation .....	20	Control Units and Electrical Parts .....	35
Information About Identification or Model Code .....	20	How to Check Terminal .....	36
Dimensions .....	22	Intermittent Incident .....	39
Wheels&Tires .....	22	Circuit Inspection .....	42

---

<b>CONSULT-III CHECKING SYSTEM</b> .....	47	CONSULT-III Data Link Connector (DLC) Circuit ...	48
Description .....	47	Wiring Diagram - CONSULT-III CHECKING SYS-	
Function and System Application .....	47	TEM - .....	49

# HOW TO USE THIS MANUAL

< HOW TO USE THIS MANUAL >

## HOW TO USE THIS MANUAL

GI

### Description

INFOID:000000000956163

This volume explains “Removal, Disassembly, Installation, Inspection and Adjustment” and “Trouble Diagnoses”.

### Terms

INFOID:000000000956164

- The captions **WARNING** and **CAUTION** warn you of steps that must be followed to prevent personal injury and/or damage to some part of the vehicle.  
**WARNING** indicates the possibility of personal injury if instructions are not followed.  
**CAUTION** indicates the possibility of component damage if instructions are not followed.  
**BOLD TYPED STATEMENTS** except **WARNING** and **CAUTION** give you helpful information.  
Standard value: Tolerance at inspection and adjustment.  
Limit value: The maximum or minimum limit value that should not be exceeded at inspection and adjustment.

### Units

INFOID:000000000956165

- The **UNITS** given in this manual are primarily expressed as the SI UNIT (International System of Unit), and alternatively expressed in the metric system and in the yard/pound system.  
Also with regard to tightening torque of bolts and nuts, there are descriptions both about range and about the standard tightening torque.

#### “Example”

##### Range

**Outer Socket Lock Nut : 59 - 78 N-m (6.0 - 8.0 kg-m, 43 - 58 ft-lb)**

##### Standard

**Drive Shaft Installation Bolt : 44.3 N-m (4.5 kg-m, 33 ft-lb)**

### Contents

INFOID:000000000956166

- **ALPHABETICAL INDEX** is provided at the end of this manual so that you can rapidly find the item and page you are searching for.
- **A QUICK REFERENCE INDEX**, a black tab (e.g. **BR**) is provided on the first page. You can quickly find the first page of each section by matching it to the section's black tab.
- **THE CONTENTS** are listed on the first page of each section.
- **THE TITLE** is indicated on the upper portion of each page and shows the part or system.
- **THE PAGE NUMBER** of each section consists of two or three letters which designate the particular section and a number (e.g. “BR-5”).
- **THE SMALL ILLUSTRATIONS** show the important steps such as inspection, use of special tools, knacks of work and hidden or tricky steps which are not shown in the previous large illustrations.  
Assembly, inspection and adjustment procedures for the complicated units such as the automatic transaxle or transmission, etc. are presented in a step-by-step format where necessary.

### Relation between Illustrations and Descriptions

INFOID:000000000956167

# HOW TO USE THIS MANUAL

## < HOW TO USE THIS MANUAL >

The following sample explains the relationship between the part description in an illustration, the part name in the text and the service procedures.

< Example 1 >

1. Remove return spring (1) from parking pawl (2).

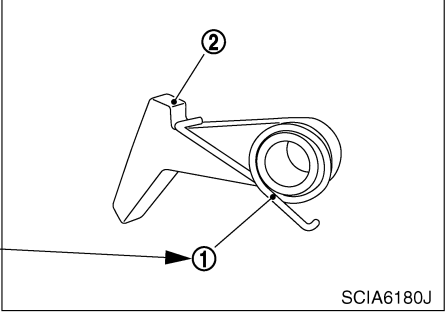

SCIA6180J

The identifier number of the part name in the text is consistent with the identifier part number in the illustration.

Direction mark

< Example 2 >

-  : Vehicle front
- Tighten rear member mounting bolts following the numerical order shown in the illustration.
- Note : View upward

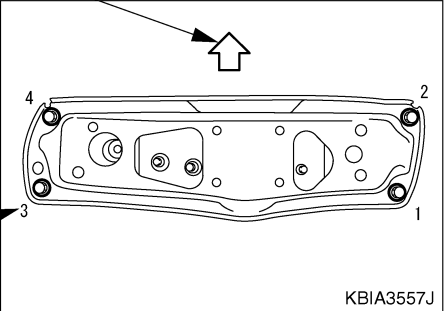

KBIA3557J

The numbers in the illustration are consistent with the service operation instructions.

SAIA0519E

## Components

INFOID:000000000956168

- **THE LARGE ILLUSTRATIONS** are exploded views (see the following) and contain tightening torques, lubrication points, section number of the **PARTS CATALOG** (e.g. SEC. 440) and other information necessary to perform repairs.

The illustrations should be used in reference to service matters only. When ordering parts, refer to the appropriate **PARTS CATALOG**.

Components shown in an illustration may be identified by a circled number. When this style of illustration is used, the text description of the components will follow the illustration.

SEC. 440

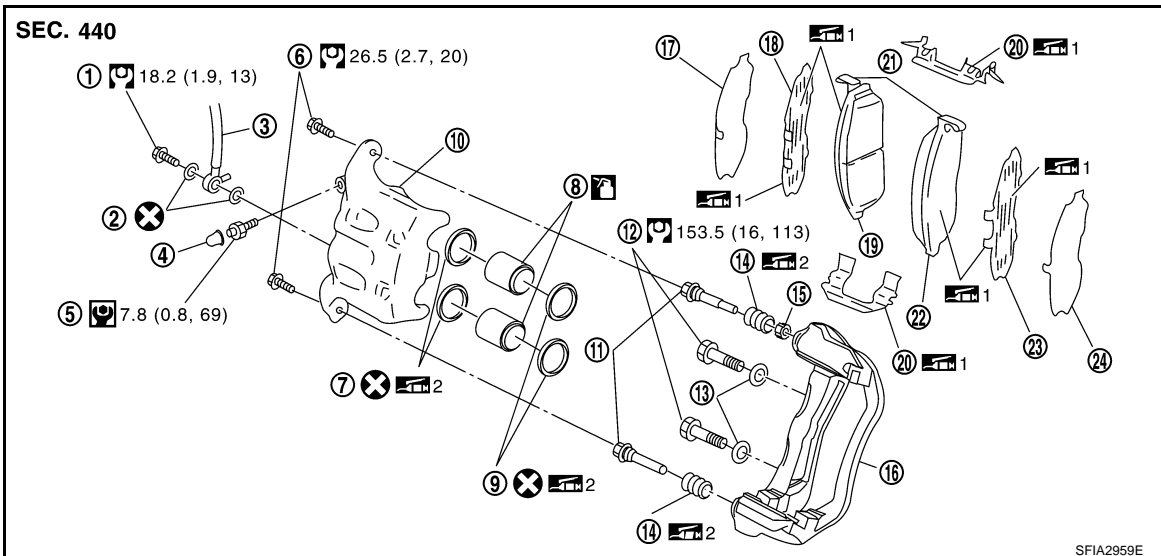



①  18.2 (1.9, 13)

② 

③

④

⑤  7.8 (0.8, 69)

⑥  26.5 (2.7, 20)

⑦ 

⑧ 

⑨ 

⑩

⑪

⑫  153.5 (16, 113)

⑬

⑭ 

⑮

⑯

⑰

⑱

⑲

⑳ 

㉑

㉒ 

㉓

㉔

SFIA2959E

# HOW TO USE THIS MANUAL

## < HOW TO USE THIS MANUAL >

- |                   |                      |                                 |
|-------------------|----------------------|---------------------------------|
| 1. Union bolt     | 2. Copper washer     | 3. Brake hose                   |
| 4. Cap            | 5. Bleed valve       | 6. Sliding pin bolt             |
| 7. Piston seal    | 8. Piston            | 9. Piston boot                  |
| 10. Cylinder body | 11. Sliding pin      | 12. Torque member mounting bolt |
| 13. Washer        | 14. Sliding pin boot | 15. Bushing                     |
| 16. Torque member | 17. Inner shim cover | 18. Inner shim                  |
| 19. Inner pad     | 20. Pad retainer     | 21. Pad wear sensor             |
| 22. Outer pad     | 23. Outer shim       | 24. Outer shim cover            |











 1: PBC (Poly Butyl Cuprysil) grease or silicone-based grease

 2: Rubber grease

 : Brake fluid

Refer to GI section for additional symbol definitions.

## SYMBOLS

SYMBOL	DESCRIPTION	SYMBOL	DESCRIPTION	
	Tightening torque The tightening torque specifications of bolts and nuts may be presented as either a range or a standard tightening torque.		: N•m (kg-m, ft-lb)	
			: N•m (kg-m, in-lb)	
	Should be lubricated with grease. Unless otherwise indicated, use recommended multi-purpose grease.		 M	Apply molybdenum added petroleum jelly.
	Should be lubricated with oil.			Apply ATF.
	Sealing point		★	Select with proper thickness.
	Sealing point with locking sealant.		☆	Adjustment is required.
	Checking point			

SAIA0749E

GI

B

C

D

E

F

G

H

I

J

K

L

M

N

O

P

# HOW TO FOLLOW TROUBLE DIAGNOSES

< HOW TO USE THIS MANUAL >

## HOW TO FOLLOW TROUBLE DIAGNOSES

### Description

INFOID:000000000956169

#### NOTICE:

Trouble diagnoses indicate work procedures required to diagnose problems effectively. Observe the following instructions before diagnosing.

- Before performing trouble diagnoses, read the “Work Flow” in each section.
- After repairs, re-check that the problem has been completely eliminated.
- Refer to Component Parts and Harness Connector Location for the Systems described in each section for identification/location of components and harness connectors.
- When checking circuit continuity, ignition switch should be OFF.
- Refer to the Circuit Diagram for quick pinpoint check.

If you need to check circuit continuity between harness connectors in more detail, such as when a sub-harness is used, refer to Wiring Diagram in each individual section and Harness Layout in PG section for identification of harness connectors.

- Before checking voltage at connectors, check battery voltage.
- After accomplishing the Diagnosis Procedures and Electrical Components Inspection, make sure that all harness connectors are reconnected as they were.

### How to Follow Test Groups in Trouble Diagnosis

INFOID:000000000956170

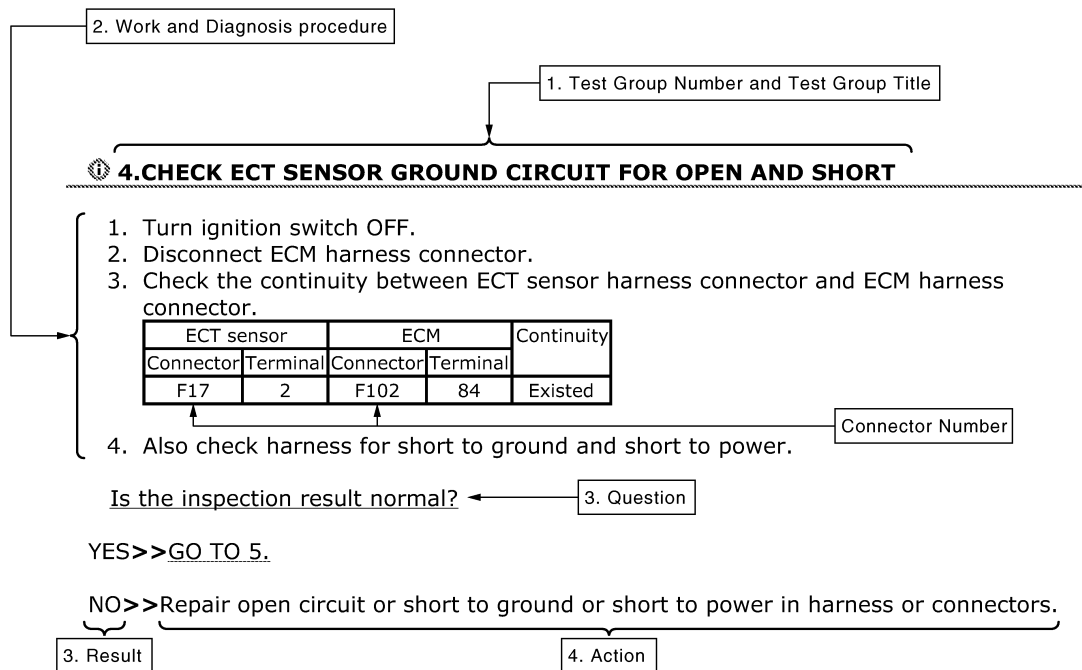

JPAIA0021GB





















1. Test group number and test group title
  - Test group number and test group title are shown in the upper portion of each test group.
2. Work and diagnosis procedure
  - Start to diagnose a problem using procedures indicated in enclosed test groups.
3. Questions and results
  - Questions and required results are indicated in test group.
4. Action
  - Next action for each test group is indicated based on result of each question.

# HOW TO FOLLOW TROUBLE DIAGNOSES

< HOW TO USE THIS MANUAL >

## Key to Symbols Signifying Measurements or Procedures

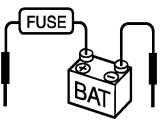
INFOID:00000000956171

SYMBOL	DESCRIPTION	SYMBOL	DESCRIPTION
	Check after disconnecting the connector to be measured.		Procedure with Generic Scan Tool. (GST, OBD-II scan tool)
	Check after connecting the connector to be measured.		Procedure without CONSULT-II, CONSULT-III or GST
	Insert key into ignition switch.		A/C switch is "OFF".
	Remove key from ignition switch.		A/C switch is "ON".
	Insert and remove key repeatedly.		REC switch is "ON".
	Turn ignition switch to "OFF" position.		REC switch is "OFF".
	Turn ignition switch to "ACC" position.		Fan switch is "ON". (At any position except for "OFF" position)
	Turn ignition switch to "ON" position.		Fan switch is "OFF".
	Turn ignition switch to "START" position.		Apply fuse.
	Turn ignition switch from "OFF" to "ACC" position.		Apply positive voltage from battery with fuse directly to components.
	Turn ignition switch from "ACC" to "ON" position.		
	Turn ignition switch from "ACC" to "OFF" position.		

SAIA1539E

GI

B

C

D

E

F

G

H

I

J

K

L

M

























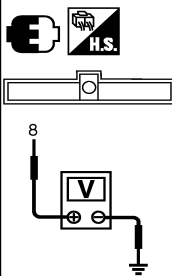

N

O

P

# HOW TO FOLLOW TROUBLE DIAGNOSES

## < HOW TO USE THIS MANUAL >

SYMBOL	DESCRIPTION	SYMBOL	DESCRIPTION
	Turn ignition switch from "OFF" to "ON" position.		Drive vehicle.
	Turn ignition switch from "ON" to "OFF" position.		
	Do not start engine, or check with engine stopped.		Disconnect battery negative cable.
	Start engine, or check with engine running.		Depress brake pedal.
	Apply parking brake.		Release brake pedal.
	Release parking brake.		Depress accelerator pedal.
	Check after engine is warmed up sufficiently.		Release accelerator pedal.
	Voltage should be measured with a voltmeter.	 <p>Pin terminal check for SMJ type ECM or TCM connectors.  <b>For details regarding the terminal arrangement, refer to the "ELECTRICAL UNITS" electrical reference page at the end of the manual.</b></p>	
	Circuit resistance should be measured with an ohmmeter.		
	Current should be measured with an ammeter.		
	Pulse signal should be checked with an oscilloscope.		
	Procedure with CONSULT-III		
	Procedure without CONSULT-III		
	Place selector lever in "P" position.		
	Place selector lever in "N" position.		
	Jack up front portion.		
	Jack up rear portion.		
	Inspect under engine room.		
	Inspect under floor.		
	Inspect rear under floor.		

SAIA1540E



# HOW TO READ WIRING DIAGRAMS

< HOW TO USE THIS MANUAL >

## HOW TO READ WIRING DIAGRAMS

GI

### Connector symbols

INFOID:000000000956172

Most of connector symbols in wiring diagrams are shown from the terminal side.

- Connector symbols shown from the terminal side are enclosed by a single line and followed by the direction mark.
- Connector symbols shown from the harness side are enclosed by a double line and followed by the direction mark.
- Certain systems and components, especially those related to OBD, may use a new style slide-locking type harness connector. For description and how to disconnect, refer to PG section, "Description", "HARNESS CONNECTOR".

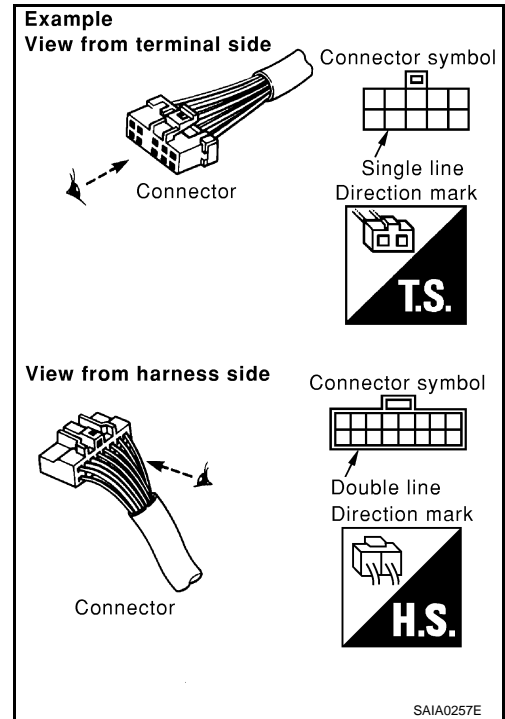

- Male and female terminals  
Connector guides for male terminals are shown in black and female terminals in white in wiring diagrams.

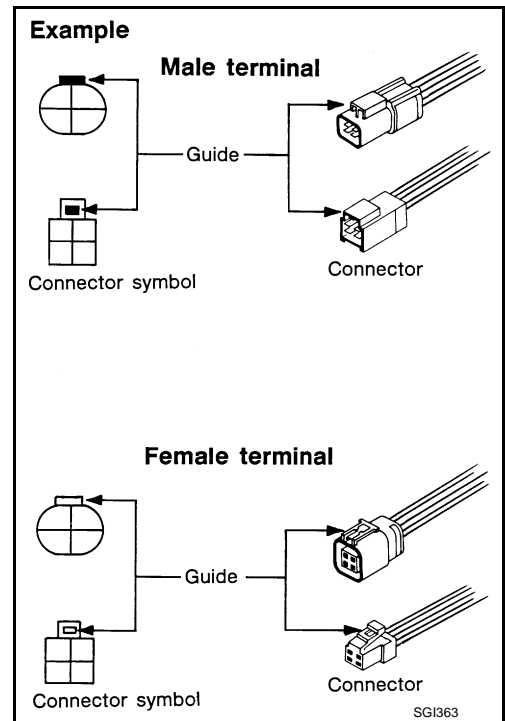

Sample/wiring diagram -example-

INFOID:000000000956173

# HOW TO READ WIRING DIAGRAMS

## < HOW TO USE THIS MANUAL >

- For detail, refer to following [GI-10. "Description"](#).

### EXAMPL

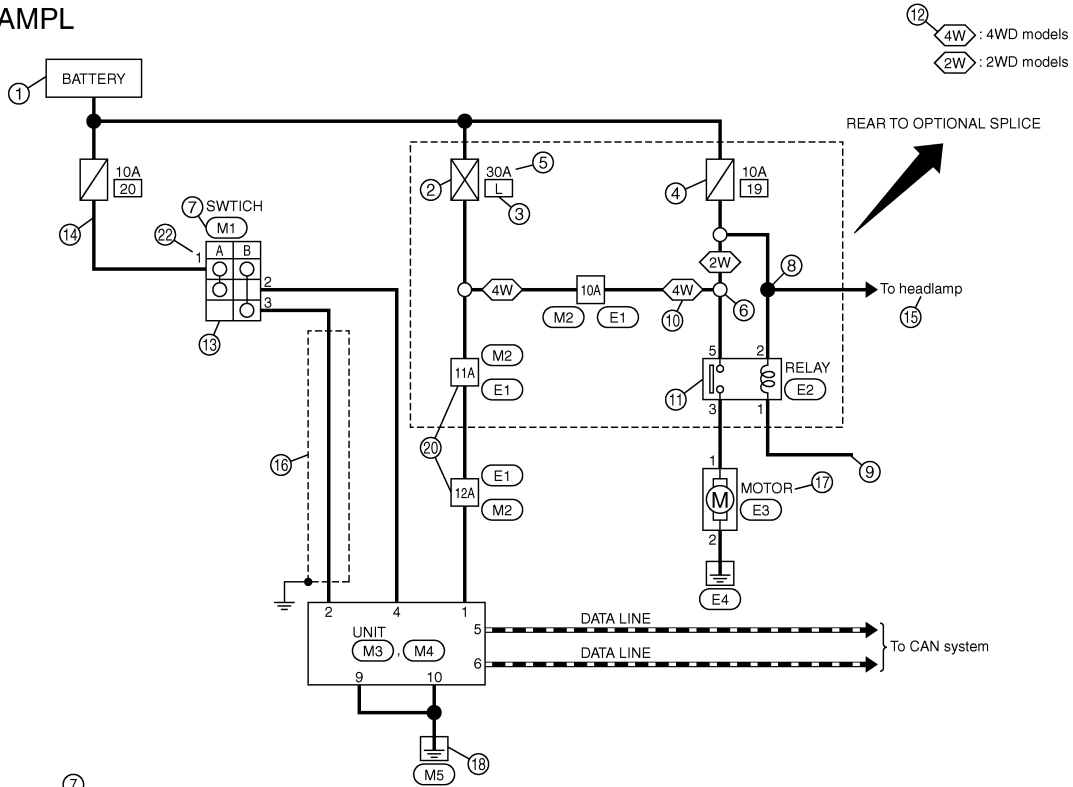

Connector No.	M3
Connector Name	UNIT
Connector Type	NS06FW-M2

Connector No.	M4
Connector Name	UNIT
Connector Type	NS10FW-CS

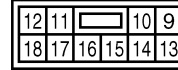
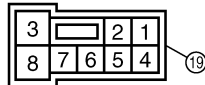

Terminal No.	Color of Wire	Signal Name [Specification]
1	W	BAT
2	G	SWITCH B
4	V	SWITCH A
5	L	CAN-H
6	P	CAN-L

Terminal No.	Color of Wire	Signal Name [Specification]
9	B	GND
10	B	GND

### Optional splice

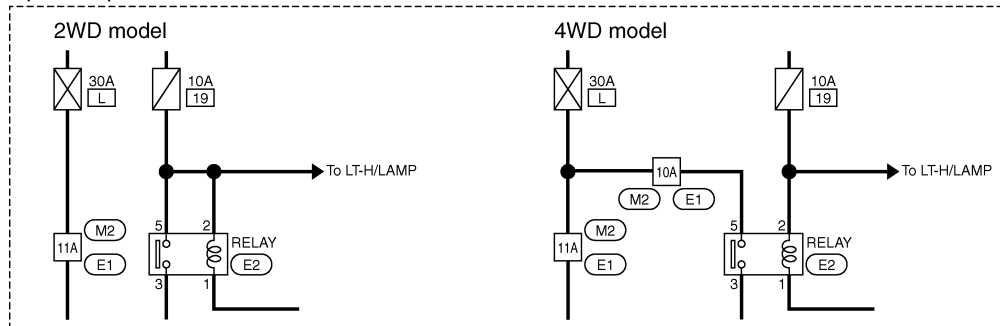

JCAWA0005GE

## Description

INFOID:000000000956174

Number	Item	Description
1	Power supply	• This means the power supply of fusible link or fuse.
2	Fusible link	• "X" means the fusible link.

# HOW TO READ WIRING DIAGRAMS

## < HOW TO USE THIS MANUAL >

Number	Item	Description																
3	Number of fusible link/fuse	<ul style="list-style-type: none"> <li>This means the number of fusible link or fuse location.</li> </ul>																
4	Fuse	<ul style="list-style-type: none"> <li>"/" means the fuse.</li> </ul>																
5	Current rating of fusible link/fuse	<ul style="list-style-type: none"> <li>This means the current rating of the fusible link or fuse.</li> </ul>																
6	Optional splice	<ul style="list-style-type: none"> <li>The open circle shows that the splice is optional depending on vehicle application.</li> </ul>																
7	Connector number	<ul style="list-style-type: none"> <li>The letter shows which harness the connector is located in.</li> <li>Example "M": main harness. For detail and to locate the connector, refer to <a href="#">PG-74, "How To Read Harness Layout"</a>, <a href="#">PG-76, "Main Harness"</a>.</li> </ul>																
8	Splice	<ul style="list-style-type: none"> <li>The shaded circle "●" means the splice.</li> </ul>																
9	Page crossing	<ul style="list-style-type: none"> <li>This circuit continues to an adjacent page.</li> </ul>																
10	Option abbreviation	<ul style="list-style-type: none"> <li>This means the vehicle specifications which layouts the circuit between "O".</li> </ul>																
11	Relay	<ul style="list-style-type: none"> <li>This shows an internal representation of the relay.</li> </ul>																
12	Option description	<ul style="list-style-type: none"> <li>This shows a description of the option abbreviation used on the page.</li> </ul>																
13	Switch	<ul style="list-style-type: none"> <li>This shows that continuity exists between terminals 1 and 2 when the switch is in the A position. Continuity exists between terminals 1 and 3 when the switch is in the B position.</li> </ul>																
14	Circuit (Wiring)	<ul style="list-style-type: none"> <li>This means the wiring.</li> </ul>																
15	System branch	<ul style="list-style-type: none"> <li>This shows that the circuit is branched to other systems.</li> </ul>																
16	Shielded line	<ul style="list-style-type: none"> <li>The line enclosed by broken line circle shows shield wire.</li> </ul>																
17	Component name	<ul style="list-style-type: none"> <li>This shows the name of a component.</li> </ul>																
18	Ground (GND)	<ul style="list-style-type: none"> <li>This shows the ground connection.</li> </ul>																
19	Connector	<ul style="list-style-type: none"> <li>This means the connector information.</li> <li>This unit-side is described by the connector symbols.</li> </ul>																
20	Connectors	<ul style="list-style-type: none"> <li>This means that a transmission line bypasses two connectors or more.</li> </ul>																
21	Wire color	<ul style="list-style-type: none"> <li>This shows a code for the color of the wire.</li> </ul> <table border="0"> <tr> <td>B = Black</td> <td>BR = Brown</td> </tr> <tr> <td>W = White</td> <td>OR or O = Orange</td> </tr> <tr> <td>R = Red</td> <td>P = Pink</td> </tr> <tr> <td>G = Green</td> <td>PU or V (Violet) = Purple</td> </tr> <tr> <td>L = Blue</td> <td>GY or GR = Gray</td> </tr> <tr> <td>Y = Yellow</td> <td>SB = Sky Blue</td> </tr> <tr> <td>LG = Light Green</td> <td>CH = Dark Brown</td> </tr> <tr> <td></td> <td>DG = Dark Green</td> </tr> </table> <ul style="list-style-type: none"> <li>When the wire color is striped, the base color is given first, followed by the stripe color as shown below: Example: L/W = Blue with White Stripe</li> </ul>	B = Black	BR = Brown	W = White	OR or O = Orange	R = Red	P = Pink	G = Green	PU or V (Violet) = Purple	L = Blue	GY or GR = Gray	Y = Yellow	SB = Sky Blue	LG = Light Green	CH = Dark Brown		DG = Dark Green
B = Black	BR = Brown																	
W = White	OR or O = Orange																	
R = Red	P = Pink																	
G = Green	PU or V (Violet) = Purple																	
L = Blue	GY or GR = Gray																	
Y = Yellow	SB = Sky Blue																	
LG = Light Green	CH = Dark Brown																	
	DG = Dark Green																	
22	Terminal number	<ul style="list-style-type: none"> <li>This means the terminal number of a connector.</li> </ul>																

## SWITCH POSITIONS

Switches are shown in wiring diagrams as if the vehicle is in the "normal" condition. A vehicle is in the "normal" condition when:

# HOW TO READ WIRING DIAGRAMS

## < HOW TO USE THIS MANUAL >

- ignition switch is "OFF",
- doors, hood and trunk lid/back door are closed,
- pedals are not depressed, and
- parking brake is released.

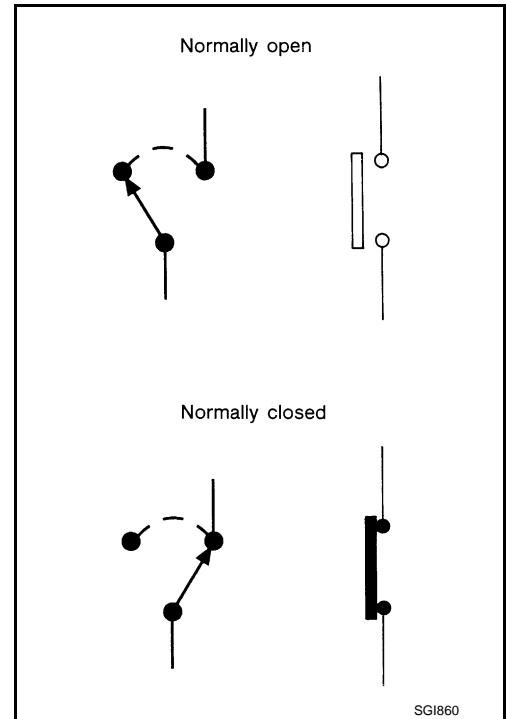

## MULTIPLE SWITCH

The continuity of multiple switch is described in two ways as shown below.

- The switch chart is used in schematic diagrams.
- The switch diagram is used in wiring diagrams.

**Example**

(SWITCH CHART)

WIPER SWITCH		OFF	INT	LO	HI	WASH
1						○
2					○	
3	○	○	○			
4	○	○				
5		○				
6		○	○	○	○	

(SWITCH DIAGRAM)

Both switches are turned in combination.

Continuity circuit of wiper switch

SWITCH POSITION	CONTINUITY CIRCUIT
OFF	3-4
INT	3-4, 5-6
LO	3-6
HI	2-6
WASH	1-6

JSAIA0017GB

# ABBREVIATIONS

< HOW TO USE THIS MANUAL >

## ABBREVIATIONS

### Abbreviation List

INFOID:000000000956175

GI

The following **ABBREVIATIONS** are used:

ABBREVIATION	DESCRIPTION
A/C	Air Conditioner
A/T	Automatic Transaxle/Transmission
ATF	Automatic Transmission Fluid
D1	Drive range 1st gear
D2	Drive range 2nd gear
D3	Drive range 3rd gear
D4	Drive range 4th gear
FR, RR	Front, Rear
LH, RH	Left-Hand, Right-Hand
M/T	Manual Transaxle/Transmission
OD	Overdrive
P/S	Power Steering
SAE	Society of Automotive Engineers, Inc.
SDS	Service Data and Specifications
SST	Special Service Tools
2WD	2-Wheel Drive
22	2nd range 2nd gear
21	2nd range 1st gear
12	1st range 2nd gear
11	1st range 1st gear

B

C

D

E

F

G

H

I

J

K

L

M

N

O

P

# TIGHTENING TORQUE OF STANDARD BOLTS

< HOW TO USE THIS MANUAL >

## TIGHTENING TORQUE OF STANDARD BOLTS

### Tightening Torque Table

INFOID:000000000956176

Grade	Bolt size	Bolt diameter * mm	Pitch mm	Tightening torque (Without lubricant)							
				Hexagon head bolt				Hexagon flange bolt			
				N·m	kg·m	ft·lb	in·lb	N·m	kg·m	ft·lb	in·lb
4T	M6	6.0	1.0	5.5	0.56	4	49	7	0.71	5	62
	M8	8.0	1.25	13.5	1.4	10	—	17	1.7	13	—
			1.0	13.5	1.4	10	—	17	1.7	13	—
	M10	10.0	1.5	28	2.9	21	—	35	3.6	26	—
			1.25	28	2.9	21	—	35	3.6	26	—
	M12	12.0	1.75	45	4.6	33	—	55	5.6	41	—
1.25			45	4.6	33	—	65	6.6	48	—	
M14	14.0	1.5	80	8.2	59	—	100	10	74	—	
7T	M6	6.0	1.0	9	0.92	7	80	11	1.1	8	97
	M8	8.0	1.25	22	2.2	16	—	28	2.9	21	—
			1.0	22	2.2	16	—	28	2.9	21	—
	M10	10.0	1.5	45	4.6	33	—	55	5.6	41	—
			1.25	45	4.6	33	—	55	5.6	41	—
	M12	12.0	1.75	80	8.2	59	—	100	10	74	—
1.25			80	8.2	59	—	100	10	74	—	
M14	14.0	1.5	130	13	96	—	170	17	125	—	
9T	M6	6.0	1.0	11	1.1	8	—	13.5	1.4	10	—
	M8	8.0	1.25	28	2.9	21	—	35	3.6	26	—
			1.0	28	2.9	21	—	35	3.6	26	—
	M10	10.0	1.5	55	5.6	41	—	80	8.2	59	—
			1.25	55	5.6	41	—	80	8.2	59	—
	M12	12.0	1.75	100	10	74	—	130	13	96	—
1.25			100	10	74	—	130	13	96	—	
M14	14.0	1.5	170	17	125	—	210	21	155	—	

\*: Nominal diameter

1. **Special parts are excluded.**
2. **This standard is applicable to bolts having the following marks embossed on the bolt head.**

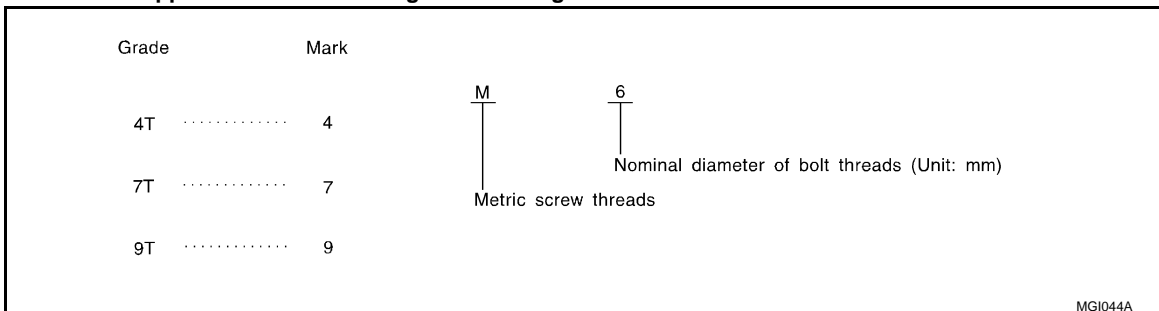

# RECOMMENDED CHEMICAL PRODUCTS AND SEALANTS

< HOW TO USE THIS MANUAL >

## RECOMMENDED CHEMICAL PRODUCTS AND SEALANTS

### Recommended Chemical Products and Sealants

INFOID:000000000956177

Refer to the following chart for help in selecting the appropriate chemical product or sealant.

	Product Description	Purpose	Nissan North America Part No. (USA)	Nissan Canada Part No. (Canada)	Aftermarket Cross-reference Part Nos.
1	Rear View Mirror Adhesive	Used to permanently re-mount rear view mirrors to windows.	999MP-AM000P	99998-50505	Permatex 81844
2	Anaerobic Liquid Gasket	For metal-to-metal flange sealing. Can fill a 0.38 mm (0.015 inch) gap and provide instant sealing for most powertrain applications.	999MP-AM001P	99998-50503	Permatex 51813 and 51817
3	High Performance Thread Sealant	Provides instant sealing on any threaded straight or parallel threaded fitting. (Thread sealant only, no locking ability.) • Do not use on plastic.	999MP-AM002P	999MP-AM002P	Permatex 56521
4	Silicone RTV	Gasket Maker	999MP-AM003P (Ultra Grey)	99998-50506 (Ultra Grey)	Permatex Ultra Grey 82194; Three Bond 1207, 1215, 1216, 1217F, 1217G and 1217H Nissan RTV Part No. 999MP-A7007
		Gasket Maker for Maxima/Quest 5-speed automatic transmission (RE5F22A)	-	-	Three Bond 1281B or exact equivalent in its quality
5	High Temperature, High Strength Thread Locking Sealant (Red)	Threadlocker	999MP-AM004P	999MP-AM004P	Permatex 27200; Three Bond 1360, 1360N, 1305 N&P, 1307N, 1335, 1335B, 1363B, 1377C, 1386B, D&E and 1388 Loctite 648
6	Medium Strength Thread Locking Sealant (Blue)	Threadlocker (service tool removable)	999MP-AM005P	999MP-AM005P	Permatex 24200, 24206, 24240, 24283 and 09178; Three Bond 1322, 1322N, 1324 D&N, 1333D, 1361C, 1364D, 1370C and 1374

# TERMINOLOGY

< HOW TO USE THIS MANUAL >

## TERMINOLOGY

### SAE J1930 Terminology List

INFOID:000000000956178

All emission related terms used in this publication in accordance with SAE J1930 are listed. Accordingly, new terms, new acronyms/abbreviations and old terms are listed in the following chart.

NEW TERM	NEW ACRONYM / ABBREVIATION	OLD TERM
Air cleaner	ACL	Air cleaner
Barometric pressure	BARO	***
Barometric pressure sensor-BCDD	BAROS-BCDD	BCDD
Camshaft position	CMP	***
Camshaft position sensor	CMPS	Crank angle sensor
Canister	***	Canister
Carburetor	CARB	Carburetor
Charge air cooler	CAC	Intercooler
Closed loop	CL	Closed loop
Closed throttle position switch	CTP switch	Idle switch
Clutch pedal position switch	CPP switch	Clutch switch
Continuous fuel injection system	CFI system	***
Continuous trap oxidizer system	CTOX system	***
Crankshaft position	CKP	***
Crankshaft position sensor	CKPS	***
Data link connector	DLC	***
Diagnostic test mode	DTM	Diagnostic mode
Diagnostic test mode selector	DTM selector	Diagnostic mode selector
Diagnostic test mode I	DTM I	Mode I
Diagnostic test mode II	DTM II	Mode II
Diagnostic trouble code	DTC	Malfunction code
Direct fuel injection system	DFI system	***
Distributor ignition system	DI system	Ignition timing control
Early fuel evaporation-mixture heater	EFE-mixture heater	Mixture heater
Early fuel evaporation system	EFE system	Mixture heater control
Electrically erasable programmable read only memory	EEPROM	***
Electronic ignition system	EI system	Ignition timing control
Engine control	EC	***
Engine control module	ECM	ECCS control unit
Engine coolant temperature	ECT	Engine temperature
Engine coolant temperature sensor	ECTS	Engine temperature sensor
Engine modification	EM	***
Engine speed	RPM	Engine speed
Erasable programmable read only memory	EPROM	***
Evaporative emission canister	EVAP canister	Canister
Evaporative emission system	EVAP system	Canister control solenoid valve
Exhaust gas recirculation valve	EGR valve	EGR valve



# TERMINOLOGY

< HOW TO USE THIS MANUAL >

NEW TERM	NEW ACRONYM / ABBREVIATION	OLD TERM	GI
Exhaust gas recirculation control-BPT valve	EGRC-BPT valve	BPT valve	
Exhaust gas recirculation control-solenoid valve	EGRC-solenoid valve	EGR control solenoid valve	B
Exhaust gas recirculation temperature sensor	EGRT sensor	Exhaust gas temperature sensor	C
EGR temperature sensor			
Flash electrically erasable programmable read only memory	FEEPROM	***	D
Flash erasable programmable read only memory	FEPROM	***	
Flexible fuel sensor	FFS	***	E
Flexible fuel system	FF system	***	
Fuel pressure regulator	***	Pressure regulator	F
Fuel pressure regulator control solenoid valve	***	PRVR control solenoid valve	
Fuel trim	FT	***	G
Heated Oxygen sensor	HO2S	Exhaust gas sensor	
Idle air control system	IAC system	Idle speed control	H
Idle air control valve-air regulator	IACV-air regulator	Air regulator	
Idle air control valve-auxiliary air control valve	IACV-AAC valve	Auxiliary air control (AAC) valve	I
Idle air control valve-FICD solenoid valve	IACV-FICD solenoid valve	FICD solenoid valve	
Idle air control valve-idle up control solenoid valve	IACV-idle up control solenoid valve	Idle up control solenoid valve	J
Idle speed control-FI pot	ISC-FI pot	FI pot	
Idle speed control system	ISC system	***	K
Ignition control	IC	***	
Ignition control module	ICM	***	L
Indirect fuel injection system	IFI system	***	
Intake air	IA	Air	M
Intake air temperature sensor	IAT sensor	Air temperature sensor	
Knock	***	Detonation	N
Knock sensor	KS	Detonation sensor	
Malfunction indicator lamp	MIL	Check engine light	O
Manifold absolute pressure	MAP	***	
Manifold absolute pressure sensor	MAPS	***	
Manifold differential pressure	MDP	***	
Manifold differential pressure sensor	MDPS	***	
Manifold surface temperature	MST	***	
Manifold surface temperature sensor	MSTS	***	P
Manifold vacuum zone	MVZ	***	
Manifold vacuum zone sensor	MVZS	***	
Mass air flow sensor	MAFS	Air flow meter	
Mixture control solenoid valve	MC solenoid valve	Air-fuel ratio control solenoid valve	
Multiport fuel injection System	MFI system	Fuel injection control	

## TERMINOLOGY

< HOW TO USE THIS MANUAL >

NEW TERM	NEW ACRONYM / ABBREVIATION	OLD TERM
Nonvolatile random access memory	NVRAM	***
On board diagnostic system	OBD system	Self-diagnosis
Open loop	OL	Open loop
Oxidation catalyst	OC	Catalyst
Oxidation catalytic converter system	OC system	***
Oxygen sensor	O2S	Exhaust gas sensor
Park position switch	***	Park switch
Park/neutral position switch	PNP switch	Park/neutral switch Inhibitor switch Neutral position switch
Periodic trap oxidizer system	PTOX system	***
Positive crankcase ventilation	PCV	Positive crankcase ventilation
Positive crankcase ventilation valve	PCV valve	PCV valve
Powertrain control module	PCM	***
Programmable read only memory	PROM	***
Pulsed secondary air injection control solenoid valve	PAIRC solenoid valve	AIV control solenoid valve
Pulsed secondary air injection system	PAIR system	Air induction valve (AIV) control
Pulsed secondary air injection valve	PAIR valve	Air induction valve
Random access memory	RAM	***
Read only memory	ROM	***
Scan tool	ST	***
Secondary air injection pump	AIR pump	***
Secondary air injection system	AIR system	***
Sequential multipoint fuel injection system	SFI system	Sequential fuel injection
Service reminder indicator	SRI	***
Simultaneous multipoint fuel injection system	***	Simultaneous fuel injection
Smoke puff limiter system	SPL system	***
Supercharger	SC	***
Supercharger bypass	SCB	***
System readiness test	SRT	***
Thermal vacuum valve	TVV	Thermal vacuum valve
Three way catalyst	TWC	Catalyst
Three way catalytic converter system	TWC system	***
Three way + oxidation catalyst	TWC + OC	Catalyst
Three way + oxidation catalytic converter system	TWC + OC system	***
Throttle body	TB	Throttle chamber SPI body
Throttle body fuel injection system	TBI system	Fuel injection control
Throttle position	TP	Throttle position
Throttle position sensor	TPS	Throttle sensor
Throttle position switch	TP switch	Throttle switch
Torque converter clutch solenoid valve	TCC solenoid valve	Lock-up cancel solenoid Lock-up solenoid

# TERMINOLOGY

< HOW TO USE THIS MANUAL >

NEW TERM	NEW ACRONYM / ABBREVIATION	OLD TERM
Transmission control module	TCM	A/T control unit
Turbocharger	TC	Turbocharger
Vehicle speed sensor	VSS	Vehicle speed sensor
Volume air flow sensor	VAFS	Air flow meter
Warm up oxidation catalyst	WU-OC	Catalyst
Warm up oxidation catalytic converter system	WU-OC system	***
Warm up three way catalyst	WU-TWC	Catalyst
Warm up three way catalytic converter system	WU-TWC system	***
Wide open throttle position switch	WOTP switch	Full switch

\*\*\*: Not applicable

GI

B

C

D

E

F

G

H

I

J

K

L

M

N

O

P

# IDENTIFICATION INFORMATION

< FEATURES OF NEW MODEL >

## FEATURES OF NEW MODEL

### IDENTIFICATION INFORMATION

#### Model Variation

INFOID:000000000956179

Destination	Body	Transmission	Engine	Axle	Model
USA	SEDAN	RE5R05A (5A/T)	VQ35HR	2WD	BLJALVN-EUA
		FS6R31A (6M/T)			BLJALFN-EUA
		RE5R05A (5A/T)			BLJALVY-EUA
CANADA		RE5R05A (5A/T)		AWD	BLJNLFN-EUA
		FS6R31A (6M/T)		2WD	BLJALVN-ENA
		RE5R05A (5A/T)			BLJALFN-ENA
				AWD	BLJALVY-ENA
					BLJNLFN-ENA

Prefix and suffix designations:

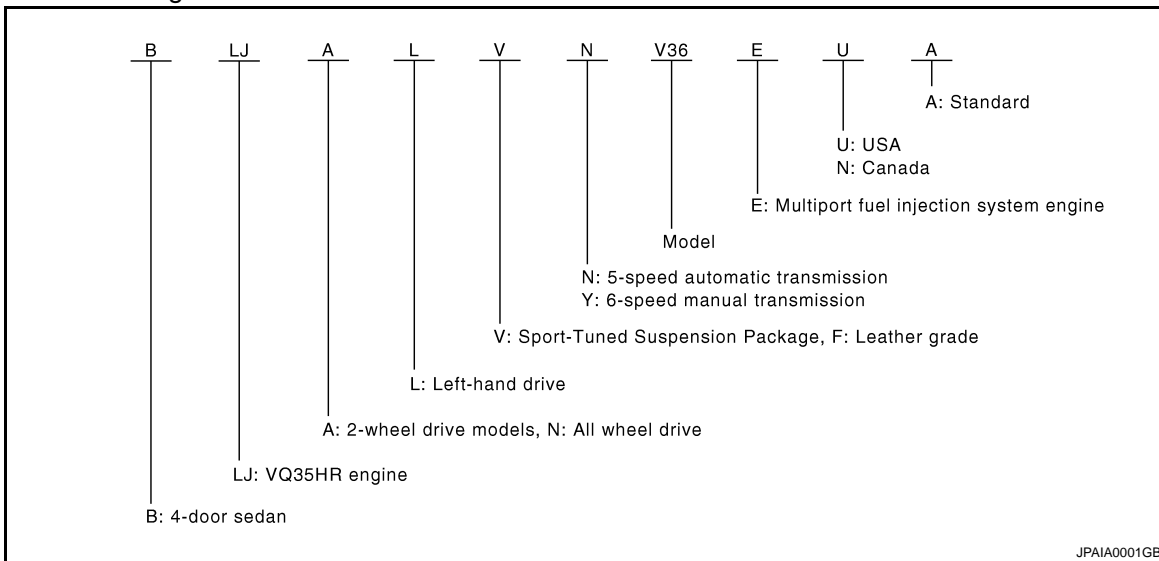

#### Information About Identification or Model Code

INFOID:000000000956180

#### IDENTIFICATION NUMBER

# IDENTIFICATION INFORMATION

## < FEATURES OF NEW MODEL >

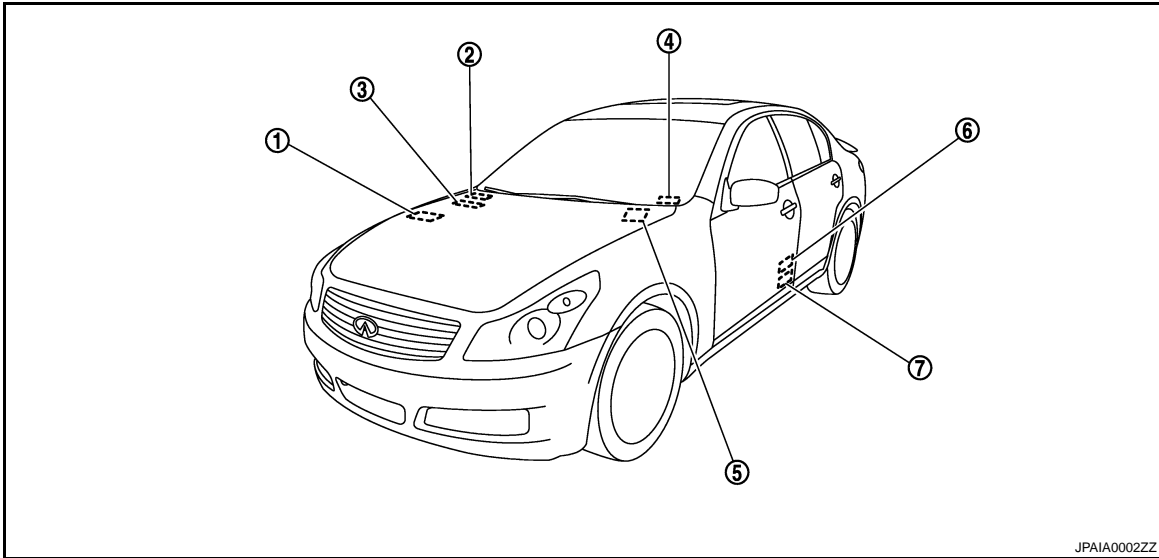

JPAIA0002ZZ

- 1. Vehicle identification plate
- 2. Emission control information label
- 3. Vehicle identification number (Chassis number)
- 4. Vehicle identification number plate
- 5. Air conditioner specification label
- 6. Tire and loading information label
- 7. FMVSS certification label

## VEHICLE Identification Number ARRANGEMENT

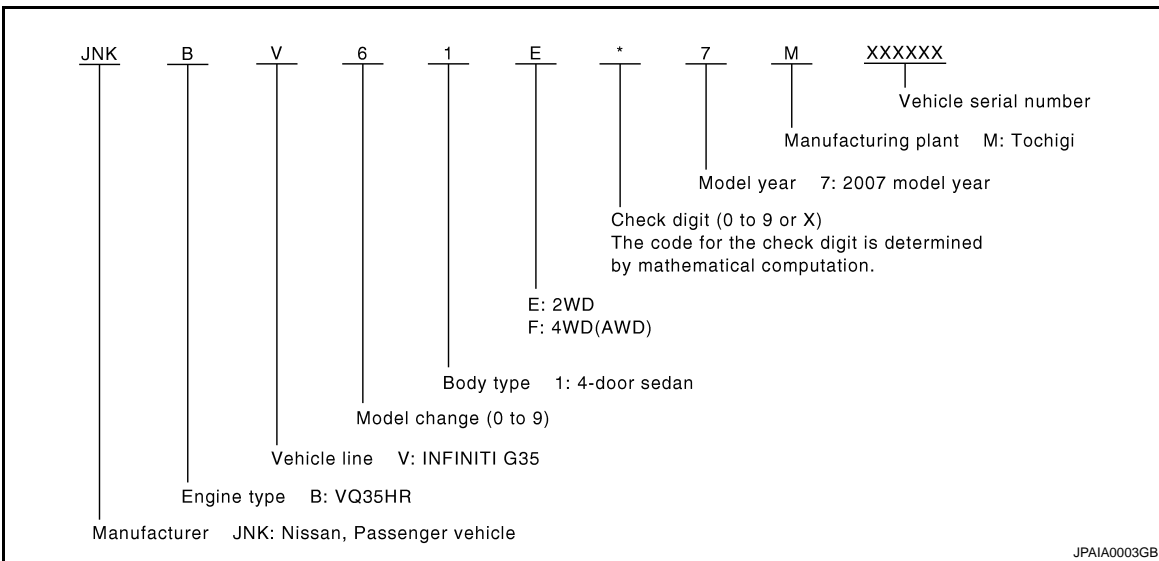

JPAIA0003GB

## IDENTIFICATION PLATE

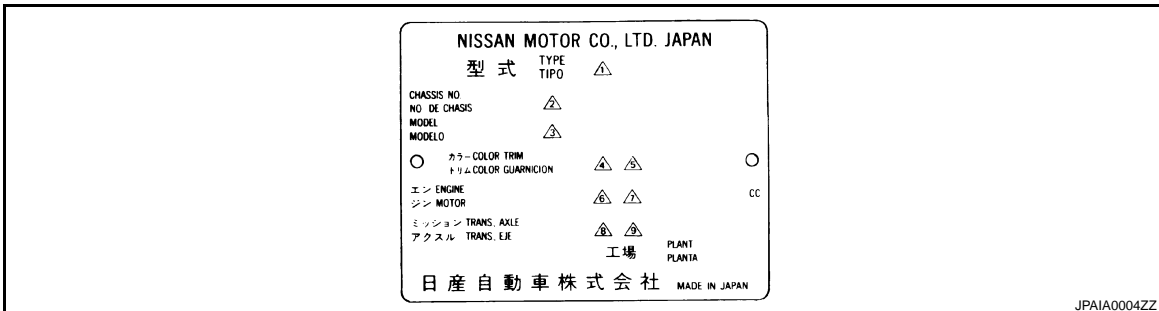

JPAIA0004ZZ

- 1. Type
- 2. Vehicle identification number (Chassis number)
- 3. Model

# IDENTIFICATION INFORMATION

## < FEATURES OF NEW MODEL >

- |                        |                       |                 |
|------------------------|-----------------------|-----------------|
| 4. Body color code     | 5. Trim color code    | 6. Engine model |
| 7. Engine displacement | 8. Transmission model | 9. Axle model   |

### ENGINE SERIAL NUMBER

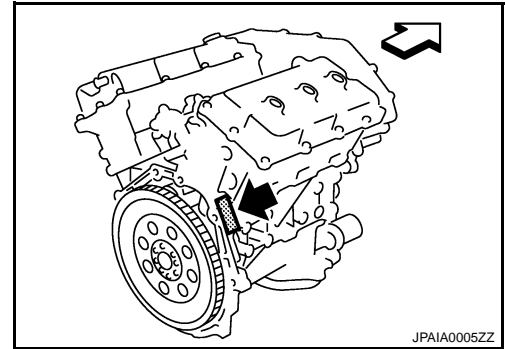

### AUTOMATIC TRANSMISSION NUMBER

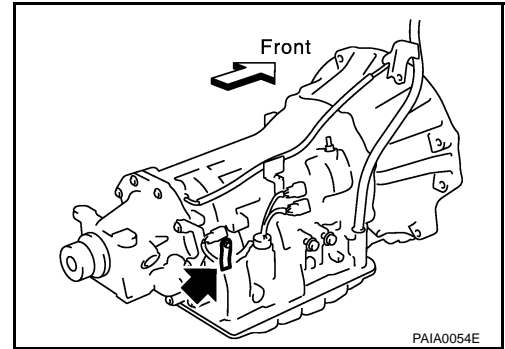

### MANUAL TRANSMISSION NUMBER

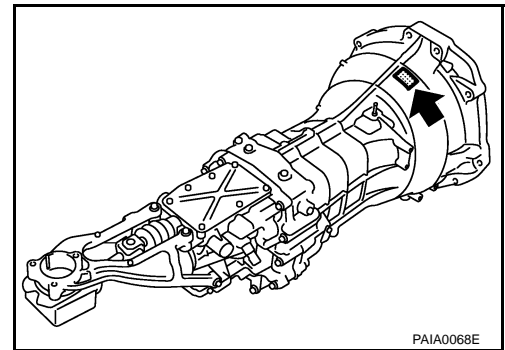

## Dimensions

INFOID:000000000956181

Unit: mm (in)

Overall length	4,755 (187.2)
Overall width	1,770 (69.7)
Overall height	1,450 (57.1)*1*3, 1,465 (57.7)*2
Front tread	1,520 (59.8)
Rear tread	1,520 (59.8)*1, 1,525 (60.0)*2, 1,530 (60.2)*3
Wheelbase	2,850 (112.2)

\*1: 2-wheel drive 18-in tire models

\*2: All-wheel drive models

\*3: 2-wheel drive 17-in tire models

## Wheels&Tires

INFOID:000000000956182

## IDENTIFICATION INFORMATION

< FEATURES OF NEW MODEL >

	Conventional	Spare
Road wheel/offset mm (in)	17 X 7-1/2J Aluminum/45 (1.77)	17 x 4T Aluminum/30 (1.18)
	Front: 18 X 7-1/2J Aluminum/45 (1.77) Rear : 18 X 8-1/2J Aluminum/50 (1.97)	
Tire size	P225/55R17-95V	T145/80D17 107M
	Front: 225/50R18 95W Rear : 245/45R18 96W	

GI

B

C

D

E

F

G

H

I

J

K

L

M

N

O

P

# PRECAUTIONS

< PRECAUTION >

## PRECAUTION

### PRECAUTIONS

#### Description

INFOID:000000000956183

Observe the following precautions to ensure safe and proper servicing. These precautions are not described in each individual section.

#### Supplemental Restraint System (SRS) "AIR BAG" and "SEAT BELT PRE-TENSIONER"

INFOID:000000000956184

The Supplemental Restraint System such as "AIR BAG" and "SEAT BELT PRE-TENSIONER", used along with a front seat belt, helps to reduce the risk or severity of injury to the driver and front passenger for certain types of collision. This system includes seat belt switch inputs and dual stage front air bag modules. The SRS system uses the seat belt switches to determine the front air bag deployment, and may only deploy one front air bag, depending on the severity of a collision and whether the front occupants are belted or unbelted. Information necessary to service the system safely is included in the SRS and SB section of this Service Manual.

#### **WARNING:**

- To avoid rendering the SRS inoperative, which could increase the risk of personal injury or death in the event of a collision which would result in air bag inflation, all maintenance must be performed by an authorized NISSAN/INFINITI dealer.
- Improper maintenance, including incorrect removal and installation of the SRS, can lead to personal injury caused by unintentional activation of the system. For removal of Spiral Cable and Air Bag Module, see the SRS section.
- Do not use electrical test equipment on any circuit related to the SRS unless instructed to in this Service Manual. SRS wiring harnesses can be identified by yellow and/or orange harnesses or harness connectors.

#### Precautions For Xenon Headlamp Service

INFOID:000000000956185

#### **WARNING:**

Comply with the following warnings to prevent any serious accident.

- Disconnect the battery cable (negative terminal) or the power supply fuse before installing, removing, or touching the xenon headlamp (bulb included). The xenon headlamp contains high-voltage generated parts.
- Never work with wet hands.
- Check the xenon headlamp ON-OFF status after assembling it to the vehicle. Never turn the xenon headlamp ON in other conditions. Connect the power supply to the vehicle-side connector. (Turning it ON outside the lamp case may cause fire or visual impairments.)
- Never touch the bulb glass immediately after turning it OFF. It is extremely hot.

#### **CAUTION:**

Comply with the following cautions to prevent any error and malfunction.

- Install the xenon bulb securely. (Insufficient bulb socket installation may melt the bulb, the connector, the housing, etc. by high-voltage leakage or corona discharge.)
- Never perform HID circuit inspection with a tester.
- Never touch the xenon bulb glass with hands. Never put oil and grease on it.
- Dispose of the used xenon bulb after packing it in thick vinyl without breaking it.
- Never wipe out dirt and contamination with organic solvent (thinner, gasoline, etc.).

#### NVIS/IVIS (NISSAN/INFINITI VEHICLE IMMOBILIZER SYSTEM - NATS) (If Equipped)

INFOID:000000000956186

NVIS/IVIS (NATS) will immobilize the engine if someone tries to start it without the registered key of NVIS/IVIS (NATS).

Both of the originally supplied ignition key IDs have been NVIS/IVIS (NATS) registered.

The security indicator is located on the instrument panel. The indicator blinks when the immobilizer system is functioning.

Therefore, NVIS/IVIS (NATS) warns outsiders that the vehicle is equipped with the anti-theft system.



# PRECAUTIONS

## < PRECAUTION >

- When NVIS/IVIS (NATS) detects trouble, the security indicator lamp lights up while ignition switch is in "ON" position.  
This lighting up indicates that the anti-theft is not functioning, so prompt service is required.
- When servicing NVIS/IVIS (NATS) (trouble diagnoses, system initialization and additional registration of other NVIS/IVIS (NATS) ignition key IDs), CONSULT-II hardware and CONSULT-II NVIS/IVIS (NATS) software is necessary.

Regarding the procedures of NVIS/IVIS (NATS) initialization and NVIS/IVIS (NATS) ignition key ID registration, refer to CONSULT-II operation manual, NVIS/IVIS (NATS).

**Therefore, CONSULT-II NVIS/IVIS (NATS) software (program card and operation manual) must be kept strictly confidential to maintain the integrity of the anti-theft function.**

- When servicing NVIS/IVIS (NATS) (trouble diagnoses, system initialization and additional registration of other NVIS/IVIS (NATS) ignition key IDs), it may be necessary to re-register original key identification. Therefore, be sure to receive all keys from vehicle owner. A maximum of four or five key IDs can be registered into NVIS/IVIS (NATS).
- When failing to start the engine first time using the key of NVIS/IVIS (NATS), start as follows.
  1. Leave the ignition key in "ON" position for approximately 5 seconds.
  2. Turn ignition key to "OFF" or "LOCK" position and wait approximately 5 seconds.
  3. Repeat step 1 and 2 again.
  4. Restart the engine while keeping the key separate from any others on key-chain.

## Precaution Necessary for Steering Wheel Rotation after Battery Disconnect

INFOID:000000000956187

### NOTE:

- Before removing and installing any control units, first turn the push-button ignition switch to the LOCK position, then disconnect both battery cables.
- After finishing work, confirm that all control unit connectors are connected properly, then re-connect both battery cables.
- Always use CONSULT-III to perform self-diagnosis as a part of each function inspection after finishing work. If a DTC is detected, perform trouble diagnosis according to self-diagnosis results.

This vehicle is equipped with a push-button ignition switch and a steering lock unit.

If the battery is disconnected or discharged, the steering wheel will lock and cannot be turned.

If turning the steering wheel is required with the battery disconnected or discharged, follow the procedure below before starting the repair operation.

### OPERATION PROCEDURE

1. Connect both battery cables.

#### NOTE:

Supply power using jumper cables if battery is discharged.

2. Carry the Intelligent Key or insert it to the key slot and turn the push-button ignition switch to ACC position. (At this time, the steering lock will be released.)
3. Disconnect both battery cables. The steering lock will remain released with both battery cables disconnected and the steering wheel can be turned.
4. Perform the necessary repair operation.
5. When the repair work is completed, re-connect both battery cables. With the brake pedal released, turn the push-button ignition switch from ACC position to ON position, then to LOCK position. (The steering wheel will lock when the push-button ignition switch is turned to LOCK position.)
6. Perform self-diagnosis check of all control units using CONSULT-III.

## Procedures without Cowl Top Cover

INFOID:000000000956188

# PRECAUTIONS

## < PRECAUTION >

When performing the procedure after removing cowl top cover, cover the lower end of windshield with urethane, etc.

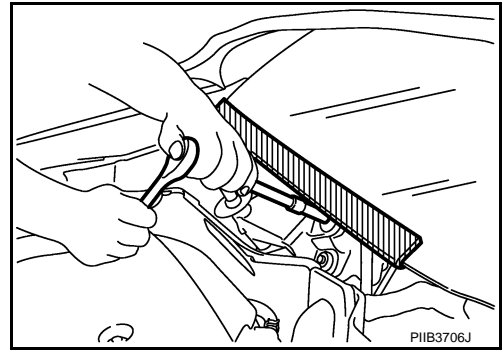

## General Precautions

INFOID:000000000956189

- Do not operate the engine for an extended period of time without proper exhaust ventilation.

Keep the work area well ventilated and free of any inflammable materials. Special care should be taken when handling any inflammable or poisonous materials, such as gasoline, refrigerant gas, etc. When working in a pit or other enclosed area, be sure to properly ventilate the area before working with hazardous materials.

Do not smoke while working on the vehicle.

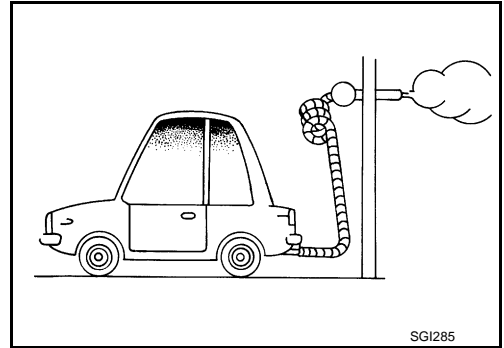

- Before jacking up the vehicle, apply wheel chocks or other tire blocks to the wheels to prevent the vehicle from moving. After jacking up the vehicle, support the vehicle weight with safety stands at the points designated for proper lifting before working on the vehicle.

These operations should be done on a level surface.

- When removing a heavy component such as the engine or transaxle/transmission, be careful not to lose your balance and drop them. Also, do not allow them to strike adjacent parts, especially the brake tubes and master cylinder.

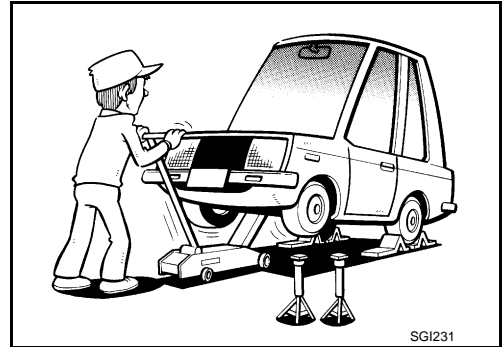

- Before starting repairs which do not require battery power:
  - Turn off ignition switch.
  - Disconnect the negative battery terminal.
- If the battery terminals are disconnected, recorded memory of radio and each control unit is erased.

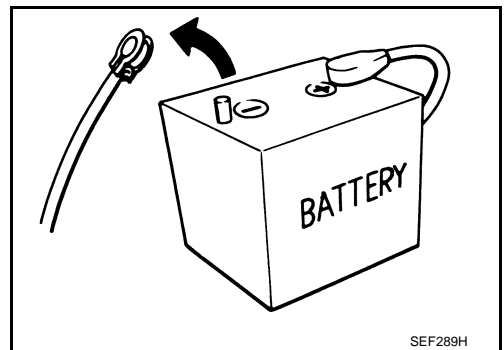

# PRECAUTIONS

## < PRECAUTION >

- To prevent serious burns:  
Avoid contact with hot metal parts.  
Do not remove the radiator cap when the engine is hot.
- Dispose of drained oil or the solvent used for cleaning parts in an appropriate manner.
- Do not attempt to top off the fuel tank after the fuel pump nozzle shuts off automatically.  
Continued refueling may cause fuel overflow, resulting in fuel spray and possibly a fire.
- Clean all disassembled parts in the designated liquid or solvent prior to inspection or assembly.
- Replace oil seals, gaskets, packings, O-rings, locking washers, cotter pins, self-locking nuts, etc. with new ones.
- Replace inner and outer races of tapered roller bearings and needle bearings as a set.
- Arrange the disassembled parts in accordance with their assembled locations and sequence.
- Do not touch the terminals of electrical components which use microcomputers (such as ECM).  
Static electricity may damage internal electronic components.
- After disconnecting vacuum or air hoses, attach a tag to indicate the proper connection.
- Use only the fluids and lubricants specified in this manual.
- Use approved bonding agent, sealants or their equivalents when required.
- Use hand tools, power tools (disassembly only) and recommended special tools where specified for safe and efficient service repairs.
- When repairing the fuel, oil, water, vacuum or exhaust systems, check all affected lines for leaks.

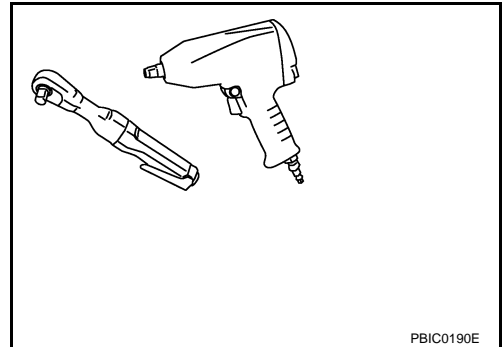
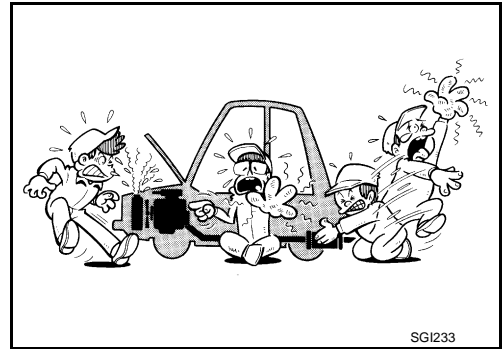

- Before servicing the vehicle:  
Protect fenders, upholstery and carpeting with appropriate covers.  
Take caution that keys, buckles or buttons do not scratch paint.

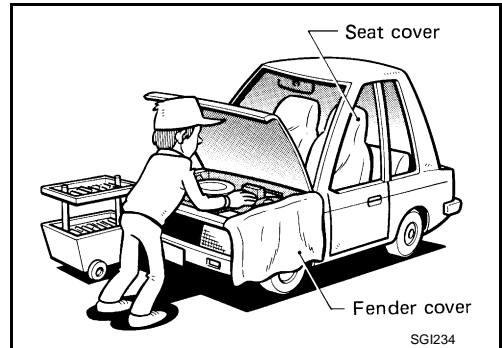

## **WARNING:**

To prevent ECM from storing the diagnostic trouble codes, do not carelessly disconnect the harness connectors which are related to the engine control system and TCM (transmission control module) system. The connectors should be disconnected only when working according to the WORK FLOW of TROUBLE DIAGNOSES in EC and AT sections.

## Three Way Catalyst

INFOID:000000000956190

If a large amount of unburned fuel flows into the catalyst, the catalyst temperature will be excessively high. To prevent this, follow the instructions.

- Use unleaded gasoline only. Leaded gasoline will seriously damage the three way catalyst.
- When checking for ignition spark or measuring engine compression, make tests quickly and only when necessary.
- Do not run engine when the fuel tank level is low, otherwise the engine may misfire, causing damage to the catalyst.

# PRECAUTIONS

## < PRECAUTION >

Do not place the vehicle on flammable material. Keep flammable material off the exhaust pipe and the three way catalyst.

### Multiport Fuel Injection System or Engine Control System

INFOID:000000000956191

- Before connecting or disconnecting any harness connector for the multiport fuel injection system or ECM:  
Turn ignition switch to "OFF" position.  
Disconnect negative battery terminal.  
Otherwise, there may be damage to ECM.
- Before disconnecting pressurized fuel line from fuel pump to injectors, be sure to release fuel pressure.
- Be careful not to jar components such as ECM and mass air flow sensor.

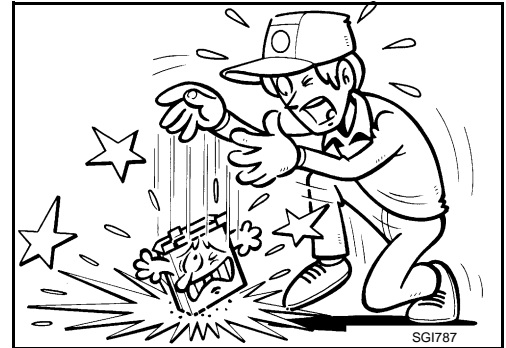

### Hoses

INFOID:000000000956192

#### HOSE REMOVAL AND INSTALLATION

- To prevent damage to rubber hose, do not pry off rubber hose with tapered tool or screwdriver.

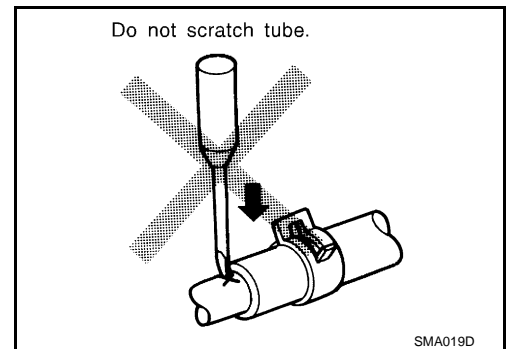

- To reinstall the rubber hose securely, make sure that hose insertion length and orientation is correct. (If tube is equipped with hose stopper, insert rubber hose into tube until it butts up against hose stopper.)

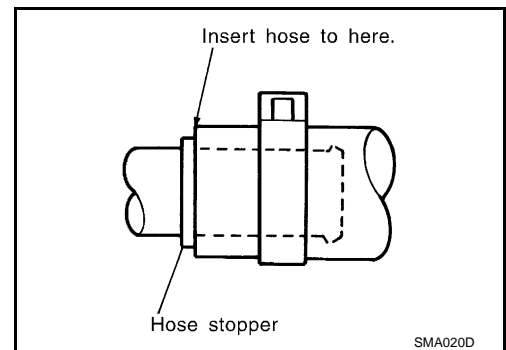

#### HOSE CLAMPING

- If old rubber hose is re-used, install hose clamp in its original position (at the indentation where the old clamp was). If there is a trace of tube bulging left on the old rubber hose, align rubber hose at that position.
- Discard old clamps; replace with new ones.

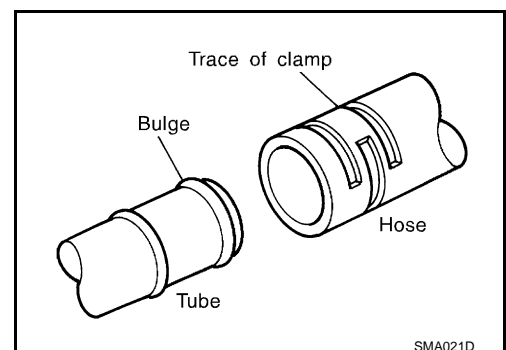

## PRECAUTIONS

### < PRECAUTION >

- After installing plate clamps, apply force to them in the direction of the arrow, tightening rubber hose equally all around.

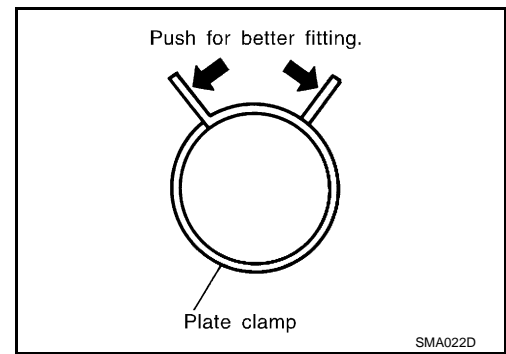

## Engine Oils

INFOID:000000000956193

Prolonged and repeated contact with used engine oil may cause skin cancer. Try to avoid direct skin contact with used oil.

If skin contact is made, wash thoroughly with soap or hand cleaner as soon as possible.

### HEALTH PROTECTION PRECAUTIONS

- Avoid prolonged and repeated contact with oils, particularly used engine oils.
- Wear protective clothing, including impervious gloves where practicable.
- Do not put oily rags in pockets.
- Avoid contaminating clothes, particularly underpants, with oil.
- Heavily soiled clothing and oil-impregnated footwear should not be worn. Overalls must be cleaned regularly.
- First aid treatment should be obtained immediately for open cuts and wounds.
- Use barrier creams, applying them before each work period, to help the removal of oil from the skin.
- Wash with soap and water to ensure all oil is removed (skin cleansers and nail brushes will help). Preparations containing lanolin replace the natural skin oils which have been removed.
- Do not use gasoline, kerosene, diesel fuel, gas oil, thinners or solvents for cleaning skin.
- If skin disorders develop, obtain medical advice without delay.
- Where practical, degrease components prior to handling.
- Where there is a risk of eye contact, eye protection should be worn, for example, chemical goggles or face shields; in addition an eye wash facility should be provided.

### ENVIRONMENTAL PROTECTION PRECAUTIONS

Dispose of used oil and used oil filters through authorized waste disposal contractors to licensed waste disposal sites, or to the waste oil reclamation trade. If in doubt, contact the local authority for advice on disposal facilities.

It is illegal to pour used oil on to the ground, down sewers or drains, or into water sources.

The regulations concerning pollution vary between regions.

## Air Conditioning

INFOID:000000000956194

Use an approved refrigerant recovery unit any time the air conditioning system must be discharged. Refer to ATC/MTC section "HFC-134a (R-134a) Service Procedure", "REFRIGERANT LINES" for specific instructions.

## FUEL

### FUEL : Unleaded Premium Gasoline Recommended

INFOID:000000000956195

INFINITI recommends the use of unleaded premium gasoline with an octane rating of at least 93 AKI (Anti-Knock Index) number (Research octane number 98).

If unleaded premium gasoline is not available, you may use unleaded regular gasoline with an octane rating of at least 87 AKI number (Research octane number 91), but you may notice a decrease in performance.

### **CAUTION:**

**Do not use leaded gasoline. Using leaded gasoline will damage the three way catalyst. Do not use E-85 fuel (85% fuel ethanol, 15% unleaded gasoline) unless the vehicle is specifically designed for E-85 fuel (i.e. Flexible Fuel Vehicle - FFV models). Using a fuel other than that specified could adversely affect the emission control devices and systems, and could also affect the warranty coverage validity.**

# LIFTING POINT

< PRECAUTION >

## LIFTING POINT

Commercial Service Tools

INFOID:000000000956196

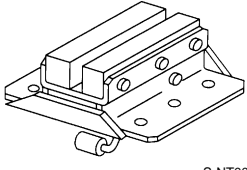
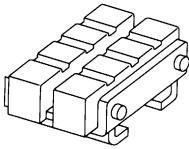
Tool name	Description
Board on attachment	 <p>S-NT001</p>
Safety stand attachment	 <p>S-NT002</p>

### CAUTION:

- Every time the vehicle is lifted up, maintain the complete vehicle curb condition.
- Since the vehicle's center of gravity changes when removing main parts on the front side (engine, transmission, suspension etc.), support a jack up point on the rear side garage jack with a mission jack or equivalent.
- Since the vehicle's center of gravity changes when removing main parts on the rear side (rear axle, suspension, etc.), support a jack up point on the front side garage jack with a mission jack or equivalent.
- Be careful not to smash or do not do anything that would affect piping parts.

### Garage Jack and Safety Stand and 2-Pole Lift

INFOID:000000000956197

### WARNING:

- Park the vehicle on a level surface when using the jack. Make sure to avoid damaging pipes, tubes, etc. under the vehicle.
- Never get under the vehicle while it is supported only by the jack. Always use safety stands when you have to get under the vehicle.
- Place wheel chocks at both front and back of the wheels on the ground.
- When lifting the vehicle, open the lift arms as wide as possible and ensure that the front and rear of the vehicle are well balanced.
- When setting the lift arm, do not allow the arm to contact the brake tubes, brake cable, fuel lines and sill spoiler.

# LIFTING POINT

< PRECAUTION >

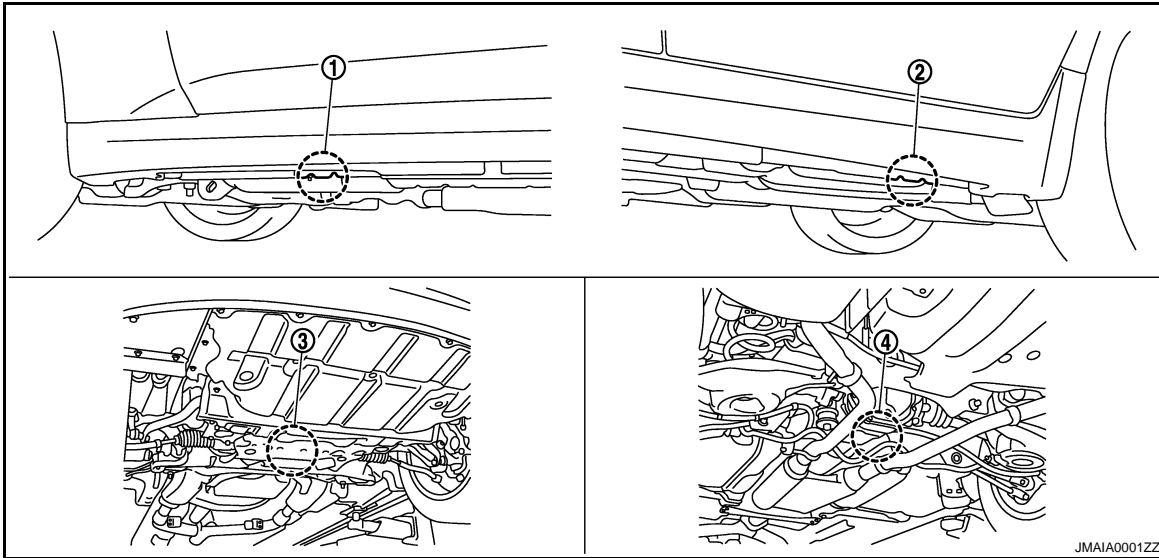

1. Safety stand point and lift up point (front)
2. Safety stand point and lift up point (rear)
3. Garage jack point (front)
4. Garage jack point (rear)

## CAUTION:

There is canister just behind Garage jack point rear. Jack up be carefully.

## Board-On Lift

INFOID:000000000956198

## CAUTION:

Make sure vehicle is empty when lifting.

- The board-on lift attachment (A) set at front end of vehicle should be set on the front of the sill under the front door opening.
- Position attachments at front and rear ends of board-on lift.

← : Vehicle front

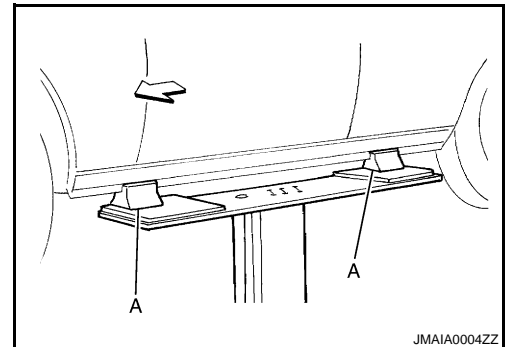

# TOW TRUCK TOWING

< PRECAUTION >

## TOW TRUCK TOWING

### Tow Truck Towing

INFOID:000000000956199

#### CAUTION:

- All applicable state or Provincial (in Canada) laws and local laws regarding the towing operation must be obeyed.
- It is necessary to use proper towing equipment to avoid possible damage to the vehicle during towing operation. Towing is in accordance with Towing Procedure Manual at dealer.
- Always attach safety chains before towing.
- When towing, make sure that the transmission, steering system and powertrain are in good order. If any unit is damaged, dollies must be used.
- Never tow an automatic transmission model from the rear (that is backward) with four wheels on the ground. This may cause serious and expensive damage to the transmission.

#### 2WD MODELS

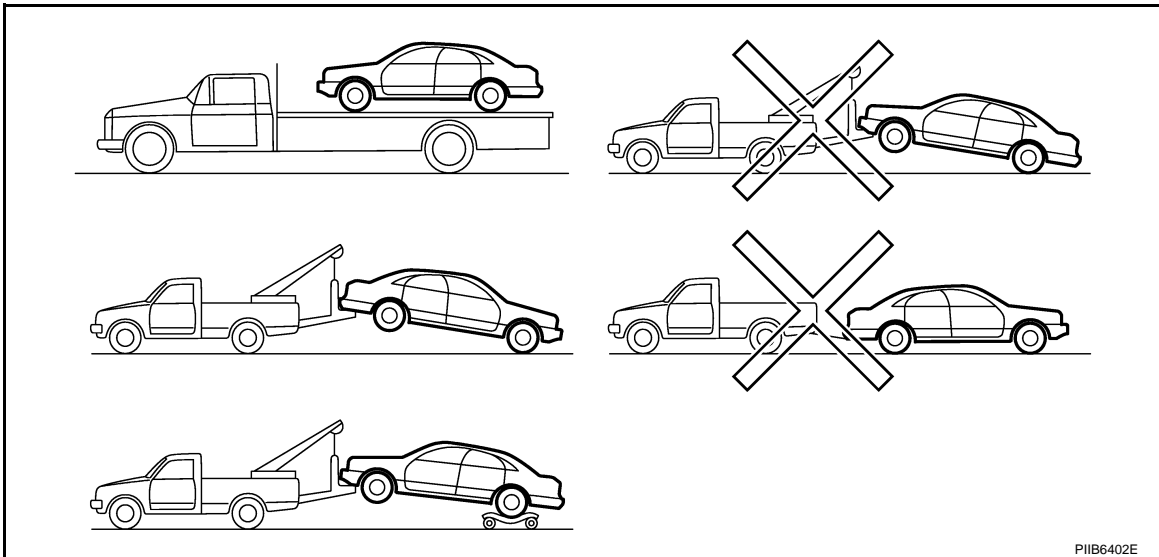

INFINITI recommends that vehicle be towed with the driving (rear) wheels off the ground or that a dolly be used as illustrated.

#### CAUTION:

- Never tow automatic transmission models with the rear wheels on the ground or four wheels on the ground (forward or backward), as this may cause serious and expensive damage to the transmission.

If it is necessary to tow the vehicle with the front wheels raised, always use towing dollies under the rear wheels.

- When towing rear wheel drive models with the front wheels on the ground or on towing dollies:
  - Turn the ignition key to the OFF position, and secure the steering wheel in a straight ahead position with a rope or similar device. Never secure the steering wheel by turning the ignition key to the LOCK position. This may damage the steering lock mechanism.
  - Move the selector lever to the N (Neutral) position.
- When the battery of vehicle equipped with the Intelligent Key system is discharged, your vehicle should be towed with the front wheels on towing dollies or place the vehicle on a flat bed truck.

If the speed or distance must necessarily be greater, remove the propeller shaft before towing to prevent damage to the transmission.



## TOW TRUCK TOWING

< PRECAUTION >

### AWD MODELS

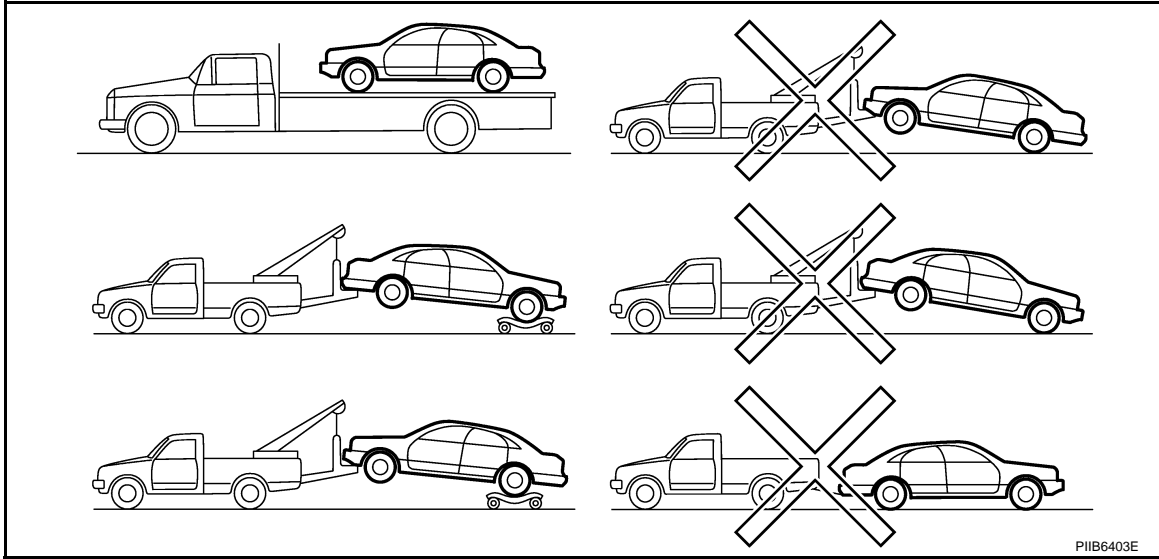

INFINITI recommends that a dolly be used as illustrated when towing AWD models.

**CAUTION:**

**Never tow AWD models with any of the wheels on the ground as this may cause serious and expensive damage to the powertrain.**

### Vehicle Recovery (Freeing a Stuck Vehicle)

INFOID:000000000956200

#### FRONT

Securely install the vehicle recovery hook stored with jacking tools. Make sure that the hook is properly secured in the stored place after use.

**WARNING:**

- Stand clear of a stuck vehicle.
- Do not spin your tires at high speed. This could cause them to explode and result in serious injury. Parts of your vehicle could also overheat and be damaged.

**CAUTION:**

- Tow chains or cables must be attached only to the vehicle recovery hooks or main structural members of the vehicle. Otherwise, the vehicle body will be damaged.
- Do not use the vehicle tie downs to free a vehicle stuck in sand, snow, mud, etc. Never tow the vehicle using the vehicle tie downs or recovery hooks.
- Always pull the cable straight out from the front of the vehicle. Never pull on the hook at an angle.
- Pulling devices should be routed so they do not touch any part of the suspension, steering, brake or cooling systems.
- Pulling devices such as ropes or canvas straps are not recommended for use in vehicle towing or recovery.

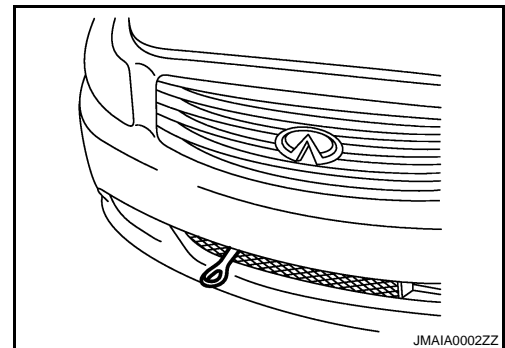

#### REAR

**WARNING:**

- Rear hook is not available.

### AUTOMATIC TRANSMISSION

To tow a vehicle equipped with an automatic transmission, an appropriate vehicle dolly **MUST** be placed under the towed vehicle's drive wheels. **Always** follow the dolly manufacturer's recommendations when using their product.

If the vehicle is stuck in sand, snow, mud, etc., use the following procedure:

1. Turn off the Vehicle Dynamic Control System.
2. Make sure the area in front and behind the vehicle is clear of obstructions.

## TOW TRUCK TOWING

### < PRECAUTION >

---

3. Turn the steering wheel right and left to clear an area around the front tires.
4. Slowly rock the vehicle forward and backward.  
Shift back and forth between R (reverse) and D (drive).  
Apply the accelerator as little as possible to maintain the rocking motion.  
Release the accelerator pedal before shifting between R and D.  
Do not spin the tires above 35 mph (55 km/h).
5. If the vehicle can not be freed after a few tries, contact a professional towing service to remove the vehicle.

# SERVICE INFORMATION FOR ELECTRICAL INCIDENT

< BASIC INSPECTION >

## BASIC INSPECTION

### SERVICE INFORMATION FOR ELECTRICAL INCIDENT

Work Flow

INFOID:000000000956201

#### WORK FLOW

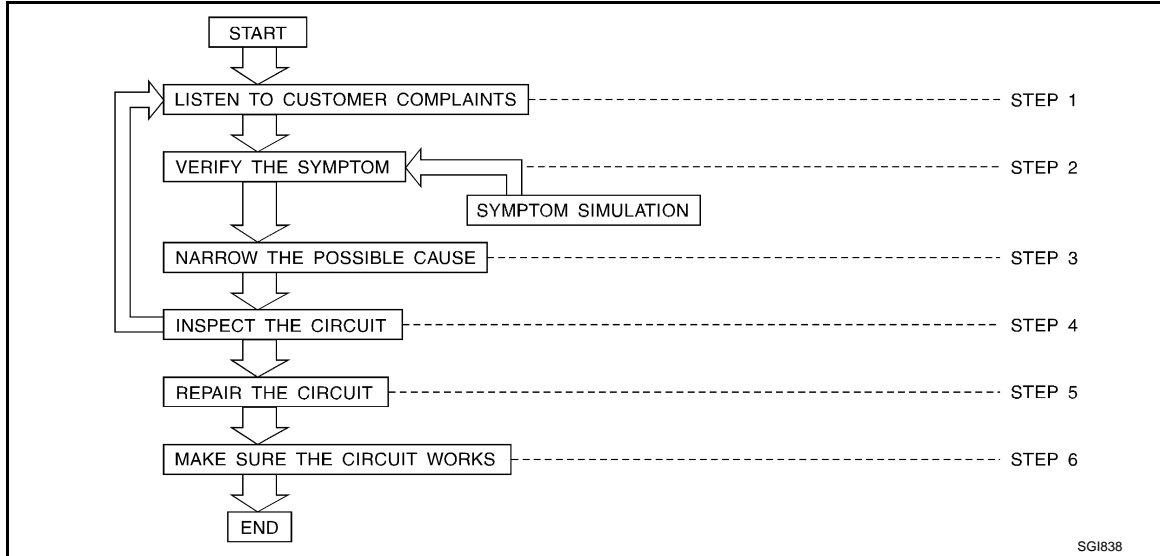

STEP	DESCRIPTION	
STEP 1	Get detailed information about the conditions and the environment when the incident occurred. The following are key pieces of information required to make a good analysis:	
	<b>WHAT</b>	Vehicle Model, Engine, Transmission/Transaxle and the System (i.e. Radio).
	<b>WHEN</b>	Date, Time of Day, Weather Conditions, Frequency.
	<b>WHERE</b>	Road Conditions, Altitude and Traffic Situation.
STEP 2	<b>HOW</b>	System Symptoms, Operating Conditions (Other Components Interaction). Service History and if any After Market Accessories have been installed.
	Operate the system, road test if necessary. Verify the parameter of the incident. If the problem cannot be duplicated, refer to "Incident Simulation Tests".	
STEP 3	Get the proper diagnosis materials together including: <ul style="list-style-type: none"> <li>• Power Supply Routing</li> <li>• System Operation Descriptions</li> <li>• Applicable Service Manual Sections</li> <li>• Check for any Service Bulletins</li> </ul> Identify where to begin diagnosis based upon your knowledge of the system operation and the customer comments.	
STEP 4	Inspect the system for mechanical binding, loose connectors or wiring damage. Determine which circuits and components are involved and diagnose using the Power Supply Routing and Harness Layouts.	
STEP 5	Repair or replace the incident circuit or component.	
STEP 6	Operate the system in all modes. Verify the system works properly under all conditions. Make sure you have not inadvertently created a new incident during your diagnosis or repair steps.	

#### Control Units and Electrical Parts

INFOID:000000000956202

#### PRECAUTIONS

- Never reverse polarity of battery terminals.
- Install only parts specified for a vehicle.
- Before replacing the control unit, check the input and output and functions of the component parts.
- Do not apply excessive force when disconnecting a connector.

## SERVICE INFORMATION FOR ELECTRICAL INCIDENT

### < BASIC INSPECTION >

- Do not apply excessive shock to the control unit by dropping or hitting it.
- Be careful to prevent condensation in the control unit due to rapid temperature changes and do not let water or rain get on it. If water is found in the control unit, dry it fully and then install it in the vehicle.
- Be careful not to let oil get on the control unit connector.
- Avoid cleaning the control unit with volatile oil.
- Do not disassemble the control unit, and do not remove the upper and lower covers.

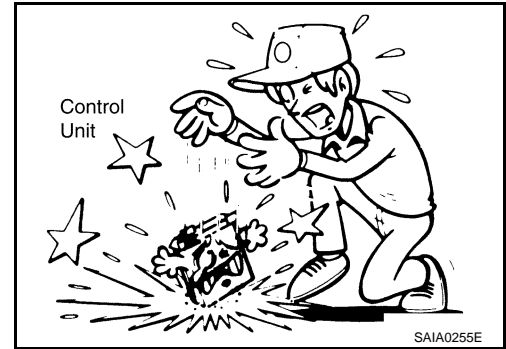

- When using a DMM, be careful not to let test probes get close to each other to prevent the power transistor in the control unit from damaging battery voltage because of short circuiting.
- When checking input and output signals of the control unit, use the specified check adapter.

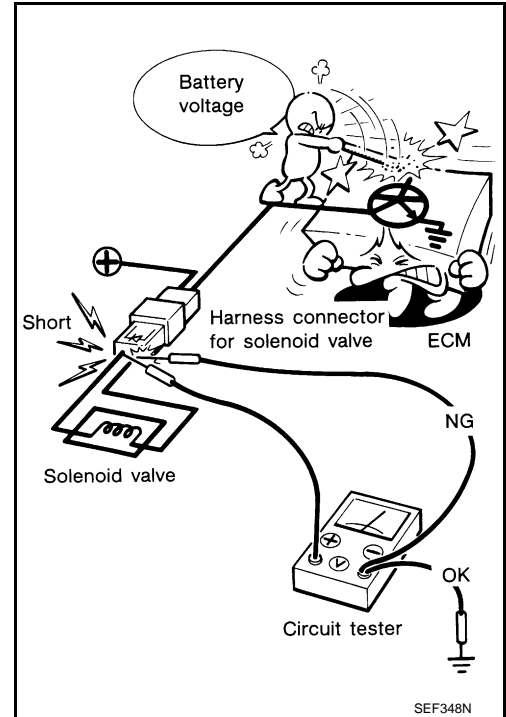

### How to Check Terminal

INFOID:000000000956203

### CONNECTOR AND TERMINAL PIN KIT

- Use the connector and terminal pin kits listed below when replacing connectors or terminals.
- The connector and terminal pin kits contain some of the most commonly used NISSAN/INFINITI connectors and terminals. For detailed connector and terminal pin replacement procedures, refer to the latest NISSAN/INFINITI CONNECTOR AND TERMINAL PIN SERVICE MANUAL.

# SERVICE INFORMATION FOR ELECTRICAL INCIDENT

## < BASIC INSPECTION >

Tool number (Kent-Moore No.) Tool name	Description
- (J38751-95NI) Connector and terminal pin kit (NISSAN) - (J38751-95INF) Connector and terminal pin kit (INFINITI) - (J42992-98KIT) OBD and terminal repair kit - (J42992-2000UPD) OBD-II Connector Kit Up- date	

GI

B

C

D

E

F

### HOW TO PROBE CONNECTORS

- Connector damage and an intermittent connection can result from improperly probing of the connector during circuit checks.
- The probe of a digital multimeter (DMM) may not correctly fit the connector cavity. To correctly probe the connector, follow the procedures below using a "T" pin. For the best contact grasp the "T" pin using an alligator clip.

#### Probing from Harness Side

Standard type (not waterproof type) connector should be probed from harness side with "T" pin.

- If the connector has a rear cover such as a ECM connector, remove the rear cover before probing the terminal.
- Do not probe waterproof connector from harness side. Damage to the seal between wire and connector may result.

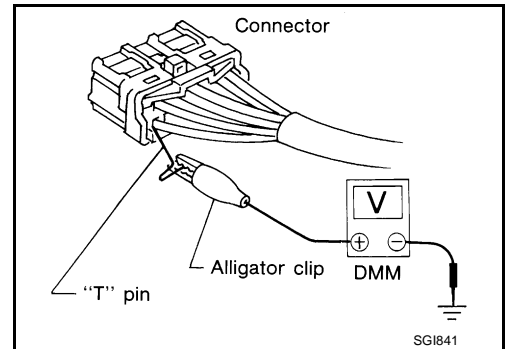

G

H

I

J

K

#### Probing from Terminal Side

#### FEMALE TERMINAL

- There is a small notch above each female terminal. Probe each terminal with the "T" pin through the notch. Do not insert any object other than the same type male terminal into female terminal.

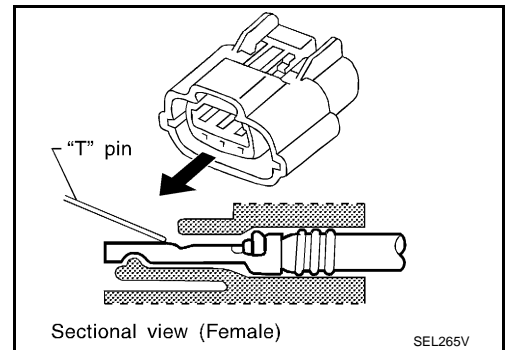

L

M

N

O

P

# SERVICE INFORMATION FOR ELECTRICAL INCIDENT

## < BASIC INSPECTION >

- Some connectors do not have a notch above each terminal. To probe each terminal, remove the connector retainer to make contact space for probing.

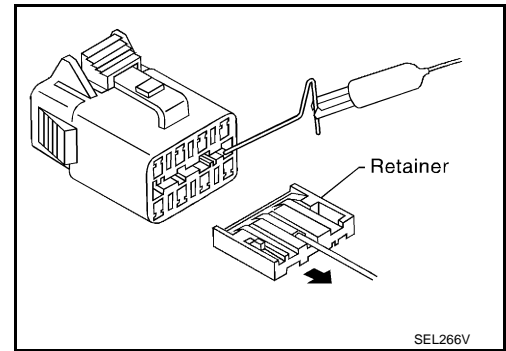

### MALE TERMINAL

- Carefully probe the contact surface of each terminal using a "T" pin.

**CAUTION:**

**Dot not bend terminal.**

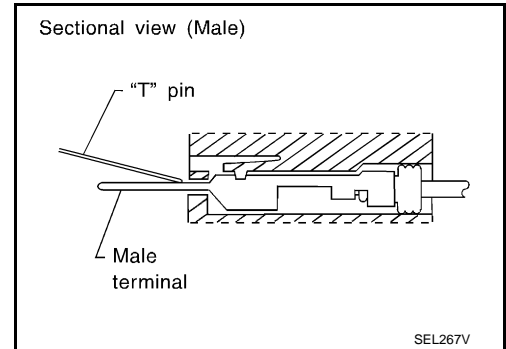

### How to Check Enlarged Contact Spring of Terminal

- An enlarged contact spring of a terminal may create intermittent signals in the circuit.
- If the intermittent open circuit occurs, follow the procedure below to inspect for open wires and enlarged contact spring of female terminal.

1. Assemble a male terminal and approx. 10 cm (3.9 in) of wire.

**NOTE:**

**Use a male terminal which matches the female terminal.**

2. Disconnect the suspected faulty connector and hold it terminal side up.

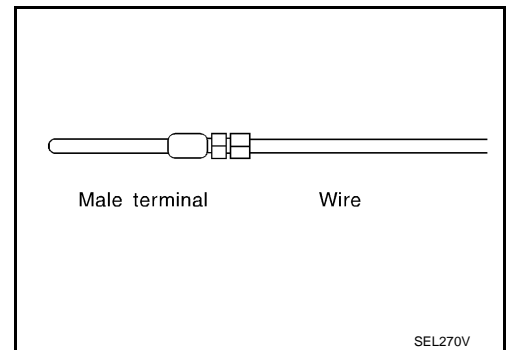

3. While holding the wire of the male terminal, try to insert the male terminal into the female terminal.

**CAUTION:**

**Do not force the male terminal into the female terminal with your hands.**

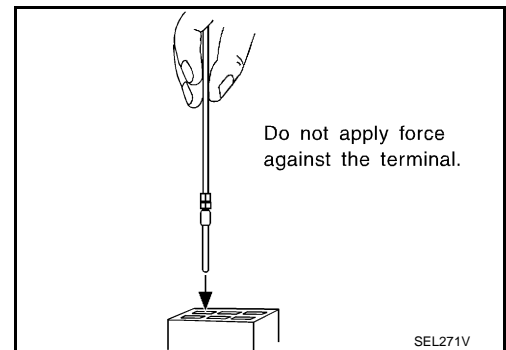

# SERVICE INFORMATION FOR ELECTRICAL INCIDENT

## < BASIC INSPECTION >

4. While moving the connector, check whether the male terminal can be easily inserted or not.

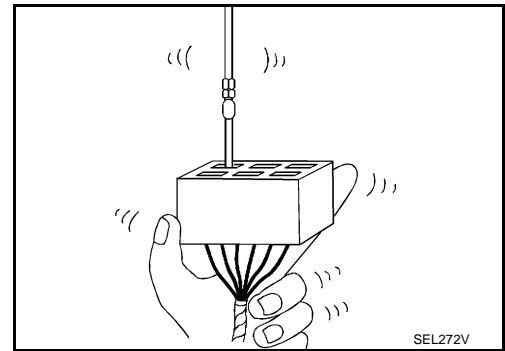

- If the male terminal can be easily inserted into the female terminal, replace the female terminal.

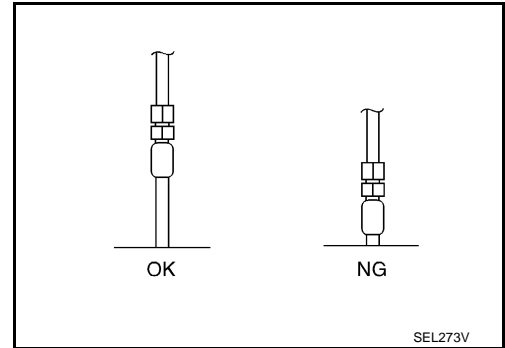

### Waterproof Connector Inspection

If water enters the connector, it can short interior circuits. This may lead to intermittent problems. Check the following items to maintain the original waterproof characteristics.

#### RUBBER SEAL INSPECTION

- Most waterproof connectors are provided with a rubber seal between the male and female connectors. If the seal is missing, the waterproof performance may not meet specifications.
- The rubber seal may come off when connectors are disconnected. Whenever connectors are reconnected, make sure the rubber seal is properly installed on either side of male or female connector.

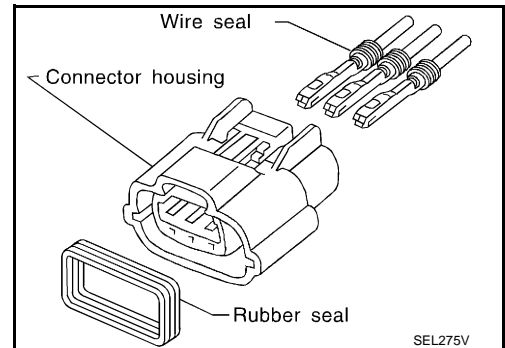

#### WIRE SEAL INSPECTION

- The wire seal must be installed on the wire insertion area of a waterproof connector. Be sure that the seal is installed properly.

### Terminal Lock Inspection

Check for unlocked terminals by pulling wire at the end of connector. An unlocked terminal may create intermittent signals in the circuit.

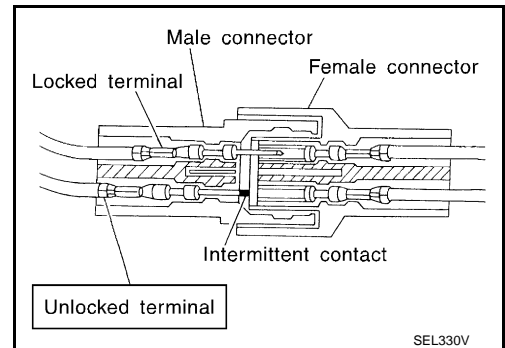

## Intermittent Incident

INFOID:000000000956204

### DESCRIPTION

Sometimes the symptom is not present when the vehicle is brought in for service. If possible, re-create the conditions present at the time of the incident. Doing so may help avoid a No Trouble Found Diagnosis. The fol-

GI  
B  
C  
D  
E  
F  
G  
H  
I  
J  
K  
L  
M  
N  
O  
P

# SERVICE INFORMATION FOR ELECTRICAL INCIDENT

## < BASIC INSPECTION >

Following section illustrates ways to simulate the conditions/environment under which the owner experiences an electrical incident.

The section is broken into the six following topics:

- Vehicle vibration
- Heat sensitive
- Freezing
- Water intrusion
- Electrical load
- Cold or hot start up

Get a thorough description of the incident from the customer. It is important for simulating the conditions of the problem.

### VEHICLE VIBRATION

The problem may occur or become worse while driving on a rough road or when engine is vibrating (idle with A/C on). In such a case, you will want to check for a vibration related condition. Refer to the following illustration.

#### Connector & Harness

Determine which connectors and wiring harness would affect the electrical system you are inspecting. Gently shake each connector and harness while monitoring the system for the incident you are trying to duplicate. This test may indicate a loose or poor electrical connection.

#### Hint

Connectors can be exposed to moisture. It is possible to get a thin film of corrosion on the connector terminals. A visual inspection may not reveal this without disconnecting the connector. If the problem occurs intermittently, perhaps the problem is caused by corrosion. It is a good idea to disconnect, inspect and clean the terminals on related connectors in the system.

#### Sensor & Relay

Gently apply a slight vibration to sensors and relays in the system you are inspecting. This test may indicate a loose or poorly mounted sensor or relay.

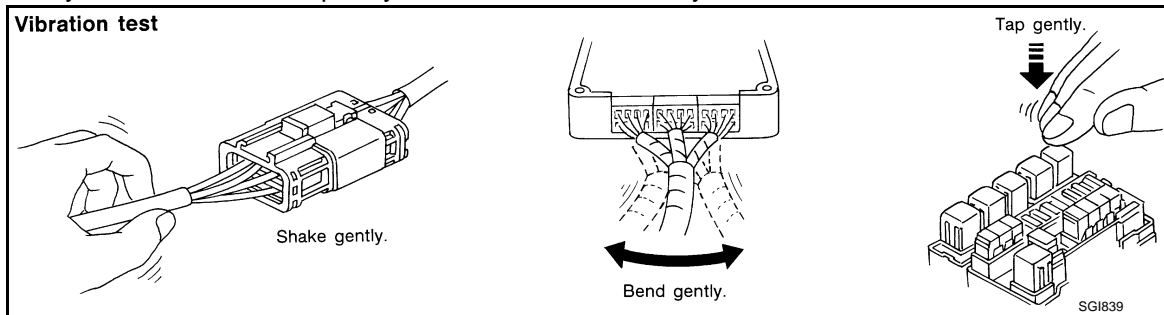

#### Engine Compartment

There are several reasons a vehicle or engine vibration could cause an electrical complaint. Some of the things to check for are:

- Connectors not fully seated.
- Wiring harness not long enough and is being stressed due to engine vibrations or rocking.
- Wires laying across brackets or moving components.
- Loose, dirty or corroded ground wires.
- Wires routed too close to hot components.

To inspect components under the hood, start by verifying the integrity of ground connections. (Refer to Ground Inspection described later.) First check that the system is properly grounded. Then check for loose connection by gently shaking the wiring or components as previously explained. Using the wiring diagrams inspect the wiring for continuity.

#### Behind the Instrument Panel

An improperly routed or improperly clamped harness can become pinched during accessory installation. Vehicle vibration can aggravate a harness which is routed along a bracket or near a screw.

#### Under Seating Areas



# SERVICE INFORMATION FOR ELECTRICAL INCIDENT

## < BASIC INSPECTION >

An unclamped or loose harness can cause wiring to be pinched by seat components (such as slide guides) during vehicle vibration. If the wiring runs under seating areas, inspect wire routing for possible damage or pinching.

### HEAT SENSITIVE

- The customer's concern may occur during hot weather or after car has sat for a short time. In such cases you will want to check for a heat sensitive condition.
- To determine if an electrical component is heat sensitive, heat the component with a heat gun or equivalent.

#### **CAUTION:**

**Do not heat components above 60°C (140°).**

- If incident occurs while heating the unit, either replace or properly insulate the component.

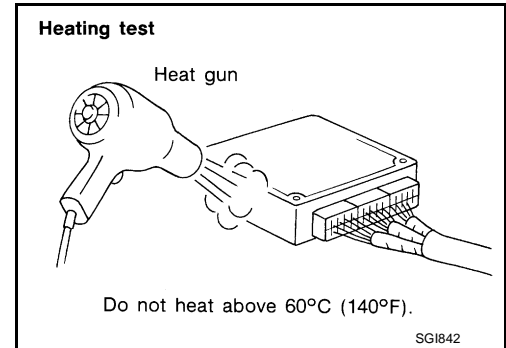

### FREEZING

- The customer may indicate the incident goes away after the car warms up (winter time). The cause could be related to water freezing somewhere in the wiring/electrical system.
- There are two methods to check for this. The first is to arrange for the owner to leave his car overnight. Make sure it will get cold enough to demonstrate his complaint. Leave the car parked outside overnight. In the morning, do a quick and thorough diagnosis of those electrical components which could be affected.
- The second method is to put the suspect component into a freezer long enough for any water to freeze. Reinstall the part into the car and check for the reoccurrence of the incident. If it occurs, repair or replace the component.

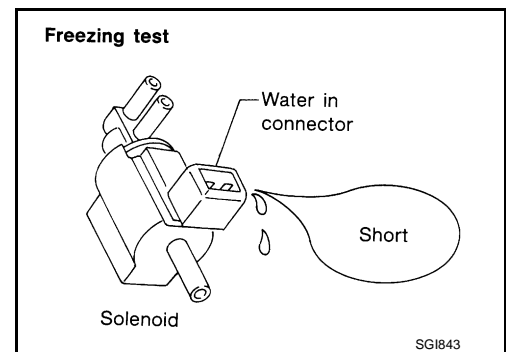

### WATER INTRUSION

The incident may occur only during high humidity or in rainy/snowy weather. In such cases the incident could be caused by water intrusion on an electrical part. This can be simulated by soaking the car or running it through a car wash.

#### **CAUTION:**

**Do not spray water directly on any electrical components.**

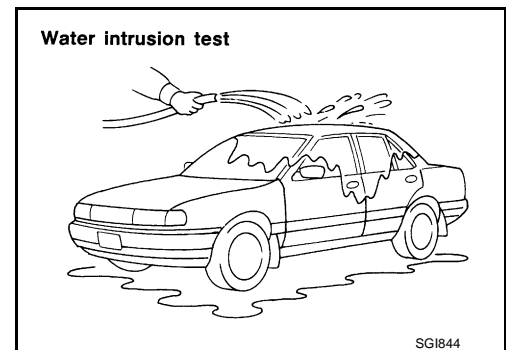

### ELECTRICAL LOAD

The incident may be electrical load sensitive. Perform diagnosis with all accessories (including A/C, rear window defogger, radio, fog lamps) turned on.

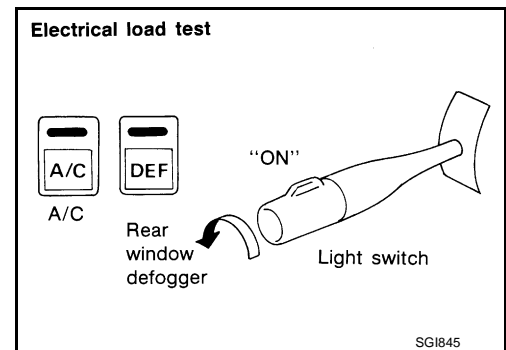

### COLD OR HOT START UP

On some occasions an electrical incident may occur only when the car is started cold, or it may occur when the car is restarted hot shortly after being turned off. In these cases you may have to keep the car overnight to make a proper diagnosis.

# SERVICE INFORMATION FOR ELECTRICAL INCIDENT

## < BASIC INSPECTION >

### Circuit Inspection

INFOID:00000000956205

#### DESCRIPTION

- In general, testing electrical circuits is an easy task if it is approached in a logical and organized method. Before beginning it is important to have all available information on the system to be tested. Also, get a thorough understanding of system operation. Then you will be able to use the appropriate equipment and follow the correct test procedure.
- You may have to simulate vehicle vibrations while testing electrical components. Gently shake the wiring harness or electrical component to do this.

OPEN	A circuit is open when there is no continuity through a section of the circuit.	
SHORT	There are two types of shorts.	
	• SHORT CIRCUIT	When a circuit contacts another circuit and causes the normal resistance to change.
	• SHORT TO GROUND	When a circuit contacts a ground source and grounds the circuit.

#### NOTE:

Refer to [GI-36, "How to Check Terminal"](#) to probe or check terminal.

#### TESTING FOR "OPENS" IN THE CIRCUIT

Before you begin to diagnose and test the system, you should rough sketch a schematic of the system. This will help you to logically walk through the diagnosis process. Drawing the sketch will also reinforce your working knowledge of the system.

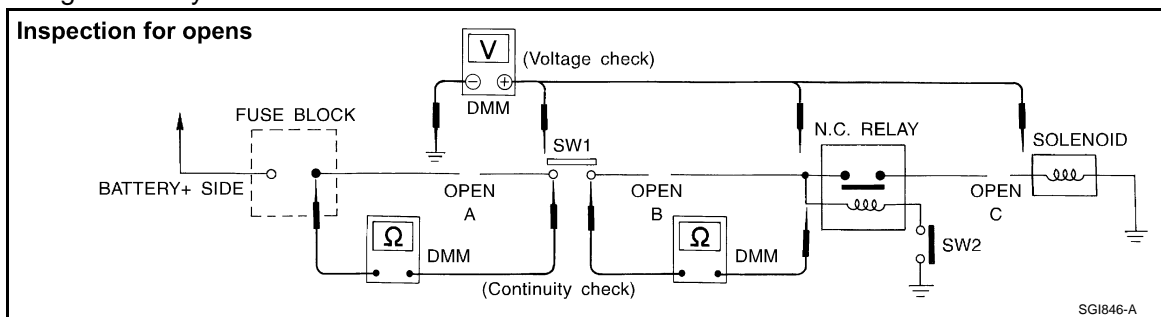

#### Continuity Check Method

The continuity check is used to find an open in the circuit. The digital multimeter (DMM) set on the resistance function will indicate an open circuit as over limit (no beep tone or no ohms symbol). Make sure to always start with the DMM at the highest resistance level.

To help in understanding the diagnosis of open circuits, please refer to the previous schematic.

- Disconnect the battery negative cable.
- Start at one end of the circuit and work your way to the other end. (At the fuse block in this example)
- Connect one probe of the DMM to the fuse block terminal on the load side.
- Connect the other probe to the fuse block (power) side of SW1. Little or no resistance will indicate that portion of the circuit has good continuity. If there were an open in the circuit, the DMM would indicate an over limit or infinite resistance condition. (point A)
- Connect the probes between SW1 and the relay. Little or no resistance will indicate that portion of the circuit has good continuity. If there were an open in the circuit, the DMM would indicate an over limit or infinite resistance condition. (point B)
- Connect the probes between the relay and the solenoid. Little or no resistance will indicate that portion of the circuit has good continuity. If there were an open in the circuit, the DMM would indicate an over limit or infinite resistance condition. (point C)

Any circuit can be diagnosed using the approach in the previous example.

#### Voltage Check Method

To help in understanding the diagnosis of open circuits please refer to the previous schematic.

In any powered circuit, an open can be found by methodically checking the system for the presence of voltage. This is done by switching the DMM to the voltage function.

- Connect one probe of the DMM to a known good ground.
- Begin probing at one end of the circuit and work your way to the other end.
- With SW1 open, probe at SW1 to check for voltage. voltage; open is further down the circuit than SW1.

# SERVICE INFORMATION FOR ELECTRICAL INCIDENT

## < BASIC INSPECTION >

- no voltage; open is between fuse block and SW1 (point A).
- Close SW1 and probe at relay.
  - voltage; open is further down the circuit than the relay.
  - no voltage; open is between SW1 and relay (point B).
- Close the relay and probe at the solenoid.
  - voltage; open is further down the circuit than the solenoid.
  - no voltage; open is between relay and solenoid (point C).

Any powered circuit can be diagnosed using the approach in the previous example.

## TESTING FOR "SHORTS" IN THE CIRCUIT

To simplify the discussion of shorts in the system, please refer to the following schematic.

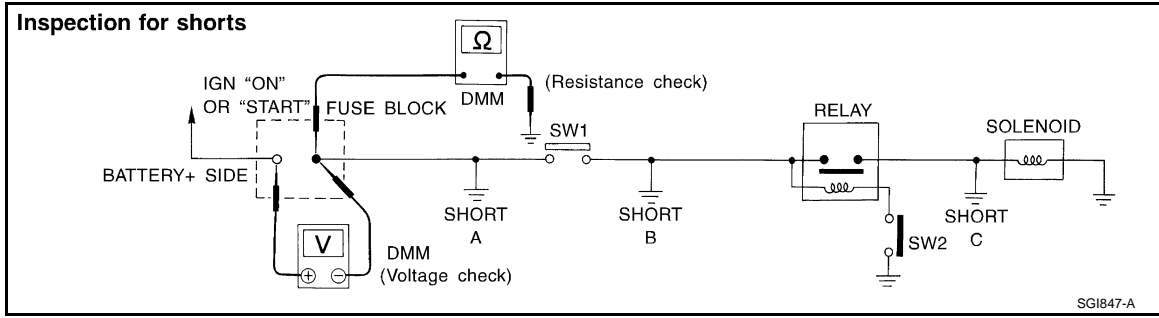

### Resistance Check Method

- Disconnect the battery negative cable and remove the blown fuse.
- Disconnect all loads (SW1 open, relay disconnected and solenoid disconnected) powered through the fuse.
- Connect one probe of the DMM to the load side of the fuse terminal. Connect the other probe to a known good ground.
- With SW1 open, check for continuity.
  - continuity; short is between fuse terminal and SW1 (point A).
  - no continuity; short is further down the circuit than SW1.
- Close SW1 and disconnect the relay. Put probes at the load side of fuse terminal and a known good ground. Then, check for continuity.
  - continuity; short is between SW1 and the relay (point B).
  - no continuity; short is further down the circuit than the relay.
- Close SW1 and jump the relay contacts with jumper wire. Put probes at the load side of fuse terminal and a known good ground. Then, check for continuity.
  - continuity; short is between relay and solenoid (point C).
  - no continuity; check solenoid, retrace steps.

### Voltage Check Method

- Remove the blown fuse and disconnect all loads (i.e. SW1 open, relay disconnected and solenoid disconnected) powered through the fuse.
- Turn the ignition key to the ON or START position. Verify battery voltage at the battery + side of the fuse terminal (one lead on the battery + terminal side of the fuse block and one lead on a known good ground).
- With SW1 open and the DMM leads across both fuse terminals, check for voltage.
  - voltage; short is between fuse block and SW1 (point A).
  - no voltage; short is further down the circuit than SW1.
- With SW1 closed, relay and solenoid disconnected and the DMM leads across both fuse terminals, check for voltage.
  - voltage; short is between SW1 and the relay (point B).
  - no voltage; short is further down the circuit than the relay.
- With SW1 closed, relay contacts jumped with fused jumper wire check for voltage.
  - voltage; short is down the circuit of the relay or between the relay and the disconnected solenoid (point C).
  - no voltage; retrace steps and check power to fuse block.

## GROUND INSPECTION

- Ground connections are very important to the proper operation of electrical and electronic circuits. Ground connections are often exposed to moisture, dirt and other corrosive elements. The corrosion (rust) can become an unwanted resistance. This unwanted resistance can change the way a circuit works.
- Electronically controlled circuits are very sensitive to proper grounding. A loose or corroded ground can drastically affect an electronically controlled circuit. A poor or corroded ground can easily affect the circuit. Even when the ground connection looks clean, there can be a thin film of rust on the surface.

# SERVICE INFORMATION FOR ELECTRICAL INCIDENT

## < BASIC INSPECTION >

- When inspecting a ground connection follow these rules:
  - Remove the ground bolt or screw.
  - Inspect all mating surfaces for tarnish, dirt, rust, etc.
  - Clean as required to assure good contact.
  - Reinstall bolt or screw securely.
- Inspect for “add-on” accessories which may be interfering with the ground circuit.
- If several wires are crimped into one ground eyelet terminal, check for proper crimps. Make sure all of the wires are clean, securely fastened and providing a good ground path. If multiple wires are cased in one eyelet make sure no ground wires have excess wire insulation.
- For detailed ground distribution information, refer to “Ground Distribution” in PG section.

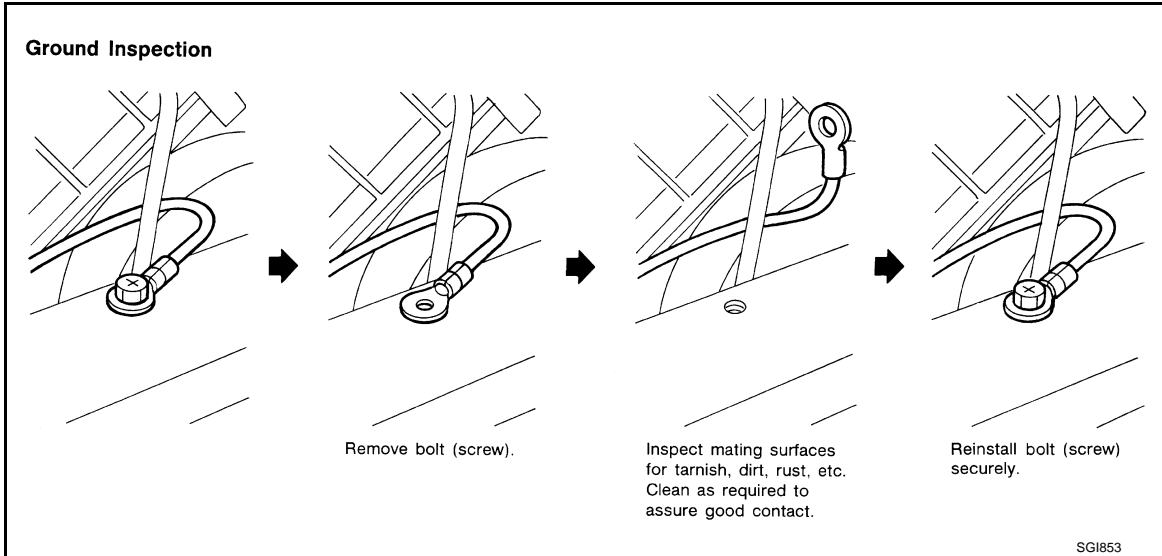

## VOLTAGE DROP TESTS

- Voltage drop tests are often used to find components or circuits which have excessive resistance. A voltage drop in a circuit is caused by a resistance when the circuit is in operation.
- Check the wire in the illustration. When measuring resistance with DMM, contact by a single strand of wire will give reading of 0 ohms. This would indicate a good circuit. When the circuit operates, this single strand of wire is not able to carry the current. The single strand will have a high resistance to the current. This will be picked up as a slight voltage drop.
- Unwanted resistance can be caused by many situations as follows:
  - Undersized wiring (single strand example)
  - Corrosion on switch contacts
  - Loose wire connections or splices.
- If repairs are needed always use wire that is of the same or larger gauge.

### Measuring Voltage Drop — Accumulated Method

- Connect the DMM across the connector or part of the circuit you want to check. The positive lead of the DMM should be closer to power and the negative lead closer to ground.
- Operate the circuit.
- The DMM will indicate how many volts are being used to “push” current through that part of the circuit.

# SERVICE INFORMATION FOR ELECTRICAL INCIDENT

## < BASIC INSPECTION >

Note in the illustration that there is an excessive 4.1 volt drop between the battery and the bulb.

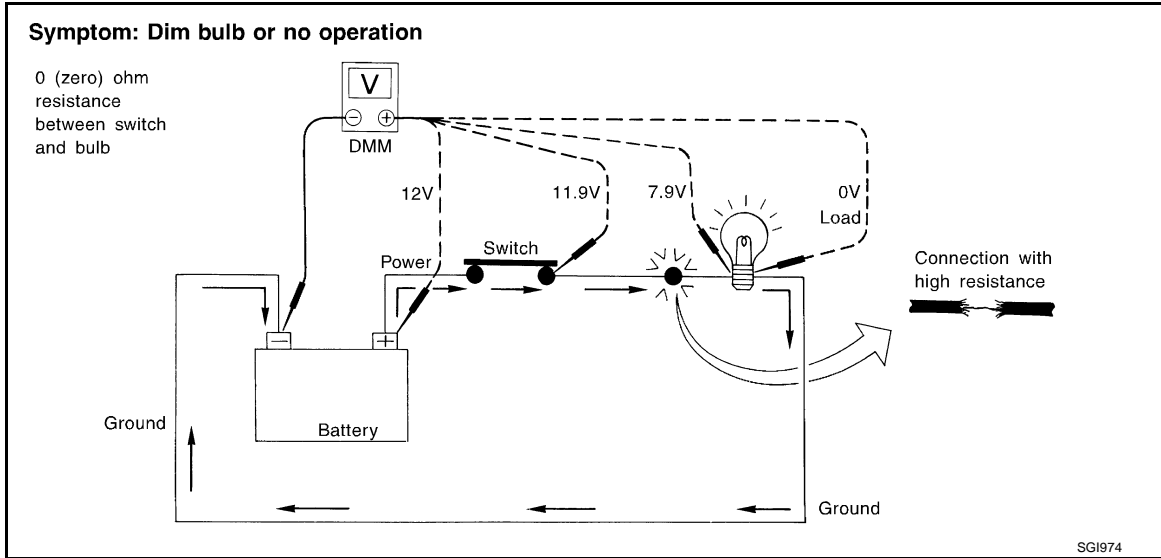

### Measuring Voltage Drop — Step-by-Step

- The step-by-step method is most useful for isolating excessive drops in low voltage systems (such as those in “Computer Controlled Systems”).
- Circuits in the “Computer Controlled System” operate on very low amperage.
- The (Computer Controlled) system operations can be adversely affected by any variation in resistance in the system. Such resistance variation may be caused by poor connection, improper installation, improper wire gauge or corrosion.
- The step by step voltage drop test can identify a component or wire with too much resistance.

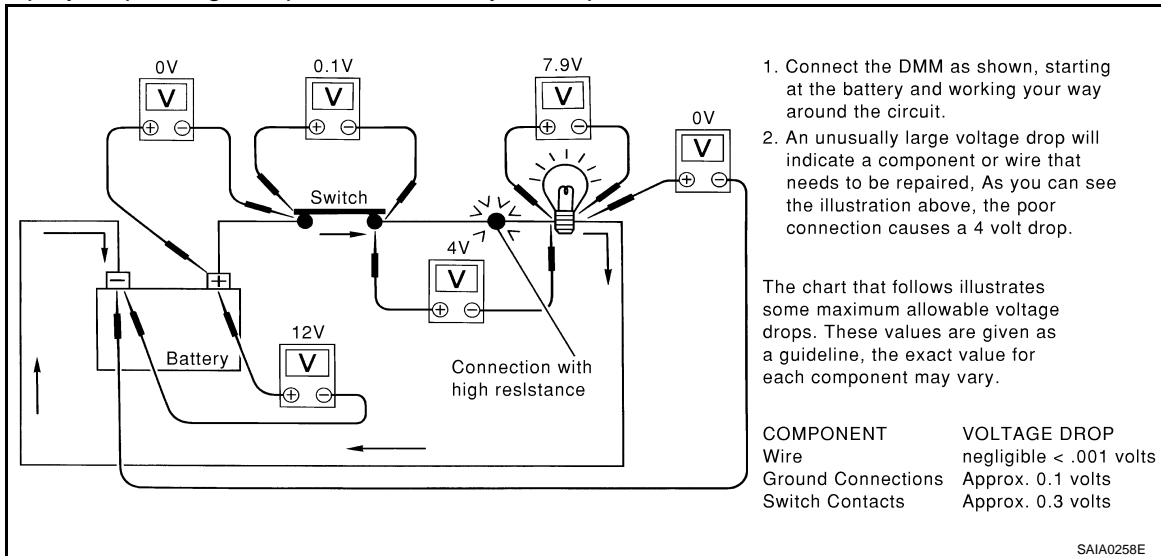

### CONTROL UNIT CIRCUIT TEST

#### System Description

- When the switch is ON, the control unit lights up the lamp.

#### CASE 1

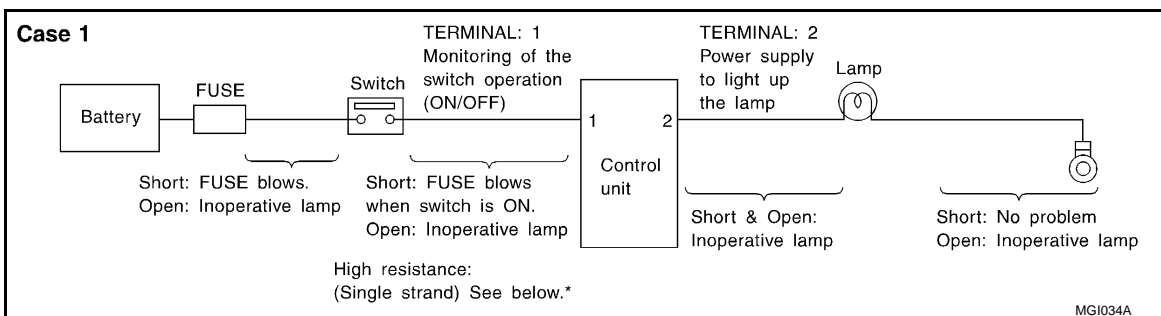

# SERVICE INFORMATION FOR ELECTRICAL INCIDENT

## < BASIC INSPECTION >

### INPUT-OUTPUT VOLTAGE CHART

Terminal No.		Description		Condition	Value (Approx.)	In case of high resistance such as single strand (V) *
+	-	Signal name	Input/Output			
1	Body ground	Switch	Input	Switch ON	Battery voltage	Lower than battery voltage Approx. 8 (Example)
				Switch OFF	0 V	Approx. 0
2	Body ground	Lamp	Output	Switch ON	Battery voltage	Approx. 0 (Inoperative lamp)
				Switch OFF	0 V	Approx. 0

- The voltage value is based on the body ground.
- \*: If high resistance exists in the switch side circuit (caused by a single strand), terminal 1 does not detect battery voltage. Control unit does not detect the switch is ON even if the switch does not turn ON. Therefore, the control unit does not supply power to light up the lamp.

### CASE 2

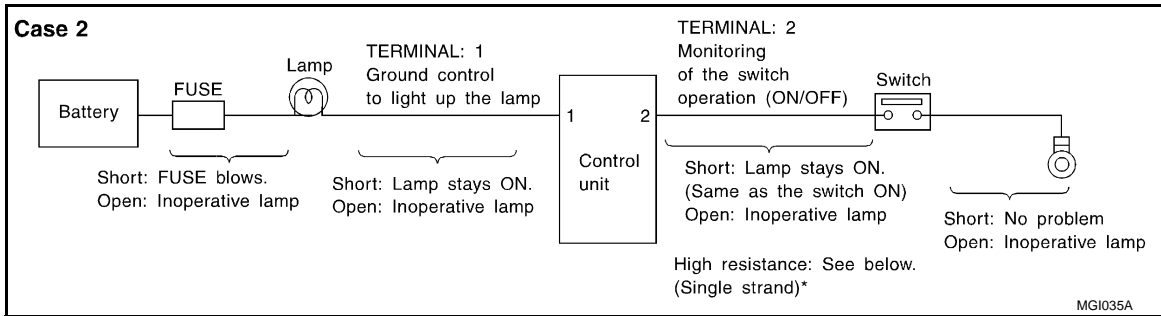

### INPUT-OUTPUT VOLTAGE CHART

Terminal No.		Description		Condition	Value (Approx.)	In case of high resistance such as single strand (V) *
+	-	Signal name	Input/Output			
1	Body ground	Lamp	Output	Switch ON	0V	Battery voltage (Inoperative lamp)
				Switch OFF	Battery voltage	Battery voltage
2	Body ground	Switch	Input	Switch ON	0 V	Higher than 0 Approx. 4 (Example)
				Switch OFF	5 V	Approx. 5

- The voltage value is based on the body ground.
- \*: If high resistance exists in the switch side circuit (caused by a single strand), terminal 2 does not detect approx. 0V. Control unit does not detect the switch is ON even if the switch does not turn ON. Therefore, the control unit does not control ground to light up the lamp.

# CONSULT-III CHECKING SYSTEM

< BASIC INSPECTION >

## CONSULT-III CHECKING SYSTEM

GI

### Description

INFOID:000000000956206

- When CONSULT-III is connected with a data link connector (A) equipped on the vehicle side, it will communicate with the control unit equipped in the vehicle and then enable various kinds of diagnostic tests.

1 : Instrument driver lower panel

- Refer to “CONSULT-III Software Operation Manual” for more information.

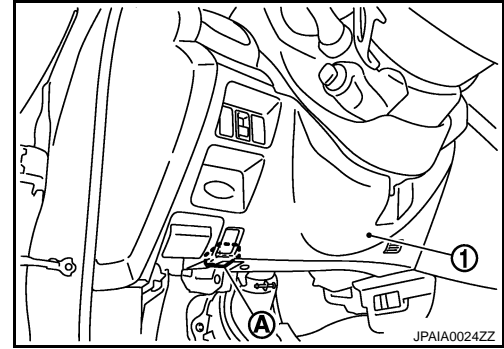

### Function and System Application

INFOID:000000000956207

Diagnostic test mode	Function	ENGINE	A/T	AIR BAG	METER/M&A	BCM	AUTO DRIVE POS.	ABS (Including VDC)	IPDM E/R	ICC	ALL MODE AWD/4WD	4WAS(FRONT)	4WAS(MAIN)/RAS/HICAS	ADAPTIVE LIGHT	MULTI AV
Work support	This mode enables a technician to adjust some devices faster and more accurately by following the indications on CONSULT-III.	x	x	-	-	x	x	x	-	x	-	-	-	x	-
Self-diagnostic results	Self-diagnostic results can be read and erased quickly.	x	x	x	x	x	x	x	x	x	x	x	x	x	x
Trouble diagnostic record	Current self-diagnostic results and all trouble diagnostic records previously stored can be read.	-	-	x	-	-	-	-	-	-	-	-	-	-	-
Data monitor	Input/Output data in the ECU can be read.	x	x	-	x	x	x	x	x	x	x	x	x	x	x
CAN diagnosis	The condition of CAN communication line can be indicated by a topology.	x	x	x	x	x	x	x	x	x	x	-	x	x	x
CAN diagnosis support monitor	The condition of CAN communication line can be read.	x	x	-	x	x	x	x	x	x	x	x	x	x	x
Active test	Diagnostic Test Mode in which CONSULT-III drives some actuators apart from the ECUs and also shifts some parameters in a specified range.	x	-	-	-	x	x	x	x	x	x	x	x	x	-
DTC & SRT confirmation	The results of SRT (System Readiness Test) and the self-diagnosis status/result can be confirmed.	x	-	-	-	-	-	-	-	-	-	-	-	-	-
DTC work support	The operating condition to confirm Diagnosis Trouble Codes can be selected.	-	x	-	-	-	-	-	-	-	-	-	-	-	-
ECU (ECM/TCM) part number	ECU (ECM/TCM) part number can be read.	x	x	-	-	x	x	x	-	x	x	x	x	x	x
ECU discriminated No.	Classification number of a replacement ECU can be read to prevent an incorrect ECU from being installed.	-	-	x	-	-	-	-	-	-	-	-	-	-	-

B  
C  
D  
E  
F  
G  
H  
I  
J  
K  
L  
M  
N  
O  
P

# CONSULT-III CHECKING SYSTEM

## < BASIC INSPECTION >

Diagnostic test mode	Function	ENGINE	A/T	AIR BAG	METER/M&A	BCM	AUTO DRIVE POS.	ABS (Including VDC)	IPDM E/R	ICC	ALL MODE AWD/4WD	4WAS(FRONT)	4WAS(MAIN)/RAS/HICAS	ADAPTIVE LIGHT	MULTI AV
Function test	This mode can show results of self-diagnosis of ECU with either 'OK' or 'NG'. For engines, more practical tests regarding sensors/ switches and/or actuators are available.	x	x	x	-	-	-	x	-	-	-	-	-	-	-
Configuration	Function to READ/WRITE vehicle configuration on BCM.	-	-	-	-	x	-	-	-	-	-	-	-	-	-
AV COMM monitor	The condition of AV communication can be indicated.	-	-	-	-	-	-	-	-	-	-	-	-	-	x

x: Applicable

## CONSULT-III Data Link Connector (DLC) Circuit

INFOID:000000000956208

### INSPECTION PROCEDURE

If the CONSULT-III cannot diagnose the system properly, check the following items.

Symptom	Check item
CONSULT-III cannot access any system.	<ul style="list-style-type: none"> <li>CONSULT-III DLC power supply circuit (Terminal 8) and ground circuit (Terminal 4)</li> </ul>
CONSULT-III cannot access individual system. (Other systems can be accessed.)	<ul style="list-style-type: none"> <li>Power supply and ground circuit for the control unit of the system (For detailed circuit, refer to wiring diagram for each system.)</li> <li>Open or short circuit between the system and CONSULT-III DLC (For detailed circuit, refer to wiring diagram for each system.)</li> <li>Open or short circuit CAN communication line. Refer to <a href="#">LAN-18, "Trouble Diagnosis Flow Chart"</a>.</li> </ul>

### NOTE:

The DDL1 and DDL2 circuits from DLC pins 12, 13, 14 and 15 may be connected to more than one system. A short in a DDL circuit connected to a control unit in one system may affect CONSULT-III access to other systems.



# CONSULT-III CHECKING SYSTEM

< BASIC INSPECTION >

## Wiring Diagram - CONSULT-III CHECKING SYSTEM -

INFOID:000000000956209

GI

### CONSULT-III CHECKING SYSTEM

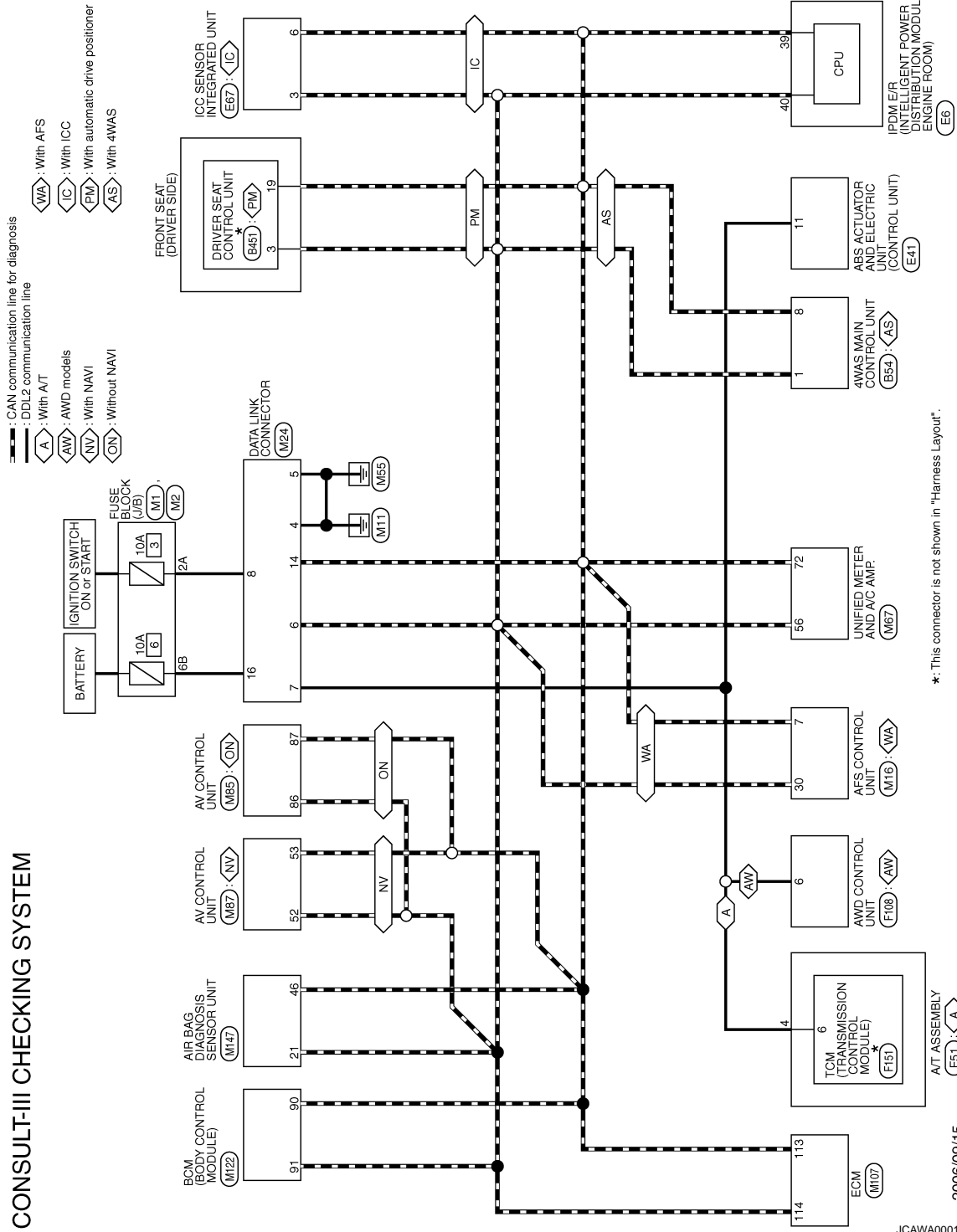

2006/09/15

JCAWA0001GB



B  
C  
D  
E  
F  
G  
H  
I  
J  
K  
L  
M  
N  
O  
P

# CONSULT-III CHECKING SYSTEM

< BASIC INSPECTION >



## CONSULT-III CHECKING SYSTEM

Connector No.	B54
Connector Name	MWAS MAIN CONTROL UNIT
Connector Type	A36FW-M4



Terminal No.	Color of Wire	Signal Name
1	L	CAN-H
8	P	CAN-L

Connector No.	B451
Connector Name	DRIVER SEAT CONTROL UNIT
Connector Type	TH32FW



Terminal No.	Color of Wire	Signal Name
3	R/Y	CAN-H
19	V	CAN-L

Connector No.	E6
Connector Name	IPDM E/R (INTELLIGENT POWER DISTRIBUTION MODULE ENGINE ROOM)
Connector Type	TH09FW-NH



Terminal No.	Color of Wire	Signal Name
39	P	-
40	L	-

Connector No.	E41
Connector Name	ABS ACTUATOR AND ELECTRIC UNIT
Connector Type	BAA42FB-AH24-LH



Terminal No.	Color of Wire	Signal Name
11	V	DIAG-K

Connector No.	E67
Connector Name	ICC SENSOR INTEGRATED UNIT
Connector Type	RS06FB-PR

Terminal No.	Color of Wire	Signal Name
3	L	CAN-H
6	P	CAN-L

Connector No.	F51
Connector Name	A/T ASSEMBLY
Connector Type	RK10FG-DG3



Terminal No.	Color of Wire	Signal Name
4	V	-

Connector No.	F108
Connector Name	AMD CONTROL UNIT
Connector Type	TH18FW-NH

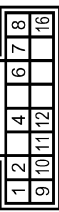
Terminal No.	Color of Wire	Signal Name
6	SB	K LINE

Connector No.	F151
Connector Name	TCM (TRANSMISSION CONTROL MODULE)
Connector Type	SPT0FB3Y

Terminal No.	Color of Wire	Signal Name
6	L	K LINE

# CONSULT-III CHECKING SYSTEM

< BASIC INSPECTION >

## CONSULT-III CHECKING SYSTEM

Connector No.	M1
Connector Name	FUSE BLOCK (J/B)
Connector Type	NS16FW-M2



Terminal No.	2A	Color of Wire	G	Signal Name	-
--------------	----	---------------	---	-------------	---

Connector No.	M2
Connector Name	FUSE BLOCK (J/B)
Connector Type	NS10FW-GS

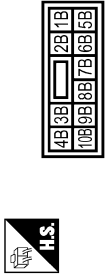

Terminal No.	6B	Color of Wire	Y	Signal Name	-
--------------	----	---------------	---	-------------	---

Connector No.	M16
Connector Name	AFS CONTROL UNIT
Connector Type	TH40FW-NH

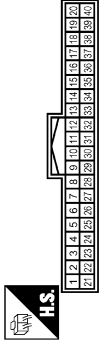

Terminal No.	7	Color of Wire	P	Signal Name	CAN-L
	30	Color of Wire	L	Signal Name	CAN-H

Connector No.	M24
Connector Name	DATA LINK CONNECTOR
Connector Type	BD16FW

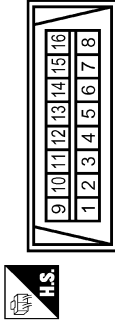

Terminal No.	4	Color of Wire	B	Signal Name	-
	5	Color of Wire	B	Signal Name	-
	6	Color of Wire	L	Signal Name	-
	7	Color of Wire	V	Signal Name	-
	8	Color of Wire	G	Signal Name	-
	14	Color of Wire	P	Signal Name	-
	16	Color of Wire	R	Signal Name	-

Connector No.	M67
Connector Name	UNIFIED METER AND A/C AMP.
Connector Type	TH32FW-NH

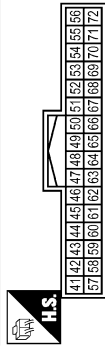

Terminal No.	56	Color of Wire	L	Signal Name	CAN-H
	72	Color of Wire	P	Signal Name	CAN-L

Connector No.	M85
Connector Name	AV CONTROL UNIT
Connector Type	TH32FW-NH

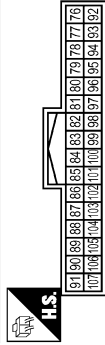

Terminal No.	86	Color of Wire	L	Signal Name	CAN-H
	87	Color of Wire	P	Signal Name	CAN-L

Connector No.	M87
Connector Name	AV CONTROL UNIT
Connector Type	TH40FW-NH

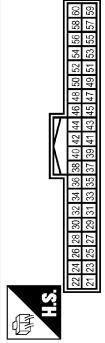

Terminal No.	52	Color of Wire	L	Signal Name	CAN-H
	53	Color of Wire	P	Signal Name	CAN-L

Connector No.	M107
Connector Name	ECM
Connector Type	MA24FGY-MEA8-LH-Z

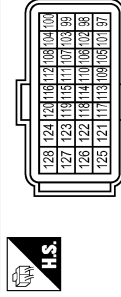

Terminal No.	113	Color of Wire	P	Signal Name	YHECAN L1
	114	Color of Wire	L	Signal Name	YHECAN R1

GI

B

C

D

E

F

G

H

I

J

K

L

M

N

O

P

JCAWA0003GB

# CONSULT-III CHECKING SYSTEM

< BASIC INSPECTION >

## CONSULT-III CHECKING SYSTEM

Connector No.	M122
Connector Name	BOM (BODY CONTROL MODULE)
Connector Type	TH40FB-NH

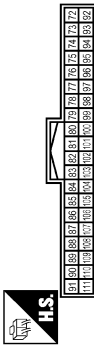

Terminal No.	Color of Wire	Signal Name
90	P	CAN-L
91	L	CAN-H

Connector No.	M147
Connector Name	AIR BAG DIAGNOSIS SENSOR UNIT
Connector Type	TK28FY-EX-SC

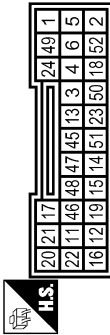

Terminal No.	Color of Wire	Signal Name
21	L	CAN-H
46	P	CAN-L

JCAWA0004GE