

Diagnosis Procedure	41	Diagnosis Procedure	62
A-BAG BRANCH LINE CIRCUIT	42	A-BAG BRANCH LINE CIRCUIT	63
Diagnosis Procedure	42	Diagnosis Procedure	63
AV BRANCH LINE CIRCUIT	43	AV BRANCH LINE CIRCUIT	64
Diagnosis Procedure	43	Diagnosis Procedure	64
BCM BRANCH LINE CIRCUIT	44	BCM BRANCH LINE CIRCUIT	65
Diagnosis Procedure	44	Diagnosis Procedure	65
PSB BRANCH LINE CIRCUIT	45	DLC BRANCH LINE CIRCUIT	66
Diagnosis Procedure	45	Diagnosis Procedure	66
TCM BRANCH LINE CIRCUIT	46	M&A BRANCH LINE CIRCUIT	67
Diagnosis Procedure	46	Diagnosis Procedure	67
AFS BRANCH LINE CIRCUIT	47	STRG BRANCH LINE CIRCUIT	68
Diagnosis Procedure	47	Diagnosis Procedure	68
DLC BRANCH LINE CIRCUIT	48	ADP BRANCH LINE CIRCUIT	69
Diagnosis Procedure	48	Diagnosis Procedure	69
M&A BRANCH LINE CIRCUIT	49	ABS BRANCH LINE CIRCUIT	70
Diagnosis Procedure	49	Diagnosis Procedure	70
STRG BRANCH LINE CIRCUIT	50	IPDM-E BRANCH LINE CIRCUIT	71
Diagnosis Procedure	50	Diagnosis Procedure	71
ADP BRANCH LINE CIRCUIT	51	CAN COMMUNICATION CIRCUIT	72
Diagnosis Procedure	51	Diagnosis Procedure	72
RAS BRANCH LINE CIRCUIT	52	CAN SYSTEM (TYPE 2)	
Diagnosis Procedure	52	COMPONENT DIAGNOSIS	74
ABS BRANCH LINE CIRCUIT	53	MAIN LINE BETWEEN BCM AND DLC CIR-	
Diagnosis Procedure	53	CUIT	74
ICC BRANCH LINE CIRCUIT	54	Diagnosis Procedure	74
Diagnosis Procedure	54	MAIN LINE BETWEEN DLC AND ADP CIR-	
IPDM-E BRANCH LINE CIRCUIT	55	CUIT	75
Diagnosis Procedure	55	Diagnosis Procedure	75
CAN COMMUNICATION CIRCUIT	56	MAIN LINE BETWEEN ADP AND ABS CIR-	
Diagnosis Procedure	56	CUIT	76
CAN SYSTEM (TYPE 1)		Diagnosis Procedure	76
COMPONENT DIAGNOSIS	58	ECM BRANCH LINE CIRCUIT	78
MAIN LINE BETWEEN BCM AND DLC CIR-		Diagnosis Procedure	78
CUIT	58	A-BAG BRANCH LINE CIRCUIT	79
Diagnosis Procedure	58	Diagnosis Procedure	79
MAIN LINE BETWEEN DLC AND ADP CIR-		AV BRANCH LINE CIRCUIT	80
CUIT	59	Diagnosis Procedure	80
Diagnosis Procedure	59	BCM BRANCH LINE CIRCUIT	81
MAIN LINE BETWEEN ADP AND ABS CIR-		Diagnosis Procedure	81
CUIT	60	DLC BRANCH LINE CIRCUIT	82
Diagnosis Procedure	60	Diagnosis Procedure	82
ECM BRANCH LINE CIRCUIT	62	M&A BRANCH LINE CIRCUIT	83

Diagnosis Procedure	83	Diagnosis Procedure	104	
STRG BRANCH LINE CIRCUIT	84	ABS BRANCH LINE CIRCUIT	105	A
Diagnosis Procedure	84	Diagnosis Procedure	105	
ADP BRANCH LINE CIRCUIT	85	ICC BRANCH LINE CIRCUIT	106	B
Diagnosis Procedure	85	Diagnosis Procedure	106	
RAS BRANCH LINE CIRCUIT	86	IPDM-E BRANCH LINE CIRCUIT	107	C
Diagnosis Procedure	86	Diagnosis Procedure	107	
ABS BRANCH LINE CIRCUIT	87	CAN COMMUNICATION CIRCUIT	108	D
Diagnosis Procedure	87	Diagnosis Procedure	108	
IPDM-E BRANCH LINE CIRCUIT	88	CAN SYSTEM (TYPE 4)		
Diagnosis Procedure	88	COMPONENT DIAGNOSIS	110	E
CAN COMMUNICATION CIRCUIT	89	MAIN LINE BETWEEN BCM AND DLC CIR-		
Diagnosis Procedure	89	CUIT	110	F
CAN SYSTEM (TYPE 3)		Diagnosis Procedure	110	
COMPONENT DIAGNOSIS	91	MAIN LINE BETWEEN DLC AND ADP CIR-		G
MAIN LINE BETWEEN BCM AND DLC CIR-		CUIT	111	
CUIT	91	Diagnosis Procedure	111	
Diagnosis Procedure	91	MAIN LINE BETWEEN ADP AND ABS CIR-		H
MAIN LINE BETWEEN DLC AND ADP CIR-		CUIT	112	
CUIT	92	Diagnosis Procedure	112	
Diagnosis Procedure	92	ECM BRANCH LINE CIRCUIT	114	I
MAIN LINE BETWEEN ADP AND ABS CIR-		Diagnosis Procedure	114	
CUIT	93	A-BAG BRANCH LINE CIRCUIT	115	J
Diagnosis Procedure	93	Diagnosis Procedure	115	
ECM BRANCH LINE CIRCUIT	95	AV BRANCH LINE CIRCUIT	116	K
Diagnosis Procedure	95	Diagnosis Procedure	116	
A-BAG BRANCH LINE CIRCUIT	96	BCM BRANCH LINE CIRCUIT	117	L
Diagnosis Procedure	96	Diagnosis Procedure	117	
AV BRANCH LINE CIRCUIT	97	PSB BRANCH LINE CIRCUIT	118	LAN
Diagnosis Procedure	97	Diagnosis Procedure	118	
BCM BRANCH LINE CIRCUIT	98	AFS BRANCH LINE CIRCUIT	119	
Diagnosis Procedure	98	Diagnosis Procedure	119	
PSB BRANCH LINE CIRCUIT	99	DLC BRANCH LINE CIRCUIT	120	N
Diagnosis Procedure	99	Diagnosis Procedure	120	
AFS BRANCH LINE CIRCUIT	100	M&A BRANCH LINE CIRCUIT	121	O
Diagnosis Procedure	100	Diagnosis Procedure	121	
DLC BRANCH LINE CIRCUIT	101	STRG BRANCH LINE CIRCUIT	122	P
Diagnosis Procedure	101	Diagnosis Procedure	122	
M&A BRANCH LINE CIRCUIT	102	ADP BRANCH LINE CIRCUIT	123	
Diagnosis Procedure	102	Diagnosis Procedure	123	
STRG BRANCH LINE CIRCUIT	103	RAS BRANCH LINE CIRCUIT	124	
Diagnosis Procedure	103	Diagnosis Procedure	124	
ADP BRANCH LINE CIRCUIT	104	ABS BRANCH LINE CIRCUIT	125	

Diagnosis Procedure	125
ICC BRANCH LINE CIRCUIT	126
Diagnosis Procedure	126
IPDM-E BRANCH LINE CIRCUIT	127
Diagnosis Procedure	127
CAN COMMUNICATION CIRCUIT	128
Diagnosis Procedure	128
CAN SYSTEM (TYPE 5)	
COMPONENT DIAGNOSIS	130
MAIN LINE BETWEEN BCM AND DLC CIR- CUIT	130
Diagnosis Procedure	130
MAIN LINE BETWEEN DLC AND ADP CIR- CUIT	131
Diagnosis Procedure	131
MAIN LINE BETWEEN ADP AND ABS CIR- CUIT	132
Diagnosis Procedure	132
ECM BRANCH LINE CIRCUIT	134
Diagnosis Procedure	134
A-BAG BRANCH LINE CIRCUIT	135
Diagnosis Procedure	135
AV BRANCH LINE CIRCUIT	136
Diagnosis Procedure	136
BCM BRANCH LINE CIRCUIT	137
Diagnosis Procedure	137
TCM BRANCH LINE CIRCUIT	138
Diagnosis Procedure	138
DLC BRANCH LINE CIRCUIT	139
Diagnosis Procedure	139
M&A BRANCH LINE CIRCUIT	140
Diagnosis Procedure	140
STRG BRANCH LINE CIRCUIT	141
Diagnosis Procedure	141
ADP BRANCH LINE CIRCUIT	142
Diagnosis Procedure	142
ABS BRANCH LINE CIRCUIT	143
Diagnosis Procedure	143
IPDM-E BRANCH LINE CIRCUIT	144
Diagnosis Procedure	144
CAN COMMUNICATION CIRCUIT	145
Diagnosis Procedure	145
CAN SYSTEM (TYPE 6)	

COMPONENT DIAGNOSIS	147
MAIN LINE BETWEEN BCM AND DLC CIR- CUIT	147
Diagnosis Procedure	147
MAIN LINE BETWEEN DLC AND ADP CIR- CUIT	148
Diagnosis Procedure	148
MAIN LINE BETWEEN ADP AND ABS CIR- CUIT	149
Diagnosis Procedure	149
ECM BRANCH LINE CIRCUIT	151
Diagnosis Procedure	151
A-BAG BRANCH LINE CIRCUIT	152
Diagnosis Procedure	152
AV BRANCH LINE CIRCUIT	153
Diagnosis Procedure	153
BCM BRANCH LINE CIRCUIT	154
Diagnosis Procedure	154
TCM BRANCH LINE CIRCUIT	155
Diagnosis Procedure	155
DLC BRANCH LINE CIRCUIT	156
Diagnosis Procedure	156
M&A BRANCH LINE CIRCUIT	157
Diagnosis Procedure	157
STRG BRANCH LINE CIRCUIT	158
Diagnosis Procedure	158
ADP BRANCH LINE CIRCUIT	159
Diagnosis Procedure	159
RAS BRANCH LINE CIRCUIT	160
Diagnosis Procedure	160
ABS BRANCH LINE CIRCUIT	161
Diagnosis Procedure	161
IPDM-E BRANCH LINE CIRCUIT	162
Diagnosis Procedure	162
CAN COMMUNICATION CIRCUIT	163
Diagnosis Procedure	163
CAN SYSTEM (TYPE 7)	
COMPONENT DIAGNOSIS	165
MAIN LINE BETWEEN BCM AND DLC CIR- CUIT	165
Diagnosis Procedure	165
MAIN LINE BETWEEN DLC AND ADP CIR- CUIT	166
Diagnosis Procedure	166

MAIN LINE BETWEEN ADP AND ABS CIRCUIT	167	MAIN LINE BETWEEN DLC AND ADP CIRCUIT	186	A
Diagnosis Procedure	167	Diagnosis Procedure	186	
ECM BRANCH LINE CIRCUIT	169	MAIN LINE BETWEEN ADP AND ABS CIRCUIT	187	B
Diagnosis Procedure	169	Diagnosis Procedure	187	
A-BAG BRANCH LINE CIRCUIT	170	ECM BRANCH LINE CIRCUIT	189	C
Diagnosis Procedure	170	Diagnosis Procedure	189	
AV BRANCH LINE CIRCUIT	171	A-BAG BRANCH LINE CIRCUIT	190	D
Diagnosis Procedure	171	Diagnosis Procedure	190	
BCM BRANCH LINE CIRCUIT	172	AV BRANCH LINE CIRCUIT	191	E
Diagnosis Procedure	172	Diagnosis Procedure	191	
PSB BRANCH LINE CIRCUIT	173	BCM BRANCH LINE CIRCUIT	192	F
Diagnosis Procedure	173	Diagnosis Procedure	192	
TCM BRANCH LINE CIRCUIT	174	PSB BRANCH LINE CIRCUIT	193	G
Diagnosis Procedure	174	Diagnosis Procedure	193	
AFS BRANCH LINE CIRCUIT	175	TCM BRANCH LINE CIRCUIT	194	H
Diagnosis Procedure	175	Diagnosis Procedure	194	
DLC BRANCH LINE CIRCUIT	176	AFS BRANCH LINE CIRCUIT	195	I
Diagnosis Procedure	176	Diagnosis Procedure	195	
M&A BRANCH LINE CIRCUIT	177	DLC BRANCH LINE CIRCUIT	196	J
Diagnosis Procedure	177	Diagnosis Procedure	196	
STRG BRANCH LINE CIRCUIT	178	M&A BRANCH LINE CIRCUIT	197	K
Diagnosis Procedure	178	Diagnosis Procedure	197	
ADP BRANCH LINE CIRCUIT	179	STRG BRANCH LINE CIRCUIT	198	L
Diagnosis Procedure	179	Diagnosis Procedure	198	
ABS BRANCH LINE CIRCUIT	180	ADP BRANCH LINE CIRCUIT	199	LAN
Diagnosis Procedure	180	Diagnosis Procedure	199	
ICC BRANCH LINE CIRCUIT	181	RAS BRANCH LINE CIRCUIT	200	N
Diagnosis Procedure	181	Diagnosis Procedure	200	
IPDM-E BRANCH LINE CIRCUIT	182	ABS BRANCH LINE CIRCUIT	201	O
Diagnosis Procedure	182	Diagnosis Procedure	201	
CAN COMMUNICATION CIRCUIT	183	ICC BRANCH LINE CIRCUIT	202	P
Diagnosis Procedure	183	Diagnosis Procedure	202	
CAN SYSTEM (TYPE 8)		IPDM-E BRANCH LINE CIRCUIT	203	
COMPONENT DIAGNOSIS	185	Diagnosis Procedure	203	
MAIN LINE BETWEEN BCM AND DLC CIRCUIT	185	CAN COMMUNICATION CIRCUIT	204	
Diagnosis Procedure	185	Diagnosis Procedure	204	

PRECAUTION

PRECAUTIONS

Precautions for Trouble Diagnosis

INFOID:000000001665994

CAUTION:

- Never apply 7.0 V or more to the measurement terminal.
- Use a tester with open terminal voltage of 7.0 V or less.
- Turn the ignition switch OFF and disconnect the battery cable from the negative terminal when checking the harness.

Precautions for Harness Repair

INFOID:000000001665995

- Solder the repaired area and wrap tape around the soldered area.

NOTE:

A fray of twisted lines must be within 110 mm (4.33 in).

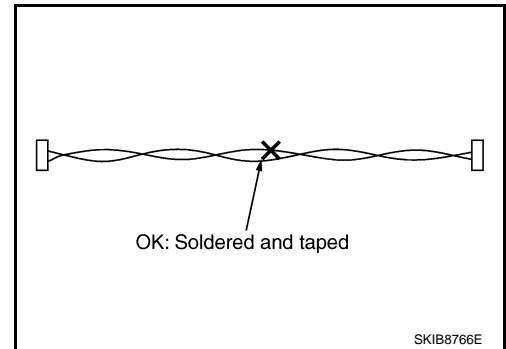

- Bypass connection is never allowed at the repaired area.

NOTE:

Bypass connection may cause CAN communication error. The spliced wire becomes separated and the characteristics of twisted line are lost.

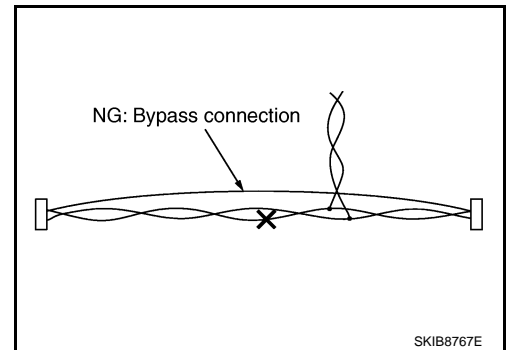

- Replace the applicable harness as an assembly if error is detected on the shield lines of CAN communication line.

FUNCTION DIAGNOSIS

CAN COMMUNICATION SYSTEM

System Description

INFOID:000000001665996

- CAN communication is a multiplex communication system. This enables the system to transmit and receive large quantities of data at high speed by connecting control units with two communication lines (CAN-H and CAN-L).
- Control units on the CAN network transmit signals using the CAN communication control circuit. They receive only necessary signals from other control units to operate various functions.
- CAN communication lines adopt twisted-pair line style (two lines twisted) for noise immunity.

System Diagram

INFOID:000000001665997

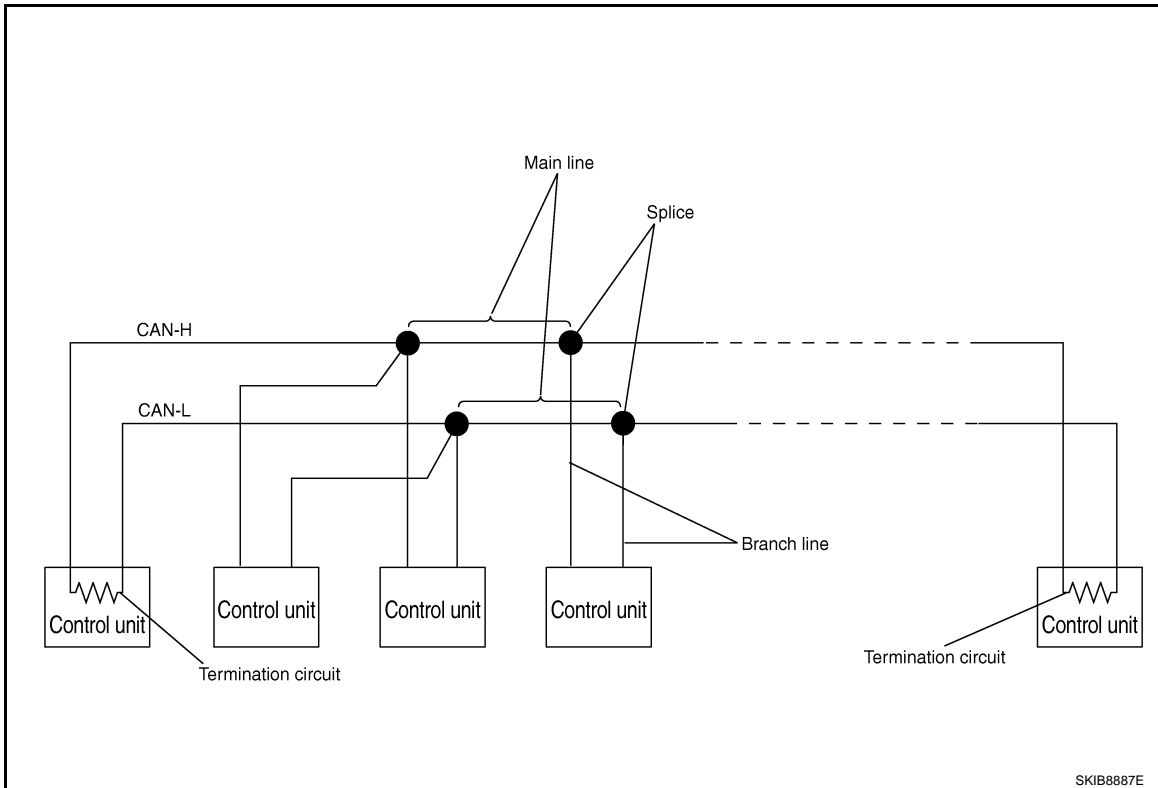

Each control unit passes an electric current to the termination circuits when transmitting CAN communication signal. The termination circuits produce an electrical potential difference between CAN-H and CAN-L. CAN communication system transmits and receives CAN communication signals by the potential difference.

Component	Description
Main line	CAN communication line between splices
Branch line	CAN communication line between splice and a control unit
Splice	A point connecting a branch line with a main line
Termination circuit	Refer to LAN-8. "CAN Communication Control Circuit" .

LAN

A
B
C
D
E
F
G
H
I
J
K
L
N
O
P

CAN COMMUNICATION SYSTEM

< FUNCTION DIAGNOSIS >

[CAN FUNDAMENTAL]

CAN Communication Control Circuit

INFOID:000000001665998

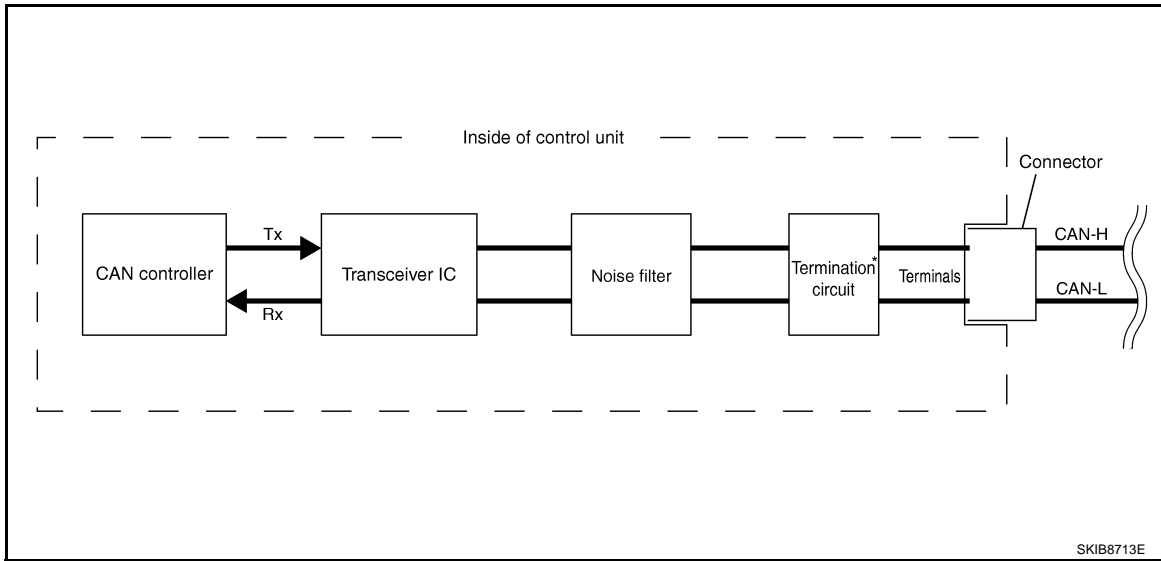

Component	System description
CAN controller	It controls CAN communication signal transmission and reception, error detection, etc.
Transceiver IC	It converts digital signal into CAN communication signal, and CAN communication signal into digital signal.
Noise filter	It eliminates noise of CAN communication signal.
Termination circuit* (Resistance of approx. 120 Ω)	It produces potential difference.

*: These are the only control units wired with both ends of CAN communication system.

DIAG ON CAN

Description

INFOID:000000001665999

“Diag on CAN” is a diagnosis using CAN communication instead of previous DDL1 and DDL2 communication lines, between control units and diagnosis unit.

System Diagram

INFOID:000000001666000

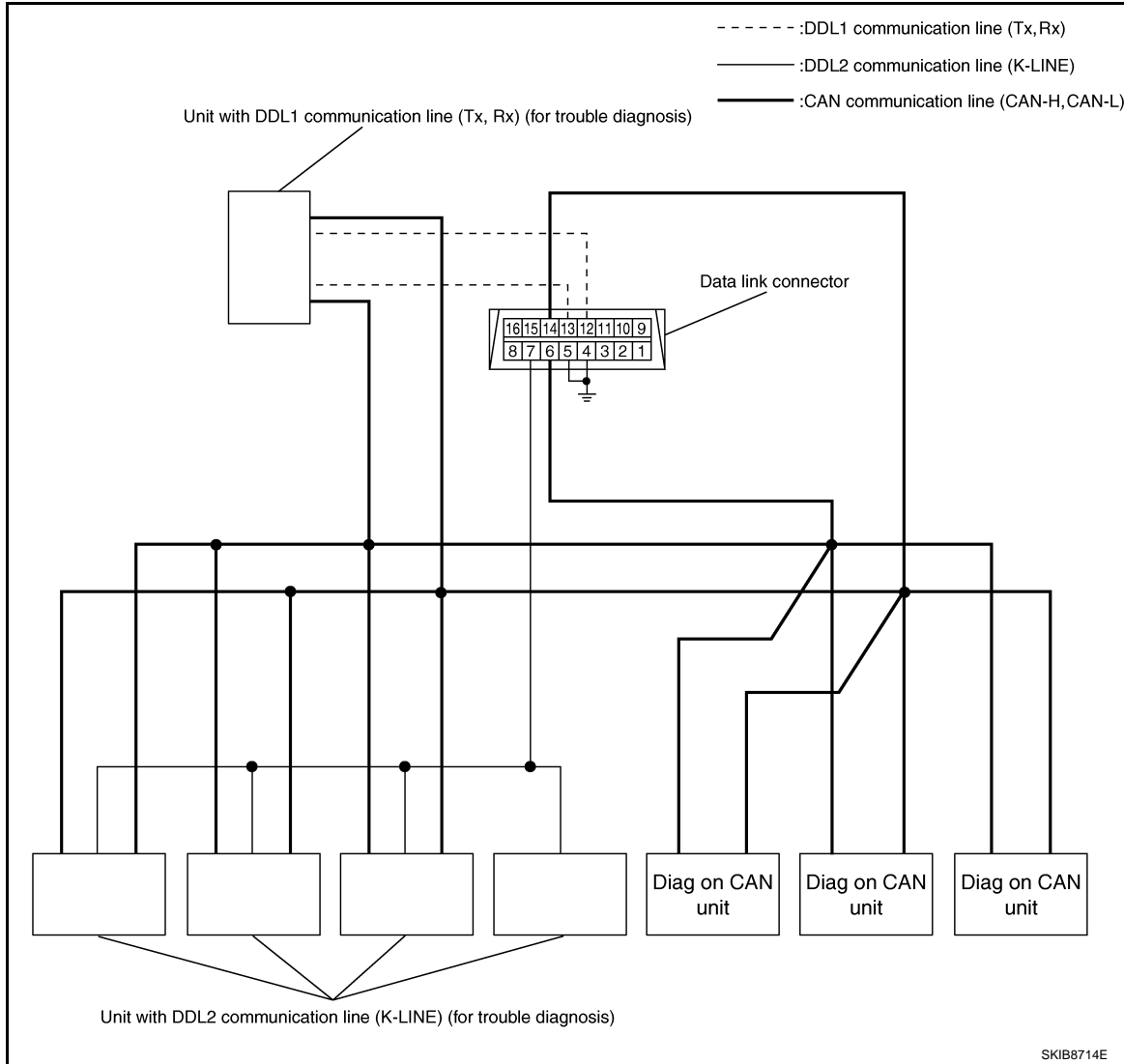

Name	Harness	Description
DDL1	Tx Rx	It is used for trouble diagnosis. (CAN-H and CAN-L are used for controlling)
DDL2	K-LINE	It is used for trouble diagnosis. (CAN-H and CAN-L are used for controlling)
Diag on CAN	CAN-H CAN-L	It is used for trouble diagnosis and control.

A
B
C
D
E
F
G
H
I
J
K
L
N
O
P

LAN

TROUBLE DIAGNOSIS

Condition of Error Detection

INFOID:000000001666001

“U1000” or “U1001” is indicated on SELF-DIAG RESULTS on CONSULT-III if CAN communication signal is not transmitted or received between units for 2 seconds or more.

CAN COMMUNICATION SYSTEM ERROR

- CAN communication line open (CAN-H, CAN-L, or both)
- CAN communication line short (ground, between CAN communication lines, other harnesses)
- Error of CAN communication control circuit of the unit connected to CAN communication line

WHEN “U1000” OR “U1001” IS INDICATED EVEN THOUGH CAN COMMUNICATION SYSTEM IS NORMAL

- Removal/installation of parts: Error may be detected when removing and installing CAN communication unit and related parts while turning the ignition switch ON. (A DTC except for CAN communication may be detected.)
- Fuse blown out (removed): CAN communication of the unit may cease.
- Voltage drop: Error may be detected if voltage drops due to discharged battery when turning the ignition switch ON (Depending on the control unit which carries out CAN communication).
- Error may be detected if the power supply circuit of the control unit, which carries out CAN communication, malfunctions (Depending on the control unit which carries out CAN communication).
- Error may be detected if reprogramming is not completed normally.

NOTE:

CAN communication system is normal if “U1000” or “U1001” is indicated on SELF-DIAG RESULTS of CONSULT-III under the above conditions. Erase the memory of the self-diagnosis of each unit.

Symptom When Error Occurs in CAN Communication System

INFOID:000000001666002

In CAN communication system, multiple units mutually transmit and receive signals. Each unit cannot transmit and receive signals if any error occurs on CAN communication line. Under this condition, multiple control units related to the root cause malfunction or go into fail-safe mode.

ERROR EXAMPLE

NOTE:

- Each vehicle differs in symptom of each unit under fail-safe mode and CAN communication line wiring.
- Refer to [LAN-21. "Abbreviation List"](#) for the unit abbreviation.

Example: TCM branch line open circuit

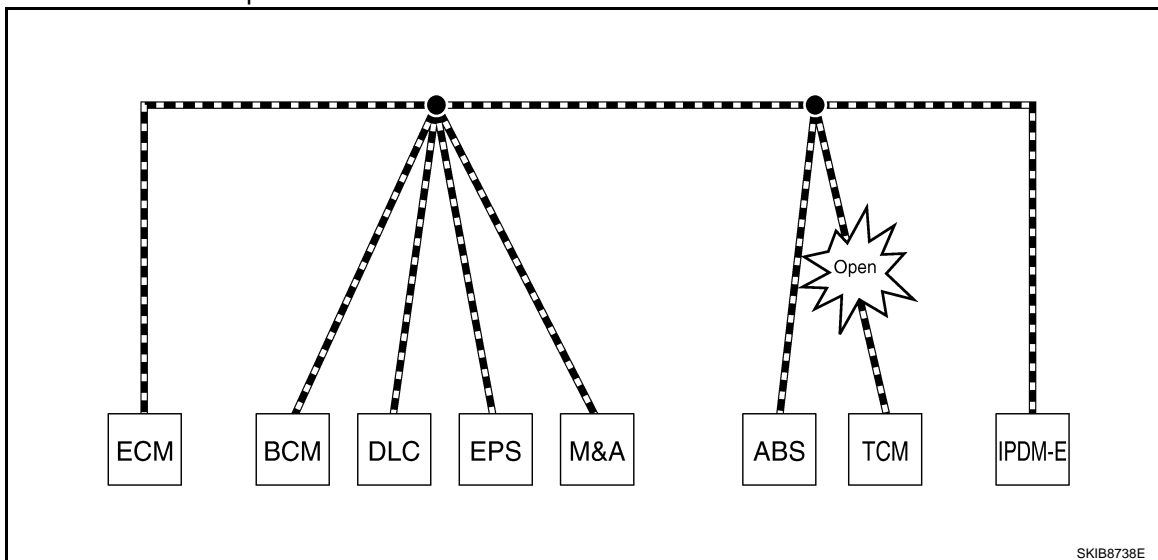

SKIB8738E

Unit name	Symptom
ECM	Engine torque limiting is affected, and shift harshness increases.
BCM	Reverse warning chime does not sound.

TROUBLE DIAGNOSIS

< FUNCTION DIAGNOSIS >

[CAN FUNDAMENTAL]

Unit name	Symptom
EPS control unit	Normal operation.
Combination meter	<ul style="list-style-type: none"> Shift position indicator and OD OFF indicator turn OFF. Warning lamps turn ON.
ABS actuator and electric unit (control unit)	Normal operation.
TCM	No impact on operation.
IPDM E/R	Normal operation.

Example: Data link connector branch line open circuit

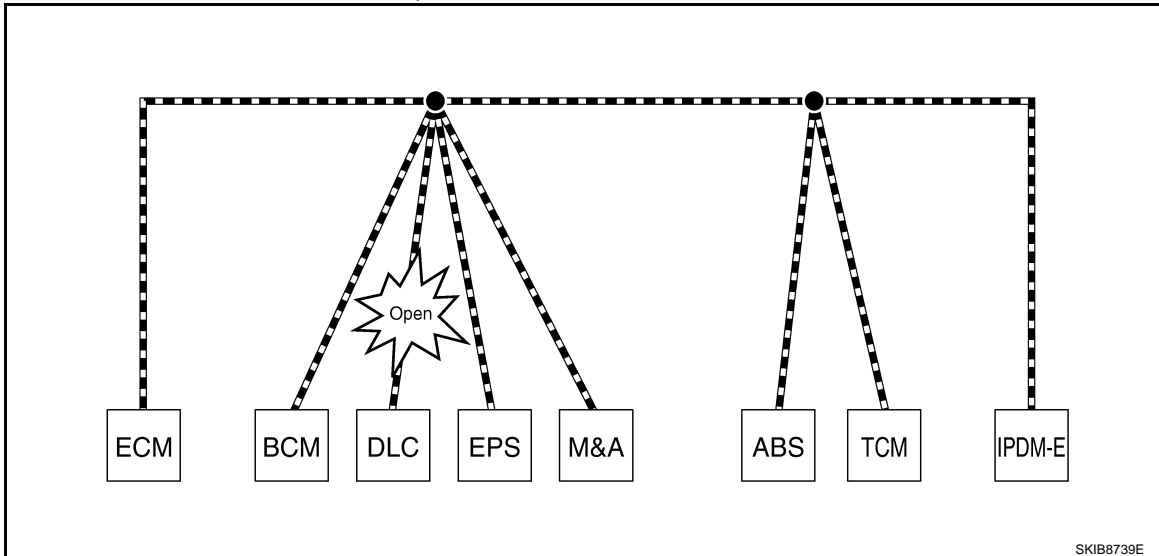

Unit name	Symptom
ECM	Normal operation.
BCM	
EPS control unit	
Combination meter	
ABS actuator and electric unit (control unit)	
TCM	
IPDM E/R	

NOTE:

- When data link connector branch line is open, transmission and reception of CAN communication signals are not affected. Therefore, no symptoms occur. However, be sure to repair malfunctioning circuit.
- The model (all units on CAN communication system are Diag on CAN) cannot perform CAN diagnosis with CONSULT-III if the following error occurs. The error is judged by the symptom.

Error	Difference of symptom
Data link connector branch line open circuit	Normal operation.
CAN-H, CAN-L harness short-circuit	Most of the units which are connected to the CAN communication system enter fail-safe mode or are deactivated.

A
B
C
D
E
F
G
H
I
J
K
L
N
O
P

LAN

TROUBLE DIAGNOSIS

< FUNCTION DIAGNOSIS >

[CAN FUNDAMENTAL]

Example: Main Line Between Data Link Connector and ABS Actuator and Electric Unit (Control Unit) Open Circuit

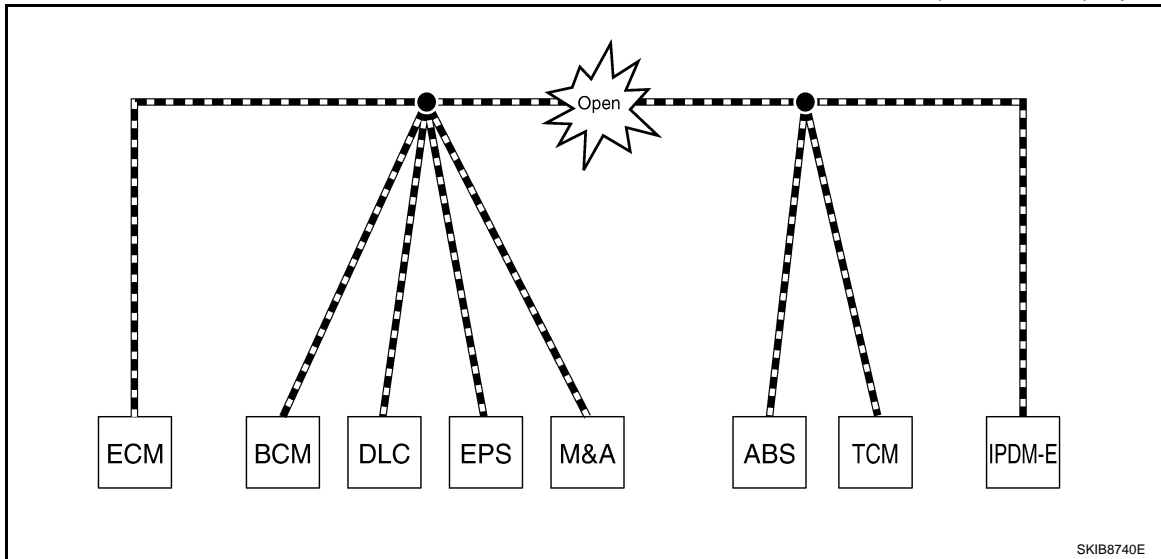

Unit name	Symptom
ECM	Engine torque limiting is affected, and shift harshness increases.
BCM	<ul style="list-style-type: none"> Reverse warning chime does not sound. The front wiper moves under continuous operation mode even though the front wiper switch being in the intermittent position.
EPS control unit	The steering effort increases.
Combination meter	<ul style="list-style-type: none"> The shift position indicator and OD OFF indicator turn OFF. The speedometer is inoperative. The odo/trip meter stops.
ABS actuator and electric unit (control unit)	Normal operation.
TCM	No impact on operation.
IPDM E/R	When the ignition switch is ON, <ul style="list-style-type: none"> The headlamps (Lo) turn ON. The cooling fan continues to rotate.

Example: CAN-H, CAN-L Harness Short Circuit

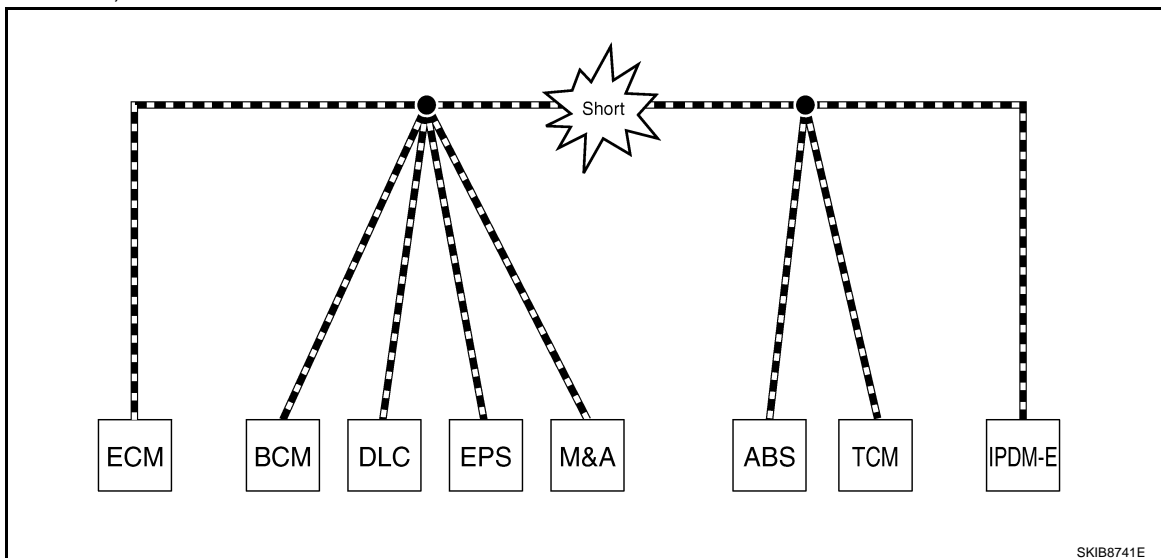

TROUBLE DIAGNOSIS

< FUNCTION DIAGNOSIS >

[CAN FUNDAMENTAL]

Unit name	Symptom
ECM	<ul style="list-style-type: none"> Engine torque limiting is affected, and shift harshness increases. Engine speed drops.
BCM	<ul style="list-style-type: none"> Reverse warning chime does not sound. The front wiper moves under continuous operation mode even though the front wiper switch being in the intermittent position. The room lamp does not turn ON. The engine does not start (if an error or malfunction occurs while turning the ignition switch OFF.) The steering lock does not release (if an error or malfunction occurs while turning the ignition switch OFF.)
EPS control unit	The steering effort increases.
Combination meter	<ul style="list-style-type: none"> The tachometer and the speedometer do not move. Warning lamps turn ON. Indicator lamps do not turn ON.
ABS actuator and electric unit (control unit)	Normal operation.
TCM	No impact on operation.
IPDM E/R	When the ignition switch is ON, <ul style="list-style-type: none"> The headlamps (Lo) turn ON. The cooling fan continues to rotate.

CAN Diagnosis with CONSULT-III

INFOID:000000001666003

CAN diagnosis on CONSULT-III extracts the root cause by receiving the following information.

- Response to the system call
- Control unit diagnosis information
- Self-diagnosis
- CAN diagnostic support monitor

Self-Diagnosis

INFOID:000000001666004

DTC	Self-diagnosis item (CONSULT-III indication)	DTC detection condition	Inspection/Action
U1000	CAN COMM CIRCUIT	When ECM is not transmitting or receiving CAN communication signal of OBD (emission-related diagnosis) for 2 seconds or more.	Start the inspection. Refer to the applicable section of the indicated control unit.
		When a control unit (except for ECM) is not transmitting or receiving CAN communication signal for 2 seconds or more.	
U1001	CAN COMM CIRCUIT	When ECM is not transmitting or receiving CAN communication signal other than OBD (emission-related diagnosis) for 2 seconds or more.	
U1002	SYSTEM COMM	When a control unit is not transmitting or receiving CAN communication signal for 2 seconds or less.	
U1010	CONTROL UNIT [CAN]	When an error is detected during the initial diagnosis for CAN controller of each control unit.	

CAN Diagnostic Support Monitor

INFOID:000000001666005

MONITOR ITEM (CONSULT-III)

TROUBLE DIAGNOSIS

< FUNCTION DIAGNOSIS >

[CAN FUNDAMENTAL]

Example: CAN DIAG SUPPORT MNTR indication

Without PAST			With PAST		
ECM			ECM		
	PRSENT	PAST		PRSENT	PAST
INITIAL DIAG	OK		TRANSMIT DIAG	OK	OK
TRANSMIT DIAG	OK		VDC/TCS/ABS	-	-
TCM	OK		METER/M&A	OK	OK
VDC/TCS/ABS	UNKWN		BCM/SEC	OK	OK
METER/M&A	OK		ICC	-	-
ICC	UNKWN		HVAC	-	-
BCM/SEC	OK		TCM	OK	OK
IPDM E/R	OK		EPS	-	-
			IPDM E/R	OK	OK
			e4WD	-	-
			AWD/4WD	OK	OK

JSMIA0015GB

Without PAST

Item	PRSENT	Description
Initial diagnosis	OK	Normal at present
	NG	Control unit error (Except for some control units)
Transmission diagnosis	OK	Normal at present
	UNKWN	Unable to transmit signals for 2 seconds or more. Diagnosis not performed
Control unit name (Reception diagnosis)	OK	Normal at present
	UNKWN	Unable to receive signals for 2 seconds or more. Diagnosis not performed
	UNKWN	No control unit for receiving signals. (No applicable optional parts)

With PAST

Item	PRSENT	PAST	Description
Transmission diagnosis	OK	OK	Normal at present and in the past
		1 – 39	Normal at present, but unable to transmit signals for 2 seconds or more in the past. (The number indicates the number of ignition switch cycles from OFF to ON.)
	UNKWN	0	Unable to transmit signals for 2 seconds or more at present.
Control unit name (Reception diagnosis)	OK	OK	Normal at present and in the past
		1 – 39	Normal at present, but unable to receive signals for 2 seconds or more in the past. (The number indicates the number of ignition switch cycles from OFF to ON.)
	UNKWN	0	Unable to receive signals for 2 seconds or more at present.
	-	-	Diagnosis not performed. No control unit for receiving signals. (No applicable optional parts)

MONITOR ITEM (ON-BOARD DIAGNOSIS)

NOTE:

For some models, CAN communication diagnosis result is received from the vehicle monitor.

TROUBLE DIAGNOSIS

< FUNCTION DIAGNOSIS >

[CAN FUNDAMENTAL]

Example: Vehicle Display

Item	Result indicated	Error counter	Description
CAN_COMM (Initial diagnosis)	OK	0	Normal at present
	NG	1 – 50	Control unit error (The number indicates how many times diagnosis has been run.)
CAN_CIRC_1 (Transmission diagnosis)	OK	0	Normal at present
	UNKWN	1 – 50	Unable to transmit for 2 seconds or more at present. (The number indicates how many times diagnosis has been run.)
CAN_CIRC_2 – 9 (Reception diagnosis of each unit)	OK	0	Normal at present
	UNKWN	1 – 50	Unable to transmit for 2 seconds or more at present. (The number indicates how many times diagnosis has been run.)
			Diagnosis not performed.
			No control unit for receiving signals. (No applicable optional parts)

How to Use CAN Communication Signal Chart

INFOID:000000001666006

The CAN communication signal chart lists the signals needed for trouble diagnosis. It is useful for detecting the root cause by finding a signal related to the symptom, and by checking transmission and reception unit.

Example: Tachometer does not move even though the engine rotates.

T: Transmit R: Receive

Signal name/Connecting unit	ECM	BCM	M&A	STRG	ABS	IPDM-E
A/C compressor feedback signal	T		R			
A/C compressor request signal	T					R
Accelerator pedal position signal	T				R	
Cooling fan motor operation signal	T					R
Engine coolant temperature signal	T		R			
Engine speed signal	T		R		R	
Fuel consumption monitor signal	T		R			
Malfunction indicator lamp signal	T		R			
A/C switch signal	R	T				
Ignition switch signal		T				R
Sleep/wake up signal		T	R			R

No communication between ECM and M&A.

It indicates that an error occurs between ECM and M&A (Shaded area).

SKIB8715E

BASIC INSPECTION

DIAGNOSIS AND REPAIR WORKFLOW

Trouble Diagnosis Flow Chart

INFOID:000000001666007

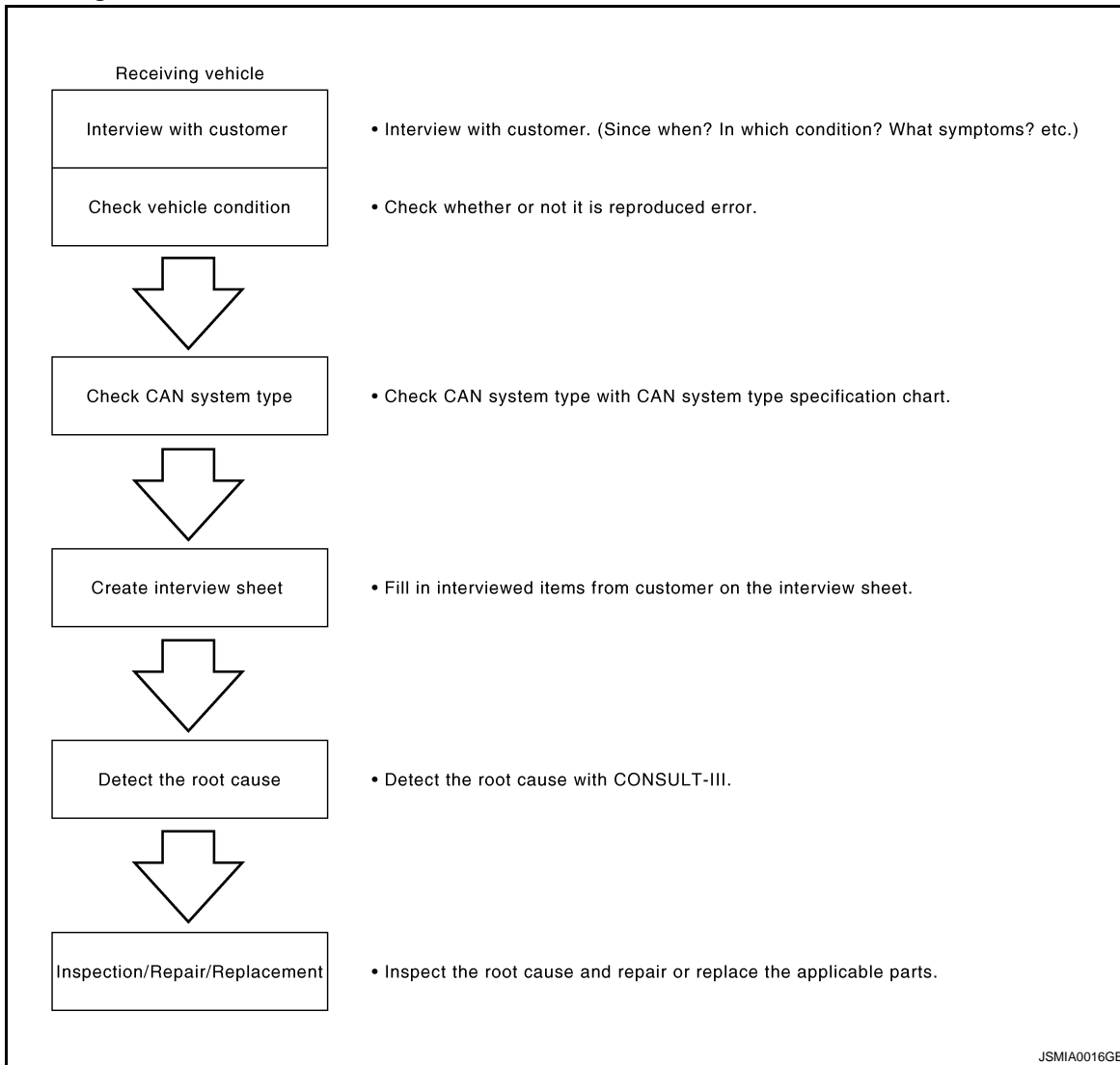

Trouble Diagnosis Procedure

INFOID:000000001666008

INTERVIEW WITH CUSTOMER

Interview with the customer is important to detect the root cause of CAN communication system errors and to understand vehicle condition and symptoms for proper trouble diagnosis.

Points in interview

- What: Parts name, system name
- When: Date, Frequency
- Where: Road condition, Place
- In what condition: Driving condition/environment
- Result: Symptom

NOTE:

- Check normal units as well as error symptoms.
- Example: Circuit between ECM and the combination meter is judged normal if the customer indicates tachometer functions normally.
- When a CAN communication system error is present, multiple control units may malfunction or go into fail-safe mode.

DIAGNOSIS AND REPAIR WORKFLOW

< BASIC INSPECTION >

[CAN FUNDAMENTAL]

- Indication of the combination meter is important to detect the root cause because it is the most obvious to the customer, and it performs CAN communication with many units.

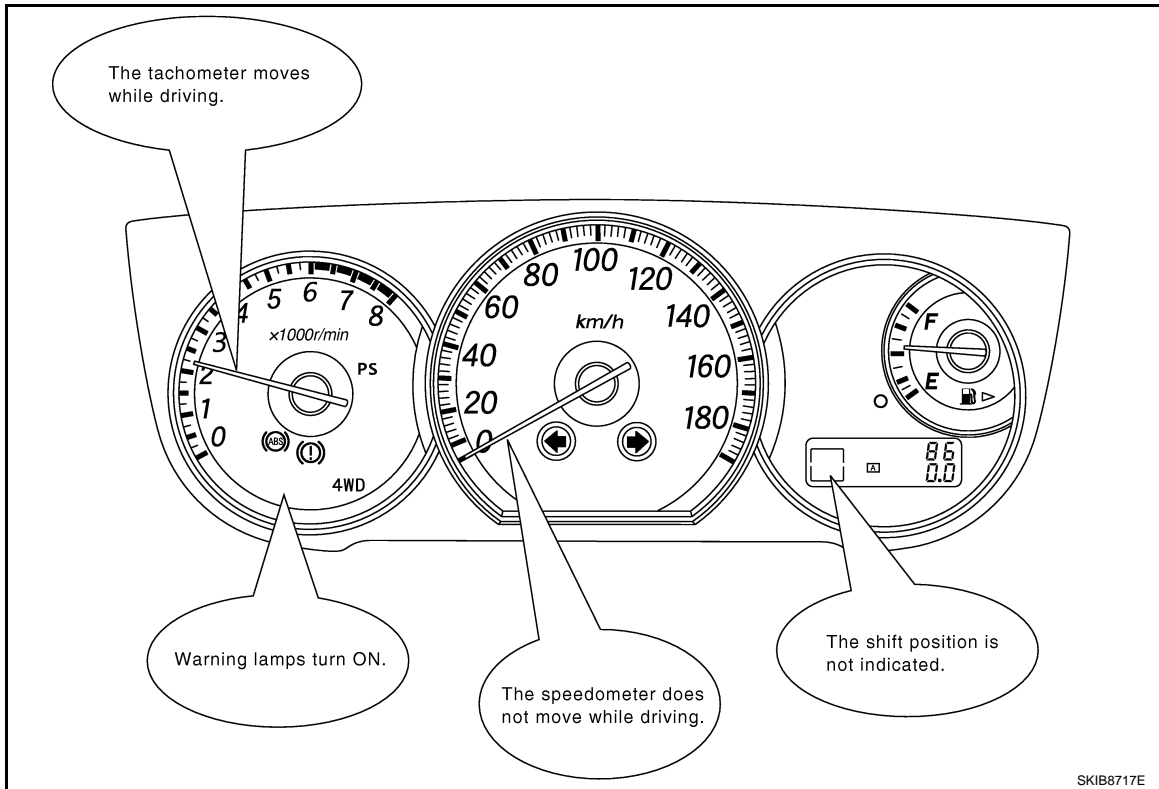

INSPECTION OF VEHICLE CONDITION

Check whether the symptom is reproduced or not.

NOTE:

Do not turn the ignition switch OFF or disconnect the battery cable while reproducing the error. The error may temporarily correct itself, making it difficult to determine the root cause.

CHECK OF CAN SYSTEM TYPE (HOW TO USE CAN SYSTEM TYPE SPECIFICATION CHART)

Determine CAN system type based on vehicle equipment.

NOTE:

- This chart is used if CONSULT-III does not automatically recognize CAN system type.
- There are two styles for CAN system type specification charts. Depending on the number of available system types, either style A or style B may be used.

CAN System Type Specification Chart (Style A)

NOTE:

A
B
C
D
E
F
G
H
I
J
K
L
N
O
P

LAN

DIAGNOSIS AND REPAIR WORKFLOW

< BASIC INSPECTION >

[CAN FUNDAMENTAL]

CAN system type is easily checked with the vehicle equipment identification information shown in the chart.

Example:
Vehicle is equipped as follows: Wagon, AWD, VQ35DE, CVT, VDC, and Intelligent Key system. (○ shows an example of CAN system type.)

CAN System Specification Chart
Determine CAN system type from the following specification chart.

Body type	Wagon					
Axle	2WD			AWD		
Engine	QR25DE		VQ35DE			
Transmission	A/T		CVT			
Brake control	ABS			VDC		
Intelligent Key system		X		X		X
CAN system type	1	2	3	4	5	6
CAN communication signal chart	XX-XX. "TYPE 1/TYPE 2"		XX-XX. "TYPE 3/TYPE 4"		XX-XX. "TYPE 5/TYPE 6"	

X : Applicable

VEHICLE EQUIPMENT IDENTIFICATION INFORMATION
NOTE:
Check CAN system type from the vehicle shape and equipment.

With VDC

VDC OFF switch

With Intelligent Key system

Ignition knob

In the above example,
• Checking VDC OFF switch leads to judge whether or not VDC is equipped.
• Checking the ignition knob leads to judge whether or not Intelligent Key system is equipped.

[For the above case, CAN system type is "6".]

JSMIA0017GB

CAN System Type Specification Chart (Style B)

NOTE:

DIAGNOSIS AND REPAIR WORKFLOW

< BASIC INSPECTION >

[CAN FUNDAMENTAL]

CAN system type is easily checked with the vehicle equipment identification information shown in the chart.

Example:
Vehicle is equipped as follows: Sedan, 2WD, MR20DE, CVT, ABS, Active AFS, Intelligent Key system, Navigation system and Automatic drive positioner. (○ shows an example of CAN system type.)

CAN System Specification Chart
Refer to the specification as shown in the chart.

Body type	Sedan		
Axle	2WD		AWD
Engine	HR15DE	MR20DE	HR15DE
Transmission	A/T	CVT	A/T
Brake control		ABS	
Specification chart	XXX SPECIFICATION CHART A	YYY SPECIFICATION CHART B	ZZZ SPECIFICATION CHART C

x: Applicable

Check the vehicle equipment with the vehicle identification number plate.
Check the vehicle equipment.
Select the applicable vehicle equipment. Refer to the specification chart.

SPECIFICATION CHART B
Determine CAN system type from the following specification chart.

Body type	Sedan											
Axle	2WD											
Engine	MR20DE											
Transmission	CVT											
Brake control	ABS											
Active AFS		x			x	x		x	x		x	
Intelligent Key system			x		x		x	x	x	x	x	
Navigation system				x		x	x		x		x	
Automatic drive positioner								x		x	x	
CAN system type	9	10	11	12	13	14	15	16	17	18	19	20
CAN communication signal chart	XXX TYPE WIPER BRAKE LIGHTER BRAKE LIGHTER BRAKE LIGHTER BRAKE LIGHTER BRAKE LIGHTER BRAKE LIGHTER BRAKE LIGHTER BRAKE LIGHTER BRAKE LIGHTER BRAKE LIGHTER BRAKE LIGHTER											

x: Applicable

Check the vehicle equipment.
The number indicates the CAN system type of the vehicle.

VEHICLE EQUIPMENT IDENTIFICATION INFORMATION
NOTE:
Check CAN system type from the vehicle shape and equipment.

<p>With active AFS</p> <p>Xenon bulb Bending lamp</p>	<p>With Intelligent Key system</p> <p>Ignition knob</p>
<p>With navigation system</p> <p>Display Multifunction switch</p>	<p>With automatic drive positioner</p> <p>Seat memory switch</p>

In the above example,
 • Checking Xenon bulb and bending lamp lead to judge whether or not Active AFS is equipped.
 • Checking the ignition knob leads to judge whether or not Intelligent Key system is equipped.
 • Checking display and multifunction switch lead to judge whether or not Navigation system is equipped.
 • Checking seat memory switch leads to judge whether or not Automatic drive positioner is equipped.

[For the above case, CAN system type is "20".]

JSMIA0018GB

CREATE INTERVIEW SHEET

Fill out the symptom described by the customer, vehicle condition, and CAN system type on the interview sheet.

DIAGNOSIS AND REPAIR WORKFLOW

< BASIC INSPECTION >

[CAN FUNDAMENTAL]

Interview Sheet (Example)

CAN Communication System Diagnosis Interview Sheet	
Date received:	3, Feb. 2006
Type: DBA-KG11	VIN No.: KG11-005040
Model: BDRARGZ397EDA-E-J-	
First registration: 10, Jan. 2001	Mileage: 62,140
CAN system type:	Type 19
Symptom (Results from interview with customer)	
<ul style="list-style-type: none">•Headlamps suddenly turn ON while driving the vehicle.•The engine does not restart after stopping the vehicle and turning the ignition switch OFF.•The cooling fan continues rotating while turning the ignition switch ON.	
Condition at inspection	
Error Symptom: Present / Past	
<p>The engine does not start. While turning the ignition switch ON,</p> <ul style="list-style-type: none">•The headlamps (Lo) turn ON, and the cooling fan continues rotating.•The interior lamp does not turn ON.	

JSMIA0019GB

DETECT THE ROOT CAUSE

CAN diagnosis function of CONSULT-III detects the root cause.

HOW TO USE THIS SECTION

< HOW TO USE THIS MANUAL >

[CAN]

HOW TO USE THIS MANUAL

HOW TO USE THIS SECTION

Caution

INFOID:000000001666009

- This section describes information peculiar to a vehicle and inspection procedures.
- For trouble diagnosis procedure, refer to [LAN-16, "Trouble Diagnosis Procedure"](#).

Abbreviation List

INFOID:000000001666010

Unit name abbreviations in CONSULT-III CAN diagnosis and in this section are as per the following list.

Abbreviation	Unit name
A-BAG	Air bag diagnosis sensor unit
ABS	ABS actuator and electric unit (control unit)
ADP	Driver seat control unit
AFS	AFS control unit
AV	AV control unit
BCM	BCM
DLC	Data link connector
ECM	ECM
ICC	ICC sensor integrated unit
IPDM-E	IPDM E/R
M&A	Unified meter and A/C amp.
PSB	Pre-crash seat belt control unit
RAS	4WAS main control unit
STRG	Steering angle sensor
TCM	TCM

A
B
C
D
E
F
G
H
I
J
K
L

LAN

N
O
P

< PRECAUTION >

PRECAUTION

PRECAUTIONS

Precaution for Supplemental Restraint System (SRS) "AIR BAG" and "SEAT BELT PRE-TENSIONER"

INFOID:000000001910555

The Supplemental Restraint System such as "AIR BAG" and "SEAT BELT PRE-TENSIONER", used along with a front seat belt, helps to reduce the risk or severity of injury to the driver and front passenger for certain types of collision. This system includes seat belt switch inputs and dual stage front air bag modules. The SRS system uses the seat belt switches to determine the front air bag deployment, and may only deploy one front air bag, depending on the severity of a collision and whether the front occupants are belted or unbelted. Information necessary to service the system safely is included in the "SRS AIRBAG" and "SEAT BELT" of this Service Manual.

WARNING:

- To avoid rendering the SRS inoperative, which could increase the risk of personal injury or death in the event of a collision which would result in air bag inflation, all maintenance must be performed by an authorized NISSAN/INFINITI dealer.
- Improper maintenance, including incorrect removal and installation of the SRS, can lead to personal injury caused by unintentional activation of the system. For removal of Spiral Cable and Air Bag Module, see the "SRS AIRBAG".
- Do not use electrical test equipment on any circuit related to the SRS unless instructed to in this Service Manual. SRS wiring harnesses can be identified by yellow and/or orange harnesses or harness connectors.

Precaution for Battery Service

INFOID:000000001910556

Before disconnecting the battery, lower both the driver and passenger windows. This will prevent any interference between the window edge and the vehicle when the door is opened/closed. During normal operation, the window slightly raises and lowers automatically to prevent any window to vehicle interference. The automatic window function will not work with the battery disconnected.

Precautions for Trouble Diagnosis

INFOID:000000001666012

CAUTION:

- Never apply 7.0 V or more to the measurement terminal.
- Use a tester with open terminal voltage of 7.0 V or less.
- Turn the ignition switch OFF and disconnect the battery cable from the negative terminal when checking the harness.

Precautions for Harness Repair

INFOID:000000001666013

- Solder the repaired area and wrap tape around the soldered area.

NOTE:

A fray of twisted lines must be within 110 mm (4.33 in).

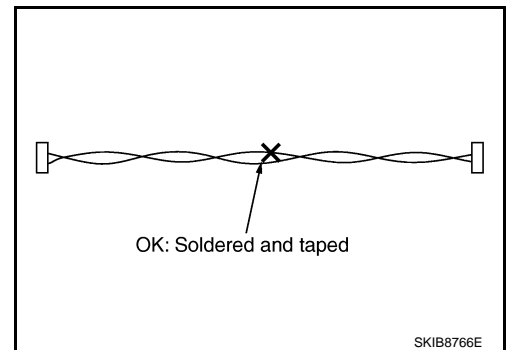

PRECAUTIONS

[CAN]

< PRECAUTION >

- Bypass connection is never allowed at the repaired area.

NOTE:

Bypass connection may cause CAN communication error. The spliced wire becomes separated and the characteristics of twisted line are lost.

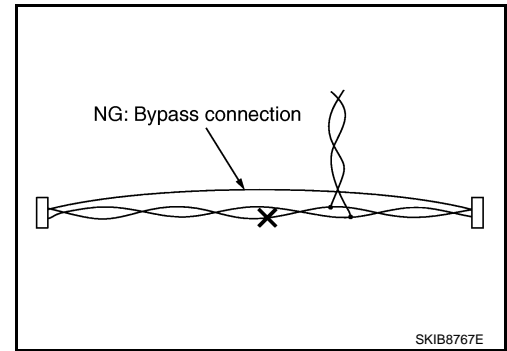

- Replace the applicable harness as an assembly if error is detected on the shield lines of CAN communication line.

A
B
C
D
E
F
G
H
I
J
K
L

LAN

N
O
P

FUNCTION DIAGNOSIS

CAN COMMUNICATION SYSTEM

CAN System Specification Chart

INFOID:000000001666015

Determine CAN system type from the following specification chart.

NOTE:

Refer to [LAN-16. "Trouble Diagnosis Procedure"](#) for how to use CAN system specification chart.

Body type	Coupe							
Axle	2WD							
Engine	VQ37VHR							
Transmission	M/T				A/T			
Brake control	VDC							
4WAS		×		×		×		×
ICC system			×	×			×	×
CAN system type	1	2	3	4	5	6	7	8
Start CAN Diagnosis (CONSULT-III)	1	2	3	4	5	6	7	8

×: Applicable

VEHICLE EQUIPMENT IDENTIFICATION INFORMATION

NOTE:

Check CAN system type from the vehicle shape and equipment.

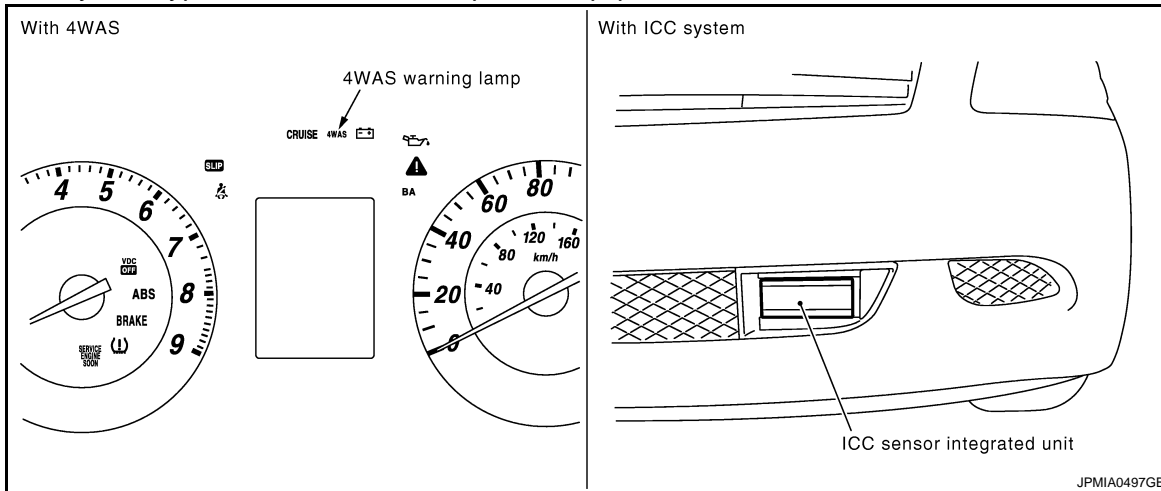

CAN Communication Signal Chart

INFOID:000000001666016

Refer to [LAN-15. "How to Use CAN Communication Signal Chart"](#) for how to use CAN communication signal chart.

NOTE:

Refer to [LAN-21. "Abbreviation List"](#) for the abbreviations of the connecting units.

T: Transmit R: Receive

Signal name/Connecting unit	ECM	AV	BCM	PSB	TCM	AFS	M&A	STRG	ADP	RAS	ABS	ICC	IPDM-E
A/C compressor request signal	T												R
Accelerator pedal position signal	T				R						R	R	
ASCD OD cancel request signal	T				R								
ASCD operation signal	T				R								

CAN COMMUNICATION SYSTEM

< FUNCTION DIAGNOSIS >

[CAN]

Signal name/Connecting unit	ECM	AV	BCM	PSB	TCM	AFS	M&A	STRG	ADP	RAS	ABS	ICC	IPDM-E
ASCD status signal	T						R						
ASCD SET indicator signal	T						R						
Closed throttle position signal	T				R							R	
Cooling fan speed request signal	T												R
Engine and A/T integrated control signal	T				R								
	R				T								
Engine coolant temperature signal	T						R						
Engine speed signal	T				R	R	R			R	R	R	
Engine status signal	T	R	R										
Fuel consumption monitor signal	T	R					R						
ICC brake switch signal	T											R	
ICC clutch switch signal ^{*1}	T											R	
ICC prohibition signal	T											R	
ICC steering switch signal	T											R	
Malfunctioning indicator lamp signal	T						R						
Park/neutral position switch signal ^{*1}	T											R	
Power generation command value signal	T												R
Snow mode switch signal	T										R	R	
	R						T						
Stop lamp switch signal	T											R	
											T	R	
			T		R								
Wide open throttle position signal	T				R								
A/C switch/indicator signal		T					R						
		R					T						
Rear window defogger switch signal		T	R										
System setting signal		T	R						R				
		R							T				
		R	T										
Buzzer output signal			T				R						
							R					T	
Door switch signal		R	T				R		R				R
Door unlock signal			T						R				
Front fog light request signal			T				R						R
Front wiper request signal			T									R	R
High beam request signal			T				R						R
Horn reminder signal			T										R
Ignition switch ON signal			T										R
			R										T
Ignition switch signal			T						R				
Interlock/PNP switch signal			T										R
			R										T

CAN COMMUNICATION SYSTEM

< FUNCTION DIAGNOSIS >

[CAN]

Signal name/Connecting unit	ECM	AV	BCM	PSB	TCM	AFS	M&A	STRG	ADP	RAS	ABS	ICC	IPDM-E	A
Key ID signal			T						R					A
Key switch signal			T						R					B
Key warning lamp signal			T				R							C
Low beam request signal			T										R	C
Meter display signal			T				R							D
Oil pressure switch signal			T				R					T		D
Position light request signal			R										T	E
Rear window defogger control signal			T										R	E
Sleep wake up signal	R	R	R										T	F
Starter control relay signal			T				R		R				R	F
Starter relay status signal			R										R	G
Starting mode signal			T							R				G
Steering lock relay signal			R										T	H
Theft warning horn request signal			T										R	H
Tire pressure signal			R				R							I
Trunk switch signal		R	T				R							J
Turn indicator signal			T				R							J
A/T CHECK indicator lamp signal					T	R	R							K
A/T self-diagnosis signal	R				T									K
Current gear position signal					T						R	R		L
Manual mode indicator signal					T		R					R		L
N range signal			R		T							R		L
Output shaft revolution signal	R				T							R		M
P range signal			R		T				R		R	R		N
R range signal					T							R		N
Shift position signal				R ^{*2}	T	R	R				R	R		O
Turbine revolution signal	R				T							R		O
AFS OFF indicator lamp signal						T	R							P
A/C evaporator temperature signal	R						T							P
A/C switch signal	R						T							P
Blower fan motor switch signal	R						T							P
Distance to empty signal		R					T							P
Fuel level low warning signal		R					T							P
Fuel level sensor signal	R						T							P
Manual mode shift down signal					R		T							P
Manual mode shift up signal					R		T							P
Manual mode signal					R		T							P
Not manual mode signal					R		T							P

LAN

CAN COMMUNICATION SYSTEM

< FUNCTION DIAGNOSIS >

[CAN]

Signal name/Connecting unit	ECM	AV	BCM	PSB	TCM	AFS	M&A	STRG	ADP	RAS	ABS	ICC	IPDM-E
Parking brake switch signal			R				T						
Seat belt buckle switch signal			R				T						
Sleep-ready signal			R				T						
			R										T
Target A/C evaporator temperature signal	R						T						
Vehicle speed signal	R	R	R	R	R	R	T		R				R
			R				R			R	T	R	
Wake up signal			R				T						
Steering angle sensor signal						R		T		R	R		
4WAS signal										T	R		
4WAS warning lamp signal							R			T			
A/T shift schedule change demand signal					R						T		
ABS malfunction signal											T	R	
ABS operation signal					R						T	R	
ABS warning lamp signal							R				T		
Brake pressure control signal											T	R	
Brake warning lamp signal							R				T		
Side G sensor signal					R						T		
SLIP indicator lamp signal							R				T		
TCS malfunction signal											T	R	
TCS operation signal											T	R	
VDC malfunction signal											T	R	
VDC OFF indicator lamp signal							R				T		
VDC OFF switch signal											T	R	
VDC operation signal											T	R	
Deceleration degree commandment value signal											R	T	
ICC operation signal	R											T	
ICC warning lamp signal							R					T	
A/T device (detention switch) signal			R										T
Front wiper stop position signal			R										T
High beam status signal	R					R							T
Hood switch signal			R										T
Low beam status signal	R					R							T
Push-button ignition switch status signal			R										T
Steering lock unit status signal			R										T

*1: M/T models only

*2: Receive reverse position signal only

NOTE:

CAN data of the air bag diagnosis sensor unit is not used by usual service work, thus it is omitted.

COMPONENT DIAGNOSIS

CAN COMMUNICATION SYSTEM

Component Parts Location

INFOID:000000001666017

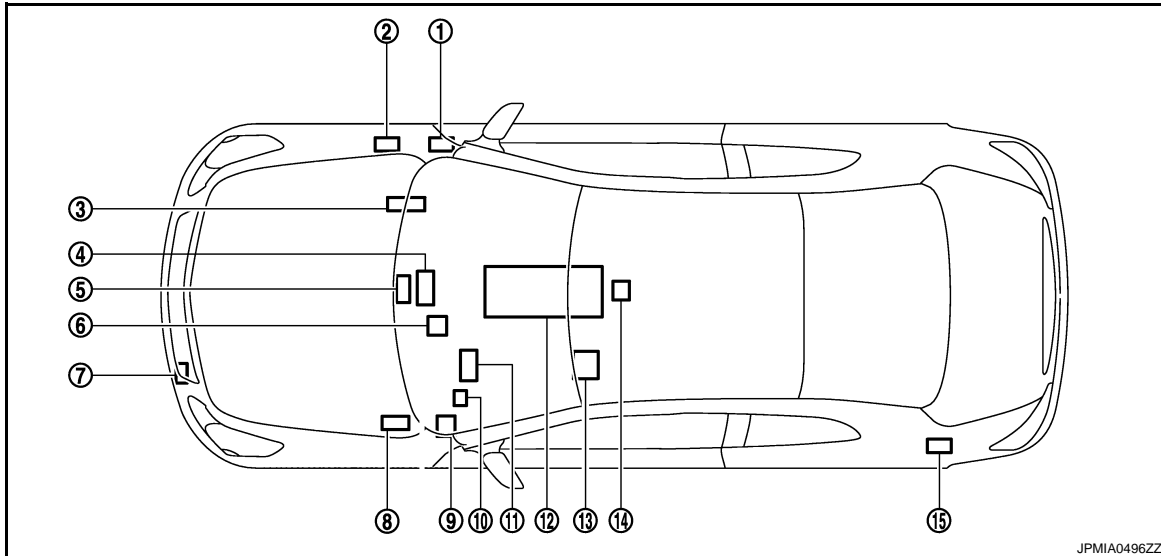

- | | | |
|---|--|--|
| 1. BCM M122 | 2. IPDM E/R E6 | 3. ECM M107 |
| 4. AV control unit
M85: Without NAVI
M87: With NAVI | 5. Unified meter and A/C amp. M67 | 6. Pre-crash seat belt control unit M110 |
| 7. ICC sensor integrated unit E67 | 8. ABS actuator and electric unit (control unit) E41 | 9. AFS control unit M16 |
| 10. Data link connector M24 | 11. Steering angle sensor M37 | 12. A/T assembly F51 |
| 13. Driver seat control unit B503 | 14. Air bag diagnosis sensor unit M147 | 15. 4WAS main control unit B54 |

A
B
C
D
E
F
G
H
I
J
K
L
N
O
P

LAN

CAN COMMUNICATION SYSTEM

[CAN]

< COMPONENT DIAGNOSIS >

Wiring Diagram - CAN SYSTEM -

INFOID:000000001666018

CAN SYSTEM

- : With A/T
- : With NAVI
- : Without NAVI
- : With AFS
- : With pre-crash seat belt

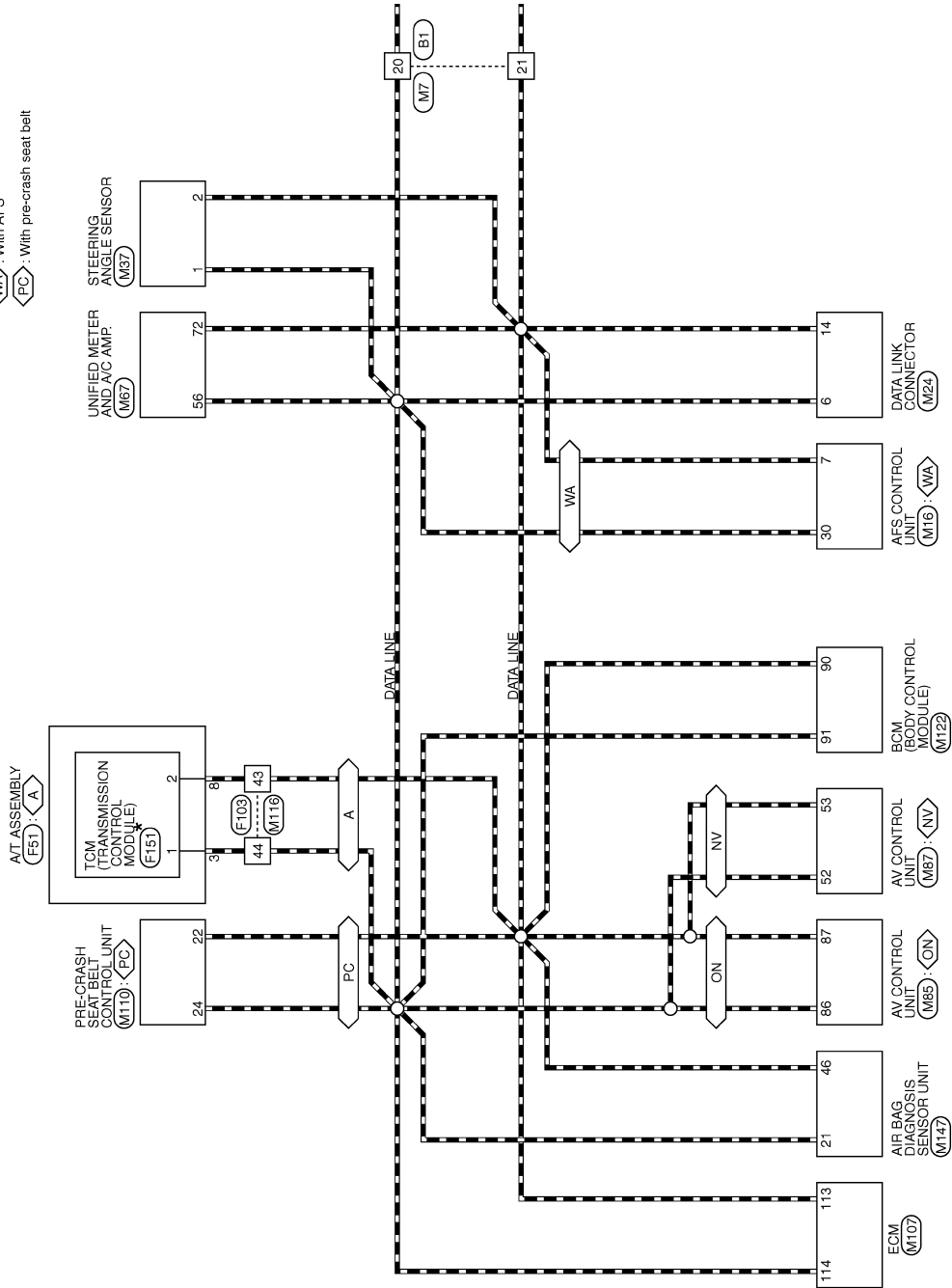

*: This connector is not shown in "Harness Layout".

2007/05/18

JCMWA0840GE

CAN COMMUNICATION SYSTEM

< COMPONENT DIAGNOSIS >

[CAN]

- IC : With ICC
- PM : With automatic drive positioner
- OP : Without automatic drive positioner
- AS : With 4WAS

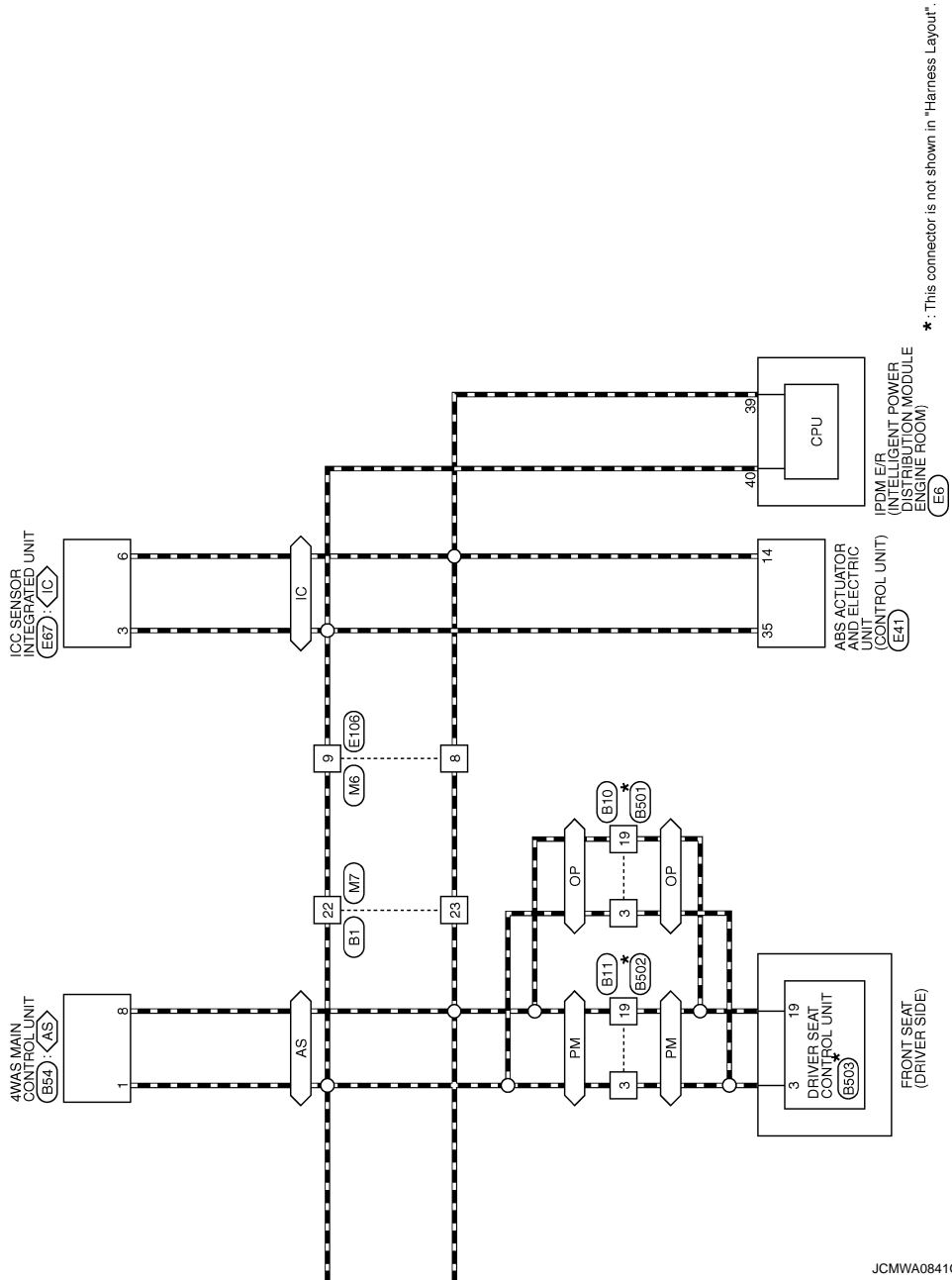

JCMWA0841GE

A
B
C
D
E
F
G
H
I
J
K
L
LAN
N
O
P

CAN COMMUNICATION SYSTEM

< COMPONENT DIAGNOSIS >

[CAN]

CAN SYSTEM

Connector No.	B1
Connector Name	WIRE TO WIRE
Connector Type	TH8DFW-CS16-TM4

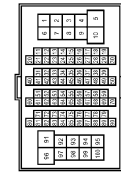

Terminal No.	Color of Wire	Signal Name [Specification]
20	L	-
21	P	-
22	L	-
23	P	-

Connector No.	B10
Connector Name	WIRE TO WIRE
Connector Type	NS12FW-CS

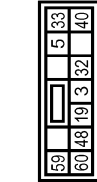

Terminal No.	Color of Wire	Signal Name [Specification]
3	L	-
19	P	-

Connector No.	B11
Connector Name	WIRE TO WIRE
Connector Type	NS16FW-CS

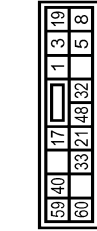

Terminal No.	Color of Wire	Signal Name [Specification]
3	L	-
19	P	-

Connector No.	B54
Connector Name	4WAS MAIN CONTROL UNIT
Connector Type	436FW-IM4

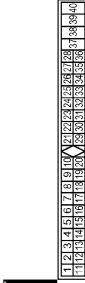

Terminal No.	Color of Wire	Signal Name [Specification]
1	L	CAN-H
8	P	CAN-L

Connector No.	B501
Connector Name	WIRE TO WIRE
Connector Type	NS12MW-CS

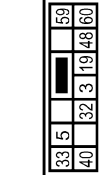

Terminal No.	Color of Wire	R/Y	V	Signal Name [Specification]
3	R/Y	-	-	-
19	V	-	-	-

Connector No.	B502
Connector Name	WIRE TO WIRE
Connector Type	NS16MW-LC

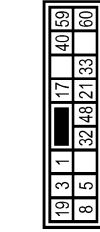

Terminal No.	Color of Wire	R/Y	V	Signal Name [Specification]
3	R/Y	-	-	-
19	V	-	-	-

Connector No.	B503
Connector Name	DRIVER SEAT CONTROL UNIT
Connector Type	TH32PW

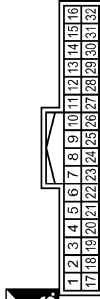

Terminal No.	Color of Wire	R/Y	V	Signal Name [Specification]
3	R/Y	-	-	CAN-H
19	V	-	-	CAN-L

Connector No.	E6
Connector Name	FRONT/REAR INTELLIGENT POWER DISTRIBUTION MODULE (ENGINE ROOM)
Connector Type	TH8DFW-1H

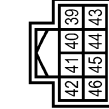

Terminal No.	Color of Wire	Signal Name [Specification]
39	P	-
40	L	-

JCMWA0842G1

CAN COMMUNICATION SYSTEM

< COMPONENT DIAGNOSIS >

[CAN]

CAN SYSTEM

Connector No.	E41
Connector Name	ABS ACTUATOR AND ELECTRIC UNIT (CONTROL UNIT)
Connector Type	BA4AFB-AH24-LH

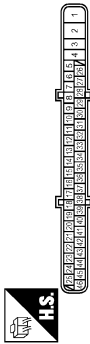

Terminal No.	Color of Wire	Signal Name [Specification]
14	P	CAN-L
35	L	CAN-H

Connector No.	E67
Connector Name	ICC SENSOR INTEGRATED UNIT
Connector Type	RS06FB-PR



Terminal No.	Color of Wire	Signal Name [Specification]
3	L	CAN-H
6	P	CAN-L

Connector No.	E105
Connector Name	WIRE TO WIRE
Connector Type	TH80FW-CS16-TM4



Terminal No.	Color of Wire	Signal Name [Specification]
8	P	-
9	L	-

Connector No.	F51
Connector Name	A/T ASSEMBLY
Connector Type	FRK10FG-DGY



Terminal No.	Color of Wire	Signal Name [Specification]
3	L	-
8	P	-

Connector No.	F103
Connector Name	WIRE TO WIRE
Connector Type	TK80FW-MS10

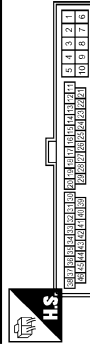

Terminal No.	Color of Wire	Signal Name [Specification]
43	P	-
44	L	-

Connector No.	F151
Connector Name	TCM (TRANSMISSION CONTROL MODULE)
Connector Type	SPT10FBGY

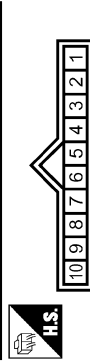

Terminal No.	Color of Wire	Signal Name [Specification]
1	BR	CAN-H
2	L/Y	CAN-L

Connector No.	M6
Connector Name	WIRE TO WIRE
Connector Type	TH80MM-CS16-TM4

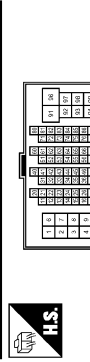

Terminal No.	Color of Wire	Signal Name [Specification]
8	P	-
9	L	-

Connector No.	M7
Connector Name	WIRE TO WIRE
Connector Type	TH80MM-CS16-TM4



Terminal No.	Color of Wire	Signal Name [Specification]
20	L	-
21	P	-
22	L	-
23	P	-

A
B
C
D
E
F
G
H
I
J
K
L
N
O
P

LAN

JCMWA0843GE

CAN COMMUNICATION SYSTEM

< COMPONENT DIAGNOSIS >

[CAN]

CAN SYSTEM

<table border="1"> <tr><td>Connector No.</td><td>M16</td></tr> <tr><td>Connector Name</td><td>AFS CONTROL UNIT</td></tr> <tr><td>Connector Type</td><td>TH40PW-NH</td></tr> </table>	Connector No.	M16	Connector Name	AFS CONTROL UNIT	Connector Type	TH40PW-NH	<table border="1"> <tr><td>Terminal No.</td><td>30</td></tr> <tr><td>Color of Wire</td><td>L</td></tr> <tr><td>Signal Name [Specification]</td><td>CAN-L</td></tr> <tr><td></td><td>CAN-H</td></tr> </table>	Terminal No.	30	Color of Wire	L	Signal Name [Specification]	CAN-L		CAN-H
Connector No.	M16														
Connector Name	AFS CONTROL UNIT														
Connector Type	TH40PW-NH														
Terminal No.	30														
Color of Wire	L														
Signal Name [Specification]	CAN-L														
	CAN-H														
<table border="1"> <tr><td>Connector No.</td><td>M24</td></tr> <tr><td>Connector Name</td><td>DATA LINK CONNECTOR</td></tr> <tr><td>Connector Type</td><td>BD16FW</td></tr> </table>	Connector No.	M24	Connector Name	DATA LINK CONNECTOR	Connector Type	BD16FW	<table border="1"> <tr><td>Terminal No.</td><td>6</td></tr> <tr><td>Color of Wire</td><td>L</td></tr> <tr><td>Signal Name [Specification]</td><td>-</td></tr> <tr><td></td><td>-</td></tr> </table>	Terminal No.	6	Color of Wire	L	Signal Name [Specification]	-		-
Connector No.	M24														
Connector Name	DATA LINK CONNECTOR														
Connector Type	BD16FW														
Terminal No.	6														
Color of Wire	L														
Signal Name [Specification]	-														
	-														
<table border="1"> <tr><td>Connector No.</td><td>M37</td></tr> <tr><td>Connector Name</td><td>STEERING ANGLE SENSOR</td></tr> <tr><td>Connector Type</td><td>TH40PW-NH</td></tr> </table>	Connector No.	M37	Connector Name	STEERING ANGLE SENSOR	Connector Type	TH40PW-NH	<table border="1"> <tr><td>Terminal No.</td><td>1</td></tr> <tr><td>Color of Wire</td><td>L</td></tr> <tr><td>Signal Name [Specification]</td><td>CAN-H</td></tr> <tr><td></td><td>CAN-L</td></tr> </table>	Terminal No.	1	Color of Wire	L	Signal Name [Specification]	CAN-H		CAN-L
Connector No.	M37														
Connector Name	STEERING ANGLE SENSOR														
Connector Type	TH40PW-NH														
Terminal No.	1														
Color of Wire	L														
Signal Name [Specification]	CAN-H														
	CAN-L														
<table border="1"> <tr><td>Connector No.</td><td>M67</td></tr> <tr><td>Connector Name</td><td>UNIFIED METER AND A.C AMP.</td></tr> <tr><td>Connector Type</td><td>TH432FW-NH</td></tr> </table>	Connector No.	M67	Connector Name	UNIFIED METER AND A.C AMP.	Connector Type	TH432FW-NH	<table border="1"> <tr><td>Terminal No.</td><td>56</td></tr> <tr><td>Color of Wire</td><td>L</td></tr> <tr><td>Signal Name [Specification]</td><td>CAN-H</td></tr> <tr><td></td><td>CAN-L</td></tr> </table>	Terminal No.	56	Color of Wire	L	Signal Name [Specification]	CAN-H		CAN-L
Connector No.	M67														
Connector Name	UNIFIED METER AND A.C AMP.														
Connector Type	TH432FW-NH														
Terminal No.	56														
Color of Wire	L														
Signal Name [Specification]	CAN-H														
	CAN-L														
<table border="1"> <tr><td>Connector No.</td><td>M85</td></tr> <tr><td>Connector Name</td><td>AV CONTROL UNIT (WITHOUT NAVI)</td></tr> <tr><td>Connector Type</td><td>TH432PW-NH</td></tr> </table>	Connector No.	M85	Connector Name	AV CONTROL UNIT (WITHOUT NAVI)	Connector Type	TH432PW-NH	<table border="1"> <tr><td>Terminal No.</td><td>87</td></tr> <tr><td>Color of Wire</td><td>L</td></tr> <tr><td>Signal Name [Specification]</td><td>CAN-H</td></tr> <tr><td></td><td>CAN-L</td></tr> </table>	Terminal No.	87	Color of Wire	L	Signal Name [Specification]	CAN-H		CAN-L
Connector No.	M85														
Connector Name	AV CONTROL UNIT (WITHOUT NAVI)														
Connector Type	TH432PW-NH														
Terminal No.	87														
Color of Wire	L														
Signal Name [Specification]	CAN-H														
	CAN-L														
<table border="1"> <tr><td>Connector No.</td><td>M87</td></tr> <tr><td>Connector Name</td><td>AV CONTROL UNIT (WITH NAVI)</td></tr> <tr><td>Connector Type</td><td>TH40PW-NH</td></tr> </table>	Connector No.	M87	Connector Name	AV CONTROL UNIT (WITH NAVI)	Connector Type	TH40PW-NH	<table border="1"> <tr><td>Terminal No.</td><td>52</td></tr> <tr><td>Color of Wire</td><td>L</td></tr> <tr><td>Signal Name [Specification]</td><td>CAN-H</td></tr> <tr><td></td><td>CAN-L</td></tr> </table>	Terminal No.	52	Color of Wire	L	Signal Name [Specification]	CAN-H		CAN-L
Connector No.	M87														
Connector Name	AV CONTROL UNIT (WITH NAVI)														
Connector Type	TH40PW-NH														
Terminal No.	52														
Color of Wire	L														
Signal Name [Specification]	CAN-H														
	CAN-L														
<table border="1"> <tr><td>Connector No.</td><td>M107</td></tr> <tr><td>Connector Name</td><td>ECM</td></tr> <tr><td>Connector Type</td><td>FR42FGY-R2Z-R-LH-Z</td></tr> </table>	Connector No.	M107	Connector Name	ECM	Connector Type	FR42FGY-R2Z-R-LH-Z	<table border="1"> <tr><td>Terminal No.</td><td>113</td></tr> <tr><td>Color of Wire</td><td>P</td></tr> <tr><td>Signal Name [Specification]</td><td>VEHCAN-LI</td></tr> <tr><td></td><td>VEHCAN-HI</td></tr> </table>	Terminal No.	113	Color of Wire	P	Signal Name [Specification]	VEHCAN-LI		VEHCAN-HI
Connector No.	M107														
Connector Name	ECM														
Connector Type	FR42FGY-R2Z-R-LH-Z														
Terminal No.	113														
Color of Wire	P														
Signal Name [Specification]	VEHCAN-LI														
	VEHCAN-HI														
<table border="1"> <tr><td>Connector No.</td><td>M110</td></tr> <tr><td>Connector Name</td><td>PRE-CRASH SEAT BELT CONTROL UNIT</td></tr> <tr><td>Connector Type</td><td>TH420PW-TBS</td></tr> </table>	Connector No.	M110	Connector Name	PRE-CRASH SEAT BELT CONTROL UNIT	Connector Type	TH420PW-TBS	<table border="1"> <tr><td>Terminal No.</td><td>22</td></tr> <tr><td>Color of Wire</td><td>P</td></tr> <tr><td>Signal Name [Specification]</td><td>CAN-L</td></tr> <tr><td></td><td>CAN-H</td></tr> </table>	Terminal No.	22	Color of Wire	P	Signal Name [Specification]	CAN-L		CAN-H
Connector No.	M110														
Connector Name	PRE-CRASH SEAT BELT CONTROL UNIT														
Connector Type	TH420PW-TBS														
Terminal No.	22														
Color of Wire	P														
Signal Name [Specification]	CAN-L														
	CAN-H														

JCMWA0844GE

CAN COMMUNICATION SYSTEM

< COMPONENT DIAGNOSIS >

[CAN]

CAN SYSTEM

Connector No.	M116
Connector Name	WIRE TO WIRE
Connector Type	TK3BMW-NS1.0

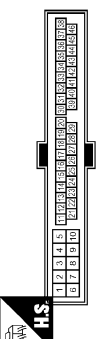

Terminal No.	Color of Wire	Signal Name [Specification]
43	P	-
44	L	-

Connector No.	M122
Connector Name	BCM (BODY CONTROL MODULE)
Connector Type	TH40FB-NH

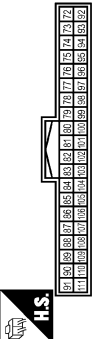

Terminal No.	Color of Wire	Signal Name [Specification]
90	P	CAN-L
91	L	CAN-H

Connector No.	M147
Connector Name	AIR BAG DIAGNOSIS SENSOR UNIT
Connector Type	TK28FY-EX-SC

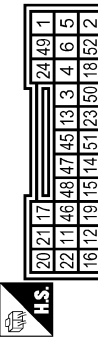

Terminal No.	Color of Wire	Signal Name [Specification]
21	L	CAN-H
46	P	CAN-L

A
B
C
D
E
F
G
H
I
J
K
L
N
O
P

LAN

JCMWA0845GE

MALFUNCTION AREA CHART

< COMPONENT DIAGNOSIS >

[CAN]

MALFUNCTION AREA CHART

Main Line

INFOID:000000001666019

Malfunction Area	Reference
Main line between BCM and data link connector	LAN-37, "Diagnosis Procedure"
Main line between data link connector and driver seat control unit	LAN-38, "Diagnosis Procedure"
Main line between driver seat control unit and ABS actuator and electric unit (control unit)	LAN-39, "Diagnosis Procedure"

Branch Line

INFOID:000000001666020

Malfunction Area	Reference
ECM branch line circuit	LAN-41, "Diagnosis Procedure"
Air bag diagnosis sensor unit branch line circuit	LAN-42, "Diagnosis Procedure"
AV control unit branch line circuit	LAN-43, "Diagnosis Procedure"
BCM branch line circuit	LAN-44, "Diagnosis Procedure"
Pre-crash seat belt control unit	LAN-45, "Diagnosis Procedure"
TCM branch line circuit	LAN-46, "Diagnosis Procedure"
AFS control unit branch line circuit	LAN-47, "Diagnosis Procedure"
Data link connector branch line circuit	LAN-48, "Diagnosis Procedure"
Unified meter and A/C amp. branch line circuit	LAN-49, "Diagnosis Procedure"
Steering angle sensor branch line circuit	LAN-50, "Diagnosis Procedure"
Driver seat control unit branch line circuit	LAN-51, "Diagnosis Procedure"
4WAS main control unit branch line circuit	LAN-52, "Diagnosis Procedure"
ABS actuator and electric unit (control unit) branch line circuit	LAN-53, "Diagnosis Procedure"
ICC sensor integrated unit branch line circuit	LAN-54, "Diagnosis Procedure"
IPDM E/R branch line circuit	LAN-55, "Diagnosis Procedure"

Short Circuit

INFOID:000000001666021

Malfunction Area	Reference
CAN communication circuit	LAN-56, "Diagnosis Procedure"

MAIN LINE BETWEEN BCM AND DLC CIRCUIT

< COMPONENT DIAGNOSIS >

[CAN]

MAIN LINE BETWEEN BCM AND DLC CIRCUIT

Diagnosis Procedure

INFOID:000000001666022

INSPECTION PROCEDURE

1. CHECK HARNESS CONTINUITY (OPEN CIRCUIT)

1. Turn the ignition switch OFF.
2. Disconnect the battery cable from the negative terminal.
3. Disconnect the following harness connectors.
 - ECM
 - BCM
4. Check the continuity between the BCM harness connector and the data link connector.

BCM harness connector		Data link connector		Continuity
Connector No.	Terminal No.	Connector No.	Terminal No.	
M122	91	M24	6	Existed
	90		14	Existed

Is the inspection result normal?

YES (Present error)>>Check CAN system type decision again.

YES (Past error)>>Error was detected in the main line between the BCM and the data link connector.

NO >> Repair the main line between the BCM and the data link connector.

A
B
C
D
E
F
G
H
I
J
K
L

LAN

N
O
P

MAIN LINE BETWEEN DLC AND ADP CIRCUIT

< COMPONENT DIAGNOSIS >

[CAN]

MAIN LINE BETWEEN DLC AND ADP CIRCUIT

Diagnosis Procedure

INFOID:000000001666024

INSPECTION PROCEDURE

1.CHECK CONNECTOR

1. Turn the ignition switch OFF.
2. Disconnect the battery cable from the negative terminal.
3. Check the following terminals and connectors for damage, bend and loose connection (connector side and harness side).
 - Harness connector M7
 - Harness connector B1

Is the inspection result normal?

YES >> GO TO 2.

NO >> Repair the terminal and connector.

2.CHECK HARNESS CONTINUITY (OPEN CIRCUIT)

1. Disconnect the harness connectors M7 and B1.
2. Check the continuity between the data link connector and the harness connector.

Data link connector		Harness connector		Continuity
Connector No.	Terminal No.	Connector No.	Terminal No.	
M24	6	M7	20	Existed
	14		21	Existed

Is the inspection result normal?

YES >> GO TO 3.

NO >> Repair the main line between the data link connector and the harness connector M7.

3.CHECK HARNESS CONTINUITY (OPEN CIRCUIT)

Check the continuity between the harness connector terminals.

Connector No.	Terminal No.		Continuity
B1	20	22	Existed
	21	23	Existed

Is the inspection result normal?

YES (Present error)>>Check CAN system type decision again.

YES (Past error)>>Error was detected in the main line between the data link connector and the driver seat control unit.

NO >> Repair the main line between the harness connector B1 and the driver seat control unit.

MAIN LINE BETWEEN ADP AND ABS CIRCUIT

< COMPONENT DIAGNOSIS >

[CAN]

MAIN LINE BETWEEN ADP AND ABS CIRCUIT

Diagnosis Procedure

INFOID:000000001666025

1. CHECK CONNECTOR

1. Turn the ignition switch OFF.
2. Disconnect the battery cable from the negative terminal.
3. Check the following terminals and connectors for damage, bend and loose connection (connector side and harness side).
 - Harness connector B1
 - Harness connector M7
 - Harness connector M6
 - Harness connector E106

Is the inspection result normal?

YES >> GO TO 2.

NO >> Repair the terminal and connector.

2. CHECK HARNESS CONTINUITY (OPEN CIRCUIT)

1. Disconnect the harness connectors B1 and M7.
2. Check the continuity between the harness connector terminals.

Connector No.	Terminal No.		Continuity
B1	20	22	Existed
	21	23	Existed

Is the inspection result normal?

YES >> GO TO 3.

NO >> Repair the main line between the driver seat control unit and the harness connector B1.

3. CHECK HARNESS CONTINUITY (OPEN CIRCUIT)

1. Disconnect the harness connectors M6 and E106.
2. Check the continuity between the harness connectors.

Harness connector		Harness connector		Continuity
Connector No.	Terminal No.	Connector No.	Terminal No.	
M7	22	M6	9	Existed
	23		8	Existed

Is the inspection result normal?

YES >> GO TO 4.

NO >> Repair the main line between the harness connectors M7 and M6.

4. CHECK HARNESS CONTINUITY (OPEN CIRCUIT)

1. Disconnect the connector of ABS actuator and electric unit (control unit).
2. Check the continuity between the harness connector and the ABS actuator and electric unit (control unit) harness connector.

Harness connector		ABS actuator and electric unit (control unit) harness connector		Continuity
Connector No.	Terminal No.	Connector No.	Terminal No.	
E106	9	E41	35	Existed
	8		14	Existed

Is the inspection result normal?

YES (Present error)>>Check CAN system type decision again.

YES (Past error)>>Error was detected in the main line between the driver seat control unit and the ABS actuator and electric unit (control unit).

MAIN LINE BETWEEN ADP AND ABS CIRCUIT

< COMPONENT DIAGNOSIS >

[CAN]

NO >> Repair the main line between the harness connector E106 and the ABS actuator and electric unit (control unit).

ECM BRANCH LINE CIRCUIT

< COMPONENT DIAGNOSIS >

[CAN]

ECM BRANCH LINE CIRCUIT

Diagnosis Procedure

INFOID:000000001666026

1. CHECK CONNECTOR

1. Turn the ignition switch OFF.
2. Disconnect the battery cable from the negative terminal.
3. Check the terminals and connectors of the ECM for damage, bend and loose connection (unit side and connector side).

Is the inspection result normal?

- YES >> GO TO 2.
NO >> Repair the terminal and connector.

2. CHECK HARNESS FOR OPEN CIRCUIT

1. Disconnect the connector of ECM.
2. Check the resistance between the ECM harness connector terminals.

ECM harness connector			Resistance (Ω)
Connector No.	Terminal No.		
M107	114	113	Approx. 108 – 132

Is the measurement value within the specification?

- YES >> GO TO 3.
NO >> Repair the ECM branch line.

3. CHECK POWER SUPPLY AND GROUND CIRCUIT

Check the power supply and the ground circuit of the ECM. Refer to [EC-140. "Diagnosis Procedure"](#).

Is the inspection result normal?

YES (Present error)>>Replace the ECM. Refer to [EC-16. "ADDITIONAL SERVICE WHEN REPLACING CONTROL UNIT \(ECM\) : Special Repair Requirement"](#).

YES (Past error)>>Error was detected in the ECM branch line.

NO >> Repair the power supply and the ground circuit.

A
B
C
D
E
F
G
H
I
J
K
L

LAN

N
O
P

A-BAG BRANCH LINE CIRCUIT

< COMPONENT DIAGNOSIS >

[CAN]

A-BAG BRANCH LINE CIRCUIT

Diagnosis Procedure

INFOID:000000001666028

1. CHECK AIR BAG DIAGNOSIS SENSOR UNIT

Check the air bag diagnosis sensor unit. Refer to [SRC-5, "Work Flow"](#).

Is the inspection result normal?

YES >> Replace the main harness.

NO >> Replace parts whose air bag system has a malfunction.

AV BRANCH LINE CIRCUIT

< COMPONENT DIAGNOSIS >

[CAN]

AV BRANCH LINE CIRCUIT

Diagnosis Procedure

INFOID:000000001666029

1. CHECK CONNECTOR

1. Turn the ignition switch OFF.
2. Disconnect the battery cable from the negative terminal.
3. Check the terminals and connectors of the AV control unit for damage, bend and loose connection (unit side and connector side).

Is the inspection result normal?

- YES >> GO TO 2.
NO >> Repair the terminal and connector.

2. CHECK HARNESS FOR OPEN CIRCUIT

1. Disconnect the connector of AV control unit.
 2. Check the resistance between the AV control unit harness connector terminals.
- Models with NAVI

AV control unit harness connector			Resistance (Ω)
Connector No.	Terminal No.		
M87	52	53	Approx. 54 – 66

- Models without NAVI

AV control unit harness connector			Resistance (Ω)
Connector No.	Terminal No.		
M85	86	87	Approx. 54 – 66

Is the measurement value within the specification?

- YES >> GO TO 3.
NO >> Repair the AV control unit branch line.

3. CHECK POWER SUPPLY AND GROUND CIRCUIT

Check the power supply and the ground circuit of the AV control unit. Refer to the following.

- Base audio without navigation: [AV-39, "AV CONTROL UNIT : Diagnosis Procedure"](#)
- BOSE audio without navigation: [AV-160, "AV CONTROL UNIT : Diagnosis Procedure"](#)
- BOSE audio with navigation: [AV-433, "AV CONTROL UNIT : Diagnosis Procedure"](#)

Is the inspection result normal?

- YES (Present error)>>Replace the AV control unit. Refer to the following.
- Base audio without navigation: [AV-109, "Exploded View"](#)
 - BOSE audio without navigation: [AV-343, "Exploded View"](#)
 - BOSE audio with navigation: [AV-608, "Exploded View"](#)

YES (Past error)>>Error was detected in the AV control unit branch line.

- NO >> Repair the power supply and the ground circuit.

BCM BRANCH LINE CIRCUIT

< COMPONENT DIAGNOSIS >

[CAN]

BCM BRANCH LINE CIRCUIT

Diagnosis Procedure

INFOID:000000001666030

1. CHECK CONNECTOR

1. Turn the ignition switch OFF.
2. Disconnect the battery cable from the negative terminal.
3. Check the terminals and connectors of the BCM for damage, bend and loose connection (unit side and connector side).

Is the inspection result normal?

- YES >> GO TO 2.
NO >> Repair the terminal and connector.

2. CHECK HARNESS FOR OPEN CIRCUIT

1. Disconnect the connector of BCM.
2. Check the resistance between the BCM harness connector terminals.

BCM harness connector			Resistance (Ω)
Connector No.	Terminal No.		
M122	91	90	Approx. 54 – 66

Is the measurement value within the specification?

- YES >> GO TO 3.
NO >> Repair the BCM branch line.

3. CHECK POWER SUPPLY AND GROUND CIRCUIT

Check the power supply and the ground circuit of the BCM. Refer to [BCS-38. "Diagnosis Procedure"](#).

Is the inspection result normal?

- YES (Present error)>>Replace the BCM. Refer to [BCS-79. "Exploded View"](#).
YES (Past error)>>Error was detected in the BCM branch line.
NO >> Repair the power supply and the ground circuit.

PSB BRANCH LINE CIRCUIT

< COMPONENT DIAGNOSIS >

[CAN]

PSB BRANCH LINE CIRCUIT

Diagnosis Procedure

INFOID:000000001666027

1. CHECK CONNECTOR

1. Turn the ignition switch OFF.
2. Disconnect the battery cable from the negative terminal.
3. Check the terminals and connectors of the pre-crash seat belt for damage, bend and loose connection (unit side and connector side).

Is the inspection result normal?

- YES >> GO TO 2.
NO >> Repair the terminal and connector.

2. CHECK HARNESS FOR OPEN CIRCUIT

1. Disconnect the connector of pre-crash seat belt control unit.
2. Check the resistance between the pre-crash seat belt control unit harness connector terminals.

Pre-crash seat belt control unit harness connector			Resistance (Ω)
Connector No.	Terminal No.		
M110	24	22	Approx. 54 – 66

Is the measurement value within the specification?

- YES >> GO TO 3.
NO >> Repair the pre-crash seat belt control unit branch line.

3. CHECK POWER SUPPLY AND GROUND CIRCUIT

Check the power supply and the ground circuit of the pre-crash seat belt control unit. Refer to the following.

- Power supply circuit: [SBC-27, "Component Function Check"](#)
- Ground circuit: [SBC-28, "Component Function Check"](#)

Is the inspection result normal?

- YES (Present error)>>Replace the pre-crash seat belt control unit. Refer to [SBC-40, "Exploded View"](#).
YES (Past error)>>Error was detected in the pre-crash seat belt control unit branch line.
NO >> Repair the power supply and the ground circuit.

A
B
C
D
E
F
G
H
I
J
K
L

LAN

N
O
P

TCM BRANCH LINE CIRCUIT

< COMPONENT DIAGNOSIS >

[CAN]

TCM BRANCH LINE CIRCUIT

Diagnosis Procedure

INFOID:000000001666031

1. CHECK CONNECTOR

1. Turn the ignition switch OFF.
2. Disconnect the battery cable from the negative terminal.
3. Check the following terminals and connectors for damage, bend and loose connection (unit side and connector side).
 - A/T assembly
 - Harness connector F103
 - Harness connector M116

Is the inspection result normal?

YES >> GO TO 2.

NO >> Repair the terminal and connector.

2. CHECK HARNESS FOR OPEN CIRCUIT

1. Disconnect the connector of A/T assembly.
2. Check the resistance between the A/T assembly harness connector terminals.

A/T assembly harness connector			Resistance (Ω)
Connector No.	Terminal No.		
F51	3	8	Approx. 54 – 66

Is the measurement value within the specification?

YES >> GO TO 3.

NO >> Repair the TCM branch line.

3. CHECK POWER SUPPLY AND GROUND CIRCUIT

Check the power supply and the ground circuit of the TCM. Refer to [TM-163, "Diagnosis Procedure"](#).

Is the inspection result normal?

YES (Present error)>>Replace the control valve with TCM. Refer to [TM-232, "Exploded View"](#).

YES (Past error)>>Error was detected in the TCM branch line.

NO >> Repair the power supply and the ground circuit.

AFS BRANCH LINE CIRCUIT

< COMPONENT DIAGNOSIS >

[CAN]

AFS BRANCH LINE CIRCUIT

Diagnosis Procedure

INFOID:000000001666032

1.CHECK CONNECTOR

1. Turn the ignition switch OFF.
2. Disconnect the battery cable from the negative terminal.
3. Check the terminals and connectors of the AFS control unit for damage, bend and loose connection (unit side and connector side).

Is the inspection result normal?

- YES >> GO TO 2.
NO >> Repair the terminal and connector.

2.CHECK HARNESS FOR OPEN CIRCUIT

1. Disconnect the connector of AFS control unit.
2. Check the resistance between the AFS control unit harness connector terminals.

AFS control unit harness connector			Resistance (Ω)
Connector No.	Terminal No.		
M16	30	7	Approx. 54 – 66

Is the measurement value within the specification?

- YES >> GO TO 3.
NO >> Repair the AFS control unit branch line.

3.CHECK POWER SUPPLY AND GROUND CIRCUIT

Check the power supply and the ground circuit of the AFS control unit. Refer to [EXL-61, "AFS CONTROL UNIT : Diagnosis Procedure"](#).

Is the inspection result normal?

- YES (Present error)>>Replace the AFS control unit. Refer to [EXL-196, "Exploded View"](#).
YES (Past error)>>Error was detected in the AFS control unit branch line.
NO >> Repair the power supply and the ground circuit.

A
B
C
D
E
F
G
H
I
J
K
L

LAN

N
O
P

DLC BRANCH LINE CIRCUIT

< COMPONENT DIAGNOSIS >

[CAN]

DLC BRANCH LINE CIRCUIT

Diagnosis Procedure

INFOID:000000001666033

1. CHECK CONNECTOR

1. Turn the ignition switch OFF.
2. Disconnect the battery cable from the negative terminal.
3. Check the terminals and connectors of the data link connector for damage, bend and loose connection (connector side and harness side).

Is the inspection result normal?

- YES >> GO TO 2.
NO >> Repair the terminal and connector.

2. CHECK HARNESS FOR OPEN CIRCUIT

Check the resistance between the data link connector terminals.

Data link connector			Resistance (Ω)
Connector No.	Terminal No.		
M24	6	14	Approx. 54 – 66

Is the measurement value within the specification?

- YES (Present error)>>Check the decision of CAN system type again.
YES (Past error)>>Error was detected in the data link connector branch line circuit.
NO >> Repair the data link connector branch line.

M&A BRANCH LINE CIRCUIT

< COMPONENT DIAGNOSIS >

[CAN]

M&A BRANCH LINE CIRCUIT

Diagnosis Procedure

INFOID:000000001666034

1. CHECK CONNECTOR

1. Turn the ignition switch OFF.
2. Disconnect the battery cable from the negative terminal.
3. Check the terminals and connectors of the unified meter and A/C amp. for damage, bend and loose connection (unit side and connector side).

Is the inspection result normal?

- YES >> GO TO 2.
NO >> Repair the terminal and connector.

2. CHECK HARNESS FOR OPEN CIRCUIT

1. Disconnect the connector of unified meter and A/C amp.
2. Check the resistance between the unified meter and A/C amp. harness connector terminals.

Unified meter and A/C amp. harness connector			Resistance (Ω)
Connector No.	Terminal No.		
M67	56	72	Approx. 54 – 66

Is the measurement value within the specification?

- YES >> GO TO 3.
NO >> Repair the unified meter and A/C amp. branch line.

3. CHECK POWER SUPPLY AND GROUND CIRCUIT

Check the power supply and the ground circuit of the unified meter and A/C amp. Refer to [MWI-50, "UNIFIED METER AND A/C AMP. : Diagnosis Procedure"](#).

Is the inspection result normal?

- YES (Present error)>>Replace the unified meter and A/C amp. Refer to [MWI-162, "Exploded View"](#).
YES (Past error)>>Error was detected in the unified meter and A/C amp. branch line.
NO >> Repair the power supply and the ground circuit.

A
B
C
D
E
F
G
H
I
J
K
L

LAN

N
O
P

STRG BRANCH LINE CIRCUIT

< COMPONENT DIAGNOSIS >

[CAN]

STRG BRANCH LINE CIRCUIT

Diagnosis Procedure

INFOID:000000001666035

1. CHECK CONNECTOR

1. Turn the ignition switch OFF.
2. Disconnect the battery cable from the negative terminal.
3. Check the terminals and connectors of the steering angle sensor for damage, bend and loose connection (unit side and connector side).

Is the inspection result normal?

- YES >> GO TO 2.
NO >> Repair the terminal and connector.

2. CHECK HARNESS FOR OPEN CIRCUIT

1. Disconnect the connector of steering angle sensor.
2. Check the resistance between the steering angle sensor harness connector terminals.

Steering angle sensor harness connector			Resistance (Ω)
Connector No.	Terminal No.		
M37	1	2	Approx. 54 – 66

Is the measurement value within the specification?

- YES >> GO TO 3.
NO >> Repair the steering angle sensor branch line.

3. CHECK POWER SUPPLY AND GROUND CIRCUIT

Check the power supply and the ground circuit of the steering angle sensor. Refer to [BRC-83, "Wiring Diagram - BRAKE CONTROL SYSTEM -"](#).

Is the inspection result normal?

- YES (Present error)>>Replace the steering angle sensor. Refer to [BRC-105, "Exploded View"](#).
YES (Past error)>>Error was detected in the steering angle sensor branch line.
NO >> Repair the power supply and the ground circuit.

ADP BRANCH LINE CIRCUIT

< COMPONENT DIAGNOSIS >

[CAN]

ADP BRANCH LINE CIRCUIT

Diagnosis Procedure

INFOID:000000001666037

1. CHECK CONNECTOR

1. Turn the ignition switch OFF.
2. Disconnect the battery cable from the negative terminal.
3. Check the following terminals and connectors for damage, bend and loose connection (unit side and connector side).
 - Models with automatic drive positioner
 - Driver seat control unit
 - Harness connector B502
 - Harness connector B11
 - Models without automatic drive positioner
 - Driver seat control unit
 - Harness connector B501
 - Harness connector B10

Is the inspection result normal?

YES >> GO TO 2.

NO >> Repair the terminal and connector.

2. CHECK HARNESS FOR OPEN CIRCUIT

1. Disconnect the connector of driver seat control unit.
2. Check the resistance between the driver seat control unit harness connector terminals.

Driver seat control unit harness connector			Resistance (Ω)
Connector No.	Terminal No.		
B503	3	19	Approx. 54 – 66

Is the measurement value within the specification?

YES >> GO TO 3.

NO >> Repair the driver seat control unit branch line.

3. CHECK POWER SUPPLY AND GROUND CIRCUIT

Check the power supply and the ground circuit of the driver seat control unit. Refer to [ADP-63. "DRIVER SEAT CONTROL UNIT : Diagnosis Procedure"](#).

Is the inspection result normal?

YES (Present error)>>Replace the driver seat control unit. Refer to [ADP-236. "Exploded View"](#).

YES (Past error)>>Error was detected in the driver seat control unit branch line.

NO >> Repair the power supply and the ground circuit.

A
B
C
D
E
F
G
H
I
J
K
L
N
O
P

LAN

RAS BRANCH LINE CIRCUIT

< COMPONENT DIAGNOSIS >

[CAN]

RAS BRANCH LINE CIRCUIT

Diagnosis Procedure

INFOID:000000001666036

1. CHECK CONNECTOR

1. Turn the ignition switch OFF.
2. Disconnect the battery cable from the negative terminal.
3. Check the terminals and connectors of the 4WAS main control unit for damage, bend and loose connection (unit side and connector side).

Is the inspection result normal?

- YES >> GO TO 2.
NO >> Repair the terminal and connector.

2. CHECK HARNESS FOR OPEN CIRCUIT

1. Disconnect the connector of 4WAS main control unit.
2. Check the resistance between the 4WAS main control unit harness connector terminals.

4WAS main control unit harness connector			Resistance (Ω)
Connector No.	Terminal No.		
B54	1	8	Approx. 54 – 66

Is the measurement value within the specification?

- YES >> GO TO 3.
NO >> Repair the 4WAS main control unit branch line.

3. CHECK POWER SUPPLY AND GROUND CIRCUIT

Check the power supply and the ground circuit of the 4WAS main control unit. Refer to [STC-134, "Diagnosis Procedure \(4WAS Main Control Unit\)"](#).

Is the inspection result normal?

- YES (Present error)>>Replace the 4WAS main control unit. Refer to [STC-178, "Exploded View"](#).
YES (Past error)>>Error was detected in the 4WAS main control unit branch line.
NO >> Repair the power supply and the ground circuit.

ABS BRANCH LINE CIRCUIT

< COMPONENT DIAGNOSIS >

[CAN]

ABS BRANCH LINE CIRCUIT

Diagnosis Procedure

INFOID:000000001666038

1. CHECK CONNECTOR

1. Turn the ignition switch OFF.
2. Disconnect the battery cable from the negative terminal.
3. Check the terminals and connectors of the ABS actuator and electric unit (control unit) for damage, bend and loose connection (unit side and connector side).

Is the inspection result normal?

- YES >> GO TO 2.
NO >> Repair the terminal and connector.

2. CHECK HARNESS FOR OPEN CIRCUIT

1. Disconnect the connector of ABS actuator and electric unit (control unit).
2. Check the resistance between the ABS actuator and electric unit (control unit) harness connector terminals.

ABS actuator and electric unit (control unit) harness connector			Resistance (Ω)
Connector No.	Terminal No.		
E41	35	14	Approx. 54 – 66

Is the measurement value within the specification?

- YES >> GO TO 3.
NO >> Repair the ABS actuator and electric unit (control unit) branch line.

3. CHECK POWER SUPPLY AND GROUND CIRCUIT

Check the power supply and the ground circuit of the ABS actuator and electric unit (control unit). Refer to [BRC-37, "Diagnosis Procedure"](#).

Is the inspection result normal?

- YES (Present error)>>Replace the ABS actuator and electric unit (control unit). Refer to [BRC-102, "Exploded View"](#).
YES (Past error)>>Error was detected in the ABS actuator and electric unit (control unit) branch line.
NO >> Repair the power supply and the ground circuit.

A
B
C
D
E
F
G
H
I
J
K
L

LAN

ICC BRANCH LINE CIRCUIT

< COMPONENT DIAGNOSIS >

[CAN]

ICC BRANCH LINE CIRCUIT

Diagnosis Procedure

INFOID:000000001666039

1. CHECK CONNECTOR

1. Turn the ignition switch OFF.
2. Disconnect the battery cable from the negative terminal.
3. Check the terminals and connectors of the ICC sensor integrated unit for damage, bend and loose connection (unit side and connector side).

Is the inspection result normal?

- YES >> GO TO 2.
NO >> Repair the terminal and connector.

2. CHECK HARNESS FOR OPEN CIRCUIT

1. Disconnect the connector of ICC sensor integrated unit.
2. Check the resistance between the ICC sensor integrated unit harness connector terminals.

ICC sensor integrated unit harness connector			Resistance (Ω)
Connector No.	Terminal No.		
E67	3	6	Approx. 54 – 66

Is the measurement value within the specification?

- YES >> GO TO 3.
NO >> Repair the ICC sensor integrated unit branch line.

3. CHECK POWER SUPPLY AND GROUND CIRCUIT

Check the power supply and the ground circuit of the ICC sensor integrated unit. Refer to [CCS-81, "Diagnosis Procedure"](#).

Is the inspection result normal?

- YES (Present error)>>Replace the ICC sensor integrated unit. Refer to [CCS-111, "Exploded View"](#).
YES (Past error)>>Error was detected in the ICC sensor integrated unit branch line.
NO >> Repair the power supply and the ground circuit.

IPDM-E BRANCH LINE CIRCUIT

< COMPONENT DIAGNOSIS >

[CAN]

IPDM-E BRANCH LINE CIRCUIT

Diagnosis Procedure

INFOID:000000001666040

1.CHECK CONNECTOR

1. Turn the ignition switch OFF.
2. Disconnect the battery cable from the negative terminal.
3. Check the terminals and connectors of the IPDM E/R for damage, bend and loose connection (unit side and connector side).

Is the inspection result normal?

- YES >> GO TO 2.
NO >> Repair the terminal and connector.

2.CHECK HARNESS FOR OPEN CIRCUIT

1. Disconnect the connector of IPDM E/R.
2. Check the resistance between the IPDM E/R harness connector terminals.

IPDM E/R harness connector			Resistance (Ω)
Connector No.	Terminal No.		
E6	40	39	Approx. 108 – 132

Is the measurement value within the specification?

- YES >> GO TO 3.
NO >> Repair the IPDM E/R branch line.

3.CHECK POWER SUPPLY AND GROUND CIRCUIT

Check the power supply and the ground circuit of the IPDM E/R. Refer to [PCS-19, "Diagnosis Procedure"](#).

Is the inspection result normal?

- YES (Present error)>>Replace the IPDM E/R. Refer to [PCS-34, "Exploded View"](#).
YES (Past error)>>Error was detected in the IPDM E/R branch line.
NO >> Repair the power supply and the ground circuit.

A
B
C
D
E
F
G
H
I
J
K
L

LAN

N
O
P

CAN COMMUNICATION CIRCUIT

[CAN]

< COMPONENT DIAGNOSIS >

CAN COMMUNICATION CIRCUIT

Diagnosis Procedure

INFOID:000000001666041

1.CONNECTOR INSPECTION

1. Turn the ignition switch OFF.
2. Disconnect the battery cable from the negative terminal.
3. Disconnect all the unit connectors on CAN communication system.
4. Check terminals and connectors for damage, bend and loose connection.

Is the inspection result normal?

- YES >> GO TO 2.
NO >> Repair the terminal and connector.

2.CHECK HARNESS CONTINUITY (SHORT CIRCUIT)

Check the continuity between the data link connector terminals.

Data link connector			Continuity
Connector No.	Terminal No.		
M24	6	14	Not existed

Is the inspection result normal?

- YES >> GO TO 3.
NO >> Check the harness and repair the root cause.

3.CHECK HARNESS CONTINUITY (SHORT CIRCUIT)

Check the continuity between the data link connector and the ground.

Data link connector		Ground	Continuity
Connector No.	Terminal No.		
M24	6		Not existed
	14		Not existed

Is the inspection result normal?

- YES >> GO TO 4.
NO >> Check the harness and repair the root cause.

4.CHECK ECM AND IPDM E/R TERMINATION CIRCUIT

1. Remove the ECM and the IPDM E/R.
2. Check the resistance between the ECM terminals.

ECM		Resistance (Ω)
Terminal No.		
114	113	Approx. 108 – 132

3. Check the resistance between the IPDM E/R terminals.

IPDM E/R		Resistance (Ω)
Terminal No.		
40	39	Approx. 108 – 132

Is the measurement value within the specification?

- YES >> GO TO 5.
NO >> Replace the ECM and/or the IPDM E/R.

5.CHECK SYMPTOM

Connect all the connectors. Check if the symptoms described in the "Symptom (Results from interview with customer)" are reproduced.

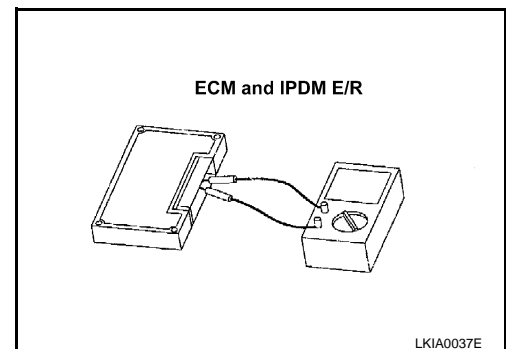

CAN COMMUNICATION CIRCUIT

[CAN]

< COMPONENT DIAGNOSIS >

Inspection result

Reproduced>>GO TO 6.

Non-reproduced>>Start the diagnosis again. Follow the trouble diagnosis procedure when past error is detected.

6.CHECK UNIT REPRODUCTION

Perform the reproduction test as per the following procedure for each unit.

1. Turn the ignition switch OFF.
2. Disconnect the battery cable from the negative terminal.
3. Disconnect one of the unit connectors of CAN communication system.

NOTE:

ECM and IPDM E/R have a termination circuit. Check other units first.

4. Connect the battery cable to the negative terminal. Check if the symptoms described in the "Symptom (Results from interview with customer)" are reproduced.

NOTE:

Although unit-related error symptoms occur, do not confuse them with other symptoms.

Inspection result

Reproduced>>Connect the connector. Check other units as per the above procedure.

Non-reproduced>>Replace the unit whose connector was disconnected.

A
B
C
D
E
F
G
H
I
J
K
L

LAN

N
O
P

MAIN LINE BETWEEN BCM AND DLC CIRCUIT

< COMPONENT DIAGNOSIS >

[CAN SYSTEM (TYPE 1)]

COMPONENT DIAGNOSIS

MAIN LINE BETWEEN BCM AND DLC CIRCUIT

Diagnosis Procedure

INFOID:000000001679385

INSPECTION PROCEDURE

1. CHECK HARNESS CONTINUITY (OPEN CIRCUIT)

1. Turn the ignition switch OFF.
2. Disconnect the battery cable from the negative terminal.
3. Disconnect the following harness connectors.
 - ECM
 - BCM
4. Check the continuity between the BCM harness connector and the data link connector.

BCM harness connector		Data link connector		Continuity
Connector No.	Terminal No.	Connector No.	Terminal No.	
M122	91	M24	6	Existed
	90		14	Existed

Is the inspection result normal?

YES (Present error)>>Check CAN system type decision again.

YES (Past error)>>Error was detected in the main line between the BCM and the data link connector.

NO >> Repair the main line between the BCM and the data link connector.

MAIN LINE BETWEEN DLC AND ADP CIRCUIT

< COMPONENT DIAGNOSIS >

[CAN SYSTEM (TYPE 1)]

MAIN LINE BETWEEN DLC AND ADP CIRCUIT

Diagnosis Procedure

INFOID:000000001679387

INSPECTION PROCEDURE

1. CHECK CONNECTOR

1. Turn the ignition switch OFF.
2. Disconnect the battery cable from the negative terminal.
3. Check the following terminals and connectors for damage, bend and loose connection (connector side and harness side).
 - Harness connector M7
 - Harness connector B1

Is the inspection result normal?

YES >> GO TO 2.

NO >> Repair the terminal and connector.

2. CHECK HARNESS CONTINUITY (OPEN CIRCUIT)

1. Disconnect the harness connectors M7 and B1.
2. Check the continuity between the data link connector and the harness connector.

Data link connector		Harness connector		Continuity
Connector No.	Terminal No.	Connector No.	Terminal No.	
M24	6	M7	20	Existed
	14		21	Existed

Is the inspection result normal?

YES >> GO TO 3.

NO >> Repair the main line between the data link connector and the harness connector M7.

3. CHECK HARNESS CONTINUITY (OPEN CIRCUIT)

Check the continuity between the harness connector terminals.

Connector No.	Terminal No.		Continuity
B1	20	22	Existed
	21	23	Existed

Is the inspection result normal?

YES (Present error)>>Check CAN system type decision again.

YES (Past error)>>Error was detected in the main line between the data link connector and the driver seat control unit.

NO >> Repair the main line between the harness connector B1 and the driver seat control unit.

MAIN LINE BETWEEN ADP AND ABS CIRCUIT

< COMPONENT DIAGNOSIS >

[CAN SYSTEM (TYPE 1)]

MAIN LINE BETWEEN ADP AND ABS CIRCUIT

Diagnosis Procedure

INFOID:000000001679389

1. CHECK CONNECTOR

1. Turn the ignition switch OFF.
2. Disconnect the battery cable from the negative terminal.
3. Check the following terminals and connectors for damage, bend and loose connection (connector side and harness side).
 - Harness connector B1
 - Harness connector M7
 - Harness connector M6
 - Harness connector E106

Is the inspection result normal?

YES >> GO TO 2.

NO >> Repair the terminal and connector.

2. CHECK HARNESS CONTINUITY (OPEN CIRCUIT)

1. Disconnect the harness connectors B1 and M7.
2. Check the continuity between the harness connector terminals.

Connector No.	Terminal No.		Continuity
B1	20	22	Existed
	21	23	Existed

Is the inspection result normal?

YES >> GO TO 3.

NO >> Repair the main line between the driver seat control unit and the harness connector B1.

3. CHECK HARNESS CONTINUITY (OPEN CIRCUIT)

1. Disconnect the harness connectors M6 and E106.
2. Check the continuity between the harness connectors.

Harness connector		Harness connector		Continuity
Connector No.	Terminal No.	Connector No.	Terminal No.	
M7	22	M6	9	Existed
	23		8	Existed

Is the inspection result normal?

YES >> GO TO 4.

NO >> Repair the main line between the harness connectors M7 and M6.

4. CHECK HARNESS CONTINUITY (OPEN CIRCUIT)

1. Disconnect the connector of ABS actuator and electric unit (control unit).
2. Check the continuity between the harness connector and the ABS actuator and electric unit (control unit) harness connector.

Harness connector		ABS actuator and electric unit (control unit) harness connector		Continuity
Connector No.	Terminal No.	Connector No.	Terminal No.	
E106	9	E41	35	Existed
	8		14	Existed

Is the inspection result normal?

YES (Present error)>>Check CAN system type decision again.

YES (Past error)>>Error was detected in the main line between the driver seat control unit and the ABS actuator and electric unit (control unit).

MAIN LINE BETWEEN ADP AND ABS CIRCUIT

< COMPONENT DIAGNOSIS >

[CAN SYSTEM (TYPE 1)]

NO >> Repair the main line between the harness connector E106 and the ABS actuator and electric unit (control unit).

A

B

C

D

E

F

G

H

I

J

K

L

LAN

N

O

P

ECM BRANCH LINE CIRCUIT

< COMPONENT DIAGNOSIS >

[CAN SYSTEM (TYPE 1)]

ECM BRANCH LINE CIRCUIT

Diagnosis Procedure

INFOID:000000001679391

1. CHECK CONNECTOR

1. Turn the ignition switch OFF.
2. Disconnect the battery cable from the negative terminal.
3. Check the terminals and connectors of the ECM for damage, bend and loose connection (unit side and connector side).

Is the inspection result normal?

- YES >> GO TO 2.
NO >> Repair the terminal and connector.

2. CHECK HARNESS FOR OPEN CIRCUIT

1. Disconnect the connector of ECM.
2. Check the resistance between the ECM harness connector terminals.

ECM harness connector			Resistance (Ω)
Connector No.	Terminal No.		
M107	114	113	Approx. 108 – 132

Is the measurement value within the specification?

- YES >> GO TO 3.
NO >> Repair the ECM branch line.

3. CHECK POWER SUPPLY AND GROUND CIRCUIT

Check the power supply and the ground circuit of the ECM. Refer to [EC-140, "Diagnosis Procedure"](#).

Is the inspection result normal?

YES (Present error)>>Replace the ECM. Refer to [EC-16, "ADDITIONAL SERVICE WHEN REPLACING CONTROL UNIT \(ECM\) : Special Repair Requirement"](#).

YES (Past error)>>Error was detected in the ECM branch line.

NO >> Repair the power supply and the ground circuit.

A-BAG BRANCH LINE CIRCUIT

< COMPONENT DIAGNOSIS >

[CAN SYSTEM (TYPE 1)]

A-BAG BRANCH LINE CIRCUIT

Diagnosis Procedure

INFOID:000000001679392

1. CHECK AIR BAG DIAGNOSIS SENSOR UNIT

Check the air bag diagnosis sensor unit. Refer to [SRC-5, "Work Flow"](#).

Is the inspection result normal?

YES >> Replace the main harness.

NO >> Replace parts whose air bag system has a malfunction.

A
B
C
D
E
F
G
H
I
J
K
L
N
O
P

LAN

AV BRANCH LINE CIRCUIT

Diagnosis Procedure

INFOID:000000001679393

1. CHECK CONNECTOR

1. Turn the ignition switch OFF.
2. Disconnect the battery cable from the negative terminal.
3. Check the terminals and connectors of the AV control unit for damage, bend and loose connection (unit side and connector side).

Is the inspection result normal?

- YES >> GO TO 2.
 NO >> Repair the terminal and connector.

2. CHECK HARNESS FOR OPEN CIRCUIT

1. Disconnect the connector of AV control unit.
 2. Check the resistance between the AV control unit harness connector terminals.
- Models with NAVI

AV control unit harness connector			Resistance (Ω)
Connector No.	Terminal No.		
M87	52	53	Approx. 54 – 66

- Models without NAVI

AV control unit harness connector			Resistance (Ω)
Connector No.	Terminal No.		
M85	86	87	Approx. 54 – 66

Is the measurement value within the specification?

- YES >> GO TO 3.
 NO >> Repair the AV control unit branch line.

3. CHECK POWER SUPPLY AND GROUND CIRCUIT

Check the power supply and the ground circuit of the AV control unit. Refer to the following.

- Base audio without navigation: [AV-39. "AV CONTROL UNIT : Diagnosis Procedure"](#)
- BOSE audio without navigation: [AV-160. "AV CONTROL UNIT : Diagnosis Procedure"](#)
- BOSE audio with navigation: [AV-433. "AV CONTROL UNIT : Diagnosis Procedure"](#)

Is the inspection result normal?

- YES (Present error)>>Replace the AV control unit. Refer to the following.
- Base audio without navigation: [AV-109. "Exploded View"](#)
 - BOSE audio without navigation: [AV-343. "Exploded View"](#)
 - BOSE audio with navigation: [AV-608. "Exploded View"](#)

YES (Past error)>>Error was detected in the AV control unit branch line.

- NO >> Repair the power supply and the ground circuit.

BCM BRANCH LINE CIRCUIT

< COMPONENT DIAGNOSIS >

[CAN SYSTEM (TYPE 1)]

BCM BRANCH LINE CIRCUIT

Diagnosis Procedure

INFOID:000000001679394

1.CHECK CONNECTOR

1. Turn the ignition switch OFF.
2. Disconnect the battery cable from the negative terminal.
3. Check the terminals and connectors of the BCM for damage, bend and loose connection (unit side and connector side).

Is the inspection result normal?

- YES >> GO TO 2.
NO >> Repair the terminal and connector.

2.CHECK HARNESS FOR OPEN CIRCUIT

1. Disconnect the connector of BCM.
2. Check the resistance between the BCM harness connector terminals.

BCM harness connector			Resistance (Ω)
Connector No.	Terminal No.		
M122	91	90	Approx. 54 – 66

Is the measurement value within the specification?

- YES >> GO TO 3.
NO >> Repair the BCM branch line.

3.CHECK POWER SUPPLY AND GROUND CIRCUIT

Check the power supply and the ground circuit of the BCM. Refer to [BCS-38, "Diagnosis Procedure"](#).

Is the inspection result normal?

- YES (Present error)>>Replace the BCM. Refer to [BCS-79, "Exploded View"](#).
YES (Past error)>>Error was detected in the BCM branch line.
NO >> Repair the power supply and the ground circuit.

A
B
C
D
E
F
G
H
I
J
K
L

LAN

N
O
P

DLC BRANCH LINE CIRCUIT

< COMPONENT DIAGNOSIS >

[CAN SYSTEM (TYPE 1)]

DLC BRANCH LINE CIRCUIT

Diagnosis Procedure

INFOID:000000001679398

1. CHECK CONNECTOR

1. Turn the ignition switch OFF.
2. Disconnect the battery cable from the negative terminal.
3. Check the terminals and connectors of the data link connector for damage, bend and loose connection (connector side and harness side).

Is the inspection result normal?

- YES >> GO TO 2.
NO >> Repair the terminal and connector.

2. CHECK HARNESS FOR OPEN CIRCUIT

Check the resistance between the data link connector terminals.

Data link connector			Resistance (Ω)
Connector No.	Terminal No.		
M24	6	14	Approx. 54 – 66

Is the measurement value within the specification?

- YES (Present error)>>Check the decision of CAN system type again.
YES (Past error)>>Error was detected in the data link connector branch line circuit.
NO >> Repair the data link connector branch line.

M&A BRANCH LINE CIRCUIT

< COMPONENT DIAGNOSIS >

[CAN SYSTEM (TYPE 1)]

M&A BRANCH LINE CIRCUIT

Diagnosis Procedure

INFOID:000000001679399

1. CHECK CONNECTOR

1. Turn the ignition switch OFF.
2. Disconnect the battery cable from the negative terminal.
3. Check the terminals and connectors of the unified meter and A/C amp. for damage, bend and loose connection (unit side and connector side).

Is the inspection result normal?

- YES >> GO TO 2.
NO >> Repair the terminal and connector.

2. CHECK HARNESS FOR OPEN CIRCUIT

1. Disconnect the connector of unified meter and A/C amp.
2. Check the resistance between the unified meter and A/C amp. harness connector terminals.

Unified meter and A/C amp. harness connector			Resistance (Ω)
Connector No.	Terminal No.		
M67	56	72	Approx. 54 – 66

Is the measurement value within the specification?

- YES >> GO TO 3.
NO >> Repair the unified meter and A/C amp. branch line.

3. CHECK POWER SUPPLY AND GROUND CIRCUIT

Check the power supply and the ground circuit of the unified meter and A/C amp. Refer to [MWI-50, "UNIFIED METER AND A/C AMP. : Diagnosis Procedure"](#).

Is the inspection result normal?

- YES (Present error)>>Replace the unified meter and A/C amp. Refer to [MWI-162, "Exploded View"](#).
YES (Past error)>>Error was detected in the unified meter and A/C amp. branch line.
NO >> Repair the power supply and the ground circuit.

A
B
C
D
E
F
G
H
I
J
K
L

LAN

N
O
P

STRG BRANCH LINE CIRCUIT

< COMPONENT DIAGNOSIS >

[CAN SYSTEM (TYPE 1)]

STRG BRANCH LINE CIRCUIT

Diagnosis Procedure

INFOID:000000001679400

1. CHECK CONNECTOR

1. Turn the ignition switch OFF.
2. Disconnect the battery cable from the negative terminal.
3. Check the terminals and connectors of the steering angle sensor for damage, bend and loose connection (unit side and connector side).

Is the inspection result normal?

- YES >> GO TO 2.
NO >> Repair the terminal and connector.

2. CHECK HARNESS FOR OPEN CIRCUIT

1. Disconnect the connector of steering angle sensor.
2. Check the resistance between the steering angle sensor harness connector terminals.

Steering angle sensor harness connector			Resistance (Ω)
Connector No.	Terminal No.		
M37	1	2	Approx. 54 – 66

Is the measurement value within the specification?

- YES >> GO TO 3.
NO >> Repair the steering angle sensor branch line.

3. CHECK POWER SUPPLY AND GROUND CIRCUIT

Check the power supply and the ground circuit of the steering angle sensor. Refer to [BRC-83, "Wiring Diagram - BRAKE CONTROL SYSTEM -"](#).

Is the inspection result normal?

- YES (Present error)>>Replace the steering angle sensor. Refer to [BRC-105, "Exploded View"](#).
YES (Past error)>>Error was detected in the steering angle sensor branch line.
NO >> Repair the power supply and the ground circuit.

ADP BRANCH LINE CIRCUIT

< COMPONENT DIAGNOSIS >

[CAN SYSTEM (TYPE 1)]

ADP BRANCH LINE CIRCUIT

Diagnosis Procedure

INFOID:000000001679401

1. CHECK CONNECTOR

1. Turn the ignition switch OFF.
2. Disconnect the battery cable from the negative terminal.
3. Check the following terminals and connectors for damage, bend and loose connection (unit side and connector side).
 - Models with automatic drive positioner
 - Driver seat control unit
 - Harness connector B502
 - Harness connector B11
 - Models without automatic drive positioner
 - Driver seat control unit
 - Harness connector B501
 - Harness connector B10

Is the inspection result normal?

YES >> GO TO 2.

NO >> Repair the terminal and connector.

2. CHECK HARNESS FOR OPEN CIRCUIT

1. Disconnect the connector of driver seat control unit.
2. Check the resistance between the driver seat control unit harness connector terminals.

Driver seat control unit harness connector			Resistance (Ω)
Connector No.	Terminal No.		
B503	3	19	Approx. 54 – 66

Is the measurement value within the specification?

YES >> GO TO 3.

NO >> Repair the driver seat control unit branch line.

3. CHECK POWER SUPPLY AND GROUND CIRCUIT

Check the power supply and the ground circuit of the driver seat control unit. Refer to [ADP-63. "DRIVER SEAT CONTROL UNIT : Diagnosis Procedure"](#).

Is the inspection result normal?

YES (Present error)>>Replace the driver seat control unit. Refer to [ADP-236. "Exploded View"](#).

YES (Past error)>>Error was detected in the driver seat control unit branch line.

NO >> Repair the power supply and the ground circuit.

A
B
C
D
E
F
G
H
I
J
K
L
N
O
P

LAN

ABS BRANCH LINE CIRCUIT

< COMPONENT DIAGNOSIS >

[CAN SYSTEM (TYPE 1)]

ABS BRANCH LINE CIRCUIT

Diagnosis Procedure

INFOID:000000001679403

1. CHECK CONNECTOR

1. Turn the ignition switch OFF.
2. Disconnect the battery cable from the negative terminal.
3. Check the terminals and connectors of the ABS actuator and electric unit (control unit) for damage, bend and loose connection (unit side and connector side).

Is the inspection result normal?

- YES >> GO TO 2.
NO >> Repair the terminal and connector.

2. CHECK HARNESS FOR OPEN CIRCUIT

1. Disconnect the connector of ABS actuator and electric unit (control unit).
2. Check the resistance between the ABS actuator and electric unit (control unit) harness connector terminals.

ABS actuator and electric unit (control unit) harness connector			Resistance (Ω)
Connector No.	Terminal No.		
E41	35	14	Approx. 54 – 66

Is the measurement value within the specification?

- YES >> GO TO 3.
NO >> Repair the ABS actuator and electric unit (control unit) branch line.

3. CHECK POWER SUPPLY AND GROUND CIRCUIT

Check the power supply and the ground circuit of the ABS actuator and electric unit (control unit). Refer to [BRC-37. "Diagnosis Procedure"](#).

Is the inspection result normal?

- YES (Present error)>>Replace the ABS actuator and electric unit (control unit). Refer to [BRC-102. "Exploded View"](#).
YES (Past error)>>Error was detected in the ABS actuator and electric unit (control unit) branch line.
NO >> Repair the power supply and the ground circuit.

IPDM-E BRANCH LINE CIRCUIT

< COMPONENT DIAGNOSIS >

[CAN SYSTEM (TYPE 1)]

IPDM-E BRANCH LINE CIRCUIT

Diagnosis Procedure

INFOID:000000001679405

1. CHECK CONNECTOR

1. Turn the ignition switch OFF.
2. Disconnect the battery cable from the negative terminal.
3. Check the terminals and connectors of the IPDM E/R for damage, bend and loose connection (unit side and connector side).

Is the inspection result normal?

- YES >> GO TO 2.
NO >> Repair the terminal and connector.

2. CHECK HARNESS FOR OPEN CIRCUIT

1. Disconnect the connector of IPDM E/R.
2. Check the resistance between the IPDM E/R harness connector terminals.

IPDM E/R harness connector			Resistance (Ω)
Connector No.	Terminal No.		
E6	40	39	Approx. 108 – 132

Is the measurement value within the specification?

- YES >> GO TO 3.
NO >> Repair the IPDM E/R branch line.

3. CHECK POWER SUPPLY AND GROUND CIRCUIT

Check the power supply and the ground circuit of the IPDM E/R. Refer to [PCS-19, "Diagnosis Procedure"](#).

Is the inspection result normal?

- YES (Present error)>>Replace the IPDM E/R. Refer to [PCS-34, "Exploded View"](#).
YES (Past error)>>Error was detected in the IPDM E/R branch line.
NO >> Repair the power supply and the ground circuit.

A
B
C
D
E
F
G
H
I
J
K
L

LAN

N
O
P

CAN COMMUNICATION CIRCUIT

< COMPONENT DIAGNOSIS >

[CAN SYSTEM (TYPE 1)]

CAN COMMUNICATION CIRCUIT

Diagnosis Procedure

INFOID:000000001679406

1. CONNECTOR INSPECTION

1. Turn the ignition switch OFF.
2. Disconnect the battery cable from the negative terminal.
3. Disconnect all the unit connectors on CAN communication system.
4. Check terminals and connectors for damage, bend and loose connection.

Is the inspection result normal?

- YES >> GO TO 2.
NO >> Repair the terminal and connector.

2. CHECK HARNESS CONTINUITY (SHORT CIRCUIT)

Check the continuity between the data link connector terminals.

Data link connector		Continuity
Connector No.	Terminal No.	
M24	6 14	Not existed

Is the inspection result normal?

- YES >> GO TO 3.
NO >> Check the harness and repair the root cause.

3. CHECK HARNESS CONTINUITY (SHORT CIRCUIT)

Check the continuity between the data link connector and the ground.

Data link connector		Ground	Continuity
Connector No.	Terminal No.		
M24	6		Not existed
	14		Not existed

Is the inspection result normal?

- YES >> GO TO 4.
NO >> Check the harness and repair the root cause.

4. CHECK ECM AND IPDM E/R TERMINATION CIRCUIT

1. Remove the ECM and the IPDM E/R.
2. Check the resistance between the ECM terminals.

ECM		Resistance (Ω)
Terminal No.		
114	113	Approx. 108 – 132

3. Check the resistance between the IPDM E/R terminals.

IPDM E/R		Resistance (Ω)
Terminal No.		
40	39	Approx. 108 – 132

Is the measurement value within the specification?

- YES >> GO TO 5.
NO >> Replace the ECM and/or the IPDM E/R.

5. CHECK SYMPTOM

Connect all the connectors. Check if the symptoms described in the "Symptom (Results from interview with customer)" are reproduced.

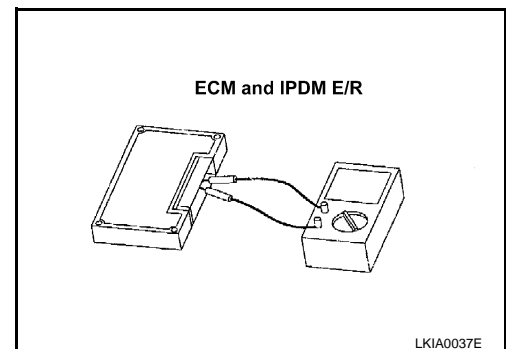

CAN COMMUNICATION CIRCUIT

< COMPONENT DIAGNOSIS >

[CAN SYSTEM (TYPE 1)]

Inspection result

Reproduced>>GO TO 6.

Non-reproduced>>Start the diagnosis again. Follow the trouble diagnosis procedure when past error is detected.

6.CHECK UNIT REPRODUCTION

Perform the reproduction test as per the following procedure for each unit.

1. Turn the ignition switch OFF.
2. Disconnect the battery cable from the negative terminal.
3. Disconnect one of the unit connectors of CAN communication system.

NOTE:

ECM and IPDM E/R have a termination circuit. Check other units first.

4. Connect the battery cable to the negative terminal. Check if the symptoms described in the "Symptom (Results from interview with customer)" are reproduced.

NOTE:

Although unit-related error symptoms occur, do not confuse them with other symptoms.

Inspection result

Reproduced>>Connect the connector. Check other units as per the above procedure.

Non-reproduced>>Replace the unit whose connector was disconnected.

A
B
C
D
E
F
G
H
I
J
K
L

LAN

N
O
P

MAIN LINE BETWEEN BCM AND DLC CIRCUIT

< COMPONENT DIAGNOSIS >

[CAN SYSTEM (TYPE 2)]

COMPONENT DIAGNOSIS

MAIN LINE BETWEEN BCM AND DLC CIRCUIT

Diagnosis Procedure

INFOID:000000001679414

INSPECTION PROCEDURE

1. CHECK HARNESS CONTINUITY (OPEN CIRCUIT)

1. Turn the ignition switch OFF.
2. Disconnect the battery cable from the negative terminal.
3. Disconnect the following harness connectors.
 - ECM
 - BCM
4. Check the continuity between the BCM harness connector and the data link connector.

BCM harness connector		Data link connector		Continuity
Connector No.	Terminal No.	Connector No.	Terminal No.	
M122	91	M24	6	Existed
	90		14	Existed

Is the inspection result normal?

YES (Present error)>>Check CAN system type decision again.

YES (Past error)>>Error was detected in the main line between the BCM and the data link connector.

NO >> Repair the main line between the BCM and the data link connector.

MAIN LINE BETWEEN DLC AND ADP CIRCUIT

< COMPONENT DIAGNOSIS >

[CAN SYSTEM (TYPE 2)]

MAIN LINE BETWEEN DLC AND ADP CIRCUIT

Diagnosis Procedure

INFOID:000000001679416

INSPECTION PROCEDURE

1. CHECK CONNECTOR

1. Turn the ignition switch OFF.
2. Disconnect the battery cable from the negative terminal.
3. Check the following terminals and connectors for damage, bend and loose connection (connector side and harness side).
 - Harness connector M7
 - Harness connector B1

Is the inspection result normal?

YES >> GO TO 2.

NO >> Repair the terminal and connector.

2. CHECK HARNESS CONTINUITY (OPEN CIRCUIT)

1. Disconnect the harness connectors M7 and B1.
2. Check the continuity between the data link connector and the harness connector.

Data link connector		Harness connector		Continuity
Connector No.	Terminal No.	Connector No.	Terminal No.	
M24	6	M7	20	Existed
	14		21	Existed

Is the inspection result normal?

YES >> GO TO 3.

NO >> Repair the main line between the data link connector and the harness connector M7.

3. CHECK HARNESS CONTINUITY (OPEN CIRCUIT)

Check the continuity between the harness connector terminals.

Connector No.	Terminal No.		Continuity
B1	20	22	Existed
	21	23	Existed

Is the inspection result normal?

YES (Present error)>>Check CAN system type decision again.

YES (Past error)>>Error was detected in the main line between the data link connector and the driver seat control unit.

NO >> Repair the main line between the harness connector B1 and the driver seat control unit.

A
B
C
D
E
F
G
H
I
J
K
L
N
O
P

LAN

MAIN LINE BETWEEN ADP AND ABS CIRCUIT

< COMPONENT DIAGNOSIS >

[CAN SYSTEM (TYPE 2)]

MAIN LINE BETWEEN ADP AND ABS CIRCUIT

Diagnosis Procedure

INFOID:000000001679418

1. CHECK CONNECTOR

1. Turn the ignition switch OFF.
2. Disconnect the battery cable from the negative terminal.
3. Check the following terminals and connectors for damage, bend and loose connection (connector side and harness side).
 - Harness connector B1
 - Harness connector M7
 - Harness connector M6
 - Harness connector E106

Is the inspection result normal?

YES >> GO TO 2.

NO >> Repair the terminal and connector.

2. CHECK HARNESS CONTINUITY (OPEN CIRCUIT)

1. Disconnect the harness connectors B1 and M7.
2. Check the continuity between the harness connector terminals.

Connector No.	Terminal No.		Continuity
B1	20	22	Existed
	21	23	Existed

Is the inspection result normal?

YES >> GO TO 3.

NO >> Repair the main line between the driver seat control unit and the harness connector B1.

3. CHECK HARNESS CONTINUITY (OPEN CIRCUIT)

1. Disconnect the harness connectors M6 and E106.
2. Check the continuity between the harness connectors.

Harness connector		Harness connector		Continuity
Connector No.	Terminal No.	Connector No.	Terminal No.	
M7	22	M6	9	Existed
	23		8	Existed

Is the inspection result normal?

YES >> GO TO 4.

NO >> Repair the main line between the harness connectors M7 and M6.

4. CHECK HARNESS CONTINUITY (OPEN CIRCUIT)

1. Disconnect the connector of ABS actuator and electric unit (control unit).
2. Check the continuity between the harness connector and the ABS actuator and electric unit (control unit) harness connector.

Harness connector		ABS actuator and electric unit (control unit) harness connector		Continuity
Connector No.	Terminal No.	Connector No.	Terminal No.	
E106	9	E41	35	Existed
	8		14	Existed

Is the inspection result normal?

YES (Present error)>>Check CAN system type decision again.

YES (Past error)>>Error was detected in the main line between the driver seat control unit and the ABS actuator and electric unit (control unit).

MAIN LINE BETWEEN ADP AND ABS CIRCUIT

< COMPONENT DIAGNOSIS >

[CAN SYSTEM (TYPE 2)]

NO >> Repair the main line between the harness connector E106 and the ABS actuator and electric unit (control unit).

A

B

C

D

E

F

G

H

I

J

K

L

LAN

N

O

P

ECM BRANCH LINE CIRCUIT

< COMPONENT DIAGNOSIS >

[CAN SYSTEM (TYPE 2)]

ECM BRANCH LINE CIRCUIT

Diagnosis Procedure

INFOID:000000001679420

1. CHECK CONNECTOR

1. Turn the ignition switch OFF.
2. Disconnect the battery cable from the negative terminal.
3. Check the terminals and connectors of the ECM for damage, bend and loose connection (unit side and connector side).

Is the inspection result normal?

- YES >> GO TO 2.
NO >> Repair the terminal and connector.

2. CHECK HARNESS FOR OPEN CIRCUIT

1. Disconnect the connector of ECM.
2. Check the resistance between the ECM harness connector terminals.

ECM harness connector			Resistance (Ω)
Connector No.	Terminal No.		
M107	114	113	Approx. 108 – 132

Is the measurement value within the specification?

- YES >> GO TO 3.
NO >> Repair the ECM branch line.

3. CHECK POWER SUPPLY AND GROUND CIRCUIT

Check the power supply and the ground circuit of the ECM. Refer to [EC-140, "Diagnosis Procedure"](#).

Is the inspection result normal?

YES (Present error)>>Replace the ECM. Refer to [EC-16, "ADDITIONAL SERVICE WHEN REPLACING CONTROL UNIT \(ECM\) : Special Repair Requirement"](#).

YES (Past error)>>Error was detected in the ECM branch line.

NO >> Repair the power supply and the ground circuit.

A-BAG BRANCH LINE CIRCUIT

< COMPONENT DIAGNOSIS >

[CAN SYSTEM (TYPE 2)]

A-BAG BRANCH LINE CIRCUIT

Diagnosis Procedure

INFOID:000000001679421

1. CHECK AIR BAG DIAGNOSIS SENSOR UNIT

Check the air bag diagnosis sensor unit. Refer to [SRC-5, "Work Flow"](#).

Is the inspection result normal?

YES >> Replace the main harness.

NO >> Replace parts whose air bag system has a malfunction.

A
B
C
D
E
F
G
H
I
J
K
L
N
O
P

LAN

AV BRANCH LINE CIRCUIT

Diagnosis Procedure

INFOID:000000001679422

1. CHECK CONNECTOR

1. Turn the ignition switch OFF.
2. Disconnect the battery cable from the negative terminal.
3. Check the terminals and connectors of the AV control unit for damage, bend and loose connection (unit side and connector side).

Is the inspection result normal?

- YES >> GO TO 2.
 NO >> Repair the terminal and connector.

2. CHECK HARNESS FOR OPEN CIRCUIT

1. Disconnect the connector of AV control unit.
 2. Check the resistance between the AV control unit harness connector terminals.
- Models with NAVI

AV control unit harness connector			Resistance (Ω)
Connector No.	Terminal No.		
M87	52	53	Approx. 54 – 66

- Models without NAVI

AV control unit harness connector			Resistance (Ω)
Connector No.	Terminal No.		
M85	86	87	Approx. 54 – 66

Is the measurement value within the specification?

- YES >> GO TO 3.
 NO >> Repair the AV control unit branch line.

3. CHECK POWER SUPPLY AND GROUND CIRCUIT

Check the power supply and the ground circuit of the AV control unit. Refer to the following.

- Base audio without navigation: [AV-39. "AV CONTROL UNIT : Diagnosis Procedure"](#)
- BOSE audio without navigation: [AV-160. "AV CONTROL UNIT : Diagnosis Procedure"](#)
- BOSE audio with navigation: [AV-433. "AV CONTROL UNIT : Diagnosis Procedure"](#)

Is the inspection result normal?

- YES (Present error)>>Replace the AV control unit. Refer to the following.
- Base audio without navigation: [AV-109. "Exploded View"](#)
 - BOSE audio without navigation: [AV-343. "Exploded View"](#)
 - BOSE audio with navigation: [AV-608. "Exploded View"](#)

- YES (Past error)>>Error was detected in the AV control unit branch line.
 NO >> Repair the power supply and the ground circuit.

BCM BRANCH LINE CIRCUIT

< COMPONENT DIAGNOSIS >

[CAN SYSTEM (TYPE 2)]

BCM BRANCH LINE CIRCUIT

Diagnosis Procedure

INFOID:000000001679423

1. CHECK CONNECTOR

1. Turn the ignition switch OFF.
2. Disconnect the battery cable from the negative terminal.
3. Check the terminals and connectors of the BCM for damage, bend and loose connection (unit side and connector side).

Is the inspection result normal?

- YES >> GO TO 2.
NO >> Repair the terminal and connector.

2. CHECK HARNESS FOR OPEN CIRCUIT

1. Disconnect the connector of BCM.
2. Check the resistance between the BCM harness connector terminals.

BCM harness connector			Resistance (Ω)
Connector No.	Terminal No.		
M122	91	90	Approx. 54 – 66

Is the measurement value within the specification?

- YES >> GO TO 3.
NO >> Repair the BCM branch line.

3. CHECK POWER SUPPLY AND GROUND CIRCUIT

Check the power supply and the ground circuit of the BCM. Refer to [BCS-38, "Diagnosis Procedure"](#).

Is the inspection result normal?

- YES (Present error)>>Replace the BCM. Refer to [BCS-79, "Exploded View"](#).
YES (Past error)>>Error was detected in the BCM branch line.
NO >> Repair the power supply and the ground circuit.

A
B
C
D
E
F
G
H
I
J
K
L

LAN

N
O
P

DLC BRANCH LINE CIRCUIT

< COMPONENT DIAGNOSIS >

[CAN SYSTEM (TYPE 2)]

DLC BRANCH LINE CIRCUIT

Diagnosis Procedure

INFOID:000000001679427

1. CHECK CONNECTOR

1. Turn the ignition switch OFF.
2. Disconnect the battery cable from the negative terminal.
3. Check the terminals and connectors of the data link connector for damage, bend and loose connection (connector side and harness side).

Is the inspection result normal?

- YES >> GO TO 2.
NO >> Repair the terminal and connector.

2. CHECK HARNESS FOR OPEN CIRCUIT

Check the resistance between the data link connector terminals.

Data link connector			Resistance (Ω)
Connector No.	Terminal No.		
M24	6	14	Approx. 54 – 66

Is the measurement value within the specification?

- YES (Present error)>>Check the decision of CAN system type again.
YES (Past error)>>Error was detected in the data link connector branch line circuit.
NO >> Repair the data link connector branch line.

M&A BRANCH LINE CIRCUIT

< COMPONENT DIAGNOSIS >

[CAN SYSTEM (TYPE 2)]

M&A BRANCH LINE CIRCUIT

Diagnosis Procedure

INFOID:000000001679428

1.CHECK CONNECTOR

1. Turn the ignition switch OFF.
2. Disconnect the battery cable from the negative terminal.
3. Check the terminals and connectors of the unified meter and A/C amp. for damage, bend and loose connection (unit side and connector side).

Is the inspection result normal?

- YES >> GO TO 2.
NO >> Repair the terminal and connector.

2.CHECK HARNESS FOR OPEN CIRCUIT

1. Disconnect the connector of unified meter and A/C amp.
2. Check the resistance between the unified meter and A/C amp. harness connector terminals.

Unified meter and A/C amp. harness connector			Resistance (Ω)
Connector No.	Terminal No.		
M67	56	72	Approx. 54 – 66

Is the measurement value within the specification?

- YES >> GO TO 3.
NO >> Repair the unified meter and A/C amp. branch line.

3.CHECK POWER SUPPLY AND GROUND CIRCUIT

Check the power supply and the ground circuit of the unified meter and A/C amp. Refer to [MWI-50, "UNIFIED METER AND A/C AMP. : Diagnosis Procedure"](#).

Is the inspection result normal?

- YES (Present error)>>Replace the unified meter and A/C amp. Refer to [MWI-162, "Exploded View"](#).
YES (Past error)>>Error was detected in the unified meter and A/C amp. branch line.
NO >> Repair the power supply and the ground circuit.

A
B
C
D
E
F
G
H
I
J
K
L
N
O
P

LAN

STRG BRANCH LINE CIRCUIT

< COMPONENT DIAGNOSIS >

[CAN SYSTEM (TYPE 2)]

STRG BRANCH LINE CIRCUIT

Diagnosis Procedure

INFOID:000000001679429

1. CHECK CONNECTOR

1. Turn the ignition switch OFF.
2. Disconnect the battery cable from the negative terminal.
3. Check the terminals and connectors of the steering angle sensor for damage, bend and loose connection (unit side and connector side).

Is the inspection result normal?

- YES >> GO TO 2.
NO >> Repair the terminal and connector.

2. CHECK HARNESS FOR OPEN CIRCUIT

1. Disconnect the connector of steering angle sensor.
2. Check the resistance between the steering angle sensor harness connector terminals.

Steering angle sensor harness connector			Resistance (Ω)
Connector No.	Terminal No.		
M37	1	2	Approx. 54 – 66

Is the measurement value within the specification?

- YES >> GO TO 3.
NO >> Repair the steering angle sensor branch line.

3. CHECK POWER SUPPLY AND GROUND CIRCUIT

Check the power supply and the ground circuit of the steering angle sensor. Refer to [BRC-83, "Wiring Diagram - BRAKE CONTROL SYSTEM -"](#).

Is the inspection result normal?

- YES (Present error)>>Replace the steering angle sensor. Refer to [BRC-105, "Exploded View"](#).
YES (Past error)>>Error was detected in the steering angle sensor branch line.
NO >> Repair the power supply and the ground circuit.

ADP BRANCH LINE CIRCUIT

< COMPONENT DIAGNOSIS >

[CAN SYSTEM (TYPE 2)]

ADP BRANCH LINE CIRCUIT

Diagnosis Procedure

INFOID:000000001679430

1. CHECK CONNECTOR

1. Turn the ignition switch OFF.
2. Disconnect the battery cable from the negative terminal.
3. Check the following terminals and connectors for damage, bend and loose connection (unit side and connector side).
 - Models with automatic drive positioner
 - Driver seat control unit
 - Harness connector B502
 - Harness connector B11
 - Models without automatic drive positioner
 - Driver seat control unit
 - Harness connector B501
 - Harness connector B10

Is the inspection result normal?

YES >> GO TO 2.

NO >> Repair the terminal and connector.

2. CHECK HARNESS FOR OPEN CIRCUIT

1. Disconnect the connector of driver seat control unit.
2. Check the resistance between the driver seat control unit harness connector terminals.

Driver seat control unit harness connector		Resistance (Ω)
Connector No.	Terminal No.	
B503	3 19	Approx. 54 – 66

Is the measurement value within the specification?

YES >> GO TO 3.

NO >> Repair the driver seat control unit branch line.

3. CHECK POWER SUPPLY AND GROUND CIRCUIT

Check the power supply and the ground circuit of the driver seat control unit. Refer to [ADP-63. "DRIVER SEAT CONTROL UNIT : Diagnosis Procedure"](#).

Is the inspection result normal?

YES (Present error)>>Replace the driver seat control unit. Refer to [ADP-236. "Exploded View"](#).

YES (Past error)>>Error was detected in the driver seat control unit branch line.

NO >> Repair the power supply and the ground circuit.

A
B
C
D
E
F
G
H
I
J
K
L
N
O
P

LAN

RAS BRANCH LINE CIRCUIT

< COMPONENT DIAGNOSIS >

[CAN SYSTEM (TYPE 2)]

RAS BRANCH LINE CIRCUIT

Diagnosis Procedure

INFOID:000000001679431

1. CHECK CONNECTOR

1. Turn the ignition switch OFF.
2. Disconnect the battery cable from the negative terminal.
3. Check the terminals and connectors of the 4WAS main control unit for damage, bend and loose connection (unit side and connector side).

Is the inspection result normal?

- YES >> GO TO 2.
NO >> Repair the terminal and connector.

2. CHECK HARNESS FOR OPEN CIRCUIT

1. Disconnect the connector of 4WAS main control unit.
2. Check the resistance between the 4WAS main control unit harness connector terminals.

4WAS main control unit harness connector			Resistance (Ω)
Connector No.	Terminal No.		
B54	1	8	Approx. 54 – 66

Is the measurement value within the specification?

- YES >> GO TO 3.
NO >> Repair the 4WAS main control unit branch line.

3. CHECK POWER SUPPLY AND GROUND CIRCUIT

Check the power supply and the ground circuit of the 4WAS main control unit. Refer to [STC-134, "Diagnosis Procedure \(4WAS Main Control Unit\)"](#).

Is the inspection result normal?

- YES (Present error)>>Replace the 4WAS main control unit. Refer to [STC-178, "Exploded View"](#).
YES (Past error)>>Error was detected in the 4WAS main control unit branch line.
NO >> Repair the power supply and the ground circuit.

ABS BRANCH LINE CIRCUIT

< COMPONENT DIAGNOSIS >

[CAN SYSTEM (TYPE 2)]

ABS BRANCH LINE CIRCUIT

Diagnosis Procedure

INFOID:000000001679432

1. CHECK CONNECTOR

1. Turn the ignition switch OFF.
2. Disconnect the battery cable from the negative terminal.
3. Check the terminals and connectors of the ABS actuator and electric unit (control unit) for damage, bend and loose connection (unit side and connector side).

Is the inspection result normal?

- YES >> GO TO 2.
NO >> Repair the terminal and connector.

2. CHECK HARNESS FOR OPEN CIRCUIT

1. Disconnect the connector of ABS actuator and electric unit (control unit).
2. Check the resistance between the ABS actuator and electric unit (control unit) harness connector terminals.

ABS actuator and electric unit (control unit) harness connector			Resistance (Ω)
Connector No.	Terminal No.		
E41	35	14	Approx. 54 – 66

Is the measurement value within the specification?

- YES >> GO TO 3.
NO >> Repair the ABS actuator and electric unit (control unit) branch line.

3. CHECK POWER SUPPLY AND GROUND CIRCUIT

Check the power supply and the ground circuit of the ABS actuator and electric unit (control unit). Refer to [BRC-37, "Diagnosis Procedure"](#).

Is the inspection result normal?

- YES (Present error)>>Replace the ABS actuator and electric unit (control unit). Refer to [BRC-102, "Exploded View"](#).
YES (Past error)>>Error was detected in the ABS actuator and electric unit (control unit) branch line.
NO >> Repair the power supply and the ground circuit.

A
B
C
D
E
F
G
H
I
J
K
L

LAN

IPDM-E BRANCH LINE CIRCUIT

< COMPONENT DIAGNOSIS >

[CAN SYSTEM (TYPE 2)]

IPDM-E BRANCH LINE CIRCUIT

Diagnosis Procedure

INFOID:000000001679434

1. CHECK CONNECTOR

1. Turn the ignition switch OFF.
2. Disconnect the battery cable from the negative terminal.
3. Check the terminals and connectors of the IPDM E/R for damage, bend and loose connection (unit side and connector side).

Is the inspection result normal?

- YES >> GO TO 2.
NO >> Repair the terminal and connector.

2. CHECK HARNESS FOR OPEN CIRCUIT

1. Disconnect the connector of IPDM E/R.
2. Check the resistance between the IPDM E/R harness connector terminals.

IPDM E/R harness connector			Resistance (Ω)
Connector No.	Terminal No.		
E6	40	39	Approx. 108 – 132

Is the measurement value within the specification?

- YES >> GO TO 3.
NO >> Repair the IPDM E/R branch line.

3. CHECK POWER SUPPLY AND GROUND CIRCUIT

Check the power supply and the ground circuit of the IPDM E/R. Refer to [PCS-19, "Diagnosis Procedure"](#).

Is the inspection result normal?

- YES (Present error)>>Replace the IPDM E/R. Refer to [PCS-34, "Exploded View"](#).
YES (Past error)>>Error was detected in the IPDM E/R branch line.
NO >> Repair the power supply and the ground circuit.

CAN COMMUNICATION CIRCUIT

< COMPONENT DIAGNOSIS >

[CAN SYSTEM (TYPE 2)]

CAN COMMUNICATION CIRCUIT

Diagnosis Procedure

INFOID:000000001679435

1.CONNECTOR INSPECTION

1. Turn the ignition switch OFF.
2. Disconnect the battery cable from the negative terminal.
3. Disconnect all the unit connectors on CAN communication system.
4. Check terminals and connectors for damage, bend and loose connection.

Is the inspection result normal?

- YES >> GO TO 2.
NO >> Repair the terminal and connector.

2.CHECK HARNESS CONTINUITY (SHORT CIRCUIT)

Check the continuity between the data link connector terminals.

Data link connector		Continuity
Connector No.	Terminal No.	
M24	6 14	Not existed

Is the inspection result normal?

- YES >> GO TO 3.
NO >> Check the harness and repair the root cause.

3.CHECK HARNESS CONTINUITY (SHORT CIRCUIT)

Check the continuity between the data link connector and the ground.

Data link connector		Ground	Continuity
Connector No.	Terminal No.		
M24	6		Not existed
	14		Not existed

Is the inspection result normal?

- YES >> GO TO 4.
NO >> Check the harness and repair the root cause.

4.CHECK ECM AND IPDM E/R TERMINATION CIRCUIT

1. Remove the ECM and the IPDM E/R.
2. Check the resistance between the ECM terminals.

ECM		Resistance (Ω)
Terminal No.		
114	113	Approx. 108 – 132

3. Check the resistance between the IPDM E/R terminals.

IPDM E/R		Resistance (Ω)
Terminal No.		
40	39	Approx. 108 – 132

Is the measurement value within the specification?

- YES >> GO TO 5.
NO >> Replace the ECM and/or the IPDM E/R.

5.CHECK SYMPTOM

Connect all the connectors. Check if the symptoms described in the "Symptom (Results from interview with customer)" are reproduced.

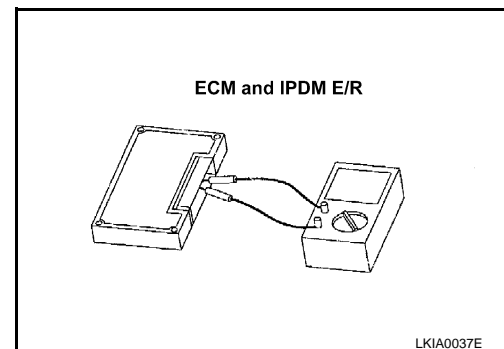

CAN COMMUNICATION CIRCUIT

< COMPONENT DIAGNOSIS >

[CAN SYSTEM (TYPE 2)]

Inspection result

Reproduced>>GO TO 6.

Non-reproduced>>Start the diagnosis again. Follow the trouble diagnosis procedure when past error is detected.

6.CHECK UNIT REPRODUCTION

Perform the reproduction test as per the following procedure for each unit.

1. Turn the ignition switch OFF.
2. Disconnect the battery cable from the negative terminal.
3. Disconnect one of the unit connectors of CAN communication system.

NOTE:

ECM and IPDM E/R have a termination circuit. Check other units first.

4. Connect the battery cable to the negative terminal. Check if the symptoms described in the "Symptom (Results from interview with customer)" are reproduced.

NOTE:

Although unit-related error symptoms occur, do not confuse them with other symptoms.

Inspection result

Reproduced>>Connect the connector. Check other units as per the above procedure.

Non-reproduced>>Replace the unit whose connector was disconnected.

MAIN LINE BETWEEN BCM AND DLC CIRCUIT

< COMPONENT DIAGNOSIS >

[CAN SYSTEM (TYPE 3)]

COMPONENT DIAGNOSIS

MAIN LINE BETWEEN BCM AND DLC CIRCUIT

Diagnosis Procedure

INFOID:000000001679442

INSPECTION PROCEDURE

1. CHECK HARNESS CONTINUITY (OPEN CIRCUIT)

1. Turn the ignition switch OFF.
2. Disconnect the battery cable from the negative terminal.
3. Disconnect the following harness connectors.
 - ECM
 - BCM
4. Check the continuity between the BCM harness connector and the data link connector.

BCM harness connector		Data link connector		Continuity
Connector No.	Terminal No.	Connector No.	Terminal No.	
M122	91	M24	6	Existed
	90		14	Existed

Is the inspection result normal?

YES (Present error)>>Check CAN system type decision again.

YES (Past error)>>Error was detected in the main line between the BCM and the data link connector.

NO >> Repair the main line between the BCM and the data link connector.

A
B
C
D
E
F
G
H
I
J
K
L
N
O
P

LAN

MAIN LINE BETWEEN DLC AND ADP CIRCUIT

< COMPONENT DIAGNOSIS >

[CAN SYSTEM (TYPE 3)]

MAIN LINE BETWEEN DLC AND ADP CIRCUIT

Diagnosis Procedure

INFOID:000000001679444

INSPECTION PROCEDURE

1.CHECK CONNECTOR

1. Turn the ignition switch OFF.
2. Disconnect the battery cable from the negative terminal.
3. Check the following terminals and connectors for damage, bend and loose connection (connector side and harness side).
 - Harness connector M7
 - Harness connector B1

Is the inspection result normal?

YES >> GO TO 2.

NO >> Repair the terminal and connector.

2.CHECK HARNESS CONTINUITY (OPEN CIRCUIT)

1. Disconnect the harness connectors M7 and B1.
2. Check the continuity between the data link connector and the harness connector.

Data link connector		Harness connector		Continuity
Connector No.	Terminal No.	Connector No.	Terminal No.	
M24	6	M7	20	Existed
	14		21	Existed

Is the inspection result normal?

YES >> GO TO 3.

NO >> Repair the main line between the data link connector and the harness connector M7.

3.CHECK HARNESS CONTINUITY (OPEN CIRCUIT)

Check the continuity between the harness connector terminals.

Connector No.	Terminal No.		Continuity
B1	20	22	Existed
	21	23	Existed

Is the inspection result normal?

YES (Present error)>>Check CAN system type decision again.

YES (Past error)>>Error was detected in the main line between the data link connector and the driver seat control unit.

NO >> Repair the main line between the harness connector B1 and the driver seat control unit.

MAIN LINE BETWEEN ADP AND ABS CIRCUIT

< COMPONENT DIAGNOSIS >

[CAN SYSTEM (TYPE 3)]

MAIN LINE BETWEEN ADP AND ABS CIRCUIT

Diagnosis Procedure

INFOID:000000001679446

1. CHECK CONNECTOR

1. Turn the ignition switch OFF.
2. Disconnect the battery cable from the negative terminal.
3. Check the following terminals and connectors for damage, bend and loose connection (connector side and harness side).
 - Harness connector B1
 - Harness connector M7
 - Harness connector M6
 - Harness connector E106

Is the inspection result normal?

YES >> GO TO 2.

NO >> Repair the terminal and connector.

2. CHECK HARNESS CONTINUITY (OPEN CIRCUIT)

1. Disconnect the harness connectors B1 and M7.
2. Check the continuity between the harness connector terminals.

Connector No.	Terminal No.		Continuity
B1	20	22	Existed
	21	23	Existed

Is the inspection result normal?

YES >> GO TO 3.

NO >> Repair the main line between the driver seat control unit and the harness connector B1.

3. CHECK HARNESS CONTINUITY (OPEN CIRCUIT)

1. Disconnect the harness connectors M6 and E106.
2. Check the continuity between the harness connectors.

Harness connector		Harness connector		Continuity
Connector No.	Terminal No.	Connector No.	Terminal No.	
M7	22	M6	9	Existed
	23		8	Existed

Is the inspection result normal?

YES >> GO TO 4.

NO >> Repair the main line between the harness connectors M7 and M6.

4. CHECK HARNESS CONTINUITY (OPEN CIRCUIT)

1. Disconnect the connector of ABS actuator and electric unit (control unit).
2. Check the continuity between the harness connector and the ABS actuator and electric unit (control unit) harness connector.

Harness connector		ABS actuator and electric unit (control unit) harness connector		Continuity
Connector No.	Terminal No.	Connector No.	Terminal No.	
E106	9	E41	35	Existed
	8		14	Existed

Is the inspection result normal?

YES (Present error)>>Check CAN system type decision again.

YES (Past error)>>Error was detected in the main line between the driver seat control unit and the ABS actuator and electric unit (control unit).

MAIN LINE BETWEEN ADP AND ABS CIRCUIT

< COMPONENT DIAGNOSIS >

[CAN SYSTEM (TYPE 3)]

NO >> Repair the main line between the harness connector E106 and the ABS actuator and electric unit (control unit).

ECM BRANCH LINE CIRCUIT

< COMPONENT DIAGNOSIS >

[CAN SYSTEM (TYPE 3)]

ECM BRANCH LINE CIRCUIT

Diagnosis Procedure

INFOID:000000001679448

1. CHECK CONNECTOR

1. Turn the ignition switch OFF.
2. Disconnect the battery cable from the negative terminal.
3. Check the terminals and connectors of the ECM for damage, bend and loose connection (unit side and connector side).

Is the inspection result normal?

- YES >> GO TO 2.
NO >> Repair the terminal and connector.

2. CHECK HARNESS FOR OPEN CIRCUIT

1. Disconnect the connector of ECM.
2. Check the resistance between the ECM harness connector terminals.

ECM harness connector			Resistance (Ω)
Connector No.	Terminal No.		
M107	114	113	Approx. 108 – 132

Is the measurement value within the specification?

- YES >> GO TO 3.
NO >> Repair the ECM branch line.

3. CHECK POWER SUPPLY AND GROUND CIRCUIT

Check the power supply and the ground circuit of the ECM. Refer to [EC-140. "Diagnosis Procedure"](#).

Is the inspection result normal?

- YES (Present error)>>Replace the ECM. Refer to [EC-16. "ADDITIONAL SERVICE WHEN REPLACING CONTROL UNIT \(ECM\) : Special Repair Requirement"](#).
YES (Past error)>>Error was detected in the ECM branch line.
NO >> Repair the power supply and the ground circuit.

A
B
C
D
E
F
G
H
I
J
K
L

LAN

A-BAG BRANCH LINE CIRCUIT

< COMPONENT DIAGNOSIS >

[CAN SYSTEM (TYPE 3)]

A-BAG BRANCH LINE CIRCUIT

Diagnosis Procedure

INFOID:000000001679449

1. CHECK AIR BAG DIAGNOSIS SENSOR UNIT

Check the air bag diagnosis sensor unit. Refer to [SRC-5, "Work Flow"](#).

Is the inspection result normal?

YES >> Replace the main harness.

NO >> Replace parts whose air bag system has a malfunction.

AV BRANCH LINE CIRCUIT

Diagnosis Procedure

INFOID:000000001679450

1. CHECK CONNECTOR

1. Turn the ignition switch OFF.
2. Disconnect the battery cable from the negative terminal.
3. Check the terminals and connectors of the AV control unit for damage, bend and loose connection (unit side and connector side).

Is the inspection result normal?

- YES >> GO TO 2.
 NO >> Repair the terminal and connector.

2. CHECK HARNESS FOR OPEN CIRCUIT

1. Disconnect the connector of AV control unit.
 2. Check the resistance between the AV control unit harness connector terminals.
- Models with NAVI

AV control unit harness connector			Resistance (Ω)
Connector No.	Terminal No.		
M87	52	53	Approx. 54 – 66

- Models without NAVI

AV control unit harness connector			Resistance (Ω)
Connector No.	Terminal No.		
M85	86	87	Approx. 54 – 66

Is the measurement value within the specification?

- YES >> GO TO 3.
 NO >> Repair the AV control unit branch line.

3. CHECK POWER SUPPLY AND GROUND CIRCUIT

Check the power supply and the ground circuit of the AV control unit. Refer to the following.

- Base audio without navigation: [AV-39, "AV CONTROL UNIT : Diagnosis Procedure"](#)
- BOSE audio without navigation: [AV-160, "AV CONTROL UNIT : Diagnosis Procedure"](#)
- BOSE audio with navigation: [AV-433, "AV CONTROL UNIT : Diagnosis Procedure"](#)

Is the inspection result normal?

- YES (Present error)>>Replace the AV control unit. Refer to the following.
- Base audio without navigation: [AV-109, "Exploded View"](#)
 - BOSE audio without navigation: [AV-343, "Exploded View"](#)
 - BOSE audio with navigation: [AV-608, "Exploded View"](#)

YES (Past error)>>Error was detected in the AV control unit branch line.

- NO >> Repair the power supply and the ground circuit.

A
B
C
D
E
F
G
H
I
J
K
L
N
O
P

LAN

BCM BRANCH LINE CIRCUIT

< COMPONENT DIAGNOSIS >

[CAN SYSTEM (TYPE 3)]

BCM BRANCH LINE CIRCUIT

Diagnosis Procedure

INFOID:000000001679451

1. CHECK CONNECTOR

1. Turn the ignition switch OFF.
2. Disconnect the battery cable from the negative terminal.
3. Check the terminals and connectors of the BCM for damage, bend and loose connection (unit side and connector side).

Is the inspection result normal?

- YES >> GO TO 2.
NO >> Repair the terminal and connector.

2. CHECK HARNESS FOR OPEN CIRCUIT

1. Disconnect the connector of BCM.
2. Check the resistance between the BCM harness connector terminals.

BCM harness connector			Resistance (Ω)
Connector No.	Terminal No.		
M122	91	90	Approx. 54 – 66

Is the measurement value within the specification?

- YES >> GO TO 3.
NO >> Repair the BCM branch line.

3. CHECK POWER SUPPLY AND GROUND CIRCUIT

Check the power supply and the ground circuit of the BCM. Refer to [BCS-38. "Diagnosis Procedure"](#).

Is the inspection result normal?

- YES (Present error)>>Replace the BCM. Refer to [BCS-79. "Exploded View"](#).
YES (Past error)>>Error was detected in the BCM branch line.
NO >> Repair the power supply and the ground circuit.

PSB BRANCH LINE CIRCUIT

Diagnosis Procedure

INFOID:000000001679452

1.CHECK CONNECTOR

1. Turn the ignition switch OFF.
2. Disconnect the battery cable from the negative terminal.
3. Check the terminals and connectors of the pre-crash seat belt for damage, bend and loose connection (unit side and connector side).

Is the inspection result normal?

- YES >> GO TO 2.
 NO >> Repair the terminal and connector.

2.CHECK HARNESS FOR OPEN CIRCUIT

1. Disconnect the connector of pre-crash seat belt control unit.
2. Check the resistance between the pre-crash seat belt control unit harness connector terminals.

Pre-crash seat belt control unit harness connector			Resistance (Ω)
Connector No.	Terminal No.		
M110	24	22	Approx. 54 – 66

Is the measurement value within the specification?

- YES >> GO TO 3.
 NO >> Repair the pre-crash seat belt control unit branch line.

3.CHECK POWER SUPPLY AND GROUND CIRCUIT

Check the power supply and the ground circuit of the pre-crash seat belt control unit. Refer to the following.

- Power supply circuit: [SBC-27, "Component Function Check"](#)
- Ground circuit: [SBC-28, "Component Function Check"](#)

Is the inspection result normal?

- YES (Present error)>>Replace the pre-crash seat belt control unit. Refer to [SBC-40, "Exploded View"](#).
 YES (Past error)>>Error was detected in the pre-crash seat belt control unit branch line.
 NO >> Repair the power supply and the ground circuit.

A
B
C
D
E
F
G
H
I
J
K
L

LAN

N
O
P

AFS BRANCH LINE CIRCUIT

< COMPONENT DIAGNOSIS >

[CAN SYSTEM (TYPE 3)]

AFS BRANCH LINE CIRCUIT

Diagnosis Procedure

INFOID:000000001679454

1. CHECK CONNECTOR

1. Turn the ignition switch OFF.
2. Disconnect the battery cable from the negative terminal.
3. Check the terminals and connectors of the AFS control unit for damage, bend and loose connection (unit side and connector side).

Is the inspection result normal?

- YES >> GO TO 2.
NO >> Repair the terminal and connector.

2. CHECK HARNESS FOR OPEN CIRCUIT

1. Disconnect the connector of AFS control unit.
2. Check the resistance between the AFS control unit harness connector terminals.

AFS control unit harness connector			Resistance (Ω)
Connector No.	Terminal No.		
M16	30	7	Approx. 54 – 66

Is the measurement value within the specification?

- YES >> GO TO 3.
NO >> Repair the AFS control unit branch line.

3. CHECK POWER SUPPLY AND GROUND CIRCUIT

Check the power supply and the ground circuit of the AFS control unit. Refer to [EXL-61, "AFS CONTROL UNIT : Diagnosis Procedure"](#).

Is the inspection result normal?

- YES (Present error)>>Replace the AFS control unit. Refer to [EXL-196, "Exploded View"](#).
YES (Past error)>>Error was detected in the AFS control unit branch line.
NO >> Repair the power supply and the ground circuit.

DLC BRANCH LINE CIRCUIT

< COMPONENT DIAGNOSIS >

[CAN SYSTEM (TYPE 3)]

DLC BRANCH LINE CIRCUIT

Diagnosis Procedure

INFOID:000000001679455

1.CHECK CONNECTOR

1. Turn the ignition switch OFF.
2. Disconnect the battery cable from the negative terminal.
3. Check the terminals and connectors of the data link connector for damage, bend and loose connection (connector side and harness side).

Is the inspection result normal?

- YES >> GO TO 2.
NO >> Repair the terminal and connector.

2.CHECK HARNESS FOR OPEN CIRCUIT

Check the resistance between the data link connector terminals.

Data link connector			Resistance (Ω)
Connector No.	Terminal No.		
M24	6	14	Approx. 54 – 66

Is the measurement value within the specification?

- YES (Present error)>>Check the decision of CAN system type again.
YES (Past error)>>Error was detected in the data link connector branch line circuit.
NO >> Repair the data link connector branch line.

A
B
C
D
E
F
G
H
I
J
K
L

LAN

N
O
P

M&A BRANCH LINE CIRCUIT

< COMPONENT DIAGNOSIS >

[CAN SYSTEM (TYPE 3)]

M&A BRANCH LINE CIRCUIT

Diagnosis Procedure

INFOID:000000001679456

1. CHECK CONNECTOR

1. Turn the ignition switch OFF.
2. Disconnect the battery cable from the negative terminal.
3. Check the terminals and connectors of the unified meter and A/C amp. for damage, bend and loose connection (unit side and connector side).

Is the inspection result normal?

- YES >> GO TO 2.
NO >> Repair the terminal and connector.

2. CHECK HARNESS FOR OPEN CIRCUIT

1. Disconnect the connector of unified meter and A/C amp.
2. Check the resistance between the unified meter and A/C amp. harness connector terminals.

Unified meter and A/C amp. harness connector			Resistance (Ω)
Connector No.	Terminal No.		
M67	56	72	Approx. 54 – 66

Is the measurement value within the specification?

- YES >> GO TO 3.
NO >> Repair the unified meter and A/C amp. branch line.

3. CHECK POWER SUPPLY AND GROUND CIRCUIT

Check the power supply and the ground circuit of the unified meter and A/C amp. Refer to [MWI-50, "UNIFIED METER AND A/C AMP. : Diagnosis Procedure"](#).

Is the inspection result normal?

- YES (Present error)>>Replace the unified meter and A/C amp. Refer to [MWI-162, "Exploded View"](#).
YES (Past error)>>Error was detected in the unified meter and A/C amp. branch line.
NO >> Repair the power supply and the ground circuit.

STRG BRANCH LINE CIRCUIT

< COMPONENT DIAGNOSIS >

[CAN SYSTEM (TYPE 3)]

STRG BRANCH LINE CIRCUIT

Diagnosis Procedure

INFOID:000000001679457

1.CHECK CONNECTOR

1. Turn the ignition switch OFF.
2. Disconnect the battery cable from the negative terminal.
3. Check the terminals and connectors of the steering angle sensor for damage, bend and loose connection (unit side and connector side).

Is the inspection result normal?

- YES >> GO TO 2.
NO >> Repair the terminal and connector.

2.CHECK HARNESS FOR OPEN CIRCUIT

1. Disconnect the connector of steering angle sensor.
2. Check the resistance between the steering angle sensor harness connector terminals.

Steering angle sensor harness connector			Resistance (Ω)
Connector No.	Terminal No.		
M37	1	2	Approx. 54 – 66

Is the measurement value within the specification?

- YES >> GO TO 3.
NO >> Repair the steering angle sensor branch line.

3.CHECK POWER SUPPLY AND GROUND CIRCUIT

Check the power supply and the ground circuit of the steering angle sensor. Refer to [BRC-83, "Wiring Diagram - BRAKE CONTROL SYSTEM -"](#).

Is the inspection result normal?

- YES (Present error)>>Replace the steering angle sensor. Refer to [BRC-105, "Exploded View"](#).
YES (Past error)>>Error was detected in the steering angle sensor branch line.
NO >> Repair the power supply and the ground circuit.

A
B
C
D
E
F
G
H
I
J
K
L

LAN

N
O
P

ADP BRANCH LINE CIRCUIT

< COMPONENT DIAGNOSIS >

[CAN SYSTEM (TYPE 3)]

ADP BRANCH LINE CIRCUIT

Diagnosis Procedure

INFOID:000000001679458

1. CHECK CONNECTOR

1. Turn the ignition switch OFF.
2. Disconnect the battery cable from the negative terminal.
3. Check the following terminals and connectors for damage, bend and loose connection (unit side and connector side).
 - Models with automatic drive positioner
 - Driver seat control unit
 - Harness connector B502
 - Harness connector B11
 - Models without automatic drive positioner
 - Driver seat control unit
 - Harness connector B501
 - Harness connector B10

Is the inspection result normal?

YES >> GO TO 2.

NO >> Repair the terminal and connector.

2. CHECK HARNESS FOR OPEN CIRCUIT

1. Disconnect the connector of driver seat control unit.
2. Check the resistance between the driver seat control unit harness connector terminals.

Driver seat control unit harness connector			Resistance (Ω)
Connector No.	Terminal No.		
B503	3	19	Approx. 54 – 66

Is the measurement value within the specification?

YES >> GO TO 3.

NO >> Repair the driver seat control unit branch line.

3. CHECK POWER SUPPLY AND GROUND CIRCUIT

Check the power supply and the ground circuit of the driver seat control unit. Refer to [ADP-63. "DRIVER SEAT CONTROL UNIT : Diagnosis Procedure"](#).

Is the inspection result normal?

YES (Present error)>>Replace the driver seat control unit. Refer to [ADP-236. "Exploded View"](#).

YES (Past error)>>Error was detected in the driver seat control unit branch line.

NO >> Repair the power supply and the ground circuit.

ABS BRANCH LINE CIRCUIT

< COMPONENT DIAGNOSIS >

[CAN SYSTEM (TYPE 3)]

ABS BRANCH LINE CIRCUIT

Diagnosis Procedure

INFOID:000000001679460

1. CHECK CONNECTOR

1. Turn the ignition switch OFF.
2. Disconnect the battery cable from the negative terminal.
3. Check the terminals and connectors of the ABS actuator and electric unit (control unit) for damage, bend and loose connection (unit side and connector side).

Is the inspection result normal?

- YES >> GO TO 2.
NO >> Repair the terminal and connector.

2. CHECK HARNESS FOR OPEN CIRCUIT

1. Disconnect the connector of ABS actuator and electric unit (control unit).
2. Check the resistance between the ABS actuator and electric unit (control unit) harness connector terminals.

ABS actuator and electric unit (control unit) harness connector			Resistance (Ω)
Connector No.	Terminal No.		
E41	35	14	Approx. 54 – 66

Is the measurement value within the specification?

- YES >> GO TO 3.
NO >> Repair the ABS actuator and electric unit (control unit) branch line.

3. CHECK POWER SUPPLY AND GROUND CIRCUIT

Check the power supply and the ground circuit of the ABS actuator and electric unit (control unit). Refer to [BRC-37, "Diagnosis Procedure"](#).

Is the inspection result normal?

- YES (Present error)>>Replace the ABS actuator and electric unit (control unit). Refer to [BRC-102, "Exploded View"](#).
YES (Past error)>>Error was detected in the ABS actuator and electric unit (control unit) branch line.
NO >> Repair the power supply and the ground circuit.

A
B
C
D
E
F
G
H
I
J
K
L

LAN

ICC BRANCH LINE CIRCUIT

Diagnosis Procedure

INFOID:000000001679461

1. CHECK CONNECTOR

1. Turn the ignition switch OFF.
2. Disconnect the battery cable from the negative terminal.
3. Check the terminals and connectors of the ICC sensor integrated unit for damage, bend and loose connection (unit side and connector side).

Is the inspection result normal?

- YES >> GO TO 2.
 NO >> Repair the terminal and connector.

2. CHECK HARNESS FOR OPEN CIRCUIT

1. Disconnect the connector of ICC sensor integrated unit.
2. Check the resistance between the ICC sensor integrated unit harness connector terminals.

ICC sensor integrated unit harness connector			Resistance (Ω)
Connector No.	Terminal No.		
E67	3	6	Approx. 54 – 66

Is the measurement value within the specification?

- YES >> GO TO 3.
 NO >> Repair the ICC sensor integrated unit branch line.

3. CHECK POWER SUPPLY AND GROUND CIRCUIT

Check the power supply and the ground circuit of the ICC sensor integrated unit. Refer to [CCS-81, "Diagnosis Procedure"](#).

Is the inspection result normal?

- YES (Present error)>>Replace the ICC sensor integrated unit. Refer to [CCS-111, "Exploded View"](#).
 YES (Past error)>>Error was detected in the ICC sensor integrated unit branch line.
 NO >> Repair the power supply and the ground circuit.

IPDM-E BRANCH LINE CIRCUIT

< COMPONENT DIAGNOSIS >

[CAN SYSTEM (TYPE 3)]

IPDM-E BRANCH LINE CIRCUIT

Diagnosis Procedure

INFOID:000000001679462

1. CHECK CONNECTOR

1. Turn the ignition switch OFF.
2. Disconnect the battery cable from the negative terminal.
3. Check the terminals and connectors of the IPDM E/R for damage, bend and loose connection (unit side and connector side).

Is the inspection result normal?

- YES >> GO TO 2.
NO >> Repair the terminal and connector.

2. CHECK HARNESS FOR OPEN CIRCUIT

1. Disconnect the connector of IPDM E/R.
2. Check the resistance between the IPDM E/R harness connector terminals.

IPDM E/R harness connector			Resistance (Ω)
Connector No.	Terminal No.		
E6	40	39	Approx. 108 – 132

Is the measurement value within the specification?

- YES >> GO TO 3.
NO >> Repair the IPDM E/R branch line.

3. CHECK POWER SUPPLY AND GROUND CIRCUIT

Check the power supply and the ground circuit of the IPDM E/R. Refer to [PCS-19, "Diagnosis Procedure"](#).

Is the inspection result normal?

- YES (Present error)>>Replace the IPDM E/R. Refer to [PCS-34, "Exploded View"](#).
YES (Past error)>>Error was detected in the IPDM E/R branch line.
NO >> Repair the power supply and the ground circuit.

A
B
C
D
E
F
G
H
I
J
K
L

LAN

CAN COMMUNICATION CIRCUIT

< COMPONENT DIAGNOSIS >

[CAN SYSTEM (TYPE 3)]

CAN COMMUNICATION CIRCUIT

Diagnosis Procedure

INFOID:000000001679463

1. CONNECTOR INSPECTION

1. Turn the ignition switch OFF.
2. Disconnect the battery cable from the negative terminal.
3. Disconnect all the unit connectors on CAN communication system.
4. Check terminals and connectors for damage, bend and loose connection.

Is the inspection result normal?

- YES >> GO TO 2.
NO >> Repair the terminal and connector.

2. CHECK HARNESS CONTINUITY (SHORT CIRCUIT)

Check the continuity between the data link connector terminals.

Data link connector			Continuity
Connector No.	Terminal No.		
M24	6	14	Not existed

Is the inspection result normal?

- YES >> GO TO 3.
NO >> Check the harness and repair the root cause.

3. CHECK HARNESS CONTINUITY (SHORT CIRCUIT)

Check the continuity between the data link connector and the ground.

Data link connector		Ground	Continuity
Connector No.	Terminal No.		
M24	6		Not existed
	14		Not existed

Is the inspection result normal?

- YES >> GO TO 4.
NO >> Check the harness and repair the root cause.

4. CHECK ECM AND IPDM E/R TERMINATION CIRCUIT

1. Remove the ECM and the IPDM E/R.
2. Check the resistance between the ECM terminals.

ECM		Resistance (Ω)
Terminal No.		
114	113	Approx. 108 – 132

3. Check the resistance between the IPDM E/R terminals.

IPDM E/R		Resistance (Ω)
Terminal No.		
40	39	Approx. 108 – 132

Is the measurement value within the specification?

- YES >> GO TO 5.
NO >> Replace the ECM and/or the IPDM E/R.

5. CHECK SYMPTOM

Connect all the connectors. Check if the symptoms described in the "Symptom (Results from interview with customer)" are reproduced.

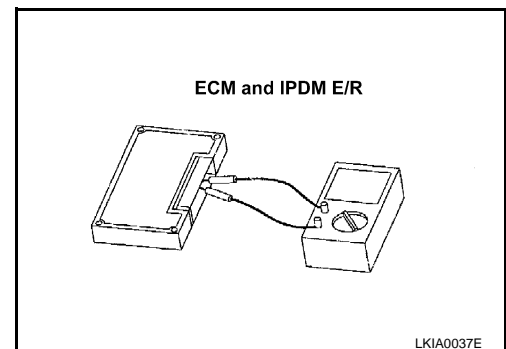

CAN COMMUNICATION CIRCUIT

< COMPONENT DIAGNOSIS >

[CAN SYSTEM (TYPE 3)]

Inspection result

Reproduced>>GO TO 6.

Non-reproduced>>Start the diagnosis again. Follow the trouble diagnosis procedure when past error is detected.

6.CHECK UNIT REPRODUCTION

Perform the reproduction test as per the following procedure for each unit.

1. Turn the ignition switch OFF.
2. Disconnect the battery cable from the negative terminal.
3. Disconnect one of the unit connectors of CAN communication system.

NOTE:

ECM and IPDM E/R have a termination circuit. Check other units first.

4. Connect the battery cable to the negative terminal. Check if the symptoms described in the "Symptom (Results from interview with customer)" are reproduced.

NOTE:

Although unit-related error symptoms occur, do not confuse them with other symptoms.

Inspection result

Reproduced>>Connect the connector. Check other units as per the above procedure.

Non-reproduced>>Replace the unit whose connector was disconnected.

A
B
C
D
E
F
G
H
I
J
K
L

LAN

N
O
P

MAIN LINE BETWEEN BCM AND DLC CIRCUIT

< COMPONENT DIAGNOSIS >

[CAN SYSTEM (TYPE 4)]

COMPONENT DIAGNOSIS

MAIN LINE BETWEEN BCM AND DLC CIRCUIT

Diagnosis Procedure

INFOID:000000001679469

INSPECTION PROCEDURE

1. CHECK HARNESS CONTINUITY (OPEN CIRCUIT)

1. Turn the ignition switch OFF.
2. Disconnect the battery cable from the negative terminal.
3. Disconnect the following harness connectors.
 - ECM
 - BCM
4. Check the continuity between the BCM harness connector and the data link connector.

BCM harness connector		Data link connector		Continuity
Connector No.	Terminal No.	Connector No.	Terminal No.	
M122	91	M24	6	Existed
	90		14	Existed

Is the inspection result normal?

YES (Present error)>>Check CAN system type decision again.

YES (Past error)>>Error was detected in the main line between the BCM and the data link connector.

NO >> Repair the main line between the BCM and the data link connector.

MAIN LINE BETWEEN DLC AND ADP CIRCUIT

< COMPONENT DIAGNOSIS >

[CAN SYSTEM (TYPE 4)]

MAIN LINE BETWEEN DLC AND ADP CIRCUIT

Diagnosis Procedure

INFOID:000000001679471

INSPECTION PROCEDURE

1.CHECK CONNECTOR

1. Turn the ignition switch OFF.
2. Disconnect the battery cable from the negative terminal.
3. Check the following terminals and connectors for damage, bend and loose connection (connector side and harness side).
 - Harness connector M7
 - Harness connector B1

Is the inspection result normal?

YES >> GO TO 2.

NO >> Repair the terminal and connector.

2.CHECK HARNESS CONTINUITY (OPEN CIRCUIT)

1. Disconnect the harness connectors M7 and B1.
2. Check the continuity between the data link connector and the harness connector.

Data link connector		Harness connector		Continuity
Connector No.	Terminal No.	Connector No.	Terminal No.	
M24	6	M7	20	Existed
	14		21	Existed

Is the inspection result normal?

YES >> GO TO 3.

NO >> Repair the main line between the data link connector and the harness connector M7.

3.CHECK HARNESS CONTINUITY (OPEN CIRCUIT)

Check the continuity between the harness connector terminals.

Connector No.	Terminal No.		Continuity
B1	20	22	Existed
	21	23	Existed

Is the inspection result normal?

YES (Present error)>>Check CAN system type decision again.

YES (Past error)>>Error was detected in the main line between the data link connector and the driver seat control unit.

NO >> Repair the main line between the harness connector B1 and the driver seat control unit.

A
B
C
D
E
F
G
H
I
J
K
L
N
O
P

LAN

MAIN LINE BETWEEN ADP AND ABS CIRCUIT

< COMPONENT DIAGNOSIS >

[CAN SYSTEM (TYPE 4)]

MAIN LINE BETWEEN ADP AND ABS CIRCUIT

Diagnosis Procedure

INFOID:000000001679473

1. CHECK CONNECTOR

1. Turn the ignition switch OFF.
2. Disconnect the battery cable from the negative terminal.
3. Check the following terminals and connectors for damage, bend and loose connection (connector side and harness side).
 - Harness connector B1
 - Harness connector M7
 - Harness connector M6
 - Harness connector E106

Is the inspection result normal?

YES >> GO TO 2.

NO >> Repair the terminal and connector.

2. CHECK HARNESS CONTINUITY (OPEN CIRCUIT)

1. Disconnect the harness connectors B1 and M7.
2. Check the continuity between the harness connector terminals.

Connector No.	Terminal No.		Continuity
B1	20	22	Existed
	21	23	Existed

Is the inspection result normal?

YES >> GO TO 3.

NO >> Repair the main line between the driver seat control unit and the harness connector B1.

3. CHECK HARNESS CONTINUITY (OPEN CIRCUIT)

1. Disconnect the harness connectors M6 and E106.
2. Check the continuity between the harness connectors.

Harness connector		Harness connector		Continuity
Connector No.	Terminal No.	Connector No.	Terminal No.	
M7	22	M6	9	Existed
	23		8	Existed

Is the inspection result normal?

YES >> GO TO 4.

NO >> Repair the main line between the harness connectors M7 and M6.

4. CHECK HARNESS CONTINUITY (OPEN CIRCUIT)

1. Disconnect the connector of ABS actuator and electric unit (control unit).
2. Check the continuity between the harness connector and the ABS actuator and electric unit (control unit) harness connector.

Harness connector		ABS actuator and electric unit (control unit) harness connector		Continuity
Connector No.	Terminal No.	Connector No.	Terminal No.	
E106	9	E41	35	Existed
	8		14	Existed

Is the inspection result normal?

YES (Present error)>>Check CAN system type decision again.

YES (Past error)>>Error was detected in the main line between the driver seat control unit and the ABS actuator and electric unit (control unit).

MAIN LINE BETWEEN ADP AND ABS CIRCUIT

< COMPONENT DIAGNOSIS >

[CAN SYSTEM (TYPE 4)]

NO >> Repair the main line between the harness connector E106 and the ABS actuator and electric unit (control unit).

A

B

C

D

E

F

G

H

I

J

K

L

LAN

N

O

P

ECM BRANCH LINE CIRCUIT

< COMPONENT DIAGNOSIS >

[CAN SYSTEM (TYPE 4)]

ECM BRANCH LINE CIRCUIT

Diagnosis Procedure

INFOID:000000001679475

1. CHECK CONNECTOR

1. Turn the ignition switch OFF.
2. Disconnect the battery cable from the negative terminal.
3. Check the terminals and connectors of the ECM for damage, bend and loose connection (unit side and connector side).

Is the inspection result normal?

- YES >> GO TO 2.
NO >> Repair the terminal and connector.

2. CHECK HARNESS FOR OPEN CIRCUIT

1. Disconnect the connector of ECM.
2. Check the resistance between the ECM harness connector terminals.

ECM harness connector			Resistance (Ω)
Connector No.	Terminal No.		
M107	114	113	Approx. 108 – 132

Is the measurement value within the specification?

- YES >> GO TO 3.
NO >> Repair the ECM branch line.

3. CHECK POWER SUPPLY AND GROUND CIRCUIT

Check the power supply and the ground circuit of the ECM. Refer to [EC-140, "Diagnosis Procedure"](#).

Is the inspection result normal?

YES (Present error)>>Replace the ECM. Refer to [EC-16, "ADDITIONAL SERVICE WHEN REPLACING CONTROL UNIT \(ECM\) : Special Repair Requirement"](#).

YES (Past error)>>Error was detected in the ECM branch line.

NO >> Repair the power supply and the ground circuit.

A-BAG BRANCH LINE CIRCUIT

< COMPONENT DIAGNOSIS >

[CAN SYSTEM (TYPE 4)]

A-BAG BRANCH LINE CIRCUIT

Diagnosis Procedure

INFOID:000000001679476

1. CHECK AIR BAG DIAGNOSIS SENSOR UNIT

Check the air bag diagnosis sensor unit. Refer to [SRC-5, "Work Flow"](#).

Is the inspection result normal?

YES >> Replace the main harness.

NO >> Replace parts whose air bag system has a malfunction.

A
B
C
D
E
F
G
H
I
J
K
L
N
O
P

LAN

AV BRANCH LINE CIRCUIT

Diagnosis Procedure

INFOID:000000001679477

1. CHECK CONNECTOR

1. Turn the ignition switch OFF.
2. Disconnect the battery cable from the negative terminal.
3. Check the terminals and connectors of the AV control unit for damage, bend and loose connection (unit side and connector side).

Is the inspection result normal?

- YES >> GO TO 2.
 NO >> Repair the terminal and connector.

2. CHECK HARNESS FOR OPEN CIRCUIT

1. Disconnect the connector of AV control unit.
 2. Check the resistance between the AV control unit harness connector terminals.
- Models with NAVI

AV control unit harness connector			Resistance (Ω)
Connector No.	Terminal No.		
M87	52	53	Approx. 54 – 66

- Models without NAVI

AV control unit harness connector			Resistance (Ω)
Connector No.	Terminal No.		
M85	86	87	Approx. 54 – 66

Is the measurement value within the specification?

- YES >> GO TO 3.
 NO >> Repair the AV control unit branch line.

3. CHECK POWER SUPPLY AND GROUND CIRCUIT

Check the power supply and the ground circuit of the AV control unit. Refer to the following.

- Base audio without navigation: [AV-39. "AV CONTROL UNIT : Diagnosis Procedure"](#)
- BOSE audio without navigation: [AV-160. "AV CONTROL UNIT : Diagnosis Procedure"](#)
- BOSE audio with navigation: [AV-433. "AV CONTROL UNIT : Diagnosis Procedure"](#)

Is the inspection result normal?

- YES (Present error)>>Replace the AV control unit. Refer to the following.
- Base audio without navigation: [AV-109. "Exploded View"](#)
 - BOSE audio without navigation: [AV-343. "Exploded View"](#)
 - BOSE audio with navigation: [AV-608. "Exploded View"](#)

YES (Past error)>>Error was detected in the AV control unit branch line.

- NO >> Repair the power supply and the ground circuit.

BCM BRANCH LINE CIRCUIT

< COMPONENT DIAGNOSIS >

[CAN SYSTEM (TYPE 4)]

BCM BRANCH LINE CIRCUIT

Diagnosis Procedure

INFOID:000000001679478

1.CHECK CONNECTOR

1. Turn the ignition switch OFF.
2. Disconnect the battery cable from the negative terminal.
3. Check the terminals and connectors of the BCM for damage, bend and loose connection (unit side and connector side).

Is the inspection result normal?

- YES >> GO TO 2.
NO >> Repair the terminal and connector.

2.CHECK HARNESS FOR OPEN CIRCUIT

1. Disconnect the connector of BCM.
2. Check the resistance between the BCM harness connector terminals.

BCM harness connector			Resistance (Ω)
Connector No.	Terminal No.		
M122	91	90	Approx. 54 – 66

Is the measurement value within the specification?

- YES >> GO TO 3.
NO >> Repair the BCM branch line.

3.CHECK POWER SUPPLY AND GROUND CIRCUIT

Check the power supply and the ground circuit of the BCM. Refer to [BCS-38, "Diagnosis Procedure"](#).

Is the inspection result normal?

- YES (Present error)>>Replace the BCM. Refer to [BCS-79, "Exploded View"](#).
YES (Past error)>>Error was detected in the BCM branch line.
NO >> Repair the power supply and the ground circuit.

A
B
C
D
E
F
G
H
I
J
K
L

LAN

N
O
P

PSB BRANCH LINE CIRCUIT

Diagnosis Procedure

INFOID:000000001679479

1. CHECK CONNECTOR

1. Turn the ignition switch OFF.
2. Disconnect the battery cable from the negative terminal.
3. Check the terminals and connectors of the pre-crash seat belt for damage, bend and loose connection (unit side and connector side).

Is the inspection result normal?

- YES >> GO TO 2.
 NO >> Repair the terminal and connector.

2. CHECK HARNESS FOR OPEN CIRCUIT

1. Disconnect the connector of pre-crash seat belt control unit.
2. Check the resistance between the pre-crash seat belt control unit harness connector terminals.

Pre-crash seat belt control unit harness connector			Resistance (Ω)
Connector No.	Terminal No.		
M110	24	22	Approx. 54 – 66

Is the measurement value within the specification?

- YES >> GO TO 3.
 NO >> Repair the pre-crash seat belt control unit branch line.

3. CHECK POWER SUPPLY AND GROUND CIRCUIT

Check the power supply and the ground circuit of the pre-crash seat belt control unit. Refer to the following.

- Power supply circuit: [SBC-27, "Component Function Check"](#)
- Ground circuit: [SBC-28, "Component Function Check"](#)

Is the inspection result normal?

- YES (Present error)>>Replace the pre-crash seat belt control unit. Refer to [SBC-40, "Exploded View"](#).
 YES (Past error)>>Error was detected in the pre-crash seat belt control unit branch line.
 NO >> Repair the power supply and the ground circuit.

AFS BRANCH LINE CIRCUIT

< COMPONENT DIAGNOSIS >

[CAN SYSTEM (TYPE 4)]

AFS BRANCH LINE CIRCUIT

Diagnosis Procedure

INFOID:000000001679481

1.CHECK CONNECTOR

1. Turn the ignition switch OFF.
2. Disconnect the battery cable from the negative terminal.
3. Check the terminals and connectors of the AFS control unit for damage, bend and loose connection (unit side and connector side).

Is the inspection result normal?

- YES >> GO TO 2.
NO >> Repair the terminal and connector.

2.CHECK HARNESS FOR OPEN CIRCUIT

1. Disconnect the connector of AFS control unit.
2. Check the resistance between the AFS control unit harness connector terminals.

AFS control unit harness connector			Resistance (Ω)
Connector No.	Terminal No.		
M16	30	7	Approx. 54 – 66

Is the measurement value within the specification?

- YES >> GO TO 3.
NO >> Repair the AFS control unit branch line.

3.CHECK POWER SUPPLY AND GROUND CIRCUIT

Check the power supply and the ground circuit of the AFS control unit. Refer to [EXL-61, "AFS CONTROL UNIT : Diagnosis Procedure"](#).

Is the inspection result normal?

- YES (Present error)>>Replace the AFS control unit. Refer to [EXL-196, "Exploded View"](#).
YES (Past error)>>Error was detected in the AFS control unit branch line.
NO >> Repair the power supply and the ground circuit.

A
B
C
D
E
F
G
H
I
J
K
L
N
O
P

LAN

DLC BRANCH LINE CIRCUIT

< COMPONENT DIAGNOSIS >

[CAN SYSTEM (TYPE 4)]

DLC BRANCH LINE CIRCUIT

Diagnosis Procedure

INFOID:000000001679482

1. CHECK CONNECTOR

1. Turn the ignition switch OFF.
2. Disconnect the battery cable from the negative terminal.
3. Check the terminals and connectors of the data link connector for damage, bend and loose connection (connector side and harness side).

Is the inspection result normal?

- YES >> GO TO 2.
NO >> Repair the terminal and connector.

2. CHECK HARNESS FOR OPEN CIRCUIT

Check the resistance between the data link connector terminals.

Data link connector			Resistance (Ω)
Connector No.	Terminal No.		
M24	6	14	Approx. 54 – 66

Is the measurement value within the specification?

- YES (Present error)>>Check the decision of CAN system type again.
YES (Past error)>>Error was detected in the data link connector branch line circuit.
NO >> Repair the data link connector branch line.

M&A BRANCH LINE CIRCUIT

< COMPONENT DIAGNOSIS >

[CAN SYSTEM (TYPE 4)]

M&A BRANCH LINE CIRCUIT

Diagnosis Procedure

INFOID:000000001679483

1.CHECK CONNECTOR

1. Turn the ignition switch OFF.
2. Disconnect the battery cable from the negative terminal.
3. Check the terminals and connectors of the unified meter and A/C amp. for damage, bend and loose connection (unit side and connector side).

Is the inspection result normal?

- YES >> GO TO 2.
NO >> Repair the terminal and connector.

2.CHECK HARNESS FOR OPEN CIRCUIT

1. Disconnect the connector of unified meter and A/C amp.
2. Check the resistance between the unified meter and A/C amp. harness connector terminals.

Unified meter and A/C amp. harness connector			Resistance (Ω)
Connector No.	Terminal No.		
M67	56	72	Approx. 54 – 66

Is the measurement value within the specification?

- YES >> GO TO 3.
NO >> Repair the unified meter and A/C amp. branch line.

3.CHECK POWER SUPPLY AND GROUND CIRCUIT

Check the power supply and the ground circuit of the unified meter and A/C amp. Refer to [MWI-50, "UNIFIED METER AND A/C AMP. : Diagnosis Procedure"](#).

Is the inspection result normal?

- YES (Present error)>>Replace the unified meter and A/C amp. Refer to [MWI-162, "Exploded View"](#).
YES (Past error)>>Error was detected in the unified meter and A/C amp. branch line.
NO >> Repair the power supply and the ground circuit.

A
B
C
D
E
F
G
H
I
J
K
L
N
O
P

LAN

STRG BRANCH LINE CIRCUIT

< COMPONENT DIAGNOSIS >

[CAN SYSTEM (TYPE 4)]

STRG BRANCH LINE CIRCUIT

Diagnosis Procedure

INFOID:000000001679484

1. CHECK CONNECTOR

1. Turn the ignition switch OFF.
2. Disconnect the battery cable from the negative terminal.
3. Check the terminals and connectors of the steering angle sensor for damage, bend and loose connection (unit side and connector side).

Is the inspection result normal?

- YES >> GO TO 2.
NO >> Repair the terminal and connector.

2. CHECK HARNESS FOR OPEN CIRCUIT

1. Disconnect the connector of steering angle sensor.
2. Check the resistance between the steering angle sensor harness connector terminals.

Steering angle sensor harness connector		Resistance (Ω)
Connector No.	Terminal No.	
M37	1	Approx. 54 – 66
	2	

Is the measurement value within the specification?

- YES >> GO TO 3.
NO >> Repair the steering angle sensor branch line.

3. CHECK POWER SUPPLY AND GROUND CIRCUIT

Check the power supply and the ground circuit of the steering angle sensor. Refer to [BRC-83, "Wiring Diagram - BRAKE CONTROL SYSTEM -"](#).

Is the inspection result normal?

- YES (Present error)>>Replace the steering angle sensor. Refer to [BRC-105, "Exploded View"](#).
YES (Past error)>>Error was detected in the steering angle sensor branch line.
NO >> Repair the power supply and the ground circuit.

ADP BRANCH LINE CIRCUIT

< COMPONENT DIAGNOSIS >

[CAN SYSTEM (TYPE 4)]

ADP BRANCH LINE CIRCUIT

Diagnosis Procedure

INFOID:000000001679485

1. CHECK CONNECTOR

1. Turn the ignition switch OFF.
2. Disconnect the battery cable from the negative terminal.
3. Check the following terminals and connectors for damage, bend and loose connection (unit side and connector side).
 - Models with automatic drive positioner
 - Driver seat control unit
 - Harness connector B502
 - Harness connector B11
 - Models without automatic drive positioner
 - Driver seat control unit
 - Harness connector B501
 - Harness connector B10

Is the inspection result normal?

YES >> GO TO 2.

NO >> Repair the terminal and connector.

2. CHECK HARNESS FOR OPEN CIRCUIT

1. Disconnect the connector of driver seat control unit.
2. Check the resistance between the driver seat control unit harness connector terminals.

Driver seat control unit harness connector			Resistance (Ω)
Connector No.	Terminal No.		
B503	3	19	Approx. 54 – 66

Is the measurement value within the specification?

YES >> GO TO 3.

NO >> Repair the driver seat control unit branch line.

3. CHECK POWER SUPPLY AND GROUND CIRCUIT

Check the power supply and the ground circuit of the driver seat control unit. Refer to [ADP-63. "DRIVER SEAT CONTROL UNIT : Diagnosis Procedure"](#).

Is the inspection result normal?

YES (Present error)>>Replace the driver seat control unit. Refer to [ADP-236. "Exploded View"](#).

YES (Past error)>>Error was detected in the driver seat control unit branch line.

NO >> Repair the power supply and the ground circuit.

A
B
C
D
E
F
G
H
I
J
K
L

LAN

N
O
P

RAS BRANCH LINE CIRCUIT

< COMPONENT DIAGNOSIS >

[CAN SYSTEM (TYPE 4)]

RAS BRANCH LINE CIRCUIT

Diagnosis Procedure

INFOID:000000001679486

1.CHECK CONNECTOR

1. Turn the ignition switch OFF.
2. Disconnect the battery cable from the negative terminal.
3. Check the terminals and connectors of the 4WAS main control unit for damage, bend and loose connection (unit side and connector side).

Is the inspection result normal?

- YES >> GO TO 2.
NO >> Repair the terminal and connector.

2.CHECK HARNESS FOR OPEN CIRCUIT

1. Disconnect the connector of 4WAS main control unit.
2. Check the resistance between the 4WAS main control unit harness connector terminals.

4WAS main control unit harness connector			Resistance (Ω)
Connector No.	Terminal No.		
B54	1	8	Approx. 54 – 66

Is the measurement value within the specification?

- YES >> GO TO 3.
NO >> Repair the 4WAS main control unit branch line.

3.CHECK POWER SUPPLY AND GROUND CIRCUIT

Check the power supply and the ground circuit of the 4WAS main control unit. Refer to [STC-134, "Diagnosis Procedure \(4WAS Main Control Unit\)"](#).

Is the inspection result normal?

- YES (Present error)>>Replace the 4WAS main control unit. Refer to [STC-178, "Exploded View"](#).
YES (Past error)>>Error was detected in the 4WAS main control unit branch line.
NO >> Repair the power supply and the ground circuit.

ABS BRANCH LINE CIRCUIT

< COMPONENT DIAGNOSIS >

[CAN SYSTEM (TYPE 4)]

ABS BRANCH LINE CIRCUIT

Diagnosis Procedure

INFOID:000000001679487

1. CHECK CONNECTOR

1. Turn the ignition switch OFF.
2. Disconnect the battery cable from the negative terminal.
3. Check the terminals and connectors of the ABS actuator and electric unit (control unit) for damage, bend and loose connection (unit side and connector side).

Is the inspection result normal?

- YES >> GO TO 2.
NO >> Repair the terminal and connector.

2. CHECK HARNESS FOR OPEN CIRCUIT

1. Disconnect the connector of ABS actuator and electric unit (control unit).
2. Check the resistance between the ABS actuator and electric unit (control unit) harness connector terminals.

ABS actuator and electric unit (control unit) harness connector			Resistance (Ω)
Connector No.	Terminal No.		
E41	35	14	Approx. 54 – 66

Is the measurement value within the specification?

- YES >> GO TO 3.
NO >> Repair the ABS actuator and electric unit (control unit) branch line.

3. CHECK POWER SUPPLY AND GROUND CIRCUIT

Check the power supply and the ground circuit of the ABS actuator and electric unit (control unit). Refer to [BRC-37, "Diagnosis Procedure"](#).

Is the inspection result normal?

- YES (Present error)>>Replace the ABS actuator and electric unit (control unit). Refer to [BRC-102, "Exploded View"](#).
YES (Past error)>>Error was detected in the ABS actuator and electric unit (control unit) branch line.
NO >> Repair the power supply and the ground circuit.

A
B
C
D
E
F
G
H
I
J
K
L

LAN

ICC BRANCH LINE CIRCUIT

Diagnosis Procedure

INFOID:000000001679488

1. CHECK CONNECTOR

1. Turn the ignition switch OFF.
2. Disconnect the battery cable from the negative terminal.
3. Check the terminals and connectors of the ICC sensor integrated unit for damage, bend and loose connection (unit side and connector side).

Is the inspection result normal?

- YES >> GO TO 2.
 NO >> Repair the terminal and connector.

2. CHECK HARNESS FOR OPEN CIRCUIT

1. Disconnect the connector of ICC sensor integrated unit.
2. Check the resistance between the ICC sensor integrated unit harness connector terminals.

ICC sensor integrated unit harness connector			Resistance (Ω)
Connector No.	Terminal No.		
E67	3	6	Approx. 54 – 66

Is the measurement value within the specification?

- YES >> GO TO 3.
 NO >> Repair the ICC sensor integrated unit branch line.

3. CHECK POWER SUPPLY AND GROUND CIRCUIT

Check the power supply and the ground circuit of the ICC sensor integrated unit. Refer to [CCS-81, "Diagnosis Procedure"](#).

Is the inspection result normal?

- YES (Present error)>>Replace the ICC sensor integrated unit. Refer to [CCS-111, "Exploded View"](#).
 YES (Past error)>>Error was detected in the ICC sensor integrated unit branch line.
 NO >> Repair the power supply and the ground circuit.

IPDM-E BRANCH LINE CIRCUIT

< COMPONENT DIAGNOSIS >

[CAN SYSTEM (TYPE 4)]

IPDM-E BRANCH LINE CIRCUIT

Diagnosis Procedure

INFOID:000000001679489

1. CHECK CONNECTOR

1. Turn the ignition switch OFF.
2. Disconnect the battery cable from the negative terminal.
3. Check the terminals and connectors of the IPDM E/R for damage, bend and loose connection (unit side and connector side).

Is the inspection result normal?

- YES >> GO TO 2.
NO >> Repair the terminal and connector.

2. CHECK HARNESS FOR OPEN CIRCUIT

1. Disconnect the connector of IPDM E/R.
2. Check the resistance between the IPDM E/R harness connector terminals.

IPDM E/R harness connector			Resistance (Ω)
Connector No.	Terminal No.		
E6	40	39	Approx. 108 – 132

Is the measurement value within the specification?

- YES >> GO TO 3.
NO >> Repair the IPDM E/R branch line.

3. CHECK POWER SUPPLY AND GROUND CIRCUIT

Check the power supply and the ground circuit of the IPDM E/R. Refer to [PCS-19, "Diagnosis Procedure"](#).

Is the inspection result normal?

- YES (Present error)>>Replace the IPDM E/R. Refer to [PCS-34, "Exploded View"](#).
YES (Past error)>>Error was detected in the IPDM E/R branch line.
NO >> Repair the power supply and the ground circuit.

A
B
C
D
E
F
G
H
I
J
K
L

LAN

N
O
P

CAN COMMUNICATION CIRCUIT

< COMPONENT DIAGNOSIS >

[CAN SYSTEM (TYPE 4)]

CAN COMMUNICATION CIRCUIT

Diagnosis Procedure

INFOID:000000001679490

1. CONNECTOR INSPECTION

1. Turn the ignition switch OFF.
2. Disconnect the battery cable from the negative terminal.
3. Disconnect all the unit connectors on CAN communication system.
4. Check terminals and connectors for damage, bend and loose connection.

Is the inspection result normal?

- YES >> GO TO 2.
NO >> Repair the terminal and connector.

2. CHECK HARNESS CONTINUITY (SHORT CIRCUIT)

Check the continuity between the data link connector terminals.

Data link connector			Continuity
Connector No.	Terminal No.		
M24	6	14	Not existed

Is the inspection result normal?

- YES >> GO TO 3.
NO >> Check the harness and repair the root cause.

3. CHECK HARNESS CONTINUITY (SHORT CIRCUIT)

Check the continuity between the data link connector and the ground.

Data link connector		Ground	Continuity
Connector No.	Terminal No.		
M24	6		Not existed
	14		Not existed

Is the inspection result normal?

- YES >> GO TO 4.
NO >> Check the harness and repair the root cause.

4. CHECK ECM AND IPDM E/R TERMINATION CIRCUIT

1. Remove the ECM and the IPDM E/R.
2. Check the resistance between the ECM terminals.

ECM		Resistance (Ω)
Terminal No.		
114	113	Approx. 108 – 132

3. Check the resistance between the IPDM E/R terminals.

IPDM E/R		Resistance (Ω)
Terminal No.		
40	39	Approx. 108 – 132

Is the measurement value within the specification?

- YES >> GO TO 5.
NO >> Replace the ECM and/or the IPDM E/R.

5. CHECK SYMPTOM

Connect all the connectors. Check if the symptoms described in the "Symptom (Results from interview with customer)" are reproduced.

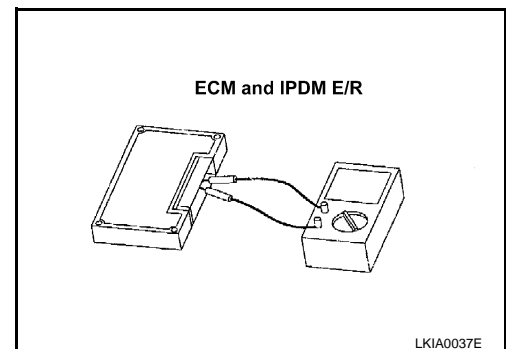

CAN COMMUNICATION CIRCUIT

< COMPONENT DIAGNOSIS >

[CAN SYSTEM (TYPE 4)]

Inspection result

Reproduced>>GO TO 6.

Non-reproduced>>Start the diagnosis again. Follow the trouble diagnosis procedure when past error is detected.

6.CHECK UNIT REPRODUCTION

Perform the reproduction test as per the following procedure for each unit.

1. Turn the ignition switch OFF.
2. Disconnect the battery cable from the negative terminal.
3. Disconnect one of the unit connectors of CAN communication system.

NOTE:

ECM and IPDM E/R have a termination circuit. Check other units first.

4. Connect the battery cable to the negative terminal. Check if the symptoms described in the "Symptom (Results from interview with customer)" are reproduced.

NOTE:

Although unit-related error symptoms occur, do not confuse them with other symptoms.

Inspection result

Reproduced>>Connect the connector. Check other units as per the above procedure.

Non-reproduced>>Replace the unit whose connector was disconnected.

A
B
C
D
E
F
G
H
I
J
K
L

LAN

N
O
P

MAIN LINE BETWEEN BCM AND DLC CIRCUIT

< COMPONENT DIAGNOSIS >

[CAN SYSTEM (TYPE 5)]

COMPONENT DIAGNOSIS

MAIN LINE BETWEEN BCM AND DLC CIRCUIT

Diagnosis Procedure

INFOID:000000001679496

INSPECTION PROCEDURE

1. CHECK HARNESS CONTINUITY (OPEN CIRCUIT)

1. Turn the ignition switch OFF.
2. Disconnect the battery cable from the negative terminal.
3. Disconnect the following harness connectors.
 - ECM
 - BCM
4. Check the continuity between the BCM harness connector and the data link connector.

BCM harness connector		Data link connector		Continuity
Connector No.	Terminal No.	Connector No.	Terminal No.	
M122	91	M24	6	Existed
	90		14	Existed

Is the inspection result normal?

YES (Present error)>>Check CAN system type decision again.

YES (Past error)>>Error was detected in the main line between the BCM and the data link connector.

NO >> Repair the main line between the BCM and the data link connector.

MAIN LINE BETWEEN DLC AND ADP CIRCUIT

< COMPONENT DIAGNOSIS >

[CAN SYSTEM (TYPE 5)]

MAIN LINE BETWEEN DLC AND ADP CIRCUIT

Diagnosis Procedure

INFOID:000000001679498

INSPECTION PROCEDURE

1.CHECK CONNECTOR

1. Turn the ignition switch OFF.
2. Disconnect the battery cable from the negative terminal.
3. Check the following terminals and connectors for damage, bend and loose connection (connector side and harness side).
 - Harness connector M7
 - Harness connector B1

Is the inspection result normal?

YES >> GO TO 2.

NO >> Repair the terminal and connector.

2.CHECK HARNESS CONTINUITY (OPEN CIRCUIT)

1. Disconnect the harness connectors M7 and B1.
2. Check the continuity between the data link connector and the harness connector.

Data link connector		Harness connector		Continuity
Connector No.	Terminal No.	Connector No.	Terminal No.	
M24	6	M7	20	Existed
	14		21	Existed

Is the inspection result normal?

YES >> GO TO 3.

NO >> Repair the main line between the data link connector and the harness connector M7.

3.CHECK HARNESS CONTINUITY (OPEN CIRCUIT)

Check the continuity between the harness connector terminals.

Connector No.	Terminal No.		Continuity
B1	20	22	Existed
	21	23	Existed

Is the inspection result normal?

YES (Present error)>>Check CAN system type decision again.

YES (Past error)>>Error was detected in the main line between the data link connector and the driver seat control unit.

NO >> Repair the main line between the harness connector B1 and the driver seat control unit.

A
B
C
D
E
F
G
H
I
J
K
L
N
O
P

LAN

MAIN LINE BETWEEN ADP AND ABS CIRCUIT

< COMPONENT DIAGNOSIS >

[CAN SYSTEM (TYPE 5)]

MAIN LINE BETWEEN ADP AND ABS CIRCUIT

Diagnosis Procedure

INFOID:000000001679500

1. CHECK CONNECTOR

1. Turn the ignition switch OFF.
2. Disconnect the battery cable from the negative terminal.
3. Check the following terminals and connectors for damage, bend and loose connection (connector side and harness side).
 - Harness connector B1
 - Harness connector M7
 - Harness connector M6
 - Harness connector E106

Is the inspection result normal?

YES >> GO TO 2.

NO >> Repair the terminal and connector.

2. CHECK HARNESS CONTINUITY (OPEN CIRCUIT)

1. Disconnect the harness connectors B1 and M7.
2. Check the continuity between the harness connector terminals.

Connector No.	Terminal No.		Continuity
B1	20	22	Existed
	21	23	Existed

Is the inspection result normal?

YES >> GO TO 3.

NO >> Repair the main line between the driver seat control unit and the harness connector B1.

3. CHECK HARNESS CONTINUITY (OPEN CIRCUIT)

1. Disconnect the harness connectors M6 and E106.
2. Check the continuity between the harness connectors.

Harness connector		Harness connector		Continuity
Connector No.	Terminal No.	Connector No.	Terminal No.	
M7	22	M6	9	Existed
	23		8	Existed

Is the inspection result normal?

YES >> GO TO 4.

NO >> Repair the main line between the harness connectors M7 and M6.

4. CHECK HARNESS CONTINUITY (OPEN CIRCUIT)

1. Disconnect the connector of ABS actuator and electric unit (control unit).
2. Check the continuity between the harness connector and the ABS actuator and electric unit (control unit) harness connector.

Harness connector		ABS actuator and electric unit (control unit) harness connector		Continuity
Connector No.	Terminal No.	Connector No.	Terminal No.	
E106	9	E41	35	Existed
	8		14	Existed

Is the inspection result normal?

YES (Present error)>>Check CAN system type decision again.

YES (Past error)>>Error was detected in the main line between the driver seat control unit and the ABS actuator and electric unit (control unit).

MAIN LINE BETWEEN ADP AND ABS CIRCUIT

< COMPONENT DIAGNOSIS >

[CAN SYSTEM (TYPE 5)]

NO >> Repair the main line between the harness connector E106 and the ABS actuator and electric unit (control unit).

A

B

C

D

E

F

G

H

I

J

K

L

LAN

N

O

P

ECM BRANCH LINE CIRCUIT

< COMPONENT DIAGNOSIS >

[CAN SYSTEM (TYPE 5)]

ECM BRANCH LINE CIRCUIT

Diagnosis Procedure

INFOID:000000001679502

1. CHECK CONNECTOR

1. Turn the ignition switch OFF.
2. Disconnect the battery cable from the negative terminal.
3. Check the terminals and connectors of the ECM for damage, bend and loose connection (unit side and connector side).

Is the inspection result normal?

- YES >> GO TO 2.
NO >> Repair the terminal and connector.

2. CHECK HARNESS FOR OPEN CIRCUIT

1. Disconnect the connector of ECM.
2. Check the resistance between the ECM harness connector terminals.

ECM harness connector			Resistance (Ω)
Connector No.	Terminal No.		
M107	114	113	Approx. 108 – 132

Is the measurement value within the specification?

- YES >> GO TO 3.
NO >> Repair the ECM branch line.

3. CHECK POWER SUPPLY AND GROUND CIRCUIT

Check the power supply and the ground circuit of the ECM. Refer to [EC-140, "Diagnosis Procedure"](#).

Is the inspection result normal?

YES (Present error)>>Replace the ECM. Refer to [EC-16, "ADDITIONAL SERVICE WHEN REPLACING CONTROL UNIT \(ECM\) : Special Repair Requirement"](#).

YES (Past error)>>Error was detected in the ECM branch line.

NO >> Repair the power supply and the ground circuit.

A-BAG BRANCH LINE CIRCUIT

< COMPONENT DIAGNOSIS >

[CAN SYSTEM (TYPE 5)]

A-BAG BRANCH LINE CIRCUIT

Diagnosis Procedure

INFOID:000000001679503

1. CHECK AIR BAG DIAGNOSIS SENSOR UNIT

Check the air bag diagnosis sensor unit. Refer to [SRC-5, "Work Flow"](#).

Is the inspection result normal?

YES >> Replace the main harness.

NO >> Replace parts whose air bag system has a malfunction.

A
B
C
D
E
F
G
H
I
J
K
L
N
O
P

LAN

AV BRANCH LINE CIRCUIT

Diagnosis Procedure

INFOID:000000001679504

1. CHECK CONNECTOR

1. Turn the ignition switch OFF.
2. Disconnect the battery cable from the negative terminal.
3. Check the terminals and connectors of the AV control unit for damage, bend and loose connection (unit side and connector side).

Is the inspection result normal?

- YES >> GO TO 2.
 NO >> Repair the terminal and connector.

2. CHECK HARNESS FOR OPEN CIRCUIT

1. Disconnect the connector of AV control unit.
 2. Check the resistance between the AV control unit harness connector terminals.
- Models with NAVI

AV control unit harness connector			Resistance (Ω)
Connector No.	Terminal No.		
M87	52	53	Approx. 54 – 66

- Models without NAVI

AV control unit harness connector			Resistance (Ω)
Connector No.	Terminal No.		
M85	86	87	Approx. 54 – 66

Is the measurement value within the specification?

- YES >> GO TO 3.
 NO >> Repair the AV control unit branch line.

3. CHECK POWER SUPPLY AND GROUND CIRCUIT

Check the power supply and the ground circuit of the AV control unit. Refer to the following.

- Base audio without navigation: [AV-39. "AV CONTROL UNIT : Diagnosis Procedure"](#)
- BOSE audio without navigation: [AV-160. "AV CONTROL UNIT : Diagnosis Procedure"](#)
- BOSE audio with navigation: [AV-433. "AV CONTROL UNIT : Diagnosis Procedure"](#)

Is the inspection result normal?

- YES (Present error)>>Replace the AV control unit. Refer to the following.
- Base audio without navigation: [AV-109. "Exploded View"](#)
 - BOSE audio without navigation: [AV-343. "Exploded View"](#)
 - BOSE audio with navigation: [AV-608. "Exploded View"](#)

YES (Past error)>>Error was detected in the AV control unit branch line.

- NO >> Repair the power supply and the ground circuit.

BCM BRANCH LINE CIRCUIT

< COMPONENT DIAGNOSIS >

[CAN SYSTEM (TYPE 5)]

BCM BRANCH LINE CIRCUIT

Diagnosis Procedure

INFOID:000000001679505

1.CHECK CONNECTOR

1. Turn the ignition switch OFF.
2. Disconnect the battery cable from the negative terminal.
3. Check the terminals and connectors of the BCM for damage, bend and loose connection (unit side and connector side).

Is the inspection result normal?

- YES >> GO TO 2.
NO >> Repair the terminal and connector.

2.CHECK HARNESS FOR OPEN CIRCUIT

1. Disconnect the connector of BCM.
2. Check the resistance between the BCM harness connector terminals.

BCM harness connector			Resistance (Ω)
Connector No.	Terminal No.		
M122	91	90	Approx. 54 – 66

Is the measurement value within the specification?

- YES >> GO TO 3.
NO >> Repair the BCM branch line.

3.CHECK POWER SUPPLY AND GROUND CIRCUIT

Check the power supply and the ground circuit of the BCM. Refer to [BCS-38, "Diagnosis Procedure"](#).

Is the inspection result normal?

- YES (Present error)>>Replace the BCM. Refer to [BCS-79, "Exploded View"](#).
YES (Past error)>>Error was detected in the BCM branch line.
NO >> Repair the power supply and the ground circuit.

A
B
C
D
E
F
G
H
I
J
K
L

LAN

N
O
P

TCM BRANCH LINE CIRCUIT

< COMPONENT DIAGNOSIS >

[CAN SYSTEM (TYPE 5)]

TCM BRANCH LINE CIRCUIT

Diagnosis Procedure

INFOID:000000001679507

1. CHECK CONNECTOR

1. Turn the ignition switch OFF.
2. Disconnect the battery cable from the negative terminal.
3. Check the following terminals and connectors for damage, bend and loose connection (unit side and connector side).
 - A/T assembly
 - Harness connector F103
 - Harness connector M116

Is the inspection result normal?

YES >> GO TO 2.

NO >> Repair the terminal and connector.

2. CHECK HARNESS FOR OPEN CIRCUIT

1. Disconnect the connector of A/T assembly.
2. Check the resistance between the A/T assembly harness connector terminals.

A/T assembly harness connector		Resistance (Ω)
Connector No.	Terminal No.	
F51	3 8	Approx. 54 – 66

Is the measurement value within the specification?

YES >> GO TO 3.

NO >> Repair the TCM branch line.

3. CHECK POWER SUPPLY AND GROUND CIRCUIT

Check the power supply and the ground circuit of the TCM. Refer to [TM-163, "Diagnosis Procedure"](#).

Is the inspection result normal?

YES (Present error)>>Replace the control valve with TCM. Refer to [TM-232, "Exploded View"](#).

YES (Past error)>>Error was detected in the TCM branch line.

NO >> Repair the power supply and the ground circuit.

DLC BRANCH LINE CIRCUIT

< COMPONENT DIAGNOSIS >

[CAN SYSTEM (TYPE 5)]

DLC BRANCH LINE CIRCUIT

Diagnosis Procedure

INFOID:000000001679509

1. CHECK CONNECTOR

1. Turn the ignition switch OFF.
2. Disconnect the battery cable from the negative terminal.
3. Check the terminals and connectors of the data link connector for damage, bend and loose connection (connector side and harness side).

Is the inspection result normal?

- YES >> GO TO 2.
NO >> Repair the terminal and connector.

2. CHECK HARNESS FOR OPEN CIRCUIT

Check the resistance between the data link connector terminals.

Data link connector			Resistance (Ω)
Connector No.	Terminal No.		
M24	6	14	Approx. 54 – 66

Is the measurement value within the specification?

- YES (Present error)>>Check the decision of CAN system type again.
YES (Past error)>>Error was detected in the data link connector branch line circuit.
NO >> Repair the data link connector branch line.

A
B
C
D
E
F
G
H
I
J
K
L

LAN

N
O
P

M&A BRANCH LINE CIRCUIT

< COMPONENT DIAGNOSIS >

[CAN SYSTEM (TYPE 5)]

M&A BRANCH LINE CIRCUIT

Diagnosis Procedure

INFOID:000000001679510

1. CHECK CONNECTOR

1. Turn the ignition switch OFF.
2. Disconnect the battery cable from the negative terminal.
3. Check the terminals and connectors of the unified meter and A/C amp. for damage, bend and loose connection (unit side and connector side).

Is the inspection result normal?

- YES >> GO TO 2.
NO >> Repair the terminal and connector.

2. CHECK HARNESS FOR OPEN CIRCUIT

1. Disconnect the connector of unified meter and A/C amp.
2. Check the resistance between the unified meter and A/C amp. harness connector terminals.

Unified meter and A/C amp. harness connector			Resistance (Ω)
Connector No.	Terminal No.		
M67	56	72	Approx. 54 – 66

Is the measurement value within the specification?

- YES >> GO TO 3.
NO >> Repair the unified meter and A/C amp. branch line.

3. CHECK POWER SUPPLY AND GROUND CIRCUIT

Check the power supply and the ground circuit of the unified meter and A/C amp. Refer to [MWI-50, "UNIFIED METER AND A/C AMP. : Diagnosis Procedure"](#).

Is the inspection result normal?

- YES (Present error)>>Replace the unified meter and A/C amp. Refer to [MWI-162, "Exploded View"](#).
YES (Past error)>>Error was detected in the unified meter and A/C amp. branch line.
NO >> Repair the power supply and the ground circuit.

STRG BRANCH LINE CIRCUIT

< COMPONENT DIAGNOSIS >

[CAN SYSTEM (TYPE 5)]

STRG BRANCH LINE CIRCUIT

Diagnosis Procedure

INFOID:000000001679511

1. CHECK CONNECTOR

1. Turn the ignition switch OFF.
2. Disconnect the battery cable from the negative terminal.
3. Check the terminals and connectors of the steering angle sensor for damage, bend and loose connection (unit side and connector side).

Is the inspection result normal?

- YES >> GO TO 2.
NO >> Repair the terminal and connector.

2. CHECK HARNESS FOR OPEN CIRCUIT

1. Disconnect the connector of steering angle sensor.
2. Check the resistance between the steering angle sensor harness connector terminals.

Steering angle sensor harness connector			Resistance (Ω)
Connector No.	Terminal No.		
M37	1	2	Approx. 54 – 66

Is the measurement value within the specification?

- YES >> GO TO 3.
NO >> Repair the steering angle sensor branch line.

3. CHECK POWER SUPPLY AND GROUND CIRCUIT

Check the power supply and the ground circuit of the steering angle sensor. Refer to [BRC-83, "Wiring Diagram - BRAKE CONTROL SYSTEM -"](#).

Is the inspection result normal?

- YES (Present error)>>Replace the steering angle sensor. Refer to [BRC-105, "Exploded View"](#).
YES (Past error)>>Error was detected in the steering angle sensor branch line.
NO >> Repair the power supply and the ground circuit.

A
B
C
D
E
F
G
H
I
J
K
L

LAN

N
O
P

ADP BRANCH LINE CIRCUIT

< COMPONENT DIAGNOSIS >

[CAN SYSTEM (TYPE 5)]

ADP BRANCH LINE CIRCUIT

Diagnosis Procedure

INFOID:000000001679512

1. CHECK CONNECTOR

1. Turn the ignition switch OFF.
2. Disconnect the battery cable from the negative terminal.
3. Check the following terminals and connectors for damage, bend and loose connection (unit side and connector side).
 - Models with automatic drive positioner
 - Driver seat control unit
 - Harness connector B502
 - Harness connector B11
 - Models without automatic drive positioner
 - Driver seat control unit
 - Harness connector B501
 - Harness connector B10

Is the inspection result normal?

YES >> GO TO 2.

NO >> Repair the terminal and connector.

2. CHECK HARNESS FOR OPEN CIRCUIT

1. Disconnect the connector of driver seat control unit.
2. Check the resistance between the driver seat control unit harness connector terminals.

Driver seat control unit harness connector			Resistance (Ω)
Connector No.	Terminal No.		
B503	3	19	Approx. 54 – 66

Is the measurement value within the specification?

YES >> GO TO 3.

NO >> Repair the driver seat control unit branch line.

3. CHECK POWER SUPPLY AND GROUND CIRCUIT

Check the power supply and the ground circuit of the driver seat control unit. Refer to [ADP-63. "DRIVER SEAT CONTROL UNIT : Diagnosis Procedure"](#).

Is the inspection result normal?

YES (Present error)>>Replace the driver seat control unit. Refer to [ADP-236. "Exploded View"](#).

YES (Past error)>>Error was detected in the driver seat control unit branch line.

NO >> Repair the power supply and the ground circuit.

ABS BRANCH LINE CIRCUIT

< COMPONENT DIAGNOSIS >

[CAN SYSTEM (TYPE 5)]

ABS BRANCH LINE CIRCUIT

Diagnosis Procedure

INFOID:000000001679514

1. CHECK CONNECTOR

1. Turn the ignition switch OFF.
2. Disconnect the battery cable from the negative terminal.
3. Check the terminals and connectors of the ABS actuator and electric unit (control unit) for damage, bend and loose connection (unit side and connector side).

Is the inspection result normal?

- YES >> GO TO 2.
NO >> Repair the terminal and connector.

2. CHECK HARNESS FOR OPEN CIRCUIT

1. Disconnect the connector of ABS actuator and electric unit (control unit).
2. Check the resistance between the ABS actuator and electric unit (control unit) harness connector terminals.

ABS actuator and electric unit (control unit) harness connector			Resistance (Ω)
Connector No.	Terminal No.		
E41	35	14	Approx. 54 – 66

Is the measurement value within the specification?

- YES >> GO TO 3.
NO >> Repair the ABS actuator and electric unit (control unit) branch line.

3. CHECK POWER SUPPLY AND GROUND CIRCUIT

Check the power supply and the ground circuit of the ABS actuator and electric unit (control unit). Refer to [BRC-37, "Diagnosis Procedure"](#).

Is the inspection result normal?

- YES (Present error)>>Replace the ABS actuator and electric unit (control unit). Refer to [BRC-102, "Exploded View"](#).
YES (Past error)>>Error was detected in the ABS actuator and electric unit (control unit) branch line.
NO >> Repair the power supply and the ground circuit.

A
B
C
D
E
F
G
H
I
J
K
L

LAN

IPDM-E BRANCH LINE CIRCUIT

< COMPONENT DIAGNOSIS >

[CAN SYSTEM (TYPE 5)]

IPDM-E BRANCH LINE CIRCUIT

Diagnosis Procedure

INFOID:000000001679516

1. CHECK CONNECTOR

1. Turn the ignition switch OFF.
2. Disconnect the battery cable from the negative terminal.
3. Check the terminals and connectors of the IPDM E/R for damage, bend and loose connection (unit side and connector side).

Is the inspection result normal?

- YES >> GO TO 2.
NO >> Repair the terminal and connector.

2. CHECK HARNESS FOR OPEN CIRCUIT

1. Disconnect the connector of IPDM E/R.
2. Check the resistance between the IPDM E/R harness connector terminals.

IPDM E/R harness connector			Resistance (Ω)
Connector No.	Terminal No.		
E6	40	39	Approx. 108 – 132

Is the measurement value within the specification?

- YES >> GO TO 3.
NO >> Repair the IPDM E/R branch line.

3. CHECK POWER SUPPLY AND GROUND CIRCUIT

Check the power supply and the ground circuit of the IPDM E/R. Refer to [PCS-19, "Diagnosis Procedure"](#).

Is the inspection result normal?

- YES (Present error)>>Replace the IPDM E/R. Refer to [PCS-34, "Exploded View"](#).
YES (Past error)>>Error was detected in the IPDM E/R branch line.
NO >> Repair the power supply and the ground circuit.

CAN COMMUNICATION CIRCUIT

< COMPONENT DIAGNOSIS >

[CAN SYSTEM (TYPE 5)]

CAN COMMUNICATION CIRCUIT

Diagnosis Procedure

INFOID:000000001679517

1. CONNECTOR INSPECTION

1. Turn the ignition switch OFF.
2. Disconnect the battery cable from the negative terminal.
3. Disconnect all the unit connectors on CAN communication system.
4. Check terminals and connectors for damage, bend and loose connection.

Is the inspection result normal?

- YES >> GO TO 2.
NO >> Repair the terminal and connector.

2. CHECK HARNESS CONTINUITY (SHORT CIRCUIT)

Check the continuity between the data link connector terminals.

Data link connector		Continuity
Connector No.	Terminal No.	
M24	6 14	Not existed

Is the inspection result normal?

- YES >> GO TO 3.
NO >> Check the harness and repair the root cause.

3. CHECK HARNESS CONTINUITY (SHORT CIRCUIT)

Check the continuity between the data link connector and the ground.

Data link connector		Ground	Continuity
Connector No.	Terminal No.		
M24	6		Not existed
	14		Not existed

Is the inspection result normal?

- YES >> GO TO 4.
NO >> Check the harness and repair the root cause.

4. CHECK ECM AND IPDM E/R TERMINATION CIRCUIT

1. Remove the ECM and the IPDM E/R.
2. Check the resistance between the ECM terminals.

ECM		Resistance (Ω)
Terminal No.		
114	113	Approx. 108 – 132

3. Check the resistance between the IPDM E/R terminals.

IPDM E/R		Resistance (Ω)
Terminal No.		
40	39	Approx. 108 – 132

Is the measurement value within the specification?

- YES >> GO TO 5.
NO >> Replace the ECM and/or the IPDM E/R.

5. CHECK SYMPTOM

Connect all the connectors. Check if the symptoms described in the "Symptom (Results from interview with customer)" are reproduced.

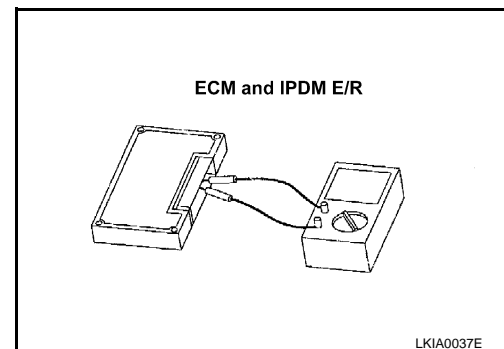

LKIA0037E

CAN COMMUNICATION CIRCUIT

< COMPONENT DIAGNOSIS >

[CAN SYSTEM (TYPE 5)]

Inspection result

Reproduced>>GO TO 6.

Non-reproduced>>Start the diagnosis again. Follow the trouble diagnosis procedure when past error is detected.

6.CHECK UNIT REPRODUCTION

Perform the reproduction test as per the following procedure for each unit.

1. Turn the ignition switch OFF.
2. Disconnect the battery cable from the negative terminal.
3. Disconnect one of the unit connectors of CAN communication system.

NOTE:

ECM and IPDM E/R have a termination circuit. Check other units first.

4. Connect the battery cable to the negative terminal. Check if the symptoms described in the "Symptom (Results from interview with customer)" are reproduced.

NOTE:

Although unit-related error symptoms occur, do not confuse them with other symptoms.

Inspection result

Reproduced>>Connect the connector. Check other units as per the above procedure.

Non-reproduced>>Replace the unit whose connector was disconnected.

MAIN LINE BETWEEN BCM AND DLC CIRCUIT

< COMPONENT DIAGNOSIS >

[CAN SYSTEM (TYPE 6)]

COMPONENT DIAGNOSIS

MAIN LINE BETWEEN BCM AND DLC CIRCUIT

Diagnosis Procedure

INFOID:000000001679526

INSPECTION PROCEDURE

1. CHECK HARNESS CONTINUITY (OPEN CIRCUIT)

1. Turn the ignition switch OFF.
2. Disconnect the battery cable from the negative terminal.
3. Disconnect the following harness connectors.
 - ECM
 - BCM
4. Check the continuity between the BCM harness connector and the data link connector.

BCM harness connector		Data link connector		Continuity
Connector No.	Terminal No.	Connector No.	Terminal No.	
M122	91	M24	6	Existed
	90		14	Existed

Is the inspection result normal?

YES (Present error)>>Check CAN system type decision again.

YES (Past error)>>Error was detected in the main line between the BCM and the data link connector.

NO >> Repair the main line between the BCM and the data link connector.

A
B
C
D
E
F
G
H
I
J
K
L
N
O
P

LAN

MAIN LINE BETWEEN DLC AND ADP CIRCUIT

< COMPONENT DIAGNOSIS >

[CAN SYSTEM (TYPE 6)]

MAIN LINE BETWEEN DLC AND ADP CIRCUIT

Diagnosis Procedure

INFOID:000000001679528

INSPECTION PROCEDURE

1. CHECK CONNECTOR

1. Turn the ignition switch OFF.
2. Disconnect the battery cable from the negative terminal.
3. Check the following terminals and connectors for damage, bend and loose connection (connector side and harness side).
 - Harness connector M7
 - Harness connector B1

Is the inspection result normal?

YES >> GO TO 2.

NO >> Repair the terminal and connector.

2. CHECK HARNESS CONTINUITY (OPEN CIRCUIT)

1. Disconnect the harness connectors M7 and B1.
2. Check the continuity between the data link connector and the harness connector.

Data link connector		Harness connector		Continuity
Connector No.	Terminal No.	Connector No.	Terminal No.	
M24	6	M7	20	Existed
	14		21	Existed

Is the inspection result normal?

YES >> GO TO 3.

NO >> Repair the main line between the data link connector and the harness connector M7.

3. CHECK HARNESS CONTINUITY (OPEN CIRCUIT)

Check the continuity between the harness connector terminals.

Connector No.	Terminal No.		Continuity
B1	20	22	Existed
	21	23	Existed

Is the inspection result normal?

YES (Present error)>>Check CAN system type decision again.

YES (Past error)>>Error was detected in the main line between the data link connector and the driver seat control unit.

NO >> Repair the main line between the harness connector B1 and the driver seat control unit.

MAIN LINE BETWEEN ADP AND ABS CIRCUIT

< COMPONENT DIAGNOSIS >

[CAN SYSTEM (TYPE 6)]

MAIN LINE BETWEEN ADP AND ABS CIRCUIT

Diagnosis Procedure

INFOID:000000001679530

1. CHECK CONNECTOR

1. Turn the ignition switch OFF.
2. Disconnect the battery cable from the negative terminal.
3. Check the following terminals and connectors for damage, bend and loose connection (connector side and harness side).
 - Harness connector B1
 - Harness connector M7
 - Harness connector M6
 - Harness connector E106

Is the inspection result normal?

YES >> GO TO 2.

NO >> Repair the terminal and connector.

2. CHECK HARNESS CONTINUITY (OPEN CIRCUIT)

1. Disconnect the harness connectors B1 and M7.
2. Check the continuity between the harness connector terminals.

Connector No.	Terminal No.		Continuity
B1	20	22	Existed
	21	23	Existed

Is the inspection result normal?

YES >> GO TO 3.

NO >> Repair the main line between the driver seat control unit and the harness connector B1.

3. CHECK HARNESS CONTINUITY (OPEN CIRCUIT)

1. Disconnect the harness connectors M6 and E106.
2. Check the continuity between the harness connectors.

Harness connector		Harness connector		Continuity
Connector No.	Terminal No.	Connector No.	Terminal No.	
M7	22	M6	9	Existed
	23		8	Existed

Is the inspection result normal?

YES >> GO TO 4.

NO >> Repair the main line between the harness connectors M7 and M6.

4. CHECK HARNESS CONTINUITY (OPEN CIRCUIT)

1. Disconnect the connector of ABS actuator and electric unit (control unit).
2. Check the continuity between the harness connector and the ABS actuator and electric unit (control unit) harness connector.

Harness connector		ABS actuator and electric unit (control unit) harness connector		Continuity
Connector No.	Terminal No.	Connector No.	Terminal No.	
E106	9	E41	35	Existed
	8		14	Existed

Is the inspection result normal?

YES (Present error)>>Check CAN system type decision again.

YES (Past error)>>Error was detected in the main line between the driver seat control unit and the ABS actuator and electric unit (control unit).

MAIN LINE BETWEEN ADP AND ABS CIRCUIT

< COMPONENT DIAGNOSIS >

[CAN SYSTEM (TYPE 6)]

NO >> Repair the main line between the harness connector E106 and the ABS actuator and electric unit (control unit).

ECM BRANCH LINE CIRCUIT

< COMPONENT DIAGNOSIS >

[CAN SYSTEM (TYPE 6)]

ECM BRANCH LINE CIRCUIT

Diagnosis Procedure

INFOID:000000001679532

1. CHECK CONNECTOR

1. Turn the ignition switch OFF.
2. Disconnect the battery cable from the negative terminal.
3. Check the terminals and connectors of the ECM for damage, bend and loose connection (unit side and connector side).

Is the inspection result normal?

- YES >> GO TO 2.
NO >> Repair the terminal and connector.

2. CHECK HARNESS FOR OPEN CIRCUIT

1. Disconnect the connector of ECM.
2. Check the resistance between the ECM harness connector terminals.

ECM harness connector			Resistance (Ω)
Connector No.	Terminal No.		
M107	114	113	Approx. 108 – 132

Is the measurement value within the specification?

- YES >> GO TO 3.
NO >> Repair the ECM branch line.

3. CHECK POWER SUPPLY AND GROUND CIRCUIT

Check the power supply and the ground circuit of the ECM. Refer to [EC-140. "Diagnosis Procedure"](#).

Is the inspection result normal?

YES (Present error)>>Replace the ECM. Refer to [EC-16. "ADDITIONAL SERVICE WHEN REPLACING CONTROL UNIT \(ECM\) : Special Repair Requirement"](#).

YES (Past error)>>Error was detected in the ECM branch line.

NO >> Repair the power supply and the ground circuit.

A
B
C
D
E
F
G
H
I
J
K
L

LAN

N
O
P

A-BAG BRANCH LINE CIRCUIT

< COMPONENT DIAGNOSIS >

[CAN SYSTEM (TYPE 6)]

A-BAG BRANCH LINE CIRCUIT

Diagnosis Procedure

INFOID:000000001679533

1. CHECK AIR BAG DIAGNOSIS SENSOR UNIT

Check the air bag diagnosis sensor unit. Refer to [SRC-5, "Work Flow"](#).

Is the inspection result normal?

YES >> Replace the main harness.

NO >> Replace parts whose air bag system has a malfunction.

AV BRANCH LINE CIRCUIT

Diagnosis Procedure

INFOID:000000001679534

1. CHECK CONNECTOR

1. Turn the ignition switch OFF.
2. Disconnect the battery cable from the negative terminal.
3. Check the terminals and connectors of the AV control unit for damage, bend and loose connection (unit side and connector side).

Is the inspection result normal?

- YES >> GO TO 2.
 NO >> Repair the terminal and connector.

2. CHECK HARNESS FOR OPEN CIRCUIT

1. Disconnect the connector of AV control unit.
 2. Check the resistance between the AV control unit harness connector terminals.
- Models with NAVI

AV control unit harness connector			Resistance (Ω)
Connector No.	Terminal No.		
M87	52	53	Approx. 54 – 66

- Models without NAVI

AV control unit harness connector			Resistance (Ω)
Connector No.	Terminal No.		
M85	86	87	Approx. 54 – 66

Is the measurement value within the specification?

- YES >> GO TO 3.
 NO >> Repair the AV control unit branch line.

3. CHECK POWER SUPPLY AND GROUND CIRCUIT

Check the power supply and the ground circuit of the AV control unit. Refer to the following.

- Base audio without navigation: [AV-39, "AV CONTROL UNIT : Diagnosis Procedure"](#)
- BOSE audio without navigation: [AV-160, "AV CONTROL UNIT : Diagnosis Procedure"](#)
- BOSE audio with navigation: [AV-433, "AV CONTROL UNIT : Diagnosis Procedure"](#)

Is the inspection result normal?

- YES (Present error)>>Replace the AV control unit. Refer to the following.
- Base audio without navigation: [AV-109, "Exploded View"](#)
 - BOSE audio without navigation: [AV-343, "Exploded View"](#)
 - BOSE audio with navigation: [AV-608, "Exploded View"](#)

YES (Past error)>>Error was detected in the AV control unit branch line.

- NO >> Repair the power supply and the ground circuit.

A
B
C
D
E
F
G
H
I
J
K
L
N
O
P

LAN

BCM BRANCH LINE CIRCUIT

< COMPONENT DIAGNOSIS >

[CAN SYSTEM (TYPE 6)]

BCM BRANCH LINE CIRCUIT

Diagnosis Procedure

INFOID:000000001679535

1.CHECK CONNECTOR

1. Turn the ignition switch OFF.
2. Disconnect the battery cable from the negative terminal.
3. Check the terminals and connectors of the BCM for damage, bend and loose connection (unit side and connector side).

Is the inspection result normal?

- YES >> GO TO 2.
NO >> Repair the terminal and connector.

2.CHECK HARNESS FOR OPEN CIRCUIT

1. Disconnect the connector of BCM.
2. Check the resistance between the BCM harness connector terminals.

BCM harness connector			Resistance (Ω)
Connector No.	Terminal No.		
M122	91	90	Approx. 54 – 66

Is the measurement value within the specification?

- YES >> GO TO 3.
NO >> Repair the BCM branch line.

3.CHECK POWER SUPPLY AND GROUND CIRCUIT

Check the power supply and the ground circuit of the BCM. Refer to [BCS-38. "Diagnosis Procedure"](#).

Is the inspection result normal?

- YES (Present error)>>Replace the BCM. Refer to [BCS-79. "Exploded View"](#).
YES (Past error)>>Error was detected in the BCM branch line.
NO >> Repair the power supply and the ground circuit.

TCM BRANCH LINE CIRCUIT

< COMPONENT DIAGNOSIS >

[CAN SYSTEM (TYPE 6)]

TCM BRANCH LINE CIRCUIT

Diagnosis Procedure

INFOID:000000001679537

1. CHECK CONNECTOR

1. Turn the ignition switch OFF.
2. Disconnect the battery cable from the negative terminal.
3. Check the following terminals and connectors for damage, bend and loose connection (unit side and connector side).
 - A/T assembly
 - Harness connector F103
 - Harness connector M116

Is the inspection result normal?

YES >> GO TO 2.

NO >> Repair the terminal and connector.

2. CHECK HARNESS FOR OPEN CIRCUIT

1. Disconnect the connector of A/T assembly.
2. Check the resistance between the A/T assembly harness connector terminals.

A/T assembly harness connector		Resistance (Ω)
Connector No.	Terminal No.	
F51	3	Approx. 54 – 66
	8	

Is the measurement value within the specification?

YES >> GO TO 3.

NO >> Repair the TCM branch line.

3. CHECK POWER SUPPLY AND GROUND CIRCUIT

Check the power supply and the ground circuit of the TCM. Refer to [TM-163, "Diagnosis Procedure"](#).

Is the inspection result normal?

YES (Present error)>>Replace the control valve with TCM. Refer to [TM-232, "Exploded View"](#).

YES (Past error)>>Error was detected in the TCM branch line.

NO >> Repair the power supply and the ground circuit.

A
B
C
D
E
F
G
H
I
J
K
L

LAN

N
O
P

DLC BRANCH LINE CIRCUIT

< COMPONENT DIAGNOSIS >

[CAN SYSTEM (TYPE 6)]

DLC BRANCH LINE CIRCUIT

Diagnosis Procedure

INFOID:000000001679539

1. CHECK CONNECTOR

1. Turn the ignition switch OFF.
2. Disconnect the battery cable from the negative terminal.
3. Check the terminals and connectors of the data link connector for damage, bend and loose connection (connector side and harness side).

Is the inspection result normal?

- YES >> GO TO 2.
NO >> Repair the terminal and connector.

2. CHECK HARNESS FOR OPEN CIRCUIT

Check the resistance between the data link connector terminals.

Data link connector			Resistance (Ω)
Connector No.	Terminal No.		
M24	6	14	Approx. 54 – 66

Is the measurement value within the specification?

- YES (Present error)>>Check the decision of CAN system type again.
YES (Past error)>>Error was detected in the data link connector branch line circuit.
NO >> Repair the data link connector branch line.

M&A BRANCH LINE CIRCUIT

< COMPONENT DIAGNOSIS >

[CAN SYSTEM (TYPE 6)]

M&A BRANCH LINE CIRCUIT

Diagnosis Procedure

INFOID:000000001679540

1. CHECK CONNECTOR

1. Turn the ignition switch OFF.
2. Disconnect the battery cable from the negative terminal.
3. Check the terminals and connectors of the unified meter and A/C amp. for damage, bend and loose connection (unit side and connector side).

Is the inspection result normal?

- YES >> GO TO 2.
NO >> Repair the terminal and connector.

2. CHECK HARNESS FOR OPEN CIRCUIT

1. Disconnect the connector of unified meter and A/C amp.
2. Check the resistance between the unified meter and A/C amp. harness connector terminals.

Unified meter and A/C amp. harness connector			Resistance (Ω)
Connector No.	Terminal No.		
M67	56	72	Approx. 54 – 66

Is the measurement value within the specification?

- YES >> GO TO 3.
NO >> Repair the unified meter and A/C amp. branch line.

3. CHECK POWER SUPPLY AND GROUND CIRCUIT

Check the power supply and the ground circuit of the unified meter and A/C amp. Refer to [MWI-50, "UNIFIED METER AND A/C AMP. : Diagnosis Procedure"](#).

Is the inspection result normal?

- YES (Present error)>>Replace the unified meter and A/C amp. Refer to [MWI-162, "Exploded View"](#).
YES (Past error)>>Error was detected in the unified meter and A/C amp. branch line.
NO >> Repair the power supply and the ground circuit.

A
B
C
D
E
F
G
H
I
J
K
L
N
O
P

LAN

STRG BRANCH LINE CIRCUIT

< COMPONENT DIAGNOSIS >

[CAN SYSTEM (TYPE 6)]

STRG BRANCH LINE CIRCUIT

Diagnosis Procedure

INFOID:000000001679541

1. CHECK CONNECTOR

1. Turn the ignition switch OFF.
2. Disconnect the battery cable from the negative terminal.
3. Check the terminals and connectors of the steering angle sensor for damage, bend and loose connection (unit side and connector side).

Is the inspection result normal?

- YES >> GO TO 2.
NO >> Repair the terminal and connector.

2. CHECK HARNESS FOR OPEN CIRCUIT

1. Disconnect the connector of steering angle sensor.
2. Check the resistance between the steering angle sensor harness connector terminals.

Steering angle sensor harness connector			Resistance (Ω)
Connector No.	Terminal No.		
M37	1	2	Approx. 54 – 66

Is the measurement value within the specification?

- YES >> GO TO 3.
NO >> Repair the steering angle sensor branch line.

3. CHECK POWER SUPPLY AND GROUND CIRCUIT

Check the power supply and the ground circuit of the steering angle sensor. Refer to [BRC-83, "Wiring Diagram - BRAKE CONTROL SYSTEM -"](#).

Is the inspection result normal?

- YES (Present error)>>Replace the steering angle sensor. Refer to [BRC-105, "Exploded View"](#).
YES (Past error)>>Error was detected in the steering angle sensor branch line.
NO >> Repair the power supply and the ground circuit.

ADP BRANCH LINE CIRCUIT

< COMPONENT DIAGNOSIS >

[CAN SYSTEM (TYPE 6)]

ADP BRANCH LINE CIRCUIT

Diagnosis Procedure

INFOID:000000001679542

1. CHECK CONNECTOR

1. Turn the ignition switch OFF.
2. Disconnect the battery cable from the negative terminal.
3. Check the following terminals and connectors for damage, bend and loose connection (unit side and connector side).
 - Models with automatic drive positioner
 - Driver seat control unit
 - Harness connector B502
 - Harness connector B11
 - Models without automatic drive positioner
 - Driver seat control unit
 - Harness connector B501
 - Harness connector B10

Is the inspection result normal?

YES >> GO TO 2.

NO >> Repair the terminal and connector.

2. CHECK HARNESS FOR OPEN CIRCUIT

1. Disconnect the connector of driver seat control unit.
2. Check the resistance between the driver seat control unit harness connector terminals.

Driver seat control unit harness connector			Resistance (Ω)
Connector No.	Terminal No.		
B503	3	19	Approx. 54 – 66

Is the measurement value within the specification?

YES >> GO TO 3.

NO >> Repair the driver seat control unit branch line.

3. CHECK POWER SUPPLY AND GROUND CIRCUIT

Check the power supply and the ground circuit of the driver seat control unit. Refer to [ADP-63. "DRIVER SEAT CONTROL UNIT : Diagnosis Procedure"](#).

Is the inspection result normal?

YES (Present error)>>Replace the driver seat control unit. Refer to [ADP-236. "Exploded View"](#).

YES (Past error)>>Error was detected in the driver seat control unit branch line.

NO >> Repair the power supply and the ground circuit.

A
B
C
D
E
F
G
H
I
J
K
L
N
O
P

LAN

RAS BRANCH LINE CIRCUIT

< COMPONENT DIAGNOSIS >

[CAN SYSTEM (TYPE 6)]

RAS BRANCH LINE CIRCUIT

Diagnosis Procedure

INFOID:000000001679543

1.CHECK CONNECTOR

1. Turn the ignition switch OFF.
2. Disconnect the battery cable from the negative terminal.
3. Check the terminals and connectors of the 4WAS main control unit for damage, bend and loose connection (unit side and connector side).

Is the inspection result normal?

- YES >> GO TO 2.
NO >> Repair the terminal and connector.

2.CHECK HARNESS FOR OPEN CIRCUIT

1. Disconnect the connector of 4WAS main control unit.
2. Check the resistance between the 4WAS main control unit harness connector terminals.

4WAS main control unit harness connector			Resistance (Ω)
Connector No.	Terminal No.		
B54	1	8	Approx. 54 – 66

Is the measurement value within the specification?

- YES >> GO TO 3.
NO >> Repair the 4WAS main control unit branch line.

3.CHECK POWER SUPPLY AND GROUND CIRCUIT

Check the power supply and the ground circuit of the 4WAS main control unit. Refer to [STC-134, "Diagnosis Procedure \(4WAS Main Control Unit\)"](#).

Is the inspection result normal?

- YES (Present error)>>Replace the 4WAS main control unit. Refer to [STC-178, "Exploded View"](#).
YES (Past error)>>Error was detected in the 4WAS main control unit branch line.
NO >> Repair the power supply and the ground circuit.

ABS BRANCH LINE CIRCUIT

< COMPONENT DIAGNOSIS >

[CAN SYSTEM (TYPE 6)]

ABS BRANCH LINE CIRCUIT

Diagnosis Procedure

INFOID:000000001679544

1. CHECK CONNECTOR

1. Turn the ignition switch OFF.
2. Disconnect the battery cable from the negative terminal.
3. Check the terminals and connectors of the ABS actuator and electric unit (control unit) for damage, bend and loose connection (unit side and connector side).

Is the inspection result normal?

- YES >> GO TO 2.
NO >> Repair the terminal and connector.

2. CHECK HARNESS FOR OPEN CIRCUIT

1. Disconnect the connector of ABS actuator and electric unit (control unit).
2. Check the resistance between the ABS actuator and electric unit (control unit) harness connector terminals.

ABS actuator and electric unit (control unit) harness connector			Resistance (Ω)
Connector No.	Terminal No.		
E41	35	14	Approx. 54 – 66

Is the measurement value within the specification?

- YES >> GO TO 3.
NO >> Repair the ABS actuator and electric unit (control unit) branch line.

3. CHECK POWER SUPPLY AND GROUND CIRCUIT

Check the power supply and the ground circuit of the ABS actuator and electric unit (control unit). Refer to [BRC-37, "Diagnosis Procedure"](#).

Is the inspection result normal?

- YES (Present error)>>Replace the ABS actuator and electric unit (control unit). Refer to [BRC-102, "Exploded View"](#).
YES (Past error)>>Error was detected in the ABS actuator and electric unit (control unit) branch line.
NO >> Repair the power supply and the ground circuit.

A
B
C
D
E
F
G
H
I
J
K
L

LAN

IPDM-E BRANCH LINE CIRCUIT

< COMPONENT DIAGNOSIS >

[CAN SYSTEM (TYPE 6)]

IPDM-E BRANCH LINE CIRCUIT

Diagnosis Procedure

INFOID:000000001679546

1. CHECK CONNECTOR

1. Turn the ignition switch OFF.
2. Disconnect the battery cable from the negative terminal.
3. Check the terminals and connectors of the IPDM E/R for damage, bend and loose connection (unit side and connector side).

Is the inspection result normal?

- YES >> GO TO 2.
NO >> Repair the terminal and connector.

2. CHECK HARNESS FOR OPEN CIRCUIT

1. Disconnect the connector of IPDM E/R.
2. Check the resistance between the IPDM E/R harness connector terminals.

IPDM E/R harness connector			Resistance (Ω)
Connector No.	Terminal No.		
E6	40	39	Approx. 108 – 132

Is the measurement value within the specification?

- YES >> GO TO 3.
NO >> Repair the IPDM E/R branch line.

3. CHECK POWER SUPPLY AND GROUND CIRCUIT

Check the power supply and the ground circuit of the IPDM E/R. Refer to [PCS-19, "Diagnosis Procedure"](#).

Is the inspection result normal?

- YES (Present error)>>Replace the IPDM E/R. Refer to [PCS-34, "Exploded View"](#).
YES (Past error)>>Error was detected in the IPDM E/R branch line.
NO >> Repair the power supply and the ground circuit.

CAN COMMUNICATION CIRCUIT

< COMPONENT DIAGNOSIS >

[CAN SYSTEM (TYPE 6)]

CAN COMMUNICATION CIRCUIT

Diagnosis Procedure

INFOID:000000001679547

1. CONNECTOR INSPECTION

1. Turn the ignition switch OFF.
2. Disconnect the battery cable from the negative terminal.
3. Disconnect all the unit connectors on CAN communication system.
4. Check terminals and connectors for damage, bend and loose connection.

Is the inspection result normal?

- YES >> GO TO 2.
NO >> Repair the terminal and connector.

2. CHECK HARNESS CONTINUITY (SHORT CIRCUIT)

Check the continuity between the data link connector terminals.

Data link connector		Continuity
Connector No.	Terminal No.	
M24	6 14	Not existed

Is the inspection result normal?

- YES >> GO TO 3.
NO >> Check the harness and repair the root cause.

3. CHECK HARNESS CONTINUITY (SHORT CIRCUIT)

Check the continuity between the data link connector and the ground.

Data link connector		Ground	Continuity
Connector No.	Terminal No.		
M24	6		Not existed
	14		Not existed

Is the inspection result normal?

- YES >> GO TO 4.
NO >> Check the harness and repair the root cause.

4. CHECK ECM AND IPDM E/R TERMINATION CIRCUIT

1. Remove the ECM and the IPDM E/R.
2. Check the resistance between the ECM terminals.

ECM		Resistance (Ω)
Terminal No.		
114	113	Approx. 108 – 132

3. Check the resistance between the IPDM E/R terminals.

IPDM E/R		Resistance (Ω)
Terminal No.		
40	39	Approx. 108 – 132

Is the measurement value within the specification?

- YES >> GO TO 5.
NO >> Replace the ECM and/or the IPDM E/R.

5. CHECK SYMPTOM

Connect all the connectors. Check if the symptoms described in the "Symptom (Results from interview with customer)" are reproduced.

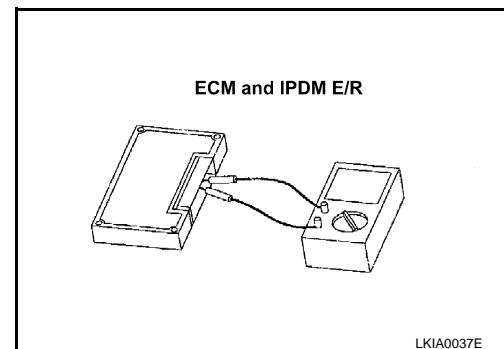

CAN COMMUNICATION CIRCUIT

< COMPONENT DIAGNOSIS >

[CAN SYSTEM (TYPE 6)]

Inspection result

Reproduced>>GO TO 6.

Non-reproduced>>Start the diagnosis again. Follow the trouble diagnosis procedure when past error is detected.

6.CHECK UNIT REPRODUCTION

Perform the reproduction test as per the following procedure for each unit.

1. Turn the ignition switch OFF.
2. Disconnect the battery cable from the negative terminal.
3. Disconnect one of the unit connectors of CAN communication system.

NOTE:

ECM and IPDM E/R have a termination circuit. Check other units first.

4. Connect the battery cable to the negative terminal. Check if the symptoms described in the "Symptom (Results from interview with customer)" are reproduced.

NOTE:

Although unit-related error symptoms occur, do not confuse them with other symptoms.

Inspection result

Reproduced>>Connect the connector. Check other units as per the above procedure.

Non-reproduced>>Replace the unit whose connector was disconnected.

MAIN LINE BETWEEN BCM AND DLC CIRCUIT

< COMPONENT DIAGNOSIS >

[CAN SYSTEM (TYPE 7)]

COMPONENT DIAGNOSIS

MAIN LINE BETWEEN BCM AND DLC CIRCUIT

Diagnosis Procedure

INFOID:000000001679553

INSPECTION PROCEDURE

1. CHECK HARNESS CONTINUITY (OPEN CIRCUIT)

1. Turn the ignition switch OFF.
2. Disconnect the battery cable from the negative terminal.
3. Disconnect the following harness connectors.
 - ECM
 - BCM
4. Check the continuity between the BCM harness connector and the data link connector.

BCM harness connector		Data link connector		Continuity
Connector No.	Terminal No.	Connector No.	Terminal No.	
M122	91	M24	6	Existed
	90		14	Existed

Is the inspection result normal?

YES (Present error)>>Check CAN system type decision again.

YES (Past error)>>Error was detected in the main line between the BCM and the data link connector.

NO >> Repair the main line between the BCM and the data link connector.

A
B
C
D
E
F
G
H
I
J
K
L
N
O
P

LAN

MAIN LINE BETWEEN DLC AND ADP CIRCUIT

< COMPONENT DIAGNOSIS >

[CAN SYSTEM (TYPE 7)]

MAIN LINE BETWEEN DLC AND ADP CIRCUIT

Diagnosis Procedure

INFOID:000000001679555

INSPECTION PROCEDURE

1. CHECK CONNECTOR

1. Turn the ignition switch OFF.
2. Disconnect the battery cable from the negative terminal.
3. Check the following terminals and connectors for damage, bend and loose connection (connector side and harness side).
 - Harness connector M7
 - Harness connector B1

Is the inspection result normal?

YES >> GO TO 2.

NO >> Repair the terminal and connector.

2. CHECK HARNESS CONTINUITY (OPEN CIRCUIT)

1. Disconnect the harness connectors M7 and B1.
2. Check the continuity between the data link connector and the harness connector.

Data link connector		Harness connector		Continuity
Connector No.	Terminal No.	Connector No.	Terminal No.	
M24	6	M7	20	Existed
	14		21	Existed

Is the inspection result normal?

YES >> GO TO 3.

NO >> Repair the main line between the data link connector and the harness connector M7.

3. CHECK HARNESS CONTINUITY (OPEN CIRCUIT)

Check the continuity between the harness connector terminals.

Connector No.	Terminal No.		Continuity
B1	20	22	Existed
	21	23	Existed

Is the inspection result normal?

YES (Present error)>>Check CAN system type decision again.

YES (Past error)>>Error was detected in the main line between the data link connector and the driver seat control unit.

NO >> Repair the main line between the harness connector B1 and the driver seat control unit.

MAIN LINE BETWEEN ADP AND ABS CIRCUIT

< COMPONENT DIAGNOSIS >

[CAN SYSTEM (TYPE 7)]

MAIN LINE BETWEEN ADP AND ABS CIRCUIT

Diagnosis Procedure

INFOID:000000001679557

1. CHECK CONNECTOR

1. Turn the ignition switch OFF.
2. Disconnect the battery cable from the negative terminal.
3. Check the following terminals and connectors for damage, bend and loose connection (connector side and harness side).
 - Harness connector B1
 - Harness connector M7
 - Harness connector M6
 - Harness connector E106

Is the inspection result normal?

YES >> GO TO 2.

NO >> Repair the terminal and connector.

2. CHECK HARNESS CONTINUITY (OPEN CIRCUIT)

1. Disconnect the harness connectors B1 and M7.
2. Check the continuity between the harness connector terminals.

Connector No.	Terminal No.		Continuity
B1	20	22	Existed
	21	23	Existed

Is the inspection result normal?

YES >> GO TO 3.

NO >> Repair the main line between the driver seat control unit and the harness connector B1.

3. CHECK HARNESS CONTINUITY (OPEN CIRCUIT)

1. Disconnect the harness connectors M6 and E106.
2. Check the continuity between the harness connectors.

Harness connector		Harness connector		Continuity
Connector No.	Terminal No.	Connector No.	Terminal No.	
M7	22	M6	9	Existed
	23		8	Existed

Is the inspection result normal?

YES >> GO TO 4.

NO >> Repair the main line between the harness connectors M7 and M6.

4. CHECK HARNESS CONTINUITY (OPEN CIRCUIT)

1. Disconnect the connector of ABS actuator and electric unit (control unit).
2. Check the continuity between the harness connector and the ABS actuator and electric unit (control unit) harness connector.

Harness connector		ABS actuator and electric unit (control unit) harness connector		Continuity
Connector No.	Terminal No.	Connector No.	Terminal No.	
E106	9	E41	35	Existed
	8		14	Existed

Is the inspection result normal?

YES (Present error)>>Check CAN system type decision again.

YES (Past error)>>Error was detected in the main line between the driver seat control unit and the ABS actuator and electric unit (control unit).

MAIN LINE BETWEEN ADP AND ABS CIRCUIT

< COMPONENT DIAGNOSIS >

[CAN SYSTEM (TYPE 7)]

NO >> Repair the main line between the harness connector E106 and the ABS actuator and electric unit (control unit).

ECM BRANCH LINE CIRCUIT

< COMPONENT DIAGNOSIS >

[CAN SYSTEM (TYPE 7)]

ECM BRANCH LINE CIRCUIT

Diagnosis Procedure

INFOID:000000001679559

1. CHECK CONNECTOR

1. Turn the ignition switch OFF.
2. Disconnect the battery cable from the negative terminal.
3. Check the terminals and connectors of the ECM for damage, bend and loose connection (unit side and connector side).

Is the inspection result normal?

- YES >> GO TO 2.
NO >> Repair the terminal and connector.

2. CHECK HARNESS FOR OPEN CIRCUIT

1. Disconnect the connector of ECM.
2. Check the resistance between the ECM harness connector terminals.

ECM harness connector			Resistance (Ω)
Connector No.	Terminal No.		
M107	114	113	Approx. 108 – 132

Is the measurement value within the specification?

- YES >> GO TO 3.
NO >> Repair the ECM branch line.

3. CHECK POWER SUPPLY AND GROUND CIRCUIT

Check the power supply and the ground circuit of the ECM. Refer to [EC-140. "Diagnosis Procedure"](#).

Is the inspection result normal?

YES (Present error)>>Replace the ECM. Refer to [EC-16. "ADDITIONAL SERVICE WHEN REPLACING CONTROL UNIT \(ECM\) : Special Repair Requirement"](#).

YES (Past error)>>Error was detected in the ECM branch line.

NO >> Repair the power supply and the ground circuit.

A
B
C
D
E
F
G
H
I
J
K
L

LAN

N
O
P

A-BAG BRANCH LINE CIRCUIT

< COMPONENT DIAGNOSIS >

[CAN SYSTEM (TYPE 7)]

A-BAG BRANCH LINE CIRCUIT

Diagnosis Procedure

INFOID:000000001679560

1. CHECK AIR BAG DIAGNOSIS SENSOR UNIT

Check the air bag diagnosis sensor unit. Refer to [SRC-5, "Work Flow"](#).

Is the inspection result normal?

YES >> Replace the main harness.

NO >> Replace parts whose air bag system has a malfunction.

AV BRANCH LINE CIRCUIT

Diagnosis Procedure

INFOID:000000001679561

1. CHECK CONNECTOR

1. Turn the ignition switch OFF.
2. Disconnect the battery cable from the negative terminal.
3. Check the terminals and connectors of the AV control unit for damage, bend and loose connection (unit side and connector side).

Is the inspection result normal?

- YES >> GO TO 2.
 NO >> Repair the terminal and connector.

2. CHECK HARNESS FOR OPEN CIRCUIT

1. Disconnect the connector of AV control unit.
 2. Check the resistance between the AV control unit harness connector terminals.
- Models with NAVI

AV control unit harness connector			Resistance (Ω)
Connector No.	Terminal No.		
M87	52	53	Approx. 54 – 66

- Models without NAVI

AV control unit harness connector			Resistance (Ω)
Connector No.	Terminal No.		
M85	86	87	Approx. 54 – 66

Is the measurement value within the specification?

- YES >> GO TO 3.
 NO >> Repair the AV control unit branch line.

3. CHECK POWER SUPPLY AND GROUND CIRCUIT

Check the power supply and the ground circuit of the AV control unit. Refer to the following.

- Base audio without navigation: [AV-39, "AV CONTROL UNIT : Diagnosis Procedure"](#)
- BOSE audio without navigation: [AV-160, "AV CONTROL UNIT : Diagnosis Procedure"](#)
- BOSE audio with navigation: [AV-433, "AV CONTROL UNIT : Diagnosis Procedure"](#)

Is the inspection result normal?

- YES (Present error)>>Replace the AV control unit. Refer to the following.
- Base audio without navigation: [AV-109, "Exploded View"](#)
 - BOSE audio without navigation: [AV-343, "Exploded View"](#)
 - BOSE audio with navigation: [AV-608, "Exploded View"](#)

YES (Past error)>>Error was detected in the AV control unit branch line.

- NO >> Repair the power supply and the ground circuit.

A
B
C
D
E
F
G
H
I
J
K
L
N
O
P

LAN

BCM BRANCH LINE CIRCUIT

< COMPONENT DIAGNOSIS >

[CAN SYSTEM (TYPE 7)]

BCM BRANCH LINE CIRCUIT

Diagnosis Procedure

INFOID:000000001679562

1.CHECK CONNECTOR

1. Turn the ignition switch OFF.
2. Disconnect the battery cable from the negative terminal.
3. Check the terminals and connectors of the BCM for damage, bend and loose connection (unit side and connector side).

Is the inspection result normal?

- YES >> GO TO 2.
NO >> Repair the terminal and connector.

2.CHECK HARNESS FOR OPEN CIRCUIT

1. Disconnect the connector of BCM.
2. Check the resistance between the BCM harness connector terminals.

BCM harness connector			Resistance (Ω)
Connector No.	Terminal No.		
M122	91	90	Approx. 54 – 66

Is the measurement value within the specification?

- YES >> GO TO 3.
NO >> Repair the BCM branch line.

3.CHECK POWER SUPPLY AND GROUND CIRCUIT

Check the power supply and the ground circuit of the BCM. Refer to [BCS-38. "Diagnosis Procedure"](#).

Is the inspection result normal?

- YES (Present error)>>Replace the BCM. Refer to [BCS-79. "Exploded View"](#).
YES (Past error)>>Error was detected in the BCM branch line.
NO >> Repair the power supply and the ground circuit.

PSB BRANCH LINE CIRCUIT

< COMPONENT DIAGNOSIS >

[CAN SYSTEM (TYPE 7)]

PSB BRANCH LINE CIRCUIT

Diagnosis Procedure

INFOID:000000001679563

1. CHECK CONNECTOR

1. Turn the ignition switch OFF.
2. Disconnect the battery cable from the negative terminal.
3. Check the terminals and connectors of the pre-crash seat belt for damage, bend and loose connection (unit side and connector side).

Is the inspection result normal?

- YES >> GO TO 2.
NO >> Repair the terminal and connector.

2. CHECK HARNESS FOR OPEN CIRCUIT

1. Disconnect the connector of pre-crash seat belt control unit.
2. Check the resistance between the pre-crash seat belt control unit harness connector terminals.

Pre-crash seat belt control unit harness connector			Resistance (Ω)
Connector No.	Terminal No.		
M110	24	22	Approx. 54 – 66

Is the measurement value within the specification?

- YES >> GO TO 3.
NO >> Repair the pre-crash seat belt control unit branch line.

3. CHECK POWER SUPPLY AND GROUND CIRCUIT

Check the power supply and the ground circuit of the pre-crash seat belt control unit. Refer to the following.

- Power supply circuit: [SBC-27, "Component Function Check"](#)
- Ground circuit: [SBC-28, "Component Function Check"](#)

Is the inspection result normal?

- YES (Present error)>>Replace the pre-crash seat belt control unit. Refer to [SBC-40, "Exploded View"](#).
YES (Past error)>>Error was detected in the pre-crash seat belt control unit branch line.
NO >> Repair the power supply and the ground circuit.

A
B
C
D
E
F
G
H
I
J
K
L

LAN

N
O
P

TCM BRANCH LINE CIRCUIT

< COMPONENT DIAGNOSIS >

[CAN SYSTEM (TYPE 7)]

TCM BRANCH LINE CIRCUIT

Diagnosis Procedure

INFOID:000000001679564

1. CHECK CONNECTOR

1. Turn the ignition switch OFF.
2. Disconnect the battery cable from the negative terminal.
3. Check the following terminals and connectors for damage, bend and loose connection (unit side and connector side).
 - A/T assembly
 - Harness connector F103
 - Harness connector M116

Is the inspection result normal?

YES >> GO TO 2.

NO >> Repair the terminal and connector.

2. CHECK HARNESS FOR OPEN CIRCUIT

1. Disconnect the connector of A/T assembly.
2. Check the resistance between the A/T assembly harness connector terminals.

A/T assembly harness connector			Resistance (Ω)
Connector No.	Terminal No.		
F51	3	8	Approx. 54 – 66

Is the measurement value within the specification?

YES >> GO TO 3.

NO >> Repair the TCM branch line.

3. CHECK POWER SUPPLY AND GROUND CIRCUIT

Check the power supply and the ground circuit of the TCM. Refer to [TM-163, "Diagnosis Procedure"](#).

Is the inspection result normal?

YES (Present error)>>Replace the control valve with TCM. Refer to [TM-232, "Exploded View"](#).

YES (Past error)>>Error was detected in the TCM branch line.

NO >> Repair the power supply and the ground circuit.

AFS BRANCH LINE CIRCUIT

< COMPONENT DIAGNOSIS >

[CAN SYSTEM (TYPE 7)]

AFS BRANCH LINE CIRCUIT

Diagnosis Procedure

INFOID:000000001679565

1. CHECK CONNECTOR

1. Turn the ignition switch OFF.
2. Disconnect the battery cable from the negative terminal.
3. Check the terminals and connectors of the AFS control unit for damage, bend and loose connection (unit side and connector side).

Is the inspection result normal?

- YES >> GO TO 2.
NO >> Repair the terminal and connector.

2. CHECK HARNESS FOR OPEN CIRCUIT

1. Disconnect the connector of AFS control unit.
2. Check the resistance between the AFS control unit harness connector terminals.

AFS control unit harness connector			Resistance (Ω)
Connector No.	Terminal No.		
M16	30	7	Approx. 54 – 66

Is the measurement value within the specification?

- YES >> GO TO 3.
NO >> Repair the AFS control unit branch line.

3. CHECK POWER SUPPLY AND GROUND CIRCUIT

Check the power supply and the ground circuit of the AFS control unit. Refer to [EXL-61, "AFS CONTROL UNIT : Diagnosis Procedure"](#).

Is the inspection result normal?

- YES (Present error)>>Replace the AFS control unit. Refer to [EXL-196, "Exploded View"](#).
YES (Past error)>>Error was detected in the AFS control unit branch line.
NO >> Repair the power supply and the ground circuit.

A
B
C
D
E
F
G
H
I
J
K
L

LAN

N
O
P

DLC BRANCH LINE CIRCUIT

< COMPONENT DIAGNOSIS >

[CAN SYSTEM (TYPE 7)]

DLC BRANCH LINE CIRCUIT

Diagnosis Procedure

INFOID:000000001679566

1. CHECK CONNECTOR

1. Turn the ignition switch OFF.
2. Disconnect the battery cable from the negative terminal.
3. Check the terminals and connectors of the data link connector for damage, bend and loose connection (connector side and harness side).

Is the inspection result normal?

- YES >> GO TO 2.
NO >> Repair the terminal and connector.

2. CHECK HARNESS FOR OPEN CIRCUIT

Check the resistance between the data link connector terminals.

Data link connector			Resistance (Ω)
Connector No.	Terminal No.		
M24	6	14	Approx. 54 – 66

Is the measurement value within the specification?

- YES (Present error)>>Check the decision of CAN system type again.
YES (Past error)>>Error was detected in the data link connector branch line circuit.
NO >> Repair the data link connector branch line.

M&A BRANCH LINE CIRCUIT

< COMPONENT DIAGNOSIS >

[CAN SYSTEM (TYPE 7)]

M&A BRANCH LINE CIRCUIT

Diagnosis Procedure

INFOID:000000001679567

1.CHECK CONNECTOR

1. Turn the ignition switch OFF.
2. Disconnect the battery cable from the negative terminal.
3. Check the terminals and connectors of the unified meter and A/C amp. for damage, bend and loose connection (unit side and connector side).

Is the inspection result normal?

- YES >> GO TO 2.
NO >> Repair the terminal and connector.

2.CHECK HARNESS FOR OPEN CIRCUIT

1. Disconnect the connector of unified meter and A/C amp.
2. Check the resistance between the unified meter and A/C amp. harness connector terminals.

Unified meter and A/C amp. harness connector			Resistance (Ω)
Connector No.	Terminal No.		
M67	56	72	Approx. 54 – 66

Is the measurement value within the specification?

- YES >> GO TO 3.
NO >> Repair the unified meter and A/C amp. branch line.

3.CHECK POWER SUPPLY AND GROUND CIRCUIT

Check the power supply and the ground circuit of the unified meter and A/C amp. Refer to [MWI-50, "UNIFIED METER AND A/C AMP. : Diagnosis Procedure"](#).

Is the inspection result normal?

- YES (Present error)>>Replace the unified meter and A/C amp. Refer to [MWI-162, "Exploded View"](#).
YES (Past error)>>Error was detected in the unified meter and A/C amp. branch line.
NO >> Repair the power supply and the ground circuit.

A
B
C
D
E
F
G
H
I
J
K
L
N
O
P

LAN

STRG BRANCH LINE CIRCUIT

< COMPONENT DIAGNOSIS >

[CAN SYSTEM (TYPE 7)]

STRG BRANCH LINE CIRCUIT

Diagnosis Procedure

INFOID:000000001679568

1. CHECK CONNECTOR

1. Turn the ignition switch OFF.
2. Disconnect the battery cable from the negative terminal.
3. Check the terminals and connectors of the steering angle sensor for damage, bend and loose connection (unit side and connector side).

Is the inspection result normal?

- YES >> GO TO 2.
NO >> Repair the terminal and connector.

2. CHECK HARNESS FOR OPEN CIRCUIT

1. Disconnect the connector of steering angle sensor.
2. Check the resistance between the steering angle sensor harness connector terminals.

Steering angle sensor harness connector			Resistance (Ω)
Connector No.	Terminal No.		
M37	1	2	Approx. 54 – 66

Is the measurement value within the specification?

- YES >> GO TO 3.
NO >> Repair the steering angle sensor branch line.

3. CHECK POWER SUPPLY AND GROUND CIRCUIT

Check the power supply and the ground circuit of the steering angle sensor. Refer to [BRC-83, "Wiring Diagram - BRAKE CONTROL SYSTEM -"](#).

Is the inspection result normal?

- YES (Present error)>>Replace the steering angle sensor. Refer to [BRC-105, "Exploded View"](#).
YES (Past error)>>Error was detected in the steering angle sensor branch line.
NO >> Repair the power supply and the ground circuit.

ADP BRANCH LINE CIRCUIT

< COMPONENT DIAGNOSIS >

[CAN SYSTEM (TYPE 7)]

ADP BRANCH LINE CIRCUIT

Diagnosis Procedure

INFOID:000000001679569

1. CHECK CONNECTOR

1. Turn the ignition switch OFF.
2. Disconnect the battery cable from the negative terminal.
3. Check the following terminals and connectors for damage, bend and loose connection (unit side and connector side).
 - Models with automatic drive positioner
 - Driver seat control unit
 - Harness connector B502
 - Harness connector B11
 - Models without automatic drive positioner
 - Driver seat control unit
 - Harness connector B501
 - Harness connector B10

Is the inspection result normal?

YES >> GO TO 2.

NO >> Repair the terminal and connector.

2. CHECK HARNESS FOR OPEN CIRCUIT

1. Disconnect the connector of driver seat control unit.
2. Check the resistance between the driver seat control unit harness connector terminals.

Driver seat control unit harness connector			Resistance (Ω)
Connector No.	Terminal No.		
B503	3	19	Approx. 54 – 66

Is the measurement value within the specification?

YES >> GO TO 3.

NO >> Repair the driver seat control unit branch line.

3. CHECK POWER SUPPLY AND GROUND CIRCUIT

Check the power supply and the ground circuit of the driver seat control unit. Refer to [ADP-63. "DRIVER SEAT CONTROL UNIT : Diagnosis Procedure"](#).

Is the inspection result normal?

YES (Present error)>>Replace the driver seat control unit. Refer to [ADP-236. "Exploded View"](#).

YES (Past error)>>Error was detected in the driver seat control unit branch line.

NO >> Repair the power supply and the ground circuit.

A
B
C
D
E
F
G
H
I
J
K
L
N
O
P

LAN

ABS BRANCH LINE CIRCUIT

< COMPONENT DIAGNOSIS >

[CAN SYSTEM (TYPE 7)]

ABS BRANCH LINE CIRCUIT

Diagnosis Procedure

INFOID:000000001679571

1. CHECK CONNECTOR

1. Turn the ignition switch OFF.
2. Disconnect the battery cable from the negative terminal.
3. Check the terminals and connectors of the ABS actuator and electric unit (control unit) for damage, bend and loose connection (unit side and connector side).

Is the inspection result normal?

- YES >> GO TO 2.
NO >> Repair the terminal and connector.

2. CHECK HARNESS FOR OPEN CIRCUIT

1. Disconnect the connector of ABS actuator and electric unit (control unit).
2. Check the resistance between the ABS actuator and electric unit (control unit) harness connector terminals.

ABS actuator and electric unit (control unit) harness connector			Resistance (Ω)
Connector No.	Terminal No.		
E41	35	14	Approx. 54 – 66

Is the measurement value within the specification?

- YES >> GO TO 3.
NO >> Repair the ABS actuator and electric unit (control unit) branch line.

3. CHECK POWER SUPPLY AND GROUND CIRCUIT

Check the power supply and the ground circuit of the ABS actuator and electric unit (control unit). Refer to [BRC-37. "Diagnosis Procedure"](#).

Is the inspection result normal?

- YES (Present error)>>Replace the ABS actuator and electric unit (control unit). Refer to [BRC-102. "Exploded View"](#).
YES (Past error)>>Error was detected in the ABS actuator and electric unit (control unit) branch line.
NO >> Repair the power supply and the ground circuit.

ICC BRANCH LINE CIRCUIT

< COMPONENT DIAGNOSIS >

[CAN SYSTEM (TYPE 7)]

ICC BRANCH LINE CIRCUIT

Diagnosis Procedure

INFOID:000000001679572

1.CHECK CONNECTOR

1. Turn the ignition switch OFF.
2. Disconnect the battery cable from the negative terminal.
3. Check the terminals and connectors of the ICC sensor integrated unit for damage, bend and loose connection (unit side and connector side).

Is the inspection result normal?

- YES >> GO TO 2.
NO >> Repair the terminal and connector.

2.CHECK HARNESS FOR OPEN CIRCUIT

1. Disconnect the connector of ICC sensor integrated unit.
2. Check the resistance between the ICC sensor integrated unit harness connector terminals.

ICC sensor integrated unit harness connector			Resistance (Ω)
Connector No.	Terminal No.		
E67	3	6	Approx. 54 – 66

Is the measurement value within the specification?

- YES >> GO TO 3.
NO >> Repair the ICC sensor integrated unit branch line.

3.CHECK POWER SUPPLY AND GROUND CIRCUIT

Check the power supply and the ground circuit of the ICC sensor integrated unit. Refer to [CCS-81, "Diagnosis Procedure"](#).

Is the inspection result normal?

- YES (Present error)>>Replace the ICC sensor integrated unit. Refer to [CCS-111, "Exploded View"](#).
YES (Past error)>>Error was detected in the ICC sensor integrated unit branch line.
NO >> Repair the power supply and the ground circuit.

A
B
C
D
E
F
G
H
I
J
K
L

LAN

N
O
P

IPDM-E BRANCH LINE CIRCUIT

< COMPONENT DIAGNOSIS >

[CAN SYSTEM (TYPE 7)]

IPDM-E BRANCH LINE CIRCUIT

Diagnosis Procedure

INFOID:000000001679573

1. CHECK CONNECTOR

1. Turn the ignition switch OFF.
2. Disconnect the battery cable from the negative terminal.
3. Check the terminals and connectors of the IPDM E/R for damage, bend and loose connection (unit side and connector side).

Is the inspection result normal?

- YES >> GO TO 2.
NO >> Repair the terminal and connector.

2. CHECK HARNESS FOR OPEN CIRCUIT

1. Disconnect the connector of IPDM E/R.
2. Check the resistance between the IPDM E/R harness connector terminals.

IPDM E/R harness connector			Resistance (Ω)
Connector No.	Terminal No.		
E6	40	39	Approx. 108 – 132

Is the measurement value within the specification?

- YES >> GO TO 3.
NO >> Repair the IPDM E/R branch line.

3. CHECK POWER SUPPLY AND GROUND CIRCUIT

Check the power supply and the ground circuit of the IPDM E/R. Refer to [PCS-19, "Diagnosis Procedure"](#).

Is the inspection result normal?

- YES (Present error)>>Replace the IPDM E/R. Refer to [PCS-34, "Exploded View"](#).
YES (Past error)>>Error was detected in the IPDM E/R branch line.
NO >> Repair the power supply and the ground circuit.

CAN COMMUNICATION CIRCUIT

< COMPONENT DIAGNOSIS >

[CAN SYSTEM (TYPE 7)]

CAN COMMUNICATION CIRCUIT

Diagnosis Procedure

INFOID:000000001679574

1. CONNECTOR INSPECTION

1. Turn the ignition switch OFF.
2. Disconnect the battery cable from the negative terminal.
3. Disconnect all the unit connectors on CAN communication system.
4. Check terminals and connectors for damage, bend and loose connection.

Is the inspection result normal?

- YES >> GO TO 2.
NO >> Repair the terminal and connector.

2. CHECK HARNESS CONTINUITY (SHORT CIRCUIT)

Check the continuity between the data link connector terminals.

Data link connector		Continuity
Connector No.	Terminal No.	
M24	6 14	Not existed

Is the inspection result normal?

- YES >> GO TO 3.
NO >> Check the harness and repair the root cause.

3. CHECK HARNESS CONTINUITY (SHORT CIRCUIT)

Check the continuity between the data link connector and the ground.

Data link connector		Ground	Continuity
Connector No.	Terminal No.		
M24	6		Not existed
	14		Not existed

Is the inspection result normal?

- YES >> GO TO 4.
NO >> Check the harness and repair the root cause.

4. CHECK ECM AND IPDM E/R TERMINATION CIRCUIT

1. Remove the ECM and the IPDM E/R.
2. Check the resistance between the ECM terminals.

ECM		Resistance (Ω)
Terminal No.		
114	113	Approx. 108 – 132

3. Check the resistance between the IPDM E/R terminals.

IPDM E/R		Resistance (Ω)
Terminal No.		
40	39	Approx. 108 – 132

Is the measurement value within the specification?

- YES >> GO TO 5.
NO >> Replace the ECM and/or the IPDM E/R.

5. CHECK SYMPTOM

Connect all the connectors. Check if the symptoms described in the "Symptom (Results from interview with customer)" are reproduced.

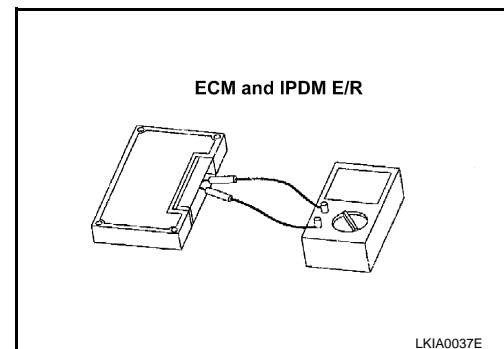

LKIA0037E

A
B
C
D
E
F
G
H
I
J
K
L

LAN

N
O
P

CAN COMMUNICATION CIRCUIT

< COMPONENT DIAGNOSIS >

[CAN SYSTEM (TYPE 7)]

Inspection result

Reproduced>>GO TO 6.

Non-reproduced>>Start the diagnosis again. Follow the trouble diagnosis procedure when past error is detected.

6.CHECK UNIT REPRODUCTION

Perform the reproduction test as per the following procedure for each unit.

1. Turn the ignition switch OFF.
2. Disconnect the battery cable from the negative terminal.
3. Disconnect one of the unit connectors of CAN communication system.

NOTE:

ECM and IPDM E/R have a termination circuit. Check other units first.

4. Connect the battery cable to the negative terminal. Check if the symptoms described in the "Symptom (Results from interview with customer)" are reproduced.

NOTE:

Although unit-related error symptoms occur, do not confuse them with other symptoms.

Inspection result

Reproduced>>Connect the connector. Check other units as per the above procedure.

Non-reproduced>>Replace the unit whose connector was disconnected.

MAIN LINE BETWEEN BCM AND DLC CIRCUIT

< COMPONENT DIAGNOSIS >

[CAN SYSTEM (TYPE 8)]

COMPONENT DIAGNOSIS

MAIN LINE BETWEEN BCM AND DLC CIRCUIT

Diagnosis Procedure

INFOID:000000001679580

INSPECTION PROCEDURE

1. CHECK HARNESS CONTINUITY (OPEN CIRCUIT)

1. Turn the ignition switch OFF.
2. Disconnect the battery cable from the negative terminal.
3. Disconnect the following harness connectors.
 - ECM
 - BCM
4. Check the continuity between the BCM harness connector and the data link connector.

BCM harness connector		Data link connector		Continuity
Connector No.	Terminal No.	Connector No.	Terminal No.	
M122	91	M24	6	Existed
	90		14	Existed

Is the inspection result normal?

YES (Present error)>>Check CAN system type decision again.

YES (Past error)>>Error was detected in the main line between the BCM and the data link connector.

NO >> Repair the main line between the BCM and the data link connector.

A
B
C
D
E
F
G
H
I
J
K
L
N
O
P

LAN

MAIN LINE BETWEEN DLC AND ADP CIRCUIT

< COMPONENT DIAGNOSIS >

[CAN SYSTEM (TYPE 8)]

MAIN LINE BETWEEN DLC AND ADP CIRCUIT

Diagnosis Procedure

INFOID:000000001679582

INSPECTION PROCEDURE

1.CHECK CONNECTOR

1. Turn the ignition switch OFF.
2. Disconnect the battery cable from the negative terminal.
3. Check the following terminals and connectors for damage, bend and loose connection (connector side and harness side).
 - Harness connector M7
 - Harness connector B1

Is the inspection result normal?

YES >> GO TO 2.

NO >> Repair the terminal and connector.

2.CHECK HARNESS CONTINUITY (OPEN CIRCUIT)

1. Disconnect the harness connectors M7 and B1.
2. Check the continuity between the data link connector and the harness connector.

Data link connector		Harness connector		Continuity
Connector No.	Terminal No.	Connector No.	Terminal No.	
M24	6	M7	20	Existed
	14		21	Existed

Is the inspection result normal?

YES >> GO TO 3.

NO >> Repair the main line between the data link connector and the harness connector M7.

3.CHECK HARNESS CONTINUITY (OPEN CIRCUIT)

Check the continuity between the harness connector terminals.

Connector No.	Terminal No.		Continuity
B1	20	22	Existed
	21	23	Existed

Is the inspection result normal?

YES (Present error)>>Check CAN system type decision again.

YES (Past error)>>Error was detected in the main line between the data link connector and the driver seat control unit.

NO >> Repair the main line between the harness connector B1 and the driver seat control unit.

MAIN LINE BETWEEN ADP AND ABS CIRCUIT

< COMPONENT DIAGNOSIS >

[CAN SYSTEM (TYPE 8)]

MAIN LINE BETWEEN ADP AND ABS CIRCUIT

Diagnosis Procedure

INFOID:000000001679584

1. CHECK CONNECTOR

1. Turn the ignition switch OFF.
2. Disconnect the battery cable from the negative terminal.
3. Check the following terminals and connectors for damage, bend and loose connection (connector side and harness side).
 - Harness connector B1
 - Harness connector M7
 - Harness connector M6
 - Harness connector E106

Is the inspection result normal?

YES >> GO TO 2.

NO >> Repair the terminal and connector.

2. CHECK HARNESS CONTINUITY (OPEN CIRCUIT)

1. Disconnect the harness connectors B1 and M7.
2. Check the continuity between the harness connector terminals.

Connector No.	Terminal No.		Continuity
B1	20	22	Existed
	21	23	Existed

Is the inspection result normal?

YES >> GO TO 3.

NO >> Repair the main line between the driver seat control unit and the harness connector B1.

3. CHECK HARNESS CONTINUITY (OPEN CIRCUIT)

1. Disconnect the harness connectors M6 and E106.
2. Check the continuity between the harness connectors.

Harness connector		Harness connector		Continuity
Connector No.	Terminal No.	Connector No.	Terminal No.	
M7	22	M6	9	Existed
	23		8	Existed

Is the inspection result normal?

YES >> GO TO 4.

NO >> Repair the main line between the harness connectors M7 and M6.

4. CHECK HARNESS CONTINUITY (OPEN CIRCUIT)

1. Disconnect the connector of ABS actuator and electric unit (control unit).
2. Check the continuity between the harness connector and the ABS actuator and electric unit (control unit) harness connector.

Harness connector		ABS actuator and electric unit (control unit) harness connector		Continuity
Connector No.	Terminal No.	Connector No.	Terminal No.	
E106	9	E41	35	Existed
	8		14	Existed

Is the inspection result normal?

YES (Present error)>>Check CAN system type decision again.

YES (Past error)>>Error was detected in the main line between the driver seat control unit and the ABS actuator and electric unit (control unit).

MAIN LINE BETWEEN ADP AND ABS CIRCUIT

< COMPONENT DIAGNOSIS >

[CAN SYSTEM (TYPE 8)]

NO >> Repair the main line between the harness connector E106 and the ABS actuator and electric unit (control unit).

ECM BRANCH LINE CIRCUIT

< COMPONENT DIAGNOSIS >

[CAN SYSTEM (TYPE 8)]

ECM BRANCH LINE CIRCUIT

Diagnosis Procedure

INFOID:000000001679586

1. CHECK CONNECTOR

1. Turn the ignition switch OFF.
2. Disconnect the battery cable from the negative terminal.
3. Check the terminals and connectors of the ECM for damage, bend and loose connection (unit side and connector side).

Is the inspection result normal?

- YES >> GO TO 2.
NO >> Repair the terminal and connector.

2. CHECK HARNESS FOR OPEN CIRCUIT

1. Disconnect the connector of ECM.
2. Check the resistance between the ECM harness connector terminals.

ECM harness connector			Resistance (Ω)
Connector No.	Terminal No.		
M107	114	113	Approx. 108 – 132

Is the measurement value within the specification?

- YES >> GO TO 3.
NO >> Repair the ECM branch line.

3. CHECK POWER SUPPLY AND GROUND CIRCUIT

Check the power supply and the ground circuit of the ECM. Refer to [EC-140. "Diagnosis Procedure"](#).

Is the inspection result normal?

YES (Present error)>>Replace the ECM. Refer to [EC-16. "ADDITIONAL SERVICE WHEN REPLACING CONTROL UNIT \(ECM\) : Special Repair Requirement"](#).

YES (Past error)>>Error was detected in the ECM branch line.

NO >> Repair the power supply and the ground circuit.

A
B
C
D
E
F
G
H
I
J
K
L

LAN

N
O
P

A-BAG BRANCH LINE CIRCUIT

< COMPONENT DIAGNOSIS >

[CAN SYSTEM (TYPE 8)]

A-BAG BRANCH LINE CIRCUIT

Diagnosis Procedure

INFOID:000000001679587

1. CHECK AIR BAG DIAGNOSIS SENSOR UNIT

Check the air bag diagnosis sensor unit. Refer to [SRC-5, "Work Flow"](#).

Is the inspection result normal?

YES >> Replace the main harness.

NO >> Replace parts whose air bag system has a malfunction.

AV BRANCH LINE CIRCUIT

Diagnosis Procedure

INFOID:000000001679588

1. CHECK CONNECTOR

1. Turn the ignition switch OFF.
2. Disconnect the battery cable from the negative terminal.
3. Check the terminals and connectors of the AV control unit for damage, bend and loose connection (unit side and connector side).

Is the inspection result normal?

- YES >> GO TO 2.
 NO >> Repair the terminal and connector.

2. CHECK HARNESS FOR OPEN CIRCUIT

1. Disconnect the connector of AV control unit.
 2. Check the resistance between the AV control unit harness connector terminals.
- Models with NAVI

AV control unit harness connector			Resistance (Ω)
Connector No.	Terminal No.		
M87	52	53	Approx. 54 – 66

- Models without NAVI

AV control unit harness connector			Resistance (Ω)
Connector No.	Terminal No.		
M85	86	87	Approx. 54 – 66

Is the measurement value within the specification?

- YES >> GO TO 3.
 NO >> Repair the AV control unit branch line.

3. CHECK POWER SUPPLY AND GROUND CIRCUIT

Check the power supply and the ground circuit of the AV control unit. Refer to the following.

- Base audio without navigation: [AV-39, "AV CONTROL UNIT : Diagnosis Procedure"](#)
- BOSE audio without navigation: [AV-160, "AV CONTROL UNIT : Diagnosis Procedure"](#)
- BOSE audio with navigation: [AV-433, "AV CONTROL UNIT : Diagnosis Procedure"](#)

Is the inspection result normal?

YES (Present error)>>Replace the AV control unit. Refer to the following.

- Base audio without navigation: [AV-109, "Exploded View"](#)
- BOSE audio without navigation: [AV-343, "Exploded View"](#)
- BOSE audio with navigation: [AV-608, "Exploded View"](#)

YES (Past error)>>Error was detected in the AV control unit branch line.

NO >> Repair the power supply and the ground circuit.

A
B
C
D
E
F
G
H
I
J
K
L
N
O
P

LAN

BCM BRANCH LINE CIRCUIT

< COMPONENT DIAGNOSIS >

[CAN SYSTEM (TYPE 8)]

BCM BRANCH LINE CIRCUIT

Diagnosis Procedure

INFOID:000000001679589

1.CHECK CONNECTOR

1. Turn the ignition switch OFF.
2. Disconnect the battery cable from the negative terminal.
3. Check the terminals and connectors of the BCM for damage, bend and loose connection (unit side and connector side).

Is the inspection result normal?

- YES >> GO TO 2.
NO >> Repair the terminal and connector.

2.CHECK HARNESS FOR OPEN CIRCUIT

1. Disconnect the connector of BCM.
2. Check the resistance between the BCM harness connector terminals.

BCM harness connector			Resistance (Ω)
Connector No.	Terminal No.		
M122	91	90	Approx. 54 – 66

Is the measurement value within the specification?

- YES >> GO TO 3.
NO >> Repair the BCM branch line.

3.CHECK POWER SUPPLY AND GROUND CIRCUIT

Check the power supply and the ground circuit of the BCM. Refer to [BCS-38. "Diagnosis Procedure"](#).

Is the inspection result normal?

- YES (Present error)>>Replace the BCM. Refer to [BCS-79. "Exploded View"](#).
YES (Past error)>>Error was detected in the BCM branch line.
NO >> Repair the power supply and the ground circuit.

PSB BRANCH LINE CIRCUIT

< COMPONENT DIAGNOSIS >

[CAN SYSTEM (TYPE 8)]

PSB BRANCH LINE CIRCUIT

Diagnosis Procedure

INFOID:000000001679590

1.CHECK CONNECTOR

1. Turn the ignition switch OFF.
2. Disconnect the battery cable from the negative terminal.
3. Check the terminals and connectors of the pre-crash seat belt for damage, bend and loose connection (unit side and connector side).

Is the inspection result normal?

- YES >> GO TO 2.
NO >> Repair the terminal and connector.

2.CHECK HARNESS FOR OPEN CIRCUIT

1. Disconnect the connector of pre-crash seat belt control unit.
2. Check the resistance between the pre-crash seat belt control unit harness connector terminals.

Pre-crash seat belt control unit harness connector			Resistance (Ω)
Connector No.	Terminal No.		
M110	24	22	Approx. 54 – 66

Is the measurement value within the specification?

- YES >> GO TO 3.
NO >> Repair the pre-crash seat belt control unit branch line.

3.CHECK POWER SUPPLY AND GROUND CIRCUIT

Check the power supply and the ground circuit of the pre-crash seat belt control unit. Refer to the following.

- Power supply circuit: [SBC-27, "Component Function Check"](#)
- Ground circuit: [SBC-28, "Component Function Check"](#)

Is the inspection result normal?

- YES (Present error)>>Replace the pre-crash seat belt control unit. Refer to [SBC-40, "Exploded View"](#).
YES (Past error)>>Error was detected in the pre-crash seat belt control unit branch line.
NO >> Repair the power supply and the ground circuit.

A
B
C
D
E
F
G
H
I
J
K
L

LAN

N
O
P

TCM BRANCH LINE CIRCUIT

< COMPONENT DIAGNOSIS >

[CAN SYSTEM (TYPE 8)]

TCM BRANCH LINE CIRCUIT

Diagnosis Procedure

INFOID:000000001679591

1. CHECK CONNECTOR

1. Turn the ignition switch OFF.
2. Disconnect the battery cable from the negative terminal.
3. Check the following terminals and connectors for damage, bend and loose connection (unit side and connector side).
 - A/T assembly
 - Harness connector F103
 - Harness connector M116

Is the inspection result normal?

YES >> GO TO 2.

NO >> Repair the terminal and connector.

2. CHECK HARNESS FOR OPEN CIRCUIT

1. Disconnect the connector of A/T assembly.
2. Check the resistance between the A/T assembly harness connector terminals.

A/T assembly harness connector		Resistance (Ω)
Connector No.	Terminal No.	
F51	3 8	Approx. 54 – 66

Is the measurement value within the specification?

YES >> GO TO 3.

NO >> Repair the TCM branch line.

3. CHECK POWER SUPPLY AND GROUND CIRCUIT

Check the power supply and the ground circuit of the TCM. Refer to [TM-163, "Diagnosis Procedure"](#).

Is the inspection result normal?

YES (Present error)>>Replace the control valve with TCM. Refer to [TM-232, "Exploded View"](#).

YES (Past error)>>Error was detected in the TCM branch line.

NO >> Repair the power supply and the ground circuit.

AFS BRANCH LINE CIRCUIT

< COMPONENT DIAGNOSIS >

[CAN SYSTEM (TYPE 8)]

AFS BRANCH LINE CIRCUIT

Diagnosis Procedure

INFOID:000000001679592

1.CHECK CONNECTOR

1. Turn the ignition switch OFF.
2. Disconnect the battery cable from the negative terminal.
3. Check the terminals and connectors of the AFS control unit for damage, bend and loose connection (unit side and connector side).

Is the inspection result normal?

- YES >> GO TO 2.
NO >> Repair the terminal and connector.

2.CHECK HARNESS FOR OPEN CIRCUIT

1. Disconnect the connector of AFS control unit.
2. Check the resistance between the AFS control unit harness connector terminals.

AFS control unit harness connector			Resistance (Ω)
Connector No.	Terminal No.		
M16	30	7	Approx. 54 – 66

Is the measurement value within the specification?

- YES >> GO TO 3.
NO >> Repair the AFS control unit branch line.

3.CHECK POWER SUPPLY AND GROUND CIRCUIT

Check the power supply and the ground circuit of the AFS control unit. Refer to [EXL-61, "AFS CONTROL UNIT : Diagnosis Procedure"](#).

Is the inspection result normal?

- YES (Present error)>>Replace the AFS control unit. Refer to [EXL-196, "Exploded View"](#).
YES (Past error)>>Error was detected in the AFS control unit branch line.
NO >> Repair the power supply and the ground circuit.

A
B
C
D
E
F
G
H
I
J
K
L

LAN

N
O
P

DLC BRANCH LINE CIRCUIT

< COMPONENT DIAGNOSIS >

[CAN SYSTEM (TYPE 8)]

DLC BRANCH LINE CIRCUIT

Diagnosis Procedure

INFOID:000000001679593

1. CHECK CONNECTOR

1. Turn the ignition switch OFF.
2. Disconnect the battery cable from the negative terminal.
3. Check the terminals and connectors of the data link connector for damage, bend and loose connection (connector side and harness side).

Is the inspection result normal?

- YES >> GO TO 2.
NO >> Repair the terminal and connector.

2. CHECK HARNESS FOR OPEN CIRCUIT

Check the resistance between the data link connector terminals.

Data link connector			Resistance (Ω)
Connector No.	Terminal No.		
M24	6	14	Approx. 54 – 66

Is the measurement value within the specification?

- YES (Present error)>>Check the decision of CAN system type again.
YES (Past error)>>Error was detected in the data link connector branch line circuit.
NO >> Repair the data link connector branch line.

M&A BRANCH LINE CIRCUIT

< COMPONENT DIAGNOSIS >

[CAN SYSTEM (TYPE 8)]

M&A BRANCH LINE CIRCUIT

Diagnosis Procedure

INFOID:000000001679594

1. CHECK CONNECTOR

1. Turn the ignition switch OFF.
2. Disconnect the battery cable from the negative terminal.
3. Check the terminals and connectors of the unified meter and A/C amp. for damage, bend and loose connection (unit side and connector side).

Is the inspection result normal?

- YES >> GO TO 2.
NO >> Repair the terminal and connector.

2. CHECK HARNESS FOR OPEN CIRCUIT

1. Disconnect the connector of unified meter and A/C amp.
2. Check the resistance between the unified meter and A/C amp. harness connector terminals.

Unified meter and A/C amp. harness connector			Resistance (Ω)
Connector No.	Terminal No.		
M67	56	72	Approx. 54 – 66

Is the measurement value within the specification?

- YES >> GO TO 3.
NO >> Repair the unified meter and A/C amp. branch line.

3. CHECK POWER SUPPLY AND GROUND CIRCUIT

Check the power supply and the ground circuit of the unified meter and A/C amp. Refer to [MWI-50, "UNIFIED METER AND A/C AMP. : Diagnosis Procedure"](#).

Is the inspection result normal?

- YES (Present error)>>Replace the unified meter and A/C amp. Refer to [MWI-162, "Exploded View"](#).
YES (Past error)>>Error was detected in the unified meter and A/C amp. branch line.
NO >> Repair the power supply and the ground circuit.

A
B
C
D
E
F
G
H
I
J
K
L

LAN

N
O
P

STRG BRANCH LINE CIRCUIT

< COMPONENT DIAGNOSIS >

[CAN SYSTEM (TYPE 8)]

STRG BRANCH LINE CIRCUIT

Diagnosis Procedure

INFOID:000000001679595

1. CHECK CONNECTOR

1. Turn the ignition switch OFF.
2. Disconnect the battery cable from the negative terminal.
3. Check the terminals and connectors of the steering angle sensor for damage, bend and loose connection (unit side and connector side).

Is the inspection result normal?

- YES >> GO TO 2.
NO >> Repair the terminal and connector.

2. CHECK HARNESS FOR OPEN CIRCUIT

1. Disconnect the connector of steering angle sensor.
2. Check the resistance between the steering angle sensor harness connector terminals.

Steering angle sensor harness connector			Resistance (Ω)
Connector No.	Terminal No.		
M37	1	2	Approx. 54 – 66

Is the measurement value within the specification?

- YES >> GO TO 3.
NO >> Repair the steering angle sensor branch line.

3. CHECK POWER SUPPLY AND GROUND CIRCUIT

Check the power supply and the ground circuit of the steering angle sensor. Refer to [BRC-83, "Wiring Diagram - BRAKE CONTROL SYSTEM -"](#).

Is the inspection result normal?

- YES (Present error)>>Replace the steering angle sensor. Refer to [BRC-105, "Exploded View"](#).
YES (Past error)>>Error was detected in the steering angle sensor branch line.
NO >> Repair the power supply and the ground circuit.

ADP BRANCH LINE CIRCUIT

< COMPONENT DIAGNOSIS >

[CAN SYSTEM (TYPE 8)]

ADP BRANCH LINE CIRCUIT

Diagnosis Procedure

INFOID:000000001679596

1. CHECK CONNECTOR

1. Turn the ignition switch OFF.
2. Disconnect the battery cable from the negative terminal.
3. Check the following terminals and connectors for damage, bend and loose connection (unit side and connector side).
 - Models with automatic drive positioner
 - Driver seat control unit
 - Harness connector B502
 - Harness connector B11
 - Models without automatic drive positioner
 - Driver seat control unit
 - Harness connector B501
 - Harness connector B10

Is the inspection result normal?

YES >> GO TO 2.

NO >> Repair the terminal and connector.

2. CHECK HARNESS FOR OPEN CIRCUIT

1. Disconnect the connector of driver seat control unit.
2. Check the resistance between the driver seat control unit harness connector terminals.

Driver seat control unit harness connector			Resistance (Ω)
Connector No.	Terminal No.		
B503	3	19	Approx. 54 – 66

Is the measurement value within the specification?

YES >> GO TO 3.

NO >> Repair the driver seat control unit branch line.

3. CHECK POWER SUPPLY AND GROUND CIRCUIT

Check the power supply and the ground circuit of the driver seat control unit. Refer to [ADP-63. "DRIVER SEAT CONTROL UNIT : Diagnosis Procedure"](#).

Is the inspection result normal?

YES (Present error)>>Replace the driver seat control unit. Refer to [ADP-236. "Exploded View"](#).

YES (Past error)>>Error was detected in the driver seat control unit branch line.

NO >> Repair the power supply and the ground circuit.

A
B
C
D
E
F
G
H
I
J
K
L
N
O
P

LAN

RAS BRANCH LINE CIRCUIT

< COMPONENT DIAGNOSIS >

[CAN SYSTEM (TYPE 8)]

RAS BRANCH LINE CIRCUIT

Diagnosis Procedure

INFOID:000000001679597

1. CHECK CONNECTOR

1. Turn the ignition switch OFF.
2. Disconnect the battery cable from the negative terminal.
3. Check the terminals and connectors of the 4WAS main control unit for damage, bend and loose connection (unit side and connector side).

Is the inspection result normal?

- YES >> GO TO 2.
NO >> Repair the terminal and connector.

2. CHECK HARNESS FOR OPEN CIRCUIT

1. Disconnect the connector of 4WAS main control unit.
2. Check the resistance between the 4WAS main control unit harness connector terminals.

4WAS main control unit harness connector			Resistance (Ω)
Connector No.	Terminal No.		
B54	1	8	Approx. 54 – 66

Is the measurement value within the specification?

- YES >> GO TO 3.
NO >> Repair the 4WAS main control unit branch line.

3. CHECK POWER SUPPLY AND GROUND CIRCUIT

Check the power supply and the ground circuit of the 4WAS main control unit. Refer to [STC-134, "Diagnosis Procedure \(4WAS Main Control Unit\)"](#).

Is the inspection result normal?

- YES (Present error)>>Replace the 4WAS main control unit. Refer to [STC-178, "Exploded View"](#).
YES (Past error)>>Error was detected in the 4WAS main control unit branch line.
NO >> Repair the power supply and the ground circuit.

ABS BRANCH LINE CIRCUIT

< COMPONENT DIAGNOSIS >

[CAN SYSTEM (TYPE 8)]

ABS BRANCH LINE CIRCUIT

Diagnosis Procedure

INFOID:000000001679598

1. CHECK CONNECTOR

1. Turn the ignition switch OFF.
2. Disconnect the battery cable from the negative terminal.
3. Check the terminals and connectors of the ABS actuator and electric unit (control unit) for damage, bend and loose connection (unit side and connector side).

Is the inspection result normal?

- YES >> GO TO 2.
NO >> Repair the terminal and connector.

2. CHECK HARNESS FOR OPEN CIRCUIT

1. Disconnect the connector of ABS actuator and electric unit (control unit).
2. Check the resistance between the ABS actuator and electric unit (control unit) harness connector terminals.

ABS actuator and electric unit (control unit) harness connector			Resistance (Ω)
Connector No.	Terminal No.		
E41	35	14	Approx. 54 – 66

Is the measurement value within the specification?

- YES >> GO TO 3.
NO >> Repair the ABS actuator and electric unit (control unit) branch line.

3. CHECK POWER SUPPLY AND GROUND CIRCUIT

Check the power supply and the ground circuit of the ABS actuator and electric unit (control unit). Refer to [BRC-37, "Diagnosis Procedure"](#).

Is the inspection result normal?

- YES (Present error)>>Replace the ABS actuator and electric unit (control unit). Refer to [BRC-102, "Exploded View"](#).
YES (Past error)>>Error was detected in the ABS actuator and electric unit (control unit) branch line.
NO >> Repair the power supply and the ground circuit.

A
B
C
D
E
F
G
H
I
J
K
L

LAN

ICC BRANCH LINE CIRCUIT

< COMPONENT DIAGNOSIS >

[CAN SYSTEM (TYPE 8)]

ICC BRANCH LINE CIRCUIT

Diagnosis Procedure

INFOID:000000001679599

1. CHECK CONNECTOR

1. Turn the ignition switch OFF.
2. Disconnect the battery cable from the negative terminal.
3. Check the terminals and connectors of the ICC sensor integrated unit for damage, bend and loose connection (unit side and connector side).

Is the inspection result normal?

- YES >> GO TO 2.
NO >> Repair the terminal and connector.

2. CHECK HARNESS FOR OPEN CIRCUIT

1. Disconnect the connector of ICC sensor integrated unit.
2. Check the resistance between the ICC sensor integrated unit harness connector terminals.

ICC sensor integrated unit harness connector			Resistance (Ω)
Connector No.	Terminal No.		
E67	3	6	Approx. 54 – 66

Is the measurement value within the specification?

- YES >> GO TO 3.
NO >> Repair the ICC sensor integrated unit branch line.

3. CHECK POWER SUPPLY AND GROUND CIRCUIT

Check the power supply and the ground circuit of the ICC sensor integrated unit. Refer to [CCS-81, "Diagnosis Procedure"](#).

Is the inspection result normal?

- YES (Present error)>>Replace the ICC sensor integrated unit. Refer to [CCS-111, "Exploded View"](#).
YES (Past error)>>Error was detected in the ICC sensor integrated unit branch line.
NO >> Repair the power supply and the ground circuit.

IPDM-E BRANCH LINE CIRCUIT

< COMPONENT DIAGNOSIS >

[CAN SYSTEM (TYPE 8)]

IPDM-E BRANCH LINE CIRCUIT

Diagnosis Procedure

INFOID:000000001679600

1.CHECK CONNECTOR

1. Turn the ignition switch OFF.
2. Disconnect the battery cable from the negative terminal.
3. Check the terminals and connectors of the IPDM E/R for damage, bend and loose connection (unit side and connector side).

Is the inspection result normal?

- YES >> GO TO 2.
NO >> Repair the terminal and connector.

2.CHECK HARNESS FOR OPEN CIRCUIT

1. Disconnect the connector of IPDM E/R.
2. Check the resistance between the IPDM E/R harness connector terminals.

IPDM E/R harness connector			Resistance (Ω)
Connector No.	Terminal No.		
E6	40	39	Approx. 108 – 132

Is the measurement value within the specification?

- YES >> GO TO 3.
NO >> Repair the IPDM E/R branch line.

3.CHECK POWER SUPPLY AND GROUND CIRCUIT

Check the power supply and the ground circuit of the IPDM E/R. Refer to [PCS-19, "Diagnosis Procedure"](#).

Is the inspection result normal?

- YES (Present error)>>Replace the IPDM E/R. Refer to [PCS-34, "Exploded View"](#).
YES (Past error)>>Error was detected in the IPDM E/R branch line.
NO >> Repair the power supply and the ground circuit.

A
B
C
D
E
F
G
H
I
J
K
L

LAN

N
O
P

CAN COMMUNICATION CIRCUIT

< COMPONENT DIAGNOSIS >

[CAN SYSTEM (TYPE 8)]

CAN COMMUNICATION CIRCUIT

Diagnosis Procedure

INFOID:000000001679601

1. CONNECTOR INSPECTION

1. Turn the ignition switch OFF.
2. Disconnect the battery cable from the negative terminal.
3. Disconnect all the unit connectors on CAN communication system.
4. Check terminals and connectors for damage, bend and loose connection.

Is the inspection result normal?

- YES >> GO TO 2.
NO >> Repair the terminal and connector.

2. CHECK HARNESS CONTINUITY (SHORT CIRCUIT)

Check the continuity between the data link connector terminals.

Data link connector		Continuity
Connector No.	Terminal No.	
M24	6 14	Not existed

Is the inspection result normal?

- YES >> GO TO 3.
NO >> Check the harness and repair the root cause.

3. CHECK HARNESS CONTINUITY (SHORT CIRCUIT)

Check the continuity between the data link connector and the ground.

Data link connector		Ground	Continuity
Connector No.	Terminal No.		
M24	6		Not existed
	14		Not existed

Is the inspection result normal?

- YES >> GO TO 4.
NO >> Check the harness and repair the root cause.

4. CHECK ECM AND IPDM E/R TERMINATION CIRCUIT

1. Remove the ECM and the IPDM E/R.
2. Check the resistance between the ECM terminals.

ECM		Resistance (Ω)
Terminal No.		
114	113	Approx. 108 – 132

3. Check the resistance between the IPDM E/R terminals.

IPDM E/R		Resistance (Ω)
Terminal No.		
40	39	Approx. 108 – 132

Is the measurement value within the specification?

- YES >> GO TO 5.
NO >> Replace the ECM and/or the IPDM E/R.

5. CHECK SYMPTOM

Connect all the connectors. Check if the symptoms described in the "Symptom (Results from interview with customer)" are reproduced.

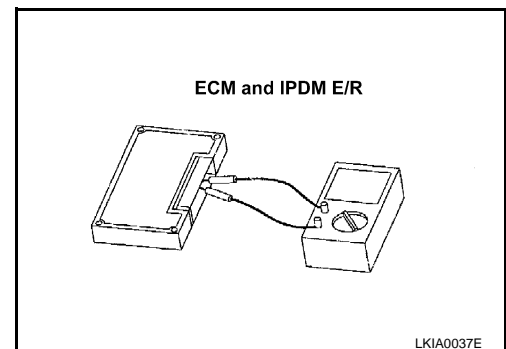

CAN COMMUNICATION CIRCUIT

< COMPONENT DIAGNOSIS >

[CAN SYSTEM (TYPE 8)]

Inspection result

Reproduced>>GO TO 6.

Non-reproduced>>Start the diagnosis again. Follow the trouble diagnosis procedure when past error is detected.

6.CHECK UNIT REPRODUCTION

Perform the reproduction test as per the following procedure for each unit.

1. Turn the ignition switch OFF.
2. Disconnect the battery cable from the negative terminal.
3. Disconnect one of the unit connectors of CAN communication system.

NOTE:

ECM and IPDM E/R have a termination circuit. Check other units first.

4. Connect the battery cable to the negative terminal. Check if the symptoms described in the “Symptom (Results from interview with customer)” are reproduced.

NOTE:

Although unit-related error symptoms occur, do not confuse them with other symptoms.

Inspection result

Reproduced>>Connect the connector. Check other units as per the above procedure.

Non-reproduced>>Replace the unit whose connector was disconnected.

A
B
C
D
E
F
G
H
I
J
K
L

LAN

N
O
P