

SECTION PCS

POWER CONTROL SYSTEM

A
B
C
D
E
F
G
H
I
J
K
L
N
O
P

CONTENTS

IPDM E/R	Diagnosis Procedure	17
FUNCTION DIAGNOSIS	POWER SUPPLY AND GROUND CIRCUIT	18
RELAY CONTROL SYSTEM	Diagnosis Procedure	18
System Diagram	ECU DIAGNOSIS	19
System Description	IPDM E/R (INTELLIGENT POWER DISTRI-	
Component Parts Location	BUTION MODULE ENGINE ROOM)	19
POWER CONTROL SYSTEM	Reference Value	19
System Diagram	Wiring Diagram - IPDM E/R -	27
System Description	Fail-safe	30
SIGNAL BUFFER SYSTEM	DTC Index	32
System Diagram	PRECAUTION	33
System Description	PRECAUTIONS	33
POWER CONSUMPTION CONTROL SYS-	Precaution for Supplemental Restraint System	
TEM	(SRS) "AIR BAG" and "SEAT BELT PRE-TEN-	
System Diagram	SIONER"	33
System Description	ON-VEHICLE REPAIR	34
Component Parts Location	IPDM E/R (INTELLIGENT POWER DISTRI-	
DIAGNOSIS SYSTEM (IPDM E/R)	BUTION MODULE ENGINE ROOM)	34
Diagnosis Description	Exploded View	34
CONSULT-III Function (IPDM E/R)	Removal and Installation	34
COMPONENT DIAGNOSIS	POWER DISTRIBUTION SYSTEM	
U1000 CAN COMM CIRCUIT	BASIC INSPECTION	35
Description	DIAGNOSIS AND REPAIR WORK FLOW	35
DTC Logic	Work Flow	35
Diagnosis Procedure	FUNCTION DIAGNOSIS	38
B2098 IGNITION RELAY ON STUCK	POWER DISTRIBUTION SYSTEM	38
Description	System Description	38
DTC Logic	Component Parts Location	40
Diagnosis Procedure	Component Description	40
B2099 IGNITION RELAY OFF STUCK	DIAGNOSIS SYSTEM (BCM)	41
Description		
DTC Logic		

PCS

COMMON ITEM	41	POWER SUPPLY AND GROUND CIRCUIT	65
COMMON ITEM : CONSULT-III Function (BCM - COMMON ITEM)	41	BCM	65
INTELLIGENT KEY	42	BCM : Diagnosis Procedure	65
INTELLIGENT KEY : CONSULT-III Function (BCM - INTELLIGENT KEY)	42	PUSH-BUTTON IGNITION SWITCH	66
COMPONENT DIAGNOSIS	47	Description	66
U1000 CAN COMM CIRCUIT	47	Component Function Check	66
BCM	47	Diagnosis Procedure	66
BCM : Description	47	Component Inspection	67
BCM : DTC Logic	47	PUSH-BUTTON IGNITION SWITCH POSI- TION INDICATOR	68
BCM : Diagnosis Procedure	47	Description	68
U1010 CONTROL UNIT (CAN)	48	Component Function Check	68
BCM	48	Diagnosis Procedure	68
BCM : DTC Logic	48	POWER DISTRIBUTION SYSTEM	70
BCM : Diagnosis Procedure	48	Wiring Diagram - PDS (POWER DISTRIBUTION SYSTEM) -	70
B2553 IGNITION RELAY	49	ECU DIAGNOSIS	81
Description	49	BCM (BODY CONTROL MODULE)	81
DTC Logic	49	Reference Value	81
Diagnosis Procedure	49	Wiring Diagram - BCM -	105
B260A IGNITION RELAY	51	Fail-safe	119
Description	51	DTC Inspection Priority Chart	122
DTC Logic	51	DTC Index	123
Diagnosis Procedure	51	PRECAUTION	126
B2614 ACC RELAY	53	PRECAUTIONS	126
Description	53	Precaution for Supplemental Restraint System (SRS) "AIR BAG" and "SEAT BELT PRE-TEN- SIONER"	126
DTC Logic	53	Precaution Necessary for Steering Wheel Rota- tion after Battery Disconnect	126
Diagnosis Procedure	53	SYMPTOM DIAGNOSIS	127
Component Inspection	55	PUSH-BUTTON IGNITION SWITCH DOES NOT OPERATE	127
B2615 BLOWER RELAY CIRCUIT	56	Description	127
Description	56	Diagnosis Procedure	127
DTC Logic	56	PUSH-BUTTON IGNITION SWITCH POSI- TION INDICATOR DOES NOT ILLUMINATE ..	128
Diagnosis Procedure	56	Description	128
Component Inspection	58	Diagnosis Procedure	128
B2616 IGNITION RELAY CIRCUIT	59	ON-VEHICLE REPAIR	129
Description	59	BCM (BODY CONTROL MODULE)	129
DTC Logic	59	Exploded View	129
Diagnosis Procedure	59	Removal and Installation	129
Component Inspection	61	PUSH BUTTON IGNITION SWITCH	130
B2618 BCM	62	Exploded View	130
Description	62	Removal and Installation	130
DTC Logic	62		
Diagnosis Procedure	62		
B261A PUSH-BUTTON IGNITION SWITCH	63		
Description	63		
DTC Logic	63		
Diagnosis Procedure	63		

FUNCTION DIAGNOSIS

RELAY CONTROL SYSTEM

System Diagram

INFOID:000000003420420

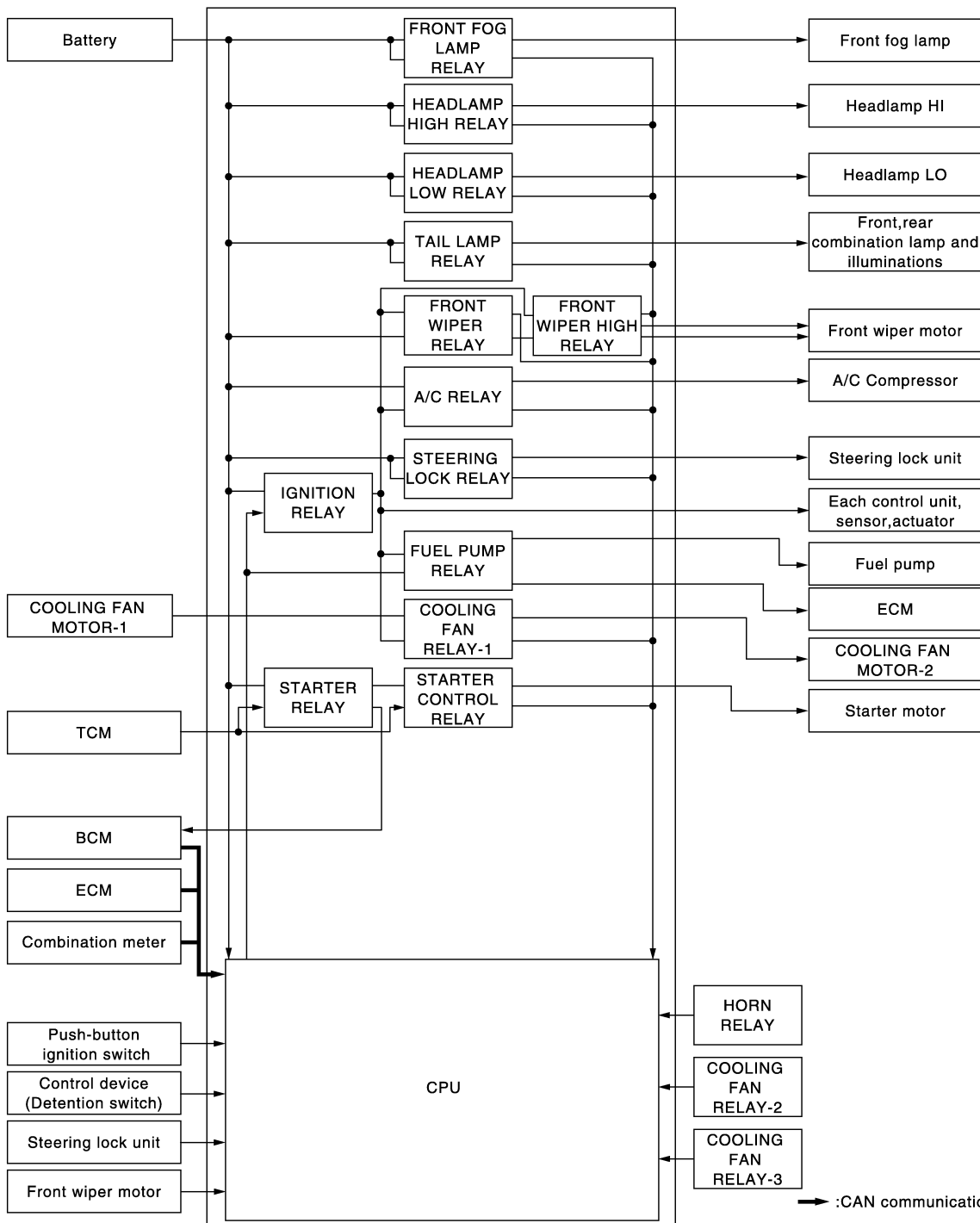

JPMIA0861GB

System Description

INFOID:000000003420421

IPDM E/R activates the internal control circuit to perform the relay ON-OFF control according to the input signals from various sensors and the request signals received from control units via CAN communication.

CAUTION:

IPDM E/R integrated relays cannot be removed.

A
B
C
D
E
F
G
H
I
J
K
L
PCS
N
O
P

RELAY CONTROL SYSTEM

< FUNCTION DIAGNOSIS >

[IPDM E/R]

Control relay	Input/output	Transmit unit	Control part	Reference page
<ul style="list-style-type: none"> Headlamp low relay Headlamp high relay 	<ul style="list-style-type: none"> Low beam request signal High beam request signal 	BCM (CAN)	<ul style="list-style-type: none"> Headlamp low Headlamp high 	<ul style="list-style-type: none"> EXL-8 (Xenon headlamp) EXL-191 (Halogen headlamp)
Front fog lamp relay	Front fog light request signal	BCM (CAN)	Front fog lamp	<ul style="list-style-type: none"> EXL-15 (Xenon headlamp) EXL-195 (Halogen headlamp)
Tail lamp relay	Position light request signal	BCM (CAN)	<ul style="list-style-type: none"> Parking lamp Side marker lamp License plate lamp Tail lamp 	<ul style="list-style-type: none"> EXL-19 (Xenon headlamp) EXL-199 (Halogen headlamp)
			Illuminations	INL-11
<ul style="list-style-type: none"> Front wiper relay Front wiper high relay 	Front wiper request signal	BCM (CAN)	Front wiper	WW-5
	Front wiper stop position signal	Front wiper motor		
Horn relay	<ul style="list-style-type: none"> Theft warning horn request signal Horn reminder signal 	BCM (CAN)	<ul style="list-style-type: none"> Horn (low) Horn (high) 	<ul style="list-style-type: none"> SEC-23 (With Intelligent Key system) SEC-253 (Without Intelligent Key system)
<ul style="list-style-type: none"> Starter relay^{NOTE} Starter control relay 	Starter control relay signal	BCM (CAN)	Starter motor	<ul style="list-style-type: none"> SEC-111 SEC-109 (With Intelligent Key system) SEC-337 SEC-335 (Without Intelligent Key system)
	Steering lock unit condition signal	Steering lock unit		
	Starter relay control signal	TCM		
Steering lock relay	Steering lock relay signal	BCM (CAN)	Steering lock unit	<ul style="list-style-type: none"> SEC-77 (With Intelligent Key system) SEC-303 (Without Intelligent Key system)
	Steering lock unit condition signal	Steering lock unit		
	Control device (Detention switch) signal	Control device (Detention switch)		
A/C relay	A/C compressor request signal	ECM (CAN)	A/C compressor (magnet clutch)	<ul style="list-style-type: none"> HAC-11 (Without 7 inch display) HAC-130 (With 7 inch display)
<ul style="list-style-type: none"> Cooling fan relay-1 Cooling fan relay-2 Cooling fan relay-3 	Cooling fan speed request signal	ECM (CAN)	<ul style="list-style-type: none"> Cooling fan motor-1 Cooling fan motor-2 	EC-60
Ignition relay	Ignition switch ON signal	BCM (CAN)	Ignition relay	PCS-16
	Vehicle speed signal	Combination meter (CAN)		
	Push-button ignition switch signal	Push-button ignition switch		

NOTE:

BCM controls the starter relay.

RELAY CONTROL SYSTEM

< FUNCTION DIAGNOSIS >

[IPDM E/R]

Component Parts Location

INFOID:000000003420422

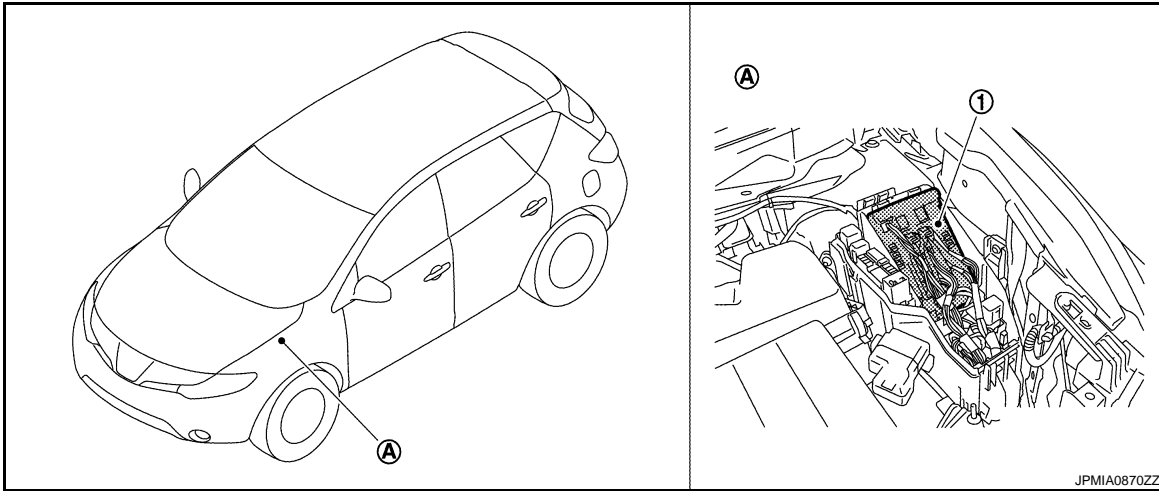

- 1. IPDM E/R
- A. Engine room (LH)

A
B
C
D
E
F
G
H
I
J
K
L

PCS

N
O
P

POWER CONTROL SYSTEM

System Diagram

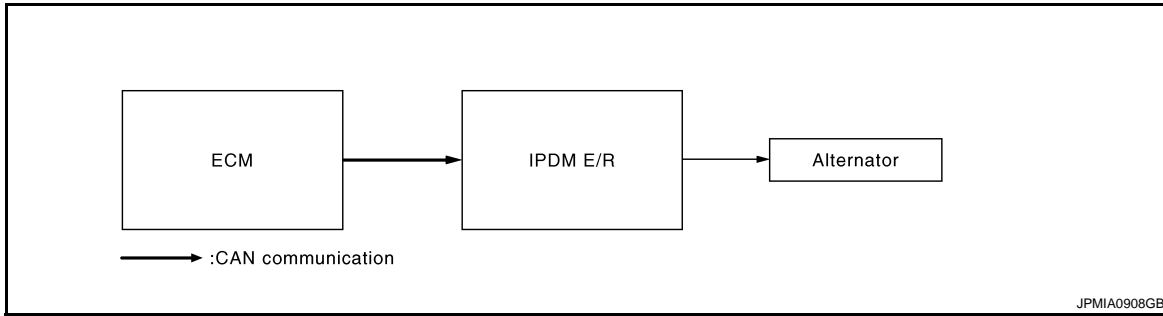

System Description

INFOID:000000003420424

ALTERNATOR CONTROL

IPDM E/R outputs power generation command signal (PWM signal) to the alternator according to the status of the power generation command value signal received from ECM via CAN communication. Refer to [CHG-7, "System Diagram"](#).

SIGNAL BUFFER SYSTEM

System Diagram

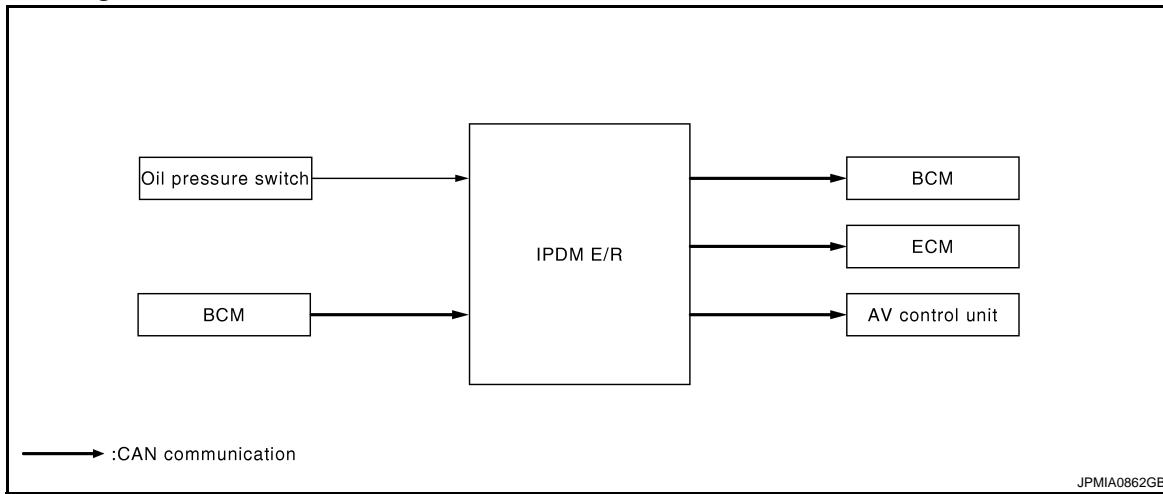

System Description

INFOID:000000003420427

- IPDM E/R reads the status of the oil pressure switch and transmits the oil pressure switch signal to BCM via CAN communication. Refer to [MWI-22, "WARNING LAMPS/INDICATOR LAMPS : System Diagram"](#).
- IPDM E/R receives the rear window defogger control signal from BCM via CAN communication and transmits it to ECM and AV control unit via CAN communication. Refer to [DEF-4, "WITH BOSE SYSTEM : System Diagram"](#).

A
B
C
D
E
F
G
H
I
J
K
L
N
O
P

PCS

POWER CONSUMPTION CONTROL SYSTEM

System Diagram

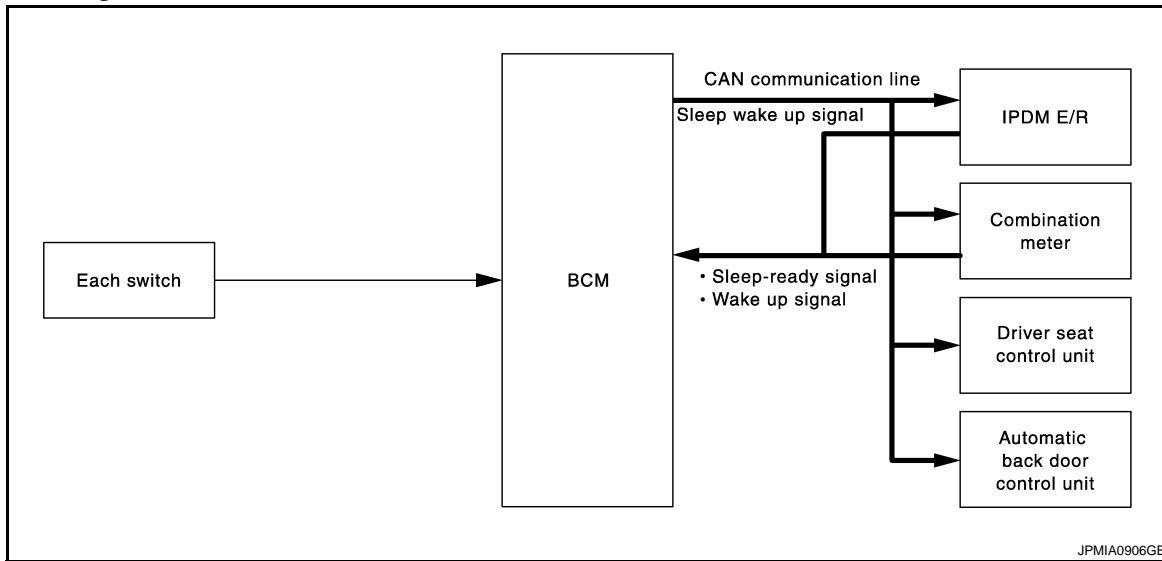

System Description

INFOID:000000003420430

OUTLINE

- IPDM E/R incorporates a power consumption control function that reduces the power consumption according to the vehicle status.
- IPDM E/R changes its status (control mode) with the sleep wake up signal received from BCM via CAN communication.

Normal mode (wake-up)

- CAN communication is normally performed with other control units.
- Individual unit control by IPDM E/R is normally performed.

Low power consumption mode (sleep)

- Low power consumption control is active.
- CAN transmission is stopped.

SLEEP MODE ACTIVATION

- IPDM E/R judges that the sleep-ready conditions are fulfilled when the ignition switch is OFF and none of the conditions below are present. Then it transmits a sleep-ready signal (ready) to BCM via CAN communication.
 - Outputting signals to actuators
 - Switches or relays operating
 - Output requests are being received from control units via CAN communication.
- IPDM E/R stops CAN communication and enters the low power consumption mode when it receives a sleep wake up signal (sleep) from BCM and the sleep-ready conditions are fulfilled.

WAKE-UP OPERATION

- IPDM E/R changes from the low power consumption mode to the normal mode when it receives a sleep wake-up signal (wake up) from BCM or any of the following conditions is fulfilled. In addition, it transmits a sleep-ready signal (not-ready) to BCM via CAN communication to report the CAN communication start.
 - Ignition switch ON
 - An output request is received from a control unit via CAN communication.

POWER CONSUMPTION CONTROL SYSTEM

< FUNCTION DIAGNOSIS >

[IPDM E/R]

Component Parts Location

INFOID:000000003470221

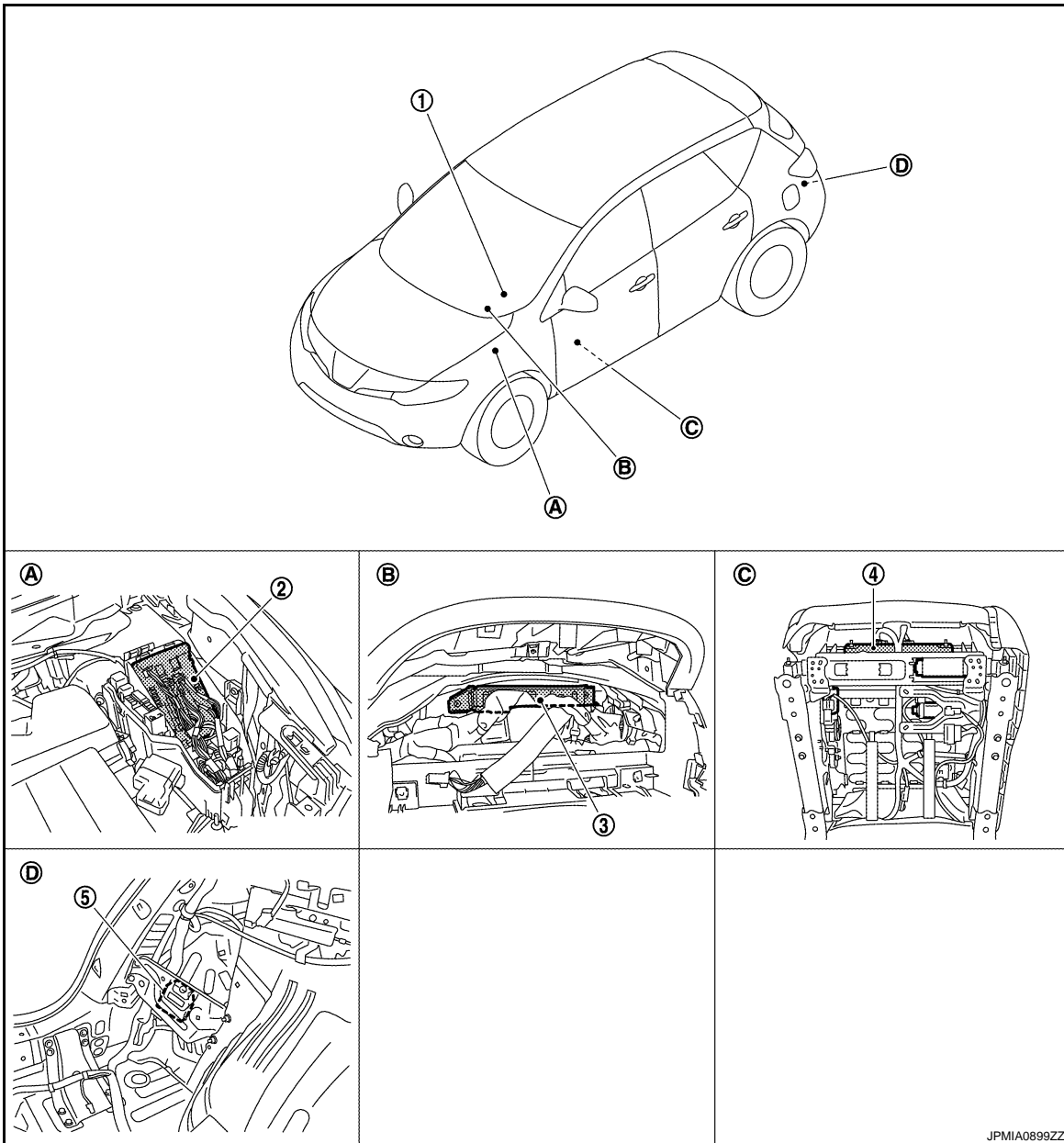

- | | | |
|-------------------------------------|-------------------------------------|---|
| 1. Combination meter | 2. IPDM E/R | 3. BCM |
| 4. Driver seat control unit | 5. Automatic back door control unit | |
| A. Engine room (LH) | B. Behind of combination meter | C. Backside of the seat cushion (driver seat) |
| D. Dash side lower (Passenger side) | | |

A
B
C
D
E
F
G
H
I
J
K
L

PCS

N
O
P

DIAGNOSIS SYSTEM (IPDM E/R)

Diagnosis Description

INFOID:000000003420432

AUTO ACTIVE TEST

Description

In auto active test mode, the IPDM E/R sends a drive signal to the following systems to check their operation.

- Oil pressure warning lamp
- Front wiper (LO, HI)
- Parking lamps
- License plate lamps
- Side maker lamps
- Tail lamps
- Front fog lamps
- Headlamps (LO, HI)
- A/C compressor (magnet clutch)
- Cooling fan

Operation Procedure

1. Close the hood and lift the wiper arms from the windshield. (Prevent windshield damage due to wiper operation)
NOTE:
 When auto active test is performed with hood opened, sprinkle water on windshield beforehand.
2. Turn the ignition switch OFF.
3. Turn the ignition switch ON, and within 20 seconds, press the front door switch (driver side) 10 times. Then turn the ignition switch OFF.
CAUTION:
Close passenger door.
4. Turn the ignition switch ON within 10 seconds. After that the horn sounds once and the auto active test starts.
5. The oil pressure warning lamp starts blinking when the auto active test starts.
6. After a series of the following operations is repeated 3 times, auto active test is completed.

NOTE:

When auto active test mode has to be cancelled halfway through test, turn the ignition switch OFF.

CAUTION:

- If auto active test mode cannot be actuated, check door switch system. Refer to [DLK-411, "Component Function Check"](#).
- Do not start the engine.

Inspection in Auto Active Test Mode

When auto active test mode is actuated, the following 6 steps are repeated 3 times.

Operation sequence	Inspection location	Operation
1	Oil pressure warning lamp	Blinks continuously during operation of auto active test
2	Front wiper	LO for 5 seconds → HI for 5 seconds
3	<ul style="list-style-type: none"> • Parking lamps • License plate lamps • Side maker lamps • Tail lamps • Front fog lamps 	10 seconds
4	Headlamps	LO ↔ HI 5 times
5	A/C compressor (magnet clutch)	ON ↔ OFF 5 times
6	Cooling fan	LO for 5 seconds → MID for 3 seconds → HI for 2 seconds

DIAGNOSIS SYSTEM (IPDM E/R)

< FUNCTION DIAGNOSIS >

[IPDM E/R]

Concept of auto active test

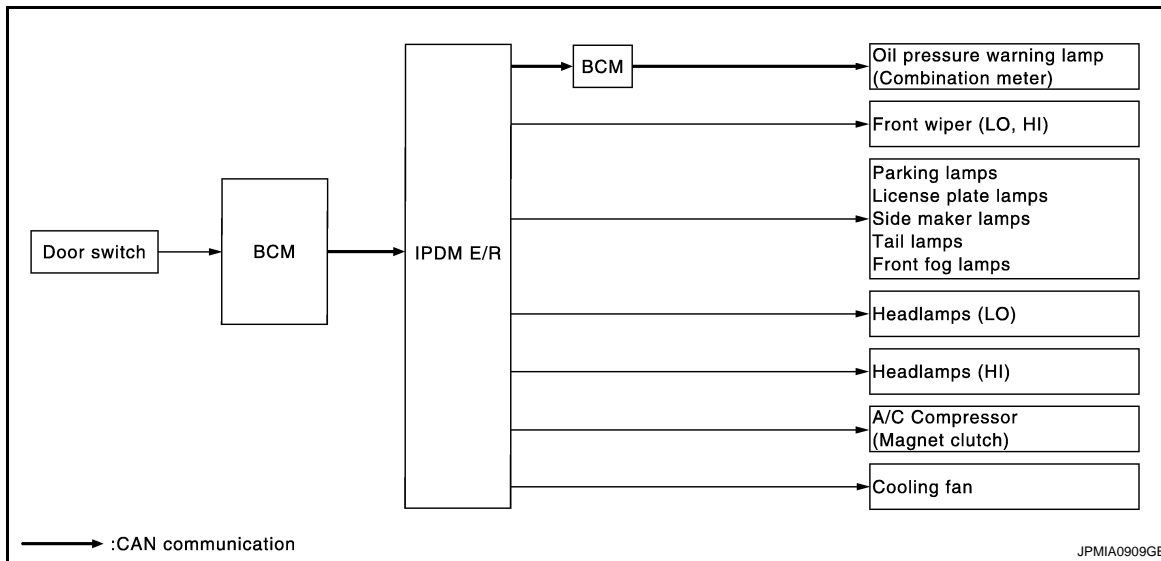

- IPDM E/R starts the auto active test with the door switch signals transmitted by BCM via CAN communication. Therefore, the CAN communication line between IPDM E/R and BCM is considered normal if the auto active test starts successfully.
- The auto active test facilitates troubleshooting if any systems controlled by IPDM E/R cannot be operated.

Diagnosis chart in auto active test mode

Symptom	Inspection contents	Possible cause
Any of the following components do not operate <ul style="list-style-type: none"> • Parking lamps • License plate lamps • Side maker lamps • Tail lamps • Front fog lamps • Headlamp (HI, LO) • Front wiper (HI, LO) 	Perform auto active test. Does the applicable system operate?	YES BCM signal input circuit
		NO <ul style="list-style-type: none"> • Lamp or motor • Lamp or motor ground circuit • Harness or connector between IPDM E/R and applicable system • IPDM E/R
A/C compressor does not operate	Perform auto active test. Does the magnet clutch operate?	YES <ul style="list-style-type: none"> • A/C amp. signal input circuit • CAN communication signal between A/C amp. and ECM • CAN communication signal between ECM and IPDM E/R
		NO <ul style="list-style-type: none"> • Magnet clutch • Harness or connector between IPDM E/R and magnet clutch • IPDM E/R
Oil pressure warning lamp does not operate	Perform auto active test. Does the oil pressure warning lamp blink?	YES <ul style="list-style-type: none"> • Harness or connector between IPDM E/R and oil pressure switch • Oil pressure switch • IPDM E/R
		NO <ul style="list-style-type: none"> • CAN communication signal between IPDM E/R and BCM • CAN communication signal between BCM and combination meter • Combination meter

A
B
C
D
E
F
G
H
I
J
K
L

PCS

N
O
P

DIAGNOSIS SYSTEM (IPDM E/R)

< FUNCTION DIAGNOSIS >

[IPDM E/R]

Symptom	Inspection contents		Possible cause
Cooling fan does not operate	Perform auto active test. Does the cooling fan operate?	YES	<ul style="list-style-type: none"> • ECM signal input circuit • CAN communication signal between ECM and IPDM E/R
		NO	<ul style="list-style-type: none"> • Harness or connector between IPDM E/R and cooling fan motor • Harness or connector between IPDM E/R and cooling fan relay • Cooling fan motor • Cooling fan relay • IPDM E/R

CONSULT-III Function (IPDM E/R)

INFOID:000000003420433

APPLICATION ITEM

CONSULT-III performs the following functions via CAN communication with IPDM E/R.

Diagnosis mode	Description
Ecu Identification	Allows confirmation of IPDM E/R part number.
Self Diagnostic Result	Displays the diagnosis results judged by IPDM E/R.
Data Monitor	Displays the real-time input/output data from IPDM E/R input/output data.
Active Test	IPDM E/R can provide a drive signal to electronic components to check their operations.
CAN Diag Support Monitor	The results of transmit/receive diagnosis of CAN communication can be read.

SELF DIAGNOSTIC RESULT

Refer to [PCS-32, "DTC Index"](#).

DATA MONITOR

Monitor item

Monitor Item [Unit]	MAIN SIGNALS	Description
MOTOR FAN REQ [1/2/3/4]	×	Displays the value of the cooling fan speed request signal received from ECM via CAN communication.
AC COMP REQ [Off/On]	×	Displays the status of the A/C compressor request signal received from ECM via CAN communication.
TAIL&CLR REQ [Off/On]	×	Displays the status of the position light request signal received from BCM via CAN communication.
HL LO REQ [Off/On]	×	Displays the status of the low beam request signal received from BCM via CAN communication.
HL HI REQ [Off/On]	×	Displays the status of the high beam request signal received from BCM via CAN communication.
FR FOG REQ [Off/On]	×	Displays the status of the front fog light request signal received from BCM via CAN communication.
FR WIP REQ [Stop/1LOW/Low/Hi]	×	Displays the status of the front wiper request signal received from BCM via CAN communication.
WIP AUTO STOP [STOP P/ACT P]	×	Displays the status of the front wiper auto stop signal judged by IPDM E/R.
WIP PROT [Off/BLOCK]	×	Displays the status of the front wiper fail-safe operation judged by IPDM E/R.
IGN RLY1 -REQ [Off/On]		Displays the status of the ignition switch ON signal received from BCM via CAN communication.

DIAGNOSIS SYSTEM (IPDM E/R)

< FUNCTION DIAGNOSIS >

[IPDM E/R]

Monitor Item [Unit]	MAIN SIG- NALS	Description
IGN RLY [Off/On]	×	Displays the status of the ignition relay judged by IPDM E/R.
PUSH SW [Off/On]		Displays the status of the push-button ignition switch judged by IPDM E/R.
INTER/NP SW [Off/On]		Displays the status of the shift position judged by IPDM E/R.
ST RLY CONT [Off/On]		Displays the status of the starter relay status signal received from BCM via CAN communication.
IHBT RLY -REQ [Off/On]		Displays the status of the starter control relay signal received from BCM via CAN communication.
ST/INH RLY [Off/ ST ON/INH ON/UNKWN]		Displays the status of the starter relay and starter control relay judged by IPDM E/R.
DETENT SW [Off/On]		Displays the status of the control device (detention switch) judged by IPDM E/R.
S/L RLY -REQ [Off/On]		Displays the status of the steering lock relay signal received from BCM via CAN communication.
S/L STATE [LOCK/UNLOCK/UNKWN]		Displays the status of the steering lock judged by IPDM E/R.
DTRL REQ [Off/On]		NOTE: The item is indicated, but not monitored.
OIL P SW [Open/Close]		Displays the status of the oil pressure switch judged by IPDM E/R.
HOOD SW [Off/On]		NOTE: The item is indicated, but not monitored.
HL WASHER REQ [Off/On]		NOTE: The item is indicated, but not monitored.
THFT HRN REQ [Off/On]		Displays the status of the theft warning horn request signal received from BCM via CAN communication.
HORN CHIRP [Off/On]		Displays the status of the horn reminder signal received from BCM via CAN communication.
CRNRNG LMP REQ [Off/On]		NOTE: The item is indicated, but not monitored.

ACTIVE TEST

Test item

Test item	Operation	Description
CORNERING LAMP	Off	NOTE: The item is indicated, but cannot be tested.
	LH	
	RH	
HORN	On	Operates horn relay for 20 ms.
FRONT WIPER	Off	OFF
	Lo	Operates the front wiper relay.
	Hi	Operates the front wiper relay and front wiper high relay.
MOTOR FAN	1	OFF
	2	Operates the cooling fan relay-1.
	3	Operates the cooling fan relay-2.
	4	Operates the cooling fan relay-2 and cooling fan relay-3.
HEAD LAMP WASHER	On	NOTE: The item is indicated, but cannot be tested.

DIAGNOSIS SYSTEM (IPDM E/R)

< FUNCTION DIAGNOSIS >

[IPDM E/R]

Test item	Operation	Description
EXTERNAL LAMPS	Off	OFF
	TAIL	Operates the tail lamp relay.
	Lo	Operates the headlamp low relay.
	Hi	Operates the headlamp low relay and ON/OFF the headlamp high relay at 1 second intervals.
	Fog	Operates the front fog lamp relay.

COMPONENT DIAGNOSIS

U1000 CAN COMM CIRCUIT

Description

INFOID:000000003420434

CAN (Controller Area Network) is a serial communication line for real time applications. It is an on-vehicle multiplex communication line with high data communication speed and excellent error detection ability. Modern vehicle is equipped with many electronic control unit, and each control unit shares information and links with other control units during operation (not independent). In CAN communication, control units are connected with 2 communication lines (CAN-H line, CAN-L line) allowing a high rate of information transmission with less wiring. Each control unit transmits/receives data but selectively reads required data only.
 CAN Communication Signal Chart. Refer to [LAN-25, "CAN Communication Signal Chart"](#).

DTC Logic

INFOID:000000003420435

DTC DETECTION LOGIC

DTC	CONSULT-III display description	DTC Detection Condition	Possible cause
U1000	CAN COMM CIRCUIT	When IPDM E/R cannot communicate CAN communication signal continuously for 2 seconds or more	CAN communication system

Diagnosis Procedure

INFOID:000000003420436

1. PERFORM SELF DIAGNOSTIC

1. Turn the ignition switch ON and wait for 2 seconds or more.
2. Check "Self Diagnostic Result" of IPDM E/R.

Is DTC "U1000" displayed?

- YES >> Refer to [LAN-16, "Trouble Diagnosis Flow Chart"](#).
- NO >> Refer to [GI-40, "Intermittent Incident"](#).

A
B
C
D
E
F
G
H
I
J
K
L

PCS

N
O
P

B2098 IGNITION RELAY ON STUCK

< COMPONENT DIAGNOSIS >

[IPDM E/R]

B2098 IGNITION RELAY ON STUCK

Description

INFOID:000000003420437

- IPDM E/R operates the ignition relay when it receives an ignition switch ON signal from BCM via CAN communication.
- Turn the ignition relay OFF by pressing the push-button ignition switch once when the vehicle speed is 4 km/h (2.5 MPH) or less.
- Turn the ignition relay OFF with the following operation when the vehicle speed is more than 4 km/h (2.5 MPH) or when an abnormal condition occurs in CAN communication from the combination meter (Emergency OFF)
 - Press and hold the push-button ignition switch for 2 seconds or more.
 - Press the push-button ignition switch 3 times within 1.5 seconds.

NOTE:

The ignition relay does not turn ON for 3 seconds after emergency OFF even if the push-button ignition switch is pressed.

DTC Logic

INFOID:000000003420438

DTC DETECTION LOGIC

DTC	CONSULT-III display description	DTC Detection Condition	Possible causes
B2098	IGN RELAY ON	The ignition relay ON is detected for 1 second at ignition switch OFF (CPU monitors the status at the contact and excitation coil circuits of the ignition relay inside it)	Ignition relay malfunction

Diagnosis Procedure

INFOID:000000003420439

1. PERFORM SELF DIAGNOSIS

1. Turn the ignition switch ON.
2. Erase "Self Diagnostic Result" of IPDM E/R.
3. Turn the ignition switch OFF, and wait for 1 second or more.
4. Turn the ignition switch ON. Check "Self Diagnostic Result" again.

Is DTC "B2098" displayed?

- YES >> Replace IPDM E/R.
NO >> Refer to [GI-40, "Intermittent Incident"](#).

B2099 IGNITION RELAY OFF STUCK

< COMPONENT DIAGNOSIS >

[IPDM E/R]

B2099 IGNITION RELAY OFF STUCK

Description

INFOID:000000003470276

- IPDM E/R operates the ignition relay when it receives an ignition switch ON signal from BCM via CAN communication.
- Turn the ignition relay OFF by pressing the push-button ignition switch once when the vehicle speed is 4 km/h (2.5 MPH) or less.
- Turn the ignition relay OFF with the following operation when the vehicle speed is more than 4 km/h (2.5 MPH) or when an abnormal condition occurs in CAN communication from the combination meter (Emergency OFF)
 - Press and hold the push-button ignition switch for 2 seconds or more.
 - Press the push-button ignition switch 3 times within 1.5 seconds.

NOTE:

The ignition relay does not turn ON for 3 seconds after emergency OFF even if the push-button ignition switch is pressed.

DTC Logic

INFOID:000000003420441

DTC DETECTION LOGIC

DTC	CONSULT-III display description	DTC Detection Condition	Possible causes
B2099	IGN RELAY OFF	The ignition relay OFF is detected for 1 second at ignition switch ON (CPU monitors the status at the contact and excitation coil circuits of the ignition relay inside it)	Ignition relay malfunction

NOTE:

When IPDM E/R power supply voltage is low (Approx. 7 - 8 V for about 1 second), the "DTC: B2099" may be detected.

Diagnosis Procedure

INFOID:000000003420442

1. PERFORM SELF DIAGNOSIS

1. Turn the ignition switch ON.
2. Erase "Self Diagnostic Result".
3. Turn the ignition switch OFF.
4. Turn the ignition switch ON. Check "Self Diagnostic Result" again.

Is DTC "B2099" displayed?

- YES >> Replace IPDM E/R.
- NO >> Refer to [GI-40, "Intermittent Incident"](#).

PCS

POWER SUPPLY AND GROUND CIRCUIT

< COMPONENT DIAGNOSIS >

[IPDM E/R]

POWER SUPPLY AND GROUND CIRCUIT

Diagnosis Procedure

INFOID:000000003420443

1. CHECK FUSES AND FUSIBLE LINK

Check that the following IPDM E/R fuses or fusible links are not blown.

Signal name	Fuses and fusible link No.
Battery power supply	E
	50
	51

Is the fuse fusing?

YES >> Replace the blown fuse or fusible link after repairing the affected circuit if a fuse or fusible link is blown.

NO >> GO TO 2.

2. CHECK POWER SUPPLY CIRCUIT

1. Turn the ignition switch OFF.
2. Disconnect IPDM E/R connector.
3. Check voltage between IPDM E/R harness connector and the ground.

Terminals		Voltage (Approx.)
(+)	(-)	
IPDM E/R		Battery voltage
Connector	Terminal	
E9	1	

Is the measurement value normal?

YES >> GO TO 3.

NO >> Repair the harness or connector.

3. CHECK GROUND CIRCUIT

Check continuity between IPDM E/R harness connectors and the ground.

IPDM E/R		Ground	Continuity
Connector	Terminal		
E10	12		Existed
E11	41		

Does continuity exist?

YES >> INSPECTION END

NO >> Repair the harness or connector.

IPDM E/R (INTELLIGENT POWER DISTRIBUTION MODULE ENGINE ROOM)

< ECU DIAGNOSIS >

[IPDM E/R]

ECU DIAGNOSIS

IPDM E/R (INTELLIGENT POWER DISTRIBUTION MODULE ENGINE ROOM)

Reference Value

INFOID:000000003420444

VALUES ON THE DIAGNOSIS TOOL

Monitor Item	Condition		Value/Status
MOTOR FAN REQ	Engine idle speed	Changes depending on engine coolant temperature, air conditioner operation status, vehicle speed, etc.	1/2/3/4
AC COMP REQ	Engine running	A/C switch OFF	Off
		A/C switch ON (Compressor is operating)	On
TAIL&CLR REQ	Lighting switch OFF		Off
	Lighting switch 1ST, 2ND, HI or AUTO (Light is illuminated)		On
HL LO REQ	Lighting switch OFF		Off
	Lighting switch 2ND HI or AUTO (Light is illuminated)		On
HL HI REQ	Lighting switch OFF		Off
	Lighting switch HI		On
FR FOG REQ	Lighting switch 2ND or AUTO (Light is illuminated)	Front fog lamp switch OFF	Off
		<ul style="list-style-type: none"> • Front fog lamp switch ON • Daytime running light activated (Only for Canada) 	On
FR WIP REQ	Ignition switch ON	Front wiper switch OFF	Stop
		Front wiper switch INT	1LOW
		Front wiper switch LO	Low
		Front wiper switch HI	Hi
WIP AUTO STOP	Ignition switch ON	Front wiper stop position	STOP P
		Any position other than front wiper stop position	ACT P
WIP PROT	Ignition switch ON	Front wiper operates normally	Off
		Front wiper stops at fail-safe operation	BLOCK
IGN RLY1 -REQ	Ignition switch OFF or ACC		Off
	Ignition switch ON		On
IGN RLY	Ignition switch OFF or ACC		Off
	Ignition switch ON		On
PUSH SW	Release the push-button ignition switch		Off
	Press the push-button ignition switch		On
INTER/NP SW	Ignition switch ON	Selector lever in any position other than P or N	Off
		Selector lever in P or N position	On
ST RLY CONT	Ignition switch ON		Off
	At engine cranking		On
IHBT RLY -REQ	Ignition switch ON		Off
	At engine cranking		On

A
B
C
D
E
F
G
H
I
J
K
L

PCS

N
O
P

IPDM E/R (INTELLIGENT POWER DISTRIBUTION MODULE ENGINE ROOM)

< ECU DIAGNOSIS >

[IPDM E/R]

Monitor Item	Condition	Value/Status
ST/INHI RLY	Ignition switch ON	Off
	At engine cranking	INHI ON → ST ON
	The status of starter relay or starter control relay cannot be recognized by the battery voltage malfunction, etc. when the starter relay is ON and the starter control relay is OFF	UNKWN
DETENT SW	Ignition switch ON <ul style="list-style-type: none"> • Press the selector button with selector lever in P position • Selector lever in any position other than P 	Off
	Release the selector button with selector lever in P position	On
S/L RLY -REQ	None of the conditions below are present	Off
	<ul style="list-style-type: none"> • Open the driver door after the ignition switch is turned OFF (for a few seconds) • Press the push-button ignition switch when the steering lock is activated 	On
S/L STATE	Steering lock is activated	LOCK
	Steering lock is deactivated	UNLOCK
	[DTC: B210A] is detected	UNKWN
DTRL REQ	NOTE: The item is indicated, but not monitored.	Off
OIL P SW	Ignition switch OFF, ACC or engine running	Open
	Ignition switch ON	Close
HOOD SW	NOTE: The item is indicated, but not monitored.	Off
HL WASHER REQ	NOTE: The item is indicated, but not monitored.	Off
THFT HRN REQ	Not operating	Off
	<ul style="list-style-type: none"> • Panic alarm is activated • Horn is activated with VEHICLE SECURITY (THEFT WARNING) SYSTEM 	On
HORN CHIRP	Not operating	Off
	<ul style="list-style-type: none"> • Door locking with Intelligent Key (horn chirp mode) • Door locking with key fob (horn chirp mode) 	On
CRNRNG LMP REQ	NOTE: The item is indicated, but not monitored.	Off

IPDM E/R (INTELLIGENT POWER DISTRIBUTION MODULE ENGINE ROOM)

< ECU DIAGNOSIS >

[IPDM E/R]

TERMINAL LAYOUT

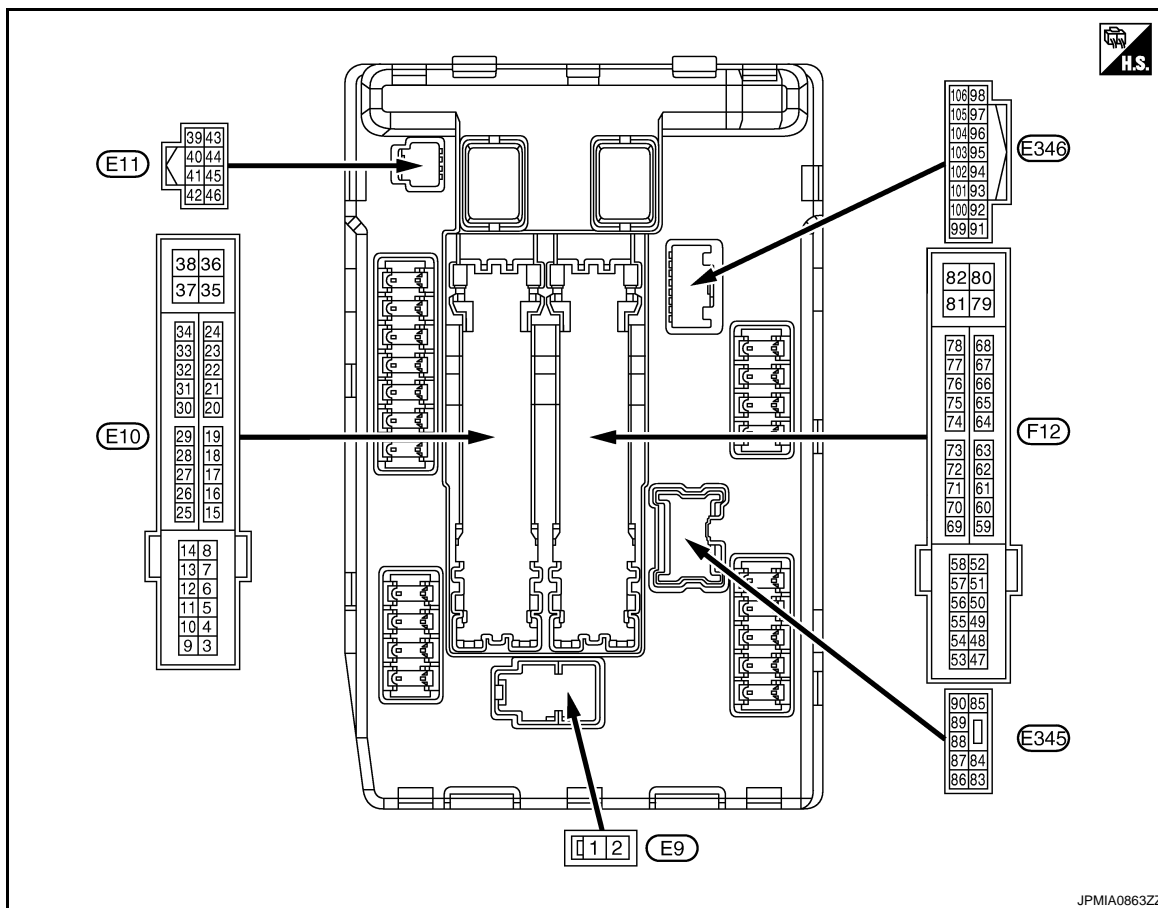

PHYSICAL VALUES

Terminal No. (Wire color)		Description		Condition		Value (Approx.)
+	-	Signal name	Input/ Output			
1 (R)	Ground	Battery power supply	Input	Ignition switch OFF		Battery voltage
2 (L)	Ground	Battery power supply	Input	Ignition switch OFF		Battery voltage
4 (LG)	Ground	Front wiper LO	Output	Ignition switch OFF	Front wiper switch OFF	0 V
				Ignition switch ON	Front wiper switch LO	Battery voltage
5 (Y)	Ground	Front wiper HI	Output	Ignition switch OFF	Front wiper switch OFF	0 V
				Ignition switch ON	Front wiper switch HI	Battery voltage
7 (GR)	Ground	Tail, license plate lamps & illuminations	Output	Ignition switch OFF	Lighting switch OFF	0 V
				Ignition switch ON	Lighting switch 1ST	Battery voltage
10 (BR)	Ground	ECM relay power supply	Output	Ignition switch OFF (More than a few seconds after turning ignition switch OFF)		0 V
				<ul style="list-style-type: none"> Ignition switch ON Ignition switch OFF (For a few seconds after turning ignition switch OFF) 		Battery voltage

A
B
C
D
E
F
G
H
I
J
K
L
N
O
P

PCS

IPDM E/R (INTELLIGENT POWER DISTRIBUTION MODULE ENGINE ROOM)

< ECU DIAGNOSIS >

[IPDM E/R]

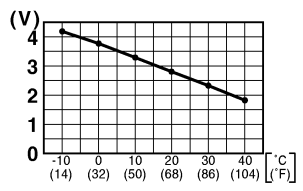
Terminal No. (Wire color)		Description		Condition		Value (Approx.)
+	-	Signal name	Input/ Output			
11 (P)	Ground	Steering lock unit power supply	Output	Ignition switch OFF	A few seconds after opening the driver door	Battery voltage
				Ignition switch LOCK	Press the push-button ignition switch	Battery voltage
				Ignition switch ACC or ON		0 V
12 (B)	Ground	Ground	—	Ignition switch ON		0 V
13 (SB)	Ground	Fuel pump power supply	Output	Approximately 1 second or more after turning the ignition switch ON		0 V
				<ul style="list-style-type: none"> • Approximately 1 second after turning the ignition switch ON • Engine running 		Battery voltage
15 (W)	Ground	Ignition relay power supply	Output	Ignition switch OFF		0 V
				Ignition switch ON		Battery voltage
16 (L/Y)	Ground	Front wiper auto stop	Input	Ignition switch ON	Front wiper stop position	0 V
					Any position other than front wiper stop position	
19 (Y)	Ground	Ignition relay power supply	Output	Ignition switch OFF		0 V
				Ignition switch ON		Battery voltage
20 (L)	Ground	Ambient sensor ground	Output	Ignition switch ON		0 V
21 (O)	Ground	Ambient sensor	Input	Ignition switch ON NOTE: Changes depending to ambient temperature		
22 (SB)	Ground	Refrigerant pressure sensor ground	Output	Engine running	<ul style="list-style-type: none"> • Warm-up condition • Idle speed 	0 V
23 (GR)	Ground	Refrigerant pressure sensor	Output	Engine running	<ul style="list-style-type: none"> • Warm-up condition • Both A/C switch and blower fan motor switch ON (Compressor operates) 	1.0 - 4.0 V
24 (G)	Ground	Refrigerant pressure sensor power supply	Input	Ignition switch OFF		0 V
				Ignition switch ON		5.0 V
25 (GR)	Ground	Ignition relay power supply	Output	Ignition switch OFF		0 V
				Ignition switch ON		Battery voltage
26* (Y)	Ground	Ignition relay power supply	Output	Ignition switch OFF		0 V
				Ignition switch ON		Battery voltage
27 (W)	Ground	Ignition relay monitor	Input	Ignition switch OFF or ACC		Battery voltage
				Ignition switch ON		0 V
28 (SB)	Ground	Push-button ignition switch	Input	Press the push-button ignition switch		0 V
				Release the push-button ignition switch		Battery voltage

IPDM E/R (INTELLIGENT POWER DISTRIBUTION MODULE ENGINE ROOM)

< ECU DIAGNOSIS >

[IPDM E/R]

Terminal No. (Wire color)		Description		Condition		Value (Approx.)	
30 (BR)	Ground	Starter relay control	Input	Ignition switch ON	Selector lever in any position other than P or N	0 V	A
					Selector lever P or N	Battery voltage	B
32 (V)	Ground	Steering lock unit condition-1	Input	Steering lock is activated		0 V	C
				Steering lock is deactivated		Battery voltage	
33 (G)	Ground	Steering lock unit condition-2	Input	Steering lock is activated		Battery voltage	D
				Steering lock is deactivated		0 V	
34 (O)	Ground	Cooling fan relay-3 control	Input	Cooling fan stopped		Battery voltage	E
				Cooling fan at HI operation		0 V	
35 (P)	Ground	Cooling fan relay-1 power supply	Input	Cooling fan stopped		Battery voltage	
				Cooling fan at LO operation		6.0 V	
36 (G)	Ground	Battery power supply	Input	Ignition switch OFF		Battery voltage	F
38 (GR)	Ground	Cooling fan relay-1 power supply	Output	Cooling fan not operating		0 V	G
				Cooling fan at LO operation		6.0 V	
39 (P)	—	CAN-L	Input/ Output	—		—	H
40 (L)	—	CAN-H	Input/ Output	—		—	
41 (B)	Ground	Ground	—	Ignition switch ON		0 V	I
42 (SB)	Ground	Cooling fan relay-2 control	Input	Cooling fan stopped		Battery voltage	
				<ul style="list-style-type: none"> • Cooling fan MID operating • Cooling fan HI operating 		0 V	J
43 (Y)	Ground	Control device (Detention switch)	Input	Ignition switch ON	Press the selector button (selector lever P)	Battery voltage	K
					<ul style="list-style-type: none"> • Selector lever in any position other than P • Release the selector button (selector lever P) 	0 V	
44 (W)	Ground	Horn relay control	Input	The horn is deactivated		Battery voltage	
				The horn is activated		0 V	
45 (O)	Ground	Horn switch	Input	The horn is deactivated		Battery voltage	PCS
				The horn is activated		0 V	
46 (BR)	Ground	Starter relay control	Input	Ignition switch ON	Selector lever in any position other than P or N	0 V	N
					Selector lever P or N	Battery voltage	
48 (W)	Ground	A/C relay power supply	Output	Engine running	A/C switch OFF	0 V	O
					A/C switch ON (A/C compressor is operating)	Battery voltage	
49 (R/B)	Ground	ECM relay power supply	Output	Ignition switch OFF (More than a few seconds after turning ignition switch OFF)		0 V	P
				<ul style="list-style-type: none"> • Ignition switch ON • Ignition switch OFF (For a few seconds after turning ignition switch OFF) 		Battery voltage	

IPDM E/R (INTELLIGENT POWER DISTRIBUTION MODULE ENGINE ROOM)

< ECU DIAGNOSIS >

[IPDM E/R]

Terminal No. (Wire color)		Description		Condition		Value (Approx.)
+	-	Signal name	Input/ Output			
51 (LG)	Ground	Ignition relay power supply	Output	Ignition switch OFF		0 V
				Ignition switch ON		Battery voltage
52 (Y/G)	Ground	Ignition relay power supply	Output	Ignition switch OFF		0 V
				Ignition switch ON		Battery voltage
53 (R/W)	Ground	ECM relay power supply	Output	Ignition switch OFF (More than a few seconds after turning ignition switch OFF)		0 V
				<ul style="list-style-type: none"> • Ignition switch ON • Ignition switch OFF (For a few seconds after turning ignition switch OFF) 		Battery voltage
54 (G/W)	Ground	Throttle control motor relay power supply	Output	Ignition switch OFF (More than a few seconds after turning ignition switch OFF)		0 V
				<ul style="list-style-type: none"> • Ignition switch ON • Ignition switch OFF (For a few seconds after turning ignition switch OFF) 		Battery voltage
55 (W/L)	Ground	ECM power supply	Output	Ignition switch OFF		Battery voltage
56 (R/Y)	Ground	Ignition relay power supply	Output	Ignition switch OFF		0 V
				Ignition switch ON		Battery voltage
57 (O)	Ground	Ignition relay power supply	Output	Ignition switch OFF		0 V
				Ignition switch ON		Battery voltage
58 (Y)	Ground	Ignition relay power supply	Output	Ignition switch OFF		0 V
				Ignition switch ON		Battery voltage
69 (W/B)	Ground	ECM relay control	Output	Ignition switch OFF (More than a few seconds after turning ignition switch OFF)		Battery voltage
				<ul style="list-style-type: none"> • Ignition switch ON • Ignition switch OFF (For a few seconds after turning ignition switch OFF) 		0 - 1.5 V
70 (O)	Ground	Throttle control motor relay control	Output	Ignition switch ON → OFF		0 - 1.0 V ↓ Battery voltage ↓ 0 V
				Ignition switch ON		0 - 1.0 V
72 (R/B)	Ground	Starter relay control	Input	Ignition switch ON	Selector lever in any position other than P or N	0 V
					Selector lever P or N	Battery voltage
75 (LG)	Ground	Oil pressure switch	Input	Ignition switch ON	Engine stopped	0 V
					Engine running	Battery voltage

IPDM E/R (INTELLIGENT POWER DISTRIBUTION MODULE ENGINE ROOM)

< ECU DIAGNOSIS >

[IPDM E/R]

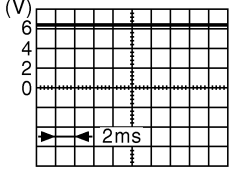
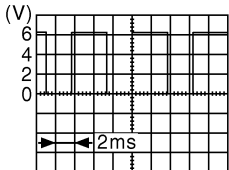
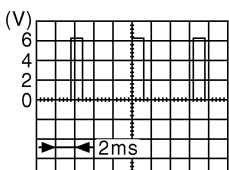
Terminal No. (Wire color)		Description		Condition		Value (Approx.)
+	-	Signal name	Input/ Output			
76 (SB)	Ground	Power generation command signal	Output	Ignition switch ON		 6.3 V
				40% is set on "ACTIVE TEST", "ALTERNATOR DUTY" of "ENGINE"		 3.8 V
				80% is set on "ACTIVE TEST", "ALTERNATOR DUTY" of "ENGINE"		 1.4 V
77 (GR)	Ground	Fuel pump relay control	Output	<ul style="list-style-type: none"> • Approximately 1 second after turning the ignition switch ON • Engine running 		0 - 1.5 V
				Approximately 1 second or more after turning the ignition switch ON		Battery voltage
80 (B)	Ground	Starter motor	Output	At engine cranking		Battery voltage
83 (Y)	Ground	Headlamp LO (RH)	Output	Ignition switch ON	Lighting switch OFF	0 V
					Lighting switch 2ND	Battery voltage
84 (L)	Ground	Headlamp LO (LH)	Output	Ignition switch ON	Lighting switch OFF	0 V
					Lighting switch 2ND	Battery voltage
86 (SB)	Ground	Front fog lamp (RH)	Output	Lighting switch 2ND	Front fog lamp switch OFF	0 V
					<ul style="list-style-type: none"> • Front fog lamp switch ON • Daytime running light activated (Only for Canada) 	
87 (GR)	Ground	Front fog lamp (LH)	Output	Lighting switch 2ND	Front fog lamp switch OFF	0 V
					<ul style="list-style-type: none"> • Front fog lamp switch ON • Daytime running light activated (Only for Canada) 	
88 (W)	Ground	Washer pump power supply	Output	Ignition switch ON		Battery voltage

A
B
C
D
E
F
G
H
I
J
K
L

PCS

N
O
P

IPDM E/R (INTELLIGENT POWER DISTRIBUTION MODULE ENGINE ROOM)

< ECU DIAGNOSIS >

[IPDM E/R]

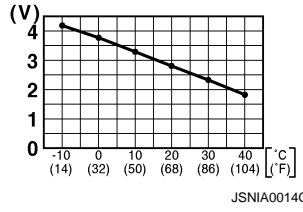
Terminal No. (Wire color)		Description		Condition		Value (Approx.)
+	-	Signal name	Input/ Output			
89 (L)	Ground	Headlamp HI (RH)	Output	Ignition switch ON	Lighting switch OFF	0 V
					<ul style="list-style-type: none"> • Lighting switch HI • Lighting switch PASS 	Battery voltage
90 (G)	Ground	Headlamp HI (LH)	Output	Ignition switch ON	Lighting switch OFF	0 V
					<ul style="list-style-type: none"> • Lighting switch HI • Lighting switch PASS 	Battery voltage
91 (R)	Ground	Parking lamp (RH)	Output	Ignition switch ON	Lighting switch OFF	0 V
					Lighting switch 1ST	Battery voltage
92 (LG)	Ground	Parking lamp (LH)	Output	Ignition switch ON	Lighting switch OFF	0 V
					Lighting switch 1ST	Battery voltage
93 (R)	Ground	Headlamp aiming motor (RH)	Output	Ignition switch ON	Lighting switch OFF	0 V
					Lighting switch 1ST	Battery voltage
94 (L)	Ground	Headlamp aiming motor (LH)	Output	Ignition switch ON	Lighting switch OFF	0 V
					Lighting switch 1ST	Battery voltage
99 (BR)	Ground	Ambient sensor ground	Input	Ignition switch ON		0 V
100 (SB)	Ground	Ambient sensor	Output	Ignition switch ON NOTE: Changes depending to ambient tem- perature		 <p style="text-align: right; font-size: small;">JSNIA0014GB</p>
101 (L)	Ground	Refrigerant pressure sen- sor ground	Input	Engine running	<ul style="list-style-type: none"> • Warm-up condition • Idle speed 	0 V
102 (B)	Ground	Refrigerant pressure sen- sor	Input	Engine running	<ul style="list-style-type: none"> • Warm-up condition • Both A/C switch and blower fan motor switch ON (Compressor operates) 	1.0 - 4.0 V
103 (P)	Ground	Refrigerant pressure sen- sor power supply	Output	Ignition switch OFF		0 V
				Ignition switch ON		5.0 V

*: AWD models only

IPDM E/R (INTELLIGENT POWER DISTRIBUTION MODULE ENGINE ROOM)

< ECU DIAGNOSIS >

[IPDM E/R]

Wiring Diagram - IPDM E/R -

INFOID:000000003420445

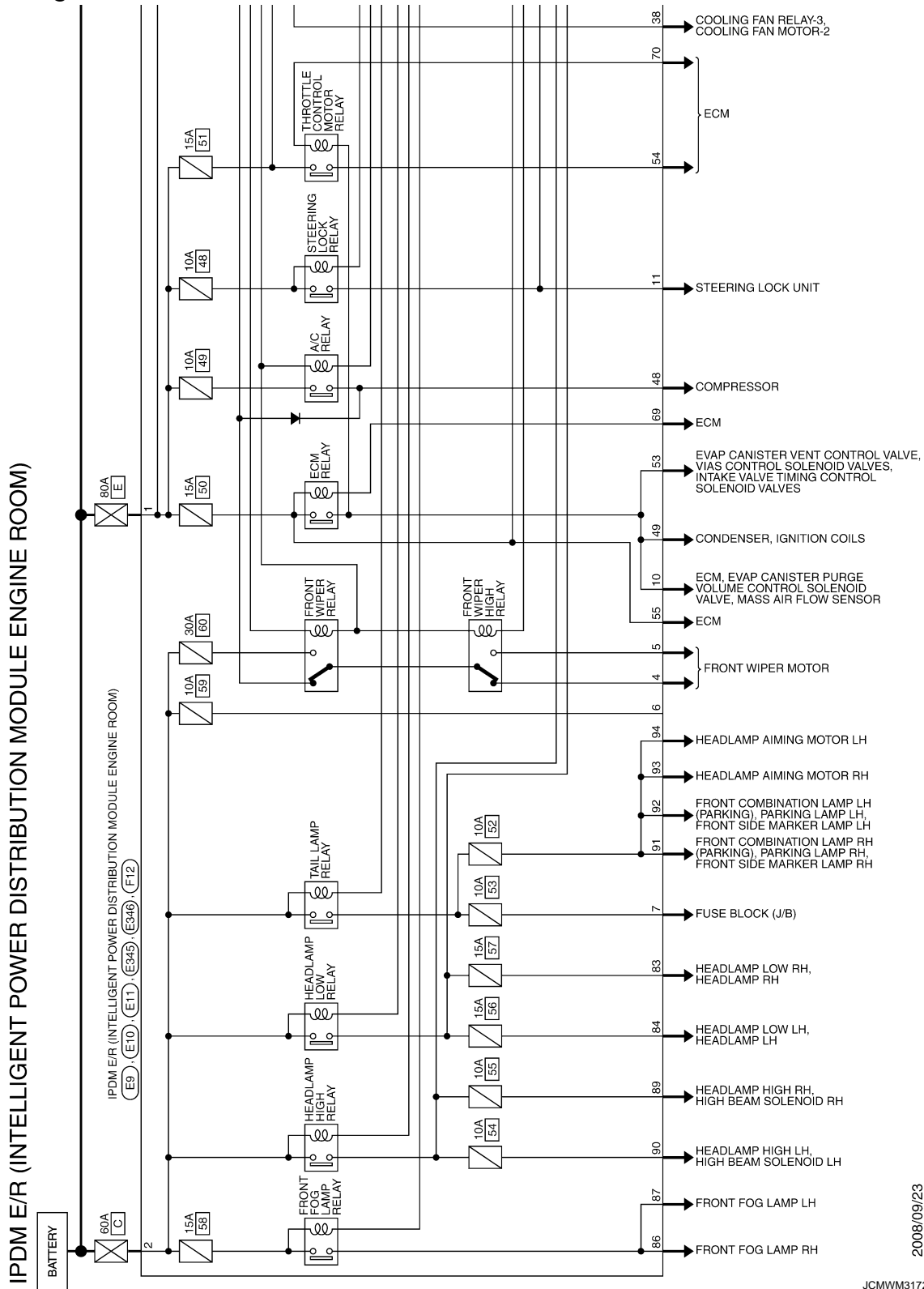

A
B
C
D
E
F
G
H
I
J
K
L
PCS
N
O
P

2008/09/23

JCMWM3172GI

A
B
C
D
E
F
G
H
I
J
K
L
N
O
P

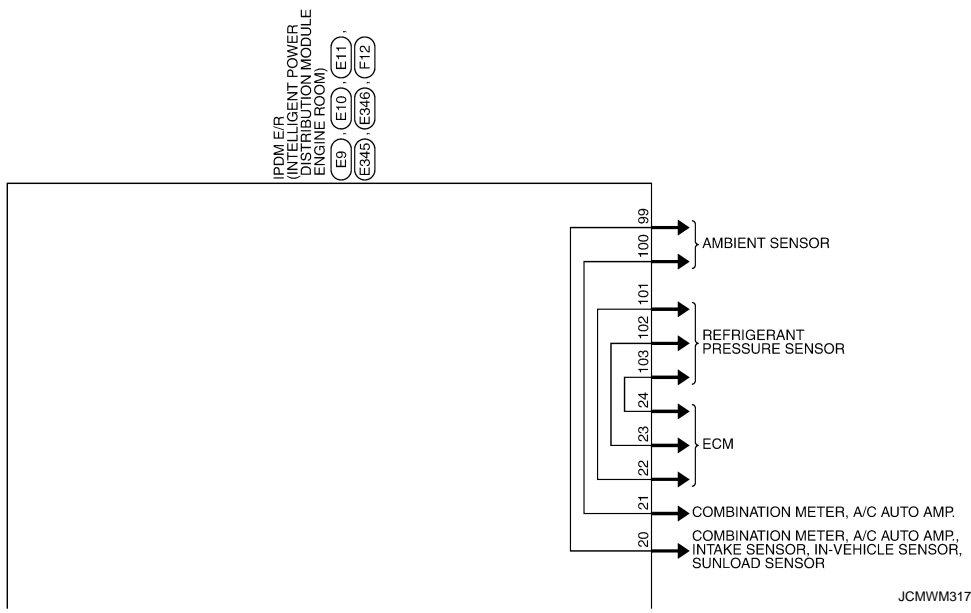

PCS

IPDM E/R (INTELLIGENT POWER DISTRIBUTION MODULE ENGINE ROOM)

< ECU DIAGNOSIS >

[IPDM E/R]

IPDM E/R (INTELLIGENT POWER DISTRIBUTION MODULE ENGINE ROOM)

Connector No.	E11
Connector Name	IPDM E/R (INTELLIGENT POWER DISTRIBUTION MODULE ENGINE ROOM)
Connector Type	TH08FW-NH



Terminal No.	Color of Wire	Signal Name [Specification]
39	P	-
40	L	-
41	B	-
42	SB	-
43	Y	-
44	W	-
45	O	-
46	BR	-

21	O	-
22	SB	-
23	GR	-
24	G	-
25	GR	-
26	Y	-
27	W	-
28	SB	-
30	BR	-
32	V	-
33	G	-
34	O	-
35	P	-
36	G	-
38	GR	-

70	O	-
72	R/B	-
75	LG	-
76	SB	-
77	GR	-
80	B	-

IPDM E/R (INTELLIGENT POWER DISTRIBUTION MODULE ENGINE ROOM)

Connector No.	F12
Connector Name	IPDM E/R (INTELLIGENT POWER DISTRIBUTION MODULE ENGINE ROOM)
Connector Type	TH20FW-CS12-M4



Terminal No.	Color of Wire	Signal Name [Specification]
48	W	-
49	R/B	-
51	LG	-
52	Y/G	-
53	R/W	-
54	G/W	-
55	W/L	-
56	R/Y	-
57	O	-
58	Y	-
68	W/B	-

IPDM E/R (INTELLIGENT POWER DISTRIBUTION MODULE ENGINE ROOM)

Connector No.	E10
Connector Name	IPDM E/R (INTELLIGENT POWER DISTRIBUTION MODULE ENGINE ROOM)
Connector Type	TH20FW-CS12-M4-1V



Terminal No.	Color of Wire	Signal Name [Specification]
4	LG	-
5	Y	-
7	GR	-
10	BR	-
11	P	-
12	B	-
13	SB	-
15	W	-
16	L/Y	-
19	Y	-
20	L	-

IPDM E/R (INTELLIGENT POWER DISTRIBUTION MODULE ENGINE ROOM)

Connector No.	E346
Connector Name	IPDM E/R (INTELLIGENT POWER DISTRIBUTION MODULE ENGINE ROOM)
Connector Type	TH16FW-NH

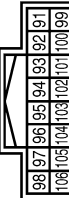

Terminal No.	Color of Wire	Signal Name [Specification]
91	R	-
92	LG	-
93	R	-
94	L	-
99	BR	-
100	SB	-
101	L	-
102	B	-
103	P	-

IPDM E/R (INTELLIGENT POWER DISTRIBUTION MODULE ENGINE ROOM)

Connector No.	E9
Connector Name	IPDM E/R (INTELLIGENT POWER DISTRIBUTION MODULE ENGINE ROOM)
Connector Type	LC2FB-MC



Terminal No.	Color of Wire	Signal Name [Specification]
1	R	-
2	L	-

IPDM E/R (INTELLIGENT POWER DISTRIBUTION MODULE ENGINE ROOM)

Connector No.	E345
Connector Name	IPDM E/R (INTELLIGENT POWER DISTRIBUTION MODULE ENGINE ROOM)
Connector Type	NS08FW-CS

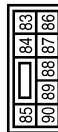

Terminal No.	Color of Wire	Signal Name [Specification]
83	Y	-
84	L	-
86	SB	-
87	GR	-
88	W	-
89	L	-
90	G	-

Fail-safe

CAN COMMUNICATION CONTROL

When CAN communication with ECM and BCM is impossible, IPDM E/R performs fail-safe control. After CAN communication recovers normally, it also returns to normal control.

If No CAN Communication Is Available With ECM

JCMWM3175G

INFOID:000000003420446

IPDM E/R (INTELLIGENT POWER DISTRIBUTION MODULE ENGINE ROOM)

< ECU DIAGNOSIS >

[IPDM E/R]

Control part	Fail-safe operation
Cooling fan	<ul style="list-style-type: none"> • Turns ON the cooling fan relay-2 and the cooling fan relay-3 when ignition switch is turned ON (Cooling fan operates at HI) • Turns OFF the cooling fan relay-1, the cooling fan relay-2 and the cooling fan relay-3 when the ignition switch is turned OFF (Cooling fan does not operate)
A/C compressor	A/C relay OFF
Alternator	Outputs the power generation command signal (PWM signal) 0%

If No CAN Communication Is Available With BCM

Control part	Fail-safe operation
Headlamp	<ul style="list-style-type: none"> • Turns ON the headlamp low relay when the ignition switch is turned ON • Turns OFF the headlamp low relay when the ignition switch is turned OFF • Headlamp high relay OFF
<ul style="list-style-type: none"> • Parking lamps • License plate lamps • Side maker lamps • Illuminations • Tail lamps 	<ul style="list-style-type: none"> • Turns ON the tail lamp relay when the ignition switch is turned ON • Turns OFF the tail lamp relay when the ignition switch is turned OFF
Front wiper	<ul style="list-style-type: none"> • The status just before activation of fail-safe control is maintained until the ignition switch is turned OFF while the front wiper is operating at LO or HI speed. • The wiper is operated at LO speed until the ignition switch is turned OFF if the fail-safe control is activated while the front wiper is set in the INT/AUTO mode and the front wiper motor is operating.
Front fog lamps	Front fog lamp relay OFF
Horn	Horn OFF
Ignition relay	The status just before activation of fail-safe is maintained.
Starter motor	Starter control relay OFF
Steering lock unit	Steering lock relay OFF

IGNITION RELAY MALFUNCTION DETECTION FUNCTION

- IPDM E/R monitors the voltage at the contact circuit and excitation coil circuit of the ignition relay inside it.
- IPDM E/R judges the ignition relay error if the voltage differs between the contact circuit and the excitation coil circuit.
- If the ignition relay cannot turn OFF due to contact seizure, it activates the tail lamp relay for 10 minutes to alert the user to the ignition relay malfunction when the ignition switch is turned OFF.

Voltage judgment		IPDM E/R judgment	Operation
Ignition relay contact side	Ignition relay excitation coil side		
ON	ON	Ignition relay ON normal	—
OFF	OFF	Ignition relay OFF normal	—
ON	OFF	Ignition relay ON stuck	<ul style="list-style-type: none"> • Detects DTC "B2098: IGN RELAY ON" • Turns ON the tail lamp relay for 10 minutes
OFF	ON	Ignition relay OFF stuck	Detects DTC "B2099: IGN RELAY OFF"

FRONT WIPER CONTROL

IPDM E/R detects front wiper stop position by a front wiper auto stop signal.

When a front wiper stop position signal is in the conditions listed below, IPDM E/R stops power supply to wiper after repeating a front wiper 10 seconds activation and 20 seconds stop five times.

IPDM E/R (INTELLIGENT POWER DISTRIBUTION MODULE ENGINE ROOM)

< ECU DIAGNOSIS >

[IPDM E/R]

Ignition switch	Front wiper switch	Front wiper stop position signal
ON	OFF	The front wiper stop position signal (stop position) cannot be input for 10 seconds.
	ON	The front wiper auto stop signal does not change for 10 seconds.

NOTE:

This operation status can be confirmed on the IPDM E/R “Data Monitor” that displays “BLOCK” for the item “WIP PROT” while the wiper is stopped.

STARTER MOTOR PROTECTION FUNCTION

IPDM E/R turns OFF the starter control relay to protect the starter motor when the starter control relay remains active for 90 seconds.

DTC Index

INFOID:000000003420447

NOTE:

- The details of time display are as follows.
 - CRNT: A malfunction is detected now.
 - PAST: A malfunction was detected in the past.
- IGN counter is displayed on FFD (Freeze Frame data).
 - The number is 0 when is detected now.
 - The number increases like 1 → 2 ... 38 → 39 after returning to the normal condition whenever IGN OFF → ON.
 - The number is fixed to 39 until the self-diagnosis results are erased if it is over 39.

×: Applicable

CONSULT display	Fail-safe	Refer to
No DTC is detected. further testing may be required.	—	—
U1000: CAN COMM CIRCUIT	×	PCS-15
B2098: IGN RELAY ON	×	PCS-16
B2099: IGN RELAY OFF	—	PCS-17
B2108: STRG LCK RELAY ON	—	SEC-103
B2109: STRG LCK RELAY OFF	—	SEC-104
B210A: STRG LCK STATE SW	—	SEC-105
B210B: START CONT RLY ON	—	SEC-109
B210C: START CONT RLY OFF	—	SEC-110
B210D: STARTER RELAY ON	—	SEC-111
B210E: STARTER RELAY OFF	—	SEC-112
B210F: INTRLCK/PNP SW ON	—	SEC-114
B2110: INTRLCK/PNP SW OFF	—	SEC-116

PRECAUTION

PRECAUTIONS

Precaution for Supplemental Restraint System (SRS) "AIR BAG" and "SEAT BELT PRE-TENSIONER"

INFOID:000000004778672

The Supplemental Restraint System such as "AIR BAG" and "SEAT BELT PRE-TENSIONER", used along with a front seat belt, helps to reduce the risk or severity of injury to the driver and front passenger for certain types of collision. This system includes seat belt switch inputs and dual stage front air bag modules. The SRS system uses the seat belt switches to determine the front air bag deployment, and may only deploy one front air bag, depending on the severity of a collision and whether the front occupants are belted or unbelted. Information necessary to service the system safely is included in the "SRS AIRBAG" and "SEAT BELT" of this Service Manual.

WARNING:

- To avoid rendering the SRS inoperative, which could increase the risk of personal injury or death in the event of a collision which would result in air bag inflation, all maintenance must be performed by an authorized NISSAN/INFINITI dealer.
- Improper maintenance, including incorrect removal and installation of the SRS, can lead to personal injury caused by unintentional activation of the system. For removal of Spiral Cable and Air Bag Module, see the "SRS AIRBAG".
- Never use electrical test equipment on any circuit related to the SRS unless instructed to in this Service Manual. SRS wiring harnesses can be identified by yellow and/or orange harnesses or harness connectors.

PRECAUTIONS WHEN USING POWER TOOLS (AIR OR ELECTRIC) AND HAMMERS

When working near the Airbag Diagnosis Sensor Unit or other Airbag System sensors while ignition switch is ON or engine is running, never use air or electric power tools or strike near the sensor(s) with a hammer. Heavy vibration may activate the sensor(s), deploy the airbag(s), possibly cause serious injury. When using air or electric power tools or hammers, always turn OFF ignition switch, disconnect the battery, and wait 3 minutes or more before performing any service.

A
B
C
D
E
F
G
H
I
J
K
L
N
O
P

PCS

ON-VEHICLE REPAIR

IPDM E/R (INTELLIGENT POWER DISTRIBUTION MODULE ENGINE ROOM)

Exploded View

INFOID:000000003420450

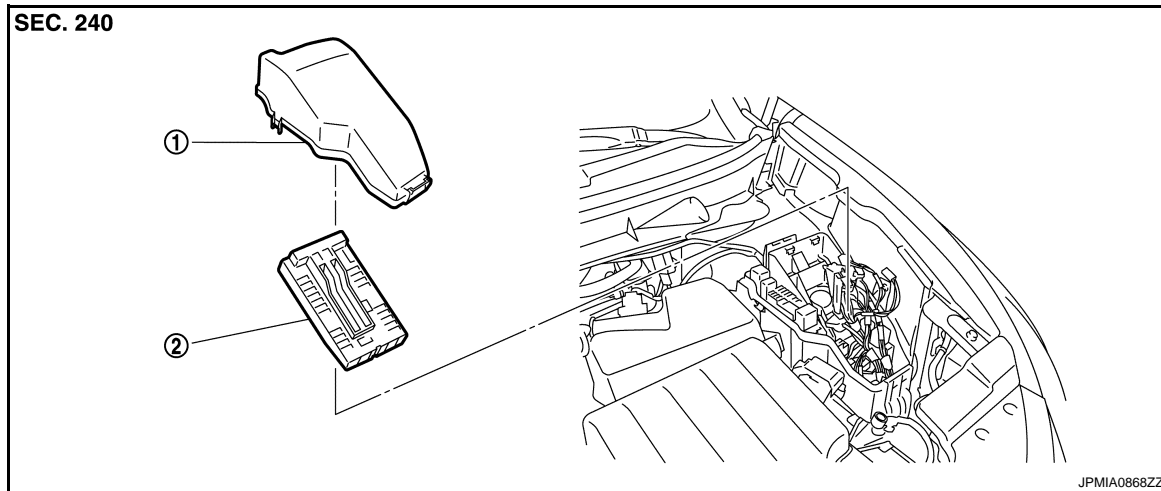

1. Relay box cover

2. IPDM E/R

Removal and Installation

INFOID:000000003420451

CAUTION:

IPDM E/R integrated relays are not serviceable parts, and must not be removed from the unit.

REMOVAL

1. Disconnect the battery cable from the negative terminal.
2. Remove the relay box cover.
3. Disconnect the harness connector from the IPDM E/R (1).
4. Press the pawl (A) and remove the IPDM E/R from relay box.

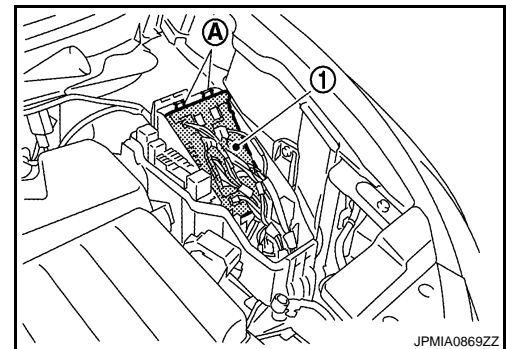

INSTALLATION

Install in the reverse order of removal.

DIAGNOSIS AND REPAIR WORK FLOW

< BASIC INSPECTION >

[POWER DISTRIBUTION SYSTEM]

BASIC INSPECTION

DIAGNOSIS AND REPAIR WORK FLOW

Work Flow

INFOID:000000003375856

OVERALL SEQUENCE

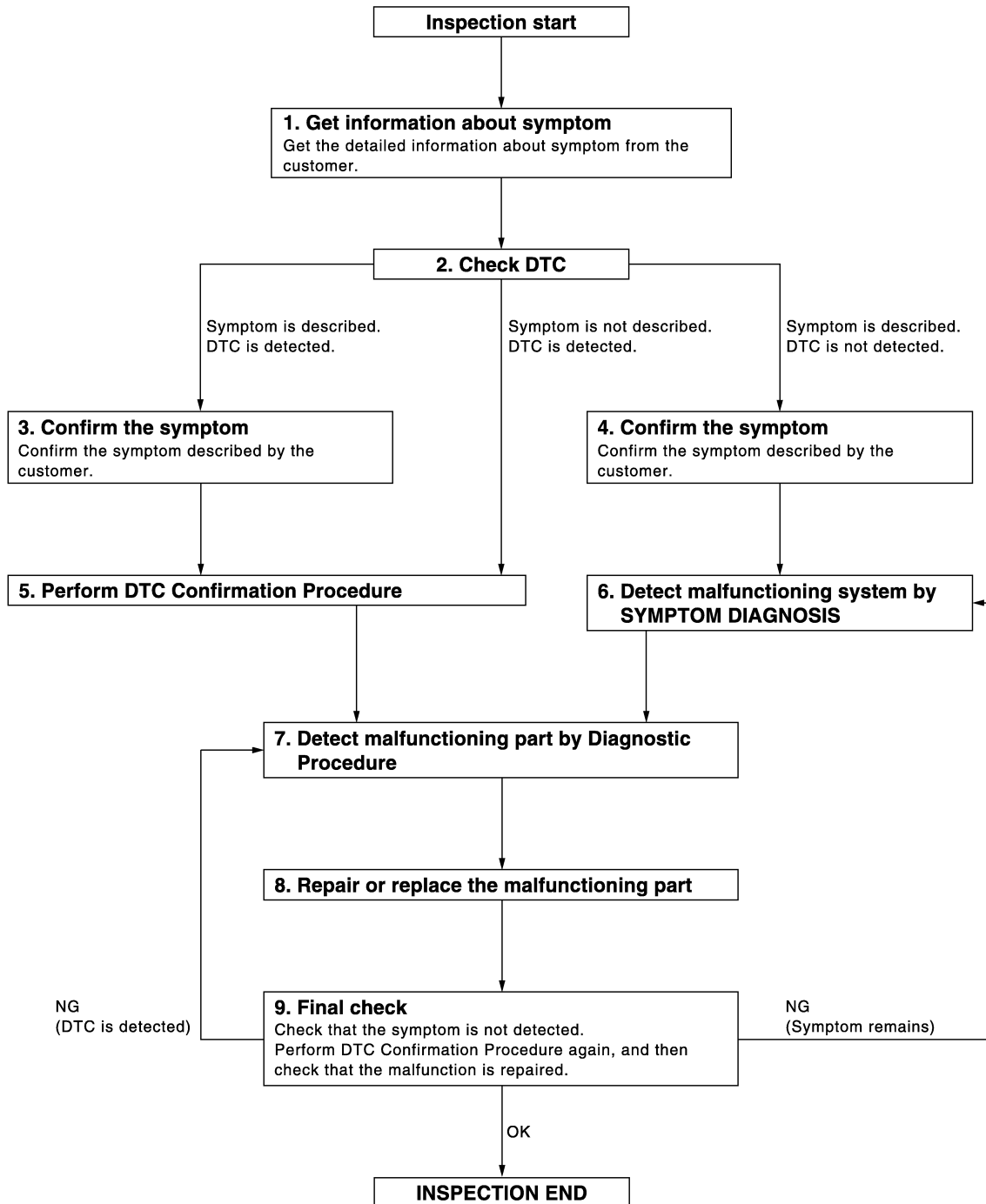

DETAILED FLOW

A
B
C
D
E
F
G
H
I
J
K
L
PCS
N
O
P

DIAGNOSIS AND REPAIR WORK FLOW

< BASIC INSPECTION >

[POWER DISTRIBUTION SYSTEM]

1.GET INFORMATION ABOUT SYMPTOM

Get the detailed information from the customer about the symptom (the condition and the environment when the incident/malfunction occurred).

>> GO TO 2.

2.CHECK DTC

1. Check DTC for BCM and IPDM E/R.
2. Perform the following procedure if DTC is detected.
 - Record DTC and freeze frame data (Print them out with CONSULT-III.)
 - Erase DTC.
 - Study the relationship between the cause detected by DTC and the symptom described by the customer.
3. Check related service bulletins for information.

Is any symptom described and any DTC detected?

Symptom is described, DTC is detected>>GO TO 3.

Symptom is described, DTC is not detected>>GO TO 4.

Symptom is not described, DTC is detected>>GO TO 5.

3.CONFIRM THE SYMPTOM

Confirm the symptom described by the customer.

Connect CONSULT-III to the vehicle in "DATA MONITOR" mode and check real time diagnosis results.

Verify relation between the symptom and the condition when the symptom is detected.

>> GO TO 5.

4.CONFIRM THE SYMPTOM

Confirm the symptom described by the customer.

Connect CONSULT-III to the vehicle in "DATA MONITOR " mode and check real time diagnosis results.

Verify relation between the symptom and the condition when the symptom is detected.

>> GO TO 6.

5.PERFORM DTC CONFIRMATION PROCEDURE

Perform DTC Confirmation Procedure for the detected DTC, and then check that DTC is detected again.

At this time, always connect CONSULT-III to the vehicle, and check diagnostic results in real time.

If two or more DTCs are detected, refer to [SEC-209. "DTC Inspection Priority Chart"](#), and determine trouble diagnosis order.

NOTE:

Perform Component Function Check if DTC Confirmation Procedure is not included in Service Manual. This simplified check procedure is an effective alternative though DTC cannot be detected during this check.

If the result of Component Function Check is NG, it is the same as the detection of DTC by DTC Confirmation Procedure.

Is DTC detected?

YES >> GO TO 7.

NO >> Refer to [GI-40. "Intermittent Incident"](#).

6.DETECT MALFUNCTIONING SYSTEM BY SYMPTOM DIAGNOSIS

Detect malfunctioning system according to SYMPTOM DIAGNOSIS based on the confirmed symptom in step 4, and determine the trouble diagnosis order based on possible causes and symptom.

>> GO TO 7.

7.DETECT MALFUNCTIONING PART BY DIAGNOSTIC PROCEDURE

Inspect according to Diagnostic Procedure of the system.

NOTE:

The Diagnostic Procedure described based on open circuit inspection. A short circuit inspection is also required for the circuit check in the Diagnostic Procedure.

DIAGNOSIS AND REPAIR WORK FLOW

[POWER DISTRIBUTION SYSTEM]

< BASIC INSPECTION >

Is malfunctioning part detected?

YES >> GO TO 8.

NO >> Check voltage of related BCM terminals using CONSULT-III.

8. REPAIR OR REPLACE THE MALFUNCTIONING PART

1. Repair or replace the malfunctioning part.
2. Reconnect parts or connectors disconnected during Diagnostic Procedure again after repair and replacement.
3. Check DTC. If DTC is detected, erase it.

>> GO TO 9.

9. FINAL CHECK

When DTC was detected in step 2, perform DTC Confirmation Procedure or Component Function Check again, and then check that the malfunction has been repaired securely.

When symptom was described from the customer, refer to confirmed symptom in step 3 or 4, and check that the symptom is not detected.

Does the symptom reappear?

YES (DTC is detected)>>GO TO 7.

YES (Symptom remains)>>GO TO 6.

NO >> **INSPECTION END**

A
B
C
D
E
F
G
H
I
J
K
L
N
O
P

PCS

FUNCTION DIAGNOSIS

POWER DISTRIBUTION SYSTEM

System Description

INFOID:000000003375857

SYSTEM DESCRIPTION

- PDS (POWER DISTRIBUTION SYSTEM) is the system that BCM controls with the operation of the push-button ignition switch and performs the power distribution to each power circuit. This system is used instead of the mechanical power supply changing mechanism with the operation of the conventional key cylinder.
- The push-button ignition switch can be operated when Intelligent Key is in the following condition. Refer to Engine Start Function for details. (With Intelligent key system)
 - Intelligent Key is in the detection area of the inside key antenna
 - Insert Intelligent Key into the key slot
- The push-button ignition switch can be operated when keyfob is in the following condition. Refer to Engine Start Function for details. (Without Intelligent key system)
 - Insert keyfob into the key slot
- The push-button ignition switch operation is input to BCM as a signal. BCM changes the power supply position according to the status and operates the following relays to supply power to each power circuit.
 - Ignition relay (inside IPDM E/R)
 - Ignition relay (inside fuse block)
 - ACC relay
 - Blower relay

NOTE:

- The engine switch operation changes due to the conditions of brake pedal, selector lever and vehicle speed.
- The power supply position can be confirmed with the lighting of the indicators around the push-button ignition switch.

BATTERY SAVER SYSTEM

When all the following conditions are met for 60 minutes, the battery saver system will cut off the power supply to prevent battery discharge.

- The ignition switch is in the ACC position
- All doors are closed
- Selector lever is in the P position

Reset Condition of Battery Saver System

In order to prevent the battery from discharging, the battery saver system will cut off the power supply when all doors are closed, the selector lever is on P position and the ignition switch is left on ACC position for 60 minutes. If any of the following conditions are met the battery saver system is released and the steering will change automatically to lock position from OFF position.

- Opening any door
- Operating with door key cylinder on door lock
- Operating with door request switch on door lock (With Intelligent Key system)
- Operating with Intelligent Key on door lock (With Intelligent Key system)
- Operating with keyfob on door lock (Without Intelligent Key system)

Press push-button ignition switch and ignition switch will change to ACC position from OFF position.

STEERING LOCK OPERATION

Steering is locked by steering lock unit when ignition switch is in the OFF position, selector lever is in the P position and any of the following conditions are met.

- Opening door
- Closing door
- Door is locked with request switch (With Intelligent Key system)
- Door is locked with Intelligent Key (With Intelligent key system)
- Door is locked with keyfob (Without Intelligent Key system)

POWER SUPPLY POSITION CHANGE TABLE BY PUSH-BUTTON IGNITION SWITCH OPERATION

The power supply position changing operation can be performed with the following operations.

NOTE:

- When an Intelligent Key is within the detection area of inside key antenna and when it is inserted to the key slot, it is equivalent to the operations below. (With Intelligent Key system)

POWER DISTRIBUTION SYSTEM

[POWER DISTRIBUTION SYSTEM]

< FUNCTION DIAGNOSIS >

- When keyfob is inserted to the key slot, it is equivalent to the operation below. (Without Intelligent Key system)
- When starting the engine, the BCM monitors under the engine start conditions,
 - Brake pedal operating condition
 - Selector lever position
 - Vehicle speed

Vehicle speed: less than 4 km/h (2.5 MPH)

Power supply position	Engine start/stop condition		Push-button ignition switch operation frequency
	Selector lever	Brake pedal operation condition	
LOCK → ACC	—	Not depressed	1
LOCK → ACC → ON	—	Not depressed	2
LOCK → ACC → ON → OFF	—	Not depressed	3
LOCK → START ACC → START ON → START	P or N position	Depressed	1
Engine is running → OFF	—	—	1

Vehicle speed: 4 km/h (2.5 MPH) or more

Power supply position	Engine start/stop condition		Push-button ignition switch operation frequency
	Selector lever	Brake pedal operation condition	
Engine is running → ACC	—	—	Emergency stop operation
Engine stall return operation while driving	N position	Not depressed	1

Emergency stop operation

- Press and hold the push-button ignition switch for 2 seconds or more.
- Press the push-button ignition switch 3 times or more within 1.5 seconds.

A
B
C
D
E
F
G
H
I
J
K
L

PCS

N
O
P

POWER DISTRIBUTION SYSTEM

< FUNCTION DIAGNOSIS >

[POWER DISTRIBUTION SYSTEM]

Component Parts Location

INFOID:000000003375858

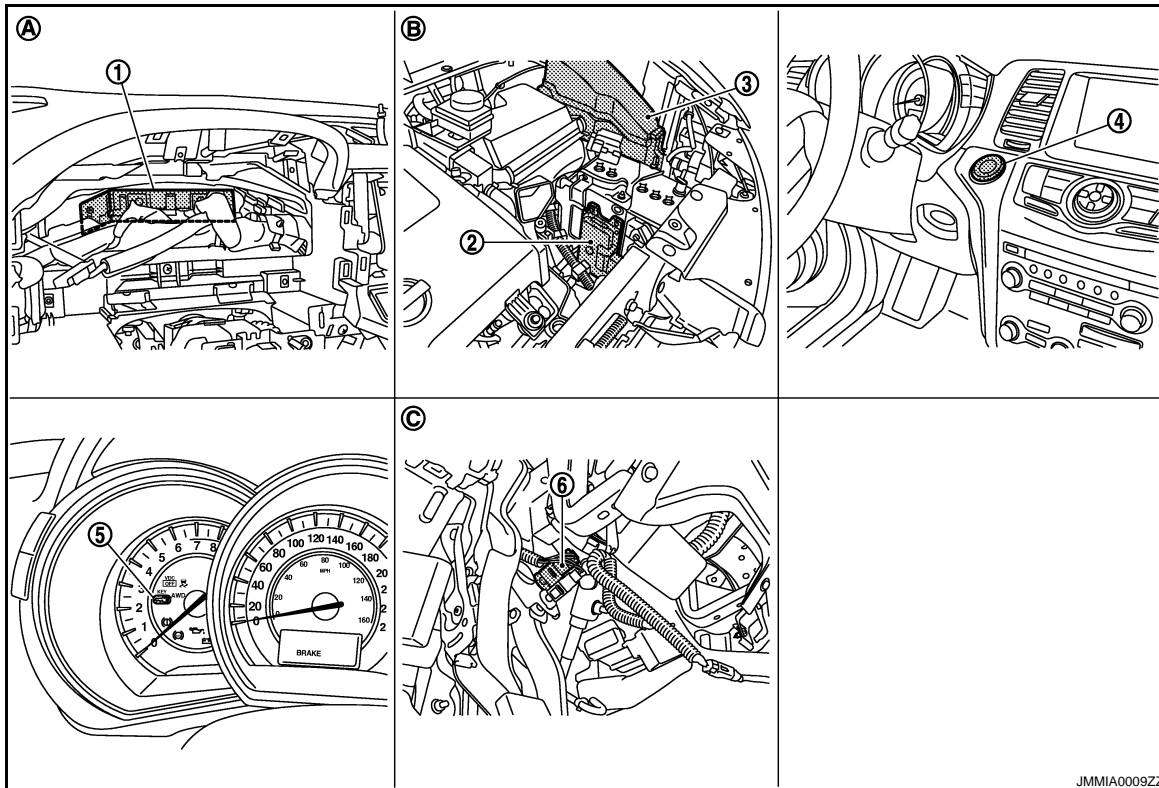

- | | | |
|-------------------------------------|---|---|
| 1. BCM M118, M119, M121, M122, M123 | 2. TCM F23 | 3. IPDM E/R E10, E11, F12 |
| 4. Push-button ignition switch M101 | 5. Combination meter (Key warning lamp) M34 | 6. Stop lamp switch E115 (TYPE A) E116 (TYPE B) |
| A. Behind the combination meter | B. Engine room dash panel (LH) | C. Behind the instrument lower panel LH |

Component Description

INFOID:000000003375859

Component	Reference
IPDM E/R	PCS-6
Ignition relay (built into IPDM E/R)	PCS-17
Ignition relay (inserted into fuse block)	PCS-49
Accessory relay	PCS-53
Blower relay	PCS-56
Stop lamp switch	SEC-59
Park/neutral position switch	SEC-65
Push-button ignition switch	PCS-66

DIAGNOSIS SYSTEM (BCM)

< FUNCTION DIAGNOSIS >

[POWER DISTRIBUTION SYSTEM]

DIAGNOSIS SYSTEM (BCM)

COMMON ITEM

COMMON ITEM : CONSULT-III Function (BCM - COMMON ITEM)

INFOID:000000004757251

APPLICATION ITEM

CONSULT-III performs the following functions via CAN communication with BCM.

Diagnosis mode	Function Description
Work Support	Changes the setting for each system function.
Self Diagnostic Result	Displays the diagnosis results judged by BCM.
CAN Diag Support Monitor	Monitors the reception status of CAN communication viewed from BCM. Refer to CONSULT-III operation manual.
Data Monitor	The BCM input/output signals are displayed.
Active Test	The signals used to activate each device are forcibly supplied from BCM.
Ecu Identification	The BCM part number is displayed.
Configuration	<ul style="list-style-type: none"> Read and save the vehicle specification. Write the vehicle specification when replacing BCM.

SYSTEM APPLICATION

BCM can perform the following functions for each system.

NOTE:

It can perform the diagnosis modes except the following for all sub system selection items.

x: Applicable item

System	Sub system selection item	Diagnosis mode		
		Work Support	Data Monitor	Active Test
Door lock	DOOR LOCK	x	x	x
Rear window defogger	REAR DEFOGGER		x	x
Warning chime	BUZZER		x	x
Interior room lamp timer	INT LAMP	x	x	x
Remote keyless entry system	MULTI REMOTE ENT*1	x	x	x
Exterior lamp	HEAD LAMP	x	x	x
Wiper and washer	WIPER	x*2	x	x
Turn signal and hazard warning lamps	FLASHER	x	x	x
—	AIR CONDITONER*3			
<ul style="list-style-type: none"> Intelligent Key system Engine start system 	INTELLIGENT KEY	x	x	x
Combination switch	COMB SW		x	
Body control system	BCM	x		
NVIS - NATS	IMMU		x	x
Interior room lamp battery saver	BATTERY SAVER	x	x	x
Back door opener system	TRUNK		x	x
Vehicle security system	THEFT ALM	x	x	x
RAP system	RETAINED PWR		x	
Signal buffer system	SIGNAL BUFFER		x	x
TPMS	TPMS (AIR PRESSURE MONITOR)	x	x	x

NOTE:

- *1: At models with Intelligent Key system this item is displayed, but is not used.
- *2: At models with rain sensor this mode is displayed, but is not used.

DIAGNOSIS SYSTEM (BCM)

[POWER DISTRIBUTION SYSTEM]

< FUNCTION DIAGNOSIS >

- *3: This item is displayed, but is not used.

FREEZE FRAME DATA (FFD)

The BCM records the following vehicle condition at the time a particular DTC is detected, and displays on CONSULT-III.

CONSULT screen item	Indication/Unit	Description	
Vehicle Speed	km/h	Vehicle speed of the moment a particular DTC is detected	
Odo/Trip Meter	km	Total mileage (Odometer value) of the moment a particular DTC is detected	
Vehicle Condition	SLEEP>LOCK	Power position status of the moment a particular DTC is detected	While turning BCM status from low power consumption mode to normal mode (Power supply position is "LOCK")
	SLEEP>OFF		While turning BCM status from low power consumption mode to normal mode (Power supply position is "OFF".)
	LOCK>ACC		While turning power supply position from "LOCK" to "ACC"
	ACC>ON		While turning power supply position from "ACC" to "IGN"
	RUN>ACC		While turning power supply position from "RUN" to "ACC" (Vehicle is stopping and selector lever is except P position.)
	CRANK>RUN		While turning power supply position from "CRANKING" to "RUN" (From cranking up the engine to run it)
	RUN>URGENT		While turning power supply position from "RUN" to "ACC" (Emergency stop operation)
	ACC>OFF		While turning power supply position from "ACC" to "OFF"
	OFF>LOCK		While turning power supply position from "OFF" to "LOCK"
	OFF>ACC		While turning power supply position from "OFF" to "ACC"
	ON>CRANK		While turning power supply position from "IGN" to "CRANKING"
	OFF>SLEEP		While turning BCM status from normal mode (Power supply position is "OFF".) to low power consumption mode
	LOCK>SLEEP		While turning BCM status from normal mode (Power supply position is "LOCK".) to low power consumption mode
	LOCK		Power supply position is "LOCK" (Ignition switch OFF with steering is locked.)
	OFF		Power supply position is "OFF" (Ignition switch OFF with steering is unlocked.)
	ACC		Power supply position is "ACC" (Ignition switch ACC)
	ON		Power supply position is "IGN" (Ignition switch ON with engine stopped)
ENGINE RUN	Power supply position is "RUN" (Ignition switch ON with engine running)		
CRANKING	Power supply position is "CRANKING" (At engine cranking)		
IGN Counter	0 - 39	<p>The number of times that ignition switch is turned ON after DTC is detected</p> <ul style="list-style-type: none"> The number is 0 when a malfunction is detected now. The number increases like 1 → 2 → 3...38 → 39 after returning to the normal condition whenever ignition switch OFF → ON. The number is fixed to 39 until the self-diagnosis results are erased if it is over 39. 	

INTELLIGENT KEY

INTELLIGENT KEY : CONSULT-III Function (BCM - INTELLIGENT KEY)

INFOID:000000004757252

BCM CONSULT-III FUNCTION

CONSULT-III performs the following functions via CAN communication with BCM.

DIAGNOSIS SYSTEM (BCM)

< FUNCTION DIAGNOSIS >

[POWER DISTRIBUTION SYSTEM]

Diagnosis mode	Function Description
WORK SUPPORT	Changes the setting for each system function.
SELF-DIAG RESULTS	Displays the diagnosis results judged by BCM.
DATA MONITOR	The BCM input/output signals are displayed.
ACTIVE TEST	The signals used to activate each device are forcibly supplied from BCM.

WORK SUPPORT

Monitor item	Description
REMO CONT ID CONFIR	It can be checked whether Intelligent Key ID code is registered or not in this mode.
AUTO LOCK SET	Auto door lock time can be changed in this mode. <ul style="list-style-type: none"> • MODE 1: 1 minute • MODE 2: 5 minutes • MODE 3: 30 seconds • MODE 4: 2 minutes
LOCK/UNLOCK BY I-KEY	Door lock/unlock function by door request switch (driver side, passenger side and back door) mode can be changed to operate (ON) or not operate (OFF) in this mode.
ENGINE START BY I-KEY	Engine start function mode can be changed to operate (ON) or not operate (OFF) with this mode.
TRUNK/GLASS HATCH OPEN	Buzzer reminder function mode by back door request switch can be changed to operate (ON) or not operate (OFF) with this mode.
PANIC ALARM SET	Panic alarm button pressing time on Intelligent Key remote control button can be selected from the following with this mode. <ul style="list-style-type: none"> • MODE 1: 0.5 sec. • MODE 2: Non-operation • MODE 3: 1.5 sec.
PW DOWN SET	Unlock button pressing time on Intelligent Key button can be selected from the following with this mode. <ul style="list-style-type: none"> • MODE 1: 3 sec. • MODE 2: Non-operation • MODE 3: 5 sec.
TRUNK OPEN DELAY	NOTE: This item is displayed, but cannot be supported.
LO- BATT OF KEY FOB WARN	Intelligent Key low battery warning mode can be changed to operate (ON) or not operate (OFF) with this mode.
ANTI KEY LOCK IN FUNCTI	Key reminder function mode can be changed to operate (ON) or not operate (OFF) with this mode.
HAZARD ANSWER BACK	Hazard reminder function mode can be selected from the following with this mode. <ul style="list-style-type: none"> • LOCK ONLY: Door lock operation only • UNLOCK ONLY: Door unlock operation only • LOCK/UNLOCK: Lock/unlock operation • OFF: Non-operation
ANS BACK I-KEY LOCK	Buzzer reminder function (lock operation) mode by door request switch (driver side and passenger side) can be selected from the following with this mode. <ul style="list-style-type: none"> • Horn chirp: Sound horn • Buzzer: Sound Intelligent Key warning buzzer • OFF: Non-operation
ANS BACK I-KEY UNLOCK	Buzzer reminder function (unlock operation) mode by door request switch can be changed to operate (ON) or not operate (OFF) with this mode.
SHORT CRANKING OUTPUT	Starter motor can operate during the times below. <ul style="list-style-type: none"> • 70 msec • 100 msec • 200 msec
INSIDE ANT DIAGNOSIS	This function allows inside key antenna self-diagnosis.
HORN WITH KEYLESS LOCK	Horn reminder function mode by Intelligent Key button can be changed to operate (ON) or not operate (OFF) with this mode.

SELF-DIAG RESULT

DIAGNOSIS SYSTEM (BCM)

[POWER DISTRIBUTION SYSTEM]

< FUNCTION DIAGNOSIS >

Refer to [DLK-255. "DTC Index"](#).

DATA MONITOR

Monitor Item	Condition
REQ SW -DR	Indicates [ON/OFF] condition of door request switch (driver side).
REQ SW -AS	Indicates [ON/OFF] condition of door request switch (passenger side).
REQ SW -RR	NOTE: This item is displayed, but cannot be monitored.
REQ SW -RL	NOTE: This item is displayed, but cannot be monitored.
REQ SW -BD/TR	Indicates [ON/OFF] condition of back door request switch.
PUSH SW	Indicates [ON/OFF] condition of push-button ignition switch.
IGN RLY2 -F/B	Indicates [ON/OFF] condition of ignition relay 2.
ACC RLY-FB	NOTE: This item is displayed, but cannot be monitored.
CLUCH SW	NOTE: This item is displayed, but cannot be monitored.
BRAKE SW 1	Indicates [ON/OFF]* condition of brake switch power supply.
BRAKE SW 2	Indicates [ON/OFF] condition of brake switch.
DETE/CANCL SW	Indicates [ON/OFF] condition of P position.
SFT PN/N SW	Indicates [ON/OFF] condition of P or N position.
S/L -LOCK	Indicates [ON/OFF] condition of steering lock unit (LOCK).
S/L -UNLOCK	Indicates [ON/OFF] condition of steering lock unit (UNLOCK).
S/L RELAY -F/B	Indicates [ON/OFF] condition of ignition switch.
UNLK SEN -DR	Indicates [ON/OFF] condition of driver door UNLOCK status.
PUSH SW -IPDM	Indicates [ON/OFF] condition of push-button ignition switch.
IGN RLY1 -F/B	Indicates [ON/OFF] condition of ignition relay 1.
DETE SW -IPDM	Indicates [ON/OFF] condition of P position.
SFT PN -IPDM	Indicates [ON/OFF] condition of P or N position.
SFT P -MET	Indicates [ON/OFF] condition of P position.
SFT N -MET	Indicates [ON/OFF] condition of N position.
ENGINE STATE	Indicates [STOP/START/CRANK/RUN] condition of engine states.
S/L LOCK-IPDM	Indicates [ON/OFF] condition of steering lock unit (LOCK).
S/L UNLK-IPDM	Indicates [ON/OFF] condition of steering lock unit (UNLOCK).
S/L RELAY-REQ	Indicates [ON/OFF] condition of steering lock relay.
VEH SPEED 1	Display the vehicle speed signal received from combination meter by numerical value [Km/h].
VEH SPEED 2	Display the vehicle speed signal received from ABS or VDC or CVT by numerical value [Km/h].
DOOR STAT-DR	Indicates [LOCK/READY/UNLOCK] condition of driver side door status.
DOOR STAT-AS	Indicates [LOCK/READY/UNLOCK] condition of passenger side door status.
ID OK FLAG	Indicates [SET/RESET] condition of key ID.
PRMT ENG STRT	Indicates [SET/RESET] condition of engine start possibility.
PRMT RKE STRT	NOTE: This item is displayed, but cannot be monitored.
KEY SW -SLOT	Indicates [ON/OFF] condition of key slot.
TRNK/HAT MNTR	NOTE: This item is displayed, but cannot be monitored.
RKE-LOCK	Indicates [ON/OFF] condition of LOCK signal from Intelligent Key.
RKE-UNLOCK	Indicates [ON/OFF] condition of UNLOCK signal from Intelligent Key.

DIAGNOSIS SYSTEM (BCM)

< FUNCTION DIAGNOSIS >

[POWER DISTRIBUTION SYSTEM]

Monitor Item	Condition
RKE-TR/BD	NOTE: This item is displayed, but cannot be monitored.
RKE-PANIC	Indicates [ON/OFF] condition of PANIC button of Intelligent Key.
RKE-P/W OPEN	Indicates [ON/OFF] condition of P/W DOWN signal from Intelligent Key.
RKE-MODE CHG	Indicates [ON/OFF] condition of MODE CHANGE signal from Intelligent Key.
RKE OPE COUN1	When remote keyless entry receiver receives the signal transmitted while operating on Intelligent Key, the numerical value start changing.
RKE OPE COUN2	NOTE: This item is displayed, but cannot be monitored.

*: OFF is displayed when brake pedal is depressed while brake switch power supply is OFF.

ACTIVE TEST

Test item	Description
BATTERY SAVER	This test is able to check interior room lamp operation. The interior room lamp will be activated after "ON" on CONSULT-III screen is touched.
PW REMOTO DOWN SET	This test is able to check power window down operation. The power window down will be activated after "ON" on CONSULT-III screen is touched.
INSIDE BUZZER	This test is able to check warning chime in combination meter operation. <ul style="list-style-type: none"> Take away warning chime sounds when "TAKE OUT" on CONSULT-III screen is touched. Key warning chime sounds when "KEY WARN" on CONSULT-III screen is touched. P position warning chime sounds when "P RNG WARN" on CONSULT-III screen is touched. ACC warning chime sounds when "ACC WARN" on CONSULT-III screen is touched.
OUTSIDE BUZZER	This test is able to check Intelligent Key warning buzzer operation. The Intelligent Key warning buzzer will be activated after "ON" on CONSULT-III screen is touched.
INDICATOR	This test is able to check warning lamp operation. <ul style="list-style-type: none"> "KEY" Warning lamp illuminates when "KEY ON" on CONSULT-III screen is touched. "KEY" Warning lamp flashes when "KEY IND" on CONSULT-III screen is touched.
INT LAMP	This test is able to check interior room lamp operation. The interior room lamp will be activated after "ON" on CONSULT-III screen is touched.
LCD	This test is able to check meter display information <ul style="list-style-type: none"> Engine start information displays when "BP N" on CONSULT-III screen is touched. Engine start information displays when "BP I" on CONSULT-III screen is touched. Key ID warning displays when "ID NG" on CONSULT-III screen is touched. Steering lock information displays when "ROTAT" on CONSULT-III screen is touched. P position warning displays when "SFT P" on CONSULT-III screen is touched. Intelligent Key insert information displays when "INSRT" on CONSULT-III screen is touched. Intelligent Key low battery warning displays when "BATT" on CONSULT-III screen is touched. Take away through window warning displays when "NO KY" on CONSULT-III screen is touched. Take away warning display when "OUTKEY" on CONSULT-III screen is touched. OFF position warning display when "LK WN" on CONSULT-III screen is touched.
TRUNK/GLASS HATCH	This test is able to check back door opener actuator open operation. This actuator opens when "ON" on CONSULT-III screen is touched.
FLASHER	This test is able to check hazard warning lamp operation. The hazard warning lamps will be activated after "ON" on CONSULT-III screen is touched.
HORN	This test is able to check horn operation. The horn will be activated after "ON" on CONSULT-III screen is touched.
IGN CONT2	This test is able to check ignition relay operation. The ignition relay will be activated after "ON" on CONSULT-III screen is touched.
P RANGE	This test is able to check control device power supply Control device power is supplied when "ON" on CONSULT-III screen is touched.
ENGINE SW ILLUMI	This test is able to check push-ignition switch illumination operation. Push-ignition switch illumination illuminates when "ON" on CONSULT-III screen is touched.
LOCK INDICATOR	NOTE: This item is displayed, but cannot be tested.

DIAGNOSIS SYSTEM (BCM)

< FUNCTION DIAGNOSIS >

[POWER DISTRIBUTION SYSTEM]

Test item	Description
ACC INDICATOR	This test is able to check indicator in push-ignition switch operation. Indicator in push-button ignition switch illuminates when "ON" on CONSULT-III screen is touched.
IGNITION ON IND	This test is able to check indicator in push-ignition switch operation. Indicator in push-button ignition switch illuminates when "ON" on CONSULT-III screen is touched.
KEY SLOT ILLUMI	This test is able to check key slot illumination operation. Key slot illumination flash when "ON" on CONSULT-III screen is touched.
AUTOMATIC BACK DOOR	NOTE: This item is displayed, but cannot be tested.
AUTOMATIC SLIDING DOOR	NOTE: This item is displayed, but cannot be tested.

COMPONENT DIAGNOSIS

U1000 CAN COMM CIRCUIT

BCM

BCM : Description

INFOID:000000003668888

CAN (Controller Area Network) is a serial communication line for real time applications. It is an on-vehicle multiplex communication line with high data communication speed and excellent error detection ability. Modern vehicle is equipped with many electronic control unit, and each control unit shares information and links with other control units during operation (not independent). In CAN communication, control units are connected with 2 communication lines (CAN H-line, CAN L-line) allowing a high rate of information transmission with less wiring. Each control unit transmits/receives data but selectively reads required data only.

CAN Communication Signal Chart. Refer to [LAN-25, "CAN Communication Signal Chart"](#).

BCM : DTC Logic

INFOID:000000003668889

DTC DETECTION LOGIC

DTC	CONSULT-III display description	DTC Detection Condition	Possible cause
U1000	CAN COMM CIRCUIT	When BCM cannot communicate CAN communication signal continuously for 2 seconds or more.	CAN communication system

BCM : Diagnosis Procedure

INFOID:000000003668890

1. PERFORM SELF DIAGNOSTIC

1. Turn ignition switch ON and wait for 2 seconds or more.
2. Check "Self Diagnostic Result".

Is "U1000: CAN COMM CIRCUIT" displayed?

- YES >> Refer to [LAN-16, "Trouble Diagnosis Flow Chart"](#).
- NO >> Refer to [GI-40, "Intermittent Incident"](#).

U1010 CONTROL UNIT (CAN)

< COMPONENT DIAGNOSIS >

[POWER DISTRIBUTION SYSTEM]

U1010 CONTROL UNIT (CAN)

BCM

BCM : DTC Logic

INFOID:000000003668894

DTC DETECTION LOGIC

DTC	CONSULT-III display description	DTC Detection Condition	Possible cause
U1010	CONTROL UNIT (CAN)	BCM detected internal CAN communication circuit malfunction.	BCM

BCM : Diagnosis Procedure

INFOID:000000003668895

1.REPLACE BCM

When DTC "U1010: CONTROL UNIT (CAN)" is detected, replace BCM.

>> Replace BCM. Refer to [BCS-96. "Exploded View"](#).

B2553 IGNITION RELAY

< COMPONENT DIAGNOSIS >

[POWER DISTRIBUTION SYSTEM]

B2553 IGNITION RELAY

Description

INFOID:000000003375868

BCM turns ON the following relays to ignition power supply to each ECU when the ignition switch is turned ON.

- Ignition relay (inside fuse box)
- Ignition relay (inside IPDM E/R)
- Blower relay

BCM checks any ignition relay ON request for consistency with the actual ignition relay operation status.

DTC Logic

INFOID:000000003375869

DTC DETECTION LOGIC

DTC No.	Trouble diagnosis name	DTC detecting condition	Possible cause
B2553	IGNITION RELAY	BCM detects a difference of signal for 2 seconds or more between the following information. <ul style="list-style-type: none">• Ignition relay (fuse block) ON/OFF operation• Ignition relay (fuse block) feedback.	<ul style="list-style-type: none">• Harness or connectors (ignition relay feedback circuit is open or short)• BCM• IPDM E/R

DTC CONFIRMATION PROCEDURE

1.PERFORM DTC CONFIRMATION PROCEDURE

1. Turn ignition switch ON under the following conditions (start the engine), and wait for at least 2 seconds.
 - Selector lever is in the P or N position.
 - Do not depress brake pedal.
2. Check "Self diagnostic result" with CONSULT-III.

Is DTC detected?

- YES >> Go to [PCS-49, "Diagnosis Procedure"](#).
NO >> INSPECTION END

Diagnosis Procedure

INFOID:000000003375870

1.CHECK DTC WITH IPDM E/R

Check "Self diagnostic result" with CONSULT-III. Refer to [PCS-32, "DTC Index"](#).

Is the inspection result normal?

- YES >> GO TO 2.
NO >> Repair or replace malfunctioning parts.

2.CHECK FUSE

Check that the following fuse are not fusing.

Signal name	Connection position	Fuse No.	Capacity
Ignition power supply	FUSE BLOCK (J/B)	3	10A

Is the fuse fusing?

- YES >> Repair the applicable circuit. And then replace the fuse.
NO >> GO TO 3.

3.CHECK IGNITION RELAY FEEDBACK INPUT SIGNAL

1. Turn ignition switch OFF.
2. Disconnect BCM connector.
3. Check voltage between BCM harness connector and ground.

B2553 IGNITION RELAY

< COMPONENT DIAGNOSIS >

[POWER DISTRIBUTION SYSTEM]

(+)		(-)	Condition		Voltage (V) (Approx.)
BCM					
Connector	Terminal				
M123	123	Ground	Ignition switch	OFF	0
				ON	Battery voltage

Is the inspection result normal?

YES >> Replace BCM. Refer to [BCS-96, "Removal and Installation"](#).

NO >> GO TO 4.

4. CHECK IGNITION RELAY FEEDBACK CIRCUIT

1. Disconnect fuse block (J/B) connector.
2. Check continuity between BCM harness connector and fuse block (J/B) harness connector.

BCM		FUSE BLOCK (J/B)		Continuity
Connector	Terminal	Connector	Terminal	
M123	123	M1	2A	Existed

3. Check continuity between BCM harness connector and ground.

BCM		Ground	Continuity
Connector	Terminal		
M123	123		Not existed

Is the inspection result normal?

YES >> Replace IPDM E/R. Refer to [PCS-34, "Removal and Installation"](#).

NO >> Repair or replace harness.

B260A IGNITION RELAY

< COMPONENT DIAGNOSIS >

[POWER DISTRIBUTION SYSTEM]

B260A IGNITION RELAY

Description

INFOID:000000003375871

BCM turns ON the following relays to ignition power supply to each ECU when the ignition switch is turned ON.

- Ignition relay (inside fuse block)
- Ignition relay (inside IPDM E/R)
- Blower relay

BCM checks any ignition relay ON request for consistency with the actual ignition relay operation status.

DTC Logic

INFOID:000000003375872

DTC DETECTION LOGIC

NOTE:

- If DTC B260A is displayed with DTC U1000, first perform the trouble diagnosis for DTC U1000. Refer to [PCS-47, "BCM : DTC Logic"](#).
- If DTC B260A is displayed with DTC U1010, first perform the trouble diagnosis for DTC U1010. Refer to [PCS-48, "BCM : DTC Logic"](#).
- If DTC B260A is displayed with DTC B261A, first perform the trouble diagnosis for DTC B261A. Refer to [PCS-63, "DTC Logic"](#).

DTC No.	Trouble diagnosis name	DTC detecting condition	Possible cause
B260A	IGNITION RELAY	BCM detects a difference of signal for 2 second or more between the following information. • Ignition relay (IPDM E/R) operation request • Ignition relay feedback from IPDM E/R (CAN).	<ul style="list-style-type: none"> • Harness or connectors (Ignition relay operation circuit is open or shorted.) • BCM • IPDM E/R

DTC CONFIRMATION PROCEDURE

1. PERFORM DTC CONFIRMATION PROCEDURE

1. Turn ignition switch ON under the following conditions, and wait for at least 2 seconds.
 - Selector lever is in the P or N position.
 - Do not depress brake pedal.
2. Check "Self diagnostic result" with CONSULT-III.

Is DTC detected?

- YES >> Go to [PCS-51, "Diagnosis Procedure"](#).
NO >> INSPECTION END

Diagnosis Procedure

INFOID:000000003375873

1. CHECK DTC WITH IPDM E/R

Check "Self diagnostic result" with CONSULT-III. Refer to [PCS-32, "DTC Index"](#).

Is DTC detected?

- YES >> Repair or replace the malfunctioning parts.
NO >> GO TO 2.

2. CHECK IGNITION RELAY INPUT SIGNAL

1. Turn ignition switch OFF.
2. Disconnect BCM connector.
3. Check voltage between BCM harness connector and ground.

(+)		(-)	Voltage (V) (Approx.)
BCM			
Connector	Terminal		
M121	47	Ground	Battery voltage

B260A IGNITION RELAY

< COMPONENT DIAGNOSIS >

[POWER DISTRIBUTION SYSTEM]

Is the inspection result normal?

YES >> Replace BCM. Refer to [BCS-96, "Removal and Installation"](#).

NO >> GO TO 3.

3. CHECK IGNITION RELAY (IPDM E/R) CIRCUIT

1. Disconnect IPDM E/R connector.
2. Check continuity between IPDM E/R harness connector and BCM harness connector.

IPDM E/R		BCM		Continuity
Connector	Terminal	Connector	Terminal	
E10	27	M121	47	Existed

3. Check continuity between IPDM E/R harness connector and ground.

IPDM E/R		Ground	Continuity
Connector	Terminal		
E10	27		Not existed

Is the inspection result normal?

YES >> Replace IPDM E/R. Refer to [PCS-34, "Removal and Installation"](#).

NO >> Repair or replace harness.

B2614 ACC RELAY

< COMPONENT DIAGNOSIS >

[POWER DISTRIBUTION SYSTEM]

B2614 ACC RELAY

Description

INFOID:000000003375877

BCM controls the various electrical components and simultaneously supplies power according to the power supply position.
BCM checks the power supply position internally.

DTC Logic

INFOID:000000003375878

DTC DETECTION LOGIC

DTC No.	Trouble diagnosis name	DTC detecting condition	Possible cause
B2614	ACC relay	An immediate operation of ACC relay is requested by BCM, but there is no response for more than 1 second.	<ul style="list-style-type: none"> Harness or connectors (ACC relay circuit is open or shorted) ACC relay

DTC CONFIRMATION PROCEDURE

1. PERFORM DTC CONFIRMATION PROCEDURE

- Turn the power supply position to ACC under the following conditions, and wait for at least 1 second.
 - Selector lever is in the P or N position.
 - Do not depress brake pedal.
- Check "Self diagnostic result" with CONSULT-III.

Is DTC detected?

- YES >> Go to [PCS-53, "Diagnosis Procedure"](#).
NO >> INSPECTION END

Diagnosis Procedure

INFOID:000000003375879

1. CHECK ACCESSORY RELAY POWER SUPPLY-1

- Turn ignition switch OFF.
- Disconnect accessory relay.
- Check voltage between accessory relay harness connector and ground.

(+) Accessory relay Terminal		(-) Ground	Condition		Voltage (V) (Approx.)
1			Ignition switch	OFF ACC	
					0 Battery voltage

Is the inspection result normal?

- YES >> GO TO 4.
NO >> GO TO 2.

2. CHECK ACCESSORY RELAY POWER SUPPLY-2

- Disconnect fuse block (J/B) connector.
- Check voltage between fuse block (J/B) harness connector and ground.

(+) Fuse block (J/B) Connector		(-) Ground	Condition		Voltage (V) (Approx.)
Terminal			Ignition switch	OFF ACC	
M2	5B				0 Battery voltage

Is the inspection result normal?

B2614 ACC RELAY

< COMPONENT DIAGNOSIS >

[POWER DISTRIBUTION SYSTEM]

- YES >> Replace fuse block (J/B).
NO >> GO TO 3.

3.CHECK ACCESSORY RELAY POWER SUPPLY CIRCUIT-1

1. Disconnect BCM connector.
2. Check continuity between fuse block (J/B) harness connector and BCM harness connector.

Fuse block (J/B)		BCM		Continuity
Connector	Terminal	Connector	Terminal	
M2	5B	M122	95	Existed

3. Check continuity between fuse block (J/B) harness connector and ground.

Fuse block (J/B)		Ground	Continuity
Connector	Terminal		
M2	5B		Not existed

Is the inspection result normal?

- YES >> Replace BCM. Refer to [PCS-129, "Removal and Installation"](#).
NO >> Repair or replace harness.

4.CHECK ACCESSORY RELAY GROUND CIRCUIT

Check continuity between accessory relay harness connector and ground.

Accessory relay		Ground	Continuity
Terminal			
2			Existed

Is the inspection result normal?

- YES >> GO TO 5.
NO >> Repair accessory relay ground circuit.

5.CHECK ACCESSORY RELAY POWER SUPPLY CIRCUIT-2

1. Connect accessory relay.
2. Turn ignition switch ACC.
3. Check voltage between accessory relay harness connector and ground.

(+)	(-)	Voltage (V) (Approx.)
Accessory relay		
Terminal		
5	Ground	Battery voltage

Is the inspection result normal?

- YES >> GO TO 7.
NO >> GO TO 6.

6.CHECK ACCESSORY RELAY

Refer to [PCS-55, "Component Inspection"](#).

Is the inspection result normal?

- YES >> Replace fuse block (J/B).
NO >> Replace accessory relay. Refer to [PG-101, "Fuse, Connector and Terminal Arrangement"](#).

7.CHECK INTERMITTENT INCIDENT

Refer to [GI-40, "Intermittent Incident"](#).

>> INSPECTION END

B2614 ACC RELAY

< COMPONENT DIAGNOSIS >

[POWER DISTRIBUTION SYSTEM]

Component Inspection

INFOID:000000003375880

1. CHECK ACCESSORY RELAY

1. Turn ignition switch OFF.
2. Remove accessory relay.
3. Check the continuity between accessory relay terminals.

Terminals	Condition	Continuity
3 and 5	12 V direct current supply between terminals 1 and 2	Existed
	No current supply	Not existed

Is the inspection result normal?

YES >> INSPECTION END

NO >> Replace accessory relay. Refer to [PG-101. "Fuse, Connector and Terminal Arrangement"](#).

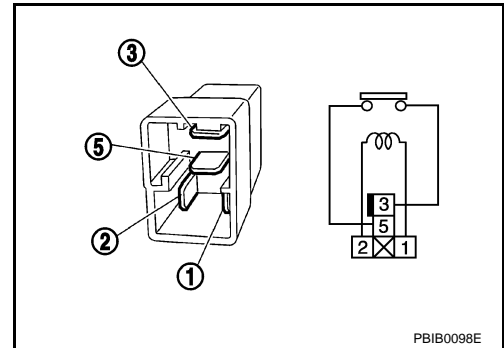

A
B
C
D
E
F
G
H
I
J
K
L
N
O
P

PCS

B2615 BLOWER RELAY CIRCUIT

< COMPONENT DIAGNOSIS >

[POWER DISTRIBUTION SYSTEM]

B2615 BLOWER RELAY CIRCUIT

Description

INFOID:000000003375881

BCM controls the various electrical components and simultaneously supplies power according to the power supply position.
BCM checks the power supply position internally.

DTC Logic

INFOID:000000003375882

DTC DETECTION LOGIC

DTC No.	Trouble diagnosis name	DTC detecting condition	Possible cause
B2615	Blower relay circuit	BCM detects a difference of signal for 1 second or more between the following information. • Blower relay ON/OFF request • Blower relay feedback	<ul style="list-style-type: none"> • Harness or connectors (Blower relay circuit is open or shorted) • Blower relay

DTC CONFIRMATION PROCEDURE

1. PERFORM DTC CONFIRMATION PROCEDURE

1. Turn ignition switch ON under the following conditions, and wait for at least 1 second.
 - Selector lever is in the P or N position
 - Do not depress brake pedal
2. Check "Self diagnostic result" with CONSULT-III.

Is DTC detected?

- YES >> Go to [PCS-56. "Diagnosis Procedure"](#).
NO >> INSPECTION END

Diagnosis Procedure

INFOID:000000003375883

1. CHECK BLOWER RELAY POWER SUPPLY-1

1. Turn ignition switch OFF.
2. Disconnect blower relay.
3. Check voltage between blower relay harness connector and ground.

(+)		(-)	Condition	Voltage (V) (Approx.)
Blower relay Terminal				
1		Ground	Ignition switch OFF or ACC	0
			ON	Battery voltage

Is the inspection result normal?

- YES >> GO TO 4.
NO >> GO TO 2.

2. CHECK BLOWER RELAY POWER SUPPLY-2

1. Disconnect fuse block (J/B) connector.
2. Check voltage between fuse block (J/B) harness connector and ground.

(+)		(-)	Condition	Voltage (V) (Approx.)
Fuse block (J/B) Connector	Terminal			
E103	6F	Ground	Ignition switch OFF or ACC	0
			ON	Battery voltage

Is the inspection result normal?

B2615 BLOWER RELAY CIRCUIT

[POWER DISTRIBUTION SYSTEM]

< COMPONENT DIAGNOSIS >

- YES >> Replace fuse block (J/B).
NO >> GO TO 3.

3.CHECK BLOWER RELAY POWER SUPPLY CIRCUIT-1

1. Disconnect BCM connector.
2. Check continuity between fuse block (J/B) harness connector and BCM harness connector.

Fuse block (J/B)		BCM		Continuity
Connector	Terminal	Connector	Terminal	
E103	6F	M122	102	Existed

3. Check continuity between fuse block (J/B) harness connector and ground.

Fuse block (J/B)		Ground	Continuity
Connector	Terminal		
E103	6F		Not existed

Is the inspection result normal?

- YES >> Replace BCM. Refer to [BCS-96. "Removal and Installation"](#).
NO >> Repair or replace harness.

4.CHECK BLOWER RELAY GROUND CIRCUIT

Check continuity between blower relay harness connector and ground.

Blower relay	Ground	Continuity
Terminal		
2		Existed

Is the inspection result normal?

- YES >> GO TO 5.
NO >> Repair blower relay ground circuit.

5.CHECK BLOWER RELAY POWER SUPPLY CIRCUIT-2

1. Connect blower relay.
2. Turn ignition switch ON.
3. Check voltage between blower relay harness connector and ground.

(+)	(-)	Voltage (V) (Approx.)
Blower relay		
Terminal		
5	Ground	Battery voltage

Is the inspection result normal?

- YES >> GO TO 7.
NO >> GO TO 6.

6.CHECK BLOWER RELAY

Refer to [PCS-58. "Component Inspection"](#).

Is the inspection result normal?

- YES >> Replace fuse block (J/B).
NO >> Replace blower relay. Refer to [PG-101. "Fuse, Connector and Terminal Arrangement"](#).

7.CHECK INTERMITTENT INCIDENT

Refer to [GI-40. "Intermittent Incident"](#).

>> INSPECTION END

A
B
C
D
E
F
G
H
I
J
K
L
N
O
P

PCS

B2615 BLOWER RELAY CIRCUIT

< COMPONENT DIAGNOSIS >

[POWER DISTRIBUTION SYSTEM]

INFOID:000000003375884

Component Inspection

1. CHECK BLOWER RELAY

1. Turn ignition switch OFF.
2. Remove blower relay.
3. Check the continuity between blower relay terminals.

Terminals	Condition	Continuity
3 and 5	12 V direct current supply between terminals 1 and 2	Existed
	No current supply	Not existed

Is the inspection result normal?

YES >> INSPECTION END

NO >> Replace blower relay. Refer to [PG-101. "Fuse, Connector and Terminal Arrangement"](#).

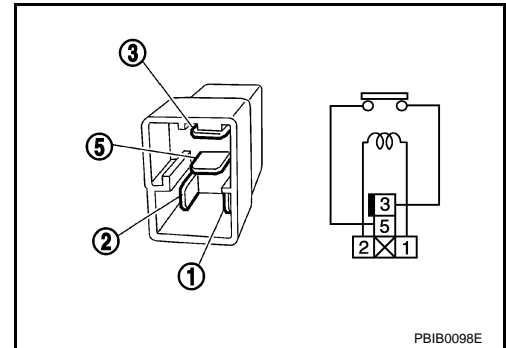

B2616 IGNITION RELAY CIRCUIT

< COMPONENT DIAGNOSIS >

[POWER DISTRIBUTION SYSTEM]

B2616 IGNITION RELAY CIRCUIT

Description

INFOID:000000003375885

BCM controls the various electrical components and simultaneously supplies power according to the power supply position.
BCM checks the power supply position internally.

DTC Logic

INFOID:000000003375886

DTC DETECTION LOGIC

DTC No.	Trouble diagnosis name	DTC detecting condition	Possible cause
B2616	Ignition relay circuit	An immediate operation of ignition relay (fuse block) is requested by BCM, but there is no response for more than 1 second	<ul style="list-style-type: none"> Harness or connectors (Ignition relay circuit is open or shorted) Ignition relay (Fuse block)

DTC CONFIRMATION PROCEDURE

1. PERFORM DTC CONFIRMATION PROCEDURE

- Turn ignition switch ON under the following conditions, and wait for at least 1 second.
 - Selector lever is in the P or N position.
 - Do not depress brake pedal.
- Check "Self diagnostic result" with CONSULT-III.

Is DTC detected?

- YES >> Go to [PCS-59, "Diagnosis Procedure"](#).
NO >> INSPECTION END

Diagnosis Procedure

INFOID:000000003375887

1. CHECK IGNITION RELAY POWER SUPPLY-1

- Turn ignition switch OFF.
- Disconnect ignition relay.
- Check voltage between ignition relay harness connector and ground.

(+) Ignition relay Terminal		(-) Ground	Condition Ignition switch	Voltage (V) (Approx.)
			OFF or ACC	0
1			ON	Battery voltage

Is the inspection result normal?

- YES >> GO TO 4.
NO >> GO TO 2.

2. CHECK IGNITION RELAY POWER SUPPLY-2

- Disconnect fuse block (J/B) connector.
- Check voltage between fuse block (J/B) harness connector and ground.

(+) Fuse block (J/B) Connector		(-) Ground	Condition Ignition switch	Voltage (V) (Approx.)
Terminal				
			OFF or ACC	0
M3	6C		ON	Battery voltage

Is the inspection result normal?

B2616 IGNITION RELAY CIRCUIT

< COMPONENT DIAGNOSIS >

[POWER DISTRIBUTION SYSTEM]

YES >> Replace fuse block (J/B).

NO >> GO TO 3.

3.CHECK IGNITION RELAY POWER SUPPLY CIRCUIT-1

1. Disconnect BCM connector.
2. Check continuity between fuse block (J/B) harness connector and BCM harness connector.

Fuse block (J/B)		BCM		Continuity
Connector	Terminal	Connector	Terminal	
M3	6C	M122	82	Existed

3. Check continuity between fuse block (J/B) harness connector and ground.

Fuse block (J/B)		Ground	Continuity
Connector	Terminal		
M3	6C		Not existed

Is the inspection result normal?

YES >> Replace BCM. Refer to [BCS-96, "Removal and Installation"](#).

NO >> Repair or replace harness.

4.CHECK IGNITION RELAY GROUND CIRCUIT

Check continuity between ignition relay harness connector and ground.

Ignition relay	Ground	Continuity
Terminal		
2		Existed

Is the inspection result normal?

YES >> GO TO 5.

NO >> Repair ignition relay ground circuit.

5.CHECK IGNITION RELAY POWER SUPPLY CIRCUIT-2

1. Connect ignition relay.
2. Turn ignition switch ON.
3. Check voltage between ignition relay harness connector and ground.

(+)	(-)	Voltage (V) (Approx.)
Ignition relay		
Terminal		
5	Ground	Battery voltage

Is the inspection result normal?

YES >> GO TO 7.

NO >> GO TO 6.

6.CHECK IGNITION RELAY

Refer to [PCS-61, "Component Inspection"](#).

Is the inspection result normal?

YES >> Replace fuse block (J/B).

NO >> Replace ignition relay. Refer to [PG-101, "Fuse, Connector and Terminal Arrangement"](#).

7.CHECK INTERMITTENT INCIDENT

Refer to [GI-40, "Intermittent Incident"](#).

>> INSPECTION END

B2616 IGNITION RELAY CIRCUIT

< COMPONENT DIAGNOSIS >

[POWER DISTRIBUTION SYSTEM]

Component Inspection

INFOID:000000003375888

1. CHECK IGNITION RELAY

1. Turn ignition switch OFF.
2. Remove ignition relay.
3. Check the continuity between ignition relay terminals.

Terminals	Condition	Continuity
3 and 5	12 V direct current supply between terminals 1 and 2	Existed
	No current supply	Not existed

Is the inspection result normal?

YES >> INSPECTION END

NO >> Replace Ignition relay. Refer to [PG-101, "Fuse, Connector and Terminal Arrangement"](#).

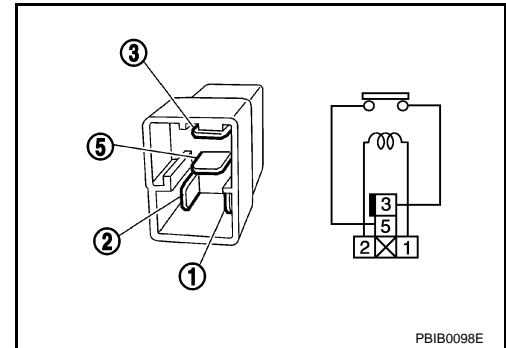

A
B
C
D
E
F
G
H
I
J
K
L
N
O
P

PCS

B2618 BCM

Description

INFOID:000000003375889

BCM controls the various electrical components and simultaneously supplies power according to the power supply position.
 BCM checks the power supply position internally.

DTC Logic

INFOID:000000003375890

DTC DETECTION LOGIC

NOTE:

- If DTC B2618 is displayed with DTC U1000, first perform the trouble diagnosis for DTC U1000. Refer to [PCS-47, "BCM : DTC Logic"](#).
- If DTC B2618 is displayed with DTC U1010, first perform the trouble diagnosis for DTC U1010. Refer to [PCS-48, "BCM : DTC Logic"](#).

DTC No.	Trouble diagnosis name	DTC detecting condition	Possible cause
B2618	BCM	An immediate operation of ignition relay (IPDM E/R) is requested by BCM, but there is no response for more than 1 second	BCM

DTC CONFIRMATION PROCEDURE

1. PERFORM DTC CONFIRMATION PROCEDURE

1. Turn ignition switch ON under the following conditions, and wait for at least 1 second.
 - Selector lever is in the P or N position.
 - Do not depress brake pedal.
2. Check "Self diagnostic result" with CONSULT-III.

Is DTC detected?

- YES >> Go to [PCS-62, "Diagnosis Procedure"](#).
 NO >> INSPECTION END

Diagnosis Procedure

INFOID:000000003375891

1. INSPECTION START

1. Turn ignition switch ON.
2. Select "Self diagnostic result" mode with CONSULT-III.
3. Touch "ERASE".
4. **Perform DTC Confirmation Procedure.**
 See [PCS-62, "DTC Logic"](#).

Is the 1st trip DTC B2618 displayed again?

- YES >> Replace BCM. Refer to [BCS-96, "Removal and Installation"](#)
 NO >> INSPECTION END

B261A PUSH-BUTTON IGNITION SWITCH

< COMPONENT DIAGNOSIS >

[POWER DISTRIBUTION SYSTEM]

B261A PUSH-BUTTON IGNITION SWITCH

Description

INFOID:000000003375892

BCM transmits the change in the power supply position with the push-button ignition switch to IPDM E/R via the CAN communication line. IPDM E/R transmits the power supply position status via CAN communication line to BCM.

DTC Logic

INFOID:000000003375893

DTC DETECTION LOGIC

DTC No.	Trouble diagnosis name	DTC detecting condition	Possible cause
B261A	PUSH-BUTTON IGNITION SWITCH	BCM detects a difference of signal for 1 second or more between the following information. <ul style="list-style-type: none"> Power supply position by push-button ignition switch Power supply position from IPDM E/R (CAN) 	Harness or connectors (Push-button ignition switch circuit is open or shorted.)

DTC CONFIRMATION PROCEDURE

1. PERFORM DTC CONFIRMATION PROCEDURE

- Press the push-button ignition switch under the following conditions, and wait for at least 1 second.
 - Selector lever is in the P or N position.
 - Do not depress brake pedal.
- Check "Self diagnostic result" with CONSULT-III.

Is DTC detected?

- YES >> Go to [PCS-63, "Diagnosis Procedure"](#).
 NO >> INSPECTION END

Diagnosis Procedure

INFOID:000000003375894

1. CHECK IGNITION SWITCH OUTPUT SIGNAL

- Turn ignition switch OFF.
- Disconnect push-button ignition switch connector and IPDM E/R connector.
- Check voltage between IPDM E/R harness connector and ground.

(+)		(-)	Voltage (V) (Approx.)
IPDM E/R			
Connector	Terminal	Ground	Battery voltage
E10	28		

Is the inspection result normal?

- YES >> GO TO 2.
 NO >> Replace IPDM E/R. Refer to [PCS-34, "Removal and Installation"](#).

2. CHECK PUSH-BUTTON IGNITION SWITCH CIRCUIT

- Disconnect BCM connector.
- Check continuity between IPDM E/R harness connector and BCM harness connector.

IPDM E/R		BCM		Continuity
Connector	Terminal	Connector	Terminal	
E10	28	M122	89	Existed

- Check continuity between IPDM E/R harness connector and ground.

A
B
C
D
E
F
G
H
I
J
K
L
N
O
P

PCS

B261A PUSH-BUTTON IGNITION SWITCH

< COMPONENT DIAGNOSIS >

[POWER DISTRIBUTION SYSTEM]

IPDM E/R		Ground	Continuity
Connector	Terminal		
E10	28		Not existed

Is the inspection result normal?

- YES >> Replace BCM. Refer to [BCS-96, "Removal and Installation"](#).
- NO >> Repair or replace harness.

POWER SUPPLY AND GROUND CIRCUIT

< COMPONENT DIAGNOSIS >

[POWER DISTRIBUTION SYSTEM]

POWER SUPPLY AND GROUND CIRCUIT

BCM

BCM : Diagnosis Procedure

INFOID:000000003375895

1.CHECK FUSE AND FUSIBLE LINK

Check that the following fuse and fusible link are not blown.

Signal name	Fuse and fusible link No.
Battery power supply	L
	10

Is the fuse fusing?

YES >> Replace the blown fuse or fusible link after repairing the affected circuit if a fuse or fusible link is blown.

NO >> GO TO 2.

2.CHECK POWER SUPPLY CIRCUIT

1. Turn ignition switch OFF.
2. Disconnect BCM connectors.
3. Check voltage between BCM harness connector and ground.

(+)		(-)	Voltage (V) (Approx.)
BCM			
Connector	Terminal	Ground	Battery voltage
M118	1		
M119	11		
M123	116		

Is the measurement value normal?

YES >> GO TO 3.

NO >> Repair or replace harness.

3.CHECK GROUND CIRCUIT

Check continuity between BCM harness connector and ground.

BCM		Ground	Continuity
Connector	Terminal		
M119	13		Existed

Does continuity exist?

YES >> INSPECTION END

NO >> Repair or replace harness.

A
B
C
D
E
F
G
H
I
J
K
L
N
O
P

PCS

PUSH-BUTTON IGNITION SWITCH

< COMPONENT DIAGNOSIS >

[POWER DISTRIBUTION SYSTEM]

PUSH-BUTTON IGNITION SWITCH

Description

INFOID:000000003375896

BCM transmits the change in the power supply position with the push-button ignition switch to IPDM E/R via the CAN communication line. IPDM E/R transmits the power supply position status via CAN communication line to BCM.

Component Function Check

INFOID:000000003375897

1.CHECK FUNCTION

1. Select "PUSH SW" in "Data Monitor" mode with CONSULT-III.
2. Check the push-button ignition switch signal under the following condition.

Test item	Condition	Status
PUSH SW	Push-button ignition switch is pressed	ON
	Push-button ignition switch is not pressed	OFF

Is the indication normal?

YES >> INSPECTION END

NO >> Go to [PCS-66, "Diagnosis Procedure"](#).

Diagnosis Procedure

INFOID:000000004757286

1.CHECK PUSH-BUTTON IGNITION SWITCH OUTPUT SIGNAL

1. Turn ignition switch OFF.
2. Disconnect push-button ignition switch connector and IPDM E/R connector.
3. Check voltage between push-button ignition switch harness connector and ground.

(+)		(-)	Voltage (V) (Approx.)
Push-button ignition switch			
Connector	Terminal	Ground	Battery voltage
M101	4		

Is the inspection result normal?

YES >> GO TO 3.

NO >> GO TO 2.

2.CHECK PUSH-BUTTON IGNITION SWITCH CIRCUIT

1. Disconnect BCM connector.
2. Check continuity between BCM harness connector and push-button ignition switch harness connector.

BCM		Push-button ignition switch		Continuity
Connector	Terminal	Connector	Terminal	
M122	89	M101	4	Existed

3. Check continuity between BCM harness connector and ground.

BCM		Ground	Continuity
Connector	Terminal		
M122	89		Not existed

Is the inspection result normal?

YES >> Replace BCM. Refer to [PCS-129, "Removal and Installation"](#).

NO >> Repair or replace harness.

3.CHECK PUSH-BUTTON IGNITION SWITCH GROUND CIRCUIT

Check continuity between push-button ignition switch harness connector and ground.

PUSH-BUTTON IGNITION SWITCH

< COMPONENT DIAGNOSIS >

[POWER DISTRIBUTION SYSTEM]

Push-button ignition switch		Ground	Continuity
Connector	Terminal		Existed
M101	1		Existed

Is the inspection result normal?

- YES >> GO TO 4.
- NO >> Repair or replace harness.

4.CHECK PUSH-BUTTON IGNITION SWITCH

Refer to [PCS-67, "Component Inspection"](#).

Is the inspection result normal?

- YES >> GO TO 5.
- NO >> Replace push-button ignition switch. Refer to [PCS-130, "Removal and Installation"](#).

5.CHECK INTERMITTENT INCIDENT

Refer to [GI-40, "Intermittent Incident"](#).

>> INSPECTION END

Component Inspection

INFOID:000000003375899

1.CHECK PUSH-BUTTON IGNITION SWITCH

1. Turn ignition switch OFF.
2. Disconnect push-button ignition switch connector.
3. Check continuity between push-button ignition switch terminals.

Push-button ignition switch		Condition	Continuity
Terminal			Push-button ignition switch
1	4	Pressed	Existed
		Not pressed	Not existed

Is the inspection result normal?

- YES >> INSPECTION END
- NO >> Replace push-button ignition switch. Refer to [PCS-130, "Removal and Installation"](#).

PCS

PUSH-BUTTON IGNITION SWITCH POSITION INDICATOR

< COMPONENT DIAGNOSIS >

[POWER DISTRIBUTION SYSTEM]

PUSH-BUTTON IGNITION SWITCH POSITION INDICATOR

Description

INFOID:000000003375900

The switch that changes the power supply position.
BCM maintains the power supply position status.
BCM changes the power supply position with the operation of the push-button ignition switch.

Component Function Check

INFOID:000000003375901

1. CHECK FUNCTION

Check push-button ignition switch ("ACC INDICATOR" and "IGNITION ON IND") in Active Test Mode with CONSULT-III.

Test item		Description	
ACC INDICATOR IGNITION ON IND	ON	Position indicator	Illuminate
	OFF		Not illuminate

Is the inspection result normal?

- YES >> INSPECTION END
NO >> Refer to [PCS-68, "Diagnosis Procedure"](#).

Diagnosis Procedure

INFOID:000000003375902

1. CHECK PUSH-BUTTON IGNITION SWITCH INPUT SIGNAL

- Turn ignition switch OFF.
- Disconnect push-button ignition switch connector.
- Check voltage between push-button ignition switch harness connector and ground.

(+)		(-)	Voltage (V) (Approx.)
Push-button ignition switch			
Connector	Terminal	Ground	Battery voltage
M101	8		

Is the inspection result normal?

- YES >> GO TO 2.
NO-1 >> Check 10A fuse [No.9, located in fuse block (J/B)]
NO-2 >> Check harness for open or short between push-button ignition switch and fuse

2. CHECK PUSH-BUTTON IGNITION SWITCH CIRCUIT

- Disconnect BCM connector.
- Check continuity between BCM harness connector and push-button ignition switch harness connector.

Indicator	BCM		Push-button ignition switch		Continuity
	Connector	Terminal	Connector	Terminal	
ACC/ON	M119	15	M101	6	Existed
	M122	93			

- Check continuity between BCM harness connector and ground.

Indicator	BCM		Ground	Continuity
	Connector	Terminal		
ACC/ON	M119	15		Not existed
	M122	93		

Is the inspection result normal?

- YES >> GO TO 3.

PUSH-BUTTON IGNITION SWITCH POSITION INDICATOR

< COMPONENT DIAGNOSIS >

[POWER DISTRIBUTION SYSTEM]

NO >> Repair or replace harness.

3.CHECK INTERMITTENT INCIDENT

Refer to [GI-40, "Intermittent Incident"](#).

>> INSPECTION END

A

B

C

D

E

F

G

H

I

J

K

L

PCS

N

O

P

POWER DISTRIBUTION SYSTEM

< COMPONENT DIAGNOSIS >

[POWER DISTRIBUTION SYSTEM]

POWER DISTRIBUTION SYSTEM

Wiring Diagram - PDS (POWER DISTRIBUTION SYSTEM) -

INFOID:000000004747843

NOTE:

- Type A: Up to VIN: JN8AZ18U*9W100000, JN8AZ18W*9W200000 (EXCEPT FOR MEXICO), JN8AZ18U*9W710000, JN8AZ18W*9W810000 (FOR MEXICO)
- Type B: From VIN: JN8AZ18U*9W100001, JN8AZ18W*9W200001 (EXCEPT FOR MEXICO), JN8AZ18U*9W710001, JN8AZ18W*9W810001 (FOR MEXICO)

Up to VIN: JN8AZ18U*9W100000, JN8AZ18W*9W200000 (EXCEPT FOR MEXICO),

POWER DISTRIBUTION SYSTEM

< COMPONENT DIAGNOSIS >

[POWER DISTRIBUTION SYSTEM]

JN8AZ18U*9W710000, JN8AZ18W*9W810000 (FOR MEXICO)

PDS (POWER DISTRIBUTION SYSTEM) (TYPE A)

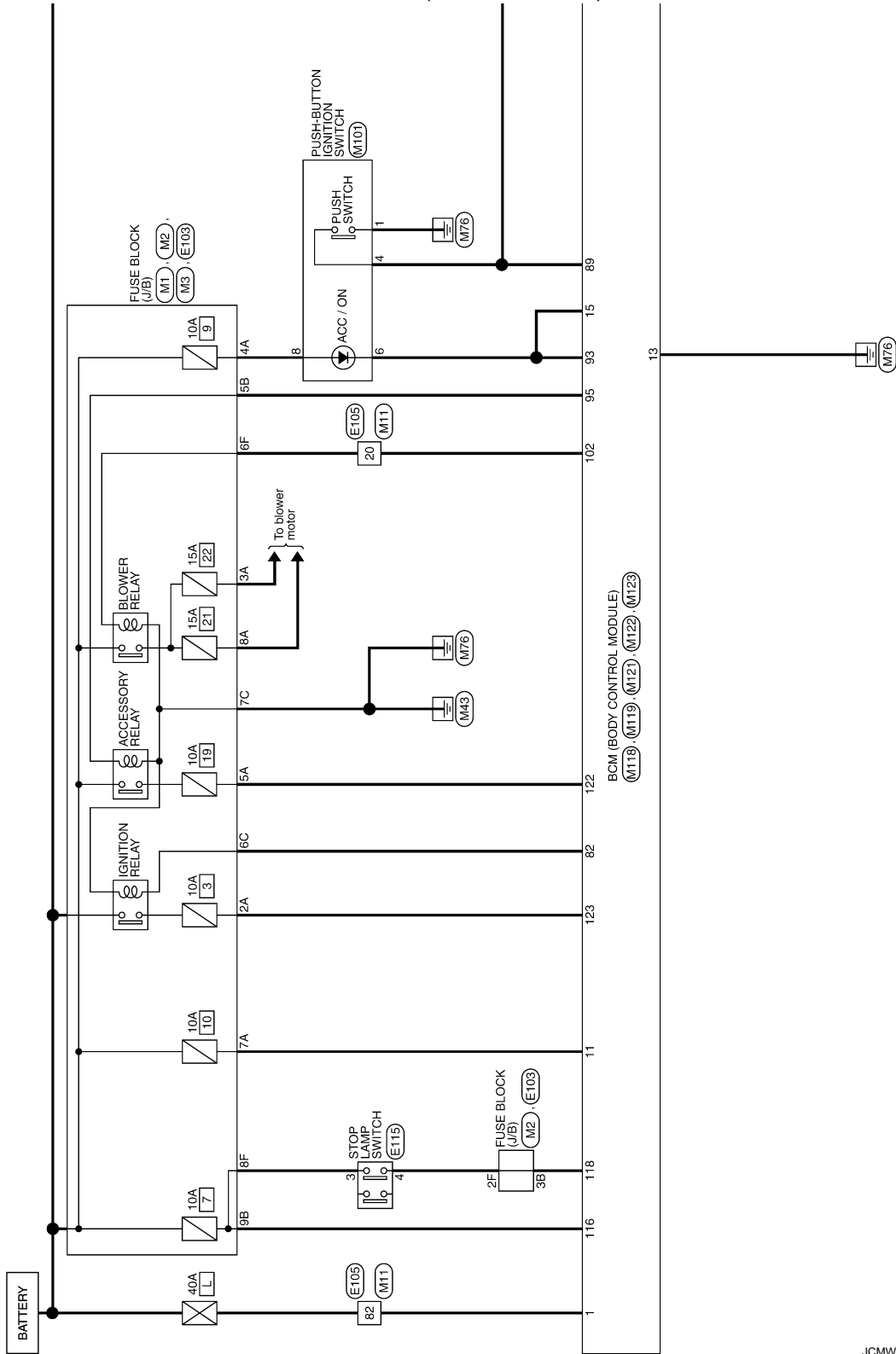

A
B
C
D
E
F
G
H
I
J
K
L
PCS
N
O
P

2008/09/23

JCMWMM3176GI

POWER DISTRIBUTION SYSTEM

< COMPONENT DIAGNOSIS >

[POWER DISTRIBUTION SYSTEM]

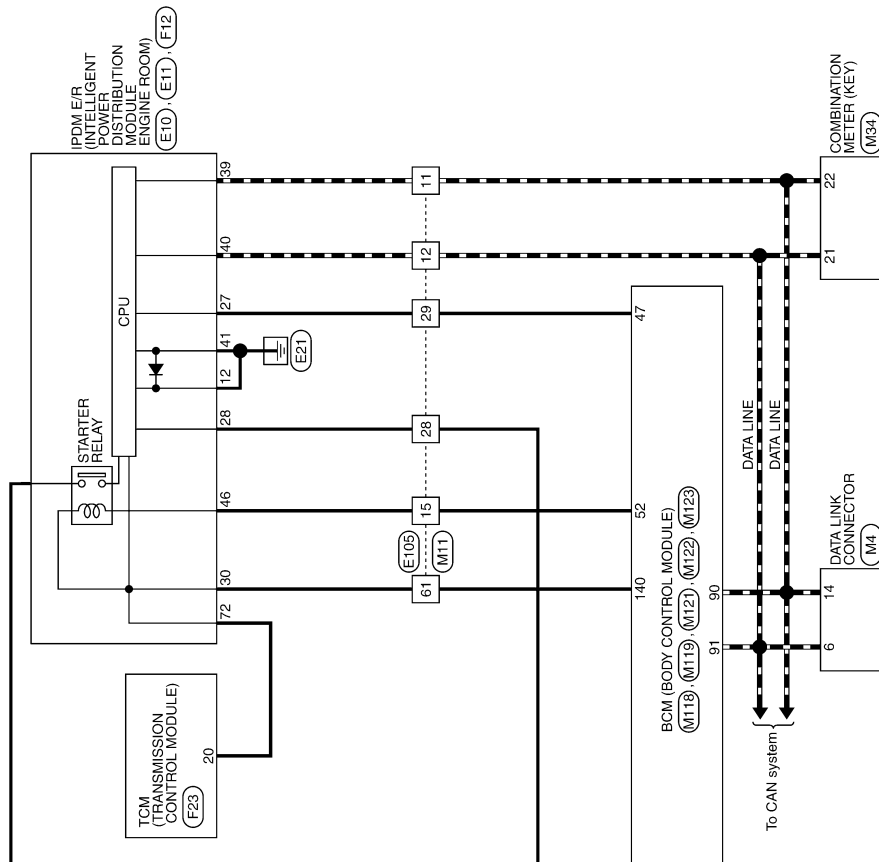

JCMWM3177G

POWER DISTRIBUTION SYSTEM

< COMPONENT DIAGNOSIS >

[POWER DISTRIBUTION SYSTEM]

PDS (POWER DISTRIBUTION SYSTEM) (TYPE A)

<table border="1"> <tr><td>Connector No.</td><td>E10</td></tr> <tr><td>Connector Name</td><td>IPDM E/R (INTELLIGENT POWER DISTRIBUTION MODULE ENGINE ROOM)</td></tr> <tr><td>Connector Type</td><td>TH20FW-CS12-M4-TV</td></tr> </table> <table border="1"> <tr><td>Terminal No.</td><td>Color of Wire</td><td>Signal Name [Specification]</td></tr> <tr><td>12</td><td>B</td><td>-</td></tr> <tr><td>27</td><td>W</td><td>-</td></tr> <tr><td>28</td><td>SB</td><td>-</td></tr> <tr><td>30</td><td>BR</td><td>-</td></tr> </table>	Connector No.	E10	Connector Name	IPDM E/R (INTELLIGENT POWER DISTRIBUTION MODULE ENGINE ROOM)	Connector Type	TH20FW-CS12-M4-TV	Terminal No.	Color of Wire	Signal Name [Specification]	12	B	-	27	W	-	28	SB	-	30	BR	-	<table border="1"> <tr><td>Connector No.</td><td>E11</td></tr> <tr><td>Connector Name</td><td>IPDM E/R (INTELLIGENT POWER DISTRIBUTION MODULE ENGINE ROOM)</td></tr> <tr><td>Connector Type</td><td>TH30FW-NH</td></tr> </table> <table border="1"> <tr><td>Terminal No.</td><td>Color of Wire</td><td>Signal Name [Specification]</td></tr> <tr><td>39</td><td>P</td><td>-</td></tr> <tr><td>40</td><td>L</td><td>-</td></tr> <tr><td>41</td><td>B</td><td>-</td></tr> <tr><td>46</td><td>BR</td><td>-</td></tr> </table>	Connector No.	E11	Connector Name	IPDM E/R (INTELLIGENT POWER DISTRIBUTION MODULE ENGINE ROOM)	Connector Type	TH30FW-NH	Terminal No.	Color of Wire	Signal Name [Specification]	39	P	-	40	L	-	41	B	-	46	BR	-	<table border="1"> <tr><td>Connector No.</td><td>E103</td></tr> <tr><td>Connector Name</td><td>FUSE BLOCK (J/B)</td></tr> <tr><td>Connector Type</td><td>NS18FW-CS</td></tr> </table> <table border="1"> <tr><td>Terminal No.</td><td>Color of Wire</td><td>Signal Name [Specification]</td></tr> <tr><td>2F</td><td>LG</td><td>-</td></tr> <tr><td>6F</td><td>Y</td><td>-</td></tr> <tr><td>8F</td><td>R</td><td>-</td></tr> </table>	Connector No.	E103	Connector Name	FUSE BLOCK (J/B)	Connector Type	NS18FW-CS	Terminal No.	Color of Wire	Signal Name [Specification]	2F	LG	-	6F	Y	-	8F	R	-	<table border="1"> <tr><td>Connector No.</td><td>E105</td></tr> <tr><td>Connector Name</td><td>WIRE TO WIRE</td></tr> <tr><td>Connector Type</td><td>TH70MW-CS10-M3</td></tr> </table> <table border="1"> <tr><td>Terminal No.</td><td>Color of Wire</td><td>Signal Name [Specification]</td></tr> <tr><td>11</td><td>P</td><td>-</td></tr> <tr><td>12</td><td>L</td><td>-</td></tr> <tr><td>15</td><td>BR</td><td>-</td></tr> <tr><td>20</td><td>Y</td><td>-</td></tr> <tr><td>28</td><td>SB</td><td>-</td></tr> <tr><td>29</td><td>W</td><td>-</td></tr> <tr><td>61</td><td>BR</td><td>-</td></tr> <tr><td>82</td><td>LG</td><td>-</td></tr> </table>	Connector No.	E105	Connector Name	WIRE TO WIRE	Connector Type	TH70MW-CS10-M3	Terminal No.	Color of Wire	Signal Name [Specification]	11	P	-	12	L	-	15	BR	-	20	Y	-	28	SB	-	29	W	-	61	BR	-	82	LG	-
Connector No.	E10																																																																																															
Connector Name	IPDM E/R (INTELLIGENT POWER DISTRIBUTION MODULE ENGINE ROOM)																																																																																															
Connector Type	TH20FW-CS12-M4-TV																																																																																															
Terminal No.	Color of Wire	Signal Name [Specification]																																																																																														
12	B	-																																																																																														
27	W	-																																																																																														
28	SB	-																																																																																														
30	BR	-																																																																																														
Connector No.	E11																																																																																															
Connector Name	IPDM E/R (INTELLIGENT POWER DISTRIBUTION MODULE ENGINE ROOM)																																																																																															
Connector Type	TH30FW-NH																																																																																															
Terminal No.	Color of Wire	Signal Name [Specification]																																																																																														
39	P	-																																																																																														
40	L	-																																																																																														
41	B	-																																																																																														
46	BR	-																																																																																														
Connector No.	E103																																																																																															
Connector Name	FUSE BLOCK (J/B)																																																																																															
Connector Type	NS18FW-CS																																																																																															
Terminal No.	Color of Wire	Signal Name [Specification]																																																																																														
2F	LG	-																																																																																														
6F	Y	-																																																																																														
8F	R	-																																																																																														
Connector No.	E105																																																																																															
Connector Name	WIRE TO WIRE																																																																																															
Connector Type	TH70MW-CS10-M3																																																																																															
Terminal No.	Color of Wire	Signal Name [Specification]																																																																																														
11	P	-																																																																																														
12	L	-																																																																																														
15	BR	-																																																																																														
20	Y	-																																																																																														
28	SB	-																																																																																														
29	W	-																																																																																														
61	BR	-																																																																																														
82	LG	-																																																																																														
<table border="1"> <tr><td>Connector No.</td><td>E15</td></tr> <tr><td>Connector Name</td><td>STOP LAMP SWITCH (TYPE A)</td></tr> <tr><td>Connector Type</td><td>MG4FW-LC</td></tr> </table> <table border="1"> <tr><td>Terminal No.</td><td>Color of Wire</td><td>Signal Name [Specification]</td></tr> <tr><td>3</td><td>R</td><td>-</td></tr> <tr><td>4</td><td>LG</td><td>-</td></tr> </table>	Connector No.	E15	Connector Name	STOP LAMP SWITCH (TYPE A)	Connector Type	MG4FW-LC	Terminal No.	Color of Wire	Signal Name [Specification]	3	R	-	4	LG	-	<table border="1"> <tr><td>Connector No.</td><td>F12</td></tr> <tr><td>Connector Name</td><td>IPDM E/R (INTELLIGENT POWER DISTRIBUTION MODULE ENGINE ROOM)</td></tr> <tr><td>Connector Type</td><td>TH20FW-CS12-M4</td></tr> </table> <table border="1"> <tr><td>Terminal No.</td><td>Color of Wire</td><td>Signal Name [Specification]</td></tr> <tr><td>72</td><td>R/B</td><td>-</td></tr> </table>	Connector No.	F12	Connector Name	IPDM E/R (INTELLIGENT POWER DISTRIBUTION MODULE ENGINE ROOM)	Connector Type	TH20FW-CS12-M4	Terminal No.	Color of Wire	Signal Name [Specification]	72	R/B	-	<table border="1"> <tr><td>Connector No.</td><td>F23</td></tr> <tr><td>Connector Name</td><td>TCM (TRANSMISSION CONTROL MODULE)</td></tr> <tr><td>Connector Type</td><td>RH40FB-R28-L-RH</td></tr> </table> <table border="1"> <tr><td>Terminal No.</td><td>Color of Wire</td><td>Signal Name [Specification]</td></tr> <tr><td>20</td><td>R/B</td><td>STARTER RELAY</td></tr> </table>	Connector No.	F23	Connector Name	TCM (TRANSMISSION CONTROL MODULE)	Connector Type	RH40FB-R28-L-RH	Terminal No.	Color of Wire	Signal Name [Specification]	20	R/B	STARTER RELAY	<table border="1"> <tr><td>Connector No.</td><td>M1</td></tr> <tr><td>Connector Name</td><td>FUSE BLOCK (J/B)</td></tr> <tr><td>Connector Type</td><td>NS30FW-M2</td></tr> </table> <table border="1"> <tr><td>Terminal No.</td><td>Color of Wire</td><td>Signal Name [Specification]</td></tr> <tr><td>2A</td><td>G</td><td>-</td></tr> <tr><td>3A</td><td>Y</td><td>-</td></tr> <tr><td>4A</td><td>GR</td><td>-</td></tr> <tr><td>5A</td><td>R</td><td>-</td></tr> <tr><td>7A</td><td>LG</td><td>-</td></tr> <tr><td>8A</td><td>Y</td><td>-</td></tr> </table>	Connector No.	M1	Connector Name	FUSE BLOCK (J/B)	Connector Type	NS30FW-M2	Terminal No.	Color of Wire	Signal Name [Specification]	2A	G	-	3A	Y	-	4A	GR	-	5A	R	-	7A	LG	-	8A	Y	-																											
Connector No.	E15																																																																																															
Connector Name	STOP LAMP SWITCH (TYPE A)																																																																																															
Connector Type	MG4FW-LC																																																																																															
Terminal No.	Color of Wire	Signal Name [Specification]																																																																																														
3	R	-																																																																																														
4	LG	-																																																																																														
Connector No.	F12																																																																																															
Connector Name	IPDM E/R (INTELLIGENT POWER DISTRIBUTION MODULE ENGINE ROOM)																																																																																															
Connector Type	TH20FW-CS12-M4																																																																																															
Terminal No.	Color of Wire	Signal Name [Specification]																																																																																														
72	R/B	-																																																																																														
Connector No.	F23																																																																																															
Connector Name	TCM (TRANSMISSION CONTROL MODULE)																																																																																															
Connector Type	RH40FB-R28-L-RH																																																																																															
Terminal No.	Color of Wire	Signal Name [Specification]																																																																																														
20	R/B	STARTER RELAY																																																																																														
Connector No.	M1																																																																																															
Connector Name	FUSE BLOCK (J/B)																																																																																															
Connector Type	NS30FW-M2																																																																																															
Terminal No.	Color of Wire	Signal Name [Specification]																																																																																														
2A	G	-																																																																																														
3A	Y	-																																																																																														
4A	GR	-																																																																																														
5A	R	-																																																																																														
7A	LG	-																																																																																														
8A	Y	-																																																																																														

A
B
C
D
E
F
G
H
I
J
K
L
PCS
N
O
P



















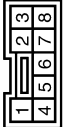

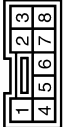
JCMWM3178G1

POWER DISTRIBUTION SYSTEM

< COMPONENT DIAGNOSIS >

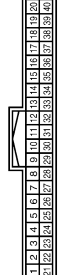
[POWER DISTRIBUTION SYSTEM]

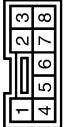
PDS (POWER DISTRIBUTION SYSTEM) (TYPE A)

<table border="1"> <tr><td>Connector No.</td><td>M2</td></tr> <tr><td>Connector Name</td><td>FUSE BLOCK (J/B)</td></tr> <tr><td>Connector Type</td><td>NS10FW-CS</td></tr> </table>  	Connector No.	M2	Connector Name	FUSE BLOCK (J/B)	Connector Type	NS10FW-CS	<table border="1"> <tr><td>Terminal No.</td><td>Color of Wire</td><td>Signal Name [Specification]</td></tr> <tr><td>3B</td><td>L</td><td>-</td></tr> <tr><td>5B</td><td>L</td><td>-</td></tr> <tr><td>9B</td><td>GR</td><td>-</td></tr> </table>	Terminal No.	Color of Wire	Signal Name [Specification]	3B	L	-	5B	L	-	9B	GR	-															
Connector No.	M2																																	
Connector Name	FUSE BLOCK (J/B)																																	
Connector Type	NS10FW-CS																																	
Terminal No.	Color of Wire	Signal Name [Specification]																																
3B	L	-																																
5B	L	-																																
9B	GR	-																																
<table border="1"> <tr><td>Connector No.</td><td>M3</td></tr> <tr><td>Connector Name</td><td>FUSE BLOCK (J/B)</td></tr> <tr><td>Connector Type</td><td>NS12FW-CS</td></tr> </table>  	Connector No.	M3	Connector Name	FUSE BLOCK (J/B)	Connector Type	NS12FW-CS	<table border="1"> <tr><td>Terminal No.</td><td>Color of Wire</td><td>Signal Name [Specification]</td></tr> <tr><td>6C</td><td>BR</td><td>-</td></tr> <tr><td>7C</td><td>B</td><td>-</td></tr> </table>	Terminal No.	Color of Wire	Signal Name [Specification]	6C	BR	-	7C	B	-																		
Connector No.	M3																																	
Connector Name	FUSE BLOCK (J/B)																																	
Connector Type	NS12FW-CS																																	
Terminal No.	Color of Wire	Signal Name [Specification]																																
6C	BR	-																																
7C	B	-																																
<table border="1"> <tr><td>Connector No.</td><td>M4</td></tr> <tr><td>Connector Name</td><td>DATA LINK CONNECTOR</td></tr> <tr><td>Connector Type</td><td>BD16FW</td></tr> </table>  	Connector No.	M4	Connector Name	DATA LINK CONNECTOR	Connector Type	BD16FW	<table border="1"> <tr><td>Terminal No.</td><td>Color of Wire</td><td>Signal Name [Specification]</td></tr> <tr><td>6</td><td>L</td><td>-</td></tr> <tr><td>14</td><td>P</td><td>-</td></tr> </table>	Terminal No.	Color of Wire	Signal Name [Specification]	6	L	-	14	P	-																		
Connector No.	M4																																	
Connector Name	DATA LINK CONNECTOR																																	
Connector Type	BD16FW																																	
Terminal No.	Color of Wire	Signal Name [Specification]																																
6	L	-																																
14	P	-																																
<table border="1"> <tr><td>Connector No.</td><td>M11</td></tr> <tr><td>Connector Name</td><td>WIRE TO WIRE</td></tr> <tr><td>Connector Type</td><td>TH70FW-CS(D)-H3</td></tr> </table>  	Connector No.	M11	Connector Name	WIRE TO WIRE	Connector Type	TH70FW-CS(D)-H3	<table border="1"> <tr><td>Terminal No.</td><td>Color of Wire</td><td>Signal Name [Specification]</td></tr> <tr><td>11</td><td>P</td><td>-</td></tr> <tr><td>12</td><td>L</td><td>-</td></tr> <tr><td>15</td><td>R</td><td>-</td></tr> <tr><td>20</td><td>Y</td><td>-</td></tr> <tr><td>28</td><td>BR</td><td>-</td></tr> <tr><td>29</td><td>L</td><td>-</td></tr> <tr><td>61</td><td>GR</td><td>-</td></tr> <tr><td>82</td><td>W</td><td>-</td></tr> </table>	Terminal No.	Color of Wire	Signal Name [Specification]	11	P	-	12	L	-	15	R	-	20	Y	-	28	BR	-	29	L	-	61	GR	-	82	W	-
Connector No.	M11																																	
Connector Name	WIRE TO WIRE																																	
Connector Type	TH70FW-CS(D)-H3																																	
Terminal No.	Color of Wire	Signal Name [Specification]																																
11	P	-																																
12	L	-																																
15	R	-																																
20	Y	-																																
28	BR	-																																
29	L	-																																
61	GR	-																																
82	W	-																																
<table border="1"> <tr><td>Connector No.</td><td>M101</td></tr> <tr><td>Connector Name</td><td>PUSH-BUTTON IGNITION SWITCH</td></tr> <tr><td>Connector Type</td><td>TK08FB</td></tr> </table>  	Connector No.	M101	Connector Name	PUSH-BUTTON IGNITION SWITCH	Connector Type	TK08FB	<table border="1"> <tr><td>Terminal No.</td><td>Color of Wire</td><td>Signal Name [Specification]</td></tr> <tr><td>1</td><td>B</td><td>-</td></tr> <tr><td>4</td><td>BR</td><td>-</td></tr> <tr><td>6</td><td>L</td><td>-</td></tr> <tr><td>8</td><td>GR</td><td>-</td></tr> </table>	Terminal No.	Color of Wire	Signal Name [Specification]	1	B	-	4	BR	-	6	L	-	8	GR	-												
Connector No.	M101																																	
Connector Name	PUSH-BUTTON IGNITION SWITCH																																	
Connector Type	TK08FB																																	
Terminal No.	Color of Wire	Signal Name [Specification]																																
1	B	-																																
4	BR	-																																
6	L	-																																
8	GR	-																																
<table border="1"> <tr><td>Connector No.</td><td>M10</td></tr> <tr><td>Connector Name</td><td>PUSH-BUTTON IGNITION SWITCH</td></tr> <tr><td>Connector Type</td><td>TK08FB</td></tr> </table>  	Connector No.	M10	Connector Name	PUSH-BUTTON IGNITION SWITCH	Connector Type	TK08FB	<table border="1"> <tr><td>Terminal No.</td><td>Color of Wire</td><td>Signal Name [Specification]</td></tr> <tr><td>1</td><td>B</td><td>-</td></tr> <tr><td>4</td><td>BR</td><td>-</td></tr> <tr><td>6</td><td>L</td><td>-</td></tr> <tr><td>8</td><td>GR</td><td>-</td></tr> </table>	Terminal No.	Color of Wire	Signal Name [Specification]	1	B	-	4	BR	-	6	L	-	8	GR	-												
Connector No.	M10																																	
Connector Name	PUSH-BUTTON IGNITION SWITCH																																	
Connector Type	TK08FB																																	
Terminal No.	Color of Wire	Signal Name [Specification]																																
1	B	-																																
4	BR	-																																
6	L	-																																
8	GR	-																																
<table border="1"> <tr><td>Connector No.</td><td>M118</td></tr> <tr><td>Connector Name</td><td>BCM (BODY CONTROL MODULE)</td></tr> <tr><td>Connector Type</td><td>M03FE-LC</td></tr> </table>  	Connector No.	M118	Connector Name	BCM (BODY CONTROL MODULE)	Connector Type	M03FE-LC	<table border="1"> <tr><td>Terminal No.</td><td>Color of Wire</td><td>Signal Name [Specification]</td></tr> <tr><td>1</td><td>W</td><td>BAT (7/L)</td></tr> </table>	Terminal No.	Color of Wire	Signal Name [Specification]	1	W	BAT (7/L)																					
Connector No.	M118																																	
Connector Name	BCM (BODY CONTROL MODULE)																																	
Connector Type	M03FE-LC																																	
Terminal No.	Color of Wire	Signal Name [Specification]																																
1	W	BAT (7/L)																																
<table border="1"> <tr><td>Connector No.</td><td>M119</td></tr> <tr><td>Connector Name</td><td>BCM (BODY CONTROL MODULE)</td></tr> <tr><td>Connector Type</td><td>NS16FW-CS</td></tr> </table>  	Connector No.	M119	Connector Name	BCM (BODY CONTROL MODULE)	Connector Type	NS16FW-CS	<table border="1"> <tr><td>Terminal No.</td><td>Color of Wire</td><td>Signal Name [Specification]</td></tr> <tr><td>11</td><td>LG</td><td>BAT (FUSE)</td></tr> <tr><td>13</td><td>B</td><td>GND</td></tr> <tr><td>15</td><td>L</td><td>ACC IND</td></tr> </table>	Terminal No.	Color of Wire	Signal Name [Specification]	11	LG	BAT (FUSE)	13	B	GND	15	L	ACC IND															
Connector No.	M119																																	
Connector Name	BCM (BODY CONTROL MODULE)																																	
Connector Type	NS16FW-CS																																	
Terminal No.	Color of Wire	Signal Name [Specification]																																
11	LG	BAT (FUSE)																																
13	B	GND																																
15	L	ACC IND																																
<table border="1"> <tr><td>Connector No.</td><td>M34</td></tr> <tr><td>Connector Name</td><td>COMBINATION METER</td></tr> <tr><td>Connector Type</td><td>TH40FW-NH</td></tr> </table>  	Connector No.	M34	Connector Name	COMBINATION METER	Connector Type	TH40FW-NH	<table border="1"> <tr><td>Terminal No.</td><td>Color of Wire</td><td>Signal Name [Specification]</td></tr> <tr><td>21</td><td>L</td><td>CAN-H</td></tr> <tr><td>22</td><td>P</td><td>CAN-L</td></tr> </table>	Terminal No.	Color of Wire	Signal Name [Specification]	21	L	CAN-H	22	P	CAN-L																		
Connector No.	M34																																	
Connector Name	COMBINATION METER																																	
Connector Type	TH40FW-NH																																	
Terminal No.	Color of Wire	Signal Name [Specification]																																
21	L	CAN-H																																
22	P	CAN-L																																
<table border="1"> <tr><td>Connector No.</td><td>M101</td></tr> <tr><td>Connector Name</td><td>PUSH-BUTTON IGNITION SWITCH</td></tr> <tr><td>Connector Type</td><td>TK08FB</td></tr> </table>  	Connector No.	M101	Connector Name	PUSH-BUTTON IGNITION SWITCH	Connector Type	TK08FB	<table border="1"> <tr><td>Terminal No.</td><td>Color of Wire</td><td>Signal Name [Specification]</td></tr> <tr><td>1</td><td>B</td><td>-</td></tr> <tr><td>4</td><td>BR</td><td>-</td></tr> <tr><td>6</td><td>L</td><td>-</td></tr> <tr><td>8</td><td>GR</td><td>-</td></tr> </table>	Terminal No.	Color of Wire	Signal Name [Specification]	1	B	-	4	BR	-	6	L	-	8	GR	-												
Connector No.	M101																																	
Connector Name	PUSH-BUTTON IGNITION SWITCH																																	
Connector Type	TK08FB																																	
Terminal No.	Color of Wire	Signal Name [Specification]																																
1	B	-																																
4	BR	-																																
6	L	-																																
8	GR	-																																

JCMWM3179G

POWER DISTRIBUTION SYSTEM

< COMPONENT DIAGNOSIS >

[POWER DISTRIBUTION SYSTEM]

PDS (POWER DISTRIBUTION SYSTEM) (TYPE A)

Connector No.	M121
Connector Name	BCM (BODY CONTROL MODULE)
Connector Type	TH4BFG-NH

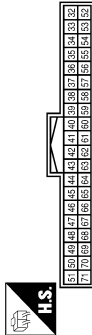

Connector No.	M122
Connector Name	BCM (BODY CONTROL MODULE)
Connector Type	TH4GFB-NH

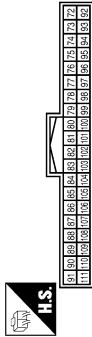

Connector No.	M123
Connector Name	BCM (BODY CONTROL MODULE)
Connector Type	TH4BFG-NH

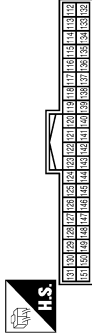

Terminal No.	Color of Wire	Signal Name [Specification]
47	L	IGN RELAY (PDM E/R CONT)
52	R	STARTER RELAY CONT

Terminal No.	Color of Wire	Signal Name [Specification]
82	BR	IGN RELAY (F/B) CONT
89	BR	PUSH SW
90	P	CAN-L
91	L	CAN-H
93	L	ON IND
95	Y	ACC RELAY CONT
102	Y	BLOWER FAN MOTOR RELAY CONT

Terminal No.	Color of Wire	Signal Name [Specification]
118	GR	FUSE CHECK
122	L	STOP LAMP SW
123	R	ACC F/B
140	GR	IGN F/B
		SHIFT N/P

JCMWM3180G

From VIN: JN8AZ18U*9W10001, JN8AZ18W*9W20001(EXCEPT FOR MEXICO),

A
B
C
D
E
F
G
H
I
J
K
L
N
O
P

PCS

POWER DISTRIBUTION SYSTEM

< COMPONENT DIAGNOSIS >

[POWER DISTRIBUTION SYSTEM]

JN8AZ18U*9W710001, JN8AZ18W*9W810001(FOR MEXICO)

PDS (POWER DISTRIBUTION SYSTEM) (TYPE B)

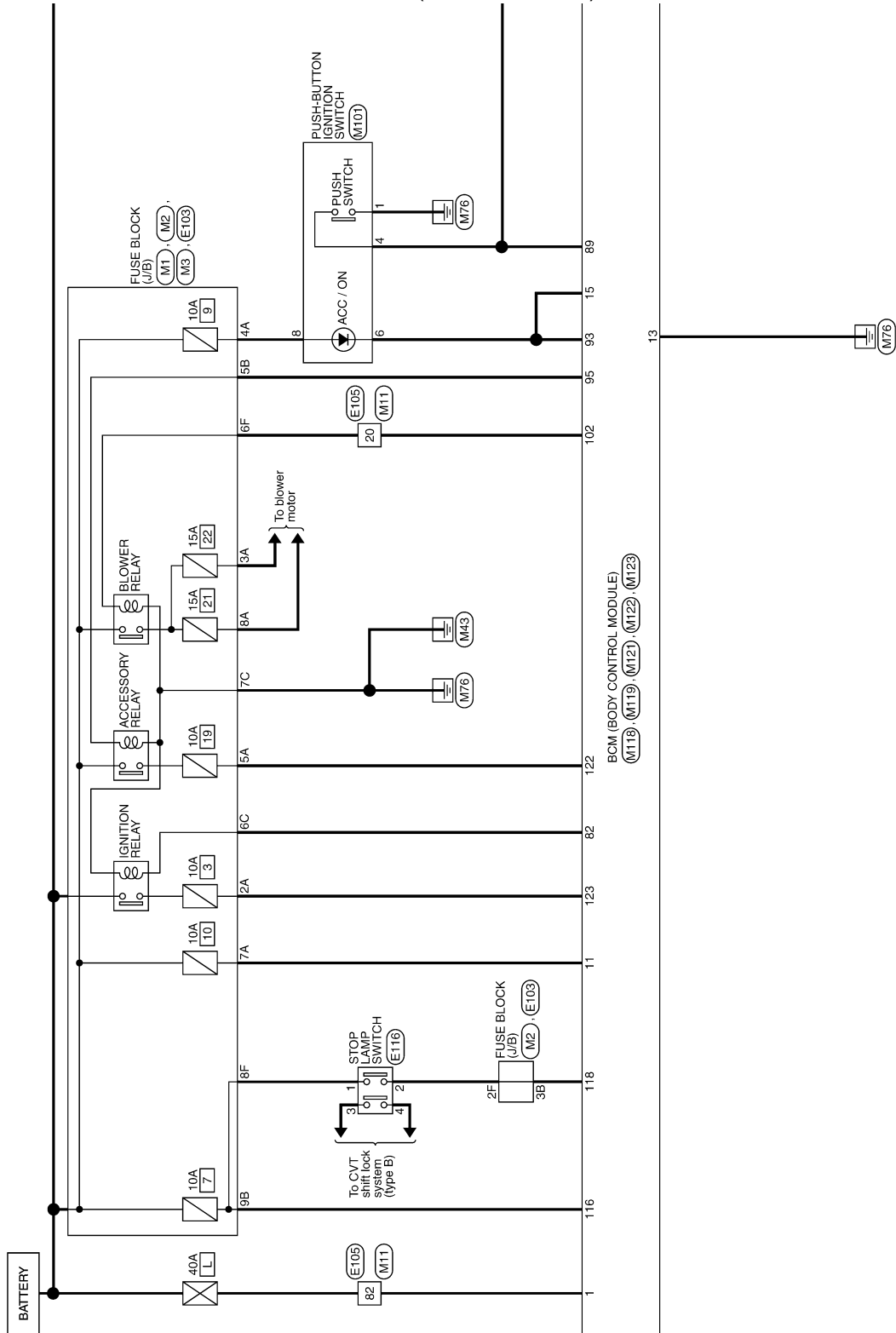

2008/09/23

JCMWM3181G

POWER DISTRIBUTION SYSTEM

< COMPONENT DIAGNOSIS >

[POWER DISTRIBUTION SYSTEM]

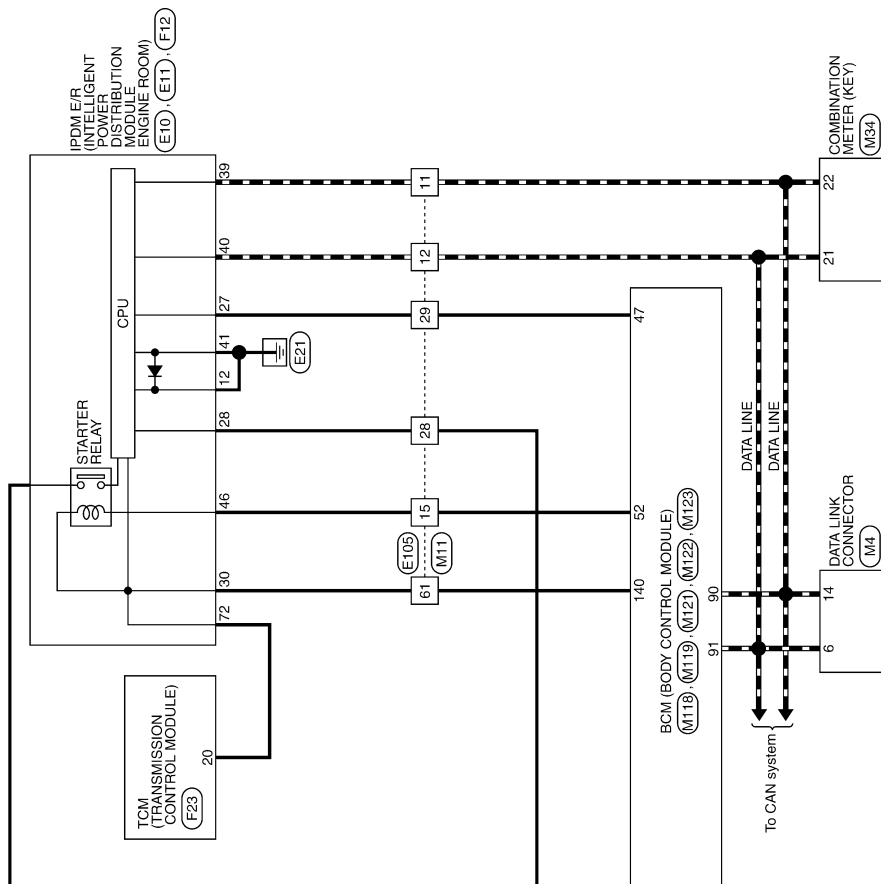

JCMWM3182GI

A
B
C
D
E
F
G
H
I
J
K
L
M
N
O
P

PCS

POWER DISTRIBUTION SYSTEM

< COMPONENT DIAGNOSIS >

[POWER DISTRIBUTION SYSTEM]

PDS (POWER DISTRIBUTION SYSTEM) (TYPE B)

Connector No.	E10
Connector Name	IPDM E/R (INTELLIGENT POWER DISTRIBUTION MODULE ENGINE ROOM)
Connector Type	TH20FW-CS12-M4-TV

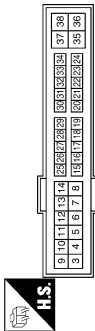

Connector No.	E11
Connector Name	IPDM E/R (INTELLIGENT POWER DISTRIBUTION MODULE ENGINE ROOM)
Connector Type	TH08FW-NH



Connector No.	E103
Connector Name	FUSE BLOCK (J/B)
Connector Type	NS16FW-CS

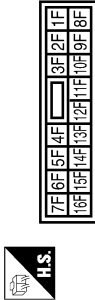

Connector No.	E105
Connector Name	WIRE TO WIRE
Connector Type	TH70MM-CS10-M3



Terminal No.	Color of Wire	Signal Name [Specification]
12	B	-
27	W	-
28	SB	-
30	BR	-

Terminal No.	Color of Wire	Signal Name [Specification]
39	P	-
40	L	-
41	B	-
46	BR	-

Terminal No.	Color of Wire	Signal Name [Specification]
2F	LG	-
6F	Y	-
8F	R	-

Terminal No.	Color of Wire	Signal Name [Specification]
11	P	-
12	L	-
15	BR	-
20	Y	-
28	SB	-
29	W	-
61	BR	-
82	LG	-

Connector No.	E116
Connector Name	STOP LAMP SWITCH (TYPE B)
Connector Type	MG4FW-LC



Connector No.	F12
Connector Name	IPDM E/R (INTELLIGENT POWER DISTRIBUTION MODULE ENGINE ROOM)
Connector Type	TH20FW-CS12-M4

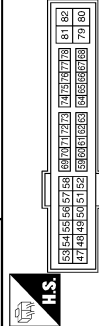

Connector No.	F23
Connector Name	TCM (TRANSMISSION CONTROL MODULE)
Connector Type	RH40FB-RZ8-L-RH



Connector No.	M1
Connector Name	FUSE BLOCK (J/B)
Connector Type	NS08FW-M2

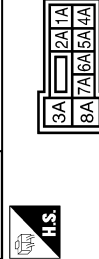

Terminal No.	Color of Wire	Signal Name [Specification]
1	R	-
2	LG	-
3	G	-
4	Y	-

Terminal No.	Color of Wire	Signal Name [Specification]
72	R/B	-

Terminal No.	Color of Wire	Signal Name [Specification]
20	R/B	STARTER RELAY













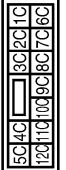

Terminal No.	Color of Wire	Signal Name [Specification]
2A	G	-
3A	Y	-
4A	GR	-
5A	R	-
7A	LG	-
8A	Y	-

POWER DISTRIBUTION SYSTEM

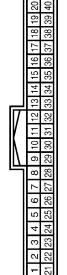
< COMPONENT DIAGNOSIS >

[POWER DISTRIBUTION SYSTEM]

PDS (POWER DISTRIBUTION SYSTEM) (TYPE B)

Connector No.	M2	Connector No.	M3	Connector No.	M4	Connector No.	M11
Connector Name	FUSE BLOCK (J/B)	Connector Name	FUSE BLOCK (J/B)	Connector Name	DATA LINK CONNECTOR	Connector Name	WIRE TO WIRE
Connector Type	NS10FW-CS	Connector Type	NS12FW-CS	Connector Type	BD16FW	Connector Type	TH10FW-CS (P-M3)
							
Terminal No.	3B	Terminal No.	6C	Terminal No.	6	Terminal No.	11
Color of Wire	L	Color of Wire	BR	Color of Wire	L	Color of Wire	P
Signal Name [Specification]	-	Signal Name [Specification]	-	Signal Name [Specification]	-	Signal Name [Specification]	-
Terminal No.	5B	Terminal No.	7C	Terminal No.	14	Terminal No.	12
Color of Wire	L	Color of Wire	B	Color of Wire	P	Color of Wire	L
Signal Name [Specification]	-	Signal Name [Specification]	-	Signal Name [Specification]	-	Signal Name [Specification]	-
Terminal No.	9B	Terminal No.		Terminal No.		Terminal No.	15
Color of Wire	GR	Color of Wire		Color of Wire		Color of Wire	R
Signal Name [Specification]	-	Signal Name [Specification]		Signal Name [Specification]		Signal Name [Specification]	-
Terminal No.		Terminal No.		Terminal No.		Terminal No.	20
Color of Wire		Color of Wire		Color of Wire		Color of Wire	Y
Signal Name [Specification]		Signal Name [Specification]		Signal Name [Specification]		Signal Name [Specification]	-
Terminal No.		Terminal No.		Terminal No.		Terminal No.	28
Color of Wire		Color of Wire		Color of Wire		Color of Wire	BR
Signal Name [Specification]		Signal Name [Specification]		Signal Name [Specification]		Signal Name [Specification]	-
Terminal No.		Terminal No.		Terminal No.		Terminal No.	29
Color of Wire		Color of Wire		Color of Wire		Color of Wire	L
Signal Name [Specification]		Signal Name [Specification]		Signal Name [Specification]		Signal Name [Specification]	-
Terminal No.		Terminal No.		Terminal No.		Terminal No.	61
Color of Wire		Color of Wire		Color of Wire		Color of Wire	GR
Signal Name [Specification]		Signal Name [Specification]		Signal Name [Specification]		Signal Name [Specification]	-
Terminal No.		Terminal No.		Terminal No.		Terminal No.	82
Color of Wire		Color of Wire		Color of Wire		Color of Wire	W
Signal Name [Specification]		Signal Name [Specification]		Signal Name [Specification]		Signal Name [Specification]	-
Connector No.	M34	Connector No.	M101	Connector No.	M118	Connector No.	M119
Connector Name	COMBINATION METER	Connector Name	PUSH-BUTTON IGNITION SWITCH	Connector Name	BCM (BODY CONTROL MODULE)	Connector Name	BCM (BODY CONTROL MODULE)
Connector Type	TH40FW-NH	Connector Type	TK08FBR	Connector Type	M03FE-LC	Connector Type	NS16FW-CS
							
Terminal No.	21	Terminal No.	1	Terminal No.	1	Terminal No.	11
Color of Wire	L	Color of Wire	B	Color of Wire	W	Color of Wire	LG
Signal Name [Specification]	CAN-H	Signal Name [Specification]	-	Signal Name [Specification]	BAT (F/L)	Signal Name [Specification]	BAT (FUSE)
Terminal No.	22	Terminal No.	4	Terminal No.	6	Terminal No.	13
Color of Wire	P	Color of Wire	BR	Color of Wire	L	Color of Wire	B
Signal Name [Specification]	CAN-L	Signal Name [Specification]	-	Signal Name [Specification]	-	Signal Name [Specification]	GND
Terminal No.		Terminal No.	6	Terminal No.	8	Terminal No.	15
Color of Wire		Color of Wire	L	Color of Wire	GR	Color of Wire	L
Signal Name [Specification]		Signal Name [Specification]	-	Signal Name [Specification]	-	Signal Name [Specification]	ACC/IND

JCMWM3184G1

A
B
C
D
E
F
G
H
I
J
K
L
PCS
N
O
P

POWER DISTRIBUTION SYSTEM

< COMPONENT DIAGNOSIS >

[POWER DISTRIBUTION SYSTEM]

PDS (POWER DISTRIBUTION SYSTEM) (TYPE B)

Connector No.	M121
Connector Name	BCM (BODY CONTROL MODULE)
Connector Type	TH40FG-NH

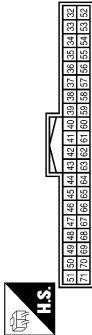

Terminal No.	Color of Wire	Signal Name [Specification]
47	L	IGN RELAY (PDM E/R CONT)
52	R	STARTER RELAY CONT

Connector No.	M122
Connector Name	BCM (BODY CONTROL MODULE)
Connector Type	TH40FB-NH

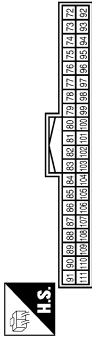

Terminal No.	Color of Wire	Signal Name [Specification]
82	BR	IGN RELAY (F/B) CONT
89	BR	PUSH SW
90	P	CAN-L
91	L	CAN-H
93	L	ON IND
95	L	ACC RELAY CONT
102	Y	BLOWER FAN MOTOR RELAY CONT

Connector No.	M123
Connector Name	BCM (BODY CONTROL MODULE)
Connector Type	TH40FG-NH

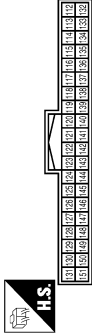

Terminal No.	Color of Wire	Signal Name [Specification]
118	GR	FUSE CHECK
119	L	STOP LAMP SW
122	R	ACC F/B
123	G	IGN F/B
140	GR	SHIFT N/P

JCMWM3185G

BCM (BODY CONTROL MODULE)

[POWER DISTRIBUTION SYSTEM]

< ECU DIAGNOSIS >

ECU DIAGNOSIS

BCM (BODY CONTROL MODULE)

Reference Value

INFOID:000000004757393

VALUES ON THE DIAGNOSIS TOOL

CONSULT-III MONITOR ITEM

Monitor Item	Condition	Value/Status
FR WIPER HI	Other than front wiper switch HI	Off
	Front wiper switch HI	On
FR WIPER LOW	Other than front wiper switch LO	Off
	Front wiper switch LO	On
FR WASHER SW	Front washer switch OFF	Off
	Front washer switch ON	On
FR WIPER INT	Other than front wiper switch INT/AUTO	Off
	Front wiper switch INT/AUTO	On
FR WIPER STOP	Front wiper is not in STOP position	Off
	Front wiper is in STOP position	On
INT VOLUME	Wiper intermittent dial is in a dial position 1 - 7	Wiper intermittent dial position
RR WIPER ON	Other than rear wiper switch ON	Off
	Rear wiper switch ON	On
RR WIPER INT	Other than rear wiper switch INT	Off
	Rear wiper switch INT	On
RR WASHER SW	Rear washer switch OFF	Off
	Rear washer switch ON	On
RR WIPER STOP	Rear wiper is in STOP position	Off
	Rear wiper is not in STOP position	On
TURN SIGNAL R	Other than turn signal switch RH	Off
	Turn signal switch RH	On
TURN SIGNAL L	Other than turn signal switch LH	Off
	Turn signal switch LH	On
TAIL LAMP SW	Other than lighting switch 1ST and 2ND	Off
	Lighting switch 1ST or 2ND	On
HI BEAM SW	Other than lighting switch HI	Off
	Lighting switch HI	On
HEAD LAMP SW 1	Other than lighting switch 2ND	Off
	Lighting switch 2ND	On
HEAD LAMP SW 2	Other than lighting switch 2ND	Off
	Lighting switch 2ND	On
PASSING SW	Other than lighting switch PASS	Off
	Lighting switch PASS	On
AUTO LIGHT SW	Other than lighting switch AUTO	Off
	Lighting switch AUTO	On
FR FOG SW	Front fog lamp switch OFF	Off
	Front fog lamp switch ON	On

BCM (BODY CONTROL MODULE)

< ECU DIAGNOSIS >

[POWER DISTRIBUTION SYSTEM]

Monitor Item	Condition	Value/Status
RR FOG SW	NOTE: The item is indicated, but not monitored.	Off
DOOR SW-DR	Driver door closed	Off
	Driver door opened	On
DOOR SW-AS	Passenger door closed	Off
	Passenger door opened	On
DOOR SW-RR	Rear RH door closed	Off
	Rear RH door opened	On
DOOR SW-RL	Rear LH door closed	Off
	Rear LH door opened	On
DOOR SW-BK	Back door closed	Off
	Back door opened	On
CDL LOCK SW	Other than power door lock switch LOCK	Off
	Power door lock switch LOCK	On
CDL UNLOCK SW	Other than power door lock switch UNLOCK	Off
	Power door lock switch UNLOCK	On
KEY CYL LK-SW	Other than driver door key cylinder LOCK position	Off
	Driver door key cylinder LOCK position	On
KEY CYL UN-SW	Other than driver door key cylinder UNLOCK position	Off
	Driver door key cylinder UNLOCK position	On
KEY CYL SW-TR	NOTE: The item is indicated, but not monitored.	Off
HAZARD SW	Hazard switch is OFF	Off
	Hazard switch is ON	On
REAR DEF SW	Rear window defogger switch OFF	Off
NOTE: At model with BOSE audio system this item is not monitored.	Rear window defogger switch ON	On
TR CANCEL SW	NOTE: The item is indicated, but not monitored.	Off
TR/BD OPEN SW	Back door opener switch OFF	Off
	While the back door opener switch is turned ON	On
TRNK/HAT MNTR	NOTE: The item is indicated, but not monitored.	Off
RKE-LOCK	LOCK button of the key is not pressed	Off
	LOCK button of the key is pressed	On
RKE-UNLOCK	UNLOCK button of the key is not pressed	Off
	UNLOCK button of the key is pressed	On
RKE-TR/BD	BACK DOOR OPEN button of the key is not pressed	Off
	BACK DOOR OPEN button of the key is pressed	On
RKE-PANIC	PANIC button of the key is not pressed	Off
	PANIC button of the key is pressed	On
RKE-P/W OPEN	UNLOCK button of the key is not pressed	Off
	UNLOCK button of the key is pressed and held	On

BCM (BODY CONTROL MODULE)

< ECU DIAGNOSIS >

[POWER DISTRIBUTION SYSTEM]

Monitor Item	Condition	Value/Status	
RKE-MODE CHG	LOCK/UNLOCK button of the key is not pressed and held simultaneously	Off	A
	LOCK/UNLOCK button of the key is pressed and held simultaneously	On	B
OPTICAL SENSOR	Bright outside of the vehicle	Close to 5 V	C
	Dark outside of the vehicle	Close to 0 V	
REQ SW -DR	Driver door request switch is not pressed	Off	D
	Driver door request switch is pressed	On	
REQ SW -AS	Passenger door request switch is not pressed	Off	E
	Passenger door request switch is pressed	On	
REQ SW -RR	NOTE: The item is indicated, but not monitored.	Off	F
REQ SW -RR	NOTE: The item is indicated, but not monitored.	Off	G
REQ SW -BD/TR	Back door request switch is not pressed	Off	H
	Back door request switch is pressed	On	
PUSH SW	Push-button ignition switch (push switch) is not pressed	Off	I
	Push-button ignition switch (push switch) is pressed	On	
IGN RLY2 -F/B	Ignition switch in OFF or ACC position	Off	J
	Ignition switch in ON position	On	
ACC RLY -F/B	NOTE: The item is indicated, but not monitored.	Off	K
CLUCH SW	NOTE: The item is indicated, but not monitored.	Off	L
BRAKE SW 1	The brake pedal is depressed when No. 7 fuse is blown	Off	PCS
	The brake pedal is not depressed when No. 7 fuse is blown, or No. 7 fuse is normal	On	
BRAKE SW 2	The brake pedal is not depressed	Off	N
	Stop lamp switch 1 signal circuit is normal	On	
DETE/CANCL SW	Selector lever in P position	Off	O
	Selector lever in any position other than P	On	
SFT PN/N SW	Selector lever in any position other than P and N	Off	P
	Selector lever in P or N position	On	
S/L -LOCK	Steering is unlocked	Off	N
	Steering is locked	On	
S/L -UNLOCK	Steering is locked	Off	O
	Steering is unlocked	On	
S/L RELAY-F/B	Ignition switch in OFF or ACC position	Off	P
	Ignition switch in ON position	On	
UNLK SEN -DR	Driver door is unlocked	Off	P
	Driver door is locked	On	
PUSH SW -IPDM	Push-button ignition switch (push-switch) is not pressed	Off	P
	Push-button ignition switch (push-switch) is pressed	On	
IGN RLY1 -F/B	Ignition switch in OFF or ACC position	Off	P
	Ignition switch in ON position	On	
DETE SW -IPDM	Selector lever in any position other than P	Off	P
	Selector lever in P position	On	

BCM (BODY CONTROL MODULE)

< ECU DIAGNOSIS >

[POWER DISTRIBUTION SYSTEM]

Monitor Item	Condition	Value/Status
SFT PN -IPDM	Selector lever in any position other than P and N	Off
	Selector lever in P or N position	On
SFT P -MET	Selector lever in any position other than P	Off
	Selector lever in P position	On
SFT N -MET	Selector lever in any position other than N	Off
	Selector lever in N position	On
ENGINE STATE	Engine stopped	Stop
	While the engine stalls	Stall
	At engine cranking	Crank
	Engine running	Run
S/L LOCK-IPDM	Steering is unlocked	Off
	Steering is locked	On
S/L UNLK-IPDM	Steering is locked	Off
	Steering is unlocked	On
S/L RELAY-REQ	Steering lock system is not the LOCK condition and the changing condition from LOCK to UNLOCK.	Off
	Steering lock system is the LOCK condition or the changing condition from LOCK to UNLOCK.	On
VEH SPEED 1	While driving	Equivalent to speedometer reading
VEH SPEED 2	While driving	Equivalent to speedometer reading
DOOR STAT-DR	Driver door is locked	LOCK
	Wait with selective UNLOCK operation (5 seconds)	READY
	Driver door is unlocked	UNLOCK
DOOR STAT-AS	Passenger door is locked	LOCK
	Wait with selective UNLOCK operation (5 seconds)	READY
	Passenger door is unlocked	UNLOCK
ID OK FLAG	Steering is locked	Reset
	Steering is unlocked	Set
PRMT ENG STRT	The engine start is prohibited	Reset
	The engine start is permitted	Set
PRMT RKE STRT	NOTE: The item is indicated, but not monitored.	Reset
KEY SW -SLOT	The key is not inserted into key slot	Off
	The key is inserted into key slot	On
RKE OPE COUN1	During the operation of the key	Operation frequency of the key
RKE OPE COUN2	NOTE: The item is indicated, but not monitored.	—
CONFIRM ID ALL	The key ID that the key slot receives is not recognized by any key ID registered to BCM.	Yet
	The key ID that the key slot receives is recognized by any key ID registered to BCM.	Done
CONFIRM ID4	The key ID that the key slot receives is not recognized by the fourth key ID registered to BCM.	Yet
	The key ID that the key slot receives is recognized by the fourth key ID registered to BCM.	Done

BCM (BODY CONTROL MODULE)

< ECU DIAGNOSIS >

[POWER DISTRIBUTION SYSTEM]

Monitor Item	Condition	Value/Status	
CONFIRM ID3	The key ID that the key slot receives is not recognized by the third key ID registered to BCM.	Yet	A
	The key ID that the key slot receives is recognized by the third key ID registered to BCM.	Done	B
CONFIRM ID2	The key ID that the key slot receives is not recognized by the second key ID registered to BCM.	Yet	C
	The key ID that the key slot receives is recognized by the second key ID registered to BCM.	Done	
CONFIRM ID1	The key ID that the key slot receives is not recognized by the first key ID registered to BCM.	Yet	D
	The key ID that the key slot receives is recognized by the first key ID registered to BCM.	Done	
TP 4	The ID of fourth key is not registered to BCM	Yet	E
	The ID of fourth key is registered to BCM	Done	
TP 3	The ID of third key is not registered to BCM	Yet	F
	The ID of third key is registered to BCM	Done	
TP 2	The ID of second key is not registered to BCM	Yet	G
	The ID of second key is registered to BCM	Done	
TP 1	The ID of first key is not registered to BCM	Yet	H
	The ID of first key is registered to BCM	Done	
AIR PRESS FL	Ignition switch ON (Only when the signal from the transmitter is received)	Air pressure of front LH tire	I
AIR PRESS FR	Ignition switch ON (Only when the signal from the transmitter is received)	Air pressure of front RH tire	J
AIR PRESS RR	Ignition switch ON (Only when the signal from the transmitter is received)	Air pressure of rear RH tire	K
AIR PRESS RL	Ignition switch ON (Only when the signal from the transmitter is received)	Air pressure of rear LH tire	L
ID REGST FL1	ID of front LH tire transmitter is registered	Done	PCS
	ID of front LH tire transmitter is not registered	Yet	
ID REGST FR1	ID of front RH tire transmitter is registered	Done	L
	ID of front RH tire transmitter is not registered	Yet	
ID REGST RR1	ID of rear RH tire transmitter is registered	Done	PCS
	ID of rear RH tire transmitter is not registered	Yet	
ID REGST RL1	ID of rear LH tire transmitter is registered	Done	PCS
	ID of rear LH tire transmitter is not registered	Yet	
WARNING LAMP	Tire pressure indicator OFF	Off	N
	Tire pressure indicator ON	On	
BUZZER	Tire pressure warning alarm is not sounding	Off	O
	Tire pressure warning alarm is sounding	On	

BCM (BODY CONTROL MODULE)

[POWER DISTRIBUTION SYSTEM]

< ECU DIAGNOSIS >

TERMINAL LAYOUT

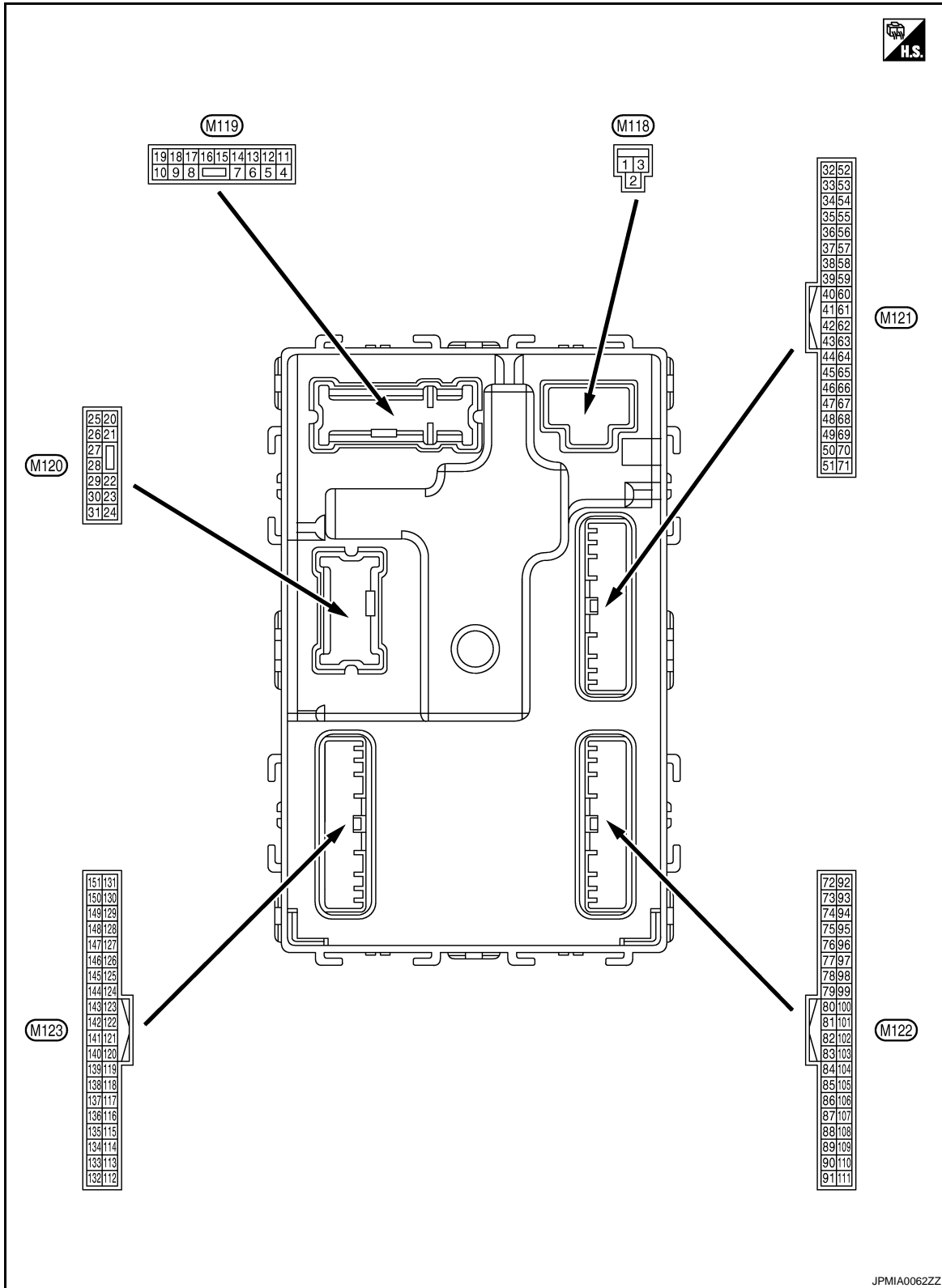

PHYSICAL VALUES

BCM (BODY CONTROL MODULE)

< ECU DIAGNOSIS >

[POWER DISTRIBUTION SYSTEM]

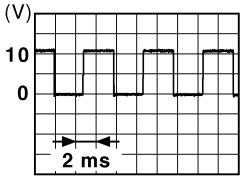
Terminal No. (Wire color)		Description		Condition		Value (Approx.)
		Signal name	Input/ Output			
+	-					
1 (W)	Ground	Battery power supply	Input	Ignition switch OFF		Battery voltage
2 (GR)	Ground	P/W power supply (BAT)	Output	Ignition switch OFF		Battery voltage
3 (L)	Ground	P/W power supply (RAP)	Output	Ignition switch ON		Battery voltage
4 (P)	Ground	Interior room lamp power supply	Output	Interior room lamp battery saver is activated. (Cuts the interior room lamp power supply)		0 V
				Interior room lamp battery saver is not activated. (Outputs the interior room lamp power supply)		Battery voltage
5 (G)	Ground	Passenger door UN- LOCK	Output	Passenger door	UNLOCK (Actuator is activated)	Battery voltage
					Other than UNLOCK (Actuator is not activated)	0 V
7 (W)	Ground	Step lamp	Output	Step lamp	ON	0 V
					OFF	Battery voltage
8 (V)	Ground	All doors LOCK	Output	All doors	LOCK (Actuator is activated)	Battery voltage
					Other than LOCK (Actuator is not activated)	0 V
9 (G)	Ground	Driver door UNLOCK	Output	Driver door	UNLOCK (Actuator is activated)	Battery voltage
					Other than UNLOCK (Actuator is not activated)	0 V
10 (P)	Ground	Rear RH door and rear LH door UN- LOCK	Output	Rear RH door and rear LH door	UNLOCK (Actuator is activated)	Battery voltage
					Other than UNLOCK (Actuator is not activated)	0 V
11 (LG)	Ground	Battery power supply	Input	Ignition switch OFF		Battery voltage
13 (B)	Ground	Ground	—	Ignition switch ON		0 V
14 (O)	Ground	Push-button ignition switch illumination ground	Output	Tail lamp	OFF	0 V
					ON	<p>NOTE: When the illumination brightening/dimming level is in the neutral position</p>  <p style="text-align: right; font-size: small;">JSNIA0010GB</p>
15 (L)	Ground	ACC indicator lamp	Output	Ignition switch	OFF	Battery voltage
					ACC	0.2 V
					ON	0 V

A
B
C
D
E
F
G
H
I
J
K
L
PCS
N
O
P

BCM (BODY CONTROL MODULE)

[POWER DISTRIBUTION SYSTEM]

< ECU DIAGNOSIS >

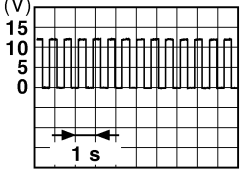
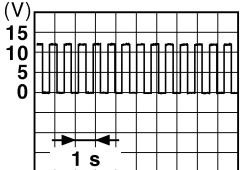
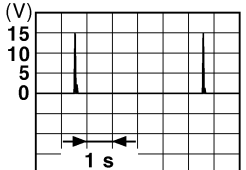
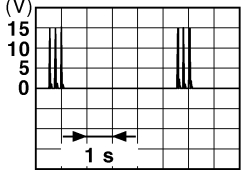
Terminal No. (Wire color)		Description		Condition	Value (Approx.)	
		Signal name	Input/ Output			
+	-					
17 (G)	Ground	Turn signal RH	Output	Ignition switch ON	Turn signal switch OFF	0 V
					Turn signal switch RH	 <p style="text-align: right; font-size: small;">PKID0926E</p>
18 (BR)	Ground	Turn signal LH	Output	Ignition switch ON	Turn signal switch OFF	0 V
					Turn signal switch LH	 <p style="text-align: right; font-size: small;">PKID0926E</p>
19 (Y)	Ground	Room lamp timer control	Output	Interior room lamp	OFF	Battery voltage
					ON	0 V
23 (BR)	Ground	Back door open	Output	Back door	OPEN (Back door opener actuator is activated)	Battery voltage
					Other than OPEN (Back door opener actuator is not activated)	0 V
26 (G)	Ground	Rear wiper	Output	Rear wiper	OFF (Stopped)	0 V
					ON (Operated)	Battery voltage
34*1 (B)	Ground	Luggage room anten- na (-)	Output	Ignition switch OFF	When Intelligent Key is in the passenger compart- ment	 <p style="text-align: right; font-size: small;">JMKIA0062GB</p>
					When Intelligent Key is not in the passenger compart- ment	 <p style="text-align: right; font-size: small;">JMKIA0063GB</p>

BCM (BODY CONTROL MODULE)

[POWER DISTRIBUTION SYSTEM]

< ECU DIAGNOSIS >

Terminal No. (Wire color)		Description		Condition	Value (Approx.)
		Signal name	Input/ Output		
+	-				
35*1 (W)	Ground	Luggage room antenna (+)	Output	Ignition switch OFF	
				When Intelligent Key is not in the passenger compartment	
38*1 (L)	Ground	Rear bumper antenna (-)	Output	When the back door request switch is operated with ignition switch OFF	
				When Intelligent Key is not in the antenna detection area	
39*1 (BR)	Ground	Rear bumper antenna (+)	Output	When the back door request switch is operated with ignition switch OFF	
				When Intelligent Key is not in the antenna detection area	
47 (L)	Ground	Ignition relay (IPDM E/R) control	Output	Ignition switch	Battery voltage
				OFF or ACC	0 V

A
B
C
D
E
F
G
H
I
J
K
L
N
O
P

PCS

BCM (BODY CONTROL MODULE)

< ECU DIAGNOSIS >

[POWER DISTRIBUTION SYSTEM]

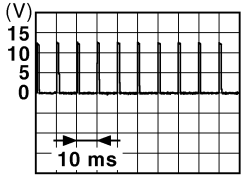
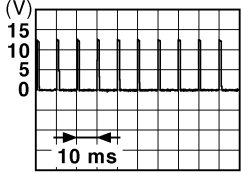
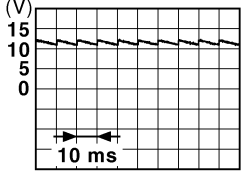
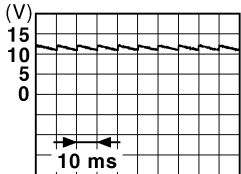
Terminal No. (Wire color)		Description		Condition		Value (Approx.)
+	-	Signal name	Input/ Output			
52 (R)	Ground	Starter relay control	Output	Ignition switch ON	When selector lever is in P or N position	Battery voltage
					When selector lever is not in P or N position	0.3 V
				Ignition switch OFF	0 V	
61*1 (R)	Ground	Back door request switch	Input	Back door re- quest switch	ON (Pressed)	0 V
					OFF (Not pressed)	 1.0 V
64*1 (GR)	Ground	Warning buzzer	Output	Warning buzzer	Sounding	0 V
					Not sounding	Battery voltage
65 (O)	Ground	Rear wiper stop posi- tion	Input	Rear wiper	In stop position	 1.0 V
					Not in stop position	0 V
66 (Y)	Ground	Back door switch	Input	Back door switch	OFF (When back door closes)	 11.8 V
					ON (When back door opens)	0 V
67 (LG)	Ground	Back door opener switch	Input	Back door opener switch	Pressed	0 V
					Not pressed	 11.8 V

BCM (BODY CONTROL MODULE)

[POWER DISTRIBUTION SYSTEM]

< ECU DIAGNOSIS >

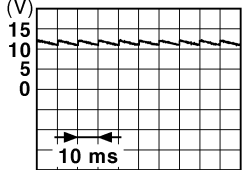
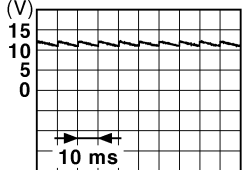
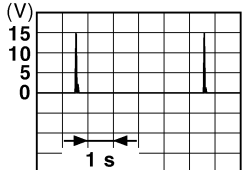
Terminal No. (Wire color)		Description		Condition	Value (Approx.)
+	-	Signal name	Input/ Output		
68 (W)	Ground	Rear RH door switch	Input	Rear RH door switch	 <p>11.8 V</p>
				OFF (When rear RH door closes)	ON (When rear RH door opens)
69 (R)	Ground	Rear LH door switch	Input	Rear LH door switch	 <p>11.8 V</p>
				OFF (When rear LH door closes)	ON (When rear LH door opens)
72*1 (B)	Ground	Room antenna 2 (-) (Center console)	Output	Ignition switch OFF	 <p>11.8 V</p>
				When Intelligent Key is in the passenger compartment	When Intelligent Key is not in the passenger compartment

A
B
C
D
E
F
G
H
I
J
K
L
N
O
P

PCS

BCM (BODY CONTROL MODULE)

[POWER DISTRIBUTION SYSTEM]

< ECU DIAGNOSIS >

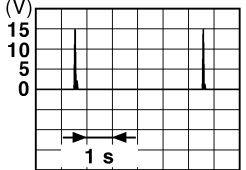
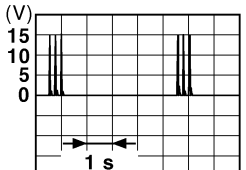
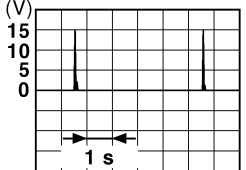
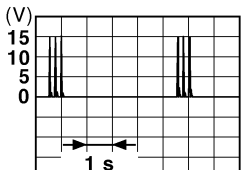
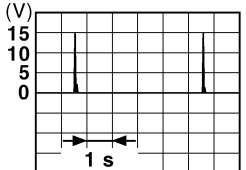
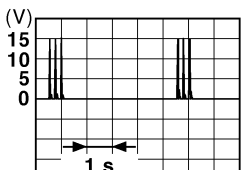
Terminal No. (Wire color)		Description		Condition	Value (Approx.)
		Signal name	Input/ Output		
+	-				
73*1 (W)	Ground	Room antenna 2 (+) (Center console)	Output	Ignition switch OFF	 <p style="text-align: right; font-size: small;">JMKIA0062GB</p>
				When Intelligent Key is not in the passenger compart- ment	 <p style="text-align: right; font-size: small;">JMKIA0063GB</p>
74*1 (Y)	Ground	Passenger door an- tenna (-)	Output	When the pas- senger door re- quest switch is operated with ig- nition switch OFF	 <p style="text-align: right; font-size: small;">JMKIA0062GB</p>
				When Intelligent Key is not in the antenna detection area	 <p style="text-align: right; font-size: small;">JMKIA0063GB</p>
75*1 (LG)	Ground	Passenger door an- tenna (+)	Output	When the pas- senger door re- quest switch is operated with ig- nition switch OFF	 <p style="text-align: right; font-size: small;">JMKIA0062GB</p>
				When Intelligent Key is not in the antenna detection area	 <p style="text-align: right; font-size: small;">JMKIA0063GB</p>

BCM (BODY CONTROL MODULE)

[POWER DISTRIBUTION SYSTEM]

< ECU DIAGNOSIS >

Terminal No. (Wire color)		Description		Condition	Value (Approx.)
		Signal name	Input/ Output		
+	-				
76*1 (V)	Ground	Driver door antenna (-)	Output	When Intelligent Key is in the antenna detection area	
				When the driver door request switch is operat- ed with ignition switch OFF	
77*1 (P)	Ground	Driver door antenna (+)	Output	When Intelligent Key is in the antenna detection area	
				When the driver door request switch is operat- ed with ignition switch OFF	
78*1 (R)	Ground	Room antenna 1 (-) (Instrument panel)	Output	Ignition switch OFF	
				When Intelligent Key is not in the passenger compart- ment	

A
B
C
D
E
F
G
H
I
J
K
L
N
O
P

PCS

BCM (BODY CONTROL MODULE)

[POWER DISTRIBUTION SYSTEM]

< ECU DIAGNOSIS >

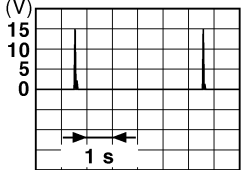
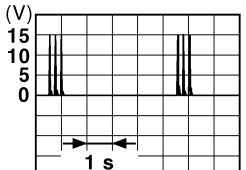
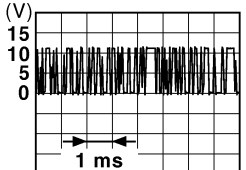
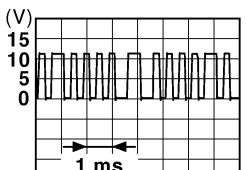
Terminal No. (Wire color)		Description		Condition	Value (Approx.)	
+	-	Signal name	Input/ Output			
79*1 (G)	Ground	Room antenna 1 (+) (Instrument panel)	Output	Ignition switch OFF	 <p style="text-align: right; font-size: small;">JMKIA0062GB</p>	
				When Intelligent Key is not in the passenger compart- ment	 <p style="text-align: right; font-size: small;">JMKIA0063GB</p>	
80 (SB)	Ground	NATS antenna amp (built in key slot)	Input/ Output	During waiting	Ignition switch is pressed while inserting the key into the key slot.	Just after pressing ignition switch. Pointer of tester should move.
81 (O)	Ground	NATS antenna amp (built in key slot)	Input/ Output	During waiting	Ignition switch is pressed while inserting the key into the key slot.	Just after pressing ignition switch. Pointer of tester should move.
82 (BR)	Ground	Ignition relay [fuse block (J/B)] control	Output	Ignition switch	OFF or ACC	0 V
				ON		Battery voltage
83 (P)	Ground	Remote keyless entry receiver communica- tion	Input/ Output	During waiting	 <p style="text-align: right; font-size: small;">JMKIA0064GB</p>	
				When operating either button on the key	 <p style="text-align: right; font-size: small;">JMKIA0065GB</p>	

BCM (BODY CONTROL MODULE)

[POWER DISTRIBUTION SYSTEM]

< ECU DIAGNOSIS >

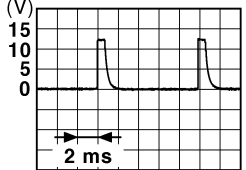
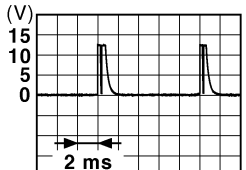
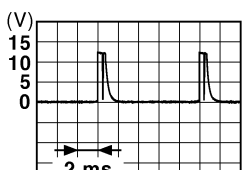
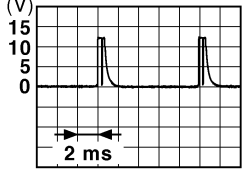
Terminal No. (Wire color)		Description		Condition	Value (Approx.)
+	-	Signal name	Input/ Output		
87 (R)	Ground	Combination switch INPUT 5	Input	Combination switch	All switches OFF (Wiper intermittent dial 4)  1.4 V <small>JPMIA0041GB</small>
					Front fog lamp switch ON (Wiper intermittent dial 4)  1.3 V <small>JPMIA0037GB</small>
					Rear wiper switch ON (Wiper intermittent dial 4)  1.3 V <small>JPMIA0039GB</small>
					Any of the conditions below with all switches OFF <ul style="list-style-type: none"> • Wiper intermittent dial 1 • Wiper intermittent dial 2 • Wiper intermittent dial 6 • Wiper intermittent dial 7  1.3 V <small>JPMIA0040GB</small>

A
B
C
D
E
F
G
H
I
J
K
L

PCS

N
O
P

BCM (BODY CONTROL MODULE)

[POWER DISTRIBUTION SYSTEM]

< ECU DIAGNOSIS >

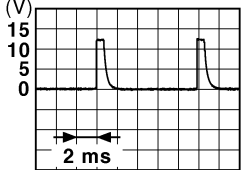
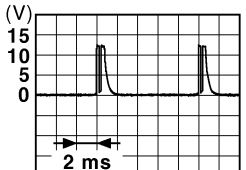
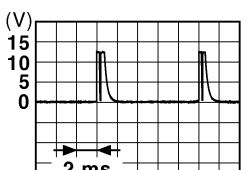
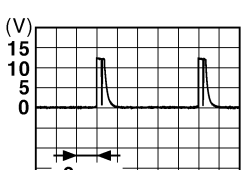
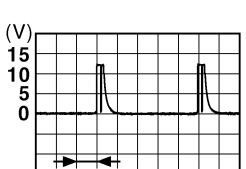
Terminal No. (Wire color)		Description		Condition	Value (Approx.)	
+	-	Signal name	Input/ Output			
88 (GR)	Ground	Combination switch INPUT 3	Input	Combination switch	All switches OFF (Wiper intermittent dial 4)	 <p style="text-align: right; font-size: small;">JPMIA0041GB</p> <p style="text-align: center;">1.4 V</p>
					Lighting switch HI (Wiper intermittent dial 4)	 <p style="text-align: right; font-size: small;">JPMIA0036GB</p> <p style="text-align: center;">1.3 V</p>
					Lighting switch 2ND (Wiper intermittent dial 4)	 <p style="text-align: right; font-size: small;">JPMIA0037GB</p> <p style="text-align: center;">1.3 V</p>
					Rear washer switch ON (Wiper intermittent dial 4)	 <p style="text-align: right; font-size: small;">JPMIA0039GB</p> <p style="text-align: center;">1.3 V</p>
					Any of the conditions below with all switches OFF	<ul style="list-style-type: none"> • Wiper intermittent dial 1 • Wiper intermittent dial 2 • Wiper intermittent dial 3  <p style="text-align: right; font-size: small;">JPMIA0040GB</p> <p style="text-align: center;">1.3 V</p>
89 (BR)	Ground	Push-button ignition switch (push switch)	Input	Push-button igni- tion switch (push switch)	Pressed	0 V
					Not pressed	Battery voltage
90 (P)	Ground	CAN - L	Input/ Output	—	—	
91 (L)	Ground	CAN - H	Input/ Output	—	—	

BCM (BODY CONTROL MODULE)

[POWER DISTRIBUTION SYSTEM]

< ECU DIAGNOSIS >

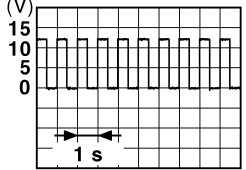
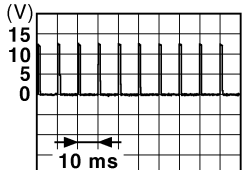
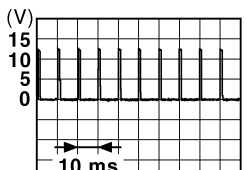
Terminal No. (Wire color)		Description		Condition		Value (Approx.)
+	-	Signal name	Input/ Output			
92 (R)*1 (L)*2	Ground	Key slot illumination	Output	Key slot illumination	OFF	0 V
					Blinking	 <p style="text-align: right; font-size: small;">JPMIA0015GB</p>
					ON	Battery voltage
93 (L)	Ground	ON indicator lamp	Output	Ignition switch	OFF or ACC	Battery voltage
					ACC	0.2 V
					ON	0 V
95 (L)	Ground	ACC relay control	Output	Ignition switch	OFF	0 V
					ACC or ON	Battery voltage
96 (Y)	Ground	Control device (de- tention switch) power supply	Output	—	—	Battery voltage
97 (O)	Ground	Steering lock condi- tion No. 1	Input	Steering lock	LOCK status	0 V
					UNLOCK status	Battery voltage
98 (L)	Ground	Steering lock condi- tion No. 2	Input	Steering lock	LOCK status	Battery voltage
					UNLOCK status	0 V
99 (V)	Ground	Selector lever P posi- tion switch	Input	Selector lever	P position	0 V
					Any position other than P	Battery voltage
100*1 (P)	Ground	Passenger door re- quest switch	Input	Passenger door request switch	ON (Pressed)	0 V
					OFF (Not pressed)	 <p style="text-align: right; font-size: small;">JPMIA0016GB</p>
101*1 (W)	Ground	Driver door request switch	Input	Driver door re- quest switch	ON (Pressed)	0 V
					OFF (Not pressed)	 <p style="text-align: right; font-size: small;">JPMIA0016GB</p>
102 (Y)	Ground	Blower fan motor re- lay control	Output	Ignition switch	OFF or ACC	0 V
					ON	Battery voltage
103 (L)	Ground	Remote keyless entry receiver power sup- ply	Output	Ignition switch OFF	—	Battery voltage



A
B
C
D
E
F
G
H
I
J
K
L
N
O
P

PCS

BCM (BODY CONTROL MODULE)

[POWER DISTRIBUTION SYSTEM]

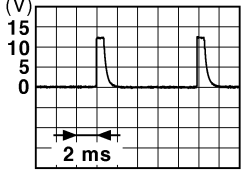

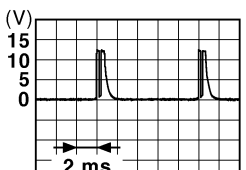
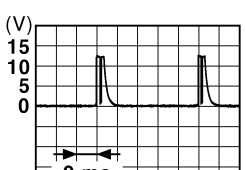
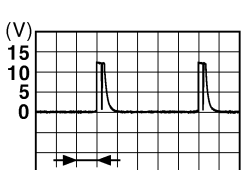

< ECU DIAGNOSIS >

Terminal No. (Wire color)		Description		Condition	Value (Approx.)	
+	-	Signal name	Input/ Output			
106 (Y)	Ground	Steering lock unit power supply	Output			Ignition switch
				ON	0 V	
107 (O)	Ground	Combination switch INPUT 1	Input	Combination switch (Wiper intermittent dial 4)	All switches OFF	 <p style="text-align: right;">1.4 V</p>
					Turn signal switch LH	 <p style="text-align: right;">1.3 V</p>
					Turn signal switch RH	 <p style="text-align: right;">1.3 V</p>
					Front wiper switch LO	 <p style="text-align: right;">1.3 V</p>
					Front washer switch ON	 <p style="text-align: right;">1.3 V</p>

BCM (BODY CONTROL MODULE)

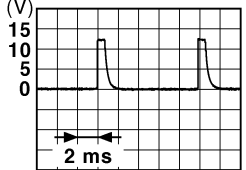
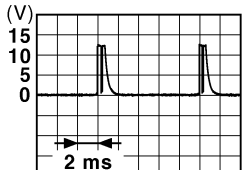
[POWER DISTRIBUTION SYSTEM]

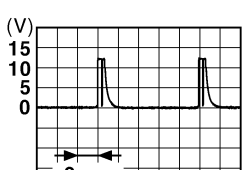
< ECU DIAGNOSIS >



Terminal No. (Wire color)		Description		Condition	Value (Approx.)	
		Signal name	Input/ Output			
+	-					
108 (P)	Ground	Combination switch INPUT 4	Input	Combination switch	All switches OFF (Wiper intermittent dial 4)	 <small>JPMIA0041GB</small> 1.4 V
					Lighting switch AUTO (Wiper intermittent dial 4)	 <small>JPMIA0038GB</small> 1.3 V
					Lighting switch 1ST (Wiper intermittent dial 4)	 <small>JPMIA0036GB</small> 1.3 V
					Rear wiper switch INT (Wiper intermittent dial 4)	 <small>JPMIA0040GB</small> 1.3 V
					Any of the conditions below with all switches OFF	 <small>JPMIA0039GB</small> 1.3 V

A
B
C
D
E
F
G
H
I
J
K
L
PCS
N
O
P

BCM (BODY CONTROL MODULE)

[POWER DISTRIBUTION SYSTEM]

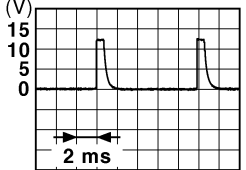
< ECU DIAGNOSIS >

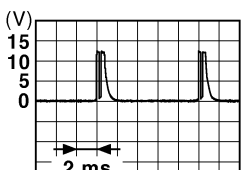
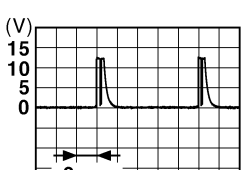
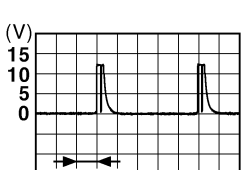
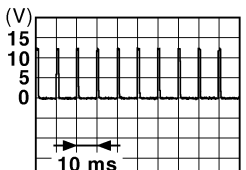
Terminal No. (Wire color)		Description		Condition	Value (Approx.)	
		Signal name	Input/ Output			
+	-					
109 (SB)	Ground	Combination switch INPUT 2	Input	Combination switch (Wiper intermittent dial 4)	All switches OFF	 <small>JPMIA0041GB</small> 1.4 V
					Lighting switch PASS	 <small>JPMIA0037GB</small> 1.3 V
					Lighting switch 2ND	 <small>JPMIA0036GB</small> 1.3 V
					Front wiper switch INT/ AUTO	 <small>JPMIA0038GB</small> 1.3 V
					Front wiper switch HI	 <small>JPMIA0040GB</small> 1.3 V
110 (G)	Ground	Hazard switch	Input	Hazard switch	ON	0 V
					OFF	 <small>JPMIA0012GB</small> 1.1 V

BCM (BODY CONTROL MODULE)

[POWER DISTRIBUTION SYSTEM]

< ECU DIAGNOSIS >

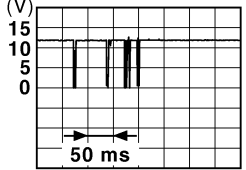
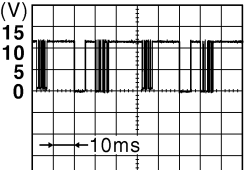
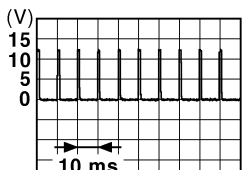
Terminal No. (Wire color)		Description		Condition	Value (Approx.)	
		Signal name	Input/ Output			
+	-					
111 (LG)	Ground	Steering lock unit communication	Input/ Output	Steering lock	LOCK status	Battery voltage
					LOCK or UNLOCK	 <p style="text-align: right; font-size: small;">JMKIA0066GB</p>
					For 15 seconds after UN- LOCK	Battery voltage
				15 seconds or later after UNLOCK	0 V	
112 (R)	Ground	Rain sensor serial link	Input/ Output	Ignition switch ON	 <p style="text-align: right; font-size: small;">JPMIA0156GB</p>	
					8.7 V	
113*3 (O)	Ground	Optical sensor	Input	Ignition switch ON	When bright outside of the vehicle	Close to 5 V
					When dark outside of the vehicle	Close to 0 V
116 (GR)	Ground	Stop lamp switch 1	Input	—	Battery voltage	
118 (L)	Ground	Stop lamp switch 2	Input	Stop lamp switch	OFF (Brake pedal is not depressed)	0 V
					ON (Brake pedal is de- pressed)	Battery voltage
119*1 (W)	Ground	Front door lock as- sembly driver side (Unlock sensor)	Input	Driver door	LOCK status (unlock sen- sor switch OFF)	 <p style="text-align: right; font-size: small;">JPMIA0012GB</p>
						UNLOCK status (unlock sensor switch ON)
121 (Y)	Ground	Key slot switch	Input	When the key is inserted into key slot	Battery voltage	
				When the key is not inserted into key slot	0 V	
122 (R)	Ground	ACC feedback	Input	Ignition switch	OFF	0 V
					ACC or ON	Battery voltage
123 (G)	Ground	IGN feedback	Input	Ignition switch	OFF or ACC	0 V
					ON	Battery voltage

A
B
C
D
E
F
G
H
I
J
K
L
N
O
P

PCS

BCM (BODY CONTROL MODULE)

< ECU DIAGNOSIS >

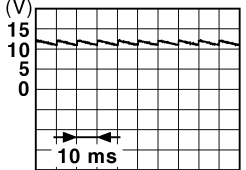
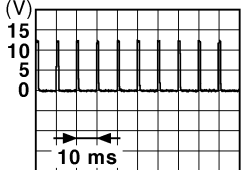
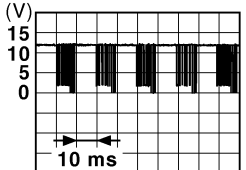
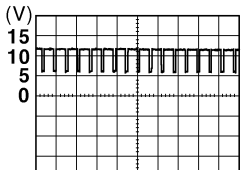

[POWER DISTRIBUTION SYSTEM]

Terminal No. (Wire color)		Description		Condition		Value (Approx.)
+	-	Signal name	Input/ Output			
124 (R)	Ground	Passenger door switch	Input	Passenger door switch	OFF (When passenger door closes)	 <small>JPMIA0011GB</small> 11.8 V
					ON (When passenger door opens)	0 V
130*4 (BR)	Ground	Rear window defogger switch	Input	Ignition switch ON	Rear window defogger switch OFF	 <small>JPMIA0012GB</small> 1.1 V
					Rear window defogger switch ON	0 V
132 (G)	Ground	Power window switch communication	Input/ Output	Ignition switch ON	 <small>JPMIA0013GB</small> 10.2 V	
				Ignition switch OFF or ACC	Battery voltage	
133 (W)	Ground	Push-button ignition switch illumination	Output	Push-button ignition switch illumination	ON (When tail lamps OFF)	9.5 V
					ON (When tail lamps ON)	<p style="text-align: center;">NOTE: The pulse width of this wave is varied by the illumination brightening/dimming level.</p>  <small>JPMIA0159GB</small>
					OFF	0 V
137 (P)	Ground	Receiver and sensor ground	Input	Ignition switch ON		0 V
138 (V)	Ground	Receiver and sensor power supply	Output	Ignition switch	OFF	0 V
					ACC or ON	5.0 V

BCM (BODY CONTROL MODULE)

[POWER DISTRIBUTION SYSTEM]

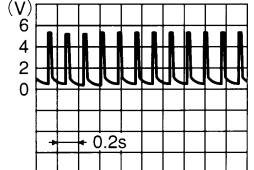
< ECU DIAGNOSIS >

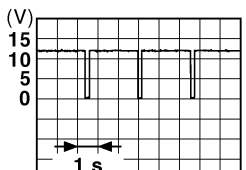
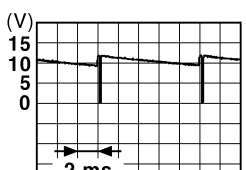
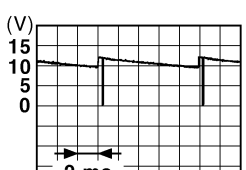
Terminal No. (Wire color)		Description		Condition	Value (Approx.)
		Signal name	Input/ Output		
+	-				
139*5 (O)	Ground	Tire pressure receiver communication	Input/ Output	Ignition switch ON	Standby state  OCC3881D
				When receiving the signal from the transmitter  OCC3880D	
140 (GR)	Ground	Selector lever P/N position	Input	Selector lever	P or N position Battery voltage
				Except P and N positions 0 V	
141 (O)	Ground	Security indicator	Output	Security indicator	ON 0 V
				Blinking  JPMIA0014GB 11.3 V	
				OFF Battery voltage	
142 (L)	Ground	Combination switch OUTPUT 5	Output	Combination switch (Wiper intermittent dial 4)	All switches OFF 0 V
				Lighting switch 1ST	 JPMIA0031GB 10.7 V
				Lighting switch HI	
				Lighting switch 2ND	
Turn signal switch RH					
143 (W)	Ground	Combination switch OUTPUT 1	Output	Combination switch	All switches OFF (Wiper intermittent dial 4) 0 V
				Front wiper switch HI (Wiper intermittent dial 4)	 JPMIA0032GB 10.7 V
				Rear wiper switch INT (Wiper intermittent dial 4)	
				Any of the conditions below with all switches OFF • Wiper intermittent dial 1 • Wiper intermittent dial 2 • Wiper intermittent dial 3 • Wiper intermittent dial 6 • Wiper intermittent dial 7	

A
B
C
D
E
F
G
H
I
J
K
L
N
O
P

PCS

BCM (BODY CONTROL MODULE)

[POWER DISTRIBUTION SYSTEM]

< ECU DIAGNOSIS >

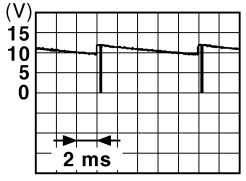
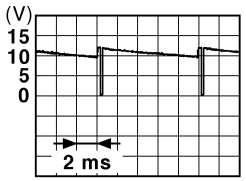
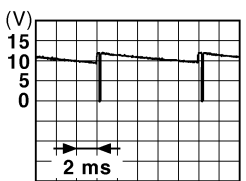
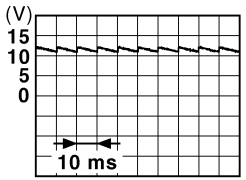
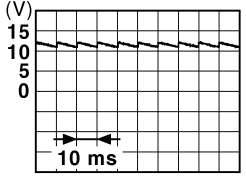
Terminal No. (Wire color)		Description		Condition	Value (Approx.)		
+	-	Signal name	Input/ Output				
144 (P)	Ground	Combination switch OUTPUT 2	Output	Combination switch	All switches OFF (Wiper intermittent dial 4)	0 V	
					Front washer switch ON (Wiper intermittent dial 4)		
					Rear wiper switch ON (Wiper intermittent dial 4)		
					Rear washer switch ON (Wiper intermittent dial 4)		
					Any of the conditions below with all switches OFF <ul style="list-style-type: none"> • Wiper intermittent dial 1 • Wiper intermittent dial 5 • Wiper intermittent dial 6 		10.7 V
145 (V)	Ground	Combination switch OUTPUT 3	Output	Combination switch (Wiper intermit- tent dial 4)	All switches OFF	0 V	
					Front wiper switch INT/ AUTO		
					Front wiper switch LO		
					Lighting switch AUTO		10.7 V
146 (Y)	Ground	Combination switch OUTPUT 4	Output	Combination switch (Wiper intermit- tent dial 4)	All switches OFF	0 V	
					Front fog lamp switch ON		
					Lighting switch 2ND		
					Lighting switch PASS		
					Turn signal switch LH		10.7 V
149*5 (W)	Ground	Tire pressure warn- ing check switch	Input	Ignition switch ON		11.8 V	
150 (SB)	Ground	Driver door switch	Input	Driver door switch	OFF (When driver door closes)		11.8 V
					ON (When driver door opens)	0 V	

BCM (BODY CONTROL MODULE)

< ECU DIAGNOSIS >

[POWER DISTRIBUTION SYSTEM]

Terminal No. (Wire color)		Description		Condition		Value (Approx.)
+	-	Signal name	Input/ Output			
151 (G)	Ground	Rear window defogger relay control	Output	Rear window defogger	Active	0 V
					Not activated	Battery voltage

NOTE:

- *1: With Intelligent Key system
- *2: Without Intelligent Key system
- *3: With auto light system
- *4: Without BOSE audio system
- *5: With TPMS

Wiring Diagram - BCM -

INFOID:000000004757394

UP TO VIN: JN8AZ18U*9W100000, JN8AZ18W*9W200000 (EXCEPT FOR MEXICO),

A
B
C
D
E
F
G
H
I
J
K
L
N
O
P

PCS

BCM (BODY CONTROL MODULE)

[POWER DISTRIBUTION SYSTEM]

< ECU DIAGNOSIS >

◁IK▷ : With Intelligent Key
 ◁SO▷ : With power seat without automatic drive positioner

* : This connector is not shown in "Harness Layout".

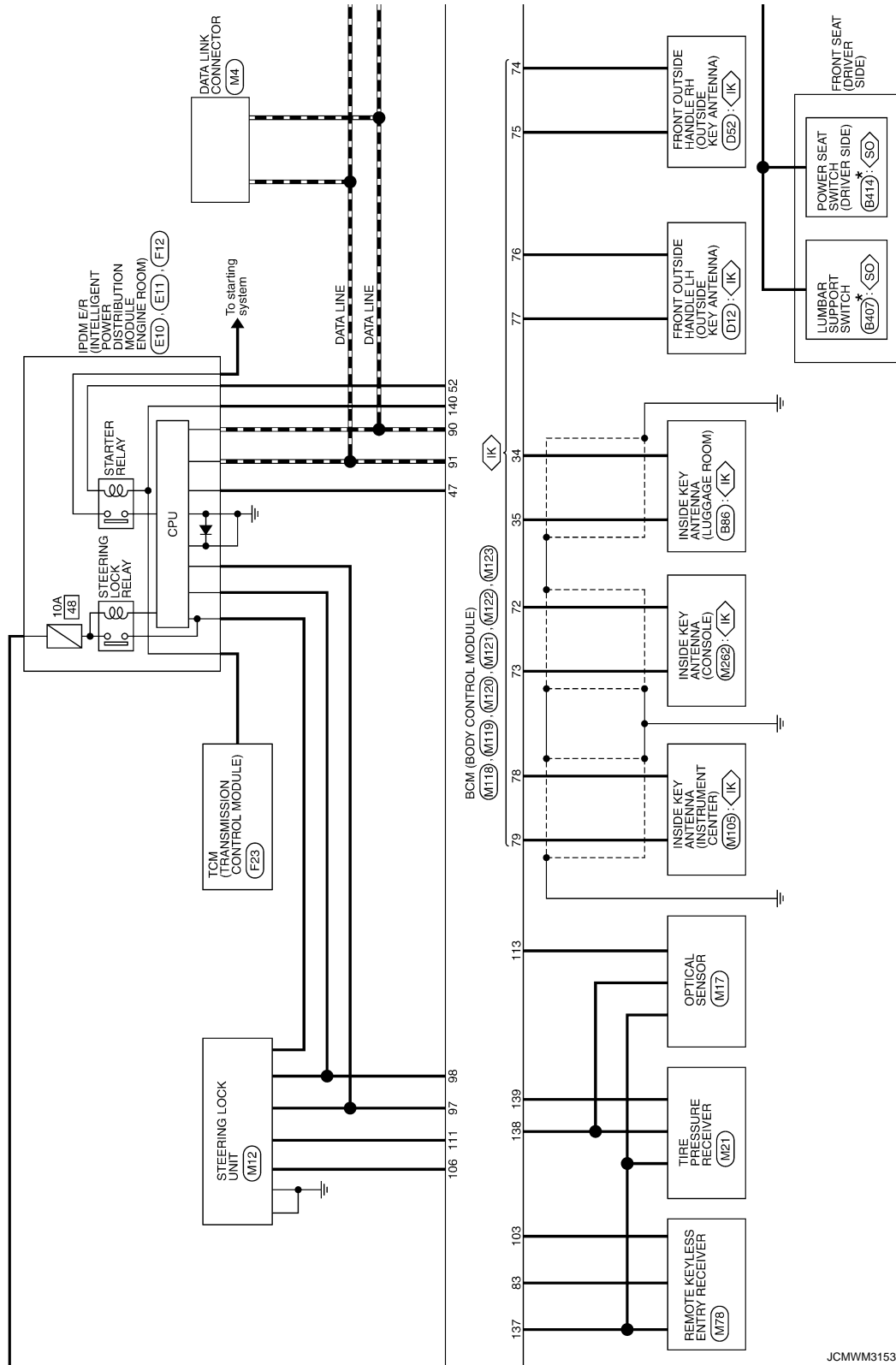

A
B
C
D
E
F
G
H
I
J
K
L
N
O
P

PCS

BCM (BODY CONTROL MODULE)

[POWER DISTRIBUTION SYSTEM]

< ECU DIAGNOSIS >

- ◊ IK : With Intelligent Key
- ◊ NV : With navigation system
- ◊ BC : With BOSE system without navigation system
- ◊ FE : With sunroof
- ◊ PM : With automatic drive positioner
- ◊ SO : With power seat without automatic drive positioner
- ◊ AB : With automatic back door

*: This connector is not shown in "Harness Layout".

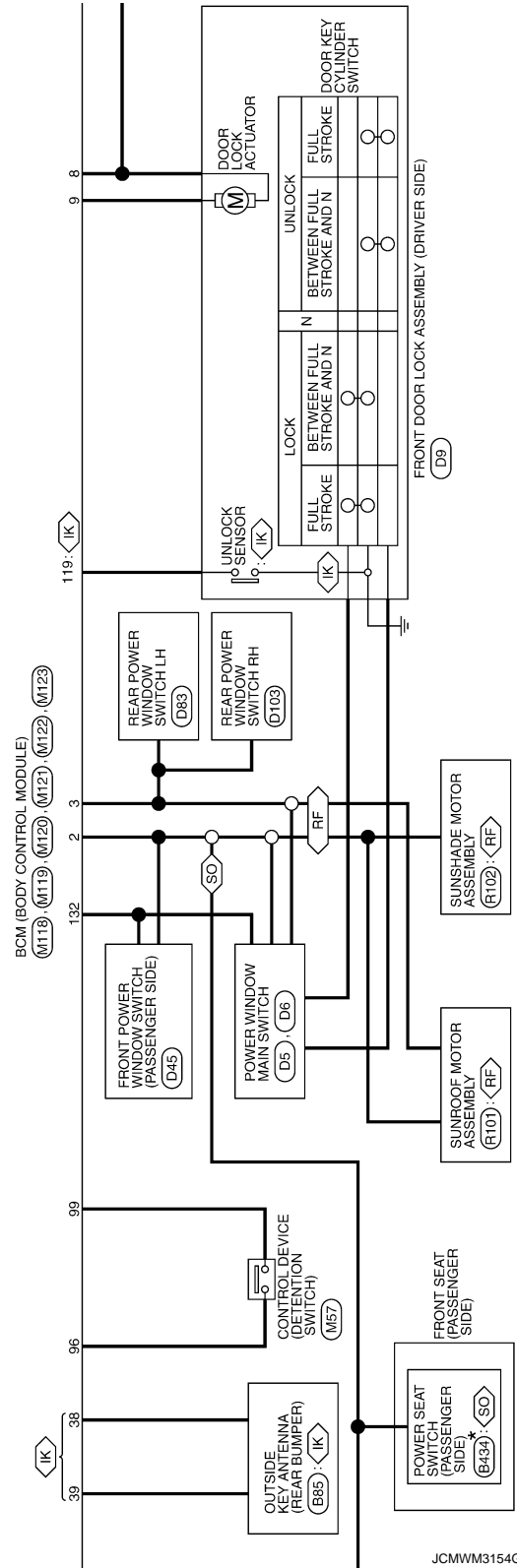
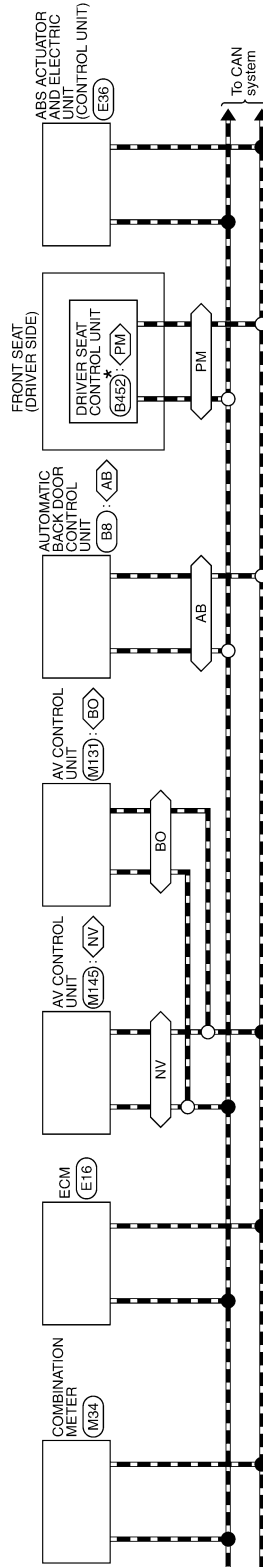

JCMWWM3154G

BCM (BODY CONTROL MODULE)

[POWER DISTRIBUTION SYSTEM]

< ECU DIAGNOSIS >

<RS> : With rain sensor
 <WX> : With xenon headlamp
 <OX> : Without xenon headlamp

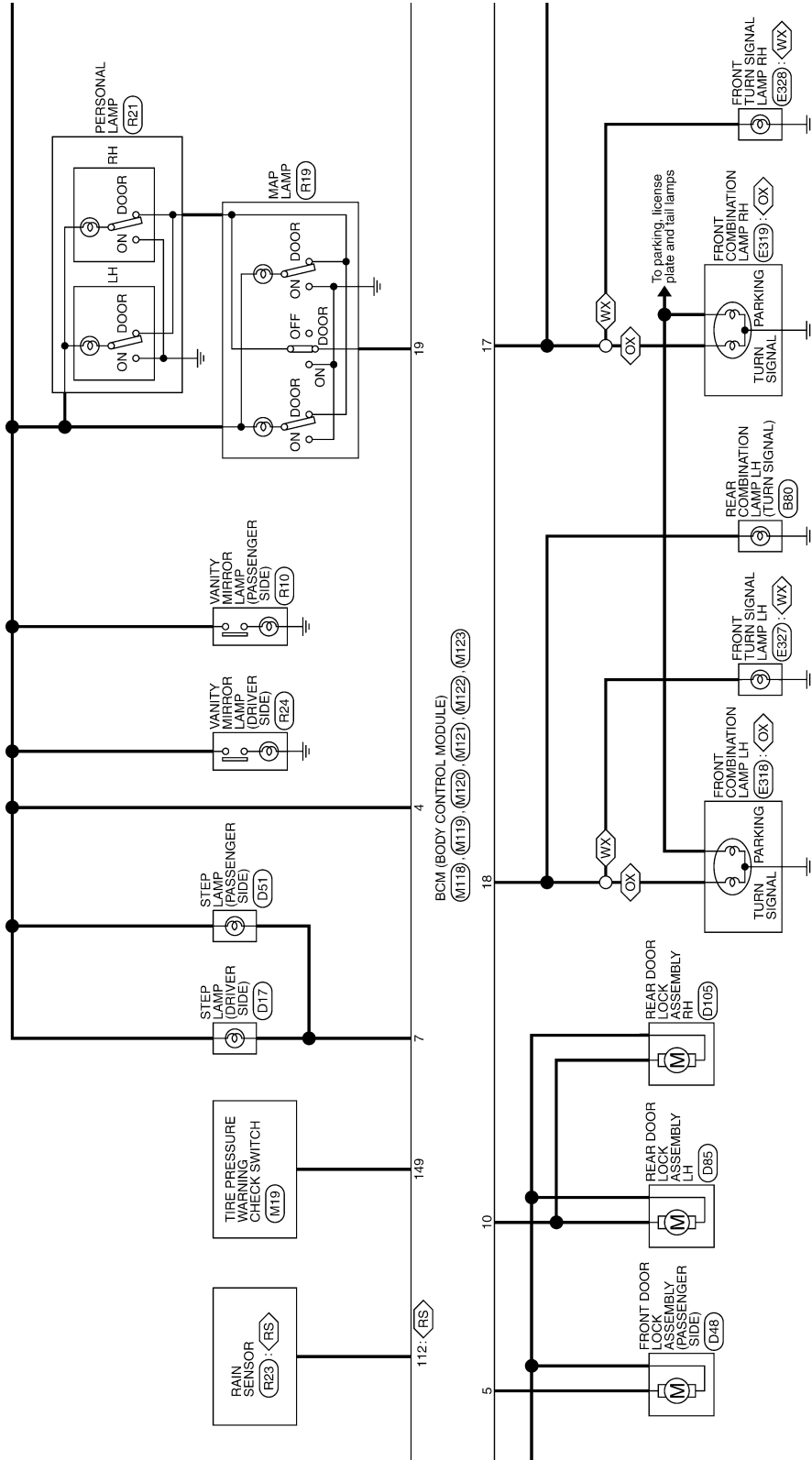

JCMWM3155G1

A
B
C
D
E
F
G
H
I
J
K
L
PCS
N
O
P

BCM (BODY CONTROL MODULE)

[POWER DISTRIBUTION SYSTEM]

< ECU DIAGNOSIS >

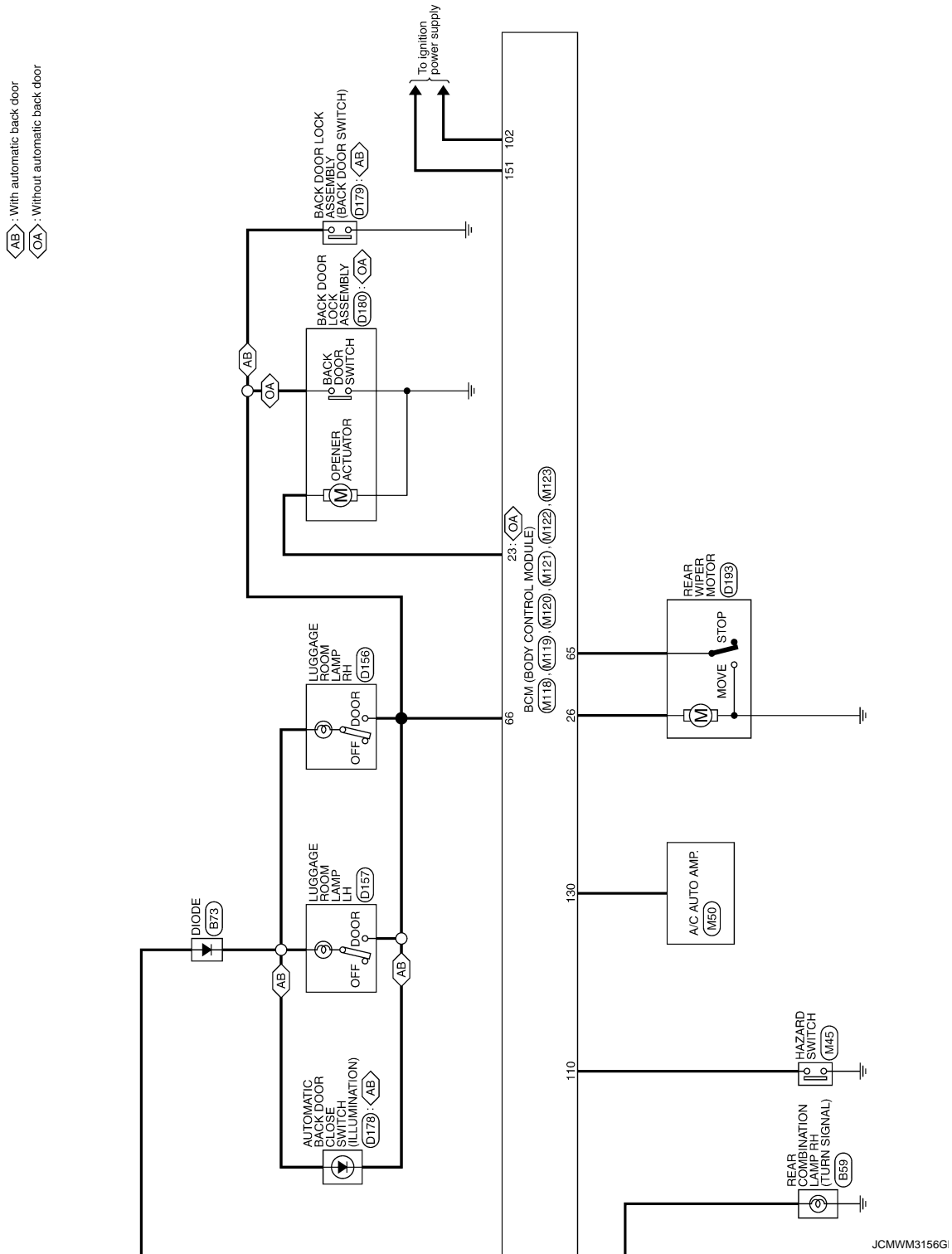

BCM (BODY CONTROL MODULE)

[POWER DISTRIBUTION SYSTEM]

< ECU DIAGNOSIS >

BCM (BODY CONTROL MODULE) (TYPE A)

Connector No.	M113
Connector Name	COMBINATION SWITCH
Connector Type	TH16FW-NH

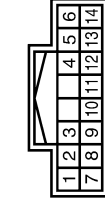

Terminal No.	Color of Wire	Signal Name [Specification]
2	Y	OUTPUT 4
3	V	OUTPUT 3
5	GR	INPUT 3
7	L	OUTPUT 5
8	SB	INPUT 2
10	P	INPUT 4
11	O	INPUT 1
12	W	OUTPUT 1
13	R	INPUT 5
14	P	OUTPUT 2

Connector No.	M120
Connector Name	BCM (BODY CONTROL MODULE)
Connector Type	NS12FW-CS



Terminal No.	Color of Wire	Signal Name [Specification]
23	BR	BACK DOOR OPEN OUTPUT
26	G	REAR WIPER OUTPUT

Connector No.	M118
Connector Name	BCM (BODY CONTROL MODULE)
Connector Type	M03FB-LC



Terminal No.	Color of Wire	Signal Name [Specification]
1	W	BAT (F/L)
2	GR	POWER WINDOW POWER SUPPLY (BAT)
3	L	POWER WINDOW POWER SUPPLY (RAP)

Connector No.	M121
Connector Name	BCM (BODY CONTROL MODULE)
Connector Type	TH40FGY-NH

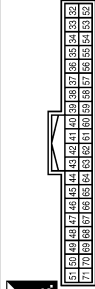

Terminal No.	Color of Wire	Signal Name [Specification]
34	B	LUGGAGE ROOM ANTI-
35	W	LUGGAGE ROOM ANTI+
38	L	REAR BUMPER ANTI-
39	BR	REAR BUMPER ANTI+
47	L	IGN RELAY (PDM E/R CONT
52	R	STARTER RELAY CONT
61	R	BACK DOOR OPENER REQUEST SW
64	GR	REQUEST SW BUZZER
65	O	REAR WIPER STOP POSITION
66	Y	BACK DOOR SW
67	LG	BACK DOOR OPENER SW

Connector No.	M119
Connector Name	BCM (BODY CONTROL MODULE)
Connector Type	NS16FW-CS

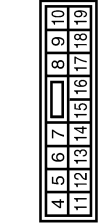

Terminal No.	Color of Wire	Signal Name [Specification]
4	P	INTERIOR ROOM LAMP POWER SUPPLY
5	G	PASSENGER DOOR UNLOCK OUTPUT
7	W	STEP LAMP OUTPUT
8	V	ALL DOOR FUEL LID LOCK OUTPUT
9	G	DRIVER DOOR FUEL LID UNLOCK OUTPUT
10	P	REAR DOOR UNLOCK OUTPUT
11	LG	BAT (FUSE)
13	B	GND
14	O	PUSH-BUTTON IGNITION SW ILL GND
15	L	ACC IND
17	G	TURN SIGNAL RH

68	W	REAR RH DOOR SW
69	R	REAR LH DOOR SW

18	BR	TURN SIGNAL LH
19	Y	ROOM LAMP TIMER CONTROL

A
B
C
D
E
F
G
H
I
J
K
L
N
O
P

PCS

BCM (BODY CONTROL MODULE)

[POWER DISTRIBUTION SYSTEM]

< ECU DIAGNOSIS >

BCM (BODY CONTROL MODULE) (TYPE A)

Connector No.	M122
Connector Name	BCM (BODY CONTROL MODULE)
Connector Type	TH40FB-NH

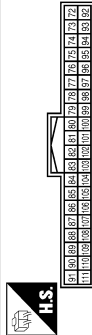

Terminal No.	Color of Wire	Signal Name [Specification]
72	B	ROOM ANT2-
73	W	ROOM ANT2+
74	Y	PASSENGER DOOR ANT-
75	LG	PASSENGER DOOR ANT+
76	V	DRIVER DOOR ANT-
77	P	DRIVER DOOR ANT+
78	R	ROOM ANT1-
79	G	ROOM ANT1+
80	SB	IMMOBI ANTENNA CONTROL
81	O	IMMOBI ANTENNA SIGNAL
82	BR	IGN RELAY (P/B) CONT

83	P	KEYLESS ENTRY RECEIVER SIGNAL
87	R	COMBI SW INPUT 5
88	GR	COMBI SW INPUT 3
89	BR	PUSH SW
90	P	CAN-L
91	L	CAN-H
92	R	KEY SLOT ILL[With Intelligent Key]
93	L	KEY SLOT ILL[Without Intelligent Key]
94	L	ON IND
95	L	ACC RELAY CONT
96	Y	A/T DEVICE POWER SUPPLY
97	O	S/L CONDITION 1
98	L	S/L CONDITION 2
99	V	SHIFT P
100	P	PASSENGER DOOR REQUEST SW
101	W	DRIVER DOOR REQUEST SW
102	Y	BLOWER FAN MOTOR RELAY CONT
103	L	KEYLESS ENTRY RECEIVER POWER SUPPLY
106	Y	S/L POWER SUPPLY
107	O	COMBI SW INPUT 1
108	P	COMBI SW INPUT 4
109	SB	COMBI SW INPUT 2
110	G	HAZARD SW
111	LG	S/L COMM

Connector No.	M123
Connector Name	BCM (BODY CONTROL MODULE)
Connector Type	TH40FG-NH

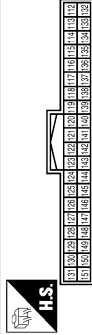

Terminal No.	Color of Wire	Signal Name [Specification]
112	R	RAIN SENSOR SERIAL LINK
113	O	OPTICAL SENSOR
116	GR	FUSE CHECK
118	L	STOP LAMP SW
119	W	DR DOOR UNLOCK SENSOR
121	Y	KEY SLOT SW
122	R	ACC F/B
123	G	IGN F/B
124	R	PASSENGER DOOR SW
130	BR	REAR DEFOGGER SW
132	G	POWER WINDOW SW COMM

133	W	PUSH-BUTTON IGNITION SW ILL POWER
137	P	RECEIVER SENSOR GND
138	V	RECEIVER SENSOR POWER SUPPLY
139	O	TIRE PRESS RECEIVER SIGNAL
140	GR	SHIFT N/P
141	O	SECURITY INDICATOR OUTPUT
142	L	COMBI SW OUTPUT 5
143	W	COMBI SW OUTPUT 1
144	P	COMBI SW OUTPUT 2
145	V	COMBI SW OUTPUT 3
146	Y	COMBI SW OUTPUT 4
149	W	TIRE PRESS WARNING CHECK SW
150	SB	DRIVER DOOR SW
151	G	REAR WINDOW DEFOGGER RELAY

JCMW3158G

FROM VIN: JN8AZ18U*9W100001, JN8AZ18W*9W200001 (EXCEPT FOR MEXICO),

BCM (BODY CONTROL MODULE)

[POWER DISTRIBUTION SYSTEM]

< ECU DIAGNOSIS >

JN8AZ18U*9W710001, JN8AZ18W*9W810001 (FOR MEXICO)

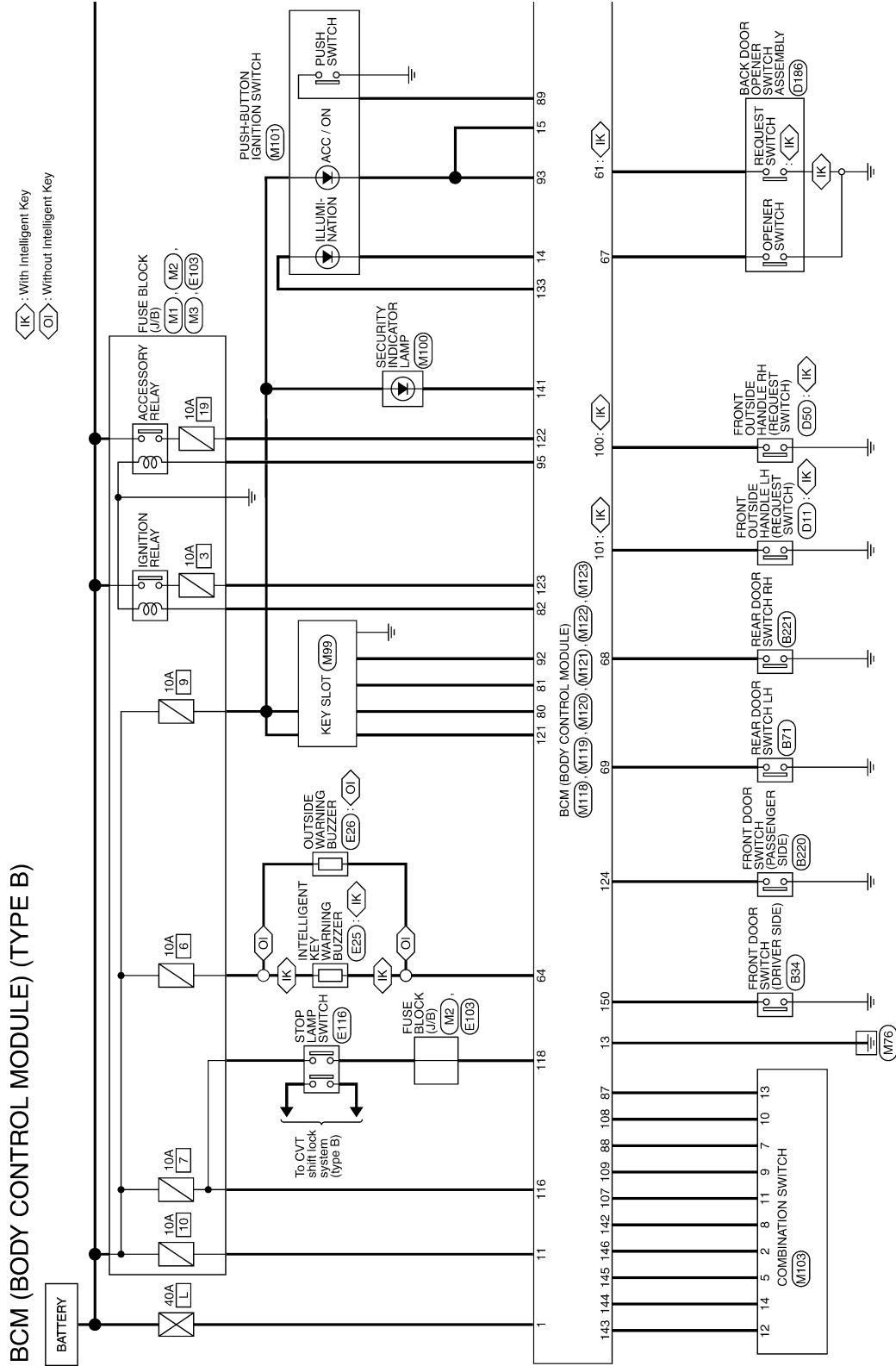

A
B
C
D
E
F
G
H
I
J
K
L
N
O
P

PCS

2008/09/23

JCMWM3159GI

BCM (BODY CONTROL MODULE)

[POWER DISTRIBUTION SYSTEM]

< ECU DIAGNOSIS >

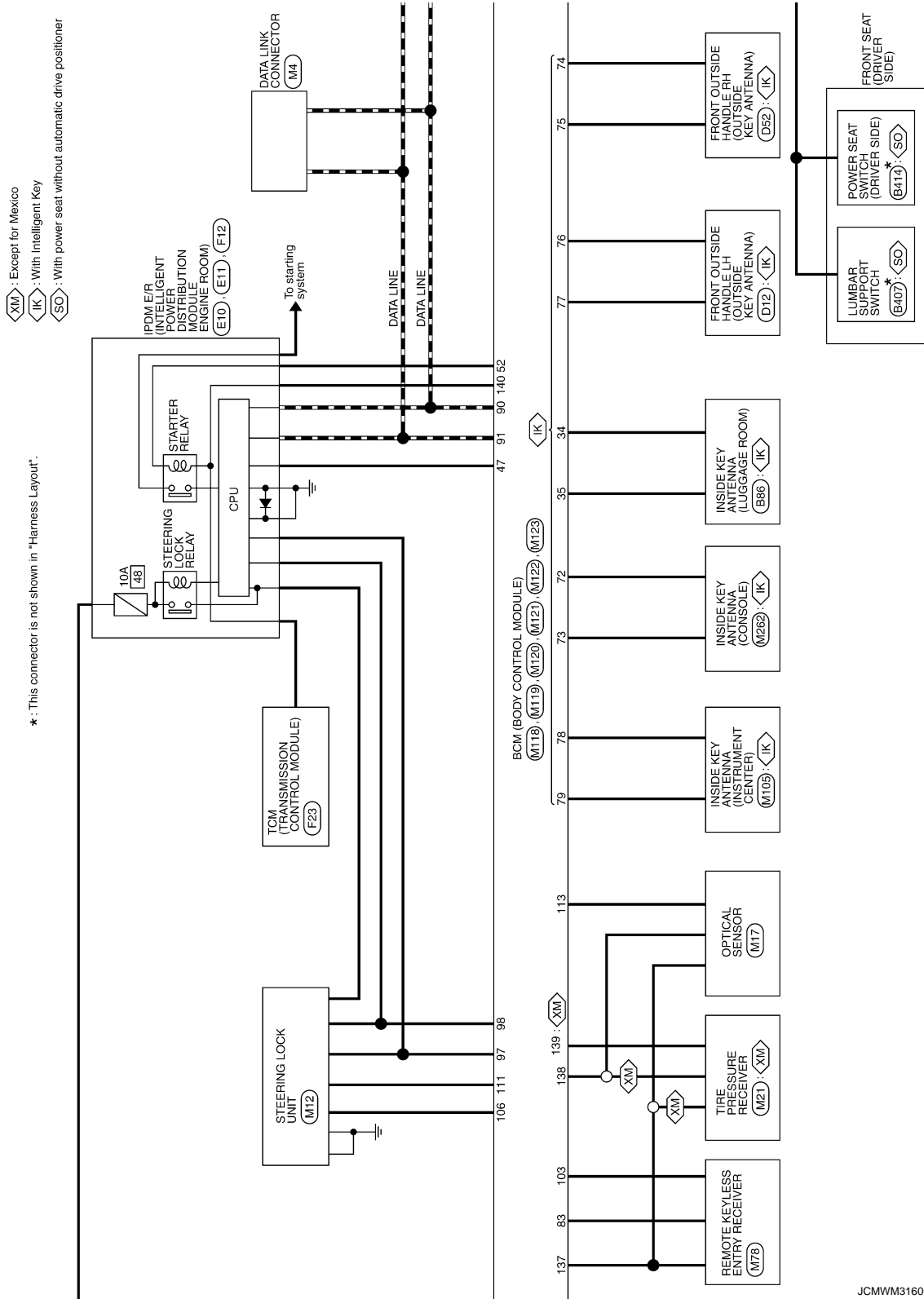

JCMWM3160G

BCM (BODY CONTROL MODULE)

[POWER DISTRIBUTION SYSTEM]

< ECU DIAGNOSIS >

- ◊ IK : With Intelligent Key
- ◊ NV : With navigation system
- ◊ BO : With BOSE system without navigation system
- ◊ PM : With sunroof
- ◊ SO : With automatic drive positioner
- ◊ AB : With automatic back door

* : This connector is not shown in "Harness Layout".

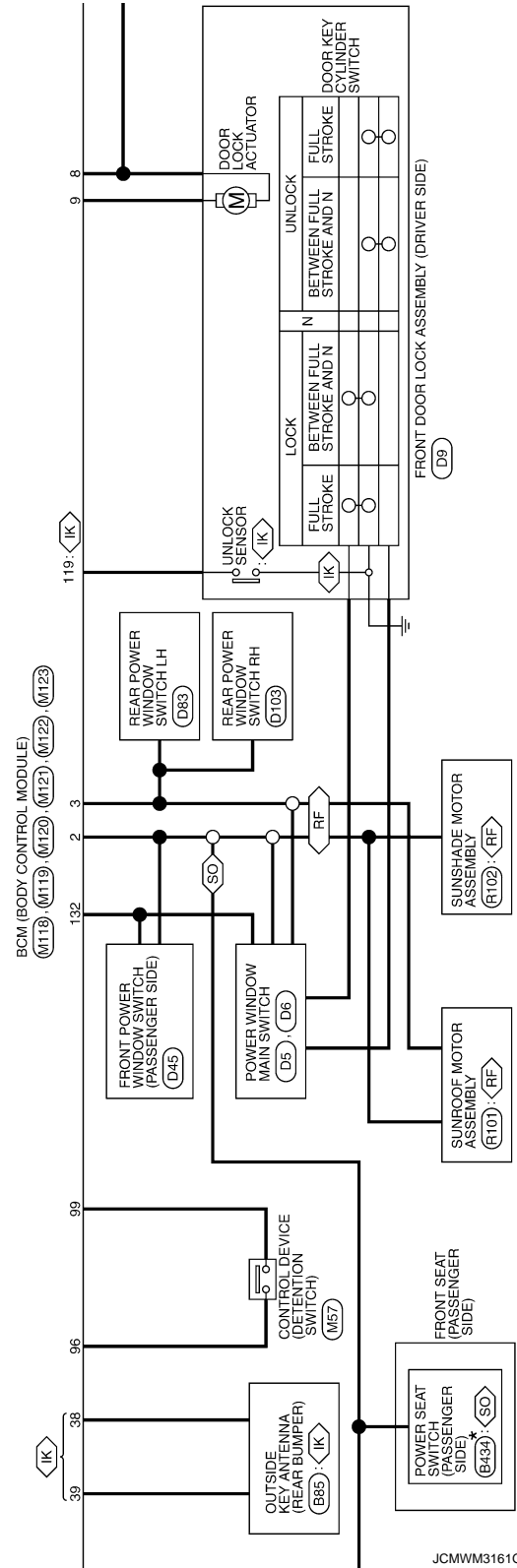
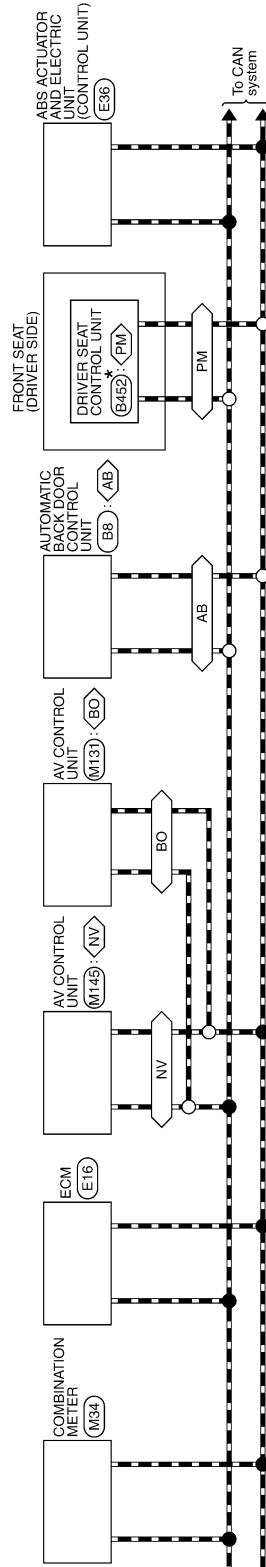

JCMWM3161G1

A
B
C
D
E
F
G
H
I
J
K
L
N
O
P

PCS

BCM (BODY CONTROL MODULE)

[POWER DISTRIBUTION SYSTEM]

< ECU DIAGNOSIS >

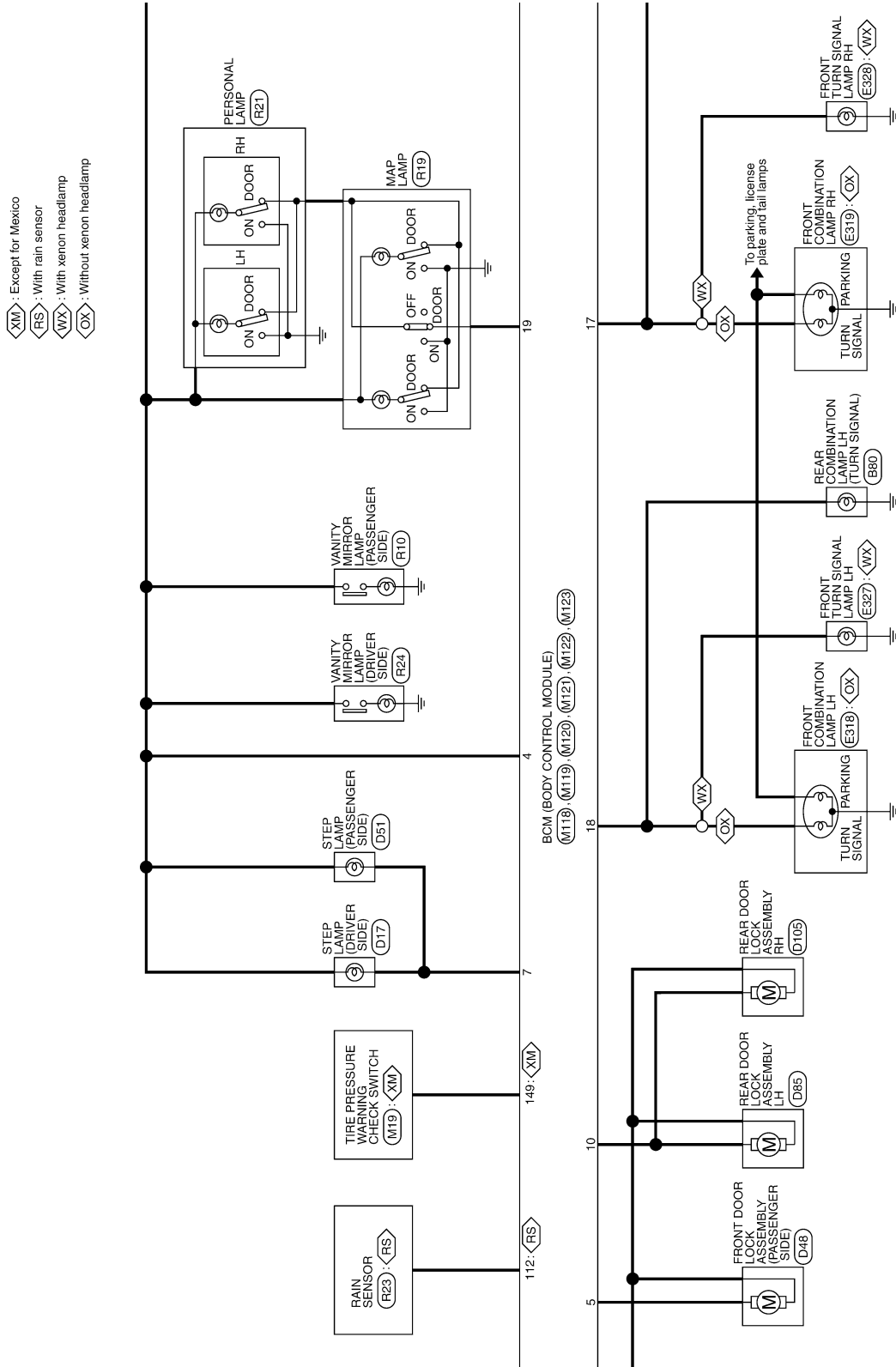

JCMW3162G

BCM (BODY CONTROL MODULE)

[POWER DISTRIBUTION SYSTEM]

< ECU DIAGNOSIS >

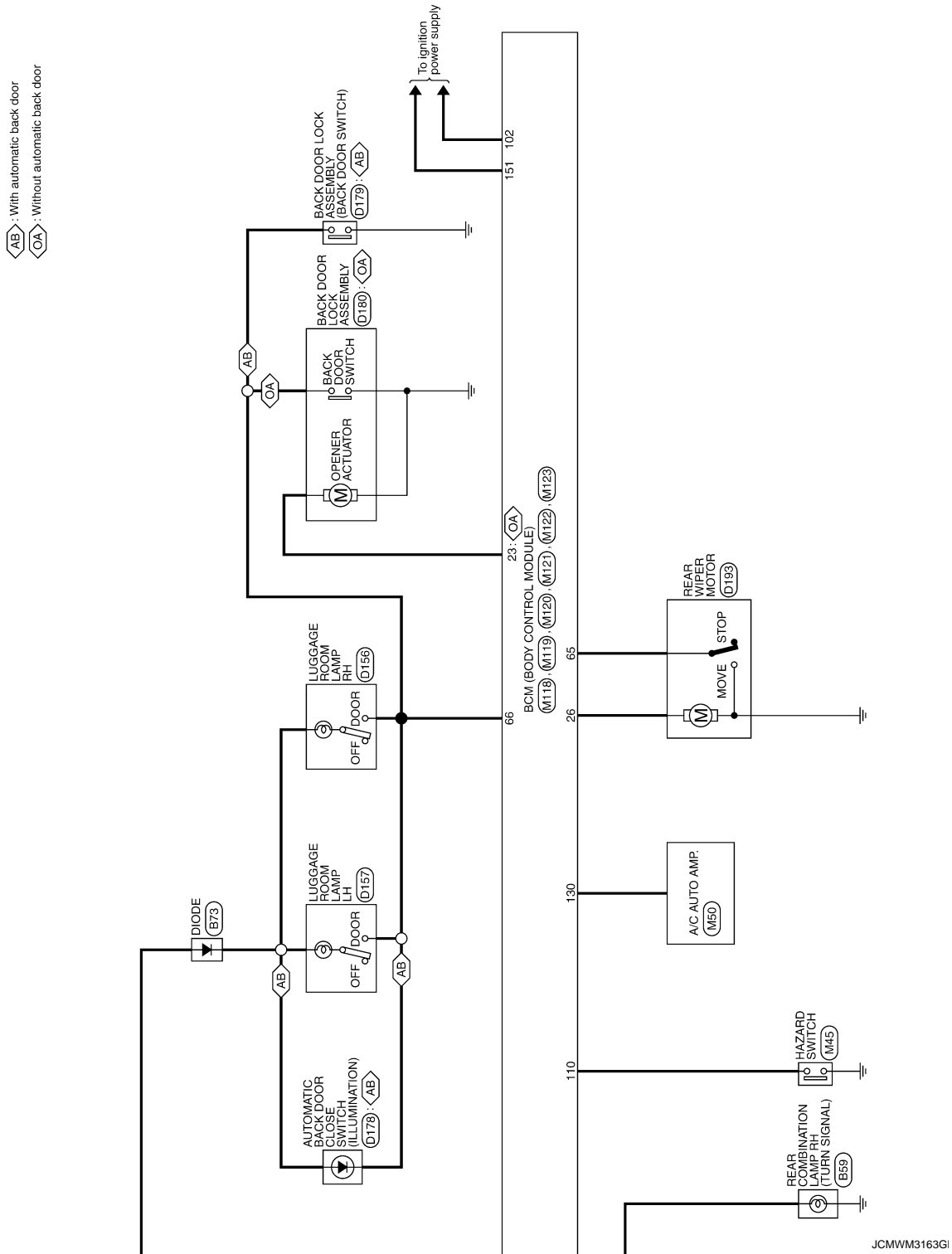

A
B
C
D
E
F
G
H
I
J
K
L
PCS
N
O
P

BCM (BODY CONTROL MODULE)

[POWER DISTRIBUTION SYSTEM]

< ECU DIAGNOSIS >

BCM (BODY CONTROL MODULE) (TYPE B)

Connector No.	M103
Connector Name	COMBINATION SWITCH
Connector Type	TH16FW-NH

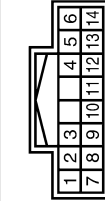

Terminal No.	Color of Wire	Signal Name [Specification]
2	Y	OUTPUT 4
5	V	OUTPUT 3
7	GR	INPUT 3
8	L	OUTPUT 5
9	SB	INPUT 2
10	P	INPUT 4
11	O	INPUT 1
12	W	OUTPUT 1
13	R	INPUT 5
14	P	OUTPUT 2



Connector No.	M120
Connector Name	BCM (BODY CONTROL MODULE)
Connector Type	NS12FW-CS



Connector No.	M118
Connector Name	BCM (BODY CONTROL MODULE)
Connector Type	M03FB-LC



Terminal No.	Color of Wire	Signal Name [Specification]
1	W	BAT (F/L)
2	GR	POWER WINDOW POWER SUPPLY (BAT)
3	L	POWER WINDOW POWER SUPPLY (RAP)

Connector No.	M121
Connector Name	BCM (BODY CONTROL MODULE)
Connector Type	TH40FGY-NH

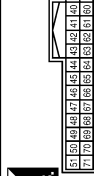

Terminal No.	Color of Wire	Signal Name [Specification]
23	BR	BACK DOOR OPEN OUTPUT
26	G	REAR WIPER OUTPUT

Connector No.	M119
Connector Name	BCM (BODY CONTROL MODULE)
Connector Type	NS16FW-CS

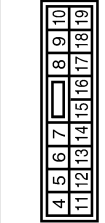

Terminal No.	Color of Wire	Signal Name [Specification]
4	P	INTERIOR ROOM LAMP POWER SUPPLY
5	G	PASSENGER DOOR UNLOCK OUTPUT
7	W	STEP LAMP OUTPUT
8	V	ALL DOOR FUEL LID LOCK OUTPUT
9	G	DRIVER DOOR FUEL LID UNLOCK OUTPUT
10	P	REAR DOOR UNLOCK OUTPUT
11	LG	BAT (GUSE)
13	B	GND
14	O	PUSH-BUTTON IGNITION SW ILL GND
15	L	ACC IND
17	G	TURN SIGNAL RH

Connector No.	M119
Connector Name	BCM (BODY CONTROL MODULE)
Connector Type	NS16FW-CS

Terminal No.	Color of Wire	Signal Name [Specification]
34	B	LUGGAGE ROOM ANTI-
35	W	LUGGAGE ROOM ANTI+
38	L	REAR BUMPER ANTI-
39	BR	REAR BUMPER ANTI+
47	L	IGN RELAY IPDM E/R CONT
52	R	STARTER RELAY CONT
61	R	BACK DOOR OPENER REQUEST SW
64	GR	REQUEST SW BUZZER
65	O	REAR WIPER STOP POSITION
66	Y	BACK DOOR SW
67	LG	BACK DOOR OPENER SW

Connector No.	M119
Connector Name	BCM (BODY CONTROL MODULE)
Connector Type	NS16FW-CS

Terminal No.	18	BR	TURN SIGNAL LH
Terminal No.	19	Y	ROOM LAMP TIMER CONTROL

BCM (BODY CONTROL MODULE)

[POWER DISTRIBUTION SYSTEM]

< ECU DIAGNOSIS >

BCM (BODY CONTROL MODULE) (TYPE B)

Connector No.	M122
Connector Name	BCM (BODY CONTROL MODULE)
Connector Type	TH40FB-NH

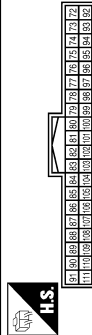

Terminal No.	Color of Wire	Signal Name [Specification]
72	B	ROOM ANT2-
73	W	ROOM ANT2+
74	Y	PASSENGER DOOR ANT-
75	LG	PASSENGER DOOR ANT+
76	V	DRIVER DOOR ANT-
77	P	DRIVER DOOR ANT+
78	R	ROOM ANT1-
79	G	ROOM ANT1+
80	SB	IMMOBI ANTENNA CONTROL
81	O	IMMOBI ANTENNA SIGNAL
82	BR	IGN RELAY (F/B) CONT

83	P	KEYLESS ENTRY RECEIVER SIGNAL
87	R	COMBI SW INPUT 5
88	GR	COMBI SW INPUT 3
89	BR	PUSH SW
90	P	CAN-L
91	L	CAN-H
92	R	KEY SLOT ILL[With Intelligent Key]
93	L	KEY SLOT ILL[Without Intelligent Key]
94	L	ON IND
95	L	ACC RELAY CONT
96	Y	A-T DEVICE POWER SUPPLY
97	O	S/L CONDITION 1
98	L	S/L CONDITION 2
99	V	SHIFT P
100	P	PASSENGER DOOR REQUEST SW
101	W	DRIVER DOOR REQUEST SW
102	Y	BLOWER FAN MOTOR RELAY CONT
103	L	KEYLESS ENTRY RECEIVER POWER SUPPLY
106	Y	S/L POWER SUPPLY
107	O	COMBI SW INPUT 1
108	P	COMBI SW INPUT 4
109	SB	COMBI SW INPUT 2
110	G	HAZARD SW
111	LG	S/L COMM

Connector No.	M123
Connector Name	BCM (BODY CONTROL MODULE)
Connector Type	TH40FG-NH

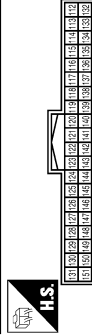

Terminal No.	Color of Wire	Signal Name [Specification]
112	R	RAIN SENSOR SERIAL LINK
113	O	OPTICAL SENSOR
116	GR	FUSE CHECK
118	L	STOP LAMP SW
119	W	DR DOOR UNL OCK SENSOR
121	Y	KEY SLOT SW
122	R	ACC F/B
123	G	IGN F/B
124	R	PASSENGER DOOR SW
130	BR	REAR DEFOGGER SW
132	G	POWER WINDOW SW COMM

133	W	PUSH-BUTTON IGNITION SW ILL POWER
137	P	RECEIVER SENSOR GND
138	V	RECEIVER SENSOR POWER SUPPLY
139	O	TIRE PRESS RECEIVER SIGNAL
140	GR	SHIFT N/P
141	O	SECURITY INDICATOR OUTPUT
142	L	COMBI SW OUTPUT 5
143	W	COMBI SW OUTPUT 1
144	P	COMBI SW OUTPUT 2
145	V	COMBI SW OUTPUT 3
146	Y	COMBI SW OUTPUT 4
149	W	TIRE PRESS WARNING CHECK SW
150	SB	DRIVER DOOR SW
151	G	REAR WINDOW DEFOGGER RELAY

Fail-safe

FAIL-SAFE CONTROL BY DTC

BCM performs fail-safe control when any DTC are detected.

JCMW3165GI

INFOID:000000004757395

A
B
C
D
E
F
G
H
I
J
K
L
N
O
P

PCS

BCM (BODY CONTROL MODULE)

[POWER DISTRIBUTION SYSTEM]

< ECU DIAGNOSIS >

Display contents of CONSULT	Fail-safe	Cancellation
B2013: ID DISCORD BCM-S/L	Inhibit engine cranking	Erase DTC
B2014: CHAIN OF S/L-BCM	Inhibit engine cranking	Erase DTC
B2190: NATS ANTENNA AMP	Inhibit engine cranking	Erase DTC
B2191: DIFFERENCE OF KEY	Inhibit engine cranking	Erase DTC
B2192: ID DISCORD BCM-ECM	Inhibit engine cranking	Erase DTC
B2193: CHAIN OF BCM-ECM	Inhibit engine cranking	Erase DTC
B2195: ANTI SCANNING	Inhibit engine cranking	Ignition switch ON → OFF
B2557: VEHICLE SPEED	Inhibit steering lock	When normal vehicle speed signals are received from ABS actuator and electric unit (control unit) for 500 ms
B2560: STARTER CONT RELAY	Inhibit engine cranking	500 ms after the following CAN signal communication status becomes consistent <ul style="list-style-type: none"> • Starter control relay signal • Starter relay status signal
B2601: SHIFT POSITION	Inhibit steering lock	500 ms after the following signal reception status becomes consistent <ul style="list-style-type: none"> • Selector lever P position switch signal • P range signal (CAN)
B2602: SHIFT POSITION	Inhibit steering lock	5 seconds after the following BCM recognition conditions are fulfilled <ul style="list-style-type: none"> • Ignition switch is in the ON position • Selector lever P position switch signal: Except P position (battery voltage) • Vehicle speed: 4 km/h (2.5 MPH) or more
B2603: SHIFT POSI STATUS	Inhibit steering lock	500 ms after the following BCM recognition conditions are fulfilled <ul style="list-style-type: none"> • Ignition switch is in the ON position • Selector lever P position switch signal: Except P position (battery voltage) • Selector lever P/N position signal: Except P and N positions (0 V)
B2604: PNP SW	Inhibit steering lock	500 ms after any of the following BCM recognition conditions are fulfilled <ul style="list-style-type: none"> • Status 1 <ul style="list-style-type: none"> - Ignition switch is in the ON position - Selector lever P/N position signal: P and N position (battery voltage) - P range signal or N range signal (CAN): ON • Status 2 <ul style="list-style-type: none"> - Ignition switch is in the ON position - Selector lever P/N position signal: Except P and N positions (0 V) - P range signal and N range signal (CAN): OFF
B2605: PNP SW	Inhibit steering lock	500 ms after any of the following BCM recognition conditions are fulfilled <ul style="list-style-type: none"> • Ignition switch is in the ON position <ul style="list-style-type: none"> - Power position: IGN - Selector lever P/N position signal: Except P and N positions (0 V) - Interlock/PNP switch signal (CAN): OFF • Status 2 <ul style="list-style-type: none"> - Ignition switch is in the ON position - Selector lever P/N position signal: P or N position (battery voltage) - PNP switch signal (CAN): ON
B2606: S/L RELAY	Inhibit engine cranking	500 ms after the following CAN signal communication status becomes consistent <ul style="list-style-type: none"> • Steering lock relay signal (Request signal) • Steering lock relay signal (Condition signal)

BCM (BODY CONTROL MODULE)

[POWER DISTRIBUTION SYSTEM]

< ECU DIAGNOSIS >

Display contents of CONSULT	Fail-safe	Cancellation
B2607: S/L RELAY	Inhibit engine cranking	500 ms after the following CAN signal communication status becomes consistent <ul style="list-style-type: none"> Steering lock relay signal (Request signal) Steering lock relay signal (Condition signal)
B2608: STARTER RELAY	Inhibit engine cranking	500 ms after the following signal communication status becomes consistent <ul style="list-style-type: none"> Starter motor relay control signal Starter relay status signal (CAN)
B2609: S/L STATUS	<ul style="list-style-type: none"> Inhibit engine cranking Inhibit steering lock 	When the following steering lock conditions agree <ul style="list-style-type: none"> BCM steering lock control status Steering lock condition No. 1 signal status Steering lock condition No. 2 signal status
B260A: IGNITION RELAY	Inhibit engine cranking	500 ms after the following conditions are fulfilled <ul style="list-style-type: none"> IGN relay (IPDM E/R) control signal: OFF (Battery voltage) Ignition ON signal (CAN to IPDM E/R): OFF (Request signal) Ignition ON signal (CAN from IPDM E/R): OFF (Condition signal)
B260F: ENG STATE SIG LOST	Maintains the power supply position attained at the time of DTC detection	When any of the following conditions are fulfilled <ul style="list-style-type: none"> Power position changes to ACC Receives engine status signal (CAN)
B2612: S/L STATUS	<ul style="list-style-type: none"> Inhibit engine cranking Inhibit steering lock 	When any of the following conditions are fulfilled <ul style="list-style-type: none"> Steering lock unit status signal (CAN) is received normally The BCM steering lock control status matches the steering lock status recognized by the steering lock unit status signal (CAN from IPDM E/R)
B2617: STARTER RELAY CIRC	Inhibit engine cranking	1 second after the starter motor relay control inside BCM becomes normal
B2618: BCM	Inhibit engine cranking	1 second after the ignition relay (IPDM E/R) control inside BCM becomes normal
B2619: BCM	Inhibit engine cranking	1 second after the steering lock unit power supply output control inside BCM becomes normal
B261E: VEHICLE TYPE	Inhibit engine cranking	BCM initialization
B26E9: S/L STATUS	<ul style="list-style-type: none"> Inhibit engine cranking Inhibit steering lock 	When BCM transmits the LOCK request signal to steering lock unit, and receives LOCK response signal from steering lock unit, the following conditions are fulfilled <ul style="list-style-type: none"> Steering condition No. 1 signal: LOCK (0V) Steering condition No. 2 signal: LOCK (Battery voltage)

HIGH FLASHER OPERATION

BCM detects the turn signal lamp circuit status by the current value.

BCM increases the turn signal lamp blinking speed if the bulb or harness open is detected with the turn signal lamp operating.

NOTE:

The blinking speed is normal while activating the hazard warning lamp.

FAIL-SAFE CONTROL BY RAIN SENSOR MALFUNCTION

- BCM judges the rain sensor serial link error by the rain sensor serial link condition and detects the rain sensor malfunction by rain sensor malfunction signal.
- When BCM detects the rain sensor serial link error or the rain sensor malfunction while front wiper AUTO operation, BCM operates a fail-safe control.

NOTE:

If rain sensor malfunction is detected when ignition switch is turned OFF ⇒ ON and front wiper switch is INT/AUTO position, BCM operates a fail-safe control.

REAR WIPER MOTOR PROTECTION

BCM detects the rear wiper stopping position according to the rear wiper stop position signal.

When the rear wiper stop position signal does not change for more than 5 seconds while driving the rear wiper, BCM stops power supply to protect the rear wiper motor.

Condition of cancellation

- More than 1 minute is passed after the rear wiper stop.

A
B
C
D
E
F
G
H
I
J
K
L

PCS

N
O
P

BCM (BODY CONTROL MODULE)

[POWER DISTRIBUTION SYSTEM]

< ECU DIAGNOSIS >

2. Turn rear wiper switch OFF.
3. Operate the rear wiper switch or rear washer switch.

DTC Inspection Priority Chart

INFOID:000000004757396

If some DTCs are displayed at the same time, perform inspections one by one based on the following priority chart.

Priority	DTC
1	B2562: LOW VOLTAGE
2	<ul style="list-style-type: none">• U1000: CAN COMM CIRCUIT• U1010: CONTROL UNIT (CAN)
3	<ul style="list-style-type: none">• B2190: NATS ANTENNA AMP• B2191: DIFFERENCE OF KEY• B2192: ID DISCORD BCM-ECM• B2193: CHAIN OF BCM-ECM• B2195: ANTI SCANNING
4	<ul style="list-style-type: none">• B2013: ID DISCORD BCM-S/L• B2014: CHAIN OF S/L-BCM• B2553: IGNITION RELAY• B2555: STOP LAMP• B2556: PUSH-BTN IGN SW• B2557: VEHICLE SPEED• B2560: STARTER CONT RELAY• B2601: SHIFT POSITION• B2602: SHIFT POSITION• B2603: SHIFT POSI STATUS• B2604: PNP SW• B2605: PNP SW• B2606: S/L RELAY• B2607: S/L RELAY• B2608: STARTER RELAY• B2609: S/L STATUS• B260A: IGNITION RELAY• B260B: STEERING LOCK UNIT• B260C: STEERING LOCK UNIT• B260D: STEERING LOCK UNIT• B260F: ENG STATE SIG LOST• B2612: S/L STATUS• B2614: ACC RELAY CIRC• B2615: BLOWER RELAY CIRC• B2616: IGN RELAY CIRC• B2617: STARTER RELAY CIRC• B2618: BCM• B2619: BCM• B261A: PUSH-BTN IGN SW• B261E: VEHICLE TYPE• B26E9: S/L STATUS• B26EA: KEY REGISTRATION• C1729: VHCL SPEED SIG ERR• U0415: VEHICLE SPEED SIG

BCM (BODY CONTROL MODULE)

[POWER DISTRIBUTION SYSTEM]

< ECU DIAGNOSIS >

Priority	DTC
5	<ul style="list-style-type: none"> • C1704: LOW PRESSURE FL • C1705: LOW PRESSURE FR • C1706: LOW PRESSURE RR • C1707: LOW PRESSURE RL • C1708: [NO DATA] FL • C1709: [NO DATA] FR • C1710: [NO DATA] RR • C1711: [NO DATA] RL • C1712: [CHECKSUM ERR] FL • C1713: [CHECKSUM ERR] FR • C1714: [CHECKSUM ERR] RR • C1715: [CHECKSUM ERR] RL • C1716: [PRESSDATA ERR] FL • C1717: [PRESSDATA ERR] FR • C1718: [PRESSDATA ERR] RR • C1719: [PRESSDATA ERR] RL • C1720: [CODE ERR] FL • C1721: [CODE ERR] FR • C1722: [CODE ERR] RR • C1723: [CODE ERR] RL • C1724: [BATT VOLT LOW] FL • C1725: [BATT VOLT LOW] FR • C1726: [BATT VOLT LOW] RR • C1727: [BATT VOLT LOW] RL • C1734: CONTROL UNIT
6	<ul style="list-style-type: none"> • B2621: INSIDE ANTENNA • B2622: INSIDE ANTENNA • B2623: INSIDE ANTENNA

DTC Index

INFOID:000000004757397

NOTE:

The details of time display are as follows.

- CRNT: A malfunction is detected now.
- PAST: A malfunction was detected in the past.

IGN counter is displayed on Freeze Frame Data. For details of Freeze Frame Data, refer to [BCS-17. "COMMON ITEM : CONSULT-III Function \(BCM - COMMON ITEM\)"](#).

CONSULT display	Fail-safe	Freeze Frame Data •Vehicle Speed •Odo/Trip Meter •Vehicle Condition	Intelligent Key warning lamp ON	Tire pressure monitor warning lamp ON	Reference page
No DTC is detected. further testing may be required.	—	—	—	—	—
U1000: CAN COMM CIRCUIT	—	—	—	—	BCS-40
U1010: CONTROL UNIT (CAN)	—	—	—	—	BCS-41
U0415: VEHICLE SPEED SIG	—	—	—	—	BCS-42
B2013: ID DISCORD BCM-S/L	×	×	—	—	SEC-55
B2014: CHAIN OF S/L-BCM	×	×	—	—	SEC-56
B2190: NATS ANTENNA AMP	×	—	—	—	SEC-47
B2191: DIFFERENCE OF KEY	×	—	—	—	SEC-50
B2192: ID DISCORD BCM-ECM	×	—	—	—	SEC-51
B2193: CHAIN OF BCM-ECM	×	—	—	—	SEC-53
B2195: ANTI SCANNING	×	—	—	—	SEC-54
B2553: IGNITION RELAY	—	×	—	—	PCS-49

BCM (BODY CONTROL MODULE)

< ECU DIAGNOSIS >

[POWER DISTRIBUTION SYSTEM]

CONSULT display	Fail-safe	Freeze Frame Data •Vehicle Speed •Odo/Trip Meter •Vehicle Condition	Intelligent Key warning lamp ON	Tire pressure monitor warning lamp ON	Reference page
B2555: STOP LAMP	—	×	—	—	SEC-59
B2556: PUSH-BTN IGN SW	—	×	×	—	SEC-61
B2557: VEHICLE SPEED	×	×	×	—	SEC-63
B2560: STARTER CONT RELAY	×	×	×	—	SEC-64
B2562: LOW VOLTAGE	—	×	—	—	BCS-43
B2601: SHIFT POSITION	×	×	×	—	SEC-65
B2602: SHIFT POSITION	×	×	×	—	SEC-68
B2603: SHIFT POSI STATUS	×	×	×	—	SEC-70
B2604: PNP SW	×	×	×	—	SEC-73
B2605: PNP SW	×	×	×	—	SEC-75
B2606: S/L RELAY	×	×	×	—	SEC-77
B2607: S/L RELAY	×	×	×	—	SEC-78
B2608: STARTER RELAY	×	×	×	—	SEC-80
B2609: S/L STATUS	×	×	×	—	SEC-82
B260A: IGNITION RELAY	×	×	×	—	PCS-51
B260B: STEERING LOCK UNIT	—	×	×	—	SEC-86
B260C: STEERING LOCK UNIT	—	×	×	—	SEC-87
B260D: STEERING LOCK UNIT	—	×	×	—	SEC-88
B260F: ENG STATE SIG LOST	×	×	×	—	SEC-89
B2612: S/L STATUS	×	×	×	—	SEC-92
B2614: ACC RELAY CIRC	—	×	×	—	PCS-53
B2615: BLOWER RELAY CIRC	—	×	×	—	PCS-56
B2616: IGN RELAY CIRC	—	×	×	—	PCS-59
B2617: STARTER RELAY CIRC	×	×	×	—	SEC-96
B2618: BCM	×	×	×	—	PCS-62
B2619: BCM	×	×	×	—	SEC-98
B261A: PUSH-BTN IGN SW	—	×	×	—	SEC-99
B261E: VEHICLE TYPE	×	×	× (Turn ON for 15 seconds)	—	SEC-102
B2621: INSIDE ANTENNA	—	×	—	—	DLK-95
B2622: INSIDE ANTENNA	—	×	—	—	DLK-97
B2623: INSIDE ANTENNA	—	×	—	—	DLK-99
B26E9: S/L STATUS	×	×	× (Turn ON for 15 seconds)	—	SEC-90
B26EA: KEY REGISTRATION	—	×	× (Turn ON for 15 seconds)	—	SEC-91
C1704: LOW PRESSURE FL	—	—	—	×	WT-16
C1705: LOW PRESSURE FR	—	—	—	×	
C1706: LOW PRESSURE RR	—	—	—	×	
C1707: LOW PRESSURE RL	—	—	—	×	

BCM (BODY CONTROL MODULE)

[POWER DISTRIBUTION SYSTEM]

< ECU DIAGNOSIS >

CONSULT display	Fail-safe	Freeze Frame Data •Vehicle Speed •Odo/Trip Meter •Vehicle Condition	Intelligent Key warning lamp ON	Tire pressure monitor warning lamp ON	Reference page
C1708: [NO DATA] FL	—	—	—	×	WT-18
C1709: [NO DATA] FR	—	—	—	×	
C1710: [NO DATA] RR	—	—	—	×	
C1711: [NO DATA] RL	—	—	—	×	
C1712: [CHECKSUM ERR] FL	—	—	—	×	WT-21
C1713: [CHECKSUM ERR] FR	—	—	—	×	
C1714: [CHECKSUM ERR] RR	—	—	—	×	
C1715: [CHECKSUM ERR] RL	—	—	—	×	
C1716: [PRESSDATA ERR] FL	—	—	—	×	WT-24
C1717: [PRESSDATA ERR] FR	—	—	—	×	
C1718: [PRESSDATA ERR] RR	—	—	—	×	
C1719: [PRESSDATA ERR] RL	—	—	—	×	
C1720: [CODE ERR] FL	—	—	—	×	WT-26
C1721: [CODE ERR] FR	—	—	—	×	
C1722: [CODE ERR] RR	—	—	—	×	
C1723: [CODE ERR] RL	—	—	—	×	
C1724: [BATT VOLT LOW] FL	—	—	—	×	WT-29
C1725: [BATT VOLT LOW] FR	—	—	—	×	
C1726: [BATT VOLT LOW] RR	—	—	—	×	
C1727: [BATT VOLT LOW] RL	—	—	—	×	
C1729: VHCL SPEED SIG ERR	—	—	—	×	WT-32
C1734: CONTROL UNIT	—	—	—	×	WT-33

A
B
C
D
E
F
G
H
I
J
K
L
N
O
P

PCS

PRECAUTION

PRECAUTIONS

Precaution for Supplemental Restraint System (SRS) "AIR BAG" and "SEAT BELT PRE-TENSIONER"

INFOID:000000004757477

The Supplemental Restraint System such as "AIR BAG" and "SEAT BELT PRE-TENSIONER", used along with a front seat belt, helps to reduce the risk or severity of injury to the driver and front passenger for certain types of collision. This system includes seat belt switch inputs and dual stage front air bag modules. The SRS system uses the seat belt switches to determine the front air bag deployment, and may only deploy one front air bag, depending on the severity of a collision and whether the front occupants are belted or unbelted. Information necessary to service the system safely is included in the "SRS AIRBAG" and "SEAT BELT" of this Service Manual.

WARNING:

- To avoid rendering the SRS inoperative, which could increase the risk of personal injury or death in the event of a collision which would result in air bag inflation, all maintenance must be performed by an authorized NISSAN/INFINITI dealer.
- Improper maintenance, including incorrect removal and installation of the SRS, can lead to personal injury caused by unintentional activation of the system. For removal of Spiral Cable and Air Bag Module, see the "SRS AIRBAG".
- Never use electrical test equipment on any circuit related to the SRS unless instructed to in this Service Manual. SRS wiring harnesses can be identified by yellow and/or orange harnesses or harness connectors.

PRECAUTIONS WHEN USING POWER TOOLS (AIR OR ELECTRIC) AND HAMMERS

When working near the Airbag Diagnosis Sensor Unit or other Airbag System sensors while ignition switch is ON or engine is running, never use air or electric power tools or strike near the sensor(s) with a hammer. Heavy vibration may activate the sensor(s), deploy the airbag(s), possibly cause serious injury. When using air or electric power tools or hammers, always turn OFF ignition switch, disconnect the battery, and wait 3 minutes or more before performing any service.

Precaution Necessary for Steering Wheel Rotation after Battery Disconnect

INFOID:000000004757478

NOTE:

- Before removing and installing any control units, first turn the push-button ignition switch to the LOCK position, then disconnect both battery cables.
- After finishing work, confirm that all control unit connectors are connected properly, then re-connect both battery cables.
- Always use CONSULT-III to perform self-diagnosis as a part of each function inspection after finishing work. If a DTC is detected, perform trouble diagnosis according to self-diagnosis results.

This vehicle is equipped with a push-button ignition switch and a steering lock unit.

If the battery is disconnected or discharged, the steering wheel will lock and cannot be turned.

If turning the steering wheel is required with the battery disconnected or discharged, follow the procedure below before starting the repair operation.

OPERATION PROCEDURE

1. Connect both battery cables.

NOTE:

Supply power using jumper cables if battery is discharged.

2. Turn the push-button ignition switch to ACC position.
(At this time, the steering lock will be released.)
3. Disconnect both battery cables. The steering lock will remain released with both battery cables disconnected and the steering wheel can be turned.
4. Perform the necessary repair operation.
5. When the repair work is completed, re-connect both battery cables. With the brake pedal released, turn the push-button ignition switch from ACC position to ON position, then to LOCK position. (The steering wheel will lock when the push-button ignition switch is turned to LOCK position.)
6. Perform self-diagnosis check of all control units using CONSULT-III.

PUSH-BUTTON IGNITION SWITCH DOES NOT OPERATE

< SYMPTOM DIAGNOSIS >

[POWER DISTRIBUTION SYSTEM]

SYMPTOM DIAGNOSIS

PUSH-BUTTON IGNITION SWITCH DOES NOT OPERATE

Description

INFOID:000000004757291

Check that vehicle is under the condition shown in “Conditions of vehicle” before starting diagnosis, and check each symptom.

NOTE:

The engine start function, door lock function, power distribution system, and NATS-IVIS/NVIS in the Intelligent Key system are closely related to each other regarding control. The vehicle security function can operate only when the door lock and power distribution system are operating normally.

Conditions of Vehicle (Operating Conditions)

With Intelligent Key system

- “ENGINE START BY I-KEY” in “WORK SUPPORT” is ON when setting on CONSULT-III.
- Intelligent Key is not inserted in key slot.
- One or more of Intelligent Keys with registered Intelligent Key ID is in the vehicle.

Without Intelligent Key system

Registered keyfob is into the key slot.

Diagnosis Procedure

INFOID:000000004757292

1.INSPECTION START

Check the vehicle type.

Which is the type?

With Intelligent Key system>>GO TO 2.

Without Intelligent Key system>>GO TO 4.

2.PERFORM WORK SUPPORT

Perform “INSIDE ANT DIAGNOSIS” on Work Support of “INTELLIGENT KEY”.

Refer to [DLK-61, "INTELLIGENT KEY : CONSULT-III Function \(BCM - INTELLIGENT KEY\)"](#).

>> GO TO 3.

3.PERFORM SELF-DIAGNOSTIC RESULT

Perform Self-Diagnostic Result of “BCM”.

Is DTC detected?

YES >> Refer to [DLK-95, "DTC Logic"](#) (instrument center), [DLK-97, "DTC Logic"](#) (console) or [DLK-99, "DTC Logic"](#) (trunk room).

NO >> GO TO 4.

4.CHECK PUSH-BUTTON IGNITION SWITCH

Check push-button ignition switch.

Refer to [PCS-66, "Component Function Check"](#).

Is the operation normal?

YES >> GO TO 5.

NO >> Repair or replace malfunctioning parts.

5.CONFIRM THE OPERATION

Confirm the operation again.

Is the inspection normal?

YES >> Check intermittent incident. Refer to [GI-40, "Intermittent Incident"](#).

NO >> GO TO 1.

PUSH-BUTTON IGNITION SWITCH POSITION INDICATOR DOES NOT ILLUMINATE

< SYMPTOM DIAGNOSIS >

[POWER DISTRIBUTION SYSTEM]

PUSH-BUTTON IGNITION SWITCH POSITION INDICATOR DOES NOT ILLUMINATE

Description

INFOID:000000003465788

- Before performing the diagnosis in the following table, check "Work Flow". Refer to [PCS-35, "Work Flow"](#).
- Check that vehicle is under the condition shown in "Conditions of vehicle" before starting diagnosis, and check each symptom.

Conditions of Vehicle (Operating Conditions)

- "ENGINE START BY I-KEY" in "WORK SUPPORT" is ON when setting on CONSULT-III.
- One or more of Intelligent Keys with registered Intelligent Key ID is in the vehicle.
- Registered keyfob is into the key slot. (Without Intelligent key system)

Diagnosis Procedure

INFOID:000000003375919

1. CHECK PUSH-BUTTON IGNITION SWITCH INDICATOR

Check push-button ignition switch indicator.

Refer to [PCS-68, "Component Function Check"](#).

Is the inspection result normal?

YES >> GO TO 2.

NO >> Repair or replace the malfunctioning parts.

2. CONFIRM THE OPERATION

Confirm the operation again.

Is the result normal?

YES >> Check intermittent incident. Refer to [GI-40, "Intermittent Incident"](#).

NO >> GO TO 1.

ON-VEHICLE REPAIR

BCM (BODY CONTROL MODULE)

Exploded View

INFOID:000000004757479

CAUTION:

Before replacing BCM, perform "READ CONFIGURATION" to save or print current vehicle specification. Refer to [BCS-3, "ADDITIONAL SERVICE WHEN REPLACING CONTROL UNIT \(BCM\) : Description"](#).

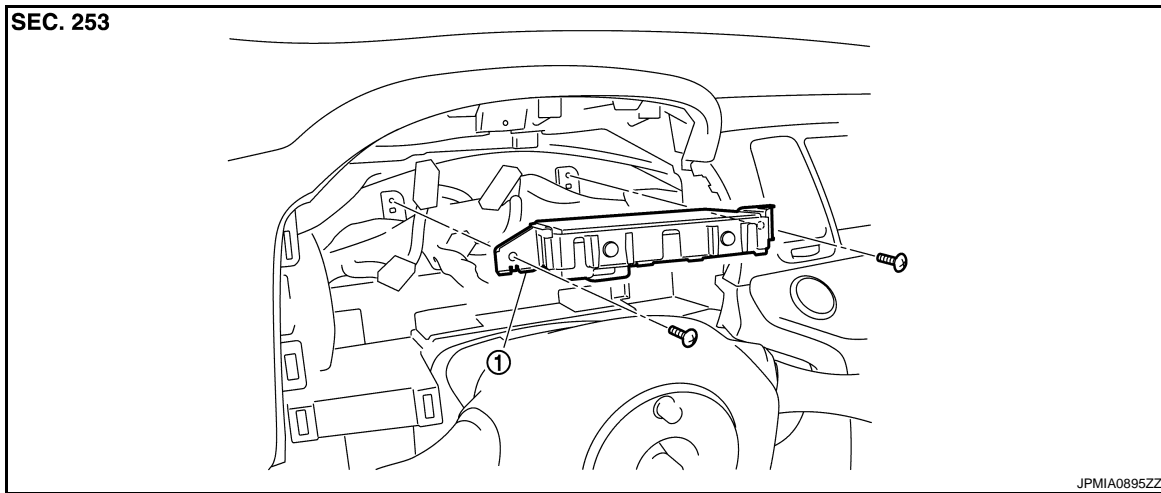

1. BCM

Removal and Installation

INFOID:000000004757480

CAUTION:

Before replacing BCM, perform "READ CONFIGURATION" to save or print current vehicle specification. Refer to [BCS-3, "ADDITIONAL SERVICE WHEN REPLACING CONTROL UNIT \(BCM\) : Description"](#).

REMOVAL

1. Remove combination meter. Refer to [MWI-145, "Exploded View"](#).
2. Remove screws.
3. Remove BCM and disconnect the connector.

INSTALLATION

Install in the reverse order of removal.

CAUTION:

- Be sure to perform "WRITE CONFIGURATION" when replacing BCM.
- Be sure to perform the system initialization (NATS) when replacing BCM. Refer to [BCS-3, "ADDITIONAL SERVICE WHEN REPLACING CONTROL UNIT \(BCM\) : Special Repair Requirement"](#).

A
B
C
D
E
F
G
H
I
J
K
L
N
O
P

PCS

PUSH BUTTON IGNITION SWITCH

< ON-VEHICLE REPAIR >

[POWER DISTRIBUTION SYSTEM]

PUSH BUTTON IGNITION SWITCH

Exploded View

INFOID:000000003466131

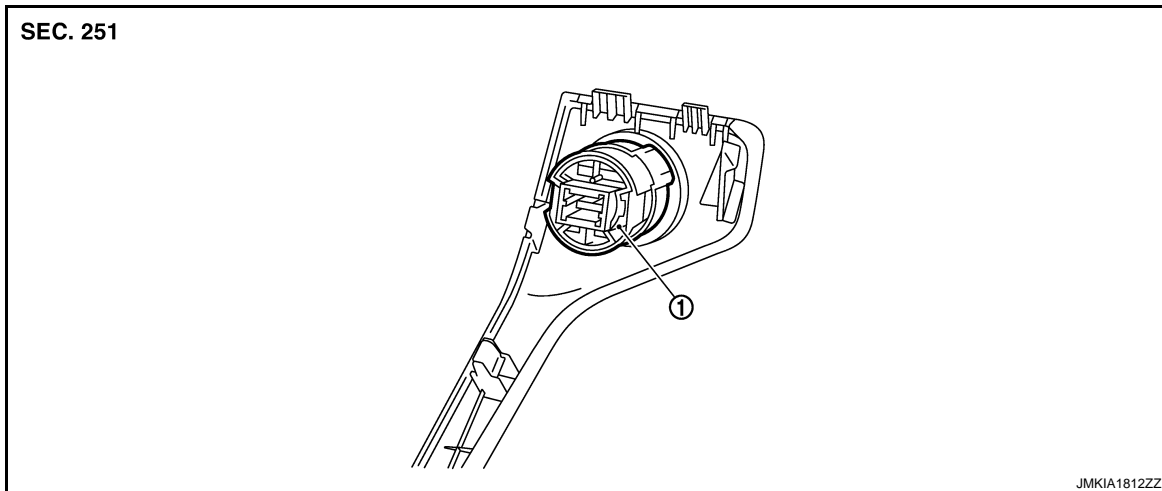

1. Push-button ignition switch

Removal and Installation

INFOID:000000003466132

REMOVAL

1. Remove the instrument stay cover LH. Refer to [IP-12, "Removal and Installation"](#).
2. Remove the push-button ignition switch (1) from instrument stay cover LH, after removing pawl (A). Press push-button ignition switch (1) back to disengage from instrument stay cover LH (2).

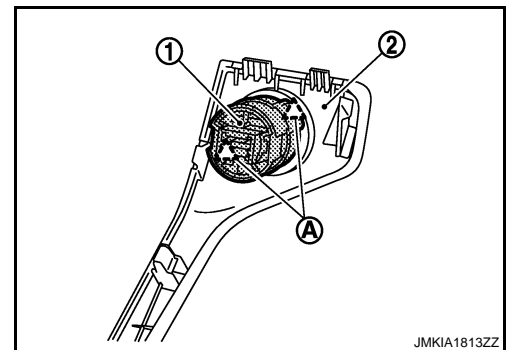

INSTALLATION

Install in the reverse order of removal.