

Fuel and Emissions

Subaru fuel and emissions systems have undergone important changes over the past few years. Some of these changes have been made to reduce emissions, while others have been made to improve engine performance and driveability. In this issue of *The End Wrench*, we'll take a brief look at some of these important changes and explain how the changes may affect your diagnosis and service of Subaru vehicles.

The Subaru "phase two" engine program began in 1999, with changes to the configurations of the Legacy 2.2 liter engine, Impreza 2.2 and 2.5 liter engines and the Forester 2.5 liter engine. The most notable change that occurred was the switch from an airflow controlled engine management system to a speed-density controlled system. The conventional airflow sensor has been eliminated and replaced by a barometric pressure sensor and a combination intake air temperature and manifold pressure sensor (a speed-density system in common parlance). This type of system is said to provide cleaner emissions than its airflow controlled predecessors.

New components of the speed-density controlled system include:

- Air Assisted Fuel Injectors,
- An Air Assist Injector Solenoid Valve,
- An Intake Air Temperature and Pressure Sensor,
- A Stepping-type Idle Air Control Solenoid Valve,
- A consolidated Ignition Coil and Igniter Assembly
- A Front Air-Fuel Ratio Sensor

Air Assisted Fuel Injectors

These injectors are supplied with fuel from the top of the injector, rather than from the bottom, as they were in the wet-bath injectors used in other Subaru fuel injection systems. Additionally, the tips of the air assisted fuel injectors are supplied with air from the idle air control solenoid valve. The air is used to provide faster atomization of fuel, resulting in lower emissions output and improved driveability.

Air from the idle air control solenoid valve is delivered through a passage in the intake manifold, which leads directly to the bottom of each injector. The negative pressure area below the injector is constantly replenished with positive pressure air supplied by the idle air control solenoid valve. This system was introduced on some 1999 models and continues with refinements on some 2000 models.

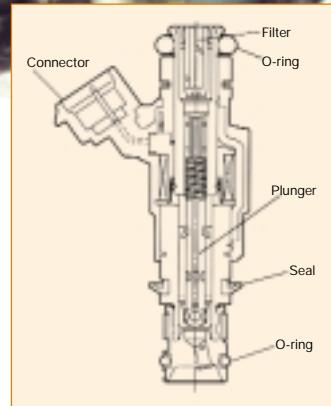
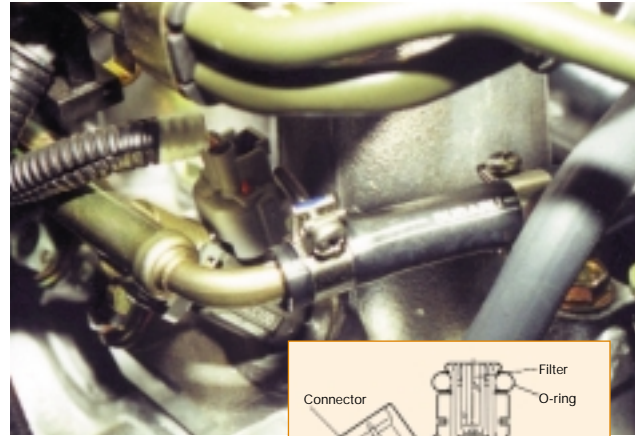

Air Assist Injector Solenoid Valve

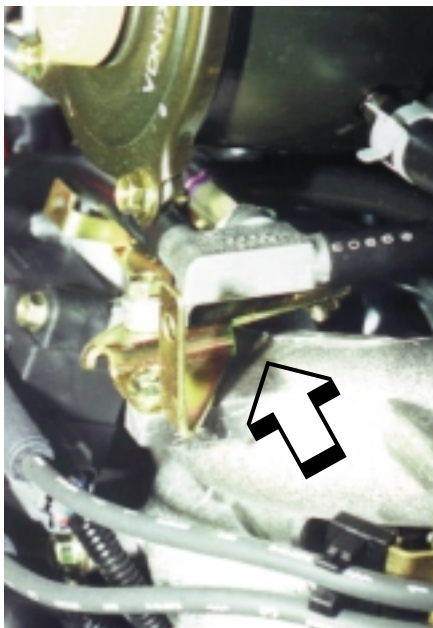

An air assist injector solenoid valve was added to 2000 Legacy automatic, Impreza 2.5 liter and all Forester models (UJ fuel system). The valve is located in the piping between the throttle body and the air assisted injectors and is secured to the intake manifold. The valve is connected to

the inlet side of the idle air control valve to regulate the flow of air to the base of the air assisted fuel injectors. At idle, the air assist solenoid is ON, allowing an airflow of 20 liter/min per injector. The air assist solenoid is

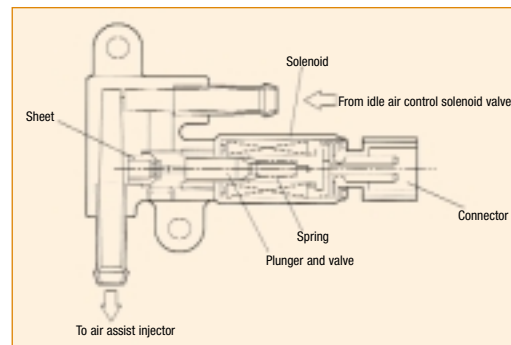

turned OFF during off idle conditions, allowing an airflow of only 5 liter/min per injector. On ND fuel systems, the flow of air to the air assisted fuel injectors is controlled by the idle air control solenoid valve alone.

Intake Air Temperature and Pressure Sensor

The intake air temperature and pressure sensor monitors the absolute pressure and temperature of the air in the intake manifold. The measured temperature and pressure is then converted into electrical signals and sent to the ECM. The ECM uses these signals to control the fuel injection amount, as well as the injection and ignition timing. UJ fuel systems continue to use a separate atmospheric pressure sensor, mounted on the right strut tower.

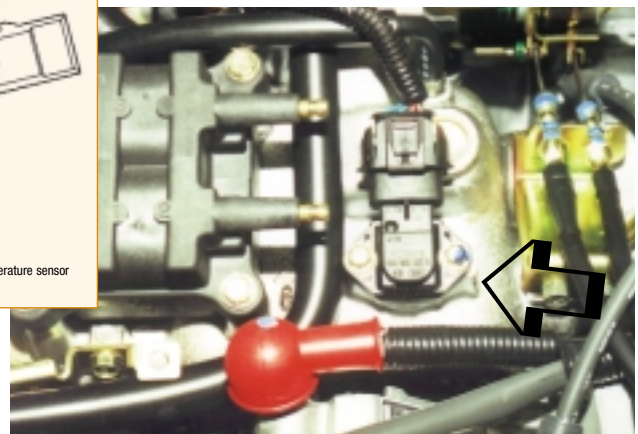
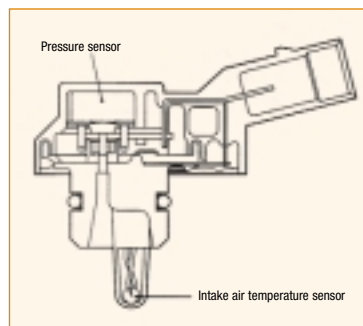

Fuel and Emissions

Atmospheric Pressure Sensor

The atmospheric pressure sensor, mounted on the right strut tower, converts the atmospheric pressure information into an electrical signal that is relayed to the ECM. The ECM compares the atmospheric pressure

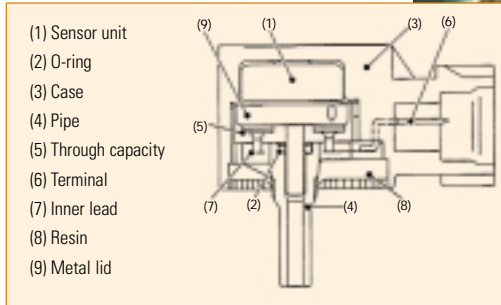
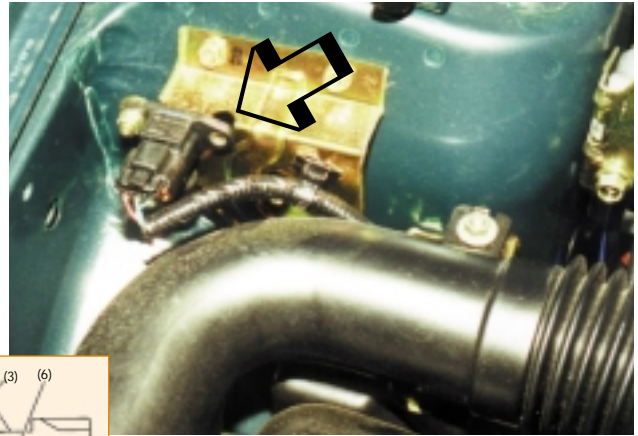

reading to the manifold absolute pressure reading supplied by the intake pressure sensor. This information, combined with engine and vehicle speed, throttle opening and other inputs, allows the ECM to determine engine load (a speed density system).

Idle Air Control Solenoid Valve

UJ fuel systems feature a stepping motor idle air control valve, while the ND system continues with a rotary idle air control valve. The stepping motor idle air control valve is attached to the throttle body and regulates the amount of intake air which bypasses the throttle valve built into the throttle body. The valve is activated by a signal from the ECM to maintain engine idle speed in the target range.

The idle air control solenoid valve is a stepping motor which consists of coils, shaft, permanent magnet, spring and housing. The housing is integral with the throttle body.

In the stepping motor type air control valve, current flows sequentially through a series of paired coils which are arranged face to face with the shaft between, while alternating the polarity for each pair of coils.

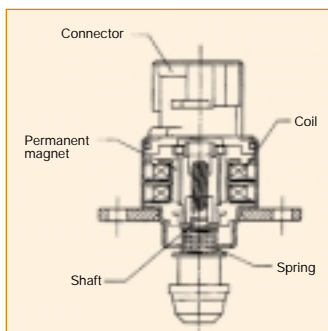
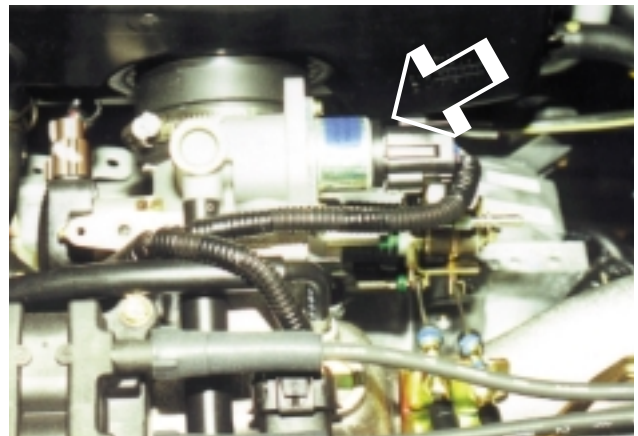

Permanent magnets surround the stepping motor's threaded shaft. As current flows through the paired coils, the N and S poles of the permanent magnets of the shaft are repelled by the same poles of the coils, which causes the shaft to turn. Because the shaft is threaded, it moves upward or downward, depending on the polarity of the alternating current through the coils. The shaft changes direction when the direction of current flow is reversed. These upward and downward shaft movements open and close the valve port, adjusting the amount of bypass air.

To initialize the idle air control valve after replacement, turn the ignition on for 15-30 seconds (KOEO). Then start the engine and allow it to idle.

Ignition Coil and Igniter Assembly

The ignition coil and igniter are now contained in a single unit. The igniter consists of four transistors.



Two of the transistors directly control grounding of the coil primary circuits. The remaining two transistors control current flow through the primary windings. The ECM sends a 12 volt

square wave to the igniter. The igniter in turn controls the coil primary winding.

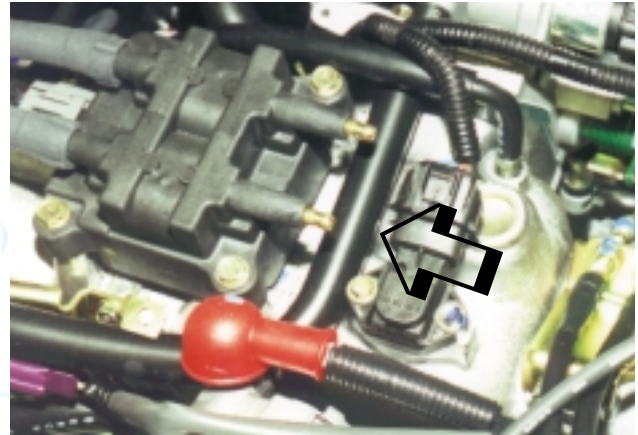

Air-Fuel Ratio Sensor

On vehicles equipped with the UJ fuel system, an air-fuel ratio sensor takes the place of the front oxygen sensor. Although physically similar to a conventional oxygen sensor, the air-fuel ratio sensor operates in a different manner and outputs a different signal to the ECM. If you are unaware of these changes, you may misdiagnose the air-fuel ratio sensor. In fact, some aftermarket scan tools are unable to recognize the information provided by the air-fuel ratio sensor. Consequently, the scan tool may report no data from the air-fuel ratio sensor, which may lead you to believe the air-fuel ratio sensor is not functioning, or that it is functioning incorrectly.

To visually identify the air-fuel ratio sensor, check the harness connectors. The connectors feature a new locking mechanism and a physically larger connector body. The sensor harness also includes an electrical compensation device that allows for manufacturing tolerances.

A portion of the air-fuel ratio sensor's zirconium oxide sensing element is exposed to the engine exhaust flow. The zirconium oxide has the property of generating an electromotive force when contacting an oxygen ion, and the amount of force generated varies depending upon the amount of oxygen ions present. The air-fuel ratio sensor detects the amount of oxygen present in the exhaust in a linear fashion. The sensor housing is grounded to the exhaust pipe, and the inside is connected to the ECM through the harness.

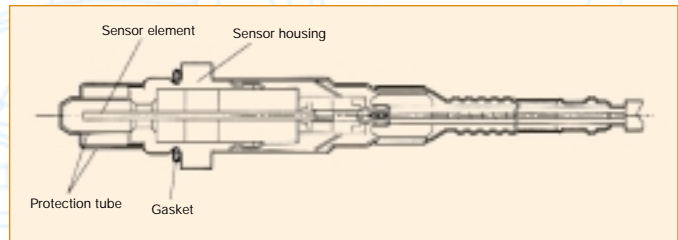

When a rich air-fuel mixture is burnt in the engine, the oxygen in the exhaust gases reacts almost completely through the catalytic action of the platinum coating on the surface of the zirconia tube. This results in a very large difference in the oxygen concentration between the inside and outside of the sensor, and the electromotive force generated by the sensor is large.

When a lean air-fuel mixture is burnt in the engine, oxygen remains in the exhaust gases even after the catalytic action. This results in a small difference in the oxygen concentration between the inside and outside of the sensor. The electromotive force generated by the sensor is very small.

The difference in oxygen concentration changes greatly in the vicinity of the optimum air-fuel ratio, and the change in the electromotive force produced by the sensor is also large at this point. This information is used by the

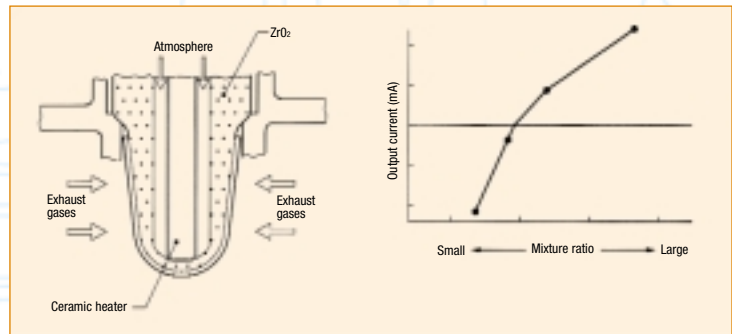

Fuel and Emissions

ECM to determine the engine's air-fuel ratio and to make appropriate adjustments to injector on-time.

The air-fuel ration sensor does not generate much electromotive force when the exhaust temperature is low. The characteristics of the electromotive force stabilize when the exhaust temperature is approximately 700 degrees C (1293 degrees F). A ceramic heater is used to improve low temperature sensor performance.

Rear Oxygen Sensor

The rear oxygen sensor is used to sense the oxygen concentration in the exhaust gas after the exhaust has passed through the catalytic converter. If the fuel ratio is leaner than the ideal stoichiometric ratio, the exhaust contains more oxygen. If the fuel ratio is richer than the ideal stoichiometric ratio, the exhaust gas contains hardly any oxygen. Therefore, examination of the oxygen concentration in the exhaust gases makes it possible to determine whether the air-fuel ratio is leaner or richer than the ideal stoichiometric ratio. In the case of the rear oxygen sensor, it is also possible to gauge the function of the catalytic converter.

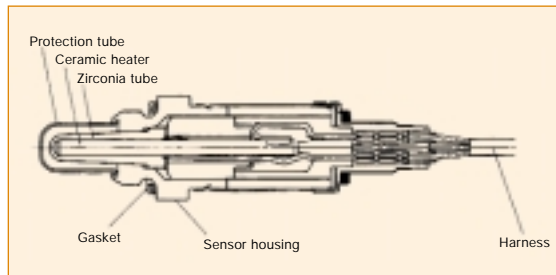

The rear oxygen sensor has a zirconia tube that generates a voltage if there is a difference in oxygen between the inside and outside of the tube. The inside of the tube is exposed to the atmosphere, while the outside of the tube is exposed to the engine exhaust.

Platinum is coated on the inside and outside of the zirconia tube. The sensor housing is grounded to the exhaust pipe, and the inside of the tube is connected to the ECM through the vehicle harness.

When a rich air-fuel ratio is burnt in the engine, the oxygen in the exhaust gases reacts almost completely through the catalytic action of the platinum coating of the

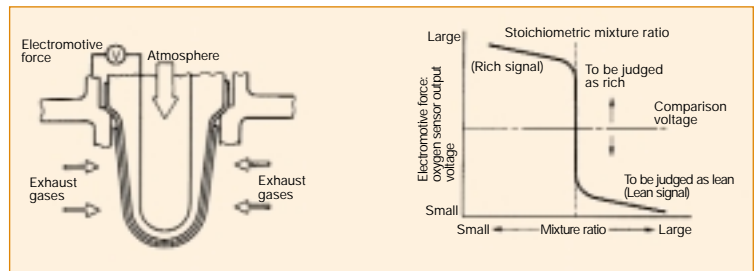

surface of the zirconia tube. This results in a very large difference in the oxygen concentration between the inside and the outside of the zirconia tube, and the electromotive force generated is large.

When a lean air-fuel mixture is burnt in the engine, oxygen remains in the exhaust gases even after the catalytic action, and this results in a small difference in the oxygen concentration. The electromotive force generated is very small.

The difference in oxygen concentration changes greatly in the vicinity of the optimum air-fuel ratio (stoichiometric), and the change in electromotive force is also large at this point. By inputting this information to the ECM, the air-fuel ratio of the supplied mixture can be determined. Since this information is collected after the exhaust gases have passed through the catalytic converter, the effectiveness of the converter can also be determined.

The oxygen sensor does not generate much electromotive force when the exhaust temperature is low. The sensor's electromotive force stabilizes at a temperature of approximately 300-400 degrees C (572-752 degrees F). A ceramic heater is employed to improve the sensor's performance at low exhaust temperatures.