



Technicians Reference Booklet

Boxer Engine
Series Module

Module 104

MSA5P0131C

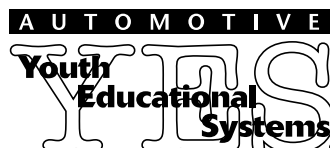

Technical Training

**© Copyright 2001
Subaru of America, Inc.**

All rights reserved. This book may not be reproduced in whole or in part without the express permission of Subaru of America, Inc.

Subaru of America, Inc. reserves the right at any time to make changes or modifications to systems, procedures, descriptions, and illustrations contained in this book without necessarily updating this document. Information contained herein is considered current as of August 2001.

Boxer Engine Series Module

Table of Contents

Slide Sequence	5
Introduction	10
General Overview	10
2.2L Engine Identification	10
2.2L Engine (Phase 1) Features	11
2.2L Engine Servicing & Diagnostics	15
In Vehicle Servicing	15
Engine Diagnostics	15
2.2L Engine Disassembly	16
2.2L Component Inspection and Servicing	21
Precautions	23
2.2L Engine Reassembly	24
Notes and Cautions	28
2.2L Engine Disassembly	28
2.2L Engine Reassembly	29
Engine Enhancements 2.2 Liter (Phase 1)	29
Other Engine Modifications	31
1999 2.2 Liter (SOHC) (Phase 2) Engine Enhancements	31
New Features of the Phase Two Engines	32
2.5 Liter Engine Features	35
Spark Plug Replacement Procedure for 2.5 Liter Engine	37
Installation	37
1997 2.5 Engine DOHC (Phase 1)	38
2.5 Engines 1999 Enhancements DOHC (Phase 1) and SOHC (Phase 2)	41
New Features of the 2.5 Liter (Phase 2) SOHC Engines	42
2.0 Liter Engine Features	45
3.0 Liter Engine	48
General Information	48
3.0 Liter Engine Features	48
3.0 Specifications	48
3.0 Liter Engine Disassembly	51
Unloading Cam Sprockets	55
Removal of Oil Pump	57
O-Ring Placement Inner Cover	58
Removal of Cylinder Head	58
Removal of Oil Pan	59
Piston Pin Access	60
Splitting Block Halves	60
Lubrication System	61
Coolant System	62
Valve Adjustment	63
Chain Tensioners	64
3.0 Liter Engine Reassembly	65
Fuji Bond Application Guide for Block Halves	69
Oil Pan Extension Housing (Upper Oil Pan)	70
Fuji Bond Application Guide for Oil Pan (Lower)	71
Fuji Bond Application Guide for Inner Cover	72
Fuji Bond Application Guide for Outer Cover (Front Chain Cover)	73
3.3 Liter Engine Service Procedures	74
Special Tools	80
General Hand Tools and Supplies	80
Reference Materials	80
Service Bulletins	82
104 Module Service Help-Line Updates	83

Slide Sequence

Slide No.	Description	Page No.
1	Title Slide (Boxer Engine Series Module)	
2	Created By	
3	Teaching Aids	
4	Introduction	10
5	General Overview	10
6	Engine Identification (Artwork)	10
7	Specifications (Artwork)	10
8	Engine Identification Numbers	10
9	Title Slide (2.2L Engine (Phase 1) Features)	11
10	Cylinder Head Design (Artwork)	11
11	Combustion Chamber	11
12	Valve Components	11
13	N/A Camshaft Supports	12
14	Rocker Shaft Assembly (Artwork)	12
15	Hydraulic Lash Adjusters	12
16	Head Gaskets	12
17	Crankcase Half	13
18	Crankshaft Assembly	13
19	Connecting Rods	13
20	N/A Pistons	13
21	Cam Belt System	14
22	Cam Belt Covers	14
23	Water Pump Assembly-Cooling System	14
24	Oil Pump	14
25	Oil Pump Cross Section (Artwork)	15
26	Title Slide (2.2L Engine Servicing & Diagnostics)	15
27	Title Slide (2.2L Engine Disassembly)	16
28	Engine on Stands	16
29	Remove Crank Pulley	16
30	Mark Cam Belt	16
31	Remove Idler Pulleys	16
32	Remove Camshaft Sprockets	17
33	Camshaft Sprockets	17
34	Tensioner Bracket Removal	17
35	Inner Cam Belt Cover Removal	17
36	Engine Accessory Removal	18
37	Remove the Water Transfer Pipe	18
38	Remove Knock Sensor	18
39	Remove Crank Angle Sensor	18
40	Remove Cam Angle Sensor	18
41	Remove Water Pump	19
42	Remove Oil Pump	19
43	Cylinder Head Removal	19
44	Remove Oil Pan	19
45	Piston Pin Removal	20
46	Crankcase Hidden Bolts (Right Bank)	20
47	Crankcase Hidden Bolts (Left Bank)	20
48	Crankcase Half with O-Rings	20
49	Title Slide (2.2L Component Inspection and Servicing)	21
50	Cylinder Head Disassembly	21
51	HLA Removal	21
52	Refilling HLAs	21
53	Depressing HLA Check Ball	21
54	Filling the HLA Sockets	22
55	Installing HLAs	22

Slide Sequence

Slide No.	Description	Page No.
56	Tensioner Inspection	22
57	Rocker Arm Inspection	22
58	Valve Guide Removal	23
59	Valve Components	23
60	Installing Valve Guides	23
61	Installing Valve Guides Oil Seal	23
62	Installing the Oil Seal	24
63	Storing Cylinder Heads	24
64	Title Slide (2.2L Engine Reassembly)	24
65	Assemble Crankshaft	24
66	Crankcase Sealer and O-Rings	24
67	Piston Installation	25
68	Circlip Removal	25
69	Installing Oil Pick-Up Tube	25
70	Oil Pan Drain Tube Seal	25
71	Dipstick Tube and Seals	26
72	Installing Rear Crankshaft Oil Seal	26
73	Installing Oil Pump	26
74	Cylinder Head Torque Sequence	26
75	Compressing the Tensioner	27
76	Cam Sprocket Installation	27
77	Installing Idler Pulleys	27
78	Loading Tensioner	28
79	Remove Retaining Pin	28
80	Install Cam Belt Cover / Accessories	28
81	Title Slide (Notes and Cautions)	28
82	Title Slide (Engine Enhancements 2.2 Liter (Phase 1))	29
83	Redesigned Piston	29
84	2.2 Liter Valve Train Assembly	30
85	Cylinder 1 (Artwork)	30
86	Cylinder 3 (Artwork)	30
87	Cylinder 2 (Artwork)	30
88	Cylinder 4 (Artwork)	30
89	Measuring Valve Clearance	31
90	Adjusting Valve Clearance	31
91	Other Engine Modifications	31
92	Title Slide (1999 2.2 Liter (SOHC) (Phase 2) Engine Enhancements)	31
93	Mounting Holes and Studs	31
94	Thrust Bearing	31
95	Main Bearing Oil Grooves	32
96	Title Slide (New Features of the Phase Two Engines)	32
97	Valve Train	32
98	New Head Gasket Design	32
99	Identification of Rocker Arms	32
100	Roller Rockers	32
101	Adjustment Screw and Nut	33
102	Camshaft Secured by Camcase	33
103	Camcase Sealing Passages	33
104	Groove Edges	33
105	Identification Marks of Rocker Arms	34
106	Torque Specs and Measurements	34
107	Bolts Sequence	34
108	Engine Cam belt Timing Marks Locations	34
109	Right Bank Timing Mark	35
110	Open Deck Design	35
111	New Piston Design	35

Slide Sequence

Slide No.	Description	Page No.
112	Title Slide (2.5 Liter Engine Features)	35
113	2.5 Liter Engine	35
114	Camshaft Sprocket (Left Bank) (Rear)	35
115	Camshaft Sprocket Timing Marks (Left Bank)	35
116	Valve Interference	36
117	Camshaft Sprocket Timing Marks (Right Bank)	36
118	Camshafts	36
119	2.2 and 2.5 Liter Head Gaskets	37
120	Valve Spring Assembly	37
121	Direct Type HLA	37
122	Spark Plug Removal	37
123	Title Slide (1997 2.5 Engine DOHC (Phase 1))	38
124	Redesign 2.5 Liter Piston	38
125	2.5 Liter Valve Assembly	38
126	2.5 Liter Head on the Car	38
127	Bucket and Shim Assembly	39
128	Identifying Shim Size	39
129	Checking Valve Clearance On The Car	39
130	Exhaust Valve Clearance on Cylinders 1 and 3	40
131	Intake Valve Clearance on Cylinders 1 and 3	40
132	Exhaust Valve Clearance on Cylinder 2 and 4	40
133	Intake Valve Clearance on Cylinders 2 and 4	40
134	Title Slide (2.5 Engines 1999 Enhancements DOHC (Phase 1) and SOHC (Phase 2))	41
135	Engine to Transmission Mounting	41
136	Thrust Bearing Location	41
137	Main Bearing Oil Grooves	42
138	Title Slide (New Features of the 2.5 Liter (Phase 2) SOHC Engines)	42
139	2 Rocker Shaft Assembly	42
140	New Head Gasket Design	42
141	Rocker Arm Identification	42
142	Roller Rockers and Wave Washers	42
143	Adjustment Screw and Nut	43
144	Camshaft Secured by Camcase	43
145	Camcase Sealing Points	43
146	Sealing Groove	43
147	Rocker Identification	44
148	Rocker Arm Measurements	44
149	Camcase Tightening Sequence	44
150	Timing Belt Marks	44
151	Right Bank Timing Mark Window	44
152	Open Deck Design	45
153	Piston with Valve Release	45
154	Title Slide (2.0 Liter Engine Features)	45
155	2.0 Liter Engine	45
156	Cam Belt and Idler Pulleys	45
157	Intake Camshaft Sprocket Timing Marks (Left Bank)	46
158	Exhaust Camshaft Sprocket Timing Marks (Left Bank)	46
159	Intake Camshaft sprocket Timing Marks (Right Bank)	46
160	Exhaust Camshaft Sprocket Timing Marks (Right Bank)	46
161	Engine Designation Number	47
162	Factory Coolant Pipe Plug	47
163	2.0 Liter Valve Train Assembly	47
164	2.0 Liter Head Bolt Access	47
165	Turbo Oil and Coolant Passages (Right Bank)	47
166	Crankshaft and Camshaft sprockets for the 2.0 Turbo Engine	47
167	Title Slide (3.0 Liter Engine)	48

Slide Sequence

Slide No.	Description	Page No.
168	3.0 Liter Engine with Stands	48
169	Single Serpentine Belt	48
170	Belt Wear Indicator	48
171	Upper Radiator Hose connections	49
172	Oil Cooler	49
173	Individual Coils	49
174	Coil and Igniter Assembly	49
175	Lower Radiator Hose	49
176	Oil Pan and Extension Case	50
177	Crankcase Ventilation System	50
178	Crank Angle Sensor with Reluctor	50
179	Title Slide (3.0 Liter Engine Disassembly)	51
180	Unloading Tensioner	51
181	Fuel Rail Assembly	51
182	Lower Alternator Bolt	51
183	Remove Accessories	51
184	Crankshaft Bolt Cover	51
185	Crankshaft Bolt Seal	52
186	Outer Cover Seals	52
187	Outer Cover Bolts	52
188	Timing Chain Routing	52
189	Timing Chain Oil Jet	53
190	Right Bank Camshafts	53
191	Left Bank Timing Marks	53
192	Camshaft Sprockets	53
193	Timing Chains	54
194	Removal of Right Bank Timing Chain Components	54
195	Removal of Left Bank Timing Chain Components	54
196	Turn Crankshaft to Prevent Piston and Valve Damage	54
197	Right Bank Camshafts in Loaded Position	55
198	Unloading Intake Camshaft	55
199	Unloading Intake Camshaft	55
200	Unloading Exhaust Camshaft	55
201	Unloading Exhaust Camshaft	56
202	Remove Camshaft Sprockets (Right Bank)	56
203	Remove Camshaft Sprockets (Left Bank)	56
204	Water Pump Assembly	56
205	Insert Bolts for Pump Removal	57
206	Oil Pump Cover	57
207	Chain Guide	57
208	Chain Guide Bolts	57
209	Oil Relief Valve Housing	58
210	Inner Cover	58
211	O-Ring Locations	58
212	Valve Train Assembly	58
213	Cylinder Block with Head Gasket	59
214	Open Deck Design	59
215	Oil Pan (Upper)	59
216	Oil Pan (Lower)	59
217	Oil Pan Bolt Locations	59
218	Block O-Ring Locations	60
219	Piston Pin Access (Front View)	60
220	Piston Pin Access (Rear View)	60
221	Engine Block Assembly Bolts (Right Bank)	60
222	Main Bearings	61
223	Crankshaft and Connecting Rods	61

Slide Sequence

Slide No.	Description	Page No.
224	Oil Flow (Artwork)	61
225	Pump Gears (Front Side)	61
226	Pump Gears (Back Side)	62
227	Relief Valve Case (Front Side)	62
228	Relief Valve Case (Back Side)	62
229	Coolant Flow (Artwork)	62
230	Water Pump Housing	63
231	Water Jackets (Left Hand Bank)	63
232	Head Gaskets Coolant Passages	63
233	Cintered Camshafts	63
234	Camshaft Sensor Reluctor	63
235	Valve Adjustment Tool	64
236	Valve Adjustment Tool Placement	64
237	Adjusting Bucket Depression Finger	64
238	Chain Tensioners (Left Bank and Right Bank)	64
239	Worm Gear Assembly	65
240	Title Slide (3.0 Liter Engine Reassembly)	65
241	Crankshaft Timing Mark	65
242	Left Bank Intake Camshaft Timing Mark	65
243	Left Bank Exhaust Camshaft Timing Mark	65
244	Matching Links to Timing Marks (Left Bank)	66
245	Installing Guides and Idlers (Left Bank)	66
246	Loading Exhaust Camshaft (Right Bank)	66
247	Loading Exhaust Camshaft (Right Bank)	66
248	Loading Intake Camshaft (Right Bank)	67
249	Loading Intake Camshaft (Right Bank)	67
250	Aligning TDC Mark	67
251	Intake Camshaft Timing Marks (Right Bank)	68
252	Exhaust Camshaft Timing Marks (Right Bank)	68
253	Lower Idler Timing Marks	68
254	Chain Guides and Idlers (Right Bank)	68
255	Fuji Bond Application Guide for Block Halves	69
256	Oil Pan Extension Housing (Upper Oil Pan)	70
257	Fuji Bond Application Guide for Oil Pan (Lower)	71
258	Fuji Bond Application Guide for Inner Cover	72
259	Fuji Bond Application Guide for Outer Cover (Front Chain Cover)	73
260	Title Slide (3.3 Liter Engine Service Procedures)	74
261	Camshaft Sprocket Alignment	74
262	Camshaft sprocket Alignment (Right Bank)	74
263	Camshaft Sprocket Alignment (Left Bank)	74
264	Camshaft Sub-Gear Servicing	74
265	Two Piece Gear	75
266	Sub-Gear Spring	75
267	Piston Pin Circlip Removal	75
268	Piston Pin Removal	75
269	Piston Removal	76
270	Piston Installation	76
271	Install Intake Camshaft	76
272	Install Intake Camshaft	76
273	Front Camshaft Cover Installation	77
274	Exhaust Camshaft Oil Seal Installation	77
275	Left Camshaft Sprocket	77
276	Crankshaft Sprocket Installation	78
277	Cam Belt Installation (Right Bank)	78
278	Cam Belt Installation (Crankshaft)	78
279	Cam Belt Installation (Left Bank)	78

Boxer Engine Series Module

Introduction

This Technicians Reference Booklet introduces the Subaru 2.2 liter (SOHC) naturally aspirated (N/A), (Phase 1) and (Phase 2) engines, the 2.5 liter (DOHC) (Phase 1) and (SOHC) (Phase 2) engines, the 2.0 liter Turbo engine and the 3.0 and 3.3 liter six cylinder engines

It reviews the mechanical features of these engines and the differences between existing engines. It also covers the procedures used in diagnosing and overhauling these engines. The text and illustrations are derived from and follow the classroom lectures and slide presentations and they are intended to supplement and reinforce classroom instruction and serve as a home-study reference source. A list of applicable Service Bulletins, Important Notes and Cautions, and Special Tools are given within this booklet. Pages for Diagnostic Tips and Notes are also provided.

Technicians worksheets are to be completed during the hands-on lab work segments of the Boxer Engine Series Module.

Always refer to the appropriate model year Subaru Service Manual and the applicable service bulletins for all specification and detailed servicing procedures.

General Overview

2.2L Engine Identification

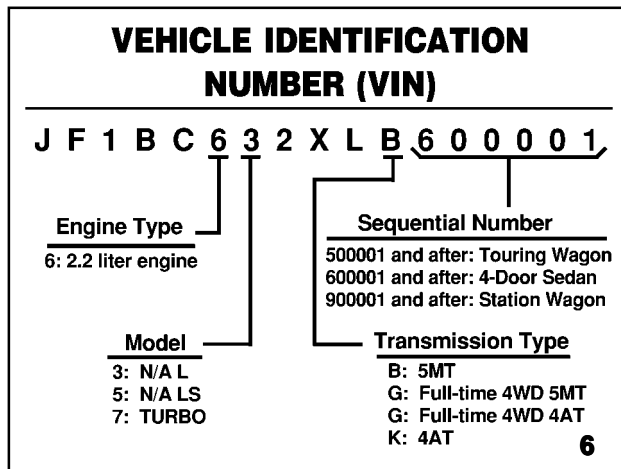

Engine Identification

The 2.2L engine designation is the sixth digit of the vehicle identification number (VIN). It is important to always first identify the engine before beginning diagnosis and servicing. Body type and transmission type, as well as the model year, are also information pertinent to engine diagnosis and servicing. As shown in the illustration, all this information is available from the VIN and the appropriate service manual.

Specifications

Displacement:.....2.2 Liters (2212cc)
Bore and Stroke:....3.815 in. x 2.953 in.
 96.9mm x 75mm
Compression Ratio:....9.5:1 (1995)
 9.7: 1 (1996-98)
 10: 1 (1999 & Later)
Firing Order:.....1 - 3 - 2 - 4
Odd numbers: right bank
Even numbers: left bank
Max. Power:....135 HP @ 5400 RPM (1995-96)
 137 HP @ 5400 RPM (1997-98)
 142 HP @ 5600 RPM (1999 & Later)
Max. Torque: 140 Ft. Lbs. @ 4400 RPM 1995-96)
 145 Ft. Lbs. @ 4000 RPM (1997-98)
 149 Ft. Lbs. @ 3600 RPM (1999 & Later)

7

2.2L N/A Engine

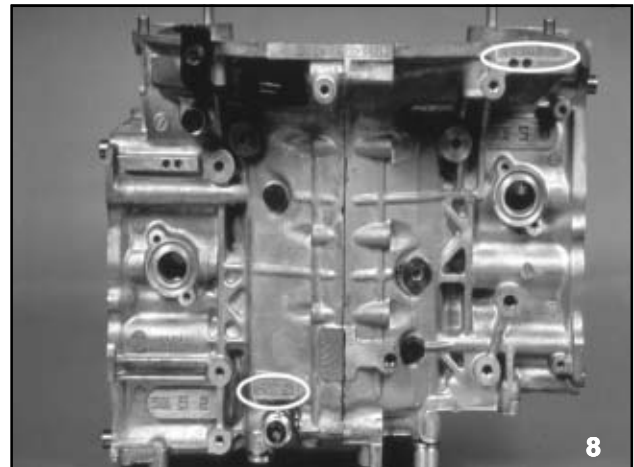

8

Engine Serial and Designation Number

The engine serial number is located on the machined boss on the left side of the clutch housing. The 2.2L engine designation is EJ22.

Boxer Engine Series Module

2.2L Engine (Phase 1) Features

The 2.2L SOHC four valves per cylinder engine is an addition to the existing Subaru "Boxer" design. The horizontally opposed, 4 stroke, 4 cylinder, liquid cooled, gasoline engine has aluminum alloy block and heads. It uses a normally aspirated MPI system. The cylinder liners are of a cast iron dry type design.

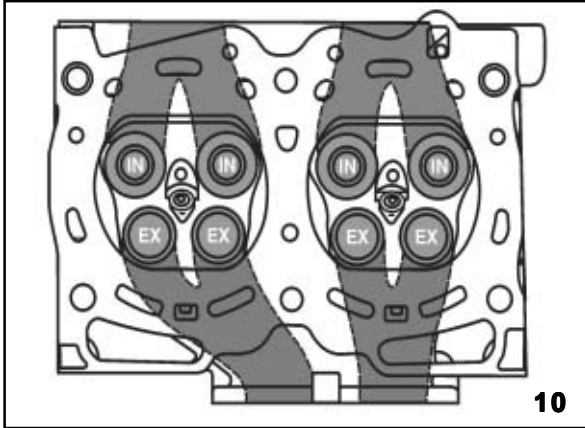

Cylinder Head Design

The 2.2L engine uses a cross-flow cylinder head design similar to the 1800cc OHC engine. Better breathing is provided by the two intake and two exhaust valves per cylinder which improves the intake and exhaust flow.

In addition, fine-tuned high velocity intake and exhaust ports are used. The dual intake and exhaust ports are siamesed to further improve intake and exhaust flow.

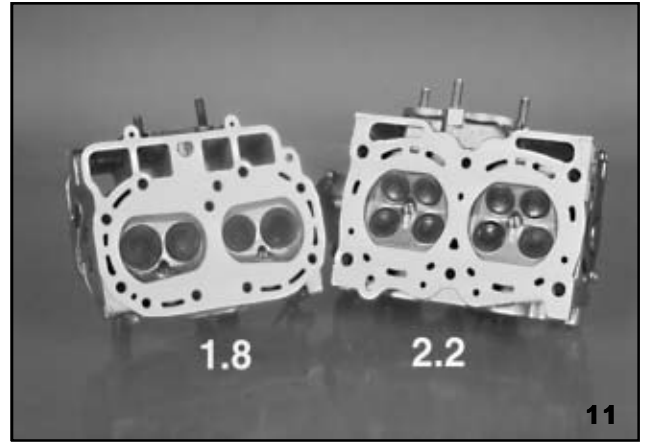

Combustion Chamber

The 2.2L engine uses a compact pentroof combustion chamber vs the bathtub design of the 1800cc/2700cc engines. It has a centrally located spark plug which provides the quickest, most efficient combustion with a uniform flame front from the plug to the top of the piston. This, combined with the 30 degree valve angle compliments the pentroof combustion chamber shape optimizing low and medium speed torque. The cylinder heads are not interchangeable.

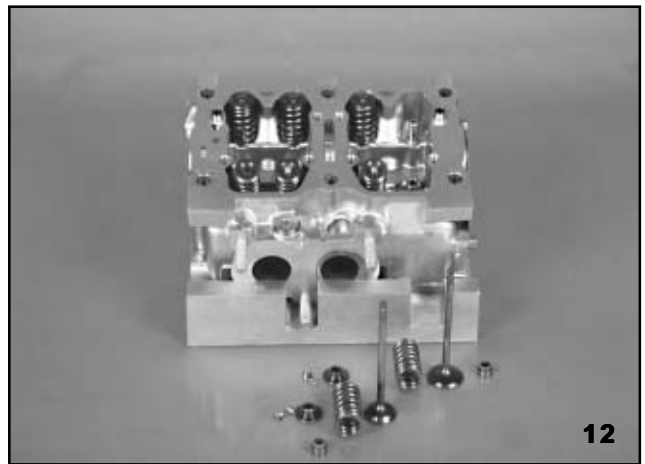

Valve Components

The valve train uses a single valve spring system vs the dual spring system of the old 1800cc engine. The intake valves are larger than the exhaust valves. The valve seal color determines location: intake seals are black, exhaust seals are brown.

Boxer Engine Series Module

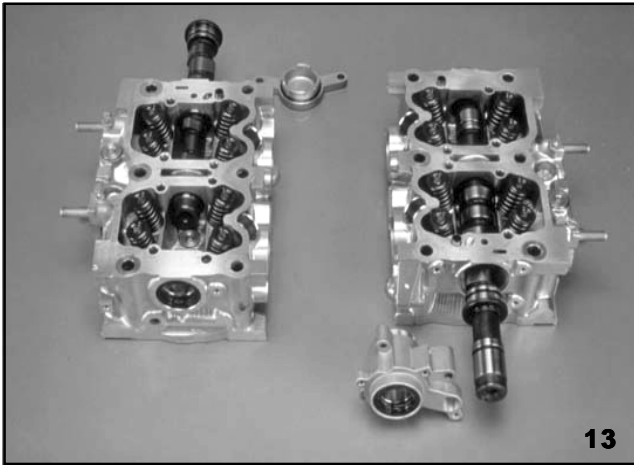

N/A Camshaft Supports

The camshaft bearing journals are located in the cylinder head. This design improves camshaft support. The left camshaft is longer than the right camshaft to properly align the cam belt sprockets due to cylinder head offset. A camshaft support bolts to the front of the left cylinder head to support the camshaft. A retaining plate, with oil seal, is attached to the rear of the left cylinder head. The rear of the right cylinder head has a cover plate which also serves as a thrust plate.

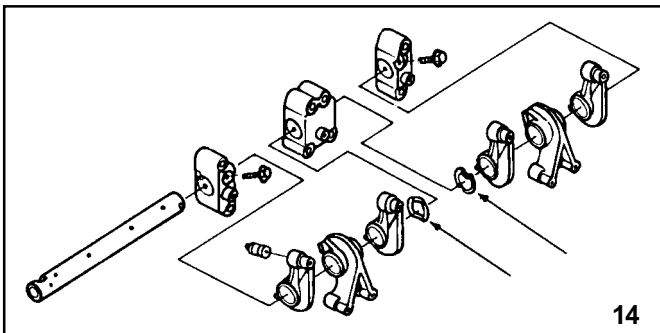

Rocker Shaft Assembly

The rocker shaft assembly bolts to the cylinder head. There are 8 bolts through the three cast iron supports. The intake valves have individual rocker arms, while a siamese rocker arm is used for each two exhaust valves. The all aluminum rocker arms have a sintered metal slipper as the cam contact. A pressed aluminum bushing is used for each rocker arm bearing surface. The position of the spring washers on the steel rocker shaft provide proper rocker alignment and spacing. These spring washers must be returned to their original position. The rocker shaft is part of the oiling system providing oil flow to the rocker bearing surfaces and HLAs. Relief valves at both ends of the rocker shafts maintain stable oil pressure to the HLAs.

NOTE: THE ROLLER ROCKER CAM FOLLOWER SYSTEM THAT WAS INTRODUCED ON THE 1.8L IMPREZA ENGINES, IS NOW ON ALL 2.2 LITER ENGINES 1995 MODEL YEAR AND LATER. THE ROLLER ASSEMBLIES ARE NOT SERVICEABLE SEPARATELY, BUT THE ROCKER ARMS MAY BE SERVICED AS INDIVIDUAL UNITS.



Hydraulic Lash Adjusters

The HLA's used in the 2.2L engine are very small in size. Compare them to the size of the 1800cc and 2700cc HLAs. One advantage of these HLAs is the reduction of reciprocating weight. The HLAs are installed in the rocker arms while the 1800cc /2700cc HLAs are installed in the cylinder head. The HLAs directly contact the valve stem instead of contacting the rocker arm as in the 1800cc / 2700cc engines.

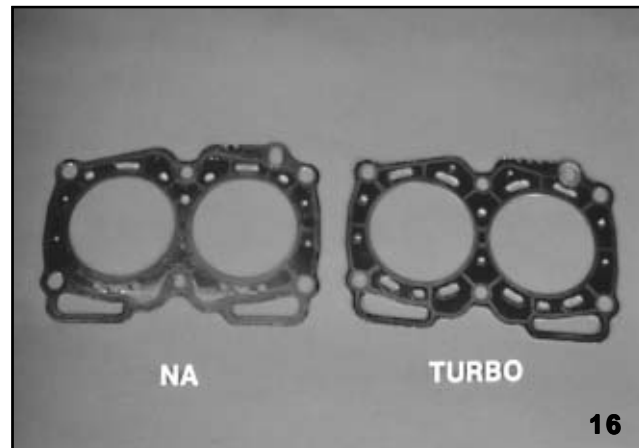

Head Gaskets

The head gaskets are carbon composition with a metal hooked core. O-rings are used to seal the oil passages. The entire gasket surface is silicon coated to improve sealing characteristics during initial installation. This also eliminates the need for re-torquing after the engine has been operated.

Boxer Engine Series Module

The water ports have been repositioned to match the passages in the heads and crankcase. The grommet area around the cylinder has been increased for improved sealing.

The gaskets can be identified by the number of notches:

*N/A: 2 notches

*TURBO: 3 notches

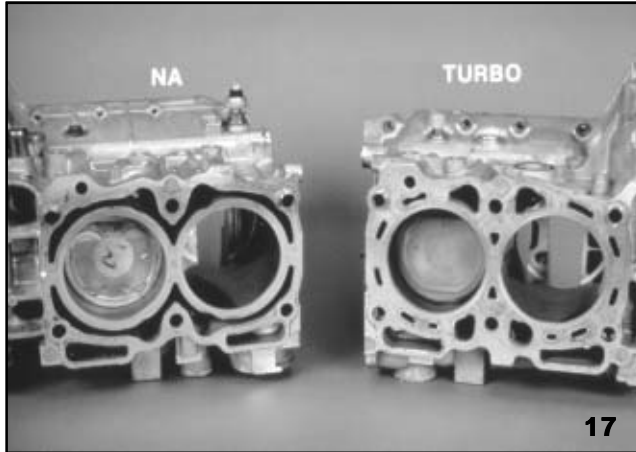

Crankcase Half

The crankcase has (5) main bearings which provide high case rigidity and improved crank support which increases engine life and performance. The crankcase uses an open deck casting design for the cylinder liners. In addition, the flywheel housing is cast with the crankcase which adds to increased rigidity and strength.



Crankshaft Assembly

The balanced forged crankshaft has fillet rolled micro-polished journals for increased strength and reduced friction. Due to the "Boxer" design, a counterbalance shaft is not required.



Connecting Rods

Due to increased material used to strengthen the large end of the rod, the rod bolts are pressed into the rod. In comparison, the 1800cc rod bolts are pressed into the bearing cap. An oiling notch is located on the large end of the rod below the FUJI symbol. This provides oil flow to the piston pin and the cylinder walls. The rods are not drilled.

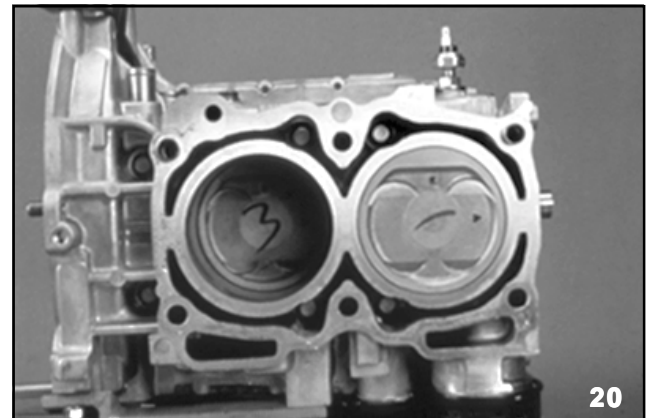

N/A Pistons

The 2.2L pistons are cast aluminum alloy and feature a 2mm offset piston pin. The pistons are directional for the left and the right side of the engine and are stamped with an "L" or "R". In addition, each piston is stamped with an arrow which must point to front of the engine. The valve reliefs for the intake and exhaust valves are different sizes to prevent valve contact with the piston should the cam belt break. The pistons use three rings, two compression and one oil.

Boxer Engine Series Module



21

Cam Belt System

A single belt is used to drive both camshafts and the water pump. This provides more precise valve timing. The cam belt width is 30mm (1.18 inches) to increase cam belt life. The belt is constructed of wear resistant double canvas and heat resistant rubber materials with a wire core. A round tooth profile is used for quieter operation. The belt has an automatic cam belt tensioner which allows for thermal expansion and contraction. The cam belt path is from the crankshaft sprocket to the tensioner, to the left camshaft sprocket, to the water pump pulley, to the lower left idler to the lower right idler, to the right camshaft sprocket, to the upper right idler and back to the crankshaft sprocket.



22

Cam Belt Covers

The cam belt covers and dust seals are resin molded and protect the timing belt from dust and water. There are additional dust seals on the left and right inner covers. These seals increase protection of the cam belt from dust and water and also improve cam belt noise isolation.



23

Water Pump Assembly-Cooling System

The water pump pulley is driven by the back side of the timing belt. The pump is mounted to the lower front of the engine. The thermostat is located in the lower part of the pump housing. This location provides even engine warm-up by improved metering of the coolant temperature. The thermostat senses the temperature of the crankcase and radiator coolant as it is mixed.

Because the thermostat housing is located on the lower front of the engine, all of the coolant must be drained to change the thermostat.

The heater core also serves as the bypass system.

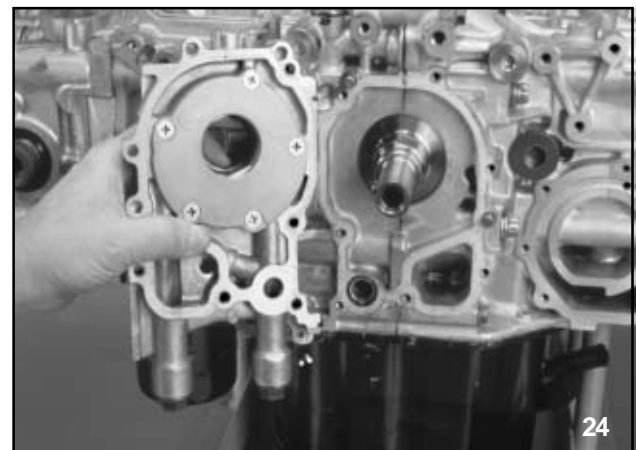

24

Oil Pump

The trichoid gear type oil pump is driven directly by the crankshaft. The pump is bolted to the front of the engine for serviceability. The relief valve located in the pump regulates oil pressure to 71 psi (5 kg-cm²). The filter bypass valve is located in the oil filter.

Boxer Engine Series Module

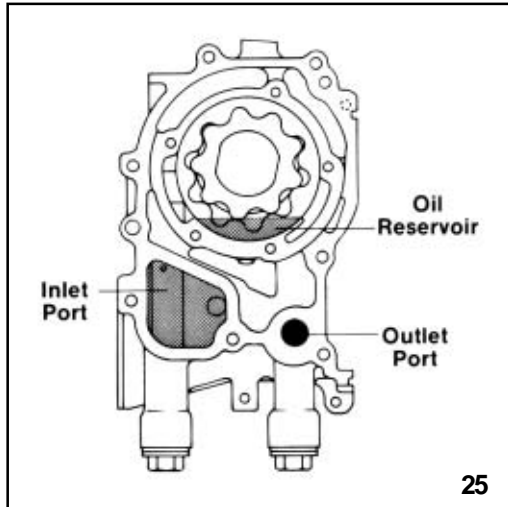

Oil Pump Cross Section

The oil pump has a reservoir which maintains oil for rotor lubrication. This is especially helpful when the engine has not been operated for extended periods of time. The reservoir also provides emergency oiling for the pump if there is temporary loss of oil supply.

2.2L Engine Servicing & Diagnostics

In Vehicle Servicing

The following services may be completed without removal of the engine from the vehicle.

- a. Removal/replacement of cam belt
- b. Water pump removal/replacement
- c. Oil pump servicing
- d. Intake manifold
- e. Rocker covers
- f. Rocker arm assemblies
- g. Cylinder head removal
- h. Camshafts

Engine Diagnostics

NOTE: THE FOLLOWING DIAGNOSTICS PERTAIN TO THE 2.2L ENGINE ONLY.

- a. Valve train noise (clacking sound). Operate the engine for approximately one (1) hour before diagnosing HLAs as the problem.
- b. If the rocker shaft relief valves are plugged, the rocker shaft oil pressure will increase during low engine temperature operation. This could result in the HLAs being forced part way out of the rocker arm sockets. A clacking sound may be produced which is similar to collapsed HLAs. Engine misfire may also occur during this condition.

If the relief valves will not hold pressure, the HLAs may collapse, again producing a clacking sound.

Boxer Engine Series Module

2.2L Engine Disassembly

NOTE: REFER TO THE SERVICE MANUAL FOR THE DETAILED STEP-BY-STEP DISASSEMBLY SEQUENCE. THE FOLLOWING INFORMATION ADDRESSES SPECIAL STEPS ONLY.

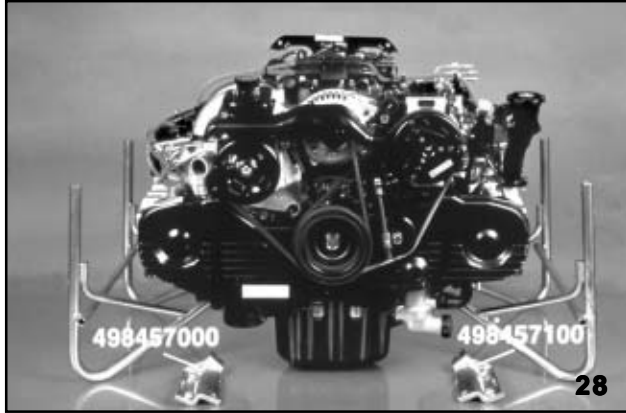

Engine on Stands

Install the 1800cc engine stands 499817000 with adapter RH 498457000 and adapter LH 498457100. Then remove the engine accessories: i.e. drive belts, alternator, air conditioning compressor, and brackets.



Remove Crank Pulley

Use crankshaft pulley wrench 499977000 to remove the crankshaft pulley bolt, then remove the pulley.

Notes:

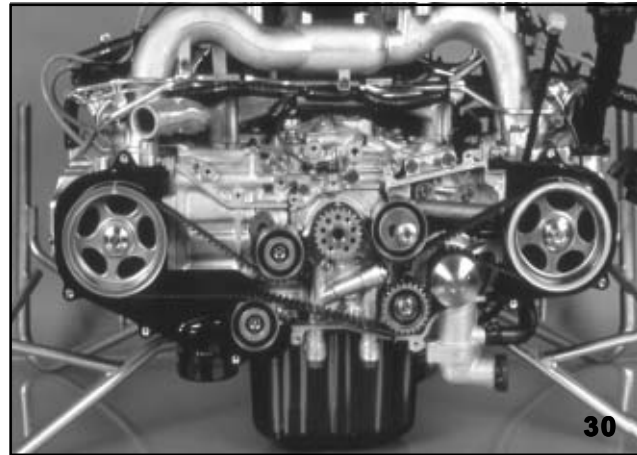

Mark Cam Belt

Use the crankshaft pulley to rotate the crankshaft to align the belt timing marks.

NOTE: THERE ARE TWO TIMING MARKS ON BOTH THE CAM PULLEYS AND THE CRANKSHAFT PULLEY, A NOTCH AND AN ARROW. ALIGN THE NOTCH ON THE OUTER RIM OF EACH CAMSHAFT PULLEY WITH THE NOTCH ON THE INNER CAM CASES. ALIGN THE NOTCH ON THE REAR FLANGE OF THE CRANKSHAFT SPROCKET WITH THE NOTCH ON THE OIL PUMP HOUSING.

Mark the belt at the three timing notches. This will make reinstallation much easier and also ensures proper placement of the belt between the left and right cam pulleys.

Mark the belt rotation direction. The belt must be reinstalled to rotate in same direction.

NOTE: NEW BELTS WILL HAVE THE TIMING MARKS PRINTED ON THE BELT AS WELL AS ARROWS INDICATING DIRECTION OF ROTATION.



Remove Idler Pulleys

Boxer Engine Series Module

First, loosen the cam belt tensioner mounting bolts.

NOTE: DO NOT REMOVE THE BOLTS.

Remove the idler pulleys in this sequence: lower right (1-3 side), then the lower left (2-4 side, next to the water pump). Then remove the cam belt.

Finally, remove the cam belt idler and tensioner assembly, and then the crankshaft sprocket.

Remove the left and right camshaft sprockets using cam wrench 499207100.

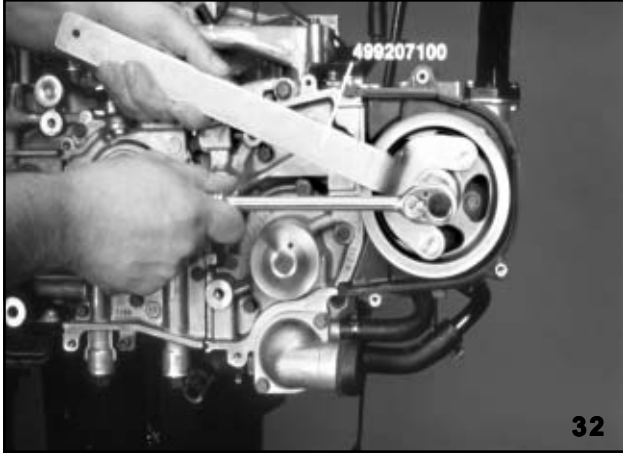

Remove Camshaft Sprockets

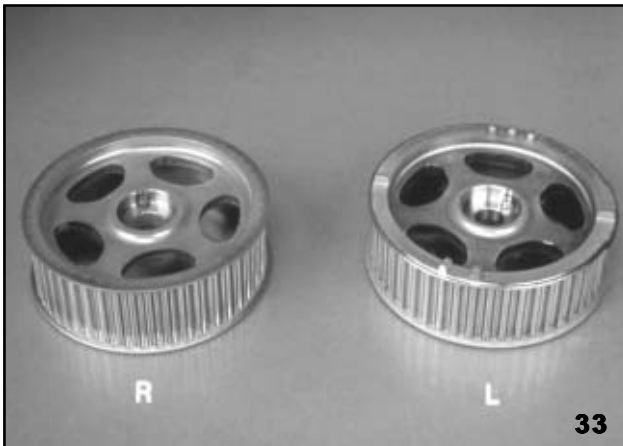

Camshaft Sprockets

Notice the locating pin on back of the sprockets for reinstallation. Also locate the reluctors on the back of the left camshaft sprocket. These are the cam angle sensor reference triggers. Inspect the locating pin and reluctors for damage.

NOTE: THE LEFT CAMSHAFT SPROCKET MUST NOT BE INSTALLED ON THE RIGHT CAM SHAFT, AS DAMAGE TO THE INNER RIGHT CAM BELT COVER MAY OCCUR. A NO START CONDITION ALSO WILL RESULT.

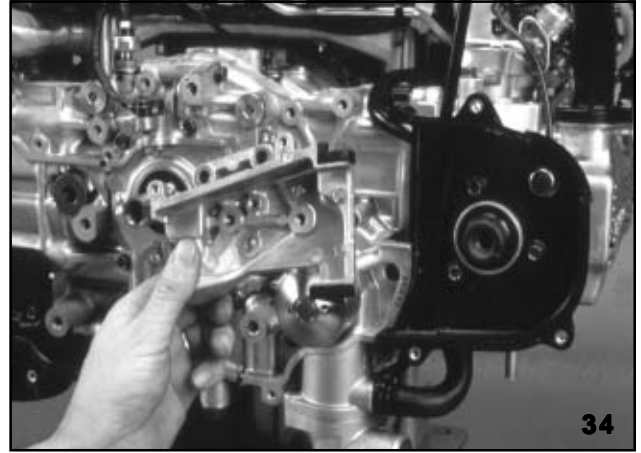

Tensioner Bracket Removal

Remove the mounting bolts and carefully remove the tensioner bracket to avoid damage to the friction-fit dust seals.



Inner Cam Belt Cover Removal

Remove the left and right inner cam belt covers. Note the location of the friction-fit dust seals.

Boxer Engine Series Module



Engine Accessory Removal

Remove the hoses, electrical connections, sensors, switches, intake manifold, and intake manifold gaskets.

NOTE: THE RUBBER COATED METAL GASKETS ARE ONETIME USE ONLY.

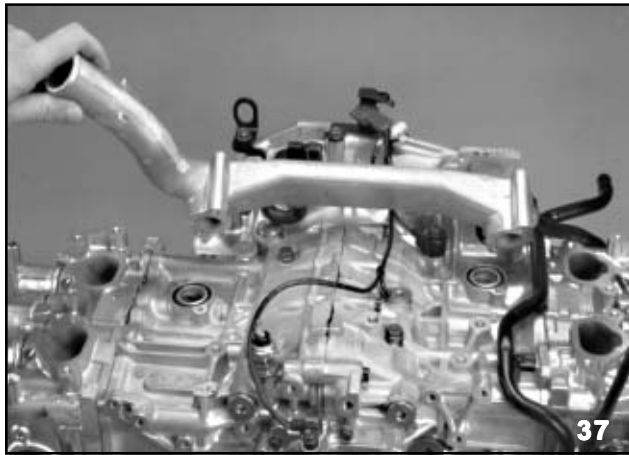

Remove the Water Transfer Pipe

Remove the water transfer pipe and O-rings. New O-rings must be used at reinstallation.

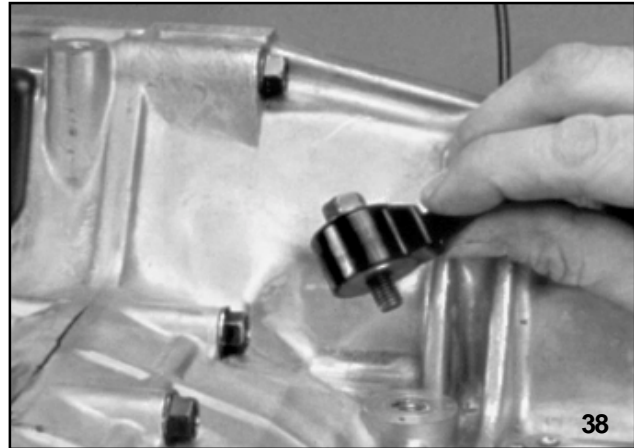

Remove Knock Sensor

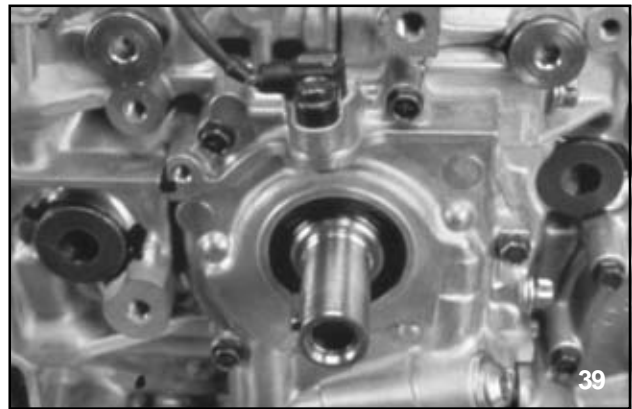

Remove Crank Angle Sensor

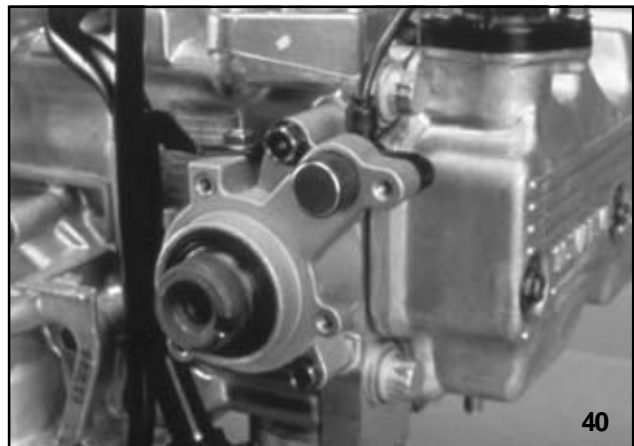

Remove Cam Angle Sensor

Boxer Engine Series Module



Remove Water Pump

Remove dip stick tube and then remove the water pump and rubber coated metal gasket. The gasket is onetime use only. Retain the dust seals for later reassembly.

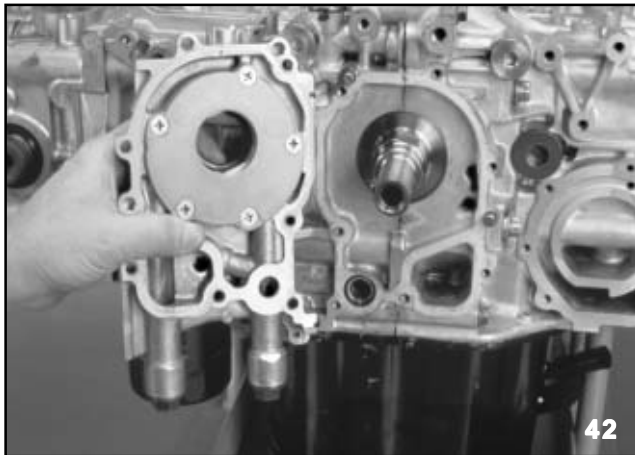

Remove Oil Pump

Remove the oil pump. Observe the condition and location of the O-ring seal and the dust seals. Retain the dust seals for later reassembly.

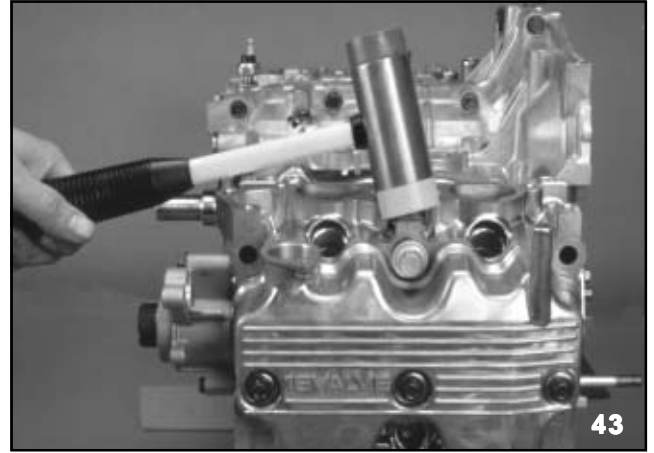

Cylinder Head Removal

Loosen all head bolts in the reverse order of the tightening sequence, and then remove all of the cylinder head bolts except #1. Lightly tap the cylinder head with a rubber mallet to loosen the head from the gasket. Then remove #1 bolt and the cylinder head with the head gasket. Repeat the above steps for the other cylinder head.

NOTE: THE HEAD GASKETS ARE CARBON COMPOSITION WITH INTEGRATED O-RINGS. ALWAYS USE NEW GASKETS. CHECK FOR PROPER ORIENTATION.

NOTE: IT IS NOT NECESSARY TO REMOVE THE VALVE COVER WHILE REMOVING THE CYLINDER HEAD UNLESS SERVICING OF THE VALVE COMPONENTS IS REQUIRED.

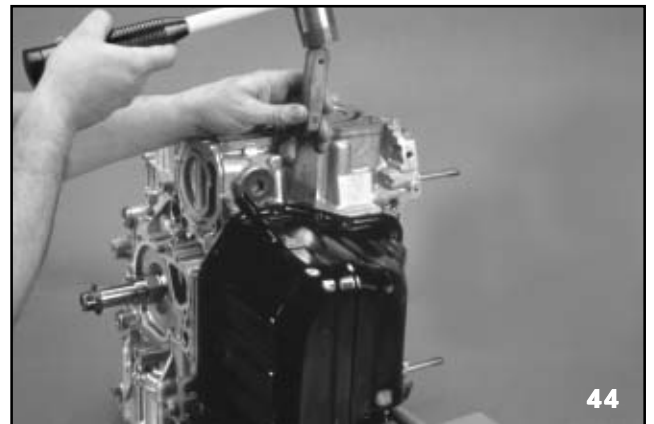

Remove Oil Pan

Remove the oil pan bolts. Use a thin gasket scraper/putty knife and a rubber mallet to loosen the oil pan. Remove the oil pan. Notice the location of the oil seal for the drain tube. Remove the oil pickup tube and also note the O-ring. Remove the oil pan baffle plate (windage tray).

Boxer Engine Series Module



Piston Pin Removal

Use piston pin remover **499097300** or **499097500** to remove the piston pin. Insert the tool 3/4 of the way into the pin and pull the tool with the pin through the access hole. Repeat for the remaining pistons. Finally, rotate the crankshaft to position the pistons at the top of the cylinders. Repeat the procedure for the other cylinders.

NOTE: USE CAUTION WHILE ROTATING THE CRANKSHAFT TO PREVENT THE CONNECTING ROD LARGE ENDS FROM DAMAGING THE LOWER CYLINDER BORES.

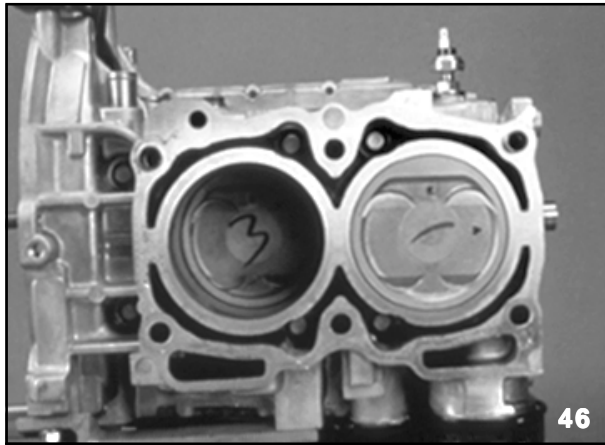

Crankcase Hidden Bolts (Right Bank)

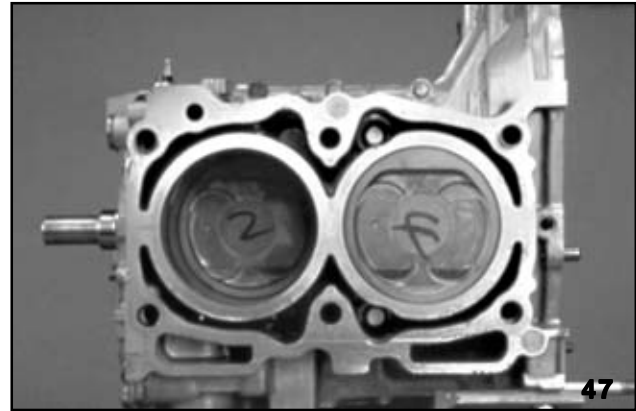

Crankcase Hidden Bolts (Left Bank)

To split the crankcase remove **ALL 16** of the crankcase bolts. Six (6) of the bolts are hidden in the water passages, four in the RH case (1-3 side) and two in the LH case (2-4 side).

NOTE: ALL SIX (6) OF THE HIDDEN SHOULDERED CRANKCASE BOLTS HAVE SEALING WASHERS. THESE BOLTS ARE NOT INTERCHANGEABLE WITH THE OTHER CRANKCASE BOLTS. THE SEALING WASHERS ARE ONE TIME USE ONLY.

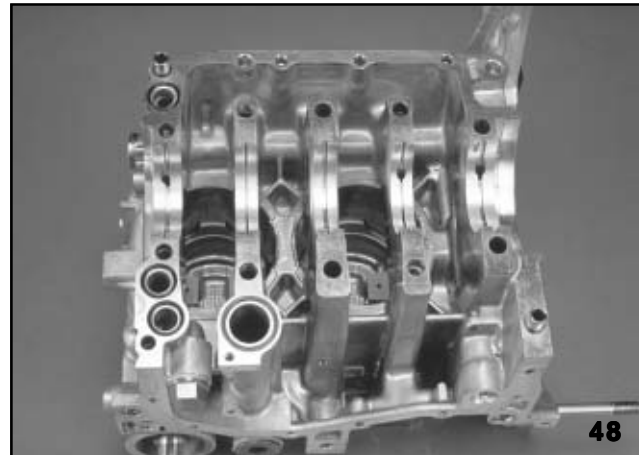

Crankcase Half with O-Rings

Carefully separate the crankcase halves.

NOTE: IDENTIFY THE LOCATION OF THE FOUR O-RINGS (THREE SMALL, ONE LARGE), IN THE MATING SURFACE OF THE RIGHT (1-3 SIDE) CRANKCASE. THE BLACK O-RINGS ARE FOR OIL PASSAGES, THE ORANGE O-RING IS FOR A COOLANT PASSAGE.

Boxer Engine Series Module

2.2L Component Inspection and Servicing



Cylinder Head Disassembly

Remove the valve rocker cover bolts and the valve rocker cover. Then remove the eight rocker shaft assembly retaining bolts and the rocker shaft assembly.

NOTE: REMOVE THE ROCKER ASSEMBLY SLOWLY TO PREVENT BINDING AGAINST THE MOUNTING DOWELS.



HLA Removal

Use a small screwdriver to remove the HLA from the rocker socket. Do not damage the o-rings or the machined surfaces when removing the HLAs. To check the HLAs for proper operation, squeeze the HLA between your thumb and finger. The HLA should not compress, it should not be spongy.



Refilling HLAs



Depressing HLA Check Ball

Place an HLA in a **clean** 12 mm socket. The socket serves as an oil reservoir. Add engine oil to the socket. Use a small Allen wrench or paper clip to depress the check ball. Depress and release the HLA plunger while you hold the check ball open. This purges the air from the HLA and fills the HLA with oil. It usually requires only one stroke to fill the HLA. Store the HLAs in engine oil for later reassembly.

NOTE: PARTIALLY FILLED HLAs WILL RESULT IN NOISY OPERATION OF THE VALVE TRAIN FOR APPROXIMATELY ONE HOUR. TO TEST, SQUEEZE THE HLA BETWEEN YOUR THUMB AND FINGER. IF THE HLA IS SPONGY, REPEAT THE FILL PROCESS. IF THE HLA CAN NOT BE PUMPED TO A FIRM CONDITION, REPLACE IT.

Boxer Engine Series Module

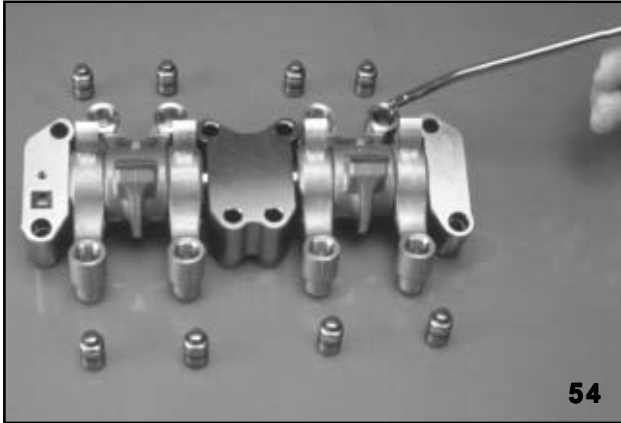

Filling the HLA Sockets

Assemble the rocker shaft components, rocker arms, spring washers, and the rocker shaft supports. Lubricate shaft and rocker arms with oil.

NOTE: THE ROCKERS AND SUPPORTS SHOULD BE RETURNED TO THEIR ORIGINAL POSITION ON THE SHAFT. THE CUT OUT PORTION OF THE ROCKER SHAFT MUST FACE THE OIL HOLE IN THE ROCKER SUPPORT. THE SPRING WASHERS MUST BE PROPERLY LOCATED ON THE SHAFT. ALWAYS REPLACE ANY DEFORMED SPRING WASHERS.

Retain the rocker shaft in the proper position with the two retaining bolts. Torque to specification. Then fill the HLA reservoir with engine oil.



Installing HLAs

Press the HLAs (by hand) into the rockers to install the HLAs in the rocker arms. Some oil will drain from the bleed hole. Press the HLA until the O-ring seats. Install the remaining HLAs. Be sure to check for spongy HLAs during installation.

NOTE: THE HLA O-RINGS SHOULD ALWAYS BE REPLACED WHEN THE HLAs ARE REINSTALLED.



Tensioner Inspection

Look for leakage from the tensioner rod and seal area. Slight traces of oil at rod oil seal does not indicate a problem.

NOTE: REFER TO 1995 SERVICE MANUAL "INSPECTION OF BELT TENSION ADJUSTER" FOR TENSIONER COMPRESSION SPECIFICATIONS. 2-3 [W3B2]

NOTE: STARTING WITH 1997MY (LATE PRODUCTION) A NEW STYLE TENSIONER WAS INTRODUCED. DO NOT USE A VISE TO COMPRESS. CONSULT 1998MY SERVICE MANUAL OR LATER FOR TESTING AND COMPRESSING PROCEDURES. CONSULT SECTION 2-3 [W2C2]. IT IS CRITICAL TENSION IS CORRECT OR THE BELT COULD JUMP CAUSING INCORRECT TIMING THUS RESULTING IN VALVE AND PISTON DAMAGE.

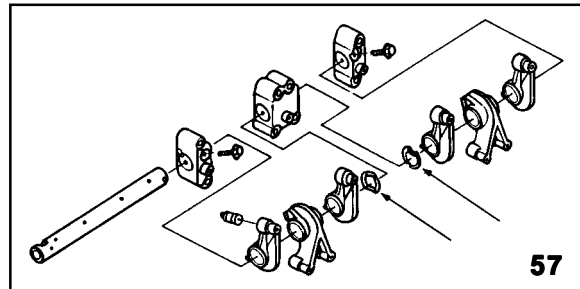

Rocker Arm Inspection

Inspect the rocker arms for damage. Also inspect the rocker arm bearing surface for wear. Replace the rocker arm if bearing wear is excessive.

NOTE: REFER TO 1995 SERVICE MANUAL SECTION 2-3 [W4C2], INSPECTION OF VALVE ROCKER ARM FOR SPECIFICATIONS.

Finally, inspect the rocker arm cam contact surface. Replace the rocker arm(s) when they are scored or gouged.

Boxer Engine Series Module

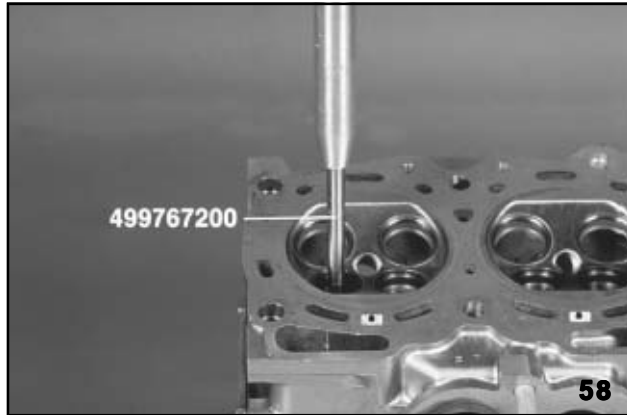

Valve Guide Removal

Use a press, cylinder head table, **498267200**, and valve guide removal tool **499767200** to remove the valve guides.

Precautions

Follow the precautions listed below when inspecting and servicing engine components.

- Clean all parts thoroughly.
- Remove all gaskets and sealing material.

CAUTION: DO NOT DAMAGE ALUMINUM MATING SURFACES

- Use compressed air to insure clear oil and coolant passages.
- Do not damage components when removing carbon.
- Keep parts in order to ease reassembly.
- Service all valves as a set.

Refer to the Service Manual for the detailed step-by-step inspection and servicing steps. The following information addresses only the special steps which are distinctive to the 2.2L engine.

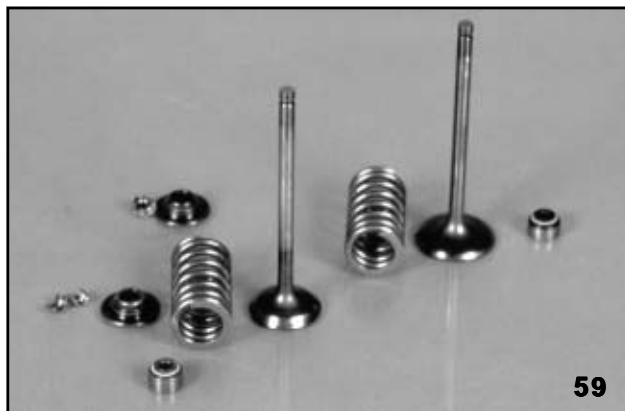

Valve Components

Use valve spring remover **499718000** to remove the valve springs. Then remove the valves and seals. The intake seals are black and the exhaust seals are brown.

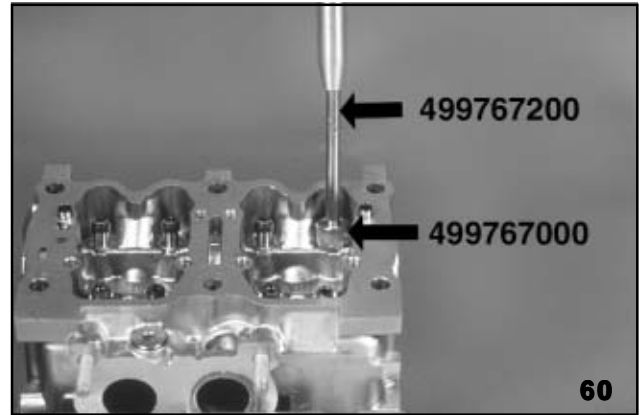

Installing Valve Guides

Install the valve guides using a press, cylinder head table **498267200**, valve guide remover **499767200**, and valve guide adjuster **499767000**.

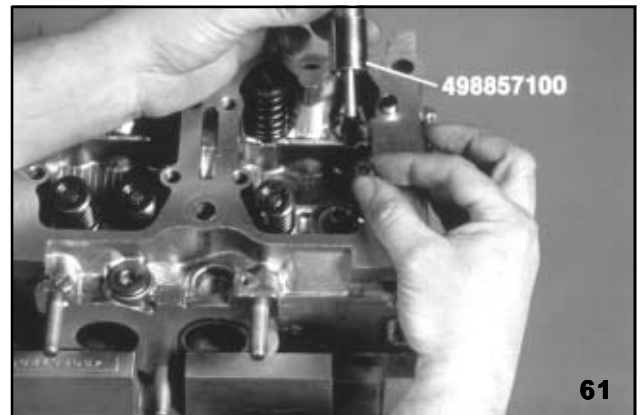

Installing Valve Guide Oil Seal

Use valve seal installer **498857100**, to install the valve guide seals (black for intake, brown for exhaust). Then use cylinder head table **498267200** and valve spring remover **499718000** to install the valve spring and retainer. Install the camshaft into the cylinder head bearing journals. Be careful to not damage or score the camshaft journals.

Boxer Engine Series Module

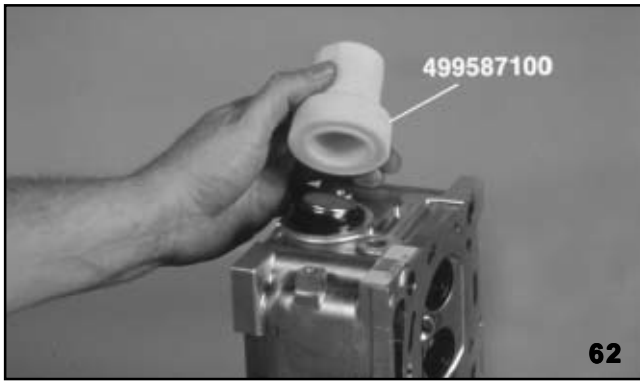

Installing the Oil Seal

Install the left rear camshaft plug (oil seal). Then install the oil seal using oil seal installer **499587100**.

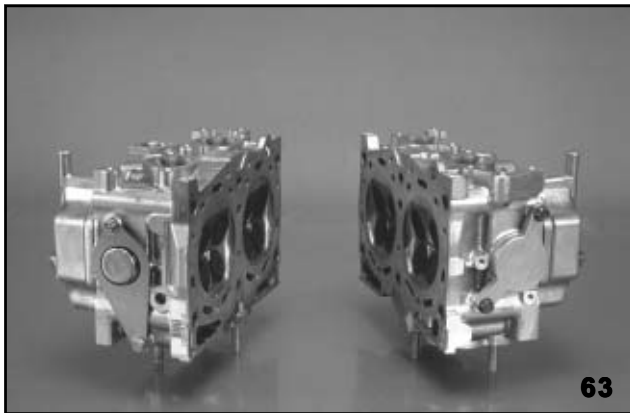

Storing Cylinder Heads

Install the rocker cover to the cylinder head. Temporarily store the cylinder head by standing it on the exhaust manifold studs. This prevents bleed down of the HLAs. Repeat these steps for the other cylinder head.

2.2L Engine Reassembly

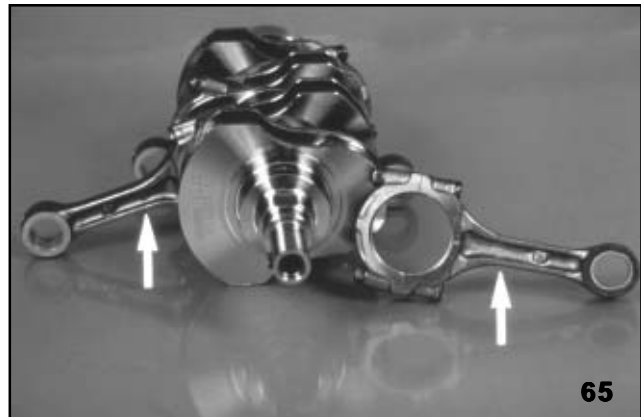

Assemble Crankshaft

Always refer to the 1995 Service Manual Section 2-3 [W7C6 to W7D1] for the bearing size, oil clearance, and torque specifications. The "FUJI" symbol on the connecting rods must face the front of the engine.

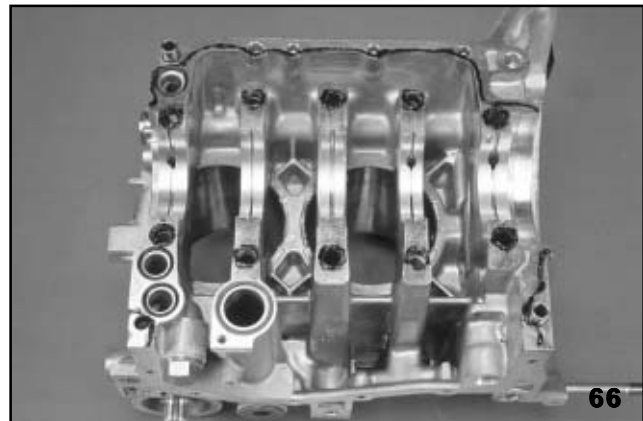

Crankcase Sealer and O-Rings

Apply sealant to the crankcase mating surface on the o-ring side of the crankcase. Do not allow the sealant to enter the O-ring grooves, oil passages, or bearing grooves. Install the crankshaft assembly. Align the connecting rods, and assemble the crankcase halves.

CAUTION: REMOVE ALL FLUIDS FROM THE THREADED PORTIONS OF THE CASE HALVES. THIS PREVENTS HYDROSTATIC LOCK AND POTENTIAL CRACKING OF THE CRANKCASE.

Install the four hidden crankcase bolts on the 1 - 3 side. Always install new seal washers to these bolts. Install the two remaining 1- 3 side crankcase bolts. Torque the 6 large bolts on the right side (1-3) to 4 to 22 ft. lbs. (2 to 3 Kg-m). Next install the two hidden crankcase bolts on the 2- 4 side. Always install new seal washers. Install all of the remaining crankcase bolts. Torque all the crankcase bolts to specifications. Start with the right side (1 - 3) bolts.

Boxer Engine Series Module

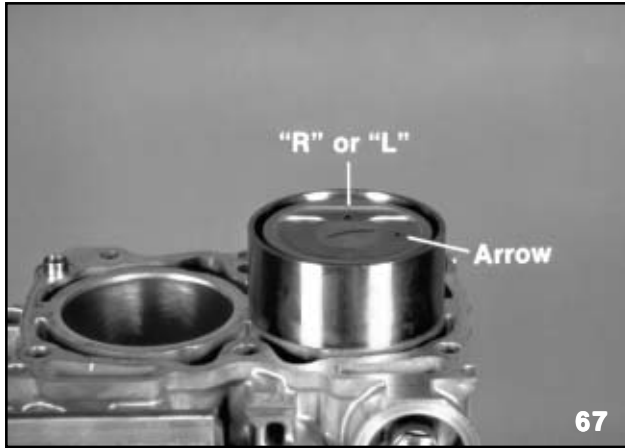

Piston Installation

The pistons are directional and must be returned to the original cylinder locations. Use piston guide **498747100** to install the pistons. The pistons are marked with an "L" for the left side and an "R" for the right side. The arrow on the head of each piston must point to the front of the engine.

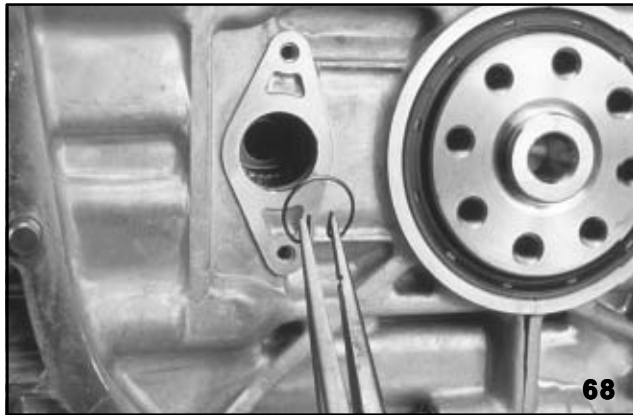

Circlip Removal

Rotate the crankshaft to position the connecting rod with the piston. Use piston pin guide **499017100** to align the piston and connecting rod. Then install the piston pin. Install the circlip. Note the proper direction of the circlip on early production models. The tang must be tilted out. Repeat for the remaining pistons. Slowly rotate the crankshaft two (2) revolutions. This confirms the proper installation of the pins. Install the front piston pin access plugs. Use new aluminum sealing rings and sealer.

NOTE: DO NOT OVER TIGHTEN. CONSULT SERVICE MANUAL FOR SPECIFICATIONS.

Install the left side access cover and new o-ring, PCV baffle plate, and piston pin plug using a new sealing ring and sealer.

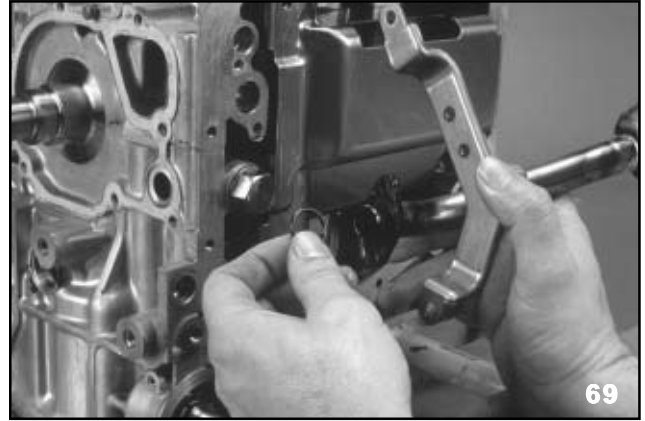

Installing Oil Pick-Up Tube

Install the oil pan baffle plate and oil pickup tube. Be sure to install a new O-ring to the oil pickup tube.

NOTE: DO NOT OVER TIGHTEN OR BOLT DAMAGE WILL OCCUR.



Oil Pan Drain Tube Seal

Install a new oil seal on the oil return tube. Apply liquid gasket sealer FUJI Bond 1207C or equivalent to the oil pan mating surface. Install the oil pan and oil pan retaining bolts. Diagonally torque the oil pan bolts on one pass to 0.5 Kg-m (3.6 ft lbs).

Boxer Engine Series Module

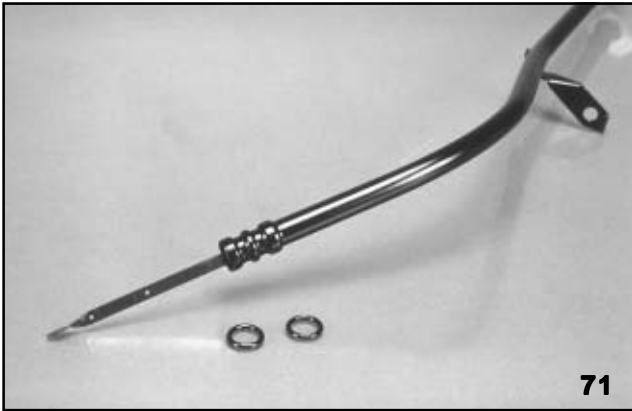

Dipstick Tube and Seals

Install the dipstick tube. Be sure to use two (2) new o-ring seals.

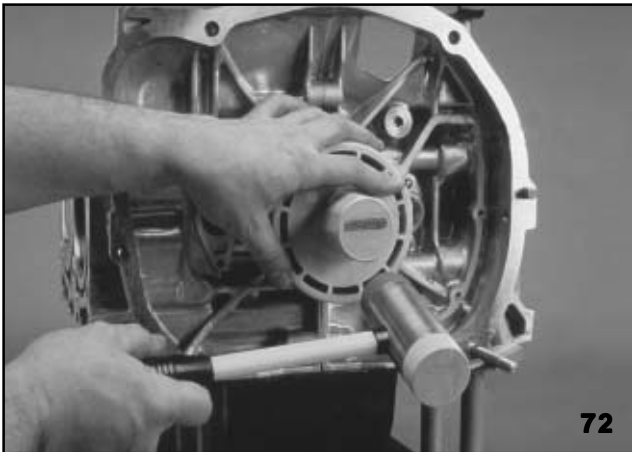

Installing Rear Crankshaft Oil Seal

Install the rear main oil seal using seal installer (**499587200**), oil seal guide (**499597100**) and a plastic hammer. Lubricate the seal with engine oil prior to installation.

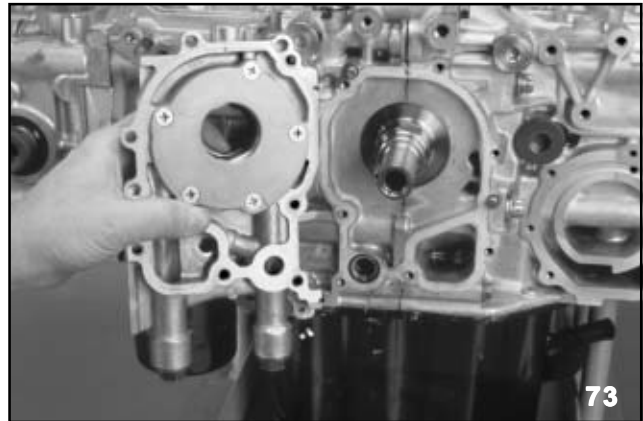

Installing Oil Pump

Install the oil pump. Refer to the 1995 service manual section 2-4 [W1E0] for proper location of the sealer and O-ring. Apply FUJI Bond 1215 sealer or equivalent to the mating surface of the oil pump. Align the flats (2) on the oil pump with the flats (2) on the crankshaft and the mounting holes in the oil pump flange with the two (2) dowel pins. Install the mounting bolts and torque to specifications.

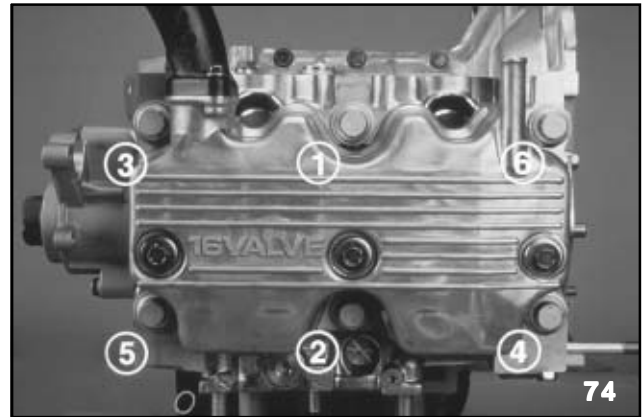

Cylinder Head Torque Sequence

Install a new cylinder head gasket (dry) and the cylinder head. Follow the bolt torque sequence and procedures listed in the 1995 Legacy Service Manual, Section 2-3 [W6E1].

Boxer Engine Series Module

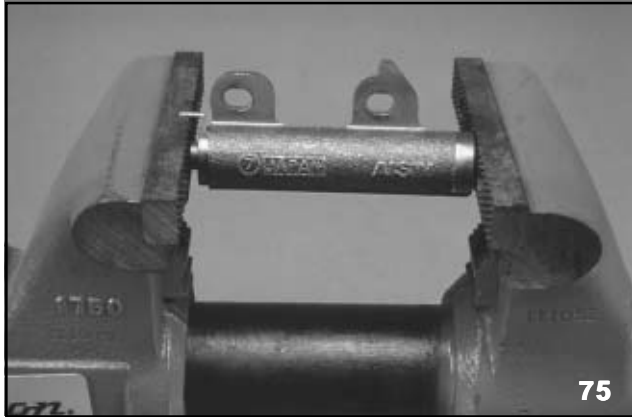

Compressing the Tensioner

Slowly compress the cam belt tensioner in a vise, using aluminum or brass jaws, until the hole in the piston aligns with the hole in the tensioner case. Install a tensioner plunger retaining pin. You may use a small Allen wrench or rivet as a retaining pin. Install tensioner assembly to the crankcase, do not tighten the mounting bolts.

NOTE: DO NOT REMOVE PLUNGER RETAINING PIN UNTIL CAM BELT IS COMPLETELY INSTALLED.

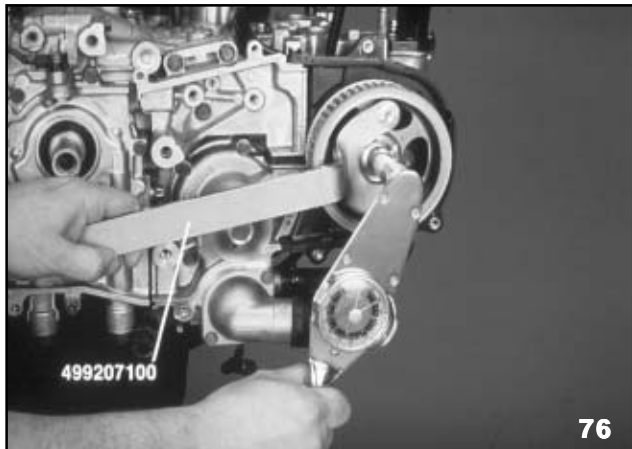

Cam Sprocket Installation

Install the camshaft sprockets using camshaft sprocket wrench **499207100**. Refer to the service manual for the proper specifications. The left sprocket has the cam angle reluctors and is not interchangeable with the right sprocket. Damage to the dust cover will result from improper installation.

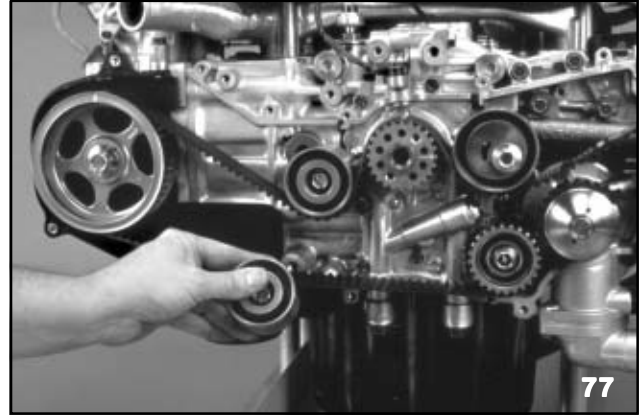

Installing Idler Pulleys

Install the cam belt idler pulleys except the lower right (1 - 3 side) and the lower left (2 - 4). Install the crankshaft sprocket and align the crankshaft sprocket and camshaft sprockets with the belt timing notches (12 o'clock). Do not rotate camshafts more than necessary as the HLAs will bleed down.

Install the cam belt in the following sequence:

- a. Begin at the crankshaft sprocket
 1. Align the mark on the cam belt with the crankshaft sprocket notch.
- b. Place the belt under the cam belt tensioner and over the left cam sprocket.
 1. Align the mark on cam belt with camshaft sprocket notch.
- c. Place the belt under the upper right idler pulley and over the right cam sprocket.
 1. Align the mark on the cam belt with camshaft sprocket notch.
- d. Place the belt over the water pump pulley.
- e. Install the lower left and right idler pulleys.

Boxer Engine Series Module



Loading Tensioner

Use a screwdriver to load the tensioner idler. Push the idler toward the crankshaft sprocket. Tighten the tensioner mounting bolts to specified torque.

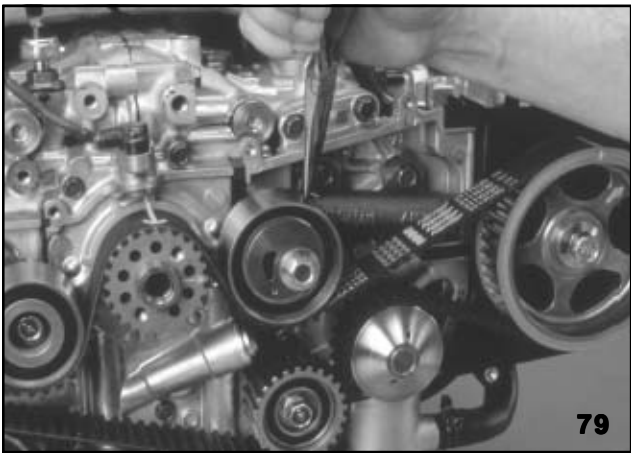

Remove Retaining Pin

Carefully remove the tensioner plunger retaining pin. This automatically sets the cam belt tension. Slowly rock the crankshaft left to right to left to distribute the cam belt tension to the belt.

NOTE: DO NOT ROTATE THE CRANKSHAFT UNNECESSARILY AS THE HLAs MAY BLEED DOWN.

Verify that the cam timing is correct by checking the cam belt alignment. The crankshaft sprocket notch and mark should be aligned. Check to be sure that the notches of the camshafts sprockets and the belt marks are properly aligned.

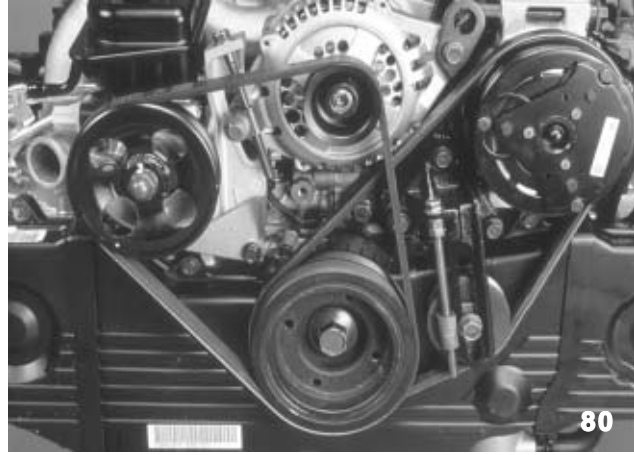

Install Cam Belt Cover/Accessories

Install the outer cam belt covers. Be sure to install the shouldered bolts in the center cover. Check the position and fit of the dust seals.

Install the pulley using crank pulley wrench **499977000**. Install the engine accessories and drive belts. Note the new style belt tension adjusters. Confirm belts for proper tension after adjustment. Fill the engine with oil.

Notes and Cautions

2.2L Engine Disassembly

There are two timing marks on both the cam pulleys and the crankshaft pulley, a notch and an arrow. Align the notch on the outer rim of each camshaft pulley with the notch on the inner cam cases. Align the notch on the rear flange of the crankshaft sprocket with the notch on the oil pump housing.

New belts will have the timing marks printed on the belt as well as arrows indicating rotation direction.

During the cam belt removal procedure, initially loosen, but do not remove, the cam belt tensioner bolts until the belt and idler pulleys have been removed.

The 1800cc cam wrench must be modified to fit the 2.2L camshaft sprocket. Tool **499207100** is the preferred tool.

The rubber coated metal intake manifold gaskets are onetime use only. Discard and replace with a new set.

It is not necessary to remove the valve cover while removing the cylinder head unless servicing of the valve components is required.

Use caution while rotating the crankshaft to prevent the connecting rod large ends from damaging the lower cylinder bores.

Boxer Engine Series Module

All six (6) of the hidden shouldered crankcase bolts have sealing washers. These bolts are not interchangeable with the other crankcase bolts. The sealing washers are onetime use ONLY.

Identify the location of the four O-rings (three small, one large), in the mating surface of the right (1-3) side crankcase. The black O-rings are for oil passages, the orange O-ring is for coolant passage.

Remove the rocker assembly slowly to prevent binding against the mounting dowels.

Partially filled HLAs will result in noisy operation of the valve train for approximately one hour. To test, squeeze the HLA between your thumb and finger. If the HLA is spongy, repeat the fill process. If the HLA can not be pumped to a firm condition, replace it.

2.2L Engine Reassembly

The rockers and supports should be returned to their original positions on the shaft. The cut out portion of the rocker shaft must face the oil hole in the rocker support. The spring washers must be properly located on the shaft. Always replace any deformed spring washers.

The HLA O-rings should always be replaced when the HLAs are reinstalled.

Install the rocker assembly carefully to prevent binding against the mounting dowels.

Remove all fluids from the threaded portions of the case halves. This prevents hydrostatic lock and potential cracking of the crankcase.

Carefully follow the cylinder head torque sequence. Remember that the retightening angle must not exceed 180 degrees. Proper use of the torque procedure eliminates the need to retorque the cylinder head bolts after running the engine. Refer to 2-3 [W6E1].

The left camshaft sprocket must not be installed on the right cam shaft, as damage to the inner right cam belt cover will result.

Do not remove the plunger retaining pin from the cam belt tensioner until the cam belt is completely installed.

Do not rotate the crankshaft unnecessarily as the HLAs may bleed down.

Engine Enhancements 2.2 Liter (Phase 1)

The 2.2 liter (SOHC) (Phase 1) has been enhanced starting with 1997 model year. The single overhead camshaft engines have had internal and external changes that yield an approximately 10 % increase in power and 3% increase in fuel economy. Accomplishing this involves many factors, one of which is engine friction reduction.

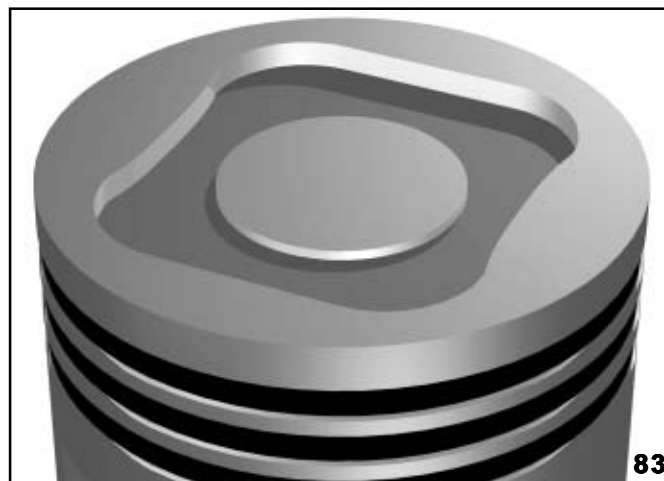

Redesigned Piston

The piston, a major source of engine friction has been coated with a friction reducing agent called Molybendum. This thin coating not only allows a smoother travel through the cylinder but also reduces cylinder wall scuffing. This coating will wear off over time and is not an indication of a problem.

The skirt of the piston has been reshaped and the overall weight has reduced by approximately 100 grams. Compression ratio has been increased to 9.7 to 1 by reshaping the crown of the piston. **This eliminates the clearance that was available between the piston at TDC and a fully opened valve.** Piston pin offset has been changed to 0.5 mm. Piston to cylinder wall clearance has been reduced by increasing the piston diameter.

Boxer Engine Series Module

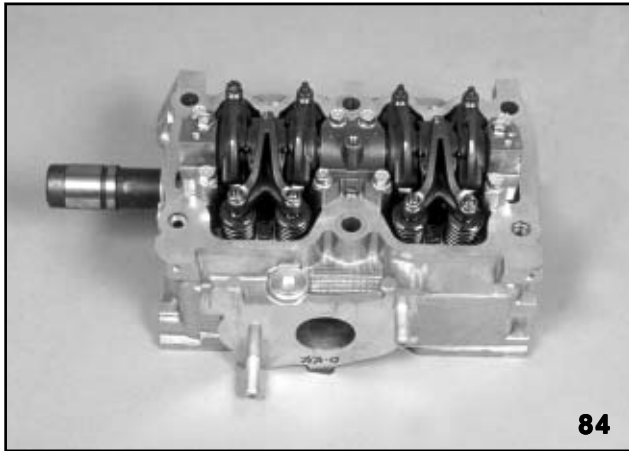

84

2.2 Liter Valve Train Assembly

Another source of high engine friction is the valve train. Hydraulic lash adjusters are always in contact with the camshaft or valve rockers. The hydraulic pressure of the lash adjuster must be overcome during operation and the most critical time of engine start. To overcome this situation and to contribute to the total reduction of friction loss the SOHC engines will have solid valve adjusters. The scheduled service of these valve trains is set at 100,000 miles and is not required during the PDI. The SOHC engine uses an adjustment screw and locknut.

Follow the instructions below for set up and adjustment.

Tools required for 2.2 valve adjustment (thickness gauge, 10mm wrench, stubby standard (negative) screwdriver, crankshaft wrench).

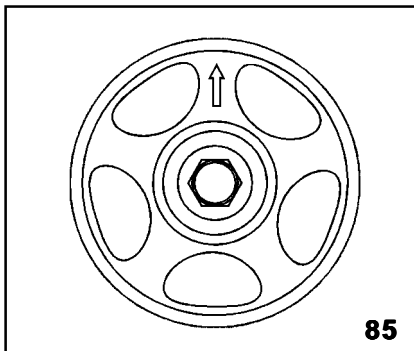

85

Cylinder 1

Step 1

Remove the right bank camshaft outer cover

Standard valve clearance

(Intake valves 0.20 +/- 0.02 mm)

(Exhaust valves 0.25 +/- 0.02 mm)

Rotate the engine until the arrow on the camshaft sprocket is at 12 o'clock. **(Please remember that the camshaft sprocket has an arrow and a mark for belt timing. Make certain that the arrow is used not the mark for valve adjustment only.)**

Using a standard thickness gauge measure the clearance of the **intake and exhaust valves on cylinder 1 only**. Adjust the clearance by loosening the locknut and turning the adjustment screw until the proper clearance is obtained.

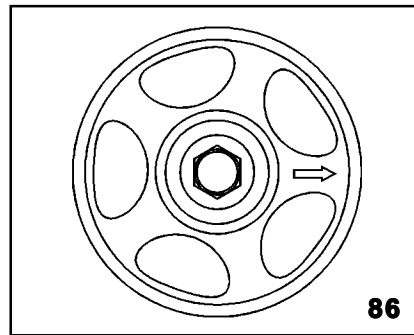

86

Cylinder 3

Step 2

Rotate the engine until the arrow on the camshaft sprocket is at 3 o'clock. Check and adjust the clearance of the **intake and exhaust valves on cylinder 3 only**.

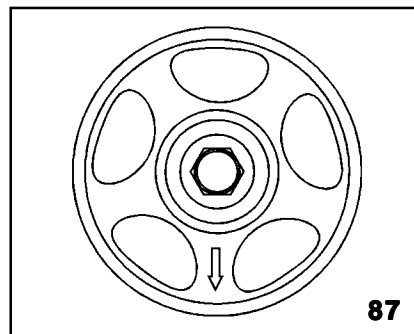

87

Cylinder 2

Step 3

Rotate the engine until the arrow on the camshaft sprocket is at 6 o'clock. Check and adjust the clearance of the intake and exhaust valves on cylinder 2 only.

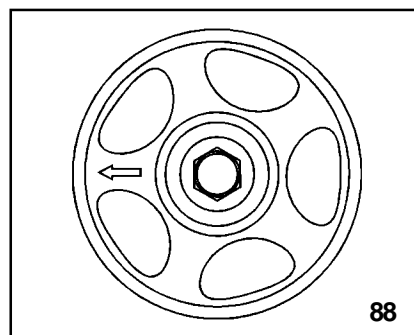

88

Cylinder 4

Step 4

Rotate the engine until the arrow on the camshaft sprocket is at 9 o'clock. Check and adjust the clearance of the intake and exhaust valves on cylinder 4 only.

Boxer Engine Series Module



Measuring Valve Clearance



Adjusting Valve Clearance

Other Engine Modifications

The intake manifold has been reshaped to increase the air flow mass and speed, contributing to improved low and mid engine speed operation. Components located on the intake manifold have been relocated as compared to the 1996 models. EGR Solenoid, Purge Control Solenoid, etc...

1999 2.2 Liter (SOHC) (Phase 2) Engine Enhancements

All 2.2 liter engine for 1999 are Phase 2 design. The 2.2 liter phase 2 engines are SOHC engine with a newly designed cylinder head.

Changes in the 2.2 liter phase 2 engines are as follows:

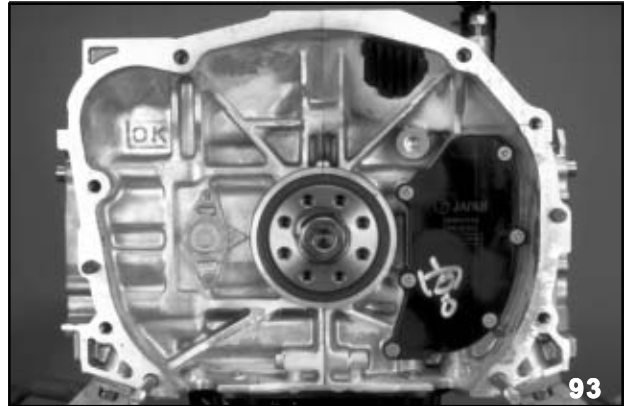

Mounting Holes and Studs

The engine and the transmission are fastened with 6 bolts and 2 studs.



Thrust Bearing

The thrust bearing has been moved to the number 5 position.

Boxer Engine Series Module



Main Bearing Oil Grooves

The oil groove in the number 1 and 3 have been changed to supply additional lubrication to the crank journal.

Additional Features of the Phase Two Engine

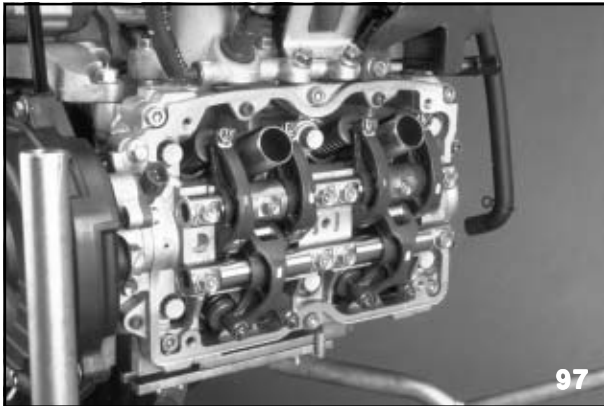

Valve Train

The cylinder head will be a 2-rocker shaft roller solid type valve system.

The valves are positioned at a larger angle than previous model years. The intake valves are positioned 23 degrees off center with the exhaust valves positioned 20 degrees off center. Prior model year engines utilized a 15-degree positioning angle.



New Head Gasket Design

Head gasket thickness is 0.7 mm.



Identification of Rocker Arms



Roller Rockers

Boxer Engine Series Module



Adjustment Screw and Nut

The intake rocker arms are marked so they are correctly placed on the rocker shaft when servicing. An IN1 or IN2 will be embossed on each rocker arm. As viewed from the front of the engine the Number 1 intake valve of each cylinder and the number 2 intake valve have an IN1 marked and IN2 marked rocker arm that mates with it. New IN1 rocker arms can also be identified by a Green painted mark on the top of the rocker arm. The IN2 rocker arms have a white mark. Proper positioning is maintained through the use of a wave washer located between the rocker shaft arm and rocker arm shaft support.

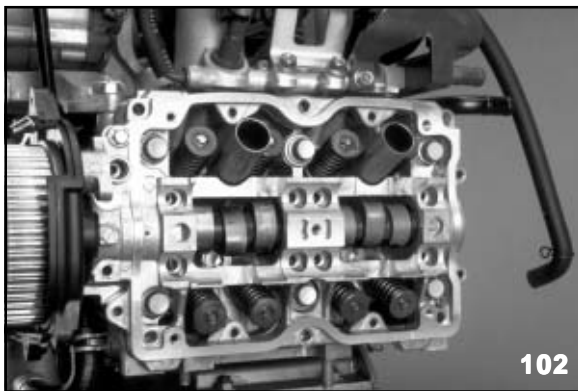

Camshaft Secured by Camcase

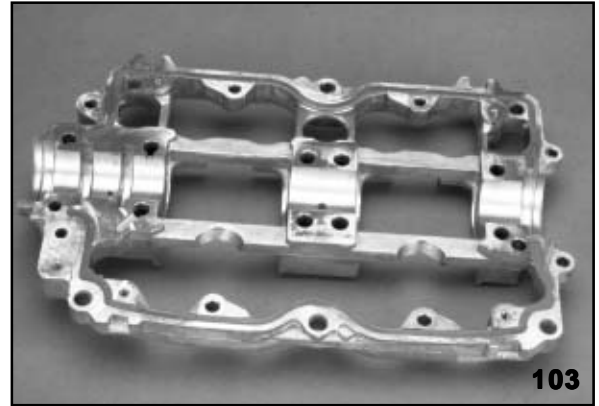

Camcase Sealing Passages



Groove Edges

The camshaft is secured to the cylinder head with the camcase. An oil passage in the cylinder head provides the passageway in the camcase with oil that leads to the intake rocker shaft. Oil from the camshaft is collected on the opposite side of the passageway leading to the intake rocker shaft to provide oil to the exhaust rocker shaft.

Sealing of the camcase is accomplished by using a thin layer of three bond (1280B) applied in the channel around the camcase edge. After the three bond is applied, the camcase must be installed to the cylinder head and onto the engine before the three bond has time to cure. Failure to do this will result in oil leaks.

NOTE: CYLINDER HEAD AND CAMCASE MUST BE REPLACED TOGETHER. (LINE BORED)

Boxer Engine Series Module

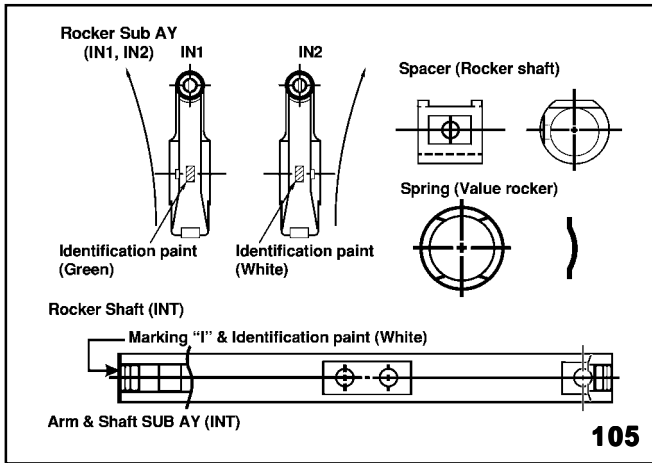

Identification Marks of Rocker Arms

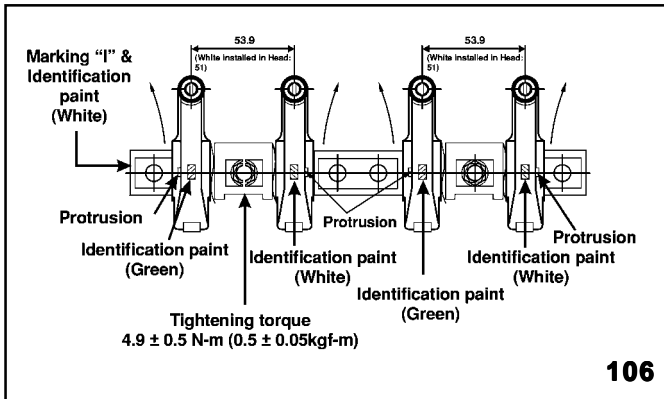

Torque Specs and Measurements

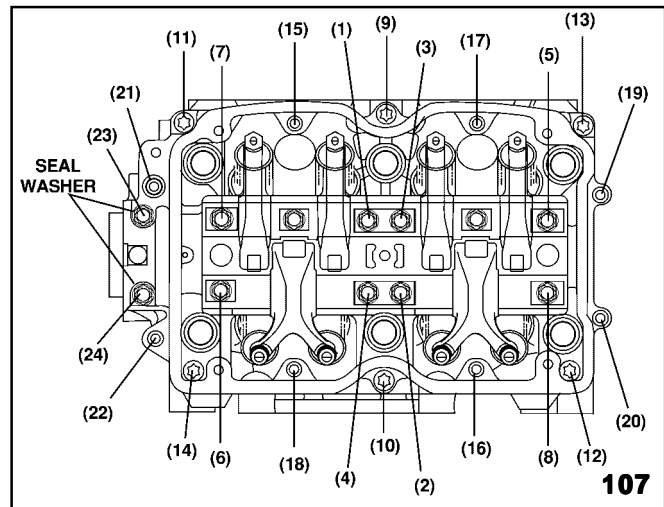

Bolt Tightening Sequence

The sparkplug pipe is pressed into the cylinder head and is not serviceable. If it becomes damaged the cylinder head must be replaced. The seals installed onto the ends of the sparkplug pipes seal against the valve covers and should be replaced when the valve cover is removed.

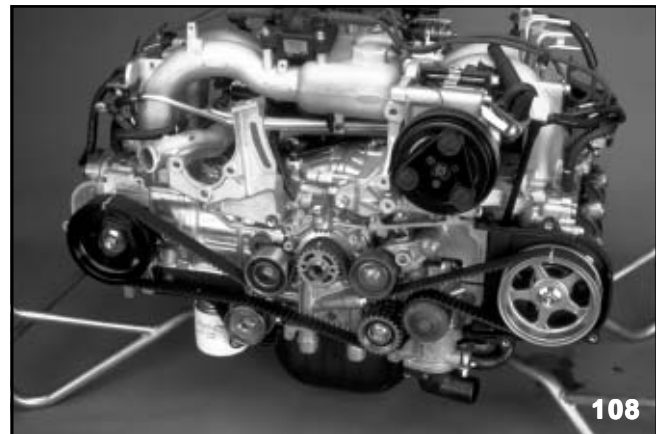

Engine Cam Belt Timing Marks Locations

Timing belt marks on the left bank will be made onto the inner timing belt cover and the edge of the camshaft sprocket. The crankshaft timing mark remains on the reluctor with engine block mark just below the crank angle sensor. The right bank camshaft sprocket has a mark at the edge that is matched with the seam line formed by the meeting of the camcase and cylinder head. (12:00 o'clock position)

Boxer Engine Series Module

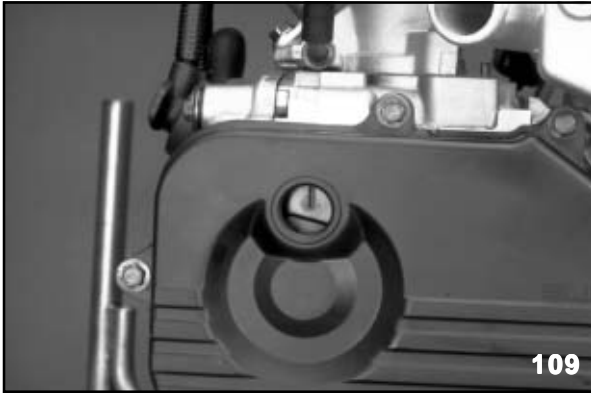

Right Bank Timing Mark

The right bank timing mark can be checked with outer cover in place using the provided window.

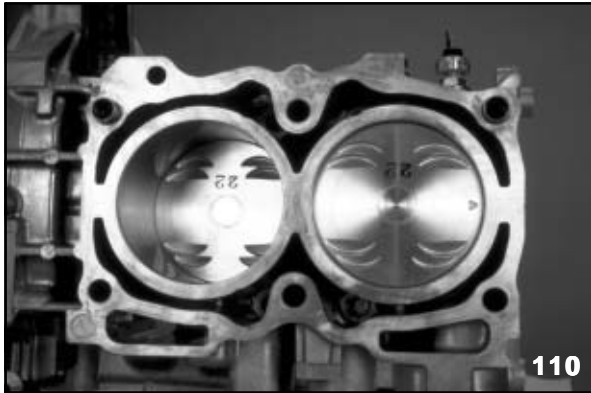

Open Deck Design



New Piston Design

Pistons on the 2.2 liter engines will have a 0.5 mm offset with the engine having a compression ratio of 10.0 to 1. The horsepower has increased to 142hp @ 5600 RPM. Maximum torque 149 ft. lbs @ 3600 RPM.

2.5 Liter Engine Features

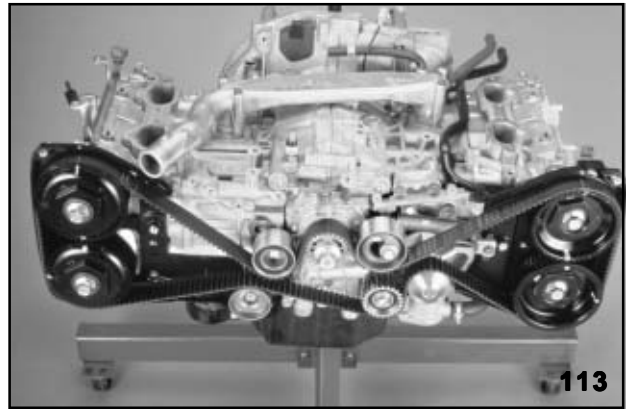

2.5 Liter Engine

The 2.5 liter engine uses double overhead camshafts that are belt driven. Belt tension is maintained through the use of the hydraulic tensioner which is also used on the 2.2 and 3.3 liter engine.

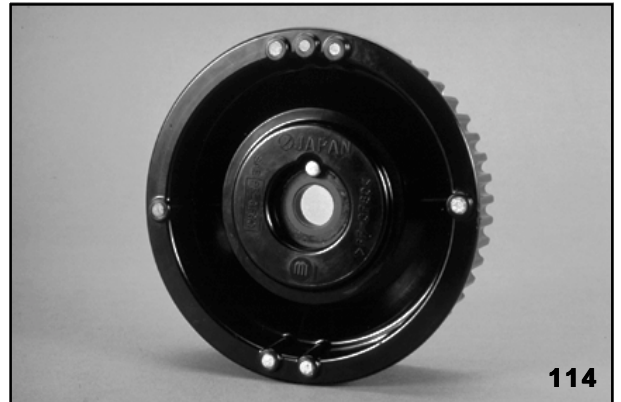

Camshaft Sprocket (Left Bank) (Rear)

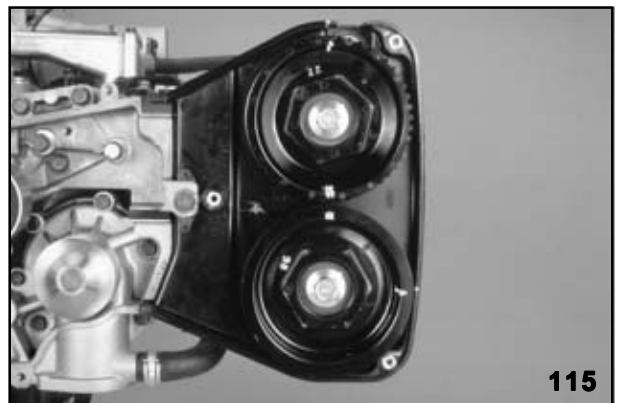

Camshaft Sprocket Timing Marks (Left Bank)

Camshaft sprockets are constructed from a resin type material with a metal key pressed into the sprocket for maintaining proper sprocket to shaft orientation.

Boxer Engine Series Module

The timing marks on the left bank intake camshaft sprocket are positioned at 12:00 o'clock and 6:00 o'clock. The 12:00 o'clock mark, which aligns with a timing mark on the timing belt housing, is used for camshaft to engine timing. The 6:00 o'clock mark is used for timing the intake camshaft to the exhaust camshaft, which has a timing mark at the 12:00 o'clock positions. The remaining timing mark on the exhaust camshaft sprocket, positioned at the 3:00 o'clock, ensures the exhaust camshaft sprocket is timed correctly to the engine. With all timing marks aligned, the intake and exhaust camshaft are in a loaded state. If the timing belt were removed, the camshafts would suddenly revolve from the force of the valve springs. To prevent this from occurring maintain the intake camshaft position and carefully unload the camshaft by allowing it to slowly rotate counterclockwise, (exhaust clockwise) while removing the belt.

NOTE: USE SPECIAL TOOL J-42908 FOR HOLDING CAMSHAFT SPROCKETS DURING BELT INSTALLATION. IT MAY ALSO BE USED FOR LOADING AS WELL AS UNLOADING THE CAMSHAFTS.

CAUTION: VALVE DAMAGE WILL OCCUR IF BOTH CAMSHAFTS ARE TURNED INCORRECTLY AFTER THE TIMING BELT HAS BEEN REMOVED.



Valve Interference



Camshaft Sprocket Timing Marks (Right Bank)

The right bank intake sprockets timing marks are similar in location and purpose as the left bank, however, the exhaust camshaft sprocket on the right bank uses a timing mark at the 9:00 o'clock position to ensure proper camshaft to engine timing (Figure 58-2).

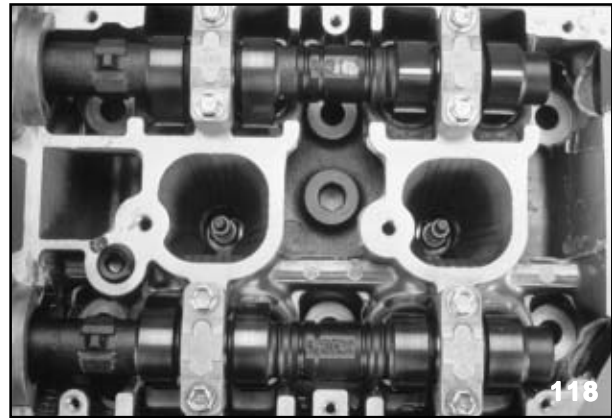

Camshafts

To access the cylinder head bolts, the camshafts must be removed. Follow the procedure outlined in the Subaru service manual for performing this task. The camshafts are held to the cylinder head with bearing caps that are marked (right side) I1TD, I3TD, E1TD, E3TD.

Boxer Engine Series Module

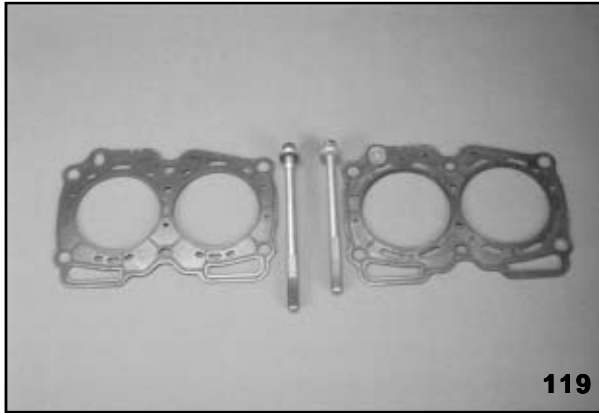

2.2 and 2.5 Liter Head Gaskets

2.5 liter engine head gaskets are identified by the 3 notches located along the gaskets edge, 2.2 liter N/A engine head gaskets have only 2 notches.

CAUTION: THE BOLT PATTERNS FOR BOTH GASKETS ARE THE SAME BUT ARE NOT INTERCHANGEABLE.

The cylinder head bolts for the 2.5 liter engine are much shorter than those of the 2.2 liter engine, and are not interchangeable.

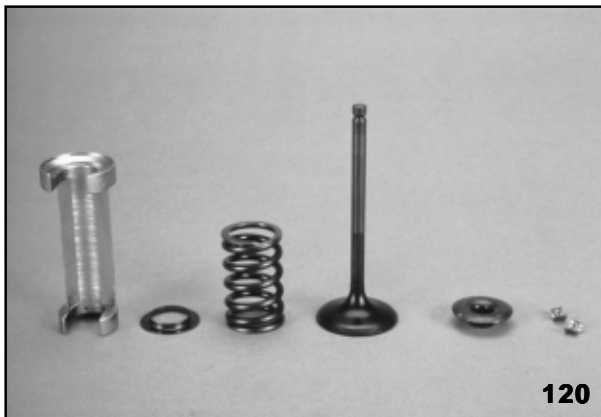

Valve Spring Assembly

Valve servicing is accomplished by utilizing special tool **499718000** and a universal valve spring compressor. The single valve spring is color coded red and rests on a metal spring seat which is used to prevent cylinder head wear. A special tool (**498267700**) will be required to adjust valve guide height, if replacement is necessary. A valve guide reamer (**499767400**) and a valve guide remover (**499767200**) will also have to be used. The hydraulic lash adjuster is of the same type as the 3.3 and requires no servicing.

Spark plugs for the 2.5 liter engine will be platinum tipped, NGK PFR5B-11. (Same maintenance schedule as the SVX.) 2.2 liter engines will use Champion RC10YC4.

Engine oil viscosity for all '96 Legacy and Outback vehicles is 5W-30 to improve fuel economy.



Direct Type HLA

Spark Plug Replacement Procedure for 2.5 Liter Engine

1. Remove battery, washer tank and air cleaner.
2. Remove high tension cords.
3. Cover ATF pipes and ABS pipes with cloth to prevent them from damage during replacement of spark plugs.
4. Remove spark plugs by using a general service tool with the special instruction described below.

Installation

1. Set the spark plug into the socket.
2. Tighten the spark plug in the cylinder head with the socket. It is necessary to support the end of the socket by a finger.
3. When the spark plug can be felt to be tightened with 2 or 3 rotations, remove the socket from the spark plug.

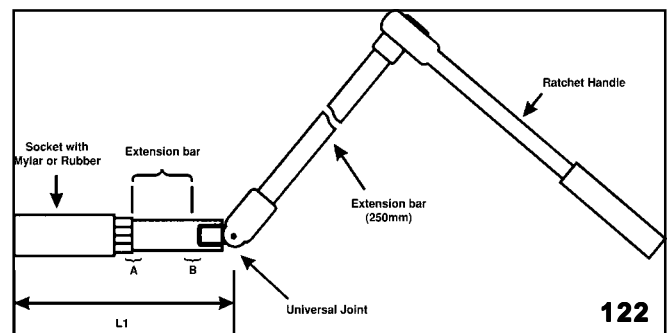

Spark Plug Removal

4. Confirm if the spark plug is screwed into the hole properly by touching it with a finger. If it is difficult to touch it by finger, confirm its condition by using mirror and so on.
5. Reset the socket on the plug then tighten it with the proper torque.
6. Install high tension cords.
7. Install battery, washer tank, and air cleaner.

Boxer Engine Series Module

Note:

1. Length L1 (100mm, 3.94") is most important for ease of removal and installation.
2. Wrap points A & B with tape to prevent them from separating during work.
3. An approximate 250mm long extension bar is recommended to be used between the ratchet and the universal joint.

1997 2.5 Engine DOHC (Phase 1)

The double overhead camshaft engines have had internal and external changes that yield an approximately 10 % increase in power and 3% increase in fuel economy. Accomplishing this involves many factors, one of which is engine friction reduction.

The piston, a major source of engine friction has been coated with a friction reducing agent called Molybdenum. This thin coating not only allows a smoother travel through the cylinder but also reduces cylinder wall scuffing.

The skirt of the piston has been reshaped and the overall weight has reduced by approximately 100 grams. Compression ratio has been increased to 9.7 to 1 by reshaping the crown of the piston. This eliminates the clearance that was available between the piston at TDC and a fully opened valve. Piston pin offset has been changed to 0.5 mm. Piston to cylinder wall clearance has been reduced by increasing the piston diameter.

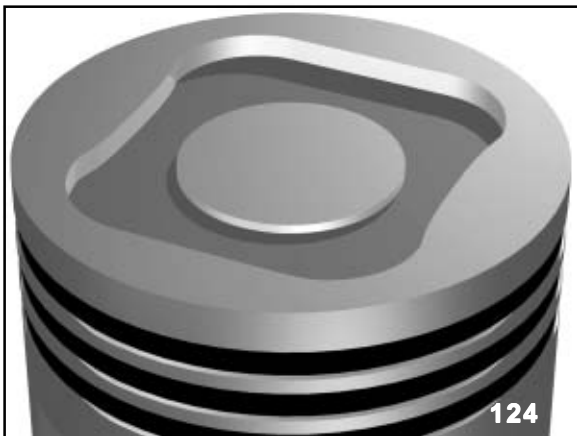

Redesigned 2.5 Liter Piston

Another source of high engine friction is the valve train. Hydraulic lash adjusters are always in contact with the camshaft or valve rockers. The hydraulic pressure of the lash adjuster must be overcome during operation and the most critical time of engine start. To overcome this situation and to contribute to the total reduction of friction loss the DOHC engines will have solid valve adjusters.

The scheduled service of these valve trains is set at **100,000 miles and is not required during the PDI**. The DOHC engine uses an adjustment shim. There are 94 shim sizes.



2.5 Liter Valve Assembly

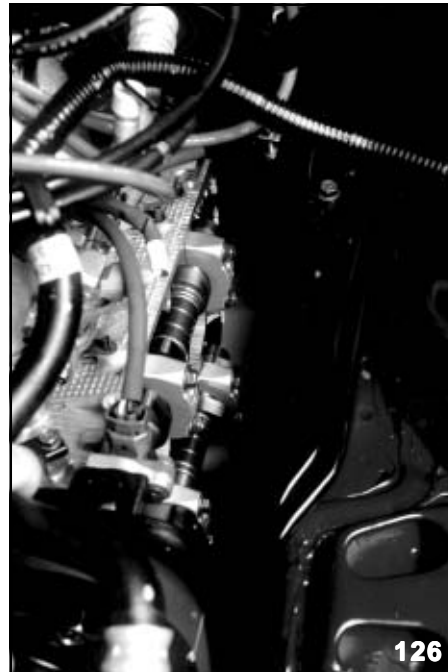

2.5 Liter Head on the car

Boxer Engine Series Module



Bucket and Shim Assembly

NOTE: USE A THIN NONMAGNETIC TOOL PLACED IN THE NOTCH OF THE LASH ADJUSTER TO REMOVE SHIM. (SPECIAL TOOL J-43979)



Checking Valve Clearance on the Car



Identifying Shim Size

NOTE: THE PRINTED SIZE OF THE SHIM SHOULD BE INSTALLED AWAY FROM THE CAMSHAFT LOBE.

As you can see the space between the valve train and the frame rail of a DOHC is some what limited, however valve adjustment is possible by performing the following: Refer to the 1997 Legacy Service Manual Supplement (Volume 6. (2.2 [07B2])

Boxer Engine Series Module

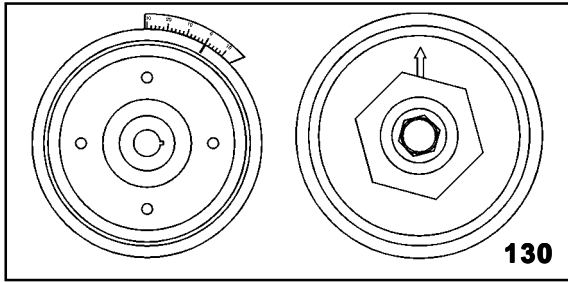

Exhaust Valve Clearance on Cylinders 1 and 3

Step 1

- Set the crankshaft sprocket at 0 degrees. (use crankshaft wrench)
- Set the left intake camshaft sprocket arrow at 12 o'clock (Please remember that the camshaft sprocket has an arrow and a mark used for belt timing. Make certain to use the arrow and not the mark for valve clearance check.)
- The engine is now set for allowing the clearance check of the exhaust valves on cylinders 1 and 3 only. (Please remember that the profile of a camshaft with solid lifters has a ramp that is used to gradually take up the clearance between the lift of the lobe and the lash adjuster.)
- Measure the clearance ensuring the thickness gauge is placed as shown on previous page.
- Record the measurement

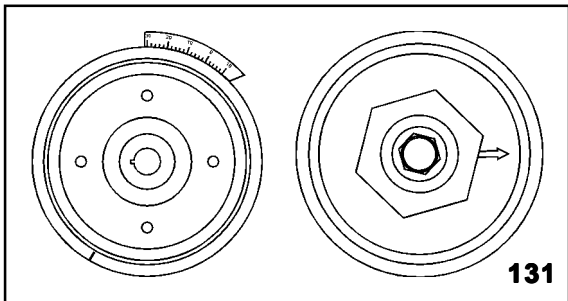

Intake Valve Clearance on Cylinders 1 and 3

Step 2

- Rotate the crankshaft 180 degrees
- The left intake camshaft arrow should now be at 3 o'clock (Figure 7).
- Check the clearance of the **intake valves on cylinders 1 and 3 only**.
- Record the measurement

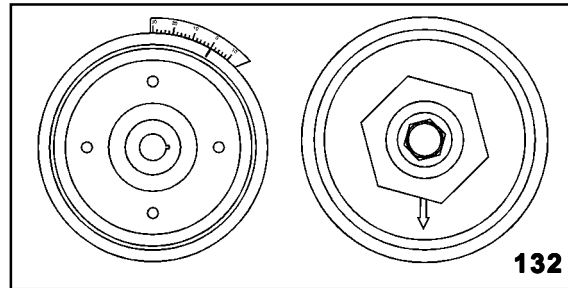

Exhaust Valve Clearance on Cylinders 2 and 4

Step 3

- Rotate the crankshaft 180 degrees.
- The left intake camshaft arrow should now be at 6 o'clock.
- Check the clearance of the **exhaust valves on cylinders 2 and 4 only**.
- Record the measurement

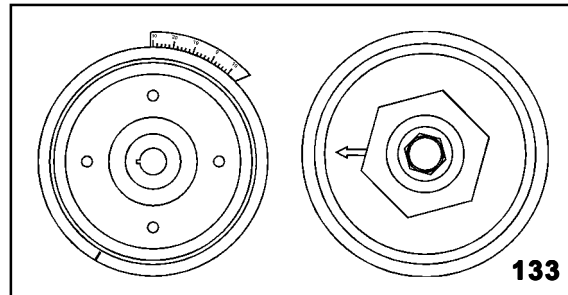

Intake Valve Clearance on Cylinders 2 and 4

Step 4

- Rotate the crankshaft 180 degrees.
- The left intake camshaft sprocket arrow should now be at 9 o'clock.
- Check the clearance of the **intake valves on cylinders 2 and 4 only**.
- Record the measurement.

Step 5

- Use the formula below to choose the new shim:

$$\text{Intake valve } S = V + T - .20$$

$$\text{Exhaust valve } S = V + T - .25$$

S = Shim thickness to be used

V = Measured valve clearance

T = Shim thickness in use

Standard valve clearance

(Intake valves 0.20 +/- 0.02 mm)

(Exhaust valves 0.25 +/- 0.02 mm)

Boxer Engine Series Module

Example:

To solve for the new shim or "T"

- Cylinder 1 intake measured valve or clearance is 0.22 mm no adjustment needed
- Cylinder 1 exhaust measured valve or clearance is 0.15 mm adjustment needed
- Cylinder 3 intake measured valve or clearance is 0.31 mm adjustment needed

The shim in use on cylinder 1 exhaust is marked 240. This refers to the shim having a thickness of 2.40 mm

$$\begin{aligned} T &= 2.40 & S &= V + T (0.25 \text{ mm}) \\ V &= 0.19 & S &= .19 + 2.4 - (0.25\text{mm}) \\ \text{SVC} &= 0.25 \pm 0.03 & S &= 2.59 - 0.25\text{mm} \\ & & \text{(Standard valve clearance)} & S = 2.34 \end{aligned}$$

The shim in use on cylinder 3 intake is marked 245. This refers to the shim having a thickness of 2.45 mm

$$\begin{aligned} T &= 2.45 & S &= V + T (0.20\text{mm}) \\ V &= 0.31 & S &= .31 + 2.45 - (.20\text{mm}) \\ \text{SVC} &= 0.20 \pm 0.03 & S &= 2.76 - .20\text{mm} \\ & & \text{(Standard valve clearance)} & S = 2.56 \end{aligned}$$

Step 6

- Current method of shim replacement is accomplished by removing the camshafts.

CAUTION: (FOLLOW THE DIRECTIONS PROVIDED IN THE APPROPRIATE SERVICE MANUAL FOR CAM-SHAFT REMOVAL AND BELT INSTALLATION.)

Refer to 2-2 [07B2] of the 1997 Service Manual Supplement (Volume 6).

NOTE: SPECIAL TOOL 498187100 MAY ALSO BE USED FOR THIS PROCEDURE.

2.5 Engines 1999 Enhancements DOHC (Phase 1) and SOHC (Phase 2)

The engines for the 1999 Subaru line will be designated phase 1 and phase 2. 2.5 liter engines equipped on the Legacy will be phase 1 design while the Impreza and Forester will utilize phase 2 design 2.5 liter engines.

The 2.5 liter phase 2 engines are SOHC engine with a newly designed cylinder head. The (phase 1) 2.5 liter engine uses the same cylinder head configuration that it has used on prior year models with the crankcase and bell housing sharing the same characteristics of the new phase 2 engines.

Common Changes in the 2.5 liter (phase 1 and 2 engines.)

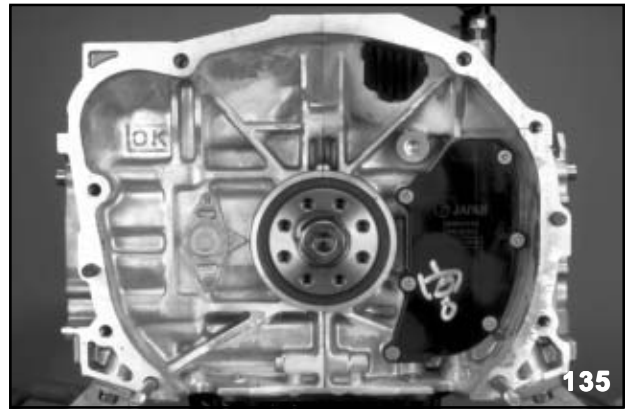

Engine to Transmission Mounting

The engine and the transmission are fastened with 6 bolts and 2 studs.



Thrust bearing Location

The thrust bearing has been moved to the number 5 position.

Boxer Engine Series Module



Main Bearing Oil Grooves

Oil groove in the number 1 and 3 have been changed to supply additional lubrication to the crank journal.

New Features of the 2.5 Liter (Phase 2) SOHC Engine

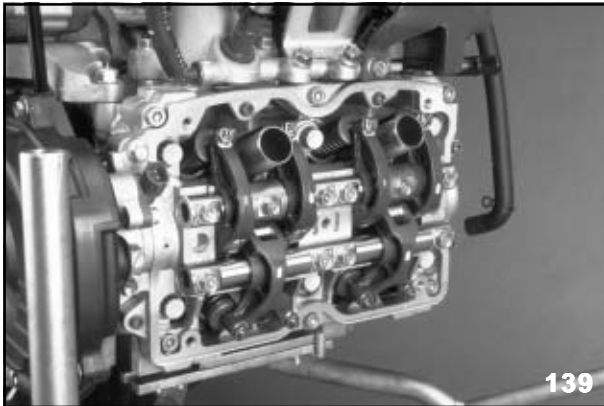

2 Rocker Shaft Assembly

The cylinder head will be a 2-rocker shaft roller solid type valve system.

The valves are positioned at a larger angle than previous model years. The intake valves are positioned 23 degrees off center with the exhaust valves positioned 20 degrees off center. Prior model year engines utilized a 15-degree positioning angle.

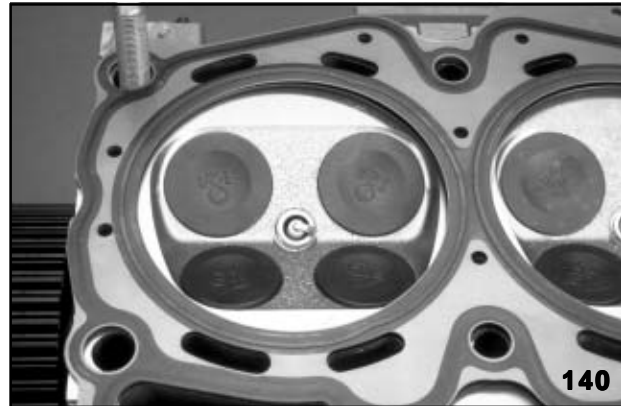

New Head Gasket Design

Head gasket thickness is 0.7 mm.



Rocker Arm Identification



Roller Rockers and Wave Washers

Boxer Engine Series Module



Adjustment Screw and Nut

The intake rocker arms are marked so they are correctly placed on the rocker shaft when servicing. An IN1 or IN2 will be embossed on each rocker arm. As viewed from the front of the engine the Number 1 intake valve of each cylinder and the number 2 intake valve have an IN1 marked and IN2 marked rocker arm that mates with it. New IN1 rocker arms can also be identified by a Green painted mark on the top of the rocker arm. The IN2 rocker arms have a white mark. Proper positioning is maintained through the use of a wave washer located between the rocker shaft arm and rocker arm shaft support.

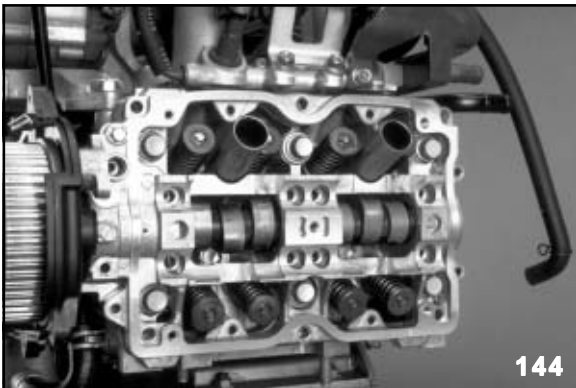

Camshaft Secured by Camcase

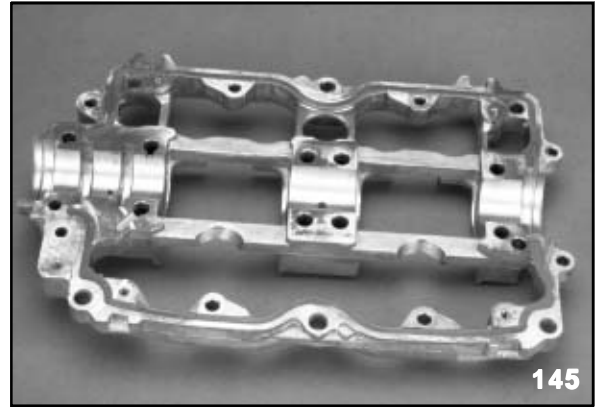

Camcase Sealing Points



Sealing Groove

The camshaft is secured to the cylinder head with the camcase. An oil passage in the cylinder head provides the passageway in the camcase with oil that leads to the intake rocker shaft. Oil from the camshaft is collected on the opposite side of the passageway leading to the intake rocker shaft to provide oil to the exhaust rocker shaft.

Sealing of the camcase is accomplished by using a thin layer of three bond applied in the channel around the camcase edge. After the three bond (1280B) is applied, the camcase must be installed to the cylinder head and onto the engine before the three bond has time to cure. Failure to do this will result in oil leaks.

NOTE: CYLINDER HEAD AND CAMCASE MUST BE REPLACED TOGETHER. (LINE BORED)

Boxer Engine Series Module

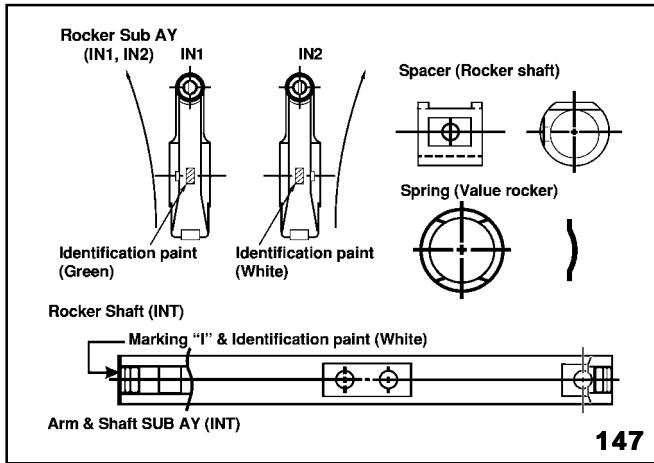

Rocker Identification

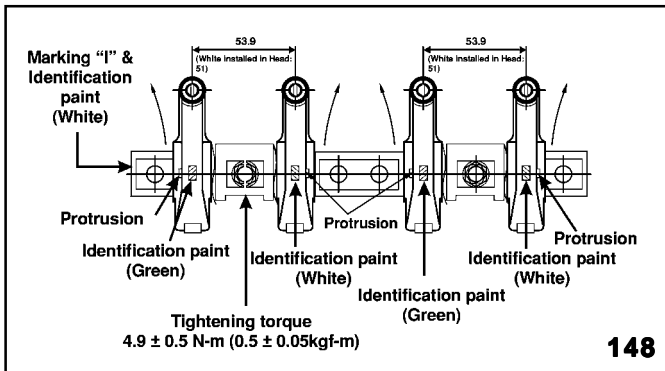

Rocker Arm Measurements

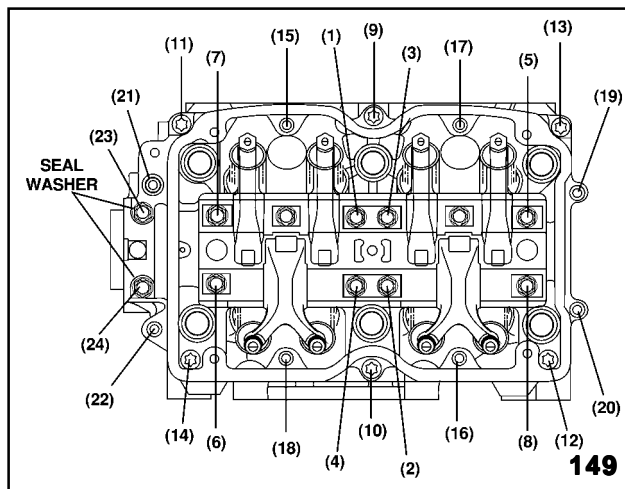

Camcase Tightening Sequence

The sparkplug pipe is pressed into the cylinder head and is not serviceable. If it becomes damaged the cylinder head must be replaced. The seals installed onto the ends of the sparkplug pipes seal against the valve covers and should be replaced when the valve cover is removed.

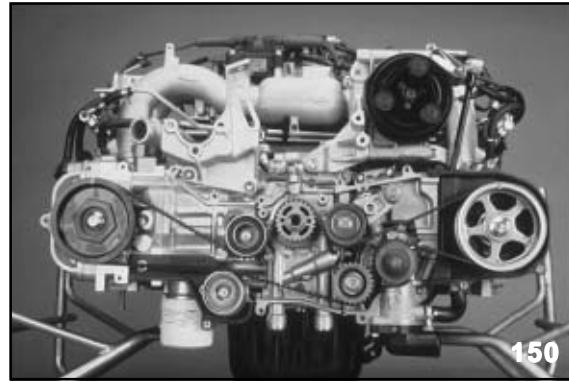

Timing Belt Marks

Timing belt marks on the left bank will be made onto the inner timing belt cover and the edge of the camshaft sprocket. The crank shaft timing mark remains on the reluctor with engine block mark just below the crank angle sensor. The right bank camshaft sprocket has a mark at the edge that is matched with the seam line formed by the meeting of the camcase and cylinder head. (12:00 o'clock position)

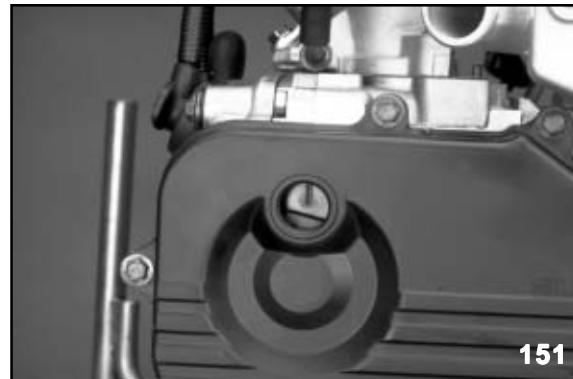

Right Bank Timing Mark Window

The right bank timing mark can be checked with outer cover in place using the provided window.

Boxer Engine Series Module

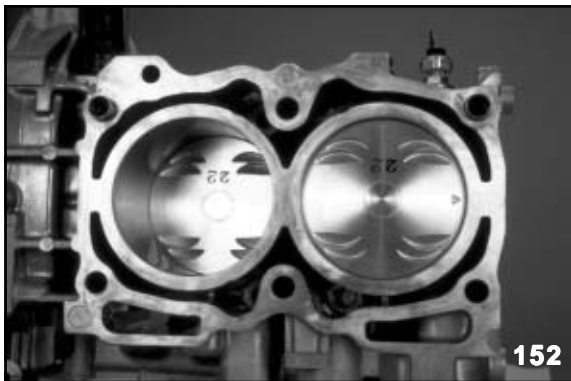

Open Deck Design



Piston With Valve Reliefs

Piston design on the 2.5 liter engine will remain the same as the 2.2 liter. The compression ratio is 9.7 to 1.

2.0 Liter Engine Features

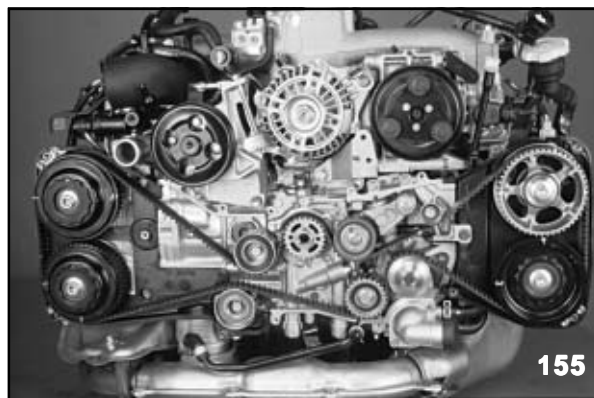

2.0 Liter Engine



Cam Belt and Idler Pulleys

The EJ-2.0 engine is a double over head camshaft engine equipped on all turbo charged Impreza vehicles. The timing belt procedure and routing is very similar to other Subaru DOHC, engines, however, the increased power output of the engine requires the use of an additional timing belt idler pulley. Manual transmission vehicles are equipped with additional belt guides that function during deceleration or fuel cut from high rpm running conditions.

NOTE: WHEN SERVICING THE TIMING BELT RETURN ALL IDLER PULLEYS AND BELT GUIDES TO THEIR ORIGINAL POSITIONS.

Boxer Engine Series Module

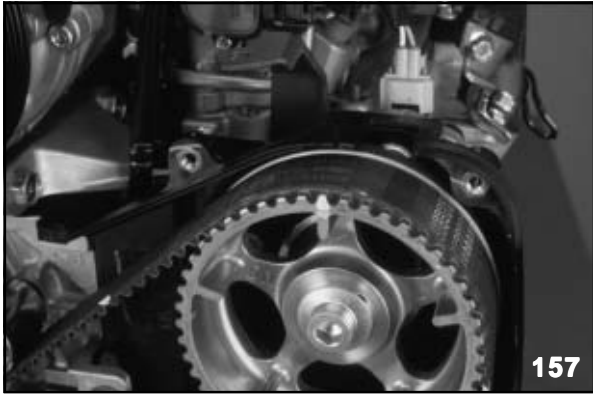

Intake Camshaft Sprocket Timing Marks (Left Bank)



Exhaust Camshaft Sprocket Timing Marks (Left Bank)

The left bank intake camshaft sprocket is metallic and the camshaft reluctor is made onto the backside. The timing marks for belt installation are at 12:00 (I) and 6:00 (II).

The left exhaust sprocket is made of a resin material with its timing marks during belt installation at 12:00 (II) and 3:00 (I). The exhaust 12:00 (II) mark lines up with 6:00 (II) of the intake sprocket. (A timing belt guide is located at the lower left side of the sprocket of manual transmission models.)



Intake Camshaft Sprocket Timing Marks (Right Bank)

The right intake sprocket is also made of a resin material with its timing marks during belt installation at 12:00 (I) and 6:00 (II). (A timing belt guide is located at the upper left side of the sprocket of manual transmission models.)

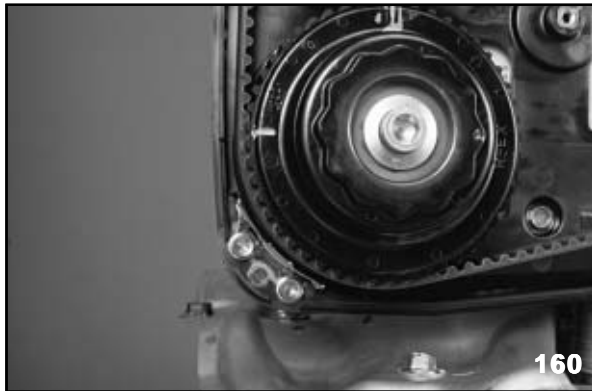

Exhaust Camshaft Sprocket Timing Marks (Right Bank)

Finally, the right exhaust sprocket is made of a resin material with its timing marks during belt installation at 9:00 (I) and 12:00 (II). The exhaust 12:00 (II) mark lines up with 6:00 (II) of the intake sprocket. (A timing belt guide is located at the lower left of the sprocket of manual transmission models.)

NOTE: IT IS CRITICAL THAT ALL TIMING MARKS BE CONFIRMED TO THE CORRECT POSITION. INCORRECT POSITIONS WILL RESULT IN VALVE AND PISTON DAMAGE.

Boxer Engine Series Module



Engine Designation Number

The engine class number (Engine designation number) is located near the front of the engine behind the oil-sending unit and in front of the engine coolant temperature sensor.



Factory Coolant Pipe Plug

A coolant pipe located on the left hand bank is sealed with a rubber plug at the factory. **Do not** remove the plug to service any part of the cooling system. When performing coolant pressure tests check plug for leaks.

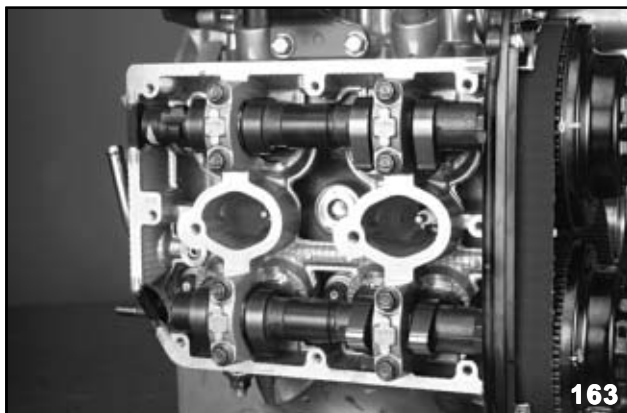

2.0 Liter Valve Train Assembly

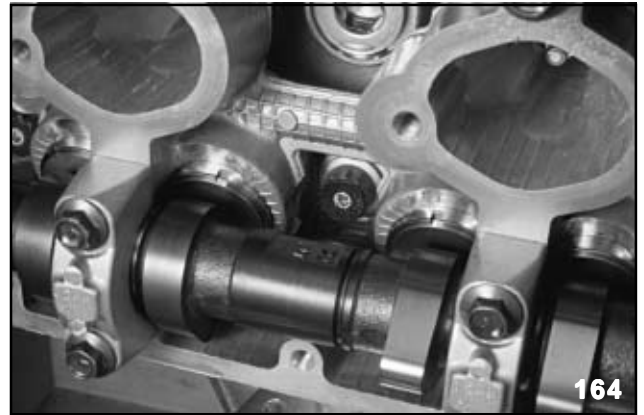

2.0 Liter Head Bolt Access

The valve train for the EJ 2.0 is the same design used on other DOHC engines. A new shim tool has been developed to allow valve adjustment without removing the camshafts. The camshaft inner cover, camshaft sprockets and camshafts must be removed to access the cylinder head bolts.

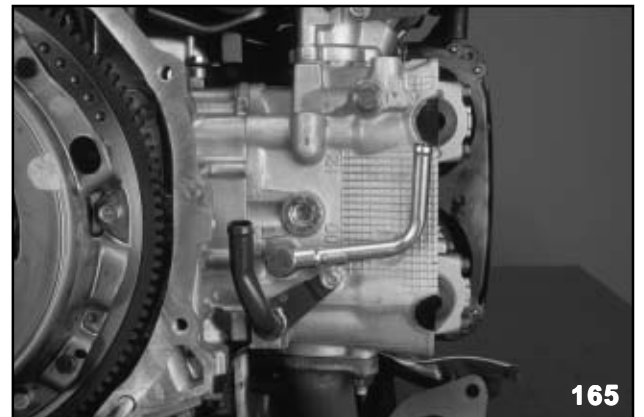

Turbo Oil and Coolant Passages (Right Bank)

The rear of the right bank cylinder head serves as the mounting for the oil and coolant passages for the Turbo Charger.

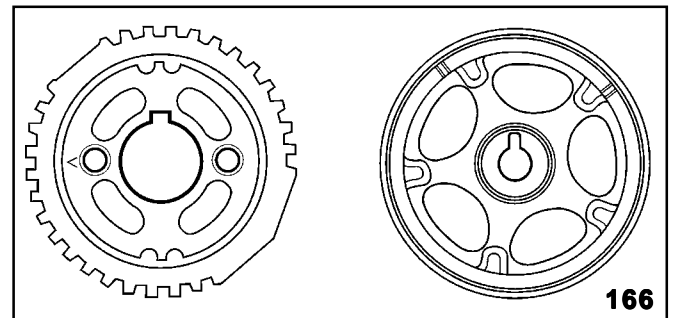

Crankshaft and Camshaft Sprockets for the 2.0 Turbo Engine

Boxer Engine Series Module

3.0 Liter Engine

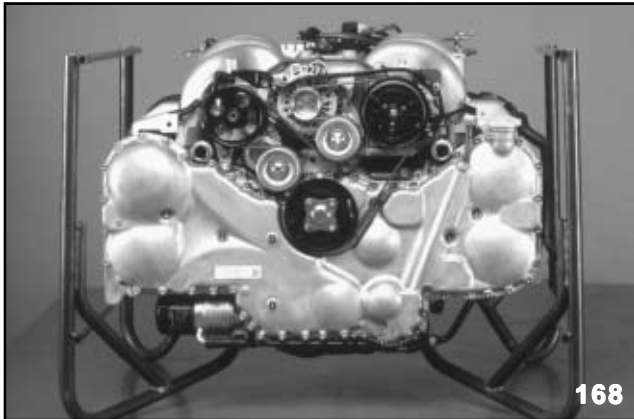

3.0 Liter Engine with Stands

General Information

The EZ-3.0 is the model name (Engine Designation) for the new 6-cylinder engine introduced for the 2001 model year Legacy. The design idea for this engine was to create a power plant that could utilize the current body style, provide more power and decreased exhaust emissions. Many of the features refined for the current 4 cylinder engine are employed on the EZ-3.0 however, new features such as Variable Intake Control and timing chain driven camshafts give the new engine a look and operation all of its own.

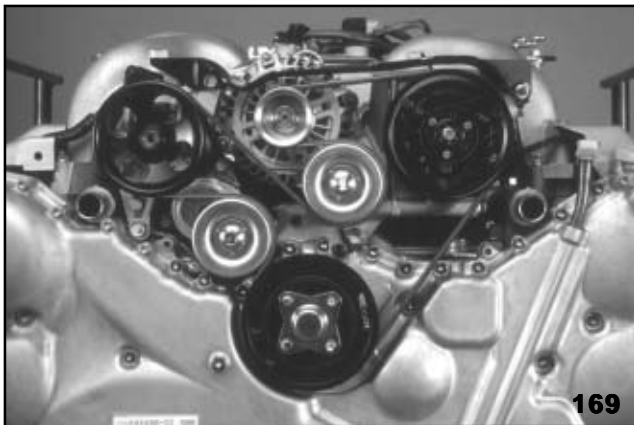

Single Serpentine Belt



Belt Wear Indicator

3.0 Liter Engine Features

The front of the engine displays the large front timing chain cover. It is secured to the inner cover with 59 bolts. There are 4 different lengths used and is sealed to the inner cover with Three Bond (1280B). Special care must be used when servicing the timing chain covers to ensure the proper length bolt and sealing procedures are used. A single serpentine belt provides the power to turn all engine accessories.

Tension to the belt is controlled with an automatic tensioner.

Replace the serpentine belt when the indicator is at or beyond this line.

3.0 Specifications

Bore and stroke 89.2 X 80 millimeters (3.51 X 3.14 inches)
Length 465 millimeters (18.3 inches)
Height 635 millimeters (24.99)
Displacement 3.0 liters (183 cubic inches)
Compression Ratio 10.7 to 1
Gasoline for use Unleaded Premium
Fuel Injection Type DMPI
Maximum Horsepower 212 at 6,000 RPM
Maximum torque 210 at 4,400 RPM

Boxer Engine Series Module

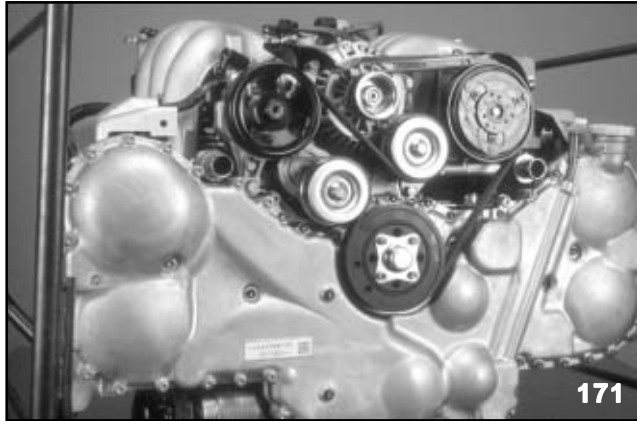

Upper Radiator Hose Connections

Two radiator hose connections are located at the top of the engine block connecting to each of the cylinder heads.

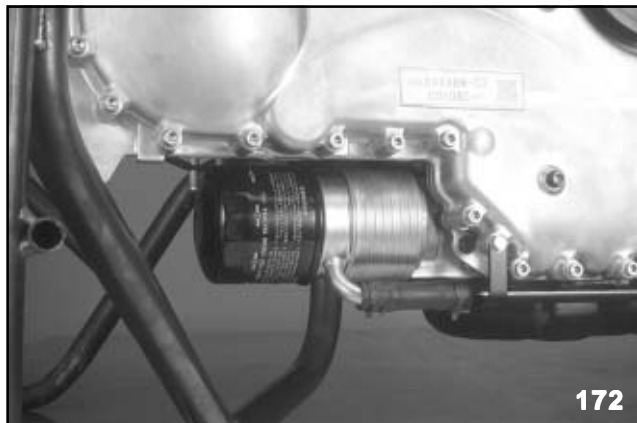

Oil Cooler

An oil cooler is used to assist with bringing the oil to operating temperature.

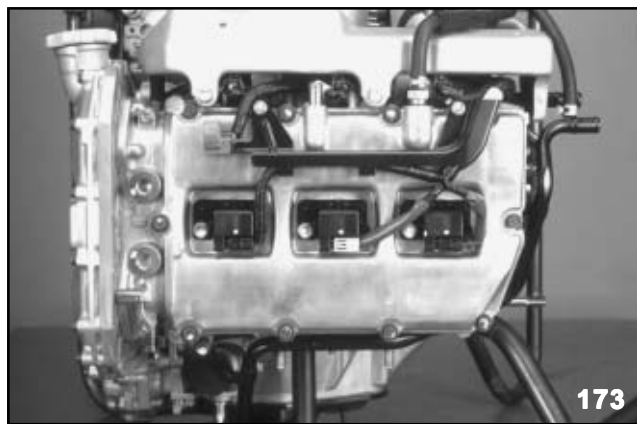

Individual Coils

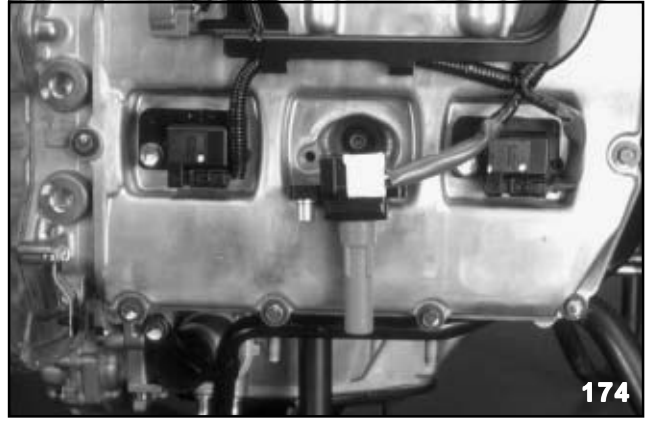

Coil and Igniter Assembly

The view of the left bank side shows the use of new direct ignition coils. The igniter and current control circuits are integrated.

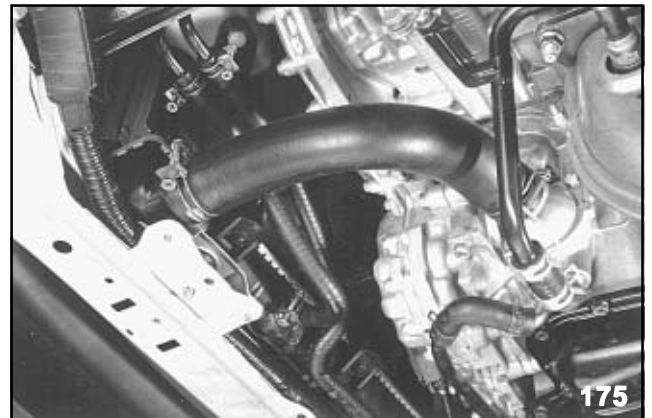

Lower Radiator Hose

The lower hose is located on the thermostat housing, connecting to the lower section of the radiator.

Boxer Engine Series Module



Oil Pan and Extension Case

The thermostat is housed in the oil pan extension case. The oil pan itself is much smaller than previous model engines and contains a small magnet to collect metallic debris.

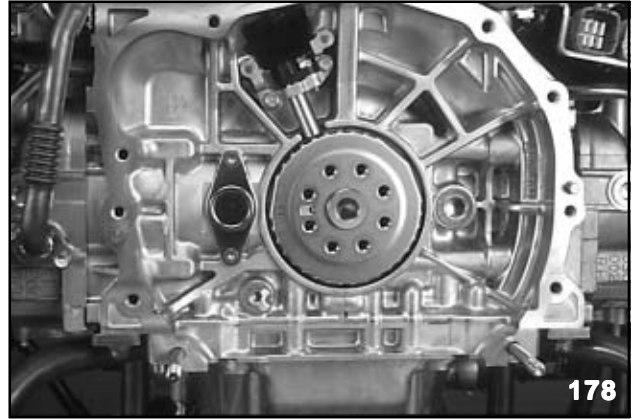

Crank Angle Sensor with Reluctor

The new crank angle sensor, reluctor, and EGR pipe. The crank angle sensor and reluctor have been moved to the rear of the crankshaft. The EGR pipe has a new design and is mounted on the left bank of the engine.

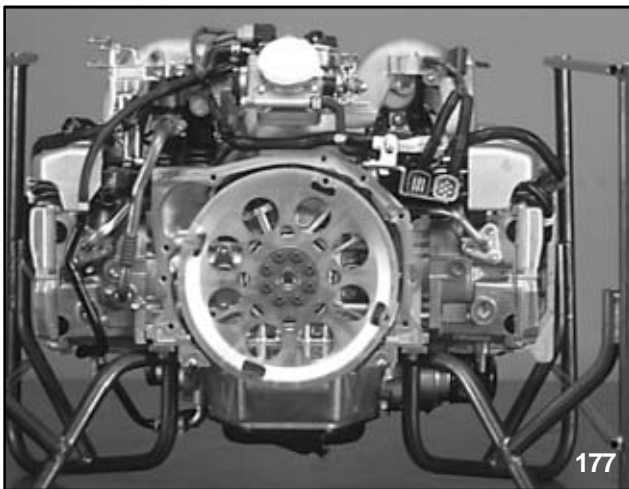

Crankcase Ventilation System

Connections for the crankcase ventilation system are located at the top of the valve cover. Pressure is equalized from the right bank with a cross over tube.

Boxer Engine Series Module

3.0 Liter Engine Disassembly

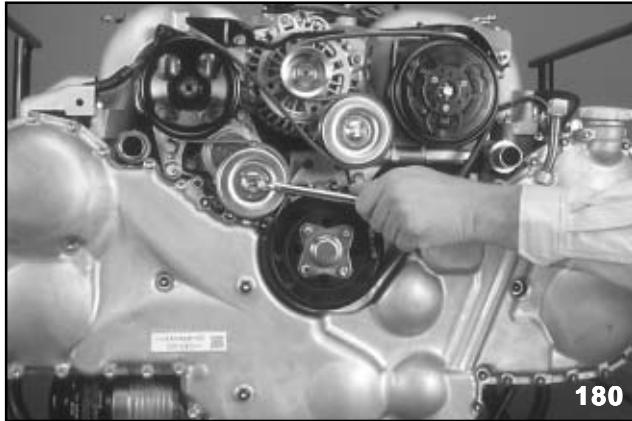

Unloading Tensioner

Begin disassembly by unloading and removing the serpentine belt.

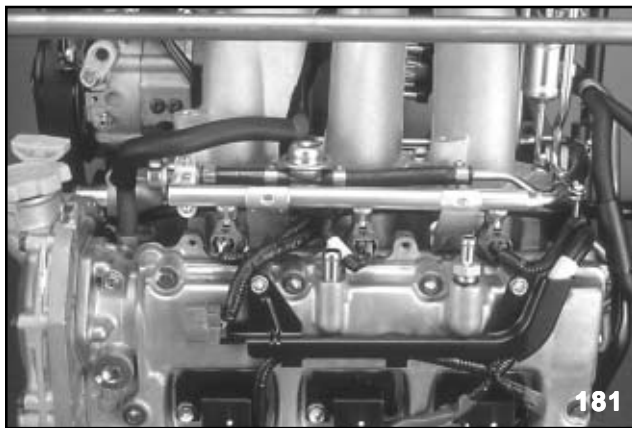

Fuel Rail Assembly

Remove the fuel rail protectors from both sides.



Lower Alternator Bolt

The lower alternator bolt must be backed out before the manifold can be removed.

Remove the intake manifold.

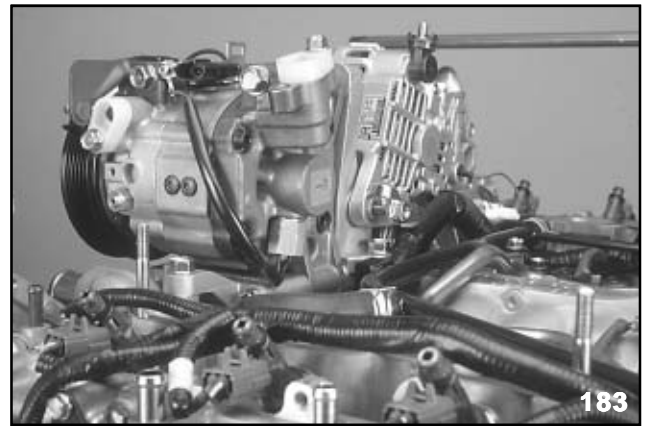

Remove Accessories

Remove the alternator, compressor and power steering pump.

NOTE: THE COMPRESSOR IS EQUIPPED WITH A SPEED SENSOR THAT SENDS A SIGNAL TO THE ECM. IF THE COMPRESSOR SPEED DROPS MORE THAN 20% COMPARED TO THE ENGINE SPEED, THE ECM TURNS THE COMPRESSOR OFF THROUGH THE A/C RELAY. THE REFRIGERANT MUST BE EVACUATED BEFORE REMOVING THE SENSOR.



Crankshaft Bolt Cover

Boxer Engine Series Module



Crankshaft Bolt Seal

Remove the crankshaft bolt cover, bolt and harmonic balancer. Do not lose the O-Ring that seals the crank shaft bolt cover to the harmonic balancer.

Begin removing the outer cover bolts. Keep them organized to ease reassembly. The bolts must be removed in the proper sequence to avoid warping the outer case.

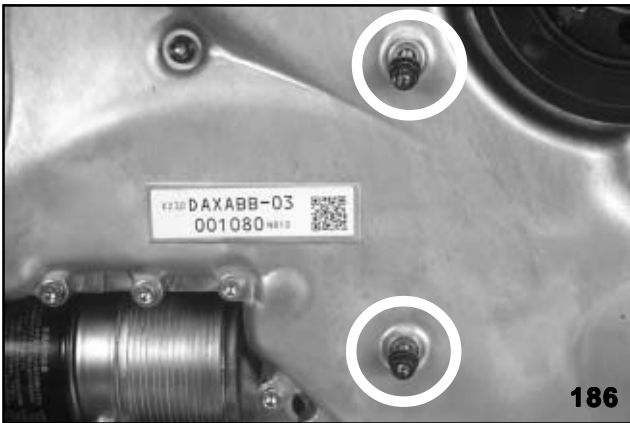

Outer Cover Seals

These two bolts use sealing washers to prevent engine oil from leaking to the outside.

The seals are not reusable.

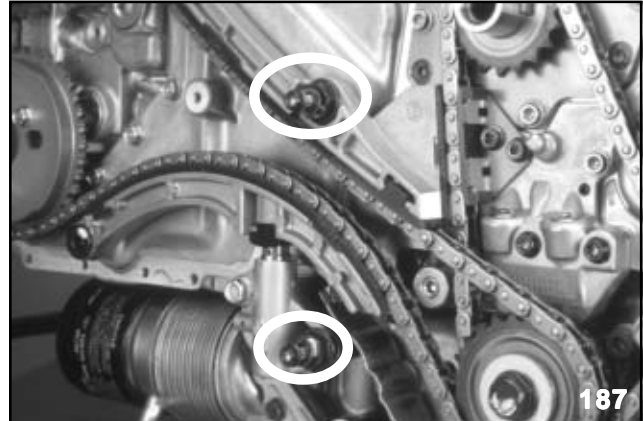

Outer Cover Bolts

The bolts circled in the above picture secure the outer cover to special bolts that have internal threads. These bolts assist with supporting the outer chain cover along the middle where there is no support from the inner case.

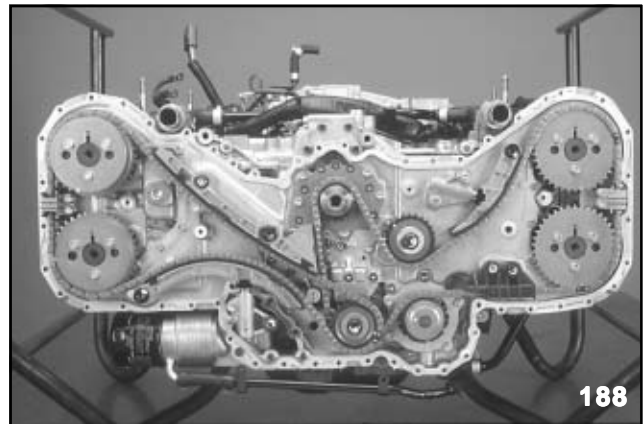

Timing Chain Routing

The timing chain on the EZ-3.0 is designed to last the life of the engine. Proper engine oil maintenance is necessary to ensure it lives up to its design. Two chains are used. Four (4) camshaft sprockets, one (1) crankshaft sprocket, two (2) idler sprockets and the water pump complete the timing chain routing.

Boxer Engine Series Module

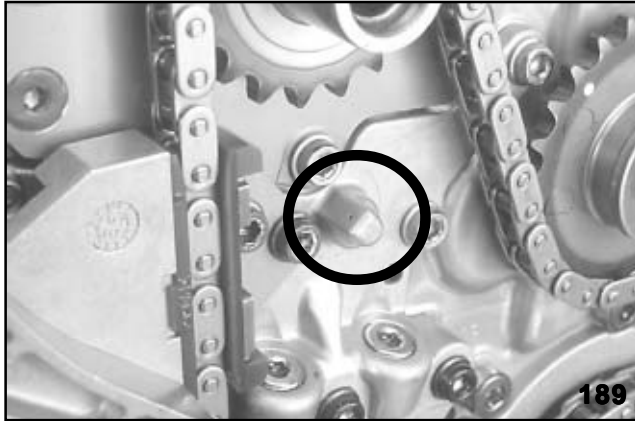

Timing Chain Oil Jet

The timing chain is sprayed with oil from this jet located on the oil pump relief valve housing.

CAUTION: THE SPROCKET TEETH ARE SHARP SO USE EXTREME CARE WHEN WORKING NEAR OR AROUND THEM.

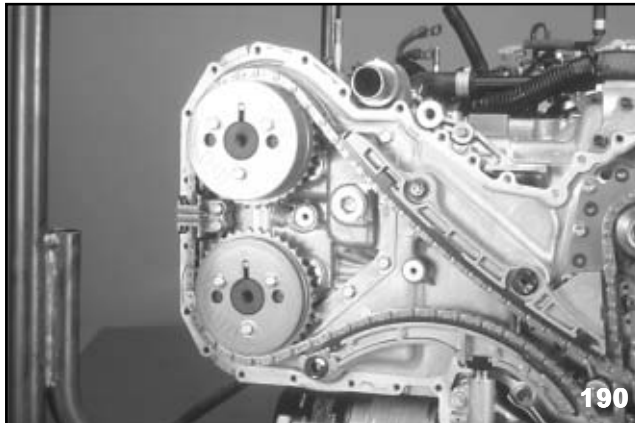

Right Bank Camshafts

The right bank camshafts are in a loaded state when the keyways are at 12:00. They must be unloaded in the proper way to prevent damage to the pistons and valves.

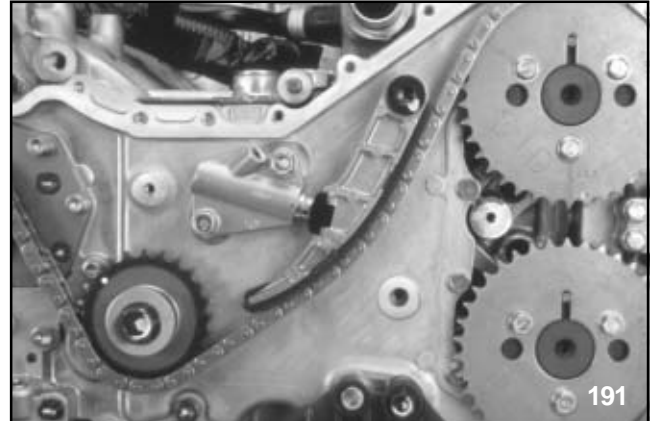

Left Bank Timing Marks

Timing marks are located on the camshaft sprockets and the crankshaft sprocket. Marks and letters on the idlers are manufactures markings and are used only to establish which side faces outward. *Do not use them to establish proper chain timing.*

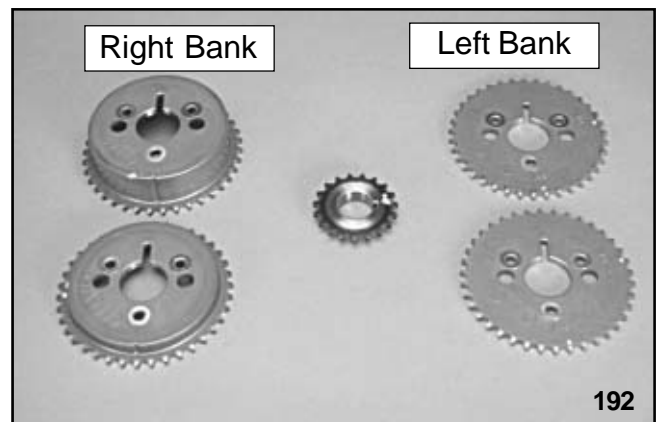

Camshaft Sprockets

The left bank camshaft sprockets are interchangeable when new. It is recommended they be returned to their original positions to maintain wear patterns after being used.

Boxer Engine Series Module

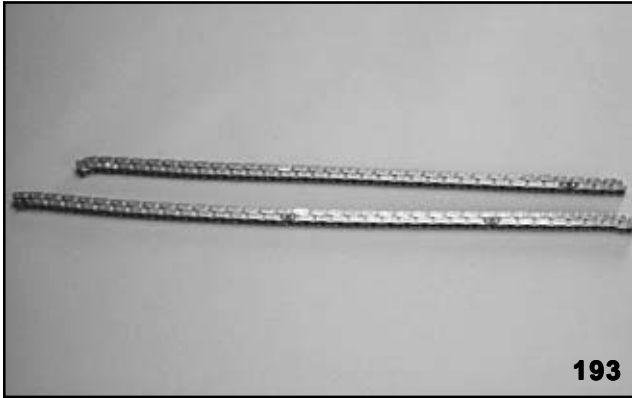

Timing Chains

The left timing chain is the longer of the two with 148 links. The right chain has 134 links.

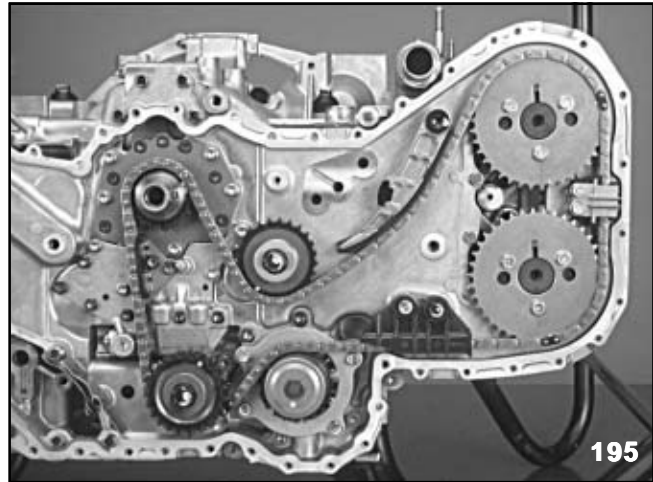

Removal of Left Bank Timing Chain Components

Remove the left bank tensioner, chain and chain guides..

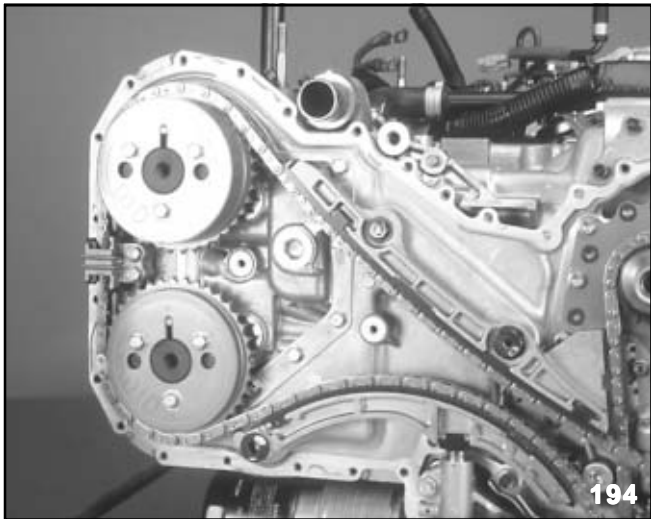

Removal of Right Bank Timing Chain Components

Turn engine clockwise to rotate it until the key ways of the cam sprockets are at the 12:00 position. Remove the right bank tensioner, chain and chain guides.

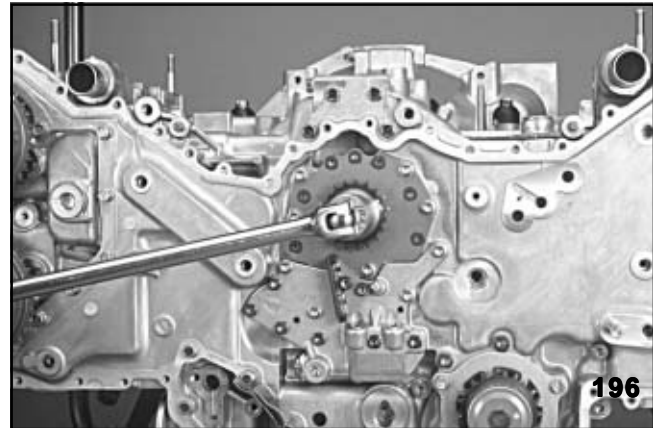

Turn Crankshaft to Prevent Piston and Valve Damage

NOTE: TURN THE CRANKSHAFT 90 DEGREES COUNTER CLOCKWISE TO REDUCE THE CHANCE OF ACCIDENTAL DAMAGE TO THE PISTONS AND VALVES IN THE EVENT THE CAMSHAFTS SUDDENLY UNLOAD.

Boxer Engine Series Module

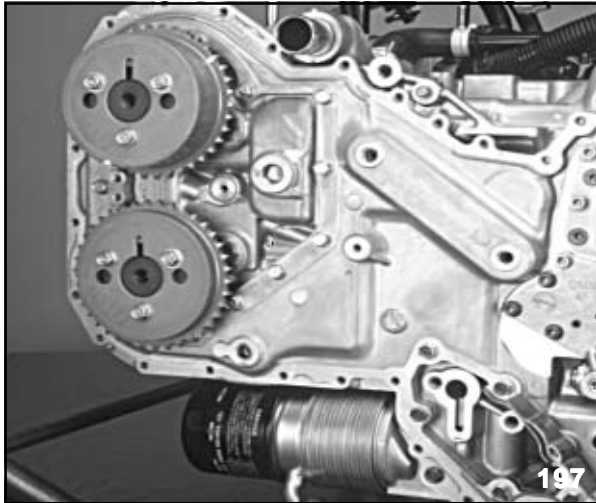

Right Bank Camshafts in Loaded Position

The left bank is currently unloaded. The right bank is loaded and must be unloaded using the procedure depicted below.

Unloading Cam Sprockets

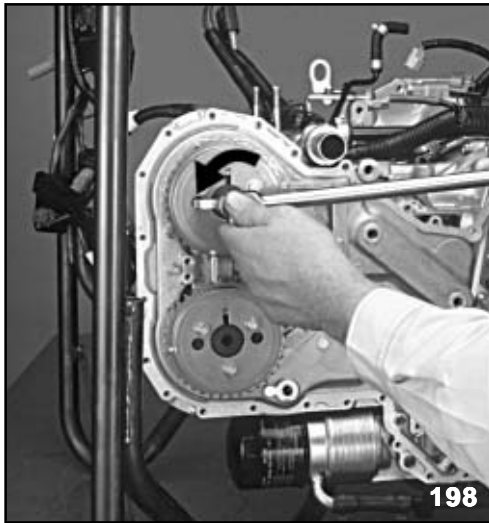

Unloading Intake Camshaft

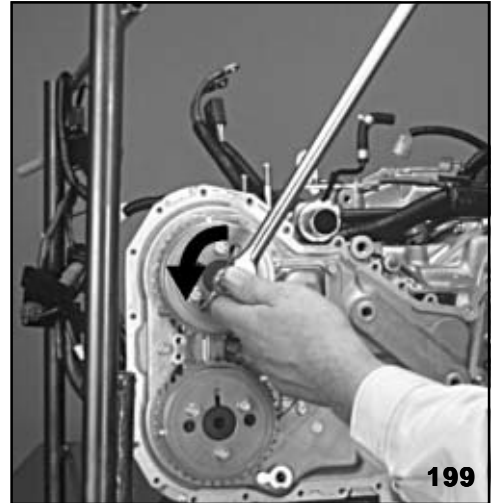

Unloading Intake Camshaft

Position the camshaft sprocket wrench on the **right bank intake** sprocket and turn 90 degrees **counter clockwise**.

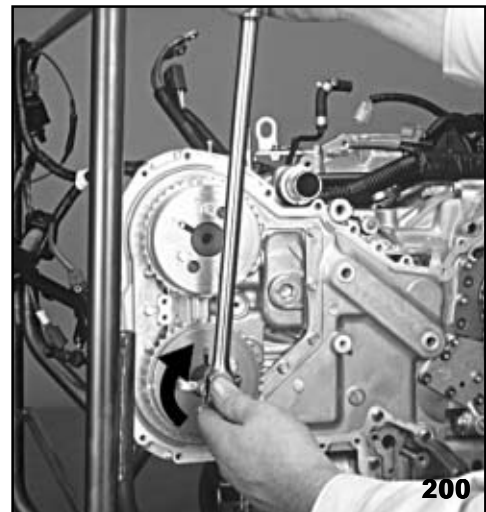

Unloading Exhaust Camshaft

Boxer Engine Series Module

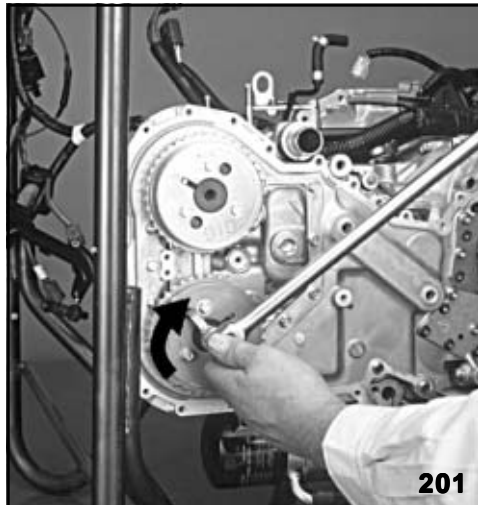

Unloading Exhaust Camshaft

Position the camshaft sprocket wrench on the **right bank exhaust** sprocket and turn 90 degrees **clockwise**. Both camshafts are now unloaded.

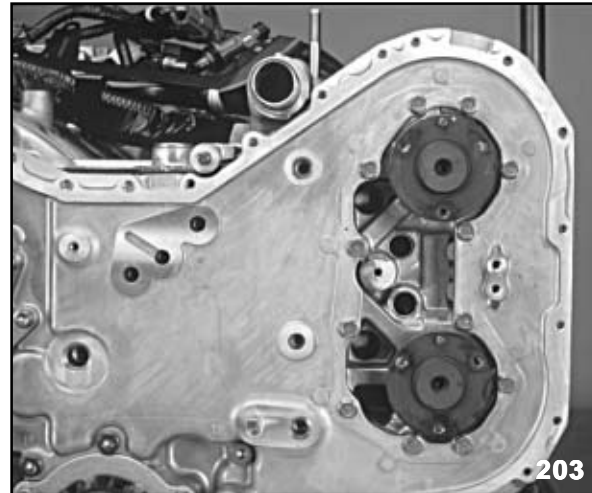

Remove Camshaft Sprockets (Left Bank)

Remove both the intake and exhaust camshaft sprockets on the left and right banks.

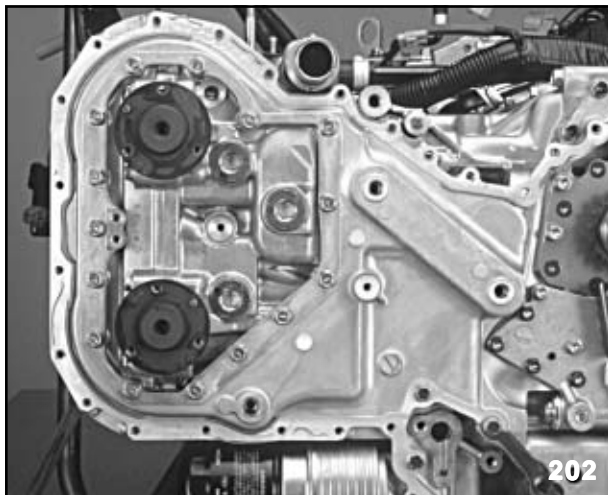

Remove Camshaft Sprockets (Right Bank)

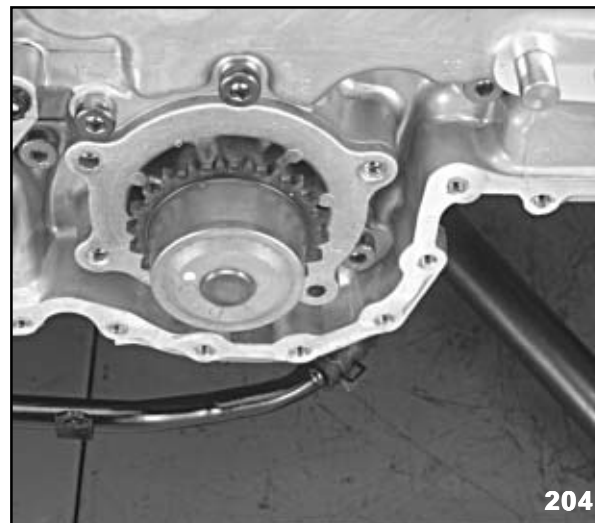

Water Pump Assembly

Remove the bolts from the water pump.

Boxer Engine Series Module

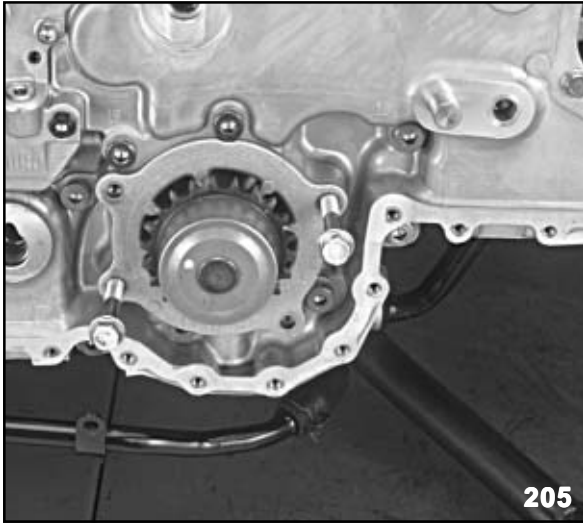

Insert Bolts for Pump Removal

Thread two eight millimeter bolts as shown and equally turn them in. This will assist with the removal of the pump.

Remove the o-ring that seals the water pump to the inner cover.

Removal of Oil Pump

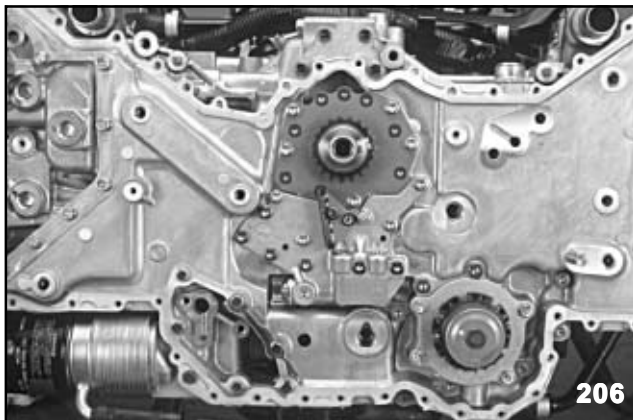

Oil Pump Cover

Remove the oil pump cover and oil pump gears.



Chain Guide

NOTE: THE CHAIN GUIDE MUST BE REMOVED BEFORE REMOVING THE OIL PUMP COVER.

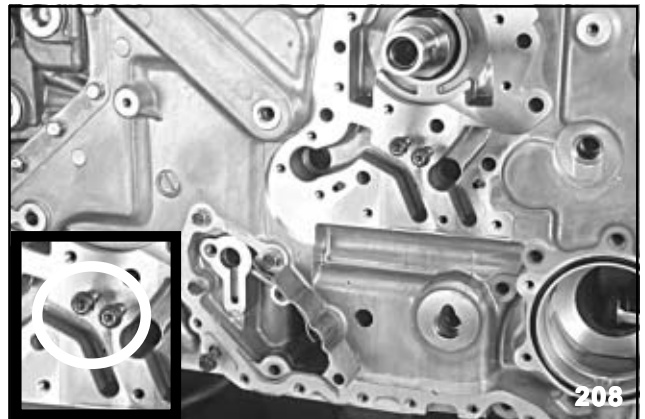

Chain Guide Bolts

The two bolts that secure the chain guide at the crankshaft pulley are pretreated with Locktite. (See insert)

Boxer Engine Series Module



Oil Relief Valve Housing

Remove the relief valve housing bolts and housing.

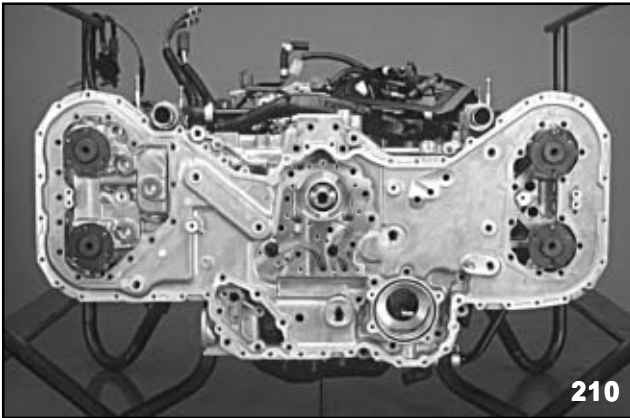

Inner Cover

NOTE: PLEASE FOLLOW PROPER SEQUENCE.

Remove the 46 bolts that secure the inner chain cover to the engine block. The numbers are embossed on the cover and must be removed in reverse order. (Start at bolt 46)

O-Ring Placement Inner Cover

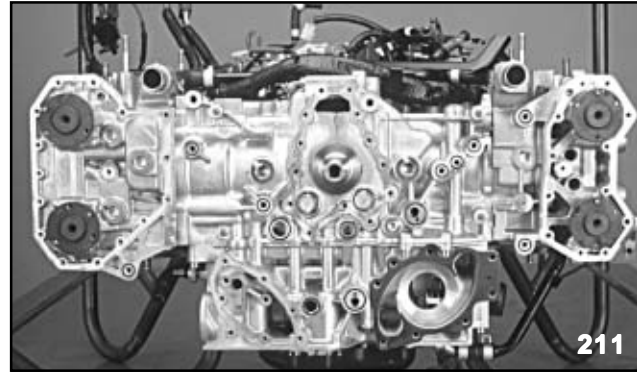

O-Ring Locations

Remove the inner cover and observe the location of the o-rings. There are fifteen (15) in total.

Care must be taken to ensure proper installation of all seals. There are 6 different length bolts in this area so use care to keep them organized. Your 6 cylinder Service Manual Supplement illustrates correct order and size of the bolts.

NOTE: COLOR OF RINGS ARE DIFFERENT FROM PREVIOUS MODELS OBSERVE PROPER PLACEMENT.

NOTE: THE PAPER-TYPE WATER PUMP GASKET.

Removal of Cylinder Head

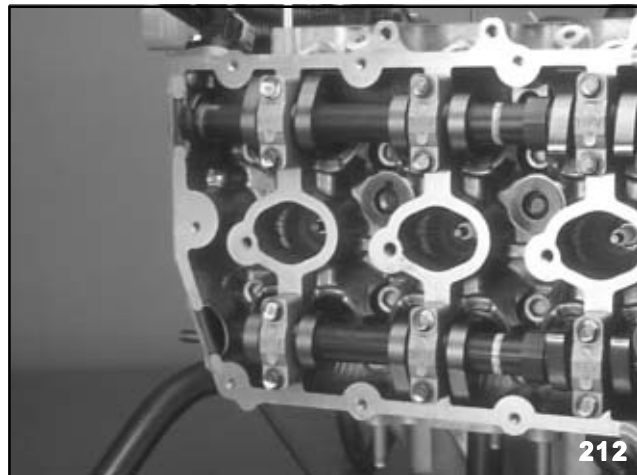

Valve Train Assembly

NOTE: PLEASE FOLLOW THE PROPER SEQUENCE. ALSO NOTE THEY ARE HEX DESIGN BOLTS.

Remove the cylinder head bolts. Use care to prevent rubbing the hex socket on the camshafts during removal.

Remove the cylinder head and gasket.

Repeat this procedure on the opposite side.

Boxer Engine Series Module

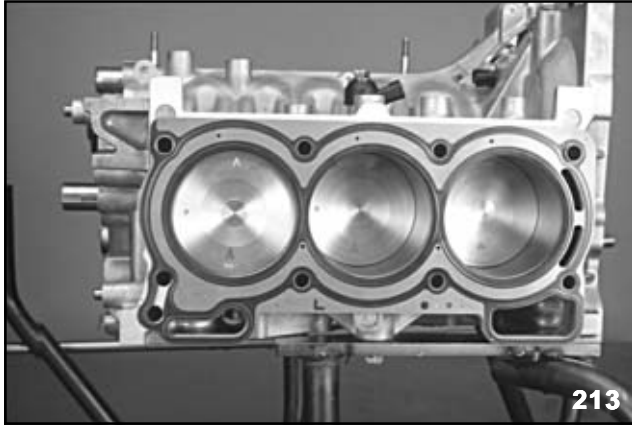

Cylinder Block with Head Gasket

The cylinder block is made from aluminum die casting with monoblock casting cast iron cylinder liners. Water jackets are independent for the RH and LH block halves.

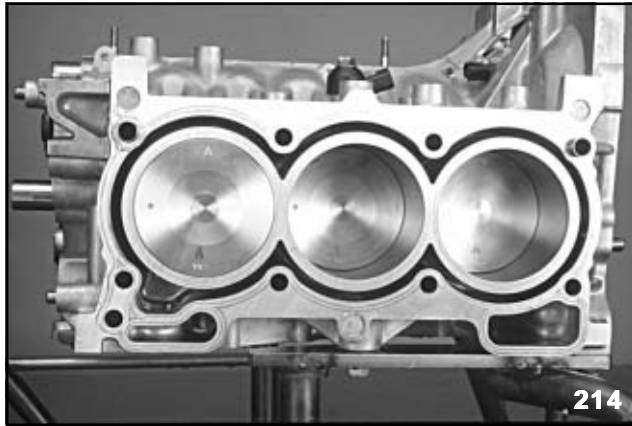

Open Deck Design

The block utilizes open deck design.

Removal of Oil Pan

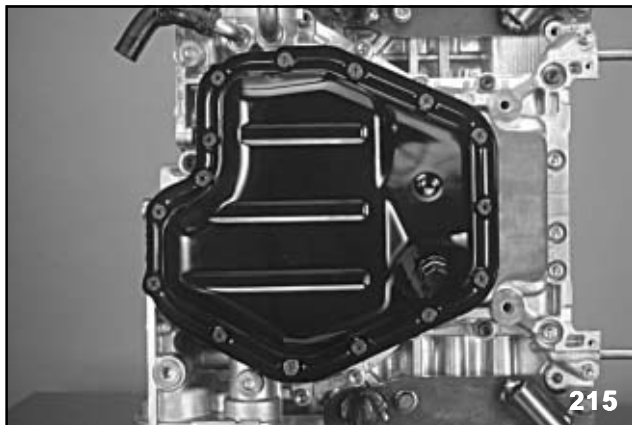

Oil Pan (Lower)

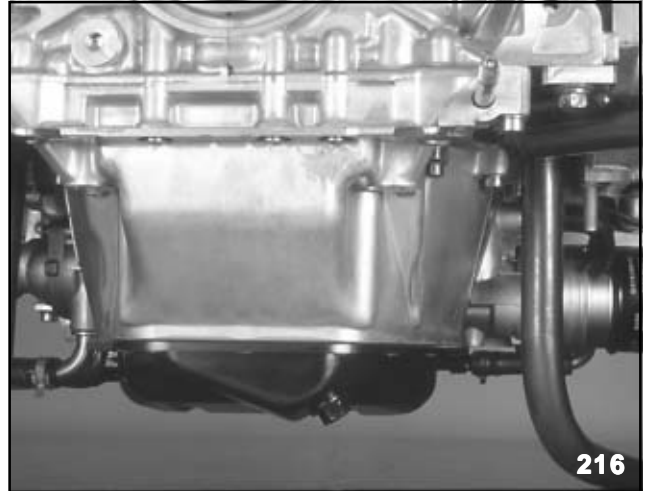

Oil Pan (Upper)

Remove the oil pan bolts and oil pan. Observe that the Oil Pan has a different design from 4 cylinder Subaru engines.

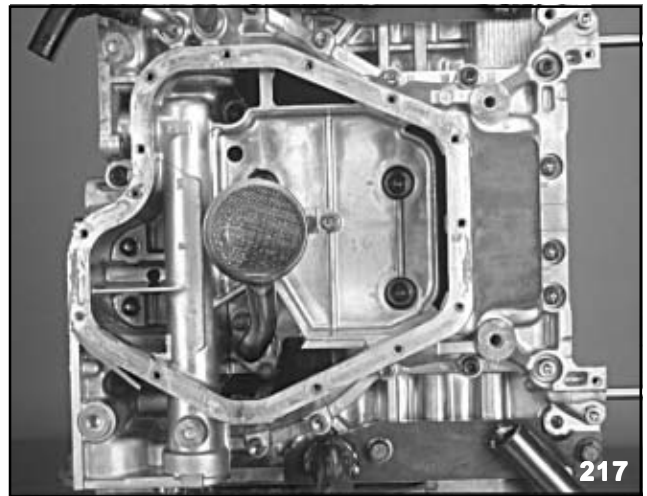

Oil Pan Bolt Locations

NOTE: PLACEMENT OF BOLTS.

Remove the oil pan extension housing bolts. There are 28 bolts with five different lengths. Follow the proper sequence to prevent warping the case.

Boxer Engine Series Module

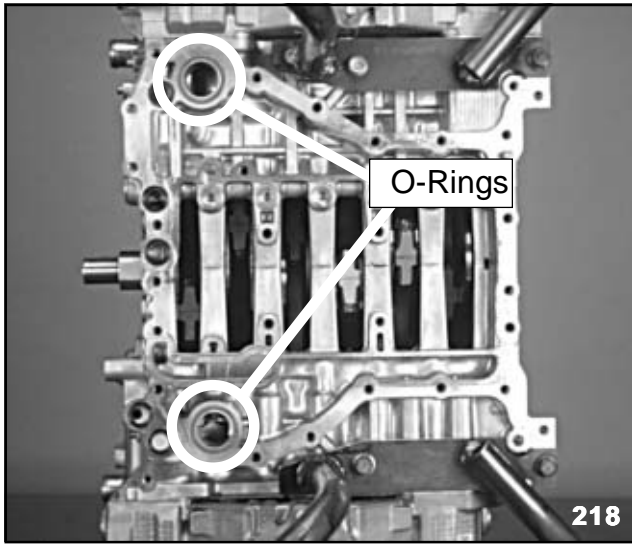

Block O-Ring Locations

NOTE: CONFIRM PLACEMENT OF O-RINGS

Piston Pin Access

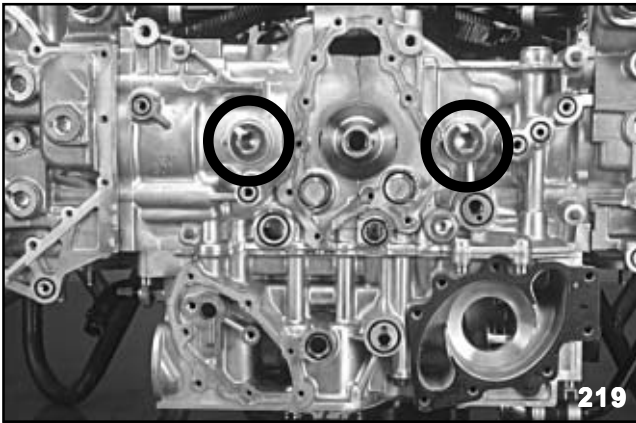

Piston Pin Access (Front View)

The piston pin access is gained from the front at these two positions.

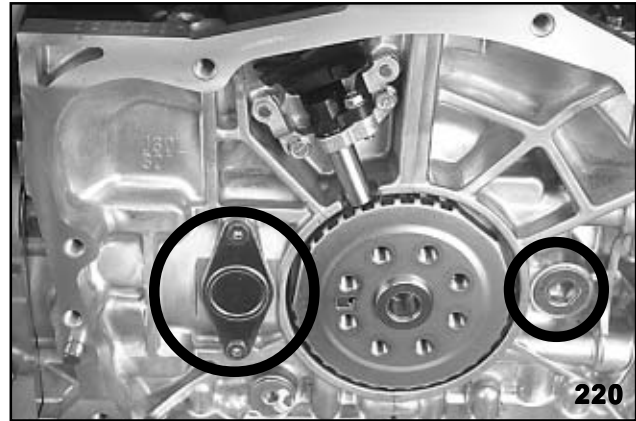

Piston Pin Access (Rear View)

Rear piston pin access is gained at these two points. Remove the piston pins and organize them for assembly to their original positions.

Splitting Block Halves

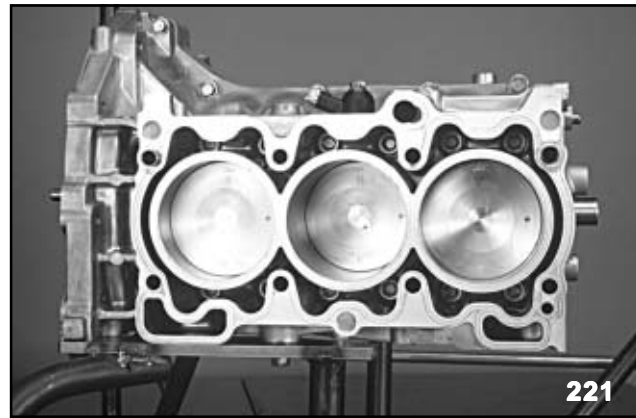

Engine Block Assembly Bolts (Right Bank)

The engine block halves are bolted together with 19 bolts. They are all located on the right bank of the engine. Remove the bolts in the proper sequence and split the engine block.

Boxer Engine Series Module

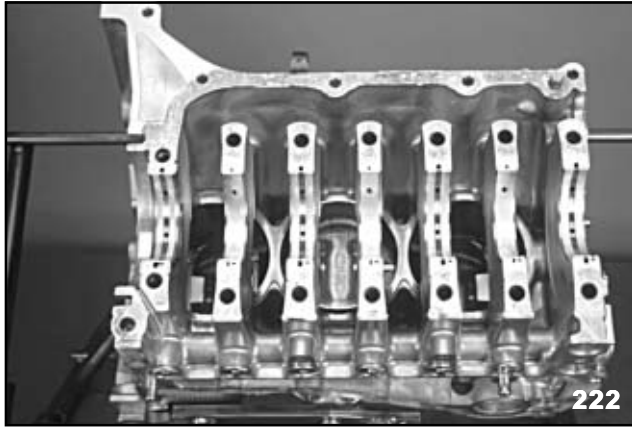

Main Bearings

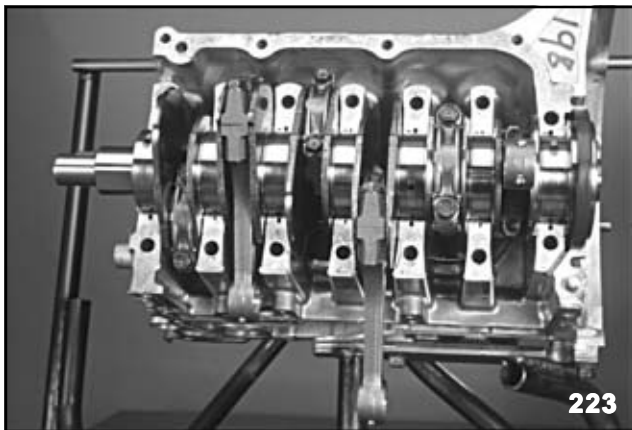

Crankshaft and Connecting Rods

Lubrication System

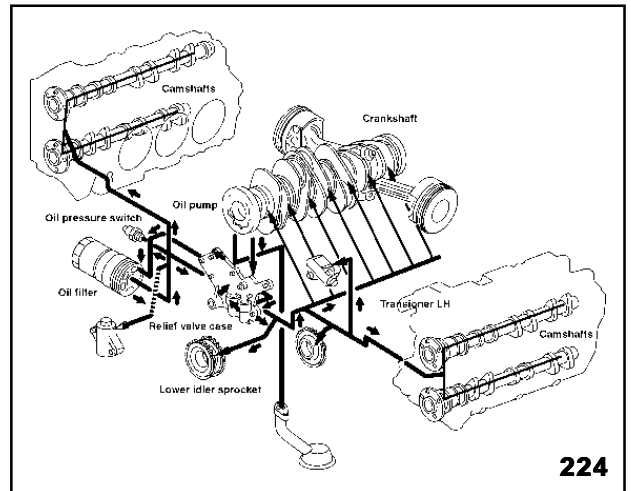

Oil Flow

Oil is drawn from the oil pan to the trochoid oil pump and on to the following:

- Oil cooler and filter
- Relief valve case. (Oil pressure is regulated and oil is supplied to the oil jet that lubricates the timing chain)
- Right bank cylinder head
- Crank shaft
- Timing chain components
- Left bank cylinder head

NOTE: FOR FURTHER INFORMATION CONSULT THE LUBRICATION (LU) SECTION OF THE 6 CYLINDER SUPPLEMENT.



Pump Gears (Front Side)

Boxer Engine Series Module



Pump Gears (Back Side)



Relief Valve Case (Front Side)



Relief Valve Case (Back Side)

A new gasket must be used upon installation.

NOTE: THE SCREEN OR FILTER IN GASKET. CONFIRM THAT IT IS NOT RESTRICTED.

Coolant System

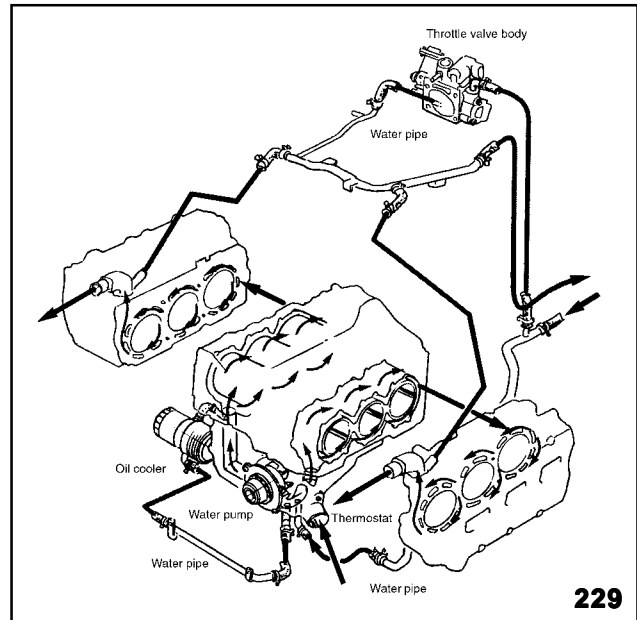

Coolant Flow

The coolant flow begins at the lower radiator hose and continues to the following:

- Thermostat
- Water pump
- Internal block passages that carry coolant through the front of the block halves continuing on to the rear of the block halves.
- From around the rear cylinders of the block halves to the head gasket of the rear cylinders. A passage in the head gasket allows coolant to the cylinder heads.
- Around the cylinder heads to the upper radiator hose connections.

Boxer Engine Series Module

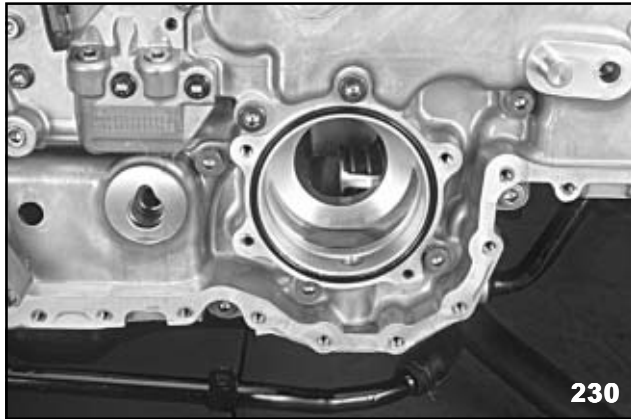

Water Pump Housing

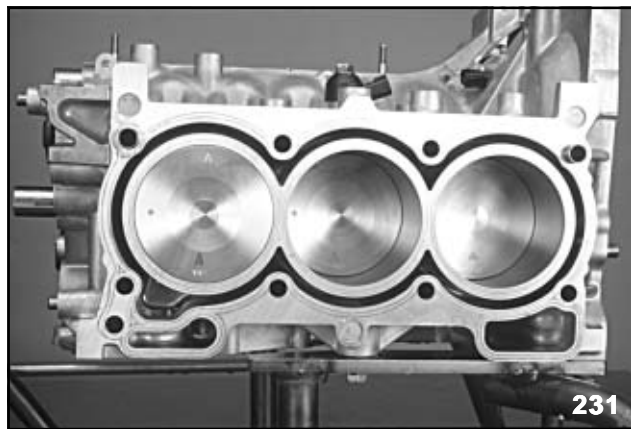

Water Jackets (Left Bank)

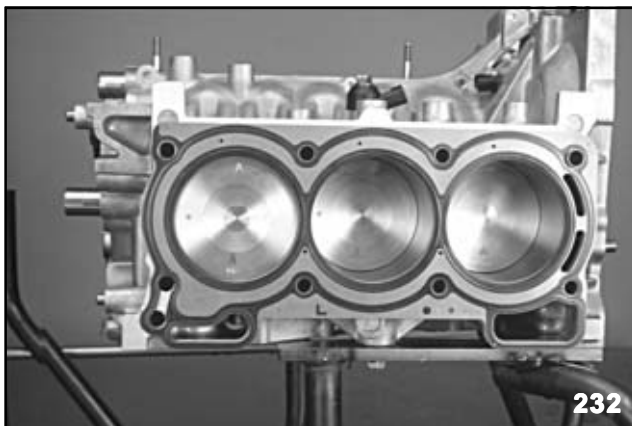

Head Gasket Coolant Passages

NOTE: FOR FURTHER INFORMATION, CONSULT THE COOLING SECTION (CO) OF THE 2001 LEGACY AND OUTBACK 6 CYLINDER SUPPLEMENT.

Valve Adjustment

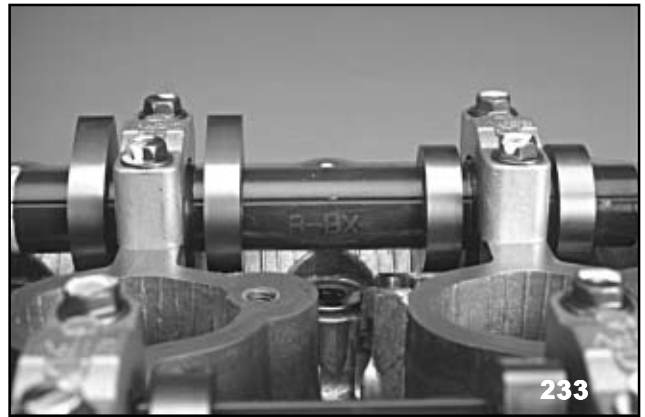

Sintered Camshaft Lobes

The camshafts are composed of carbon steel pipes with Sintered metal lobes. During construction, the lobes are positioned on the pipe using a sintered metal paste. The camshafts are then baked until the paste is hardened. The lobes of the camshafts are offset by 1 millimeter to rotate the camshaft bucket and shim which will reduce wear.

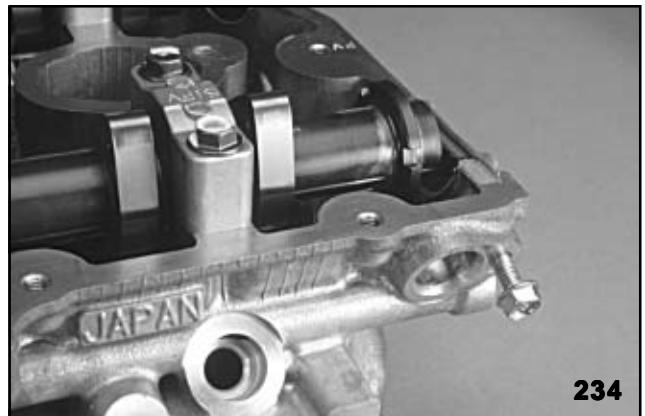

Camshaft Sensor Reluctor

The right bank intake camshaft has a reluctor built onto the end. The new camshaft sensor uses this reluctor to help determine injection and ignition timing.

Boxer Engine Series Module



Valve Adjustment Tool

The valve adjustment procedure is the same as other DOHC Subaru engines however a new tool has been designed to work specifically on the EZ-3.0 Engine.

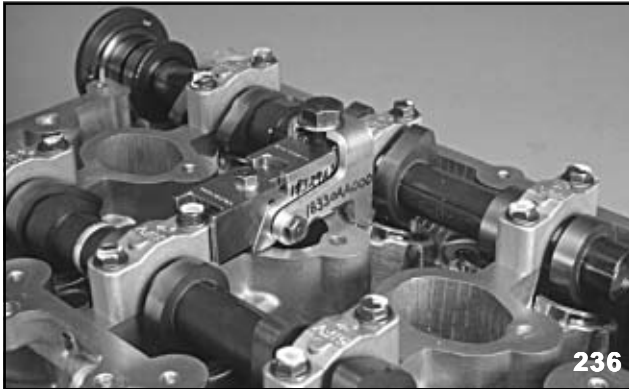

Valve Adjustment Tool Placement

The tool is wedge fitted into place over the two shims requiring removal.

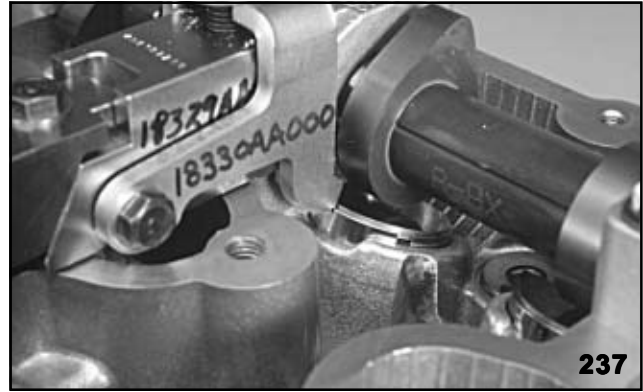

Adjusting Bucket Depression Finger

Some adjustment will be required to properly seat the bucket depression finger. Turning the top bolt pushes the fingers down allowing room for the shim to be removed.

Chain Tensioners



Chain Tensioners (Left and Right Bank)

The chain tensioners are fed oil pressure from the engine oiling system. The supplied pressure combined with spring tension keeps the timing chains operating at the correct tension.

NOTE: LEFT BANK AND RIGHT BANK TENSIONERS ARE NOT INTERCHANGEABLE.

Boxer Engine Series Module

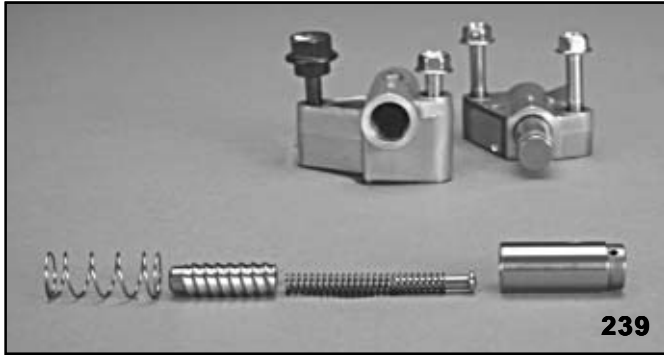

Worm Gear Assembly

The worm gear assembly and spring tension keep tension on the chains with the engine off, eliminating any tension problems that could occur during engine start up.

The tensioners are turned in by hand for reassembly. Observe the order of the worm gear assembly. Make sure your hands are dry when depressing the tensioners. A rivet or large paper clip will hold tensioner in place. Do not use a press to depress tensioner.

3.0 Liter Engine Reassembly



Crankshaft Timing Mark Location

Position the crankshaft sprocket to TDC. Indicated by the triangle mark. Place the chain over the water pump and lower idler sprocket.

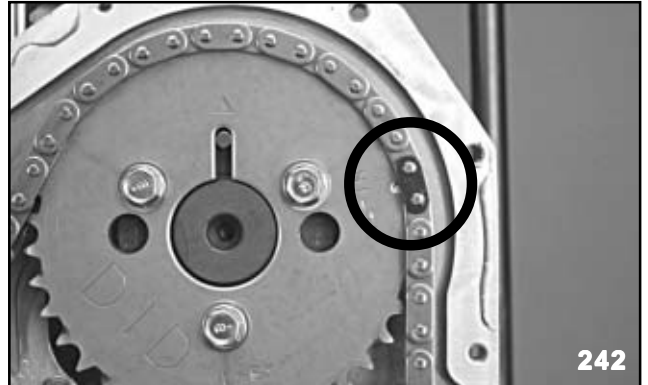

Left Bank Intake Camshaft Timing Mark

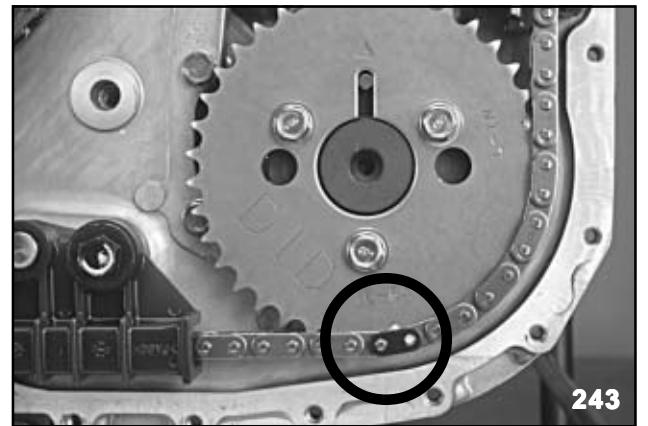

Left Bank Exhaust Camshaft Timing Mark

Place the gold link over the small circular timing mark of the crankshaft sprocket. Ensure the keyways for the left bank camshafts are at the 12:00 position.

Boxer Engine Series Module

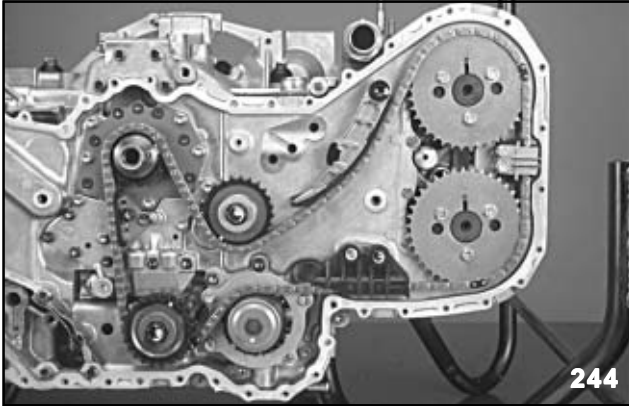

Matching Links to Timing Marks (Left Bank)

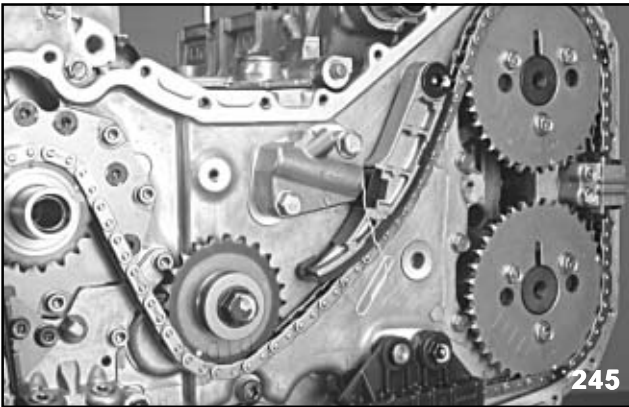

Installing Guides and Idlers (Left Bank)

Place the black link over the circular timing mark of the intake sprocket and the other black link over the circular timing mark of the exhaust sprocket. Install the upper idler and chain guides. Install the chain tensioner but **do not pull the pin**. Confirm the timing marks once again and pull the pin.

Turn the **crank shaft** 90 degrees **counter clockwise** to prepare for installing the **right bank** timing chain.

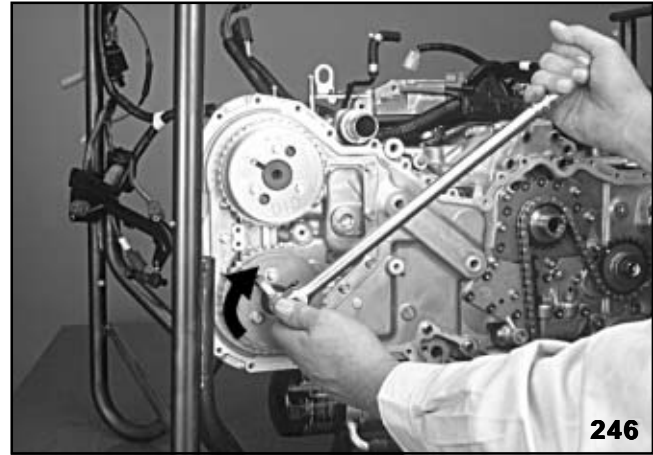

Loading Exhaust Camshaft (Right Bank)

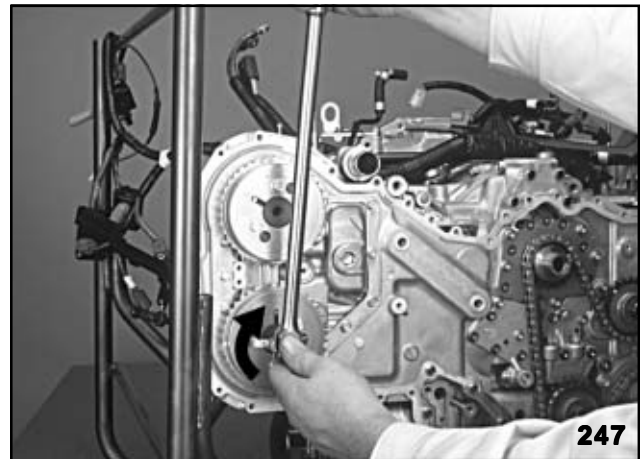

Loading Exhaust Camshaft (Right Bank)

Return the key way for the **right bank exhaust** camshaft to 12:00 by turning the sprocket **counter clockwise**.

Boxer Engine Series Module

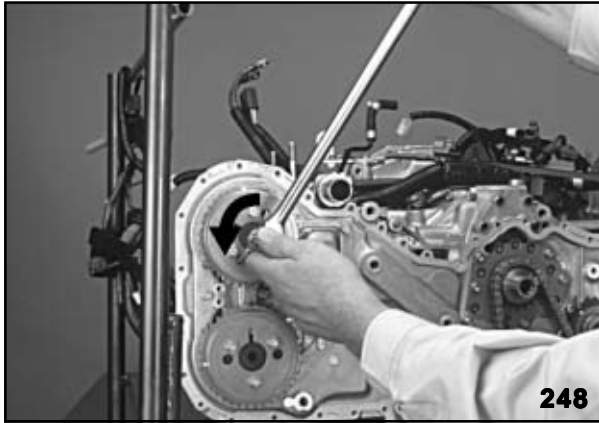

Loading Intake Camshaft (Right Bank)

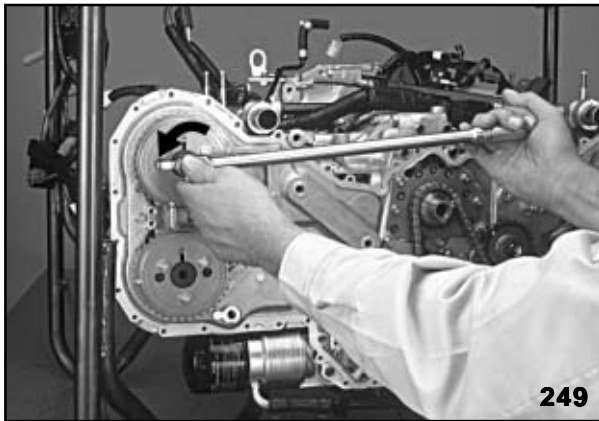

Loading Intake Camshaft (Right Bank)

Return the key way for the **right bank intake** camshaft to 12:00 by turning the sprocket **clockwise**.

Both right bank camshaft sprockets should now be in the correct position for timing chain installation. **Do not forget to turn the crank shaft TDC mark back to 12:00.**

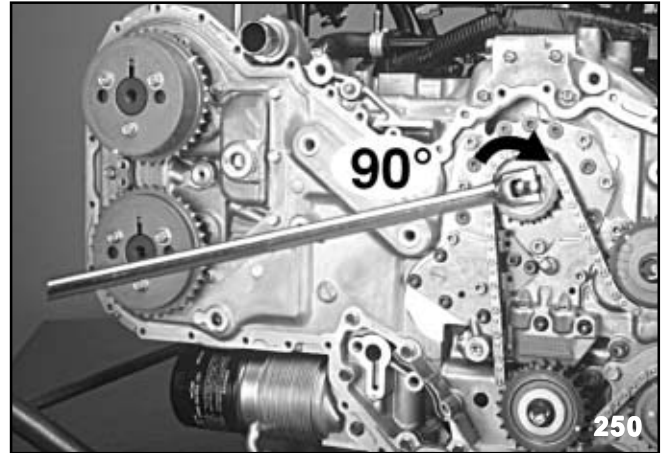

Aligning TDC Mark

Boxer Engine Series Module

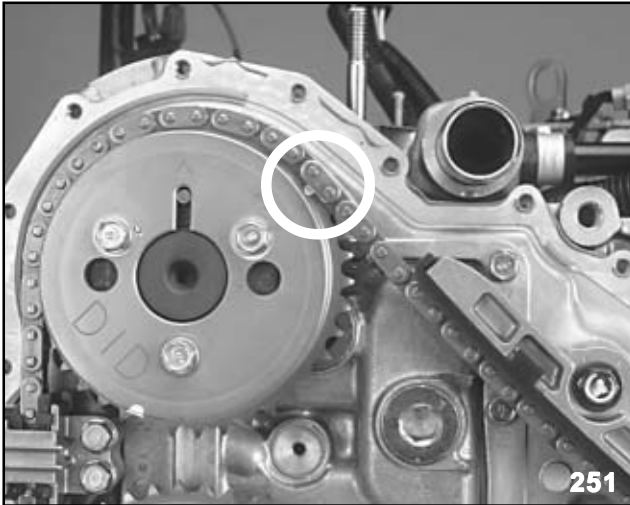

Intake Camshaft Timing Marks (Right Bank)

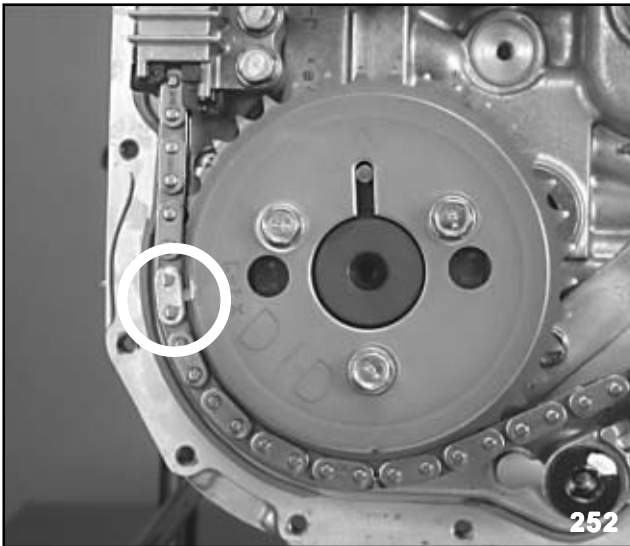

Exhaust Camshaft Timing Marks (Right Bank)

Place the lower gold link on the small circular mark of the exhaust cam sprocket and the upper gold link on the small circular timing mark of the intake camshaft sprocket.

NOTE: IT IS CRITICAL THAT TIMING MARKS ARE CONFIRMED TO BE CORRECT. IF THE MARKS ARE OFF MORE THAN 1 (ONE) TOOTH ON THE INTAKE OR 2 (TWO) TEETH ON THE EXHAUST, VALVE AND PISTON DAMAGE WILL OCCUR.

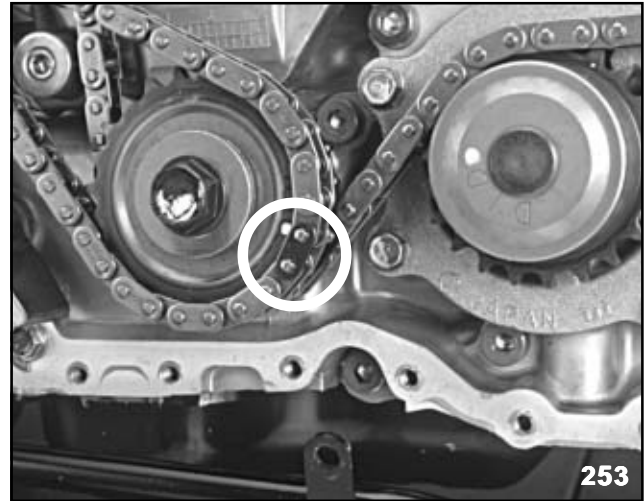

Lower Idler Timing Marks

Place the black link of the right bank timing chain over the lower idler so that it indexes with the black link of the left bank chain.

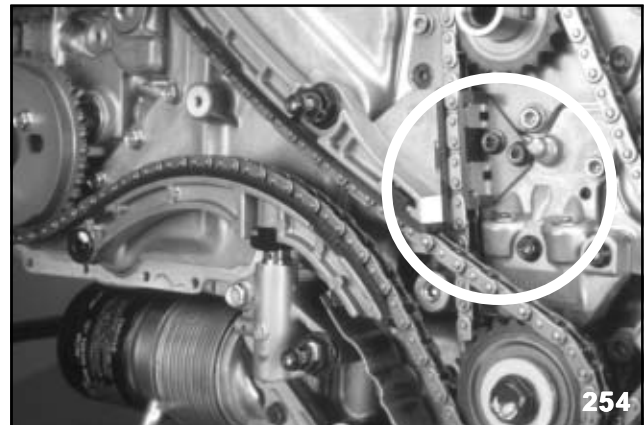

Chain Guides and Idlers (Right Bank)

Install the timing chain guides and tensioner. **Do not pull the pin.** Confirm the timing marks once again and if correct pull the pin.

NOTE: THE CHAIN GUIDE LOCATED ON THE OIL PRESSURE RELIEF HOUSING MUST BE ADJUSTED AS CIRCLED ABOVE.

Follow procedures in the appropriate service manual during reassembly and for checking chain guide clearances.

Boxer Engine Series Module

Fuji Bond Application Guide for Block Halves

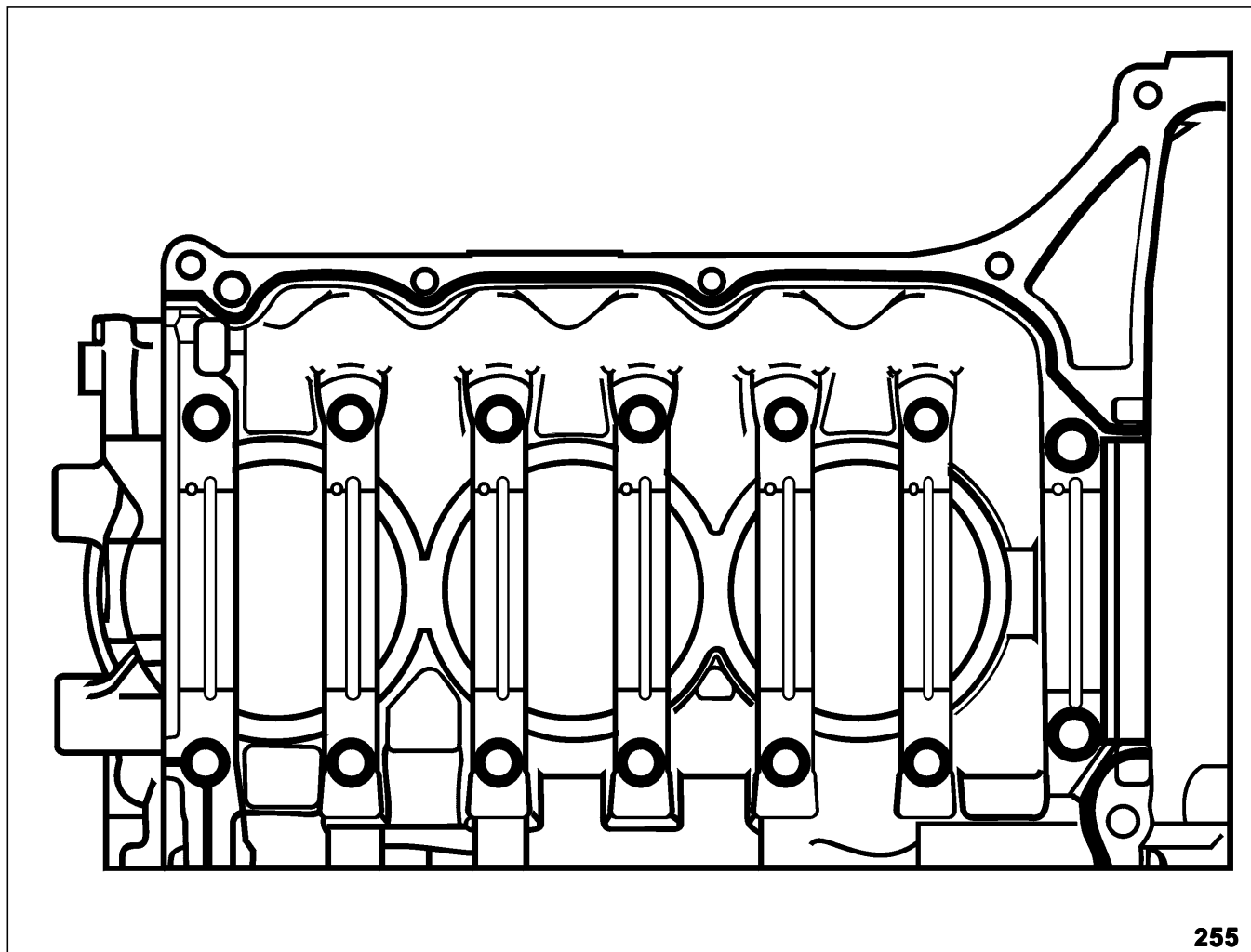

Refer to the Legacy and Outback 2001 Service Manual 6 Cylinder Supplement.

ME (H6) 65 to 69 for proper sealing, bolt sizes and sequence. Torque to proper specifications.

Boxer Engine Series Module

Oil Pan Extension Housing (Upper Oil Pan)

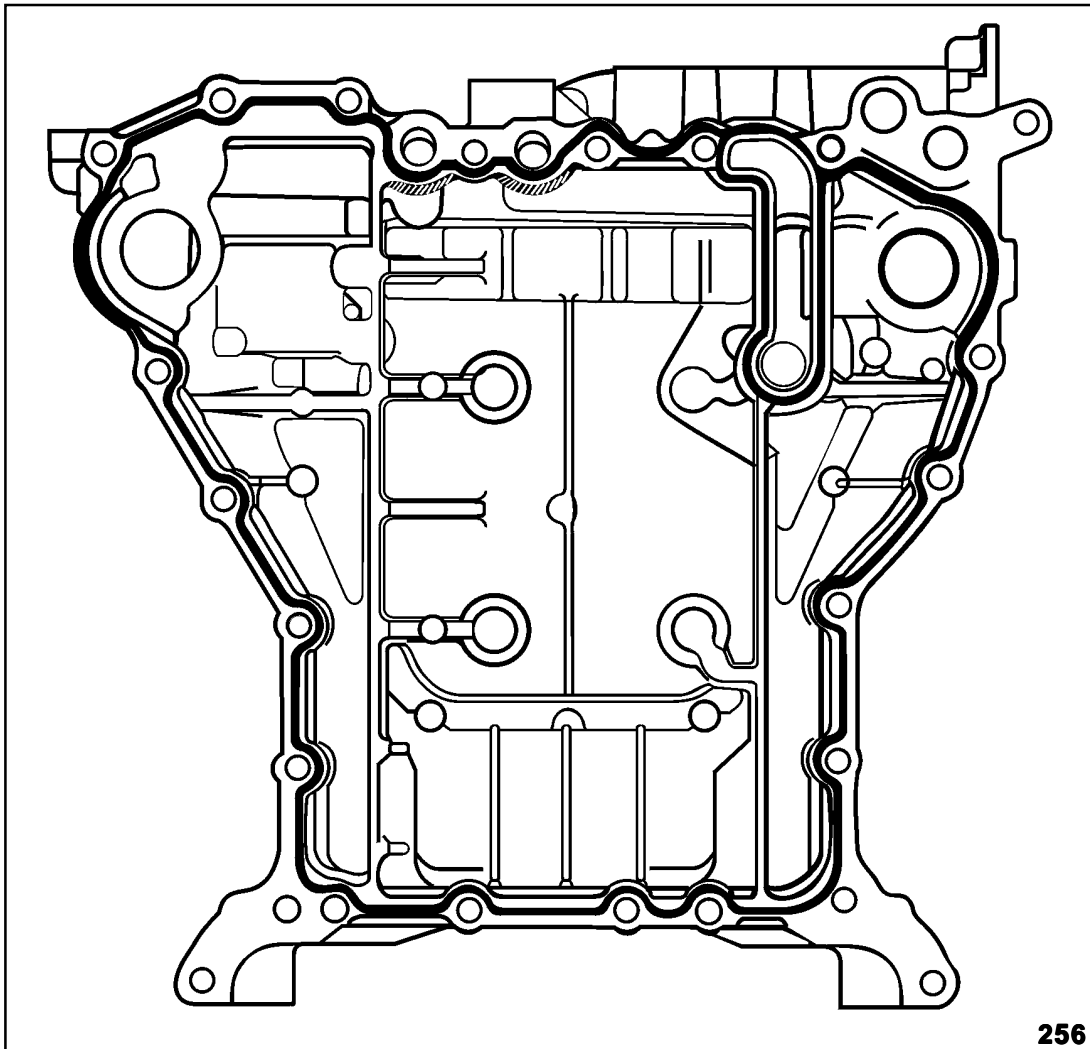

Refer to the Legacy and Outback 2001 Service Manual 6 Cylinder Supplement.

Boxer Engine Series Module

ME (H6) 65 to 69 for proper sealing, bolt sizes and sequence. Torque to proper specifications.

Fuji Bond Application Guide for Oil Pan (Lower)

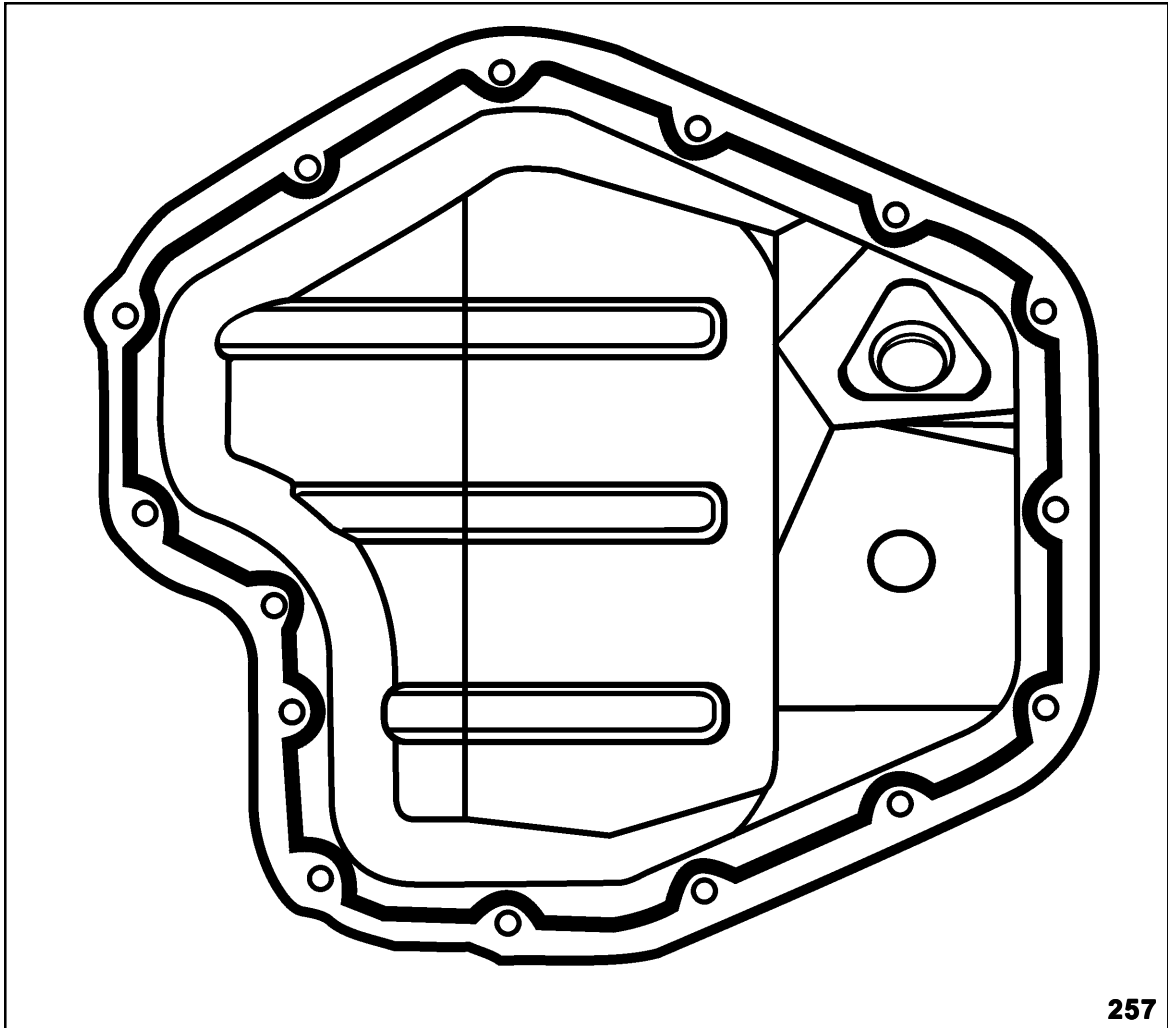

Refer to the Legacy and Outback 2001 Service Manual 6 Cylinder Supplement.

ME (H6) 65 to 69 for proper sealing, bolt sizes and sequence. Torque to proper specifications.

Boxer Engine Series Module

Fuji Bond Application Guide for Inner Cover

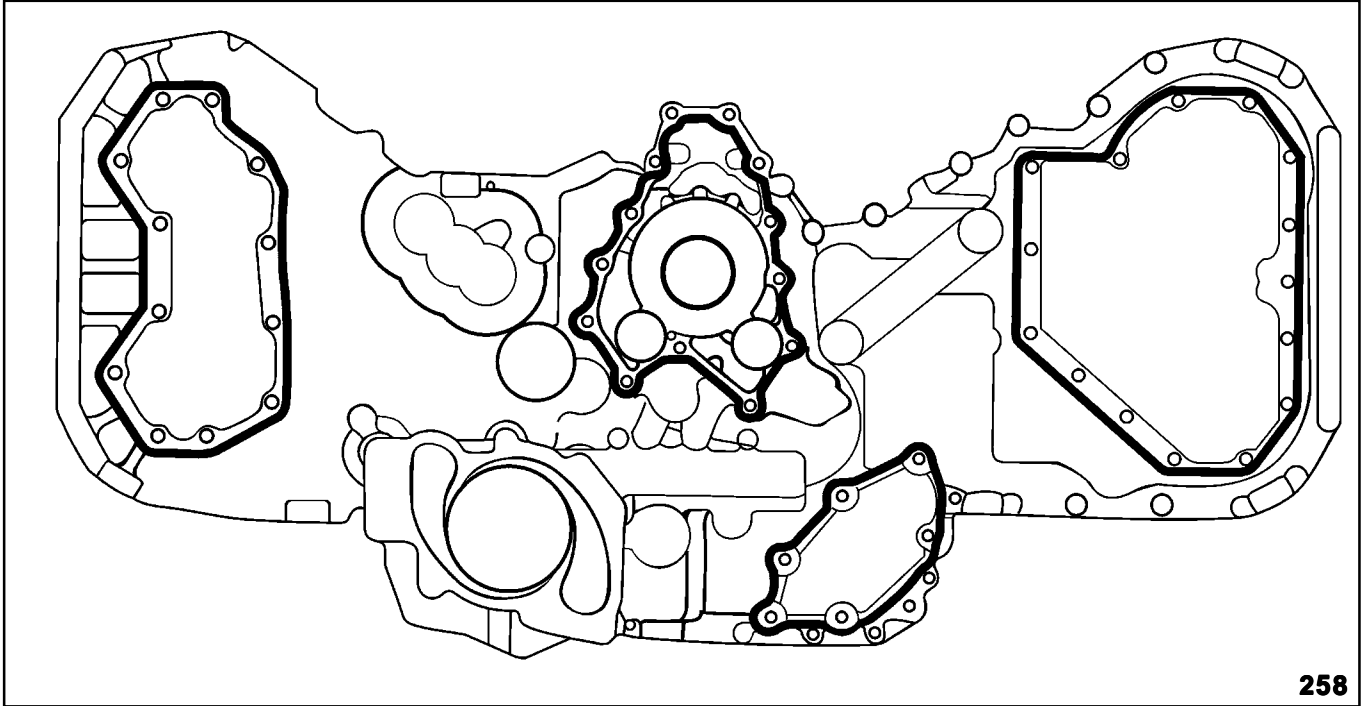

Refer to the Legacy and Outback 2001 Service Manual 6 Cylinder Supplement.

ME (H6) 52 for proper sealing, (including O-Ring placement) bolt sizes and sequence. Torque to proper specifications.

Boxer Engine Series Module

Fuji Bond Application Guide for Outer Cover (Front Chain Cover)

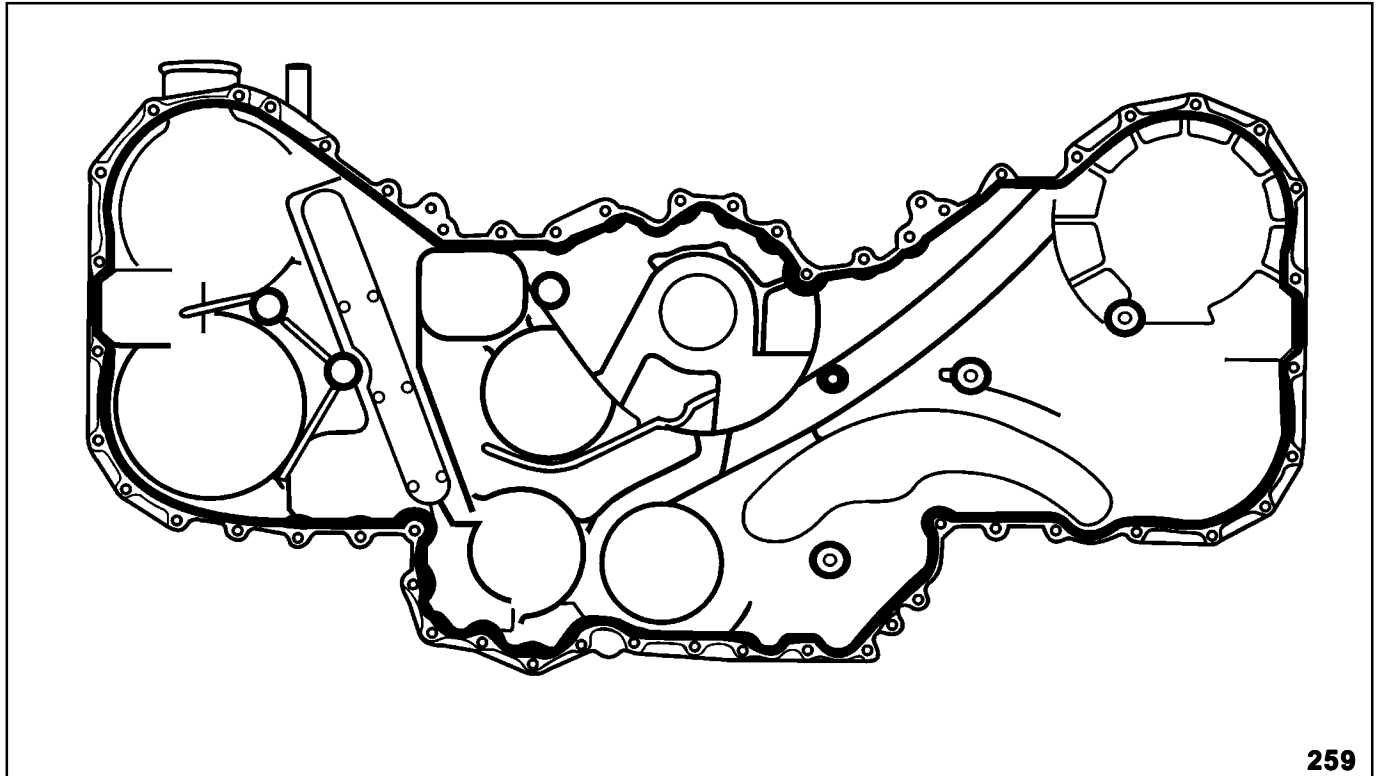

Refer to the Legacy and Outback 2001 Service Manual 6 Cylinder Supplement.

ME (H6) 43 for proper sealing, bolt sizes and sequence. Torque to proper specifications.

Boxer Engine Series Module

3.3 Liter Engine Service Procedures

Remove the left, right and the center cam belt front covers.

NOTE: THE CENTER CAM BELT COVER USES SHOULDER TYPE BOLTS. THESE BOLTS ARE NOT INTERCHANGEABLE WITH THE STANDARD BOLTS USED IN THE LEFT AND RIGHT CAM BELT COVERS.

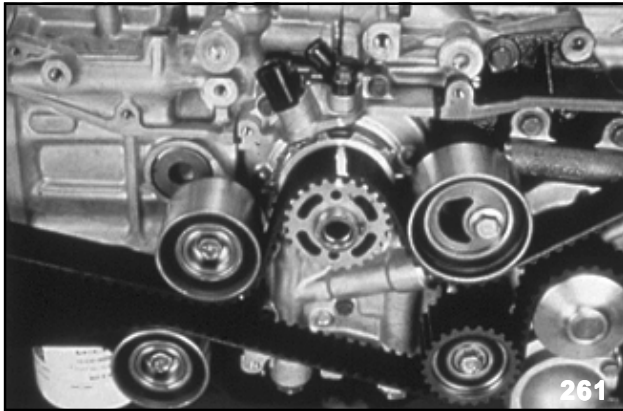

Crankshaft Sprocket Alignment

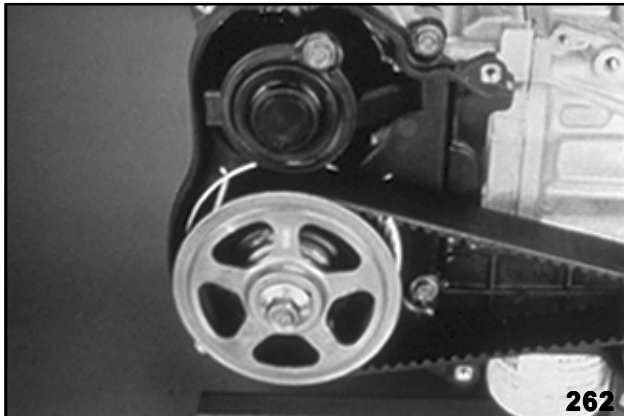

Camshaft Sprocket Alignment (Right Bank)

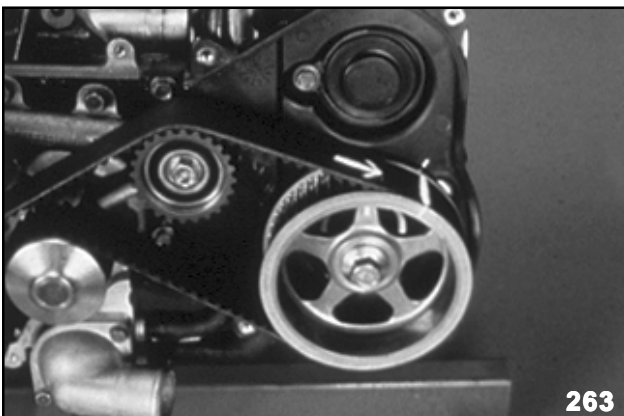

Camshaft Sprocket Alignment (Left Bank)

Use the crankshaft pulley to rotate the crankshaft clockwise to properly align the timing marks. There are two timing marks on each of the cam sprockets, a notch and an arrow. There is an alignment notch on the crank sprocket. Align the notch on the outer rim of each camshaft sprocket with the notch on the inner cam belt covers. Align the notch on rear flange of the crankshaft sprocket with the notch on the oil pump housing. The crank and cam sprocket arrows should be at 12 o'clock.

When the camshaft and the cam belt timing marks are properly aligned and the crankshaft timing mark is at the 12 o'clock position, the engine is at TDC for the number 1 cylinder compression stroke. The alignment marks must be aligned with the marks on the cam belt covers.

When the belt is going to be reinstalled, use a crayon or paint marker to mark the belt and the cam and crank sprockets at the three timing notches and to indicate the belt rotation direction. The remaining belt removal procedures are the same as the 2.2L engine. Remove the left, right and the center cam belt front covers.



Camshaft Sub-Gear Servicing

NOTE: THE FOLLOWING INFORMATION OUTLINES THE STEPS LISTED IN THE SUBARU SVX SERVICE MANUAL, SEC 2-3, [W3B1] TO DISASSEMBLE AND SERVICE THE INTAKE CAMSHAFT SUB-GEAR. REFER TO THE APPROPRIATE MY SERVICE MANUAL AND REVIEW THE DISASSEMBLY STEPS.

Pad the vice jaws with soft jaws or a shop cloth and then secure the shaft portion of camshaft in the vice. Do not clamp the vice to the cam lobe or journal surfaces. Use camshaft gear wrench **499207200** to slightly rotate the sub-gear "clockwise", and remove the service bolt. Next use a snap ring pliers to remove the snap ring.

Boxer Engine Series Module



Two Piece Gear

Remove the wave washer, the sub-gear and sub-gear spring.



Sub-Gear Spring

Check the free distance between the camshaft gear spring ends. The proper tolerance (free distance) should be: 0.980 - 1.137 in (24.88 - 28.88 mm). Be sure to position the components in the order of removal to ease reassembly. Assembly is the reverse of the disassembly steps. Use the camshaft gear wrench **499207200** to reset the sub-gear tension and to reinstall the service bolt to the sub-gear.



Piston Pin Circlip Removal

NOTE: REMOVAL OF THE WATER PUMP, OIL PUMP, OIL PAN, PCV Baffle Plate, PISTON PIN ACCESS PLUGS AND PISTON PINS ARE SIMILAR TO THE 2.2L AND 2.7L ENGINES.

Follow the appropriate MY service manual procedure to remove each piston pin. First remove the access plugs and then the piston pin retaining circlips. Use circlip pliers **499897200** (or SNAP-ON 911CP).



Piston Pin Removal

Use piston pin remover **499097500** to remove the piston pins through the service holes located in the front and back of the crankcase. Removal of the center piston pins requires the removal of one of the outer pistons. Removal of the center piston pin is similar to the procedure for the 2.7L engine.

Boxer Engine Series Module

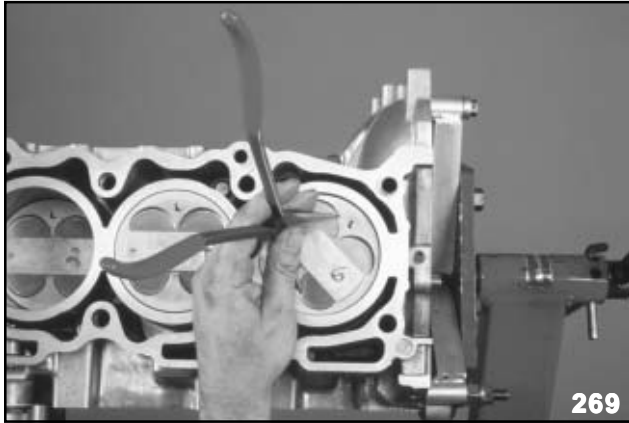

Piston Removal

Number the pistons prior to removal as the pistons must be returned to the original cylinders. The pistons are marked "L" for left and "R" for right, with arrows which must point towards the front of the engine.

TIP: TO REMOVE THE PISTONS, SLOWLY ROTATE THE CRANKSHAFT TO BRING THE PISTON TO THE TOP OF THE BORE. CONTINUE TO ROTATE THE CRANKSHAFT TO BRING THE ROD TO THE BOTTOM OF THE STROKE. USE NEEDLE NOSE PLIERS TO CAREFULLY ROTATE THE PISTON EITHER DIRECTION 90 DEGREES. DO NOT SCRATCH THE PISTON. SLOWLY ROTATE THE CRANKSHAFT, THE CONNECTING ROD WILL PUSH THE PISTON OUT OF THE CYLINDER.

NOTE: USE CARE NOT TO JAM THE CONNECTING ROD LARGE END INTO THE CYLINDER BORE WHILE ROTATING THE CRANKSHAFT DURING PISTON REMOVAL.

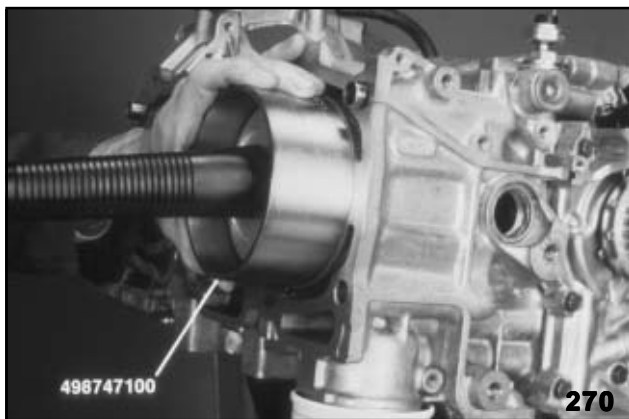

Piston Installation

NOTE: THE INSTALLATION OF PISTONS, PISTON PINS AND CIRCLIPS, PISTON PIN PLUGS, PCV BAFFLE, OIL PICK-UP TUBE, OIL PUMP, WATER PUMP, AND OIL PAN ARE SIMILAR TO THE 2.2L ENGINE.

Return the pistons and pins to the original cylinders. Install the piston and pin first. The installation procedures are similar to the 2.7L engine. The arrows on the pistons must point to the front of the engine. Confirm the pistons marked R for the right side and L for the left side are installed in the correct crankcase half. The complete piston installation procedures are listed in the appropriate service manual, section 2-3 [W5D4]-[W5D6].

NOTE: THE "EXHAUST" AND "INTAKE" CAMSHAFTS THRUST CLEARANCES ARE MINIMAL, CAREFULLY INSTALL EACH CAMSHAFT SLOWLY WHILE KEEPING THE CAMSHAFT PARALLEL TO THE CYLINDER HEAD. DAMAGE TO THE THRUST BEARING WILL OCCUR IF THE CAMSHAFT IS NOT PARALLEL TO THE HEAD DURING INSTALLATION. ALWAYS FOLLOW THE INSTALLATION SEQUENCE DEFINED IN SECTION 2-3, [W3E1] OF THE APPROPRIATE MY SUBARU SVX SERVICE MANUAL.



Install Intake Camshaft



Install Intake Camshaft

Boxer Engine Series Module

Install the intake camshaft. First center the match (punch) mark on the back of the intake camshaft gear between the two match (punch) marks on the back of the exhaust camshaft gear. The front notch on the L/H side should be at 6 o'clock and the front notch on the R/H side should be at 12 o'clock. Next, install the intake camshaft bearing caps to the original locations, tighten in the proper sequence, and torque to specifications. Remember to remove the service bolts from both intake camshaft sub-gears.

CAUTION: FAILURE TO REMOVE THE SERVICE BOLTS MAY CAUSE THE CAMSHAFTS TO PRODUCE A KNOCKING SOUND. IF THE BOLT LOOSENS IT COULD DAMAGE THE CAMSHAFT GEARS AND THE CYLINDER HEAD.

NOTE: FAILURE TO KEEP CAMSHAFT PARALLEL TO THE HEAD DURING INSTALLATION MAY DAMAGE THE CAMSHAFT OR BEARING CAPS. TORQUE SPECS FOR BEARING CAPS IS VERY LOW DO NOT OVER TORQUE OR USE AIR TOOLS.

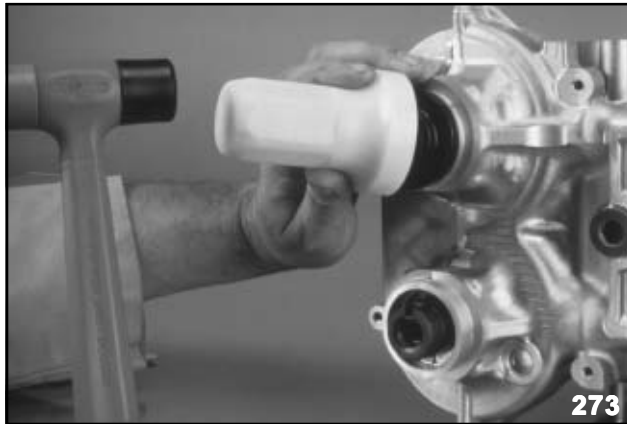

Front Camshaft Cover Installation

Sparingly use FUJI Bond 1215C or the equivalent to install the front camshaft covers. Install the intake camshaft plug using intake installer **499587300**.

CAUTION: EXCESSIVE USE OF SEALANT CAN CAUSE BLOCKAGE OF THE CAMSHAFT OIL FEED HOLES.



Exhaust Camshaft Oil Seal Installation

Use camshaft oil seal installer **498037100** to install the exhaust camshaft oil seal. Then install the camshaft cover gasket and camshaft cover. Then install the left and right inner cam belt covers.



Left Camshaft Sprocket

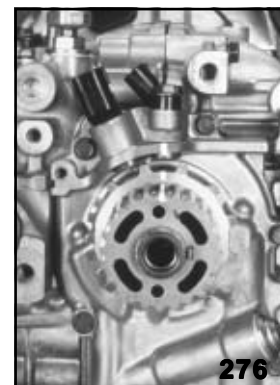

Crankshaft Sprocket Installation

Notice the cam angle reluctor located behind the left camshaft sprocket and the locating pin on the back of each of the sprockets. Install the camshafts sprockets and the crankshaft sprocket.

Boxer Engine Series Module

NOTE: LOCATING PINS SHOULD BE LOCATED AT 6 O'CLOCK ON LEFT HAND SIDE AND AT 12 O'CLOCK ON THE RIGHT HAND SIDE CAMSHAFT SPROCKET.

Align the crankshaft sprocket arrow in the 12 o'clock position which corresponds to the mark on the crank sensor casting.

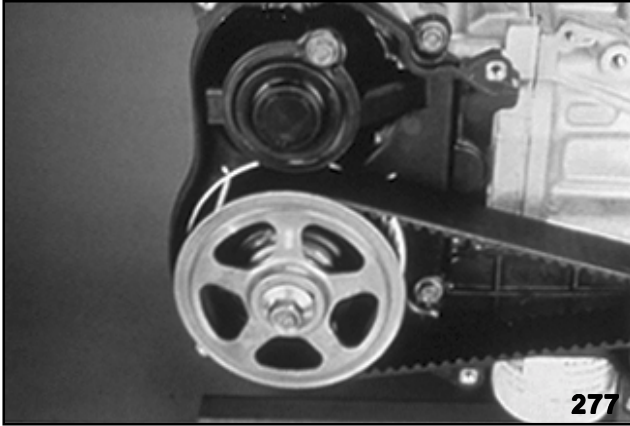

Cam Belt Installation (Right Bank)

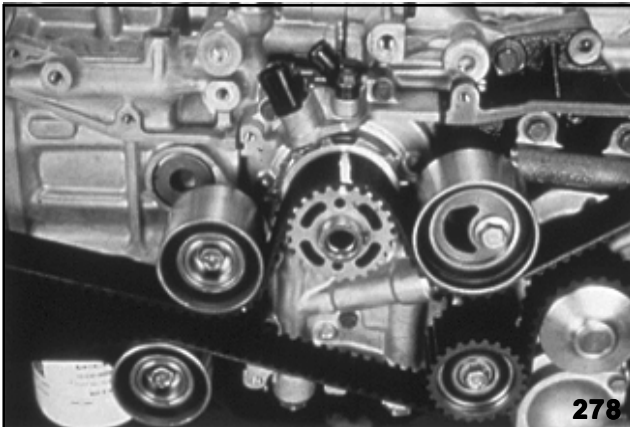

Cam Belt Installation (Crankshaft)

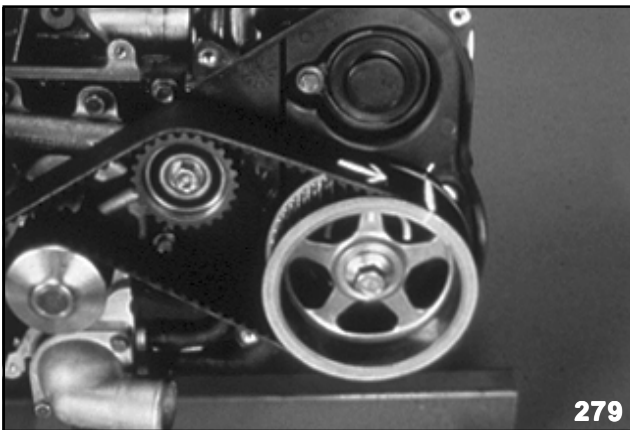

Cam Belt Installation (Left Bank)

The camshaft sprockets are stamped with timing marks, the right sprocket timing mark should be at 11 o'clock with the arrow at 12 o'clock while the left sprocket timing mark should be at 1 o'clock with the arrow at 12 o'clock. The timing marks on the sprockets should align with the timing marks on the inner cam belt covers.

Prior to installing the timing belt, install the following:

- *Tensioner bracket
- *Cam belt tensioner

Then install the camshaft timing belt. The belt is directional and must be installed with the arrows pointing in the direction of rotation. When you are replacing the original belt, be sure to align the match marks on the belt with the marks on the sprockets and belt covers and the crankshaft sprocket. New belts have alignment marks to insure proper camshaft timing.

NOTE: THERE SHOULD BE 53 TEETH BETWEEN THE CRANKSHAFT SPROCKET MARK AND EACH OF THE CAMSHAFT SPROCKET MATCH (PUNCH) MARKS.

NOTE: THE REMAINING ENGINE ASSEMBLY STEPS ARE THE REVERSE OF THE PROCEDURE FOR ENGINE DISASSEMBLY. ALWAYS REFER TO THE APPROPRIATE MY SERVICE MANUAL FOR A DETAILED DESCRIPTION OF THE ENGINE ASSEMBLY STEPS.

Boxer Engine Series Module

General Hand Tools and Supplies

Dial indicator
 Dye penetrant
 Feeler gauge
 Micrometers
 Plastigauge
 Press
 Rubber or Plastic Hammer
 Fuji Bond 1105 or equivalent

Fuji Bond 1280B or equivalent
 Fuji Bond 1107C or equivalent
 Fuji Bond 1215 or equivalent
 Torque wrench (ft-lb) and (in. lb.)
 Vernier calipers

Reference Materials

Subaru Service Manuals
 Technician Reference Booklets

Special Tools

	2.0L	2.2L	(1996) (HLA's) DOHC (Phase 1) 2.5L	(97 to 99) (Solid) DOHC (Phase 1) 2.5L	(1999 & Later) SOHC (Phase 2) 2.5L	3.0
399094310 Piston pin remover (1800cc tool)		X				
479587300 Oil seal installer		X				
498037100 Camshaft journal plug installer		X				
498267200 Cylinder head table		X				
498457000 Engine stand adapter RH	X	X		X		X
498457100 Engine stand adapter LH	X	X		X		X
498747100 Piston guide		X		X		
498857100 Valve oil seal guide	X	X		X	X	X
499017100 Piston pin guide	X	X	X	X	X	
499037100 Connecting rod bushing remover & installer	X	X		X	X	
499097500 Piston pin remover		X		X		X
499207100 Camshaft sprocket wrench		X		X	X	
499587100 Camshaft oil seal installer	X	X	X	X	X	X
499587200 Crankshaft oil seal installer	X	X	X	X	X	X
499587300 Camshaft oil seal installer						
499587400 Oil pump seal installer						
499597000 Camshaft oil seal guide		X	X	X	X	X
499718000 Valve spring remover	X	X	X	X	X	X
499718400 Valve spring compressor adapter		X				
499767000 Valve guide adjuster	X	X				
499767200 Valve guide remover	X	X		X	X	
499767400 Valve guide reamer	X	X		X	X	
499817000 Engine stands (2)	X	X	X	X		
499977000 Crank pulley wrench		X	x			
898968600 Circlip pliers (or SNAP-ON long nose pliers 911CP)		X	X			
499597100 Crankshaft oil seal guide	X	X	X		X	X
498747300 Piston guide			X	X	X	

Boxer Engine Series Module

			(1996) (HLA's) DOHC (Phase 1) 2.5L	(97 to 99) (Solid) DOHC (Phase 1) 2.5L	(1999 & Later) SOHC (Phase 2) 2.5L	
	2.0L	2.2L				3.0
499207300	Camshaft sprocket wrench		X	X		
498267600	Cylinder head table	X	X	X		
498267700	Valve guide adjuster	X	X	X		
499987500	Crankshaft socket		X		X	
J-43979	Shim remover tool	X		X		X
J-42908	Camshaft sprocket holding tool		X	X		
498497100	Crankshaft stopper	X		X	X	X
18254AA00	Piston guide					X
18253AA000	Connecting rod bushing remover & installer					X
18350AA000	Camshaft sprocket wrench					X
499587700	Camshaft oil seal installer	X			X	X
18251AA000	Valve guide adjuster					X
499765700	Valve Guide remover					X
499765900	Valve Guide reamer					X
499977100	Crank pulley wrench			X	X	X
18252AA00	Crankshaft socket					X
499587500	Oil seal installer				X	X
18329AA000	Shim replacer assemble					X
18233AA000	Piston pin circlip pliers					X
398744300	Piston guide	X				
499097700	Piston pin remover assembly	X			X	
499207400	Camshaft sprocket wrench	X			X	
499977300	Crank pulley wrench	X		X		
499987500	Crankshaft socket	X		X		
499587600	Oil seal guide	X				
499597200	Oil seal guide	X				
498187200	Shim replacer	X				X
499767700	Valve guide adjuster (intake)				X	
499767800	Valve guide adjuster (Exhaust)				X	
499817100	Engine stand (2)	X			X	
49949700	Torx plus				X	
499097600	Piston pin remover assembly			X		
498187100	Shim replacer kit			X		

Boxer Engine Series Module

Service Bulletins

No.	Date	Title	Remarks
01-143-96	12/23/96	Recommended sealants and adhesives	

Boxer Engine Series Module

104 Module Service Help-Line Updates

Date Subject

02/95	Idle quality complaints on '95 Legacy
02/95	Synthetic engine oil
04/95	Engine testing-back to basics
07/95	Synthetic lubricant usage - updated information
10/95	Oil viscosity change for 1996 Subaru vehicles
01/96	2.5 Liter motor engine knocking or tapping noise
09/96	1997MY engine noise
09/96	Legacy 2.2L and Impreza 1.8L, 2.2L engine oil filling
10/96	Welcome to shim city
04/97	New cam belt tensioner
08/97	Assembling 1997 and Newer engines
10/97	Molybdenum coating on pistons
11/97	Engine noise
11/97	2.5L engine cylinder head bolt tightening sequence
05/98	Legacy engine belt guides
09/98	1996 2.5L exhaust valves
10/98	2.2L front crankshaft oil seals
11/98	1999 Legacy short blocks
01/99	Leaking front crankshaft oil seals
03/99	SIA installed engine oil
04/00	2000MY spark plug application chart (revised 01-31-00)
08/00	Engine noise when cold
01/01	Oil pumps - replacement vs resealing
02/01	3.0L 6 cylinder engine valve train servicing
02/01	Engine noise when cold
05/01	Three Bond 1280B



Subaru of America, Inc.