

BACK-UP LIGHT SYSTEM

WIRING SYSTEM

23.Back-up Light System

A: WIRING DIAGRAM

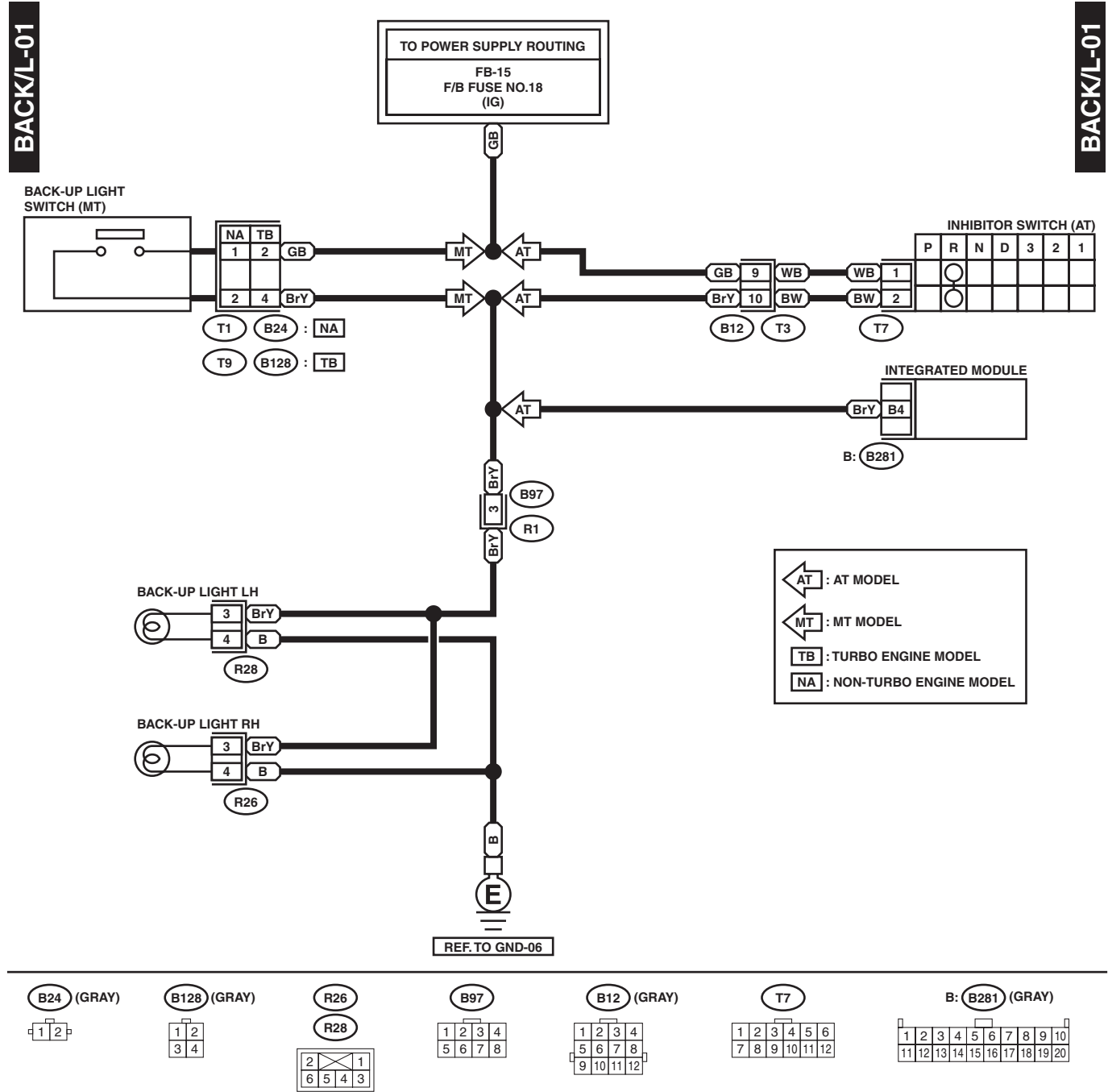

WI-03064