

# STOP LIGHT SYSTEM

WIRING SYSTEM

## 28. Stop Light System

### A: WIRING DIAGRAM

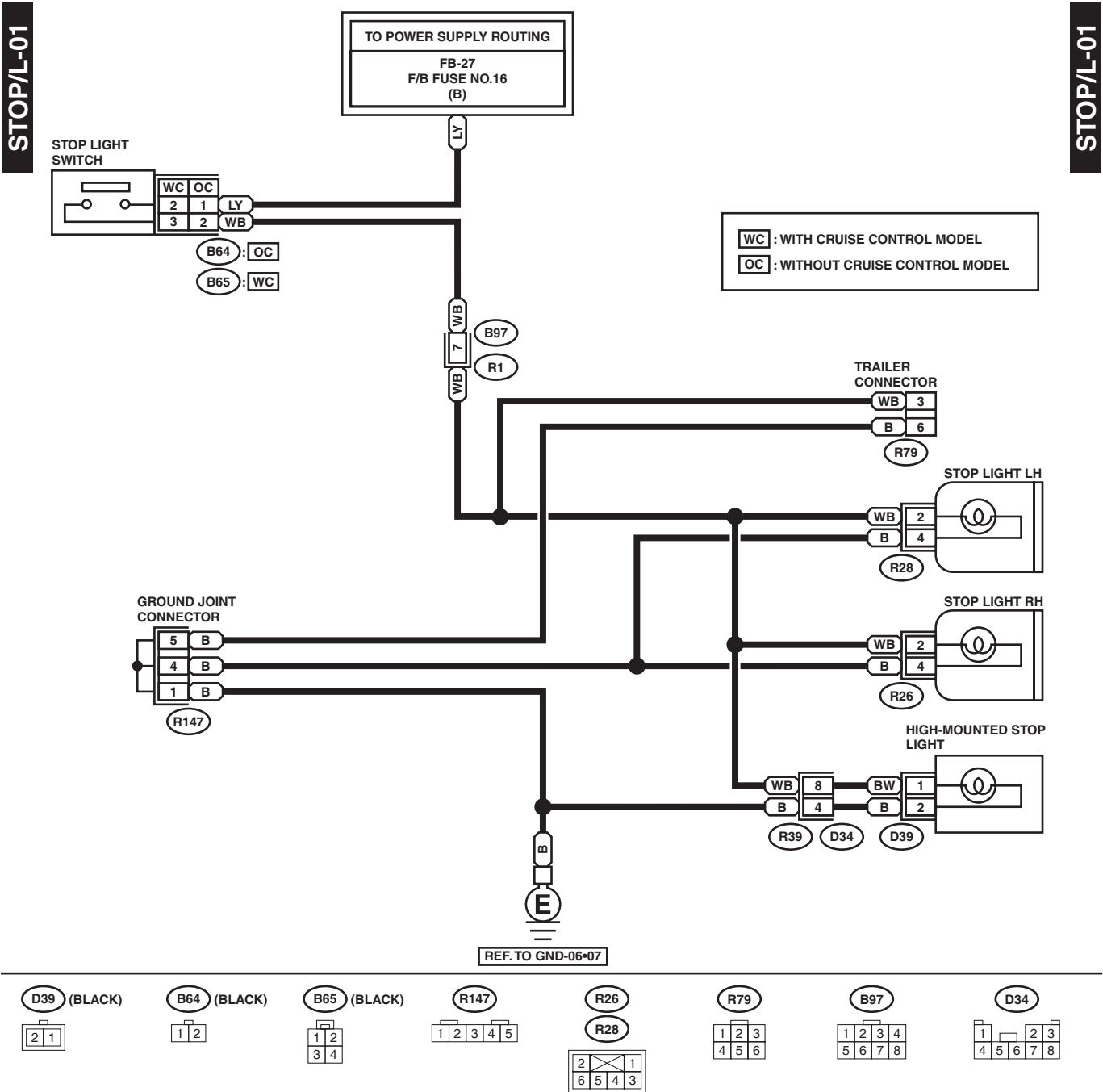

WI-03074