

1. Engine Mounting

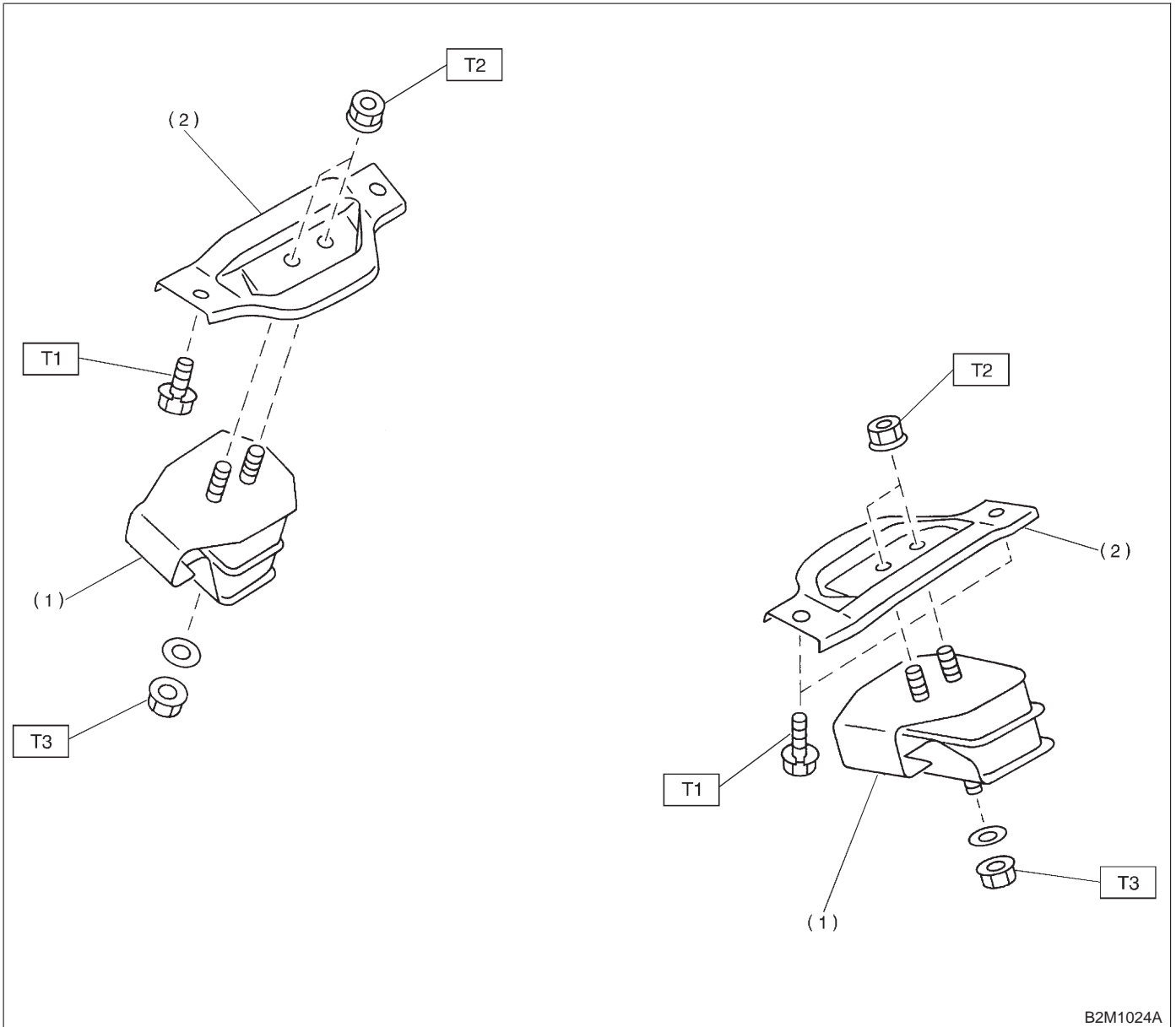

- (1) Front cushion rubber
- (2) Front engine mounting bracket

Tightening torque: N-m (kg-m, ft-lb)

T1: 26±7 (2.7±0.7, 19.5±5.1)

T2: 41±10 (4.2±1.0, 30±7)

T3: 83±15 (8.5±1.5, 61±11)

B2M1024A