

## 8. Anti-lock Brake System

### A: WIRING DIAGRAM

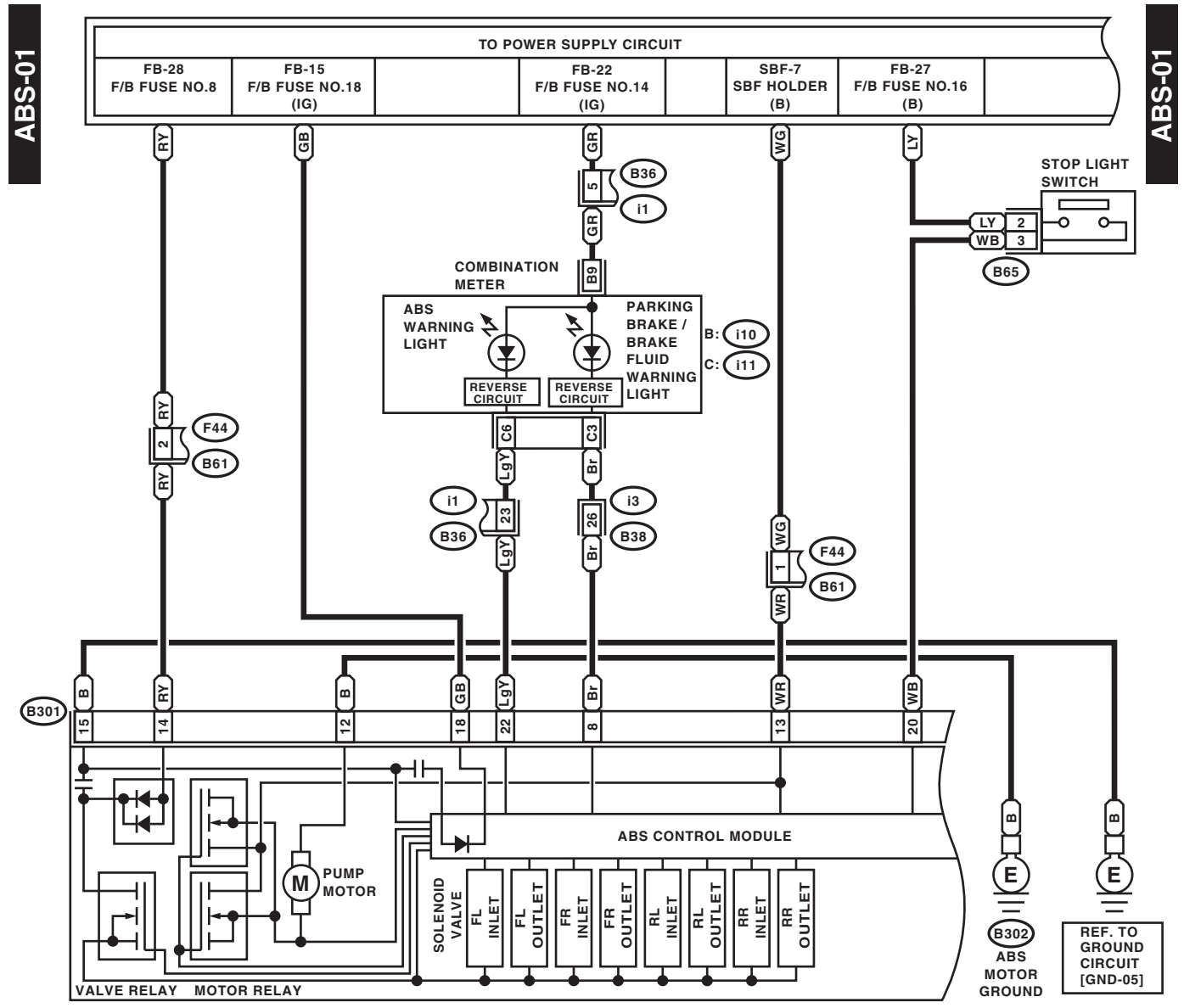

B65 (BLACK) F44 (BLACK)

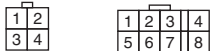

c: i11 (GREEN)

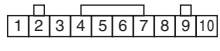

B36

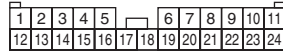

B301 (BLACK)

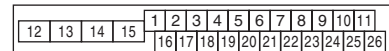

B: i10 (GREEN)

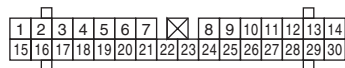

B38

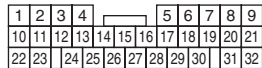

# Anti-lock Brake System

## WIRING SYSTEM

ABS-02

ABS-02

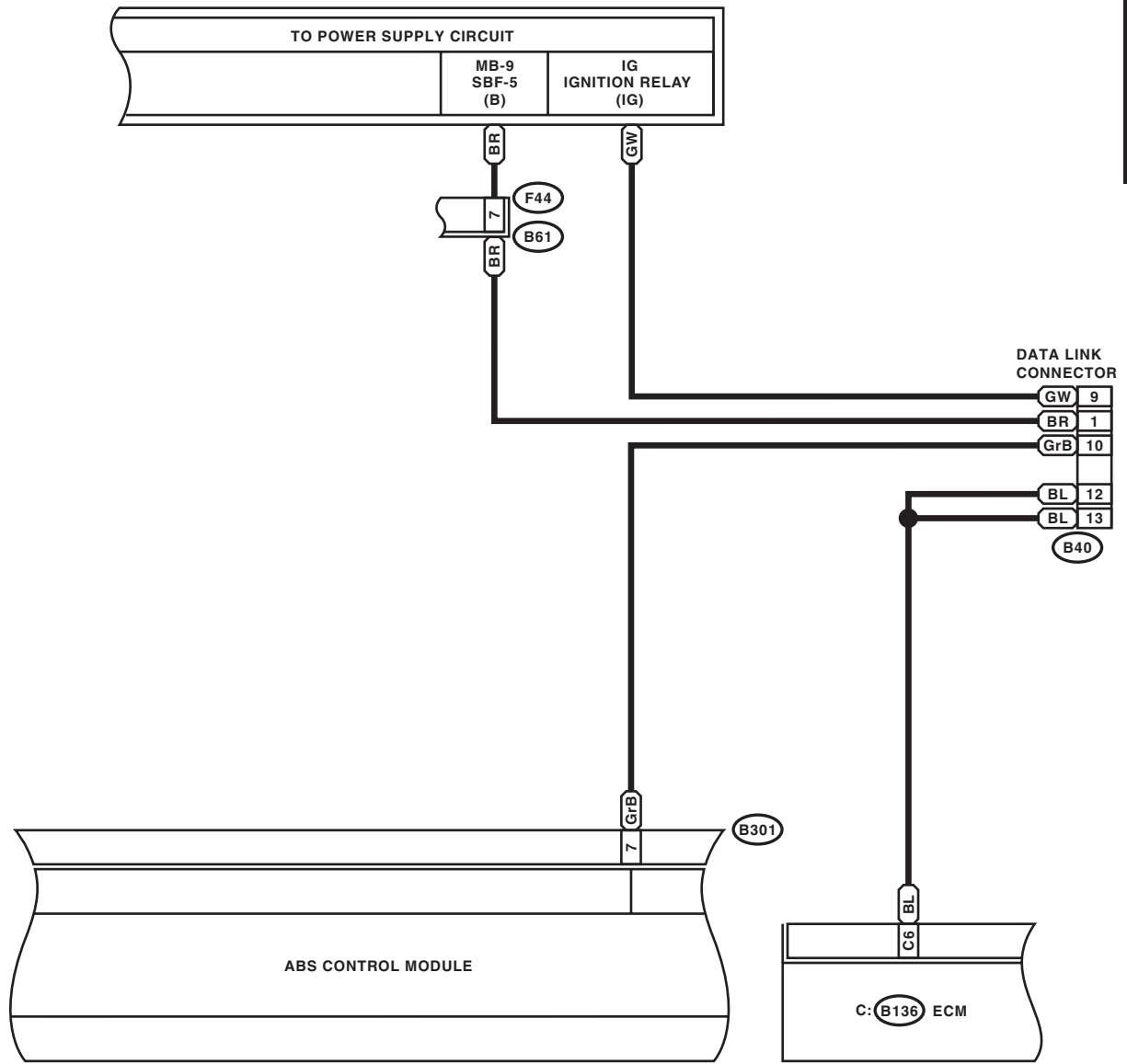

(B75) (GREEN)



(F44) (BLACK)



(B40) (BLACK)

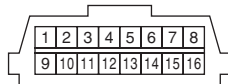

(B301) (BLACK)

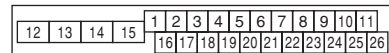

C: (B136) HR

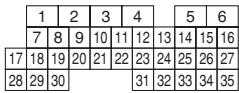

WI-11618

# Anti-lock Brake System

WIRING SYSTEM

ABS-03

ABS-03

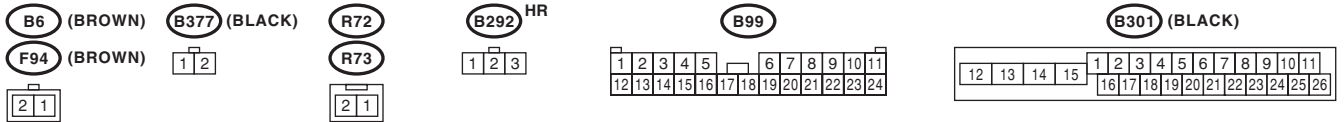
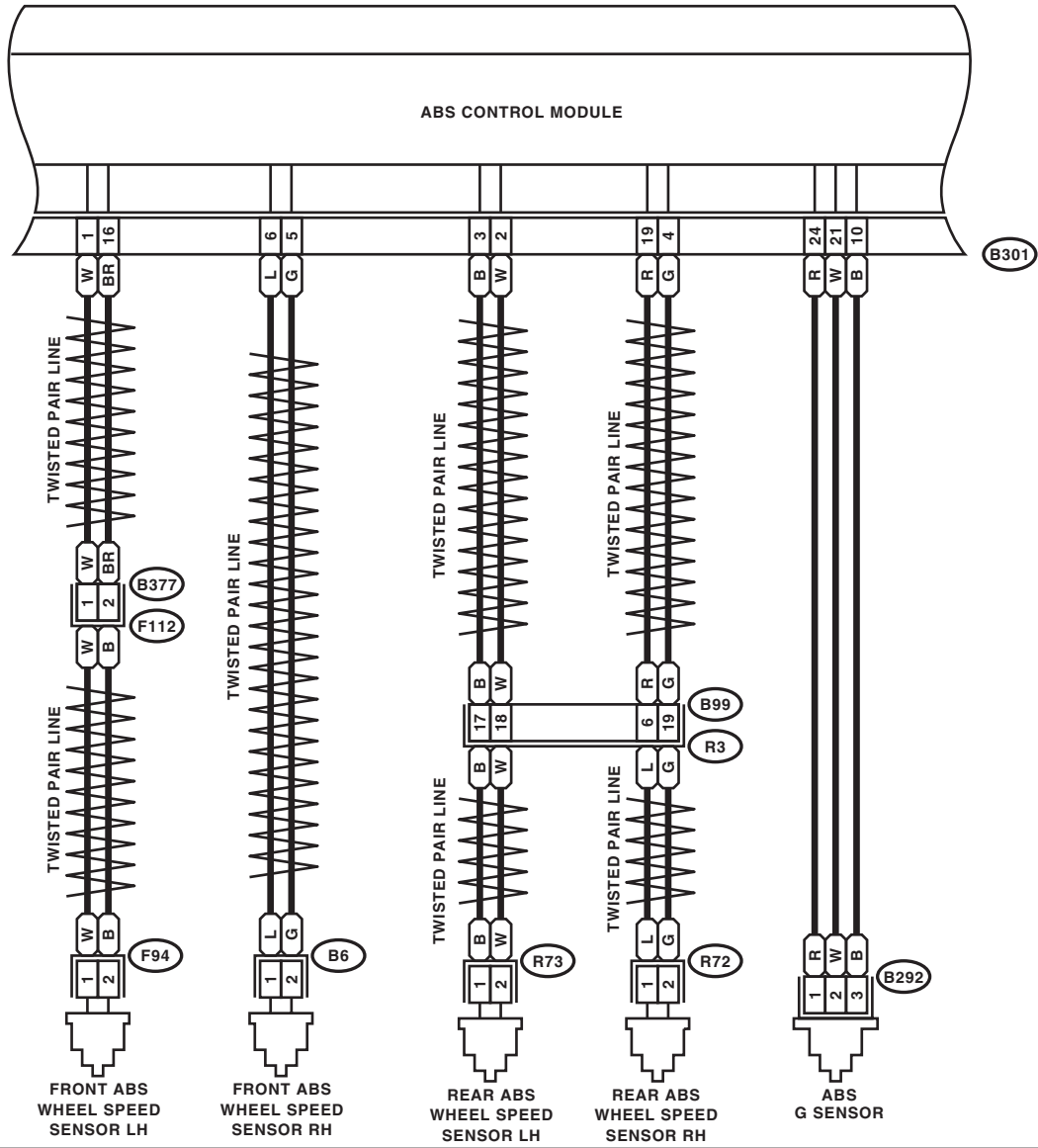

WI-11619

# Anti-lock Brake System

WIRING SYSTEM

ABS-04

ABS-04

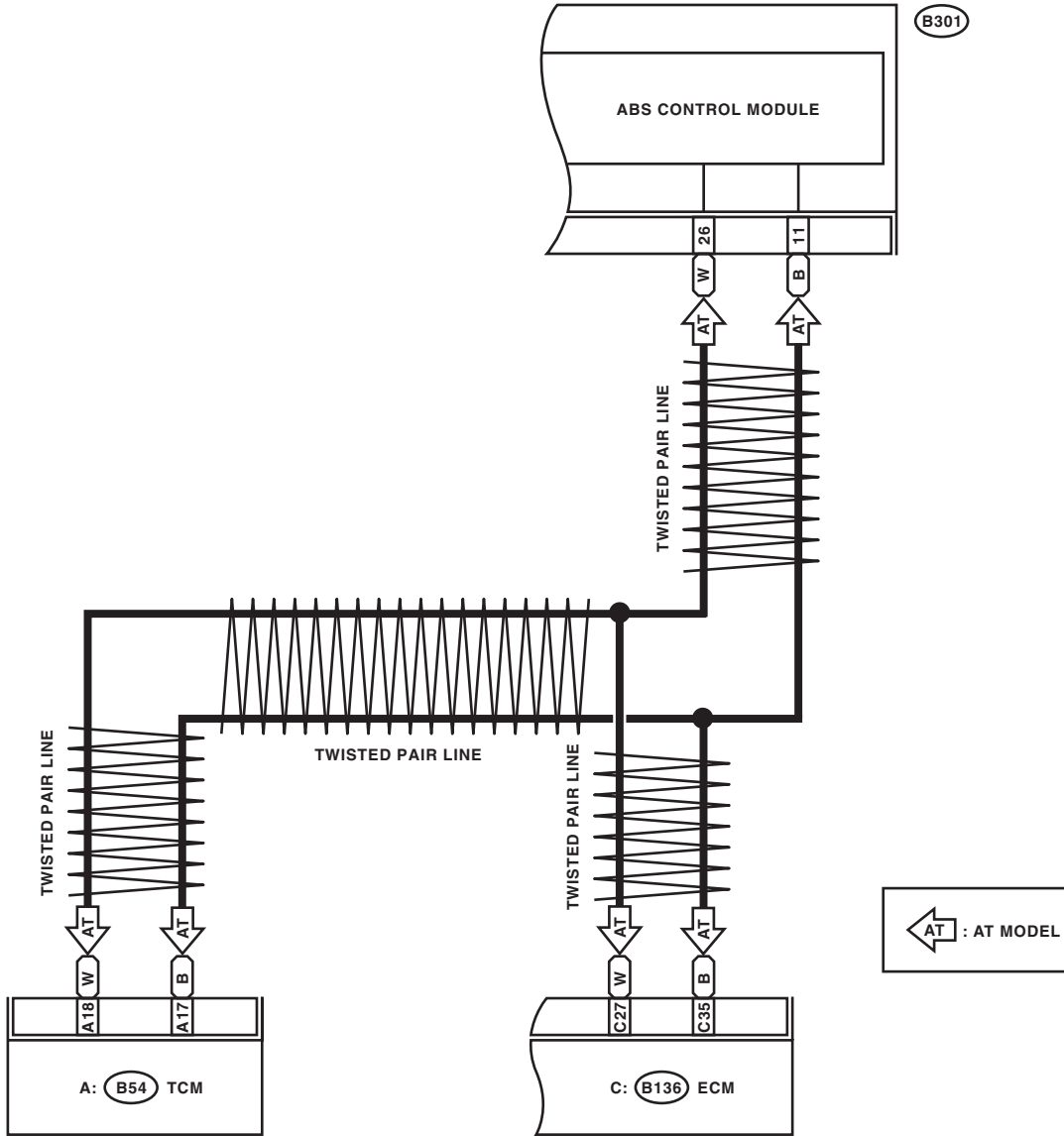

**(B301) (BLACK)**

12	13	14	15	1	2	3	4	5	6	7	8	8	10	11
				16	17	18	19	20	21	22	23	24	25	26

**A: (B54) HR**

**C: (B136) HR**

1	2	3	4	5	6
7	8	9	10	11	12
13	14	15	16		
17	18	19	20	21	22
23	24	25	26	27	
28	29	30		31	32
				33	34
					35

WI-11620