

2. Horn System

A: WIRING DIAGRAM

1. HORN

<Ref. to WI-128, WIRING DIAGRAM, Horn System.>

B: INSPECTION

1. HORN RELAY

Measure the security horn relay resistance between terminals (indicated in the table below) when connecting terminal No. 4 to battery positive terminal and terminal No. 3 to battery ground terminal.

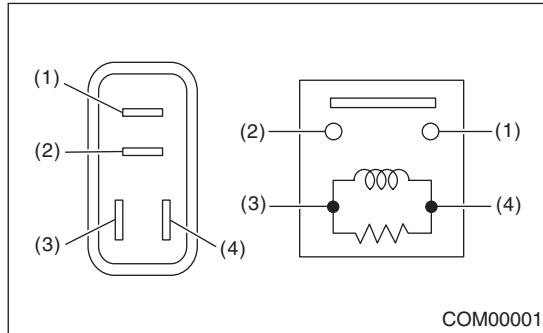

Continuity	Terminal No.	Standard
Yes	1 and 2	Less than 1 Ω
No		1 M Ω or more