

Rearview Mirror System

WIRING SYSTEM

44.Rearview Mirror System

A: WIRING DIAGRAM

a

a

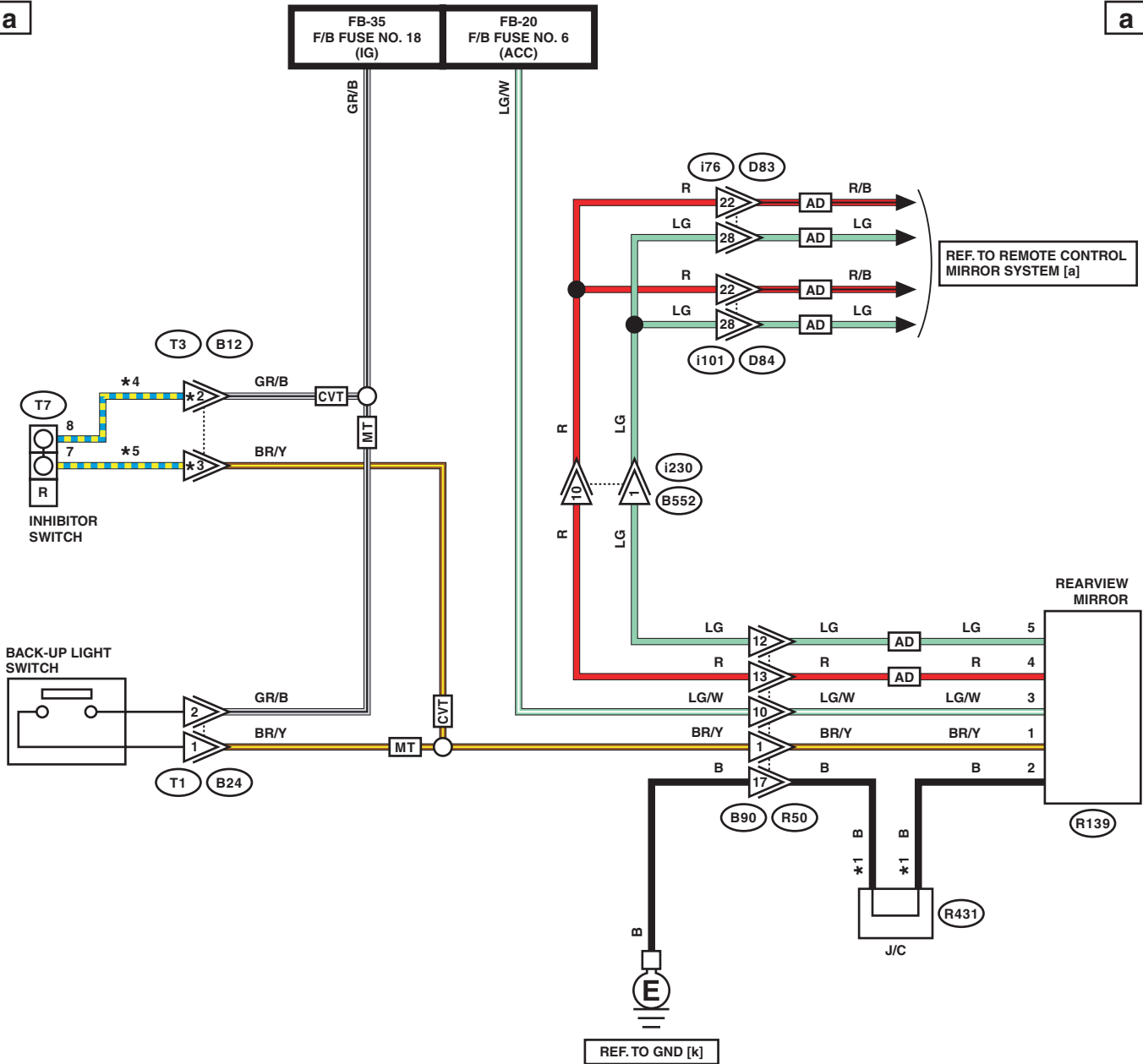

AD : WITH AUTOMATIC ANTI-GLARE

*1 : TERMINAL No. OPTIONAL ARRANGEMENT

*2 : NON-TURBO MODEL : 13
TURBO MODEL : 9

*3 : NON-TURBO MODEL : 14
TURBO MODEL : 10

*4 : NON-TURBO MODEL : L
TURBO MODEL : W/B

*5 : NON-TURBO MODEL : W/B
TURBO MODEL : B/W

WI-40919

b

b

LIST OF CONNECTORS

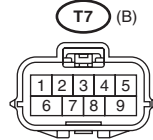
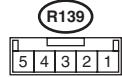
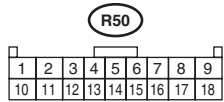
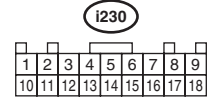
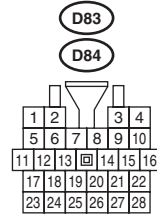
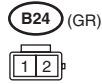
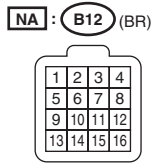
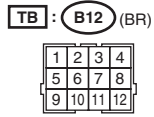

NA : NON-TURBO MODEL

TB : TURBO MODEL