



Technicians Reference Booklet

4EAT Phase II

Module 304

**© Copyright 2001
Subaru of America, Inc.**

All rights reserved. This book may not be reproduced in whole or in part without the express permission of Subaru of America, Inc.

Subaru of America, Inc. reserves the right at any time to make changes or modifications to systems, procedures, descriptions, and illustrations contained in this book without necessarily updating this document. Information contained herein is considered current as of April 2001.

4EAT Phase 2

Table of Contents

Slide Sequence	4
Introduction	6
Disassembly	7
Variable Torque Distribution (VTD)	9
4EAT Phase 2 Disassembly Continued.....	13
Servicing the Oil Pump	17
Servicing the High and Reverse clutch	18
Servicing the Planetary Gear Assembly and Low Clutch	19
Hydraulic Control	21
Line Pressure	21
Lock up Engagement	22
Lock up Release	22
1st gear	24
2nd Gear	25
3rd Gear	26
4th Gear	27
TCM Control	29
Normal Shifting	29
Slope Control	29
Control at Low Temperature	29
Control During ABS Operation.....	29
Engine Over Speed Prevention Control	29
Timing Control	30
Low Clutch Timing Control	31
Engine Torque Control.....	31
Learning Control	32
Reverse Inhibit Control	32
Engine Brake Control.....	33
Self Diagnosis	34
Failsafe Function	35
2002 Impreza 4EAT Phase 2 Enhancements "Chopper Voltage Signal"	36

Slide Sequence

Slide No.	Description	Page No.
1	Title Slide (4EAT Phase 2)	
2	Created By	
3	Teaching Aids	
4	Title Slide (General Information)	6
5	Left Side (Introduction)	6
6	Right Side	6
7	Bell Housing	6
8	Disassembly	7
9	Extension Housing	7
10	Transfer Clutch	7
11	Reduction Gears	7
12	Hammer and Punch	7
13	Tool Usage	7
14	Gear on Bench	7
15	Tool Usage	8
16	Filter	8
17	Solenoid	8
18	Artwork	8
19	Oil Pan	9
20	Title Slide (Variable Torque Distribution (VTD))	9
21	Rear View of 4EAT	9
22	Transfer Planetary	9
23	Transfer Area	10
24	Transfer Planetary	10
25	Reduction Drive Shaft	10
26	Power Split	11
27	Transfer Clutch	11
28	Transfer Planetary	11
29	Piston Clutch Side	12
30	Piston Case Side	12
31	Pressure Ports	12
32	Valve Body with Artwork	13
33	Valve Body	13
34	Failsafe	13
35	Seal Pipe Removal	14
36	Oil Pump	14
37	High Clutch	14
38	Hub	14
39	Front Sun Gear	14
40	Leaf Spring	14
41	2-4 Clutches	14
42	High Clutch	15
43	High Clutch Hub and Front Sun Gear	15
44	Leaf Spring	15
45	Planetary	15
46	2-4 Brake Piston	15
47	Tool Usage	16
48	Tool Usage	16
49	2-4 Brake Piston	16
50	Spring Retainer	16

Slide Sequence

Slide No.	Description	Page No.
51	Leaf Spring	16
52	Valve Body with Seal Pipe	16
53	One-Way Clutch Inner Race	16
54	One-Way Clutch Outside Bolts	16
55	Wave Washer	17
56	Piston and Seal	17
57	Oil Pump	17
58	Oil Pump Inner	17
59	High Clutch	18
60	Tool Usage	18
61	Planetary	19
62	Front Planetary and Rear Sun Gear	19
63	Rear Planetary	19
64	Low Clutch	19
65	Tool Usage	20
66	Tool Usage	20
67	Title Slide (Hydraulic Control)	21
68	Artwork: Line Pressure	21
69	Artwork: Line Pressure	21
70	Artwork: Lock-Up Engagement	22
71	Artwork: 1 st Gear	24
72	Artwork: 2 nd Gear	25
73	Artwork: 3 rd Gear	26
74	Artwork: 4 th Gear	27
75	Input / Output Charts	28
76	Input / Output Charts	28
77	Artwork: 2-4 Brake Timing	29
78	Artwork: Low Clutch Timing	30
79	Artwork: Reverse Inhibit Control	32
80	Artwork: Engine Brake Control	33
81	Title Slide (Self Diagnosis)	34
82	Self Diagnosis (11-15)	34
83	Self Diagnosis (16-24)	34
84	Self Diagnosis (25-36)	34
85	Title Slide (Failsafe Function)	35
86	Failsafe Function	35
87	Failsafe Function	35
88	Title Slide (2002 Impreza 4EAT Phase 2 Enhancements)	36
89	Ignition On / Engine Off	36
90	Idle	36
91	Part Throttle	36
92	Half Throttle	36
93	Stall Speed	36
94	Copyright	
95	The End	

4EAT Phase 2

Introduction

The 4EAT Phase 2 (introduced on 1999 Model Year vehicles) provides the same type of electronic control used by prior model year vehicles and shares many of the same diagnostic procedures, however there have been internal and external changes that require this 4EAT to be viewed as an entirely new automatic transmission. Additionally, beginning with the 2001 model year, an enhancement to the all wheel drive transfer section was introduced. This enhancement, Variable Torque Distribution (VTD), is covered in this reference booklet starting on page 9.

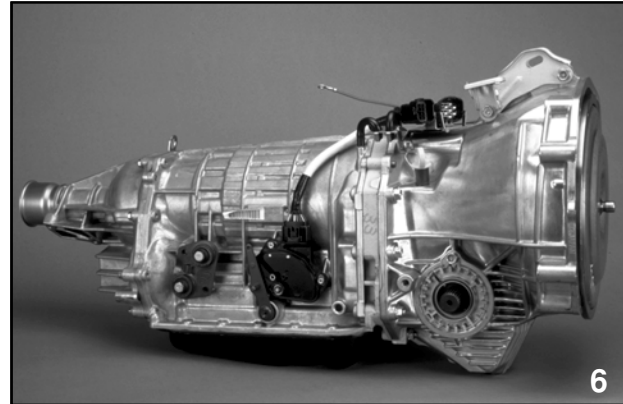
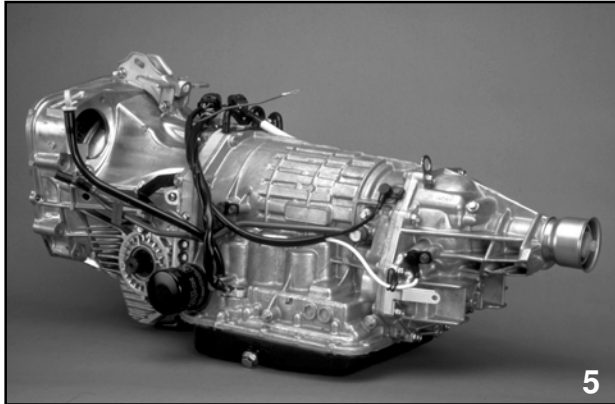

Externally, the number of bolts in the torque converter housing area have increased to match the increase in the number of bolts in the bell housing of the engine. The use of an external canister type oil filter has been adopted which requires no scheduled maintenance. Three speed sensors are now located on the outside surface of the transmission case reading rotational speeds of internal components improving transmission characteristics.

Internally the Brake Band and Servo Mechanism have been deleted and in its place an additional clutch pack is used as a holding member for second and fourth gear. Also the remaining clutch assemblies and the valve body have been redesigned requiring new disassembly and assembly procedures.



4EAT Phase 2

Disassembly

Before beginning the disassembly process, label the speed sensors so that they are not incorrectly installed during reassembly.

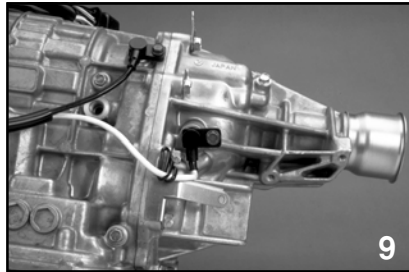

Remove vehicle Speed Sensor 1 from the extension case. Followed by the bolts that secure the extension case to the rear of the transmission.

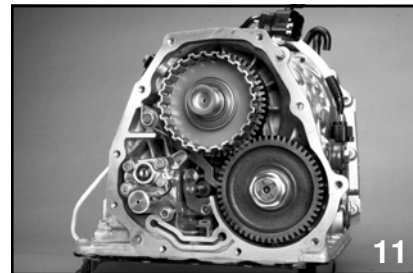
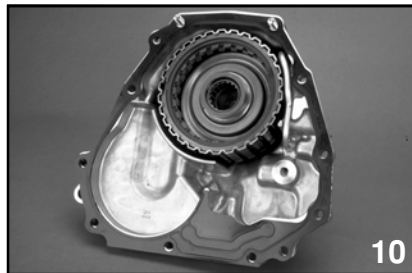

Set the select lever to the park position to engage the Parking Pawl to the front of the reduction drive gear.

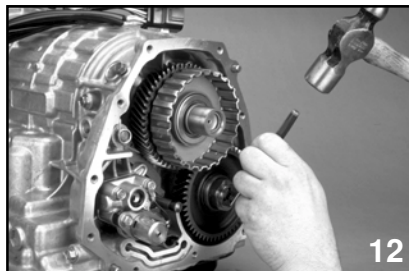

Straighten the peen mark of the locknut. (This locknut is designed to be used only once.) Remove the locknut and washer.

Clean the threaded portion of the backside of the Reduction Driven Gear and install the special tool puller. (499737000 and 899524100)

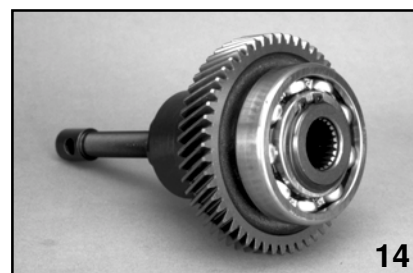

Turn the puller until the Reduction Driven Gear has cleared the Pinion shaft.

4EAT Phase 2

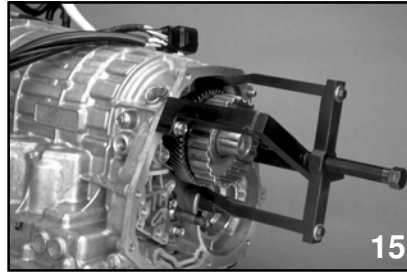

Install the reduction drive gear puller to the rear of the transmission as shown and slowly remove the drive gear assembly. (499737100 and 899524100)

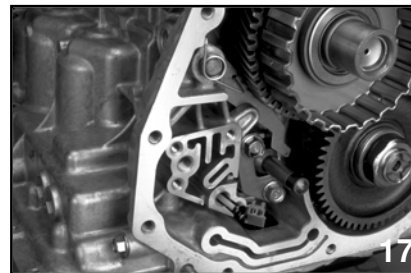
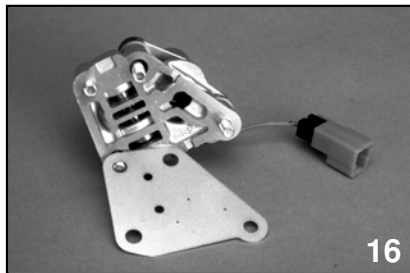

Disconnect the Transfer Duty Solenoid Connector and remove the bolts that secure the Duty Solenoid and Transfer Control Valve to the Transmission Case. Remove the small filter from the cavity in the Transmission case at this time. Remove the Parking Pawl, spring and Parking Pawl Shaft.

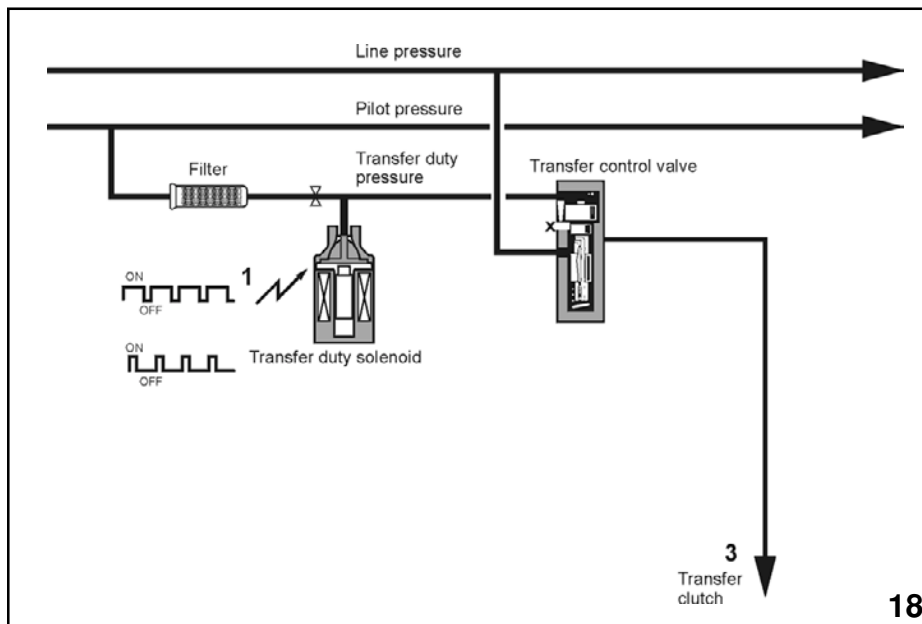

The Transfer Duty Solenoid controls the amount of pilot pressure supplied to the backside of the Transfer Control Valve Piston. If the duty ratio signal from the Transmission Control Unit (TCU) is small the Transfer Duty Solenoid stays off more than it is on and drains less of the pilot pressure. This will result in an upward movement of the control valve increasing the amount of line pressure to the Transfer Clutch. An increase in the duty ratio turns the solenoid on more than it is off and drains more of the pilot pressure. The Transfer Control Valve moves downward restricting the amount of line pressure to the Transfer Clutch.

4EAT Phase 2

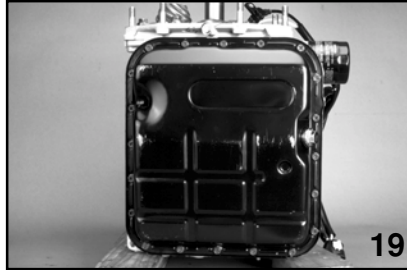

The next step in the disassembly process is to remove the Oil Pan. Position the transmission on the worktable with the Oil Pan facing upward and held in position with wooden blocks.

Remove the Oil Pan Bolts. Use a putty knife or similar tool with a hammer and carefully separate the pan from the transmission. Do not score or scratch the mating surface.

Variable Torque Distribution (VTD)

Variable Torque Distribution (VTD) is an addition to the current 4EAT transfer section. VTD is designed to smoothly transfer and divide the power from the engine to the wheels. This new system for North America is equipped on all Subaru vehicles with Vehicle Dynamic Control (VDC).

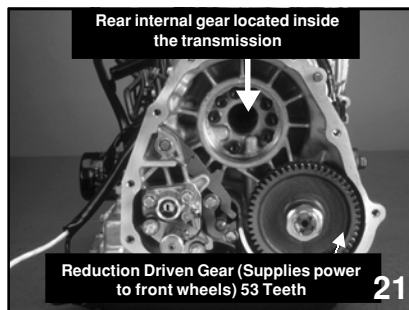

The view of the extension case area is similar to the current 4EAT Phase 2. The difference is the Reduction Drive Assembly.

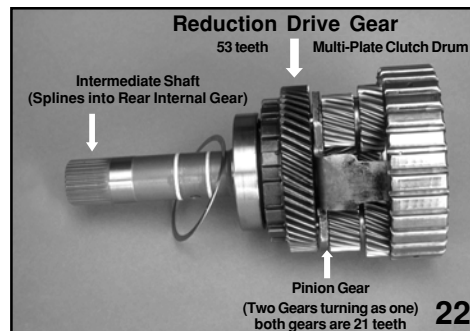

An Intermediate Shaft is splined to the Rear Internal Gear, carrying power to a Sun Gear. The Sun Gear is made onto the end of the Intermediate Shaft. The rotating Sun Gear delivers power to a set of Pinion Gears.

4EAT Phase 2

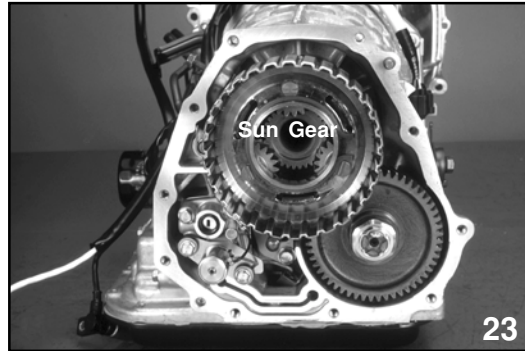

The Pinion Gears are two gears made together. The smaller gear and larger gear have the same number of teeth. The Intermediate Sun Gear drives the smaller Pinion Gear and the larger Pinion Gear.

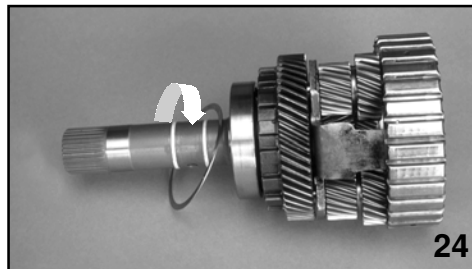

The Pinion Gear is secured to the carrier and delivers power to it. The carrier will now rotate, driving the Reduction Drive Gear. This supplies power to the front wheels. At the same time, the larger Pinion Gear is driving the Rear Drive Shaft.

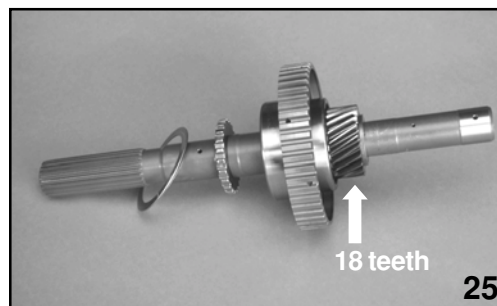

A Sun Gear made on to the end of the Rear Drive Shaft receives the power and transfers the power to the shaft.
The final drive shaft is splined to the Rear Drive Shaft. This carries power to the rear differential.

4EAT Phase 2

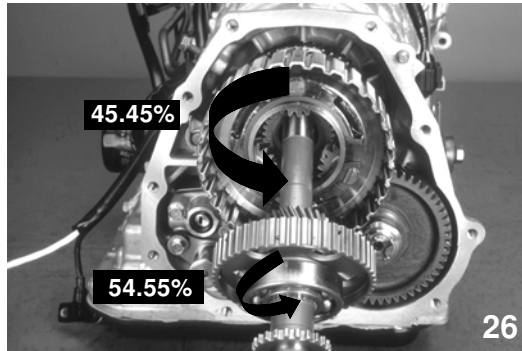

Assuming the friction of the front and rear tires is the same, the power is split 54.55% to the rear and 45.45% to the front.



The Front Wheels load the reduction drive and driven gears.
The Rear Wheels load the Rear Drive Shaft and Pinion Gears.
Driving the vehicle results in the Pinion Gears rotating and advancing around the Intermediate Sun Gear.
The Intermediate Sun Gear has 33 teeth; the Small Pinion has 21 teeth.
The Rear Drive Shaft Sun Gear has 18 teeth; Large Pinion has 21 teeth.
You can calculate the power split by dividing 18 by 33 for the Rear Wheels. The remaining power drives the Front Wheels.

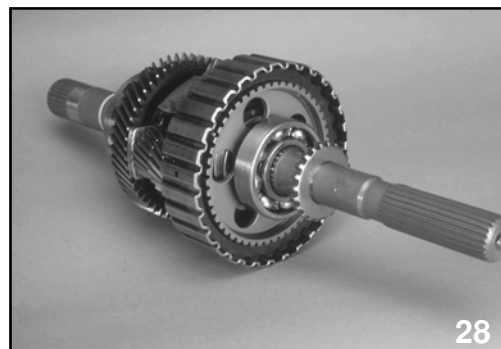

The TCM adjusts the duty ratio of the MPT clutch to maintain the optimum transfer of power. A large speed difference in the rear to the front wheels results in the MPT clutch locking the Rear Drive Shaft to the carrier. Power is then split 50% to the front and 50% to the rear.

4EAT Phase 2

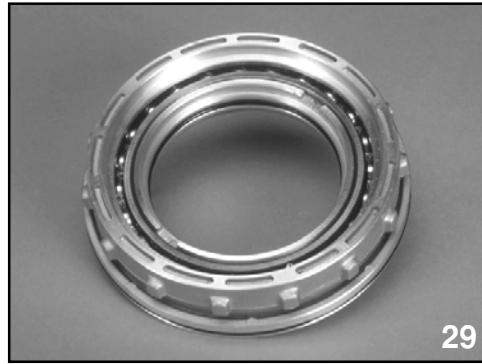

The piston for the MPT Clutch is machined to spline with the MPT Drum. The piston will rotate with the drum.

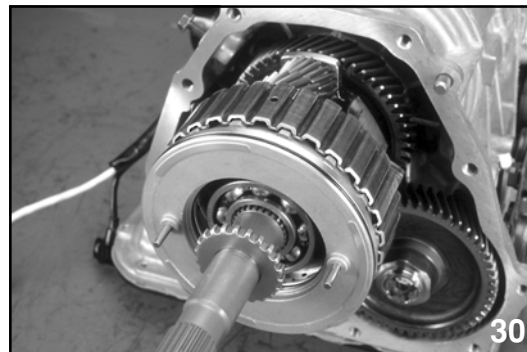

The backside of the piston is made with two locating pins. This prevents the backside of the piston from rotating.

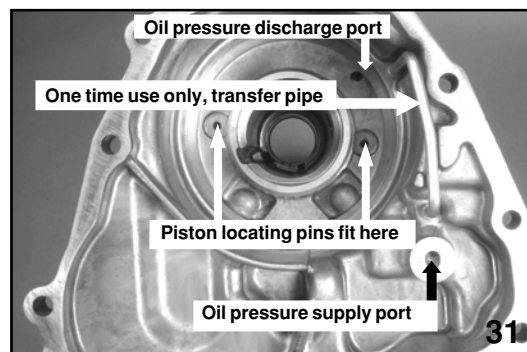

Pressure port locations.

Note: Oil Pressure Transfer Pipe is one-time use only.

4EAT Phase 2

4EAT Phase 2 Disassembly Continued

Carefully disconnect and remove the wiring harness.

Remove the control valve body. There are 8 short bolts marked with an (8) and 5 long bolts marked with (7B).

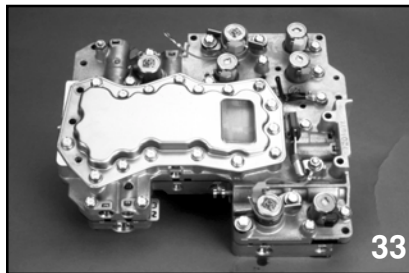
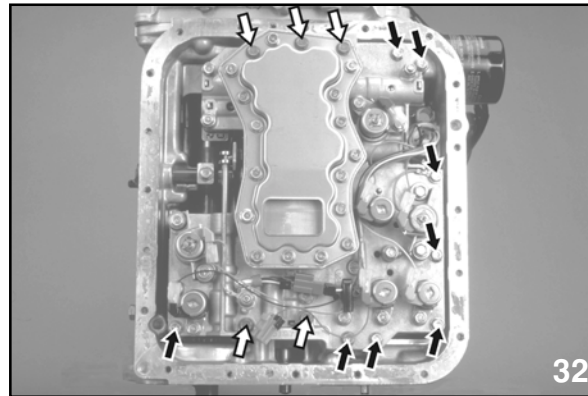

Carefully disconnect all solenoids. Observe the color of the connectors and the color of the wire that connects to them.

Solenoid	Color	Failsafe
2-4 Brake	Red	1 st and 3rd
2-4 Brake Timing	Black	1 st and 3rd
Shift A	Green	3rd
Shift B	Yellow	3rd
PL	Red	1 st and 3rd Line press set at maximum
Low Clutch Timing	Gray	1 st and 3rd
Lock Up	Blue	no lock up

34

4EAT Phase 2

Reposition the transmission to vertical using the wooden blocks to stabilize the case. Remove the bolts and nuts that secure the pump assembly to the transmission case. Remove Seal Pipe.

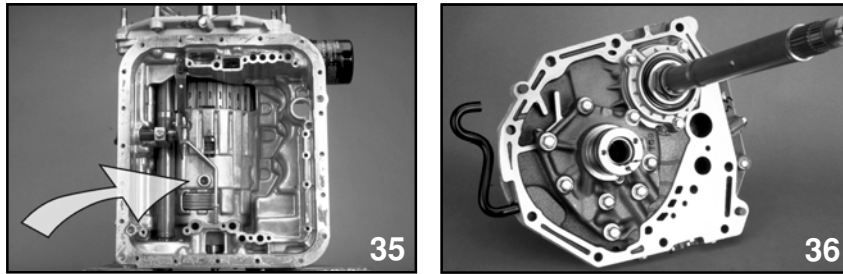

Use the stator support as a handle and remove the pump assembly and gasket. **Caution: the Thrust Needle Bearing may stick to the pump. Ensure it is set aside as it may be used during reassemble if the total end play requires the thickness of the needle bearing to be the same as the original.**

Remove the High Clutch Drum, Thrust Needle Bearing and the High Clutch Hub.

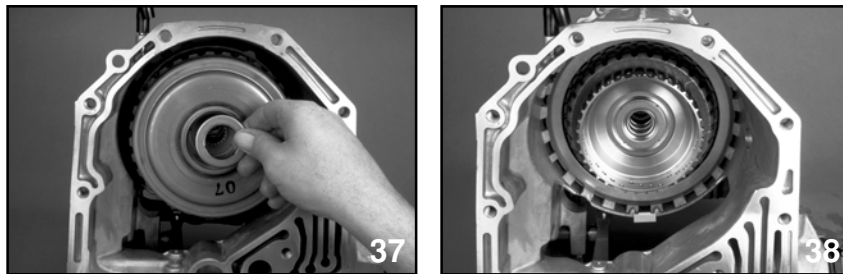

Remove the Thrust Needle Bearing and the front Sun Gear.

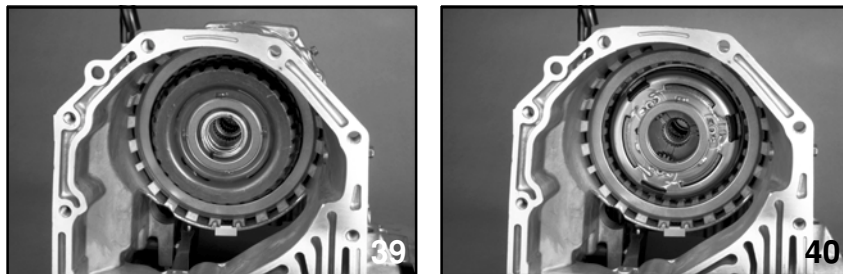

Remove the Snap Ring and the drive and driven plates of the 2-4 brake clutch with pressure plate.



Note: When installing the 2-4 brake clutch, line up the grooves to ensure proper leaf spring positioning.

4EAT Phase 2

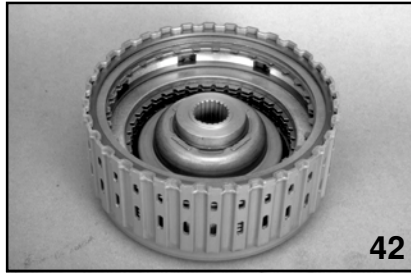

The High Clutch Drum houses the high and reverse clutch. The high clutch is applied in all 3rd and 4th gear ranges. The Reverse clutch is applied in the reverse range only. Position the high clutch with the open end facing upward. The lower positioned clutch assembly is the high clutch. The wide end of the High Clutch Hub engages with these drive and driven plates while the smaller end of the High Clutch Hub engages with the Front Planetary Carrier.

The reverse clutch plates engage with the top section of the front Sun Gear. The lower section of the front Sun Gear engages with the 2-4 brake clutch. Any time the 2-4 brake clutch is applied the front Sun Gear assembly is fixed to the case of the transmission and cannot rotate.

The High Clutch Drum itself is splined to the turbine shaft. When the high clutch is applied the power from the drum is transferred to the rear Sun Gear via the High Clutch Hub and turns the rear planetary carrier.

Remove the Upper Leaf Spring. This device reduces chatter and vibration. Carefully observe its location.

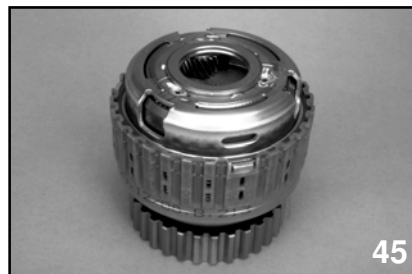

Remove the planetary assembly as a unit. Followed by the Snap Ring and Spring Retainer of the 2-4 Brake Piston. Observe the location of the 2-4 locating lug of the 2-4 Brake Piston so that it is properly positioned during reassembly.

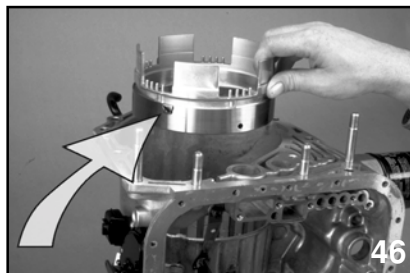

4EAT Phase 2

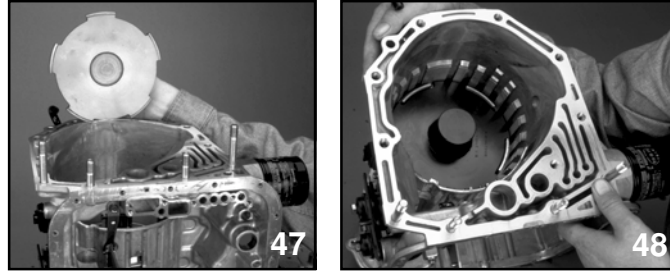

During reassembly, the installation of the Snap Ring of the 2-4 brake Spring Retainer requires the use of a special tool. Carefully position the Snap Ring over the retainer and place the special tool on top of the Snap Ring. Apply steady, firm pressure until you hear the Snap Ring fully seat. Remove the tool and check that the Snap Ring is fully seated. Using both hands, remove the 2-4 Brake Piston. It may be necessary to provide a wobbling motion to expedite its removal. The piston retainer may come out with the piston. If it does not, remove it at this time.



Remove the Lower Leaf Spring followed by the Snap Ring and Low and Reverse Brake Clutch. Observe the orientation of the Dish Plate so it is properly positioned during reassemble.



The Seal Pipe carries pressure from the valve body to the 2-4 Brake Clutch Piston Retainer.

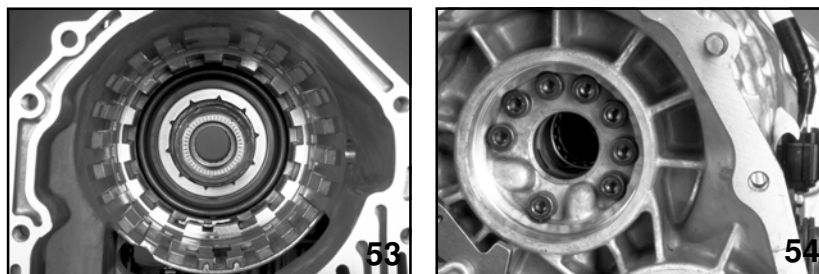

Remove the Thrust Needle Bearing from the machined surface of the one way clutch inner race. Reposition the transmission case horizontally and remove the bolts that secure the one way inner race to the transmission case. Carefully remove the inner race from the transmission.

4EAT Phase 2

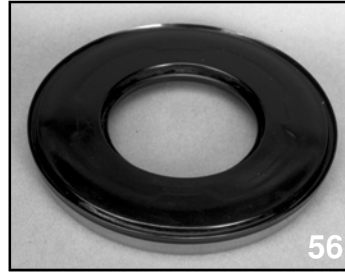

Also remove the Spring Retainer, Wave Washer and the Low and Reverse Brake Piston.

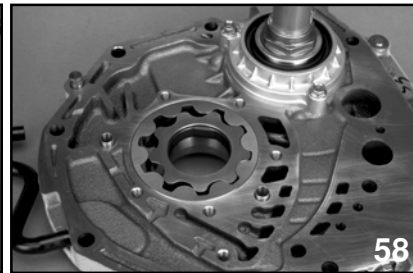
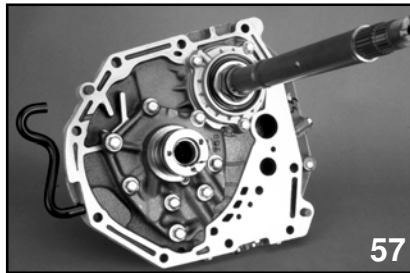

Servicing the Oil Pump

Remove the seven bolts from the Oil Pump Cover. Lift the cover off and inspect the inner and outer rotor for damage. Check for wear, seizing, and deformation of parts and clogged or dirty oil passages.

Measure the clearance between the inner and outer rotor.

Standard value 0.02-0.15 mm

Measure the side clearance of the inner and outer rotor.

Standard value 0.02-0.04 mm

If the side clearance is beyond specifications replace the rotors as a set. Choose the thickness of the set that will place the side clearance within specifications.

Parts number	Thickness
15008AA060	11.37-11.38
15008AA070	11.38-11.39
15008AA080	11.39-11.40

Line the dowel pins of the oil pump housing with the alignment holes of oil pump cover and set the cover into place. Torque the bolts to the proper specifications.

Caution: The cover must sit flush on the pump before it is tightened. Failure to do this will result in a cracked pump and or cover.

Note: When installing new friction plates soak them in automatic transmission fluid for at least 2 hours before installation.

4EAT Phase 2

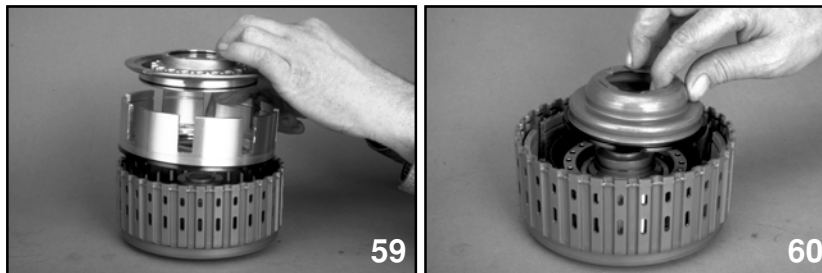

Servicing the High and Reverse Clutch

Remove the Snap Ring from the open end of the High Clutch Drum.

Caution: the Retaining Plate of the High Clutch is directional. Observe how it is positioned so it is properly placed during reassemble.

Caution: the Dish Plate is directional. Observe how it is positioned so it is properly placed during reassemble. Remove the drive and driven plates.

Remove the Snap Ring and the Drive and Driven Plates of the Reverse Clutch.

Position the High Clutch Drum with the open-end facing upward on suitable press plates. Carefully position the compressor and seat against the High Clutch Spring Retainer. Apply slow steady pressure until there is enough room to remove the Snap Ring. Slowly release the pressure ensuring the Spring Retainer does not move to one side partially engaging with the Snap Ring groove.

Remove the Spring Retainer, spring, High Clutch Piston and Reverse Clutch Piston.

Reassemble parts in reverse order of disassembly. Check the operation of the high and reverse clutch by applying air pressure to the their pressure ports.

Check for proper clearance between the Snap Ring and Retaining Plate of each clutch assembly.

If the clearance is beyond specifications replace the Retaining Plate with one that will provide the proper clearance.

Retaining Plate High Clutch		Retaining Plate Reverse Clutch	
High Clutch	Thickness	Reverse Clutch	Thickness
31567AA710	4.7	31567AA750	3.8
31567AA720	4.8	31567AA760	4.0
31567AA740	5.0	31567AA780	4.4
31567AA730	4.9	31567AA770	4.2
31567AA670	5.1	31567AA790	4.6
31567AA680	5.2	31567AA800	4.8
31567AA690	5.3	31567AA810	5.0
31567AA700	5.4	31567AA820	5.2

4EAT Phase 2

Servicing the Planetary Gear Assembly and Low Clutch

Position the planetary gear assembly with the open end upward. Remove the Snap Ring.
Caution: There are 2 Thrust Needle Bearings and Thrust Washers used in this assemble. They may stick to components when they are removed. Use extreme care when handling.

Remove the Front Planetary Carrier, Thrust Needle Bearing and rear Sun Gear.

Note: All bearings, washers, and gears are directional.

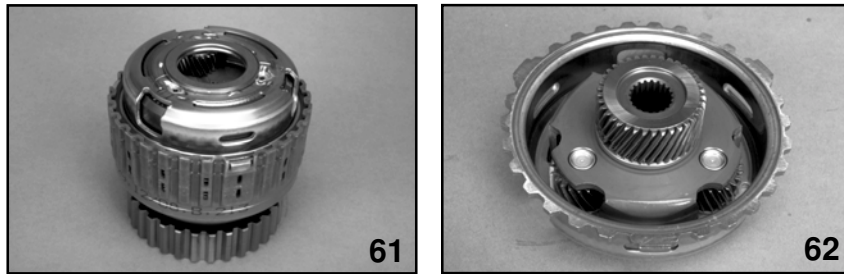

Remove the Rear Planetary Carrier, Thrust Washer, and Thrust Needle Bearing. Remove the Rear internal gear and Thrust Washer.

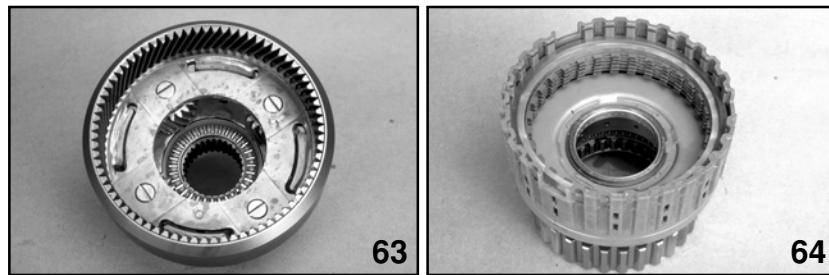

Remove the Snap Ring and Retaining Plate. Next remove Drive and Driven Plates.

Caution: The Retaining Plate of the Low Clutch is directional. Observe how it is positioned so it is properly placed during reassemble.

Position the Low Clutch Drum with the open-end facing upward on suitable press plates. Carefully position the compressor and seat against the Low Clutch Spring Retainer. Apply slow steady pressure until there is enough room to remove the Snap Ring. Slowly release the pressure ensuring the Spring Retainer does not move to one side partially engaging with the Snap Ring groove.

4EAT Phase 2

Remove the Spring Retainer, Spring, and Low Clutch piston.

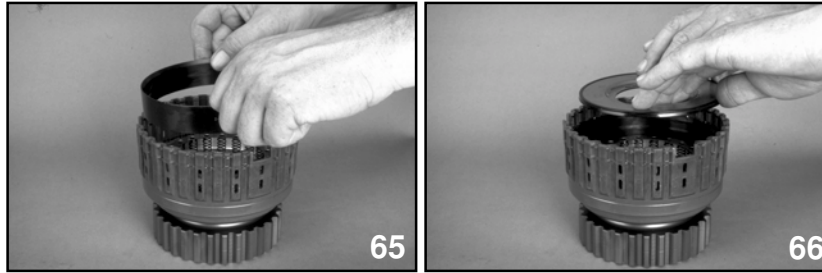

Reassemble parts in reverse order of disassembly. Use the Low Clutch Spring Retainer guide to help center and maintain the position of the retainer. This prevents the guide from catching on the Snap Ring groove. Check for proper clearance between the Snap Ring and Retaining Plate.

If the clearance is beyond specifications replace the Retaining Plate with one that will provide the proper clearance.

Available Retaining Plates Part Number	Thickness
31567AA830	3.8
31567AA840	4.0
31567AA850	4.2
31567AA860	4.4
31567AA870	4.6

Check the operation of the Low Clutch by placing the one way clutch inner race into the bottom of the Low Clutch Drum and applying air pressure to the pressure port.

Caution: Do not place hands inside drum when air checking.

Check the operation of the One Way Clutch at this time. It should **not** allow the Low Clutch Drum to rotate counter clockwise. The Low Clutch is applied in all forward gears except 4th. When applied the Low Clutch locks the rear internal gear to the Low Clutch Drum.

In 1st gear this action initially turns the Low Clutch Drum counterclockwise. However, the One Way Clutch catches the drum and prevents it from turning. The rear internal gear locked to Low Clutch Drum via the Low Clutch now makes the planetary pinions revolve around the rear Sun Gear. This turns the rear planetary carrier, which is connected, to the reduction drive gear assembly.

4EAT Phase 2

Hydraulic Control

Line Pressure

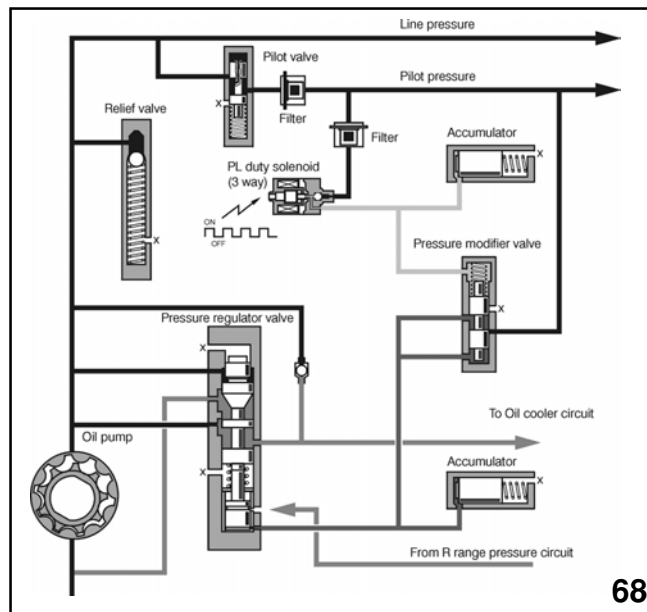

Line pressure provides the force necessary to engage driving and holding members as well as lubricate and cool the transmission. Adjusting the line pressure to various levels reduces the amount of load placed on the engine and minimizes wear on the transmission.

Line pressure is adjusted using data that indicates throttle opening, vehicle speed, and other input signals. Control of the pressure during low load conditions results in a duty ratio, or on verses off time that is large. This duty ratio results in the PL Duty Solenoid staying on more than it is off. Pilot pressure is drained away from the Pressure Modifier Valve. Resulting circuit action lowers the pressure in the lower side of the Pressure Regulator Valve allowing line pressure in the upper side of the valve to push the valve down increasing the amount of pressure drained from the line pressure circuit.

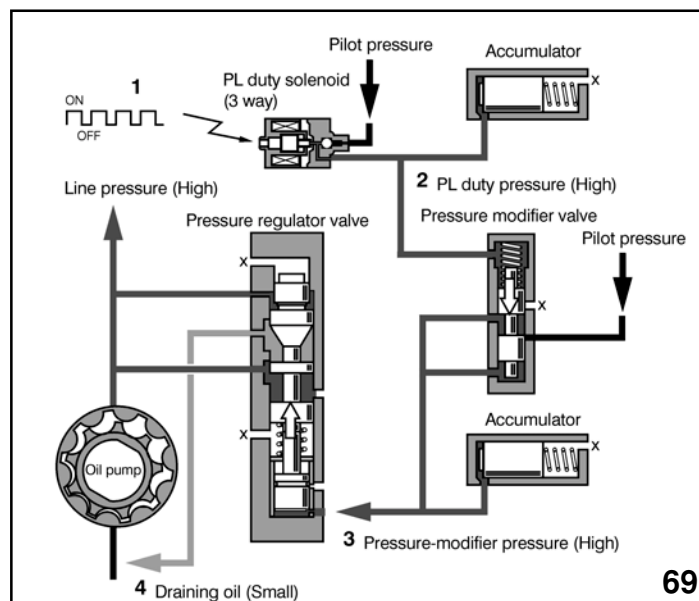

4EAT Phase 2

Control during high load conditions results in a low duty ratio increasing the pressure to the pressure modifier valve. This will result in an increase in pressure to the bottom of the pressure regulator valve creating an upward movement of the pressure regulator valve. Reducing the amount of line pressure drained. The amount of line pressure throughout the transmission will then increase.

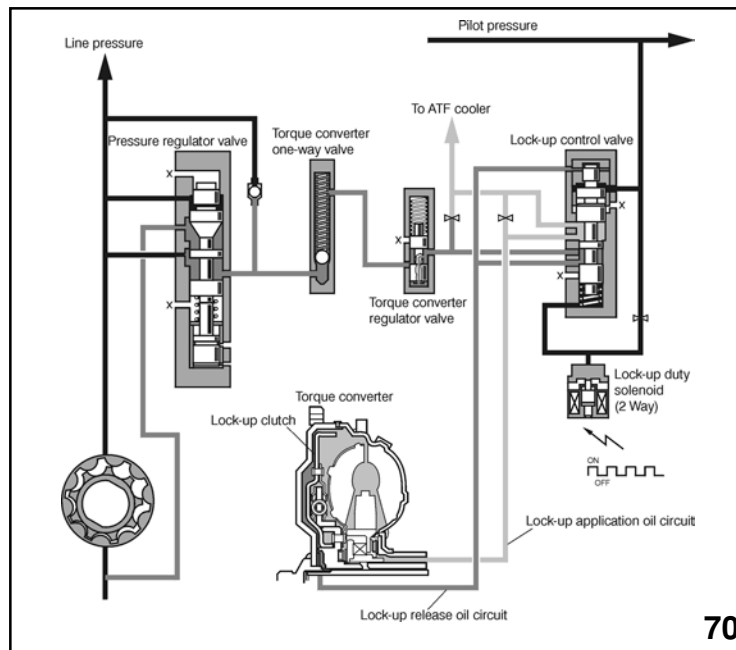

Lock up control engages the Lock Up Clutch inside the Torque Converter when traveling in 4th gear under uniform conditions, transmitting engine power directly to the Input Shaft.

Lock up Engagement

1. The TCM increases the duty ratio and the oil drainage rate increases in proportion to the duty ratio.
2. The lock up control valve is pushed down, connecting the torque converter regulator valve port and the lock up application port.
3. Oil pressure from the Torque Converter Regulator Valve is conducted through the application port to the torque converter and the Torque Converter Clutch. The lock up release port ATF is drained through the lockup control valve at this time.
4. The lock up clutch is engaged by the oil pressure from the lock up application port. After the clutch is engaged, the TCM lock up duty solenoid ratio is fixed in the on position.

Lock up Release

1. The Duty Ratio of the Lock up solenoid is adjusted to 5%. Drainage of the duty solenoid oil is stopped and the lock up duty pressure rises.
2. The lock up control valve spool is pushed up, connecting the torque converter regulator valve port and the torque converter release port.

4EAT Phase 2

3. Oil pressure from the Torque Converter Regulator Valve is conducted through the release port to the Torque Converter Clutch and the Torque Converter Application Circuit.
4. The Clutch Plate moves away from the Torque Converter Case and the Lock up Clutch is released.

Gear Shift Control

The shift control operates the engagement and release of the Low Clutch, 2-4 Brake, and the High Clutch. TCM output signals control Shift Solenoid A and Shift Solenoid B based on input from vehicle speed and throttle opening.

The solenoids in turn supply or remove pilot pressure from Shift Valve A and Shift Valve B. The positioning of the shift valves route line pressure to the correct clutch and or brake assemblies.

4EAT Phase 2

1st gear

When the selector lever is placed in the D range the manual valve opens the port to the shift valves A and B supplying Line pressure. Shift solenoids A and B are turned on by the TCM and pilot pressure is applied to the top of both Shift Valves. The Shift valves move to the bottom of their bores providing a route for line pressure to the Low Clutch.

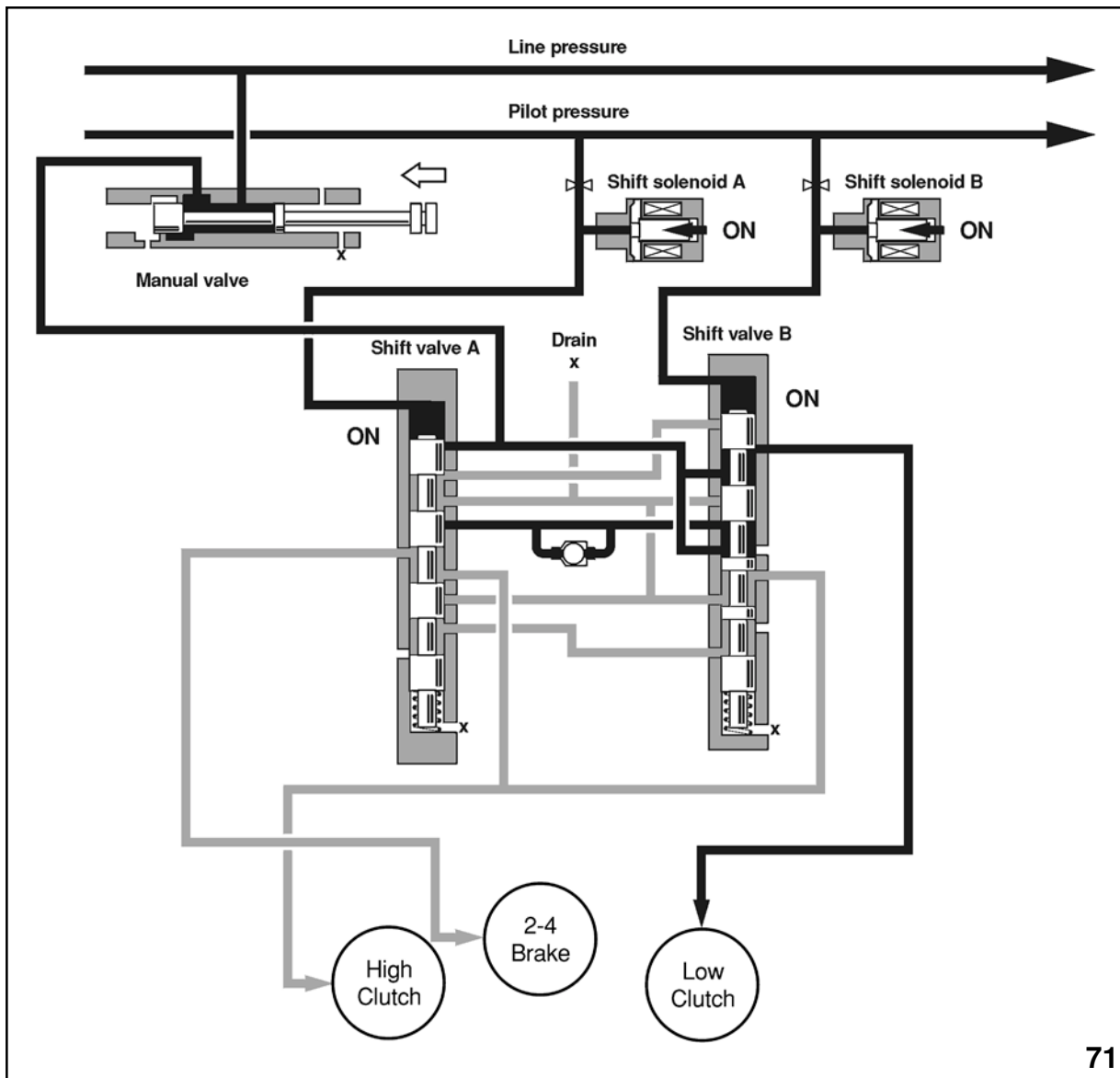

4EAT Phase 2

2nd Gear

TCM output turns shift solenoid A off and shift solenoid B on. Shift valve A moves upward and opens the 2-4-Brake port. The Low Clutch and 2-4 brake are now applied.

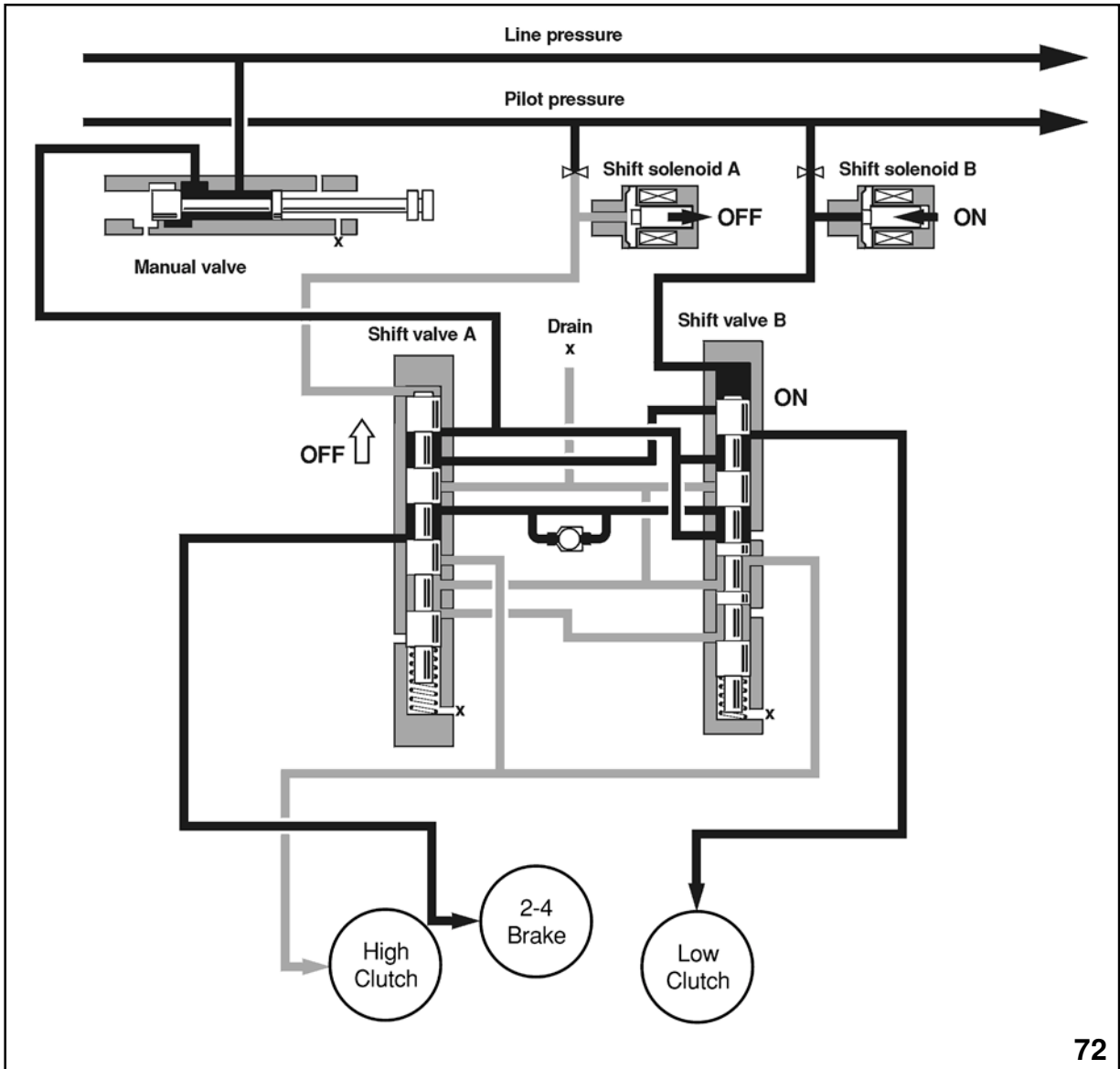

72

4EAT Phase 2

3rd Gear

Both solenoids are turned off allowing the pilot pressure supplied to the shift valve to drain. The shift valves move upward allowing line pressure to the Low Clutch and the High Clutch.

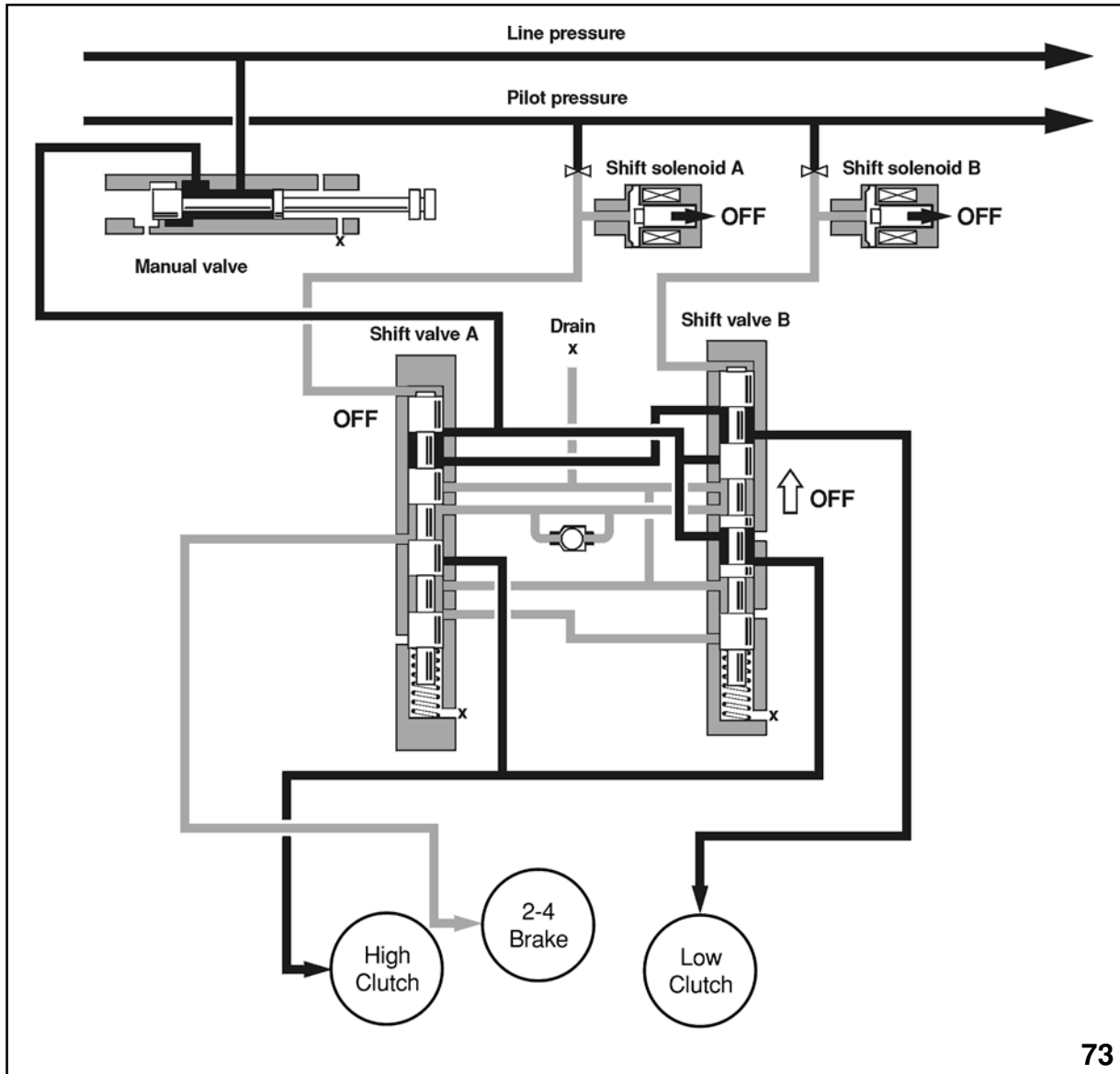

73

4EAT Phase 2

4th Gear

The TCM turns shift solenoid A on and B off. Pilot pressure is supplied to the top of shift valve A which results in the valve moving downward closing the passage for the Low Clutch and opening the passage for the 2-4 brake. The High Clutch and 2-4 brake is now applied.

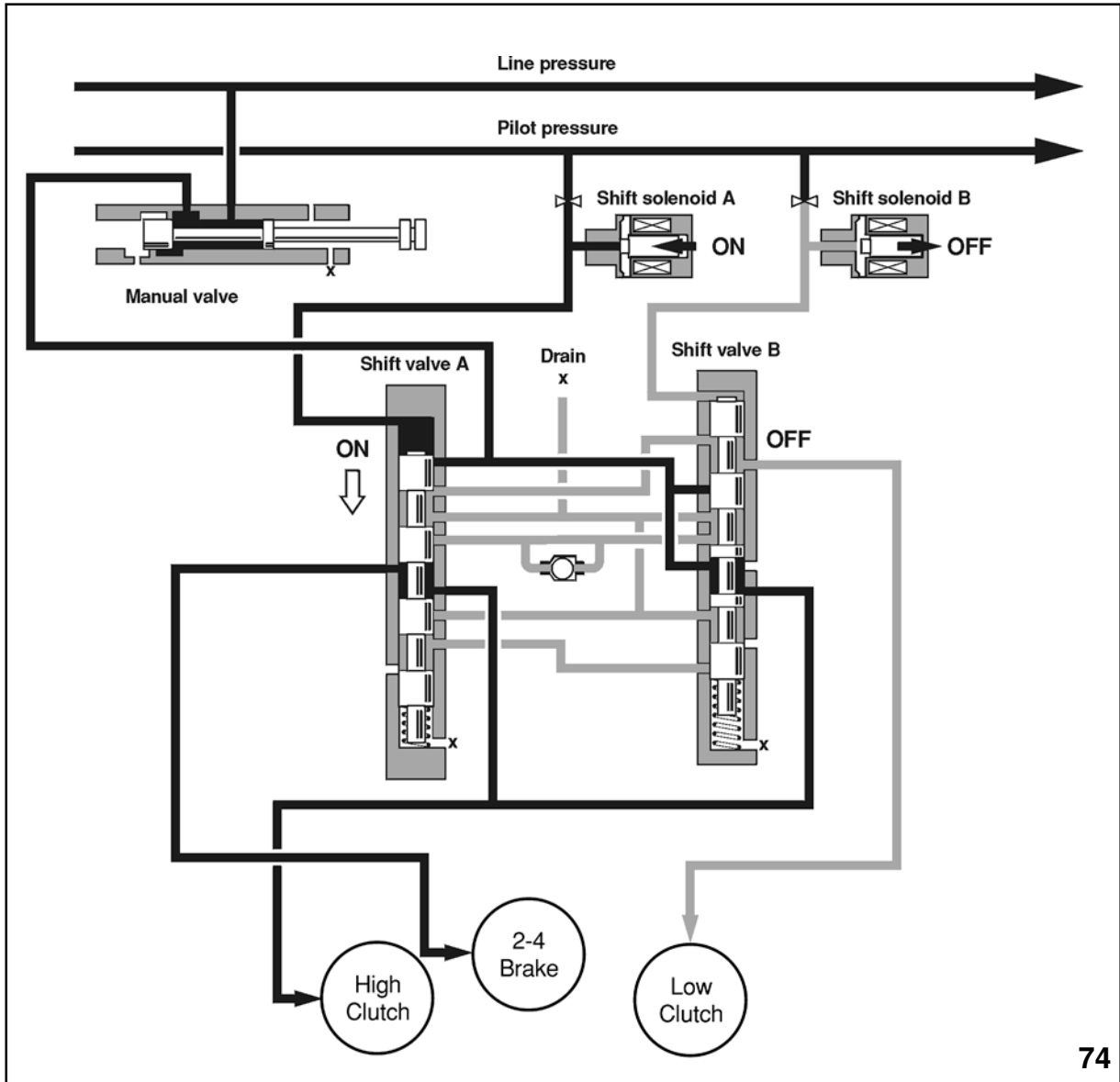

4EAT Phase 2

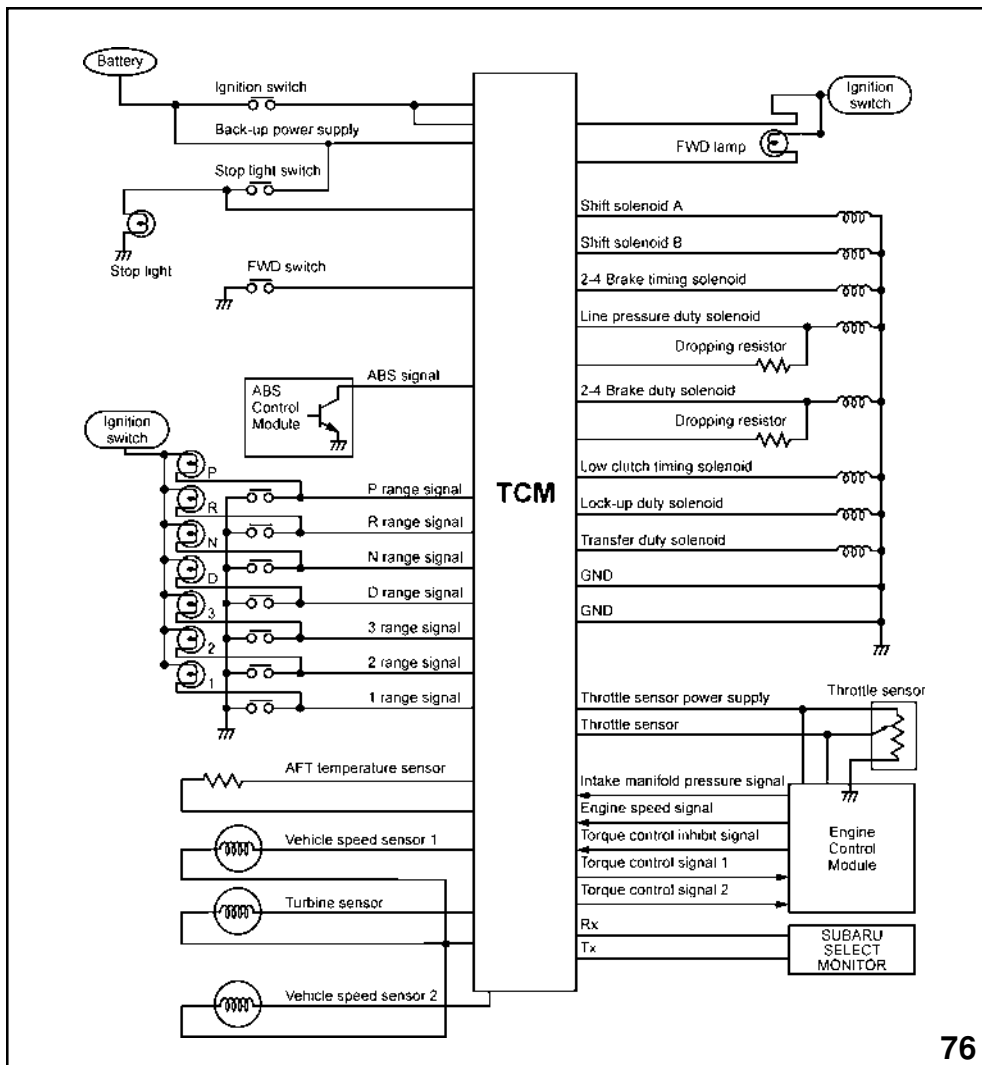
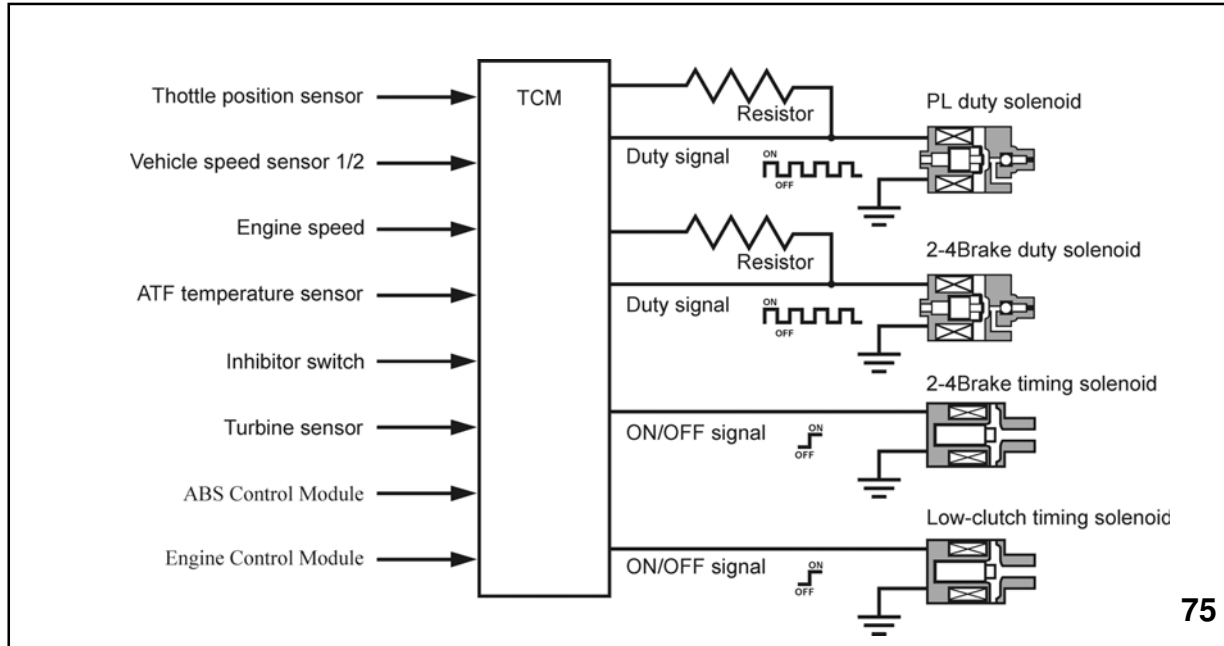

4EAT Phase 2

TCM Control

Normal Shifting

The logic for all gear ranges is stored in the TCM memory and is mainly influenced by the throttle opening and vehicle speed. Monitoring of these signals enables the TCM to turn on or off the shift solenoids enabling up and down shifting.

Slope Control

This control regulates shifting up from 3rd to 4th gear when traveling uphill and forcefully downshifts from the 4th to 3rd gear when traveling downhill.

The TCM determines the driving force of the traveling vehicle from input of the speed sensor signals, throttle signal, turbine sensor signal, etc.. and forcefully maintains 3rd gear.

Control at Low Temperature

To prevent shift shock, shifting up to D range 4th gear is not performed when the ATF temperature is below approximately 12 degrees C.

Control During ABS Operation

During ABS operation the TCM forces the transmission to 3rd gear. This allows the ABS control to exhibit its maximum effect.

Engine Over Speed Prevention Control

Engine over speed is controlled by a fuel cut.

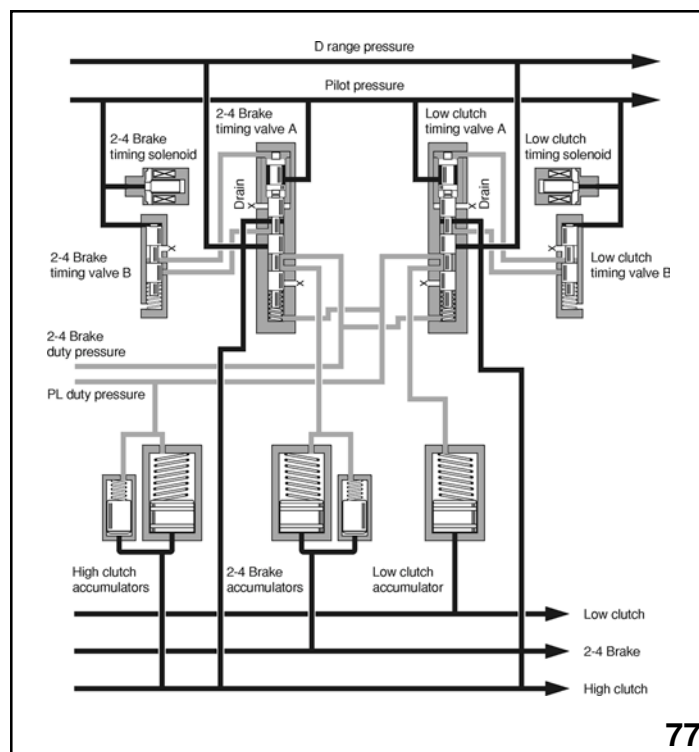

4EAT Phase 2

Timing Control

Timing control is designed to prevent shift shock and engine racing. Two types of timing control are used with the new eat. 2-4 brake timing and Low Clutch Timing.

2-4 brake timing is utilized during the upshift from 2nd to 3rd gear. This control temporarily engages both the 2-4 brake and the high clutch, preventing shift shock and engine racing when upshifting from 3rd to 4th gear.

When the TCM turns the 2-4 brake timing solenoid on the 2-4 brake-timing valve A is acted upon by the high clutch pressure.

The 2-4-Brake Timing Valve Spool is pushed down as the high clutch pressure overcomes the set pressure.

The movement of the spool valve changes the draining characteristics of the 2-4 brake accumulators. The faster the back pressure of the accumulators drain the faster the release of the 2-4-Brake Clutch.

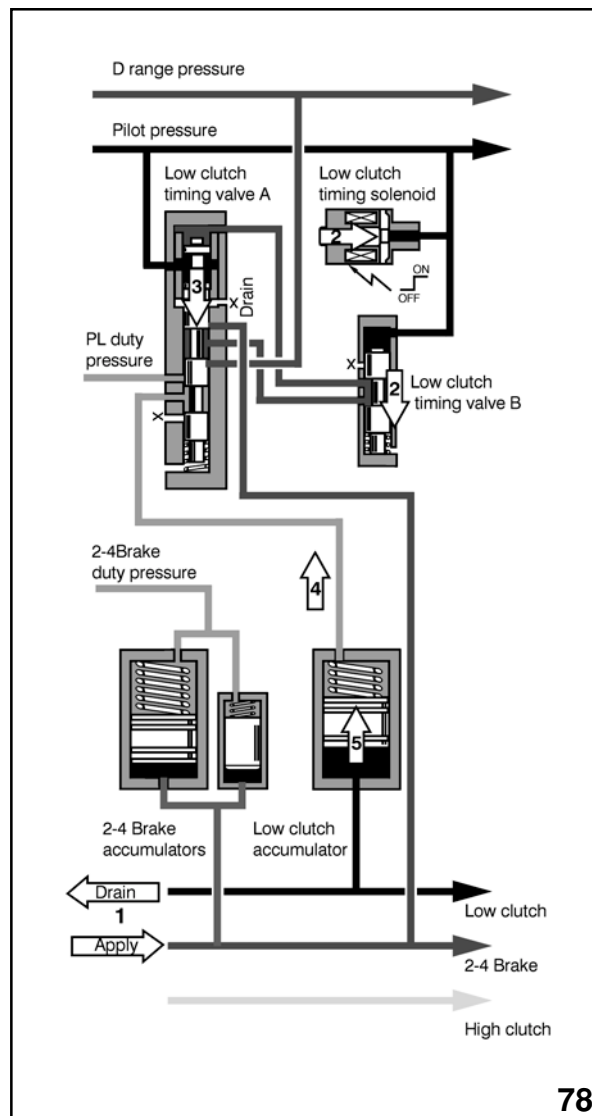

4EAT Phase 2

Low Clutch Timing Control

Low Clutch Timing Control is designed to prevent shift shock and engine racing when the transmission is upshifting from 3rd to 4th gear.

During the upshift to 4th gear the 2-4-Brake clutch and the Low Clutch are temporarily engaged together. At the same time the Low Clutch Timing Solenoid is activated controlling the pilot pressure applied to top side of the Low Clutch Timing valve B.

The movement of the Low Clutch Timing valve B spool regulates the 2-4 brake apply pressure to the top of Low Clutch Timing valve A. When this pressure overcomes the set pressure the spool valve moves down, changing the draining characteristics of the Low Clutch accumulator back pressure. The faster the back pressure of the accumulator drains the faster the low clutch fully disengages.

Control performed by the PL Duty Solenoid and the 2-4 Brake Duty Solenoid

The line pressure duty solenoid and the 2-4 brake duty solenoid are adjusted to set values determined from preexisting conditions of the vehicle just before an up shift or down shift occurs. This set value is lower than the applied value and is designed to prevent shift shock and improve shifting characteristics.

The drop in both duty pressures cause the accumulator control valve A and B spool valves to move up, and the low clutch and 2-4 brake accumulator back pressures to be reduced.

This allows the accumulators to absorb a larger shock when the clutches are applied.

The turbine sensor detection signal inputted to the TCM influences the rate in which the duty ratios are increased.

Down shifting from 4th to 3rd

The line pressure and 2-4 brake duty solenoid are adjusted to a lower set value just before the actual downshift.

This drops the back pressure in the high and 2-4 brake accumulators. The lowered back pressure allows the applied pressures to be lower, creating a slipping condition of the high and 2-4 brake. Higher engine speeds will then be obtained, generating a higher driving force to the rear internal gear.

The TCM gradually increases the duty ratios eliminating the slip.

Engine Torque Control

Engine torque control is performed by the engine control module which lowers the engine torque by retarding the engine ignition timing and cutting the fuel supply, reducing shift shock.

While shifting is in progress, the TCM detects the brake and clutch engagement \ release conditions by comparing the turbine sensor signal and the speed sensor signals. The TCM outputs a signal to the ECM to reduce the torque when set conditions are reached.

4EAT Phase 2

Learning Control

Learning control is utilized to prevent shift shock that is created because of clutch and brake wear.

The TCM always detects the turbine sensor signal after starting shift control. It measures the time from when this signal changes until the clutch or brake starts to engage and the time from that point until the clutch or brake fully engages.

The TCM compares these times and their respective target values and determines the clutch or brake status. Based on the results, it decides the operating characteristics of the line pressure control solenoid and the 2-4 brake duty solenoid. By controlling the line pressure control solenoid and the 2-4-Brake solenoid based on these operating characteristics, increased shift shock due to change with passage of time can be prevented.

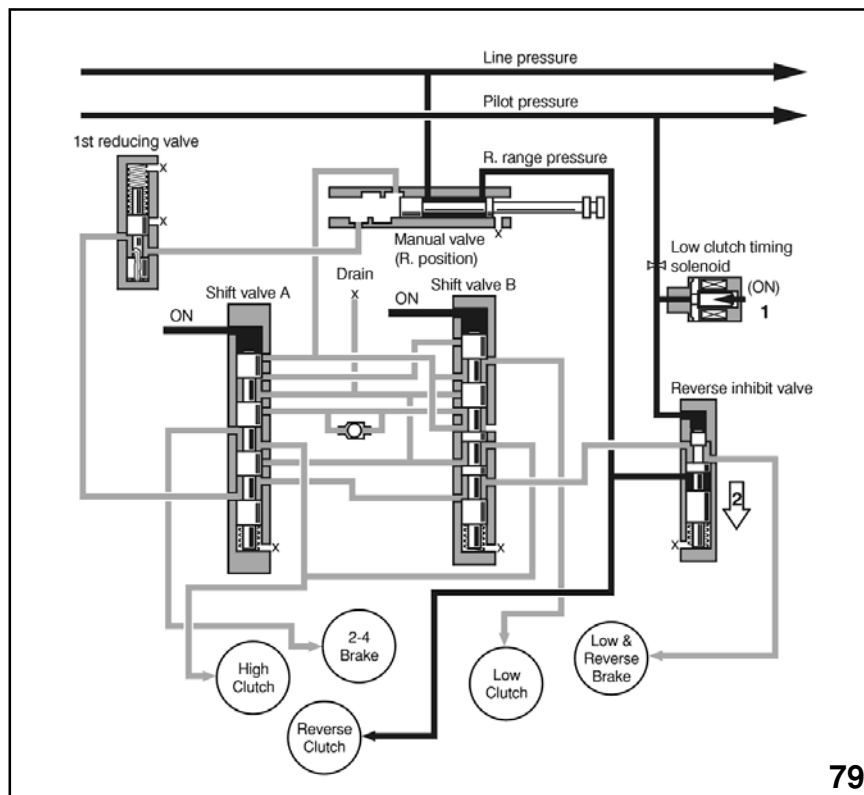

Reverse Inhibit Control

Designed to prevent the accidental shift into reverse gear. This feature is only active above 10km/h (6 m.p.h.). The Low Clutch Timing solenoid is turned on allowing pilot pressure to build up on the top side of the Reverse Inhibit valve. The valve spool is then pushed down blocking the passageway to the low and reverse brake.

4EAT Phase 2

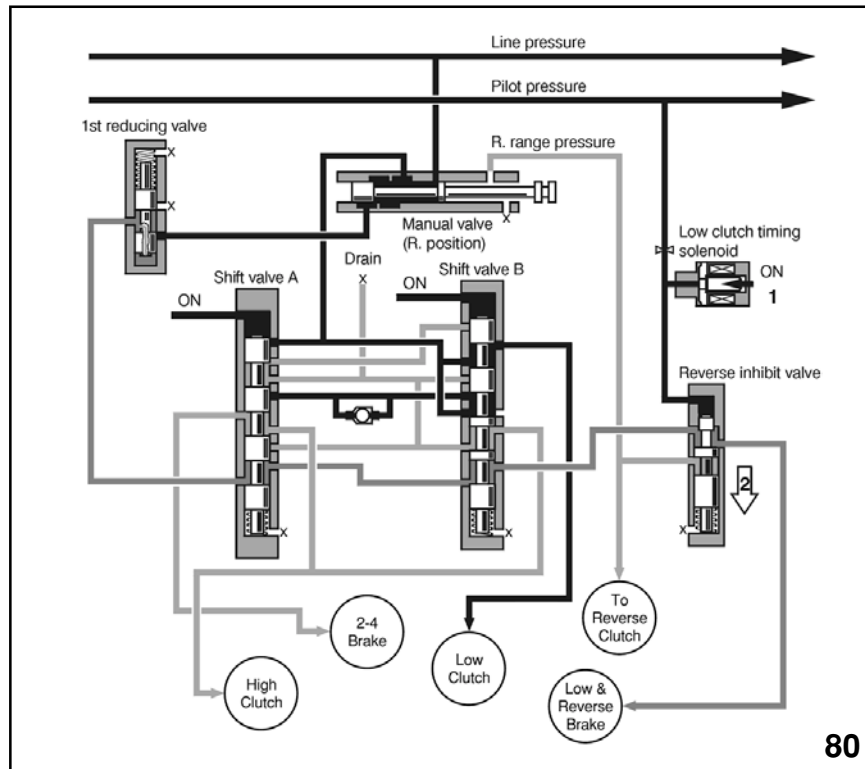

Engine Brake Control

Engine brake operation will occur in the 1 range 1st gear. The TCM turns the Low Clutch Timing Solenoid on and supplies pilot pressure to the reverse inhibit valve. The pilot pressure causes the reverse inhibit valve spool to move downward, opening the port to the low and reverse brake. Pressure from the 1st reducing valve engages the low and reverse brake. The Low Clutch Drum is then fixed to the transmission case and the rotation of the wheels is transmitted to the engine side, operating the engine brake effect.

4EAT Phase 2

Self Diagnosis

Slides 82, 83, and 84

The TCM detects trouble in the detection signals from the sensors and the signals output to the actuators. This function is referred to as the self-diagnosis function.

When either signal is faulty, the TCM indicates system trouble by flashing the ATF lamp in the combination meter.

By counting the flashes of the lamp a trouble code can be specified.

CODE	ITEM	DIAGNOSIS	TROUBLE
11	Line pressure duty solenoid	Short or Disconnection in solenoid driving circuit	More severe shifting shock and faulty shifting
12	Lockup duty solenoid	Short or disconnection in solenoid driving circuit	Fails to lock up (after warm-up)
13	2-4 brake timing solenoid	Short or disconnection in solenoid driving circuit	Faulty shifting
14	Shift solenoid B	Short or disconnection in solenoid driving circuit	Fails to shift
15	Shift solenoid A	Short or disconnection in solenoid driving circuit	Fails to shift
16	2-4 brake duty solenoid	Short or disconnection in solenoid driving circuit	Faulty shifting
21	ATF temperature sensor	Short or disconnection in input circuit	Faulty shifting when cold
22	Pressure sensor	Short or disconnection in input circuit	More severe shifting shock
23	Engine speed signal	No signal input above 10km/h	Fails to lock up (after warm-up)
24	Transfer (AWD duty solenoid)	Short or disconnection in solenoid driving circuit	Excessive tight corner braking phenomena
25	Engine torque control signal	Short or disconnection in engine torque control signal circuit	More severe shifting shock
31	Throttle sensor	Short or disconnection in input circuit	Faulty shifting and excessive shifting shock
32	Vehicle speed sensor 1	No signal input to speed sensor 1 above 20km/h	Speed sensor 1 malfunctions: more severe shifting shock One or the other malfunctions: excessive tight corner braking phenomena Both malfunction: fails to shift
33	Vehicle speed sensor 2	No signal input to speed Sensor 2 above 20km/h	
34	Turbine sensor	No signal input in ranges other than N range (vehicle speed sensors 1 and 2 are operating normally) while vehicle is traveling	More severe shifting shock
36	Low clutch timing solenoid	Short or disconnection in solenoid driving circuit	Faulty shifting

4EAT Phase 2

Failsafe Function

Failsafe function is a TCM controlled function that enables the vehicle to be driven in the event of malfunction of the vehicle speed sensors, throttle sensor, inhibitor switch, or the various solenoids.

In the event of trouble the TCM executes the following control.

Item	Failsafe Function
Line pressure duty solenoid	TCM turns the solenoid off and sets the transmission so only 1st and 3rd are available . The line pressure is also set to maximum.
Lockup duty solenoid	TCM turns the solenoid off and torque converter lock up does not occur.
2-4 brake timing solenoid	TCM turns the solenoid off and sets the transmission so only 1st and 3rd are available.
Shift solenoid B	When either solenoid malfunctions the TCM turns both solenoids off and sets the transmission to 3rd gear.
Shift solenoid A	When either solenoid malfunctions the TCM turns both solenoids off and sets the transmission to 3rd gear.
2-4 brake duty solenoid	TCM turns the solenoid off and sets the transmission so only 1st and 3rd are available
Transfer (AWD duty solenoid)	TCM turns the solenoid off and adjusts the transfer clutch pressure to maximum.
Throttle sensor	TCM assumes the throttle opening of 3/8 open and continues at that level.
Vehicle speed sensor 1	Vehicle speed sensor 2
Vehicle speed sensor 2	Vehicle speed sensor 1 (If both sensors malfunction then the TCM sets the transmission to 3rd gear.)
Low Clutch Timing Solenoid	TCM turns the solenoid off and sets the transmission so only 1st and 3rd are available

86 and 87

4EAT Phase 2

2002 Impreza 4EAT Phase 2 Enhancements "Chopper Voltage Signal"

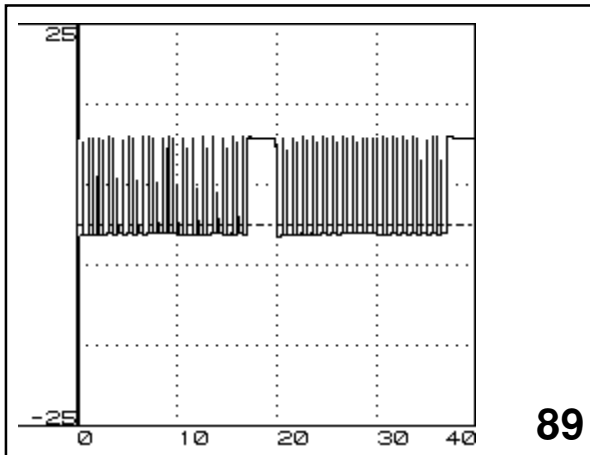

Ignition On Engine Off (line pressure)

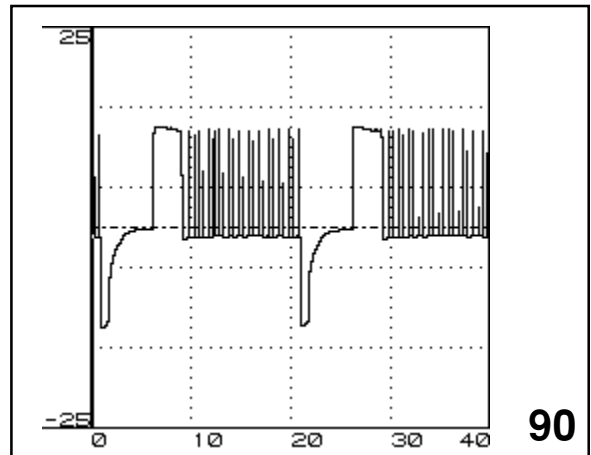

Idle (line pressure)

The external dropping resistors for the 4EAT have been eliminated. The TCM now incorporates circuitry that produces a "chopper voltage signal" during the time the resistors previously operated.

The "chopper voltage signal" is a series of voltage pulses up to 12 volts that average out to approximately 3 volts. This will function to hold the line pressure control and 2-4 brake solenoid in the open position until the signal is removed.

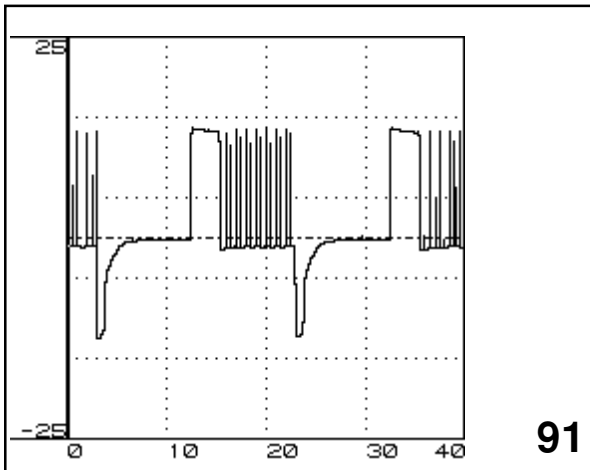

Part Throttle (line pressure)

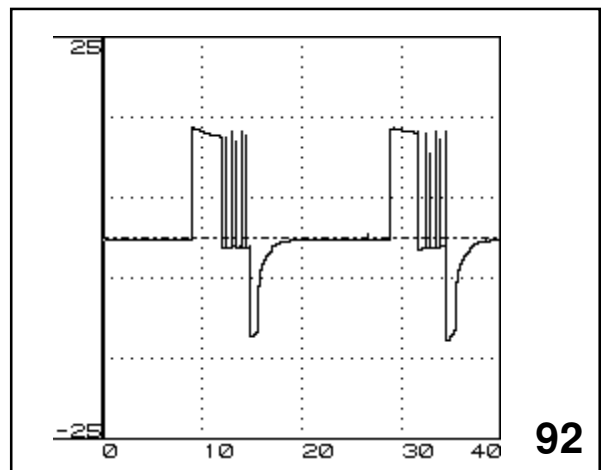

Half Throttle (line pressure)

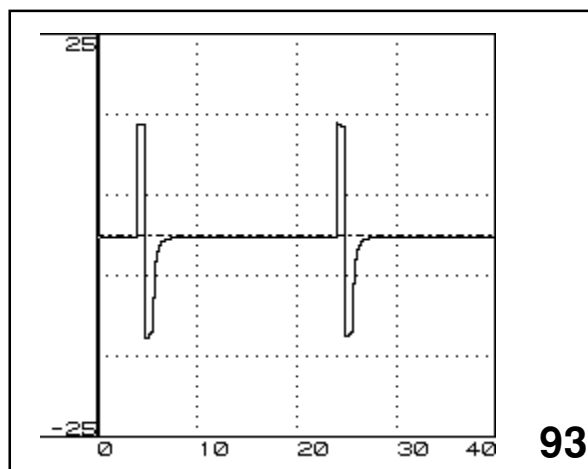

Stall Speed (line pressure)