

A/T CONTROL SYSTEM

WIRING SYSTEM

9. A/T Control System

A: SCHEMATIC

1. TURBO ENGINE MODEL

AT(TB)-01

AT(TB)-01

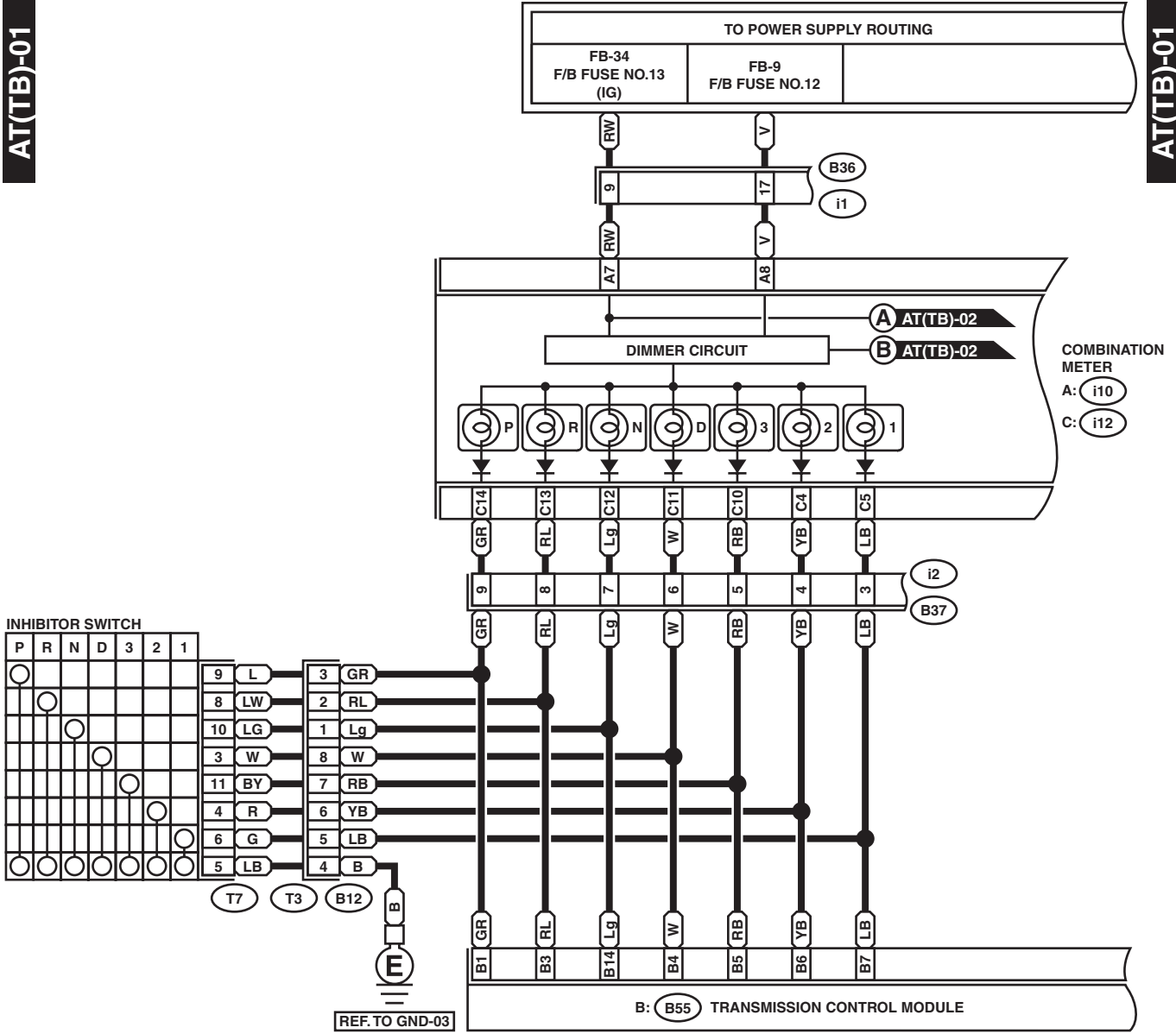

A: i10 (GREEN)

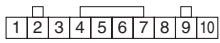

B12

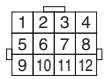

T7

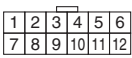

C: i12 (GREEN)

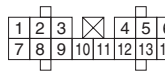

i1

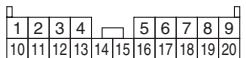

B: B55 (GRAY)

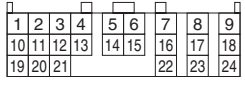

i2 (BROWN)

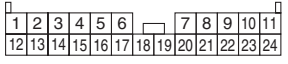

A/T CONTROL SYSTEM

WIRING SYSTEM

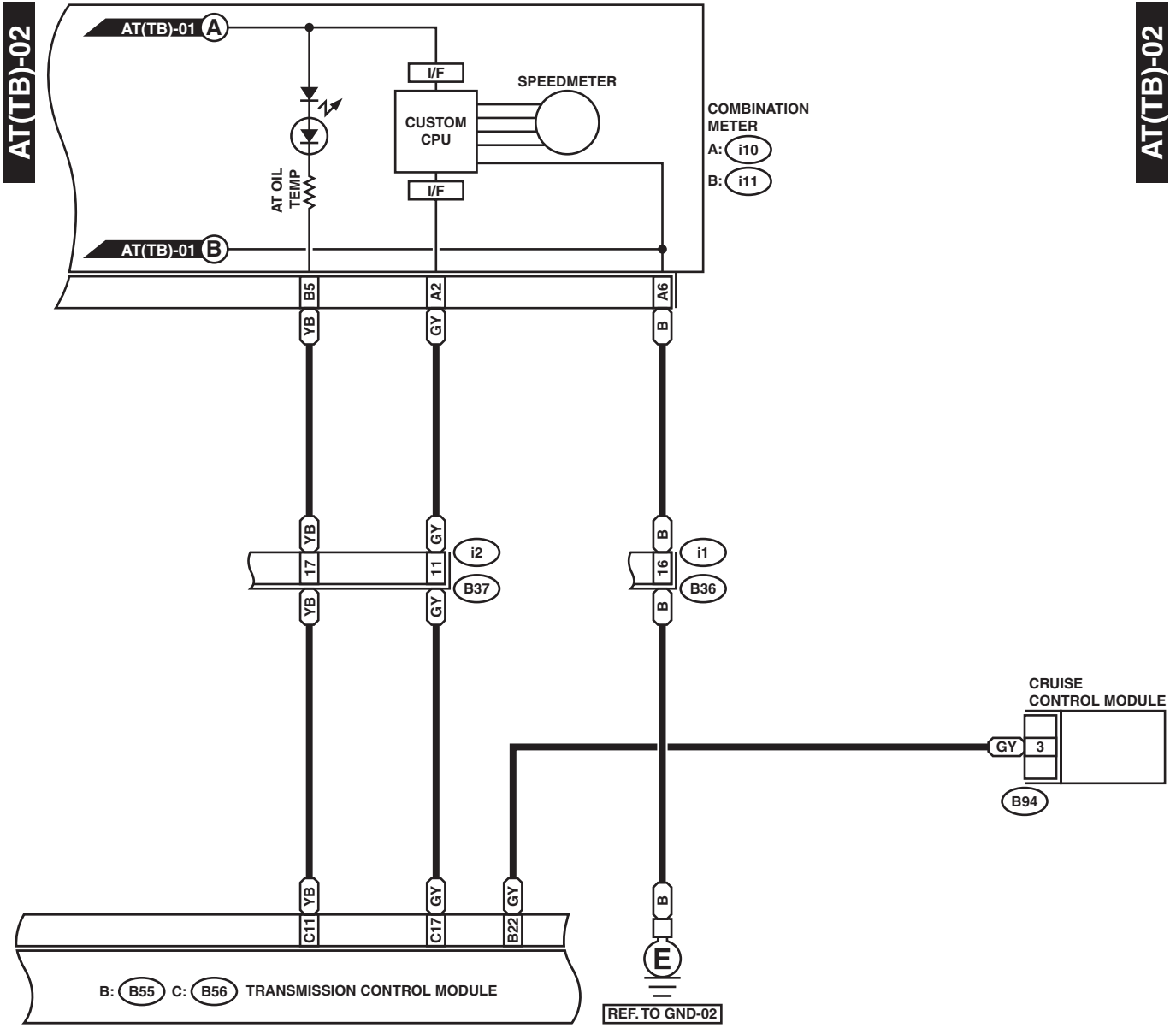

A: i10 (GREEN)

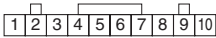

B94 (BLACK)

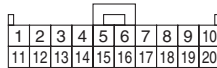

i1

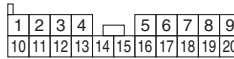

B: B55 (GRAY)

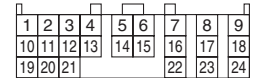

C: B56 (GREEN)

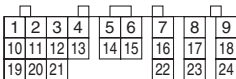

i2 (BROWN)

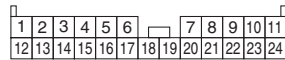

B: i11 (GREEN)



WI-01110

A/T CONTROL SYSTEM

WIRING SYSTEM

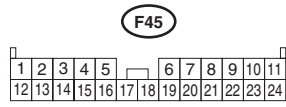
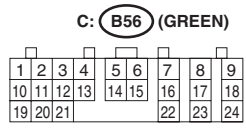
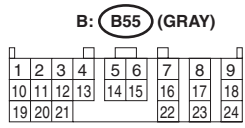
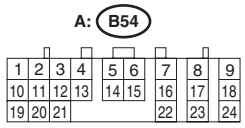
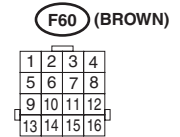
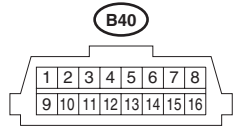
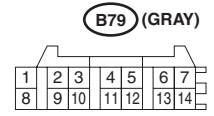
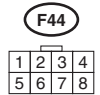
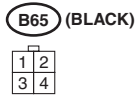
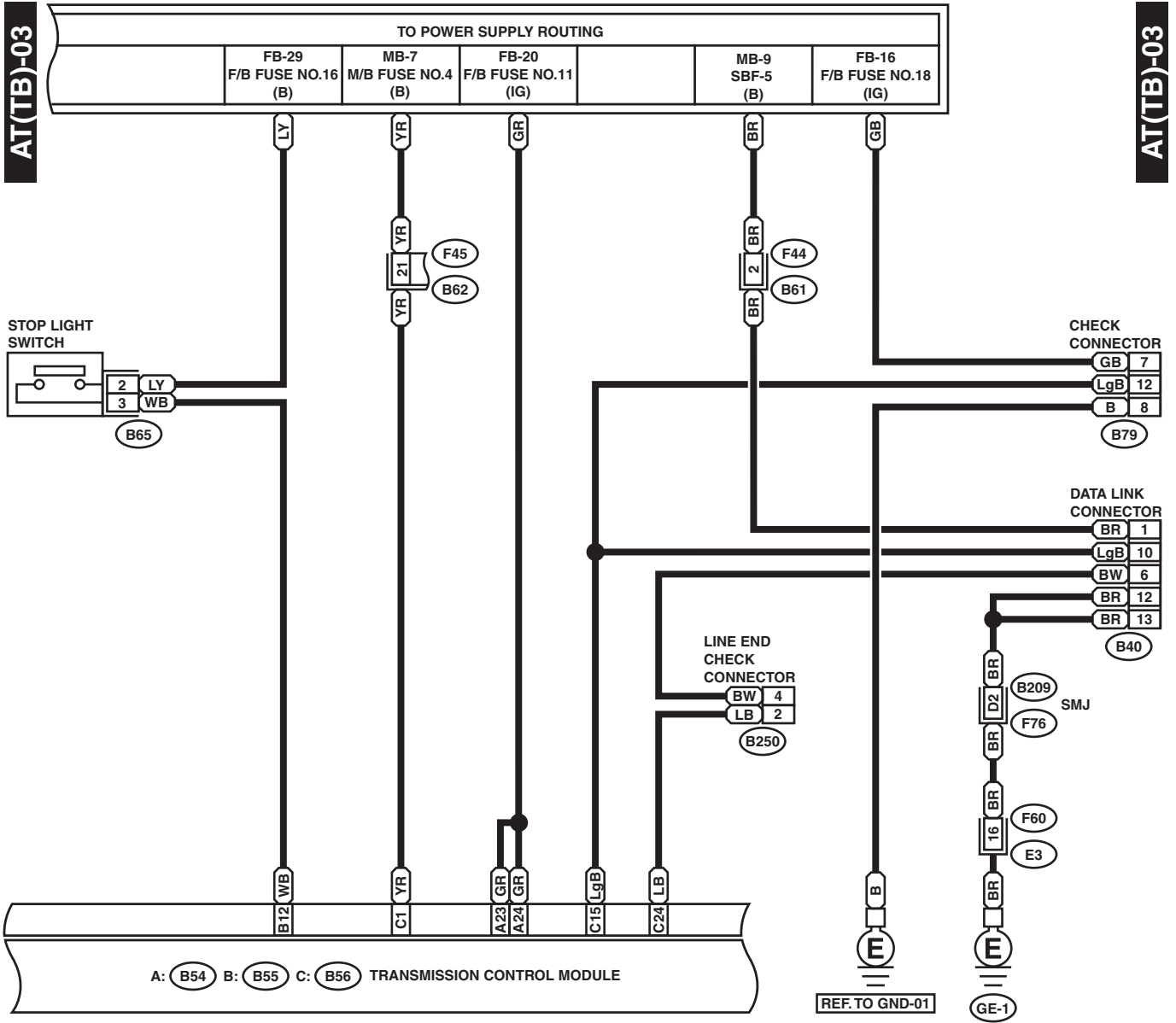

WI-01111

A/T CONTROL SYSTEM

WIRING SYSTEM

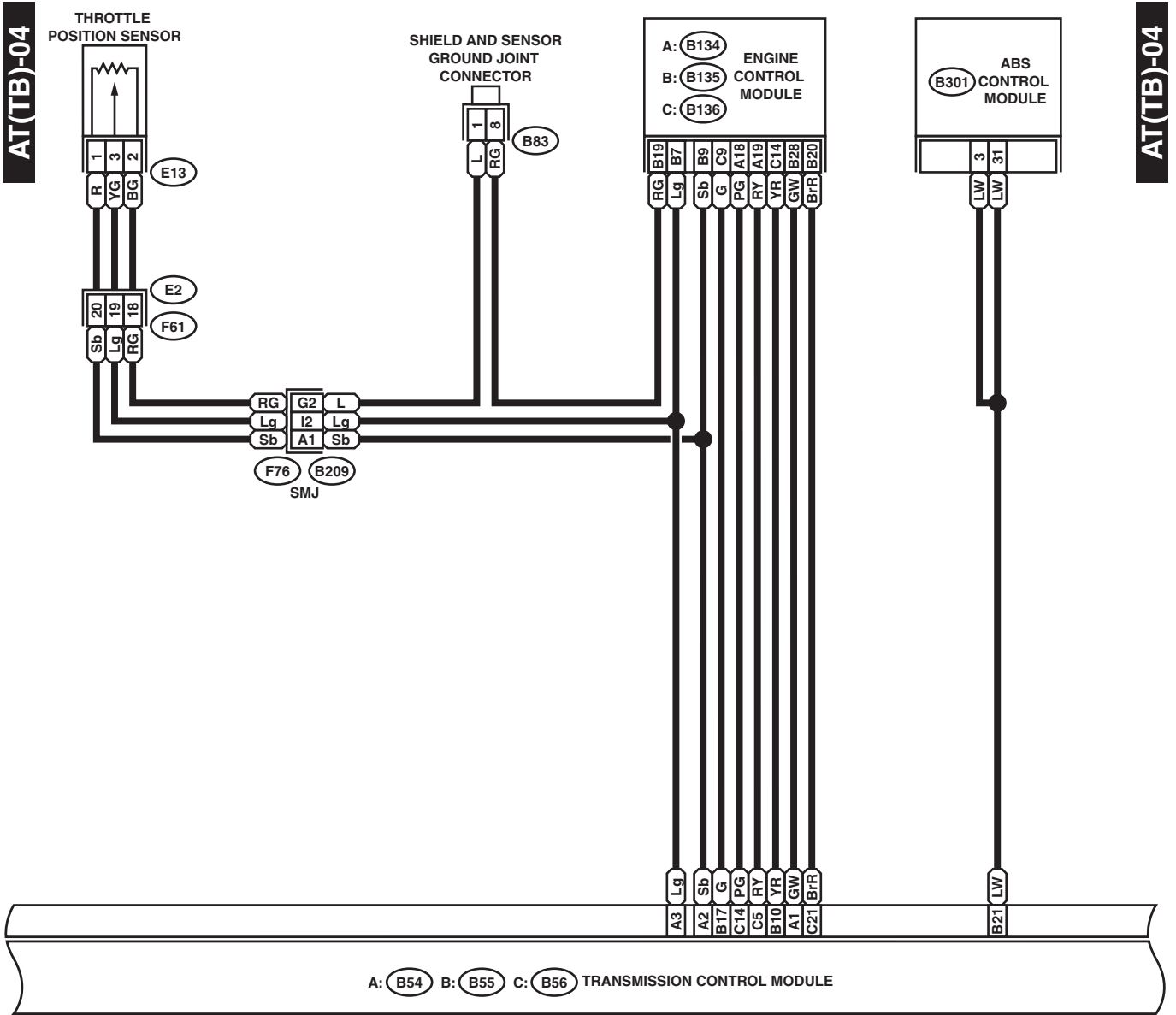

E13 (BLACK)

1	2	3
---	---	---

B83

1	2	3	4
5	6	7	8

F61 (BLACK)

1	2	3	4
5	6	7	8
9	10	11	12
13	14	15	16
17	18	19	20

A: B134

1	2	3	4	5	6	7	
8	9	10	11	12	13	14	15
16	17	18	19	20	21	22	

A: B54

1	2	3	4	5	6	7	8	9
10	11	12	13	14	15	16	17	18
19	20	21	22	23	24			

B: B55 (GRAY)

1	2	3	4	5	6	7	8	9
10	11	12	13	14	15	16	17	18
19	20	21	22	23	24			

C: B56 (GREEN)

1	2	3	4	5	6	7	8	9
10	11	12	13	14	15	16	17	18
19	20	21	22	23	24			

C: B136

1	2	3	4	5	6	7		
8	9	10	11	12	13	14	15	16
17	18	19	20	21	22	23	24	

C: B135

1	2	3	4	5	6	7	8	9	
10	11	12	13	14	15	16	17	18	
19	20	21	22	23	24	25	26	27	28

B301

1	2	3	4	5	6	7	8	9	10	11	12	13	14	15
16	17	18	19	20	21	22	23	24	25	26				
27	28	29	30	31										

WI-01112

A/T CONTROL SYSTEM

WIRING SYSTEM

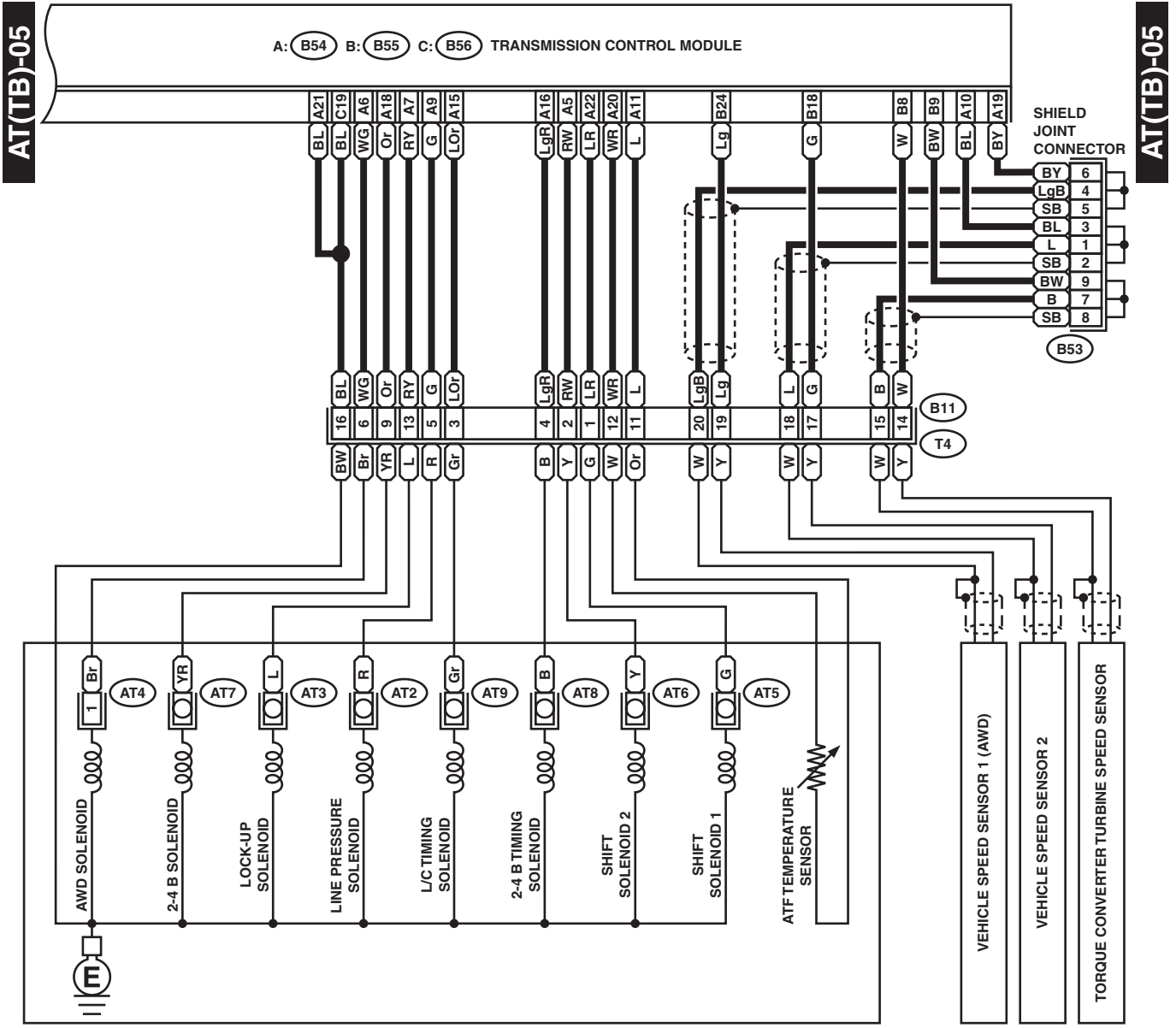

AT4 (BROWN)



B53 (BLACK)

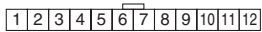

B11 (BLACK)

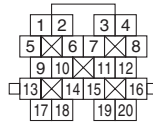

A: (B54)

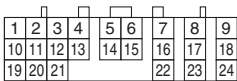

B: (B55) (GRAY)

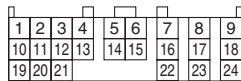

C: (B56) (GREEN)

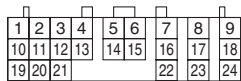

WI-02171

A/T CONTROL SYSTEM

WIRING SYSTEM

2. NON-TURBO ENGINE MODEL

AT(NA)-01

AT(NA)-01

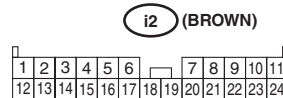
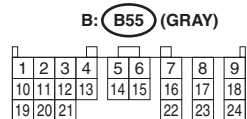
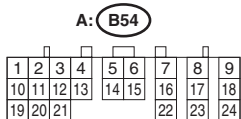
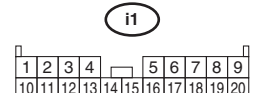
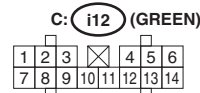
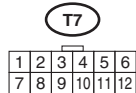
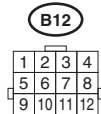
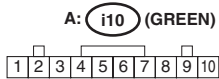
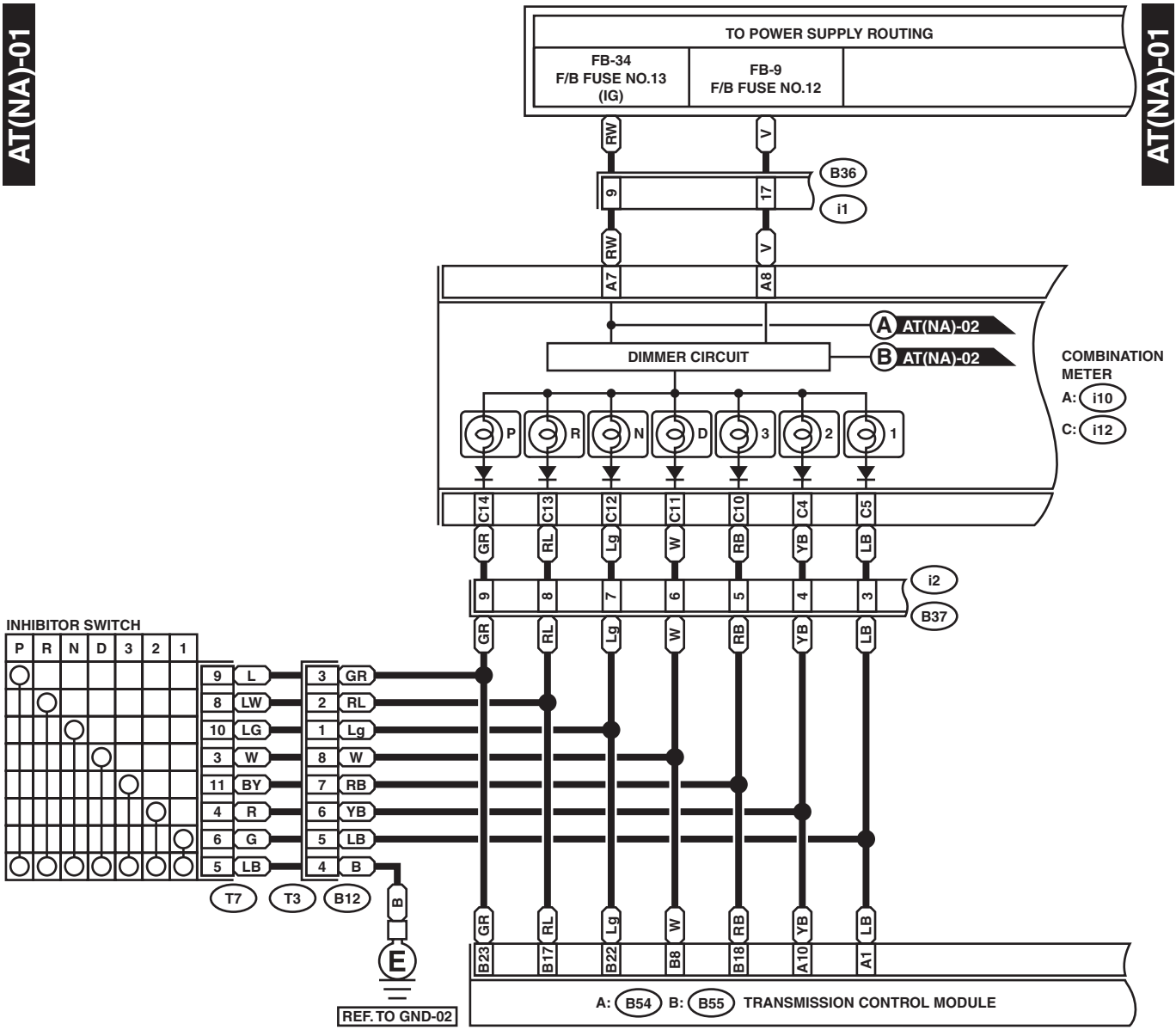

WI-01113

A/T CONTROL SYSTEM

WIRING SYSTEM

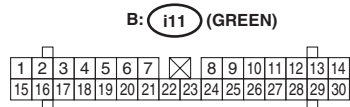
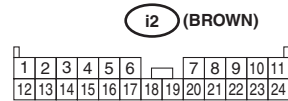
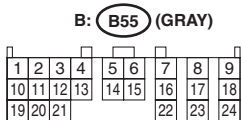
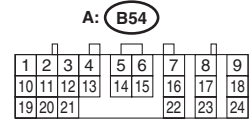
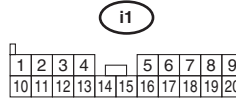
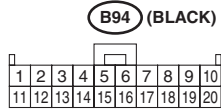
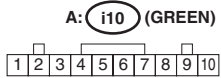
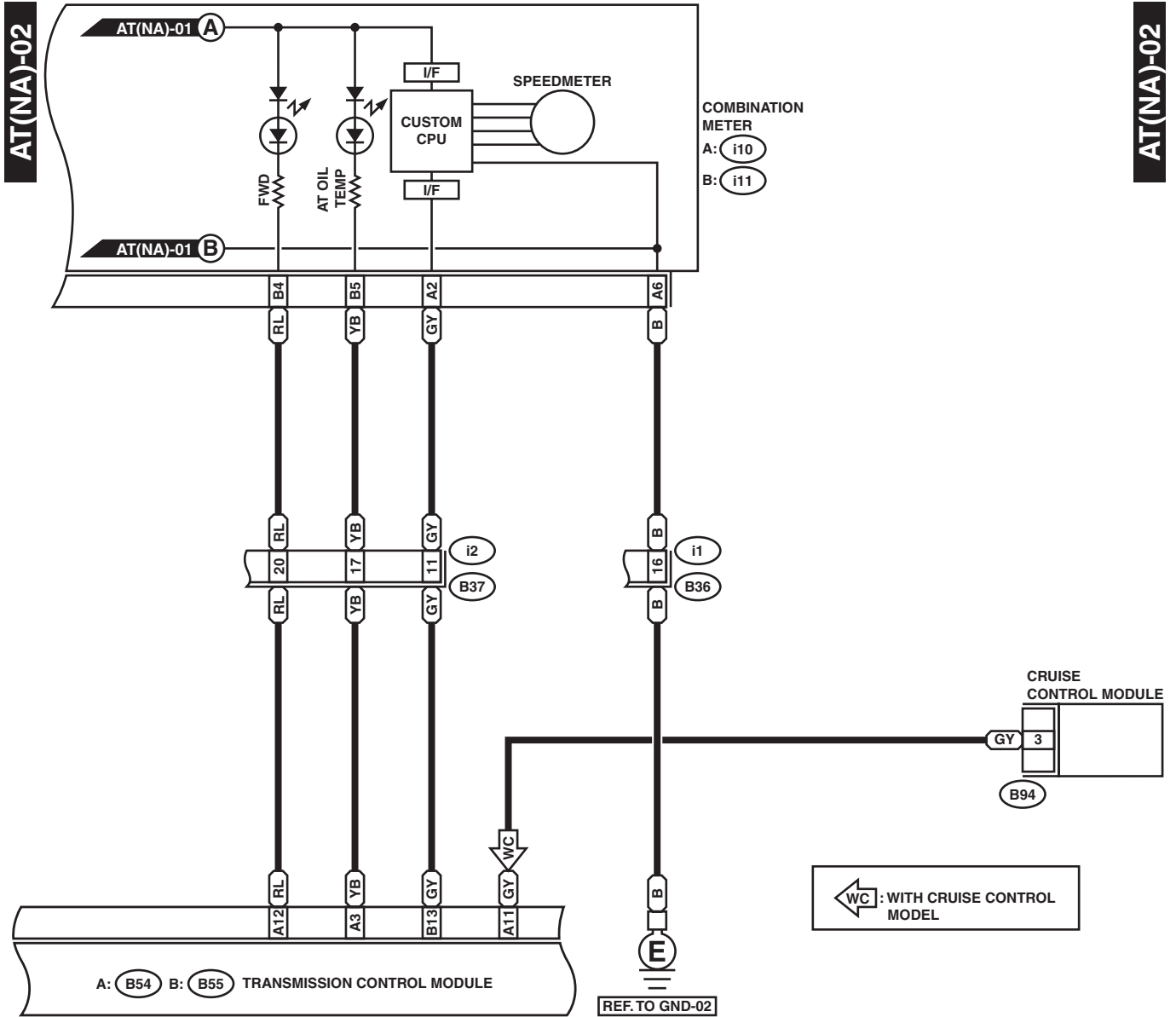

WI-01114

A/T CONTROL SYSTEM

WIRING SYSTEM

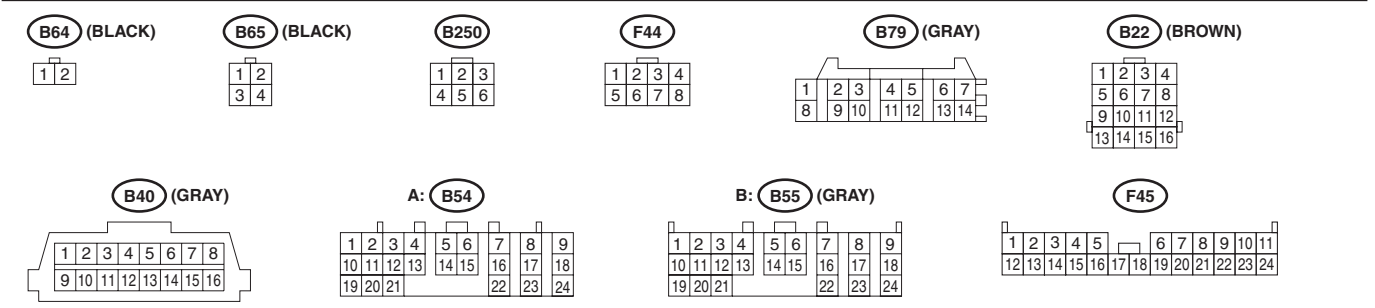
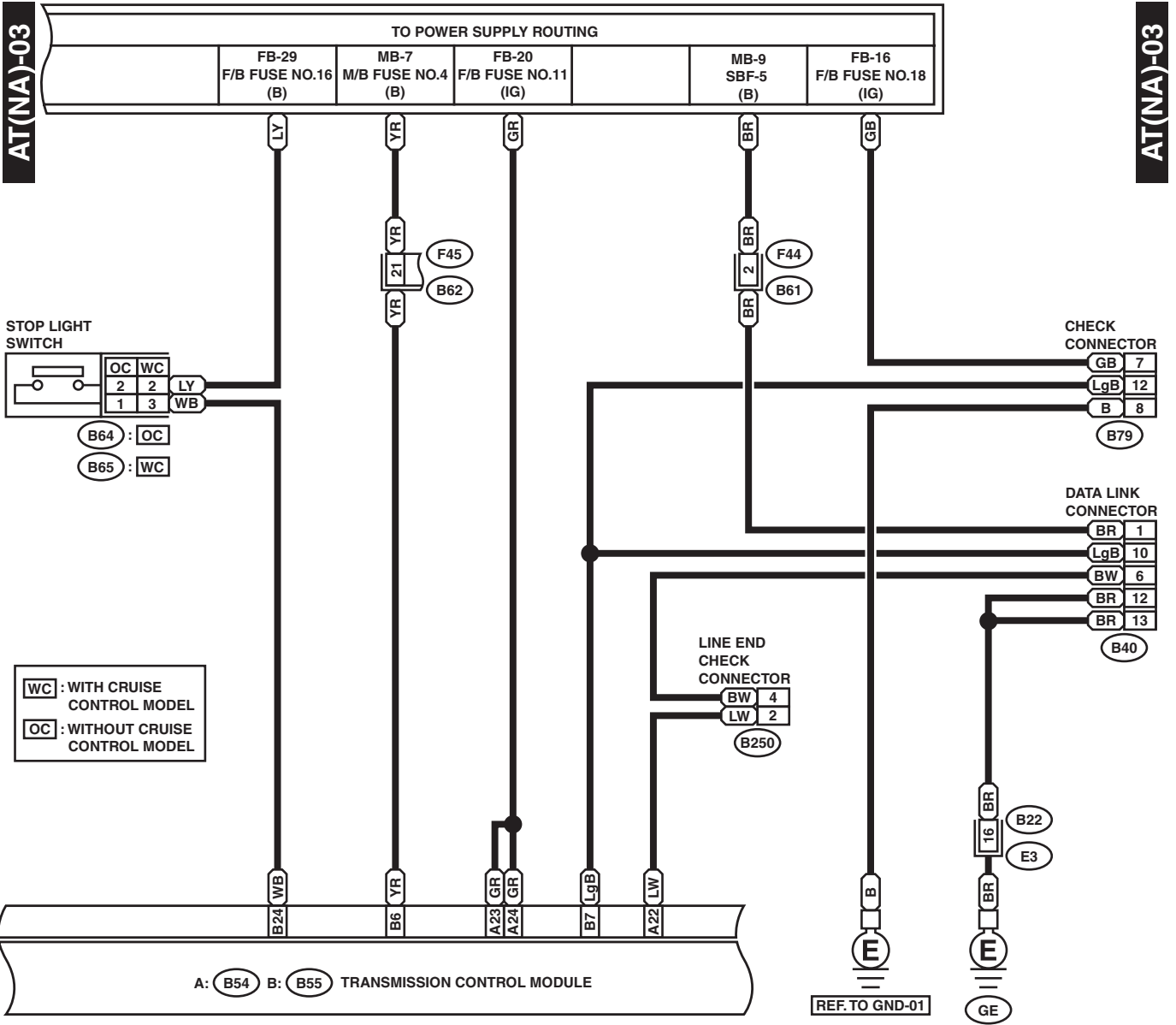

WI-01115

A/T CONTROL SYSTEM

WIRING SYSTEM

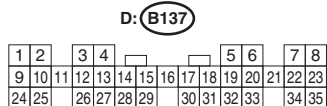
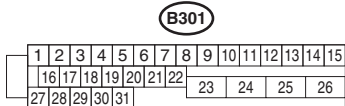
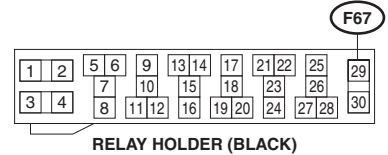
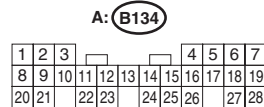
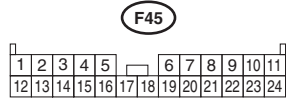
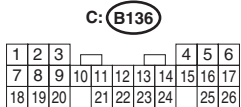
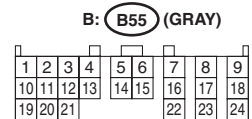
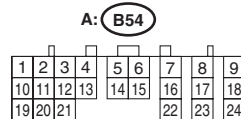
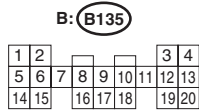
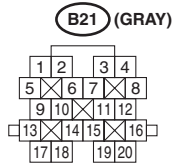
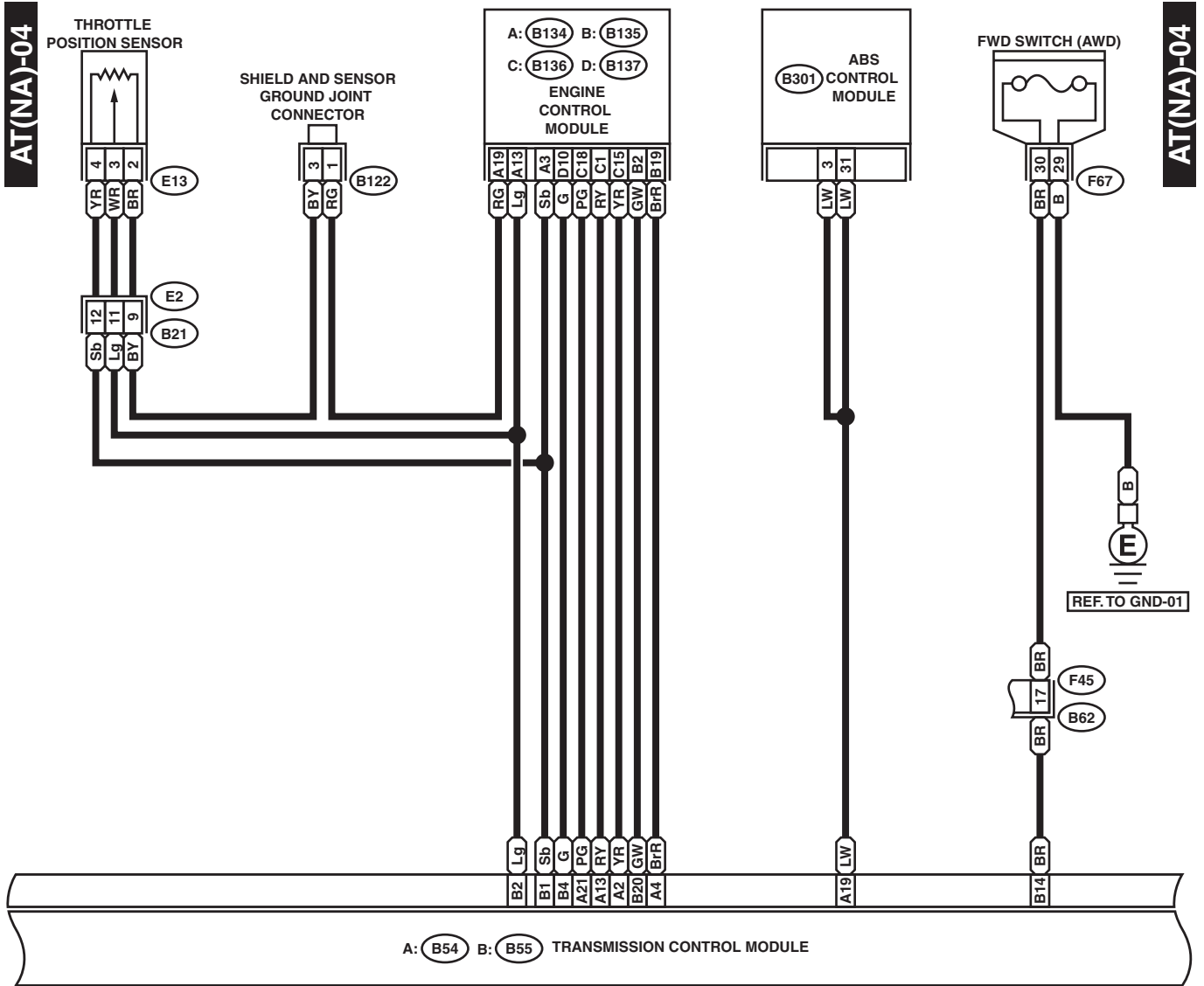

WI-01116

A/T CONTROL SYSTEM

WIRING SYSTEM

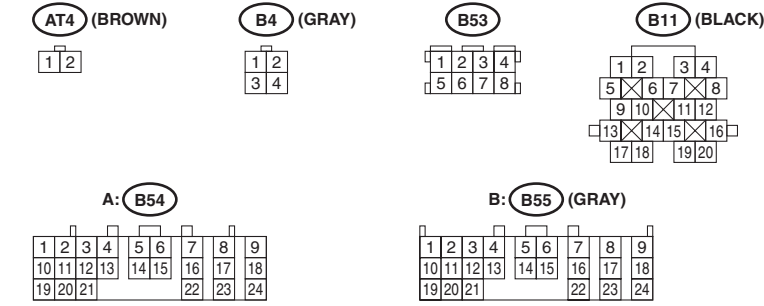
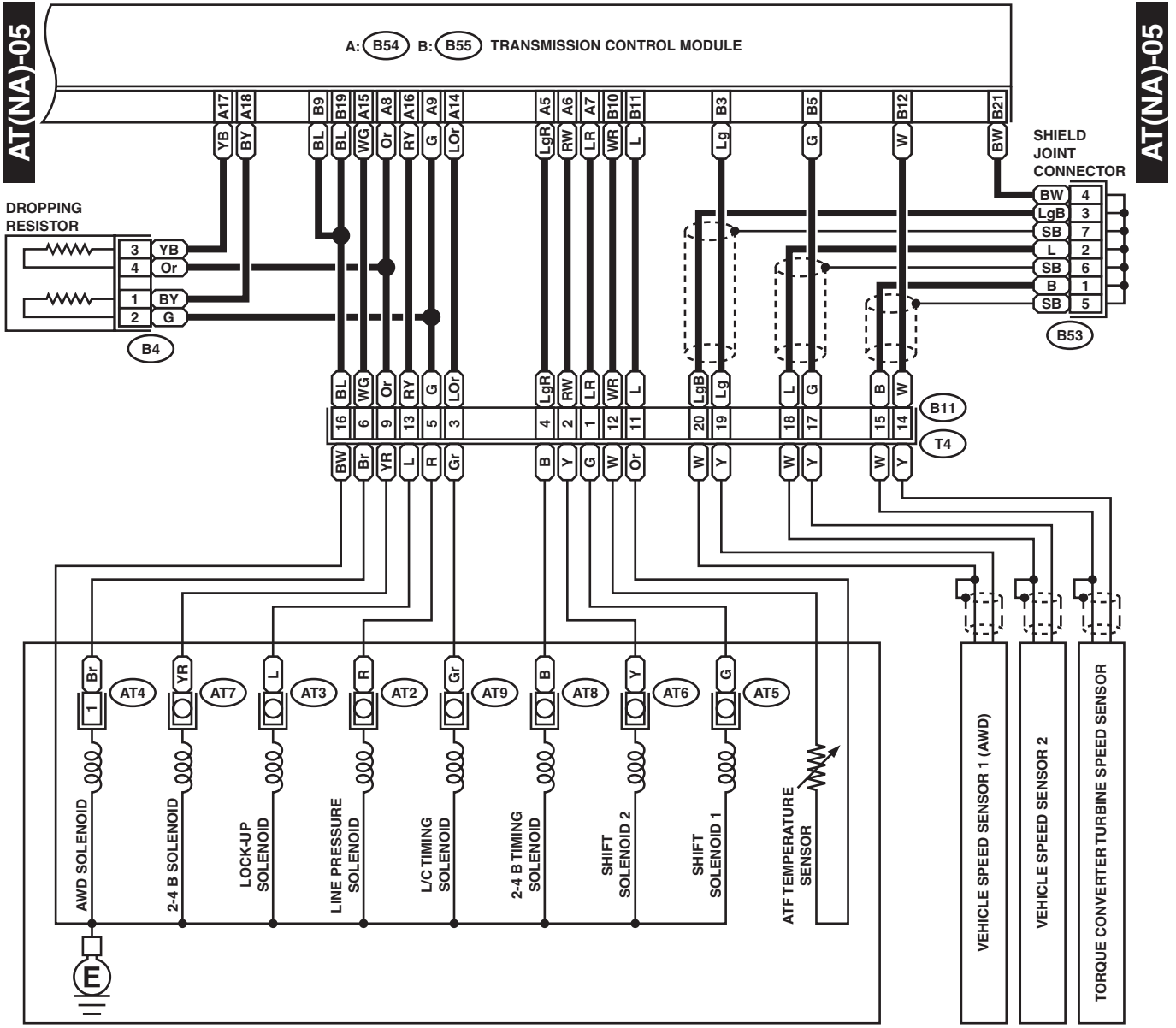

WI-01117