

**EXHAUST**

# General Description

EXHAUST

## 1. General Description

### A: COMPONENT

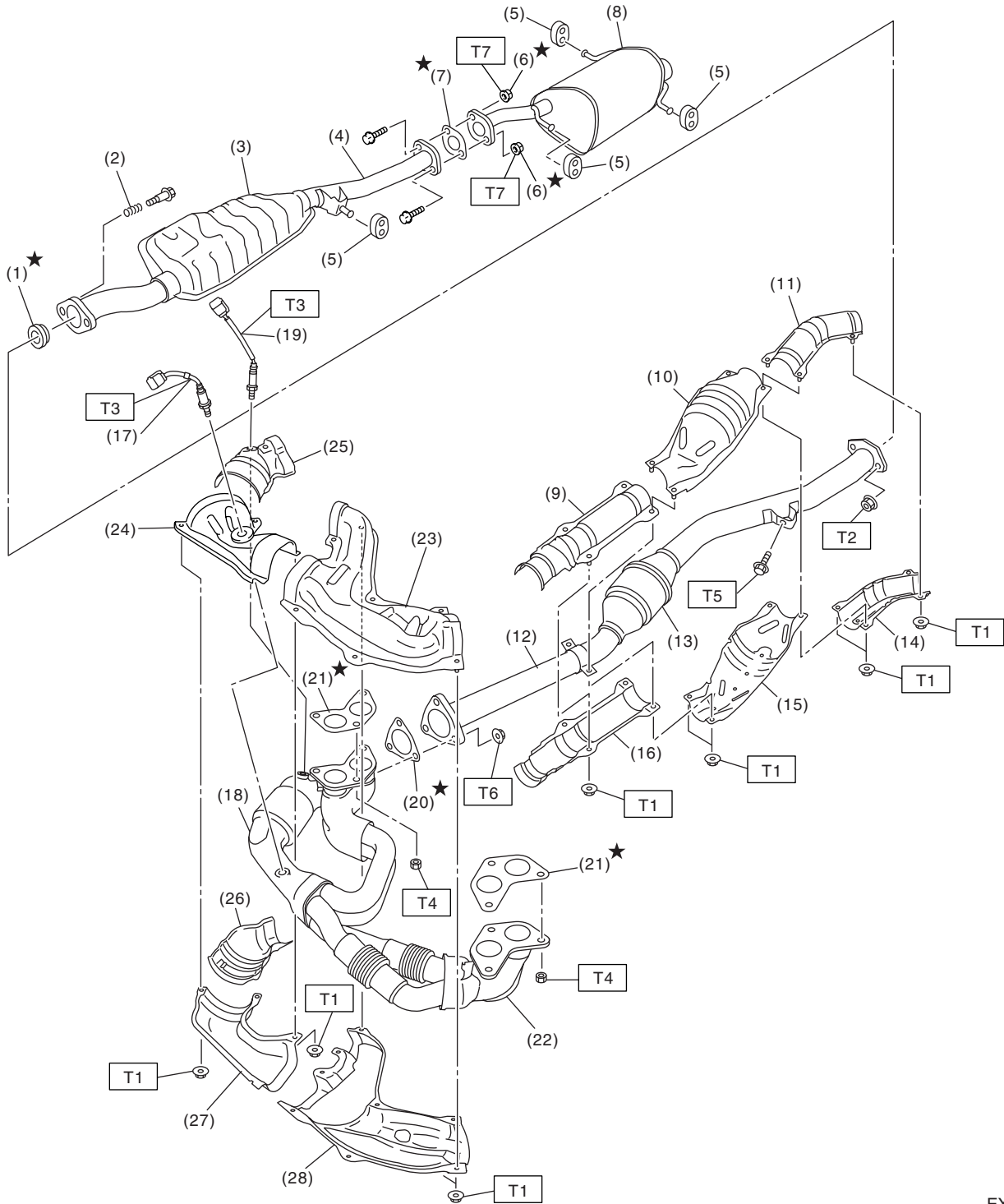

EX-02142

EX(H4SO)-2

# General Description

EXHAUST

(1) Gasket	(14) Center exhaust pipe rear lower cover	(25) Front catalytic converter upper cover
(2) Spring	(15) Rear catalytic converter lower cover	(26) Front catalytic converter lower cover
(3) Chamber	(16) Center exhaust pipe front lower cover	(27) Front exhaust pipe lower cover RH
(4) Rear exhaust pipe	(17) Front oxygen (A/F) sensor	(28) Front exhaust pipe lower cover LH
(5) Cushion rubber	(18) Front catalytic converter	
(6) Self-locking nut	(19) Rear oxygen sensor	
(7) Gasket	(20) Gasket	
(8) Muffler	(21) Gasket	
(9) Center exhaust pipe front upper cover	(22) Front exhaust pipe	
(10) Rear catalytic converter upper cover	(23) Front exhaust pipe upper cover LH	
(11) Center exhaust pipe rear upper cover	(24) Front exhaust pipe upper cover RH	
(12) Center exhaust pipe		
(13) Rear catalytic converter		

---

**Tightening torque: N-m (kgf-m, ft-lb)**

**T1: 13 (1.3, 9.4)**

**T2: 18 (1.8, 13.0)**

**T3: 21 (2.1, 15.2)**

**T4: 30 (3.1, 22.4)**

**T5: 35 (3.6, 26.0)**

**T6: 40 (4.1, 29.5)**

**T7: 48 (4.9, 35.4)**

---

## B: CAUTION

- Wear work clothing, including a cap, protective goggles, and protective shoes during operation.
- Remove contamination including dirt and corrosion before removal, installation or disassembly.
- Keep the disassembled parts in order and protect them from dust and dirt.
- Before removal, installation or disassembly, be sure to clarify the failure. Avoid unnecessary removal, installation, disassembly, and replacement.
- Be careful not to burn yourself, because each part on the vehicle is hot after running.
- Be sure to tighten fasteners including bolts and nuts to the specified torque.
- Place shop jacks or rigid racks at the specified points.
- Before disconnecting electrical connectors of sensors or units, be sure to disconnect the ground cable from battery.

# Front Exhaust Pipe

EXHAUST

## 2. Front Exhaust Pipe

### A: REMOVAL

- 1) Disconnect the ground cable from battery.
- 2) Disconnect the front oxygen (A/F) sensor connector (A) and rear oxygen sensor connector (B).

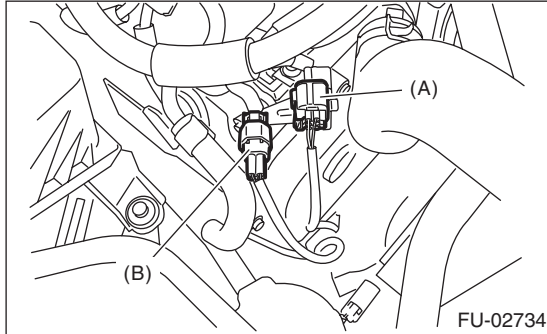

- 3) Lift-up the vehicle.
- 4) Separate the front and center exhaust pipe assembly and rear exhaust pipe.

#### CAUTION:

Be careful, the exhaust pipe is hot.

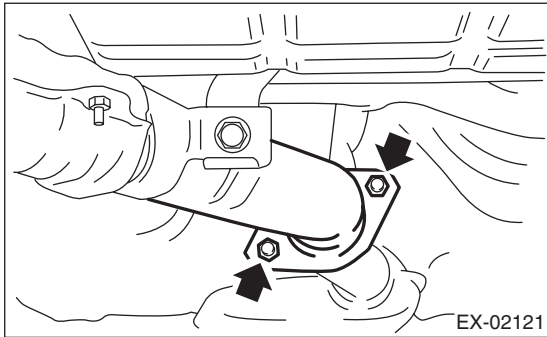

- 5) Remove the under cover.
- 6) Remove the nuts which hold the front exhaust pipe onto cylinder heads.

#### CAUTION:

Be careful not to pull down the front and center exhaust pipe assembly.

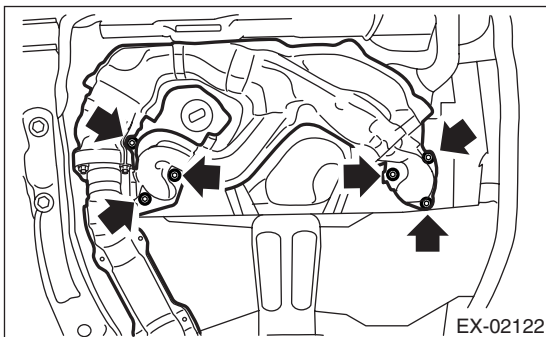

- 7) Remove the bolt which installs the front and center exhaust pipe assembly to hanger bracket.

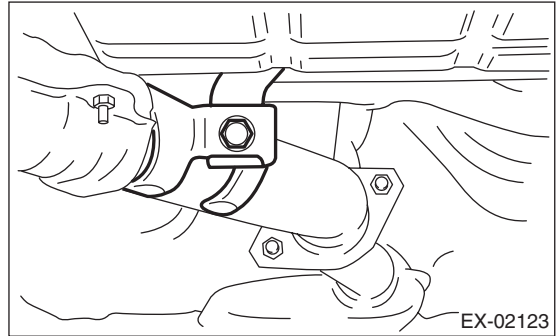

- 8) Remove the front and center exhaust pipe assembly from vehicle.

#### CAUTION:

- Be careful not to let the front and center exhaust pipe assembly fall off when removing as it is quite heavy.
- After removing the front and center exhaust pipe assembly, do not apply excessive pulling force on the rear exhaust pipe.

- 9) Separate the front exhaust pipe from center exhaust pipe.

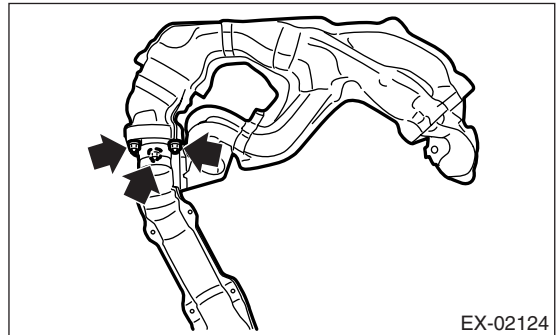

- 10) Remove the front oxygen (A/F) sensor and the rear oxygen sensor. <Ref. to FU(H4SO)-36, REMOVAL, Front Oxygen (A/F) Sensor.> <Ref. to FU(H4SO)-37, REMOVAL, Rear Oxygen Sensor.>

### B: INSTALLATION

#### CAUTION:

If the covers have been removed, tighten the front catalytic converter cover first for noise suppression. Then install the other covers.

- 1) Install the front oxygen (A/F) sensor and the rear oxygen sensor. <Ref. to FU(H4SO)-36, INSTALLATION, Front Oxygen (A/F) Sensor.> <Ref. to FU(H4SO)-37, INSTALLATION, Rear Oxygen Sensor.>
- 2) Install the front exhaust pipe to center exhaust pipe.

#### NOTE:

Replace the gaskets with new ones.

**Tightening torque:**  
**40 N·m (4.1 kgf·m, 29.5 ft·lb)**

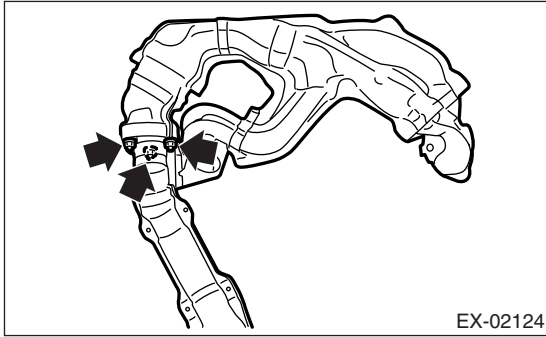

- 3) Install the front and center exhaust pipe assembly to vehicle.
- 4) Temporarily tighten the bolt which installs the front and center exhaust pipe assembly to hanger bracket.

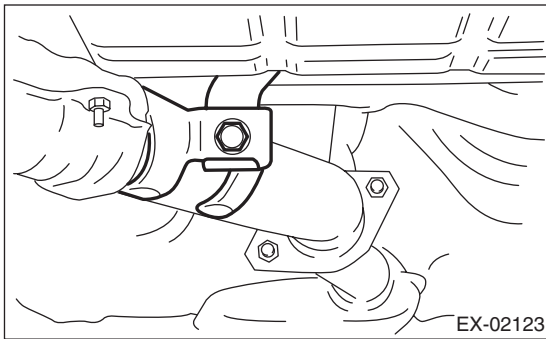

- 5) Tighten the nuts which hold the front exhaust pipe onto cylinder heads.

**Tightening torque:**  
**30 N·m (3.1 kgf·m, 22.4 ft·lb)**

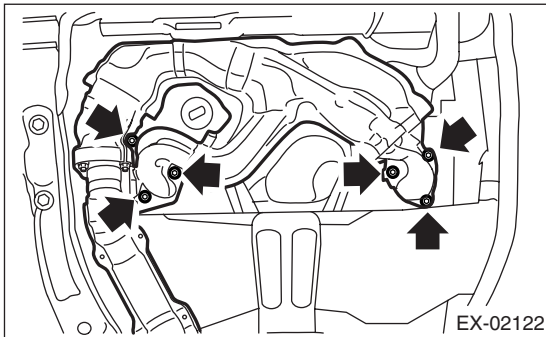

- 6) Install the under cover.
- 7) Tighten the bolts which install the front and center exhaust pipe assembly to rear exhaust pipe.

**Tightening torque:**  
**18 N·m (1.8 kgf·m, 13.0 ft·lb)**

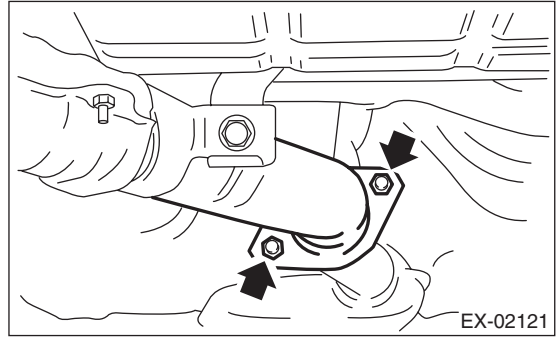

- 8) Tighten the bolt which holds the front and center exhaust pipe assembly to hanger bracket.

**Tightening torque:**  
**35 N·m (3.6 kgf·m, 26.0 ft·lb)**

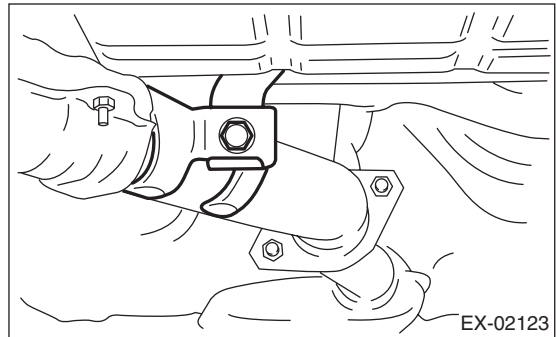

- 9) Lower the vehicle.
- 10) Connect the front oxygen (A/F) sensor connector (A) and rear oxygen sensor connector (B).

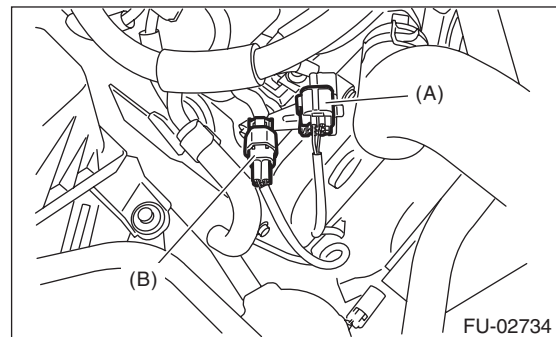

- 11) Connect the ground cable to battery.

## C: INSPECTION

- 1) Make sure there are no exhaust leaks from connections and welds.
- 2) Make sure there are no holes or rusting.

### 3. Center Exhaust Pipe

#### A: REMOVAL

After removing the center and front exhaust pipes as one unit, separate them. Refer to the procedure for removing the front exhaust pipe. <Ref. to EX(H4SO)-4, REMOVAL, Front Exhaust Pipe.>

#### B: INSTALLATION

Install the center exhaust pipe and front exhaust pipe as one unit. Refer to the procedure for installing the front exhaust pipe. <Ref. to EX(H4SO)-4, INSTALLATION, Front Exhaust Pipe.>

#### C: INSPECTION

- 1) Make sure there are no exhaust leaks from connections and welds.
- 2) Make sure there are no holes or rusting.

## 4. Rear Exhaust Pipe

### A: REMOVAL

1) Separate the rear exhaust pipe from center exhaust pipe.

**CAUTION:**

Be careful, the exhaust pipe is hot.

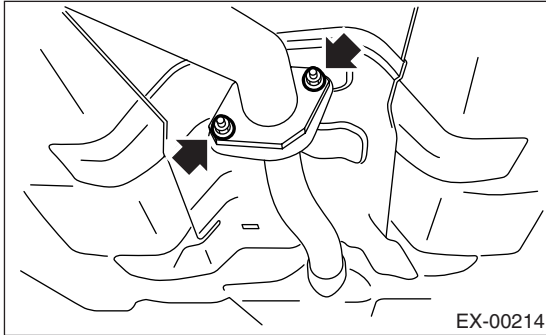

2) Separate the rear exhaust pipe from muffler.

**CAUTION:**

Be careful not to pull down the rear exhaust pipe.

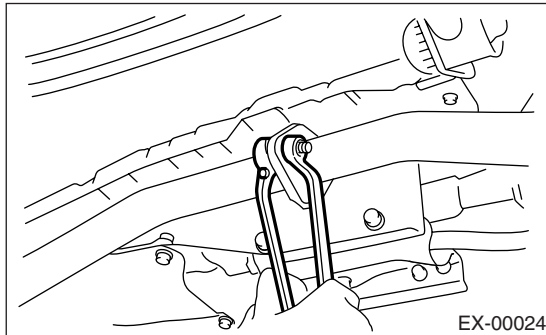

3) Apply a coat of spray type lubricant to the mating area of cushion rubbers in advance.

4) Remove the rear exhaust pipe bracket from cushion rubber.

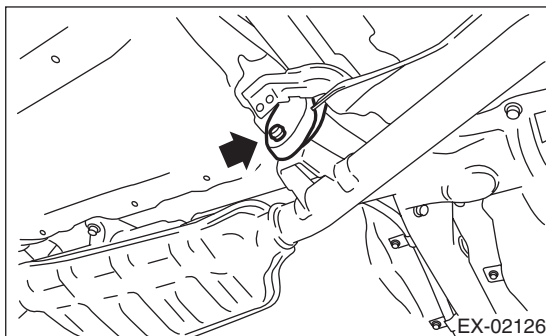

### B: INSTALLATION

1) Apply a coat of spray type lubricant to the mating area of cushion rubbers in advance.

2) Install the rear exhaust pipe bracket to cushion rubber.

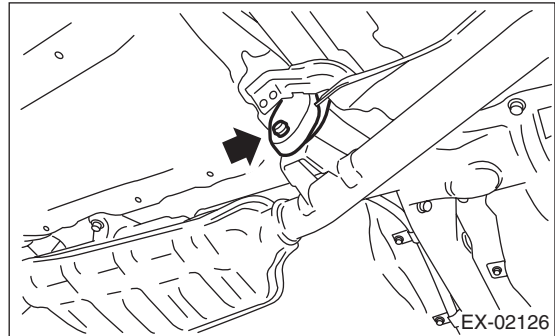

3) Install the rear exhaust pipe to muffler.

**NOTE:**

Replace the gaskets and self-locking nuts with new ones.

**Tightening torque:**

**48 N·m (4.9 kgf-m, 35.4 ft-lb)**

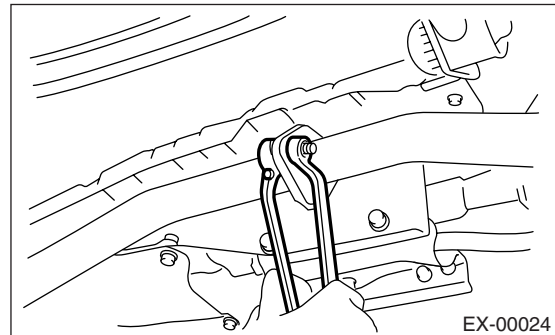

4) Install the rear exhaust pipe to center exhaust pipe.

**Tightening torque:**

**18 N·m (1.8 kgf-m, 13.0 ft-lb)**

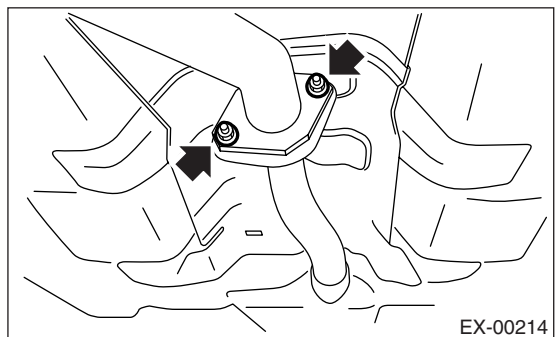

### C: INSPECTION

1) Make sure there are no exhaust leaks from connections and welds.

2) Make sure there are no holes or rusting.

3) Make sure the cushion rubber is not worn or cracked.

# Muffler

## EXHAUST

### 5. Muffler

#### A: REMOVAL

1) Separate the muffler from rear exhaust pipe.

#### CAUTION:

Be careful, the exhaust pipe is hot.

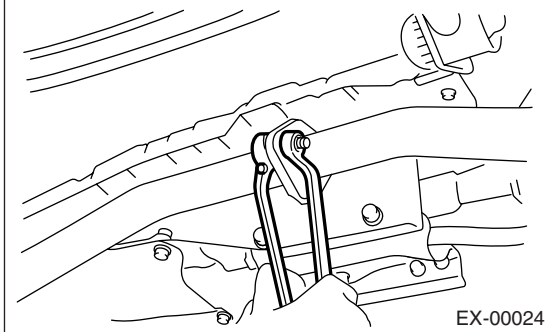

2) Apply a coat of spray type lubricant to the mating area of cushion rubbers in advance.

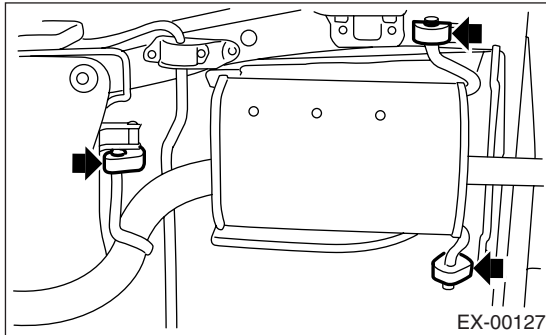

3) Remove the front, right and left cushion rubber, and detach the muffler assembly.

#### B: INSTALLATION

Install in the reverse order of removal.

#### NOTE:

Replace the gasket and self-locking nuts with new ones.

#### Tightening torque:

**48 N·m (4.9 kgf·m, 35.4 ft·lb)**

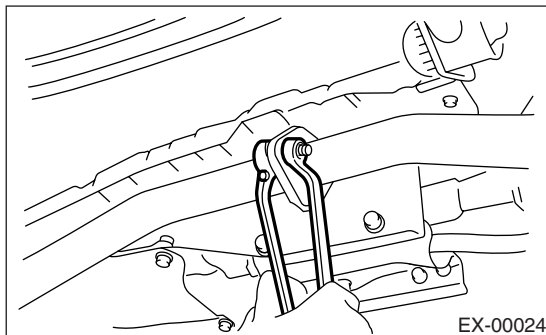

#### C: INSPECTION

1) Make sure there are no exhaust leaks from connections and welds.

2) Make sure there are no holes or rusting.

3) Make sure the cushion rubber is not worn or cracked.